

**OPERATING AND
SERVICE INSTRUCTIONS
FOR...**

**COMMUNICATION
RECEIVER
MODEL SX-117**

the hallicrafters CO.



A Subsidiary of Northrop Corporation

WARRANTY

"The Hallicrafter's Company warrants each new radio product manufactured by it to be free from defective material and workmanship and agrees to remedy any such defect or to furnish a new part in exchange for any part of any unit of its manufacture which under normal installation, use and service discloses such defect, provided the unit is delivered by the owner to our authorized radio dealer, wholesaler, from whom purchased, or, authorized service center, intact, for examination, with all transportation charges prepaid within ninety days from the date of sale to original purchaser and provided that such examination discloses in our judgment that it is thus defective.

This warranty does not extend to any of our radio products which have been subjected to misuse, neglect, accident, incorrect wiring not our own, improper installation, or to use in violation of instructions furnished by us, nor extended to units which have been repaired or altered outside of our factory or authorized service center, nor to cases where the serial number thereof has been removed, defaced or changed, nor to accessories used therewith not of our own manufacture.

Any part of a unit approved for remedy or exchange hereunder will be remedied or exchanged by the authorized radio dealer or wholesaler without charge to the owner.

This warranty is in lieu of all other warranties expressed or implied and no representative or person is authorized to assume for us any other liability in connection with the sale of our radio products."

the hallicrafters co.
A Subsidiary of Northrop Corporation



092-0145578



Figure 1. Hallicrafters' Model SX-117.

SECTION I

GENERAL DESCRIPTION

The Model SX-117 is a triple-conversion, super-heterodyne-type communications receiver having the following features:

- Operation on most frequencies from 85 KC to 30 MC (see paragraph 5-7).
- A VFO which can be used as a crystal-locked oscillator for fixed-channel operation (see paragraph 5-8).
- A high order of mechanical and electrical stability.
- An easy-to-read dial.
- A constant tuning rate on all bands.
- A transmitter-type VFO.
- Backlash-free combination pinch and gear drive.
- Crystal-controlled first and third conversion oscillators.
- Less than 1/2 microvolt sensitivity on SSB/CW.
- Excellent spurious and image rejection.
- Selectable sidebands.
- Selectivity variable in three steps, 500 CPS, 2.5 KC, and 5 KC.
- Amplified fast-attack, slow-release AVC for SSB/CW; fast-attack, fast-release for AM.
- Product detector for SSB/CW; envelope detector for AM.
- IF-type noise limiter.
- 100-KC Crystal Calibrator.
- Audio inverse feedback.
- Approximate 1-KC marks on tuning knob skirt.
- Variable T-Notch rejection filter.
- Greatly reduced weight through use of aluminum for chassis, panel, cabinet, brackets, etc.
- New smaller size.

SECTION II

TECHNICAL SPECIFICATIONS

Basic Frequency Coverage

*WWV	9.5 MC to 10.0 MC
80-Meter Band	3.5 MC to 4.0 MC
40-Meter Band	7.0 MC to 7.5 MC
20-Meter Band	14.0 MC to 14.5 MC
15-Meter Band	21.0 MC to 21.5 MC
*10-Meter Band	28.0 MC to 28.5 MC
10-Meter Band	28.5 MC to 29.0 MC
*10-Meter Band	29.0 MC to 29.5 MC
*10-Meter Band	29.5 MC to 30.0 MC

*Crystals not supplied.

Note - See paragraph 5-7 for additional information.

IF Frequencies:	6.5 MC to 6.0 MC (Variable), 1650 KC, and 50.75 KC.
Reception:	AM, CW, and Single Sideband (SSB).
Sensitivity - AM:	Less than 1 microvolt for 10-DB signal-to-noise ratio 3 MC to 30 MC (30% modulation).
Sensitivity - SSB/CW:	Less than 1/2 microvolt. 3 MC to 30 MC
Sensitivity (with HA-10):	5 to 10 microvolts. 85 KC to 3 MC
Selectivity:	Variable in three steps providing 0.5 KC, 2.5 KC, and 5 KC at 6 DB down.
Stability:	Better than 300 CPS after warmup.
Calibration Accuracy:	Better than 2 KC between adjacent 100-KC calibration points after indexing.
IF Rejection:	More than 50 DB.
In-Band Tweets:	Less than 1/2 microvolt equivalent (within amateur bands).
Audio Power Output:	3/4 watt with less than 10% distortion.
AVC Figure of Merit:	More than 80 DB.
Power Source:	105 volts to 125 volts, 50/60 cycles.
Power Consumption:	70 watts.
Number of Tubes:	14 (one not supplied), plus four silicon diodes.
Audio Output Impedance:	3.2 ohms and 500 ohms; rear-mounted screw terminals.
Headphone Output:	50 ohms to 2000 ohms; panel-mounted jack accepts standard 1/4-inch plug.
Antenna Input Impedance:	50 ohms to 70 ohms unbalanced; rear-mounted RCA-type (High Frequency) phono jack accepts RCA-type phono plug.

NOTE: Chassis punched to accept Amphenol Type SO-239 coaxial receptacle; for use from 3.0 MC to 30 MC.

Low Frequency Input: High impedance to first mixer grid; for use with external-tuned circuit from 85 KC to 3.0 MC. RCA-type phono jack accepts RCA-type phono plug.

Remote Standby Control: Rear-mounted screw terminals.

Dimensions: 7-3/4 inches high, 15 inches wide, and 14-3/4 inches deep.

Net Weight: 18-1/2 pounds.

Shipping Weight: 21 pounds (approximately).

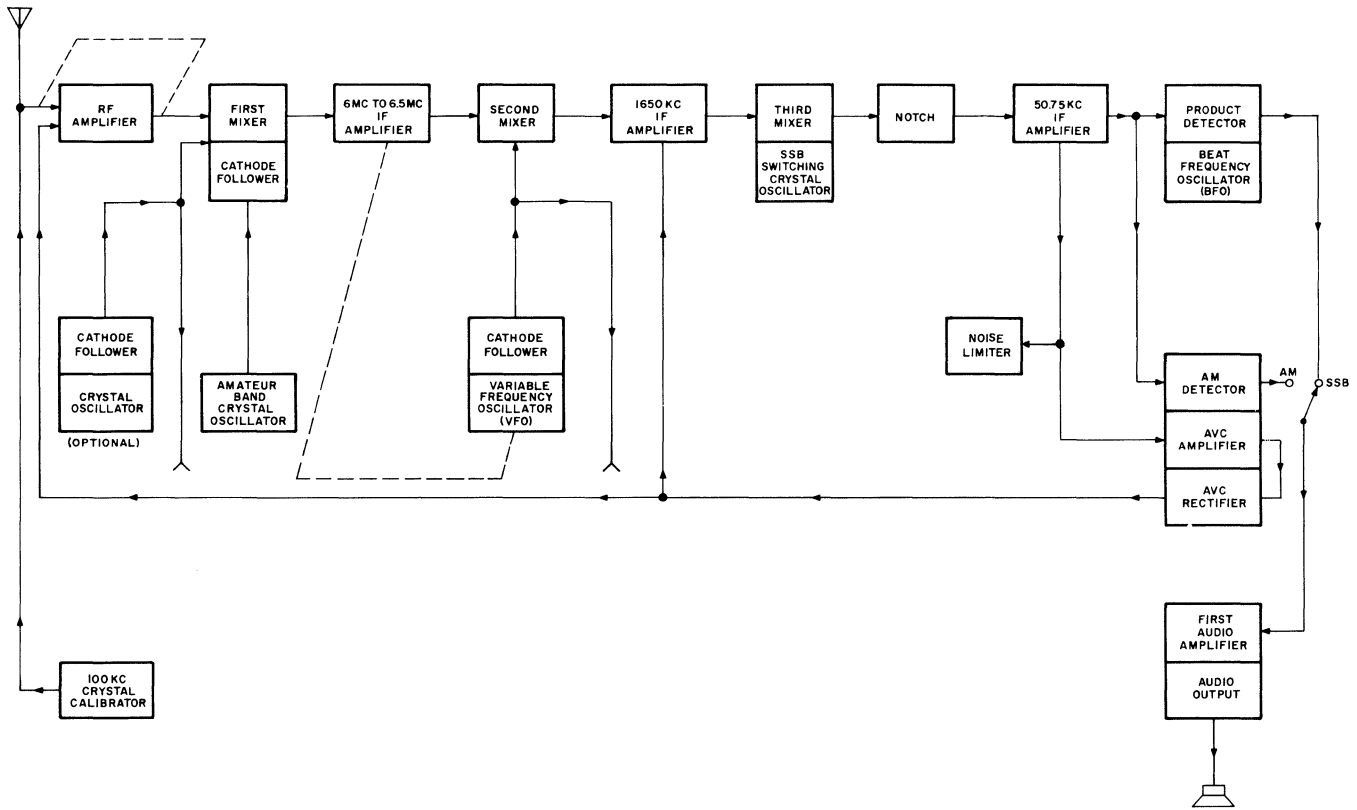

Figure 2. Block Diagram of the Receiver.

092-015642

TUBES AND FUNCTIONS

6DC6	RF Amplifier	6EA8	Third Mixer, SSB-Switching Crystall Oscillator
6EA8	First Mixer, Cathode Follower	6BA6	50.75-KC IF Amplifier
12AT7	Amateur-Band Crystall Oscillator	6BE6	Product Detector, BFO
*6EA8	Auxiliary Crystall Oscillator	6BN8	AM Detector, AVC Amplifier, AVC Rectifier
6BA6	6-MC to 6.5-MC IF Amplifier	6GW8	First Audio Amplifier, Audio Output
6BE6	Second Mixer	6AU6	100-KC Crystall-Calibrator Oscillator
6EA8	VFO, Cathode Follower		Two each Silicon Noise-Limiter Diodes.
6DC6	1650-KC IF Amplifier		Two each Silicon Power-Supply Diodes.

*Not Supplied

SECTION III

INSTALLATION

3-1. UNPACKING.

After unpacking the receiver, examine it for damage which may have occurred in transit. Should any sign of damage be apparent, file a claim immediately with the carrier stating the extent of damage. Carefully check all shipping labels and tags for instructions before removing or destroying them.

IMPORTANT

To remove top cover, turn screws approximately one quarter turn counterclockwise.

Do not attempt to remove screws.

3-2. LOCATION.

The receiver may be placed in any location that will permit free air circulation through the ventilation holes and openings in the cabinet. Avoid excessively warm locations such as those near radiators and heating vents. Also avoid direct blasts of air from circulating fans, etc. Do not place speakers or any other objects on the cabinet cover in a manner that will impair natural ventilation.

3-3. ANTENNAS.

The Model SX-117 uses an input circuit designed for an unbalanced 50-ohm to 70-ohm input. Any of the popular dipole or beam antennas using 50-ohm to 70-ohm coaxial transmission line will suffice. It should be remembered, however, that these antennas will give optimum results over a limited frequency range only. Generally speaking, the same rules that apply to transmitting antennas will hold true for receiving antennas. For further information on this subject, refer to the "Radio Amateur's Handbook" or the "A.R.R.L. Antenna Book," both published by the American Radio Relay League, West Hartford, Connecticut, U.S.A.

IMPORTANT

Some form of lightning protection should be provided which will comply with local-code requirements.

3-4. GROUNDS.

All station equipment should be bonded together with heavy copper wire or braid and connected to a cold-water pipe or earth ground. An external chassis ground terminal is provided on the rear of the Model SX-117 for this purpose.

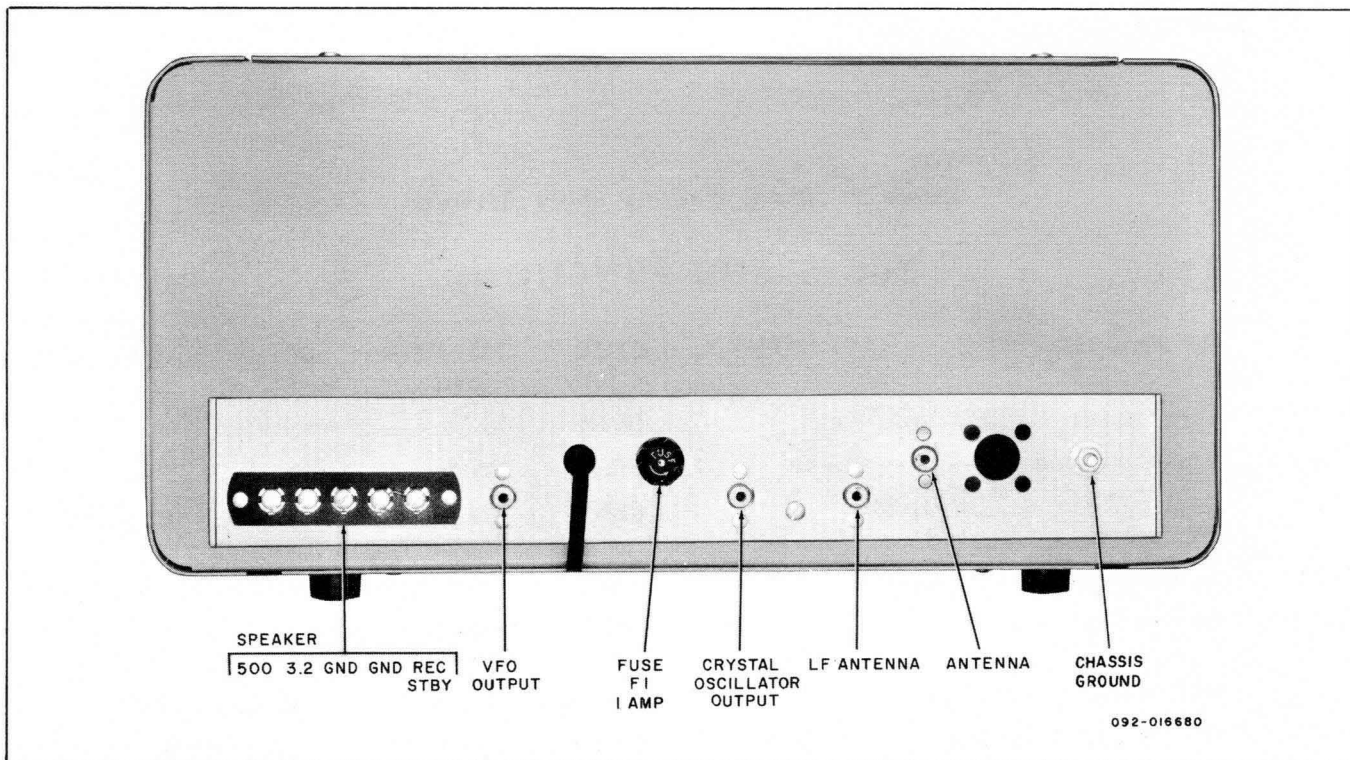

Figure 3. View Showing Rear Chassis Connections.

3-5. POWER SOURCE.

The SX-117 is designed to operate from a 105-volt to 125-volt, 50/60-cycle, AC power source. Power consumption is 70 watts.

NOTE

If in doubt about your power source, contact your local power company prior to inserting the power cord into any power outlet. Plugging the power cord into the wrong source can cause extensive damage to the unit.

3-6. SPEAKER.

A terminal strip, marked G, 3.2, and 500, is provided at the rear of the receiver for connecting an external speaker or line (see figure 3). Any permanent-magnet type speaker with a 3.2-ohm voice coil can be used by connecting the two leads from the speaker voice coil to the terminals marked 3.2 and G. If it is desired to use a speaker with a voice-coil impedance other than 3.2 ohms, a matching transformer should be employed to insure optimum performance. The transformer should be mounted on or near the speaker, should have a 500-ohm primary impedance, and should have a secondary impedance to match that of the speaker voice coil. Connect the primary of the matching transformer to the terminals marked 500 and G and the secondary to the speaker voice coil terminals.

The Hallicrafters Model R47 Speaker is particularly suited for voice and CW use. Model R48A Speaker, with its two-position VOICE-FIDELITY switch will give excellent results for all modes of operation. The leads of either speaker are to be connected to the terminals marked 3.2 and G.

3-7. HEADPHONES.

The headphone jack marked PHONES is located on the front panel and is wired so that the 3.2-ohm speaker output is automatically disabled when the headphones are inserted. The headphone impedance is not critical, and any headphones ranging in impedance from 50 ohms to 2000 ohms will provide satisfactory performance.

It should be noted that, although insertion of the headphone plug into the front panel jack will silence the 3.2-ohm speaker output, the 500-ohm output will remain in operation at all times.

3-8. REMOTE RECEIVE-STANDBY SWITCHING.

The receiver may be disabled from a remote location by removing the jumper between the terminals marked STANDBY and G on the rear of the chassis and then connecting a SPST switch or relay between these terminals. The switch or relay contacts should be so wired as to close in Receive and open in Transmit.

The receiver may also be disabled in Transmit by turning the RF GAIN control to 0 (fully counterclockwise).

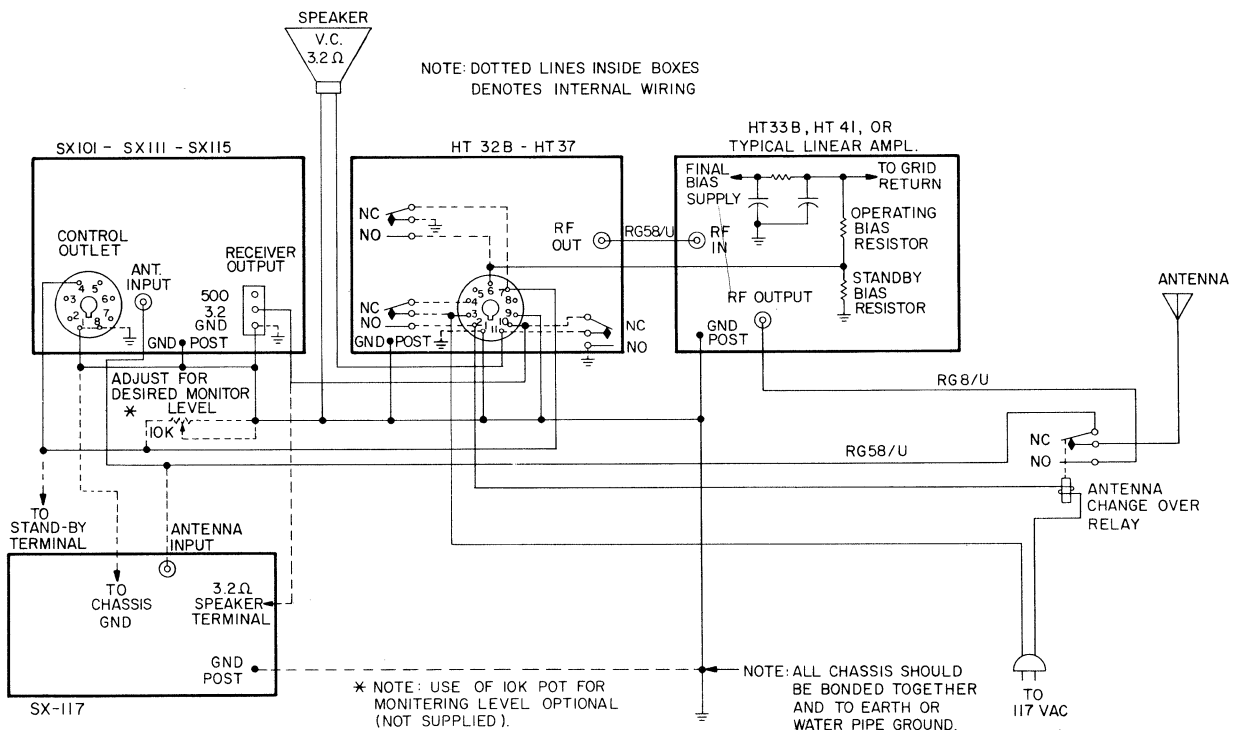

Figure 4. Typical Station Setup.

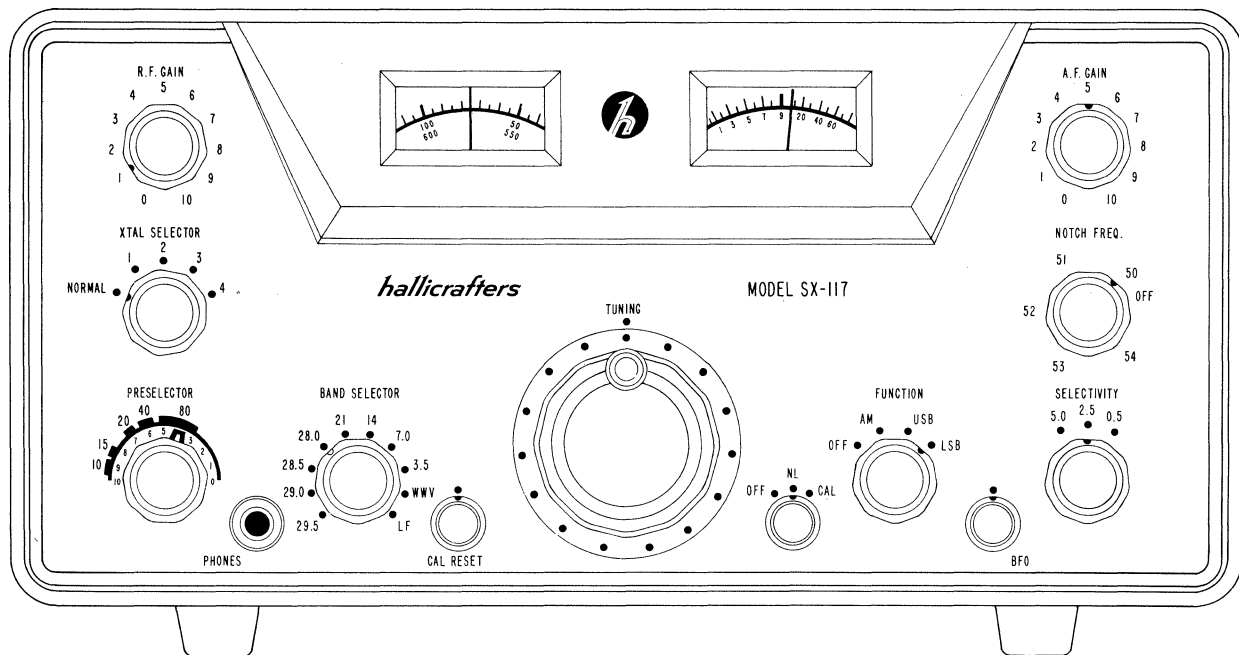

Figure 5. Front Panel View of Receiver.

SECTION IV

FUNCTIONS OF OPERATING CONTROLS

4-1. RF GAIN CONTROL.

The RF GAIN control varies the gain of the RF amplifier and the 50.75-KC IF amplifier. Maximum sensitivity is obtained with the control set at 10 (fully clockwise). In this position, the tubes being controlled are operating at maximum gain with minimum cathode bias. As the control is rotated counterclockwise, the cathode bias is increased with a resultant decrease in gain.

The normal setting of the RF GAIN control will vary with conditions. When searching for weak signals, the control should be well advanced. When copying strong signals under crowded or noisy conditions, it may be found desirable to reduce the RF GAIN control setting.

It should be remembered that the S-Meter calibration will be correct only with the RFGAIN control fully advanced to 10.

AVC is automatically controlled by the RF GAIN control so that it is not necessary to disable the AVC circuitry for any mode of reception.

4-2. BAND SELECTOR CONTROL.

The BAND SELECTOR control operates the bandswitch to place the proper crystal and coils into the circuit to cover the desired frequency range.

It should be noted that several bandswitch positions are identified by a red dot. When the switch is rotated to one of these positions, the red dial scale should be used.

In the LF position, the bandswitch disconnects the internal-tuned circuits and connects the first mixer grid to the LF INPUT jack on the rear panel.

4-3. PRESELECTOR.

The PRESELECTOR control provides precise tuning of the antenna and mixer coils to give maximum gain and optimum signal-to-noise ratio. It also allows coverage of the entire 3.0-MC to 30-MC range (see paragraph 5-7).

NOTE

Care should be exercised when setting the PRESELECTOR control on the 40-meter (7.0 MC) or WWV bands. It is possible to tune the PRESELECTOR control to the 6.5-MC to 6.0-MC first IF frequency. The correct setting for the 40-meter band is indicated by the block marked 40. The correct setting for WWV (9.5 MC to 10 MC) will be between 8 and 9 on the PRESELECTOR logging scale.

Under certain conditions where excessive noise or interference is encountered, it may be found desirable to slightly detune the PRESELECTOR control for optimum reception.

4-4. AF (AUDIO) GAIN CONTROL.

The AF GAIN control adjusts the audio output level at the speaker terminals and PHONES jack. Clockwise rotation increases the signal voltage applied to the grid of the audio amplifier, thus increasing the audio output.

4-5. SELECTIVITY SWITCH.

The SELECTIVITY switch is used to vary the IF bandwidth to suit receiving conditions. Three degrees of selectivity are available, ranging from 500 CPS for CW reception under crowded-band conditions to 5 kilocycles for maximum fidelity on voice or music-modulated signals where conditions permit. The three positions are marked on the front panel and indicate the 50.75-KC IF bandwidth at the 6-DB points. See figure 6 for typical IF selectivity curves.

The recommended positions for the various modes of operation are as follows:

- CW 0.5 KC or 2.5 KC
- SSB 2.5 KC
- AM 2.5 KC or 5.0 KC

4-6. FUNCTION SWITCH.

The FUNCTION switch is a four-position rotary switch performing the following functions:

<u>Position</u>	<u>Function</u>
OFF	disconnects the 117-volt, 60-cycle, AC power.
AM	a. Connects the 117-volt, 60-cycle, AC power. b. Disables the BFO. c. Connects audio to the envelope detector. d. Selects fast-attack, fast-release AVC. e. Connects the 1700-KC sideband-switching crystal.
USB	a. Connects audio to the product detector. b. Energizes the BFO.

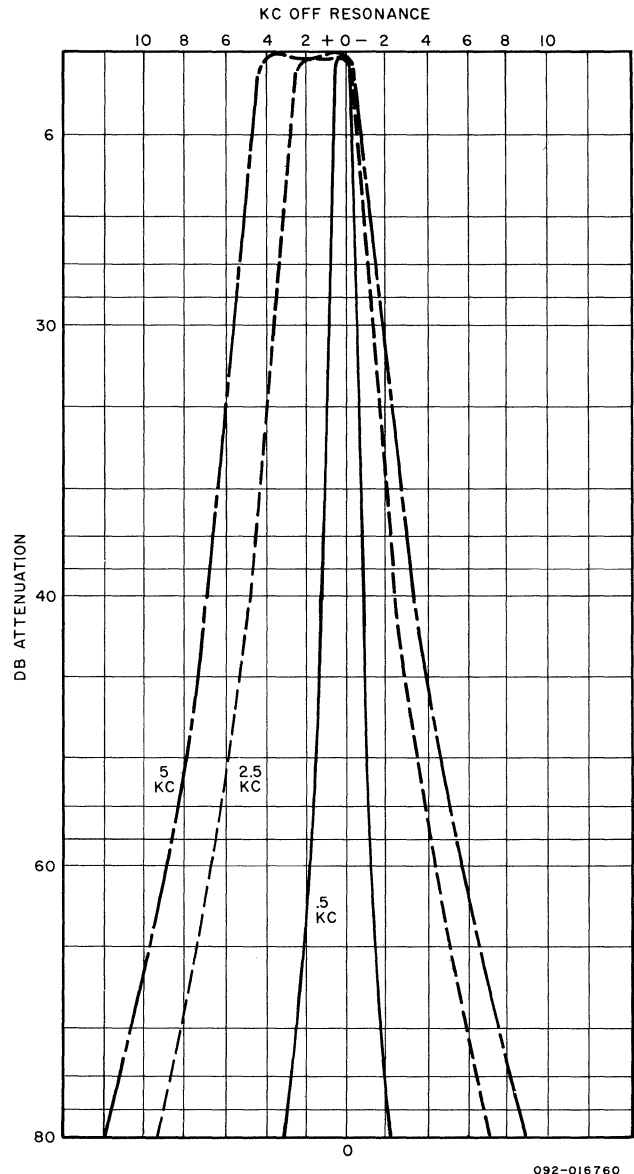

Figure 6. IF Selectivity Curves.

- c. Selects fast-attack, slow-release AVC.
- d. Connects the 1700-KC sideband-switching crystal.
- LSB
- a. Connects audio to the product detector.
- b. Energizes the BFO.
- c. Selects fast-attack, slow-release AVC.
- d. Connects 1600-KC sideband-switching crystal.

To illustrate how selectable-sideband reception is accomplished, a numerical example is given. Consider an incoming signal at 7000 KC, modulated 1 KC. Since modulation of a carrier causes the generation of sideband frequencies numerically equal to the carrier frequency plus or minus the modulation frequency, the incoming signal consists of the carrier at 7000 KC, a lower sideband at 6999 KC, and an upper sideband at 7001 KC. See figure 7A.

The incoming signal is first heterodyned with the output of the first conversion oscillator in the first mixer. The first conversion oscillator operates at a frequency higher than the incoming signal by an amount equal to the first IF frequency of 6.500 MC (variable IF). As a result of this, three new lower frequencies are produced in the output of the first mixer: the carrier at 6.500 MC, the lower sideband at 6.501 MC, and the upper sideband at 6.499 MC. These signals are amplified by the 6.500-MC to 6.000-MC IF stage and then heterodyned with the output of the VFO (4.85 MC to 4.35 MC) in the second mixer. Three new lower frequencies are again produced in the output of this mixer stage: a center frequency of 1650 KC, a lower sideband of 1651 KC, and an upper sideband of 1649 KC. These signals are amplified by the 1650-KC IF amplifier and fed to the third mixer, where they are heterodyned with the output of either the 1600-KC (lower sideband) or the 1700-KC (upper sideband) crystal-controlled third conversion oscillator. When the FUNCTION switch is placed in the LSB position, three new lower frequencies

are produced: the carrier frequency at 50 KC, the lower sideband at 51 KC, and the upper sideband at 49 KC. By referring to figure 7D, it can be seen that the lower sideband falls within the IF passband and the upper sideband is rejected. When the FUNCTION switch is placed in USB position, the carrier frequency remains at 50 KC but the sidebands are reversed in the heterodyning process. The upper sideband will now be 51 KC and falls within the IF passband, while the lower sideband will appear at 49 KC and be rejected.

4-7. NOTCH FREQ (FREQUENCY) CONTROL.

The NOTCH FREQ control varies the notch frequency within the 50.75-KC IF passband and is very useful in attenuating an undesirable heterodyne. Since the notch width is quite narrow, it is essentially a single-frequency device and cannot attenuate more than one heterodyne if the heterodynes are separated in frequency by more than 500 CPS.

The NOTCH FREQ control is very effective when using exalted carrier reception (AM with BFO on). The notch control is adjusted to approximately 50 KC so that the incoming signal carrier is removed. This will remove the low-frequency heterodyne which may be heard if the receiver is not tuned to exactly zero beat with the incoming signal. The AM signal under these conditions will tune similar to double-sideband suppressed carrier and may be received in the USB (upper-sideband) or the LSB (lower-sideband) position.

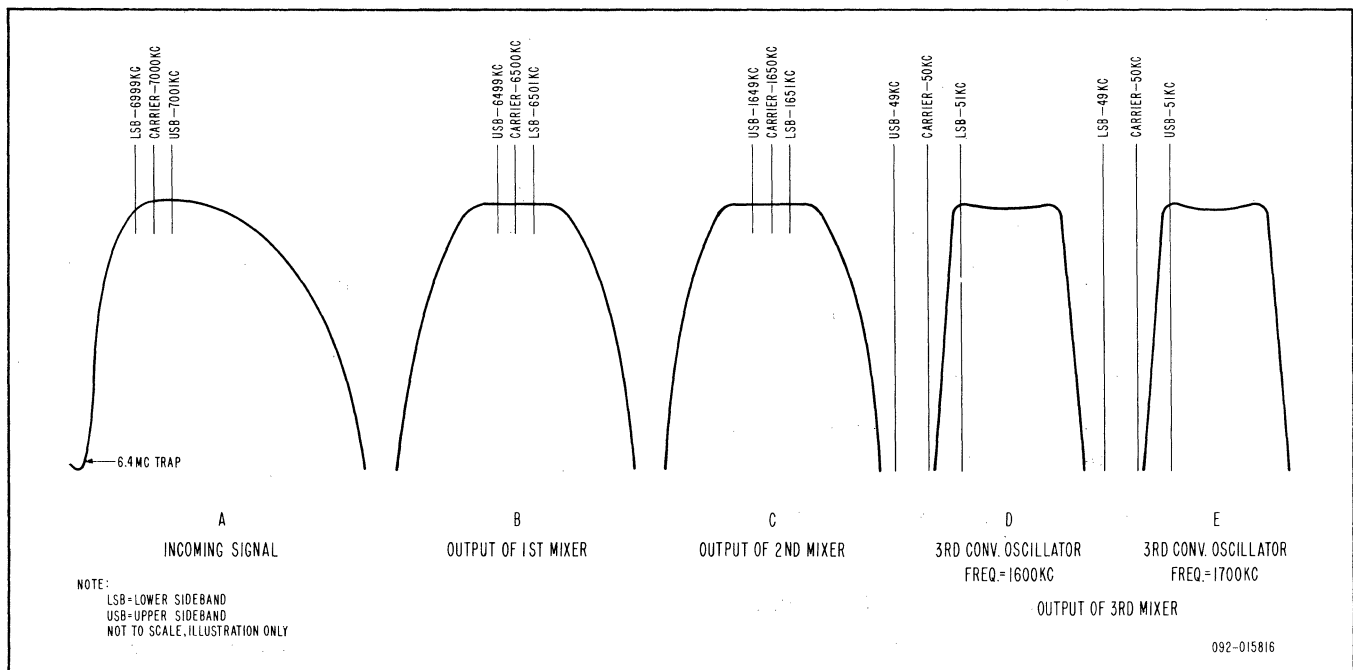

Figure 7. Selectable-Sideband Response Curves.

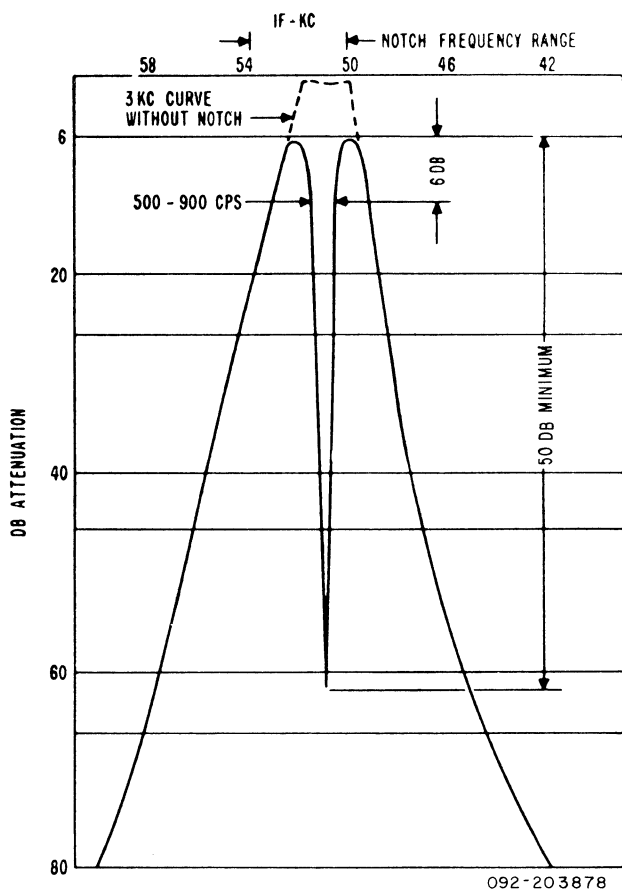

Figure 8. IF Selectivity with Notch.

The notch calibration is quite accurate and may be used as a guide in determining where the NOTCH FREQ control should be set to attenuate an interfering signal, provided the BFO frequency is set as described under BFO operation. For example, if the heterodyne is approximately 1000 CPS, the null point would be near 51 KC. If the heterodyne is 2000 CPS, the null point would be near 52 KC, etc.

4-8. BFO CONTROL.

The BFO control is a front-panel adjustment which allows the beat frequency oscillator to be set at exactly 50 KC.

NOTE

The BFO control should not be used for tuning purposes as the BFO frequency must be maintained if optimum performance is to be obtained.

The correct setting will be near the point where the knob and panel marks coincide. The exact point may be found by placing the FUNCTION switch in USB, the SELECTIVITY control at 5.0 KC, and tuning in a CW signal or crystal calibrator to near zero beat. Switch the FUNCTION control to

LSB. The beat note should not change frequency. If it does, adjust the BFO control until the beat note frequency remains the same in the USB or LSB position. The control should always be at this point.

4-9. TUNING CONTROL.

The TUNING control is used to vary the frequency of the VFO to allow reception of the desired signal. It also rotates the dial past a stationary pointer to indicate the frequency in kilocycles.

It should be noted that two scales appear on the dial: 0 to 500 KC and 500 KC to 1000 KC. If the band being tuned starts at the even megacycle, (e.g., 7.0), the frequency is read on the 0 to 500-KC scale; if the band starts on 0.5 megacycle (e.g., 3.5), the frequency is read on the 500-KC to 1000-KC scale.

If the BANDSELECTOR is set opposite a red dot, the red dial scale should be used to indicate the correct frequency.

The skirt on the TUNING knob is divided into 15 segments. Each division will represent approximately one kilocycle of frequency change.

4-10. CAL RESET CONTROL.

The CAL RESET control operates a variable trimmer to allow the VFO calibration to be set exactly to frequency at any check point.

If the dial calibration does not agree with the frequency of a known signal, such as a crystal calibrator, the CAL RESET control should be adjusted as necessary to correct the calibration error.

4-11. OFF-NL-CAL SWITCH.

The OFF-NL-CAL control is a three-position rotary switch performing the following functions:

1. OFF - In this position, both the noise limiter and 100-KC crystal calibrator circuits are disabled.
2. NL - In this position, the noise limiter is placed in operation (see paragraph 5-6).

3. CAL - In this position, the 100-KC crystal calibrator is placed in operation to provide marker signals at every 100-KC point on the dial.

NOTE

The 100-KC crystal calibrator should not be left in the ON position after dial calibration is completed. Under certain conditions it can cause spurious responses to be developed.

4-12. XTAL SELECTOR SWITCH.

The XTAL SELECTOR switch is a five-position rotary switch performing the following functions:

1. NORMAL - In the NORMAL position, plate voltage is removed from the auxiliary crystal oscillator (6EA8

not supplied) and the receiver will operate on the ranges indicated by the BAND SELECTOR knob.

2. 1 AND 2 - Positions 1 and 2 of the XTAL SELECTOR switch will disable the 12AT7 first crystal oscillator, apply voltage to the 6EA8 auxiliary oscillator, and select crystals inserted in auxiliary crystal sockets 1 or 2. Use only type CR-18/U crystals whose frequencies fall between 6.5 MC and 20.00 MC (inclusive) in these sockets (see paragraph 5-7).
3. 3 AND 4 - Positions 3 and 4 also disable the 12AT7 first crystal oscillator, apply plate voltage to the 6EA8 auxiliary oscillator, and select crystals inserted in auxiliary crystal sockets 3 and 4. Use only type CR-23/U crystals whose frequencies fall between 20.5 MC and 34.0 MC (inclusive) in these sockets (see paragraph 5-7).

SECTION V

OPERATION

5-1. SINGLE-SIDEBAND RECEPTION.

Set the front panel controls as outlined below.

RF GAIN Usually at 10 (may be reduced as noise and QRM dictate).

NOTE

S-Meter reading will be correct only with the RF GAIN control set at 10.

- BAND SELECTOR. . . To desired band.
- AUDIO GAIN Approximately 2.
- SELECTIVITY 2.5 KC.
- FUNCTION Usually LSB for 80 and 40 meters and USB for 20, 15 and 10 meters.
- BFO Center or 0 position (do not use BFO control for tuning purposes).
- NOTCH OFF
- PRESELECTOR Peaked for maximum signal.

XTAL CAL OFF

NL (Noise Limiter). Use as noise conditions dictate.

TUNING As desired.

Slowly adjust the TUNING control until the voice modulation sounds natural. Peak the PRESELECTOR for maximum S-Meter indication and adjust the AUDIO GAIN control as desired. If an undesirable heterodyne appears, adjust the NOTCH control for maximum attenuation.

It should be remembered that an SSB signal will convey intelligence only when the correct sideband position has been selected on the FUNCTION switch. If the signal does not tune in properly, change the FUNCTION switch to the other SSB position and retune.

The RF GAIN control should normally be set at 10 (maximum sensitivity). Under adverse conditions, it may be found advantageous to reduce the RF GAIN to improve reception. It should be remembered that, as the RF GAIN is reduced, the AVC will be reduced. Also, correct S-Meter readings will be indicated only with the RF GAIN at 10.

5-2. CW RECEPTION.

Set all controls as described under single-sideband reception except for the SELECTIVITY and noise limiter controls.

The SELECTIVITY control will usually be in the 0.5 KC position for CW.

The NL (noise limiter) can be used to advantage at all times in CW reception and will be very effective in reducing impulse noise, key clicks, etc.

The NOTCH control should be used as necessary to attenuate interfering signals and heterodynes.

The RF GAIN control should be adjusted as conditions dictate for best reception.

NOTE

Do not use the BFO control for tuning purposes.

5-3. AM RECEPTION.

Set all controls as described under single-sideband reception except for the FUNCTION control. The FUNCTION control should be placed in the AM position.

The SELECTIVITY control may be placed in the 5.0-KC position for improved fidelity where band conditions permit.

The RF GAIN control will normally be set at 10 for AM reception except on extremely strong local signals.

If the NL (noise limiter) is used on AM, distortion can be reduced by reducing the RF GAIN control setting to the lowest practical level.

The NOTCH control should be used as necessary for removing undesirable heterodynes.

5-4. EXALTED CARRIER AM RECEPTION.

In short-wave reception, it frequently happens that transmission conditions are different for waves of slightly different frequencies. As a result, in the case of voice modulated transmissions, AM particularly, which involve sideband frequencies differing slightly from the carrier frequency, the carrier and sideband components may not be received in the same relative amplitudes and phases that were present at the transmitter. This effect, known as selective fading, causes severe distortion of the signal.

This type of distortion can be reduced considerably by utilizing the selectable-sideband feature of the Model SX-117 receiver operating in an exalted carrier mode (i.e., the transmitted carrier is positioned out of the receiver's IF pass-band along with one sideband, producing a suppressed carrier single-sideband signal). The carrier is subsequently reinserted by the receiver's BFO and the signal is detected in the same manner as a single-sideband signal.

All controls should be set as described under single-sideband reception. Place the FUNCTION switch in the SSB position that gives best reception. In addition, the NOTCH control should be adjusted to the carrier frequency (approximately 50 KC) to null out the incoming signal carrier.

If noise conditions warrant, the noise limiter should be used.

5-5. USE AND ADJUSTMENT OF S-METER.

The S-Meter provides a visual means of determining whether or not the receiver is properly tuned, as well as providing an indication of the signal strength. The S-Meter is calibrated in S-units to 9 and in decibels to 70 DB above S9. The meter calibration will be correct only when the RF GAIN control is set at 10 (fully clockwise).

S9 represents a 50-microvolt signal at the antenna input. Each S-unit represents approximately 6 DB change in signal strength.

For accurate readings, the meter zero should be checked periodically. To adjust the electrical zero on the meter, turn the RF GAIN control to 0 (fully counterclockwise). Rotate the Meter Zero control as necessary so that the meter pointer is aligned with the last calibration mark on the left side of the meter scale.

IMPORTANT

To remove top cover, turn screws approximately one quarter turn counterclockwise.

Do not attempt to remove screws.

The Meter Zero control may be found directly under the rear of the meter housing.

CAUTION

Do not disturb the adjustment of the Notch Depth or Factory Gain controls.

5-6. USE OF NOISE LIMITER (NL).

The noise limiter is an IF-type limiter and is very effective in reducing impulse-type noise particularly on SSB and CW. It will be found useful on AM as well. Recommended use is as follows:

For CW Operation:

The noise limiter should be on at all times for elimination of impulse noise and key clicks.

For SSB Operation:

Use the noise limiter as noise conditions dictate.

For AM Operation:

Use the noise limiter as noise conditions dictate. It will be noticed that the noise limiter will introduce considerable distortion on a fully modulated AM signal. Distortion may be reduced by decreasing the RF GAIN control setting.

5-7. GENERAL COVERAGE OPERATION.

The Model SX-117 Receiver may be used on most frequencies from 85 KC to 30.0 MC by inserting the correct heterodyne crystals into the auxiliary oscillator sockets. The frequencies, whose use is not recommended, are 1600 KC, 1650 KC, 1700 KC and the 5.5-MC to 7.0-MC range.

In the low frequency range (i.e., 85 KC to 3.0 MC), an external-tuned circuit (Model HA-10) should be connected between the antenna and the LF INPUT jack (see figure 19).

NOTE

In primary service areas of high-power broadcast stations, good results can be obtained by connecting an antenna directly to the LF INPUT jack.

The following chart contains the information needed to cover the 85-KC to 30-MC range:

Signal Frequency	Crystal Frequency	Crystal Type	Crystal Selector & Socket	Preselector Calibration	Dial Scale	Band Selector
85 KC to 500 KC	6.5 MC	CR-18/U	1 or 2	Use	Black	LF
500 KC to 1.0 MC	7.0 MC	CR-18/U	1 or 2		Red	LF
1.0 MC to 1.5 MC	7.5 MC	CR-18/U	1 or 2	Model	Black	LF
1.5 MC to 2.0 MC	8.0 MC	CR-18/U	1 or 2		Red	LF
2.0 MC to 2.5 MC	8.5 MC	CR-18/U	1 or 2	HA-10	Black	LF
2.5 MC to 3.0 MC	9.0 MC	CR-18/U	1 or 2		Red	LF
3.0 MC to 3.5 MC	9.5 MC	CR-18/U	1 or 2	1	Black	3.5
3.5 MC to 4.0 MC	--	--	Normal	80	Red	3.5
4.0 MC to 4.5 MC	10.5 MC	CR-18/U	1 or 2	7	Black	3.5
4.5 MC to 5.0 MC	11.0 MC	CR-18/U	1 or 2	2	Red	7.0
5.0 MC to 5.5 MC	11.5 MC	CR-18/U	1 or 2	3	Black	7.0
7.0 MC to 7.5 MC	--	--	Normal	40	Black	7.0
7.5 MC to 8.0 MC	14.0 MC	CR-18/U	1 or 2	7	Red	7.0
8.0 MC to 8.5 MC	14.5 MC	CR-18/U	1 or 2	7-1/2	Black	7.0
8.5 MC to 9.0 MC	15.0 MC	CR-18/U	1 or 2	8	Red	7.0
9.0 MC to 9.5 MC	15.5 MC	CR-18/U	1 or 2	8-1/2	Black	7.0
9.5 MC to 10 MC	--	--	Normal	9	Red	7.0
10 MC to 10.5 MC	16.5 MC	CR-18/U	1 or 2	9-1/2	Black	7.0
10.5 MC to 11 MC	17.0 MC	CR-18/U	1 or 2	4-1/2	Red	14
11 MC to 11.5 MC	17.5 MC	CR-18/U	1 or 2	5	Black	14
11.5 MC to 12 MC	18.0 MC	CR-18/U	1 or 2	5-1/2	Red	14
12 MC to 12.5 MC	18.5 MC	CR-18/U	1 or 2	6	Black	14

Signal Frequency	Crystal Frequency	Crystal Type	Crystal Selector & Socket	Preselector Calibration	Dial Scale	Band Selector
12.5 MC to 13 MC	19.0 MC	CR-18/U	1 or 2	6-1/2	Red	14
13 MC to 13.5 MC	19.5 MC	CR-18/U	1 or 2	7	Black	14
13.5 MC to 14 MC	20.0 MC	CR-18/U	1 or 2	7	Red	14
14 MC to 14.5 MC	--	--	Normal	20	Black	14
14.5 MC to 15 MC	21.0 MC	CR-23/U	3 or 4	7-1/2	Red	14
15 MC to 15.5 MC	21.5 MC	CR-23/U	e or 4	7-1/2	Black	14
15.5 MC to 16 MC	22.0 MC	CR-23/U	3 or 4	8	Red	14
16 MC to 16.5 MC	22.5 MC	CR-23/U	3 or 4	8	Black	14
16.5 MC to 17 MC	23.0 MC	CR-23/U	3 or 4	8-1/2	Red	14
17 MC to 17.5 MC	23.5 MC	CR-23/U	3 or 4	8-1/2	Black	14
17.5 MC to 18 MC	24.0 MC	CR-23/U	3 or 4	9	Red	14
18 MC to 18.5 MC	24.5 MC	CR-23/U	3 or 4	7	Black	21
18.5 MC to 19 MC	25.0 MC	CR-23/U	3 or 4	7	Red	21
19 MC to 19.5 MC	25.5 MC	CR-23/U	3 or 4	7-1/2	Black	21
19.5 MC to 20 MC	26.0 MC	CR-23/U	3 or 4	7-1/2	Red	21
20 MC to 20.5 MC	26.5 MC	CR-23/U	3 or 4	8	Black	21
20.5 MC to 21 MC	27.0 MC	CR-23/U	3 or 4	8	Red	21
21 MC to 21.5 MC	--	--	Normal	15	Black	21
21.5 MC to 22 MC	28.0 MC	CR-23/U	3 or 4	8-1/2	Red	21
22 MC to 22.5 MC	28.5 MC	CR-23/U	3 or 4	8-1/2	Black	21
22.5 MC to 23 MC	29.0 MC	CR-23/U	3 or 4	9	Red	21
23 MC to 23.5 MC	29.5 MC	CR-23/U	3 or 4	9	Black	21
23.5 MC to 24 MC	30.0 MC	CR-23/U	3 or 4	9-1/2	Red	21
24 MC to 24.5 MC	30.5 MC	CR-23/U	3 or 4	9-1/2	Black	21
24.5 MC to 25 MC	31.0 MC	CR-23/U	3 or 4	7-1/2	Red	28.0
25 MC to 25.5 MC	31.5 MC	CR-23/U	3 or 4	8	Black	28.0
25.5 MC to 26 MC	32.0 MC	CR-23/U	3 or 4	8	Red	28.0
26 MC to 26.5 MC	32.5 MC	CR-23/U	3 or 4	8-1/2	Black	28.0
26.5 MC to 27 MC	33.0 MC	CR-23/U	3 or 4	8-1/2	Red	28.0
27 MC to 27.5 MC	33.5 MC	CR-23/U	3 or 4	9	Black	28.0
27.5 MC to 28 MC	34.0 MC	CR-23/U	3 or 4	9	Red	28.0
28 MC to 28.5 MC	--	--	Normal	10	Black	28.0
28.5 MC to 29 MC	--	--	Normal	10	Red	28.5
29 MC to 29.5 MC	--	--	Normal	10	Black	29.0
29.5 MC to 30 MC	--	--	Normal	10	Red	29.5

Crystals for General Coverage Operation should be ordered through an authorized Hallicrafters Dealer, allowing reasonable time for delivery. Because of the large quantity of crystal required to satisfy varied user requirements, neither The Hallicrafters Company nor its dealers will normally stock crystals for general coverage service.

Substitution of crystal types other than specified should be avoided. Proper operation and frequency correlation is dependent on precise characteristics of the CR-18/U and CR-23/U types as listed.

NOTE

Those crystals which are shipped with the Model SX-117 Receiver and the additional 10-meter and WWV crystals are available at The Hallicrafters Company. See the Service Repair Parts List for part numbers of these crystals.

5-8. USE OF VFO AS CRYSTAL-LOCKED OSCILLATOR.

The VFO (variable frequency oscillator) may be used as a crystal-controlled oscillator for fixed-frequency operation.

This may be accomplished as follows:

1. Insert a 4.5-MC type CR-18/U crystal in the VFO crystal socket, SO1.
2. Add 6.15 megacycles (IF frequency) to the desired signal frequency. This will determine the heterodyning crystal frequency.

3. If the heterodyning crystal frequency is 20 MC or less, specify type CR-18/U and insert in auxiliary oscillator crystal socket 1 or 2.
4. If the heterodyning crystal frequency is more than 20 MC, specify type CR-23/U and insert in auxiliary oscillator crystal socket 3 or 4.
5. The PRESELECTOR calibration and BAND SELECTOR setting may be determined from the general-coverage chart (paragraph 5-7).
6. The VFO dial should be set at approximately 375. Slight frequency warping may be achieved by moving the dial slightly from this point.

Example 1 - The desired signal frequency is 12.950 MC; the heterodyning crystal frequency is 12.950 MC + 6.15 MC = 19.100 MC. From the general-coverage chart, it can be determined that, for a signal frequency of 12.950 MC, the PRESELECTOR should be set at 6 1/2 and the BAND SELECTOR should be at 14. The correct crystal would be a 19.100-MC type CR-18/U crystal inserted in either crystal socket 1 or 2.

Example 2 - The desired signal frequency is 18.4 MC; the heterodyning crystal frequency is 18.4 MC + 6.15 MC = 24.55 MC. From the general coverage chart, it can be determined that, for a signal frequency of 18.4 MC, the PRESELECTOR should be set at 7 and the BAND SELECTOR at 21. The correct crystal would be a 24.55-MC type CR-23/U crystal inserted in either crystal socket 3 or 4.

SECTION VI ALIGNMENT

6-1. GENERAL.

Alignment should not be attempted until all other possible causes of faulty operation have been exhausted.

NOTE

Do not make any adjustments unless the operation of this receiver is fully understood and adequate test equipment is available.

6-2. TEST EQUIPMENT REQUIRED.

1. Signal generator with 50-KC to 30-MC coverage, a calibrated output level meter, and a 50-ohm termination.

2. Vacuum tube voltmeter (VTVM).
3. Output meter (or AC scale of VTVM). If a VTVM is used, connect it to terminals 500 and G and terminate the output with a 500-ohm, 2-watt, dummy load.
4. 9.5-MC and 18-MC type CR-18/U crystals.
5. Alignment tool, such as GENERAL CEMENT #8606, and a small screwdriver.

6-3. INITIAL CONTROL SETTINGS.

BAND SELECTOR. As indicated in chart.
AUDIO AND RF. . . 10 (maximum).
GAIN

Figure 9. Top View of Receiver Chassis.

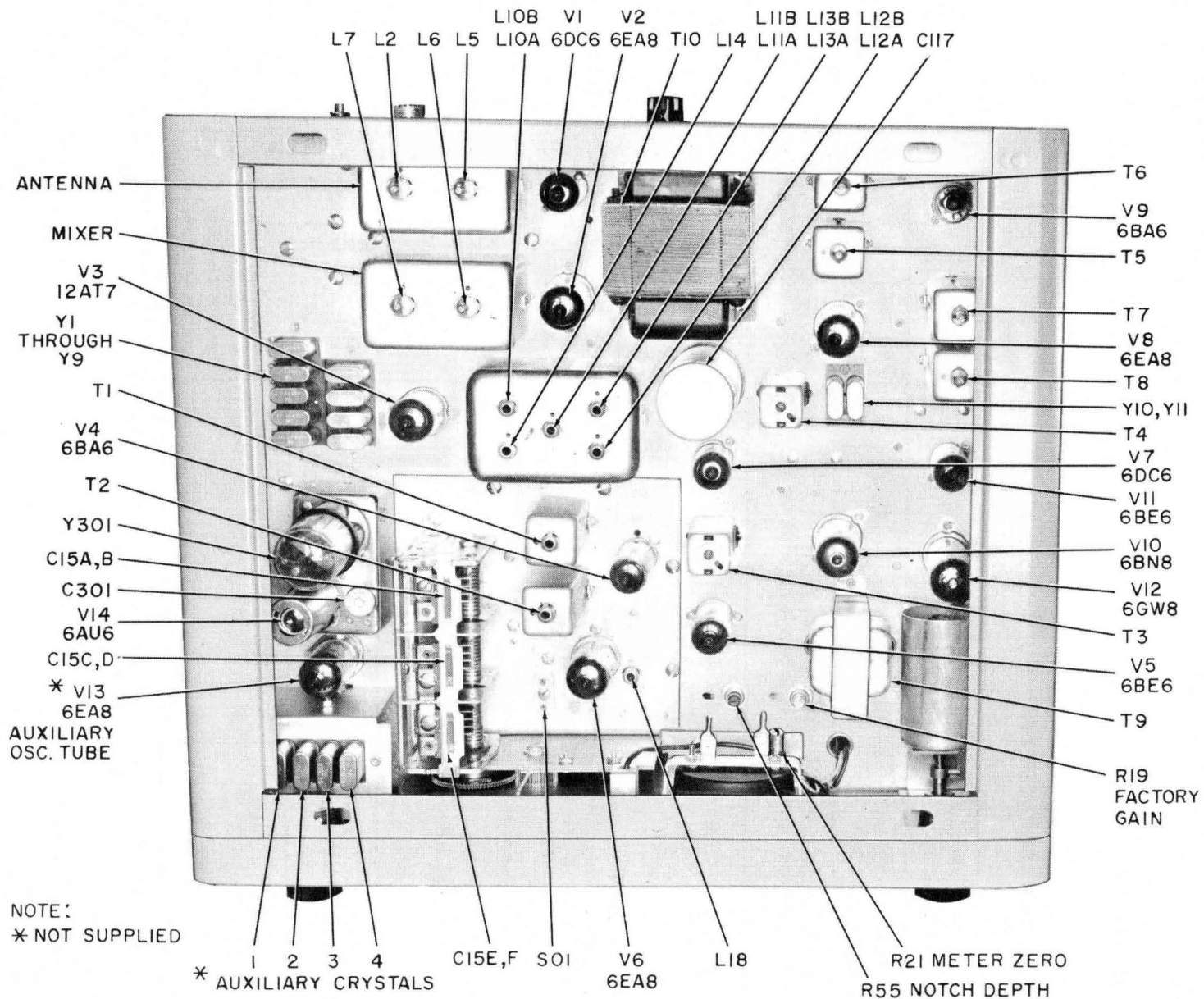

092-016681

SELECTIVITY As indicated in chart.

BFO 0 (center point).

FUNCTION AM

IMPORTANT

TUNING As indicated on chart.

To remove top cover, turn screws approximately one quarter turn counterclockwise.

NOTCH OFF.

Do not attempt to remove screws.

XTAL CAL-NL . . . OFF.

6-4. ALIGNMENT PROCEDURE.

Step	Signal Generator Connections	Generator Frequency	Band	Output Connections	Selectivity
1	High side directly to Pin 2 of V8	50.75 KC un-mod. (critical)	80 Meters	VTVM DC probe to Pin 6 of V10	0.5 KC
Adjust top cores of T5, T6, T7, and T8 for maximum indication. Reduce generator output as necessary to maintain approximately a 1-volt reading on VTVM. (Use screwdriver.)					
2	High Side directly to Pin 7 of V5	1650 KC, 400 cycles, 30% mod.	80 Meters	Output meter across appropriate speaker output terminals	5.0 KC
Slowly tune generators through 1650 KC to determine center of IF passband. Set generator at center of IF passband and adjust generator output to maintain approximately a 1/2-watt receiver output. Adjust top and bottom cores of T3 and T4 for maximum receiver output.					
3	High side directly to Pin 2 of V2	6.050 MC, 400 cycles, 30% mod.	80 Meters	Output meter across appropriate speaker output terminals	5.0 KC
Adjust receiver tuning until a signal is heard at approximately 3.95 MC. Adjust top cores of T1 and T2 for maximum receiver output.					
4	High side directly to Pin 2 of V2	6.45 MC mod.	80 Meters	Output meter across appropriate speaker output terminals	5.0 KC
Adjust receiver tuning until a signal is heard at approximately 3.55 MC. Adjust middle and rear trimmers C15B and C15D for maximum receiver output. Repeat core and trimmer adjustments until no further increase in output is noted.					

6-5. ADJUSTMENT OF CRYSTAL-CONTROLLED FIRST CONVERSION OSCILLATOR.

separate adjustments (i.e., 80 M and 10 M-1, 40 M and 10 M-2, etc). In all cases, the top core will be the low frequency adjustment and the 10 M adjustment will be the bottom core (see figure 10). All adjustments may be made from the top or bottom of the chassis when using an alignment tool such as General Cement's No. 8606.

All of the coil forms in this group, except the WWV coil, have two separate coils and two

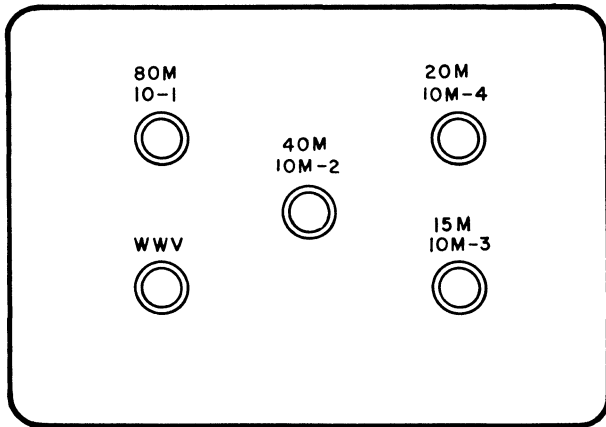

092-016629

Figure 10. Crystal Oscillator Coil Locations.

Connect a VTVM (set to read negative DC voltage on 10-volt scale) at point where R30 (1 megohm) connects to terminal strip near V2. Starting with 80 M, adjust each core in order of increasing frequency, for maximum voltage indication as the BAND SELECTOR switch is advanced through the various ranges.

NOTE

After all adjustments have been made, it is permissible to warp the crystal frequency by rotating the appropriate core slightly to allow more accurate band-to-band calibration, consistent with positive oscillator start as the BAND SELECTOR is rotated through each range.

6-6. PRESELECTOR ALIGNMENT.

To align the PRESELECTOR, 9.5-MC and 18.0-MC type CR-18/U crystals will be required. Insert the 9.5-MC crystal in Auxiliary Oscillator socket No. 1 and the 18-MC crystal in Auxiliary Oscillator socket No. 2.

Step 1

- a. Set generator frequency to 3.0 MC.
- b. Set receiver TUNING dial to 0.
- c. Set BAND SELECTOR to 3.5.
- d. Set PRESELECTOR to 0 (Maximum capacity).
- e. Set XTAL SELECTOR to 1.
- f. Connect generator to antenna input.

Adjust L5 (antenna coil) and L6 (mixer coil) for maximum receiver output.

Step 2

- a. Set generator frequency to 11.5 MC.
- b. Leave receiver TUNING dial at 0.
- c. Set BAND SELECTOR to 7.0.
- d. Set PRESELECTOR to 10 (Minimum capacity).
- e. Set XTAL SELECTOR to 2.

Adjust trimmers C3B and C3D for maximum receiver output.

Repeat steps 1 and 2 until no further increase in output is noted.

Step 3

- a. Set generator to 28.0 MC.
- b. Leave TUNING dial at 0.
- c. Set PRESELECTOR pointer to right edge of 10 M calibration block.
- d. Set BAND SELECTOR to 28.0 MC.
- e. Set XTAL SELECTOR to normal.

Adjust L2 and L7 (antenna and mixer shunt coils) for maximum receiver output.

6-7. ALIGNMENT OF IF TRAP.

Controls should be set as follows:

- RF GAIN 10
- AUDIO GAIN 10
- FUNCTION AM
- NOTCH OFF
- XTAL CAL-NL . . . OFF
- XTAL SELECTOR . Normal
- BAND SELECTOR . 7.0
- TUNING 7.1 MC
- PRESELECTOR . . . Peak on 7.1-MC signal.

- a. Connect generator to antenna input.
- b. Set generator frequency to 6.4 MC and increase output level approximately 50 DB above 1 microvolt.

Figure 11. Bottom View of Receiver Chassis.

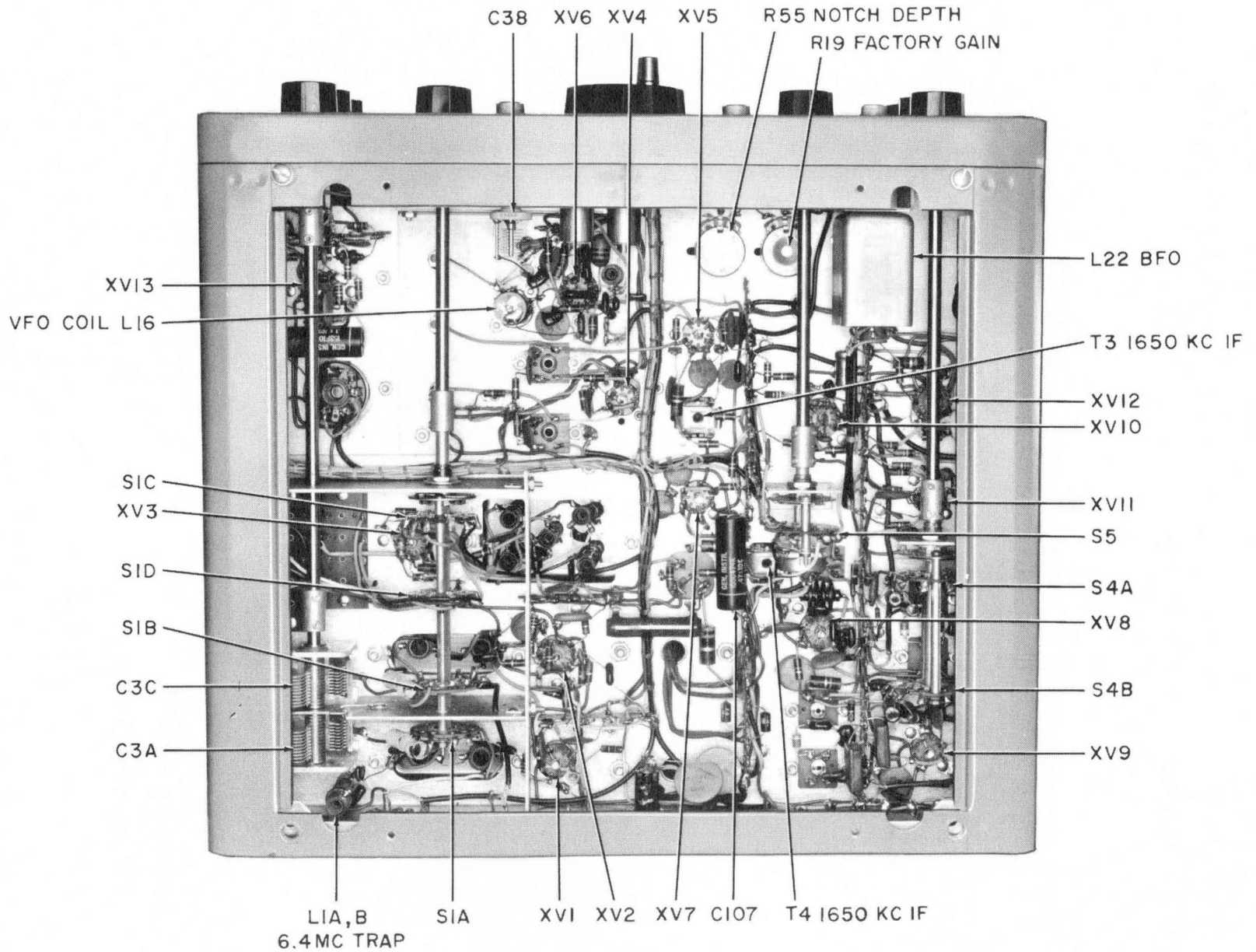

092-016682

c. Adjust both cores in L1 (IF Trap) for minimum receiver audio output. Repeat adjustments until no further decrease in output is obtained.

6-8. VFO CALIBRATION ALIGNMENT.

If the electrical index check at the 100-KC check points on all bands shows that the calibration marks consistently fall to one side of the pointer, a trimmer adjustment is indicated. (This will be necessary only if the calibration is beyond tuning range of the CAL RESET control.)

Proceed as follows:

- a. Adjust TUNING until dial is at 500 (3.5 MC).
- b. Set BAND SELECTOR at 3.5, FUNCTION to USB, SELECTIVITY to 2.5, and XTAL CAL to ON.
- c. Carefully adjust C15F (front trimmer on top of three-section gang) in very small increments until zero beat is heard. Care should be exercised to make sure that the correct 100-KC beat note is tuned in with the trimmer.
- d. Check across the dial at the 100-KC check points. If the frequency error is less than 3000 CPS, the calibration is within acceptable limits. If the error at the high frequency end of the dial (4.0 MC) is greater than 3000 CPS, the VFO may require a coil adjustment in addition to the trimmer adjustment.

6-9. CONDITIONS REQUIRING COIL AND TRIMMER ADJUSTMENT.

If the dial error progressively increases in the same direction with the high frequency end running out more than 3000 CPS, both L16 and C15F should be adjusted.

- a. Tune dial to 1000 (4.0 MC) and adjust L16 to zero beat.
- b. Tune dial to 500 (3.5 MC) and adjust C15F to zero beat.
- c. Repeat steps a and b until both 3.5 MC and 4.0 MC are exactly on frequency.
- d. Check across the dial at the 100-KC points. If the frequency error is less than 3000 CPS, the calibration is within acceptable limits. If the error is in excess of 3000 CPS at any of the mid-points, with the end limits at zero error, the VFO capacitor should be knifed. This operation should not be attempted by other than qualified personnel thoroughly familiar with the technique.

NOTE

When the VFO dial is at 3.5 MC, the VFO frequency should be 4.85 MC. With the VFO dial set at 4.0 MC, the VFO frequency should be 4.35 MC.

6-10. ADJUSTMENT OF FACTORY GAIN METER CONTROL.

Controls should be set as follows:

AUDIO GAIN 0
RF GAIN 10
FUNCTION AM
SELECTIVITY 2.5 KC
TUNING 14.3 MC
BAND SELECTOR 20 M
NOTCH OFF
XTAL CAL-NL OFF

- a. Connect signal generator to the antenna input. Set generator output level to 50 microvolts unmodulated and tune to 14.3 MC.
- b. Carefully adjust TUNING for maximum S-Meter deflection and peak PRESELECTOR.
- c. If S-Meter does not read S9, adjust Factory Gain control for correct reading.
- d. Turn RF GAIN control to 0 and check for electrical zero at left end of meter scale.
- e. Adjust Meter Zero control as necessary and repeat the above steps until the meter reads S9 with the RF GAIN control at 10 and 0 with the RF GAIN control at 0.

6-11. BFO FREQUENCY ADJUSTMENT.

The beat frequency oscillator (BFO) has been adjusted at the factory so that its frequency is exactly 50 KC when the BFO knob is set at 0. A slight readjustment may be necessary occasionally because of normal component aging. To determine if adjustment is required, proceed as follows.

With the SELECTIVITY control at 5 KC, FUNCTION at USB, XTAL CAL. at ON, and PITCH control at 0, adjust TUNING to zero beat at any 100-KC check point. Leaving the receiver TUNING unchanged, switch the FUNCTION switch to LSB. If the beat oscillator frequency is correct,

zero beat will be maintained in both the USB and LSB positions. If the beat oscillator is off frequency, a beat note will be heard when switching from USB to LSB. Adjustment of the oscillator is recommended only if the frequency of the audible beat note exceeds 200 CPS with the BFO knob at 0.

NOTE

In instances where the beat frequency oscillator is considerably off frequency, it may not be possible to obtain a zero beat when tuning through a signal. If this is the case, it will be necessary to roughly set the BFO to 50 KC as follows: Set SELECTIVITY to 0.5 KC, FUNCTION to USB, and tune receiver to a noisy part of band (not to a signal). Remove the BFO knob and adjust the BFO slug for minimum noise. Set the SELECTIVITY control to 5 KC and make the BFO frequency check as outlined above.

If the BFO frequency check indicates adjustment is necessary, proceed as follows:

- a. Remove the BFO control knob, turn the BFO slug a few degrees in the direction that lowers the beat note frequency, and repeat the BFO frequency check.
- b. Continue varying the setting of the slug in small steps and repeat the BFO frequency check until zero beat is obtained in both USB and LSB positions.
- c. After the correct slug setting has been determined, replace the BFO knob with 0 in the top center position, being careful not to disturb the slug setting.

6-12. NOTCH FREQUENCY AND DEPTH ADJUSTMENTS.

Readjustment of the notch filter circuit is not normally necessary unless the components in the notch circuit are replaced. To check the circuit, proceed as follows:

- a. Check the BFO frequency as previously described so that zero beat is maintained in either sideband position.

- b. Set FUNCTION to USB, SELECTIVITY to 2.5 KC, and tune in an unmodulated signal (strength approximately S9) to zero beat.

- c. Tune NOTCH control for minimum audio output.

- d. Adjust notch depth (on top of chassis, right side of VFO) for further decrease in audio output.

- e. Repeat steps c and d until no further decrease in audio output is noted. At this point, the notch frequency should indicate 50 KC.

If the notch frequency does not indicate 50 KC with the receiver at zero beat as described above, loosen knob and reset it to 50 KC.

6-13. CRYSTAL CALIBRATOR ADJUSTMENT.

The crystal adjust trimmer is used to adjust the 100-KC crystal exactly to frequency by comparison with the 10-MC signal transmitted by WWV.

- a. Set all receiver controls for AM reception, set BAND SELECTOR to WWV, and adjust TUNING to WWV signal.

- b. During the period of no signal modulation, turn XTAL CAL. ON and carefully set the crystal adjust so that the crystal calibrator zero beats with the signal received from WWV.

NOTE

If this adjustment is attempted during periods that WWV is modulated, an erroneous zero beat may be obtained with the modulating frequency instead of the desired carrier frequency.

SECTION VII

SERVICE DATA

7-1. 50.75-KC IF SYSTEM.

Figure 12 shows the type of coupling used in the 50.75-KC IF system. Note that inductive coupling is avoided by careful shielding of the IF coils and signal transfer occurs only through capacitance and resistance. By increasing the value of "C" and decreasing "R", the selectivity is made

sharper; by decreasing "C" and increasing "R", the selectivity is made broader. The proper values of "C" and "R" are switched in the circuit by means of the SELECTIVITY control. "R" varies the "Q" of the tuned circuit and "C" varies the coupling. This R-C coupling arrangement affords a more accurate means of selectivity control than that readily obtainable by any other method.

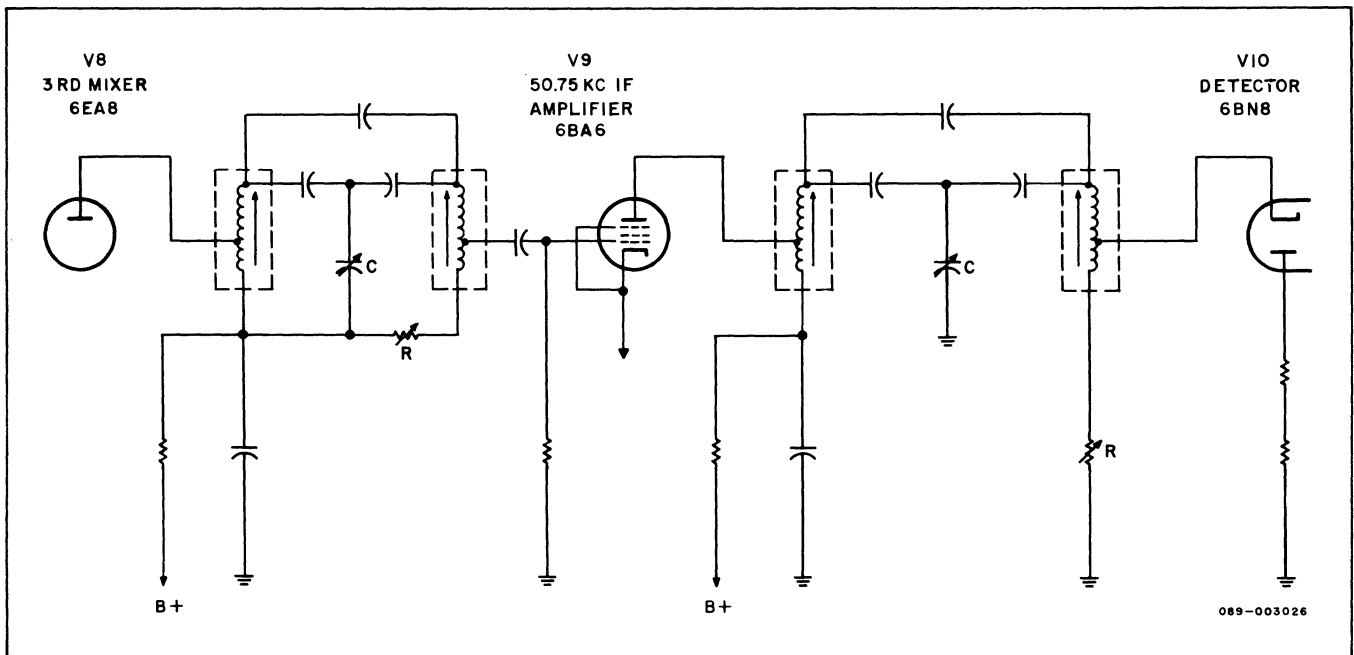

Figure 12. Equivalent Schematic Diagram of the 50.75-KC IF System.

7-2. CHASSIS REMOVAL.

Most service work can be accomplished by removing the top and bottom plates from the cabinet.

The top plate (cover) may be removed by turning the four screws approximately one quarter turn counterclockwise. Do not attempt to remove the screws.

The bottom plate may be removed by completely removing the four screws in the corners of the bottom plate.

The chassis may be removed by removing the four outer screws in the cabinet bottom and sliding the chassis forward through the cabinet front.

7-3. SERVICE OR OPERATING QUESTIONS.

For further information regarding operation or servicing of the Model SX-117 Receiver, contact the dealer from whom the unit was purchased. The Hallicrafters Company maintains an extensive system of Authorized Service Centers where any required service will be performed promptly and efficiently at no charge if this equipment is delivered to the service center within 90 days from

date of purchase by the original buyer and the defect falls within the terms of the warranty. It is necessary to present the bill of sale in order to establish warranty status. After the expiration of the warranty, repairs will be made for a nominal charge. All Hallicrafters Authorized Service Centers display the sign shown below. For the location of the one nearest you, consult your dealer or your local telephone directory.

Make no service shipments to the factory as The Hallicrafters Company will not accept responsibility for unauthorized shipments.

The Hallicrafters Company reserves the privilege of making revisions in current production of equipment and assumes no obligation to incorporate such revisions in earlier models.



NOTES:

1. 20,000 OHMS PER VOLT METER USED FOR MEASUREMENTS.

2. CONTROL SETTINGS:

A. AF AND RF GAIN CONTROLS MAXIMUM COUNTER CLOCKWISE (CCW) UNLESS OTHERWISE NOTED.

B. BAND SELECTOR, FUNCTION AND SELECTIVITY CONTROL SETTINGS NOT CRITICAL UNLESS OTHERWISE NOTED.

C. XTAL SELECTOR CONTROL NORMAL UNLESS OTHERWISE NOTED.

3. ALL VOLTAGES POSITIVE (+) UNLESS OTHERWISE NOTED.

* USE HEWLETT-PACKARD HP-410B OR EQUIVALENT FOR THIS VOLTAGE.

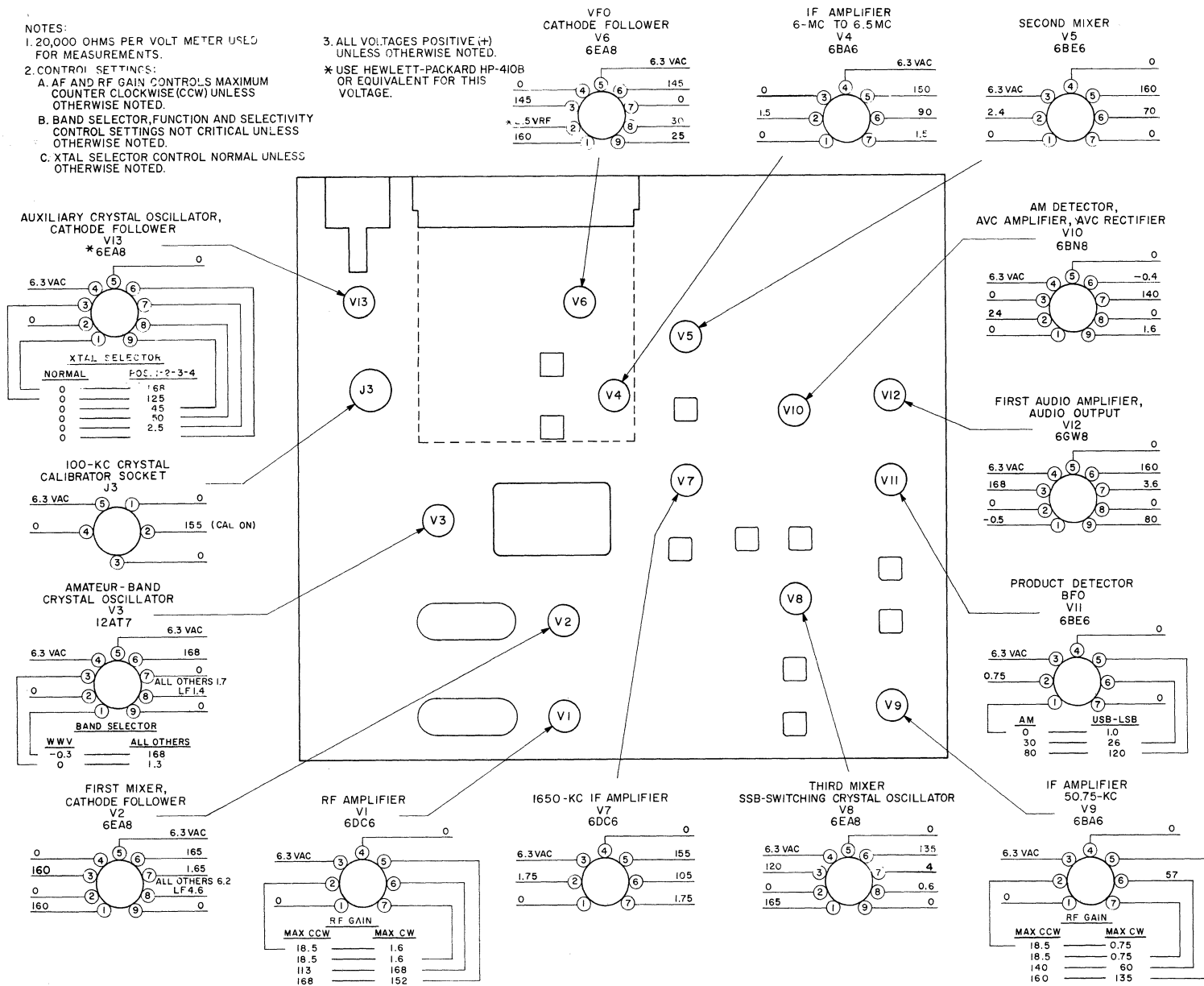

Figure 13. Voltage Chart.

NOTES:

1. 20,000 OHMS PER VOLT METER USED FOR MEASUREMENTS.
2. CONDITIONS:
 - A. RECEIVE - STANDBY JUMPER IN PLACE.
 - B. SWITCH POSITIONS:
 - XTAL SELECTOR-NORMAL
 - NL-OFF
 - FUNCTION-AM
 - SELECTIVITY-5.0
 - RF GAIN-10
 - AUDIO GAIN-10
 - BAND SELECTOR-3.5

* NOT SUPPLIED

AUXILIARY CRYSTAL OSCILLATOR, CATHODE FOLLOWER

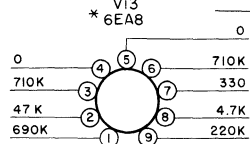

100-KC CRYSTAL CALIBRATOR SOCKET

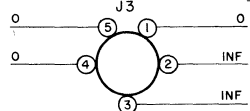

AMATEUR-BAND CRYSTAL OSCILLATOR

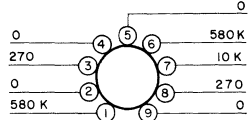

FIRST MIXER, CATHODE FOLLOWER

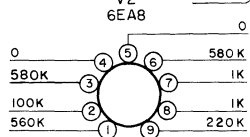

RF AMPLIFIER

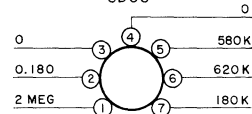

VFO CATHODE FOLLOWER

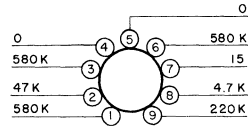

1650-KC IF AMPLIFIER

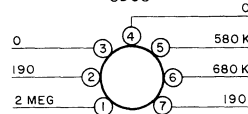

IF AMPLIFIER

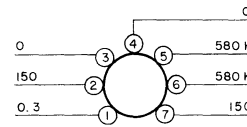

THIRD MIXER

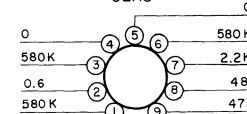

SECOND MIXER

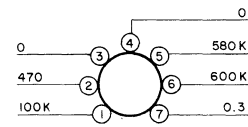

AM DETECTOR, AVC AMPLIFIER, AVC RECTIFIER

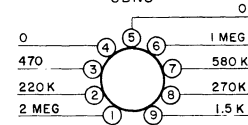

FIRST AUDIO AMPLIFIER, AUDIO OUTPUT

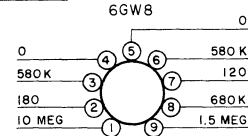

PRODUCT DETECTOR

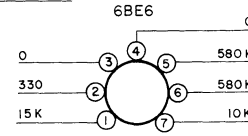

IF AMPLIFIER

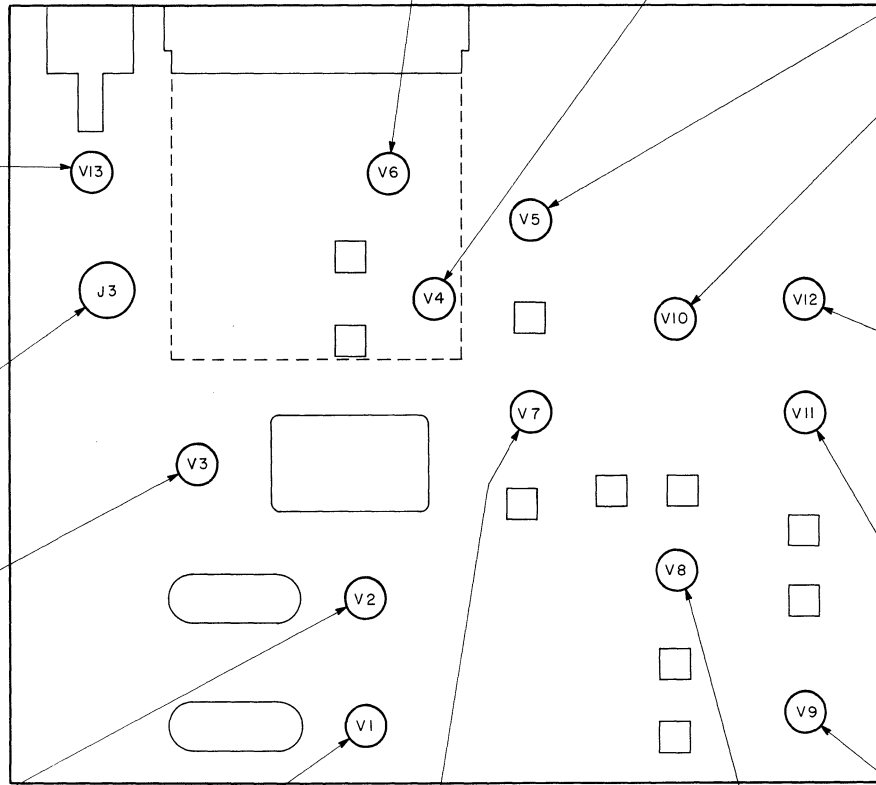
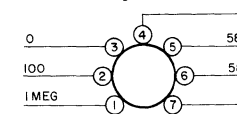

Figure 14. Resistance Chart.



Figure 15. Hallicrafters' Model HA-10, LF/MF Tuner.

SECTION VIII

LF/MF TUNER

MODEL HA-10

8-1. DESCRIPTION.

The Model HA-10 is an optional plug-in accessory to be used with the Model SX-117 Receiver for extending the tuning range from 3.0 MC to 85 KC.

A five-position switch is provided to select the following ranges:

- OFF
- 85 KC to 200 KC.
- 200 KC to 500 KC.
- 500 KC to 1200 KC.
- 1200 KC to 3.0 MC.

The OFF position on the RANGE switch provides straight-through antenna switching so that the common station antenna system may be used for both low and high frequency reception. See figure 16.

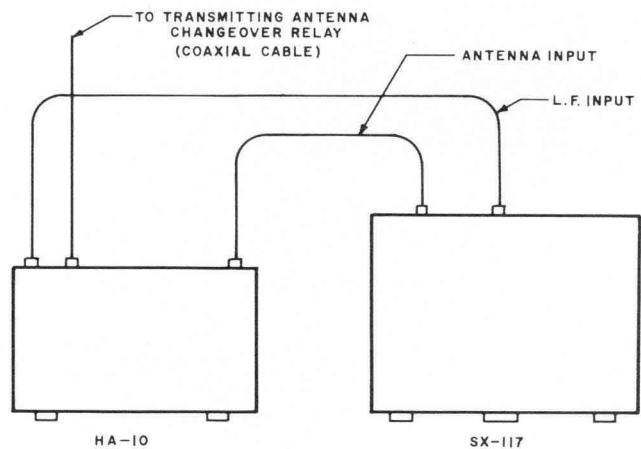

092-016650

Figure 16. Connecting the Model HA-10, Using a Common Antenna.

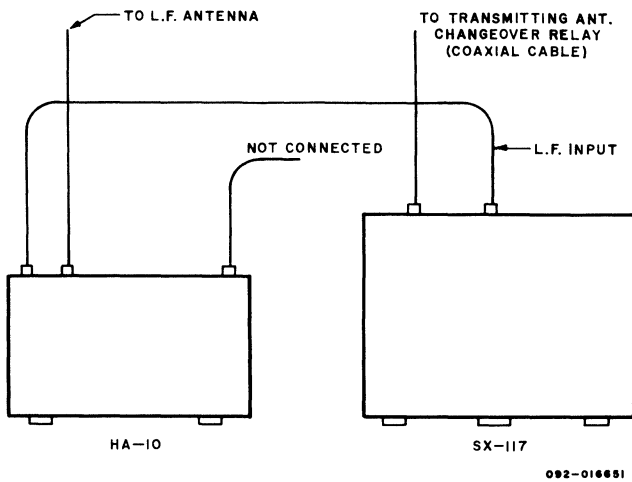

Figure 17. Connecting the Model HA-10, Using a Separate Low-Frequency Antenna.

If desired, separate antennas may be used for low and high frequency reception. See figure 17.

In most cases, a dipole antenna cut for 7.0 MC or lower, or a long-wire antenna will give satisfactory results over the tuning range of the Model HA-10.

The Model HA-10 input is designed to accept 50-ohm to 70-ohm transmission line. However, a long-wire antenna may be used.

8-2. OPERATION OF THE MODEL HA-10.

Proceed as follows:

- a. Connect unit to a Model SX-117 Receiver as shown in figures 16 or 17.
- b. Install desired heterodyning crystal in the Model SX-117 Receiver and position XTAL SELECTOR switch.

c. Set the Model SX-117 BAND SELECTOR switch to LF.

d. Set the Model HA-10 RANGE switch to desired range.

e. Peak the Model HA-10 TUNING control for maximum signal output. (Detune on extremely strong signals.)

Desired Signal Range	HA-10 RANGE Switch	SX-117 Heterodyning Crystal Frequency
85 KC-200 KC	85 KC-200 KC	6.5 MC
200 KC-500 KC	200 KC-500 KC	6.5 MC
500 KC-1000 KC	500 KC-1200 KC	7.0 MC
1000 KC-1200 KC	500 KC-1200 KC	7.5 MC
1200 KC-1500 KC	1200 KC-3000 KC	7.5 MC
1500 KC-2000 KC	1200 KC-3000 KC	8.0 MC
2000 KC-2500 KC	1200 KC-3000 KC	8.5 MC
2500 KC-3000 KC	1200 KC-3000 KC	9.0 MC

To restore the Model SX-117 Receiver to normal high-frequency operation, the Model HA-10 RANGE switch should be set at OFF and the Model SX-117 XTAL SELECTOR switch returned to normal.

8-3. ALIGNMENT OF THE MODEL HA-10.

Set up the Model SX-117 and the Model HA-10 for LF, AM operation as described in paragraphs 5-3 and 5-7, using correct heterodyning crystals to cover the frequencies listed below.

HA-10 Range Switch	HA-10 Tuning	SX-117 Tuning	Generator Frequency into HA-10 @ 400 CPS Mod.	Adjustment
85-200 KC	0 (Maximum Capacity)	80 KC	80 KC	Adjust L204 for maximum receiver output
200-500 KC	0 (Maximum Capacity)	195 KC	195 KC	Adjust L203 for maximum receiver output
500-1200 KC	0 (Maximum Capacity)	490 KC	490 KC	Adjust L202 for maximum receiver output
1200-3000 KC	0 (Maximum Capacity)	1175 KC	1175 KC	Adjust L201 for maximum receiver output

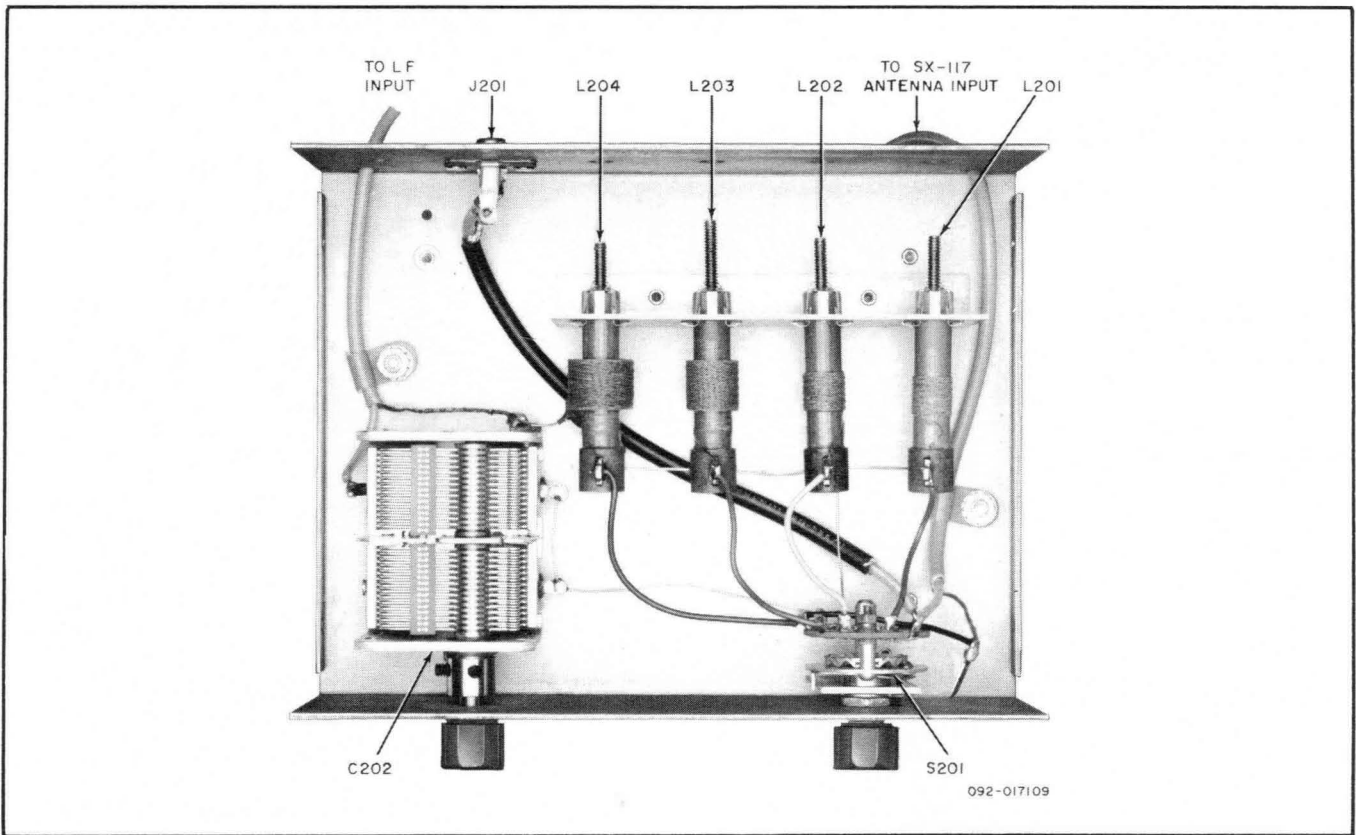
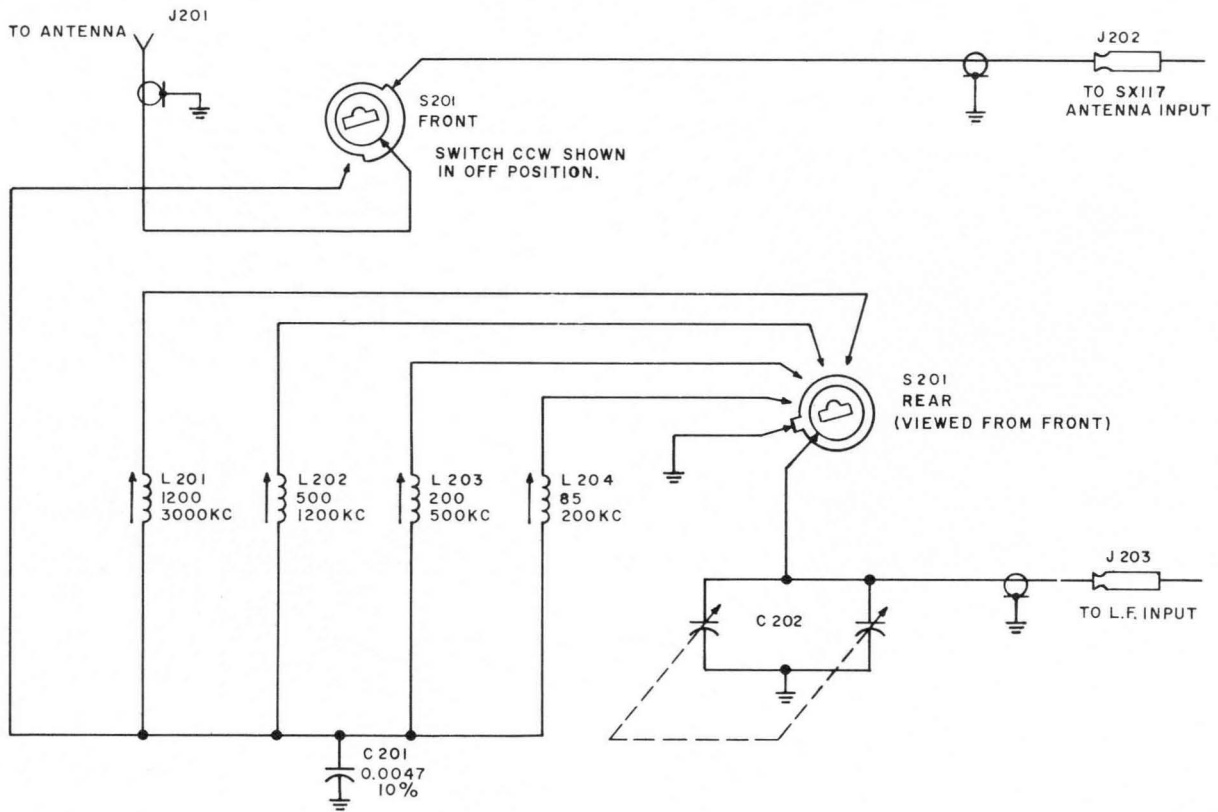

Figure18. Internal View of the LF/MF Tuner.



089-003023

Figure19. Schematic Diagram, Model HA-10 Tuner.

SERVICE REPAIR PARTS LIST

100-KC CRYSTAL CALIBRATOR

Schematic Symbol	Description	Hallicrafters' Part Number
C301	Assembly, 100-KC Crystal Marker Capacitor, Variable, Trimmer, 8 $\mu\mu\text{F}$ to 50 $\mu\mu\text{F}$, N750, Crystal Calibrator Adjustment	001-004394 044-200437
C303, 305	Capacitor, 0.01 μF , 500V, Ceramic Disc	047-100224
C304	Capacitor, 82 $\mu\mu\text{F}$, 10%, Mica	470-213820
P3	Connector, Plug, 5-pin	035-100038
CR301	Diode, type 1N295	019-301980
V14	Electron Tube, type 6AU6	090-900808
Y301	Marker Crystal, 100-KC	019-202351
R301, 304	Resistor, 220K ohms, 10%, 1/2 watt	451-252224
R302	Resistor, 4.7K ohms, 10%, 1/2 watt	451-252472
R303	Resistor, 100K ohms, 10%, 1/2 watt	451-252104
	Shield, Cover	069-001719
	Shield, Tube	069-201191
	Socket, Octal	006-200696
	Socket, Tube	006-100759

SERVICE REPAIR PARTS LIST

MODEL HA-10

	Assembly, LF/MF Tuner (Model HA-10)	001-004488
	Cabinet Bottom	066-003736
	Cabinet Cover	066-003701
J202, 203	Cable and Plug Assembly	087-007651
C201	Capacitor, 4700 $\mu\mu\text{F}$, 10%, 500V, Ceramic Disc	047-001506
C202	Capacitor, Variable, TUNING	048-000535
	Clamp, Cable	076-202740
L201	Coil, RF, 1200 KC to 3.0 MC	051-003540
L202	Coil, RF, 500 KC to 1200 KC	051-003539
L203	Coil, RF, 200 KC to 500 KC	051-003538
L204	Coil, RF, 100 KC to 200 KC	051-003537
J201	Connector, Phono	036-100041
	Foot, Mounting	016-200980
	Iron Core (L201 through L204)	077-100260
	Knob, TUNING and RANGE KC	015-001775
	Plate, Switch Mounting	063-006054
S201	Switch, Rotary, RANGE KC	060-002566
	Trim Strip	007-000816

NOTES:

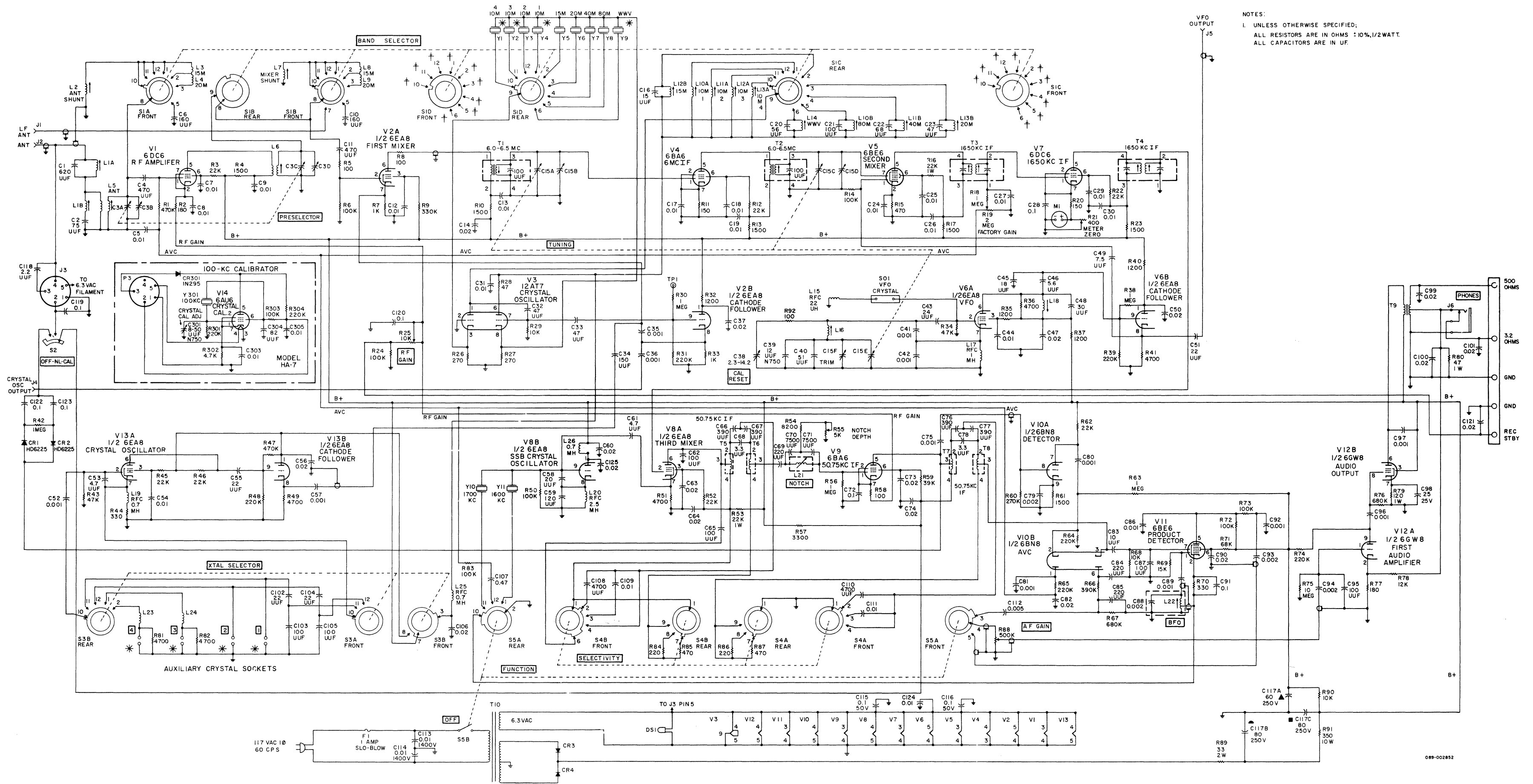

NOTES:
 1. UNLESS OTHERWISE SPECIFIED;
 ALL RESISTORS ARE IN OHMS ; 10%, 1/2WATT.
 ALL CAPACITORS ARE IN UF.

Figure 20. Schematic Diagram, Model SX-117 Receiver.

**SERVICE REPAIR PARTS LIST
MODEL SX-117**

Schematic Symbol	Description	Hallicrafters Part Number	Schematic Symbol	Description	Hallicrafters Part Number	Schematic Symbols	Description	Hallicrafters Part Number	Schematic Symbols	Description	Hallicrafters Part Number
CAPACITORS			CAPACITORS (CONT)			COILS AND TRANSFORMERS			SWITCHES		
C1	620 μ F, 5%, 300V, Plastic Mica	481-162621	C83	10 μ F, 5%, 300V, Plastic Mica	481-132100	L1A&B L2,7	Coil, 6-MC Trap Coil, Shunt (Antenna and Mixer)	050-000877 051-003496	S1	Rotary, Wafer, BAND SELECTOR	060-002523
C2	75 μ F, 5%, 300V, Plastic Mica	481-162750	C88	2000 μ F, 5%, 300V, Plastic Mica	481-262202	L3,8	Coil, 15-Meter Series (Antenna and Mixer)	051-003494	S2 S3	Rotary, Wafer, NL-CAL Rotary, Wafer, CRYSTAL SELECTOR	060-002528 060-002525
C3 C4,11	Variable, PRESELECTOR 470 μ F, 5%, 300V, Plastic Mica	048-000534 481-162471	C89	1000 μ F, 5%, 300V, Plastic Mica	481-262102	L4,9	Coil, 20-Meter Series (Antenna and Mixer)	051-003495	S4	Rotary, Wafer, SELECTIVITY	060-002511
C5,7,8,9, 12,13,17, 18,19,24, 25,26,27, 29,30,31, 44,54,124 C6,10	0.01 μ F, +80%, -20%, 500V, Ceramic Disc	047-100224	C98	25 μ F, 25V, Electrolytic Mica	045-000883	L5 L6 L10A&B	Coil, Antenna Coil, Mixer Coil, Oscillator (10-1 and 80 Meters)	051-003498 051-003499 051-003487	S5	Rotary, Wafer, FUNCTION (Inc. ON/OFF)	060-002510
C14,37, 47,50,56, 60,63,64, 73,74,82, 90,99,100, 101,106,121,125	160 μ F, 5%, 300V, Plastic Mica	481-162161	C107	0.47 μ F, 10%, 200V, Paper Tubular	046-001302-04	L11A&B	Coil, Oscillator (10-2 and 40 Meters)	051-003488	CRYSTALS		
C15	Variable, TUNING	048-000533	C108,110	4700 μ F, 5%, 400V, Paper Tubular	046-001312-03	L12A&B	Coil, Oscillator (10-3 and 15 Meters)	051-003491	Y1	10-4 Meter Band, 36.000 MC	019-002886
C16	15 μ F, 5%, 300V, Plastic Mica	481-132150	C109,111	0.01 μ F, 5%, 400V, Paper Tubular	046-001316-03	L13A&B	Coil, Oscillator (10-4 and 20 Meters)	051-003490	Y2	10-3 Meter Band, 35.500 MC	019-002885
C20	56 μ F, 5%, 300V, Plastic Mica	481-162560	C112	0.005 μ F, GMV, 500V, Ceramic Disc	047-100168	L14	Coil, Oscillator (WWV)	051-003489	Y3	10-2 Meter Band, 35.000 MC	019-002884
C21,62, 65,87,95, 103,105 C22	100 μ F, 5%, 300V, Plastic Mica	481-162101	C113,114	0.01 μ F, 1400V, Ceramic Disc	047-001309	L15	Coil, RF Choke (22 UH)	053-000659	Y4	10-1 Meter Band, 34.500 MC	019-002883
C23	47 μ F, 5%, 300V, Plastic Mica	481-152470	C117A,B, & C	60 μ F, 250V; 2 x 80 μ F, 250V, Electrolytic	045-000884	L16	Coil, VFO	051-003509	Y5	15-Meter Band, 27.500 MC	019-002882
C28,72,91, 115,116, 120,122,123	0.1 μ F, +80%, -20%, 50V, Ceramic Disc	047-001146	C118	2.2 μ F, 10%, Gimmick Tubular	047-200403-04	L17	Coil, RF Choke (1 MH)	053-000580	Y6	20-Meter Band, 20.500 MC	019-002881
C32,33	47 μ F, 10%, 500V, N2200, Ceramic Tubular	479-026470	C119	0.1 μ F, 10%, 400V, Paper Tubular	046-001329-04	L18	Coil, Peaking	051-003497	Y7	40-Meter Band, 13.500 MC	019-002880
C34	150 μ F, 5%, 300V, Plastic Mica	481-162151	RESISTORS*			L19,25,26	Coil, RF Choke (0.7 MH)	053-000530	Y8	80-Meter Band, 10.000 MC	019-002879
C35,36,52, 57,75,80, 81,86,92, 96,97 C38	0.001 μ F, 20%, 500V, Ceramic Disc	047-100503	R1,47	470K ohms	451-252474	L20	Coil, RF Choke (2.5 MH)	053-000335	Y9	WWV, 16.000 MC	019-002965
C39	Variable, Trimmer, CAL RESET	044-000565	R2,77	180 ohms	451-252181	L21	Coil, T-NOTCH (Bridge)	051-202270	Y10&11	1600 KC and 1700 KC, Matched Pair	019-002961
C40	12 μ F, 10%, N750, Ceramic Tubular	491-006120-95	R3,12,22, 45,46,52,62	22K ohms	451-252223	L22	Coil, BFO	054-000059	Y12,13, 14,15	General Coverage Crystals (Not Supplied)	-----
C41,42	1000 μ F, 2%, 300V, Plastic Mica	481-261102	R4,10,13, 17,23,61	1500 ohms	451-252152	L23,24	Coil, Warping (Crystal Oscillator)	051-003500	CONNECTORS AND SOCKETS		
C43	24 μ F, 2%, 300V, Plastic Mica	481-151240	R5,8,58,92	100 ohms	451-252101	T1,2	Transformer, Variable IF (6.0 MC to 6.5 MC)	050-000869	J1	Connector, LF Antenna	036-100041
C45	18 μ F, 2%, 300V, Plastic Mica	481-131180	R6,14,24,50 72,73,83	100K ohms	451-252104	T3,4 T5,6,7,8 T9	Transformer, IF (1650 KC) Transformer, IF (50.75 KC) Transformer, Output	050-000788 050-200735 055-000449	J2 J3	Connector, Antenna Connector, 100-KC Crystal, 5-pin	036-100041 006-100186
C46	5.6 μ F, 2%, 300V, Plastic Mica	481-131056	R7,33	1000 ohms	451-252102	T10	Transformer, Power	052-000989	J4	Connector, Crystal Oscillator Output	036-100041
C48	30 μ F, 2%, 300V, Plastic Mica	481-151300	R9	330K ohms	451-252334	ELECTRON TUBES AND DIODES			J5	Connector, VFO Output	036-100041
C49	7.5 μ F, 2%, 300V, Plastic Mica	481-131075	R11,20	150 ohms	451-252151	V1	Electron Tube, type 6DC6; RF Amplifier	090-901328	J6	Connector, PHONES	036-100002
C51	22 μ F, 2%, 300V, Plastic Mica	481-151220	R15,85,87	470 ohms	451-252471	V2	Electron Tube, type 6EA8; First Mixer, Cathode Follower	090-901350	SO1	Socket, VFO Crystal	006-100320
C53,61	4.7 μ F, 5%, 300V, Plastic Mica	481-132047	R16,53	22K ohms, 1 watt	451-352223	V3	Electron Tube, type 12AT7; Amateur-Band Crystal Oscillator	090-900034	MISCELLANEOUS		
C55,102, 104 C58	22 μ F, 5%, 300V, Plastic Mica	481-152220	R18,30,38, 42,56,63	1 megohm	451-252105	V4	Electron Tube, type 6BA6; 6-MC to 6.5-MC IF Amplifier	090-901112	F1	Fuse, 1 Ampere, 3AG, Slow-Blow Type	067-010598
C59	120 μ F, 5%, 300V, Plastic Mica	481-162121	R19	Variable, 2 megohms, 30%, 1/4 watt, Factory Gain	025-001957	V5	Electron Tube, type 6BE6; Second Mixer	090-901124		Fuse Holder	006-100451
C66,67,76, 77 C68,78	390 μ F, 5%, 300V, Plastic Mica	481-162391	R21	Variable, 400 ohms, 2 watts, Meter Zero	025-002121	V6	Electron Tube, type 6EA8; VFO, Cathode Follower	090-901350		Iron Core (L2,5,6,7)	077-100260
C69,84,85	3.3 μ F, 10%, Gimmick	047-200403-05	R25	Variable, 10K ohms, 20%, 1 watt, RF GAIN	025-002120	V7	Electron Tube, type 6DC6; 1650-KC IF Amplifier	090-901328		Knob, PRESELECTOR	015-001752-01
C70,71	7500 μ F, 5%, 500V, Silver Mica	470-422752	R28	270 ohms	451-252271	V8	Electron Tube, type 6EA8; Third Mixer, SSB-Switching Crystal Oscillator	090-901350		Knob, CAL RESET, OFF-NL-CAL, and BFO	015-001758
C79,93,94	0.002 μ F, 500V, Ceramic Disc	047-100395	R28,27	270 ohms	451-252271	V9	Electron Tube, type 6BA6; 50.75-KC IF Amplifier	090-901112		Knob, TUNING	015-001759
			R28	47 ohms	451-252470	V10	Electron Tube, type 6BA6; AM Detector, AVC Amplifier, AVC Rectifier	090-901112	DS1	Knob, RF GAIN, XTAL SELECTOR, BAND SELECTOR, FUNCTION, AF GAIN, NOTCH FREQ, and SELECTIVITY	015-001760
			R29,68,90 R31,39,48, 64,65,74 R32,35,37, 40 R34,43	10K ohms 220K ohms 1200 ohms 47K ohms	451-252103 451-252224 451-252122 451-252473	V11	Electron Tube, type 6BE6; Product Detector, BFO	090-901124		Bracket, Meter	067-010598
			R36,41,49, 51,81,82	4700 ohms	451-252472	V12	Electron Tube, type 6GW8; First Audio Amplifier, Audio Output	090-001502		Clip, Coil Mounting	076-000986
			R44,70	330 ohms	451-252331	V13	Electron Tube, type 6EA8; Auxiliary Crystal Oscillator, Cathode Follower (Not Supplied)	090-901350		Clip, Spring	076-100682
			R54	8200 ohms	451-252822	V14	Electron Tube, type 6AU6; See Repair Parts List for 100-KC Crystals Calibrator	-----		Core, Coil (L19,25)	077-002158
			R55	Variable, 5000 ohms, 20%, 1/4 watt, NOTCH DEPTH	025-201716	CR1,2 CR3,4	Diode, Type HD 6225 Diode, Rectifier, Silicon	019-002354 027-000306		Foot, Mounting	016-201072
			R57	3300 ohms	451-252332					Front Panel	068-001309
			R59	39K ohms	451-252393					Fuse, 1 Ampere, 3AG, Slow-Blow Type	039-100438
			R60	270K ohms	451-252274					Fuse Holder	006-100451
			R66	390K ohms	451-252394					Knob, PRESELECTOR	015-001752-01
			R67,76	680K ohms	451-252684					Knob, CAL RESET, OFF-NL-CAL, and BFO	015-001758
			R69	15K ohms	451-252153					Knob, TUNING	015-001759
			R71	68K ohms	451-252683					Knob, RF GAIN, XTAL SELECTOR, BAND SELECTOR, FUNCTION, AF GAIN, NOTCH FREQ, and SELECTIVITY	015-001760
			R75	10 megohms	451-252106					Lamp, Pilot Light, No. 47	039-100004
			R78	12K ohms	451-252123					Line Cord	087-100078
			R79	120 ohms, 1 watt	451-352121					Lock, Line Cord	076-000397
			R80	47 ohms, 1 watt	451-352470					Plug, Phono (J2)	010-100221
			R84,86	220 ohms	451-252221					Shield, Pilot Light	069-001758
			R88	Variable, 500K ohms, 20%, 1/8 watt, AF GAIN	025-002119					Socket, Crystal (Y10&11)	006-200873
			R89	33 ohms, 2 watts	451-652330					Socket, Pilot Light	086-000626
			R91	350 ohms, 10 watts, Wire Wound	453-062351					Socket, Tube, 7-pin miniature	006-001048
										Socket, Tube, 9-pin miniature	006-000913
										Switch Wafer, Antenna	062-000203
										Switch Wafer, Mixer	062-000204
										Terminal Board, Antenna (5 Connection)	088-002442
										Window, Dial	022-000696

* All RESISTORS are carbon type, 1/2 watt, 10% unless otherwise stated.

