

RS-232C LINE MONITOR

MODEL: AK-232EMI

INSTRUCTION MANUAL

October 16, 1986.

INDEX

1)	DESCRIPTION-----	Page.	2.
2)	SPECIFICATIONS-----	Page.	2.
3)	OUTWARD-----	Page.	3.
4)	FUNCTIONS-----	Page.	4.
5)	BLOCK DIAGRAM-----	Page.	5.
6)	PROCEDURE-----	Page.	6-9.
7)	CONNECTION-----	Page.	10-11.
8)	SIGNAL INDICATIONS OF INTERFACE ICs AND CONNECTORS-----	Page.	12.

1) Description

- * This unit is designed for EIA RS-232C standard. In spite of being the most popular interface for computer data transfer, RS-232C causes much of troubles due to its free and various uses. AK-232EMI is a compact, useful support equipment for system develop debug, products inspection and system maintenance.

2) Specifications

- * Model: AK-232EMI
- * CPU: 8048
- * RAM capacity: 2048 bytes (1024 bytes each for TRX/RX)
- * Display: 20 figures x 2 lines
- * Operation keys: Mode keys x 5
Function keys x 3
Baud rate selection (thum wheei) x 1
DB-25Sx2 (multi connection)
- * I/O connector: AC95-132V 50/60Hz
- * Power supply: 3VA
- * Power consumption: Communication cable 1m (with DB25P)
- * Accessory:

3) Outward

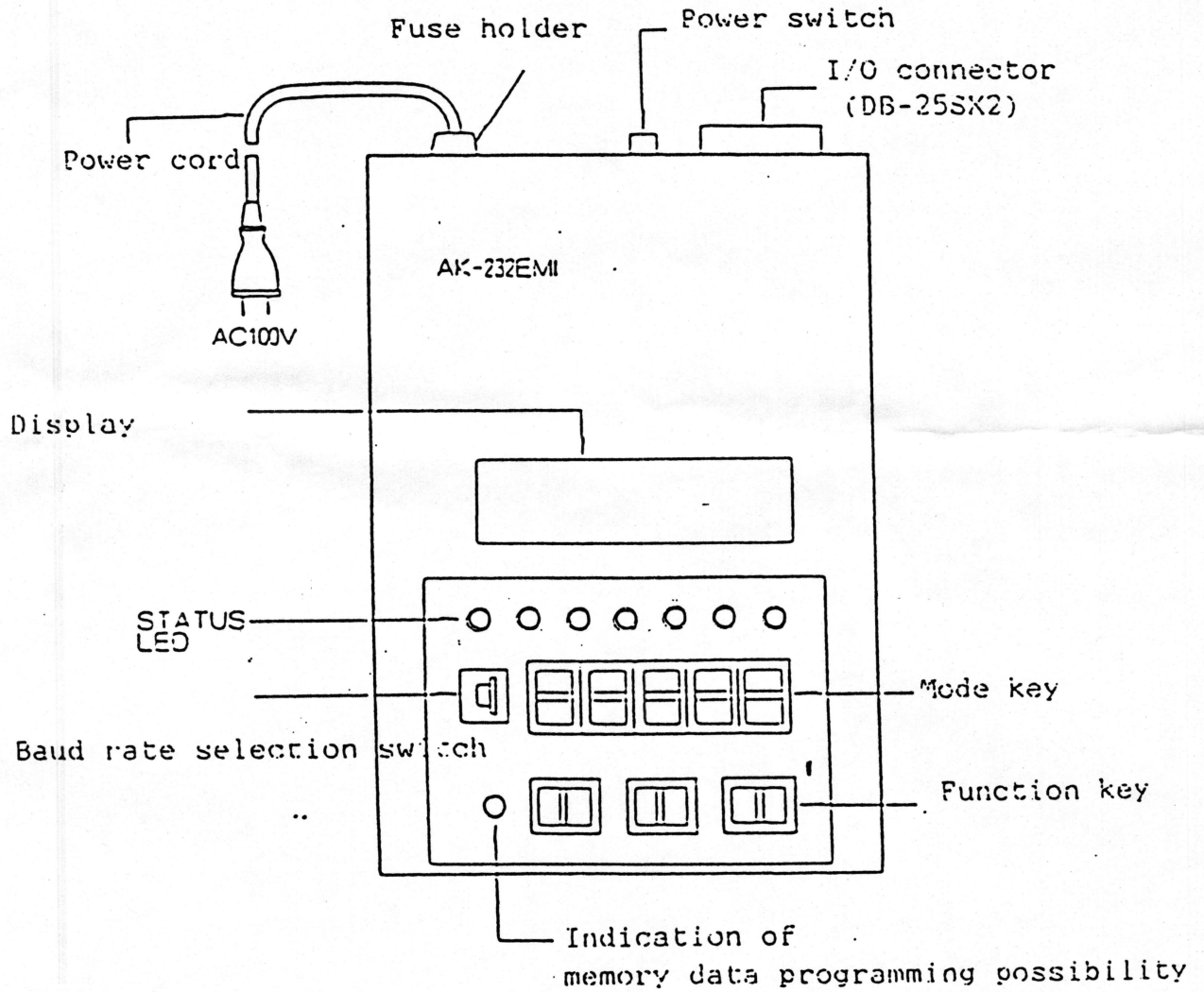

4) Functions

- a) LCD display - indicates SD/RD data status.
- b) LED display - indicates signals of SD, RD, RTS, CTD, DSR, CD and ER.
- c) Mode keys -
 - * allows for selection of 7/8 bits word length.
 - * allows for selection of on/off parity operation.
 - * allows for selection of even/odd on parity operation.
 - * allows for selection of stop/ignorance if data-transfer error is causes. If you change to stop mode, the operation stops when parity/framing error is caused and indicates the status on display.
 - * allows for indication of which code is used at the time even on transmission or memory read-out function.
- d) Function keys -
 - * allows for indication of head part of data when is on memory read-out function.
 - * allows for programming the data transfer into memory by setting the key on "start" point.
 - * allows for read-out the data programmed in memory by setting the key on "stop" point.
 - * allows for data-increment/decrement when the memory read-out function is operated.
- e) Thum wheel switch - allows for selection among the following baud rates.
19200, 9600, 4800, 2400, 1200, 600, 300, BOAD

5) Block diagram

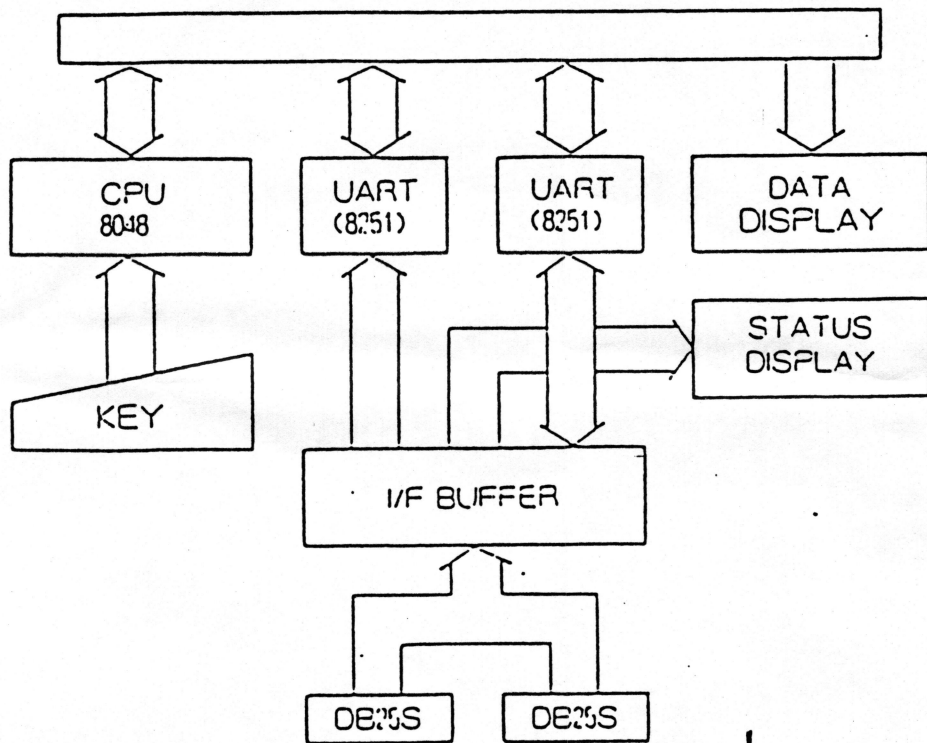

6) Procedure

- a) Power on.
- b) Set the "start/stop" key on "stop" point and display will turn as follow.

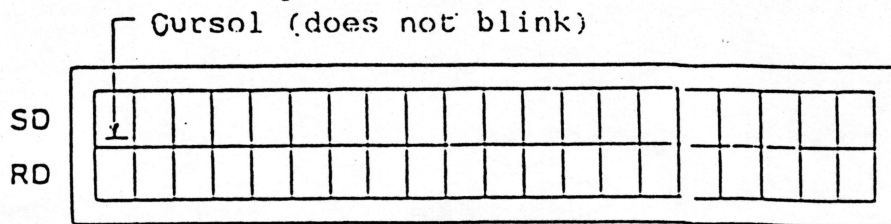

- c) Set the mode keys.
 - * Word length (7/8 bits)
 - * Parity (on/off)
 - * Parity on (even/odd)
 - * Stop or Ignorance when transfer error is caused.
If ignorance, set the key on "off".
 - * Under the above functions, STATUS LED indicates the status of transfer line.
- d) Set the "start/stop" key on "start" point and clear memory buffer to FF code. LED on left side of start key starts lightening and the unit is ready to be started. After that, "FULL DOT" blink appears at head point of display and the operation will be as waiting status.

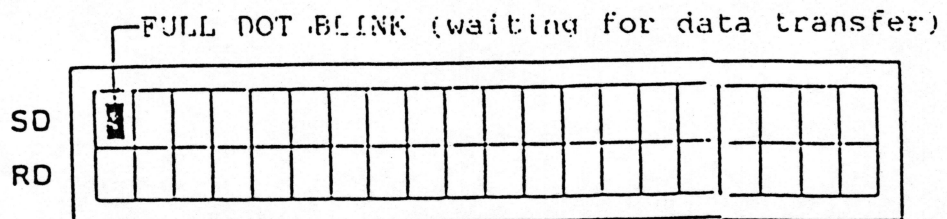

Procedure (continued)

- e) The following are samples of the case if 1 BATE data is transmit to SD. (ex. "A" for ASCII)

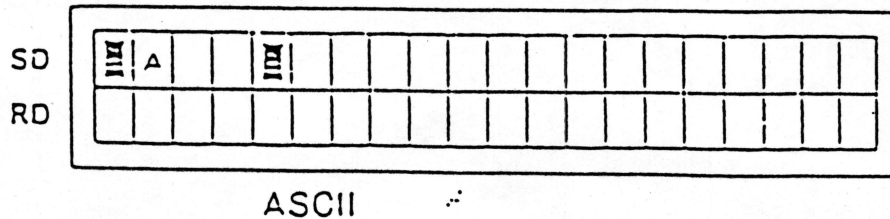
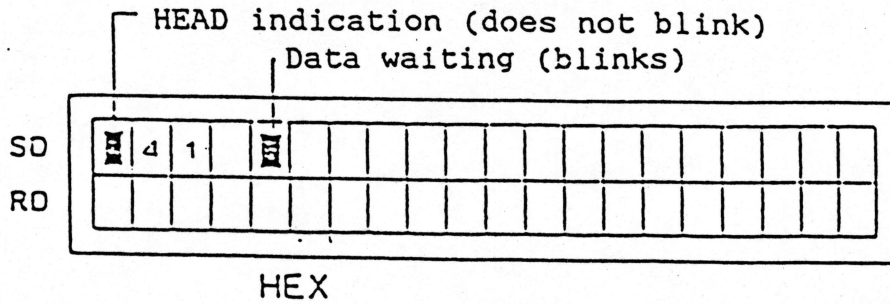

- f) Under the above e) status, if the key is set on "stop", display will turn as follow.

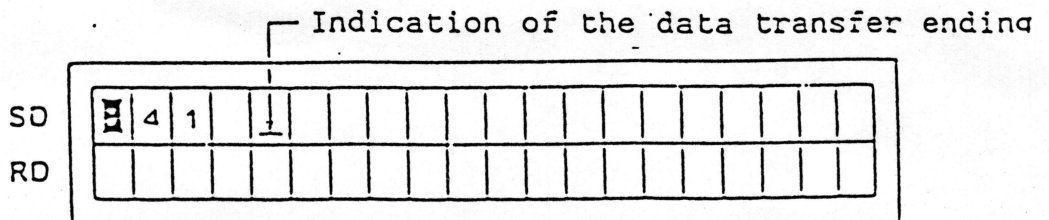

- g) If SD:RD data transfers are operated at the same time under both way communication. SD data transfer is to be operated prior. The following is the indication of the case if "ABCD" under SD and "AB" under RD function are transfered at the same time.

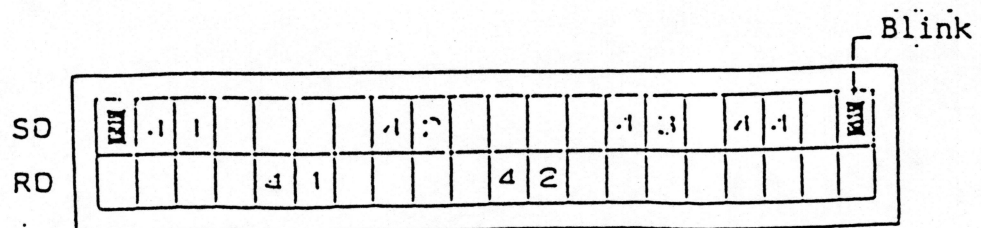

Procedure (continued)

- * If the key is stayed on either point of increment/decrement over for 1 second, the unit continues such operation until the key is reset as nutral point.
- * If the HEAD key (normaly on nutral point) is set on right/left, the unit operates the data head-out function. See the following.

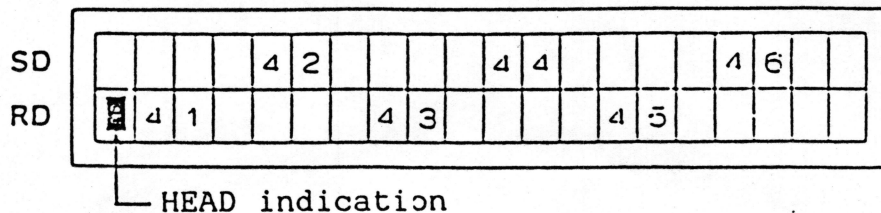

i) The following are display styles of error indications.

- *P.err!! Parity error
- *F.err!! Framing error
- *M. err!! Memoriful error

Parity/Framing error indications subject to be changed under the difference of baud rates or mode selection.

It is undefind which the display indicates P.err!! or F.err!! according to the reception timing, however, both of such mean transfer error. Therefore it is necessary to check the equipments connected.

NOTE: This unit sets UART after reading the mode selection key (except HEX/ASCII key) when "stop" is changed to "start" operation. Therefore mode key selection is needed at "stop" operation time to time. Also this unit operates memory-clear function at the same time, but memory clears FF(HEX) code and recognizes the communication as the end of transfer, if such code is realized.

7) Connection

* This line monitor is only available for reception.

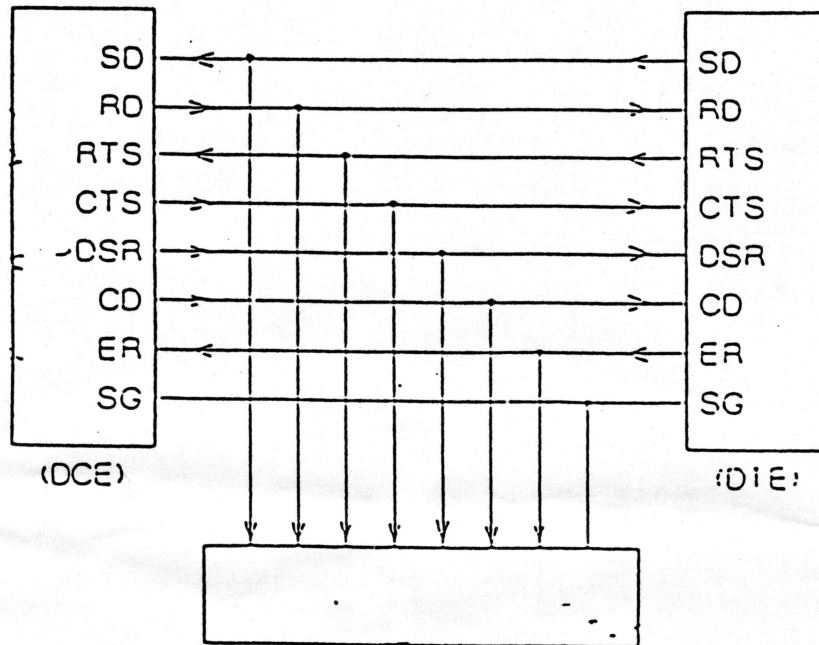

* Between each terminals, it is necessary to notice for different connection styles. The following is one of popularity, for example.

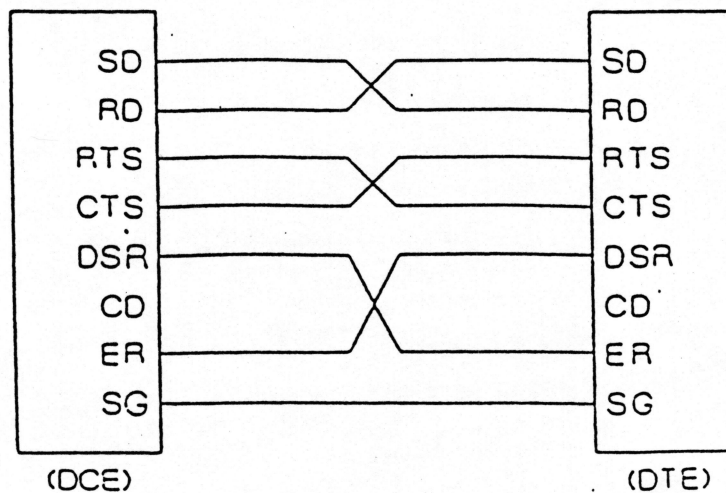

Connection (continued)

* Also it is necessary to notice for computers compatible as DCE and DTE.

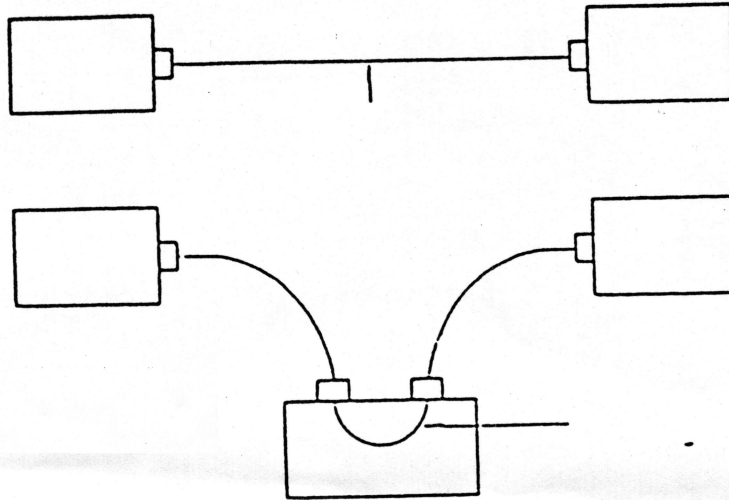

* Separate one side of communication cable and join it to the connector of the unit. Join the attached cable to the opening connector of the unit. 2pcs of the installed connectors on the unit are multi-connected inside.

8) Signal indications of interface ICs and connectors

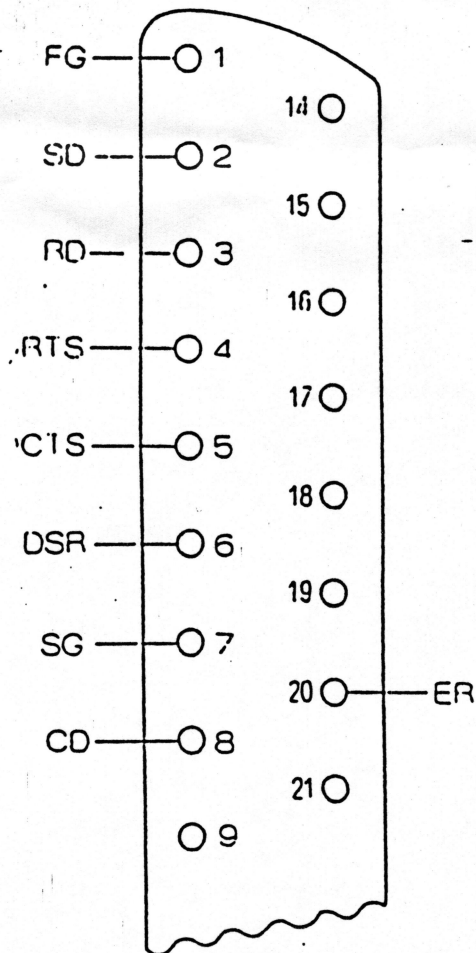
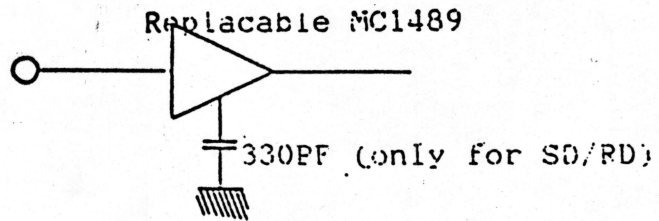

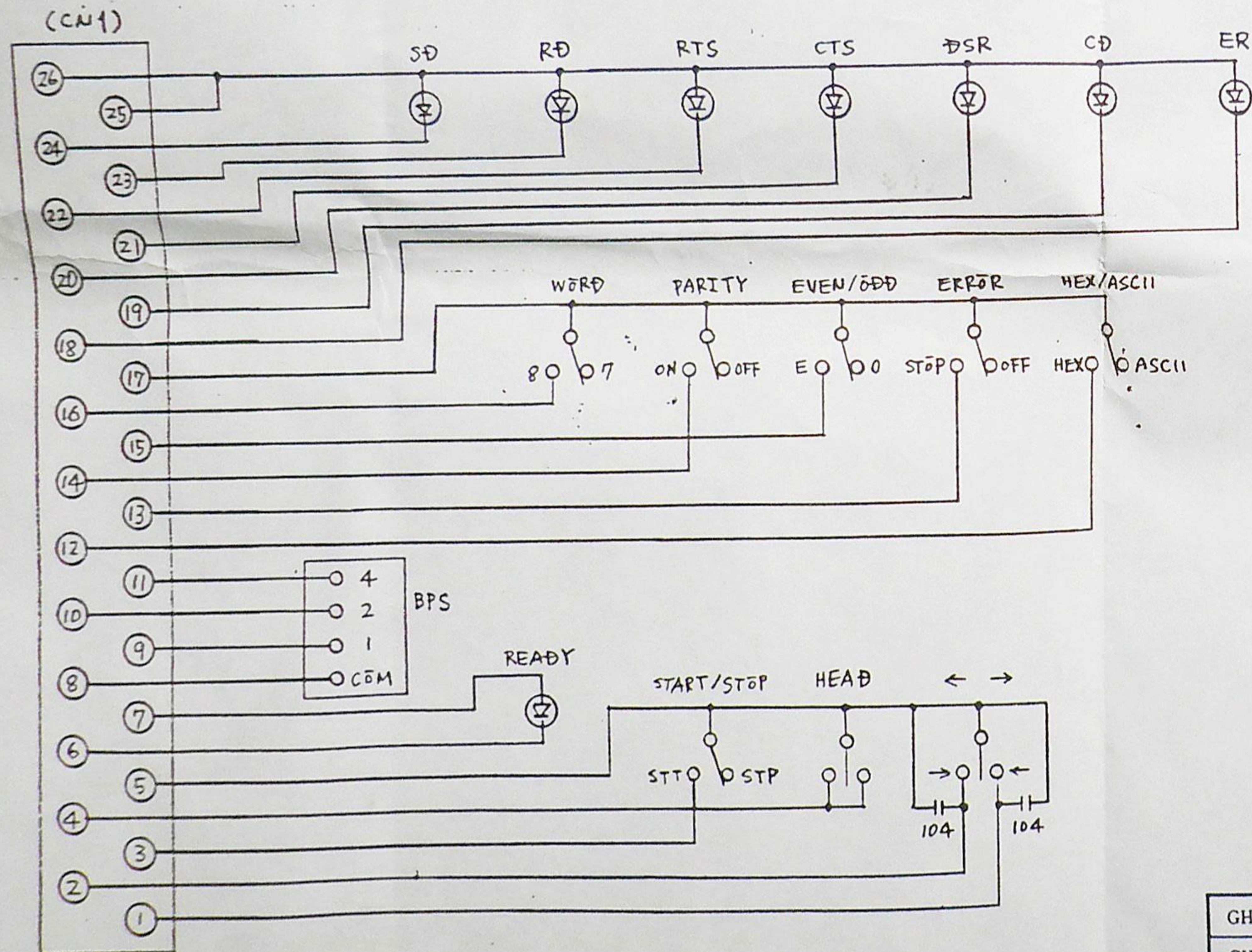
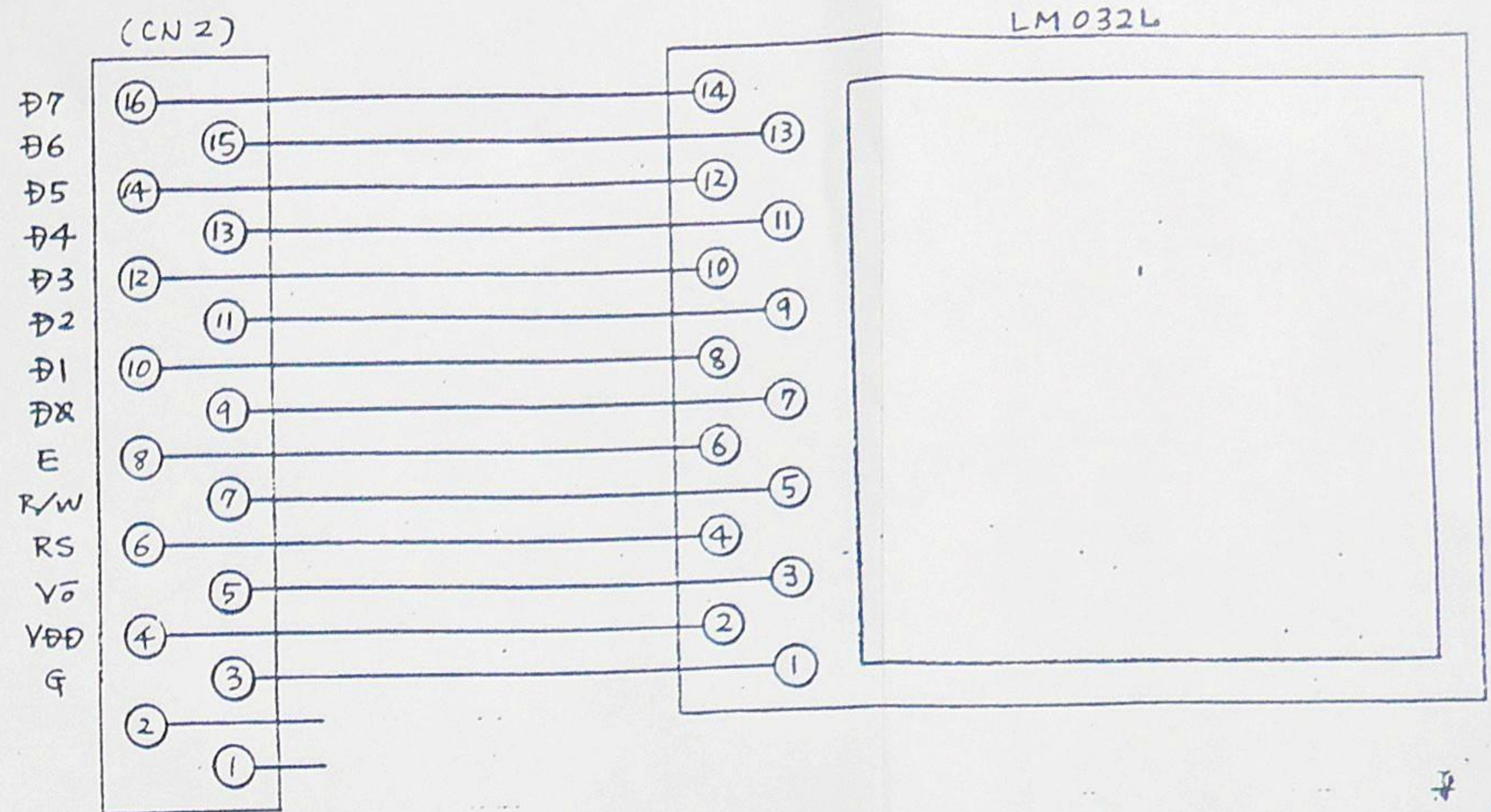
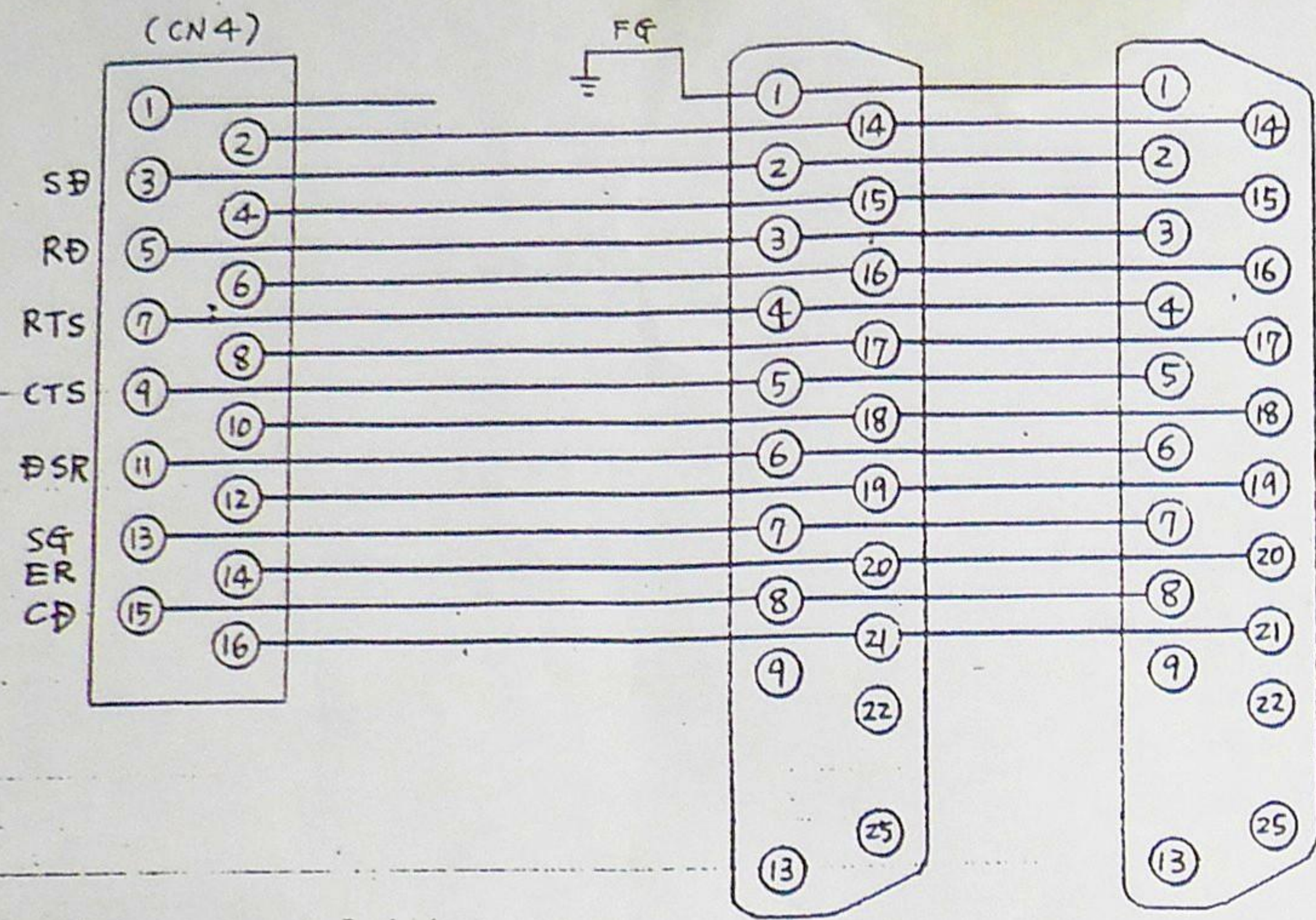

CHIEF OF DS	CUSTOMER	MESSRS	株式会社 システム プロジェクト SYSTEM PROJECT CO., LTD
CHECKED BY	S NO		
DRAWN BY	名称	TITLE	図面番号 DRAWING NO.
SCALE / DIM	/	RS232C LINE MONITOR	
DATE		KEY BOARD & DISPLAY	