

AMP's line of bundling and harnessing products provide maximum cable protection for intermittent and continuous bundling requirements. Hand and power tools are available to speed application.

Self-locking cable ties for indoor and outdoor use and available with mounting clamps

AMP-TY Cable Ties	27-3
AMP-TY All-Plastic Cable Ties	27-5
AMP-TY Stainless Steel Cable Ties	27-7

Plastic cable wrap for individual bundling, color-coded for easy identification	27-9
SPIRAP Plastic Cable Wrap	

CABLE TIES & BUNDLING

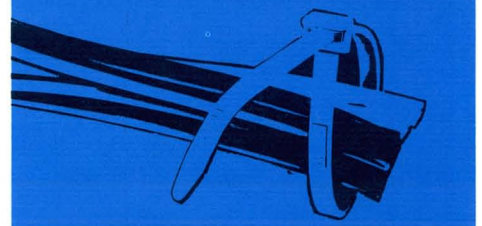

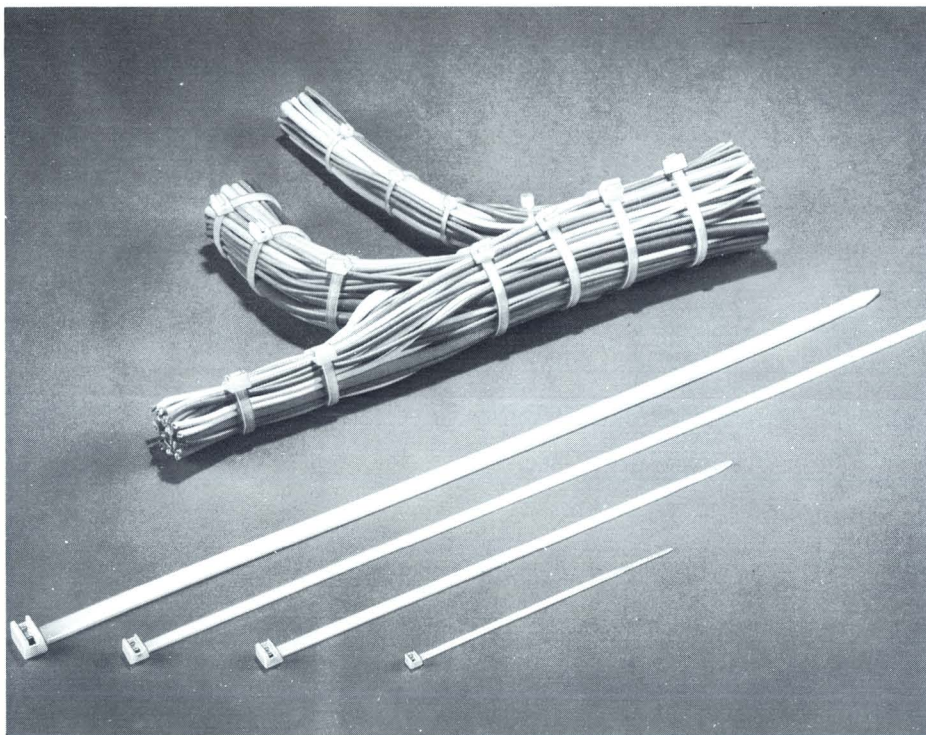

AMP-TY Cable Ties

AMP-TY Cable Ties are an improved tying system designed to provide a reliable and economical method of bundling and harnessing cables. Providing up to twice the bundling tensile strength of other similar tying devices, these cable ties offer more reliably and uniformly tied harnesses ... with the additional benefits of reduced harnessing costs and installation time. They are ideally suited for both indoor and outdoor use and can be quickly and easily installed by hand or with the use of an AMP or MS installation tool.

AMP Cable Ties are molded from military specified nylon material and incorporate stainless steel pawls to assure positive locking on the wire bundle. A tapered end design also permits easy location requiring only light hand tension for threading through its self-locking head. This combination of quality construction and design features also provides the ties with many other outstanding physical characteristics such as abrasion resistance, lightweight, toughness, fungus inert, plus

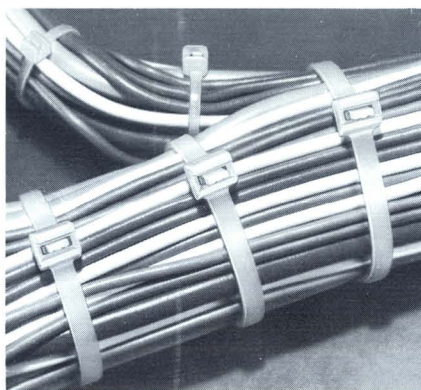

excellent resistance to common solvents, alkalis, dilute acids, oils and greases.

AMP-TY Cable Ties are available in four different sizes to accommodate all bundle diameters from 1/16" to 4-1/8"; each size being infinitely adjustable within its specified range. They are furnished in standard natural color, outdoor weather resistant black, plus other Military Standard colors upon request.

Features

- Self-locking application by either hand or tool
- Requires only light hand tension for threading through the self-locking head
- Locking pawls provide tensile strength in excess of MIL-S-23190 requirements
- Used with virtually any bundle configuration
- Four sizes accommodate all bundle diameters from 1/16" to 4-1/8"
- Each size infinitely adjustable within its specified range
- Tough, smooth nylon suitable for both indoor and outdoor use
- Meets or exceeds requirements of Military Specification MIL-S-23190 and Military Standard MS3367

Note: All dimensions in inches unless indicated otherwise.

Specifications subject to change. Consult AMP Incorporated for latest design specifications.

Specifications

AMP-TY Cable Ties

Material

Strap: Nylon per MIL-M-20693A, Type I
 Strap Lock: Stainless steel per QQ-S-766

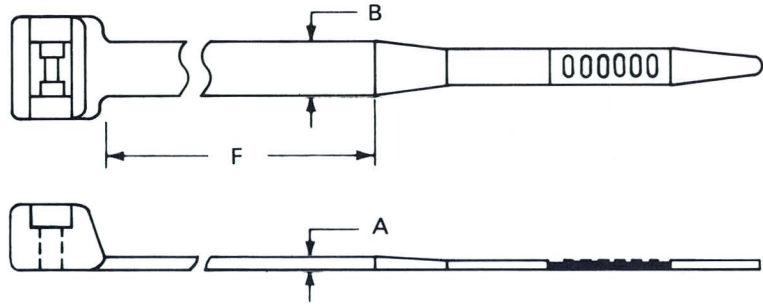

Bundle Dia. (Min.) (Max.)	Dimensions			Tensile Strength* lb. (Min.)	Part Number	Packaging Quantity	Military Standard (MS3367)	Installation Tools	
	A (Max.)	B (Max.)	F (Min.)					MS No.	AMP No.
1/16 7/8	.046	.081	3.12	18	1-350045-9	100/Pkg.	-4	90387-1	350450-1
					2-350045-9	1000/Pkg.			
1/16 2	.052	.160	6.12	50	1-350047-9	100/Pkg.	-1	90387-1	350450-1
					2-350047-9	1000/Pkg.			
1/16 4-1/8	.052	.160	13.12	50	1-350049-9	100/Pkg.	-2	90387-1	350450-1
					2-350049-9	1000/Pkg.			
3/16 4	.078	.280	12.5	120	1-350051-9	100/Pkg.	-3	90387-2	—
					3-350051-9**	500/Pkg.			

* Per MIL-S-23190 Split Mandrel Method

** Packaged 500 each because of bulk size.

Note: When ordering AMP-TY cable ties, quantity specified should be the *total* number of cable ties desired. For colors, standard color is natural; outdoor black and military standard colors are also available upon request.

Mounting Base

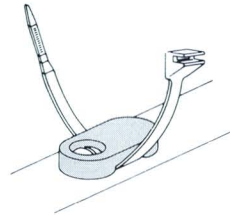

Material: Black nylon (other colors available upon request)

Part Numbers:
 1-350087-0 — 100/Pkg.
 2-350087-0 — 1000/Pkg.

AMP Hand Tool, Part No. 350450-1

Features

- Two operating modes:
 - Take-up & Tension
 - Take-up, Tension & Cut-off
- Adjustable tension settings
- Small nose
- Meets MS90387-1 requirements



This versatile AMP hand tool applies AMP-TY cable ties to wire bundles having any small-to-intermediate cross-section. It is specifically designed for ease of operation, and to assure reliable bundling at the lowest possible applied cost.

The tool features an incremental tension adjustment and a cut/no-cut

selector. The tension adjustment regulates the amount of tension applied to a cable tie during installation. The cut/no-cut selector controls the tool's cutting mechanism. It is slid rearward (the word "YES" being visible) for strap cut-off, and forward (the word "NO" being visible) if the strap is not to be cut off.

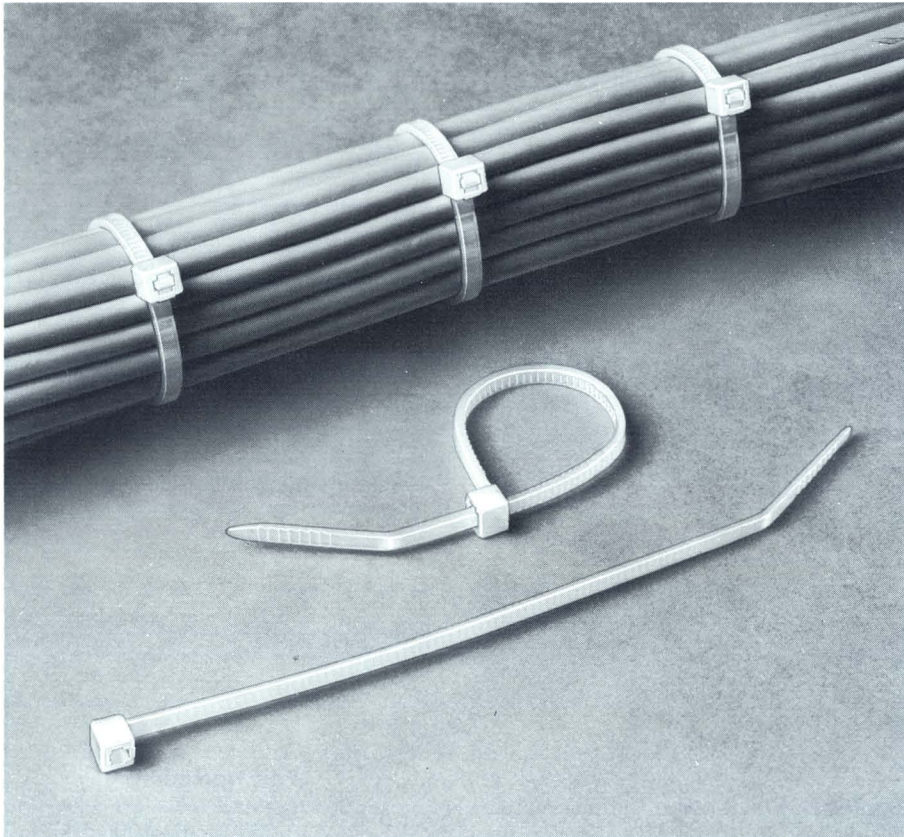

AMP-TY All-Plastic Cable Ties are an improved tying system designed to provide a reliable and economical method of bundling and harnessing cables. These cable ties offer more reliably and uniformly tied harnesses . . . with the additional benefits of reduced harnessing costs and installation time. They are ideally suited for both indoor and outdoor use and can be quickly and easily installed by hand or with the use of AMP or MS installation tool.

AMP All-Plastic Cable Ties are molded from military specified nylon material and incorporate a bent tail for quick, easy installation and handling. A tapered end design also permits easy location requiring only light hand tension for threading through its self-locking head. This combination of quality construction and design features also provides the ties with many other outstanding physical characteristics such as abrasion resistance, light-weight,

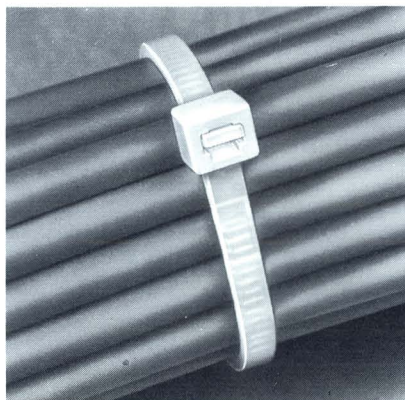

toughness, fungus inert, plus excellent resistance to common solvents, alkalies, dilute acids, oils and greases.

AMP-TY All-Plastic Cable Ties are available to accommodate bundle diameters from 1/16" to 1". They are furnished in standard natural color and outdoor weather resistant black.

AMP-TY All-Plastic Cable Ties

Features

- Self-locking application by either hand or tool
- Requires only light hand tension for threading through the self-locking head
- Locking pawl provides tensile strength specified in MIL-S-23190 requirements (18 lbs. min. per MS3367-4)
- Used with virtually any bundle configuration
- Accommodates diameters from 1/16" to 1"
- Tough, smooth nylon suitable for both indoor and outdoor (black) use
- Designed to meet or exceed requirements of Military Specification MIL-S-23190 and Military Standard MS3367-4

Note: All dimensions in inches.

Specifications subject to change. Consult AMP Incorporated for latest design specifications.

AMP-TY All-Plastic Cable Ties

Mounting Base

AMP Hand Tool Part No. 350450-1

Features

- Two operating modes:
 - Take-up & Tension
 - Take-up, Tension & Cut-off
- Adjustable tension settings
- Small nose
- Meets MS90387-1 requirements

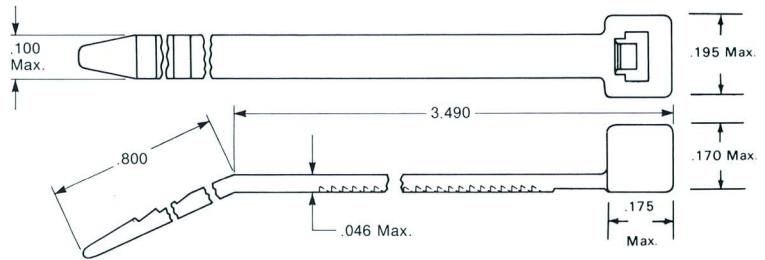

Material:

Nylon per MIL-M-20693A, Type I

Installation Tools:

AMP No. 350450-1
MS No. 90387-1

Bundle Diameter:

Min.—1/16"
Max.—1"

Color	Part Number	
	100/Pkg.	1000/Pkg.
Black*	1-350667-0	2-350667-0
Natural	1-350667-9	2-350667-9

* Recommended for outdoor use.

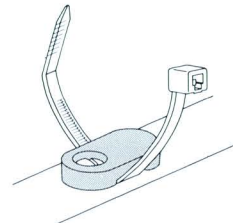

Material: Black nylon (other colors available upon request)

Part Numbers:

1-350087-0—100/Pkg.
2-350087-0—1000/Pkg.

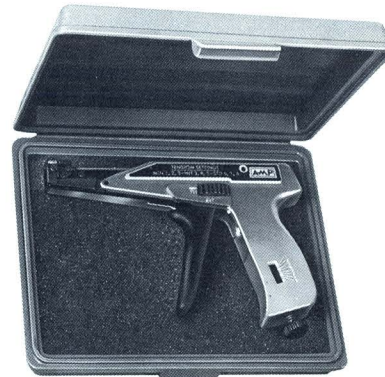

This versatile AMP hand tool applies AMP-TY cable ties to wire bundles having any small-to-intermediate cross-section. It is specifically designed for ease of operation, and to assure reliable bundling at the lowest possible applied cost.

The tool features an incremental tension adjustment and a cut/no-

cut selector. The tension adjustment regulates the amount of tension applied to a cable tie during installation. The cut/no-cut selector controls the tool's cutting mechanism. It is slid rearward (the word "YES" being visible) for strap cut-off, and forward (the word "NO" being visible) if the strap is not to be cut off.

Cable Ties and Bundling

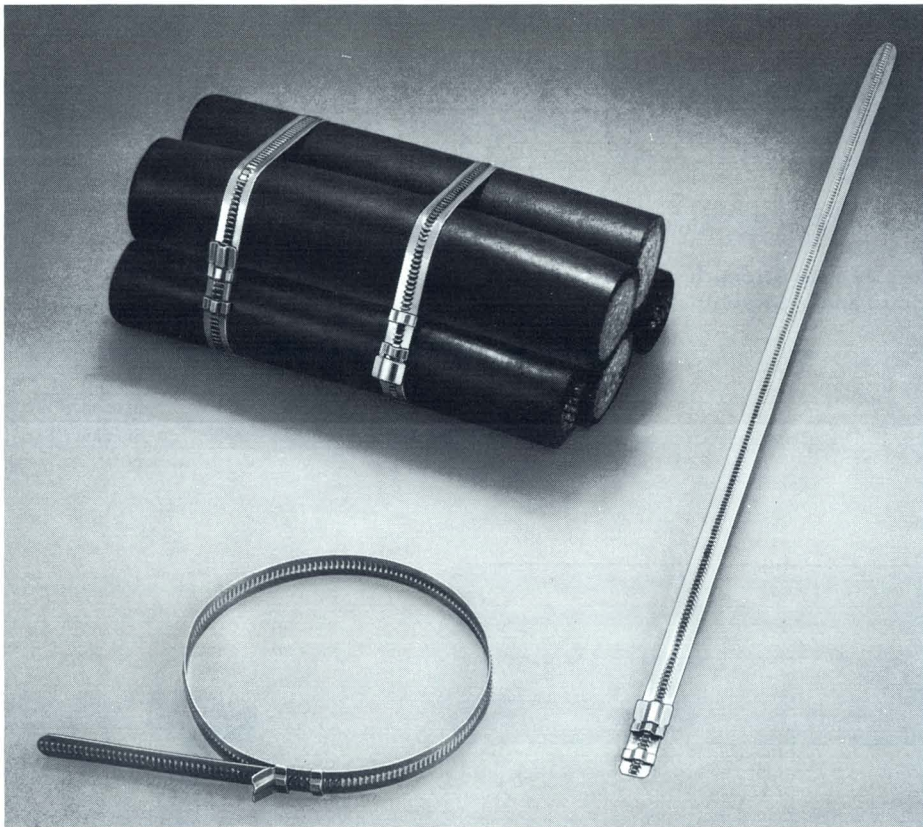
AMP-TY
Stainless Steel
Cable Ties

Features

- High strength
- Self-locking application using common electrician's tools
- Requires only light hand tension for threading through the self-locking head
- Used with virtually any bundle configuration
- Non-magnetic
- Seven sizes accommodate all bundle diameters from 1" to 10-3/4"
- Each size adjustable within its specified range
- Non-magnetic 302 stainless steel suitable for both indoor and outdoor use
- Rounded strap edge

Note: All dimensions in inches.

Specifications subject to change. Consult AMP Incorporated for latest design specifications.

AMP-TY Stainless Steel Cable Ties are an improved tying system designed to provide a high strength method of bundling and harnessing cables. They are also used for other applications such as clamping, anchoring, fastening, and banding. Providing up to six times the bundling tensile strength of other similar tying devices, these cable ties offer more reliably and uniformly tied harnesses. They are ideally suited for both indoor and outdoor use and can be quickly and easily installed by hand.

AMP Stainless Steel Cable Ties are stamped from non-magnetic 302 stainless steel and incorporate a patented positive locking device. The rounded end and edges permit easy insertion through the self-locking head. Quality construction provides the ties with outstanding physical characteristics—abrasion resistance, lightweight, toughness and imperviousness to corrosive atmospheres and radiation.

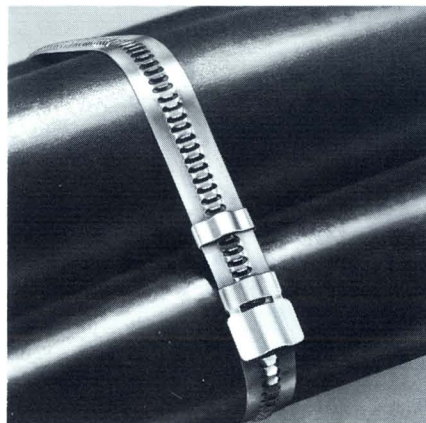

AMP-TY Stainless Steel Cable Ties are available in seven different sizes to accommodate all bundle diameters from 1" to 10-3/4"; each size being adjustable within its specified range.

Specifications

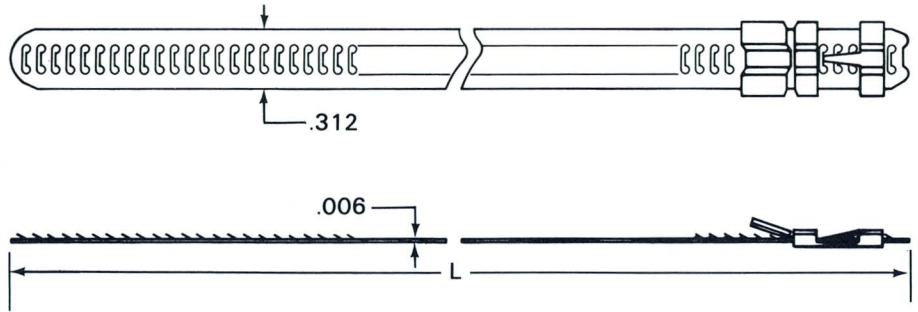

Material: Type 302 Stainless steel per QQ-S-766

Strap Tensile Strength: 150 lb., min.

Hoop Tensile Strength: 300 lb., min.

Bundle Dia. (Min.)	Bundle Dia. (Max.)	Dim. L	Part Number
1	1-1/2	7	350631-1
1	2-1/2	10	350632-1
2	3-3/4	14	350463-1
3-1/4	5	18	350633-1
4-1/2	7	24	350634-1
6-1/2	8-3/4	30	350635-1
8-1/4	10-3/4	36	350636-1

Typical Application

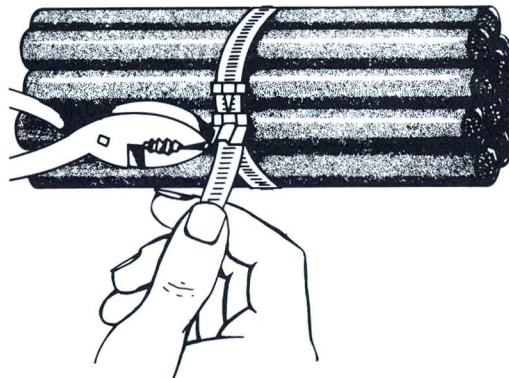

1. Strap around bundle pulled tight.

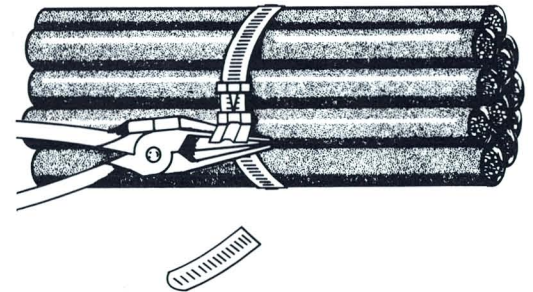

2. Tail under tab cut off.

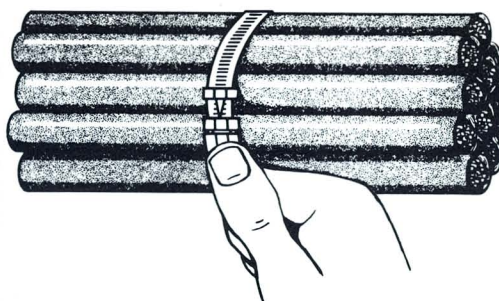

3. Finished assembly with tab pushed down.

Cable harnessing and bundling applications include:

- Automotive
- Appliance
- Aircraft
- Heavy Equipment
- Extreme Environments;
 - Corrosive atmospheres
 - Radiation
 - High and low temperatures

SPIRAP

PLASTIC CABLE WRAP



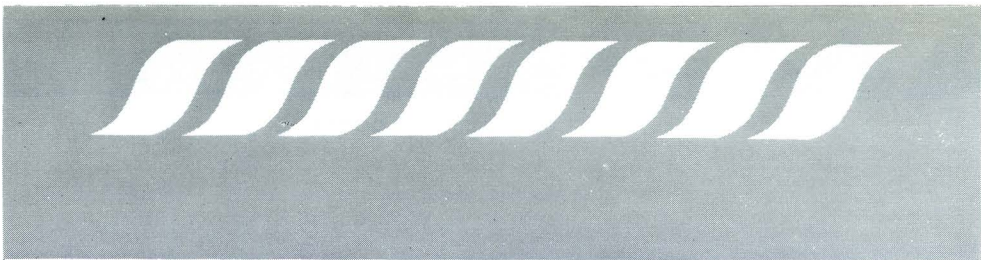

SPIRAP PLASTIC CABLE WRAP

- Abrasion protection—for wires, hoses, tubing, and cables
- Reusable—a plus feature in repairs and modification
- Attractive—makes neat, compact wire bundles
- Break-out—at any point along wire bundle
- Moisture resistant—won't hold "cable-rotting" moisture
- Color—coded for easy bundle identification
- Acceptance—meets military and commercial specifications
- 3 Sizes—covers from 1/16" diameter to 4" diameter bundles
- 6 Materials available—affords proper material for particular needs
- Quickly applied—hand and power wrapping tools available

TEMPERATURE RANGE OF SPIRAP CABLE WRAP

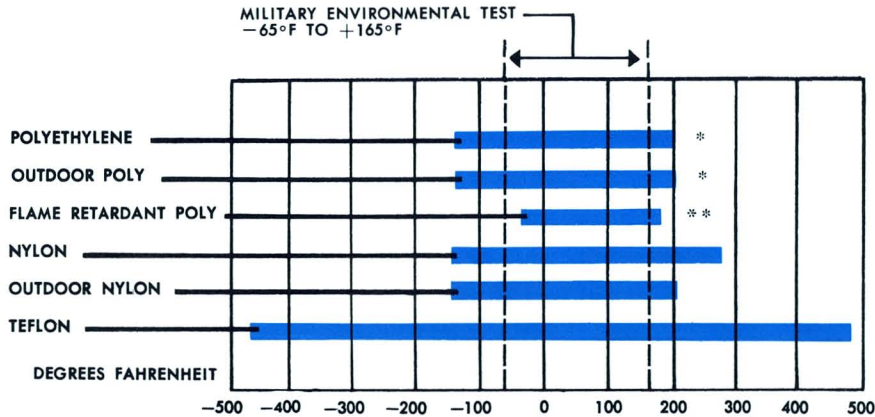

* NOT ACCEPTABLE FOR MOST MILITARY APPLICATIONS DUE TO FLAMMABILITY.
 ** NOT ACCEPTABLE FOR MOST MILITARY APPLICATIONS DUE TO LIMITED LOW TEMPERATURE.

BUNDLE RANGE GUIDE

SIZE OF SPIRAP CABLE WRAP	ACCOMMODATES BUNDLE DIAMETER
1/8" O. D.	1/16" to 1/2"
1/4" O. D.	3/16" to 2"
1/2" O. D.	3/8" to 4"

SPECIFICATIONS

PROPERTIES	ASTM TEST	UNIT	NATURAL POLYETHYLENE	OUTDOOR POLYETHYLENE	FLAME RETARDANT POLYETHYLENE	NATURAL NYLON	OUTDOOR NYLON	TEFLON
Max. Operating Temperature	AMP Test	°F	215	215	200	250 (3000 hrs.) 300 (600 hrs.)	200 (700 hrs.) 230 (100 hrs.)	500
Min. Operating Temperature	D746-51T	°F	-105	-105	-8	-148	-148	-450
Flammability	AMP Test	In./Min. on wire bundle	1.0	1.0	0 (Self-extinguishing)	0 (Self-extinguishing)	0 (Self-extinguishing)	0 (Non-flammable)
Abrasion Resistance	Taber*	mg. Loss/M cycles	22	20	27	15	3	7
Specific Gravity	D792-50	—	.92	.93	1.29	1.14	1.15	2.1
Tensile at 73°F.	D412-51T D638-52T	PSI	1800 —	2000 —	1500 —	— 10,000	— 10,000	— 3000
Water Absorption	D570-42	%	.01	.03	.02	1.5	1.5	.005
Effect of Organic Solvents	—	—	No appreciable effect below 130°F.	No appreciable effect below 130°F.	No appreciable effect below 130°F.	No Effect	No Effect	No Effect
Effect of Alkalies	—	—	No Effect	No Effect	No Effect	No Effect	No Effect	No Effect
Effect of Acids	—	—	No Effect	No Effect	No Effect	Satisfactory with weak acids	Satisfactory with weak acids	No Effect
Weather Resistance	—	—	Poor 1 to 1½ yrs.	Excellent 15 to 20 yrs.	Poor 1 to 1½ yrs.	Poor 1 to 1½ yrs.	Excellent 15 to 20 yrs.	Excellent

*Taber Test measures amount of material removed. A lower number indicates a more abrasion resistant material

LENGTH OF SPIRAP CABLE NEEDED PER FOOT OF BUNDLE LENGTH

FOR VARIOUS BUNDLE DIAMETER

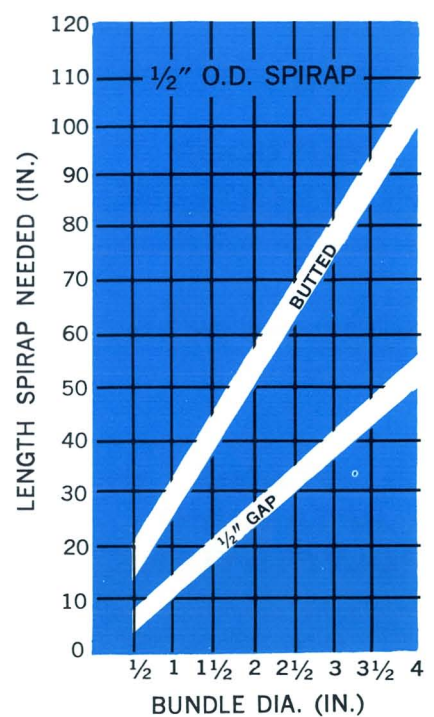
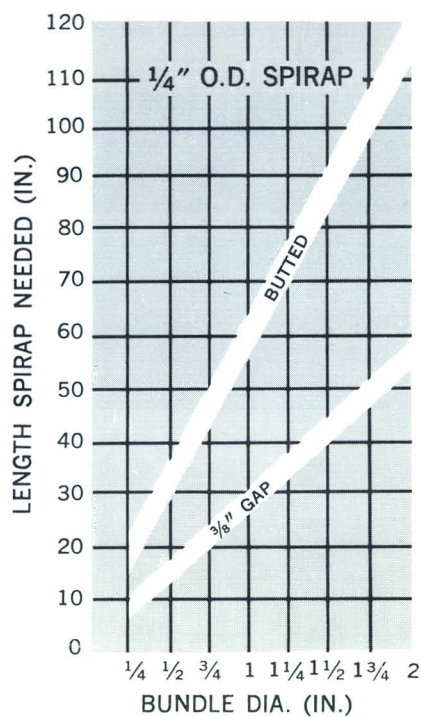
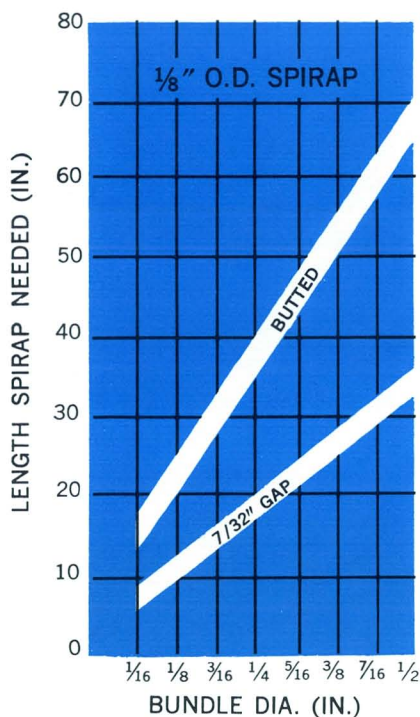

DIMENSIONS

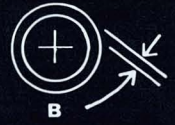
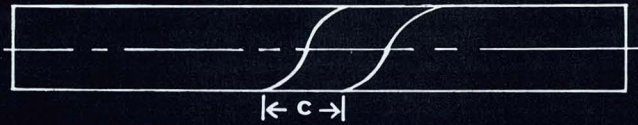

6

TYPES COVER ALL REQUIREMENTS

NATURAL POLYETHYLENE

General-use wrap primarily for commercial applications . . . good temperature range . . . excellent chemical resistance.

Size	Color	B	C	Weight lbs./M.ft.	Ft./Box	Part No.				
1/8"	Natural	.031	.218	4	100	500000-2				
					250	500000-4				
1/4"	Natural	.045	.375	11½	50	500001-1				
					100	500001-2				
					1M	500001-3				
1/4"	Red	.045	.375	11½	100	3-500001-2				
					Natural	.032	.375	9	100	500038-2 500038-3
1/2"	Natural	.062	.500	35	50	500002-1				
					Red	.062	.500	35	50	3-500002-1
										Natural

OUTDOOR POLYETHYLENE

For continuous outdoor service in commercial applications . . . good temperature range . . . excellent chemical resistance.

Size	Color	B	C	Weight lbs./M.ft.	Ft./Box	Part No.
1/8"	Black	.031	.218	4	250	500029-4
1/4"	Black	.045	.375	11½	50	500030-1
					100	500030-2
1/2"	Black	.062	.500	35	50	500031-1
					100	500031-2
1/2"	Black	.062	.750	35	100	380605-1

FLAME RETARDANT POLYETHYLENE

Primarily for commercial application . . . good high temperature limit . . . self-extinguishing . . . excellent chemical resistance.

Size	Color	B	C	Weight lbs./M.ft.	Ft./Box	Part No.
1/8"	White	.031	.218	5¾	250	500003-4
1/4"	White	.045	.375	16½	100	500004-2
	Black	.045	.375	16½	100	5-500004-2
1/2"	White	.062	.500	49	50	500005-1
					100	500005-2

DIMENSIONS

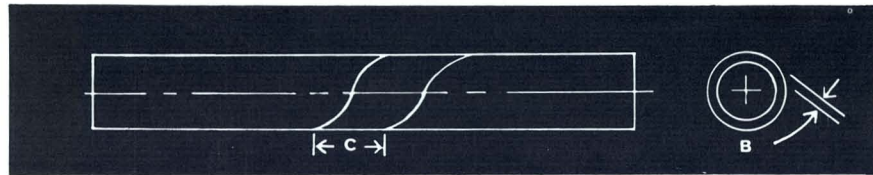

Size	Color	B	C	Weight lbs./M.ft.	Ft./Box	Part No.
1/8"	Natural	.015	.218	2 1/2	50	500013-1
					100	500013-2
					1M	500013-3
					250	500013-4
1/8"	Yellow	.015	.218	2 1/2	100	2-500013-2
					250	2-500013-4
	Red				100	3-500013-2
					250	3-500013-4
1/8"	Blue	.015	.218	2 1/2	100	4-500013-2
					250	4-500013-4
	Natural				50	500015-1
					100	500015-2
1/4"	Yellow	.023	.375	8	1M	500015-3
					100	2-500015-2
	Red				100	3-500015-2
	Blue				100	4-500015-2
	Green				100	5-500015-2
	Orange				100	6-500015-2
1/2"	Natural	.032	.500	23	50	500017-1
					100	500017-2
					1M	500017-3
	Yellow				50	2-500017-1
					100	2-500017-2
	Red				50	3-500017-1
					100	3-500017-2
	Blue				50	4-500017-1
100		4-500017-2				

NATURAL NYLON

Ideal for military and commercial applications . . . very wide temperature range . . . self-extinguishing . . . good chemical resistance.

DIMENSIONS

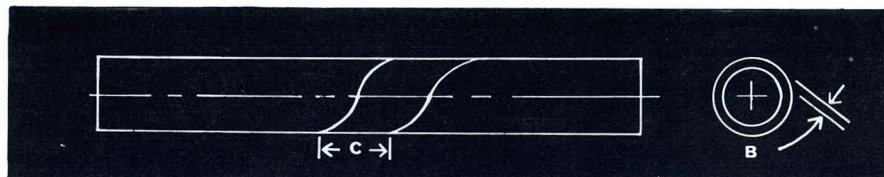

OUTDOOR NYLON

Ideal for continuous outdoor service in military and commercial applications . . . good temperature range . . . self-extinguishing . . . good chemical resistance.

Size	Color	B	C	Weight lbs./M.ft.	Ft./Box	Part No.
1/8"	Black	.015	.218	2 1/2	100	500035-2
					250	500035-4
1/4"	Black	.023	.375	8	50	500036-1
					100	500036-2
1/2"	Black	.032	.500	23	50	500037-1
					100	500037-2
					500	500037-5

TEFLON † INSULATION

Choice material for critical applications . . . widest temperature range . . . highest abrasion resistance . . . completely non-flammable . . . best chemical resistance.

Size	Color	B	C	Weight lbs./M.ft.	Ft./Box	Part No.
1/8"	Natural	.020	.218	6	100	500023-2
	Yellow				100	2-500023-2
	Red				100	3-500023-2
	Blue				100	4-500023-2
1/4"	Natural	.030	.375	19	50	500024-1
	Natural				100	500024-2
	Yellow				50	2-500024-1
	Red				50	3-500024-1
	Blue				50	4-500024-1
	Yellow				100	2-500024-2
	Red				100	3-500024-2
	Blue				100	4-500024-2

† Trademark of DuPont