

SDK-85 System Design Kit User's Manual

Manual Order Number 9800451B

intel[®]

SDK-85 System Design Kit User's Manual

Manual Order Number 9800451B

Copyright © 1978 Intel Corporation

Intel Corporation, 3065 Bowers Avenue, Santa Clara, California 95051

Additional copies of this manual or other Intel literature may be obtained from:

Literature Department
Intel Corporation
3065 Bowers Avenue
Santa Clara, CA 95051

The information in this document is subject to change without notice.

Intel Corporation makes no warranty of any kind with regard to this material, including, but not limited to, the implied warranties of merchantability and fitness for a particular purpose. Intel Corporation assumes no responsibility for any errors that may appear in this document. Intel Corporation makes no commitment to update nor to keep current the information contained in this document.

Intel Corporation assumes no responsibility for the use of any circuitry other than circuitry embodied in an Intel product. No other circuit patent licenses are implied.

Intel software products are copyrighted by and shall remain the property of Intel Corporation. Use, duplication or disclosure is subject to restrictions stated in Intel's software license, or as defined in ASPR 7-104.9(a)(9).

No part of this document may be copied or reproduced in any form or by any means without the prior written consent of Intel Corporation.

The following are trademarks of Intel Corporation and may be used only to describe Intel products:

i	iSBC	Multimodule
ICE	Library Manager	PROMPT
iCS	MCS	Promware
Insite	Megachassis	RMX
Intel	Micromap	UPI
Inteleview	Multibus	μ Scope
Intellec		

and the combination of ICE, iCS, iSBC, MCS, or RMX and a numerical suffix.

CONTENTS

CHAPTER 1		
DESCRIPTION	1-1	Move Memory Command, M 4-11
CHAPTER 2		Substitute Memory Command, S 4-12
HOW TO ASSEMBLE THE KIT		Examine/Modify CPU Registers
GENERAL	2-1	Command, X 4-12
GETTING ORGANIZED	2-1	Programming Debugging —
SELECTING TOOLS AND MATERIALS	2-2	Breakpoint Facility 4-13
UNPACKING AND SORTING PARTS	2-3	Error Conditions — Invalid Characters 4-13
A REVIEW OF BASIC ASSEMBLY AND		Address Value Errors 4-13
SOLDERING TECHNIQUES	2-6	
ASSEMBLY PROCEDURE	2-7	
CHAPTER 3		CHAPTER 5
FINAL ASSEMBLY AND CHECKOUT		THE HARDWARE
GENERAL	3-1	OVERVIEW 5-1
STRAPPING OPTIONS	3-1	SYSTEM COMPONENTS 5-1
POWER SUPPLY WIRING	3-1	The 8085 CPU & The System Buses 5-1
INSTALLING LARGE IC DEVICES	3-4	The 8155 5-1
STARTING THE FIRST TIME	3-6	The 8355 & 8755 5-2
WHAT IF IT DOESN'T?	3-7	The 8279 5-2
CONNECTING A TELETYPEWRITER	3-8	The 8205 5-2
CHAPTER 4		SDK-85 MEMORY ADDRESSING 5-3
OPERATING INSTRUCTIONS		INPUT/OUTPUT PORT AND
WHAT IT DOES	4-1	PERIPHERAL DEVICE ADDRESSING 5-5
THE BUTTONS AND DISPLAYS	4-1	Accessing the 8279 Keyboard/Display
Reset	4-2	Controller 5-5
Substitute Memory	4-2	PROCESSOR INTERRUPT
Examine Registers	4-4	ALLOCATION 5-7
Go	4-6	THE SERIAL DATA INTERFACE 5-7
Single Step	4-8	CONVERTER CIRCUIT FOR
Vector Interrupt	4-9	RS232C SERIAL PORT 5-8
Program Debugging —		ADDITIONAL INTERFACES 5-8
The Use of Breakpoints	4-9	
Error Conditions — Illegal Key	4-9	CHAPTER 6
Memory Substitution Errors	4-9	THE SOFTWARE
TELETYPEWRITER OPERATION	4-9	THE SDK-85 MONITOR 6-1
Console Commands	4-9	PROGRAMMING HINTS 6-1
Use of the Monitor for Programming		Stack Pointer 6-1
and Checkout	4-10	RAM-I/O Command Status Register (CSR) 6-1
Command Structure	4-10	Access to Monitor Routines 6-1
Display Memory Command, D	4-10	PROGRAMMING EXAMPLES 6-1
Program Execute Command, G	4-10	
Insert Instructions into RAM, I	4-11	APPENDIX A
		MONITOR LISTING
		APPENDIX B
		DIAGRAMS



Figure 1-1. SDK-85 System Design Kit

CHAPTER 1 DESCRIPTION

The MCS-85 System Design Kit (SDK-85) contains all the parts with which you can build a complete 8085 microcomputer system on a single board, and a library of MCS-85 literature to help you learn to use it. The finished computer has the following built-in features:

- High-performance, 3-MHz 8085A cpu (1.3 μ s instruction cycle)
- Popular 8080A Instruction Set
- Direct Teletypewriter Interface
- Interactive LED Display
- Large Wire-Wrap Area for Custom-Designed Circuit
- System Monitor Software in ROM

You can assemble the kit in as little as 3 to 5 hours, depending upon your skill and experience at building electronic kits. Only a 5 Volt power source capable of delivering 1.3 Amperes is then needed to make the computer operate, using its built-in display and keyboard. If you wish to interface a Teletypewriter to the SDK-85, you will also need a -10 Volt power supply. After you have completed the basic kit, you may expand both memory and I/O by adding more RAM-I/O or ROM-I/O devices in the spaces provided for that purpose. Other spaces are allocated for bus expansion drivers and buffers that allow you to address and use external devices located either in the wire-wrap area of the board or off the board. You can, for example, access up to 64K of external memory via the expansion bus.

SDK-85 SPECIFICATIONS

Central Processor

CPU: 8085A

Instruction Cycle: 1.3 microsecond

T_{cy} : 330 ns

Memory

ROM: 2K bytes (expandable to 4K bytes)
8355 or 8755

RAM: 256 bytes (expandable to 512 bytes) 8155

Addressing: ROM 0000-07FF (expandable to 0FFF with an additional 8355 or 8755) RAM 2000-20FF (2800-28FF available with an additional 8155)

Input/Output

Parallel: 38 lines (expandable to 76 lines).

Serial: Through SID/SOD ports of 8085. Software generated baud rate.

Baud Rate: 110

Interfaces

Bus: All signals TTL compatible.

Parallel I/O: All signals TTL compatible.

Serial I/O: 20 mA current loop TTY.

Note: By populating the buffer area of the board, you have access to all bus signals which enable you to design custom system expansions into the kit's wire-wrap area.

Interrupts

Three Levels: (RST 7.5) - Keyboard Interrupt
(RST 6.5) - TTL Input
(INTR) - TTL Input

DMA

Hold Request: Jumper selectable. TTL compatible input.

Software

System Monitor: Preprogrammed 8755 or 8355 ROM

Addresses: 0000-07FF

I/O: Keyboard/Display or TTY (serial I/O)

Literature

Design Library (Provided with kit):

- SDK-85 User's Manual

- Microcomputer Systems Databook
- MCS-85 User's Manual
- 8080/8085 Assembly Language Programming Manual

Physical Characteristics

Width: 12.0 in.

Height: 10 in.

Depth 0.50 in.

Weight: approx. 12 oz.

Electrical Characteristics (DC Power Required)

V_{CC} : +5V \pm 5% 1.3A

V_{TTY} : -10V \pm 10% 0.3A

(V_{TTY} required only if teletypewriter is to be connected to the kit)

Environmental

Operating Temperature: 0-55°C

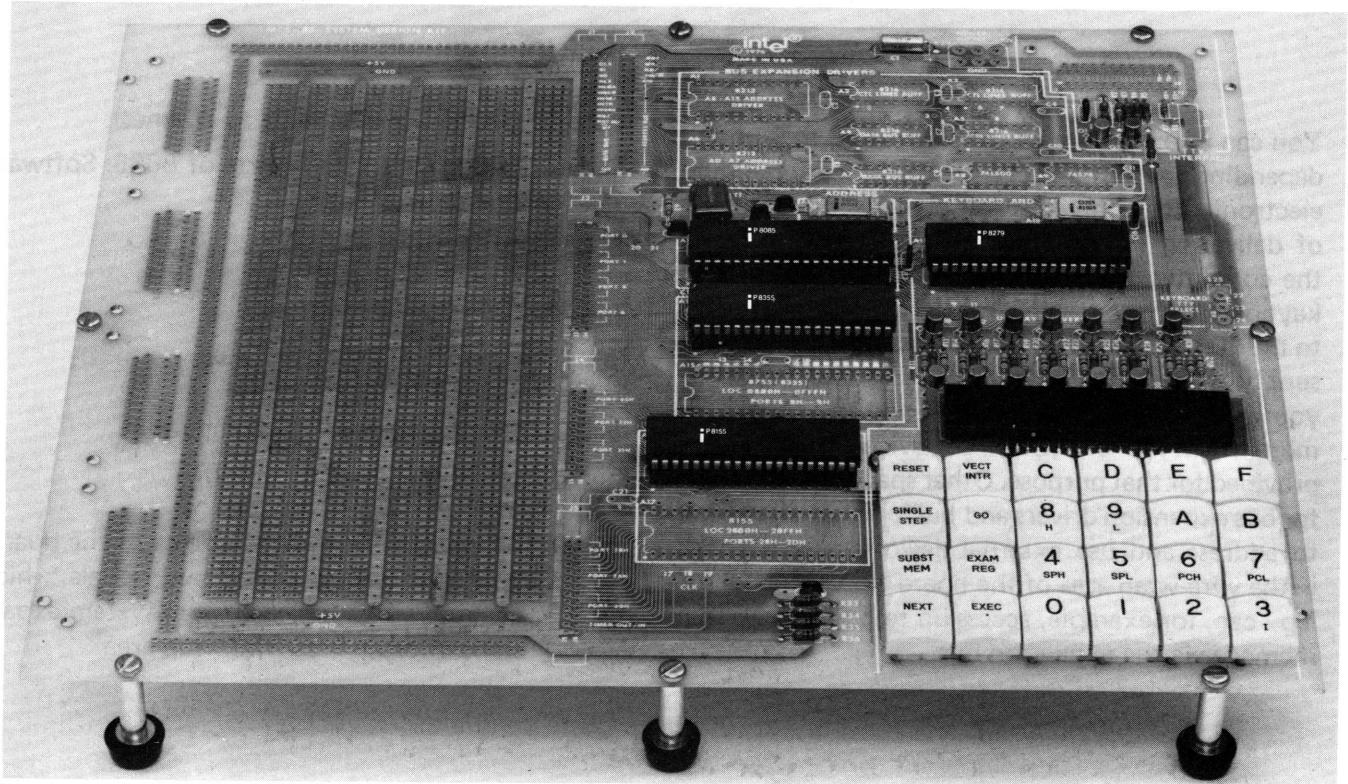

Figure 1-2. Finished Computer

CHAPTER 2

HOW TO ASSEMBLE THE KIT

2-1 GENERAL

Don't unpack your parts yet. Do a little reading first, and you may save yourself time and expense.

CAUTION

The metal-oxide-semiconductor (MOS) devices in this kit are susceptible to static electricity. Do not remove them from the protective, black foam backing sheet until you have read the precautions and instructions in paragraph 2-4.

This manual was published only after the assembly of several kits by a number of persons of varying experience. In this chapter you will find virtually everything you need to know to put together your MCS-85 System Design Kit.

There are suggestions for laying out an efficient work area. All of the tools and materials you need are described in a checklist. There is a complete and detailed parts list. Basic assembly and soldering techniques are reviewed. Following the step-by-step assembly instructions in this chapter, you can't go wrong.

If you're an experienced kitbuilder, you already know that it's not a bad idea to read through this entire chapter first, before starting the job. That

way, there won't be any surprises later. Take your time. Don't rush, and don't skip over quality-checking each step you perform. Desoldering, removing, and replacing just one DIP component because it was not oriented properly when first installed will cost you more time than double-checking all of them. Your objective is surely to produce a working computer, not to win a race.

2-2 GETTING ORGANIZED

Before starting work, it's a good idea to plan and organize your workplace. Be sure you have room to accommodate this book, lying open, and also the circuit board, along with tools and the hot soldering pencil. Unless you have the cordless, battery-powered soldering instrument, you'll want to arrange its cord out of the way to keep from accidentally pulling the soldering pencil off its holder. A muffin pan, an egg carton, or some small boxes could be used to sort parts into, if you don't have the traditional plastic, compartmented parts boxes. It might be helpful, too, to write the part values and reference designators on small cards as you sort them, and put these with the parts for quick identification. Arrange everything within comfortable reach, and you'll do the job quickly with little chance of errors.

2-3 SELECTING TOOLS AND MATERIALS

These tools and materials will be required to assemble the kit:

- Needle-nose pliers
- Small Phillips screwdriver
- Small diagonal cutters
- Soldering pencil, not more than 30 watts, with extra-small-diameter tip. (1/16 in. isn't too small.) You should also have a secure holder for it.
- Rosin-core solder, 60:40 (60% tin), small diameter (.05 in. or less) wire

Note: Soldering paste is not needed. The solder will contain sufficient flux.

- Volt-Ohm-Milliammeter

It is also useful to have the following:

- Soldering aid, with a small-tipped fork at one end and a reamer at the other, to help in coaxing component leads into holes and manipulating small parts.

If you should happen to make a soldering error and have to remove solder from joints, the job will be made much, much easier if you have the following:

- Solder sucking device, either the bulb variety (shown) or the pump variety
- Large-area desoldering tip for your soldering pencil, to spread heat over several leads of an IC device at the same time
- Length of copper braid to sop up solder like a sponge



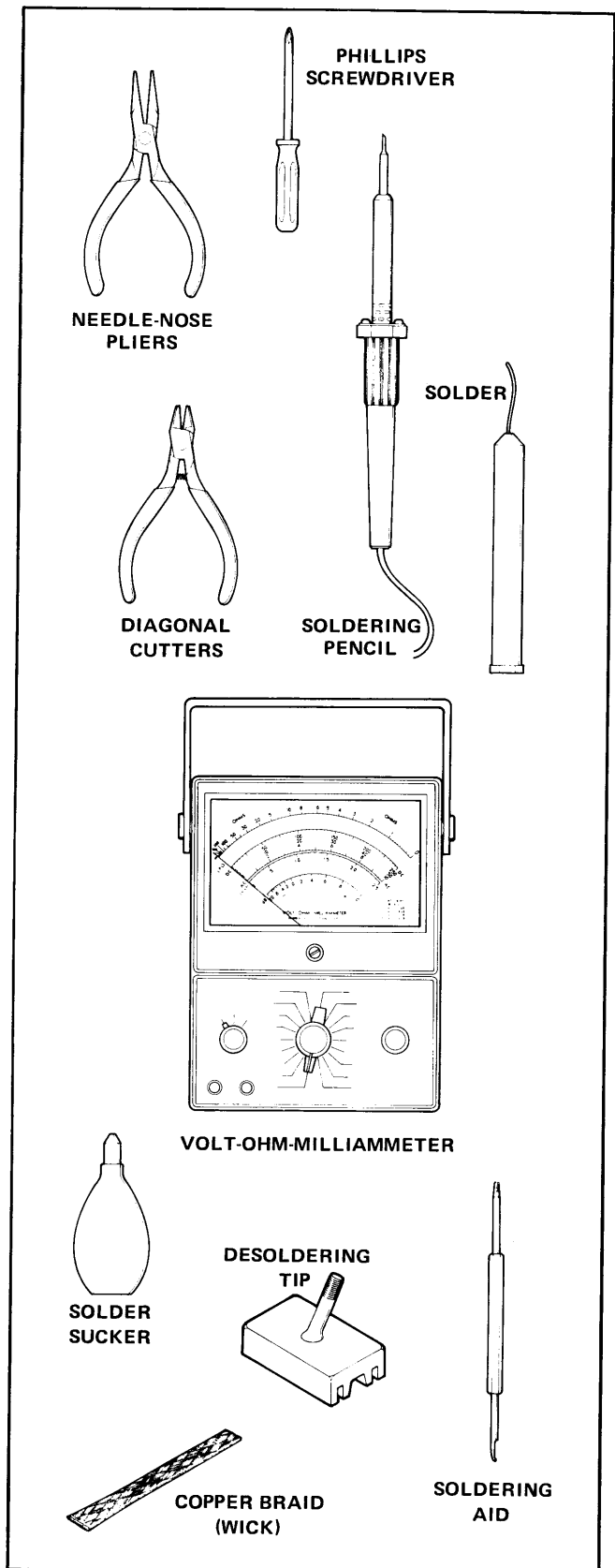

Note: It is extremely difficult to remove DIP components using just a soldering pencil.



2-4 UNPACKING AND SORTING PARTS

The MCS-85 System Design Kit is shipped skin-packed on a card that includes a conductive backing to protect its metal-oxide-semiconductor (MOS) devices from static charge. Don't remove the four larger-size Intel devices from the foam backing until you have completed all of the instructions in this chapter and are ready to place them on the board. As a further protection against possible damage, these four devices are to be installed in sockets, rather than soldered on the board.

With a knife or sharp-pointed scissors, slit the film around the edges of the small-parts bags in the lower left corner of the skin-pack and remove them. First, open the bag of hardware and check to be sure you have:

- 9 rubber feet 
- 9 Nylon spacers, 7/16 in. long 
- 9 screws, 3/4 in. long 
- 18 Nylon washers 
- 9 nuts 

CAUTION

Don't remove the other components from the skin-pack. The black foam backing is an electrically conductive material that protects the integrated-circuit devices from static electricity as well as from physical damage to their leads and ceramic substrates.

Underneath the two bags of small parts and hardware will be found:

- Red plastic window (covered with protective paper)
- Two strips of double-coated adhesive tape

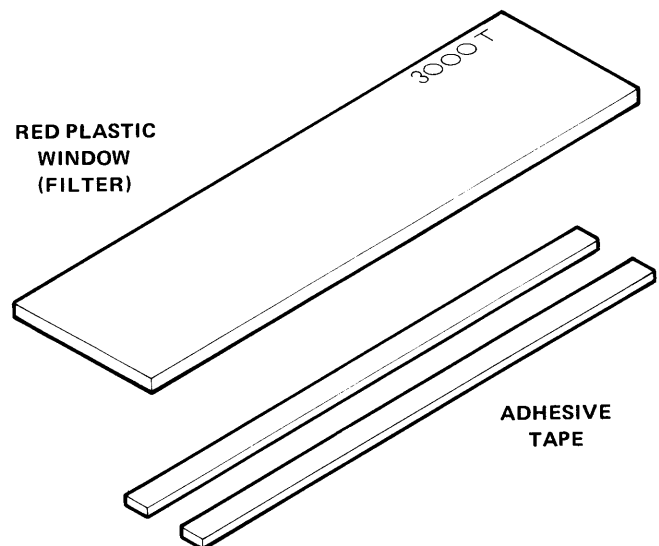

Next, open the bag of electrical parts and sort them out by type and value. Give yourself plenty of unobstructed work space and try not to let tiny parts skitter away from you. The bag should yield the following:

Resistors, 1/4 Watt



- 8 24 Ohm (red-yellow-black) R11, 14, 17, 20, 23, 26, 27, 30
- 1 47 Ohm (yellow-violet-black) R5
- 1 200 Ohm (red-black-brown) R33
- 6 270 Ohm (red-violet-brown) R10, 13, 16, 19, 22, 25
- 2 1k (1,000) Ohm (brown-black-red) R4, 31
- 1 1.6k Ohm (brown-blue-red) R3
- 1 2.7k Ohm (red-violet-red) R6
- 9 3k Ohm (orange-black-red) R7, 9, 12, 15, 18, 21, 24, 28, 29
- 1 3.9k Ohm (orange-white-red) R8
- 1 4.7k Ohm (yellow-violet-red) R2
- 1 51k Ohm (green-brown-orange) R32

Resistor, 1/2 Watt



- 1 100 Ohm (brown-black-brown) R1

Resistors, 1 Watt



- 1 200 Ohm (red-black-brown) R34
- 1 430 Ohm (yellow-orange-brown) R35

Capacitor, tantalum



- 1 22 μ f, 15V C1

Capacitor, mono

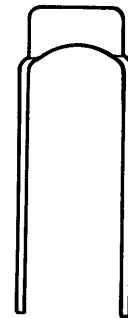

- 2 1 μ f, 25V C5, 20

Resistor Color Code

Resistors are commonly identified by means of a code using color bands. Each color represents a number.

The first three bands employ the color code below:

Black	0	Green	5
Brown	1	Blue	6
Red	2	Violet	7
Orange	3	Gray	8
Yellow	4	White	9

The fourth band indicates percentage tolerance of the resistor value.

First significant digit

Second significant digit

Number of following zeroes

Gold = 5%; silver = 10% tolerance



Capacitor, ceramic



- 7 0.1 μ f C11-16, 18

Transistor

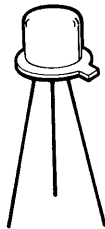

- 16 2N2907 transistors Q1-16

Crystal, clock

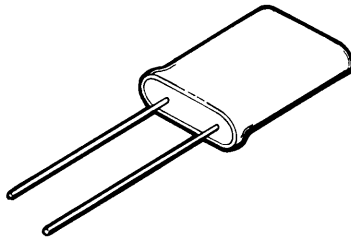

- 1 6.144 MHz Y1

Besides the small-parts bags, the skin-pack contains:

- 4 40-pin DIP (dual in-line package) sockets for the four large integrated circuits included in the kit

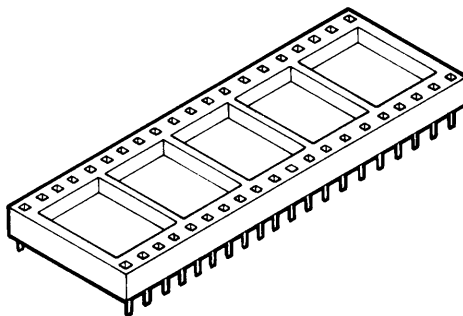

- 6 alphanumeric LED (light-emitting diode) displays

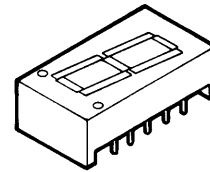

DS1-6

- 24 pushbutton switches, with keycaps labeled

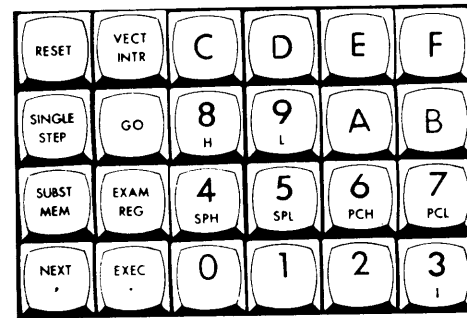

S1-24

Note: It's a good idea to check all switches with the ohmmeter before installing. If one is bad, you'll save a lot of work.

Large, 40-pin ICs (integrated circuits)

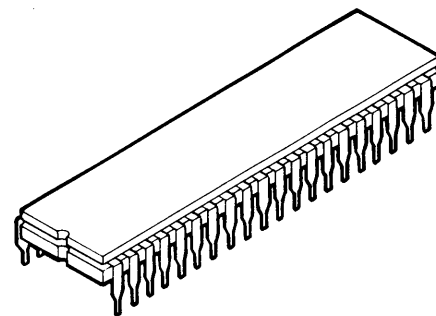

- 1 8085A microprocessor (cpu) A11
- 1 8355 (or 8755) ROM (read-only memory) with I/O (input/output) ports A14
- 1 8155 RAM (random-access, read-write memory) with I/O ports and timer A16
- 1 8279 keyboard/display interface A13

Small, 16-pin ICs

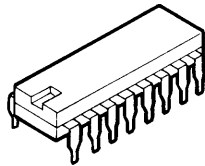

- 1 8205 address decoder A10
- 1 74LS156 scan decoder A12

CAUTION

Large-scale integrated circuits are fragile! Dropping, twisting, or uneven pressure may break them. The discharge of static electricity can destroy them internally. Leave them embedded in the conductive-foam backing sheet until ready to install on the board. Never press down hard upon, twist, or bend the larger devices. Touch the exposed metal traces of the board with your hand before inserting one in its socket. The soldering of large devices directly on the circuit board is not recommended.

2-5 A REVIEW OF BASIC ASSEMBLY AND SOLDERING TECHNIQUES

The steps to producing a professional quality assembled circuit board are:

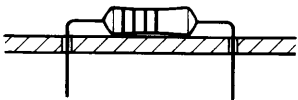
1. Have your work area organized before starting work, and keep it that way. (See paragraph 2-2.) Sort all parts into bins, cups, trays or boxes so they will be easily located by value when needed.
 2. To prepare a part for soldering, bend its leads carefully with needle-nose pliers to make the part fit exactly the way you want it to.
- 
- It is good practice to orient color-coded resistors so that the codes are readily read, top-to-
3. Fit each part in place and see that no undue stress is placed on the leads. Double-check and be sure you have the correct part inserted in the correct holes, properly oriented. Don't trim leads before soldering.
 4. When ready to solder, be sure your soldering pencil is hot enough to melt solder quickly. Then turn the board face-down on your work surface. If necessary, hold the parts you are about to solder in place while turning it over so they won't fall out, and place something under the board to hold the parts in position while you solder on the back surface of the board. Some people prefer to crimp the leads to hold the parts in place. That's all right, too.
 5. Bring the point of your soldering pencil into contact with the pad to be soldered, simultaneously also touching the lead.
 6. At once, touch the end of the solder wire to the pad and lead, opposite the pencil tip. The amount of time required to melt the solder will depend upon the amount of foil surface there is on the board to carry away heat by conduction. The smallest pads will heat up in less than a second with a 25- or 30-watt pencil; large, ground-plane areas may require over five seconds.
 7. The instant you see and feel the solder start to melt, withdraw the solder wire from the joint. Only a tiny drop of solder is needed to make a good joint.
 8. The instant you see the solder draw into the hole, become shiny, and spread smoothly over the surface of both pad and lead, withdraw the soldering pencil. It will take only a moment for this to happen after step 7.
 9. Don't reheat a joint unless there's something wrong with it: not enough solder, too much solder (causing a "bridge" to an adjacent pad or trace), or a "cold solder joint," which

appears dull on the surface or does not surround the lead completely and fill the hole.

Note: A little rosin from the solder core, remaining on the board, does no harm. Don't try to clean it off.

10. Clip off the excess length of lead that projects beyond the solder "bead," within 1/8 inch of the board. Save cut ends to use for strapping optional connections. (See paragraph 3-2.)

WARNING

Avoid eye injury when clipping excess lead ends. Hold lead end as you clip it, so it can't fly up in your face.

There are two important conditions that govern good soldering technique. They are:

1. Use no more heat than absolutely the minimum that will make a solid joint.
2. Use enough heat to cause solder to flow into the hole in the board and around the lead that's being soldered into it.

These conditions are both met simultaneously and easily only if you are careful, have the proper tools, and arrange your workplace so that the circuit board can lie flat while you apply steady, firm (but not hard) pressure with the soldering pencil without slipping. A small-diameter soldering tip is a **must!** Likewise, small-diameter solder wire is essential to achieving satisfactory results.

Note: Do not apply soldering paste to the work. Fluxing is not required in printed-circuit soldering, as the boards and component leads are plated or tinned to prevent oxidation of the copper.

Always inspect carefully for cold solder joints, solder bridges, or (perish the thought!) lifted traces after each soldering operation. A good way to check for solder bridges is to hold the newly-soldered connection up to a light. If you can't see

light between the soldered pad and any adjacent pads or traces that aren't supposed to be connected to it, it might be well to slip a solder-sucker or wick over the lead under examination, quickly remelt the solder and draw off the excess.

2-6 ASSEMBLY PROCEDURE

Follow these instructions in order and make a check mark in the box opposite each step when it is completed.

- First, place the board on your work surface, lettered side up.
- Install the nine rubber feet. Eight go around the edge of the board, and one goes near the middle of the board, to the left of the keyboard and display area. At each location, press a nut into the recess in a rubber foot, string a washer on a screw, and insert the screw through the hole in the board from the top.

Place a spacer, then another washer on the screw, then place the nut and foot on the end of the screw, and tighten, with the screwdriver, just enough to hold the foot firmly.

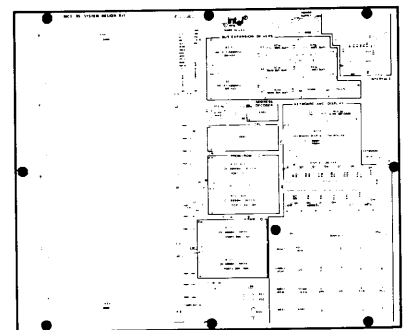
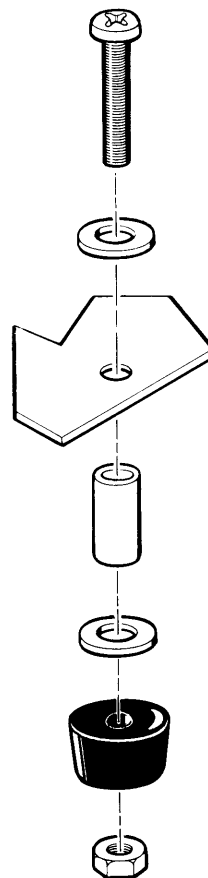

- Install capacitor C1 near the top edge of the board.
- Solder C1 in place. Clip excess lead ends.

WARNING

Avoid eye injury. Hold lead ends as you clip them so they can't fly up at you.

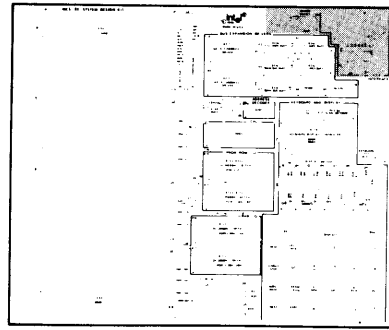

Assembly of TTY Interface Area—

- Install a 100 Ohm, 1/2 Watt resistor (brown-black-brown) at R1.
- Install a 4.7k Ohm resistor (yellow-violet-red) at R2.
- Install a 1.6k Ohm resistor (brown-blue-red) at R3.
- Install a 1k Ohm resistor (brown-black-red) at R4.
- Install a 47 Ohm resistor (yellow-violet-black) at R5.
- Install a 2.7k Ohm resistor (red-violet-red) at R6.
- Solder the six resistors in place, then clip their excess lead ends.
- Install a 1 uf capacitor at C5, and solder and clip it.
- Install a 200 Ohm, 1 Watt resistor (red-black-brown) at R34.

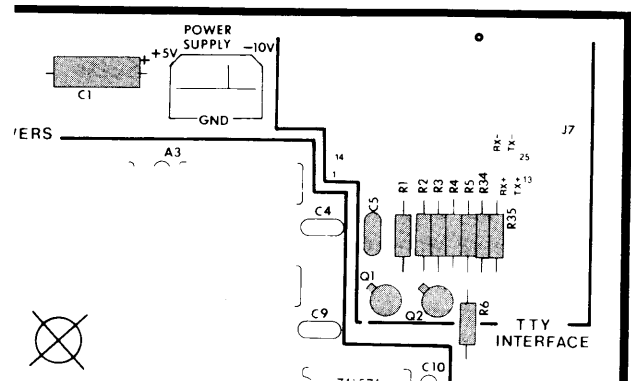

- Install a 430 Ohm resistor (yellow-orange-brown) at R35.
- Solder these two resistors in place, then clip their excess lead ends.
- Install transistors Q1 and Q2, and solder and clip them.

Assembly of Processing Area

The processing area includes the clock crystal, address decoder, cpu, RAM-I/O and ROM-I/O areas, and related components.

- Install the crystal at Y1, with its leads bent so that the device lies flat on the board in the space outlined for it.
- Take a piece of scrap wire trimmed from a component previously mounted on the board. Bend it into the shape of a staple. Install it over the crystal, to hold it firmly in place.
- Solder the four connections just made.
- Install the 8205 address decoder at A10 and solder it.

Install three DIP sockets, crimping the corner leads of each to hold in place, at:

- A11, for the 8085 cpu.
- A14, for the PROM (ROM)-I/O device, an 8755 or 8355.

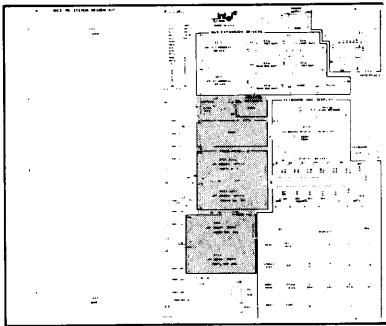

- A16, for the RAM-I/O device, an 8155.
- Solder the three sockets in, and check carefully for solder bridges.

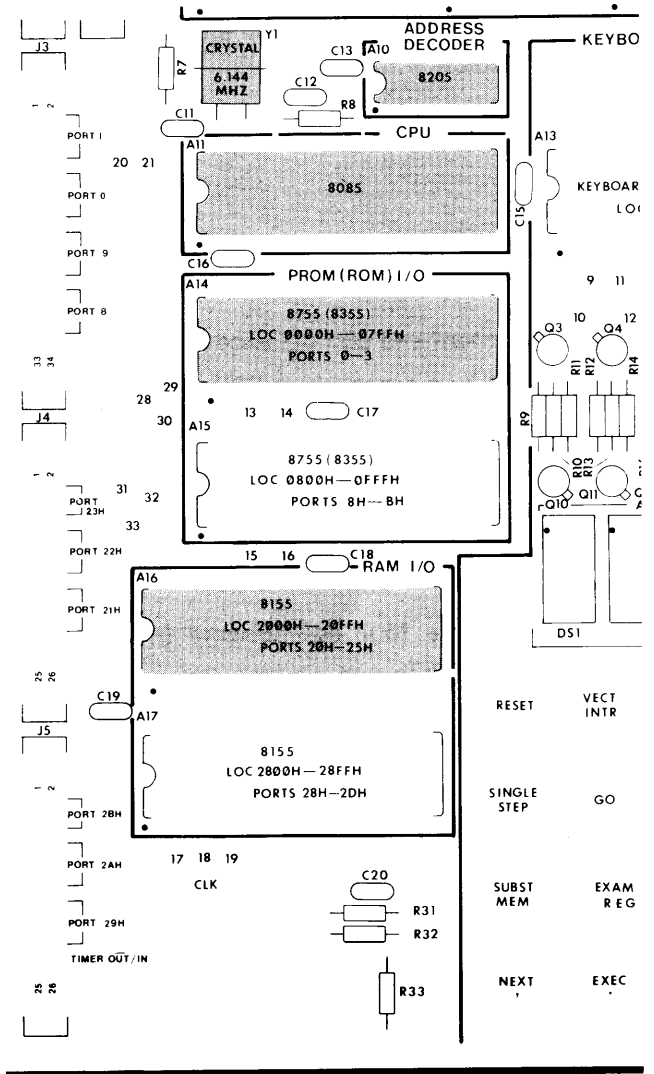

- Install a 3k Ohm resistor (orange-black-red) at R7.
- Install a 3.9k Ohm resistor (orange-white-red) at R8.
- Solder these two resistors and clip off their lead ends.

Install three 0.1 uf ceramic capacitors at:

- C11
- C12
- C13
- Solder them and clip off excess lead length.
- Install a 1 uf capacitor at C20.
- Install a 1k resistor (brown-black-red) at R31.
- Install a 51k resistor (green-brown-orange) at R32.
- Install a 200 Ohm resistor (red-black-brown) at R33.
- Solder these four components in place and trim their leads.

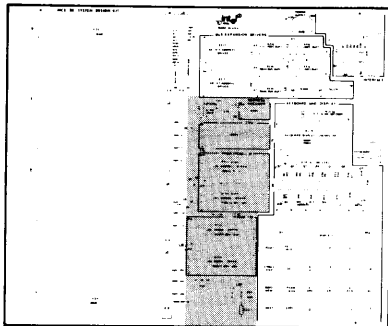

Install 0.1 uf ceramic capacitors at:

- C16
- C18
- Now solder the capacitors you have installed, and clip off their excess lead ends.

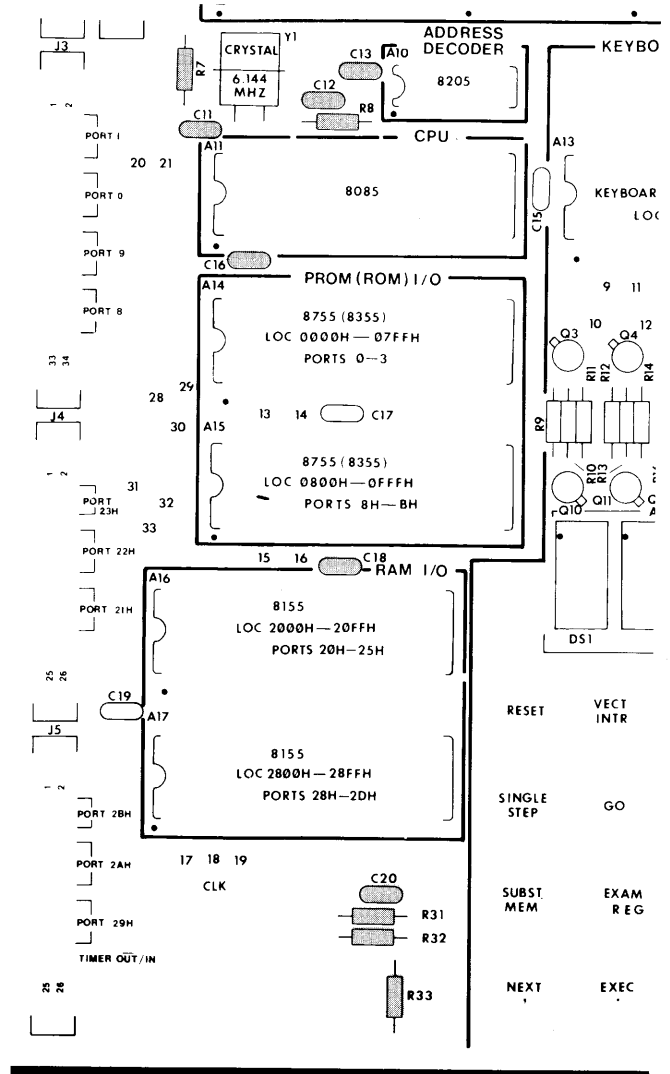

Assembly of Keyboard and Display Area

Find where the row of resistors, R9 through R30, go. Install eight 3k resistors (orange-black-red) at:

- R9
- R12
- R15
- R18
- R21
- R24
- R28 (Careful—the location pattern changes here!)
- R29
- Now solder all eight resistors in place and clip their excess lead ends.

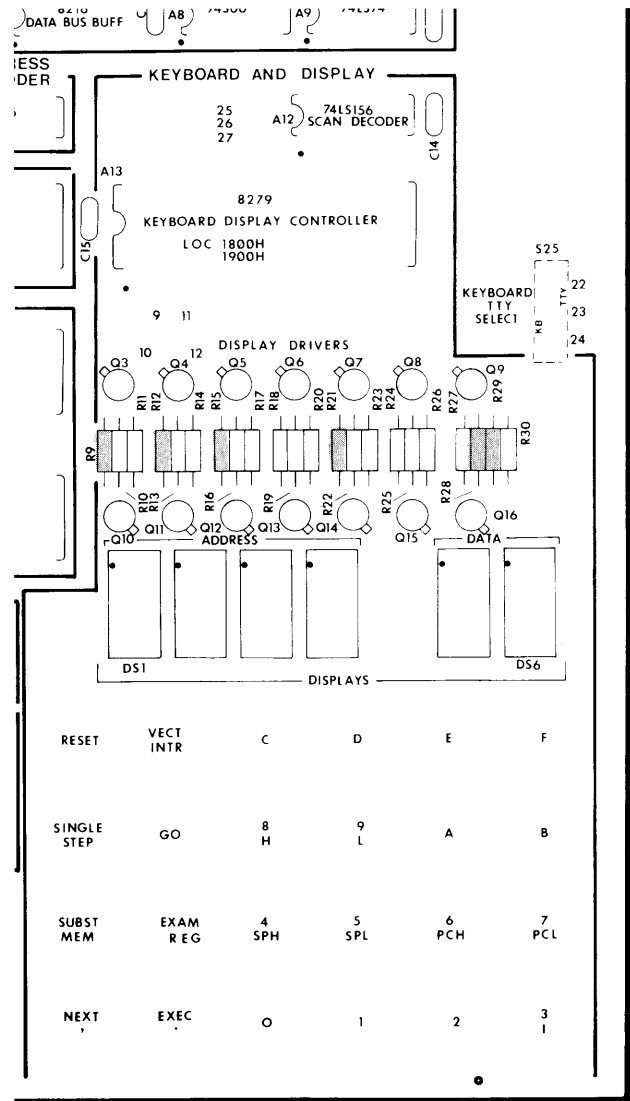
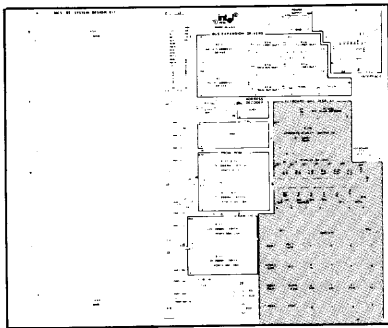

Install six 270 Ohm resistors (red-violet-brown) at:

- R10
- R13
- R16
- R19
- R22
- R25
- Solder these six resistors and clip their excess lead ends.

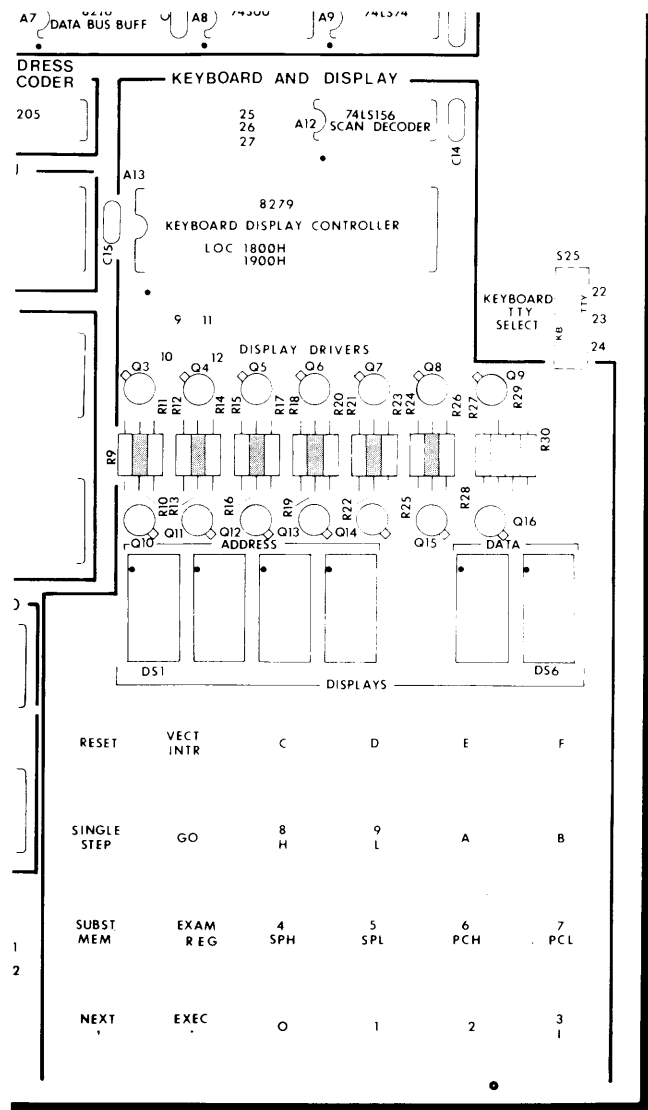
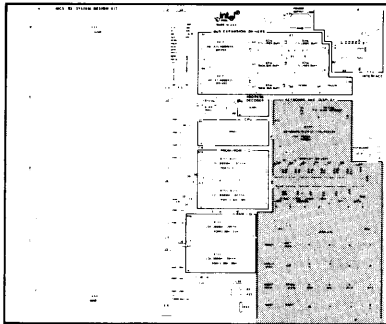

Install eight 24 Ohm resistors (red-yellow-black) at:

- R11
- R14
- R17
- R20
- R23
- R26
- R27 (Again, note the change in location pattern.)
- R30
- Solder these eight resistors and clip their excess lead ends.

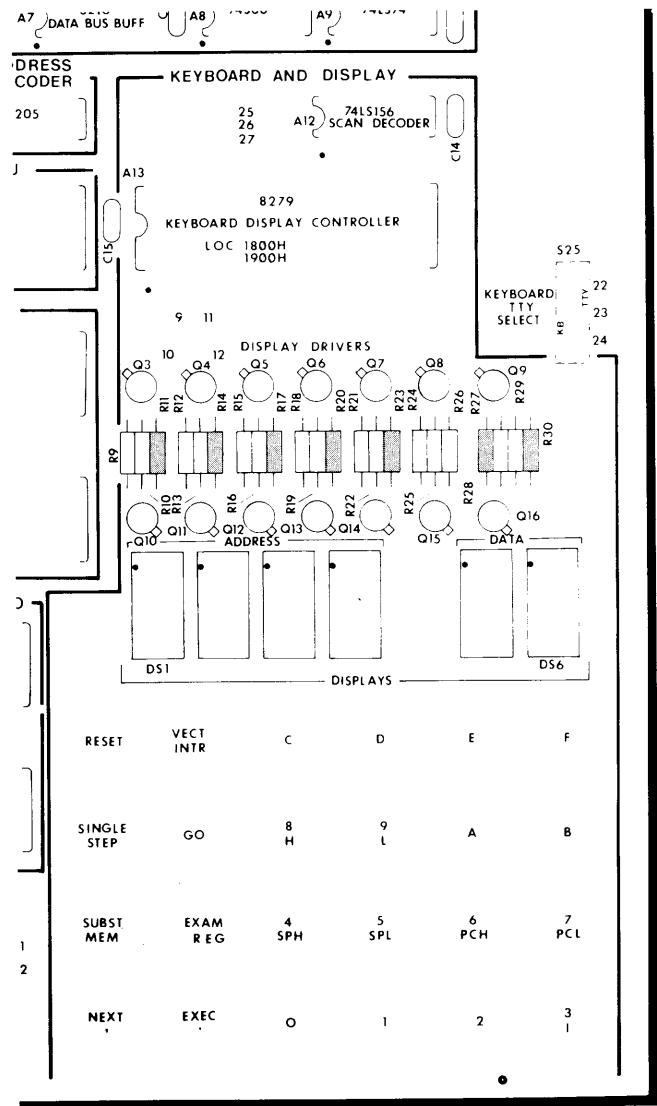
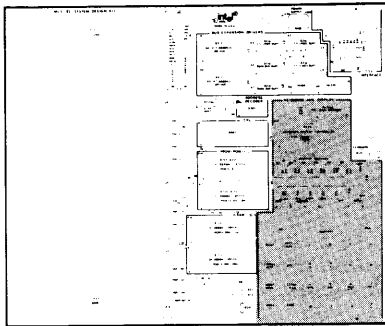

Install fourteen 2N2907 transistors in two rows.
Position the seven transistors in the top row so that their indexing tabs point upward and to the left, at:

- Q3
- Q4
- Q5
- Q6
- Q7
- Q8
- Q9

Position the seven transistors in the bottom row so that their indexing tabs point down and to the right, at:

- Q10
- Q11
- Q12
- Q13
- Q14
- Q15
- Q16
- Press all of the transistors down to about 1/8 inch from the surface of the board. Let them stand approximately straight up. Then, turn the board over and solder all of their leads in place and trim the lead ends.

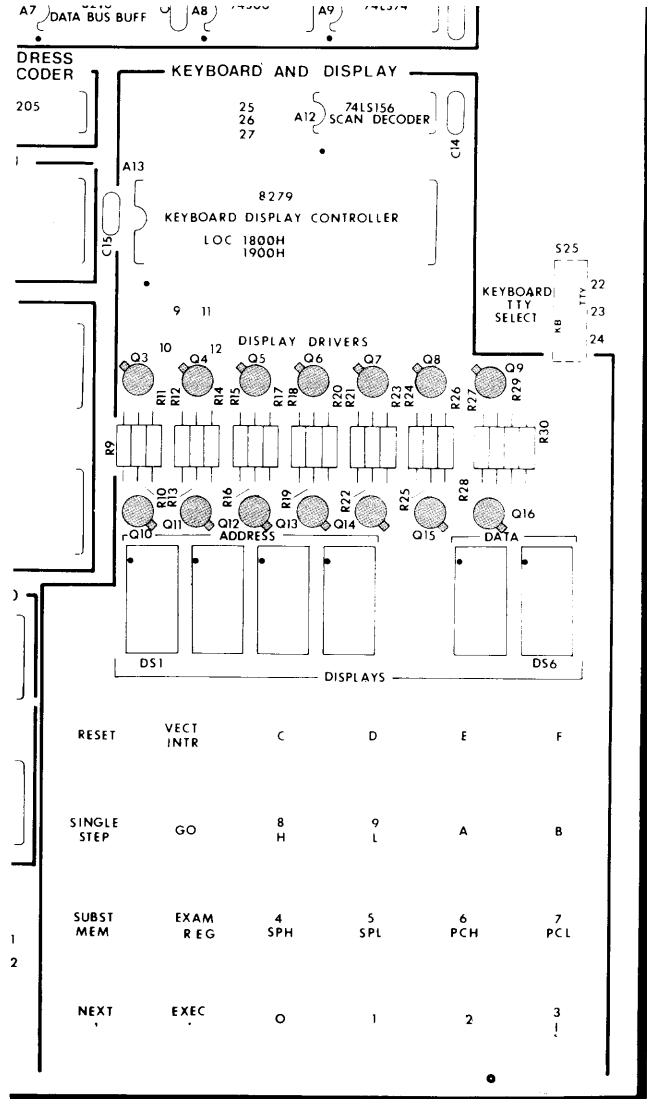
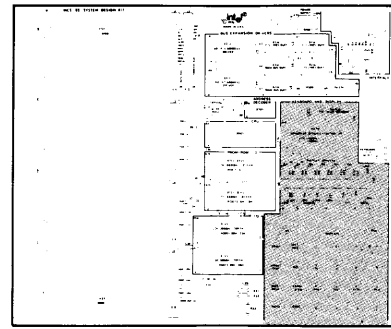

- Install one of the 40-pin DIP sockets, for the 8279 Keyboard-Display Controller, at A13, and solder it in.
- Install the 74LS156 scan decoder at A12, and solder it.

Be careful to orient the six alphanumeric LED displays so that the decimal points are even with the **bottom** of the digits and install at:

- DS1
- DS2
- DS3
- DS4
- DS5
- DS6

Note: If these components are provided with long, wirewrap leads, you will probably find it easiest to insert, solder, and clip them one at a time because of crowded quarters. The order shown above with the board turned bottomside up will be most convenient for you if you hold the soldering pencil in your left hand. If you solder right-handed, you may prefer to work from DS6 to DS1.

Note: Don't install the red filter over the display yet. It's a good idea to wait until after final assembly and checkout to do this, on the remote chance that you might have to remove one of the character displays.

Install two 0.1 uf ceramic capacitors at:

- C14
- C15
- Solder the leads and clip them off close to the board.

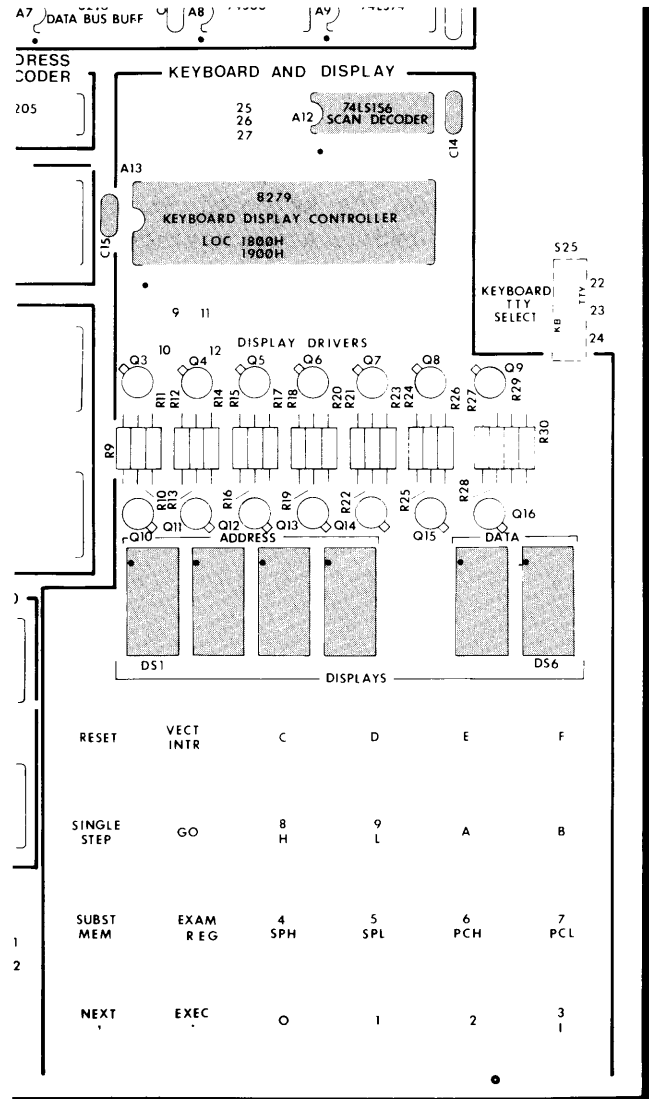
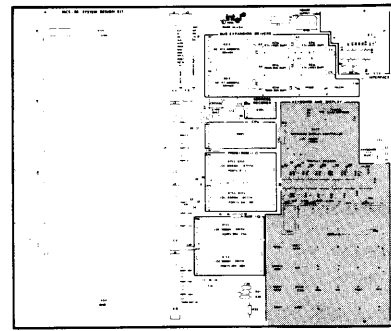

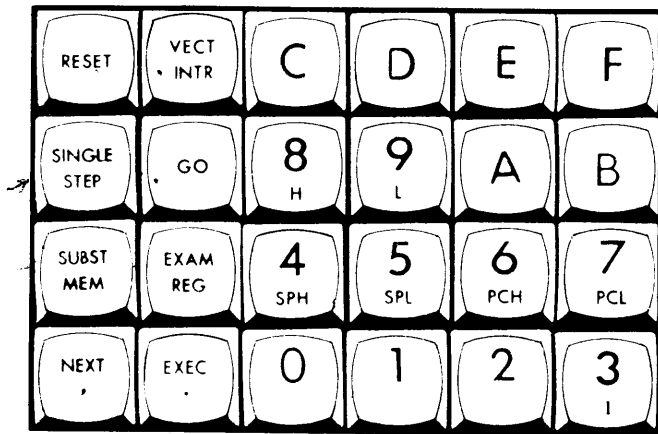

- Install the twenty-four pushbutton switches that make up the keyboard. Be sure each button is rightside up and in its proper position before soldering.

The easiest method of doing this is to insert each button in its turn, bend its leads over on the back of the board to hold it in place, and go on until all buttons are in place, then solder all of them in one pass, with the board lying flat on the work surface and weighted down to make sure the switches are uniformly held firmly against the front surface of the board.

- RESET VECT INTR C D E F
- SINGLE STEP GO 8 H 9 L A B
- SUBST MEM EXAM REG 4 SPH 5 SPL 6 PCH 7 PCL
- NEXT EXEC 0 1 2 3 I
- All soldered in place

CHAPTER 3 FINAL ASSEMBLY AND CHECKOUT

3-1 GENERAL

Now that most of the components are soldered on your circuit board, it's time to give your handiwork a quick visual check to make sure all of the devices are oriented correctly. The notched ends of the ICs should all be toward your left, and the decimal points of the LED displays should be at the bottom line of the characters.

It is recommended that the basic kit computer be checked out using the procedure in this chapter before adding any external options such as teletypewriter or expansion memory. It is well for you to have the assurance that you have a working cpu and display-keyboard before you add peripherals to your system. It is therefore recommended that you first wire the strapping options in Table 3-1 for the 8355 (or 8755) ROM-I/O that was furnished with the kit (and contains the SDK-85 System Monitor). Then install the strap in Table 3-2 for keyboard operation, and in Table 3-4 for the basic kit without expansion memory. (See paragraph 3-2.)

Paragraph 3-3 tells you how to hook up power to the MCS-85 System Design Kit, and paragraph 3-4 tells you how to start it up and see if it's working right. The subsequent paragraphs list the add-on options you can use without inventing any new circuitry on the board or off.

3-2 STRAPPING INSTRUCTIONS

The MCS-85 System Design Kit will accept 8355 or 8755 ROM-I/O devices at positions A14 and A15. These different devices are not completely electrically interchangeable, so you must make the strapping connections in Table 3-1, appropriate to the type of device in each socket.

To make a strapping connection (jumper), bend a short length of bare wire (such as the excess lead end cut from a resistor) to fit between the two holes you wish to strap together, insert the ends of the wire in the holes, and solder them. Then clip the remaining excess ends, just as you did with the components. When you install a jumper and solder it, be sure it doesn't touch any intervening traces or pads.

IMPORTANT: For normal operation of the SDK-85, it is *mandatory* to strap the following:

1. One of the three options in Table 3-1.
2. One of the two options in Table 3-2.
3. The two jumpers listed in Table 3-3.
4. Either basic kit operation or one of several expansion options listed in Table 3-4.

The keyboard-teletypewriter selection function may be done with a miniature printed circuit-board mount, single-pole, double-throw switch, S25, not furnished in the kit, or may be strapped with wire. Table 3-2 lists the connections. Table 3-3 lists keyboard strapping connections always made.

Tables 3-5 through 3-10 list all of the bus and port expansion connector pinouts. Table 3-11 lists suggested connector types.

3-3 POWER SUPPLY WIRING (See Figure 3-6.)

Connect a +5 Volt, regulated power supply with its positive output at the +5V POWER SUPPLY point on the board. A 6-pin Molex connector will fit the

(Text continues on page 3-4.)

TABLE 3-1
ROM/PROM STRAPPING

Device Location	8355 Figure 3-1	8755 Figure 3-2a	8755A Figure 3-2b
A14 (The SDK-85 Monitor ROM)	No Straps Required	Strap 28-29	Strap 29-30
A15		Strap 31-32	Strap 32-33

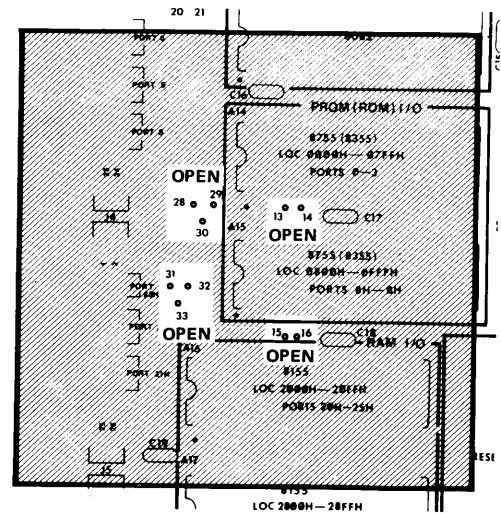

Figure 3-1 No Strapping Required for 8355 ROMs

TABLE 3-2
TELETYPEWRITER-KEYBOARD
STRAPPING

TELETYPEWRITER Figure 3-3	KEYBOARD Figure 3-4
Strap 22-23	Strap 23-24

TABLE 3-3
DISABLING UNUSED KEYBOARD
CONTROLLER FUNCTIONS

Figure 3-5
Always strap 9-10.
Always strap 11-12.

Note: These two straps not usually removed, since the MCS-85 System Design Kit does not have SHIFT or CONTROL keys on its keyboard. These straps have no effect on operation of the corresponding key functions on a teletypewriter or other ASCII terminal that is connected to the TTY interface. They are provided for your use if you wish to modify the SDK-85's keyboard functions and replace its monitor software with your own.

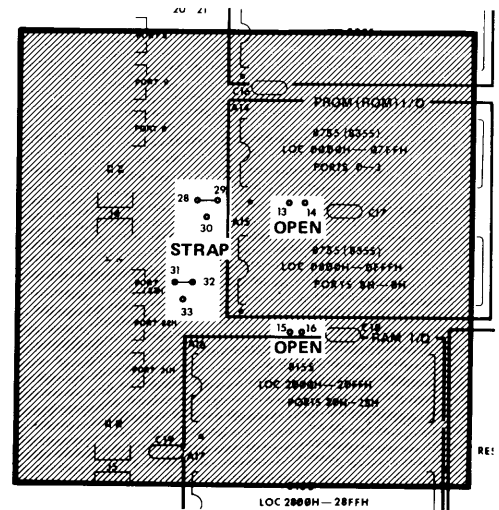

Figure 3-2a Strapping Connections for 8755 PROMS

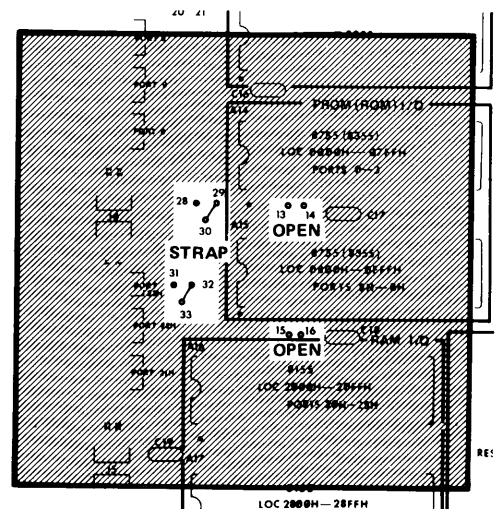

Figure 3-2b Strapping Connections for 8755A PROMS

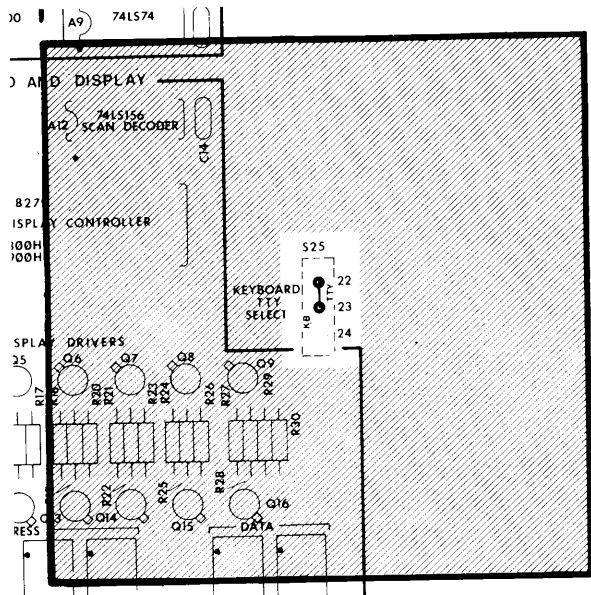

Figure 3-3 Teletypewriter Strapping Connection

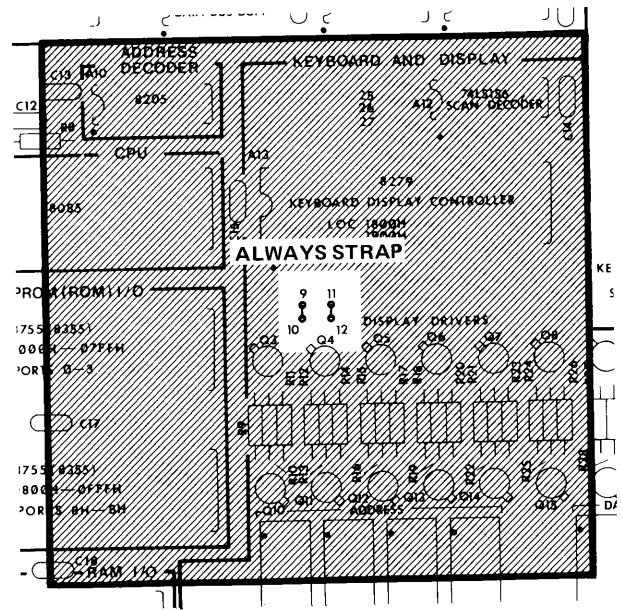

Figure 3-5 Disabling Unused Keyboard Controller Functions

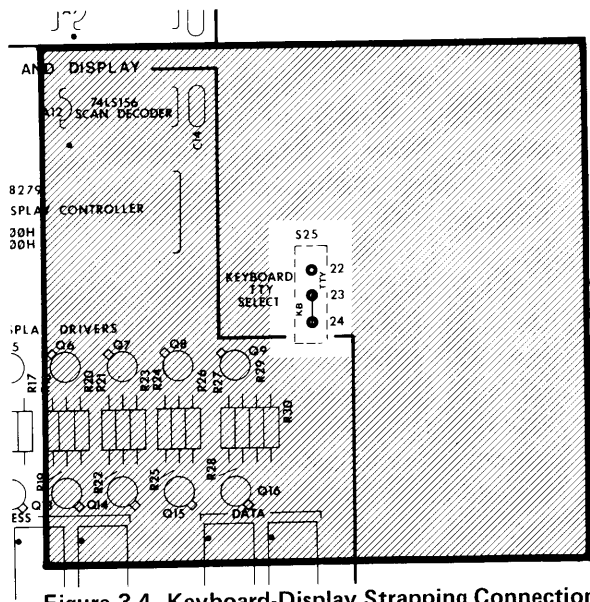

Figure 3-4 Keyboard-Display Strapping Connection

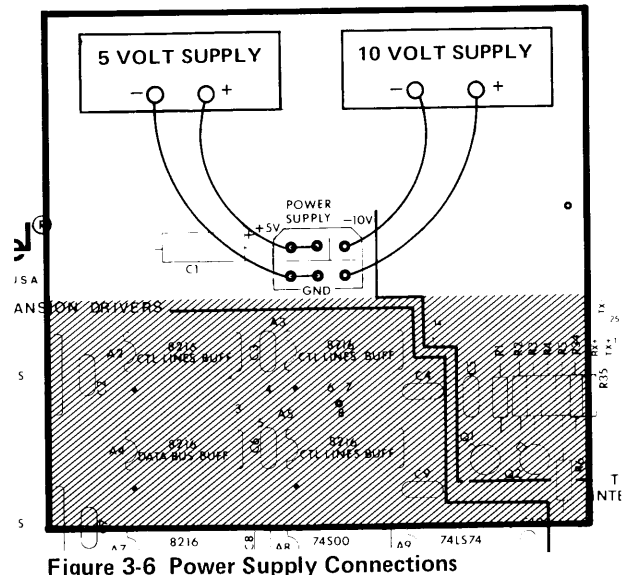

Figure 3-6 Power Supply Connections

hole pattern on the board (see p. 3-13 for the part number). If you are going to use a teletypewriter, connect a -10 Volt power supply with its negative output at the -10V point on the board. Connect the positive side of the -10 Volt power supply to the GND bus.

CAUTION

Do not turn on power until instructed to do so.

3-4 INSTALLING LARGE IC DEVICES

When you've finished all soldering operations on the board and are ready to fire it up, then it's time to plug in the large ICs. Once more, please make note of the precautions for handling these large MOS devices.

(Text continues on page 3-6.)

**TABLE 3-4
BUS EXPANSION STRAPPING**

FUNCTION	BASIC KIT WITHOUT EXPANSION MEMORY (Figure 3-7)	AUGMENTED KIT WITH EXPANSION MEMORY (Figure 3-8) (Also See Paragraph 3-7.)
RST 6.5	Strap 3-5	Strap 3-4 if no input is connected to J1-20. Leave 3, 4, and 5 not strapped if input is to be supplied for this restart function.
HOLD	Strap 6-8	Strap 7-8 if no input is connected to J1-14. Leave 6, 7, and 8 not strapped if input is to be supplied for this function.
INTR	Strap 20-21	Strap 20-21 if no input is connected to J1-18. Leave 20-21 not strapped if input is to be supplied for this function.
Memory Address Locations	Leave 25-26-27 unstrapped.	Strap 25-26 if all memory locations are external, i.e., addressed via bus expansion drivers.* (See Figure 3-9.) Strap 25-27 to enable the bus expansion drivers only when the upper 32K memory locations (8000H-FFFFH) are addressed. (See Figure 3-10.)
*Note: No devices may be installed in positions A13, A14, A15, A16, and A17 if this option is strapped.		

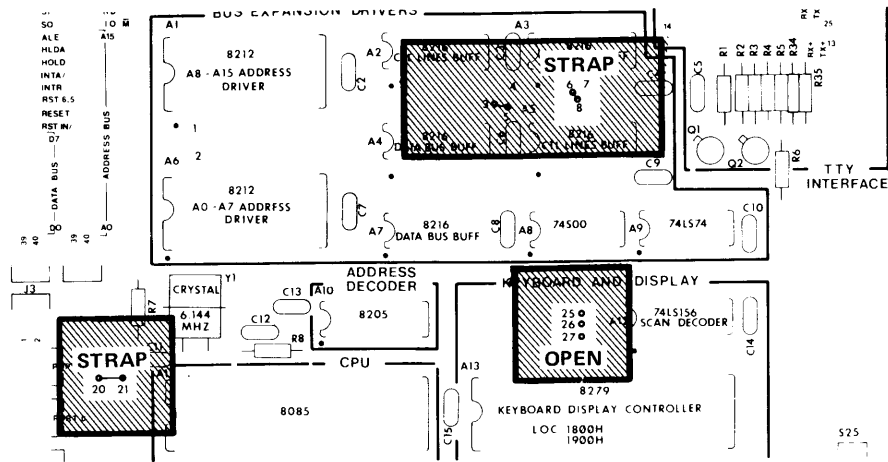

Figure 3-7 Strapping Required for Basic Kit (No Bus Expansion)

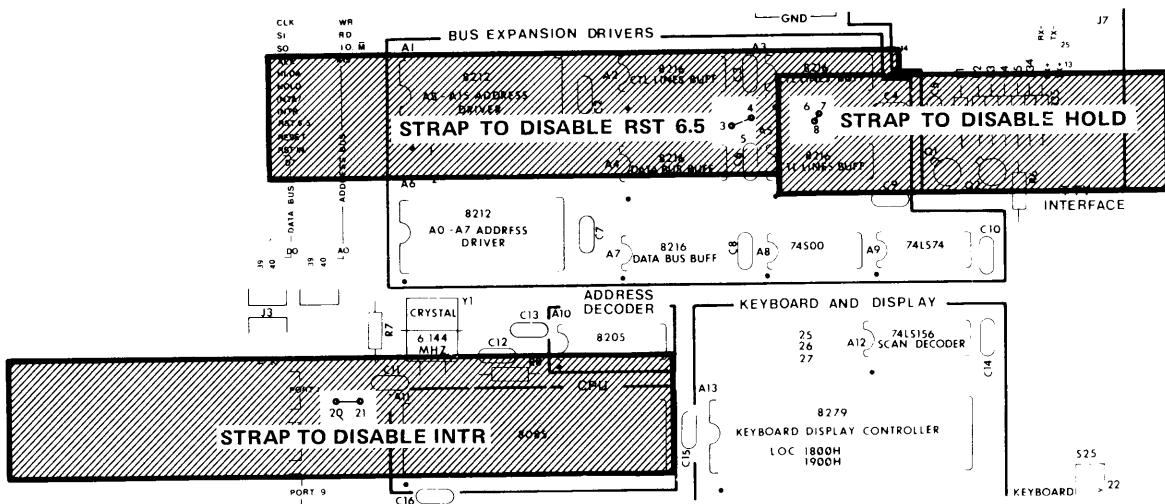

Figure 3-8 Strapping Options for Bus Expansion Control Lines

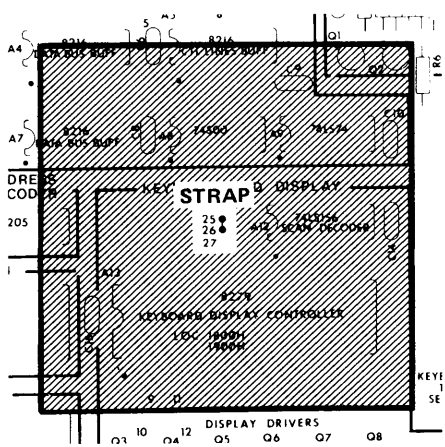

Figure 3-9 Strapping Options for all External Memory

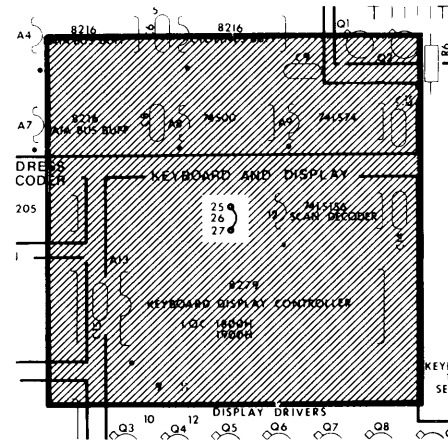

Figure 3-10 Strapping Options for Internal/External Memory

CAUTION

Large-scale integrated circuits are fragile! Dropping, twisting, or uneven pressure may break them. The discharge of static electricity can destroy them internally. Leave them embedded in the conductive-foam backing sheet until ready to install on the board. Never press down hard upon, twist, or bend the larger devices. Touch the exposed metal traces of the board with your hand before inserting one in its socket. The soldering of large devices directly on the circuit board is not recommended. If your Kit is provided with 8755 EPROM, do not remove the opaque sticker covering the window. Ultraviolet radiation including sunlight, can erase the monitor software contained in the device.

Inspect each IC to see that its leads are reasonably straight. (It's okay for the device to be a bit bow-legged.) The forked end of the soldering aid is a good tool for straightening bent leads. Carefully place an IC on its intended socket, oriented properly, with one row of its pins resting lightly in the socket holes. With your fingers or with the soldering aid, gently tease the other row of pins into their socket holes. Be sure no single pins have escaped. Once all pins have started, press down gently with fingers or with something flat to seat the device in its socket.

Each device must be oriented properly in its socket or it won't work. Every DIP device made has either a notch of some kind or a dot at one end. On the SDK-85 board, each notch or mark must face to the left. The markings on the board indicate this orientation. They also show which device type goes where. (See the pictorials on pages 2-9 and 2-15.)

3-5 STARTING THE FIRST TIME

Once you are certain that all parts are properly installed, the correct strapping options are soldered, and the power supplies connected, you are ready to start your MCS-85 System Design Computer. Clear the surface of your work table of any tools or wire that could come in contact with the underside of the circuit board and short it, and be sure there aren't any wire clippings on top of the board by accident.

Peel the coverings from the red window and lay it on the display. (Don't stick it down yet.)

Energize the +5 Volt power supply.

Press the  button on the keyboard. The display should respond by reading out "- 80 85."

If the above readout appears, go on to Chapter 4 of this book and try out each button and function. Verify that each command produces the specified result, and that all segments of each 7-segment character display light.

Once you know the displays are all working right, peel the backing from the two strips of double-sided tape and use them to stick the red window in place.

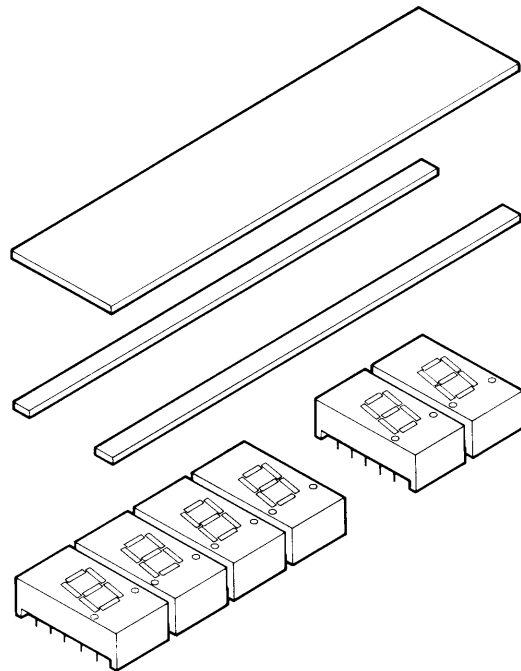

3-6 WHAT IF IT DOESN'T?

If there is no response to the RESET command,

- Use the multimeter to check for the presence and proper polarity of +5 Volts on the board.
- Check all of the strapping connections, and be sure they are in the right places for the configuration you chose.
- Check carefully the seating of each and every pin of each of the four large ICs. Be sure no pins have accidentally bent over and missed the socket.
- Go back over the Chapter 2 assembly procedure and scan and check off all of the component values and all of the solder connections.
- Check the orientation of all semiconductor devices.
- Inspect for solder bridges or loose solder joints.

If all devices are properly soldered or firmly in their sockets and still there's no result, it can be presumed that there is a bad part somewhere. The keyboard switches can be checked using the multimeter, as mentioned in Chapter 2. If all switches are closing positively when pressed, and opening when released, further effective troubleshooting can be accomplished if you have a dual-trace oscilloscope of at least 5 MHz bandwidth, or a logic analyzer.

- Pin 37 of cpu A11 (8085) should show a clock output of 3.072 MHz (326 ns period). If it doesn't, there's something wrong with the 8085 or the crystal.
- Pin 30 of A11 should have a positive-going pulse about 160 ns wide every μ s or so. This is the ALE pulse that indicates that the cpu is executing instructions.
- Pin 1 of address decoder A10 (8205) should pulse. If not, your 8085 is probably bad.
- If pin 1 of A10 pulses, check pin 15 of A10. If A10-15 doesn't follow A10-1, or has bad output voltage levels, the 8205 is either bad or installed wrong.
- If all else fails, call the Intel Service Hotline and describe the results of the foregoing procedure.

The numbers are:

- (800) - 538-8014 when calling from out-
- (800) - 538-8015 side California
- (800) - 672-3507 California only

Note: The Service Hotline is available to provide limited support to help you get your kit running. If we can't help you over the phone, you may be directed to return your kit to us and we'll fix it for a flat fee and send it back to you. **The Service Hotline is available Monday through Friday, between 8 AM and 3:30 PM, Pacific time.**

IMPORTANT: The Service Hotline *is not* able to provide help to you in writing programs for your kit or in making hardware modifications. Please rely on the documentation provided with your kit for assistance.

**TABLE 3-5
INTERFACE CONNECTOR J7
PIN ASSIGNMENTS**

PIN	MARKING	ASSIGNMENT
1	—	Open
2	14	Open
3	15	Open
4	16	Open
5	17	Open
6	18	Open
7	19	Open
8	20	Ground
9	21	Open
10	22	Open
11	23	Open
12	24	Open
13	25	Open
	RX—	Receive Return (—)
	RX+	Receive (+)
	TX—	Transmit Return (—)
	TX+	Transmit (+)

3-7 CONNECTING A TELETYPEWRITER

If you wish to use a teletypewriter with your SDK-85 computer, connect it at Interface Connector J7 as shown in Table 3-5. You may use either a male connector or a female connector. (See

Table 3-11.) Only four pins of this connector are assigned for Teletypewriter use; the remaining pins may be wire-wrapped to serve any function you choose.

TABLE 3-6
BUS EXPANSION CONNECTOR J1 PIN ASSIGNMENTS

ASSIGNMENT	PIN	PIN	MARKING	ASSIGNMENT	I/O	
GND	1	2	—	OPEN	—	
GND	3	4	CLK	Buffered CLK	O	
GND	5	6	S1	Buffered S1	O	
GND	7	8	S0	Buffered S0	O	
GND	9	10	ALE	Buffered ALE	O	
GND	11	12	HLDA	Buffered HLDA	O	
GND	13	14	HOLD	Buffered HOLD	I	
GND	15	16	INTA/	Buffered $\overline{\text{INTA}}$	O	
GND	17	18	INTR	INTR	I	
GND	19	20	RST 6.5	Buffered RST 6.5	I	
GND	21	22	RST	Buffered RESET OUT	O	
GND	23	24	RST IN/	$\overline{\text{RESET INPUT}}$	I	
GND	25	26	D7	Buffered D7	I/O	
GND	27	28	— DATA BUS —	Buffered D6	I/O	
GND	29	30		Buffered D5	I/O	
GND	31	32		Buffered D4	I/O	
GND	33	34		Buffered D3	I/O	
GND	35	36		Buffered D2	I/O	
GND	37	38		Buffered D1	I/O	
GND	39	40		D0	Buffered D0	I/O

TABLE 3-7
BUS EXPANSION CONNECTOR J2 PIN ASSIGNMENTS

ASSIGNMENT	PIN	PIN	MARKING	ASSIGNMENT	I/O	
GND	1	2	RDY	READY	I	
GND	3	4	WR/	Buffered \overline{WR}	O	
GND	5	6	RD/	Buffered \overline{RD}	O	
GND	7	8	IO/ \overline{M}	Buffered IO/ \overline{M}	O	
GND	9	10	A15	Buffered A15	O	
GND	11	12	 — ADDRESS BUS — 	Buffered A14	O	
GND	13	14		Buffered A13	O	
GND	15	16		Buffered A12	O	
GND	17	18		Buffered A11	O	
GND	19	20		Buffered A10	O	
GND	21	22		Buffered A9	O	
GND	23	24		Buffered A8	O	
GND	25	26		Buffered A7	O	
GND	27	28		Buffered A6	O	
GND	29	30		Buffered A5	O	
GND	31	32		Buffered A4	O	
GND	33	34		Buffered A3	O	
GND	35	36		Buffered A2	O	
GND	37	38		Buffered A1	O	
GND	39	40		A0	Buffered A0	O

**TABLE 3-8
I/O PORT CONNECTOR J3 PIN ASSIGNMENTS**

ASSIGNMENT	PIN	PIN	MARKING	ASSIGNMENT
P1-6*	1	2	} PORT 1	P1-7
P1-4	3	4		P1-5
P1-2	5	6		P1-3
P1-0	7	8		P1-1
P0-6	9	10	} PORT 0	P0-7
P0-4	11	12		P0-5
P0-2	13	14		P0-3
P0-0	15	16		P0-1
P9-6	17	18	} PORT 9	P9-7
P9-4	19	20		P9-5
P9-2	21	22		P9-3
P9-0	23	24		P9-1
P8-6	25	26	} PORT 8	P8-7
P8-4	27	28		P8-5
P8-2	29	30		P8-3
P8-0	31	32		P8-1
GROUND	33	34		GROUND

- *Note:**
1. Pn-m stands for PORT n Bit m (e.g. P9-6 means PORT 9H Bit 6).
 2. Ports 0 & 1 are Ports A and B of 8355 (A14).
 3. Ports 8 & 9 are Ports A and B of 8755 (A15).

TABLE 3-9
I/O PORT CONNECTOR J4 PIN ASSIGNMENTS

ASSIGNMENT	PIN	PIN	MARKING	ASSIGNMENT
P23H-4	1	2	} PORT 23H }	P23H-5
P23H-2	3	4		P23H-3
P23H-0	5	6		P23H-1
P22H-6	7	8	} PORT 22H }	P22H-7
P22H-4	9	10		P22H-5
P22H-2	11	12		P22H-3
P22H-0	13	14		P22H-1
P21H-6	15	16	} PORT 21H }	P21H-7
P21H-4	17	18		P21H-5
P21H-2	19	20		P21H-3
P21H-0	21	22		P21H-1
OPEN	23	24		OPEN
GROUND	25	26		GROUND
<p>Note: Port 21H is Port A } Port 22H is Port B } of 8155 (A16). Port 23H is Port C }</p>				

TABLE 3-10
I/O PORT AND TIMER CONNECTOR J5 PIN ASSIGNMENTS

ASSIGNMENT	PIN	PIN	MARKING	ASSIGNMENT
P2BH-4	1	2	} PORT 2BH }	P2BH-5
P2BH-2	3	4		P2BH-3
P2BH-0	5	6		P2BH-1
P2AH-6	7	8	} PORT 2AH }	P2AH-7
P2AH-4	9	10		P2AH-5
P2AH-2	11	12		P2AH-3
P2AH-0	13	14		P2AH-1
P29H-6	15	16	} PORT 29H }	P29H-7
P29H-4	17	18		P29H-5
P29H-2	19	20		P29H-3
P29H-0	21	22		P29H-1
Timer $\overline{\text{OUT}}$	23	24	TIMER OUT/IN	Timer In
GROUND	25	26		GROUND

Note: Port 29H is Port A }
 Port 2AH is Port B } of expansion RAM 8155 (A17).
 Port 2BH is Port C }
 Timer is on the same 8155 (A17).

**TABLE 3-11
SUGGESTED CONNECTOR TYPES**

REFERENCE DESIGNATION	FUNCTION	NO. OF PINS	MFR.	MFR'S. PART NO.
J1	Bus Expansion	40	Spectra Strip	800-576
J2	Bus Expansion	40	Spectra Strip	800-576
J3	I/O Ports	34	Spectra Strip	800-579
J4	I/O Ports	26	Spectra Strip	800-583
J5	I/O Ports and Timer	26	Spectra Strip	800-583
J6	Not Used			
J7	TTY Interface	25		
	Female } Optional		AMP	206584
	Male }		AMP	206604
—	Power Supply	6	Molex	Model No. 1261
	Recepticle			03-09-1064
	Plug			03-09-2062



CHAPTER 4 OPERATING INSTRUCTIONS

4-1 WHAT IT DOES

The things you can do with the basic SDK-85 kit are:

- Examine the contents of all memory and register locations
- Deposit program steps or data in RAM or register locations
- Execute programs or subroutines upon command
- Reset (start) the monitor upon command
- Interrupt and start operation at a location you specify upon command

You may select either the keyboard and display on the board or a teletypewriter as the console device by operating a switch or by placing a jumper wire at the appropriate place on the board. (See Chapter 3.) Keyboard/display operation and teletypewriter operation are described separately in the following paragraphs.

Two of the keyboard buttons continue to function in teletypewriter mode, as well as in keyboard/display mode. These are the  and the  keys.

4-2 THE BUTTONS AND DISPLAYS

















Keyboard/display operation is done by pressing keys on the keypad. Responses are displayed either by echoing the key pressed or by prompting you with a message or prompt. When the  button is pressed, the monitor is ready to accept commands. For numeric arguments, the valid range is from 1 to 4 hexadecimal digits for address information and 1 to 2 hex digits for register and memory data.

Longer numbers may be entered, but such numbers will be evaluated modulo 2^{16} or 2^8 respectively,

i.e., only the last four or the last two digits entered will be accepted.

As noted, the number system being used in the SDK-85 is the hexadecimal, or base-16 number system. Table 4-1 lists the hexadecimal, decimal (base 10), and binary (base two) equivalents. The table also shows how each hex digit will appear in the seven-segment LED displays.

TABLE 4-1
NUMBER SYSTEMS

HEX	DECIMAL	BINARY	LED DISPLAY
0	0	0000	
1	1	0001	
2	2	0010	
3	3	0011	
4	4	0100	
5	5	0101	
6	6	0110	
7	7	0111	
8	8	1000	
9	9	1001	
A	10	1010	
B	11	1011	
C	12	1100	
D	13	1101	
E	14	1110	
F	15	1111	

Whenever the monitor expects a command, the display shows a dash (“-”) at the left edge of the address field (possibly along with an error message). When the monitor expects a parameter, a decimal point will be displayed at the right edge of the field into which the argument will be placed. A parameter will be either an address or a byte of data which is used during the execution of a command.

In the descriptions of the command modes, upper case letters and numbers enclosed in boxes represent keyboard keys. Words or phrases in lower case enclosed in brackets “<>” describe the nature of the command parameters you may input.

The () in the Format Statement indicates an optional argument.

Reset:

The **RESET** key causes a hardware reset, and starts the monitor. The message “-80 85” will be displayed across the address and data field of the display if you are in display-keyboard mode. If in teletypewriter mode, the sign on message “SDK-85 VER X.X” will be printed. The monitor is ready to accept a command after a reset, and saves no information about the state of any user program before the reset.

Substitute Memory:

SUBST **MEM** <address> **NEXT** (<data>) **NEXT** (<data>) . . . **EXEC**

The substitute memory command allows you to read the contents of ROM memory and to examine and modify the contents of RAM memory locations.

The address argument denotes the contents of the memory address to be examined, and may be from 1 to 4 hex digits. If you enter longer numbers, only the last 4 digits entered are used). As soon as the number is terminated by the **NEXT** key, the contents of that location are shown in the data field, along with a decimal point at the right edge of the field. Entering a new number will cause that number to be displayed in the data field; however, the contents of the memory location will not be changed until an **EXEC** or **NEXT** key is pressed.

Pressing **NEXT** will place the contents displayed in the data field into the displayed memory address. Then the address and contents of the next higher memory location will automatically be shown. Pressing **EXEC** will place the contents displayed in the data field into the memory address displayed in the address field, and will also terminate the command.

Pressing **NEXT** while the address FFFF is being displayed will cause address 0000 to be displayed.

Whenever the command changes the contents of a memory location, it also verifies that the change has occurred correctly. If the contents of the location do not agree with what the new value should be (i.e., if the memory location is in ROM or is nonexistent), an error message is generated.

SUBSTITUTE MEMORY EXAMPLE 1

Using **SUBST MEM** to list the first few Monitor locations:

KEY	ADDR	DATA
SUBST MEM	.	
0	0000.	
NEXT	0000	3E.
NEXT	0001	00.
NEXT	0002	32.
NEXT	0003	00.
EXEC	-	

SUBSTITUTE MEMORY EXAMPLE 2

Using **SUBST MEM** to enter a small program:

KEY	ADDR	DATA
SUBST MEM	.	
2	0002.	
0	0020.	
0	0200.	
0	2000.	
NEXT	2000	**.
3	2000	03.
E	2000	3E.
NEXT	2001	**.
4	2001	04.
7	2001	47.
NEXT	2002	**.
C	2002	0C.
F	2002	CF.
EXEC	-	

NOTE: ** represents unpredictable values.

After loading the above program, use **SUBST MEM** again to go back and check locations 2000-2002 to see that they contain:

<u>ADDRESS</u>	<u>DATA</u>	<u>CORRESPONDING 8085 ASSEMBLY LANGUAGE INSTRUCTIONS</u>
2000	3E	MVI A, 47H
2001	47	
2002	CF	RST 1

This program will load the A register with the number 47 and jump back to the monitor.

Examine Registers:

EXAM REG <reg> **NEXT** (<data>) **NEXT** (<data>) ... **EXEC**

The examine command allows you to display and modify the contents of the 8085 CPU registers. Pressing the **EXAM REG** key blanks both the address and data fields, and displays a decimal point at the right edge of the address field. At this point, you must press a register key (register names are denoted by legends on the keyboard). Any other key will generate an error response.

If a register key is pressed, the name of the register will appear in the address field, and the contents of the register will appear in the data field, along with a decimal point at the right hand edge. Entering a number will cause the number to be displayed in the data field; however, the contents of the register will not be changed until an **EXEC** or **NEXT** key is pressed.

Pressing **NEXT** will place the contents displayed in the data field into the register named in the address field, then will display the name and contents of the next register in sequence (See Table 4-2). Pressing **EXEC** will place the contents displayed in the data field in the register named in the address field, and will also terminate the command.

Pressing **NEXT** while register PCL is being displayed has the same effect as pressing **EXEC**.

The format for the I register is the lower 4 bits of the accumulator following execution of a RIM instruction. A "1" in an interrupt mask field denotes a masked condition. A "0" must be entered to use that interrupt.

The format for the I register is:

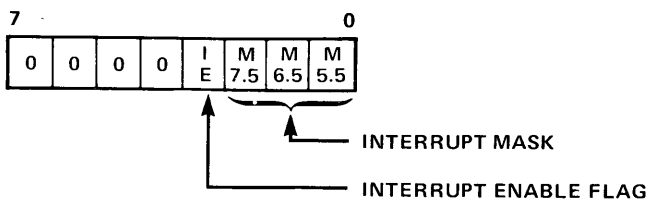
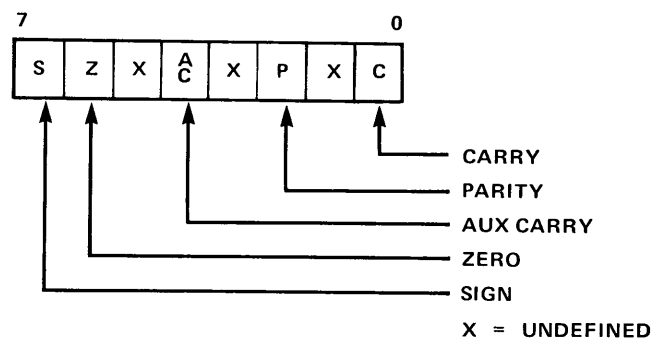

TABLE 4-2
REGISTER DISPLAY SEQUENCE

KEY/DISPLAY CODE	REGISTER
A	CPU register A
B	CPU register B
C	CPU register C
D	CPU register D
E	CPU register E
F	CPU flags byte
I	interrupt mask
H	CPU register H
L	CPU register L
SPH	most significant byte of stack pointer
SPL	least significant byte of stack pointer
PCH	most significant byte of program counter
PCL	least significant byte of program counter

The flag byte contains the 8085 CPU's condition flags.

The format for the flag byte is:



For more information about the 8085's flags and interrupt mask feature, consult the **MCS-85 User's Manual**.

EXAMINE REGISTER EXAMPLE 1

Using to initialize the 8085's stack pointer to 20C2:

KEY	ADDR	DATA
<input type="button" value="EXAM REG"/>	.	
<input type="button" value="4 SPH"/>	SPH	**.
<input type="button" value="2"/>	SPH	02.
<input type="button" value="0"/>	SPH	20.
<input type="button" value="NEXT"/>	SPL	**.
<input type="button" value="C"/>	SPL	0C.
<input type="button" value="2"/>	SPL	C2.
<input type="button" value="EXEC"/>	-	

EXAMINE REGISTER EXAMPLE 2

Using to examine the contents of the 8085's Registers:

KEY	ADDR	DATA
<input type="button" value="EXAM REG"/>	.	
<input type="button" value="A"/>	A	**.
<input type="button" value="NEXT"/>	b	**.
<input type="button" value="NEXT"/>	C	**.
<input type="button" value="NEXT"/>	d	**.
<input type="button" value="NEXT"/>	E	**.
<input type="button" value="NEXT"/>	F	**.
<input type="button" value="NEXT"/>	I	**.
<input type="button" value="NEXT"/>	H	**.
<input type="button" value="NEXT"/>	L	**.
<input type="button" value="NEXT"/>	SPH	**.
<input type="button" value="NEXT"/>	SPL	**.
<input type="button" value="NEXT"/>	PCH	**.
<input type="button" value="NEXT"/>	PCL	**.
<input type="button" value="NEXT"/> or <input type="button" value="EXEC"/>	-	

NOTE: ** represents the contents of the register whose name is in the address field of the display.

Go:

(<address>)

Pressing the key causes the contents of the program counter (PCH and PCL) to be displayed in the addressed field, along with a decimal point at the right edge of the field. The program counter is available for change, and any number entered (a number is optional) becomes the new contents of the program counter.

Pressing the key transfers control of the CPU to the address in the address field (contents of the program counter). Before the transfer of control, the address and data display fields are cleared, and an 'E' is displayed at the left edge of the address field.

Pressing any other key but generates an error message.

The monitor regains control of the CPU only after a or after execution of an RST 0, RST 1, or JMP 0 instruction in program.

IMPORTANT:

Note that because of the way the GO and SINGLE STEP commands are implemented in the Monitor, and will not work unless the 8085's stack pointer is pointing to an existing portion of RAM memory. If at any time these two commands don't seem to be working, set SPH to 20 and SPL to C2 using , then try it again. (Locations 20C2 to 20FF are reserved for the monitor program, therefore the stack pointer must be set to 20C2 or lower so as not to interfere with the monitor.)

GO COMMAND EXAMPLE

Now you can execute the program you entered in Example 2 of the **SUBST MEM** command. First, check to make sure the 3- location program is in memory, then the program will be executed.





Recall that this small program loads the A register with the number 47 and restarts the monitor. To verify that the A register now holds 47 and to get more practice using **EXAM REG**, try the following sequence:

KEY	ADDR	DATA	COMMENTS	KEY	ADDR	DATA	COMMENT
SUBST MEM	.	.		EXAM REG	.	.	
2	0002.			A	A	47.	A reg now holds 47.
0	0020.			0	A	00.	
0	0200.			EXEC	-		Now A holds 0
NEXT	2000	3E.	MVI A, 47	GO	****.	**	
NEXT	2001	47.		2	0002.		
NEXT	2002	CF.	RST 1	0	0020.		Run the small Program again
EXEC	-			0	0200.		
GO	****.	**		0	2000.		
2	0002.			EXEC	- 80	85	
0	0020.			EXAM REG	.	.	
0	0200.			A	A	47	Now A holds 47 again
0	2000.						
EXEC	- 80	85					

NOTE: **** denotes "don't care" values



Now try placing other values in location 2001 using **SUBST MEM** and use **GO** to execute the program again, seeing how those values are loaded into the A register after execution.

Single Step:

 (<address>)   ... 

Pressing the  key causes the contents of the program counter (PCH and PCL) to be displayed in the address field of the display along with a decimal point at the right hand edge of the field. The data field contains the contents of the address denoted by the contents of the program counter. The program counter is made available for change, and any number entered (a number is optional) becomes the new contents of the program counter.







Pressing the  key causes the CPU to execute the one instruction pointed to by the program counter. After execution the monitor regains control of the CPU, and the address and data fields show the new contents of the program counter (address of next instruction to execute) and contents of the byte addressed by the program counter, respectively. The decimal point is turned on at the right hand edge of the address field, indicating that the program counter is available again.

If the  key is pressed, no instruction is executed. The address displayed in the address field is made the contents of the program counter and the single step command is terminated. You may now examine or modify registers and memory locations to verify program execution. Pressing the  key takes you back to the single step mode, and subsequent pressing of the  key allows you to continue, instruction by instruction, through your program.



Single stepping is implemented in the SDK-85 hardware by repeatedly interrupting the processor. Since interrupts cannot be recognized during the EI and DI instructions of the 8085, single step will not stop at either of these instructions.

SINGLE STEP EXAMPLE

Single stepping through the SDK-85 Monitor. This is what you should see on the display:

KEY	ADDR	DATA
	****.	**
	0008.	
	000b.	E1
	000C.	22
	000F.	F5
	0010.	E1

To resume full speed operation at this point, do the following:

	-	
	0010.	E1
	- 80	85

Vector Interrupt:

The **VECT INTR** key is similar to the **GO** key in the respect that it takes control away from the monitor and gives it to another program. The interrupt key causes immediate recognition of RST 7.5 interrupt and control passes to location 3C in the monitor. This location contains an unconditional branch to instruction location 20CE in user RAM. You may place any instruction you wish in Locations 20CE thru 20D0 (e.g., a branch to a keyboard interrupt routine). The monitor does not regain control without specific action (a **RESET** command, or a RST 0, RST 1, or JMP 0 program instruction). In branching back to the monitor, unless the RST 1 instruction is executed, the monitor loses all past information about the user program.

Since an interrupt is recognized by the hardware, the monitor cannot clear the display; thus the display may remain unchanged after interrupt.

IMPORTANT: Two conditions must be satisfied for the Vector Interrupt feature to be enabled:

1. Interrupts must be enabled (by executing an EI instruction).
2. RST 7.5 must be unmasked (mask reset by the SIM instruction or by modifying the I-Register).

Program Debugging – The Use of Breakpoints

Along with the “cold start” reset caused when the **RESET** button is pressed, the monitor also implements a “warm start” procedure. Execution of an RST 1 instruction will cause the monitor to enter this “warm start” routine. The monitor will display the same message as a **RESET** (‘-80 85’), but all registers and user memory will be preserved in the state they were in at the time of execution of the RST 1. No system reset or initialization will be performed.

By placing RST 1 instructions at key RAM locations where you want to examine the CPU status, you can break from your program and then examine and set memory locations and registers, or single-step a portion of your program.

To resume execution of the user program, press **GO**. The PC value of the next instruction appears in the address field of the display. Then press **EXEC** to continue execution.

Error Conditions – Illegal Key

If a key is pressed which is illegal in its context (e.g., a command key is pressed when the monitor is expecting a number), the command is aborted and an error message is generated. This message takes the form “-Err”, displayed in the address field. The monitor is then ready to accept a command. The error message will be cleared when a command key is pressed. Therefore, you can cancel a command before you press **NEXT** or **EXEC** by pressing any illegal key instead.

Memory Substitution Errors

If the substitute memory command determines that the contents of a memory location were not changed correctly (i.e. location is in ROM or is nonexistent), the command is aborted and an error message is generated. This message also takes the form “-Err”, displayed in the address field. The monitor is then ready to accept a new command. The error message will be cleared when a command key is pressed.

4-3 TELETYPEWRITER OPERATION

Console Commands

This portion of the SDK-85 monitor communicates via a teletypewriter (console). Operation consists of dialogue between the operator and the monitor in the monitor’s command language. After you press the **RESET** button on the SDK-85 keypad, the monitor begins the dialogue by typing a sign-on message on the console (“MCS-85 Kit”) and then requests a command by typing a prompt character (“.”). Commands are in the form of a single alphabetic character specifying the command, followed by a list of numeric or alphabetic parameters. Numeric parameters are entered as hexadecimal numbers. The monitor recognizes the characters 0 through 9 and A through F as legal hexadecimal digits. Longer numbers may be entered, but only the last four digits will be retained.

The only command requiring an alphabetic parameter is the "X" command. The nature of such parameters will be discussed in the section explaining the command.

Use of the Monitor for Programming and Checkout

The monitor allows you to enter, check out, and execute small programs. It contains facilities for memory display and modification, 8085 CPU register display and modification, program loading from the console device, and program initiation with a breakpoint facility. In addition, the  key on the keyboard may be used to initiate your own keyboard interrupt routine.

Command Structure

In the following paragraphs, the monitor command language is discussed. Each command is described, and examples of its use are included for clarity. Error conditions that may be encountered while operating the monitor are described on page 4-13.

The monitor requires each command to be terminated by a carriage return. With the exception of the "S" and "X" commands, the command is not acted upon until the carriage return is sensed. Therefore, you may abort any command, before entering the carriage return, by typing any illegal character (such as RUBOUT).

Except where indicated otherwise, a single space is synonymous with the comma for use as a delimiter. Consecutive spaces or commas, or a space or comma immediately following the command letter, are illegal in all commands except the "X" command (see below).

Items enclosed in parentheses "()" are optional.

Display Memory Command, D:

D <low address>, <high address>

Selected areas of addressable memory may be accessed and displayed by the D command. The D command produces a formatted listing of the memory contents between <low address> and <high address>, inclusive, on the console. Each line of the listing begins with the address of the first memory location displayed on that line, represented as 4 hexadecimal digits, followed by up to 16 memory locations, each one represented by 2 hexadecimal digits.

Program Execute Command, G:

G (<entry point>)

Control of the CPU is transferred from the monitor to the user program by means of the program execute command G. The entry point should be an address in RAM which contains an instruction in the program. If no entry point is specified, the monitor uses, as an address, the value on top of the stack when the monitor was entered.

G COMMAND EXAMPLE

G2000

Control is passed to location 2000.

D COMMAND EXAMPLE

D9, 26

0009	EF	20	E1	22	F2	20	F5									
0010	E1	22	ED	20	21	00	00	39	22	F4	20	21	ED	20	F9	C5
0020	D5	C3	3F	00	C3	57	01									

Insert Instructions into RAM, I:

```
I <address>  
  <data>
```

Single instructions, or an entire user program, are entered into RAM with the I command. After sensing the carriage return terminating the command line, the monitor waits for the user to enter a string of hexadecimal digits (0 to 9, A to F). Each digit in the string is converted into its binary value, and then loaded into memory, beginning at the starting address specified and continuing into sequential memory locations. Two hexadecimal digits are loaded into each byte of memory.

Separators between digits (spaces, commas, carriage returns) are ignored; illegal characters, however, will terminate the command with an error message (see page 4-13). The character ESC or ALT-MODE (which is echoed to the console as "\$") terminates the digit string.

I COMMAND EXAMPLE 1

```
I2010
```

```
112233445566778899$
```

This command puts the following pattern into RAM:

```
2010 11 22 33 44 55 66 77 88 99
```

I COMMAND EXAMPLE 2

```
I2040
```

```
123456789$
```

This command puts the following pattern into RAM:

```
2040 12 34 56 78 90
```

Note that since an odd number of hexadecimal digits was entered initially, a zero was appended to the digit string.

Move Memory Command, M:

```
M <low address>, <high address>, <destination>
```

The M command moves the contents of memory between <low address> and <high address> inclusive, to the area of RAM beginning at <destination>. The contents of the source field remain undisturbed, unless the receiving field overlaps the source field.

The move operation is performed on a byte-by-byte basis, beginning at <low address>. Care should be taken if <destination> is between <low address> and <high address>. For example, if location 2010 contains 1A, the command M2010, 201F 2011 will result in locations 2010 to 2020 containing "1A1A1A . . .", and the original contents of memory will be lost.

The monitor will continue to move data until the source field is exhausted, or until it reaches address FFFF. If the monitor reaches FFFF without exhausting the source field, it will move data into this location, then stop.

M COMMAND EXAMPLE

```
M2010, 204F, 2050
```

64 bytes of memory are moved from 2010-204F to 2050-208F by this command.

Substitute Memory Command, S:

S <address> (<data>)

The S command allows you to examine and optionally modify memory locations individually. The command functions as follows:

1. Type an S, followed by the hexadecimal address of the first memory location you wish to examine, followed by a space or comma.
2. The contents of the location are displayed, followed by a dash (-).
3. To modify the contents of the location displayed, type in the new data, followed by a space, comma, or carriage return. If you do not wish to modify the location, type only the space, comma, or carriage return. The next higher memory location will automatically be displayed as in step (2).
4. Type a carriage return. The S command will be terminated.

S COMMAND EXAMPLE

S2050 AA- BB-CC 01-13 23-24

Location 2050, which contains AA, is unchanged, but location 2051 (which used to contain BB) now contains CC, 2052 (which used to contain 01) now contains 13, and 2053 (which used to contain 23) now contains 24.

Examine/Modify CPU Registers Command, X:

X (<register identifier>)

Display and modification of the CPU registers is accomplished via the X command. The X command uses <register identifier> to select the particular register to be displayed. A register identifier is a single alphabetic character denoting a register, as defined in Table 4-3.

TABLE 4-3
X COMMAND REGISTER IDENTIFIERS

IDENTIFIER CODE	REGISTER
A	Register A
B	Register B
C	Register C
D	Register D
E	Register E
F	Flags byte
I	Interrupt Mask
H	Register H
L	Register L
M	Registers H and L combined
S	Stack Pointer
P	Program Counter

The command operates as follows:

1. Type an X, followed by a register identifier or a carriage return.
2. The contents of the register are displayed (two hexadecimal digits for A, B, C, D, E, F, I, H, and L, four hexadecimal digits for M, S, & P), followed by a dash (-).
3. The register may be modified at this time by typing the new value, followed by a space, comma, or carriage return. If no modification is desired, type only the space, comma, or carriage return.
4. If a space or comma is typed in step (3), the next register in sequence will be displayed as in step 2 (unless P was just displayed which case the command is terminated). If a carriage return is entered in step 3, the X command is terminated.

- If a carriage return is typed in step (1) above, an annotated list of all registers and their contents is displayed.

Note: The bits in the flag byte (F) and interrupt mask (I) are encoded as follows:

The format for the F register:

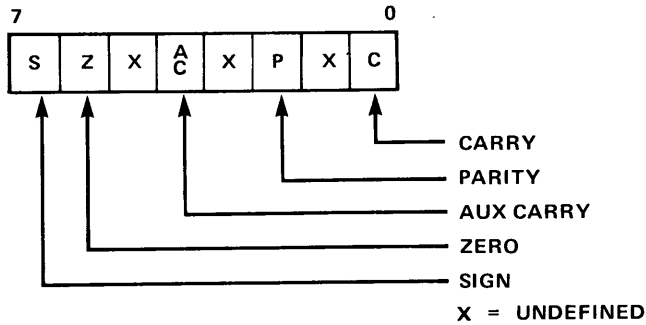

The format for the I register:

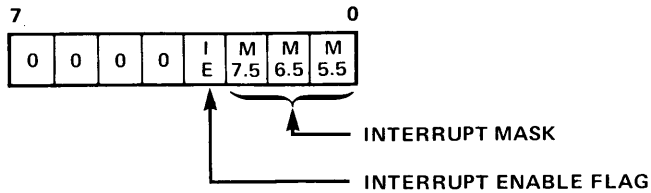

Note: For more information on the 8085's interrupt masks, please consult the **MCS-85 User's Manual**.

Program Debugging – Breakpoint Facility

The monitor treats the RST 1 instruction (CF) as a special sequence initiator. Upon execution of an RST 1 instruction the monitor will automatically save the complete CPU status and output the sign-on message "MCS-85 Kit" to the console. You may at that time display the contents of the CPU status register by initiating an "X" command. After examining the machine status and making any necessary changes you can resume execution of the program by inputting "G" and Carriage Return on the console. You can step through large portions of your program by inserting RST 1 instructions at key locations.

Error Conditions – Invalid Characters

Each character is checked as it is entered from the console. As soon as the monitor determines that the last character entered is illegal in its context, it aborts the command and issues an "*" to indicate the error.

INVALID CHARACTER EXAMPLE

D2000, 205G*

The character G was encountered in a parameter list where only hexadecimal digits and delimiters are valid.

Address Value Errors

Some commands require an address pair of the form <low address>, <high address>. If, on these commands, the value of <low address> is greater than or equal to the value of <high address>, the action indicated by the command will be performed on the data at low address only. Addresses are evaluated modulo 2^{16} . Thus, if a hexadecimal address greater than FFFF is entered, only the last 4 hex digits will be used. Another type of address error may occur when you specify a part of memory in a command which does not exist in the hardware configuration you are using.

In general, if a nonexistent portion of memory is specified as the source field for an instruction, the data fetched will be unpredictable. If a nonexistent portion of memory is given as the destination field in a command, the command has no effect.

CHAPTER 5 THE HARDWARE

5-1 OVERVIEW

This portion of the SDK-85 User's Manual should provide you with sufficient knowledge to write programs to exercise the basic system as well as providing capability to use the basic kit as a nucleus around which you can build larger systems.

Figure 5-1 is a functional block diagram of the SDK-85. The components enclosed in dashed boxes have places in the SDK-85 printed circuit board, but these are not needed for a minimum system and are not included in the kit. In addition, some control lines have been omitted from the block diagram for the sake of simplicity. The full SDK-85 schematic diagrams have been included in an appendix for your reference.

The text to follow describes each of the elements in the system:

5-2 SYSTEM COMPONENTS

The 8085 CPU & The System Buses

The 8085 CPU is an evolutionary enhancement of Intel's industry standard 8080A. It is 100% software compatible with the 8080A while offering the benefits of single power supply, higher integration, higher performance, and improved system timing.

The 8085 CPU is fully described in the Intel® **MCS-85™ User's Manual** so a detailed description will not be repeated here.

As the system block diagram shows, the 8085 derives its timing inputs directly from a crystal. In addition the 8085 drives the system with control signals available on-chip. No additional status decoding circuitry is required for most small- to

medium-sized systems. The 8085 multiplexes its data bus with the low 8 bits of its address bus. The 8155 and 8355/8755 Memory I/O components in the kit are designed to be compatible with this bus structure, precluding the need for external bus latches.

Four vectored interrupt inputs are available in addition to the standard 8080A-type interrupt. There is also a serial input and serial output data line pair that is exercised under program control to provide the SDK-85's simple teletype I/O.

The basic clock frequency of the 8085 in the kit is 3.072 MHz (internally divided by 2 from the 6.144 MHz crystal input).

The 8155

The 8155 is a highly integrated chip designed for compatibility with the 8085's bus structure. It contains 256 bytes of static RAM memory, 22 programmable I/O lines, and a 14-bit timer/counter. The function of the 8155 is described in detail in the Intel **MCS-85 User's Manual**.

One 8155 is included with the SDK-85 kit and space for another has been provided on the circuit board. The RAM memory in the 8155 is available for storage of user programs as well as for temporary storage of information needed by system programs.

The 8155's timer is used by the SDK-85 monitor's Single Step routine to interrupt the processor following the execution of each instruction.

The 8355 & 8755

The 8355 and 8755 are two more chips specially designed for compatibility with 8085 systems. The 8355 contains 2048 bytes of mask programmed read only memory (ROM) and 16 I/O lines. The 8755 has an identical function and pinout to the 8355, but contains ultraviolet erasable and reprogrammable read only memory (EPROM) instead of the ROM.

The SDK-85 contains either one 8355 or one 8755 that is programmed with the system monitor. Space for a second 8755 or 8355 has been allocated on the PC board.

The 8279

The 8279 is a keyboard/display controller chip that handles the interface between the 8085 and the keypad and LED display on the SDK-85 board. The 8279 refreshes the display from an internal memory while scanning the keyboard to detect keyboard inputs. The 8279 is described in detail in the *MCS-85 User's Manual*.

The 8205

The basic SDK-85 also contains an 8205 chip (one-out-of-8 decoder) that decodes the 8085's memory address bits to provide chip enables for the 8155, the 8355/8755, and the 8279.

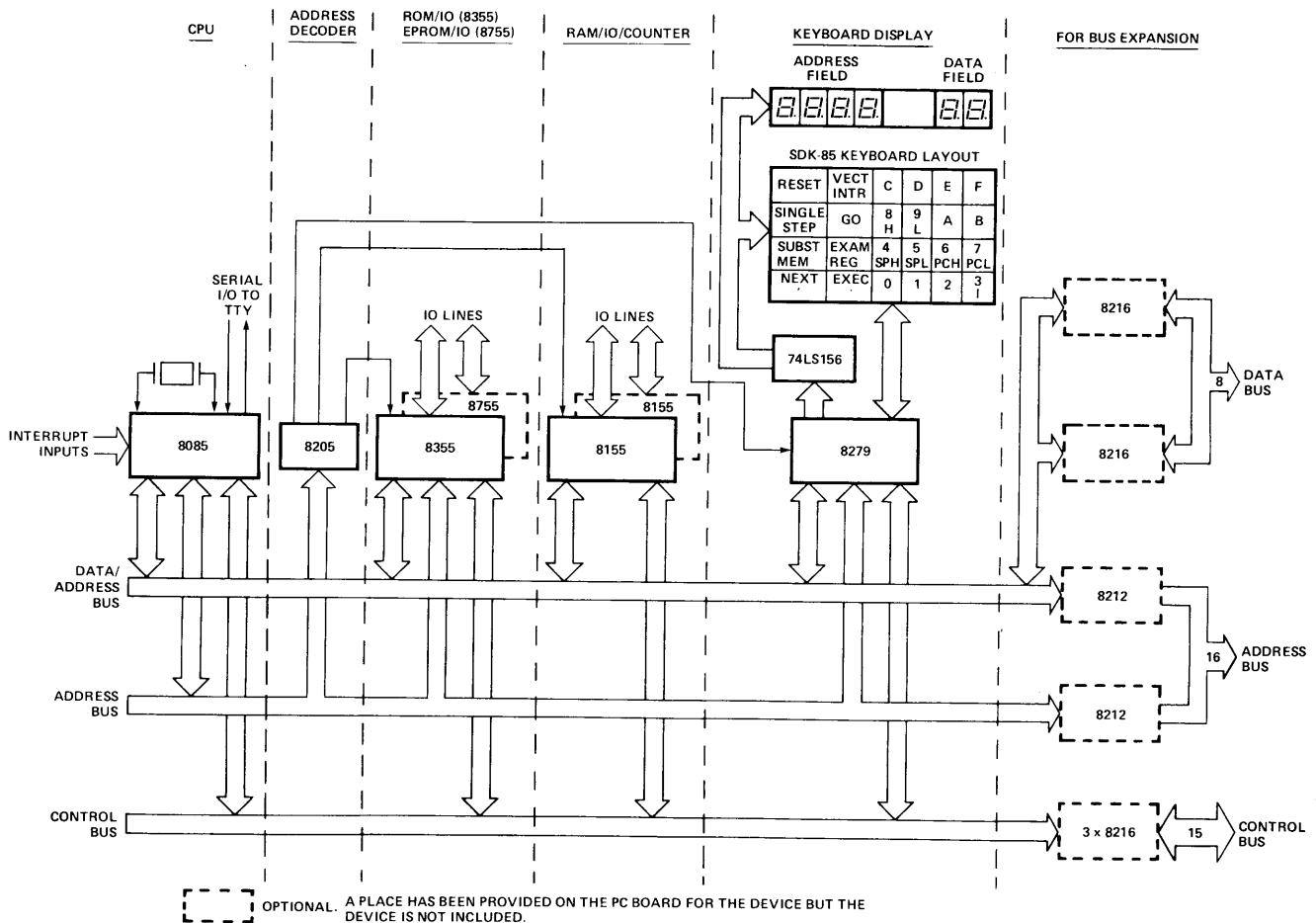

Figure 5-1 SDK-85 Functional Block Diagram

**TABLE 5-1
8205 CHIP ENABLES**

OUTPUT	ACTIVE ADDRESS RANGE	SELECTED DEVICE
CS0	0000-07FF	8755/8355 MONITOR ROM (A14)
CS1	0800-0FFF	8755/8355 EXPANSION ROM (A15)
CS2	1000-17FF	N/C
CS3	1800-1FFF	8279 KEYBOARD/DISPLAY CONTROLLER (A13)
CS4	2000-27FF	8155 BASIC RAM (A16)
CS5	2800-2FFF	8155 EXPANSION RAM (A17)
CS6	3000-37FF	N/C
CS7	3800-3FFF	N/C

AXX = IC# on schematic diagram in Appendix
N/C = not connected – available for user expansion

5-3 SDK-85 MEMORY ADDRESSING

Each memory/I/O chip in the basic SDK-85 System of Figure 5-1 is enabled by a signal coming from the 8205 address decoder. Table 5-1 lists each chip enable output accompanied by the address space over which it is active and the SDK-85 device that is selected.

Note that the 8279 is really an input/output device that is communicated with by the 8085 as though it were a series of memory locations.

The above chip enable table can be expanded to form a memory map that illustrates the active portions of the SDK memory (see Figure 5-2). Using the terminology of Figure 5-2, the basic SDK-85 with no additional memory/I/O chips provides the memory blocks marked MONITOR ROM and BASIC RAM. You must confine your programs to a subset of the space available in the BASIC RAM, the remainder of BASIC RAM being required for monitor storage locations. A list of the monitor-reserved RAM locations is provided in Table 5-2.

Note that RAM memory locations 20C2 through 20D0 are places for jump instructions pointing to the places in memory for the computer to go following the execution of an RST 5 instruction, an RST 6 instruction, an interrupt signal on the RST 6.5 input, etc. If you do not use any of these instructions or interrupt lines, then this RAM area is available for other programming.

When you add an expansion 8155 in the space provided on the SDK-85 board, the RAM locations shown in Figure 5-2 as EXPANSION RAM are made available for programming. The monitor reserves no space in the EXPANSION RAM, so all 256 locations are available for programming.

An extra 8355 or 8755 device when plugged into the appropriate spot on the board gives you program memory space in the area denoted EXPANSION ROM in the memory map.

The areas marked "FOLD BACK" in Figure 5-2 indicate address space that is unused, but unavailable for expansion, because these locations are multiple mappings of the basic locations.

**TABLE 5-2
MONITOR-RESERVED RAM LOCATIONS**

LOC.	CONTENTS
20C2	User may place a JMP instr. to a RST 5 routine in locs 20C2 – 20C4.
20C5	JMP to RST 6 routine
20C8	JMP to RST 6.5 routine (hardwired user interrupt)
20CB	JMP to RST 7 routine
20CE	JMP to "VECT INTR" key routine
20D1-20E8	Monitor Stack (temporary storage used by monitor)
20E9	E Register
20EA	D Register
20EB	C Register
20EC	B Register
20ED	Flags
20EE	A Register
20EF	L Register
20F0	H Register
20F1	Interrupt Mask
20F2	Prog. Cntr. – Low byte
20F3	Prog. Cntr. – HI byte
20F4	Stack Ptr. – Low byte
20F5	Stack Ptr. – Hi byte
20F6	Current Address
20F8	Current Data
20F9-20FC	Output buffer & Temp Locs.
20FD	Register Pointer
20FE	Input Buffer
20FF	8155 Command/Status Register image

} Loaded
by
user

} storage for user register images

MEMORY ADDRESS

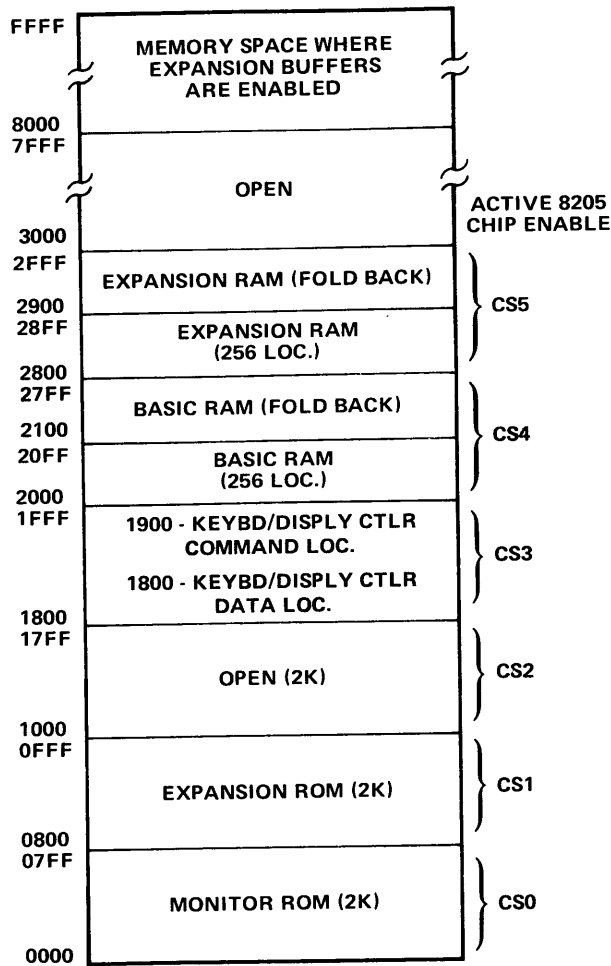

Figure 5-2 SDK-85 Memory Map

Any of the areas marked "OPEN" in Figure 5-2 are free for expansion. You may mount extra memory chips in the wire-wrap area of the SDK-85 board or on other circuit boards. The 8205 address decoder has 3 uncommitted chip select lines to allow the addition of three 2048-byte memory blocks without additional decoding circuitry.

If you want to expand on the basic SDK-85 you don't have to stick to the multiplexed-bus MCS 85 memory/I/O family. Mounting pads are present on the circuit board that accommodate an 8212 latch for address/data bus demultiplexing. To provide the current drive capability to operate much larger systems, spaces are also allocated for another 8212 to buffer the unmultiplexed half of the address and five 8216 buffer/drivers to buffer the data bus, and control signals. The function of these components is described in detail in the 8085 manual. The functional positioning of the optional latch, buffers,

and drivers in the SDK-85 system structure is shown in Figure 5-1.

IMPORTANT:

As Figure 5-2 indicates, the optional expansion buffers leading to the SDK-85 board's prototyping area are enabled only over the address range 8000-FFFF. If you desire to use any of the "OPEN" expansion areas shown in Figure 5-2 (enabled by the 8205 chip selects), you will have to become familiar with the SDK-85 schematics at the back of this manual and implement custom modifications to the SDK-85 circuitry.

5-4 INPUT/OUTPUT PORT AND PERIPHERAL DEVICE ADDRESSING

As mentioned before, the 8155 and 8355/8755 that come with the SDK-85 Kit have on-board input/output ports. These ports are accessed using the IN and OUT instructions of the 8085. Each individual port being referenced has a unique 8-bit address. Table 5-3 contains all the port addresses for an expanded SDK-85 containing two 8155's and two 8355/8755's.

Please consult the **MCS-85 User's Manual** for the use of the various special purpose registers referred to in the table (Direction Registers, Command/Status Registers, etc.), and for complete instructions for exercising the memory-I/O chips (8155/8355/8755).

Hardware Note: The timer/counter of the first 8155 (RAM) is dedicated as a timer. It is hardwired to receive the 8085's system clock (3.072 MHz CLK) as its count input. This timer is used by the keyboard monitor's SINGLE STEP function, so you should beware of timer conflicts if you desire to count and use the SINGLE STEP function at the same time. (See paragraph 6-2.)

Accessing the 8279 Keyboard/Display Controller

As was mentioned in the memory addressing sections, the 8279 is a peripheral chip that is selected using memory-mapped I/O. Table 5-4 shows the two memory locations that are used to communicate with the 8279. Consult the **MCS-85 User's Manual** for detailed operating instructions.

**TABLE 5-3
SDK-85 I/O PORT MAP**

PORT	FUNCTION
00	Monitor ROM PORT A
01	Monitor ROM PORT B
02	Monitor ROM PORT A Data Direction Register
03	Monitor ROM PORT B Data Direction Register
08	Expansion ROM PORT A
09	Expansion ROM PORT B
0A	Expansion ROM PORT A Data Direction Register
0B	Expansion ROM PORT B Data Direction Register
20	BASIC RAM COMMAND/STATUS Register
21	BASIC RAM PORT A
22	BASIC RAM PORT B
23	BASIC RAM PORT C
24	BASIC RAM Low Order Byte of Timer Count
25	BASIC RAM High Order Byte of Timer Count
28	EXPANSION RAM COMMAND/STATUS Register
29	EXPANSION RAM PORT A
2A	EXPANSION RAM PORT B
2B	EXPANSION RAM PORT C
2C	EXPANSION RAM Low Order Byte of Timer Count
2D	EXPANSION RAM High Order Byte of Timer Count

The data format for character bytes being displayed by the 8279 is one bit corresponding to each of the seven LED segments plus one bit for the decimal point. Figure 5-3 shows the bit configuration.

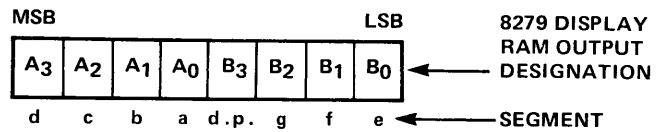
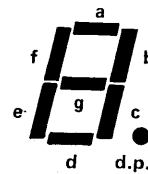

Figure 5-3 Data Format

The hardware is designed so that writing a zero into a bit position turns on the corresponding LED segment.

Example: a "4" would be represented as
1001 1001 = 99 (Hex)

These are six active LED displays available for use. They are configured in a four-place address field and a two-place data field as in Figure 5-4.

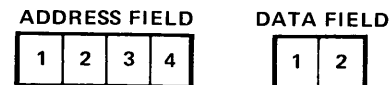

Figure 5-4 Display Configuration

**TABLE 5-4
ACCESSING THE 8279
KEYBOARD DISPLAY CONTROLLER**

LOCATION	READ/ WRITE	FUNCTION
1800	Read	Read Keyboard FIFO
	Write	Write Data to Display
1900	Read	Read Status Word
	Write	Write Command Word

The display digits are stored within the 8279 display RAM in the locations listed in Table 5-5.

TABLE 5-5

8279 DISPLAY RAM LOCATION	PURPOSE
0	Address digit 1
1	2
2	3
3	4
4	Data Digit 1
5	2
6	UNUSED
7	UNUSED

5-5 PROCESSOR INTERRUPT ALLOCATION

The 8085 has four Vector Interrupt input pins in addition to an 8080A-compatible interrupt input. The name of each interrupt and its function in the SDK-85 hardware is listed in Table 5-6.

The function of the on-chip interrupts is described in detail in the 8085 Manual.

**TABLE 5-6
8085 ON-CHIP INTERRUPT ALLOCATION**

INPUT	FUNCTION
RST 5.5	Dedicated to 8279
RST 6.5	Available User Interrupt
RST 7.5	 button interrupt
TRAP	8155 Timer Interrupt
INTR	Available User Interrupt

5-6 THE SERIAL DATA INTERFACE

The SDK-85 has the capability of communicating with a teletype, using the 8085 serial input and serial output data lines (SID and SOD respectively) to send and receive the serial bit strings that encode data characters.

To send data to the teletype, the 8085 must toggle the SOD line in a set/reset fashion controlled by software timing routines in the SDK-85 monitor.

Input data is obtained by monitoring and timing changes in the level of the SID pin. Again, a monitor routine is called upon to do the job.

These teletype communications routines are accessible to the user.

Both subroutines communicate at a data rate of 110 baud, the standard rate for teletypewriters.

Since the 8085 serial input and output lines are designed for communicating with other integrated circuits, additional electronic circuitry is needed before they can be connected to a terminal. The TTY interface in the top right corner of the board allows the SDK-85 to be connected to any teletype that uses 20 mA "current-loop" input and output.

5-7 CONVERTER CIRCUIT FOR RS232C SERIAL PORT

If you are fortunate enough to have a CRT terminal that can operate at a 110-baud rate, and wish to use it with the SDK-85 computer, you may find that it is compatible only with "RS232c" voltage-level serial ports and not with current loops. If this is the case,

- Wire the MC1488 and MC1489 converter circuit (shown in Figure 5-5) into the wire-wrap area of the SDK-85 board.
- Remove R6, and connect the input line of the converter circuit to its lower pad. (You could put a switch in this line if you wanted to.)
- Open both the TTY and KEYBOARD jumpers, and connect the output line of the converter to the middle pad, which is strapping

point 23. (If you are using a switch, one with a center off position could be used.)

- Connect your CRT as shown in Figure 5-5.
- Connect the 3 different voltages to the circuit.

5-8 ADDITIONAL INTERFACES

Additional interface considerations are discussed in Intel Application Note AP-29, which also describes a low-cost cassette tape-recorder interface, that can be added to your SDK-85 kit. AP-29 can be ordered by sending \$1.00 to: Literature Department, Intel Corp., 3065 Bowers Ave., Santa Clara, Ca. 95051.

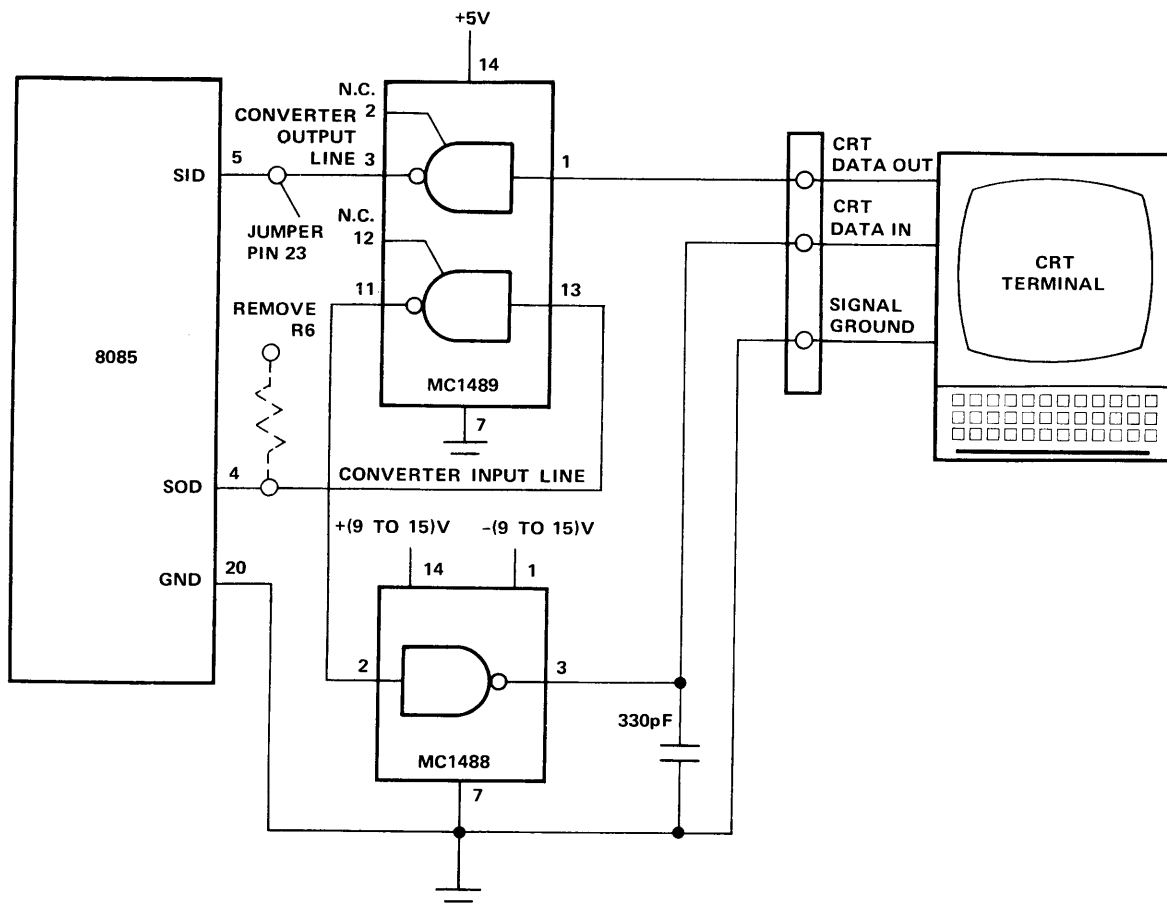

Figure 5-5 Modification for RS-232c Operation

CHAPTER 6 THE SOFTWARE

6-1 THE SDK-85 MONITOR

The SDK-85 monitor program provides utility functions employing either a teletypewriter or the kit's on-board keyboard and display as console. The program resides in 2k (k = 1024) bytes of the ROM memory, between location 0 and location 7FF. The routines that service each console device are independent; the two devices do not function simultaneously. You may select either the keyboard and display or the teletypewriter as the console device by actuating a switch (not furnished) or by changing strapping connections. Both can be used to perform substantially the same tasks. (See Chapter 4.)

6-2 PROGRAMMING HINTS

Stack Pointer

The 8085 makes use of a 16-bit internal register called the Stack Pointer to point to an area of memory called the stack. The 8085's stack is used for saving many things, such as memory addresses for returns from subroutines.

It is important always to define the stack pointer at the beginning of your program to avoid storing data in the wrong place. Locations 20C2 through 20D0 in RAM are reserved by the monitor for jump instructions when all interrupts are used. Thus, you should set the stack pointer initially at 20C2 (by the use of the program instruction LXI SP, 20C2H (31 C2 20), the keyboard command

EXAM
REG

4
SPH

 (20)

NEXT
C2

EXEC

, or the teletypewriter "XS" command) in order to keep your own stack clear of data and programs you want to protect. If less than the full complement of interrupts is

utilized, some or all of the unused space above 20C2 can be allocated to stack as described above. Remember that the stack must still occupy an unbroken string of contiguous memory locations.

RAM-I/O Command Status Register (CSR)

The basic 8155 command status register (port 20) is used to set up the on-chip I/O ports and timer. It can only be written to; it cannot be read. You can write to this register in your programs, but there is a precaution you should take: at any time when you write to the CSR in the basic RAM, you should also write the same pattern to RAM location 20FF. The reason is this: The

SINGLE
STEP

 command causes the monitor to change the CSR in order to set up the timer for execution of the command. If it is not told what value you previously put there (by saving the value in 20FF), that value will inevitably be overwritten and lost. Following each single step, the monitor reads location 20FF, logically ORs its timer command to the content of that location, and writes the CSR with the new command, thereby retrieving your previous configuration.

Access to Monitor Routines

You may "borrow" several of the SDK-85 monitor routines to simplify your programming task. Table 6-1 provides descriptions and calling addresses for these routines.

6-3 PROGRAMMING EXAMPLES

The programming examples presented at the end of this chapter demonstrate how to use the monitor routines to operate the keyboard and display.

TABLE 6-1
MONITOR ROUTINE CALLING ADDRESSES

Calling Address	Mnemonic	Description
07FD	CI	<p>Console Input</p> <p>This routine returns a character (in ASCII code — see 8085/8080 reference card for codes) received from the teletype to the caller in the A register. The A register and CPU condition codes are affected by this operation</p>
07FA	CO	<p>Console Output</p> <p>This routine transmits a character (in ASCII code), passed from the caller in the C register, to the teletypewriter. The A and C registers, and the CPU condition codes are affected.</p>
05EB	CROUT	<p>Carriage Return, Line Feed</p> <p>CROUT sends carriage return and line feed characters to the teletype. The contents of the A, B, and C registers are destroyed and the CPU condition codes are affected.</p>
06C7	NMOUT	<p>Hex Number Printer</p> <p>NMOUT converts the 8-bit unsigned integer in the A register into 2 ASCII characters representing the 2 hex digits and prints the two digits on the teletypewriter. The contents of the A, B and C registers and the condition code flags are affected.</p>
0363	UPDAD	<p>Update Address</p> <p>Update address field of the display. The contents of the D-E register pair are displayed in the address field of the display. The contents of all the CPU registers and flags are affected.</p>
036E	UPDDT	<p>Update Data</p> <p>Update data field of the display. The contents of the A register are displayed in hex notation in the data field of the display. The contents of all of the CPU registers and flags are affected.</p>
02E7	RDKBD	<p>Read Keyboard</p> <p>This routine waits until a character is entered on the hex keypad and upon return places the value of the character in the A register. The A, H, and L registers and the flag flip flops are affected.</p> <p>NOTE: For RDKBD to work correctly, you must first:</p> <ol style="list-style-type: none"> 1. Unmask RST 5.5 using the SIM instruction.
05F1	DELAY	<p>Time Delay</p> <p>This routine takes the 16-bit contents of register pair DE and counts down to zero, then returns to the calling program. The A, D, and E registers and the flags are affected.</p>

TABLE 6-1
MONITOR ROUTINE CALLING ADDRESSES (CONT'D)

Calling Address	Mnemonic	Description																																																
02B7	OUTPT	<p>Output Characters to Display</p> <p>The routine sends characters to the display with the parameters set up by registers A, B, H and L.</p> <p>Reg A = 0 = use address field = 1 = use data field</p> <p>Reg B = 0 = decimal point off = 1 = decimal point at right edge of field</p> <p>Reg HL = starting address of characters to to sent.</p>																																																
		<table style="width: 100%; border-collapse: collapse;"> <thead> <tr> <th style="text-align: center;">Character Displayed</th> <th style="text-align: center;">Hexadecimal memory content pointed to by the HL register</th> </tr> </thead> <tbody> <tr><td style="text-align: center;">0</td><td style="text-align: center;">00</td></tr> <tr><td style="text-align: center;">1</td><td style="text-align: center;">01</td></tr> <tr><td style="text-align: center;">2</td><td style="text-align: center;">02</td></tr> <tr><td style="text-align: center;">3</td><td style="text-align: center;">03</td></tr> <tr><td style="text-align: center;">4</td><td style="text-align: center;">04</td></tr> <tr><td style="text-align: center;">5</td><td style="text-align: center;">05</td></tr> <tr><td style="text-align: center;">6</td><td style="text-align: center;">06</td></tr> <tr><td style="text-align: center;">7</td><td style="text-align: center;">07</td></tr> <tr><td style="text-align: center;">8</td><td style="text-align: center;">08</td></tr> <tr><td style="text-align: center;">9</td><td style="text-align: center;">09</td></tr> <tr><td style="text-align: center;">A</td><td style="text-align: center;">0A</td></tr> <tr><td style="text-align: center;">b</td><td style="text-align: center;">0B</td></tr> <tr><td style="text-align: center;">C</td><td style="text-align: center;">0C</td></tr> <tr><td style="text-align: center;">d</td><td style="text-align: center;">0D</td></tr> <tr><td style="text-align: center;">E</td><td style="text-align: center;">0E</td></tr> <tr><td style="text-align: center;">F</td><td style="text-align: center;">0F</td></tr> <tr><td style="text-align: center;">H</td><td style="text-align: center;">10</td></tr> <tr><td style="text-align: center;">L</td><td style="text-align: center;">11</td></tr> <tr><td style="text-align: center;">P</td><td style="text-align: center;">12</td></tr> <tr><td style="text-align: center;">I</td><td style="text-align: center;">13</td></tr> <tr><td style="text-align: center;">r</td><td style="text-align: center;">14</td></tr> <tr><td style="text-align: center;">S</td><td style="text-align: center;">05</td></tr> <tr><td style="text-align: center;">Blank</td><td style="text-align: center;">15</td></tr> </tbody> </table>	Character Displayed	Hexadecimal memory content pointed to by the HL register	0	00	1	01	2	02	3	03	4	04	5	05	6	06	7	07	8	08	9	09	A	0A	b	0B	C	0C	d	0D	E	0E	F	0F	H	10	L	11	P	12	I	13	r	14	S	05	Blank	15
Character Displayed	Hexadecimal memory content pointed to by the HL register																																																	
0	00																																																	
1	01																																																	
2	02																																																	
3	03																																																	
4	04																																																	
5	05																																																	
6	06																																																	
7	07																																																	
8	08																																																	
9	09																																																	
A	0A																																																	
b	0B																																																	
C	0C																																																	
d	0D																																																	
E	0E																																																	
F	0F																																																	
H	10																																																	
L	11																																																	
P	12																																																	
I	13																																																	
r	14																																																	
S	05																																																	
Blank	15																																																	

PROGRAM EXAMPLE – RDKBD

After executing 2000, the program waits until a key is pressed. Then the value of the key is placed in the A register and the monitor is restarted. Use to see that the key value is now in the A register.

ADDRESS	DATA	SYMBOLIC	COMMENTS
2000	31	LXI SP, 20C2H	; define stack pointer
2001	C2		
2002	20		
2003	3E	MVI A, 08H	
2004	08		
2005	30	SIM	; unmask interrupt
2006	CD	CALL RDKBD	; read keyboard value
2007	E7		; into Reg A
2008	02		
2009	CF	RST 1	; break point, go back to monitor

PROGRAM EXAMPLE – UPDDT

Display FF in data field of display.

ADDRESS	DATA	SYMBOLIC	COMMENTS
2000	31	LXI SP, 20C2H	; define stack pointer
2001	C2		
2002	20		
2003	3E	MVI A, FFH	; load FF into Reg A
2004	FF		
2005	CD	CALL UPDDT	; output Reg A to data field
2006	6E		
2007	03		
2008	76	HLT	; HALT

To change the display value use to vary the content of location 2004

PROGRAM EXAMPLE – RDKBD, UPDDT

Putting the two preceding examples together into one program causes the display to show the key value.

ADDRESS	DATA	SYMBOLIC	COMMENTS
2000	31C220	LXI SP, 20C2H	; define stack pointer
2003	3E08	MVI A, 08H	
2005	30	SIM	; unmask interrupt
2006	CDE702	LOOP: CALL RDKBD	; read keyboard value into Reg A
2009	CD6E03	CALL UPDDT	; output Reg A to data field
200C	C30620	JMP LOOP	; keep looping

PROGRAM EXAMPLE – ADD TWO NUMBERS IN HEX NOTATION

This program is an adaptation of the program above. The computer reads in two one-digit numbers using RDKBD. Then it adds them, and displays the sum (base 16) on the LED display using UPDDT.

ADDRESS	DATA	SYMBOLIC	COMMENTS
2000	31C220	LXI SP, 20C2H	; initialize stack pointer
2003	3E08	MVI A, 08H	
2005	30	SIM	; unmask interrupts
2006	CDE702	LOOP: CALL RDKBD	; get first number
2009	47	MOV B,A	; save number in B reg.
200A	CDE702	CALL RDKBD	; get second number
200D	80	ADD B	; add the two numbers
200E	CD6E03	CALL UPDDT	; display the sum
2011	C30620	JMP LOOP	; keep looping

Note: for decimal (base10) addition of digits 0-9, insert the DAA instruction (opcode 27) between ADD B and CALL UPDDT in the above program.



Additional Suggestion: Try modifying this program to perform 2-digit decimal number addition. (Hint: use the 8085's RLC instruction.)

PROGRAM EXAMPLE – 4-DIGIT HEX COUNTER



This program displays a 4-digit hexadecimal (base 16) count in the address field of the display using the UPDAD routine from the monitor.

ADDRESS	DATA	SYMBOLIC	COMMENTS
2000	31C220	LXI SP 20C2	; initialize stack pointer
2003	13	LOOP: INX D	; add 1 to the 16-bit count
2004	D5	PUSH D	; save the count in the stack
2005	CD6303	CALL UPDAD	; display the count
2008	110018	LXID, 1800	; set delay count
200B	CDF105	CALL DELAY	; wait out the delay
200E	D1	POP D	; restore the count to D & E regs
200F	C30320	JMP LOOP	; keep counting

PROGRAM EXAMPLE – DECIMAL COUNTER

The following program displays a count in the data field of the display. The count may be stopped by pressing the  button. The count resumes when any other key (except ) is pressed. The "E" in the address field of the display signifies that a user program is executing.

ADDRESS	DATA	SYMBOLIC	COMMENTS
2000	31	LXI SP, 2080H	; INITIALIZE STACK POINTER.
2001	80		
2002	20		
2003	3E	MVI A, 08	; USE THE 8085's SIM INSTR TO
2004	08		; ENABLE THE VECT INTR BUTTON.
2005	30	SIM	
2006	FB	LOOP: EI	
2007	78	MOV A, B	
2008	3C	INR A	; INCREMENT AND ADJUST THE COUNT
2009	27	DAA	; FOR DECIMAL COUNTING.
200A	47	MOV B, A	
200B	C5	PUSH B	
200C	CD	CALL UPDDT	; DISPLAY COUNT IN DATA FIELD OF
200D	6E		; DISPLAY.
200E	03		
200F	16	MVI D, 18H	
2010	18		
2011	CD	CALL DELAY	; WAIT OUT A PROGRAMMABLE DELAY
2012	F1		; PERIOD BEFORE CONTINUING.
2013	05		
2014	C1	POP B	
2015	C3	JMP LOOP	; GO BACK TO THE BEGINNING.
2016	06		
2017	20		
—			
20CE	FB	EI	; CONTROL BRANCHES TO LOCATION
			; 20CE WHEN VECT INTR IS PRESSED.
20CF	76	HLT	; WAIT HERE FOR KEY DEPRESSION.
20D0	C9	RET	; RESUME THE COUNT.

To execute the program, type in  2000 .

Try to stop the count right at 00 using the  key.

Change the speed of the count by using  to vary the contents of location 2010.

Additional Suggestions:

This counter can be turned into a digital stopwatch second counter by *inserting* the following instructions between DAA and MOV B, A in the above program:

200A	FE60	CPI A, 60	; check to see if count = 60
200C	C21020	JNZ 2010	; continue if count ≠ 60.
200F	AF	XRA A	; if count = 60 then set the count = 0

In addition, you will have to insert another MVI D and CALL DELAY before POP B and vary both delay counts in order to get exactly one second between counts on the LED display.

Additional Programming Idea: Expand on the digital stopwatch program by displaying hours and minutes in the address field of the LED display.

PROGRAM EXAMPLE – FLASH HELP

Load into Locations 2000 through 2007 (use the Substitute Memory command) the following data: 10, OE, 11, 12, 15, 15, 15, 15. Then load and execute the following program (GO 2010 EXEC). The display will flash "HELP".

ADDRESS	DATA	SYMBOLIC	COMMENTS
2010	31C220	LXI SP, 20C2H	; define stack pointer
2013	3E01	MVI A, 1	; use data field
2015	0600	MVI B, 0	; no decimal indicator
2017	210620	LXI H, 2006H	; use characters starting ; at Location 2006
201A	CDB702	CALL OUTPT	; output the two characters ; to data field
		DPY:	
201D	3E00	MVI A, 0	; use address field
201F	0600	MVI B, 0	; no decimal indicator
2021	210020	LXI H, 2000H	; use characters starting ; at Location 2000
2024	CDB702	CALL OUTPT	; output the four characters ; to address field
		;	
2027	11FFFF	LXI D, 0FFFFH*	; set up delay value
202A	CDF105	CALL DELAY	; time delay
		;	
202D	3E00	MOV A, 0	;
202F	0600	MOV B, 0	;
2031	210420	LXI H, 2004H	; output BLANKS to
2034	CDB702	CALL OUTPT	; Display
		;	
2037	11FFFF	LXI D, 0FFFFH	;
203A	CDF105	CALL DELAY	; time Delay
203D	C31D20	JMP DPY	; REPEAT

*Delay time proportional to value. Any number from 1 through FFFF may be chosen.

Additional Suggestions:

You may select any other 4-letter word from the characters on p. 6-3 and place the hex codes for those letters in memory locations 2000-2003. Then restart the program from location 2010 and your new word will flash on the display.

In addition, you may place the hex codes from p. 6-3 for a 2-letter word (like "HI") in memory locations 2004 and 2005, and the 2-letter word will flash in between the flashes of the 4-letter word.

PROGRAM EXAMPLE – USING THE 8155 AND 8355 DEVICE OUTPUT PORTS

ADDRESS	DATA	SYMBOLIC	COMMENTS
2000	31C220	LXI SP, 20C2H	; initialize stack pointer
2003	3E03	MVI A, 03	; put 8155 command in A reg.
2005	D320	OUT 20H	; program the 8155 CSR
2007	3EFF	MVI A, FF	; put 8355 DDR value in A reg.
2009	D302	OUT 02	; program PORT A DDR
200B	D303	OUT 03	; program PORT B DDR
200D	03	LOOP: INXB	; increment 16-bit count
200E	79	MOV A, C	;
200F	D321	OUT 21	; send low byte of count
2011	D300	OUT 0	; to 8155 PORT A and ; to 8355 port A
2013	78	MOV A, B	;
2014	D322	OUT 22	; send hi byte of ; count to 8155 port B
2016	D301	OUT 01	; send hi byte of ; count to 8355 port B
2018	C30D20	JMP LOOP	; loop back.

This program is an example showing how to configure the input/output ports of the 8155 and 8355 devices as output ports. The command register of the 8155 is loaded with the value 03 at the beginning of the program to signify that both 8155 ports A and B will be outputs. Likewise, both ports A and B of the 8355 are programmed to be outputs by writing all one's (FF) to both Data Direction Registers in the 8355.

The program increments a 16-bit binary count and sends the count out through the ports of the 8155 and 8355. If you have a logic probe or oscilloscope, you can look at the corresponding outputs on connector pads J3 and J4 on the SDK-85 PC board.

APPENDIX A MONITOR LISTING

```

LOC  OBJ      SEQ      SOURCE STATEMENT
1 ;*****
2 ;
3 ;          PROGRAM: SDK-85 MONITOR   VER 2.1
4 ;
5 ;          COPYRIGHT (C) 1977
6 ;          INTEL CORPORATION
7 ;          3065 BOWERS AVENUE
8 ;          SANTA CLARA, CALIFORNIA  95051
9 ;*****
10 ;
11 ;
12 ; ABSTRACT
13 ; =====
14 ;
15 ; THIS PROGRAM IS A SMALL MONITOR FOR THE INTEL 8085 KIT AND
16 ; PROVIDES A MINIMUM LEVEL OF UTILITY FUNCTIONS FOR THE USER EMPLOYING
17 ; EITHER AN INTER-ACTIVE CONSOLE (I.E. TELETYPE) OR THE KIT'S
18 ; KEYBOARD/LED DISPLAY. THE KEYBOARD MONITOR ALLOWS THE USER TO PERFORM
19 ; SUCH FUNCTIONS AS MEMORY AND REGISTER MANIPULATION, PROGRAM LOADING,
20 ; PROGRAM EXECUTION, INTERRUPTION OF AN EXECUTING PROGRAM, AND
21 ; SYSTEM RESET.
22 ;
23 ; PROGRAM ORGANIZATION
24 ; =====
25 ;
26 ; THE PROGRAM IS ORGANIZED AS FOLLOWS :-
27 ;     1) COLD START ROUTINE (RESET)
28 ;     2) WARM START - REGISTER SAVE ROUTINE
29 ;     3) INTERRUPT VECTORS
30 ;     4) KEYBOARD MONITOR
31 ;     5) TTY MONITOR
32 ;     6) LAYOUT OF RAM USAGE
33 ;
34 ; THE KEYBOARD MONITOR BEGINS WITH THE COMMAND RECOGNIZER, FOLLOWED BY
35 ; THE COMMAND ROUTINE SECTION, UTILITY ROUTINE SECTION AND MONITOR
36 ; TABLES. THE COMMAND AND UTILITY ROUTINES ARE IN ALPHABETICAL ORDER
37 ; WITHIN THEIR RESPECTIVE SECTIONS.
38 ; THROUGHOUT THE KEYBOARD MONITOR, A COMMENT FIELD BEGINNING
39 ; WITH "ARG - " INDICATES A STATEMENT WHICH LOADS A VALUE INTO
40 ; A REGISTER AS AN ARGUMENT FOR A FUNCTION. WHEN THE DESIRED VALUE
41 ; LIST OF KEYBOARD MONITOR ROUTINES
42 ; ====
43 ;
44 ; CMMND
45 ; -----
46 ; EXAM
47 ; GOCMD
48 ; SSTEP
49 ; SUBST
50 ; -----
51 ; CLEAR
52 ; CLDIS
53 ; CLDST
54 ; DISPC
55 ; ERR
56 ; GTHEX
57 ; HXDSP
58 ; ININT
59 ; INSDG
60 ; NXTRG
61 ; OUTPT
62 ; RDKBD
63 ; RETF
64 ; RETT
65 ; RGLOC
66 ; RSTOR
67 ; SETRG
68 ; UPDAD
69 ; UPDDT
70 ;
71 ;          NAME      SDK85
72 ;
73 ;*****
74 ;
75 ;          SET CONDITIONAL ASSEMBLY FLAG
76 ;
77 ;*****
78 ;
79 ;
0000 80 WAITS  SET      0          ;0=NO WAIT STATES
81 ;          ;1=A WAIT STATE IS GENERATED FOR EVERY M CYCLE
82 ;          ;THE APPROPRIATE DELAY TIME MUST BE USED FOR
83 ;          ;TTY DELAY OR SET UP SINGLE
84 ;          ;STEP TIMER FOR EACH CASE
85 ;
86 ;
87 ;*****
88 ;
89 ;          MONITOR EQUATES
90 ;
91 ;*****
92 ;
2000 93 RAMST  EQU      2000H      ; START ADDRESS OF RAM - THIS PROGRAM ASSUMES
94 ; THAT 256 BYTES OF RANDOM ACCESS MEMORY BEGIN AT THIS ADDRESS.
95 ; THE PROGRAM USES STORAGE AT THE END OF THIS SPACE FOR VARIABLES,
96 ; SAVING REGISTERS AND THE PROGRAM STACK
97 ;

```

```

LOC  OBJ      SEQ      SOURCE STATEMENT
0017      98 RMUSE  EQU    23      ; RAM USAGE - CURRENTLY, 23 BYTES ARE USED FOR
          99      ; /SAVING REGISTERS AND VARIABLES
          100 ;
0018      101 SKLN  EQU    24      ; MONITOR STACK USAGE - MAX OF 12 LEVELS
          102 ;
000F      103 UBRLN EQU    15      ; 5 USER BRANCHES - 3 BYTES EACH
          104 ;
0000      105 ADPLD EQU    0       ; INDICATES USE OF ADDRESS FIELD OF DISPLAY
0090      106 ADISP EQU    90H     ; CONTROL CHARACTER TO INDICATE OUTPUT TO
          107 ; /ADDRESS FIELD OF DISPLAY
1900      108 CNTRL  EQU   1900H    ; ADDRESS FOR SENDING CONTROL CHARACTERS TO
          109 ; /DISPLAY CHIP
0011      110 COMMA  EQU    11H     ; COMMA FROM KEYBOARD
0000      111 CSNIT  EQU    0       ; INITIAL VALUE FOR COMMAND STATUS REGISTER
0020      112 CSR    EQU    20H     ; OUTPUT PORT FOR COMMAND STATUS REGISTER
0094      113 DDISP  EQU    94H     ; CONTROL CHARACTER TO INDICATE OUTPUT TO
          114 ; /DATA FIELD OF DISPLAY
0001      115 DOT    EQU    1       ; INDICATOR FOR DOT IN DISPLAY
1800      116 DSPLY  EQU   1800H    ; ADDRESS FOR SENDING CHARACTERS TO DISPLAY
0001      117 DTFLD  EQU    1       ; INDICATES USE OF DATA FIELD OF DISPLAY
0008      118 DTMSK  EQU    08H     ; MASK FOR TURNING ON DOT IN DISPLAY
0080      119 EMPTY  EQU    80H     ; HIGH ORDER 1 INDICATES EMPTY INPUT BUFFER
00CC      120 KBNIT  EQU    0CCH    ; CONTROL CHARACTER TO SET DISPLAY OUTPUT TO
          121 ; /ALL ONES DURING BLANKING PERIOD
0000      122 KMODE  EQU    0       ; CONTROL CHAR. TO SET KEYBOARD/DISPLAY MODE
          123 ; (2 KEY ROLLOVER, 8 CHARACTER LEFT ENTRY)
20E9      124 MNSTK  EQU   RAMST + 256 - RMUSE ; START OF MONITOR STACK
0000      125 NODOT  EQU    0       ; INDICATOR FOR NO DOT IN DISPLAY
          126 ; NUMC - DEFINED LATER ; NUMBER OF COMMANDS
          127 ; NUMRG - DEFINED LATER ; NUMBER OF REGISTER SAVE LOCATIONS
0010      128 PERIO  EQU    10H     ; PERIOD FROM KEYBOARD
00FB      129 PRMPT  EQU    0FBH    ; PROMPT CHARACTER FOR DISPLAY (DASH)
0040      130 READ   EQU    40H     ; CONTROL CHARACTER TO INDICATE INPUT FROM
          131 ; /KEYBOARD
0025      132 TIMHI  EQU    25H     ; OUTPUT PORT FOR HIGH ORDER BYTE OF TIMER VALUE
0024      133 TIMLO  EQU    24H     ; OUTPUT PORT FOR LOW ORDER BYTE OF TIMER VALUE
0040      134 TMODE  EQU    40H     ; TIMER MODE - SQUARE WAVE, AUTO RELOAD
00C0      135 TSTRT  EQU    0C0H    ; START TIMER
000E      136 UNMSK  EQU    0EH     ; UNMASK INPUT INTERRUPT
20C2      137 USRBR  EQU   RAMST + 256 - (RMUSE + SKLN + UBRLN) ; START OF USER
          138 ; /BRANCH LOCATIONS
          139 IF 1-WAITS ;TIMER VALUE FOR SINGLE STEP IF NO WAIT STATE
00C5      140 TIMER  EQU    197     ; /BRANCH LOCATIONS
          141 ENDF
          142 IF WAITS ;TIMER VALUE FOR SINGLE STEP IF ONE WAIT STATE INSERTED
          143 TIMER  EQU    237
          144 ENDF
          145 ;
          146 ;*****
          147 ;
          148 ;
          149 ;
          150 ;*****
          151 ;
          152 TRUE  MACRO  WHERE ; BRANCH IF FUNCTION RETURNS TRUE
          153 JC   WHERE
          154 ENDM
          155 ;
          156 FALSE MACRO  WHERE ; BRANCH IF FUNCTION RETURNS FALSE
          157 JNC  WHERE
          158 ENDM
          159 ;
          160 ;
          161 ;*****
          162 ;
163 ; ***** "RESET" KEY ENTRY POINT - COLD START
164 ; ***** RST 0 ENTRY POINT
165 ;
0000 3E00      166 MVI  A,KMODE ; GET CONTROL CHARACTER
0002 320019    167 STA  CNTRL ; SET KEYBOARD/DISPLAY MODE
0005 C3F101    168 JMP  CLDST ; GO FINISH COLD START
          169 CLDBK: ; THEN JUMP BACK HERE
          170 ;
          171 ; ***** RST 1 ENTRY POINT - WARM START
          172 ;
0008      173 ORG 8
          174 ; SAVE REGISTERS
0008 22EF20    175 SHLD LSAV ; SAVE H & L REGISTERS
000B E1      176 POP  H ; GET USER PROGRAM COUNTER FROM TOP OF STACK
000C 22F220    177 SHLD PSAV ; /AND SAVE IT
000F F5      178 PUSH PSW
0010 E1      179 POP  H
0011 22ED20    180 SHLD FSAV ; SAVE FLIP/FLOPS & REGISTER A
0014 210000    181 LXI  H,0 ; CLEAR H & L
0017 39      182 DAD  SP ; GET USER STACK POINTER
0018 22F420    183 SHLD SSAV ; /AND SAVE IT
001B 21ED20    184 LXI  H,BSAV+1 ; SET STACK POINTER FOR SAVING
001E F9      185 SPHL ; /REMAINING REGISTERS
001F C5      186 PUSH B ; SAVE B & C
0020 D5      187 PUSH D ; SAVE D & E
0021 C33F00    188 JMP  RES10 ; LEAVE ROOM FOR VECTORED INTERRUPTS
          189 ;
          190 ; ***** TIMER INTERRUPT (TRAP) ENTRY POINT (RST 4.5)
0024      191 ORG 24H
0024 C35701    192 JMP  STP25 ; BACK TO SINGLE STEP ROUTINE
          193 ;
          194 ; ***** RST 5 ENTRY POINT
          195 ;
0028      196 ORG 28H

```



```

LOC OBJ      SEQ      SOURCE STATEMENT
0028 C3C220  197      JMP      RSET5 ; BRANCH TO RST 5 LOCATION IN RAM
198 ;
199 ; ***** INPUT INTERRUPT ENTRY POINT (RST 5.5)
200 ;
002C         201      ORG      2CH
002C C38E02  202      JMP      ININT ; BRANCH TO INPUT INTERRUPT ROUTINE
203 ;
204 ; ***** RST 6 ENTRY POINT
205 ;
0030         206      ORG      30H
0030 C3C520  207      JMP      RSET6 ; BRANCH TO RST 6 LOCATION IN RAM
208 ;
209 ; ***** HARD WIRED USER INTERRUPT ENTRY POINT (RST 6.5)
210 ;
0034         211      ORG      34H
0034 C3C820  212      JMP      RST65 ; BRANCH TO RST 6.5 LOCATION IN RAM
213 ;
214 ; ***** RST 7 ENTRY POINT
215 ;
0038         216      ORG      38H
0038 C3CB20  217      JMP      RSET7 ; BRANCH TO RST 7 LOCATION IN RAM
218 ;
219 ; ***** "VECTORED INTERRUPT" KEY ENTRY POINT (RST 7.5)
003C         220      ORG      3CH
003C C3CE20  221      JMP      USINT ; BRANCH TO USER INTERRUPT LOCATION IN RAM
222 ;
223 RES10:   ; CONTINUE SAVING USER STATUS
003F 20      224      RIM      ; GET USER INTERRUPT STATUS AND INTERRUPT MASK
0040 E60F    225      ANI      0FH ; KEEP STATUS & MASK BITS
0042 32F120  226      STA      ISAV ; SAVE INTERRUPT STATUS & MASK
0045 3E0E    227      MVI      A,UNMSK ; UNMASK INTERRUPTS FOR MONITOR USE
0047 30      228      SIM      ;
0048 F3      229      DI      ; INTERRUPTS DISABLED WHILE MONITOR IS RUNNING
230 ; ; (EXCEPT WHEN WAITING FOR INPUT)
0049 20      231      RIM      ; TTY OR KEYBOARD MONITOR ?
004A 07      232      RLC      ; IS TTY CONNECTED ?
004B DAFA03  233      JC      GO ; YES - BRANCH TO TTY MONITOR
234 ; ; NO - ENTER KEYBOARD MONITOR
235 ;
236 ; *****
237 ;
238 ; BEGINNING OF KEYBOARD MONITOR CODE
239 ;
240 ; *****
241 ;
242 ; OUTPUT SIGN-ON MESSAGE
004E AF      243      XRA      A ; ARG - USE ADDRESS FIELD OF DISPLAY
004F 0600    244      MVI      B,NODOT ; ARG - NO DOT IN ADDRESS FIELD
0051 21A603  245      LXI      H,SGNAD ; ARG - GET ADDRESS OF ADDRESS FIELD PORTION OF
246 ; ; /SIGN-ON MESSAGE
0054 CDB702  247      CALL     OUTPT ; OUTPUT SIGN-ON MESSAGE TO ADDRESS FIELD
0057 3E01    248      MVI      A,DTFLD ; ARG - USE DATA FIELD OF DISPLAY
0059 0600    249      MVI      B,NODOT ; ARG - NO DOT IN DATA FIELD
005B 21AA03  250      LXI      H,SGNDT ; ARG - GET ADDRESS OF DATA FIELD PORTION OF
251 ; ; /SIGN-ON MESSAGE
005E CDB702  252      CALL     OUTPT ; OUTPUT SIGN-ON MESSAGE TO DATA FIELD
0061 3E80    253      MVI      A,EMPTY
0063 32FE20  254      STA      Ibuff ; SET INPUT BUFFER EMPTY FLAG
255 ;
256 ; *****
257 ;
258 ; FUNCTION: CMMND - COMMAND RECOGNIZER
259 ; INPUTS: NONE
260 ; OUTPUTS: NONE
261 ; CALLS: RDKBD,ERR,SUBST,EXAM,GOCMD,SSTEP
262 ; DESTROYS: A,B,C,D,E,H,L,F/F'S
263 ;
264 CMMND:
0066 21E920  265      LXI      H,MNSTK ; INITIALIZE MONITOR STACK POINTER
0069 F9      266      SPHL
267 ;
006A 210019  268      LXI      H,CNTRL ; GET ADDRESS FOR CONTROL CHARACTER
006D 3690    269      MVI      M,ADISP ; OUTPUT CONTROL CHARACTER TO USE ADDRESS FIELD
006F 25      270      DCR      H ; ADDRESS FOR OUTPUT CHARACTER
0070 36FB    271      MVI      M,PRMPT ; OUTPUT PROMPT CHARACTER
0072 CDE702  272      CALL     RDKBD ; READ KEYBOARD
0075 010400  273      LXI      B,NUMC ; COUNTER FOR NUMBER OF COMMANDS IN C
0078 217803  274      LXI      H,CMDTB ; GET ADDRESS OF COMMAND TABLE
275 CMD10:
007B BE      276      CMP      M ; RECOGNIZE THE COMMAND ?
007C CA8700  277      JZ      CMD15 ; YES - GO PROCESS IT
007F 23      278      INX      H ; NO - NEXT COMMAND TABLE ENTRY
0080 0D      279      DCR      C ; END OF TABLE ?
0081 C27B00  280      JNZ     CMD10 ; NO - GO CHECK NEXT ENTRY
281 ; ; YES - COMMAND UNKNOWN
0084 C31502  282      JMP      ERR ; DISPLAY ERROR MESSAGE AND GET ANOTHER COMMAND
283 CMD15:
0087 217C03  284      LXI      H,CMDAD ; GET ADDRESS OF COMMAND ADDRESS TABLE
008A 0D      285      DCR      C ; ADJUST COMMAND COUNTER
286 ;
008B 09      287      DAD      B ; COUNTER ACTS AS POINTER TO COMMAND ADDRESS TABLE
008C 09      288      DAD      B ; ADD POINTER TO TABLE ADDRESS TWICE BECAUSE
008D 7E      289      MOV      A,M ; TABLE HAS 2 BYTE ENTRIES
008E 23      290      INX      H ; GET LOW ORDER BYTE OF COMMAND ADDRESS
008F 66      291      MOV      H,M ; GET HIGH ORDER BYTE OF COMMAND ADDRESS IN H
0090 6F      292      MOV      L,A ; PUT LOW ORDER BYTE IN L
293 ; ; COMMAND ROUTINE ADDRESS IS NOW IN H & L
0091 E9      294      PCHL   ; BRANCH TO ADDRESS IN H & L
295 ;

```

```

LOC  OBJ      SEQ      SOURCE STATEMENT
;*****
296 ;*****
297 ;
298 ;
299 ;           COMMAND ROUTINES
300 ;*****
301 ;
302 ; FUNCTION: EXAM - EXAMINE AND MODIFY REGISTERS
303 ; INPUTS: NONE
304 ; OUTPUTS: NONE
305 ; CALLS: CLEAR,SETRG,ERR,RGNAM,RGLOC,UPDDT,GTHEX,NXTRG
306 ; DESTROYS: A,B,C,D,E,H,L,F/F'S
307 ;
308 EXAM:
0092 0601      309          MVI    B,DOT  ; ARG - DOT IN ADDRESS FIELD OF DISPLAY
0094 CDD701    310          CALL   CLEAR  ; CLEAR DISPLAY
0097 CD4403    311          CALL   SETRG  ; GET REGISTER DESIGNATOR FROM KEYBOARD AND
312          ;/SET REGISTER POINTER ACCORDINGLY
313          ; WAS CHARACTER A REGISTER DESIGNATOR?
314          FALSE   ERR   ; NO - DISPLAY ERROR MSG. AND TERMINATE COMMAND
009A D21502    315+         JNC     ERR
316 EXM05:
009D CD0903    317          CALL   RGNAM  ; OUTPUT REGISTER NAME TO ADDRESS FIELD
00A0 CDFC02    318          CALL   RGLOC  ; GET REGISTER SAVE LOCATION IN H & L
00A3 7E        319          MOV     A,M     ; GET REGISTER CONTENTS
00A4 32F820    320          STA    CURDT  ; STORE REGISTER CONTENTS AT CURRENT DATA
00A7 0601      321          MVI    B,DOT  ; ARG - DOT IN DATA FIELD
00A9 CD6B03    322          CALL   UPDDT  ; UPDATE DATA FIELD OF DISPLAY
00AC 0601      323          MVI    B,DTFLD ; ARG - USE DATA FIELD OF DISPLAY
00AE CD2B02    324          CALL   GTHEX  ; GET HEX DIGITS - WERE ANY DIGITS RECEIVED?
325          FALSE   EXM10 ; NO - DO NOT UPDATE REGISTER CONTENTS
00B1 D2B800    326+         JNC     EXM10
00B4 CDFC02    327          CALL   RGLOC  ; YES - GET REGISTER SAVE LOCATION IN H & L
00B7 73        328          MOV     M,E     ; UPDATE REGISTER CONTENTS
329 EXM10:
00B8 FE10      330          CPI    PERIO  ; WAS LAST CHARACTER A PERIOD ?
00BA CAE901    331          JZ     CLDIS  ; YES - CLEAR DISPLAY AND TERMINATE COMMAND
00BD FE11      332          CPI    COMMA  ; WAS LAST CHARACTER ',' ?
00BF C21502    333          JNZ    ERR    ; NO - DISPLAY ERROR MSG. AND TERMINATE COMMAND
00C2 CDA802    334          CALL   NXTRG  ; YES - ADVANCE REGISTER POINTER TO
335          ;/NEXT REGISTER
336          ; ANY MORE REGISTERS ?
337          TRUE    EXM05 ; YES - CONTINUE PROCESSING WITH NEXT REGISTER
00C5 DA9D00    338+         JC     EXM05
00C8 C3E901    339          JMP    CLDIS  ; NO - CLEAR DISPLAY AND TERMINATE COMMAND
340 ;
341 ;*****
342 ;
343 ; FUNCTION: GOCMD - EXECUTE USER PROGRAM
344 ; INPUTS: NONE
345 ; OUTPUTS: NONE
346 ; CALLS: DISPC,RDKBD,CLEAR,GTHEX,ERR,OUTPT
347 ; DESTROYS: A,B,C,D,E,H,L,F/F'S
348 ;
349 GOCMD:
00CB CD0002    350          CALL   DISPC  ; DISPLAY USER PROGRAM COUNTER
00CE CDE702    351          CALL   RDKBD  ; READ FROM KEYBOARD
00D1 FE10      352          CPI    PERIO  ; IS CHARACTER A PERIOD ?
00D3 CAEC00    353          JZ     G10    ; YES - GO EXECUTE THE COMMAND
354          ; NO - ARG - CHARACTER IS STILL IN A
00D6 32FE20    355          STA    IBUFF  ; REPLACE CHARACTER IN INPUT BUFFER
00D9 0601      356          MVI    B,DOT  ; ARG - DOT IN ADDRESS FIELD
00DB CDD701    357          CALL   CLEAR  ; CLEAR DISPLAY
00DE 0600      358          MVI    B,ADFLD ; ARG - USE ADDRESS FIELD
00E0 CD2B02    359          CALL   GTHEX  ; GET HEX DIGITS
00E3 FE10      360          CPI    PERIO  ; WAS LAST CHARACTER A PERIOD ?
00E5 C21502    361          JNZ    ERR    ; NO - DISPLAY ERROR MSG. AND TERMINATE COMMAND
00E8 EB        362          XCHG  ; PUT HEX VALUE FROM GTHEX TO H & L
00E9 22F220    363          SHLD  PSAV  ; HEX VALUE IS NEW USER PC
364 G10:
00EC 0600      365          MVI    B,NODOT ; YES - ARG - NO DOT IN ADDRESS FIELD
00EE CDD701    366          CALL   CLEAR  ; CLEAR DISPLAY
00F1 AF        367          XRA    A     ; ARG - USE ADDRESS FIELD OF DISPLAY
00F2 0600      368          MVI    B,NODOT ; ARG - NO DOT IN ADDRESS FIELD
00F4 21A203    369          LXI    H,EXMSG ; GET ADDRESS OF EXECUTION MESSAGE IN H & L
00F7 CDB702    370          CALL   OUTPT  ; DISPLAY EXECUTION MESSAGE
00FA C31B03    371          JMP    RSTOR  ; RESTORE USER REGISTERS INCL. PROGRAM COUNTER
372          ;/I.E. BEGIN EXECUTION OF USER PROGRAM
373 ;
374 ;*****
375 ;
376 ; FUNCTION: SSTEP - SINGLE STEP (EXECUTE ONE USER INSTRUCTION)
377 ; INPUTS: NONE
378 ; OUTPUTS: NONE
379 ; CALLS: DISPC,RDKBD,CLEAR,GTHEX,ERR
380 ; DESTROYS: A,B,C,D,E,H,L,F/F'S
381 ;
382 SSTEP:
00FD CD0002    383          CALL   DISPC  ; DISPLAY USER PROGRAM COUNTER
0100 CDE702    384          CALL   RDKBD  ; READ FROM KEYBOARD
0103 FE10      385          CPI    PERIO  ; WAS CHARACTER A PERIOD ?
0105 CAE901    386          JZ     CLDIS  ; YES - CLEAR DISPLAY AND TERMINATE COMMAND
0108 FE11      387          CPI    COMMA  ; WAS LAST CHARACTER ',' ?
010A CA2601    388          JZ     STP20  ; YES - GO SET TIMER
389          ; NO - CHARACTER FROM KEYBOARD WAS NEITHER PERIOD NOR COMMA
010D 32FE20    390          STA    IBUFF  ; REPLACE THE CHARACTER IN THE INPUT BUFFER
0110 0601      391          MVI    B,DOT  ; ARG - DOT IN ADDRESS FIELD
0112 CDD701    392          CALL   CLEAR  ; CLEAR DISPLAY
0115 0600      393          MVI    B,ADFLD ; ARG - USE ADDRESS FIELD OF DISPLAY
0117 CD2B02    394          CALL   GTHEX  ; GET HEX DIGITS - WERE ANY DIGITS RECEIVED ?
395          FALSE   ERR   ; NO - DISPLAY ERROR MSG. AND TERMINATE COMMAND

```

```

LOC OBJ      SEQ      SOURCE STATEMENT
011A D21502  396+      JNC      ERR
011D EB      397      XCHG     ; HEX VALUE FROM GTHEX TO H & L
011E 22F220  398      SHLD    PSAV ; HEX VALUE IS NEW USER PC
0121 FE10    399      CPI     PERIO ; WAS LAST CHARACTER FROM GTHEX A PERIOD ?
0123 CAE901  400      JZ      CLDIS ; YES - CLEAR DISPLAY AND TERMINATE COMMAND
          401      ; NO - MUST HAVE BEEN A COMMA
          402 STP20:
0126 3AF120  403      LDA     ISAV ; GET USER INTERRUPT MASK
0129 E608    404      ANI     08H ; KEEP INTERRUPT STATUS
012B 32FD20  405      STA     TEMP ; SAVE USER INTERRUPT STATUS
012E 2AF220  406      LHLD   PSAV ; GET USER PC
0131 7E      407      MOV     A,M ; GET USER INSTRUCTION
0132 FEF3    408      CPI     (DI) ; DI INSTRUCTION ?
0134 C23B01  409      JNZ    STP21 ; NO
0137 AF      410      XRA     A ; YES - RESET USER INTERRUPT STATUS
0138 C34201  411      JMP     STP22
          412 STP21:
013B FEFB    413      CPI     (EI) ; EI INSTRUCTION ?
013D C24501  414      JNZ    STP23 ; NO
0140 3E08    415      MVI     A,08H ; YES - SET USER INTERRUPT STATUS
          416 STP22:
0142 32FD20  417      STA     TEMP ; SAVE NEW USER INTERRUPT STATUS
          418 STP23:
0145 3E40    419      MVI     A,(TIMER SHR 8) OR TMODE ; HIGH ORDER BITS OF TIMER VALUE
          420      ; /OR'ED WITH TIMER MODE
0147 D325    421      OUT    TIMHI
0149 3EC5    422      MVI     A,TIMER AND 0FFH ; LOW ORDER BITS OF TIMER VALUE
014B D324    423      OUT    TIMLO
014D 3AFF20  424      LDA     USCSR ; GET USER IMAGE OF WHAT'S IN CSR
0150 F6C0    425      ORI     TSTRT ; SET TIMER COMMAND BITS TO START TIMER
0152 D320    426      OUT    CSR ; START TIMER
0154 C31B03  427      JMP     RSTOR ; RESTORE USER REGISTERS
          428 ;
          429 STP25:
          430      ; BRANCH HERE WHEN TIMER INTERRUPTS AFTER
          431      ;/ONE USER INSTRUCTION
0157 F5      431      PUSH   PSW ; SAVE PSW
0158 3AFF20  432      LDA     USCSR ; GET USER IMAGE OF WHAT'S IN CSR
015B E63F    433      ANI     3FH ; CLEAR 2 HIGH ORDER BITS
015D F640    434      ORI     40H ; SET TIMER STOP BIT
015F D320    435      OUT    CSR ; STOP TIMER
0161 F1      436      POP    PSW ; RETRIEVE PSW
0162 22EF20  437      SHLD   LSAV ; SAVE H & L
0165 E1      438      POP    H ; GET USER PROGRAM COUNTER FROM TOP OF STACK
0166 22F220  439      SHLD   PSAV ; SAVE USER PC
0169 F5      440      PUSH   PSW
016A E1      441      POP    H
016B 22ED20  442      SHLD   FSAV ; SAVE FLIP/FLOPS AND A REGISTER
016E 210000  443      LXI     H,0 ; CLEAR H & L
0171 39      444      DAD    SP ; GET USER STACK POINTER
0172 22F420  445      SHLD   SSAV ; SAVE USER STACK POINTER
0175 21ED20  446      LXI     H,BSAV+1 ; SET MONITOR STACK POINTER FOR
          447      SPHL ;/SAVING REMAINING USER REGISTERS
0179 C5      448      PUSH   B ; SAVE B & C
017A D5      449      PUSH   D ; SAVE D & E
017B 20      450      RIM ; GET USER INTERRUPT MASK
017C E607    451      ANI     07H ; KEEP MASK BITS
017E 21FD20  452      LXI     H,TEMP ; GET USER INTERRUPT STATUS
0181 B6      453      ORA     M ; OR IT INTO MASK
0182 32F120  454      STA     ISAV ; SAVE INTERRUPT STATUS & MASK
0185 3E0E    455      MVI     A,UNMSK ; UNMASK INTERRUPTS FOR MONITOR USE
0187 30      456      SIM
0188 C3FD00  457      JMP     SSTEP ; GO GET READY FOR ANOTHER INSTRUCTION
          458 ;
          459 ;*****
          460 ;
          461 ; FUNCTION: SUBST - SUBSTITUTE MEMORY
          462 ; INPUTS: NONE
          463 ; OUTPUTS: NONE
          464 ; CALLS: CLEAR,GTHEX,UPDAD,UPDDT,ERR
          465 ; DESTROYS: A,B,C,D,E,H,L,F/F'S
          466 ;
          467 SUBST:
018B 0601    468      MVI     B,DOT ; ARG - DOT IN ADDRESS FIELD
018D CDD701  469      CALL   CLEAR ; CLEAR THE DISPLAY
0190 0600    470      MVI     B,ADFLD ; ARG - USE ADDRESS FIELD OF DISPLAY
0192 CD2B02  471      CALL   GTHEX ; GET HEX DIGITS - WERE ANY DIGITS RECEIVED?
          472      FALSE ERR ; NO - DISPLAY ERROR MSG. AND TERMINATE COMMAND
0195 D21502  473+      JNC      ERR
0198 EB      474      XCHG     ; ASSIGN HEX VALUE RETURNED BY GTHEX TO
0199 22F620  475      SHLD   CURAD ; / CURRENT ADDRESS
          476 SUB05:
019C FE11    477      CPI     COMMA ; WAS ',' THE LAST CHARACTER FROM KEYBOARD?
019E C2CF01  478      JNZ    SUB15 ; NO - GO TERMINATE THE COMMAND
01A1 0600    479      MVI     B,NODOT ; ARG - NO DOT IN ADDRESS FIELD
01A3 CD5F03  480      CALL   UPDAD ; UPDATE ADDRESS FIELD OF DISPLAY
01A6 2AF620  481      LHLD   CURAD ; GET CURRENT ADDRESS IN H & L
01A9 7E      482      MOV     A,M ; GET DATA BYTE POINTED TO BY CURRENT ADDRESS
01AA 32F820  483      STA     CURDT ; STORE DATA BYTE AT CURRENT DATA
01AD 0601    484      MVI     B,DOT ; ARG - DOT IN DATA FIELD
01AF CD6B03  485      CALL   UPDDT ; UPDATE DATA FIELD OF DISPLAY
01B2 0601    486      MVI     B,DTFLD ; ARG - USE DATA FIELD
01B4 CD2B02  487      CALL   GTHEX ; GET HEX DIGITS - WERE ANY HEX DIGITS RECEIVED?
01B7 F5      488      PUSH   PSW ; (SAVE LAST CHARACTER)
          489      FALSE SUB10 ; NO - LEAVE DATA UNCHANGED AT CURRENT ADDRESS
01B8 D2C401  490+      JNC      SUB10
01BB 2AF620  491      LHLD   CURAD ; YES - GET CURRENT ADDRESS IN H & L
01BE 73      492      MOV     M,E ; STORE NEW DATA AT CURRENT ADDRESS
          493      ; MAKE SURE DATA WAS ACTUALLY STORED IN CASE
          494      ;/CURRENT ADDRESS IS IN ROM OR IS NON-EXISTANT
01BF 7B      495      MOV     A,E ; DATA TO A FOR COMPARISON
    
```

```

LOC OBJ          SEQ          SOURCE STATEMENT
01C0 BE          496          CMP      M          ; WAS DATA STORED CORRECTLY?
01C1 C21502     497          JNZ      ERR        ; NO - DISPLAY ERROR MSG. AND TERMINATE COMMAND
                                498          SUB10:
01C4 2AF620     499          LHLD    CURAD      ; INCREMENT CURRENT ADDRESS
01C7 23         500          INX     H
01C8 22F620     501          SHLD   CURAD
01CB F1         502          POP    PSW        ; RETRIEVE LAST CHARACTER
01CC C39C01     503          JMP     SUB05      ;
                                504          SUB15:
01CF FE10       505          CPI    PERIO      ; WAS LAST CHARACTER '.' ?
01D1 C21502     506          JNZ      ERR        ; NO - DISPLAY ERROR MSG. AND TERMINATE COMMAND
01D4 C3E901     507          JMP     CLDIS     ; YES - CLEAR DISPLAY AND TERMINATE COMMAND
                                508          ;
                                509          ;
01D7 AF         510          ;*****
                                511          ;
                                512          ;           UTILITY ROUTINES
                                513          ;
                                514          ;*****
                                515          ;
                                516          ; FUNCTION: CLEAR - CLEAR THE DISPLAY
                                517          ; INPUTS: B - DOT FLAG - 1 MEANS PUT DOT IN ADDRESS FIELD OF DISPLAY
                                518          ;           - 0 MEANS NO DOT
                                519          ; OUTPUTS: NONE
                                520          ; CALLS: OUTPT
                                521          ; DESTROYS: A,B,C,D,E,H,L,F/F'S
                                522          ; DESCRIPTION: CLEAR SENDS BLANK CHARACTERS TO BOTH THE ADDRESS FIELD
                                523          ; AND THE DATA FIELD OF THE DISPLAY. IF THE DOT FLAG IS
                                524          ; SET THEN A DOT WILL APPEAR AT THE RIGHT EDGE OF THE
                                525          ; ADDRESS FIELD.
                                526          ;
                                527          CLEAR:
01D8 219A03     528          XRA    A          ; ARG - USE ADDRESS FIELD OF DISPLAY
01DB CDB702     529          ;           ; ARG - FLAG FOR DOT IN ADDR. FIELD IS IN B
01DE 3E01       530          LXI    H,BLNKS   ; ARG - ADDRESS OF BLANKS FOR DISPLAY
01E0 0600       531          CALL  OUTPT      ; OUTPUT BLANKS TO ADDRESS FIELD
01E2 219A03     532          MVI    A,DTFLD  ; ARG - USE DATA FIELD OF DISPLAY
01E5 CDB702     533          MVI    B,NODOT  ; ARG - NO DOT IN DATA FIELD
01E8 C9         534          LXI    H,BLNKS   ; ARG - ADDRESS OF BLANKS FOR DISPLAY
                                535          CALL  OUTPT      ; OUTPUT BLANKS TO DATA FIELD
                                536          RET          ; RETURN
                                537          ;
                                538          ;*****
                                539          ;
                                540          ; FUNCTION: CLDIS - CLEAR DISPLAY AND TERMINATE COMMAND
                                541          ; INPUTS: NONE
                                542          ; OUTPUTS: NONE
                                543          ; CALLS: CLEAR
                                544          ; DESTROYS: A,B,C,D,E,H,L,F/F'S
                                545          ; DESCRIPTION: CLDIS IS JUMPED TO BY COMMAND ROUTINES WISHING TO
                                546          ; TERMINATE NORMALLY. CLDIS CLEARS THE DISPLAY AND
                                547          ; BRANCHES TO THE COMMAND RECOGNIZER.
                                548          ;
                                549          CLDIS:
01E9 0600       550          MVI    B,NODOT  ; ARG - NO DOT IN ADDRESS FIELD
01EB CDD701     551          CALL  CLEAR     ; CLEAR THE DISPLAY
01EE C36600     552          JMP     CMMND    ; GO GET ANOTHER COMMAND
                                553          ;
                                554          ;*****
                                555          ;
                                556          ; FUNCTION: CLDST - COLD START
                                557          ; INPUTS: NONE
                                558          ; OUTPUTS: NONE
                                559          ; CALLS: NOTHING
                                560          ; DESTROYS: A
                                561          ; DESCRIPTION: CLDST IS JUMPED TO BY THE MAIN COLD START PROCEDURE,
                                562          ; COMPLETES COLD START INITIALIZATION, AND JUMPS BACK
                                563          ; TO THE MAIN COLD START PROCEDURE.
                                564          ;
                                565          CLDST:
01F1 3ECC       566          MVI    A,KBNIT  ; GET CONTROL CHARACTER
01F3 320019     567          STA   CNTRL     ; INITIALIZE KEYBOARD/DISPLAY BLANKING
01F6 3E00       568          MVI    A,CSNIT  ; INITIAL VALUE OF COMMAND STATUS REGISTER
01F8 D320       569          OUT   CSR      ; INITIALIZE CSR
01FA 32FF20     570          STA   USCSR    ; INITIALIZE USER CSR VALUE
01FD C30800     571          JMP     CLDBK   ; BACK TO MAIN PROCEDURE
                                572          ;
                                573          ;*****
                                574          ;
                                575          ; FUNCTION: DISPC - DISPLAY PROGRAM COUNTER
                                576          ; INPUTS: NONE
                                577          ; OUTPUTS: NONE
                                578          ; CALLS: UPDAD,UPDDT
                                579          ; DESTROYS: A,B,C,D,E,H,L,F/F'S
                                580          ; DESCRIPTION: DISPC DISPLAYS THE USER PROGRAM COUNTER IN THE ADDRESS
                                581          ; FIELD OF THE DISPLAY, WITH A DOT AT THE RIGHT EDGE
                                582          ; OF THE FIELD. THE BYTE OF DATA ADDRESSED BY THE PROGRAM
                                583          ; COUNTER IS DISPLAYED IN THE DATA FIELD OF THE DISPLAY.
                                584          ;
                                585          DISPC:
0200 2AF220     586          LHLD   PSAV     ; GET USER PROGRAM COUNTER
0203 22F620     587          SHLD  CURAD    ; MAKE IT THE CURRENT ADDRESS
0206 7E         588          MOV   A,H      ; GET THE INSTRUCTION AT THAT ADDRESS
0207 32F820     589          STA   CURDT    ; MAKE IT THE CURRENT DATA
020A 0601       590          MVI    B,DOT   ; ARG - DOT IN ADDRESS FIELD
020C CD5F03     591          CALL  UPDAD    ; UPDATE ADDRESS FIELD OF DISPLAY
020F 0600       592          MVI    B,NODOT ; ARG - NO DOT IN DATA FIELD
0211 CD6B03     593          CALL  UPDDT    ; UPDATE DATA FIELD OF DISPLAY
0214 C9         594          RET
                                595          ;

```

```

LOC  OBJ      SEQ      SOURCE STATEMENT
-----
596 ;*****
597 ;
598 ; FUNCTION: ERR - DISPLAY ERROR MESSAGE
599 ; INPUTS: NONE
600 ; OUTPUTS: NONE
601 ; CALLS: OUTPT
602 ; DESTROYS: A,B,C,D,E,H,L,F/F'S
603 ; DESCRIPTION: ERR IS JUMPED TO BY COMMAND ROUTINES WISHING TO
604 ;                TERMINATE BECAUSE OF AN ERROR.
605 ;                ERR OUTPUTS AN ERROR MESSAGE TO THE DISPLAY AND
606 ;                BRANCHES TO THE COMMAND RECOGNIZER.
607 ;
608 ERR:
0215 AF      609      XRA      A          ; ARG - USE ADDRESS FIELD
0216 0600    610      MVI      B,NODOT ; ARG - NO DOT IN ADDRESS FIELD
0218 219E03  611      LXI      H,ERMSG ; ARG - ADDRESS OF ERROR MESSAGE
021B CDB702  612      CALL     OUTPT ; OUTPUT ERROR MESSAGE TO ADDRESS FIELD
021E 3E01    613      MVI      A,DTFLD ; ARG - USE DATA FIELD
0220 0600    614      MVI      B,NODOT ; ARG - NO DOT IN DATA FIELD
0222 219A03  615      LXI      H,BLNKS ; ARG - ADDRESS OF BLANKS FOR DISPLAY
0225 CDB702  616      CALL     OUTPT ; OUTPUT BLANKS TO DATA FIELD
0228 C36600  617      JMP      CMMND ; GO GET A NEW COMMAND
618 ;
619 ;*****
620 ;
621 ; FUNCTION: GTHEX - GET HEX DIGITS
622 ; INPUTS: B - DISPLAY FLAG - 0 MEANS USE ADDRESS FIELD OF DISPLAY
623 ;                - 1 MEANS USE DATA FIELD OF DISPLAY
624 ; OUTPUTS: A - LAST CHARACTER READ FROM KEYBOARD
625 ;                DE - HEX DIGITS FROM KEYBOARD EVALUATED MODULO 2**16
626 ;                CARRY - SET IF AT LEAST ONE VALID HEX DIGIT WAS READ
627 ;                - RESET OTHERWISE
628 ; CALLS: RDKBD,INSDG,HXDSP,OUTPT
629 ; DESTROYS: A,B,C,D,E,H,L,F/F'S
630 ; DESCRIPTION: GTHEX ACCEPTS A STRING OF HEX DIGITS FROM THE KEYBOARD,
631 ;                DISPLAYS THEM AS THEY ARE RECEIVED, AND RETURNS THEIR
632 ;                VALUE AS A 16 BIT INTEGER. IF MORE THAN 4 HEX DIGITS
633 ;                ARE RECEIVED, ONLY THE LAST 4 ARE USED. IF THE DISPLAY
634 ;                FLAG IS SET, THE LAST 2 HEX DIGITS ARE DISPLAYED IN THE
635 ;                DATA FIELD OF THE DISPLAY. OTHERWISE, THE LAST 4 HEX
636 ;                DIGITS ARE DISPLAYED IN THE ADDRESS FIELD OF THE
637 ;                DISPLAY. IN EITHER CASE, A DOT WILL BE DISPLAYED AT THE
638 ;                RIGHTMOST EDGE OF THE FIELD. A CHARACTER WHICH IS NOT
639 ;                A HEX DIGIT TERMINATES THE STRING AND IS RETURNED AS
640 ;                AN OUTPUT OF THE FUNCTION. IF THE TERMINATOR IS NOT
641 ;                A PERIOD OR A COMMA THEN ANY HEX DIGITS WHICH MAY HAVE
642 ;                BEEN RECEIVED ARE CONSIDERED TO BE INVALID. THE
643 ;                FUNCTION RETURNS A FLAG INDICATING WHETHER OR NOT ANY
644 ;                VALID HEX DIGITS WERE RECEIVED.
645 ;
022B 0E00    646      GTHEX:
022D C5      647      MVI      C,0          ; RESET HEX DIGIT FLAG
022E 110000  648      PUSH     B          ; SAVE DISPLAY AND HEX DIGIT FLAGS
0231 D5      649      LXI      D,0          ; SET HEX VALUE TO ZERO
0233 650     650      PUSH     D          ; SAVE HEX VALUE
0235 651     651      GTH05:
0237 CDE702  652      CALL     RDKBD ; READ KEYBOARD
0235 FE10    653      CPI      10H ; IS CHARACTER A HEX DIGIT?
0237 D25502  654      JNC      GTH20 ; NO - GO CHECK FOR TERMINATOR
023A D1      655      ; YES - ARG - NEW HEX DIGIT IS IN A
023B CD9F02  656      POP      D          ; ARG - RETRIEVE HEX VALUE
023E C1      657      CALL     INSDG ; INSERT NEW DIGIT IN HEX VALUE
023F 0E01    658      POP      B          ; RETRIEVE DISPLAY FLAG
0241 C5      659      MVI      C,1 ; SET HEX DIGIT FLAG
0242 D5      660      ;/(I.E. A HEX DIGIT HAS BEEN READ)
0243 78      661      PUSH     B          ; SAVE DISPLAY AND HEX DIGIT FLAGS
0244 0F      662      PUSH     D          ; SAVE HEX VALUE
0245 D24902  663      MOV      A,B ; TEST DISPLAY FLAG
0248 53      664      RRC      ; SHOULD ADDRESS FIELD OF DISPLAY BE USED ?
0249 CD6C02  665      JNC      GTH10 ; YES - USE HEX VALUE AS IS
024C 78      666      ; NO - ONLY LOW ORDER BYTE OF HEX VALUE SHOULD
024D 0601    667      ;/BE USED FOR DATA FIELD OF DISPLAY
024E CDB702  668      MOV      D,E ; PUT LOW ORDER BYTE OF HEX VALUE IN D
0252 C33202  669      GTH10:
0249 CD6C02  670      ; ARG - HEX VALUE TO BE EXPANDED IS IN D & E
024C 78      671      CALL     HXDSP ; EXPAND HEX VALUE FOR DISPLAY
024D 0601    672      ; ARG - ADDRESS OF EXPANDED HEX VALUE IN H & L
024E CDB702  673      MOV      A,B ; ARG - PUT DISPLAY FLAG IN A
0252 C33202  674      MVI      B,DOT ; ARG - DOT IN APPROPRIATE FIELD
024C 78      675      CALL     OUTPT ; OUTPUT HEX VALUE TO DISPLAY
024E CDB702  676      JMP      GTH05 ; GO GET NEXT CHARACTER
0255 D1      677      GTH20:
0256 C1      678      ; LAST CHARACTER WAS NOT A HEX DIGIT
0257 FE11    679      POP      D          ; RETRIEVE HEX VALUE
0259 CA6702  680      POP      B          ; RETRIEVE HEX DIGIT FLAG IN C
025C FE10    681      CPI      COMMA ; WAS LAST CHARACTER ',' ?
025E CA6702  682      JZ      GTH25 ; YES - READY TO RETURN
025C FE10    683      CPI      PERIO ; NO - WAS LAST CHARACTER '.' ?
025E CA6702  684      JZ      GTH25 ; YES - READY TO RETURN
0261 110000  685      ; NO - INVALID TERMINATOR - IGNORE ANY HEX DIGITS READ
0264 C3F702  686      LXI      D,0 ; SET HEX VALUE TO ZERO
0261 110000  687      JMP      RETF ; RETURN FALSE
0267 47      688      GTH25:
0268 79      689      MOV      B,A ; SAVE LAST CHARACTER
0269 0F      690      MOV      A,C ; SHIFT HEX DIGIT FLAG TO
026A 78      691      RRC      ;/CARRY BIT
026B C9      692      MOV      A,B ; RESTORE LAST CHARACTER
0267 47      693      RET      ; RETURN
694 ;*****
695 ;

```

```

LOC OBJ      SEQ      SOURCE STATEMENT
696 ; FUNCTION: HXDSP - EXPAND HEX DIGITS FOR DISPLAY
697 ; INPUTS: DE - 4 HEX DIGITS
698 ; OUTPUTS: HL - ADDRESS OF OUTPUT BUFFER
699 ; CALLS: NOTHING
700 ; DESTROYS: A,H,L,F/F'S
701 ; DESCRIPTION: HXDSP EXPANDS EACH INPUT BYTE TO 2 BYTES IN A FORM
702 ; SUITABLE FOR DISPLAY BY THE OUTPUT ROUTINES. EACH INPUT
703 ; BYTE IS DIVIDED INTO 2 HEX DIGITS. EACH HEX DIGIT IS
704 ; PLACED IN THE LOW ORDER 4 BITS OF A BYTE WHOSE HIGH
705 ; ORDER 4 BITS ARE SET TO ZERO. THE RESULTING BYTE IS
706 ; STORED IN THE OUTPUT BUFFER. THE FUNCTION RETURNS THE
707 ; ADDRESS OF THE OUTPUT BUFFER.
708 ;
709 HXDSP:
026C 7A      710      MOV      A,D      ; GET FIRST DATA BYTE
026D 0F      711      RRC          ; CONVERT 4 HIGH ORDER BITS
026E 0F      712      RRC          ; /TO A SINGLE CHARACTER
026F 0F      713      RRC          ;
0270 0F      714      RRC          ;
0271 E60F    715      ANI      0FH
0273 21F920 716      LXI      H,OBUFF ; GET ADDRESS OF OUTPUT BUFFER
0276 77      717      MOV      M,A      ; STORE CHARACTER IN OUTPUT BUFFER
0277 7A      718      MOV      A,D      ; GET FIRST DATA BYTE AND CONVERT 4 LOW ORDER
0278 E60F    719      ANI      0FH      ; /BITS TO A SINGLE CHARACTER
027A 23      720      INX      H      ; NEXT BUFFER POSITION
027B 77      721      MOV      M,A      ; STORE CHARACTER IN BUFFER
027C 7B      722      MOV      A,E      ; GET SECOND DATA BYTE
027D 0F      723      RRC          ; CONVERT 4 HIGH ORDER BITS
027E 0F      724      RRC          ; /TO A SINGLE CHARACTER
027F 0F      725      RRC          ;
0280 0F      726      RRC          ;
0281 E60F    727      ANI      0FH
0283 23      728      INX      H      ; NEXT BUFFER POSITION
0284 77      729      MOV      M,A      ; STORE CHARACTER IN BUFFER
0285 7B      730      MOV      A,E      ; GET SECOND DATA BYTE AND CONVERT LOW ORDER
0286 E60F    731      ANI      0FH      ; /4 BITS TO A SINGLE CHARACTER
0288 23      732      INX      H      ; NEXT BUFFER POSITION
0289 77      733      MOV      M,A      ; STORE CHARACTER IN BUFFER
028A 21F920 734      LXI      H,OBUFF ; RETURN ADDRESS OF OUTPUT BUFFER IN H & L
028D C9      735      RET
736 ;
737 ;*****
738 ;
739 ; FUNCTION: ININT - INPUT INTERRUPT PROCESSING
740 ; INPUTS: NONE
741 ; OUTPUTS: NONE
742 ; CALLS: NOTHING
743 ; DESTROYS: NOTHING
744 ; DESCRIPTION: ININT IS ENTERED BY MEANS OF AN INTERRUPT VECTOR (IV2C)
745 ; WHEN THE READ KEYBOARD ROUTINE IS WAITING FOR A
746 ; CHARACTER AND THE USER HAS PRESSED A KEY ON THE
747 ; KEYBOARD (EXCEPT "RESET" OR "VECTORED INTERRUPT").
748 ; ININT STORES THE INPUT CHARACTER IN THE INPUT BUFFER AND
749 ; RETURNS CONTROL TO THE READ KEYBOARD ROUTINE.
750 ;
751 ININT:
028E E5      752      PUSH     H      ; SAVE H & L
028F F5      753      PUSH     PSW     ; SAVE F/F'S & REGISTER A
0290 210019 754      LXI      H,CNTRL ; ADDRESS FOR CONTROL CHARACTER OUTPUT
0293 3640    755      MVI      M,READ  ; OUTPUT CONTROL CHARACTER FOR READING
756 ; /FROM KEYBOARD
0295 25      757      DCR      H      ; ADDRESS FOR CHARACTER INPUT
0296 7E      758      MOV      A,M      ; READ A CHARACTER
0297 E63F    759      ANI      3FH      ; ZERO 2 HIGH ORDER BITS
0299 32FE20 760      STA      Ibuff   ; STORE CHARACTER IN INPUT BUFFER
029C F1      761      POP      PSW     ; RESTORE F/F'S & REGISTER A
029D E1      762      POP      H      ; RESTORE H & L
029E C9      763      RET
764 ;
765 ;*****
766 ;
767 ; FUNCTION: INSDG - INSERT HEX DIGIT
768 ; INPUTS: A - HEX DIGIT TO BE INSERTED
769 ; DE - HEX VALUE
770 ; OUTPUTS: DE - HEX VALUE WITH DIGIT INSERTED
771 ; CALLS: NOTHING
772 ; DESTROYS: A,F/F'S
773 ; DESCRIPTION: INSDG SHIFTS THE CONTENTS OF D & E LEFT 4 BITS
774 ; (1 HEX DIGIT) AND INSERTS THE HEX DIGIT IN A IN THE LOW
775 ; ORDER DIGIT POSITION OF THE RESULT. A IS ASSUMED TO
776 ; CONTAIN A SINGLE HEX DIGIT IN THE LOW ORDER 4 BITS AND
777 ; ZEROS IN THE HIGH ORDER 4 BITS.
778 ;
779 INSDG:
029F EB      780      XCHG          ; PUT D & E IN H & L
02A0 29      781      DAD      H      ; SHIFT H & L LEFT 4 BITS
02A1 29      782      DAD      H
02A2 29      783      DAD      H
02A3 29      784      DAD      H
02A4 85      785      ADD      L      ; INSERT LOW ORDER DIGIT
02A5 6F      786      MOV      L,A
02A6 EB      787      XCHG          ; PUT H & L BACK IN D & E
02A7 C9      788      RET
789 ;
790 ;*****
791 ;
792 ; FUNCTION: NXTRG - ADVANCE REGISTER POINTER TO NEXT REGISTER
793 ; INPUTS: NONE
794 ; OUTPUTS: CARRY - 1 IF POINTER IS ADVANCED SUCCESSFULLY

```

```

LOC OBJ      SEQ      SOURCE STATEMENT
795 ;                - 0 OTHERWISE
796 ; CALLS: NOTHING
797 ; DESTROYS: A,F/F'S
798 ; DESCRIPTION:  IF THE REGISTER POINTER POINTS TO THE LAST REGISTER IN
799 ;                THE EXAMINE REGISTER SEQUENCE, THE POINTER IS NOT
800 ;                CHANGED AND THE FUNCTION RETURNS FALSE. IF THE REGISTER
801 ;                POINTER DOES NOT POINT TO THE LAST REGISTER THEN THE
802 ;                POINTER IS ADVANCED TO THE NEXT REGISTER IN THE SEQUENCE
803 ;                AND THE FUNCTION RETURNS TRUE.
804 ;
805 NXTRG:
02A8 3AFD20  806     LDA     RGPTR ; GET REGISTER POINTER
02AB FE0C    807     CPI     NUMRG-1 ; DOES POINTER POINT TO LAST REGISTER?
02AD D2F702  808     JNC     RETF  ; YES - UNABLE TO ADVANCE POINTER - RETURN FALSE
02B0 3C      809     INR     A      ; NO - ADVANCE REGISTER POINTER
02B1 32FD20  810     STA     RGPTR ; SAVE REGISTER POINTER
02B4 C3FA02  811     JMP     RETT  ; RETURN TRUE
812 ;
813 ;*****
814 ;
815 ; FUNCTION: OUTPT - OUTPUT CHARACTERS TO DISPLAY
816 ; INPUTS: A - DISPLAY FLAG - 0 = USE ADDRESS FIELD
817 ;                1 = USE DATA FIELD
818 ;                B - DOT FLAG - 1 = OUTPUT DOT AT RIGHT EDGE OF FIELD
819 ;                0 = NO DOT
820 ;                HL - ADDRESS OF CHARACTERS TO BE OUTPUT
821 ; CALLS: NOTHING
822 ; DESTROYS: A,B,C,D,E,H,L,F/F'S
823 ; DESCRIPTION:  OUTPT SENDS CHARACTERS TO THE DISPLAY. THE ADDRESS
824 ;                OF THE CHARACTERS IS RECEIVED AS AN ARGUMENT. EITHER
825 ;                2 CHARACTERS ARE SENT TO THE DATA FIELD, OR 4 CHARACTERS
826 ;                ARE SENT TO THE ADDRESS FIELD, DEPENDING ON THE
827 ;                DISPLAY FLAG ARGUMENT. THE DOT FLAG ARGUMENT DETERMINES
828 ;                WHETHER OR NOT A DOT (DECIMAL POINT) WILL BE SENT
829 ;                ALONG WITH THE LAST OUTPUT CHARACTER.
830 ;
831 OUTPT:
02B7 0F      832     RRC     ; USE DATA FIELD ?
02B8 DAC202  833     JC     OUT05 ; YES - GO SET UP TO USE DATA FIELD
02BB 0E04    834     MVI     C,4  ; NO - COUNT FOR ADDRESS FIELD
02BD 3E90    835     MVI     A,ADISP ; CONTROL CHARACTER FOR OUTPUT TO ADDRESS
836 ;                ; /FIELD OF DISPLAY
02BF C3C602  837     JMP     OUT10
838 OUT05:
02C2 0E02    839     MVI     C,2  ; COUNT FOR DATA FIELD
02C4 3E94    840     MVI     A,DDISP ; CONTROL CHARACTER FOR OUTPUT TO DATA FIELD
841 ;                ; /OF DISPLAY
842 OUT10:
02C6 320019  843     STA     CNTRL
844 OUT15:
02C9 7E      845     MOV     A,M   ; GET OUTPUT CHARACTER
02CA EB      846     XCHG    ; SAVE OUTPUT CHARACTER ADDRESS IN D & E
02CB 218403  847     LXI     H,DSPTB ; GET DISPLAY FORMAT TABLE ADDRESS
02CE 85      848     ADD     L     ; USE OUTPUT CHARACTER AS A POINTER TO
02CF 6F      849     MOV     L,A   ; /DISPLAY FORMAT TABLE
02D0 7E      850     MOV     A,M   ; GET DISPLAY FORMAT CHARACTER FROM TABLE
02D1 61      851     MOV     H,C   ; TEST COUNTER WITHOUT CHANGING IT
02D2 25      852     DCR     H     ; IS THIS THE LAST CHARACTER ?
02D3 C2DC02  853     JNZ     OUT20 ; NO - GO OUTPUT CHARACTER AS IS
02D6 05      854     DCR     B     ; YES - IS DOT FLAG SET ?
02D7 C2DC02  855     JNZ     OUT20 ; NO - GO OUTPUT CHARACTER AS IS
02DA F608    856     ORI     DTMSK ; YES - OR IN MASK TO DISPLAY DOT WITH
857 ;                ; /LAST CHARACTER
858 OUT20:
02DC 2F      859     CMA     ; COMPLEMENT OUTPUT CHARACTER
02DD 320018  860     STA     DSPLY ; SEND CHARACTER TO DISPLAY
02DE EB      861     XCHG    ; RETRIEVE OUTPUT CHARACTER ADDRESS
02E1 23      862     INX     H     ; NEXT OUTPUT CHARACTER
02E2 0D      863     DCR     C     ; ANY MORE OUTPUT CHARACTERS ?
02E3 C2C902  864     JNZ     OUT15 ; YES - GO PROCESS ANOTHER CHARACTER
02E6 C9      865     RET     ; NO - RETURN
866 ;
867 ;*****
868 ;
869 ; FUNCTION: RDKBD - READ KEYBOARD
870 ; INPUTS: NONE
871 ; OUTPUTS: A - CHARACTER READ FROM KEYBOARD
872 ; CALLS: NOTHING
873 ; DESTROYS: A,H,L,F/F'S
874 ; DESCRIPTION:  RDKBD DETERMINES WHETHER OR NOT THERE IS A CHARACTER IN
875 ;                THE INPUT BUFFER. IF NOT, THE FUNCTION ENABLES
876 ;                INTERRUPTS AND LOOPS UNTIL THE INPUT INTERRUPT
877 ;                ROUTINE STORES A CHARACTER IN THE BUFFER. WHEN
878 ;                THE BUFFER CONTAINS A CHARACTER, THE FUNCTION FLAGS
879 ;                THE BUFFER AS EMPTY AND RETURNS THE CHARACTER
880 ;                AS OUTPUT.
881 ;
882 RDKBD:
02E7 21FE20  883     LXI     H,IBUFF ; GET INPUT BUFFER ADDRESS
02EA 7E      884     MOV     A,M   ; GET BUFFER CONTENTS
885 ;                ; HIGH ORDER BIT = 1 MEANS BUFFER IS EMPTY
02EB B7      886     ORA     A     ; IS A CHARACTER AVAILABLE ?
02EC F2F302  887     JP     RDK10 ; YES - EXIT FROM LOOP
02EF FB      888     EI     ; NO - READY FOR CHARACTER FROM KEYBOARD
02F0 C3E702  889     JMP     RDKBD
890 RDK10:
02F3 3680    891     MVI     M,EMPTY ; SET BUFFER EMPTY FLAG
02F5 F3      892     DI     ; RETURN WITH INTERRUPTS DISABLED
02F6 C9      893     RET

```

```

LOC OBJ      SEQ      SOURCE STATEMENT
      894 ;
      895 ;*****
      896 ;
      897 ; FUNCTION: RETF - RETURN FALSE
      898 ; INPUTS: NONE
      899 ; OUTPUTS: CARRY = 0 (FALSE)
      900 ; CALLS: NOTHING
      901 ; DESTROYS: CARRY
      902 ; DESCRIPTION: RETF IS JUMPED TO BY FUNCTIONS WISHING TO RETURN FALSE.
      903 ; RETF RESETS CARRY TO 0 AND RETURNS TO THE CALLER OF
      904 ; THE ROUTINE INVOKING RETF.
      905 ;
      906 RETF:
02F7 37      907 STC          ; SET CARRY TRUE
02F8 3F      908 CMC          ; COMPLEMENT CARRY TO MAKE IT FALSE
02F9 C9      909 RET
      910 ;
      911 ;*****
      912 ;
      913 ; FUNCTION: RETT - RETURN TRUE
      914 ; INPUTS: NONE
      915 ; OUTPUTS: CARRY = 1 (TRUE)
      916 ; CALLS: NOTHING
      917 ; DESTROYS: CARRY
      918 ; DESCRIPTION: RETT IS JUMPED TO BY ROUTINES WISHING TO RETURN TRUE.
      919 ; RETT SETS CARRY TO 1 AND RETURNS TO THE CALLER OF
      920 ; THE ROUTINE INVOKING RETT.
      921 ;
      922 RETT:
02FA 37      923 STC          ; SET CARRY TRUE
02FB C9      924 RET
      925 ;
      926 ;*****
      927 ;
      928 ; FUNCTION: RGLOC - GET REGISTER SAVE LOCATION
      929 ; INPUTS: NONE
      930 ; OUTPUTS: HL - REGISTER SAVE LOCATION
      931 ; CALLS: NOTHING
      932 ; DESTROYS: B,C,H,L,F/F'S
      933 ; DESCRIPTION: RGLOC RETURNS THE SAVE LOCATION OF THE REGISTER
      934 ; INDICATED BY THE CURRENT REGISTER POINTER VALUE.
      935 ;
      936 RGLOC:
02FC 2AFD20 937 LHLD      RGPTR ; GET REGISTER POINTER
02FF 2600    938 MVI       H,0   ; /IN H & L
0301 01ED03 939 LXI      B,RTBL ; GET REGISTER SAVE LOCATION TABLE ADDRESS
0304 09      940 DAD      B      ; POINTER INDEXES TABLE
0305 6E      941 MOV      L,M    ; GET LOW ORDER BYTE OF REGISTER SAVE LOC.
0306 2620    942 MVI      H,(RAMST SHR 8) ; GET HIGH ORDER BYTE OF
0308 C9      943          ; /REGISTER SAVE LOCATION
      944 RET
      945 ;
      946 ;*****
      947 ;
      948 ; FUNCTION: RGNAM - DISPLAY REGISTER NAME
      949 ; INPUTS: NONE
      950 ; OUTPUTS: NONE
      951 ; CALLS: OUTPT
      952 ; DESTROYS: A,B,C,D,E,H,L,F/F'S
      953 ; DESCRIPTION: RGNAM DISPLAYS, IN THE ADDRESS FIELD OF THE DISPLAY,
      954 ; THE REGISTER NAME CORRESPONDING TO THE CURRENT
      955 ; REGISTER POINTER VALUE.
      956 ;
      957 RGNAM:
0309 2AFD20 958 LHLD      RGPTR ; GET REGISTER POINTER
030C 2600    959 MVI      H,0
030E 29      960 DAD      H      ; MULTIPLY POINTER VALUE BY 4
030F 29      961 DAD      H      ;/(REGISTER NAME TABLE HAS 4 BYTE ENTRIES)
0310 01B903 962 LXI      B,NMTBL ; GET ADDRESS OF START OF REGISTER NAME TABLE
0313 09      963 DAD      B      ; ARG - ADD TABLE ADDRESS TO POINTER - RESULT IS
      964          ;ADDRESS OF APPROPRIATE REGISTER NAME IN H & L
0314 AF      965 XRA      A      ; ARG - USE ADDRESS FIELD OF DISPLAY
0315 8600    966 MVI      B,NODOT ; ARG - NO DOT IN ADDRESS FIELD
0317 CDB702 967 CALL     OUTPT  ; OUTPUT REGISTER NAME TO ADDRESS FIELD
031A C9      968 RET
      969 ;
      970 ;*****
      971 ;
      972 ; FUNCTION: RSTOR - RESTOR USER REGISTERS
      973 ; INPUTS: NONE
      974 ; OUTPUTS: NONE
      975 ; CALLS: NOTHING
      976 ; DESTROYS: A,B,C,D,E,H,L,F/F'S
      977 ; DESCRIPTION: RSTOR RESTORES ALL CPU REGISTERS, FLIP/FLOPS,
      978 ; INTERRUPT STATUS, INTERRUPT MASK, STACK POINTER
      979 ; AND PROGRAM COUNTER FROM THEIR RESPECTIVE
      980 ; SAVE LOCATIONS IN MEMORY. BY RESTORING THE PROGRAM
      981 ; COUNTER, THE ROUTINE EFFECTIVELY TRANSFERS CONTROL TO
      982 ; THE ADDRESS IN THE PROGRAM COUNTER SAVE LOCATION.
      983 ;
      984 ;
      985 ; THE TIMING OF THIS ROUTINE IS CRITICAL TO THE
      986 ; CORRECT OPERATION OF THE SINGLE STEP ROUTINE.
      987 ; IF ANY MODIFICATION CHANGES THE NUMBER OF CPU
      988 ; STATES NEEDED TO EXECUTE THIS ROUTINE THEN THE
      989 ; TIMER VALUE MUST BE ADJUSTED BY THE SAME NUMBER.
      990 ; ***** THIS IS ALSO THE ENTRY POINT FOR THE TTY MONITOR
      991 ; TO RESTORE REGISTERS.
      992 ;
      993 RSTOR:

```

LOC	OBJ	SEQ	SOURCE STATEMENT
031B	3AF120	994	LDA ISAV ; GET USER INTERRUPT MASK
031E	F618	995	ORI 18H ; ENABLE SETTING OF INTERRUPT MASK AND
		996	; /RESET RST.7.5 FLIP FLOP
0320	30	997	SIM ; RESTORE USER INTERRUPT MASK
		998	RESTORE USER INTERRUPT STATUS
0321	3AF120	999	LDA ISAV ; GET USER INTERRUPT MASK
0324	E600	1000	ANI 08H ; SHOULD USER INTERRUPTS BE ENABLED ?
0326	CA2D03	1001	JZ RSR05 ; NO - LEAVE INTERRUPTS DISABLED
0329	PB	1002	EI ; YES - ENABLE INTERRUPTS FOR USER PROGRAM
032A	C33103	1003	JMP RSR10
		1004	RSR05: ; DUMMY INSTRUCTIONS - WHEN SINGLE STEP ROUTINE
032D	37	1005	STC ; /IS BEING USED, THE TIMER IS RUNNING AND
032E	D23103	1006	JNC RSR10 ; /EXECUTE TIME FOR THIS ROUTINE MUST NOT
		1007	; /VARY.
		1008	
		1009	RSR10: ; SET MONITOR STACK POINTER TO START OF STACK
0331	21E920	1010	LXI H,MNSTK ; /WHICH IS ALSO END OF REGISTER SAVE AREA
0334	F9	1011	SPHL ; RESTORE REGISTERS
0335	D1	1012	POP D
0336	C1	1013	POP B
0337	F1	1014	POP PSW
0338	2AF420	1015	LHLD SSVAV ; RESTORE USER STACK POINTER
033B	F9	1016	SPHL
033C	2AF220	1017	LHLD PSAV
033F	E5	1018	PUSH H ; PUT USER PROGRAM COUNTER ON STACK
0340	2AEF20	1019	LHLD LSAV ; RESTORE H & L REGISTERS
0343	C9	1020	RET ; JUMP TO USER PROGRAM COUNTER
		1021	;
		1022	*****
		1023	;
		1024	; FUNCTION: SETRG - SET REGISTER POINTER
		1025	; INPUTS: NONE
		1026	; OUTPUTS: CARRY - SET IF CHARACTER FROM KEYBOARD IS A REGISTER DESIGNATOR
		1027	RESET OTHERWISE
		1028	; CALLS: RDKBD
		1029	; DESTROYS: A,B,C,H,L,F/F'S
		1030	; DESCRIPTION: SETRG READS A CHARACTER FROM THE KEYBOARD. IF THE
		1031	CHARACTER IS A REGISTER DESIGNATOR, IT IS CONVERTED TO
		1032	THE CORRESPONDING REGISTER POINTER VALUE, THE POINTER IS
		1033	SAVED, AND THE FUNCTION RETURNS 'TRUE'. OTHERWISE, THE
		1034	FUNCTION RETURNS 'FALSE'.
		1035	;
		1036	SETRG:
0344	CDE702	1037	CALL RDKBD ; READ FROM KEYBOARD
0347	FEL0	1038	CPI 10H ; IS CHARACTER A DIGIT?
0349	D2F702	1039	JNC RETF ; NO - RETURN FALSE - CHARACTER IS NOT A
		1040	; /REGISTER DESIGNATOR
034C	D603	1041	SUI 3 ; YES - TRY TO CONVERT REGISTER DESIGNATOR TO
		1042	; / INDEX INTO REGISTER POINTER TABLE
		1043	; WAS CONVERSION SUCCESSFUL?
034E	DAF702	1044	JC RETF ; NO - RETURN FALSE
0351	4F	1045	MOV C,A ; INDEX TO B & C
0352	0600	1046	MVI B,0 ;
0354	21AC03	1047	LXI H,RGPTB ; GET ADDRESS OF REGISTER POINTER TABLE
0357	09	1048	DAD B ; INDEX POINTS INTO TABLE
0358	7E	1049	MOV A,M ; GET REGISTER POINTER FROM TABLE
0359	32FD20	1050	STA RGPTR ; SAVE REGISTER POINTER
035C	C3FA02	1051	JMP RETT ; RETURN TRUE
		1052	;
		1053	*****
		1054	;
		1055	; FUNCTION: UPDAD - UPDATE ADDRESS FIELD OF DISPLAY
		1056	; INPUTS: B - DOT FLAG - 1 MEANS PUT DOT AT RIGHT EDGE OF FIELD
		1057	0 MEANS NO DOT
		1058	; OUTPUTS: NONE
		1059	; CALLS: HXDSP,OUTPT
		1060	; DESTROYS: A,B,C,D,E,H,L,F/F'S
		1061	; DESCRIPTION: UPDAD UPDATES THE ADDRESS FIELD OF THE DISPLAY USING
		1062	THE CURRENT ADDRESS.
		1063	;
		1064	UPDAD:
035F	2AF620	1065	LHLD CURAD ; GET CURRENT ADDRESS
0362	EB	1066	XCHG ; ARG - PUT CURRENT ADDRESS IN D & E
0363	CD6C02	1067	CALL HXDSP ; EXPAND CURRENT ADDRESS FOR DISPLAY
		1068	; ARG - ADDRESS OF EXPANDED ADDRESS IS IN H & L
0366	AF	1069	XRA A ; ARG - USE ADDRESS FIELD OF DISPLAY
		1070	; ARG - DOT FLAG IS IN B
0367	CDB702	1071	CALL OUTPT ; OUTPUT CURRENT ADDRESS TO ADDRESS FIELD
036A	C9	1072	RET
		1073	;
		1074	*****
		1075	;
		1076	; FUNCTION: UPDDT - UPDATE DATA FIELD OF DISPLAY
		1077	; INPUTS: B - DOT FLAG - 1 MEANS PUT DOT AT RIGHT EDGE OF FIELD
		1078	0 MEANS NO DOT
		1079	; OUTPUTS: NONE
		1080	; CALLS: HXDSP,OUTDT
		1081	; DESTROYS: A,B,C,D,E,H,L,F/F'S
		1082	; DESCRIPTION: UPDDT UPDATES THE DATA FIELD OF THE DISPLAY USING
		1083	THE CURRENT DATA BYTE.
		1084	;
		1085	UPDDT:
036B	3AF820	1086	LDA CURDT ; GET CURRENT DATA
036E	57	1087	MOV D,A ; ARG - PUT CURRENT DATA IN D
036F	CD6C02	1088	CALL HXDSP ; EXPAND CURRENT DATA FOR DISPLAY
		1089	; ARG - ADDRESS OF EXPANDED DATA IS IN H & L
0372	3E01	1090	MVI A,DTFLD ; ARG - USE DATA FIELD OF DISPLAY
		1091	; ARG - DOT FLAG IS IN B
0374	CDB702	1092	CALL OUTPT ; OUTPUT CURRENT DATA TO DATA FIELD

```

LOC OBJ      SEQ      SOURCE STATEMENT
0377 C9      1093      RET
              1094 ;
              1095 ;*****
              1096 ;
              1097 ;          MONITOR TABLES
              1098 ;
              1099 ;*****
              1100 ;
              1101 ; COMMAND TABLE
              1102 ;  COMMAND CHARACTERS AS RECEIVED FROM KEYBOARD
              1103 CMDTB:
0378 12      1104      DB      12H      ; GO COMMAND
0379 13      1105      DB      13H      ; SUBSTITUTE MEMORY COMMAND
037A 14      1106      DB      14H      ; EXAMINE REGISTERS COMMAND
037B 15      1107      DB      15H      ; SINGLE STEP COMMAND
0004         1108 NUMC  EQU      $-CMDTB ; NUMBER OF COMMANDS
              1109 ;
              1110 ;*****
              1111 ;
              1112 ; COMMAND ROUTINE ADDRESS TABLE
              1113 ; (MUST BE IN REVERSE ORDER OF COMMAND TABLE)
              1114 CMDAD:
037C FD00    1115      DW      SSTEP   ; ADDRESS OF SINGLE STEP ROUTINE
037E 9200    1116      DW      EXAM     ; ADDRESS OF EXAMINE REGISTERS ROUTINE
0380 8B01    1117      DW      SUBST   ; ADDRESS OF SUBSTITUTE MEMORY ROUTINE
0382 CB00    1118      DW      GOCMD   ; ADDRESS OF GO ROUTINE
              1119 ;
              1120 ;*****
              1121 ;
              1122 DSPTB: ; TABLE FOR TRANSLATING CHARACTERS FOR OUTPUT
              1123 ;
              1124 ;          DISPLAY
              1125 ;          FORMAT  CHARACTER
              1126 ;          =====  =====
              1127 ;
0000         1128 ZERO  EQU      $ - DSPTB
0384 F3      1129      DB      0F3H    ; 0
0385 60      1130      DB      60H     ; 1
0386 B5      1131      DB      0B5H   ; 2
0387 F4      1132      DB      0F4H   ; 3
0388 66      1133      DB      66H     ; 4
0005         1134 FIVE  EQU      $ - DSPTB
0005         1135 LETRS EQU      $ - DSPTB
0389 D6      1136      DB      0D6H    ; 5 AND S
038A D7      1137      DB      0D7H    ; 6
038B 70      1138      DB      70H     ; 7
0008         1139 EIGHT EQU      $ - DSPTB
038C F7      1140      DB      0F7H    ; 8
038D 76      1141      DB      76H     ; 9
000A         1142 LETRA EQU      $ - DSPTB
038E 77      1143      DB      77H     ; A
000B         1144 LETRB EQU      $ - DSPTB
038F C7      1145      DB      0C7H    ; B (LOWER CASE)
000C         1146 LETRC EQU      $ - DSPTB
0390 93      1147      DB      93H     ; C
000D         1148 LETRD EQU      $ - DSPTB
0391 E5      1149      DB      0E5H    ; D (LOWER CASE)
000E         1150 LETRE EQU      $ - DSPTB
0392 97      1151      DB      97H     ; E
000F         1152 LETRF EQU      $ - DSPTB
0393 17      1153      DB      17H     ; F
0010         1154 LETRH EQU      $ - DSPTB
0394 67      1155      DB      67H     ; H
0011         1156 LETRL EQU      $ - DSPTB
0395 83      1157      DB      83H     ; L
0012         1158 LETRP EQU      $ - DSPTB
0396 37      1159      DB      37H     ; P
0013         1160 LETRI EQU      $ - DSPTB
0397 60      1161      DB      60H     ; I
0014         1162 LETRR EQU      $ - DSPTB
0398 05      1163      DB      05H     ; R (LOWER CASE)
0015         1164 BLANK EQU      $ - DSPTB
0399 00      1165      DB      00H     ; BLANK
              1166 ;
              1167 ;*****
              1168 ;
              1169 ; MESSAGES FOR OUTPUT TO DISPLAY
              1170 ;
039A 15      1171 BLNKS: DB      BLANK,BLANK,BLANK,BLANK ; FOR ADDRESS OR DATA FIELD
039B 15
039C 15
039D 15
039E 15      1172 ERMSG: DB      BLANK,LETRE,LETRR,LETRR ; ERROR MESSAGE FOR ADDR. FIELD
039F 0E
03A0 14
03A1 14
03A2 0E      1173 EXMSG: DB      LETRE,BLANK,BLANK,BLANK ; EXECUTION MESSAGE
03A3 15
03A4 15
03A5 15
              1174 ; /FOR ADDRESS FIELD
03A6 15      1175 SGNAD: DB      BLANK,BLANK,EIGHT,ZERO ; SIGN ON MESSAGE (ADDR. FIELD)
03A7 15
03A8 08
03A9 00
03AA 08      1176 SGNDT: DB      EIGHT,FIVE ; SIGN ON MESSAGE (DATA FIELD)
03AB 05
              1177 ;
              1178 ;*****

```

```

LOC OBJ      SEQ      SOURCE STATEMENT
1179 ;
1180 RGPTB: ; REGISTER POINTER TABLE
1181 ; THE ENTRIES IN THIS TABLE ARE IN THE SAME ORDER
1182 ; AS THE REGISTER DESIGNATOR KEYS ON THE KEYBOARD.
1183 ; EACH ENTRY CONTAINS THE REGISTER POINTER VALUE WHICH
1184 ; CORRESPONDS TO THE REGISTER DESIGNATOR. REGISTER
1185 ; POINTER VALUES ARE USED TO POINT INTO THE REGISTER
1186 ; NAME TABLE (NMTBL) AND REGISTER SAVE LOCATION
1187 ; TABLE (RGTBL).
1188 ;
03AC 06      1189      DB      6      ; INTERRUPT MASK
03AD 09      1190      DB      9      ; SPH
03AE 0A      1191      DB     10     ; SPL
03AF 0B      1192      DB     11     ; PCH
03B0 0C      1193      DB     12     ; PCL
03B1 07      1194      DB      7      ; H
03B2 08      1195      DB      8      ; L
03B3 00      1196      DB      0      ; A
03B4 01      1197      DB      1      ; B
03B5 02      1198      DB      2      ; C
03B6 03      1199      DB      3      ; D
03B7 04      1200      DB      4      ; E
03B8 05      1201      DB      5      ; FLAGS
1202 ;
1203 ;*****
1204 ;
1205 NMTBL: ; REGISTER NAME TABLE
1206 ; NAMES OF REGISTERS IN DISPLAY FORMAT
1207      DB      BLANK,BLANK,BLANK,LETRA ; A REGISTER
03B9 15
03BA 15
03BB 15
03BC 0A
03BD 15      1208      DB      BLANK,BLANK,BLANK,LETRB ; B REGISTER
03BE 15
03BF 15
03C0 0B
03C1 15      1209      DB      BLANK,BLANK,BLANK,LETRC ; C REGISTER
03C2 15
03C3 15
03C4 0C
03C5 15      1210      DB      BLANK,BLANK,BLANK,LETRD ; D REGISTER
03C6 15
03C7 15
03C8 0D
03C9 15      1211      DB      BLANK,BLANK,BLANK,LETR E ; E REGISTER
03CA 15
03CB 15
03CC 0E
03CD 15      1212      DB      BLANK,BLANK,BLANK,LETRF ; FLAGS
03CE 15
03CF 15
03D0 0F
03D1 15      1213      DB      BLANK,BLANK,BLANK,LETRI ; INTERRUPT MASK
03D2 15
03D3 15
03D4 13
03D5 15      1214      DB      BLANK,BLANK,BLANK,LETRH ; H REGISTER
03D6 15
03D7 15
03D8 10
03D9 15      1215      DB      BLANK,BLANK,BLANK,LETRL ; L REGISTER
03DA 15
03DB 15
03DC 11
03DD 15      1216      DB      BLANK,LETRS,LETRP,LETRH ; STACK POINTER HIGH ORDER BYTE
03DE 05
03DF 12
03E0 10
03E1 15      1217      DB      BLANK,LETRS,LETRP,LETRL ; STACK POINTER LOW ORDER BYTE
03E2 05
03E3 12
03E4 11
03E5 15      1218      DB      BLANK,LETRP,LETRC,LETRH ; PROGRAM COUNTER HIGH BYTE
03E6 12
03E7 0C
03E8 10
03E9 15      1219      DB      BLANK,LETRP,LETRC,LETRL ; PROGRAM COUNTER LOW BYTE
03EA 12
03EB 0C
03EC 11
1220 ;
1221 ;*****
1222 ;
1223 ; REGISTER SAVE LOCATION TABLE
1224 ; ADDRESSES OF SAVE LOCATIONS OF REGISTERS IN THE ORDER IN WHICH
1225 ; THE REGISTERS ARE DISPLAYED BY THE EXAMINE COMMAND
1226 ;
1227 RGTBL:
03ED EE      1228      DB      ASAV AND 0FFH ; A REGISTER
03EE EC      1229      DB      BSAV AND 0FFH ; B REGISTER
03EF EB      1230      DB      CSAV AND 0FFH ; C REGISTER
03F0 EA      1231      DB      DSAV AND 0FFH ; D REGISTER
03F1 E9      1232      DB      ESAV AND 0FFH ; E REGISTER
03F2 ED      1233      DB      FSAV AND 0FFH ; FLAGS
03F3 F1      1234      DB      ISAV AND 0FFH ; INTERRUPT MASK
03F4 F0      1235      DB      HSAV AND 0FFH ; H REGISTER
03F5 EF      1236      DB      LSAV AND 0FFH ; L REGISTER
03F6 F5      1237      DB      SPHSV AND 0FFH ; STACK POINTER HIGH ORDER BYTE
03F7 F4      1238      DB      SPLSV AND 0FFH ; STACK POINTER LOW ORDER BYTE
03F8 F3      1239      DB      PCHSV AND 0FFH ; PROGRAM COUNTER HIGH ORDER BYTE

```

```

LOC OBJ      SEQ      SOURCE STATEMENT
03F9 F2      1240      DB          PCLSV AND 0FFH ; PROGRAM COUNTER LOW ORDER BYTE
000D          1241      NUMRG EQU      ($ - RGTBL) ; NUMBER OF ENTRIES IN
          1242          ; /REGISTER SAVE LOCATION TABLE
          1243 ;
          1244 ;*****
          1245 ;*****
          1246 ;
          1247 ;          SDK-85 TTY MONITOR
          1248 ;
          1249 ;*****
          1250 ;*****
          1251 ;
          1252 ;
          1253 ; ABSTRACT
          1254 ; =====
          1255 ;
          1256 ; THIS PROGRAM WAS ADAPTED, WITH FEW CHANGES, FROM THE SDK-80 MONITOR.
          1257 ; THIS PROGRAM RUNS ON THE 8085 BOARD AND IS DESIGNED TO PROVIDE
          1258 ; THE USER WITH A MINIMAL MONITOR. BY USING THIS PROGRAM,
          1259 ; THE USER CAN EXAMINE AND CHANGE MEMORY OR CPU REGISTERS, LOAD
          1260 ; A PROGRAM (IN ABSOLUTE HEX) INTO RAM, AND EXECUTE INSTRUCTIONS
          1261 ; ALREADY IN MEMORY. THE MONITOR ALSO PROVIDES THE USER WITH
          1262 ; ROUTINES FOR PERFORMING CONSOLE I/O.
          1263 ;
          1264 ;
          1265 ; PROGRAM ORGANIZATION
          1266 ; =====
          1267 ;
          1268 ; THE LISTING IS ORGANIZED IN THE FOLLOWING WAY. FIRST THE COMMAND
          1269 ; RECOGNIZER, WHICH IS THE HIGHEST LEVEL ROUTINE IN THE PROGRAM,
          1270 ; NEXT THE ROUTINES TO IMPLEMENT THE VARIOUS COMMANDS. FINALLY,
          1271 ; THE UTILITY ROUTINES WHICH ACTUALLY DO THE DIRTY WORK. WITHIN
          1272 ; EACH SECTION, THE ROUTINES ARE ORGANIZED IN ALPHABETICAL
          1273 ; ORDER, BY ENTRY POINT OF THE ROUTINE.
          1274 ;
          1275 ; MACROS USED IN THE TTY MONITOR ARE DEFINED IN THE KEYBOARD MONITOR.
          1276 ;
          1277 ; LIST OF FUNCTIONS
          1278 ; ----
          1279 ;
          1280 ; GETCM
          1281 ; ----
          1282 ;
          1283 ; DCMD
          1284 ; GCMD
          1285 ; ICMD
          1286 ; MCMD
          1287 ; SCMD
          1288 ; XCMD
          1289 ; ----
          1290 ;
          1291 ; CI
          1292 ; CNVBN
          1293 ; CO
          1294 ; CROUT
          1295 ; DELAY
          1296 ; ECHO
          1297 ; ERROR
          1298 ; FRET
          1299 ; GETCH
          1300 ; GETHX
          1301 ; GETNM
          1302 ; HILO
          1303 ; NMOUT
          1304 ; PRVAL
          1305 ; REGDS
          1306 ; RGADR
          1307 ; SRET
          1308 ; STHF0
          1309 ; STHLF
          1310 ; VALDG
          1311 ; VALDL
          1312 ; ----
          1313 ;
          1314 ;
          1315 ;*****
          1316 ;
          1317 ;
          1318 ;          MONITOR EQUATES
          1319 ;
          1320 ;
          1321 ;*****
          1322 ;
          1323 ;
          001B 1324 BRCHR EQU 1BH ; CODE FOR BREAK CHARACTER (ESCAPE)
          07FA 1325 BRTAB EQU 07FAH ; LOCATION OF START OF BRANCH TABLE IN ROM
          000D 1326 CR EQU 0DH ; CODE FOR CARRIAGE RETURN
          001B 1327 ESC EQU 1BH ; CODE FOR ESCAPE CHARACTER
          000F 1328 HCHAR EQU 0FH ; MASK TO SELECT LOWER HEX CHAR FROM BYTE
          00FF 1329 INVRT EQU 0FFH ; MASK TO INVERT HALF BYTE FLAG
          000A 1330 LF EQU 0AH ; CODE FOR LINE FEED
          0000 1331 LOWER EQU 0 ; DENOTES LOWER HALF OF BYTE IN ICMD
          1332 ; LSGNON EQU --- ; LENGTH OF SIGNON MESSAGE - DEFINED LATER
          1333 ; MNSTK EQU --- ; START OF MONITOR STACK - DEFINED IN
          1334 ; /KEYBOARD MONITOR
          1335 ; NCMSD EQU --- ; NUMBER OF VALID COMMANDS - DEFINED LATER
          000F 1336 NEWLN EQU 0FH ; MASK FOR CHECKING MEMORY ADDR DISPLAY
          007F 1337 PRTY0 EQU 07FH ; MASK TO CLEAR PARITY BIT FROM CONSOLE CHAR
          1338 ; RAMST EQU --- ; START ADDRESS OF RAM - DEFINED IN
          1339 ; KEYBOARD MONITOR
    
```

```

LOC  OBJ      SEQ      SOURCE STATEMENT
-----
0080      1340 ;RTABS EQU    ---      ; SIZE OF ENTRY IN RTAB TABLE
0080      1341 SSTRF EQU    80H      ; SHIFTED START BIT
0040      1342 STOPB EQU    40H      ; STOP BIT
00C0      1343 STRT  EQU    0C0H     ; UNSHIFTED START BIT
001B      1344 TERM  EQU    1BH      ; CODE FOR ICMD TERMINATING CHARACTER (ESCAPE)
00FF      1345 UPPER EQU    0FFH     ; DENOTES UPPER HALF OF BYTE IN ICMD
1346
1347 ;DELAY VALUES IF NO WAIT STATE
1348 ;
1349      1349      IF      1-WAITS
048C      1350 IBTIM EQU    1164     ;INTER-BIT TIME DELAY
048C      1351 OBTIM EQU    1164     ;OUTPUT INTER-BIT TIME DELAY
1230      1352 TIM4  EQU    4656     ;4 BIT TIME DELAY
0246      1353 WAIT  EQU    582      ;DELAY UNTIL READY TO SAMPLE BITS
1354      1354      ENDIF
1355 ;
1356 ;DELAY VALUES IF ONE WAIT STATE
1357 ;
1358      1358      IF      WAITS
1359 IBTIM EQU    930      ;INTER-BIT DELAY
1360 OBTIM EQU    930      ;OUTPUT INTER-BIT TIME DELAY
1361 TIM4  EQU    3720     ;4 BIT TIME DELAY
1362 WAIT  EQU    465      ;DELAY UNTIL READY TO SAMPLE BITS
1363      1363      ENDIF
1364 ;
1365 ;
1366 ;*****
1367 ;
1368 ;
1369 ;
1370 ;
1371 ;
1372 ;*****
1373 ;
1374 ;
1375 ;
1376 ;*****
1377 ;
1378 ;
1379 ;
1380 ;
1381 ;
1382 ;*****
1383 ;
1384 ;
1385 GO:
1386      LXI    H,SGNON ; GET ADDRESS OF SIGNON MESSAGE
03FA 218C07 1387      MVI    B,LSGNON ; COUNTER FOR CHARACTERS IN MESSAGE
03FD 0614
1388 MSGL:
03FF 4E      1389      MOV    C,M ; FETCH NEXT CHAR TO C REG
0400 CDC405 1390      CALL  CO ; SEND IT TO THE CONSOLE
0403 23      1391      INX   H ; POINT TO NEXT CHARACTER
0404 05      1392      DCR   B ; DECREMENT BYTE COUNTER
0405 C2FF03 1393      JNZ   MSGL ; RETURN FOR NEXT CHARACTER
1394 ;
1395 ;
1396 ;*****
1397 ;
1398 ;
1399 ;
1400 ;
1401 ;
1402 ;*****
1403 ;
1404 ; FUNCTION: GETCM
1405 ; INPUTS: NONE
1406 ; OUTPUTS: NONE
1407 ; CALLS: GETCH,ECHO,ERROR
1408 ; DESTROYS: A,B,C,H,L,F/F'S
1409 ; DESCRIPTION: GETCM RECEIVES AN INPUT CHARACTER FROM THE USER
1410 ; AND ATTEMPTS TO LOCATE THIS CHARACTER IN ITS COMMAND
1411 ; CHARACTER TABLE. IF SUCCESSFUL, THE ROUTINE
1412 ; CORRESPONDING TO THIS CHARACTER IS SELECTED FROM
1413 ; A TABLE OF COMMAND ROUTINE ADDRESSES, AND CONTROL
1414 ; IS TRANSFERRED TO THIS ROUTINE. IF THE CHARACTER
1415 ; DOES NOT MATCH ANY ENTRIES, CONTROL IS PASSED TO
1416 ; THE ERROR HANDLER.
1417 ;
1418 GETCM:
0408 21E920 1419      LXI    H,MNSTK ; ALWAYS WANT TO RESET STACK PTR TO MONITOR
040B F9      1420      SPHL ; /STARTING VALUE SO ROUTINES NEEDN'T CLEAN UP
040C 0E2E    1421      MVI    C,'.' ; PROMPT CHARACTER TO C
040E CDF805 1422      CALL  ECHO ; SEND PROMPT CHARACTER TO USER TERMINAL
0411 C31404 1423      JMP    GTC03 ; WANT TO LEAVE ROOM FOR RST BRANCH
1424 GTC03:
0414 CD1F06 1425      CALL  GETCH ; GET COMMAND CHARACTER TO A
0417 CDF805 1426      CALL  ECHO ; ECHO CHARACTER TO USER
041A 79      1427      MOV    A,C ; PUT COMMAND CHARACTER INTO ACCUMULATOR
041B 010600 1428      LXI    B,NCMD5 ; C CONTAINS LOOP AND INDEX COUNT
041E 21AE07 1429      LXI    H,CTAB ; HL POINTS INTO COMMAND TABLE
1430 GTC05:
0421 BE      1431      CMP    M ; COMPARE TABLE ENTRY AND CHARACTER
0422 CA2D04 1432      JZ    GTC10 ; BRANCH IF EQUAL - COMMAND RECOGNIZED
0425 23      1433      INX   H ; ELSE, INCREMENT TABLE POINTER
0426 0D      1434      DCR   C ; DECREMENT LOOP COUNT
0427 C22104 1435      JNZ   GTC05 ; BRANCH IF NOT AT TABLE END
042A C31106 1436      JMP    ERROR ; ELSE, COMMAND CHARACTER IS ILLEGAL
1437 GTC10:
042D 21A007 1438      LXI    H,CADR ; IF GOOD COMMAND, LOAD ADDRESS OF TABLE
1439 ; /OF COMMAND ROUTINE ADDRESSES

```

LOC	OBJ	SEQ	SOURCE STATEMENT
0430	09	1440	DAD B ; ADD WHAT IS LEFT OF LOOP COUNT
0431	09	1441	DAD B ; ADD AGAIN - EACH ENTRY IN CADR IS 2 BYTES LONG
0432	7E	1442	MOV A,M ; GET LSP OF ADDRESS OF TABLE ENTRY TO A
0433	23	1443	INX H ; POINT TO NEXT BYTE IN TABLE
0434	66	1444	MOV H,M ; GET MSP OF ADDRESS OF TABLE ENTRY TO H
0435	6F	1445	MOV L,A ; PUT LSP OF ADDRESS OF TABLE ENTRY INTO L
0436	E9	1446	PCHL ; NEXT INSTRUCTION COMES FROM COMMAND ROUTINE
		1447 ;	
		1448 ;	
		1449 ;	*****
		1450 ;	
		1451 ;	
		1452 ;	COMMAND IMPLEMENTING ROUTINES
		1453 ;	
		1454 ;	
		1455 ;	*****
		1456 ;	
		1457 ;	
		1458 ;	FUNCTION: DCMD
		1459 ;	INPUTS: NONE
		1460 ;	OUTPUTS: NONE
		1461 ;	CALLS: ECHO,NMOUT,HILO,GETCM,CROUT,GETNM
		1462 ;	DESTROYS: A,B,C,D,E,H,L,F/F'S
		1463 ;	DESCRIPTION: DCMD IMPLEMENTS THE DISPLAY MEMORY (D) COMMAND
		1464 ;	
		1465	DCMD:
0437	0E02	1466	MVI C,2 ; GET 2 NUMBERS FROM INPUT STREAM
0439	CD5B06	1467	CALL GETNM
043C	D1	1468	POP D ; ENDING ADDRESS TO DE
043D	E1	1469	POP H ; STARTING ADDRESS TO HL
		1470	DCM05:
043E	CDEB05	1471	CALL CROUT ; ECHO CARRIAGE RETURN/LINE FEED
0441	7C	1472	MOV A,H ; DISPLAY ADDRESS OF FIRST LOCATION IN LINE
0442	CDC706	1473	CALL NMOUT
0445	7D	1474	MOV A,L ; ADDRESS IS 2 BYTES LONG
0446	CDC706	1475	CALL NMOUT
		1476	DCM10:
0449	0E20	1477	MVI C,' ' ; USE BLANK AS SEPARATOR
044B	CDP805	1478	CALL ECHO ; GET CONTENTS OF NEXT MEMORY LOCATION
044E	7E	1479	MOV A,M ; DISPLAY CONTENTS
044F	CDC706	1480	CALL NMOUT ; SEE IF ADDRESS OF DISPLAYED LOCATION IS
0452	CDA006	1481	CALL HILO ; /GREATER THAN OR EQUAL TO ENDING ADDRESS
		1482	
		1483	FALSE DCM15 ; IF NOT, MORE TO DISPLAY
0455	D25E04	1484+	JNC DCM15
0458	CDEB05	1485	CALL CROUT ; CARRIAGE RETURN/LINE FEED TO END LINE
045B	C30804	1486	JMP GETCM ; ALL DONE
		1487	DCM15:
045E	23	1488	INX H ; IF MORE TO GO, POINT TO NEXT LOC TO DISPLAY
045F	7D	1489	MOV A,L ; GET LOW ORDER BITS OF NEW ADDRESS
0460	E60F	1490	ANI NEWLN ; SEE IF LAST HEX DIGIT OF ADDRESS DENOTES
		1491	
		1492	JNZ DCM10 ; /START OF NEW LINE
0462	C24904	1493	JMP DCM05 ; NO - NOT AT END OF LINE
0465	C33E04	1494	
		1495 ;	
		1496 ;	*****
		1497 ;	
		1498 ;	
		1499 ;	FUNCTION: GCMD
		1500 ;	INPUTS: NONE
		1501 ;	OUTPUTS: NONE
		1502 ;	CALLS: ERROR,GETHX,RSTTF
		1503 ;	DESTROYS: A,B,C,D,E,H,L,F/F'S
		1504 ;	DESCRIPTION: GCMD IMPLEMENTS THE BEGIN EXECUTION (G) COMMAND.
		1505 ;	
		1506	GCMD:
0468	CD2606	1507	CALL GETHX ; GET ADDRESS (IF PRESENT) FROM INPUT STREAM
		1508	FALSE GCM05 ; BRANCH IF NO NUMBER PRESENT
046B	D27D04	1509+	JNC GCM05
046E	7A	1510	MOV A,D ; ELSE, GET TERMINATOR
046F	FE0D	1511	CPI CR ; SEE IF CARRIAGE RETURN
0471	C21106	1512	JNZ ERROR ; ERROR IF NOT PROPERLY TERMINATED
0474	21F220	1513	LXI H,PSAV ; WANT NUMBER TO REPLACE SAVE PGM COUNTER
0477	71	1514	MOV M,C
0478	23	1515	INX H
0479	70	1516	MOV M,B
047A	C38304	1517	JMP GCM10
		1518	GCM05:
047D	7A	1519	MOV A,D ; IF NO STARTING ADDRESS, MAKE SURE THAT
047E	FE0D	1520	CPI CR ; /CARRIAGE RETURN TERMINATED COMMAND
0480	C21106	1521	JNZ ERROR ; ERROR IF NOT
		1522	GCM10:
0483	C31B03	1523	JMP RSTOR ; RESTORE REGISTERS AND BEGIN EXECUTION
		1524	
		1525 ;	
		1526 ;	
		1527 ;	*****
		1528 ;	
		1529 ;	
		1530 ;	FUNCTION: ICMD
		1531 ;	INPUTS: NONE
		1532 ;	OUTPUTS: NONE
		1533 ;	CALLS: ERROR,ECHO,GETCH,VALDL,VALDG,CNVBN,STHLF,GETNM,CROUT
		1534 ;	DESTROYS: A,B,C,D,E,H,L,F/F'S
		1535 ;	DESCRIPTION: ICMD IMPLEMENTS THE INSERT CODE INTO MEMORY (I) COMMAND.
		1536 ;	
		1537	ICMD:
0486	0E01	1538	MVI C,1

LOC	OBJ	SEQ	SOURCE STATEMENT
0488	CD5B06	1539	CAL GETNM ; GET SINGLE NUMBER FROM INPUT STREAM
048B	3EFF	1540	MVI A,UPPER
048D	32FD20	1541	STA TEMP ; TEMP WILL HOLD THE UPPER/LOWER HALF BYTE FLAG
0490	D1	1542	POP D ; ADDRESS OF START TO DE
		1543	ICM05:
0491	CD1F06	1544	CALL GETCH ; GET A CHARACTER FROM INPUT STREAM
0494	4F	1545	MOV C,A
0495	CDF805	1546	CALL ECHO ; ECHO IT
0498	79	1547	MOV A,C ; PUT CHARACTER BACK INTO A
0499	FE1B	1548	CPI TERM ; SEE IF CHARACTER IS A TERMINATING CHARACTER
049B	CAC704	1549	JZ ICM25 ; IF SO, ALL DONE ENTERING CHARACTERS
049E	CD7907	1550	CALL VALDL ; ELSE, SEE IF VALID DELIMITER
		1551	TRUE ICM05 ; IF SO SIMPLY IGNORE THIS CHARACTER
		1552+	JC ICM05
04A1	DA9104	1553	CALL VALDG ; ELSE, CHECK TO SEE IF VALID HEX DIGIT
04A4	CD5E07	1554	FALSE ICM20 ; IF NOT, BRANCH TO HANDLE ERROR CONDITION
		1555+	JNC ICM20
04A7	D2C104	1556	CALL CNVBN ; CONVERT DIGIT TO BINARY
04AA	CDBB05	1557	MOV C,A ; MOVE RESULT TO C
04AD	4F	1558	CALL STHLF ; STORE IN APPROPRIATE HALF WORD
04AE	CD3F07	1559	LDA TEMP ; GET HALF BYTE FLAG
04B1	3AFD20	1560	ORA A ; SET F/F'S
04B4	B7	1561	JNZ ICM10 ; BRANCH IF FLAG SET FOR UPPER
04B5	C2B904	1562	INX D ; IF LOWER, INC ADDRESS OF BYTE TO STORE IN
04B8	13	1563	ICM10:
04B9	EEFF	1564	XRI INVRT ; TOGGLE STATE OF FLAG
04BB	32FD20	1565	STA TEMP ; PUT NEW VALUE OF FLAG BACK
04BE	C39104	1566	JMP ICM05 ; PROCESS NEXT DIGIT
		1567	ICM20:
04C1	CD3407	1568	CALL STHF0 ; ILLEGAL CHARACTER
04C4	C31106	1569	JMP ERROR ; MAKE SURE ENTIRE BYTE FILLED THEN ERROR
		1570	ICM25:
04C7	CD3407	1571	CALL STHF0 ; HERE FOR ESCAPE CHARACTER - INPUT IS DONE
04CA	CDEB05	1572	CALL CROUT ; ADD CARRIAGE RETURN
04CD	C30804	1573	JMP GETCM
		1574 ;	
		1575 ;	
		1576 ;	*****
		1577 ;	
		1578 ;	
		1579 ;	FUNCTION: MCMD
		1580 ;	INPUTS: NONE
		1581 ;	OUTPUTS: NONE
		1582 ;	CALLS: GETCM,HILO,GETNM
		1583 ;	DESTROYS: A,B,C,D,E,H,L,F/F'S
		1584 ;	DESCRIPTION: MCMD IMPLEMENTS THE MOVE DATA IN MEMORY (M) COMMAND.
		1585 ;	
		1586	MCMD:
04D0	0E03	1587	MVI C,3
04D2	CD5B06	1588	CALL GETNM ; GET 3 NUMBERS FROM INPUT STREAM
04D5	C1	1589	POP B ; DESTINATION ADDRESS TO BC
04D6	E1	1590	POP H ; ENDING ADDRESS TO HL
04D7	D1	1591	POP D ; STARTING ADDRESS TO DE
		1592	MCM05:
04D8	E5	1593	PUSH H ; SAVE ENDING ADDRESS
04D9	62	1594	MOV H,D
04DA	6B	1595	MOV L,E ; SOURCE ADDRESS TO HL
04DB	7E	1596	MOV A,M ; GET SOURCE BYTE
04DC	60	1597	MOV H,B
04DD	69	1598	MOV L,C ; DESTINATION ADDRESS TO HL
04DE	77	1599	MOV M,A ; MOVE BYTE TO DESTINATION
04DF	03	1600	INX B ; INCREMENT DESTINATION ADDRESS
04E0	78	1601	MOV A,B
04E1	B1	1602	ORA C ; TEST FOR DESTINATION ADDRESS OVERFLOW
04E2	CA0004	1603	JZ GETCM ; IF SO, CAN TERMINATE COMMAND
04E5	13	1604	INX D ; INCREMENT SOURCE ADDRESS
04E6	E1	1605	POP H ; ELSE, GET BACK ENDING ADDRESS
04E7	CDA006	1606	CALL HILO ; SEE IF ENDING ADDR>=SOURCE ADDR
		1607	FALSE GETCM ; IF NOT, COMMAND IS DONE
04EA	D20804	1608+	JNC GETCM
04ED	C3D804	1609	JMP MCM05 ; MOVE ANOTHER BYTE
		1610 ;	
		1611 ;	
		1612 ;	*****
		1613 ;	
		1614 ;	
		1615 ;	FUNCTION: SCMD
		1616 ;	INPUTS: NONE
		1617 ;	OUTPUTS: NONE
		1618 ;	CALLS: GETHX,GETCM,NMOUT,ECHO
		1619 ;	DESTROYS: A,B,C,D,E,H,L,F/F'S
		1620 ;	DESCRIPTION: SCMD IMPLEMENTS THE SUBSTITUTE INTO MEMORY (S) COMMAND.
		1621 ;	
		1622	SCMD:
04F0	CD2606	1623	CALL GETHX ; GET A NUMBER, IF PRESENT, FROM INPUT
04F3	C5	1624	PUSH B
04F4	E1	1625	POP H ; GET NUMBER TO HL - DENOTES MEMORY LOCATION
		1626	SCM05:
04F5	7A	1627	MOV A,D ; GET TERMINATOR
04F6	FE20	1628	CPI ' ' ; SEE IF SPACE
04F8	CA0005	1629	JZ SCM10 ; YES - CONTINUE PROCESSING
04FB	FE2C	1630	CPI ',' ; ELSE, SEE IF COMMA
04FD	C20804	1631	JNZ GETCM ; NO - TERMINATE COMMAND
		1632	SCM10:
0500	7E	1633	MOV A,M ; GET CONTENTS OF SPECIFIED LOCATION TO A
0501	CDC706	1634	CALL NMOUT ; DISPLAY CONTENTS ON CONSOLE
0504	0E2D	1635	MVI C,'-'
0506	CDF805	1636	CALL ECHO ; USE DASH FOR SEPARATOR
0509	CD2606	1637	CALL GETHX ; GET NEW VALUE FOR MEMORY LOCATION, IF ANY

LOC	OBJ	SEQ	SOURCE STATEMENT
		1638	FALSE SCM15 ; IF NO VALUE PRESENT, BRANCH
050C	D21005	1639+	JNC SCM15
050F	71	1640	MOV M,C ; ELSE, STORE LOWER 8 BITS OF NUMBER ENTERED
		1641	SCM15:
0510	23	1642	INX H ; INCREMENT ADDRESS OF MEMORY LOCATION TO VIEW
0511	C3F504	1643	JMP SCM05
		1644 ;	
		1645 ;	
		1646 ;	
		1647 ;	
		1648 ;	
		1649 ;	FUNCTION: XCMD
		1650 ;	INPUTS: NONE
		1651 ;	OUTPUTS: NONE
		1652 ;	CALLS: GETCH,ECHO,REGDS,GETCM,ERROR,RGADR,NMOUT,CROUT,GETHX
		1653 ;	DESTROYS: A,B,C,D,E,H,L,F/F'S
		1654 ;	DESCRIPTION: XCMD IMPLEMENTS THE REGISTER EXAMINE AND CHANGE (X)
		1655 ;	COMMAND.
		1656 ;	
		1657	XCMD:
0514	CD1F06	1658	CALL GETCH ; GET REGISTER IDENTIFIER
0517	4F	1659	MOV C,A
0518	CDF805	1660	CALL ECHO ; ECHO IT
051B	79	1661	MOV A,C
051C	FE0D	1662	CPI CR
051E	C22705	1663	JNZ XCM05 ; BRANCH IF NOT CARRIAGE RETURN
0521	CDEA06	1664	CALL REGDS ; ELSE, DISPLAY REGISTER CONTENTS
0524	C30804	1665	JMP GETCM ; THEN TERMINATE COMMAND
		1666	XCMD05:
0527	4F	1667	MOV C,A ; GET REGISTER IDENTIFIER TO C
0528	CD1B07	1668	CALL RGADR ; CONVERT IDENTIFIER INTO RTAB TABLE ADDR
052B	C5	1669	PUSH B
052C	E1	1670	POP H ; PUT POINTER TO REGISTER ENTRY INTO HL
052D	0E20	1671	MVI C,' '
052F	CDF805	1672	CALL ECHO ; ECHO SPACE TO USER
0532	79	1673	MOV A,C
0533	32FD20	1674	STA TEMP ; PUT SPACE INTO TEMP AS DELIMITER
		1675	XCMD10:
0536	3AFD20	1676	LDA TEMP ; GET TERMINATOR
0539	FE20	1677	CPI ' ' ; SEE IF A BLANK
053B	CA4305	1678	JZ XCM15 ; YES - GO CHECK POINTER INTO TABLE
053E	FE2C	1679	CPI ',' ; NO - SEE IF COMMA
0540	C20804	1680	JNZ GETCM ; NO - MUST BE CARRIAGE RETURN TO END COMMAND
		1681	XCMD15:
0543	7E	1682	MOV A,M
0544	B7	1683	ORA A ; SET F/F'S
0545	C24E05	1684	JNZ XCM18 ; BRANCH IF NOT AT END OF TABLE
0548	CDEB05	1685	CALL CROUT ; ELSE, OUTPUT CARRIAGE RETURN LINE FEED
054B	C30804	1686	JMP GETCM ; AND EXIT
		1687	XCMD18:
054E	E5	1688	PUSH H ; PUT POINTER ON STACK
054F	5E	1689	MOV E,M
0550	1620	1690	MVI D,RAMST SHR 8 ; ADDRESS OF SAVE LOCATION FROM TABLE
0552	23	1691	INX H
0553	46	1692	MOV B,M ; FETCH LENGTH FLAG FROM TABLE
0554	D5	1693	PUSH D ; SAVE ADDRESS OF SAVE LOCATION
0555	D5	1694	PUSH D
0556	E1	1695	POP H ; MOVE ADDRESS TO HL
0557	C5	1696	PUSH B ; SAVE LENGTH FLAG
0558	7E	1697	MOV A,M ; GET 8 BITS OF REGISTER FROM SAVE LOCATION
0559	CDC706	1698	CALL NMOUT ; DISPLAY IT
055C	F1	1699	POP PSW ; GET BACK LENGTH FLAG
055D	F5	1700	PUSH PSW ; SAVE IT AGAIN
055E	B7	1701	ORA A ; SET F/F'S
055F	CA6705	1702	JZ XCM20 ; IF 8 BIT REGISTER, NOTHING MORE TO DISPLAY
0562	2B	1703	DCX H ; ELSE, FOR 16 BIT REGISTER, GET LOWER 8 BITS
0563	7E	1704	MOV A,M
0564	CDC706	1705	CALL NMOUT ; DISPLAY THEM
		1706	XCMD20:
0567	0E2D	1707	MVI C,'-'
0569	CDF805	1708	CALL ECHO ; USE DASH AS SEPARATOR
056C	CD2606	1709	CALL GETHX ; SEE IF THERE IS A VALUE TO PUT INTO REGISTER
		1710	FALSE XCM30 ; NO - GO CHECK FOR NEXT REGISTER
056F	D28705	1711+	JNC XCM30
0572	7A	1712	MOV A,D
0573	32FD20	1713	STA TEMP ; ELSE, SAVE THE TERMINATOR FOR NOW
0576	F1	1714	POP PSW ; GET BACK LENGTH FLAG
0577	E1	1715	POP H ; PUT ADDRESS OF SAVE LOCATION INTO HL
0578	B7	1716	ORA A ; SET F/F'S
0579	CA7E05	1717	JZ XCM25 ; IF 8 BIT REGISTER, BRANCH
057C	70	1718	MOV M,B ; SAVE UPPER 8 BITS
057D	2B	1719	DCX H ; POINT TO SAVE LOCATION FOR LOWER 8 BITS
		1720	XCMD25:
057E	71	1721	MOV M,C ; STORE ALL OF 8 BIT OR LOWER 1/2 OF 16 BIT REG
		1722	XCMD27:
057F	110300	1723	LXI D,RTABS ; SIZE OF ENTRY IN RTAB TABLE
0582	E1	1724	POP H ; POINTER INTO REGISTER TABLE RTAB
0583	19	1725	DAD D ; ADD ENTRY SIZE TO POINTER
0584	C33605	1726	JMP XCM10 ; DO NEXT REGISTER
		1727	XCMD30:
0587	7A	1728	MOV A,D ; GET TERMINATOR
0588	32FD20	1729	STA TEMP ; SAVE IN MEMORY
058B	D1	1730	POP D ; CLEAR STACK OF LENGTH FLAG AND ADDRESS
058C	D1	1731	POP D ; /OF SAVE LOCATION
058D	C37F05	1732	JMP XCM27 ; GO INCREMENT REGISTER TABLE POINTER
		1733 ;	
		1734 ;	

```

LOC OBJ      SEQ      SOURCE STATEMENT
1735 ;*****
1736 ;
1737 ;
1738 ;           UTILITY ROUTINES
1739 ;
1740 ;
1741 ;*****
1742 ;
1743 ;
1744 ; FUNCTION: CI
1745 ; INPUTS: NONE
1746 ; OUTPUTS: A - CHARACTER FROM TTY
1747 ; CALLS: DELAY
1748 ; DESTROYS: A,F/F'S
1749 ; DESCRIPTION: CI WAITS UNTIL A CHARACTER HAS BEEN ENTERED AT THE
1750 ; TTY AND THEN RETURNS THE CHARACTER, VIA THE A
1751 ; REGISTER, TO THE CALLING ROUTINE. THIS ROUTINE
1752 ; IS CALLED BY THE USER VIA A JUMP TABLE IN RAM.
1753 ;
1754 CI:
0590 F3      1755      DI
0591 D5      1756      PUSH    D      ; SAVE DE
1757      CI05:
0592 20      1758      RIM          ; GET INPUT BIT
0593 17      1759      RAL          ; INTO CARRY WITH IT
0594 DA9205  1760      JC          CI05  ; BRANCH IF NO START BIT
0597 114602  1761      LXI    D,WAIT ; WAIT UNTIL MIDDLE OF BIT
059A CDF105  1762      CALL    DELAY
059D C5      1763      PUSH    B      ; SAVE BC
059E 010800  1764      LXI    B,8    ; B<--0, C<--# BITS TO RECEIVE
1765      CI10:
05A1 118C04  1766      LXI    D,IBTIM ; WAIT UNTIL MIDDLE OF NEXT BIT
05A4 CDF105  1767      CALL    DELAY
05A7 20      1768      RIM          ; GET THE BIT
05A8 17      1769      RAL          ; INTO CARRY
05A9 78      1770      MOV    A,B      ; GET PARTIAL RESULT
05AA 1F      1771      RAR          ; SHIFT IN NEXT DATA BIT
05AB 47      1772      MOV    B,A      ; REPLACE RESULT
05AC 0D      1773      DCR    C      ; DEC COUNT OF BITS TO GO
05AD C2A105  1774      JNZ    CI10  ; BRANCH IF MORE LEFT
05B0 118C04  1775      LXI    D,IBTIM ; ELSE, WANT TO WAIT OUT STOP BIT
05B3 CDF105  1776      CALL    DELAY
05B6 78      1777      MOV    A,B      ; GET RESULT
05B7 C1      1778      POP    B
05B8 D1      1779      POP    D      ; RESTORE SAVED REGISTERS
05B9 FB      1780      EI
05BA C9      1781      RET          ; THAT'S IT
1782 ;
1783 ;
1784 ;*****
1785 ;
1786 ;
1787 ; FUNCTION: CNVBN
1788 ; INPUTS: C - ASCII CHARACTER '0'-'9' OR 'A'-'F'
1789 ; OUTPUTS: A - 0 TO F HEX
1790 ; CALLS: NOTHING
1791 ; DESTROYS: A,F/F'S
1792 ; DESCRIPTION: CNVBN CONVERTS THE ASCII REPRESENTATION OF A HEX
1793 ; CNVBN INTO ITS CORRESPONDING BINARY VALUE. CNVBN
1794 ; DOES NOT CHECK THE VALIDITY OF ITS INPUT.
1795 ;
1796 CNVBN:
05BB 79      1797      MOV    A,C
05BC D630    1798      SUI    '0'    ; SUBTRACT CODE FOR '0' FROM ARGUMENT
05BE FE0A    1799      CPI    10    ; WANT TO TEST FOR RESULT OF 0 TO 9
05C0 F8      1800      RM          ; IF SO, THEN ALL DONE
05C1 D607    1801      SUI    7      ; ELSE, RESULT BETWEEN 17 AND 23 DECIMAL
05C3 C9      1802      RET          ; SO RETURN AFTER SUBTRACTING BIAS OF 7
1803 ;
1804 ;
1805 ;*****
1806 ;
1807 ;
1808 ; FUNCTION: CO
1809 ; INPUTS: C - CHARACTER TO OUTPUT TO TTY
1810 ; OUTPUTS: C - CHARACTER OUTPUT TO TTY
1811 ; CALLS: DELAY
1812 ; DESTROYS: A,F/F'S
1813 ; DESCRIPTION: CO SENDS ITS INPUT ARGUMENT TO THE TTY.
1814 ;
1815 CO:
05C4 F3      1816      DI
05C5 C5      1817      PUSH    B      ; SAVE BC
05C6 D5      1818      PUSH    D      ; SAVE DE
05C7 3EC0    1819      MVI    A,STRT  ; START BIT MASK
05C9 0607    1820      MVI    B,7     ; B WILL COUNT BITS TO SEND
1821      CO05:
05CB 30      1822      SIM          ; SEND A BIT
05CC 118C04  1823      LXI    D,OBTIM ; WAIT FOR TTY TO HANDLE IT
05CF CDF105  1824      CALL    DELAY
05D2 79      1825      MOV    A,C      ; PICK UP BITS LEFT TO SEND
05D3 1F      1826      RAR          ; LOW ORDER BIT TO CARRY
05D4 4F      1827      MOV    C,A      ; PUT REST BACK
05D5 3E00    1828      MVI    A,SSTRT ; SHIFTED ENABLE BIT
05D7 1F      1829      RAR          ; SHIFT IN DATA BIT
05D8 EE00    1830      XRI    80H     ; COMPLEMENT DATA BIT
05DA 05      1831      DCR    B      ; DEC COUNT
05DB F2CB05  1832      JP     CO05    ; SEND IF MORE BITS NEED TO BE SENT
05DE 3E40    1833      MVI    A,STOPB ; ELSE, SEND STOP BITS
05E0 30      1834      SIM

```

```

LOC  OBJ          SEQ          SOURCE STATEMENT
05E1 113012      1835          LXI    D,TIM4 ; WAIT 4 BIT TIME (FAKE PARITY + 3 STOP BITS)
05E4 CDF105      1836          CALL   DELAY
05E7 D1          1837          POP    D
05E8 C1          1838          POP    B ; RESTORE SAVED REGISTERS
05E9 FB          1839          EI
05EA C9          1840          RET    ; ALL DONE
1841 ;
1842 ;
1843 ;*****
1844 ;
1845 ;
1846 ; FUNCTION CROUT
1847 ; INPUTS: NONE
1848 ; OUTPUTS: NONE
1849 ; CALLS: ECHO
1850 ; DESTROYS: A,B,C,F/F'S
1851 ; DESCRIPTION: CROUT SENDS A CARRIAGE RETURN (AND HENCE A LINE
1852 ; FEED) TO THE CONSOLE.
1853 ;
1854 CROUT:
05EB 0E0D        1855          MVI    C,CR
05ED CDF805      1856          CALL   ECHO
05F0 C9          1857          RET
1858 ;
1859 ;
1860 ;*****
1861 ;
1862 ;
1863 ; FUNCTION: DELAY
1864 ; INPUTS: DE - 16 BIT INTEGER DENOTING NUMBER OF TIMES TO LOOP
1865 ; OUTPUTS: NONE
1866 ; CALLS: NOTHING
1867 ; DESTROY3: A,D,E,F/F'S
1868 ; DESCRIPTION: DELAY DOES NOT RETURN TO CALLER UNTIL INPUT ARGUMENT
1869 ; IS COUNTED DOWN TO 0.
1870 ;
1871 DELAY:
05F1 1B          1872          DCX    D ; DECREMENT INPUT ARGUMENT
05F2 7A          1873          MOV    A,D
05F3 B3          1874          ORA    E
05F4 C2F105      1875          JNZ    DELAY ; IF ARGUMENT NOT 0, KEEP GOING
05F7 C9          1876          RET
1877 ;
1878 ;
1879 ;*****
1880 ;
1881 ;
1882 ; FUNCTION: ECHO
1883 ; INPUTS: C - CHARACTER TO ECHO TO TERMINAL
1884 ; OUTPUTS: C - CHARACTER ECHOED TO TERMINAL
1885 ; CALLS: CO
1886 ; DESTROYS: A,B,F/F'S
1887 ; DESCRIPTION: ECHO TAKES A SINGLE CHARACTER AS INPUT AND, VIA
1888 ; THE MONITOR, SENDS THAT CHARACTER TO THE USER
1889 ; TERMINAL. A CARRIAGE RETURN IS ECHOED AS A CARRIAGE
1890 ; RETURN LINE FEED, AND AN ESCAPE CHARACTER IS ECHOED AS $.
1891 ;
1892 ECHO:
05F8 41          1893          MOV    B,C ; SAVE ARGUMENT
05F9 3E1B        1894          MVI    A,ESC
05FB B8          1895          CMP    B
05FC C20106      1896          JNZ    ECH05 ; SEE IF ECHOING AN ESCAPE CHARACTER
05FF 0E24        1897          MVI    C,'$' ; YES - ECHO AS $
1898 ECH05:
0601 CDC405      1899          CALL   CO ; DO OUTPUT THROUGH MONITOR
0604 3E0D        1900          MVI    A,CR
0606 B8          1901          CMP    B
0607 C20F06      1902          JNZ    ECH10 ; SEE IF CHARACTER ECHOED WAS A CARRIAGE RETURN
060A 0E0A        1903          MVI    C,LF ; NO - NO NEED TO TAKE SPECIAL ACTION
060C CDC405      1904          CALL   CO ; YES - WANT TO ECHO LINE FEED, TOO
1905 ECH10:
060F 48          1906          MOV    C,B ; RESTORE ARGUMENT
0610 C9          1907          RET
1908 ;
1909 ;
1910 ;*****
1911 ;
1912 ;
1913 ; FUNCTION: ERROR
1914 ; INPUTS: NONE
1915 ; OUTPUTS: NONE
1916 ; CALLS: ECHO,CROUT,GETCM
1917 ; DESTROYS: A,B,C,F/F'S
1918 ; DESCRIPTION: ERROR PRINTS THE ERROR CHARACTER (CURRENTLY AN ASTERISK)
1919 ; ON THE CONSOLE, FOLLOWED BY A CARRIAGE RETURN-LINE FEED,
1920 ; AND THEN RETURNS CONTROL TO THE COMMAND RECOGNIZER.
1921 ;
1922 ERROR:
0611 0E2A        1923          MVI    C,'*'
0613 CDF805      1924          CALL   ECHO ; SEND * TO CONSOLE
0616 CDEB05      1925          CALL   CROUT ; SKIP TO BEGINNING OF NEXT LINE
0619 C30804      1926          JMP    GETCM ; TRY AGAIN FOR ANOTHER COMMAND
1927 ;
1928 ;
1929 ;*****
1930 ;
1931 ;
1932 ; FUNCTION: FRET
1933 ; INPUTS: NONE

```

```

LOC OBJ      SEQ      SOURCE STATEMENT
1934 ; OUTPUTS: CARRY - ALWAYS 0
1935 ; CALLS: NOTHING
1936 ; DESTROYS: CARRY
1937 ; DESCRIPTION: FRET IS JUMPED TO BY ANY ROUTINE THAT WISHES TO
1938 ; INDICATE FAILURE ON RETURN. FRET SETS THE CARRY
1939 ; FALSE, DENOTING FAILURE, AND THEN RETURNS TO THE
1940 ; CALLER OF THE ROUTINE INVOKING FRET.
1941 ;
1942 FRET:
061C 37      1943      STC          ; FIRST SET CARRY TRUE
061D 3F      1944      CMC          ; THEN COMPLEMENT IT TO MAKE IT FALSE
061E C9      1945      RET           ; RETURN APPROPRIATELY
1946 ;
1947 ;
1948 ; *****
1949 ;
1950 ;
1951 ; FUNCTION: GETCH
1952 ; INPUTS: NONE
1953 ; OUTPUTS: C - NEXT CHARACTER IN INPUT STREAM
1954 ; CALLS: CI
1955 ; DESTROYS: A,C,F/F'S
1956 ; DESCRIPTION: GETCH RETURNS THE NEXT CHARACTER IN THE INPUT STREAM
1957 ; TO THE CALLING PROGRAM.
1958 ;
1959 GETCH:
061F CD9005 1960      CALL      CI          ; GET CHARACTER FROM TERMINAL
0622 E67F    1961      ANI      PRTY0      ; TURN OFF PARITY BIT IN CASE SET BY CONSOLE
0624 4F      1962      MOV      C,A        ; PUT VALUE IN C REGISTER FOR RETURN
0625 C9      1963      RET
1964 ;
1965 ;
1966 ; *****
1967 ;
1968 ;
1969 ; FUNCTION: GETHX
1970 ; INPUTS: NONE
1971 ; OUTPUTS: BC - 16 BIT INTEGER
1972 ; D - CHARACTER WHICH TERMINATED THE INTEGER
1973 ; CARRY - 1 IF FIRST CHARACTER NOT DELIMITER
1974 ; - 0 IF FIRST CHARACTER IS DELIMITER
1975 ; CALLS: GETCH,ECHO,VALDL,VALDG,CNVBN,ERROR
1976 ; DESTROYS: A,B,C,D,E,F/F'S
1977 ; DESCRIPTION: GETHX ACCEPTS A STRING OF HEX DIGITS FROM THE INPUT
1978 ; STREAM AND RETURNS THEIR VALUE AS A 16 BIT BINARY
1979 ; INTEGER. IF MORE THAN 4 HEX DIGITS ARE ENTERED,
1980 ; ONLY THE LAST 4 ARE USED. THE NUMBER TERMINATES WHEN
1981 ; A VALID DELIMITER IS ENCOUNTERED. THE DELIMITER IS
1982 ; ALSO RETURNED AS AN OUTPUT OF THE FUNCTION. ILLEGAL
1983 ; CHARACTERS (NOT HEX DIGITS OR DELIMITERS) CAUSE AN
1984 ; ERROR INDICATION. IF THE FIRST (VALID) CHARACTER
1985 ; ENCOUNTERED IN THE INPUT STREAM IS NOT A DELIMITER,
1986 ; GETHX WILL RETURN WITH THE CARRY BIT SET TO 1;
1987 ; OTHERWISE, THE CARRY BIT IS SET TO 0 AND THE CONTENTS
1988 ; OF BC ARE UNDEFINED.
1989 ;
1990 GETHX:
0626 E5      1991      PUSH     H          ; SAVE HL
0627 210000  1992      LXI     H,0       ; INITIALIZE RESULT
062A 1E00    1993      MVI     E,0       ; INITIALIZE DIGIT FLAG TO FALSE
1994 GHX05:
062C CD1F06 1995      CALL    GETCH      ; GET A CHARACTER
062F 4F      1996      MOV     C,A        ;
0630 CDF805 1997      CALL    ECHO       ; ECHO THE CHARACTER
0633 CD7907 1998      CALL    VALDL      ; SEE IF DELIMITER
1999      FALSE    GHX10   ; NO - BRANCH
0636 D24506 2000+    JNC     GHX10      ; YES - ALL DONE, BUT WANT TO RETURN DELIMITER
0639 51      2001      MOV     D,C        ;
063A E5      2002      PUSH    H          ;
063B C1      2003      POP     B          ; MOVE RESULT TO BC
063C E1      2004      POP     H          ; RESTORE HL
063D 7B      2005      MOV     A,E        ; GET FLAG
063E B7      2006      ORA     A          ; SET F/F'S
063F C23207 2007      JNZ     SRET       ; IF FLAG NON-0, A NUMBER HAS BEEN FOUND
0642 CA1C06 2008      JZ      FRET       ; ELSE, DELIMITER WAS FIRST CHARACTER
2009 GHX10:
0645 CD5E07 2010      CALL    VALDG      ; IF NOT DELIMITER, SEE IF DIGIT
2011      FALSE    ERROR   ; ERROR IF NOT A VALID DIGIT, EITHER
0648 D21106 2012+    JNC     ERROR      ;
064B CDBB05 2013      CALL    CNVBN      ; CONVERT DIGIT TO ITS BINARY VALUE
064E 1EFF    2014      MVI     E,0FFH     ; SET DIGIT FLAG NON-0
0650 29      2015      DAD     H          ; *2
0651 29      2016      DAD     H          ; *4
0652 29      2017      DAD     H          ; *8
0653 29      2018      DAD     H          ; *16
0654 0600    2019      MVI     B,0        ; CLEAR UPPER 8 BITS OF BC PAIR
0656 4F      2020      MOV     C,A        ; BINARY VALUE OF CHARACTER INTO C
0657 09      2021      DAD     B          ; ADD THIS VALUE TO PARTIAL RESULT
0658 C32C06 2022      JMP     GHX05      ; GET NEXT CHARACTER
2023 ;
2024 ;
2025 ; *****
2026 ;
2027 ;
2028 ; FUNCTION: GETNM
2029 ; INPUTS: C - COUNT OF NUMBERS TO FIND IN INPUT STREAM
2030 ; OUTPUTS: TOP OF STACK - NUMBERS FOUND IN REVERSE ORDER (LAST ON TOP
2031 ; OF STACK)
2032 ; CALLS: GETHX,HIL0,ERROR
2033 ; DESTROYS: A,B,C,D,E,H,L,F/F'S

```

LOC	OBJ	SEQ	SOURCE STATEMENT
		2034	; DESCRIPTION: GETNM FINDS A SPECIFIED COUNT OF NUMBERS, BETWEEN 1
		2035	AND 3, INCLUSIVE, IN THE INPUT
		2036	STREAM AND RETURNS THEIR VALUES ON THE STACK. IF 2
		2037	OR MORE NUMBERS ARE REQUESTED, THEN THE FIRST MUST BE
		2038	LESS THAN OR EQUAL TO THE SECOND, OR THE FIRST AND
		2039	SECOND NUMBERS WILL BE SET EQUAL. THE LAST NUMBER
		2040	REQUESTED MUST BE TERMINATED BY A CARRIAGE RETURN
		2041	OR AN ERROR INDICATION WILL RESULT.
		2042	;
		2043	GETNM:
065B	2E03	2044	MVI L,3 ; PUT MAXIMUM ARGUMENT COUNT INTO L
065D	79	2045	MOV A,C ; GET THE ACTUAL ARGUMENT COUNT
065E	E603	2046	ANI 3 ; FORCE TO MAXIMUM OF 3
0660	C8	2047	RZ ; IF 0, DON'T BOTHER TO DO ANYTHING
0661	67	2048	MOV H,A ; ELSE, PUT ACTUAL COUNT INTO H
		2049	GNM05:
0662	CD2606	2050	CALL GETHX ; GET A NUMBER FROM INPUT STREAM
		2051	FALSE ERROR ; ERROR IF NOT THERE - TOO FEW NUMBERS
0665	D21106	2052+	JNC ERROR
0668	C5	2053	PUSH B ; ELSE, SAVE NUMBER ON STACK
0669	2D	2054	DCR L ; DECREMENT MAXIMUM ARGUMENT COUNT
066A	25	2055	DCR H ; DECREMENT ACTUAL ARGUMENT COUNT
066B	CA7706	2056	JZ GNM10 ; BRANCH IF NO MORE NUMBERS WANTED
066E	7A	2057	MOV A,D ; ELSE, GET NUMBER TERMINATOR TO A
066F	FE0D	2058	CPI CR ; SEE IF CARRIAGE RETURN
0671	CA1106	2059	JZ ERROR ; ERROR IF SO - TOO FEW NUMBERS
0674	C36206	2060	JMP GNM05 ; ELSE, PROCESS NEXT NUMBER
		2061	GNM10:
0677	7A	2062	MOV A,D ; WHEN COUNT 0, CHECK LAST TERMINATOR
0678	FE0D	2063	CPI CR
067A	C21106	2064	JNZ ERROR ; ERROR IF NOT CARRIAGE RETURN
067D	01FFFF	2065	LXI B,0FFFFH ; HL GETS LARGEST NUMBER
0680	7D	2066	MOV A,L ; GET WHAT'S LEFT OF MAXIMUM ARG COUNT
0681	B7	2067	ORA A ; CHECK FOR 0
0682	CA8A06	2068	JZ GNM20 ; IF YES, 3 NUMBERS WERE INPUT
		2069	GNM15:
0685	C5	2070	PUSH B ; IF NOT, FILL REMAINING ARGUMENTS WITH 0FFFFH
0686	2D	2071	DCR L
0687	C28506	2072	JNZ GNM15
		2073	GNM20:
068A	C1	2074	POP B ; GET THE 3 ARGUMENTS OUT
068B	D1	2075	POP D
068C	E1	2076	POP H
068D	CDA006	2077	CALL HILO ; SEE IF FIRST >= SECOND
		2078	FALSE GNM25 ; NO - BRANCH
0690	D29506	2079+	JNC GNM25
0693	54	2080	MOV D,H
0694	5D	2081	MOV E,L ; YES - MAKE SECOND EQUAL TO THE FIRST
		2082	GNM25:
0695	E3	2083	XTHL ; PUT FIRST ON STACK - GET RETURN ADDR
0696	D5	2084	PUSH D ; PUT SECOND ON STACK
0697	C5	2085	PUSH B ; PUT THIRD ON STACK
0698	E5	2086	PUSH H ; PUT RETURN ADDRESS ON STACK
		2087	GNM30:
0699	3D	2088	DCR A ; DECREMENT RESIDUAL COUNT
069A	F8	2089	RM ; IF NEGATIVE, PROPER RESULTS ON STACK
069B	E1	2090	POP H ; ELSE, GET RETURN ADDR
069C	E3	2091	XTHL ; REPLACE TOP RESULT WITH RETURN ADDR
069D	C39906	2092	JMP GNM30 ; TRY AGAIN
		2093	;
		2094	;
		2095	*****
		2096	;
		2097	;
		2098	; FUNCTION: HILO
		2099	; INPUTS: DE - 16 BIT INTEGER
		2100	; HL - 16 BIT INTEGER
		2101	; OUTPUTS: CARRY - 0 IF HL<DE
		2102	; - 1 IF HL>=DE
		2103	; CALLS: NOTHING
		2104	; DESTROYS: F/F'S
		2105	; DESCRIPTION: HILO COMPARES THE 2 16 BIT INTEGERS IN HL AND DE. THE
		2106	INTEGERS ARE TREATED AS UNSIGNED NUMBERS. THE CARRY
		2107	BIT IS SET ACCORDING TO THE RESULT OF THE COMPARISON.
		2108	;
		2109	HILO:
06A0	C5	2110	PUSH B ; SAVE BC
06A1	47	2111	MOV B,A ; SAVE A IN B REGISTER
06A2	E5	2112	PUSH H ; SAVE HL PAIR
06A3	7A	2113	MOV A,D ; CHECK FOR DE = 0000H
06A4	B3	2114	ORA E
06A5	CAC106	2115	JZ HIL05 ; WE'RE AUTOMATICALLY DONE IF IT IS
06A8	23	2116	INX H ; INCREMENT HL BY 1
06A9	7C	2117	MOV A,H ; WANT TO TEST FOR 0 RESULT AFTER
06AA	B5	2118	ORA L ; /INCREMENTING
06AB	CAC106	2119	JZ HIL05 ; IF SO, HL MUST HAVE CONTAINED 0FFFFH
06AE	E1	2120	POP H ; IF NOT, RESTORE ORIGINAL HL
06AF	05	2121	PUSH D ; SAVE DE
06B0	3EFF	2122	MVI A,0FFH ; WANT TO TAKE 2'S COMPLEMENT OF DE CONTENTS
06B2	AA	2123	XRA D
06B3	57	2124	MOV D,A
06B4	3EFF	2125	MVI A,0FFH
06B6	AB	2126	XRA E
06B7	5F	2127	MOV E,A
06B8	13	2128	INX D ; 2'S COMPLEMENT OF DE TO DE
06B9	7D	2129	MOV A,L
06BA	83	2130	ADD E ; ADD HL AND DE
06BB	7C	2131	MOV A,H
06BC	8A	2132	ADC D ; THIS OPERATION SETS CARRY PROPERLY
06BD	D1	2133	POP D ; RESTORE ORIGINAL DE CONTENTS

LOC	OBJ	SEQ	SOURCE STATEMENT
06BE	78	2134	MOV A,B ; RESTORE ORIGINAL CONTENTS OF A
06BF	C1	2135	POP B ; RESTORE ORIGINAL CONTENTS OF BC
06C0	C9	2136	RET ; RETURN WITH CARRY SET AS REQUIRED
		2137	HIL05:
06C1	E1	2138	POP H ; IF HL CONTAINS 0FFFFH, THEN CARRY CAN
06C2	78	2139	MOV A,B ; /ONLY BE SET TO 1
06C3	C1	2140	POP B ; RESTORE ORIGINAL CONTENTS OF REGISTERS
06C4	C33207	2141	JMP SRET ; SET CARRY AND RETURN
		2142 ;	
		2143 ;	
		2144 ;	*****
		2145 ;	
		2146 ;	
		2147 ;	FUNCTION: NMOUT
		2148 ;	INPUTS: A - 8 BIT INTEGER
		2149 ;	OUTPUTS: NONE
		2150 ;	CALLS: ECHO,PRVAL
		2151 ;	DESTROYS: A,B,C,F/F'S
		2152 ;	DESCRIPTION: NMOUT CONVERTS THE 8 BIT, UNSIGNED INTEGER IN THE
		2153 ;	A REGISTER INTO 2 ASCII CHARACTERS. THE ASCII CHARACTERS
		2154 ;	ARE THE ONES REPRESENTING THE 8 BITS. THESE TWO
		2155 ;	CHARACTERS ARE SENT TO THE CONSOLE AT THE CURRENT PRINT
		2156 ;	POSITION OF THE CONSOLE.
		2157 ;	
		2158	NMOUT:
06C7	E5	2159	PUSH H ; SAVE HL - DESTROYED BY PRVAL
06C8	F5	2160	PUSH PSW ; SAVE ARGUMENT
06C9	0F	2161	RRC
06CA	0F	2162	RRC
06CB	0F	2163	RRC
06CC	0F	2164	RRC ; GET UPPER 4 BITS TO LOW 4 BIT POSITIONS
06CD	E60F	2165	ANI HCHAR ; MASK OUT UPPER 4 BITS - WANT 1 HEX CHAR
06CF	4F	2166	MOV C,A
06D0	CDE206	2167	CALL PRVAL ; CONVERT LOWER 4 BITS TO ASCII
06D3	CDF805	2168	CALL ECHO ; SEND TO TERMINAL
06D6	F1	2169	POP PSW ; GET BACK ARGUMENT
06D7	E60F	2170	ANI HCHAR ; MASK OUT UPPER 4 BITS - WANT 1 HEX CHAR
06D9	4F	2171	MOV C,A
06DA	CDE206	2172	CALL PRVAL
06DD	CDF805	2173	CALL ECHO
06E0	E1	2174	POP H ; RESTORE SAVED VALUE OF HL
06E1	C9	2175	RET
		2176 ;	
		2177 ;	
		2178 ;	*****
		2179 ;	
		2180 ;	
		2181 ;	FUNCTION: PRVAL
		2182 ;	INPUTS: C - INTEGER, RANGE 0 TO F
		2183 ;	OUTPUTS: C - ASCII CHARACTER
		2184 ;	CALLS: NOTHING
		2185 ;	DESTROYS: B,C,H,L,F/F'S
		2186 ;	DESCRIPTION: PRVAL CONVERTS A NUMBER IN THE RANGE 0 TO F HEX TO
		2187 ;	THE CORRESPONDING ASCII CHARACTER, 0-9,A-F. PRVAL
		2188 ;	DOES NOT CHECK THE VALIDITY OF ITS INPUT ARGUMENT.
		2189 ;	
		2190	PRVAL:
06E2	21B407	2191	LXI H,DIGTB ; ADDRESS OF TABLE
06E5	0600	2192	MVI B,0 ; CLEAR HIGH ORDER BITS OF BC
06E7	09	2193	DAD B ; ADD DIGIT VALUE TO HL ADDRESS
06E8	4E	2194	MOV C,M ; FETCH CHARACTER FROM MEMORY
06E9	C9	2195	RET
		2196 ;	
		2197 ;	
		2198 ;	*****
		2199 ;	
		2200 ;	
		2201 ;	FUNCTION: REGDS
		2202 ;	INPUTS: NONE
		2203 ;	OUTPUTS: NONE
		2204 ;	CALLS: ECHO,NMOUT,ERROR,CROUT
		2205 ;	DESTROYS: A,B,C,D,E,H,L,F/F'S
		2206 ;	DESCRIPTION: REGDS DISPLAYS THE CONTENTS OF THE REGISTER SAVE
		2207 ;	LOCATIONS, IN FORMATTED FORM, ON THE CONSOLE. THE
		2208 ;	DISPLAY IIS DRIVEN FROM A TABLE, RTAB, WHICH CONTAINS
		2209 ;	THE REGISTER'S PRINT SYMBOL, SAVE LOCATION ADDRESS,
		2210 ;	AND LENGTH (8 OR 16 BITS).
		2211 ;	
		2212	REGDS:
06EA	21C407	2213	LXI H,RTAB ; LOAD HL WITH ADDRESS OF START OF TABLE
		2214	REG05:
06ED	4E	2215	MOV C,M ; GET PRINT SYMBOL OF REGISTER
06EE	79	2216	MOV A,C
06EF	B7	2217	ORA A ; TEST FOR 0 - END OF TABLE
06F0	C2F706	2218	JNZ REG10 ; IF NOT END, BRANCH
06F3	CDEB05	2219	CALL CROUT ; ELSE, CARRIAGE RETURN/LINE FEED TO END
06F6	C9	2220	RET ; /DISPLAY
		2221	REG10:
06F7	CDF805	2222	CALL ECHO ; ECHO CHARACTER
06FA	0E3D	2223	MVI C,'='
06FC	CDF805	2224	CALL ECHO ; OUTPUT EQUALS SIGN, I.E. A=
06FF	23	2225	INX H ; POINT TO START OF SAVE LOCATION ADDRESS
0700	5E	2226	MOV E,M ; GET LSP OF SAVE LOCATION ADDRESS TO E
0701	1620	2227	MVI D,RAMST SHR 8 ; PUT MSP OF SAVE LOC ADDRESS INTO D
0703	23	2228	INX H ; POINT TO LENGTH FLAG
0704	1A	2229	D ; GET CONTENTS OF SAVE ADDRESS
0705	CDC706	2230	CALL NMOUT ; DISPLAY ON CONSOLE
0708	7E	2231	MOV A,M ; GET LENGTH FLAG
0709	B7	2232	ORA A ; SET SIGN F/F
070A	CA1207	2233	JZ REG15 ; IF 0, REGISTER IS 8 BITS

```

LOC OBJ      SEQ      SOURCE STATEMENT
070D 1B      2234      DCX      D      ; ELSE, 16 BIT REGISTER SO MORE TO DISPLAY
070E 1A      2235      LDAX     D      ; GET LOWER 8 BITS
070F CDC706  2236      CALL     NMOUT  ; DISPLAY THEM
                2237      REG15:
0712 0E20    2238      MVI     C,' '
0714 CDF805  2239      CALL     ECHO
0717 23      2240      INX     H      ; POINT TO START OF NEXT TABLE ENTRY
0718 C3ED06  2241      JMP     REG05  ; DO NEXT REGISTER
                2242 ;
                2243 ;
                2244 ;*****
                2245 ;
                2246 ;
                2247 ; FUNCTION: RGADR
                2248 ; INPUTS: C - CHARACTER DENOTING REGISTER
                2249 ; OUTPUTS: BC - ADDRESS OF ENTRY IN RTAB CORRESPONDING TO REGISTER
                2250 ; CALLS: ERROR
                2251 ; DESTROYS: A,B,C,D,E,H,L,F/P'S
                2252 ; DESCRIPTION: RGADR TAKES A SINGLE CHARACTER AS INPUT. THIS CHARACTER
                2253 ; DENOTES A REGISTER. RGADR SEARCHES THE TABLE RTAB
                2254 ; FOR A MATCH ON THE INPUT ARGUMENT. IF ONE OCCURS,
                2255 ; RGADR RETURNS THE ADDRESS OF THE ADDRESS OF THE
                2256 ; SAVE LOCATION CORRESPONDING TO THE REGISTER. THIS
                2257 ; ADDRESS POINTS INTO RTAB. IF NO MATCH OCCURS, THEN
                2258 ; THE REGISTER IDENTIFIER IS ILLEGAL AND CONTROL IS
                2259 ; PASSED TO THE ERROR ROUTINE.
                2260 ;
                2261      RGADR:
071B 21C407  2262      LXI     H,RTAB ; HL GETS ADDRESS OF TABLE START
071E 110300  2263      LXI     D,RTABS ; DE GET SIZE OF A TABLE ENTRY
                2264      RGA05:
0721 7E      2265      MOV     A,M    ; GET REGISTER IDENTIFIER
0722 B7      2266      ORA     A    ; CHECK FOR TABLE END (IDENTIFIER IS 0)
0723 CA1106  2267      JZ      ERROR ; IF AT END OF TABLE, ARGUMENT IS ILLEGAL
0726 B9      2268      CMP     C    ; ELSE, COMPARE TABLE ENTRY AND ARGUMENT
0727 CA2E07  2269      JZ      RGA10 ; IF EQUAL, WE'VE FOUND WHAT WE'RE LOOKING FOR
072A 19      2270      DAD     D    ; ELSE, INCREMENT TABLE POINTER TO NEXT ENTRY
072B C32107  2271      JMP     RGA05 ; TRY AGAIN
                2272      RGA10:
072E 23      2273      INX     H    ; IF A MATCH, INCREMENT TABLE POINTER TO
072F 44      2274      MOV     B,H   ; /SAVE LOCATION ADDRESS
0730 4D      2275      MOV     C,L   ; RETURN THIS VALUE
0731 C9      2276      RET
                2277 ;
                2278 ;
                2279 ;*****
                2280 ;
                2281 ;
                2282 ; FUNCTION: SRET
                2283 ; INPUTS: NONE
                2284 ; OUTPUTS: CARRY = 1
                2285 ; CALLS: NOTHING
                2286 ; DESTROYS: CARRY
                2287 ; DESCRIPTION: SRET IS JUMPED TO BY ROUTINES WISHING TO RETURN SUCCESS.
                2288 ; SRET SETS THE CARRY TRUE AND THEN RETURNS TO THE
                2289 ; CALLER OF THE ROUTINE INVOKING SRET.
                2290 ;
                2291      SRET:
0732 37      2292      STC          ; SET CARRY TRUE
0733 C9      2293      RET          ; RETURN APPROPRIATELY
                2294 ;
                2295 ;
                2296 ;*****
                2297 ;
                2298 ;
                2299 ; FUNCTION: STHF0
                2300 ; INPUTS: DE - 16 BIT ADDRESS OF BYTE TO BE STORED INTO
                2301 ; OUTPUTS: NONE
                2302 ; CALLS: STHLF
                2303 ; DESTROYS: A,B,C,H,L,F/F'S
                2304 ; DESCRIPTION: STHF0 CHECKS THE HALF BYTE FLAG IN TEMP TO SEE IF
                2305 ; IT IS SET TO LOWER. IF SO, STHF0 STORES A 0 TO
                2306 ; PAD OUT THE LOWER HALF OF THE ADDRESSED BYTE;
                2307 ; OTHERWISE, THE ROUTINE TAKES NO ACTION.
                2308 ;
                2309      STHF0:
0734 3AFD20  2310      LDA     TEMP  ; GET HALF BYTE FLAG
0737 B7      2311      ORA     A    ; SET F/F'S
0738 C0      2312      RNZ          ; IF SET TO UPPER, DON'T DO ANYTHING
0739 0E00    2313      MVI     C,0   ; ELSE, WANT TO STORE THE VALUE 0
073B CD3F07  2314      CALL     STHLF ; DO IT
073E C9      2315      RET
                2316 ;
                2317 ;
                2318 ;*****
                2319 ;
                2320 ;
                2321 ; FUNCTION: STHLF
                2322 ; INPUTS: C - 4 BIT VALUE TO BE STORED IN HALF BYTE
                2323 ; DE - 16 BIT ADDRESS OF BYTE TO BE STORED INTO
                2324 ; OUTPUTS: NONE
                2325 ; CALLS: NOTHING
                2326 ; DESTROYS: A,B,C,H,L,F/F'S
                2327 ; DESCRIPTION: STHLF TAKES THE 4 BIT VALUE IN C AND STORES IT IN
                2328 ; HALF OF THE BYTE ADDRESSED BY REGISTERS DE. THE
                2329 ; HALF BYTE USED (EITHER UPPER OR LOWER) IS DENOTED
                2330 ; BY THE VALUE OF THE FLAG IN TEMP. STHLF ASSUMES
                2331 ; THAT THIS FLAG HAS BEEN PREVIOUSLY SET
                2332 ; (NOMINALLY BY ICMD).
                2333 ;

```

```

LOC OBJ      SEQ      SOURCE STATEMENT
-----
                2334 STHLF:
073F D5      2335      PUSH      D
0740 E1      2336      POP        H          ; MOVE ADDRESS OF BYTE INTO HL
0741 79      2337      MOV        A,C        ; GET VALUE
0742 E60F    2338      ANI       0FH        ; FORCE TO 4 BIT LENGTH
0744 4F      2339      MOV        C,A        ; PUT VALUE BACK
0745 3AFD20  2340      LDA       TEMP       ; GET HALF BYTE FLAG
0748 B7      2341      ORA       A          ; CHECK FOR LOWER HALF
0749 C25207  2342      JNZ      STH05      ; BRANCH IF NOT
074C 7E      2343      MOV        A,M        ; ELSE, GET BYTE
074D E6F0    2344      ANI       0F0H       ; CLEAR LOWER 4 BITS
074F B1      2345      ORA       C          ; OR IN VALUE
0750 77      2346      MOV        M,A        ; PUT BYTE BACK
0751 C9      2347      RET
                2348 STH05:
0752 7E      2349      MOV        A,M        ; IF UPPER HALF, GET BYTE
0753 E60F    2350      ANI       0FH        ; CLEAR UPPER 4 BITS
0755 47      2351      MOV        B,A        ; SAVE BYTE IN B
0756 79      2352      MOV        A,C        ; GET VALUE
0757 0F      2353      RRC
0758 0F      2354      RRC
0759 0F      2355      RRC
075A 0F      2356      RRC          ; ALIGN TO UPPER 4 BITS
075B B0      2357      ORA       B          ; OR IN ORIGINAL LOWER 4 BITS
075C 77      2358      MOV        M,A        ; PUT NEW CONFIGURATION BACK
075D C9      2359      RET
                2360 ;
                2361 ;
                2362 ;*****
                2363 ;
                2364 ;
                2365 ; FUNCTION: VALDG
                2366 ; INPUTS: C - ASCII CHARACTER
                2367 ; OUTPUTS: CARRY - 1 IF CHARACTER REPRESENTS VALID HEX DIGIT
                2368 ;           - 0 OTHERWISE
                2369 ; CALLS: NOTHING
                2370 ; DESTROYS: A,F/F'S
                2371 ; DESCRIPTION: VALDG RETURNS SUCCESS IF ITS INPUT ARGUMENT IS
                2372 ; AN ASCII CHARACTER REPRESENTING A VALID HEX DIGIT
                2373 ; (0-9,A-F), AND FAILURE OTHERWISE.
                2374 ;
                2375 VALDG:
075E 79      2376      MOV        A,C
075F FE30    2377      CPI       '0'        ; TEST CHARACTER AGAINST '0'
0761 FALC06  2378      JM        FRET       ; IF ASCII CODE LESS, CANNOT BE VALID DIGIT
0764 FE39    2379      CPI       '9'        ; ELSE, SEE IF IN RANGE '0'-'9'
0766 FA3207  2380      JM        SRET       ; CODE BETWEEN '0' AND '9'
0769 CA3207  2381      JZ        SRET       ; CODE EQUAL '9'
076C FE41    2382      CPI       'A'        ; NOT A DIGIT - TRY FOR A LETTER
076E FALC06  2383      JM        FRET       ; NO - CODE BETWEEN '9' AND 'A'
0771 FE47    2384      CPI       'G'
0773 F21C06  2385      JP        FRET       ; NO - CODE GREATER THAN 'F'
0776 C33207  2386      JMP       SRET       ; OKAY - CODE IS 'A' TO 'F', INCLUSIVE
                2387 ;
                2388 ;
                2389 ;*****
                2390 ;
                2391 ;
                2392 ; FUNCTION: VALDL
                2393 ; INPUTS: C - CHARACTER
                2394 ; OUTPUTS: CARRY - 1 IF INPUT ARGUMENT VALID DELIMITER
                2395 ;           - 0 OTHERWISE
                2396 ; CALLS: NOTHING
                2397 ; DESTROYS: A,F/F'S
                2398 ; DESCRIPTION: VALDL RETURNS SUCCESS IF ITS INPUT ARGUMENT IS A VALID
                2399 ; DELIMITER CHARACTER (SPACE, COMMA, CARRIAGE RETURN) AND
                2400 ; FAILURE OTHERWISE.
                2401 ;
                2402 VALDL:
0779 79      2403      MOV        A,C
077A FE2C    2404      CPI       ','        ; CHECK FOR COMMA
077C CA3207  2405      JZ        SRET*      ;
077F FE0D    2406      CPI       CR         ; CHECK FOR CARRIAGE RETURN
0781 CA3207  2407      JZ        SRET
0784 FE20    2408      CPI       ' '        ; CHECK FOR SPACE
0786 CA3207  2409      JZ        SRET
0789 C31C06  2410      JMP       FRET       ; ERROR IF NONE OF THE ABOVE
                2411 ;
                2412 ;
                2413 ;*****
                2414 ;
                2415 ;
                2416 ; MONITOR TABLES
                2417 ;
                2418 ;
                2419 ;*****
                2420 ;
                2421 ;
                2422 SGNON:      ; SGNON MESSAGE
078C 0D      2423      DB        CR,LF,'SDK-85 VER 2.1',CR,LF
078D 0A
078E 53444B2D
0792 38352020
0796 20564552
079A 20322E31
079E 0D
079F 0A
0014
                2424 LSGNON EQU    $-SGNON ; LENGTH OF SGNON MESSAGE
                2425 ;
                2426 CADR:      ; TABLE OF ADDRESSES OF COMMAND ROUTINES

```

LOC	OBJ	SEQ	SOURCE STATEMENT
07A0	0000	2427	DW 0 ; DUMMY
07A2	1405	2428	DW XCMD
07A4	F004	2429	DW SCMD
07A6	D004	2430	DW MCMD
07A8	8604	2431	DW ICMD
07AA	6804	2432	DW GCMD
07AC	3704	2433	DW DCMD
		2434 ;	
		2435 CTAB:	; TABLE OF VALID COMMAND CHARACTERS
07AE	44	2436	DB 'D'
07AF	47	2437	DB 'G'
07B0	49	2438	DB 'I'
07B1	4D	2439	DB 'M'
07B2	53	2440	DB 'S'
07B3	58	2441	DB 'X'
0006		2442 NCMD5	EQU \$-CTAB ; NUMBER OF VALID COMMANDS
		2443 ;	
		2444 DIGTB:	; TABLE OF PRINT VALUES OF HEX DIGITS
07B4	30	2445	DB '0'
07B5	31	2446	DB '1'
07B6	32	2447	DB '2'
07B7	33	2448	DB '3'
07B8	34	2449	DB '4'
07B9	35	2450	DB '5'
07BA	36	2451	DB '6'
07BB	37	2452	DB '7'
07BC	38	2453	DB '8'
07BD	39	2454	DB '9'
07BE	41	2455	DB 'A'
07BF	42	2456	DB 'B'
07C0	43	2457	DB 'C'
07C1	44	2458	DB 'D'
07C2	45	2459	DB 'E'
07C3	46	2460	DB 'F'
		2461 ;	
		2462 RTAB:	; TABLE OF REGISTER INFORMATION
07C4	41	2463	DB 'A' ; REGISTER IDENTIFIER
07C5	EE	2464	DB ASAV AND 0FFH ; ADDRESS OF REGISTER SAVE LOCATION
07C6	00	2465	DB 0 ; LENGTH FLAG - 0=8 BITS, 1=16 BITS
0003		2466 RTABS	EQU \$-RTAB ; SIZE OF AN ENTRY IN THIS TABLE
07C7	42	2467	DB 'B'
07C8	EC	2468	DB BSAV AND 0FFH
07C9	00	2469	DB 0
07CA	43	2470	DB 'C'
07CB	EB	2471	DB CSAV AND 0FFH
07CC	00	2472	DB 0
07CD	44	2473	DB 'D'
07CE	EA	2474	DB DSAV AND 0FFH
07CF	00	2475	DB 0
07D0	45	2476	DB 'E'
07D1	E9	2477	DB ESAV AND 0FFH
07D2	00	2478	DB 0
07D3	46	2479	DB 'F'
07D4	ED	2480	DB FSAV AND 0FFH
07D5	00	2481	DB 0
07D6	49	2482	DB 'I'
07D7	F1	2483	DB ISAV AND 0FFH
07D8	00	2484	DB 0
07D9	48	2485	DB 'H'
07DA	F0	2486	DB HSAV AND 0FFH
07DB	00	2487	DB 0
07DC	4C	2488	DB 'L'
07DD	EF	2489	DB LSAV AND 0FFH
07DE	00	2490	DB 0
07DF	4D	2491	DB 'M'
07E0	F0	2492	DB HSAV AND 0FFH
07E1	01	2493	DB 1
07E2	53	2494	DB 'S'
07E3	F5	2495	DB SSAV+1 AND 0FFH
07E4	01	2496	DB 1
07E5	50	2497	DB 'P'
07E6	F3	2498	DB PSAV+1 AND 0FFH
07E7	01	2499	DB 1
07E8	00	2500	DB 0 ; END OF TABLE MARKERS
07E9	00	2501	DB 0
		2502 ;	
07FA		2503	ORG BRTAB ; BRANCH TABLE FOR USER ACCESSIBLE ROUTINES
		2504 ;	
07FA	C3C405	2505	JMP CO ; TTY CONSOLE OUTPUT
07FD	C39005	2506	JMP CI ; TTY CONSOLE INPUT
		2507	
		2508 ;	*****
		2509 ;	
		2510 ;	IN THE FOLLOWING LOCATIONS, THE USER MAY PLACE JUMP INSTRUCTIONS TO
		2511 ;	ROUTINES FOR HANDLING THE FOLLOWING:-
		2512 ;	A) RST 5,6 & 7 INSTRUCTIONS
		2513 ;	B) HARDWIRED USER INTERRUPT (RST 6.5)
		2514 ;	C) KEYBOARD "VECTORED INTERRUPT" KEY (RST 7.5)
		2515 ;	
20C2		2516	ORG USRBR ; START OF USER BRANCH LOCATIONS
		2517 ;	
20C2	00	2518	RSET5: DB 0,0,0 ; JUMP TO RST 5 ROUTINE
20C3	00		
20C4	00		
20C5	00	2519	RSET6: DB 0,0,0 ; JUMP TO RST 6 ROUTINE
20C6	00		
20C7	00		
20C8	00	2520	RST65: DB 0,0,0 ; JUMP TO RST 6.5 (HARDWIRED USER INTERRUPT)
20C9	00		
20CA	00		

```

LOC OBJ      SEQ      SOURCE STATEMENT
20CB 00      2521 RSET7:  D3      0,0,0  ; JUMP TO RST 7 ROUTINE
20CC 00
20CD 00
20CE 00      2522 USINT:  DB      0,0,0  ; JUMP TO "VECTORED INTERRUPT" KEY ROUTINE
20CF 00
20D0 00

2523 ;
2524 ;*****
2525 ;
2526 ; SPACE IS RESERVED HERE FOR THE MONITOR STACK
2527 ;
2528 ;*****
2529 ;
20E9 2530      ORG      MNSTK  ; START OF MONITOR STACK
2531 ;
2532 ;      SAVE LOCATIONS FOR USER REGISTERS
2533 ;
20E9 00      2534 ESAV:  DB      0      ; E REGISTER
20EA 00      2535 DSAV:  DB      0      ; D REGISTER
20EB 00      2536 CSAV:  DB      0      ; C REGISTER
20EC 00      2537 BSAV:  DB      0      ; B REGISTER
20ED 00      2538 FSAV:  DB      0      ; FLAGS
20EE 00      2539 ASAV:  DB      0      ; A REGISTER
20EF 00      2540 LSAV:  DB      0      ; L REGISTER
20F0 00      2541 HSAV:  DB      0      ; H REGISTER
20F1 00      2542 ISAV:  DB      0      ; INTERRUPT MASK
2543      PS AV:      ; PROGRAM COUNTER
20F2 00      2544 PCLSV:  D3      0      ; LOW ORDER BYTE
20F3 00      2545 PCHSV:  DB      0      ; HIGH ORDER BYTE
2546      S SAV:      ; STACK POINTER
20F4 00      2547 SPLSV:  DB      0      ; LOW ORDER BYTE
20F5 00      2548 SPSHV:  DB      0      ; HIGH ORDER BYTE
2549 ;
2550 ;*****
2551 ;
2552 ;      MONITOR STORAGE LOCATIONS
2553 ;
20F6 0000    2554 CURAD:  DW      0      ; CURRENT ADDRESS
20F8 00      2555 CURDT:  DB      0      ; CURRENT DATA
0004      2556 OBUFF:  DS      4      ; OUTPUT BUFFER
2557      ; TEMPORARY LOCATION FOR TTY MONITOR
20FD 00      2558      ; TEMPORARY LOCATION FOR SINGLE STEP ROUTINE
2559      RG PTR:  DB      0      ; REGISTER POINTER
20FE 00      2560 IBUFF:  DB      0      ; INPUT BUFFER
20FF 00      2561 USCSR:  DB      0      ; USER SHOULD STORE IMAGE OF CSR HERE EACH TIME
2562      ; /CSR IS CHANGED. OTHERWISE, SINGLE STEP
2563      ; /ROUTINE WILL DESTROY CSR CONTENTS.
2564      END
    
```

PUBLIC SYMBOLS

EXTERNAL SYMBOLS

USER SYMBOLS

ADFLD A 0000	ADISP A 0090	ASAV A 20EE	BLANK A 0015	BLNKS A 039A	BRCHR A 001B	BRTAB A 07FA
BSAV A 20EC	CADR A 07A0	CI A 0590	CI05 A 0592	CII0 A 05A1	CLDBK A 0008	CLDIS A 01E9
CLDST A 01F1	CLEAR A 01D7	CMD10 A 007B	CMD15 A 0087	CMDAD A 037C	CMDTB A 0378	CMNND A 0066
CNTRL A 1900	CNVBN A 05BB	CO A 05C4	CO05 A 05CB	COMMA A 0011	CR A 000D	CROUT A 05EB
CSAV A 20EB	CSNIT A 0000	CSR A 0020	CTAB A 07AE	CURAD A 20F6	CURDT A 20F8	DCM05 A 043E
DCM10 A 0449	DCM15 A 045E	DCMD A 0437	DDISP A 0094	DELAY A 05F1	DIGTB A 07B4	DISPC A 0200
DOT A 0001	DSAV A 20EA	DSPLY A 1800	DSPTB A 0384	DTFLD A 0001	DTMSK A 0008	ECH05 A 0601
ECH10 A 060F	ECHO A 05F8	EIGHT A 0008	EMPTY A 0080	ERMSG A 039E	ERR A 0215	ERROR A 0611
ESAV A 20E9	ESC A 001B	EXAM A 0092	EXM05 A 009D	EXM10 A 00B8	EXMSG A 03A2	FALSE + 0001
FIVE A 0005	FRET A 061C	FSAV A 20ED	G10 A 00EC	GCM05 A 047D	GCM10 A 0483	GCMD A 0468
GETCH A 061F	GETCM A 0408	GETHX A 0626	GETNM A 065B	GHX05 A 062C	GHX10 A 0645	GNM05 A 0662
GNM10 A 0677	GNM15 A 0685	GNM20 A 068A	GNM25 A 0695	GNM30 A 0699	GO A 03FA	GOCMD A 00CB
GTC03 A 0414	GTC05 A 0421	GTC10 A 042D	GTH05 A 0232	GTH10 A 0249	GTH20 A 0255	GTH25 A 0267
GTHX A 022B	HCHAR A 000F	HIL05 A 06C1	HILO A 06A0	HSAV A 20F0	HXDSP A 026C	IBTIM A 048C
IBUFF A 20FE	ICH05 A 0491	ICM10 A 04B9	ICM20 A 04C1	ICM25 A 04C7	ICMD A 0486	ININT A 028E
INSDG A 029F	INVRT A 00FF	ISAV A 20F1	KBNIT A 00CC	KMODE A 0000	LETRA A 000A	LETRB A 000B
LETRC A 000C	LETRD A 000D	LETRE A 000E	LETRF A 000F	LETRH A 0010	LETRI A 0013	LETRL A 0011
LETRP A 0012	LETRR A 0014	LETRS A 0005	LF A 000A	LOWER A 0000	LSAV A 20EF	LSGNON A 0014
MCM05 A 04D8	MCMD A 04D0	MNSTK A 20E9	MSG1 A 03FF	NCMDS A 0006	NEWLN A 000F	NMOUT A 06C7
NMTBL A 03B9	NODOT A 0000	NUMC A 0004	NUMRG A 000D	NXTRG A 02A8	OBTIM A 048C	OBUFF A 20F9
OUT05 A 02C2	OUT10 A 02C6	OUT15 A 02C9	OUT20 A 02DC	OUTPT A 02B7	PCHSV A 20F3	PCLSV A 20F2
PERIO A 0010	PRMPT A 00FB	PRTY0 A 007F	PRVAL A 06E2	PSAV A 20F2	RAMST A 2000	RDK10 A 02F3
RDKBD A 02E7	READ A 0040	REG05 A 06ED	REG10 A 06F7	REG15 A 0712	REGDS A 06EA	RES10 A 003F
RETF A 02F7	RETT A 02FA	RGA05 A 0721	RGA10 A 072E	RGADR A 071B	RGLOC A 02FC	RGNAM A 0309
RGPTB A 03AC	RGPTR A 20FD	RGTBL A 03ED	RMUSE A 0017	RSET5 A 20C2	RSET6 A 20C2	RSET7 A 20CB
RSR05 A 032D	RSR10 A 0331	RST65 A 20C8	RSTOR A 031B	RTAB A 07C4	RTABS A 0003	SCM05 A 04F5
SCM10 A 0500	SCM15 A 0510	SCMD A 04F0	SETRG A 0344	SGNAD A 03A6	SGNDT A 03AA	SGNON A 078C
SKLN A 0018	SPHSV A 20F5	SPLSV A 20F4	SRET A 0732	SSAV A 20F4	SSTEP A 00FD	SSTRT A 0080
STH05 A 0752	STHF0 A 0734	STHLF A 073F	STOPB A 0040	STP20 A 0126	STP21 A 013B	STP22 A 0142
STP23 A 0145	STP25 A 0157	STRT A 00C0	SUB05 A 019C	SUB10 A 01C4	SUB15 A 01CF	SUBST A 018B
TEMP A 20FD	TERM A 001B	TIM4 A 1230	TIMER A 00C5	TIMHI A 0025	TIMLO A 0024	TMODE A 0040
TRUE + 0000	TSTRT A 00C0	UBRLN A 000F	UNMSK A 000E	UPDAD A 035F	UPDDT A 036B	UPPER A 00FF
USCSR A 20FF	USINT A 20CE	USRBR A 20C2	VALDG A 075E	VALDL A 0779	WAIT A 0246	WAITS A 0000
XCM05 A 0527	XCM10 A 0536	XCM15 A 0543	XCM18 A 054E	XCM20 A 0567	XCM25 A 057E	XCM27 A 057F
XCM30 A 0587	XCMD A 0514	ZERO A 0000				

ASSEMBLY COMPLETE, NO ERRORS

STP21	409	412#														
STP22	411	416#														
STP23	414	418#														
STP25	192	429#														
STRT	1343#	1819														
SUB05	476#	503														
SUB10	490	498#														
SUB15	478	504#														
SUBST	467#	1117														
TEMP	405	417	452	1541	1559	1565	1674	1676	1713	1729	2310	2340	2557#			
TERM	1344#	1548														
TIM4	1352#	1835														
TIMER	140#	419	422													
TIMHI	132#	421														
TIMLO	133#	423														
TMODE	134#	419														
TRUE	152#	337	1551													
TSTRT	135#	425														
UBRLN	103#	137														
UNMSK	136#	227	455													
UPDAD	480	591	1064#													
UPDDT	322	485	593	1085#												
UPPER	1345#	1540														
USCSR	424	432	570	2561#												
USINT	221	2522#														
USRBR	137#	2516														
VALDG	1553	2010	2375#													
VALDL	1550	1998	2402#													
WAIT	1353#	1761														
WAITS	80#	139	1349													
XCM05	1663	1666#														
XCM10	1675#	1726														
XCM15	1678	1681#														
XCM18	1684	1687#														
XCM20	1702	1706#														
XCM25	1717	1720#														
XCM27	1722#	1732														
XCM30	1711	1727#														
XCMD	1657#	2428														
ZERO	1128#	1175														

CROSS REFERENCE COMPLETE

RGNAM	317	957#																		
RGPTB	1047	1180#																		
RGPTR	806	810	937	958	1050	2559#														
RTBL	939	1227#	1241																	
RMUSE	98#	124	137																	
RSET5	197	2518#																		
RSET6	207	2519#																		
RSET7	217	2521#																		
RSR05	1001	1004#																		
RSR10	1003	1006	1009#																	
RST65	212	2520#																		
RSTOR	371	427	993#	1523																
RTAB	2213	2262	2462#	2466																
RTABS	1723	2263	2466#																	
SCM05	1626#	1643																		
SCM10	1629	1632#																		
SCM15	1639	1641#																		
SCMD	1622#	2429																		
SDK85	71																			
SETRG	311	1036#																		
SGNAD	245	1175#																		
SGNDT	250	1176#																		
SGNON	1386	2422#	2424																	
SKLN	101#	137																		
SPHSV	1237	2548#																		
SPLSV	1238	2547#																		
SRET	2007	2141	2291#	2380	2381	2386	2405	2407	2409											
SSAV	183	445	1015	2495	2546#															
SSTEP	382#	457	1115																	
SSTRT	1341#	1828																		
STH05	2342	2348#																		
STHF0	1568	1571	2309#																	
STHLF	1558	2314	2334#																	
STOPB	1342#	1833																		
STP20	388	402#																		
STP21	409	412#																		
STP22	411	416#																		
STP23	414	418#																		
STP25	192	429#																		
STRT	1343#	1819																		
SUB05	476#	503																		
SUB10	490	498#																		
SUB15	478	504#																		
SUBST	467#	1117																		
TEMP	405	417	452	1541	1559	1565	1674	1676	1713	1729	2310	2340	2557#							
TERM	1344#	1548																		
TIM2	1352#	1835																		
TIMER	140#	419	422																	
TIMHI	132#	421																		
TIMLO	133#	423																		
TMODE	134#	419																		
TRUE	152#	337	1551																	
TSTRT	135#	425																		
UBRLN	103#	137																		
UNMSK	136#	227	455																	
UPDAD	480	591	1064#																	
UPDDT	322	485	593	1085#																
UPPER	1345#	1540																		
USCSR	424	432	570	2561#																
USINT	221	2522#																		
USRBR	137#	2516																		
VALDG	1553	2010	2375#																	
VALDL	1550	1998	2402#																	
WAIT	1353#	1761																		
WAITS	80#	139	1349																	
XCM05	1663	1666#																		
XCM10	1675#	1726																		
XCM15	1678	1681#																		
XCM18	1684	1687#																		
XCM20	1702	1706#																		
XCM25	1717	1720#																		
XCM27	1722#	1732																		
XCM30	1711	1727#																		
XCMD	1657#	2428																		
ZERO	1128#	1175																		

CROSS REFERENCE COMPLETE

APPENDIX B DIAGRAMS

8

7

6

5

4

3

2

1

REVISIONS				SIGNATURE AND DATE		
LTR	DESCRIPTION	DFT	CHK	ENGR	DATE	
A	PROD REL				7/77	

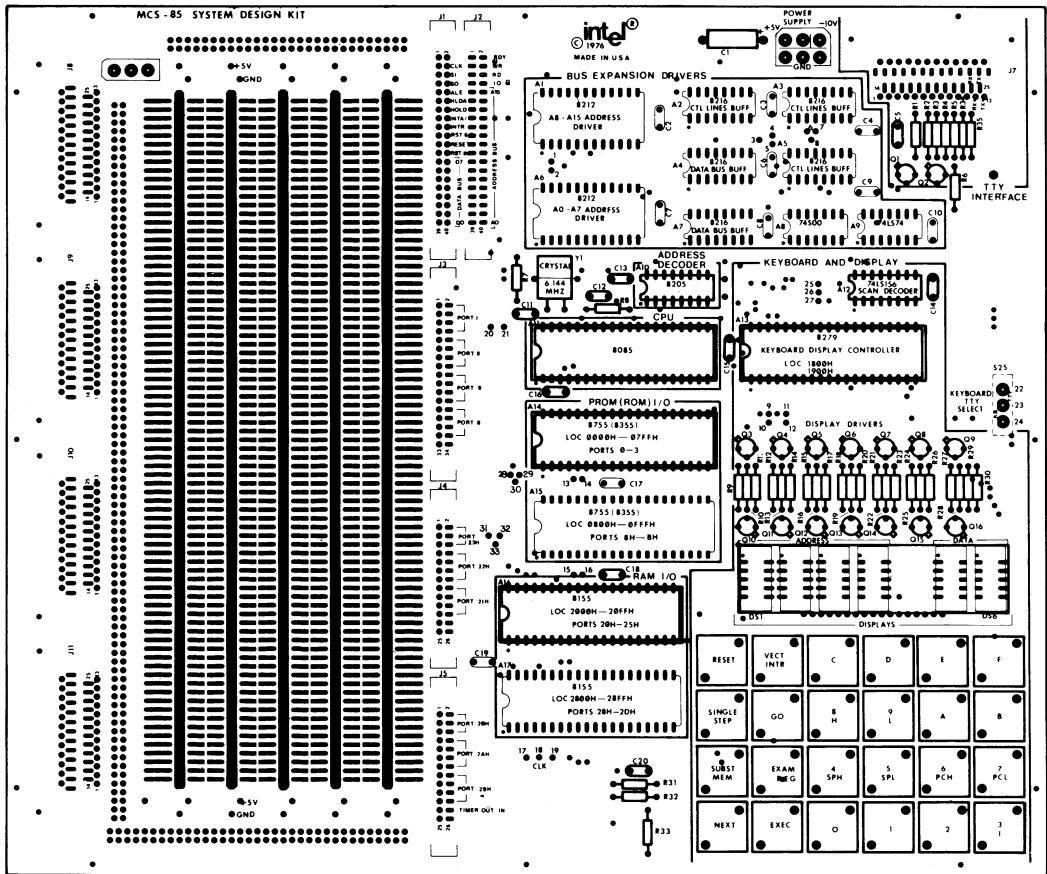

D

C

B

A

D

C

B

A

QUANTITY PER DASH NO		ITEM NO	PART NUMBER	DESCRIPTION
SCALE: NONE		SIGNATURE		DATE
TOL: 2 PLC 3 PLC ANGLE		DRN BY: <i>S.M. Cooney</i>		5/77
MATERIAL:		CHK BY: <i>J.B. Charwin</i>		5/77
FINISH:		DFT		
NEXT ASSY		APPR		
USED ON		ENGR		
		AUTH BY: <i>A. Chong</i>		5/77
		CODE		
		SHEET 1		OF 1
PARTS LIST				REV
TITLE: PWA SYSTEM DESIGN KIT				A
DRAWING NO. 1001119				
DEPT. D				
SIZE 416				

REVISIONS		
LTR	DESCRIPTION	SIGNATURE AND DATE
A1	PROD REL	3/57 [Signature] 4/1/77

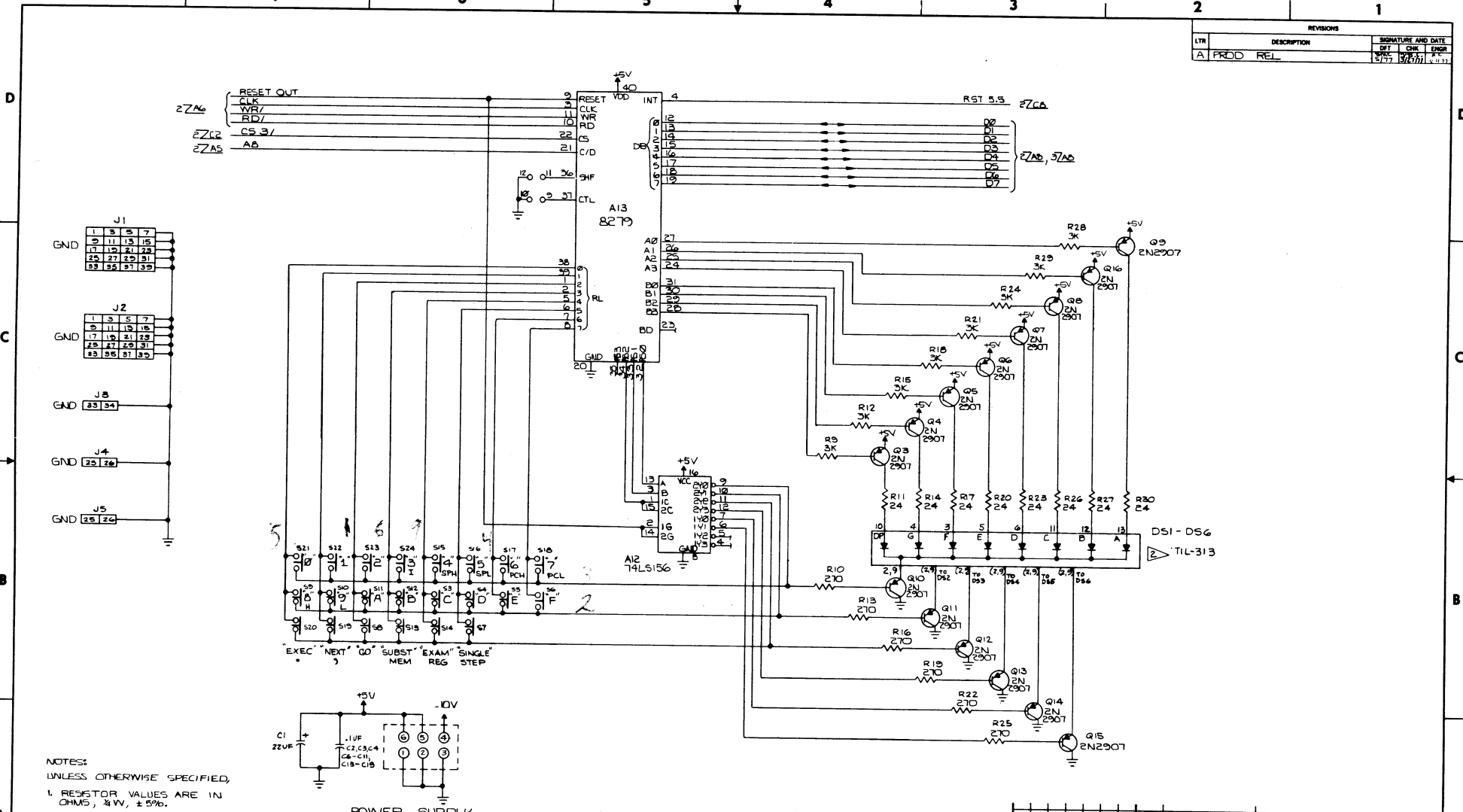

NOTES:
UNLESS OTHERWISE SPECIFIED,
1. RESISTOR VALUES ARE IN OHMS, $\frac{1}{2}W$, $\pm 5\%$.

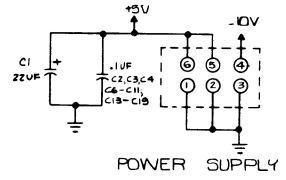

THIS PIN OUT ARRANGEMENT REPRESENTS 6 INDIVIDUAL 7 SEGMENT LED DISPLAYS (TIL 313). ALL ANODE CONNECTIONS OF THE CORRESPONDING SEGMENTS ARE WIRED SEPARATELY TO EACH TRANSISTOR (Q10-Q15)

JUMPER 5 TO 3 AND 6 TO 8 WHEN BUS EXPANSION CIRCUITS ARE NOT INSTALLED.

SPARE GATE COUNT				REF DESIGNATIONS	
TYPE	REF DES	QTY	LAST USED	NOT USED	
	C20				
	A17				
	R35				
	Q16				
	DS6				
	33				
	525				

QUANTITY PER DASH NO.			ITEM NO.	PART NUMBER	DESCRIPTION
SCALE:	NONE				
TOL:	2 P/LC	3 P/LC	ANGLE		
MATERIAL:					
FINISH:					

SIGNATURE		DATE	PARTS LIST	
[Signature]		5/76		
DRN BY: [Signature]		5/76	2800 BOWERS AVE. SANTA CLARA CALIF. 95051	
CHK BY: [Signature]		7/8/76	TITLE: SCHEMATIC SYSTEM DESIGN KIT	
APP'D: [Signature]		1/5/77	SIZE: DEPT. DRAWING NO. 2001051	
AUTH BY: [Signature]		6/1/77	REV: A	
CODE:	SHEET 1	OF 3		

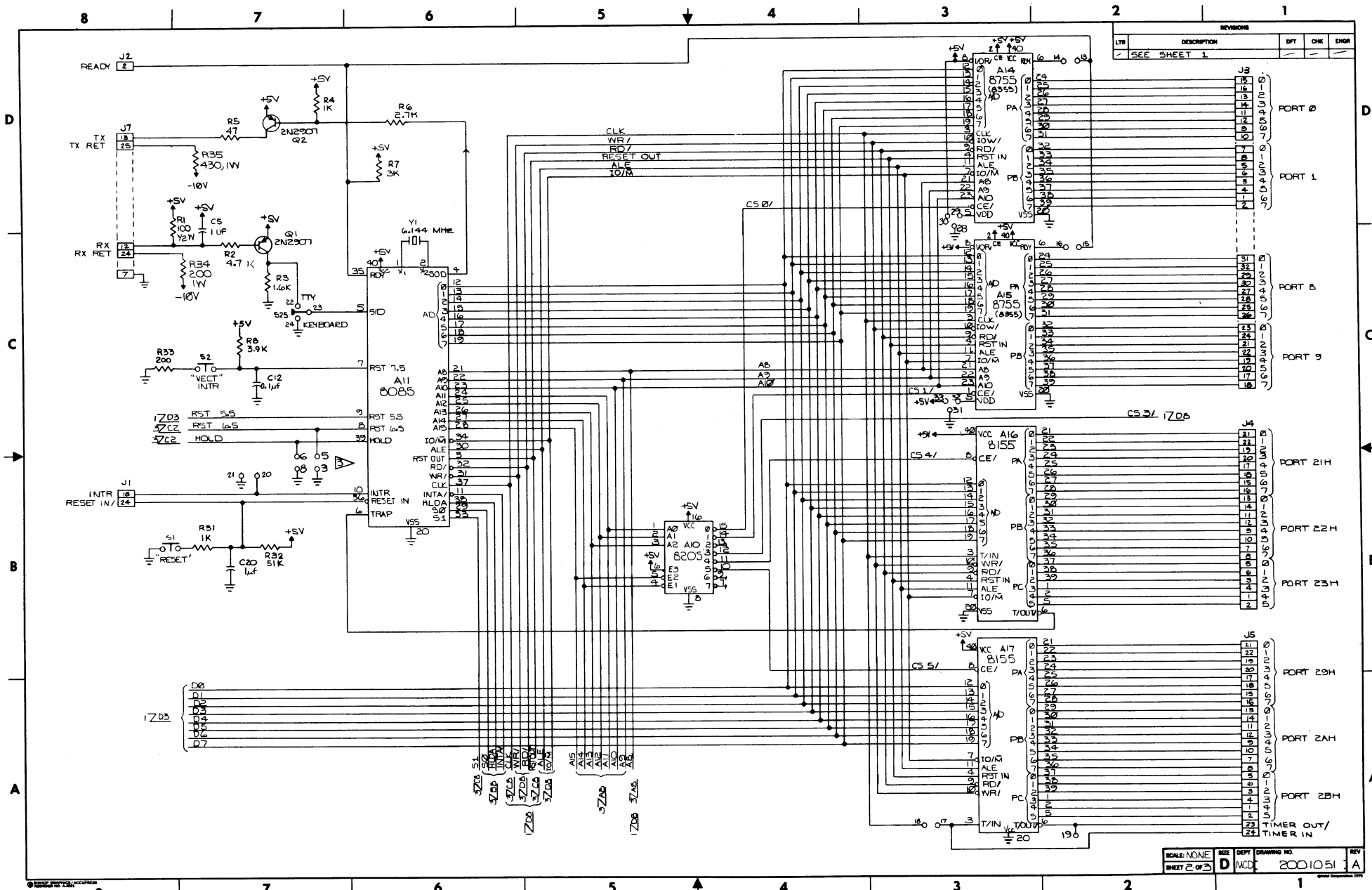

REVISIONS			
LTR	DESCRIPTION	BY	CHK
1	SEE SHEET 1		

SCALE: NONE
 SHEET 2 OF 3
 SIZE: D
 DEPT: MCD
 DRAWING NO: 2001051
 REV: A

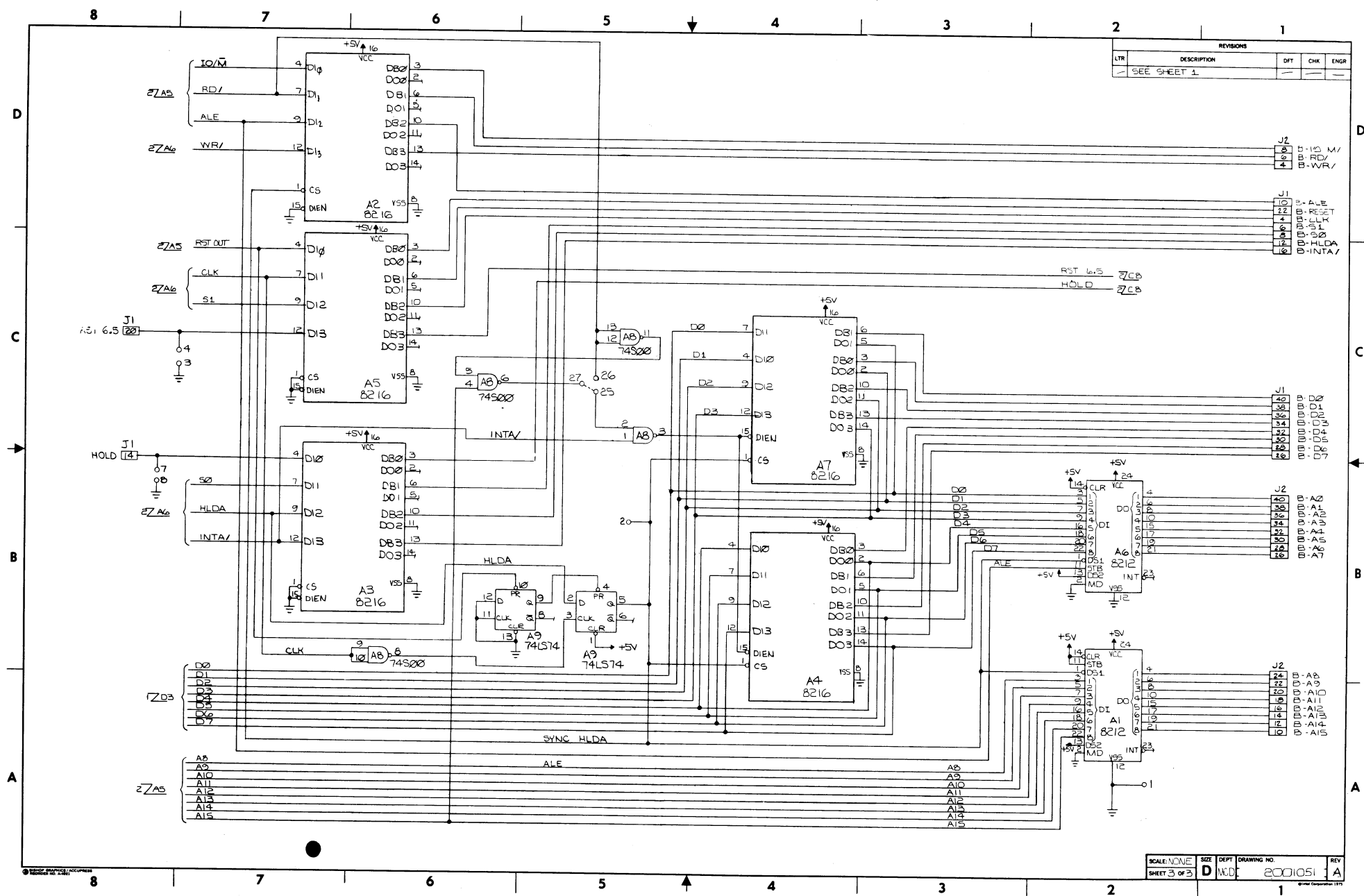

REVISIONS				
LTR	DESCRIPTION	DFT	CHK	ENGR
1	SEE SHEET 1			

SCALE: NONE	SIZE: D	DEPT: MCD	DRAWING NO: 2001051	REV: A
SHEET 3 OF 3				



REQUEST FOR READER'S COMMENTS

The Microcomputer Division Technical Publications Department attempts to provide documents that meet the needs of all Intel product users. This form lets you participate directly in the documentation process.

Please restrict your comments to the usability, accuracy, readability, organization, and completeness of this document.

1. Please specify by page any errors you found in this manual.

2. Does the document cover the information you expected or required? Please make suggestions for improvement.

3. Is this the right type of document for your needs? Is it at the right level? What other types of documents are needed?

4. Did you have any difficulty understanding descriptions or wording? Where?

5. Please rate this document on a scale of 1 to 10 with 10 being the best rating. _____

NAME _____ DATE _____

TITLE _____

COMPANY NAME/DEPARTMENT _____

ADDRESS _____

CITY _____ STATE _____ ZIP CODE _____

Please check here if you require a written reply.

WE'D LIKE YOUR COMMENTS ...

This document is one of a series describing Intel products. Your comments on the back of this form will help us produce better manuals. Each reply will be carefully reviewed by the responsible person. All comments and suggestions become the property of Intel Corporation.



**NO POSTAGE
NECESSARY
IF MAILED
IN U.S.A.**



BUSINESS REPLY MAIL
FIRST CLASS PERMIT NO. 1040 SANTA CLARA, CA

POSTAGE WILL BE PAID BY ADDRESSEE

**Intel Corporation
Attn: Technical Publications M/S 6-2000
3065 Bowers Avenue
Santa Clara, CA 95051**



INTEL CORPORATION, 3065 Bowers Avenue, Santa Clara, CA 95051 (408) 987-8080

Printed in U.S.A.