

TEXAS INSTRUMENTS
FIELD PROGRAMMABLE LOGIC DEPARTMENT
PROGRAMMING ALGORITHM SPECIFICATION

DEVICE FAMILY PAL20XXA
DEVICES INCLUDED PAL20L8A, PAL20R4A, PAL20R6A, PAL20R8A

PROGRAMMING PROCEDURE:

Array fuses are programmed using a linear select method. Each fuse can be opened by selecting the appropriate (1 of 40) Input Line and then pulsing the correct (1 of 64) Product Line. The levels for selecting Input Lines and Product Lines are shown in Table 1-2.

- Step 1: Raise PGM ENABLE to V_{IH}
- Step 2: Select an Input Line by applying appropriate levels to L/R and PI pins. Apply V_{IL} or V_{IH} to selected PI pin (See Table 1-2).
- Step 3: Select Product Line by applying appropriate levels to PA pins (See Table 1-2).
- Step 4: Raise V_{CC} to V_{IH} .
- Step 5: Blow the fuse by pulsing the appropriate PO pin to V_{IH} .
- Step 6: Return V_{CC} to 5 volts and pulse PGM VERIFY. The PO pin will exhibit a low output if the fuse is blown.

Four fuse locations can be verified simultaneously, however, fuses should be addressed and blown sequentially.

If the fuse is still intact, steps 4 thru 6 may be repeated until the fuse is successfully blown, not to exceed 4 retries. Do not apply additional pulses to a fuse once it is correctly programmed.

For Input and Product Line selection see Table 1-2.

For programming waveforms see Figure 1-1.

To prevent further verification, two security fuses may be blown by raising PGM ENABLE and PGM VERIFY to 16 volts. V_{CC} must be at 0 volts during this operation (See Figure 1-2).

PREPARED BY B. Cole PAL20-1.DWG	DATE 10/15/86	TEXAS INSTRUMENTS		
CHECKED BY <i>Donald B. Jones</i>	DATE 04/12/88	TITLE: ALGORITHM SPECIFICATION PAL20XXA		
ENGINEER Jim Giddings	DATE 10/15/86			
APPROVED BY <i>Donald B. Jones</i>	DATE 04/29/88	REVISION C	SIZE A	PAL24002
RELEASED BY 	DATE / /	LETTER	SIZE	SHEET 1 11

PIN ASSIGNMENTS IN PROGRAMMING MODE

PRODUCT TERMS 0 THRU 31

PRODUCT TERMS 32 THRU 63

(TOP VIEW)

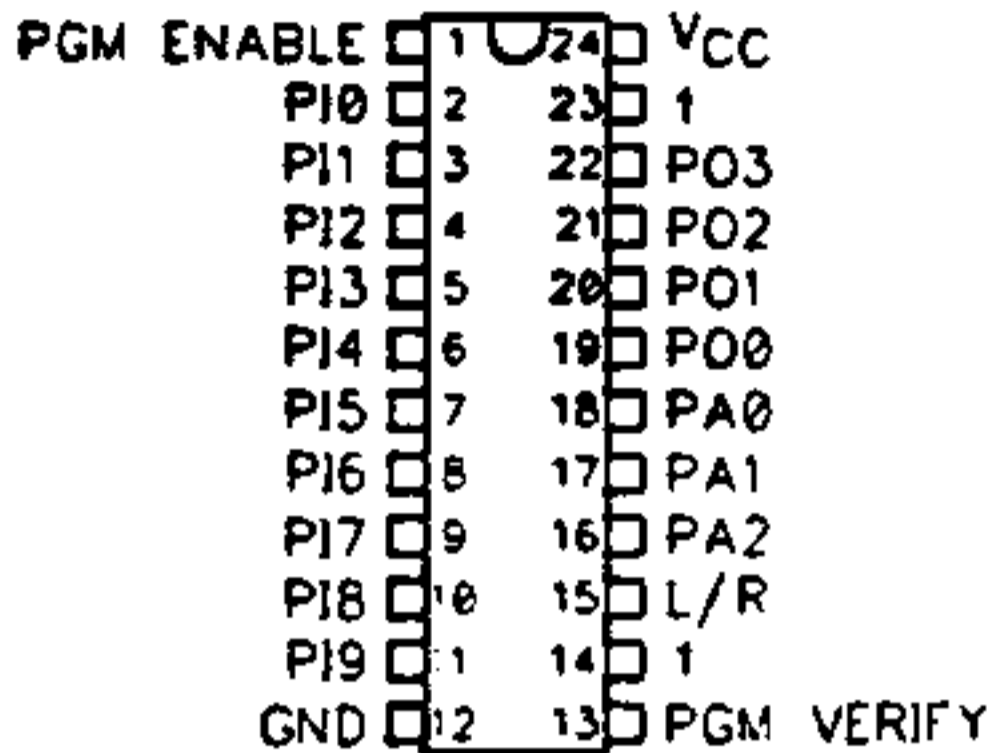

(TOP VIEW)

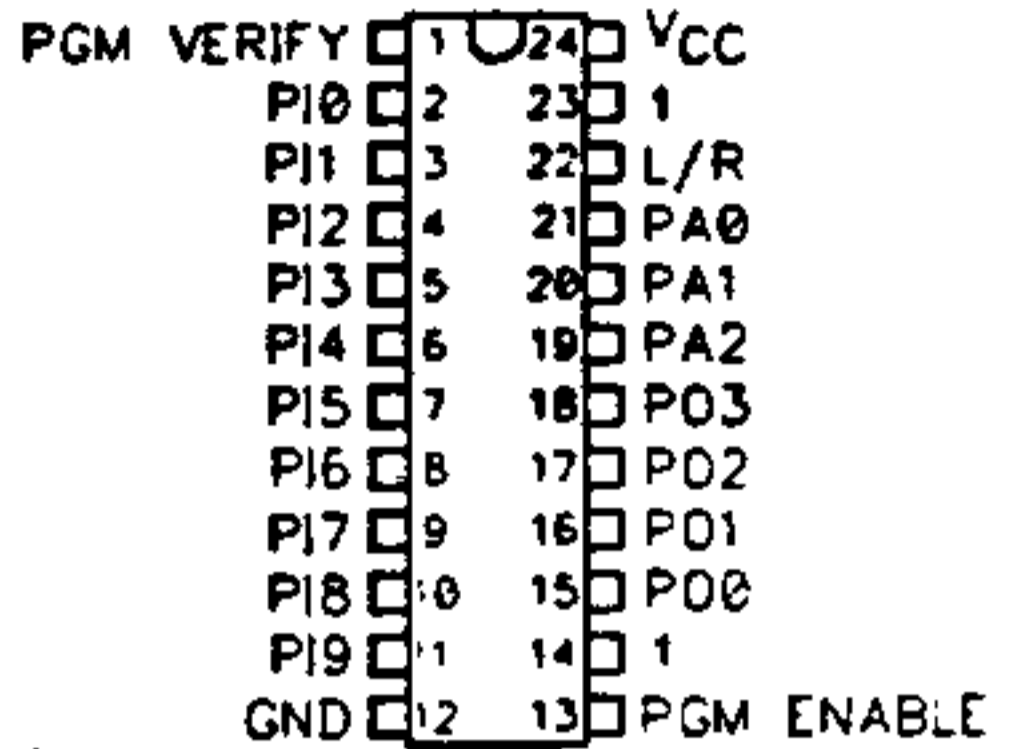

[†]Pins 14 and 23 have no programming function. Make no connection.

(TOP VIEW)

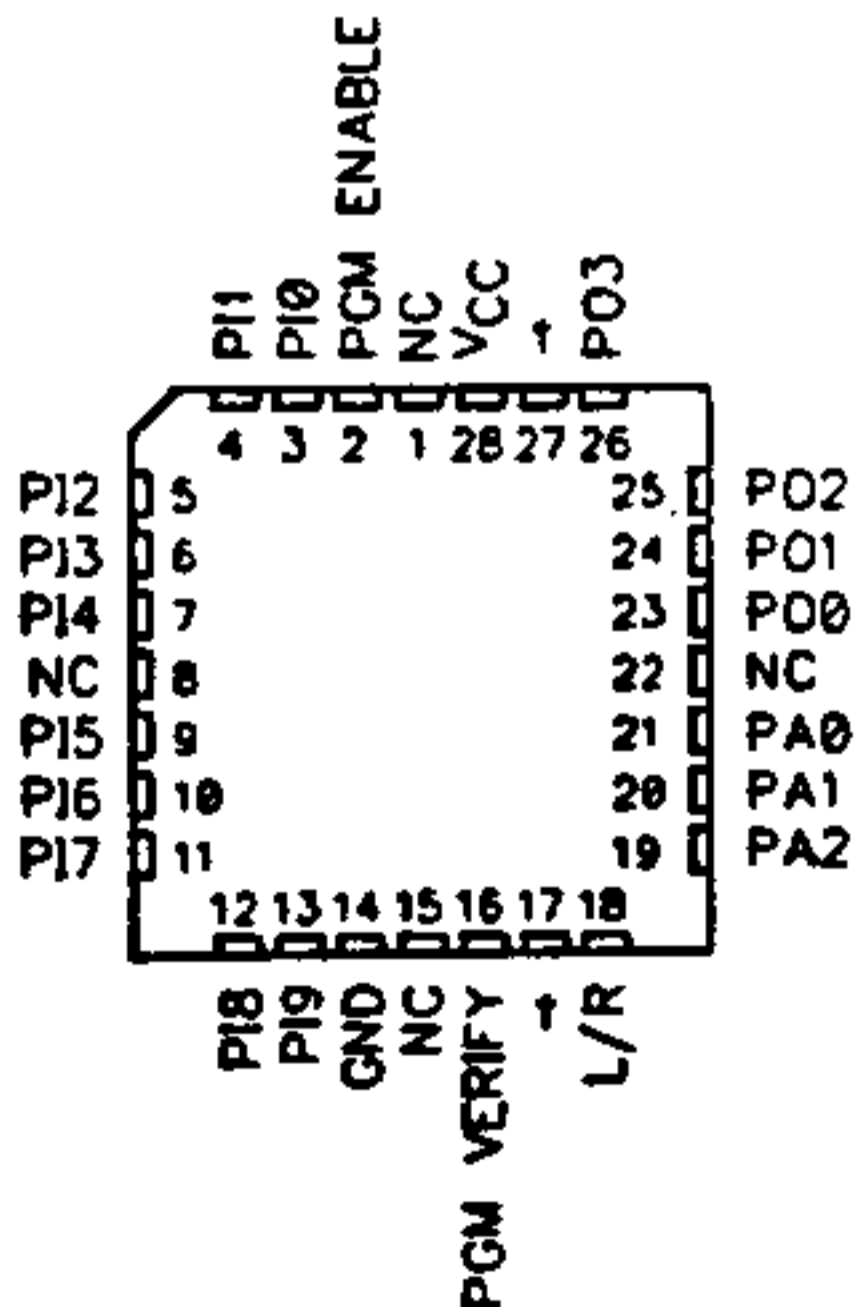

(TOP VIEW)

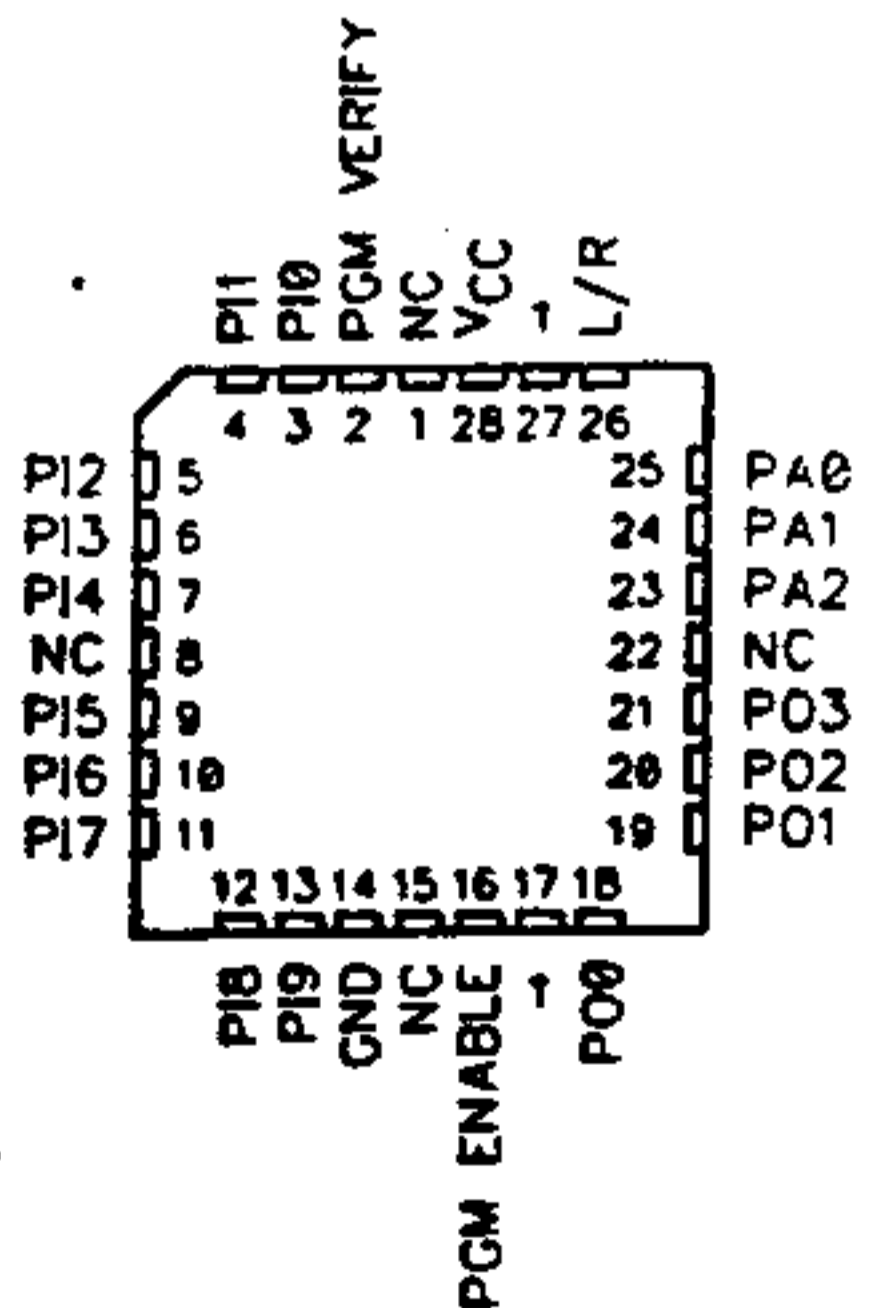

TABLE 1-1. PROGRAMMING PARAMETERS, TA = 25°C

PARAM	DESCRIPTION	MIN	NOM	MAX	UNIT
VCC	Verify-level supply voltage	4.75	5.00	5.25	V
V _{IH}	High-Level input voltage	2.40		5.50	V
V _{IL}	Low-level input voltage			0.50	V
V _{IHH}	Program-pulse voltage	10.25	10.50	10.75	V
I _{IHH}	Program-pulse current		20	50	Ma
	PGM ENA, L/R		10	25	Ma
	PI, PA		1.5	5	Ma
	I _{CC}		250	400	Ma
t _{w1}	Program-pulse duration at PO	10		50	μS
	Prog.-pulse duty cycle, PO, VCC			25	%
t _{w2}	Pulse duration at PGM VERIFY	100			nS
t _{SU}	Set-up time	100			nS
t _H	Hold time	100			nS
t _{d1}	Delay time from VCC to 5V to PGM VERIFY	100			μS
t _{d2}	Delay time from PGM VERIFY pulse to valid output	200			nS
	Voltage at pins 1 and 11 to open verify-protect (security) fuse		16		V
	Current to open security fuse			400	Ma
	Security fuse pulse duration	20		50	μS
t _{w3}	VCC during security fusing		0	0.40	V

TABLE 1-2. INPUT/PRODUCT LINE SELECT

TABLE 1 - INPUT LINE SELECT

TABLE 2 - PRODUCT LINE SELECT

INPUT LINE NO.	PIN NAME										
	PI9	PI8	PI7	PI6	PI5	PI4	PI3	PI2	PI1	PI0L/R	
0	H	H	H	H	H	H	H	H	H	L	Z
1	H	H	H	H	H	H	H	H	H	H	Z
2	H	H	H	H	H	H	H	H	H	L	H
3	H	H	H	H	H	H	H	H	H	H	H
4	H	H	H	H	H	H	H	H	L	H	Z
5	H	H	H	H	H	H	H	H	H	H	Z
6	H	H	H	H	H	H	H	H	L	H	H
7	H	H	H	H	H	H	H	H	H	H	H
8	H	H	H	H	H	H	H	L	H	H	Z
9	H	H	H	H	H	H	H	H	H	H	Z
10	H	H	H	H	H	H	H	L	H	H	H
11	H	H	H	H	H	H	H	H	H	H	H
12	H	H	H	H	H	H	L	H	H	H	Z
13	H	H	H	H	H	H	H	H	H	H	Z
14	H	H	H	H	H	H	L	H	H	H	H
15	H	H	H	H	H	H	H	H	H	H	H
16	H	H	H	H	H	L	H	H	H	H	Z
17	H	H	H	H	H	H	H	H	H	H	Z
18	H	H	H	H	H	L	H	H	H	H	H
19	H	H	H	H	H	H	H	H	H	H	H
20	H	H	H	H	L	H	H	H	H	H	Z
21	H	H	H	H	H	H	H	H	H	H	Z
22	H	H	H	H	L	H	H	H	H	H	H
23	H	H	H	H	H	H	H	H	H	H	H
24	H	H	H	L	H	H	H	H	H	H	Z
25	H	H	H	H	H	H	H	H	H	H	Z
26	H	H	H	L	H	H	H	H	H	H	H
27	H	H	H	H	H	H	H	H	H	H	H
28	H	H	L	H	H	H	H	H	H	H	Z
29	H	H	H	H	H	H	H	H	H	H	Z
30	H	H	L	H	H	H	H	H	H	H	H
31	H	H	H	H	H	H	H	H	H	H	H
32	H	L	H	H	H	H	H	H	H	H	Z
33	H	H	H	H	H	H	H	H	H	H	Z
34	H	L	H	H	H	H	H	H	H	H	H
35	H	H	H	H	H	H	H	H	H	H	H
36	L	H	H	H	H	H	H	H	H	H	Z
37	H	H	H	H	H	H	H	H	H	H	Z
38	L	H	H	H	H	H	H	H	H	H	H
39	H	H	H	H	H	H	H	H	H	H	H

PROD. LINE NO.	PIN NAME						
	PO0	PO1	PO2	PO3	PA2	PA1	PA0
0,32	Z	Z	Z	HH	Z	Z	Z
1,33	Z	Z	Z	HH	Z	Z	HH
2,34	Z	Z	Z	HH	Z	HH	Z
3,35	Z	Z	Z	HH	Z	HH	HH
4,36	Z	Z	Z	HH	HH	Z	Z
5,37	Z	Z	Z	HH	HH	Z	HH
6,38	Z	Z	Z	HH	HH	HH	Z
7,39	Z	Z	Z	HH	HH	HH	HH
8,40	Z	Z	HH	Z	Z	Z	Z
9,41	Z	Z	HH	Z	Z	Z	HH
10,42	Z	Z	HH	Z	Z	HH	Z
11,43	Z	Z	HH	Z	Z	HH	HH
12,44	Z	Z	HH	Z	HH	Z	Z
13,45	Z	Z	HH	Z	HH	Z	HH
14,46	Z	Z	HH	Z	HH	HH	Z
15,47	Z	Z	HH	Z	HH	HH	HH
16,48	Z	HH	Z	Z	Z	Z	Z
17,49	Z	HH	Z	Z	Z	Z	HH
18,50	Z	HH	Z	Z	Z	HH	Z
19,51	Z	HH	Z	Z	Z	HH	HH
20,52	Z	HH	Z	Z	HH	Z	Z
21,53	Z	HH	Z	Z	HH	Z	HH
22,54	Z	HH	Z	Z	HH	HH	Z
23,55	Z	HH	Z	Z	HH	HH	HH
24,56	HH	Z	Z	Z	Z	Z	Z
25,57	HH	Z	Z	Z	Z	Z	HH
26,58	HH	Z	Z	Z	Z	HH	Z
27,59	HH	Z	Z	Z	Z	HH	HH
28,60	HH	Z	Z	Z	HH	Z	Z
29,61	HH	Z	Z	Z	HH	Z	HH
30,62	HH	Z	Z	Z	HH	HH	Z
31,63	HH	Z	Z	Z	HH	HH	HH

L = V_{IL} , H = V_{IH} , HH = V_{IHH} , Z = high impedance (e.g. 10 kΩ to GND except for pin being verified = 10 kΩ to 5V).

FIGURE 1-1. PROGRAMMING WAVEFORMS

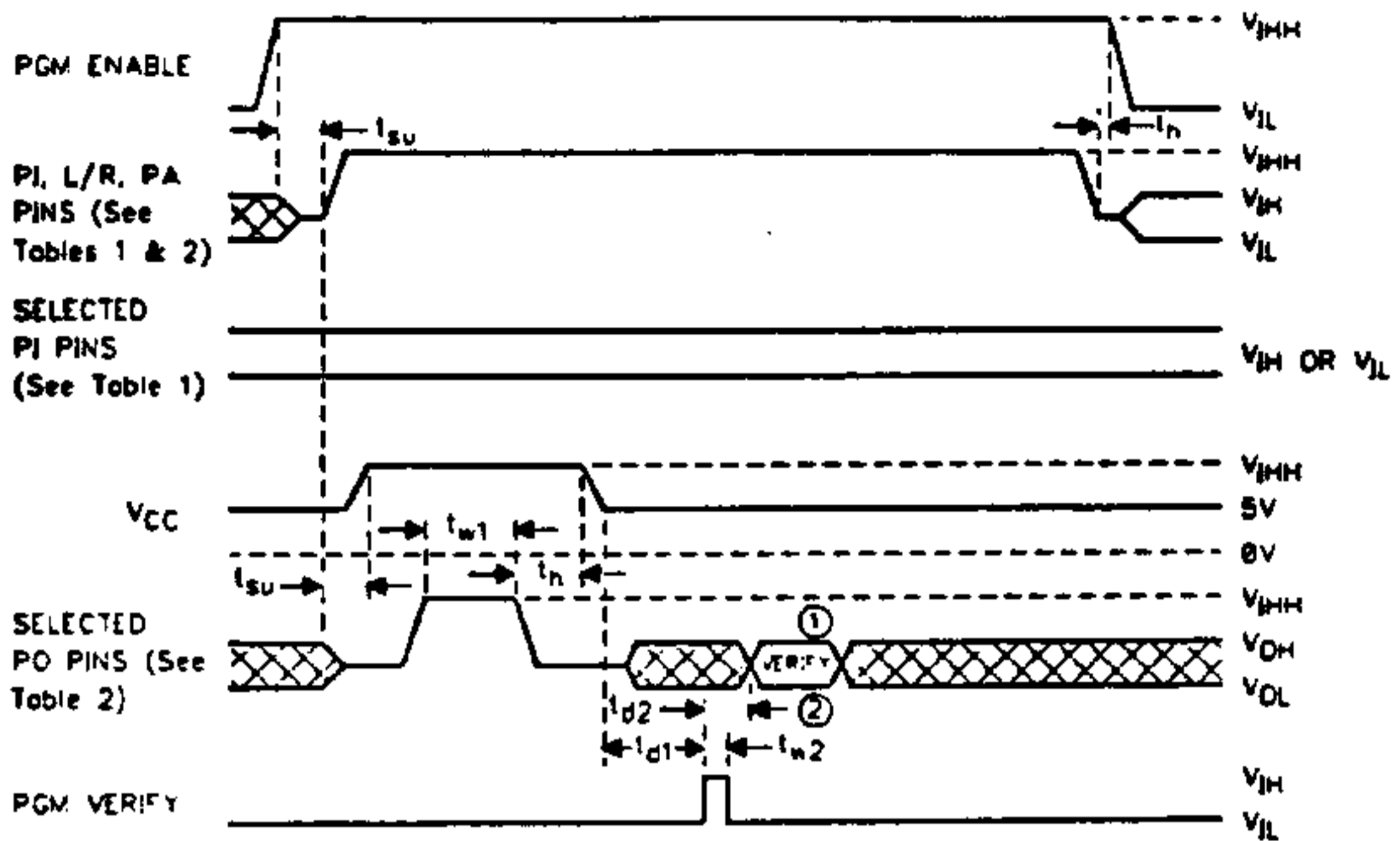

- ① A high level during the verify interval indicates that programming has not been successful.
- ② A low level during the verify interval indicates that programming has been successful.

FIGURE 1-2. SECURITY FUSE WAVEFORMS

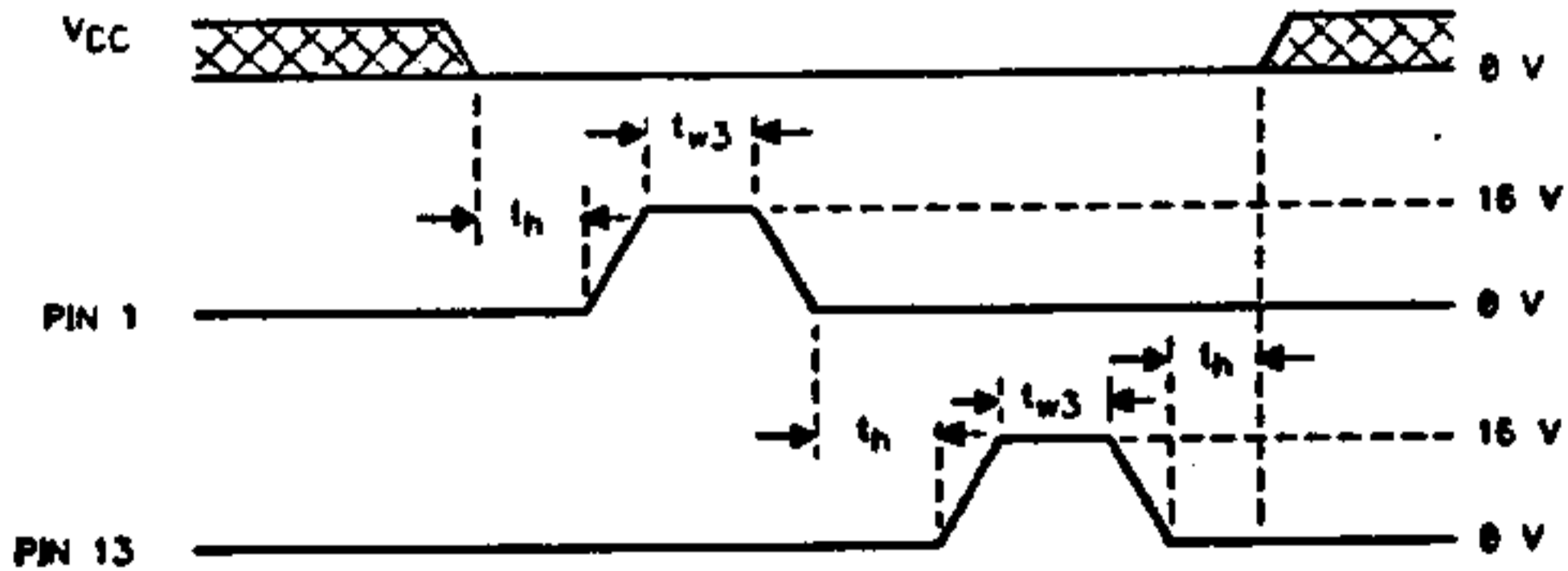

FIGURE 1-3. PRELOAD PROCEDURES

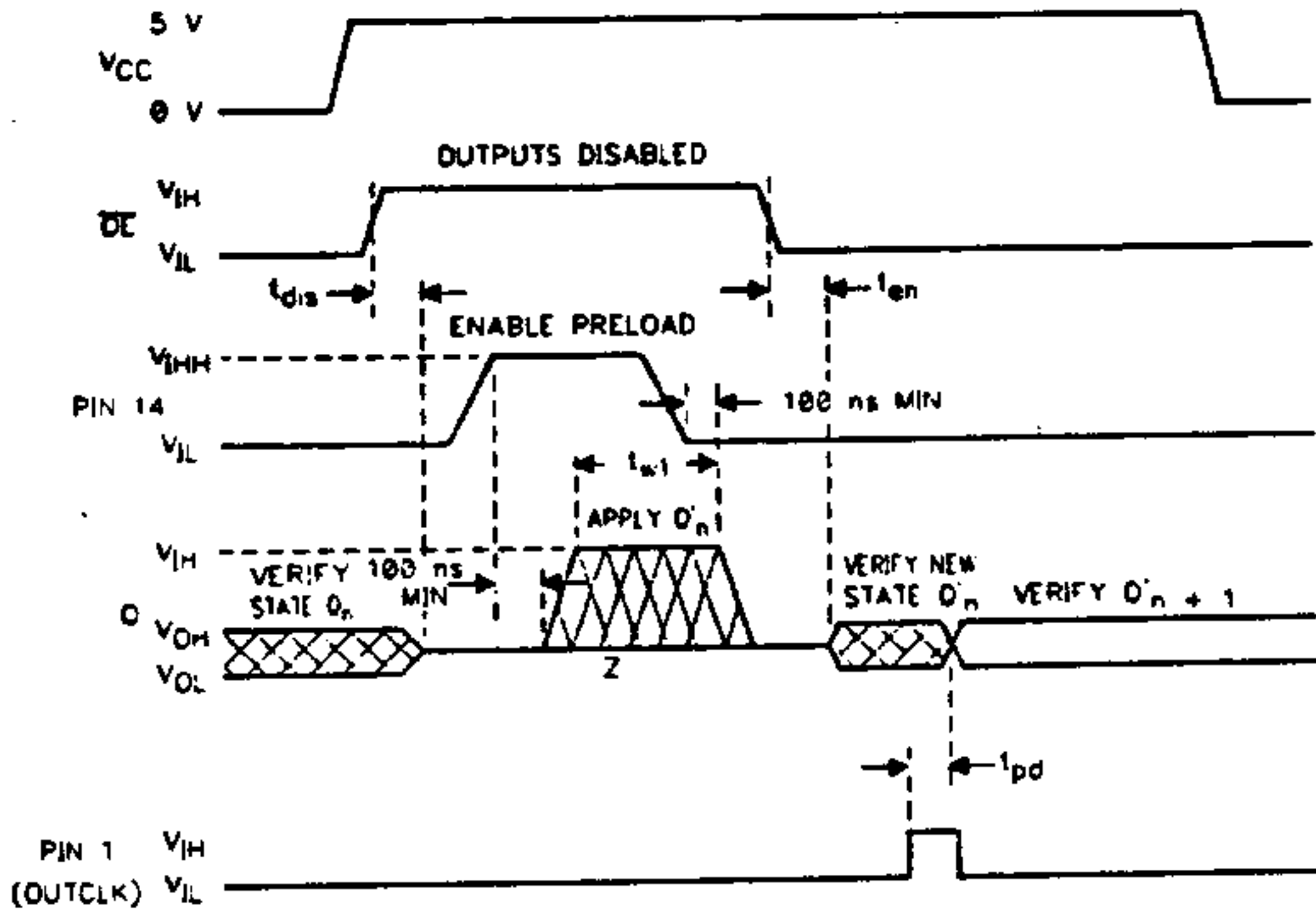
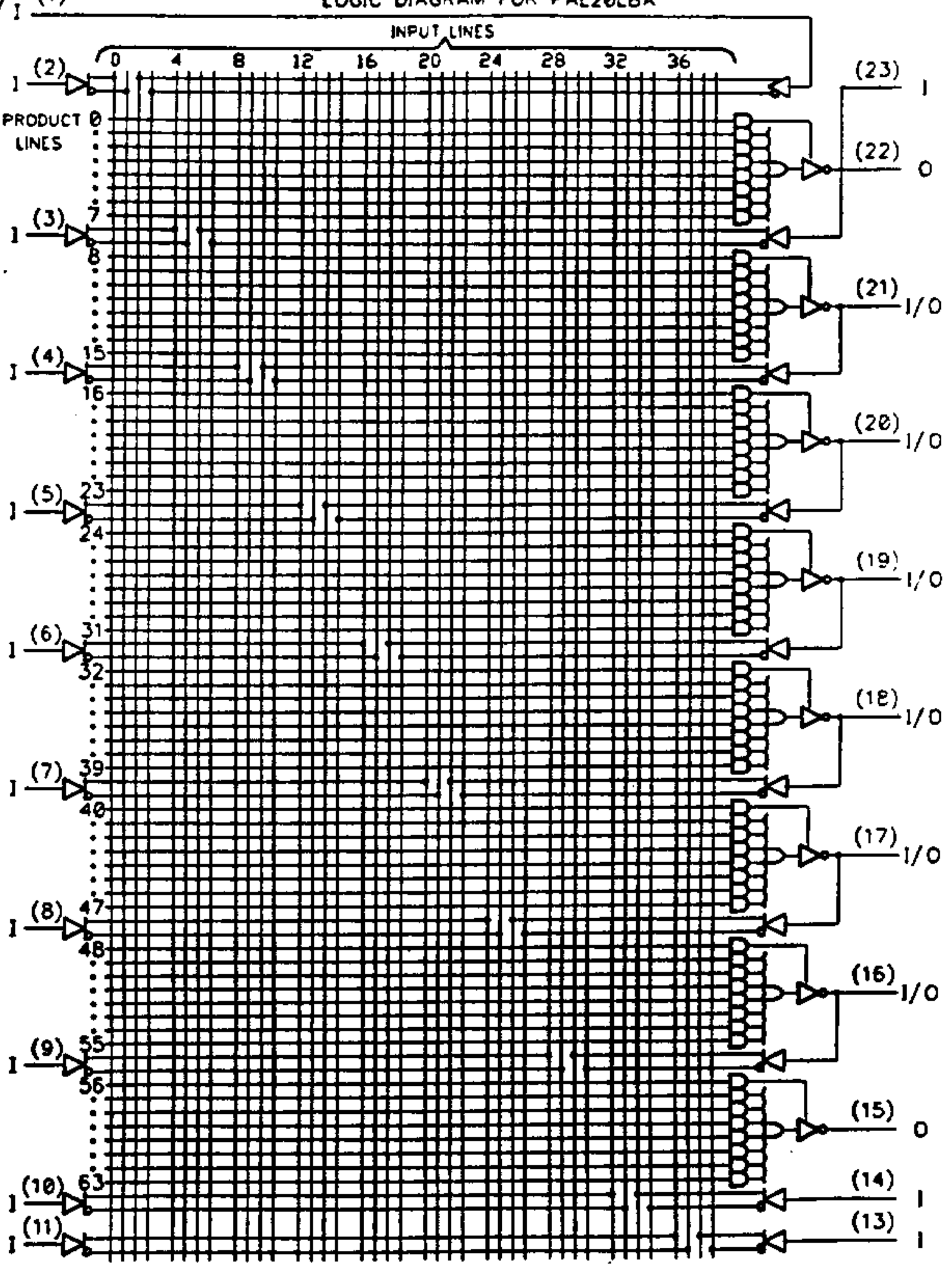

FIGURE 1. PRELOAD WAVEFORMS

preload procedure for registered outputs

- Step 1: Pin 13 to V_{IH} , PIN 1 TO V_{IL} , AND V_{CC} to 5 volts.
- Step 2: Pin 14 to V_{IHH} for 10 to 50 microseconds.
- Step 3: Apply V_{IL} for a low and V_{IH} for a high at the Q outputs.
- Step 4: Pin 14 to V_{IL} .
- Step 5: Remove the voltages applied to the outputs.
- Step 6: Pin 13 to V_{IL} .
- Step 7: Check the output states to verify preload.

LOGIC DIAGRAM FOR PAL20L8A



LOGIC DIAGRAM FOR PAL20R4A

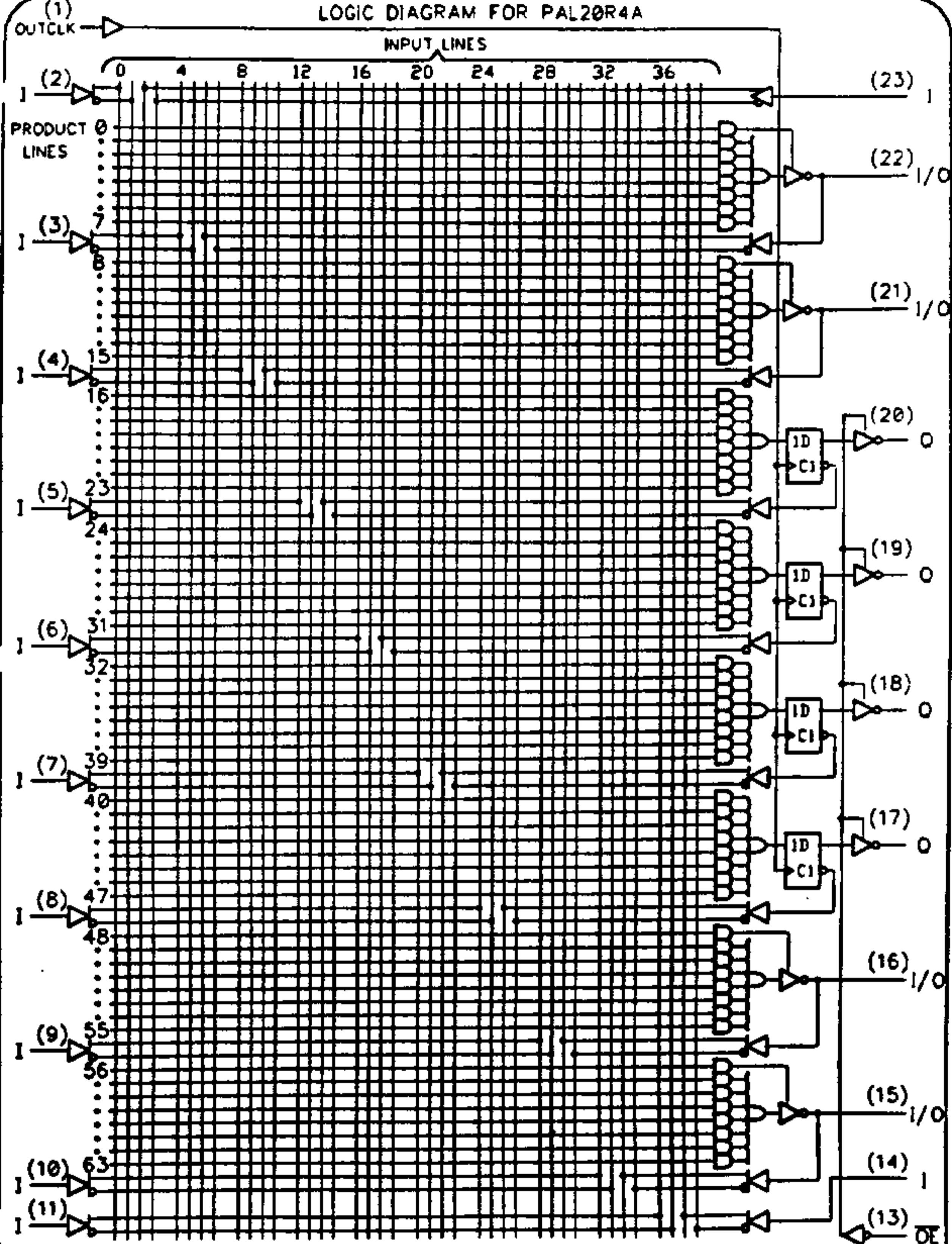

LOGIC DIAGRAM FOR PAL20R6A

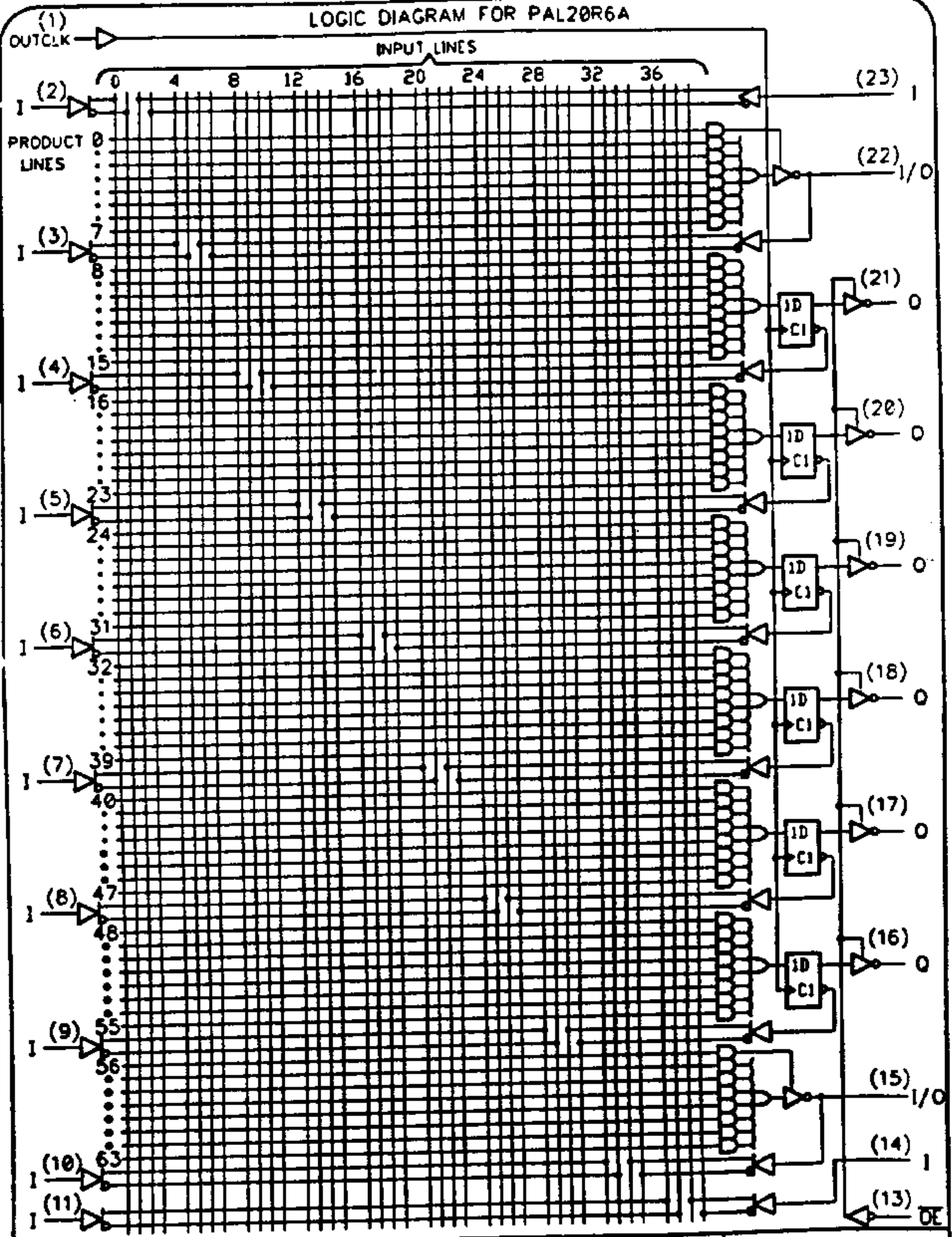

LOGIC DIAGRAM FOR TIBPAL20R8

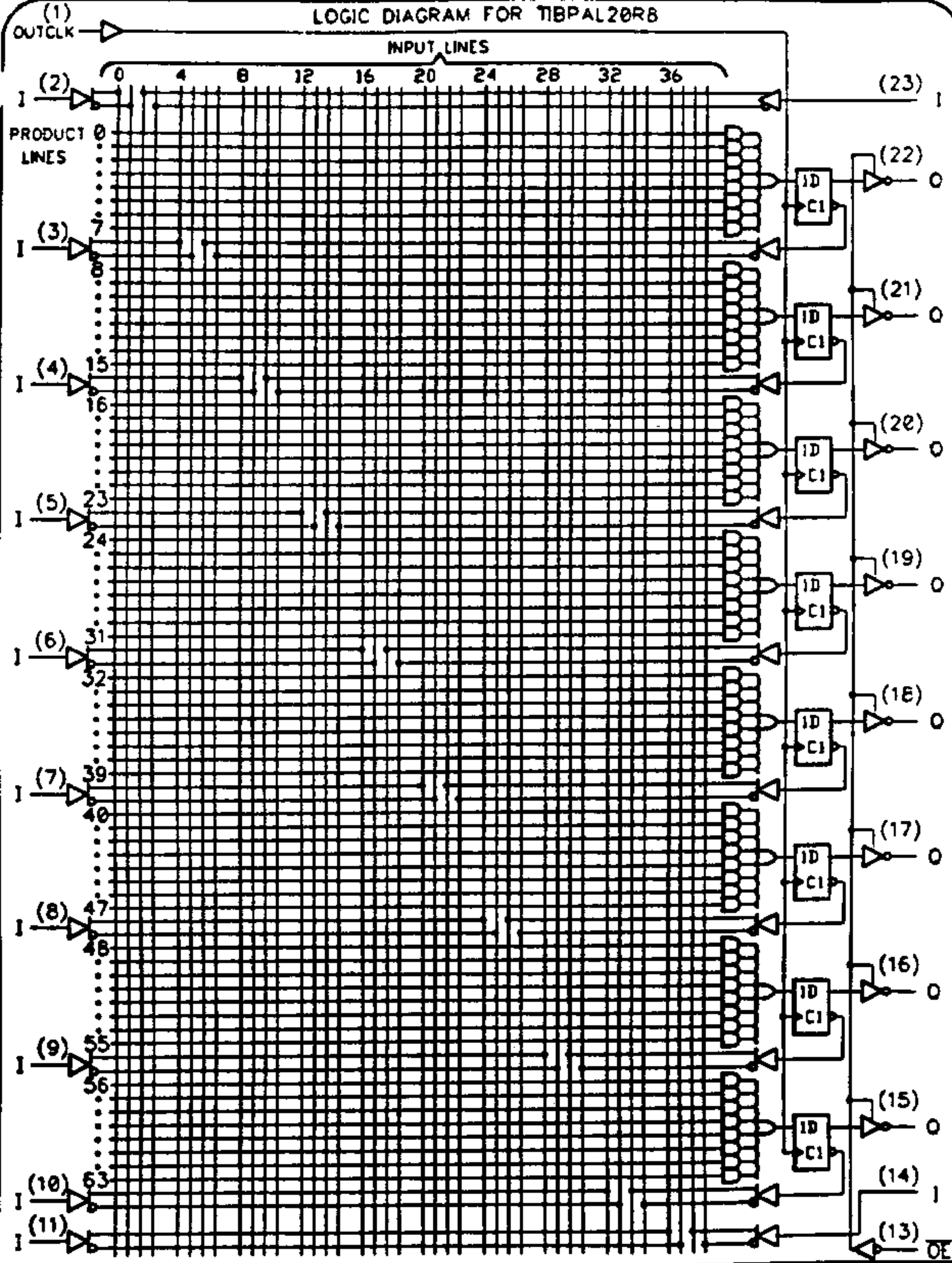

REVISION HISTORY

REVISION LTR.	DATE	ENGINEER	DESCRIPTION OF CHANGES
A	11-86	Giddings	Security fuse statement added to programming procedure. Table 1-2; Z (high impedance) redefined Table 1-1; Corrected security fuse voltage. Figure 1-2; Pin 11 changed to pin 13. Figure 1-3; Preload waveforms added.
B	12-87	Thomas	Changed pin 11 to pin 13 in Figure 1-2.
C	4-88	Thomas	Sht. 2; Added PLCC Pinout. Sht. 3; Added $V_{CC} = 4.75$ Min. and $V_{CC} = 5.25$ Max.