

# electronics

(Photo at right)

## CIRCUIT IN NEEDLE'S EYE

*differential amplifier  
on silicon block, p 37*

---

## INTERCEPT RECEIVER

*uses only passive  
tuning circuits, p 40*

---

## MAGNETIC PEGBOARD

*generates digital  
test signals, p 46*

---

## IMPROVING AMPLIFIERS

*new method optimizes  
gain-bandwidth, p 54*

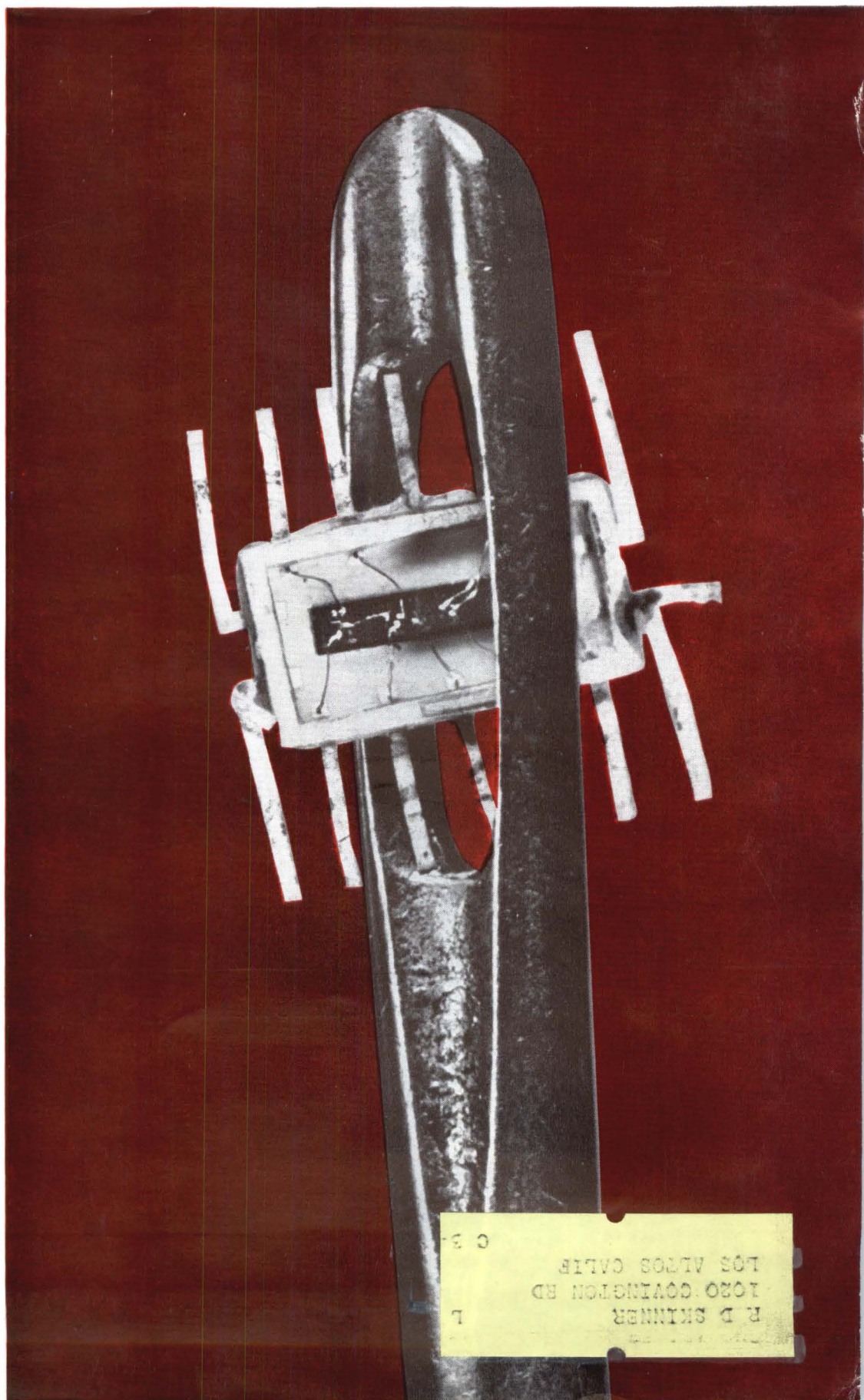

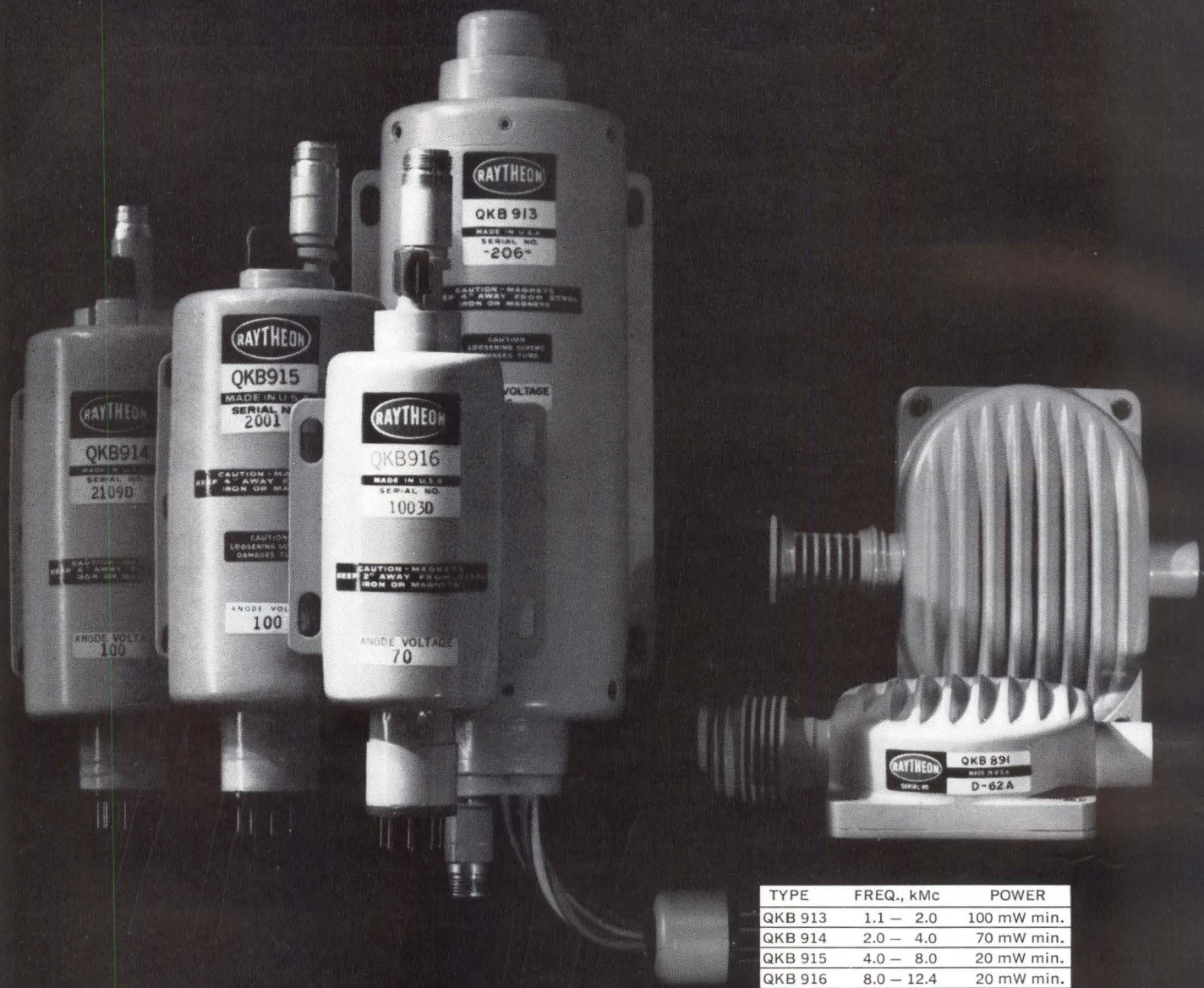

TYPICAL RAYTHEON O-TYPE BWO'S FOR LABORATORY INSTRUMENTS\*

TYPE	FREQ., kMc	POWER
QKB 913	1.1 - 2.0	100 mW min.
QKB 914	2.0 - 4.0	70 mW min.
QKB 915	4.0 - 8.0	20 mW min.
QKB 916	8.0 - 12.4	20 mW min.
QKB 890	12.4 - 18.0	40-180 mW
QKB 891	18.0 - 26.5	40-180 mW

\*Complete O-type BWO line includes 45 different tubes

## Why 3 out of 5 BWO's in new microwave signal generators are Raytheon

Certainly it's more convenient to select from Raytheon's 45 different BWO's. But most needs are met with six tubes covering 1 to 26.5 kMc (above). They're unusually compact and incorporate grids for low-voltage pulse and amplitude modulation or the application of AGC. Write for more reasons in technical data. Raytheon Co. □ Microwave and Power Tube Div., Waltham 54, Mass.

CIRCLE 900 READERS SERVICE CARD



# electronics

A McGraw-Hill Publication 75 Cents



W. W. MacDONALD, Editor

J. M. CARROLL, Managing Editor  
 SENIOR EDITORS: Samuel Weber, George W. Sideris. SENIOR ASSOCIATE EDITOR: Michael F. Wolff. ASSOCIATE EDITORS: Michael F. Tomaino, Sylvester P. Carter, William P. O'Brien, John F. Mason, Thomas Emma, Sy Vogel, Leslie Solomon, George J. Flynn, Laurence D. Shergalis. ASSISTANT EDITORS: Nilo Lindgren, Stanley Froud, Stephen B. Gray, Roy J. Bruun, George V. Novatny, Leon H. Dulberger. REGIONAL EDITORS: Harold C. Hood (Pacific Coast, Los Angeles), Thomas Maguire (New England, Boston), Cletus M. Wiley (Midwest, Chicago). ART DIRECTOR: Harry Phillips; Howard R. Berry. PRODUCTION EDITOR: John C. Wright, Jr. EDITORIAL ASSISTANTS: Gloria J. Meurer, Bernice Duffy, Lorraine Rossi, Virginia T. Bastian, Lynn Emery, Bette H. Snyder, Rosemary Abbruzzese, Judy Haskins, Ann Mella. FOREIGN NEWS BUREAU: Director, John Wilhelm, Alyne Elias. LONDON—John Shinn, Derek Barlow, Nicholas Landon. Bonn—Peter Forbath, Silke McQueen. Paris—Robert Farrell, Arthur Erikson. Milan—Marc A. Messina. Mexico City—Bruce Bendow. Rio de Janeiro—Leslie Warren. Moscow—Stewart Ramsey. Tokyo—Richard Halloran, Charles Cohen, John Yamaguchi.

JAMES GIRDWOOD, Publisher

**MICROMINIATURE** general-purpose differential amplifier developed by Autonetics division of North American Aviation is being fabricated by Texas Instruments. *It can be used in automatic control systems such as autonavigators, flight controls and computer input-output circuits. See p 37* COVER

**ELECTRONICS STOCKS** in Wall Street's Shakeout. Prices of our industry's issues were more erratic, but are expected to bounce back faster. *Financing plans of some companies will be affected, but general financial health of the industry is sound* 20

**OPTICAL MOSAICS** of Photosensitive Cells Seen as Future Space Guidance Technique. Solid-state mosaic fabrication is outlined at IAS meeting. *Another proposal: power-generating radiation shields* 26

**TV STEREO AUDIO** System Splits L-R Channel. Negative and positive portions are positioned in horizontal scan. *System is considered two years ahead of consumer electronics market* 28

**LOUDSPEAKER COLOR CODES?** Electronic Industries Association is considering new rating system. *Customers could tell at a glance how good general performance is* 30

**FIRST DETAILS:** Differential Amplifier Grown in Silicon Block. Performs functions of five transistors, five resistors and two diodes. It accomplishes practically all small-signal audio-frequency and d-c amplifier requirements. *Does away with need for large transformers and capacitors.* By W. F. DeBoice, North American Aviation, and J. F. Bowker, Montana State College 37

**COMMUNICATIONS COUNTERMEASURES** Wideband Receiver Tunes With Passive Elements Only. Unit includes wide band-pass filter, frequency discriminator with matched detectors and crt display. *It provides 100-percent intercept probability without tuning oscillators or filters.* By R. B. Hankin, and M. Ross, Hallicrafters 40

**D-C LEVEL SHIFTER** Checks New Computer Modules. Gives adjustable shift of zero to plus 18 volts. Delay is a few nanoseconds and attenuation is 3 db at 32 Mc. *It is used in checking out new computer modules whose d-c levels differ widely.* By T. Mollinga, Burroughs 44

**NOVEL DIGITAL SIGNAL GENERATOR** Uses Magnetic-Core Pegboard. Small permanent magnets are plugged into 64-by-10-hole pegboard over a magnetic-core matrix to set up desired digital pattern. *Generator provides programs for testing digital control devices; its speed is 300,000 steps a second.* By Way Dong Woo, Cybetronics 46

Published weekly, with Electronics Buyers' Guide and Reference issue, as part of the subscription, by McGraw-Hill Publishing Company, Inc. Founder: James H. McGraw (1860-1948).

Indexed Annually in Buyers' Guide and Reference issue.

Title ® registered U.S. Patent Office; © copyright 1962 by McGraw-Hill Publishing Co., Inc. All rights reserved, including the right to reproduce the contents of this publication, in whole or in part.

Executive, editorial, circulation and advertising offices McGraw-Hill Building, 330 West 42nd Street, New York 36, N. Y. Telephone Longacre 4-3000. Teletype TWX N.Y. 1-1636. Cable McGrawhill, N. Y. PRINTED IN ALBANY, N. Y.; second class postage paid at Albany, N. Y.

OFFICERS OF THE PUBLICATIONS DIVISION: Nelson L. Bond, President; Shelton Fisher, Wallace F. Traendly, Senior Vice Presidents; John R. Callahan, Vice President and Editorial Director; Joseph H. Allen, Vice President and Director of Advertising Sales; A. R. Venezian, Vice President and Circulation Coordinator; Daniel F. Crowley, Vice President and Controller.

OFFICERS OF THE CORPORATION: Donald C. McGraw, President; Hugh J. Kelly, Harry L. Waddell, Executive Vice Presidents; L. Keith Goodrich, Executive Vice President and Treasurer; John J. Cooke, Vice President and Secretary.

Subscriptions are solicited only from those actively engaged in the field of the publication. Position and company connection must be indicated on orders. Subscription rates: United States and Possessions, \$6.00 one year; \$9.00 two years; \$12.00 three years. Canada, \$10.00 one year. All other countries \$20.00 one year. Single Copies, United States and Possessions and Canada 75¢. Single copies all other countries \$1.50.

THE PUBLISHER, UPON WRITTEN REQUEST FROM ANY SUBSCRIBER TO OUR NEW YORK OFFICE, AGREES TO REFUND THAT PART OF THE SUBSCRIPTION PRICE APPLYING TO COPIES NOT YET MAILED.

Subscribers: Please address all correspondence, change of address notices, subscription orders or complaints to Fulfillment Manager, Electronics, at above address. Change of address notices should provide old as well as new address, including postal zone number if any. If possible, attach address label from recent issue. Allow one month for change to become effective.

Postmaster: Please send Form 3579 to Fulfillment Manager, Electronics, 330 West 42nd Street, New York 36, New York.



Audited Paid Circulation

CONTENTS continued

TWO TRANSISTORS Equal One Constant-Current Device. The constant-current diode invented recently in England is still in the laboratory stage, but this two-transistor circuit does the same job. *It is the current analog of a zener diode.*  
By G. Watson, English Electric 50

NEW DESIGN METHOD Optimizes Gain-Bandwidth. This technique optimizes the power-gain  $\times$  bandwidth product of tetrode and pentode amplifiers. *Provides method for choosing proper double-tuned circuit values.*  
By A. I. Sinsky and H. M. Mayrovitz, Bendix 54

DEPARTMENTS

Crosstalk. <i>Competition from Japan</i>	3
Comment. <i>More on Abbreviations</i>	4
Electronics Newsletter. <i>Microwave Power Transmission Now Considered Practical. Industry and Government Begin All-Channel Tv Talks</i>	7
Washington Outlook. <i>Executive Salary Limits on Nonprofit Contracts. Midwest Losing Defense Business</i>	12
Meetings Ahead. <i>Ultrasonics Symposium</i>	32
Research and Development. <i>Increasing Bandwidth of Ultrasonic Radiators</i>	60
Components and Materials. <i>Taking Contact Bounce Out of Reed Relays for Light-Load Switching</i>	66
Production Techniques. <i>Circuit Inspections Speeded with Infrared</i>	72
New Products Design and Application. <i>High-Performance Limiter-Discriminator Uses Nano-second Diodes</i>	80
Literature of the Week	93
People and Plants. <i>Foxboro Erecting Research Center</i>	94
Index to Advertisers	105

## Competition from Japan

IT IS APPARENT that Japanese and American electronics companies have become intimately connected just as U.S. and European electronics companies have become financially and technically intermixed. The companies that have entered into such agreements have done so because it has been profitable.

There seems to be little argument that the two-way flow of technical information across the Pacific raises the state of the art on both shores. Another type of partnership is the manufacturing agreement under which a Japanese firm makes American-developed products for sale in Asia and other overseas markets. Such arrangements have been sought by American companies that could not otherwise profitably compete against local producers with lower costs, or against trade restrictions.

The Japanese-American business activity that most disturbs the U.S. electronics industry is the importing of lower-priced components and consumer goods. This cuts into sales of some domestic products, especially transistors and transistor radios. Less publicity—chiefly because American firms play these cards close to their vest—has been given the purchase in Japan of parts of components (not the components themselves) and subassemblies for consumer products. These are assembled here and carry the tag "Made in USA."

Are these practices reprehensible? Should they be stopped or restricted? American companies that have been hurt think so, and say so. Less vocal are American companies that have turned to lower-cost Japanese products in their effort to remain competitive in world markets.

More than two years ago, the Electronic Industries Association petitioned the government for import quotas on Japanese transistors, on grounds that quotas would preserve our ability to produce sufficient transistors for defense. A few weeks ago, EIA finally got the answer: No. The Office of Emergency Planning said that despite the imports U.S. industry was expanding. Actually, it has excess production capacity, caused partly by foreign and partly by domestic competition.

The government's reasons for not imposing more trade barriers on Japanese electronics



products are potent. For one, Japan is a fruitful market for many U.S. products and other industries would be hurt if we built more trade barriers and the Japanese replied in kind, (Japan does impose quotas and minimum quality standards on some consumer electronics products and is trying to control the flow of still cheaper products from Hong Kong and Okinawa). Second, the electronics industry is vital to Japan. It is a prime source of capital money to buy needed imports, employment and military strength. It would be foolish for our government to take any action that would materially weaken a strong ally in the Far East.

Our heart is with American companies that want protection against Japanese imports. But our mind is with those who feel that it is self-defeating to create trade barriers in an effort to solve domestic economic problems.

### Coming In Our July 13 Issue

**AUTOTESTING.** Automatic checkout equipment is frequently required for today's complex systems, especially when the time that would be needed to test all circuits by manually operated instruments would be prohibitive. Assistant Editor Novotny has surveyed the latest trends and techniques in methods used to test systems, how checkout equipment is designed and made adaptable to varying needs and what changes are coming in new automatic checkout systems.

Another up-to-date report, by A. P. Heyman, of GE, gives first design details on a new parametric amplifier that tracked a space probe 70,000 miles.

# CALIBRATED Thermistor Mounts

For Greater Accuracy  
in Power Measuring Systems



Model 675-A

## Coaxial Thermistor Mount

The Model 675-A is a 200 ohm thermistor mount for use in the 100 to 4000 mc range. Its extremely long thermal time constant virtually eliminates effects of ambient temperature changes. Calibration factor is supplied to an accuracy of 2% at 400, 1000 and 1500 mc.

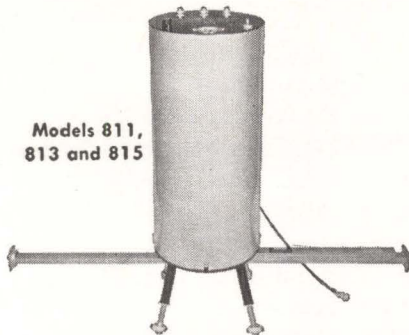

Models 811,  
813 and 815

## X-Band Power Standard

This 200 ohm thermistor mount-coupler-temperature chamber combination operates over any specified 200 mc band between 8.2 and 11.2 kmc. The thermostatically controlled constant temperature chamber eliminates effects of ambient temperature changes. An NBS test report is supplied giving the calibration factor to an accuracy of 1%.

## Precision Power Bridges

Weinschel Engineering also manufactures precision power bridges for use with these thermistor mounts. These bridges give accuracies to 0.1% of substituted power.

**WEINSCHEL**  
ENGINEERING

10503 METROPOLITAN AVENUE  
KENSINGTON, MARYLAND  
Tel.: 949-0141 (Area Code 301)  
TWX: KENS 446  
In California: 631 Wilshire Blvd.  
Santa Monica  
TWX: SMON 7185

## COMMENT

### More on Abbreviations

In his letter printed in the *Comment* column of your May 18 edition (p 4), Mr. Charles F. Roberts attacked the growing misuse of abbreviations, which you answered in your note by saying that space may be saved by such abbreviations.

May I add some comment to that question from the viewpoint of a non-American reader of your journal. I fully agree that it will always be necessary to use abbreviations and symbols in technical literature. However, a general rule should be kept, either by the author himself or by the editor of the journal. All abbreviations used should be standard abbreviations which, if necessary, can be looked up in some list of standards, preferably an internationally recognized list such as an I.E.C. (International Electrotechnical Commission) or an I.S.O. (International Standards Organization) list of standards.

Readers of American technical literature whose native tongue is not English (and especially not American) very often are at a loss to understand some abbreviations which may be in current use in the U. S. but which are in contradiction with internationally established practice and standards. I suppose that, for example, most European engineers will understand abbreviations like min for minute,  $\mu$ sec for microsecond (though international standards recommend  $\mu$ s in this case), va for volt-ampere (though international standards are in favour of VA instead), etc. These are all abbreviations which refer to units used by engineers in every country of the world.

A very different thing, however, is the use of abbreviations like those quoted by Mr. Roberts: *iff*, *spdt* (where I really do not know what is meant), *avc* and *prf*, which are simply derived from the corresponding American expressions. In view of the fact that American technical literature is more and more read by readers of other countries, I think it could at least be recommended to print in full length every expression of that kind the first time it appears in the text of an article, followed by the abbrevi-

ation in parenthesis (or the other way around, if this is preferred).

Another, still better, solution would be to give a list of the symbols and abbreviations used, just ahead of or underneath the article. Still another possibility, not so good but yet a way out, might be the publication of a list of abbreviations by the journal which could be kept and used by the reader, especially the foreign reader.

Above all, however, all this trouble about abbreviations and symbols once again shows the necessity of having international standards. Some personal experience in the field of international standardization has shown me that the relative importance of such questions has not always been recognized in the U. S. However, I think that the fact of our world getting smaller and smaller every day, and of international cooperation becoming more and more important, will induce a rapid change in that attitude.

H. OSWALT

Laboratory of the  
Hasler Foundation  
Zurich, Switzerland

A technical subcommittee of the Institute of Radio Engineers is now at work on a list of standard abbreviations for use in electronics that will enable readers to look up unfamiliar ones. The foreword to the standard echoes reader Oswald's admonition against overuse of abbreviations. The watchword is "When in doubt, spell it out."

### Still More on Abbreviations

May I add my vote to that of reader Charles F. Roberts.

In his case, he understands the abbreviations. Too often, I do not. It is a poor showing for my BSME degree, but to me *iff* stands for "identification, friend or foe." And does *spdt* mean "stupid people don't think"? I recognized *avc* instantly as "all value cash," or is it Russian, meaning "any vacancies, comrade"? That *prf* throws me completely, unless it refers to Roger Maris and means "position, right field."

BRUCE B. WINTER

Handy & Harman  
New York, New York

# ➔ Here are some **COOL** customers for critical hot spots

**Model 094567  
SINGLE STAGE STUD MOUNTED COOLER**

Cooling Capacity:  
 —33°C with no load  
 —30°C with 10 mw load  
 Heat Sink Capacity: 0.5 watt  
 Input Power: 5 amps at 0.1 VDC



**Model 094492  
SINGLE STAGE COOLER**

Cooling Capacity:  
 —33°C with no load  
 —25°C with 200 mw load  
 Heat Sink Capacity: 3 watts  
 Input Power: 3.5 amps at 0.85 VDC

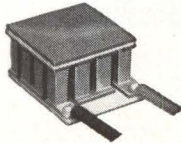

**Model 094446  
SINGLE STAGE COOLER**

Cooling Capacity:  
 —33°C with no load  
 —31°C with 50 mw load  
 Heat Sink Capacity: 3 watts  
 Input Power: 7 amps at 0.4 VDC

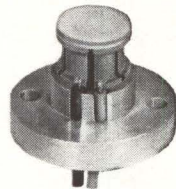

**Model 094447  
TWO-STAGE CASCADE COOLER**

Cooling Capacity:  
 —53°C with no load  
 —50°C with 20 mw load  
 Heat Sink Capacity: 4 watts  
 Input Power: 3 amps at 1.2 VDC

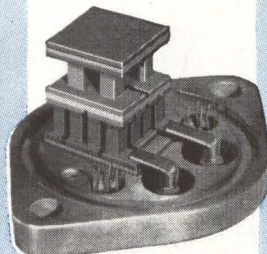

**Model 094520  
THREE-STAGE CASCADE COOLER**

Cooling Capacity:  
 —75°C with no load  
 —65°C with 15 mw load  
 Heat Sink Capacity: 1 watt  
 Input Power: 6 amps at 0.17 VDC

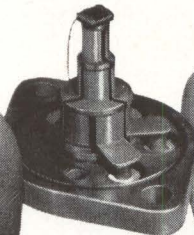

Models illustrated are actual size. All ratings taken in vacuum with heat sink temperatures 27°C.

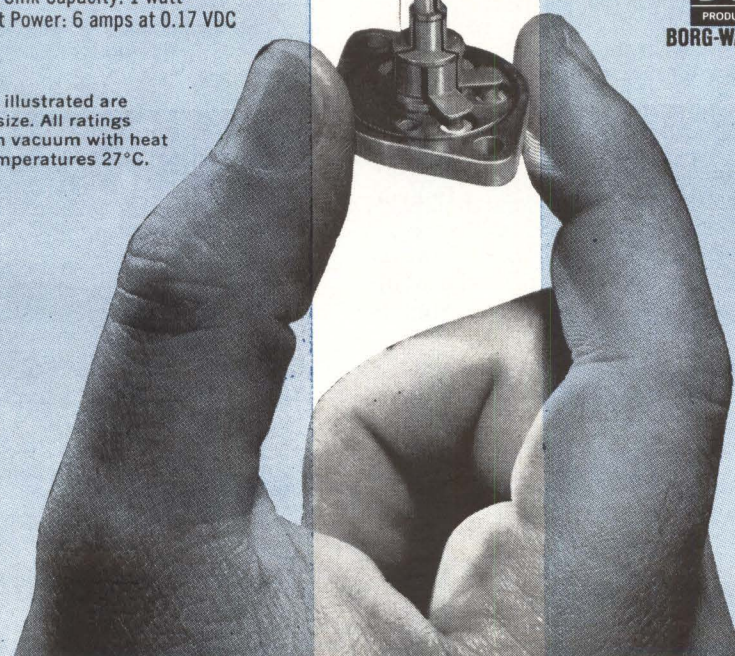

## PESCO THERMOELECTRIC COOLERS

**GIVE HIGH DELTA-T WITH LOW CURRENT INPUT IN A COMPACT MINIATURIZED PACKAGE .**

PESCO thermoelectric coolers are entirely electronic in operation . . . can be used wherever spot cooling will increase sensitivity in devices such as infrared detectors, semiconductors, electronic components, and specialized instrumentation. PESCO'S unique capability to cascade elements in miniaturized packages that will withstand rugged usage make these units extremely suitable for applications where space is limited. Many other designs with greater pumping capabilities can be supplied.

*Discuss your cooling requirements with thermoelectric specialists at . . .*



**PRODUCTS  
BORG-WARNER,**

**PESCO PRODUCTS DIVISION  
BORG-WARNER CORPORATION**

24700 North Miles Road Bedford, Ohio

**Export Sales:**  
 Borg-Warner International Corporation  
 36 South Wabash Avenue, Chicago 3, Ill.  
 © 1962 Borg-Warner Corporation

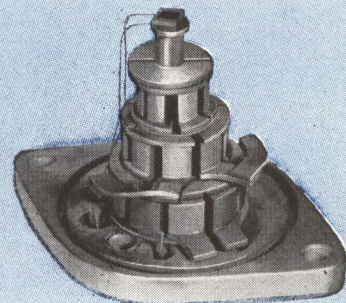

**Model 094438  
FOUR-STAGE CASCADE COOLER**

Cooling Capacity:  
 —87°C with no load  
 —78°C with 15 mw load  
 Heat Sink Capacity: 12 watts  
 Input Power: 20 amps at 0.6 VDC  
 Can be provided complete with heat sink, blower, motor, and heat exchanger.

10740-PC

# Versatile programming

plug-in programming for each individual column, code options with plug-in column cards

## Fast data transfer

takes just 2 msec;  
prints up to 5 lines per second

## Flexible BCD input

1-2-2-4 BCD input is standard; dual input available

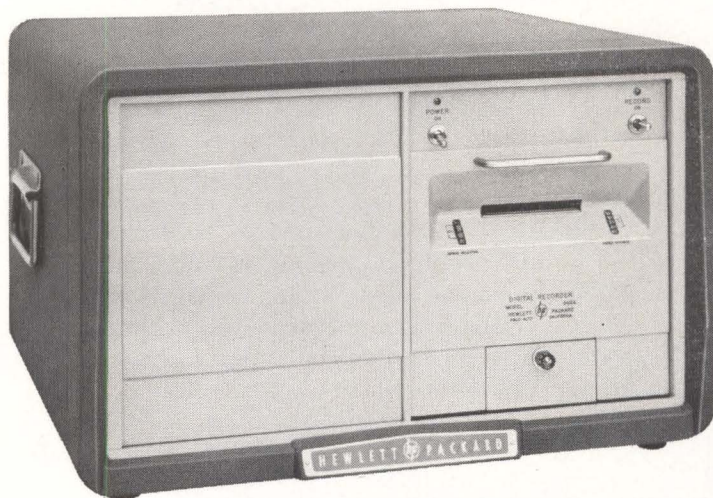

# all yours with this new 562A SOLID STATE DIGITAL RECORDER

### SPECIFICATIONS

- Printing Rate:** 5 lines/sec. maximum
- Column Capacity:** To 11 columns (12 available on special order)
- Print Wheels:** 12-position, 0 through 9, a minus and a blank (Many special character wheels available from stock)
- Driving Source:** Parallel-entry 4-line BCD, 1-2-2-4. Other codes available on plug-in cards. Source reference voltages establish "0" and "1" states, which may be as much as 150 v above or below ground. "1" state 4 to 75 v above "0" reference. Driving power approx. 30  $\mu$ a into 270,000 ohms
- Print Command:**  $\pm$  pulse, 20  $\mu$ sec or greater in width, 6 to 20 v
- Hold Signal:** (Available for each data source) -7 v to +15 v and +15 v to -7 v
- Transfer Time:** 2 msec
- Paper Required:** Standard 3" roll or folded
- Line Spacing:** Single or double, adjustable
- Size:** Cabinet, 20 $\frac{3}{4}$ " x 12 $\frac{1}{2}$ " x 18 $\frac{1}{2}$ "; Rack, 19" x 10 $\frac{1}{2}$ " x 16 $\frac{7}{8}$ " deep behind panel
- Price:**  562A, 11 digit printer with six logic cards, \$1,625.00 (cabinet), \$1,600.00 (rack mount). 12th print wheel, additional logic cards, analog output optional

7087R

New, solid state  562A Digital Recorder prints digital data on 3" paper as fast as 5 lines per second, each line containing up to 12 digits. The instrument incorporates a unique data storage unit for each digit column that allows the data source to transfer data to the recorder in just 2 milliseconds, after which the source is free to collect new data.

Besides the standard parallel-entry 4-line BCD code (1-2-2-4), you can easily use other 4-line codes just by substituting plug-in column cards. Ten-line code operation (without data storage feature) is also available with plug-in cards.

Further,  562A accepts dual input (optional) and prints data simultaneously from two unsynchronized sources. A "patch panel" permits programming these two separate, unsynchronous inputs (even if coded differently) in any manner. Combinations of plug-in column code cards and "patch panel" column programming give complete flexibility in both dual-source data acquisition and data print positioning.

Analog output for high-resolution strip chart and X-Y recording is available as an extra-cost built-in feature of the 562A or through the new  580A Digital-Analog Converter, a separate solid state, high-precision instrument.

Designed for use with solid state and vacuum tube counters, Model 562A is ideal for a wide variety of individual and system applications. Call your  representative today.

## HEWLETT-PACKARD COMPANY

1501 Page Mill Road, Palo Alto, California, Area Code 415, DA 6-7000

*Sales and service representatives in all principal areas;*

Europe, Hewlett-Packard S.A.,

54-54bis Route des Acacias, Geneva;

Canada, Hewlett-Packard (Canada) Ltd.,  
8270 Mayrand Street, Montreal



2087



# ELECTRONICS NEWSLETTER

## Microwave Power Transmission Now Practical

WIRELESS TRANSMISSION of power through microwave transmitters and receivers is now practical and economically feasible for some applications, reports Purdue University. A program begun at Purdue in 1960 under Air Force sponsorship has achieved 60 percent efficiency in converting transmitted microwave energy into useful electrical energy.

Purdue says present techniques could be used to transmit power to satellites for changing orbital directions and powering radio and tv equipment.

No new hardware is required, according to Purdue. Standard tubes and semiconductor devices are used. Efficiency was raised from the 30 percent attainable a few years ago to 60 percent by optimizing diode circuits. Maximum power converted by a single circuit is 40 watts. This can be increased by paralleling circuits, and by further circuit and components improvements. It was pointed out that microwave tubes generating 200 Kw to 400 Kw are expected to become available at a cost of \$10 a kilowatt.

The 60 percent conversion efficiency was attained by a team of investigators headed by E. M. Sabbagh, professor at the School of Electrical Engineering.

## Peace Pipe Being Lit By FCC and TV Makers

NEW YORK—Morris Sobin, chairman of EIA's consumer products division and president of Olympic Radio said last week at an EIA symposium that industry would comply with the all-channel tv legislation despite initial objections by EIA. He pointed out, however, that most manufacturers have just introduced their new lines and will need more time to start changing assembly methods.

"We have our marching orders," said Edward E. Taylor, president of Motorola Consumer Products, "so let's go after this new market aggressively. Competition will provide the spur."

Indications that initial FCC specifications for all-channel sets

will be flexible was reflected in a speech by Senator Gale W. McGee (D.-Wyo.). FCC appears to be relying on competition to guarantee quality. McGee said he was sure FCC would make every effort to effect the changeover with minimum disturbance to inventories, marketing and manufacturing.

Meanwhile, in Washington, FCC and manufacturers began a series of meetings to discuss the technical aspects.

## To Track Booster, Use Hemispheric Laser Beam

PASADENA — Electro-Optical Systems, Inc., says that a highly accurate rocket booster tracking system could be built around a ruby laser beacon carried by the rocket. The proposal resulted from a six-month feasibility study sponsored by NASA.

The beam from a single 20-joule laser would be diverged into a 180-degree hemisphere by cassegranian lens and fiber optics bundles. The laser would flash every 10 seconds.

Ballistic cameras now used on the

Atlantic Missile Range would be pointed to Cape Canaveral. After locking onto the beam, a photomultiplier tracker would point the cameras. The beam's monochromaticity would be exploited by interference filters. High-speed camera shutters, programmed to open as the laser flashed, would minimize background light.

The hemispheric beam would enable several ground stations to track the booster. The company says maximum practical daylight tracking distance would be 500 miles.

## Navy Defends Award of Contract without Bidding

WASHINGTON—The Navy told a House Armed Services investigations subcommittee that it has "re-affirmed" plans to award a contract to Collins Radio for production of 641 uhf AN/PRC-41 radio sets (p 12, June 22). The contract has been delayed for a few months pending a Navy review of criticism by Rep. Earl Wilson (R.-Ind.) over the Navy's failure to seek competitive bids. Wilson charged that a bid by Arvin Industries was 34 percent lower.

Kenneth E. Belieu, assistant secretary of the Navy for installations and logistics, told the subcommittee the equipment is urgently needed and that Collins, the developer, would produce the sets "in the shortest possible time." Any other producer, he said, took "many months longer to deliver."

J. C. Cruden, of the Office of

## Complexity Isn't Progress, Says Air Force

WASHINGTON—The electronics industry is being "engulfed" by a "disease" that confuses gadgetry and complexity with progress and invention, said Brockway McMillan, assistant secretary of the Air Force for R&D, at the IRE's military electronics convention last week.

He criticized the "notion that the 'best' design is the one with the most additional unimportant functions and the greatest growth potential." He blamed the military for "specifying complicated equipment, or failing to recognize that there may be simple and less elegant ways to solve the problem."

McMillan said the Pentagon is considering more use of performance specifications in R&D contracts and detailed specifications or a typical design for "clarifying the intent." Contractors would be encouraged by bonuses to reduce cost and complexity

Naval Materiel, said that a review of the two bids showed that "Arvin's proposal did not completely cover the job to be done, that major items were omitted or underestimated by Arvin, and that Collins' proposal will require adjustments downward in negotiations leading to the definitive contract."

## Supply Agency Is Not Start of Military Merger

WASHINGTON—Rep. Porter Hardy (D.-Va.), chairman of a House Armed Services subcommittee investigating the trend toward unification in the Defense Department, last week questioned the legality of the Defense Supply Agency created for centralized procurement of common use items (p 12, May 25, and p 28, Jan. 19).

Hardy implied that the agency was a step toward eventual merger of the services. Defense Secretary McNamara denied that he plans such a merger. The agency was created under a 1958 law authorizing single-agency supply activities.

Despite the challenges of Hardy and other unification critics in Congress, DSA's future appears safe. Strong support is being given the agency by other congressmen, notably House Speaker McCormick who, with Rep. Thomas B. Curtis (R.-Mo.), introduced the measure authorizing DSA.

## Microcore Mosaics Form New Computer Memories

MICROFERRITE techniques will be used in a family of high-speed computer memories to be sold by RCA's Semiconductor and Materials division. Processing speed will be up to 2 million bits a second. Experimental units able to process 10 million bits a second have been built at RCA Labs.

They consist of small, two-hole ferrite squares assembled in flat mosaics and interconnected by evaporated metal paths. Small hole diameters and the use of impulse switching for changing magnetic field polarity around the holes provide the high speed, RCA says.

Initial commercial units will have capacities in multiples of 32 30-bit

words. Typical drive requirements will be 350 ma for read pulse, 250 ma for partial write pulse and 70 ma for digit pulse.

## Britain Considers Switch To 625-Line TV Standard

LONDON—A gradual changeover from the 405-line tv standard used in Britain to the European 625-line standard was recommended last week by a government advisory committee. The committee, headed by Sir Harry Pilkington, was set up in 1960 to consider the future of radio and tv in Britain.

The committee recommends two new uhf channels be allowed, one for BBC and one for the Independent Television Authority, operating at 625 lines. Existing BBC and ITA vhf stations would continue on 405 lines until the majority of viewers have 625-line receivers, then these stations would also switch to 625 lines.

The committee also recommended establishment of color tv service in two or three years at 625 lines. Which color system will be used has not been decided. Radio broadcasting was found adequate, but the committee recommended BBC operate local community stations financed by revenues from existing licenses.

## FAA Still Looking for Anticollision Equipment

WASHINGTON — Federal Aviation Agency will sponsor a government-industry symposium July 12 and 13 on airborne equipment to help prevent midair plane collisions. A broad cross-section of the electronics and aviation industries have been invited to participate in the Washington meeting to review anticollision research and development work, outline accomplishments to date and discuss future plans. Since 1958, FAA and seven contracting firms have been seeking a solution to the problem for both light and heavy aircraft. A range-altitude type system developed by Bendix Radio is currently being tested at FAA's Atlantic City research installation.

## In Brief . . .

HOUSE Commerce Committee has approved a resolution allowing FCC to authorize power above 50 Kw in clear-channel radio stations.

PAY TV broadcasts were begun last Friday by WHCT, Hartford, Conn. Broadcasts are decoded at the set by a Zenith decoder. The station hopes to increase number of subscribers, now 300, to 4,000 or 5,000 by the end of the year.

EIA REPORTS transistor shipments and revenue declined 3 million units and \$3 million, to 19.6 million and \$25 million, in April.

NUCLEAR power source in Transit-4A satellite had its first anniversary in space last Friday. It had produced 23,650 watt-hours of electricity, could keep going for decades, AEC said.

TV CAMERA and other sensors, slaved to an infrared tracker, have been installed on an Air Force plane to watch spacecraft reentries. Camera was built by Philco.

SYLVANIA plans to curtail germanium alloy transistor production, step up output of germanium mesa, silicon planar epitaxial types and integrated circuit.

AEROSPACE Industries Association will support the trade expansion bill now before Congress.

NASA'S DIRECTOR of reliability will outline its viewpoint at a reliability training conference sponsored by IRE-PGRQC and ASQC next week at Princeton, N. J.

DALMO VICTOR reports it got \$6.8 million in military radar antennas and magnetic system orders last month.

ORTRONIX has received \$3.9 million in Signal Corps contracts for mobile area communications systems and shelters.

GENERAL Services Administration has ordered \$2.4 million in radiation monitors from Victoreen.

**NOW  
AVAILABLE  
WITH WELDABLE  
LEADS**

**RUGGED END-CAP  
CONSTRUCTION FOR  
LONG TERM STABILITY**

**EXCEPTIONAL RESISTANCE  
TO MOISTURE  
AND MECHANICAL  
DAMAGE**

**SURPASS MIL-R-10509  
PERFORMANCE  
REQUIREMENTS**

**AVAILABLE IN  
REEL PACKING  
FOR AUTOMATED  
PWB INSERTION**

# FILMISTOR<sup>®</sup> METAL FILM RESISTORS

**OFFER 5 DISTINCT  
TEMPERATURE  
COEFFICIENTS TO  
MEET ALL CIRCUIT  
REQUIREMENTS**

Providing close accuracy, reliability and stability with low controlled temperature coefficients, these molded case metal-film resistors outperform precision wirewound and carbon film resistors. Prime characteristics include minimum inherent noise level, negligible voltage coefficient of resistance and excellent long-time stability under rated load as well as under severe conditions of humidity.

Close tracking of resistance values of 2 or more resistors over a wide temperature range is another key performance characteristic of molded-case Filmistor Metal Film Resistors. This is especially important where they are used to make highly accurate ratio dividers.

Filmistor Metal Film Resistors, in 1/8, 1/4, 1/2 and 1 watt ratings, surpass stringent performance requirements of MIL-R-10509D, Characteristics C and E. Write for Engineering Bulletin No. 7025 to: Technical Literature Section, Sprague Electric Co., 35 Marshall Street, North Adams, Mass.

*For application engineering assistance write:  
Resistor Division, Sprague Electric Co., Nashua, New Hampshire.*

**SPRAGUE COMPONENTS**

RESISTORS  
CAPACITORS  
MAGNETIC COMPONENTS  
TRANSISTORS

INTERFERENCE FILTERS  
PULSE TRANSFORMERS  
PIEZOELECTRIC CERAMICS  
PULSE-FORMING NETWORKS

HIGH TEMPERATURE MAGNET WIRE  
CERAMIC-BASE PRINTED NETWORKS  
PACKAGED COMPONENT ASSEMBLIES  
FUNCTIONAL DIGITAL CIRCUITS

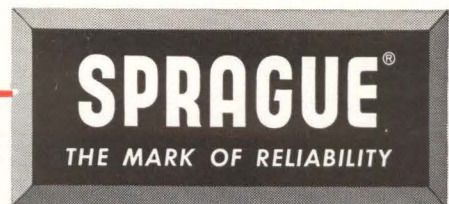

'Sprague' and '®' are registered trademarks of the Sprague Electric Co.

# Now from LAMBDA new LE SERIES Transistorized Regulated

DESIGNED  
TO PERFORM  
TO MILITARY  
ENVIRONMENT  
SPECIFICATIONS

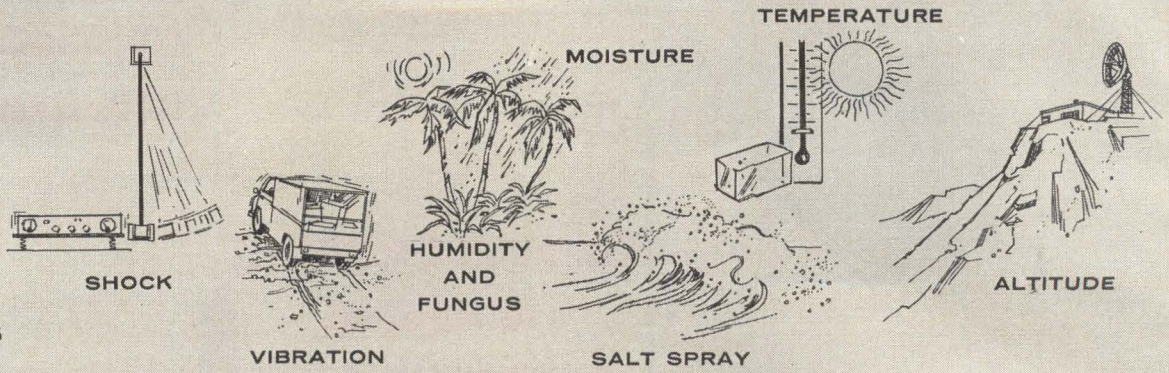

**E**nvironment-engineered...  
...at mass-production prices

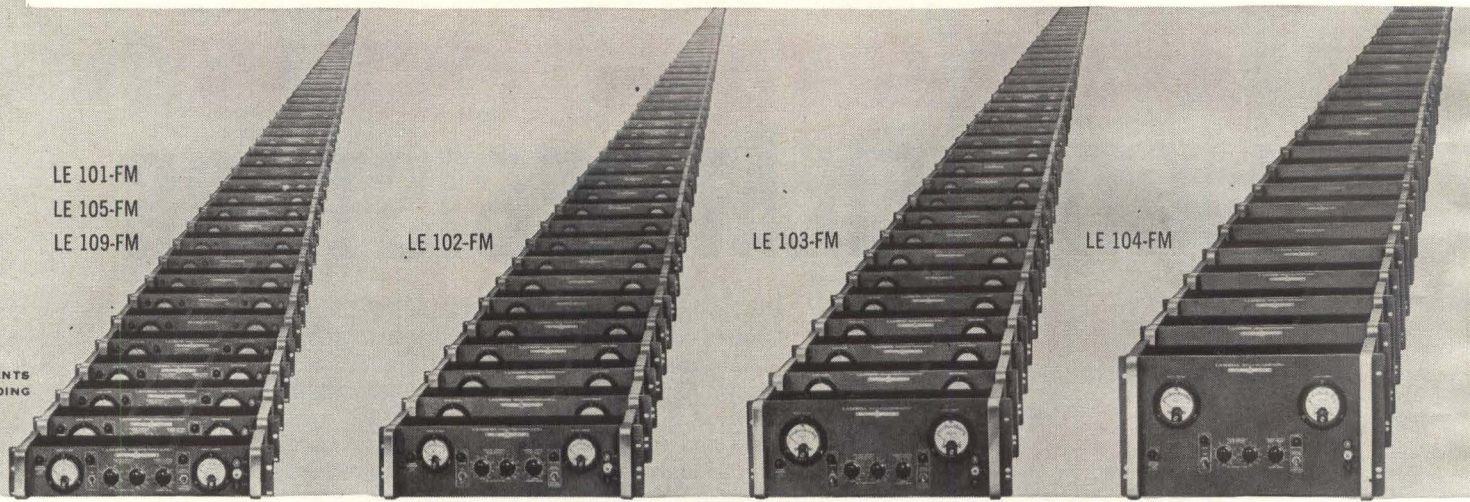

LE 101-FM  
LE 105-FM  
LE 109-FM

LE 102-FM

LE 103-FM

LE 104-FM

PATENTS  
PENDING

for:

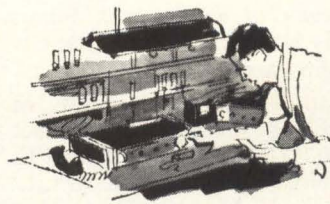

LABORATORY

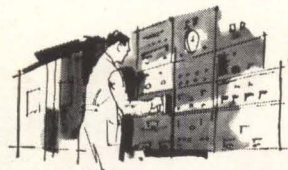

INDUSTRIAL

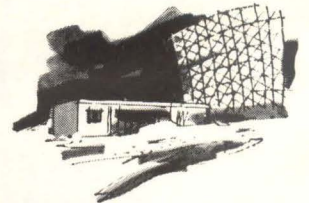

MILITARY  
APPLICATIONS



**LAMBDA ELECTRONICS CORP.**

515 BROAD HOLLOW ROAD • HUNTINGTON, L. I., NEW YORK • 516 MYRTLE 4-4200

Western Regional Office: 230 North Lake Avenue, Pasadena, California • Phone: Code 213, MUrray 1-2544

New England Regional Office: 275 Boston Post Road, Marlboro, Massachusetts • Phone: Code 617, HUntley 5-7122

Middle Atlantic District Office: 515 Broad Hollow Road, Huntington, L. I., New York • Phone: Code 516, MYrtle 4-4200

Southeastern Region: W. A. Brown & Associates, Inc., Engineering Representatives

# Power Supplies

## CONVECTION COOLED

No blowers or filters; maintenance free.

## CONSTANT VOLTAGE CONSTANT CURRENT

by automatic switchover.

**6 MODELS  
AVAILABLE**

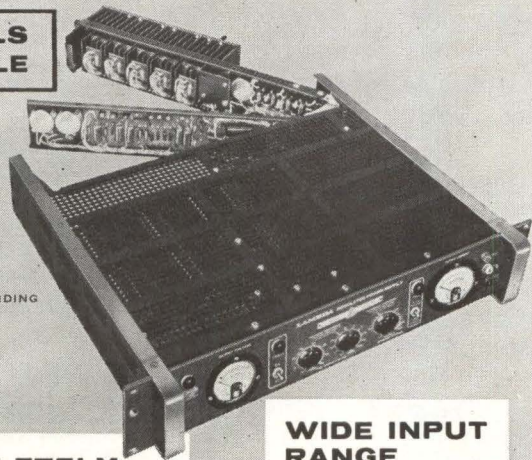

PATENTS PENDING

## COMPLETELY PROTECTED

against—short circuit and electrical overload; input line voltage transients; excessive ambient temperatures. No voltage spikes due to "turn-on, turn-off" or power failure.

## WIDE INPUT RANGE

Wide input voltage and frequency range—105-135 VAC, 45-66 CPS and 320-480 CPS in two bands selected by switch.

## REMOTELY PROGRAMMABLE AND CONTINUOUSLY VARIABLE

Voltage continuously variable over entire range. Programmable over voltage and current range.

## OTHER FEATURES

- Adjustable automatic current limiting.
- 0°C to +50°C ambient.
- Grey ripple finish.
- Ruggedized voltmeters and ammeters per MIL-M-10304B on metered models.



## 5-YEAR GUARANTEE

**covers all Lambda Power Supplies  
including LE Series models**

Every Lambda power supply sold since 1953 has been backed by Lambda's 5-year guarantee, which covers workmanship and materials (except for tubes and fuses).

Visit  
**LAMBDA**  
at the Wescon Show  
Booths 3421-3422.

## LE SERIES

## CONDENSED TENTATIVE DATA

### DC OUTPUT (VOLTAGE REGULATED FOR LINE AND LOAD) (1)

Model	Voltage Range	Current Range	Price (2)
LE101	0-36 VDC	0- 5 Amp	\$420
LE102	0-36 VDC	0-10 Amp	525
LE103	0-36 VDC	0-15 Amp	595
LE104	0-36 VDC	0-25 Amp	775
LE105	0-18 VDC	0- 8 Amp	425
LE109	0- 9 VDC	0-10 Amp	430

(1) Current rating applies over entire voltage range.

(2) Prices are for nonmetered models. For models with ruggedized MIL meters add suffix "M" to model number and add \$40 to the nonmetered price. For metered models and front panel control add suffix "FM" and add \$50 to the nonmetered price.

### REGULATED VOLTAGE:

Regulation (line) ..... Less than .05 per cent or 8 millivolts (whichever is greater). For input variations from 105-135 VAC.

Regulation (load) ..... Less than .05 per cent or 8 millivolts (whichever is greater). For load variations from 0 to full load.

Transient Response  
(line) .... Output voltage is constant within regulation specifications for any 15 volt line voltage change within 105-135 VAC.

(load) .... Output voltage is constant within 25 MV for load change from 0 to full load or full load to 0 within 50 microseconds of application.

Remote Programming ... 50 ohms/volt constant over entire voltage range.

Ripple and Noise ..... Less than 0.5 millivolt rms either positive or negative terminal grounded.

Temperature Coefficient. . . Less than 0.015%/°C.

### DC OUTPUT (CURRENT REGULATED FOR LINE AND LOAD) (3)

Current range 10% to 100% rated load for entire voltage range. Full specifications upon request.

AC INPUT ..... 105-135 VAC; 45-66 CPS and 320-480 CPS in two bands selected by switch.

### OPERATING AMBIENT TEMPERATURE AND DUTY CYCLE.....

Continuous duty at full load 0°C to +50°C (122°F) ambient.

### OVERLOAD PROTECTION:

Thermal ..... Thermostat, reset by power switch, thermal overload indicator light front panel.

### Electrical:

#### External Overload

Protection ..... Adjustable, automatic electronic current limiting circuit limits the output current to the preset value upon external overloads, including direct short, thereby providing protection for load as well as power supply. Current limiting settable from 10% to 110% of load.

METERS:..... Ruggedized voltmeter and ammeter to Mil-M-10304B specifications on metered models.

### CONTROLS:

DC Output Controls ... Coarse and fine voltage adjust and current adjust on front panel for models with suffix "FM", all other models same controls are mounted in rear.

### PHYSICAL DATA:

Mounting..... Standard 19" rack mounting.

Size..... LE101, LE105, LE109 3½" H x 19" W x 16" D  
LE102, 5¼" H x 19" W x 16" D  
LE103, 7" H x 19" W x 16½" D  
LE104, 10½" H x 19" W x 16½" D

**WRITE FOR COMPLETE CATALOG**

CIRCLE 11 ON READER SERVICE CARD

# WASHINGTON OUTLOOK

**REVELATION THAT** the government is studying ways to put ceilings on salaries of high-paid defense contracting executives has stirred up lots of scare talk in industry. Officials in the Budget Bureau, in charge of the study, say the scare talk is exaggerated.

The proposed salary restrictions would apply to a very limited number of executives: mostly to those with nonprofit research institutions working full-time on R&D contracts which have been awarded without competition and whose salaries are directly chargeable to the military under cost-reimbursement clauses.

This means that executives whose salaries are paid out of their company's fee or profit are not involved. Neither are those working on projects which have been awarded through competition or which are under fixed-price provisions.

As things stand now, the salary schedules of executives on non-competitive, cost-type research contracts have to be approved by contracting officers. The Budget Bureau wants to set uniform standards on such salaries, however, to keep the pay "comparable" to salaries paid elsewhere. The Bureau is not concerned with salaries paid on competitive contracts that, officials say, already have "built-in controls set by the market place."

**NEW PENTAGON REPORT** documents how burgeoning missile and electronic procurement over the past decade has dramatically shifted the regional distribution of defense contracts.

The rate of prime contracts to the five major midwestern states, for example, has declined from an average annual level of \$8.7 billion during the Korean War to \$2.6 billion. Overall, the region's share of the defense procurement dollar has dropped 57 percent. New York, Pennsylvania, and New Jersey are also down in the volume of contracting, but not as much as the midwest.

The big gainer has been California, which has zoomed from 13.6 percent of prime contracts to 23.9 percent. Massachusetts, Texas, Colorado and Florida have also gained.

**ACCELERATION OF THE TREND** is anticipated. R&D contracting is particularly concentrated. About 90 percent of R&D contracts are centered in 12 states. This means, the Pentagon says, that follow-on production contracts are likely to go where the R&D work is now being done.

Behind the regional shifts are these factors: procurement of conventional ordnance (tanks, guns, etc.) has been cut from 50 percent of military buying to 12.4 percent; missiles have jumped from 0.5 percent of contracting a decade ago to 33.6 percent, and electronics rose from 11.2 to 18 percent. The R&D shares of missile contracting (57.9 percent) and electronics-communications (24.9 percent) are larger than for any other type of military hardware.

What this all boils down to is this: R&D activity, notably basic research by universities and non-profit institutions, lures manufacturing industry. The midwest, which has failed to diversify into missiles and electronics and to engage heavily in R&D to as great an extent as other regions, is rapidly losing stature as a center of defense industry work, the report indicates.

## NONPROFIT CONTRACT SALARY CEILINGS

## MIDWEST LOSING DEFENSE BUSINESS

## REASON: MILITARY CONTRACTS FOLLOW R&D

Are there limits to Centralab

Rotary  
Switch  
Design?



Of course—but they are much broader than you might think. The illustrated units are just a few of the difficult and unusual switches that CENTRALAB has been called upon to design.

What kind of special switch do you need? CENTRALAB engineers can modify an existing type, or design an entirely new switch to solve your problems.

For immediate attention, write directly to CENTRALAB'S Switch Sales Manager, outlining your problem.

1. Switches 36 circuits progressively in missile check-out application. Used with stepping relay in limited equipment area. Glass silicone insulation.
2. Sub-miniature 24 position switch provides 50% space reduction over conventional switch construction. Has rugged, accurate indexing for long life. Glass epoxy insulation.
3. Low voltage switch with auxiliary high voltage snap action switch which breaks heavy load to rotary switch during switch cycle. Has guarded detent.
4. 5 pole, 9 position low voltage switch with locking action make and break on integral snap action switch. Snap action switch breaks load to rotary switch during switch cycle.
5. Dual concentric switch in which inner shaft operates rotors of all 3 sections while outer shaft operates rotor on front section independently. Used in aerial photography equipment.
6. 3 pole, 18 position unit with 6 positions on each section. Has high torque for positive positioning of contacts. Glass epoxy insulation. Used in ground support equipment.

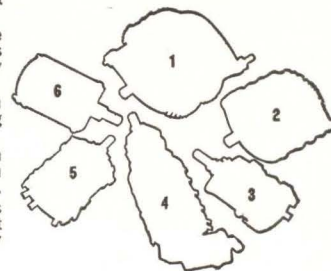

**Centralab**  
CRL

THE ELECTRONICS DIVISION OF GLOBE-UNION INC.  
914 G E. KEEFE AVENUE • MILWAUKEE 1, WISCONSIN  
In Canada: Centralab Canada Ltd., P.O. Box 400, Ajax, Ontario

P-6131

ELECTRONIC SWITCHES • VARIABLE RESISTORS • CERAMIC CAPACITORS • PACKAGED ELECTRONIC CIRCUITS • ENGINEERED CERAMICS

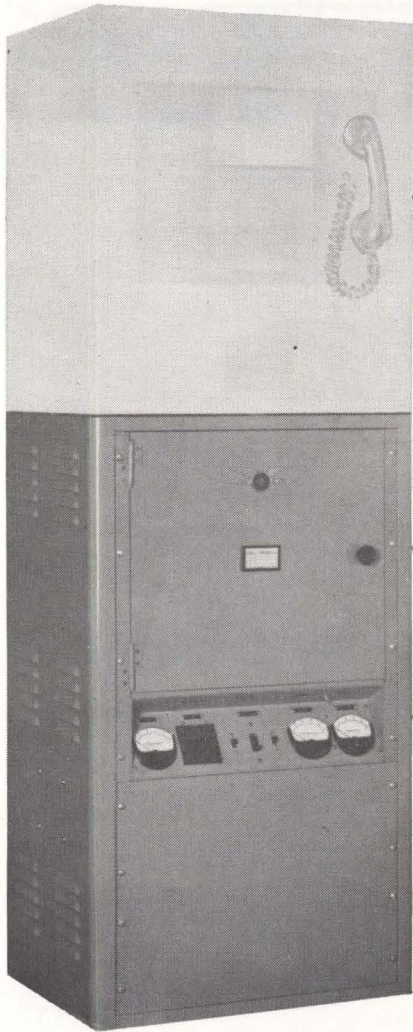

# USE AEROCOM'S AMPLIFIER FOR MORE COMMUNICATION POWER!

AEROCOM'S Linear Amplifier used with conventional low power SSB transceivers for excitation, provides power output of 1000 watts PEP, continuous service. The SSB exciter should have at least an output of 65 watts PEP to obtain maximum output of the amplifier.

The Model 10LA amplifier is housed in a cabinet (22" Wx14<sup>3</sup>/<sub>4</sub>" Dx36<sup>3</sup>/<sub>4</sub>" H) which can serve as a base for conventional SSB exciter, or amplifier may be placed a short distance away from the associated exciter, if necessary for convenience.

Frequency range of 10LA is from 2 to 20mc, covered in 6 bands. Up to 4 independent non-simultaneous channels are provided. These four channels are selected externally by exciter channel control. One tuning unit is provided for each frequency specified up to maximum of four.

The 10LA amplifier is designed to work into a 50 ohm coaxial feed line. One output coaxial receptacle,

common to all four channels, or 4 output coaxial receptacles (one for each channel) are available; each channel normally requiring its own antenna. For multi-channel operation with 1 antenna it is recommended that Aerocom Model ATU-410 antenna coupler be used.

A built-in directional coupler provides monitoring of output power and SWR. Grid current, plate current, filament voltage and high voltage are metered.

Harmonic output attenuation: second harmonic is at least 55 db down and higher harmonics are at least 70 db down. Noise level is 40 db below 1000 watts PEP output. Distortion products, in two-tone test, are at least 35 db down, depending on characteristics of exciter.

This linear amplifier, like all Aerocom equipment, is ruggedly constructed to give long trouble-free service. Additional information and technical data on request.

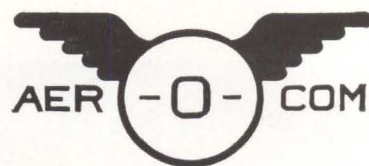

3090 S. W. 37th Avenue — Miami 33, Florida





Varian Associates' family of pulsed driver traveling wave tubes is the most complete in the microwave industry. These state-of-the-art tubes are available in power ranges from 5 kW to 50 kW, to satisfy requirements of modern radar systems. Tube construction employs contra-wound helix or ring-bar circuits to permit efficient operation.

Varian's driver TWT family covers a wide range of varying operational requirements. All have wide bandwidth and flat gain characteristics. Most are periodic permanent magnet focused, some are solenoid focused for use in phased array systems or other special applications. Varian pulsed TWT's feature high duty cycles, long pulse capability, high efficiency.

If your special radar requirements demand high-performance driver TWT's, Varian has (or can design) the tube for you. For additional information, contact Tube Division.

Tube Type	Frequency Range (Gc)	Peak Power (kW)	Average Power (watts)	Pulse Width (Microseconds)	Gain (db)	Focusing	Modulation
VA 134B	0.5-0.6	5	350	600	35	PPM	Grid
VA 137C	0.87-1.00	5	350	600	45	PPM	Grid
VA 133D	1.25-1.40	5	350	600	50	PPM	Grid
VA 131E	1.25-1.70	25	150	35	35	PPM	Grid
VA 131B	1.25-1.70	50	200	30	40	PPM	Grid
VA 128C	2.9-3.35	5	15	10	30	PPM	Grid
VA 139A	5.20-5.90	5	10	10	50	Solenoid	Cathode Pulsed



**VARIAN associates**  
PALO ALTO 1, CALIFORNIA

Varian Subsidiaries: BOMAC LABORATORIES, INC. • S-F-D LABORATORIES, INC. • SEMICON ASSOCIATES, INC. VARIAN ASSOCIATES OF CANADA, LTD. • SEMICON OF CALIFORNIA, INC. • VARIAN A. G. (SWITZERLAND)



## **You have one week to balance this**

Walk down this Farmall tractor assembly line and you'll see 50 distinct products in the making. All tractors, but all different. Some farm, some industrial. Diesel, gasoline, LP and high altitude engines. Different transmissions, different hydraulic systems, different steering mechanisms. Different accessories. To suit the customer.

You'd think this would make line balancing a problem. But it doesn't—not with an IBM Computer helping out. Production line balancing with an IBM Computer has helped International Harvester's Farmall Works shave one to two weeks off the task. They now balance the line for a complete schedule change in less than a week.

This frees key technical people for more creative work. It helps International Harvester act faster to meet the needs of a changing market. It helps them use men and machines more efficiently... allocate manpower more accurately.

It probably can help you. Ask your IBM representative about it.



## mixed line—can you do it?



■ You zone your assembly line, identify jobs, give a precedence to each. The job list provides the input data for all work assignment by the computer.



■ The computer starts the assignment process, determines the best set of jobs for one operator, prints out the detailed information.

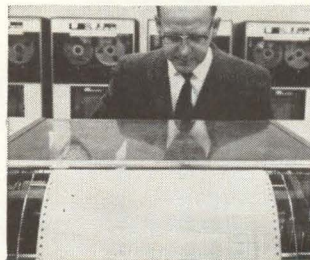

■ As all jobs in one zone are assigned, the computer reads in the job data for the next zone, repeating the process until the line is balanced.

**IBM®**  
DATA PROCESSING

## Collins communications careers point

Every American voice from space — from the X-15 and Mercury — has been carried by Collins communications systems for the next and most ambitious U.S. space effort, NASA's Apollo manned lunar spacecraft. To further extend this leadership in space communications, Collins requires specialists in HF, VHF, UHF equipment, digital communications, spacecraft antennas, TV, radar, modulation techniques, tracking and ranging, information theory, and ground systems. If interested in this challenge, write Mr. L. R. Nuss, Cedar Rapids, Iowa; Mr. C. P. Nelson, Dallas, Texas; Mr. E. Montano, Newport Beach, California.

UP

carried by Collins communications systems for the next and most ambitious U.S. space effort, NASA's Apollo manned lunar spacecraft. To further extend this leadership in space communications, Collins requires specialists in HF, VHF, UHF equipment, digital communications, spacecraft antennas, TV, radar, modulation techniques, tracking and ranging, information theory, and ground systems. If interested in this challenge, write Mr. L. R. Nuss, Cedar Rapids, Iowa; Mr. C. P. Nelson, Dallas, Texas; Mr. E. Montano, Newport Beach, California.



# The QUALITY line of ROTARY COMPONENTS



**CLIFTON PRECISION PRODUCTS CO., INC.**

**cppe**

Clifton Heights, Pa.  
Colorado Springs, Colo.

# Prices of Electronic Stocks Were More Erratic

*But our issues are expected to bounce back faster*

By THOMAS EMMA  
Associate Editor

ELECTRONICS STOCKS performed more erratically than those of general industry during the recent period when stocks fell to their lowest prices in years. Despite this, there are indications that electronics prices may show an earlier recovery than others.

The business outlook for our industry continues to be sound despite the stock situation. Backlogs continue high, new contract awards are still coming in and industry projections on sales and earnings are optimistic.

Commentators within both the electronics industry and the financial community are beginning to speak of some of the positive aspects and trends arising from the recent stock shakeout: more realistic profit margins, healthier capital-raising conditions and more accurate price/earnings ratios.

**PROFIT MARGINS**—Profit margins have been declining for industry in general. In the first quarter of this year they fell to 4.3 cents per dollar of sales as compared with 4.8 cents in the last quarter of 1961. The 4.3 rate, however, is equal to the average of 1961 and 1960.

Electronics industry profit margins have also fallen somewhat recently, although no quantitative figures exist in federal statistical

sources of information.

The Securities and Exchange Commission, which tabulates profit and sales information for industry, includes electronics with electrical machinery. In this grouping, sales for first quarter 1961 are given as \$7,023 million, with profits of \$206 million. In the fourth quarter 1961, sales rose to \$8,083 million and profits to \$350 million. In the first quarter of 1962 sales dipped \$7,767 million and profits dropped to \$274 million.

These figures, which represent sales and profits after taxes for publicly held companies, give some indication of our industry position as compared with all industry.

Sales for all industries amounted to \$82,592 million, and profits to \$2,900 million, in the first quarter of 1961. In the fourth quarter of 1961, sales rose to \$95,154 million and profits to \$4,609 million. The all-industry figures for 1962's first quarter also show a drop, to \$92,833 million in sales and \$4,004 million in profits.

"Profit margins for different segments of the electronics industry will be affected in different ways," according to Donald Siebert of Electronics Capital Corp.

"Some manufacturers of nonproprietary items have been handling orders at greatly reduced profit margins just to keep busy. In many cases this has been based on the philosophy that indications of high volume and backlog in the annual reports and other financial statements would retain the interest of the investing public.

"In cases where this philosophy translated itself into lower and lower profit margins, the idea just didn't work.

"Companies with proprietary products and sound financial philosophies haven't had to rely on such financial devices and are likely to see their stock prices recover in much better order," Siebert says.

**VULNERABILITY** — Chance for continued downturns for the electronics industry is lower than for

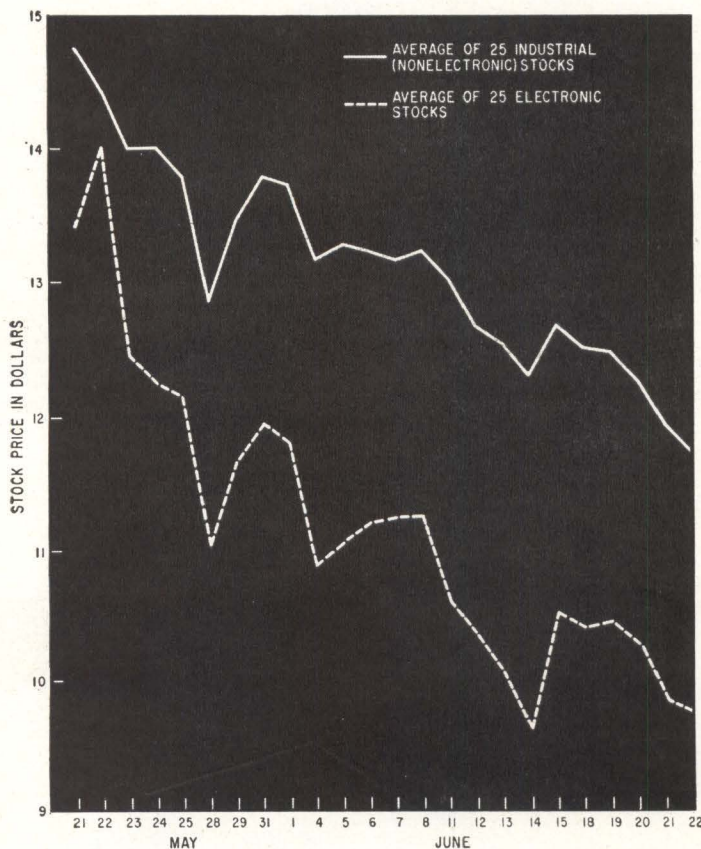

ELECTRONICS STOCKS fluctuated more widely in price than industrial stocks during late May and June. Stocks used in deriving these curves had appeared consistently among the most active in both groups through 1961

# During the Market's Shakeout

industries based primarily on consumer products, in the opinion of William Prior, a partner in Hammond, Kennedy & Co.

"Consumer-oriented businesses are likely to see continued effects of the indecision and lack of confidence the investing public is feeling. The electronics industry, on the other hand, is built to a major extent on a stable base of government contracts, giving an advantage not many other industries have at this time."

**RAISING CAPITAL**—Ways of acquiring capital are due for some changes as far as the electronics industry is concerned. From all indications, public underwritings are likely to remain scarce for some time. Public underwriting firms have been withdrawing applications filed with SEC, counseling clients to bide their time and in some cases turning a deaf ear to companies wanting to talk about going public.

Jerome Kohlberg, Jr., a partner in Bear Stearns, told *ELECTRONICS* "There's a hiatus now. A new set of values are coming into play and maybe preferred stocks and bonds will see a more prominent role in financing. Common stock investors have learned a sharp lesson and, hopefully, the market has run out of customers who buy first and think later. Let's hope so anyway."

A commentator for one major brokerage house describes the market for equity financing as "soft".

"Capital is available," he adds, "but not through public underwritings. Issues right now would be hard to sell even though the electronics industry is sound. We deal with some of the more sizable companies in the electronics industry and they agree with us that they should wait before initiating public underwritings."

Hardie Shepard, a partner in Payson & Trask, says "there's no problem in the electronics industry.

"It's just that in the past some companies had too easy a time in obtaining public underwritings and then the investing public let com-

mon sense run away from them. Many truly sound electronics companies enjoyed price-earnings ratios that were higher than industry averages, and deserved these ratios.

"The trouble started," Shepard thinks, "when companies not really meriting such price-earnings ratios began seeing them. There'll be a recovery, but for some of the one-time glamor stocks the old saying that 'a month of boom takes a year of recovery' may apply."

**MERGER PATTERNS** — Merger patterns are not likely to be affected, so far as the number of transactions that take place go. However, mergers and acquisitions that were in process at the time of the decline will be reexamined.

"This situation will kill some deals and make possible others which would at one time have been unfeasible," said one commentator.

Lower stock prices will certainly affect transactions based on exchanges of shares. Many preliminary merger talks are now being based on statements like "we will sign on the dotted line if the price of the stock doesn't go below X dollars before the closing date."

**SBICs**—Several analysts indicate a belief that current financial conditions will mean more business for Small Business Investment Companies (*ELECTRONICS*, p 26, Aug. 25, 1961). Many SBICs have been sitting tight on portions of their available capital, preferring to maintain a reserve in the form of government bonds rather than risk funds in an uncertain market. With the avenue of public offerings frequently closed off by present conditions, there will be a growing number of applications and transactions with SBICs, according to some Wall Streeters.

Summing up a good portion of financial opinion about the present state of the electronics industry is the comment from one financier, "Technology as a creator of wealth is still strong, market conditions notwithstanding."

"Nothing is impossible to diligence and skill"  
Samuel Johnson

These are the trademarks of some of our customers—each an important contributor to a dramatically growing industry. We at Potter pledge our diligence and skills to this growth through a constantly expanding program of research and development.

Technical Paper Available from

**POTTER**

## "High-Speed Computer Bulk Storage"

by Dr. Andrew Gabor  
Systems Engineering Manager

The operation and theory of magnetic drums, magnetic discs, magnetic cards and magnetic tapes is described in a new technical paper which surveys present-day bulk storage devices. A summary details magnetic tape drives and cites the advantages that account for their frequent use in modern computer systems. These include:

- Fast start-stop time (between 1 and 2 milliseconds)
- High storage capacity (40 million to 400 million bits/reel)
- High transfer rates (100,000 to over one million bits/second)
- Extreme economy (cost per bit is several times lower than with any other recording medium)

To receive your copy, simply write us.



- Digital Magnetic Tape Systems
- Perforated Tape Readers
- High Speed Printers
- Data Storage Systems

**POTTER INSTRUMENT CO., INC.**  
Sunnyside Boulevard • Plainview, New York

# For protection of value

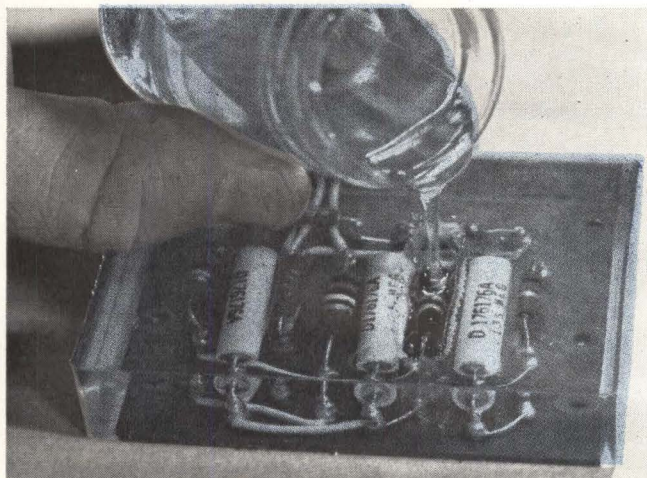
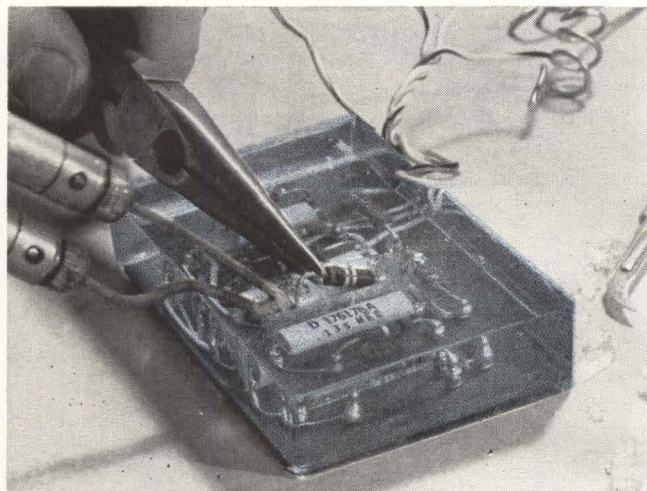
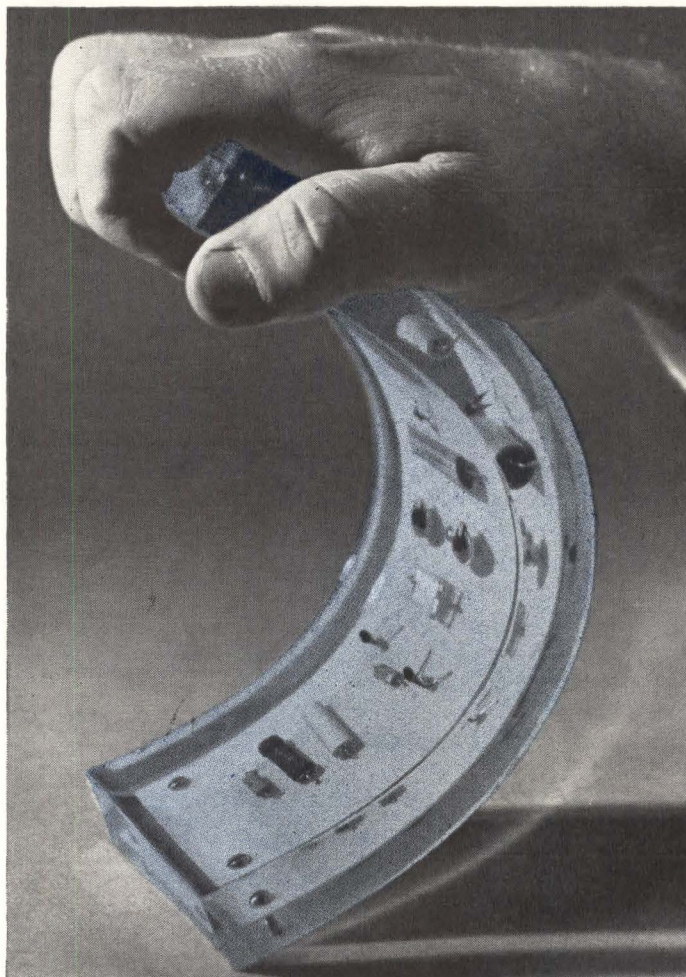

## New casting resin - Sylgard® 182 - is tough, flexible and repairable

Visual inspection . . . environmental protection . . . ease of processing . . . simplicity of repairs — these and other features make Sylgard 182 an important new tool when engineering for value.

**Tough yet flexible**, this solventless silicone casting resin cushions against shock and vibration from  $-70$  to  $225$  C . . . assures constant dielectric strength in any environment . . . resists the effects of ozone, voltage stress, heat aging and thermal cycling.

**Processing is simplified** since Sylgard 182 and its curing agent are not toxic to the skin . . . nor do they give off toxic fumes or heat during blending or curing. Curing time can be controlled by the external heat applied — from as little as 15 minutes at  $150$  C to four hours at  $65$  C.

**Deep sections cure thoroughly.** There are no solvent fumes to be trapped . . . and visibility is excellent. Applied as a fluid, Sylgard 182 resin flows readily around intricate shapes . . . cures even in deep sections without damage from internal stresses or exothermic heating.

Repairability is assured when circuits are embedded in Sylgard 182. Defective components can be removed and replaced after cutting away the cured resin with a sharp knife. New resin, poured over the repaired area, adheres to the existing encapsulant restoring the entire unit to its original condition.

CIRCLE 289 ON READER SERVICE CARD

Dow Corning is your best source for a broad line of silicone fluids, gels, elastomers and rigid forms for potting, filling, embedding and encapsulating.



# Dow Corning



# -- specify these silicones

## Visually inspect . . . instrument check and replace faulty parts with ease

*Dielectric Gel* permits both visual and instrument inspection of potted circuits and components. Poured as a liquid, Dielectric Gel fills all voids, then sets up as a transparent, heat-stable, resilient mass. No significant stresses or exothermic heating develops during cure. Even the most delicate electronic components are safe. Instrument probes can be inserted and withdrawn repeatedly without damaging the outstanding dielectric properties of this Dow Corning silicone potting material.

*Circuit Repair* is easy to accomplish. Simply cut away the gel surrounding a defective component with knife or scissors. After the circuit is repaired, simply pour new gel into the repaired area to restore original high quality protection.

CIRCLE 290 ON READER SERVICE CARD

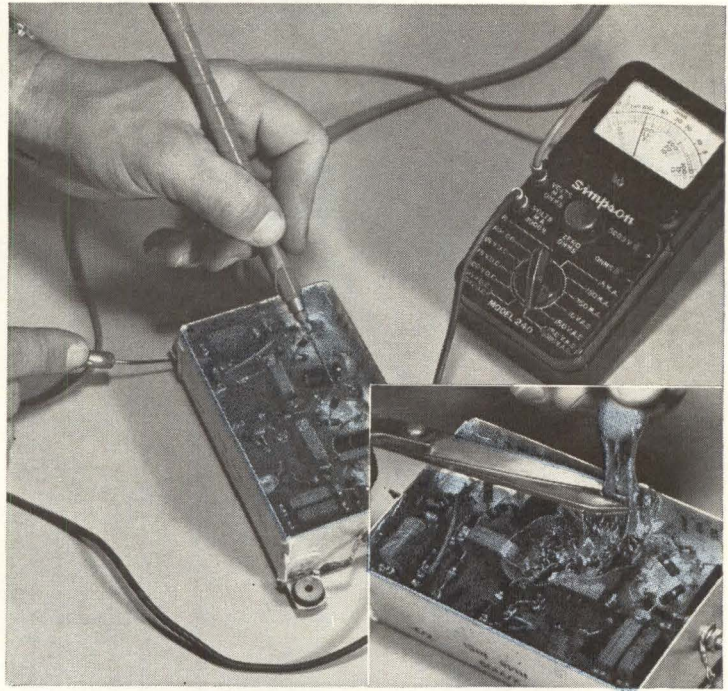

## Deep section . . . rugged protection with repairable Silastic® RTV

*Silastic RTV*, Dow Corning's fluid silicone rubber that vulcanizes at room temperature, is available in several variations. Select the best one suited for your application or processing requirements. All have excellent dielectric properties, low water absorption, stability under extreme temperatures, resistance to thermal cycling and aging. The newest Silastic RTV cures in thick sections in 24 hours at 77 F. Variations in thickness have no significant effect on curing rate or material uniformity.

*Vulcanized Patch.* Defective parts embedded or encapsulated in Silastic RTV . . . even where thick sections are used . . . can be replaced. The cured Silastic RTV is cut away with a knife, the component replaced, and new Silastic RTV applied to the repair area. The fresh material bonds to the original, restoring the encapsulant's integrity.

CIRCLE 291 ON READER SERVICE CARD

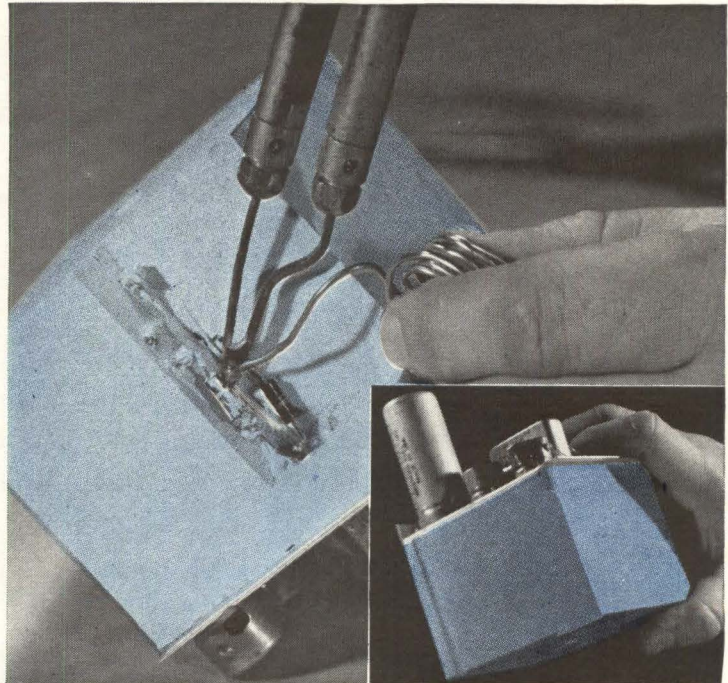

VISIT OUR BOOTH 3905-3906-3907, AT WESCON SHOW

Free 12-page manual, "Silicones for the Electronic Engineer".  
Write Dept. 3907, Dow Corning Corporation, Midland, Michigan.

# MILLION

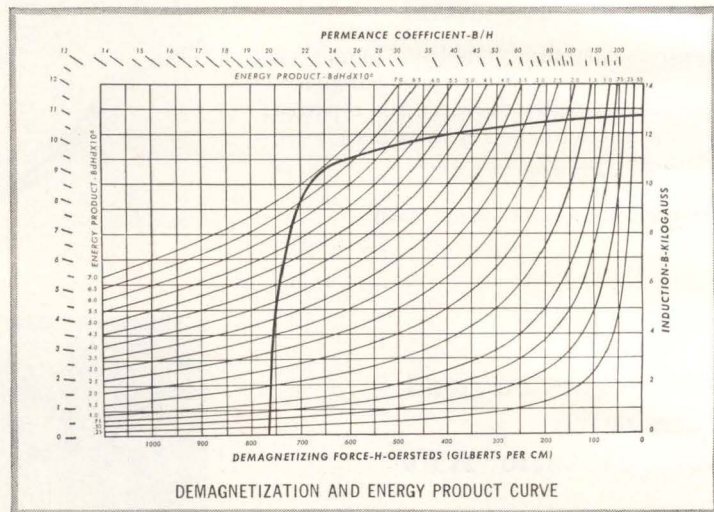

Alnico V-7 produces more magnetic energy per unit volume or weight than any of the Alnicos — 7 million BH max. This space age Alnico allows considerable reduction in magnet size and weight without sacrificing energy. Typical applications are: lightweight ground and airborne generators and alternators in a full range of frequencies; oscillographs, galvanometers, recording instruments, magnetometers and meters; and missile-borne guidance and recording equipment. Indiana General engineers — backed by over 50 years of permanent magnet application experience — are specialists in designing the right magnet for your application. Call or write for technical assistance to Indiana General Corporation, Magnet Division, Valparaiso, Indiana. **Ask for bulletin #350.**

## INDIANA GENERAL

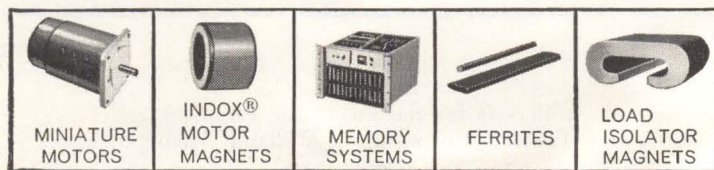

## NEWS FROM BELL LABORATORIES

### **A simple, highly sensitive microwave amplifier**

Bell Laboratories engineers have developed an extremely sensitive parametric amplifier which approaches the maser in sensitivity. Both will be used in experiments with Telstar, the Bell System's experimental communications satellite.

- Heart of the parametric amplifier is a newly developed semiconductor diode with very low intrinsic noise. Previously, the sensitivity of such amplifiers at microwave frequencies was severely limited by the unwanted noise generated in their diodes. The new diode, no bigger than the eye-end of a needle, solved this problem.

Our engineers also devised new circuitry to stabilize precisely the output of the klystron (microwave generator) supplying power for the amplifier. To reduce further the intrinsic noise of the amplifier, they immersed the diode and its circuits in liquid nitrogen, utilizing a new cooling arrangement which economically maintains a low temperature for many days without attention.

The new amplifier fills a need in the communications field for a simple microwave amplifier of high sensitivity in applications for which the higher sensitivity of the maser does not justify its additional complication.

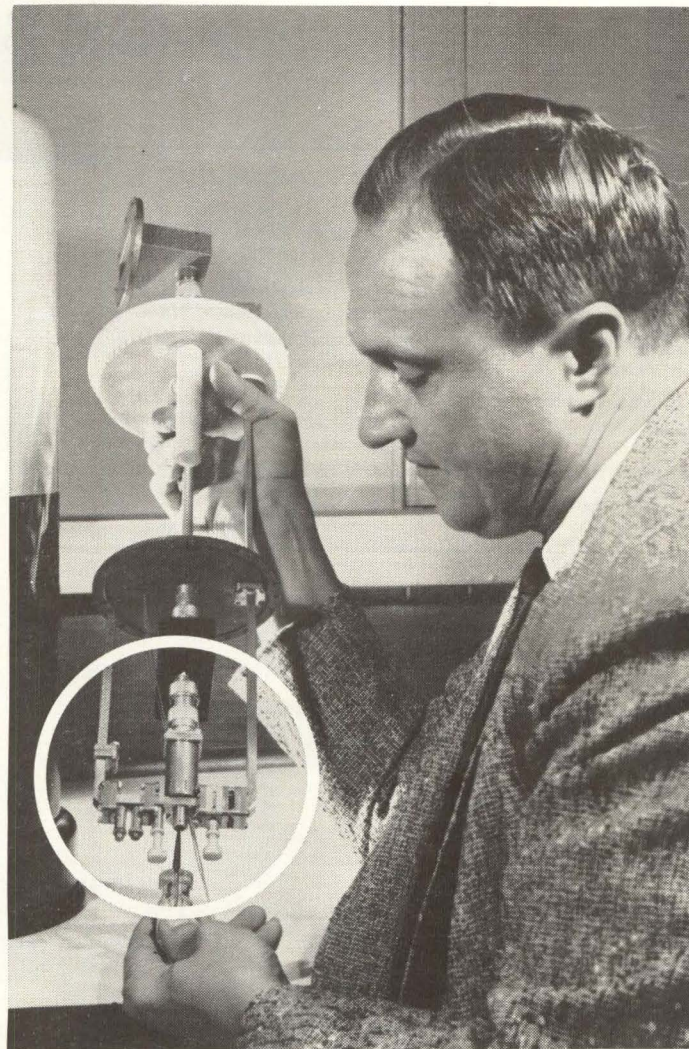

Bell Laboratories' Michael Chroney adjusts waveguide assembly (in circle) housing the diode. After adjustment the entire parametric amplifier will be immersed in liquid nitrogen in dewar at left. The new amplifier operates at 4170 megacycles (center of band) and provides an almost flat gain of 38 db over a 50-megacycle band with a noise figure of approximately 0.6 db.

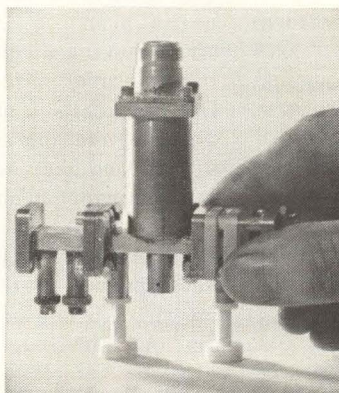

Close-up of the waveguide assembly, in which Bell Telephone Laboratories' newly developed diode is located.



Heart of amplifier—a hermetically sealed gallium arsenide diode—is compared with eye of average-sized sewing needle.



**BELL TELEPHONE LABORATORIES**

*World center of communications research and development*

# Designers See Space Guidance Systems

## AEROSPACE MERGER

LOS ANGELES—Proposed merger of the Institute of the Aerospace Sciences and the American Rocket Society was urged by L. Eugene Root, IAS president, at the IAS meeting. He said merger would eliminate much duplication of effort by two organizations having parallel purposes and activities.

IAS and ARS officers are to review merger plans shortly. Members would vote this fall. If the plans go through, the new Institute of Aeronautics and Astronautics would be created on February 1, 1963. Combined membership of IAS and ARS is 30,000

## Another proposal: radiation shields converting nuclear energy to power

LOS ANGELES—Plans for longer spacecraft missions have been steadily directing guidance component development away from inertial reference systems and toward optical guidance, it was reported in a survey paper on advanced mosaic guidance systems presented at the National Summer Meeting of the Institute of the Aerospace Sciences late last month.

Goal is an optical guidance system that will not require an expensive and complex inertial platform and high-accuracy sensors, said Eugene F. Lally, of Jet Propulsion Laboratory, and Mortimer Penberg, of Aerojet-General. Development of optical systems, they added, will be based on developments in visual and infrared sensors, thin-film and semiconductor network fabrication, and microminiature computers with high-capacity memories.

**MAKING MOSAICS**—Lally and Penberg described a method of fabricating mosaic guidance components that would reduce noise and the volume of detector channels. Arrays of photocells, each with its own solid-state, signal-amplifying, shaping and processing circuits, would feed an onboard computer as

shown in the diagram.

The cells would respond to visual and infrared stimuli originating from stellar and planetary bodies. The stimulus information presented by the optics of the system to the image plane (the mosaic of cells) would then be refined to a signal useful for guidance.

To fabricate the primary components, photoconductive material is deposited on long, rectangular quartz strips 3 mils wide. Gold deposits mask off each side of the strip, leaving a center strip of photoconductive material 1 mil wide. Detector cells 1 mil wide are produced by etching and are bonded to a semiconductor substrate containing the information channels.

**RADIATION SHIELDS**—Other developments outlined at the IAS meeting include new methods of radiation shielding.

Space vehicle shielding may be provided by dipole-like magnetic fields using superconducting coils, said Robert F. Tooper and William O. Davis, of Armour Research Foundation. Shielding is necessary to protect crews from charged particles in space.

Regions of shielding obtained

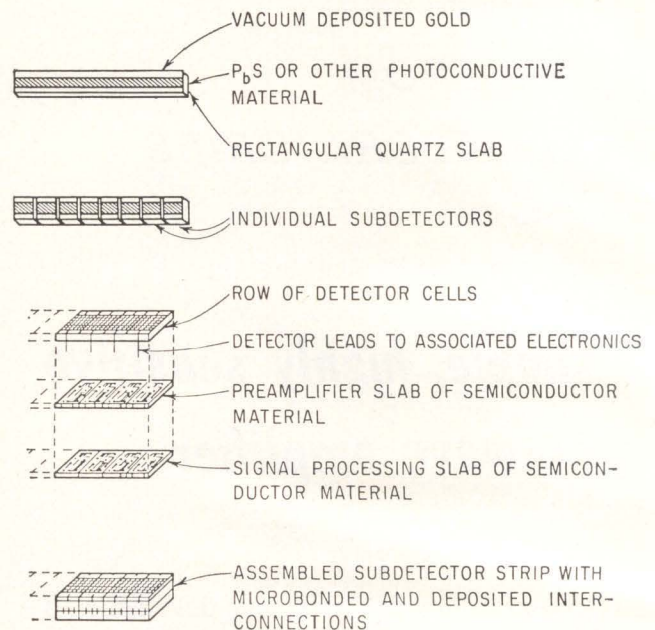

MOSAIC GUIDANCE fabrication technique

with a dipole magnetic field are dependent on the Störmer unit,  $C_{st}$ , as shown in the diagram. This length represents the radius of a circular particle orbit in the equatorial plane of a dipole, and is dependent on the total energy of the particle. Computations indicate that a dipole of moment  $3 \times 10^{11}$  gauss cm<sup>3</sup> over the equator of a sphere of 2 meters diameter will completely shield protons of energy less than 866 Mev and partially shield protons of energy less than 8.1 Bev.

Axially symmetrical regions are obtained by rotating the figure shown about the dipole axis.

The discovery of materials that maintain their property of superconductivity in the presence of strong magnetic fields, such as the niobium-zirconium alloys and certain other niobium intermetallic compounds, has led to the possibility of magnetic shields.

Tooper and Davis feel this type of shield will lead to a significant payload weight saving. Disadvantages to be overcome include the continuous cooling power required, the vulnerability of the system to mechanical and electrical damage, and the effect of the strong mag-

# Turning into Mosaics of Optical Cells

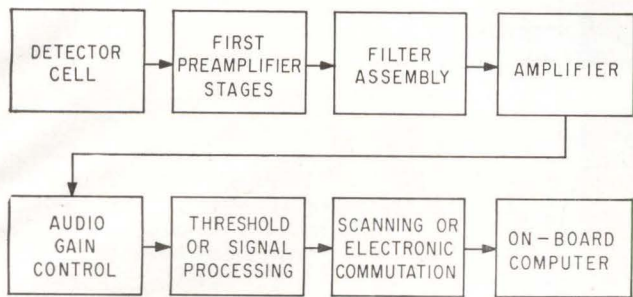

*SUBDETECTOR input and output electronics for mosaic guidance*

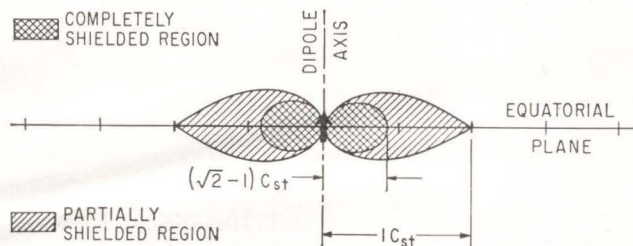

*MAGNETIC DIPOLE field shielding regions*

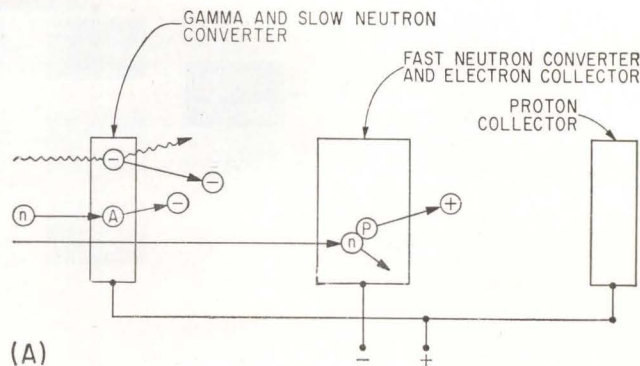

(A)

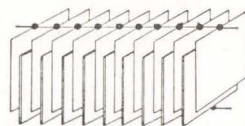

(B)

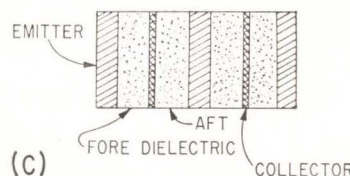

(C)

*RADIATION SHIELD to convert neutrons and gamma rays into electrical energy. Electrodes (A) may be arranged into stack of plates (B) or solid cell (C)*

netic fields on instrumentation. This work is being supported by the Air Force.

**ENERGY CONVERSION**—A technique for converting escaping nuclear reactor radiation directly into electrical energy by an active shield was proposed by Bernard Raab, of Republic Aviation.

As illustrated, the shield would consist of three electrodes that could be stacked in plate or solid form to provide a conversion cell.

The first electrode, composed of a high-atomic-number material, would be a gamma and slow neutron converter that would emit negative particles and have a positive charge. Compton scattering converts gamma rays to electrons. The target, of high-absorption cross-section, converts slow neutrons by transmuting them to beta-decaying isotope with a short half-life.

The second electrode, composed of a low-atomic-number material, collects the negative particles. Fast neutrons would penetrate to this electrode and scatter protons from this thin, hydrogenous target, increasing this electrode's negative charge. A third electrode, a high-atomic-number material, collects the

protons and has a positive charge.

A 1,500-watt solar thermionic power system, based on state-of-the-art components, was reported by T. J. McCusker, of Thompson Ramo Wooldridge. The system includes thermionic generators, orientation systems to keep the generators aligned with the sun, storage batteries for use during the shaded portion of the orbit, power regulators for the system, and a system for deploying the generators.

A goal of one-year life is proposed for the system. McCusker feels that neither the thermionic converter nor the battery has fully demonstrated this capability.

**PECAN**—The Pulse Envelope Correlation Air Navigation (Pecan) system, which enables airborne measurement of velocity and ground-track, was described by James Salerno, of Diamond Ordnance Fuze Laboratories. The system correlates variations in pulse radar terrain returns received by two antennas, mounted fore and aft along the longitudinal axis of an aircraft. The two antennas receive identical return signals at a time differential determined by aircraft velocity.

Experiments support the feasibility of the Pecan system, Salerno said. Experimental data indicate that system errors may be less than 1 percent. Weight problems are expected to become negligible with the development of solid state signal processing circuits. Salerno pointed out that conversion from a modern pulse-type radio altimeter to the Pecan system would require only the addition of a third antenna and a signal processing package.

## Bell Telephone System Hardening Its Arteries

**EASTERN THIRD** of a blast-resistant transcontinental cable system, running from Washington to New York, will be completed late this summer by the Bell Telephone System. Underground cables, amplifier stations and communications centers are designed to withstand all but direct nuclear hits.

The system will be completed to the west coast by 1964. Costing about \$200 million, it will include 4,000 miles of coaxial cables, 900 amplifier stations and nine communications centers.

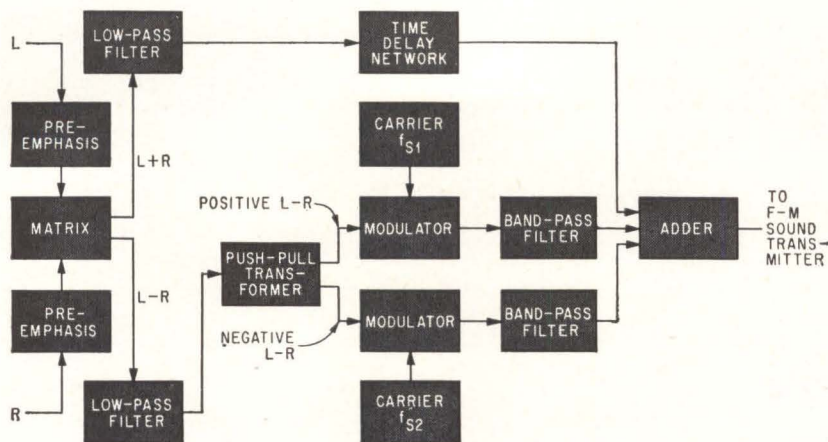

STEREO TV SOUND system employs three information channels.  $L+R$  signal can be received on unmodified sets

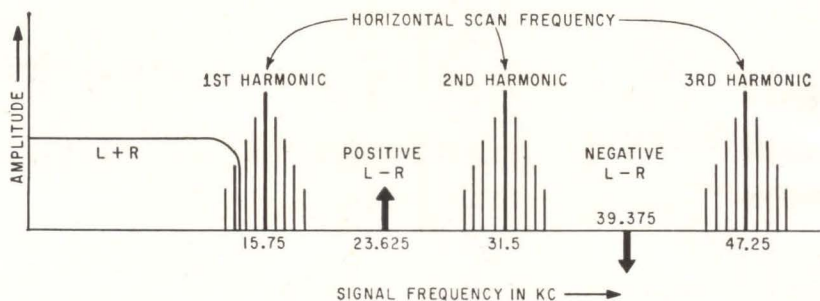

POSITIONING of  $L+R$  and two halves of  $L-R$  signals in horizontal scan frequencies

## Latest Design Idea for Television Audio Stereo

*Negative and positive portions are positioned in horizontal scan*

DES PLAINES, ILL.—Stereo audio system for television considered by its designers as two years ahead of the consumer market was introduced at the IRE's Spring Conference and Television Receivers. Multipath interference tests of the system are being completed this summer by General Electric. Filing for approval will follow.

Other topics at the conference included the feasibility of using silicon planar transistors in tv receivers, ways of cutting cost by improved circuits and components and new transistor tuners for f-m radios and uhf tv (p 25, June 29).

R. W. Galvin, president of Motorola, urged those attending the conference to support passage in Congress of HR 11088, to help limit

government patent activity to licensing. Attendance totaled more than 700 persons, over 100 more than last year.

TELEVISION—The tv audio stereo system, described by R. B. Dome, of GE, transmits three audio channels (see illustrations). The positive half of the  $L-R$  signal is positioned midway between the first and second harmonic of the horizontal scan (23.625 Kc). The negative half is positioned midway between the second and third harmonic (39.375 Kc). The  $L+R$  signal, is transmitted between 50 cps to 15 Kc, can be received by an unmodified receiver.

A noise-reducing system recombines the signals in a circuit containing coils and four diodes. Signal degradation would be about 23 db down from monaural—about the same as for f-m stereo.

John MacIntosh, of Fairchild

Semiconductor, discussed the feasibility of using silicon planar transistors for a tv receiver. He said a circuit using 22 transistors and 13 diodes outperformed a 19-inch, 110-degree top-of-the-line tube version, except in small-signal modulation. Push-pull, r-f amplifier and common base operations more than equals tube performance, and further improvements are still to be expected, MacIntosh claimed.

Significant economies without loss of performance or reliability can be obtained by toroid coils in vertical deflection yokes, reported Kenneth Fulton, of Motorola. He said a less costly 6FK6 tube and a smaller and more economical output transformer can be used. Transformer cost is cut 25 percent because the higher inductance of the toroid requires lower transformer inductance, for the desired time constant. Core size may then be reduced by  $\frac{1}{4}$  by  $\frac{1}{4}$  inch. A 140-volt

supply has proven adequate for 114-degree deflection in one configuration. Total power input of  $7\frac{1}{2}$  watts in one circuit and 9 watts in another is comparable with the 13 watts required for saddle yoke deflection. Tubes run cooler and more reliably, Fulton added.

Strap frame grid manufacturing techniques were credited with enhancing life and reliability of a new uhf tv local oscillator discussed by L. R. Maguire, Sylvania. Eliminating the possibility of intermittent grid-to-cathode shorts, the tubes are said to operate 17 percent cooler, due to reduced heater power and current drain.

**RADIO** — Post-alloy-diffused germanium transistors operating on voltages as low as 1 v were introduced in a two-transistor, f-m car radio tuner circuit by William King, Amperex. Permeability tuning is least susceptible to the auto's mechanical vibration. Signal sensitivities of  $1.6 \mu\text{v}$  and  $2.6 \mu\text{v}$  for 20 db and 30 db of quieting, with inherent power gains of 28 db and image rejections of 42 db, are attainable, he said. Diodes help counter overload, a leading trouble in transistor receivers. High cutoff frequency transistors, such as the part 2N2494 connected in a common-emitter configuration as an r-f amplifier, deliver more power gain in the front end. A zener-regulated power source compensates for changes in tuning caused by variations in supply voltage and signal strength.

### Robot Draftsman

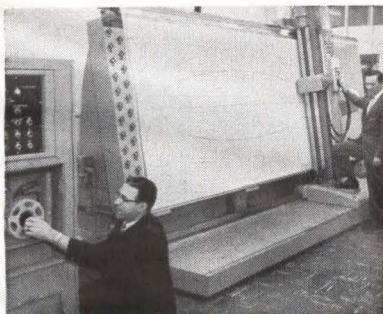

*NUMERICALLY* controlled drafting machine built for General Dynamics/Fort Worth by Ekstrom, Carlson and Co. prepares design drawings and master lofting layouts. Rate is 10 linear feet a minute and accuracy is 0.005 inch over a 12-foot span

July 6, 1962

## services for aerospace contractors:

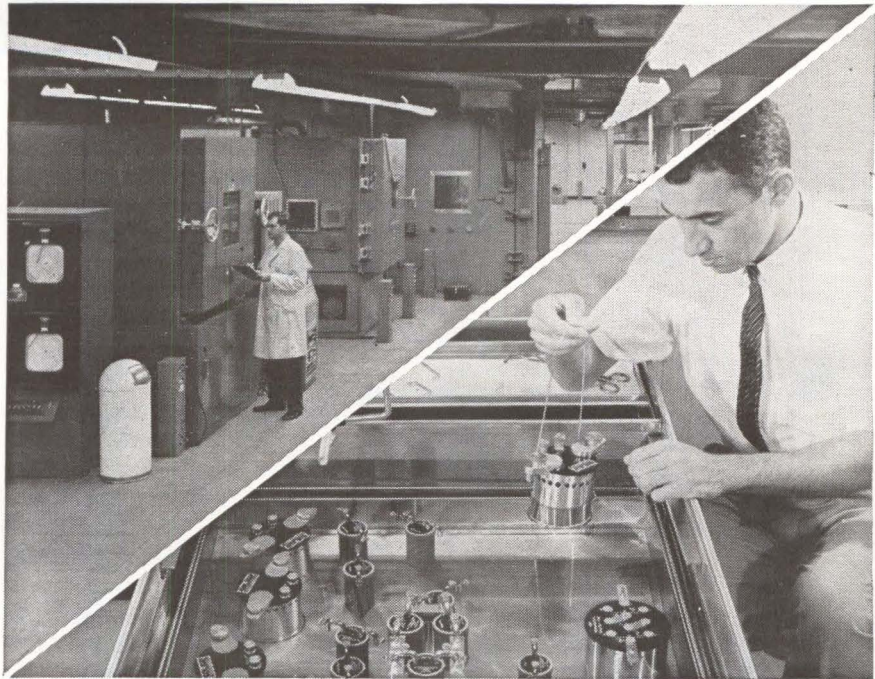

## ENVIRONMENTAL EVALUATION

Arma environmental laboratories are among the finest in the nation, originally designed for stringent testing of the all-inertial guidance equipment now in operational service on Air Force ATLAS missiles. These facilities, including the world's most precise large centrifuge test unit, can now provide complete engineering evaluation services for contractors. Outstanding simulation equipment plus a competent staff of experienced engineers is available to help design and develop better, more reliable equipment and components through environmental testing.

## STANDARDS AND MEASUREMENTS

Comparable in many respects to National Bureau of Standards facilities, the Arma standards & measurement laboratory is available to outside contractors for assistance on specialized measurement problems and quality control activities. Certification of reference and working standards and maintenance of records can be provided. Facilities for electrical measurements in the audio spectrum are the finest available.

These Arma laboratories were used in the development and production of the Atlas all-inertial guidance system and the B-52 fire control system. These sophisticated projects fully demonstrate Arma's qualifications to offer expert assistance to those seeking the finest in facilities, personnel, and experience.

Complete technical information on the services available is contained in a 24 page brochure ESAT-1. Write Corporate Government Marketing, Arma Division, American Bosch Arma Corporation, Garden City, N. Y.



**ARMA** DIVISION

**AMERICAN BOSCH ARMA CORPORATION**

8797

CIRCLE 29 ON READER SERVICE CARD

29

# SPRAGUE<sup>®</sup>

## MODEL 500 INTERFERENCE LOCATOR

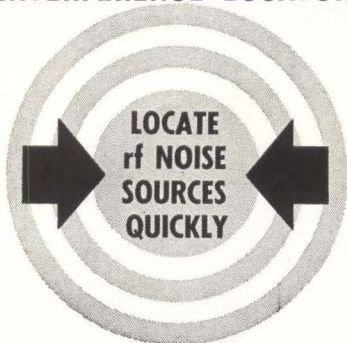

This versatile instrument is a highly sensitive interference locator—with the widest frequency range of any standard available unit! Model 500 tunes across the entire standard and FM broadcast, shortwave, and VHF-TV spectrums from 550 kc. to 220 mc. in 6 bands.

It's a compact, portable, rugged, versatile instrument—engineered and designed for most efficient operation in practical field use. It features a transistorized power supply, meter indications proportional to carrier strength as well as sensitivity of 5 microvolts minimum for 5% meter deflection over entire tuning range.

For full details, send for brochure IL-106.

**SPRAGUE ELECTRIC COMPANY**  
35 Marshall Street, North Adams, Mass.

**SPRAGUE<sup>®</sup>**  
THE MARK OF RELIABILITY

## Loudspeaker Rating System Proposed

CHICAGO—Loudspeaker rating system for consumers and industrial buyers was proposed by Lincoln Walsh, of Walsh Engineering, at the Loudspeaker Industry Meeting late last month. The rating and color-coding system would tell customers three things about a loudspeaker: frequency range, acoustic power producing capacity, and a number which indicates general performance.

"The rating system serves primarily the customer by giving accurate information on the performance capabilities and limitations. It does not distinguish between products that are in the same performance range. It does point out the products that are in the category he wants," Walsh said.

The general performance number is the sum of scores on six tests: response uniformity, transient effects, distortion, diffusion of sound, efficiency or sensitivity, and listening quality (a test to be made by impartial judges). Measurements based on fundamental acoustic principles determine what quality rating any speaker receives.

The coding system uses different colors to indicate frequency range, and several kinds of symbols to indicate acoustical power capacity. The number of symbols indicates performance number. For example, five gold stars would indicate an excellent speaker with one watt of acoustical power capacity and a frequency range of 20 to 20,000 cops.

Walsh said that essentially the same form of quality rating system can be used for radio and television receivers and phonographs, whether monaural or stereo. In modified form it could be used to rate audio performance of tuners, amplifiers or pickups, he added.

Walsh's rating system started two months ago when the FTC asked Electronic Industries Association to develop a definition of hi-fi. EIA, in turn, asked its members to give their definition; they received 154 replies, of which Walsh's was one.

Another EIA meeting was to be held late in June to try to hammer out a definition of hi-fi "with which the industry can live," said one spokesman. This definition will be submitted to the FTC. As one member put it, "the problem is to develop a definition which will not be too stringent."

## Portable Tv Recorder Uses Helical Scanning

NINETY-POUND, portable, closed-circuit tv tape recorder was demonstrated last month by Mach-Tronics, Inc., a newly-formed company in Mountain View, Calif. It employs the helical scanning principle, using two recording heads 180 degrees apart.

Some 96 minutes can be recorded on a 10½-inch reel of 1-inch tape running at 7½ inches a second. The company says video frequency response will be ±3 db from 30 cps to 3 Mc with reference to 100 Kc and will be down no more than 6 db at 3.5 Mc. Signal to noise ratio will be 40 db. Price, with an eight-inch tv monitor, is pegged at \$10,800.



TV RECORDER is also expected to find applications in cro and radar recording



DISPLAYING  
**HIGH-SPEED  
 SWITCHING**  
 CHARACTERISTICS WITH A  
**TEKTRONIX DUAL-BEAM  
 OSCILLOSCOPE**

*Photographed at Motorola Semiconductor Products Inc.,  
 Phoenix, Arizona.*



**Type 551 Dual-Beam Oscilloscope**

Here's one of many applications possible with the Tektronix Type 551 Dual-Beam Oscilloscope . . .

At Motorola Semiconductor Products Division in Phoenix, the Quality-Control Personnel rely upon accurate waveform displays from the Type 551 to verify total turn-off time of epitaxial Germanium and Silicon Mesa switching transistors. In this quality-control test, the upper trace on the oscilloscope shows the inverted input to a silicon saturated switching circuit, and the lower trace shows the output. Observing time-coincidence characteristics from the sharp dual-beam display, the operator can determine quickly and accurately if the Mesa transistors meet test specifications.

For your own dc-to-25 mc applications, consider the signal-handling ease and capabilities of this high-performance dual-beam oscilloscope.

By interchanging combinations of 16 letter-series plug-in units, you can equip the Type 551 for applications such as dual-beam pulse sampling . . . strain-gage and other transducer measurements . . . semiconductor-diode-recovery-time studies . . . differential-comparator work . . . as well as multiple-trace displays in most waveform-comparison analyses—and you can do it simply and dependably.

*CHARACTERISTICS OF TYPE 551  
 DUAL-BEAM OSCILLOSCOPE*

Common X—Independent Y Deflection • DC-to-25 MC, 14-nanosecond risetime with Fast-Rise Plug-In Units • 24 Calibrated Sweep Rates from 0.1  $\mu$ sec/cm to 5 sec/cm • 5X Magnifier • Single-Sweep Provision • Amplitude-Level (Manual) Selection or Fully Automatic Triggering Facilities • 10-KV Accelerating Potential • 4-cm by 10-cm Display for Each Beam, with 2-cm Overlap • Amplitude Calibrator.

*TYPE 551 DUAL-BEAM OSCILLOSCOPE*

(without plug-in units) . . . \$1850

Includes: Indicator Unit, Power Supply, 4 Probes, 7 other accessories.

Type L Plug-In Unit (as illustrated). . . \$ 210

U.S. Sales Prices f.o.b. Beaverton, Oregon

**Ask your Tektronix Field Engineer to demonstrate the value of this dual-beam oscilloscope in your own application.**

**Tektronix, Inc.** P. O. BOX 500 • BEAVERTON, OREGON | Mitchell 4-0161 • TWX—BEAV 311 • Cable: TEKTRONIX

**TEKTRONIX FIELD OFFICES:** Albuquerque, N. Mex. • Atlanta, Ga. • Baltimore (Towson) Md. • Boston (Lexington) Mass. • Buffalo, N.Y. • Chicago (Park Ridge) Ill. • Cleveland, Ohio • Dallas, Texas • Dayton, Ohio • Denver, Colo. • Detroit (Lathrup Village) Mich. • Endicott (Endwell) N.Y. • Greensboro, N.C. • Houston, Texas • Indianapolis, Ind. • Kansas City (Mission) Kan. • Los Angeles, Calif. Area (Encino • Orange Pasadena • West Los Angeles) • Minneapolis, Minn. • New York City Area (Albertson, L.I., N.Y. • Stamford, Conn. • Union, N.J.) • Orlando, Fla. • Philadelphia (Bala-Cynwyd) Pa. • Phoenix (Scottsdale) Ariz. • Pittsburgh (Monroeville) Pa. • Portland, Ore. • Poughkeepsie, N.Y. • San Diego, Calif. • San Francisco, Calif. Area (Lafayette • Palo Alto) • Seattle, Wash. • Syracuse, N.Y. • Washington, D.C. (Annandale, Va.),

**TEKTRONIX CANADA LTD:** Montreal, Quebec • Toronto (Willowdale) Ontario.

**ENGINEERING REPRESENTATIVES:** Kentron Hawaii Ltd., Honolulu, Hawaii. Tektronix is represented in twenty-five overseas countries by qualified engineering organizations.

European and African countries, the countries of Lebanon and Turkey, please contact TEKTRONIX INTERNATIONAL A.G., Terrassenweg 1A, Zug, Switzerland, for the name of your local engineering representative. Other Overseas areas, please write or cable directly to Tektronix, Inc., International Marketing Department, P. O. Box 500, Beaverton, Oregon, U.S.A. Cable: TEKTRONIX.

# HOW CHEAP IS "CHEAP"?

*"Why should we buy from you when we can get the 'same thing' from other suppliers at a lower price?"*

In selecting a supplier of lacing tape (or any component), price and compliance with specifications are not the only criteria. But too often, manufacturers ignore the other factors involved and consequently lose money.

For example, in a \$15,000 piece of equipment there may be only 15 cents worth of Gudebrod lacing tape. It costs \$75 to work this tape. It may be possible to buy the same amount of tape from other suppliers for 2 or 3 cents less . . . it "will meet the specs" according to these suppliers. But one of our customers recently pointed out why he still specifies only Gudebrod lacing tape in such cases.

"We tried buying some cheaper tape that 'met the specs.' Within a few months our production was off by 50% . . . boy, did the production people really scream about that tape. And our labor costs doubled . . . our costing people really flipped!

"Another thing, why should we risk the possible loss of thousands of dollars when the original material cost difference is only a few cents. Once you put cheaper tape on and something goes wrong after the equipment is finished . . . you've had it. No, thank you! We learned our lesson! We buy Gudebrod lacing tape!"

Whether your firm uses one spool of lacing tape or thousands, there are four advantages in specifying Gudebrod for all your lacing requirements:

1. *Gudebrod lacing tape guarantees increased production!*
2. *Gudebrod lacing tape guarantees reduced labor costs!*
3. *Gudebrod lacing tape guarantees minimal maintenance after installation!*
4. *Gudebrod guarantees quality!* On every spool is a lot number and seal which guarantees that all Gudebrod lacing tape is produced under strict quality control. Our standards are more exacting than those required for compliance with Mil-T.

Our Technical Products Data Book explains in detail the complete line of Gudebrod lacing tapes for both civilian and military use. For your copy write to Mr. F. W. Krupp, Vice President, Electronics Division

## **GUDEBROD BROS. SILK CO., INC.**

Electronics Division  
225 West 34th Street  
New York 1, New York

Executive Offices  
12 South 12th Street  
Philadelphia 7, Pa.

## MEETINGS AHEAD

RADIO PROPAGATION COURSE, NBS and University of Colorado; NBS Boulder Laboratories, Boulder, Colo., July 16-Aug. 3.

RELIABILITY TRAINING CONFERENCE, IRE, ASQC; Princeton Inn, Princeton, N. J., July 9-13.

LUNAR MISSIONS MEETING, American Rocket Society; Pick-Carter and Statler-Hilton Hotels, Cleveland, Ohio, July 17-19.

MEDICINE & BIOLOGY DATA ACQUISITION AND PROCESSING, IRE-PGME, AIEE, ISA; Strong Memorial Hosp., Rochester, N. Y., July 18-19.

INTERNATIONAL SOUND FAIR, Institute of High Fidelity Manufacturers, Magnetic Recording Industry Assoc., et al; Cobo Hall, Detroit, July 25-29.

INDUSTRIAL RESEARCH CONFERENCE, Columbia University; Arden House, Harriman, N. Y., Aug. 5.

ENERGY CONVERSION PACIFIC CONFERENCE, AIEE; Fairmount Hotel, San Francisco, Calif., Aug. 13-16.

PRECISION ELECTRONIC MEASUREMENTS INTERNATIONAL CONFERENCE, IRE-PGI, NBS, AIEE; NBS Boulder Labs, Boulder, Colo., Aug. 14-16.

CRYOGENIC ENGINEERING CONFERENCE, University of California; at UCLA, Los Angeles, Calif., Aug. 14-16.

ELECTRONIC CIRCUIT PACKAGING SYMPOSIUM, U. of Colorado, et al; Boulder, Colo., Aug. 15-17.

AIRCRAFT & MISSILES CONFERENCE, ASQC; Benjamin Franklin Hotel, Seattle, Wash., Aug. 16-18.

APPLICATIONS & RELIABILITY SYMPOSIUM, Precision Potentiometer Manufacturer's Assoc.; Statler-Hilton Hotel, Los Angeles, August 20.

WESTERN ELECTRONICS SHOW AND CONFERENCE, WEMA, IRE; Los Angeles, Calif., Aug. 21-24.

METALLURGY OF SEMICONDUCTORS; the American Institute of Mining, et al; Ben Franklin Hotel, Philadelphia, Pa., Aug. 27-29.

BALLISTIC MISSILE & SPACE TECHNOLOGY SYMPOSIUM, US Air Force and Aerospace Corp.; Statler Hilton Hotel, Los Angeles, August 27-29.

MAINTAINABILITY OF ELECTRONIC EQUIPMENT, EIA Engineering Dept. & Dept. of Defense; U. of Colorado, Boulder, Colo., Aug. 28-30.

## **ADVANCE REPORT**

ULTRASONICS SYMPOSIUM, IRE-PGUE; Columbia University, New York City, Nov. 28-30. Aug. 13 is the deadline for submitting 3 copies of a 200-word abstract to: R. N. Thurston, Technical Program Chairman, Bell Telephone Laboratories, Murray Hill, N. J. Particular emphasis will be given to microwave ultrasonics, but contributed papers are being sought in any of the various specialties of ultrasonics.

Save Space by the  
circuitboardful !

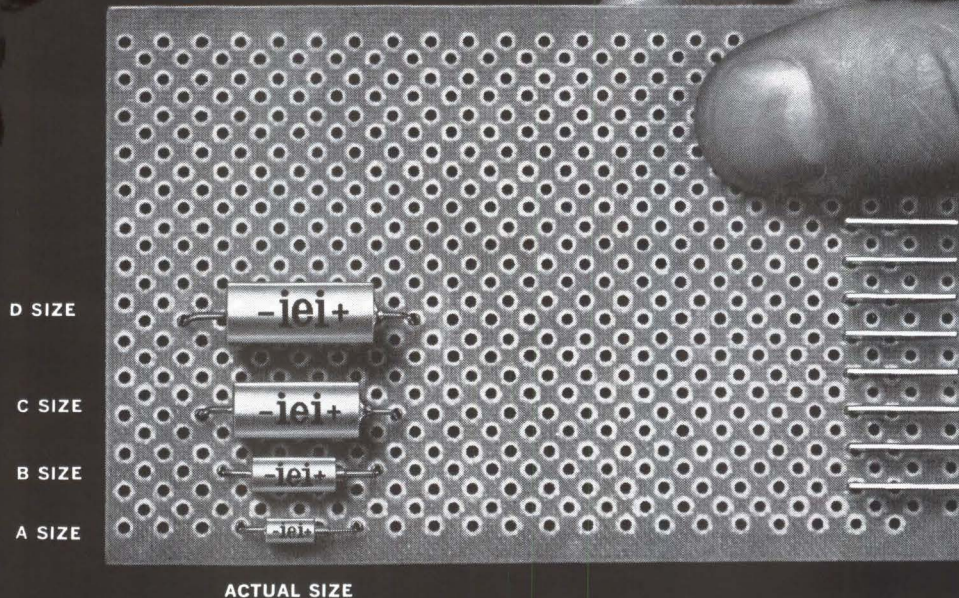

ACTUAL SIZE

# iei Solid Tantalum Electrolytic Capacitors

These widgeits are midgets because they have the highest capacitance-voltage product per volume unit of any type capacitor. And their one-piece, sintered core makes them inherently rugged and reliable.

STANDARD CASE SIZE	HIGHEST CE VALUE	TYPICAL RATING
D	2000	100mfd, 20WVDC
C	1200	120mfd, 10WVDC
B	390	39mfd, 10WVDC
A	49.5	3.3mfd, 15WVDC

**iei** Solid Tantalum "dry slug" capacitors equal or exceed all requirements of MIL-C-26655. They are completely dry and inorganic.

**iei** processes them from start to finish with

**iei** Solid Tantalum capacitors, as well as wet slug, tantalum foil and aluminum foil miniature electrolytic capacitors, are in stock NOW at leading distributors.

utmost care to exclude moisture and impurities.

**iei** "dry slugs" show stable capacitance  $\pm 5\%$  from 125° to -50° C. They can be operated down to -80° C.

**iei** solid tantalum units have a true hermetic seal made with high-temp solder. Leads are secured at the case for extra strength (no external welds).

**iei** solid tantalum capacitors are 100% stabilized to give peak performance even after long shelf life. Full specifications in Form 2743, free on request. Write to International Electronic Industries, Box 9036- 94, Nashville, Tenn. A Division of Standard Pressed Steel Co.

International Electronic Industries Div.

**SPS**

where reliability replaces probability

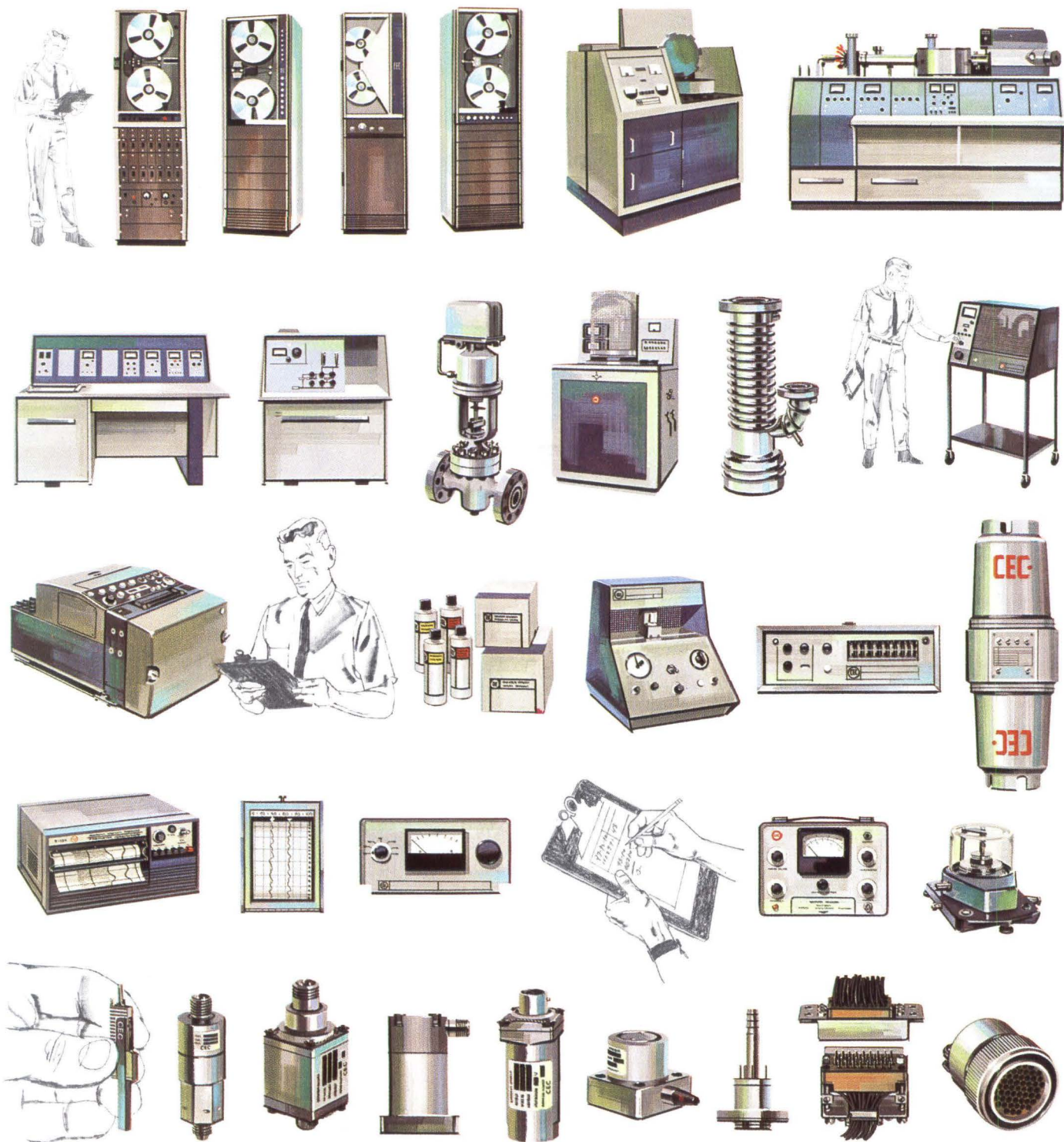

## How many of these do you know?

They're all from CEC—instruments for measuring and recording physical and chemical phenomenon... analytical instruments... process control instrumentation... high vacuum technology. They deliver one important end product: FACT—mathematical fact—vast amounts of data obtained quickly, accurately and reliably. If information is a key element in your industry... whether in research and development or in production... CEC instrumentation may be of

service to you. Why not find out? A call to your nearby CEC sales and service office will bring an expert to consult with you—or your request will bring our new 28-page brochure describing CEC's capabilities. Ask for Bulletin CEC 203.

## CEC/Bell & Howell

CONSOLIDATED ELECTRODYNAMICS, Pasadena, California. divisions: ANALYTICAL & CONTROL • TRANSDUCER • DATA RECORDERS DEVAR-KINETICS • subsidiary: CONSOLIDATED VACUUM CORPORATION

# NEW PC CONNECTOR

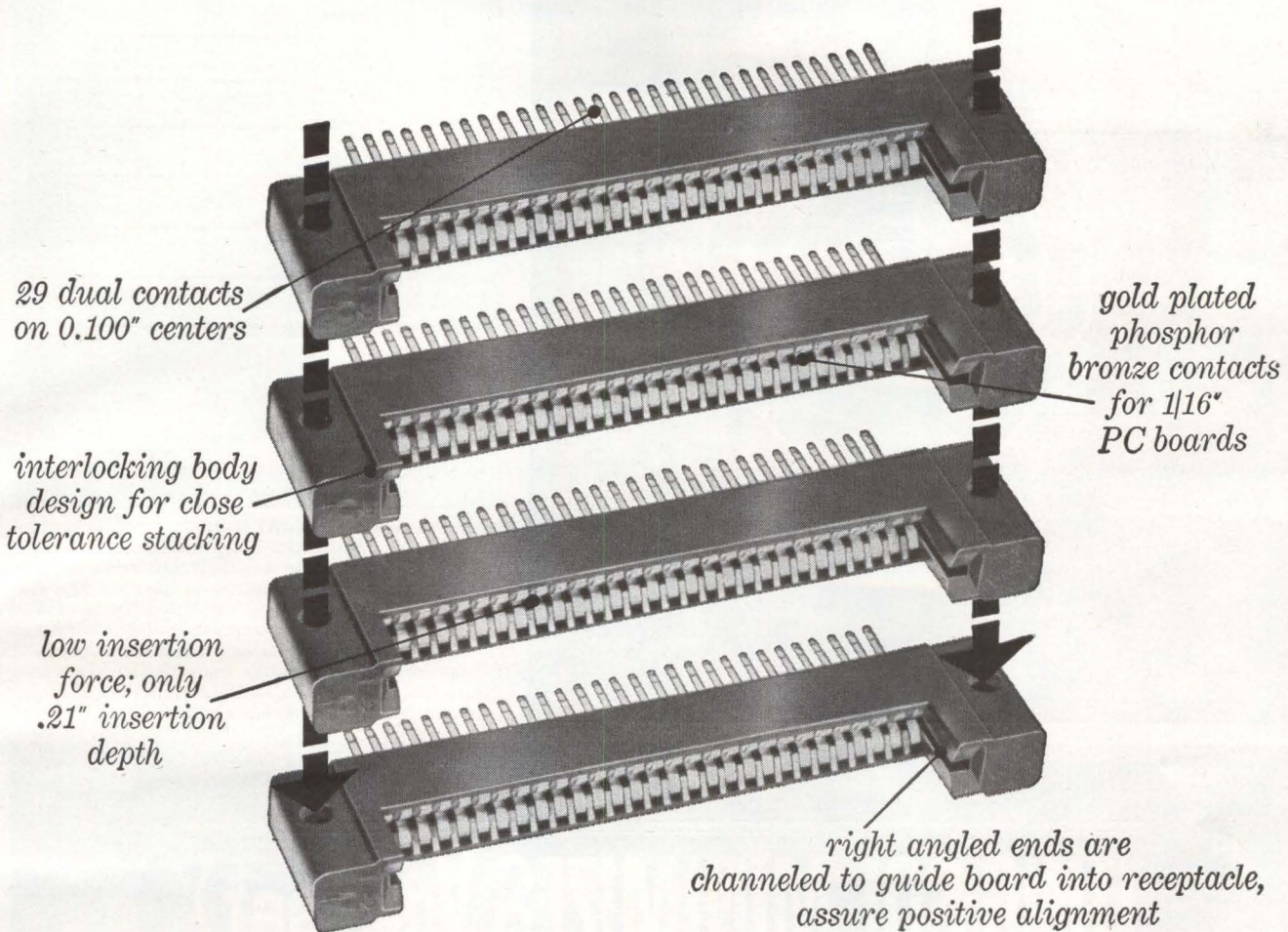

## FOR HIGH DENSITY CIRCUITS

Model 600-121-29X connectors pictured here are Continental's answer to tough problems of high density printed circuit packaging. Designed for 1/16" PC board, they provide 29 dual contacts on .100 center-to-center spacing. And—their interlocking body design permits connectors to be stacked in any reasonable quantity, with less than .02" cumulative width tolerance in a stack of ten. The unique right angled ends are channeled to guide the circuit board into the receptacle, assure positive alignment and contact with minimum board insertion depth. Solder lug terminations accept #24 AWG wire.

At Continental, new high density connector designs are constantly under development. Our Engineering Department will be pleased to assist you in solving special connector problems. Simply call or write, outlining your requirements.

### DESIGNERS' DATA FILE

If you're designing for high density packaging you'll want to have Continental's Con-Dex File PC, compiled to help you select and specify the PC connectors best suited to your needs. For your copy, please write to: Continental Connector Corporation, 34-63 56th Street, Woodside 77, New York, or call TW 9-4422.

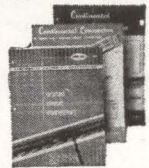

MICRO-MINIATURE • SUB-MINIATURE • MINIATURE • PRINTED CIRCUIT • RIGHT ANGLE PIN & SOCKET • CENTER SCREWLOCK

# CONTINENTAL CONNECTORS

OR CORPORATION • WOODSIDE 77, NEW YORK

CIRCLE 35 ON READER SERVICE CARD 35

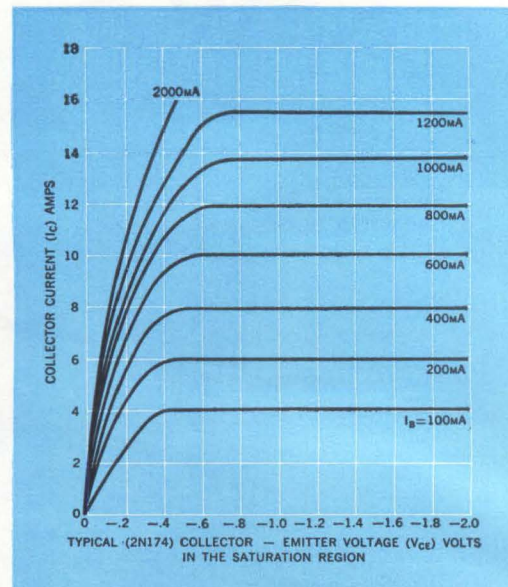
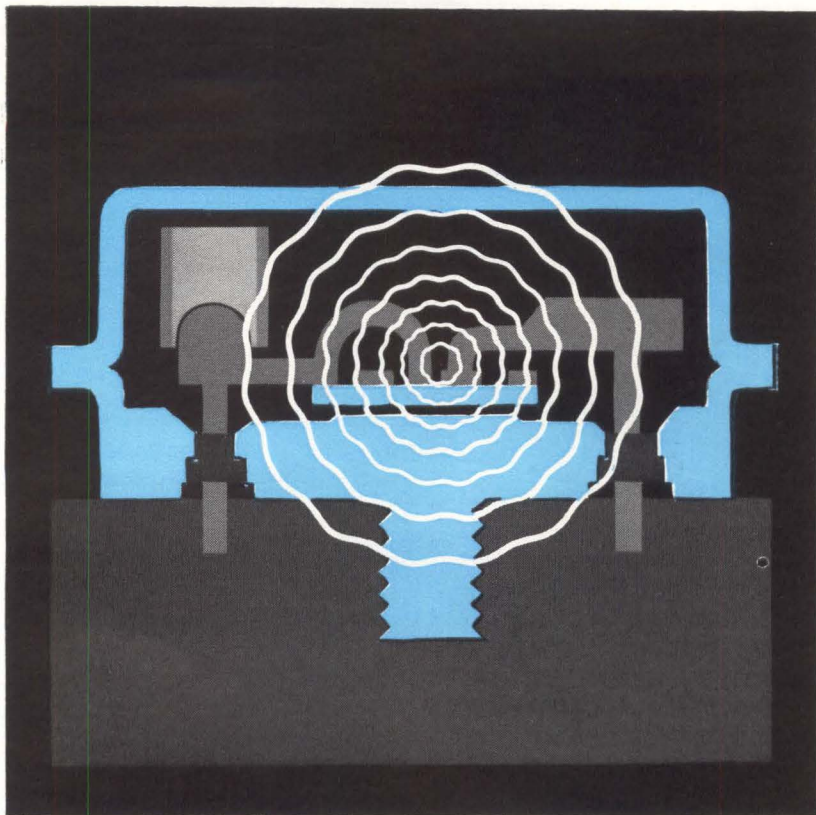

Saturation voltage  $V_{CE}(\text{sat})$  is an extremely important transistor characteristic. When the collector to base voltage of a transistor is either zero or in the forward direction and the emitter to base voltage also is in the forward direction the transistor is said to be in saturation. Low saturation voltage improves circuit efficiency and reduces transistor dissipation in applications in which the transistor is driven into saturation. This results in lower junction temperature and improved temperature stability.

## TUNG-SOL MINIMIZES $V_{CE}(\text{sat})$

TO PRODUCE POWER TRANSISTORS THAT DELIVER FULL POWER

Power transistors can be rated by at least a score of characteristics. For most of these, the ratings of an ordinary transistor may be equivalent to the ratings of a Tung-Sol transistor—under optimum conditions.

But Tung-Sol engineers have long recognized that power transistors are rarely operated under the so-called optimum conditions. Circuit requirements vary widely and so do operating environments. A better measure of power transistor quality and capability are the characteristics which contribute to transistor reliability and performance under less-than-optimum conditions.

One such characteristic is saturation voltage. Tung-Sol transistors are designed with the lowest possible saturation voltage consistent with other performance requirements.

Low saturation voltage results in lower transistor dissipation and lower junction temperature. This reduces the variation of the temperature dependent parameters of the tran-

sistor with resultant improvement in circuit and operational stability. Low saturation voltage decreases internal resistance and temperature and increases useful power-handling. Therefore, a low saturation voltage becomes increasingly important as the transistor is operated closer to its maximum power or in a high-temperature environment.

Low saturation design is typical of the care taken by Tung-Sol to provide the industry with transistors that reliably deliver full power. Ratings, based on stringent environmental and electrical tests, are given for junction temperatures of  $110^{\circ}\text{C}$ . Thermal resistance is low, while breakdown voltages are high.

Two more power pluses are Cold-Welded copper cases, for better heat dissipation and prevention of contamination, and flat-ground mounting surfaces, for full contact with heat sinks. Talk to Tung-Sol about your transistor problems. Tung-Sol Electric Inc., Newark 4, N. J. TWX:NK193.

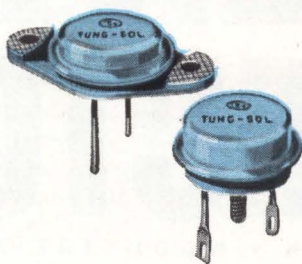

**TUNG-SOL**® FULL POWER  
POWER TRANSISTORS

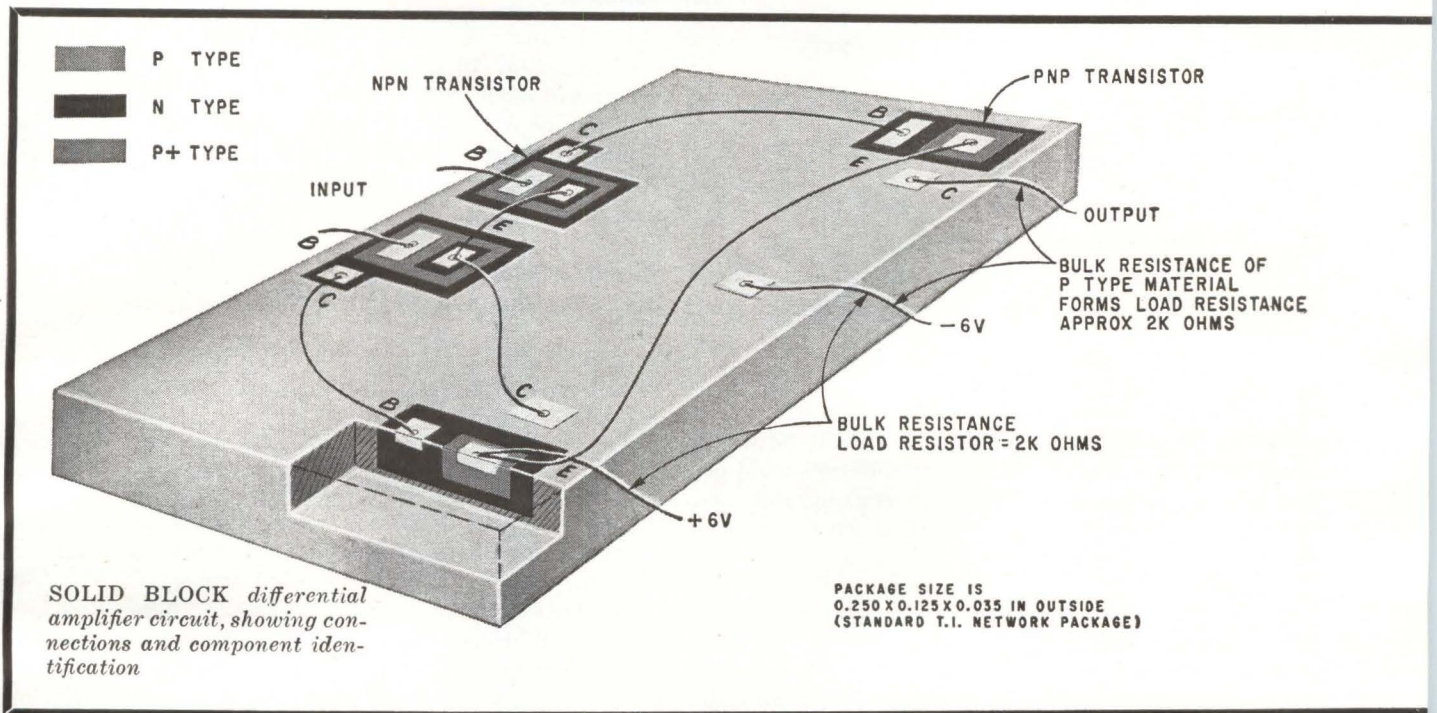

## FIRST DETAILS Differential Amplifier Grown in Silicon Block

*Push to analyze circuit functions for translation into silicon block equivalents leads to simple block version of general-purpose differential amplifier. Device fulfills many needs in navigation, fire-control and computer circuits*

By W. F. DeBOICE

Senior Technical Specialist,  
Autonetics Division,  
North American Aviation, Inc.,  
Downey, Calif.

J. F. BOWKER

Research Engineer,  
Electronics Research Laboratory,  
Montana State College,  
Bozeman, Montana

A CONCERTED EFFORT to put molecular electronic techniques to use in inertial navigation, armament and flight control systems led to an examination of system requirements for small-signal linear amplifiers. In high-gain audio-frequency amplifiers, large reactive elements were being used in bypass and coupling circuits to reduce d-c gain to a point that bias uncertainties would not result in d-c saturation of the amplifier. Counterparts for these large reactive elements did not exist in molecular form. It appeared, however, that this problem might be avoided if an amplifier circuit having sufficiently low bias uncertainty could be developed. Such a circuit would also be useful as a d-c amplifier. Thus development of a direct-coupled general-purpose amplifier that duplicated in molecular form was undertaken.

Techniques of molecular electronics lend themselves to the fabrication of well matched pairs of elements. A differential amplifier was chosen to exploit this capability. For simplicity in application of the

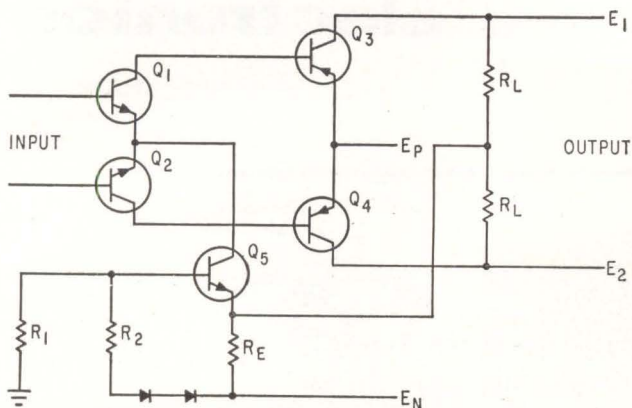

GENERAL PURPOSE amplifier. Circuit design, amplifier characteristics, and differential characteristics are analyzed for block production—Fig. 1

basic amplifier block the nominal quiescent bias potential at both input and output should be zero. The transfer function of the amplifier block should be simple so that feedback circuits of considerable variety can be attached without creating excessive stability problems.

**CURRENT CONTROL**—The long-tail circuit, in which transistors are biased by an active current source, achieves low common-mode gain, but does not, however, solve the problem of common-mode bias offset. A means of actively controlling the current source was needed to bring the common-mode output voltage to zero. This was achieved feedback to the emitter of the long-tail current-source transistor,  $Q_5$  (Fig. 1).

Neglecting the effect of finite current gain in the transistors and assuming that each of the diode voltages,  $V_D$ , and the base emitter voltage of  $Q_5$ ,  $V_{BE}$ , are equal

$$V_D = V_{BE} \quad (1)$$

Also

$$R_1 = R_2 \quad (2)$$

and

$$R_E = 1/2 R_L \quad (3)$$

Defining the common-mode output voltage

$$E_o = \frac{E_1 + E_2}{2} \quad (4)$$

Under these conditions,

$$1/2(E_N - 2V_D) + V_{BE} = 1/2(E_N - E_o) \quad (5)$$

Equation 5 is satisfied when  $E_o = 0$  which is desired. This result is independent of values of supply voltages and absolute values of the circuit parameters, and depends on ratios of certain quantities.

The principal effect of finite current gain in the transistors is to introduce an error due to transistor emitter current in  $R_E$ . For the transistors in use in the circuit, the maximum common emitter current gain,  $\beta$  is 200 and the minimum is 50. With these ratios for  $\beta$ , the  $Q_5$  emitter current in  $R_E$  is approximately 1/2 percent and 2 percent of the bias current in  $R_E$ . The error in  $E_o$  may be reduced slightly by adjusting  $R_E$  to correct the effect at the design center. This is, however, a trivial refinement because the tol-

erance that can be obtained on the ratios of the resistors is probably no better than one percent.

Although the experience in production of the circuit in molecular form is inadequate to determine the magnitude of reasonable tolerances, results indicate that the resistance and  $\beta$  spreads and the other less significant uncertainties can be held to a combined tolerance of 10 percent, or possibly 5 percent. The common-mode offset voltage due to this tolerance is computed by applying the tolerance to one-half the magnitude of the negative supply voltage,  $E_N$ . Hence, for a negative 10-v supply, the common-mode offset may be held to a tolerance of 0.25 to 0.5 volt. An additional common-mode offset-voltage term is due to the inequality of  $V_D$  and  $V_{BE}$ . The term may be held to a maximum of about 0.1 volt.

**ANALYZING GAIN**—The circuit's low-frequency gain characteristics are analyzed with the general diode equation

$$I = I_s \left( e^{\exp \frac{qV}{kT}} - 1 \right) \quad (6)$$

which may be solved to determine the approximate incremental input resistance of a common-emitter transistor. At typical operating temperature of 300 K, the incremental input resistance (neglecting the small difference between collector and the emitter current) is

$$R_B \cong R_E h_{FE} \cong \frac{kT}{q} \frac{h_{FE}}{I_c} \quad (7)$$

at normal temperature:

$$R_B = \frac{0.026}{I_c} h_{FE} \quad (8)$$

where  $I_c$  is the collector current and  $h_{FE}$  is the incremental common emitter current gain.

Assuming that the transistor pairs and the load resistors,  $R_L$ , are perfectly matched and that the common-mode voltage is zero, the differential voltage gain may be formulated based on

- $\beta$   $\equiv$  d-c current gain of transistor
- $h_{FE}$   $\equiv$  small-signal current gain of transistor
- $I_c$   $\equiv$  d-c collector current
- $I_B$   $\equiv$  d-c base current

Voltage across each of the load resistors is one-half  $E_N$ . Thus

$$I_{C3} = I_{C4} = \frac{E_N}{2R_L} \quad (9)$$

And

$$I_{C1} = I_{C2} = \frac{E_N}{2R_L \beta_3} \quad (10)$$

Making use of Eq. 8

$$R_{B1} = R_{B2} = \frac{0.026 h_{FE1} 2R_L \beta_3}{E_N} \quad (11)$$

The input signal current is related to the input voltage by the input resistance. The differential voltage gain is

$$G_V = h_{FE1} h_{FE3} \frac{R_L}{R_{B1}} \quad (12)$$

Substituting Eq. 11 and reducing

$$G_V = \frac{E_N h_{FE3}}{0.052 \beta_3} \quad (13)$$

In typical transistors,  $h_{FE}$  is nearly equal to  $\beta$  and



so the parameters may be dropped out of eq. 13. The resulting conclusion that the voltage gain is independent of circuit constants is found to be valid to within 10 percent.

In the derivation of  $R_B$  (Eq. 7),  $I_s$  is negligible compared to  $I_c$ . For silicon transistors the error is less than one percent. A more significant source of uncertainty in the gain stems from the 5 to 10-percent tolerance on the common-mode bias. The linear dependence of  $R_B$  on absolute temperature in Eq. 11, is also noted.

This circuit analysis also neglects the effects of internal feedback in the transistors, base ohmic resistance, and collector leakage currents. These effects are, however, trivial in view of the magnitude of the other uncertainties.

Equation 13 states that the voltage gain of the amplifier is linearly dependent upon the negative supply voltage,  $E_N$ . This characteristic is useful in mechanizing automatic gain control, amplitude control and signal multiplication. The amplifier functions with  $E_N$  as low as 3 volts, which results in a voltage gain of about 30 db. With a supply voltage of 20 volts, the gain is 50 db.

The collector-base capacitance of the second pair of transistors affords the primary limitation to the amplifier's frequency response. Transistors used in experimental models have resulted in an upper frequency response down 3 db at 50 to 100 Kc. This characteristic may be improved by more optimum design of the transistors in the molecular version of the circuit. Because of the push-pull operation of the circuit, second harmonic distortion is low.

The differential input impedance and the differential output impedances are  $2R_B$  and  $2R_L$ . In a differential load, a current flowing out of one of the output terminals is returned to the other output terminal. These two currents add to zero at the junction of the two load resistors,  $R_L$ , and so the common-mode control circuit does not sense the presence of the load. If a single-ended load is connected between one of the outputs and ground, however, the common-mode circuit maintains the sum of the currents in the two load resistors,  $R_L$ , at the value existing under no load conditions. The action alters the current from the  $E_P$  supply (while maintaining constant current from the  $E_N$  supply) by changing the currents in  $Q_3$  and  $Q_4$  equally. Analysis shows that the single-ended output impedance is

$$\frac{1}{2}R_L$$

The common mode control circuit also augments the common-mode input signal rejection of the am-

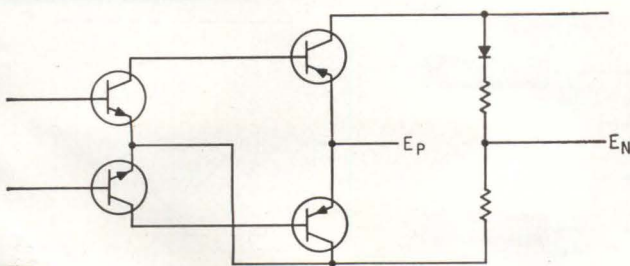

Single-ended amplifier, a simple variation of the circuit on p 38—Fig. 2

plifier. Analytical determination of common-mode rejection is laborious and involves many transistor parameters that are at present not determined for the molecular version of the circuit. Experimental results show common-mode rejection of 100 db and higher.

Data is not sufficient to predict the balance obtained in the transistor pairs and in the load resistors. It is expected that the sum of the mismatch in  $h_{FE}$  of the two pairs of transistors, and mismatch of the load resistors, may be specified at 20 percent maximum. The differential voltage offset, therefore, may be specified to a maximum of 10 millivolts. Because many applications will not require particularly close matching, parts will be graded by the manufacturer with respect to matching.

CURRENT-GAIN—Mismatch and load-resistance mismatch are: the sum of the effects operates on the input d-c bias current to produce an input current offset; mismatches unbalance the gain to the two output terminals; and the sum of the unbalance of  $\beta_b$ ,  $\beta_i$  and the load resistors results in a differential input current offset term that operates on the incremental input resistance,  $R_B$ , to produce an offset voltage that adds to the unbalance in the  $V_{BE}$  of the two input transistors to determine the effective differential-voltage offset.

If the single-ended output of the amplifier is used, the common-mode offset adds to the differential offset. The typical common-mode offset of 0.5 volt and voltage gain of 40 db, however, results in an offset of only 5 millivolts when referred to the input.

A variation of the basic circuit, suggested by Lee Evans of Texas Instruments is shown in Fig. 2. This circuit has the advantage of simplicity, and a factor-of-two increase in voltage gain over the circuit in Fig. 1 when the single-ended gain is considered with equal bias voltage across the load resistors.

This circuit does not operate the transistors in push-pull, and so second-harmonic distortion is high.

The preliminary model of the operational circuit was formed as shown on p. 37. This device was an embodiment of the circuit shown in Figure 2. Model shows two pnp transistors at the ends of the bar of silicon. The two npn transistors are along the cross axis of the bar. The  $p$  type bulk material is the resistance element between the two  $pnp$  collectors with the  $p$  + pads provided for connection to the  $pnp$  collectors and to the junction of the two load resistors. Interconnections between the circuit elements were formed in this preliminary model by jumper wires bonded to the contact points on circuit elements.

The authors acknowledge the valuable leadership of T. Mitsutomi of Autonetics in establishing the Molecular Electronics Team (MET), and express appreciation to other members of the group.

Acknowledgment is also given to personnel of the Electronics Research Laboratory of Montana State College for their assistance to J. F. Bowker in carrying out additional work on the circuit.

Personnel of the semiconductor networks department of Texas Instruments and particularly John Kilby, Art Evans and Lee Evans have been most helpful.

# Countermeasures Receiver

*Frequency-determining section is a discriminator composed of passive elements.*

*The WHIP (Wideband High-Intercept-Probability) receiver consists of a wide band-pass filter, the discriminator and a crt that displays the frequencies of input signals*

THIS RECEIVER gives frequency information over a wide spectrum and provides a 100-percent probability of detecting incoming signals. It does this without tuning oscillators or tuning filters, unlike typical frequency-determining receivers. Since its frequency-determining elements are entirely passive, only the video amplifiers and the display require a power supply. The receiver may be packaged in a volume of less than one-tenth cubic foot, exclusive of the display. The weight of the frequency-determining section should be under one pound. Frequency resolution is about 1 or 2 percent. This is comparable to a channeled receiver using 80 filter sections in the S-band.

The receiver consists of a widebandpass filter, frequency discriminator (including two matched detectors and display. The display consists of two video amplifiers, crt and low- and high-voltage power supply. The display does not require sweep or synchronization circuits.

Absolute frequency indication is independent of incoming power as long as the law of the video detector does not change. This suggests the use of a broadband limiter ahead of the frequency discriminator if large signal environments are expected. Manually operated r-f attenuators may also be used to

examine an occasional large signal.

**DISCRIMINATOR** — Figure 1 shows the discriminator, which can be used at any frequency at which a TEM mode can be maintained. Although the schematic is shown in two-wire lines, coaxial, or other line configurations, may be used. The table defines the circuit parameters.

If the line lengths comprising the short circuit and the open circuit are identical, and of the same characteristic impedance (sections  $L_1$  to  $L_4$  (see Table on p 43) have the same  $Z_0$ ) and are terminated in a resistance  $R_0$  equal to the  $Z_0$  of the lines, then the ratio of  $V_{1out}$  to  $V_{2out}$  will uniquely define a frequency if that frequency has been fed into the r-f input. The frequency range over which the uniqueness of frequency is determined is defined by the lengths of the shorted and open line sections.

If  $n = 1$  and  $\lambda_0$  is the wavelength of the lowest frequency ( $f_0$ ) to be determined, then the ratio of  $V_{1out}$  to  $V_{2out}$  will be unique from  $f_0$  to  $2f_0$  or an octave. If  $n$  is greater than 1, then the frequency range will be smaller. The ratio of  $V_{1out}$  to  $V_{2out}$  will uniquely describe the frequency from  $f_0$  to  $2f_0$  if the stub lengths are  $\lambda_0/4 = c/4f_0$ ; also  $Z_{in} = Z_0$ , independent of frequency.

Voltage  $V_{1out}$  is fed to the horizontal deflection plates of a crt, and  $V_{2out}$  is fed to its vertical deflection

plates. Thus, the crt bright spot is deflected from the origin when there is an incoming signal.

If a signal at  $f_0$  produces the deflection shown in the inset of Fig. 1, a signal at  $2f_0$  will be angularly displaced from the signal at  $f_0$  by 90 deg ( $\theta_2 = 90$  deg) and all frequencies between  $f_0$  and  $2f_0$  will have angular displacements between 0 and 90 deg, as illustrated by  $\theta_1$ . Although this is not the only display method, it is simple.

At higher frequencies, where a waveguide is required instead of wire transmission line, it is not feasible to use open-end stubs; a discrimination method is available using shorted stubs only. In this system (Fig. 2A) the incoming r-f power is equally divided by the power splitter and fed through ferrite isolators to shorted stubs. In one arm, the stub is in shunt (narrow-wall stub) with the main line. In the other, the stub is in series (broad-wall stub) with main line.

With this system, as in the coaxial system, if the shorted-stub lengths are  $\lambda_0/4$  long, then the ratio of  $V_1$  to  $V_2$  will determine the frequency uniquely over the range from  $f_0$  to  $2f_0$ . If the length of the shorted stubs is chosen to be  $n \lambda_0/4$  then the frequency range will be from  $f_0$  to less than  $2f_0$ , depending on the integer  $n$ .

Figure 2B shows another system of frequency discrimination that

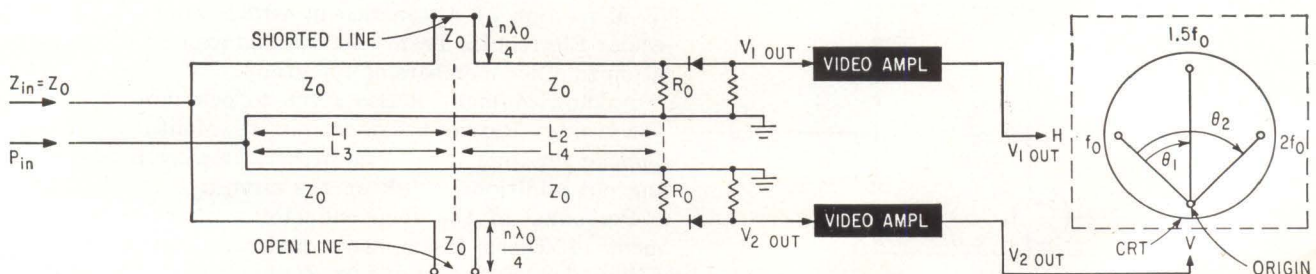

BASIC CONFIGURATION of WHIP receiver discriminator. Inset shows frequency display appearing on crt—Fig. 1

# Tunes With Passive Elements

By ROBERT B. HANKIN  
MONTE ROSS

Research and Development Div.,  
The Hallicrafters Company,  
Chicago, Ill.

uses only one shorted stub line. This system also provides a unique relationship between the ratio of  $V_1$  and  $V_2$  and the incoming frequency over an octave or less, depending on stub length. Although the stub is shown in series with the load, it may be also in shunt.

Figure 2C shows a frequency discriminator that uses two shorted stubs and a broadband hybrid. This is easy to construct and reproduce. Since the stubs are in shunt with the line, when the frequency is such that the stubs are  $\lambda/4$  long, all the signals entering the signal input port will be transmitted to terminations  $A$  and  $A'$  after being equally divided and shifted in phase by the hybrid. At the frequency where the stubs are  $\lambda/2$  long, the stubs appear as short circuits across the output lines and all the signals at output lines 3 and 4 are reflected. Because of the phase-shift characteristics of the hybrid, none of the signal is returned to the input port 1, but all of it is reflected to termination  $B$  at Port 2. This scheme has been experimentally verified in the 500 to 1,000-Mc range.

**EXPERIMENTAL MODELS**—Several models have been built and tested. An X-band unit has been constructed in a waveguide for a feasibility demonstration. This unit operates over the range of 8.5 Gc to 10 Gc with a crt display operating over one quadrant. A uhf model had been built with microstrip and was successful. Additional uhf models as well as S-band models have been built using the hybrid technique and these have worked well. The hybrid technique (Fig. 2C) seems attractive since it is possible to use shunt coaxial elements while series elements are required in some of the other types. This type is, therefore, simple to construct. The frequency-determin-

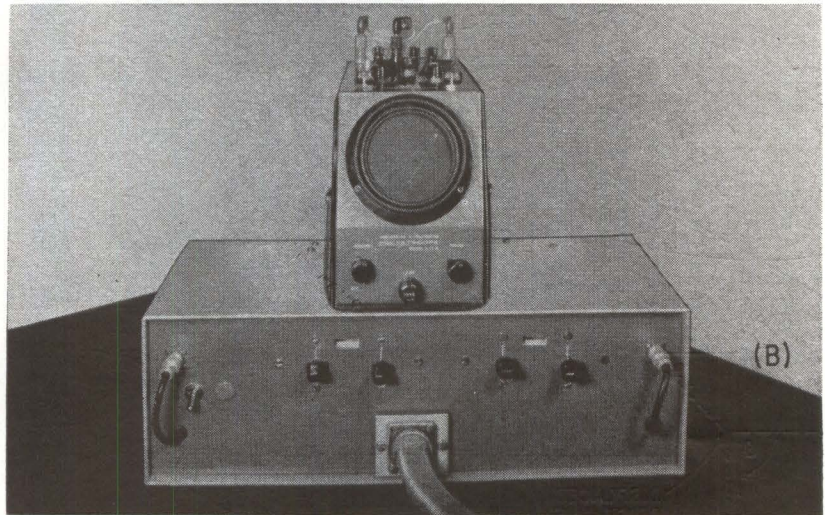
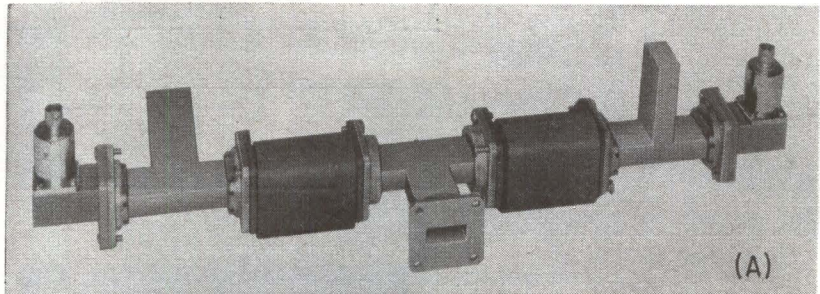

X-BAND DISCRIMINATOR (top) is shown in Fig. 2A. Lower photo shows the demonstrator unit and display

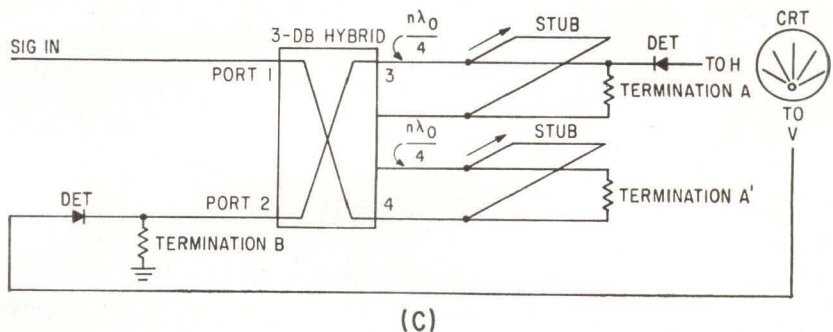
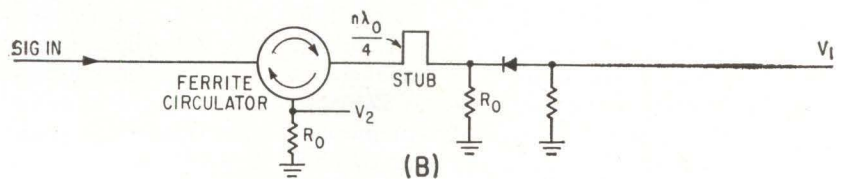
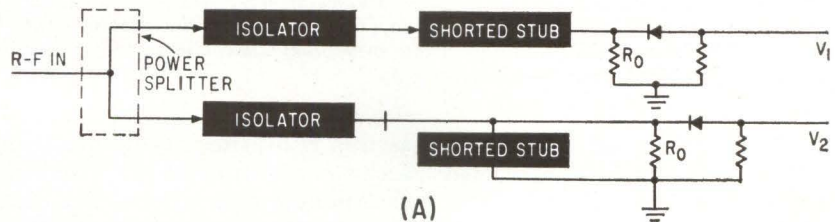

WAVEGUIDE DISCRIMINATOR of (A) is shown in photo. Discriminator (B) uses circulator, discriminator (C) uses hybrid—Fig. 2

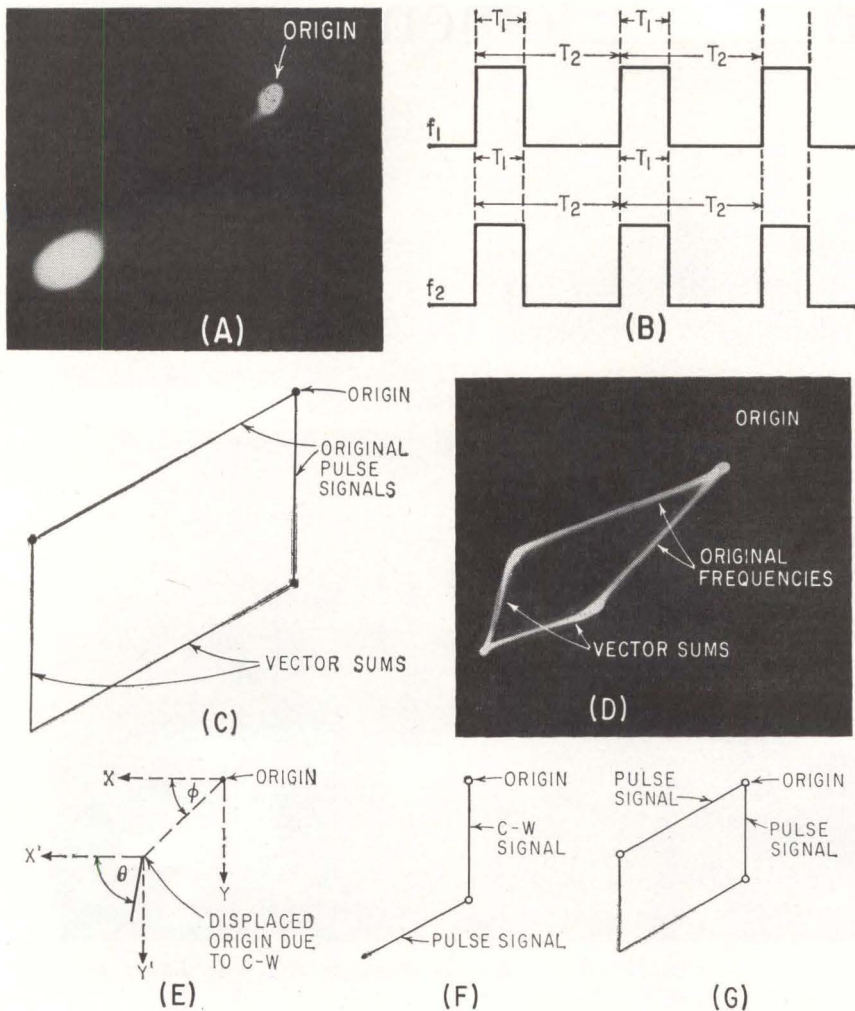

SMALL SIGNAL PLUS NOISE (A). Pulses in (B) are coincident in time and pulse width. Traces in (C) and (D) are two partially coincident signals. Displays of (E) and (F) show c-w plus pulse signals; (G) two partially-coincident pulses—FIG. 3

ing devices using series elements should most easily be constructed in Stripline or Microstrip.

The sensitivity of this receiver is within three db of a crystal video receiver. This sensitivity can be improved by a twt preamplifier in front of the receiver; however, tangential sensitivity with this type of receiver is not useful for frequency determination. The highest attainable working sensitivity of this type of device is about 5 db lower than the normal tangential sensitivity. Frequency resolution improves with improved signal-to-noise ratio (see Fig. 3A).

The crystal detectors used in each of the frequency determining sections of the receiver have been matched pairs of reflectometer crystal and crystal mounts made by Hewlett-Packard. These detectors have been selected for their good r-f match to the transmission line,

as this is a prime requirement for accurate operation of the frequency determining elements; in fact, that is a general requirement as well as a limitation to the frequency resolution. Matching is important since mismatches cause frequency errors.

Difficulty has been encountered in increasing the frequency range of the X-band unit above 10.5 Gc. This difficulty can occur when the physical dimensions of the waveguide stubs become comparable to a wavelength at the higher operating frequencies. It may be possible to lower the impedance of the guide to overcome this problem.

**SIGNALS**—In spite of multiple signal inputs, the receiver provides frequency information for each signal input as long as two or more of the incoming signals are not received in time and pulse-width coincidence. Pulses that are not al-

ways coincident in time and pulse width will be correctly displayed. Pulses that are absolutely coincident, as in Fig. 3B, will give an erroneous frequency indication, which in the crt display is the vector sum of the incoming signals; however, in most signal environments, consistently coincident signals are rare.

Incoming signals that are only partially coincident will provide a display of the original frequencies as well as the vector products. The original frequencies are easily discernible from the vector products as shown in Fig. 3C and 3D.

A c-w signal provides a special problem since it is coincident with all other incoming signals. This signal may be handled in several different ways:

(1) Eliminate c-w signals from the display by a-c coupling to the video stages.

(2) Use all d-c coupling to display the c-w component as a displacement of the origin according to the c-w frequency. The pulse-signal display then starts from the new origin, (Fig. 3E). The angle  $\phi$  from the  $x$  coordinate to a line drawn through the original origin and displaced origin is equivalent to the frequency of the c-w signal. The pulse signal may now be measured from its new origin or the input to the video amplifiers may be switched to a-c coupling, eliminating the c-w signal.

An operator can recognize signals that are pulses mixed with c-w just as they were recognized in the d-c coupled case. Figures 3F and 3G illustrate this.

The photographs show the waveguide assembly and X-band feasibility demonstration model. The waveguide circuit is that of Fig. 2A, containing a power divider, ferrite isolators, series and shunt shorted stubs, and a pair of matched crystal mounts. This unit operates over the 8.5-Gc to 10-Gc frequency range, providing an angular frequency display on a modified commercial cro. The tangential sensitivity is  $-38$  dbm with an operating sensitivity of  $-33$  dbm. The feasibility model has two video preamplifiers, plus the cro integral video amplifiers.

The modifications to the cro consist of:

(1) Adding video clamping diodes

## DEFINITIONS OF CIRCUIT PARAMETERS

Term	Definition
$P_{in}$	R-f power input point
$Z_o$	Line characteristic impedance
$R_o$	Line termination, resistive ( $=Z_o$ )
$\lambda_o$	Wavelength of lowest frequency to be discriminated
$n$	Integers 1, 2, 3, 4
$V_{1 out}$	Detected voltage output of shorted line
$V_{2 out}$	Detected voltage output of open line
$L_1, L_2, L_3, L_4$	Length of line
$\frac{n\lambda_o}{4}$	Length of shorted or open line given as integral number of quarter wavelengths at lowest frequency to be discriminated

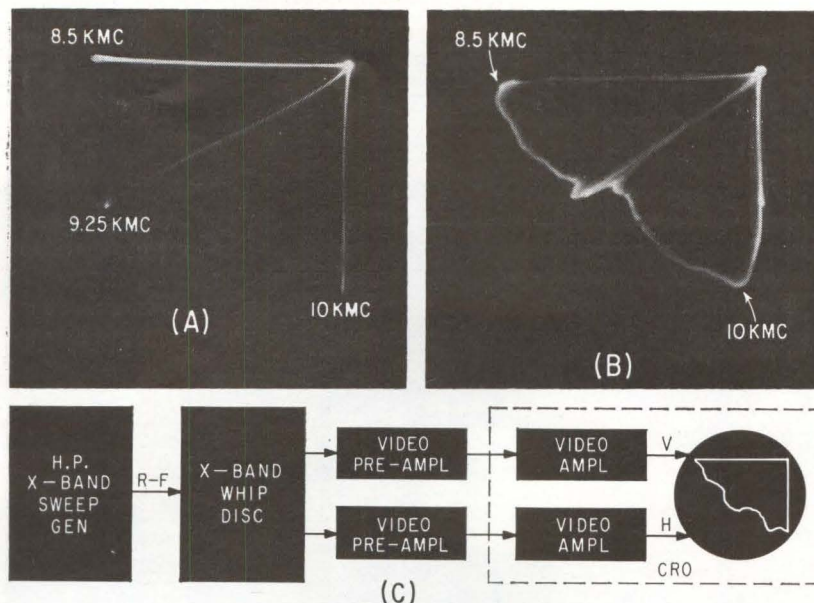

TRACE IN (A) shows pulse signals at three frequencies and (B) trace shows swept r-f input; (C) shows test setup—FIG. 4

to the cro input circuit to provide a fixed d-c reference level independent of input voltage.

(2) Using capacitive feedback in the video channels to provide an integrated output.

(3) Increasing the high voltage to brighten the trace. Oscilloscope displays of this unit are shown in Fig. 4A and 4B. Figure 4C is a block diagram of the test setup. Integration of the pulses in the video amplifier provides a bright line trace, rather than a bright dot at the end of a dim line. The clamping diodes at the scope input allow the use of a-c coupling in the pre-amplifiers, providing drift-free operation with an overall preamplifier gain above 80 db. The cro video amplifiers are identical d-c coupled channels. The detectors are Hewlett-Packard matched-pair reflectometer diodes having a vswr of less than 1.25. The input vswr of the discriminator is less than 1.25

over 8.2 to 10.2 Gc.

In the future, improved frequency resolution or increased frequency range may be obtained in the following manner: Consider the inherent repetitive nature of the frequency-determining elements. That is, since

$$\tan \theta = \tan (n\pi/2) (f/f_o)$$

if stubs are cut to a quarter wavelength at  $f_o$ , then from  $2f_o$  to  $3f_o$ , the angle  $\theta$  goes from  $\pi/2$  to  $\pi$  and then repeats from  $3f_o$  to  $4f_o$  to  $5f_o$ .

It is now necessary only to determine whether the incoming signal is between  $f_o$  and  $2f_o$  or  $2f_o$  and  $3f_o$ , and to use this information to control the display.

**DESIGN PROBLEM**—Display frequency in the range 2 to 3 Gc over a 180-degree angle on a crt, using one discriminator.

If the stub lengths of the discriminator are cut to correspond to 1 wavelength at 2 Gc, the angle will

rotate 90 deg every 500 Mc.

The deflection plates (Fig. 5A) of the two guns are in parallel except for the horizontal deflection plate of gun II, which receives a phase-inverted signal. Then the gun I display is in quadrant I, while the gun II display is in quadrant II (Fig. 5B). To prevent each signal from being displayed simultaneously in both quadrants, part of the incoming r-f signal is fed to a pair of band-pass filters with passbands of 2 to 2.5 Gc and 2.5 to 3 Gc. Pulses from the filters are detected, amplified and fed to the control grids ( $G_I, G_{II}$ ) of the crt guns, and used to turn on the electron beam, which is normally cut off.

The authors are indebted to H. Hodara (Hallicrafters) and to A. C. Todd (Illinois Inst. of Technology).

## BIBLIOGRAPHY

B. B. May, A Wide-Band Frequency Discriminator Using Open and Shorted Stubs, Tech. Report No. 791-2, Stanford Electronics Laboratory, Stanford, Cal.

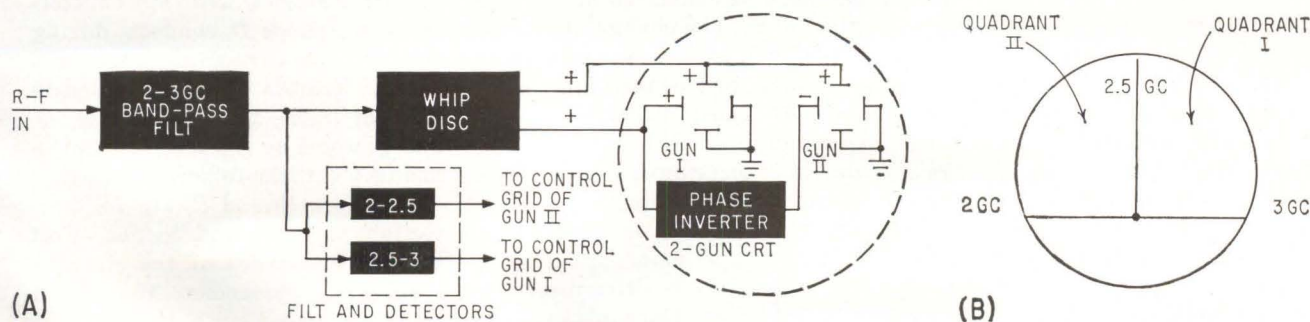

ARRANGEMENT (A) for displaying frequency over a 180 deg angle on a crt; (B) shows a typical trace—FIG. 5

# D-C Level

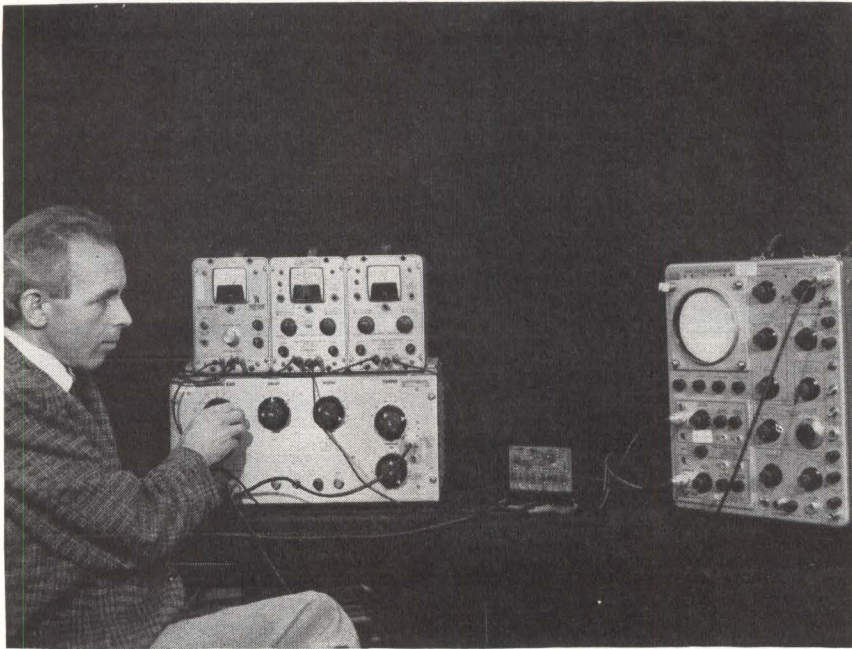

AUTHOR CHECKS response of level converter

*Transistor level converter has adjustable shift of 0 to 18 volts. Circuit operates up to 32 Mc and has only few nanoseconds delay*

By THOMAS MOLLINGA, ElectroData Div., Burroughs Corp., Pasadena, Calif.

IN CIRCUITS it is often necessary to shift a d-c level or signal. This shift should be such that any change in input causes the same change in output. That is, the output signal should be an exact replica of the input signal.

Described here is a high-speed level converter with an adjustable shift of 0 to +18 volts. Delay between input and output is of the order of a few nanoseconds; attenuation is 3 db at 32 Mc.

The circuit has a high input impedance and a low output impedance and is useful for restoring or adjusting the signal level in wide-band d-c amplifiers, or for reversing the polarity of the output signal of a square-wave generator.

The basic circuit is shown in Fig. 1A. The emitter impedance of  $Q_1$  includes constant-current generator  $Q_2$ . Thus, the current through  $R_o$  is constant and any change in input voltage causes the same voltage change at any point along  $R_o$ . The signal is coupled into output emitter-follower  $Q_3$  from which the output is taken.

Due to the finite input impedance of  $Q_3$  and the finite output imped-

ance of  $Q_2$ , some loss of amplitude will occur. Maximum loss will be at point  $L$ .

**LOSS REDUCTION**—This loss is reduced by connecting a low impedance zener diode ( $D_z$ ) across  $R_o$  as shown in Fig. 1B. Thus,  $L$  becomes a low impedance point and maximum loss occurs when  $R_o$  is about half value. Maximum loss is now reduced to  $\frac{1}{2}$  the original value.

When the frequency of the input signal becomes sufficiently high, the output impedance of constant-current source  $Q_2$  will decrease. The ratio of the impedances between  $L$  and  $N$  and between  $K$  and  $L$  will decrease. To keep this ratio high, capacitor  $C$  is connected across one section of  $R_o$ . The change of charge across  $C$  will always be small since the voltage between  $K$  and  $M$  is practically constant. Capacitor  $C$  corrects differences between  $K$  and  $M$  that may occur during high-speed or transient conditions.

The complete circuit is shown in Fig. 1C. A maximum signal shift of 18 volts in the positive direction can be obtained. The constant current source supplies a current of

about 7.3 ma. The 652C5 zener diodes each have a breakdown voltage of 6 v. A current of 3.6 ma flows through  $R_o$ , leaving 3.7 ma for the zener diodes. Dynamic impedance of each diode at this current is about 17 ohms.

At high frequencies the input impedance of  $Q_2$  decreases due to a decrease in  $\beta$ . To compensate for this,  $Q_2$  is preceded by emitter-follower  $Q_1$ . When high-speed signals are applied to the input,  $Q_1$  and  $Q_2$  will be cut off when the signal goes positive due to unavoidable circuit capacitance at the emitters. High-speed diodes  $D_1$  and  $D_2$  discharge the stray capacitance through their low forward impedances.

Output stage  $Q_3$  is an *npn* emitter-follower. Diode  $D_3$  conducts during the fast negative-going edge of a signal. Transistors can be used in place of  $D_1$ ,  $D_2$  and  $D_3$ . Then  $Q_1$ ,  $Q_2$  and  $Q_3$  would be replaced by complementary emitter-follower stages.

Resistors  $R_1$  and  $R_2$  are for protection purposes and do not affect the characteristics of the circuit.

At low frequencies, the signal source is loaded with a current of approximately  $7.3/\beta(Q_1) \times \beta(Q_2)$

# Shifter Checks New Computer Modules

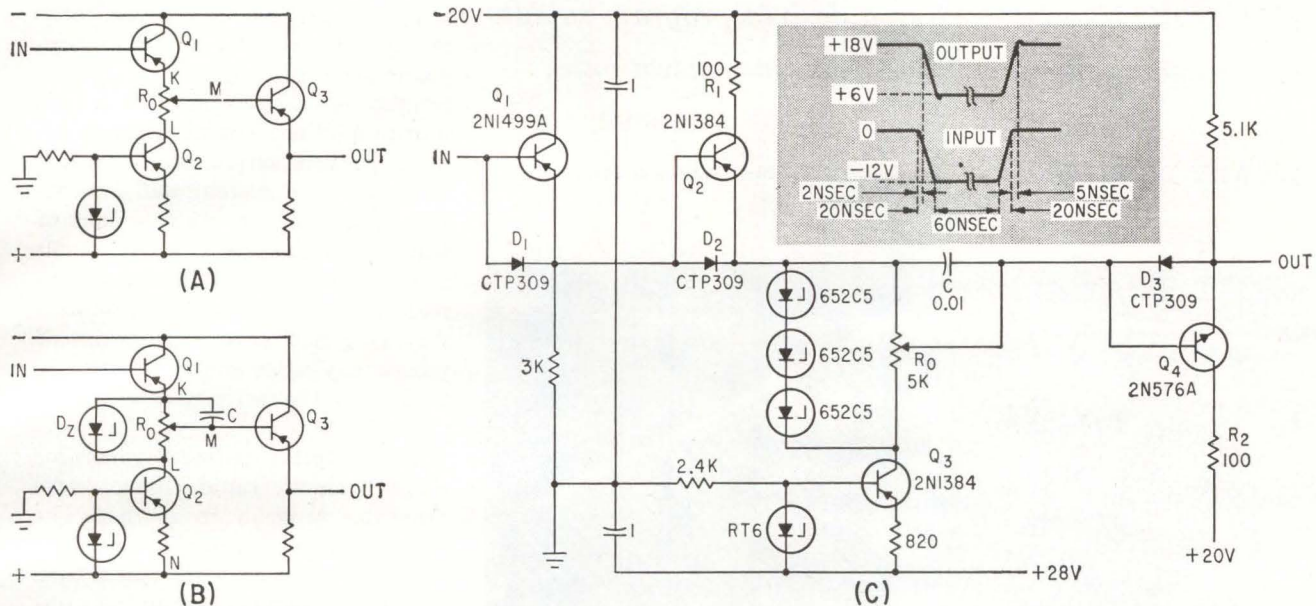

BASIC CONVERTER (A) is improved in (B) to reduce loss and improve h-f response. Final circuit (C) uses 5-percent tolerance resistors—Fig. 1

$\cong 0.01$  ma. When the frequency becomes of the order of 20 Mc this load current will be much larger (1 ma) due to the smaller values of  $\beta(Q_1)$  and  $\beta(Q_2)$ . Therefore, source impedance at these frequencies should be 200 ohms or less.

The high-frequency operation is limited by the output impedance of  $Q_3$  and the collector-to-base capacitances  $C_{cb}$  of all transistors. Capacitances  $C_{cb}(Q_1)$  and  $C_{cb}(Q_2)$  constitute a capacitive load for the source. Effect of this load is small when the source impedance is small, which is practically always the case when high frequencies or high switching speeds are involved. Capacitance  $C_{cb}(Q_4)$  is a capacitive load for the output and also  $C_{cb}(Q_3)$  when  $R_o$  is in its maximum position. When the input signal is a fast pulse, a small overshoot at the output occurs due to these loads.

**CIRCUIT RESPONSE**— Figure 1C shows response when high-speed square pulses are applied. The input signal is a 12-v negative-going pulse coming from a transistor switch with a collector resistor of 200 ohms. The output signal is de-

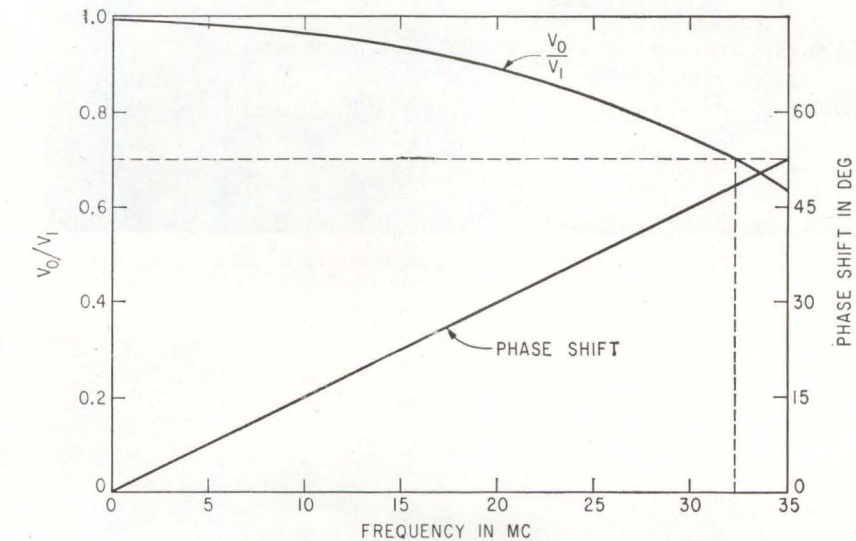

Phase-shift and gain characteristics vary with frequency—Fig. 2

layed from the input signal on the leading and trailing edge by 2 nsec and 5 nsec respectively. Loss in output is less than 2 percent.

Figure 2 shows the response for sine waves. The 3 db-point is at about 32 Mc; here phase shift is slightly over 45 degrees.

The circuit adds a d-c voltage to a signal without affecting the shape of the signal or delaying it. Smaller

maximum shifts than the +18 volts of the circuit of Fig. 1C can be obtained by reducing the zener voltage across  $R_o$ . The value of  $R_o$  can then be made smaller, along with the current from the constant current source and the supply voltages. Take opposite steps to achieve larger shifts.

The author thanks H. C. Wilck and E. B. Lutz for their assistance.

# Novel Digital Signal Generator

*Miniature permanent magnets are inserted in removable plastic boards to set up a desired program rapidly and economically for digital pattern generation*

By WAY DONG WOO, President, Cybetronics, Inc., Waltham, Mass.

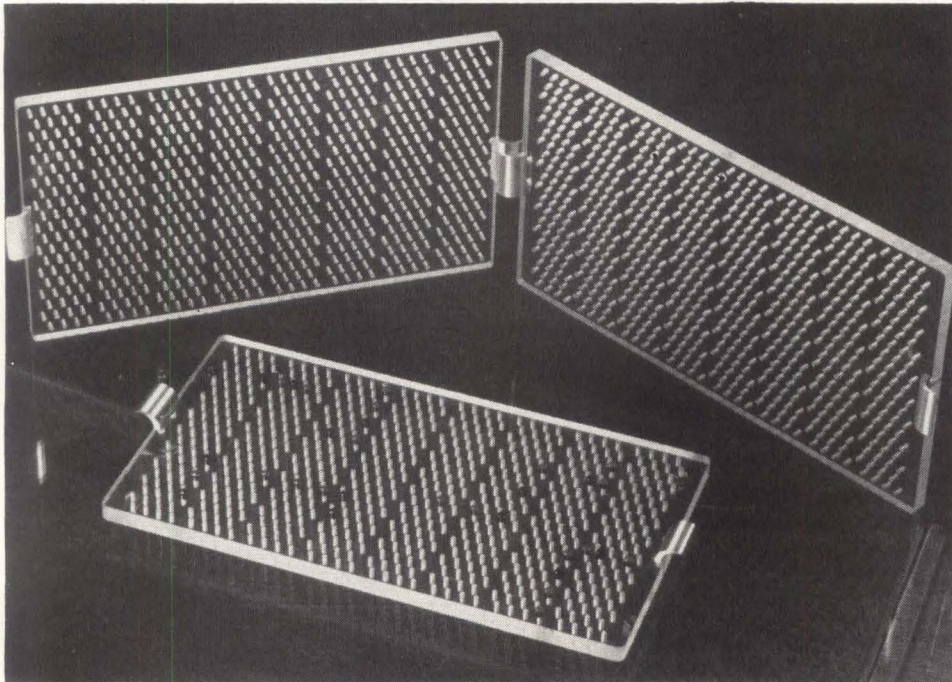

DIGITAL PATTERN generator uses plug-in magnets to set up program

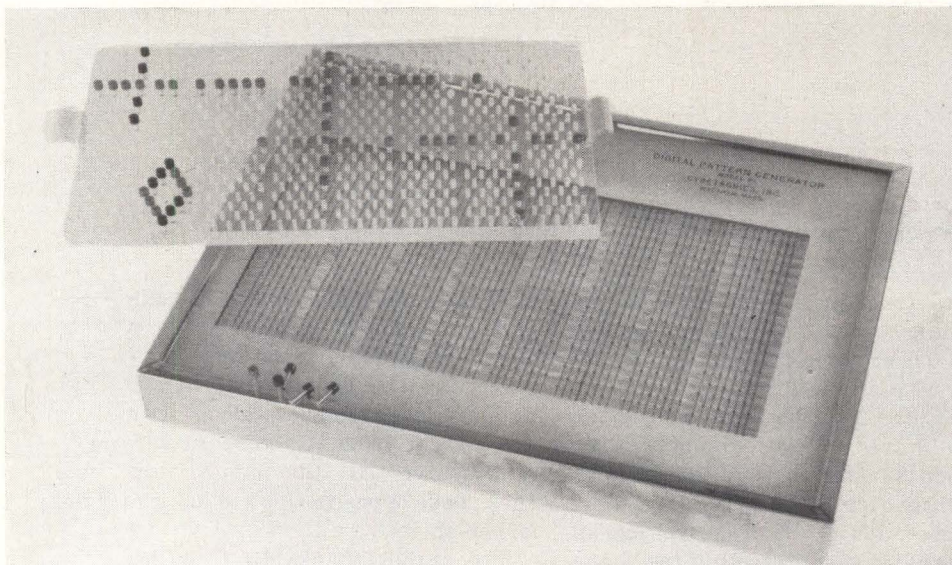

PLUG-IN BOARDS can be replaced as particular tests require

DURING development and testing of digital control devices and large-scale data processing systems, there is often a need for a set of programmed digital signals to simulate commands and responses from one unit to another. The need arises because of interaction among different parts of a system, and interaction of bit patterns as functions of time. In many cases a tester is built for fixed programs. During equipment tests, unforeseen problems requiring new sets of programs of pulses may occur and time is lost in modifying the tester to deliver such pulses.

This digital pattern generator (DPG) allows rapid change-overs from one program to another. The device produces on each of ten output lines a sequence of 64 bits, each of which is determined by the presence of a miniature permanent magnet. No switches are used to set up the program of pulses and the maximum operating speed is 300,000 steps per second.

**REQUIRED PROGRAM** — Digital pulses are stored in an array of small permanent magnets which are plugged into a pegboard of 64 by 10 holes. Under the pegboard is a 64 by 10 magnetic-core matrix in registration with the pegboard. The core matrix is operated as an 8 by 8 by 10 coincident current magnetic core memory, except that a single reset driver is used in place of digit drivers. The presence of a magnet above a core biases the memory core in a flux pattern as shown in Fig. 1A. Such a biased memory core is unable to switch to a clockwise or counterclockwise flux pattern as shown in Fig. 1B or 1C; therefore, no flux change will result when the core is driven by the X and Y or by the reset winding.

The plug-in magnets are Alnico cylindrical rods having a diameter of 0.125 in. and length of  $\frac{1}{2}$  in. The magnetic cores are conventional memory cores with full switching magnetizing force of approximately 400 milliampere-turns. The magnets can be as much as  $\frac{1}{8}$  in. away from



# Uses Magnetic-Core Pegboard

the memory cores and still reliably inhibit core switching. Magnetic field intensity required is estimated to be about ten oersteds.

When a core is not under the influence of the biasing magnet, a voltage results when full switching current is applied. The wave form of the induced voltage is as shown in the first cycle of Fig. 2. When the core is under the influence of the biasing magnet, little voltage is induced, and the wave form is as shown in the second cycle of Fig. 2. This is the basic phenomenon used in this device.

Figure 2 is a timing diagram of the operation of the DPG. The command pulse  $H_1$  causes the DPG to read out a word of 10 parallel bits;  $P_1$  is triggered by the leading edge of  $H_1$  and lasts for  $1.5 \mu\text{s}$  and  $P_2$  is initiated by the trailing edge of  $P_1$  and lasts for  $1.5 \mu\text{s}$ . During  $P_1$ , the  $X$  driver corresponding to the 3-low order address bits is turned on. The  $Y$  driver current is on normally except during  $P_2$ . Both  $X$  and  $Y$  driver currents are approximately 100 ma. Waveform (d) shows the sum of  $X$  and  $Y$  currents. Reset current  $I_R$ , approximately 200 ma, is turned on at  $P_2$  time. At  $P_1$  time, both  $X$  and  $Y$  driver currents are on, causing a core to switch to the zero state, and a large positive voltage is obtained about  $1.5 \mu\text{s}$  after the rise of  $P_1$ . When  $P_1$  goes off and  $P_2$  goes on, the core resets, giving a large negative voltage. The sense winding output is amplified and sampled by strobing pulse  $g$ . During the digit cycle after the first  $H_1$ , it is assumed that the memory core corresponding to the  $X$ - $Y$  address has no magnet above. A positive voltage is induced in the sense winding. It reaches its positive peak about  $1.5 \mu\text{s}$  after  $X$  and  $Y$  drivers are both on. A strobing pulse, derived from  $P_1$ , samples the output of the sense amplifier. The output flip-flop register is caused to go to 0 state if there is a positive voltage during strobe time. In the cycle after the second  $H_1$  pulse, it is assumed that there is a magnet above the core corresponding to the  $X$ - $Y$  address. The magnet inhibits

switching of this core so that practically no voltage is induced in the sense winding. The absence of a positive voltage at stroke time causes the output flip-flop register to go into zero state.

The logical block diagram is shown in Fig. 3. Selection of a core in the 8 by 8 by 10 coincident current magnetic core memory is done by coincidence driving of  $X$  and  $Y$  currents. There are eight  $X$  and eight  $Y$  drivers and a reset driver which threads through all 640 cores. The  $X$  drivers are selected by the three lower order bits of the address counter and the eight  $Y$  drivers are selected by the three higher order bits of the address counter. An  $X$  winding, a  $Y$  winding, and a reset winding are threaded through a column of 10 cores. A sense winding is threaded through each row of 64 cores and is connected to a sense amplifier and detector combination. The output of the detector is strobed and the output FF is set or reset according to whether a sense amplifier output signal was present or not.

The six stages of binary counters are driven by the clock circuit which may be triggered from an external source or from an internal variable frequency multivibrator. The counter, in combination with the  $X$  and  $Y$  driver circuits, energizes an  $X$  and a  $Y$  winding. One column of the core matrix will have coincidence of  $X$  and  $Y$  currents, causing the cores in this column to switch to a state of 0. The pattern of windings is such that the fully driven column advances to the right with every advance in the counter. When there is

a magnet above the core, no output will be produced in the sense winding, and the output FF will be set to  $-5$  v. When no magnet is above the core, the corresponding output line will be set to ground level.

**TIMING**—Figure 2 shows the timing of the device. Trigger pulse  $H$  for each digit cycle can be triggered externally, or internally from a variable frequency multivibrator. Prior to  $H$ , the particular  $Y$  driver, as determined by the three high order bits of the address counter, has already been on. Pulse  $H$  now turns on the  $X$  driver as determined by the three low order bits of the address counter. Where the addressed core is not biased by a magnet, a large pulse will be produced, as shown in the first digit cycle. If there is a magnet above, there will be a small pulse, as shown in the second digit cycle. The sense amplifier output is strobed by a narrow pulse and the output register will assume its final level about  $1.5 \mu\text{s}$  after the initial trigger pulse.

When the strobe pulse is over,  $X$  and  $Y$  drivers are turned off, and the reset driver is turned on for about  $1 \mu\text{s}$ . When that is over, a  $Y$  driver is turned on and the generator is ready for the next cycle.

The 640 cores are arranged in 10 rows of 64 cores, with the rows zig-zagged to achieve compactness. The dimension of the core matrix plane is  $8 \times 14$  inches. The first  $X$  winding passes through columns 1, 9, 17, 25, and so forth. The first  $Y$  windings pass through columns 1, 2, 3, 4, 5, 6, 7, 8, and the second  $Y$  windings pass through columns 9, 10, 11, 12, 13, 14, 15, 16, and so forth. The reset windings pass through all the cores. Each winding threads through a core twice to conserve driving current. Each sense winding threads through a row of the offset matrix twice to obtain a high output.

The cores rest in the grooves of a matrix board, and are protected by a thin layer of clear vinyl. The pegboard rests above the core matrix. Magnets are prevented from dam-

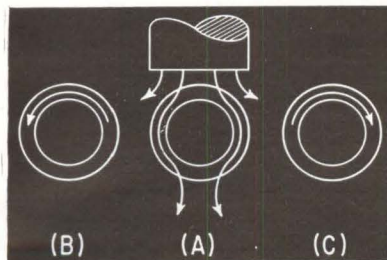

FLUX PATTERN in magnetically biased core—Fig. 1

aging the cores by the sheet vinyl and the edges of the groove of the core matrix board.

**SETTING A PROGRAM** — The miniature magnets are inserted into the proper holes in the pegboard. The program can be charged by relocating specific magnets, facilitating alteration of any portion of a program without having to start from the beginning.

For specific programs the miniature magnets can be easily arranged with prepunched perforated cards as overlays on the pegboard. The magnets are inserted through the holes in the card. For frequently used programs, it is not necessary to reset the magnets every time. The entire pegboard, with the magnets arranged in the desired pattern, can be removed and stored for later applications. Another pegboard can be placed in position in a few seconds and the unit is ready for generation of the new program of pulses.

The *X* and *Y* current driving circuits are shown in Fig. 4A. Each driver consists of a pulse driver and eight steering drivers. The pulse driver causes a current of fast rise and fall time to flow through whichever steering driver that has been activated by the outputs of the address counter. The current pulses are nominally 100 ma for the *X* and *Y* driver, and 225 ma for the reset drivers. Since there are two turns in each driver winding, the half select magnetizing force is 200 ma-t and the reset magnetizing force is 450 ma-t.

Figure 4B shows the schematic diagram of the sense amplifier. The input to the sense amplifier is nominally 100 mv. It is amplified and clipped before it is gated with the strobing pulse in the output register flip-flop.

In the repeat mode of operation, the tenth output line is used to operate a 3-stage binary counter (*UVW* of Fig. 3) which inhibits the carry from *ABC* counter to *DEF* counter until *UVW* has reached a count of eight. By this arrangement, the three lower order bits will repeat a number of times as specified by the tenth output line, which is internally controlled by the plug-in configuration. The allowable number of repetitions are 1, 2, 3, 4, 8, or indefinitely until the

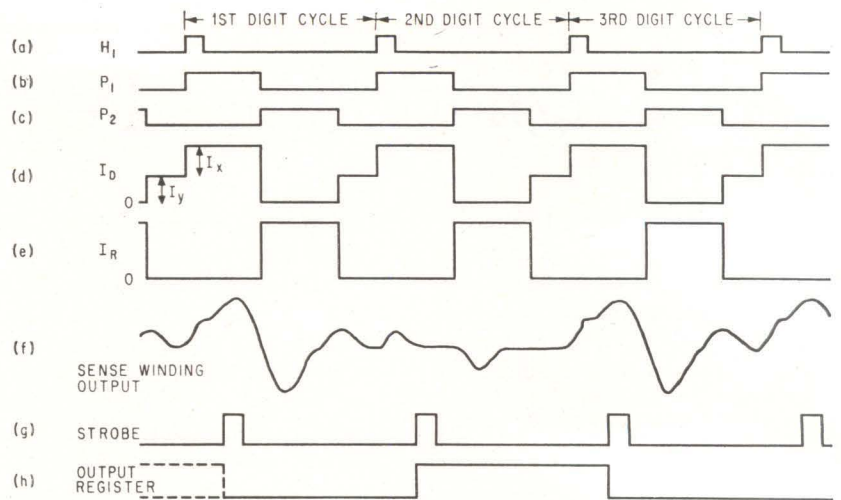

TIMING of digital pattern generator—Fig. 2

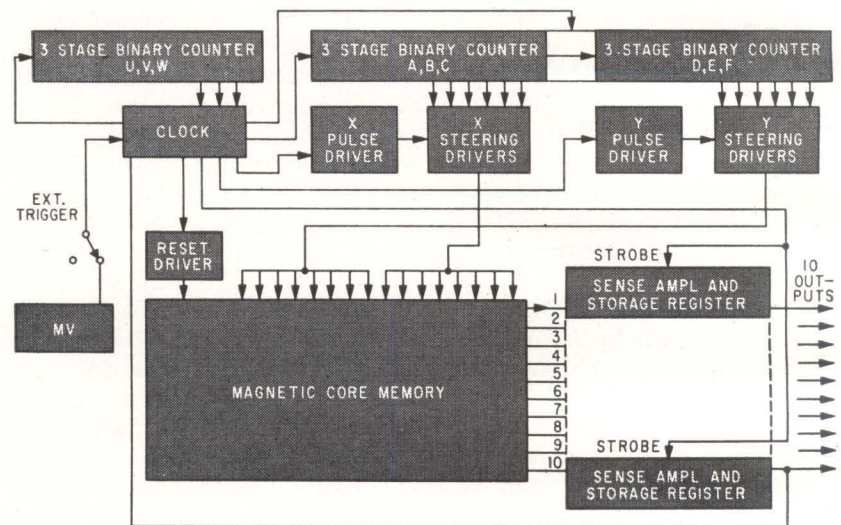

LOGICAL BLOCKS of digital pattern generator—Fig. 3

plug-in is changed. One can obtain a much longer sequence of digital pulses than the 64 columns provided.

For one shot, single-frame operation, a single frame is read out when the start button is pushed. The output levels will remain until the start button is pushed again, when the next frame will be read out.

In the one-shot, complete cycle, all sixty-four frames will be read at the rate of the internal multivibrator; readout stops after the last frame. If the board is set for repeat operation, the cycle will include such repetition and stops after the last repetition of the last step.

By using one of the output levels, it is possible to stop at any arbitrary frame, and then re-

start again from the first frame.

#### DUO-FREQUENCY OPERATION

—One of the output lines can be used to control the selection of either internal multivibrator. This will allow two speeds of the programmed pulses.

The DPG can also be operated as a storage device for constant data. By sending a 6-bit address to the *X* and *Y* selection circuits the column of cores as specified by the address will be read out into the output register, where the data will remain until a new address and demand signal is received. The maximum rate of reference is 300,000 times a second. This mode of operation is accomplished by setting the address counter to assume the state prescribed by the input address. In the



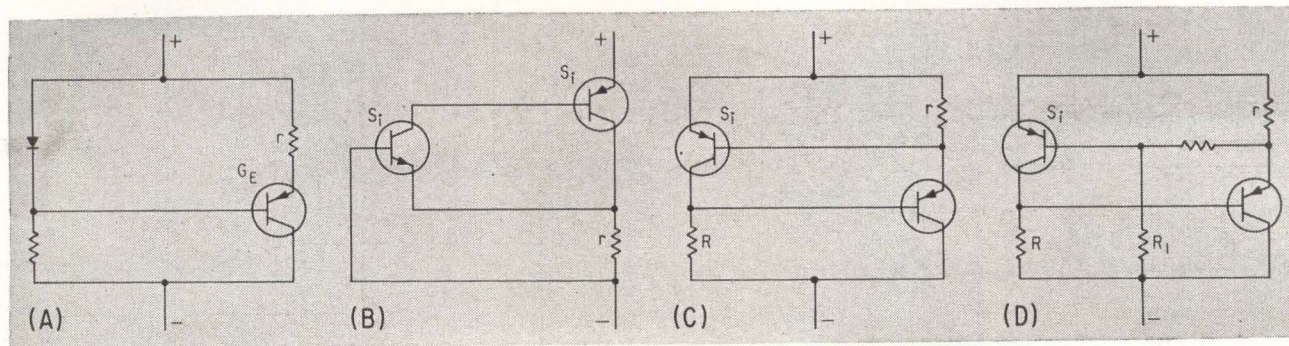

CIRCUIT OPERATES over narrow voltage range (A); ideal circuit using complementary transistors is impracticable (B); adaption of ideal circuits uses pnp transistors (C) and improved version has cancellation components added (D)  
—Fig. 1

## Two Transistors Equal One

*Performance of the two-terminal device is analogous to a zener diode except it anchors current not voltage; provides constant current over 5 to 25-volt range*

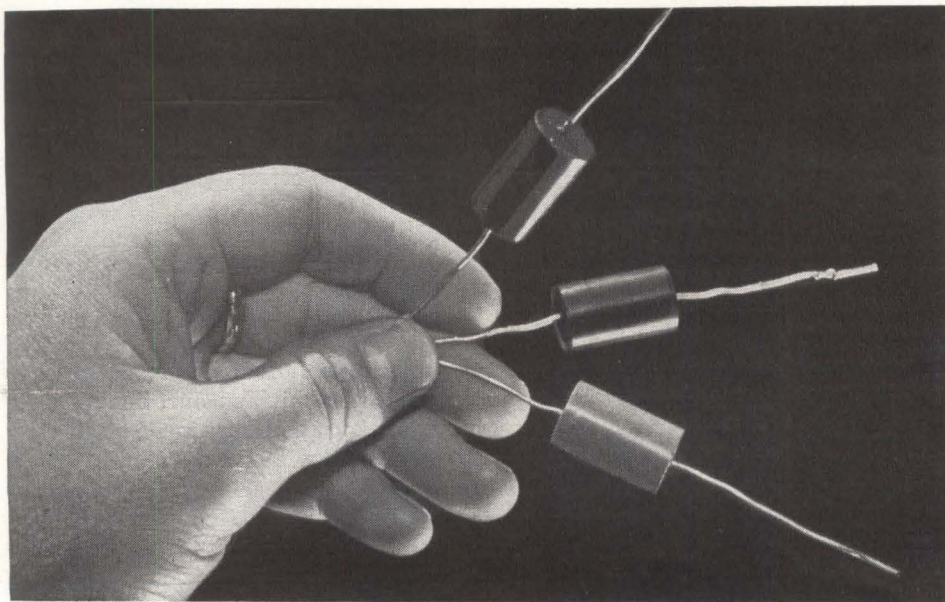

TWO-TERMINAL units contain pair of transistors wired to give constant-current characteristics over 5:1 voltage range

THIS SIMPLE, INEXPENSIVE circuit has only two external connections and yields a constant-current characteristic over a range from 5 to 25 volts. It may be used in applications requiring a constant-current drive that cannot be obtained by a resistor. The device may be considered as a circuit element, and

as an alternative to the constant-current diode<sup>1</sup>, which although developed, has not as yet appeared on the market.

The circuit is temperature sensitive; however, this is not important for most applications, and there are several methods of reducing this sensitivity.

A useful equivalent to the constant-current diode must be simple and cheap and occupy minimum space. The constant-current-diode equivalent circuit meets these requirements.

To facilitate the discussion of constant-current devices, it is convenient to define a figure of merit  $F$  that relates increments of applied voltage to changes in current.

Such a figure of merit is arbitrarily defined as

$$F = \frac{I}{V} \times \frac{\Delta V}{\Delta I}$$

where  $V$  is the applied voltage,  $I$  is the standing current at the applied voltage,  $\Delta V$  is a small change in the standing voltage and  $\Delta I$  is the change in current produced by  $\Delta V$ . Thus a perfect constant-current element would have a figure of merit of infinity, while the figure for a resistor would be unity.

A germanium transistor with its base returned to emitter through a resistor is a rough approximation to a constant-current element if the variable voltage is applied between its collector and emitter. The stability of such a circuit with temperature is poor. However, if the base of the transistor is fed from

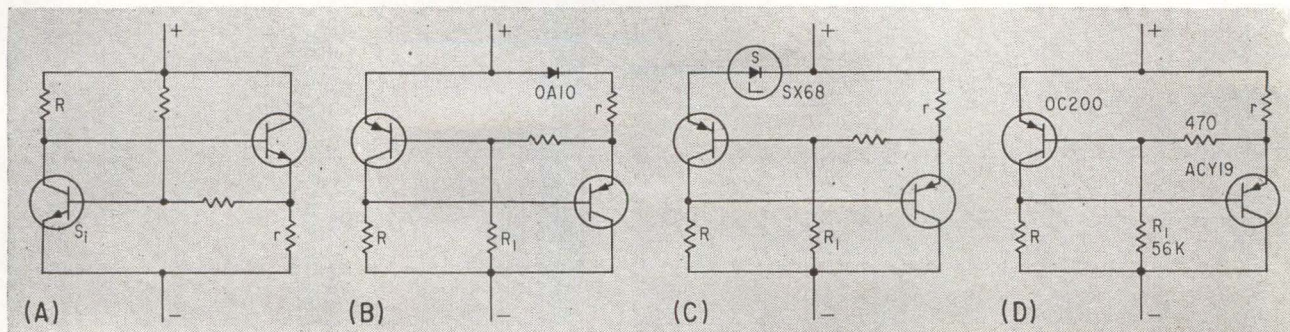

UNIT WITH NPN TRANSISTORS is expensive (A); diode is introduced to reduce current variation with temperature (B); zener reduces current variation to 0.005 percent per degree (C). Final circuit (D) has values of  $r$  at 470, 220 and 91 ohms for currents 1, 2, and 5 ma, respectively with  $R$  at 47,000 ohms up to 2 ma and 33,000 ohms for 5 ma.—Fig. 2

# Constant-Current Diode

By G. WATSON

English Electric Aviation Ltd.,  
Stevenage, England

a constant voltage, and an emitter resistor is added, then there is a considerable improvement in current stability with temperature. Practical methods of providing the constant voltage result in a resistance appearing across the element's terminals, Fig. 1A. This sets a limit to the figure of merit  $F$  obtainable, and with normal transistors,  $F$  would be about seven. No simple method of cancelling the remaining current variation with voltage is possible with this circuit.

The final circuit has an additional stage, in which the  $V_{be}$  requirement of a silicon amplifier transistor is compared with the voltage dropped across a resistor inserted in series with the first transistor. The voltage dropped across this resistor is a measure of the first transistor's current. With correct polarity, the circuit forms a negative-feedback loop tending to hold the first transistor's current constant. As this current constitutes almost all of the unit's current, an almost perfect constant-current element would be formed. Fig. 1B shows a complementary pair of transistors which would indeed function perfectly if the level of the  $V_{be}$  voltage were correct. Fig. 1C is an adaptation of Fig. 1B using all *pn*p types, and here the level of the  $V_{be}$  is correct. However, drive current must be supplied to the collector of the amplifier through a resistor  $R$ . Therefore, a practical limit to the

figure of merit  $F$  is found. Cancellation of the remaining current variation is now possible as there is a phase-inverting stage. This cancellation is effected by a series resistance in the base circuit of the amplifier. A current that varies with applied voltage is now provided by  $R_1$ . It is possible to achieve a figure of merit of infinity at any spot voltage, although this will not hold exactly for other voltages.

A figure of merit that never falls below fifty over a wide range of voltages is attainable. The complete circuit including the cancellation components is shown in Fig. 1D. An all *n*pn version of the circuit is shown in Fig. 2A although this is less useful, owing to the relatively high cost of *n*pn transistors.

## TEMPERATURE EFFECTS—

The  $V_{be}$  voltage requirement of the amplifier transistor is compared with the voltage dropped across the other transistor's emitter load resistor. To a first order this voltage is a measure of the total current drawn by the unit, so that temperature induced  $V_{be}$  variations will show up as variations of current. To minimize the temperature coefficient of current, it is necessary to use a silicon type for the amplifier transistor, as these transistors have a higher

ratio of  $V_{be}$  drop to  $V_{be}$  variation with temperature, than germanium.

With a typical silicon transistor, the  $V_{be}$  drop at room temperature in this circuit is about 500 millivolts. This gives a variation of current with temperature of about  $-2.5 \times 10^{-3} \times 100/500 \times 10^{-3}$  percent = -0.5 percent per degree C.

Such a variation is not considered to be excessive because in most applications a circuit's d-c standing current is chosen arbitrarily, and may usually be allowed to vary slowly within relatively wide limits. Similar current variations are to be expected from a constant-current diode.

If the temperature coefficient of current of about -0.5 percent per degree C is intolerable, it is possible to effect some improvement by including a diode in the amplifier circuit. In Fig. 2B the diode has been included in the emitter circuit of the final transistor. About 0.25 volt will be dropped across an OA10 type of diode, and this voltage will have a negative temperature coefficient opposing the  $V_{be}$  voltage variation of the amplifier transistor. This method does not produce complete cancellation of temperature coefficient however. If a much higher minimum operating voltage for the whole unit

**FREE REPRINT**

Single copy of this article available free by simply checking the READER SERVICE CARD

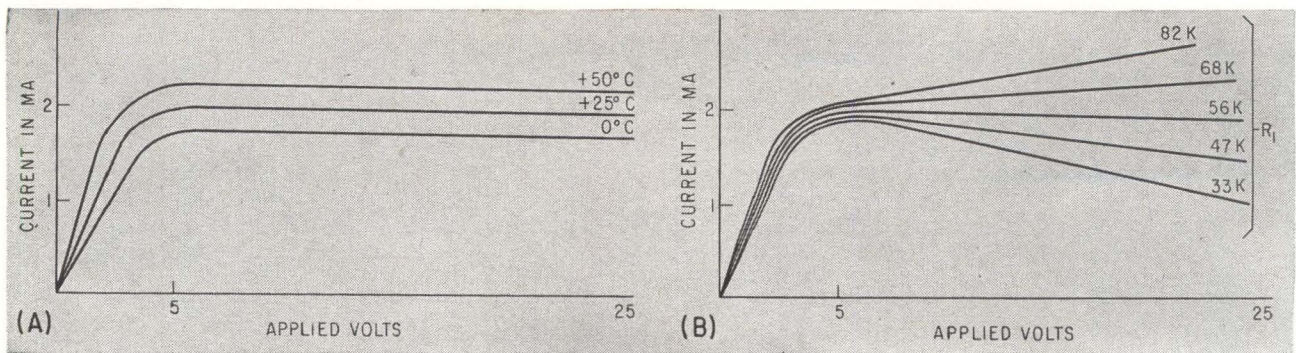

VOLTAGE VERSUS CURRENT characteristic of circuit for 2 ma (A); variation of cancellation resistance  $R_1$  gives positive or negative characteristic (B)—Fig. 3

can be tolerated, then almost complete cancellation of temperature coefficient is possible by including a zener diode with positive coefficient in series with the amplifier's emitter. A circuit incorporating the SX68 zener is shown in Fig. 2C. By selecting either the amplifier transistor or the SX68 zener diode, it is possible to achieve 0.005 percent per degree C variation of current for a 50 degree C temperature variation. A minimum of 10 volts is necessary for this circuit to operate.

Practical considerations limit the choice of transistor for the amplifier stage to a silicon type, and for extreme cheapness the *pn*p version of the circuit is used. Common emitter gain is not of primary importance, neither is voltage rating, so that the transistor can be chosen on a cost basis only.

#### IMPROVING PERFORMANCE—

If a good figure of merit is to be retained down to low voltages, a high-gain transistor is required in the output stage. The primary advantage of using a high-gain transistor is that the base feed resistance to this stage may be made higher. This means that less cancellation is required, and irregularities in the cancellation at differing voltages have less effect. A silicon type could be used, but it would make the cancellation a little less effective. A practical choice for this stage is the ACY19, since these transistors have a reasonable voltage rating combined with a high gain. They are also cheap.

If this circuit is to replace the constant-current diode, then a range of current ratings is necessary.

The basic circuit shown in Fig. 2D is adaptable to a range of current ratings from 1.0 ma to 5.0 ma. For other current ratings a redesign is required, although if a lower figure of merit can be tolerated, the present circuit may be extended both up and down in current. The most popular current ratings would seem to be 1.0 ma, 2.0 ma and 5.0 ma, and the units were designed for these values. The circuit could probably be adapted to include current ratings down to at least 0.1 ma by using planar transistors, which hold their gain figure down to low currents. In the other direction, using high-gain medium-power silicon transistors in the output stage could extend the range of current ratings up to at least 20 ma.

The minimum voltage for satisfactory operation is about five volts. Operation down to three volts is permissible if the lower figure of merit obtained is tolerable. Extra cancellation may be used however, and a good figure of merit over a voltage range from say three to eight volts is then possible. The maximum voltage that the unit will stand is determined by the output transistor alone. For the ACY19 transistor a provisional maximum voltage of 25 v is suggested: this allows a good safety factor, as the ACY19 is rated at 40 v for low collector currents.

Prototype circuits have been constructed as potted cylinders 1.3 cm diameter by 2.6 long. This construction incorporates miniature high-stability resistors and is shown in the illustration.

Figure 3A shows a typical voltage versus current characteristic for

the 2 ma circuit at various temperatures. This unit has been adjusted to give the flattest response over a voltage range of from 5 to 25 v. A similar curve is obtained for other units. The h-f characteristic is such that the unit appears as a capacitance of about 120 pf in parallel with its d-c impedance. (For an applied d-c potential of 6 volts only; the capacitance is mainly due to Miller effect acting upon the collector-to-base depletion layer capacitance.) There seems to be little requirement for h-f performance in excess of that provided by the unit. If a better h-f performance is required, an h-f type transistor should effect considerable improvement.

The value of current obtained from any unit over the stated voltage range is always within  $\pm 25$  percent of its nominal value at temperatures from 0 C to +50 C. Operation at temperatures above +50 C is not advised because leakage current in the output transistor becomes excessive and this makes the amplifier draw more current. The cancellation is found to become ineffective under these conditions. If high-temperature operation is specifically required then a high-gain silicon type must be used in the output stage.

Figure 3B shows the effect of varying  $R_1$ . It shows that the characteristic can be adjusted to give a range of slopes from positive to negative.

#### REFERENCE

- 1) T. K. Hemingway, Applications of the Constant Current Diode, *ELECTRONICS*, p 60, Oct. 20, 1961.

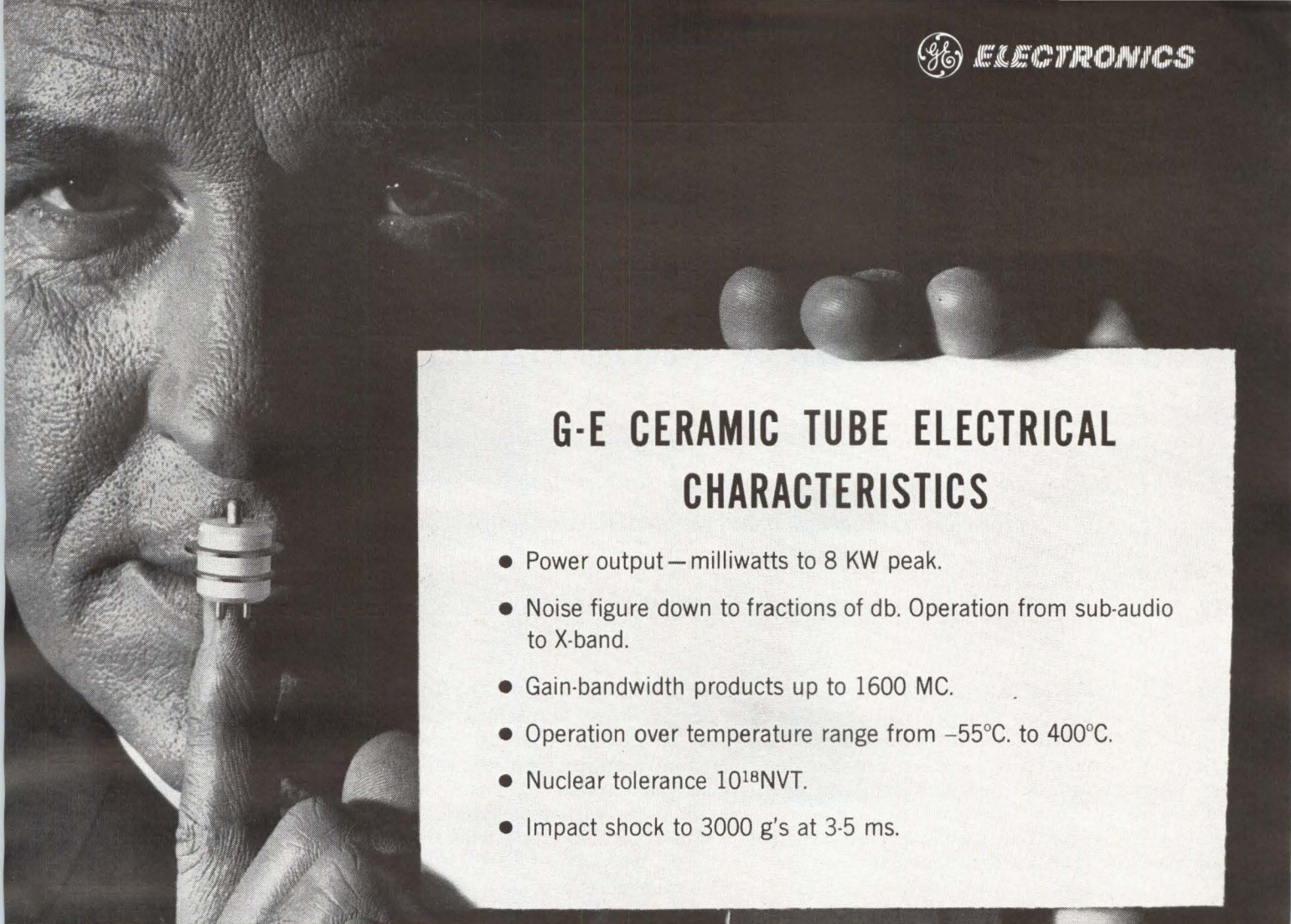

## G-E CERAMIC TUBE ELECTRICAL CHARACTERISTICS

- Power output — milliwatts to 8 KW peak.
- Noise figure down to fractions of db. Operation from sub-audio to X-band.
- Gain-bandwidth products up to 1600 MC.
- Operation over temperature range from -55°C. to 400°C.
- Nuclear tolerance 10<sup>18</sup>NVT.
- Impact shock to 3000 g's at 3-5 ms.

New General Electric ceramic tubes give high-gain, low-noise microwave performance for as low as  $\frac{1}{94}$  the price and  $\frac{1}{40}$  the size

**Detailed value-analysis chart shows how size, cost and performance advantages can be yours. Clip coupon, or circle reader service number, for free copy.**

No other microwave device can match the electrical performance of G-E ceramic tubes without sacrificing either small size, low cost, high-temperature tolerance, or radiation resistance. In many UHF applications up to 10 Gc (KMC), General Electric ceramic tubes can perform functions which now use TWT's, klystrons, magnetrons or parametric amplifiers. The result: component size-and-weight reductions up to 40:1, component cost reductions as high as \$1,400.

**High-gain, low-noise G-E ceramic tubes** simplify circuitry and lower power requirements in such microwave applications as: power amplifiers, oscillators, or frequency multipliers. Planar construction of ceramic tubes, with the terminals as integral parts of the structure, results in low lead inductance, low interelectrode capacitances and good isolation between input and output circuits. Solid brazing of the integral parts gives an extremely tight tube struc-

ture and virtually eliminates tube element vibration. This also results in excellent thermal coupling which allows unsurpassed tube-performance at temperatures as high as 400°C. Most G-E ceramic tubes are on approved MIL-spec lists and are available "off-the-shelf" from your local G-E Receiving Tube Sales Representative. For more information, clip coupon below.

*Progress Is Our Most Important Product*

**GENERAL  ELECTRIC**

**G-E TIPS (Technical Information & Product Service)  
General Electric Receiving Tube Department  
Room 1731A, Owensboro, Ky.**

Please rush my free copy of "Ceramic Tube Value-Analysis Data."

Name..... Title.....  
Company.....  
Address.....  
City..... Zone..... State.....

**CERAMIC  
TUBE  
VALUE  
ANALYSIS  
DATA**

# New Design Method Optimizes Gain-Bandwidth

*When power gain-bandwidth product is a prime consideration, this method for determining double tuned circuit parameters assures optimized design*

By ALLEN I. SINSKY and HARVEY M. MAYROVITZ The Bendix Corp., Baltimore, Md.

POWER GAIN-BANDWIDTH is optimized by proper choice of double-tuned circuit parameters. A method is described here for determining these parameters and also the comparative improvement that a double-tuned circuit provides over a single-tuned circuit.

In designing r-f power amplifiers it is often necessary to couple the output of a tetrode or pentode stage to a resistive load

such that the power into the load remains above a specified level over a given frequency band. Maximum attainable power gain-bandwidth product should be realized for each tube type.

For a tetrode or pentode amplifier, when the screen and suppressor grids provide good isolation between the input and output circuits, the output current can be considered as proportional to the input voltage

only. For a given input voltage (constituting a given input power), the output power, and consequently the power gain ( $P_{out}/P_{in}$ ), is a function of the plate load impedance. However, owing to the shunt output capacitance of the tube, the power gain is sensitive to frequency; a four-terminal network inserted between the output terminals of an amplifier tube and a frequency insensitive resistive load ( $R_L$ ) optimizes power gain-bandwidth.

**POWER GAIN-BANDWIDTH**—Power gain-bandwidth is defined as the product of the mid-band power gain and the bandwidth at some prescribed power level below that at midband. In optimization of this parameter, it should be realized that more complex networks (Fig. 1C and Fig. 1D) have better frequency rejection characteristics than the double tuned circuit, but frequency rejection is not the prime consideration in this analysis.

The power gain-bandwidths of the single, double, triple and quadruple isochronously tuned, transitionally coupled circuits of Fig. 1 were determined assuming an infinite Q for all but the output loops. This is a valid approximation if the Q's of the

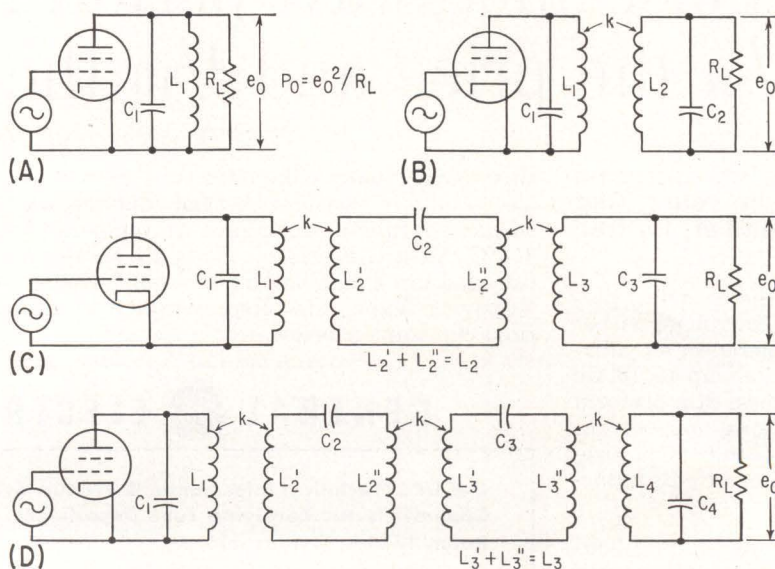

ISOCHRONOUSLY TUNED coupled circuits: single tuned (A); double tuned (B); triple tuned (C); and quadruple tuned (D)—Fig. 1



# small, medium or

# LARGE ?

Our smallest antenna positioner is a 200 foot-pound model. Our largest, the 350,000 foot-pound unit shown here. Within this range Scientific-Atlanta can supply you positioners that will fit your specific application—large or small, simple or complex, manually driven or servo controlled.

Scientific-Atlanta's precision positioner line includes 12 sizes and types of azimuth positioners, 5 elevation mounts, 7 polarization mounts, and 16 types of multi-axis positioners. If none of our standard positioners satisfies your needs, we can design and assemble special units at economical prices because of our modular style.



#### NEW DATA FILE TELLS THE FULL STORY

An 18 page illustrated data file with complete information on Scientific-Atlanta positioners is yours for the asking. This new data file also contains a discussion of the terms used to specify and describe positioners. Please address Scientific-Atlanta, Inc., 2162 Piedmont Road, N.E., Atlanta 9, Georgia, phone: 875-7291.

Scientific-Atlanta's Model PAEA 85 precision antenna positioner. This positioner can withstand a bending moment of 350,000 foot-pounds and a maximum vertical load of 40,000 pounds—yet it has an elevation position accuracy of  $\pm 0.03$  degree and an azimuth accuracy of  $\pm 0.02$  degree.

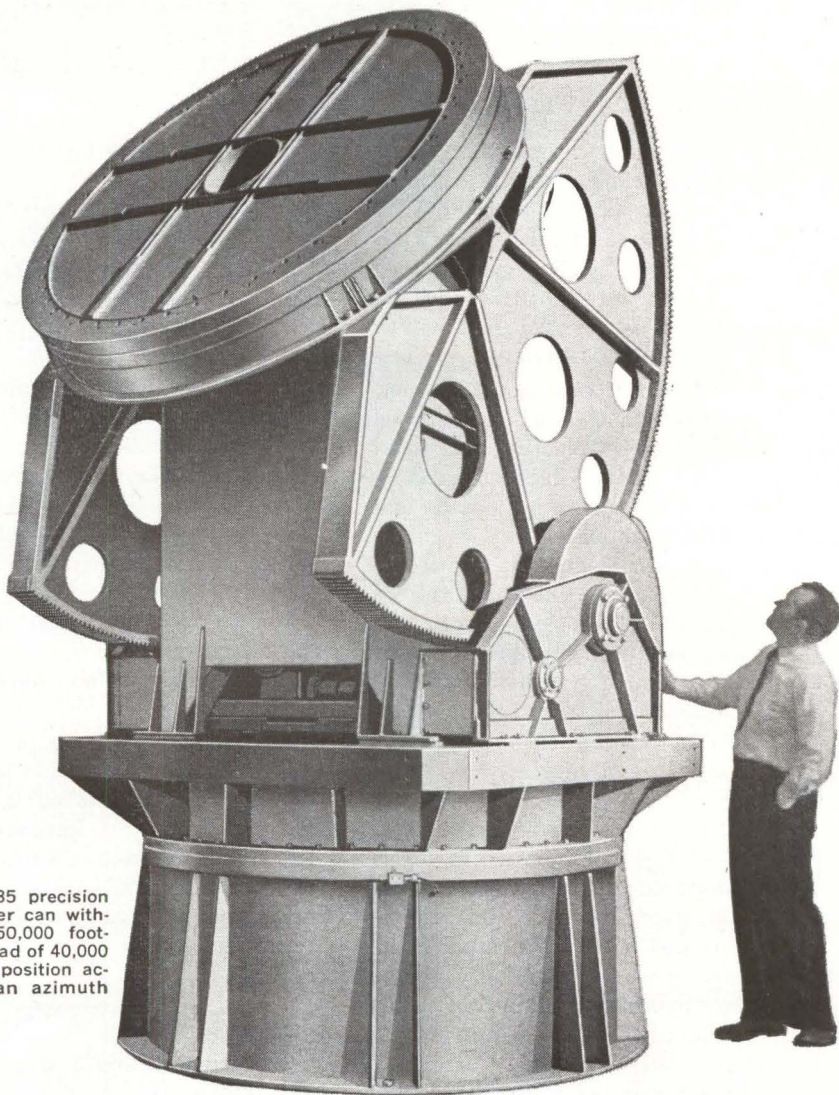

## SCIENTIFIC-ATLANTA, INC.

See Us At WESCON,  
Booth #2039 - 2040

Challenging opportunities for mechanical and electronic engineers with five to ten years' design experience. Please send complete resume to Personnel Manager. An equal opportunity employer.

17

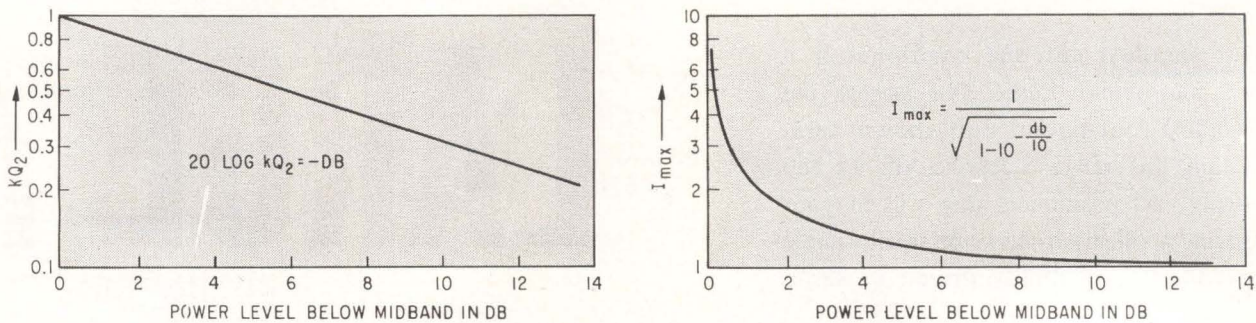

OPTIMUM  $kQ_2$  (to left) and maximum power gain-bandwidth improvement of double tuned circuit over single tuned circuit (right) for various values of  $db$ —Fig. 2

primary and intermediate loops can be made as large as desired while the loaded  $Q$  of the output loop remains small in comparison.

It was found that the improvement in power gain-bandwidth of the transitionally double-tuned circuit was  $\sqrt{2}$  times better than that of a single tuned circuit and that the additional improvement with the more complex networks was small and rapidly approaching a finite limit. Considering the additional losses (that is, intermediate  $Q$ 's not infinite), increased cost, and inherent tuning problems in the more complex networks it becomes evident that the most desirable configuration is the double-tuned circuit.

**POWER LEVEL**—Frequently, it is the bandwidth at levels other than the half power points that are of interest. It is, therefore, desirable to formulate the conditions necessary to achieve the maximum gain-bandwidth product when the bandwidth is measured to some arbitrary power level below that at center frequency.

The improvement factor ( $I$ ), which is the improvement in power gain-bandwidth of a double-tuned circuit over a single-tuned circuit, has been de-

rived and is given by:

$$I = \frac{[2(kQ_2)^2 - 1 + \sqrt{1 - 4(kQ_2)^2 + 4(kQ_2)^4 10^{db/10}}]^{1/2}}{(kQ_2)^2 \sqrt{2(10^{db/10} - 1)}} \quad (1)$$

Where  $k$  is the coefficient of coupling,  $Q_2$  is the loaded secondary  $Q$  (refer to Fig. 1B), and  $db$  is the power in decibels below midband power corresponding to the level at which the improvement is determined. Equation 1 reveals that, for any value of  $db$ , the improvement ( $I$ ) depends only upon the product of  $kQ_2$  rather than upon their individual values.

For a particular value of  $db$  there is a value of  $kQ_2$  that maximizes  $I$ . This value, found by differentiation, is

$$kQ_2 = 10^{-db/20} \quad (2)$$

Substituting the value of  $kQ_2$  from eq. 2 back into eq. 1 gives the maximum improvement ( $I_{max}$ ) of the double-tuned circuit over the single-tuned circuit for a particular value of  $db$ . This value of  $I_{max}$  is

$$I_{max} = \frac{1}{\sqrt{1 - 10^{-db/10}}} \quad (3)$$

Equations 2 and 3 are plotted in Fig. 2 so that it is possible to find the maximum attainable improvement over the single tuned circuit as well as the value of  $kQ_2$  to achieve this improvement. The value of  $k$  is found to be equal to the percentage band-

width for maximum power gain bandwidth improvement so that  $Q_2$  and  $k$  can be uniquely determined.

An example of the use of this analysis is given in a problem. It is desired to build an r-f tetrode power amplifier stage such that the power output remains greater than 4  $db$  below the center frequency power output 5 Mc either side of the band center. The band center frequency is 100 Mc. Maximum power gain-bandwidth is desired.

The values of  $k$  and  $Q_2$  are found and the power gain-bandwidth is determined. Step I: The value of  $k$  is equal to the percentage bandwidth,  $k = \Delta f/f_0 = 10\text{Mc}/100\text{Mc} = 0.1$ . Step II: The value of  $kQ_2$  corresponding to 4  $db$  is found from Fig. 2 to be 0.63. Step III: Solving for  $Q_2$ , knowing  $k$  and  $kQ_2$ ,  $Q_2 = 6.3$ .

The power gain bandwidth improvement is found from Fig. 2 to be 1.29 times better than that of a single-tuned circuit.

**SUMMARY**—This analysis provides a method for choosing double-tuned circuit parameters when power gain-bandwidth product is the prime design consideration. The curves of Fig. 2 allow the designer to establish quickly the values of these parameters for his application.

CIRCLE 57 ON READER SERVICE CARD →



Take an engineer's critical look at



## MERCURY-WETTED CONTACT RELAYS

☆☆☆ by **P&B** ☆☆☆

Your product demands a *superior* relay? Can't tolerate contact bounce, welding or pitting? Must have billions of operations? Need fast switching . . . complete stability and reliability? Our JM Series mercury-wetted contact relays meet all these requirements. No other type relay gives you the combination of all these features:

**LONG LIFE** BILLIONS OF OPERATIONS

 **NO BOUNCE**

**HIGH** (100 cps) **SPEED**

**SUPERIOR RELIABILITY**

☆☆☆☆☆☆

### ENGINEERING SPECIFICATIONS

**Speed:** SPDT Operate: 3 milliseconds (approx.) at 2 watts. Release: 3.2 milliseconds (approx.).

**Contact Rating:** 5 amperes maximum, 500 volt maximum, 250 volt-amp max. (with required contact protection).

**Contact Configuration:** Each capsule SPDT., combination of capsules in one enclosure can form DPDT, 3PDT, 4PDT. (All Form D.)

**Terminals:** Octal type plugs, 8 and 11-pin; Solder lugs; 14 or 20-pin miniature; AN connectors.

**Coil Resistance:** 2 to 58,000 ohms.

**FREE CATALOG**  
WRITE TODAY



JM Relays are now available at your local electronic parts distributor.



**POTTER & BRUMFIELD**

DIVISION OF AMERICAN MACHINE & FOUNDRY COMPANY • PRINCETON, INDIANA  
IN CANADA: POTTER & BRUMFIELD, DIVISION OF AMF CANADA LIMITED, GUELPH, ONTARIO

**BOURNS TRIMPOT<sup>®</sup>  
POTENTIOMETERS**

---

**THE ENCYCLOPEDIA ANSWER  
TO PROBLEMS IN**

**HUMIDITY**

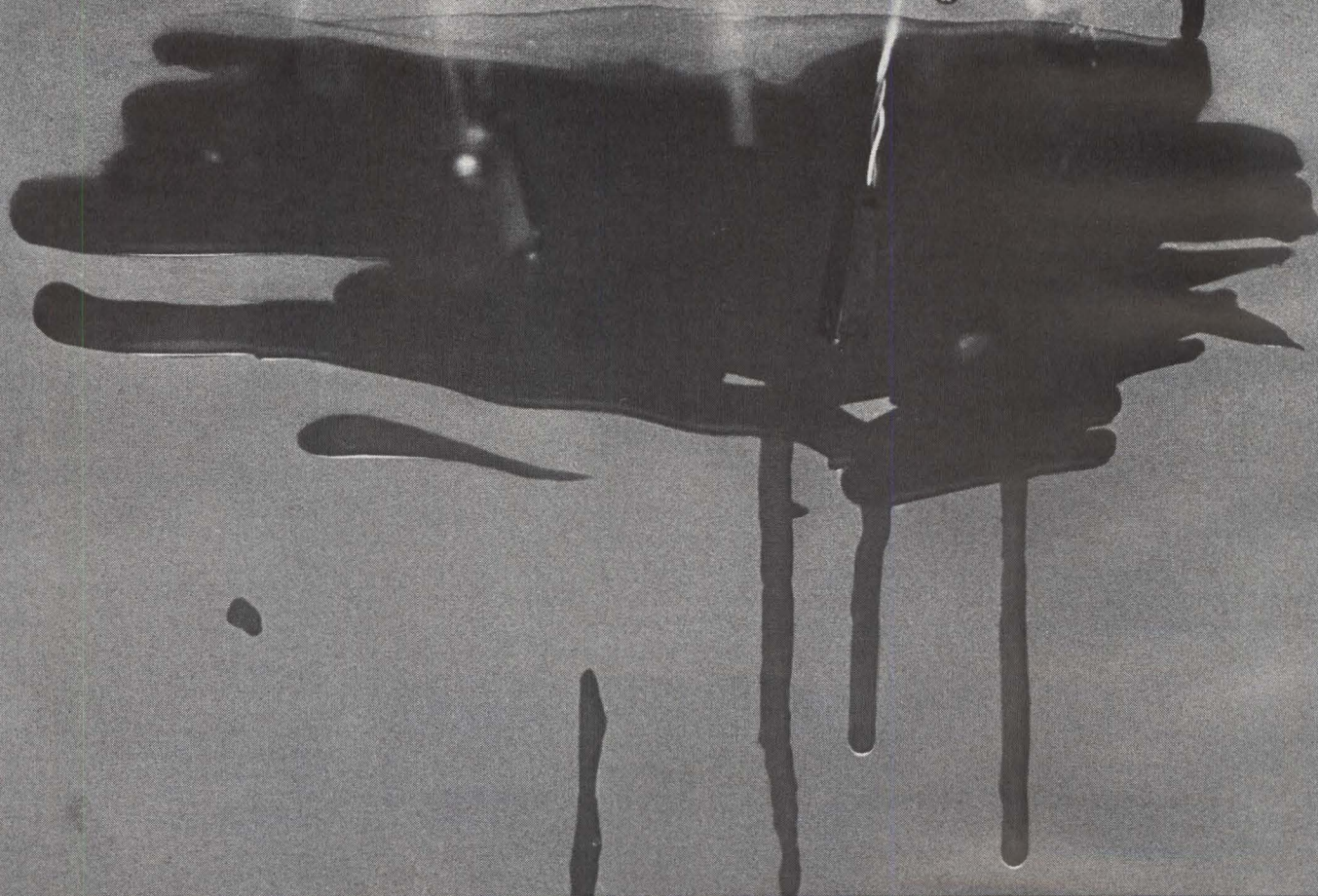

Bourns Trimpot potentiometers offer you 16 proven answers to both the environmental and the semantic problems of humidity. This is by far the nation's largest off-the-shelf assortment.

Trimpot humidity models are divided into two categories: units that meet military cycling humidity specs and units that meet military steady-state humidity specs. This method of classifying eliminates such equivocations as "moisture-resistant" and "humidity-defying." Our definitions—and specifications—are precise. And behind every specification is an important fact—a fact proven in virtually every U. S. space and defense program: even when it's wet, Trimpot potentiometers work.

### CYCLING HUMIDITY MODELS

For your severest applications. Units meet or exceed MIL-STD-202A, Method 106, 10 days.

These units pass the most stringent humidity specs in the book without requiring additional preparations, such as coatings or potting. They are completely sealed against humidity, liquids, and potting materials. Even in your most demanding applications they will perform exactly according to their published specifications.



MODEL 3000 Micro-miniature, high-temperature, wirewound; 50Ω to 20K; 0.5W; Max. oper. temp. 175°C.



MODEL 3250 Square, high-temperature, wirewound; 100Ω to 50K; 1.0W; Max. oper. temp., 175°C.



MODEL 3001 High-temperature, Resiston® carbon; 20K to 1 Meg.; 0.20W; Max. oper. temp., 150°C.



MODEL 3251 Square, high-temperature, Resiston® carbon; 20K to 1 Meg.; 0.25W; Max. oper. temp., 150°C.



MODEL 3010 High-temperature, wirewound; 10Ω to 100K; 1.0W; Max. oper. temp., 175°C.



MODEL 3280 Square, micro-miniature, wirewound; 100Ω to 50K; 1.0W; Max. oper. temp., 175°C.



MODEL 3011 High-temperature, Resiston® carbon; 20K to 1 Meg.; 0.25W; Max. oper. temp. 150°C.

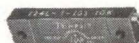

MODEL 224 High-temperature, wirewound; 10Ω to 100K; 1.0W; Max. oper. temp., 175°C.



MODEL 220 Sub-miniature, high-temperature, wirewound; 100Ω to 30K; 1.0W; Max. oper. temp., 175°C.



MODEL 3051 High-temperature, Resiston® carbon; 20K to 1 Meg.; 0.25W; Max. oper. temp., 150°C.



MODEL 3020 High-power, high-temperature, wirewound; 3.75W; Max. oper. temp., 200°C.

### STEADY-STATE HUMIDITY MODELS

Humidity protection at a low price. Units meet or exceed MIL-STD-202A, Method 103A.

Most industrial and many military requirements are readily met by Trimpot steady-state humidity units, which conform to MIL-STD-202A, Method 103A. These potentiometers withstand tests of 96 hours at 95% to 100% relative humidity and display high insulation resistance (100 megohms min. after four hours of drying). Here is genuine humidity protection with outstanding economy.

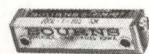

MODEL 200 General-purpose, wirewound; 10Ω to 100K; 0.25W; Max. oper. temp., 105°C.



MODEL 3368 Single-turn, Resiston® carbon, sub-miniature; 20K to 1 Meg.; 0.25W; Max. oper. temp., 105°C.



MODEL 260 High-temperature, wirewound; 10Ω to 100K; 1.0W; Max. oper. temp., 175°C.



MODEL 3500 Precision wirewound, 10-turn, bushing mount; 500Ω to 125K; 2.0W; ¼" dia.; Max. oper. temp., 125°C.



MODEL 215 General-purpose, Resiston® carbon; 20K to 1 Meg.; 0.25W; Max. oper. temp., 125°C.



MODEL 3510 Precision wirewound, 3-turn, bushing mount; 200Ω to 50K; 1.0W; ¼" dia.; Max. oper. temp., 125°C.



MODEL 3067 Commercial, wirewound; 100Ω to 20K; 0.5W; Max. oper. temp. 85°C.



MODEL 3520 Precision wirewound, 5-turn, bushing mount; 200Ω to 75K; 1.5W; ¼" dia.; Max. oper. temp., 125°C.



MODEL 3068 Commercial, Resiston® carbon; 20K to 1 Meg.; 0.2W; Max. oper. temp., 85°C.



MODEL 3367 Single-turn, wirewound, sub-miniature; 100Ω to 20K; 0.5W; Max. oper. temp., 105°C.



MODEL 3600 Precision readout, wirewound (Knobpot®), 10-turn; 1K to 100K; 1.5W; ¼" dia.; Max. oper. temp., 85°C.

NOTE: Models 3500, 3510 and 3520 can also be supplied to meet cycling humidity specs.

**MOST UNITS AVAILABLE IMMEDIATELY FROM STOCKING DISTRIBUTORS ACROSS THE NATION**

Write for complete information



BOURNS, INC., TRIMPOT DIVISION  
1200 COLUMBIA AVE., RIVERSIDE CALIF.  
PHONE: 684-1700 • TWX: RZ9222  
CABLE: BOURNSINC.

Units shown 1/2 actual size unless otherwise indicated

PLANTS: RIVERSIDE, CALIFORNIA; AMES, IOWA; AND TORONTO, CANADA. MANUFACTURER: TRIMPOT® POTENTIOMETERS; TRANSDUCERS FOR POSITION, PRESSURE, ACCELERATION.

CIRCLE 59 ON READER SERVICE CARD

# Increasing Bandwidth of Ultrasonic Radiators

*Signal-to-noise ratio is also improved by propagating Rayleigh ultrasonic waves*

By H. MACK THAXTON

Englehard Hanovia, Inc.  
Hanovia Lamp Div., Newark, N. J.

O. L. GALLAGHER

Englehard Industries, Inc.,  
Amersil Quartz Div., Hillside, N. J.

EXPERIMENTS indicate that bandwidth of an ultrasonic radiator may be increased while also increasing signal-to-noise ratio. The investigation also indicates that the magnitude of noise level is reduced by propagating Rayleigh waves.

Bandwidth of an ultrasonic radiator can be increased about 750 Kc by radiating into mercury<sup>1</sup> because of its high impedance. However, the increase in bandwidth is accompanied by a loss in efficiency in converting electrical to mechanical energy.

The series of experiments were undertaken to determine the extent that bandwidth could be increased by radiating longitudinal pulses into mercury and then converting to Rayleigh waves. Another objective of the project was to determine how much bandwidth could be increased with minimum loss in conversion efficiency by taking into account impedance considerations at the transducer.

The efforts to increase signal-to-noise ratio were concerned primarily with the effect on signal-to-noise ratio resulting from interference of backward reflections from the ultrasonic radiator. The propagation medium was assumed

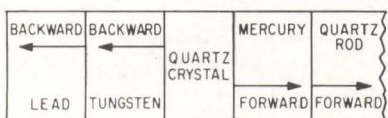

CONVERSION efficiency of impedance-coupling system in transducer assembly determines extent of bandwidth increase—Fig. 1

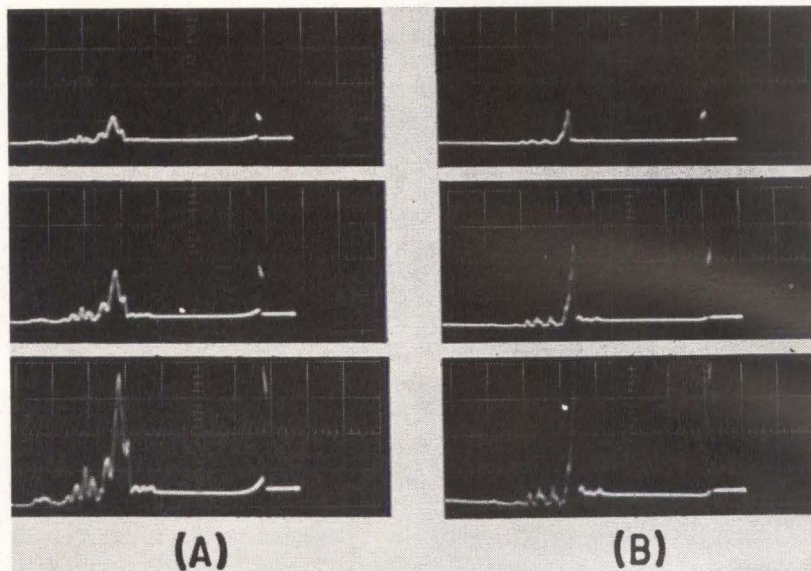

BANDWIDTH of Rayleigh-wave pulse patterns using only lead backing (A) is increased using tungsten-lead system (B)—Fig. 2

to be optical grade quartz rod adequately annealed to eliminate sources of reflective and interfering stresses and of impurities.

The impedance-coupling system at the transducer is shown in Fig. 1. Forward ultrasonic intensity is

$$I_F = 4e_{ik}^2 E^2 \frac{(R_q R_{hg} + R_q R_{hg} \tan^2 x_{hg})}{R_{hg} (R_q^2 + R_{hg}^2 \tan^2 x_{hg})} \quad (1)$$

and backward ultrasonic intensity is

$$I_B = 4e_{ik}^2 E^2 \frac{(R_w R_{pb} + R_w R_{pb} \tan^2 x_w)}{R_w (R_{pb}^2 + R_w^2 \tan^2 x_w)} \quad (2)$$

where  $e_{ik}$  is appropriate piezoelectric constant for the material in which  $i$  and  $k$  are integers;  $E$  is electric field amplitude;  $R_q$ ,  $R_{hg}$ ,  $R_w$  and  $R_{pb}$  are longitudinal impedances of quartz, mercury, tungsten and lead, respectively;  $x_{hg} = 2\pi f T_{hg} / V_w$  in which  $f$  is resonant frequency,  $T_{hg}$  is mercury layer thickness and  $V_w$  is propagation velocity in tungsten; and  $x_w = 2\pi f T_w / V_w$  in which  $T_w$  is tungsten thickness.

The ratio of forward to backward ultrasonic radiation intensity is

$$I_F/I_B = R_q \sec^2 x_{hg} \frac{(R_{pb}^2 - R_w^2 \tan^2 x_w)}{R_{pb} \sec^2 x_w (R_q^2 + R_{hg}^2 \tan^2 x_{hg})} \quad (3)$$

If  $k_w = 4e_{ik}^2 E^2 V_{hg}$ , from Eq. 1:

$$dI_F/dx_{hg} = 2k_w R_q \sec^2 x_{hg} \tan x_{hg} \frac{(R_q^2 - R_{hg}^2)}{V_{hg} (R_q^2 + R_{hg}^2 \tan^2 x_{hg})^2} \quad (4)$$

where  $V_{hg}$  is propagation velocity in mercury. Hence, for maximum intensity  $I_F$ ,  $\sec^2 x_{hg} = 0$  or  $T_{hg} = \lambda/4$ , where  $\lambda$  is wavelength. Similarly, from Eq. 2,  $T_w = \lambda/4$  for maximum  $I_B$ .

Using the values of  $T_{hg}$  and  $T_w$  for maximum intensities, Eq. 3 reduces to

$$I_F/I_B = R_q R_w^2 / R_{pb} R_{hg}^2 \quad (5)$$

Inserting the values of longitudinal impedance<sup>2</sup> for the materials,

$$I_F/I_B = 15.51 \quad (6)$$

Signal-to-noise ratio using the results of Eq. 6 is thus  $S/N = 23.8$ . Similarly, the value of intensity for the system using lead backing alone is

$$I_F/I_B = R_q R_{pb} / (R_q^2 \cos^2 x_{hg} + R_{hg}^2 \sin^2 x_{hg}) \quad (7)$$

Signal-to-noise ratio is thus significantly improved using Rayleigh wave propagation.

Typical pulse patterns of Rayleigh waves obtained using the system with lead backing alone are shown in Fig. 2A, while the Rayleigh wave pulse pattern of the sys-

# yes

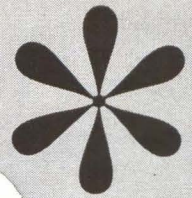

actual size



**Gamewell made a sector pot with .0006" wire.** This subminiature sector pot is wound with .0006" wire at over 1000 turns per inch. Required winding length tolerance is only .005". ■ Here's one example of the hundreds of "special" pot design requests that Gamewell is answering with an unqualified YES. ■ Find out what Gamewell YES service — Your Engineered Specials service — can do for you. Write to Gamewell today for the complete facts. \***y**our **e**ngineered **s**pecials service



THE GAMEWELL COMPANY, POTENTIOMETER DIVISION, 1618 CHESTNUT STREET, NEWTON UPPER FALLS 64, MASSACHUSETTS. A SUBSIDIARY OF E. W. BLISS COMPANY.

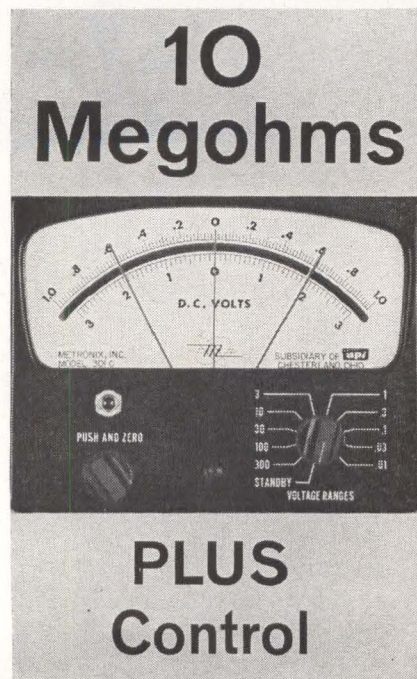

### An electronic voltmeter with a meter-relay

This happy combination makes an extremely versatile and acute instrument.

It has critical measuring ability that goes with high input impedance, in space-saving panel-mounting style.

It also has the reliable, simple control of a locking contact meter-relay, with adjustable set points.

Many difficult functions can be easily controlled: conductivity cells, life testing of components or systems, production testing and sorting, automatic Go-No Go of missile circuits.

### Ready When Needed

Metronix DC instruments such as Model 301-C-CMR (illustrated) have input resistances up to 10 megohms. AC input impedances go as high as 5 megohms. Like all Metronix panel-mounting electronic voltmeters (PMEV's), they are always connected—immediately available for continuous monitoring of critical parameters.

Send for data sheets describing Metronix PMEV's in single or multiple ranges, DC or AC, with either meter-relays or conventional indicating meters.



**METRONIX**  
The Electronic Instrument Division  
of Assembly Products, Inc.  
Chesterland, Ohio

Telephone: HAMILTON 3-4440

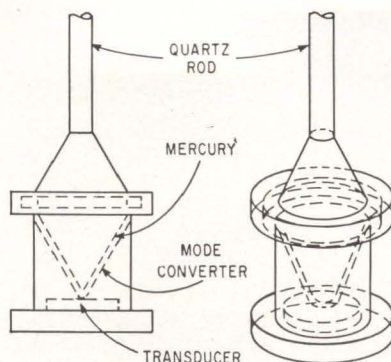

QUARTZ MODE converter is used to obtain Rayleigh waves—Fig. 3

tem in Fig. 1 is shown in Fig. 2B. Bandwidth of the patterns in Fig. 2A is 0.5 Mc and in Fig. 2B is 2 Mc. Driving resonant frequency is 5 Mc, and average attenuation is about 50 db in all cases. Velocity of the Rayleigh waves is 0.342 cm/ $\mu$ sec, corresponding to a delay of 350  $\mu$ sec in a straight quartz rod.

The quartz Rayleigh wave mode converter is shown in Fig. 3.

#### REFERENCES

- (1) W. P. Mason, "Electromechanical Transducers and Wave Filters," D. Van Nostrand Co., Inc., p 413, 1958.
- (2) W. P. Mason, "Physical Acoustics and Properties of Solids, D. Van Nostrand Co., Inc., p 17.

## New Optical Masers Use Dissociative Mechanism

PHYSICAL PRINCIPLE underlying operation of two new optical masers suggests a new family of these devices. Laser action results from dissociative excitation transfer.

One of the new lasers uses a mixture of neon and oxygen and the other a mixture of argon and oxygen. Both devices, announced by Bell Telephone Laboratories, radiate in the near infrared at a wavelength 8,446 angstroms. Thus the lasers also provide a new frequency for optical communications.

In dissociative excitation transfer, an excited atom of a noble gas such as neon breaks up an oxygen molecule. To operate the lasers, molecular oxygen is mixed with neon or argon, and the mixture is excited with an r-f discharge.

Energy transferred from the neon or argon to the oxygen molecule results in its dissociation into two atoms. One of the atoms immediately or very shortly after attains an excited state, from which it radiates at 8,446 angstroms.

The experiments suggest that the mechanism of dissociative excitation of a molecule by energy transfer from a metastable atom may be more useful in optical maser technology than the inelastic atom-to-atom collisions responsible for maser action in helium-neon mixtures. In the latter devices, electrons in the discharge created by the r-f generator excite helium atoms to their metastable state. This state is comparable to the upper state of neon. As a result, helium atoms can impart their energy to the neon atoms by collision. The neon atoms then radiate to a lower energy level.

## Computer Study Planned Of Reactor Efficiency

PROCESS COMPUTER installation at a nuclear generating plant will provide information for improving reactor-fuel technology. Although it will not perform any plant control functions, it is expected to provide operating experience in using a computer to automate a nuclear plant.

The process computer will be used at the Big Rock Point Nuclear Power plant of Consumers Power Company, Michigan. Use of the computer was described in a paper by L. K. Holland and E. S. Beckjard, General Electric Atomic Power Equipment Department, at the American Nuclear Society Meeting in Boston.

The 40,000-word G-E 312 process computer will monitor reactor power level, thermal-hydraulic performance of the reactor core, neutron exposure of each segment of the fuel, instruments and reactor vessel. It will also be used to develop methods for achieving maximum fuel burnup by scheduling of control rods.

Comprehensive information obtained in the computer study will be used to improve operating efficiency, to simplify fuel inventory and plant management, and to improve power-producing capability of the fuel.

Measured coolant flow rates, temperatures and pressures will be used to calculate reactor power level. Readings of core conditions from 24 in-core ion chambers, accumu-



**NEW**  
FROM WESTON

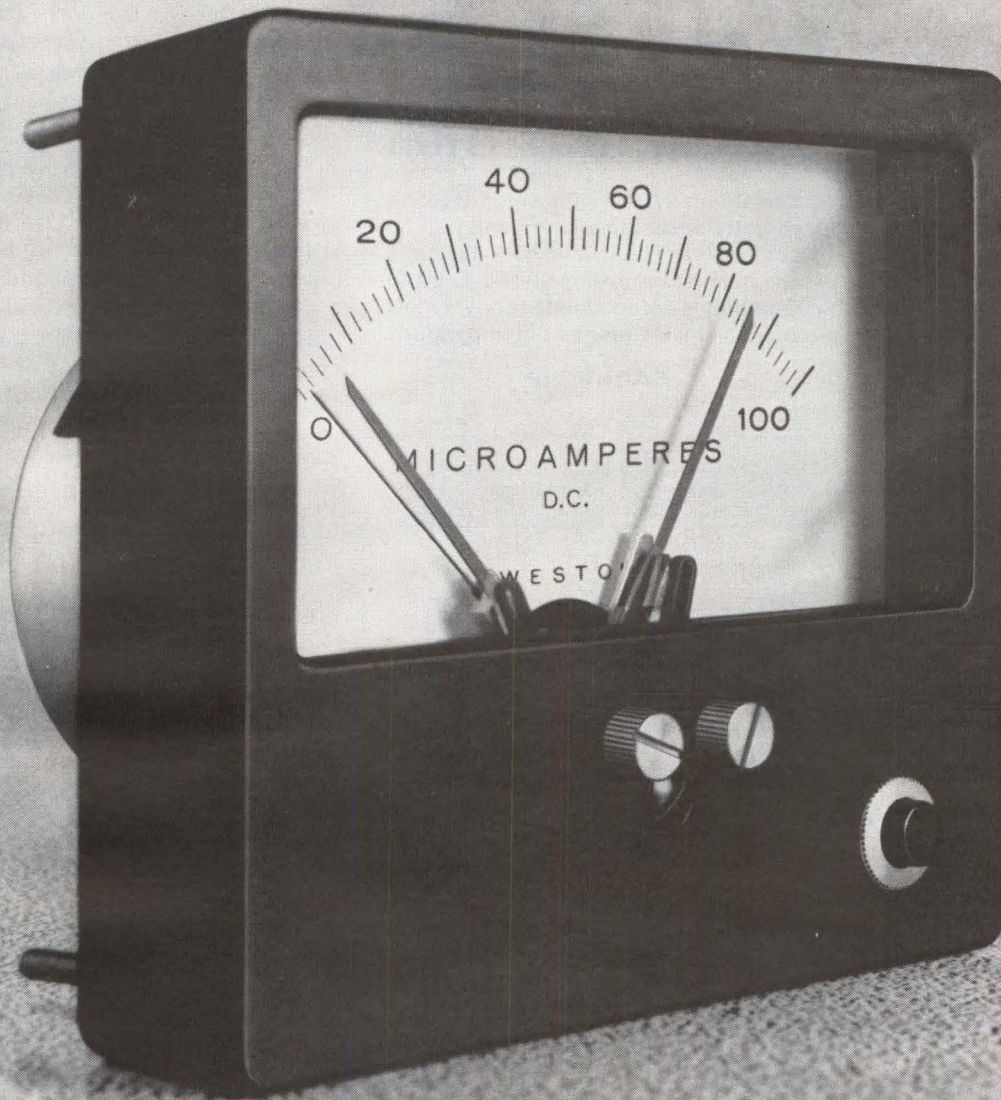

# CONTACT

DOUBLE-ACTION PRINCIPLE ASSURES RELIABILITY OF CONTACT CLOSURE

MagTrak™ Relays combine magnetic attraction with a load current contact aiding circuit. This combination increases contact pressure by a factor of 100 times on the most sensitive ranges. Weston's new MagTrak design gives you greatly increased reliability plus easy resetability.

You can always depend on MagTrak—even for low voltage operation and after long periods of inactivity.

- Sensitivities as low as 10  $\mu$ a, full scale
- Can operate as a pyromillivoltmeter

- Available with high or low set points, or both
- Standard, self-contained, full-scale ranges: 10  $\mu$ a to 5 a and 20 mv to 500 v or higher
- Kilowatt loads can be switched when accessory power package is used
- Scale length: 3.47 inches

Weston supplies the most complete line of relays available. More are now in use than any other kind . . . proof of their dependability. Write for new catalog or applications assistance from our experienced relay engineers. Dept. 37.

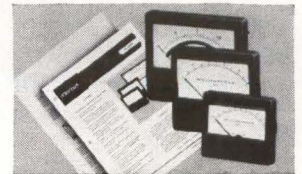

NEW RELAY CATALOG gives details on MagTrak. Another Weston catalog describes the matching line of Series 1900 Panel Instruments, pictured above. Send for both today.

**WESTON INSTRUMENTS** *Division of Daystrom, Incorporated, Newark 14, New Jersey*

Aerospace Instrumentation • Bimetal Thermometers • Calibration & Test Equipment • Panel & Switchboard Meters • Photosensitive Devices • Precision Metal Film Resistors • Relays & Tachometers • Systems Design & Development

# CANNON

## engineering notes:

### DUAL-SHORE<sup>®</sup> AND BACK-CLIP RETENTION

Cannon has developed two major contact retention systems for crimp-type removable contacts. Both incorporate closed-entry socket insulators and can be used in rack and panel as well as circular connectors. The Dual-Shore design is best for general applications requiring excellent moisture sealing on MIL-C-26636 contacts at relatively low cost. Back-Clip retention is recommended for very low contact insertion forces, high retention forces, and wide ranges of temperature.

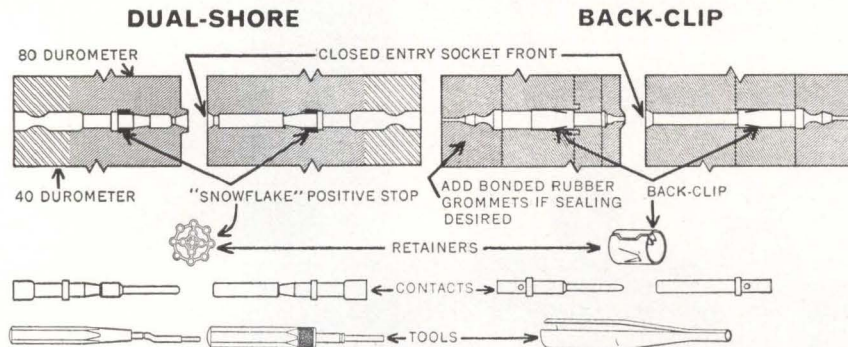

#### Features:

1. Closed-entry socket front provides positive alignment of pins and sockets.
2. Dual-Shore rubber provides sealing over most of the surface of the contact, giving more efficient sealing than is now possible with other retention systems. Readily passes "bucket test" of MIL-C-26500.
3. Utilizes MIL-C-26636A (USAF) contacts. Standard MS insertion and extraction tools.
4. Wire barrel on contact in accordance with MS3190, and accepts MS3191 (WEP) crimp tool.
5. Elastomer materials may be applied for severe environment applications: Polychloroprene for general purpose material, and butyl for exotic fuel resistance. Silicone compounds will soon be available for higher temperatures.
6. Contacts inserted and removed from the rear of the connector. Connectors must be disengaged because removal tools are inserted from front face.
7. Simplicity of construction, relatively low cost.

#### Features:

1. Closed-entry socket front provides positive alignment of pins and sockets.
2. Low insertion force, high retention force for contacts.
3. Utilizes a simple, strong contact with cylindrical surfaces. Especially important for size 20 contacts (which bend easily when handled). One disposable plastic tool serves for both insertion and extraction.
4. Wire barrel on contact in accordance with MS3190, and accepts MS3191 (WEP) crimp tool.
5. Retention clip is sandwiched between hard dielectric inserts, fabricated from high-temperature materials. Silicone rubber may be bonded to the hard dielectric parts to afford a moisture seal at elevated temperature (460° F). Unsealed ceramic versions can be made for high temperature (1000° F).
6. Contacts inserted and removed from the rear of the connector. It is not necessary to disengage the connector to remove or insert contacts because tool inserts from rear.
7. Higher cost and complexity of insert construction, offset by universality of application to any connector style.

For testing and evaluation, Dual-Shore types are available in Cannon KPTM and RX lines. Back-Clip models are available in Cannon DPD, DPX, DPY, DPJM, and D-Miniature series.

*James H. Cannon*  
Vice President, Engineering

<sup>®</sup>CANNON TRADEMARK

*Imaginative Engineering For The Space Era.*



**CANNON ELECTRIC COMPANY, 3208 Humboldt St., Los Angeles 31, Calif.**

lated constantly and stored in the computer memory, will assist in determining a finer power distribution in the reactor core. Predetermined control-rod sequences will be stored in the computer and monitored by the reactor operator for most efficient operation. The sequences are calculated from measured and computed reactor data, which is one of the major areas in the development effort of applying computers to nuclear plants.

The computer system will include the central processor, an input-output unit, computer control console, two operator control units, four logging and on-demand typewriters, and three punched paper tape units.

### Bird-Brain Telemetry Is Used in Pigeon Study

TEL AVIV — Electroencephalograph has been developed that enables the brain impulses of pigeons to be recorded. The miniature telemetry system was developed at the Electronics Department of the Weizman Institute of Science at the request of the Institute of Physiology of Pisa University. The 1-ounce instrument occupies only 15 cubic inches.

The bird-brain project, as it is called, grew out of an earlier project in which a device was developed for telemetering the cortical activity of the brains of unrestrained cats. Special emphasis was placed on recording brain impulses during states of increased activity and convulsions of the unrestrained animals. An amplifier-transmitter weighing about 3½ ounces was mounted on the head of the cat, and data on feline cerebral action was telemetered to the physiologists.

As disturbances arising from general activity of the body of the subject animals and variations in electrode contacts were eliminated, records free of artifact interference were obtained. Further progress has enabled development of the 1-ounce amplifier-transmitter.

Other modifications were made to improve performance of the instrument. A differential amplifier was designed for bipolar recording. The circuit was also designed to reject in-phase signals from the power lines. Noise relative to the input has been almost completely eliminated.

# A NEW CONCEPT FROM CANNON... SHOULDER CLIP RETENTION

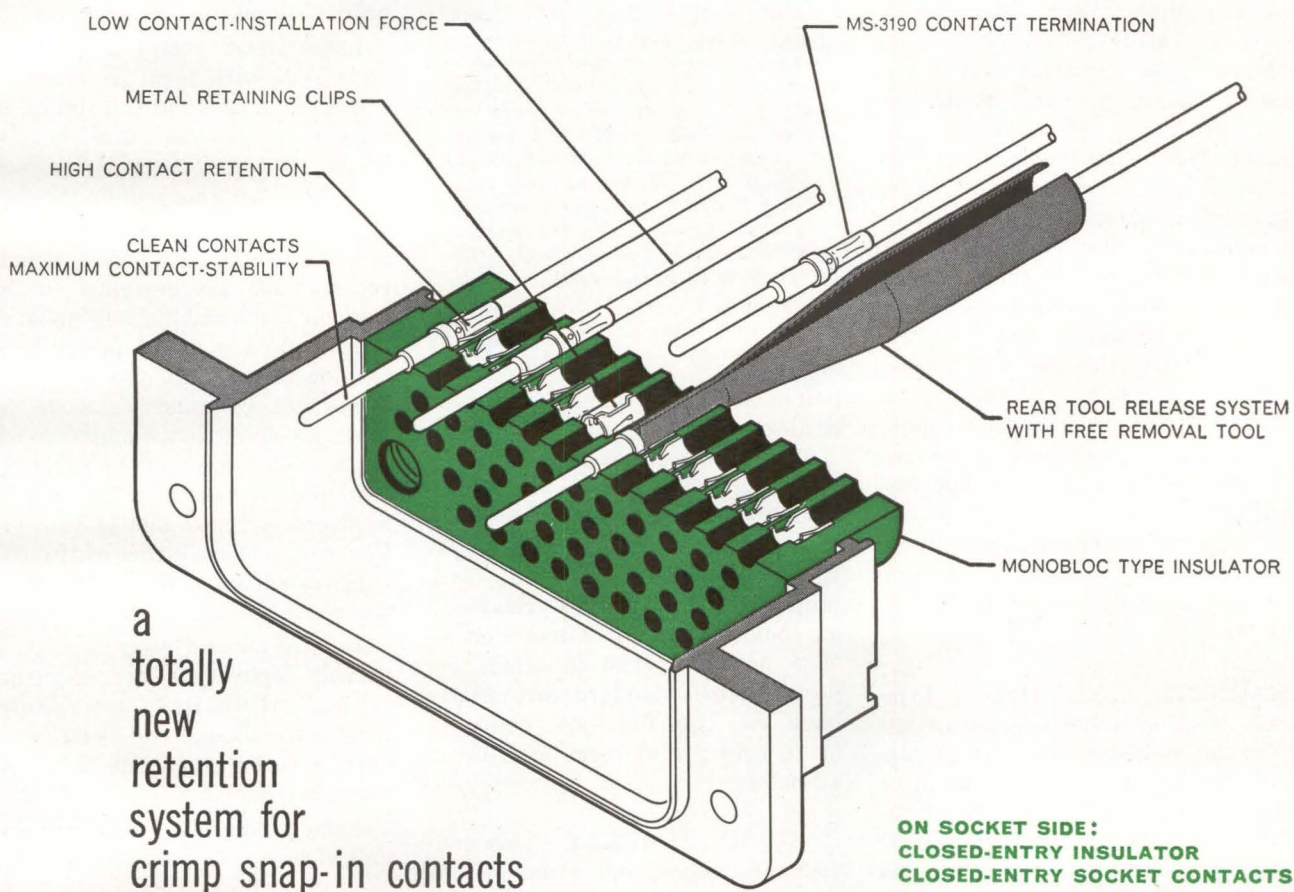

**Featuring Rear Tool-Release System**—Cannon's New concept for crimp snap-in contacts exceeds all the requisites for reliability in electrical connectors—*plus* all these advantages: METAL RETAINING CLIPS • CLOSED ENTRY SOCKET CONTACT • CLOSED ENTRY INSULATOR • HIGH CONTACT RETENTION • LOW CONTACT-INSTALLATION FORCE • REAR TOOL-RELEASE SYSTEM • FREE

REMOVAL TOOL • MAXIMUM CONTACT-STABILITY • CLEAN CONTACTS • MONOBLOC TYPE INSULATORS • MS-3190 CONTACT TERMINATION. Shoulder clip retention is presently available in dual-panel rectangular plugs, miniature rectangular plugs, and sealed miniature rectangular plugs; they will be available in other lines quickly. For additional information write to:

*Imaginative Engineering For The Space Era.*

**CANNON ELECTRIC COMPANY**, 3208 Humboldt Street, Los Angeles 31, Calif.



# Taking Bounce Out of Reed Relays

*Recent improvements offer wider use for millisecond switching*

By HUGH CULLIN  
Chief Engineer,  
Struthers-Dunn, Inc.,  
Pitman, N. J.

THE HEART of the reed relay is a magnetic switch sealed in a glass capsule that contains an inert gas (ELECTRONICS, Sept. 30, 1960, p 63). The magnetic switch consists of two nickel iron alloy reed elements having precious metal contact surfaces. The contact surfaces are normally open, closing when a magnetic field of proper strength is applied.

Since the introduction of reed relays a few years ago, their use has grown steadily. They are ideally suited for transistor drive applications and find wide use in data processing systems, ground control for missiles and satellites in weapons and in communications systems. Although reed switching is not fast enough for all computer applications, it is fast enough for some—switching information heads and voltage reference circuits, for instance.

**MAGNETIC SWITCHES**—Typically, reed switches operate in less than one millisecond including contact bounce time, and release in no more than 0.3 millisecond. The basic dry reed relay consists of one or more dry reed switches enclosed by a single direct-current magnetizing coil, with the necessary parts to hold the units together.

Typical contact rating for standard reeds is 15 watts, one amp or 250 volts resistive. Life expectancy is 20 million operations at maximum rating; 100 million operations at one-half maximum; 200 million at dry circuit level. Miniature reeds have typical contact ratings of 4 watts, 250 v max., 125 ma max. Life expectancy is 3 million operations at maximum rating; 10 mil-

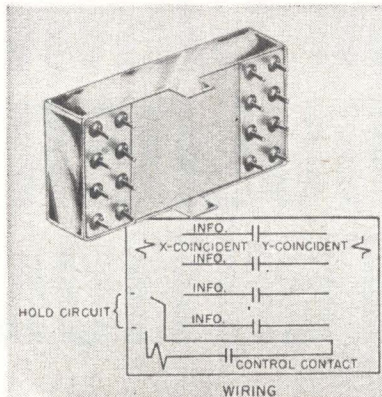

**NEW MINIATURE reed crosspoint relay for printed circuit cards features magnetic shielding and twist-tab mounting. Contact rating is 4 watts. Two coils are identical and act as X and Y coordinate coils with a third coil as the holding coil. Simultaneously energizing X and Y closes the contacts; these remain closed until holding coil is interrupted or until either X or Y is reverse-pulsed**

lion operations at one-half max.; 20 million at dry circuit level.

The glass-enclosed reed switch is completely impervious to atmospheric contamination. Further protection against damage and breakage is provided by molding both miniature and standard relays in an epoxy resin or in a metal enclosure with only the terminals exposed. Most standard size relays have one, two, four, six, eight, 12 or 20 poles; miniatures have up to 12 poles.

**BASIC REED RELAY**—This consists of one coil operating one or more reed switches, and it is used for conventional on-off switching. Standard coil voltages are 6, 12, and 24 v d-c.

Pulse reed relay combines one pulse coil and one holding coil operating one or more reed switches. The holding coil does not have sufficient power to operate a switch, but keeps it operated after the pulse coil has received the proper signal. The pulse coil operates the switch, independent of the holding coil, from a signal which is addi-

tive to the flux generated by the holding coil.

Crosspoint reed relays have one holding coil, two coincident current coils, and from two to five reeds including the control reed. Simultaneously energizing two coordinate coils closes one reed contact permanently wired in series with the holding coil. The holding coil then picks up and closes the information contacts. All contacts remain closed until the holding coil is externally interrupted, or until one of the coordinate coils is reverse pulsed.

Latch reed relay is magnetic latch reed with form A or form C contacts. A pulse to the coil of the relay keeps it closed until it is released by a reverse polarity pulse or pulse to another coil on the reed.

Logic reed relay has from two to five coils operating one or more reeds. Coils are designed so that various coil combinations must be energized at nominal power levels to operate the reed. For *and* operation, one coil and a second coil must be energized simultaneously. To prevent false contact closure, care must be taken not to overdrive or overpower any one of the coils. For *or* operation, either of two coils supplies sufficient power to operate the reed.

Infinite margin relay is a highly refined logic type for extremely critical circuits in an *and* arrangement. The second coil must be energized, even when one is greatly overpowered.

Early reed relays had long terminals of heavy magnetic metal. When they were clipped close to the board, the return path of the magnetic field was greatly reduced. Operating values often changed substantially. Bonding the reed ends of the terminals often affected their operating points.

**MOST MODERN TYPES**—Reed relays now terminate in non-magnetic tin-coated copper wires of about 0.030-in. diam, soldered internally to the reed ends. Clipping or bending has no effect on reed op-

# SOLAtron LINE VOLTAGE REGULATOR

keeps  
voltage  
inside

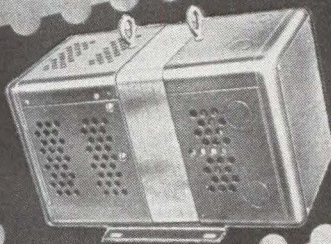

the  
regulation  
"envelope"

Starts corrective action the instant output departs from nominal... long before voltage even approaches the boundaries of the regulation envelope. In fact, response is *10 times faster* than mechanical regulators. Even under extreme conditions, return to nominal will *never* exceed 10 cycles. And no moving parts means no electro-mechanical wear. Maintenance is reduced to insignificant static-design proportions. A solid-state sensor triggers a magnetic flux "valving action" to maintain nominal voltage.

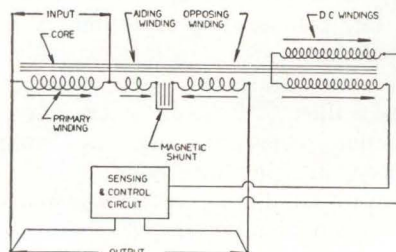

## SOLA



Division of Basic  
Products Corporation  
SOLA ELECTRIC CO., Dept. E-72, 1717 Busse Road,  
Elk Grove Village, Illinois, HEmpstead 9-2800  
IN CANADA, SOLA BASIC PRODUCTS, LTD.,  
377 Evans Avenue, Toronto 18, Ontario

**Excellent regulation** — for specified input range, zero to full load.

**Efficiency** — 95% at full load.

**Ultra Compact** — smaller and lighter than other equivalent regulators.

**Complete Mounting Flexibility** — designed for either horizontal or vertical orientation. Adaptable for mounting inside OEM equipment or can be externally employed on any surface or support.

New Solatron Line Voltage Regulators are available in 3-100 kva ratings for 120 and 240 vac, indoor applications. Write today for complete details and prices. S-20-62

**1/4%  
ACCURACY**

**WITH  
DIRECT READOUT**



**NEW  
UNIVERSAL BRIDGE**

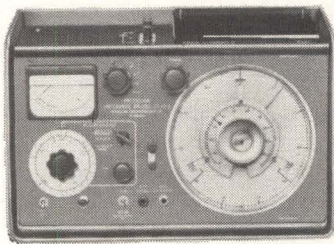

Model 1313  
Price \$590

**MEASURES:**

L: .....  $1\mu\text{H}$  to  $110\text{H}$   
C: .....  $1\text{pF}$  to  $110\mu\text{F}$   
R: .....  $0.01\Omega$  to  $110\text{M}\Omega$

With 1/4% Accuracy

**EXCEPTIONAL RESOLUTION**  
5,000 divisions per range

**BUILT-IN 1 AND 10Kc OSC/DET**  
100 cps to 20 Kc with ext. osc.

Automatic dial mechanism eliminates multiplying factors, giving surprising ease of use.

ASK FOR FULL DESCRIPTION **NOW**

**MARCONI  
INSTRUMENTS**

DIVISION OF ENGLISH ELECTRIC CORPORATION  
111 CEDAR LANE • ENGLEWOOD, NEW JERSEY  
MAIN PLANT: ST. ALBAN'S, ENGLAND

eration, and they are easy to solder.

Reed relay lead terminals are now aligned on 0.2-in. grid spacings, and are brought out on one side of the relay enclosure for convenient printed board mounting without bending or cutting. Far more reed switching can be packed into less space than ever before.

In earlier types, the magnetic coupling effect between reeds operating in close proximity was close enough so that one reed would not drop out even though its coil circuit was de-energized. This difficulty is now greatly reduced by packaging reeds in magnetically-shielded enclosures.

With the variety of types now available, reed relays are being used in increasing number of applications. A new miniature reed relay in a magnetically-shielded case only 1.25 in. by 0.80 in. by 0.40 in. does the job of conventional can types in applications requiring long life and extreme contact reliability on dry circuit and light load switching.

Reed relays are not across-the-board substitutes for many switching applications, however. Their advantages and limitations must be weighed carefully in each circuit. Reed relays do offer the designer great latitude in placing components, they are adaptable to logic circuits, and their life is remarkable. The contact capsules are, however, somewhat limited in their contact ratings.

**A RECENT DEVELOPMENT—** Reed relay usefulness will be expanded as a true form C break-before-make reed with practically negligible bounce of its normally-closed contact. This design will greatly reduce form C unit costs.

The reed method of switching is less complicated and less expensive than solid-state switching, although the millisecond range of the reeds cannot approach the switching speeds of solid-state systems.

With solid state switching, many components and somewhat complicated circuits are required to produce a contact that is neither wholly *on* nor wholly *off*. Solid-state circuits are always partially *on*, basically representing a change from a low impedance to a high impedance circuit. And inputs and outputs are not isolated. Reed relays, on the other hand, provide positive *on* and

positive *off* switching, and the inputs and outputs are isolated.

Developments indicate a real place for reed switches where rapid switching, minimum size, low operating power requirements, long life, reliability, and moderate cost are important factors.

**New Technique Joins  
Refractory Metals**

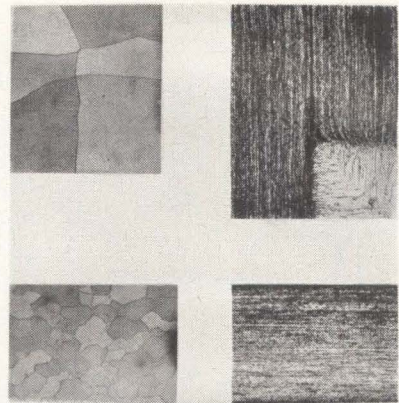

**MICROSCOPIC specimen of thin tungsten sheet, left. At right, a similar specimen joined by thermochemical bond shows complete lack of crystallization apparent in photos on left**

**BRITTLINESS** caused by recrystallization from the heat of existing welding methods often contaminate surrounding areas, as well as weaken structural elements. A technique developed by Martin consists of thermochemically depositing a filler of the base metal between the metal sheets to be joined. This provides a firm bond in which the base metal grain structure is not recrystallized by high welding temperatures. This method permits wider use of refractory metals, particularly tungsten and molybdenum, in missile and space vehicles.

Filler refractory material is deposited in the joint by combined nucleation and reduction of refractory-bearing halogen gases. Heat is applied to the base sheet to be joined and the temperature of the entire operation kept below 1,500 deg F, well below the recrystallization temperature of these materials.

The method results in a filler material with a somewhat dendritic but fine grain structure having a hardness level equal to the base metal.

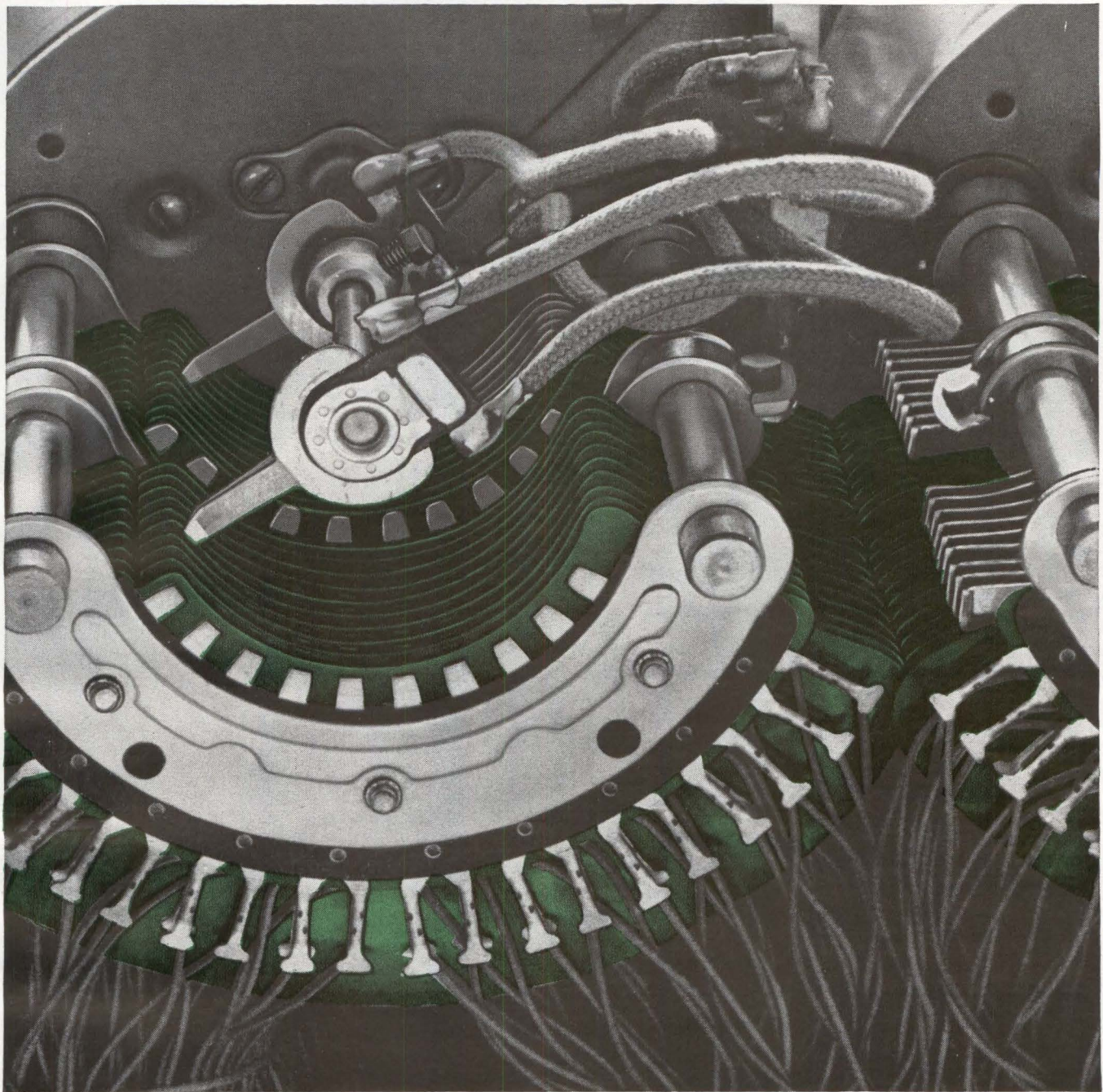

The insulation of "Mylar" is shown in green.

## HOW MYLAR® CUT STEP-SWITCH COSTS FOR WESTERN ELECTRIC

This step-by-step switch handles 300 trunk calls a day. A hundred thousand times a year the central contact wiper flashes between the tough spacers of Du Pont "Mylar" polyester film.

Western Electric Co. picked "Mylar" to replace stiff phenolic fiber. It reduced manufacturing costs, since separate insulators could be punched out automatically at high speeds from rolls of "Mylar". Phenolic fiber was available only in sheets, not adaptable to full automation. "Mylar" was tougher and more durable: resisted cracking when flexed or bent. It had a higher dielectric rating, allowing valuable space reductions.

"Mylar" today is the standard insulation in a wide variety of electrical/electronic applications. In motors, capacitors, switches and wiring, its superb dielectric,

chemical and thermal properties guarantee years of trouble-free performance. The high performance of "Mylar" in thinner gauges frequently gives substantial savings—since you use less "Mylar" than conventional materials.

Additional cost reductions can come from design modifications and manufacturing economies. Why not investigate its unique properties in your application? Save time and money now by writing to: Du Pont Company, Film Dept., Wilmington 98, Delaware.

only DU PONT makes

**MYLAR®**  
POLYESTER FILM



BETTER THINGS FOR BETTER LIVING  
... THROUGH CHEMISTRY

Visit our Booth at Wescon—Booth #3734-35

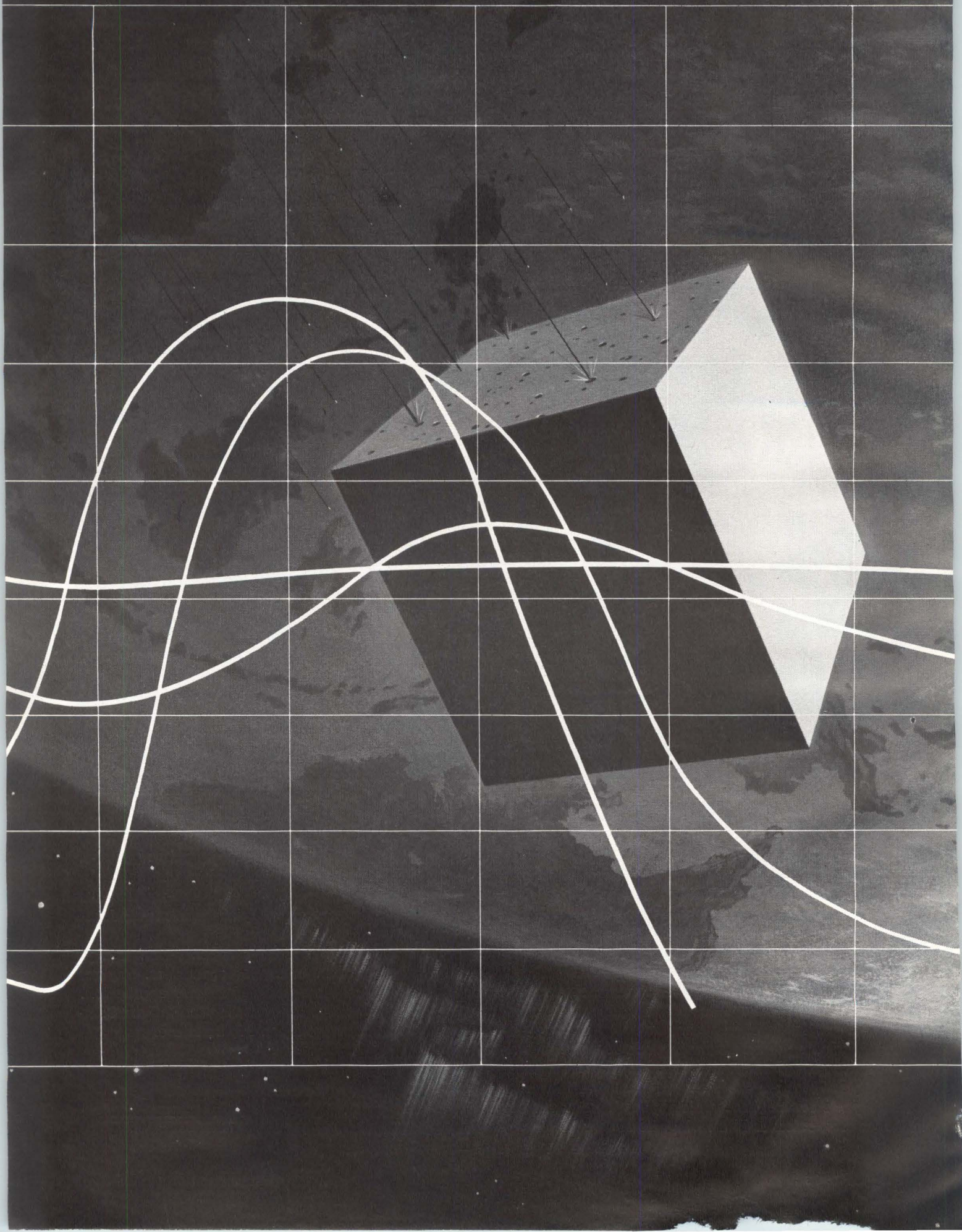





## A MATERIALS LABORATORY IN SPACE

A comprehensive understanding of the reaction of materials to outer space is an important key to this country's space program. In their study of materials, scientists at Lockheed Missiles & Space Company found the problem could be most graphically depicted by showing the various environmental factors impinging on a simple cube-shaped vehicle. A cube, placed in a noon polar circular orbit, would allow unusual isolation of the effects of space on materials; make their measurement simpler and more accurate; and offer a built-in control of the results.

For example: The horizontal surface facing away from the earth would receive only direct solar insolation, while that facing the earth would get mostly earth shine and earth-reflected solar radiation. This hypothetical model lucidly illustrates the effects of such phenomena as: Solar irradiation, sputtering, micro-meteoritic erosion, solar corpuscular radiation, auroral radiation and the like.

Guided by engineers and scientists of outstanding calibre, Lockheed Missiles & Space Company has won its place in the forefront of many disciplines in missile and space technology. And such progress constantly creates key positions for others of proven ability. Lockheed's location in Sunnyvale and Palo Alto on the beautiful San Francisco Peninsula is ideal. So is the climate—physical and mental.

If you are interested in correlating your specialty to one of Lockheed's many challenging assignments, please write to: Research & Development Staff, Dept. M-37E, 599 North Mathilda Avenue, Sunnyvale, California.  
An equal opportunity employer.

### **LOCKHEED MISSILES & SPACE COMPANY**

*A GROUP DIVISION OF LOCKHEED AIRCRAFT CORPORATION*

Systems Manager for the Navy POLARIS FBM and the AGENA vehicle in various Air Force Satellite programs. Other current projects include such NASA programs as the OGO, ECHO, and NIMBUS.

SUNNYVALE, PALO ALTO, VAN NUYS, SANTA CRUZ, SANTA MARIA, CALIFORNIA • CAPE CANAVERAL, FLORIDA • HAWAII

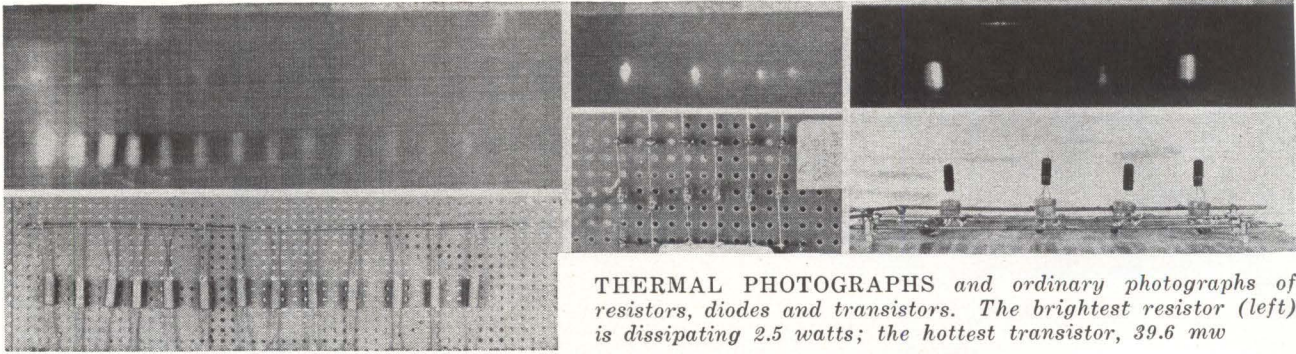

THERMAL PHOTOGRAPHS and ordinary photographs of resistors, diodes and transistors. The brightest resistor (left) is dissipating 2.5 watts; the hottest transistor, 39.6 mw

## Circuit Inspections Speeded with Infrared

*Nondestructive test method quickly shows up defective components and wiring*

INFRARED RADIATION from electronic components is being used to determine whether a circuit is operating correctly and at design levels or whether some defect in wiring or circuit device is causing overheating. According to the technique devised by Riccardo Vanzetti, Equipment division of Raytheon Co., circuits can be checked while operating, using either an infrared scanning camera or an infrared radiometer.

The infrared camera takes thermal photographs of operating circuits. Current passing through wires and components causes heat-

ing and thus increases infrared emission. By scanning the circuit a line at a time and converting the infrared picked up from each point into an equivalent visible light signal (see sketch), a thermal picture of the circuit is obtained. When this photograph is compared with a previously made standard, open circuits and overloaded components are immediately pinpointed.

The infrared camera used to take the accompanying thermal photographs of resistors, diodes and transistors is a Barnes Model I-8A equipped with Polaroid film. Since the light source is essentially the circuit itself, no other illumination is required. From 3.25 to 13 minutes (depending on width and height of scan) are required for each photograph. As the photo-

graphs show, the hotter the component the brighter the equivalent image on film. The brightest resistor in the illustration above is operating at 2.5 watts and the one next to it is operating at 1.45 watts. The dissipation of the remaining resistors shown in progressively less and the farthest right resistor is operating at only 0.045 watts. The circuit board beneath the hottest resistors is also heated and several of the connection points are hotter than the current carrying wires.

The brightest of the six diodes, above, is operating at 31.5 mw and the coolest at 6.05 mw. The transistors are operating at, from left, 39.6 mw, 9.9 mw, 14.9 mw and 30.7 mw.

Thermal photographs are useful

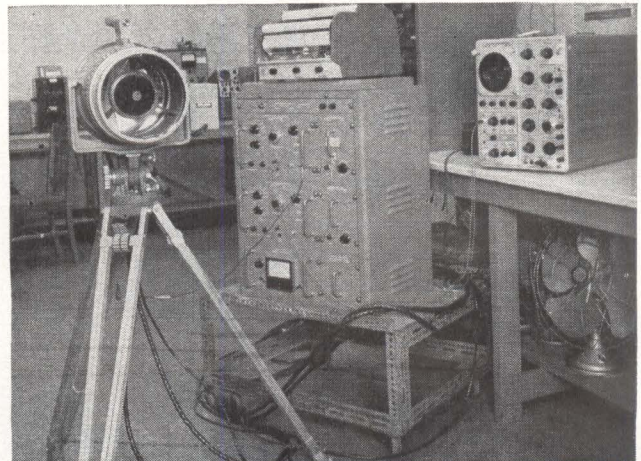
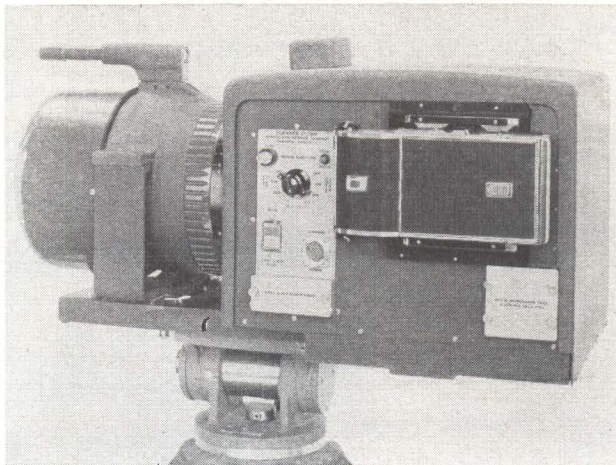

INFRARED CAMERA (left) showing adjustments (but not electronic circuits) and light sensitive camera back. Radiometer and electronic circuits (right) with recorder

## Low Current Silicon Rectifiers

22 types, with ratings from 0.15 amps to 1.50 amps; 100 to 2800 piv. Send for Bulletin 62CC4.

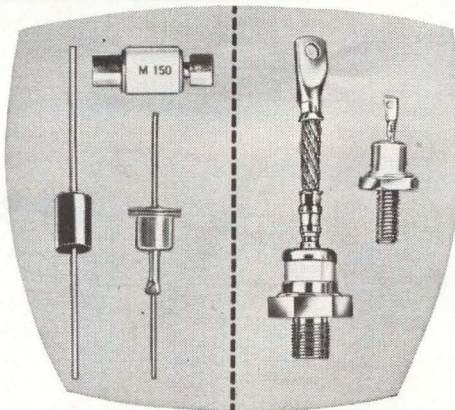

## Hermetically Sealed Silicon Rectifiers

Ratings from 2 amps to 250 amps; 50 to 600 piv; choice of positive or negative base polarity in most styles. Send for Bulletin 62CC4.

## Controlled Silicon Rectifiers

Two series, 3 and 5 amps; 25 to 400 piv. Stud mounted and hermetically sealed. Send for Bulletin 62SCR5.

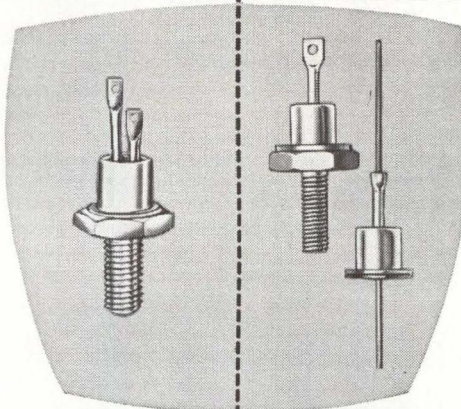

## Silicon Voltage Regulators

Regular series: 93 types in 1/4, 1, and 10-watt classifications; 5.6 to 100 volts breakdown. Special series: 17 types in 1-watt, 6 to 105 volts breakdown. Excellent performance at low cost. Ask for Bulletin 61VR11.

## Silicon Rectifier Assemblies

336 types, ratings from 5 amps to 1250 amps; 50 to 500 piv. Configurations include single-phase bridge and center-tap, and three-phase half-wave, bridge, and full-wave center tap. Ask for Bulletin 62SA3.

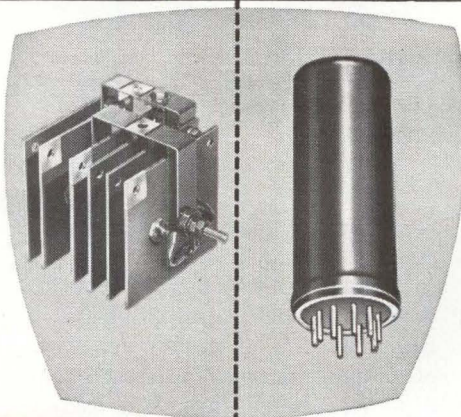

## Tube Replacement Silicon Rectifiers

Long life, cool-operating, compact units replace 95% of all popular vacuum tube rectifiers. Ratings from 1600 to 10,400 piv; 250 to 750 ma dc output current. Send for Bulletin 62TR5.

# 7 invitations

to invention in circuit design... seven lines of Tarzian semiconductor products offering dependable performance at realistic prices, plus interested and informed application engineering service and production and development facilities to help you solve special problems or meet special requirements. Tell us your need or send for our newest catalogs, or both.

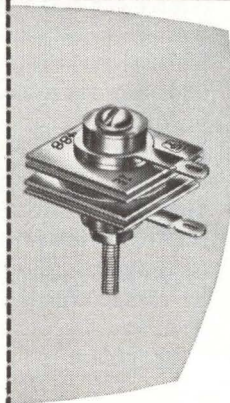

## —klipvolt— Surge Suppressors

136 types, polarized, single phase and three-phase non-polarized; maximum discharge currents from 0.25 to 33 amps. Ask for Bulletin 61KV10.



**SARKES TARZIAN, INC.**  
World's Leading Manufacturers of TV and FM Tuners • Closed Circuit TV Systems • Broadcast Equipment • Air Trimmers • FM Radios • Magnetic Recording Tape • Semiconductor Devices  
**SEMICONDUCTOR DIVISION • BLOOMINGTON, INDIANA**

# ELECTRONICS IN MAINE



Excellent female labor supply  
Dependable . . . highly productive

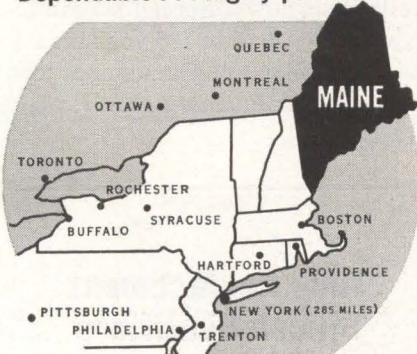

Near major research centers,  
markets and sources of supply



Modern Plants  
Lease-purchase for as little  
as 55¢ per sq. ft. per year

An independent research organization reports that lower overall operating costs contribute to maintaining firms in a competitive industry position. Raytheon, Dielectric, Sylvania and other firms have large facilities in Maine. May we give you more facts on electronics in Maine?

Write for electronic facts:

Lloyd K. Allen, Commissioner  
Maine Dept. of Economic Development  
State Capitol Room 211H Augusta, Maine

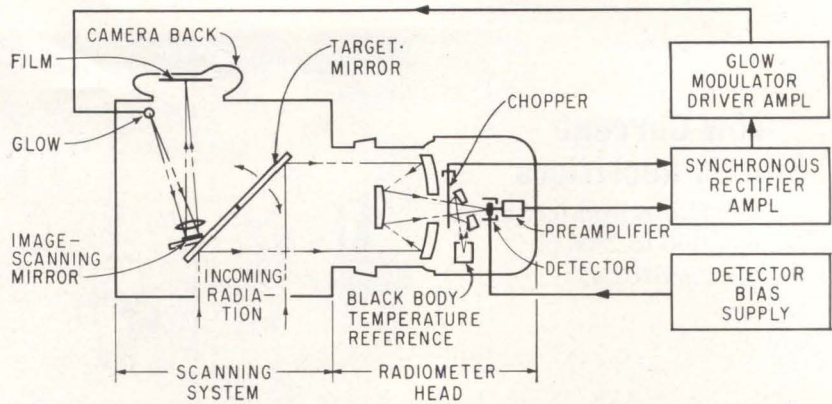

SCANNING MIRROR directs light to infrared detector. Amplifying circuit drives glow tube to produce a line of varying intensity on film. Scanning mirror has quick return and tilts to cover a field 20 degrees wide and 5 to 10 degrees high

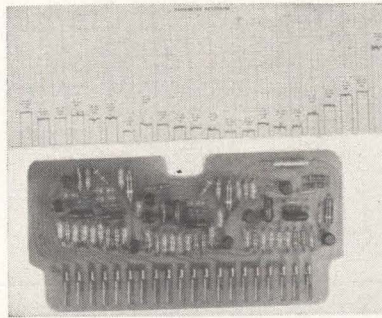

CIRCUIT BOARD and radiometer recording for normal operating conditions. Recordings (and ir photographs) can be used as inspection standards

for many type of nondestructive testing but they are not as accurate in determining absolute current flow or device dissipation as a radiometer. The radiometer, however, must be pointed at each component being measured, and its output is typically applied to a servewriter or recorder. One of the illustrations shows a circuit board and the radiometer recording developed from it during an operating test. The radiometer used to take the readings has a field of view of about 4 mm<sup>2</sup> and a theoretical temperature resolution of 0.005 C. Power in electronic circuits can be determined to 0.01 milliwatt with radiometer techniques.

APPLICATIONS—Applications of infrared circuit inspection include design engineering, production line inspection, and quality control and reliability studies.

In design engineering, measuring instruments sometimes introduce excessive loading, while tem-

perature measurements can be upset by the thermal capacity of the measuring probes. Infrared inspection methods do not introduce either of these two complicating factors.

For production line inspection and quality control of complex electronic equipment, infrared techniques are capable of faster and more comprehensive evaluation than conventional methods, which usually consist of measuring voltage, current and resistance at key points in the circuit. Conventional trouble shooting may require that suspected components be disconnected from the circuit or replaced, and assemblies such as computer boards containing thousands of components may take several days to correct. With infrared techniques, defects such as incorrect wiring, shorts, opens, poor connections, and defective components become apparent by comparing two pictures or two recordings.

Radiometer inspection can be automated with straightforward methods. Radiometer output can be compared electronically with a standard recording and components above or below tolerances can be indicated by IBM cards or in other ways.

## X-Ray Inspection with Television Display

AN X-RAY-SENSITIVE closed circuit tv system that eliminates any need for intermediate imaging devices has been developed by Ohio State's

The Oak Approach

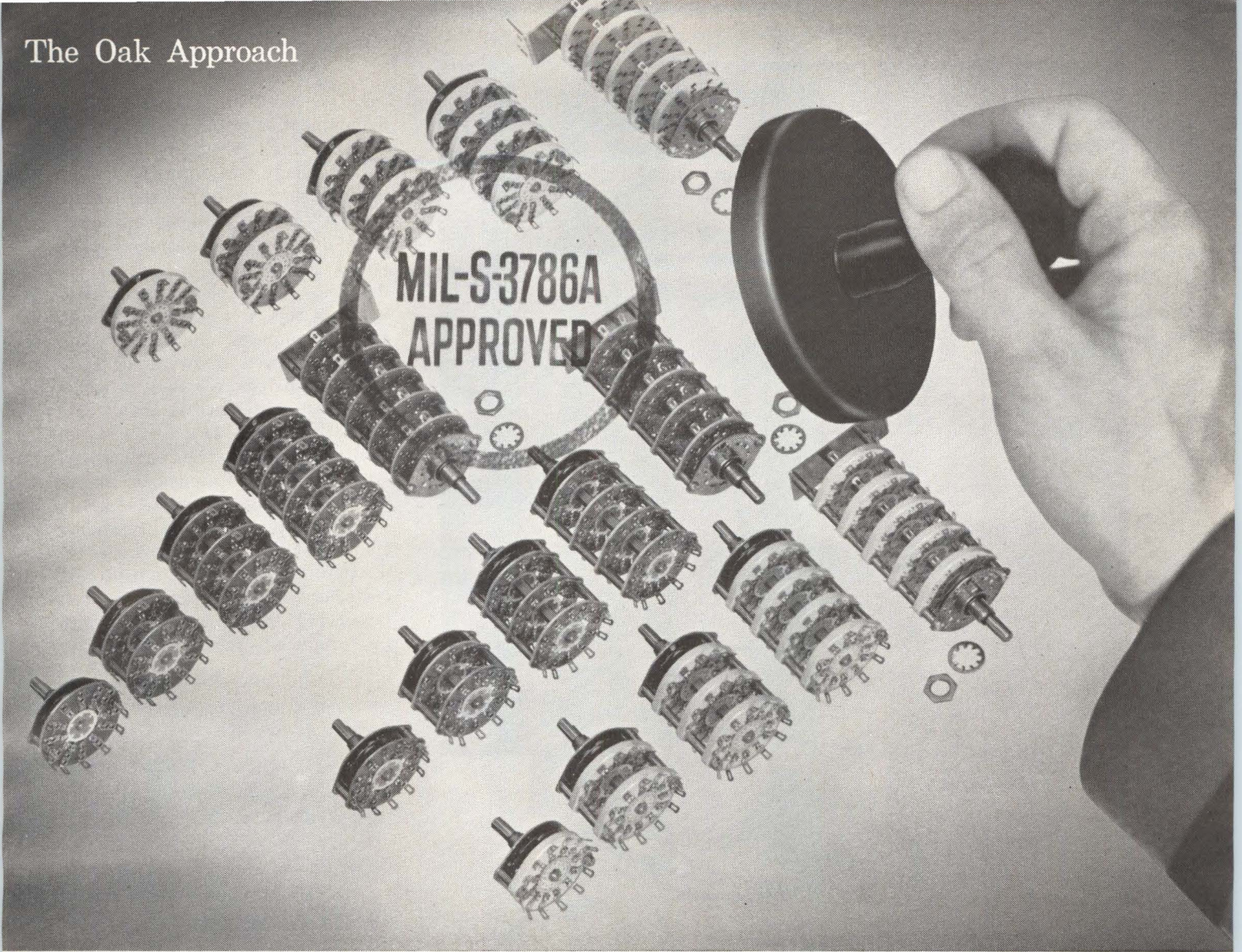

## Oak is the first major manufacturer to announce MIL-S-3786A *approved* rotary switches!

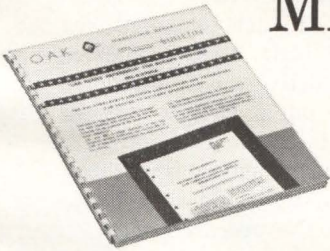

• Military Approved, ready-made versions of these rotary switches also are available — “right off the shelf” — from your nearest authorized Oak distributor.

Talk about ease of obtaining Military-Approved switches: Here are a whole slew . . . some *ceramic* and some *phenolic* insulated . . . first of MANY Oak switches now scheduled for official QPL listing. Read about them all in detail, in our new “Ready Reference Guide to MIL-S-3786A” — with handy correlations between the MIL SPEC slash-sheet numbers and each equiva-

lent Oak switch type! There’s even a copy of MIL-S-3786A in its entirety, appended for your convenience. You’ll find information on our special new test laboratory too—ASESA certified for testing all switches to military requirements. Contact your Oak representative now for assistance, and a copy of “Ready Reference Guide to MIL-S-3786A.” Or write us direct.



**OAK MANUFACTURING CO.**

CRYSTAL LAKE, ILLINOIS • Telephone: Area Code 815; 459-5000; TWX: CRYSLK 2350-U  
Plants in Crystal Lake, Illinois • Elkhorn, Wisconsin

**Subsidiaries:** OAK ELECTRONICS CORPORATION      DELTA-f, INC.      MCCOY ELECTRONICS CO.  
Culver City, Calif.      Geneva, Ill.      Mt. Holly Springs, Pa.

ROTARY AND PUSHBUTTON SWITCHES • TELEVISION TUNERS • VIBRATORS • APPLIANCE  
AND VENDING CONTROLS • ROTARY SOLENOIDS • CHOPPERS • CONTROL ASSEMBLIES

CIRCLE 75 ON READER SERVICE CARD



## Now! from Weldmatic— PUSHBUTTON WELDING

DEMAND ANY OF 6 PRECISE PRESET HEATS  
AT THE PUSH OF A BUTTON.

With a Weldmatic Model 1059B-1068 you can get a variety of precisely repeatable heat settings with push-button ease and speed. It's the positive way to increase production efficiency, minimize operator decision and error, cut rejects and waste.

Highest accuracy, too. Weldmatic Model 1059B Power Supply (voltage regulated) has a dual energy range of 45 and 9 watt-seconds. Model 1068 Weld Energy Selector mounts on top, plugs directly in, and becomes an integral part of the power supply. Operator selects one of five available weld energy settings (a sixth is obtained by depressing M Button for return to power supply) in either of the two ranges, as predetermined by the weld schedule. Button illuminates to indicate activated heat setting. Concealed heat adjustment panel (shown at left) minimizes inadvertent setting changes. Can be used with one or two welding heads. Ask your Weldmate representative or write to the Weldmatic Division/Unitek, 950 Royal Oaks Drive, Monrovia, California.



**WELDMATIC DIVISION / UNITEK**

department of welding engineering.

Inspecting electronic printed boards, the tv x-ray imaging system detects semiconductor and solder porosity, missing solder at terminals, diode contamination, broken wires, and breaks in copper conductors. Small closed assemblies such as relays, geared assemblies, springs, ratchets, and contacts can all be observed if x-rays of sufficient intensity are used to penetrate case materials. It shows considerable promise as a useful tool in military and industrial applications where x-rays are needed to inspect continuous production techniques.

Instantaneous image reproduction would allow considerable reduction in production inspection costs, according to the developers. Observing personnel would also be protected from exposure to

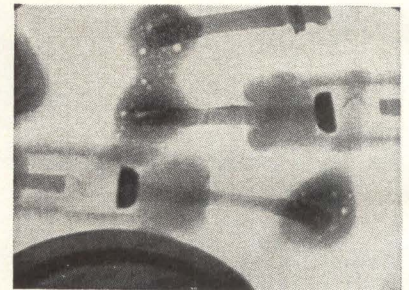

ONE-INCH diameter x-ray sensitive camera is used to develop image on 17-inch picture tube

heavy ionizing radiations from industrial x-ray sources.

The  $\frac{3}{8}$  by  $\frac{1}{2}$  inch sensing area of the one inch x-ray sensitive camera tube delivers a 30 diameter enlargement on a 17-inch picture tube. This is about the optimum possible enlargement without introducing objectionable scan lines, according to the research team.

X-ray sensing vidicon camera tubes constructed to order by Machlett labs are similar in size and appearance to conventional photoconductive vidicon tubes, but include special windows and target materials. Beryllium's inherent transparency to x-rays is reported to offer tube windows about 1.8 times more sensitive than glass.

The x-ray sensitive camera tube operates similarly to the ordinary light sensitive vidicon tube to develop an electrical signal.

*Mindpower and Manpower...  
shaping the future in*

## **COMMUNICATIONS and ELECTRONIC SYSTEMS**

**ENGINEERS:** Today the men at Motorola are developing resourceful solutions to the complex problems of America's most advanced communications and electronic systems. Creative mindpower is being applied to such vital areas as the Navy's sonobouy and oceanographic instrumentation programs...the Army's VHF single side band radio central system...the Air Force's UHF ground-air communications system...and NASA's cis-lunar and deep space tracking programs. Advanced studies are also being made in random access digital communications, digital-to-voice translation, high speed teleprinting, phased arrays and solid state circuitry. To participate in this challenging work, write today describing in detail your experience in the following areas:

**Systems Design** • analysis and synthesis of complete systems for operation in hydro-space, surface and aerospace environments. Human factors engineering and operations research.

**Equipment Design** • high performance solid state receivers, transmitters, frequency synthesizers and data handling equipment for radar and communications systems, oceanographic instrumentation systems and display complexes.

**Familiarity with State-of-the-Art** • statistical communications theory, advanced signal processing techniques, ultra-reliability through application of low-level redundancy, advanced structural and thermal designs for severe environments.

We are particularly interested in the programs on which this experience was obtained, and the extent of your technical responsibility. Address information to our Manager of Engineering at the location of your choice for immediate and confidential attention.

*An equal  
opportunity  
employer*



**MOTOROLA**

### **Military Electronics Division**

CHICAGO 51, Illinois, 1415 North Cicero Avenue  
SCOTTSDALE, Arizona, 8201 East McDowell Road  
RIVERSIDE, California, 8330 Indiana Avenue



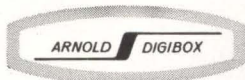

# a complete line of versatile modules for the design or test engineer

## DECADE TRANSFORMERS RESISTORS • CAPACITORS • INDUCTORS

Arnold digiboxes are designed as functional tools to provide direct visual presentation of component values.

These compatible laboratory-quality instruments can be quickly interconnected to provide a highly-reliable means of circuit simulation . . . digital adjustment of design parameters . . . fast evaluation of component tolerances.

Four units described below are first of a continuing line of associated devices. Future designs include: power supplies, transistor modules, meters, amplifiers, signal transformers, and voltage dividers.

Small size. All units are 4" x 5" x 3" high.

Easily stacked, interconnected. All digiboxes are same size and configuration. Front panel terminals speed hook-up. You can set up an entire circuit in minutes—read off every value required directly . . . digitally.

<p><b>DECADE TRANSFORMER MODEL TDA</b></p> <p>Number of Digits: 4 Range: 0 to .9999 Ratio Steps of: 0.0001 (Ratio) Accuracy: ± 0.08% + 0.0005 Frequency: 50 cps to 10 KC</p>	<p><b>DECADE CAPACITOR MODEL CDB*</b></p> <p>Number of Digits: 4 Range: 0 to 9999 MFD Steps of: 100 MMFD Accuracy: ± 1% *(Model CDA: Accuracy ± 3%)</p>
<p><b>DECADE RESISTOR MODEL RDC</b></p> <p>Number of Digits: 4 Range: 0 to 99.99 K ohms Steps of: 10 ohms Accuracy: ± 1% Power Rating: 10 Watts Maximum</p>	<p><b>DECADE INDUCTOR MODEL IDB*</b></p> <p>Number of Digits: 4 Range: 0 to 9.999 Henries Steps of: 1 mh Accuracy: ± 1% Frequency: 30 cps to 200 KC *(This unit uses Toroidal Inductors exclusively.)</p>

See us at WESCON . . . Booth 3209

FREE . . . complete set of 4 DIGIBOXES, and 9 individual DIGIBOXES of your choice will be awarded for the most unique ideas in the ARNOLD DIGIBOX APPLICATIONS CONTEST.

Contest blanks sent with all requested literature. Or pick them up at WESCON . . . Booth 3209. Contest closes August 31, 1962.

**ARNOLD MAGNETICS, CORP.**  
6050 W. JEFFERSON BLVD., LOS ANGELES 16, CALIF.  
VERMONT 7-5313 — UPTON 0-6284

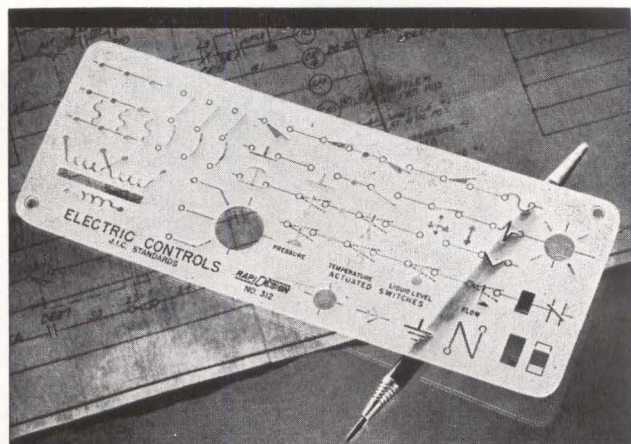

## NO. 312 ELECTRONIC CONTROLS TEMPLATE ACTUAL SIZE 9" X 3 3/4"

J. I. C. STANDARD SYMBOLS AS RECOMMENDED BY THE JOINT INDUSTRIAL CONFERENCE IN MARCH 1953.

DESIGNED TO ASSIST IN THE DEPICTION OF CIRCUITS IN ELECTRICALLY CONTROLLED MACHINERY AND ELECTRIC AUTOMATION OF PRODUCTION PROCESSES.

MADE OF .030 MATTE FINISH MATHEMATICAL QUALITY PLASTIC. ONE OF THE MORE THAN FIFTY RAPIDESIGN TIME-SAVER TEMPLATES — ALL OF WHICH ARE BETTER MADE, MORE USEFUL AND LESSER PRICED.

\$2.50 AT YOUR LOCAL DEALER

CATALOGUE NO. 55 AVAILABLE UPON REQUEST

**RAPIDESIGN** INC.

P. O. BOX 592 • GLENDALE, CALIF.

CIRCLE 200 ON READER SERVICE CARD

# BUDELMAN POINT-TO-POINT Economical • Reliable • Effective

# 2KMC

## Type 14C Microwave Radio Terminals

provide needed communication and data transmission for railroads, telephone companies, public utilities, public safety services and the armed forces.

Whether for a "thin-route" gap filler or a 48-channel multi-hop system, Budelman Type 14C, 1700-2300 MC Microwave and Speech Multiplex equipment "proves in" where others cannot.

Write for Spec-sheets, Engineering Analysis or Systems Proposals... without obligation.

**BUDELMAN ELECTRONICS CORP.**

A Subsidiary of General Railway Signal Co.

375 Fairfield Ave., Stamford, Conn. • 203 FI 8-9231

CIRCLE 201 ON READER SERVICE CARD

electronics



SO HERSHEYMER  
COMES IN AND  
I TELL HIM  
I'M QUITTING!



AND HE SAYS  
**WHY?** YOU'RE  
GETTING AS MUCH  
AS SIEFRIED  
AND LUCAS!



SO I SAID: MONEY!  
WHAT'S MONEY? YOU  
BUSINESSMEN JUST  
DON'T UNDERSTAND  
THE MIND  
OF AN  
ENGINEER!

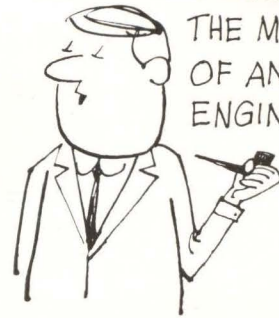

I WANT TO WORK  
WITH A COMPANY  
RUN BY  
ENGINEERS  
FOR  
ENGINEERS!

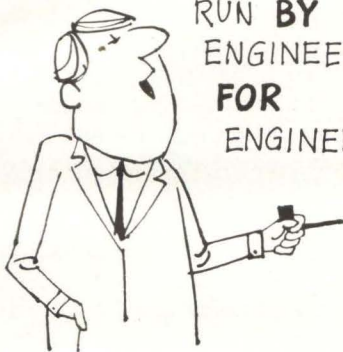

I WANT **FULLFILLMENT**  
I WANT TO WORK ON  
THE **SURVEYOR**  
AT HUGHES!



JUST THINK!  
SOMEDAY THERE'LL  
BE A LITTLE  
PIECE OF **ME**  
ON THE  
MOON!



NO MORE ELECTRONIC  
EGG-TIMERS! I'LL  
BE **CONTRIBUTING!**  
I'LL BE DOING  
SOMETHING **SIGNIFICANT!**  
SOMETHING **INTER-PLANETARY!**



BESIDES—  
HUGHES  
IS CLOSER  
TO THE  
BEACH.



**Hughes is hiring!** Numerous opportunities now exist in a variety of advanced projects and studies. Examples include: The SURVEYOR—which will soft land an instrumented payload on the moon. ARPAT—terminal anti-missile defense system. VATE—automatic test equipment for ballistic missiles. SYNCOM—synchronous-orbit communications satellite. BAMBI—ballistic anti-missile booster intercept. Positions are open at all levels for specialists with degrees from accredited universities.

**CONTROLS ENGINEERS.** Concerns airborne computers and other controls related areas for: missiles and space vehicles, satellites, radar tracking, control circuitry, control systems, control techniques, transistorized equalization networks and control servomechanisms.

**CIRCUIT DESIGNERS.** Involves analysis and synthesis of systems for: telemetering and command circuits for space vehicles, high efficiency power supplies for airborne and space electronic systems, space command, space television, guidance and control systems, and many others.

**INFRARED SPECIALISTS.** To perform systems analysis and preliminary design in infrared activities for satellite detection and identification, air-to-air missiles AICBM, infrared range measurement, air-to-air detection search sets, optical systems, detection cryogenics and others.

**SYSTEMS ANALYSTS.** To consider such basic problems as: requirements of manned space flight; automatic target recognition requirements for unmanned satellites or high speed strike reconnaissance systems; IR systems requirements for ballistic missile defense.

Please airmail  
your resume to:

**Mr. Robert A. Martin**  
Head of Employment  
Hughes Aerospace Divisions  
11940 W. Jefferson Blvd.  
Culver City 68 California



Creating a new world with Electronics

**HUGHES**

HUGHES AIRCRAFT COMPANY  
AEROSPACE DIVISIONS

An equal opportunity employer.

# DESIGN AND APPLICATION

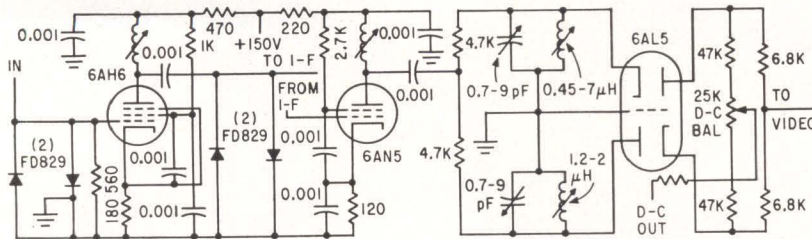

## High-Speed Diodes Make Limiting Smooth

*Features linearity to 1% and peak-to-peak video output capability of 35 volts*

MANUFACTURED by RHG Electronics, 94 Milbar Blvd., Farmingdale, N. Y., the models D606 and D306 limiter discriminators have 8 Mc peak-to-peak bandwidth, 5-percent linearity over a 6-Mc bandwidth, 0 dbm sensitivity for hard limiting, video output of 5 v/Mc and direct-coupled output of 2 v/Mc. The D606 is centered at 60 Mc and D306 is centered at 30 Mc. Some novel techniques are used in this device (see sketch). First is the use of ultra high-speed silicon diode pairs in two stages as limiters. Very smooth limiting is assured with no reversals and no time constant problems. Since these diodes can switch in nanoseconds, they can limit to beyond 100 Mc. The second design feature is the discriminator. Conventional discriminators use complex transformers or capacita-

tive coupling to the tank circuits. The discriminator shown in the sketch consists of two single poles resistively coupled to the driving tube. Tuning can be accomplished without interaction. Semiconductors are not used because of temperature sensitivity and resultant detuning. In this device, temperature stability of the crossover fre-

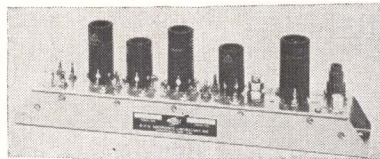

quency has been obtained to as low as 10 ppm/degree C. These units can be used in telemetry, measurements involving instantaneous frequency resolution, frequency shift during a pulse (observable as a-m on the video output), highly accurate a-c systems and conventional f-m systems.

CIRCLE 301, READER SERVICE CARD

## Portable Reference Supply For Meter Calibration

ANNOUNCED by Tensor Electric Development Co. Inc., 1873 Eastern Parkway, Brooklyn 33, N. Y., the model 5890 portable reference supply can be used for meter calibration, a source of accurate a-c/d-c voltage up to 1 watt, an accurate

a-c/d-c voltmeter in the 0 to 100 v range and a general source of a-c or d-c voltages. Output is 0 to 100 v,

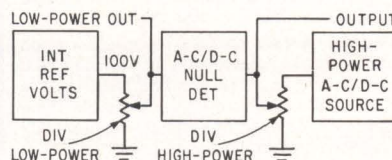

a-c or d-c, in four ranges; 0 to 0.1, 1, 10 and 100 v to 1 watt. Accuracy is  $\pm 0.25$  percent of set voltages above 0.01 v and  $\pm 0.2$  percent of set voltage ( $+5 \mu\text{V}$ ) below 0.01 v. After 15 minute warmup, output voltage will remain within specifications for at least 5 minutes without readjustment. Provisions are made to accommodate external a-c inputs at frequencies other than 60 cps. Loading with high power output is up to 10 ma at any voltage and low-power output loading is 2.5 megohm minimum load impedance. The internal reference voltage is compared to a zener reference in a bridge circuit and standardized by balancing a reference galvanometer. The desired voltage can be set on the low power divider in direct reading digital form. Divider output can be used directly without sacrificing accuracy if load impedance is greater than 2.5 megohms. For lower load impedances, the output terminals are used. To use as a voltmeter, unknown voltage is substituted for high power. (302)

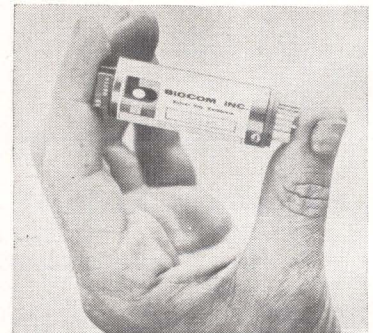

## Amplifier for Low-Level Bioelectrical Signals

NEW for Biocom Inc., 5883 Blackwelder St., Culver City, California, the model 120 bioamplifier is used for acquisition of such low-level signals as eeg, ekg, emg and fetal ekg. It features a differential gain

# BLUE LINE

# NEW FROM WEINSCHEL...

## General Utility Coaxial Components

RUGGED STABLE MODERATELY PRICED

Now the same ruggedness and stability which has marked Weinschel Precision Coaxial Devices for years is available in a lower priced line of general utility components. **Blueline** is a new series of coaxial attenuators and terminations designed for applications where price and performance are

important but a high degree of precision is not required.

Despite their lower price, **Blueline** units will use Weinschel's own film resistors which give excellent shock and vibration resistance while assuring stability under temperature and humidity cycling. These resistors are capable of withstanding appreciable peak

pulse powers and reasonable overloads without changes in characteristics.

Specifications for the Model HF-N **Blueline** Attenuator and the Model CT-N **Blueline** Termination are given below. For complete information on **Blueline** components, contact Weinschel Engineering, Kensington, Maryland,



THE **BLUE LINE** MODEL HF-N ATTENUATOR

### SPECIFICATIONS

<b>Nominal Attenuation:</b>	3 db, 6 db, 10 db and 20 db
<b>Frequency Range:</b>	2 to 10 KMC for 3 db, 6 db and 10 db units 2.5 to 10 KMC for 20 db units
<b>Impedance:</b>	50 Ohms
<b>Average Power:</b>	5 watts for 3 db units; 3 watts for 6 db units; 1 watt for 10 and 20 db units
<b>Peak Power:</b>	10 kw for 3 db units; 6 kw for 6 db units; 2 kw for 10 db units; 1 kw for 20 db units
<b>Maximum VSWR:</b>	1.35 for 3 db and 6 db units 1.40 for 10 db and 20 db units
<b>Connectors:</b>	Type "N", one male and one female.
<b>Price:</b>	\$25.00
<b>Delivery:</b>	From stock

**Blueline** components are produced and sold by Weinschel Engineering, one of the most respected names in the precision components field. For your more exacting requirements, we invite you to inquire about Weinschel Precision Attenuators and Terminations.

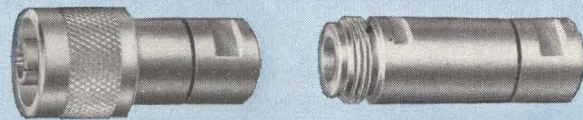

THE **BLUE LINE** MODEL CT-N TERMINATIONS

### SPECIFICATIONS

<b>Frequency Range:</b>	DC to 10 KMC
<b>Impedance:</b>	50 Ohms
<b>Average Power:</b>	1 watt
<b>Peak Power:</b>	1 kw (maximum pulse duration, 5 microseconds)
<b>Maximum VSWR:</b>	DC to 3 KMC-1.10 3 to 10 KMC-1.25
<b>Connectors:</b>	Type "N" male or female
<b>Price:</b>	\$25.00
<b>Delivery:</b>	From Stock

# WEINSCHHEL

ENGINEERING COMPANY • KENSINGTON, MARYLAND • Phone 949-0141 Area Code: 301 • TWX: KENS 446  
In CALIFORNIA • 631 Wilshire Boulevard, Santa Monica • TWX: SMON 7185

## dial any output from 0-1000 volts!

Keithley Regulated DC Supplies provide the stability, ease and accuracy necessary for a wide range of laboratory tests. Typical applications include calibration of meters and dc amplifiers; testing insulation, diode, and capacitor leakage resistances; or furnishing potentials for photo-multiplier tubes and ionization chambers.

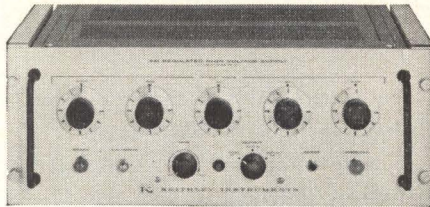

### MODEL 241—0.05% accuracy

A dc secondary standard featuring a long-life photo-chopper and zener reference. It is immune to shock and vibration, and offers long-term calibration stability.

- **Accuracy:** 0.05% or 1 millivolt.
- **DC Output Voltage:** 0-1000 volts—plus, minus or floating, with 5 calibrated dials and 100  $\mu$ v resolution.
- **Output Current:** 20 milliamperes max.
- **Stability:** 0.005% short term.
- **Ripple:** less than 1 mv RMS.
- **Overload Protection:** fast-acting relay circuit.
- **Price:** \$800.00

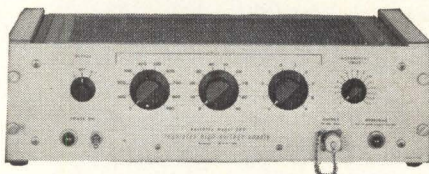

### MODEL 240—1.0% accuracy

A general-purpose version of the Model 241 available at lower cost.

- **Accuracy:** 1.0% or 100 millivolts.
- **DC Output Voltage:** 0-1000 volts—plus or minus, with 3 calibrated dials and 10 mv resolution.
- **Output Current:** 10 milliamperes max.
- **Stability:** 0.05% per eight hours.
- **Ripple:** less than 3 mv RMS above 5 cps.
- **Overload Protection:** Fast-acting relay circuit.
- **Price:** \$345.00



full details in latest catalog

**KEITHLEY  
INSTRUMENTS**

12415 Euclid Avenue • Cleveland 6, Ohio

of 6,000, has an input impedance of 0.5 megohms, output impedance of 30,000 ohms, frequency response between 0.4 cps to 5 Kc, common-mode rejection of 80 db minimum, noise level of 3  $\mu$ v peak-to-peak, and is less than  $\frac{1}{8}$ -cubic inch in size. The unit is essentially three differential stages. The first is an emitter follower for high input impedance. Low noise level is obtained by operating this stage at hushed levels. Common mode rejection balance is accomplished by balancing emitter currents in the first stage. Following two stages are long-tailed pair differential amplifiers. Construction is three-dimensional cord-wood method. Dynamic range is between the low microvolt level up to two to three millivolts. Price is \$195.

CIRCLE 303, READER SERVICE CARD

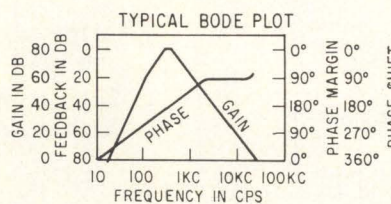
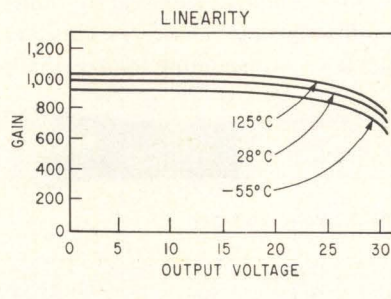

### Servo Amplifier Features 5 Watts in 1 Cubic Inch

RECENTLY ANNOUNCED by Clifton Precision Products Co. Inc., Marple at Broadway, Clifton Heights, Pennsylvania, the SA 2802 servo amplifier is a variable gain, high-performance servo amplifier using over 20 db negative feedback plus internal feedback over the various stages. Preamplifier stages use d-c stabilization and a two-stage, push-pull output provide a phase shift on saturation of less than 10 degrees. With a suitable load, the unit will provide 5 watts of output power at 40 v rms over a temperature range from -55 to +125 C with a frequency range between 380 and 420 cps. Power required is 28 v d-c and maximum efficiency of 70 per-

cent with zero-signal drain of 40 ma is typical. The large feedback factor is coupled with a gain margin of 20 db and phase margin of 70 degrees. Low input impedance (approximately 2,000 ohms) allows use as a summing amplifier via multiple input resistors. A voltage gain of  $60 \pm 1$  db is obtained with phase shift of  $180 \pm 6$  degrees with a 10,000-ohm input resistor. Gain is inversely proportional to input impedance with 66 db maximum. (304)

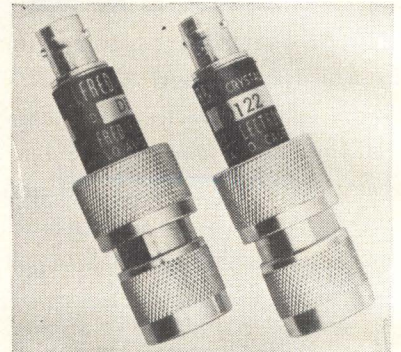

### Crystal Detectors Come in Matched Sets

ALFRED ELECTRONICS, 3176 Porter Drive, Palo Alto, Calif., has available matched crystal detector sets for 1 to 11 Gc operation. The sets are matched to  $\pm \frac{1}{2}$  db for frequency and  $\pm 1$  db for square law response. Models D121, -2, and -3 operate from 1 to 4, 4 to 8 and 7 to 11 Gc respectively. Sensitivity is greater than 0.1 v/mw at rated video load. (305)

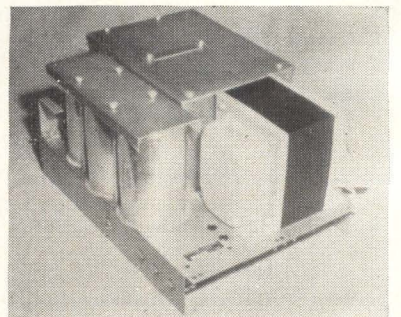

### D-C Power Supply in Modular Form

DRESSEN-BARNES ELECTRONICS CORP., 250 N. Vinedo Ave., Pasadena, Calif. Model 24269 150 v, 1 amp modular d-c power supply is 8  $\frac{3}{4}$  in. wide by 12  $\frac{1}{2}$  in. long by 7 in. high. Device is completely solid state;

series regulator circuit driven from differential amplifier using Zener reference. Temperature coefficient is typically 0.03 percent per deg C. Price is \$350. (306)



### Video Amplifier Tube Uses Strap Frame Grid

SYLVANIA ELECTRIC PRODUCTS INC., 1100 Main St., Buffalo 9, N. Y. The 6JT8, a triode-pentode, offers high performance and, if desired, permits removal of one of the i-f stages. Constructions include a T9 bulb and miniature 9 pin base. Combined with the pentode video section in the envelope is a general purpose medium mu triode intended for use as a voltage amplifier or sync separator. Structure features the strap frame grid in combination with a flat Bikini type cathode. (307)

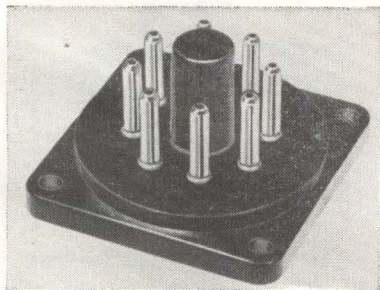

### Molded Header Comes in Octal or Eleven Pin

CATON INDUSTRIES, 646 W. First Ave., Roselle, N. J., offers a molded thermosetting plastic module header with octal or 11 pin configuration for use on relay, amplifier, filter, logic packages, etc. It has a four hole mounting flange; holes are on

July 6, 1962

Itek

## Crystal Filters do Wonderful Things

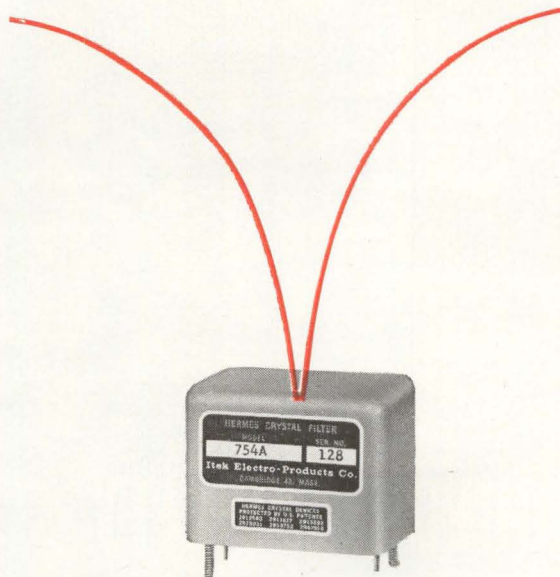

Needle-sharp filtering in a single jump is a wonderful thing! Itek Crystal Filter 754A is only 10 cycles wide at the 3db points — a bandwidth requiring a "Q" that only crystal can provide. Circuit simplification, ruggedness, temperature and long time stability, and utmost reliability are built-in extras.

Perhaps you don't need a 10 cycle wide crystal filter. But could you use the ingenuity that built one? Could Itek technical leadership help you?

Of course, the world's largest and most complete selection of stock crystal filters is available, too. Choose from more than 3,000 Itek-Hermes designs.

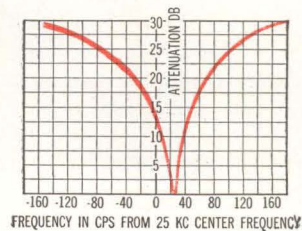

Write for free Brochure "WEESKACFAACP" or, *What Every Engineer Should Know About Crystal Filters At A Cocktail Party. You'll enjoy it.*

Itek Electro-Products Company

75 CAMBRIDGE PARKWAY, CAMBRIDGE 42, MASS. A DIVISION OF

Itek

CIRCLE 83 ON READER SERVICE CARD

83

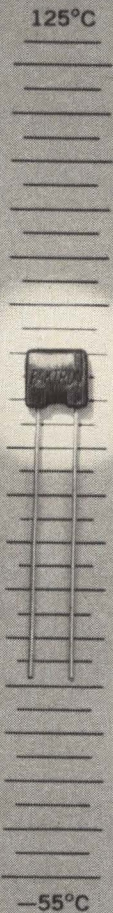

(ACTUAL SIZE)

## MEASURED STABILITY

The Paktron Mylar\* MR 330 Capacitor has a change less than 2.5%, 25°C — 85°C. Temperature range from —55°C to 125°C derating above 85°C to 50% at 125°C. Other features are low dissipation factor, excellent dielectric strength, good insulation and moisture resistance and low cost. For additional information write.

**i t PAKTRON**  
**w** PACKAGED ELECTRONICS  
 DIVISION OF ILLINOIS TOOL WORKS, INC.  
 1321 LESLIE AVENUE • ALEXANDRIA, VIRGINIA

AREA CODE 703 King 8-4400

\*\*DUPONT

1½ in. centers. Outside dimensions are 1⅜ in. by 1⅜ in. Material is general purpose phenolic.

CIRCLE 308, READER SERVICE CARD

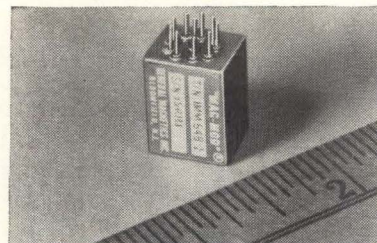

### Magnetic Modulators Microminiaturized

GENERAL MAGNETICS INC., 135 Bloomfield Ave., Bloomfield, N. J. New Micro Mag Mods provide absolute reliability and infinite standby and service life. Features: broad bandwidth, carrier frequencies as high as 1 Mc, input signal current resolution better than 0.01  $\mu$ a, low milliwatt power consumption. (309)

### Amplifier-Meter Monitors G-Level

COLUMBIA RESEARCH LABORATORIES, MacDade Blvd. & Bullens Lane, Woodlyn, Pa. Model 6003-1/6A03 amplifier-meter system permits the simultaneous monitoring from three channels during vibration tests with piezoelectric accelerometers while operating into a recording oscillograph or magnetic tape equipment. (310)

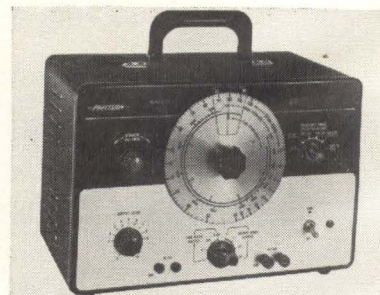

### Versatile Generator For Sine and Square Waves

PRECISION APPARATUS CO., INC., 70-31 84th St., Glendale 27, L. I., N. Y. Model E-330 has coverage of 7 cps to 750 Kc (sine and square wave) in 6 bands. It provides complete signal facilities for a wide variety of audio and video test sit-

uations. Frequency accuracy is  $\pm 5$  percent. (311)

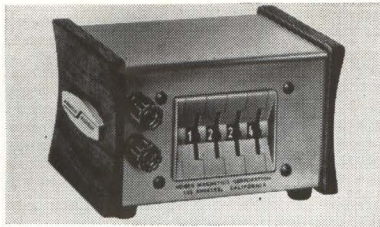

### Decade Capacitor Comes in a Compact Unit

ARNOLD MAGNETICS CORP., 6050 W. Jefferson Blvd., Los Angeles, Calif. Model CDB provides direct digital presentation of component values. Operating range is 0 to 0.9999  $\mu\text{f}$ , in steps of 100  $\mu\text{f}$ . Accuracy:  $\pm 1$  percent. Frequency range: 30 cps to 200 Kc. Size: 4 in. by 5 in. by 3 in. high. (312)

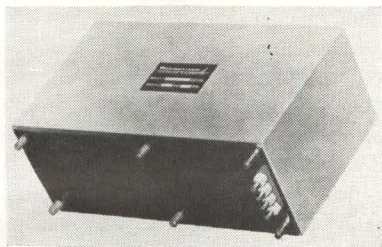

### D-C Power Modules Are All Solid State

TECHNIPOWER, INC., 18 Marshall St., South Norwalk, Conn., has extended its line of power modules to the 300 w power level. Line extension includes 46 models covering the range of 3 to 250 v. Either 0.05 or 0.5 percent regulation accuracy is available at any voltage level. Ripple options are either 1 or 5 mv rms maximum. (313)

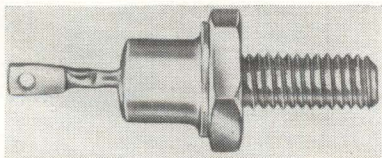

### Sealed Rectifiers With 12-Amp Max

SARKES TARZIAN, INC., 415 N. College, Bloomington, Ind., offers series 2 hermetically sealed rectifiers with d-c load current ratings of 12 amp max. Peak inverse ratings of

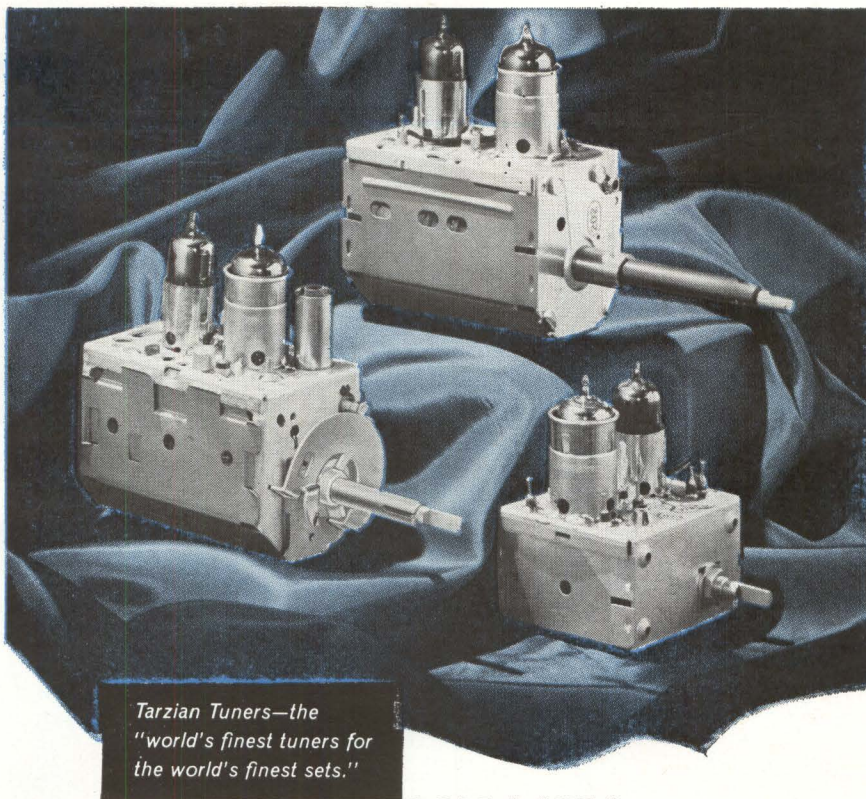

**QUALITY...  
DEPENDABILITY  
AND  
EXCELLENT  
PERFORMANCE  
AT LOW COST**

Engineering excellence, reliability and sensible pricing on ALL Tarzian products are a part of our approach to "Practical Ingenuity in Electronics." You'll find it in all of these electronic products from SARKES TARZIAN, INC.: TV and FM TUNERS . . . SEMICONDUCTORS . . . AIR TRIMMERS . . . RADIO and TV BROADCAST EQUIPMENT . . . CLOSED CIRCUIT TELEVISION for Educational and Commercial use . . . MAGNETIC TAPE . . . FM RADIOS and AM/FM RADIOS.



*Electronic Products of Tomorrow—Today*

**SARKES TARZIAN INC**

east hillside drive • bloomington, indiana edison 2-7251

# NEW TWIN TRANSDUCERS

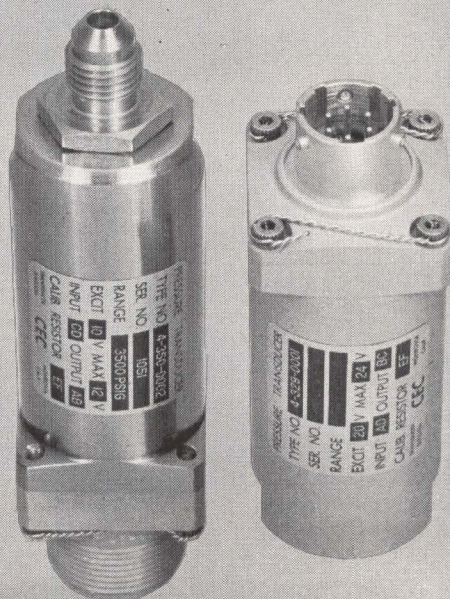

## Give data continuity for ground and airborne pressure tests

Two new members of the CEC family of high-range pressure transducers – the ground-based 4-350 and its airborne twin, 4-329—give you data in figures that are immediately comparable. Because they have the same sensing elements, performance curves are the same.

**Type 4-350** is rugged. Cased in 17-4PH SS to resist corrosion and severe test-stand conditions, it features a unique 10-X overpressure stop—assures safety plus continuing precision during successive test usage. Price: \$360.

**Type 4-329** is lightweight—aluminum-cased for flight use. It has the same pressure range as 4-350: 0-100 through 0-5000 psia or psig. Price: \$395.

For more facts, write for Bulletins CEC 4350-X7 and 4329-X7, or call CEC sales and service office.

# CEC

Transducer Division

**CONSOLIDATED ELECTRODYNAMICS**  
PASADENA, CALIFORNIA • A SUBSIDIARY OF BELL & HOWELL

100 to 600 v are offered in 100-v increments. Mounting is simplified by a choice of base polarity. Prices range from approximately \$3 to \$9 in sample quantities.

CIRCLE 314, READER SERVICE CARD

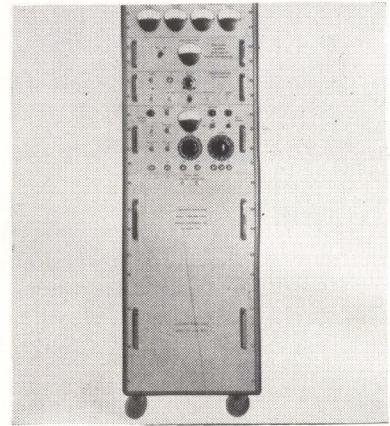

## Soft Tube Modulator Uses Modular Construction

AMULEX ELECTRONICS, INC., 467 Connecticut Ave., S. Norwalk, Conn. Model STM-1MW-6250 is representative of a line of soft tube modulators ranging from 250 Kw through 25 Mw. Equipment features modular design, providing flexibility and economy through interchangeability of modules, which are also available for purchase on an individual basis. Price for unit pictured is \$4,975. (315)

## Gage Block Calibrator

TEXAS INSTRUMENTS INC., 3609 Buffalo Speedway, Houston, Texas, Model GBC-1 optical gage block calibrator provides simple, precise calibration of gage blocks for flatness, parallelism, surface quality and length. (316)



## 90 to 650-Kc Oscillator Is Crystal-Controlled

REEVES-HOFFMAN DIV. of Dynamics Corp. of America, Cherry and North Sts., Carlisle, Pa. Model S1331, for the 90 Kc to 650 Kc range, performs to the demanding



MIL-E-19400 specification for airborne sonar. Output is sinusoidal, 1 v, rms, across a load of 3,000 ohms. Frequency deviation is  $\pm 0.015$  percent over a temperature range of from  $-30$  C to  $55$  C. Oscillator requires input power of 10 ma, 30 v, d-c. Approximate size, 1 by 4 in. (317)

### Electronic Teletypewriter

SMITH-CORONA MARCHANT INC., 410 Park Ave., New York 22, N. Y. Model 311 transistorized teletypewriter receives data in serial or parallel form. It is capable of handling both standard, 60 to 100 word per min direct wire communications, as well as input and output for computers requiring high speed, line at a time printing. (318)

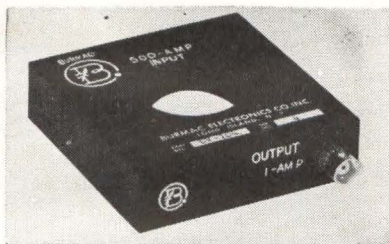

### Transformer Can Be Used for Current Pulses

BURMAC ELECTRONICS CO., INC., 24 Central Drive, Farmingdale, N. Y. The CV series of transformers are used to view and to measure current pulses in the range of a few amperes to up to 2,000 amp, peak pulse, without disturbing existing circuitry. Pulse widths reproduced by the transformers range from a fraction of a  $\mu$ sec to ms. (319)



### A-D Converters Use Modular Construction

NAVIGATION COMPUTER CORP., Valley Forge Industrial Park, Norristown, Pa., announces the 2200 series of analog-to-digital converters. They have an absolute accuracy of 0.05

# & SOME OF THEIR FAMILY

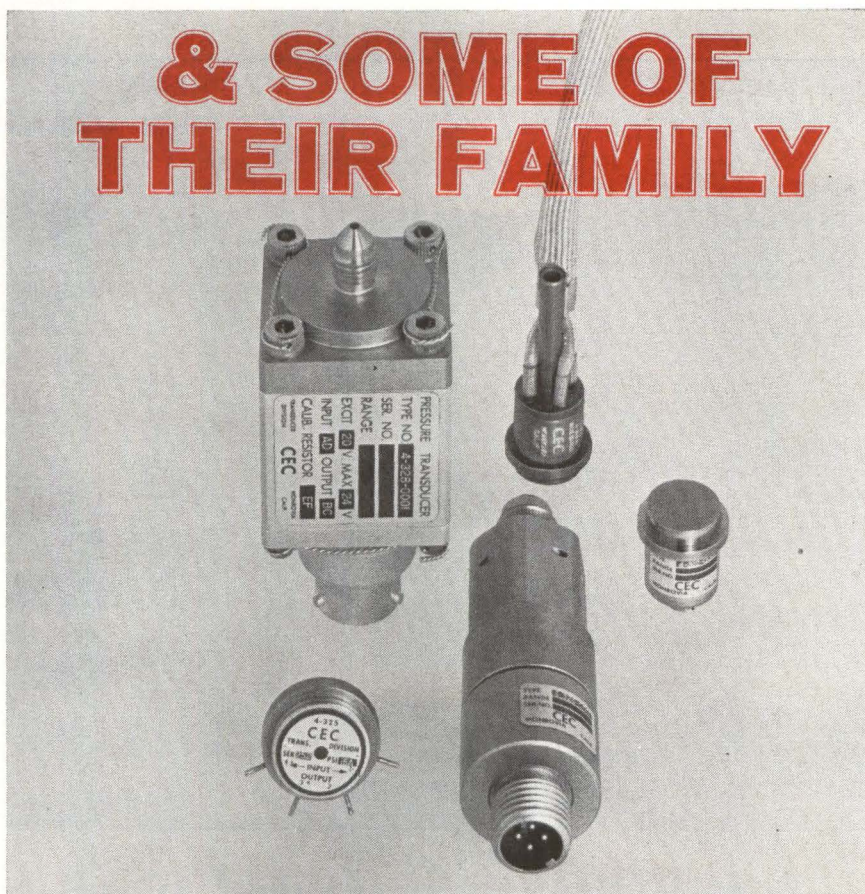

## For accurate pressure measurement in a full range of applications

Meet 5 more good reasons for saying, "When you think of transducers... think of CEC!" (Clockwise, from top left):

**Type 4-328** is the most sophisticated instrument yet developed for rugged airborne use in missiles - shunt-compensated, low-range (0-15 psi to 0-99 psi abs.)

**Type 4-317** is ideal for high pressure measurement in high temperatures or nuclear radiation. Operates continuously, accurately at  $600^{\circ}$ F. Pressure ranges 0-100 through 0-5000 psig, psid.

**Type 4-312**, midget lightweight, is a workhorse. Pressure ranges 0-10 through 0-150 psia, psig, psid,  $\pm 5$  through  $\pm 50$  psi bidirectional differential.

**Type 4-326**, best for universal use, is operable in environments as rugged as 1000-g. Six models: -0001 Medium to High Range psia, psig; -0003 Low Range psia, psig; -0004 Low Range psid; -0005 Medium to High Range psid; -0008 Extra Corrosion Resistant; -0009 10-X overpressure protected.

**Type 4-325**, smallest of all (wt.: 8 gms.), can take temperature, vibration, acceleration, shock. Pressure ranges 0-10 through 0-100 psia, 0-2 through 0-100 psig,  $\pm 2$  through  $\pm 50$  psi bidirectional differential.

More data? Write now for Bulletin CEC 1308-X3.

# CEC

Transducer Division

**CONSOLIDATED ELECTRODYNAMICS**

PASADENA, CALIFORNIA • A SUBSIDIARY OF BELL & HOWELL

**NEW DIMENSIONS IN RELIABILITY...**



## Complex computer boards wired automatically by Wire-Wrap<sup>®</sup> machines

2480 wires and 4960 connections are contained in this complicated back panel—automatically wired by a Gardner-Denver "Wire-Wrap" machine.

This is typical of how Gardner-Denver brings new dimensions to the reliability of complex electrical connections. This machine, with its punched card control system, wires complicated modular panels fast—in just about any conceivable pattern . . . makes literally thousands of connections in a small space.

And these connections are the most reliable in the world—because they're solderless wrapped connections. Just how good are they? Over a billion without reported failure.

If you're looking for ways to make lasting, trouble-free connections, fast—consult one of our engineers, or write for bulletin 14-121.

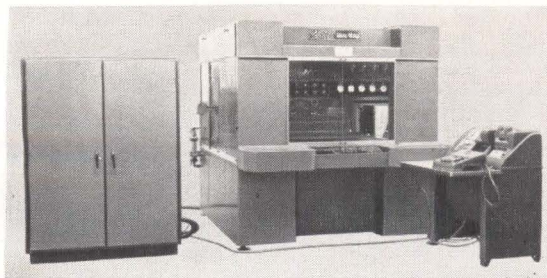

EQUIPMENT TODAY FOR THE CHALLENGE OF TOMORROW

### **GARDNER - DENVER**

Gardner-Denver Company, Gardner Expressway, Quincy, Illinois

In Canada: Gardner-Denver Company, (Canada), Ltd., 14 Curity Ave., Toronto 16, Ontario

88 CIRCLE 88 ON READER SERVICE CARD

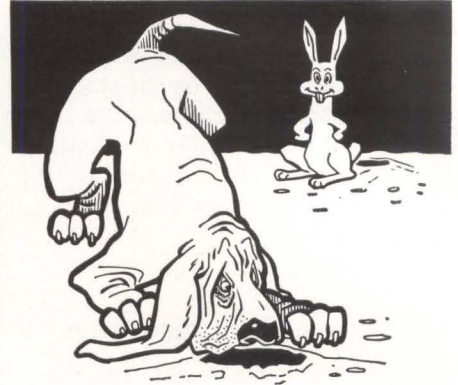

# **DON'T HUNT!**

*for connectors or components*

Even with a bloodhound you can't beat the ease of POWELL'S catalog 62 when looking for the exact connector or component you need.

POWELL'S catalog 62 is the only catalog to have **BENDIX PYGMY** and **WINCHESTER ELECTRONICS, INC.** connectors completely listed, illustrated and priced.

POWELL'S catalog 62 also contains design and dimensional data, as well as prices, of **DAGE — MICRODOT — ELCO — RAYTHEON — SEAELECTRO** — and 13 other major component manufacturers.

Powell Electronics, Inc., an authorized stocking distributor for the 20 manufacturers in catalog 62, offers this unique reference manual as evidence of our stock and our effort toward ever improving service.

**Write today for your FREE copy**



# **Powell**

**ELECTRONICS**  
INCORPORATED

P.O. BOX 8765 • PHILADELPHIA 1 • PA.

SARATOGA 4-1900 • TWX PH45

CIRCLE 88 ON READER SERVICE CARD

electronics

percent, and a conversion rate of 8,000 samples per sec. Models are available for unipolar or bipolar inputs, and come with either binary or binary-coded-decimal outputs. Prices start at \$2,775.

CIRCLE 320, READER SERVICE CARD

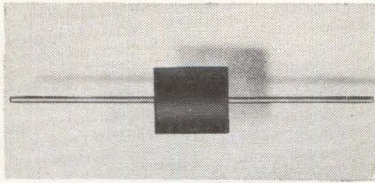

### Solid-State Rectifier Has Axial Leads

SOLITRON DEVICES, INC., 500 Livingston St., Norwood, N. J. Solid state rectifier is designed to deliver 3 amp without heat sink at voltages up to 1,200 v. Unit has an hermetically sealed insulated body which has been transfer molded by a process that utilizes thermoset silicon quartz-filled material. Electrical ratings include 25  $\mu$ a leakage at 25 C, 325 amp single cycle surge and 1.0 voltage drop. (321)

### Ceramic Capacitors Feature Miniature Size

AEROVOX CORP., New Bedford, Mass. Cerol capacitors are rolled ceramic capacitors in the high capacitance range of paper and plastic film dielectrics but are considerably smaller in size. Designed for general applications in by-pass coupling, filtering and blocking circuits, the capacitors are highly advantageous in applications where a low series resistance at high frequencies is required. (322)



### Variable Time Delay Features Gated SCR

ADC ELECTRONICS, 1205 S. Santa Fe Ave., Compton, Calif. Features an RC unijunction transistor timing circuit to gate a scr rated at 1/2 amp at 25 C. Delay range of 1 to 120 sec



**BIRD Model 8890 TERMALINE Coaxial RF Load Resistor with Model BA-88 Blower accessory.**

# NEW 5 KW LOAD

**BIRD Model 8890 RF Load with blower accessory features forced air cooling. No water required!**

The BIRD Model 8890 TERMALINE Coaxial RF Load Resistor is a portable, general purpose 50-ohm coaxial load. It provides an accurate, non-radiating termination for RF transmission lines.

The Model 8890 uses BIRD "QC" Quick-Change Connectors to accommodate any standard series of coaxial line fittings. Female Type LC (illustrated) is normally supplied. Continuous power rating for the Model 8890 utilizing normal air convection cooling is 2500 watts. With accessory blower Model BA-88, this power rating is **doubled** to 5000 watts continuous duty.

#### SPECIFICATIONS

	<b>BIRD Model 8890 TERMALINE</b>
<b>Resistance:</b>	50 ohms nominal
<b>Power rating:</b>	2.5 KW (air convection cooled) 5 KW with BA-88 Blower accessory
<b>VSWR:</b>	1.1 max. 0-1000 mc
<b>Weight:</b>	33 pounds net (with blower 49 pounds)
<b>Ambient Air Temperature Range:</b>	-40°C to +45°C.
<b>Blower Model BA-88:</b>	115V, 50/60 cy, 27w

**NOTE:** Other models available in this series are: Model 8891 with 3/8" EIA flanged line connector Model 8892 with 1/2" EIA flanged line connector

#### Prices, F.O.B. Factory:

Model 8890	\$410
Model 8891	425
Model 8892	415
Model BA-88	250

Contact BIRD for more information on these and other BIRD products.



## BIRD ELECTRONIC CORPORATION

30303 Aurora Rd., Cleveland 39 (Solon), Ohio  
Churchill 8-1200 TWX CGN FS 679

Western Representative:  
VAN GROOS COMPANY, Woodland Hills, Calif.

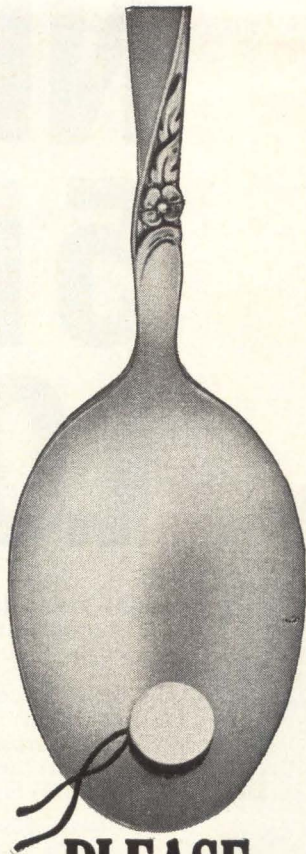

**PLEASE  
DON'T  
SWALLOW  
OUR  
MOTOR**

...IT'S HIDING BEHIND THE ASPIRIN. Actually, we set out to build an easy-to-read tiny timer...but we first had to build an aspirin-sized motor to drive it. This assignment might have been a headache for a sorcerer, but A. W. Haydon did it. And there is something magical about these micro-miniature elapsed time indicators and companion events counters. ■ This digital elapsed time indicator has many outstanding features: size is only 1/2" square x 1 1/16" long...weight .75 ounce...

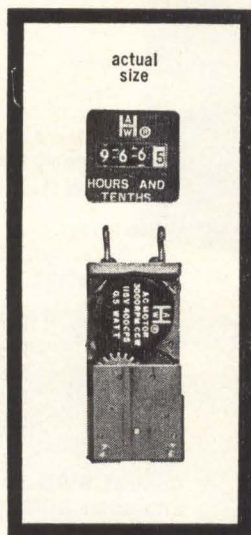

meets all mil specs...temp. range -54 to +125°C...vibration to 2000 cps at 20 G...choice of two ranges (hours to 9999, tenths to 999.9)...power input .5 watt, max. In fact, the complete data outweighs the equipment. Send for our heavyweight literature on the 19200 ETI right now. ■ Electrical or electronic, the A. W. Haydon Company works wonders in time. For electronic requirements call Culver City. For electro-mechanical devices call on our wizards in Waterbury.

**THE AWHAYDON COMPANY**

235 North Elm Street, Waterbury 20, Conn.

can be obtained by varying an external resistor. Ambient temperature range is -55 C to +85 C. Fully encapsulated to conform with MIL-E-5272. Has reset time of 20 milli-sec max and life in excess of 10 million cycles.

CIRCLE 323, READER SERVICE CARD

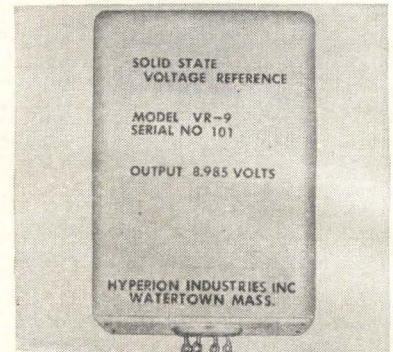

### Voltage Reference Uses Standard Cell

HYPERION INDUSTRIES, INC., Watertown, Mass. Model VR-9 solid state standard cell provides an output voltage of 9 v d-c  $\pm 5$  percent, factory-calibrated to  $\pm 5$  mv for zero current drain, and marked accordingly. Standard units drive loads up to 1 ma; custom units drive loads up to 20 ma. Input voltage is 100 to 130 v a-c, 50 to 1,200 cps. Temperature stability is 25  $\mu$ v/deg C, -55 C to +85 C. (324)

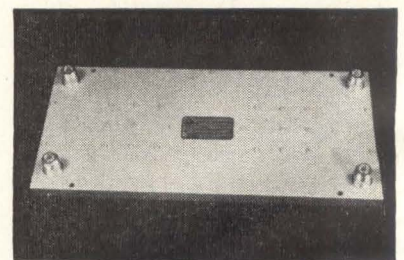

### Compact Hybrids Made of Stripline

ELECTRONIC SPECIALTY CO., 5121 San Fernando Road, Los Angeles 39, Calif. Series CH-1212 180-degree hybrids are constructed in stripline and furnished with type N coaxial terminals. Standard units are immediately available in octave bandwidths throughout the spectrum from 60 Mc to 4,000 Mc. Power handling is 300 w c-w. Phase deviation over an octave is less than  $\pm 10$  deg. Minimum isolation is 20 db. (325)

**PRODUCT BRIEFS**

**TEMPERATURE CONTROLLER** thermistor based. Yellow Springs Instrument Co., Inc., Box 106, Yellow Springs, O. (326)

**CHASSIS SLIDES** extruded aluminum. Chassis-Trak, Inc., 525 S. Webster, Indianapolis, Ind. (327)

**SNUBBER DISPENSER** for precut wire assembly. Highland Products, Inc., Dover, N. J. (328)

**SILVER-ZINC MISSILE BATTERY** arc-shaped. Yardney Electric Corp., 40-50 Leonard St., New York 13, N. Y. (329)

**ULTRASONIC CLEANER** has 75 gallon capacity. Ultrasonic Systems, Inc., POB 11085, Palo Alto, Calif. (330)

**PROCESS CONTROL COMPUTERS** high-speed. Westinghouse Electric Corp., Box 2278, Pittsburgh 30, Pa. (331)

**CRYOGENIC FLASK** up to triple liquid gas holding times. Texas Instruments Inc., 3609 Buffalo Speedway, Houston, Texas. (332)

**SUBMINIATURE GERMANIUM DIODE** for demodulator circuits. Telefunken GMBH, Presseabteilung, Ernst-Reuter-Platz 7, Berlin-Charlottenburg 1, Germany. (333)

**MAGNETIC SHIELDING CELL** isolates large variety of components. Magnetic Shield Division Perfection Mica Co., 1322 No. Elston Ave., Chicago 22, Ill. (334)

**A-C REVERSING MOTOR** with brake. U. S. Industries, Inc., 6312 Hollister Ave., Goleta, Calif. (335)

**COINCIDENT CURRENT MEMORY** 2  $\mu$ sec. Indiana General Corp., Electronics division, Keasbey, N. J. (336)

**EVENT RECORDER** four-channel. Gulton Industries, Inc., 212 Durham Ave., Metuchen, N. J. (337)

**ALUMINA OR BERYLLIA PARTS** gold coated. Alloys Unlimited, Inc., 21-01 43rd Ave., Long Island City 1, N. Y. (338)

**D-C VOLTMETER** servo-operated. F. L. Moseley Co., 409 N. Fair Oaks Ave., Pasadena, Calif. (339)

**RADAR POWER SUPPLY** low-ripple. General Electric Co., Schenectady 5, N. Y. (340)

**PRECISION POT MODULE** 4-gang unit. Technology Instrument Corp. of California, 850 Lawrence Drive, Newbury Park, Calif. (341)

**HIGH CURRENT SUPPLIES** programmable. Kepco Inc., 131-38 Sanford Ave., Flushing 52, N. Y. (342)

**POWER TRANSFORMERS** miniature, 400 cps. Electro Windings and Components, Inc., 239 Hollywood Ave., Hillside, N. J. (343)

**MICROMINIATURE COAX CONNECTOR'S** cut cable assembly time. DuTron

# NEW BALLANTINE VTVM MEASURES SIGNALS AS LOW AS 30 MICROVOLTS

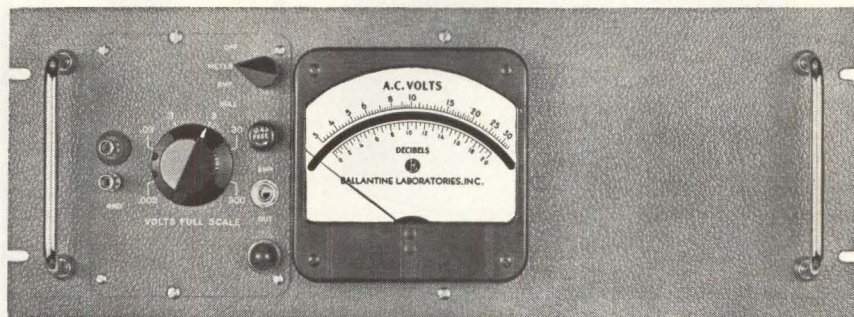

Model 300-H-S/2 Price: \$235.

**One logarithmic voltage scale, individually calibrated for the same high accuracy over the entire 5 inches of mirror-backed scale**

★ ★ ★

**Over 5,000 hours of life within specifications between calibrations**

★ ★

**Indicated voltage changes less than 1/2% for line voltage change of 10% from nominal of 115 volts.**

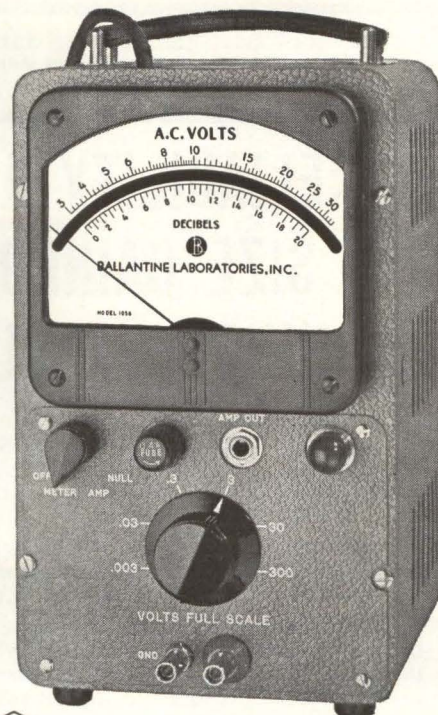

**SPECIFICATIONS**

- Voltage Range . . . . . 30  $\mu$ V to 300 V
- Frequency Range . . . . . 10 cps to 1 Mc
- Accuracy . . . . . 300  $\mu$ V to 300 V
  - 2%, 10 cps — 700 kc
  - 3%, 700 kc — 1 Mc
  - 30  $\mu$ V to 300  $\mu$ V
  - 5%, 100 cps to 100 kc

Write for brochure





Model 300-H  
Price: \$230.

**BALLANTINE LABORATORIES INC.**  
Boonton, New Jersey

CHECK WITH BALLANTINE FIRST FOR LABORATORY AC VACUUM TUBE VOLTMETERS, REGARDLESS OF YOUR REQUIREMENTS FOR AMPLITUDE, FREQUENCY, OR WAVEFORM. WE HAVE A LARGE LINE, WITH ADDITIONS EACH YEAR. ALSO AC DC AND DC AC INVERTERS, CALIBRATORS, CALIBRATED WIDE BAND AF AMPLIFIER, DIRECT-READING CAPACITANCE METER, OTHER ACCESSORIES.

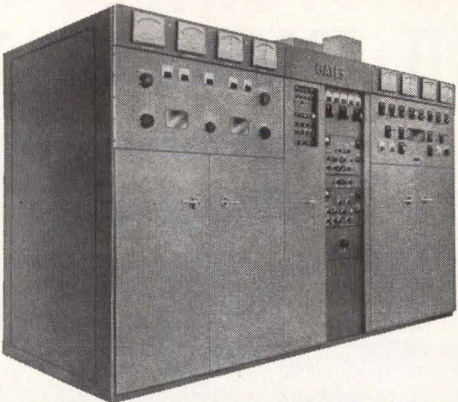
# GATES RADIO COMPANY BUILDS 50 KW TRANSMITTER FOR VOICE OF AMERICA

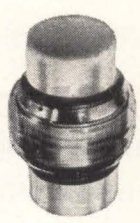
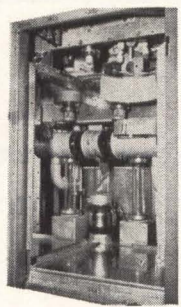
**UCSXHF 450**  
40 kv  
60 AMPS

**UCSF 500**  
15 kv  
45 AMPS

**MMHC 450**  
55 kv  
125 AMPS

**A.** Output network of Gates HF-50C using Jennings UCSF 500 vacuum variable capacitors. **B.** Power amplifiers with Jennings UCSXHF 450 capacitors in the plate tuning circuit. Jennings capacitors are also used for grid loading, neutralizing, and plate by-pass.

## RELIABILITY AND REDUCED SIZE GAINED BY USING JENNINGS VACUUM CAPACITORS

These new 50 kw high frequency transmitters built by Gates Radio Company are the first available to meet rigid USIA specifications that harmonic and spurious radiation be attenuated at least 80 db. The transmitters only occupy 5x11x6½ feet and are tunable through front panel controls over the entire range of 3.9 to 30 mc.

Jennings vacuum capacitors are the logical choice where compactness is desired because the high strength vacuum dielectric allows them to be made much smaller which results in the added effectiveness of lower inductive losses.

Jennings vacuum capacitors are more reliable because the sealed plates never become contaminated. They possess an extremely wide capacity change ratio that makes possible a wide frequency range. Further, vacuum capacitors have a very low dielectric loss and are self sealing after moderate overloads.

Jennings 350 types of fixed and variable vacuum capacitors permits selection of the right capacitor to meet your circuit requirements.

Write today for more detailed information about our complete line of vacuum fixed and variable capacitors.

RELIABILITY MEANS VACUUM / VACUUM MEANS *Jennings*®

JENNINGS RADIO MFG. CORP., 970 McLAUGHLIN AVE., SAN JOSE 8, CALIF., PHONE CYpress 2-4025

Corp., 777 W. 17th St., Costa Mesa, Calif. (344)

AUTOTRANSFORMER cased 5-amp unit. General Radio Co., West Concord, Mass. (345)

ELECTROMETER and power supply combination. Gyra Electronics Corp., Washington & Elm Sts., LaGrange, Ill. (346)

H-PLANE R-F SWITCHES excellent isolation. The Douglas Research Corp., Mt. Vernon, N. Y. (347)

SWEEPING OSCILLATORS plug-in type. Kay Electric Co., 14 Maple Ave., Pine Brook, N. J. (348)

MILLIVOLTMETER low-cost, full four-digit. Non-Linear Systems, Inc., Del Mar, Calif. (349)

FREQUENCY MULTIPLIER phase-coherent. Resdel Eng. Corp., 330 S. Fair Oaks Ave., Pasadena, Calif. (350)

SMALL GAS DRYER for tactical missiles. Lear Inst. Div., 110 Ionia Ave., N.W., Grand Rapids 2, Mich. (351)

POWER RHEOSTAT miniaturized. Tru-Ohm Products, 3426 W. Diversey Ave., Chicago 47, Ill. (352)

ULTRASONIC DEBURRER cuts production costs. Powertron Ultrasonics Corp., Fairchild Ave., Expressway Ind. Park, Plainview, L. I., N. Y. (353)

CONNECTORS for plug-in circuit modules. U.S. Dielectric Inc., 181 Greenwood St., Worcester, Mass. (354)

STEP REFLECTORS for optical maser systems. Perkins-Elmer Corp., Norwalk, Conn. (355)

DATA PROCESSING SYSTEMS four new models. Burroughs Corp., 219 Park Ave., South, N. Y. 3, N. Y. (356)

POWER SUPPLIES close regulation, low ripple. Acopian Technical Co., 927 Spruce St., Easton, Pa. (357)

SENSITIVE VTVM chopper stabilized. Dynatran Electronics Corp., 178 Herricks Rd., Mineola, N. Y. (358)

TAPER PIN P-C CONNECTORS dual-tube. Viking Ind., Inc., 21343 Roscoe Blvd., Canoga Park, Calif. (359)

PROGRAMMER for sequential control. Granger Associates, 974 Commercial St., Palo Alto, Calif. (360)

FLOW COMPUTER provides instant measurement. Daniel Orifice Fitting Co., 9720 Katy Road, Houston, Texas. (361)

CIRCUIT BUILDERS BREADBOARD small size. Circuit Structures Lab, P.O. Box 36, Laguna Beach, Calif. (362)

PHOTOELECTRIC CONTROL UNITS transistorized. Melpar, Inc., 3000 Arlington Boulevard, Falls Church, Va. (363)

HEADSET-MICROPHONE ASSEMBLY for adverse noise environments. Roanwell Corp., 180 Varick St., New York 14, N. Y. (364)

## Literature of the Week

**DIGITAL CIRCUIT CARDS** Engineered Electronics Co., 1441 E. Chestnut Ave., Santa Ana, Calif. Catalog G42a covers G series 10 Mpps digital circuit card modules. (365)

**METAL FILM RESISTORS** Daven Division of General Mills, Inc., Livingston, N. J. A catalog and price list on metal film resistors. (366)

**PRODUCT MARKING** Markem Machine Co., Keene, N. H. Catalog describes methods, machines, type, and ink for identifying all types of electronic products. (367)

**NUVISTOR TUBES** Radio Corp. of America, Harrison, N. J. Temperature ratings and thermal considerations for Nuvistor tubes. *Application Note AN-194.* (368)

**COMMAND-DESTRUCT ANTENNA** Andrew Corp., P.O. Box 807, Chicago 42, Ill. Bulletin 9734 covers a high gain ground-to-air command-destruct antenna. (369)

**TRANSISTOR AND DIODE TESTER** Texas Instruments Inc., 3609 Buffalo Speedway, P.O. Box 66027, Houston 6, Texas. Bulletin A-704 illustrates and describes model 654 fast go/no-go transistor/diode tester. (370)

**BROADBAND ROTATING JOINTS** DeMornay-Bonardi, 780 South Arroyo Parkway, Pasadena, Calif. Brochure covers a line of ultramicro-wave and microwave waveguide broadband rotating joints. (371)

**LEAK DETECTOR** Consolidated Electrodynamics Corp., 360 Sierra Madre Villa, Pasadena, Calif. Bulletin describes type 24-120A Mass-spectrometer leak detector. (372)

**TAPE SPOOLER** Electronic Engineering Co. of California, Box 58, Santa Ana, Calif. Data sheet describes the TS-405 tape spooler which winds at speeds up to 50 ips. (373)

**TERMINAL BLOCKS** Burndy Corp., Norwalk, Conn. Catalog contains technical description of miniature and standard size terminal block construction. (374)

**ROSIN FLUX REMOVER** Supracote Development Laboratory, 11 First St., Bloomingdale, N. J. Illustrated bulletin describes Reflux safety solvent for fast, efficient removal of rosin flux residues, and general metal cleaning. (375)

**SIGNAL GENERATOR** Boonshaft and Fuchs, Inc., Hatboro Industrial Park, Hatboro, Pa. Bulletin 711A-1 describes a variable-phase, l-f signal generator for use in frequency response analyses. (376)

**ULTRASONIC DRILLS** Gulton Industries, Inc., 212 Durham Ave., Metuchen, N. J., has issued bulletin V7d on its Glennite Hi-T ultrasonic impact drills. (377)

## New From T/I MODEL 654 transistor and diode tester

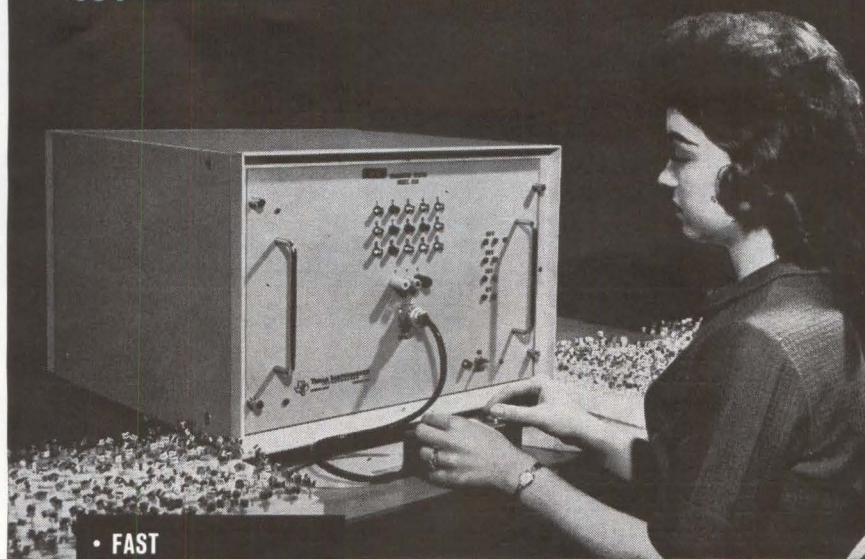

- FAST
- FOOLPROOF
- AUTOMATIC SORTING
- EASILY PROGRAMMED
- FLEXIBLE

## 15 Tests in Less Than a Second!

Texas Instruments Model 654 Transistor and Diode Tester combines speed and accuracy with complete flexibility of application. Fast reprogramming through use of printed circuit boards makes the Model 654 equally useful for high-volume, single-device testing or batch testing of a variety of devices.

**High Speed.** Fifteen parameter testing of 1800 devices per hour. Each test position can be set to provide a testing time of 50 milliseconds to 3 seconds.

**High Accuracy.** Null detector senses variations of less than 2 millivolts and/or 10 nanoamps. Power supply regulation is better than 1 per cent.

**Minimum Operator Training.** Only two controls are accessible to the operator, the ON-OFF switch on the front panel and the START push button on the test fixture. The testing cycle starts when the push button is released. Lights indicating failed tests remain on until the operator starts the next test cycle.

**Fast Reprogramming.** Electrical conditions for each test are preprogrammed on printed circuit boards. By merely changing circuit boards a completely new program may be obtained.

**Flexible System.** Circuit boards built to customer specifications. Modular power supplies permit direct substitution for special requirements. Automatic sorters in six- and eight-bin sizes are available as standard accessories.

Write for complete information.

APPARATUS DIVISION  
PLANTS IN HOUSTON  
AND DALLAS, TEXAS



**TEXAS INSTRUMENTS**  
INCORPORATED  
3609 BUFFALO SPEEDWAY  
P. O. BOX 66027 HOUSTON 6, TEXAS

495



## Foxboro Erecting Research Center

START of construction for a \$700,000 research center at Foxboro, Mass., has been announced by the Foxboro Co. The building will house the firm's expanding R & D activities, facilitating greater emphasis on advanced instrument engineering for the process industries, according to W. E. Vannah, director of research. Completion is scheduled for January, 1963.

The three-story structure will bring the total research facilities to nearly 50,000 square feet and enlarge the plant area at Foxboro, Mass., to 611,000 square feet.

The first floor will include an auditorium and a simulation laboratory with analog and digital equip-

ment for the study of systems and product design problems. The second floor will house laboratories, offices and conference rooms. The third floor will be an information center, with library, patent files and study rooms. The basement will be largely devoted to heavy processing equipment and test gear needed for application research and evaluation projects.

The architectural theme is flexibility. Floor plans can be varied as research requirements change. The brick and steel building is designed in four-foot modules. Walls are easily moved and utilities can be brought up in any desired location from a below-stairs walkway.



### North Atlantic Promotes Herman

SIDNEY HERMAN recently advanced from director of engineering to vice president of engineering for North Atlantic Industries, Inc., Plainville, N. Y.

Company is engaged in the de-

sign, development and manufacture of electronic test instruments, measuring instruments, control systems and instrument servos.

### Western Scientific Opens Laboratory

OPENING of a commercial primary standards laboratory in Los Angeles, Calif., has been announced by Gordon S. Marshall, president of Marshall Industries, San Marino.

The laboratory will be operated by the Western Scientific Instrument Co., a subsidiary of Marshall Industries. Western Scientific specializes in the calibration, maintenance, and repair of electronic test equipment used in R&D, produc-

tion-line testing and final testing. The laboratory equipment assures the accuracy of Western Scientific's testing devices in accordance with the measurements established by the National Bureau of Standards.

### Belock Appoints Two Executives

JEREMY TAYLOR has been named executive assistant to the president and acting director of programs at Belock Instrument Corp., College Point, N. Y. He was previously associated with Lockheed Missiles and Space Corp.

Arthur J. Minasy, formerly with Sperry Gyroscope Co., has been appointed vice president for operations in charge of production and engineering of Belock.



### Greenwald Advances At Norden Division

PROMOTION of Martin H. Greenwald to assistant chief—radar and communications in the engineering department at United Aircraft Corporation's Norden division, Norwalk, Conn., is announced.

With Norden since 1955, Greenwald most recently has been responsible for the design and development of video, data processing, and display equipment for radar systems.

### Appoint Bernier ASTIA Director

CHARLES L. BERNIER was recently appointed director of the Armed Services Technical Information Agency, which has its headquarters at Arlington Hall Station, Va.

Bernier has been serving as tech-



# NEW

*all solid-state plug-in*

## DECADE COUNTER MODULE

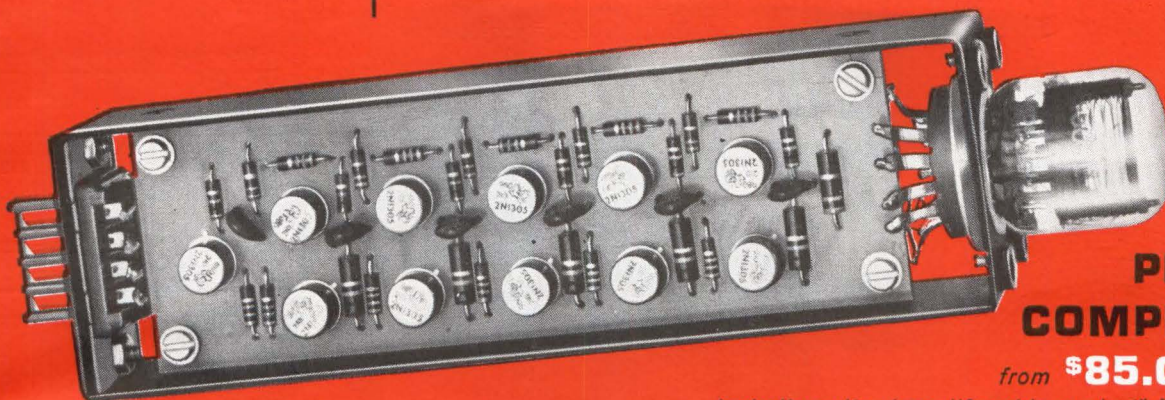

**PRICE COMPLETE**

from **\$85.00** each

*including ultra long-life wide-angle 1" Nixie tube*

The new Anadex plug-in module features an entirely new circuit that is simple, reliable, and rugged. These modules can be interconnected to perform totalizing and counting operations from 0 to 100 KC:

- Measures 1 1/4" wide x 1 3/4" high x 6 1/2"
- Low current consumption—only 10 ma per decade
- Requires only one power supply voltage
- Mounting panels and input amplifier available

## ANADEX INSTRUMENTS INC.

7617 Hayvenhurst Avenue Van Nuys, California

*Anadex*

CIRCLE 202 ON READER SERVICE CARD

### electronics

#### Editorial Opportunity

IT DOESN'T HAPPEN OFTEN, but **electronics**, "bible of the industry" and a McGraw-Hill publication, has an opening for an Assistant Editor.

Ideally, the man we are looking for and to whom a post on our New York staff could be a long-term challenge, would have an electrical engineering degree or technical equivalent, practical experience in our field and a demonstrated aptitude for editing, writing, reporting. He probably lives somewhere in the metropolitan area and therefore would have no relocation problem.

Write **The Editor, electronics**, 330 W. 42nd St., New York 36, stating experience, aspirations and past earnings. Mark the envelope "Confidential" and it will be kept that way.

### IN DIGITAL DATA COMMUNICATIONS...

DD LINE = RELIABILITY + FLEXIBILITY + LOW COST

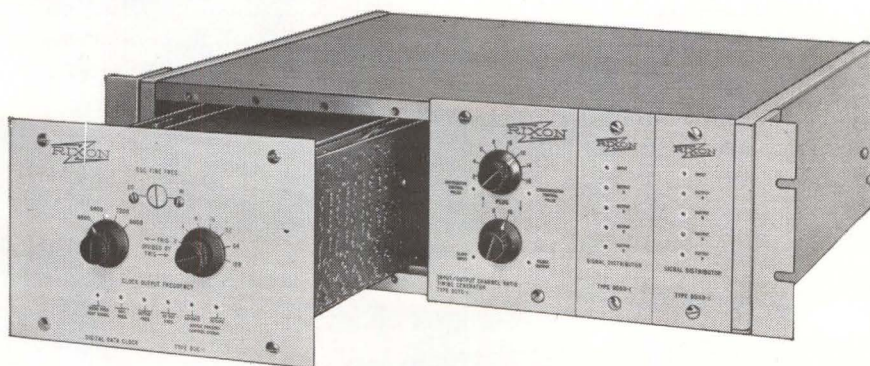

The need for reliable and flexible low-cost data communications equipment has led to the design and development of the Rixon **DD Line**. **DD** is the packaging of basic data communications system components into functional units. Now the system designers can build a system from **DD** modules to meet their exact requirements in either medium—wire line or HF radio circuits. Available now are modulators, demodulators, clocks, phase resolvers, delay equalizers, and serial-to-parallel converters, just to mention a few—at bit rates from 600 to 4800 bps.

Advantage? Reliability and complete flexibility at low cost—a result of over five years experience with data transmission systems.

Availability? Now!!!

**RIXON** ELECTRONICS, INC.

2121 Industrial Parkway—Montgomery Industrial Park—Silver Spring, Maryland  
Telephone: 622-2121

TWX: S Spg 213  
CIRCLE 95 ON READER SERVICE CARD

## Acoustical Components of Superior Quality

JAPAN PIEZO supplies 80% of Japan's crystal product requirements.

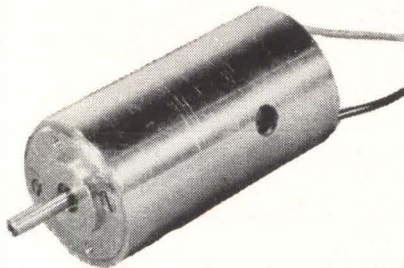
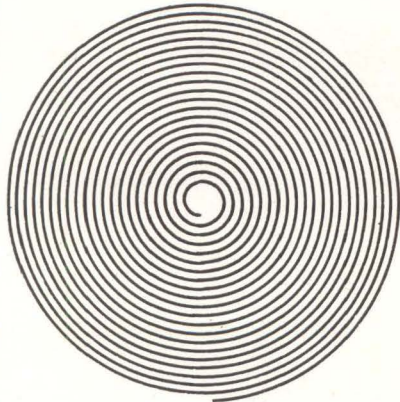

### PHONOGRAPH MOTOR — DC PM — 31-1

9V, 2,500RPM: No-load current, 35 mA; load current, 80 mA. Starting torque, 13 g-cm; load torque, 5 g-m. Size: 2.4 cm x 4.6 cm. Weight: 100 gm.

Write for detailed catalog on our complete line of acoustical products including pickups, cartridges, microphones, record players and many associated products.



## JAPAN PIEZO ELECTRIC CO., LTD.

Kami-renjaku, Mitaka, Tokyo, Japan

nical advisor to this agency, which as a central service of the Department of Defense, provides an interchange of technical information to serve engineers and scientists working on the nation's weapon systems and other priority projects.



### Brown Accepts Wellington Post

APPOINTMENT of Robert C. Brown to the position of director of engineering of Wellington Electronics, Inc., Englewood, N. J., is announced.

He was formerly associated with Westinghouse Electric Corp., at the R&D center, Pittsburgh, Pa.



### Acoustica Associates Elevates Knox





CAMERON KNOX, corporate director of research for Acoustica Associates, Inc., Los Angeles, Calif., has been elected a vice president.

A specialist in oceanography, Knox has been with Acoustica since April, 1961.

### Set Up Engineering Services Company

CHARLES H. STANDISH has announced the formation of a new

## Coto-Coils for Contact Capsules

TYPE	DC-V	Ohms	Nom. Watts	Nom. Amp/Turns
S 	6	100	.40	250
	12	360		
	24	1400		
M 	6	50	.70	250
	12	175		
	24	820		
T 	6	100	.35	125
	12	400		
	24	1600		
	32	2800		
	48	4600		
U 	6	150	.24	125
	12	600		
	24	2500		

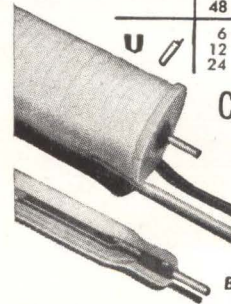

Coil Windings  
WIRE SIZES  
#6 to #56  
CLASSES  
A, B, F and H

Write for  
Bulletin and Prices

Since 1917 Coto-Coil has wound all types of coils for every application. Complete design and engineering service is available.

**Coto-Coils** COTO-COIL CO., INC.,  
65 Pavilion Avenue  
Providence 5, R. I.  
CIRCLE 203 ON READER SERVICE CARD

'On PW Boards'

**DYNASERT**  
COMPONENT  
INSERTING  
MACHINE  
CAN PAY  
FOR ITSELF

**IN A YEAR  
or less!**



BY DYNASERT  
BY HAND



With only a few hundred PW boards a week, when Dynasert automatically feeds, prepares and inserts components, direct labor is cut to a fraction. Insertion rates go up to ten times faster, model changeovers made in seconds, boards are neater, more dependable, easier to solder tightly. Result: Savings that can return the cost of Dynasert in six months' to a year's time, plus more accurate and uniform insertions.

Send for the facts and figures. Dynasert Dept., United Shoe Machinery Corp., Boston, Mass.

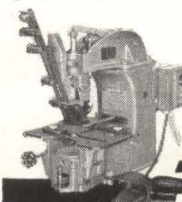

**United**  
**DYNASERT** US1-71

CIRCLE 204 ON READER SERVICE CARD

Of interest to engineers and scientists

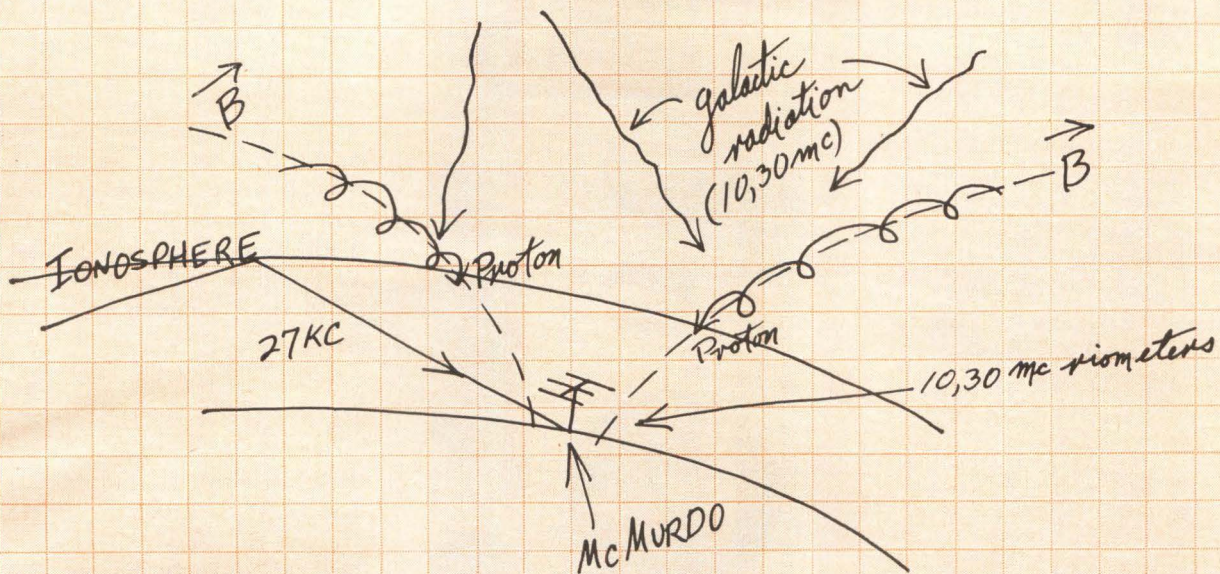

## ANTARCTIC RIOMETER PROGRAM

...one of more than 500 R&D programs under way at Douglas

This Douglas program is being conducted in cooperation with the National Science Foundation with these objectives:

To investigate the apparent existence of a world-wide semi-annual variation in the occurrence of polar cap absorption events; to determine the frequency and time-intensity of solar cosmic ray events; to correlate North and South Pole riometer measurements and study differences in the polar ionospheres; to study the effects of radiation on ionospheric parameters.

The program will continue through the next solar sunspot maximum in 1969. Among other aspects, it will be useful in setting up criteria for the protection of astronauts from radiation.

**Of career interest to engineers and scientists**  
Douglas has entered into a period of greatly expanded activity in research programs like the one above and huge development projects like

Skybolt, Saturn IV, Rebound, and others. Outstanding positions are now open in practically all scientific and engineering fields related to missile systems and space exploration.

Scholarships and financial assistance are available to continue your studies in such nearby universities as U.C.L.A., Southern California and Cal Tech.

Send us your resume or fill out and mail the coupon. Within 15 days from the receipt of your letter, we will send you specific information on opportunities in your field at Douglas.

Mr. F. V. Edmonds  
Missiles and Space Systems Division  
Douglas Aircraft Company  
3000 Ocean Park Boulevard  
Santa Monica, California

F-4

Please send me full information on professional opportunities in my field at Douglas.

Name \_\_\_\_\_

Engineering or scientific field \_\_\_\_\_

Address \_\_\_\_\_

City \_\_\_\_\_ State \_\_\_\_\_

# DOUGLAS

Missile and Space Systems Division

An equal opportunity employer

# 20 to 200 D.P.

Send your prints  
for quotations

- SPURS
- HELICALS
- WORM AND WORM GEARS
- STRAIGHT BEVELS
- LEAD SCREWS
- RATCHETS
- CLUSTER GEARS
- RACKS
- INTERNALS
- ODD SHAPES

A few of the many varieties of straight bevels we are regularly producing are shown above. Tell us your needs.

## STRAIGHT BEVELS

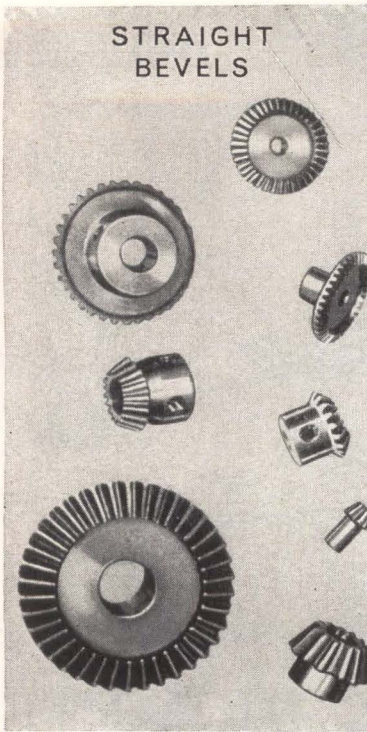

THE *Finest*  IN GEARS

# Beaver Gear Works Inc.

1021 PARMELE STREET, ROCKFORD, ILLINOIS



CIRCLE 206 ON READER SERVICE CARD



Exceptionally  
Uniform



Well-Bonded  
to Base Wire



Quality with  
Economy



Since 1901

## Electroplated Wires

Years of experience and technical know-how enable us to combine quality with economy in electroplating wire. . . . One application is the Gold plating of Nickel Wire. This combines the desirable characteristics of the base metal with the corrosion-resistance of Gold. . . . In our process of continuous electroplating, adherence and quantity deposited are precisely controlled. . . . We'll gladly make recommendations based on your specific plating requirements.

**SIGMUND COHN** Manufacturing Co., Inc.  
121 So. Columbus Ave., Mount Vernon, N.Y.

SIGMUND COHN CORP. OF CALIFORNIA • 151C NORTH MAPLE STREET, BURBANK, CALIF.

company, Research for Industry, Inc., in Cleveland, O. This firm will certify the services of technically skilled personnel, which it will contract to industry and government.

Standish is joined in the new organization by Jack M. Stewart, who will be president and general manager. Stewart will continue to operate his management consulting and engineering firm, Industrial Technological Associates, Inc. Jay C. Standish will be vice president of the new company.

## PEOPLE IN BRIEF

**John P. Nash** advances to v-p of Lockheed Missiles & Space Co. **Harold S. Pike, Jr.**, promoted to post of asst. to the president of Nytronics, Inc. **Ira M. Rosenthal** leaves Minneapolis-Honeywell to join Oak Mfg. Co. as chief industrial engineer. **Booz, Allen Applied Research Inc.** ups **John R. Shirley** to v-p. **Barry Coetsee**, previously with ITT-Kellogg, appointed an electronic engineer at Commucom, div. of Chaskin-Dimmick Corp. **James H. Schaefer**, formerly with Amphenol-Borg Electronic Corp., named v-p and g-m of Viking Industries, Inc. **Marvin Rubinstein**, from the Garrett Corp. to Electro-Optical Systems, Inc., as supervisor of the Computer facility. **Rocco Tamburello** moves up to quality control mgr. for KinTel div., Cohu Electronics, Inc. **Mallory Semiconductor Co.** elevates **Ronald McWilliams** to chief engineer. **John W. Smith**, ex-Gates Radio, now mgr. of engineering for Vitro Electronics. **Western Scientific Instrument Co., Inc.**, promotes **Martin L. Lundquist** to mgr., quality control. **Paul I. Richards**, of Technical Operations, Inc., appointed a corporate fellow of the firm. **Frank G. Daveler**, formerly with International Resistance Co., named v-p and g-m of all Eastern operations of Crescent Engineering & Research Co. **Robert M. Mitori** leaves McDonnell Aircraft Co. to become a senior staff engineer with Rixon Electronics Inc. **Bernard Epstein**, ex-Electrosolids Corp., joins Endevco Corp. as technical service engineer on piezoelectric transducers.

## MINIATURE INDUCTORS STILL TOO BIG?

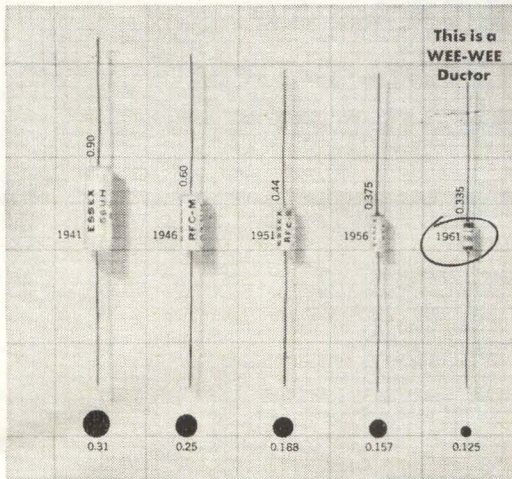

try the new **WEE-WEE DUCTOR** for size — the smallest inductor immediately available to the engineer with a complete set of values from 0.10  $\mu$ h to 1000  $\mu$ h. Meets Mil Spec. MIL-C-15305 B.

For complete engineering data, write to Dept. WL-15, or phone 464-9300.

### **NYTRONICS, INC.**

550 SPRINGFIELD AVENUE, BERKELEY HEIGHTS, N. J.

**CIRCLE 205 ON READER SERVICE CARD**

## REDUCE HEATING PROCESS COSTS

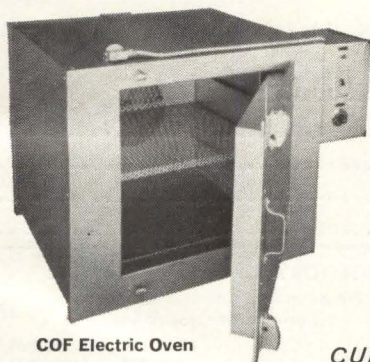

COF Electric Oven

with  
**CHOICE**  
of  
**GAS FIRED**  
or  
**ELECTRIC**  
**OVENS**

**ONLY TRENT**  
**CUBIC OVEN DESIGN**

OFFERS QUALITY FEATURES AT LOWEST COST

- Controlled Temperatures to 1200°F.
- Forced Air Re-circulation-Direct Drive Fan
- Steel Inner and Outer Casing
- Hinged Door w/Explosion Release Latch
- 1 to 96 cubic foot Size Range
- Wide Selection of Optional Features
- TRENT "Folded and Formed" Electric Heating Element or Minimixer Gas Burner

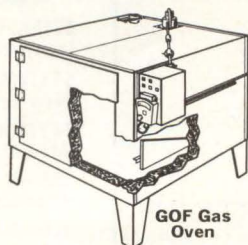

GOF Gas Oven

WRITE FOR BULLETIN 71-TH Electric or BULLETIN GOF Gas

Let **TRENT ENGINEERS** study your needs and determine the type of oven best suited for your use.

202R

**TRENT**

Electric & Gas Heated Industrial Equipment  
203 Leverington Ave., Philadelphia 27, Pa.

In Canada: Pioneer Electric Eastern Ltd., Toronto

**CIRCLE 210 ON READER SERVICE CARD**

July 6, 1962

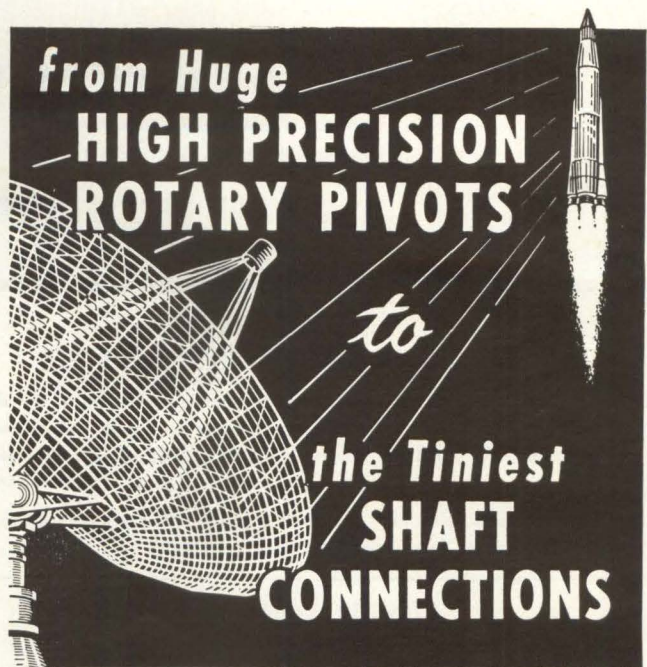

## THOMAS FLEXIBLE COUPLINGS

are indispensable for  
reliable power and  
motion transmission.

Designed especially to meet critical operating requirements, Thomas Flexible Couplings offer many important advantages plus long life, reliability and a wide range of styles and sizes to meet the particular requirements of your application. Special materials may be specified where high temperatures, corrosive atmospheres or other unusual conditions exist. For detailed information write for Engineering Catalog 60.

**THOMAS**  
FLEXIBLE COUPLINGS

**THOMAS FLEXIBLE COUPLING CO.**  
A Subsidiary of Koppers Company, Inc.  
WARREN, PENNSYLVANIA, U.S.A.

**CIRCLE 99 ON READER SERVICE CARD**

99

# electronics

## WEEKLY QUALIFICATION FORM FOR POSITIONS AVAILABLE

### ATTENTION: ENGINEERS, SCIENTISTS, PHYSICISTS

This Qualification Form is designed to help you advance in the electronics industry. It is unique and compact. Designed with the assistance of professional personnel management, it isolates specific experience in electronics and deals only in essential background information.

The advertisers listed here are seeking professional experience. Fill in the Qualification Form below.

#### STRICTLY CONFIDENTIAL

Your Qualification form will be handled as "Strictly Confidential" by ELECTRONICS. Our processing system is such that your form will be forwarded within 24 hours to the proper executives in the companies you select. You will be contacted at your home by the interested companies.

#### WHAT TO DO

1. Review the positions in the advertisements.
2. Select those for which you qualify.
3. Notice the key numbers.
4. Circle the corresponding key number below the Qualification Form.
5. Fill out the form completely. Please print clearly.
6. Mail to: D. Hawksby, Classified Advertising Div., ELECTRONICS, Box 12, New York 36, N. Y. (No charge, of course).

COMPANY	SEE PAGE	KEY #
BRISTOL COMPANY Waterbury, Connecticut	104	1
COLLINS RADIO COMPANY Dallas, Texas	18	2
DOUGLAS AIRCRAFT CO. Missile and Space Systems Division Santa Monica, California	97	3
GENERAL DYNAMICS/ELECTRONICS Div. of General Dynamics Corp. Rochester, New York	102	4
INTERNATIONAL BUSINESS MACHINES CORP. Space Guidance Center Owego, New York	101	5
LOCKHEED MISSILES & SPACE CO. Div. of Lockheed Aircraft Corp. Sunnyvale, California	70, 71	6
MCDONNELL St. Louis, Missouri	147*	7
MELPAR, INC. Sub. of Westinghouse Air Brake Co. Falls Church, Virginia	101	8
MICROWAVE SERVICES INTERNATIONAL, INC. Denville, New Jersey	145*	9
NATIONAL AERONAUTICS AND SPACE ADMINISTRATION Washington, D. C.	146*	10
NORTHROP CORP. Norair Division Hawthorne, California	135*	11
NORTHROP CORP. Space Laboratories Hawthorne, California	137*	12
PHILCO WESTERN DEVELOPMENT LABS. Palo Alto, California	103	13
REPUBLIC AVIATION CORPORATION Missile Systems Division Mineola, L.I., New York	145°	14

(CONTINUED ON PAGE 104)

(cut here)

### electronics WEEKLY QUALIFICATION FORM FOR POSITIONS AVAILABLE

(cut here)

(Please type or print clearly. Necessary for reproduction.)

#### Personal Background

NAME .....

HOME ADDRESS .....

CITY ..... ZONE ..... STATE .....

HOME TELEPHONE .....

#### Education

PROFESSIONAL DEGREE(S) .....

MAJOR(S) .....

UNIVERSITY .....

DATE(S) .....

#### FIELDS OF EXPERIENCE (Please Check)

7/6/62

- |  |  |                                       |
|--|--|---------------------------------------|
| <input type="checkbox"/> Aerospace           | <input type="checkbox"/> Fire Control        | <input type="checkbox"/> Radar        |
| <input type="checkbox"/> Antennas            | <input type="checkbox"/> Human Factors       | <input type="checkbox"/> Radio-TV     |
| <input type="checkbox"/> ASW                 | <input type="checkbox"/> Infrared            | <input type="checkbox"/> Simulators   |
| <input type="checkbox"/> Circuits            | <input type="checkbox"/> Instrumentation     | <input type="checkbox"/> Solid State  |
| <input type="checkbox"/> Communications      | <input type="checkbox"/> Medicine            | <input type="checkbox"/> Telemetry    |
| <input type="checkbox"/> Components          | <input type="checkbox"/> Microwave           | <input type="checkbox"/> Transformers |
| <input type="checkbox"/> Computers           | <input type="checkbox"/> Navigation          | <input type="checkbox"/> Other .....  |
| <input type="checkbox"/> ECM                 | <input type="checkbox"/> Operations Research | <input type="checkbox"/> .....        |
| <input type="checkbox"/> Electron Tubes      | <input type="checkbox"/> Optics              | <input type="checkbox"/> .....        |
| <input type="checkbox"/> Engineering Writing | <input type="checkbox"/> Packaging           | <input type="checkbox"/> .....        |

#### CATEGORY OF SPECIALIZATION

Please indicate number of months experience on proper lines.

	Technical Experience (Months)	Supervisory Experience (Months)
RESEARCH (pure, fundamental, basic)	.....	.....
RESEARCH (Applied)	.....	.....
SYSTEMS (New Concepts)	.....	.....
DEVELOPMENT (Model)	.....	.....
DESIGN (Product)	.....	.....
MANUFACTURING (Product)	.....	.....
FIELD (Service)	.....	.....
SALES (Proposals & Products)	.....	.....

CIRCLE KEY NUMBERS OF ABOVE COMPANIES' POSITIONS THAT INTEREST YOU

1 2 3 4 5 6 7 8 9 10 11 12 13 14 15 16 17 18 19 20 21 22 23 24 25

# EMPLOYMENT OPPORTUNITIES



The Advertisements in this section include all employment opportunities—executive, management, technical, selling, office, skilled, manual, etc. Look in the forward section of the magazine for additional Employment Opportunities advertising.

Positions Vacant      Civil Service Opportunities  
Positions Wanted      Selling Opportunities Wanted  
Part Time Work      Selling Opportunities Offered

Employment Agencies  
Employment Services  
Labor Bureaus

## — RATES —

**DISPLAYED:** The advertising rate is \$40.17 per inch for all advertising appearing on other than a contract basis. Contract rates quoted on request.

An advertising inch is measured 7/8" vertically on a column—3 columns—30 inches to a page.

Subject to Agency Commission.

**UNDISPLAYED:** \$2.70 per line, minimum 3 lines. To figure advance payment count 5 average words as a line.

Box numbers—count as 1 line.

Discount of 10% if full payment is made in advance for 4 consecutive insertions.

Not subject to Agency Commission.

## PHYSICISTS

Melpar's more than 17 years of outstanding achievements, exceptional opportunities continue to be created at

### MELPAR

Excellent assignments in our expanding RESEARCH DIVISION for—

#### MICROWAVE PHYSICIST

Engage in research in millimeter wave propagation through solids, higher order mode transmission, and problems involving general electromagnetic theory.

Ph.D or MS and 3 years experience required.

#### ADVANCED CIRCUIT PHYSICIST

Advanced circuit physicist for creative research in function synthesis and quantum mechanics, including material in solid, liquid and gaseous state. Ph.D. required.

Write in confidence to—

#### J. HAVERFIELD

Employment Manager

### MELPAR, INC.

A Subsidiary of Westinghouse Air Brake Co.

3322 Arlington Blvd.  
Falls Church, Va.

An equal opportunity employer

# Peel back the sky

## IBM Space Guidance Center

IBM engineers and scientists are helping to map the heavens by developing a digital data processor and memory for the NASA Orbiting Astronomical Observatory (OAO).

The memory, largest of its type for space application, will collect observations free of the earth's atmospheric distortion. As the vehicle orbits at 18,000 miles/hr., the data processor will tell the OAO's sensitive telescope where and when to look, check for occulted and malfunctioning star trackers, start and stop each experiment. Over 200,000 bits of information, stored in the satellite's random-access memory, can be telemetered to the ground in 7.5 seconds. In designing the memory and processor, a redundancy technique provided a system far more reliable than conventional designs.

Other projects include: guidance and control systems for manned aircraft, satellites, spacecraft, submarines, and other vehicles. Engineers and scientists are invited to inquire about openings in . . . reliability statistics; logic design; circuit design; programming; quality engineering; control systems engineering; solid-state physics (radiation effects studies); mechanical engineering (heat transfer/stress analysis). IBM is an Equal Opportunity Employer. Please write, outlining your background and interests; Fred Guth, Dept. 554T1, IBM Space Guidance Center, Owego, New York.

# IBM

# ELECTRONICS ENGINEERS

## GENERAL DYNAMICS | ELECTRONICS ROCHESTER

### POSITIONS OPEN IN

#### ELECTRONIC RECONNAISSANCE SYSTEMS

##### SENIOR ANTENNA ENGINEER

BSEE with 3 to 4 years experience on ground-based antennas and radomes. Knowledge of antenna test data reduction and analysis required. Frequency spectrum VHF and up. To design systems antenna configurations, analyze existing designs, reduce and analyze antenna test data and make recommendations for necessary re-design.

##### SENIOR RELIABILITY ENGINEER

BSEE with 3 to 5 years experience. Must be systems oriented in the reliability field, preferably with some operations research background. Will be responsible for designing and implementing a reliability program on a large electronic system and will make the necessary data reduction involved in such a program.

##### SENIOR DESIGN ENGINEERS

BS with 8 years experience, of which 5 must have been in design in two or more of the following: digital, RF, pulse, audio, CRT, photorecorders, magnetic recorders, pulse multiplex and frequency multiplex. To assist in evaluation of complex electronic reconnaissance systems.

##### DESIGN ENGINEERS

BS with 3 to 5 years experience in RF and microwave receivers, digital display circuits, data handling and CRT displays including storage tube circuits. To assist in evaluation of complex electronic reconnaissance systems.

#### HYDROACOUSTICS

##### SENIOR SONICS ENGINEER

BS or MS in ME or Physics with at least 5 years experience in Industrial Sonics. Should have background in sonic cleaning, processing and impact drilling plus a basic knowledge of acoustics, general physics and chemistry.

#### TEST EQUIPMENT & INSTALLATIONS

##### PROJECT ENGINEERS

To supervise design and integration of test stations. Knowledge should include 1 or more of the following areas: flight control systems, radar indicators, HF-VHF navigation and communication equipment, microwave equipment, antenna systems and ECM. Should be familiar with all types of testing techniques and equipment associated with particular areas of interest. BSEE.

##### SENIOR DESIGN ENGINEERS

BSEE with thorough background in one of the following: microwave signal generators and receivers; low frequency signal generators, HF-UHF signal generators, digital and pulse circuits, AGE Systems.

#### TECHNICAL WRITING

Requires thorough background in the electronics industry in preparation of military handbooks and manuals or in engineering proposals.

#### RECONNAISSANCE EQUIPMENT DESIGN

##### Engineers at all levels, experienced in design of:

**RECEIVERS** — Panoramic, signal seeking, manually tuned. **DISPLAYS** — Digital, CRT amplitude-time, storage tube direction finder, panadapter, high-speed pulse recording. **REMOTE CONTROLS** — Antenna servo followers, antenna and receiver remote positioning and tuning. **DATA HANDLING** — Transistorized timer-programmer, on-line printer, automatic signal analyser, magnetic tape analysis equipment. **EQUIPMENT INTEGRATION** — Console and rack design, sub-system layout and blackbox compatibility, design standardization, sub-system analysis, man-machine optimum design, blackbox sub-system specifications. **RADIO FREQUENCY INTERFERENCE CONTROL** — Analysis of equipment RFI problems, establishment of design procedures, testing to MIL-I-26600, reports, vendor liaison and direction.

For further information on how YOU can contribute to one of the various programs now in progress, send a complete resume to Mr. M. J. Downey, Dept. 22.

**GENERAL DYNAMICS | ELECTRONICS**  
AN EQUAL OPPORTUNITY EMPLOYER **ROCHESTER**

1400 N. GOODMAN ST., ROCHESTER 3, NEW YORK





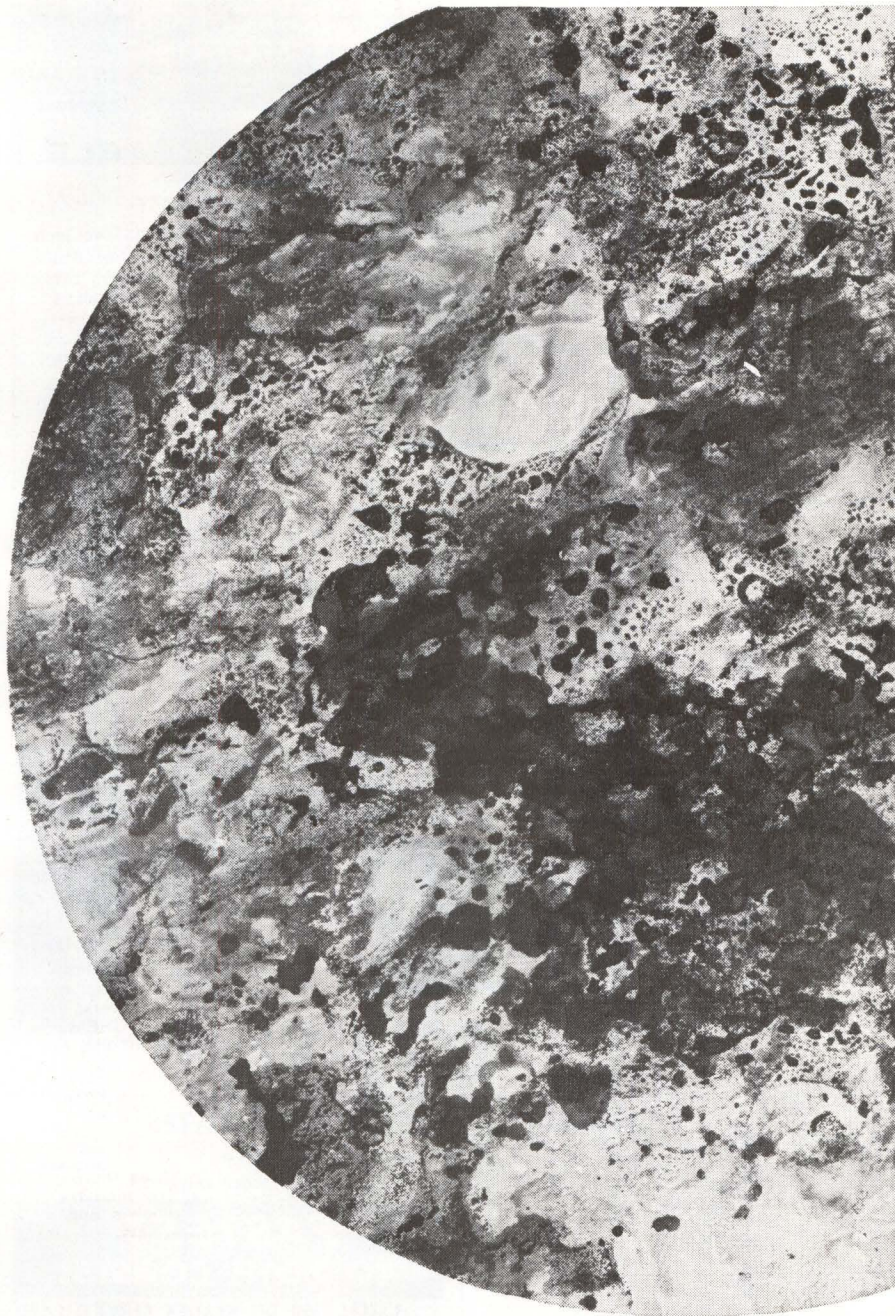

## IF TODAY'S REALITY

## IS TOMORROW'S MYSTERY.

What we know today is insignificant alongside what we will know tomorrow, and Philco Western Development Laboratories' advanced technology leads the way to better solutions for bigger problems . . . and to your career. With its space age achievement a matter of record in some of the Nation's most important satellite programs, Philco WDL extends a penetrating probe into the mysteries of tomorrow's universe: Cosmic ray and ruby laser optics, solid state microwave electronics, microwave miniaturization, signal detection techniques, deep-space communications. These are advanced fields being explored today at Philco WDL. Your career there can be as successful as your adventuring spirit. Tomorrow's space age problem is today's task at WDL.

Write in confidence for information on how you can find your career at Philco WDL, with the additional rewards of ideal living on the San Francisco Peninsula and professional and monetary advancement commensurate with your own ability. Requirements include B.S. or advanced degree (electronics, mathematics, physics), U. S. Citizenship or current transferable D.O.D. clearance. Address Mr. Patrick Manning, Department E-7.

# PHILCO

A SUBSIDIARY OF  
*Ford Motor Company*

## WESTERN DEVELOPMENT LABORATORIES

3875 Fabian Way, Palo Alto, California

an equal opportunity employer

7759

**Electronic Instrument Technicians**  
**The Oak Ridge National Laboratory**  
 Operated by  
**UNION CARBIDE NUCLEAR COMPANY**  
 at  
**Oak Ridge, Tennessee**  
**Has openings for**

Highly skilled electronic instrument technicians to work with electronic engineers in the development, installation and maintenance of electronic systems. Digital data handling, transistorized pulse height analyzers, analog and digital computer systems are only a few examples.

Minimum high school education, with additional training in electronics and at least three years' experience in installation and maintenance of complex electronic systems. Entrance rate \$3.10 per hour; \$3.16 per hour after six months. Reasonable interview and relocation expenses paid by Company.

**Excellent Working Conditions**  
 and  
**Employee Benefit Plans**  
**An Equal Opportunity Employer**  
 Send detailed resume to:

**Central Employment Office**  
**UNION CARBIDE NUCLEAR COMPANY**  
 Post Office Box M Oak Ridge, Tennessee

Engineering or Science Graduates  
 to be trained as  
**INSTRUMENT SALES ENGINEERS**  
 with  
**The Bristol Company**

Leading manufacturer of automation equipment and control systems requires men, preferably 25 to 35 years old, to sell high quality, nationally accepted products to wide variety of industrial markets.

Openings in various areas of the country. Successful applicants take comprehensive three-months course at headquarters. Salary and expenses

All replies confidential; every inquiry answered.

Write: Charles F. Johnson, Mgr. of Sales Training  
**The Bristol Company**  
 Waterbury 20, Conn.

**POSITIONS VACANT**

**Electronic Engineers for permanent positions** with Federal Communications Commission, Washington, D. C., GS-12, \$8,955 to GS-13, \$10,635. Must be graduate engineers with good knowledge of problems involved in the area of space communications. Government will pay expenses for transportation of employee, his family, and household goods to Washington. Attractive fringe benefits include retirement, life and health insurance, automatic pay increases. Good opportunity to enter government career service. Reply to Personnel Officer, Federal Communications Commission, Washington 25, D. C.

**electronics**

**WEEKLY QUALIFICATIONS FORM  
 FOR POSITIONS AVAILABLE**

(Continued from page 100)

SCOPE PROFESSIONAL PLACEMENT CENTER	145*	15
Waltham, Massachusetts		
SPACE TECHNOLOGY LABORATORIES INC.	26*	16
Sub. of Thompson Ramo Wooldridge Inc.		
Redondo Beach, California		
SPERRY GYROSCOPE COMPANY	147*	17
Div. of Sperry Rand Corp.		
Great Neck, L.I., New York		
UNION CARBIDE NUCLEAR COMPANY	104	18
Oak Ridge, Tennessee		

\*These advertisements appeared in the 6/29/62 issue.

**SEARCHLIGHT SECTION**

(Classified Advertising)

BUSINESS OPPORTUNITIES  
 EQUIPMENT - USED or RESALE

**DISPLAYED RATE**

The advertising rate is \$27.25 per inch for all advertising appearing on other than a contract basis. Contract rates quoted on request. AN ADVERTISING INCH is measured 7/8 inch vertically on one column, 3 columns—30 inches—to a page. EQUIPMENT WANTED or FOR SALE ADVERTISEMENTS acceptable only in Displayed Style.

**UNDISPLAYED RATE**

\$2.70 a line, minimum 3 lines. To figure advance payment count 5 average words as a line.

PROPOSALS, \$2.70 a line an insertion. BOX NUMBERS count as one line additional in undisplayed ads.

DISCOUNT OF 10% if full payment is made in advance for four consecutive insertions of undisplayed ads (not including proposals).

**LIFSCHULTZ  
 FAST FREIGHT**

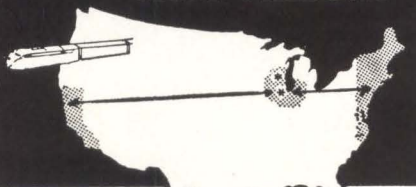

**PIGGYBACK  
 TO BOTH COASTS  
 TRUCKLOAD RATES  
 TO BOTH COASTS**

•We welcome your inquiry.

PROMPT  
 DAILY  
 PICKUP  
 and  
 DELIVERY

**FASTEST  
 TO BOTH COASTS!**

CIRCLE 950 ON READER SERVICE CARD

**FOR RESEARCH — DEVELOPMENT  
 & EXPERIMENTAL WORK**

Over 10,000 different electronic parts: waveguide, radar components and parts, test sets, pulsers, antennas, pulse xmfrs, magnetrons, IF and pulse amplifiers, dynamotors, 400 cycle xmfrs, 584 ant. pedestals, etc.  
**PRICES AT A FRACTION OF ORIGINAL COST!**  
**COMMUNICATIONS EQUIP CO.**  
 343 CANAL ST., N. Y. 13, WO 6-4045  
 CHAS. ROSEN (Formerly at 131 Liberty St.)

CIRCLE 951 ON READER SERVICE CARD

**WEAK IN MATH?**

Don't let inadequacy in mathematics hold you back. Now you can learn the basic math you must know to succeed as a technical man. Learn through Grantham Schools' unusual home study math course for technicians, engineers, and mechanics. Write for details today.

Write to: Dept. 2E.  
**GRANTHAM SCHOOLS, INC.**  
 1505 N. Western Ave. Los Angeles 27, Calif.

CIRCLE 952 ON READER SERVICE CARD

**Your Inquiries to Advertisers  
 Will Have Special Value . . .**

—for you—the advertiser—and the publisher, if you mention this publication. Advertisers value highly this evidence of the publication you read. Satisfied advertisers enable the publishers to secure more advertisers and—more advertisers mean more information on—more products or better service—more value—to YOU.

**Method for  
 measuring  
 an engineer...**

**What's his  
 technical ?  
 publication ?**



When an engineer pays for a technical publication, it's a safe bet that that is the one he respects most.

He makes it his business to read **electronics**. It keeps him well informed of up - to - the - minute events and developments in the electronics industry and the technology to which he contributes his experience.

Where your recruitment program calls for engineers and other technical people of this calibre, you can reach them in the **EMPLOYMENT OPPORTUNITIES** section of:

**electronics**

A MCGRAW-HILL PUBLICATION  
 CLASSIFIED ADVERTISING DIVISION  
 POST OFFICE BOX 12 NEW YORK 36, NEW YORK

# INDEX TO ADVERTISERS



## Audited Paid Circulation

Aerocom .....	14	Potter Instrument Co., Inc.....	21
American Bosch Arma Corp. Arma Div..	29	Potter and Brumfield,	57
American Machine & Foundry Co.		Div. American Machine & Foundry Co.	57
Potter & Brumfield Div. ....	57	Powell Electronics Inc.....	88
Anadex Instruments Inc. ....	95		
Arnold Magnetics Corp. ....	78	Radio Corporation of America....	4th Cover
		Rapidesign, Inc. ....	78
Ballantine Laboratories, Inc. ....	91	Raytheon Company .....	2nd Cover
Beaver Gear Works, Inc. ....	98	Rixon Electronics Inc.....	95
Bell Telephone Laboratories .....	25		
Bird Electronic Corporation .....	89	Sarkes Tarzian Inc. ....	73, 85
Bourns Inc. ....	58, 59	Scientific-Atlanta Inc. ....	55
Brush Instruments,		Sola Electric Co. ....	67
Div. of Clevite Corp.....	3rd Cover	Sprague Electric Co. ....	9, 30
Budelman Electronics Corp. ....	78		
		Tektronix, Inc. ....	31
Cannon Electric Co. ....	64, 65	Texas Instruments Incorporated	
Centralab, The Electronics		Apparatus Division .....	93
Div. of Globe-Union Inc. ....	13	Thomas Flexible Coupling Co.....	99
Chassis-Trak Inc. ....	106	Trent Inc. ....	99
Clifton Precision Products Co., Inc....	19	Tung-Sol Electric, Inc.....	36
Cohn Mfg. Co., Inc., Sigmund .....	98		
Collins Radio Co. ....	18	United Shoe Machinery Corp.....	96
Consolidated Electrodynamics			
Corp. ....	33, 86, 87	Varian Associates .....	15
Continental Connector Corp. ....	35		
Coto-Coil Co., Inc. ....	96	Weinschel Engineering .....	4, 81
		Weldmatic Div./Unitek .....	76
Douglas Aircraft Co., Missiles & Space		Weston Instruments	
Systems Div. ....	97	A Division of Daystrom Inc.....	63
Dow Corning Corp. ....	22, 23		
duPont de Nemours & Co., Inc. E. I. ....	69		
Dynatran Electronics Corp. ....	105		
Electronic Instrument Co., Inc. (EICO) ..	105		
Gamewell Co., The .....	61		
Gardner-Denver Company .....	88		
General Electric Co.			
Receiving Tube Dept. ....	53		
Gudebrod Bros. Silk Co., Inc. ....	32		
Haydon Co., A. W. ....	90		
Hewlett-Packard Company .....	6		
Hughes Aircraft Co.			
Aerospace Divisions .....	79		
IBM .....	16, 17		
Indiana General Corp. ....	24		
International Electronic Industries, Inc.			
Itek Electro-Products Co. ....	83		
Japan Piezo Electric Co., Ltd.....	96		
Jennings Radio Manufacturing Corp.....	92		
Keithley Instruments, Inc.....	82		
Lambda Electronics Corp.....	10, 11		
Lockheed Missiles & Space Co.....	70, 71		
Maine Dept. of Economic Development..	74		
Marconi Instruments .....	68		
Metronix, Inc. ....	62		
Motorola Military Electronics Div.....	77		
Nytronics Inc. ....	99		
Oak Mfg. Co. ....	75		
Paktron Packaged Electronics, Div. of			
Illinois Tool Works, Inc.....	84		
Pesco Products Div. of Borg-Warner			
Corp. ....	5		

July 6, 1962



**PUTS THE BEST IN  
CREATIVE ELECTRONICS  
INTO YOUR HANDS**

Send for  
**FREE**  
Catalog



**28 pages of professional electronic equipment in kit and wired form - for Lab . . . Line . . . Home**

EICO, 3300 N. Blvd., L.I.C. 1, N. Y. **E-7A**

Send free 32-page catalog & dealer's name.

Send new 36-page Guidebook to HI-FI for which I enclose 25¢ for postage & handling.

Name \_\_\_\_\_

Address \_\_\_\_\_

City \_\_\_\_\_ Zone \_\_\_\_\_ State \_\_\_\_\_

**EICO** 3300 N. Blvd., L.I.C. 1, N. Y.  
Export Dept., Roburn Agencies  
431 Greenwich St., N. Y. 13, N. Y.

**CIRCLE 207 ON READER SERVICE CARD**

**Measure . . . . .  
MILLIVOLTS . . . . .  
- - - - NANOAMPERES  
accurately at low cost  
with DYNATRAN's - - -**



Model  
1829  
**SENSITIVE  
DC  
VTVM**

Write for complete information about this and other quality instruments for laboratory, production, incoming inspection and quality control.

**DYNATRAN**

*electronics corporation*

178 HERRICKS ROAD  
MINEOLA, NEW YORK

Pioneer 1-4141

CIRCLE 105 ON READER SERVICE CARD 105

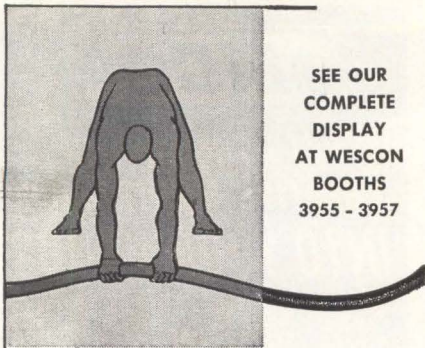

SEE OUR  
COMPLETE  
DISPLAY  
AT WESCON  
BOOTHS  
3955 - 3957

## YOUR HIDDEN HELPER

—eliminates the old bugaboo of cable entanglement which damages tubes and components in lower chassis each time the one above is withdrawn for service and returned to position.

Our new Cable Retractor's double action maintains constant tension and correct suspension of cable at all times—permits ample cable length for full extension and tilting of chassis without hazard of snagging.

For use with all types of chassis or drawer slides, adjustable to fit varying chassis lengths, simple to install, inexpensive, proven thoroughly reliable in operation.

Mounts on rear support rails on standard 1 3/4" hole increments. Cadmium plated CRS. Write for Bulletin CR-100E

Victoria 9-6821

## CHASSIS-TRAK CORP.

555 FRONT STREET, BURBANK, CALIFORNIA  
CIRCLE 208 ON READER SERVICE CARD



## Operational guidance for buyers

That's what your 1961 **electronics Buyers' Guide** and Reference Issue gives you . . . this year more than ever before.

Your EBG is bigger and better this year than ever . . . and more helpful than ever . . . with more new exclusive features than ever. Keep it close at hand, you'll find it's useful day in and day out.

**electronics**  
**BUYERS' GUIDE**  
and Reference Issue

The Basic Buying Guide  
in Electronics *since 1941*

## electronics



Audit Bureau  
of Circulations

Associated Business  
Publications

Audited Paid Circulation

JAMES T. HAUPTLI

Advertising Sales Manager

R. S. QUINT:  
Assistant Publisher Buyers'  
Guide and Business Manager  
FRED STEWART:  
Promotion Manager  
B. ANELLO:  
Market Services Manager

RICHARD J. TOMLINSON:  
Production Manager  
GEORGE E. POMEROY:  
Classified Manager  
HUGH J. QUINN:  
Circulation Manager

### ADVERTISING REPRESENTATIVES

NEW YORK (36):  
Donald H. Miller, Henry M. Shaw,  
George F. Werner  
500 Fifth Avenue, LO-4-3000  
(area code 212)

BOSTON (16):  
William S. Hodgkinson, Donald R. Furth  
McGraw-Hill Building, Copley Square,  
Congress 2-1160 (area code 617)

PHILADELPHIA (3):  
Warren H. Gardner, William J. Boyle  
6 Penn Center Plaza, LOcust 8-4330  
(area code 215)

CHICAGO (11):  
Harvey W. Wernecke, Robert M. Denmead  
645 North Michigan Avenue, Mohawk 4-5800  
(area code 312)

CLEVELAND (13):  
Paul T. Fegley  
55 Public Square, Superior 1-7000  
(area code 216)

SAN FRANCISCO (11):  
R. C. Alcorn  
255 California Street, Douglas 2-4600  
(area code 415)

LOS ANGELES (17):  
Peter S. Carberry, Ashley P. Hartman  
1125 W. 6th St., Huntley 2-5450  
(area code 213)

DENVER (2):  
J. W. Patten  
Tower Bldg., 1700 Broadway,  
Alpine 5-2981 (area code 303)

ATLANTA (9):  
Michael H. Miller, Robert C. Johnson  
1375 Peachtree St. N.E., Trinity 5-0523  
(area code 404)

HOUSTON (25):  
Joseph C. Page, Jr.  
Prudential Bldg., Holcomb Blvd.,  
Riverside 8-1280 (area code 713)

DALLAS (1):  
Frank Le Beau  
The Vaughn Bldg., 1712 Commerce St.  
Riverside 7-9721 (area code 214)

LONDON W1:  
Edwin S. Murphy Jr.  
34 Dover St.

FRANKFURT/Main:  
Matthée Herfurth  
85 Westendstrasse

GENEVA:  
Michael R. Zeynel  
2 Place du Port

### "Headquarters for Business Information"

### McGraw-Hill Technical and Business Publications

American Machinist/Metal-  
working Manufacturing  
Aviation Week and Space  
Technology  
Business Week  
Chemical Engineering  
Chemical Week  
Coal Age  
Construction Methods and  
Equipment  
Construction Daily  
Control Engineering  
Electrical Construction  
and Maintenance  
Electrical Merchandising Week  
Electrical Newsletter  
Electrical West

Electrical Wholesaling  
Electrical World  
Electronics  
Engineering Digest  
Engineering and Mining Journal  
E & MJ Metal and Mineral  
Markets  
Engineering News-Record  
Factory  
Fleet Owner  
Industrial Distribution  
National Petroleum News  
Nucleonics  
Nucleonics Week  
Platt's Oilgram News  
Platt's Oilgram Price Service  
Power

Product Engineering  
Purchasing Week  
Science Week  
Textile World

Overseas only:  
Automobile International  
(English, Spanish)  
Ingenieria Internacional  
Construccion (Spanish)  
International Management  
(English, Spanish  
Portuguese editions)  
Metalworking Production  
(Great Britain)

Available by subscription only — to qualified persons actively engaged in the field of the publication. For subscription rates and information describing the editorial coverage of any of the above publications, write to: *Subscription Manager, Circulation Department, McGraw-Hill Publishing Company, 330 West 42nd Street, New York 36, N. Y.*

this is  
the Brush  
Mark II...

anyone  
can  
plug  
it in

put it  
in writing  
anywhere



There is no direct writing recorder on the market that approaches the compact Mark II in sheer usefulness. It is a completely integrated engineering tool that can be operated by anyone . . . in the shop or in the field . . . for countless research or design requirements. Every function necessary for uniform, crisp, easily reproduced readouts is "built-in". The Mark II gives you two analog channels plus two event markers; 4 chart speeds; DC to 100 cps response with 40 mm amplitude; 10 mv/mm sensitivity; high input impedance. Ink or electric writing models. Immediate shipment from stock.

**brush** INSTRUMENTS

DIVISION OF

37TH AND PERKINS

**CLEVITE**  
CORPORATION

CLEVELAND 14, OHIO

CIRCLE 901 READERS SERVICE CARD

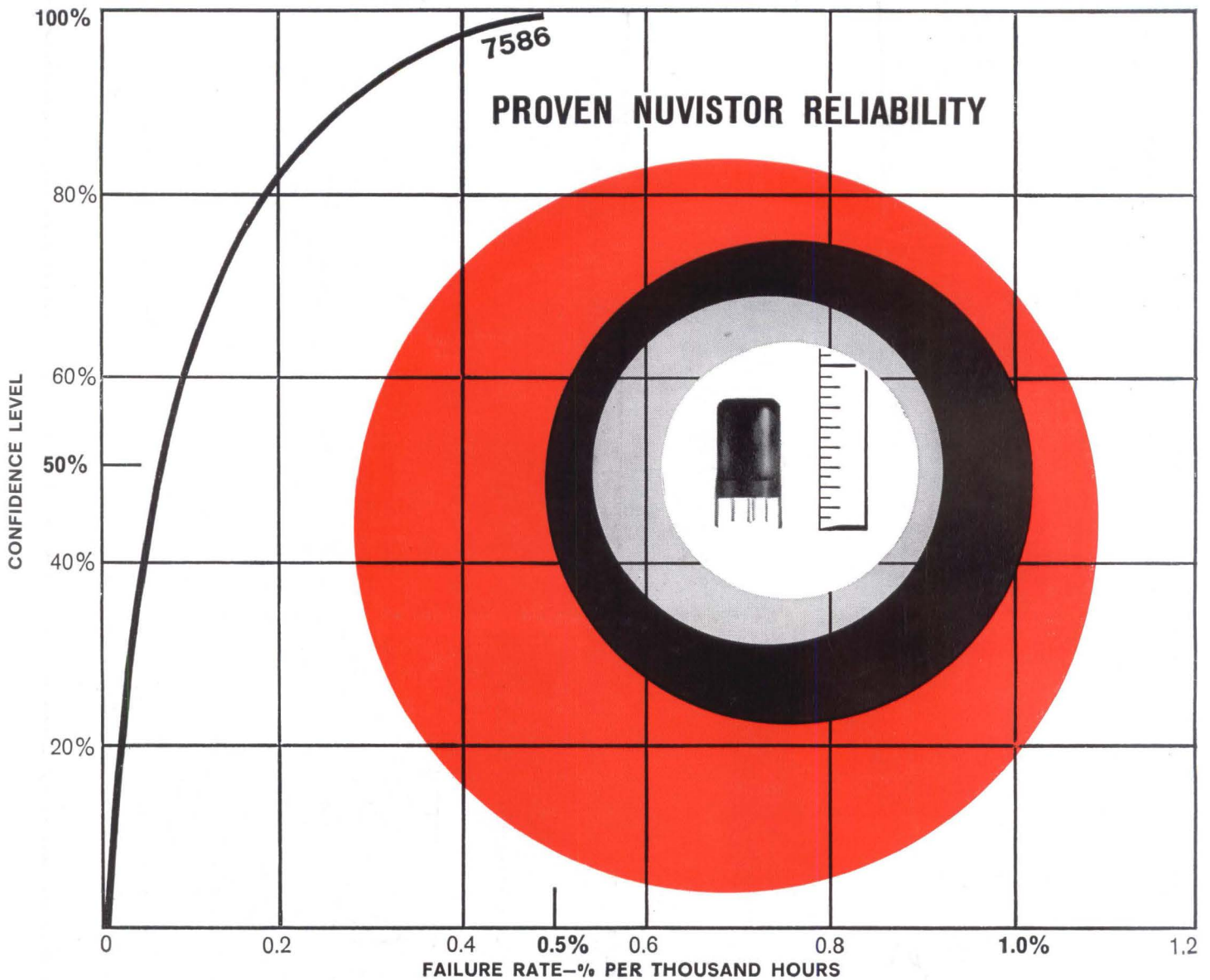

**RCA-7586 FAILURE RATE IS:**

**0.36% OR LESS PER THOUSAND HOURS WITH A 95% CONFIDENCE LEVEL**

...and at a 50% confidence level, the failure rate is only 0.084% or less per 1,000 hours. These extremely low failure rates shown with corresponding confidence levels on the chart above, are based on more than 1,000,000 tube hours of *actual* life testing. Many of the life tests have been run beyond 5000 hours with no sustained downward trend in transconductance observable in the distribution.

This data indicates you can be 95% sure that RCA-7586 nuvistor triodes, operated under conditions equivalent to those described, would have less than 4 failures out of each 100 tubes after 10,000 hours of operation.

These life test results demonstrate conclusively the *extra* reliability the tiny nuvistor tube brings to your electronic systems.

**FIELD OFFICES:**

**EAST:** 744 Broad St., Newark 2, New Jersey  
HUMboldt 5-3900

**MIDWEST:** Suite 1154, Merchandise Mart Plaza  
Chicago 54, Illinois  
WHitehall 4-2900

**WEST:** 6801 E. Washington Blvd.  
Los Angeles 22, Calif.  
RAYmond 3-8361

1838 El Camino Real, Burlingame, Calif.  
OXford 7-1620

Tests were conducted under two sets of field conditions as shown:

**NUVISTOR LIFE TEST CONDITIONS**

	<i>Test Conditions #1</i>	<i>Test Conditions #2</i>
Heater Volts	6.3	6.3
Heater-Cathode Volts	100	0
Plate Volts	100	—
Plate-Supply Volts	—	75
Grid Volts	-1.85	—
Cathode Resistor—Ohms	—	100
Grid-Circuit Resistance—Megohm	0.5	0.5
Metal-Shell Temperature—°C	150	150
Plate Dissipation—Watts	1	0.75

Start now to give your circuits the extra advantage of nuvistor reliability and performance. For technical data on the 7586, get in touch with your RCA Field Representative or write Commercial Engineering, Section G-19-DE-1, RCA Electron Tube Division, Harrison, N.J.



**The Most Trusted Name in Electronics**