

electronics®

(photo at right)

PIN-DIODE MODULATORS

*Devices also provide
attenuation, p 40*

NEW LOOK IN DESIGN

*Circuits use negative-
resistance, p 35*

FIELD-EFFECT TRANSISTORS

*Getting even higher
input impedance, p 44*

WIDE SIGNALS, NARROW BAND

*Receiver conserves
sideband energy, p 47*



The versatile new **hp** 310A High Frequency Wave Analyzer separates an input signal so that the fundamental, harmonics or intermodulation products can be determined and analyzed. Any signal component between 1 kc and 1.5 mc may be selected for measurement. Additionally, a front panel Mode switch lets the 310A function as an efficient tuned voltmeter for accurately measuring relative or absolute signal levels, as a signal source for selective response measurements, and as either an AM receiver or carrier reinsertion oscillator for demodulating sideband signals.

High sensitivity of 10 μ v full scale, and the wide dynamic range of 75 db allows measurements of weak harmonic components down to 1 μ v or strong signals up to 100 v. A switch above the input attenuator can be flipped from Absolute to Relative to permit signal readings at any arbitrary point on the meter for simplifying relative-strength measurements for harmonic components.

Three passbands, selected with a front panel control, increase the versatility of the 310A even more. The 200 cps passband discriminates between harmonics for exact identification. The 1 kc passband simplifies calculations of noise power per cycle bandwidth. The 3 kc passband admits carrier channel signals for evaluation and is wide enough to pass intelligible voice signals, but contributes so little noise that even the 10 μ v range can be used. Rapid drop-off of 24 db per octave on either side of the band's cutoff frequency assures accurate readings.

The 310A is extremely easy to use. To prevent ambiguity of reading, proper voltage range, corresponding

to full scale sensitivity, is automatically shown on an illuminated display on a 15-place front panel range scale indicator. Frequency tuning is continuous and linear over the entire range with no bandswitching. Frequency can be easily read from a 4-place digital type dial which has a resolution of better than 200 cps over the entire band, any setting being accurate to \pm (1% + 300 cps).

An AFC control has a dynamic hold-in range of \pm 3 kc (at 100 kc) with response rapid enough to lock signals with drift rates in excess of 100 cps/second.

Outputs include restored frequency, which permits accurate measurement of the input frequency of the signal to which the 310A is tuned, plus a dc output for driving a recorder.

The output from the BFO is a derived sine wave that corresponds to the tuning indicator's setting, and it can be used effectively to make selective or narrow-band response tests on such as filter circuits and transmission systems. The BFO and tuned voltmeter are simultaneously controlled by the frequency indicator, tracking together, and can be conveniently used as a self-contained measuring system—the BFO output fed through a device under test, then back to the tuned voltmeter input for comparative analysis.

A carrier reinsertion oscillator is included to provide for the demodulation of single sideband signals, either normal or inverted. The demodulated signal is available for aural or recording purposes.

Call your nearby Hewlett-Packard representative today for a demonstration of this remarkable new instrument.

ANALYZER

SPECIFICATIONS

Frequency Range:	1 kc to 1.5 mc (200-cps passband); 5 kc to 1.5 mc (1,000-cps passband); 10 kc to 1.5 mc (3,000-cps passband)
Frequency Accuracy:	\pm (1% + 300 cps)
Frequency Calibration:	Linear graduation, 1 division per 200 cps
Selectivity:	Three IF passbands; 3 db points at \pm 100 cps for 200 cps passband; \pm 500 cps for 1,000 cps passband; \pm 1,500 cps for 3,000 cps passband. Drop off is 24 db/octave from 3 db points. Mid-passband indicated by rejection 1 cps wide
Voltage Range:	10 μ v to 100 volts full scale
Voltage Accuracy:	\pm 6% full scale
Dynamic Range:	Greater than 75 db
Input Resistance:	Determined by input attenuator; 10K ohms on most sensitive range; 30K ohms on next range; 100K ohms on other ranges
Automatic Frequency Control:	Dynamic hold-in range is \pm 3 kc, minimum, at 100 kc. Tracking speed is approximately 100 cps/sec for signal as low as 70 db below zero db reference on range attenuator
Restored Frequency Output:	Restored signal frequency maximum output is at least 0.25 volts across 135 ohms with approximately 30 db of level control provided. Output impedance, approximately 135 ohms
BFO Output:	0.5 volt across 135 ohms with approximately 30 db of level control provided
Recorder Output:	1 ma dc into 1,500 ohms or less for single-ended recorders
Receiver Function (Aural or Recording Provision):	Internal carrier reinsertion oscillator is provided for demodulation of either normal or inverted single sideband signals. AM signal also can be detected
Power:	115 or 230 volts \pm 10%, 50 to 1,000 cps; approx. 16 watts
Dimensions:	16 $\frac{3}{4}$ " wide, 10 $\frac{1}{2}$ " high, 18 $\frac{3}{8}$ " deep. Hardware furnished converts panel to 10 $\frac{1}{4}$ " x 19" rack mount. 44 lbs.
Price:	\$2,000.00

Data subject to change without notice. Price f. o. b. factory.

**HEWLETT
PACKARD
COMPANY**

1501 Page Mill Road, Palo Alto, California, Area Code 415, DA 6-7000
Sales and service representatives in all principal areas; Europe, Hewlett-Packard S.A., 54-54bis Route des Acacias, Geneva; Canada, Hewlett-Packard (Canada) Ltd., 8270 Mayrand Street, Montreal



8121

CIRCLE 900 ON READER SERVICE CARD

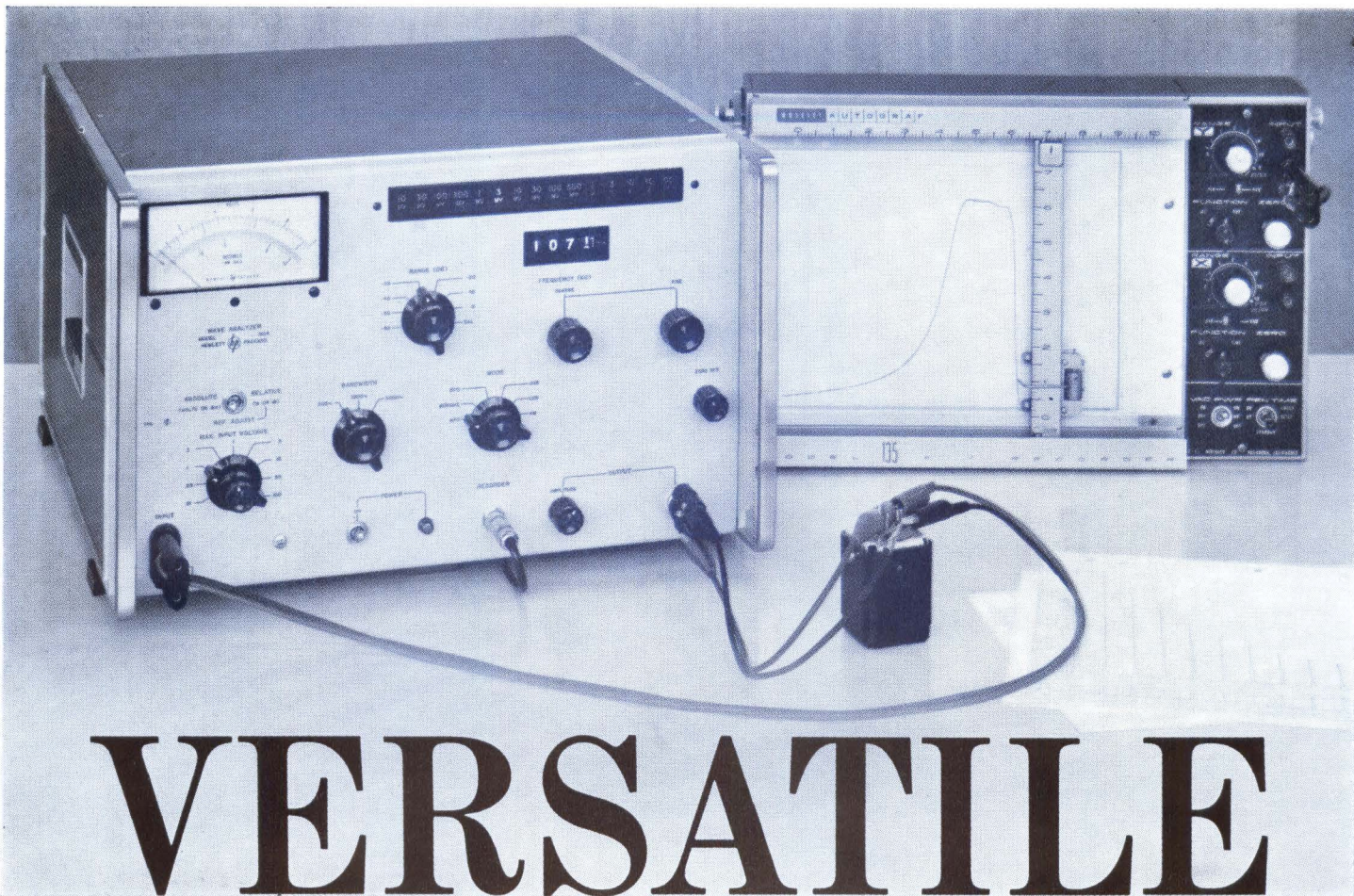

VERSATILE

Curve on recorder shows frequency response of filter under test in 1 mc range; recording on table shows odd order harmonics of square wave.

With the NEW hp 310A:

- Analyze complex audio and rf waveforms
- Measure frequency response of filters and amplifiers
- Measure multi-channel carrier waves
- Make long line telephone measurements
- Measure transmission line characteristics
- Analyze sonar signals

Check these features:

- Covers 1 kc to 1.5 mc, three passbands
- High sensitivity of 10 microvolts full scale
- Wide dynamic range, over 75 db
- Continuous linear tuning, no frequency range switching
- Digital frequency readout
- Automatically tracks drifting signal
- Restored frequency output
- Carrier reinsertion oscillator
- All solid state with plug-in board construction
- High input resistance

ver·sa·tile

(vûr'sətīl), *adj.* 1. capable of or adapted for turning with ease from one to another of various tasks, subjects, etc.; many-sided in abilities.

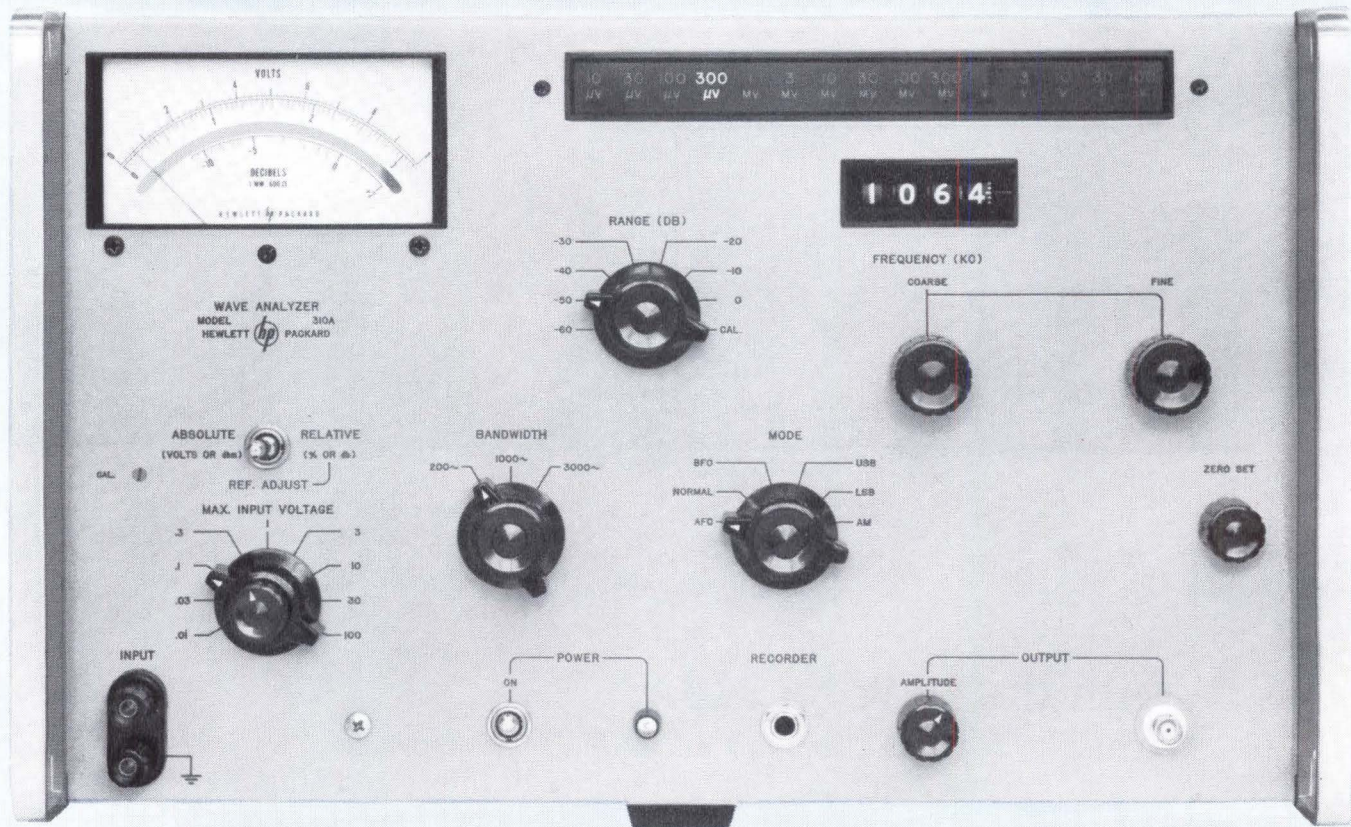

Count the capabilities of this high sensitivity, high frequency New hp 310A Wave Analyzer

TURN THE PAGE for details on the usefulness of the 310A for analyzing complex audio and rf waveforms—measuring frequency response of filters and amplifiers—making multi-channel carrier measurements—making long line telephone measurements—analyzing transmission line characteristics—analyzing sonar signals...

electronics

A McGraw-Hill Weekly 75 Cents



W. W. MacDONALD, Editor

J. M. CARROLL, Managing Editor
SENIOR EDITORS: Samuel Weber, George W. Sideris. **SENIOR ASSOCIATE EDITORS:** Michael F. Wolff, John F. Mason. **ASSOCIATE EDITORS:** Michael F. Tomaino, Sylvester P. Carter, William P. O'Brien, Sy Vogel, Leslie Solomon, George J. Flynn, Laurence D. Shergalis, George V. Novatny, Leon H. Dulberger. **ASSISTANT EDITORS:** Nilo Lindgren, Stanley Froud, Stephen B. Gray, Roy J. Bruun, Barry A. Briskman. **REGIONAL EDITORS:** Harold C. Hood (Pacific Coast, Los Angeles), Thomas Maguire (New England, Boston), Cletus M. Wiley (Midwest, Chicago). **ART DIRECTOR:** Howard R. Berry. **ASSISTANT ART DIRECTOR:** John C. Wright, Jr. **EDITORIAL ASSISTANTS:** Lorraine Rossi, Virginia T. Bastian, Lynn Emery, Ann Mella, Lorraine Werner, Alice M. O'Brien. **FOREIGN NEWS BUREAU:** Director, John Wilhelm; Alyne Elias, Betsy Wilson. **LONDON—**John Shinn, Derek Barlow, Nicholas Landon. **BONN**—Bruce Bendow, Richard Mikton, Silke McQueen. **BRUSSELS—**Peter Forbath. **PARIS—**Robert Farrell, Arthur Erikson. **MILAN—**Marc A. Messina. **MEXICO CITY—**Wesley Perry, Jr. **RIO DE JANEIRO—**Leslie Warren. **MOSCOW—**Stewart Ramsey. **TOKYO—**Richard Haloran, Charles Cohen, John Yamaguchi.

W. W. GAREY, Publisher

STEADY HAND positions tiny Hewlett-Packard *pin* diodes on $\frac{1}{8}$ -inch diameter posts. When mounted across transmission line and back biased, they offer little attenuation, when forward biased they absorb energy without reflection—a *new idea in microwave modulators and attenuators*. See p 40

FROG'S EYE Goes to Air Force. It isn't very pretty and it is unwieldy, but this newly developed electronic retina represents an important advance in bionics. *The system may well be a first step towards a new class of reconnaissance equipments*

18

COMPUTER SPEEDS Pushed Higher. Fast electrical delay line memory uses tunnel diodes, achieves bit-rate frequency of 114 Mc. *High-speed logics and some new microwave circuits are also reported by solid-state conference speakers*

19

NO ICBM DEFENSE FOR CITIES. While the Administration plans to spend some \$450 million next year on developing missile defenses, it now plans to defend only hardened bases. *Here's a rundown of the technical—and political—problems Nike faces*

24

MARKET for New Techniques. Defense Department plans to spend more than \$1 billion for exploratory development in fiscal 1964. *Air Force is concentrating on space, Navy on asw warfare, ARPA on missile defense*

27

TRADE EXPANSION ACT: Help or Hazard? Look for the overseas opportunities, advises one U.S. electronics firm. *This company has proved U.S. manufacturers can compete with foreign firms on their home grounds*

28

NEGATIVE-RESISTANCE DEVICES: New Look in Design. Two common negative-resistance devices are available to engineers: the voltage-mode tunnel diode and the current-mode four-layer diode. Both are amazingly versatile but little understood. *Here are designs for flip-flop, multivibrators, coupling circuits, staircase generators and other circuits.*

By V. Uzunoglu, Westinghouse Electric

35

THE PIN DIODE: Versatile Microwave Component. In these junction diodes, the *p* and *n* regions are separated by an *i*, or intrinsic layer. In the past they have been used mostly as a substitute for *t-r* and *atr* boxes. *Now they can be used to modulate the output of a microwave generator with sine waves, square waves or pulses.*

By R. E. Heller, Hewlett-Packard

40

FIELD-EFFECT TRANSISTORS: How to Get Maximum Input Impedance. The field-effect transistor combines the high input impedance of the vacuum tube with the size and power economies of the conventional bipolar transistor. *Many engineers find this combination particularly appealing. Now here's how to make a good thing even better.*

By T. R. Bignell, Electro Instruments

44

electronics

March 8, 1963 Volume 36 No. 10

Published weekly, with Electronics Buyers' Guide as part of the subscription, by McGraw-Hill Publishing Company, Inc. Founder: James H. McGraw (1860-1948).

Title ® registered U.S. Patent Office; © copyright 1963 by McGraw-Hill Publishing Co., Inc. All rights reserved, including the right to reproduce the contents of this publication, in whole or in part.

Executive, editorial, circulation and advertising offices: McGraw-Hill Building, 330 West 42nd Street, New York 36, N. Y. Telephone Longacre 4-3000. Teletype TWX N.Y. 212-640-4646. Cable McGrawhill, N. Y. PRINTED IN ALBANY, N. Y.; second class postage paid at Albany, N. Y.

OFFICERS OF THE PUBLICATIONS DIVISION: Shelton Fisher, President; Vice Presidents: Joseph H. Allen, Operations; John R. Callahan, Editorial; Ervin E. DeGraff, Circulation; Donald C. McGraw, Jr., Advertising Sales; Angelo R. Venezian, Marketing.

OFFICERS OF THE CORPORATION: Donald C. McGraw, President; Hugh J. Kelly, Harry L. Waddell, Executive Vice Presidents; L. Keith Goodrich, Executive Vice President and Treasurer; John J. Cooke, Vice President and Secretary.

Subscriptions are solicited only from those actively engaged in the field of the publication. Position and company connection must be indicated on orders. Subscription rates: United States and Possessions, \$6.00 one year, \$9.00 two years, \$12.00 three years. Canada: \$10.00 one year. All other countries \$20.00 one year. Single copies, United States and Possessions and Canada 75¢. Single copies all other countries \$1.50.

THE PUBLISHER, UPON WRITTEN REQUEST FROM ANY SUBSCRIBER TO OUR NEW YORK OFFICE AGREES TO REFUND THAT PART OF THE SUBSCRIPTION PRICE APPLYING TO COPIES NOT YET MAILED.

Subscribers: Please address change of address notices, subscription orders or complaints to Fulfillment Manager, Electronics, at above address. Change of address notices should provide old as well as new address, including postal zone number if any. If possible, attach address label from recent issue. Allow one month for change to become effective.

Postmaster: Please send Form 3579 to Fulfillment Manager, Electronics, 330 West 42nd Street, New York 36, New York.



Audited Paid Circulation

FITTING A WIDE-BAND SIGNAL Into A Narrow Band. Here is an article that gives the communications engineer the nearest thing to something for nothing: a narrow-band f-m receiver can make use of a wide-band signal without loss of sideband energy. *Frequency feedback is used to reduce the modulation index of the receiver.* By S. Kallus, B. Rabinovici and A. Newton, Radio Corp. of America 47

MICROWAVE PHASE MEASUREMENTS: Easy Ways to Make Them. Here are several methods for measuring the phase difference between two microwave signals and for measuring phase shift through microwave devices and materials. *They do not require specialized test equipment.* By I. Share, Suffolk County Community College 50

IMPROVING SIDEBAND COMMUNICATIONS With Simple Transistor Modulators. Carrier-leak suppression in conventional telephone carrier systems using single-sideband techniques calls for careful selection of components and equipment adjustment. *These transistor modulator-demodulator circuits provide an advantage over diode circuits usually used.* By A. S. Robinson, Telephone & Electrical Industries Sydney, Australia 54

DEPARTMENTS

Crosstalk. <i>Warm Bodies and the Cold War</i>	3
Comment. <i>Photodiodes. Engineering Image</i>	4
Electronics Newsletter. <i>Japanese Will Buy Small "Sage"</i>	7
Washington This Week. <i>Congress Pushes Again for More RS-70 Work</i>	12
Meetings Ahead. <i>International Scientific Radio Union Spring Meeting</i>	32
Research and Development. <i>New Underwater Gamma Spectrometer</i>	56
Components and Materials. <i>High-Temperature Ceramic Transmits Light</i>	62
Production Techniques. <i>Encapsulating Precision Antennas in Plastic</i>	68
New Products. <i>Operational Amplifier Has Multiple Uses</i>	74
Literature of the Week	84
People and Plants. <i>Solomon: Employer of the Year</i>	86
Index to Advertisers	96

Warm Bodies and the Cold War

THE COMPLEXITY of modern technology, particularly in the fields of weaponry and space exploration, not only calls for more engineers and physical scientists, but for more such men trained to the full limit of their intellectual capacity.

According to F.A. Terman, Provost of Stanford University, inadequately trained personnel accounts for the failure of many current programs. He criticizes as too narrow the viewpoint of those who believe that "... if only more of our high school graduates would choose engineering and science as a career, so that we could turn out more warm bodies stamped BS, we would have no need to worry." An even more important goal, thinks Terman, is to improve the quality of tomorrow's manpower pool through more emphasis on graduate training.

His suggestion: get more productivity from those who have already entered the collegiate pipeline, by three basic steps . . .

- Increase the number of master's and doctor's degree candidates in engineering and mathematics.

- Shorten the time required to obtain advanced degrees.

- Improve quality of training by strengthening existing centers of graduate study, and developing new ones.

The Terman steps are basically a plea for support of the recent proposal put forth by the President's Science Advisory Committee, of which he is a member. The PSAC called for a massive \$4.7-billion program to be shared 60-40 by government and private interests (p 8, December 21, 1962). The President's new education bill embodies many of the features called for.

We share Terman's view that in the U.S. the training of engineers and physical scientists at advanced levels is too often a byproduct, rather than a primary objective. We therefore endorse his proposal and support the recommendation of the PSAC. However, as we have stated previously (p 3 Nov. 2, 1962), extraordinary efforts are also called for to stimulate the interest of young people in engineering as a career.

There is no guarantee that even doubling the number of advanced degrees by 1970 would automatically assure us victory in the cold war. Thus it is essential that a continued flow of



CAMPUS SCENE at Columbia University, one of the centers of graduate education in the United States

well-trained BS engineers be maintained beyond that date.

With all the resources available to this nation and this industry, we can afford quantity and quality.

Coming In Our March 15 Issue

IEEE SPECIAL. Next week, we salute the first IEEE International Convention with a special king-sized issue. We will print more than a score of extra editorial pages to provide room for previews of important technical papers, roundups of the new products being exhibited, profiles of the engineers being honored by IEEE, and other articles designed to help make the convention more meaningful.

The issue will still contain a full ration of other feature articles:

- Details on high-speed integrated circuits with load-compensated diode-transistor logic
- Unique synchronization method that increases digital transmission rates
- New method of measuring equipment performance that displays both positive and negative gain
- Semipermanent memory built with twistors
- Sonar trainer that generates ship wakes.

TOUGH



... AS A
TURTLE'S BACK

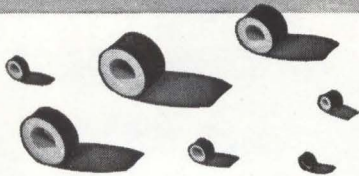

ARMAG*-PROTECTED
DYNACOR®
BOBBIN CORES

AT NO EXTRA COST!

Tough-as-tortoise-shell Armag armor is an exclusive Sprague development. It is a thin, non-metallic laminated jacket for bobbin cores that replaces the defects of nylon materials and polyester tape with very definite advantages—and, you pay no premium for Armag extra protection.

Tough Armag is suitable for use with normal encapsulation techniques on both ceramic and stainless steel bobbins. It withstands 180°C without deterioration—is completely compatible with poured potted compounds—has no abrasive effect on copper wire during winding—fabricates easily to close-tolerance dimensions—inner layer is compressible to assure tight fit on bobbin—does not shrink, age or discolor.

For complete data covering the wide range of Dynacor standard and custom Bobbin Cores, write for Engineering Bulletins to Technical Literature Service, Sprague Electric Company, 35 Marshall Street, North Adams, Mass.

*TRADEMARK

SPRAGUE®

THE MARK OF RELIABILITY

4S-512-R1

Get The Full Story at IEEE BOOTH 2424

4 CIRCLE 4 ON READER SERVICE CARD

COMMENT

Electronics Markets

I have just seen the recent issue of Electronics Markets: 1963 (p 43, Jan 4), and would like to send along my congratulations for a job well done. It must have been quite an effort to assemble all the material, make all the contacts, organize the material and put it down in such interesting form.

MELVILLE MORRIS

Black-Russell-Morris
Newark, New Jersey

Photodiodes

I think that [The Versatile Point-Contact Diode, p 82, Jan. 4] is a well-done piece of work, and that the demonstration of photodetection and parametric amplification in one and the same diode is a very useful contribution.

My belief is that the photo diode and the microwave phototube (photo-twt) at present are partly competitive and partly complementary devices. As the authors point out, the diode's strong points are its high quantum efficiency and its usefulness in the infrared (beyond 1 micron) where no good photocathodes are known.

On the other hand, the photodiode has problems with transit-time limitations, RC time-constant limitations, and resulting bandwidth and frequency limitations which are inherent in the device. The microwave phototube has the advantages of presenting a much higher effective load resistance to the photocurrent that is generated than does the diode. In addition, the inherent bandwidth of the phototube is enormous; i.e., 4:1 frequency coverage with little difficulty. Finally, the only real difficulty in extending the phototube to higher frequencies (above 10 Gc) is that the parts get a bit small.

The sensitivity figure of merit for a photodevice is $\eta^2 R_{eq}$, η being the quantum efficiency and R_{eq} the effective load resistance. On this criterion, the diode is much better in the ir; but a phototube with one of the better photosurfaces is more sensitive in the visible, plus having

a much larger bandwidth.

In general, I'm sure that the competition between photodiode and microwave phototube will continue to stimulate all of us working in the field for some time to come. I might just add that in addition to the work that we are carrying on at Stanford University, a group under Dr. B. J. McMurtry at Sylvania Microwave Development Laboratories, Mountain View, California, is carrying on a large effort in microwave phototube design, construction and testing; and microwave modulation and demodulation of light beams are now and everyday activity in this group.

A. E. SIEGMAN

Stanford University
Stanford, California

For more on the work at Mountain View, see p 37, July 20, 1962.

Engineering Image

Your *Crosstalk* article in the Nov. 2, 1962, issue (p 3), *Who's Minding The Stockroom?*, should be an excellent reminder to a number of engineering managers of the deeply pressing necessity to get across to the general public what engineers do and what really fabulous opportunities they have to do pioneering work. My long-time efforts at the local, state, and national level to get across some of these ideas probably have had less impact than this one article should have.

You will be interested in the comment I received when I suggested that a firm use some of its institutional advertising budget to disseminate a correct image of engineering as a profession to the public. The reaction was, "Well, that's a good idea, but we can't divert any of our advertising money to it." But lack of this diversion is going to cost the company many millions of dollars to meet the 4 to 5 percent annual increase in the starting-level salaries of engineering graduates, and which will show up in a very few years in a tremendous increase in the company's salary budget for engineers.

A. PEMBERTON JOHNSON
Director

Counseling Center
Newark College of Engineering
Newark, New Jersey

March 8, 1963 • electronics

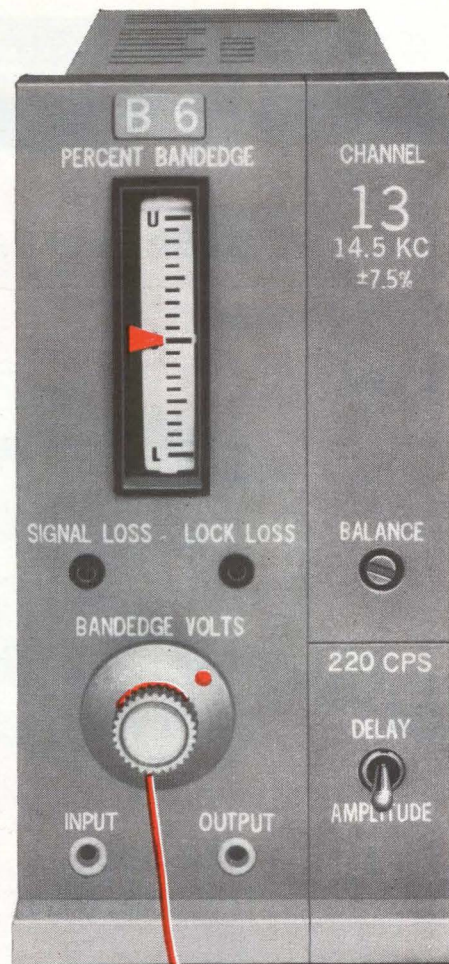

\$1615

... buys EMR's Model 210, a precision phase - locked - loop discriminator that's available at quick - look discriminator prices. It is telemetry's biggest bargain. It's not just a low-cost discriminator ... field tests have proved again and again that it is the best available at any price. Try it yourself. Write Sec. 117 for details.



**ELECTRO-MECHANICAL
RESEARCH, INC.**

Sarasota Products Div. Sarasota, Fla.

In HIGH RELIABILITY COMPONENTS if it's news, expect it first from IRC

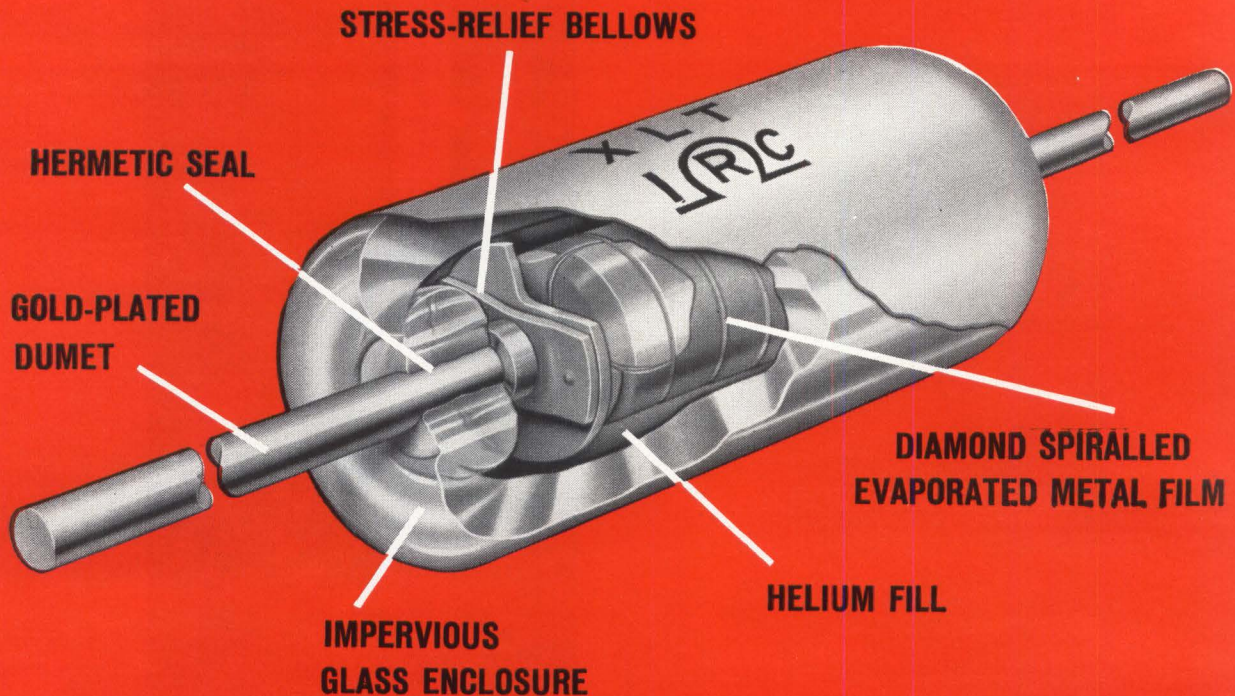

The resistor with a 3-year headstart on

MIL-R-55182

This is the resistor that pioneered Documented Reliability . . . forerunner of the MIL-R-55182 concept of component reliability. It was designed to meet the most stringent reliability standard ever set forth. The standard that was adopted by the Military in 1958 for critical missiles.

To date, the ultra-reliable XLT resistor has been tested for more than 260,000,000 unit hours, demonstrating a failure rate of 0.00036%/1,000 hours (1/16W., 25°C, proved to 60% confidence, failure defined as $\Delta R > 0.5\%$).

Under higher stress conditions, IRC has accumulated 35,100,000 unit hours, demonstrating a failure rate of 0.0027%/1,000 hours (1/8W., 100°C, proved to 60% confidence, failure defined as $\Delta R > 2\%$).

MIL-R-55182 reliability levels are established at 1%, .1%, .01% and .001% at $\Delta R > 2\%$. Testing to this specification, IRC has already accumulated 6,200,000 unit hours . . . WITH NO FAILURES . . . and is still going,

demonstrating a failure rate of 0.015%/1,000 hours (1/8W., 125°C, proved to 60% confidence).

IRC's experience with the ultra-reliable XLT is now being applied to other types of IRC precision film resistors. If you want a headstart on MIL-R-55182, write: International Resistance Co., Philadelphia 8, Pa.



Type XLT
actual size

CAPSULE SPECIFICATIONS

Resistance:	10 to 100,000 ohms
Tolerances:	$\pm 1.0\%$ and $\pm 0.5\%$
Power, nominal:	$\frac{1}{8}$ watt at 125°C 0 watts at 165°C
Temperature coefficient:	100, 50 and 25 ppm/°C
Body dimensions:	.155" diameter x .281"



Japanese Will Buy Small "Sage"

TOKYO—Japan Defense Agency is planning to buy in the near future a semiautomatic air warning and control system costing between \$80 million and \$110 million. Bidders are GE, Hughes and Litton—all of whom have tie-ups with Japanese firms to manufacture large portions of the system in Japan.

System functions will include detection of aircraft and air-breathing missiles, tracking, identification, threat evaluation, weapons assignment and control of fighter planes and surface-to-air missiles such as Nike and Hawk.

Under the present manual system, 24 sites are already equipped with Bendix search radar, GE height finding radar and communications. These will be retained. Data-processing gear, consoles and controls and ecm equipment will be added.

All equipment to be used is identical to U.S. military equipment already in use, although some gear might require modifications. Besides getting the bid, the successful contractor will set up a large organization that JDA might feel obligated to give contracts to at a later date.

Plastic Laser Emits Bright Crimson Light

WEDNESDAY, a plastic laser—reportedly the first—was demonstrated. The experimental device, developed by RCA Princeton Labs, produces bright crimson light but the technique may be extended to get coherent light at any wavelength from infrared to ultraviolet.

The laser consists of clear plastic fibers containing traces of the rare earth europium. The fibers are placed in a liquid nitrogen dewar and exposed to intense flashes of ultraviolet light. Energy is transmitted by the fibers to chelates that absorb energy and transfer it to the europium atoms causing them to

emit flashes of red light.

The fibers, each 20 times the diameter of a human hair, grab most of the light and force it to travel over their 15-inch length. Each time a flash occurs, it sweeps along a fiber stimulating other flashes all of which combine to create a single burst of coherent light that bursts from the end of the fibers with enormous power. Potentially the device can be made in the form of flat sheets.

Study Ion Implants, Plasma Deposition

BURLINGTON, MASS.—Ion implantation and plasma deposition techniques are being explored here as approaches to microelectronics, with particular emphasis on components and circuits which would have long life in high radiation fields. Work is being done at Ion Physics Corp., a subsidiary of High Voltage Engineering Corp. Preliminary research is being applied to experimental fabrication of solar cells.

Various ion species are being implanted in silicon, for example, phosphorus in *p*-type silicon to fabricate an *n-on-p* cell. A spe-

cially designed Van de Graaff accelerator has made it possible to insert ions at varying depths with accurately determined impurity concentrations. Penetrations up to 9 microns can be achieved precisely with higher accelerations.

Techniques are also being developed for deposition of thin-film circuit components directly from plasmas. Research so far has involved plasma deposition of silicon and titanium on glass substrates.

Firms Might Get Preview Of Space Developments

WASHINGTON—Indiana University wants to set up a center to channel space technology to potential industrial users. It is currently negotiating a \$150,000 contract with NASA for this purpose. Some 30 companies in the university area would each contribute \$5,000 to match the NASA funds.

NASA would benefit by selling nonexclusive licensing agreements to firms, which would get a chance to preview technical developments made under NASA contracts before they are announced publicly. In some cases, the university would

New Type of Transistor Operates Optically

OPTICAL TRANSISTOR, in which signals are carried by light rather than by electric current, has been devised by Richard F. Rutz of IBM's Watson Research Center. It has been operated as an oscillator at 1 Mc. Ultimate speed in the gigacycle range is expected.

Made of gallium arsenide, it converts some of the energy of the incoming electric current into light. After passing partly through the device, the light is absorbed and frees electrons on the output side. Electrons then pass into the external circuit as output current.

Advantage is that light moves much faster than electric charges through the base of the device, so extremely thin base regions which are difficult to fabricate are not necessary. The devices show a power gain of as much as 50 at 77 K. Current gains at room temperature have been as high as 0.1. IBM scientists believe it will be possible to raise the current gain to high enough levels for practically the whole range of high-frequency transistor applications

adapt a technology to industrial use. The center, which would be established as a test project, could be the forerunner of others in different parts of the country.

Wanted: Mobile Satellite Trackers

GE IS TRYING to develop mobile satellite tracking antennas with accuracies that will match the best permanent pulse radars. Firm has \$70,000 contract from Army. Goal is a tracker with 0.5 beamwidth accuracy that can be set up within 12 hours. Present high precision satellite and missile trackers require prepared foundations and take several weeks before they become operational. New trackers are expected to have reflectors 30 to 40 feet in diameter and operate from 1 to 10 Gc.

Overseas Air Control System Ready for Test

MOBILE AIR WEAPONS control system, the 412L, will be tested by the AF this month when F-102 supersonic jet fighters turn 200 square miles of North and South Carolina skies into an electronic battleground. The F-102's will be directed in mock intercepts of jet targets by the 412L, which can be disassembled and transported by truck or C-130 cargo aircraft.

Control sites for 412L's have self-contained radar, communications and power systems. The 412L will track, identify and provide guidance to fighter aircraft.

House Authorizes Half Billion More Than DOD

HOUSE COMMITTEE on Armed Services voted a total \$15,856,391,000 for procurement and r&d of aircraft, missiles and naval vessels—almost a half billion more than the Defense Department requested. Additional money is for the RS-70 (see p 12) and two attack submarines.

Army will get 1,600 of the new planes to form new air assault divisions, air-cavalry combat brigades, and corps aviation brigades. Many

of these planes will carry antitank weapons. Helicopters will be armed with missiles.

TW Amplifier Uses Plasma Slow-Wave Structure

LONDON—An experimental traveling-wave amplifier, developed by the Hirst Laboratories of GE here, uses a plasma-filled waveguide to convert beam energy to microwave power. The mechanical slow-wave structure is eliminated, thus removing the mechanical limitation to the construction of millimeter and uhf tubes.

This amplifier operates at 10 Gc and uses circular axially-magnetized waveguide filled with hydrogen or deuterium into which the electromagnetic waves are propagated. Electron beam velocity is equal to the plasma waves and results in about 30 db amplification by interaction of the electron beam with the forward waves supported by the plasma.

Telstar Switches Off Batteries, Silent Again

TELSTAR is again failing to respond to commands from the ground and is not transmitting any signals, Bell Laboratories reports. The satellite apparently misinterpreted a command and disconnected its storage batteries, Bell said. Because this malfunction resembles the previous one in many ways, engineers at Andover, Me. and Cape Canaveral are hopeful it can be remedied. Suspected troublemaker is the continued inhibiting effects of radiation on transistors.

Parabolic Antenna Vital in Mars Bounce

PARABOLIC ANTENNA 85 feet in diameter was used by CalTech's Jet Propulsion Laboratory to bounce the first radar beam off Mars recently. Antenna focused 100 Kw signal from the transmitter into a beam 3/10 of a degree wide, in effect magnifying signal to about 25 billion watts. About 1 watt hit Mars.

In Brief . . .

ELECTRONIC FAILURE was apparently responsible for Syncom's silence, although some engineers are theorizing that the telemetry and command antennas may have been torn off when the apogee motors fired. Satellite, found last week, is traveling about 300 miles lower than its scheduled synchronous orbit.

STRATOSCOPE II finally got off the ground last week, rose to a height of 15 miles, where it scanned Mars with its 36-inch telescope.

RAYTHEON is phasing out its Lewiston, Me., and Lowell, Mass., semiconductor operations. It will continue to produce advanced silicon planar devices, integrated circuits and germanium and silicon hearing aid units at its Mountain View, Calif., facility.

ELECTRONIC DEFENSE SYSTEM contracts for the B-58 'Hustler' totaled \$11 million last year at General Telephone.

FOUR companies were given a team award for a photo mapping system for the AF that may have a potential value of \$50 million. Initial contract is for \$3,364,493. Firms are Kollsman, Filtron, Lear-Siegler and Instrument Corp. of America.

DIGITAL TV research will be performed for AF by Electro-Mechanical Research, Inc. Purpose is to develop bandwidth compression systems for transmitting tv data from manned spacecraft to earth.

OVER 6,000 digital computers will be delivered in U.S. this year for data processing applications, according to a prediction by GE. Total value is estimated at \$2.6 billion.

U.S. SONICS received Navy contract for a "large number" of ASW hydrophone transducers for new Artemis system, to be installed in Arctic depths.

ITALY WILL LAUNCH a satellite into equatorial orbit next year from a platform floating in the Indian Ocean, according to NASA. Scout vehicle will be used.

WHICH DO YOU NEED -- FINE...or... SUPERFINE?



POWERLYTIC® CAPACITORS

for 65 C Operation

With metal cases ranging from 1 3/8" diameter x 2 1/8" long to 3" diameter x 4 5/8" long, Type 36D capacitors pack the highest capacitance values available in these physical sizes. Their maximum capacitance values range from 150,000 μ F at 3 volts to 1000 μ F at 450 volts.



COMPULYTIC® CAPACITORS

for 85 C Operation

The Type 32D Series offers the ultimate in reliable long-life electrolytic capacitors for computer service. With case sizes similar to those of Type 36D, these higher-temperature units have maximum capacitance values ranging from 130,000 μ F at 2.5 volts to 630 μ F at 450 volts.

Both Powerlytics and Compulytics have all of the qualities you expect from Sprague electrolytic capacitors—low equivalent series resistance, low leakage currents, excellent shelf life, and high ripple current capability. They are available with tapped terminal inserts, often preferred for strap or bus bar connections, as well as solder lugs for use with permanently wired connections.



Popular ratings of Type 36D Powerlytics are now available for fast delivery from your Sprague Industrial Distributor.

For complete technical data on Type 36D Powerlytics, write for Engineering Bulletin 3431. For the full story on "blue ribbon" Type 32D Compulytics, write for Bulletin 3441B to the Technical Literature Section, Sprague Electric Company, 35 Marshall St., North Adams, Mass.

SPRAGUE COMPONENTS

CAPACITORS	INTERFERENCE FILTERS	HIGH TEMPERATURE MAGNET WIRE
TRANSISTORS	PULSE TRANSFORMERS	CERAMIC-BASE PRINTED NETWORKS
MAGNETIC COMPONENTS	PIEZOELECTRIC CERAMICS	PACKAGED COMPONENT ASSEMBLIES
RESISTORS	PULSE-FORMING NETWORKS	FUNCTIONAL DIGITAL CIRCUITS
MICRO CIRCUITS	TOROIDAL INDUCTORS	ELECTRIC WAVE FILTERS

49-416

GET THE FULL STORY AT IEEE Booth 2424



Sprague and *®* are registered trademarks of the Sprague Electric Co.



NEW WAYS TO IMPROVE YOUR CIRCUIT RELIABILITY

UNI/G* Diodes – most significant advance in diode packaging in 5 years. “Extra” environmental capability and reliability.

An entirely new packaging technique — UNITIZED CONSTRUCTION — has made possible the UNI/G Diode Series. These new medium-power, fast-switching diodes are produced with an inherent built-in mechanical ruggedness not obtainable with other known diode packaging methods — mechanical parts, such as the whisker,

have been eliminated. The diodes have a *thermal-compression* bond between the glass-passivated silicon wafer and plugs. All have matched thermal coefficients of expansion. Here are diodes with a solid construction... no soldered connections, no parts to shift, open, or short-out under extreme environmental conditions.†

The UNI/G Computer Diode is your best switching diode buy! Specify UNI/G Diodes when you are ordering:

1N251	1N663	1N916B
1N625	1N914	1N917
1N626	1N914A	1N3064
1N627	1N914B	
1N659	1N915	
1N660	1N916	
1N662	1N916A	

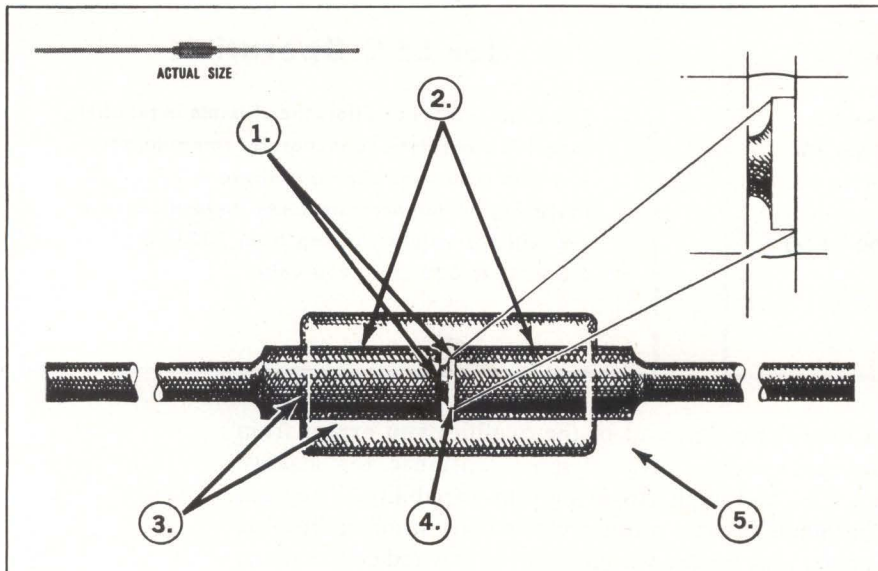

1. NO SOLDERED CONNECTIONS
Integral positive contact on both sides of wafer — elimination of whisker.

2. INCREASED DISSIPATION CAPABILITY
Double-plug configuration allows rapid heat transfer away from junction.

3. HIGH THERMAL SHOCK CAPABILITY
Glass-to-Metal Seal with matched thermal coefficient of expansion.

4. LONG LIFE AND STABILITY
Glass passivated diffused silicon wafer.

5. COMPACT CONSTRUCTION
Fits existing applications and is the transition step to future miniaturized assemblies.

†UNI/G Diodes have been transferred immediately from molten solder (+230°C) into liquid nitrogen (−196°C) with no catastrophic mechanical or electrical failures.

Compare UNI/G* Diodes Qualifications with the requirements of MIL-S-19500C:

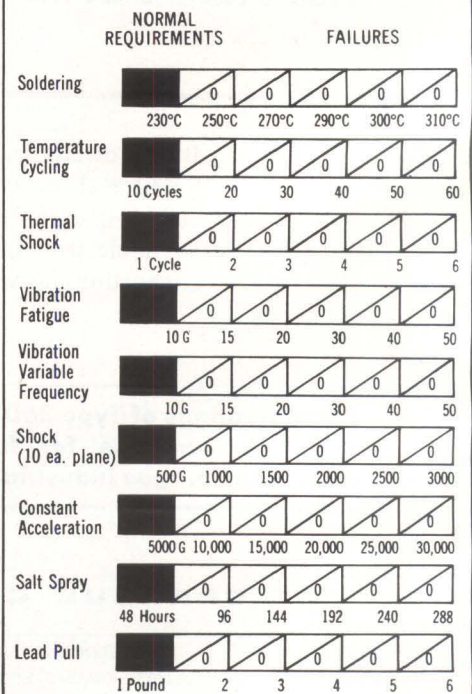

*Trademark of Texas Instruments Incorporated

Work with highly reliable power transistors having a guaranteed 10-megacycle minimum f_T —the TI 2N1722 & 2N1724

Wide-band audio amplifiers, DC-DC converters, fast-servo amplifiers, transient-sensitive DC power regulators—for applications like these, where frequency response is critical and reliable performance is a must, you can specify TI 2N1722 and 2N1724 50-watt silicon transistors with confidence. Their performance has been demonstrated, time and again, in stringent acceptance tests for such major high-reliability programs as Minuteman, Delta, Polaris, Titan, Syncom, and Gemini.

In a typical series of tests to assure you maximum reliability, these devices are subjected to vibration, mechanical shock, extreme moisture conditions, hermetic seal tests, salt atmosphere, high temperature storage, temperature cycling, operating life conditions, barometric pressure, stud torque and more. The 2N1722 and 2N1724 also offer you:

HIGH EFFICIENCY—Low con-

tact resistance to wafer elements minimizes junction temperature and electrical losses—"extra" reliability.

STABILITY—Exceptional stability is achieved by advanced mechanical and electrical design features. Wafer is alloyed to header to provide matched thermal expansion coefficients. Base and emitter leads are welded to wafer contacts and header terminals. (No soft solders or fluxes are used.) Junction surface passivation stabilizes leakage current and current gain, as demonstrated by the operating life test results at right.

HIGH FREQUENCY— f_T nominal is 15 mc—an advantage of TI's triple-diffused mesa construction.

HIGH BREAKDOWN VOLTAGE—Another feature of TI's triple-diffused mesa process is the high collector-emitter sustaining breakdown voltage (80 volts BV_{CEO}) obtained with low collector satura-

tion voltage (1 volt $V_{CE(sat)}$ at 2 amperes collector current). This represents a significant advance over earlier diffused process compromises on these fundamentally incompatible parameters.

WRITE for data sheets on the 2N1722 and 2N1724, or outline your specific reliability requirements.

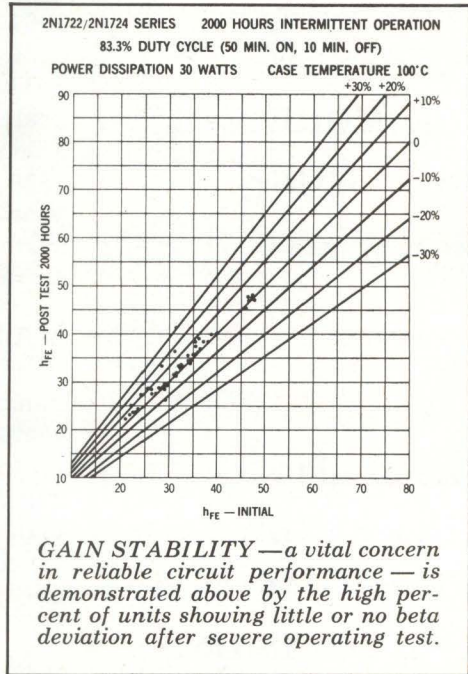

Overload test demonstrates superior reliability of TI hard-glass resistors

The two resistors in the photograph at right are identical . . . except for encapsulation. TI's exclusive hard-glass hermetic encapsulation made the big difference when both were subjected to 40 times their rated load.

Both units were RN65B resistors ($\frac{1}{4}$ -watt full load at 70°C), rated at 1.33 kilohms. Each was required to dissipate more than 10 watts when 120 volts was applied across the terminals. The molded resistor, a highly reliable unit under less severe conditions, was destroyed in seconds. Its hard-glass counterpart can be safely operated at this load for days!

Also capable of withstanding violent thermal and mechanical shock, these solderless CG $\frac{1}{8}$, CG $\frac{1}{4}$ and CG $\frac{1}{2}$ hard-glass resistors can be subjected to rapid alternate immersion in ice water and molten solder without leakage.

Reliability has been proven in almost 40 million unit test hours without a single catastrophic failure. Failure rate has been less than 0.003% per thousand hours at 60% confidence level.

TI hard-glass resistors are economical as well . . . in lower ratings, they are priced competitively with molded resistors and one half the

price of ordinary ceramic solder-sealed units.

A detailed report on hard-glass resistor reliability is yours for the asking. Just write.

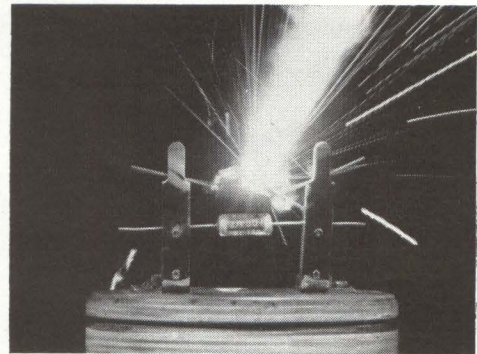

Here's a dramatic test of resistor reliability under extreme overload conditions. The effect of 120 volts on the molded unit is catastrophic in seconds; TI's hard-glass resistor can withstand it for days without damage.

SEMICONDUCTOR-COMPONENTS
DIVISION



TEXAS INSTRUMENTS

INCORPORATED
13500 N. CENTRAL EXPRESSWAY
P. O. BOX 5012 • DALLAS 22, TEXAS

19744

WASHINGTON THIS WEEK

CONGRESS PUSHES AGAIN FOR MORE RS-70 WORK

THE RS-70 RUMPUS is starting up again, as predicted (ELECTRONICS, p 18, Feb. 1). The House Armed Services Committee last week voted \$363.7 million to expand development work on the aircraft in fiscal 1964. The committee wants Air Force to build two more test planes equipped as complete weapon systems.

The administration did not seek any additional funds for RS-70 next year, plans to build two stripped-down prototypes and one equipped with a bomb-nav system. So far, it has approved but not released one-quarter (\$50 million) of the extra funds Congress appropriated for RS-70 last year—all of it going into advanced research on side-view radar, display systems, and other special reconnaissance-strike electronics equipment.

SATELLITE FIRM'S NEW EXECS FACE KEY DECISIONS

MAJOR DECISIONS facing the satellite communications corporation should be settled more quickly now that top officers have been named. Decision on what type of system to build is needed so the company can set initial capitalization and sell stock. The company has up to \$5 million in bank credits, but must repay the loans by February 28, 1964. Also, Congress will want to know soon what the company's plans are for a research program. Congress is getting edgy about the slowness with which the new corporation is moving and about continued government spending on communications satellite research (ELECTRONICS, p 10, March 1).

Leo D. Welch, presently chairman of Standard Oil (N. J.), will be chairman of the board and chief executive officer. Joseph V. Charyk, former under secretary of the Air Force, will be president and chief operating officer. Charyk starts work immediately, Welch is due to join the company about April.

JAPANESE PROTEST PLAN TO TAX ELECTRON MICROSCOPES

BILL TO REINSTATE import duties on electron microscopes imported from Japan by U. S. nonprofit educational and scientific organizations has been introduced in the House by Rep. William J. Green (D.-Pa.). A bill passed in 1961 waived the duty for nonprofit groups. Congress is expected to pass Green's bill unless importers wage a successful lobbying fight. Last year, Green's bill passed the House but died in the Senate.

(McGraw-Hill World News in Tokyo reports that three Japanese makers, Hitachi, Japan Electron Optics and Akashi Seisaku, plan to protest the bill and will seek Japanese government support. About 40 percent of Japanese microscope production goes to the U. S. and U. S. sales total about 200 units. The Japanese say RCA has 40 percent of the U. S. market but that nonprofit groups with low budgets prefer the foreign microscopes—chiefly Japanese and German.)

DATACOM NET IS COMPLETED

AIR FORCE has placed in full operation what it calls "the world's largest and most advanced data communications network." Datacom is the first phase of the Defense Communications System's world-wide digital data communications network. Datacom has five automatic electronic switching centers. Its major purpose is to handle Air Force supply requisitions. Some 300 Air Force and Defense Dept. installations and defense contractors can interchange information at speeds to 3,000 words a minute. Western Union is prime contractor.



Why Sylvania developed a mass spectrometer that sells for less than \$200

Like a lot of other people, we are constantly trying to create a perfect vacuum—the best of all possible conditions for tube performance and life. Lacking the ideal 0 mm Hg, then, we need a sensitive device to tell us quickly and accurately exactly what is left in our evacuated tube. Low cost is important since large numbers of tubes need this kind of analysis during life tests.

Answering this need, Sylvania engineers

developed an omegatron mass spectrometer so simple, portable and inexpensive that we think it will be of interest to others involved in vacuum physics. Functionally, it is a highly efficient miniature cyclotron, with the sensitivity and resolution of far more complex mass spectrometers. But the cost is far less—especially when you consider that only one magnet and recording setup is needed with any number of omega-

trons attached to any number of vacuum systems.

The Sylvania Omegatron is more than a product available and for sale. It's an example of how integrated research and engineering were brought to bear on a problem—typical of the way Sylvania works. For more information write to Electronic Tube Division, Sylvania Electric Products Inc., Box 87, Buffalo, New York.

SYLVANIA

SUBSIDIARY OF

GENERAL TELEPHONE & ELECTRONICS



SEE US AT IEEE—
BOOTHS 2322-2332
AND 2415-2425

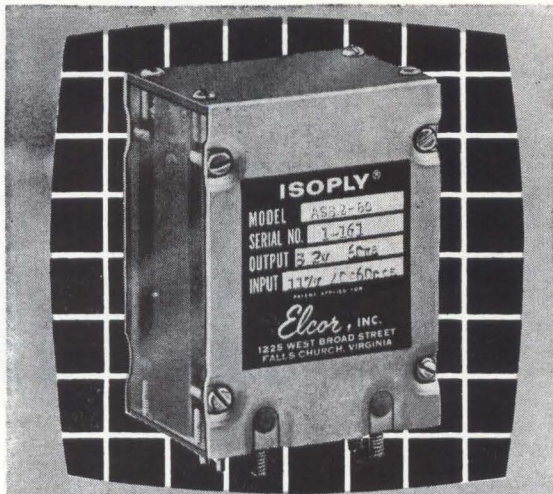

TYPICAL A49 SERIES ISOPLY

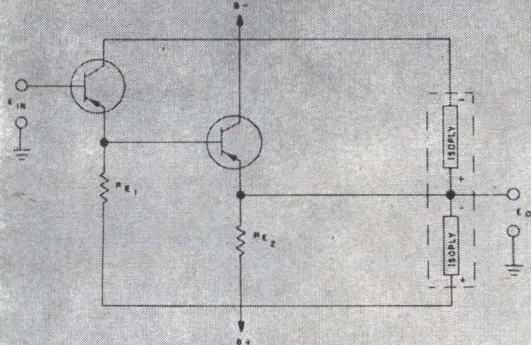

BOOTSTRAPPED EMITTER FOLLOWER WITH DUAL ISOPLY

Eldcor IsoPLY Circuitry Handbook (60 pages) available... Price \$1.00

What can a power supply contribute to circuit design?

PLENTY... if it's an *ISOPLY®

SPECIFY ELCOR FOR:

Servo design . . . ISOPLY substantially eliminates ground loop problems and zero errors.

Bridge design . . . ISOPLY eliminates common-mode signal . . . no differential amplifier needed. Ground referenced Bridge output available.

Digital design . . . ISOPLY allows DE-coupled DIRECT coupled circuits.

Amplifier design . . . ISOPLY is ideal for bootstrap cathode or emitter follower and related circuits.

Nuclear design . . . ISOPLY changes polarity from the detectors to suit the instrument.

RFI design . . . ISOPLY can meet MIL-I-16910 or other appropriate specifications.

Bio-medical design . . . ISOPLY provides the isolation required for neuro-physiological stimulation experiments.

Special designs . . . ISOPLY construction lends itself to design flexibility and variation capable of meeting many special requirements.

Multiple output design . . . ISOPLYS with as many as four outputs are available.

***Highly isolated power sources** . . . ISOPLYS . . . offer a completely new dimension in circuit design flexibility by removing the constraint imposed by dependence upon ground referenced power.

Other Eldcor Products . . . ISOFORMERS® (Isolated Transformers) up to 1 KW . . . ISOREX® (Isolated Transformer-Rectifier) units and unregulated but isolated power packs . . . Current Indicators and Integrators and related measurement instruments . . . specify Eldcor.

for further information, write, wire or phone:



ELCOR, Incorporated

Subsidiary of Welx Electronics Corporation
1225 West Broad Street, Falls Church, Va.
Telephone Code 703—JE 2-8850
(FAX No.-RFJ, Falls Church, Va.)
Some areas still open for representation

CIRCLE 201 ON READER SERVICE CARD

If your plant belongs in FLORIDA

Plant City

is the most STRATEGIC LOCATION

LOCATION — In the center of Florida — closer to all Florida markets — served by two railroads, major truck lines; only minutes from deep-water port and international airport.

LAND — Low cost sites in city-owned industrial park. Large acreage also available.

LABOR — Excellent local labor market.

LIVING — Established community with all educational, civic, and cultural advantages.

All correspondence in strict confidence.

SEND FOR INDUSTRIAL SURVEY

Dick Prewitt, General Manager
INDUSTRIAL DEVELOPMENT COMMITTEE
P.O. Box 1509-E
Plant City, Florida

City MOST Convenient to ALL Florida

IEEE

SPEAK

TO OUTSTANDING
ELECTRONICS ENGINEERS,
SCIENTISTS, PHYSICISTS

at

I-TRIPLE-E's

International Convention
and Exhibition in New York

MARCH 25, 26, 27, 28

The COLISEUM at Columbus Circle
& The WALDORF ASTORIA HOTEL

admission: MEMBERS \$1.00; NON-MEMBERS \$3.00
MINIMUM AGE: 18

SHOW

(formerly the IRE Show)

AMP set the GOLD standard!

In this AMPin-cert* Blade Connector, gold over nickel plating is standard, never an option . . . never an extra. Gold over nickel plating coupled with engineered contact pressures assure longer life, maximum performance and reliability, setting the highest standard in crimp, snap-in type printed circuit connectors. AMP research and testing have proved conclusively that gold over nickel plating is superior in every way. Crimp, snap-in type contacts are plated with .000030" gold (min.) over .000030" nickel (min.). Uniformity in plating thickness is controlled by X-ray measurement. There is no metal "creep" and no debili-

tating oxide insulation buildup. Three areas of contact are pressure engineered to avoid excessive or quick plating wear.

Another bonus feature is that AMPin-cert Printed Circuit Connectors are not pre-loaded. They can be loaded to accommodate only those circuits actually required. You buy and use only the receptacle contacts you need.

ADDITIONAL FEATURES:

- Encapsulated male tabs prevent misalignment of contacts
- Staked down male tab housing eliminates board warpage
- Guide pins assure positive mating of connector halves
- Raised barrier section and large contact cavities avoid moisture entrapment
- Built-in egg crate construction, and crimp snap-in receptacle contacts eliminate sleeving and soldering.

Why not insure your own standard of quality and reliability by using AMPin-cert Printed Circuit Connectors. You'll find they exceed the most stringent applicable requirements both military and commercial.

Send for more information and a free copy of "A Compilation of Papers published on AMP Research Activities in the Field of Plating."

*Trademark of AMP Incorporated

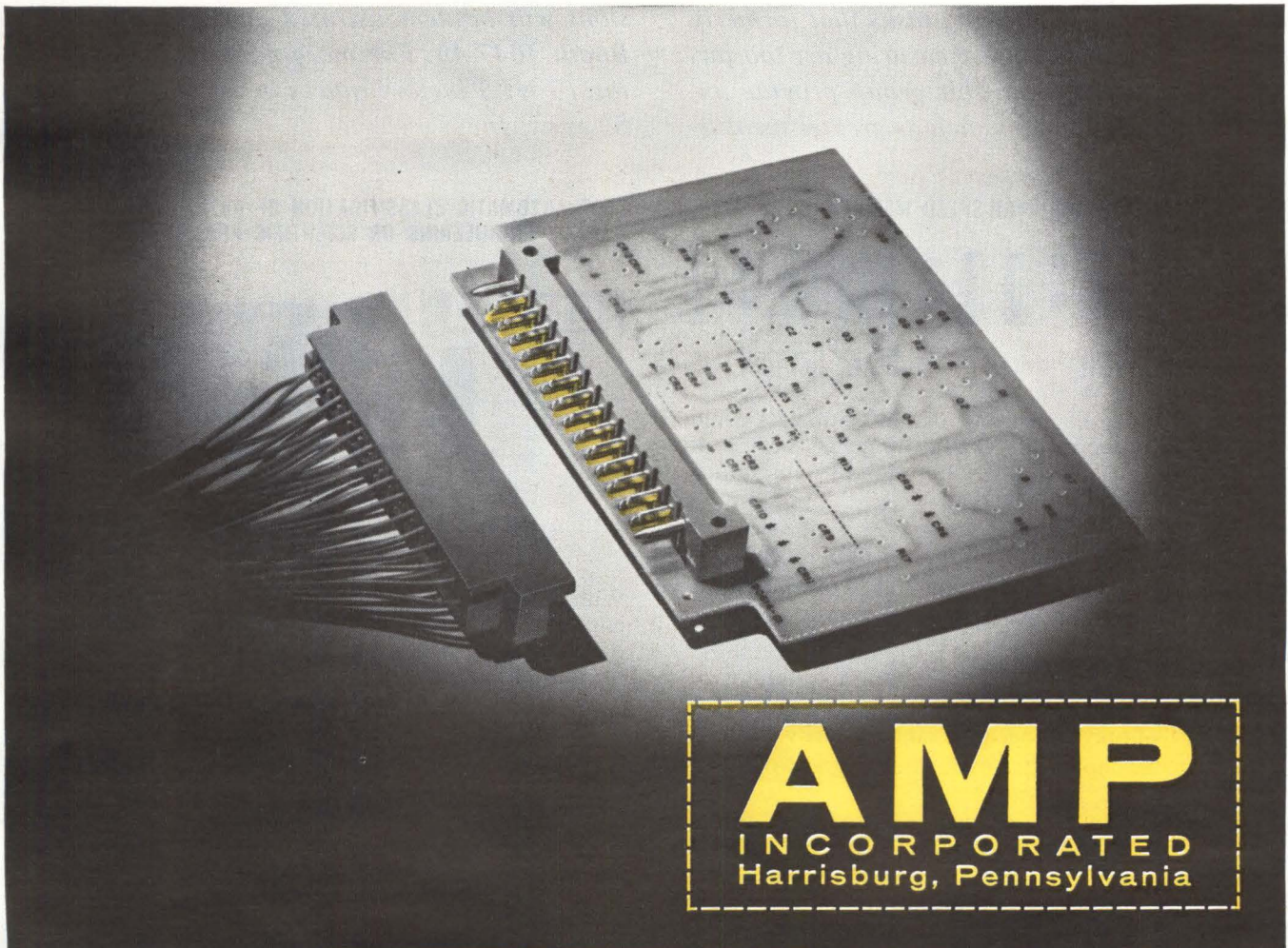

AMP
INCORPORATED
Harrisburg, Pennsylvania

AMP products and engineering assistance are available through subsidiary companies in: Australia • Canada • England • France • Holland • Italy • Japan • Mexico • West Germany

Your digital measuring capability just increased...

These 12 new developments in digital measuring instruments from NLS constitute a significant expansion of your measuring capability.

For example, it is now possible and practical to automatically classify voltages for statistical purposes...measure peaks and varying voltages accurately...convert AC to DC with 0.01% accuracy...automate mass spectrometer data...or accomplish other measuring tasks that formerly stretched the state of the measuring art too far.

Other instruments in this group provide important user advantages such as greater measur-

ing speed at lower cost. A case in point is the V91 — a high-speed, all-electronic, completely automatic digital voltmeter that measures DC voltages from a millivolt to a kilovolt. Its price is considerably less than \$3000. Are these models really new and significant? We'll let the instruments themselves do our shouting.

SEE THEM IN ACTION. Production versions will be demonstrated at the IEEE Show, Booth 3047-49. For more data, contact any of the 19 NLS factory offices or write Non-Linear Systems, Inc.

FOR LOW-COST HIGH-SPEED MEASURING

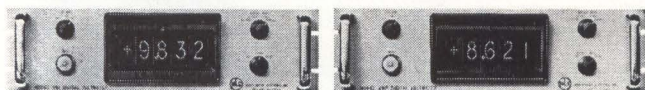

V91 ALL-ELECTRONIC DIGITAL VOLTMETER

V91P ALL-ELECTRONIC DVM WITH PRINTOUT

These high-speed, all-electronic digital voltmeters could become the most popular NLS instruments because of their balance of outstanding features at low cost. Most important advantages include:

- ✦ High speed — 100 readings/sec. in any one range; 15-25 ms. additional for range or polarity changes.
- ✦ Wide measuring range — millivolt to a kilovolt.
- ✦ High accuracy — $\pm 0.01\%$ of full scale on each range ± 1 digit.
- ✦ Automatic range-polarity changing; ranges of $\pm 9.999/99.99/999.9$ volts.
- ✦ Logic that prevents needless range-polarity changes.
- ✦ Switchable input filter with three degrees of filtering.
- ✦ Same high-quality construction as the most expensive NLS digital voltmeters.

Their low prices result from design advancements such as replacement of the usual wiring harness (most expensive single item) with printed circuitry. The V91P has automatic print control and printer output — V91 does not. V91: \$2,585. V91P: \$2,985.

FOR AUTOMATIC CLASSIFICATION OF DATA IN PRODUCTION, ENGINEERING OR SCIENTIFIC APPLICATIONS

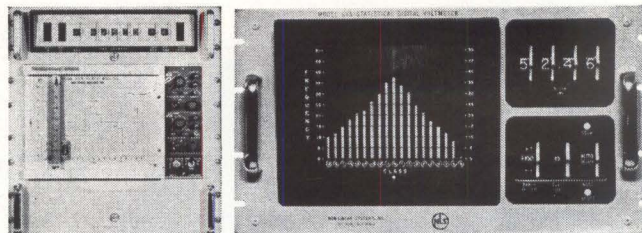

SV2 STATISTICAL DIGITAL VOLTMETER

SV3 STATISTICAL DIGITAL VOLTMETER

With a push of a button, these instruments provide an engineer, scientist or manufacturer an accurate statistical description of a test, experiment or production run. Wherever data must be evaluated in statistical form, the SV2 and SV3 automatically classify input voltages and display results as a bar graph (frequency distribution histogram). With suitable transducers, they'll classify lengths, pressures, temperatures, weights, resistors, etc. Accuracy of each instrument is approximately $\pm 0.01\%$.

The SV2 accepts up to 3 entries per second, stores them internally, and within 30 seconds after command completes plotting a 22-class histogram on chart paper.

The SV3, with a speed of 5 entries per second, presents its 19-class histogram on a visual display which can be examined, photographed or traced prior to being cleared to zero. SV2: \$9,385. SV3: \$7,385.

FOR DYNAMIC MEASUREMENTS

Digital voltmeters — even high-speed analog-to-digital converters — generally measure only non-varying voltages accurately. The CH3 now permits highly accurate measurement of either the peak value of a varying voltage or the voltage existing at the precise instant when reading is commanded. Non-varying voltages can be measured, too. Ranges are $\pm 9.999/99.99/999.9$ volts... constant 10 megs input resistance... accuracy up to $\pm 0.02\%$... 3/30/300 kilovolts/sec. slewing rates... decimal and B-C-D digital outputs available simultaneously... transistor circuitry... time per measurement is approx. 13.4 millisecc. in clamp and hold mode. \$6,185.

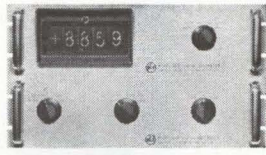

CH3 CLAMP-AND-HOLD AND PEAK READING DVM

FOR GROUND ISOLATION AND PORTABILITY

Measure voltage anywhere with the RV2 that features virtually infinite ground isolation, completely automatic operation, 4 readings/sec., transistor circuits, and long-lasting reed relays (250 million readings, average). Ranges of $\pm 9.999/99.99/999.9$ volts... 10 megs input resistance... accuracy $\pm (0.01\%$ of scale on each range +1 digit)... input filter... nickel-cadmium cells. \$2,185.



RV2 BATTERY-OPERATED DVM

FOR HIGHEST ACCURACY AC MEASUREMENT

Designed for use with NLS DVMs, this converter provides ultra-accurate AC voltage measurement. Accuracy of conversion from 50 cps-10 kc up to 9,999 volts is $\pm (0.01\%$ of reading +0.001% of full scale) plus accuracy of standard used for calibration; accuracy decreases at higher frequencies or higher voltages. Automatically selected ranges 9.9999/99.999/999.99 v... input impedance, 1 meg and 20 μmf ... 3 sec. max. settling time within a range. \$1,985.



225 AC/DC CONVERTER

FOR DIGITAL DATA TELEMETERING

Instead of 40 wires normally needed to transmit 4-digit numbers, this system requires only 4 wires (plus ground) to transmit DVM readings up to 1 mile away. Transmission is error free, even with low quality lines. Transmits in 36 ms. \$3,750.



190/210 DIGITAL TELEMETER

FOR BINARY-TO-DECIMAL CONVERSION

The S44 converts pure binary signals to a decimal number system display. 6,000 11-bit conversions per sec. Other versions available. \$4,035.



S44 CONVERTER

FOR LOW-COST DATA LOGGING

This standard system automatically scans 20 double-pole input channels, connects them to a DVM (not supplied), and provides a punched tape record of measurements identified by channel. It will operate from any NLS instrument having digital output. Any 5, 6, 7 or 8-channel code can be accommodated. Maximum word length is 33 digits. \$2,685.

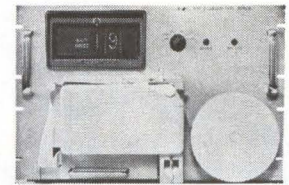

RS3 TAPE PUNCH DATA LOGGER

FOR AUTOMATING MASS SPECTROMETERS

Proven in use by a leading chemical processor, the MSD2 automatically provides printed and punched tape records of mass spectrometer ion voltage peaks and their associated acceleration voltages immediately after each run. It's also useful for highly accurate measurement of voltage peaks in other applications. Important features are its high reliability (completely transistorized), high accuracy (mass number resolution is ± 0.2 under worst conditions), speed (4 peaks/sec.), and elimination of noise and spurious peak problems (via unique digital peak analyzer). \$24,885.

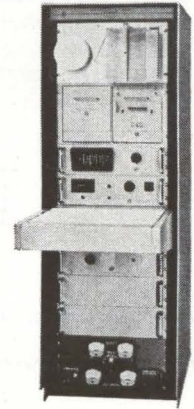

MSD2 MASS SPECTROMETER DIGITIZER

FOR MEASURING VARYING VOLTAGES

With this accessory, an NLS Model 15 Analog-To-Digital Converter will sample and accurately measure the value of a rapidly varying voltage at the precise instant of command. Input resistance exceeds 10 megs. Input and output voltage range is ± 10 volts at a gain of 1 (other gains available). Gain accuracy is $\pm 0.01\%$. \$2,500.

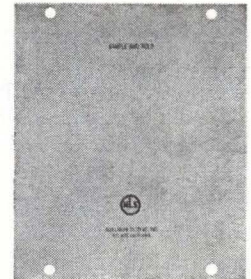

IDS2 SAMPLE AND HOLD MODULE

FOR PRECISE AMPLIFICATION

This general purpose, differential AC/DC amplifier with isolated ground and isolated input provides outstanding performance. Gains are $\times 1/3/10/30/100/300/1000$ plus a vernier... bandwidth 0-10 kc... full scale output 10 volts... linearity $\pm 0.025\%$... stability $\pm 0.025\%$... 120 db common mode rejection @ 60 cps, with 1,000 Ω unbalance. \$985.

144 PREAMPLIFIER



Note: Specs and prices are subject to change without notice. Prices are FOB destination within U.S.A. except Hawaii and Alaska.



Originator of the Digital Voltmeter

non-linear systems, inc.

DEL MAR, CALIFORNIA

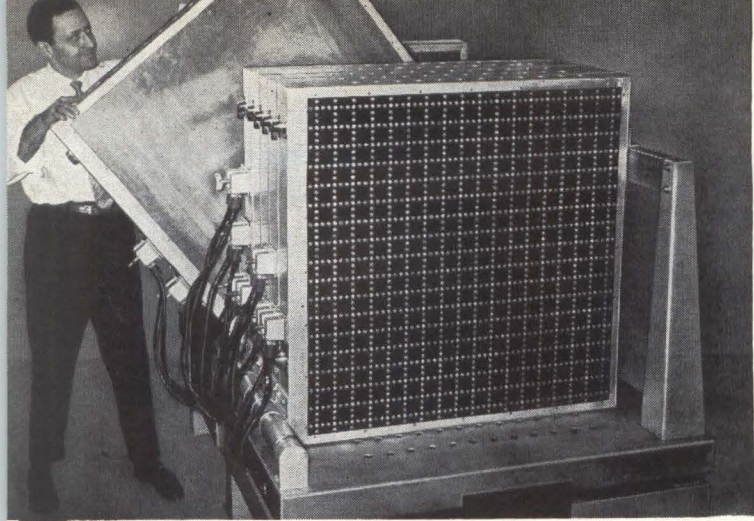

RETINA of electronic frog's eye has 1,296 photoconductive receptors, processes visual information through 7 neural-type layers

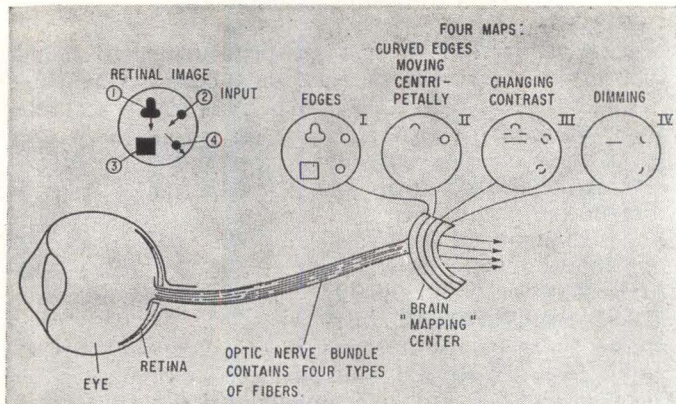

FROG'S eye maps out features (edges, etc.) of objects it sees. The electronic model represents one of the first truly "bionic" equipments to be built

Frog's Eye Goes to Air Force

Recon work may benefit by visual pattern-recognition techniques

By NILO LINDGREN
Assistant Editor

AN IMPORTANT piece of hardware has been delivered to the Bionics Branch of Aeronautical Systems Division at Wright-Patterson Air Force Base just in time for the 2nd ASD Bionics Symposium, March 19-21. It is an electronic frog's eye that simulates many of the information-processing properties of the frog's visual system.

The completed frog's eye model

(see photo), designed and built by RCA engineers at Princeton and Camden, N. J., may well be a first step towards a new class of unusual parallel-processing surveillance and reconnaissance equipments.

Much as a frog sees and instantly recognizes objects that interest it, such as flies, retinal-type surveillance devices might be designed to recognize missiles instantly, thus saving precious time now required for ballistic-type computations.

RETINA MODEL—Many of the frog's known visual feature-abstraction properties (ELECTRONICS, p. 40, Feb. 16, 1962) have been incorporated into the retina model. If a dark object moves across its field of vision, the retina sorts out or maps edges, moving convexities, contrast changes and light dim-

ming, as shown in figure above.

In both the frog and the electronic functional model, this visual information-processing takes place in different neural layers. In the photo, the layers are as follows: (1) bipolar receptors, (2) edge detectors, (3) convexity detectors, (4) amacrine cells, (5) changing-contrast detectors, (6) dimming detectors (shown tilted out) and (7) output indicators.

Interconnections between the first four processing layers are by neon lamps on the back of each layer to photoconductors on the front of each following layer. These "light connections" are made by more than 2,000 neon-lamp/photoconductor pairs.

SYSTEM LOGIC—To detect edges (class 1 ganglion), the "eye"

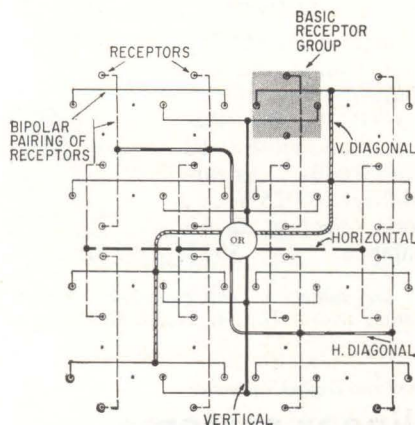

(A)

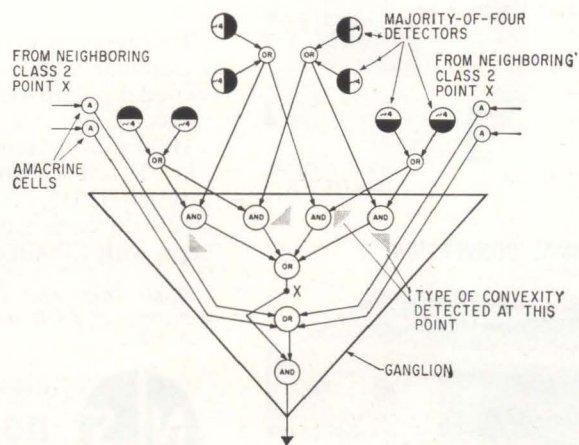

(B)

PHOTOCONDUCTIVE RECEPTORS are connected as shown (A) for the detection of object edges (class 1 ganglion); outputs of class 1 ganglia feed into the so-called class 2 ganglia, as shown here (B), to provide detection of moving curves

senses horizontal and vertical contrasts with bipolar neurons, consisting of two photoconductive receptors connected to two neon lamps in a balanced-bridge circuit. Thus, contrasts will activate the neon output lamps. These outputs are combined in majority-logic circuits. When an edge focused on the receptor plane is long enough to activate outputs from at least 3 of 4 adjacent bipolars, that edge will be detected. Summing of non-adjacent bipolars leads to detection of diagonal edges. Figure (A) shows the directional summations for a complete class 1 ganglion.

The method of tracking convexities (class 2 ganglion) is indicated below (B). The majority detectors of class 1 ganglia provide neon-lamp inputs to the class 2 photoconductive cells. Output signals of four possible combinations of convexities are combined in an OR gate to show the presence of any convexity within the field of view of the ganglion. Tracking of lateral motion of convex objects is provided by the amacrine cells (B).

Class 3 ganglia abstract changes

of contrast of relatively large dark objects in the receptive field. They take their inputs from class 1 outputs. Class 4 dimming ganglia abstract dimming changes by differentiating summed receptor potentials.

Important features of the frog's eye model include overlapping at various processing levels and differently-sized responsive-receptive fields for each type of ganglion, which physiologically is true to the frog.

However, whereas the frog is equipped to detect and track flies, the electronic functional model is not. It will probably serve as a research tool for future studies in pattern recognition, feature abstraction and parallel processing. Details of the development, which was funded by the U. S. Air Force, will be presented by M. B. Herscher and T. P. Kelley at the Bionics Symposium on March 20.

The development is based on the now-classic electrophysiological findings of Lettvin *et al* at MIT ("What the Frog's Eye Tells the Frog's Brain," published in 1959).

Computer Speeds Go Higher

*Fast electrical delay
line memory uses
tunnel diodes*

PHILADELPHIA—New developments in microwave and computer circuits commanded attention of circuit designers at the recent International Solid-State Circuits Conference (ELECTRONICS, p 12, March 1). Here are the highlights:

DIGITAL MEMORIES—Bit-rate frequencies at speeds above those of the fastest computer circuits available are claimed by using tunnel diodes in an electrical delay line memory. Paper by H. H. Harris and W. D. Pricer, of IBM, discussed the basic memory cell consisting of a printed delay line and capacitor, a tunnel diode that amplifies and reshapes pulses, a conventional

diode for access to the individual cells, and a load resistor. Each cell operates serially in time but a complete system can use circuits for conversion to parallel from serial operation to achieve parallel input and output.

A fully operative model has been built, but not completely populated, which is representative of a 256-word system. It has a full read/write cycle time of 240 nsec and a bit-rate frequency of 114 Mc. Experiments with a coaxial line as the delay medium have operated an individual cell with a 5-ma, 3-pf tunnel diode at a bit rate of 810 Mc.

Memory cell that would utilize the quantization of trapped flux in superconductors (ELECTRONICS, p 12, Oct. 12, 1962) was described by D. J. Dumin and J. F. Gibbons, of Stanford University. Flux is trapped in a quantizing loop (see p 20) and the critical current of the

THE POTTER MT-36 digital magnetic tape transport

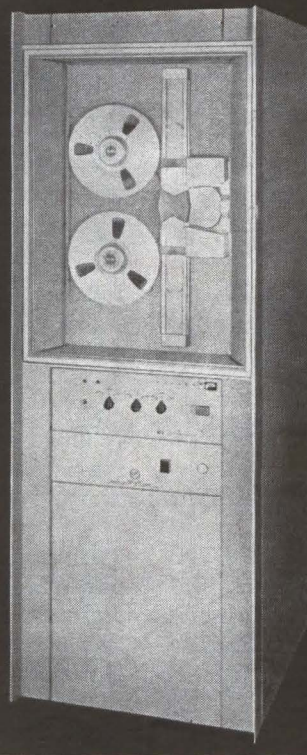

MT-36: THE MOST RELIABLE TRANSPORT in its price range

The Potter MT-36 Digital Magnetic Tape Transport offers maximum reliability for computer systems requiring an economical transport. The Potter MT-36 features:

- **NO PROGRAM RESTRICTIONS...** up to 200 commands per second at 36 ips.
- **SOLID STATE CIRCUITRY...** photo electric sensing minimizes the need for switches and relays.
- **VACUUM TROUGH GUIDES...** provide smooth tape stops.
- **IMPROVED PINCH-ROLLER CIRCUITS...** offer fast tape starts and stops.
- **EASE OF MAINTENANCE...** drive electronics and fully regulated power supply are mounted on individual plug-in boards.
- **RAPID TAPE THREADING...** Just 15 seconds for complete threading.
- **BUILT IN TAPE CLEANER...** vacuum on trough guide removes all loose oxide and dust.

For full information and specifications on the MT-36 Digital Magnetic Tape Transport, write today.



POTTER INSTRUMENT CO., INC.
TAPE TRANSPORT DIVISION
151 Sunnyside Boulevard • Plainview, New York

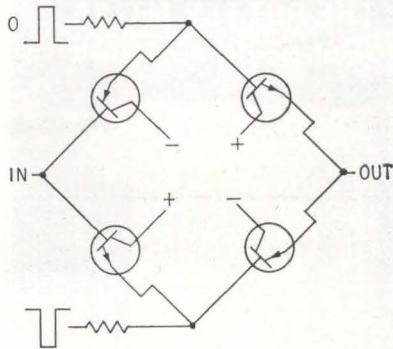

BASIC diamond circuit developed at MIT Lincoln Lab

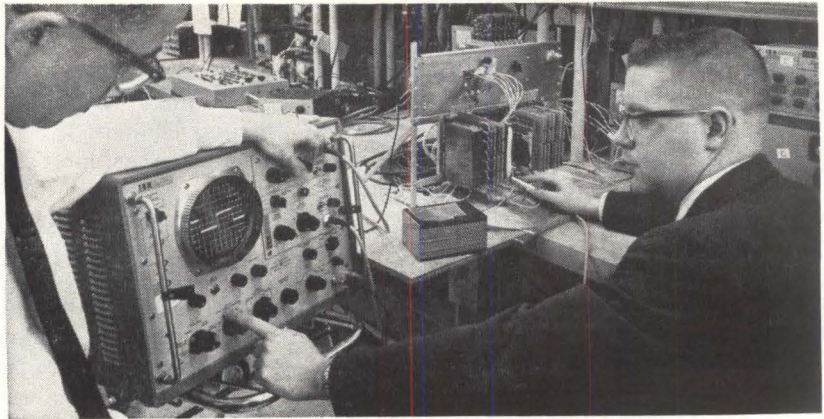

OPERATIVE MODEL of electrical delay line memory using tunnel diodes is tested at IBM

tin detector, which will change due to the presence of the trapped magnetic field, is measured.

LOGIC CIRCUITS — High gain without loss of bandwidth is claimed for a new logic circuit developed by B. E. Sear, of Martin-Marietta, and J. S. Cubert and W. F. Chow, of Sperry Rand. The circuit, which uses tunnel diodes in conjunction with charge-storage diodes, is seen as permitting 1 nsec propagation delays per stage. Feasibility model containing 150 logic circuits has operated with logic delay per stage of 2 to 4 nsec. Fan-in and fan-out of 5 are possible with storage diode gain of 10.

Microwave logic circuits using Esaki diodes were described by Y. Komamiya, of the University of Illinois. System uses asynchronous logic in which a binary ONE and ZERO correspond to an oscillating wave and d-c level signal, respectively. Necessary time for the high-speed carry circuit of a 40-bit binary parallel adder is estimated at less than 8 nsec at 300 Mc.

New circuit for bridging the gap between analog and digital methods, particularly in space instrumentation, was reported by R. H. Baker of MIT Lincoln Laboratory. Known as the diamond circuit (above) it is essentially a bridge modulator in which diodes are replaced with transistors with power gain. Circuit is a digital-analog hybrid which samples the data signal with low losses and transfers the signal to the output at a high power level with adjustable threshold and/or offset. Signal losses are avoided by automatic

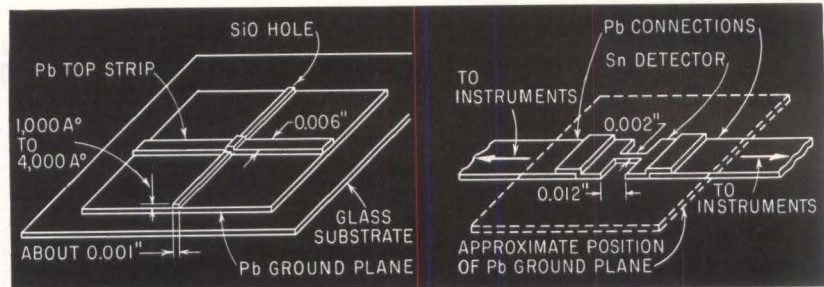

QUANTIZER loop (left) and detector being studied at Stanford University

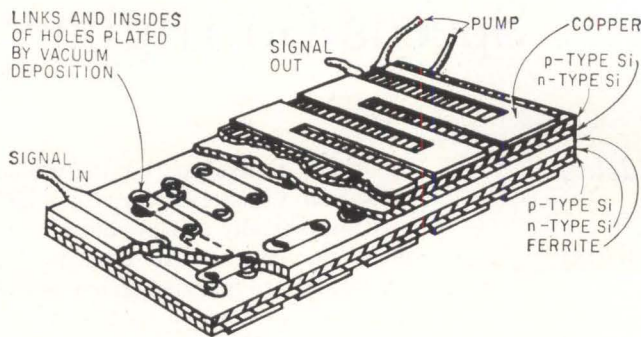

PROPOSED INTEGRATED circuit version of parametric delay line described by A. R. Owens of University College of North Wales

reference to the input.

MICROWAVE CIRCUITS — Non-reciprocal parametric amplifier has been constructed at Telefunken, Germany, with two parametric diodes as the active components.

K. H. Locher reported forward gain of 8 db per stage with 2.55 db noise figure and reverse gain of -40 db. Signal frequency was 200 Mc, total bandwidth 6 Mc.

Operation of a 4-Gc nondegenerate parametric amplifier at liquid helium temperature was discussed by D. C. Hanson, of Bell Labs. Overall effective input noise temperature is expected to be less than 10 deg

K with a 40-db preamplifier gain and 50-Mc bandwidth.

Solid-state 13.3-Gc microwave source capable of delivering 50 mw was described by S. L. Johnson, of Microwave Associates. The multiplier chain contains two triplers and two quadruplers, is driven by 5 w at 92.5 Mc. Chain provides better than 40 db of undesired harmonic suppression and has a 3-db output bandwidth of 130 Mc. Commercially available varactor diodes are used. From the floor, M. Uenohara, of Bell Labs, reported that 70-percent efficiency had been obtained at 12 Gc using experimental silicon epitaxial diodes.

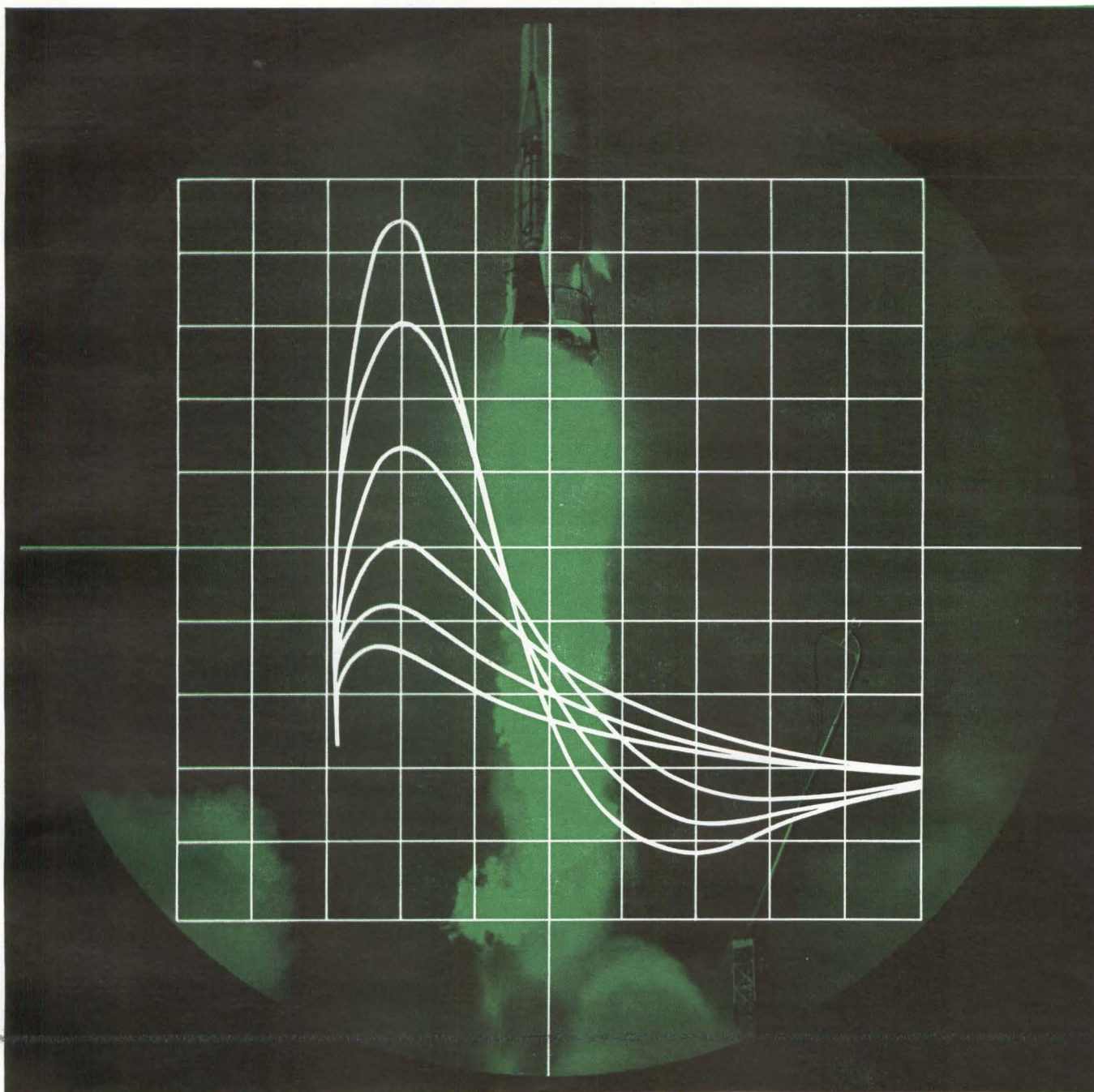

Hughes Memo-scope® writes non-recurrent phenomena at one million inches per second and stores them indefinitely

High-speed instrument provides exciting new test capabilities. The Hughes high-frequency Memo-scope® Oscilloscope, with its 10 mc bandpass and one million inches per second writing speed, can store fleeting phenomena for an indefinite period of time. It displays these non-recurring transients for thorough study until intentionally erased.

The unique qualities of the Hughes Memo-scope Oscilloscope provide exciting new test capabilities that no other instrument can attain. Here are some examples:

Analog Comparison—The trace shown in the illustration above demonstrates the ability of the Memo-scope in studies of various energy weld pulses. Superimposed display allows rapid comparison of various waveforms.

High Speed XYZ Plotting—The high writing speed of the Hughes Memo-scope gives it capabilities for XY plotting far beyond those of electromechanical recorders. The Z-axis input allows plotting of three variables simultaneously.

Data Reduction—Fast evaluation of raw data can be made with the Memo-scope. Its high speed storage capability enhances data reduction and a particular display can be retained for prolonged study or erased in 150 milliseconds.

New uses for the Hughes Memo-scope are constantly being found in electronics, nucleonics, medicine, geology and many other fields. Consider it for your test needs. For full information, write or call HUGHES INSTRUMENTS, 2020 Short Street, Oceanside, Calif. For export information write Hughes International, Culver City, Calif.



Creating a new world with electronics

HUGHES

HUGHES AIRCRAFT COMPANY
VACUUM TUBE PRODUCTS DIVISION

ReCap

The latest
technical information on Fansteel
Rectifiers, Capacitors, and Semiconductors

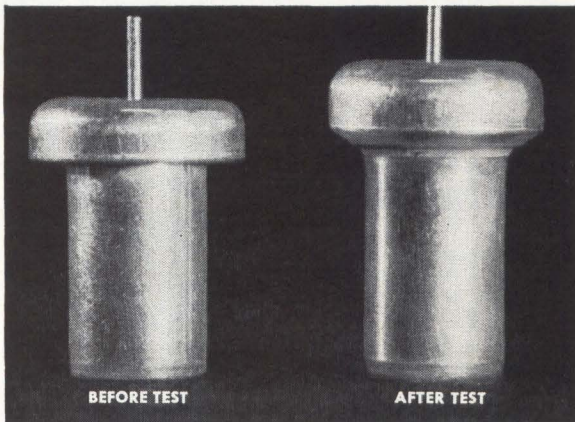

Crimp-sealed Fansteel tantalum capacitors stay leak-proof* even in outer space

Fansteel Type CL44 and 45 tantalum capacitors are crimp-sealed by a patented process that produces a virtually hermetic seal, even in the vacuum of outer space encountered by modern spacecraft.

Built to conform to Characteristic C of specification MIL-C-3965, these space age capacitors operate from -55°C to 125°C . Ratings range from 1.7 to 560 microfarads, and from 6 to 85 volts, as specified in MIL-C-3965.

Now these high-performance tantalum capacitors are being produced at Fansteel's expanded facilities. Your Fansteel field sales engineer can quote price and off-the-shelf delivery.

*This photo (twice actual size) shows a Fansteel "PP" type tantalum capacitor before and after being subjected to internal pressures of 600 psi. As shown, the test resulted in a stretching and deformation of the silver case, but no failure or leakage whatsoever in the seal.



Shrinkable, transparent insulation jackets add only 0.008 inches to capacitor diameter

Now Fansteel straight-sided tantalum capacitors can be outfitted with clear plastic insulating sleeves that provide high dielectric strength within a minimum of space.

These snug-fitting jackets are shrunk into place. No cement is required. Data on capacitor cases can be easily read. Yet the excellent insulating properties of the polyester material provides permanent and positive protection, even in highly miniaturized circuits where components may be mounted side-by-side.

FANSTEEL

METALLURGICAL CORPORATION

RECTIFIER-CAPACITOR DIVISION

North Chicago, Illinois.

Your Fansteel Rectifier-Capacitor Sales Offices, Representatives, and Distributors

339 Auburn St.

AUBURNDALE 66, MASS., DEcatur 2-7880

214 Main St., HACKENSACK, NEW JERSEY

Diamond 2-2878 (HACKENSACK)

LOngacre 3-6940 (NEW YORK)

606 Edmondson Avenue

BALTIMORE 28, MARYLAND

Phone: 747-6244

11750 Shaker Boulevard

CLEVELAND 20, OHIO, SKyline 2-2900

3304 North Harlem Avenue

CHICAGO 34, ILLINOIS, TUxedo 9-3200

7415 Wayzata Boulevard

MINNEAPOLIS 26, MINNESOTA

Phone: 544-2210

Dale Hjort

P. O. Box 13405

DALLAS 20, TEXAS, FLeeewood 2-4038

2425 Mission Street

SAN MARINO, CALIF., MUrray 2-2125

175 S. San Antonio Road

LOS ALTOS, CALIFORNIA

Phone: 941-0261

Howe and Howe, P. O. Box 10497

4344 E. Indian School Road

PHOENIX, ARIZONA, Phone: 265-9185

J. C. Rowley and Company

955 Folsom, SALT LAKE CITY, UTAH

DAvis 2-2041

Emory Design & Equipment Co.

P. O. Box 9013, BIRMINGHAM 13, ALABAMA

TR 1-1369

also: P. O. Box 426A, HUNTSVILLE, ALABAMA

Phone: 536-8543

W. Ben Wimberly Co.

532 S. Ft. Harrison Ave.

CLEARWATER, FLORIDA

Phone: 446-7072

also: 500 S. Osceola St.

ORLANDO, FLORIDA

Phone: GA 5-3083

Canada

D. T. Shaw Company

2340 Lucerne Road

MONTREAL 16, QUEBEC

735-1541

also: P. O. Box 33

WESTON, ONTARIO

CHerry 4-5072

Aviation Electric Pacific Ltd.

VANCOUVER A.M.F.

BRITISH COLUMBIA

CRestwood 8-2184

Stocking Distributors

Kann-Ellert Electronics

2050 Rockrose Ave., BALTIMORE, MD.

TUxedo 9-4242

also: 611 DeKalb Pike

KING OF PRUSSIA, PA.

Phone: 265-3505

also: 11222 Triangle Lane

SILVER SPRING, MD.

Phone: 949-5200

Kierulff Electronics, Inc.

2884 Middlefield Road

MOUNTAINVIEW, CALIF. Phone: 968-6292

Westates Electronics Corp.

6344 Arizona Circle

LOS ANGELES 45, CALIF.

Phone: 645-0700

Solid State Electronics Co. of Texas

P. O. Box 20299, DALLAS 20, TEXAS

FLeeewood 2-4038

R & D Supply, Inc.

1492 Highland Ave., NEEDHAM, MASS.

HILLcrest 4-4500

Solid State Electronics, Inc.

1925 Harlem Ave., CHICAGO 35, ILLINOIS

Phone: 889-8033

Radio & Electronic Parts Corp.

3235 Prospect Ave., CLEVELAND 15, OHIO

UTah 1-6060

Eastern Radio Corporation

312 Clifton Ave., CLIFTON, NEW JERSEY

GRegory 1-6600 (CLIFTON)

CHickering 4-2268 (NEW YORK)

The Lew Bonn Co.

1211 LaSalle Ave., MINNEAPOLIS 3, MINN.

FE 9-6351

Avionics Sales, Inc.

6770 Perimeter Rd. S., SEATTLE 8, WASH.

PArkway 3-7602

What kind of a component buyer are you?



SKEPTIC

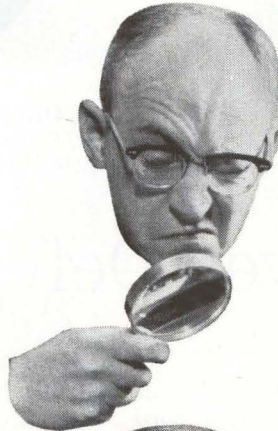

NIT-PICKER



SHOPPER



PANIC-BUTTON PUSHER

It takes all kinds of buyers to make a market. Fansteel makes components—capacitors, rectifiers, and diodes—for the buyer who cares. Like you, perhaps.

If you've been using tantalum capacitors for very long, you may be a bit skeptical of many suppliers' claims and counterclaims. The policy at Fansteel is to give you less to be skeptical about. If we can't document a claim, we don't make it. We're Skeptics, too. We have to be.

The Nit-Picker is, in many ways, our best friend. He's a man who examines things closely—even minutely. Fansteel components are made to be examined—and tested, qualified, specified . . . and used. And so they are.

When brands are alike, it pays to

be a Shopper. That's why it has always been a Fansteel practice to give you more than a low price on which to base your choice . . . things like certified reliability tests, application engineering, and honest ratings and data.

Buyers push panic buttons when they need capacitors fast—often right away. We can't always make delivery as fast as that, but we have built a network of stocking distributors and field warehouses to anticipate demand before it occurs. We've

put down many a panic, maybe yours.

Perhaps you don't fit any of these archetypes. We would be surprised, though, if we couldn't meet your component needs. After all, that's our business at Fansteel.

FANSTEEL

METALLURGICAL CORPORATION

RECTIFIER-CAPACITOR DIVISION

North Chicago, Illinois.



NIKE ZEUS in test firing is framed by two missile-track radars that will guide it to the intercept point

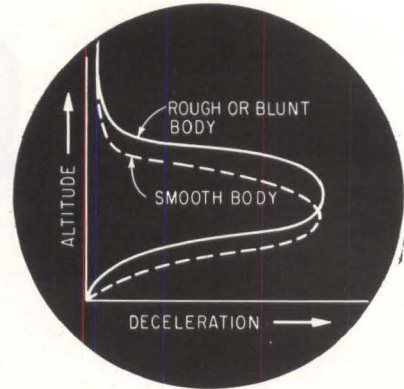

DECELERATION CURVES of re-entry bodies help identify decoys. First bend predicts rest of curve

Zeus May Never Defend Cities

Antimissile systems are being considered only for key bases

IT IS VERY UNLIKELY that an anti-ICBM urban defense system will ever be approved by the administration, Washington sources report. No decision to deploy any system has been made. Present thinking, moreover, is that if and when a system is deployed, it would defend hardened bases, not large cities.

The recent decision to rush work on Nike X with a \$246-million appropriation in fiscal 1964, compared to the \$86 million allotted to Nike Zeus, lends credence to the report. Zeus (ELECTRONICS, p 24, Jan. 13, 1961, and p 20, April 21, 1961) is primarily an area defense system such as cities would require. Nike

X (p 12, Feb. 8, 1963) is expected to become both a backup for Zeus and a short-range defense for hardened bases.

However, the Nike Zeus system has strong proponents. There is little doubt in Washington that the issue of whether to begin immediate production of Zeus will flare up again in Congress.

ECONOMICS AND POLITICS—Costs to deploy Zeus have been estimated at \$8 billion to \$10 billion. Technological breakthroughs might lower anti-ICBM costs enough to make city defense economic.

But many administration officials believe city defense would be "pro-

vocative"—would make the Russians believe the U.S. was plotting a nuclear attack. Other objections to city defense are that it would be relatively useless unless all incoming ICBM's are knocked out and the populace is protected against fallout.

Defending hardened bases might make them invulnerable, or at least keep losses tolerable. At the same time, it could make enemy attack economically impossible by greatly increasing attack requirements.

CHANGING ZEUS TO X—Major modifications from Nike Zeus to Nike X are primarily the high-acceleration Sprint missile and the Zmar radar (Zeus Multifunction Array Radar).

Zmar will be bulky, like present Zeus radar, but since it is phased-array, not motor-driven, it can be hardened for defending ICBM silos

SOME RADAR FUNCTIONS in the present Nike Zeus system, shown here, will be doubled up in the Nike X system, which will have phased-array radar

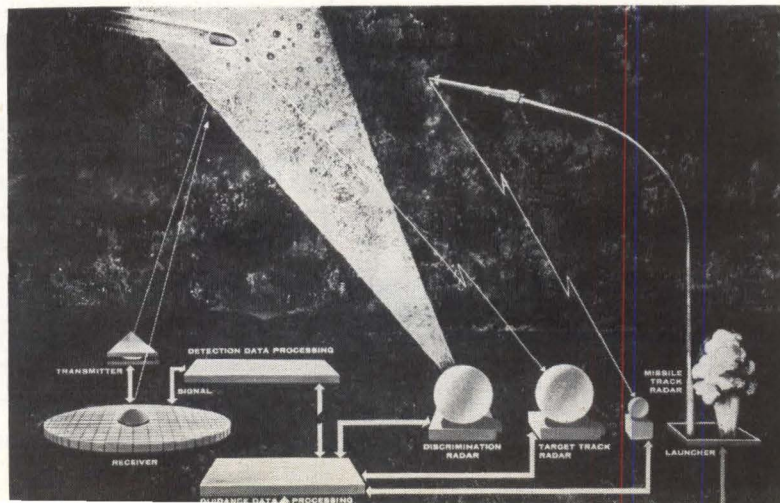

and underground command and control posts. Also, Zmar simplifies the system by combining acquisition, discrimination and target tracking. Missile command guidance will still use a separate radar.

Work on Zmar has been underway for some time; Army expects to award Sprint development contracts this spring.

Army sees use of both systems as a "defense in depth"—Zeus knocking down incoming warheads 70 to 100 miles up; Nike X's Sprint fighting close-in, at 20 to 30 miles. Army says Zeus could be operational in 1966 if production starts this year. Nike X will not be tested until 1965 and could not be operational until about 1970.

WOULD ZEUS WORK? — Army reports that Zeus has made three successful intercepts of ICBM reentry targets, including one accompanied by decoys. Army feels the Nike system can already do 95 percent of the job assigned it. Rep. Gerald Ford (R.-Mich.), of the House Appropriations Committee, told *ELECTRONICS* that Congress would probably buy Nike when it was convinced it had an 80 to 90 percent chance of success.

A spokesman for the Advanced Research Projects Agency told *ELECTRONICS* that no technical breakthroughs are needed for missile defense. ARPA has no substitute to recommend now for Nike-type terminal defense.

However, the Pentagon's top echelon still doubts Zeus's capabilities against decoys and salvo attacks. This is why Nike X is being rushed. They also say further studies are required in reentry phenomena, decoy discrimination and the effects of an intercepting missile's nuclear blast on the rest of the defense system. For such studies, related to Nike development, Project Defender will get \$128 million in fiscal 1964.

Other sources say the decoy problem is not as tough as it first appeared. If the decoys are not the same shape or weight as warheads, flight characteristics will differ and they can be discriminated. If they are the same weight, it would be just as cheap to deliver warheads. Putting radar countermeasures in warheads probably would not affect the powerful Zeus radar.

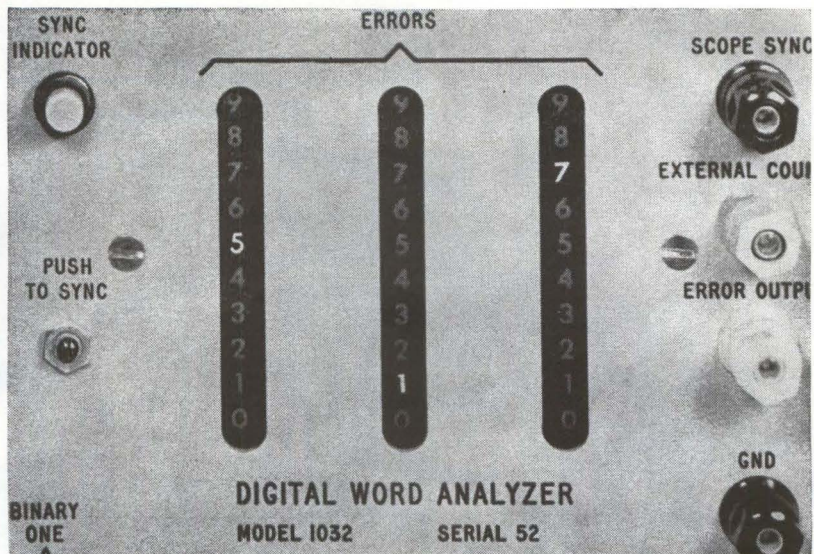

For Sale: Machine Talk

Data transmission systems periodically require testing, trouble shooting, and evaluation, and two extremely valuable instruments for system checkout are Rixon's model 132 Digital Word Generator, and model 1032 Digital Word analyzer.

The Word Generator provides a repetitive digital word in length up to 32 bits for transmission through the system. The Word Analyzer at the receive location generates an identical word, comparing this with the received word. Discrepancies between these two words are totalized by a three digit error counter and visually displayed on the front panel of the analyzer. Other features?

- EIA input/output interfaces . . .
- line loop back unnecessary . . .
- word bit length to 32 bits . . .
- instant push button sync . . .
- compatible with data rates to 9600 bps . . .

For further information, contact our Marketing Department.

Visit us at IEEE, March 25-28,
Booth 3034-3035

RIXON ELECTRONICS, INC.

2121 INDUSTRIAL PARKWAY—MONTGOMERY INDUSTRIAL PARK—SILVER SPRING, MARYLAND
TELEPHONE: 622-2121 TWX: 301 622-2292

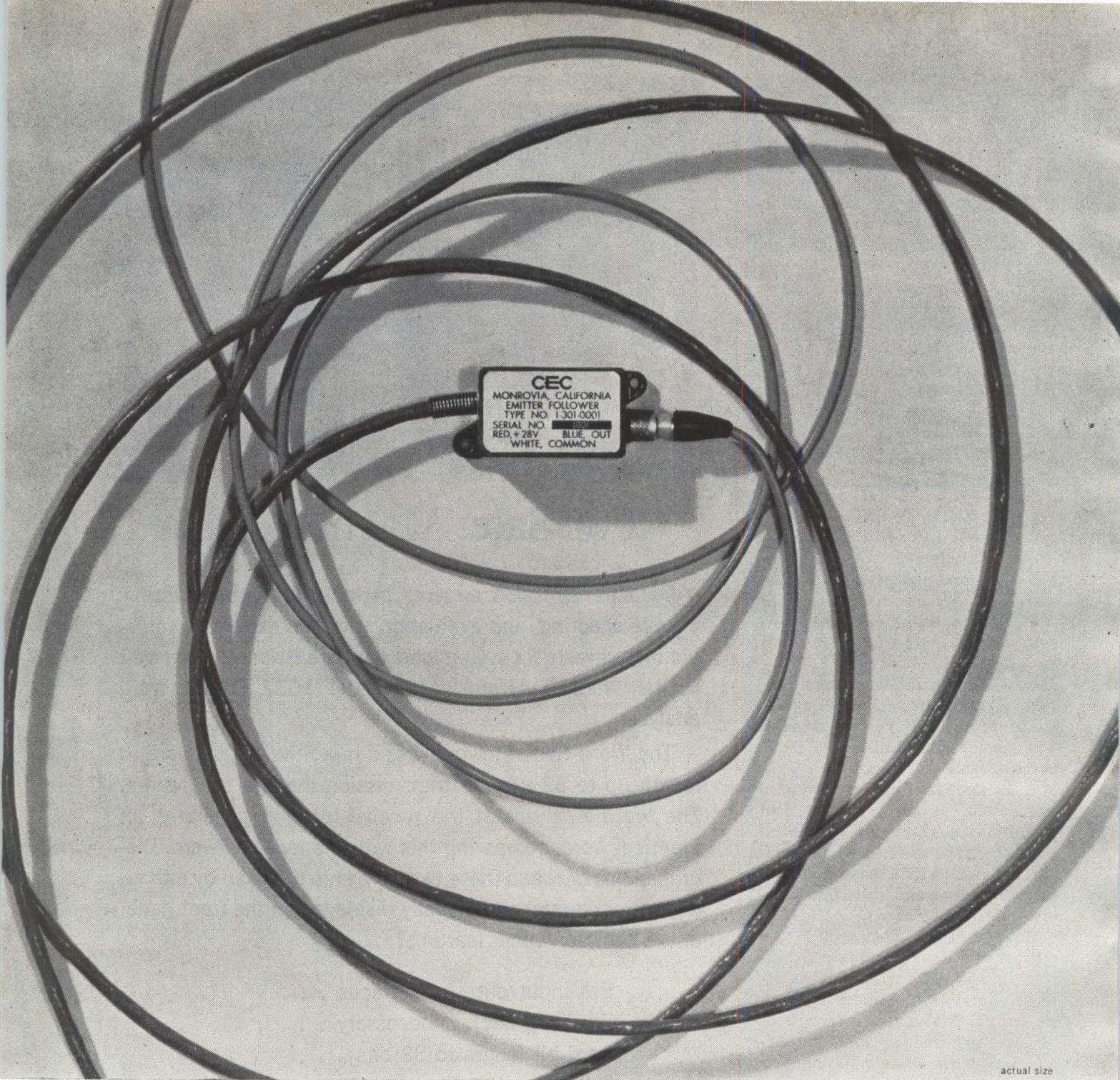

actual size

Awfully small, but it carries a big load

(CEC's 1-301 Emitter Follower for piezoelectric accelerometers)

Tiny as two sugar cubes, CEC's 1-301's a giant on the job. Just put it to work... you'll soon know why it leads all other followers, in the lab or airborne. Here's a performance unexcelled in the market—plus, the reliability of all-solid-state, all-welded construction. And you can't buy a smaller, lighter impedance matching device anywhere. (Size? .53" x .64" x 1.03". Weight? 16 grams.) And rugged? You can even mount it next to the accelerometer.

Low power consumption (less than 2 ma)

makes it ideal for battery power. Another plus factor: high input impedance (300 meg) and a very low output impedance (100 ohms), with no loss of voltage sensitivity.

Compatible? Certainly. You can use it with any piezoelectric transducer...although it's designed for CEC Types 4-270 and 4-271. What's more, high input impedance and flat frequency response ($\pm 5\%$ from 2 cps to 10 kc) insure a wide frequency range of measurements. Further data? Call CEC. Or write for Bulletin CEC 1301-X3.



CEC
Transducer Division

CONSOLIDATED ELECTRODYNAMICS
A Subsidiary of Bell & Howell • Pasadena, California

CIRCLE 26 ON READER SERVICE CARD

2 more reasons to measure with CEC

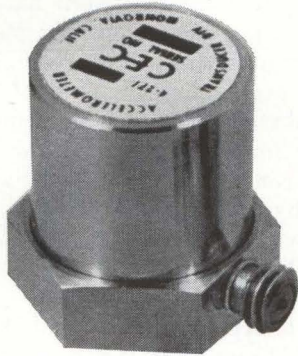

Measuring dynamic acceleration? Consider CEC's 4-270 and 4-271 Piezoelectric Accelerometers. You'll get matchless high first resonance and low cross axis sensitivity. In addition, minimum case sensitivity and negligible response to acoustic noise. That's because inside each instrument, the seismic mass is point-loaded by a ball and compliant diaphragm, compressing the crystal independently of the case. This unique (patent pending) isolation of the sensing element delivers the great sensitivity inherent in the piezoelectric effect with minimum spurious response. CEC's 4-270 (high sensitivity) and 4-271 (high capacity) measures dynamic accelerations and shocks up to 10,000g in the frequency range from 2 to 7000 cps and 7 to 8000 cps. For complete information, write for detailed specifications contained in CEC Bulletins 4270-X7 and 4271-X7, or call your CEC office.

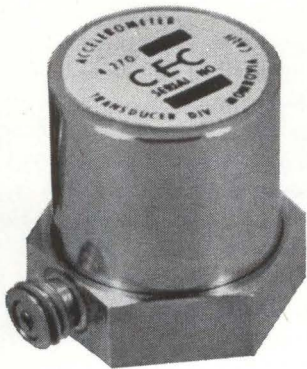

CEC
Transducer Division

CONSOLIDATED ELECTRODYNAMICS

A Subsidiary of Bell & Howell • Pasadena, Calif.

CIRCLE 27 ON READER SERVICE CARD

electronics • March 8, 1963

Market For New Techniques

*Exploratory development
for defense will get
one billion plus in 1964*

NEW CONTRACT opportunities for studies to solve specific military problems will soon open up under the Defense Department's budget category "Exploratory Developments." Described by Secretary of Defense McNamara as work that ranges from "fairly fundamental efforts to sophisticated breadboard hardware, study, programming and planning," the category will get \$1,171 million in funds for fiscal year 1964.

Army will buy "design studies for night viewing equipment."

NAVY—Navy will contract for work on detection and localization of underwater, surface and air targets; environmental surveillance with emphasis on air/ocean interface; command and control; weaponry; and navigation.

Under the surveillance program contracts will be awarded for work on radar, ASW detection devices, data correlation techniques, and

communications for both ships and aircraft.

In the field of ordnance, emphasis will be placed on nonnuclear air launch systems. For missiles, guidance systems and counter measures will be studied.

AIR FORCE—Included are studies, experimentation and component developments for guidance, flight control, life sciences, and surveillance.

Technology will be improved for advanced tactical and strategic missiles, V/STOL aircraft (*ELECTRONICS*, p 30, Feb. 15) communications, command and control, computer and data processing, and electromagnetic warfare.

ARPA — Project Defender will get \$128 million to study missile phenomenology needed for developing a defense against enemy missiles and assessing the ability of our missiles to penetrate Soviet defenses. Project Vela will get \$52 million to continue efforts to develop a capability to detect nuclear explosions underground and at high altitudes. Project Agile, to develop equipment for guerrilla warfare, will get \$26 million.

Liquid Laser Emits Visible Light

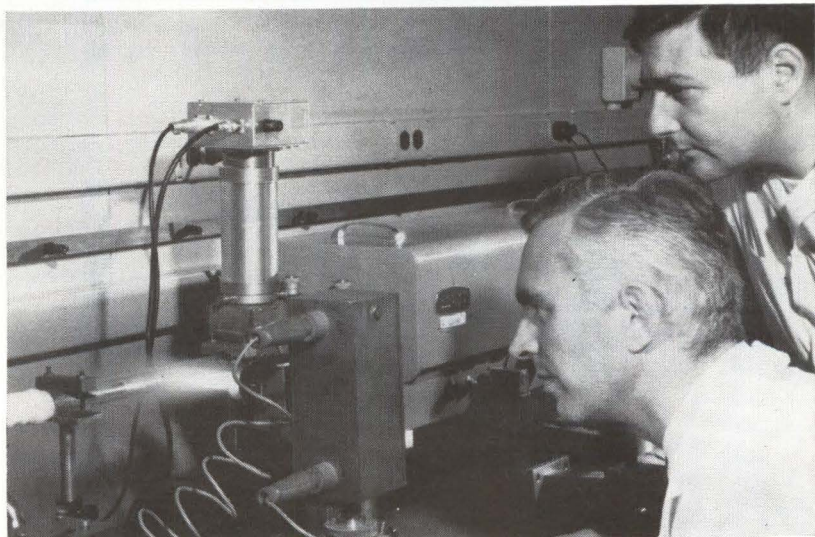

EUROPIUM IN A LIQUID host is employed in a laser developed by General Telephone & Electronics Corp. The active ions are incorporated in an organic chelate (*ELECTRONICS*, p 7, Mar. 1) contained in a quartz cavity, maintained at -130 degrees centigrade. Output is 6,129 angstroms

TRADE EXPANSION ACT: Help

Look for the overseas opportunities, advises U. S. electronics firm

By E. A. CARTER
President
Oak Manufacturing Co.
Crystal Lake, Ill.

"THINK INTERNATIONAL."
These two words sum up the most serious challenge the electronics in-

dustry has ever had to face.

Many American industries have oriented their marketing programs around this phrase, while others fear foreign competition. What many companies anticipate as the broadening of their markets, other firms regard as their eventual corporate doom.

No one can deny that eliminating trade barriers between the United States and the remainder of the Free World will bring with it competition from our overseas counterparts. But, at the same time, the

deletion of tariffs between nations will also expand the market places for our products.

The proposed revamping of our foreign trade policy has been in the hopper for several years. Now, the most concrete steps have been taken by the Administration, which sponsored recent passage of the Trade Expansion Act.

TRADE ACT — President Kennedy's Trade Expansion Act of 1962 gives him more power over our foreign trade policies than any President in our history.

Very briefly, the new legislation provides for:

- Presidential power to abolish completely during the next five years tariffs on groups of products in which the U. S. and the European Common Market members together account for 80 percent of the world's trade

- Presidential power to cut other tariffs by 50 percent in "reciprocal negotiations" over the next five years

- Provision for a new program to help businessmen, workers and farmers hurt by increased imports to "adjust" to the competition

- Important modifications of the clauses in the present law that in recent years have allowed hundreds of tariff boosts.

Most of the measures called for in the Trade Expansion Act are in the right direction. However, it is our opinion that the federal government has not fully explored the potential impact of foreign trade on the U. S. economy.

In the past, our theory has been to force off-shore competitors out of the American market place by slapping a prohibitive tariff on their goods.

Now, however, the plan is to provide federal aid to the American companies which will be hurt by foreign competition. This aid—monetary assistance to modernize plant facilities, retrain workers, unemployment allowances and aid in moving to other communities—would be another tax drain on every citizen.



FRINGE BENEFITS make overseas labor costs higher than hourly wages indicate. Here, employees at Noble-Oak, Japan, play in in-plant recreational facilities

PRODUCTION LINE at an Oak plant in England, Diamond-H Switches

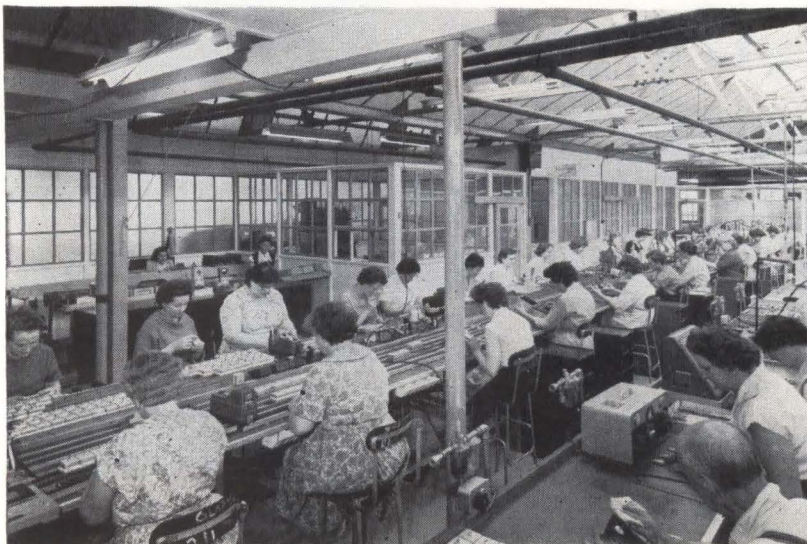

or Hazard?

We, at Oak, feel that this is not the answer. Every U. S. company should be able to "pay its own way."

TRADE STUDY—To date, no industry-wide associations or individual companies have reported making a study of what the future holds for their respective industry.

Two years ago, we inaugurated such a study. It is still going on. The early findings have prompted us to be extremely optimistic. While some members of the electronics industry in the U. S. are hiding under the waning tariff shell, we have taken the opposite stand.

We don't believe the transformation will thwart our growth. On the contrary, we look for new markets.

The two sections which are to be "feared" more than others are Western Europe and Japan. However, U. S. total exports to Western Europe during 1961, were more than 50 percent above our total imports from that region.

American exports to Japan last year were 70 percent greater than our total imports. This does not make a very good case for those who think we cannot compete with off-shore competition.

An important consideration, however, is that many foreign producers have caught up with "in-country" demand. For example, one Japanese tv tuner producer must turn to foreign markets or go out of business. Therefore, American markets look quite favorable to such foreign manufacturers.

The big bone of contention continually put forth by those opposed to free trade is the vast difference in the hourly wages of American and foreign workers. However, when this is carefully examined it is not so different, as the table of wages and productivity in Europe points out.

OPERATING ABROAD—We welcome foreign competition, and we look forward to the tremendous potential of the market areas which will soon be accessible.

Thus far, we have completed

electronics • March 8, 1963

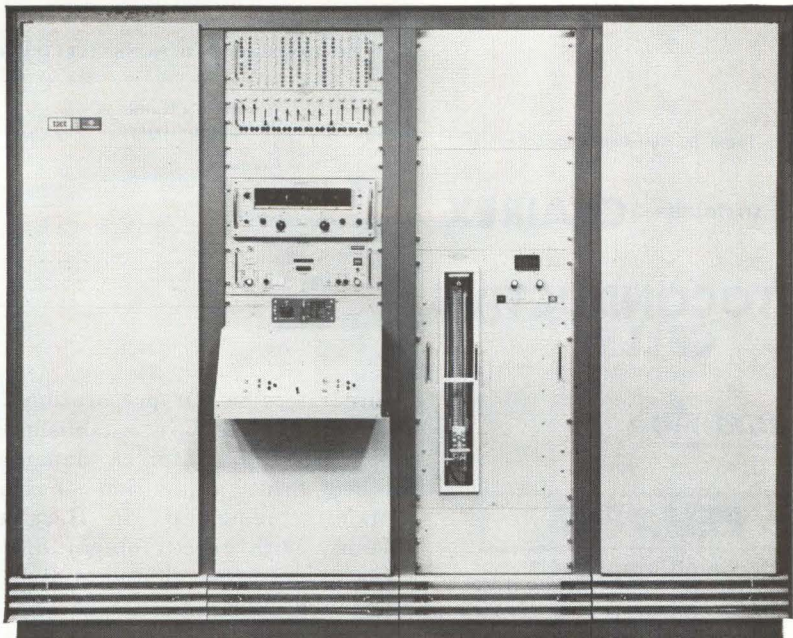

State of the Art

tact, Texas Instruments Transistor And Component Tester . . . keeps pace with testing requirements

A universally applicable transistor and component tester, TACT has been proved on every major missile program to date . . . is keeping pace with the newest testing concepts. The TACT system design incorporates anti-obsolescence features that provide unlimited testing flexibility for future expansion and component development.

Versatile, expandable TACT now offers: duty cycle pulse testing to 500 volts or 25 amperes; switching time measurements from 1 nanosecond to 1 microsecond; low current measurements from 1 picoampere automatic ranging — all in one system. Additional plug-in module capacity and system accessories such as environmental chambers and scanners for various component mounting boards are available.

The basic TACT system provides sequentially controlled reliability testing of transistors, diodes, capacitors, resistors, relays and other components. Digital control of analog functions with punched card pre-programming on each device assures absolute repeatability — eliminates operator variation.

Only TACT can fulfill both your present and future testing requirements. Write for information.

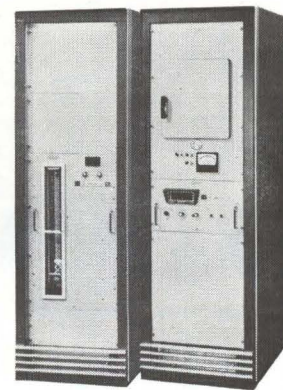

INDUSTRIAL
PRODUCTS
GROUP



TEXAS INSTRUMENTS
INCORPORATED
P. O. BOX 66027 HOUSTON 6, TEXAS

SENSING • RECORDING • TESTING • DIGITIZING INSTRUMENTS
THE INSTRUMENTS OF TEXAS INSTRUMENTS

871

CIRCLE 29 ON READER SERVICE CARD

29

"The Light Touch In Automation and Control"

IBM STARTED USING CLAIREX

PHOTOCONDUCTIVE CELLS

6 Years Ago

as

RELIABLE

System Components

And Still Does!

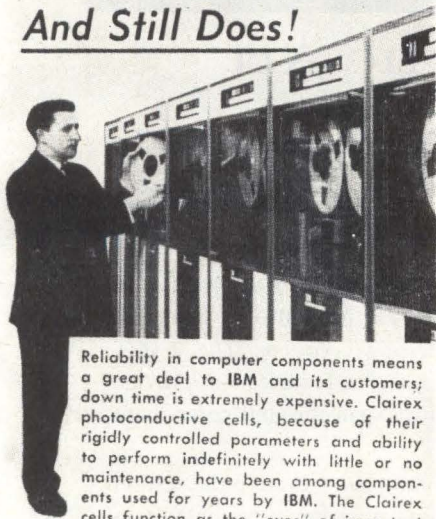

Reliability in computer components means a great deal to IBM and its customers; down time is extremely expensive. Clairex photoconductive cells, because of their rigidly controlled parameters and ability to perform indefinitely with little or no maintenance, have been among components used for years by IBM. The Clairex cells function as the "eyes" of important IBM light-actuated tape drive controls.

These tape drives are now operating in thousands of computer systems around the world — providing daily proof through performance of Clairex reliability!

You too can enjoy this confidence in supply. Clairex cells have been employed by hundreds of major firms in outer space, photography and dozens of other interesting fields. These cells offer a broad range of characteristics to the design engineer in the largest line of both glass and metal photoconductive cells available to the industry.



CLAIREX CORPORATION

The Oldest Manufacturer of Cadmium Sulfide and Cadmium Selenide Photoconductive Cells

8 West 30th Street, N. Y. 1, N. Y.

See us at the IEEE Show Booth 1217

TABLE—WAGES OF NONSKILLED ELECTRONIC COMPONENT WORKERS IN EUROPE

Country's Rank by Productivity	Hourly Wage	Hours a Week	Added Fringe Benefits
1. West Germany.....	0.51	42	50%
2. Italy.....	0.40	44	64%
3. Holland.....	0.40	45	40%
4. Scotland.....	0.42	42	60%
5. England.....	0.56	42	60%
6. Sweden.....	1.40	45	30%
7. Spain.....	0.30	48	100%

three steps in our preparation for the future. They are: establishment of Noble-Oak, Ltd., a Japanese-based firm; acquisition of Hart Manufacturing Co., in Hartford, Conn., with three foreign operations; and personal studies of Europe and Japan to determine the strengths and weaknesses of the electronics industry and markets.

Noble-Oak will solve what appears to be our most vulnerable area, the manufacture of tv tuners. Our domestic tuner facilities will not be able to keep up with the expanding tuner business. The Japanese venture will take up the slack, and, more importantly, will place us in an excellent position to take advantage of potential Asian markets.

The acquisition of Hart provided us with companies in England, Canada and South Africa.

The third step, our study of European markets, has enabled us to formulate plans to develop markets for Oak products.

EUROPE'S BOOM LEVELS—It's become quite apparent that the European Economic Community boom is beginning to level off. It is also increasingly apparent that the economics of free Europe are tied directly to that of the U. S.

As these countries improve their standard of living, they appear more and more attractive as market places for U. S. manufactured goods. Wages and the cost of fringe benefits within these countries continue to climb, thus shortening the gap between the cost of U. S. and European production.

Several sections within the Common Market would make excellent locations for a venture.

For example, Northern Italy is characterized by a favorable labor rate and productivity, aggressiveness, ingenuity, population growth and economic strength.

Holland must be considered because of its relatively low labor cost and high productivity.

West Germany affords good productive skills plus good inventive and technical capabilities. However, there are less opportunities for such a joint venture due to the intense activity that has been concentrated in West Germany.

France represents a rapidly growing electronics industry, but is hindered by the unstable political atmosphere and high cost of labor.

THE COMING TEST—The biggest "threat" according to many is the prospect that we will be unable to compete with foreign imports here at home. But, only about one-fourth of the total value of our imports is in lines which directly compete with U. S. production.

U. S. industries will be put to a test—a test, we think, which will show the tremendous flexibility of American business, a flexibility no other country can match.

The electronics industry in the U. S. will be putting its technical know-how right on the line when this foreign competition is welcomed into this country.

We are getting ready for this certain eventuality.

We plan to forestall any adverse impact on our company's operations, and we certainly do not wish to be dependent upon the government should we come on hard times because of this new legislation. We plan to provide enough flexibility in our own operations to prepare us for whatever adversities the future may hold.

We can't help but profit by advantageous investment in overseas companies (such as Noble-Oak), and firmly believe we will emerge in an even stronger position than we now enjoy in our product areas.

We truly will continue to "Think International."

Spectrum Analyzer/Wave Analyzer ONE COMPACT PACKAGE!

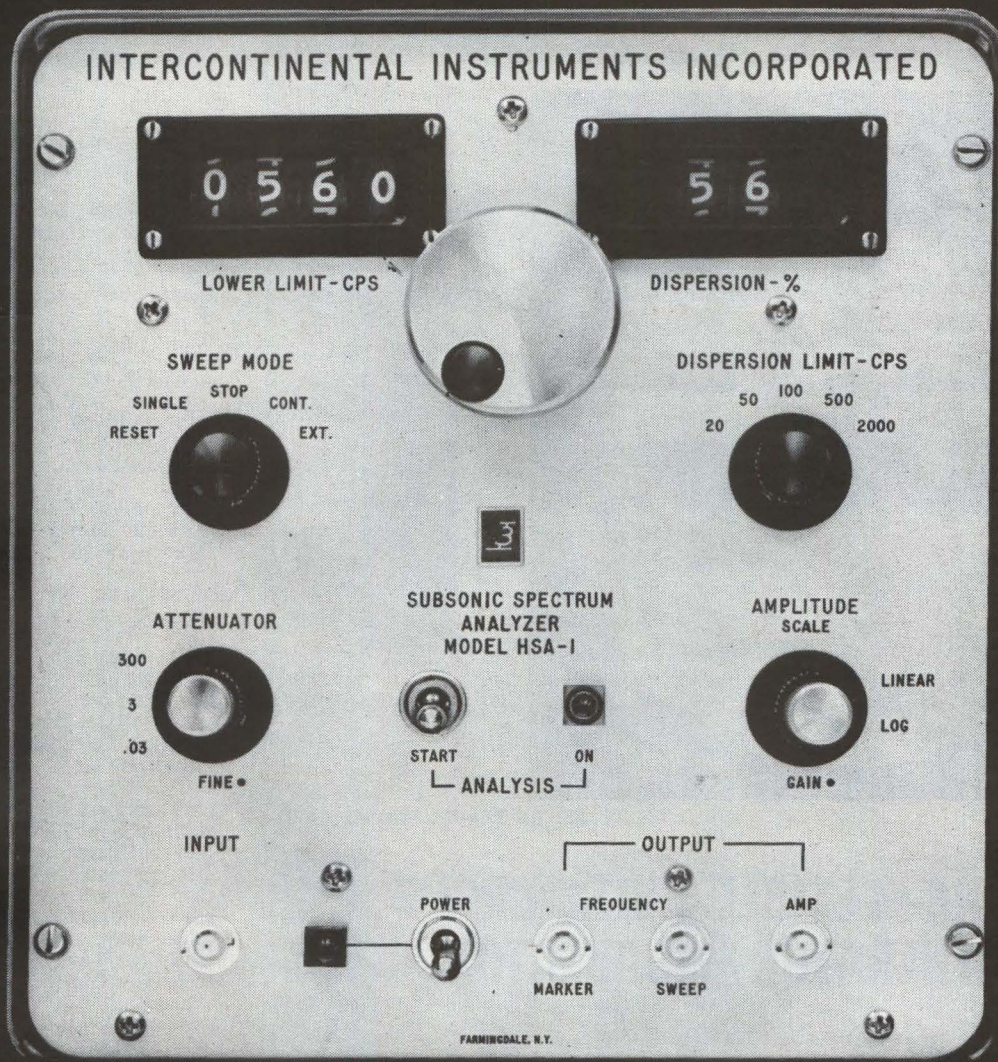

Intercontinental's new HSA series gives you *both* spectrum analyzer *and* wave analyzer in a single 8¼ by 9 by 14¼" unit. Choice of operation takes only the turn of a switch. (No need for external drive devices.) Three economical, all-transistor models cover the sub-audio, audio and ultrasonic frequency ranges. All provide large dynamic range, excellent resolution, linear or logarithmic output, odometer frequency readout. *Plus* digital frequency output for data processing. Automatic

scan, AFC and BFO output are provided for wave analyzer operation.

They're lightweight (less than 35 pounds), may be bench or rack mounted. You can use them with standard types of strip chart, X-Y, or cathode ray tube readouts. (No need to duplicate equipment you already have.) Or we can supply companion readouts units, separately, or integrally mounted for rack installation. Abridged specifications are given below. A call brings complete data.



MODEL HSA-1
 Freq. 1-4000 cps
 Dispersion 20, 50, 100, 500, 2000 cps
 Freq. Accy. ±1% of dispersion
 Input 50 mv, optional 1 mv
 Output 10 v full scale linear or 60 db log
 Resolution 1 and 20 cps
 Price \$2200



MODEL HSA-2
 Freq. 10-20,000 cps
 Dispersion 100-2000 cps, 1000-20,000 cps
 Freq. Accy. ±1%
 Input 1 mv fs, 1 meg.
 Output 10 v full scale linear or 60 db log
 Resolution 10 and 200 cps
 Price \$2050



MODEL HSA-3
 Freq. 200-400,000 cps
 Dispersion 1500-15,000 cps, 20,000-200,000 cps
 Freq. Accy. ±1%
 Input 1 mv fs, 1 meg.
 Output 10 v full scale linear or 60 db log
 Resolution 150 and 2000 cps
 Price \$2050

INTERCONTINENTAL INSTRUMENTS INCORPORATED

123 GAZZA BOULEVARD, FARMINGDALE, NEW YORK
 TELEPHONE: (516) MYrtle 4-6060

During I.E.E.E.—see us at Henry Hudson Hotel, Suite 444

Giant klystrons, which are providing megawatts of peak power for space radar systems, are part of the extensive line of Litton microwave tubes and display devices. San Carlos, California. In Europe, Box 110, Zurich 50, Switzerland.

LITTON INDUSTRIES
ELECTRON TUBE DIVISION

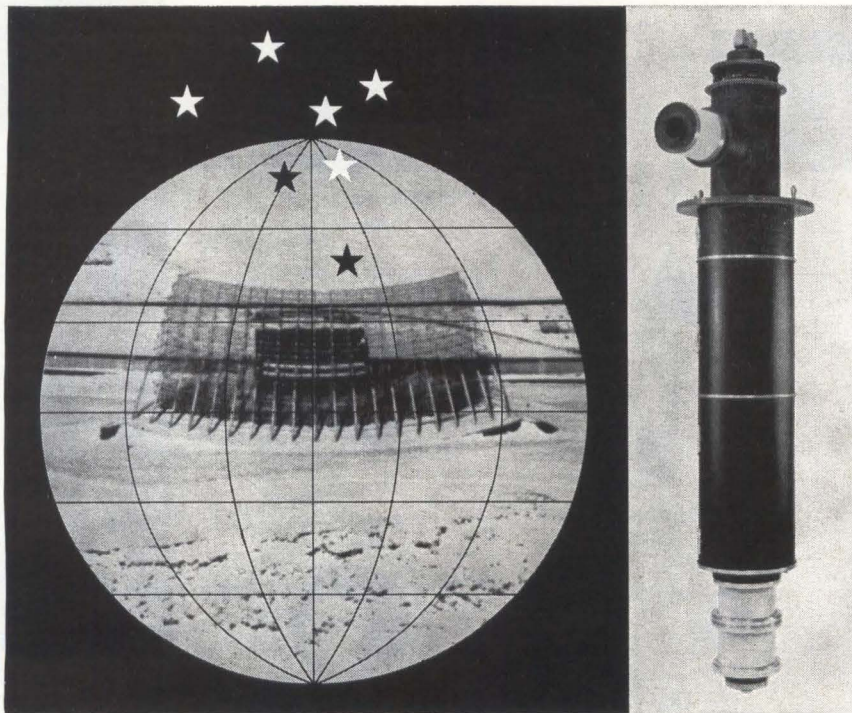

CIRCLE 203 ON READER SERVICE CARD

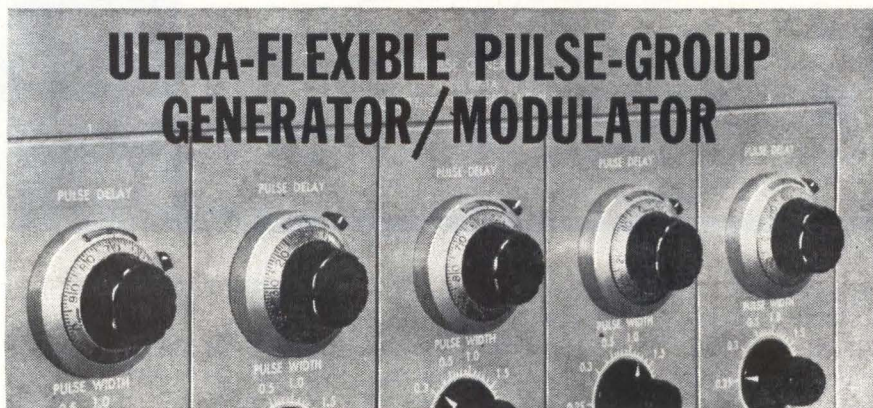

5 IDENTICAL, INDEPENDENT CHANNELS

Build coded pulse trains with complete, independent control of pulse width and delay and every modulation, synchronization, trigger, marker, and gate facility a reasonable man could want! 0.1 μ sec rise and decay time, output 20 V into 100 Ω markers every μ sec, 10-10,000 cps group rep. rate, 0.2-2 μ sec pulse-width range, 0-300 μ sec delay (group width). Inexpensive, simple to operate, laboratory quality — hundreds of applications, from bench to console . . . **MODEL MP-1A.**

Call your POLARAD Field Engineer for a prompt, free demonstration!



POLARAD
ELECTRONIC INSTRUMENTS
A Division of Polarad Electronics Corporation
World Leader in Microwave Instrumentation
34-04T Queens Blvd., Long Island City 1, New York

MEETINGS AHEAD

RESIDUAL GASES IN ELECTRON TUBES SYMPOSIUM, Italian Society of Physics; Scientific and Technical Assoc., Milano, Italy, March 12-15.

THIN-FILM VACUUM METALLIZING CONFERENCE, Society of Vacuum Coaters; Park-Sheraton Hotel, New York City, March 14-15.

PACIFIC COMPUTER CONFERENCE, IEEE; California Institute of Technology, Pasadena, Calif., March 15-16.

BIONICS SYMPOSIUM, United States Air Force; Biltmore Hotel, Dayton, Ohio, March 18-21.

EUROPEAN ELECTRONICS MARKET, EIA; Statler Hilton, New York City, March 19-22.

IEEE INTERNATIONAL CONVENTION, Institute of Electrical and Electronics Engineers; Coliseum and Waldorf-Astoria Hotel, New York, N. Y. March 25-28.

ENGINEERING ASPECTS OF MAGNETO-HYDRODYNAMICS SYMPOSIUM, IEEE, IAS, University of California; at UC, Berkeley, Calif., April 10-11.

OHIO VALLEY INSTRUMENT-AUTOMATION SYMPOSIUM, ISA, et al; Cincinnati Gardens, Cincinnati, Ohio, April 16-17.

CLEVELAND ELECTRONICS CONFERENCE, IEEE, Case Institute, Western Reserve University, ISA; Hotel Sheraton, Cleveland, O., April 16-18.

OPTICAL MASERS SYMPOSIUM, IEEE, American Optical Society, Armed Services, et al; Waldorf Astoria Hotel, New York City, April 16-18.

INTERNATIONAL NONLINEAR MAGNETICS CONFERENCE, IEEE; Shoreham Hotel, Washington, D. C., April 17-19.

SOUTHWESTERN IEEE CONFERENCE & ELECTRONICS SHOW, IEEE (Region 5); Dallas Memorial Auditorium, Dallas, Texas, April 17-19.

BIO-MEDICAL ENGINEERING SYMPOSIUM, IEEE, et al; Del Webb's Ocean House, San Diego, Calif., April 22-24.

NATIONAL ELECTROMAGNETIC RELAY CONFERENCE; Oklahoma State University; OSU, Stillwater, Okla., April 23-25.

ADVANCE REPORT

INTERNATIONAL SCIENTIFIC RADIO UNION SPRING MEETING, URSI, IEEE; National Academy of Sciences, Washington, D. C., April 29-May 2. March 15 is deadline for submitting 200-word abstract in duplicate to: M. G. Morgan, Secretary, USA National Committee of URSI, Dartmouth College, Hanover, New Hampshire. Sessions include: radio measurement methods and standards, radio propagation in nonionized media, ionospheric radio, magnetospheric radio, radio and radar astronomy, radio waves and information transmission, and radio electronics.

NEW!

usefulness,
with simplicity

Model 135C, new member of the Moseley 135 series X-Y recorder family gives wide usefulness, at low cost. Standard size graph paper (7" x 10" writing area), solid state for ruggedness, floating inputs, transformer isolated, 10 fixed input ranges from 0.5 mv/in to 10 v/in each axis, and stepless range control. Rack or table model, \$1190.

(Versatile Model 135, offers 16 ranges, Zener reference, built-in time sweep, high accuracy, \$1650.)

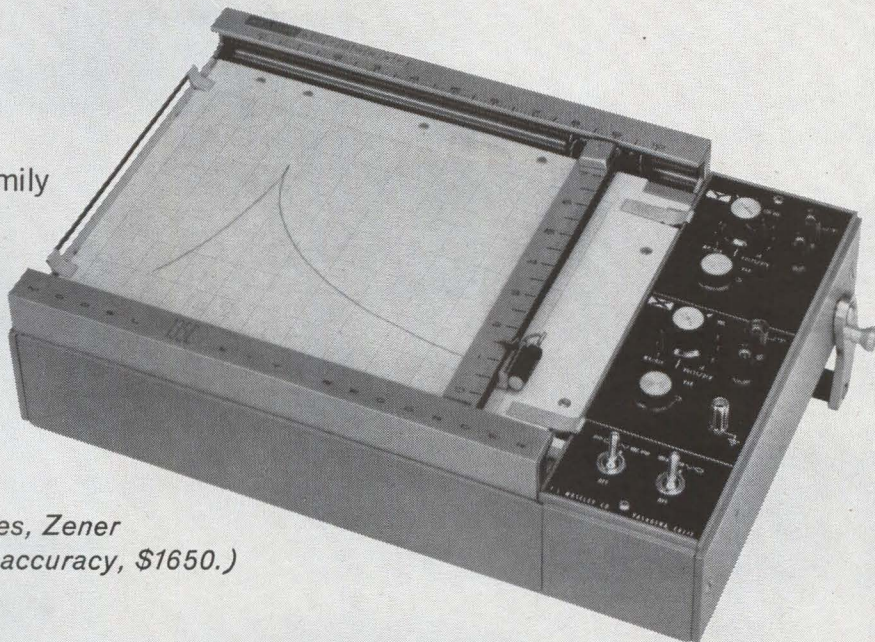

companion model
for larger paper

Model 2D-4 is the newest addition to the Moseley 2D series of precision X-Y recorders. Uses standard graph paper with 10" x 15" writing area. Electrical specs similar to 135C above. Input accessories include log converter, two channel ac-dc converter, waveform translator for high frequency repetitive signals. Variable speed, roll chart is optional. Rack or table model, \$1490.

(Other 2D series models provide more ranges, electronic reference, built-in time sweep, high accuracy, operation with curve follower, digital-to-analog translators, delay simulation, etc.)

See your Moseley Rep or write us today for data

F. L. MOSELEY CO. 409 N. Fair Oaks Ave., Pasadena, California
hp an affiliate of Hewlett-Packard Company

8372

OPERATE THEM YOURSELF AT I.E.E.E.

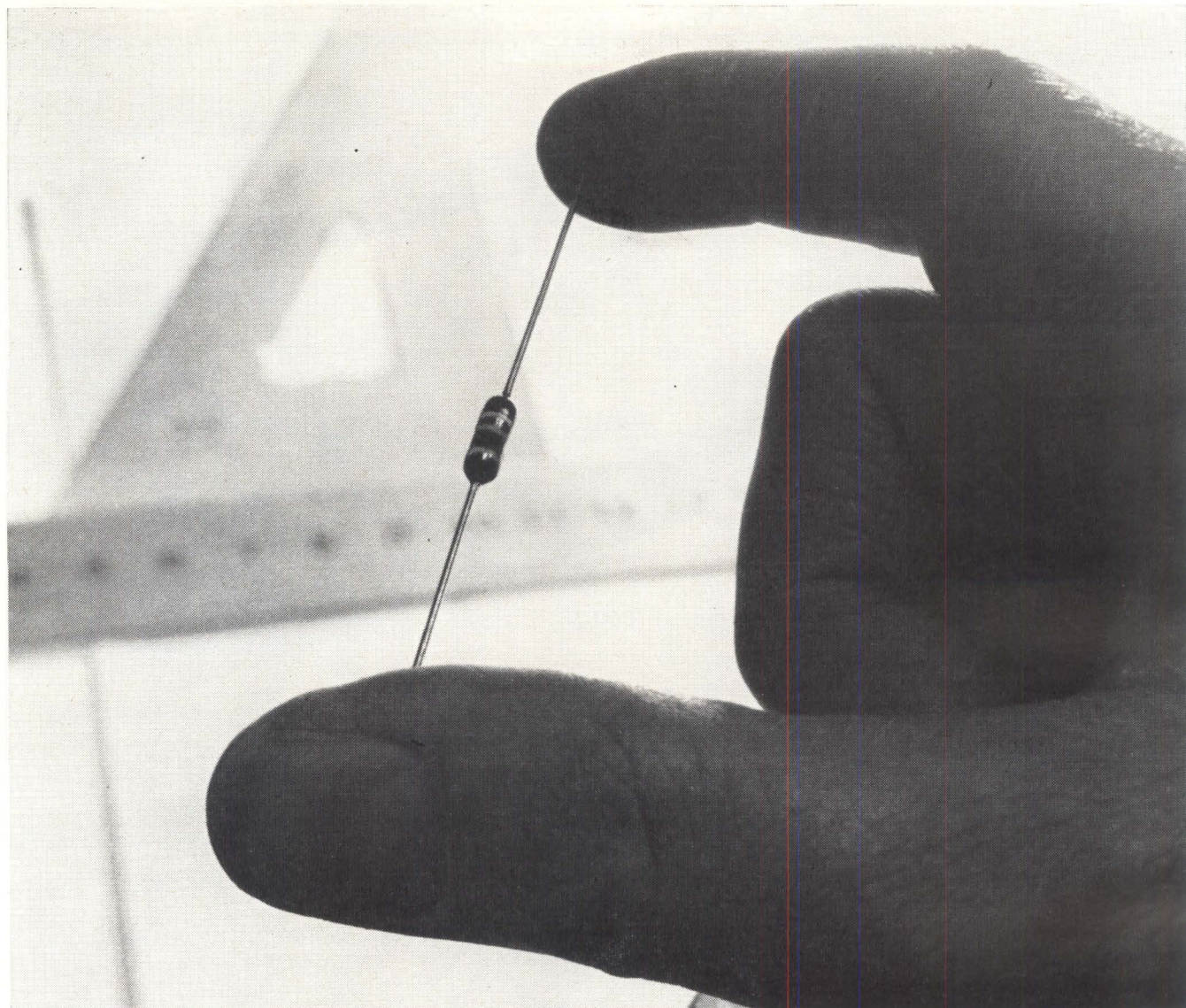

Why more good circuits start with Corning C resistors

First, you get performance within precision parameters from general purpose C-style resistors.

Second, C resistors let you plan a circuit within *known* limits of total resistance change from nominal—as little as 5%. Our new Corning Design Tolerances, based on extended load-life tests, give you that assurance.

Third, you get this predictably high performance at low

cost. C resistors are priced competitively with composition types.

C resistors give you these design advantages uniformly because we control the composition of their materials, and the way those materials bond together, in a continuous process.

C resistors that meet MIL-R-22684 are available from your Corning distributor in four sizes and values.

Get data sheets, test reports, and a brochure, "The Story Behind the Corning C Resistor," by writing Corning Glass Works, 3901 Electronics Drive, Raleigh, N. C.

Type	Wattage	Resistance (ohms)		Nominal Dimensions	Design Tolerance Full power, 70°C.
		min.	max.		
C07, Mil Style RL07	¼	51	150K	.250" x .090"	5% plus purchase tolerance
C20, Mil Style RL20	½	51	150K	.375" x .138"	
C32, Mil Style RL32	1	51	470K	.562" x .190"	
C42S, Mil Style RL42	2	10	1.3 meg	.688" x .318"	

CORNING

Electronic Components

PHYSICAL appearance and mounting of a four-layer structure as used in the circuits of this article

Unique coupling and driver circuits are used with tunnel and four-layer diodes to develop simple counters and waveform generators.

The circuits consist of semiconductors and resistors only, thus integrated circuits are easily realizable

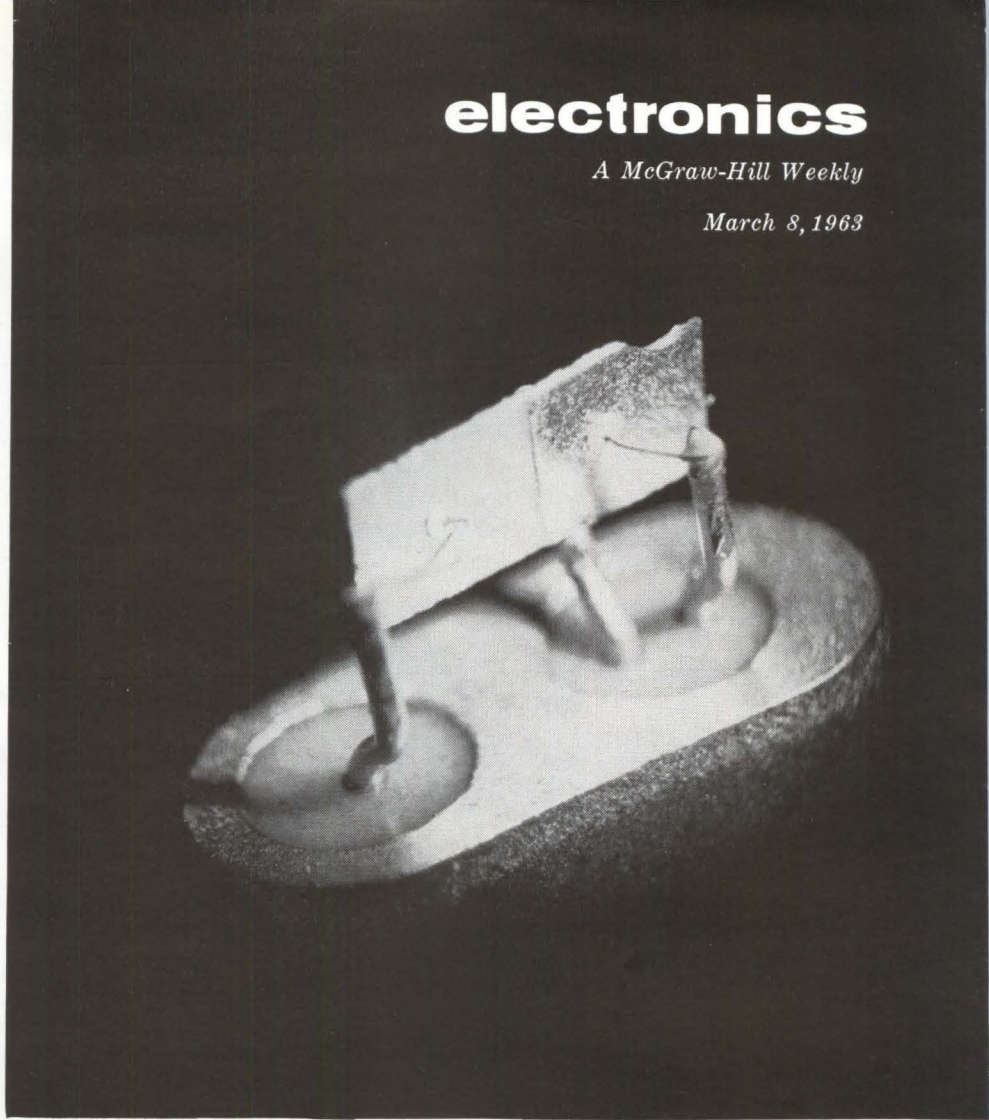

A NEW LOOK AT

Negative-Resistance Devices

By VASIL UZUNOGLU, Solid-State Laboratory, Westinghouse Electric Corp., Baltimore, Maryland

NEGATIVE RESISTANCE is a phenomena controlled either by current or voltage but not both together.¹ Solid-state devices displaying a negative-resistance region such as the tunnel diode, *pnpn* four-layer diode, point-contact transistor, and the unijunction transistor are numerous. Electrically, such negative-resistance devices may be thought of as elements having some internal positive feedback.

Whatever the source and nature of the negative resistance, electrically they may be divided into volt-

age-stable devices such as the tunnel diode and current-stable devices such as the *pnpn* diode.

In voltage-stable devices, the control effect comes from the voltage source, and in the current-stable devices, control comes from the current source. A load line drawn perpendicular through the corresponding source should cut the *V-I* characteristic at one point only. Intersection at more than one point corresponds to an unstable condition as shown in Fig. 1A and 1B. The difference between the two

characteristics is that in the voltage-stable element, dI/dV goes negative passing through zero.

The two most familiar devices displaying negative resistance are the tunnel diode and the *pnpn* four-layer diode. The first displays the quantum-mechanical effect² and the second is due to a combination of avalanche multiplication and amplification resembling an arc or gas discharge with energy-storage. These are coming into greater use.

TUNNEL DIODE FLIP-FLOP—

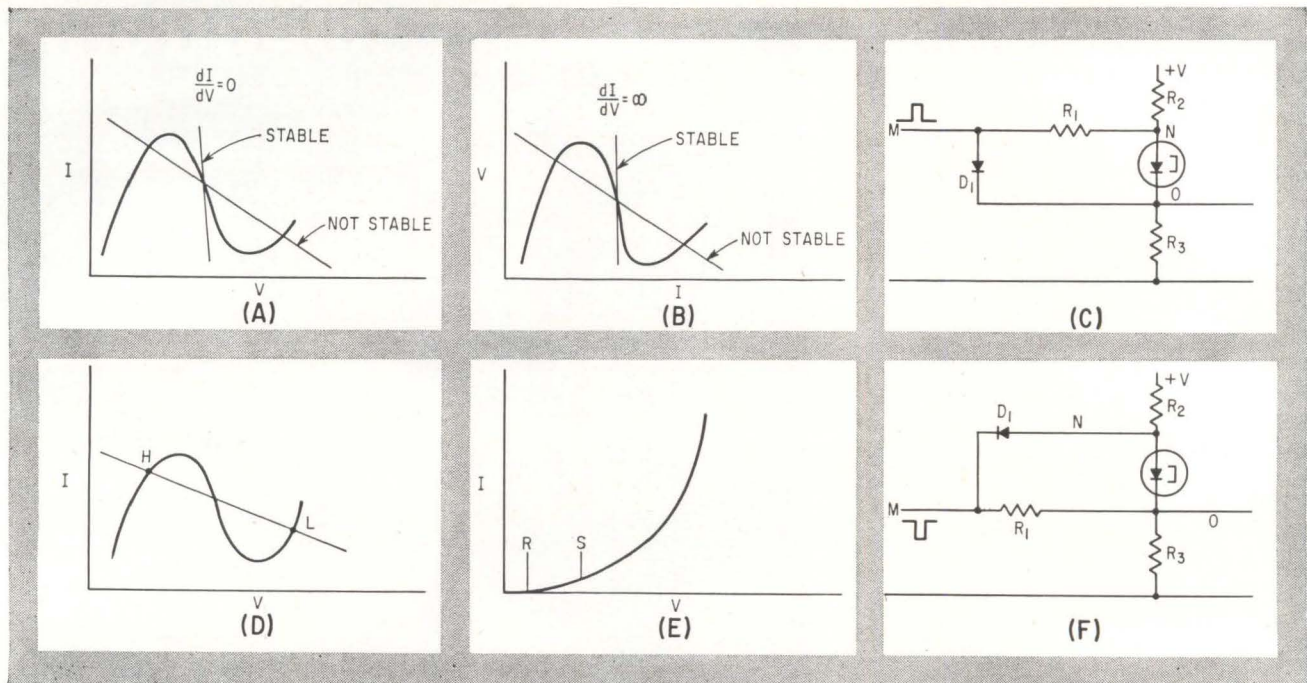

STABLE and unstable load lines (A and B). Positive-pulse-triggered tunnel diode flip-flop (C) with V-I characteristics (D) and diode characteristics (E). Negative-pulse-triggered tunnel diode flip-flop shown at (F)—Fig. 1

The circuit shown in Fig. 1C incorporates all necessary features of a bistable flip-flop driven by a positive pulse.⁸ The speed-limiting element is diode D_1 .

Using the V-I characteristic shown in Fig. 1D with the tunnel diode resting at high-current level H , and assuming that the driving source does not disturb the potential levels, the voltage across $M-O$ (Fig. 1C) is equal to the voltage across $N-O$. As the tunnel diode is in low-voltage state H , voltage across D_1 is low. Under this condition, bias on D_1 is shown as point R in Fig. 1E.

Assume a positive pulse applied to M whose amplitude is not high enough to put D_1 in its low-impedance level (not exceeding S). The pulse appears at N but not at O because it is blocked by diode D_1 . The pulse appearing at N will shift the operating point to L in Fig. 1D. As the tunnel diode changes state, bias across D_1 shifts to a point in the vicinity of S and normally does not exceed this point. A second pulse applied to M will appear at N as well as O as D_1 can conduct with the applied pulse.

The pulse appearing at N cannot change the operating level as the tunnel diode is already in high-voltage state L . The same pulse appears at O with a slight delay due to transit time of carriers across

D_1 . This positive pulse is now able to shift the operating level back to H . Every pulse changes the state of the circuit and this is the necessary condition for bistable multivibrator action. Speed of such a flip-flop can be in the Gc range. Limitation is in D_1 that constitutes the circuit energy-storing element. Circuits of this type have been tested at 30 Mc and no attempt made to go to higher frequencies.

Circuit sensitivity depends on location of the load line on the characteristic curve. Location of points H and L closer to the negative-resistance region reduces stability. The effective load line is composed of R_2 and R_3 in series and the effective V-I characteristic is of the device across R_1 in series with D_1 , when the diode is conducting. Both R_1 and D_1 across the tunnel diode are assumed to have small effect on the tunnel diode overall characteristic.

The principle of operation of a bistable flip-flop using a tunnel diode driven by a negative pulse is the same as the one explained for positive-pulse triggering. Such a circuit is shown in Fig. 1F and the V-I characteristic is shown in Fig. 1D. Assume the tunnel diode resting at point H . The voltage drop across the tunnel diode is low as is the forward bias across D_1 . A negative pulse applied to M will not affect H as diode D_1 is not conducting. The pulse will appear at O and will shift the operating point to L . The voltage drop across the tunnel diode is high as is the bias across D_1 . A second negative pulse applied to M will appear at O as well as N . The pulse appearing at O will not change the tunnel diode state, but the same pulse appearing at a slightly later time at N will shift the operating level back to H . The specifications and requirements for the positive-driven pulse

THE NEW LOOK

When designing circuits using negative-resistance devices, too many engineers use run-of-the-mill ideas. This article presents a new view of these circuits and covers both the voltage and current-controlled versions. If you are in the pulse-counting or waveshape-generating business, this is for you

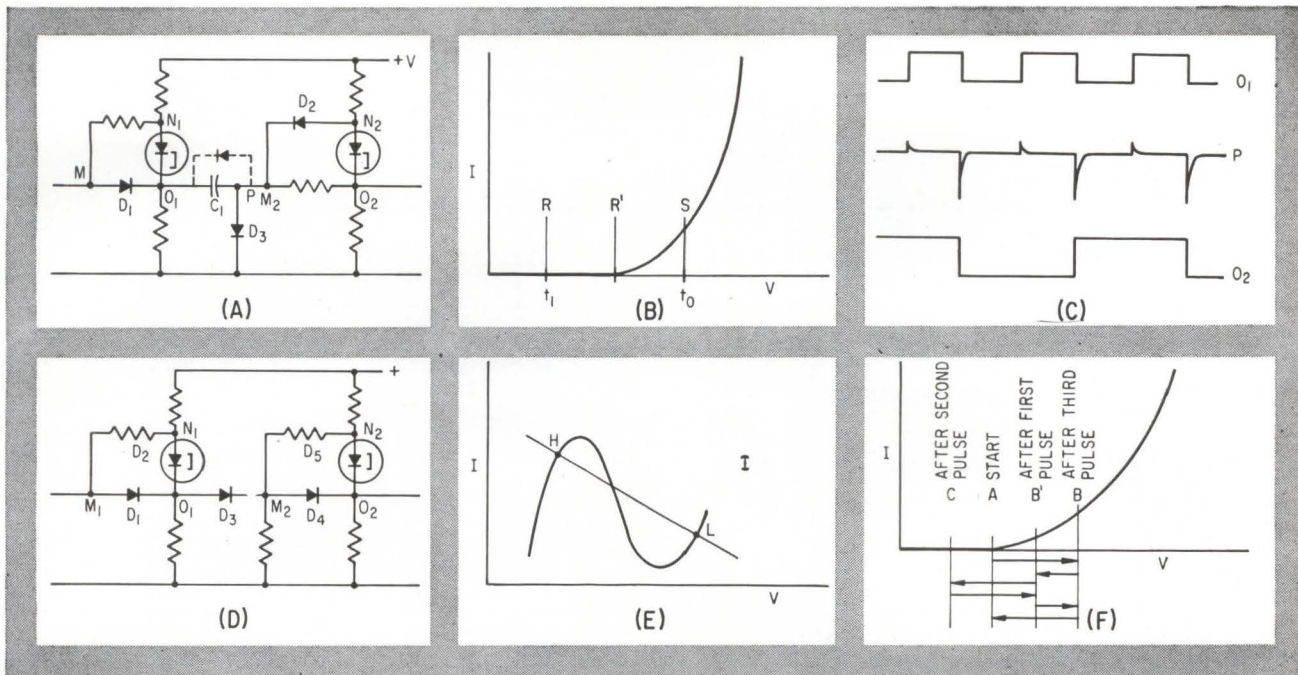

POSITIVE and negative-pulse-driven flip-flop (A) with diode curve (B) and internal waveshapes (C). A simpler coupling (D) with tunnel-diode curve (E) and diode curve (F)—Fig. 2

circuit also hold for this circuit.

COUPLING — In this approach, use is made of one positive driven and one negative driven bistable flip-flop as shown in Fig. 2A. The function of coupling network C_1 (or a reverse-biased diode) and D_3 is to differentiate the waveform at O_1 and pass only the negative-going pulses that actuate the second stage. There may be low-level positive pulses at P but they are not large enough to trigger the second stage. To have the necessary waveshape at point P , the bias across D_3 has to be as shown in Fig. 2B so that at t_0 , the diode has to be in high-conduction state S whenever the waveform at O_1 goes high. The bias at P is dependent on the operating level of the second stage. To accomplish the necessary condition, bias due to the second stage at point P must be kept between R and R' so that only positive-going

pulses at O_1 can make D_3 go to its high-conduction state.

Several stages of the negative-pulse type can be coupled to the 4:1 counter circuit to increase the counting level. Waveshapes of each stage are shown in Fig. 2C.

Three such stages have been coupled and operated at approximately 12 Mc although this is not the highest frequency of operation. Square wave rise and fall times are below $0.1 \mu\text{sec}$. Lack of faster measuring equipment prevented more precise measurements.

A simpler coupling can be realized by adjustment of bias developed across D_3 as shown in Fig. 2D. Operation is explained with use of tunnel diode curve (Fig. 2E) and diode curve (Fig. 2F).

Assume D_2 at low-current level L , D_5 in high-current level H and the operating point of D_3 at point A . A positive pulse applied to M_1 will shift the operating point of D_2 to H .

The potential at O_1 starts rising, raising potential level across D_3 to point B that enables a positive potential to appear at point M_2 and shift the operating level of D_5 to L . As soon as stage 2 changes state, the potential across D_4 is at a new level B' , lower than B . A second pulse applied to M_1 will make D_2 go to its low-current level L and the potential across D_3 goes to a new lower

level shown as point C .

As some negative pulse may appear at M_2 , the load line of D_5 has to be adjusted so that a negative-going pulse cannot affect its state. A third positive pulse applied to M_1 will shift the operating level of D_2 to H and the potential across D_3 will be increased to point B' . A positive pulse appearing at M_2 shifts the operating point of D_5 to H . As soon as D_5 changes state, the operating point of D_3 shifts further to the right. A fourth pulse at M_1 shifts the operating point of D_2 but a negative pulse cannot affect D_5 because it is in high-current state H and needs a positive-going pulse to activate it. Three such counting stages have been coupled (8:1 count) with the overall frequency characteristics in the same order as the previous one. The action depends on the correct bias of D_3 and not on pulse differentiation. With adjustable parameters and potential levels, counting levels can be further increased. Output of the second and third stages of a three-stage counter are shown in the Fig. 3 oscilloscope photograph.

A third type of coupling is shown in Fig. 4A, based on principles mentioned in the two previous methods. The waveshapes shown on the circuit make operation self-explanatory. The coupling capacitor used to connect the two stages

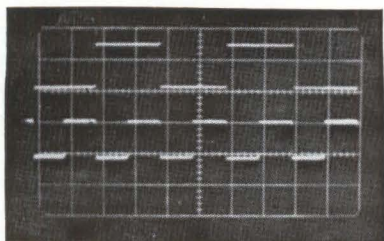

OUTPUT of second and third stage of a three-stage counter—Fig. 3

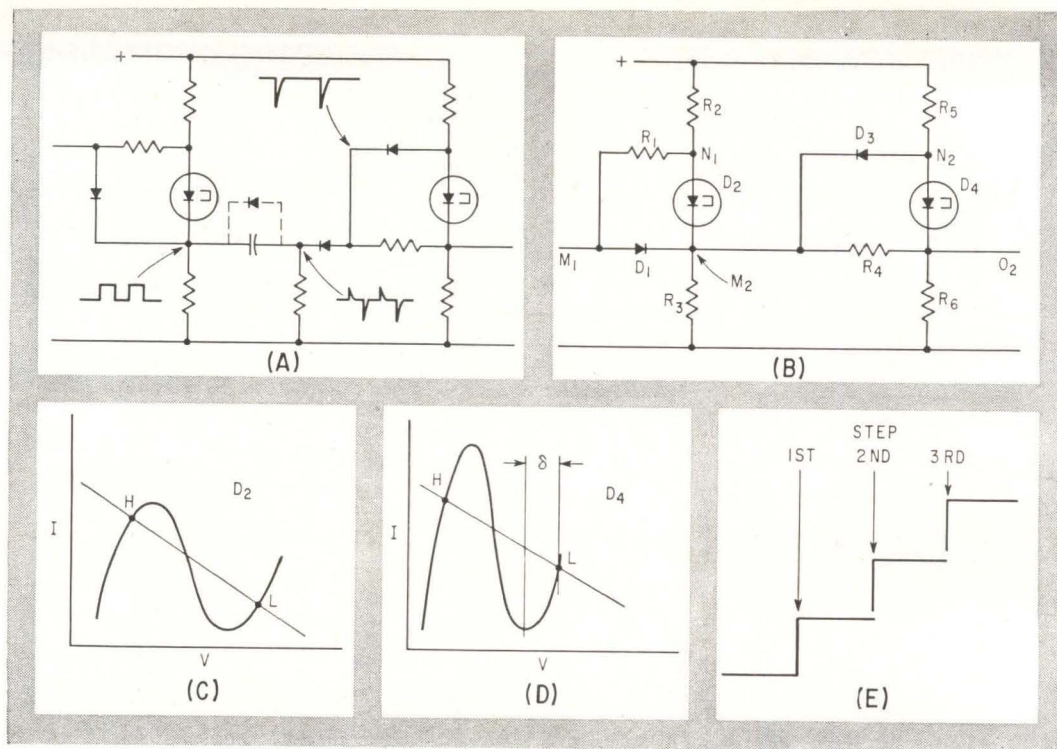

THIRD type of coupling is shown at (A). Staircase generator (B) with tunnel diode characteristics (C and D). Resultant output waveform is shown at (E)—Fig. 4

can be replaced by a reverse-biased diode (shown dotted).

STAIRCASE GENERATOR — In this circuit, use is made of the four states of two cascaded flip-flops.⁴ By arrangement of the operating points, a staircase generator can be realized as shown in Fig. 4B. The first stage is a positive driven flip-flop and the second stage is a negative-driven one. No delaying action is required through D_3 .

Assume both stages are at low-current levels L as shown in Figs. 4C and 4D.

A positive pulse applied at M_1 will shift the operating point of D_2 to its H state. Operation of D_2 depends on operation of D_1 and is actuated only under certain conditions. When D_2 changes state from L to H , the increasing voltage across R_3 appears at O_2 and tends to shift the level of D_1 . This is prevented by biasing D_1 further up the I - V characteristic, which necessitates a voltage of amplitude δ to actuate D_1 . The effective voltage at O_2 has to be less than δ . A positive-going pulse decreases the potential across D_3 and no voltage appears at N_2 . The first step in the output level shown in Fig. 4E, is produced as the current across R_6 is increased due to D_2 .

A second pulse applied to M_1 shifts the level of D_2 to point L . In doing so, a decreasing voltage across R_3 will make D_3 conduct and shift the operating point of D_4 to H . An important consideration is that conductance of D_3 at this point has to be higher than that of R_4 to be able to actuate D_4 . The second step in the output level (shown in Fig. 4E) is due to higher current level of D_4 .

A third pulse applied to M_1 actuates D_2 but not D_1 . When D_2 goes from state L to state H , an increasing voltage at M_2 will make D_3 further nonconductive and shift can only occur due to a pulse appearing at O_2 . A negative pulse is necessary at O_2 to make D_4 change state, therefore D_4 does not change state.

To return both stages to their L level, a fourth pulse is applied to M_1

that shifts D_2 to level L . In doing so, a negative-going voltage appears at M_2 and actuates D_1 . A negative pulse will also appear at point N_2 and may shift D_4 back to the H state. To prevent this, the delay across D_3 has to be minimized then D_4 remains in the L state.

Better performance can be achieved by replacing D_3 by a zener diode in which case, almost no delay exists. This also meets the requirements of high conductance.

For proper operation, interaction of the stages is brought to a minimum by proper input circuits.

Typical waveshapes resulting from this circuit are shown in Fig. 5.

PNPN DIODES—The four-layer diode can be used to switch current levels in the order of amperes. The bistable flip-flop using four layer diodes⁵ shown in Fig. 6A, is a basic building block for cascaded counter stages.

Assume the device resting on H (Fig. 6B). A positive pulse applied to point M will be differentiated at N - O . The positive-going portion of the pulse will shift the operating point to L' and as the pulse dies out, the load line tries to return to point L . Before there is any appreciable movement from point L'

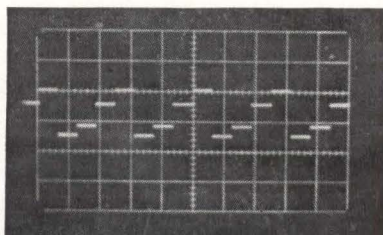

STAIRCASE generator output waveform—Fig. 5

to L , the negative-going portion appears at the device input terminals. This pulse is not high enough to shift the operating point back to H and the device rests at L . A second positive pulse applied to M will be differentiated but the positive pulse cannot make the device change state but pushes the operating point to the right. The load line moves slowly under high-current levels and before it moves, the negative-going portion of the pulse appears at N and shifts the operating point back to H . For proper operation, it is necessary that movement of the load line is slow under both operating conditions. Such devices have been operated in the 80 Kc range and if higher frequencies are to be realized, faster and narrower actuating pulses can be used with faster *pnpn* devices.

The five-layer structure shown in Fig. 6C, can use the entire fifth junction in connection with the bulk material as a differentiator.

The p -region with the n_2 region form the capacitance and the bulk material of the n_2 region forms the differentiator resistor. The equivalent circuit is shown in Fig. 6D, with a small-value resistor connecting the differentiator and the device.

COUPLING PNPN DEVICES—

Coupling *pnpn* diodes for use as counters has been realized by the circuit shown in Fig. 6E. The coupling network uses two differentiating circuits with the second incorporated into the second device.

Diode D_3 bypasses the negative-going pulses of the first differentiating circuit incorporating D_1 and R_1 . Fig. 6F shows the waveshapes appearing at each point within the circuit of Fig. 6E.

L-F ASTABLE MULTIVIBRATOR

—Here, use is made of the thermal effect associated with avalanche breakdown. Operation of the circuit shown in Fig. 6G can be explained by use of Fig. 6H. Assume operating point resting at point L . High current through the device causes heating and increases the avalanching point of the device. The new characteristic is shown as a dotted line in Fig. 6H. Under the new characteristic, the operating point at L is not stable enough and the characteristic is switched to

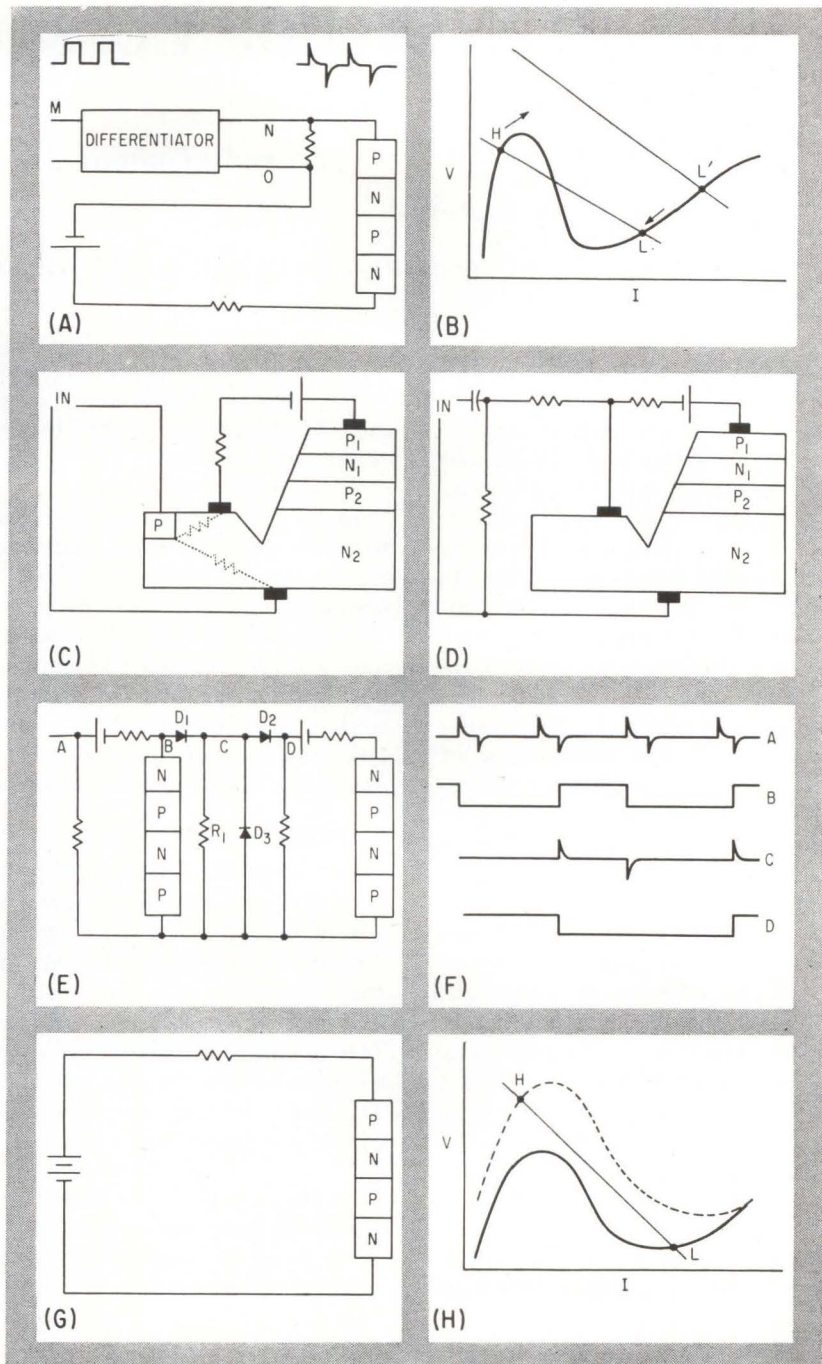

FOUR-LAYER diode basic flip-flop (A) with characteristic curve (B). Typical four-layer structure (C) can be part of circuit (D). Coupling *pnpn* diodes (E) use two differentiating circuits and produce waveshapes shown in (F). A low-frequency astable multivibrator (G) with its associated waveshapes (H)—Fig. 6

point H . At this level, current through the device is low and it starts cooling. It then returns to its original position. Point H , under this circumstance, does not exist and the operating point returns to L . This is a slow process and oscillations as low as 0.1 cps has been achieved using Ge four-layer diodes. Frequency variations for long periods of oscillation were within 3 percent.

REFERENCES

- (1) W. Shockley and W. P. Mason, Dissected Amplifiers Using Negative Resistance, *Jour. of Applied Physics*, 25, p 677.
- (2) C. Brunetti, The Clarification of Average Negative Resistance With Criterion of Its Use, *Proc IRE*, p 1,595, Dec 1937.
- (3) E. W. Harold, Negative Resistance and Devices for Obtaining It, *Proc IRE*, p 1,201, Oct 1935.
- (4) L. Esaki, *Physical Review*, 1958.
- (5) V. Uzunoglu, A Bistable Flip-Flop Circuit Using Tunnel Diode, *Proc IRE*, p 1,440, Sept 1961.
- (6) First observed by F. Shirik, Solid State Laboratory, Air Arm Division, Westinghouse Electric Corporation.
- (7) First observed by E. Goins, Solid State Laboratory, Air Arm Division, Westinghouse Electric Corporation.

The PIN Diode: Versatile Microwave

Absorption-type attenuators formed of pin diodes amplitude modulate all r-f sources without disturbing oscillator or amplifier elements. Jitter in the voltage-controlled modulator is unmeasurable and harmonic content is low

SINE-WAVE, square-wave and pulse modulation of microwave generators including klystron oscillators is achieved with *pin* diodes and a transmission line. Transistors can be used to drive the voltage-controlled modulator, which exhibits unmeasurable jitter on a 1,000-Mc sampling oscilloscope. The *pin* diodes can also be used to level output of an r-f generator throughout its frequency range.

Advanced techniques are making more evident the limitations of modulators now used for instrumentation. For example, it has been nearly impossible to modulate a klystron oscillator directly with anything but a square wave or pulse. Sine-wave modulation can result in significant frequency shifts with changes in amplitude.

Conventional klystron oscillators have relatively slow rise and decay times and poor frequency stability. Jitter in the r-f pulse is too high for precise pulse measurements. Klystron r-f pulse misfires are such a problem that one manufacturer makes a misfire counter to test its radar system. Also, modulators for lower frequency triode and pentode

generators have low on-off ratios, and speed of rise and decay of the modulated signal is limited by Q of the modulated stage.

A high-speed absorption-type attenuator that can be placed in series with the output of any signal generator can be made using *pin* diodes. As diode bias is changed in accordance with the modulating signal, greater or lesser amounts of power are absorbed from the signal source, effectively amplitude modulating the output. Frequency band and power limits must be observed.

THEORY — An intrinsic silicon wafer is used to make *pin* diodes. This slice of high-purity silicon has nearly equal *p* and *n* traces, but additional *p* type impurities are diffused from one side and additional *n* type impurities from the other. The middle intrinsic layer is left, which accounts for the name *pin*. The wafer is sliced into diode chips, which are placed into appropriate mounting configurations.

At frequencies below 100 Mc, the *pin* diode assembly rectifies as any other junction diode. Because the intrinsic layer acts as a dielectric

barrier separating the *p* and *n* regions, capacitance is low. However, rectification efficiency drops rapidly as frequency increases above 100 Mc because of carrier storage in the intrinsic layer.

When forward bias current is flowing through the *pin* diode, holes and electrons are stored in the *i* layer. The number of stored charge carriers increases with bias current. Before a back bias can be applied to the diode, all these charge carriers must be removed. Above several hundred megacycles, currents do not flow in the reverse direction long enough to remove these charge carriers. Thus microwave currents do not significantly change the instantaneous number of charge carriers stored, and there is negligible rectification.

However, there is a resistance to microwave current flow in the *pin* diode. It is inversely proportional to the number of charge carriers stored in the *i* layer, which in turn is proportional to forward bias current. By varying the bias from back bias (no stored charge) to about $\frac{1}{2}$ ma forward bias, resistance to microwave currents varies from

PIN DIODES MODULATE MICROWAVES

The behavior of a semiconductor device has again provided the basis for overcoming some long-standing problems. This time it is the *pin* diode, and it is performing modulation functions formerly regarded as nearly impossible. The mechanism that governs the flow of microwave currents through these devices is discussed with a variety of practical applications

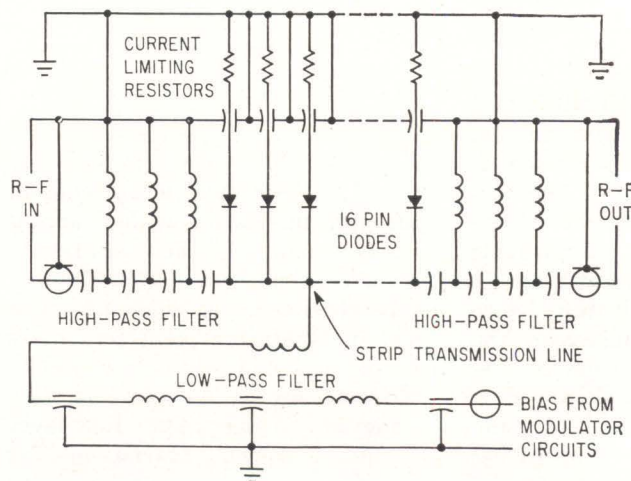

BIAS controls absorptive properties, permitting reflectionless modulation or attenuation—Fig. 1

Component

By ROBERT E. HELLER

Applications Engineer
Microwave Division
Hewlett-Packard Company,
Palo Alto, California

about 5,000 ohms to 30 ohms.

This concept can be demonstrated by assuming that the *pin* diode has been mounted across a transmission line with a characteristic impedance of 50 ohms. When the diode is back biased to about 5,000 ohms, the microwave signal on the transmission line is not attenuated because 5,000 ohms compared to a 50-ohm line impedance has little effect. However, when the diode is forward biased to about 30 ohms, most of the microwave current flows through the 30-ohm diode instead of propagating down the 50-ohm line. Since this diode current represents microwave energy dissipated as heat, the diode actually absorbs microwave energy.

Negligible rectification means that resistance of the *pin* diode is about the same throughout a microwave cycle, and the diode behaves essentially as a linear microwave resistor. On the other hand, operation of the diode harmonic generator is based on the change in its resistance during the cycle. If resistance of the *pin* diode is constant throughout the microwave cycle, harmonic content of the modulated output must be low compared to other diode devices.

MODULATOR BOX—To use the microscopic *pin* diode, it must be mounted on a metal post. Reactance of the post is compensated by selecting dimensions that give proper values of capacitance and inductance, leaving only the resistive component. These posts are shown in the photograph of a typical setup for *pin* diode assembly. After assembling the diodes on the posts, they are placed at quarter-wavelength (at midband) intervals along a 50-ohm strip transmission line.

A series of diode-post elements is used to achieve the required maximum attenuation. Higher resist-



DIODE posts are shown on rotary assembly jigs but pin chip is visible only under microscope

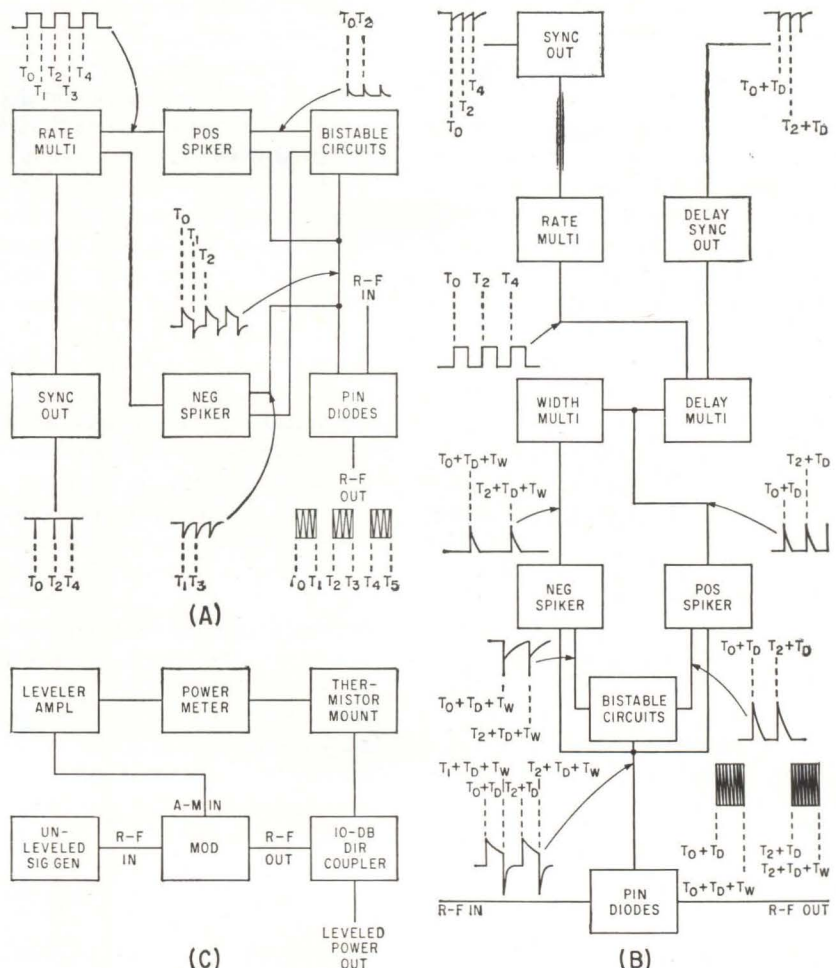

CIRCUITS enable *pin* diodes to be programmed for square-wave (A) or pulse (B) modulation. Output of signal generator (C) is leveled by feeding back sample of output power to modulator—Fig. 2

DETECTED pulses (A) are shown at 0.1 and 0.5 μsec per large division; carrier (B) and detected pulse (C) appear at 20 nsec per division; and rise times of carrier (D) and detected pulse (E) are displayed at 5 nsec per division—Fig. 3

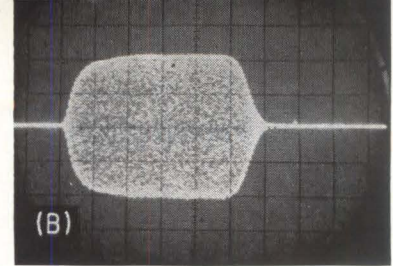
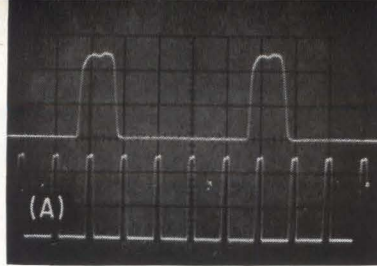

ance *pin* elements are used at each end of the stripline to improve attenuator match and reduce reflections. Loss characteristics of the modulator box are shaped like those of a resistance card in a waveguide flap attenuator.

The typical modulator box in Fig. 1 has 16 *pin* units, although any number may be used depending on required attenuation. The quarter-wavelength spacing is not critical since the attenuator works well over a 3:1 frequency range. However, quarter-wavelength spacing at mid-band produces the lowest average swr because reflections from each element tend to be absorbed and cancelled by adjacent diodes. This internal reduction of reflections is important in achieving low overall swr. Diode series resistors give equal current distribution. Modulation circuits external to the box are protected by the low-pass filter in Fig. 1, which prevents r-f leakage. If leakage were present, it could cause erratic action in the driving circuits and objectionable r-f interference. The high-pass filters permit r-f energy to enter and leave the stripline while keeping the low-frequency modulating signals from entering the r-f circuits preceding or following the *pin* modulator.

In constructing the *pin* diode box, care must be taken to assure good r-f matches for maximum power transfer. Not only does each *pin* diode represent a possible mismatch or reflection point, but the filters and connectors also contribute to mismatch. Mechanical tolerances of the box and the stripline are also important.

Modulator boxes have been successfully constructed having bandwidth ratios of 3:1 with low swr in both on and off conditions. For example, a typical 16-diode box for 800 to 2,400 Mc has a minimum insertion loss of 1 to 2 db and maximum attenuation of at least 80 db. Maximum swr may range from 1.5 to 2, and a response time of about 2 nsec is typical. Power handling

capabilities are about 1 watt, and r-f harmonic content is low.

DRIVING CIRCUITS—The *pin* diode box can be modulated with any desired amplitude-time function. When modulating with sine waves, minimum distortion is obtained by setting d-c bias so that it is centered on the most linear portion of the *pin* diode characteristic curve. For normal modulation values (such as 50 percent), bias level is about 7 db down from no attenuation bias. Nonlinear distortion can be decreased even more by using diode shaping circuits to approximate the inverse of the *pin* characteristic curve. A feedback arrangement of the detected output would also be useful in reducing distortion in sine-wave systems. However, even without shaping circuits or feedback, harmonic distortion of less than 8 percent can be achieved with over 50 percent modulation.

For maximum speed in pulse and square-wave modulation, enough energy must be supplied to the intrinsic layer to sweep charge carriers rapidly into and out of each diode. Therefore, a spiked driving front is applied to the *pin* modulating pulse during changes of state. The energy levels required are readily obtained with transistors.

In the typical square-wave modulator in Fig. 2A, a square-wave rate multivibrator initiates the modulating circuits. Care must be taken to design a symmetrical square-wave device and to maintain this symmetry through the r-f output. In fact, the ratio of the integrated square wave to c-w power should be exactly 3 db. This 3-db figure can also be useful when measuring degradation in microwave systems.

The bistable circuits driving the *pin* diodes have a holding characteristic and provide a back bias of several volts for no attenuation. For maximum attenuation, the bistable circuits provide the required bias current. The diodes are held at min-

imum microwave resistance by bias current throughout the off period of the r-f pulse.

In the pulse modulator in Fig. 2B, modulation is again initiated by the rate multivibrator. Output of the rate multivibrator is symmetrical, and a width multivibrator provides the required pulse width. The delay multivibrator is useful for oscilloscope synchronization, target simulation or other instrumentation. The delay feature is particularly desirable when the modulator is operated with a sampling oscilloscope. All three functions—pulse rate, width and delay—are front panel controls. Time sequences are indicated in Fig. 2A and B. Commercial units have been constructed with internal square-wave and pulse repetition rates from 50 cps to 50 Kc. Pulse length and pulse delay are adjustable from 0.1 to 100 microseconds.

To permit external pulse modulation or synchronization, an externally actuated Schmitt trigger is substituted for the rate multivibrator. In commercial units, repetition rates have been extended up to 1 or 2 Mc with the Schmitt circuit. Pulse length and pulse delay are also adjustable from 0.1 to 100 microseconds for external synchronization. In external modulation, the modulating pulse determines length.

AMPLITUDE MODULATION—In conventional amplitude modulation, power output from the signal generator is usually varied by changing the d-c power supplied to one of the oscillating or amplifying elements. However, this method may introduce extraneous f-m and spectral impurities. Frequency characteristics are not always the same at all generator amplitudes. For example, klystron oscillator frequency depends heavily on klystron amplitude control, so that the klystron cannot be successfully amplitude modulated in the conventional manner. However, the *pin* diode

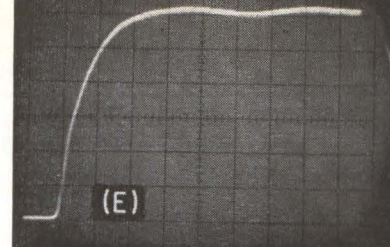
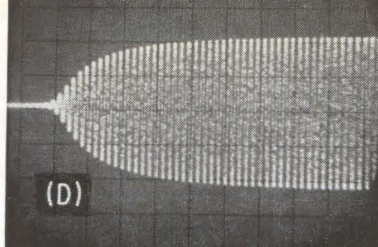
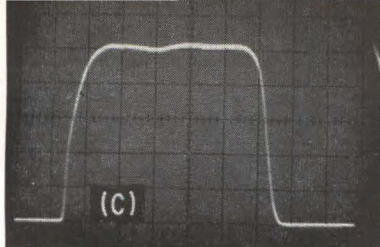

system does not disturb the oscillating or amplifying elements. It can amplitude modulate signals from all r-f sources and provides a practical way to amplitude modulate signals from klystron oscillators.

PULSE MODULATION—In conventional pulse modulation, klystron repeller potential is switched between two voltages or beam current is switched on and off. A reasonably stable frequency output can be achieved if the modulating pulse applied to the klystron is clamped when the generator is full on. However, frequency shift can be introduced if, for example, the clamp voltage shifts with modulation rate. In the full-off position, the klystron modulation pulse must be switched off completely. Even with these precautions, there are still frequency shifts and spectral problems because of the start-up and shut-down characteristics of the klystron oscillator.

Rise and fall times of the modulator pulse are also important. Poorly shaped wave fronts can introduce serious spectral problems that can cause errors in slotted-line and reflectometer measurements. With the *pin* modulator, however, the klystron oscillator operates continuously. The output r-f is switched on and off by the high-speed *pin* absorptive attenuator without disturbing klystron operating conditions.

Occasionally, high-speed switching diodes are used as r-f switches for klystrons and signal generators, but they can introduce reflections and mismatch errors during switching. They present different impedances to the generator for maximum and minimum conduction. Switching diodes are usually narrow-band devices, and this technique provides no filtering for control or transmission of r-f energy. The *pin* diode modulator has no disturbing effect on the r-f source as a result of loading and can introduce no erroneous pulse reflections. Klystron fre-

quency pulling because of loading is not a problem because *pin* modulators present a constant impedance during modulation.

HIGH-SPEED SWITCHING—The *pin* diode modulator is useful for high pulse rates. Rise times of 20 nsec are easily obtainable. Since jitter times are unmeasurable with a 1,000-Mc sampling oscilloscope, jitter must be well below 1 nsec. Some typical high-speed *pin* modulator waveforms are shown in Fig. 3. All traces were made using a 1,000-Mc carrier frequency, a 0.1- μ sec pulse width and a 2-Mc repetition rate. A 50-Mc oscilloscope was used for Fig. 3A and a 1,000-Mc oscilloscope for all others.

High-speed, pulse-code modulation of r-f signals by the *pin* diode modulator is well suited to telemetry and data transmission systems. For example, it is possible to frequency modulate a klystron and also pulse modulate or sine-wave modulate the r-f output. The amplitude channel might carry digital data while the f-m channel was used as a communications link. Other applications include synchronous pulsed f-m systems, such as pulsed-doppler and chirp radar. The modulator for high-speed switching provides increased accuracy and better r-f pulse resolution.

R-F LEVELING—Because the *pin* modulator is a current-controlled

r-f attenuator, it can control level in r-f systems, as in Fig. 2C. A conventional signal generator is used. The variation in r-f output over the frequency range of a typical unlevelled signal generator can be from $\frac{1}{2}$ to 5 mw or 10 db, but it is possible to level within $\frac{1}{2}$ db. The signal generator power that flows through the *pin* box is sampled from the directional coupler and fed to a temperature-compensated thermistor-type power meter. Power meter output is amplified and fed back to the modulator to control *pin* diode bias. System response time, which is limited by gain in the feedback loop and thermal lag of the thermistor, may be a fraction of a second. Accuracy is limited by the thermistor mount and characteristics of the directional coupler.

If faster response is needed, a crystal detector with negative output voltage could be used in place of the power meter. Response characteristics of the detector mount would have to be considered because they are not always as flat as thermistor mounts. Changes in crystal rectification efficiency with temperature might also be a problem.

SIGNAL GENERATORS—A commercial signal generator for 800 to 2,400 Mc has been built using a *pin* diode modulation system. The klystron operates continuously, and output is leveled within ± 1 db across the band. Output as plotted with a temperature-compensated thermistor power meter and recorded by an x-y recorder is shown in Fig. 4.

Weight and size of this compact signal generator have been reduced by using the *pin* diode modulator. Amplitude modulation is a standard feature. Performance has been improved by eliminating spurious f-m during square-wave modulation, increasing power output and providing uniform power output at all frequencies by *pin* diode leveling.

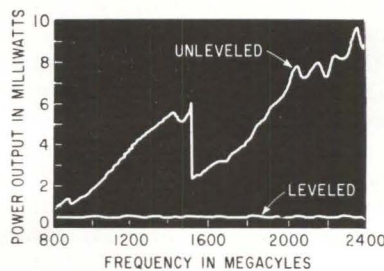

LEVELED and unleveled outputs of signal generator are shown as a function of frequency with identical output attenuation setting—Fig. 4

NARROWING THE GAP

The introduction of field-effect transistors has significantly narrowed the gap between tube and transistor circuit design. This discussion illustrates a typical case, in which the techniques used in vacuum-tube circuits have been successfully adapted to the field-effect transistor. As new semiconductor devices are developed, and a wider range of applications is recognized, a combination of the best attributes of both tubes and transistors will result

EQUIVALENT CIRCUITS: actual circuit (A); simplified equivalent circuit (B); equivalent circuit (C)—Fig. 1

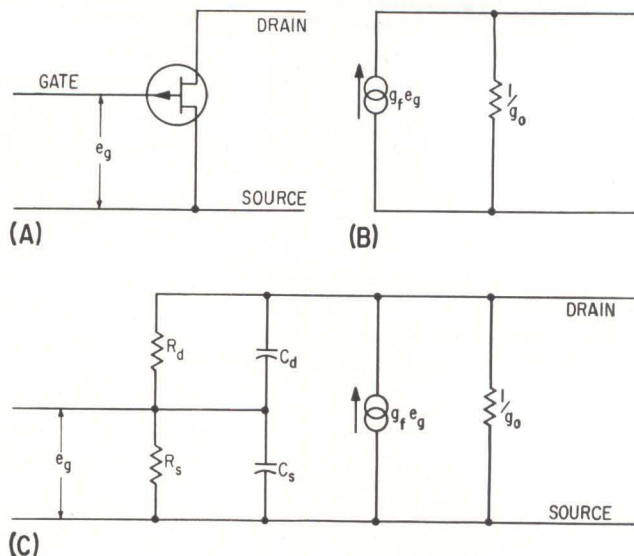

HOW TO GET Maximum Input Impedance

THE FIELD-EFFECT transistor, being a voltage-controlled device, is more nearly the equivalent of a vacuum tube than of a current-controlled conventional transistor. The main advantages of the field-effect transistor over the tube are its low power consumption with the elimination of excess heat, and its small size. In d-c amplifiers it eliminates the drift due to filament voltage variations, although it does have a drift term associated with the leakage current of the reverse-biased gate diode. Its advantages over conventional transistors are its high input impedance (that of a reverse-biased diode), its reduced noise figure, and its high power gain, which approaches that of a good vacuum tube. The application ideally suited to the characteristics of a field-effect transistor is an amplifier requiring a low-level input, high input impedance and low power consumption.

For this type of amplifier, a number of parameters are of interest. A high d-c input resistance is needed; this can be deduced from the gate-diode leakage current on the specification sheet for the device. At frequencies above a few cycles per second, the input impedance is determined principally by input capacitance, which therefore should be kept to a minimum. An additional factor of importance is the noise figure, which in low-level applications will determine the minimum signal amplitude that can be passed by an amplifier. Finally, a high gain is desirable, since this will effectively reduce the noise contributed by succeeding stages. In the field-effect transistor, the gain is determined by the forward transfer conductance.

The characteristic curves of field-effect transistors are similar to those of a pentode, and show the drain (plate) current as a function of gate (grid) bias and

drain-to-source (plate-to-cathode) voltage. As in a pentode, a simple equivalent circuit can be used to represent the field effect transistor; a current generator $g_f e_g$ in parallel with a resistance $1/g_o$, where g_f is the forward transfer conductance, and g_o is the output conductance. Figures 1A and 1B show the actual and simple equivalent circuits.

Typical values for present devices show g_f with a range from less than 1,000 micromhos to about 5,000 micromhos, and g_o from about 1 to 500 micromhos.

EQUIVALENT CIRCUIT—In the equivalent circuit shown in Fig. 1C, R_d and R_s represent the reverse-bias resistances of the gate diode, which are reflected into the drain and source circuits respectively. These resistances have typical values of hundreds or thousands of megohms. Shunting these high-resistance paths are small values of capacitance C_d and C_s , which have values of 15 pf or less. Above a few cycles per second, the input impedance of the device is determined mainly by these shunt capacitances.

In designing a high input impedance stage, the input capacitance must be kept at a minimum. A source (cathode) follower can be utilized to minimize the gate-to-source capacitance C_s , as shown in Fig. 2A and 2B.

The addition of a source resistance R_s produces negative feedback which, in addition to the stabilizing effect it has on the circuit, reduces the voltage appearing across the gate-to-source capacitance C_s . This voltage e is the difference between the input and output signals which are in phase

$$e = e_{in} - e_o \quad (1)$$

The voltage gain of the amplifier can be computed

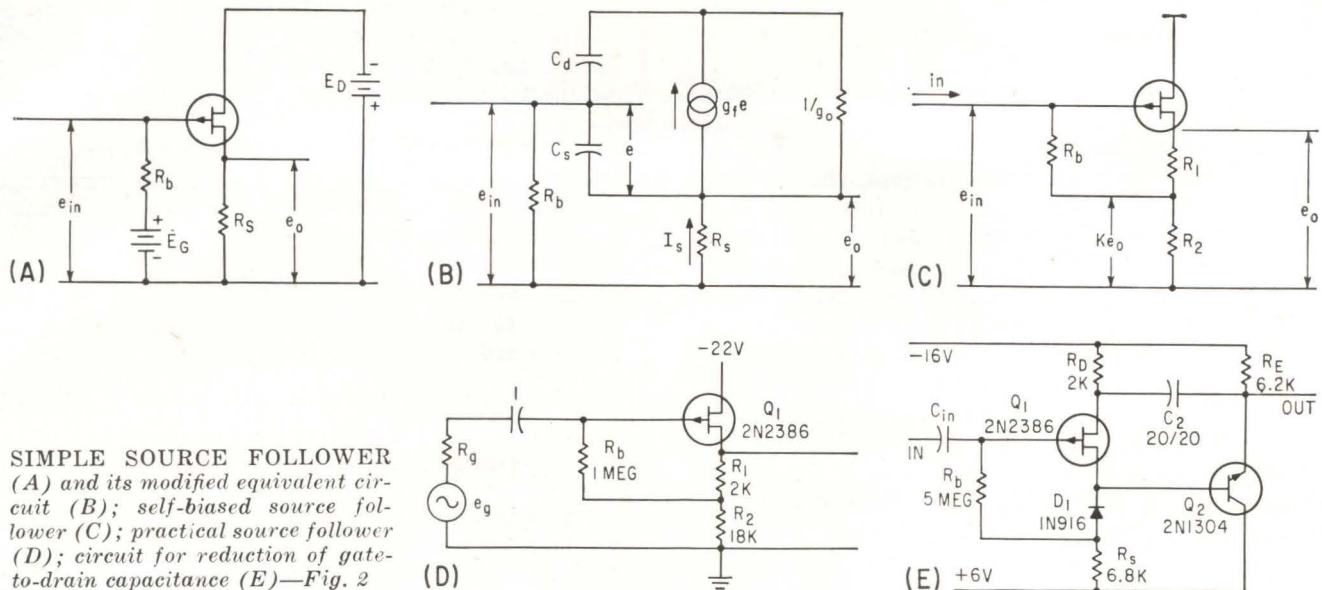

SIMPLE SOURCE FOLLOWER (A) and its modified equivalent circuit (B); self-biased source follower (C); practical source follower (D); circuit for reduction of gate-to-drain capacitance (E)—Fig. 2

With Field-Effect Transistors

By T. ROSS BIGNELL
Project Engineer
Electro Instruments, Inc.,
San Diego, California

$$e_o = I_s R_s = g_f e R_s = g_f (e_{in} - e_o) R_s \quad (2)$$

This simplifies to

$$G = \frac{e_o}{e_{in}} = \frac{g_f R_s}{1 + g_f R_s} \quad (3)$$

The gate-to-source capacitance C_s is now equivalently reduced to

$$C_{eq} = C_s (1 - G) \quad (4)$$

As the gain approaches unity, C_{eq} approaches zero. The virtual elimination of C_s almost doubles the a-c input impedance of a source follower over other conventional circuits. By the application of similar feedback techniques to the drain, the gate-to-drain capacitance C_d also can be substantially reduced. However, the controlling factor at low frequency still remains R_b and in the interests of stability this should be kept below a maximum value of about one megohm. As in most other applications, a compromise between stability and input impedance must be made.

SELF-BIASING—By a self-biasing technique common in vacuum-tube design, the equivalent gate bias resistance can be increased by bootstrapping, as shown in Fig. 2C.

The d-c input resistance of the stage will be considered as being due entirely to R_b . The input resistance is the ratio of input voltage to input current

$$R_{in} = \frac{e_{in}}{i_{in}} \quad (5)$$

If the gate presents an open circuit to the input, then all the input current will flow through R_b . A portion of output voltage, $K e_o$, is used to bootstrap the

resistance R_b and the input current becomes

$$i_{in} = \frac{e_{in} - K e_o}{R_b} \quad (6)$$

$$\text{where } K = \frac{R_2}{R_1 + R_2}, \text{ and } e_o = G e_{in} \quad (7)$$

$$\text{and finally } R_{in} = \frac{e_{in} - \frac{R_2}{R_1 + R_2} G e_{in}}{R_b} \quad (8)$$

$$\text{which reduces to } R_{in} \approx R_b \left(\frac{R_1 + R_2}{R_1} \right) \text{ if } G \approx 1 \quad (9)$$

The circuit shown in Fig. 2D uses the techniques of a self-biased source follower. It has a d-c input impedance of 10 megohms and at least 1 megohm input impedance at 10 Kc. The required range of input signal level is from 1 millivolt to 10 volts, with a bandwidth of from 10 cycles to 10 Kc.

The theoretical input impedance derived from Eq. 9 is 10 megohms. The actual input impedance at 10 cycles is slightly under 8 megohms. The frequency at which the input impedance drops to 1 megohm is about 25 Kc, corresponding to an input capacitance of about 6 pf.

Figure 3 (top) is a graphical comparison between actual and theoretical input impedance of the circuit in Fig. 2D, expressed as a function of frequency.

From Eq. 3, using $g_f = 1,500$ micromhos, the theoretical voltage gain is 0.97. Actual voltage gain was 0.96. The 3-db bandwidth of the stage extends from below 1 cycle to above 10 Mc. The voltage gain is linear over the specified range from 1 millivolt to 10 v., and, using a 1-megohm generator resistance,

the output signal-to-noise ratio at 1 millivolt input is greater than 20 db.

STABILITY—Although temperature considerations were not part of this design study, the stability of the stage as a function of temperature shows an improvement over other configurations, due to the large negative feedback imposed by the source resistance. Temperature stability is less of a problem with field-effect transistors than with conventional ones. The base-emitter voltage variation due to temperature is eliminated, and only the leakage current of the gate diode needs to be considered. The change in forward transfer conductance, g_f , also is somewhat less than the change in h_{fe} in conventional transistors.

From Eq. 3, since the gain is always less than unity, it follows that the output voltage drift will always be less than the input voltage drift. If the worst case condition is assumed ($\Delta e_o = \Delta e_{in}$), then Δe_o can be considered independent of variations in g_f . Assuming that all temperature variation in field effect transistors is due to leakage current, then

$$\Delta e_{in} = I_l R_b \quad (10)$$

where I_l is the gate diode leakage current, and R_b is the gate bias resistor.

Again if worst case conditions are assumed; that

is, I_l is the maximum specified (10×10^{-9} amp at 25 deg C), and if it doubles every 8 deg C, then the maximum input voltage drift from 0 to 50 deg C generated across the 1-megohm bias resistor is

$$\Delta e_{in}(\max) = 10 \times 10^{-9} \text{ amp} \times 2^{3.1} \times 10^6 \Omega = 0.086 \text{ volt}$$

The actual input drift over this temperature range is slightly less than 0.02 volt.

The gate-to-drain capacitance can be reduced by bootstrapping to produce an extremely low overall input capacitance for the stage. In the circuit shown in Fig. 2E, the design goals and actual values obtained were

Design	Actual
$R_{in} = 50 \text{ megohms}$	47.5 megohms
$C_{in} < 0.5 \text{ pf}$	0.45 pf

The diode D_1 gives maximum a-c bootstrapping of the gate bias resistance, while providing the required d-c bias. A signal in phase with the input is coupled by the emitter follower Q_2 to the drain circuit of the field effect transistor. Capacitor C_2 provides a low-impedance a-c path between drain and emitter, while maintaining the d-c relationship between source and drain.

Figure 3 (bottom) is a graph of the theoretical and actual values of input impedance as a function of frequency for the circuit in Fig. 2E.

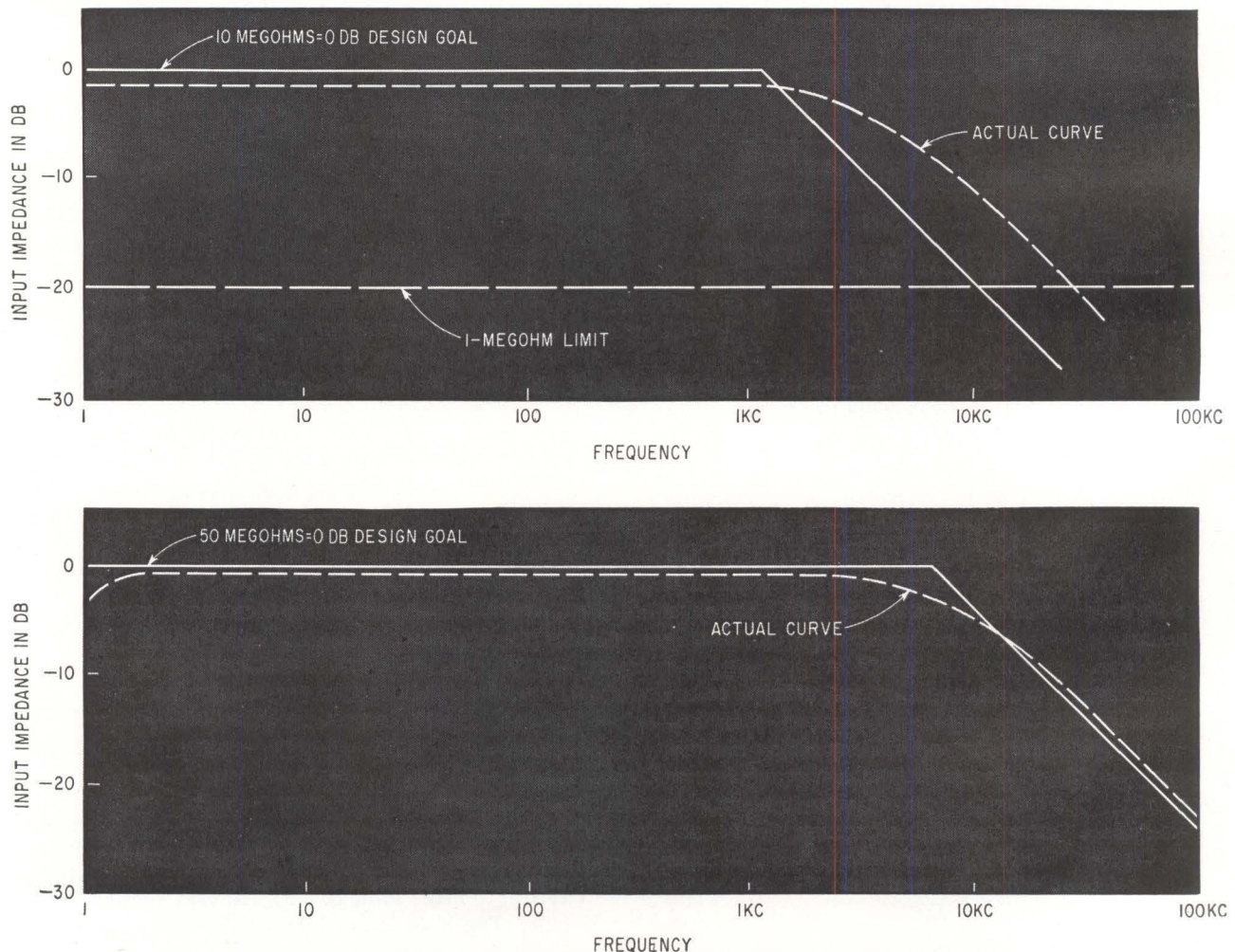

NORMALIZED theoretical and actual input impedances versus frequency for circuit of Fig. 2D (top) and Fig. 2E (bottom)—Fig. 3

RECEIVER includes a voltage-controlled oscillator and phase-correction network — Fig. 1

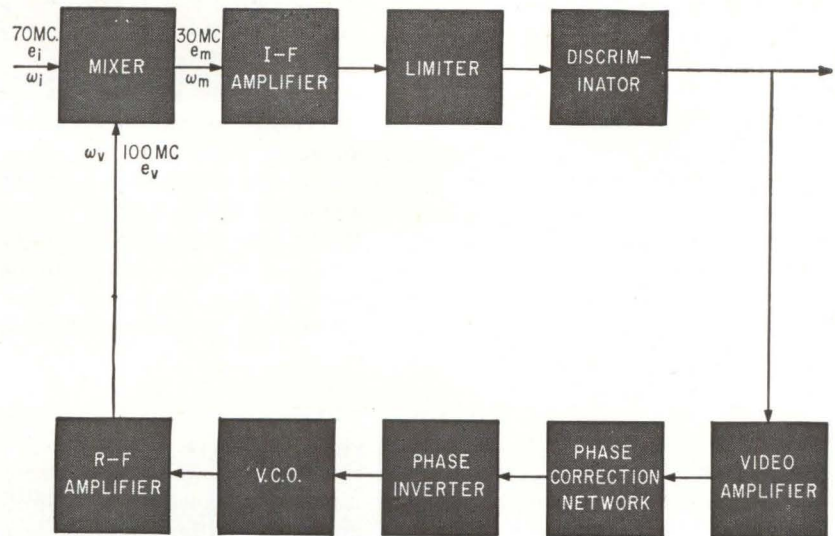

Fitting a Wide-Band Signal Into a Narrow-Band Receiver

Modulation index of an f-m receiver may be reduced with frequency-modulation feedback techniques. This enables a narrow-band receiver to make use of a wide-band signal without loss of sideband energy. Here is a method of reducing threshold effects using these principles

By S. KALLUS, B. RABINOVICI and A. NEWTON
Defense Electronics Products,
Radio Corporation of America, New York, N. Y.

FREQUENCY MODULATION offers an improvement in signal-to-noise ratio relative to a-m for modulation indices (β) greater than 0.6. However in conventional systems,

this improvement is accompanied by reduced threshold sensitivity because receiver bandwidth (and noise bandwidth) is proportional to the modulation index.

Wide transmission bandwidth¹ does not by itself impose a fundamental limitation on threshold sensitivity. In f-m, as in other systems, threshold sensitivity is related principally to intelligence bandwidth.

The f-m feedback principle (FMFB) has been studied^{1,2,3,4} as a way to reduce required receiver bandwidth. The method uses frequency feedback to reduce the modulation index in the receiver. This enables the transmission of a wide-band signal through a receiver of reduced bandwidth without loss of

sideband energy.

Receiver power sensitivity can be expressed as $S_i = K\eta\beta_r$, where η is the noise spectral density, K is between 15 and 20 and β_r is the receiver bandwidth. In conventional f-m systems, $\beta_r = 2f_m(1 + \beta)$, where f_m is the maximum modulating frequency; FMFB acts to reduce β , thus reducing β_r to $2f_m$ in the limit.

Frequency compression is shown in Fig. 1. Voltages e_i , e_v and e_m are the input, local oscillator and i-f voltages respectively. The frequencies associated with these signals are ω_i , ω_v and ω_m .

The system changes the local oscillator frequency $\Delta\omega_v$, due to a change in the i-f, $\Delta\omega_m$. Quantities

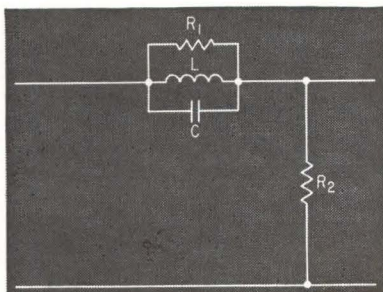

LAG-LEAD network corrects loop phase shift and improves stability — Fig. 2

$\Delta\omega_m$ and $\Delta\omega_v$ are in the same sense if $\omega_m = \omega_i - \omega_v$, and the opposite sense if $\omega_m = \omega_v - \omega_i$.

If loop gain $A_o = \Delta\omega_v/\omega_m$, the frequency changes are related by $\Delta\omega_m = \Delta\omega_i - A_o \Delta\omega_m$.

The i-f deviation is compressed relative to input signal deviation by $1/(1+A_o)$ that is, $\Delta\omega_m = \Delta\omega_i / (1 + A_o)$. Theoretically, the deviation can be reduced indefinitely by increasing loop gain. Subject to bandwidth limitations of the feedback loop, compression will be achieved for a band of modulating frequencies, and the modulation index will be proportionally reduced. In practice the amount of compression is limited by the stability of the loop and by threshold considerations.

PRACTICAL USE—A block diagram of the FMFB receiver used is shown in Fig. 1. This receiver has an intermediate frequency of 30 Mc, a baseband of 100 Kc, a modulation index of 4 and 20 db of loop gain. In the absence of feedback, the FMFB receiver reduces to a narrow band f-m receiver consisting of a mixer, i-f amplifier, limiter and discriminator. The feedback loop consists of a video amplifier fed from the discriminator output, a phase-correction network, a phase-inverting amplifier, a voltage-controlled oscillator (vco) and a r-f amplifier feeding back into the receiver. The overall characteristics of the FMFB system with closed loop provides wide-band signal transmission at the receiver input.

LOOP CIRCUITS—The mixer con-

sists of a 6AS6 pentode with a 70-Mc signal at the grid and a 100-Mc oscillator signal applied to the suppressor. The plate tank is tuned to the 30 Mc i-f and has a 6-Mc bandwidth to minimize modulation-envelope delay.

The narrow band i-f amplifier is a pentode with a high-Q (100) plate tank. This Q is attained by loosely coupling the coil to the pentode and feeding the plate of the tube through a shunt-connected r-f choke.

Limiting is accomplished by a pair of self-biased, double-ended diode clippers in the grid circuit of the discriminator driver tubes. The input impedance to the limiter is low and a buffer-amplifier is interposed between the i-f amplifier and the limiter diodes. The bandwidth of the driver is also 6 Mc wide to minimize its contribution to the phase-shift of the loop.

The discriminator uses two pentodes driving two tuned circuits, one of which is tuned above and the other below 30 Mc resonance. The detected outputs are subtracted, and an S curve with 8-Mc peak-separation is obtained. The detector time-constant is kept low, and requires a 30-Mc trap to filter out the carrier. The phase-shift contribution of the discriminator over the operating range is negligible.

The video amplifier consists of a high- g_m 6688 pentode with a small plate load and provides gain with wide bandwidth. The cathode is fed from a low-impedance voltage source. Cathode bias cannot be used since this would require a bypass

HOW FREQUENCY FEEDBACK REDUCES THRESHOLD

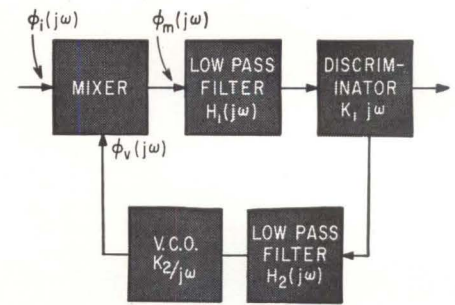

capacitor and cause severe phase-shift at low frequencies.

The lag-lead network of Fig. 2 corrects loop phase-shift and stabilizes the loop. The phase-inverting amplifier required for negative feedback drives the 100-ohm video input impedance of the succeeding vco.

The vco consists of a 3N35 silicon tetrode transistor connected as an oscillator as shown in Fig. 3. Video voltage is applied to the base thereby changing the collector-base capacitance (varying as V_o^{-1}) at a video rate. The result is a frequency-modulated oscillator that is voltage sensitive. Deviations of 1 Mc can be obtained without exces-

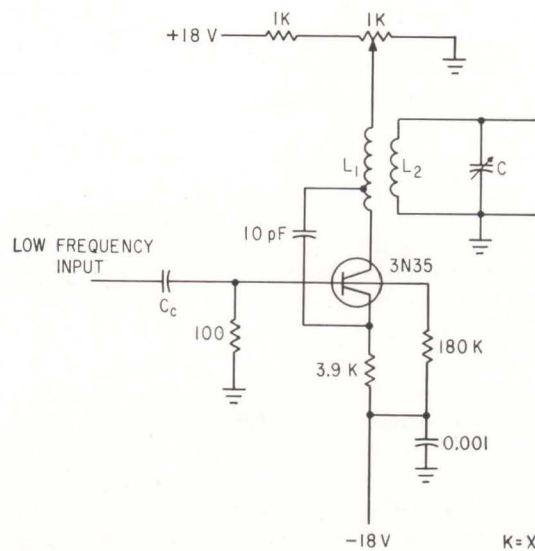

- LEGEND
- L₁—4 TURNS NO. 18 WIRE
1/2" DIAM. TAPPED
AT 1 1/4 TURNS
 - L₂—2 TURNS NO. 18 WIRE
1/2" DIAM.
 - C — TO RESONATE L₂
AT 100 MC.
 - C_c— COUPLING CAPACITOR

VOLTAGE-controlled oscillator uses a silicon tetrode transistor and operates at a frequency of 100 Mc—Fig. 3

Frequency modulation can improve signal-to-noise ratio as compared to a-m. In most systems, however, the improvement is degraded by reduced threshold sensitivity because receiver and noise bandwidths are related to the modulation index.

This system reduces the modulation index in an f-m receiver.

LOW-LEVEL CHARACTERISTICS—To express the response of the system to the modulating signal, let

$$\begin{aligned} e_i &= \cos [\omega_i t + \phi_i(t)] \\ e_v &= \cos [\omega_v t + \phi_v(t)] \\ e_m &= \cos [\omega_m t + \phi_m(t)] \end{aligned}$$

The radian frequency, ω , is defined by

$$\begin{aligned} \omega_i(t) &= d/dt[\omega_i t + \phi_i(t)] \\ \omega_v(t) &= d/dt[\omega_v t + \phi_v(t)] \\ \omega_m(t) &= d/dt[\omega_m t + \phi_m(t)] \end{aligned}$$

If $\phi_m(t)$ is reduced to a small value by feedback

$$\begin{aligned} e_m &= \cos [\omega_m t + \phi_m(t)] \\ &= \cos \omega_m t \cos \phi_m(t) - \sin \omega_m t \sin \phi_m(t) \end{aligned}$$

this reduces to

$$e_m \approx \cos \omega_m t - \phi_m(t) \sin \omega_m t$$

If $\phi_m(t)$ is a sinusoidal function of time given by

$$\omega_m(t) = \beta \sin \rho t$$

then

$$\begin{aligned} e_m &\approx \cos \omega_m t - \beta \sin \rho t \sin \omega_m t \\ &= \cos \omega_m t + \frac{\beta}{2} [\cos (\omega_m + \rho)t - \cos (\omega_m - \rho)t] \end{aligned}$$

The choice of the i-f, ω_m is inconsequential. If set equal to zero, the low-pass analog results, as shown in the diagram.

In the limit, as the gain is increased, the bandwidth requirements of the i-f filter $H(j\omega)$ used, must be compatible only with the baseband frequency, ρ . A significant quantity, with respect to the s/n ratio is the closed-loop bandwidth given by³

$$B_r = \left[\frac{1 + K_1 K_2}{K_1 K_2} \right]^2 \int_{-\infty}^{\infty} \left| \frac{K_1 K_2 H_1(j\omega) H_2(j\omega)}{1 + K_1 K_2 H_1(j\omega) H_2(j\omega)} \right|^2 df$$

where $(1 + K_1 K_2)$ is the amount of frequency compression. For large compression factors, the bandwidth of the $H_1(j\omega)$ filter can be reduced and the open-loop bandwidth can be reduced. The closed-loop bandwidth, however, increases relative to the open-loop bandwidth as gain is increased

sive distortion.

The r-f amplifier uses a 6688 pentode that provides the necessary voltage gain for the vco output to reach the level required by the mixer.

A plot of loop gain and envelope phase-shift response against frequency is shown in Fig. 4. A phase correction network was inserted in the loop between the video amplifier and inverter to obtain stable operation with a sufficient safety margin for an open loop gain of 17.5 db. The measured compression of the frequency deviation was 18.3 db, and the improvement in threshold sensitivity was 5 db. The improvement in threshold agrees well with

the calculated value.

The narrow-band i-f must be tuned to the carrier frequency, since any mistuning results in excessive phase-shift, and can cause instability.

LOOP STABILITY—As in any feedback system, stability is determined by the open-loop frequency and phase response. This includes a voltage to frequency transducer and a frequency to voltage transducer (discriminator).

CONCLUSIONS—The advantage of the high signal to noise ratio characteristics of a large modulation index, can be realized without

substantial degradation of threshold sensitivity. The degree of improvement realized in practice by the frequency-feedback technique, is proportional to the modulation index at the receiver input.

The authors acknowledge the contributions of J. Frankle and R. Fastrig to this work.

REFERENCES

- (1) J. Chaffee, Application of Negative Feedback to Frequency Modulation Systems, *B.S.T.J.* 18, 1939, p 404.
- (2) J. Carson, and T. Fry, Variable Frequency Electric Circuit Theory, *B.S.T.J.*, Vol 16, p 536.
- (3) L. Enloe, "Decreasing the Threshold in FM by Frequency Feedback, *Proc. of the IRE*, Jan 1962, p 18.
- (4) C. Ruthroff, F. M. Demodulators with Negative Feedback, *B.S.T.J.*, July 1961, p 1149.

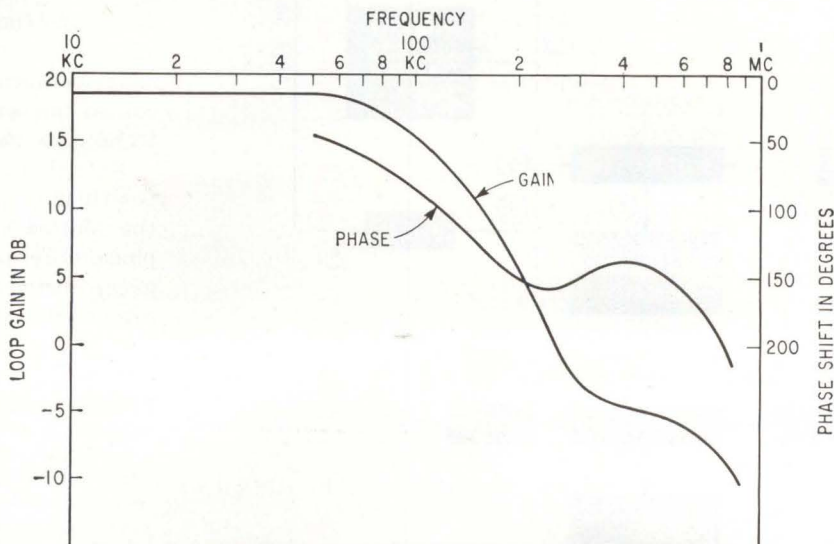

GAIN and phase response of the FMFB loop in terms of loop gain and frequency—Fig. 4

Describes several methods for measuring the difference in phase between microwave signals and for measuring the phase shift through microwave devices and materials. These methods are simple to apply and do not require expensive, specialized equipment

By IRWIN SHARE, Suffolk County Community College, Selden, N. Y.

Easy Ways to Make MICROWAVE

LABORATORY METHODS for measuring phase difference between coherent microwave signals can be classified as frequency-translating and nonfrequency-translating methods. A frequency-translating scheme first converts the microwave signal into a lower frequency and then compares the phase of the lower frequencies by simple techniques. A nonfrequency-translating (or direct) method compares phase at the microwave frequency. This article will discuss nonfrequency-translating methods.

GENERAL PRINCIPLES — The principle of the nonfrequency-trans-

lating method of measurement is that a standing-wave pattern results when two matched coherent signals are applied at opposite ends of a transmission line. Matching can be maintained by applying the signals through pads. The standing-wave pattern results from the combined effects of two coherent signals of the same frequency that are propagating in opposite directions. The position of the minimum (or maximum) on the standing wave pattern depends upon the phase difference between the two microwave signals. Relative phase difference readings are therefore proportional to the change in position between

respective minima (or maxima). The relative minimum reading rather than the relative maximum reading is preferable since minimum readings are sharply defined. This is especially true when the two signals being compared have the same amplitude. Thus, padding to equalize signal amplitudes can be used to improve the sensitivity of the measurement.

Once a method of achieving a calibrated reference minimum position is obtained, absolute phase difference readings can be taken. Various test procedures result from different methods of achieving a reference. This article discusses two techniques for obtaining a calibrated reference. Other modifications result from efforts to further improve accuracies, to increase resolution or to further simplify the test procedure. Still other modifications allow the techniques for measuring the phase difference between two signals to be applied to determine the phase characteristics of microwave structures. All possible modifications will not be discussed but some of the more basic techniques will be indicated.

Note that a shift in the minimum positions of β electrical degrees on the slotted line corresponds to a phase difference of 2β electrical degrees between electrical signals. Signals out of phase by 180 degrees

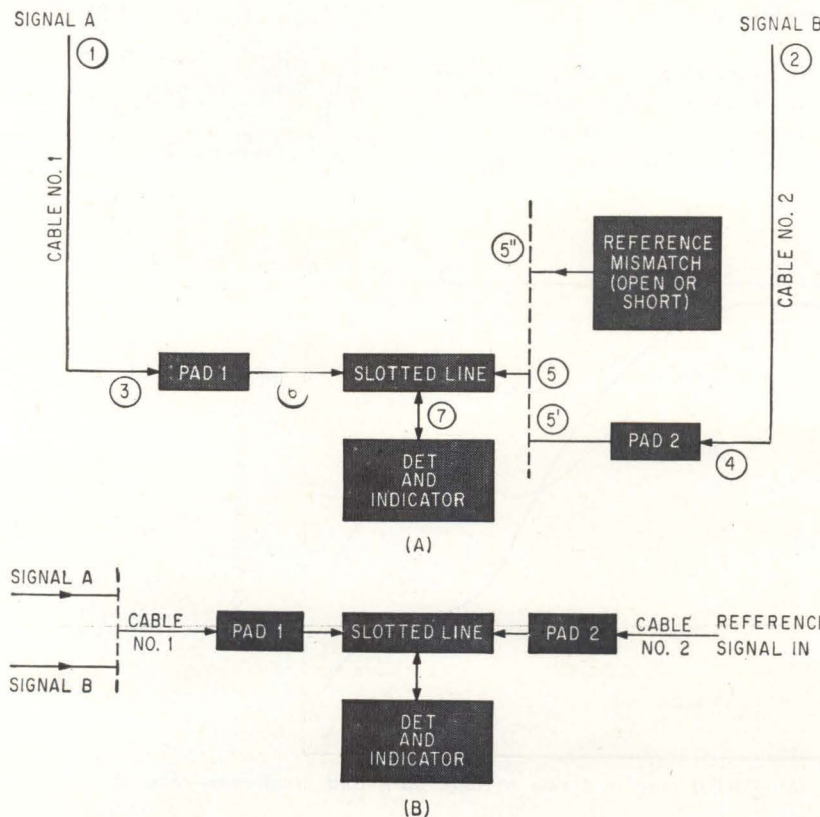

PHASE DIFFERENCE between signals A and B is measured in (A) by moving slotted-line probe after inserting signal B in place of the reference mismatch. Similar procedure is used in (B), but here a reference signal is compared to signals A and B alternately — Fig. 1

HOW TO USE IT

With inexpensive lab equipment, the phase-measuring techniques described here can be applied to pulsed microwave signals as well as c-w or a-m microwave signals. When working with extremely narrow pulse widths, keep the differential line lengths short to make sure that the pulses overlap within the slotted line

PHASE MEASUREMENTS

produce a minimum at a given position while signals in phase produce a maximum at the same position; these conditions are equivalent to a short circuit terminating and an open circuit terminating a slotted line, respectively; since a minimum and a maximum are only 90 electrical degrees apart on a slotted line, the slotted-line phase-difference positions must be doubled.

TEST PROCEDURES—The first method of obtaining a calibrated reference minimum position and performing measurements is shown in Fig. 1A. Signal A at point 1 and signal B at point 2 are the two coherent microwave signals whose phase difference is to be measured. For maximum sensitivity signal A and signal B should have the same amplitude. A reference minimum position on the slotted line is obtained by replacing pad No. 2 and cable No. 2 at point 5 by an open circuit or a short circuit termination 5". Any reactive mismatch whose phase characteristic is known could be used.

The minimum reference position corresponds to applying an in-phase signal (for the open circuit termination) or a 180 degree out-of-phase signal for the short circuit termination at point 5. A new minimum position is obtained with signal A applied to the slotted line through cable No. 1 and pad 1 while signal B is applied to the other end of the slotted line through cable No. 2 and pad 2. If the phase shifts in-

troduced by cable No. 1 and pad 1 were identical to the phase shifts introduced by cable No. 2 and pad 2, then the change in minimum position, together with the known phase characteristic of the reference termination, can be used to compute the absolute phase difference between signal B and signal A. If there is a differential phase shift introduced by the cables and pads, then this phase reading corresponds to the phase difference between signal B and signal A at point 5 and point 6.

Consider the case where the reference minimum is obtained with an open circuit termination at point

5. Let the frequency be f in cps and let the shift in minimum when both signals are applied, be d units closer to point 5. The guide wavelength, λ_g , is computed from

$$\lambda_g = \frac{\lambda_0}{[1 - (f_c/f)^2]^{1/2}}$$

where $\lambda_0 = c/f$ = the free space wavelength, c = velocity of light and f_c = cut-off frequency of the waveguide. For a dispersionless TEM line, the free space wavelength, λ_0 , is used. To convert the shifted length, d , into electrical degrees (β), use

$$\beta = \frac{360d}{\lambda_g}$$

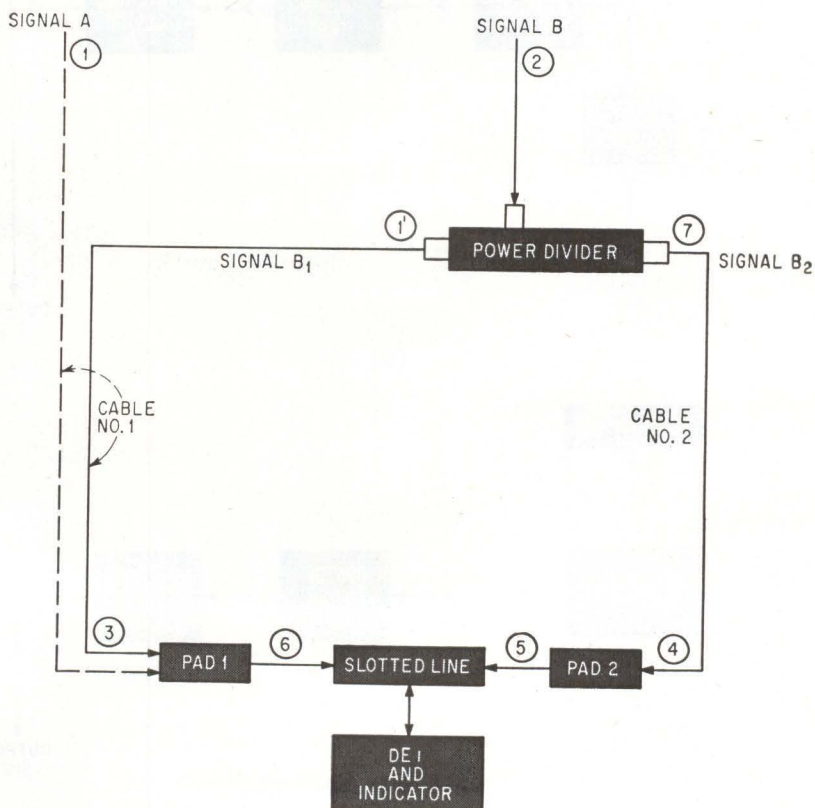

POWER DIVISION of signal B provides a reference signal for determining phase difference between signals A and B—Fig. 2

The phase shift, θ , between signal B and signal A at point 5 and point 6 is computed (assuming no differential phase shifts due to the paths)

$$\theta_{B/A} = \theta_r + 2\beta$$

where θ_r = reference phase shift (0 deg in this example) and $\theta_{B/A}$ = the phase of signal B relative to signal A at points 5 and 6. Note that the sign of β changes when the shifted distance, d , is in the opposite direction, that is, when the shift is in the direction of point 6.

If the phase shift between point 1 and point 6 is equal to the phase shift between point 2 and point 5, then the point-5-to-point-6 shift equals the phase shift between signal A and signal B at points 1 and 2. To correct for differential phase shifts, cable No. 1 and pad 1 are interchanged with cable No. 2 and pad 2 and a new set of readings are taken. The average of the two readings gives the correct phase difference between signal A and signal B in spite of differential phase shifts that can occur between the two signals. This error is averaged out.

The second measurement procedure is shown in Fig. 1B. Each of

the two coherent signals being compared are alternately applied to one end of a slotted line through the same pad and cable, while a coherent reference signal is applied to the other end of the slotted line. The change in the minimum position is used to compute the phase difference between the two signals. Differential phase shifts in the different signal paths have no effect on this measurement since each of the signals being compared against the reference signal are applied through the same cables and matching pad.

A coherent reference signal can always be derived from one of the signals by a power divider as shown in Fig. 2. A reference minimum is obtained by applying the same signal to both sides of the slotted line through matching pads. This minimum corresponds to the in-phase or zero degree position. In Fig. 2, the larger signal, signal B , is applied to power dividing network and signals B_1 and B_2 are derived. Signal B_1 is applied to the slotted line through cable No. 1 and matching pad 1; signal B_2 is applied to the slotted line through cable No. 2 and

matching pad 2. The minimum on the slotted line thus obtained corresponds to in-phase signals since the same signals are applied to the same line. Next, signal A is applied through cable No. 1 and pad 1. The change in the minimum position, d , is used to calculate the phase shift directly, since the reference position corresponds to zero degrees. The phase difference between signal A and signal B is $\theta_{B/A} = 2(360)d/\lambda$ in degrees; where λ is the wavelength in the slotted line, d is the shift in the minimum and is considered positive if shifts are toward point 5 and $\theta_{B/A}$ is the phase shift that signal B leads signal A .

APPLICATIONS — Some baluns have two single-ended outputs that ideally should be 180 degrees out of phase. The two grounds are tied together and the center conductors can feed an antenna in a balanced fashion. The antenna pattern of such an arrangement would depend upon the relative output phase of the outputs from the balun. The phase difference between the output signals from the balun could be measured directly by the previous techniques.

Measuring the phase shift across a two-port device will now be considered. The most important consideration in measuring phase shift between two-port devices is to obtain signals that are proportional only to the incident wave and the output wave. If this is not done, the phase of signal being measured is a function of reflections and substantial error can result. The effects of reflected waves can be minimized by improving the match that the input generator sees looking into the device, and the match that the output from the device sees looking into the load. Thus, matching pads or tuners can be used to improve accuracy of the measurement (Fig. 3A). An even better procedure is to use a high-directivity directional coupler at the input of the device to obtain signals that are propor-

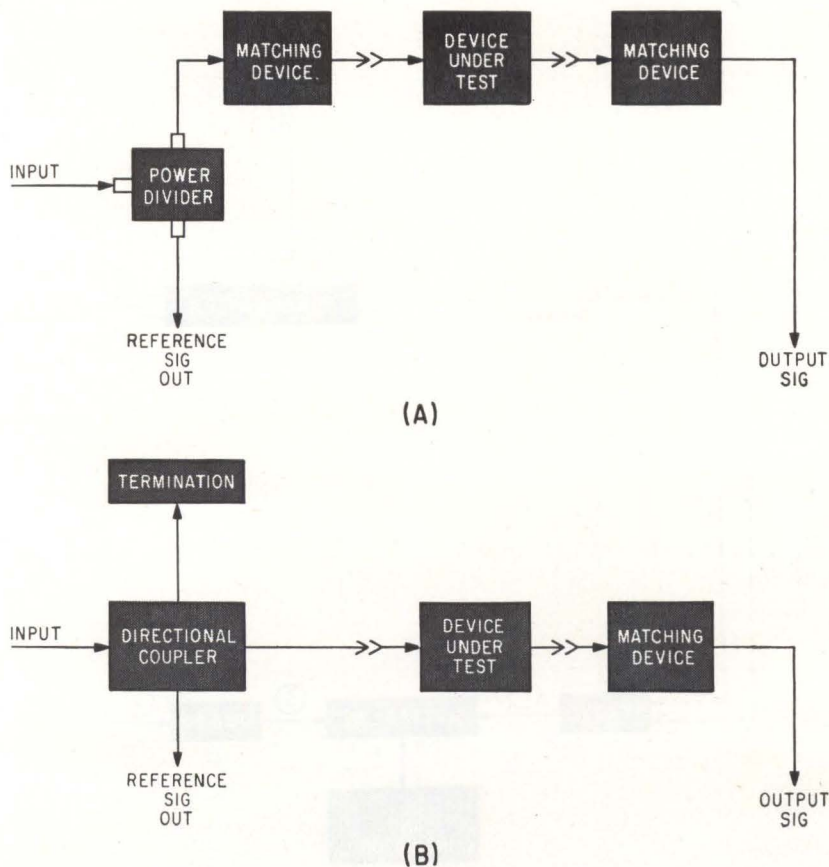

PHASE SHIFT through a microwave device is measured in both (A) and (B); power divider provides phase reference in (A) and directional coupler provides phase reference in (B)—Fig. 3

tional to the input (see Fig. 3B). When performing the phase measurement, a reference reading is taken without the device in the test configuration and the relative change in phase is measured with the device in the system. This procedure tends to cancel errors due to line length.

MEASUREMENT ERRORS—Several sources of error exist in the above methods for measuring the phase difference between two microwave signals. Some errors are obvious to anyone familiar with the lab equipment being used; other errors, which are more subtle and thus likely to be overlooked, will be discussed in this section. It is assumed that the slotted line is dispersionless, well matched to the system, free from slope effects and free from internal discontinuities. In addition, it is assumed that the generator is well padded and free from harmonics or that external filtering and matching are used.

Reflections from small discontinuities and mismatches are often thought of as second order effects, but when measuring the phase difference between two coherent microwave signals it is a major source of error. This will be shown with the aid of Fig. 4, which shows a typical standing-wave pattern (Fig. 4A) and crank diagrams (Fig. 4B and C). As shown in Fig. 4B, the position of minimum amplitude, which contains the phase information, corresponds to vector subtraction of the two signals on the slotted line. In Fig. 4B and C, the large broken-line circle shows the locus of all possible phase angles. If reflections exist they can be combined into an error voltage, E_r , which can be considered as rotating at the tip of the second voltage, E_2 (Fig. 4C). At the minimum position the two main voltages almost cancel and the effect of the small error voltage predominates. The worst error can occur in the position shown in Fig. 4C. As shown, the phase-angle error that results is θ_E . If the error voltage due to reflections is small and E_1 is almost equal to E_2 , the vector triangle can be approximated by a right triangle and the phase error can be approximated by $\theta_E = \tan^{-1}$

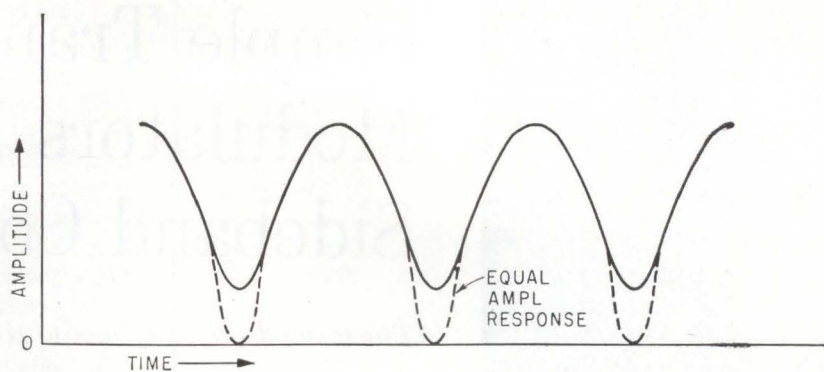

(A)

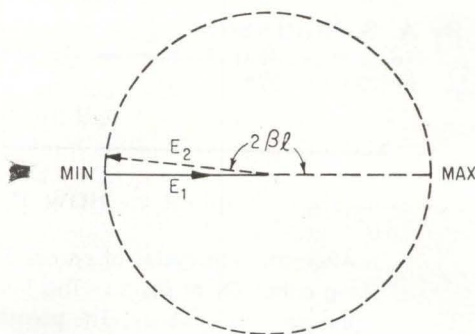

(B)

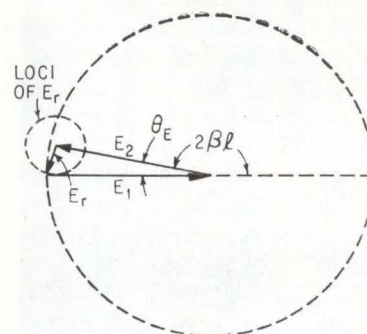

(C)

STANDING WAVE PATTERN in (A) is formed by combination of two signals; broken-line extension shows minima that would be obtained if two signals have equal amplitudes. Crank diagram in (B) shows vector addition of signals E_2 and E_1 ; (C) shows how reflections (E_r) also add, cause error in phase reading—Fig. 4

E_r/E_1 . An alternate approximation which can be used for $E_1 \approx E_2$ and small E_r is to assume that E_r is correctly given by the arc of the circular locus of the cord. Then $\theta_E = E_r/E_1$, where θ_E is in radians. This approximation is not in disagreement since for very small angles $\tan \theta \approx \sin \theta \approx \theta$ radians.

Reasonably small vswr's can cause phase errors of several degrees. A similar argument can show that other reflections in other places in the test configuration such as at the input and output of the two port device that is being measured can introduce similar phase errors. Here

$$\theta_E = \tan^{-1} \frac{E_2}{E_1} \Gamma_i = \tan^{-1} \frac{E_1}{E_1} \Gamma_o$$

where Γ_i is the input reflection coefficient, Γ_o is the output reflection coefficient and E_1 and E_2 are the

sampled signals at the input and output of the device, respectively.

BIBLIOGRAPHY

- Sparks, Microwave Phase Measurements, *Microwaves*, Jan. 1963.
- P. Lacy, A Versatile Phase Measurement Method for Transmission Line Networks, *IRE Trans on Microw Th and Tech*, MTT-9, Nov. 62.
- P. Lacy, Analysis and Measurement of Phase Characteristic in Microwave Systems, *IRE Wescon Record*, Aug. 1961.
- Robertson, A Method of Measuring Phase at Microwave Frequencies, *BSTJ*, 28, p99-103, Jan. 1949.
- Schafer, A Modulated Subcarrier Technique of Measuring Phase Shifts, *IRE Trans on Instr*, 1-9, p217-219, Sept. 60.
- Finnila, Roberts and Susskind, Measurements of Relative Phase Shifts at Microwave Frequencies, *IRE Trans on MTT*, MTT-8, p143-6, Mar. 1960.
- Klander, Price, Darlington and Albersheim, The Theory and Design of Chirp Radars, *BSTJ*, 39, p745-808, July 1960.
- W. H. Van Auleck, Properties of Phased Arrays, *Proc IRE*, 48, p1715-1727, Oct. 1960.
- Magid, Precision Microwave Phase Shift Measurements, *IRE Trans on Instr*, 1-7, p321-331, Dec. 1958.
- Mathers, Homodyne Generator and Detection System *IRE Wescon Record*, PA 1, p184-200, 1957.
- Swarup and Yang, Phase Adjustment of Large Antennas, *IRE Trans on Ant and Prop*, AP-9, p75-81, Jan. 1961.
- Johnson, "Transmission Lines and Filters."

Simple Transistor Modulators Improve Sideband Communications

These modulator-demodulator circuits for telephone carrier communications suppress carrier leak better than conventional diode circuits

By A. S. ROBINSON
Telephone & Electrical Industries, Pty. Ltd.,
Sydney, Australia

HOW IT WORKS

Alternate half cycles of carrier f_c short-circuit input f_s by switching either Q_1 or Q_2 on. This interrupts modulation voltage f_s at the carrier frequency. The polarity of input f_s determines whether Q_1 or Q_2 goes fully on. For example, if the upper line of input f_s , which is connected to the emitter of Q_2 and the collector of Q_1 , is positive, only Q_2 is turned on (and off) at the carrier rate

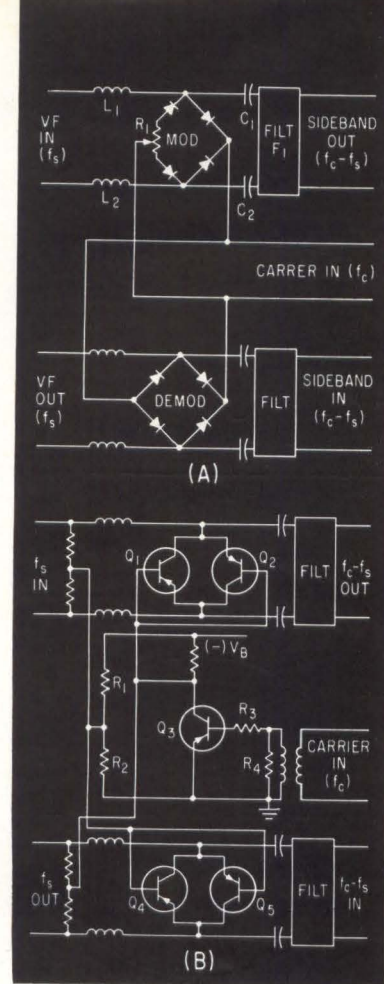

MODULATOR - DEMODULATOR circuits shown in (A) use diodes; improved circuits (B) use transistors

MANY carrier telephone systems use diode modulators and demodulators with crystal filters to produce a group of 4-Kc channels in the 60 to 108-Kc band.

A conventional arrangement for one channel is shown simplified in (A). Here voice-frequency (vf) signals are applied to a Cowan shunt modulator. Crystal filter F_1 selects the lower sideband for transmission. Carrier leak is partially suppressed by the filter but is usually minimized by diode selection (quadding) and adjustment of R_1 . Selection procedures are expensive and the degree of balance required is hard to maintain throughout the life of the equipment. Inductors L_1 and L_2 and capacitors C_1 and C_2 provide reactive terminations for the modulator, minimizing conversion loss. Receiver demodulator is similar, but doesn't usually incorporate carrier leak adjustment beyond normal diode quadding.

Carrier frequencies for banks of channel equipment are usually supplied from a master generating rack equipped with distribution networks but carrier voltage is only about 0.3 volt at the modulators. At this low level, modulators tend to be sensitive to temperature variations and drifts in carrier level. Overload characteristics of modulators are poor, leading to speech-immunity problems with inbuilt tone-signaling equipment.

The simple modulator (B) overcomes these difficulties. It comprises a pair of r-f transistors (Q_1 - Q_2) connected back to back and driven from a carrier-squaring amplifier (Q_3).

Transistors Q_1 - Q_2 form a shunt modulator and Q_1 - Q_3 the corresponding demodulator. If $R_1 = R_2$ the standing bias in the modulator is $\frac{1}{2} V_B$ while the input carrier drives the collector of Q_3 from 0 through V_B volts. Thus the bases of the

modulator transistors are driven by a square wave of peak-to-peak amplitude V_B that is independent of carrier level over a wide range. Resistors R_3 and R_4 set the drive to Q_3 while masking base-input-impedance variations. This allows carrier input impedance to be well defined. Modulator Q_1 - Q_2 and demodulator Q_1 - Q_3 are driven in opposite phase to equalize the load on Q_3 .

The modulator, which uses OC44 germanium transistors, will tolerate carrier-level variations of ± 6 db about normal and is insensitive to temperature variations over a range 0 to 50 C. Carrier leak is better than 30 db below sideband level, without transistor selection. Voltage V_B , normally 5.6 volts, is obtained from a zener diode used for decoupling other panel components. Low carrier power permits three times as many panels to be fed from existing distribution as the conventional method.

New from Cubic Corporation . . . creator of the reed relay digital voltmeter!

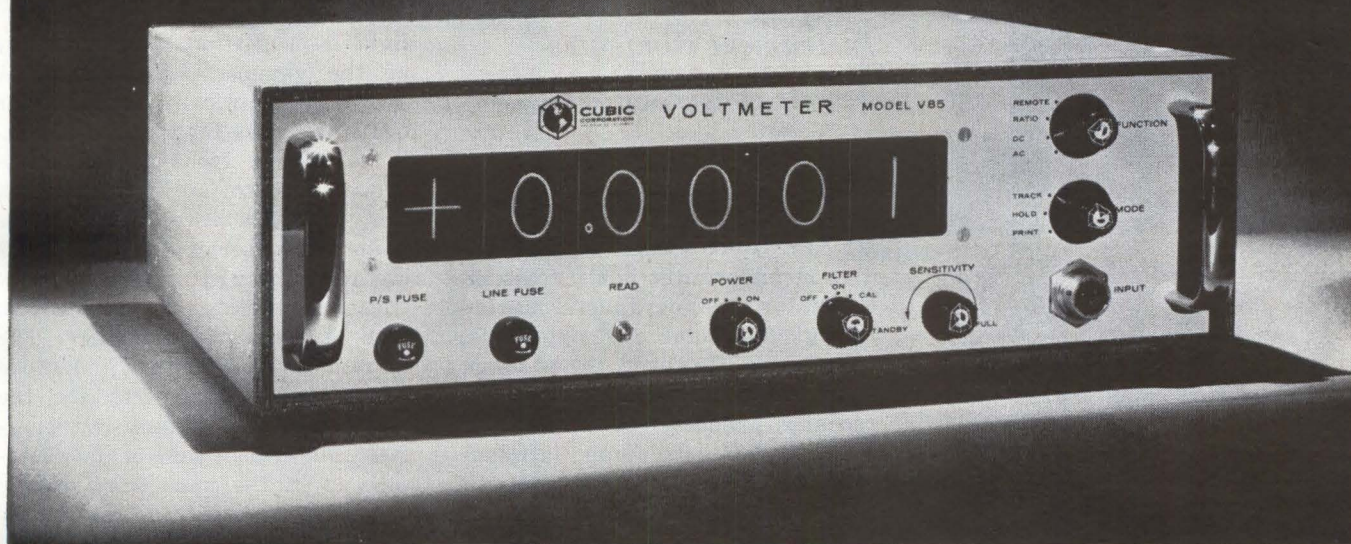

Announcing the Cubic 5-digit reed relay voltmeter

From Cubic Corporation, the originator of the reed relay concept for digital voltmeters, comes a new instrument destined to take a major place in the Cubic line of quality DVM's. It's the V-85, a true 5-digit, reed relay voltmeter that incorporates a unique new concept in the bridge circuit for unparalleled accuracy.

The V-85 is *not* a stepping switch meter that was redesigned to use reed relays. It is an all new *true* 5-digit instrument planned specifically to take full advantage of the long life and outstanding performance features of the reed relay. Features include built-in print controls, front and rear input, 100-microvolt sensitivity. The encapsulated, advance-design reed relays give 3 readings per second without noise or maintenance. For easy access, top and bottom are removable with $\frac{1}{4}$ turn fasteners and all circuits are on plug-in boards with built-in extractors. Buffer modules for use with a wide variety of output devices are available. Capable of remote programming for systems use. For detailed information, write to Department B-126.

SPECIFICATIONS

Accuracy: .01% ± 1 digit (of reading)

Reference Stability: .005% per month; .01% 1 year; temperature coefficient .0002%, 15°C to 45°C

Input: Full-floating, 10 megohms at balance, 1 megohm minimum, 1000 megohms on ratio and low range

Balance Time: 300 msec average, 600 msec maximum

CMR: 80 db at 60 cps

Power: 40 VA, 50-400 cps, 115-230 V

Ranges: DC Volts ± 0.0001 to ± 9.9999 , ± 10.000 to ± 99.999 , ± 100.00 to ± 999.99 ; DC-DC Ratio .00000 to .99999 (bi-polar)

Functions: AC, DC, Ratio, Remote

Automatic Features: Range, Polarity



CUBIC CORPORATION
SAN DIEGO 23, CALIFORNIA

SEE US AT THE I.E.E.E. SHOW IN BOOTHS 3054 AND 3055

New Underwater Gamma Spectrometer

By GORDON K. RIEL

U. S. Naval Ordnance Laboratory, Silver Spring, Maryland

*Instrument eliminates
sample collecting and
laboratory analysis*

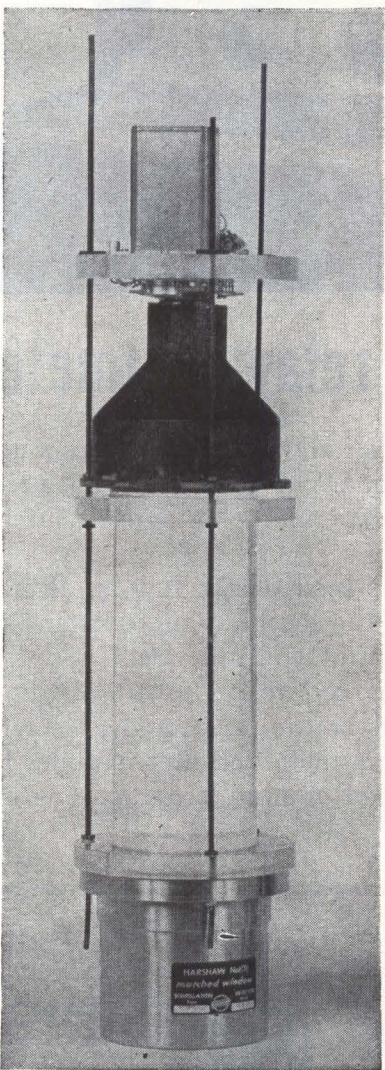
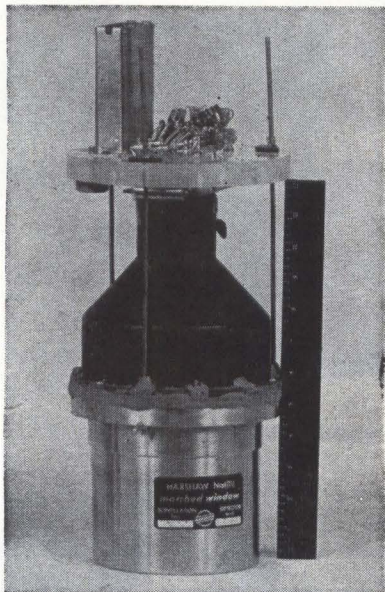

SPECTROMETER, showing scintillation detector that uses a single NaI crystal, with electronics mounted on top—Fig. 1

MEASUREMENT OF GAMMA radiation underwater holds great interest for oceanographers, marine biologists, cosmic ray physicists, and others. However, the problem had received little attention until recently, primarily because of the difficulty of developing satisfactory instrumentation.

To measure the spectrum of gamma radiation underwater, it was necessary to package the components of a laboratory-type precision scintillation spectrometer for remote use in the ocean. The electronic problems to be solved included: provide a stable (± 0.01 percent) high voltage supply for the phototube, provide a linear current amplifier to drive a mile of coaxial cable, and provide sufficient electrical power for at least eight hours of operation. Practical considerations required that this device operate from a single-conductor coaxial cable.

DETECTOR TUBE—The scintillation spectrometer developed at the Naval Ordnance laboratory consists of a detector (scintillator), phototube, amplifier, and pulse height analyzer. This system uses a five-inch-diameter by six-inch-long single crystal of NaI(Tl) for the detector. For each gamma ray captured by the crystal, a pulse of light is produced which lasts for about $\frac{1}{4}$ microsecond. The frequency of the light is an inherent property of the crystal. The intensity of the

light is proportional to the energy of the gamma ray captured. A phototube is optically coupled to the detector. Since the number of electrons emitted from its cathode is proportional to the light intensity, the current is proportional to the gamma-ray energy. These electrons cascade through ten secondary emission surfaces (dynodes) with a gain of six to ten per stage. The current in each pulse at the anode is several microamperes for the usual range of gamma-ray energies. The transit time of the phototube is in the nanosecond range, and since this is faster than the relaxation time of the scintillator, each gamma ray captured in the crystal gives only one pulse at the phototube anode. Thus the height of each pulse is proportional to the energy of the gamma ray producing it. The pulse duration is in the microsecond range, so that current amplification is required if more than a few feet of signal cable is used. The multichannel analyzer measures the height of each pulse and remembers it. After several thousand pulses have been sorted, the energy spectrum of the radiation captured by the detector is obtained by reading out the analyzer's magnetic core memory.

PHOTOTUBE CIRCUIT — The final design (block diagram, Fig. 2A) was made possible by the use of a high-output phototube. The EMI 9579 phototube was chosen for its superior energy resolution. This phototube's peak linear output current of 50 milliamps is 1,000 times that of the tube previously used. This gives adequate pulse height for analysis across a 50-ohm cable load resistor, so that no signal am-

can you use the advantages of Kepco's
AUTOMATIC VOLTAGE-CURRENT CROSSOVER

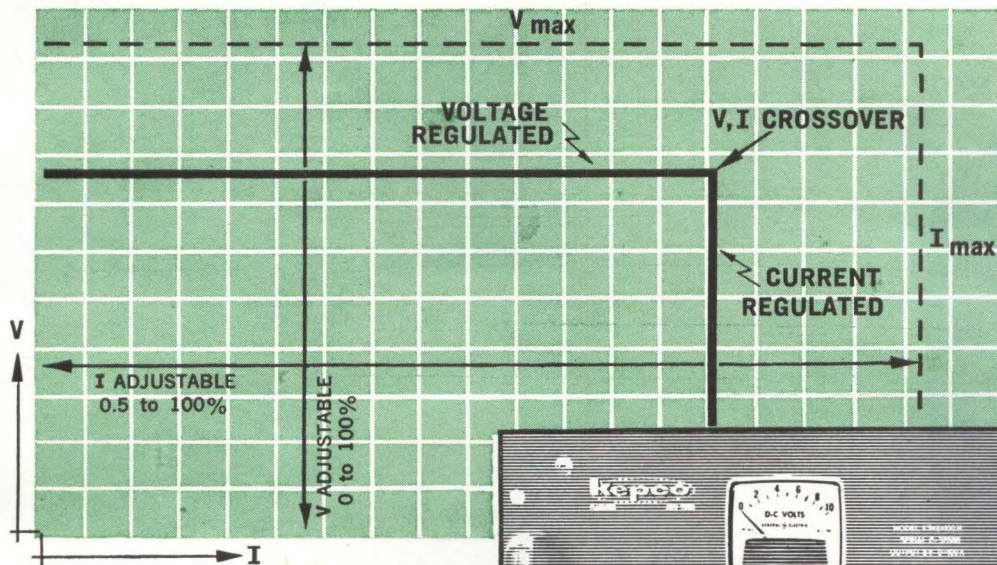

KEPCO



POWER SUPPLIES

Automatic Voltage-Current Crossover is the characteristic of a power supply that automatically changes the method of regulation from *constant-voltage* to *constant-current* (or vice-versa), as dictated by varying load conditions. The constant-voltage and constant-current levels can be independently adjusted within their specified voltage and current limits. The intersection of the constant-voltage and constant-current lines is called the crossover point (V,I, as shown in the graph above), and may be located anywhere within the volt-ampere range.

Kepco's KS Group of HIGH-POWER, highly regulated DC power supplies provides two panel control

knobs that allow *automatic crossover* to be set from less than 0.5% to 100% of rated current and 0 to 100% of rated voltage.

- Programming of output voltage
- Programming of output current
- Remote error signal sensing
- High resolution adjustment
- No voltage overshoot

0.01% REGULATION and STABILITY	MODEL	DC OUTPUT RANGE		PRICE
		VOLTS	AMPS	
	KS 8—100M	0—8	100	\$1,395
	KS 18—50M	0—18	50	\$1,295
	KS 36—30M	0—36	30	\$1,195
	KS 60—20M	0—60	20	\$1,295

for complete specifications on more than 250 standard models, write for NEW Catalog B-631



131-38 SANFORD AVENUE • FLUSHING 52, N.Y., U.S.A.
 N.Y. Phone (212) IN 1-7000 • TWX# (212) 539-6623
 Cable Address: KEPPOWER NEWYORK

VISIT US AT IEEE BOOTH NOS. 2636-2638



ratio
with
one-finger
control

Unique thumb-wheel operation and in-line readout permit ease of setting even under severe field conditions. Sealed switch modules and environment-proof case make these Ratio Boxes ideal for rigorous GSE and commercial applications. In addition to high readability and accuracy in minimum space, they provide previously unavailable design and performance features:

- Four digit in-line readout
- Ratio range to 1.1110
- Accuracy 10 ppm
- Frequency range to 10 kc
- Series impedance as low as 0.8 ohm
- No switching transients
- Splash and drip-proof design
- Meets rugged MIL requirements

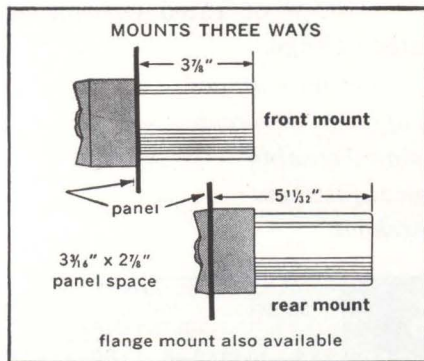

For complete data,
write today for Bulletin RB520/521



NORTH ATLANTIC
industries, inc.

TERMINAL DRIVE, PLAINVIEW, L.I., NEW YORK
Telephone: OVerbrook 1-8600

See us at IEEE-Booth 3939

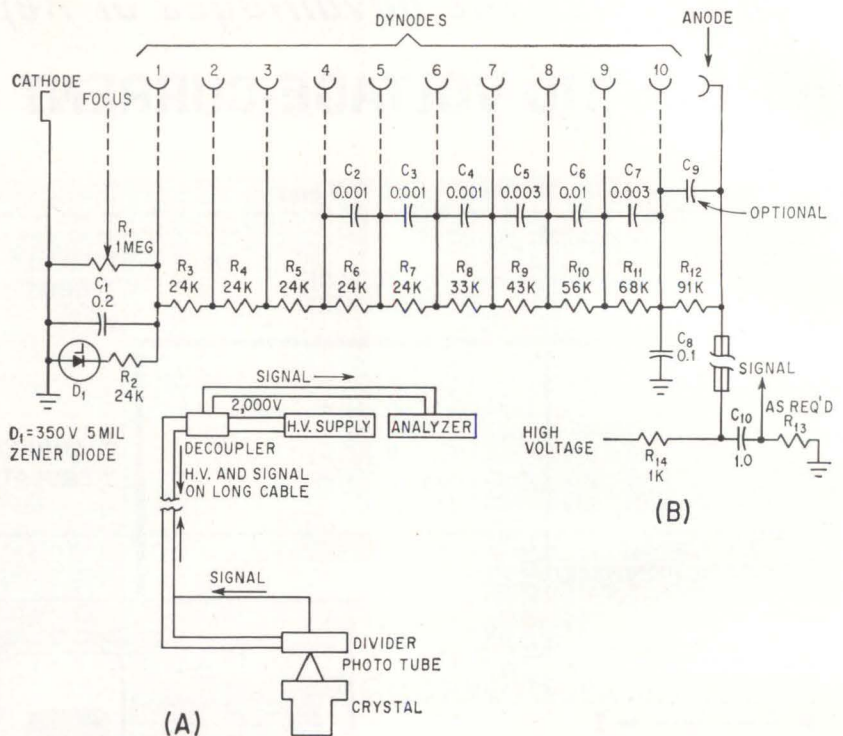

CIRCUIT block diagram, (A), shows that only a minimum of equipment is on submerged end of single-conductor coaxial cable. Circuit diagram (B) is final version of divider—Fig. 2

plification is required. A pulse shaping capacitor C_9 , Fig. 2B, of $0.01 \mu\text{f}$ is required for this low impedance. With this circuit a pulse height of approximately 0.1 volt is obtained from a 0.662 Mev gamma (Cs^{137}) source with 2,000 volts on the phototube. The elimination of amplification results in the simple system shown in Fig. 1 and 2. Variations of this circuit have been used with EMI phototube types 9579 and 9530, and with CBS phototube type 7819. This very simple design has been in use for over a year with

very good results. This design will be useful wherever space and weight are limited. It is also useful where reliability is a problem, for instance when large arrays of phototubes are used with liquid scintillators. The advantages of eliminating tens or hundreds of preamplifiers are manifold.

Servo Controls Helium-Neon Gas Laser Output

LOS ANGELES—Closed-loop control to keep a helium-neon laser's output at maximum intensity was reported recently as one of the new crop of practical laser applications.

The servo system automatically aligns the laser's cavity mirrors to minimize the effects of thermal and seismic disturbances, according to H. A. Gustafson and J. E. Killpatrick of Minneapolis-Honeywell. Thermal and magnetostrictive transducers are used for two-axis control of the driven mirror.

In the future the control concept may be extended to control laser

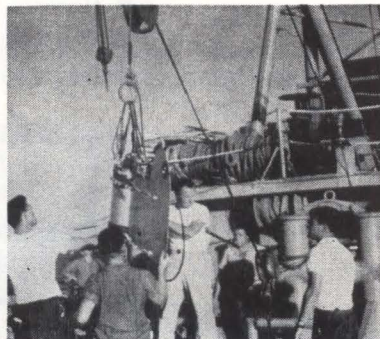

UNDERWATER INSTRUMENT shown in practical use, just before going overboard

cavity length. Photoelectric mixing of the axial modes, they predict, can produce control signals for three transducers in parallel; mirror alignment can be controlled at the same time.

TECHNIQUE—The signal from a lead-sulfide photosensor monitoring the laser's output is fed through a preamplifier and a tuned amplifier (see Fig. 1) that rejects disturbances, such as intensity modulation due to variations in r-f pumping, that might cause spurious mirror motion.

Since response times of thermal and magnetostrictive effects differ, and since both are used for adjustment in each axis, a division of control between the two effects is used.

The synchronous demodulator has a reference input of 1,350 cps in one axis and 2,800 cps in the other. The d-c amplifier passes frequencies of 0 to 0.1 cps to the thermal loop, and the a-c amplifier al-

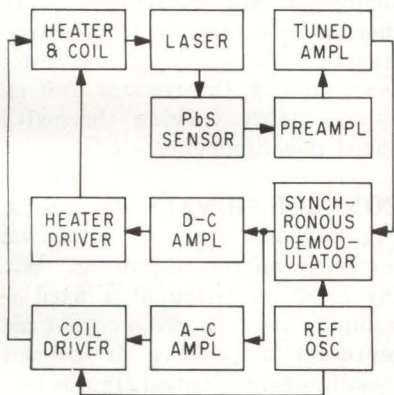

SERVO circuit block diagram—
Fig. 1

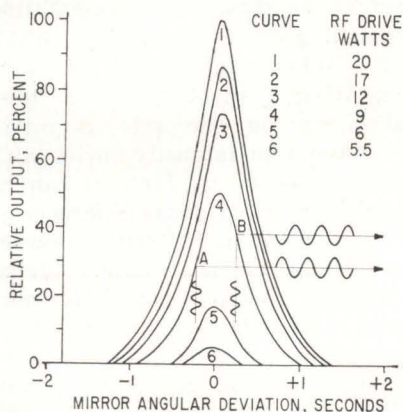

LASER OUTPUT plotted against alignment—Fig. 2

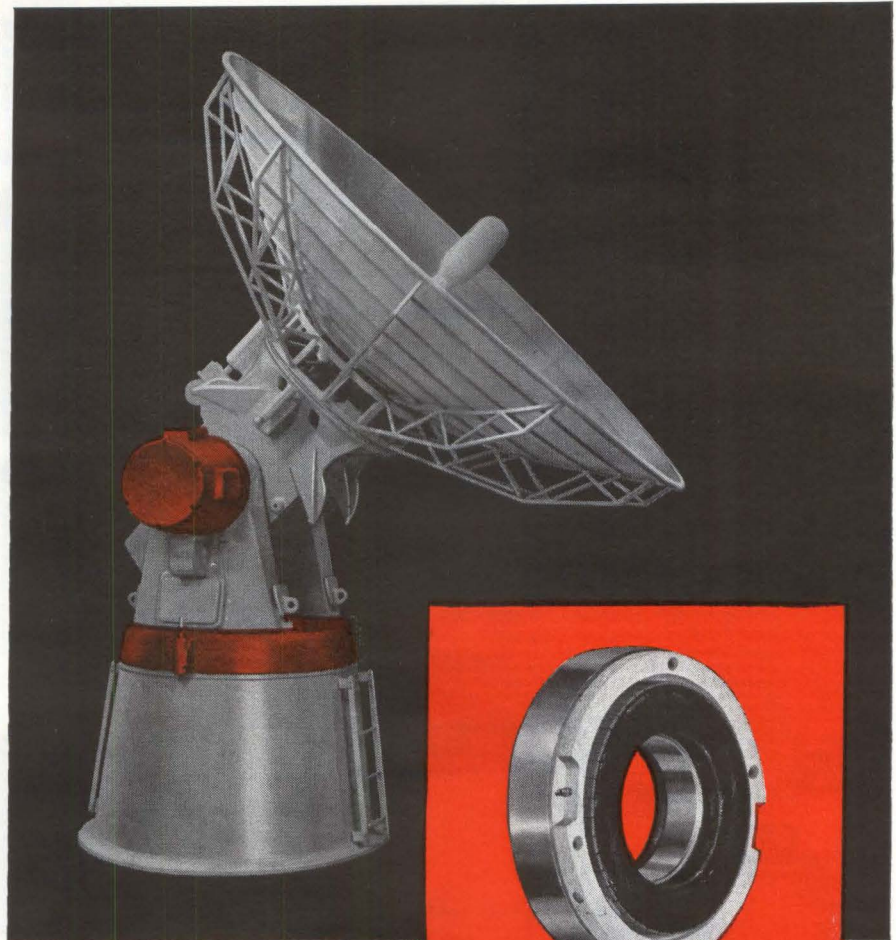

Photo by Reeves Instrument Corporation
Garden City, New York

Inland Gearless Torquers give 2-axis precision to Reeves Radar Pedestals

Precision Radar Pedestals . . . manufactured by Reeves Instrument Corporation, Subsidiary of Dynamics Corporation of America . . . play vital roles in major satellite and missile programs. Designed to accommodate reflectors up to 30-feet in diameter, they feature 5-second angular accuracy, azimuth load bearing ratings at 250,000 pounds and tracking rates from zero to 10 rpm in azimuth and from zero to 1/2 radian/second in elevation.

Accurate 2-axis servo-positioning of these Reeves Pedestals is effected by Inland Gearless Torquers ranging in torque output from 500 to 3,000 pound-feet.

Fast, high-resolution response to servo-position error signals is a major reason why Inland Gearless Torquers win so many missile and space-vehicle assignments. The superior performance of these direct-drive d-c torque motors comes from torque-to-inertia ratios 10 times higher than equivalent gear-train servo motors. Moreover, their compact pancake configuration meets space and weight restrictions.

What's your problem? If you're currently planning a servo system calling for output torque between 20 ounce-inches and 3000 pound-feet*, compare Inland Gearless Torquers with any alternative. Write for all the facts today, 347 King Street, Northampton, Massachusetts.

*Higher torque output levels can be provided on special order.

 **INLAND MOTOR**
CORPORATION
SUBSIDIARY OF **KOLLMORGEN**

FLIGHT	ARRIVE	DEPART	GATE	REMARKS	FLIGHT	ARRIVE	DEPART
845	12:15	1:30	E2	NOW BOARDING	439	1:45	
753	12:40	1:30	E5	NOW BOARDING	203	1:45	
837	12:25	1:30	F1	NOW BOARDING	164		2:15
214		1:30	F3	NOW BOARDING	238		2:15
411	12:45	1:35	E4	NOW BOARDING	488		2:15
756	1:10	1:35	F5	NOW BOARDING	614		2:15
603				CANCELLED INBOUND	206		2:15
728	1:45	2:15	F2	BOARDING AREA OPEN	486		2:15
838	4:30			INBOUND SECTION	604	2:30	
838				CANCELLED OUTBOUND	604		3:15
150		2:20		WASHINGTON & INT STOP	167	2:40	
646	1:35	2:25			656	2:50	



BARBER-COLMAN MICROPOSITIONER®

Ultrasonic relays

HELP FLIGHT INFORMATION BOARDS GO ELECTRIC

Passenger communications keep pace with the jets scheduled out of United Air Lines' lobby at the new O'Hare International Airport, Chicago. Flight information appears on General Indicator Corporation display boards—through back-lighted photo-teletapes.

For each of 72 teletapes, a Barber-Colman Micropositioner polarized relay "reads" new data remotely key-punched into the system—then automatically positions any one of 40 possible tape legends into exact alignment on the board . . . in seconds.

If you can add value to your equipment by eliminating costly electronic gear—yet retain dependable, ultra-sensitive control—investigate the versatility of Barber-Colman Micropositioners. Write for free, 8-page Control Applications Bulletin.

Barber-Colman Micropositioner polarized d-c relays operate on input power as low as 40 microwatts. Available in three types of adjustment: null-seeking, magnetic-latching "memory," and form C break-make transfer. Also transistorized types with built-in preamplifier.



BARBER-COLMAN COMPANY

Dept. N, 1859 Rock Street, Rockford, Illinois

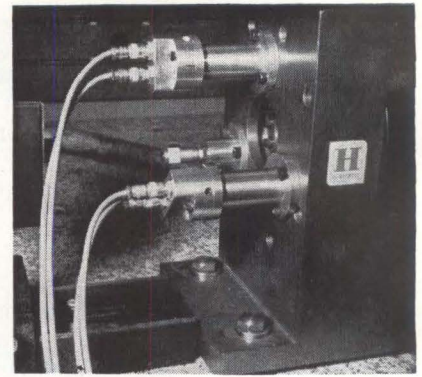

TWO TRANSDUCER assemblies are shown mounted on the end of laser, right

lows signals from 0.1 to 30 cps to pass to the magnetostrictive loop.

Each transducer assembly (see photo) is a $\frac{1}{4}$ -inch-diameter hollow nickel rod, rigidly fixed at one end and surrounded by a coil. Its extensional motion positions the mirror. Higher frequencies from the magnetostrictive loop pass through the coil. In the core of each rod is a chain of heater resistors for controlling the thermal expansion. Thermal effect due to a change in coil current is compensated by a change in the current from the thermal loop through the resistors. Having a thermal time constant of four minutes, the resistor unit can handle slowly varying thermal-induced misalignments.

CONTROL SIGNALS—Graph (A), Fig. 2, shows how laser output varies with mirror alignment. With the laser operating at a fixed r-f pumping input, a given output may represent a positive or negative misalignment. Control signals bearing the proper polarity are generated by detecting the slope of the curve at any given point. This is done by introducing small dither signals as shown at representative operating points A and B in Graph (B). When dither signal $\theta(t)$, representing a small sinusoidal misalignment in one axis, is introduced, output intensity varies with time as shown by $I(t)$. It can be seen that output phase difference at the two points is 180 deg. Phase relationship of the output signal points to a positive or negative misalignment, and signal amplitude is proportional to the slope of the curve at the operating point. Enough information is thus provided for control loop operation.

REDUCE HEATING PROCESS COSTS



GOF Electric Oven

CUBIC OVEN DESIGN

with
CHOICE
of
GAS FIRED
ELECTRIC
OVENS

OFFERS QUALITY FEATURES AT LOWEST COST

- Controlled Temperatures to 1200°F.
- Forced Air Re-circulation-Direct Drive Fan
- Steel Inner and Outer Casing
- Hinged Door w/Explosion Release Latch
- 1 to 96 cubic foot Size Range
- Wide Selection of Optional Features
- TRENT "Folded and Formed" Electric Heating Element or Minitrimer Gas Burner

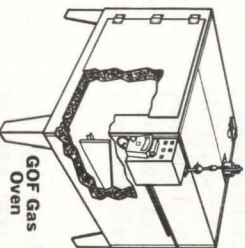

GOF Gas Oven

WRITE FOR BULLETIN 71-TH Electric or BULLETIN GOF Gas

Let TRENT ENGINEERS study your needs and determine the type of oven best suited for your use.

2028

TRENT

203 Leverington Ave., Philadelphia 27, Pa.
Electric & Gas Heated Industrial Equipment

In Canada: Pioneer Electric Eastern Ltd., Toronto

CIRCLE 202 ON READER SERVICE CARD

IEEE MEET

THE BEST BRAINS,
THE BEST PRODUCTS
IN THE INDUSTRY

at

I-TRIPLE-E's

International Convention
and Exhibition in New York

MARCH 25, 26, 27, 28

The COLISEUM at Columbus Circle
& The WALDORF ASTORIA HOTEL

admission: MEMBERS \$1.00; NON-MEMBERS \$3.00
MINIMUM AGE: 18

SHOW

(formerly the IRE Show)

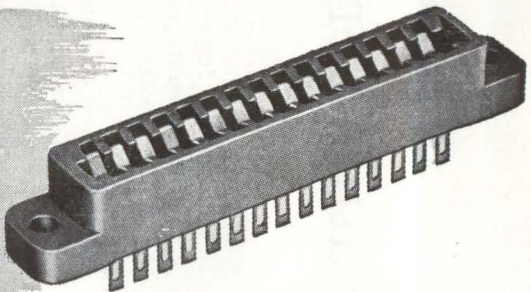

Illustrated literature
and technical
data are available
upon request.



Methode
Electronics, Inc.
7447 West Wilson Avenue
Chicago 31, Illinois



COMPARISON CHART METHODE RELI-ACON CONNECTORS Vs. COMPARABLE COMPETITORS' CONNECTORS

TESTS PERFORMED MIL-C-21097 (SHIPS)*	METHODE	CONNECTOR "A"	CONNECTOR "B"	CONNECTOR "C"	CONNECTOR "D"
Paragraph 4.4.3 High potential	2,200 V.DC Sea Level 585 V.DC 70,000 Ft.	2,000 V.DC Sea Level 525 V.DC 70,000 Ft.	1,900 V.DC Sea Level 500 V.DC 70,000 Ft.	2,000 V.DC Sea Level 500 V.DC 70,000 Ft.	1,900 V.DC Sea Level 500 V.DC 70,000 Ft.
Paragraph 4.4.4.1 Resistance of contacts in Millivolts (Average of ten contacts tested at 4 V.DC and 7.5 Amps)	24.3 MV	31.9 MV	46.0 MV	96.6 MV	34.6 MV
Paragraph 4.4.2 Insulation resistance	500,000 Meg Ohms	500,000 Meg Ohms	500,000 Meg Ohms	500,000 Meg Ohms	500,000 Meg Ohms
Paragraph 4.4.5 Vibration 10 to 55 cps, plus additional test as required per MIL-E-5272 Procedure IV (20 to 2000 cps) tested for intervals of 12 minutes to 3 hours.	No loss of contact thru- out entire vibration sweep or at resonance in any of the 3 planes after 3 hours test.	First loss of contact after 25 minutes, with continued inter- mittent loss up to 49 minutes when test was discontinued.	Failed intermit- tently after one minute with in- creased loss of contact after 12 minutes test discontinued.	Intermittent loss of contact thru- out vibration sweep and at resonance, com- plete contact loss.	No loss of con- tact up to 21 minutes, then only intermittent contact loss throughout balance of 2 hours.
Paragraph 4.4.6.1 Contact Insertion (Average of ten pair of contacts)	Average 6 ounces; Maximum pair 9 ounces.	Average 9 ozs; Maximum pair 14 ounces	Average 1 oz; Maximum pair 3 ounces	Average 2 ozs; Maximum pair 5 ounces	Average 6 ozs; Maximum pair 13 ounces
Paragraph 4.4.6 Contact retention	Will hold 3 ounces All contacts	Will hold 3 ounces on only 4 pair of contacts	Will Not hold 3 ounces on any contacts	Will Not hold 3 ounces on any contacts	Will hold 3 ounces on 8 contacts
Paragraph 4.4.8 Durability (Average of 10 contacts tested)	Passed insertion average 5 ozs. Withdrawal all held 3 ozs. Millivolt drop average 32 Millivolt.	Failed	Failed	Failed	Failed

*Additional vibration requirement
of MIL-E-5272 Procedure IV

COMPARE!



**"RELI-ACON"
CONNECTORS**
are the Finest!

One large and complete source for
the finest RELI-ACON card receptacles
and sockets which are designed for
switch gear, computers, instruments,
telephone panels, airborne communi-
cations equipment, guidance systems,
telemetering equipment and other au-
tomatic control devices using printed
circuitry for military and commercial
applications.

High-Temperature Ceramic Transmits Light

Use may extend to space gear in microwave and infrared radiation

NEED for a ceramic with light-transmitting properties has led to the development of a translucent alumina that is as hard as sapphire, nearly as translucent as frosted glass, and as heat resistant as a refractory metal.

Made of powdered 99.99 percent pure aluminum oxide, General Electric's Lucalox ceramic is a polycrystalline material closely related to sapphire and ruby gem stones. The material is claimed to be superior to these gems in its ability to with-

stand high temperatures, being stable at temperatures close to 3,600 F. Melting point of the ceramic is 3,704 F.

The new ceramic has the appearance of frosted glass and transmits more than 90 percent of the visible light which strikes it. It is also claimed to be an excellent transmitter of infrared and high-frequency radiation.

APPLICATIONS—Ability of the material to transmit light and the resistance of the ceramic to alkali-vapor attack is of significance to lighting applications that employ metallic vapors at high pressures and temperatures.

Other potential fields in which

Lucalox ceramic is expected to find demand, according to GE spokesmen, are in microwave windows and domes; parts in atomic energy systems, where resistance to the corrosive effects of coolants is required; components of guidance and electronic systems and instruments employed in rockets and space vehicles; and furnaces and metalworking applications.

A particularly interesting application is foreseen in the use of the non-porous ceramic for circuit substrates.

At this time, Lucalox ceramic can be manufactured in billets to 3 in. diameter and 10-in. long, and extruded in sizes down to 0.060-in. diameter. But GE considers size as an equipment limitation and sees no reason why the ceramic cannot be made in larger sizes and different configurations.

Lack of porosity and higher purity of the new ceramic can be of paramount importance in certain melting applications.

The translucent ceramic was developed by General Electric's Research Laboratory in Schenectady, N. Y. Product is now being marketed by company's Lamp Glass department, Cleveland, Ohio.

Amplifiers Near-Infrared Region

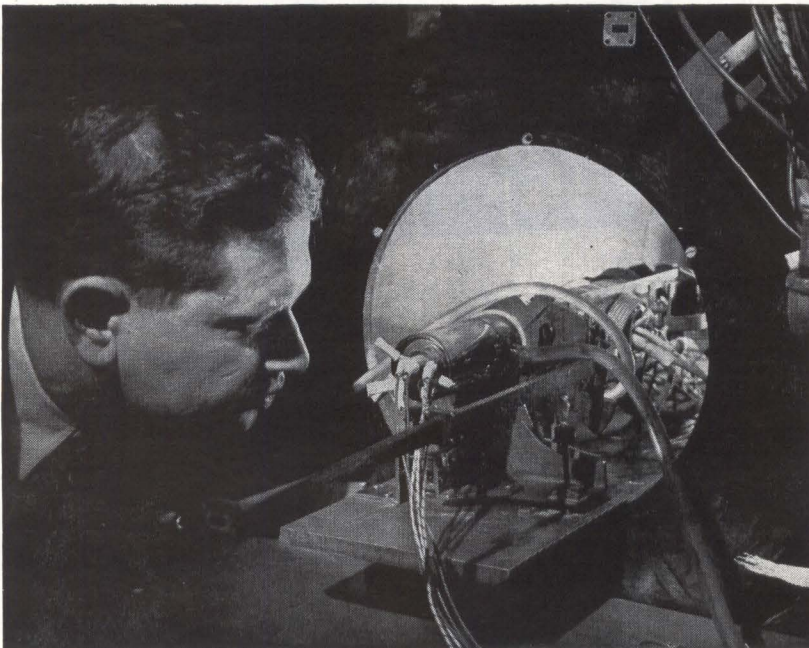

EXPERIMENTAL tube may open up new communications and radar channels well above ceiling for today's microwave systems. Device uses interaction of pulsating electron beam and gaseous cesium plasma. Here RCA's G. A. Swartz tests large beam-plasma tube that can operate continuously over long periods. Such tubes could become basis for new communications, radar and control systems

Report Evaluates Welded Connections

DETAILED report on modular interconnections for microassemblies has been issued by United Aircraft. Study concerns the use of electron beam welding techniques used in forming microassembly stacks.

Program definitely establishes fact that electron beam affords reliable means for constructing mechanically strong, low-resistance electrical connections for miniature components.

Connections studied have ter-

Capacitors of MYLAR[®] often cost no more than paper—sometimes cost less

AT LOW PRICES

This graph is an analysis of capacitor prices using capacitance range versus typical unit costs as ordinates. The graph was plotted by using average capacitor prices of a variety of representative capacitor manufacturers.

Analysis of this graph demonstrates that for a wide range of capacitance values, from approximately .001 to 1 mfd., capacitors using "Mylar" polyester film are lower in cost than paper capacitors. In addition, capacitors of "Mylar" are comparable in price to paper units throughout the entire capacitance range. In fact, for the sizes and voltage ratings found in typical electronic gear, the average price for a group of capacitors of "Mylar" would be little different than comparable paper types.

Improved size and weight factors, circuit and packaging simplification often brings the total performance cost below other types of capacitors.

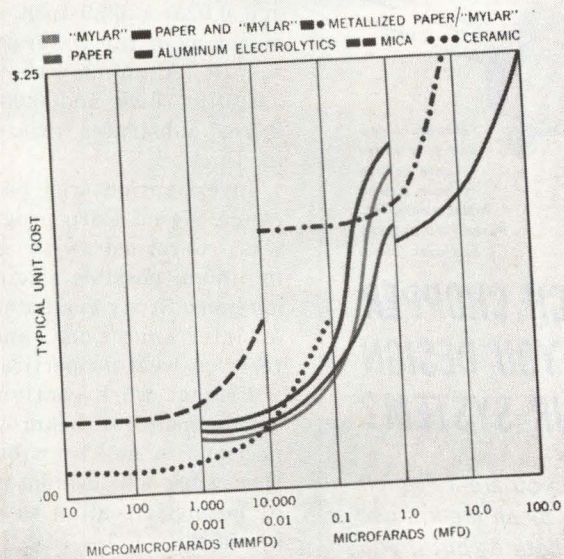

As shown by an analysis of industry prices

A recent industry survey made by Du Pont showed that most design engineers did not consider capacitors of "Mylar"* in the same low price range as paper. Yet a study of manufacturers' average prices, as reported in our capacitor booklet, points out THAT OVER A RANGE OF SIMILAR CAPACITANCES AND RATINGS—UNITS MADE WITH "MYLAR" COMPARE CLOSELY IN PRICE WITH THOSE OF PAPER.

This means, at no greater cost, you get the extra

reliability of "Mylar"—superior dielectric strength, moisture resistance, and thermal stability over a wide range of temperatures. And you can design more compact components with the reduced capacitor size permitted by "Mylar".

Write for this industry study and price chart. Evaluate the full advantages and properties of "Mylar" before specifying your choice of capacitors. Du Pont Co., Film Dept., Wilmington 98, Del.

*"Mylar" is Du Pont's registered trademark for its polyester film.



BETTER THINGS FOR BETTER LIVING... THROUGH CHEMISTRY

electronics • March 8, 1963

only DU PONT makes

MYLAR[®]
POLYESTER FILM

CIRCLE 63 ON READER SERVICE CARD

63

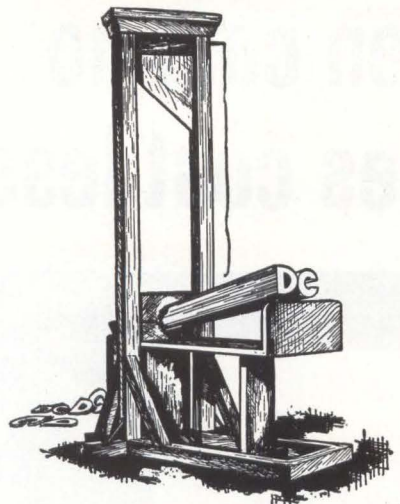

ACTUAL SIZE

Manufactured
and sold under
sole license
from Rawco
Instruments, Inc.
Patent # 2,959,648
and pats. pend.

WHICH CHOPPER WOULD YOU DESIGN INTO YOUR SYSTEM?

If you are a French executioner, by all means use the guillotine; but if you are an electrical engineer, we recommend USEC's new Talon 70A DC-AC chopper. Due to its extremely low noise level (in the sub-microvolt region), the new Talon 70A DC-AC chopper permits vastly improved signal-to-noise ratios so necessary in small signal applications. It operates from a 1-200 cps 6V source and is hermetically sealed. Its universal mounting permits printed circuit applications, as well as normal wire-in techniques.

Write today for complete operating specifications. Manufacturer's representatives territories are open.

usec

**UNITED STATES
ENERGY CORP.**

(A subsidiary of Talon, Inc.)
300 MT. LEBANON BLVD., PITTSBURGH 34, PA.
Telephone (Area Code 412) 561-3440

mination densities of up to 1,600 interconnections per square inch. Connections in these modules use conductor ribbons welded to alumina wafers and Pyrex substrates. Discrete pads were formed on the edges of the wafers by electron beam etching of unfired metallized materials. Pads were electroplated with nickel. Terminal areas measured 0.013-in. wide and overlapped top and bottom sides of the substrates.

STACKS—Ten-wafer microassembly stacks were interconnected by twenty conductor ribbons on each of four edges of individual wafers.

Grids measured 0.025-in. square and 0.025 × 0.50 inch. Lateral dimensions of the wafers were 0.6-in. square. Alumina wafers measured 0.010-in. thick and 0.030-in. thick. Pyrex substrates measured 0.030-in. thick.

Investigation was part of long-range Signal Corp program. Work was concerned with establishing minimum possible size of interconnections. Study evaluated proximity of interconnections, and their effects on weld properties.

Present work continues towards development of beam welded connections to multi-pin header. Further work will evaluate application of hermetic sealing to soldered assemblies.

A design has been detailed that incorporates wafer stacks to hermetic header. A can is welded to the header to provide a hermetic seal. Approach is amenable to wafers joined by welded riser wires, or wafersoldered to header-pin extensions.

New Thin-Film Circuits Developed for Navy

OFFICE of Naval Research announced that development of a new family of thin-film circuits is being carried out by the Radio Corporation of America under contract funded by the U. S. Bureau of Weapons.

Miniature circuits comprise active and passive elements evaporated as a film on glass. Initial application of the circuits will be in aircraft cockpit displays. RCA claims recent advance demonstrates

feasibility of applying thin film technique to active components. This permits the simultaneous, single process fabrication of an entire circuit with thin-films. Such circuits can pack as many as a million components in a cubic foot of space.

Objective of Navy program is to advance the state of the science in the ability to build circuits, both active and passive, by thin-film techniques. Program will also explore the possibility of developing circuits using materials like cadmium sulfide which could use light signals directly without prior conversion to electrical signals.

When Will Thin-Films Reach Main Street?

SPECULATION made by George H. Siegel, manager of General Electric's new Microelectronics Laboratory, is that microcircuits may not follow traditional route of evolution from military to industrial to commercial application. Rather, the pressure of rapidly decreasing prices may well permit incorporation of microcircuits in commercial and home entertainment equipment—tv, radios and photographs—prior to their widespread use in industrial applications.

Consumer-oriented microelectronics will depend upon when and how some giant electrical companies call their shots. Fact is that American firms are not in position to call these shots at this time. Pressure may come from abroad as witnessed by interest in applying microelectronics techniques to entertainment equipment shown by N. V. Philips Gloeilampenfabriken (see ELECTRONICS, Sept. 28, p 86).

SPEARHEAD of microelectronic development at General Electric is company's new microelectronics laboratory at Utica, N. Y. Although now geared for handling military needs, composition of new GE laboratory indicates pattern that company may follow in its approach to consumer electronics.

Spokesmen at GE indicate that company plans to maintain total competence in several promising microelectronic techniques. New laboratory will work closely with its

IEEE

HEAR

DISTINGUISHED
SPEAKERS &
PANELISTS

at

I-TRIPLE-E's

International Convention
and Exhibition in New York

MARCH 25, 26, 27, 28

The COLISEUM at Columbus Circle
& The WALDORF ASTORIA HOTEL

admission: MEMBERS \$1.00; NON-MEMBERS \$3.00
MINIMUM AGE: 18

SHOW

(formerly the IRE Show)



MORE TIMING PROBLEMS

more effectively solved...

...because HANSEN
takes more time
to be sure!



HANSEN SYNCHRON® Timing Motors and Movements are results of thorough and continuous research and development. None is released until it has been solidly tested and proved for its applications. Each is a product of more than 50 years of specializing in this one area.

This adds up to an unequalled backlog of engineering experience that you command at Hansen. Whatever your timing problem, you can count on Hansen engineers to come up with the most effective solution — with the timing motor or movement that has been *pre-proved right* for the job.

Distance no obstacle to
Hansen service



Hansen service knows no limits — as present customers know from profitable experience. A company airplane stands ready to fly Hansen engineers to study "on-the-job" difficulties — and to determine the surest solution to every timing problem.

SEND TODAY for complete data on all
Hansen SYNCHRON Motors and Clock
Movements.

HANSEN REPRESENTATIVES:

THE FROMM COMPANY
Chicago, Illinois

H. C. JOHNSON AGENCIES, INC.
Binghamton, N.Y.
Fayetteville, N.Y.
Rochester, N.Y.
Schenectady, N.Y.
Williamsville, N.Y.

WINSLOW ELECTRIC COMPANY
Essex, Connecticut
New York, N.Y.
Philadelphia, Pa.

EXPORT DEPARTMENT
15 Moore Street, New York, N.Y.



HANSEN
MANUFACTURING
COMPANY, INC.
PRINCETON, INDIANA

BEST MINIATURIZED INDICATOR

RADIATOR

SB-305

V-403

R-201

R-101

- R-101 Tuning indicator and Battery residual capacity indicator
- F-102 FM tuning indicator
- V-103 Audio level indicator
- A-104 AM tuning indicator
- SB-105 Stereo balancing indicator
- B-106 Battery indicator
- R-201 Smaller type tuning and battery indicator
- V-203 Smaller type level indicator
- B-206 Smaller type battery indicator
- R-301 Larger type tuning and battery indicator
- V-303 Larger type level indicator
- SB-305 Larger type stereo balancing indicator
- V-403 VU meter
- V-403B Audio level indicator
- SB-405 Null indication stereo balancing indicator

ACCEPTABLE SPECIAL DIAL UPON YOUR REQUEST

DISTRIBUTOR
ATAKA NEW YORK, INC. **ATAKA & CO., LTD.**

633 THIRD AVENUE
14TH FLOOR
NEW YORK 17, N.Y., U.S.A.
PHONE: OXFORD 7-7480

OHEMACHI BLDG.
1-CHOME, OHEMACHI
CHIYODA-KU, TOKYO
PHONE: 201-6411

MAKER
TOYO MUSEN CO., LTD.

75, WAKABAYASHI-CHO, SETAGAYA-KU, TOKYO

CIRCLE 204 ON READER SERVICE CARD

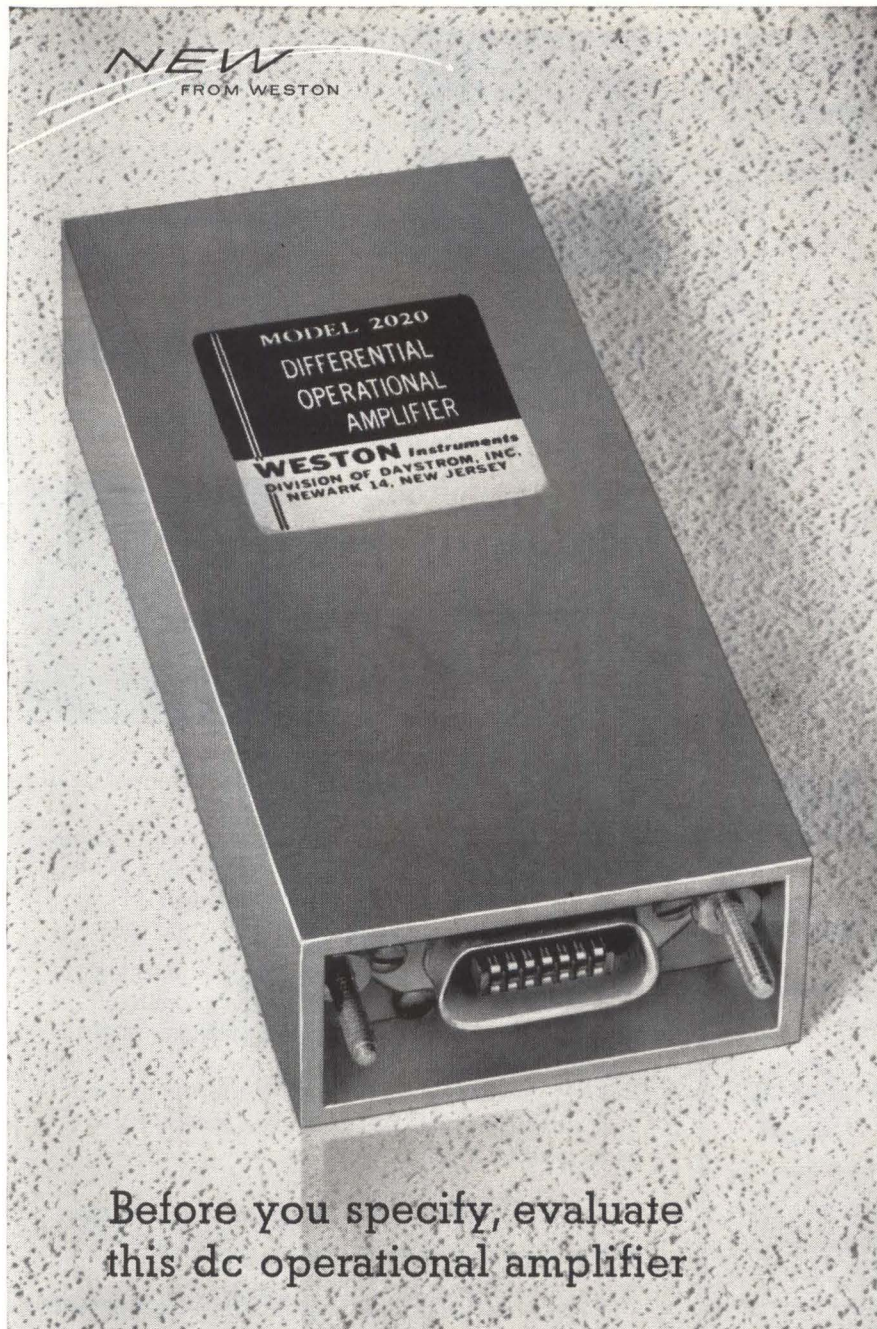

Before you specify, evaluate
this dc operational amplifier

Weston solid state dc amplifiers are units of a modular design series which provide outstanding performance in a wide range of applications— analog computation, complex data handling, control and process systems, and instrumentation. Model 2020 Differential Operational Amplifier is the basic modular unit.

This versatile amplifier is small, rugged, and has low power consumption. It combines low noise and drift with a gain bandwidth product of 200 kc. Common mode signals are attenuated by 15,000 to 1, power supply variations by 2,000 to 1.

Other modular units, which can be used alone or in combination, include choppers for lowest noise, lowest drift, and boosters for use when high current output is needed. Applications assistance is readily available from Weston, and we can arrange to supply units for your own evaluation. Write for details on this or any Weston product.

 **WESTON**
Instruments & Electronics

Division of
Daystrom, Incorporated
Newark 14, New Jersey

Aerospace instrumentation • Bimetal thermometers • Daystrom potentiometers • Electrical measuring instruments
• Electronic test equipment • Non-contact gauges • Nuclear instrumentation • Photosensitive devices • Precision
metal film resistors • Recorders and controllers • Relays and tachometers • Systems design and development

sister departments, such as Semiconductor Products Division. The Utica facility, called Light Military Electronics Department, will extend competence in thin-film approach, evaluate high usage and standard functional blocks, and design circuits and systems with their end-use in a particular equipment as the ruling factor.

General Electric purposely refrains from restricting its microelectronics effort to one technique, is ready to take advantage of advances in any area.

New GE microelectronics laboratory is capable of producing 1,000 thin-film circuits a month, represents an investment of over \$650,000.

Springs Measure Loads In Millimicrograms

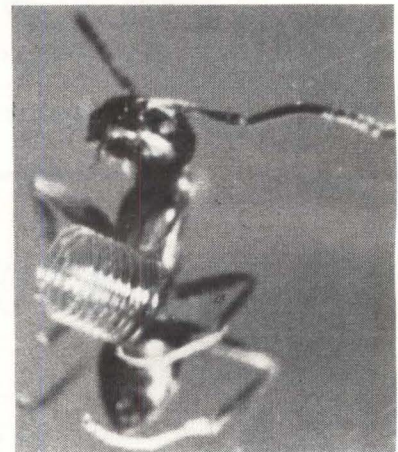

TINY ant poses with tinier spring. No plaything for friendly ants, springs less than a millimeter in diameter detect weight changes as low as a millimicrogram.

In operation, miniature spring serves as spring support for pendulum. Impact against pendulum causes a reflected light beam to move across the face of a lateral photocell. Photocell senses movement, converting it to electrical signals that can be telemetered to a ground tracking station.

Helical quartz spring is claimed to assure long-term accuracy several orders of magnitude better than metallic springs and reliability exceeding that of present transducers.

Springs, developed at Electro-

Optical Systems Inc., make it possible to develop novel spacecraft instrumentation.

Filaments are drawn by machine consisting of mechanism that feeds a quartz rod into the flame of a miniature torch. Filaments are pulled by a reel that spins at speeds controlled to produce desired diameters. A fiber is drawn from the molten tip of the rod, attached to the reel, and drawn into a continuous filament with a diameter that varies inversely with the speed of the reel.

The most promising device using tiny springs, is designed to measure flux, momentum, and energy of micrometeorites colliding with space vehicles.

Fused quartz spring material has needed strength, extremely low hysteresis, and low thermal expansion coefficient.

Thin Dielectrics for High-Density Circuits

BARIUM titanate dielectric wafers, cut in thin sheets ranging from 0.0025 inch to 0.04 inch thick, are available from Gulton for micro-circuit applications. Wafer 0.0025-in. thick by 0.050 in. sq has capacitance of 1,500 picofarads. Capacitance of 0.04-in. thick wafers of same size is one picofarad. Temperature coefficient of these wafers are zero from -55 C to 150 C.

Ceramic wafers are prepared in form of liquid suspension of powders. Liquid flows on to a moving stainless-steel belt. Thickness of deposited film is governed by a micrometer blade. Film dries slowly as belt moves through a long low-temperature drying chamber.

Gulton claims thin sheet matures quickly and uniformly in firing because of its lack of bulk and freedom from temperature gradients. Small wafers can be cut from the fired sheets by diamond wheel or from the green sheet before firing. Thin sheets are claimed to be more homogeneous, higher dielectric strength and better controlled properties than ceramics formed by pressing.

Very close tolerances can be held on temperature coefficients.

MULTILAYER CIRCUITRY WITHOUT PLATED THRU HOLES

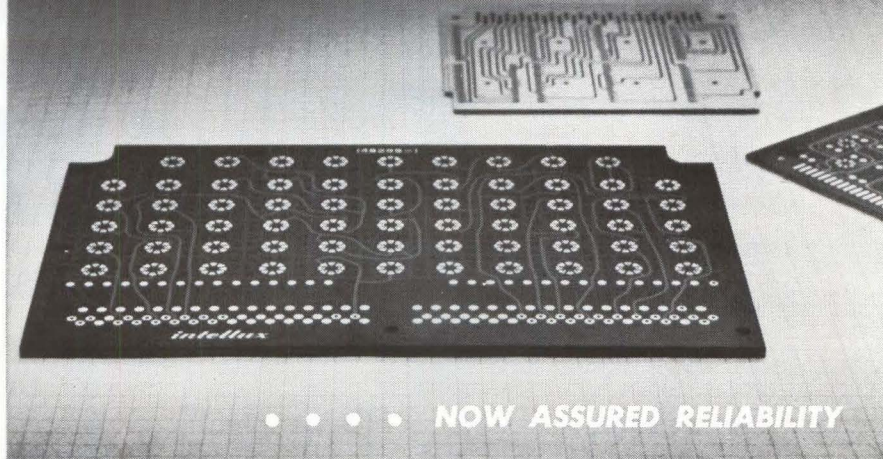

Intellux multilayer circuit boards are electroformed in three dimensions. This exclusive process enables the construction of solid copper feed-thru busses and land areas. Reliability is assured by proven performance and they make economic sense.

ADVANTAGES ARE MANY:

- ▶ Higher circuit density
- ▶ Blind subsurface layer/layer interconnections
- ▶ Freedom in ground plane design
- ▶ Board may be flexed without circuit damage
- ▶ Pads can be wave, dip or iron soldered and series welded
- ▶ Design changes can be readily made at minimum expense

Write for complete Intellux multilayer data and specifications.

intellux
INCORPORATED

P.O. Box 929, Santa Barbara, Calif.

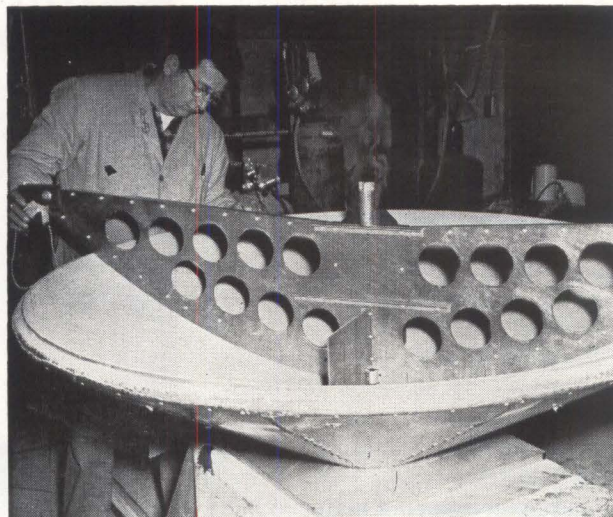
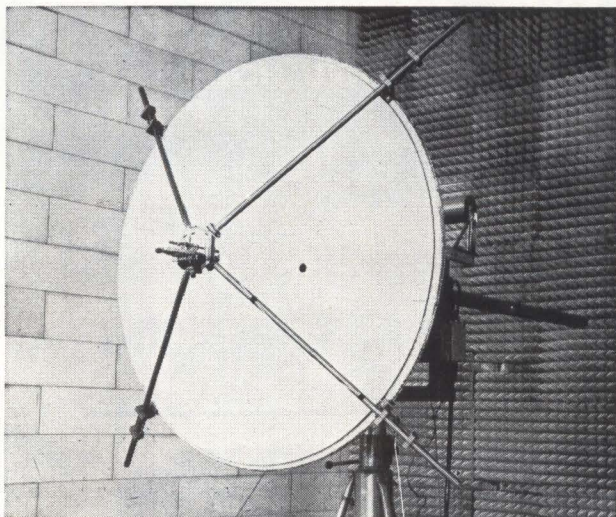

TESTS at 39 Kmc (left) showed no measurable signal losses or distortions during daylight hours due to surface inaccuracy of aluminum-spun reflector insulated by plastic-foam sandwich core. During fabrication, reflector surface is checked with a conforming template (right)

Encapsulating Precision Antennas in Plastic

By C. A. PAPPAS and E. B. MURPHY
MIT Lincoln Laboratory, Lincoln, Mass.

Maintain uniform metal-structure temperature to retain reflector surface

FOAMED MATERIALS help meet stringent requirements governing design of a precision antenna reflector. These requirements include conformity of reflector surface to a true parabolic within a few thousandths of an inch while operating under moderate weather conditions. Furthermore, reflector must be self-supporting under any exposure to elements (survival conditions) and must return to its specified surface tolerance once moderate weather conditions reappear. Also, antenna must maintain this tolerance for several years.

BASIC CONCEPT—Precision antenna configurations developed at Lincoln Laboratory have basic reflector structures of aluminum (and

other metals) that are temperature-insulated by encapsulating or potting them with a lightweight rigid foam such as polyurethane or styrene. An exterior insulating surface is furnished by syntactic phenolic foam, a lightweight surfacing material easily formed or machined to close tolerances. Such encapsulating and surfacing keep structures at even temperatures under non-uniform thermal loadings. In so doing, structure dimensional stability and close surface tolerances are maintained during fabrication as well as during operation of reflector in antenna system.

FABRICATION SCHEMES—Two alternate fabrication designs have been developed.

Shown in Fig. 1 is a 62-inch diameter reflector built-up from a parabolic spun aluminum dish that serves as a "front" surface of a sandwich structure. Rear surface is presently fabricated from alumi-

ANTENNA CONFIGURATION PROBLEM

With radar-art advances in tracking, communications, astronomy and deep-space probe applications, there is a great need for large, precision antennas. During initial stages of an antenna study at Lincoln Laboratory, it became evident that non-insulated precision antennas cannot be used effectively during daylight hours. Thermal gradients caused by solar radiation distort structure and reflecting surface sufficiently to prevent precision functioning

num sheet but future units would be of reinforced fiberglass. Core of sandwich contains both radial aluminum ribs and rigid urethane foam at 6 pcf (pounds per cubic foot). On outer surface of spun dish, a 2-inch layer of the syntactic phenolic foam (SPF) with epoxy binder is tamped into place and allowed to cure for 120 hours at room temperature. Then, SPF surface is contoured on a tape-controlled boring mill. Highly absorbant SPF is sealed with polyurethane (formulation C1—see table). Fi-

Simplex Electronic Cables...

Float at Sea

Eliminate Hosing Problems

Link Rockets to Ground Control

Many inner space projects require cable that will not sink to the ocean floor. To meet such requirements, Simplex has designed and produced special cables with built-in flotation. If desired, cables can be designed with plastic tubes to be used as gas, pneumatic or hydraulic lines.

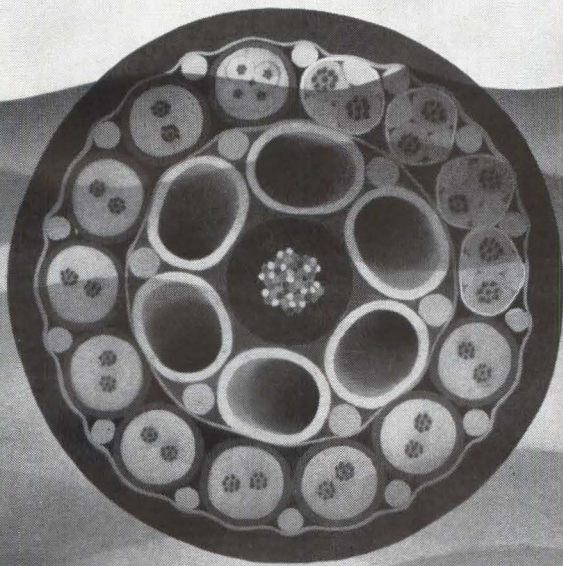

For the growing number of installations where hosing of water through a cable could cause serious trouble, Simplex offers a "non-hosing" cable construction. Cables with this construction contain a special filler compound which eliminates wicking action even if the cable jacket is damaged.



Umbilical cables manufactured by Simplex are used to connect rockets to their sites before firing. Essential characteristics of these cables include flexibility, exceptional reliability, resistance to mechanical damage and chemical attack by exotic fuels.

There's a Simplex electronic cable to meet virtually every existing application involving the transmission of power, control and communications. And Simplex has unique capabilities for solving any problems you may encounter in these areas. For further information, write Department 365, Simplex Wire & Cable Co., Cambridge, Mass.



Simplex

WIRE & CABLE CO.

EXECUTIVE OFFICES: Cambridge, Mass.

Plants at Cambridge, Mass., Portsmouth, N.H.,

Westbury, L.I., Monrovia, Calif.

CIRCLE 69 ON READER SERVICE CARD

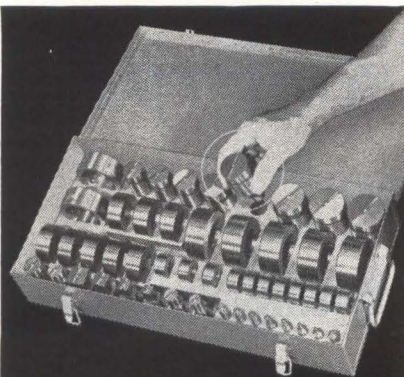

the right punch & die
at your finger tips...
**NEW DI-ACRO
PUNCH PAKS**

Punch Pak No. 1 - \$139.50
Punch Pak No. 2 - \$259.50

- Off the shelf delivery
- Adapters to fit any punch press

Di-Acro Punch-Paks save you money, cut production delays. No time lost looking for the right size or waiting for special orders. Cost is approximately 10 per cent less than individual punch and die sets—with the rugged, steel store-or-carry chest free. All Di-Acro Punches and Dies are precision made of quality tool steel.

PUNCH-PAK NO. 1 contains 30 sizes of round punches and dies from $3/64"$ to $1/2"$ in increments of $1/64"$.

PUNCH-PAK NO. 2 contains round punches and dies from $1/16"$ to $1/2"$ in $1/16"$ increments, round sizes from $1/2"$ to $2"$ in $1/8"$ increments, squares in $1/2"$, $5/8"$, $3/4"$ and $1"$ sizes, one die holder and two die adapters.

Die Adapter A-2 $3/4"$ diameter— $1 1/4"$ bore, Die Adapter B-2 $3/4"$ diameter— $2 1/8"$ bore.

DIMENSION DATA

All Di-Acro Punches to $1/2"$ have $1/2"$ diameter shanks, $2 13/32"$ length.
All Di-Acro Punches from $1/2"$ to $2"$ have $1"$ diameter shanks, $3 1/8"$ length.
All Di-Acro Dies to $3/4"$ are $1 1/4"$ diameter, $3/8"$ high.
All Di-Acro Dies from $3/4"$ to $1 3/8"$ are $2 1/8"$ diameter, $7/8"$ high.
All Di-Acro Dies from $1 1/2"$ to $2"$ are $2 3/4"$ diameter, $1 5/32"$ high.

PUNCH AND DIE HOLDERS

which adapt Di-Acro Punches and Dies to any punch press are listed in literature on single station punch and die program. Ask for it... also for literature on new Adjustable Punch and Die program.



For full information consult Yellow Pages of your phone book under Machinery-Machine Tools for the name of your Di-Acro distributor or write us.

Pronounced die-ack-ro

DI-ACRO CORPORATION
Formerly O'Neil Irwin Mfg. Co.

433 Eighth Avenue
Lake City, Minnesota • U.S.A.

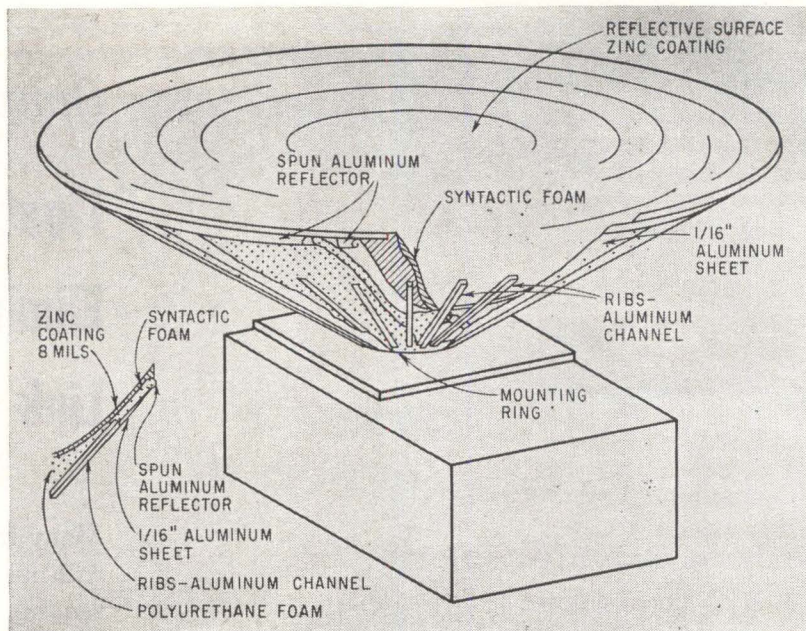

SUPPORT STRUCTURE for spun-aluminum reflector includes aluminum sheet, radial aluminum ribs and rigid urethane foam. Syntactic foam covers reflector and is in turn covered with reflective zinc coating—Fig. 1

nally, a thin layer of zinc (0.008 inch) is applied by a hot-spray process. Zinc coating serves as a radar reflecting surface. Surface, measured with a precision template, had an error of only 0.002 inch.

Another approach is the egg-crate configuration shown in Fig. 2. Supporting "base-plate" here is a ribbed grid structure. Top edges of

all 20-mil thick ribs are identical in parabolic contour. To prepare ribs for machining, they are all securely clamped together with top edges flush and parallel. In a tape-controlled milling machine, an accurate parabolic curve is cut along top edge of ganged ribs in one pass. This assures an identical parabolic curve on each rib. Thus, when these

PLASTIC FORMULATIONS

FORMULATION A
Syntactic Phenolic Foam (SPF) flexible
960 parts Phenolic Spheres BJO-0930
187 parts Epon No. 812
125 parts Versamid No. 125

FORMULATION B
100 parts by wt. Bakelite ERL-2795
30 parts by wt. Hardener ZZLA-0822
0.5 parts by wt. Ferro pigment epoxy base red
5 parts by wt. Cabosil

FORMULATION B1
Same as Formulation B except no Cabosil

FORMULATION C
Elastomeric Adhesive
80 parts by wt. Prepoly Tranco 2A
20 parts by wt. Polyol TP 440 Union Carbide
0.8 Metal & Thermit's T-9 Catalyst

FORMULATION C1
First Sealer
80 parts by wt. Tranco 2A
20 parts by wt. Xylol
25 parts by wt. TP440
25 parts by wt. M & T T-9 Catalyst

FORMULATION D
Syntactic Phenolic Foam (SPF) rigid
120 Bakelite Epoxy No. 2772
36 parts by wt. Hardener-0822
480 Phenolic Spheres BJO-0930

FORMULATION E
17 parts by wt. Glass Micro-balloons Eccospheres S1
58 Bakelite Resin 2772
18 Bakelite Hardener—0822

FORMULATION F
100 parts Tranco No. 560
0.5 parts Catalyst 7A
25 parts Xylene
20 parts Ferro V-2

FORMULATION G
Muralo No. 500 white paint polyvinyl acetate emulsion

FORMULATION H
Syntactic Glass Foam (SGF)
700 parts by wt. Eccosphere S1
360 parts by wt. ERL No. 2772
110 parts by wt. ZZLA No. 0822

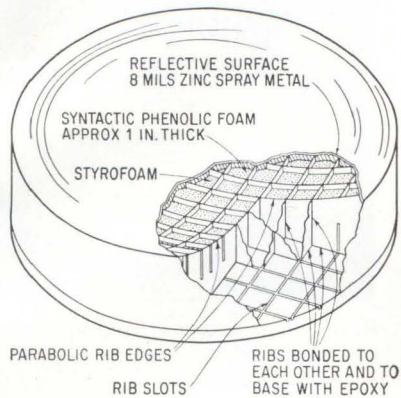

EGG-CRATE reflector assembly's aluminum ribs describe a perfect paraboloid of revolution for supporting syntactic phenolic foam, which is covered with a thin zinc deposit—*Fig. 2*

ribs are positioned 4 inches apart, an accurate paraboloid of revolution is generated. A base-plate having slots for ribs assures accurate positioning.

Following rib alignment, all joints between ribs and base plate are bonded with a generous application of epoxy adhesive (formulation B and B1). Each box is filled with styrene foam (1 pcf) to within 1 inch of the parabolic surface. Then, sides of ribs and surface of styrene foam are covered with a polyurethane elastomer (formulation C). Next, syntactic phenolic foam with an epoxy binder (formulation D or A) is tamped into each box until approximate surface of paraboloid is defined. A precisely-contoured roller is then used to form surface between each pair of ribs. Roller contour has been designed to allow an excess of 0.010 inch. Foam is permitted to cure. A precisely-contoured plate is then repeatedly drawn over grids or guides to remove excess foam until surface between grids conforms to desired contour. Again, a hot spray process is used to apply a thin zinc coating forming the reflecting surface. Final sealing is completed by applying a white, weather-resistant polyurethane coating (formulation F) over zinc. Measured average surface error is in the order of 0.006 inch to 0.008 inch.

ISOTHERMAL ANTENNA — As study progressed, it became evident that covering structures with insulating foams was not the complete solution to thermal problem. An additional scheme could be the an-



Set up any waveform in seconds with **VARI-BIT**

Now you can set up any waveform simply by positioning small magnets along a wire. For the first time you can obtain accurate timing patterns, delay functions, control signals, and a variable length dynamic store, all from one piece of test equipment... *Vari-Bit*. ■ To change from one type of test to another, all you do is turn a selector switch. Con

Avionics unique "Torsmag" principle makes operating a *Vari-Bit* as simple as drawing an output waveform. ■ Development labs across the country report *Vari-Bit* saves hundreds of hours of bread board design and fabrication. Every lab needs one or more. ■ Learn the full facts and specs of this unique new multi-purpose tester. Write today.

CONSOLIDATED AVIONICS CORPORATION

800 SHAMES DR. WESTBURY, L. I., NEW YORK

See Us at the IEEE Show Booth 1324



any size panels

engraved in your own plant

Engrave 1-inch nameplates or 6-foot panels by unskilled labor.

Spindle covers 18 1/4" x 6" in one set-up — more than any other machine of its kind.

Bench type model I-R — \$685.

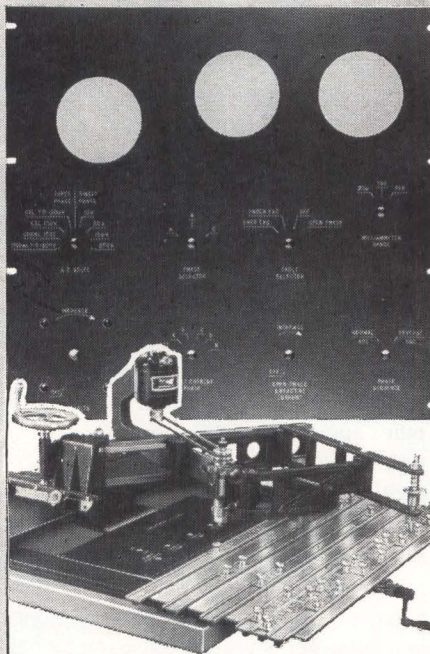

Send for complete catalog ZR-4
Write direct on your letterhead.

new hermes ENGRAVING MACHINE CORP.

154 WEST 14th STREET, NEW YORK 11, N. Y. IN CANADA: 359 St. James Street West, Montreal, P. Q.

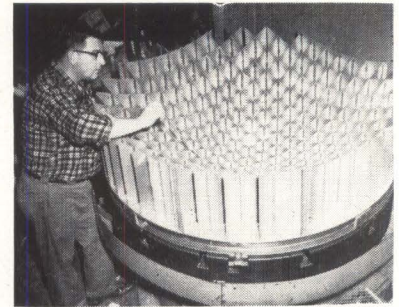

RIBS of egg-crate reflector are epoxy-bonded to each other and base plate—Fig. 3

answer: tubing, insulated from direct thermal exposure by foam, is held in intimate thermal contact with antenna structure. Water or other fluid is circulated through it. If local cooling or heating takes place in any part of structure, circulating fluid eliminates thermal gradients within structure. Thus, entire structure may change temperature slightly but, since change is uniform, parabolic shape is retained.

To illustrate this principle, sample "sandwich" and "egg-crate" antennas were prepared and tested:

One sandwich antenna was made with aluminum structural surface-exposed. Another was prepared with structural surfaces completely covered with foam.

One egg-crate antenna was modified with coils of tubing around aluminum structure and covered with foam—iso-thermal concept.

Similar heat loads were applied to the three arrangements and comparison was based on deflections due to thermal loads over a specified length of time.

Antenna (A) with completely exposed structure—deflection 0.020 in.

Antenna (B) with foam-insulated structure—deflection 0.0065 in.

Antenna (C) with both coils and foam—deflection 0.001 in.

After the first 30 minutes of exposure to heat load, antenna B deflected only 1/3 the amount of antenna A. This three-fold difference is due to effectiveness of insulation in shielding structural elements from primary heat source. Particularly under transient thermal exposure (e.g., wind cooling), insulation of structure should be helpful in stabilizing precision antennas.

Drop in deflection of antenna C with commencement of water circulation was rapid, requiring only 8 minutes to reach 0.001 in.

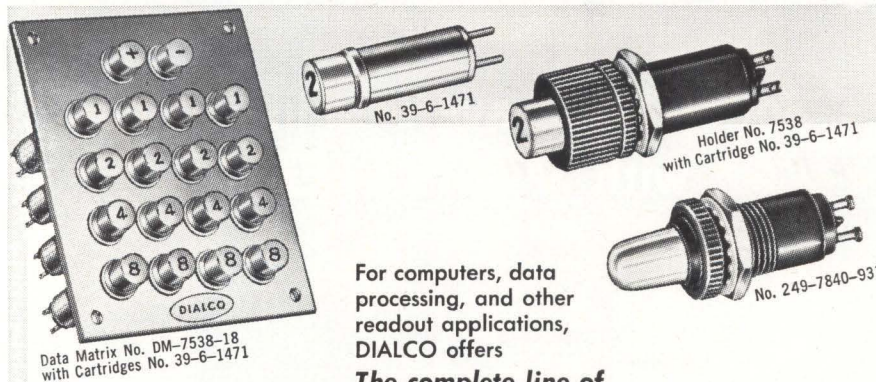

Data Matrix No. DM-7538-18
with Cartridges No. 39-6-1471

For computers, data processing, and other readout applications, DIALCO offers

The complete line of

DATALITES®

Ultra-miniature DATALITES are available in several basic styles: CARTRIDGE HOLDERS that accommodate DIALCO's own replaceable Neon or Incandescent LAMP CARTRIDGES. Unit mounts in 3/8" clearance hole...For multi-indication, LAMP CARTRIDGES are mounted on a DATA STRIP or DATA MATRIX in any required configuration...DATALITES with permanent (not replaceable) Neon Lamps may be had with or without built-in resistors...The "DATA CAP" series features a rotatable read-out lens cap; accommodates a clear (colorless) cartridge. LEGENDS may be hot-stamped on cylindrical lenses...Styles shown here are only typical. Send for information on the complete line.

Write for 8-page Datalite Brochure L-160C.



60 STEWART AVE., BROOKLYN 37, N.Y. • Area Code 212, HYacinth 7-7600

Booths 2518 - 2519 - 2520 at the IEEE Show

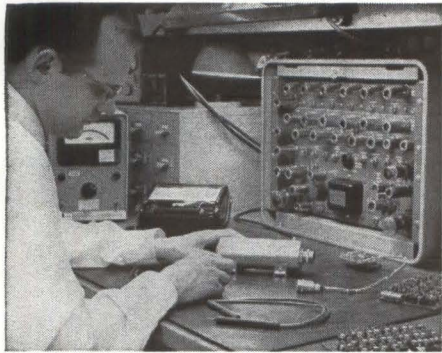

Here, at Lockheed Missiles & Space Company's Space Communications Laboratory, scientists are re-investigating the possibility of using the moon to facilitate earth communications. Possibilities for the use of the moon as a relay station for earth-to-earth communications have been largely neglected because the moon's shape and rugged surface greatly distorted a return signal. But Lockheed research into the extension of communications on difficult communication channels, using techniques applicable to dispersive time variant channels, is making significant inroads into this problem.

Another area receiving intense study at Lockheed is satellite tracking of deep space probes. Since tracking accuracy

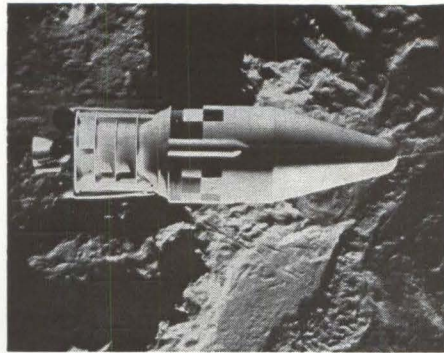

depends greatly on stations being as far from each other as possible, while retaining line-of-sight communications, Lockheed is studying the use of two earth-orbiting satellite tracking stations, 8000 miles apart. Not only would great accuracy be gained by the separation, but it would be further enhanced by the positioning of the stations above the earth's atmosphere, thus eliminating atmospheric distortion.

Examples of other research projects being pursued by Lockheed in the communications area include: Random multiplexing, satellite readout techniques, scatter communications, radar mapping, submarine tracking, modulation of optical energy, communications over multipath channels, and learning systems.

LOOK AT LOCKHEED... AS A CAREER

Consider Lockheed's leadership in space technology. Evaluate its accomplishments—such as the Polaris missile and the Agena vehicle's superb record of space missions. Examine its outstanding advantages—location, advancement policies, creative climate, opportunity for individual recognition.

Then write for a brochure that gives you a more complete Look at Lockheed. Address: Research & Development Staff, Dept. M-43B, P.O. Box 504, Sunnyvale, California. Lockheed is an equal opportunity employer.

SCIENTISTS & ENGINEERS: In addition to positions in the research and development of communications and optics, other important openings include: Inertial guidance • Orbit thermodynamics • Electromagnetics • Mission & trajectory analysis • Gas dynamics • Chemical and nuclear propulsion • Systems engineering

LOCKHEED

MISSILES & SPACE COMPANY

A GROUP DIVISION OF LOCKHEED AIRCRAFT CORPORATION

Sunnyvale, Palo Alto, Van Nuys, Santa Cruz, Santa Maria, California • Cape Canaveral, Florida • Huntsville, Alabama • Hawaii

LOOK AT LOCKHEED IN SPACE COMMUNICATIONS:

Where outstanding successes have created aerospace leadership

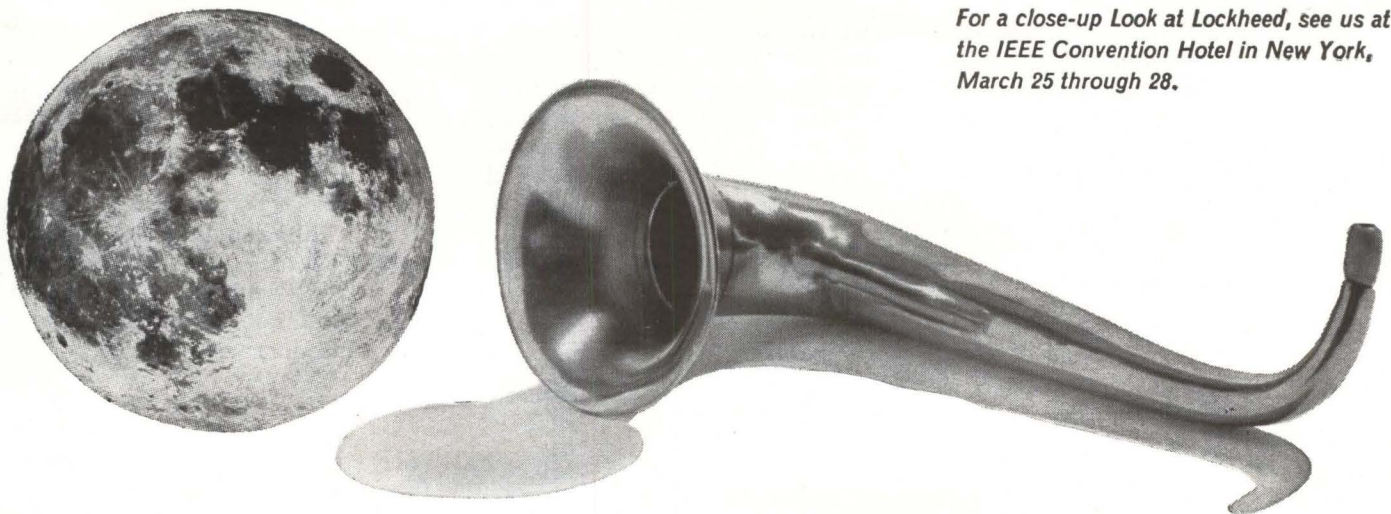

For a close-up Look at Lockheed, see us at the IEEE Convention Hotel in New York, March 25 through 28.

Operational Amplifier Has Multiple Uses

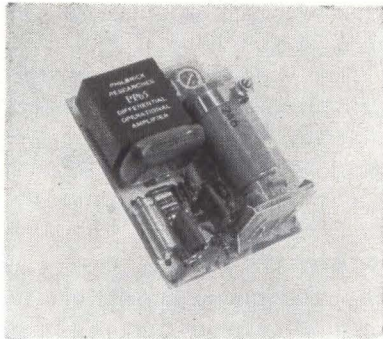

Volume of 0.8 cu in. and 1 ounce weight permits printed board mounting

ANNOUNCED by George A. Philbrick Researches, Inc., 127 Clarendon St., Boston 16, Massachusetts, the model PP65 is the first of a new series of epoxy-embedded, all solid-state, silicon d-c amplifiers for a wide variety of feedback applications. D-c gain is 300,000 for current, 20,000 for voltage (open loop), input impedance is 10 megohms to

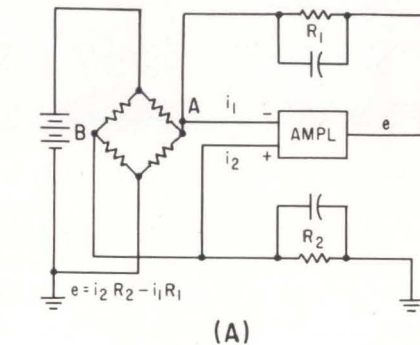

ground and 150,000 ohms between inputs, transconductance is 2 mhos and output capability is greater than 11 v at 1.1 ma. Narrow-band short-circuit noise is 1 to 2 μ v referred to input, small signal pass band exceeds 1 Mc, full output is available to 10 Kc and power requirement is 4 ma at ± 15 v. Current noise is less than 10^{-8} ampere thermal offset is less than 10 mv and 0.3 μ a between -25 and $+85$ C and random drift per day at constant temperature is less than 50 μ v and 10^{-8} ampere. Volume is less than 0.8 cubic inch and weight less than 1 oz. A typical application,

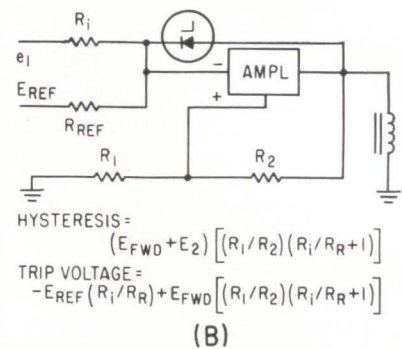

shown in sketch (A), is a voltage null bridge amplifier. The amplifier acts as a low-impedance, current-measuring galvanometer measuring bridge output as current. The output changes so as to maintain potential at point A equal to potential at point B. At current balance, if R_1 equals R_2 , e will be equal to zero. This arrangement is ideal for low-frequency strain-gage measurements. A voltage comparator application is shown in sketch B. This circuit will resolve difference signals in the mv or 10 ns range.

CIRCLE 301, READER SERVICE CARD

Generating Sine Waves With 0.02-Percent Distortion

MANUFACTURED by Optimization, Inc., 7243 Atoll Ave., North Hollywood, California, the model RCD-1 is a high-purity sine-wave oscillator covering the range from 1 cps to 100 Kc. A new circuit produces an

open-circuit output of 5 v rms with maximum distortion of less than 0.02 percent from 90 cps to 20 Kc and less than 0.1 percent at 20 cps and 100 Kc. Output amplitude exhibits less than 0.01-percent jitter,

noise and short-term variation and less than 0.02-percent variation with 10-percent line-voltage change. Output frequency is less than ± 1 percent, is independent of line or load variations and changes less than ± 0.025 percent per degree C. Direct in-line dialing and readout provide exact resetability and fast frequency selection. Illuminated numbers and traveling decimal point eliminate errors. (302)

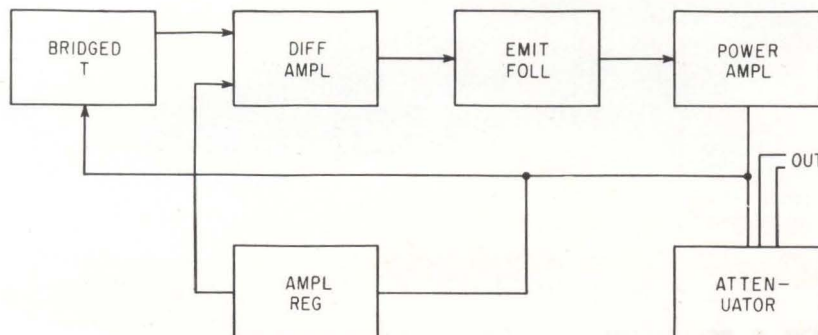

Microcurrent Measurement Sensor Uses Relay Action

RECENTLY announced by Warnecke Electron Tubes, Inc., 175 West

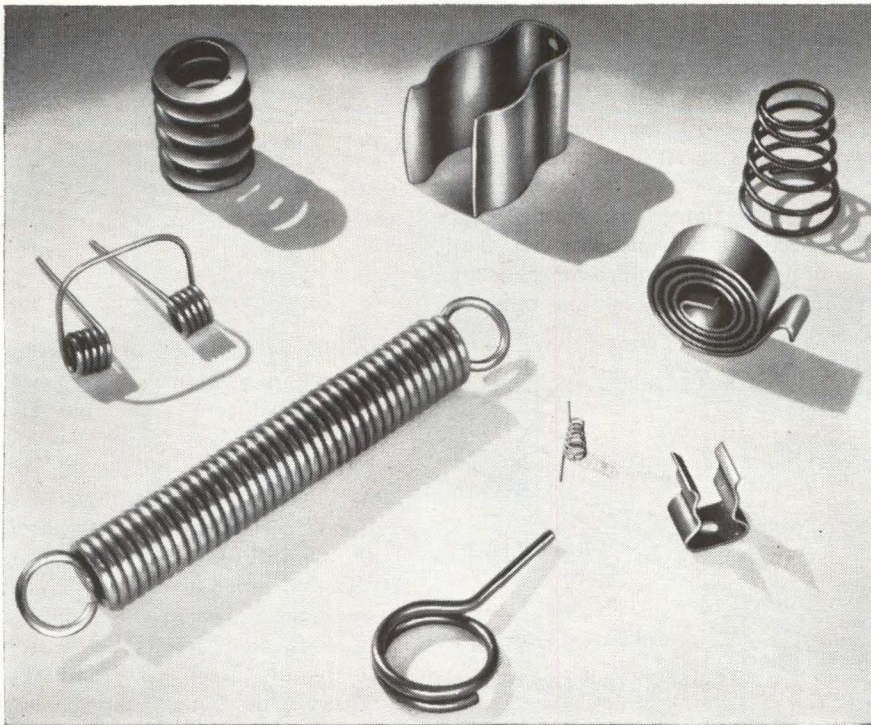

Design Stress for age-hardened DURANICKEL Alloy 301 and PERMANICKEL Alloy 300 springs at elevated temperatures.

Coiling Method	Maximum Shearing Stress for temperatures (°F.) indicated	
	Up to 400°F.	550 to 600°F.
Cold	70,000 psi	60,000 psi
Hot	70,000 psi	60,000 psi

Nickel Alloy Springs last longer in Corrosive Environments and at High Temperatures

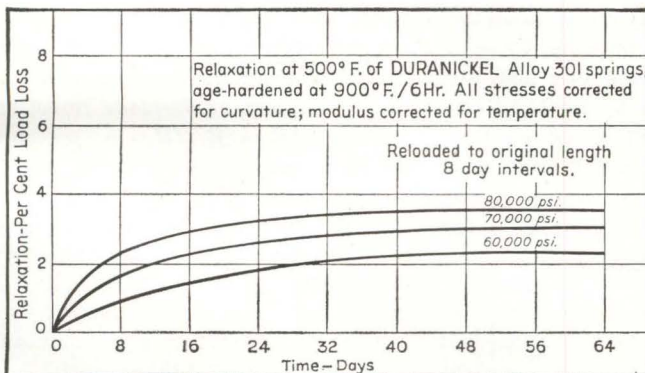

PHYSICAL CONSTANT	DURANICKEL Alloy 301	PERMANICKEL Alloy 300*
SPECIFIC GRAVITY, GM/CM	8.26	8.75
DENSITY, LB./CU. IN.	0.298	0.316
THERMAL CONDUCTIVITY AT (32°-212°F.) BTU./SQ. FT./HR. °F./IN.	128/137**	400
ELECTRICAL RESISTIVITY OHMS/CIR.		
MIL. FT. (68°F.)	260**	94.5**
MICROHMS/CM. (20°C.)	43**	15.7**
TEMP. COEF. OF RESISTIVITY		
PER°F. (68°-212°F.)	0.0006	0.002
PER°C. (20°-100°C.)	0.001	0.0036
MEAN COEF. OF THERMAL EXPAN. AT (77°-212°F.), IN./IN./°F. AT (25-100°C.) CM./CM./°C.	0.0000072 0.000013	0.0000072 0.000013
MAGNETIC TRANSFORMATION TEMP. F. (APPROX.)	200**	563**

The physical constants of DURANICKEL Alloy 301 and PERMANICKEL Alloy 300

Kick out switches, relays, circuit breakers, solenoid valves, diaphragms and other spring type assemblies play a vital part in the efficiency of electrical equipment. If corrosion or high temperatures are important factors in the reliability and service life of your spring assembly, make sure they are made from a high nickel alloy for: (1) high strength stability; (2) resistance to relaxation at elevated temperatures; (3) oxidation resistance; (4) resistance to corrosive environments with good electrical properties.

INCONEL* Alloy X-750 is the out-

standing choice for springs operating up to 1200° F because of its high strength stability, good oxidation and corrosion resistance, and resistance to relaxation.

DURANICKEL* Alloy 301 gives excellent service at temperatures up to 600° F. It is used for infrared bulb spring contacts, springs in sun lamps and spark plugs, electric toaster coils and numerous other applications requiring relaxation resistance at elevated temperatures.

Other nickel alloys recommended for electrical spring assemblies include —

PERMANICKEL* Alloy 300 for high electrical and thermal conductivity, ...MONEL* Alloy 400 for general applications requiring resistance to corrosion and temperatures up to 450° F and INCONEL Alloy 600 for good strength, ductility, resistance to oxidation and good spring properties up to 750° F.

More information? Write for our technical bulletin T-35. "High Nickel Alloy Helical Springs." Our corrosion and high temperature engineers will be glad to help with any specific problem you have.

*Registered trademark

HUNTINGTON ALLOYS



HUNTINGTON ALLOY PRODUCTS DIVISION
THE INTERNATIONAL NICKEL COMPANY, INC.
HUNTINGTON 17 • WEST VIRGINIA

for maximum reliability

BIRTCHEP PCB-TAINERS®



**1-PIECE SPRING
CLIPS RETAIN
PRINTED CIRCUIT
BOARDS SAVE
TIME & MONEY
PROVIDE MAXIMUM
RETENTION &
QUICK ACCESS**

Birtcher PCB-Tainers® simplify design and production, provide important cost savings. Tested and certified to retain printed circuit boards under more than 30Gs shock, vibration to 2,000 cps. Available in more than 70 sizes and types from 1½" to 10" long. Permits boards to be mounted on 17/32" centers for maximum density packaging.

**PROVIDES EXCELLENT
ELECTRICAL GROUND
AND THERMAL PATH**

Available from authorized distributors



Send for new catalog—
just off the press

THE BIRTCHEP CORPORATION

INDUSTRIAL DIVISION
745 S. Monterey Pass Rd.

Mailing Address: P. O. Box D, Monterey Park, Calif.
Angelus 8-8584, Area Code 213, TWX 213-266-6814

**TUBE/TRANSISTOR/COMPONENT
RETENTION AND COOLING DEVICES
SEMICONDUCTOR TEST SETS**

Oakton St., Des Plaines, Illinois, the model RW600 is a micro-current sensor for measuring electric charges of 10^{-10} coulombs or currents such as 10^{-10} amperes. Insulation resistance at 20 C is greater than 10^{15} ohms, minimum active capacitance is approximately 2 pf, contacts stick at approximately 30 v, and accuracy at constant tempera-

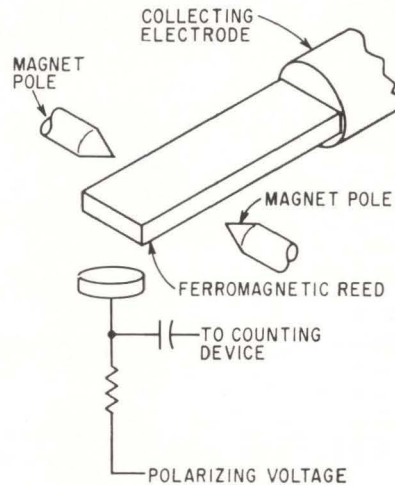

ture is ± 1.5 percent. As shown in the sketch, operation is based on electrostatic attraction between two charged bodies. Opposing force is from action of a magnetic field and elasticity of the relay reed. At rest (no charges present), an electrically-insulated ferromagnetic reed is maintained centered between two poles of the magnetic circuit, by the effect of the magnetic field. An electrically-insulated stationary contact is opposite the free end of the reed. When device is connected to a current generator (or of charges), the charges load the reed and stationary contact. Resulting electrostatic force increases and upsets the balance of the reed-opposing force. The strip then makes contact with the stationary contact, discharging the small capacitor created and feeding the load impedance with an electrical charge.

CIRCLE 303, READER SERVICE CARD

Wideband D-C Amplifier For Low-Level Pickups

ON the market from Analytic Systems Co., 370 South Fair Oaks Ave., Pasadena, California, the model DA-23 wideband solid-state d-c

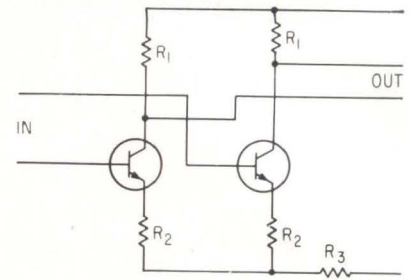

amplifier is designed primarily for thermocouples, strain gages, resistive transducers, variable-reluctance pickups and similar low-level d-c devices. Gain is 25, 50, 100, 200, 400 and 800 calibrated to 0.5 percent, response is d-c to 20 Kc with ± 0.3 db to 10 Kc and 3 db at 20 Kc and noise level of 8 μ v peak-to-peak measured broadband. Common-mode rejection is better than 115 db, d-c to 60 cps. Stability is unaffected by source impedance in excess of 10,000 ohms or reactive loads in excess of 0.1 μ f. Recovery from overload is 50 μ sec for 500-percent overload with typical recovery 20 μ sec or less. Long-term drift is less than ± 4 μ v (48 hours). A typical stage is shown in the sketch. Differential stage gain is approximately equal to R_1/R_2 while common-mode gain is $[R_1/(R_2 + R_3)]$. Stage common-mode rejection then is $[(R_2 + R_3)/R_2]$. A rejection of 20 db per stage is readily attainable, and the unit has better than 115 db rejection of common-mode signals in excess of 5 v. Eighty db common-mode rejection is achieved within 20 μ sec after switching time for 5 v common-mode variation. (304)

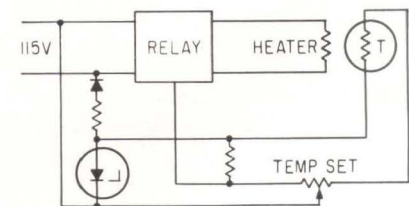

Proportional Controller Holds Heat Within 0.25 F

NEW from Airborne Accessories Corp., 1414 Chestnut Avenue, Hillside 5, New Jersey, the ultRelay proportional controller supplies up to 350 w power to heating circuits proportionally rather than in an on-off manner. Signal source can be

William J. Kennedy
Sales Manager
shown 14 db down
Model 9316-10
Coaxial Attenuator
shown actual size.



50-OHM COAXIAL ATTENUATORS

■ "Our Model 9316-10 Coaxial Attenuator is one of several models in our SAGE-LINE of 50-ohm attenuators. It provides attenuation of 10 db, ± 1.0 db maximum, from DC-5000 MC. Maximum VSWR is 1.15 from DC-1500 MC, and 1.30 from 1500-5000 MC. Peak power capability is 1 KW; average power, 1 watt. ■ Connectors on the 9316-10 are type N. Dimensions are $2\frac{7}{8}$ " in diameter and $2\frac{1}{2}$ " in length. Weight is 3 ounces. ■ The price of the 9316-10 is \$25.00, FOB Natick. Quantity discounts are available. Delivery is from stock for quantities up to 100. ■ If you have a question or would like to place an order, I hope you will call the number shown below. We'll look forward to talking with you." ■

William J. Kennedy / Sales Manager



SAGE LABORATORIES, INC.

3 HURON DRIVE • NATICK, MASS. • Tel: 617-653-0844
TWX: 617-653-6193 • Cable: SAGELABS-NATICK

CIRCLE 205 ON READER SERVICE CARD

IEEE

SEE

THE NEW
ELECTRONIC
WIZARDRY

at

I-TRIPLE-E's

International Convention
and Exhibition in New York

MARCH 25, 26, 27, 28

The COLISEUM at Columbus Circle
& The WALDORF ASTORIA HOTEL

admission: MEMBERS \$1.00; NON-MEMBERS \$3.00
MINIMUM AGE: 18

SHOW

(formerly the IRE Show)

GAS LASER SYSTEMS • LIQUID LASERS •

For Demonstration of Laser
phenomena and for study of
Laser beams in Communications,
Ranging and other applications.

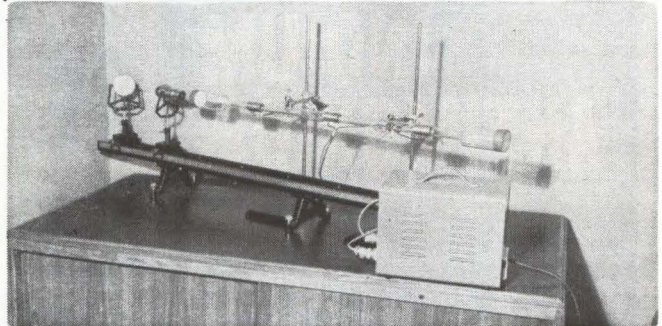

NEW from SEMI-ELEMENTS, INC.
"SELASER" LAMPS



LASER DIODES
Optical Quality Cuprous Chloride
from America's Largest Stock of
SINGLE CRYSTALS

"FERROGLASS"
Optically Transparent Magnetic Glass

Write or Call Today for
Complete Literature

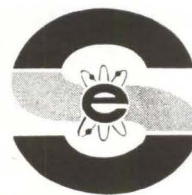

semi-elements, inc.

Saxonburg Boulevard, Saxonburg, Pa.
Phone: 412-352-1548

**ANNOUNCING
A MAJOR NEW
SOURCE FOR
INDIUM
ANTIMONIDE**

**INFRA-
RED
CELLS**

DAVERS CORPORATION, HORSHAM, PA.

CIRCLE 206 ON READER SERVICE CARD

a low-resistance thermocouple or high-resistance thermistors. Power required is less than $\frac{1}{2} \mu W$ with a minimum signal of 1 mv for the low-resistance model and $10 \mu A$ for the high-resistance model. Low-resistance model has 3.2 ohms nominal input resistance while the high-resistance model is 220 ohms. The proportional output rating is zero to 350 w continuous duty (resistive) and temperature control is to ± 0.25 F. A typical application is shown in sketch p 76. The thermistor forms one arm of a bridge and when the temperature is below setpoint, change of thermistor resistance unbalances the bridge and provides a control signal to the relay. As the temperature increases, thermistor resistance decreases and the bridge approaches a balanced condition such that the control signal diminishes and conduction of load current (through an scr) allows proportionately less power transfer to the load until thermal equilibrium is reached.

CIRCLE 305, READER SERVICE CARD

COMINCO

HIGH PURITY METALS
AVAILABLE FORMS

clip and save

Product	ALUMINUM	ANTIMONY	ARSENIC	BISMUTH	CADMIUM	GOLD	INDIUM	LEAD	SILVER	TIN	ZINC
BARS	✓	✓	✓	✓	✓	✓	✓	✓	✓	✓	✓
SHEETS	✓				✓	✓	✓	✓	✓	✓	✓
WIRE	✓				✓		✓	✓		✓	✓
POWDER		✓	✓	✓	✓	✓	✓	✓	✓	✓	✓
SHOT		✓		✓	✓	✓	✓	✓	✓	✓	✓
ROD	✓			✓	✓		✓	✓	✓	✓	✓
RIBBON							✓	✓			
PRE-FORMS	✓				✓	✓	✓	✓	✓	✓	✓
SALTS					✓		✓				

COMINCO PRODUCTS, INC.

electronic materials division

933 West Third Avenue, Spokane 4, Washington
Phone Area Code 509 RI 7-7103 • TWX 509 328-1207

3402

Sliding Termination For Broad Band Use

ASTROLAB INC., 120 Morris Ave., Springfield, N. J. Air gap sliding coaxial termination is a broad band component using Astrolite for terminating 50 ohm $\frac{3}{8}$ in. transmission line and moves at least $\frac{1}{2}$ wavelength at the lowest frequency of 2,000 Mc. All connectors are made as an integral part of the component. Frequency range is 2 Gc to 12 Gc; vswr (element only), less than 1.05; max vswr with connector, 1.19; power, 10 w average; weight 24 oz. (306)

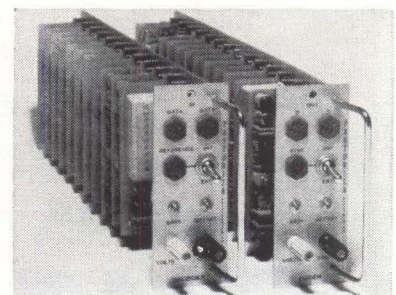

Coder and Decoder Feature Small Size

PASTORIZA ELECTRONICS, INC., 285
Columbus Ave., Boston 16, Mass.,

announces a companion set of computer input-output converters. Coder has 100,000 ohms input impedance, 2 μ sec/bit conversion time, external clocking, and 8-bit accuracy at low cost. Decoder has a bipolar output with impedance 2000 ohms, can multiply an analog reference voltage by the digital input over 4 quadrants, and responds in 2 μ sec to digital and 5 μ sec to analog inputs. Both coder and decoder have an analog signal range of ± 10 v and use ground and -8 v for the digital signals. Supply voltages are ± 15 v. (307)

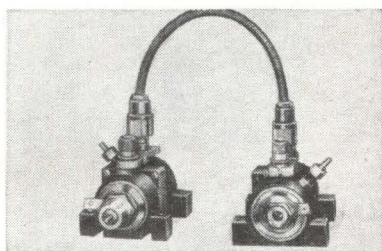

Triode Cavity Amplifier Operates at 1300 Mc

GOMBOS MICROWAVE INC., Webro Road, Clifton, N. J. Model 1532-1 two-stage triode cavity amplifier operates at 1300 Mc and has a gain of 35 db (minimum). Bandwidth is 4 Mc nominal at 30 db, 2 Mc nominal at 45 db gain. R-F input power is rated at 0.5 μ w. A-C and D-C power: E_p , 150 v d-c; I_p , 50 ma max; E_r , 6.3 v. Physical dimensions, one stage, are: diameter 1.5 in., overall length 3 in., excluding mounting bracket and output connector. Input and output connectors TNC female. (308)

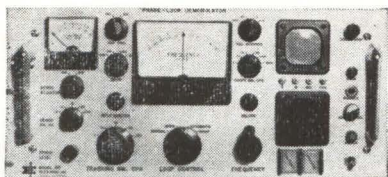

Demodulator for Telemetry Signals

ELECTRAC, INC., 1001 Arlee Place, Anaheim, Calif. Model 215 phase-lock demodulator is designed to demodulate a-m phase modulated telemetry signals. The equipment operates from the i-f of instrumentation receivers. Doppler shift on the carrier can be tracked with band-

APPLICATION ENGINEERING NOTE FROM ALADDIN ELECTRONICS

Blocking oscillator circuits

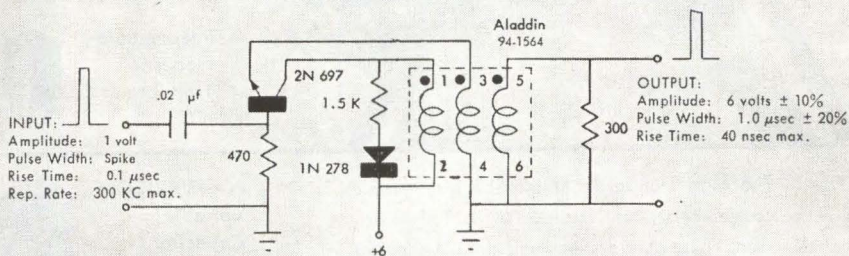

for 40 nanoseconds rise time

Shown above is a common base transistor blocking oscillator using the popular 2N697 transistor. This circuit offers a rise time of 40 nanoseconds maximum as well as a duty cycle of 30%.

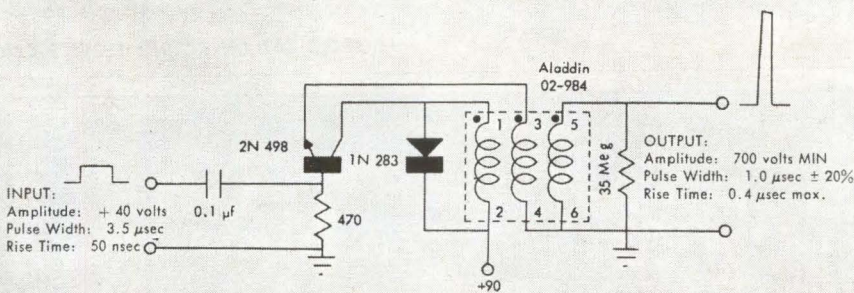

for 700 volt amplitude

A look at the output characteristics of the circuit above indicates it will produce a one microsecond wide pulse with an amplitude of at least 700 volts. Ideal for circuits where high voltage is needed and the current drain is low—e.g., igniting a thyratron.

Using other transistors or transformers in the circuits shown above, it is possible to get many combinations of performance characteristics. For information to assist you in the design of circuits involving pulse transformers, wide band coupling transformers or inductors, write for your free copy of our "Product Directory!"

Write Department 2-C

where the magic of magnetism is a science...
Aladdin[®]
electronics
 nashville 10, tennessee phone: 242-3411, code 615
 twx: 615-244-1534

Write for our catalogue



Good parts work best!

Intermediate Frequency Transformer IFT



The high standards of MITSUMI electronic components are insured by a fully-automated assembly system, and double-checked by rigid quality controls. Mitsumi Electric Company is Japan's largest manufacturer of components for radio, television and communications equipment.

POLYVARICON Variable Capacitor



MITSUMI PARTS

MITSUMI ELECTRIC CO., LTD.



CIRCLE 207 ON READER SERVICE CARD

widths of 3 to 300 cps over a ± 50 Kc range. The equipment incorporates a 3rd order loop filter, uses coherent agc, has automatic sweep and memory features and handles information bandwidths up to 150 Kc.

CIRCLE 309, READER SERVICE CARD

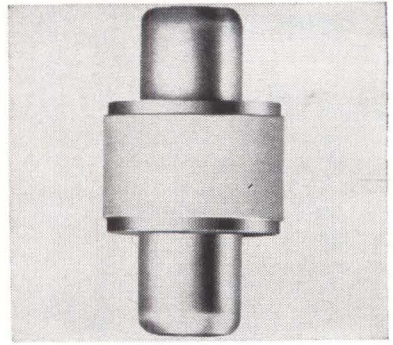

Varactor Diodes Rated at 6 V

MSI ELECTRONICS INC., 116-06 Myrtle Ave., Richmond Hill 18, N. Y. Point contact gallium arsenide varactor diodes feature a minimum working voltage of 6 v. The reverse characteristics extend from 9 to 15 v before avalanche. The 361 series are packaged in the miniature prong configuration featuring a diameter of 0.100 in. and an overall length of 0.205 in., making them ideal for use in coax and stripline. Series is also available in ranges of junction capacity from 0.1 pf to 0.9 pf. Package capacitance is less than 0.2 pf, and the frequency cutoff values from 40 to 180 Gc. (310)



Powertron

AC POWER SUPPLIES

A complete line of single phase, two phase and three phase electronic power supplies with output power ranging from 3 watts to 9 KVA.

Featuring:

- Precision 400 C.P.S. output (other fixed or variable frequency ranges available).
- Regulated output voltage.
- Low distortion.
- Many standard optional features to suit your requirements.

WRITE FOR OUR NEW POWERTRON SPECIFICATION CATALOG

INDUSTRIAL TEST EQUIPMENT CO.
55 EAST 11th STREET • NEW YORK 3, N. Y.

Visit Booth 3310—1963 IEEE Show N. Y. Coliseum—March 25-28

80 CIRCLE 80 ON READER SERVICE CARD

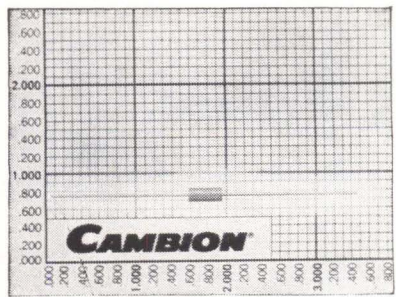

R-F Molded Chokes Conform to MS-16225

CAMBRIDGE THERMIONIC CORP., 445 Concord Ave., Cambridge 38, Mass. Series of 57 molded-type miniature r-f chokes cover the range from 0.15 μ h to 33.0 μ h and measure

March 8, 1963 • electronics



AUDIOTRAN TRANSISTORIZED AUDIO AMPLIFIERS

High gain, self-contained, low distortion, completely transistorized Audio Amplifier modules.

FEATURES: Plugs into 7- or 8-pin socket; hermetically sealed; rugged military construction; cool-running; high stability; driver plus P-P output transformer; negative or positive 15 V., DC operation.

MODEL	POWER OUTPUT	INPUT RES. ohms	OUTPUT RES. ohms	POWER GAIN	DIST.	PRICE
AA-1	150 mw	600	6	57 db.	2%	\$75
AA-2L	135 mw	4700	600	44 db.	1.5%	75
AA-3-3	2 W	600	3.2	38 db.	3%	85
AA-3-8	2 W	600	8.0	36 db.	4%	85
AA-4-3	2 W	600	3.2	64 db.	2.0%	125
AA-4-8	2 W	800	8.0	66 db.	2.3%	125
AA-4L	3 W	800	250	68 db.	4.3%	125
AA-5	2 W	800	3.2	63 db.	3.0%	125
AA-5H	2 W	2.3 K	3.2	58 db.	2.3%	125
AA-6-3	4 W	600	3.2	61 db.	4.6%	130

CASE SIZES: AA-1, AA-2L—2½"×2"×2½"; AA-3 thru AA-6—3"×2½"×4¼". IMPEDANCES OPTIONAL. FOR COMPLETE LINE SEE EEM PGS. 624-625.

FERROTRAN ELECTRONICS CO.
693 BROADWAY • N. Y. 12, N. Y. • AL 4-5810
Makers of A-F and I-F Amplifiers • Transistor Power Supplies and Miniature Transformers

CIRCLE 208 ON READER SERVICE CARD

- SCAN CONVERSION
- FLICKERLESS DISPLAY STORE
- VIDEO STORAGE

RECORDING STORAGE TUBE SYSTEMS

Single-gun, dual-gun, multi-tube systems to convert scan for radar, sonar, television, and to perform analog processing, data analysis, contract or expand time scale, auto correlation.

- SLOWED TELEVISION TRANSMISSION

by telephone line or other narrow-band systems.

- IMAGE ENGINEERING

OPTICAL CHART READERS, FLYING SPOT SCANNERS, LOW-LIGHT-LEVEL CAMERAS, and IMAGE RECTIFICATION. Automatic inspection and recognition of size, shape, color, and texture.



Write or call for complete information:



INSTRUMENTS, Inc.

2300 Washington Street
Newton 62, Massachusetts
617 WOODWARD 9-8440

CIRCLE 209 ON READER SERVICE CARD

electronics • March 8, 1963

0.156 in. in diameter by 0.375 in. in length. All 57 chokes are wound with 5 percent inductance tolerances with 23 of them in preferred EIA values. All conform to military standard MS-16225. (311)



Photo Attachment For CRO

ON THE MARKET from Honig Laboratories, Inc., 6720 Bay Parkway, Brooklyn, New York, the model R-5 oscilloscope attachment can be used with a conventional Polaroid camera and any oscilloscope having a 5½-in. outside diameter bezel to record up to 8 multiple signals, using the oscilloscope vertical displacement, make conventional photographs or combination photograph and multiple oscilloscope trace prints. (312)



D-C Amplifier Is Chopper Stabilized

COHU ELECTRONICS, INC., 5725 Kearny Villa Road, San Diego 12, Calif. Designed for applications where thermocouple and strain gage measurements require extremely low drift, noise and excellent stability, the 118 has 0.5 percent gain



NO STRIPPED THREADS

METER MANUFACTURER CHOOSES CLECOMATIC* BECAUSE . . .

- (1) Previous fastener driving methods proved inadequate for precise Quality Assurance Standards.
- (2) SERIES 3 and 6 CLECOMATICS provided the precise control required to meet those quality standards.

(3) Automatic shut-off prevents fracturing of meter box coatings, stripping of threads and damaging of screws resulting in dramatic reduction in the number of rejects.

What the precision torque, fully automatic CLECOMATIC has done for this manufacturer, it can do for you. Call your CLECO Representative, he will be glad to help you with your production line problems.

*Fully warranted for one year by the GOLDEN CIRCLE guarantee



A DIVISION OF
REED ROLLER BIT COMPANY
P. O. Box 2541 • Houston, Texas

CIRCLE 81 ON READER SERVICE CARD

81

Straits Tin Report

Tin in Mercury spacecraft. Structural ribs of NASA's Mercury spacecraft are made of a tin alloy — Ti-5Al-2.5Sn. To these ribs are attached the panels of commercially pure titanium which form the spacecraft's double-wall pressure shell.

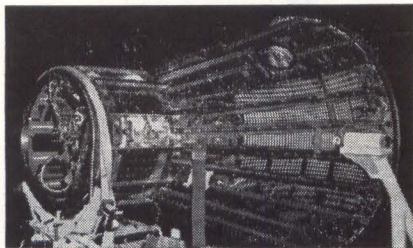

Photo courtesy McDonnell Aircraft

The use of tin adds 15,000 psi tensile strength to the alloy at an aluminum level of 5%.

Tin and aluminum are used together, according to Titanium Metals Corporation of America, to impart added strength to pure titanium without any sacrifice in the weldability of the unalloyed titanium. The aluminum content of the alloy is limited to a maximum of 6%.

-423°F to 750°F is the useful temperature range of this alloy. Control of oxygen and iron content produces a metal with exceptional properties at the temperature of liquid hydrogen, -423°F. This particular titanium-aluminum-tin alloy has been used extensively in jet engine compressor cases, in liners of engine cowlings, and in other aircraft applications where a reduction in weight is desirable and the material is required to withstand a temperature of 750°F.

Free Bulletin
Write today for a free subscription to **TIN NEWS**—a monthly bulletin on tin supply, prices and new uses.



The Malaysian Tin Bureau
Dept. T-25C, 2000 K Street, N.W.
Washington 6, D.C.

accuracy and 0.02 percent gain stability. It is a floating, 3-terminal amplifier with all signal terminals isolated from chassis ground. Output load specifications are less than 0.25 ohm d-c to 500 cps; less than 1 ohm d-c to 2 Kc. Output load variations, within the output load specifications and signal source impedances up to 1000 ohms, will not affect gain accuracy, stability or linearity.

CIRCLE 313, READER SERVICE CARD

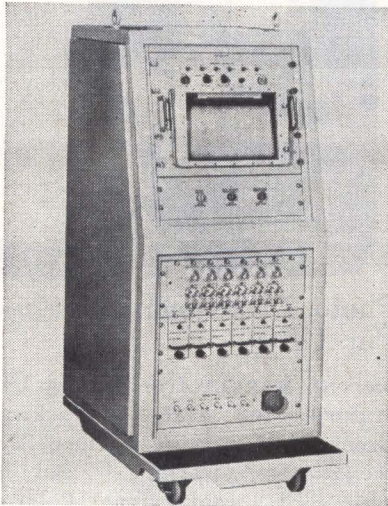

Recording System Is Direct Writing

BRUSH INSTRUMENTS, division of Clevite Corp., 37th and Perkins, Cleveland 14, O. Six-channel direct writing recording system that meets all pertinent military specifications including rigid specifications for r-f interference and has been proven in field checkouts of major weapons systems, is now available for commercial applications. Model 13-1662-60 contains interchangeable plug-in modular preamplifiers. With slight modification individual channels can be provided with these preamplifiers for specialized applications including strain recording and servo system analysis. (314)

Coaxial Duplexers Are Low Frequency Units

MICROWAVE ASSOCIATES, INC., Burlington, Mass. Low frequency coaxial duplexers for state-of-the-art system are available with 2.5 Kw peak and 80 w average for opera-

NEW AXIAL FIELD GAUSSMETER



- 2 rotating coils for 3D measurements on solenoids and focusing coils.
- Measures both axial and transverse fields.
- Long operating life due to new design features.
- Wide range of measurements 0.4/1/4/10/40/120 kilogausses.

Write for Bulletin 729



111 Potter Street • Cambridge, Mass.

CIRCLE 210 ON READER SERVICE CARD

NIMS

NATIONWIDE IMPROVED
MAIL SERVICE PROGRAM

For Better Service
Your Post Office
Suggests

That You Mail Early
In The Day!

tion in the vhf region. Devices are characterized by extremely small size, light weight, high reliability and instantaneous recovery time. They have no spike leakage. (315)

Wide Band Amplifier Takes Little Space

AMTRON INC., 14631 S. Waverly Ave., Midlothian, Ill., announces type 1339 Mili-Min wide band amplifier with 36 db gain. Frequency response is flat within 1 db from 100 cps to 600 Kc. Uses +10 v supply with approximately 7 ma current drain. Input impedance, 4500 ohm; output impedance, 600 ohm. Max output level 3 mw at 600 ohm. Self lead mounting. Dimensions 0.8 by 0.65 by 0.56 high. (316)

X-Band Klystron Features Small Size

METCOM, INC., 76 Lafayette St., Salem, Mass. New X-band klystron features a dielectric tuner that can be placed in any desirable position, a low temperature coefficient, typically 50 Kc/deg C, low hysteresis and flat power across 20 percent band with low microphonics. (317)



Hall Effect Kit For Test Uses

F. W. BELL INC., 1356 Norton Ave., Columbus 12, O., announces a compact kit for the purpose of demonstrating and exploring the Hall effect and solving related problems. Included in the kit are: a model BH206 Hall-Pak Hall effect device; a small circuit board, containing a balancing network and a d-c transistorized amplifier with a voltage gain of approximately 50, for easy hook-up and application of the Hall-Pak; two bar magnets to provide a stable d-c field for many Hall effect applications; and a complete instruction booklet. (350)

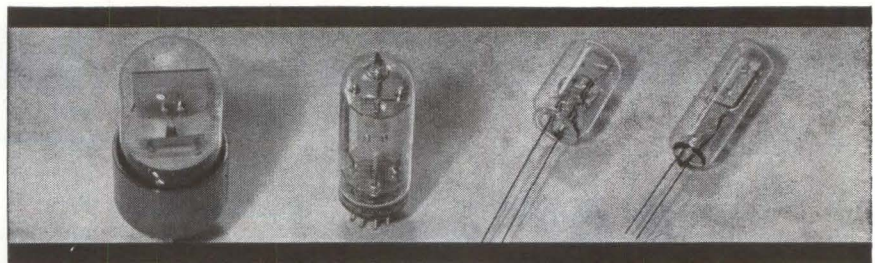

LOW FREQUENCY CRYSTALS

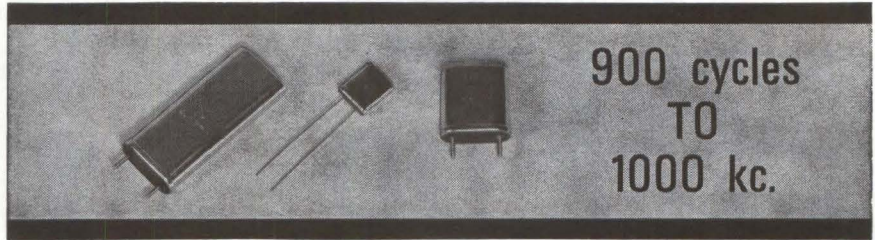

• for OSCILLATOR, FILTER and SPECIAL APPLICATIONS



If a special low-frequency crystal is your current problem, tell it to Knights. The James Knights Company builds all low-frequency types to commercial or military standards, to specific requirements, in metal or glass, in all holder configurations. For a wide choice of "regular types", or for more information on special applications, write or wire:

THE JAMES KNIGHTS COMPANY • Sandwich, Ill.

CIRCLE 211 ON READER SERVICE CARD

You Get Things Done With Boardmaster Visual Control

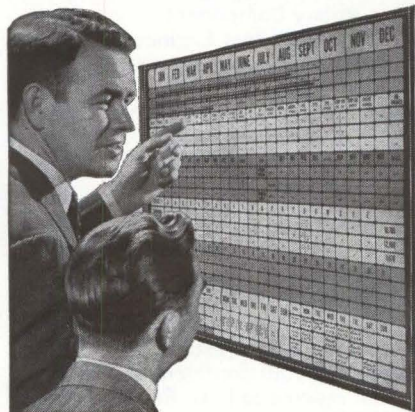

- ☆ Gives Graphic Picture of Your Operations—Spotlighted by Color
- ☆ Facts at a glance—Saves Time, Saves Money, Prevents Errors
- ☆ Simple to operate—Type or Write on Cards, Snap in Grooves
- ☆ Ideal for Production, Traffic, Inventory, Scheduling, Sales, Etc.
- ☆ Made of Metal. Compact and Attractive. Over 750,000 in Use

Full price **\$4950** with cards

FREE 24-PAGE BOOKLET NO. C-40 Without Obligation

Write for Your Copy Today
GRAPHIC SYSTEMS
Yanceyville, North Carolina
CIRCLE 212 ON READER SERVICE CARD

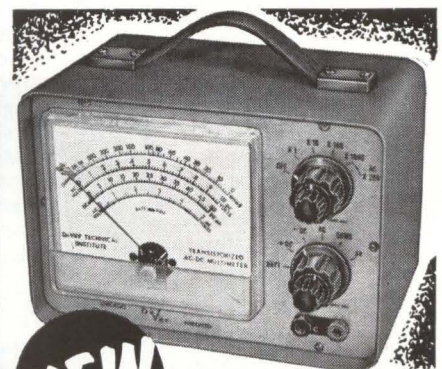

NEW DeVry TECHNICAL INSTITUTE'S

TRANSISTORIZED METER

PORTABLE LOW-PRICED

\$89⁵⁰

FACTORY WIRED Unwired Kit . . \$64.50 F.O.B. Chicago

Combines the advantages of a vacuum tube voltmeter and a sensitive microammeter plus full protection for the meter movement! High input impedance, temperature stability, silicon semiconductors, 1% attenuator resistors, wide frequency response. Order direct (not sold through distributors). Satisfaction guaranteed.

SPECIFICATIONS: DC Current 0-50/0-500 μ a. 0-5/0-50 ma. DC Voltage 0-1/0-10/0-100/0-1000. AC Voltage 0-5/0-500/0-1000. Resistance to 0-10 Megohms in four ranges. Battery powered.



Product Research Division—Dept. RD-5
DeVry Technical Institute
4141 Belmont Ave., Chicago 41, Ill.

CIRCLE 83 ON READER SERVICE CARD 83

MEN



ON THE WAY UP

Men at Honeywell are on their way up! How do you measure your success? Is it through the attainment of broader responsibilities, or through a constantly rising level of experience and competence within your specialized field of interest? Capability, in either direction, is rewarded at Honeywell in Florida and professional assignments leading to your career growth are open at all levels.

Among our immediate needs are . . .
Systems Engineers / Circuit Designers
/ Logic Designers / Systems Analysts
/ Programmers / Packaging
Engineers / Rotary Component
Designers / Systems Test Engineers
/ Materials & Component Engineers /
Test Equipment Designers /
Manufacturing Prototype Development
Engineers / Reliability Engineers /
Quality Control System Engineers.

This long list reflects our continuing expansion in every phase of precision guidance systems and techniques. We are currently working on such vital projects as Gemini, Dyna-Soar, Centaur and others. Interested? We'll promptly reply to your confidential inquiry. Send resume to L. C. Ericson

And remember, your family will enjoy Florida's Suncoast living.

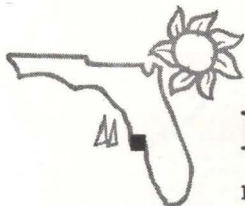

Honeywell

13350 U S. Highway 19, St. Petersburg, Florida
 AN EQUAL OPPORTUNITY EMPLOYER
 "A Good Place to Live . . . A Good Place to Work"

To investigate professional openings in other Honeywell facilities, send your resume to H. F. Eckstrom, Honeywell, Minneapolis 8, Minnesota.

HONEYWELL ENGINEERS ARE DOING THINGS IN FLORIDA

Literature of the Week

POLYURETHANE CASTING RESIN Isochem Resins Co., 221 Oak St., Providence 9, R. I. Technical data bulletin covers PolyUCast, a low cost repairable polyurethane casting resin. CIRCLE 318, READER SERVICE CARD

MICROCIRCUITS Corning Electronic Components, Raleigh, N. C., has available a data sheet on thin film microcircuits. (319)

SCR TESTER Electronic Research Associates, Inc., 67 Factory Place, Cedar Grove, N. J. Catalog sheet describes model SCR100 silicon controlled rectifier test set. (320)

OSCILLATORS Monitor Products Co., Inc., 815 Fremont Ave., South Pasadena, Calif., offers its 4-page crystal controlled oscillator booklet. (321)

HIGH-SPEED PRINTER SYSTEM Potter Instrument Co., Inc., 151 Sunnyside Blvd., Plainview, N. Y., has available a brochure on the LP-1200 high-speed printer system for computers. (322)

SELECTIVE NETWORKS Raytheon Co., 55 Chapel St., Newton 58, Mass., offers a handbook on a line of selective networks spanning the frequency spectrum from 1 cps to 50 Mc. (323)

R-F SHIELDED ENCLOSURES Erik A. Lindgren & Associates, Inc., 4515 N. Ravenswood Ave., Chicago 40, Ill. Chart gives comparative performances in tabular form from 60 cps in magnetic field to 10 Gc in electric and plane wave. (324)

CONTROLLED RECTIFIERS Westinghouse Semiconductor Division, Youngwood, Pa. Technical data 54-565 covers Trinistor controlled rectifiers for controlling medium-power loads of up to 55 amp rms. (325)

PORTABLE TEST CHAMBER Greenberg Electric Co., Inc., 9 Commercial Ave., Garden City, N. Y. Catalog sheet covers the Vari-Temp portable test chamber designed for shock and general lab testing from -100 to +425 F. (326)

CONTACT STRIPS AND RINGS Braun Tool and Instrument Co., Inc., 140 Fifth Ave., Hawthorne, N. J., offers a 16-page catalog on beryllium copper contact strips and rings. (327)

COMPOSITION ELEMENT POTENTIOMETERS Clarostat Mfg. Co., Inc., Dover, N. H. Catalog contains specifications on lines of molded carbon element potentiometers. (328)

RELIABILITY GLOSSARY Autonetics, 9150 E. Imperial Highway, Downey, Calif. Reliability glossary contains more than 600 terms common to electronics and aerospace reliability specialists. (329)

TRIMMING POTENTIOMETERS Helipot Division of Beckman Instruments, Inc., 2500 Harbor Blvd., Fullerton,

Calif. Data sheet describes Helitrim model 50 trimming potentiometers and introduces the new Helitrim model 55. (330)

MICROLOGIC Fairchild Semiconductor, 545 Whisman Road, Mountain View, Calif., has available six data sheets and technical paper 22 for updating the Micrologic Handbook. (331)

DATA-REDUCTION INSTRUMENTS The Gerber Scientific Instrument Co., P. O. Box 305, Hartford, Conn. Five scientific instruments to reduce data quickly and precisely are covered in a 6-page folder. (332)

CERAMIC CAPACITORS Vitramon, Inc., P. O. Box 544, Bridgeport 1, Conn. A 32-page brochure contains specification information and sequential testing plan for VK general purpose ceramic capacitors. (333)

MICROWAVE SWITCH Somerset Radiation Laboratory, Inc., 192 Central Ave., Stirling, N. J. Application note describes a simple procedure for using a single-diode microwave switch to obtain over 60 db switching range. (334)

HEAT DISSIPATORS The Staver Co., Inc., 45 N. Saxon Ave., Bay Shore, L. I., N. Y. Folder shows how to select the proper heat dissipator for a given semiconductor application. (335)

TEST EQUIPMENT Daven Division of General Mills, Inc., Livingston, N. J., has published a 24-page catalog describing its complete line of electronic test equipment. (336)

MICRO-POSITIONER ANGLE GENERATORS OPTOmechanisms, Inc., Plainview, N. Y. Four-page brochure describes a line of micro-positioner angle generators, both single and two-axes. (337)

INTERMETALLIC SEMICONDUCTOR MATERIALS Monsanto Chemical Co., 800 N. Lindbergh Blvd., St. Louis 66, Mo., makes available to electronic device manufacturers a computer prepared catalog of III-V intermetallic semiconductor materials. (338)

ELECTRONIC HARDWARE Concord Electronics Corp., 37 Great Jones St., New York 12, N. Y., has released a 32-page catalog covering expanded lines of machined terminals, terminal boards and panel & chassis hardware. (339)

MEGAWATT KLYSTRONS Sperry Gyroscope Co., Great Neck, N. Y. A technical booklet deals with megawatt klystrons that cover four bands—L, S, C, and X. (340)

COMPUTER TRAINING EQUIPMENT Digital Electronics, Inc., 2200 Shames Drive, Westbury, L. I., N. Y., has released a short form catalog sheet on its line of educational training aids for the electronics and digital computer fields. (341)

LABORATORY CHROMATOGRAPH Consolidated Electrodynamics Corp., 360 Sierra Madre Villa, Pasadena, Calif. A four-page bulletin describes the capabilities of the modular 26-204 laboratory chromatograph. (342)

Magneline[®]
THE INDICATOR WITH INHERENT MEMORY

Two new series for digital readout, ideal for multiplex applications

SERIES 14000—FOR SOLID STATE LOGIC

Character Size..... $\frac{9}{32}$ " x $\frac{1}{4}$ "
No. of Characters.....Up to 11
Leads.....11 plus a common
Watts.....2.4

SERIES 15000—FOR RELAY LOGIC

Character Size..... $\frac{5}{16}$ " x $\frac{1}{4}$ "
No. of Characters.....Up to 10
Leads.....5 plus a common*
Watts.....1.3-1.7

*Requires switching of lead in combination with reversal of polarity to change indicator.

Units hold last reading without power. Totally enclosed, self-stacking housing for front or rear mounting. Jewel bearings, only one moving part. Standard voltages 6, 12, 24, or 28 V.D.C. Readability 12 feet at normal room lighting. Options include special voltage, special characters, and internal lighting for dark room applications.



External appearance of 14000 or 15000 series

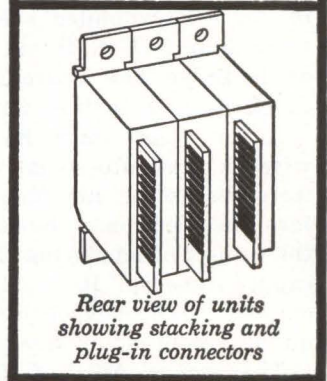

Rear view of units showing stacking and plug-in connectors

Write or teletype (203-753-9341) for free literature

PATWIN[®] ELECTRONICS
A DIVISION OF THE PATENT BUTTON COMPANY
WATERBURY 20, CONNECTICUT
CIRCLE 213 ON READER SERVICE CARD

AM-FM Tuner Unit

AM SEC. CAPACITY: MAX. 377FF
: MIN. 12PF
TUBE: 6AQ8, 12DT8, 17EW8

PLASTIC VARIABLE CONDENSER

Square Size:
15 mm., 17 mm.,
20 mm., 21 mm.,
Single band
2 band, 3 band
and for FM only.

SANKAISHA CO., LTD.
Cable address: SANESVARICON TOKYO
1425, 4-chome, Higashinakanobu,
Shinagawa-ku, Tokyo, Japan.

CIRCLE 214 ON READER SERVICE CARD

NEW MINIATURE DELAY LINES

$\frac{1}{4}$ CU. INCH PER μ SEC.

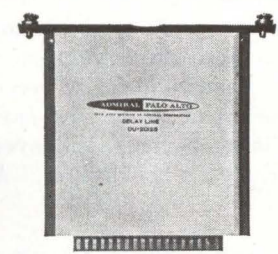

Total delay of 20.3 μ sec. in 2 lines with 14 taps
Overall size 4" x 4"



- Total delay accuracy better than $\frac{1}{2}$ of 1%
- Total delay to rise time ratio better than 30:1
- Distortion under 4%
- Temp. coefficients less than 50 ppm/ $^{\circ}$ C

WRITE FOR DETAILS
 ADMIRAL PALO ALTO
Palo Alto Division of Admiral Corporation
Stanford Industrial Park, Palo Alto, California

CIRCLE 85 ON READER SERVICE CARD 85

Solomon: Employer of the Year

WHEN AARON N. SOLOMON was an Army Air Corps captain during World War II, he helped receive and re-route plane loads of severely wounded soldiers returning to the U. S. from the Battle of the Bulge. The future these men faced made a lasting impression.

A few years later, he and his wife—a graduate social worker—were discussing his plans to get into the electronics business, and the subject of employing the handicapped came up. It would be work on small, light components, not requiring mobility or strength.

That was in April of 1952.

Eleven years after Solomon had founded Ace Electronics Associates, Somerville, Mass., for the manufacture of potentiometers and other components, he was recently named Employer of the Year by The President's Committee on Employment of the Handicapped. Out of Ace's 275 employees, 240 have some kind of handicap—physical, mental or emotional. As a matter of policy, at least 75 percent of the jobs at Ace are held by handicapped men and women. Four of the plant foremen, promoted from bench work, direct operations from wheelchairs.

Solomon says industrial employers are showing more interest in hiring the handicapped in recent years. "The trend is up," he says. "I get calls now from employers looking for, e.g., a bookkeeper." As



chairman of the Governor's Committee on Employment of the Handicapped in Massachusetts, he is a kind of clearing-house of information on jobs for the partially disabled.

"All it takes is a little understanding," says Solomon. "All it costs is the expense of making doors a little wider so wheelchairs can get through."

The Ace workers enjoy the benefits of group life insurance, and the firm's rates for workmen's compensation insurance are low because of an outstanding safety record—not a single disabling injury in the company's 10-year history.

For a long time, Solomon would

not talk about his "Hire the Handicapped" policy. He was afraid it would look like a small company's "sympathy bid for business." But now Ace is over the hump. In a highly competitive field, it has moved along steadily, with gross sales of \$1,750,000 last year. In the first year after the firm was founded by Solomon and vice president-chief engineer Louis Berni, gross was \$40,000.

Pay scales are at least comparable to those for comparable jobs in the industry, Solomon says. "And my employees are like others in the electronics industry. Many move on to bigger companies and better jobs after training here."

"But on stormy mornings," he says quietly and admiringly, "who are the first to arrive, waiting outside for the doors to open? The handicapped employees. And on the day after a holiday or a big weekend, what is the absentee rate? Zero."

Ace Electronics Associates is located in a densely-populated section of Somerville. Solomon has no intention of moving out to Route 128, "Electronics Highway" in the airy suburbs surrounding metropolitan Boston. "My employees couldn't get to work out there."

Ace does its own R&D, is about ready now to produce non-linear pots of a conductive plastic material made in-house. Experimental work also includes development of a ferrite switch for microwave applications. And for further diversification, Ace has organized an environmental test laboratory as a subsidiary firm and has acquired a plastics business.

IMC Magnetics Expands in Arizona



RECENTLY dedicated 20,000-square foot plant of the Arizona division of IMC Magnetics Corp., of Westbury, N. Y. The new plant, situated on a five-acre tract at Tempe, Ariz., has twice as much floor space and three times productive capacity of the former facility in Phoenix. The division manufactures products for aerospace fuel management systems

PPMA Announces Election of Officers

GEORGE MUCHER, executive vice president, Clarostat Mfg. Co., Inc., has been elected president of the Precision Potentiometer Manufacturers Association, Chicago, Ill. He succeeds R. C. Chase, vice president, Spectrol Electronics Corp., who will



SOLID STATE IN Electronics

Men of vision thrive here. And it takes men of vision to cope with today's electronics and space problems. Space in more ways than just up. Space problems of a different nature plague the manufacturer who must expand, but hasn't the land to expand on.

Here in Florida we have the space, the climate, the work force. Florida has more to offer electronics firms than any other area on earth. Men think better where life is pleasant, where off hours can be devoted to just plain *living*—and to just plain *thinking*.

Yes, Florida is a Solid State in Electronics. Already the sun, Mother of Life, shines on over sixty thriving electronics firms in our busy state.

Cape Canaveral is here, too, with its massive, awesome missiles blasting off to make space history. Electronics makes possible every thrust into the universe. Every hope of getting to the moon depends upon electronics—and the first American to the moon will definitely soar to history from Florida.

Engineers and their families dream of living here in Florida. Give them this dream by moving your plant here. Nurture the brains that will give your business a greater and greater stature in this, the Electronics Age.

For complete details of the many advantages Florida offers the Electronics Industry, write us. Let us tell you why some of the greatest names in electronics have impressive plants here in Florida.

FLORIDA'S ASSURANCE POLICY

"You have my personal assurance of a sunny business climate here in Florida. You have positive assurance of every aid and assistance possible from our Florida Development Commission and from the overwhelming majority of our businessmen, industrialists, and financiers. We have everything to make your large or small enterprise healthy and successful. Write, wire, or phone us TODAY. The only thing better than a FLORIDA vacation is having your plant here."



FARRIS BRYANT
Governor

Investigate

Florida

... NOW AN 11 BILLION DOLLAR MARKET

Ask about free film "Profile of Progress" FLORIDA FOR CONVENTIONS— Write for free information on Florida's wonderful facilities for your group meeting.



Mr. Wendell Jarrard, Chairman
FLORIDA DEVELOPMENT COMMISSION
Box 4247E, Tallahassee, Florida

Please send me brochure, "Why Your New Plant Should Be Located In Florida," containing the facts about FLORIDA's opportunities for New Industry, the 11 BILLION DOLLAR CONSUMER MARKET, Labor, Climate, Schools, Natural Resources, Favorable Tax Structure.

Name.....
Firm Name.....
Address.....
City.....Zone.....State.....

OMARK Gramweld

Percussive Stud Welding

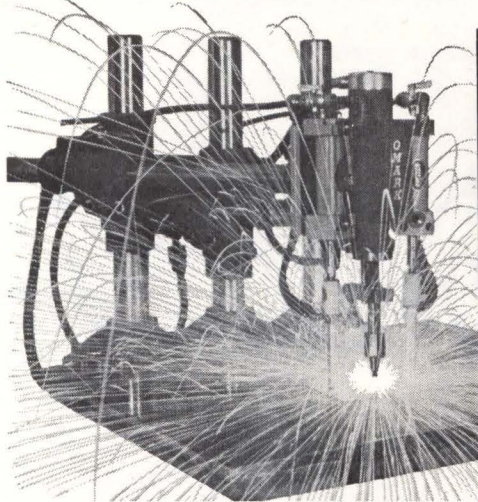

developing
new
concepts
in metal
fastening
for
industry

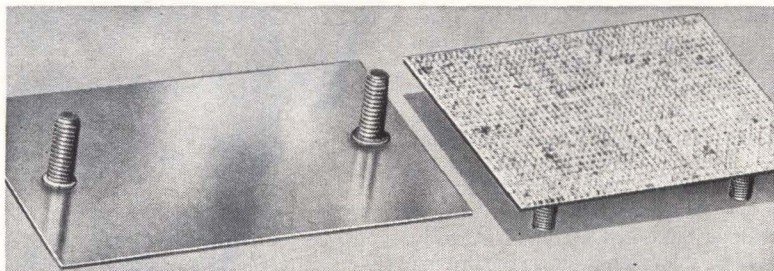

OMARK GRAMWELD aluminum studs are welded to vinyl clad aluminum panels for curtain wall use. There is no burn-through or distortion to harm the finished appearance of the panels. The system can be used on many metals including copper, lead-free brass, die-cast zinc, and steel.

If these typical Gramweld Percussive Stud Welding applications suggest answers to your own exacting requirements for rapid, economical, dependable metal fastenings, call one of OMARK's 27 U.S. marketing outlets. A factory-trained, technically qualified representative is ready to go to work on your problem immediately.

© Copyright
1963 by



OMARK
Industries, Inc.

Portland, Oregon • Cincinnati, Ohio
Guelph, Ontario, Canada
Amsterdam, Holland • Varberg, Sweden
Branches in 27 major U.S. cities
Consult the "yellow pages"

CIRCLE 88 ON READER SERVICE CARD



Your electronics BUYERS' GUIDE should be kept in your office at all times—as accessible as your telephone book.

continue as a member of the board.

R. E. Ackerman, Borg-Equipment Division, was elected vice president of PPMA.

Newly elected directors include D. C. Lawton, TIC Division, Bowmar Instruments Corp.; R. W. Quinn, Fairchild Controls Corp.; and E. P. Medlock, International Resistance Co.

Murphy Assumes New Post

DONALD J. MURPHY, former general manager of the Operations division of Lockheed Missiles & Space Co., Sunnyvale, Calif., has been appointed president of United Electro Dynamics, Inc., in Pasadena, and has been elected to membership on the board of directors.

Murphy succeeds R. G. Sohlberg who has resigned. Sohlberg will continue as a director of the corporation.



RCA Upgrades Douglas Smith

PROMOTION of Douglas Y. Smith to the newly created position of vice president and general manager, RCA Electronic Components and Devices is announced. In his new post he will be responsible for the management and direction of the RCA Electron Tube division and the RCA Semiconductor and Materials division.

A veteran of more than 30 years with the corporation, Smith has been vice president and general manager, RCA Electron Tube division, since 1954. He will continue as executive head of that division. Alan M. Glover will continue as

Mullard tubes for Audio

ECL86

6GW8

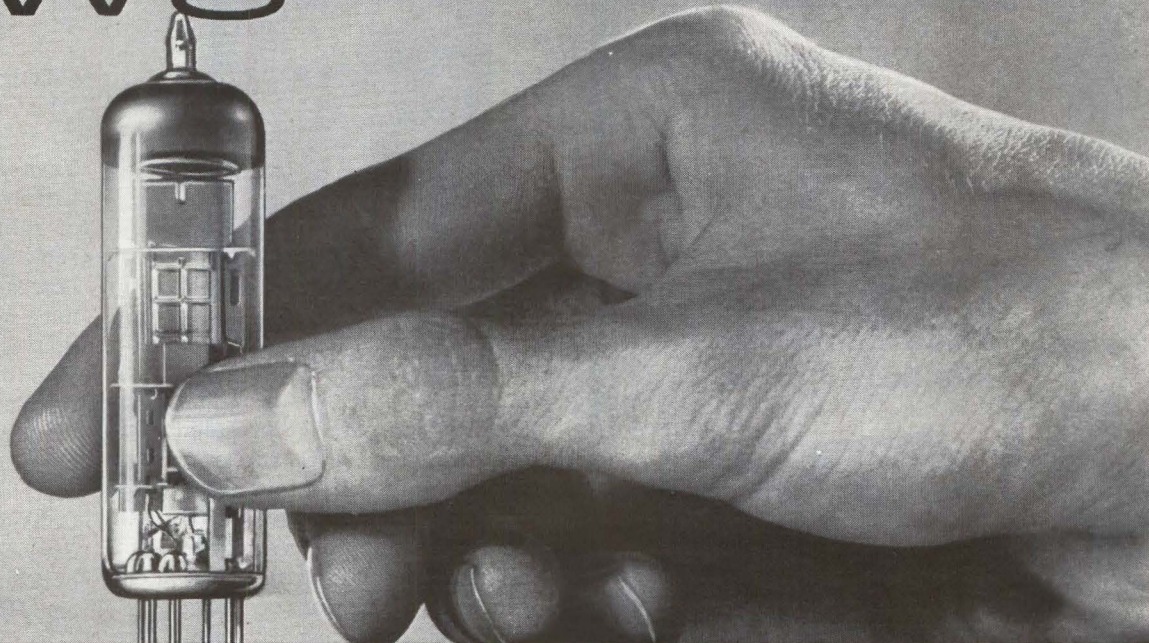

COMBINED HIGH MU TRIODE AND 9 WATT PENTODE

High sensitivity, coupled with high output power make the ECL86 the ideal tube for audio amplifiers. The high sensitivity of this tube stems from a triode amplification factor of 100 combined with a pentode slope of 10 mA/V. A single ECL86 will give an audio output of 4W ($B+ = 250V$), and two in push-pull will provide 14.3W ($B+ = 300V$).

CHARACTERISTICS

Pentode Section

g_m	10	mA/V
P_p	9	W
r_p	48	k Ω
E_b	250	V
E_{c2}	250	V
E_{c1}	-7.0	V
I_b	36	mA
I_{c2}	6.0	mA

Triode Section

μ	100	
g_m	1.6	mA/V
r_p	62	k Ω
E_b	250	V
E_c	-1.9	V
I_b	1.2	mA

Full details on the Mullard range of tubes for stereo, high-fidelity and television available from:

INTERNATIONAL ELECTRONICS CORPORATION,
81 SPRING STREET, NEW YORK 12, N.Y.

Worth 6-0790



Mullard

ELECTRONIC TUBES

MULLARD OVERSEAS LIMITED · LONDON · ENGLAND

Mullard is the trade mark of Mullard Limited

Win your P.E. license FASTER

Here's great news for the electrical or electronics engineer who wants to add "P.E." after his name. Available now is a 5-volume Library that helps you prepare for and pass examinations for professional engineer. It takes you swiftly, confidently through vital steps—from preparation of application and records . . . through thousands of practice questions from actual tests that make you feel right at home in the exam room . . . to formulas, pointers, shortcuts and practical applications you'll need to pass the detailed examination for the Electrical Engineer group.

ELECTRICAL ENGINEER'S LICENSE EXAMINATION LIBRARY

5 vols., 1936 pp.,
1313 illus., \$34.95

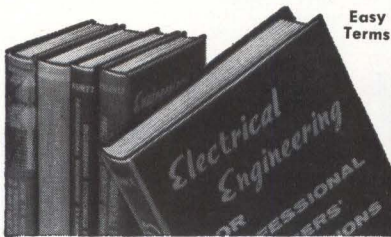

Easy
Terms

Special Library price saves you \$6.55

With this wealth of material on electrical engineering—including electronics—you review the effect of temperature changes on resistance—determining power in electrical circuits—electron theory of vacuum tubes—hundreds of exam topics. You also get pointers on applying, on taking exams; expert guidance on all engineering specialties, as well as economics; worked-out answers to typical questions; short-cuts, and other problem-solving aids.

Library contains these helpful books

Constance's— <i>Electrical Engineering For P.E.'s Examinations</i>	Kurtz's— <i>Engineering Economics For P.E.'s Examinations</i>
Constance's— <i>How To Become A P.E.</i>	Polentz's— <i>Engineering Fundamentals For P.E.'s Examinations</i>
LaLonde's— <i>P.E.'s Examination Questions and Answers</i>	

ALSO AVAILABLE—*Complete Professional Engineer's License Examination Library*. Includes all books described above, plus Constance's *Mechanical Engineering For P.E.'s Examinations*; and Kurtz's *Structural Engineering For P.E.'s Examinations*. 7 vols., 2731 pp., 1819 illus., \$44.95.
Special Library price saves you \$16.55

10 DAYS' FREE TRIAL Direct from Publisher

McGraw-Hill Book Company, Inc., Dept. L-3-8
327 W. 41st St., New York 36, N. Y.

Send me the Library checked below for 10 days' examination on approval. In 10 days I will remit for my Library on terms shown or return books postpaid.

Send me the Electrical Engineer's License Examination Library. In 10 days I will send \$6.95, then \$7.00 a month until \$34.95 is paid.

Send me the Complete Professional Engineer's License Examination Library. In 10 days I will send \$8.95 then \$9.00 a month until \$44.95 is paid.

Name

Address

City..... Zone..... State....

Company

Position

For price and terms outside U. S.
Write McGraw-Hill Int'l., N. Y. C.

L-3-8

vice president and general manager of the Semiconductor and Materials division, reporting to Smith.



LFE Electronics Names Wight

ALBERT B. WIGHT has been named to the new post of vice president, operations, for LFE Electronics, a division of Laboratory For Electronics, Inc., Boston, Mass. He will be responsible for management of all manufacturing, research and engineering operations.

Wight had formerly been vice president, systems.



ITT Elevates Robert Watson

ELECTION of Robert T. Watson as president of ITT Industrial Laboratories division by the board of directors of ITT Corp. has been announced.

Watson, a specialist in physical electronics, had been vice president since September 1961.

Lockheed Electronics Advances Pritchard

APPOINTMENT of E. M. Pritchard as general manager of the Military Systems division and vice presi-

dent of Lockheed Electronics Co., Plainfield, N.J., has been announced.

Pritchard has served as director of engineering, Military Systems, since 1960, and as acting general manager of that division since last September.

PEOPLE IN BRIEF

Vernon L. Grose, formerly with Litton Industries, named director of reliability technology at Northrop's Ventura div. Albert P. Smith leaves Ralph M. Parsons Engineering Co. to join United Aerospace div. of United Electro-Dynamics, Inc., as mgr. of engineering. George Q. Herrick, previously with Radio Condenser Co., appointed product mgr. at Singer Metrics div. of The Singer Mfg. Co. William R. Miller, ex-Fairchild Strato Corp., now chief engineer of Electronic Teaching Labs. Robert Hodges, from Arma Corp. to Giannini Research Laboratory as mgr. James C. Parker, recently on the staff of the U. of Florida, named mgr. of design and product engineering and elected to board of Atkins Technical, Inc. Edward D. Sherman, formerly with California Technical Industries, now plant production mgr. at Eldorado Electronics. James H. Cannon promoted to v-p, new products, at Cannon Electric Co. Francis J. Foley, ex-U. S. Industries, becomes director of operations at Rixon Electronics, Inc. Morgan E. Chase moves up to director of materiel for Military Systems at Lockheed Electronics Co. Kenneth S. Yamamoto advances to mgr. of Networks Electronic's Special Products div. Halvor T. Darracott, Col. A.U.S., Ret., named an executive engineer in the systems engineering dept., Government Products div. of Adler Electronics, Inc. Bernard Kopelman, ex-Beryllium Corp., now technical director of Yardney Electric Corp. Harlan James, from Pacific Automation Products Co. to Jefferson Electronics, Inc., as g-m. Ralph R. Pappito, recently with Lear-Siegler Corp., appointed corporate v-p of Glass-Tite Industries, Inc. Robert E. Wolin, formerly with Daystrom, Inc., appointed g-m of the Industrial div. of Cubic Corp.

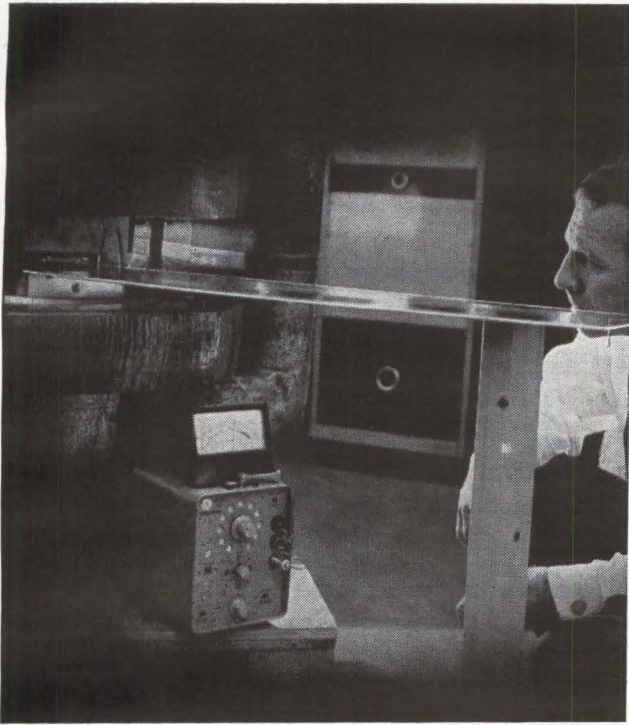

The above photo illustrates one of the many interesting programs underway at High Voltage Engineering Corporation.

THIS ENGINEER

is investigating the performance of a ninety degree analyzing magnet which can be used to measure the energy of accelerated proton beams up to 72 MEV. The ion beam is simulated by means of a fine wire under known tension carrying a known direct current. Using this technique it is possible to make very precise measurements of the optical properties of the magnet. This particular experiment is intended to determine the effect of differential hysteresis in the magnet iron on the energy calibration of the analyzer.

Similar experiments are in progress on large non-dispersive, achromatic, multiple beam handling systems.

Engineers and Scientists with experience in the following areas are invited to investigate career opportunities.

CONTROL SYSTEMS
STABILIZATION SYSTEMS
MAGNETIC FIELD-MEASURING DEVICES
MAGNET OPTICS

Please contact Mr. Louis B. Ennis
P. O. Box 98 Burlington, Mass.

**HIGH VOLTAGE
ENGINEERING CORP.**

BURLINGTON, MASSACHUSETTS
(12 Miles North of Boston)

An equal opportunity employer

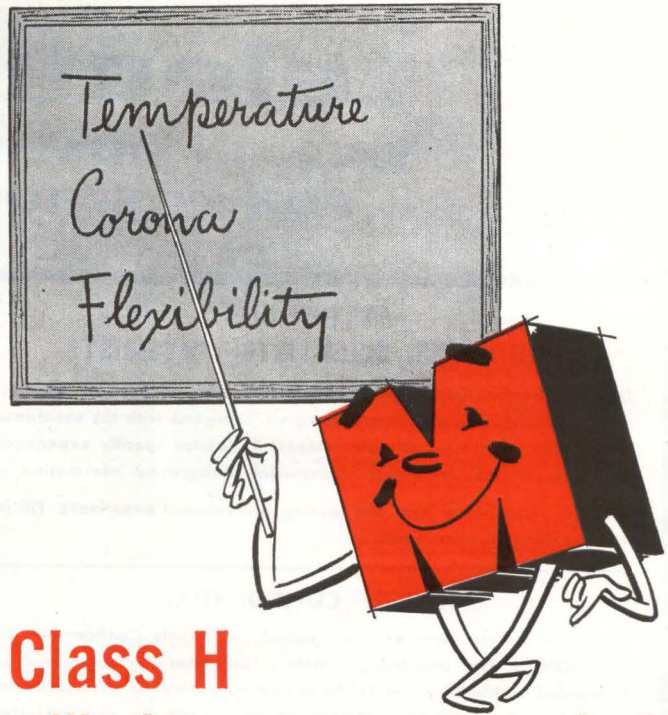

**Class H
will please come to order!**

Markel silicone rubber materials stand at the head of Class H (-70° to 210°C) because they meet the strictest requirements for high and low temperature flexibility, corona resistance, weathering, other conditions. Standard items stocked from coast to coast to speed your order.



SR-398

Silicone Rubber Coated Fiberglass Sleeving. Closely woven inorganic base with silicone rubber coating. Especially noted for toughness, flexibility, and dependable dielectric strength.



SR-200

Silicone Rubber Extruded Tubing. Extremely elastic tubing of high-strength compound combining high-temperature stability with low-temp. flexibility. Outstanding corona resistance.

L. FRANK **MARKEL** & SONS Norristown, Pa.
SINCE 1927

SILICONE

RUBBER

INSULATIONS

TGL Guide Line Tape
Self-adhering wrapping tape. Insures perfect lapping, void-free insulation.

SR-404 Sleeving
Reinforced with fiberglass. Stretches over terminals, irregular shapes.

Lead Wire & Cable
Variety of standard and special constructions. Ask for our FLEXLEAD Wire & Cable Selector.

electronics

WEEKLY QUALIFICATION FORM FOR POSITIONS AVAILABLE

ATTENTION: ENGINEERS, SCIENTISTS, PHYSICISTS

This Qualification Form is designed to help you advance in the electronics industry. It is unique and compact. Designed with the assistance of professional personnel management, it isolates specific experience in electronics and deals only in essential background information.

The advertisers listed here are seeking professional experience. Fill in the Qualification Form below.

STRICTLY CONFIDENTIAL

Your Qualification form will be handled as "Strictly Confidential" by ELECTRONICS. Our processing system is such that your form will be forwarded within 24 hours to the proper executives in the companies you select. You will be contacted at your home by the interested companies.

WHAT TO DO

1. Review the positions in the advertisements.
2. Select those for which you qualify.
3. Notice the key numbers.
4. Circle the corresponding key number below the Qualification Form.
5. Fill out the form completely. Please print clearly.
6. Mail to: Classified Advertising Div., ELECTRONICS, Box 12, New York 36, N. Y. (No charge, of course).

COMPANY	SEE PAGE	KEY #
ACF INDUSTRIES INC. Albuquerque Division Albuquerque, New Mexico	72*	1
ATOMIC PERSONNEL INC. Philadelphia, Penna.	93	2
COLUMBIA UNIVERSITY Nevis Labs. Irvington-on-Hudson, N. Y.	69*	3
GENERAL DYNAMICS, ELECTRIC BOAT Groton, Conn.	72*	4
GENERAL DYNAMICS/ELECTRONICS Rochester 1, N. Y.	71*	5
HIGH VOLTAGE ENGINEERING CORPORATION Burlington, Mass.	91	6
HONEYWELL St. Petersburg, Fla.	84	7
LOCKHEED MISSILES & SPACE COMPANY Div. of Lockheed Aircraft Corp. Sunnyvale, California	73	8
PERSPECTIVE Needham, Mass.	72*	9

(Continued on opposite page)

(cut here)

electronics WEEKLY QUALIFICATION FORM FOR POSITIONS AVAILABLE

(cut here)

(Please type or print clearly. Necessary for reproduction.)

Personal Background

NAME

HOME ADDRESS

CITY ZONE STATE

HOME TELEPHONE

Education

PROFESSIONAL DEGREE(S)

MAJOR(S)

UNIVERSITY

DATE(S)

FIELDS OF EXPERIENCE (Please Check)

3863

- | | | |
|----------------------------------------------|----------------------------------------------|---------------------------------------|
| <input type="checkbox"/> Aerospace | <input type="checkbox"/> Fire Control | <input type="checkbox"/> Radar |
| <input type="checkbox"/> Antennas | <input type="checkbox"/> Human Factors | <input type="checkbox"/> Radio-TV |
| <input type="checkbox"/> ASW | <input type="checkbox"/> Infrared | <input type="checkbox"/> Simulators |
| <input type="checkbox"/> Circuits | <input type="checkbox"/> Instrumentation | <input type="checkbox"/> Solid State |
| <input type="checkbox"/> Communications | <input type="checkbox"/> Medicine | <input type="checkbox"/> Telemetry |
| <input type="checkbox"/> Components | <input type="checkbox"/> Microwave | <input type="checkbox"/> Transformers |
| <input type="checkbox"/> Computers | <input type="checkbox"/> Navigation | <input type="checkbox"/> Other |
| <input type="checkbox"/> ECM | <input type="checkbox"/> Operations Research | <input type="checkbox"/> |
| <input type="checkbox"/> Electron Tubes | <input type="checkbox"/> Optics | <input type="checkbox"/> |
| <input type="checkbox"/> Engineering Writing | <input type="checkbox"/> Packaging | <input type="checkbox"/> |

CATEGORY OF SPECIALIZATION

Please indicate number of months experience on proper lines.

	Technical Experience (Months)	Supervisory Experience (Months)
RESEARCH (pure, fundamental, basic)
RESEARCH (Applied)
SYSTEMS (New Concepts)
DEVELOPMENT (Model)
DESIGN (Product)
MANUFACTURING (Product)
FIELD (Service)
SALES (Proposals & Products)

CIRCLE KEY NUMBERS OF ABOVE COMPANIES' POSITIONS THAT INTEREST YOU

1 2 3 4 5 6 7 8 9 10 11 12 13 14 15 16 17 18 19 20 21 22 23 24 25

QUALIFIED ENGINEERS

BY THE THOUSANDS

PAY to read **electronics** every week because its high calibre editorial content is designed and edited for engineers. . . . That's why your

RECRUITMENT ADVERTISING

in **electronics** can pinpoint a most concentrated source of experienced engineers. **electronics** selective circulation is your inexpensive, efficient, most direct link to these qualified, specialized men!

YOUR AD GETS RESULTS NOT WASTE CIRCULATION.

* If your recruitment program calls for qualified technical personnel, plan to use **electronics** EMPLOYMENT OPPORTUNITIES now!

electronics

A MCGRAW-HILL PUBLICATION
CLASSIFIED ADVERTISING DIVISION
POST OFFICE BOX 12 NEW YORK 36, NEW YORK



EMPLOYMENT OPPORTUNITIES

The Advertisements in this section include all employment opportunities—executive, management, technical, selling, office, skilled, manual, etc. Look in the forward section of the magazine for additional Employment Opportunities advertising.

Positions Vacant
Positions Wanted
Part Time Work

Civil Service Opportunities
Selling Opportunities Wanted
Selling Opportunities Offered

Employment Agencies
Employment Services
Labor Bureaus

DISPLAYED

The advertising rate is \$40.17 per inch for all advertising appearing in other than a contract basis. Contract rates quoted on request.

An advertising inch is measured 7/8" vertically on a column—3 columns—30 inches to a page.

Subject to Agency Commission.

RATES

UNDISPLAYED

\$2.70 per line, minimum 3 lines. To figure advance payment count 5 average words as a line.

Box Numbers—counts as 1 line.

Discount of 10% if full payment is made in advance for 4 consecutive insertions.

Not subject to Agency Commission.

Send NEW ADS to CLASSIFIED ADV. DIV. of ELECTRONICS, P.O. Box 12, N. Y. 36, N. Y.

MEN WANTED

for 12 months duty at isolated bases in Antarctica

Must be physically sound, temperamentally adaptable to the conditions of Antarctic service, and able to be away from home for 12 to 18 months.

Electronic engineers and physicists experienced with the operation and maintenance of radar, guided missiles, or with other complicated electro-mechanical and electronic systems are desired. Salary range from \$7,000 to \$12,000 depending upon experience and capability. Reporting date, Boulder, Colorado, July 1, 1963. Send one page resume to: Personnel Officer, National Bureau of Standards, Boulder Laboratories, Boulder, Colorado.

An Equal Opportunity Employer



E. E.'s
for FEE-PAID Positions
WRITE US FIRST!

Use our confidential application for professional, individualized service . . . a complete national technical employment agency.
ATOMIC PERSONNEL, INC.
Suite 1207L, 1518 Walnut St., Phila. 2, Pa.

electronics

WEEKLY QUALIFICATIONS FORM FOR POSITIONS AVAILABLE

(Continued from opposite page)

PHILCO WESTERN DEVELOPMENT LABS.	51*	10
SPACE TECHNOLOGY LABORATORIES, INC. Sub. of Thompson Ramo Wooldridge, Inc. Redondo Beach, California	23*	11
U. S. DEPT. OF COMMERCE National Bureau of Standards Boulder Labs. Boulder, Colorado	93	12
P 1652	93	13

* These advertisements appeared in the March 1st issue.

TRANSISTOR CIRCUIT DESIGNER

This immediate opening for a man qualified to contribute to unique applications of transistor circuitry is created by the spectacular expansion of a major non-defense manufacturer located near the L.A. International Airport and within 3 minutes of the Pacific Ocean.

To qualify, you should be capable of assuming responsibility for conceptual design and follow-through into production—applying ingenuity to create simple, inexpensive designs for our newly-conceived line of high-volume, low-cost consumer products in a highly competitive market. A detailed knowledge of Japanese sources and manufacturing capabilities is very helpful.

Rewards include unparalleled opportunity for professional growth, excellent salary and comprehensive benefits including profit sharing.

Address your resume in confidence to:

P-1652, ELECTRONICS

255 California St.,
San Francisco 11, Calif.

PROFESSIONAL SERVICES

GIBBS & HILL, Inc.
Consulting Engineers

Systems Engineering
Operations Research • Development
Field Studies • Design • Procurement
Power • Transportation • Communications
Water Supply • Waste Treatment
393 Seventh Avenue New York 1, N. Y.

SEARCHLIGHT SECTION

(Classified Advertising)

BUSINESS OPPORTUNITIES

EQUIPMENT - USED or RESALE

DISPLAYED
The advertising is \$27.25 per inch for all advertising other than on a contract basis. AN ADVERTISING INCH is measured 7/8" vert. on a column, 3 cols.—30 inches—to a page. EQUIPMENT WANTED or FOR SALE ADVERTISEMENTS acceptable only in Displayed Style.

Send NEW ADS or Inquiries to Classified Adv. Div. of Electronics, P. O. Box 12, N. Y. 36, N. Y. The publisher cannot accept advertising in the Searchlight Section, which lists the names of the manufacturers of resistors, capacitors, rheostats, and potentiometers or other names designed to describe such products.

RATES

\$2.70 a line, minimum 3 lines. To figure advance payment count 5 average words as a line. BOX NUMBERS count as one line additional.

UNDISPLAYED

DISCOUNT of 10% if full payment is made in advance for four consecutive insertions.

ANTENNA PEDESTAL SCR 584-MP 61B

Full azimuth and elevation sweeps 360 degrees in azimuth, 210 degrees in elevation. Accurate to 1 mil, or better over system. Complete for full tracking response. Angle acceleration rate: AZ, 9 degrees per second squared EL, 4 degrees per second squared. Angle slewing rate: AZ 20 degrees per sec. EL 10 degrees per sec. Can mount up to a 20 ft. dish. Angle tracking rate: 10 degrees per sec. Includes pedestal drives, selsyns, potentiometers, drive motors, control amplidydes. New condition. Quantity in stock for immediate shipment. Ideal for missile & satellite tracking, antenna pattern ranges, radar system, radio astronomy, any project requiring accurate response in elevation and azimuth. Complete description in McGraw-Hill Radiation Laboratory Series, Volume 1, page 284 and page 209, and Volume 26, page 233.

MIT MODEL 9 PULSER 1 MEGAWATT-HARD TUBE

Output 25kv 40 amp. Duty cycle .002. Pulse lengths. 25 to 2 microsec. Also .5 to 5 microsec. and .1 to .5 msec. Uses 6C21 Input 115v 60 cycle AC Mfr. GE. Complete with driver and high voltage power supply. Ref: MIT Rad. Lab. Series Vol. 5 pps. 152-160.

500KW THYRATRON PULSER
Output 22kv at 28 amp. Rep. rates: 2.25 micro-sec. 300 pps. 1.75 msec 550 pps. .4 msec 2500 pps. Uses 5C22 hydrogen thyatron. Complete with driver and high voltage power supply. Input 115v 60 cy AC.

2 MEGAWATT PULSER
Output 30 kv at 70 amp. Duty cycle .001. Rep rates: 1 microsec 600 pps. 1 or 2 msec 300 pps. Uses 5C22 hydrogen thyatron. Complete with driver and high voltage power supply.

15KW PULSER-DRIVER
Biased multivibrator type pulse generator using 3E29. Output 3kv at 5 amp. Pulse lgths .5 to 5 microsec. easily adj. to .1 to .5 msec. Input 115v 60 cy AC. \$475. Ref: MIT Rad. Lab. Series Vol. 5 pp 157-160.

SCR 584 RADAR AUTO-TRACK
3 CM & 10 CM. Our 584s in like new condition, ready to go, and in stock for immediate delivery. Used on Atlantic Missile Range, Pacific Missile Range, NASA Wallaps Island, A.B.M.A. Write us. Fully Desc. MIT Rad. Lab. Series, Vol 1, pps. 207-210, 228, 284-286.

300 to 2400MC RF PKG.
300 to 2400MC CW. Tuneable, Transmitter 10 to 30 Watts. Output. As new \$475.

AN/TPS-1D RADAR
500 kw. 1220-1359 mcs. 160 nautical mile search range P.P.I. and A. Scopes, MTI, thyatron mod. 5J26 magnetron. Complete system.

AN/TPS 10D HEIGHT FINDER
250 KW X-Band. 60 & 120 mile ranges to 60,000 feet. Complete.

AN/APS-15B 3 CM RADAR
Airborne radar. 40kw output using 725A magnetron. Model 3 pulser. 30 in. parabola stabilized antenna. PPI scope. Complete system. \$1200 each. New.

100 KW 3 CM. X BAND RADAR
Complete AN/APS-27 radar system using 4J52 magnetron, PPI, antenna 360 degree rotation azimuth, 60 degree elevation apx. Complete installation including gyro & AMTI \$2800.

L BAND RF PKG.
20KW peak 990 to 1040mc. Pulse width .7 to 1.2 micro sec. Rep rate 180 to 420 pps. Input 115 vac. Incl. Receiver \$1200.

CARCINOTRONS
Type CSF CM706A Freq. 3000 to 4000 mcs. Type CSF CM710A. Freq. 2400 to 3100 mcs. CW. Output 200 Watts minimum. New. Pull wty.

AN/CPS-9 WEATHER RADAR
250 kw. 3 cm. 360 deg. az. 90 deg. elev. scan. PPI, RHI A scopes.

RADIO RESEARCH INSTRUMENT CO.
550 FIFTH AVE., NEW YORK
JUDSON 6-4691

CIRCLE 950 ON READER SERVICE CARD

LIFSCHULTZ FAST FREIGHT

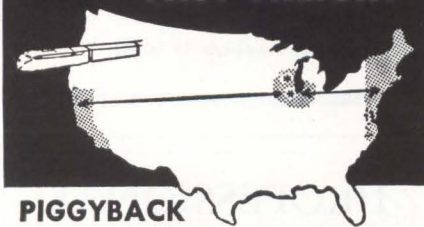

PIGGYBACK TO BOTH COASTS TRUCKLOAD RATES TO BOTH COASTS
•We welcome your inquiry.

FASTEST TO BOTH COASTS!

CIRCLE 951 ON READER SERVICE CARD

SMALL AD but BIG STOCK
of choice test equipment and surplus electronics
Higher Quality—Lower Costs
Get our advice on your problem
ENGINEERING ASSOCIATES
434 Patterson Road — Dayton 19, Ohio

CIRCLE 952 ON READER SERVICE CARD

GLASS TUBING
PYREX - NONEX - URANIUM
BULB & CYLINDERS
WRITE FOR FREE MONTHLY LIST
HOUE GLASS COMPANY
PHONE COLFAX 4-4800
P.O. Box 206 Keyport, N. J.

CIRCLE 953 ON READER SERVICE CARD

TUBE & COMPONENT FREE...CATALOG BARRY ELECTRONICS
512 BROADWAY WALKER 5-7000
NEW YORK 12, N.Y. TWX: NY 1-3731

CIRCLE 954 ON READER SERVICE CARD

FREE Catalog OF THE WORLD'S FINEST ELECTRONIC GOV'T SURPLUS BARGAINS



HUNDREDS OF TOP QUALITY ITEMS — Receivers, Transmitters, Microphones, Inverters, Power Supplies, Meters, Phones, Antennas, Indicators, Filters, Transformers, Amplifiers, Headsets, Converters, Control Boxes, Dynamotors, Test Equipment, Motors, Blowers, Cable, Keys, Chokes, Handsets, Switches, etc., etc. Send for Free Catalog—Dept. E-3

FAIR RADIO SALES
2133 ELIDA RD. • Box 1105 • LIMA, OHIO

CIRCLE 955 ON READER SERVICE CARD

CAPACITORS

MFD	VOLTS	PRICE	MFD	VOLTS	PRICE
.001	75KV	80.00	† 2	6000V	24.50
*.025	50KV	29.50	† 2	16KV	69.95
*†.2	50KV	64.50	3	20KV	125.00
†.25	15KV	15.95	4	10KV	67.50
†.25	20KV	22.50	5	10KV	70.50
†.25	32.5KV	44.50	9	10KV	115.00
†.5	25KV	29.50	† 10	5000V	45.00
†† 1	7500V	8.00	† 15	5000V	48.00
1	25KV	59.50	75	6000V	69.50

— SPECIAL —
32 mfd—600 V. \$3.50
Comprising four 8 mfd sections, 5 solder lug terms.
Dims. 4 3/8 x 3 3/8 x 3 3/4. Large qua. available.
* Case Common
† Large qua. available
Write for complete listing
MONMOUTH RADIO LABS.
BOX 247—OAKHURST, N. J.
CAPITOL 2-0121 ART HANKINS, Prop.

CIRCLE 956 ON READER SERVICE CARD

"TAB" TEST EQUIPMENT! "TAB"
BALLANTINE #300 Electronic Voltmtr/RMS \$79.50
WESTON Model 3 std. cell @ \$4.00 3 for \$10.00
DUMONT Scopes #208, 264, 304 Begin at \$69.00
TEKTRONIX Scopes #511, 512, 513, 514 Begin at \$175

111E Liberty St.
N. Y. 6, N. Y., U.S.A.
Send 25¢ for Catalog Rector 2-6245

CIRCLE 957 ON READER SERVICE CARD

MODERN INTER-COMM SPECIAL 2 for \$19.95!

For communication between 2 or more points, all ring, all talk. Wire 2¢ per ft. (twisted pr.) 2 batteries, required for each telephone. \$1.00 each. Shipments FOB Simpson, Pa. Write for free list.

TELEPHONE ENGINEERING CO.
Simpson Dept. E-383 Penna.
CIRCLE 958 ON READER SERVICE CARD

GENERAL RADIO SOUND LEVEL METER
With case & calibrator
latest model—1/2 original cost
C. STAHNKE
505 Washington Ave. Golden, Colorado

CIRCLE 959 ON READER SERVICE CARD

POTTING APPLICATORS MANUAL AND DISPOSABLE
6cc 12cc 30cc
FOR POTTING, ENCAPSULATING, AND SEALING OF MINIATURE COMPONENTS
PHILIP FISHMAN CO.
7 CAMERON ST., WELLESLEY 81, MASS.

CIRCLE 960 ON READER SERVICE CARD

WANTED Pulse Generator by GR, HP or Measurements. Electrostatic Voltmeter 50 kv or higher by Sensitive Research. Late Model Tektronix Scope. 50 kv Power Supply. Small Spot Welders. Write
W-1702, Electronics
Class. Adv. Div., P.O. Box 12, N. Y. 36, N. Y.

CIRCLE 961 ON READER SERVICE CARD

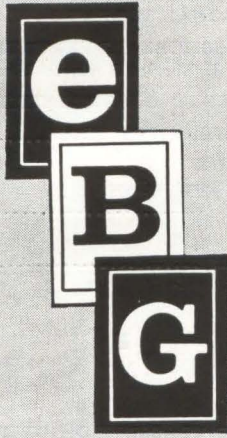

Make sure you know your electronics BUYERS' GUIDE

Review THE CONTENTS PAGE

- **PRODUCT LISTINGS**, streamlined by engineers for engineers.

- **COMPANY STATISTICS**: number of employees, product lines, names of key people, dollar volume.

- **EDITORIAL INDEX** to electronics for July 1961 through June, 1962.

- **ABSTRACTS** of Feature Articles in the current Editorial Index.

eBG

HAS MUCH FOR YOU
BE SURE TO USE IT
ALL... REVIEW
THE CONTENTS PAGE

SPECIAL PURPOSE TUBES

OA2	.80	4-125A	20.00	100TH	12.00	826	5.00	5836	50.00
OA2WA	1.50	4-250A	35.00	FG-105	25.00	828	17.50	5837	50.00
OA3	.85	4-400A	35.00	FG-172	25.00	829B	10.00	5840	2.50
OA5	5.75	4-1000A	95.00	HF-200	15.00	832A	6.00	5842	7.50
OB2	.70	4AP10	10.00	212E	50.00	833A	37.50	5845	6.00
OB2WA	1.50	4B31	15.00	242C	10.00	836	2.50	5847	7.50
OB3	.75	4C35	15.00	244A	3.50	837	1.50	5852	5.00
OC3	.50	4CX250B	30.00	249B	8.50	842	5.00	5876	9.50
OD3	.50	4CX300A	40.00	249C	6.50	845	12.50	5879	1.00
CTA	7.50	4CX1000A	135.00	250R	10.00	849	75.00	5881	2.50
1AD4	1.75	4D32	15.00	250TH	25.00	851	50.00	5886	3.50
1B24	7.50	4E27	10.00	251A	75.00	866A	2.00	5893	10.00
1B24A	17.50	4J32	100.00	259A	5.00	872A	5.00	5894	19.85
1B35A	3.50	4J34	100.00	V-262	125.00	884	1.25	5915	1.00
1B59/R1130B	10.00	4J50	100.00	262B	4.00	885	1.00	5933	3.50
1B63A	10.00	4J52	35.00	267B	5.00	889RA	150.00	5948	150.00
1C/3B22	4.00	4J63	150.00	271A	10.00	891R	300.00	5949	100.00
1D21/5N4	6.00	4J63	150.00	274A	3.50	892R	300.00	5963	1.00
CT1K	7.50	4J64	150.00	279A	200.00	913	12.50	5964	.85
1P21	30.00	4PR60A	50.00	283A	3.50	927	2.50	5965	.85
1P22	8.00	4X150A	12.50	287A	3.50	931A	5.00	5976	50.00
1P25	10.00	4X150D	12.50	QK-288	200.00	1000T	100.00	5993	5.00
1P28	15.00	4X150F	20.00	HF-300	35.00	VC-1257	500.00	6005	1.50
1Z2	2.50	4X150G	25.00	300B	5.00	VC-1258	15.00	6012	4.00
2-O1C	12.50	4X250B	25.00	304TH	30.00	K-1303	35.00	6021A	2.00
2AP1A	8.50	4X250F	30.00	304TL	40.00	1500T	200.00	6028	2.75
2B23	20.00	4X500A	105.00	310A	3.50	1603	3.50	6032	50.00
2BP1	10.00	5ABP1	20.00	311A	3.50	1614	2.00	6045	1.15
2C36	22.50	5AHP7A	25.00	313C	1.50	1620	4.00	6072	1.25
2C39	5.00	5BP1A	9.50	323A	6.00	1624	1.00	6073	1.00
2C39A	10.00	5C22	15.00	328A	4.50	1629	.50	6074	1.50
2C39B	15.00	5CP1A	9.50	329A	4.50	1645A	4.00	6080	3.35
2C40	7.50	5J26	75.00	336A	2.50	1846	50.00	6080WA	4.35
2C42	4.00	5LP1A	20.00	337A	3.50	2000T	285.00	6080WB	10.00
2C43	7.50	5R4GY	1.25	348A	4.50	2050	1.35	6081	25.00
2C50	4.00	5R4WGA	4.00	349A	3.50	ZB-3200	150.00	6082	3.35
2C53	7.50	5R4WGB	6.00	350A	3.50	5514	7.50	6087	2.50
2D21	.65	5R4WGY	2.00	350B	2.50	5516	7.50	6101	1.50
2D21W	1.25	5RP1A	35.00	352A	8.50	5528/C6L	3.50	6115A	65.00
2E22	3.00	5UP1	12.50	354A	12.50	5531	425.00	6130	6.50
2E24	3.50	5Y3WGT	1.25	355A	12.50	5545	25.00	6136	1.25
2E26	2.50	6AC7W	1.00	393A	5.00	5550	35.00	6146	3.25
2J42	88.85	6AG5WA	1.50	394A	3.00	5551/FG271	50.00	6161	50.00
2J51	50.00	6AG7Y	1.00	403B	3.00	5552/FG235	60.00	6163	15.00
2J55	100.00	6AK5W	1.25	404A	7.50	5553/FG258	125.00	6164	45.00
2J66	20.00	6AL5W	.60	407A	3.75	5556/PJ8	20.00	6167	25.00
2K22	25.00	6AN5	1.75	408A	2.75	5557/FG17	5.00	6186	1.60
2K25	8.50	6AN5WA	3.50	GL-414	80.00	5558/FG32	10.00	6189	1.60
2K26	35.00	6AQ5W	1.00	416B	20.00	5559/FG57	10.00	6197	1.75
2K28	20.00	6AS7G	2.50	417A	7.50	5560/FG95	20.00	6199	35.00
2K29	25.00	6AU6WA	1.10	418A	7.50	5561/FG104	40.00	6201	1.50
2K30	50.00	6B4G	3.85	420A	5.00	5586	100.00	6202	1.50
2K33A	175.00	6BA6W	.75	421A	7.50	5590	1.00	6211	.75
2K34	100.00	6BF7W	2.00	422A	10.00	5591	3.00	6213	2.50
2K35	200.00	6BL6	25.00	423A	4.00	5603	3.00	6216	3.00
2K39	125.00	6BM6	25.00	427A	4.00	5608A	5.00	6236	125.00
2K41	35.00	6BM6A	30.00	429A	6.50	5636	2.25	6263	9.00
2K42	150.00	6C4W	2.50	432B	7.00	5641	2.00	6279	22.50
2K43	175.00	6C21	25.00	GL-434A	10.00	5642	2.25	6280	30.00
2K44	125.00	6C24	35.00	450TH	50.00	5643	2.50	6291	35.00
2K45	20.00	6F4	5.00	450TL	40.00	5647	3.50	6292	40.00
2K47	150.00	6GJ	10.00	QK-531	35.00	5651	1.00	6293	4.50
2K48	60.00	6J4	1.75	QK-532	35.00	5654	1.50	6299	40.00
2K50	100.00	6J4WA	2.50	QK-549	45.00	5656	5.00	6303	65.00
2K54	15.00	6J6WA	1.00	575A	15.00	5665	40.00	6316	100.00
2K55	15.00	6L4	3.00	578	5.00	5667	125.00	6328	7.50
2K56	50.00	6L6GAY	1.25	NL-615	7.50	5670	1.00	6336	8.75
2X2A	1.25	6L6WGA	1.50	NL-623	10.00	5672	1.35	6336A	12.75
3A5	1.00	6L6WGB	2.00	631-P1	6.00	5675	9.50	6350	1.25
3AP1A	12.50	6Q5G	2.50	673	15.00	5678	1.50	6360	4.00
3B4	2.50	6S7WGT	1.25	677	50.00	5684	9.50	6363	90.00
3B24W	3.00	6SK7W	1.00	BL-696	35.00	5685	15.00	6364	130.00
3B24WA	5.00	6SL7WGT	1.25	707B	2.50	5686	2.25	6385	10.00
3B25	2.50	6SN7W	.75	NL-710	10.00	5687	1.50	6390	125.00
3B26	3.50	6SN7WGT	1.00	715C	15.00	5691	5.00	6394	12.75
3B28	3.00	6V6GTY	1.00	719A	12.50	5692	3.50	6442	25.00
3B29	5.00	6X4W	.75	721B	5.00	5693	3.50	6476	10.00
3BP1A	7.50	6X5WGT	1.00	723A/B	3.50	5696	1.00	6478	5.00
3C/4B24	4.00	7MP7	22.50	725A	12.50	5718	1.00	6484	4.00
3C22	25.00	10KP7	15.00	726A	5.00	5721	90.00	6485	1.50
3C23	5.00	12AT7WA	1.25	726B	5.00	5725/6A56W	1.50	6528	12.75
3C24/24G	5.00	12AU7WA	1.50	726C	10.00	5726	.75	6550	3.50
3C45	5.00	12AX7W	1.35	750TL	112.50	5727	1.25	6655	40.00
3CX100A5	15.00	12AY7	1.00	NL-760	25.00	5728/FG67	20.00	6807	25.00
3D21A	5.00	12GP7	25.00	BL-800	75.00	5734	15.00	6816	40.00
3E29	7.50	X-13	150.00	802	7.50	5749	1.00	6877	12.50
3GP1A	12.50	CT16J	25.00	803	5.00	5750/6BE6W	2.00	6883	3.50
C3J	7.50	HK-24	5.00	804	15.00	5751WA	1.50	6896	250.00
3J21	35.00	25T	7.50	805	7.50	5755	5.00	6922	2.75
3J31	100.00	26Z5W	1.50	807	1.50	5763	1.75	6939	7.50
3K21	125.00	FG-32	10.00	807W	2.50	5777	150.00	7236	7.00
3K22	125.00	35T	7.50	809	4.75	5778	150.00	7391	47.50
3K23	200.00	35TG	3.75	810	18.85	5783	2.25	7521	100.00
3K27	150.00	FP-54	150.00	811	3.00	5784WA	3.35	7580	35.00
3K30	100.00	FG-57	10.00	811A	4.75	5787	2.50	8000	18.85
3KP1	9.75	RK-60/1641	1.50	812A	4.75	5800	7.50	8008	6.00
3RP1	7.50	HY-69	3.00	813	12.50	5803	5.00	8013A	5.00
3WP1	12.50	75TL	15.00	814	4.50	5814A	1.35	8020	6.00
3X2500A3	150.00	KU-99	12.50	815	3.50	5819	40.00	9003	2.00
4-65A	12.00	HF-100	10.00	816	2.00	5829	1.00	9005	3.50

ALL TUBES ARE NEW, INDIVIDUALLY CARTONED, FULLY GUARANTEED

western engineers

TELEX or TWX:
916-681-3061
Telephone:
916-685-9582

ELK GROVE, CALIFORNIA

SUPPLIERS OF ELECTRON TUBES SINCE 1932

Prices FOB
Min order \$10

CIRCLE 962 ON READER SERVICE CARD

INDEX TO ADVERTISERS

• AMP Incorporated	15	• Litton Industries		PROFESSIONAL SERVICES	93
Aladdin Electronics	79	Electron Tube Division.....	32	CLASSIFIED ADVERTISING	
		Lockheed Missiles & Space Co.....	73	F. J. Eberle, Business Mgr.	
Barber-Colman Co.	60			EMPLOYMENT OPPORTUNITIES ..	93
Bircher Corporation, The.....	76	Malayan Tin Bureau.....	82	SPECIAL SERVICES	94
• Clairex Corp.	30	• Markel & Sons, L. Frank.....	91	EQUIPMENT	
Cleco		McGraw-Hill Book Co. Inc.....	90	(Used or Surplus New)	
Division of Reed Roller Bit Co.....	81	• Methode Electronics, Inc.....	61	For Sale	94, 95
Cominco Products, Inc.....	78	• Mitsumi Electric Co., Ltd.....	80	WANTED	
Consolidated Avionics Corp.....	71	• Moseley Co., F. L.	33	Equipment	94
Consolidated Electrodynamics Corp.....	26, 27	• Mullard Ltd.	89		
• Corning Electronic Components.....	34				
Cubic Corp.	55	• New Hermes Engraving Machine Corp.	72		
		• Non-Linear Systems, Inc.....	16, 17		
Davers Corp.	78	• North Atlantic Industries, Inc.....	58		
De Vry Technical Institute.....	83				
• Dialight Corporation	72	Omark Industries Inc.....	88		
Di Aero Corp.	70				
duPont de Nemours & Co., Inc. E. I.	63	Palo Alto			
		Div. of Admiral Corp.....	85		
Elcor, Inc.	14	Patwin Electronics	85		
Electro-Mechanical Research, Inc.....	5	Plant City	14		
		• Polarad Electronic Instruments			
Fansteel Metallurgical Corp.....	22, 23	Div. of Polarad Electronics Corpo-			
Ferrortan Electronics Co.....	81	ration	32		
Florida Development Commission.....	87	• Potter Instrument Co., Inc.....	19		
Graphic Systems, Inc.	83	• Radio Corporation of America...4th Cover			
		Rawson Electrical Instrument Co.....	82		
Hansen Mfg. Co., Inc.....	65	Rixon Electronics, Inc.....	25		
• Hewlett-Packard					
Company	Inside Front Cover	• Sage Laboratories Inc.....	77		
High Voltage Engineering Corp.....	91	Sankaisha Co., Ltd.....	85		
Honeywell	84	• Semi-Elements, Inc.	77		
Hughes Aircraft Co.....	21	Simplex Wire & Cable Co.....	69		
Huntington Alloys		Sprague Electric Co.....	4, 9		
Div. of International Nickel Co., Inc.	75	Sylvania Electric Products, Inc.			
		Electron Tube Div.....	13		
• Image Instruments Inc.....	81				
• Industrial Test Equipment Co.....	80	Texas Instruments Incorporated			
Inland Motor Corp.		Industrial Products Group.....	29		
Sub. of Kollmorgen.....	59	Texas Instruments Incorporated			
Intellux Inc.	67	Semiconductor-Components Division.....	10, 11		
Intercontinental Instruments Inc.....	31	Toyo Musen Co., Ltd.....	65		
International Resistance Co.....	6	Trent Inc.	61		
I Triple E.....	14, 61, 65, 77				
		United States Energy Corp.....	64		
• Kepco, Inc.	57				
Kintel		Weston Instruments & Electronics....	66		
A Division of Cohu Electronics					
Inc.	3rd Cover				
• Knights Company, James.....	83				

INDEX TO CLASSIFIED ADVERTISERS

Atomic Personal Inc.....	93
• Barry Electronics Corp.....	94
• Engineering Associates	94
• Fair Radio Sales.....	94
Fishman Co., Philip.....	94
• Houde Glass Co.....	94
Lifschultz Fast Freight.....	94
• Monmouth Radio Labs.....	94
• Radio Research Instrument Co.....	94
Stahnke C.	94
• TAB	94
• Telephone Engineering Co.....	94
U. S. Dept. of Commerce, National...	Bureau of Standards Boulder Labs... 93
• Western Engineers	95

• See advertisement in the July 25, 1962 issue of Electronics Buyers' Guide for complete line of products or services.

This index and our Reader Service Numbers are published as a service. Every precaution is taken to make them accurate, but electronics assumes no responsibilities for errors or omissions.

electronics

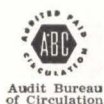

Audit Bureau
of Circulation



Associated Business
Publications

Audited Paid Circulation

JAMES T. HAUPTLI

Advertising Sales Manager

R. S. QUINT

General Manager,
Electronics Buyers' Guide

B. ANELLO

Market Services Manager

DAVID CUNNIFF

Promotion Manager

RICHARD J. TOMLINSON

Business Manager

GEORGE E. POMEROY

Classified Manager

HUGH J. QUINN

Circulation Manager

ADVERTISING REPRESENTATIVES

ATLANTA (9):

Michael H. Miller, Robert C. Johnson
1375 Peachtree St. N.E., Trinity 5-0523
(area code 404)

BOSTON (16):

William S. Hodgkinson, Donald R. Furth
McGraw-Hill Building, Copley Square,
Congress 2-1160 (area code 617)

CHICAGO (11):

Harvey W. Wernecke, Robert M. Denmead
645 North Michigan Avenue, Mohawk 4-5800
(area code 312)

CLEVELAND (13):

Paul T. Fegley
55 Public Square, Superior 1-7000
(area code 216)

DALLAS (1):

Frank Le Beau
The Vaughn Bldg., 1712 Commerce St.
Riverside 7-9721 (area code 214)

DENVER (2):

J. W. Patten
Tower Bldg., 1700 Broadway,
Alpine 5-2981 (area code 303)

HOUSTON (25):

Joseph C. Page, Jr.
Prudential Bldg., Halcombe Blvd.,
Riverside 8-1280 (area code 713)

LOS ANGELES (17):

Ashley P. Hartman, W. C. Gries,
John G. Zisch
1125 W. 6th St., Huntley 2-5450
(area code 213)

NEW YORK (36):

Donald H. Miller, Henry M. Shaw,
George F. Werner
500 Fifth Avenue, LO-4-3000
(area code 212)

PHILADELPHIA (3):

Warren H. Gardner, William J. Boyle
6 Penn Center Plaza, LOcust 8-4330
(area code 215)

SAN FRANCISCO (11):

R. C. Alcorn
255 California Street, Douglas 2-4600
(area code 415)

LONDON W1:

Edwin S. Murphy Jr.
34 Dover St.

FRANKFURT/Main:

Matthée Herfurth
85 Westendstrasse

GENEVA:

Michael R. Zeynel
2 Place du Port

TOKYO:

George Olcott,
1, Kotohiracho, Shiba, Minato-ku

KIN TEL

**world's
largest
DC amplifier
manufacturer**

**has an
amplifier
to fit
your**

requirements



Solid state, non inverting amplifier

Model 121A/A. Response from DC to beyond 200 kc. Input impedance greater than 10 megohms; output capability ± 15 volts, 100 ma; output impedance < 0.2 ohm in series with 50 microhenries. Price \$1000.

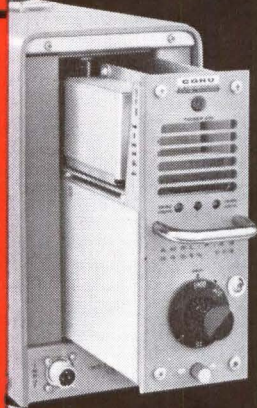

Narrow band, 3 terminal amplifier

Model 118. Signal terminals isolated from chassis ground. DC to 85 cps. Input impedance greater than 40 megohms; output capability ± 10 volts, 10 ma; output impedance < 0.25 ohm to 500 cps; < 1 ohm to 2 kc. Price \$795.

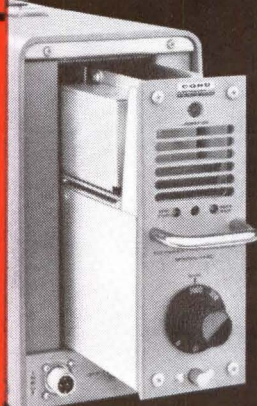

Floating, differential amplifier

Model 114C. High common mode rejection, low effective input capacity. DC to 85 cps. Input impedance greater than 40 megohms; output capability ± 10 volts, 10 ma; output impedance < 0.25 ohm to 500 cps; < 1 ohm to 2 kc. Price: \$895..

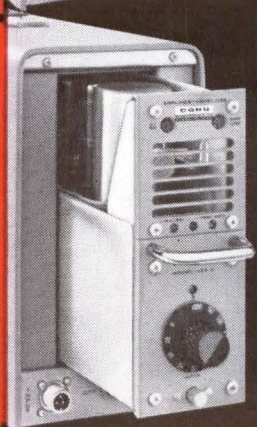

Wideband amplifier

Model 112A. Four different plug-in attenuator units. DC to 40 kc. Input impedance 100 K ohms; output capability ± 35 volts, 40 ma; output impedance < 1 ohm in series with 25 microhenries. Prices: \$575. to \$685.

Visit Booth Number 3601 at the IEEE Show, March 25-28

All KIN TEL DC data amplifiers: have drift less than $2\mu\text{v}$ • accuracy of 0.01% for any single gain step • fit six to a standard 19-inch rack • are available in portable cabinets • have an integral power supply • are chopper-stabilized • have exceptional linearity and low output impedance.

All prices FOB, San Diego, California. (Export charge 5%.) Write for additional information. Representatives in all major cities.

5725 Kearny Villa Road
San Diego 12, California
Phone 277-6700
(Area Code 714)



CIRCLE 901 ON READER SERVICE CARD

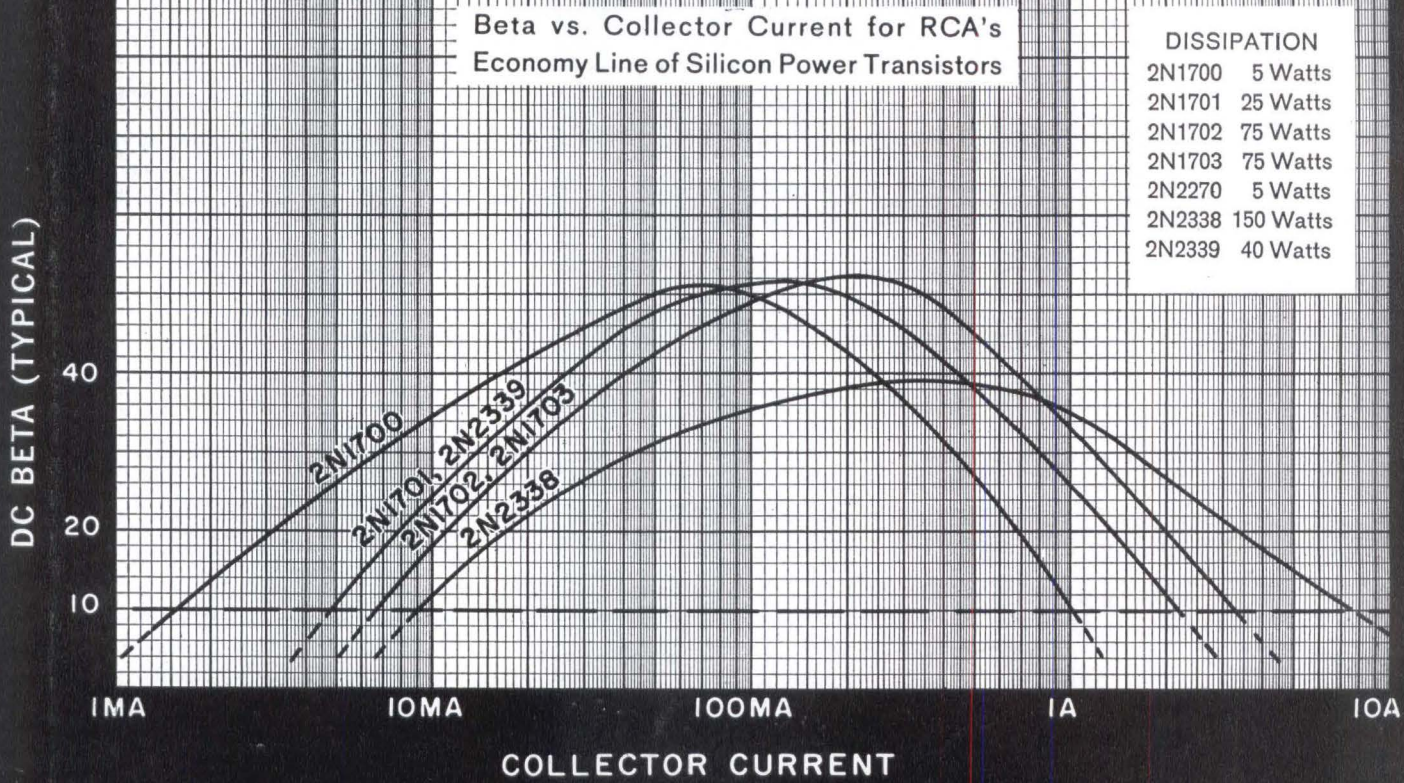

RCA EXPANDS ECONOMY SILICON LINE FOR LOW COST DESIGN FLEXIBILITY UP TO 150 WATTS

Now, RCA adds 3 new types, 2N2338, 2N2339, 2N2270 to its line-up of low-cost silicon transistors at prices starting as low as comparable Germanium Power Types.

Here's RCA's answer to today's value and performance requirements for industrial and military applications... a broad new economy line of silicon transistors. This low-cost, high performance line now includes three new types, 2N2338 and 2N2339, high and medium power types, respectively, and the 2N2270, RCA's new economy version of the "Universal" triple-diffused planar silicon transistor type 2N2102. With these additions, RCA's economy silicon line now offers:

- High dissipation... up to 150 watts
- Top performance at high temperatures... up to 200°C
- Wide-range beta control... up to 10 amps

These low-cost silicon types are immediately available to bring you new economy and greater design freedom for industrial and military circuits demanding the reliability and performance of silicon transistors.

AVAILABLE THROUGH YOUR RCA DISTRIBUTOR

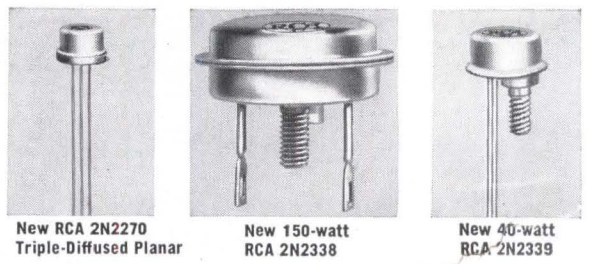

For new low prices call your RCA representative today. For FREE Technical Bulletin in RCA's Economy Silicon Line, write RCA Semiconductor and Materials Division, Commercial Engineering, Section IN3-2, Somerville, N. J.

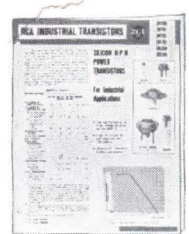

FIELD OFFICES...
 EAST: Newark, N. J., 744 Broad St., HU 5-3900 • (Camden-Philadelphia Area) Eriton, N. J., 605 Marlton Pike, HA 8-4802 • Syracuse, N. Y., 731 James St., Rm. 402, GR 4-5591 • Baltimore, Md., EN 9-1850 • NORTHEAST: Needham Heights 94, Mass., 64 "A" St., HI 4-7200 • SOUTHEAST: Orlando, Fla., 1520 Edgewater Dr., Suite #1, GA 4-4768 • EAST CENTRAL: Detroit 2, Mich., 714 New Center Bldg., TR 5-5600 • CENTRAL: Chicago, Ill., Suite 1154, Merchandise Mart Plaza, WH 4-2900 • Indianapolis 5, Ind., 2132 East 52nd St., CL 1-1405 • Minneapolis 16, Minn., 5805 Excelsior Blvd., WE 9-0676 • Denver 11, Colorado, Continental Terrace Bldg., Suite 301, 2785 N. Speer Blvd., 477-1688 • WEST: Los Angeles 22, Calif., 6801 E. Washington Blvd., RA 3-8361 • (San Francisco Area) Burlingame, Calif., 1838 El Camino Real, OX 7-1620 • Seattle 4, Wash., 2250 First Ave. S., MA 2-8816 • SOUTHWEST: Dallas 7, Texas, 7905 Carpenter Freeway, ME 1-9720 • GOV'T: Dayton, Ohio, 224 N. Wilkinson St., BA 6-2366 • Washington, D. C., 1725 "K" St., N.W., FE 7-8500 • RCA INTERNATIONAL DIV., 30 Rockefeller Plaza, N. Y. 20, N. Y. Cable Address: RADIOINTER, N. Y.

THE MOST TRUSTED NAME IN ELECTRONICS

CIRCLE 902 ON READER SERVICE CARD
VISIT THE RCA EXHIBIT AT IEEE