

electronics®

Tower At Barstow

Low-frequency system can resist nuclear activity

(photo right)

NEXT WEEK AT NEREM

Highlights of the technical program

IT'S THE p-MOST

Field-effect device uses hole current

PLATED HOLES FOR MEMORIES

Getting benefits of thin films and cores

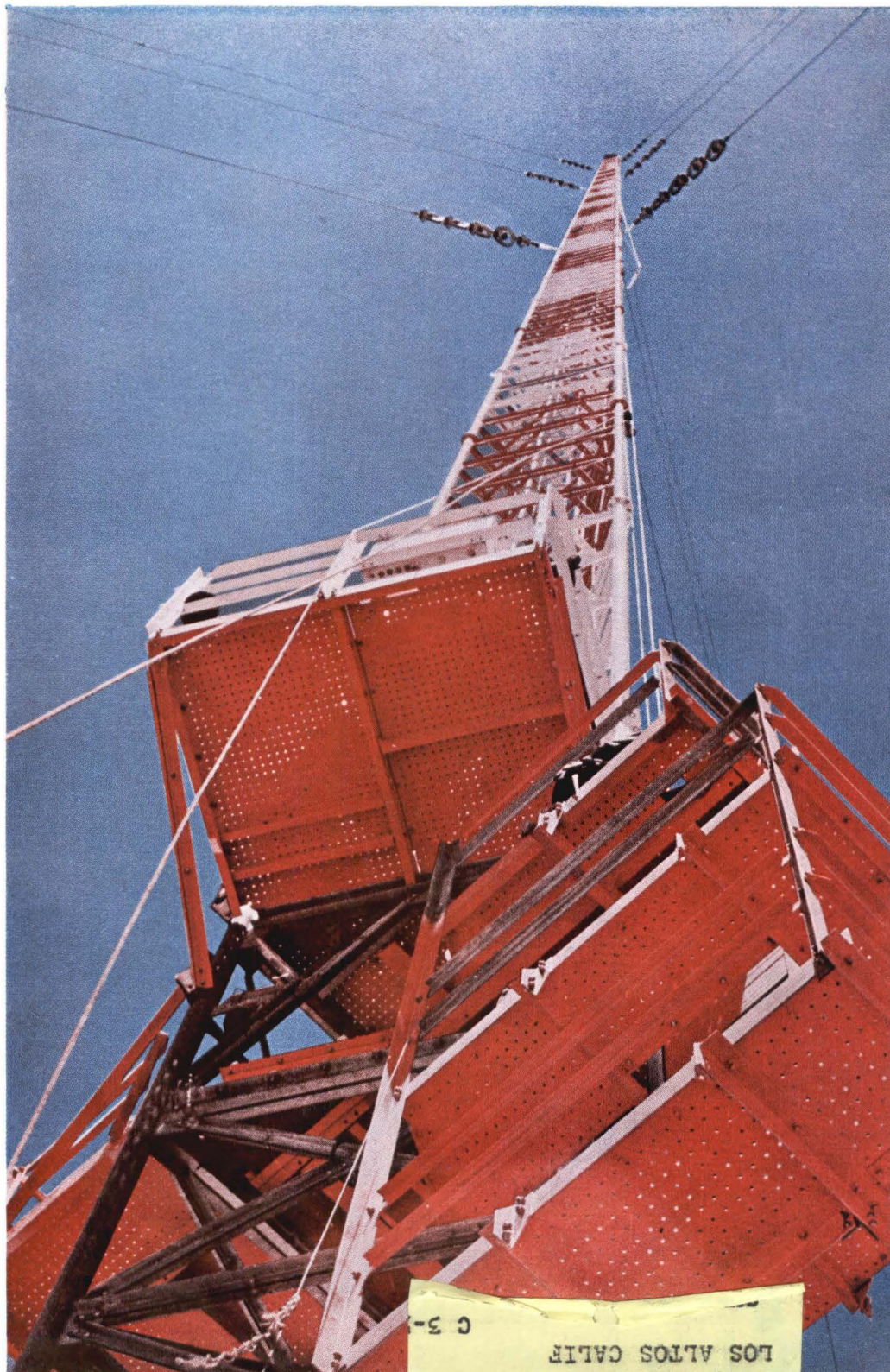

MULTIMETER CONVENIENCE

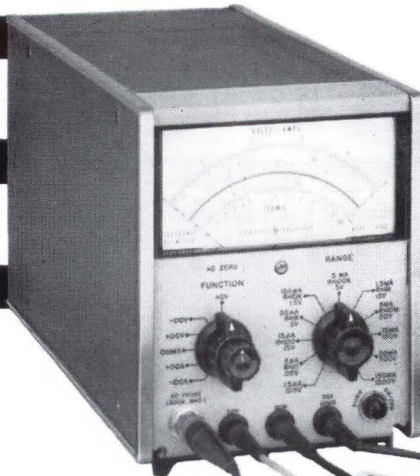

with
**LABORATORY
PRECISION!**

Look what you can measure with the hp 410C Electronic Voltmeter:

1. dc voltage, 1.5 mv to 1500 v; no zero set
2. dc current, 0.15 nanoamps to 150 ma; no zero set
3. ac voltage, 50 mv to 300 v; to 700 mc
4. resistance, 0.2 ohm to 500 megohms; no zero or ∞ set

Never in electronic measurement has so small an instrument done so much so well! Ideal for use in the lab or service department or on the production line. A unique hybrid circuit eliminates drift (and the need for a zero set) and provides such features as 100 megohms dc voltmeter input impedance; low resistance recorder output, 1.5 v dc at full scale; dc voltage accuracy of $\pm 2\%$ of full scale, current accuracy of $\pm 3\%$ of full scale, floating input for measurement to 400 v above chassis ground. The 410C also incorporates a rugged individually calibrated taut band meter movement. Get all the facts from the specifications below. Then get a demonstration from your Hewlett-Packard field engineer.

Data subject to change without notice. Prices f.o.b. factory.

**HEWLETT
PACKARD
COMPANY**



1501 Page Mill Road, Palo Alto, Calif. 94304, (415) 326-7000. Sales and service in all principal areas. Europe, Hewlett-Packard S.A., 54 Route des Acacias, Geneva, Switzerland; Canada, Hewlett-Packard (Canada) Ltd., 8270 Mayrand St., Montreal, Que.

8690

DC VOLTMETER

Range: ± 15 mv to ± 1500 v full scale
Accuracy: $\pm 2\%$ of full scale, any range
Input resistance: 100 megohms $\pm 1\%$ on 500 mv range and above; 10 megohms $\pm 1\%$ on 15 mv, 50 mv and 150 mv ranges

DC AMMETER

Ranges: ± 1.5 μ a to ± 150 ma full scale
Accuracy: $\pm 3\%$ of full scale, any range
Input resistance: decreasing from 9 k ohms on 1.5 μ a scale to approx. 0.3 ohm on 150 ma scale
Special current ranges: ± 1.5 , ± 5 , and ± 15 nanoamps to $\pm 5\%$ on the 15, 50 and 150 mv ranges using voltmeter probe

OHMMETER

Range: 10 ohms to 10 megohms, center scale
Accuracy: $\pm 5\%$ of reading at mid-scale

AMPLIFIER

Voltage gain: 100 maximum
Output: proportional to meter indication; 1.5 v dc at full scale; maximum current 1 ma; impedance less than 3 ohms at dc

AC rejection: 3 db at $\frac{1}{2}$ cps; approx. 66 db at 50 cps and higher frequencies for signals less than 1600 v peak or 30 times full scale, whichever is smaller

Noise: less than 0.5% of full scale on any range (p-p)
DC drift: less than 0.5% of full scale/year at constant temperature; less than 0.02% of full scale/ $^{\circ}$ C

Recovery: recovers from 100:1 overload in less than 3 sec

AC VOLTMETER (hp 11036A AC Probe required)

Ranges: 0.5 v to 300 v full scale, 7 ranges
Accuracy: $\pm 3\%$ of full scale at 400 cps for sinusoidal voltages from 0.5 to 300 v rms; ac probe responds to the positive peak-above-average value of applied signal
Frequency response: $-3\% \pm 2\%$ at 100 mc; $\pm 10\%$ from 20 cps to 700 mc (400 cps reference); indications to 3000 mc

Frequency range: 20 cps to 700 mc
Input impedance: input capacity 1.5 pf, input resistance greater than 10 megohms at low frequencies; at high frequencies impedance drops because of dielectric loss

Meter: calibrated in rms volts for sine wave input

GENERAL

Maximum input: dc-100 v on 15, 50 and 150 mv ranges; 500 v on 0.5 to 15 v ranges; 1600 v on higher ranges; ac-100 times full scale or 450 v peak, whichever is less

Power: 115 or 230 volts $\pm 10\%$, 50 to 100 cps; 13 watts (20 watts with hp 11036A probe)

Dimensions: 6-17/32" high, 5-1/8" wide, 11" deep behind panel

Price: hp 410C, \$300
Option 01: hp 11036A Probe calibrated with instrument, add \$50 to price of 410C; 11036A, \$60 when ordered separately

electronics

A MCGRAW-HILL WEEKLY 75 CENTS

W. W. MacDONALD, Editor
Telephone Area Code 212 (971-2645)

J. M. CARROLL, Managing Editor (2293)

SENIOR EDITORS
Samuel Weber (2371)
George W. Sideris (3444)

SENIOR ASSOCIATE EDITORS
Michael F. Wolff (2600)
John F. Mason (2666)

ASSOCIATE EDITORS
Michael F. Tomaino (2071)
William P. O'Brien (2297)
George J. Flynn (2188)
George V. Novotny (3151)
Leon H. Dulberger (3446)
Alexander A. McKenzie (2685)

ASSISTANT EDITORS
Stephen B. Gray (2245)
Barry A. Briskman (2306)
Dan Smith (2467)
Joel A. Strasser (2127)

REGIONAL EDITORS
Harold C. Hood,
1125 W. 6th St., Los Angeles 90017, Calif.
(213-482-5450)
Laurence D. Shergalis,
John Hancock Bldg., 255 California St.,
San Francisco 94111, Calif. (415-362-4600)
Thomas Maguire
McGraw-Hill Bldg., 607 Boylston St.,
Boston 02116, Mass. (617-262-1160)
Cletus M. Wiley,
Blair Bldg., 645 N. Michigan Ave.,
Chicago 60611, Ill. (312-664-5800)

ART DIRECTOR
Howard R. Berry (2430)

ASSISTANT ART DIRECTOR
John C. Wright, Jr. (3430)

EDITORIAL ASSISTANTS
Lorraine Rossi, Virginia T. Bastian,
Lynn Emery, Ann Mella, Lorraine Werner,
Alice M. O'Brien, Sharon Parks,
Claire Benell, Kay Fontana

FOREIGN NEWS BUREAU
DIRECTOR, John Wilhelm, (2532);
Lawrence Mihlon (2997), Alyne Elias
(2998)
LONDON—John Shinn, Derek Barlow,
Nicholas Landon, 34 Dover St., London
W.1, England
BONN—Bruce Bendow, Richard Mikton,
Silke McQueen, Mittelstrasse 39, Bad
Godesberg, Germany
BRUSSELS—27 Rue Ducarle, Brussels,
Belgium
PARIS—Robert Farrell, Arthur Erikson,
17 Ave. Matignon, 3rd Fl., Paris 8,
France
MILAN—Marc A. Messina, Via Manzoni
No. 12, Milan, Italy
MEXICO CITY—Wesley Perry, Jr.,
Lafragua 4-314, Mexico 1 D.F. Mexico
RIO DE JANEIRO—Leslie Warren, Rua
Mexico 3-S/1507 1509, Rio de Janeiro,
Brazil
MOSCOW—Stewart Ramsey,
Kutuzovsky Prospekt 19, Apt. 28-29,
Moscow, USSR
TOKYO—Richard Halloran, Charles Cohen,
John Yamaguchi, Toranomon Sangyo
Bldg., 1 Kotohiracho Shiba, Minato-Ku,
Tokyo, Japan

CIRCULATION MANAGER
Hugh J. Quinn (2310)

C. C. RANDOLPH, Publisher (2016)

TALL TOWER. Rising 1,210 feet above the California desert near Barstow is an antenna that marks the center of a communications site being developed by Space-General for the Air Force Electronics Systems Division. The installation also includes transmitters, receivers and buried antenna elements. It is said to make up a low-frequency communications system capable of maintaining contact between USAF bases even during a nuclear attack. *About half the guywire system acts also as an antenna.*
See p 11

COVER

A RADIO FOR EVERY SOLDIER? In its hunt for radio sets that can be carried by front-line soldiers, Army is now trying miniature receivers and transmitters, instead of transceivers. *Army hopes they can eliminate hand signals and shouting among squad members, which now expose combat patrols to enemy detection* 10

SURVIVABLE COMMUNICATIONS. Air Force is investigating low-frequency communications, as a means of maintaining global communications despite nuclear-caused radio blackout and ionospheric height changes. *For tests, a 1,210-ft antenna has been built near Edwards Air Force Base* 11

MINUTEMAN'S MICROCOMPUTER. Completion of the first microelectronic computer for the Improved Minuteman ICBM was reported last week. It required a steady acceleration in supplies of integrated circuits. *Integrated-circuit yields are still low* 14

NEREM SESSION. A post-deadline session has just been scheduled, the first in NEREM's history. *There won't be any new-product-oriented seminars this year, but one NEREM official favors adding them by 1965* 14

RESEARCH IN NEW ENGLAND. Our sampling of next week's NEREM meeting includes: semiconductor laser radar using a high-power GaAs diode, hydrogen-oxygen fuel battery system, traveling-wave parametric amplifier, traveling-wave coherent-light modulators, microelectronic synchronous filter for telephone switching, construction of a high-frequency monolithic linear amplifier and rheotaxial or vacuum-deposited silicon thin films. *The high-frequency microcircuit amplifier makes use of both thin-film and diffusion processes.*

By T. Maguire 23

GLASS-TUBE ARRAY PRODUCES MANY BEAMS. The problem was to arrive at a modular design for military antennas that could provide various radiation characteristics controlled by simple mechanical means and present a narrow, nonmetallic silhouette. The answer was a mechanically steerable zoom antenna composed of glass-fiber rods. *Separation and angles between array elements are controlled by rotation of spiral-slot disks in front and back of the tubes.*

By K. Ikrath and W. Schneider, US Army Electronics R&D Lab. 28

Published weekly, with Electronics Buyers' Guide as part of the subscription, by McGraw-Hill Publishing Company, Inc. Founder: James H. McGraw (1860-1948).

Title ® registered U.S. Patent Office; © copyright 1963 by McGraw-Hill Publishing Co., Inc. All rights reserved, including the right to reproduce the contents of this publication, in whole or in part.

Executive, editorial, circulation and advertising offices: McGraw-Hill Building, 330 West 42nd Street, New York, N. Y., 10036. Telephone Area Code 212 971-3333. Teletype TWX N. Y. 212-640-4646. Cable McGrawhill, N. Y. PRINTED IN ALBANY, N. Y.; second class postage paid at Albany, N. Y.

OFFICERS OF THE PUBLICATIONS DIVISION: Shelton Fisher, President; Vice Presidents: Joseph H. Allen, Operations; John R. Callahan, Editorial; Ervin E. DeGraff, Circulation; Donald C. McGraw, Jr., Advertising Sales; Angelo R. Venezian, Marketing.

OFFICERS OF THE CORPORATION: Donald C. McGraw, President; Hugh J. Kelly, Harry L. Waddell, L. Keith Goodrich, Executive Vice Presidents; John L. McGraw, Treasurer; John J. Cooke, Vice President and Secretary.

Subscriptions are solicited only from those actively engaged in the field of the publication. Position and company connection must be indicated on orders. Subscription rates: United States and Possessions and Canada, \$6.00 one year, \$9.00 two years, \$12.00 three years. All other countries \$20.00 one year. Single copies, United States and Possessions and Canada 75¢. Single copies all other countries \$1.50.

THE PUBLISHER, UPON WRITTEN REQUEST TO OUR NEW YORK OFFICE FROM ANY SUBSCRIBER, AGREES TO REFUND THAT PART OF THE SUBSCRIPTION PRICE APPLYING TO COPIES NOT YET MAILED.

Subscribers: Please send change of address notices, subscription orders or complaints to Fulfillment Manager, Electronics, at the address below. Change of address notices should provide old as well as new address, including postal zone number if any. If possible, attach address label from recent issue. Allow one month for change to become effective.

Postmaster: Please send Form 3579 to Fulfillment Manager, Electronics, P. O. Box 430, Hightstown, New Jersey, 08520.



Audited Paid Circulation

Contents continued

NOVEL FIELD-EFFECT DEVICE PROVIDES BROADBAND GAIN. Field-effect, hole-conducting metal-oxide-semiconductor transistors (p-MOST) consist of an *n*-type silicon substrate into which are diffused two adjacent islands of *p*-type conductivity. A silicon-oxide insulating layer overlays the area between the two *p* regions and a thin metal gate electrode is deposited on the oxide layer. *A p-MOST does not conduct until the gate is biased with the same polarity voltage as the output. It is a voltage-operated device whose gate draws no d-c.* By F. M. Wanlass, Fairchild Semiconductor 30

PLATED HOLES SIMPLIFY MEMORY DESIGN. New thin-film memories afford higher-speed operation than conventional ferrite cores; however, the open-flux nature of most of these devices gives rise to phenomena such as creep and dispersion. *This approach combines the advantages of a thin-film memory with the desirable characteristics of closed-flux magnetic paths.* By J. S. Sallo, Honeywell Research Center 34

X-RAYS AND COMPUTERS. Biomedical researchers find that digital and analog processing of radiographs enable them to make sharper analyses. *In one case, a lung malignancy that could not be seen by the unaided eye became visible after digital processing* 38

DEPARTMENTS

Crosstalk. Lean and Hungry 5

Comment. Vela Hotel. Capacitance Chargers 6

Electronics Newsletter. Implanted Radio Receiver Aids Paraplegics 17

Meetings Ahead. National Aerospace Electronics Conference 18

Washington This Week. Stimulants for R&D Sought as Defense-Space Work Wanes 20

Research and Development. Thick-Film Memory Has High Output 40

Components and Materials. Light Isolates Amplifier Stages 43

Production Techniques. Wires Cut Crystals Accurately 46

New Products. Camera Aids Luminous Transient Studies 49

Literature of the Week 52

People and Plants. NCC Expanding Plant 54

Index to Advertisers 60

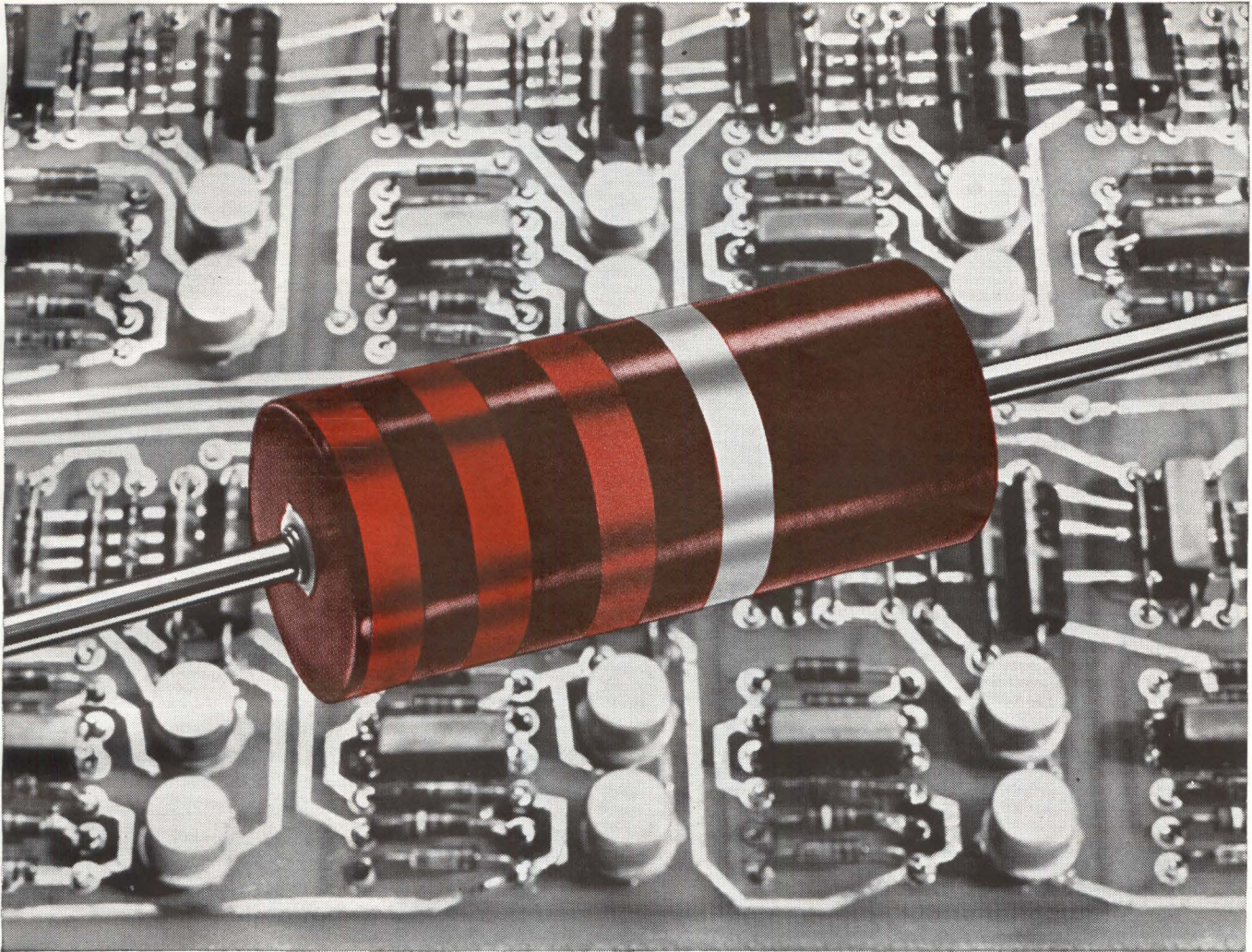

Why Allen-Bradley hot molding is so important to resistor performance

■ First and foremost, Allen-Bradley's exclusive hot molding provides a uniformity that cannot be matched by any other resistors on the market—a fact with which hundreds of Allen-Bradley customers have become acquainted through their experience for over 30 years. Such history of uniformity in physical dimensions and electrical properties from one resistor to the next . . . from one order to the next . . . has been demonstrated in the production of more than *ten billion resistors*.

In addition, with their stable characteristics and conservative ratings providing an *extra* margin of safety, you can accurately predict long term resistor performance under various circuit conditions—and at all times be certain of *complete freedom from catastrophic failures*.

A unique manufacturing method is the key which

makes all this possible. Allen-Bradley's hot molding technique is unlike anything in the industry, because both the process and the automatic machines—with built-in precision control—were developed and perfected by Allen-Bradley. Here, the resistance material, insulation material, and lead wires are hot molded into one solid integral structure that's mechanically strong—completely free of cracks which might admit moisture.

There are additional reasons why more and more leading electronic manufacturers are standardizing on Allen-Bradley hot molded resistors. Complete specifications are furnished in Technical Bulletin 5050. Please send for your copy, today: Allen-Bradley Co., 110 W. Greenfield Ave., Milwaukee, Wis. 53204. In Canada: Allen-Bradley Canada Ltd., Galt, Ont.

TYPE TR 1/10 WATT		MIL TYPE RC 06
TYPE CB 1/4 WATT		MIL TYPE RC 07
TYPE EB 1/2 WATT		MIL TYPE RC 20
TYPE GB 1 WATT		MIL TYPE RC 32
TYPE HB 2 WATTS		MIL TYPE RC 42



ALLEN-BRADLEY

QUALITY ELECTRONIC COMPONENTS



Product of the Month: MAGNETIC LATCH

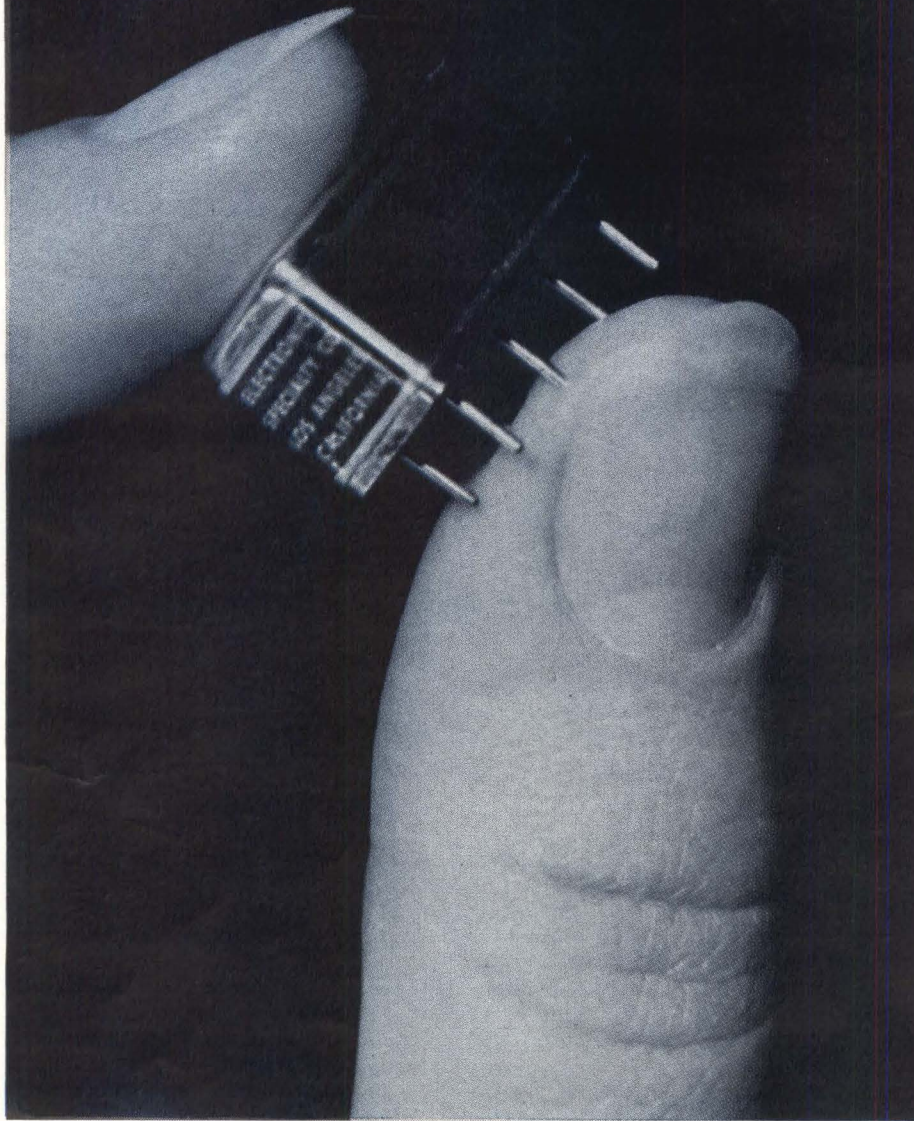

Increasingly complex advanced systems depend heavily on basic components for reliability, weight and space savings. Knowing this, Electronic Specialty developed a micro-micro-miniature magnetic latching relay that is ideally suited to sophisticated aerospace systems as well as technically advanced industrial applications. The new "pico" relay is a hermetically sealed, two pole double throw type that weighs only 0.35 ounce, with a contact rating from 10 microamperes to 2 amperes, and an operating life and reliability equal to that of relays twice the size and weight. □ For additional information on the "pico" relay, write to the Director of Marketing, address below.

ES is a diversified, dynamic, multi-divisional organization serving defense and industry over a broad range of vital areas with advanced systems, sub-systems, and state-of-the-art components. Major contributions are currently being made in the following:

ELECTRONIC AND ELECTROMECHANICAL CONTROLS:

gyroscopes, relays, static switching devices, sensors, flashers, regulators, converters, rotary and linear actuators; motors, generators, weapon and camera controls, electromechanical assemblies for aerospace applications.

COMMUNICATIONS:

antennas, flexible and rigid waveguides, coaxial switches, diplexers, power dividers, filter, radio telescopes, solar furnaces, matching networks, antenna drive motors and controls.

POWER:

precise power systems, dynamometers, computer power sources, motor - generators, actuators, starter generators, power conversion systems, transmission towers for public utilities.

SPACE CONDITIONING:

electronically programmed environmental controls and systems for industrial, commercial, and military applications.

SYSTEMS:

Systems Laboratories conduct research, development and study programs in reconnaissance, electronic countermeasures, interferometer phased array systems, and total energy packages; integrating divisional components, sub-systems, and specialized technical skills.

For information concerning the corporate systems capability, product line, or research and development programs, write to the Director of Marketing, address below.



ELECTRONIC SPECIALTY CO.

5121 San Fernando Road • Los Angeles 39, California

Lean and Hungry

ALL IS NOT ROSES with all of the electronics industry everywhere. Grand totals continue to be impressive on a national level, but in regions relying heavily on defense-space electronics the Administration's current attitude toward new R&D and procurement is causing considerable concern.

For example, while gathering material for this week's preview of the NEREM conference, our regional editor in Boston, Tom Maguire, surveyed the business situation locally and came up with the following conclusion: "There's nothing wrong with electronics in New England that isn't wrong with the defense-space business everywhere."

The area, Maguire says, is afflicted with "the triple malady of the defense-space business today: stretch-out, overcapacity, concentration of business within a relatively few firms." Besides the Defense Department's procurement-cycle stretchout, he says, New England now fears a stretchout in Apollo and other NASA programs. The situation is further aggravated by DOD's stand against "proliferation of R&D contracts." New England, Maguire points out, has most of its eggs in the RDT&E basket.

A rash of merger negotiations indicates the plight of many small firms. Increased use of fixed-price or incentive contracts is raising the investment needs of such companies and jeopardizing the small cost-plus-fixed-fee type of research outfit characteristic of New England. These companies also depend largely on subcontracts, and today prime contractors are keeping more work in-house despite frequent allegations to the contrary.

The Boston area hopes the proposed NASA electronics research center will be located nearby and will at least partially solve the problem. But it may be a long time coming, and might not do for New England



RADIOTELESCOPE at Sagamore Hill peers into a darkening sky. This installation is part of the Air Force's research complex centered in Bedford, Mass.

what the NASA center in Houston might do for Texas. In Boston, the surrounding industrial complex already exists.

What then is the solution for New England? Like other parts of the country in a similar position, New England is trying hard to get big new defense-space contracts. It is also going after new civilian markets. New England appears to be seeking new civilian markets, in fact, with more vigor than most other areas because, Maguire says, engineers and management people are already becoming "lean and hungry."

"You don't develop new products on full stomachs," he quotes an industry leader. "The fluff has gone out of this business, so now more of us are applying imagination and ingenuity to translating defense R&D into products for a big-volume civilian market."

Coming In Our November 8 Issue

NEW COMPUTER MEMORIES. While ferrite cores, magnetic drums and disks, and tapes are still the lords of the memory domain, the microelectronics revolution is fostering the development of new forms of memories.

Laminated ferrites, thin films, cryoelectric devices and organic diodes—these are some of the approaches being tried in the attempt to find memories more compatible with microelectronic computers.

Next week, our lead feature article will provide you with an opportunity to catch up with these developments that may eventually lead to memories that are high in speed, large in capacity and low in cost despite their small size.

Other topics that will be covered next week include:

- Beam plasma amplifier. This millimeter-wave de-

vice shows promise as a means of generating substantial power in a largely untapped portion of the spectrum. The device reported on has shown a power gain of 40 db at 38 Gc.

- R-f properties of solid-state components. This is an important consideration in weapons-system design, since with adequate information control designers can prevent premature actuation of weapons.

- Analog ratio computer that uses a Hall-effect multiplier. This unique computer required development of a new type of transducer.

- Using varactors to extend frequency control range. Described in this article will be an afc circuit that improves performance of transistorized radio receivers, but requires fewer components.

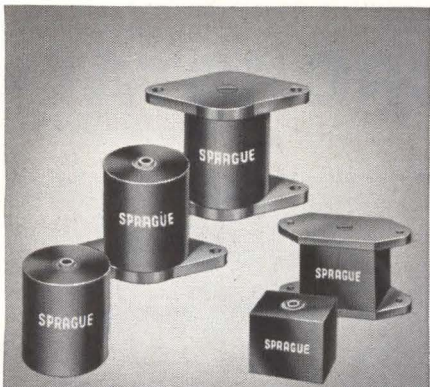

**FIRST MAJOR CHANGE
IN
High-Power
Mica Capacitors
IN OVER 25 YEARS!**



**SPRAGUE CAST MICA
CAPACITORS**

Encapsulated in high-temperature epoxy resin by specially patented process
One-third smaller in size and weight than old-fashioned potted assemblies

New shapes and mountings—can be used with or without mounting plates

Operation to 125 C without derating
Superior thermal conductivity—higher r-f current capabilities

Rugged cast housing with hermetic seals eliminates use of potting waxes

Exceed MIL Specifications



For application engineering assistance write to Mica Capacitor Section, Field Engineering Dept. For complete technical data write for Engineering Bulletins 1230 and 1240 to Technical Literature Service, Sprague Electric Co., 35 Marshall St., North Adams, Massachusetts.



45C-141-63

VELA HOTEL

In ELECTRONICS, Oct. 18 (p 57), Test-Ban Monitors Set for Launch, by John Wasik, he mentions that the Vela Hotel project is part of a "highly classified program" and that it is governed by "tight-lipped officials." Yet he goes on to give voluminous details on the satellite: its purpose, its altitude, its ground support stations, its detectors, logic system—in short, everything one would want to know about it. Fine reporting, but. . . . He calls them secret satellities.

ROY PAANANEN

Concord, Massachusetts

• Vela Hotel is not *that* secret. If it were, it would not have been launched from Cape Canaveral (a noted tourist attraction), nor would information on it be available in AEC publications and in published Congressional hearings.

As to our article giving voluminous details, a detailed article in ELECTRONICS usually contains schematics or at least block diagrams. Almost no information on the logic and telemetry systems of Vela Hotel has been made available to the press, and therefore we printed virtually no information on these "sensitive" subsystems.

VALUE ENGINEERING

In the Oct. 25 Comment (p 6), Dave Fram's engineering training seems to have been unusual. The one commonly predominant concept that was characteristic of most of my engineering courses was the engineer's responsibility for designs that were "cheaper and more efficient." In fact, this phrase was used as a stock student's answer to an instructor's questions for which one might have been unprepared, and invariably it was correct.

I think reader Fram is confusing the engineer with the scientist. This is understandable, since many engineers can and do make the transition by virtue of their scientific backgrounds and aptitudes.

I agree that the mentioned value program is imperative, but not for convincing the practicing engineer that "cost is just as important as function." The good old American spirit of competition has been and is doing just that since 1776. Let's convince him to be more aggressive towards this end, now more significant than ever, as evidenced by DOD specs.

WILLIAM PLEXNIES

Jamaica, New York

mW, NOT MW

I have just made some giant step through your issue of Sept. 13, and have been shocked to read on p 65 that there should exist a shift register which requires "Only 17 MW Per Bit". . . .

We know here in Europe that in your country there has been for a long time some struggle how to write correctly the different multiples of decimal multipliers. . . .

OSKAR STURZINGER

Baar, Zug
Switzerland

• Leider pfuscht. Or, we goofed.

CAPACITANCE CHARGERS

In my article, Capacitance Chargers for Space Employ Controlled Rectifiers (p 32, Oct. 11), there are these errors:

The last sentence of p 32 should read: "For an SCR charger, the actual current waveshape obtained is shown in Fig. 3."

Line 6 of p 33 should read: ". . . may be calculated to be 0.38 that of the ideal charger.

The caption for Fig. 2 should read: "HALF-SINE waveform A1 has an average value that equals A2 . . . SCR firing angle varies in proportion to the voltage on the charged capacitance. . . ."

The Fig. 3 caption should read: "SCR charger waveforms, voltage, top, and current, bottom (A); complete duty cycle (B)—Fig. 3"

FELIX ELLERN

Republic Aviation Corporation
Farmingdale, New York

stands

up under
the most
punishing
applications

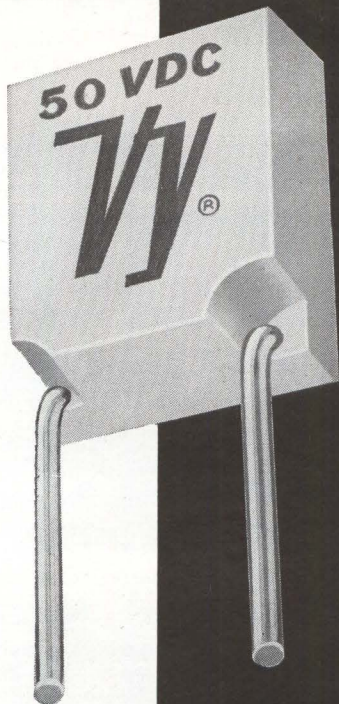

takes
up
less
space
on your
circuit board



End Radial PORCELAIN CAPACITORS

Here's a rugged, upright capacitor that leaves room for other components on your transistor circuit board and provides the exceptional reliability for which "Vitramon" solid state porcelain capacitors are famous.

POST LIFE PERFORMANCE DATA
(10,000 hours at 125°C and 150% rated voltage)
Dissipation Factor, .00203;
Insulation Resistance, 10^{10} ;
Capacitance Drift, typically 0.1 mmf.

Available in values from 10 to 1000 mmf, 50 vdc.

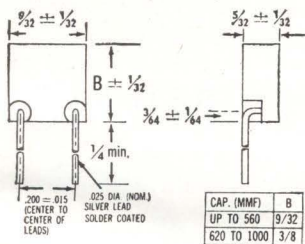

Conforms to MIL-C-11272B

- * low loss
- * low noise
- * greater stability
- * wide temperature range
- * impervious to humidity

© Vitramon, Inc. 1963

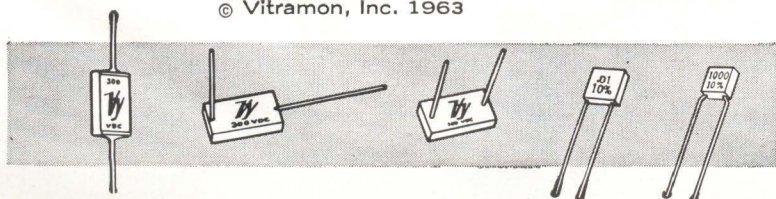

Vitramon

INCORPORATED

Box 544 • Bridgeport 1, Connecticut

ministore

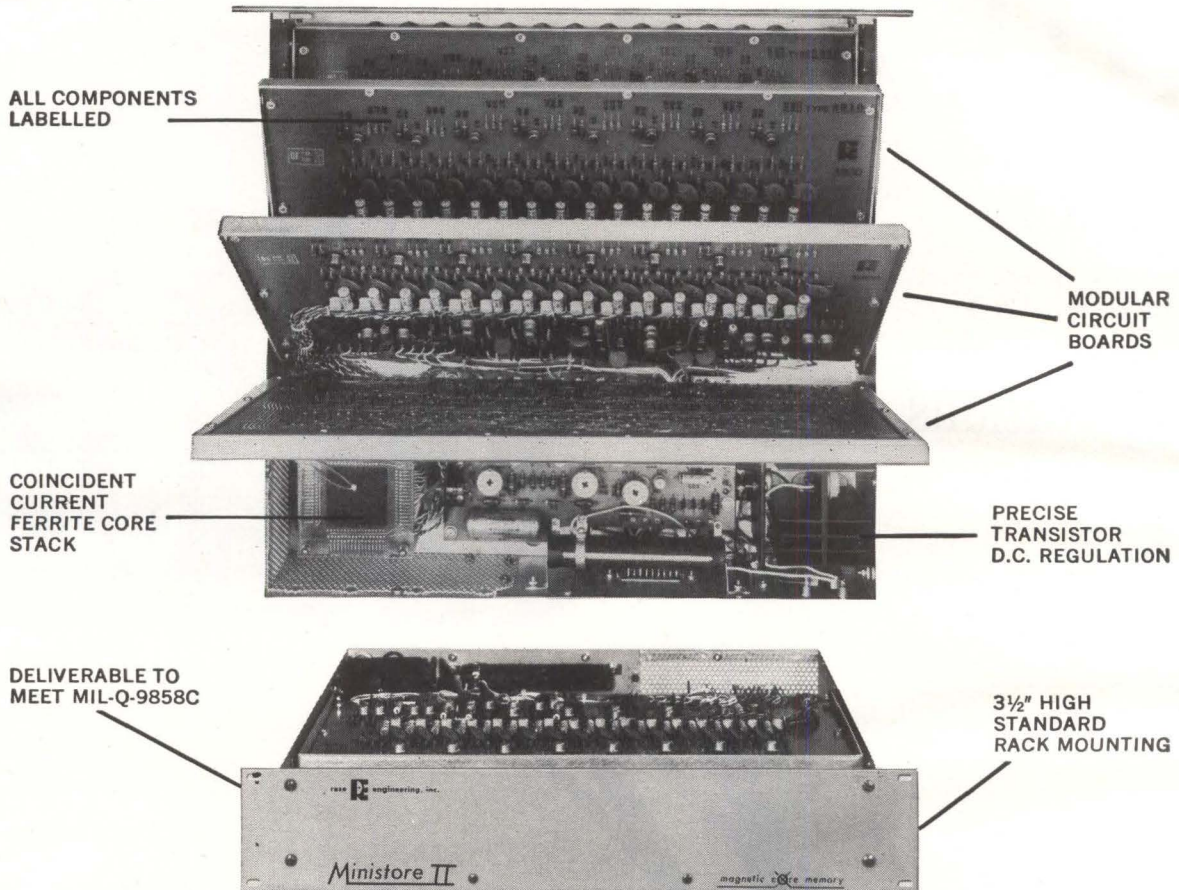
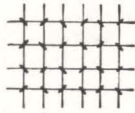

A COMPLETE MAGNETIC CORE MEMORY

PRICES
START
FROM

\$\$\$10000

Here is a complete random access, ferrite core memory with an outstanding specification—price. Compact, modular and miniaturized, Ministore is completely Value Engineered from its unique circuit design to its superior packaging technique. And its price tag is less than half that of other memories. Available in a number of word lengths and addresses and a range of prices from \$1000 to \$5000, Ministore opens up a new area of application for random access storage techniques. For complete details or a demonstration, contact Rese Engineering, A and Courtland Streets, Philadelphia, Penna., 19120. Ph. (215) GL 5-9000.

rese engineering, inc.

8 CIRCLE 8 ON READER SERVICE CARD

November 1, 1963 electronics

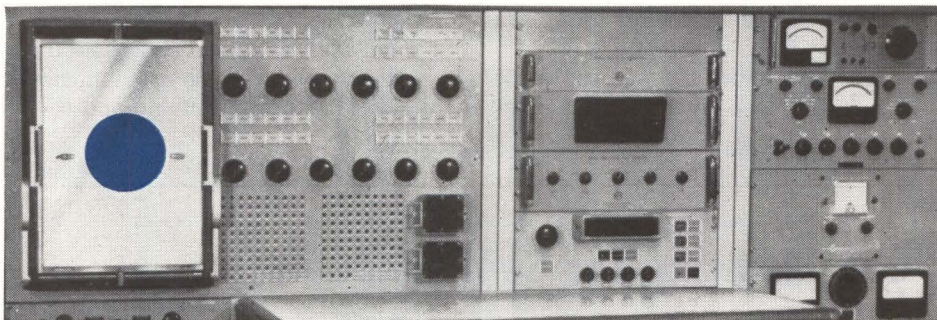
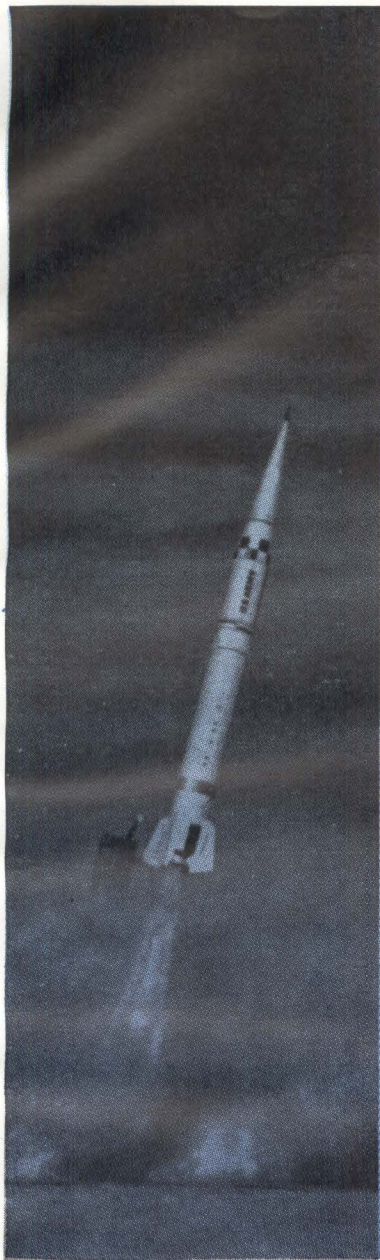

A fighting non-com meets the test

Sperry Utah uses A-MP* Patchcord Programming Systems to test Army's supersonic ballistic missile—the Sergeant. Giving the Sergeant system "before-combat physicals" is the job of Sperry Utah developed Sergeant Manual Test Station (SMTS).

Currently used in more than 60 individual test programs in Sperry's Sergeant manufacturing process; SMTS could easily be adapted to perform 100 or 1,000 programs.

Key to SMTS's flexibility is A-MP Patchcord Programming System which makes possible production line, 4th echelon, depot, or other high-speed, sub-assembly level testing.

Some significant features of A-MP Patchcord Programming Systems:

- Double wiping action in contact design assures maximum conductivity at all times—even in the

microvolt region of operation.

- Semi-permanent or permanent twin detent patchcords.
- Pre-insulated crimped contacts.
- Precise silk screening for multi-color circuit identification.
- Complete assortment of program system sizes in both universal and shielded types.

Get the full story on A-MP Patchcord Programming Systems. Send for complete details today.

*Trademark of AMP INCORPORATED.



AMP products and engineering assistance are available through subsidiary companies in: Australia • Canada • England • France • Holland • Italy • Japan • Mexico • West Germany



HELMET-ATTACHED receiver and hand-carried transmitter are expected to improve combat control

Army May Buy Radios for Every Front-Line Soldier

Now being tested are 15-ounce transmitters and 9-ounce receivers

WASHINGTON, D. C.—In its hunt for radio sets small enough to be used by every private in a combat patrol, Army has now come up with a 9-ounce receiver and a 15-ounce transmitter. Army's hope is that squad members will be able to communicate without the shouting or hand-waving that now exposes them to enemy detection.

The new radio set was shown at the annual meeting of the Associa-

tion of the U. S. Army, held here last week. Other equipment unveiled included an electronic hit-kill indicator for firing weapons at live targets, the first engineering mockup of the Lance missile system, and a new battlefield surveillance drone.

Miniature Radio—The new squad radios are compatible with other f-m radios used by Army in forward areas, so they can be used for tactical as well as intra-squad communications. A soldier clips the receiver to his helmet and listens to a small built-in speaker, or puts the set in his pocket and uses an ear-piece. The transmitter is hand-car-

ried or is clipped to the soldier's pack harness. Antennas are a 12-inch flexible tape, for receiving, and a telescoping, 24-inch whip for transmitting.

The band in which they operate, 47 to 57 Mc, has 100 channels. The receiver (AN/PRR-9) can be preset to a single channel, the transmitter (AN/PRT-2) to 2 channels. Both units are crystal controlled. Transmitter range is 500 yards in a low-power (70 mw) channel and 1 mile in a high-power (350 mw) channel. The sets operate for 24 hours before batteries are changed.

Receiver circuits (r-f amplifiers, a double-conversion i-f amplifier, audio and squelch circuits) use 14 transistors and 8 diodes, mounted on printed-circuit boards. The transmitter uses 13 transistors and 2 diodes in its voltage regulator, audio amplifier, crystal-stabilized modulator, crystal oscillator, mixer circuits and r-f amplifiers. Receiver sensitivity is 0.5 mv for a 10-db s/n ratio.

The sets were designed at USAERDL, Fort Monmouth. Delco Radio aided in development and is building the sets that will be used for field tests.

Hit-Kill Indicator — Trainees at Army's Combat Developments Experimentation Center are "destroying" tanks and other live targets with a device that uses infrared flash pulses and a photo-electric telescope to hit and record the results. The paper "ammunition" is a data card fed into the control unit on the firing weapon to instruct it to lock and fire on a target which sends back the same identifying ir pulse. The device, developed by Aircraft Armaments, completes a fire mis-

Bad Medicine for Semiconductors

Without shielding in space, solar flares would sap 70 percent of gain

BALTIMORE—Unshielded 50-Mc npn silicon transistors and 10-Mc pnp germanium transistors would suffer a reduction of 70 percent in common emitter current gain when subjected to class 3+ solar flares if used in LEM during an Apollo mission to the moon.

Lower-frequency transistor types would suffer even greater degradation. Resistors and capacitors, on the other hand, will remain unaffected even by 10 times the radiation experienced during a solar flare.

These estimates were given by RCA last week at the East Coast Conference on Aerospace and Navigational Electronics.

Ionization Effects—Speaking on the effects of radiation on electronic components for LEM (lunar excursion module), D. A. Gandolfo and J. J. Stekert, of RCA Applied Research, indicated that in-can ionization dose from a solar flare is 1.17×10^5 rads and that the resulting surface effects would be shown by an increase in reverse leakage current. Depending on the magnitude of the bias, this current could increase by factors of from 5 to 10^4 . A 1-gm/cm² aluminum shield would reduce the damage by a factor of 4 in silicon and 5 in germanium transistors.

sion in less than a half second, can be used for weapons capable of 4,000-meter ranges. Other versions are man-portable for simulated combat with the M-14 rifle.

Radio data link is used to interrogate all targets. Signal is pulsed f-m at 219.3 Mc. Ir receiver in electro-optical data link operates from 0.75 to 1.9 microns. Ir beacon uses pulsed xenon filtered light with 50-kw peak power, and a 2-micro-second rise time.

Lance Missile—Full-scale engineering mock-up of Army's supersonic, surface-to-surface ballistic missile, Lance, was displayed for the first time. Designed to replace Lacrosse, Honest John and possibly Little



KILLING END of the hit-kill indicator is a photoelectric telescope in the tank's barrel

John, the missile is still under development. Production decision will be withheld pending demonstration of its predicted performance.

Lance will use a simplified inertial guidance and control concept, described as a low-cost, rugged package conceived and developed by Army Missile Command, Huntsville, Ala. Prime contractor for the entire system is Ling-Temco-Vought.

New Drone—Northrop's Ventura div. unveiled a new battlefield surveillance drone, the NV-104, said to double performance and payload of current equipment while offering major cost savings. Measuring 15 feet in length with an 11-foot wingspan, the NV-104 is controlled by ground-based radio and can carry cameras and other sensory equipment.

Can L-F Communications Beat Nuclear Blackout?

Air Force built that tall tower at Barstow to investigate the idea

By **HAROLD HOOD**
Regional Editor, Los Angeles

LOS ANGELES—Test phase has recently been completed on a survivable communications system prototype employing one of the world's tallest structures—a 1,210-foot vertical low-frequency transmitting antenna (cover photo).

The program, aimed at determining the effectiveness of long-distance, l-f communications in the presence of nuclear activity, was under the direction of the Electronic Systems Division, U. S. Air Force Systems Command, and carried out by Space-General Corp (an Aerojet-General subsidiary).

One of three originally planned for the Southern California area, the top-loaded, base-insulated monopole is located in the Lucerne Valley 30 miles east of Edwards Air Force Base. An Air Force spokesman told **ELECTRONICS** that plans for additional towers have not yet been formulated, and that results of the test program cannot be revealed at this time.

It has been reported, however, that engineers have succeeded in sending data in excess of 1,200 miles, and it is believed that twice this distance could be achieved with existing equipment.

Beating the Blackout—Air Force planners believe that, in case of nuclear attack, l-f global communications systems would be less vulnerable to such nuclear-caused phenomena as radio blackout and change in ionosphere height. Having long-range capabilities, such systems also maintain reasonably good phase stability and remain relatively unaffected by normal atmospheric changes such as those

occurring at daybreak and nightfall.

One way to combat the possibility of the Air Forces' conventional communications being knocked out, they reason, is to erect multiple l-f antennas at strategic locations across the nation. Communications between the antenna site and nearby air bases, for example, would be by "conventional means." If one or two were knocked out, the surviving antennas could carry on the job.

Tower Design—The prototype tower, built by Dressor-Ideco, Inc., is triangular in cross-section and approximately 7 feet on a side. Three sets of three guy wires support the structure and the tip-mounted "umbrella" is formed by six guy wires. Radial elements are imbedded slightly beneath the ground surface for the purpose of testing propagation characteristics of buried antenna systems.

A square Copperweld ground mat, roughly 200 feet on a side, lies on the desert surface at the base of the antenna. Trailer-enclosed electronic gear, operated by a four-man Air Force crew, is located nearby. The antenna structure is said to be capable of withstanding winds up to 160 miles per hour.

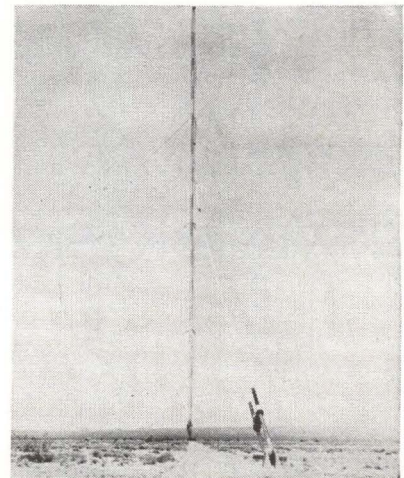

ANTENNA is almost as tall as Empire State Building

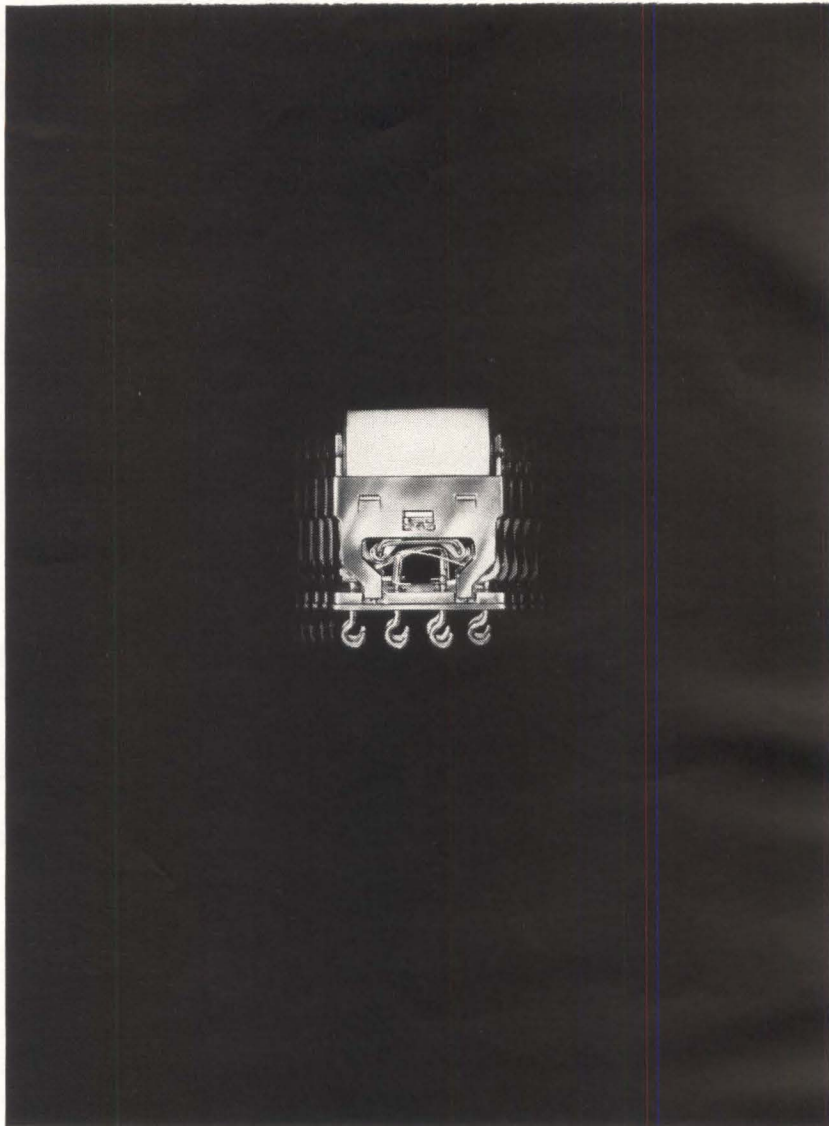

This Relay Obeys A 50-mw Signal...Even at 30 g's

The Sigma Series 32 contacts don't chatter during vibration of 30 g's to 5,000 cycles, or shock of 100 g's. The unique cross-leaf contact structure and magnetic circuit with horizontal coil also result in the 32's ability to switch reliably up to 2 amps, with an input signal as small as 50-mw—pulsed, sustained or gradually changing.

The Series 32 is a polarized, subminiature DC magnetic latching relay. Its con-

tacts are held magnetically in the position last energized—without continuous coil signal.

The relay is rugged, compact and operates at temperature extremes of -65°C to $+125^{\circ}\text{C}$. So reliable, the Series 32 helps shoot missiles, orbit satellites—and keeps computers and office equipment humming.

To help you take advantage of the outstanding capabilities of this relay, we'd

like to send you our Design Bulletin describing nearly 1,000 standard variations of the Series 32. Write to Department #32... or ask our application engineers to help you select the right switching control for your particular need.

You can choose from more than 100,000 different standard Sigma relays—both latching and non-latching, electromagnetic and solid state.

SIGMA DIVISION  SIGMA INSTRUMENTS INC
Assured Reliability With Advanced Design/Braintree 85, Mass.

Is your circuit power limited?

Magnetic latching relays can conserve power when used in a circuit like this. For example, the Sigma Series 32 requires only 950 micro-joules with a matching RC constant of 450 microseconds. Single pulse operation of relays is covered more completely in Sigma technical paper APN 2.3. Write Department 196 for a copy.

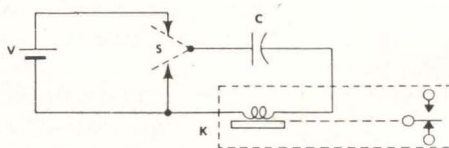

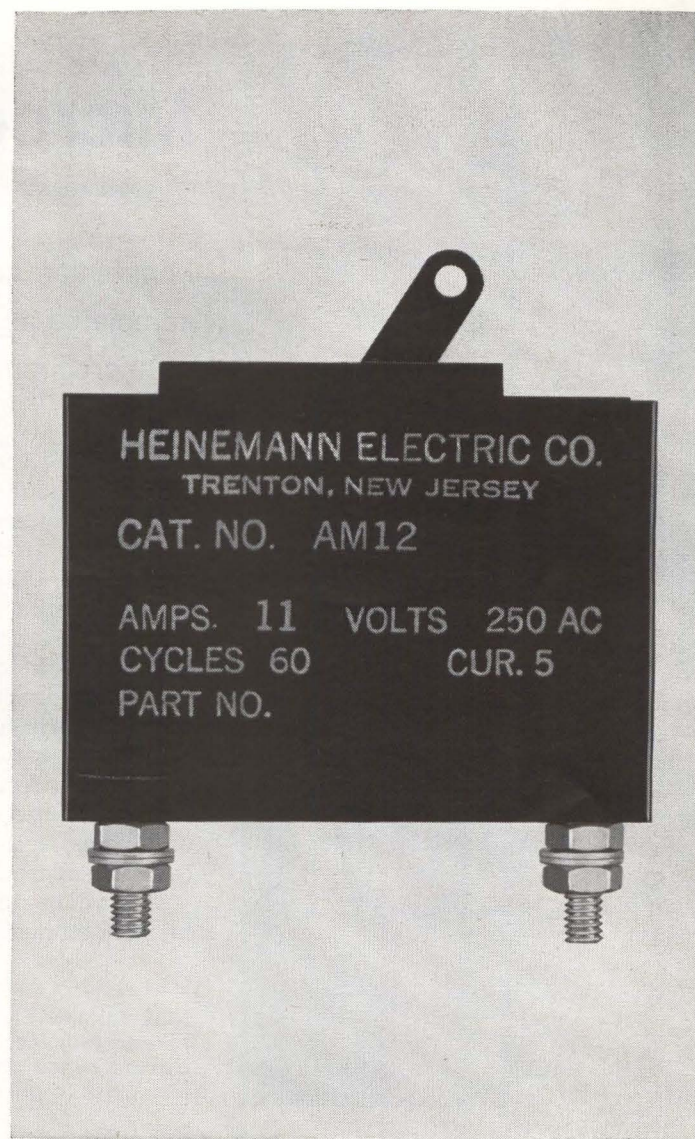
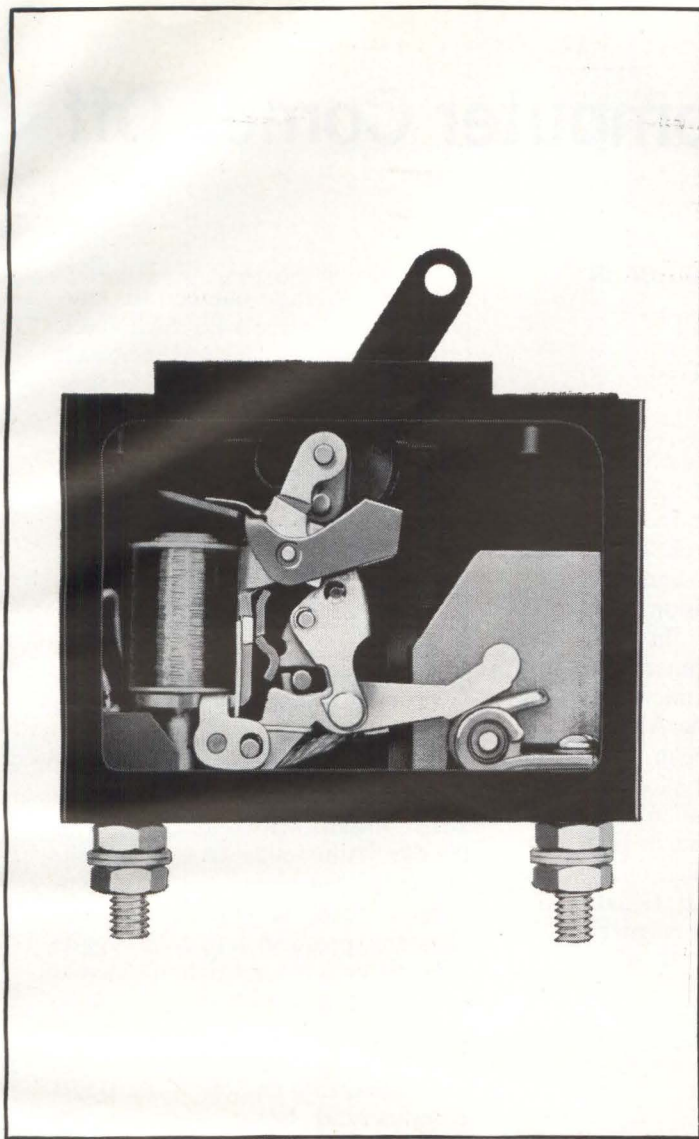

An open and shut case for tight-spec overcurrent protection

You can't find another overcurrent-protection device that quite equals the Heinemann circuit breaker in adaptability to close-tolerance protective functions.

With Heinemann you can match the breaker to every important characteristic of your application because you can write the specs for every major parameter of breaker performance.

Take current rating, for example. By altering the number of ampere turns in the breaker's sensing coil, we can make the precise integral or fractional current rating you specify. Anything from 0.010 to 200 amps. Even unusual ratings like 4.67 or 83.75 amps are no problem. (Some of our customers regularly spec current ratings out to three decimal places.)

Application load characteristics can be matched just as precisely with a hydraulically-controlled time-delay response. This prevents nuisance tripping by allowing for starting inrush and transient overloads.

Every breaker model is available in a choice of several different response times. Or with instantaneous-trip action.

Also optional are a variety of special internal circuits which permit the breaker to

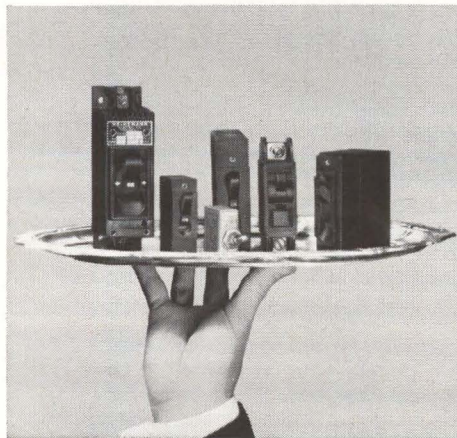

perform additional protective and control functions. (Series-trip, relay-trip, and shunt-trip to name the more popular. There are others.) You can spec these internal circuits in any combination on multi-pole breakers, too. The possibilities are virtually unlimited.

About the only parameter not open to specification is hydraulic-magnetic actuation. Every Heinemann breaker has it. It assures you that the specified current rating and trip points will not vary under any ambient temperature within the breaker's overall operating range.

Other than that, you're welcome to adapt any breaker in the Heinemann line to suit your own needs. We have a wide range of models from subminiature size on up (eight distinctively different series in all). Our Engineering Guide will give you detailed technical information, and may even suggest some new circuit design possibilities. Just ask for Bulletin 202.

HEINEMANN ELECTRIC COMPANY



2600 BRUNSWICK PIKE, TRENTON 2, N. J.

CIRCLE 13 ON READER SERVICE CARD

Microcomputer Comes Off

Minuteman computer is completed as supply of microcircuits rise

LOS ANGELES—Last week, completion of the first of the microelectronic computers for the Improved Minuteman ICBM (ELECTRONICS, p 26, Feb. 15) was announced by the Autonetics division of North American Aviation. In fact, said Autonetics, the computer is the first production-designed microelectronic computer built for the Air Force.

The program, begun two years ago, is considered a pioneering effort in the use of microelectronics on a large scale—and in their production and packaging.

According to Al Grant, who memory storage is a magnetic disk.

NEW COMPUTER is small in comparison with the D17 computer (on carriers in top photo) now used in Minuteman's guidance system

heads Autonetics' data systems division, the average number of integrated circuits received each week in July was 305. This was increased to 611 in August and during September to 1,449 a week. To stay on schedule for Minuteman B, the suppliers will have to pump 4,375 circuits a week into Autonetics production lines by December. As of last week, 12,837 integrated circuits had been received for engineering purposes and 6,106 for production purposes.

A big problem at present is low yields. Integrated-circuit yields, considering all process steps, are reported to be less than 1 percent. The main problems are leaking case seals, unsatisfactory bonding, and the like. Autonetics stressed the reliability requirements for the computers. Because the Minuteman sites are spread so far apart, repairs must be kept to a minimum to avoid severe logistic problems.

Computer Functions—Initial working engineering models of the D37B computer are being integrated into Minuteman's new N-17 inertial guidance. The D37B is a general-purpose, digital data processor.

Before flight, the computer decodes and performs tasks assigned by ground equipment. It controls inertial platform alignment and checks out the guidance and control system. It controls the terminal countdown and transmits the launching signal.

During flight, the computer accepts angular attitude and rate attitude information from the inertial guidance platform, determining position in relation to launch point and programmed target. Output commands to flight control units keep the missile on true ballistic trajectory.

During test flights, the computer also makes available to the instrumentation package synchronized signals and numerical data to be telemetered to ground stations.

Computer Operation — Internal memory storage is a magnetic disk.

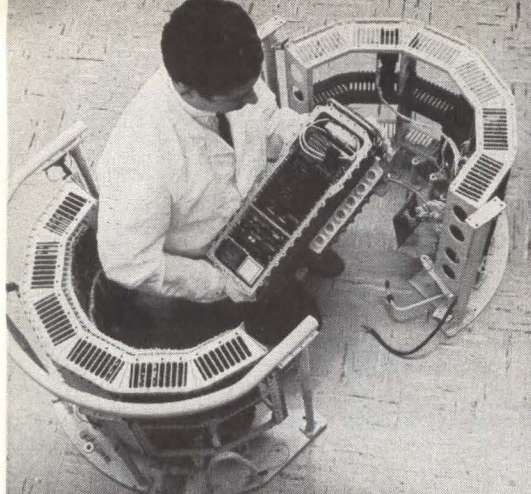

NEREM: NEW SESSION BUT NO SEMINARS YET

BOSTON—For the first time in its history, NEREM will offer a post-deadline session, to permit late reports on Tyco Labs silicon-carbide, room-temperature laser (ELECTRONICS, P 17, Sept. 6) and MIT's microwave measurements during the solar eclipse in July (p 37, July 26). The special session will be at 1:30 p.m. next Tuesday in the Hotel Somerset.

The program for the 17th Northeast Electronics Research and Engineering Meeting next week will be heavily flavored with invited review-type papers on frontier research.

One invitation declined was an offer from NEREM to the Electronic Industries Association. EIA is sponsoring a conference on microwave component needs Sunday at the Sheraton-Plaza Hotel. NEREM invited EIA to hold the conference Monday morning, before the regular NEREM program.

The EIA conference is the nearest thing to a "rump" session that has come to the attention of the NEREM committee. They discussed, but did not act on permitting company-sponsored seminars, such as those presented this week at the National Electronics Conference in Chicago (p 26, Oct. 25).

Like WESCON, NEREM is just "watching" such seminars (p 29, Aug. 9). But one NEREM committee member says: "We'll probably go hunting for outside sessions by 1965. If there is substantial interest in them, this would indicate the outside sessions ought to be inside."

He says a rump session is a "natural" for an aggressive sales department, especially since many people who attend NEREM "are floored by the high-level technical sessions. They come to see the exhibits and would also be happy to attend more applications-oriented seminars"

the Line

Logical mechanization of the computer uses the NAND gating structure.

The D37B operates under the control of an internally stored program entered from tape, control equipment keyboard, or similar input devices. The computer can search and/or read the next instruction while executing the current instruction.

The disk memory is driven by a synchronous motor and is supported on both sides by air bearings. The memory contains dual headplates, one on each side, of the rotating magnetic disk. The disk rotates synchronously with the 3-phase, 400-cycle memory motor power supply at a nominal 6,000-rpm speed. Total working capacity is 6,966 24-bit words.

The number system used for internal computations is natural binary with the 2's representing negative numbers. A word may have one of several formats depending on its use as an instruction, a full or split number.

Hermetic Packaging—The computer is packaged in a hermetically sealed aluminum chassis with an installation envelope measuring $20\frac{7}{8} \times 10\frac{1}{2} \times 5\frac{5}{8}$ inches. It weighs 36 $\frac{1}{2}$ lbs, not including the coolant. It is conduction-cooled by a liquid-cooled chassis. The computer is divided into three sections: memory, logic and input/output, and power supplies.

The memory includes five circuit modules, and a master interconnect board. Each module has 10 layers of etched circuitry; outside layers provide for bonding of heat dissipators and integrated circuits, pin connections to the master interconnect board, and a 160-pin test connector.

The master interconnect board has 11 layers of etched circuits. It provides interconnections between the memory, circuit modules and logic section. The logic, input-output section has 15 modules and contains another master interconnect board.

"THIS BETTER BE GOOD!"....

... I wouldn't have taken the time, if Standards hadn't sent you. As I understand it, you sold them an oscillator, which they think can help me! Did they fill you in?

Yes — they tell me the final test on your new line of amplifiers seems to be chewing up a lot more time than you'd like.

Time? Please! Every time the brass walks through here and sees those unshipped instruments, I get visions of my merit file being stuffed with nasty little notes! Big problem's been in checking for frequency response and harmonic distortion. Just too bloody long on each instrument!

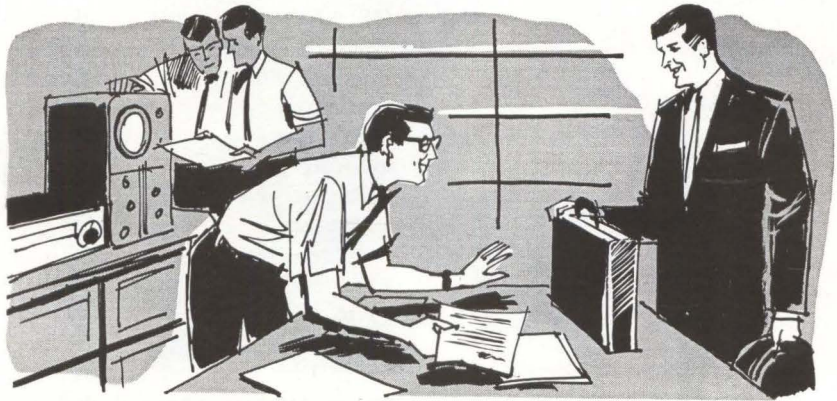

Take the tests one at a time. Frequency response. Been feeding preset amplitudes at frequency steps, reading amplifier output and comparing? Have to go back to the signal source each time to check and reset its output amplitude at every frequency?

Sure! Otherwise, I've got oscillator amplitude error in my gain figure.

OK. You don't have to. The frequency response of the Krohn-Hite 446 oscillator is within 0.01 db up to 20 kc, within 0.05 db all the way from 10 cps to 100 kc. And short-term amplitude stability of 0.01%! So, forget about resetting voltage every time you change frequency.

Beautiful! Eliminating rechecking the source and re-setting will really speed things up.

Now — what are you doing to the input signal when you measure harmonic distortion of the amplifier? Have to purify the oscillator output?

Naturally!

Not at all . . . use the 446 as your source and forget about harmonic distortion — it's less than 0.02% from 400 cps to 5 kc, and only 0.2% at 20 cps and 20 kc. Another thing — the 446 is available fully programmable for automatic check-out — including self-checking, "enable" and "completed" circuits.

Brother — you've just saved me 8 hours an instrument! I'm going upstairs right now and pinch a 446. We can ship some amplifiers tonight!

Hold it! They're right in the middle of DVM calibrations with their 446's. But I'll let you buy your own from me.

Dammit, progress always costs!



**KROHN-HITE
CORPORATION**

580 Massachusetts Avenue, Cambridge 39, Mass.
Area Code 617 491-3211

Pioneering in Quality Electronic Instruments

How Potter & Brumfield precision-cleans missile relays for top reliability!

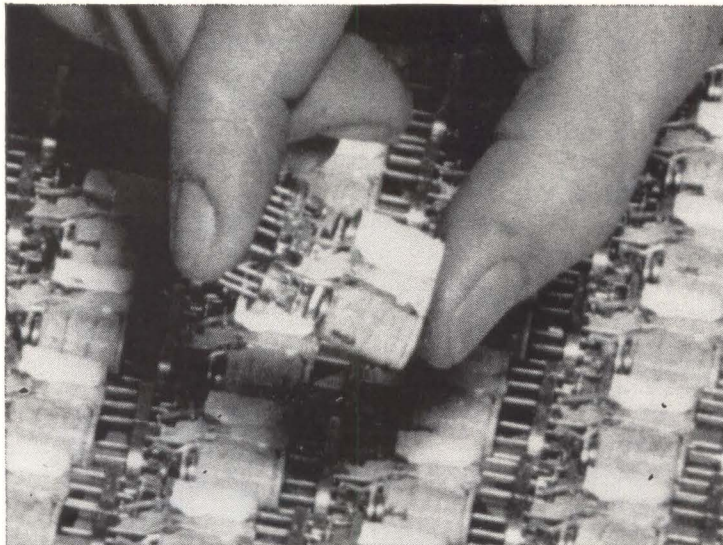

PROBLEM: How to reduce an unacceptably high reject rate on critical "crystal-case" electrical relays (first photo) at Potter & Brumfield, Division of American Machine & Foundry Company... eliminate employee problems of headaches and nausea due to solvent vapors.

SOLUTION: A new cleaning system using "Freon" fluorinated solvents. "Freon" is an excellent selective cleaning agent. It removes solder flux, dust, lint and other contaminants, yet doesn't harm delicate relay parts. Also, "Freon" is virtually non-toxic, thus eliminating complaints about vapors.

In the cleaning process, a basket of relays is first given a 15-second ultrasonic bath in "Freon" TMC, then an ultrasonic bath in "Freon" TF for 15 seconds (second photo), and a 15-second rinse in TF vapor. Because of its low surface tension, "Freon" quickly penetrates the tiny spaces in the relays, allowing precision cleaning of delicate parts.

As a final cleaning step, the relay contacts are washed in a spray of "Freon" TF, while being electrically actuated (third photo). This assures that no particles are entrapped between the contacts. Only the high dielectric strength of "Freon" makes this operation possible.

According to Potter & Brumfield, the adoption of "Freon" solvent cleaning has upgraded product quality, meeting their critically high standards, equivalent to a 17% increase in production capacity while at the same time decreasing labor costs. They point out that "Freon" dries quickly and leaves no residue, and that its non-flammability and low toxicity let them operate without expensive ventilating equipment. They've found "Freon" solvents economical to use because they can be recovered in simple equipment for reuse...over and over again. Most important, "Freon" solvents have eliminated employee complaints on nausea and headaches.

• • • • •
We'll be glad to give you help in selecting "Freon" solvents for use in your own cleaning operation. Just write on your letterhead to Du Pont, 2420E-11 Nemours Bldg., Wilmington 98, Delaware.

FREON[®]
solvents



BETTER THINGS FOR BETTER LIVING . . . THROUGH CHEMISTRY

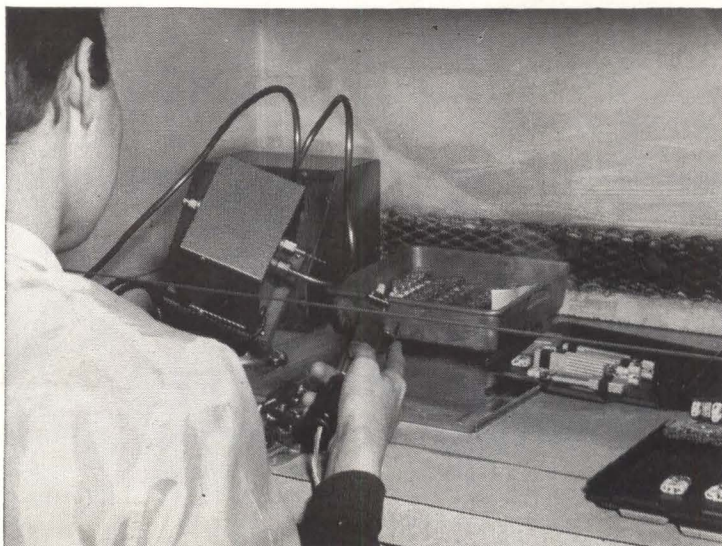

Implanted Radio Aids Paraplegics

SAN FRANCISCO—An implanted radiophysiological stimulator that controls bladder evacuation was reported yesterday at a meeting of the American College of Surgeons. Doctors say the device might extend the lives of the estimated 200,000 paraplegics in the country. More than half the deaths of paraplegics are now attributed to complications involving the urinary tract.

The wrist-watch-shaped radio receiver weighs 4 ounces and requires no internal power source. It is placed within a subcutaneous pocket on the left side of the abdomen. Two stainless steel electrodes lead to the detrusor muscle of the bladder.

A small transmitter, powered by four transistor-radio batteries, is held by the subject near the receiver. When activated, it transmits pulses of predetermined duration, frequency and amplitude causing bladder contraction and urine expulsion. No wires pass through the body, avoiding the serious risks of abdominal infection.

The device was developed at Avco-Everett Research Laboratory in Everett, Mass., and Maimonides Hospital in Brooklyn. It was designed by Gurdon R. Abell of Avco. The work at Maimonides is headed by Dr. Adrian Kantrowitz and Dr. Martin Schaumann. Director of the Avco Lab is Arthur Kantrowitz, Adrian's brother.

Lightweight IR Detector Described in Detail

CHICAGO—Details of Martin's lightweight, long-wavelength (8 to 13-micron) infrared detector were given this week at the National Electronic Conference by Donald L. Fresh. He said the detector does not rely on heating effects. Instead, it counts impinging photons—absorbed photons produce detectable free-charge carriers. The device is $2 \times 2 \times 5$ mm and uses a mercury-

Syncom Time Delay Tolerable

NEW YORK—Time delay in two-way voice transmission—considered one of the major drawbacks of synchronous communications satellites—is not as disconcerting as NASA engineers originally feared.

On Tuesday, one of our editors interviewed Russ Burke, NASA's Syncom project director via the Syncom II satellite. The telephone conversation was relayed by regular telephone ground line from Washington to Goddard Space Flight Center in Greenbelt, Md., to Syncom II in orbit 22,300 miles above Brazil, from Syncom II to Lakehurst, N. J., and from Lakehurst by ground line back to Goddard then on to New York.

Total transmission distance was approximately 50,000 miles. One-way time delay during the conversation was estimated at 0.3 second. This caused a slightly unnatural effect, but did not materially impede the conversation

doped germanium crystal cooled to 30 deg K by a North American Philips cryogenic refrigerator. It has been flight-tested in an HRB-Singer infrared mapping system.

Arecibo Completed

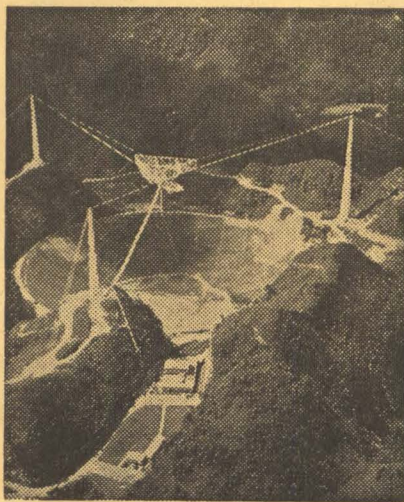

ARECIBO Ionospheric Observatory—world's most powerful research instrument for radio astronomy—was dedicated today in north central Puerto Rico. (For engineering details, see p 20, Jan. 27, 1961; p 46, July 7, 1961; p 18, May 12, 1963)

Camera Tube Has 100 Times Vidicon Sensitivity

CAMERA TUBE with a sensitivity approximately 100 times that of a vidicon was reported by G. W. Goetze and A. H. Boerio, of Westinghouse Research Labs, at the IEEE Electron Devices Meeting in Washington this week. The tube is slated for use on NASA's OAO satellite, and is considered as simple as a vidicon. The storage target operates on a principle called secondary electron conduction. This involves the efficient and lagless conversion of high-energy electrons into a larger number of low-energy electrons by exciting a low-density insulating layer with key-range electrons.

Tougher-to-Track ICBM Sought by Air Force

WILMINGTON, MASS. — Under a \$15½-million contract, Avco Corp.'s Research and Advanced Development division will develop and flight-test a new ICBM reentry vehicle that should have the lowest level

of radar observability yet achieved. The shape of the vehicle will probably be refined to make it more slender and softer in surface configuration than, for example, the Mark 11 now at Cape Canaveral. New materials and coatings with low radar reflectivity will be used, neutralizing or minimizing the detectability of the vehicle's ionized wake.

New England Firms Shying From Area Bidding Plan

BOSTON—The regional move to set up a company to bid on major space contracts and then parcel out subcontracts to area firms (p 24, Nov. 2, 1962, and p 8, March 15, 1963) has bogged down. Area officials say frankly that the plan behind the nonprofit Bay State Science Foundation and its intended offspring, the profit-making Advanced Technology Inc., is not being well received by industry.

The official word is that the proposal is "now being reappraised by industrial executives" but the feeling

is that the outcome will probably be a nonprofit study institution which will tackle work not appropriate for academic institutions. Between 40 and 50 organizations have reportedly contributed more than \$750,000 to date, but Bay State trustees have not yet activated Advanced Technology Inc. Critics of the plan argue it would set up one more barrier between industry and government. It could also compete with industry, they claim.

Japanese Sell Russia Digital Computer

TOKYO—Russia has purchased Japan's first export-aimed digital computer—a \$30,000 management-control device with a 1,024-word memory suitable for medium-sized factories. Fujitsu Ltd. said negotiations are in progress to sell Russia others. The stored-program machine, displayed at the recent Japan Scientific Instrument Exhibition in Moscow, includes a magnetic drum unit (capacity: 16,394 words),

typewriter and tapepuncher at extra-cost.

Industrial Electronics Showing Gain in Sales

CHICAGO—Sales of industrial electronics and communications equipment should total \$8½ billion this year, a gain of 7.6 per cent over last year, according to Joseph Miller, managing director of the National Electrical Manufacturers Association. Electrical manufacturing as a whole should top \$26 billion, an increase of about 7 per cent, Miller told the annual NEMA meeting last week. Industrial products for conventional and automated machines will gain 5.2 per cent in sales, for a total of \$4,050,000,000, he said. Communications total includes military sales.

U. S. Nuclear Satellite Overflew Moscow

WASHINGTON—The nuclear-powered satellite launched from Vandenberg AFB Sept. 28 passed directly over Moscow during its initial pass with an "extremely high" probability of orbital success, informed sources disclosed to ELECTRONICS last week. The spacecraft was powered by a 27-pound Snap-9A isotopic generator with a 25-watt d-c output and was launched with a Thor-Able-Star booster. Although the satellite's operating lifetime is five years, it is reportedly in the most perfect orbit ever achieved by a U. S. satellite and could stay aloft 900 years.

MEETINGS AHEAD

RADIO FALL MEETING, IEEE, EIA; Hotel Manger, Rochester, N. Y., Nov. 11-13.

FALL JOINT COMPUTER CONFERENCE, AFIPS, IEEE, ACM; Las Vegas Convention Center, Las Vegas, Nev., Nov. 12-14.

MAGNETISM-MAGNETIC MATERIALS ANNUAL CONFERENCE, AIP, IEEE-PTGMITT; Chalfonte-Haddon Hall, Atlantic City, N. J., Nov. 12-15.

MEASURE TESTING-CONTROL AUTOMATION INTERNATIONAL EXHIBITION, MESUCORA; Palais de la Defense, Paris, France, Nov. 14-21.

TECHNICAL WRITING WORKSHOP, University of California Extension Center; San Francisco, Calif., Nov. 18-19.

DIGITAL COMPUTER EQUIPMENT USERS SOCIETY MEETING, DECUS, Lawrence Radiation Laboratory; Livermore, Calif., Nov. 18-19.

ENGINEERING IN MEDICINE AND BIOLOGY ANNUAL CONFERENCE, IEEE, ISA; Lord Baltimore Hotel, Baltimore, Md., Nov. 18-20.

ULTRASONICS ENGINEERING SYMPOSIUM, IEEE-PTGUE; Marriott Motor Hotel, Washington, D. C., Dec. 4-6.

VEHICULAR COMMUNICATIONS NATIONAL CONFERENCE, IEEE-PTGVC; Adolphus Hotel, Dallas, Texas, Dec. 5-6.

FALL URSI MEETING, IEEE Seattle Section, URSI, Boeing Scientific Research Laboratories; University of Washington, Seattle, Wash., Dec. 9-12.

FIRST MICROELECTRONICS CONFERENCE, EIA; Irvine Auditorium, University of Pennsylvania, Philadelphia, Penn., Dec. 10-11.

NON-LINEAR PROCESSES IN THE IONOSPHERE MEETING, NBS; Central Radio Propagation Laboratory, Boulder, Colo., Dec. 16-17.

AMERICAN ASSOCIATION FOR THE ADVANCEMENT OF SCIENCE MEETING, AAAS; Cleveland, Ohio, Dec. 26-30.

ADVANCE REPORT

NATIONAL AEROSPACE ELECTRONICS CONFERENCE, IEEE-PTGANE, AIAA; Dayton, Ohio, May 11-13, 1964; Dec. 16 is deadline for submitting in triplicate a 250 to 300-word abstract and short biographical sketch to Mr. Yale Jacobs, NAECON Papers Chairman, 1917 Burbank Drive, Dayton, Ohio 45406. Topics include devices, techniques, equipment, and systems of aerospace-aeronautical electronics, plus application and management problems.

IN BRIEF

Diode Lases at 5.2 Microns

BOSTON—Solid-state group at MIT Lincoln Laboratory today reported laser action in indium antimonide. Output at 5.2 microns pushes the semiconductor laser range to longer wavelengths, farther into the infrared region.

Just one year ago, first disclosure was made of coherent radiation at 0.84 micron from gallium arsenide junctions by IBM, GE and Lincoln Lab. (p 7, Nov. 9, 1962). In May 1963, Lincoln Lab announced InAs laser action at 3.1 microns. Predicted and later verified was laser action at intermediate wavelengths—indium-gallium-arsenide diodes gave outputs of 1.77, 2.07 and 2.4 microns. InAs work also showed that output could be altered by magnetic fields for fine tuning.

The indium antimonide, Lincoln Lab workers say, is even more sensitive to magnetic fields. The diodes are fabricated from tellurium-doped single crystal of InSb. Predicted, but not yet verified, is that various types of indium arsenide antimonide will give intermediate outputs between 3.1 and 5.2 microns.

Meanwhile, others are moving toward shorter wavelengths. GE, for example, has achieved laser action at 0.71 micron and at 0.64 with gallium phosphide arsenide

WASHINGTON observers do not know how Apollo program will be affected in the long run by the Soviets' latest statement that they are not in the moon race. Immediate effect is to dash what little hopes NASA had to get a new budget substantially higher than the \$5.1 billion already voted by the House (p 20, Oct. 18).

OPTICS TECHNOLOGY, Inc. is experimenting with gastroscopes made of flexible fiber-optics bundles for medical treatments deep within the body.

STABISTORS, first used in rechargeable flashlights, could give Air Force space vehicles four times more battery capacity and cut charging periods in flight from 16 hours to one, according to Sonotone and P. E. Mallory.

KEARFOTT'S two-axis non-floated gyro, first used in the Miniature Inertial Navigation System, will serve as an antenna referencing device in the Hughes Phoenix missile. The hand-size gyro packs three times more momentum than comparable gyros, the firm says.

SANDIA CORP. has awarded Eitel-McCullough a \$260,000 contract for the further development of a long-life high-voltage battery powered by nuclear energy. The device gets its energy from the decomposition of Krypton 85.

BOEING has fabricated cadmium-sulfide triodes with a two-month shelf life. The thin-film, field-effect devices have transconductances ranging from 100 to 5,000 μ a per volt and voltage gains to 10.

RAYTHEON'S new gas laser, operating at 3.51 microns, weighs less than 10 pounds. Voice communications can be obtained by installing an optional modulator circuit in the same case.

RCA has introduced the RCA 30 Newscom computer, designed for automatic typesetting operations at smaller newspapers.

DAHLBERG is marketing a hearing aid weighing 1/8-oz, with battery.

DIEBOLD GROUP is beginning a two-year study of the growth prospects for the computer field.

ELECTRONIC Specialty Co. has agreed to acquire Peerless Corp., subject to the approval of Peerless shareholders.

Device Tightens Control Of Coherent Laser Beams

INTERFEROMETRIC module that splits or attenuates coherent laser beams has been designed for the Air Force by Electro-Optical Systems Inc. It meets needs for controlling both visible and infrared radiation, the firm says, and gives laser beam-phase shifting, power division and attenuation from one interferometric configuration without mechanical movement. The system includes two gas-cell phase shifters able to shift beam phases up to 360 degrees. The cells are located between mirror-type beam splitters. To vary amplitude output ratio from 0 to -30 db, cell gas pressure is varied.

Computer Speeds Up Hot-Strip Steel Mill

DETROIT—Daystrom's 136 digital computer is giving closer tolerances in strip size and temperature control at Great Lakes-Steel's auto-

mated hot-strip mill. With it, steel-makers can set up for a new order in 6 to 7 seconds, compared with two minutes manually, and roll out a full rated capacity of 3,000 feet per minute instead of the 2,400 fpm otherwise.

Norden's Low-Light TV Helps Missile Tracking

NORDEN has built a low light-level tv camera for tracking, automatically at night, missiles earthbound from space. The firm said its system will be mounted on board a converted Air Force KC-135 jet tanker to help aim other equipment in tests at the Pacific Missile Range. With the camera itself are a zoom lens and relay optical components, to perform automatic tracking, plus two transistorized tv monitors—one to record tracking on film, the other to permit operator viewing. Ground radar-computers first direct the camera on target, then operators initiate automatic tracking.

Stimulants for R&D Sought as Defense-Space Work Wanes

Future of government-supported research and development depends in large measure on a dialogue now underway in Washington.

The President and his science advisers are beginning to worry about the health of the nation's scientific and technological "establishment" as the glamor of military and space efforts wanes. Major atomic and space programs are facing stiffer criticism and budget cutting. Lesser programs designed to fill the pipeline for the future with trained manpower, science-based industrial productivity and new university sources of scientific excellence are also pinched.

The point was made succinctly last week by Kennedy's top scientific adviser, Jerome B. Wiesner, in a congressional hearing: "We have reached a point of relative stability in that aspect of our technology—the development of weapons for military purpose—which has stimulated much of our scientific progress over the last 10 years." Wiesner's concern is economic as well as scientific. Leveling off the military effort—including R&D—in an expanding economy means a relatively smaller investment in science. In recent years, economists have come to regard this investment as a key factor for a growing economy.

To fill the gap, Wiesner and his staff are devoting considerable effort to developing programs and priorities in oceanography, meteorology, life sciences, energy and natural resources research, pollution control, and the like. These, they are convinced, must be the future targets of science and technology. But a major hurdle lies in developing public—and thus congressional—support. This won't be easy in fields without the urgency that pushed space and military efforts.

New Engineers Get Best Raises —Not the Boss

Salaries for engineers are rising faster for the BS graduate and for project leaders than for the engineer in charge of company engineering programs, Bureau of Labor Statistics' latest annual survey of salaries discloses.

Average pay of the fledgling engineers is \$7,056, a 5.2-percent increase since last year and experienced engineering supervisors average \$12,540, a 5.6-percent increase, but top engineering managers average \$19,992, only a 2.1-percent rise.

The figures also show that government's starting salaries remain below private industry. On January 1, the starting range will become \$4,690 to \$6,130, compared to the industry average of \$7,056. But the middle-grade supervisor in government will be able to reach \$12,620, a bit higher than the industry average. Top government engineers will be paid up to \$19,270, almost industry average.

Detection Tests Are Postponed

Government program to develop methods of detecting small underground nuclear explosions has hit a snag. Under Project Dribble, three explosions scheduled for this summer have been postponed until April. AEC contractors have had trouble preparing emplacement holes at the Tatum salt dome near Hattiesburg, Miss. Pentagon's Advanced Research Projects Agency has lined up 100 U. S. seismic stations to monitor the 5-kiloton "Salmon," the series first, and largest, explosion. Forty stations are ARPA's portables; others belong to Coast and Geodetic Survey, oil companies and universities.

Development of MMRBM Resumes

Air Force has ordered its contractors to resume development of the Mobile Mid-Range Ballistic Missile. Work was cut back when the House of Representatives reduced funds this summer, but now Defense Department has a \$73.1-million appropriation for MMRBM.

Reliability of Mallory XT Tantalum Capacitors proved by 10,260,000 piece-hours of testing

The original high temperature wet slug tantalum capacitor, the Mallory XT series has compiled a unique record of reliability in tests made in our own laboratories, by independent laboratories and by military equipment manufacturers. Here are typical results:

In 10,260,000 piece-hours of testing* standard production capacitors, the mean time between failure is presently 960,000 hours.

Independent tests over a two year period show that Mallory XT capacitors have *twice* the anticipated mean time to failure of other tantalum capacitors.

Ten-year shelf life tests prove that even after extremely long storage, Mallory XT capacitors meet original specification limits of d-c leakage.

Seal tests by independent laboratories indicate that the leak rate of the glass-to-metal hermetic seal used in Mallory XT capacitors is 1×10^{-11} standard cc. These capacitors are being used in airborne military equipment where stringent specifications for seal reliability must be met.

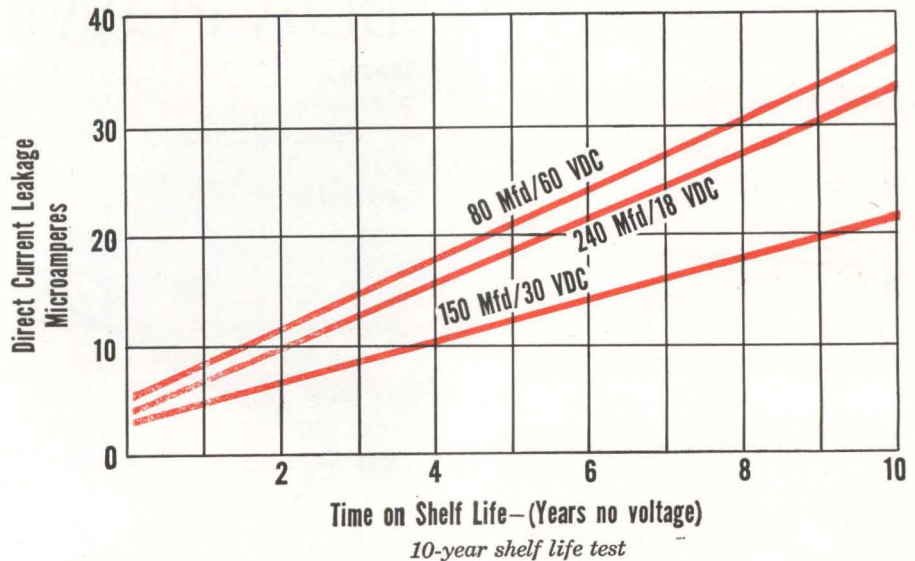

The XT line has been in continuous production by Mallory for nearly 15 years . . . for the past five years operating under the Signal Corps RIQAP plan. For each production lot, individual records of quality control test data are kept for a five-year period.

The XT series includes 175°C and 200°C ratings in many configurations, including a broad range of MIL types and new radiation-resistant models. For complete data and a consultation, write to Mallory Capacitor Company, Indianapolis 6, Indiana—a division of P. R. Mallory & Co. Inc.

*Test conditions at rated voltage at 85°C and 175°C

Type	Temp. Range	Capacity Range	WVDC (85°C)
XTM	-55 to +175°C	4 — 14 mfd	340— 8V
XTK	-55 to +175°C	2 — 70 mfd	340— 8V
XTH	-55 to +200°C	7 — 240 mfd	630—18V
XTL	-55 to +200°C	3.5— 120 mfd	630—18V
XTV	-55 to +200°C	12 —2200 mfd	630—12V

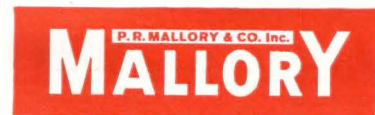
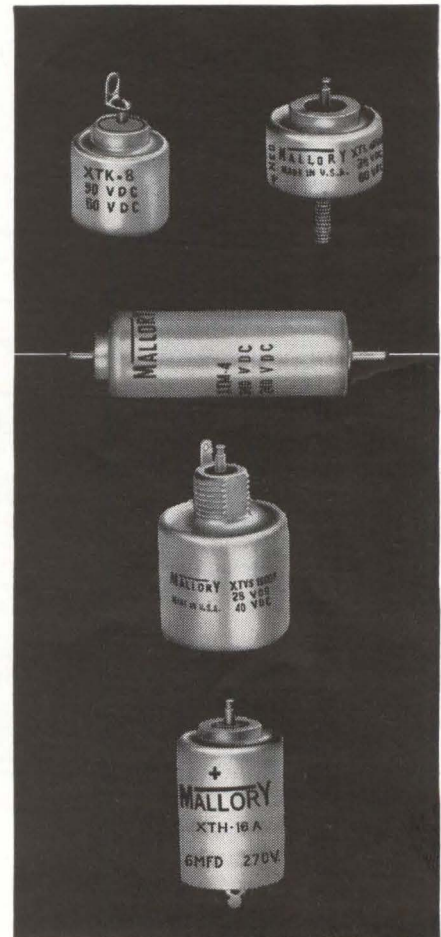

WET SLUG, FOIL AND SOLID TANTALUM CAPACITORS

WHY MILITARY SYSTEMS DESIGNERS CHOOSE LAMBDA POWER SUPPLIES

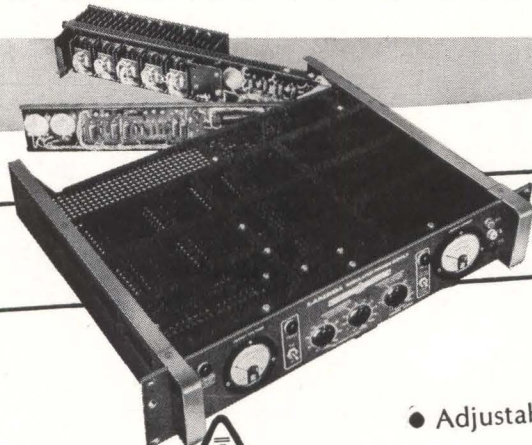

MIL SPEC DESIGNS

VIBRATION: MIL-T-4807A
 HUMIDITY RESISTANCE
 FUNGUS RESISTANCE
 SALT SPRAY
 TEMPERATURE SHOCK
 MIL-E-5272C • (ASG) Procedure 1
 SHOCK: MIL-E-4970A • Procedure 1 & 2
 ALTITUDE: MIL-E-4970A • (ASG) Procedure 1
 QUALITY: MIL-Q-9858
 MARKING: MIL-STD-130
 (Certified Test Data available upon request)

ADVANCED ENGINEERING FEATURES

- All solid state
- Completely protected
- Adjustable automatic current limiting
- Continuously variable
- Constant voltage/constant current
- Wide input frequency and voltage range
- Convection cooled
- Series/Parallel operation
- Remotely programmable
— resistance and voltage



MASS PRODUCTION PRICES

LE SERIES CONDENSED DATA

DC OUTPUT (VOLTAGE REGULATED FOR LINE AND LOAD) ⁽¹⁾	Voltage Range	Current Range	Price ⁽²⁾
Model			\$420
LE101	0-36 VDC	0- 5 Amp	525
LE102	0-36 VDC	0-10 Amp	595
LE103	0-36 VDC	0-15 Amp	775
LE104	0-36 VDC	0-25 Amp	425
LE105	0-18 VDC	0- 8 Amp	590
LE106	0-18 VDC	0-15 Amp	695
LE107	0-18 VDC	0-22 Amp	430
LE109	0- 9 VDC	0-10 Amp	675
LE110	0- 9 VDC	0-20 Amp	

⁽¹⁾ Current rating applies over entire voltage range.
⁽²⁾ Prices are for nonmetered models. For models with ruggedized MIL meters add suffix "M" to model number and add \$40 to the metered price. For metered models and front panel control add suffix "FM" and add \$50 to the nonmetered price.

REGULATED VOLTAGE:

Regulation (line and load) Less than .05 per cent or 8 millivolts (whichever is greater). For input variations from 105-135 VAC and for load variations from 0 to full load.
 Remote Programming 50 ohms/volt constant over entire voltage range.
 Ripple and Noise Less than 0.5 millivolt rms.
 Temperature Coefficient Less than 0.015%/°C.

AC INPUT: 105-135 VAC; 45-66 CPS and 320-480 CPS in two bands selected by switch.

PHYSICAL DATA:

Mounting Standard 19" rack mounting.
 Size LE 101, LE 105, LE 109 3½" H x 19" W x 16" D
 LE 102, LE 106, LE 110 5¼" H x 19" W x 16" D
 LE 103, LE 107 7" H x 19" W x 16½" D
 LE 104 10½" H x 19" W x 16½" D

SEND FOR COMPLETE LAMBDA CATALOG.



LAMBDA ELECTRONICS CORP.

515 BROAD HOLLOW ROAD • MELVILLE, L. I., NEW YORK • 516 MYRTLE 4-4200

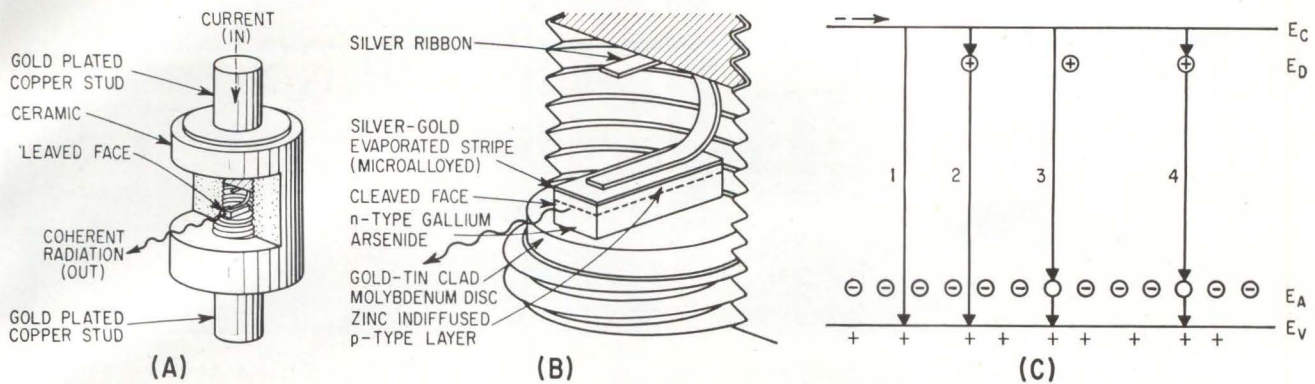

HIGH-PULSE-POWER laser package (A), with window cut in ceramic spacer for the coherent output radiation; diode laser detail (B). Four mechanisms (C) for radioactive transitions: (1) conduction to valence band; (2) donor to valence band; (3) conduction band to acceptor; (4) donor to acceptor—Fig. 1

RESEARCH IN NEW ENGLAND

Technical sessions to be presented next week at NEREM will describe applications of semiconductor lasers, new laser materials, nonlinear optical phenomena, direct energy conversion, and microelectronics using packaged circuits, making microcircuits on silicon bars and by thin-film deposition

By **THOMAS MAGUIRE**, Regional Editor, Boston

ONE YEAR after announcements of semiconductor injection lasers, preliminary discussion of systems applications will be among highlights of the 17th Northeast Electronics Research and Engineering Meeting (NEREM), Nov. 4-6 in Boston at the Commonwealth Armory and the Hotel Somerset.

Some preliminary successes with semiconductor laser radar have been

achieved at MIT Lincoln Laboratory, and these will be reported at NEREM. In conjunction with cloud height radar studies, a gallium arsenide laser beam was recently bounced off a chimney 600 yards away and successfully detected. The experiment was conducted at night, but work is proceeding on filtering techniques to permit daytime detection.

In an invited paper at NEREM, the state of the art "one year after" will be surveyed by R. H. Rediker of Lincoln Laboratory, who points out that both spectral range of injection laser action and output power have been increased significantly.¹

A package developed by T. M. Quist at Lincoln Laboratory and designed for high pulse power is

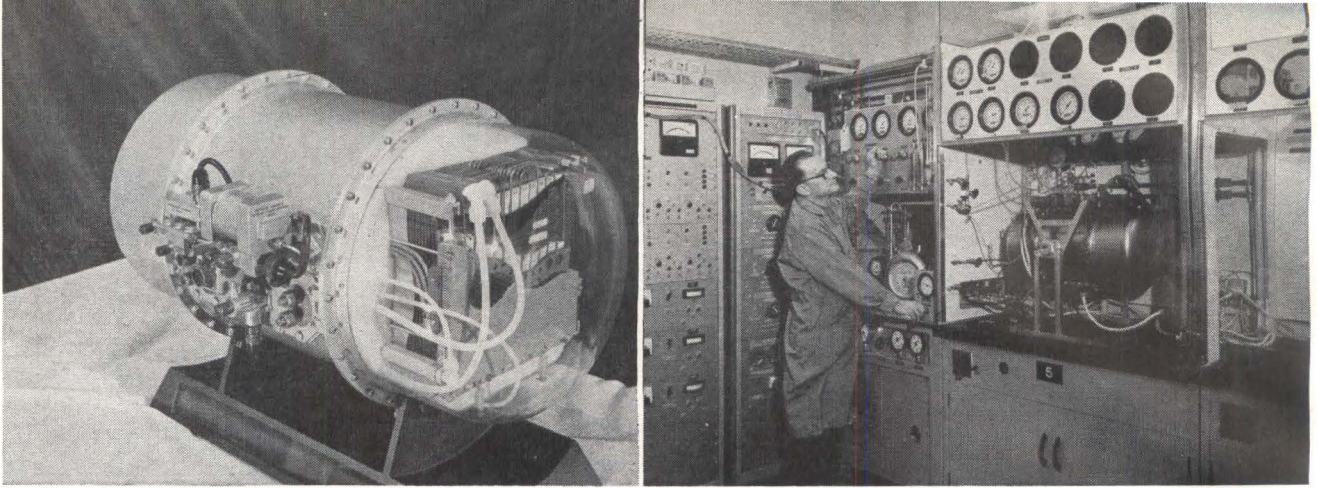

MOCKUP of Gemini fuel cell built by GE (left); fuel cell section on test (right). Load control center behind operator simulates spacecraft load demands—Fig. 2

shown in Fig. 1A. A modified version of the microwave diode package developed in the 1940's, it is suited for short-pulse work. The copper stud separated from the GaAs laser by a molybdenum disk has both the desired heat conductivity and heat capacity. In Fig. 1B, the diode laser is shown in more detail and some fabrication steps indicated.

When the diode is operating as a laser, a plane of inverted population is produced by carrier injection for an estimated distance of 10^{-4} cm from the junction. The flat and parallel short sides from which coherent radiation is emitted define an optical cavity. They need not be silvered, Rediker says, because the mismatch in dielectric constant at the GaAs-air interface is large enough to ensure at least 30 percent reflection at these surfaces. The junction area is typically $1 \text{ mm} \times 0.25 \text{ mm}$.

The cleaving technique which exposes the (110) plane in III-V crystals makes it possible to produce reflecting surfaces of the cavity that are both flat and parallel to within 5 angstroms. Rediker points out that the high fabrication yield of reproducible injection lasers is not surprising since with cleaving, the crystal structure guarantees perfect cavities and the diodes are operated at such high forward current densities that surface leakage is unimportant.

Figure 1C shows four possible mechanisms of the radiative transition both in injection lasers and in injection luminescence diodes. Also under investigation are the mechanisms for current transport across

the junction. In both cases it appears there is no unique mechanism for all injection lasers, but the mechanism depends on the semiconductor doping and the diode fabrication.

Fuel Cell—Widespread commercial utilization of fuel cells or fuel batteries is still several years away, but application for space-vehicle power generation is imminent, and this will be followed by military adaptation.

A hydrogen-oxygen fuel battery system has been developed for Project Gemini by the GE Direct Energy Conversion Operation in Lynn, Mass. Engineering problems will be reported at NEREM.²

Figure 2 (left) is a mockup showing cutaway cell and manifolding. In Fig. 2 (right), a unit is being tested prior to delivery. A GE fuel cell will be used on an unmanned space flight, probably this year, and is scheduled to be aboard the manned Gemini spacecraft when it is launched, hopefully in 1964.

The fuel cell consists primarily of an anode, a cathode and an electrolyte. Electrochemical oxidation of the fuel takes place at the anode with release of electrons to the load circuit. After passing through the load, these electrons combine with oxygen at the cathode. The electrical circuit is completed by either passage in the electrolyte of positive ions from anode to cathode, or passage of negative ions from cathode to anode.

Development efforts presently revolve around two aspects of fuel cell operation: need for electrodes that are inert electronic conductors with a large surface area, and electrolytic

systems in which the composition of the electrolyte does not change appreciably during the period of operation. This period ranges from days to years depending on the application.

The most difficult problem by far in the design of fuel battery systems is adequate control of the heat and mass transfer processes.

Paramp—Recent demonstrations of extremely low-noise parametric amplifiers at liquid helium temperature have generated a debate on relative desirability of the paramp or the traveling-wave maser for applications demanding receivers of highest sensitivity.

Among centers of interest are MIT Lincoln Laboratory and Bell Telephone Laboratories. At Lincoln, a group headed by Carl Blake is developing parametric amplifiers for Project West Ford (p 12, July 5) and for Haystack (p 49, Nov. 9, 1962). And BTL is developing paramps for Telstar ground-station receivers.

At the NEREM technical session on Microwave and Solid State, Michiyuki Uenohara of BTL will discuss the applicability of extremely low noise parametric amplifiers.³

According to Uenohara, a broadband extremely-low-noise paramp with a sensitivity comparable to the maser's can be built. He adds that extreme care must be taken to achieve the ultimate sensitivity and stability, also that further development of unilateral parametric amplifiers may facilitate solution of these problems.

Figure 3A shows the theoretical

minimum excess noise temperatures at 3 levels and the experimental results of seven amplifiers ranging from 1 to 8 Gc.

Uenohara pinpoints these advantages of the parametric amplifier over the maser: (1) No intrinsic operating temperature limitation. The same amplifier can be operated from room temperature down to liquid helium with a minor circuit adjustment—and a cryogenic failure does not completely close the system operation. (2) No intrinsic pump frequency requirement. Only performance requirements restrict the designer. (3) More than 10 percent bandwidth can be obtained with a fixed pump-frequency supply. (4) Dynamic range is about 20 db larger than that of the maser.

Uenohara points out these disadvantages: (1) The gain stability and transmission characteristics are susceptible to pump-source and circuit-impedance fluctuations—so an extremely stable pump supply and a rugged, stable circuit construction are necessary. (2) For a one-port paramp, an extremely good circulator, preferably operated at the same temperature as the amplifier, is needed.

In addition, to achieve maximum sensitivity the diode must be carefully chosen so that its crystal does not have intolerable dislocations, and overpumping must be avoided to eliminate excess noise generation. Also, input and output circuits should be extremely well-matched to avoid noise contribution from a room temperature load. For the same reason, the idler circuit should be well-isolated from the pump input circuit.

TW Modulator — Traveling-wave coherent-light modulators constructed of cubic crystals such as cuprous chloride or zinc sulfide have exhibited bandwidths of about 10 Gc.⁴

At NEREM 1962, C. J. Peters of Sylvania described a modulator of this type which had a bandwidth of 1 Gc. The new modulator is only a few inches long, the reduction in length arising not because the cubic materials have a larger electro-optic coefficient, but because they have a larger index of refraction and a smaller dielectric coefficient than the materials such as ADP from which the first modulator was built.

Increase in bandwidth can be attributed both to the decrease in length resulting in a relaxation in the synchronism requirements between the light and modulation voltage velocity, and also to the more compatible dielectric constant and index of refraction.

The traveling wave modulator consists of a two-conductor transmission line in which a portion of the dielectric is an electro-optic material; that is, the velocity of light or index of refraction of the material can be varied in response to an applied electric field. Typical cross-sections of such a transmission line are shown in Fig. 3. Varying the velocity of propagation of light as it traverses the crystal imposes a phase variation on the light. If the light and modulation travel in synchronism, appreciable modulation depths can be achieved with modest power. A phase or frequency modulator can be constructed from materials such as ADP or KDP. From the cubic materials phase, frequency or amplitude modulators can be made.

Reduction in length results in an increase in modulator bandwidth. Ordinarily the modulator is designed so that at lower frequencies the velocity of the modulation on the composite transmission line is equal to the velocity of the light in the electro-optic material. This equivalence of velocity is achieved by apportioning the dielectric between the high dielectric constant electro-optic material and some lower dielectric material such as air. The velocity of the microwave signal on the transmission line is not independent of frequency, however, so that the equivalence in velocity between the signal and the light is destroyed as the signal frequency increases. It is this mismatch in velocity that determines the bandwidth of the modulator.

Phone Switching—In telephone and telegraph equipments, discrete tones below 3,000 cps are often used for signaling or information transmission. A unique circuit has been built to replace the heavy LC filters that have been used to achieve the

THEORETICAL minimum excess noise temperatures of par-amps at 300, 77 and 4 deg K, and experimental results of seven amplifiers (A). Excess noise from the circulator and following states is shown by dotted lines, excess noise temperature of diode and mount alone, by dots. Cross-section view of traveling-wave light modulators (B) —Fig. 3

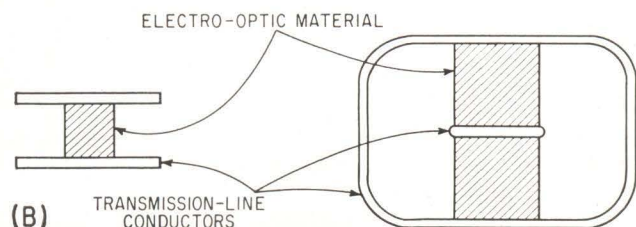
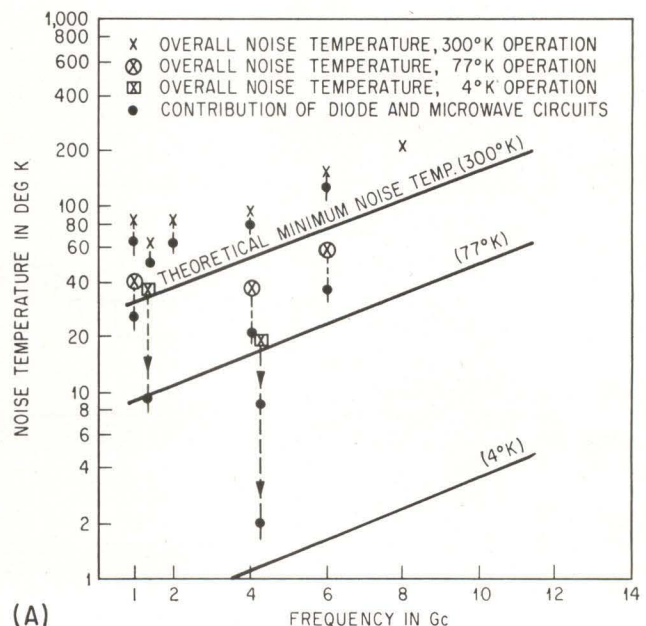

desired selectivity at low frequencies. Using the properties of a synchronous filter, the circuit will recognize the desired frequencies with an order of magnitude in space and weight saving, and using components readily adaptive to microelectronic techniques.⁵

The circuit depends upon the properties of a synchronous filter: a very narrow bandwidth whose width is independent of the center frequency of the pass band. Each

capacitor is connected to ground one-fourth of the time and left floating for the rest. The output voltage at any given time will be the voltage across the capacitor that is grounded at that time. Only when its switch is closed can a capacitor lose or gain charge, or similarly, can the voltage on the capacitor change.

The most difficult problem associated with the design of the filter involves switching. In some early applications, like doppler sonar,

mechanical switching was adequate, but electronic switching is required now that the emphasis is on miniaturization and higher frequencies.

A simple transistor proved to be an acceptable switch. Various circuits can supply the necessary pulses to open and close the transistor switches. One choice (Fig. 4A) contains both Fairchild Micrologic integrated circuits and conventional components. It may be driven by either a square-wave or sinewave generator operating at twice the desired commutation frequency.

If the circuit of Fig. 4B is connected to the synchronous filter, the flip-flop will remain in one state until a critical frequency is applied to the filter input. Then a sufficiently high voltage will change the state of the flip-flop. This then is a semi-permanent record that a particular frequency has been received. By paralleling the filters and flip-flops, a group of incoming tones could identify the sender, the party to be called, or any other digital information—a technique particularly applicable to automatic switchboards.

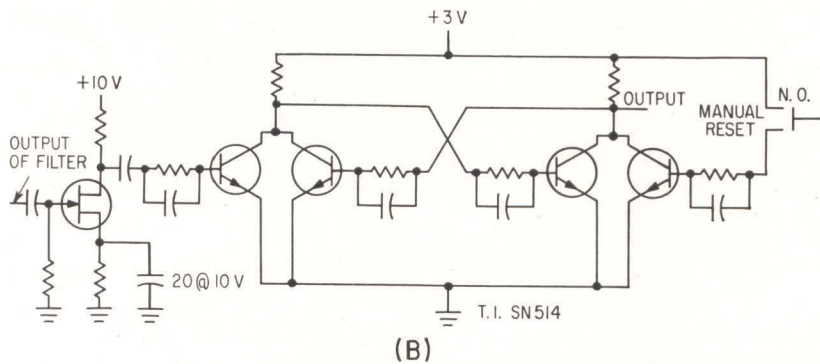
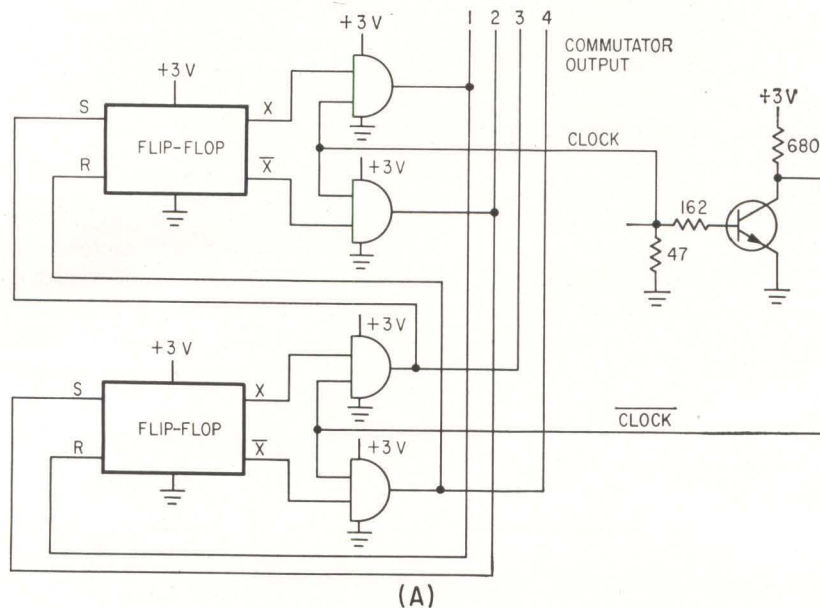

FLIP-FLOP and gate circuit (A) for opening and closing transistor switches; flip-flop (B) changes state when critical frequency is applied to filter—Fig. 4

Monolithic Amplifier—In construction of a practical high-frequency monolithic linear amplifier, two approaches were found to help alleviate some of the problems.⁶ First, the use of thin films instead of the diffusion process permits higher quality resistors and capacitors. Secondly, circuits designed specifically for monolithic fabrication reduce the performance demands on the more difficult components.

Thin-film resistors using nichrome were found to have a low parasitic capacitance, and to be capable of tight tolerance control. Thus they are much suited to high-frequency linear amplifier design. Nichrome resistors are fabricated in compatible integrated circuits by depositing a thin film of nichrome on top of the silicon dioxide that is thermally grown on the Si substrate. The thick thermal oxide lowers the parasitic capacitance by increasing the thickness of the dielectric and by lowering the dielectric constant. The dielectric constant of silicon dioxide is approximately 1/3 that of Si.

Use of thin films has also been found to be the solution to fabrication of capacitors. Success has been

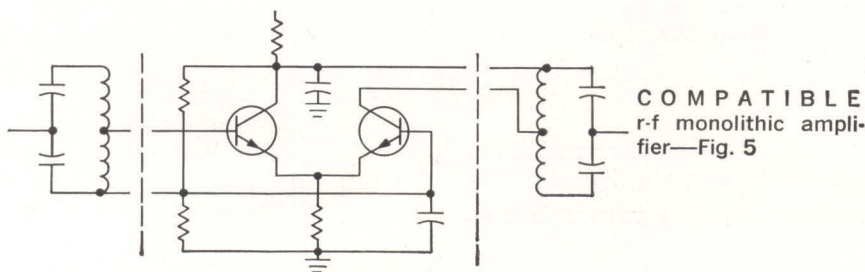

achieved by using an emitter diffusion at the bottom electrode. A thin layer of oxide is then grown for use as the dielectric. Aluminum metalization forms the top electrode and completes the fabrication.

An r-f amplifier using an emitter coupled configuration was chosen for monolithic fabrication using compatible thin-film techniques (Fig. 5). This stage is used as the r-f amplifier of a 120-Mc transceiver. The noise figure is relatively low, the input impedance relatively high; and the reverse feedback parameter is quite low, thus causing the input tuning to be relatively insensitive to the output tuning.

This circuit is particularly adaptable to monolithic design because the usual large emitter bypass capacitor is not used. Instead, a much smaller capacitor is used to bypass the higher impedance base of the second transistor. This reduction in capacitor size gives the integrated circuit designer the choice of: (1) Trying for the minimum die size by using as small a capacitance as possible, and using as thin an oxide as possible to get the maximum capacitance per square mil. Or (2), using a larger die size with a conservatively designed capacitor. The latter approach was taken. A die size of 50×100 mils was chosen. The capacitor size was increased above what was actually needed to a size that would fill the chip. Good performance can be obtained at as low as 12 Mc because of this large capacitor size.

When used as the r-f stage of a transceiver, this monolithic r-f amplifier with nichrome resistors and thin-film capacitors had a sensitivity of less than 1 microvolt for a 6-db s-n ratio. Selectivity of the two loaded coils was sufficient to reject by more than 40 db a frequency 24 Mc away from the 120-Mc carrier frequency.

Rheotaxial — Rheotaxial growth technique has been extended to vacuum deposition of device-quality Si films.⁷ At NEREM 1962, chemical vapor deposition of Si diodes and transistors on a fluid layer of high surface mobility was reported. The growth tends to follow the orientation of the first crystallites of Si on top of the fluid layer, giving rise to the name rheotaxial growth.

The more recent results demonstrate that Si thin-film active devices, both diodes and transistors, can be deposited directly onto glazed ceramic substrates by electron beam vacuum deposition methods—which are compatible with other thin-film fabrication techniques.

The work is being continued to demonstrate the suitability of these Si thin film active devices for vacuum-deposited all-thin-film circuits which perform basic logic functions.

A view of the vacuum chamber showing the substrate heater, mask changer, and source holder is shown in Fig. 6.

Vacuum-deposited silicon thin films have been examined by optical microscopy, x-ray diffraction and electron diffraction. Conductivity type was determined by hot-probe and Hall-effect methods. The resistivity was measured by a 4-point probe, and mobility was calculated from resistivity and Hall measurements.

To fabricate *pn* structures, a rheotaxial film of Si was deposited on the oxide-coated substrate. Silicon of the opposite conductivity was

then deposited in isolated squares through a mask without breaking the vacuum. Reverse breakdowns of 15-20 volts have been obtained with such diodes.

Transistor structures were deposited in a geometrical form as shown in Fig. 6 (inset). A set of 20 separate collectors was rheotaxially grown on the oxide-coated substrate by depositing Si with antimony doping. The bases were then formed by depositing aluminum-doped Si and the transistor structures were completed by the final deposition of antimony-doped emitters to give *npn* transistors.

REFERENCES

All papers prepared for delivery at NEREM, Boston, Nov. 4-6, 1963.

- (1) R. H. Rediker, MIT Lincoln Laboratory, Injection Lasers and Injection Luminescence.
- (2) D. L. Douglas, General Electric Co., Fuel Cells.
- (3) Michiyuki Uenohara, Bell Telephone Laboratories, Extremely Low Noise Parametric Amplifiers.
- (4) C. J. Peters, Sylvania Electronic Systems, Further Developments in Wideband Coherent Light Modulators.
- (5) J. Hohmann and A. Bramble, Army Electronics R and D Laboratory, Unique Lightweight Tone Recognition Circuit.
- (6) Robert L. Hartley, Motorola, Integrated Circuit Compatible R-F Amplifier.
- (7) Egons Rasmanis and James E. Cline, Sylvania Electronic Systems, Vacuum Deposited Silicon Thin Film Diodes and Transistors.



SUBSTRATE HEATER, mask holder and multiple source holder; inset shows vacuum-deposited thin-film transistors with ohmic contacts—Fig. 6

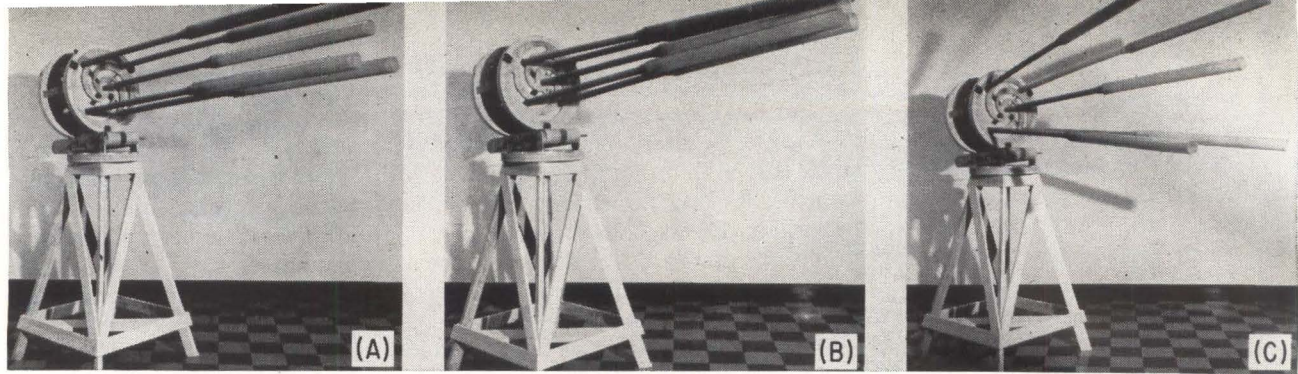

GLASS-FIBER tube array has different silhouettes. Coplanar colinear setting (A), coplanar convergent conical setting (B), and noncoplanar divergent conical setting (D)—Fig. 1

GLASS-FIBER ARRAY Produces

Zoom antenna for 4 to 6 Gc produces a multitude of different radiation patterns and simple mechanical adjustment. Flexibility is achieved by varying both array parameters and

By **K. IKRATH** and **W. SCHNEIDER**
U. S. Army Electronics R & D Laboratory,
Fort Monmouth, New Jersey

MECHANICALLY steerable glass-fiber tube zoom array is an extension of research performed earlier in a Signal Corps program. Operating between 4 Gc and 6 Gc, this array uses four and 5 elements to yield practically any desired beam-width equal to or larger than 4 degrees. Moreover, almost any radiation pattern such as single lobe, notched and split lobe can be obtained by mechanical adjustment of effective length of the glass fiber tubes, separation of array elements and angles between the elements.

Construction—The basic antenna module for the 4-Gc to 6-Gc range is a single glass-fiber zoom antenna¹. An experimental array for this range is shown in Fig. 1, where adjustment of separation and angles between array elements is made by rotating the spiral-slot disks in the front or tube side, and in the back or feeder side. Rotation of the spiral disks causes the support rods of the outer tubes to slide

radially in the radial slots of the front and back support disks mounted on the turntable atop the pedestal. Figure 1A shows the tubes aligned colinearly corresponding to equal settings of both front and back spiral disks; Figure 1B shows the tubes convergent conically and aligned corresponding to setting the front disk at a lower rim mark than the back disk. The divergent conical alignment shown in Fig. 1C corresponds to a higher setting of the front spiral disk than of the back. Geometry of the mechanical structure and the calibration of the spiral disk settings on the rim determine array element separation and the angle α between the outer and center elements or the symmetry axes. The spiral-slot disk rim is marked directly in S , where S is the shortest center-to-center distance in centimeters between two outer support rods in the slots of a spiral-slot disk. The distance between the front and back spiral-slot disk is 35.3 cm. The angle is then: $\alpha = \arctan (S_f - S_b) / 50$ (cm), where α is counted positive for divergent alignments of the array elements.

Each support rod can, within limits determined by the flexibility of the feeder cable, be shifted axially back and forth within the slot holder, permitting coplanar or noncoplanar alignment of the individual array elements. In addition to these array adjustments, the tube of each element can be shifted relative to the helix coupler as shown in Fig. 1D.

Support rods are calibrated from 0 to 90 cm, from the feed end towards the helix coupler. The 90-cm mark corresponds to the full effective length of the tubes counted from the base plate of the helix coupler to the end of the fiber glass tube. Support-rod markings also denote the distance between the helix coupler and the front spiral disk. Array elements are fed in parallel using three coaxial-tee connectors for the 4-element array and four coax tees for the 5-element

STRENGTH AND VERSATILITY

In an earlier article (ELECTRONICS, Sept. 21, 1962, p 44), the authors described an antenna innovation in which a helical element encased in a glass-fiber tube focused a microwave beam.

After further research, results show that the original antenna can be grouped (in four or five units) to provide a versatile array capable of variable beamwidth and pattern when steered by simple mechanical means

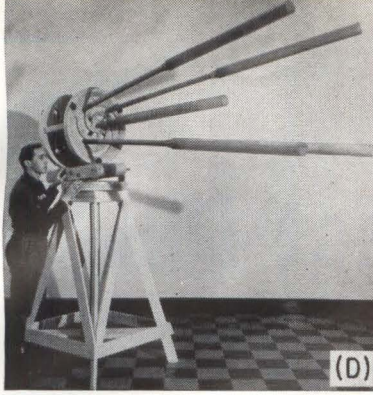

coplanar divergent conical setting (C),

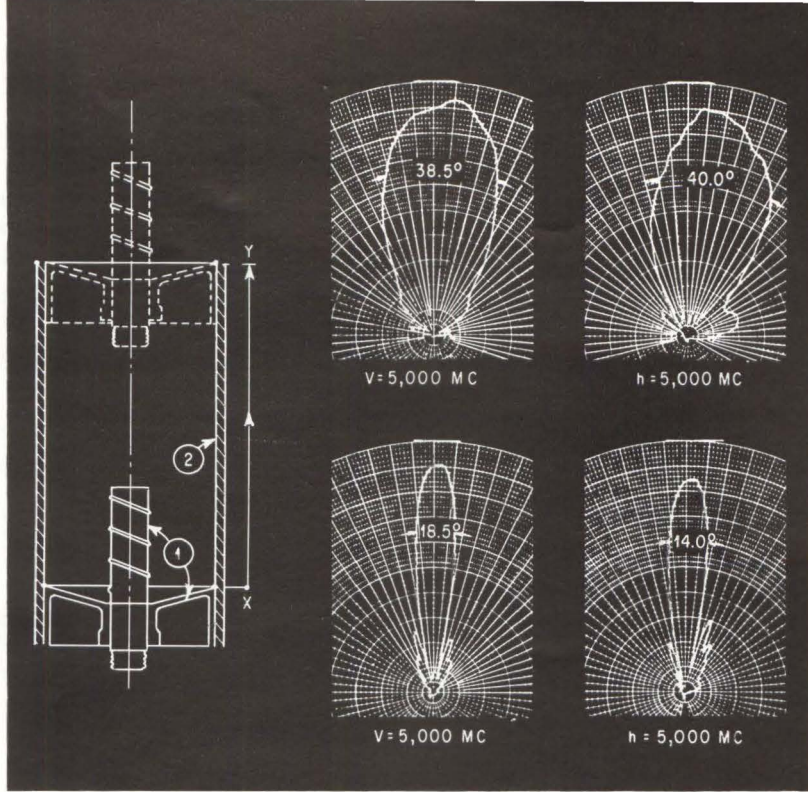

LINEAR radiation patterns for two extreme positions of the helix coupler within the glass-fiber tube—Fig. 2

Many Beams

variable beamwidths by
number of elements

array. Symmetry inaccuracies in the feed system and associated phasing errors are compensated by shifting the support rods relative to each other. This compensation is periodic with frequency.

In practice, nearly equal rod-mark settings are chosen so that the outer helix couplers and the tube ends are almost geometrically coplanar. The phase adjustment procedure involves attaining maximum received signal at the bore-sight alignment to the receiver or transmitter, with the array adjusted for narrow beam. Phasing can normally be corrected within ten minutes by slightly shifting three or four support rods relative to one another by fractions of the wavelength.

Performance—The beam-focusing effectiveness of the glass fiber tube by the linear radiation patterns obtained for two extreme positions of the helix coupler inside the tube are shown in Fig. 2. Terms v (vertical) and h (horizontal) refer to the orientation of the linearly-polarized-horn antenna of the pattern-recorder receiver. Influence of array element separation and angle α on the shape of the radiation pattern are demonstrated by the patterns shown in Fig. 3. Convergent alignment of the array elements (negative α) and close proximity of the array elements produces wide beam patterns with side lobes of different character.

Analysis—Narrowest radiation patterns and lowest side-lobe levels are obtained when the separation of the tube elements is equal to or more than 4 wavelengths. This separation corresponds roughly to the effective fictitious aperture of a single glass-fiber tube radiator. The lowest side-lobe levels are obtained for slightly divergent alignment of the array tubes corresponding to angle α of about 2 degrees. In the 5-element array, side-lobe levels are also reduced by using only two thirds of the lengths of the outer glass-fiber tubes. Wide-beam radiation patterns are produced by convergent alignment of the array tubes or by colinear alignment at tube separations equal to or less than 3 wavelengths. In addition to further studies of the coupling system between the tube radiators, practical means for weather protection must be found. Test have shown that thin layers of water and ice on the glass-fiber tube surface introduce extremely high losses. Thin, clear, plastic-cloth covers were found to be effective in eliminating these losses.

This article reflects the teamwork of many of our colleagues at USAERDL. The glass fiber tubes were fabricated in the plastic shop and the array made in the machine and carpenter shops. Personnel of the Advanced Development Branch, Applied Sciences Division aided in evaluating array performance. Special thanks are due J. Blaker and W. Kennbeck for testing and devising weather protection.

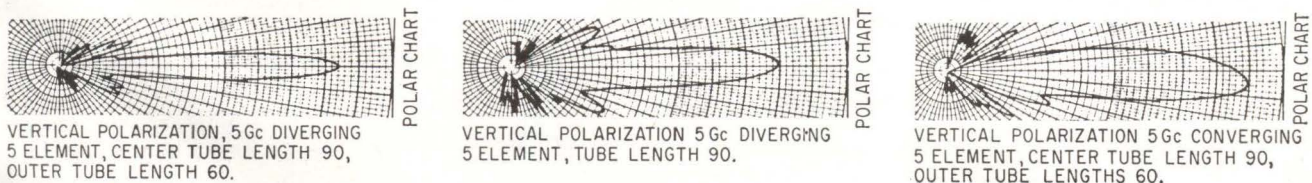

INFLUENCE of element separation and angle α on pattern shape—Fig. 3

Novel Field-Effect Device

Hole-conducting metal-oxide-semiconductor transistor characteristics provide a three-stage gain of 1,350 from 5 cycles to 72 kc

By F. M. WANLASS, Fairchild Semiconductor Research and Development Laboratory, Palo Alto, California

THE *p*-MOST AS AN A-C AMPLIFIER

Field-effect hole-conducting metal-oxide semiconductor transistors (*p*-MOSTs) are easily applied to a-c coupled amplifier circuits because of two operating characteristics. The device does not conduct appreciable current unless its input gate is biased in the same polarity as its output. Its gate is voltage-operated, never drawing d-c. By contrast, the *p-n* junction input field-effect transistor, like the electron tube, requires input bias opposite to the polarity of its output for small-signal amplification. Ease of biasing the *p*-MOST to a correct operating point makes practical wide-band a-c amplifiers without large coupling or bypass capacitors

BASIC STRUCTURE of a *p*-MOST, shown in Fig. 1A, comprises a silicon substrate of *n*-type conductivity into which are diffused two adjacent islands of *p*-type conductivity. A silicon-dioxide insulating layer overlays the area between the two diffused regions and a thin metal gate electrode is deposited on top of this SiO₂ layer. In addition to the gate electrode, one of the *p* islands is tied to the *n*-type substrate to act as the source electrode, and the other *p* island is the drain electrode.

The operation of this insulated gate *p*-MOST is based on the fact that when its gate is biased negatively, electrons will tend to be repelled out of the *n*-type silicon immediately beneath the gate and holes will be attracted to this region. If the gate is made negative enough, the *n*-type

silicon will actually convert to *p*-type in the region close to the Si-SiO₂ interface, so that there will be a *p*-type link connecting the diffused source and drain islands. The negative gate voltage at which conduction between source and drain can first occur is called the gate threshold voltage V_{GST} . As the gate is made more and more negative beyond V_{GST} the *p*-type link connecting source and drain will progressively widen resulting in lower and lower source-drain resistance. Since, when current does flow between source and drain, it is carried by holes, which are the majority carriers, the device shown in Fig. 1A is called a *p*-type MOST or *p*-MOST.

To have a low threshold voltage V_{GST} and high transconductance in a MOST, it is necessary to have a

thin oxide beneath the gate and close spacing between source and drain islands. It is presently possible to obtain reproducible spacings down to about 5 microns and thicknesses to about 1,000 Å. These critical geometrical parameters are controlled using standard manufacturing techniques. Compared to active elements such as the *p-n* junction input field-effect transistor the MOST is simple and several can be integrated in the same slice of silicon without isolation problems or increase in the number of processing steps.

Characteristics—In operation (Fig. 1B) the bias voltage V_{DS} applied to the drain of a *p*-MOST with respect to its source must always be negative, so the drain *p-n* junction is reverse biased. If the gate voltage

Provides Broadband Gain

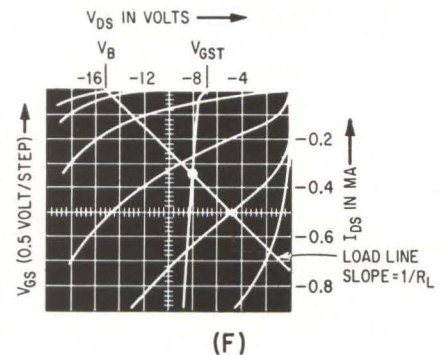
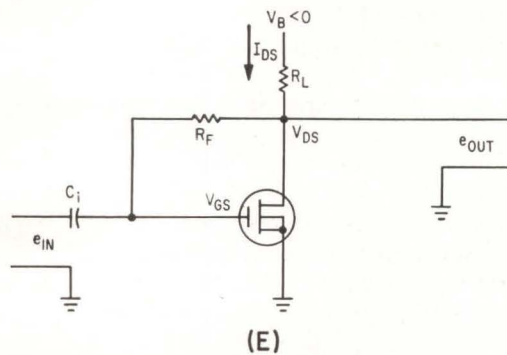
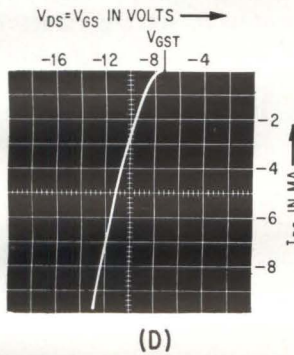
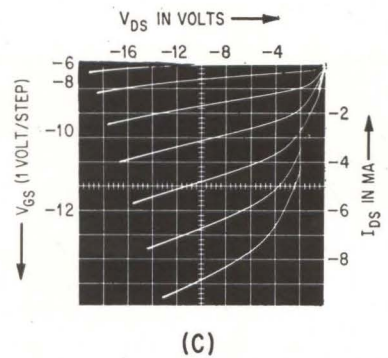
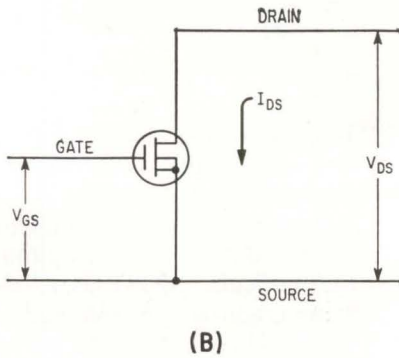
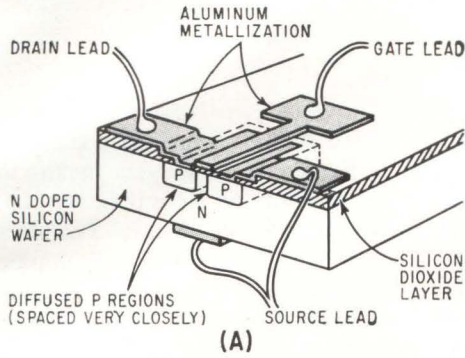

SECTIONAL view of p-MOST (A), suggested symbol and terminal notation (B), drain current vs drain voltage with gate voltage a parameter (C), drain current vs drain voltage with gate tied to drain with gate threshold voltage -8 v (D), automatically biased a-c amplifier stage (E), graphical operating point determination (F)—Fig. 1

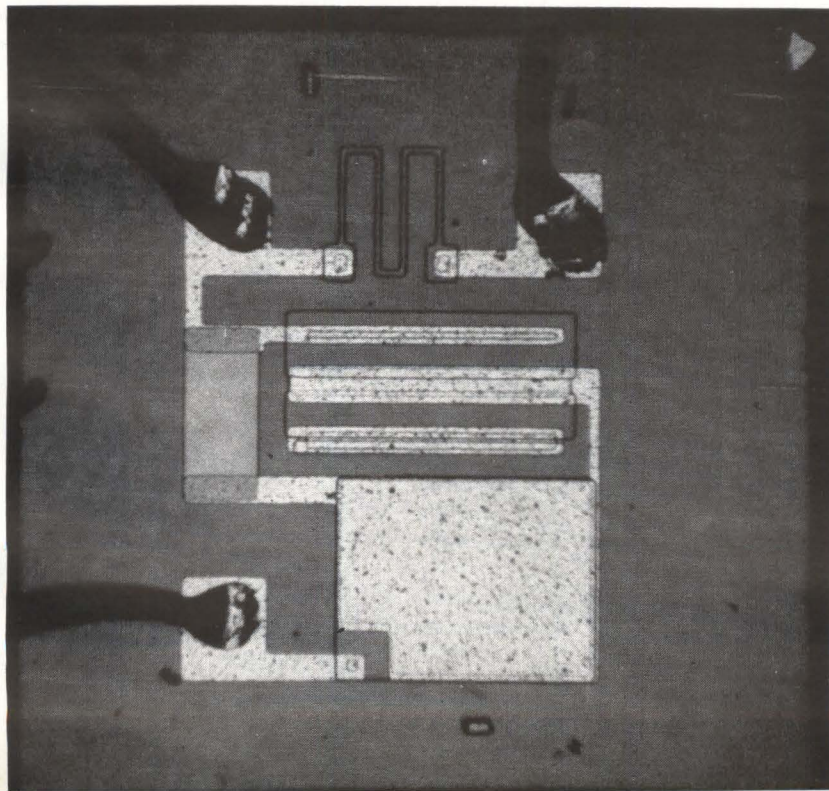

INTEGRATED a-c amplifier of Fig. 2E shown as a microphotograph

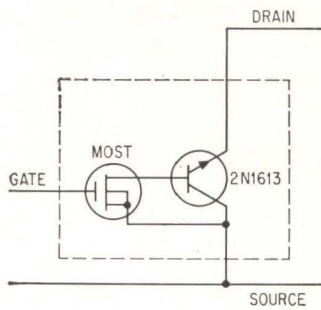

(A)

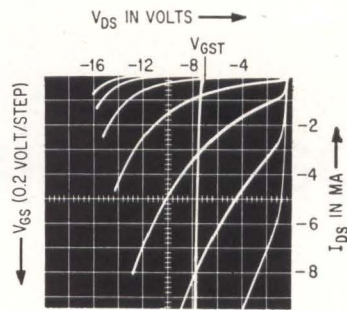

(B)

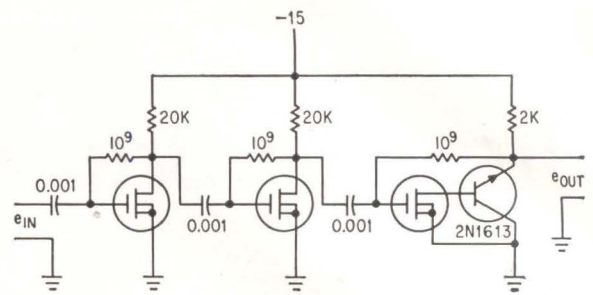

(C)

V_{GS} is more positive than V_{GST} , the drain current I_{DS} is small (it will be that flowing in a reverse biased silicon junction, or $< 10^{-9}$ amp). When V_{GS} is made more negative than V_{GST} drain current will increase and it will increase considerably if V_{GS} is made negative enough. Data on typical present devices are shown in Fig. 1C, where for $V_{DS} = V_{GS} = -11$ volts, I_{DS} is approximately -5 ma. For gate voltages more negative than V_{GST} the characteristic curves resemble those of a pentode, in that the dynamic output resistance is high.

A convenient way to determine the gate threshold voltage V_{GST} at which drain current I_{DS} first flows is to tie the gate to the drain and then plot I_{DS} vs V_{DS} on a transistor curve tracer as in Fig. 1D. Usually it is desirable to have devices for which $|V_{GST}|$ is as small as possible. But V_{GST} is a parameter that can be adjusted within wide limits during manufacturing, by adjusting the oxide thickness under the gate. If desirable, $|V_{GST}|$ can be made large for high-power, high-voltage amplifier applications.

Automatic Biasing—Consider the single-stage amplifier of Fig. 1E with a supply voltage V_B that is several volts more negative than the gate threshold voltage of the MOST. Without input signal ($e_{IN} = 0$) drain voltage V_{DS} is determined as follows. Gate $V_{GS} = V_{DS}$ independent of the value of R_f (since no gate current flows). Voltage V_{DS} cannot equal V_B , because then the MOST would conduct current causing a voltage drop in R_L . Also, V_{DS} must be at least as negative as V_{GST} to produce any drain current flow at all. It appears, therefore, that V_{DS} will be automatically biased to a value between V_{GST} and V_B . This

is a bias region in which the MOST has appreciable small signal gain. To find exactly the small signal operating point for the circuit of Fig. 1E I_{DS} vs $V_{DS} = V_{GS}$ is plotted for the particular MOST used. On the same graph is superimposed a load line of slope $1/R_L$, with an x intercept of V_B . The intersection of these two curves (Fig. 1F) gives the operating point current I_{DSO} and voltage $V_{DSO} = V_{GSO}$. If the characteristic curves are now also superimposed on the same graph, the variations ΔI_{DS} and ΔV_{DS} owing to small variations ΔV_{GS} about V_{GSO} can be obtained. This graphical operating point determination is performed in Fig. 1F for the same MOST that was used to obtain the data of Fig. 1C and D. It is evident from Fig. 1F that the stage will automatically bias itself to a point of useful gain for almost any value of its load resistor R_L . The value of R_L is not critical, since it is difficult to saturate V_{DS} at extreme voltage.

For determining static bias conditions the values of R_f and C_i are unimportant in the circuit of Fig. 1E. Consider the conditions necessary for amplification of a small input signal e_{IN} . For a small change e_{gs} in the gate voltage the drain voltage will change in the opposite direction. Thus, the first requirement to obtain a-c gain is that the input coupling capacitor C_i must be much larger than the gate-drain capacitance C_{GD} . This is satisfied because a typical MOST has only about 0.2 pf for C_{GD} . More importantly, the degenerative effect of signal coupling through R_f from drain to gate must be kept small in comparison to the signal coupled to the gate through C_i . This means that a-c amplification can only be obtained down to a frequency f_e equivalent to $1/R_f C_i$.

To make an amplifier stage that is flat down to 1 cycle means that the product of R_f and C_i should be several seconds at least. The advantage of a MOST becomes apparent since the gate requires no d-c input current, R_f can be made extremely large in value and C_i fairly small to obtain the large $R_f C_i$ product. Feedback resistors R_f having values beyond 10^{12} ohms have been successfully used. With such large feedback resistors, input capacitor C_i must have an exceedingly low leakage current.

An accurate value for R_f is not important as long as the product $R_f C_i$ is much greater than the period of the lowest frequency signal to be amplified.

Transistor Addition—In an a-c amplifier stage driving a heavy load, an npn transistor can be added as an emitter follower, so the drain of the MOST need only supply base current to the transistor. This arrangement is shown in Fig. 2A. This combination of MOST and transistor can be considered a new species of three-lead device. This composite has some characteristics, shown in Fig. 2B, that are similar to a single MOST. For example, the gate threshold voltage V_{GST} is a comparable negative value. However, the transconductance of the composite, when it has started to conduct, is much larger than for a single MOST. The composite g_m is the product of the g_m of the MOST and the β of the transistor. Another slight difference between the composite and the single MOST is that, regardless of gate voltage, the drain of the composite must be more negative than approximately -0.7 volt to have conduction. This is the voltage required between the base and the emitter of the transistor before

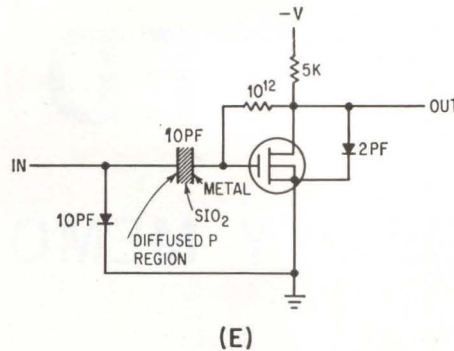
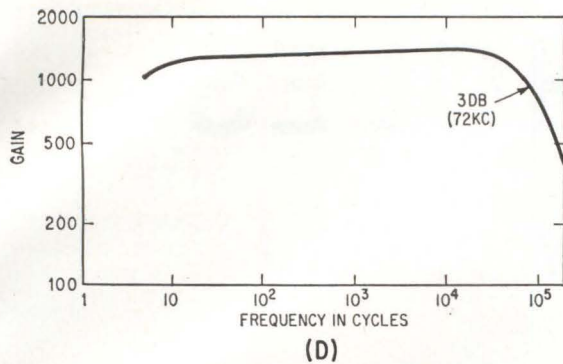

COMBINATION of MOST and npn transistor gives increased g_m (A), input-output characteristics for combination shown previously (B), high input impedance amplifier circuit (C), gain of amplifier vs frequency (D), circuit of integrated a-c amplifier stage showing parasitic reverse-biased diode capacitance (E)—Fig. 2

any base current will begin to flow.

The composite can be used in self-biased stages like that of Fig. 1E. If desirable, load resistor R_L can be made smaller to get more power gain. In fact, several transistors can be connected from a MOST in a Darlington configuration, so that practically any size load can be driven with automatic bias point stabilization.

A-C Amplifier—Figure 2C shows a practical high-input-impedance, low-output-impedance voltage amplifier comprising cascaded stages, each like that of Fig. 1E. The 10^9 ohm feedback resistors were made especially for this application by depositing a thin film of amorphous silicon onto an insulating substrate, etching into a pattern and bonding on leads. The resistors are physically small, in the order of 0.01 by 0.01 in. Together with 0.001- μ f coupling capacitors they produce a low-frequency response of about 5 cycles at 3 db down.

At low frequencies such that the interelectrode capacitances of the MOST can be neglected, but at frequencies high enough that there is not too much degenerative feedback through R_f , the gain of one stage of the amplifier of Fig. 2C should be $G_s = e_o/e_{IN} = g_m r_D R_L / (r_D + R_L)$, where r_D is the dynamic output resistance of the MOST. The total voltage gain should be the product of three such terms and when calculated is $G = 1,290$, using values of g_m and r_D from the characteristic curves in Fig. 1C and Fig. 2B. The measured gain of about 1,350 agrees favorably with this calculated value over a bandwidth from 5 cycles to 72 kc (3 db down points) as shown in Fig. 2D.

The constant gain bandwidth could be extended, at the sacrifice

of low frequency gain, by connecting more degenerative capacitance from drain to gate of each MOST in the circuit of Fig. 2C.

Input Impedance—For a solid-state amplifier the circuit of Fig. 2C has an extremely high input impedance Z_{IN} . Above a few cps Z_{IN} results almost exclusively from gate-drain capacitance C_{GD} of the first MOST multiplied by the gain of the first stage, plus the gate-source capacitance C_{GS} . With typical values of $C_{GS} = 1.5$ pf, $C_{GD} = 0.2$ pf, and G about 8, we get C_{TOTAL} about 3 pf. At a signal frequency of 50 kc the input impedance is still greater than 1 megohm.

Transients—Since the gate of the MOST is insulated from its body it can never draw current for either positive or negative voltage excursions. Therefore, if the a-c amplifier shown in Fig. 2C has a momentary extra large input pulse, normal low level signal amplification can proceed immediately afterwards. No capacitor blocking phenomenon will occur like that in a-c coupled vacuum-tube amplifiers. An upper limit is set by the breakdown voltage of the oxide layer beneath the gate, but this voltage can be made 100 volts or higher depending on the thickness used.

Integration—An attractive feature of the a-c amplification scheme is the ease with which it might be integrated into a single silicon chip. An a-c coupled amplifier with gain down to very low frequencies is generally impossible to integrate because large values of coupling capacitance are needed. Here, if the feedback resistance R_f of a stage is made about 10^{12} ohms the input capacitor C_i can be as low as 10 pf,

and gain is obtained down to a few cycles per second.

Figure 2E is the equivalent circuit of the integrated stage shown in the microphotograph. The input capacitor to this stage consists of a metal electrode separated from a p island by a thin SiO_2 insulating layer. The metal electrode goes to the gate of the MOST and the p island is the input terminal to the stage. This MOS capacitor with SiO_2 as its dielectric has low leakage current to the metal electrode, so that it is possible to use a thin film silicon resistor of about 10^{12} ohms connected from drain to gate to set the bias level. However, there is an unavoidable parasitic capacitance of about 10 pf between the p island and the n-type substrate. This parasitic capacitance basically limits the stage to relatively low frequency amplification. Other types of thin-film input capacitors still to be developed could extend the high frequency response.

The integrated stage has a voltage gain of about 5. Several cascaded stages without other components produce any total desired gain. The stages are not critical with respect to supply voltage or to internal component tolerance.

BIBLIOGRAPHY

- C. T. Sah, A New Semiconductor Tetrode—The Surface-Potential Controlled Transistor, *Proc. IRE*, 49, p 1,623, Nov. 1961.
- P. K. Weimer, The TFT—A New Thin-Film Transistor, *Proc. IRE*, 50, p 1,462, June 1962.
- D. Kahng and M. M. Atalla, Solid-State Device Res. Conf. at the Mellon Inst. & Carnegie Inst. of Technology, Pittsburgh, Pa., June 1960.
- M. F. Wolff, Advances in Microminiaturization, *ELECTRONICS* 36, p. 51, Feb. 15, 1963.
- F. M. Wanlass, Field-Effect Metal-Oxide-Semiconductor-Transistors and Microelectronics, WESCON Preprint for 1963.

PLATED HOLES

SIMPLIFY MEMORY DESIGN

This new magnetic-storage unit combines the operating speed and manufacturing simplicity of a thin-film memory with the closed-flux configuration afforded by ferrite cores. It increases application flexibility and reduces design problems

By J. S. SALLO, Honeywell Research Center, Hopkins, Minnesota

GREAT improvements have been made in random-access magnetic stores. At the present, ferrite cores are the most widely used elements in such systems, and improvements in ferrite compositions have led to higher-temperature operation and lower switching coefficients. The use of smaller cores has lowered drive requirements and reduced stack size. Partial switching, coupled with word organized readout, has further increased the speed of such systems. But even with automated wiring techniques such systems are relatively costly, temperature limited, and, barring some major breakthrough, limited in ultimate speed capability.

Metallic magnetic thin films have now come into limited use in memories. These thin films are inherently high-speed devices and utilize magnetic anisotropy in their operation. Problems such as creep and dispersion are presently being studied and appear to be due largely to the open-flux nature of the device¹. As a partial solution to this problem, recent memories have used a pair of films to partially close the flux^{2,3}. Despite the remaining problems, this class of device offers great promise in high-speed applications.

Film devices are limited to high-speed operation due to the small amount of flux available. A third class of devices, usually plated wires, are capable of higher output; examples of these are the Twistor⁴, bit-wire⁵, rod⁶, and plated tensor⁷. Except for the tensor, all these have open flux paths. In addition, all but the rod are limited to two-wire applications. Examples of the newer devices which are not plated wires are the woven screen⁸, Permalloy sheet⁹, and waffle iron¹⁰. All have closed-flux paths or approach a closed flux configuration. These devices are so new, however, that the data available for evaluation is inadequate for objective analysis.

Design—The Orthocore¹¹ is designed to provide a highly-flexible closed flux store. In principle, a group of wire is fixed to connectors to form the desired wir-

NO WIRES CROSSED

Silhouette to the contrary, this device functions according to plan and is intended to provide a more flexible closed flux store for magnetic memories. Using printed-circuit wiring, Orthocore contains a series of magnetic-memory cores within the criss-cross grids of its structure. One construction advantage is the elimination of all welding and soldering. Moreover, the techniques used permit either a coincident-current or word-organized memory to be constructed

ing pattern. This wiring configuration is placed inside a carefully machined two-part steel mold and the mold is filled with a suitable insulating material such as a plastic. In the finished part, a plastic cylinder is formed around each conjunction of several wires that will become a memory bit. When this form is coated with a magnetic material, these cylinders will become memory cores.

In practice, the use of actual wires is impractical, as they tend to come to the surface of mold and short out to the magnetic material. In addition, the use of straight wires presents a limitation in the diameter-to-length ratio of the magnetic cores since some wires must be on a diagonal through the core. Moreover, the use of straight wires soldered to a connector board is a potentially expensive operation.

All of these limitations can be eliminated by using printed wires on thin plastic sheets; the wires need not be straight and they provide a greater flexibility in wiring configurations with lower cost. In addition, wire ends can be thickened and used as the connectors, so that soldering and welding is eliminated.

A drawing of an Orthocore plane prepared in this way is shown in Fig. 1A. The squares represent holes in the plane; one of these is indicated as A. Each hole is surrounded by four cores; the cores around hole A

GRIDS in the Orthocore actually house a highly flexible, closed-flux store

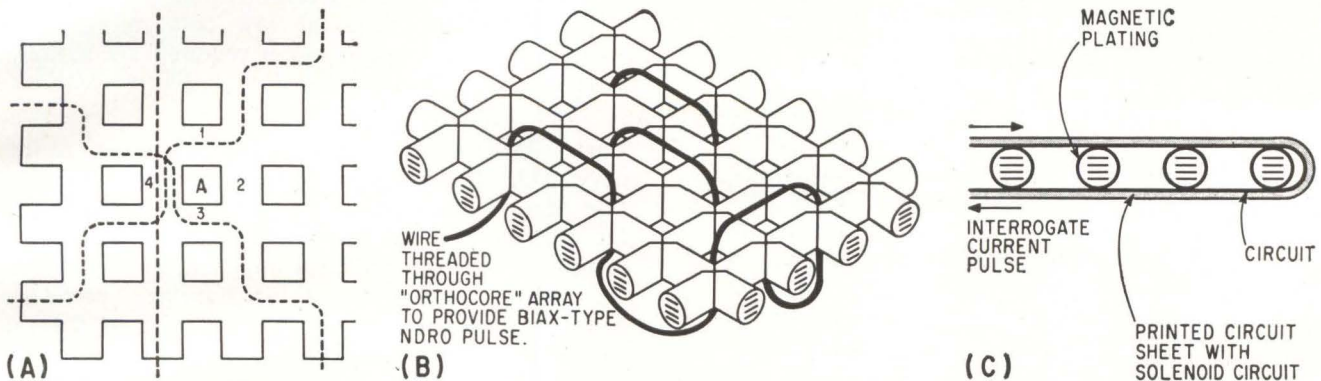
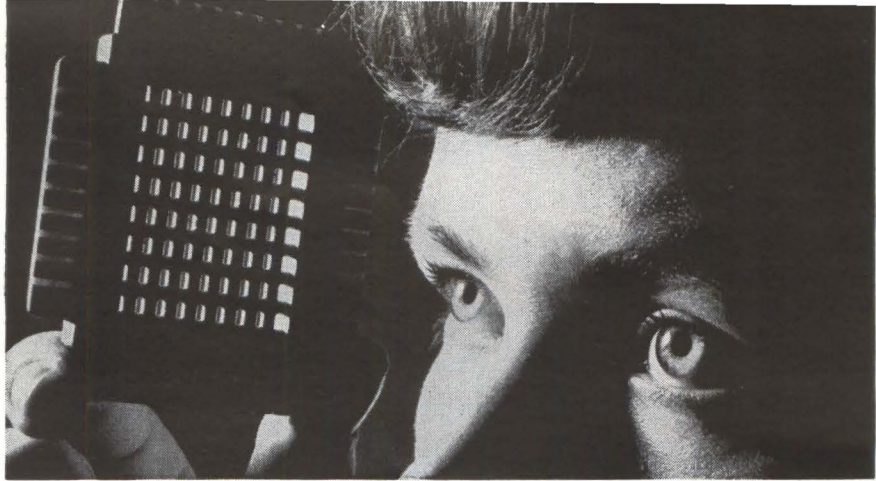

PLANE with one possible wiring configuration (A), use of core for biax-type nondestructive readout interrogate pulse (B), and cross section of plane containing printed-circuit sheets (C)—Fig. 1

are shown as 1, 2, 3, and 4. Each core passes along the top of the cylinder, down through one of the adjacent holes, back along the bottom of the cylinder, and up through the other adjacent hole to complete its closed flux path. Thus, each core requires two holes to accomplish its flux closure and each hole is surrounded by four cores. The broken lines show a possible configuration of imbedded wires that might be used to select core 4 in a three-wire memory. The two zigzag wires meet only in core 4 and are used to select this core in a coincident-current write operation.

Advantages—The Orthocore has the advantage of eliminating the wiring of individual magnetic toroids, leading to a large cost saving relative to conventional ferrite memories. The magnetic elements are present in a true closed-flux path configuration that is not limited to a two-wire memory system. In fact, a great flexibility in wiring is provided. Since small cores need not be wired, a reduction in core diameter is also possible leading to a very compact memory. Figure 2A shows an experimental Orthocore form using 0.030-inch diameter cores on 0.060-inch centers. The cores are 0.030-inch long and each hole forms a flux-closure link for four cores. The active area contains 144 bits and is $\frac{1}{2} \times \frac{1}{2} \times 0.030$ -inch in size, leading to a bit density of 20,000 bits/cubic inch. The connectors at the edge of the plane are formed by the printed wires themselves. One of the printed wiring sheets used in the fabrication of the 0.030-inch form is shown in Fig. 2B.

Non Destructive Readout—The techniques described are applicable to either a coincident-current or a

word-organized memory. Both schemes employ a destructive readout of the memory bit. Many applications exist, particularly in military and space systems, where readout of the memory bit without destroying the stored information is desirable. This can be obtained in either of two ways with the Orthocore. One of these techniques utilizes the geometry of the form itself. Figure 1B shows a perspective drawing of the Orthocore plane. Since the hole in the form is coated with magnetic material, a magnetic core exists in the plane of the form inside this hole. This core forms a common link with the memory cores and is orthogonal to them. This is the same configuration as is found in the ferrite biax element¹² also shown in Fig. 1B. A wire threaded through the hole in the plane as shown will, when pulsed, produce an NDRO output on the four cores surrounding this hole. The Orthocore provides an advantage in wiring simplicity, cost, size, and temperature stability relative to the single ferrite elements.

The second NDRO scheme requires that a solenoid be wound around the plane. When this solenoid is pulsed to yield a transverse field, the magnetization vector rotates against the anisotropy of the material. When the solenoidal field is removed, magnetization returns to its easy direction. This type of NDRO is used in the tensor. Figure 1C illustrates a cross-section of an Orthocore plane showing the single-turn solenoid strip in position.

Problems—The Orthocore offers advantages in fabrication of closed-flux and magnetic-film devices; however, it presents some severe problems in terms of the deposition of the magnetic materials. Magnetic ma-

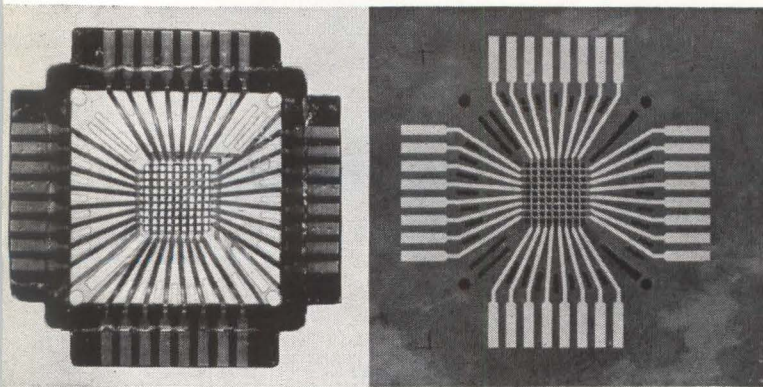

DEVICE with 0.030-inch core diameter prior to deposition of magnetic material (A) and one set of printed wires used in the 0.030-inch form (B)—Fig. 2

material must be uniformly deposited along the entire circumference of the substrate cylinder. This is particularly difficult to achieve inside the holes in the form. With present planes, we are dealing with a square hole 0.030-inch on an edge. Smaller bit spacings are contemplated that will require deposition inside even smaller holes. Most techniques for deposition of magnetic materials such as evaporation and electrodeposition will suffer from extreme uniformity problems when applied to this complex geometry. Electroless deposition is remarkably free of these geometry limitations and will form a uniform deposit inside the small holes. Therefore, hypophosphite reduction of nickel and cobalt was chosen as the technique for the formation of materials for the device.

Deposition on plastic tubes has shown that a wide range of magnetic properties are available from Ni-Co-P materials prepared by this technique. Coercivities ranging from 0.2 oersted to above 5 oersteds are attainable. Moreover, deposition in a circumferential magnetic field induces anisotropy in the deposit and leads to a square hysteresis loop in the desired direction. Deposition thickness is readily varied from under 1,000 Å to above 50 microns at a nominal rate of 2,000 to 4,000 Å/min. The deposition process is relatively inexpensive, particularly with the utilization of new bath-stabilization techniques that have been developed. The composition of the magnetic deposit is nominally 35 % Co, 63 % Ni and 2 % P.

Switching Coefficient—In terms of coincident current and linear-select classes of magnetic stores, the switching coefficient, Sw ,¹³ is of prime importance. This value is a figure of merit that determines the switching time to be expected for a given drive in a wall-motion switching process. If a thick film (over 10,000 Å) Orthocore store is to be considered, Sw must be compared with ferrite materials. In ferrite materials, Sw is usually in the order of 0.5-oersted microseconds. Presently Orthocore materials have Sw of about 2-oersted microseconds. This means that on a 0.030-inch cylinder, a half-select drive of about 400-ma turns is required to produce a 1-microsecond switching time in coincident-current write or read application. Slower switching speeds will require less drive. Linear select schemes permit a faster read-out with

larger drives. Partial switching-write techniques could also be considered for linear select applications.

Continuing research on the electroless class of magnetic materials is expected to improve the properties of this class of wall-motion Orthocore stores. However, materials presently available have many potential applications. Experimental planes, although still in the development stage, are showing good uniformity characteristics. These planes can be prepared at low cost and at high packing density. NDRO can be obtained if desired and occurs in the nanosecond-speed region depending upon the rise time of the applied pulse. Therefore, the present device is applicable to high-speed, read-only applications. In addition, any memory problems requiring low cost and random access where high speed is not required are entirely suitable for this device.

Logic—Due to the flexibility of wiring inherent to the device, Orthocore logic is a good possibility. Utilization of this flexibility can lead to low-cost schemes for shift registers, counters, and other magnetic logic components. In most of these applications, the switching coefficient is not of great importance and extensive hand wiring greatly increases the present cost. Several similar applications are currently under investigation.

The Orthocore also possesses possibilities as a thin-film, high-speed device. In this usage, a memory would retain the closed flux path of the present device where positioning of wires is not important and creep and dispersion problems are minimized. The study of closed-flux electroless thin films has just begun and the properties of the films are still virtually unknown. Flat films have properties similar to those of evaporated or electrodeposited films. In order to produce this type of memory, the size of the Orthocore form must be substantially reduced in order to solve the propagation time problem.

Orthocore device provides a means of obtaining prewired closed-flux, magnetic-memory arrays. The main advantages of this technique are low cost, wiring flexibility, small size, and temperature stability. Although present materials fall outside of the high-speed memory class, many applications exist for the present class of materials. Future work is expected to lead to high-speed devices where the full potential of the concept can be realized.

The author wishes to acknowledge the advice and assistance of R. J. Prosen, T. J. Cebulla and R. B. Fryer.

REFERENCES

- (1) J. M. Daughton and A. V. Pohm, *Proceedings of the Intermag Conference*, 15-5 1963.
- (2) A. V. Pohm, R. J. Zirgg, G. A. Watson, T. A. Smay, R. M. Stewart, Jr., *Proceedings of the Intermag Conference*, 9-5 1963.
- (3) R. P. Halverson, C. A. Rowland, *Proceedings of the Intermag Conference*, 9-3 1963.
- (4) A. H. Bobeck, *J. Appl. Phys.* 29, 485 1958.
- (5) S. J. Schwartz, J. S. Sallo, *IRE Trans. EC-8*, 465 1959.
- (6) D. A. Meier, *J. Appl. Phys.* 30, 455 1959.
- (7) T. R. Long, *J. Appl. Phys.* 31, 1235 1960.
- (8) R. A. Howard, P. E. Wells, L. Cann, J. S. Davis, *Large Capacity Memory Techniques for Computing Systems*, Macmillan Co., 361 1962.
- (9) G. R. Briggs, J. W. Tuska, *Proceedings of the Intermag Conference*, 3-4 1963.
- (10) A. H. Bobeck, *Proceedings of the Intermag Conference*, 3-2 1963.
- (11) J. S. Sallo, *Proceedings of the Intermag Conference*, 3-6 1963.
- (12) C. L. Wanlass, S. D. Wanlass, *Wescon Convention Record*, pt. IV, 40 1959.
- (13) N. Menyuk, J. B. Goodenough, *J. Appl. Phys.* 26, 8 1955.

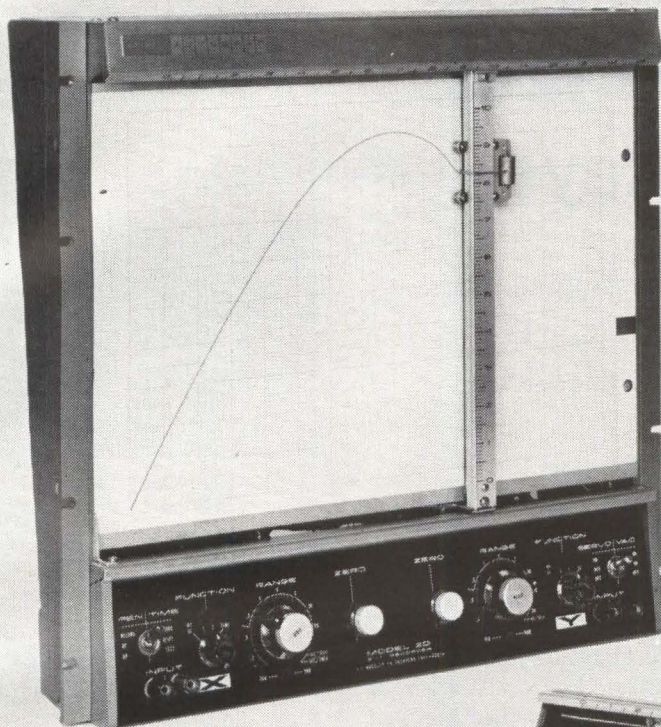

Moseley 2DR, compact, rack mounting

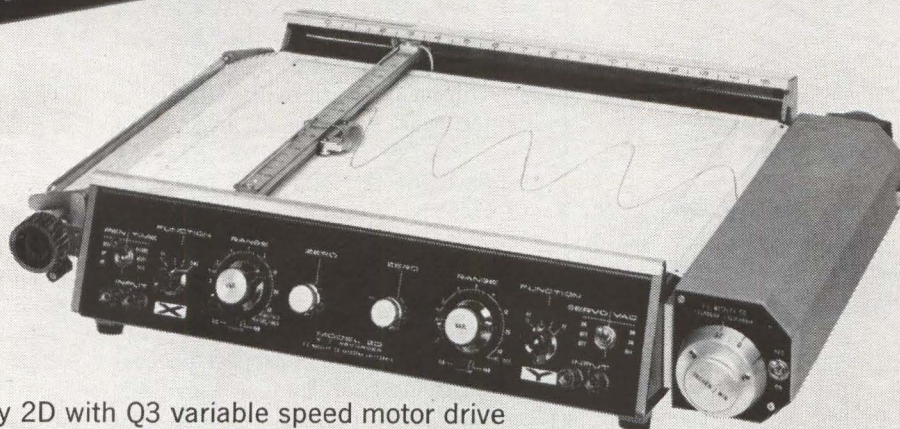

Moseley 2D with Q3 variable speed motor drive

MOSELEY X-Y T* RECORDERS

MODEL 2D 11" x 17" series AUTOGRAF® RECORDERS are offered in 9 different units, tailored to your exact need.

MODEL 2D (Bench type) and 2DR (Rack type). Versatile series leaders feature dc and ac inputs, X-axis time basis, continuous electronic reference, and facilities for a built-in magnetic curve follower. MODEL 2D or 2DR, \$2450.

MODEL 2D-2 and 2DR-2. Include all standard features of 2D, 2DR except ac input facility. MODEL 2D-2 or 2DR-2, \$2050.

MODEL 2D-3 and 2DR-3. Specially designed for operation with ± 100 volt external computer reference supply. Include alternate built-in electronic reference, omit time base and ac signal input features. MODEL 2D-3 or 2DR-3, \$2050.

MODEL 2D-4 and 2DR-4. Low cost versions with reduced accuracy for basic dc signal recording. Furnished without time base, ac input, or curve follower facilities. 2D-4 or 2DR-4, \$1490.

MODEL 2D-5. Combines all features of Model 2D with Type F-3 Photo-Electric Line Follower. Records, reproduces a function signal with desired transport delay simulation.

7524R2

No other 11" x 17" Recorder offers all these standard features

½ mv/in. Sensitivity

16 Calibrated dc Ranges Plus Stepless Control (Vernier)

One Megohm Input Resistance on all Ranges (Optional)

Built-in X-Axis Time Base

Electronic Reference

Full Scale Zero and Full Scale Zero Offset

Self Contained Vacuum System for Paper Holddown

Optional AC Input

Optional Roll Chart Capabilities

Operates with Both Magnetic and Optical Curve and Line Followers

F. L. MOSELEY CO.

409 N. Fair Oaks Ave., Pasadena, California

an affiliate of Hewlett-Packard



Acoustical Components of Superior Quality

JAPAN PIEZO supplies 80% of Japan's crystal product requirements.

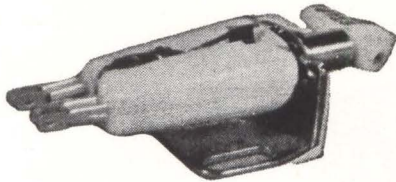
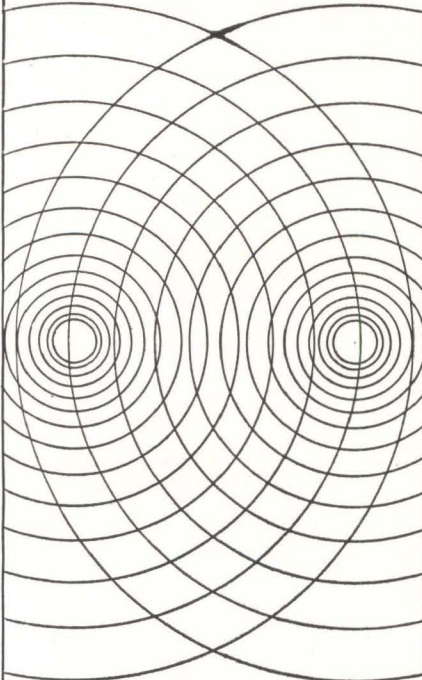

STEREO CARTRIDGE Crystal — "PIEZO" Y-130 X'TAL STEREO CARTRIDGE

At 20°C, response: 50 to 10,000 c/s with a separation of 16.5 db. 0.6 V output at 50 mm/sec. Tracking force: 6 ± 1 gm. Compliance: 1.5×10^{-6} cm/dyne. Termination: $1M\Omega + 150$ pF.

Write for detailed catalog on our complete line of acoustical products including pickups, microphones, record players, phonograph motors and many associated products.



**JAPAN PIEZO
ELECTRIC CO., LTD.**

Kami-renjaku, Mitaka, Tokyo, Japan

Computer Analyzes X-Rays

Data-processing methods show progress in EEG and EKG studies, too

By **JOHN M. CARROLL**
Managing Editor

NEW ORLEANS—Progress in the use of electronic computers, instruments and displays to study diseases was demonstrated here last week at Tulane University's Bio-Medical Computing System Center.

A joint venture with IBM, the center was established two years ago with a five-year, \$1,674,854 grant from the National Institutes of Health. Equipment includes an IBM 1410 systems with two channels and 40,000-character memory, also a 1401.

X-Ray Images—For digital processing a flying-spot scanner with 380-line resolution dissects a 3×3 -inch section of a radiograph into 190,000 elemental areas. Video output is quantized into 100 gray-scale levels by an analog-digital converter. Digits go through the 1401 where the quantized information is stored, typically on 70 ft of $\frac{1}{2}$ -in. tape.

The digital image can be altered to assist the radiologist by presenting less information, but uncluttered. For example, a gray-scale range from 30 to 35 might be extended from 00 (black) to 99 (white). A digital-analog converter then presents conditioned data on a 5-inch crt. The system allows differential diagnosis of pathological lesions. In one case it revealed a lung malignancy not apparent to the unaided eye.

Analog x-ray enhancement permits gray-scale expansion and study of various sections of the radio-



TV SCANNING system that enlarges selected portions of x-ray images is one of

graph. The radiograph is scanned with a vidicon equipped with a zoom lens. Signal-conditioning circuits pass the video to a 21-inch tv monitor. The equipment permits enhancing sharp changes in density. The video, which has a 10 to 12-Mc bandwidth is impressed on a differential amplifier as is an image passed down to a 40-Mc, lumped-constant, variable delay line. This configuration effectively subtracts out background and leaves in the intelligence transmitted in sharp changes in density. Thus the system differentiates the image.

EEG Patterns—Techniques basic in speech recognition have been used to teach a computer to discriminate between normal and abnormal electroencephalograms. The EEG signals are multiplied in frequency (and compressed in time) by a factor of 240. A bank of 36 filters then separates out frequency components, which are analyzed simultaneously. In this work, an IBM 7090 was shown the awake but relaxed patterns of 4 normal patients. It was then shown patterns from both normal patients and from patients suffering from brain disease. In the latter case, there was low correlation with the previously learned patterns.

EKG Records—A 1401 has helped cardiologists study parameters of electrocardiograms. The EKG output is fed to an A-D converter and



displays being developed at Tulane University center

to a 1401 which flags significant parts of the waveform and determines significant changes. The program ignores short-term noise. It may be useful in operating-room and intensive-care monitoring.

Medical Records—Modern information storage and retrieval techniques may reduce bulky medical records and permit their storage on magnetic tape. The Tulane project includes 5,000 case histories supplied by 3 hospitals. Records can be searched at the rate of 1,000 in five minutes instead of months as in manual searching.

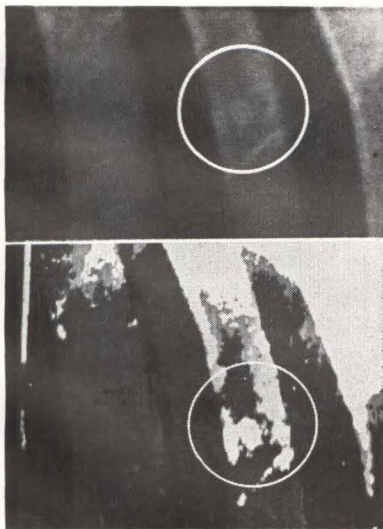

METASTATIC cancer nodule (circled area) barely visible in x-ray (top) is seen in computer-processed image (bottom)

Now — addressable and sequential multiplexing in one unit

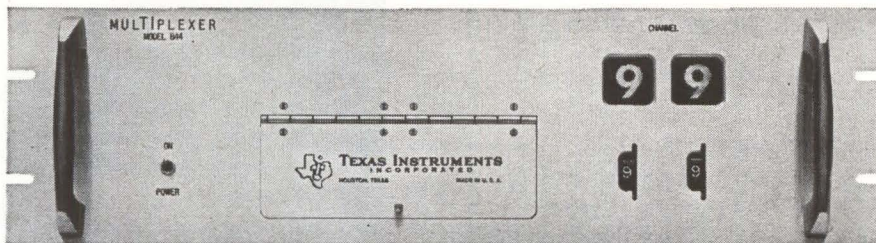

choose either binary or BCD channel address and confirmation

- features**
- Sampling rate to 50,000 channels/sec
 - Variable frame length
 - Accuracy $\pm 0.02\%$ full scale
 - Input levels to ± 10 V

Texas Instruments Multiplexers are all solid state units providing accurate, high-speed bipolar operation with low dynamic crossfeed, fast settling time, and variable strobe. Manual channel select switches facilitate system set-up and check-out. Frame length is selectable from front panel. Expandable to 160 channels by means of plug-in printed circuit cards. Case size 5¼ by 19 by 18 inches for standard relay rack mounting.

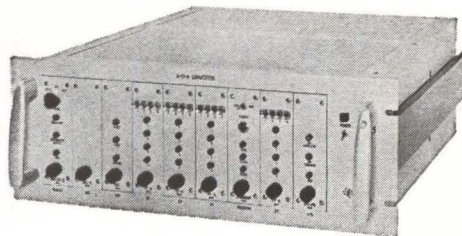

TI's high speed Model 834 Analog-Digital Converter, ideal companion instrument to the TI Multiplexer.

High speed: 1.5 μ sec per bit
Built-in sample and hold

Accuracy: $\pm 0.05\%$ full scale
Automatic zero stabilization

Ask a TI Application Engineer for further information on digital data handling equipment for your specific needs.

INDUSTRIAL
PRODUCTS
GROUP



TEXAS INSTRUMENTS
INCORPORATED
P. O. BOX 66027 HOUSTON 6, TEXAS

SENSING • RECORDING • TESTING • DIGITIZING INSTRUMENTS
THE INSTRUMENTS OF TEXAS INSTRUMENTS

Thick-Film Memory Has High Output

IBM uses orthogonal magnetization scheme on cylindrical cores

NEW TYPE of computer memory with output signals in excess of ± 15 mv with a read-drive risetime of 20 nsec was described at NEC this week by N. F. Lockhart of IBM's Data Systems Division, Poughkeepsie, N. Y.

Called the cylindrical film memory, the system is based on orthogonal-mode cylindrical cores of nickel-iron metal. For a substrate, each elementary device uses a 0.1-inch piece of glass tubing approximately 0.015 inch i.d. and 0.025 inch o.d. An 80-20 Permalloy (thick) film is deposited by electroplating to a thickness of about 6,000 Å on the outside surface. No surface preparation is needed except for a thin gold underlayer to serve as a highly conductive surface for the electroplating. The Permalloy film is deposited in the presence of a circumferentially oriented d-c magnetic field. A highly oriented uniaxial magnetic film results; its easy axis of magnetization is aligned with the circumferential direction,

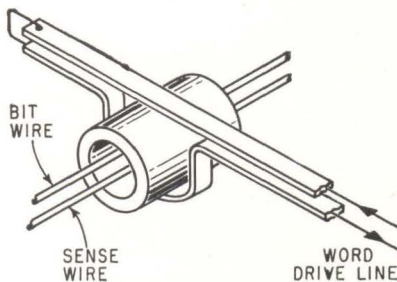

BIT GEOMETRY shows word line and bit line arrangements: word line produces circumferential flux, bit line axial flux. Sense wire passes through center of core

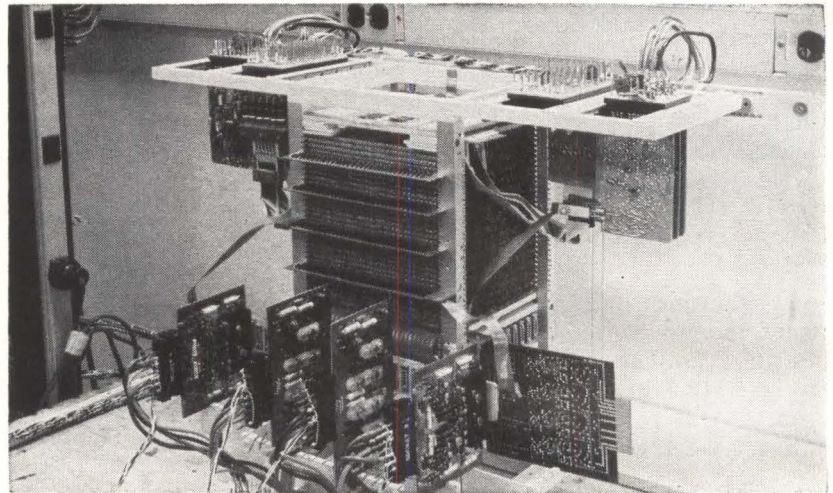

TEST ARRAY of 2,048 words used direct coupled word and gate drivers in diode selection matrix for word drive system, low-impedance stripline cables and close spacing

and the hard axis is parallel to the cylinder's axis.

Orthogonal Mode—The cylindrical film device has been developed for orthogonal mode operation, characterized by two mutually perpendicular directions of excitation. A current in the word conductor produces a field parallel to the hard axis. Application of the word field rotates the stored remanent magnetization of the core from its circumferential alignment into alignment with the hard axis. The change that occurs at this time in circumferential flux links the sense winding, and produces a positive or negative output signal. The output polarity depends on the nature of the stored remanent state—either plus or minus remanence.

The bit drive is so positioned that a bit drive pulse produces a circumferentially oriented field in the cylindrical core. If this field is applied at the same time as a word field, the magnetization vector is inclined in either the clockwise or the

counterclockwise direction, depending on the bit drive polarity. Removal of the word field allows the magnetization vector to align itself in the direction favored by the bit field; subsequent removal of the bit field completes the writing portion of the cycle.

Experimental Array—A memory array of 2,048 72-bit word capacity was built and tested for evaluation of the basic device, using the basic horseshoe-type geometry shown in the figure, and a packaging approach that kept to a minimum the necessary array wiring lengths. Two models were built: the first used an electrostatic shield for the purpose of reducing read noise. The second, more successful, did not, and achieved a word gate noise of less than 3 millivolts, and bit noise of 150 millivolts peak when driving and sensing in a single bit position. The circuit and array delays in the model memory indicated that a 400-500 nsec cycle is possible in a system of up to 16,000 words.

KEPCO

ADDS EXTRA VALUE

VIX REGULATED POWER SUPPLIES

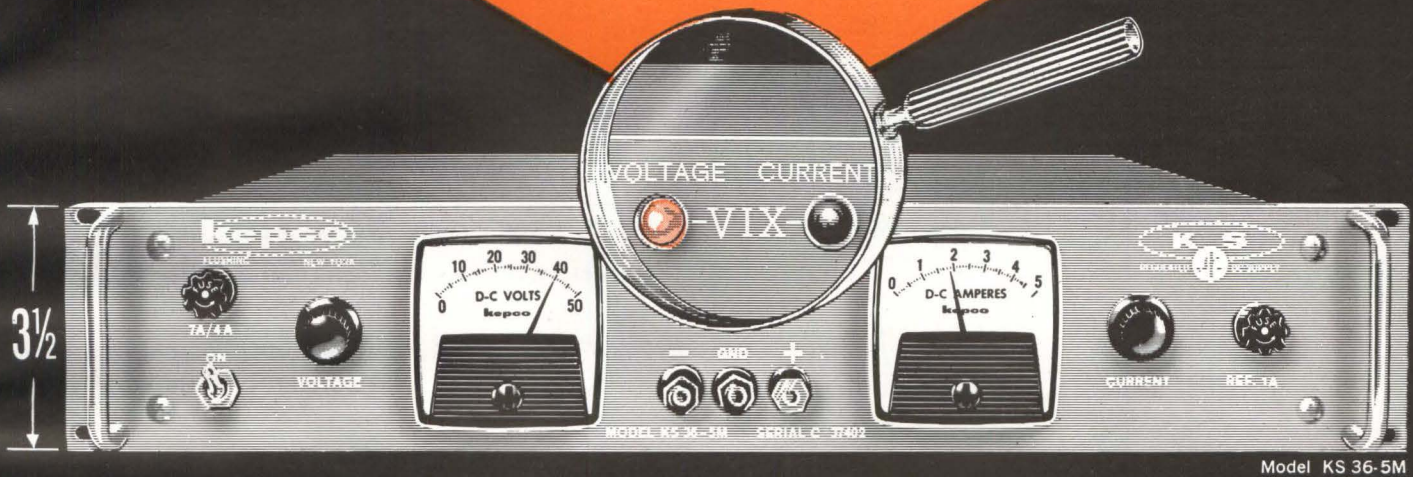

NEW VIX* INDICATORS AT NO EXTRA COST!

Kepco voltage/current regulated power supplies in the KS series now come equipped with voltage/current mode indicators called "VIX". Time saving and added utility are provided by these indicators which show at a glance whether the power supply is in its voltage regulating mode or its current regulating mode. This indication is especially useful in the Kepco KS Models since they have extremely sharp cross-over characteristics.

*VOLTAGE/CURRENT CROSSOVER SIGNAL

Send for complete data on
Kepco KS Models
featuring NEW "VIX" Indicators

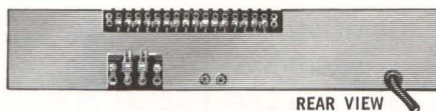

KEPCO 3 1/2" K S MODELS
REGULATED DC SUPPLY

0.01% REGULATION and STABILITY

DC OUTPUT RANGE		MODEL	PRICE
VOLTS	AMPS		
0-8	0-15	KS 8-15M	\$595.00
0-18	0-10	KS 18-10M	550.00
0-36	0-5	KS 36-5M	495.00
0-60	0-2	KS 60-2M	495.00

kepco
Inc. ®

131-38 SANFORD AVE. • FLUSHING, N.Y. 11352
Phone (212) IN 1-7000 • TWX# 212-539-6623
Cable Address: KEPPOWER NEWYORK

Other features include:

- High Power in Compact Design
3 1/2" H x 19" W x 14" D
- SCR Preregulation
- 10-turn-pot Resolution
- Flexible Programming
- Dual Kepco "Bridge Circuitry" with Automatic Cross-over
- Remote VIX Signal
- Key Circuitry brought to rear Terminal Board
- Six Operating Modes with External Connections
- Series/Parallel Versatility

† Patents issued and pending.

See our complete
Catalog in

eem Sec. 4000
PAGES 321-352 **EBG**

CIRCLE 41 ON READER SERVICE CARD

HERE'S A SWITCH

1500 watts inductive
2000 watts resistive

Delco's silicon 2N2580 series

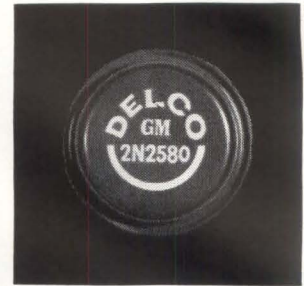

Switch ultrahigh voltages at peak power levels with Delco Radio's family of silicon transistors—2N2580, 2N2581, 2N2582, 2N2583.

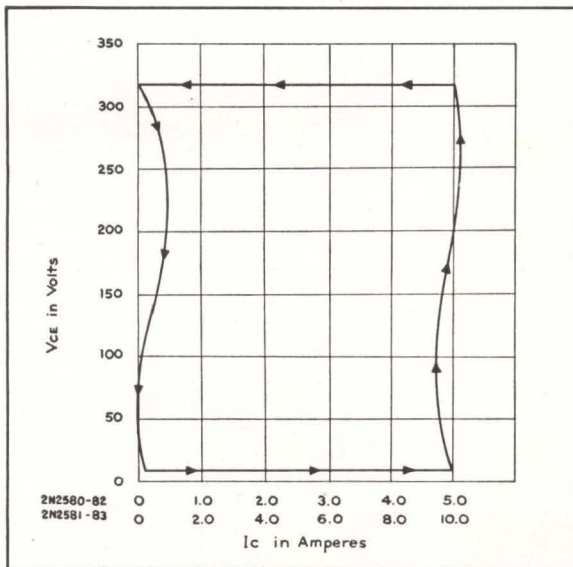

Typical inductive switching curve

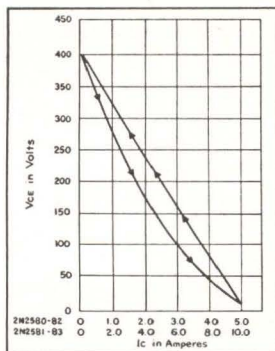

Typical resistive switching curve

Each transistor features a maximum sustaining voltage (VCE sus.) of 325V, and has VCBO, VCEX and VCEO ratings of either 400 or 500 volts in either of two gain ranges.

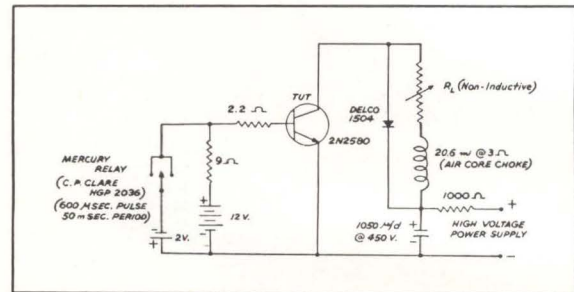

Test circuit—inductive load

Inductive or resistive loads can be switched at full rated collector current (up to 10 amperes) within the 325-volt safe operating area—with freedom from secondary breakdown.

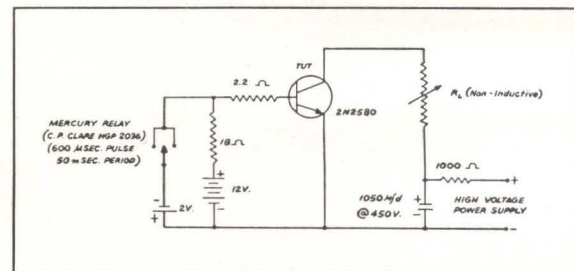

Test circuit—resistive load

All 2N2580 series transistors are available now at new reduced prices. For complete data, contact your Delco Radio semiconductor distributor or any of the sales offices listed below.

Union, New Jersey
324 Chestnut Street
Murdock 7-3770
AREA CODE 201

Palo Alto, California
201 Town & Country Village
Davenport 6-0365
AREA CODE 415

Syracuse, New York
1054 James Street
GRanite 2-2668
AREA CODE 315

Detroit, Michigan
57 Harper Avenue
TRinity 3-6550
AREA CODE 313

Santa Monica, California
726 Santa Monica Blvd.
UPton 0-8807
AREA CODE 213

Chicago, Illinois
5151 N. Harlem Ave.
775-5411
AREA CODE 312

General Sales Office: 700 E. Firmin, Kokomo, Ind., Gladstone 2-8211—Ext. 500 • Area Code 317

DELCO
DEPENDABILITY
RADIO
RELIABILITY

Division of General Motors, Kokomo, Indiana

Light Isolates Amplifier Stages

Optically-coupled device promises more accurate measuring instruments

By **LAURENCE D. SHERGALIS**
Regional Editor
San Francisco

PALO ALTO, CALIF.—Electrical isolation of input from output has been achieved with a relatively simple solid-state device that uses optical coupling. Developed at Hewlett-Packard Associates, the device is a four-terminal network that electrically isolates input from output while retaining the characteristics of conventional transistors, Fig. 1A. H-P Associates did the background work on the device under an Air Force contract for advanced functional block development in which the light emitting characteristics of the gallium-arsenide mesa diode were investigated. Now, the diode has been combined with a phototransistor. Results of this work will be reported in a paper, "An Optically Coupled Amplifying Device" by Dave Earle and Richard Soshea at the Electron Devices Meeting this week.

Basically, the device consists of a gallium-arsenide mesa diode mounted on a silicon phototransistor. Two methods are used to couple the two units. In one scheme, Fig. 1B, the *p*-layer of the diode is very thin. Thus, the distance from the light-emitting junction to the phototransistor is very small. The problem is in controlling this thickness, which can be of the order of only a few microns. Also the contacting surface is made in a screen

form. Using this type of construction, a light energy peak at 1.41 electron volts can be observed and utilized. This peak is absorbed in gallium-arsenide if the material is thicker than a few microns.

Although the effect is strong, the excitation mechanism isn't really understood. Light can be readily seen at liquid-nitrogen temperatures. But H-P is striving to produce a device that will be useful at room temperature. Thus, unless the thickness of the *p*-layer is made small, another method must be used.

The 1.41-ev light peak can be ignored and a 1.37 electron-volt peak, obtained from zinc-doped material, may be used. This peak, while not as strong as the 1.41 peak, may be observed at room temperature and is not absorbed in the gallium-arsenide material. Therefore, the diode is turned over and the *n*-layer

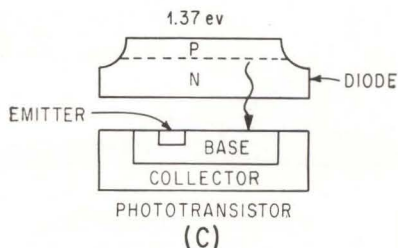
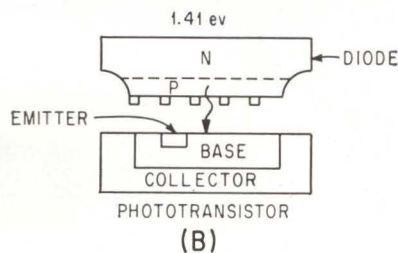
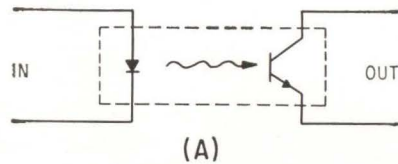

BASIC light amplifier circuit (A). Two methods are used to mount gallium arsenide diode to silicon phototransistor. (B) gives higher gain but requires more precise manufacturing tolerances. (C) uses light energy peak that is not absorbed in the diode and is visible at room temperature, Fig. 1

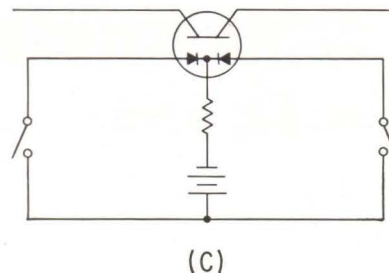
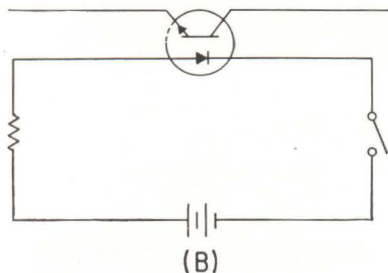
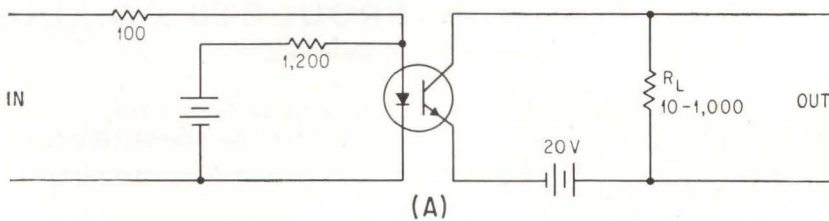

TYPICAL amplifier circuit (A). Load resistance R_L is kept to a minimum to increase operating speed. Applications include simple relay (B) and OR relay (C), Fig. 2



Displays in digital readout any angular displacement from a remotely located synchro transmitter. Very useful for computer groups and systems engineers for developmental experimentation and substantiation.

Accurate and rugged. Removable face allows modification to your own panel requirements. Miniature version available.

Contact any of our local offices or representatives.

APPLICATIONS

- Gyro Alignments
- Vector Analysis of Many Circuits
- Servo Loop Analysis
- Ground Support Equipment

SPECIFICATIONS

- Slewing speed 25°/sec.
- Accuracy ± 6 minutes standard. Higher accuracy available on special order.
- Repeatability ± 1.0 minute.
- Life—2000 hours minimum with scheduled maintenance.
- Shock—Built to withstand applicable shock and vibration environments without damage.
- Standard panel mounting.
- Power—25 VA @ 115 V 400.
- Choice of synchro or potentiometer.
- *Choice of single, two-speed, or dual inputs.
- *Auxiliary synchro or potentiometer may be included up to size 15.

*Not available in miniature version

CLIFTON PRECISION PRODUCTS CO., INC.

CLIFTON HEIGHTS, PA.

MAIN SALES OFFICE: 5050 STATE RD., DREXEL HILL, PA. • 215 MA 2-1000 • TWX 215 623-6068

CIRCLE 44 ON READER SERVICE CARD

**WANT TO
DO BUSINESS
WITH THE
GOVERNMENT ????????**

Then check the Military and Government Procurement Guide in the orange section of your **ELECTRONICS BUYERS' GUIDE**.

placed in contact with the phototransistor, Fig. 1C.

One disadvantage of this type of construction is that light is lost and overall gain of the device is less. But because of the ability of the devices to work at room temperature and the relative ease of fabrication, most of the experimental work has been carried on with units constructed in this way.

Efficiency—Light output varies with current to the diode. The authors say they are still conducting experiments to determine ways to achieve a linear relationship between current in and photons out. Conversion efficiency, they find, is dependent upon both current level and temperature. Another factor in determining efficiency is the difference in index of refraction of the gallium-arsenide material and the material through which the light passes upon leaving the diode. Index of refraction of the gallium arsenide is 3.5, and the high reflection at the surface makes it difficult to get light out. A very narrow critical angle—only 16 degrees—has been found. Light hitting the surface head on—at 90 degrees—suffers a loss of about one-third due to reflections.

The trick, say the authors, is to fill the space between the diode surface and the phototransistor with a material having an index of refraction approaching that of gallium-arsenide. Various potting materials and glasses are being tried.

Phototransistor—This is a conventional silicon unit with very high beta. Betas of the order of 500 to 1,000 are being used. This requirement puts tight tolerances upon the manufacturing processes. Presently, the phototransistor is the limiting factor in the speed of the amplifier.

Speed of operation—Two factors influence speed of operation. There appear to be a high lateral resistance in the base and a parallel capacitance between the base and emitter. A solution to this problem is being approached by designing various emitter configurations. A stripe and a vee shape are being tried.

Collector-base capacitance influences speed of operation also. While it is only a few picofarads, it is multiplied by the beta of the photo-

transistor in this type of operation and becomes a major factor. This capacitance plus the load resistor form an RC network with a finite time constant. Load resistance values are held to a minimum.

Characteristics — Combining the pair, some preliminary tests show a current gain of about 0.5 to 2.0, with a 100-ohm load resistance. Voltage gain is about 2.5 to 11 and power gain is about 1.5 to 22. Cut-off frequency is about 250 kc at 3 db down. Work is continuing to extend cutoff frequency by a factor of 3 or 4. Current-carrying capacity is limited by the thermal characteristics of the transistor. Total harmonic distortion from zero to 500 kc is about 3 percent, and needs to be improved by a factor of 10 to 100.

Applications—Work on the optically-coupled amplifier, Fig. 2A is now product oriented, on applications where no interaction between input and output is desired. Hewlett-Packard is interested in the device for measuring instruments.

Some interest has also been shown for telephone applications to replace certain types of relays. A few test circuits have been tried, including a simple relay, 2(B) OR relay, 2(C) and various configurations of choppers. Because of the high speed of this device, it may replace neon photoconductor devices and relays. The amplifier is still in the laboratory stage.

Airspeed Transducer For Gemini Paraglider

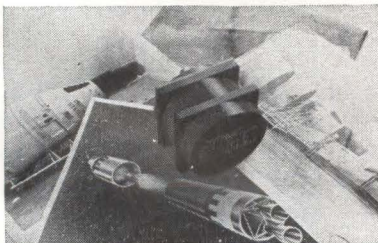

FAIRCHILD Controls' TP-350 Airspeed Transducers will provide precise airspeed measurement during the descent phase of Gemini flights. A new landing system, employing a Rogallo type paraglider, is planned for Gemini to assure the spacecraft's maneuverability during landing operations where anticipated airspeed is between 25 and 75 knots.

Attend

**the greatest annual show in
the electronics industry**

from February 7 to 12, 1964

Paris, Porte de Versailles

**INTERNATIONAL
SALON
OF**

COMPONENTS

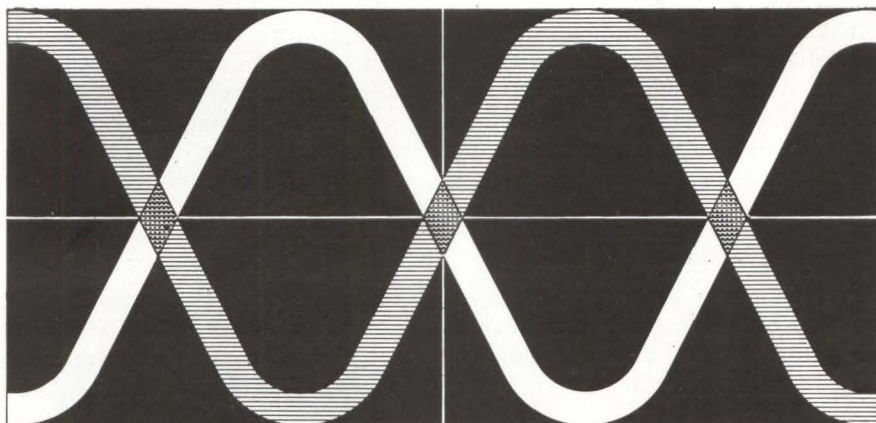

ELECTRONICS

All components, tubes
and semiconductors,
measuring and control
and electro-acoustic
devices . . .



For all information
and forms:

S.D.S.A. 23 RUE DE LUBECK
PARIS 16: (TEL.) PASSY 01-16

Wires Cut Crystals Accurately

Slurry and moving wires do precision slicing and dicing

By **E. H. LEDERER**
Semiconductor Products Dept.
General Electric Co.
Syracuse, New York

WIRE OR ROPE has been used, with abrasive slurry, to cut hard materials such as stone since the building of the pyramids. Now that wire with extremely high tensile strength is available, the method can be used for slicing and dicing semiconductor crystals, and for cutting glass, quartz, ceramics, carbides and sapphire.

While wire cutting is much slower than diamond-saw cutting (it takes a wire two hours to cut through a 1-inch-diameter crystal), surface finish of 10 microinches rms and

taper tolerances less than 0.005 inch per inch of cut can be realized. Gentle action and smooth edges with little corner chipping are other desirable features. Multiwire cutting helps compensate for the slowness.

Cutting Method—Generally a tungsten wire 0.005 to 0.007 inch in diameter is pulled under tension over the work piece at a rate of approximately 200 ft/min. An abrasive slurry of silicon carbide (600 to 800 grit) in oil is applied to the work piece and wires. The motion of the wire draws imbedded abrasive across the work.

Special orientation mounting fixtures are used to accurately position the work below the wires.

The work is attached to a mounting plate with a cement that sets up hard and brittle and is readily cut. This plate is clamped in place beneath the wires. The work is directed against the wires with a force of about 20 gms/inch of wire. The

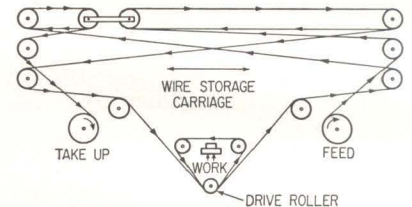
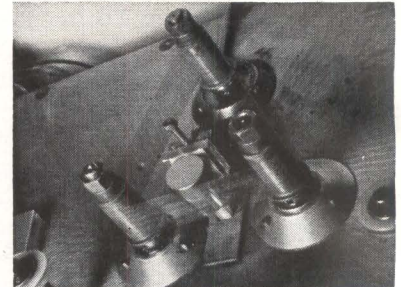

WIRING LOOP reverses direction after running its full 10 meters in one direction. Photo shows semiconductor ingot in position for multi-wire cut

cutting speed through the work under the above conditions is approximately $\frac{1}{4}$ to $\frac{1}{2}$ inch/hr.

Wire Carriage—To conserve wire (which costs 2.5¢/meter) it is run in one direction for a distance of 10 meters, reversed and rerun. While this alternating procedure is taking place, the used wire is taken up at a rate of 2 meters/min.

A carriage system provides wire storage to permit running in alternate directions while still feeding in and taking up used wire at a constant velocity. Wire is stored between the eight pulleys on the ends of the machine and eight more on each side of the carriage.

The slurry wears out the multi-grooved wire guide rollers in approximately 4 hours of use. Roller cost, depending on material, quantity and accuracy required, may vary from \$15 to \$150 each. Hardened stainless steel (RC 50-55) proved most economical. European tungsten wire performed best.

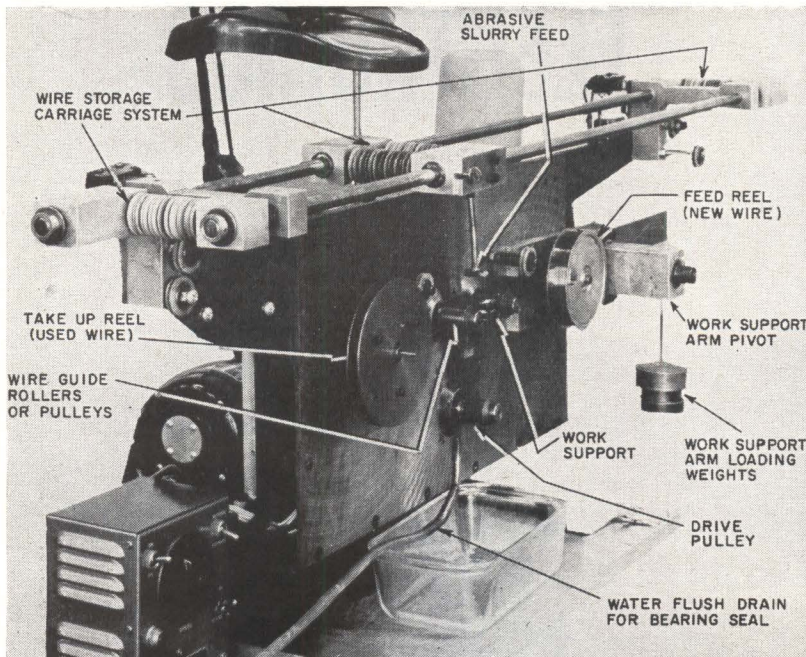

WIRE CUTTER designed and built by GE. A 1/20-hp gear-reduction motor drives the system

HOW TO USE YOUR ELECTRONICS BUYERS' GUIDE*

The Two-Way Product Locator



Most products advertised in the ELECTRONICS BUYERS' GUIDE are listed twice for your convenience. After the Product Heading, advertising page numbers appear where appropriate (when advertisements of one kind are grouped together in the book). Next to the individual product listing, the page number of associated advertising material is cited. Thus you can locate all of the advertisements for a particular product category, or any specific advertisement, quickly, accurately, and conveniently. Keep your ELECTRONICS BUYERS' GUIDE close to your work area at all times.

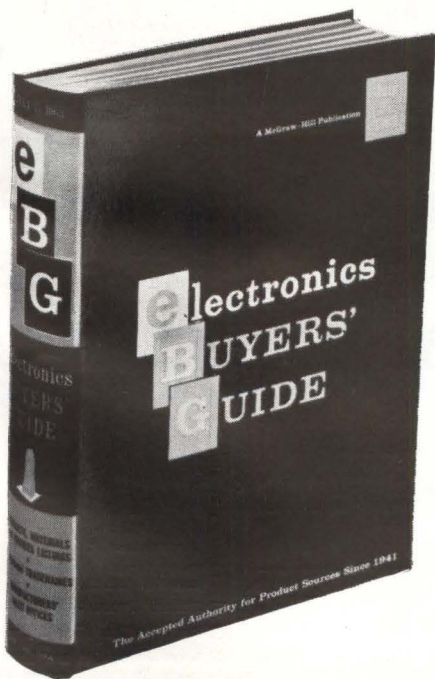

A.C. OR D.C. SMALLEST VANEAXIAL BLOWERS

Only 1 1/8" in diameter by a maximum 1 3/4" long, these smallest blowers move 10 cfm of air against 0.6" H₂O back pressure! Use these rugged sub-miniature blowers for spot cooling of critical components where space is cramped and weight is important.

VAX-1 blowers operate on 26 v.d.c. or less, or 26 v.a.c., 400 cycles. Weight is 1.4 ounces. Mounts with standard servo ring clamps. (Globe makes larger blowers also.) Request Bulletin XAV from Globe Industries, Inc., 1784 Stanley Avenue, Dayton 4, Ohio.

GLOBE INDUSTRIES, INC.

CIRCLE 200 ON READER SERVICE CARD

exclusively
for
industry

free

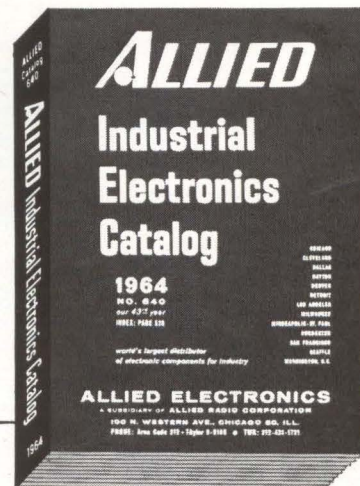

ask for
your
1964 **ALLIED INDUSTRIAL CATALOG 640**

540 PAGES • COMPLETE INDUSTRIAL ELECTRONICS CATALOG FOR THE SPECIAL USE OF PURCHASING AGENTS AND ENGINEERS

- World's Largest Stocks of Electronic Components
- Same Day Shipment • Factory OEM Prices

for **FREE** copy, check reader service card or write direct

ALLIED ELECTRONICS

subsidiary of ALLIED RADIO CORPORATION

100 N. Western Ave., Dept. 80-L, Chicago 80, Ill.

For separate Catalog No. 230 featuring hi-fi, build-your-own kits, home tape recording, ham gear, etc., write directly to Allied Radio, Dept. AX, 100 N. Western Ave., Chicago 80, Ill.

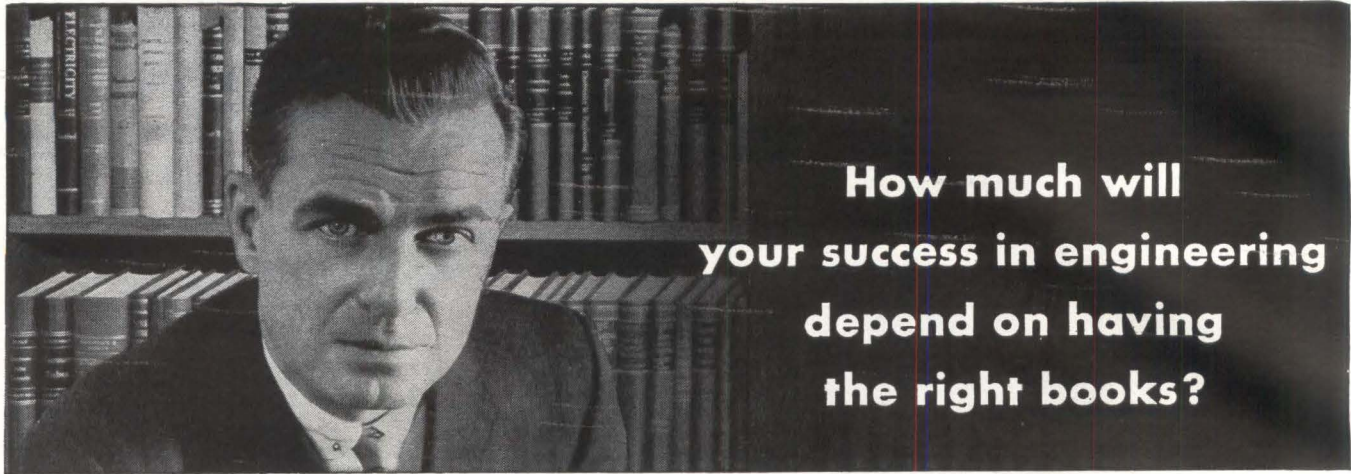

How much will
your success in engineering
depend on having
the right books?

The Electronics and Control Engineers' Book Club helps you keep ahead in your field . . . at a savings

Start your membership with any of these selections:



Electronic Switching, Timing, and Pulse Circuits by J. M. Pettit. Provides a practical understanding of operation of complex circuits.

Publisher's Price, \$8.50
Club Price, \$7.25



Information Transmission, Modulation, and Noise by M. Schwartz. A unified approach to communication systems.

Publisher's Price, \$12.50
Club Price, \$10.65



Mathematics for Electronics with Applications by H. M. Nodelman and F. W. Smith, Jr. Methods for solving practical problems.

Publisher's Price, \$7.00
Club Price, \$5.95



Digital Computer and Control Engineering by R. S. Ledley. Full coverage from basic electronic design to advanced programming techniques.

Publisher's Price, \$14.50
Club Price, \$12.35



Modern Transistor Circuits by J. Carroll. Presents almost 200 modern transistor circuits in 101 separate articles.

Publisher's Price, \$10.00
Club Price, \$8.50



Magnetic Recording Techniques by W. E. Stewart. Full description of magnetic recording methods and devices.

Publisher's Price, \$9.00
Club Price, \$7.65



Wave Generation and Shaping by L. Strauss. Essential features and techniques of practical wave-generating and shaping circuits.

Publisher's Price, \$12.50
Club Price, \$10.65

Your engineering career owes a great deal to books. Why not take advantage of this convenient, economical way to have the best professional books available when you need them? THE ELECTRONICS AND CONTROL ENGINEERS' BOOK CLUB brings you the essential technical literature in your field. It also helps you overcome today's high cost of building a professional library by saving you an average of 15% from publisher's prices.

How the Club Operates. You regularly receive free of charge *The Electronics and Control Engineers' Book Bulletin*. This gives complete advance notice of the next selection-of-the-month, as well as many alternate selections. If you want the main selection you do nothing; the book will be mailed to you. If you want an alternate selection—or no book at all—you can notify the Club by returning the convenient card enclosed with each *Bulletin*.

Saves You Time and Money. You agree only to the purchase of three books in a year. Certainly out of the large number of books in your field offered in any twelve months there are at least three you would buy anyway. By joining the Club you save both money and the trouble of searching.

Send No Money Now. Just check the book you want as your first selection on the coupon below. With it you will be sent *Transistor Circuit Design* for only one dollar. Take advantage of this offer and receive two books for less than the regular price of one. (If coupon is detached, write to The Electronics and Control Engineers' Book Club, Dept. L-11-1, 330 W. 42nd St., New York, N. Y. 10036.



ACCEPT THIS
BIG, NEW
\$15.00 BOOK

FOR ONLY \$1.00

with membership in
The Electronics and
Control Engineers'
Book Club

TRANSISTOR CIRCUIT DESIGN

Prepared by the Engineering Staff
of Texas Instruments Incorporated

Here's a practical reference that can ease your transistor circuit design work. It brings you a wealth of data and facts prepared by the engineering staff of Texas Instruments, Inc. Reflecting the combined knowledge and experience of 32 expert circuit design engineers, this book makes conveniently available the actual design procedures and circuits most often requested from Texas Instruments.

Transistor Circuit Design is typical of the selections of THE ELECTRONICS AND CONTROL ENGINEERS' BOOK CLUB. All books are chosen by qualified editors and consultants. Their thoroughgoing understanding of the standards and values of the literature in your field guarantees the authoritativeness of the selections.

(NOTE: If you already own this volume, you may substitute any other book on this page as your DOLLAR book. Check two books below and you will receive the higher priced selection for only \$1.00.)

CLIP AND MAIL THIS COUPON TODAY

The Electronics and Control Engineers' Book Club, Dept. L-11-1
330 West 42nd Street, New York, N. Y. 10036

Please enroll me as a member of The Electronics and Control Engineers' Book Club. You will bill me for my first selection indicated at right at the special club price and \$1 for *Transistor Circuit Design* (or alternate choice), plus few cents delivery costs. (The Club assumes this charge on prepaid orders.) Forthcoming selections will be described in advance and I may decline any book. I need take only 3 selections or alternates in 12 months of membership. (This offer good in U. S. only.)

PLEASE PRINT

Name

Address

City..... State..... Zip Code.....

Company

NO RISK GUARANTEE: If not completely satisfied, you may return your first shipment within 10 days and your membership will be canceled.

Send as my first selection: (If more than one book is checked we will send the higher priced selection as your \$1.00 book.)

- Electronic Switching, Timing, and Pulse Circuits, \$7.25
- Information Transmission, Modulation, and Noise, \$10.65
- Mathematics for Electronics with Applications, \$5.95
- Digital Computer and Control Engineering, \$12.35
- Modern Transistor Circuits, \$8.50
- Magnetic Recording Techniques, \$7.65
- Wave Generation and Shaping, \$10.65

L-11-1

Camera Aids Transient Studies

Diagnostic instrument
has 5 nsec to 200 nsec
exposure time

IMAGE CONVERTER camera model 1D is designed to aid studies of high-speed luminous transient events in plasma physics, lasers, exploding wires and hyperballistics. It provides both streaking and framing operation through the use of interchangeable plug-in units. Three frames per event are obtained at exposure times adjustable from 5 nsec to 200 nsec, with independently adjustable framing intervals between 5,000 and 20×10^6 exposures per second. Streak writing rates range from 1,000 mm/ μ sec to 0.25 mm/ μ sec. Both framing and streak operation can be altered through optics.

According to the manufacturer, the camera has a 50-times light gain that makes possible the study of low-luminosity events at nanosecond exposure times. This corresponds to an energy transfer efficiency at least 300 times better than a rotating-mirror camera and 1,000 times better than a Kerr-cell unit.

Unit can be either optically or

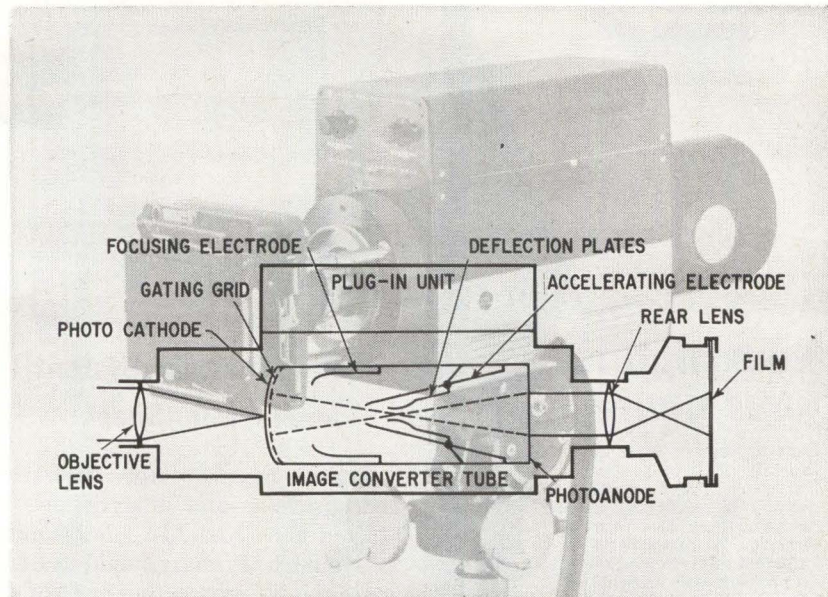

electrically triggered and can record images on either Polaroid or standard cut film. The double-coated rear lens has maximum transmission matched to the 4,500 angstrom spectral response of the phosphor, and provides uniform illumination anywhere on the image size.

Device's unusual performance is made possible by converting the luminous image to an electron

image. Shuttering, focusing, image deflection and light amplification are then performed by electronic and pulse techniques applied to electrodes inside the image converter tube. Interchangeable tubes permit responses from ultraviolet to infrared. STL Products, Div. of Space Technology Laboratories, Inc., 139 Illinois St., El Segundo, Calif.

CIRCLE 301, READER SERVICE CARD

Receiver Corrects Internal Phase Shift

CONTINUOUS and permanent record of correlation between plant or laboratory frequency standards and National Bureau of Standards referenced very-low-frequency transmissions is obtained with model

3004 A vlf receiver and phase comparator. Unit is optionally fixed tuned to 16, 18, 20 or 60 kc frequency standard transmissions, and provides no-knob, unattended operation.

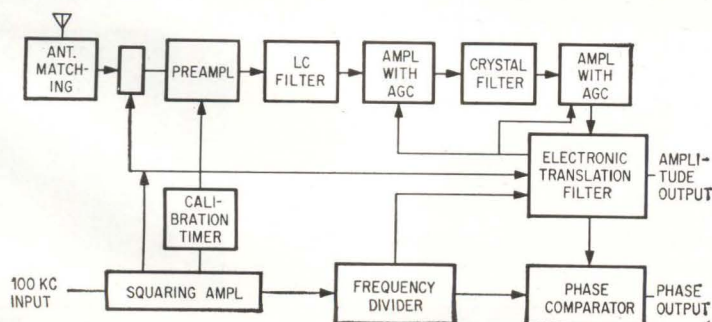

According to company engineers, the receiver allows improved dependability and lower maintenance costs by using a solid-state electronic translation filter, rather than a mechanical servo for phase tracking. Moreover, a unique phase-shift calibration system effectively cancels out internal phase shift. The phase comparator provides an output voltage bearing a linear relationship to the phase difference between a signal derived from the monitored frequency standard and that from the NBS referenced vlf standard.

Model 3004 B will simultaneously receive any two vlf transmissions from a single antenna with two-fre-

How high is your goal?

Ours are out of sight in the labyrinth of space. But your opportunities are a tangible reality, here and now at North American's Space and Information Systems Division. Trained, creative engineering minds, attuned to the research, development and production of manned spacecraft, large booster systems, inflatable winged recovery systems and missile weapon systems will find fertile fields to grow in at S&ID.

ADVANCED INTELLIGENCE SYSTEMS

This group is engaged in developing advanced intelligence systems concepts, in evolving techniques applicable to advanced design, and performing analytical studies to ascertain preliminary configuration of these systems.

Several creative research and engineering positions, as well as high level supervisory positions, are available in the following areas:

DATA COLLECTION SYSTEMS

Sensor and multi-sensor systems, both conventional (photo, infrared, radar, electronic devices, T.V. etc.) and nonconventional (seismic devices).

SYSTEMS SYNTHESIS

Evolving complete systems concepts, from data collection to data transfer and display. Emphasis on data collection for aerospace and ground operations (mobile and fixed).

If you have experience in systems synthesis, reconnaissance intelligence, sensor systems, or indicator analysis and have a technical degree (preferably advanced) please contact:

Mr. P. L. MALLOT
DEPARTMENT 020
ENGINEERING AND
SCIENTIFIC EMPLOYMENT
12214 LAKEWOOD BLVD.
DOWNEY, CALIFORNIA

All qualified applicants will receive consideration for employment without regard to race, creed, color, or national origin.

**SPACE AND INFORMATION
SYSTEMS DIVISION**
NORTH AMERICAN AVIATION



quency tailored response. Price: model 3004 A, \$2,500; model 3004 B, \$4,000. Develco, Inc., 440 Pepper St., Palo Alto, Calif.
CIRCLE 302, READER SERVICE CARD

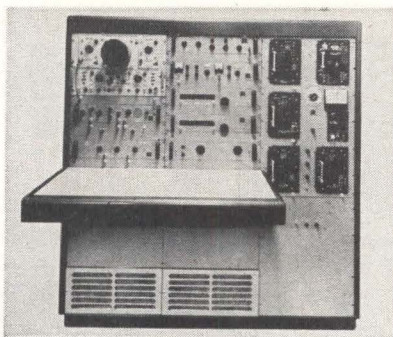

RFI Analysis System Meets MIL Specs

SYSTEM CONSOLE for specialized measurement and analysis of conducted and radiated r-f interference is available. Primary function of the system is to provide a means of displaying and measuring repetitive r-f interference in the presence of non-coincident, synchronous and/or random rfi signals. The detected signals may be displayed on a dual-beam oscilloscope with a long-persistence crt. One beam is intensity modulated to display the raster presentation, the second beam displays a monitor signal from the suspected source. The interfering source is then identified when a correlation is noted between these displays. Among system equipments are r-f preamps covering from 0.150 to 1,000 Mc, and a wideband amplifier which spans 1.5 kc to 1.6 Mc. Electro International, Inc., Box 391, Annapolis, Md. (303)

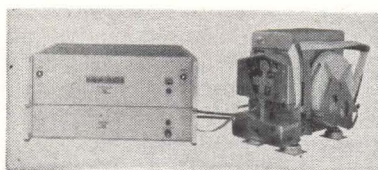

Tape Punch Set Features Data Storage

HIGH-SPEED perforated tape punch set, designed to accept output information from a digital voltmeter or electronic counter and convert it to a permanent, computer-compat-

HOW TO USE YOUR ELECTRONICS BUYERS' GUIDE

Advertising Product Sections

Advertisements in the ELECTRONICS BUYERS' GUIDE are grouped together according to the kind of product advertised. All Power Supply advertisements, for example, will be found in the same section of the book. Thus it is made convenient for you to "shop" through the specifications presented to you by advertisers, without having to flip pages back and forth constantly. Keep your ELECTRONICS BUYERS' GUIDE close to your work area at all times.

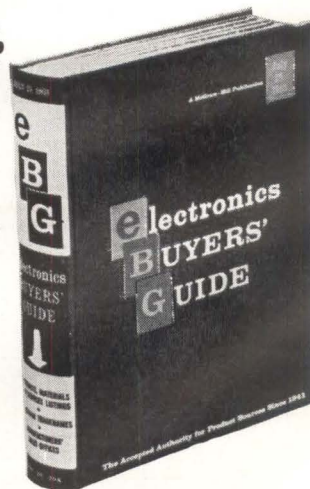

ible record is available. The DY-2545 automatically punches at a 110 character per sec rate, normally in IBM 8-level code. Data storage during punching permits fast data sampling when used in data acquisition systems with scanners. Simultaneous printer readout is optionally available. Ease of operation and maintenance are highlighted in the tape punch set. The DY-2545, including BRPE11 punch, is priced at \$3,900. Dymec, a division of Hewlett-Packard Co., 395 Page Mill Road, Palo Alto, Calif. (304)

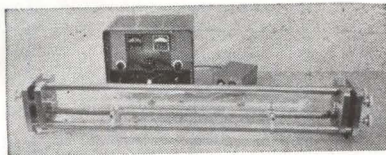

C-W Gas Laser Has Variable Light Beam

NOW AVAILABLE is model 720 c-w gas laser, which provides a coherent source of c-w power at 0.6328 micron. The light beam is emitted from both ends of a 30-in. quartz discharge tube, and is continuously variable up to 3.5 mw. Simple substitution of the Brewster angle quartz confocal mirrors make it possible to operate the unit at 1.5 micron and 3.39 microns. Audio modulation of the beam is provided through the power unit for communication experiments. A simple microphone input can be used to amplitude modulate the laser beam; which, when detected by an optical detector, such as the model 361, can be used to transmit speech or music. Maser Optics, Inc., 89 Brighton Ave., Boston 34, Mass. (305)

D-C Amplifier Offers High Gain Linearity

MODEL AMS-47 d-c amplifier uses a 10-kc drive frequency in the chopper circuit to produce a fast signal output rise time and a 3,000-cps bandwidth. Complete isolation between input and output is provided. Sufficient feedback is used in the carrier amplifier to insure a high degree of gain linearity. Airpax Electronics Inc., Fort Lauderdale, Fla. (306)

NEW

VERSATILITY IN LIGHT MEASUREMENT

lite-mike

measures:

MEASUREMENT	MONOCHROMATIC SPECTRUM		CHROMATIC SPECTRUM
	LASER	GALLIUM ARSENIDE	
WAVESHAPE Rise Time Fall Time Duration Amplitude	Yes	Yes	Yes
Average Power (watts)	Yes	Yes	*
Energy (joules)	Yes	Yes	*

*Can be calculated within spectral response capabilities.

		RESPONSE RANGE									
		1.13 μ					0.35 μ				
ANGSTROMS	NEAR IR	9,000	8,000	7,000	6,000	VISIBLE	5,000	4,000	3,000	NEAR UV	3,000
	10 μ	0.9	0.8	0.7	0.6	0.5	0.4	0.3			
MICRONS											

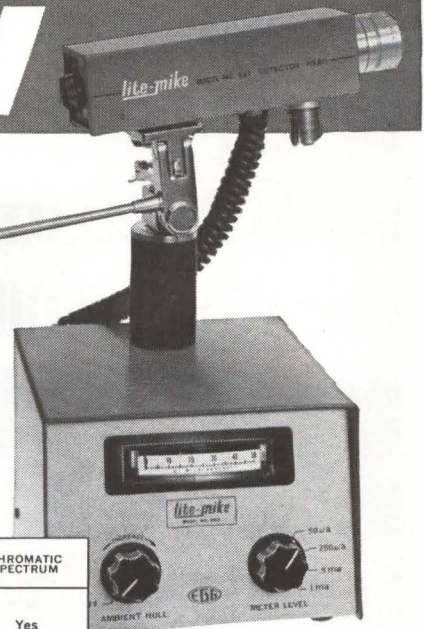

Compact (10" high) and lightweight, the EG&G LITE-MIKE has built-in controls for sensitivity and balancing of ambient light. Head is swivel-mounted for ease of alignment with source.

NEW

SD-100 SILICON

PHOTODIODE offers this

unique combination of advantages

- (1) **FAST RESPONSE** / Rise time: 4×10^{-9} sec. @ 90v
Fall time: 15×10^{-9} sec. @ 90v
- (2) **WIDE SPECTRUM** 0.35 to 1.13 microns (10% points)
- (3) **HIGH SENSITIVITY** 0.25 microamps per microwatt
- (4) **LOW NOISE** 1×10^{-12} watts \cdot (cps) $^{-1/2}$
- (5) **WIDE DYNAMIC RANGE** 0.1 amp to approx. 10^{-8} amp

Applications: receiving equipment for lasers and injection laser systems; measurements on modulator and pulsed light sources; measurements of light intensity and wave forms, detection of color changes.

For full information on LITE-MIKES and SD-100 photodiodes, contact: Marketing Dept., EG&G, 176 Brookline Ave., Boston 15, Mass.



EDGERTON, GERMESHAUSEN & GRIER, INC.

1007

BOSTON • LAS VEGAS • SANTA BARBARA

ARNOLD: WIDEST SELECTION OF MO-PERMALLOY POWDER CORES FOR YOUR REQUIREMENTS

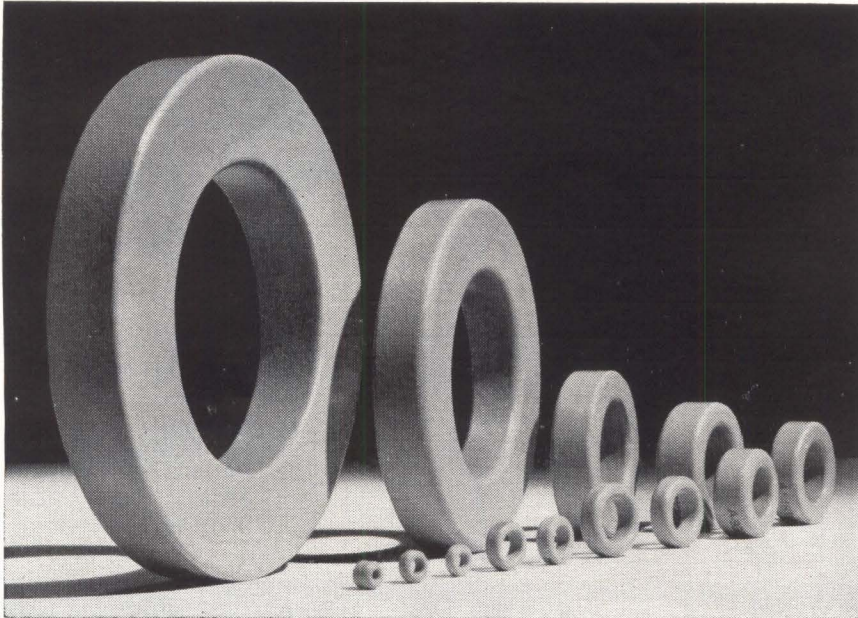

For greater design flexibility, Arnold leads the way in offering you a full range of Molybdenum Permalloy powder cores . . . 25 different sizes, from the smallest to the largest on the market, from 0.260" to 5.218" OD. Standard permeabilities are 14, 26, 60 and 125 Mu, and the high permeability range includes cores of 147, 173 and 205 Mu.

In addition to pioneering the development of the cheerio-size cores, Arnold is the exclusive producer of the largest 125 Mu core commercially available. A huge 2000-ton press is required for its manufacture, and insures its uniform physical and magnetic properties. This big core is also available in 14, 26 and 60 Mu.

High-permeability cores up to 205 Mu are now available in most sizes. These cores are specifically designed for low-frequency applications where

the use of 125 Mu cores does not result in sufficient Q or inductance per turn. They are primarily intended for applications at frequencies below 2000 cps.

Most sizes of Arnold M-PP cores can be furnished with a controlled temperature coefficient of inductance in the range of 30 to 130° F. Many can be supplied temperature stabilized over the MIL-T-27 wide-range specification of -55 to +85°C . . . another special Arnold feature.

Graded cores are available upon special request. All popular sizes of Arnold M-PP cores are produced to a standard inductance tolerance of + or -8%, and many of these sizes are available for immediate delivery from strategically located warehouses.

Let us supply *your* requirements for Mo-Permalloy powder cores (*Bulletin PC-104C*) and other Arnold products.

ADDRESS DEPT. E-11



ARNOLD

SPECIALISTS in MAGNETIC MATERIALS

THE ARNOLD ENGINEERING COMPANY, Main Office: MARENGO, ILL.
BRANCH OFFICES and REPRESENTATIVES in PRINCIPAL CITIES

1167R1D

—LITERATURE OF

MAGNETIC CORE TESTER Computer Test Corp., Route 384 Longwood Ave., Cherry Hill, N. J. Technical bulletin describes a bench-top magnetic core tester with 8-step current pulse programming.

CIRCLE 360, READER SERVICE CARD

BALUNS Spectran Electronics Corp., 146 Main St., Maynard, Mass., offers a technical bulletin and catalog sheets on baluns for low frequency instrumentation. (361)

PERFORATED TAPE READER Cook Electric Co., Data-stor Division, 8100 Monticello Ave., Skokie, Ill. Brochure DSD-SR-20 contains specifications and operating characteristics of model 54 perforated tape reader. (362)

GLOW LAMP APPLICATION Signalite, Inc., Neptune, N. J., is offering a periodic 12-page application newsletter devoted to better circuit design through the use of neon glow lamps. (363)

TUBE SHIELDS Cinch Mfg. Co., 1026 South Homan Ave., Chicago, Ill. 60624. Catalog CM-37 is devoted to a line of military type heat dissipating tube shields. (364)

PANEL TESTER Reliance Electric and Engineering Co., 24701 Euclid Ave., Cleveland 17, O., has released bulletin H-9003 explaining the operation of a portable tester for solid state electronic panels. (365)

ANTENNAS General Electric Co., 100 Plastics Ave., Pittsfield, Mass. A 20-page illustrated brochure (GED-4923) describes GE's antenna design, development and manufacturing capabilities and facilities. (366)

CABLES Rome Cable Division of Alcoa, 669 Alcoa Building, Pittsburgh 19, Pa. Military and electronic design engineers will benefit from a new manual, "Instrumentation Cables, Cable Assemblies and Hook-up Wires". (367)

ENCODER/READOUT SYSTEMS Vernistat Division, Perkin-Elmer Corp., Main Ave., Norwalk, Conn. Brochure 5E4 covers a complete line of one brush digital encoder and readout equipment used for monitoring and control. (368)

MOISTURE SENSOR Atlantic Instruments & Electronics, Inc., 103 N. Beacon St., Boston 34, Mass. Bulletin 700 explains the operation and applications of the Hygristor electronic moisture sensor. (369)

TRANSISTOR POWER MODULES Deltron Inc., Fourth and Cambria Sts., Philadelphia 33, Pa. Bulletin describes the PI series of highly regulated, modular plug-in transistor power supplies. (370)

THE WEEK

SOLID-STATE COUNTERS Anadex Instruments Inc., 7617 Hayvenhurst Ave., Van Nuys, Calif., announces availability of a six-page solid-state counter catalog. (371)

MICROWAVE CATALOG PRD Electronics, Inc., 202 Tillary St., Brooklyn 1, N.Y. Short form catalog features a complete line of microwave and electronic test equipment. Request on company letterhead.

TAPE TRANSPORT S-I Electronics, Inc., 103 Park Ave., Nutley 10, N.J. Model DX-01 rapid start-stop tape transport, for reading pre-recorded tapes in airborne and all vehicular applications, is described in a specification sheet. (373)

INTEGRATED CIRCUITS Signetics Corp., 680 West Maude Ave., Sunnyvale, Calif., has published an 8-page condensed catalog devoted to integrated circuits. (374)

MICROWAVE COMPONENTS Radar Design Corp., Pickard Drive, Syracuse 11, N.Y. New catalog describes microwave test components available for off-the-shelf delivery. (375)

SOLDER JOINTS Alpha Metals, Inc., 56 Water St., Jersey City 4, N.J. An illustrated technical bulletin on inspection and quality control of solder joints is available. (376)

DATA/LOG Litton Industries, Electron Tube Division, San Carlos, Calif., has available new and revised color-coded data sheets for insertion in the Litton Data/Log file. (377)

SILICON RECTIFIERS Allis-Chalmers, Milwaukee, Wisc. 53201. Design and construction features of single-package general-purpose silicon rectifiers are described in bulletin 12C1635. (378)

RECORDING SYSTEM ACCESSORIES Brush Instruments, division of Clevite Corp., 37th and Perkins, Cleveland, O., 44114. Catalog sheet 1750 describes the line of accessories and supplies for a series of recording systems. (379)

POWER SUPPLIES SBD Systems, Inc., 90 Rome St., Farmingdale, N.Y. Brochure describes design and manufacturing capabilities for custom MIL spec power supplies. (380)

INTERFERENCE FILTERS RF Interonics, Inc., 15 Neil Court, Oceanside, N.Y., has released bulletin 3609 on the RF1100 series of high insertion loss, reduced size, cylindrical interference filters. (381)

RMS VOLTMETER/AMPLIFIER: B&K Instruments, Inc., 3044 West 106th St., Cleveland 11, O., announces an 8-page specification sheet on the models 2603 and 2604 rms voltmeter/amplifiers. (382)

SUBMINIATURE CONNECTOR Sealectro Corp., 139 Hoyt St., Mamaroneck, N.Y. A subminiature connector with a low-pass filter installed in one end of the connector body is described in data sheet CX-1. (383)



THE EXTRA MEASURE OF JULIE IS PRECISION

Create a new philosophy of DC measurement. Make it accurate, stable, reliable, simple . . . and guarantee it. Develop a system that does this . . . and call it RATIOOMETRY. Then build the component hardware necessary to make it work with one part per million accuracy. That's the extra measure of Julie . . . precision. The Julie RATIOMETRIC™ System of Calibration promises 1 ppm accuracy and delivers it. Perhaps it's old-fashioned thinking, but equipment should perform to specifications without excuses, double-talk or cumulative error. Check Julie specs . . . examine them carefully. Just write or call collect for details of the system and how to institute your own DC primary standards laboratory.

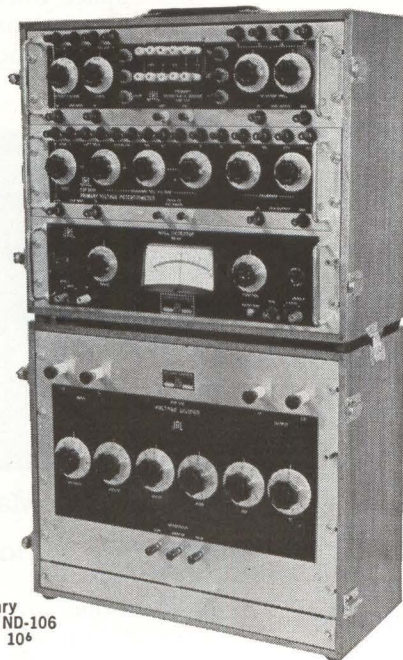

Julie portable
DC primary standards
laboratory: PRB-205
Primary Resistance
Bridge, PVP-1000 Primary
Voltage Potentiometer, ND-106
Null Detector, VDR-106 10⁶
Voltage Divider.

JULIE RESEARCH

LABORATORIES, INCORPORATED

211 West 61st Street, New York, N.Y. 10023, 212-CI-5-2727



© Julie Research Laboratories, Inc., 1963

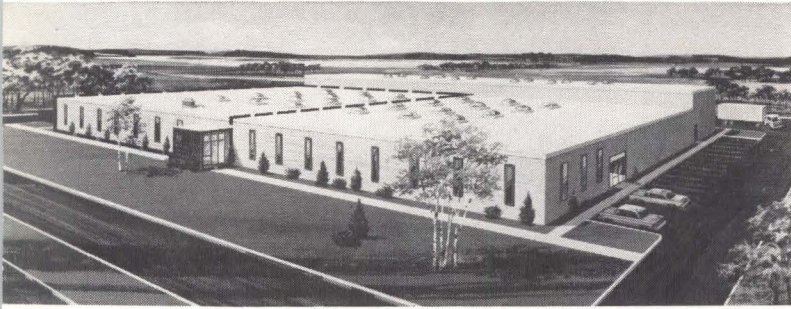

NCC Expanding Plant

NATIONAL CONNECTOR Corporation will almost triple its manufacturing facilities by January 1, 1964, announced Leonard E. Lindquist, president.

First step in this expansion plan is an addition to the present plant (shown by dotted line at left in sketch), to increase floor space from 20,000 to 55,000 square feet. Part of the addition is now being occupied and the entire new plant will be in full production by January 1.

Garner Moves Up at Stromberg-Carlson

JOHN E. GARNER has been appointed director of government marketing for Stromberg-Carlson, Rochester, N.Y., a division of General Dynamics. In his new post he will report directly to John H. Voss, president.

Associated with Stromberg-Carlson since 1953, Garner most recently has been director of special military projects and in charge of this division's program to engineer, manufacture and install communication systems for all Titan missile bases. He also has been director of military marketing for the western area of the U.S. for the past year.

GE Huntsville Promotes Albert

JOSEPH ALBERT has been named manager of technologies for the Huntsville Operation of the General Electric Computer Department.

The GE Huntsville operation provides programming, operational and

technical support to the Computation Division of NASA's Marshall Space Flight Center. Albert served as its manager of scientific computation prior to his new appointment.



Mallory Battery Honors Ruben

TARRYTOWN, N.Y.—Mallory Battery Company's new headquarters and engineering laboratories have been formally opened here and dedicated to Samuel Ruben. Ruben is the inventor of the mercury battery and other energy systems, the dry electrolytic capacitor, and hundreds of semiconductor devices.

G. Barron Mallory, president of

Dwight H. Chambers, operations vice president, stated that the total plant with additional machinery installed will be a \$1.25-million facility. Increased manufacturing capability will allow a much higher percentage of "in house" processing than previously. National Connector will have the latest automatic processing and inspection equipment available, says Chambers. A new environmental testing laboratory will also be installed.

National Connector is situated on 9½ acres of the Science Industry Center in suburban Minneapolis which will allow expansion to 120,000 square feet at this site. The company now employs 250 people.

When National Connector entered the connector manufacturing field three and a half years ago it ranked 187th in a list of 187 competitive firms. Today, according to sales vice president F. Lewis Cahill, it ranks in the top 10 for printed-circuit connector sales.

In the first five months of 1963, National shipped connectors to 50 different companies. While most of this business is from computer manufacturers, the nation's aerospace programs are closely involved. National's connectors are used in the Gemini, Polaris, Minuteman, Apollo, and Nike-Zeus projects and in many other space applications.

P. R. Mallory & Co. Inc. said, "Over the years we have spent many millions of dollars in support of Ruben-inspired devices. Ruben has helped us pioneer new avenues of technical achievement. And I hope that we, in turn, have helped him bring his visionary genius into focus with today's technological needs."

At the dedication, Philip R. Mallory, founder of the corporation, also announced the establishment by the P. R. Mallory Foundation of the Samuel Ruben Fellowship, a \$1,000 annual grant at Columbia University for graduate study in chemical engineering over the next ten years. P. R. Mallory & Co. Inc. is an Indianapolis-based concern.

McGarry Rejoins ITT System

APPOINTMENT of James H. McGarry as vice president, manufacturing, for ITT Federal Laboratories, Nutley, N.J., is announced.

McGarry joins the ITT System from the Daven division of General Mills where he held the post of

To Order Reprints

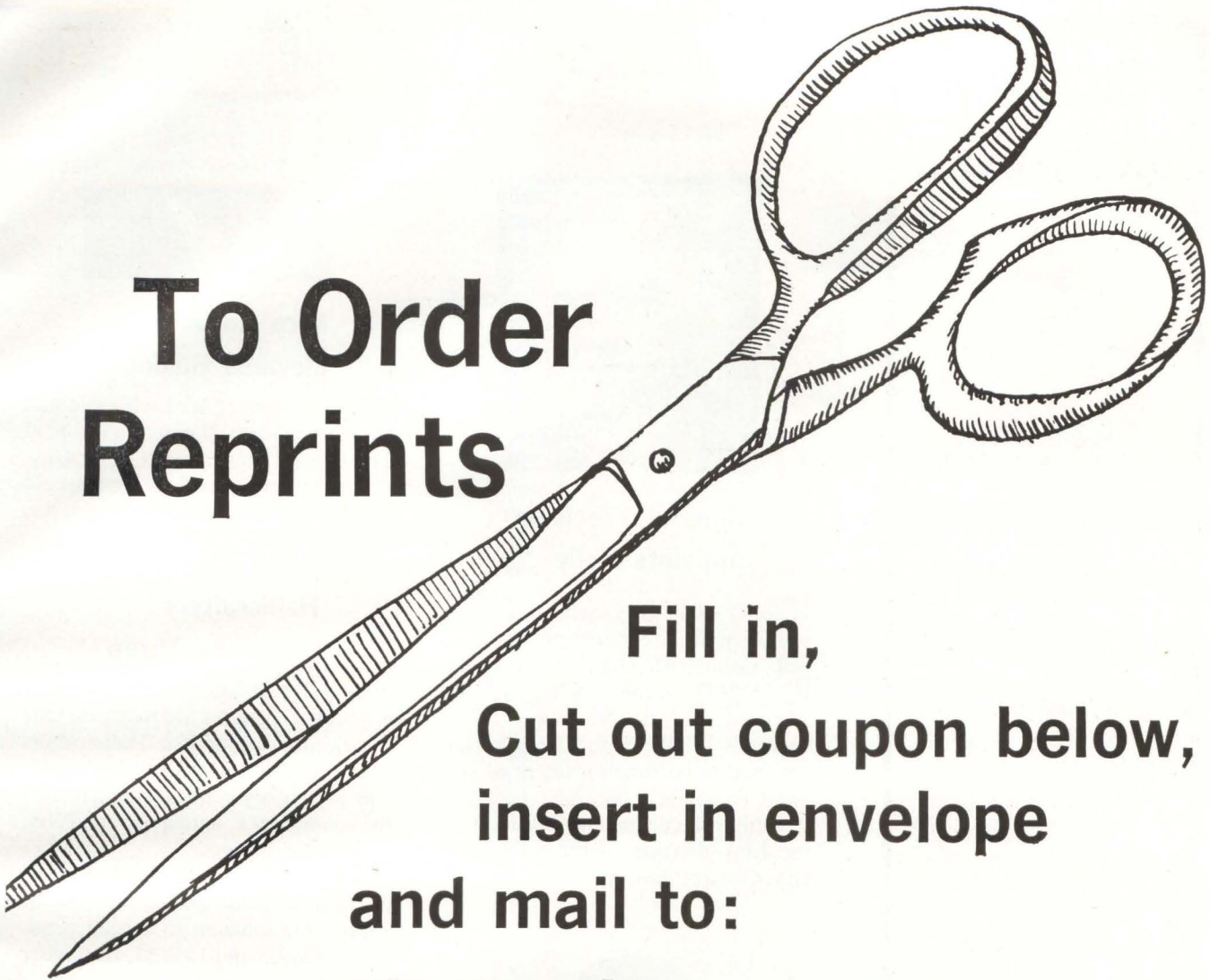

Fill in,
Cut out coupon below,
insert in envelope
and mail to:

electronics Reprint Dept.
330 West 42nd Street,
New York, N. Y.—10036

REPRINT ORDER FORM

For Listing of Reprints Available See Reader Service Card

(To help expedite mailing of your reprints please send cash, check or money order with your order.)

For Reprints of the latest Special Report:

Materials for space age electronics.

Send me Reprints of Key No. R-42 at 50¢ each.

For Reprints of previous **Special Reports** or **Feature Articles** fill in below:

Send me Reprints of Key No.(s) @ ¢ each. (For prices, see chart above.)

*For orders of Bulk Reprints of other editorial articles in **this issue** or **past issues**:

Send me Reprints of page (no.(s)) of issue
of article entitled

*Minimum bulk order 100 copies. You will be advised of costs by return mail.

Name

Number and Street

City, Zone No., State

ELECTRICAL ENGINEERS

Melpar's Engineering Division has immediate need for engineers in the areas noted below. These openings include positions of major responsibility for Senior Engineers as well as unusual opportunities for advancement for recent graduates.

MICROWAVE RECEIVER DESIGN

Specific problems include parametric amplifiers, varactor techniques, microwave filters, ultrastable programmable oscillators and dual and triple channel balanced receivers for monopulse and guard antenna gating.

SYSTEMS DESIGN

For the logic design of digital equipment, specifying necessary digital/analog interface equipment, the analysis of real-time flight simulation systems and the design of analog computer systems for flight simulators.

ANTENNA DESIGN

Working with modern techniques of achieving narrow beam, low side-lobe, d/f antennas in the microwave region. Must have a strong theoretical background.

PROGRAMMING

To write and debug programs for fixed-point real-time computers to be used with special purpose digital and analog equipment for the real time simulation of aircraft.

For further details, write in strictest confidence to:
John A. Haverfield

Manager, Professional Placement

MELPAR INC.

(A Subsidiary of Westinghouse Air Brake Company)

3428 Arlington Boulevard
Falls Church, Virginia
(a suburb of Washington, D. C.)
an equal opportunity employer

general manager. Prior to joining General Mills in 1960, he held executive positions with ITT companies since 1953 both at Clifton, N.J., and Fort Wayne, Ind.



General Precision Appoints Kelly

APPOINTMENT of Lloyd L. Kelly as president of the Simulation and Control Group of General Precision, Inc., Binghamton, N.Y., is announced. As of November 1 he succeeds W. W. Wood, Jr. who has resigned to become president of Applied Dynamics, Inc.

Kelly will continue as president of the Link division of the Simulation and Control Group.



Bassett Assigned to New Avco Post

APPOINTMENT of Ormon E. (Sam) Bassett to the position of general manager of engineering for Avco Corporation's Electronics division was announced at the division's headquarters in Cincinnati, Ohio. He replaces H. L. Flowers, who has resigned.

Bassett was formerly director of Information and Control Systems at Avco's Research and Advanced Development division in Wilmington, Mass.



Mica Corporation Elevates Goldman

APPOINTMENT of Richard Goldman as vice president of manufacturing at The Mica Corporation, Culver City, Calif., is announced. He moves up from the post of operations manager.

Hallicrafters Promotes Three

WILLIAM F. TEICHMILLER has been appointed general manager of the Pacific division of The Hallicrafters Co., Chicago electronics firm. He was previously contracts manager of the company's aerospace division, based in Chicago.

Robert F. Halligan, president, also announced the promotions of Emory G. Johnson to special products manager and Jack M. Hollander to data systems manager as part of a divisional reorganization program under way at the Santa Ana, Calif., facility for the past two months.

Houston Fearless Names Ryan

F. C. MEHNER, president of Houston Fearless Corp., has announced the appointment of Frank A. Ryan as director of operations at the corporation's West Los Angeles plant. Ryan will be responsible for the manufacturing processes and methods in the production of a line of film processing equipment as well as major lines of related photographic information storage, retrieval and evaluation equipment.

Before taking this post, Ryan was with the Atlas Corp. as vice president of its Western Sky Industries subsidiary and director of marketing of its Titeflex Santa Monica division.

Informatics Hires

Two Directors

WALTER F. BAUER, president of Informatics Inc., Culver City, Calif., has announced the appointment of Lynn W. Jones II as director of operations and Roy V. Bigelow as director of the company's Houston operations.

Jones was formerly with Thompson Ramo-Wooldridge and Space Technology Labs, Inc.

Bigelow had previously been with Aerospace Corp. and IBM.

PEOPLE IN BRIEF

Peter Bercoe, former president of Alpha Wire Corp., named board chairman of Precision Circuits, Inc.

Arthur A. F. Aschauer leaves Royal McBee Corp. to join Univac as exec asst. to the senior v-p, marketing.

Paul Schiffres, previously with Bogart Mfg. Corp., appointed a senior microwave staff engineer of Paradyamics, Inc. **Nick Milakovich** promoted to director of mfg. at Lockheed Missiles & Space Co.

W. Benton Harrison, from Ryder Industries, Inc. to Harris-Intertype Corp. as v-p, corporate development. Torwico Electronics, Inc., ups

Robert M. Savino to chief electrical engineer. **Gregory L. Laserson** advances to director of research at AMF's R&D div. **Michael F. Maguire** and **Thomas P. Fahy** raised

to asst. directors of engineering for the Electro-Optical div., Perkin-Elmer Corp. **Arthur F. Pelster**, ex-Aladdin Electronics, and **Richard F. Gregori**, formerly with Cornell-Dubilier, named g-m and mgr. of engineering, respectively, of International Electronic Industries div. of Standard Pressed Steel Co.

William J. L. Boreas, previously with Underwriters' Laboratories Inc., now lab mgr. for The Thomas & Betts Co. **William K. Kindle** advances to new product program mgr. for Electronic Associates, Inc.

Robert A. Lapetina transfers from Edo (Canada) Ltd. to take post of president of Electro-Ceramics, Inc., another subsidiary of Edo Corp. **Joseph W. Halina** elevated to deputy to the v-p of engineering for ITT Communication Systems, Inc.

Gold Immersion Solution

by

Sigmund Cohn

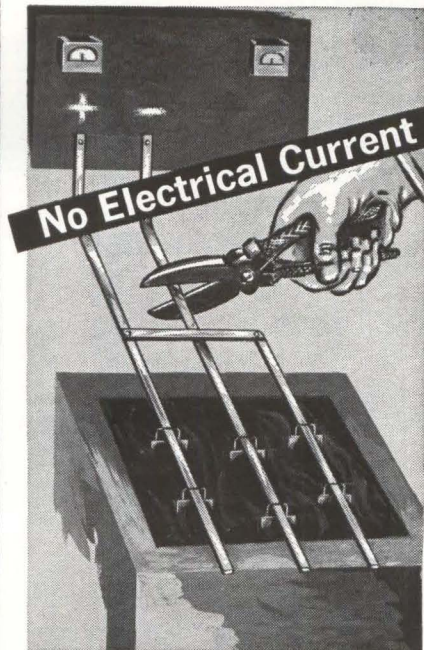

- Greater Throwing Power
- Uniformity of Deposit
- Consult us about best methods of application



Since 1901

SIGMUND COHN CORP.

121 So. Columbus Avenue
Mt. Vernon, New York

CIRCLE 57 ON READER SERVICE CARD

THE

electronics Buyers' Guide sectionalizes its advertising pages by basic product categories as a "quick locator" aid to 63,000 users. Helpful? 96%* of them say so. **Better budget space for the next electronics Buyers' Guide** / a McGraw-Hill publication.

*Survey of August, 1963



EMPLOYMENT OPPORTUNITIES

The Advertisements in this section include all employment opportunities—executive, management, technical, selling, office, skilled, manual, etc. Look in the forward section of the magazine for additional Employment Opportunities advertising.

Positions Vacant
Positions Wanted
Part Time Work

Civil Service Opportunities
Selling Opportunities Wanted
Selling Opportunities Offered

Employment Agencies
Employment Services
Labor Bureaus

DISPLAYED

The advertising rate is \$40.17 per inch for all advertising appearing in other than a contract basis. Contract rates quoted on request.

An advertising inch is measured 3/8" vertically on a column—3 columns—30 inches to a page.

Subject to Agency Commission.

Send NEW ADS to CLASSIFIED ADV. DIV. of ELECTRONICS, P.O. Box 12, N. Y., N. Y. 10036

RATES

\$2.70 per line, minimum 3 lines. To figure advance payment count 5 average words as a line.

Box Numbers—counts as 1 line.

Discount of 10% if full payment is made in advance for 4 consecutive insertions.

Not subject to Agency Commission.

UNDISPLAYED

ELECTRONIC CIRCUIT DESIGNERS ELECTRONIC ENGINEERS Bausch & Lomb

has openings for EXPERIENCED ENGINEERS IN R & D AND PRODUCT DESIGN SECTIONS.

Products are Scientific Instruments (Bio-Medical, Analytical, measuring, recording instruments, etc.) Mechanical-Electrical Optical in nature. Ability to take electronic design responsibility from concept to saleable product, Engineering Degree (BS or MSEE) required, experience desirable.

Positions entail circuit design and testing, co-ordination of customer requirements with Mechanical and Optical Engineers, supervision of detail draftsmen and technicians, assistance to Production Engineers on factory problems and follow up on special customer designs.

Those who can qualify and are interested in real design responsibility are invited to send resume with salary requirements to E. P. Faro, Professional Employment, Bausch and Lomb, Inc., 17 Bausch Street, Rochester, New York.

AN EQUAL OPPORTUNITY EMPLOYER



E. E.'s for FEE-PAID Positions WRITE US FIRST!

Use our confidential application for professional, individualized service . . . a complete national technical employment agency.

ATOMIC PERSONNEL, INC.
Suite 1207L, 1518 Walnut St., Phila. 2, Pa.

SEARCHLIGHT SECTION

(Classified Advertising)

BUSINESS OPPORTUNITIES
EQUIPMENT - USED or RESALE

X Band Radar Front End Dual dbl. bal.
Mixer Varian clyst. mt. RCA MA-7 \$125

RADAR AUTO-TRACK & TELEMETRY ANTENNA PEDESTALS
3 & 10 CM. SCR 584 AUTOTRACK RADARS. M-33 RADAR
TPS-10 SEARCH. APS-45 TPS-100 HT. FINDERS. WX RADARS.
FPN-320GA. APS-10 APS-15B APS-27 (AMT) SEARCH. ■ ■ ■
APN-102 DOPPLER. DOZENS MORE. CARCINOTRONS. PFN'S.
.25-.5-1-2-3-6 MEGAWATT PULSE MODULATORS. CAVITIES.
PULSE TRANSFORMERS. IF STRIPS. WAVEGUIDE. BENDS
200 MC. 1 KMC. 3 KMC. 6 KMC. 9 KMC. 24 KMC. RF PKGS.
RADIO RESEARCH INSTRUMENT CO.
550 5TH AVE., NEW YORK 36, N. Y. JU 6-4691

CIRCLE 950 ON READER SERVICE CARD

COMMERCIAL OPPORTUNITIES FOR MANUFACTURING ENGINEER

To establish and implement most economic methods for volume manufacturing of new computer system. Should know economics, associated with various assembly techniques including the application of automatic component handling equipment coupled with experience in minimizing costs connected with electronic assembly work.

ELECTRONIC ENGINEERS

To design the logic, memory, read-write amplifiers, power supply and related automatic test and check-out equipment for a new advanced computer system.

ELECTRONIC PACKAGING ENGINEER

To design component layout, printed circuit art work and mounting hardware. Must have a knowledge of high volume, low cost assembly techniques.

ELECTRONIC TECHNICIAN

Please send resume
(in complete confidence) to:

J. LEWIS, PERSONNEL MANAGER

DATA PROCESSING SYSTEMS DIVISION SCM CORPORATION

6701 San Pablo Ave., Oakland 8, Calif.

An Equal Opportunity Employer

"Put Yourself in the Other
Fellow's Place"

TO EMPLOYERS

TO EMPLOYEES

Letters written offering Employment or applying for same are written with the hope of satisfying a current need. An answer, regardless of whether it is favorable or not, is usually expected.

MR. EMPLOYER, won't you remove the mystery about the status of an employee's application by acknowledging all applicants and not just the promising candidates.

MR. EMPLOYEE you, too, can help by acknowledging applications and job offers. This would encourage more companies to answer position wanted ads in this section. We make this suggestion in a spirit of helpful cooperation between employers and employees.

This section will be the more useful to all as a result of this consideration.

Classified Advertising Division

McGraw-Hill Publishing Co., Inc.

330 West 42nd St., New York, N. Y. 10036

QUALIFIED ENGINEERS

BY THE THOUSANDS

PAY to read **electronics** every week because its high calibre editorial content is designed and edited for engineers . . . That's why your

RECRUITMENT ADVERTISING

in **electronics** can pinpoint a most concentrated source of experienced engineers. **electronics** selective circulation is your inexpensive, efficient, most direct link to these qualified, specialized men!

YOUR AD GETS RESULTS NOT WASTE CIRCULATION.

* If your recruitment program calls for qualified technical personnel, plan to use **electronics** EMPLOYMENT OPPORTUNITIES now!

electronics

A McGRAW-HILL PUBLICATION

CLASSIFIED ADVERTISING DIVISION

POST OFFICE BOX 12 NEW YORK 36, NEW YORK

If you're on this list, there's a place for you at JPL now.

RELIABILITY AND QA

Engineering Specialist—BS plus 10 years experience. Coordinate reliability technical effort with technical divisions. Represent Parts Reliability Staff Office at appropriate Design Reviews including assistance in preparation of Review materials. Perform surveillance and monitoring function on Lab Piece Part Reliability activities. Perform liaison, training and consultation to all parts reliability efforts at JPL.

Staff Engineer—BS in Engineering or Physics mandatory. Basic grounding in engineering design and test at the working and supervisory level. Quality Control engineering and supervisory experience in weapon systems or major electronic assemblies.

SYSTEMS

Senior Research Engineer—MS with 3 years experience. Analytical studies of complex lunar spacecraft missions from point of view of relating the celestial mechanics problems to the expected "value" obtained by alternate actions. Development of analytical techniques to handle such problems.

Research Engineer—MS with at least 2 years in research or engineering problems related to space flight. Define and analyze mathematical models of guidance for lunar spacecraft with particular emphasis on control theory and statistical estimation. Study of the interacting problems of orbit determination and trajectory correction to develop optimal techniques for specific objectives.

Senior Engineer—BS plus 5 years experience required. Will have the system responsibility of integrating the various scientific experiments (e. g. radiometer, plasma detectors, magnetometer, etc.) with the remaining subsystems on the spacecraft. Specific duties include: 1) Accept inputs and schedule necessary test time for his area of responsibility. 2) Write procedures covering the interfaces between his area and the remainder of the spacecraft. 3) Evaluate and write related reports from test data.

Research Engineer—MS plus 2 years experience. To develop mathematical models of complex man-machine system operations leading to computer simulation and empirical evaluation of system performance.

SPACE SCIENCES

Senior Research Specialist—BS with MS desirable. Advanced courses in geometrical and physical optics, with 15 or more years experience. Responsible for detailed technical monitoring and progress on all the optical instrumentation elements related to the specific space program connected with the television spacecraft systems. To review in technical detail, the approach and perform-

ance of the vertical contractors and sub-contractors to assure conformance with specifications and mission success.

Senior Scientist—PhD with emphasis in space-oriented subjects. Three or more years experience. Must have conceived, designed and carried out some original research in experimental physics.

Design Engineer—BS plus 5 years minimum design experience in instrument or small mechanism design or equivalent. Design of physical science experiments and instruments and breadboard models of flight scientific instruments.

TELECOMMUNICATIONS

Senior Research Engineer—MS plus 5 years experience in RF systems and/or circuitry. Development work in RF subsystems. Work concerned with wide band RF frequency multipliers and with frequency synthesizers characterized by low phase jitter and high spectral purity.

Operations Project Engineer—BS plus 8 to 10 years experience. Experience in operation of tracking station and networks, also with the technical systems and subsystems in tracking stations. Involves planning and scheduling of tracking operations. Will act as liaison between the DSIF and other JPL organizations in establishing the equipment and procedures to meet requirements.

Senior Research Engineer—BS with MS desirable. Two to 4 years experience in design and analysis of microwave antennas and microwave components desirable. General familiarity with antenna measurement techniques. Design and analysis of feed systems and wave guide components for large ground antennas.

Research Engineer—MS plus 2 years experience in communication, telemetry or radar system design and analysis. Analyze and solve telecommunication system problems in direct support of design, development and use of spacecraft telecommunications systems.

Senior Development Engineer—BSEE necessary and MSEE preferred. Five to 10 years experience in microwave system development. Radio communications techniques; UHF and microwave systems development of receiving and transmitting ground equipment.

GUIDANCE AND CONTROL

Research Engineer—BSEE or MSEE with background in probability and statistics desirable. Develop advanced, reliable automatic test equipment for use with space vehicle guidance and control systems in laboratory, system and field checkout operations. Includes determination of functional requirements, design of circuits and logic, breadboarding, supervise prototype fabrication and participation as flight/GSE cognizant engineer in testing operations at JPL and Cape Canaveral.

ENGINEERING MECHANICS

Senior Engineers (Structures)—Requiring active participation in the structural design and development of spacecraft; working familiarity with problems ranging from "nuts and bolts" to matrix methods of structural analysis; sufficient interest in academic pursuits to promote state-of-art advancements. Requires MS with 7-10 years experience in project support of aircraft, missile or spacecraft programs.

Structural Dynamics Engineers—Responsible for initiation and performance of model vibration analysis, dynamic loads analysis and testing in support of spacecraft design and development. Must have working familiarity with launch vehicle dynamics, including aeroservoelastic coupling. MS with 7-10 years experience applicable to position requirements.

ENVIRONMENTAL

Senior Research Engineer—BS with some course work in heat transfer. MS desirable with 5-10 years direct experience in testing. Environmental testing experience is preferred but other types of testing are acceptable such as wind tunnel or flight testing.

Senior Research Engineer—BS with MS preferred. Five to 10 years direct experience in hardware testing. Environmental testing experience preferred particularly in the acoustic, vibration and shock areas. Other types of testing such as flight testing, flutter and vibration may be considered.

Senior Design Engineer—BS required, MS preferred. Six to 8 years minimum experience of a broad nature, analysis and project areas. Prefer some experience outside aircraft industry. Perform technical and economic feasibility studies of advanced facilities in vacuum technology, cryogenics, electricity, magnetism, optical and thermal systems, structures, aerothermodynamics, etc.

PROPULSION

Advanced Propulsion Engineers—For analysis, evaluation and development of power conditioning systems for advanced electrically propelled spacecraft. BS or MS in EE or Physics with 4 years experience in aircraft or missile electric power generation and distribution system design and test. Some servomechanism experience also desirable.

Send complete resume to:



JET PROPULSION LABORATORY

4814 Oak Grove Drive, Pasadena, California
Attention: Personnel Department 11

"An equal opportunity employer."

Jet Propulsion Laboratory is operated by the California Institute of Technology for the National Aeronautics and Space Administration.

INDEX TO ADVERTISERS

● AMP Incorporated	9	Japan Piezo Electric Co., Ltd.	38	Texas Instruments Incorporated Industrial Products Group	39
Allen-Bradley Co.	3	Julie Research Laboratories, Inc.	53		
Allied Electronics Sub. of Allied Radio Corp.	47			● Vitramon, Inc.	7
Arnold Engineering Co., The	52				
		● Kepco, Inc.	41		
		Krohn-Hite Corp.	15		
● Clifton Precision Products Co., Inc.	44				
● Cohn Corp., Sigmund	57				
		● Lambda Electronics Corp.	22		
Delco Radio	42	Mallory and Co., Inc., P. R.	21		
duPont de Nemours & Co., Inc. E. I.	16	McGraw-Hill Book Co.	48		
		Melpar Inc.	56		
		● Moseley Co., F. D.	37		
Edgerton, Germeshausen & Grier Inc.	51	Radio Corporation of America 4th cover			
Electronic Specialty Co.	4	Rese Engineering Inc.	8		
● Federation Nationale des Industries Electroniques	45				
		● Sigma Instruments, Inc.	12		
		Space and Information Systems Div. of North American Aviation	50		
● Globe Ind.	47	Sperry Electronic Tube Div. Sperry Rand Corp.	3rd cover		
		Sprague Electric Co.	6		
Heinemann Electric Co.	13				
● Hewlett-Packard Company 2nd cover					

CLASSIFIED ADVERTISING
F. J. Eberle, Business Mgr. (2557)
EMPLOYMENT OPPORTUNITIES 58-59

EQUIPMENT
(Used or Surplus New)
For Sale 58
CLASSIFIED ADVERTISERS INDEX
Atomic Personnel Inc. 58
Bausch and Lomb Inc. 58
Jet Propulsion Laboratory 59
● Radio Research Instrument Co. 58
SCM Corp.
Data Processing Systems Div. 58

● See advertisement in the July 25, 1963 issue of electronics Buyers' Guide for complete line of products or services.

This Index and our Reader Service Numbers are published as a service. Every precaution is taken to make them accurate, but **electronics** assumes no responsibilities for errors or omissions.

electronics



Audit Bureau
of Circulation



Associated Business
Publications

AUDITED PAID CIRCULATION

JAMES T. HAUPTLI (2210)
Advertising Sales Manager

HENRY M. SHAW (3485)
Market Research Manager

electronics Buyers' Guide

R. S. QUINT (2335)
General Manager

RICHARD J. TOMLINSON (3191)
Business Manager

THEODORE R. GEIPEL (2044)
Production Manager

NEW YORK TELEPHONE: Dial Direct:
971 plus number in parenthesis,
Area Code 212

ADVERTISING REPRESENTATIVES

ATLANTA, GA. 30009
Michael H. Miller, Robert C. Johnson
1375 Peachtree St. N.E.,
Trinity 5-0523 (area code 404)

BOSTON, MASS. 02116
William S. Hodgkinson
McGraw-Hill Building, Copley Square,
Congress 2-1160 (area code 617)

CHICAGO, ILL. 60611
Harvey W. Wernecke,
Robert M. Denmead
645 North Michigan Avenue,
Mohawk 4-5800 (area code 312)

CLEVELAND, OHIO 44113
Paul T. Fegley
55 Public Square, Superior 1-7000
(area code 216)

DALLAS, TEXAS 75201
Frank Le Beau
The Vaughn Bldg.,
1712 Commerce St.
Riverside 7-9721 (area code 214)

DENVER, COLO. 80202
John W. Patten
Tower Bldg., 1700 Broadway,
Alpine 5-2981 (area code 303)

HOUSTON, TEXAS 77025
Kenneth George
Prudential Bldg., Halcombe Blvd.,
Riverside 8-1280 (area code 713)

LOS ANGELES, CALIF. 90017
Ashley P. Hartman, John G. Zisch,
1125 W. 6th St., Huntley 2-5450
(area code 213)

NEW YORK, N. Y. 10036
Donald H. Miller (212) 971 3615
George F. Werner (212) 971 3617
Donald R. Furth (212) 971 3616
500 Fifth Avenue

PHILADELPHIA, PA. 19103
Warren H. Gardner, William J. Boyle
6 Penn Center Plaza,
LOcust 8-4330 (area code 215)

SAN FRANCISCO, CALIF. 94111
Richard C. Alcorn
255 California Street,
Douglas 2-4600 (area code 415)

LONDON W1:
Edwin S. Murphy Jr.
34 Dover St.

FRANKFURT/Main:
Matthee Herfurth
85 Westendstrasse

GENEVA:
Michael R. Zeynel
2 Place du Port

TOKYO:
George Olcott,
1, Kotohiracho, Shiba, Minato-ku



For higher TWT efficiency...a hollow beam



STS-188, a 2 kW, S band TWT proves Sperry's capability in depressed collectors. Six other models ranging through S, C, and X bands, are also operational at 10 W, 20 W and 2 kW power levels.

This photograph of a hollow, high-perveance electron beam helps us measure our progress toward a goal of higher efficiency for traveling wave tubes. That's because its halo shows us how we're doing on beam control, and lets us know how our higher perveance electron gun designs are working out.

We do a lot of other things to increase TWT efficiency. Seven different types of depressed-collector TWT's are already in the field . . . operating at power levels as high as 2 kW. And we're making constant progress on the design and manufacture of shorter, more effective attenuators.

In short, Sperry is doing quite a job on the technical considerations that improve efficiency of traveling wave tubes. 25% efficiency is already a reality on many of our models, and better things are coming.

A FREE TECHNICAL PAPER gives the details, both theoretical and practical. If you are searching for higher efficiency in broadband microwave systems, get your copy today. Write Sperry, Gainesville, Florida, or contact your Cain & Co. representative. In Europe, contact Sperry Europe Continental, Paris.



SPERRY RAND CORPORATION
GAINESVILLE FLORIDA

CIRCLE 901 ON READER SERVICE CARD

simplify YOUR NEW SSB CIRCUITS

with the remarkable **RCA-7360 Beam-Deflection Tube**

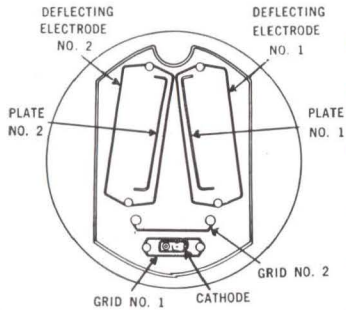

CROSS-SECTIONAL VIEW OF MAIN ELEMENTS OF RCA-7360

One of the most significant advances made in tubes designed for SSB—the RCA-7360 operates simultaneously as a balanced-mixer and oscillator or balanced-modulator and oscillator—at frequencies up to 100 Mc.

- **Excellent Carrier Suppression**—60 db in balanced modulators. 60 db in self-excited balanced mixers. 40-db oscillator-signal suppression in balanced-mixer service.
- **Exceptional gain and signal-handling capabilities** make it possible to eliminate intermediate- or buffer-amplifier stage.
- **High sensitivity... low distortion.**
- **Ultra-stable.** Tuning “stays put” with life over a wide dynamic range and temperature range.
- **Self-excitation.** Operates as a balanced mixer or a balanced modulator without the need for a separate oscillator.
- **Balanced push-pull output from single-ended AF and RF inputs** eliminates need for audio-input transformer in balanced-modulator circuits.
- **High transconductance... high input impedance.**

Find out today how you can achieve better SSB performance and simpler circuits with the RCA-7360! Call your RCA Field Representative or write: Commercial Engineering, Section K-19Q-1 RCA Electronic Components and Devices, Harrison, New Jersey.

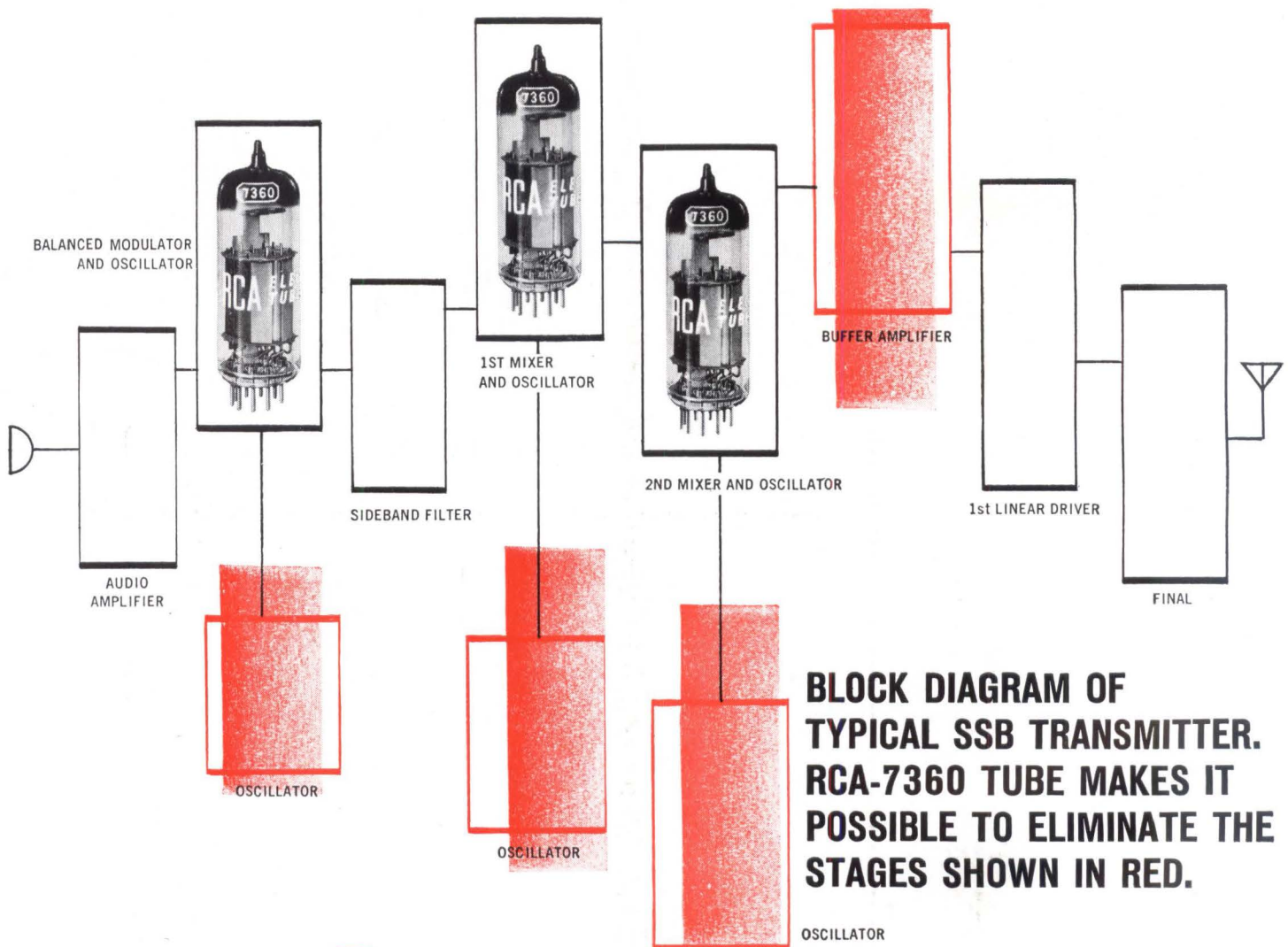

BLOCK DIAGRAM OF TYPICAL SSB TRANSMITTER. RCA-7360 TUBE MAKES IT POSSIBLE TO ELIMINATE THE STAGES SHOWN IN RED.



The Most Trusted Name in Electronics