

# electronics®

## LORAN-C RECEIVER

Digital instrument  
uses microcircuits

## CASCADE MULTIS

New circuits produce  
narrower pulses

## SOLID-STATE ALTERNATOR

SCRs in ring  
counter drive motor

CELL SCANNER aids cancer research. Records light density of microscope slides digitally on magnetic tape





# SPECIAL PULSE TRANSFORMERS TO YOUR REQUIREMENTS

The pulse units illustrated below show a few of the thousands of special types produced by UTC, to customers' requirements, and only slightly indicate the scope of present pulse transformer design. Range covered on special pulse units is from microwatts to 10 megawatts.

Almost thirty years of pioneering in the design and production of transformers plus exhaustive life testing programs and rigid quality control measures guarantee components of the highest reliability in the industry. . . . You can stake YOUR reputation on UTC products.

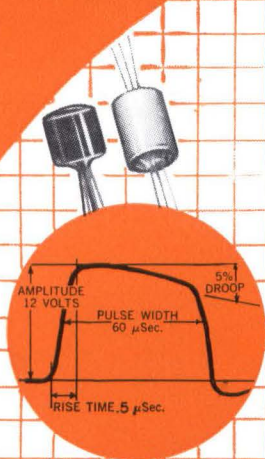

25 KC pulse transformer, DO-T or DI-T configuration. Pulse width 60  $\mu$ Sec. Rise time less than 0.5  $\mu$ Sec. Secondary C.T. balance each side to within 1% to ground. MIL-T-27A, GR 4. Size: DO-T,  $\frac{3}{16}$  dia. x  $\frac{13}{32}$ " x  $\frac{1}{10}$  oz.; DI-T,  $\frac{3}{16}$  dia. x  $\frac{1}{4}$ ", wt. 1/20 oz.

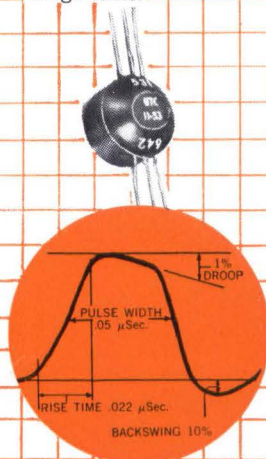

Special precision miniature pulse transformers. Designed in our standard stock mold to your specs. Checked and precisely adjusted in your tube or transistor blocking oscillator circuit. Sizes:  $\frac{3}{8}$  dia. x  $\frac{3}{8}$ ", 1 gram;  $\frac{1}{16}$  dia. x  $\frac{1}{16}$ ", 4 grams;  $\frac{5}{8}$  dia. x  $\frac{5}{8}$ ", 6 grams.

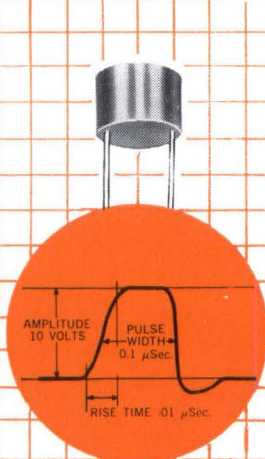

Ferrite core blocking oscillator transformer. 0.1  $\mu$ Sec.  $\pm 10\%$  @ 200 KC PPS. 2 windings, rise time .01  $\mu$ Sec. Epoxy case. MIL-T-27A;  $\frac{3}{16}$  dia. x  $\frac{1}{4}$ ", .07 oz.

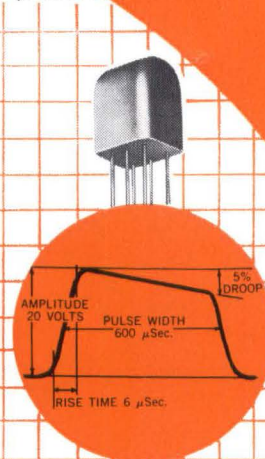

600  $\mu$ Sec. coupling transformer for printed circuit application. 3 windings, mu metal case for extreme shielding. Z=20 K  $\Omega$ , 10 V. MIL-T-27A; standard UTC ML case;  $\frac{3}{16}$  x  $\frac{3}{4}$  x  $\frac{3}{16}$ " h., .2 oz.

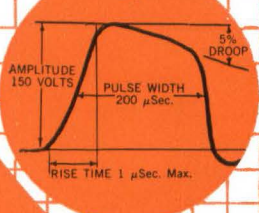
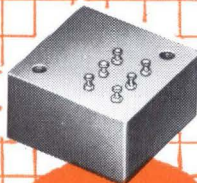

Toroidal pulse transformer, 150 V, 200  $\mu$ Sec. @ 400 PPS. Molded in epoxy, 3 windings, low leakage, less than 1  $\mu$ Sec. rise time; -40°C. to +85°C.; output voltage within 1%. MIL-T-27A; 1 $\frac{1}{8}$  sq. x  $\frac{3}{4}$ "; 1.5 oz.

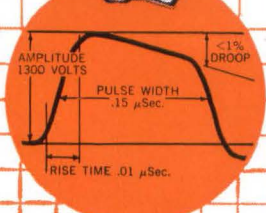

Output to 2J42 magnetron. Input 1300 V.-50 ohms. Output 6.5 KV to 1200 ohms and .6A. bifilar filament winding. .15  $\mu$ Sec., 1000 PPS. Trigger winding. MIL-T-27A GR 5; 1 $\frac{1}{2}$  x 2 $\frac{1}{2}$  x 2 $\frac{3}{4}$ ", 10 oz.

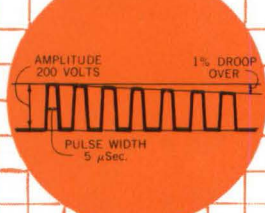

Output to Klystron, 5  $\mu$ Sec. pulses in groups of pulse trains at high rep rate. Droop 1% over pulse trains. 30 KV W.V., 43 KV hipot; -53°C. to +85°C.; MIL-T-27A; 4 $\frac{1}{4}$  x 5 x 6 $\frac{3}{4}$ "; 11 $\frac{1}{2}$  lbs.

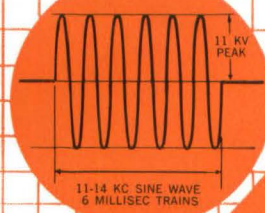
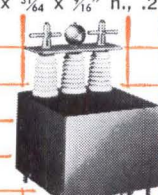

Sonar sine wave pulse output transformer. PP 4-65A's, 11-14 KC flat. Pri. 11 KV; 28 KV hipot. Spark gap protected. Sec. 1500 V. @ 800 $\Omega$ , 60 millisecon, 6% duty cycle. MIL-T-27A; -65°C. to +85°C.; 6 x 6 x 8 $\frac{1}{2}$ ", 13 lbs.

Plus over 1,000 STOCK ITEMS with UTC High Reliability from your local distributor



write for catalog

## UNITED TRANSFORMER CORP.

150 VARICK STREET, NEW YORK 13, N. Y.

PACIFIC MFG. DIVISION: 3630 EASTHAM DRIVE, CULVER CITY, CALIF.  
EXPORT DIVISION: 13 EAST 40th STREET, NEW YORK 16, N. Y. CABLE: "ARLAB"

LEWIS H. YOUNG, Editor  
Dial Direct: (971-2645)  
Area Code 212

J. M. CARROLL, Managing Editor (2293)

SENIOR EDITORS  
Samuel Weber (2371)  
George W. Sideris (3444)

SENIOR ASSOCIATE EDITORS  
Michael F. Wolff (2600)  
John F. Mason (2666)

ASSOCIATE EDITORS  
Michael F. Tomaino (2071)  
William P. O'Brien (2297)  
George J. Flynn (2188)  
George V. Novotny (3151)  
Leon H. Dulberger (3446)  
Alexander A. McKenzie (2685)

ASSISTANT EDITORS  
Stephen B. Gray (2245)  
Barry A. Briskman (2306)  
Dan Smith (2467)  
Joel A. Strasser (2127)  
Vincent S. Acunto (2592)  
C. R. Whetstone (3495)  
Eric Valentine (2710)  
Louis S. Gomolak (2472)  
G. G. Tirellis (2187)

REGIONAL EDITORS  
Harold C. Hood,  
1125 W. 6th St., Los Angeles 90017, Calif.  
(213-482-5450)  
Laurence D. Shergalis,  
John Hancock Bldg., 255 California St.,  
San Francisco 94111, Calif. (415-362-4600)  
Thomas Maguire  
McGraw-Hill Bldg., 607 Boylston St.,  
Boston 02116, Mass. (617-262-1160)  
Cletus M. Wiley,  
Blair Bldg., 645 N. Michigan Ave.,  
Chicago 60611, Ill. (312-664-5800)

ART DIRECTOR  
Howard R. Berry (2430)

ASSISTANT ART DIRECTOR  
John C. Wright, Jr. (3430)

EDITORIAL ASSISTANTS  
Lorraine Rossi, Virginia T. Bastian,  
Lynn Emery, Ann Mella, Lorraine Werner,  
Alice M. Moyer, Sharon Parks,  
Claire Benell, Kay Fontana,  
Sandra A. Le Mond, Mary Jo Jadin

FOREIGN NEWS BUREAU  
DIRECTOR, John Wilhelm, (2532);  
Lawrence Mihlon (2997), Alyne Elias  
(2998)  
LONDON—John Shinn, Derek Barlow,  
Nicholas Landon, 34 Dover St., London  
W.1, England  
BONN—Richard Mikton,  
Silke McQueen, Mittelstrasse 39, Bad  
Godesberg, Germany  
BRUSSELS—Arthur Erikson, 27 Rue Ducarle,  
Brussels, Belgium  
PARIS—Robert Farrell, 17 Ave. Matignon,  
3rd Fl., Paris 8, France  
MILAN—Bruce Bendow, Via Manzoni  
No. 12, Milan, Italy  
MEXICO CITY—Wesley Perry, Jr.,  
Lafregua 4-314, Mexico 1 D.F. Mexico  
RIO DE JANEIRO—Leslie Warren, Rua  
Mexico 3-S/1507 1509, Rio de Janeiro,  
Brazil  
MOSCOW—Donald Winston,  
Kutuzovsky Prospekt 19, Apt. 28-29,  
Moscow, USSR  
TOKYO—Richard Halloran, Charles Cohen,  
John Yamaguchi, Toranomom Sangyo  
Bldg., 1 Kotohiracho Shiba, Minato-Ku,  
Tokyo, Japan

CIRCULATION MANAGER  
Hugh J. Quinn (2310)

C. C. RANDOLPH, Publisher (2016)

JANUARY 31, 1964

# electronics

A MCGRAW-HILL PUBLICATION 75 CENTS

**DIGITAL CELL SCANNER.** New cancer research tool called CYDAC (cytology data conversion system) converts light density of cells into digital form for computer input. Instrument by Airborne Instruments Lab uses a crt or mechanical scanner, video processor, A-D converter and tape recorder. *The video processer uses logarithmic conversion. See p 40* COVER

**RADIATION VS. SOLID STATE.** How well will microelectronics stand up to transient radiation resulting from nuclear explosions? Are thin-film or intergrated circuits best? *The missile dependability controversy focuses attention on this topic next week at the Military Electronics Convention* 10

**HAND-HELD RADAR.** Designed for front-line troops, and for police, too, this set sounds off when it detects a moving target. *Its weight, 8 lb, can be cut to 5 lb with microcircuits* 11

**EMPLOYMENT OUTLOOK.** Department of Labor has just issued a new survey of the employment and occupational outlook in the electronics industry. *A continuing rise in the percentage of professional and white-collar workers is forecast, despite the budget cut* 14

**LORAN-C RECEIVER USES MICROCIRCUITS.** One of the first uses for the new Texas Instruments Series 53 line of digital microcircuits described in our January 10 issue is in this airborne navigational instrument. *The receiver even uses digital techniques in servo loops and filters; only r-f amplification remains analog.* By R. D. Frank and A. H. Phillips, Sperry Gyroscope 23

**FREE-RUNNING CASCODE MULTIVIBRATORS.** Series-connected, or cascode, multivibrators can produce linear sawtooth waveforms, square waveforms, sinewaves or pulses as can the common tandem-connected, or cascade, multivibrator. *However, the cascode circuit may be able to deliver a narrower pulse.* By Chang Sing, National Taiwan Univ., Taipei, Taiwan, China 28

**STATIC ALTERNATOR FOR MOTOR CONTROL.** Solid-state generator drives a hysteresis motor at speeds variable throughout the range of 1,200 to 18,000 rpm. *The circuit makes use of silicon controlled rectifiers in a modified ring-counter configuration.* By R. H. Murphy, Transiron Electronic, Ltd., England 30

Contents continued

Published weekly, with Electronics Buyers' Guide as part of the subscription, by McGraw-Hill, Inc. Founder: James H. McGraw (1860-1948).

**SUBSCRIPTIONS:** Available only by paid subscription. Publisher reserves the right to refuse non-qualified subscriptions. Subscriptions to Electronics solicited only from those actively engaged in the field of the publication. Position and company connection must be indicated on subscription orders forwarded to address shown below. Subscription rates for individuals in the field of the publication: U. S. and possessions and Canada \$6 one year, \$9 two years, \$12 three years (single copies 75¢). All other countries \$20 one year (single copies \$1.50).

**EXECUTIVE, EDITORIAL, CIRCULATION and ADVERTISING OFFICES:** McGraw-Hill Building, 330 West 42nd Street, New York, N. Y., 10036. Telephone Area Code 212. 971-3333. Teletype TWX N. Y. 212-640-4646. Cable McGrawhill, N. Y. Printed in Albany, N. Y. Second class postage paid at Albany, N. Y. Title reg. ® in U. S. Patent Office. Copyright © 1964 by McGraw-Hill, Inc. All Rights Reserved. The contents of this publication may not be reproduced either in whole or in part without consent of copyright owner.

**OFFICERS OF MCGRAW-HILL PUBLICATIONS:** Shelton Fisher, President; Vice Presidents: Joseph H. Allen, Operations; John R. Callahan, Editorial; Ervin E. DeGraff, Circulation; Donald C. McGraw, Jr., Advertising Sales; Angelo R. Venezian, Marketing.

**CORPORATION OFFICERS:** Donald C. McGraw, President; L. Keith Goodrich, Hugh J. Kelly, Harry L. Waddell, Executive Vice Presidents; John J. Cooke, Vice President and Secretary; John L. McGraw, Treasurer.

**UNCONDITIONAL GUARANTEE:** The publisher, upon written request, agrees to refund the part of the subscription price applying to the remaining unfilled portion of the subscription if service is unsatisfactory.

**SUBSCRIBERS:** Please address all correspondence regarding subscriptions, change of address notices, and subscription orders to Fulfillment Manager, Electronics, P. O. Box 430 Hightstown, N. J., 08520. Change of address notices should be sent promptly; provide old as well as new address; include zip code or postal zone number if any. If possible, attach address label from recent issue. Please allow one month for change of address to become effective.

**POSTMASTER:** Please send Form 3579 to Fulfillment Manager, Electronics, P. O. Box 430, Hightstown, N. J., 08520.



Audit Bureau of Circulation



Associated Business Publications

**Contents continued**

**RESOLVING ONE-NANOSECOND INTERVALS.** Two quinary scalars operating in parallel against a 500-Mc time-base signal make up a nanosecond time-interval meter. *A tunnel diode is used as a level discriminator.* By R. Engelmann, Consultant 34

**CANADA'S NEW SUB HUNTERS.** Canada's six new destroyer escorts show how the navies of the world are relying more and more on electronic battle aids. *In these ships, the helm is moved from the bridge to below decks. Only the radar is on the bridge* 38

**DEPARTMENTS**

**Crosstalk.** Time to Take Stock 5

**Comment.** Electronics Markets. Negative Resistance 6

**Electronics Newsletter.** Boston Gets Set for NASA's Electronics Research Center 17

**Meetings Ahead.** Chicago Spring Conference on Broadcast and Television Receivers 18

**Washington this Week.** Pentagon Trying to Hold Design Teams Together 20

**Research and Development.** Video Tube Probes Human Cells 40

**Components and Materials.** Photochrome Glass May Bring New Devices, Systems 42

**Production Techniques.** Big YIGs Grow in Salt 44

**New Products.** Laser Diode Has Low Threshold 46

**Literature of the Week** 49

**People and Plants.** RCA Names Division V-P's 50

**Index to Advertisers** 52

## Dependable Construction, Size Reduction, Low Cost Are Features of Pacer® Filmite® 'E' Capacitors

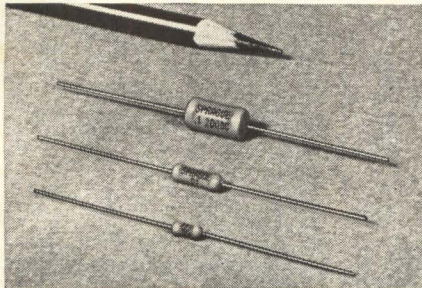

MULTI-ADVANTAGE construction in a *low-cost* film capacitor has been achieved in Pacer® Filmite® 'E' Capacitors, which utilize a specially selected ultra-thin polyester film dielectric that permits dramatic size reductions.

Type 192P miniature Pacer Capacitors, designed and developed by the Sprague Electric Company, are one-third the size of conventional paper and paper-film tubulars, making them ideal for transistorized circuitry and other space-saving applications where small size *with dependability* is an important consideration.

### Special End Cap Design

Metal end caps over extended foil sections assure best possible non-inductive capacitors, since all turns of the electrodes are positively contacted. The end caps also act as effective barriers against the entrance of moisture into the ends of the capacitor section. Type 192P Pacer Capacitors are further protected by a hard, durable, orange epoxy coating.

Unlike other epoxy coated units, Pacer Capacitors, with their special end-cap construction, assure the rigid fixed diameters needed for use with automatic insertion equipment. The metal end caps also provide a firm base to which the wire leads are welded.

### Engineering Information Available

For complete technical data on Type 192P Pacer Capacitors write for Engineering Bulletin 2066 to Technical Literature Service, Sprague Electric Company, 35 Marshall Street, North Adams, Massachusetts.

45C-153-43

**CIRCLE 3 ON READER SERVICE CARD**  
electronics January 31, 1964

# 6 Reasons Why SPRAGUE is a Major Resistor Supplier

## FILMISTOR® PRECISION FILM RESISTORS



metal-film, molded case

Distinct limited temperature coefficients and low tolerances to meet exacting application requirements. Rugged end cap construction for long-term stability and reliability. Superior resistance to humidity and mechanical damage. Surpass MIL-R-10509D requirements. Send for Bulletin 7025B.



deposited-carbon, molded case

Approach precision wirewounds in reliability and stability, yet are smaller in size and have lower self-inductance. Low, controlled temperature coefficient. Dense molded case provides outstanding humidity protection. Send for Bulletin 7000A.



deposited-carbon, conformal coated

Full rated load operation at 70 C with no wattage derating. Assured uprated loads at lower operating temperatures. Ideal for circuitry where small size, humidity resistance, and close tolerance ( $\pm 1\%$ ) are required. Send for Bulletin 7005A.

**CIRCLE 270 ON READER SERVICE CARD**

## KOOLOHM® CERAMIC-SHELL POWER WIREWOUND RESISTORS

Exclusive ceramic-insulated resistance wire permits "short-proof" multilayer windings for higher resistance values. Standard and non-inductive designs. Non-porous ceramic shell for moisture protection and electrical insulation. Axial-lead, axial-tab, and radial-tab styles. Send for Bulletins 7300B, 7305, 7310.

**CIRCLE 273 ON READER SERVICE CARD**

## GLASS-JACKETED POWER WIREWOUND RESISTORS



Ferrule terminals soldered to metallized ends of glass casing for true hermetic seal. Virtually failure-proof, even in extremely corrosive industrial and salt atmosphere. Standard and non-inductive windings. External meter-multiplier types also available. Send for Bulletins 7350, 7420, 7421.

**CIRCLE 274 ON READER SERVICE CARD**

For complete technical data, write for engineering bulletins on the resistors in which you are interested to: Technical Literature Service, Sprague Electric Company, 35 Marshall Street, North Adams, Massachusetts.

45R-106-43

## ACRASIL® PRECISION/POWER WIREWOUND RESISTORS



silicone-encapsulated

Combine the best features of both precision and power wirewound types. Resistance tolerances to  $\pm 0.05\%$ . Unusually tough encapsulation protects against shock, vibration, moisture, fungus. Meet MIL-R-26C requirements. Smaller than conventional wirewounds, yet greater in stability. Send for Bulletin 7450.

**CIRCLE 271 ON READER SERVICE CARD**

## BLUE JACKET® VITREOUS ENAMEL POWER WIREWOUND RESISTORS

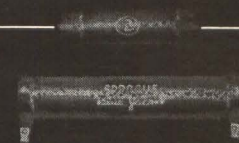

All-welded end cap construction with special vitreous coating for long-term dependability. Axial-lead style for conventional wiring or on printed boards. Tab terminals for higher wattage applications. Meet MIL-R-26C requirements. Send for Bulletins 7400B, 7410D, 7411A.

**CIRCLE 272 ON READER SERVICE CARD**

## STACKOHM® POWER WIREWOUND RESISTORS



Flat silhouette permits stacking of resistor banks in close quarters. Aluminum thru-bar simplifies mounting and conducts heat from resistance element. Vitreous enamel protective coating. Meet MIL-R-26C performance requirements. Send for Bulletin 7430.

**CIRCLE 275 ON READER SERVICE CARD**

**SPRAGUE®**  
THE MARK OF RELIABILITY

# Two reliable techniques for finding faults on cables

## TRADITIONAL

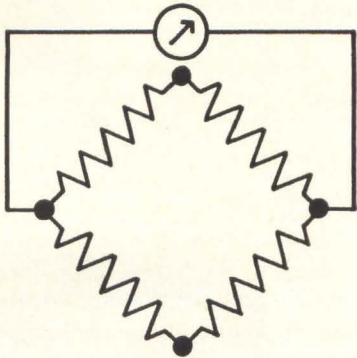

**Step 1.** Dispatch a field engineer to closest cable termination beyond the fault site.

**Step 2.** Field engineer attaches a pair of test leads to the tie point, completing a Wheatstone bridge circuit to the central station.

**Step 3.** Fault on cable changes resistance on one side of the bridge; an operator at the central station adjusts resistance on opposite side of circuit to balance the bridge.

**Step 4.** When the galvanometer reaches the zero point, the operator reads amount of resistance in ohms required to balance the bridge.

**Step 5.** Turning from meter to map file, he consults a table to find the gauge of cable section under test.

**Step 6.** Operator calculates resistance of that gauge cable in ohms-per-feet.

**Step 7.** Resistivity of cable in ohms-per-feet is divided into ohms resistance required to balance bridge circuit.

**Step 8.** Dividend equals distance in feet from tie point back to cable fault (without compensating for changes in ambient temperature and humidity which can affect performance of the bridge circuit).

*For further information on this widely used technique of fault-finding, collar any power engineer who has had extensive experience on a test board.*

## MODERN

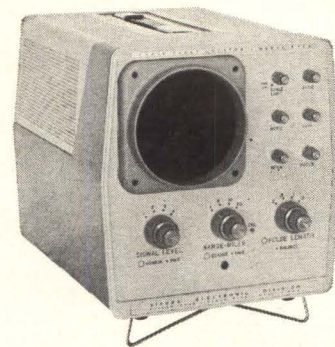

**Step 1.** Assign an operator to scan up to 30 miles of cable through a Sierra 370A Cable Fault Locator.

**Step 2.** See opens, shorts, or impedance variations the instant they occur; read distance to fault directly in feet from the pip on the scope.

*For further information on this time and labor-saving technique of pinpointing cable faults, get in touch with Sierra Electronic Division of Philco. Ask for data on the Model 370A Cable Fault Locator. While you're at it, you might call in your nearest Sierra sales representative for a fault-finding demonstration.*

SIERRA ELECTRONIC DIV.  
OF  
**PHILCO**  
A SUBSIDIARY OF *Ford Motor Company*

Sierra Electronic Division/3885 Bohannon Drive/Menlo Park 1, California

# Time To Take Stock

*"The Federal Government provides major support for the research and development which underlie our striking technological advances. In the past much of our research and development has been connected with national defense. Now, as military outlays level off, we face:*

*"A challenge to apply the nation's growing scientific and engineering resources to new socially profitable uses;*

*"An opportunity to accelerate the technological progress of our civilian industries.*

*"The Federal Government should join with private business and our universities in speeding the development and spread of new technology. I have directed the Department of Commerce to explore new ways to accomplish this."*

from President Johnson's  
Economic Report to Congress,  
January 20, 1964

**WASHINGTON** is no longer hinting and warning that it will cut back military procurement and R&D. The new federal budget does precisely that, reducing military spending by more than a billion dollars—a third of it lopped off military R&D.

Since the reduction is primarily based on a peaking of strategic weapons spending, the cutback may well turn into an irreversible trend if the Administration attains its goal of negotiating with the Soviet Union a "verified freeze" on strategic weapons.

In fact, total government electronic procurement and R&D is leveling off. The rapid buildup in NASA's budget is also slowing, indicating that the hoped-for expansion in space programs will not take up the slack in military spending.

Business leaders are well aware that a leveling off of military-space electronics work will sharpen competition throughout the entire electronics industry, and firms heavily engaged in military-space work are striving to compete more strongly in other fields.

Every engineer and scientist in the industry must consider now the effect that these government and business policies may have upon his individual employment now and his future career. The individual and personal competition in both government and non-government electronics fields is likely to become as sharp as the business competition.

Spurred by military-space R&D, the industry has built a huge force of engineers and scientists. Will the drive to expand nonmilitary electronics be strong enough to insure full professional employment if military-space R&D slacks off severely? We don't know the answer yet, but we can cite some sobering statistics.

The Department of Labor this month released a survey of electronics industry personnel. While total employment in electronics tripled between 1951 and 1960, the number of engineers and scientists increased 10-fold—largely because of R&D and low-volume production needs. In mid-1962, engineers made up 6 percent of the work force of consumer electronics companies, but were 21 percent of the military-space electronics work force (see p 14).

Clearly, a majority of engineers in the industry depend on government funding for employment now. Others have estimated that as much as 85 percent of electronics engineers depend on government work, directly or indirectly, for their pay check.

In its survey, the Department of Labor assumes that military-space electronics work will continue to expand at its familiar pace. This may prove true, but it seems a risky assumption, in view of the new budget and President Johnson's recent policy statements.

Another cause for concern—and this gets more personal than the statistics—is that military-space R&D has created an unusual degree of engineering specialization. While specialization is a high-road to success in sophisticated electronics, it can well create employment problems in more mundane electronics fields.

Refusing to specialize is no solution, either. Obviously a man must become expert in a specific field to advance professionally. It is quite another thing, however, to fall into the trap of knowing more and more about less and less. What happens if your employer no longer needs that narrow specialty?

This is why we think it is time for every engineer and scientist in the industry to take fresh stock of his personal inventory. We think the times require a broadening of individual interests. We think that the specialist, like his employer, should begin planning his diversification now. Don't expect somebody else's development to open up some virgin field in the vague future.

NOW...

THE FAMOUS  
**JERROLD**  
**900-B**  
SWEEP SIGNAL  
GENERATOR



OFFERS CENTER  
FREQUENCIES FROM  
**500 kc to 2,000 mc**  
without plug-ins

The versatile Jerrold Model 900-B Sweep Signal Generator now extends its useful frequency range all the way up to 2,000 mc, with sweep widths ranging from 10 kc to 800 mc. A diode frequency doubler, priced at only \$150, increases the usefulness of the 900-B without the need for plug-ins.

**Frequency Doubler Specifications**

Input Frequency .... 500-1000 mc  
Output Frequency ... 1000-2000 mc  
Conversion loss at  
1 volt RMS ..... less than 12 db  
Output component, other  
than harmonic  
of input ..... 20 db or more below  
Maximum Input ..... 1 volt RMS  
Connectors ..... 50 ohm, BNC

The diode frequency doubler can also be used with the economical Jerrold 900-A Sweep Generator.

Model 900-B ..... \$1,980  
Model 900-A ..... \$1,260  
Frequency Doubler ..... \$ 150

Write for complete technical data,  
Jerrold Electronics Corporation, 15th  
& Lehigh Ave., Philadelphia 32, Pa.



A subsidiary of THE JERROLD CORPORATION

**COMMENT**

**ELECTRONICS MARKETS**

I was very pleased to again see your Electronics Markets projections (p 37, Jan. 3). The type of information you have put together is indeed of inestimable value to all of us working in the electronics industry.

GORDON B. BAUMEISTER

Barnes Engineering Company  
Stamford, Connecticut

**NEGATIVE RESISTANCE**

The problems involved in representing resistances as circuit elements are made more difficult because the notation and the definitions are not standardized. This is particularly apparent in the teaching of a first course in electronics circuits, where an attempt is made to present a foundation for more advanced work. Several letters published in *Comment* regarding the definition of negative resistance have exemplified this lack of agreement. (Sproull, p 4, April 26, 1963; Lyon, May 24; Villasenor, June 21; Todd, July 5; Harris, July 12; Minot, July 19; Eberz, Aug. 23; Cote, p 6, Oct. 4).

A completely general and inclusive definition of electrical resistance is rather difficult to formulate. If an intuitive notion of resistance is accepted, then, assuming "resistive" elements, the following definitions can be formulated and the notation can be made consistent with the IRE standards for Letter Symbols for Semiconductor Devices (*Proc IRE*, Vol. 44, No. 7, July, 1956, pp 934-937):

(1) Instantaneous resistance = (instantaneous voltage)/(instantaneous current). This is denoted with a lower-case letter and upper-case subscripts. For example, consider the instantaneous collector resistance for the common-emitter connection:  $r_{ce} = v_{ce}/i_c$ . The instantaneous plate resistance of a vacuum tube is  $r_{pk} = v_{pk}/i_p$ . Instantaneous conductance is the reciprocal of the instantaneous resistance. Considering the above two examples,  $g_{ce} = i_c/v_{ce}$  and  $g_{pk} = i_p/v_{pk}$ .

(2) Static resistance = (average voltage)/(average current). This is denoted with an upper-case letter and upper-case subscripts. The static resistance is the instantaneous resistance at the operating point. Using the above two examples,  $R_{ce} = V_{ce}/I_c$  and  $G_{ce} = I_c/V_{ce}$ ;  $R_{pk} = V_{pk}/I_p$  and  $G_{pk} = I_p/V_{pk}$ .

(3) The differential resistance is still defined as in the past, and is denoted using a lower-case letter with lower-case subscripts. Consider the same two examples,  $r_{ce} = v_{ce}/i_c$  and  $g_{ce} = i_c/v_{ce}$ ;  $r_{pk} = v_{pk}/i_p$  and  $g_{pk} = i_p/v_{pk}$ .

These definitions include "negative" resistance. In many cases the instantaneous resistance is positive, but the differential resistance is negative over part of the range. There are examples where both the instantaneous resistance and the differential resistance may be negative as in the case of the plate resistance of a tetrode. In this case, the instantaneous resistance approaches infinity at the points where the instantaneous plate current approaches zero, because there is a finite terminal voltage and zero current. This is intuitively reasonable and indicates that the instantaneous resistance may not be a very useful representation at such a point.

Both the notation of instantaneous resistance and differential resistance are needed, so it is important to establish definitions and notation so that there is a minimum of ambiguity.

The definitions and the notation as given here are general enough to be applied to "resistive" electronic devices of all types. These have been used for several years in electronics courses and are most helpful in discussing "equivalent" circuits.

EDWIN LOWENBERG

The University of Texas  
Austin, Texas

**GAS PRESSURE IN VACUUM TUBES**

Several errors were introduced in my article on determining gas pressure inside vacuum tubes, Tube Is Own Vacuum Gage (p 8, Jan. 3).

The opening paragraph states that a difference in pressure of only  $10^{-9}$  Torr is enough to cause internal arcing. This is not true. In my manuscript, I wrote, "The vacuum in power tubes must be better than  $1 \times 10^{-7}$  Torr and should preferably approach  $1 \times 10^{-9}$  Torr." Later, after discussing the method, I added, "It is, consequently, difficult to distinguish a tube that has a very high vacuum—say,  $1 \times 10^{-9}$  Torr—from a tube that has a vacuum in the order of  $1 \times 10^{-7}$  Torr. At high voltage, the difference between these two pressures apparently causes considerable difference in the probability of an internal arc during a given time period."

In the edited version of the above statement, the vacuum of  $10^{-7}$  Torr was called a low vacuum. I did not call it a low vacuum in my manuscript.

FRED KOHLER

Thermatool Corporation  
New Rochelle, New York



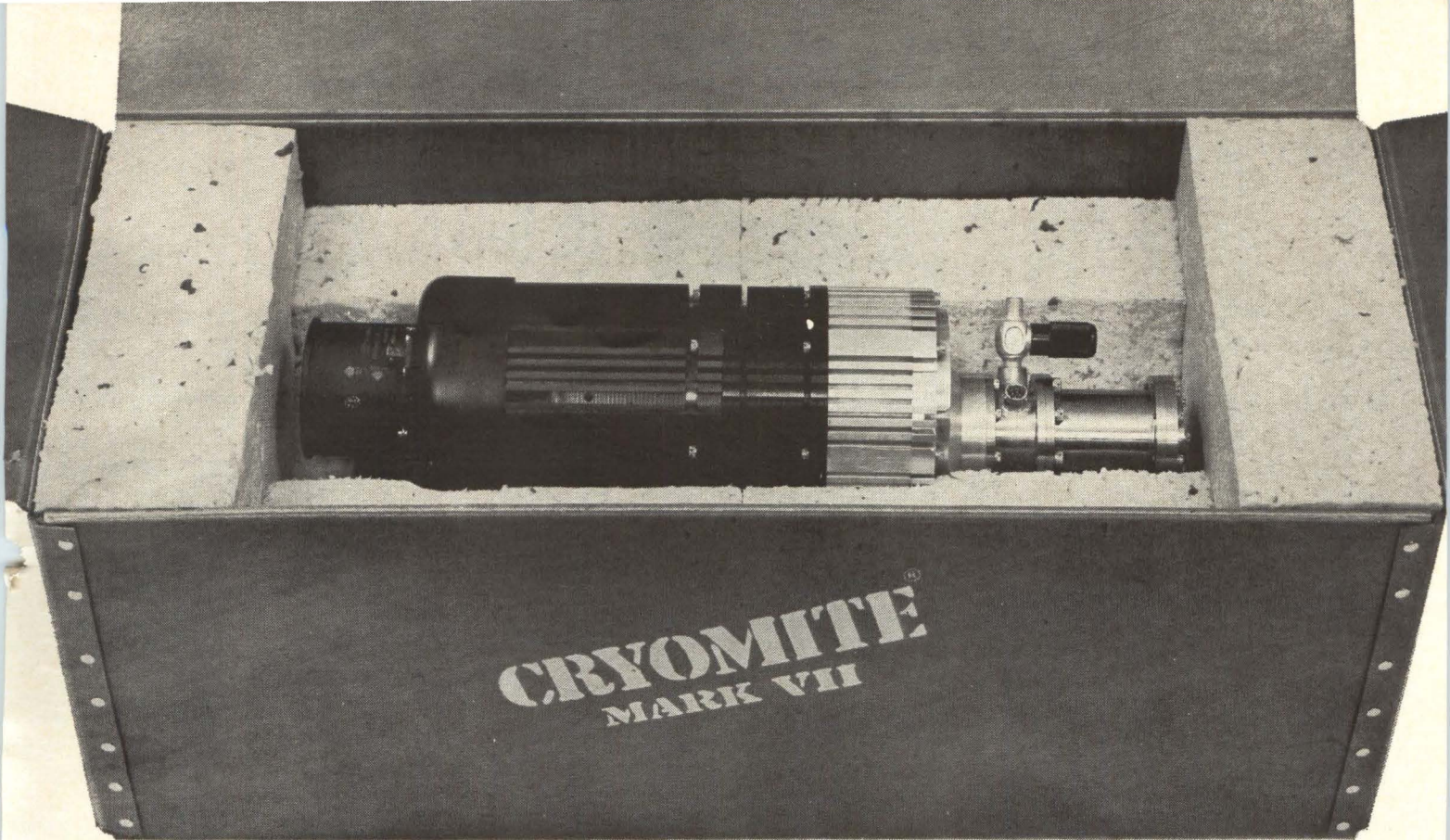

**Chet Pawelski wanted a miracle.**

His specifications called for a closed cycle miniature cryogenic refrigerator no longer than 14" including motor. He insisted that it reach 28°K in less than 15 minutes, be air-cooled, non-lubricated and weigh less than 12 pounds.

We delivered it nine days after  
his phone call.

CIRCLE 7 ON READER SERVICE CARD

***Malaker***



LABORATORIES, INC.  
HIGH BRIDGE, NEW JERSEY



# Reliability oriented engineers

DOUGLAS IS SEEKING ENGINEERS WITH DESIGN OR SYSTEMS BACKGROUNDS AT ALL DEGREE AND EXPERIENCE LEVELS. OBJECTIVE: TO ASSURE THAT SUCH VITAL PROGRAMS AS SATURN, ZEUS, DELTA AND OTHERS OPERATE WITH OUTSTANDING RELIABILITY.

## **STAFF POSITIONS ARE OPEN WITH THE FOLLOWING FUNCTIONS:**

Develop subsystem and system mathematical models, perform reliability predictions, and evaluate test results.

Participate in design review meetings, assign reliability goals, and assist designers in reliability trade-off studies.

Conduct failure effects and failure mode analyses.

Conduct system availability and effectiveness analyses.

Conduct failure-cause analyses, recommend and initiate corrective action.

Effectively communicate results of investigations to management and to design engineers.

## **MANAGEMENT POSITIONS ARE OPEN WITH THE FOLLOWING REQUIREMENTS:**

Should be a senior engineer familiar with aspects of an engineering reliability program. Must know how to set up, implement, and administer programs for mathematical models, design review, drawing review, systems analysis, allocation, prediction, testing, and procurement. Requires proven capability and preferably an advanced engineering degree.

Please send resume to: Mr. C. F. Ames



**MISSILE & SPACE SYSTEMS DIVISION**

2700 Ocean Park Boulevard  
Santa Monica, California

*An equal opportunity employer*

UNTIL  
**Transitron**  
**COMBINED**

**FAST RECOVERY WITH**



**CONTROLLED AVALANCHE**

IN

THEIR NEW  
12 AMP  
TFR1220Z  
SILICON  
RECTIFIER  
THESE  
SPECIFICATIONS  
WERE  
UNATTAINABLE!

Recovery Time  
(fastest ever)  
100 nanoseconds

Forward Voltage  
Drop  
1.2V @ 12 amps

Reverse Avalanche  
Ratings up to  
600 Volts

Reverse Power  
Dissipation  
15 Watts

Rated at 150°C  
Case under  
operating  
conditions

Transitron's 7/16" stud-mounted TFR1220Z keynotes a significant advance in the state of the art. For the first time in a single device, the reliability of controlled avalanche has been combined with the superior characteristics of fast recovery.

In addition to the 12 amp series, Transitron offers these units in 1, 3, 6, 20 and 30 amp versions, each of which can be obtained either in standard stud-mounted or micro package. Transitron also produces the 1N3884-1N3913 Fast Recovery Rectifiers, plus a series of Avalanche Rectifiers to answer a wide number of applications. All of these devices are now available through your Transitron Distributor. For complete product details, write our Wakefield installation for Fast Recovery/Avalanche Bulletins.

**Transitron**  
electronic corporation  
wakefield, melrose, boston, mass.



SALES OFFICES IN PRINCIPAL CITIES THROUGHOUT THE U.S.A. AND EUROPE. CABLE ADDRESS: TRELCO

PARTICULARLY SIGNIFICANT to missile and space electronics is increase in transient-radiation-effect range with altitude (left). Center graph shows radiation-induced shunt leakage resistance in thin-film resistors. Intercept of curves with zero voltage ordinate indicates injected current. Radiation effects in two circuits at right are discussed in text

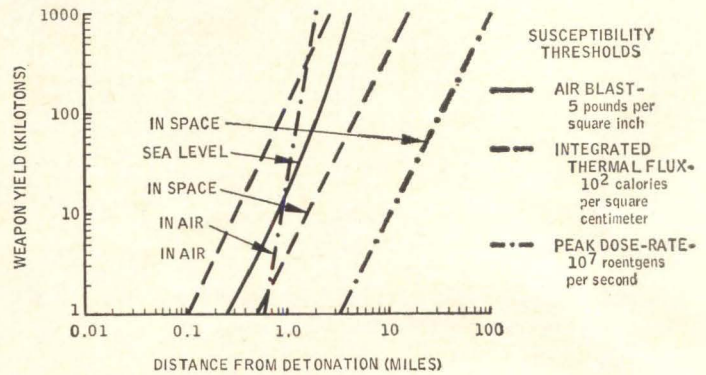

## Transient Radiation: ICBM Bugaboo?

Dependability question focuses attention on microcircuits' resistance

By HAROLD C. HOOD  
Regional Editor, Los Angeles

**LOS ANGELES**—Standing-room-only attendance for two sessions on radiation effects at next week's Fifth Winter Convention on Military Electronics here appears assured by Senator Barry Goldwater's recent blast at ICBM dependability.

Even before Goldwater's implication that Russian bombs could seriously interfere with missile operation put the problem on the front pages, the drive was on to design circuits less vulnerable to high-yield explosions.

One session is secret. In the unclassified session, two papers are based on work at Hughes Aircraft's Nucleonics division, which is investigating for Navy BuWeps the relative effects of transient nuclear radiation on monolithic silicon and thin-film integrated circuits and devices. Resulting from gamma-ray emission, transient radiation effects are much farther ranging than heat-blast and permanent-damage effects.

Of particular significance to missile and space electronics is the fact that the range of transient radiation effects increases rapidly with altitude. Military insistence that transient-radiation specifications be written for systems such as the TFX airplane and the mobile mid-range ballistic missile points up the hazards.

**What Radiation Does**—In the first Hughes paper, R. W. Marshall and E. P. Mitchell detail findings from simulation of bomb blasts with a linear electron accelerator.

Marshall and Mitchell lump effects on electronic gear into two general categories: Ionization of air and component materials increases resistor conductivity and causes leakage in the insulating layers of resistors, capacitors and other components. Injection of currents into active and passive components results from a charge scattering effect. In transistors, this current appears in the base region and is multiplied by the device's beta. Consequent redistribution of charge in the circuit can cause temporary circuit malfunctions leading to system failure.

Since the transient radiation effect is proportional to the junction area, high-frequency transistors and high-speed diodes are less affected. In monolithic silicon integrated circuits, active and passive components are isolated by a silicon substrate that is the equivalent of large back-to-back *p-n* junctions. Such circuits are more vulnerable than their hybrid thin-film counterparts in which insulating substrates isolate individual components.

**Thin Films Better**—Hughes' tests show that thin-film resistors are at least an order of magnitude superior to silicon breadboard circuit resistors under radiation. The graph shows thin-film resistor characteristics.

The Signetics SE102K gate shown (left-hand schematic) proved to be the most resistant to transient

radiation effects during the series of tests run on monolithic silicon circuits. The authors feel that this is because it uses only one h-f transistor, and when in the OFF position, one or more of its input diodes are forward biased. Transient radiation effects are relatively slight on forward-biased diodes.

The comparable Philco experimental hybrid thin-film 7006 gate (right-hand schematic) exhibited about 80 percent of its counterpart's voltage change. Both circuits were OFF during the test, and it is believed that the relatively small difference in performance was due to the isolation diode in the Signetics circuit.

In conclusion, the experimenters suggest that:

- At present, hybrid thin-film circuits using h-f transistors should be used for microelectronics applications in transient radiation environments greater than  $10^6$  rads/sec.

- *P-n* junction field-effect transistors do not perform as well as present h-f bipolar devices in nuclear environments.

- Experimental thin-film, insulated-gate, field-effect transistors can withstand transient radiation dose rates of  $10^8$  rad/sec.

- With thin-film active devices, such as those being developed at Hughes Semiconductor, Melpar, and RCA, and with continuous-process, thin-film, integrated-circuit production now underway, radiation-resistant circuits should be available in 1 or 2 years.

**Antiradiation Design**—J. E. Bell, of Hughes, emphasizes the high cost of experimental radiation ef-

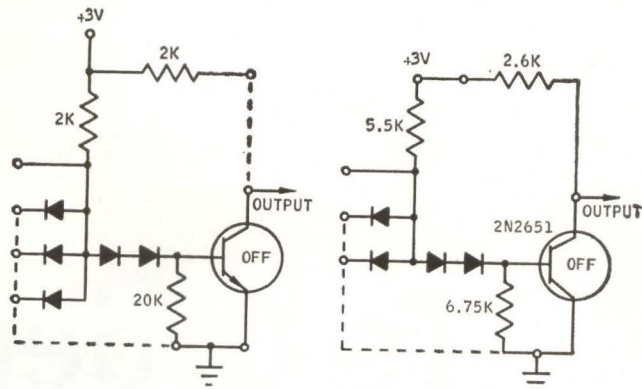
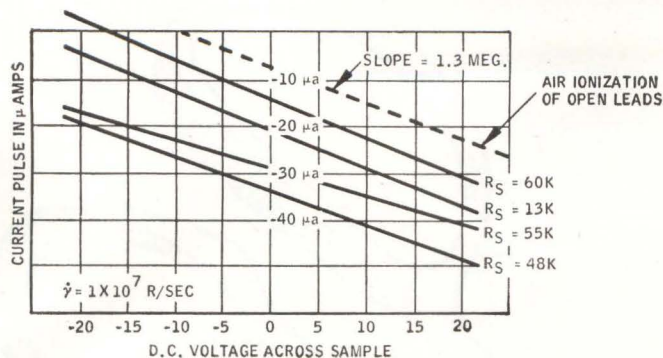

fects programs and stresses the need for analytical techniques to predict radiation responses. He describes basic-interaction, component, circuit analog circuit direct, and subsystem approaches, all computer-supported.

Charge redistribution in circuits and systems is the key to all five approaches. Also vital is a clear definition of the nuclear environment—nuclear weapon yield, detonation altitude, and system operating characteristics. "Prompt" radiation, for example (from  $10^6$  to  $10^{12}$  rads/sec), is of greatest concern to missiles.

In the circuit analog method, the basic circuit information is combined with specific transient-radiation-effects data to predict transient radiation responses of circuits. Besides using equivalent circuits to simulate circuit effects, three analogous radiation mechanisms are introduced. Redistribution of existing circuit charge is simulated by a leakage resistance or conductance between circuit nodes. Generation of new charge is handled by injecting current generators. Storage of either type of charge is simulated by capacitors or operational integrators in the computer program.

All possible charge conditions and their redistribution have then been considered, says Bell, and any circuit can be analyzed without new equations for each added part.

An example of radiation-hardening is the Forest (Fast Ordered Radiation Effects Sampling Technique) circuit. Essentially a digital memory device, this read-out circuit brackets the time duration and magnitude of any input signal pulse. It has successfully passed radiation exposure tests at  $10^9$  rads/sec of gammas and  $10^{13}$  nvt total neutron dose, reportedly the highest yet for a digital circuit.

## New Baby: 8-lb Radar

**LOS ANGELES** — Hand-carried, self-powered radar for use in either military or commercial applications will be demonstrated next week at the Military Electronics conference.

Able to detect and track a variety of moving objects, the compact demonstrator unit weighs only eight pounds. Integrated circuits will reduce weight of future models to five

pounds. The basic package offers all-range, coherent doppler detection. Range is 1,000 meters.

The set was developed by General Dynamics/Electronics. Applications include front-line military detection and surveillance despite low visibility or wooded areas. In addition, the radar can be used for communications with close support aircraft or vehicles as well as such commercial uses as border patrol surveillance, police detection and industrial security patrol.

Audio target signals can be received through a small loudspeaker on the rear of the unit or through a set of earphones worn by the operator.

The radar itself is a solid state f-m/c-w system. Its X-band transmitter is a crystal-controlled multiple chain which can be frequency modulated, permitting a choice of



OPERATOR uses dial at set's left rear to get target range

c-w ranging techniques.

The antenna is a four-quadrant fed slotted array with a bandwidth of 200 Mc. With feed modification the antenna may function as a monopulse. The sum pattern of 16 degrees may also be programmed in a conical scan or lobe switch function for improved resolution.

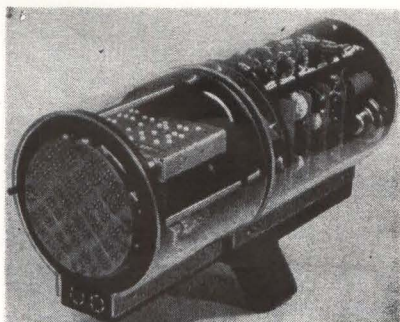

SCREWS TUNE antenna array

# To Order Reprints



Fill in,  
Cut out coupon below,  
insert in envelope  
and mail to:

**electronics** Reprint Dept.  
330 West 42nd Street,  
New York, N. Y.—10036

## REPRINT ORDER FORM

For Listing of Reprints Available See Reader Service Card

(To help expedite mailing of your reprints please send cash, check or money order with your order.)

For Reprints of the latest Special Report:

**Electronics Markets New Directions 1963-64-67**

Send me . . . . . Reprints of Key No. R-47 at 50¢ each.

For Reprints of previous **Special Reports** or **Feature Articles** fill in below:

Send me . . . . . Reprints of Key No.(s) . . . . . @ . . . . . ¢ each. (For prices, see chart above.)

\*For orders of Bulk Reprints of other editorial articles in **this issue** or **past issues**:

Send me . . . . . Reprints of page (no.(s)) . . . . . of issue . . . . .

of article entitled . . . . .

\*Minimum bulk order 100 copies. You will be advised of costs by return mail.

Name . . . . .

Number and Street . . . . .

City, Zone No., State . . . . .

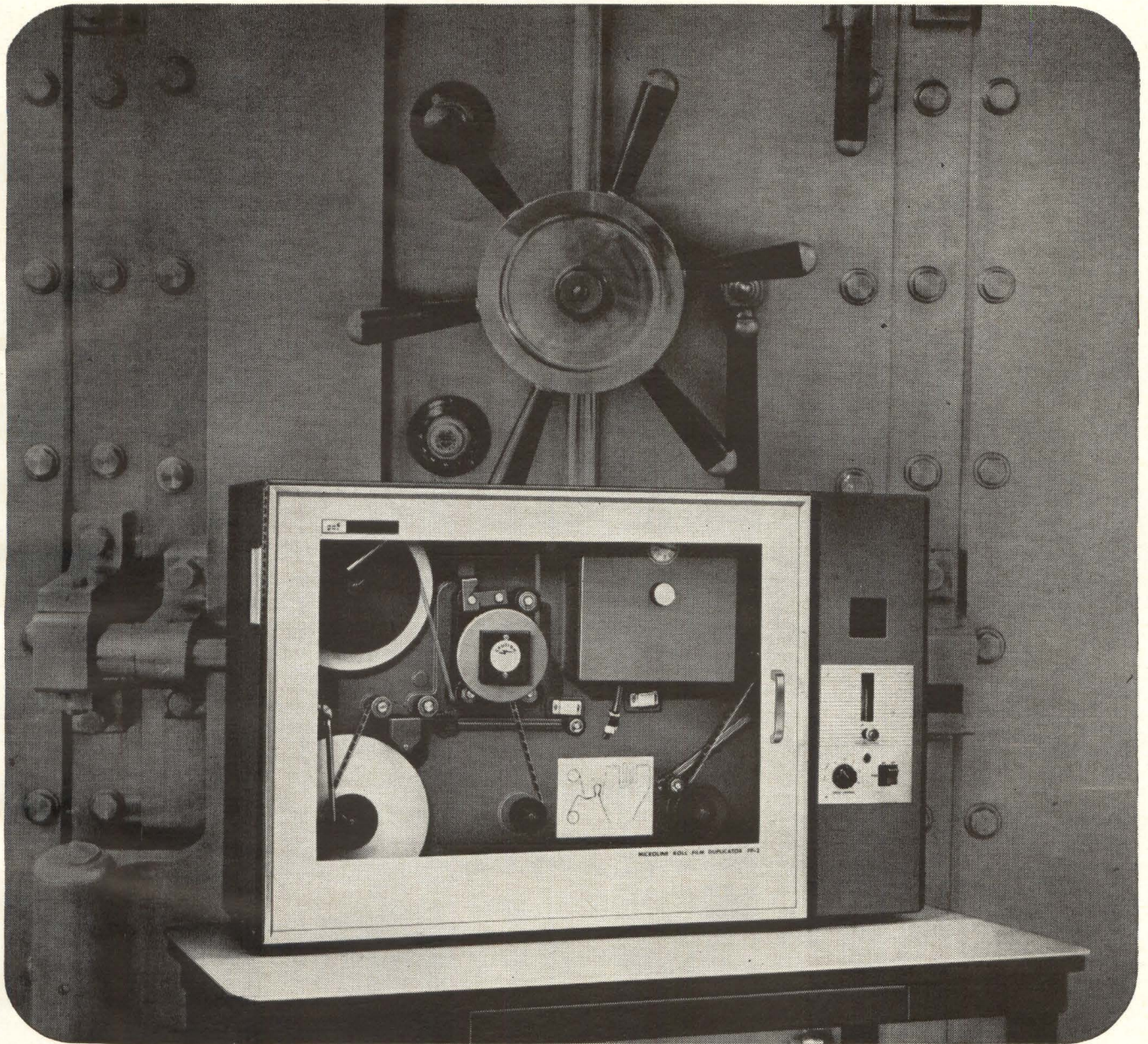

KEEP YOUR MICROFILM ORIGINALS SAFELY TUCKED AWAY!

## New Microline Rollfilm Duplicator makes perfect diazo working copies for day-to-day use!

Think of it! Now you needn't risk damage to, (or worse, loss of) precious microfilm originals that may occur in filing, sorting, retrieval and reproduction.

The new GAF Microline Rollfilm Duplicator can copy *perfectly* 100 ft. of silver microfilm in as little as 7 minutes!—with continuous inspection—dry—and ready for instant use! (Takes up to 1,000 ft. of 16mm or 35mm materials).

Put this new machine right on a desk . . . takes up only 4 $\frac{1}{2}$  sq. ft. and has an odor-free anhydrous developing system.

### New, too! Microline 18.24 Reader Printer

This all-new reader printer bridges the gap between stored information and working prints. It's the only unit now available that provides translucent blowbacks for diazo reproduction. Provides big savings on reproduction costs.

Ask your GAF Microfilm Representative to show you how these new machines, as well as GAF Microfilm and supplies, can bring really important savings to your operation.

**gaf** **MICROLINE**  
 MICRO IMAGE PRODUCTS  
 GENERAL ANILINE & FILM CORPORATION  
 BINGHAMTON NEW YORK

# How Many Jobs in 1970?

Department of Labor says electronics will need 1.1 million workers in 1970

**ELECTRONICS EMPLOYEES** should number 1.1 million by 1970—a 38-percent rise over 1961's figure of 778,000, says a report by the Labor Department.

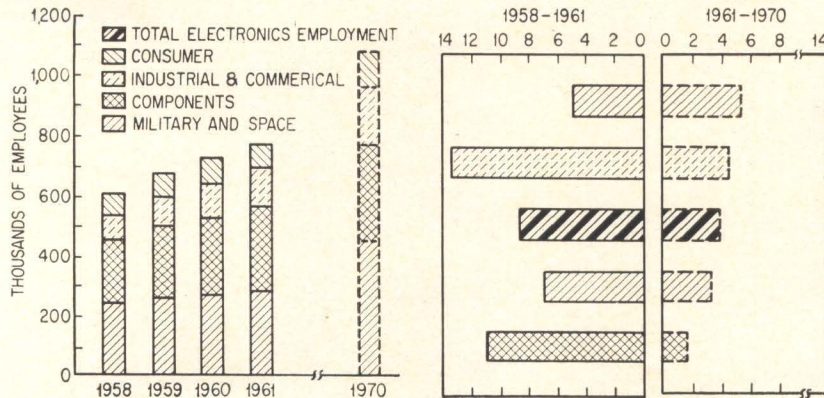

ESTIMATES of employment in electronics manufacturing, according to type of product, are shown in graph at left. Second graph shows percentage of employment increase per year in each field

The report sees an uptrend in all industry areas—military-space, industrial-commercial, consumer, components—despite “levelings,” “phaseouts,” plateaus” and despite what Manpower Studies Chief F. Fulton termed “yearly aberrations” such as the current \$1.1-billion defense-budget cut.

Fulton said last week that he’ll stick by his figures for military-space electronics, despite the industry’s concern that spending will slack off (see *Crosstalk*, p 5, and our special report, *Electronics Markets*, p 37, Jan. 3).

Fulton said that his figures are “conservative” to begin with, they cover “the long run” and, when compiled for the period ending in 1961, accounted for announced or anticipated modifications in long haul military-space objectives. In missiles, for instance, electronic needs will at least remain constant, he said.

But the report predicts growth rates will vary. Military-space and component manufacture, in 1961 absorbed 36 percent each of the industry-wide jobs, 16 percent went toward industrial-commercial operations, 11 percent to consumer.

The proportion by 1970, however, should be this: 42 percent military-space, 30 percent components, 17 per cent industrial, 11 percent consumer.

**Military-space** — Here, the most rapid growth is seen—from 1961’s 283,000 to 459,000 persons in 1970. It would occur most before 1965, the report said; later, defense R&D projects should be well into production. NASA work is predicted to level off too; but compared to DOD’s 50-percent rise, the space agency’s should be three-fold.

Until the mid-1970’s, military-space buildups would be due to three factors: increasing electronic complexity, aerospace vehicle sophistication, and efforts to achieve a manned lunar landing.

**Electronics Manufacturing Employees—TABLE I**

Product Category and Type of Worker	Number of Workers (thousands)		% of Employment in Product Category	
	1961	1970	1961	1970
Total employment.....	777.7	1,084.5		
Nonproduction.....	314.3	516	40.4	47.6
Production.....	463.4	568.3	59.6	52.4
Military-Space and Industrial-Commercial Products...	409	645.2		
Nonproduction.....	214.3	386.5	52.4	59.9
Production.....	194.7	258.7	47.6	40.1
Consumer Products.....	88.7	119.2		
Nonproduction.....	23.8	33.3	26.8	27.9
Production.....	64.9	85.9	73.2	72.1
Components.....	280	319.9		
Nonproduction.....	76.2	96.2	27.2	30.1
Production.....	203.8	223.7	72.8	69.9

**Occupational Distributions, Mid-1962—TABLE II**

Occupation	Military and Space Products Percent	Consumer Products
Nonproduction workers.....	60	30
Engineers and other technical workers.....	33.4	11
Engineers <sup>1</sup> .....	21	6
Technicians.....	7.7	3
Draftsmen.....	4.7	2
Administrative and executive.....	13.2	12
Clerical and stenographic.....	13.4	7
Production workers.....	40	70

<sup>1</sup> Includes such occupations as electrical, electronics, design, industrial, mechanical, value, test and quality control and chemical engineers. Military and space products also includes a small number of scientists, such as physicists, chemists, mathematicians and metallurgists.



**Industrial-commercial** — Employment here should increase from 1961's 126,000 to 186,000 in 1970. The reasons: population-center shifts and growth rates, aided by increases in per-capita real income; automation and quality control; and expanded communications systems.

**Consumer Products**—Reasons for the anticipated job increase (see table) include rising population and incomes, increasing numbers of women workers demanding more labor-saving devices, and new families. Continuing as main items would be television sets, radios, phonographs.

**Components** — From 280,000 workers in 1961, the number should reach 320,000 in 1970. While the report says the demand for components reflects the demand for end products, component employment will increase 1.5 percent—less than in other categories.

This will be due to component shipments per worker rising faster than the industry average, and because replacement rates seem to wane as components gain in efficiency and versatility.

The report is obtainable for 40¢ from the Superintendent of Documents, Government Printing Office, Washington 25, D.C. 20402.

### Backpack TV Studio



NEWSCHIEF tv broadcast system developed by Sylvania is being used by ABC to cover the 1964 Olympics in Austria. Cameraman's backpack transmits video and audio over 1-mile range. Power output of the 2-Gc, f-m transmitter is about 1 w

## WHY MACHLETT OFFERS THREE COOLING/INSULATION OPTIONS IN RADAR SWITCH TUBES

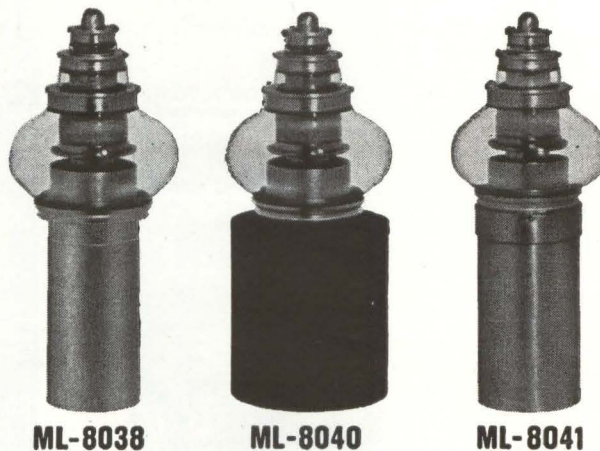

**Oil cooled ML-8038.** Anode dissipation: oil (convection) to 5 kW\*; Max. dc Plate Volts, 125 kV; Pulse Cathode Current, 175 amp.; Pulse Power Output, to 20 Mw.

**Forced air cooled ML-8040.** Anode dissipation: forced air cooled to 10 kW; Max. dc Plate Volts, 60 kV; Pulse Cathode Current, 175 amp.; Pulse Power Output, to 10 Mw.

**Water cooled\*\* ML-8041.** Anode dissipation: water cooled to 60 kW; Max. dc Plate Volts, 60 kV; Pulse Cathode Current, 175 amp.; Pulse Power Output, to 10 Mw.

**TO HELP YOU OPTIMIZE DESIGN,** Machlett offers three coaxial switch tubes (to 125 kV... 20 Mw... 1000  $\mu$ sec Pulse) in three cooling/insulation options. All tubes are of the same family: ( $\mu$ : 120, low inductance, terminal structure; thoriated-tungsten-cathode). All incorporate internal shielding to assure high voltage stability and achieve low x-radiation yield. All tubes are aged and operated above peak ratings in Machlett test equipment.

**Applications:** Radar systems, linear accelerators, klystron and/or amplatron test equipment. For complete technical data get our 74-page Hard Pulse Modulator Tube Brochure. Write: The Machlett Laboratories, Inc., Springdale, Conn. An affiliate of Raytheon Company.

\*Forced oil cooling considerably increases this figure.

\*\*May be operated oil insulated (and not water cooled) to 125 kV.



ELECTRON TUBE SPECIALIST

## TWO AN/FRR-41 RADIO SETS

*but there's a difference*

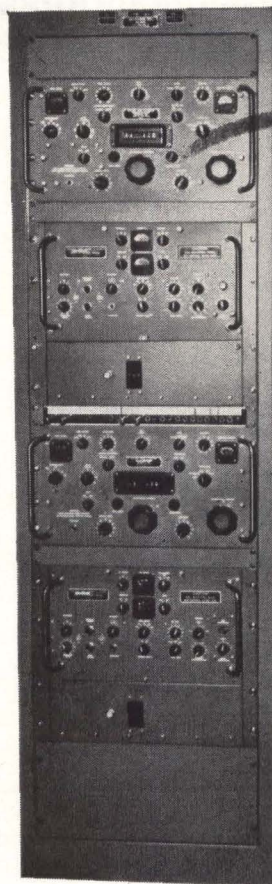

**STANDARD**  
AN/FRR-41 RADIO SET

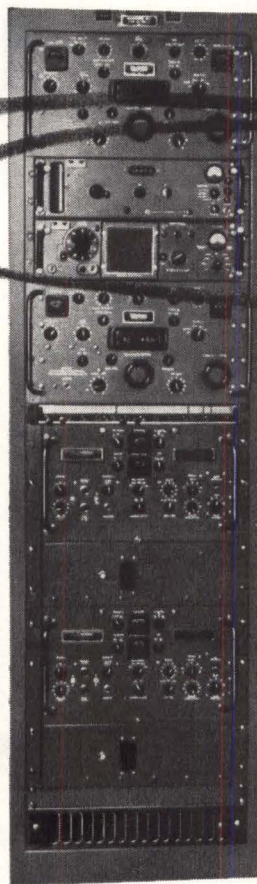

**STABILIZED**  
AN/FRR-41 RADIO SET

*The entire AN/FRR-41 Radio Set is stabilized to 1 part in 10<sup>8</sup> per day by this single Manson SBM-1100 Sideband Stabilization Kit.*

The difference is fully stabilized sideband communications. What makes the difference is the Manson SBM-1100 Sideband Stabilization Kit. Add this kit to a complete ISB receiving system such as the AN/FRR-41 or even a single R-390A receiver, and full compliance with D.C.A. stability and tuning requirements is provided.

Of basic importance in today's military communications systems, the AN/FRR-41 is a dual diversity ISB receiving system consisting of two R-390A Receivers and two CV-157 Sideband Converters. A stability of better than 1 part in 10<sup>8</sup> per day is provided for the entire system including the CV-157's by a single Manson Kit. The stabilized AN/FRR-41 tunes in 100 cps steps, as well as on a continuous basis, with a calibrated accuracy and resettability of better than 0.02 cps at 2 mcs and 0.3 cps at 30 mcs. This high set-up accuracy and frequency stability permits the reception of completely suppressed carrier sideband transmissions and

assures precise netting of the AN/FRR-41 with today's most advanced, synthesized military transmitters. Full compatibility is maintained with non-stabilized transmitters by means of automatic frequency control, selectable at the operator's discretion.

Today's large investment in communications equipment dictates economical modernization with a minimum of equipment obsolescence. The Manson SBM-1100 Stabilization Kit meets these demands and answers the urgent requirement for high stability, multi-channel suppressed carrier ISB communications. Over twenty-five different configurations of Manson Stabilization Kits are available to meet the specific requirements for each radio service. Simple plug-in modular design and full step-by-step procedures permit complete field installation by on-site military operating and maintenance personnel. Write today for full engineering and application information.



375 Fairfield Ave Stamford, Conn

*Shaping the future of communications*

# Will DOD Use ComSat Satellites?

DEFENSE DEPARTMENT may decide to let the publicly-owned Communications Satellite Corp. handle the military's communications satellite requirements rather than build a separate military system. This announcement was made on Monday by Secretary of Defense Robert McNamara in his 1965 budget statement to the House Armed Services Committee.

Until the decision is made, the DOD's R&D effort will continue but no new operational capabilities will be initiated.

Major problems yet to be resolved, McNamara said, are related to global services, security of military circuits, and location and control of the ground stations. "However, even if these problems cannot be worked out satisfactorily, close cooperation between DOD and the corporation might still make possible the joint development and production of the satellites, boosters, and other elements of the system."

- Other highlights of McNamara's testimony:

- The problem of defending against submarine-launched missiles is second only to defense against intercontinental missiles. "Certain radars" have the capability of detecting such missiles, and selected air-defense radars along the nation's coasts are being modified for this purpose.

- A prototype system of a newly-developed over-the-horizon radar is now in operation. If successful, it

will be able to detect missiles attacking from any direction, including the South Pole area which is not now covered by BMEWS. In addition it could provide earlier information on missile raids than BMEWS.

- A prototype multifunction array radar (MAR) will be installed at the White Sands, N. M. missile range in June and several other phased-array radars will also be tested during the next year in connection with the Nike X antimissile missile system.

- Planes of the airborne command system, which has a command post aircraft in the air at all times, are being re-equipped with an improved integral electronics system which will "considerably enhance their overall effectiveness."

## Echo II in Trouble?

WASHINGTON—Echo II, launched last week, may be losing shape, according to NASA. Radar data show variations in reflectivity characteristics, although optical trackers report steady brightness—no abnormalities. Relay II, also sent up last week, is reportedly doing well.

## Boston Still Favored For Electronics Center

IT APPEARS certain that Boston remains NASA's choice for the location of its proposed Electronic Research Center. Tomorrow is the deadline for Administrator James E. Webb to submit to Congress a new justification for the center and for its location in the Boston area. Prodded by a statement by Rep. Charles Halleck of Indiana, Webb said last week that "a first cut" at the data gathered by the NASA area survey committee gave him no reason to believe that NASA's selection of Boston will be changed.

So confident of this are Massachusetts political and business leaders that more than 100 site presentations have been made to NASA officials in Washington in the past few months. Prime requirement for the site will be proximity or at least easy access to the university-in-

dustry electronics complex in the Boston-Cambridge area and along Route 128.

## Aerospace Computer Highly Reliable

ST. PETERSBURG, FLA.—A family of eight aerospace digital computers with a predicted mean time between failures of up to 10 years was unveiled this week by Honeywell's Florida Aeronautical Division. New concepts in modules, packaging and memory were reported for the Adept computers. The modules—general-purpose computers without memories—can each perform the same operations. A four-module system could still operate after three modules failed, only slower.

The packaging technique produces a single-circuit package with 25 integrated circuits connected by

the diffused molecular junction technique. The Orthocore memory (p 34, Nov. 1, 1963), which uses closed-flux geometry, is a three-dimensional film memory produced with photographic techniques.

## Japanese Pushing Transistor Production

TOKYO—Electronic Industries Association of Japan estimates that transistor production here this year will increase to about 330-million units, or 26 percent above that in 1963. When major manufacturers complete production facilities now under construction—probably sometime in the last half of this year—capacity should rise to at least 50 percent above the 1963 figure. There is currently a severe shortage of transistors here because of increased exports and increased use of the de-

vices in equipment in which they were not formerly used, such as tv sets and tape recorders. In November, latest month for which statistics are available, exports were almost 20 percent of production. This is expected to go up to about 30 percent during 1964.

## Disarmament Effects— U.S. Wants Them Spelled Out

ARMS CONTROL and Disarmament Agency has requested proposals for a study on the "Implications of Reduced Defense Demand for the Electronics Industry." The Agency says the study should take three man years, and be completed by June 30, 1965. Proposals must be in by Feb. 7. A fixed-price contract is contemplated.

The study will examine the extent and nature of the dependence of the electronics industry on national defense; identification of the industry's markets—such as military, industrial, consumer, space—with the employment generated by each; and

how to aid industry in finding new nonmilitary markets here and abroad.

## Next Solid-State Package a Cube?

WASHINGTON — Packaging scheme modeled after the arrangement of neurons in the human brain was envisioned for microelectronic digital computers here last week. Jan Narud, of Motorola Semiconductor, suggested that placing microcircuit chips on five faces of a cube with the interconnections then made inside the cube would eliminate cross-overs and be practical for high-power circuits. Connections to other cubes would be made from the sixth face.

Narud predicted this approach as well as that of stacking chips on multilayer circuit boards would replace present cans and flat packages, which he termed an "interim" approach. His remarks were made in an engineering progress report to military representatives, in which he

also predicted that integrated circuits would allow designing airborne digital systems capable of employing the techniques used in present large scientific machines.

## Computer Speeds Message Handling

NEW YORK — Demonstrating the speed of their new computer-controlled Electronic Telegraph System (ETS), RCA Communications engineers last week sent a message from the New York central office to San Francisco, where it was instantaneously relayed back to New York. Forty seconds after the original message had been fed into the computer-transmission complex, its duplicate came out of a monitor teleprinter. In that time, besides handling the message four times, the equipment verified the incoming message number and inserted an outgoing number, recorded and printed out on a comparison list the inward and corresponding outward numbers and entered the message on tape for six-month storage. For overseas messages, the computer automatically reads or assigns a destination code, inserts local delivery code, determines message precedence, detects lost messages and handles billings.

## Ship Data Relayed To Land Automatically

LONDON—Performance data of 15 Shell Oil tankers on duty throughout the world will soon be monitored and immediately relayed by radio to a company receiving center here. Instrumentation on the tankers will read temperature, pressure, fuel consumption, wave height, and wind direction, and transfer the data to punched tape. Information will be relayed via special single-sideband radio signal.

Shell has already installed equipment on one tanker; two others are being fitted with sending apparatus. If operation with the first 15 ships is successful, the system will likely be used for the company's entire world-wide tanker fleet.

## MEETINGS AHEAD

ELECTRONIC SALES MARKETING ASSOCIATION MEETING, ESMA; Barbizon Plaza Hotel, New York, N. Y., Feb. 3-5.

MILITARY ELECTRONICS WINTER CONVENTION, IEEE-PTGMIL; Ambassador Hotel, Los Angeles, Calif., Feb. 5-7.

ELECTRONIC COMPONENTS INTERNATIONAL EXHIBITION, FNIE, SDSA; Paris Exhibition Park, Paris, France, Feb. 7-12.

INFORMATION STORAGE-RETRIEVAL INSTITUTE, American University; University, Washington, D. C., Feb. 17-21.

PHYSICAL METALLURGY OF SUPERCONDUCTORS MEETING, AIMMPE Metallurgical Society; Hotel Astor, New York, N. Y., Feb. 18.

INTERNATIONAL SOLID STATE CIRCUITS CONFERENCE, IEEE, University of Pennsylvania; Sheraton Hotel and University of Pennsylvania, Philadelphia, Pa., Feb. 19-21.

SOCIETY FOR INFORMATION DISPLAY NATIONAL SYMPOSIUM, SID; El Cortez Hotel, San Diego, Calif., Feb. 26-27.

WELDED ELECTRONIC PACKAGING SYMPOSIUM, WEPA; Miramar Hotel, Santa Monica, Calif., Feb. 26-27.

SCINTILLATION-SEMICONDUCTOR COUNTER SYMPOSIUM, IEEE, AEC, NBS; Hotel Shoreham, Washington, D. C., Feb. 26-28.

ELECTRONIC INDUSTRIES ASSOCIATION SYMPOSIUM, EIA; Statler Hilton Hotel, Washington, D. C., March 9.

EXPLODING CONDUCTOR PHENOMENON CONFERENCE, AFCL; Boston, Mass., March 10-12.

IRON AND STEEL INDUSTRY INSTRUMENTATION CONFERENCE, ISA; Roosevelt Hotel, Pittsburgh, Pa. March 11-12.

IEEE INTERNATIONAL CONVENTION, IEEE; Coliseum and New York Hilton Hotel, New York, N. Y., March 23-26.

## ADVANCE REPORT

CHICAGO SPRING CONFERENCE ON BROADCAST AND TELEVISION RECEIVERS, IEEE-PTGBTR; O'Hare Inn, Des Plaines, Ill., June 15-16; Feb. 17 is deadline for submitting 2,500-world papers plus three copies of 50 to 100-word summaries, to Francis H. Hilbert, Papers Committee, Motorola Inc., 9401 W. Grand Avenue, Franklin Park, Illinois. Topics include all aspects of the home entertainment and television industry, including new concepts, techniques in product design.

## Giants Merge Divisions Into New Computer Firm

NEW YORK—Faced with high overhead and low profits at its TRW Computer Division in Canoga Park, Calif., Thompson Ramo Wooldridge last week made a deal. Observers thought it was a good one for TRW, which usually shows good footwork in the clinches.

The computer division will be combined with Martin Marietta's Electronics Systems & Products division, forming a new company, Bunker-Ramo Corp. Martin, which will put up the capital for the new corporation, will own about 90 percent of the stock and TRW about 10 percent. To seal the bargain, Martin gave TRW an undisclosed sum of cash and an option to buy 10 percent more B-R stock.

The deal could be a good one for Martin too, some thought. It puts Martin in the military command and process control business, which it has wanted to get into for some time. George M. Bunker, Martin president, will be chairman of the new firm and Simon Ramo president.

## Lab Reports Progress On Thin-Film Inductors

PHOENIX—Latest report from Motorola Solid State Systems Division on progress in developing miniature thin-film, flat-spiral inductors says that a 21-turn device has yielded 1.6 mh when deposited on a non-magnetic material and 3.3 mh when deposited on a ferrite substrate.

Outer diameter of the spiral is 0.29 inch. Ultimate goals of the program, sponsored by Navy BuShips, are for 38 to 1,000 mh with Q-values in excess of 100 when measured at 1 Mc. Program has been underway since June, 1961.

Gold conductors of 2-mil width are deposited through electroformed nickel-on-copper masks. To provide required mask rigidity, circular pattern is etched in eights and deposition is accomplished in two stages. It is expected that considerably higher inductances will be achieved by encapsulating the deposited gold spiral with a thin ferrite overlay.

## Computers Answer Questions Over Phone

AUDIO RESPONSE unit will permit five different IBM computers (1440, 1401, 1460, 1410, 7010) to give verbal output data over the telephone. The IBM 7770 unit assembles an answer from a magnetic-drum vocabulary in response to a telephoned numerical query, and is designed for activities requiring immediate information on the status of accounts, such as in banking, insurance, finance, manufacturing and retailing.

The North Electric digital-to-voice converter (p 18, March 29, 1963), devised for the Teleregister Corp's stock quotation system, is due to be installed around the end of next month at the American Stock Exchange. It has a 60-word vocabulary stored on a magnetic drum, and can handle up to 750 simultaneous telephone inquiries.

## IN BRIEF

**TELCAN** home video tape recorder, developed in England, will probably be manufactured in the U.S. by Minnesota Mining (p 10, Dec. 27, 1963). Cinerama, which holds the Western-hemisphere rights to the device, also received bids from Webcor, Ranger Electronics and Sears Roebuck.

**ONR** has awarded a prime contract to Technical Communications Corp. for a study of self-organizing, multiple-access, discrete-addressed (SOMADA) communications systems capable of handling messages from satellite, amphibious, asw and other sources.

**TEXAS INSTRUMENTS** is marketing a solid-state control for clothes dryers that measures, by resistance, exact desired dryness. Last year TI reported it was working on solid-state controls for a wide-range of home appliances (p 14, Sept. 13, 1963).

**ELECTRONIC** Representatives Association reports the average representative is netting only 9.9 percent of total income, before taxes. For the average instruments representative, this drops to 6.1 percent.

**AMPEX** and Tokyo-Shiba are forming a joint manufacturing company to serve the Japanese market. It will make Ampex videotape recorders, computer memory products and scientific instrumentation recorders.

**LEAR SIEGLER** has purchased an 83 percent interest in C. A. Steinhilf Soehne GmbH Optische Werke, a Munich optics firm.

**YOKOGAWA**—Hewlett-Packard Ltd. has begun manufacturing operations within Yokogawa's facilities. Construction work is underway on a Yokogawa—Hewlett-Packard factory.

**PERFORMANCE** of two Vela Hotel nuclear-test-detection satellites launched by the Air Force two months ago has been so successful that the R&D program of which they are an initial part has been pushed up by more than a year.

**GE CLAIMS** two more firsts in digital computer control. A GE/PAC 4000 computer and Directo-Matic II solid-state control will automate the Alton and Southern Railroad's Gateway Yard in E. St. Louis, Ill. GE's 412 process control computer will be used to control nuclear solvent extraction at the AEC's Hanford Labs in Washington.

## Johnson Salutes Midas

MIDAS got its first kind word from the Administration this week when President Johnson told Congress that two satellites last year detected missiles being launched from U.S. missile ranges. The first successful Midas went up on May 9 from Vandenberg, two days after Harold Brown had almost given up on the project (p 7, May 31, 1963). ELECTRONICS carried the first published report of the Midas shot.

## **Pentagon Trying To Hold Design Teams Together**

**Defense Department is acting** to help contractors, wherever possible, keep skilled teams of engineers and other specialists intact even if a major military contract or development program is terminated. A new policy directive tries to avoid breaking up such teams by: 1) excluding from contract termination work by the teams that might be of continuing value to the government; 2) searching for additional work requiring such teams' skills and expediting placement of contracts that would eventually go to their employers. The new policy will be of benefit first to teams of experts working on the cancelled Dynasoar spacecraft and Typhon missile programs.

## **NASA Reshuffles Project Funds: More for SST and Some Satellites**

**NASA has notified Congress** that it is reshuffling its fiscal 1964 funds on some 22 research projects. The change includes a \$4-million boost (to \$67.8 million) for meteorological satellites, primarily for the Tiros cartwheel configuration designed to increase earth-viewing time. Development of space vehicle systems is increased from \$53.4 million to \$57.9 million, primarily to develop instrumentation for Project Fire, the study of effects of reentry on lunar spacecraft. An advanced Project Fire study of interplanetary craft reentry is scrubbed.

Some \$18.5 million is earmarked to start the new advanced technology satellite program. The satellite will carry a variety of experiments into synchronous orbit. Work on nuclear electric systems is reduced from \$68.7 million to \$46.7 million. Funding for aeronautical studies goes up from \$16.2 million to \$24.3 million, mainly to support the supersonic transport development.

## **Airliners May Carry Low-Cost Crash Beacons**

**Federal Aviation Agency has endorsed** the use of crash-locator beacons on civil aircraft. Tests show that suitably-equipped search planes can home in on a beacon's transmitted emergency signal. FAA is now seeking assurances that industry can produce the beacons at a reasonable price and that aircraft owners will buy or rent them. If so, FAA will install search equipment in the planes that now routinely check on the accuracy of navigation aids. To be fully compatible with equipment to be installed in FAA planes, crash-locator beacons must radiate at least 225 milliwatts for 24 to 48 hours, transmit at 121.5 Mc, be crystal controlled with audio tone sweeping between 2,000 and 2,300 cps two to three times per second, and have 70 to 90-percent modulation.

## **Library Automation Pilot Program Cost Put at \$50 Million**

**Program to automate** the Library of Congress as a prototype adaptable to the needs of other large research libraries has been recommended by a panel of specialists, headed by Gilbert S. King, vice president of Itek Corp. Working under a \$100,000 grant from the Council on Library Resources, the team proposed that bibliographic processing, catalog searching and document retrieval are now technically and economically feasible. Automatic retrieval of the contents of volumes is not yet feasible for large collections; but, the team suggested, progress on this would be a byproduct of automation of other processes now. The team recommended a \$750,000 request for system specifications for automation of internal operations of the library, and funds for design implementation. The \$50-million to \$70-million estimated overall cost roughly equals the library's operating budget for three years. L. Quincy Munford, librarian, says that several months' study will be needed before a decision is made on whether to ask Congress for planning funds.

This is what  
diodes looked like

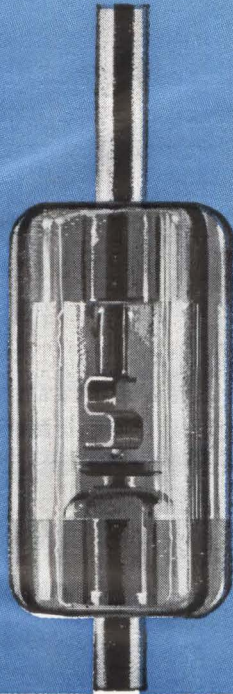

before  
Unitrodes



REMEMBER?

Remember the fragile whisker so easily burned out? The cavity where, in time, contaminants were sure to degrade reverse characteristics eventually? The delicate construction that was likely to fail under thermal and mechanical stress? The limited service life even under the best of conditions?

Never again.

Unitrodes have changed all that with an entirely new approach to diode design. The silicon wafer is high-temperature bonded *directly* between the terminal pins, and a hard glass sleeve is fused to *all* exposed silicon. Result: a void-free junction that can't be contaminated. Broad current-carrying surfaces that can withstand 10 watt power overloads — continuously — with no after-effect. A one-piece unit indifferent to shock, vibration,

acceleration . . . unperturbed by thermal shock or cycling from  $-195^{\circ}\text{C}$  to  $+300^{\circ}\text{C}$ .

And this small: 

Naturally you'd expect performance like this to cost a bit more, and it does. Mainly because of rigid manufacturing standards and because every Unitrode® diode is 100% final tested. But if you're working in high reliability, you owe it to yourself to watch your Unitrode representative's 15-minute demonstration. We'd be happy to send him around with our entire line of diffused 3 ampere silicon diodes, fast switching rectifiers, 3 watt zeners, high voltage stacks and bridge assemblies. We never cease to be amazed ourselves. Write or call . . . UNITRODE TRANSISTOR PRODUCTS, INC., 214 Calvary Street, Waltham, Massachusetts 02154, Tel: (617) 899-8988 TWX: (617) 894-9876.

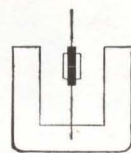

UNITRODE

**New from Potter...**

# TRANSPORTS "matched" to the performance of your computer

You're looking at the business end of a Potter MT-36, one of a family of 3 new digital magnetic tape transports now available for prompt delivery to value-conscious buyers.

Compact . . . reliable, each of these new vacuum-column tape memory systems was designed to serve a specific data range. You don't have to pay for performance you can't use. All of these new units look alike, operate alike, are designed alike — with most parts interchangeable. You can get the benefits of standardization, yet still have choice of performance and price.

## PACKING DENSITIES TO 800 bpi

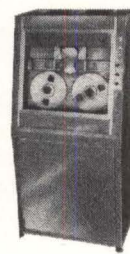

### **MT-24**

1-36ips —  
data transfer  
to 28.8kc

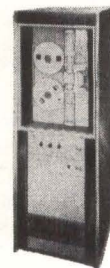

### **MT-36**

1-50ips —  
data transfer  
to 40kc

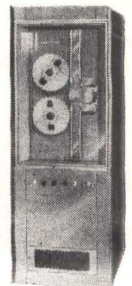

### **MT-75**

1-75ips —  
data transfer  
to 60kc

IBM or other computer formats

Interested? Call Potter today (516) OV 1-3200

## POTTER®

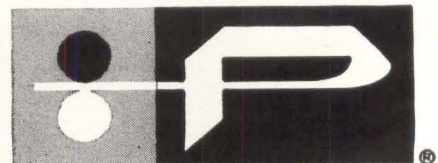

**INSTRUMENT CO., INC.**  
151 Sunnyside Boulevard, Plainview, New York

CIRCLE 22 ON READER SERVICE CARD



TYPICAL CIRCUIT module using digital microcircuits and a few discrete components. Digital techniques allow cockpit operation of Loren-C receiver for first time

# DIGITAL LORAN-C RECEIVER Uses Microcircuits

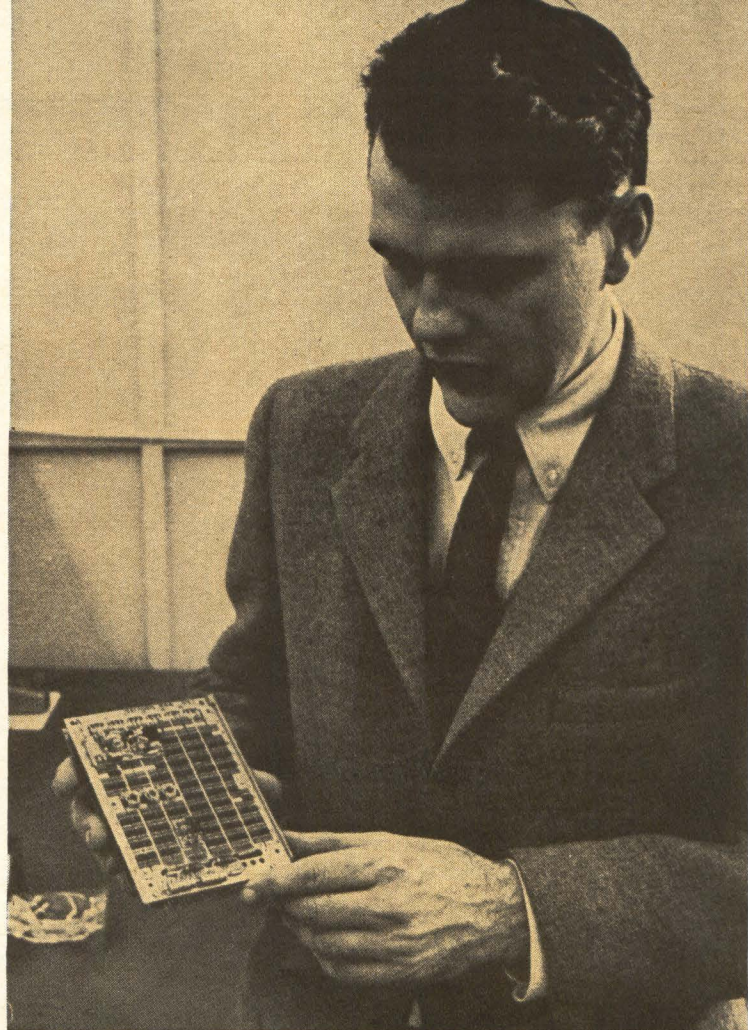

Redesigning an analog receiver to use digital techniques requires a new approach to system design. Even servo loops and filters are digital, and only r-f amplification remains analog

By **ROBERT L. FRANK** and **ALAN H. PHILLIPS**, Sperry Gyroscope Co., Great Neck, New York

**REDUCED SIZE**, weight and power consumption combined with simpler operation are the results of marrying digital techniques and microcircuits in a new Loran-C receiver for general aircraft use. But digital circuits could not be substituted for analog circuits on a straightforward function-by-function basis. Complete redesign of the receiver on a system-function basis was necessary. Some of the design techniques developed have applications in radar and communications systems.<sup>1</sup>

The basic Loran-C navigation system consists of a master station and two associated slave stations. Each station transmits precisely timed pulses on a carrier frequency

of 100 kc, which results in usable ground-wave signals to 1,900 n.m. over water and 1,500 n.m. over land.<sup>2</sup>

A Loran-C receiver in the aircraft measures the time difference between the reception of a signal from the master and each of two slaves to establish two unique hyperbolic contours or lines of position with the stations as foci. The intersection of the two lines locates the aircraft, as indicated in Fig. 1.

As a result of a completely new system and circuit design that maximizes the use of digital integrated microcircuits and eliminates all moving parts, it has been possible to obtain the following advantages.

- Operator controls are reduced

from 26 to 6 and the usual crt is eliminated, making cockpit operation feasible for the first time.

- Weight is 20 lb instead of 100.
- Power consumption is 150 watts instead of 500.
- Reliability is increased by a factor of three.

**Signal characteristics**—Loran-C signals are complex and many factors are involved.

- Each Loran-C chain broadcasts a group of eight pulses, with the signals of the master followed by two or more slave station signals in sequence. Each chain uses a different repetition rate.

- The pulses are carrier-phase coded for station identification and to permit compression of the eight



ORIGINAL LORAN-C equipment, left, and new digital system

## NOW: LORAN IN THE COCKPIT

Although the Loran-C navigation system was developed approximately 12 years ago, widespread aircraft use for general navigation was not likely until the receiving equipment was simple to operate, could be installed in the cockpit, and could provide information similar in form to that from DME, VOR, or TACAN. A digital Loran-C receiver showed promise of meeting the requirement, since digital logic could substitute for operator logic—making the receiver simple to operate—and microelectronics could reduce size and weight

pulse groups into one higher energy pulse.

- All except the first three cycles may be contaminated by skywave signals reflected from the ionosphere. Skywaves may be as much as 30 db larger than the desired ground-wave signal.

- The signals may be immersed in atmospheric noise as much as 20 db above the ground wave, and in interference as much as 35 db above the ground wave.

- The signals may have an amplitude anywhere within a 120-db range, depending on distance from the stations.

- Aircraft motion produces a doppler shift up to 0.2 cps at 1,200 knots.

With such signals, the Loran-C receiver must make phase measurements without ambiguity to an accuracy of 0.1  $\mu$ sec, which is 1/100 of a carrier cycle.

**Requirements**—Receiver operation is indicated in Fig. 2. Master search requires examination of the entire 100,000  $\mu$ sec loran interval to find and identify the master signal arriving at an unknown time. Slave search requires tracking on the master (since slave identification is determined by approximate timing in relation to the master), but only a small time delay range must be examined.

Settling requires that the receiver tracking gates settle on the signal in spite of doppler shift. Furthermore, the settling must determine first the groundwave signal, then a particular cycle of the groundwave.

Tracking requires that the receiver integrate the information over a 10-sec period (800 pulses) to give the accuracy to overcome noise

and c-w interference, and to follow aircraft maneuvers. Readout requires a presentation of measured time difference to an accuracy of 0.1- $\mu$ sec over a 100,000  $\mu$ sec interval.

For data processing, serial operation at 1-Mc is adequate, except for storing loran signal timing (necessary for coherent detection) and measuring the loran time-difference; both these require a precision of 0.1  $\mu$ sec. Computing at 10-Mc was not possible with available integrated microcircuits so a hybrid design was developed. The loran signal-timing reference is stored in real time with a few 10-Mc chip circuits performing simple operations; the remainder of the functions are performed on a special purpose 1-Mc computer operating independently of loran time.

**System**—A simplified block dia-

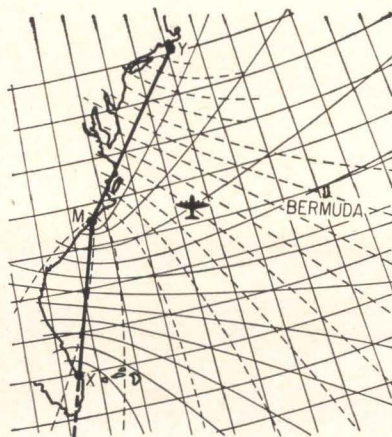

LORAN-C position lines are generated by master and slave transmitters. Photographic overlay shows analog receiver equipment and new digital equipment designed to replace it and make cockpit operation feasible—Fig. 1

gram is shown in Fig. 3. The r-f amplifier, of necessity analog, amplifies the Loran-C signals from a level as low as 5  $\mu$ volts to the 1-volt range.

The r-f signals are sampled directly and converted to digital form. Quadrature-channel operation required for coherent detection is provided by sampling separated by 2½  $\mu$ sec (90 degrees at the carrier frequency). For the cycle resolution, an envelope derivation network forms a zero point on the leading edge of the received pulse envelope. Five samplings are made on each pulse: two guard samples ahead of the signal to resolve skywaves and ground waves, one for cycle phase, one envelope sample to resolve cyclic ambiguity, and one for automatic gain control.

The data processor performs smoothing, integrating, transfer, timing, and threshold-detection functions. A circulating memory with a magnetostrictive delay line is used. This data processor is controlled by a synchronizer and programmer. Outputs from the data processor control the r-f amplifier gain (through a D/A converter), the various mode registers, and the loran timers.

Sampling is controlled by three loran timers—one for each station. The timers run from a 10-Mc oscillator and form a real-time memory of the expected time of arrival of the loran signals. They can be shifted in small steps under control of the data processor. A pulse counter and coder combines signals from the three timers and introduces proper phase coding.

Time difference indication is provided by a readout counter started by the master timer and

stopped by a selected slave timer. The count (in cycles of 10 Mc) provides the loran time difference, and is displayed on numerical display tubes in the control-indicator unit.

**Computer** — Digital, integrated microcircuits are used in all digital functions. A plug-in card containing up to 250 individually replaceable microcircuits is shown in one of the photographs.

The disparate requirements of master search and other modes are handled by a completely reorganized computer between these modes.

In modes other than master search, the memory is organized into three sectors corresponding to the three loran signals to be tracked. In each sector, the words store data derived from the five samplings of each signal and secondary data derived therefrom.

The required data processing is accomplished with only addition and subtraction operations. Scaling is accomplished by (1) programming the memory into which the input data bits are inserted and (2) programming the memory bits examined for threshold and selected for transfer into secondary data words.

The digital functions include nine digital servo loops of various degrees of complexity and ten smoothing filters that operate threshold detectors.

Extensive time sharing is used in the A/D converters, digital-processing elements, mode registers, and D/A converters for agc.

**Digital Servo Loops**—The receiver has functions equivalent to nine servo loops, six of which were electromechanical in earlier Loran-C receivers. The most complex are the three phase-lock loops.

Analysis indicated the receivers required a second-order (zero velocity lag) tracking loop with bandwidth switching to meet the noise reduction and maneuver requirements.

A simplified diagram of the Loran-C digital phase-lock loop, Fig. 4, shows that the sampling pulse output of the digital loop for  $e$   $\mu$ sec error is

$$\left( \frac{aen}{bP} + \frac{aen^2t}{bPQ} \right) \mu\text{sec}/\text{sec}$$

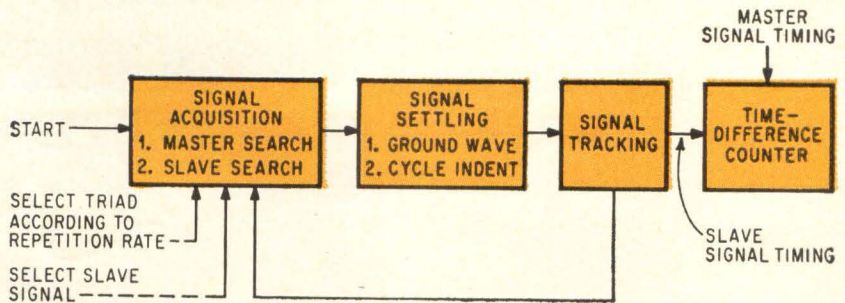

RECEIVER OPERATION requires identification of master and slave signals and determination of time relationships between them—Fig. 2

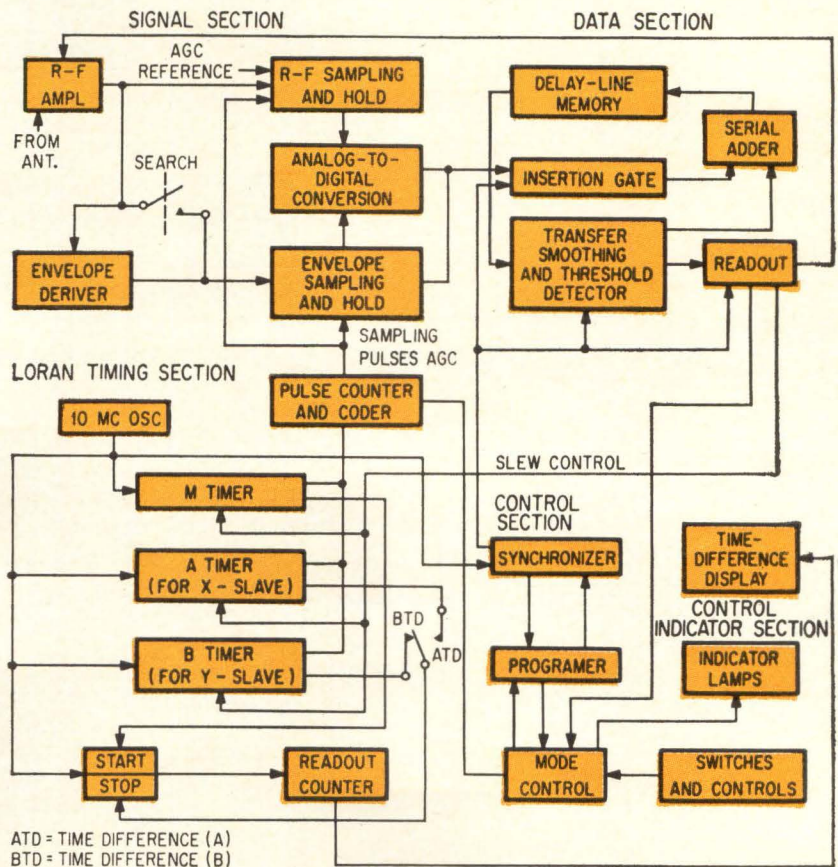

ATD = TIME DIFFERENCE (A)  
BTD = TIME DIFFERENCE (B)

DIGITAL OPERATIONS are accomplished with 839 microcircuits consisting of five types of 11 series 53 circuits: flip-flops, single and dual **ord** gates and single and dual **nord** gates—Fig. 3

where the terms are defined in the diagram.

The equivalent Laplace transform of the loop, Fig. 5, shows an output of  $(Ae + Aket)$   $\mu$ sec/sec for a fixed error of  $e$   $\mu$ sec, where  $A$  and  $K$  are coefficients in the equivalent Laplace transform.

The equating of the coefficients of  $e$  and  $et$  yields

$$A = an/bP$$

$$AK = an^2/bPQ$$

Therefore  $K = n/Q$ . Transient response, noise bandwidth, and signal-to-noise improvement of the system can be computed from Laplace transform theory.

The block marked cycle word in Fig. 4 is instrumented as follows. The sampled phase error is fed in digital form into the insertion gate (Fig. 3). From there it is shifted into the adder and, at the proper time, is added serially to the cycle word in the memory. The addition takes place for each sample of the signal ( $n$  times per sec). The cycle word continues to increase in value (if the error persists) until it overflows, returning to zero. The overflow is detected by the threshold detection and readout and is fed to the slew control, which causes a change of  $a$   $\mu$ sec in the timing of the

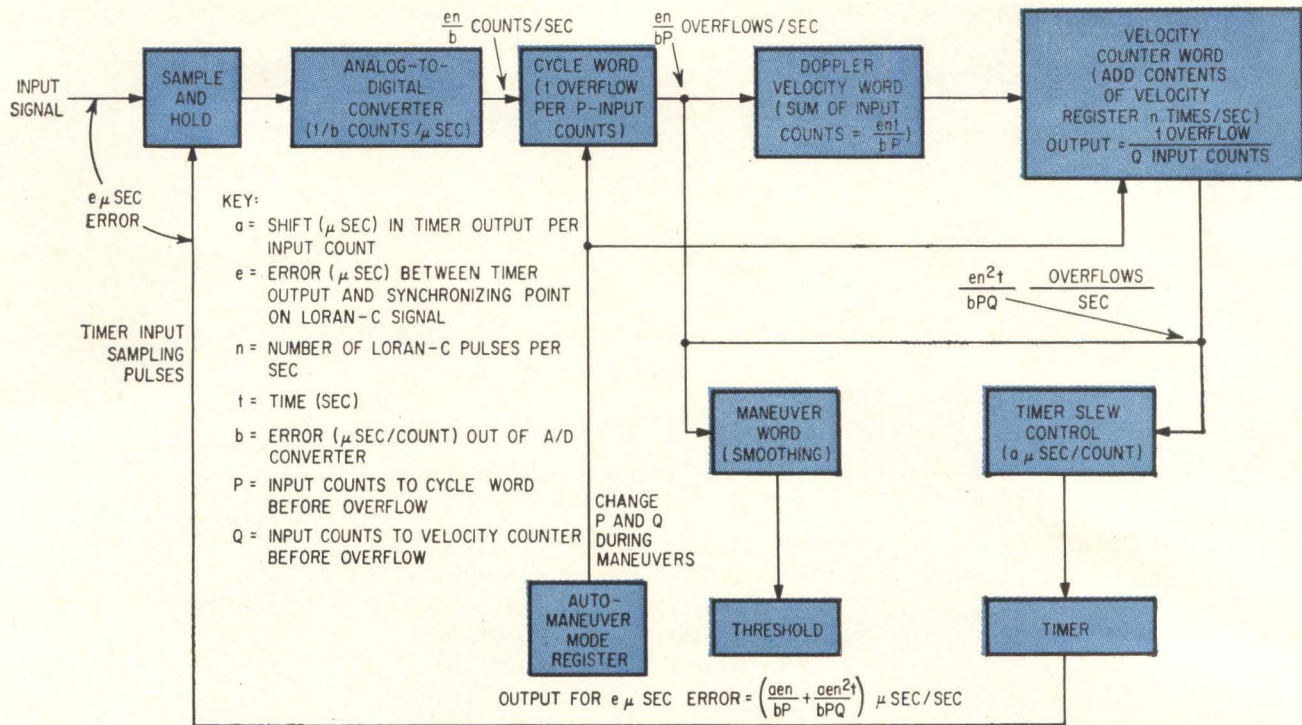

DIGITAL PHASE-LOCK servo loop, of which three are used. A total of nine servo loops are used, of which six were electro-mechanical in previous equipment—Fig. 4

sampling pulses. The overflow is also stored and put into the insertion gate at the proper time to be added to the doppler-velocity word.

The doppler-velocity word is added to the velocity-counter word  $n$  times per sec. The velocity-counter word precedes the doppler-velocity word in the memory. The doppler-velocity data are transferred to the velocity-counter word by bypassing a one word shift register (marked transfer in Fig. 3). The least significant bits come into the adder coincident with the least significant bits of the velocity-counter word.

After  $Q$  input counts to the velocity-counter word, the word overflows and returns to zero. Each overflow jumps the timer by  $a \mu\text{sec}$  (by way of the threshold detection and readout and the timer slew control).

The stored-cycle-word overflow is also added to the maneuver word (through the insertion gate). The maneuver word is a smoothed version of the cycle servo-error signal. The most significant bits of the maneuver word are subtracted from its least significant bits as described in the next section on smoothing. Thus the maneuver word, if it exceeds a threshold, puts a 1 into the automaneuver register and

causes the previously described changes in  $P$  and  $Q$ . These changes are brought about because the auto-maneuver register causes a change in the synchronizer that, in turn, changes the time of insertion of the A/D converter output into the memory. The error signal is added to more significant bits in the cycle word and causes a higher gain (larger  $P$ ). There is also a change in the gating of the velocity-counter word bit (changing  $Q$ ).

**Digital Smoothing**—The Loran-C receiver must render decisions based on the presence or absence of certain signals that, at the input, may be submerged in noise and interference. Thus a low-pass filter is used to average the input over a length of time to enable the signal component to integrate sufficiently above the noise level to be identifiable. The simplest filter is a resistance-capacitance network with

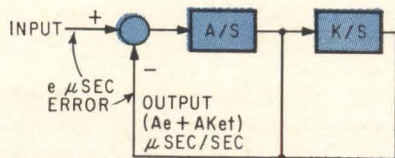

EQUIVALENT Laplace transform of servo loop shown in Fig. 4—Fig. 5

a time constant  $\tau = RC$ . This type of filter is readily mechanized as a digital filter using the dynamic data processing loop consisting of the tapped shift register, a serial adder, and the magnetostrictive delay-line memory. The digital filter and its analog equivalent are shown in Fig. 6.

The impulse response  $\exp[-t/\tau]$  is derived in the data processor by the application of exponential decay to an infinite memory storage loop. Infinite memory allows all inputs to be lumped into a simple storage cell. The exponential decay is applied as a decrement to the lumped inputs by the single operation of subtracting a fraction of the data from the data itself. The decay factor is adjustable from multiple tap positions on the shift register (as shown in Fig. 6B) and is identified as factor  $r$  in

$$x_n + 1 = x_n (1 - 1/2^r)$$

where  $x_n$  is the smoothed output after the  $n$ th iteration.

By applying 2's complementation in the subtractor (complementator) a simple serial subtraction is accomplished. The filter equation is

$$x_n + 1 = x_n (1 - 1/2^r) + x_i$$

where  $x_i$  is the instantaneous  $x(t)$  input, and  $x_n$  is the accumulation of past inputs.

Three fundamental rules apply to

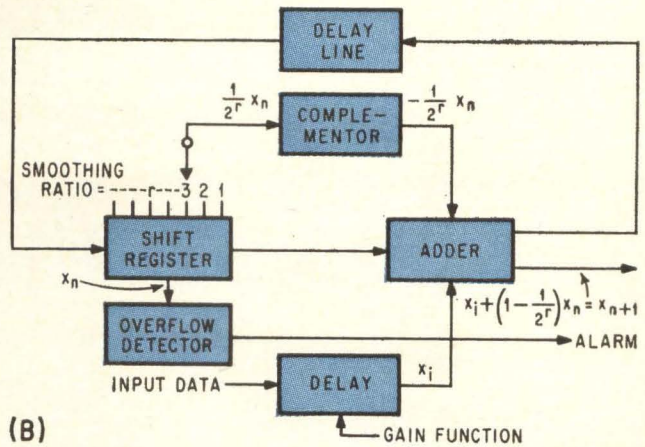
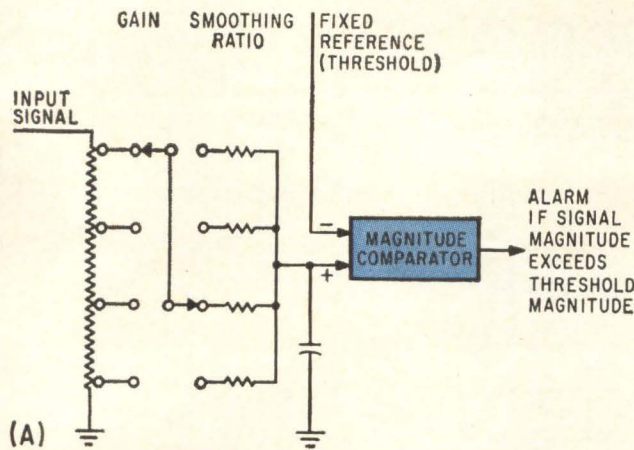

ANALOG FILTER (A) and digital equivalent (B). Signal to noise enhancement is a function of smoothing ratio  $r$ —Fig. 6

the digital smoothing functions:

(1) The filtered signal approaches the limit of  $2^r \times A$  for an input of average value ( $A$ ) as the number of samples approach infinity.

(2) The effective time constant ( $\tau$ ) of the digital filter is equal to the sampling period ( $T$ ) multiplied by the factor  $2^r$  or  $\tau = T \times 2^r$ .

(3) The signal enhancement (S/N improvement factor) =  $2^{(r+1)}$ .

**Threshold Detection** — Threshold detection involves the identification of a quantity according to whether it exceeds a fixed magnitude. Since the data may be bipolar according to sign-bit storage, magnitude detection consists of detecting overflow into certain most-significant-bit positions in the data word by testing each of these bits for opposite polarity from the sign bit.

In the signal it was possible to adjust the input-gating-gain parameter (timing) so that the threshold could be set at discrete binary levels. This greatly simplifies the threshold detector.

**Dynamic Range**—The resolution required affects the design of discrete systems. This is reflected in the number of binary bits required to represent a specific quantity, and, in turn, the complexity of the analog-to-digital interfaces or converters. The fineness of the resolution (smallness of unit quantum) is a measure of how closely the discrete system approaches a true linear system. The usual concept of the resolution requirement is that the data be quantized into steps no greater than the smallest increment of data of interest in the output or

in the control process. This, in fact, applies to the three timers that maintain the loran time references. Six binary decimal decade counter sections are required to quantize the 100,000- $\mu$ sec repetition interval of the loran signal in units of 0.1  $\mu$ sec for time difference readout accuracy. However, in the digital filter and digital (sampled data) feedback loops, the unit quantum can be much larger than the increment of signal to be detected.

The required 0.1  $\mu$ sec instrumental precision is obtained by a data-sign conversion separate from the level quantization. The sign is determined to a very small fraction of the unit-quantization level.

In the presence of noise or c-w interference, these extraneous random processes provide effective interpolation between levels, and a linear system action results. For clean signals, the servo loops tend toward a hard-limiting type of operation. This side effect of coarse quantization gives a desirable adaptive behavior, as shown in Fig. 7.

**System Simulation**—The Loran-C digital receiver lends itself readily to simulation on a digital computer. The processes taking place in the computer can be made to correspond exactly to the processes that take place in the data section (Fig. 3) of the receiver. Quantization of the error signal and jumping of the timer in discrete jumps are also simulated exactly.

In Fig. 3 the time delay of the input signal from the antenna is represented by a number, as is the time delay of the sampling pulses. The output of the A/D converter is a function of the difference of these

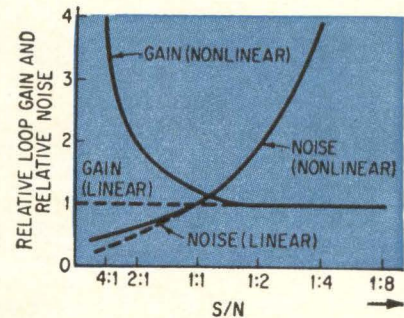

LOOP GAIN of digital servo shows adaptive behavior, decreasing as signal to noise ratio falls—Fig. 7

time delays. Since a sample is taken of the pulse-modulated r-f signal, the output of the A/D converter is a pulse-modulated sinusoidal function of the difference of the time delays. This function is stored in the digital computer memory. The output of the A/D conversion of the envelope deriver is a different function, also stored in the computer memory. The effect of vehicle motion is simulated by causing the time delay of the input signal to vary as a function of time. Response of the output and various intermediate points in the system are printed out.

Digital system design of the AN/ARN-7 receiver is, to a great degree, the result of work by Sperry research engineer James Meranda. He was assisted by the engineers in the Radio Navigation Equipment Department.

#### REFERENCES

- (1) E. S. Lurin, Digital Radar Techniques, *Sperry Engineering Review*, 15, No. 3 p 10, (Winter 1962).
- (2) E. Durbin, Recent Developments in Loran C, *Navigation*, 9, No. 2, p 138, (Summer 1962).
- (3) S. Claypoole and J. King, Loran-C Inertial Navigation, *National Aerospace Electronics Conference Proceedings*, May 1963.

# Advantages of Free-Running Cascode

Series-connected—or cascode—multivibrators produce the same type waveforms as the tandem-connected—or cascade—variety. The cascode circuit, however appears able to produce a narrower pulse than the cascade circuit

**MOST FREE-RUNNING** multivibrators are cascade circuits. Cascode circuits, however, can also be used as free-running multivibrator circuits to produce a linear sawtooth waveform, square waveform, sine-wave or pulse.

**Circuits**—When B+ is first applied to the circuit of Fig. 1A, there is no potential difference between the grid and cathode of  $V_1$  but the  $V_2$  grid is positive. Capacitors  $C_3$  and  $C_4$  are charged by the B+ supply and eventually both  $V_1$  and  $V_2$  conduct. Due to the positive potential at the  $V_2$  grid,  $V_2$  draws more current than  $V_1$ . The plate potential of  $V_2$  falls (Fig. 1B) and drives the  $V_1$  grid negative. The plate current of  $V_1$  is thus reduced, which results in the grid of  $V_2$  becoming

more positive to increase the plate current of this tube still further. Thus the effect is cumulative and  $V_2$  conducts heavily and  $V_1$  cuts off. During  $V_1$  cut-off, plate current of  $V_2$  is supplied from stored energy in  $C_4$  and the plate potential of  $V_2$  begins to fall exponentially. But at the same time  $C_1$  discharges opposing the  $V_2$  plate current through  $R_2$ . Potential at the  $V_1$  cathode is the sum of the potentials across  $R_2$  and  $V_2$  in series. When the  $C_1$ - $R_3$  time constant is too large or too small, the potential at the cathode of  $V_1$  does not change linearly, as is illustrated in Fig. 1C. Use of circuit values shown in Fig. 1A gives linear operation.

As the grid potential of  $V_1$  increases,  $V_1$  begins to draw plate current. As soon as this occurs, the

cumulative effect takes place but in the reverse direction;  $V_1$  conducts heavily and  $V_2$  cuts off. During  $V_2$  cut-off, the plate current of  $V_1$  is supplied from stored energy in  $C_3$ , and  $C_2$  discharges mainly through  $V_1$ ,  $C_4$  and  $R_4$ . The cathode potential of  $V_1$  increases linearly if the  $C_2$ - $R_4$  time constant is suitable. When  $C_2$  has discharged sufficiently to permit plate current to flow once more in  $V_2$ , the action repeats.

When values of circuit components are decreased, the frequency increases and conversely;  $C_3$  and  $C_4$  are effective for controlling frequency. When values of circuit components are decreased, the magnitude of the waveforms is decreased and conversely. But  $C_3$  and  $C_4$  are less effective as controls on waveform magnitude. So far as the corresponding pair of components are identical the waveshape is symmetrical. The circuit will also work well when asymmetrical.

**Modifications**—An interesting modification to the circuit of Fig. 1A is to remove  $C_3$ . Then, when B+ is first applied,  $V_1$  conducts. When  $C_4$  is charged sufficiently,  $V_2$  conducts and its plate potential drops. This drives  $V_1$  grid voltage down with it. The plate potential of  $V_1$  rises in turn to drive the  $V_2$  grid more positive. By cumulative action  $V_1$  cuts off and  $V_2$  conducts heavily. The stored energy in  $C_4$  discharges through  $V_2$  to maintain its conduction. When  $C_1$  discharges through  $R_3$  and  $R_4$ , the  $V_1$  grid is driven toward the turn-on point until  $V_1$  begins to conduct. The drop of plate potential of  $V_1$  switches the operation over;  $V_1$  conducts heavily and  $V_2$  cuts off;  $C_4$  then charges through  $V_1$  and  $C_2$  discharges until  $V_2$  begins to conduct. The action is then repeated.

Another modification is to remove

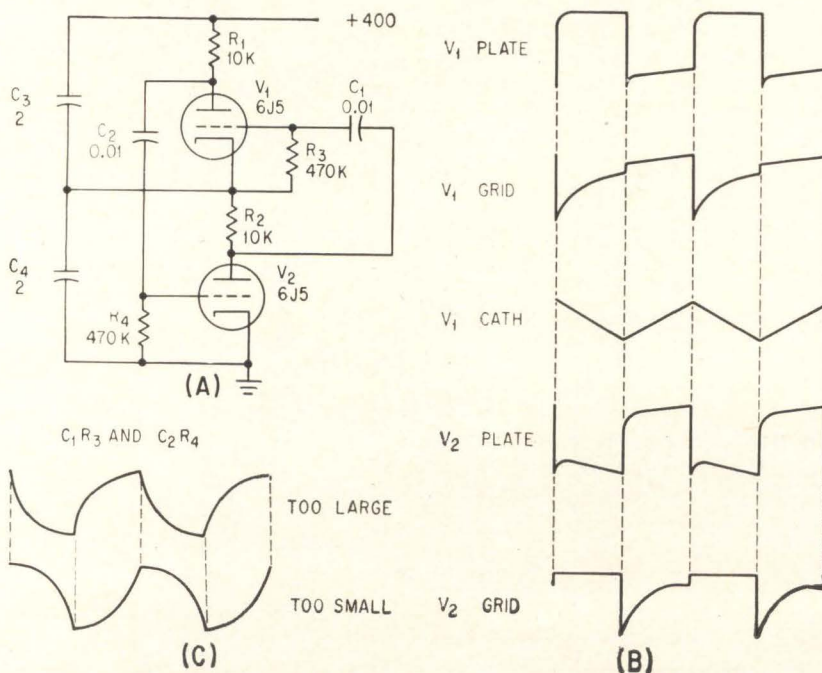

**SERIES-CONNECTED** or cascode multivibrator (A) uses two capacitors in a voltage-divider storage circuit. Waveforms (B) show details of circuit operation. Cathode waveforms are nonlinear (C) if time constants  $C_1R_3$  and  $C_2R_4$  are inappropriate. Major frequency control elements in (A) are  $C_3$  and  $C_4$ . Circuit variations are obtained by removing  $C_3$  or  $C_4$  or both—Fig. 1

# Multivibrators

By CHANG SING, National Taiwan University, Taipei, Taiwan, China

$C_4$ . When  $B+$  is applied,  $C_3$  is charged through  $V_2$ . Thus  $V_2$  conducts and  $V_1$  is cut off. When  $C_3$  is charged sufficiently  $V_1$  begins to conduct. By cumulative action  $V_1$  conducts heavily and  $V_2$  cuts off, with plate current for  $V_1$  supplied from stored energy in  $C_3$ . The second switching action is similar as the negative  $V_2$  grid potential reaches tube turn-on point;  $V_2$  then conducts heavily and  $V_1$  cuts off.

Waveforms for the modified circuits are similar to Fig. 1B. If either  $C_4$  or  $C_3$  is too small, waveforms at the plates are deformed.

The last modification is to remove both  $C_3$  and  $C_4$ , as shown in Fig. 2A. The circuit then acts as an oscillator because of positive feedback and it must therefore be

designed so that loop gain is equal to unity. In other words, the condition for obtaining a sine-wave output is that the product of the gains for the tubes must be equal to unity. With the identical components for each tube, the load will be approximately  $1/g_m$ ;  $R_1$  must be kept above 5,000 ohms to maintain oscillation.

**Pulse Polarity**—A series free-running multivibrator is shown in Fig. 2B, where resistors  $R_5$  and  $R_6$  replace  $C_3$  and  $C_4$  in the circuit of Fig. 1A. Waveforms are shown in Fig. 2C. During the  $V_1$  conduction, plate current flows through the lower part of the bleeder,  $R_6$ . During  $V_1$  cut-off,  $V_2$  plate current flows through  $R_5$ . The signal obtained at

the  $V_1$  cathode is a nearly perfect square wave.

In conventional cascade multivibrators, if circuit components are selected to produce an asymmetrical square wave to obtain a pulse waveform, pulse polarity is fixed. In the series multivibrator circuit, however, a positive or negative pulse can be obtained at the cathode of  $V_1$  by adjusting the potential divider. Also, a narrower pulse can be obtained than from a conventional cascade multivibrator.

All the above circuits will function well with transistors, as illustrated in Fig. 3A and 3B. Figure 3C shows waveforms for Fig. 3A; the same waveforms apply to Fig. 3B if the  $Q_1$  emitter waveform is replaced by a square wave.

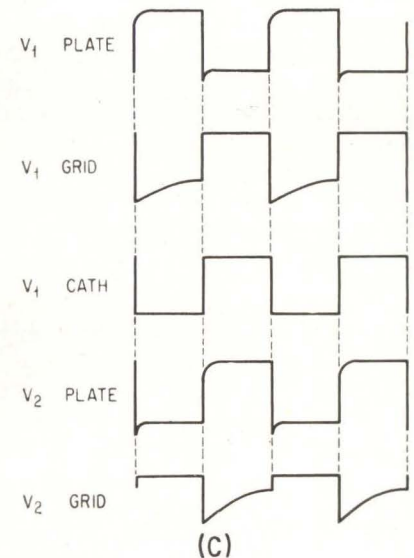
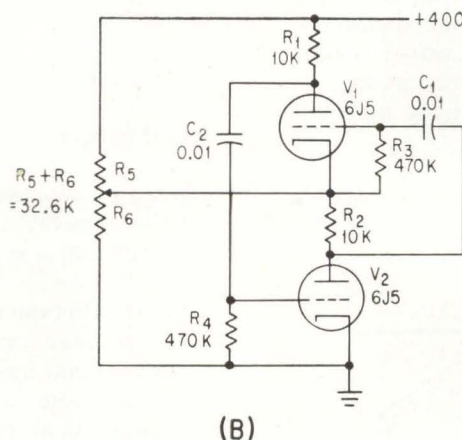
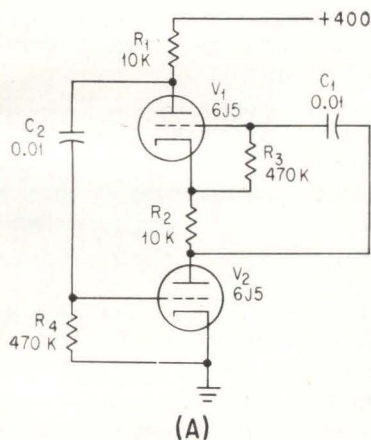

**FREE-RUNNING** cascode oscillator results (A) when both  $C_3$  and  $C_4$  of Fig. 1A are removed; when capacitors are replaced by potentiometer (B), signal at  $V_1$  cathode (C) is exceptionally square—Fig. 2

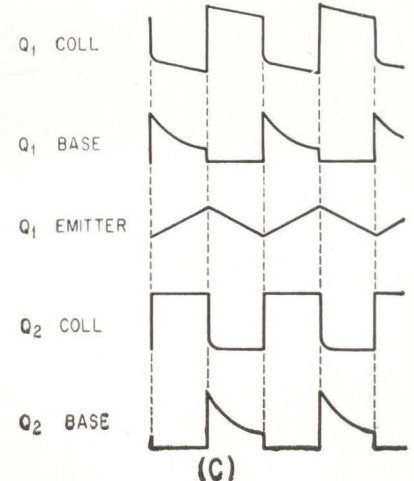
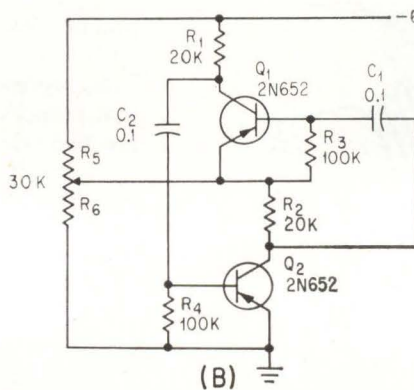
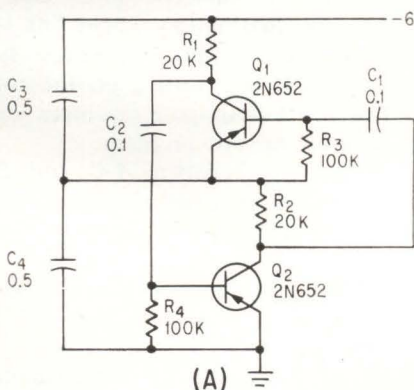

**TRANSISTOR** versions (A) and (B) of circuits of Fig. 1 and 2 are obtained by straightforward substitution; waveforms (C) are similar—Fig. 3

# Static Alternator Controls Three-

Solid state generator using scr's in a modified ring-counter configuration drives a hysteresis motor at speeds from 1,200 to 18,000 rpm

By **ROBERT H. MURPHY**, Chief Engineer  
Transitron Electronic, Ltd., London, England

**POLYPHASE** a-c motors can be operated with direct current using an scr ring counter to produce the rotating magnetic field. Speed ranges much greater than 10 to 1 with constant torque and reasonable efficiency are possible with such a circuit.

The motor control circuits were originally proposed<sup>1</sup> for application to 3-phase induction motors having center-tapped windings, with the driving waveforms shaped to approach sinusoids.

The technique of producing approximately sinusoidal waveforms has been temporarily abandoned because it appears to be incompatible with the necessity for at least a 10-to-1 output frequency range. Instead, a sequentially switched rotating magnetic field has been developed, working the scr's of a modified ring counter into significantly inductive loads. The major difficulty of making the d-c input voltage proportional to the speed of the motor—to keep the efficiency approximately constant—has been overcome by employing an scr chopper circuit synchronized to the trigger pulses that drive the main circuit.

**Basic Problem**—The mechanism of a polyphase motor of the induction, hysteresis or synchronous variety,

depends on the torque produced by the interaction of a rotating magnetic field and that induced in, or permanently attributable to, the rotor. Normally the rotating field comprises the resultant of several sinusoidally varying, but physically static, fluxes induced by the currents in polyphase stator windings. The speed of the motor depends upon the frequency and amplitude of these currents.

A practically constant torque characteristic constitutes one of the main advantages of these motors but hampers attempts to vary their speed by independently varying either the frequency or the input voltage and hence current amplitude. If the frequency alone is changed, the output power (expressed in terms of torque  $\times$  rpm) tries to maintain direct proportionality but the input power remains approximately constant. This condition leads to gross inefficiency with overheating at low speeds and stalling at high speeds. If the input voltage alone is varied, the input power varies approximately with its square and a nonlinear speed characteristic results, that is, the speed range is restricted.

Thus for efficient speed control over a wide range both frequency and input voltage must be varied in unison. This basic problem faces any attempt to replace by solid-state techniques the many excellent but bulky, costly and nondurable, electromechanical speed control systems.

**Static Alternator**—It has been shown that scr's in a ring-counter configuration can sequentially switch high currents and induce a magnetic field that steps around a static core system in a manner analogous to the rotating field produced by polyphase currents. An equivalent mechanical switch model is shown in Fig. 1. Here a flux induced in cores  $AA'$  by the closure of switch 1 should transfer to  $BB'$  when 1 is opened and 2 closed, and so on. However this ignores the magnetic coupling between adjacent cores and in practice part of the flux distribution would link  $AB$  and  $A'B'$  resulting in a flux reversal in cores  $AA'$ . This represents a counteracting torque on the rotor that reduces its efficiency. For six-pole machines there are two ways of overcoming this problem.

A resultant flux midway between  $AA'$  and  $BB'$  could be established by closing switches 1 and 2, and then moved to midway between  $BB'$  and  $CC'$  by opening 1 and closing 3.

A resultant flux in  $BB'$  could be established by closing switches 1, 2 and 3, and then moved to  $CC'$  by opening 1 and closing 4.

In the circuit to be described, the latter method was chosen because it allows a better utilization factor (ratio of peak to average current) for the scr's that replace the switches of Fig. 1. In contrast, the

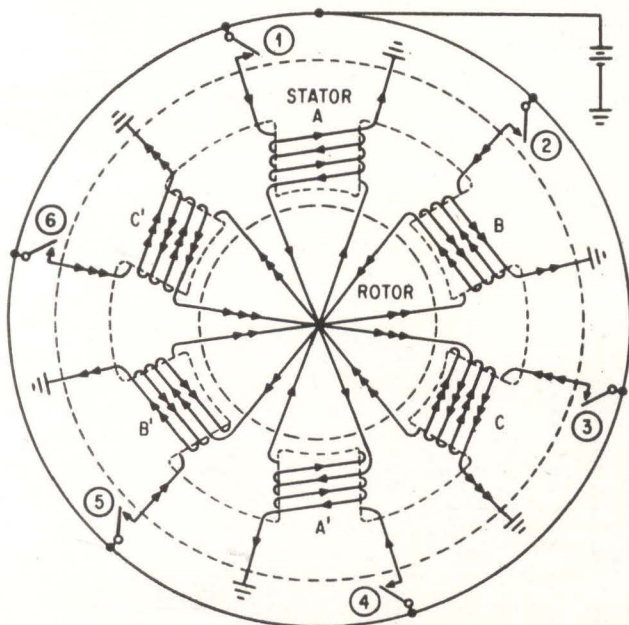

**EQUIVALENT** mechanical switch model demonstrates how a rotating field, analogous to that produced by polyphase currents, can be set up. Details of the switching needed to set up a mid-flux is explained in text—Fig. 1



# Phase Motor

former method provides a more nearly sinusoidal flux distribution but raises spurious mode problems when ring-counter diode gating is used to trigger the scr's.

**Modified Ring**—An scr ring counter modified to work in the switching mode described above is shown with resistive loads in Fig. 2A. When the first stage is on the reverse voltage across the first diode is reduced from  $E$  to approximately zero volts. This diode will gate the next trigger pulse to the second scr that will turn on and prime the third stage for firing by the third pulse. Thus the first three scr's will arrive at the on state and the fourth will be primed for firing. The fourth pulse will fire the fourth scr and turn off the first by commutating capacitor action. The fifth pulse will fire the fifth scr and turn off the second, and so on. Hence the output waveforms across each  $R_L$  will appear as shown in Fig. 2B. The switching mode complies with that described above at no cost in circuit complexity.

As with the simple ring counter, the trigger pulse is sharply differentiated by the  $C_c R_g$  networks. This in no way affects operation into purely resistive loads but severely limits the magnitude of the allowable inductive components of the stator windings with the poor power factors that occur under starting and stalled conditions. Drawing from a transformer analogy, the loads under normal running conditions may be considered as reflected resistances shunted by leakage inductances, but when the rotor is stationary and the output power is zero, the reflected loads disappear leaving leakage inductance and coil resistance series combinations.

The difficulty of trying to turn on an scr ring counter stage into such loads is illustrated in Fig. 2C where it is seen that a long  $L/r$  time constant combined with a short  $C_c R_g$  time constant can lead to failure to maintain sufficient gate current while the anode current builds up to the holding or pick-up current value and hence failure to trigger the device. Increasing either  $C_c$  or  $R_g$  does not work in practice because the effective value of the latter is limited by the shunting gate-cathode impedance of the scr and the former cannot be increased without significantly reducing the upper switching frequency limit of the ring. This depends upon the time taken for  $C_c$  to discharge through  $R_b$ , the preceding scr, and  $R_g$  when priming takes place.

**Holding Current**—The incorporation of a parallel resistor  $R$  (Fig. 2D) able to supply the holding current to the scr, solves the problem with little decrease in efficiency since it allows the energizing current curve to start off at the holding current value, as shown superimposed on Fig. 2C for comparison. The series rectifier in Fig. 2D prevents spurious modes owing to the commutation of scr's by negative pulses arriving from other stages via transformer action.

With these modifications and the stator coil geometry described above, the remaining major ring

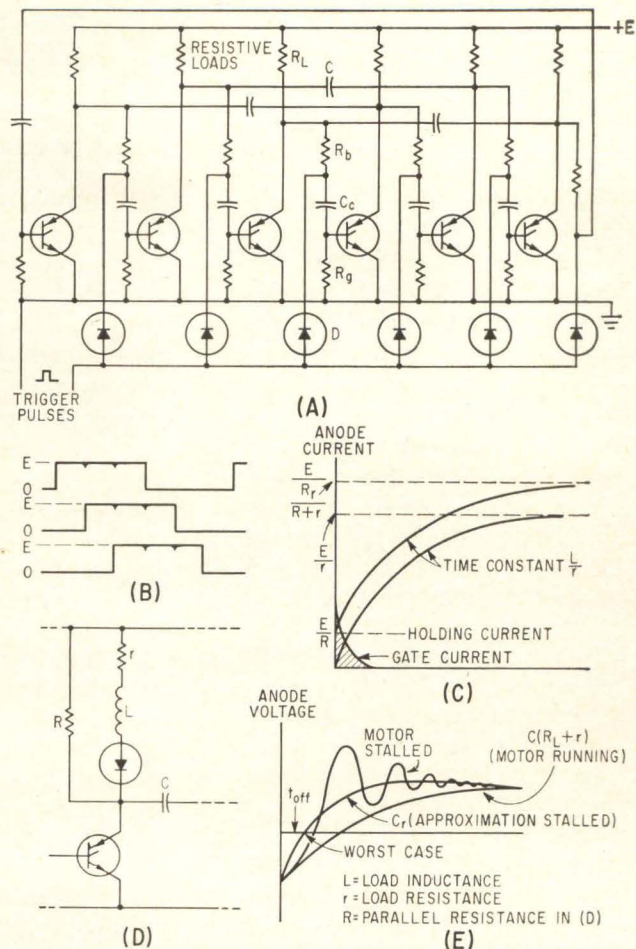

RESISTANCE loaded modified ring counter (A) anode waveforms on three adjacent stages (B) anode current plot showing turn-on problem (C) and stage modification to overcome it (D) anode voltage plot illustrating turn-off problem (E)—Fig. 2

counter design consideration is the size of the commutating capacitors. Here the determining factor is again an ability to cope with starting and stalled conditions since the scr's must then turn-off when supplied through the  $rL$  loads. A detailed analysis shows that the turn-off reverse bias has an exponentially decaying sinusoidal form rather than the usual exponential of time constant  $rC$ .

A good approximation for fractional horse-power motors is to assume the latter (worst case) condition and make  $rC$  greater than  $2t_{off}$  where  $t_{off}$  is the specified maximum turn-off time of the devices under the same current conditions. This assumption again involves the idea that the coupled load resistance from the rotor disappears under stalled conditions and the effect of the approximation is illustrated in Fig. 2E. Since  $r$  can be of the order of 1 ohm or less, large capacitors of the non-polarized type must be used. Hence an additional advantage of using the 3 on-3 off mode is that only 3 of these are required. In the 2 on-4 off mode 6 would be needed.

**Varying Input**—Figure 3A shows an scr high level chopper capable of varying the d-c supply to the ring counter in direct proportion to the triggering frequency of the latter and hence to the motor speed. The gate pulses required for this are shown in Fig. 3B

where  $G_1$  refers to the ring counter trigger pulses (variable period  $T$ ) and  $G_2$  pulses generated to arrive a fixed period  $\tau$  after these pulses. The output (Fig. 3C) supplies the ring counter through a choke input filter that assesses the mean voltage of this waveform, that is,  $E\tau/T$  or  $E\tau f$  assuming 100 percent efficiency.

In practice it is expedient to employ a tapped supply and an additional rectifier (shown dotted in Fig. 3A) to supply constant filter, ring counter and motor losses, for at low speeds these become a significant proportion of the total output power and would occasion severe operating problems if not taken into consideration in this way. The mean voltage would then be taken as  $E_v\tau f + E_c$ . However, this modification will be ignored.

Considering only transformer action of  $L_T$ , when scr 1 is triggered the center tap of  $L_T$  goes to approximately  $E$  volts and the diode end to approximately  $2E$  volts, thus charging  $C_c$  to a voltage  $E$  in the direction shown. When scr 2 is fired this voltage appears in the reverse direction across scr 1 and turns the latter off. Rectifier scr 2 then turns off when the capacitor has discharged and the circuit becomes quiescent again.

Advantage may be taken of the fact that  $L_T C_c$  forms a resonant circuit and hence  $C_c$  charges to a voltage in excess of  $E$ . This greatly assists turn off of scr 1 under heavy load conditions. Provided then that

$2\pi\sqrt{L_T C_c}$  is much greater than the turn-on time of scr 1 and less than approximately  $\tau/4$  so that  $C_c$  may become fully charged, the value of  $L_T$  is unimportant.

Bleeder resistor  $R_x$  enables the chopper to work into an otherwise open circuit load that assists starting and greatly simplifies the design criteria for  $C_c$  and the filter components. If the inductance  $L_s$  is greater than the critical value, the exponential discharge of  $C_c$  after commutation has the time constant  $C_c R_x$ , which must be greater than  $2t_{off}$ . The term critical implies the usual choke-input filter sense that the current in the choke be continuous. The condition for criticality is then simply

$$\frac{C_c R_x^2}{L_s} = 3.24 \text{ for } C_c R_x \text{ of the order } 2T_{max}$$

In this equation the question arises as to what exactly constitutes  $R_x$ . Fortunately this type of ring counter takes a constant current  $I$  (except during the commutation periods of a few microseconds when current pulses of roughly  $4I/3$  are drawn) so that the lowest value of  $R_x$  as required by the equation may be calculated from

$$\eta E_{max} I = \eta \frac{(E\tau f_{max})^2}{R_x} = \text{motor power rating at max. speed}$$

where  $\eta$  is the overall system efficiency (assumed 40 to 50 percent) and  $E_{max}$  is chosen to suit the particular power requirements of the motor.

The method of deriving the pulses for the chopper can be conventional and need not be discussed in detail.

During the experimental investigation of the prototype system, a commercial double pulse generator was used to drive a low power scr bistable circuit (two-stage anode commutated ring counter) and the output pulses,  $G_1$  and  $G_2$  were taken from resistors in the cathode leads. However, a self-contained system would probably use a free-running, variable frequency, relaxation oscillator followed by an scr or transistor monostable circuit.

**Experiment**—The complete circuit of the experimental version is shown in Fig. 4 with component values appropriate for a 6-pole fractional horse-power hysteresis motor designed for 400-cps, 12,000-rpm operation in aircraft servomechanisms. This motor was rewound with bifilar windings according to the scheme shown in Fig. 1 in which individual coils have the following characteristics

$$\begin{aligned} \text{Series resistance, } r &= 1.75 \text{ ohms} \\ \text{Leakage inductance, } L &= 8 \text{ mH} \end{aligned}$$

A design speed range of 1,200 to 18,000 rpm has been attained and the motor run up to speed when the ring counter triggering frequency was set to any value appropriate for this range (for example 240 to 3,600 cps.) In fact, when operated in an experimental inefficient mode, without the chopper, a speed range from zero to over 48,000 rpm was found possible with no circuit modifications. The torque at very low speeds was rather intermittent and the motor would not always run in excess of about 24,000 rpm because spurious, pulsating torque modes then developed, but general operation was satisfactory. By modifying the stator geometry, a speed range from

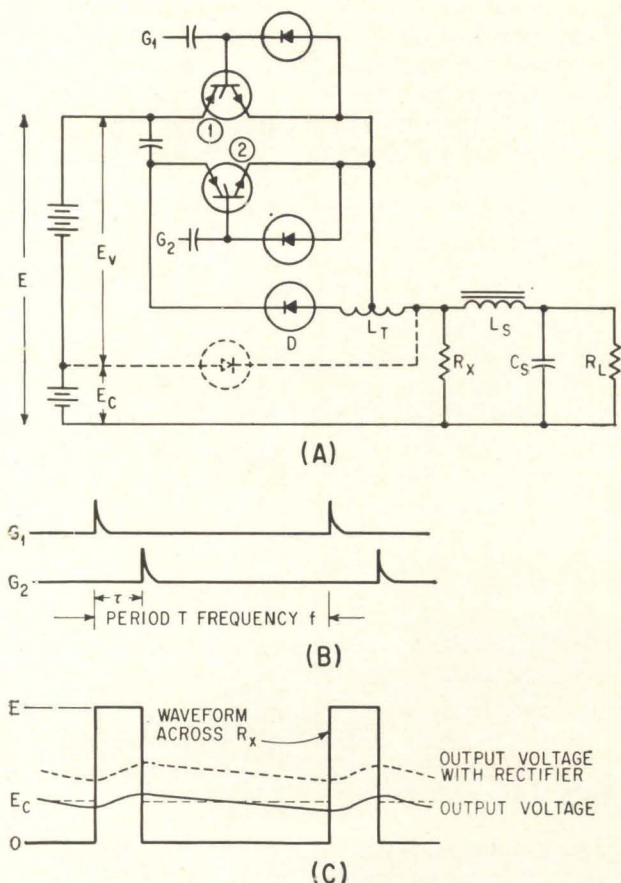

VARIABLE input voltage proportional to frequency is accomplished by scr chopper (A) for which gate pulses (B) produce output waveforms (C)—Fig. 3

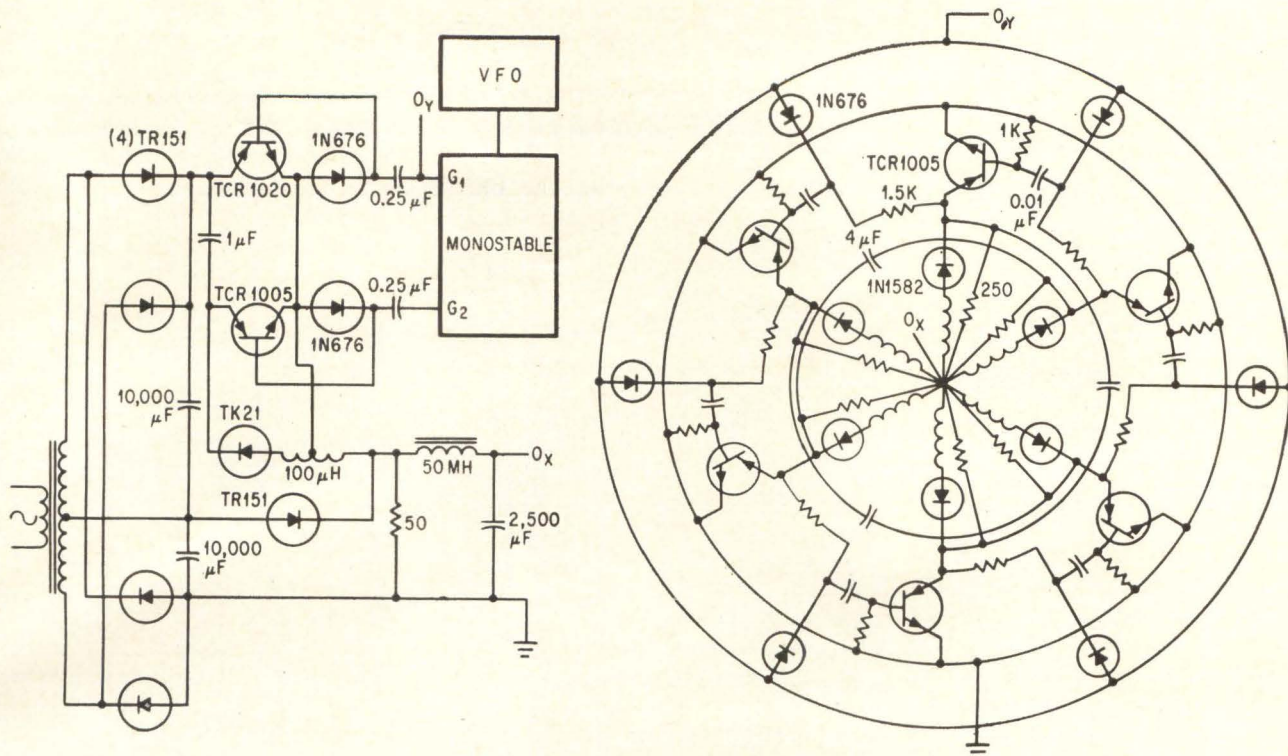

HYSTERESIS motor rewind with bifilar windings has been run from 1,200 to 18,000 rpm using the circuit shown—Fig. 4

zero to 96,000 rpm is certainly feasible.

One problem experienced with motors of the hysteresis, or synchronous induction type that are able to reach synchronous speed under lightly loaded conditions, is that the resultant synchronous emfs can cause the ring counter to go into a spurious mode by preventing the scr's from turning on in the right sequence. This problem also occurs under dynamic braking conditions with motors or loads of high inertia when the triggering frequency is abruptly reduced, but a simple solution is to use overswing diodes from the stator scr connections to the positive supply rail, as is usual in inductive load inverter practice. These then allow power to be returned to the supply during overrunning and synchronous conditions. It is interesting to note that the system thus lends itself to easy modification for efficient dynamic braking provided the reservoir capacitor of the chopper is sufficiently large to absorb the excess energy without inhibiting the chopper-switching action.

**Application** — The self-starting advantages of hysteresis motors are known and with this type of motor the system achieves maximum versatility. The almost constant torque from standstill to synchronism finds compatibility with the design philosophy described, and for such applications as gyroscope, scientific instrument, and tachometer calibration equipment drives, where light loads or constant loads of high inertia are under consideration, variable speed accuracy at reasonable efficiency and component utilization, is a significant advantage of the hysteresis motor and static alternator combination.

For servomechanisms, radar antenna drives and similar systems of varying load, the use of hysteresis or squirrel cage motors would entail a complex feed-

back loop to vary the d-c supply according to an error signal, for maintaining a fixed relationship between motor speed and triggering pulses. However, here it should be possible to employ true synchronous motors and run them slowly up to the required narrow speed range, whence their rotation should keep exactly in step with the ring counter frequency. This would permit the latter's triggering pulses (which could be crystal calibrated) to be used for other synchronization purposes.

With reference to potentialities for motors of greater than 1 hp, a reasonable efficiency could only be obtained if an attempt were made to create a sinusoidal flux pattern. The motor itself helps, to some extent, since it tends to draw a sinusoidal current, but the losses due to the torques developed by higher harmonics with square wave voltage drive would probably make the system prohibitive. However, the 2 on 4 off mode would be a step in the right direction and with a 12-pole motor, much more elaborate synthesis techniques are possible with little increase in complexity. These techniques have been applied to three phase inverters where systems that eliminate all harmonics up to the 11th are possible, using only 12 scr's in the ring.

The author acknowledges the many helpful suggestions made by Roger B. Dellor, now at Imperial College of Science and Technology, University of London, who carried out the preliminary experimental work on the system.

#### REFERENCE

- (1) R. H. Murphy, Developing true solid-state static alternators, *ELECTRONICS*, p 58, May 24, 1963.

# QUINARY SCALERS

## Measure Time Intervals

By RUDOLPH ENGELMANN, Manchester, N. H.

Circuit can resolve one nanosecond with two quinary scalers operating in parallel against a 500-Mc time-base signal

**HIGH-SPEED** counting places stringent requirements upon time-base generator stability and especially on short-term stability. While cesium-gas references may provide adequate long-term stability, their short-term characteristics are inadequate. Moreover, the bulkiness and cost of cesium-gas references preclude their general use in time-interval measurement systems.

Quartz crystal oscillators used with frequency multipliers can produce stabilities of parts in  $10^{10}$ . However, these are obtainable only in an environment of tightly controlled temperature and supply volt-

ages, and with circuits corrected for the effects of component aging.

Accepting state-of-the-art development of crystal oscillators and crystal-oscillator ovens permits meaningful time-interval measurements of up to one second to an accuracy of one nanosecond. Longer time periods require a significant advance in time-base generator technology. Time periods shorter than 0.5 sec can be measured to an accuracy of 0.5 nsec.

One nanosecond can be resolved by two quinary scalers operating in parallel against a 500-Mc time-base signal as shown in Fig. 1A. By

shifting the phase of the time base 180 degrees to one scaler, the two scalers will, in effect, count the half cycles of the time-base signal. One scaler will count the positive half cycles and the other the negative half cycles. Since the period of one cycle is 2 nsec, the period of one-half cycle is 1 nsec; therefore, the system counts 1-nsec increments of time directly.

Each scaler contains from zero to four counts for any one measurement. Upon completion of a measurement, the count in one scaler leads, equals or lags the count in the second scaler. This lead or lag in all cases is one count, resulting in a relatively simple logic that forms a decade for display purposes and an output of 100 Mc for further decimal division. Figure 2 shows the block logic for operating a decimal indicator.



AUTHOR tests a nanosecond time-interval meter that uses the circuits discussed in this article

### STRINGENT REQUIREMENTS

Achieving both short and long-term stability in a counting circuit requires careful design attention to the time-base generator. Even sophisticated frequency standards such as the cesium gas reference have disadvantages in high-speed counting.

The author shows how to use a pair of quinary scalers and some novel circuits to achieve resolution that is beyond the scope of present time-base generator technology

**Operation**—To avoid the ambiguity of  $\pm$  one count resulting from the random relationship of the start and stop gates to the phase of the time-base signal, it is necessary to provide for synchronizing the gates with the time base. A circuit that accomplishes this synchronization is shown in Fig. 1B. The base of  $Q_1$  is biased at a d-c level of +1 volt. The base of  $Q_2$  is at zero volts d-c through terminating loop  $L_1$ . A portion of the 500-Mc time-base signal, 0.5 volt peak-to-peak, is applied across  $L_1$  to the base of  $Q_2$ , swinging  $Q_2$  from 0.25 volt negative to 0.25 volt positive at a 500-Mc rate. Transistor  $Q_1$  will be turned on, and  $Q_2$  will be turned off. No signal will be present on the collector of  $Q_2$ .

A negative step function of 1 volt derived from the start signal is now applied to the base of  $Q_1$ . A 500-Mc signal will appear at the collector of  $Q_2$  when the signal on the base goes more positive than the bias on the base of  $Q_1$  which is zero volts. Emitter current will pass through  $Q_2$  and appear at the collector. Transistor  $Q_2$  will turn on

# Digitally

and off when the 500-Mc time-base signal is applied to its base. The collector signal is applied to one of the quinary scalars.

An identical circuit is applied to the second quinary scaler, but the time-base signal is shifted or inverted 180 degrees relative to the first case. The phasing of the start gate, which is applied simultaneously to both synchronizing circuits with the primary time base, will determine which of the two quinary scalars will accomplish the first count and lead the other quinary scaler for the duration of the measurement.

The stop operation is accomplished by applying a negative step function directly to the quinary-scaler input bias. This signal carries the input bases of the scaler out of the switching region and stops the scaler from functioning. Since the scaler input was initially biased positive to its switching reference level, it will accomplish its first half count as a negative leading edge emerges from the synchronizing circuit. Moreover, since the stop gate consists of negative step function superimposed upon the signal from the synchronizing circuit, it is incumbent upon the scaler to accomplish at least one-half count, even for a zero time interval between the start and stop signals. This half count is ignored in the readout and transfer logic. Provision of separate step functions for the start and stop operations is desirable since a single gate circuit that turns on and off accurately in one nanosecond is at best, difficult to achieve.

Propagation of the 100-Mc output of the quinary scalars to a second decade presents a minor problem since a 100-Mc signal appears as an output from both scalars. However, since these outputs are always within one-half cycle of being in phase with the 500-Mc time-base signal, the two outputs are simply summed at the input to an amplifier stage. The output of this

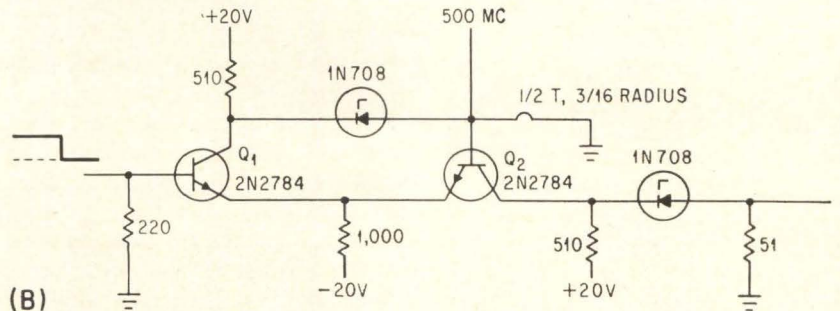
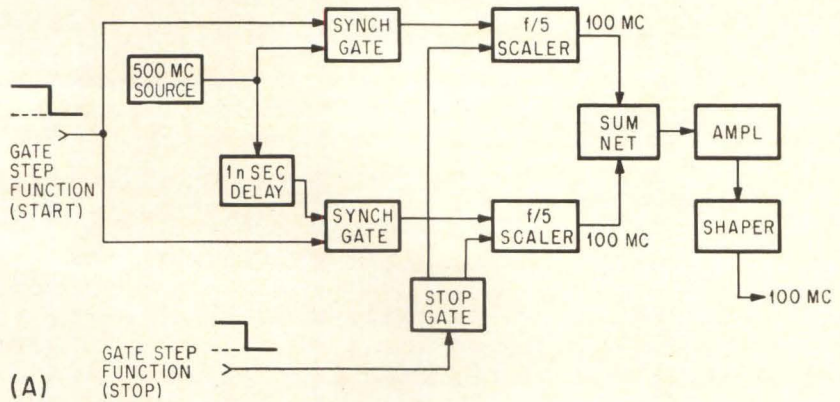

TWO quinary scalars operate in parallel against a 500-Mc time-base signal. Gates, summing network and shaper (A) and schematic of the synchronization circuit (B)—Fig. 1

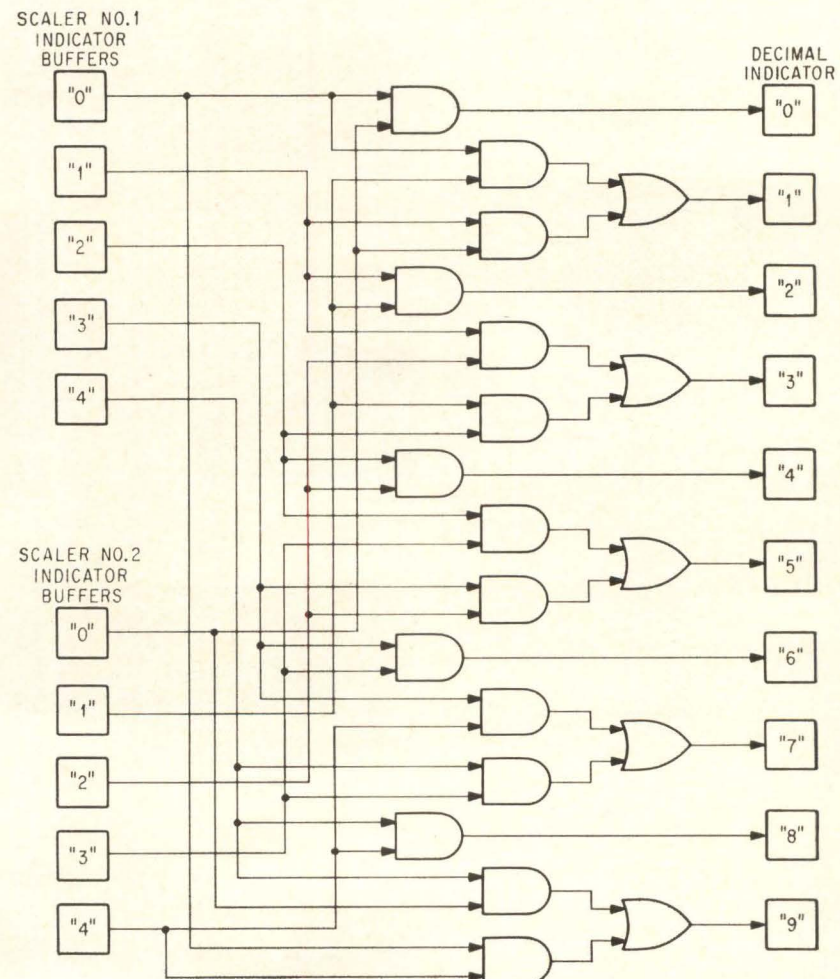

LOGIC for combining the count content of two f/5 scalars to form decimal readout—Fig. 2

stage reaches a maximum level when the quinary scalars each contain a zero count simultaneously. A current-mode switch triggers on this maximum level and delivers either a pulse or a rectangular wave to the next decade for counting, as illustrated in Fig. 3A.

**Accuracy**—A circuit for obtaining further accuracy of  $0.5 \text{ nsec} \pm 0.25 \text{ nsec}$  is shown in Fig. 3B. Two current-mode switches operate with  $Q_2$  in the first switch, controlled by 1,000 Mc obtained by a doubler from the 500-Mc time base. This 1,000 Mc is applied to the base of  $Q_2$ ; if the gate-step function arrives during the negative half cycle of the 1,000 Mc signal, an output from the collector of  $Q_2$  will be delayed until its base swings positive. At this time, the collector of  $Q_2$  will deliver a negative step function to the base of  $Q_4$  through zener diode  $D_2$ . The gate step function is ap-

plied simultaneously to the base of  $Q_1$  and a calibrated delay is applied to the base of  $Q_3$ . The amount of delay is dependent upon the delay characteristics of the transistors used in the circuit. Nominally, it will range from 0.25 to 0.5 nsec for 1-Gc transistors.

If the step function from the collector of  $Q_2$  arrives at the base of  $Q_4$  before the delayed gate step arrives at the base of  $Q_3$ , the second current switch formed by  $Q_3$  and  $Q_4$  will not trigger, and no signal will appear at the collector of  $Q_4$ . If, however, the delayed gate step arrives at the base of  $Q_3$  before the step from the collector of  $Q_2$  arrives at the base of  $Q_4$ ,  $Q_3$  and  $Q_4$  will exchange states and a negative step function will appear on the collector of  $Q_4$ .

This step can be interpreted as 0.5 nsec in the readout. Since error can appear on both start and stop, a resolver will be required in both

channels and the sum of the counts in the two resolvers will be 0.5, 1 or 0.

A reset mechanism triggers upon the AND application of the start-and-stop step functions. The reset pulse is delivered first to the start-step function generator and then to the stop-step function generator as well as to the scalars and the resolvers if they are used.

The step-function generators are simple current-mode switches that are triggered by the pulse or step events representing the time instances referred to for measurement. A hysteresis value is selected for these switches to prevent their turning off until the application of the reset pulse. These generators must deliver step functions that are consistent in rise time over a wide range of amplitude and rise time of the signals representing the start and stop events. A trigger mechanism employing a tunnel diode that acts as a level discriminator is shown in Fig. 3C. The rise time of the tunnel diode is consistent over a wide range of amplitude and rise time of the signal applied to it. Consistency is enhanced by applying the tunnel diode to a high-gain amplifier stage. Since the tunnel-diode signal is characteristically 0.4 volt in amplitude and will rise in less than 5 nsec, even upon application of a slowly rising input signal, the amplifier base-time constant will more surely determine the rise time of the output signal from the amplifier. The amplifier stage drives the step-function generator which is biased to trigger at about the 20-percent amplitude level of the amplifier output signal. The 80-percent overdrive results in a step function rising in less than 1 nsec, which is sufficient for operation of the system described. The overdrive further enhances gate stability over a wide range of input signal characteristics. Normally, it is not prohibitive to require 1 volt/ $\mu\text{sec}$  at the input; the system will operate well under this specification.

**Conclusions**—System accuracy can be no better than the time base provided for its operation. The quality of internal time base generators will be limited by the physical space available in reasonably-sized package. The user who can provide an external time reference will obtain better results.

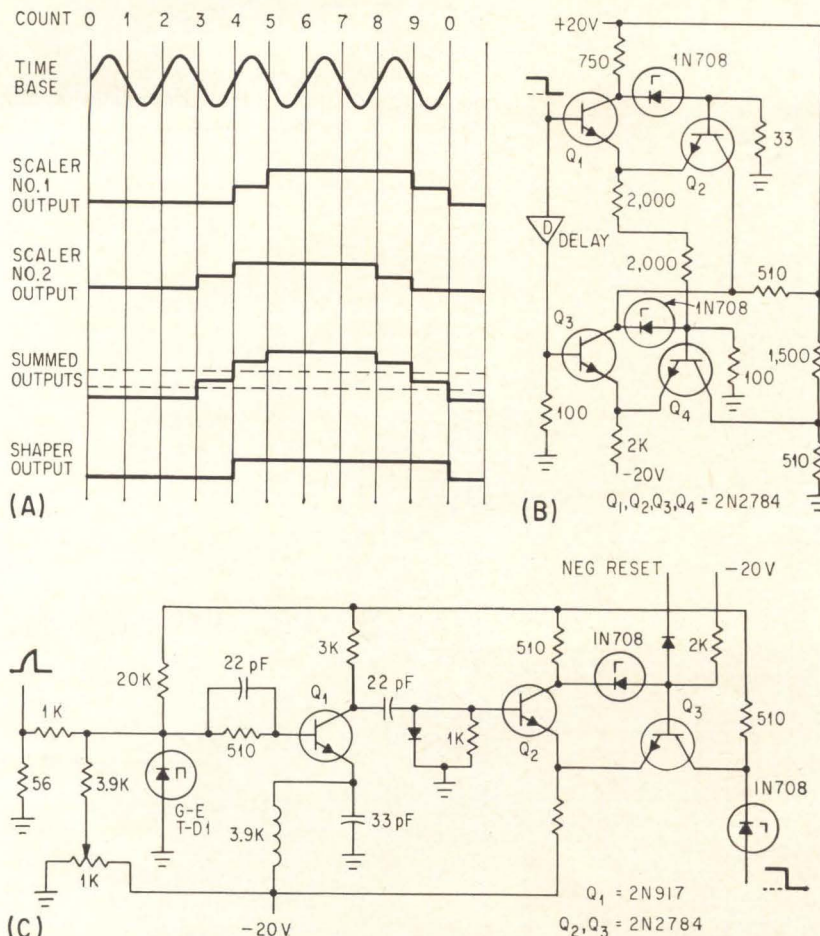

WAVEFORMS at outputs of the two scalars, summing network and shaper, and that of the time-base generator (A). Highly accurate circuit includes two current-mode switches (B), and trigger mechanism using a tunnel diode as a level discriminator (C)—Fig. 3

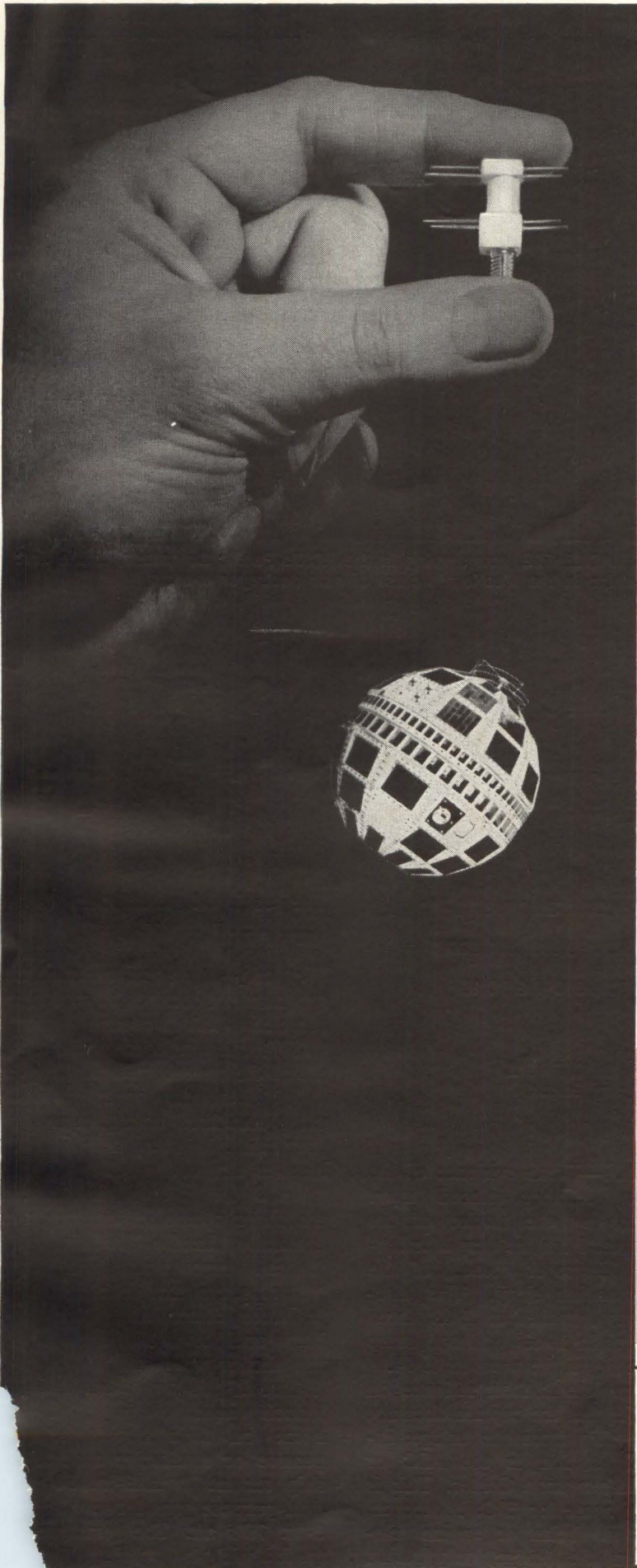

## TELSTAR WOULDN'T WORK WITHOUT OUR WIDGETS

*(Mycalex is one of only hundreds of companies that can make this claim)*

Telstar is a triumphant achievement for the entire Free World. It has enormous potential for improving communications between peoples everywhere. Bell Telephone Laboratories initiated and guided this vast undertaking, but some 1955 companies contributed their special skills to making it a success. Mycalex Corporation of America was one of them.

Mycalex developed dielectric parts fabricated of our SUPRAMICA® 555 ceramoplastic that are used in 13 different series of adjustable inductors and transformers that operate in both the receiving and sending sections of the Telstar satellite. Both physical and dielectric specifications were rigid. SUPRAMICA (we make three kinds designated 555, 560 and 620 "BB") is only one of the products we produce as the world's leading specialists in high-temperature, high-reliability ceramic insulation materials and components. We are proud to have had a hand in Telstar. If we can give you a hand in some electrical or electronic insulation project—large or small—that you are about to embark on, please fill out the coupon below and send for our new 36-page color catalog. No obligation.



## MYCALEX CORPORATION OF AMERICA

World's largest manufacturer  
of ceramoplastics, glass-bonded mica  
and synthetic mica products

Mycalex Corporation of America  
Dept. O, Clifton Blvd., Clifton, New Jersey  
Please send me information on SUPRAMICA 555  
ceramoplastic and other Mycalex products.  
My specific interest is \_\_\_\_\_  
Name \_\_\_\_\_  
Title \_\_\_\_\_  
Company \_\_\_\_\_  
City \_\_\_\_\_ State \_\_\_\_\_

**New from Sprague!**



**Improved Type 150D  
Solid-Electrolyte  
TANTALEX®  
CAPACITORS**

**PERFORMANCE  
CHARACTERISTICS  
NEVER BEFORE POSSIBLE**

- Dissipation factor cut by 1/2 for 20 volt and higher ratings!
- Higher permissible a-c ripple currents!
- Lower impedance at high frequency!
- Lower leakage currents!
- Better capacitance stability!
- New ratings to 100 vdc!

For complete technical data on Improved Type 150D Capacitors, write for Engineering Bulletin 3520E to Technical Literature Service, Sprague Electric Co., 35 Marshall Street, North Adams, Massachusetts.

**SPRAGUE®**

THE MARK OF RELIABILITY

68C-140-93

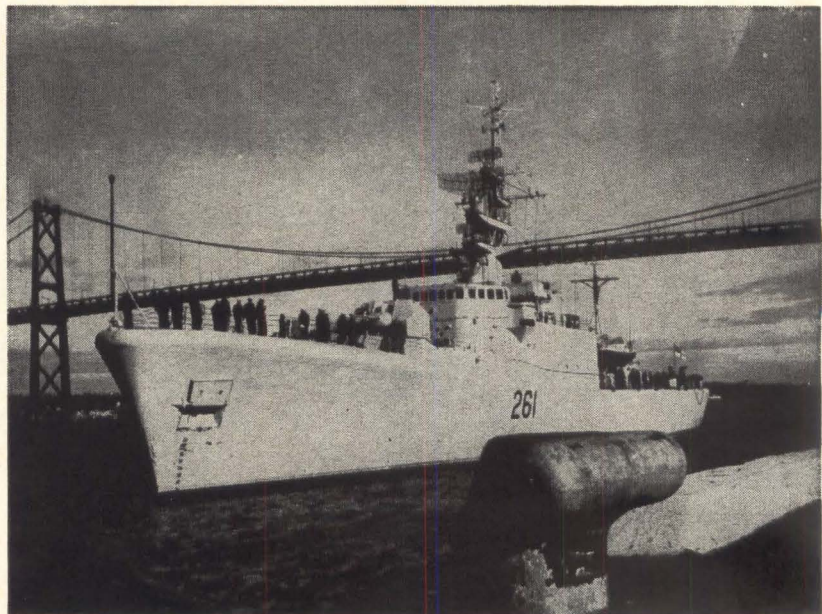

HMCS MACKENZIE, now serving in the RCN's Pacific Command, is the first of six ships in the MacKenzie class of asw destroyer escorts

## Canadian Ships Fight From Electronic Bridge

Reliance on radar and sonar moves helm from bridge to below decks

By JOHN M. CARROLL  
Managing Editor

**HALIFAX**—Fresh evidence of the increasing reliance placed upon electronics by the navies of the world comes from the new *Mackenzie* class destroyer escorts of the Royal Canadian Navy. The *Mackenzie* was launched in 1962, three sister ships in 1963, and two more are to go down the ways in 1964.

So complete is their reliance on electronics that the captain does not fight the ship from the bridge; instead his station is the AIC or Action Information Center. This is the RCN name for CIC. Moreover, there is no helm or engine telegraphs on the bridge, only radar.

The enclosed wheelhouse is two decks below the bridge.

**Weapons**—Main armament of these sub hunters consists of two three-barreled antisubmarine warfare (ASW) mortars located in a well aft of the superstructure. They are fully automatic muzzle loaders using semifixed ammunition which they can loft in any direction. The mortars are controlled by a computer slaved to data received from the sonar attack set and are automatically fuzed. The six hydrostatically fuzed bombs are fired in a star pattern that brackets the sub in three dimensions. The Royal Navy and Royal Netherlands Navy use similar weapons.

Two K-gun projectors amidship launch acoustic torpedoes to home on their targets in either passive or semiactive modes. The ship mounts twin 3-in. 50-cal dual-purpose guns forward and 3-in. 70's aft. The guns are controlled solely by radar.



**Ranging**—Underwater eyes of the ship are three sonar sets, two for search and one for attack. The attack set has a bearing-deviation display-plan position indicator (PPI). The sonar projectors extend 6 ft downwards from open trunks.

The two newest ships to be launched this year will use Canadian variable-depth sonar suspended from the stern. They will also have platforms for ASW helicopters.

There are radar sets for navigation, surface search and air search. The IFF provides a number of operating modes. Nerve center of the ship is the AIC. Here two plotting tables and two radar consoles display the tactical situation. The plotting tables take information from the ships' speed log, gyro-compass (there are two transistorized sets), radar and sonar and display two targets: a red light slaved to the sonar (sub) and a green light slaved to the radar (ASW helicopter). Center of the table is the ship's position shown by electromechanical latitude and longitude counters. The AIC adjoins the electronics countermeasures room, sonar plot and navigation room where the Loran and Decca instruments are located.

**Communications**—The ship uses uhf and vhf radio for ship-to-ship and ship-to-air communications as well as h-f, m-f, and l-f for ship-shore. Infrared is also used for inter-ship communications. There are 12 separate telephone systems and 12 separate intercom systems that can be operated from 28 different locations. For radio direction finding, there is a l-f loop and circular array of vhf-uhf quarter-wave monopoles.

**General**—The *Mackenzies* are 366-ft, 2,900-ton (full-load) ships with a 42-ft beam and 15.5-ft draft. They carry 12 officers and 217 men. Their main propulsion consists of two 30,000-shaft-horsepower geared steam turbines and they can make 28 knots. Their twin screws and twin rudders permit extremely tight turning. A weather deck covers the capstan and other equipment on the foredeck and the anchor flukes are retracted and covered to facilitate nuclear decontamination and simplify operations in the Arctic.

# WHAT THIS DATA-FILE CAN DO FOR YOU...

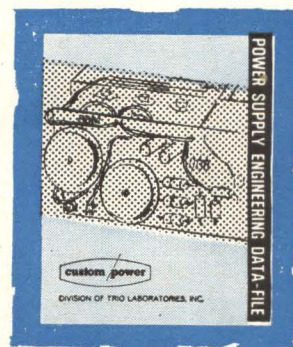

It can help you to buy exactly the Power Supply you want and need—faster and at lower cost.

It can help you to specify a Power Supply that will enhance the reliability of your system—instead of reducing it.

It can save you the time, expense, pain, and possible embarrassment of writing a specification that contains a loop-hole or potential misunderstanding.

It can help you to understand where the cost lies in your Power Supply specification,—so that you (a) can minimize that cost; (b) don't accuse your vendor of overcharging you.

## WHAT THIS DATA-FILE CANNOT DO-FOR ANYONE

It cannot make you into a competent Power Supply designer, unless you already have a great deal of experience in the field.

It cannot show you how to overcome the basic physical realities of thermodynamics, electrokinetics, or the principal of conservation of energy.

It cannot change the density of steel, the melting point of germanium, or the specific heat of air.

Finally, it cannot show you how to "cut corners" on quality or reliability—because we have never made a study of either practice.

### CONTENTS

SOLID-STATE POWER SUPPLIES: TYPES AND TECHNIQUES

HOW TO CHECK YOUR POWER-SUPPLY SPECIFICATION FOR VALIDITY.

PROTECTING THE POWER SUPPLY AND ITS LOAD FROM EACH OTHER

THE PRIMARY-BRIDGE AND PRIMARY-CLIPPER REGULATORS —TWO NEW APPROACHES

LOW-DISSIPATION REGULATORS AND PROTECTIVE CIRCUITS

HOW BIG? HOW HEAVY? HOW EFFICIENT? HOW HOT? HOW MUCH?

REFERENCE SUPPLIES—CURRENT AND VOLTAGE PROGRAMMING POWER SUPPLIES—ANALOG AND DIGITAL TECHNIQUES

CASE HISTORIES—ALL OF THEM WITH HAPPY ENDINGS!

HOW FAR—THE CUSTOM/POWER RANGE OF SIZES AND TYPES DEFINED—AT LAST!

custom power

A DIVISION OF TRIO LABORATORIES INC.  
Plainview, L.I., N.Y., (516) OVerbrook 1-0400, TWX: 516-433-9573

# Video Tube Probes Human Cells

System analyzes cells instantly and records data in digital form

By **C. R. WHETSTONE**  
Assistant Editor

**CANCER RESEARCHERS** have a new tool that speeds up cell analysis. Called **CYDAC**—for cytology data conversion system—the new system automatically converts optical density of cells into a form compatible with a digital computer. The new system, made for the Diagnostic Research Branch of the National Cancer Institute by AIL division of Cutler Hammer is composed of four major parts (see figure): the crt scanner and mechanical scanner, the video processor, the analog-to-digital con-

verter, and the magnetic tape recorder. Briefly, Cydac scans a microscope slide—either a 25 or 50-micron square area—using the crt scanner or the mechanical scanner and converts the light density of the slide into an analog readout using a multiplier phototube. A video processor and analog-to-digital converter provide a digital signal which is recorded on tape by the recorder. Additional data can also be entered into the tape manually to identify further the cell being studied.

**CRT Scanner**—A cathode-ray tube is used as a flying-spot microscanner by projecting the crt spot through the reverse path of the microscope onto the microscope stage. A crt scanner was chosen for versatility and resolution. The light passing through the cell in the microscope field is collected and applied to the multiplier phototube. The output

is the video signal containing the cell data.

At a magnification of 760 $\times$ , the spot is reduced in size so that the scan resolution is 0.52 micron. A square scan raster is generated by linear X and Y sweeps. Two raster sizes are provided—for large cells, a 50  $\times$  50 micron scan field with 192 lines scanned in 6.4 sec, and for small cells a 25  $\times$  25 micron, 96-line field is scanned in 1.6 seconds. The actual illuminated area on the microscope stage can be reduced by a variable field stop in the microscope eyepiece and by blanking out selected scan lines, thus isolating a single cell for each measurement.

**Mechanical Scanner**—The mechanical scanner is similar to the scanners used in early television cameras. The image is projected onto a scan disk, and a series of 48 holes—spirally positioned on the

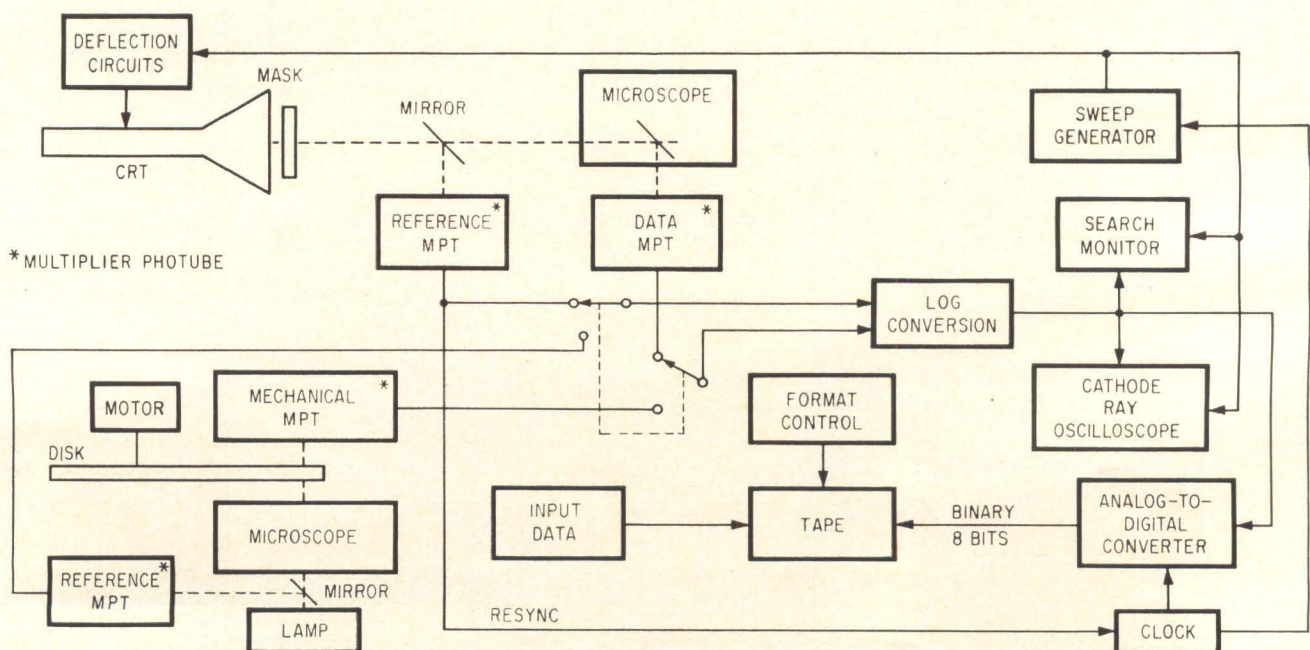

BLOCK DIAGRAM OF CYDAC equipment; mechanical scanning can be selected in place of crt scanning to obtain light with different spectral characteristics. Actual equipment is illustrated on the cover of this week's issue

rotating disk—dissect the image into a quasi-rectilinear scan pattern. The light passing through the scan holes is converted by the multiplier phototube to form the video output signal. The mechanical scanner can use any convenient light source to permit varying the spectral characteristics of the light.

**Video Processing**—The phototube signal output is converted to optical density units by applying it to a logarithmic converter. To cancel out variations in the light source, a beam splitter reflects a fraction of the light output into a reference multiplier phototube. The reference signal passes through an identical logarithmic amplifier and the two signals are applied to a difference amplifier with common-mode rejection. The output of the difference amplifier is fed to a low-pass filter with a 1,500-cps cut-off frequency that reduces high-frequency noise components.

In addition to converting the signal to optical density, both space and density integrals are taken, providing on-line measurements of the area and absorbance of a cell.

**Analog-to-Digital Conversion**—The signal from the video processor is converted to an 8-bit binary code by the analog-to-digital converter. A successive-approximation converter with a 7-microsecond per bit conversion time gives a sampling rate of 600 samples per second.

For calibration and monitoring, both the sum of denstometer readings for all sample points and the density of the mid-scan sample point of one scan line can be selected for display on decimal indicators.

**Recording**—Digital data from the analog-to-digital converter are recorded on magnetic tape in a format compatible with a Honeywell-800 computer. The tape has eight data tracks, a clock track, and a parity track. A data record and status record are recorded for each cell measurement. After recording the data, the tape stops, and another cell measurement cannot then be made until the operator either accepts or rejects the measurement. When the previous data record is accepted or rejected, a status record is then recorded, and the equipment is ready for another measurement.

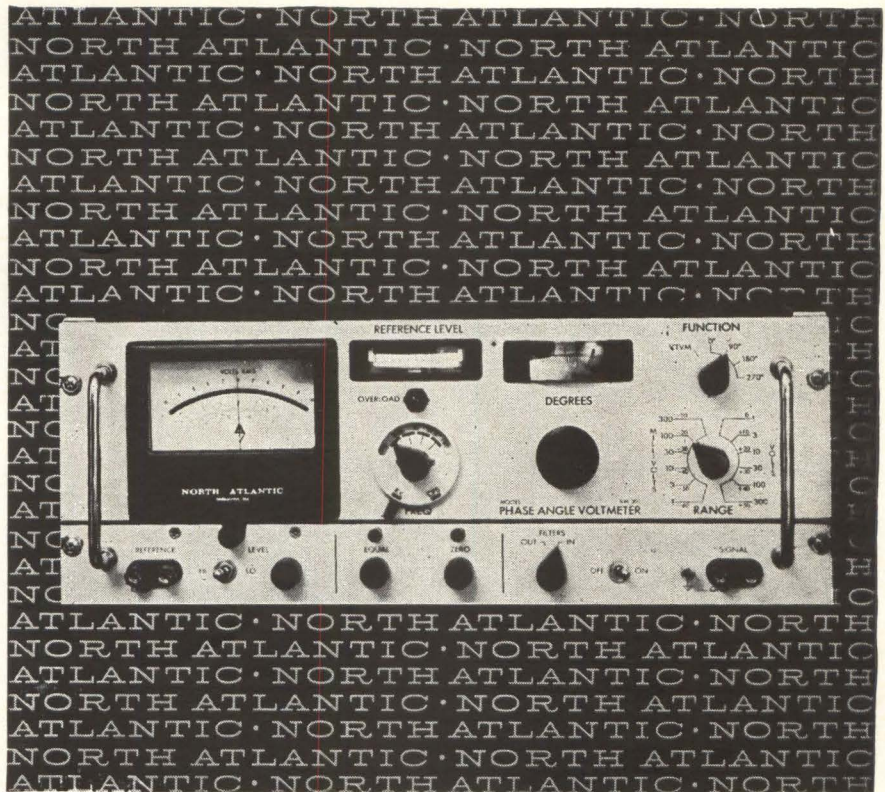

## how to measure in-phase, quadrature and angle while sweeping frequency to 100 kc

North Atlantic's latest addition to the PAV line of Phase Angle Voltmeters\* enables you to make measurements while frequency is varying over half-decades without recalibration. The VM-301 **Broadband Phase Angle Voltmeter**\* provides complete coverage from 10 cps to 100 kc, and incorporates plug-in filters to reduce the effects of harmonics in the range of 50 cps to 10 kc with only 16 sets of filters. Vibration analysis and servo analysis are only two of the many applications for this unit. Abridged specifications are listed below:

Voltage Range.....	1 mv to 300 volts full scale
Voltage Accuracy.....	2% full scale
Phase Dial Range.....	0° to 90° with 0.1° resolution (plus 4 quadrants)
Phase Accuracy.....	0.25°
Input Impedance.....	10 megohms, 30μf for all ranges (signal and reference inputs)
Reference Level Range.....	0.15 to 130 volts
Harmonic Rejection.....	50 db
Nulling Sensitivity.....	less than 2 microvolts
Size.....	19" x 7" x 10" deep
Price.....	\$1990.00 plus \$160.00 per set of filters

North Atlantic's sales representative in your area can tell you all about this unit as well as other Phase Angle Voltmeters\* for both production test and ground support applications. Send for our data sheet today.

\*Trademark



**NORTH ATLANTIC** industries, inc.  
TERMINAL DRIVE, PLAINVIEW, L. I., NEW YORK • Overbrook 1-8600

# New Glass Changes Color When Light Waves Strike

Silicate compounds  
react to light; process  
is reversible

**OPTOELECTRONIC SYSTEMS** designers soon will be working with new transparent glasses that darken when exposed to light, and clear up when the light source is removed. Unusual properties of the new photochromic glasses were revealed for the first time last week at the annual American Physical Society meeting by Dr. S. D. Stookey, Director of Fundamental Research at Corning Glass Works.

By definition, photochromic compounds change color (exhibit spectral absorption effects) on exposure to radiant energy in the visible or near visible portion of the spectrum. Moreover the color change is reversible. Characteristics of this sort have been reported for certain organic dyes (*ELECTRONICS*, June 29, 1962, p 62), and have been suggested for information storage. But as far as known, photochromism has not been previously reported in glass compounds.

Corning's light-sensitive glasses are silicates that contain crystals of silver halides (silver compounds containing chlorine, bromine or iodine). These are not yet in commercial production, but thousands of different compositions of mixed halides have been prepared and tested in the laboratory. Samples are available for study.

**Applications**—Many potential applications for the photochromic glasses in electronic systems are now being suggested. Experiments indicate that glasses with these properties can be useful in optical systems for electronics, self-erasing memory dis-



**LIGHT-SENSITIVITY** can be confined to one part of the glass, as shown. The upper area lets through about 30 percent of the visible light. The lower part allows 86 percent light transmission

plays, readout displays for air-traffic controls, instruments, and optical transmission systems.

Photochromic glasses were developed by Dr. Stookey and Dr. William Armistead, Vice President and director of Corning's technical staff division. A few years ago, they noted that silver-halide crystals in glass behaved differently from the way they behaved in gelatin emulsion. In photography, much larger crystals of the same composition are precipitated in gelatin emulsions and decompose during exposure to light. They form a permanent silver image. When precipitated in glass, smaller crystals darken under exposure to light. The glass changes color. But when the light is removed the color disappears, and the glass retains its former transparency. This darkening and clearing cycle can be repeated indefinitely.

**Example**—One sample of the photochromic glass, 4-mm thick and roughly 2-in. in diameter was exposed to light, using a flash bulb having a peak intensity of 7,000 Angstroms (ordinary sunlight has wavelength of about 5,600 Å). The exposed glass darkened to about 45 or 50 percent, and returned to its original transparency in about 2 minutes. Duration of the flash was 40 ms total, half-peak duration was about 15 ms. Glass samples are also temperature dependent. In the example cited above, the same sample will darken to about 20 percent in a cold, wintry environment. According to Dr. Stookey, the small size of the silver-halide particles, and the fact that they are embedded in rigid, impervious and chemically-inert glass, insures that the color centers of the silver-halide crystals cannot diffuse away, grow into stable silver particles, or react chemically to produce an irreversible decomposition of the silver halide.

By keeping the size of silver-halide crystals below about 600 Angstroms (1/10th the wavelength of red light), it is possible to produce a highly-crystalline transparent body.

**Spectrum**—The wavelengths that induce darkening range from the near ultraviolet through the whole visible spectrum, again depending upon chemical composition. Glasses containing silver chloride are sensitive from roughly 3,000 Å to 4,000 Å. Silver chloride with silver bromide, or silver bromide alone, is sensitive from about 3,000 Å to about 5,500 Å. Silver chloride with silver iodide is sensitive from about 3,000 Å to about 6,500 Å.

Workers at Corning have observed that the properties of the glass depend upon composition, and

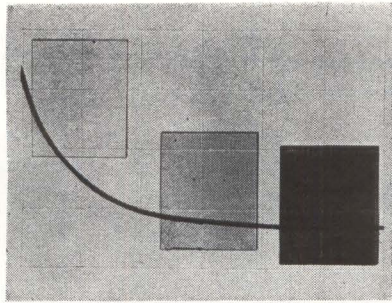

**PHOTOCHROMIC** glass darkens when exposed to light, completely clears within minutes. Darkening depends upon light exposure time (vertical scale) and the degree of transmittance (horizontal scale). Curve indicates the drop in light transmission as the glass darkens from exposure to ultraviolet

heat treatment during manufacture. Some batches for example have been made up that pass only one percent of light rays. High transparency can be combined with high mechanical strength, low-thermal expansion, high dielectric constant, and other useful characteristics. Sample sheets of glass have shown no deterioration in performance after more than two years of day and night outdoor exposure, and after outdoor testing through thousands of cycles of darkening and clearing. Corning plans to continue research on photochromism with the aim of developing specific optical devices.

### Dielectric Gas Studies Promise New Insulators

ROME (N. Y.) Air Development Center, reporting on dielectric-gas studies, says it now has a way to dilute sulphur hexafluoride (SF<sub>6</sub>) with nitrogen. The result is a less expensive mixture with insulating properties essentially unchanged at microwave frequencies, according to V. C. Vannicola, of RADC. Applying it to radar systems, and other high power microwave equipment, could bring substantial cost savings.

Also, the Air Force experiments showed that oxygen traces severely degrade electric-field holdoff characteristics of SF<sub>6</sub>. Purifying the gas may aid development of nanosecond multimewatt microwave spark gap switches, by helping to improve power handling capabilities and recovery times. Pulse compression techniques may also be affected.

### Building-Block Concept Applied to Electron Tubes

OWENSBORO, KY—Basic tube sections—diodes, triodes, pentodes—are being standardized here by General Electric, and packaged together in one "bottle" according to customers' requirements.

Idea is an extension of the GE compactron (Electronics, July 8, 1960, p 70). In the compactron, a combined oscillator, converter and intermediate frequency amplifier were packaged within a single tube. The sections are built up by using various combinations of "building blocks". A new 6T9 triode-pentode is built up with sections similar to a 12AX7 and a 6AQ5 pentode. General Electric says the new multi-function tube actually performs better than either prototype as a result of new materials used and new construction techniques. A new color television compactron, the 6BH11, consists basically of a 6GH8 triode-pentode unit and a medium mu triode section with characteristics like the 6BQ7.

General Electric says they can produce any quantity of the standard diode, triode or pentode sections and then use them in any combination as subassemblies to make different, multifunction electron tubes. W. L. Carl, tube design engineer here, says that significant future economies will result as they refine the building block plan for electron tubes. "Basically, the building block plan reaps the advantages of both the modular construction concept and of mass production in the highly-complex business of tube making," Carl says.

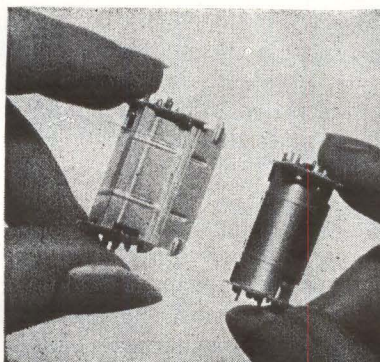

GE'S prefabricated tube sections can be "bottled" to customer's specs

### Save time with these tested transistor design circuits

Here's a ready source of quick, time-saving answers to your transistor circuit problems... practical guidance on essential phases of today's semiconductor developments. Because these three volumes bring you the successful work of practicing engineers, every topic has permanent reference value and contributes to the Library's usefulness in your work.

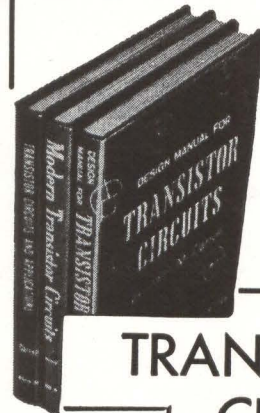

You'll have at your fingertips hundreds of *proved* transistor circuits — with all the necessary design information and component values required to utilize them in your own designs — and save valuable man-hours of time and effort.

## TRANSISTOR CIRCUITS LIBRARY

Edited by  
John M. Carroll  
Managing  
Editor  
Electronics

3 vols. 932 pp.,  
1735 illus. and  
tables, \$24.95—  
payable \$8.95 in  
10 days, \$8.00  
monthly

Praise by  
experts...

"... a valuable  
reference to  
the circuit de-  
signer and en-  
gineer."  
—Electronics

"... useful to  
those who are  
entering the  
field of semi-  
conductor circuit design."  
—Control

"... a conven-  
ient and com-  
prehensive  
source of trans-  
istor information."  
—Radio-Elec-  
tronics

These three big manuals supply hundreds and hundreds of transistor circuits ready to be adapted to your specific needs... give valuable material on transistor characteristics, structures, and techniques. Articles, photographs, design charts, nomographs, and ready-to-use circuits cover a vast range of applications... from simple one-transistor "push-pull" amplifiers... to complex computer switching circuits with high-power transistors. You get data and circuits for home-entertainment and broadcast equipment... computer and servomechanism circuits... missile, aircraft, and satellite equipment... and many more.

Library includes...  
Transistor Circuits and  
Applications  
Modern Transistor  
Circuits  
Design Manual for  
Transistor Circuits

Save \$5.05. Bought separately, books would cost \$30.00. But under special Library offer, they come to you at a \$5.05 saving—and you may pay in small, convenient installments.

### SEE LIBRARY 10 DAYS FREE Direct from Publisher

McGraw-Hill Book Co., Dept. L-1-31  
327 W. 41st St., N. Y. C. 10036

Send me the Transistor Circuit Library. In 10 days I will (check one)  remit full price of \$24.95; or  only \$8.95 in 10 days and \$8.00 monthly. Otherwise I will return books postpaid. (If you remit in full with coupon, plus local tax, refund and return privileges still apply.)

Name .....

Address .....

City ..... State ..... Zip .....

Company .....

Position .....

Far price and terms outside U. S. write McGraw-Hill Int'l., N. Y. C. 10036 L-1-31

# Big YIG's Grow in Salt

Large furnace and tight temperature control make narrow-linewidth spheres

By **J. W. NIELSEN**  
 Manager,  
 Solid State Labs,  
 Airtron Div. Litton, Ind.  
 Morris Plains, N. J.

**YTTRIUM-IRON GARNET,  $Y_3Fe_5O_{12}$  (YIG) crystals** have made possible the development of many devices such as microwave tunable filters and limiters which in turn require the production and processing of these crystals in large quantities. A molten-salt technique for growing crystals is used because of its ability to grow large, sound crystals up to 300 grams that exhibit the desirable narrow linewidth characteristics, 0.3 oersted or less, needed in these applications. The success of this technique depends on the use of large systems and good temperature control. Other crystals currently grown with this process are ruby, zinc oxide and gallium or aluminum garnet.

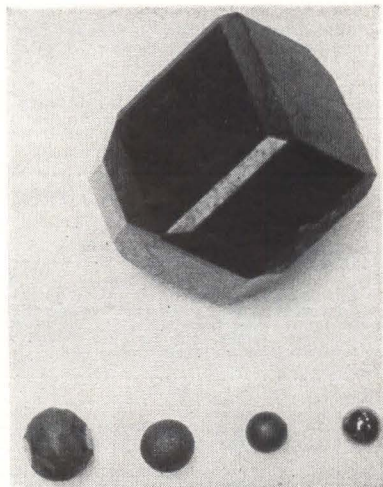

YIG SPHERES are formed from rough-sawed crystal

**Process**—Oxide and fluoride powders are mixed together and pressed or premelted in a platinum crucible. Enough is added to load the crucible to at least two-thirds of its volume. A pure lead-oxide fluoride mixture is placed on top of the melt to minimize sintering and caking of the YIG on the surface. The final composition of the melt is approximately  $PbF_2$ ,  $PbO$ ,  $Fe_2O_3$ ,  $Y_2O_3$ , in proportion of 9, 6, 3, 2, by weight.

The platinum crucible is then placed in the furnace at 1,260 deg C and held there for four hours while rotating the pedestal on which it sits. After the holding or "soak" period, the furnace is cooled uniformly at about 0.5 deg C per hour.

At a temperature not below 1,040 deg C, the crucible is withdrawn and the excess liquid is poured off the crystals. (Below 1,040 deg C a retrograde region of solubility exists for YIG and it redissolves.) The remaining solvent clinging to the crystals is removed with a mixture of dilute nitric and acetic acids.

The position of the crucible in the furnace during the run is very important because the bottom of the crucible must be slightly cooler than the top. This restricts nucleation of the crystals to the bottom of the crucible, and since the crystals must nucleate by epitaxy, only a few large crystals are grown.

**Doped YIG**—Compositional uniformity is an additional problem when producing substituted YIG because the melt is now a solid solution rather than a fixed compound. Gallium doped YIG has been found to be preferred over indium or aluminum doping because crystals grow larger and have less flaws. Narrow linewidths are always obtained from the largest crystals. Although they show the widest variation in saturation magnetization, linewidth depends upon the gradient concentration of gallium atoms per cc per

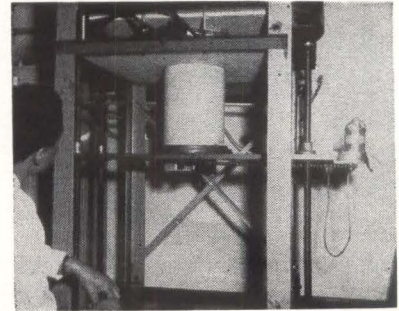

ELEVATOR and rotator permit stirring and temperature control

unit length of crystal. Thus substituted YIG is grown in as large a batch as possible and nucleation is restricted as much as possible through careful temperature control. This is achieved by permitting the crucible to be hotter at its top. There is also an optimum cooling rate that provides optimum uniformity for a given concentration.

**Processing**—Yttrium iron garnet crystals are hard and brittle. Their hardness is about equal to that of quartz.

All commercially available devices now using YIG crystals require a spherical sample. This sphere must be perfect and possess an optically sound finish—surface preparation of spheres for filter and limiter applications is the most critical part of the processing.

Raw crystals are cut with a diamond saw into approximately cubic samples slightly larger than the diameter of the spheres desired and placed in a tumbling mill to reduce these samples to rough spheres. The diameter of the spheres is controlled by the time in the mill. The crystals are given a rapid microscopic examination to pick out obvious defectives and sized. Spheres of approximately the same size are placed in Airtron race-type polishers and polished to a high finish.

In order to generate and maintain a true sphere, random or non-

repeating motion of the sphere against the grinding holder is necessary. As one plate rotates with respect to the other, the portion of the sphere furthest from the center of the plate moves at a greater velocity than the closer portion, thus adding a twisting moment to the natural rolling of the sphere. In order to precisely control the size of the YIG spheres, the outermost groove, filled with steel ball bearings stop the grinding operation when the spheres have reached the required size.

Certain devices under development require YIG disks and rods of special orientations. These orientations along the simple axes, (100), (110), and (111), accurate to  $\pm 2$  deg can be achieved using the natural (110) face of the crystal. The major problem in processing large samples of garnet is that great care must be taken. Diamond saws and tools must be used and cutting must be performed at a slow rate. The sawing and turning of YIG require experienced machinists.

The production of quantities of rods and disks depends principally upon having a suitable raw crystal. Given a sufficiently large crystal, this is achieved by mounting the crystal on a block for machining.

This development was supported in part by the Manufacturing Technology Laboratory, U. S. Air Force, Wright Patterson Air Force Base, Ohio, Robert Bratt, Project Engineer.

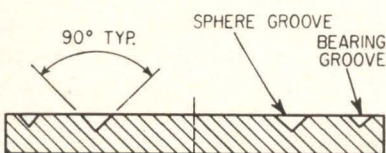
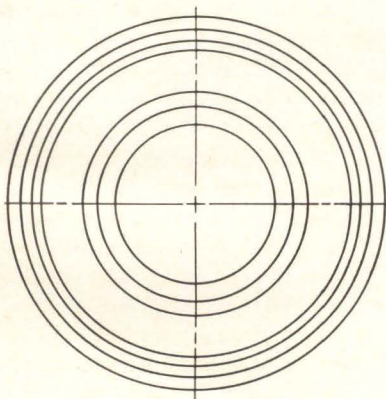

RACE-TYPE POLISHER is used for large quantity production

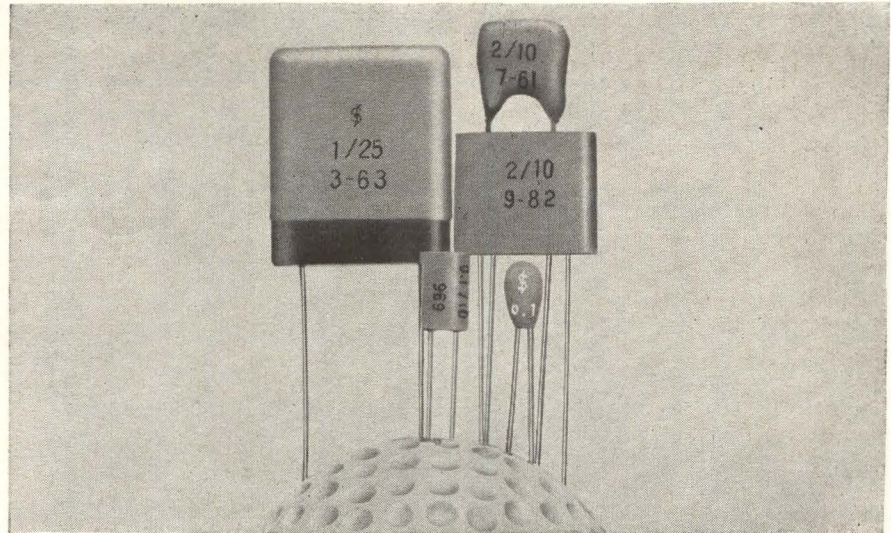

## The Fujitsu 'Aloxcon' A New Electrolytic Capacitor:

### The high quality of tantalum at the low cost of aluminum

Designed for use in printed and transistorized circuits, Fujitsu's newly developed aluminum solid electrolytic capacitor 'Aloxcon' functions effectively at temperatures ranging from  $-60^{\circ}\text{C}$  to  $-80^{\circ}\text{C}$  and frequencies up to 100 kc or more. A semiconductor layer replaces the usual type of electrolytic and so the capacitance of an 'Aloxcon' is less affected by temperature and frequency than other types. 'Aloxcon' capacitors are highly resistant to moisture, and have low leakage current and extremely high life expectancy. They are ideal for transistor circuits requiring low impedance and miniaturization. Detailed specifications and application data available from our representatives.

Type	Voltage/ Capacitance	Working Voltage(V)	Surge Voltage(V)	Capacitance (mf)				
AZ (Dipped)	6	8	8			0.1	0.2	0.5
GZ (Encased)	10 25	12 30	12 30	0.01	0.02	0.05	0.1	0.2
AR (Dipped)	6	8	8			1	2	5 10 20
DR (Encased)	10 25	12 30	12 30	0.1	0.2	0.5	1	2 5 10
HR (Hermetically Sealed)	6	8	8			1	2	5 10 20
	10 25	12 30	12 30	0.1	0.2	0.5	1	2 5 10



**FUJITSU LIMITED**

Communications and Electronics

Tokyo, Japan

Represented by: U.S.A.: THE NISSHO AMERICAN CORP. 80 Pine St., New York 5, N.Y., Phone: WH 3-7840 THE NISSHO PACIFIC CORP. 120 Montgomery St., San Francisco 4, California, Phone: YU 2-7901/7906 CANADA: NISSHO (CANADA) LTD. 100 University Avenue, Toronto, Phone: EM 2-4794 UNITED KINGDOM: WALMORE ELECTRONICS LIMITED 11-15 Betterton Street, Drury Lane, London W.C. 2, Phone: TEM 0201-5 GERMANY: NEUMULLER & CO. GMBH 8 München 13, Schraudolphstr. 2a Phone: 29 97 24 SCANDINAVIA: SCAPRO AB Kungsbroplan 2, Stockholm K, Sweden, Phone: 53 04 36, 53 04 51

CIRCLE 45 ON READER SERVICE CARD

**HELP YOUR POST OFFICE  
TO SERVE YOU BETTER**

BY

**MAILING EARLY IN THE DAY  
NATIONWIDE IMPROVED MAIL SERVICE  
PROGRAM**

## Laser Diode Has Low Threshold

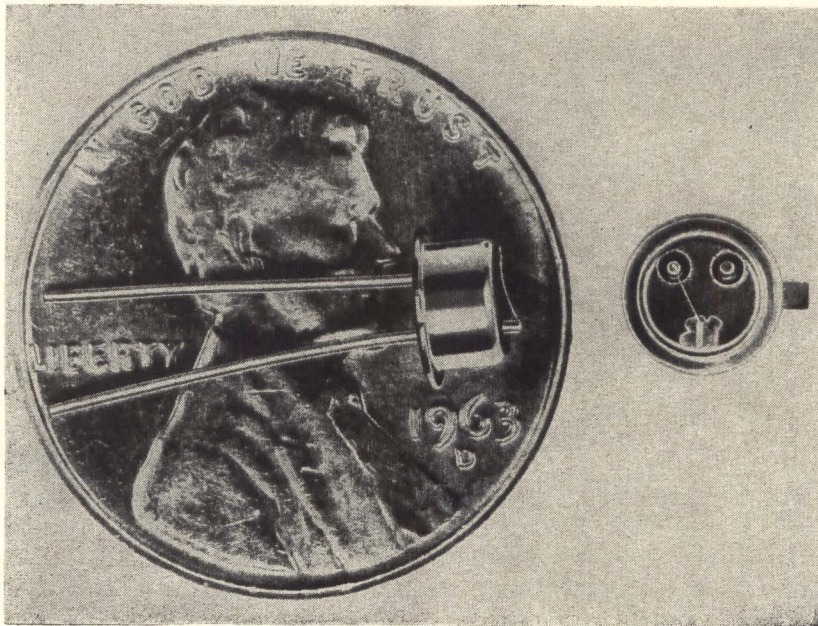

Dielectric coating reduces lasing current drive

**SEMICONDUCTOR** laser model K-S1 is constructed so that a Fabry-Perot resonator is formed between the two sides of the junction in the gallium-arsenide material. Multi-

layer dielectric coatings are deposited on one end of the resonator, yielding a film with a reflectivity that exceeds 95%. This results in a significant decrease of threshold current as compared to uncoated units. Photons are created as electrons recombine with holes in the vicinity of the junction. Coherent emission occurs when the gain due to stimulated emission equals the total losses experienced by an elec-

tromagnetic wave travelling the length of the resonator.

According to the manufacturer, model K-S1 has distinct advantages over optically-pumped laser elements, since it affords direct conversion of current to light. Moreover, the quantum efficiency of the device varies markedly with temperature. Practical threshold currents are obtained when operating the unit at 77 K. Operation at 20 K will reduce threshold current densities by about 1 order of magnitude and increase power output accordingly.

Specifications for model K-S1 include threshold current density of 2,000 amperes/cm<sup>2</sup> at 77 K; threshold current of 6 amperes or less; peak power output of 1 watt minimum in the coherent beam, with 40 ampere 1- $\mu$ sec pulses; maximum average power dissipation of 1 watt, beam power of approximately 0.1 watt/steradian, and spectral output at 8,400 Å to 8,450 Å depending upon the power dissipated at the junction. Moreover, the device has a linewidth of 8 Å at threshold, to about 25 Å at 5 times threshold and a modulation bandwidth in the 100-Mc range. Response time is in the nanosecond range. Korad Corp., 2520 Colorado Ave., Santa Monica, Calif.

CIRCLE 301, READER SERVICE CARD

## Amplifiers Feature Wide Response

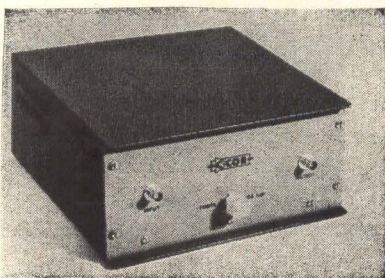

**SERIES** of solid-state amplifiers feature high output and wide response. Bandpass is 100 kc to 150 Mc with 6 volts peak-to-peak output into 50 ohms at 10 Mc. Input and output impedances are 50 ohms, with noise and hum down to 12- $\mu$ volt rms equivalent input.

Units are available with gains of 20 db, 40 db and 60 db nominal.

They are multiple feedback amplifiers using a modified complementary-symmetry output circuit. Conventional tube devices capable of an equivalent bandwidth were of the distributed type, making it impossible to achieve extreme bandwidth while maintaining low impedance levels. According to the manufacturer, these amplifiers suffer



none of the obvious drawbacks while producing substantial power output when compared to most units with equivalent bandwidth characteristics. Price varies from \$450 to \$1,700 depending upon the series and model selected. Community Engineering Corp., P. O. Box 824, State College, Pa. (302)

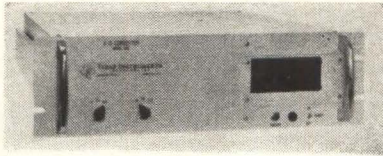

### A/D Converter Operates at High Speed

MODEL 846 analog-to-digital converter, designed for applications using binary coded decimal format, can make 50,000 conversions per sec, including its built-in sample and hold feature. Accuracy is  $\pm 0.05$  percent full scale  $\pm 1$  least significant digit. Specifications include input impedance greater than 100 megohms, voltage ranges from 1 to 10 v, and aperture time of 100 nsec. Manual or external range selection is provided. Single conversions can be made with a front panel push-button. The instrument utilizes modular p-c board construction throughout. Texas Instruments Inc., 3609 Buffalo Speedway, Houston, Texas. (303)

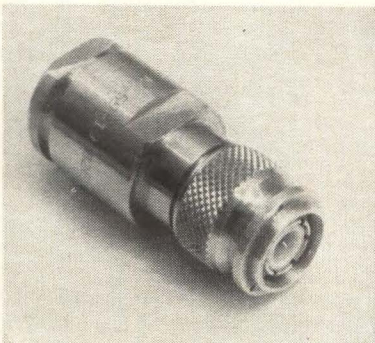

### Aluminum Plug Has Teflon Insulator

LIGHT-WEIGHT aluminum plug, KA59-19, features a brass contact, Teflon insulator and butyl rubber gasket. The small rugged unit has a positive locking threaded coupling. Its coupling nut is provided with lock wire holes to assure low noise

level. The KA59-19 is designed for use with RG115A/U JTM cable. Kings Electronics Co., Inc., 40 Marbledale Road, Tuckahoe, N.Y. 10707. (304)

### Inductive Resistor for Computer Applications

A BASIC CHARACTERISTIC of the new LR inductive resistor is a fixed time constant which does not vary with resistance value over the range of frequency applications encountered in computer pulse applications. The

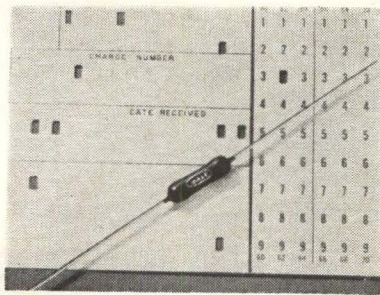

LR-20 provides a 20-nsec time delay ( $\pm 10$  percent) from low frequencies up to 10 Mc. Resistance range is 20 ohms to 1,000 ohms. Power rating,  $\frac{1}{2}$  w. The LR-30 provides a 30-nsec time delay ( $\pm 10$  percent) from low frequencies up to 10 Mc. Resistance range and power rating are the same as those for the LR-20. Dale Electronics, Inc., P. O. Box 488, Columbus, Nebr. (305)

### Electronic Touch Button Is Self-Indicating

NEWLY DEVELOPED tube is triggered by touching an external circular metal disk. Because of the capacity-to-ground of the body touching the button, the tube fires and conducts up to 15 ma, sufficient current to pull in a relay. The cathode glow is bright orange and appears as an annular ring clearly visible from the front. This tube is used as a self-indicating touch button in applications similar to the familiar elevator button. Advantages are long life (approximately 10,000 hr of conduction, corresponding to many years' use), zero stand-by power, and automatic indication of

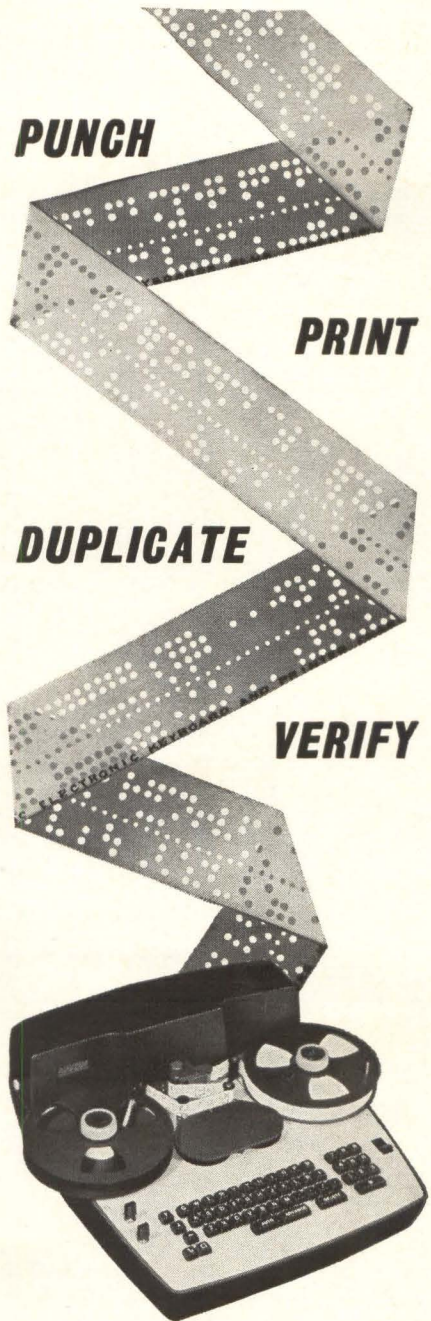

## TAPEWRITER

Now . . . prepare and verify tapes with one unit, at typing speeds. Series 1010 TAPEWRITERS have numeric or full alphanumeric electronic keyboards . . . semiconductor circuits . . . printed characters for instant visual verification, and easy deletion of typing errors. Custom codes and keyboards plus compatibility with remote data systems give complete flexibility. 75% electronic . . . low cost . . . low maintenance.

# NAVCOR

NAVIGATION COMPUTER CORPORATION  
Valley Forge Industrial Park  
NORRISTOWN, PENNSYLVANIA

for your silicon power transistor

# AVNET

requirements specify STC

over 150 2N type nos. in 12 package sizes in power ratings from 5 to 300 watts. 21 MIL approvals; features major breakthrough in miniaturized power without heat sink; isolated collector in 75-85 watts; PNP transistor with NPN complements.

contact Avnet for on-time delivery

# S.T.C.

of STC silicon power transistors



call your nearest Avnet office

# AVNET

10 Local Headquarters, coast to coast

CIRCLE 48 ON READER SERVICE CARD

## NIMS

NATIONWIDE IMPROVED  
MAIL SERVICE PROGRAM

For Better Service  
Your Post Office  
Suggests

That You Mail Early  
In The Day!

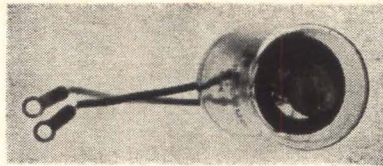

"on" condition. The tube is operated on approximately 200 v d-c plus 110 v a-c. Ambient operating temperature range: -20 C to +80 C. Amark Corp., 92 North Ave., New Rochelle, N. Y.

CIRCLE 306, READER SERVICE CARD

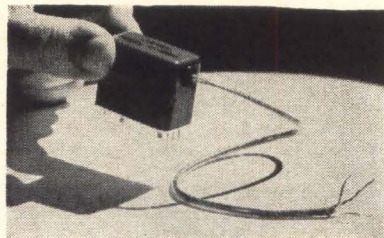

### Chopper Relays Are High-Speed Devices

A LINE of high-speed, dpdt, light-resistive Photocom chopper relays for either a-c or self-driven d-c operation and each with an isolated leadout coil for use as modulator-demodulators, dual modulators, comparators or high speed relays. The a-c model, C-4850, incorporates elements that will operate over a wide frequency range and switch up to 2,000 cps. Three d-c models, C-4860, - 1 and - 2 operate at 200, 400 and 1,000 cps, respectively. Noise of all models is less than 3  $\mu$ v rms into a load of 1 megohm. Thermal drift is less than 1  $\mu$ v. James Electronics, Inc., 4050 N. Rockwell St., Chicago, Ill. 60618. (307)



### Coax Power Divider Has Three Outputs

MODEL D2391 has an input vswr of 1.2 maximum over the frequency range of 1 to 2 Gc. Insertion loss is 0.5 db maximum and outputs are identical within 0.3 db. Price and

delivery is \$80, two weeks, respectively. Radar Design Corp., Pickard Drive, Syracuse, N. Y. (308)

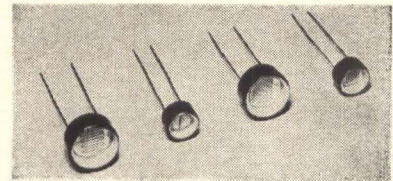

### Photoconductive Cells Offer High Stability

NOW AVAILABLE are Cadmium Sulpho-Selenide photoconductive cells. Combination of the best characteristics of cadmium sulphide and cadmium selenide has resulted in a more stable and more reliable photocell. Cell can be tailored to customer specifications throughout the visible and near infrared range. Features include: spectral responses to  $\pm$  50 angstroms; resistances to 200 ohms at 2 ft candles; speeds of response, 0.5 millisecond; greater sensitivity at both high and low light levels; weight as low as 700 milligrams. Angstrom Electronics Corp., Sagamore Hill Drive, P.O. Box 712, Port Washington, N. Y. (309)

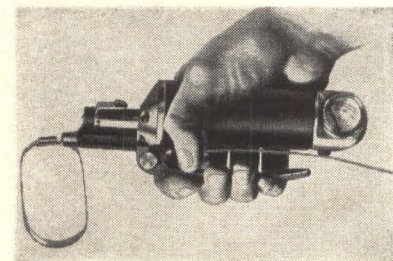

### Banding Tool Reduces Rejects

A HAND-SIZED compressed-air tool for banding C and E cores for transformers with greatly increased accuracy has been introduced. The new tool, by providing a consistent, pre-set banding tension, reduces to a negligible minimum rejects due to unequal pressures supplied by banding equipment heretofore used in assembly line operations. The tool, equipped with a foot switch, can provide up to 150 lb of pull from an air-line pressure of 80 to 100 psi. The Inter-Technical Group, Inc., P.O. Box 23, Irvington-on-Hudson, N.Y. (310)

# HOW TO USE YOUR ELECTRONICS BUYERS' GUIDE

## Advertising Product Sections

Advertisements in the **ELECTRONICS BUYERS' GUIDE** are grouped together according to the kind of product advertised. All Power Supply advertisements, for example, will be found in the same section of the book. Thus it is made convenient for you to "shop" through the specifications presented to you by advertisers, without having to flip pages back and forth constantly. Keep your **ELECTRONICS BUYERS' GUIDE** close to your work area at all times.

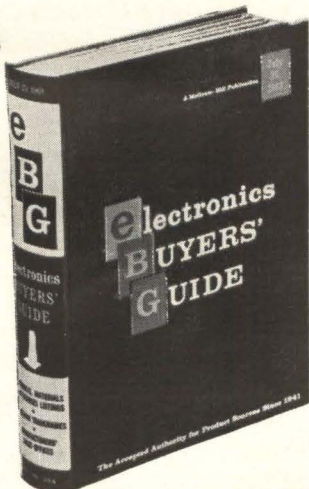

## LITERATURE OF THE WEEK

**EXOTIC METALS** Metal Hydrides Inc., 12-24 Congress St., Beverly, Mass., has available a bulletin describing specialty metal powder alloys and the company's ability to custom make exotic metal powders of uniform particle size and super-purified alloy specialties. (361)

**PROXIMITY SWITCH** Micro Switch, a division of Honeywell, Freeport, Ill. Data sheet 213a discusses a new proximity switch that detects any electroconductive metal. (362)

**NAVIGATIONAL AIDS** Montek Division of MEMCOR, 4438 South State St., Salt Lake City 7, Utah, has published a brochure describing its capability in the field of navigational aids. (363)

**EXTRUDED TEFLON TAPE** Tensolite Insulated Wire Co., Inc., West Main St., Tarrytown, N. Y., has issued a bulletin on extruded Teflon tape for wire wrapping applications. (364)

**RECEIVING TUBES** General Electric Co., Owensboro, Ky. A new receiving tube selection chart now available is entitled "High Reliability Tubes for Critical Applications." (365)

**ATTENUATION MEASUREMENT** Sperry Microwave Electronics Co., P.O. Box 1828, Clearwater, Fla. Wide range microwave attenuation measurements with high accuracy are described in *Application Note No. 1*. (366)

**AEROSPACE PRODUCTS** Electronic Space Products, Inc., P.O. Box 18795, Los Angeles 18, Calif., has available a 124-page catalog listing high purity materials and other products used by the aerospace and electronic industries, and research laboratories. Request copy on company letterhead.

**MONOPULSE TRACKING & TELEMETRY DATA RECEIVER** Defense Electronics, Inc., Rockville, Md. Bulletin TTR-1 describes engineering features, specifications and applications for use throughout the 215 to 265-Mc range. (367)

**DIGITAL CLOCK TECHNIQUE** C. P. Clare & Co., 3101 Pratt Blvd., Chicago, Ill. 60645. Bulletin 1002 describes the versatility of the company's control modules as the basic circuitry for digital clock applications. (368)

**VOICE COMMUNICATIONS SYSTEMS** Remanco, Inc., 1805 Colorado Ave., Santa Monica, Calif. An 8-page capability brochure on operational voice communications systems, voice paging systems, and allied terminal equipment is available. (369)

**NICKEL-CADMIUM BATTERIES** Sonotone Corp., Elmsford, N. Y., has released a spec sheet on fast-charging nickel-cadmium batteries. (370)

**PULSE HEIGHT ANALYZER** Digital Equipment Corp., 146 Main St., Maynard, Mass. A 4-page brochure describes the new PDP-5 computer in a pulse height analysis configuration. (371)

specify the new Sperry Products  
contact Avnet for best service

# AVNET

on-time delivery of the latest  
Sperry Semiconductors

including NPN and PNP silicon  
planar & PNP silicon alloy transistors  
(many types QPL approved),  
silicon planar differential & darlington  
amplifiers, dual emitter  
differential choppers

many other Sperry products are  
available immediately from Avnet

# SPERRY

call your local Avnet Headquarters  
The Avnet System, coast to coast

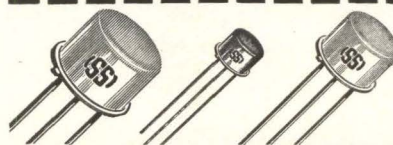

Westbury, L. I.; Chicago; Phoenix;  
Burlington, Mass.; Syracuse, N. Y.;

# LOCAL

Salt Lake City; Bellevue, Wash.;  
San Diego, L. A., Sunnyvale, Cal.

CIRCLE 49 ON READER SERVICE CARD

# WANT TO DO BUSINESS WITH THE GOVERNMENT

??????????????

Then check the Military  
and Government Procurement  
Guide in the orange section of  
your **ELECTRONICS BUYERS'  
GUIDE**.

!!!!!!!!!!!!!!!!!!!!



E. S. McCollister



R. G. Dee

## RCA Names Division V-P's

**EDWIN S. McCOLLISTER** has been appointed division vice president and operations manager, Radio Corporation of America, Electronic Data Processing, it was announced by Arnold K. Weber, recently elected staff vice president. Weber continues as EDP general manager.

McCollister, previously division vice president for business planning and marketing, now assumes direct responsibility for engineering, manufacturing, project management, business planning, and domestic and international marketing functions for the computer systems activity. He is headquartered in Cherry Hill, N.J.

Also announced is the appointment of Robert G. Dee as division vice president, marketing, for RCA Electronic Data Processing. Formerly manager of product planning, Dee will direct the EDP marketing effort in the U.S. and abroad—including computer sales, leasing and supporting services for business, science and government.

### Signetics To Build \$5 Million Complex

SIGNETICS CORPORATION, Sunnyvale, Calif., will start construction next month on a new \$5 million, 250,000-sq-ft laboratory and building complex on a 16-acre site in that city.

First phase of the 3-year construction program will include an H-shaped manufacturing and administration building of about 100,000 sq ft, scheduled for occupancy in November. It will be a 2-story building, connecting to a 67,000-sq-ft manufacturing building via a one-story cafeteria and conference room structure.



### Hallicrafters Elects Shapiro

**JONAS M. SHAPIRO** has been elected vice president-technical adviser of The Hallicrafters Company, Chi-

cago-based electronics firm.

A veteran of more than 30 years in electronics, Shapiro has been vice president-communications engineering at Manson Laboratories, Inc., Stamford, Conn., a Hallicrafters subsidiary which specializes in military communications equipment. He will retain these responsibilities and continue to be based at Manson, which will transfer operations shortly to a new plant at Wilton, Conn.



### Oak Manufacturing Appoints Bradshaw

**CARL J. BRADSHAW** has been named head of Far Eastern Operations for Oak Manufacturing Co., Crystal Lake, Ill.

In his new capacity Bradshaw becomes president of Oak Manufacturing Co. (Japan) Ltd., and assistant to the president of Oak Manufacturing Co. He will headquarter in Tokyo.

Prior to joining Oak, Bradshaw was on the staff of the U. of Washington in Seattle.

### Three Specialists Join GIC Group

**THREE** top-echelon appointments in the General Instrument Corporation Thermoelectric division have been announced by Melvin Barmat, general manager of the division.

Samuel S. Shapiro founder and former president of Materials Electronic Products Corporation (Melcor), has been named director of

materials engineering of the division, a new post.

Jean R. Fortier, former manager of thermoelectric products for Westinghouse Electric Corp., has been appointed manager, special projects, of the division, also a new post.

Martin A. Rubinstein, previously technical assistant to the president of Lithium Corp., is named engineering manager of the GI Thermo-electric division.

## PEOPLE IN BRIEF

**Ross D. Siragusa, Jr.**, moves up to marketing and sales v-p of Admiral Corp. **Gilbert Goodman** leaves GE Research Laboratory to become director of research at Vitramon, Inc. **Marvin L. Bookin** advances to director of advanced engineering for Data Display, Inc. **Arie Vernes**, president and board member of Philips Electronics and Pharmaceutical Industries Corp., elected chairman of the board. He is succeeded in the presidency by **Oliver H. Brewster**, who has been v-p and director. **Frank A. Seeburger**, ex-Combustion Engineering, Inc., named disc file materials mgr. for Bryant Computer Products. **Walter Prince**, director of mfg. for the Martin Co. Baltimore div., appointed director of the company's Aircraft Modification Center. He is succeeded by **Edwin N. Laurance**, previously with the Denver div. **W. Earl Stewart** promoted to v-p, mfg., for The Standard Register Co. **Richard J. DeCloux** elevated to v-p of Beede Electrical Instrument Co., inc. IBM ups **John H. Ciovacco** and **William E. Harding** to asst. mgr's. of product operations, manufacturing and engineering respectively, in the Components div. **Robert F. Robinson**, from Analytic Services, Inc. to Bendix Systems div. as mgr. of the systems analysis dept. **Matthew P. Tubinis**, ex-Stromberg Carlson, now mgr. of systems engineering at James Cunningham, Son & Co. **John M. Embree**, former president of Embree Electronics, has founded Computer Dynamics, Inc., div. of John Embree Associates.

## EMPLOYMENT OPPORTUNITIES



The advertisements in this section include all employment opportunities—executive, management, technical, selling, office, skilled, manual, etc.

Look in the forward section of the magazine for additional Employment Opportunities advertisements.

### — RATES —

**DISPLAYED:** The advertising rate is \$52.00 per inch for all advertising appearing on other than a contract basis. Contract rates quoted on request.

An advertising inch is measured  $\frac{1}{8}$ " vertically on a column—3 columns—30 inches to a page.

Subject to Agency Commission.

**UNDISPLAYED:** \$2.70 per line, minimum 3 lines. To figure advance payment count 5 average words as a line.

Box numbers—count as 1 line.

Discount of 10% if full payment is made in advance for 4 consecutive insertions.

Not subject to Agency Commission.



**E. E.'s**  
for FEE-PAID Positions  
**WRITE US FIRST!**  
Use our confidential application for professional, individualized service . . . a complete national technical employment agency.  
**ATOMIC PERSONNEL, INC.**  
Suite 1207L, 1518 Walnut St., Phila. 2, Pa.

**INDUSTRIAL ELECTRON TUBES SALESMAN**  
DYNAMIC, WITH BROAD MARKET CONTACTS AND FOLLOWING. LIBERAL COMMISSION.  
**METROPOLITAN SUPPLY CORP.**  
443 PARK AVE. S., NEW YORK 16, N. Y.  
(212) MU 6-2835

ADDRESS BOX NO. REPLIES TO: Box No.  
Classified Adv. Div. of this publication.  
Send to office nearest you.  
NEW YORK, N. Y. 10036: P. O. Box 12  
CHICAGO, Ill. 60611: 645 N. Michigan Ave.  
SAN FRANCISCO, Cal. 94111: 255 California St.

### POSITION VACANT

**Electronic and Electro/Mechanical Technicians, designers, checkers, draftsmen and detailers—Work for leading firm of licensed professional Engineers. Write to United Engineers, 150 Causeway Street, Boston 14, Mass.**

### EMPLOYMENT SERVICES

Resumes and application letters that make employers want you. Composed, printed by Executive Resumes, Dept. F, Executive Suite, 744 Broad St., Newark, N. J.

### BUSINESS OPPORTUNITY

**Electronic Stock Quotation Monitoring System.** Trader oriented. Significant advance over existing systems. Patent pending. No prototype. Inquiries invited. Box BO-3667, Electronics.

### Your Inquiries to Advertisers Will Have Special Value . . .

—for you—the advertiser—and the publisher, if you mention this publication. Advertisers value highly this evidence of the publication you read. Satisfied advertisers enable the publishers to secure more advertisers and—more advertisers mean more information on more products or better service—more value—to YOU.

## SEARCHLIGHT SECTION

(Classified Advertising)

BUSINESS OPPORTUNITIES

EQUIPMENT—USED or RESALE

### DISPLAYED RATE

The advertising rate is \$27.25 per inch for all advertising appearing on other than a contract basis. Contract rates quoted on request. AN ADVERTISING INCH is measured  $\frac{1}{8}$  inch vertically on one column, 3 columns—30 inches—to a page. EQUIPMENT WANTED or FOR SALE ADVERTISEMENTS acceptable only in Displayed Style.

### UNDISPLAYED RATE

\$2.70 a line, minimum 3 lines. To figure advance payment count 5 average words as a line.

PROPOSALS, \$2.70 a line an insertion.

BOX NUMBERS count as one line additional in undisplayed ads.

DISCOUNT OF 10% if full payment is made in advance for four consecutive insertions of undisplayed ads (not including proposals).

RADAR AUTO TRACK & TELEMETRY ANTENNA PEDESTALS 3 & 10 CM. SCR 584 AUTOTRACK RADARS M 13 RADAR TPS 1D SEARCH APS-45 TPS 100 HT FINDERS WX RADARS FPN 32GCA APS 10 APS 15B APS 27 (AMTI) SEARCH ■ ■ APN-102 DOPPLER DOZENS MORE CARCINOTRONS PFN'S 25-51 2 3 6 MEGAWATT PULSE MODULATORS CAVITIES PULSE TRANSFORMERS IF STRIPS WAVEGUIDE BENDS 200 MC 1 KMC 3 KMC 6 KMC 9 KMC 24 KMC RF PKGS

**RADIO RESEARCH INSTRUMENT CO.**  
550 5TH AVE., NEW YORK 36, N. Y. JU 6-4691

CIRCLE 951 ON READER SERVICE CARD

**OPTICAL BENCHES**  
\$13. to \$13,000. New Catalog  
**THE Ealing CORP.**  
2250 Massachusetts Avenue, Cambridge, Mass., 02140

CIRCLE 952 ON READER SERVICE CARD

**SALE or RENT**  
**MODERN ELECTRONIC BUILDING**  
31,000 Sq. Feet  
Yonkers, New York  
**HAROLD OSHLAG**  
New Rochelle, N. Y.  
Area Code 914—NE 6-6700

CIRCLE 953 ON READER SERVICE CARD

WRITE FOR NEW **KEYSTONE**  
**free catalog**  
We are the leading producers of BATTERY HOLDERS, TERMINALS, TERMINAL BOARDS & ELECTRONIC HARDWARE  
KEYSTONE ELECTRONICS CORP., 49 BEECHER ST., NEW YORK 12, N. Y.  
CIRCLE 954 ON READER SERVICE CARD

### OFFICIAL PROPOSALS

Bids: February 28, 1964

### General Purpose Analogue Computing System

Tenders are invited for supply and delivery to the Chemical Research Laboratories, Fishermen's Bend, Melbourne, Australia of a General Purpose Analogue Computing System and associated peripheral and maintenance equipment in accordance with Specification No. H.O. 32.

Copies of the Specification may be obtained from the Secretary, C.S.I.R.O., 314 Albert Street, East Melbourne, Australia, with whom tenders close at 4 p.m. on Friday, February 28, 1964.

# INDEX TO ADVERTISERS

• Avnet Electronics Corp. . . . . 48, 49

Douglas Aircraft Company  
Missile & Space Systems Div. 8

• Fujitsu Co., Ltd. . . . . 45

Jerrold Electronics Corp. . . . . 6

Machlett Laboratories Inc., The. 15

Malaker Laboratories Inc. . . . . 7

Manson Laboratories . . . . . 16

McGraw-Hill Book Co. . . . . 43

Microline, Div. of General Aniline  
& Film Corp. . . . . 13

• Mycalex Corp. of America. . . . . 37

National Research Corporation  
Metals Division . . . . . 3rd cover

• Navigation Computer Corp. . . . . 47

• North Atlantic Industries, Inc. . . . . 41

Potter Instrument Co., Inc. . . . . 22

Radio Corporation of America  
4th cover

Sierra, Electronic Div. of  
Philco . . . . . 4

Sprague Electric Co. . . . . 3, 38

Transitron Electronic Corp. . . . . 9

Trio Laboratories, Inc. . . . . 39

• United Transformer Corp. 2nd cover

Unitrode Transistor Products  
Inc. . . . . 21

**CLASSIFIED ADVERTISING**  
F. J. Eberle, Business Mgr. (2557)

**EMPLOYMENT OPPORTUNITIES . . . 51**

**BUSINESS OPPORTUNITIES . . . . 51**

**EQUIPMENT**  
(Used or Surplus New)  
For Sale . . . . . 51

**CLASSIFIED ADVERTISERS INDEX**

Atomic Personnel Inc. . . . . 51  
Ealing Corp. . . . . 51  
Keystone Electronics Corp. . . . . 51  
Metropolitan Supply Corp. . . . . 51  
Oshlag, Harold . . . . . 51  
• Radio Research Instrument Co. 51

• See advertisement in the July 25, 1963 issue of electronics Buyers' Guide for complete line of products or services.

This Index and our Reader Service Numbers are published as a service. Every precaution is taken to make them accurate, but **electronics** assumes no responsibilities for errors or omissions.

## electronics



AUDITED PAID CIRCULATION



Associated Business Publications

**JAMES T. HAUPTLI (2210)**  
Advertising Sales Manager

**HENRY M. SHAW (3485)**  
Market Research Manager

**DAVID M. TEMPEST (3139)**  
Promotion Manager

### electronics Buyers' Guide

**R. S. QUINT (2335)**  
General Manager

**RICHARD J. TOMLINSON (3191)**  
Business Manager

**THEODORE R. GEIPEL (2044)**  
Production Manager

NEW YORK TELEPHONE: Dial Direct:  
971 plus number in parenthesis,  
Area Code 212

### ADVERTISING REPRESENTATIVES

ATLANTA, GA. 30309  
Michael H. Miller, Robert C. Johnson  
1375 Peachtree St. N.E.,  
Trinity 5-0523 (area code 404)

BOSTON, MASS. 02116  
William S. Hodgkinson  
McGraw-Hill Building, Copley Square,  
Congress 2-1160 (area code 617)

CHICAGO, ILL. 60611  
Harvey W. Wernecke,  
Robert M. Denmead  
645 North Michigan Avenue,  
Mohawk 4-5800 (area code 312)

CLEVELAND, OHIO 44113  
Paul T. Fegley  
55 Public Square, Superior 1-7000  
(area code 216)

DALLAS, TEXAS 75201  
Frank Le Beau  
The Vaughn Bldg.,  
1712 Commerce St.  
Riverside 7-9721 (area code 214)

DENVER, COLO. 80202  
John W. Patten  
Tower Bldg., 1700 Broadway,  
Alpine 5-2981 (area code 303)

HOUSTON, TEXAS 77025  
Kenneth George  
Prudential Bldg., Halcombe Blvd.,  
Riverside 8-1280 (area code 713)

LOS ANGELES, CALIF. 90017  
Ashley P. Hartman, John G. Zisch,  
1125 W. 6th St., Huntley 2-5450  
(area code 213)

NEW YORK, N. Y. 10036  
Donald H. Miller (212) 971 3615  
George F. Werner (212) 971 3617  
Donald R. Furth (212) 971 3616  
500 Fifth Avenue

PHILADELPHIA, PA. 19103  
Warren H. Gardner, William J. Boyle  
6 Penn Center Plaza,  
LOcust 8-6161 (area code 215)

SAN FRANCISCO, CALIF. 94111  
Richard C. Alcorn  
255 California Street,  
Douglas 2-4600 (area code 415)

LONDON W1:  
Edwin S. Murphy Jr.  
34 Dover St.

FRANKFURT/Main:  
Matthee Herfurth  
85 Westendstrasse

GENEVA:  
Michael R. Zeynel  
2 Place du Port

TOKYO:  
Shigeo Chiba,  
1, Kotohiracho, Shiba, Minato-ku

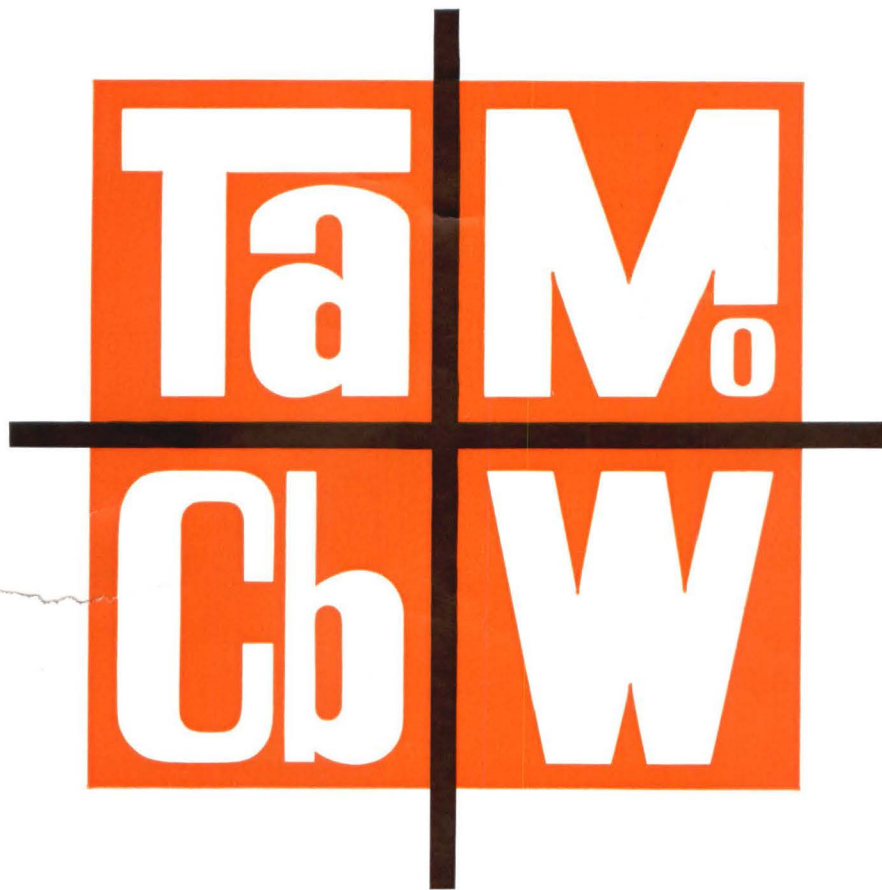

# NATIONAL RESEARCH CORP. METALLWERK PLANSEE

**NEW — ONE SOURCE** for refractory metal products produced by the leading American and European firms.

NATIONAL RESEARCH CORPORATION is the exclusive U.S. distributor of tungsten and molybdenum products produced by METALLWERK PLANSEE of Austria. PLANSEE is the leading European manufacturer of refractory products; NRC is a major producer of tantalum and the world's principal manufacturer of capacitor grade tantalum and columbium products.

NRC NOW offers you these four refractory metals for your applications requiring high temperature or corrosion-resistance capabilities. From ONE SOURCE you can get all mill forms such as

sheet, foil, ribbon, rod, wire, tubing and manufactured parts of all kinds. Included are furnace heating elements and parts, X-ray targets, rocket nozzles, vaporizing boats, heat shields, emission cathodes, electronic structural parts, contact materials, Densimet (heavy metal) and a wide variety of other formed parts.

FOR more information, write to:



METALS DIVISION

**NATIONAL RESEARCH CORPORATION**

A SUBSIDIARY OF NORTON COMPANY

45 Industrial Place, Newton, Massachusetts • 02164



CIRCLE 901 ON READER SERVICE CARD

1952—



## RCA introduced the 6146

### RCA DESIGNED:

- Small, sturdy structure
- High efficiency
- High power sensitivity

Early 1963—



## RCA announced improved-design 6146A

### RCA ADDED:

- "Dark Heater"
- Controlled power output at reduced heater voltage
- Controlled zero-bias plate current

NOW—

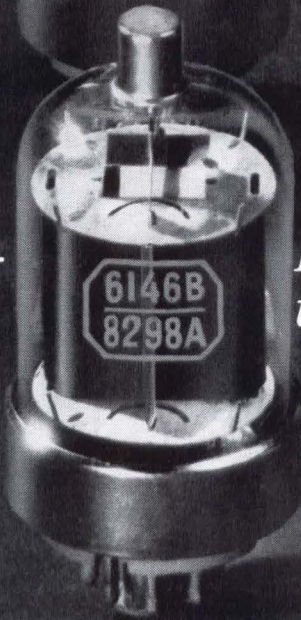

## RCA-6146B/8298A with even more improvements

- Higher plate dissipation and plate current ratings
- Withstands heater overvoltage
- Higher temperature operation
- Higher power output

### GET HIGHER POWER OUTPUT IN NEW EQUIPMENT DESIGNS

Now! Use and specify the RCA-6146B/8298A. This new RCA Beam Power Tube at once brings more power in new equipment designs and extended tube life in renewal use. In existing 6146, 6146A and 8298 sockets, RCA-6146B/8298A can give extended life while offering OEM designers increased power capability.

A direct result of RCA's power-tube research, the RCA-6146B/8298A permits higher plate dissipation (35 watts max. CW ICAS) for increased plate current. It also offers all the advantages of improved performance and mechanical stability that only RCA "Dark Heater" tech-

### GET EXTENDED LIFE WHEN REPLACING 6146, 6146A or 8298

nology provides. At normal heater ratings, capabilities are: 85 watts CW output (ICAS) at 60 Mc; 50 watts CW output (ICAS) at 175 Mc.

In fixed station use, 6.3 volts is the recommended value for the tube's "Dark Heater." In mobile service, the tube operates efficiently over a range of heater voltages from 5 volts to 8 volts.

For further details on the RCA-6146B/8298A, consult your RCA Representative. For a technical bulletin, write: Commercial Engineering, Section A-19-Q-5, RCA Electronic Components and Devices, Harrison, N.J.

AVAILABLE THROUGH YOUR AUTHORIZED RCA INDUSTRIAL TUBE DISTRIBUTOR



The Most Trusted Name in Electronics