

ROM's make logic design easy 88

\$1.00 A McGraw-Hill Publication

Spotlighting upcoming conferences 137

January 5, 1970

C/MOS—expensive plaything or workhorse? 147

Electronics®



1970: LAUNCHING THE
DIGITAL DECADE

LSI

WAVEGUIDES

TEST SYSTEM

MEGABIT

CHANNELS

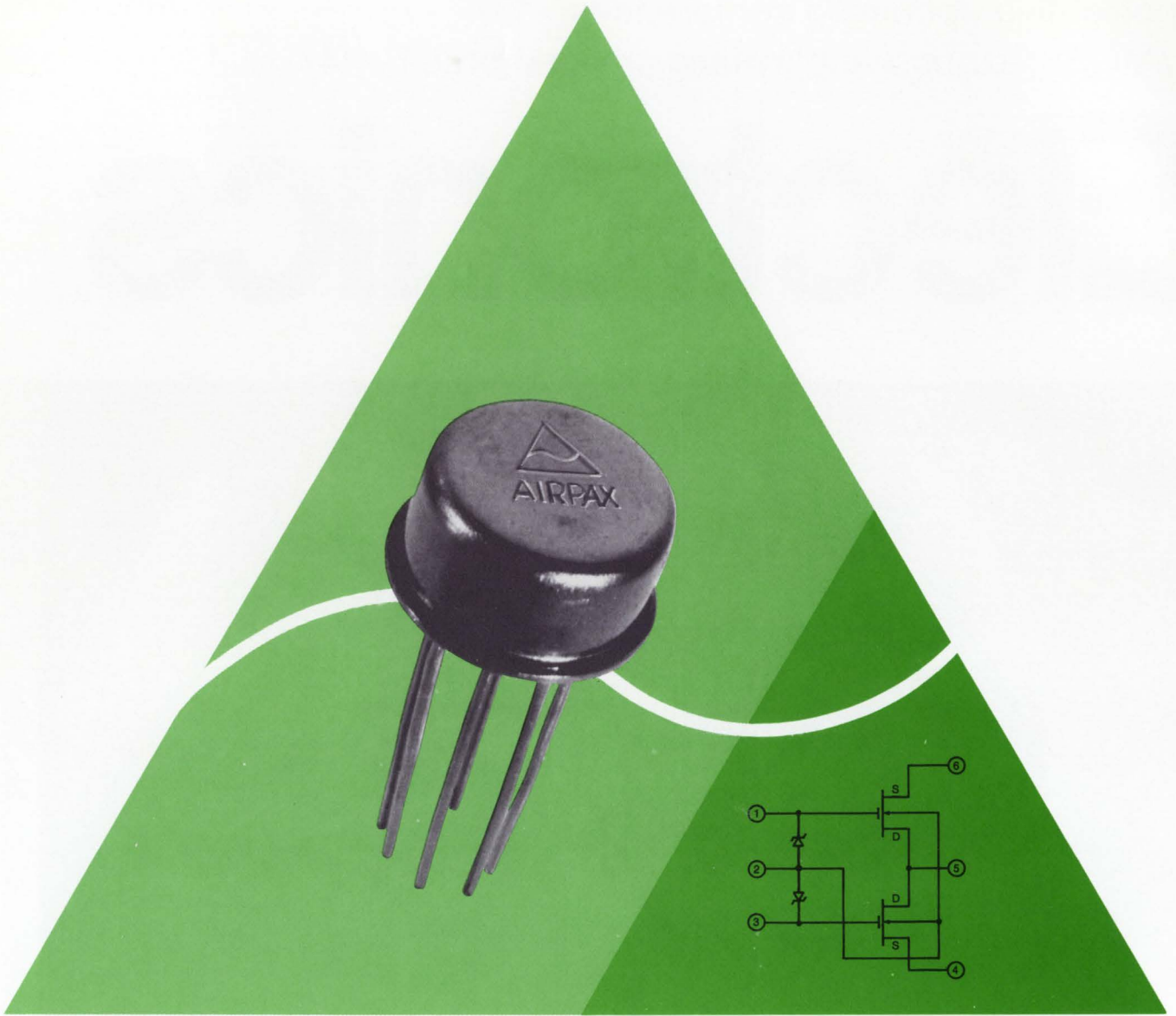

Copper leads reduce offset and increase MOS FET chopper performance.

Thermal voltage generation is the **number one problem** you face when working in the low microvolt region. Airpax engineers have chosen a specially designed 6-pin header for the new Model IC-1 MOS FET chopper that greatly reduces the offset problem! **Another Airpax component of confidence.** □ Maximum DC offset voltage is **only 5 microvolts**, and a typical value is 1.5 microvolts. And the Model IC-1 SPDT chopper uses MOS field-effect transistors to insure maximum

noise level of only 15 microvolts rms. □ Compact, solid state monolithic circuitry incorporates built-in zener protection for the drive gates. Drive signals can be either sine wave or square wave. □ Applications include half-wave and full-wave modulators; summing, comparing, and time-sharing circuits.

□ Contact an Airpax sales representative or write **Airpax Electronics, Cambridge Division**, Cambridge, Maryland 21613. Phone (301) 288-4600. Telex: 8-7715. TWX: (710) 865-9655.

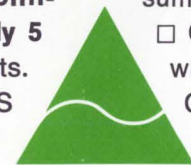

AIRPAX ... components of confidence.

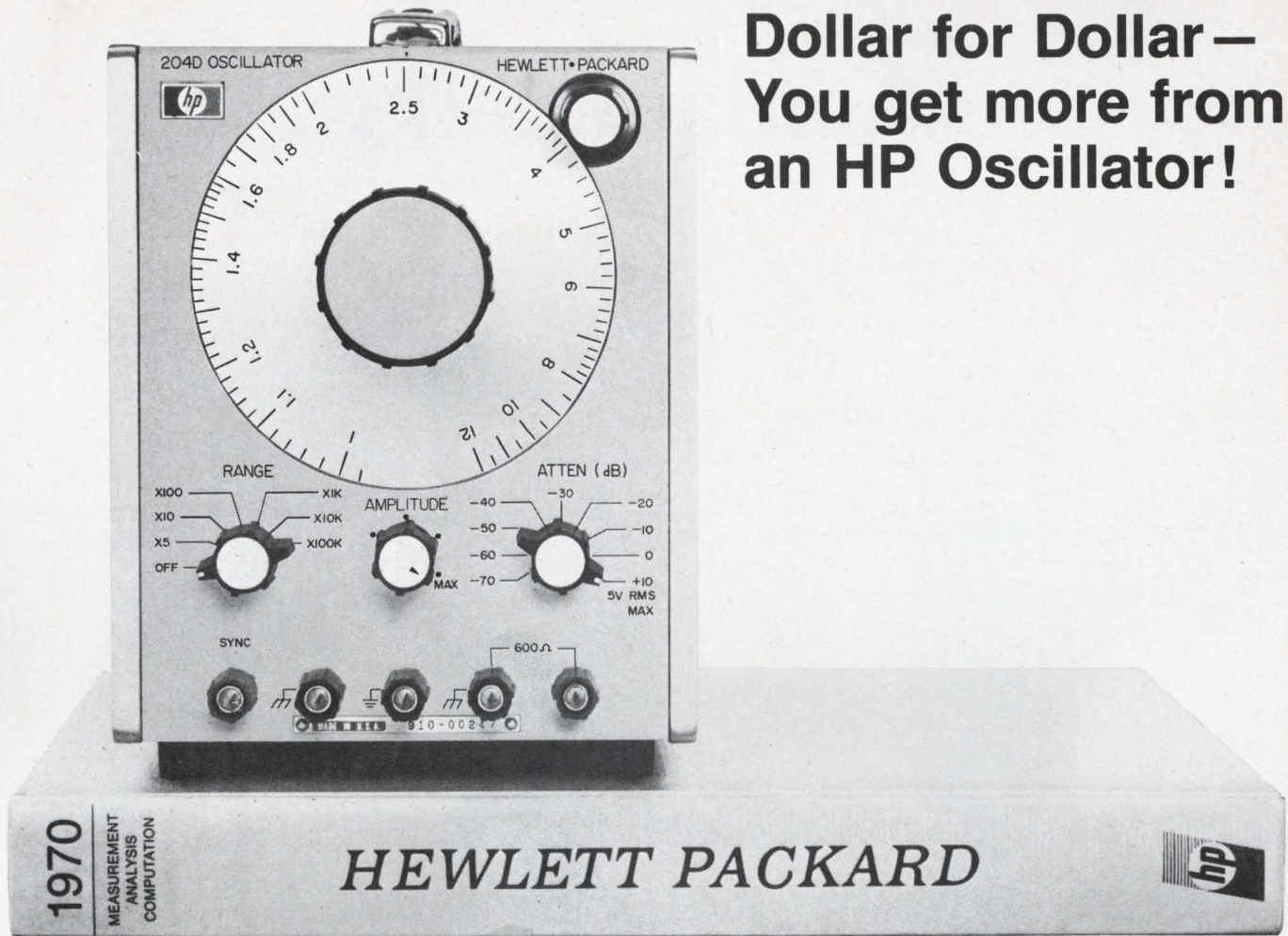

Dollar for Dollar— You get more from an HP Oscillator!

Most ac work starts with an oscillator... why not start with the best?

And best does not necessarily mean more expensive. It means selecting the right oscillator for your requirements at the right price.

Sounds simple, until you sit down to decide which oscillator is best for you. Then, you have to compare your technical requirements against what is available. Next you make the necessary trade-offs between performance and price to insure that you get the best oscillator for your job at the best price. Finally you have to weigh the intangibles, like company reputation, service and reliability.

But there is an easier way!

HP has been in the oscillator business for a long time. In fact they invented the first stable wide bandwidth Wein-bridge oscillator. And since that time HP oscillators have built a solid reputation for performance and reliability—in fact most of you have used them in the past.

So, all you really have to do to get all the information you need to decide which oscillator is best for you is turn to page 267 of your 1970 HP catalog.

Not only will you get information on all of HP's complete line of oscillators...you also get the background information to help make your choice more meaningful.

HP oscillators give you a wide range of choices. Frequencies start as low as 0.00005 Hz and go as high as 32 MHz. You can even get power outputs as high as 5 watts.

And, if you have any questions, just call your local HP field engineer. He will be more than happy to answer your questions and give you any help you may need in selecting the best oscillator for your requirements.

Or, write to Hewlett-Packard, Palo Alto, California 94304. We will send you complete information and application notes on HP's oscillators. Europe: 1217 Meyrin-Geneva, Switzerland. Prices on HP oscillators start as low as \$215.

090/3

HEWLETT  PACKARD
S I G N A L S O U R C E S

Maintainability³

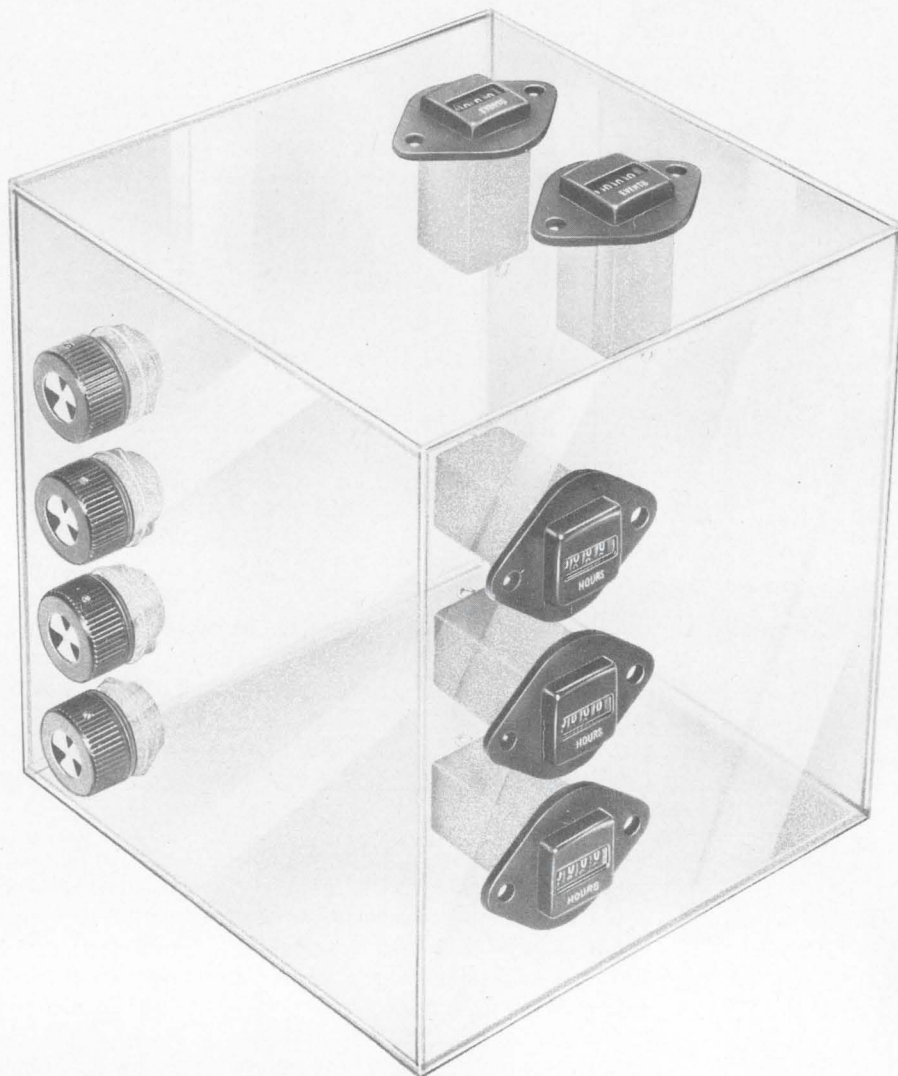

Systems maintainability is assured by Minelco's power of 3: BITE (Built in test equipment) indicators that pinpoint circuit faults, say GO or NO GO. Elapsed Time indicators that tell you how long things have been going on. Events Counters that tell you how often they've happened. And Minelco is the exponent of the maintainability component. Miniature and subminiature—in a size, configuration, and type for every requirement—for *your* requirement. Minimize downtime... get up with the Big Time.



MINELCO®

SPACE AND SYSTEMS DIVISION



GENERAL TIME

135 South Main Street, Thomaston, Conn. 06787

For information and specifications, contact our local representative:

Huntsville, Ala. (205) 883-0244 / Phoenix, Ariz. (602) 267-3916 / Palo Alto, Calif. (415) 326-4186 / San Diego, Calif. (714) 298-1121 / Orlando, Fla. (305) 851-1210 / Marietta, Ga. (404) 422-8242 / Berkeley, Ill. (312) 544-7400 / Indianapolis, Ind. (317) 925-3528 / Santa Monica, Calif. (213) 451-5711 / Wichita, Kans. (316) 683-7518 / Waltham, Mass. (617) 894-9165 / Bridgeton, Mo. (314) 731-3011 / Plainview, N.Y. (516) 681-8710 / Utica, N.Y. (315) 735-8341 / Columbus, Ohio (614) 231-4571 / Dayton, Ohio (531) 224-0728 / Devon, Pa. (215) 688-5157 / Fort Worth, Tex. (817) 335-4541 / Arlington, Va. (703) 525-1191 / Bellevue, Wash. (206) 454-7922.

BITE INDICATORS • ELAPSED TIME INDICATORS • EVENTS COUNTERS • ROTARY SWITCHES • TRIMMER POTENTIOMETERS

News Features

Probing the News

- 147 **Solid state:** C/MOS's appeal is basic; yields are up, prices down
155 **Consumer:** Radar braking is set for market debut

U.S. Reports

- 45 **Government:** Office of Telecommunications Management faces ax
46 **Commercial electronics:** Auto fuel-injection system
47 **Management:** EIA's internal feud breaks loose
50 **Advanced technology:** Surface acoustic waves headed for tv sets
52 **Optoelectronics:** 70-foot fiber-optic bundles
54 **Memories:** Optical ROM as a microprogrammer
57 **For the record**

Electronics International

- 71 **Japan:** Optical deflection system for holographic file memory
72 **Great Britain:** MOS for organs
72 **France:** Program handles wiring list generation; two new high-speed electronic cameras
74 **West Germany:** Flash exposure control; Olympic-sized transmitter

New Products

- 161 **In the spotlight**
161 PDP-11 runs off single bus
165 **Components review**
165 Photorelay drives IC directly
166 Alumina substrate isolates triac
168 **Instruments review**
168 Monitor measures film thickness
173 **Data handling review**
173 Core memory is fast, inexpensive
177 **Industrial electronics review**
177 Instruments provide quick alert
180 **Semiconductor review**
180 Schottky diode has chrome electrode
182 Thyristor controls 2,000 volts
183 IC op amp has FET input stage
186 **New materials**

Technical Articles

- Memories** 88 **Standard read-only memories simplify complex logic design**
Large-scale integration of semiconductors has made standard memories practical for use in implementing combinational and sequential logic
Floyd Kvamme,
National Semiconductor
- Circuit design** 96 **Designer's casebook**
▪ Op amps reject line noise in a-d converter's input
▪ Resistors come to light in digital display system
▪ Unijunction controls oscillator in simple underwater pinger
- Special report** 101 **Market pacesetters: 1970**
Electronics' annual survey indicates a small increase of 3.4% over the 1969 market.
- 105 **Bold new inroads for the computer as the digital era gets under way**
Increased demands for peripherals, remote terminals, minicomputers, computer-controlled testing, and data modems characterize electronics technology this year
- Conference calendar** 137 **Spotlighting major meetings**
Four-page foldout offers checklist of events through June 1970
- German IC's** 142 **Symmetrical ECL doubles IC NOR function efficiently**
An extra function adds to the virtues of this fast advanced-logic family while holding delay to 0.9 nsec and power dissipation to 35 mw
Hans-Wilhelm Ehlbeck and Herbert Stopper,
AEG-Telefunken

Departments

- | | | | |
|----|--------------------------|-----|--------------------------|
| 4 | Editorial Comment | 48 | Index of Activity |
| 5 | Readers Comment | 69 | International Newsletter |
| 9 | Who's Who in this issue | 79 | Washington Newsletter |
| 12 | Who's Who in electronics | 187 | New Books |
| 22 | Meetings | 188 | Technical Abstracts |
| 33 | Electronics Newsletter | 192 | New Literature |

Electronics

Editor-in-Chief: Donald Christiansen

Senior staff editors

Technical: Stephen E. Scrupski

News: Robert Henkel

International: Arthur Erikson

Art director: Gerald Ferguson

Assistant managing editors: H. Thomas

Maguire, Howard Wolff, William Bucci,

Richard Gundlach, Frederick Corey

Special projects editor: Roger Kenneth Field

Senior staff writer: John Johnsrud

Reader communications manager: John

Drummond

Department editors

Senior associate editors: Joseph Mittleman, Harry R. Karp; Advanced technology: Laurence Altman; Communications: Leon M. Magill; Computers: Wallace B. Riley, George Weiss; Design theory: Joseph Mittleman; Industrial electronics: Harry R. Karp; Instrumentation: Owen Doyle; Military/Aerospace: Alfred Rosenblatt; New products: William P. O'Brien; Solid state: George Watson, Stephen Wm. Fields

Copy editors: Edward Flinn, William S. Weiss

Assistant art director: Charles Ciatto

Production editors: Susan Hurlburt, Arthur C.

Miller; Editorial research: Virginia Mundt; Editorial secretaries: Lorraine Longo, Claire Good-

lin, Bernice Pawlak, Barbara Razulis, Vickie

Green.

Field bureaus

Boston: James Brinton, manager, Gail Farrell; Los Angeles: Lawrence Curran, manager, Ralph Selph; New York: Peter Schuyten; San Francisco: Stephen Wm. Fields; Washington: Ray Connolly, manager; Robert Westgate, Lois Vermillion; Frankfurt: John Gosch; London: Michael Payne; Paris: Arthur Erikson; Tokyo: Charles Cohen

Reprints: Virginia Mundt; Circulation: Isaaca Siegel

Publisher: Gordon Jones

Associate publisher: Dan McMillan

Assistant to the publisher: Wallace C. Carmichael

January 5, 1970

As computers go, so goes electronics

If anything will make the 1970's a "swinging decade" for electronics, it will be computers. For the electronics business, the computer represents both a market and a tool. The all-pervasive nature of the computer is exemplified by its strong insinuation into nearly every area of the electronics art with the exception of consumer electronics—and its threat to enter that area is clear. Furthermore, the other great common denominator of electronics, communications, can scarcely be discussed without considering computers. One is tempted to coin a descriptive term linking the two. Teleprocessing does not seem to say it all, while computations seems to lack a certain zing.

While designers are developing next-generation computers and computer systems, they will not go shoeless as do the proverbial shoemaker's children, but rather will exploit computers in both design and production tasks. The pundits are guessing that upwards of \$100 million will be spent each year to develop computer-aided design (CAD) programs and techniques. Computer-aided testing (CAT) is becoming indispensable for an increasing range of components and systems, such as large-scale integrated arrays containing several hundred elements. The logical extension of CAD, particularly in the case of integrated circuits, is computer-aided manufacturing (CAM). The ideal case would be to specify system parameters and get hardware topology as an output (for example, a set of masks for an LSI array). Then, process-control computers would be used to monitor and keep manufacturing steps within limits.

On-line, interactive methods of design will surge in popularity. (However, it will take improved hardware and a lot

of savvy to use them effectively.) One indication of their growth is a forecast that sales of graphic displays will rise from 3,000 units in 1970 to 40,000 by 1975. One designer says if it's not interactive, "it ain't design."

If one needs reassurance that the computer market is indeed burgeoning, it is available in a report just issued by the Diebold Research Program. Annual shipments of computers are expected to reach 18,000 this year and 46,000 by 1975. The report ties the five-year growth to the continuing sale of medium- and large-scale systems as well as to the introduction and wide acceptance of minicomputers. Projections of strong gains by minicomputers are linked to "babysitting" applications, such as life-test monitoring, turning factory lights on and off, and controlling environmental conditions for both manufacturing processes and factory personnel. Diebold's estimates for the shipments of computers for monitoring and control applications are 5,000 units in 1970 and 22,000 in 1975. Such computers are finding their way into a variety of instrumentation systems, as well. For example, the satellite navigation system of the superliner Queen Elizabeth 2 uses a minicomputer.

While the total number of small computers shipped will soar from 13,000 to 37,300 between now and 1975, the value of such shipments by 1975 will represent only about 5% of the total, compared to about 20% today. What should not be overlooked, however, is the role of the small computer as terminals for access to larger systems, as buffers, communications processors, and controllers.

In its look ahead, the Diebold report sums up the consensus viewpoint of technical observers with these predictions for the

Published every other Monday by McGraw-Hill, Inc. Founder: James H. McGraw 1860-1948. Publication office 99 North Broadway, Albany, N. Y. 12202; second class postage paid at Albany, N. Y. and additional mailing offices. Executive, editorial, circulation and advertising addresses: Electronics, McGraw-Hill Building, 330 W. 42nd Street, New York, N. Y. 10036. Telephone (212) 971-3333. Teletype TWX N. Y. 710-581-4235. Cable address: MCGRAW HILL N. Y.

Subscriptions solicited only from those professionally engaged in electronics technology. Subscription rates: qualified subscribers in the United States and possessions and Canada, \$8.00 one year, \$12.00 two years, \$16.00 three years; all other countries \$25.00 one year. Non-qualified subscribers in the U.S. and possessions and Canada, \$25.00 one year; all other countries \$50.00. Air freight service to Japan \$50.00 one year. Single copies: United States and possessions and Canada, \$1.00; all other countries, \$1.75.

Officers of McGraw-Hill Publications Company: Joseph H. Allen, President; John R. Emery, J. Elton Tuohig, Senior Vice Presidents; Gordon L. Jones Jr., Group Vice President; Vice Presidents: John R. Callahan, Editorial; John M. Holden, Marketing; David G. Jensen, Manufacturing; Jerome D. Luntz, Planning & Development; Robert F. Marshall, Administration; Robert M. Wilhelm, Finance; Director of Circulation: Ralph Blackburn.

Officers of the Corporation: Shelton Fisher, President and Chief Executive Officer; John L. McGraw, Chairman; Robert E. Slaughter, Executive Vice President; Daniel F. Crowley, Donald C. McGraw, Jr., Bayard E. Sawyer, Senior Vice Presidents; John J. Cooke, Vice President & Secretary; Gordon W. McKinley, Vice President & Treasurer.

Title © registered in U.S. Patent Office; © Copyright 1970 by McGraw-Hill, Inc. All rights reserved. The contents of this publication may not be reproduced either in whole or in part without the consent of copyright owner.

Subscribers: The publisher, upon written request to our New York office from any subscriber, agrees to refund that part of the subscription price applying to copies not yet mailed. Please send change of address notices or complaints to Fulfillment Manager; subscription orders to Circulation Manager, Electronics at address below. Change of address notices should provide old as well as new address, including postal zip code number, if possible, attach address label from recent issue. Allow one month for change to become effective.

Postmaster: Please send form 3579 to Fulfillment Manager, Electronics, P.O. Box 430, Hightstown, New Jersey 08520.

Readers Comment ▶

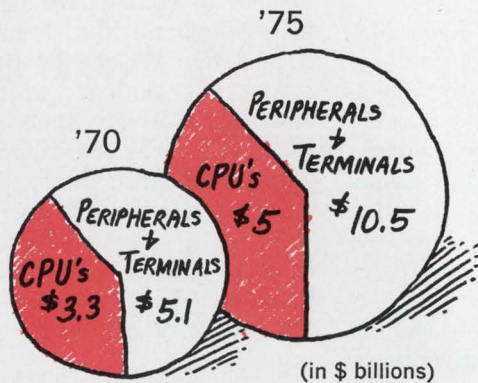

five-year period:

- ▶ Hundreds of logic functions will be crammed into one LSI circuit chip, and circuit failure rates will reach $10^{-6}\%$ per 1,000 hours.
- ▶ Core memories will be supplanted by batch fabricated memories. Access time to main memories will improve by three orders of magnitude. Extensions to the main memory of up to 200×10^6 bits will be available, accessible in a micro-second at a cost of less than one cent per bit.
- ▶ Large scale (15×10^9 byte) solid state files will cost \$0.0001 per bit.
- ▶ Recording densities will approach 10,000 bytes per inch and tape transport speeds, 500 ips.
- ▶ Non-impact printers will run at 10,000 lines per minute; card readers at 2,500 cards per minute.
- ▶ Keyboard costs will be cut in half when electronic, rather than electromechanical, connections come into widespread use. Communications interface units will continue to decline in cost as the Federal Communications Commission ok's more foreign attachments, and one IC chip will contain most of the adapter.
- ▶ Pulse-code modulation will be a principal means of transcontinental transmission.
- ▶ A small-scale computer having a 16-K memory, 10 micro-second add time, read-only microprogram memory, typewriter, and telephone coupler may sell for as little as \$6,500.

On its 25th anniversary, the electronic computer holds forth the promise of a future that will outshine its past. And appropriately, the computer will play an important part in creating its own future.—D.C. ●

McGraw-Hill News Service

Director: Arthur L. Moore; Atlanta: Fran Ridgway; Chicago: Robert E. Lee; Cleveland: Arthur Zimmerman; Dallas: Marvin Reid; Detroit: James Wargo; Houston: Barbara LaRouax; Los Angeles: Michael Murphy; San Francisco: Margaret Drossel, Tyler Marshall; Seattle: Ray Bloomberg; Washington: Charles Gardner, James Canan, Herbert W. Cheshire, Seth Payne, Warren Burkett, William D. Hickman; Bonn: Robert F. Ingersoll; Brussels: James Smith; Hong Kong: Kate Mattock; London: John Shinn; Mexico City: Gerald Parkinson; Milan: Jack Star; Moscow: Jack Winkler; Paris: Robert E. Farrell, Stewart Toy; Tokyo: Marvin Petal

Plotting impurities

To the Editor:

The article on the Copeland Wafer Analyzer [Sept. 15, 1969, p. 167] compared this device with the plotter designed by Peter Baxandall and marketed by J.A.C. Electronics. In the article, John Copeland commented that at small depths, our instrument measured an average, not the actual, density.

I can't understand Mr. Copeland's comment. At the minimum d-c bias of 0.5 volt, the a-c signal applied is 50 millivolts, which induces a motion of the depletion layer considerably smaller than a Debye length. In practice, the two instruments do precisely the same job, which we have verified by means of comparison testing.

Using an epitaxial layer of gallium arsenide, the divergence between the two curves is less than the quoted error of either instrument, and less than the difference normally observed between different diodes on the same slice.

C. Hilsum

Ministry of Technology
Worcestershire, England

Mr. Copeland's comment was based on information available at the time [*Electronics*, March 31, 1969, p. 179]. Then it was stated that the J.A.C. machine had two a-c signals at 1 kilohertz and 100 khz, each with 0.15 volt rms amplitude. This would mean a peak-to-peak a-c voltage of 0.84 volt, not a small figure compared with the bias voltage used to measure profiles near the surface, or for high carrier densities. Thus averaging would result. Operation at the smaller value of a-c signal specified by Mr. Hilsum would indeed reduce this effect to where it would be negligible in most normal cases. (Both Messrs. Copeland and Hilsum are well known in the microwave bulk-effect device field. Mr. Hilsum, as well as B.K. Ridley and T.B. Watkins of Mullard Research Laboratories, predicted the mechanism for the Gunn effect before it was demonstrated. Mr. Copeland is credited with first demonstrating the LSA mode of operation in bulk-effect devices.)

Missed keyboards

To the Editor:

I was disappointed in Leon Magill's article on electronic keyboards [Nov. 10, 1969, p. 145] in that he overlooked Connecticut Technical Corp.'s 10-year history of keyboard manufacturing. Perhaps this is our own fault, for lacking a flair for publicity. But to set the record straight, CTC furnishes keyboards both in coded and uncoded form, and quotes to speci-

(continued on p. 6)



BINARY DECODE DRIVERS

Problem: Decode binary counter output into separate lines to drive indicator lamps or FET switches.

Solution: Siliconix D132L for the lamps, D129L for MOS FET switches. Both drivers provide four output channels, inputs are compatible with most TTL or DTL logic circuits, and outputs are capable of 50 volt switching.

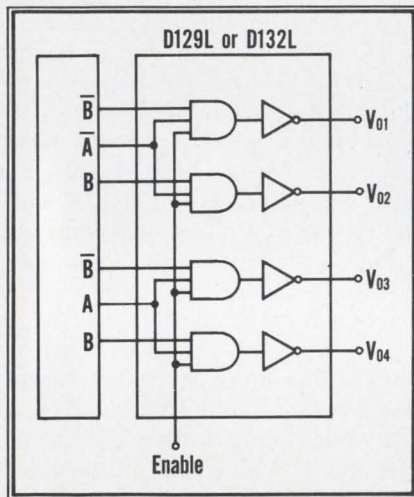

TRUTH TABLE					
Counter State		Output			
A	B	V ₀₁	V ₀₂	V ₀₃	V ₀₄
0	0	0	1	1	1
0	1	1	0	1	1
1	0	1	1	0	1
1	1	1	1	1	0

Write for complete data. For instant information and applications assistance, call the number below.



2201 Laurelwood Rd. • Santa Clara, Calif. 95054
(408) 246-8000 Ext. 201 • TWX: 910-338-0227

* Applications Power: Providing the product and service to make your product serve better!

Readers Comment

fication, which as you noted, is the industry's practice.

Harold M. Kneller

President,
Connecticut Technical Corp.
Hartford, Conn.

To the Editor:

I read with interest Leon Maggill's round up of the electronic keyboard industry, and I wish to commend him for his candid and descriptive summary of the industry. However, I found the article somewhat incomplete as no mention was made of the solid state keyboards produced by Nucleonics Products Inc. I recognize that it is difficult to be 100% aware of all the manufacturers in a given market place and that this is undoubtedly the reason for the oversight occurring, as it did, in the article.

Howard K. Cooper

Executive vice president,
Nucleonics Products Inc.
Canoga Park, Calif.

Telephone tie-ins

To the Editor:

Roger Kenneth Field, in his special report on communications [Nov. 24, 1969, p. 73], refers to certain specifications which must be met to connect foreign objects to a telephone line. I have questioned the Wisconsin Bell Telephone Co. and it professes no knowledge of any such specifications. What was your reference and authority to print them, and where can I get an official copy?

Richard McBeth

Project engineer
Ipsophne Corp.
Milwaukee, Wis.

▪ The source is the AT&T Co., Long Lines Department, Administrator of Rates and Tariffs, 32 Avenue of the Americas, New York, N.Y. 10013. The specific document is "Long Distance Message Telecommunications Service," Tariff FCC No. 263.

Not descriptive

To the Editor:

I would like to point out that Plumbicon is a registered trademark of N.V. Philips Gloilampenfabrieken for tv camera tubes, registration No. 770,662, dated June 2, 1964. It should not be used as a descriptive word as occurred in one of your articles on video tubes [Nov. 10, 1969, p. 235].

Lucien G. Farron

New York City

Oneupmanship

To the Editor:

I want to bring to your attention a printing error that occurred in your article about active filters [Oct. 27, 1969, p. 106]. The equation for T_1 has $T_1 = 1/\sqrt{1 + \lambda}$. However, it should read $T_1 = 1/\sqrt{1 + \lambda}$. This would then result in $d_{min} = 2\sqrt{1 + \lambda}$, as in your article.

Alexander Galosi

Galion, Ohio

SUBSCRIPTION SERVICE

Please include an Electronics Magazine address label to insure prompt service whenever you write us about your subscription.

Mail to: Fulfillment Manager
Electronics
P.O. Box 430
Hightstown, N.J. 08520

To subscribe mail this form with your payment and check new subscription renew my present subscription

Subscription rates: qualified subscribers in the U.S.: 1 year \$8; two years, \$12; three years, \$16. Non-qualified: 1 year \$25. Subscription rates for foreign countries available on request.

CHANGE OF ADDRESS

ATTACH LABEL HERE

If you are moving, please let us know five weeks before changing your address. Place magazine address label here, print your new address below.

name

address

city

state

zip code

...like more capacitance in aluminum 'lytics?

Get **SPRAGUE Type 36D** **POWERLYTIC[®]** **CAPACITORS**



INFORMATION RETRIEVAL NO. 310

- Large cylindrical electrolytic capacitors for use in digital computer power supplies, industrial control equipment, energy storage applications, etc
- Low impedance construction
- Largest case (3" dia. x 8 5/8" high) provides 650,000 μ F at 3 volts!
- Can be operated at +85 C
- Tapped No. 10-32 terminals simplify filter bank assembly
- Available with or without outer plastic insulating sleeves
- Request Engineering Bulletin 3431C

45C9153R1

...want high volume efficiency in tubular 'lytics?

Use **SPRAGUE Type 39D** **POWERLYTIC[®]** **CAPACITORS**

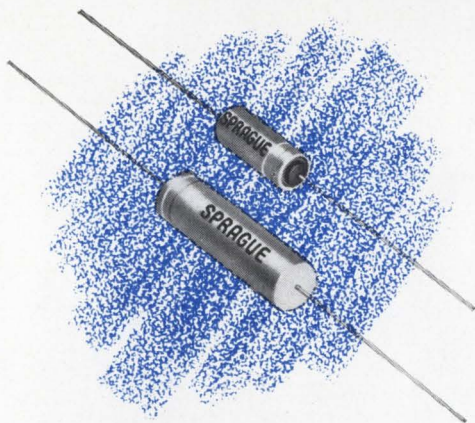

INFORMATION RETRIEVAL NO. 311

- Provide maximum capacitance in smaller cases with axial leads
- No internal riveted or pressure connections
- Welds at critical anode and cathode terminals
- Molded end covers
- Life expectancy of 10 years or more in normal service
- Very low effective series resistance and leakage current
- Request Engineering Bulletin 3415

45C-9154R1

For Engineering Bulletins as noted above, write to:
Technical Literature Service, Sprague Electric Co., 35
Marshall Street, North Adams, Massachusetts 01247.



'Sprague' and '®' are registered trademarks of the Sprague Electric Co.

THE BROAD-LINE PRODUCER OF ELECTRONIC PARTS



Help exterminate the QUADRADECAPEDE!

West Concord, Mass. - Doctors here announced a cure for the virus streptocircuitus integratus, transmitted by the fourteen-legged logic bug and prime cause of inflamed logic and many chronic output diseases.

A statement released by the group said in part, "By using the new General Radio 1790 Logic-Circuit Analyzer, with all its active ingredients, we are now in a position to perform 100% functional testing — on even the most complex modules. The computer-controlled 1790 can test devices with as many as 96 inputs and 144 outputs, checking from a simple functional GO/NO-GO test to a detailed step-by-step analysis for the debugging of defective units, and the optional programmable logic levels permit marginal testing!

"For only \$32,500 we can't see why any user of printed-circuit boards or integrated arrays would be without one — especially since extensive programming knowledge isn't

required. The results have been overwhelming! In several thousand test cases we've been able to eliminate defective IC's and modules early in the game, thereby producing harmony, well-being, and great cost savings in production."

Help increase the yield and longevity of logic circuits! Write or phone for more information from General Radio Company, West Concord, Massachusetts 01781; telephone (617) 369-4400. In Europe write Postfach 124, CH 8034 Zurich 34, Switzerland. Price applies in U.S.A.

GENERAL RADIO

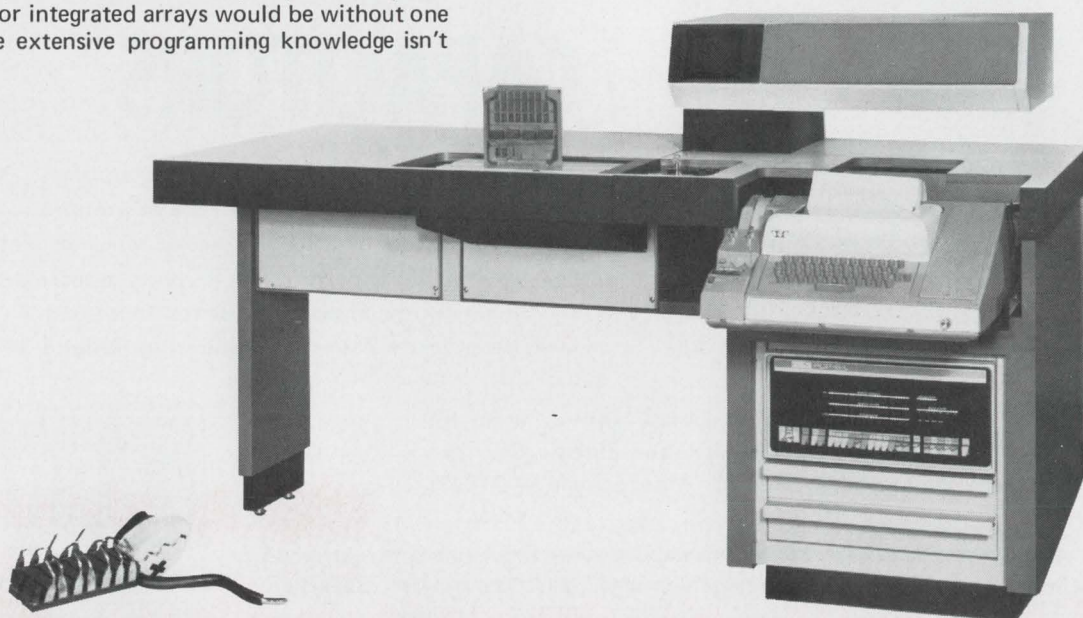

Who's Who in this issue

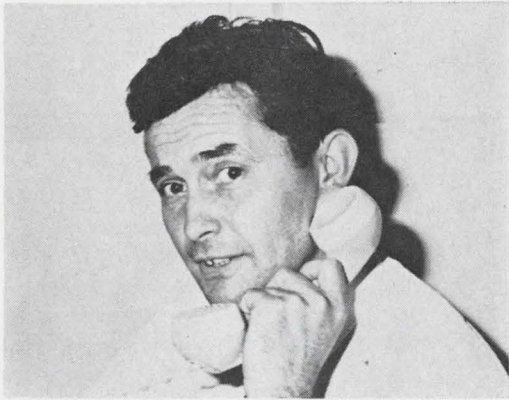

Ehlbeck



Stopper

In addition to working on high-speed circuits, Heinz-Wilhelm Ehlbeck, author of the article beginning on page 142, has supervised work on computer-aided mask-making, multilayer interconnection, and complementary MOS circuits. He is in charge of advanced IC development at AEG-Telefunken. Co-author Herbert Stopper's main interest has been high-speed circuits, first with General Electric Co.'s computer group in Phoenix, then with AEG-Telefunken, and now with National Cash Register Co.

Floyd Kvamme, microcircuits product manager at the National Semiconductor Corp. in Santa Clara, Calif., was among those responsible for National's move from the red ink to the black two years ago. Author of the article starting on page 88, Kvamme worked his way through the University of California as a carpenter. He holds a master's degree from Syracuse University, and has worked at General Electric Space Technology Laboratories, and Fairchild Semiconductor. A star softball player, Kvamme is a Bible scholar, and teaches at his church one night a week. In his spare moments he has found time to lecture on the semiconductor business and technology in such diverse locations as Japan, Israel, and Germany—visiting all these nations since last Labor Day.

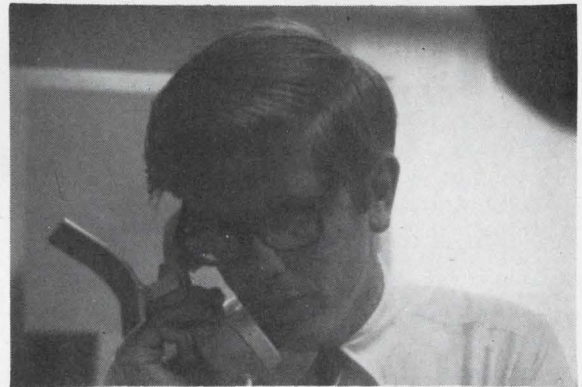

Kvamme



Weiss Strassler Flinn Hurlburt Ferguson

Forecasting technological trends for 1970 was the mandate given to *Electronics'* editors, who drew upon the varied technological expertise of engineers and managers at companies across the nation. Their findings, and the market statistics compiled by market research manager David Strassler and his staff, comprise the 36-page report beginning on page 101. Art director Jerry Ferguson prepared the cover designs and supervised the layouts symbolizing the digital techniques that will characterize the 1970's. And production editor Sue Hurlburt and copy editors Bill Weiss and Ed Flinn were among the behind-the-scenes people who helped polish and produce the report.

National/TTL

54s. 74s. Low power and Hi-rel.

- Send me the TTL tally.
- Send me your new IC catalog.

Name _____

Title _____

Company _____

Address _____

City _____ State _____ Zip _____

National/DTL

Old favorites. The whole 930 series.

- Send me the DTL data.
- Send me your new IC catalog.

Name _____

Title _____

Company _____

Address _____

City _____ State _____ Zip _____

National/MOS

ROMs and registers, quite a bit better.

- Send me your MOS material.
- Send me your new IC catalog.

Name _____

Title _____

Company _____

Address _____

City _____ State _____ Zip _____

National/Linear

Hands-down leaders in the linear line up.

- Send me the Linear Lit Pack.
- Send me your new IC catalog.

Name _____

Title _____

Company _____

Address _____

City _____ State _____ Zip _____

National/Hybrids

Big performers with a chip on the shoulder.

- Send me the Hybrid hypothesis.
- Send me your new IC catalog.

Name _____

Title _____

Company _____

Address _____

City _____ State _____ Zip _____

National/FET

Featuring the fabulous monolithic Dual.

- Send me the facts on your FETs.
- Send me your new IC catalog.

Name _____

Title _____

Company _____

Address _____

City _____ State _____ Zip _____

We care enough to send the very best.

National/Transistors

NPNs. PNP's. By the numbers.
Buy the carload.

- Send me your Transistor tabulation.
- Send me your new IC catalog.

Name _____

Title _____

Company _____

Address _____

City _____ State _____ Zip _____

National/Dice

The wherewithal to do your own thing.

- Send me the Chip charts.
- Send me your new IC catalog.

Name _____

Title _____

Company _____

Address _____

City _____ State _____ Zip _____

National/883

We put put a lot of stock in hi-rel inventory.

- Send me the numbers on 883.
- Send me your new IC catalog.

Name _____

Title _____

Company _____

Address _____

City _____ State _____ Zip _____

It's all in our new IC catalog.

Loaded with specs, schematics and design data. High-flying lowdown on circuit design, performance and reliability. Best be National.

National Semiconductor, 2900 Semiconductor Drive, Santa Clara, California 95051

Reply in confidence to

National Semiconductor

2900 Semiconductor Drive
Santa Clara, California 95051

The best is right for me. Send me your

- New IC catalog.
- Plus shortform material on
- Transistors FETs Dice.

Name _____

Title _____

Company _____

Address _____

City _____ State _____ Zip _____

A SYSTEM

IS ONLY AS
STRONG AS ITS
WEAKEST LINK

Electronics systems depend on the smooth, integrated functioning of every component. A system with weak links isn't really a system.

ROMOHAWK leaves the weak links out

Romohawk is an electronics systems engineering company. We don't make weak links. With R & D, design, and production facilities in-house, we make systems and subsystems that work. And our technical services can keep any system working.

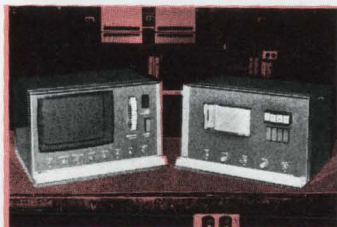

ECG and Central Station Monitors engineered by Romohawk

These units make up a hospital intensive care system that keeps constant check on a patient's condition. They feature multiple trace CRT displays, very high gain, low noise differential amplifiers, and logic circuits for alarm processing. Romohawk was able to design, test, and produce quantities of these units in just 90 days.

ROMOHAWK, WHERE ENGINEERING IS MORE THAN INTERCONNECT DIAGRAMS AND PURCHASE ORDERS.

ROMOHAWK
ELECTRONICS CORP.
811 Court St., Utica, N.Y. 13502
315-797-5445

Who's Who in electronics

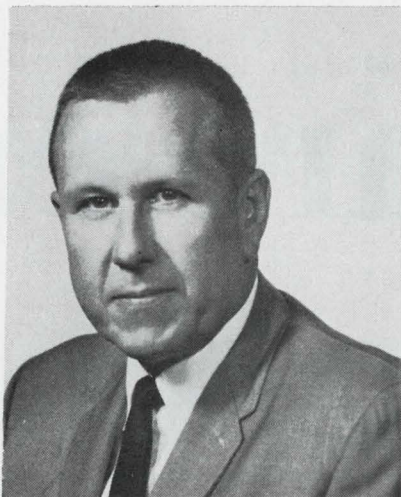

George D. Butler

Meteorologists know that a hurricane's eye is the calmest, safest spot. Now Electronic Industries Association president George D. Butler has demonstrated the phenomenon once more following the management storm that swept through the EIA last month. The storm broke when Butler, after six months in office, fired Jack Wayman from the job of Consumer Products division vice president which he had held for seven years [see p. 47]. The resultant furor appears to have left the EIA president untouched; if George Butler lost his cool, it never showed.

Undismayed by the fact that he will soon become a grandfather at age 50, Butler is pushing ahead with plans to bolster EIA's position as the industry spokesman in the capital. Recognizing the diverse and sometimes polarized positions of elements within the industry—such as those of the consumer products free-traders as opposed to the protectionist-oriented parts producers—Butler plans a legislative action group which would attempt to resolve these differences and consolidate now-fragmented efforts into a strong lobbying force. This promises to be a more visible change in the EIA reorganization set in motion last June when Butler took office as the association's first salaried president.

Flyer. Son of a Stetson hat salesman, Butler earned degrees in chemistry and physics at Princeton,

but ultimately wound up in management. Before joining the EIA, he had been president of the Electra/Midland Corp. until that company was acquired by the Transitron Electronics Corp. Though Butler's job has changed, his hobby has not. He still likes to fly his own airplane, which he uses for sightseeing and training pilots.

The crew-cut executive surprised some of his detractors when he tangled with Wayman and won. But George Butler is trying to put that dispute behind him. And now he is anxious to get on with the job of bringing industry's positions on a variety of issues into better focus, and making them better known. He feels that job is important as electronics moves into heretofore unexploited markets, and becomes increasingly involved with more federal agencies.

"There's no question that the domestic sector will obtain a greater share of our natural resources than in the past," says Butler, and the enlarging domestic markets will be mass transportation, communications, pollution, air traffic control, and the problems of the cities. "It's a real challenge for the electronics industry, which has not been as active in providing equipment, systems, and services in these areas as it might have been."

Long look. To get a handle on what will be expected from industry in the future, Butler is instituting a long-range planning group to look at the "technological, political, and sociological forces in the country," and to come up with a picture of how the industry is going to look like in the next 15 to 20 years. The study, he says, will take about a year, and will encompass not only marketing, but also the domestic and international structure of the industry.

"The big semiconductor houses have often turned down customers trying to apply new technology because they can't always see a quick

JFD COMPONENTS

RELIABILITY PROVEN IN DEEP SPACE



MINUTEMAN

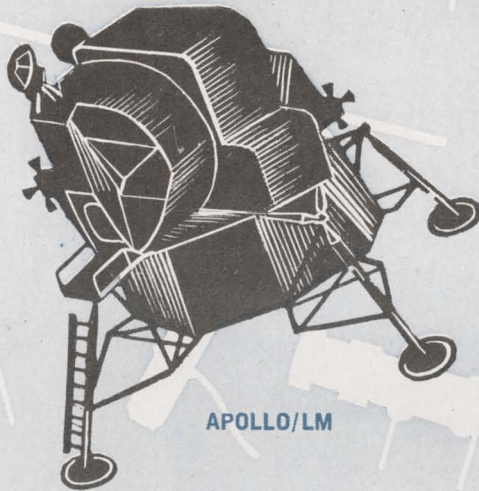

APOLLO/LM

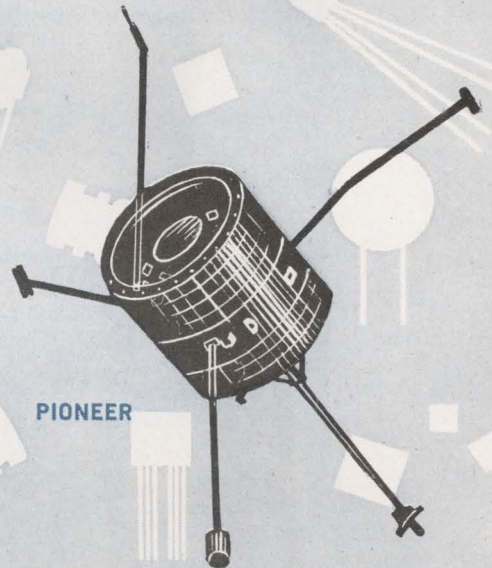

PIONEER

JFD continues to earn its reputation as a leading state-of-the-art discrete components manufacturer. OEM manufacturers — Military, Space and Commercial — display their confidence by specifying JFD for miniaturized fixed and variable capacitors, LC networks and tuners.

JFD components have helped make possible such sophisticated systems as — Minuteman, guidance and control (Autonetics Division North American Rockwell Corp.) — Apollo Command Module S-band transponder and Up Data Link and Lunar Module S-band transceiver (Motorola Inc.) — Pioneer, deep space data probe (TRW Inc.). These are only a few of JFD's more dramatic application credits.

JFD will continue to innovate and set higher industry standards of quality and reliability essential to 'Space Age' circuitry.

Use the coupon at the right to learn more about JFD components.



SUBSIDIARY OF RIKER-MAXSON CORPORATION

JFD ELECTRONICS CORP. / COMPONENTS DIVISION

15th Avenue at 62nd Street • Brooklyn, N. Y. 11219/Phone 212-331-1000 • TWX 710-584-2462

PLEASE SEND ME THE LATEST DATA ON THE FOLLOWING COMPONENTS LINES:

- PISTON TRIMMER & TUNING CAPACITORS
- MVM/VAM AIR VARIABLE CAPACITORS
- CERAMIC VARIABLE DISC AND MICROMINIATURE CAPACITORS
- STANGARD 'LOW-COST' FIXED & VARIABLE CAPACITORS
- UNICERAM — SUBMINIATURE & MICROMINIATURE HI Q AND HI K FIXED CERAMIC CAPACITOR
- COMPACTUNER-MODULAR MULTIGANG TUNERS
- MINIATURE LC TUNERS
- MICROMINIATURE MTLT TUNERS
- MINIATURE TANK CIRCUITS
- METALIZED INDUCTORS
- METAL FILM & WIREWOUND RESISTORS
- LADDER NETWORKS

NAME _____ TITLE _____

COMPANY _____

ADDRESS _____

JUST HOW SMALL CAN YOU MAKE A SUB-MINIATURE POWER RESISTOR?

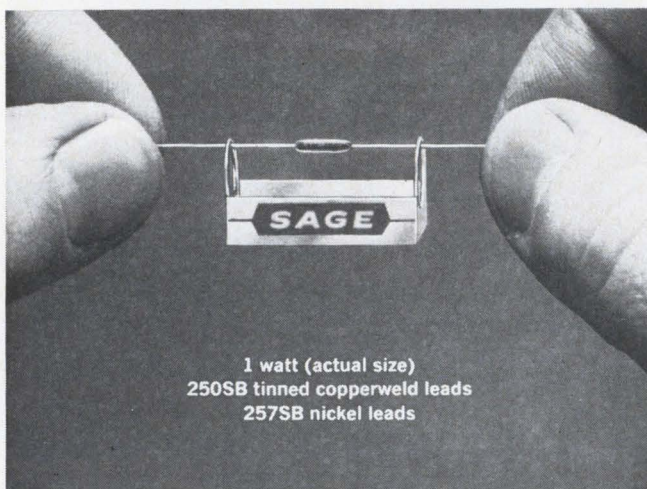

PRETTY SMALL!

Consider this SAGE SILICOHM® 1 watt unit in comparison to the vintage grid leak drip pan* pictured above. What's more, this tiny resistor, designed to operate hot, provides stability and precision features ordinarily associated with the finest of low power precision resistors.

SAGE Type SB styles feature superior heat dispersion by means of beryllium oxide cores, as first used in Advanced Minuteman parts. Assigned wattage ratings are 1 to 15 watts at 25°C ambient, thus offering dramatic new circuit miniaturization possibilities for commercial and regular military applications. We welcome the opportunity to discuss your requirements. SAGE ELECTRONICS CORP., Box 3926, Rochester, N. Y. 14610. Phone: (716) 586-8010.

**For the record, we don't make grid leak drip pans.*

Precision Power Resistors
SAGE
ELECTRONICS
SUBSIDIARY OF GULTON INDUSTRIES, INC.

Who's Who in electronics

production return," says E. David Metz, "and it's about time we—the industry—did something about it." With that statement, Metz, 42, the new director of the Motorola Integrated Circuits Application Research laboratory, pretty well sums up the new charter he's just been handed.

Job shop. "The idea is not to develop new technology," Metz continues, "but to apply existing technology to new applications. We hope to shorten the time scale for a customer to apply existing technology or technology that may not be quite ready for production. We may push new technology into production. We will be comparable to a job shop that can turn out small quantities, but with all the technology and knowhow that Motorola can bring to bear on the customer's needs," Metz explains.

The new lab is a corporate entity, established after Daniel E. Noble, vice chairman of the board and chief technical officer of Motorola, recognized the need for it. Metz will be housed under the same roof with, and report to, Richard Abraham, director of advanced IC programs for the Semiconductor Products division at the integrated circuit facility in Mesa, Ariz.

"I have no technological axe to grind," Metz says. "I want to apply the technology the customer needs." The lab is so new that it has no business yet, and Metz expects his will be a one-man operation for some time, but he brings formidable credentials to the new task.

Omnibus. In his 11 years with Motorola, most recently as assistant director of the Semiconductor Products division's Central Research laboratories, he has had pilot-line production and process-development responsibilities. "I've been involved in everything, including the fundamental characteristics of radio-frequency devices, all kinds of processing technology, including the photochemistry of photochemistry of photoresist. I've done fundamental work on MOS and I've worked on radiation resistance."

Beckman 136MHz \$1375.

Universal Counter and Timer
Fully Programmable
Field Replaceable ICs
Signal Level Indicators

Two Counters in One • Burst Mode • Frequency • Period • Single-Channel Pulse Width & Pulse Separation • Two-Channel Time Interval • Multiple Period • Ratio • Multiple Ratio • 25 μ s Recycle Time

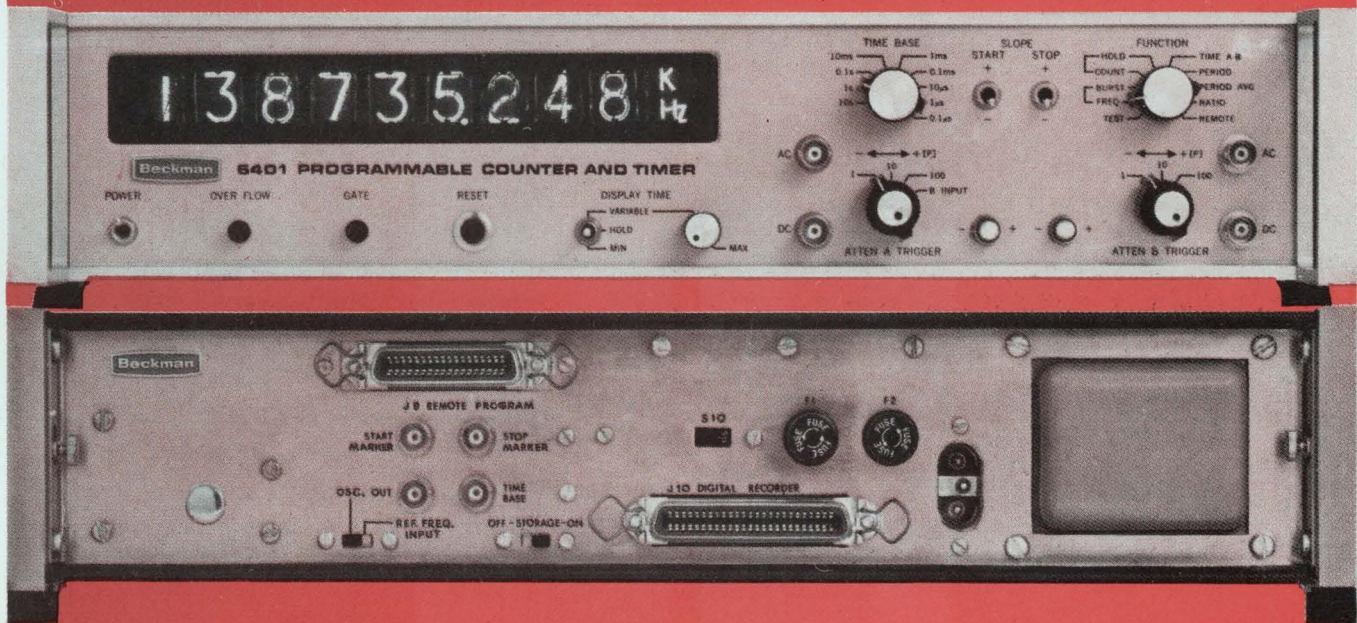

Beckman

INSTRUMENTS, INC.
ELECTRONIC INSTRUMENTS DIVISION
RICHMOND, CALIFORNIA • 94804

Place your order for the Model 6401 with your local Beckman representative:

Barnhill Associates • Denver, (303) 934-5505 • Albuquerque, (505) 265-7766 • Phoenix, (602) 263-1250 • Houston, (713) 621-0040 • Richardson, (214) 231-2573 • Salt Lake City, (801) 487-1327 • BCS Associates, Inc. • Orlando, (305) 843-1510 • Greensboro, (919) 273-1918 • Huntsville, (205) 881-6220 • Williamsburg, (707) 229-6198 • Plantation, Fla., (305) 584-7556 • Burlingame Associates, Ltd. • Mount Vernon, (914) 664-7530 • New York City area, (212) 933-5555 • Rockville, (301) 427-1255 • Bala Cynwyd, (215) 835-2080 • Syracuse, (315) 454-2408 • New York State, Enterprise 9-6400 • Moxon Electronics • Los Angeles, (213) 272-9311 • Sunnyvale, (415) 734-4352 • San Diego, (714) 274-6525 • Pivan Engineering • Chicago, (312) 539-4838 • Cedar Rapids, (319) 365-6635 • Mission, Kansas, (913) 722-1030 • Indianapolis, (317) 253-1681 • St. Louis, (314) 872-8424 • Minneapolis, (612) 537-4501 • Brookfield, (414) 786-1940 • Seatronics, Inc. • Seattle, (206) 767-4330 • S. Sterling Company • Cleveland, (216) 442-8080 • Pittsburgh, (412) 922-5720 • Dayton, (513) 298-7573 • Southfield, (313) 357-3700 • Yewell Electronic Sales, Inc. • Lexington, (617) 861-8620 • Easton, (203) 261-2241 • Beckman Instruments, Inc., Electronic Instruments Division, Richmond Operations, (415) 526-7730

INTERNATIONAL SUBSIDIARIES: AMSTERDAM; CAPE TOWN; GENEVA; GLENROTHES, SCOTLAND; LONDON; MEXICO CITY; MUNICH; PARIS; STOCKHOLM; TOKYO; VIENNA

The new small rack and panels with the big difference.

Bendix is the difference.

The difference in distribution, delivery and supply. The difference that means you can get the rack and panels you need when you need them.

A big difference. A big advantage. But there are others. Bendix Regal B subminiatures are built to MIL-C-24308. Application potentials are practically unlimited. Use them in switching circuits, computers, business machines. In industrial equipment, communications, test equipment. And in rack and panel modular or printed circuit technology.

The selection of mounting options is just about endless, too. Choose from among .120 or .154-inch diameter, straight-through holes, clinch nuts, float mounts, lock posts, plain flange and through-bulkhead types. Neoprene spacers or grommets. And solder or printed circuits. Even a crimp version with rear-release contacts comes in a variety of shell sizes and mounting configurations. All interchangeable with existing rack and panel connectors.

For more details, write: The Bendix Corporation, Electrical Components Division, Sidney, New York 13838.

Bendix

Electronics

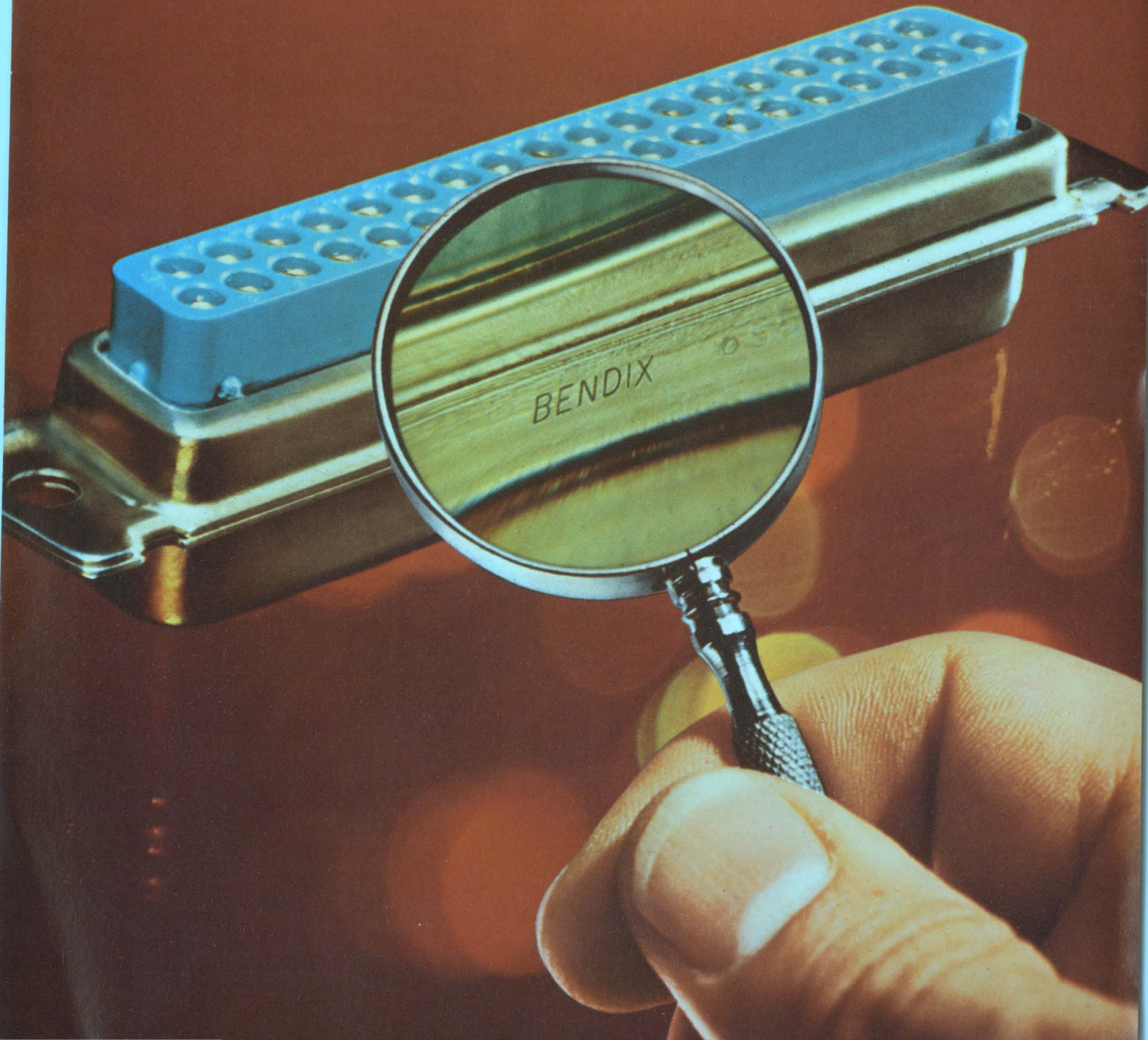

BENDIX

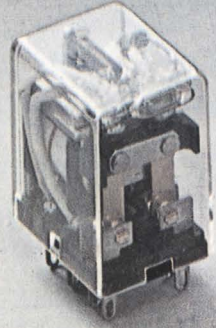
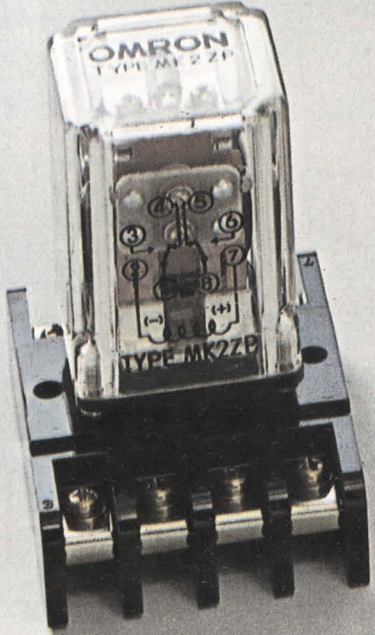
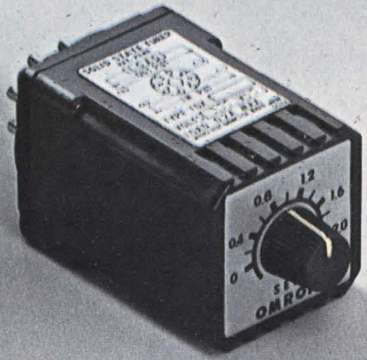
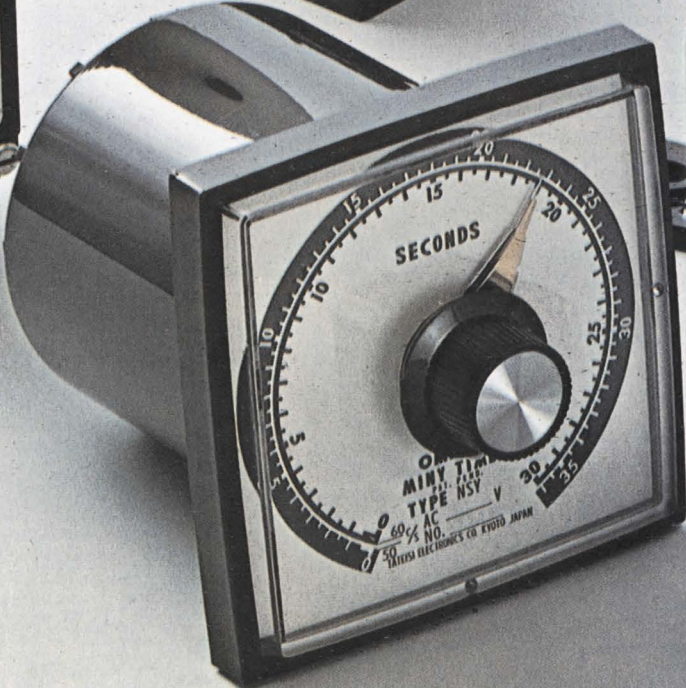
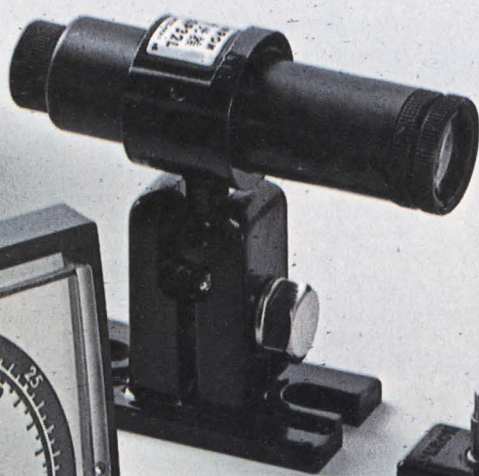
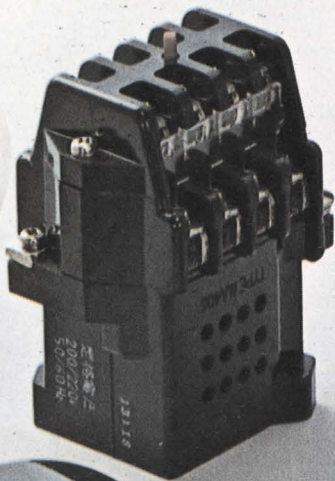

OMRON and the '70 s. A decisive decade.

We at Omron fully intend to impress our point on the American market and around the world. Two points really.

First, as Japan's largest multi-component specialist, we have available, right now, a vast range of controls that for quality and straight ingenuity of design has no peer.

Second point concerns our unique R&D system. It's unique because it makes possible volume-production of proved new designs. The system, which evolved from MIL-Q5923C and which was given a peculiarly Japanese twist, we call PESIC.

The PESIC system combined with Omron's talented young engineers has produced an unusual capability for innovation. The results of which you will soon be able to see and evaluate for yourself. And one more point. Omron controls have full UL, CSA, SEC and SECV international authorization.

Components, Control Devices, Systems. An original world of electronics.



OMRON TATEISI ELECTRONICS CO.

SALES OFFICE/Toa Bldg., 5, Yonban-cho, Chiyoda-ku, Tokyo, Japan
Phone (265) 4611 Telex 232-2179 Cable Address OMRONELCO TOKYO
OVERSEAS DISTRIBUTORS: ● AUSTRALIA/H.Rowe & Co., Pty., Ltd.
● AUSTRIA/Carlo Gavazzi-Billman G.m.b.H. ● ITALY/Carlo Gavazzi S.p.A.
● BELGIUM/Carlo Gavazzi Belgium s.a. ● ENGLAND/Keyswitch Relays Ltd.
● FORMOSA/Hai Nan Trading Co., Ltd./Sheng Ching Trading Co., Ltd.
● FRANCE/Billman-Carlo Gavazzi S.A.R.L.
● HOLLAND/Carlo Gavazzi-Billman Nederland N.V.
● SPAIN/Carlo Gavazzi-Reguladores Billman s.a. ● MEXICO/Schultz Y Cia., S.A.
● SWEDEN/Billman Regulator ab. ● SWITZERLAND/Carlo Gavazzi-Billman AG.
● U.S.A./Sigma Instruments Inc. ● SOUTH AFRICA/P.J.Yelland & Co. (Pty) Ltd.
● WEST GERMANY/Carlo Gavazzi-Billman Industrierlieferung G.m.b.H.

Circle 19 on reader service card

Describe the display storage tube you need. Westinghouse will build it.

Commercial airborne radar? Medical monitoring systems? Industrial instrumentation? Military radar and sonar systems?

Name your application. Westinghouse will design and custom package a display storage tube with unmatched resolution, controllable persistence, and high brightness.

Westinghouse has designed and manufactured all types of DSTs for both commercial and ruggedized military applications for more than 15 years. The split screen storage tube is our most recent innovation. It combines storage and cathode ray functions in a single tube.

The Westinghouse display design/application team is ready to assist you. For more information, write Westinghouse Electronic Tube Division, Elmira, New York 14902. Ask for brochure SA-10249.

ET-5-69

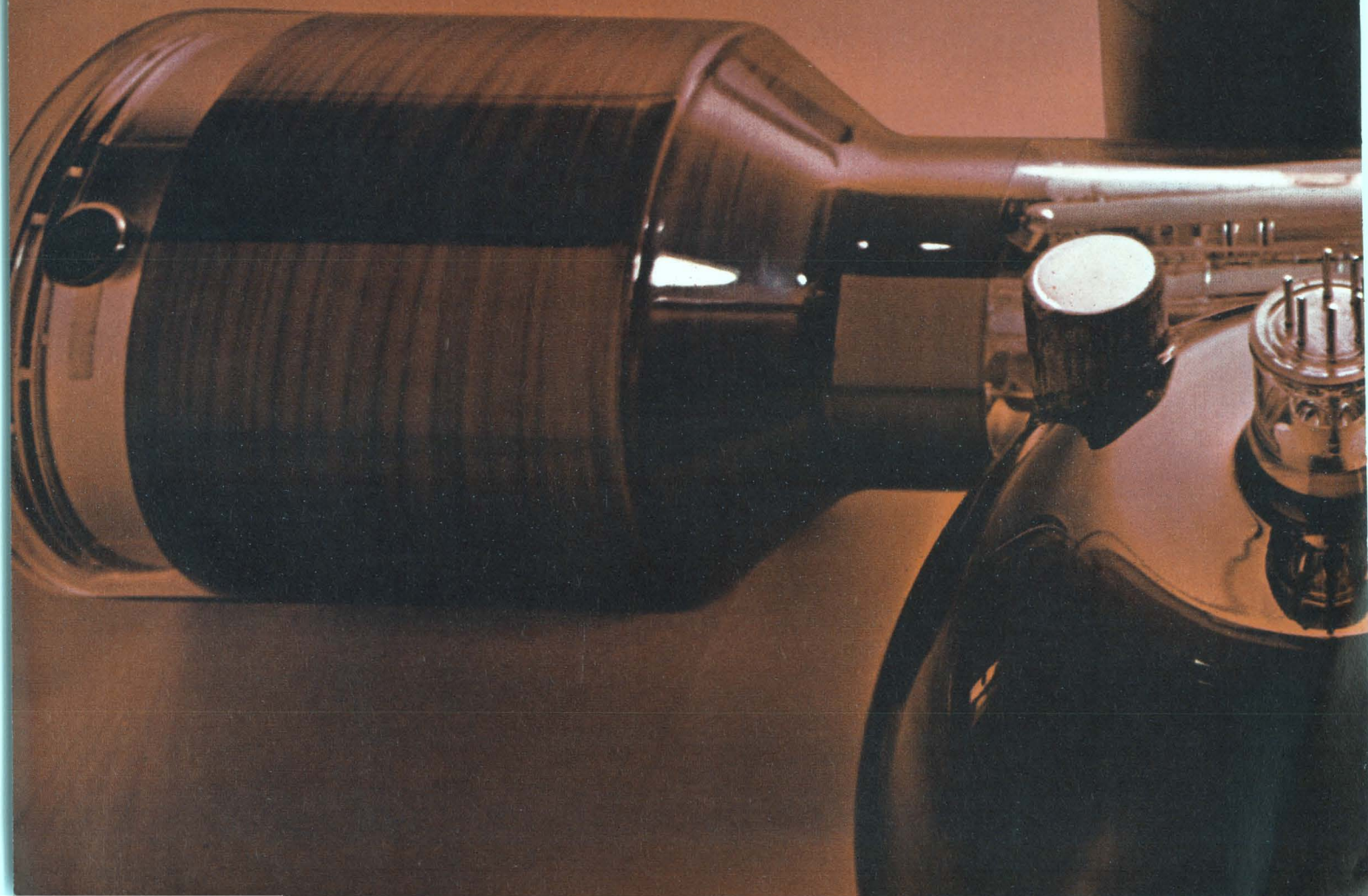

You can be sure...if it's Westinghouse

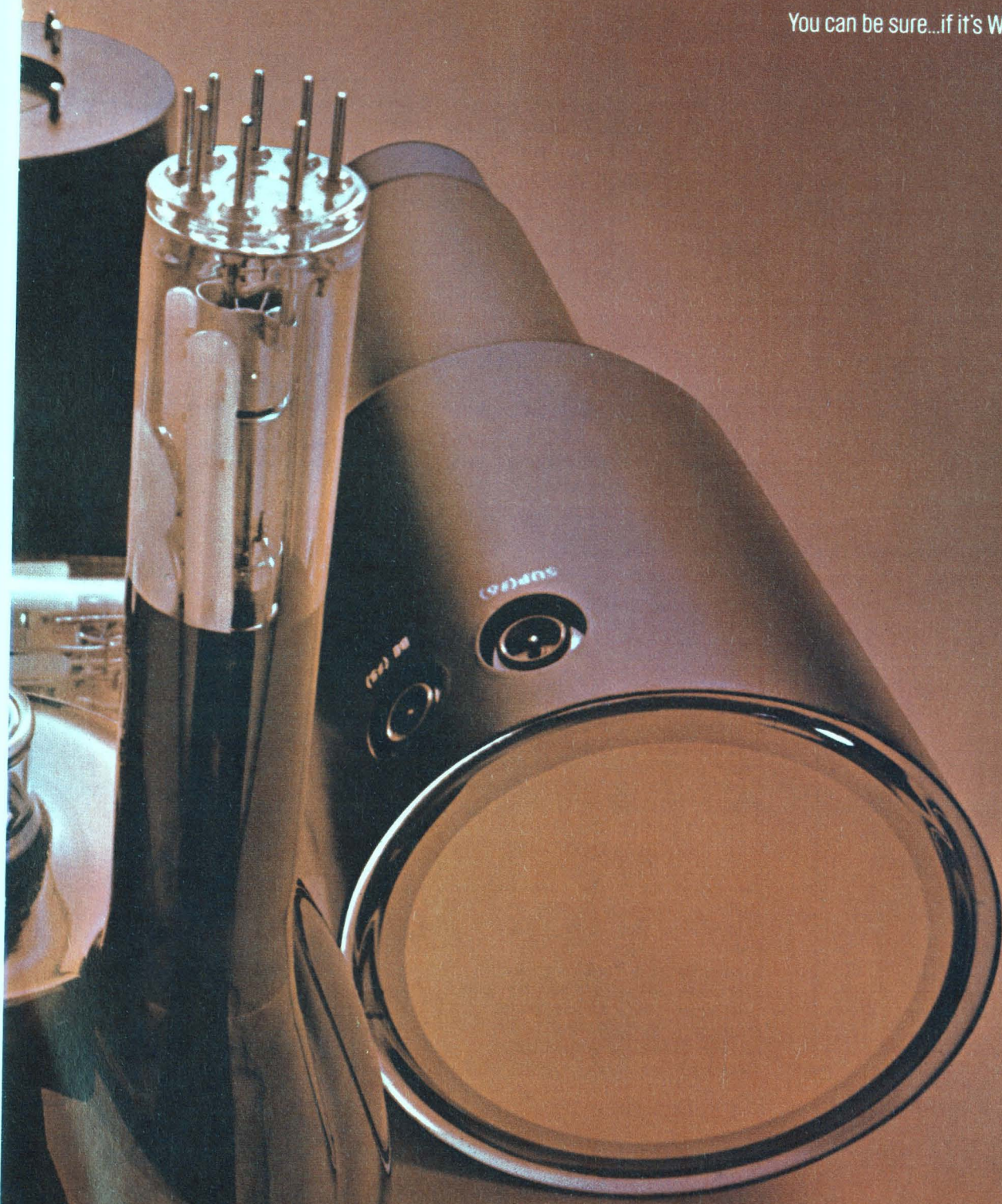

Circle 21 on reader service card

LOWEST COST . . . FULL WAVE BRIDGE RECTIFIERS & ASSEMBLIES

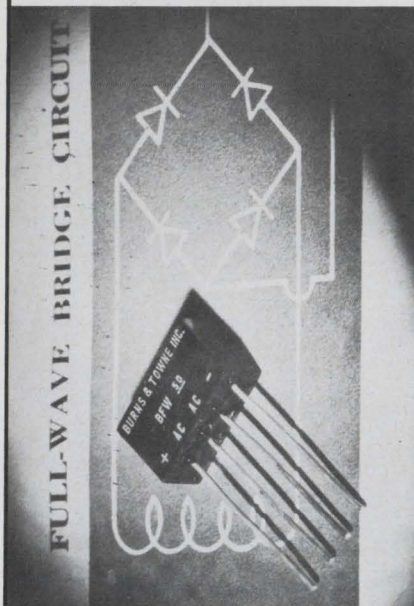

Burns & Towne pre-packaged rectifier circuits represent a significant cost savings over individual components used in multi-rectifier units. Yet, you are always assured of quality and reliability. The low cost BFW family of single phase full wave bridges . . . features high current capability of up to 2.0 amps.

Part No.	Max. PRV (volts)
BFW-50	50
BFW-100	100
BFW-200	200
BFW-300	300
BFW-400	400
BFW-500	500
BFW-600	600
BFW-800	800
BFW-1000	1000

Call or write for full specifications and price data.

Contact FRED SEIGEL

BURNS & TOWNE INC.
550 Old Country Road
Hicksville, L.I., N.Y., Tel. (516) 935-0522

Meetings

Semiconductor memories fill the air

Any skepticism that you might have had about the burgeoning importance of semiconductor memories should be dispelled by a look at the program of the 1970 International Solid State Circuits Conference. Two daytime sessions and an informal discussion in the evening will review recent developments in random-access memories, while another daytime session will be devoted to read-only memories.

The meeting will take place February 18-20 in Philadelphia at the University of Pennsylvania and the Sheraton Hotel. The university and the IEEE are the sponsors.

According to the papers that will be given, semiconductor memories are rapidly getting bigger, better, and cheaper. For example, W.M. Regitz of Honeywell's Computer Control Division and J. Karp of the Intel Corp. will describe an MOS array they've designed for use in the main memory of a computer. The array is fully decoded, and has a 500-nanosecond read and write cycle and a 345-nsec access time.

Faster yet is a 30-mil-square memory cell designed by D.J. Lynes and D.A. Hodges of Bell Telephone Laboratories. The cell employs Schottky diodes and epitaxial sheet resistors. In large arrays, cycle time is expected to be 60 nsec. The clincher: expected cost is only 1 cent per bit.

The evening discussion session will have panel participants from manufacturers and user companies. They'll discuss the potential of semiconductor memories and the merits of each of the various circuit types.

Other subjects to be considered at the conference include avalanche diode circuits, microwave transistor amplifiers, computer-aided design and modeling, and acoustic and transferred-electron circuits. Special emphasis will be given to display devices and to techniques for addressing matrix displays; today, the address techniques—not the devices—are a limiting factor.

For further information contact Lewis Winner, 152 W. 42 St., New York N.Y. 10036.

Calendar

Winter Power Meeting, IEEE; Statler Hilton Hotel, New York; **Jan. 25-30, 1970.**

Annual Symposium on Reliability, Group on Reliability of the IEEE, American Society for Quality Control, American Society for Nondestructive Testing, and the Institute of Environmental Sciences; Biltmore Hotel, Los Angeles; **Feb. 3-5, 1970.**

International Solid State Circuits Conference, IEEE, University of Pennsylvania; Sheraton Hotel and University of Pennsylvania, Philadelphia, **Feb. 18-20, 1970.**

Second National Conference and Exposition on Electronics in Medicine, Electronics/Management Center, Electronics, Medical World News, Modern Hospital, Postgraduate Medicine; Fairmont Hotel, San Francisco, **Feb. 12-14, 1970.**

Symposium on Management and

Economics in the Electronics Industry, IEE; University of Edinburgh, Scotland, **March 17-20, 1970.**

International Convention, IEEE; New York Hilton Hotel and the New York Coliseum, **March 23-26, 1970.**

Meeting of the Association for the Advancement of Medical Instrumentation, Statler Hilton Hotel, Boston, Mar. 23-25, 1970.

Symposium on Submillimeter Waves, IEEE, Polytechnic Institute, Brooklyn, New York, March 31-April 2, 1970.

Communications Satellite Systems Conference, American Institute of Aeronautics and Astronautics; International Hotel, Los Angeles, **April 6-8, 1970.**

Reliability Physics Symposium, IEEE; Stardust Hotel and Country Club, Las Vegas, Nevada, **April 7-9, 1970.**

(Continued on p. 24)

TRY TO MATCH THIS

for size and reliability

you can't!

For their size, Type BB resistors pack a tremendous power dissipating ability. Rated 1/8 watt at 70°C in a 0.0004375 cu. in. volume.

And miniaturization has not reduced reliability. Tests prove it. They satisfy the highest level—the S level—of the latest MIL-R-39008 Established Reliability Specifications in all resistance values.

The key is hot molding—the Allen-Bradley way. A-B developed and built the machines. Only A-B uses them. They're fully automatic. Built-in precision control. A high degree of uniformity. Predictable performance from resistor to resistor—year after year.

For immediate delivery at factory prices call your authorized A-B industrial electronics distributor. Or write Marketing Dept., Electronics Division, Allen-Bradley Co., 1201 South Second St., Milwaukee, Wis. 53204. Export Office: 1293 Broad St., Bloomfield, N.J., U.S.A. 07003. In Canada: Allen-Bradley Canada Limited.

© Allen-Bradley Company 1969

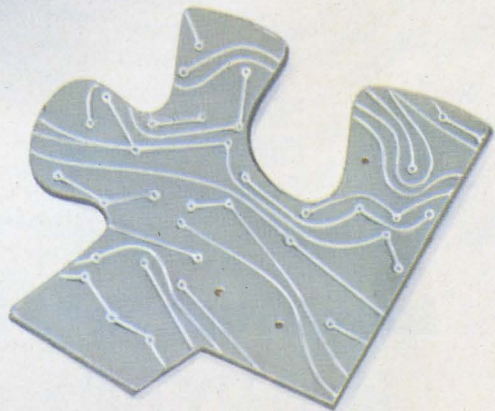

Exclusive

Only A-B Type BB
RCR05 meets MIL-R-39008
ER (established reliability)
for 1/8-watt resistors
at the S level.
Shown actual size.



ALLEN-BRADLEY

QUALITY ELECTRONIC COMPONENTS

EC69-80



**Look what \$345 buys
in a 1 μ V Full Scale**

DC Null Detector/Microvoltmeter

It buys you a portable performer with 0.15 microvolt resolution. It's handy and convenient to use. It's rugged, too—works more than 1000 continuous hours on four carbon-zinc batteries. It's the Keithley Model 155—the lowest-priced electronic null detector on the market today.

The 0.03 μ V rms input noise is quieter than any other in its price class. Coupled with better than $\frac{1}{2}$ μ V per day stability and 1 megohm input resistance at 1 μ V full scale, the 155 is ideal as a null detector for potentiometers, bridges, ratio devices and comparator circuits.

When the Model 155 isn't working as

a null detector, it doubles as a 1 μ V to 1000 volt microvoltmeter with 19 zero center ranges. Use it for measuring thermocouple and thermopile potentials, contact resistance, making Hall Effect studies, or whatever.

See this little giant perform. Call your Keithley Sales Engineer for your demonstration. Or contact Keithley Instruments, Inc. for complete details—28775 Aurora Road, Cleveland, Ohio 44139. In Europe: 14, Ave. Villardin, 1009 Pully, Suisse. Prices slightly higher outside the U.S.A. and Canada.



KEITHLEY

Meetings

(Continued from p. 22)

Meeting and Technical Conference, Numerical Control Society; Statler Hilton, Boston, April 8-10, 1970.

Computer Graphics International Symposium, IEE; Uxbridge, Middlesex, England, April 13-16, 1970.

International Geoscience Electronics Symposium, IEEE; Marriott Twin Bridges Motor Hotel, Washington, April 14-17, 1970.

American Power Conference, IEEE; Sherman House, Chicago, April 21-23, 1970.

International Magnetics Conference (INTERMAG), IEEE; Statler Hilton Hotel, Washington, April 21-24, 1970.

Annual Frequency Control Symposium, U.S. Army Electronics Command; Shelburne Hotel, Atlantic City, N.J., April 27-29, 1970.

National Telemetry Conference, IEEE; Statler Hilton Hotel, Los Angeles, April 27-30, 1970.

National Relay Conference, Oklahoma State University and the National Association of Relay Manufacturers; Oklahoma State University campus, April 28-29, 1970.

Transducer Conference, IEEE; National Bureau of Standards, Washington, May 4-5, 1970.

National Appliance Technical Conference, IEEE; Leland Motor Hotel, Mansfield, Ohio, May 5-6, 1970.

Short courses

Generalized Machine Theory Applications, IEEE; Statler Hilton Hotel, New York, Jan. 25-30, 1970. \$30 fee.

Topics in Quantum Electronics, University of California; Berkeley campus, Feb. 2-6, 1970. \$300 fee.

Theory and Design of Reliable (Fault-Tolerant) Computers: Protective Redundancy, Diagnosis, Self-Repair, University of California; Los Angeles campus, Feb. 2-13, 1970. \$395 fee.

Minicomputers, National Electronics Conference; Pheasant Run Lodge, St. Charles, Ill., Feb. 8-11, 1970. \$390 fee.

Computer Language Approach to Network Analysis and Design, University of

(Continued on p. 26)



**METALS THAT TALK, SING
AND LISTEN...A SPECIAL
CAPABILITY OF CARPENTER!**

The reassuring sound of a family voice . . . the perfect fidelity of a favorite recording . . . theatres of color that bring lavish entertainment into millions of homes. These are the exciting developments in the field of audio/visual communications that all of us can enjoy. And essential to the flawless performance required of these products . . . specialty metals that make them talk, sing and listen. Carpenter produces a full range of electronic alloys used throughout industry, including Magnetic Core Irons, Glass Sealing Alloys, High Permeability Alloys, Electrical Resistance Alloys, Magnetostrictive and High Saturation Alloys, Controlled Expansion Alloys, and others. Why don't you entertain the thought of applying Carpenter electronic alloys to your product? See your Carpenter representative. Steel Division, Carpenter Technology Corporation, Reading, Pa. 19603.

*European Office: Emmastraat 39,
Amsterdam-Z, The Netherlands*

CarTech CARPENTER
TECHNOLOGY

INTEGRATED CIRCUIT SEMINARS

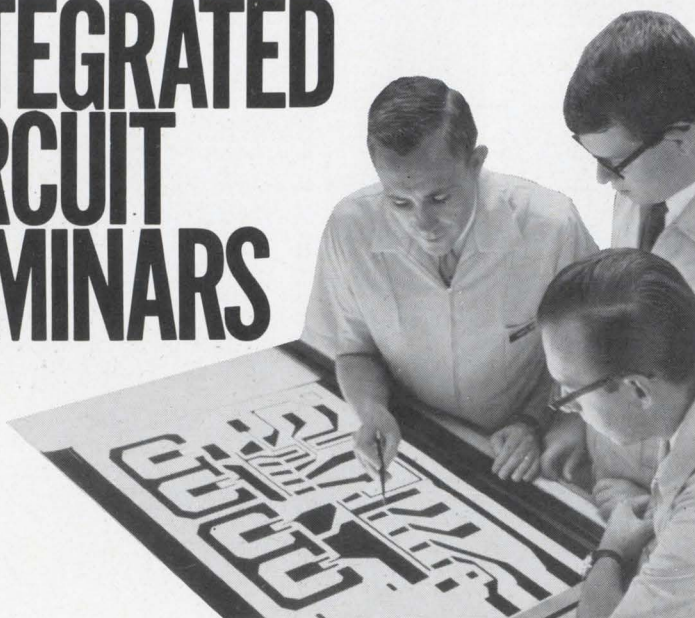

At ICE's seminars practical experience is taught — what others have learned the hard way. As an unbiased party, ICE *evaluates* all of the IC processing techniques used throughout the industry. ICE has no hardware to promote, only sound technical information to dispense. Fees cover tuition, course materials and texts. Enrollment is limited. For a complementary copy of "MOS Integrated Circuits — The Designer's Dilemma" given by Glen R. Madland at WESCON 1969, write to Robert L. McLellan, Publications Manager, ICE.

4-DAY IC ENGINEERING SEMINARS

AND ONE-DAY SPECIALIZED SEMINARS

The 4-day seminar provides a solid understanding of IC technology for both management and engineering personnel. Optional 1-day and 1½ day seminars are offered on specific IC subjects.

DATES	SEMINAR CONTENT
January 19-23	4-day engineering seminar plus 1-day seminars on COMPUTER AIDED DESIGN and PRODUCT ANALYSIS.
February 16-20	4-day engineering seminar plus 1-day seminars on RELIABILITY and MOS LAYOUT.
April 6-10	4-day engineering seminar plus 1-day seminars on PURCHASING/MARKETING and MANAGEMENT.
May 18-23	4-day engineering seminar plus 1-day seminar on LSI or 1½ days on FAILURE ANALYSIS.

Registration Fees, including ICE's Basic Technology (500 page fifth edition): \$500 for 4-day seminars, \$175 for 1-day seminars, \$275 for 1½ day seminars. Seminar dates for the balance of 1970 will be announced later in the year.

FOR COMPLETE DETAILS CIRCLE READER SERVICE # 504

4-WEEK IC DESIGN/ FABRICATION SEMINAR

Covers entire spectrum of procedures used today in the IC industry as well as specialized techniques developed by ICE. Laboratory periods are devoted to student IC design and fabrication instruction in ICE's modern research facility.

1970 SEMINAR DATES
February 23 to March 20
September 21 to October 16

Registration fee, including a complete set of the five-volume Process Compendium (1,489 pages, 831 illustrations), ICE's Basic Technology, laboratory workbook and all laboratory materials, is \$10,000.

FOR COMPLETE INFORMATION
CIRCLE READER SERVICE # 505

2-WEEK IC PROCESSING SEMINAR

This ICE seminar provides intensive familiarization with detailed processing techniques for production of silicon monolithic IC's. Course combines classroom lectures with actual operating experience in ICE's modern prototype laboratory.

1970 SEMINAR DATES
June 1 to June 12

Registration fee, including ICE's Basic Technology (500 page fifth edition), Processing Notes (a complete processing "recipe book"), workbook and laboratory notebook, is \$3,000.

FOR COMPLETE INFORMATION
CIRCLE READER SERVICE # 506

ICE

INTEGRATED CIRCUIT ENGINEERING CORPORATION
4900 EAST INDIAN SCHOOL ROAD/PHOENIX, ARIZONA 85018
PHONE (602) 959-4760/TWX (910) 950-1285/CABLE ICE PHOENIX

Meetings

(Continued from p. 24)

California; Los Angeles campus, **Feb. 9-13, 1970.** \$285 fee.

Systems Engineering Institute, Division of Continuing Education and the College of Engineering of the University of Arizona; Pioneer International Hotel, Tucson, **Feb. 9-13.** \$250 fee.

Electronic Components, University of Wisconsin; Madison campus, **Feb. 19-20, 1970.** \$70 fee.

Introduction to Process Computer Control, University of California; Los Angeles campus, **March 9-13, 1970.** \$285 fee.

Dynamics in Nonlinear Systems, University Extension, UCLA, Engineering and Physical Sciences Extension; University of California, Los Angeles, **March 16-20.** \$285 fee.

Theory of Computer Arithmetic: Algorithms and Design of Digital Arithmetic Processors, University Extension UCLA, Engineering and Physical Sciences Extension; University of California, Los Angeles, **March 16-21.** \$345 fee.

Call for papers

USNC/URSI-IEEE Spring Meeting, National Academy of Sciences, National Research Council; Statler Hilton Hotel, Washington, April 16-19; 1970. **Feb. 2, 1970** is deadline for submission of abstracts to Francis S. Johnson, University of Texas at Dallas, P.O. Box 30365, Dallas, Texas 75230.

Intersociety Energy Conversion Engineering Conference, IEEE American Nuclear Society; Las Vegas, Nev., Sept. 21-25. **Feb. 1** is deadline for submission of abstracts to Energy-70, Box 9123, Albuquerque N.M. 87119.

Midwest Symposium on Circuit Theory, Department of Conferences and Institutes Department of Electrical Engineering, University of Minnesota; University of Minnesota, Minneapolis, May 7-8. **Feb. 5** is deadline for submission of summaries to Prof. B.A. Sheno, Department of Electrical Engineering, University of Minnesota, Minneapolis 55455.

Applied Superconductivity Conference, Bureau of Standards, University of Colorado, Office of Naval Research, and American Institute of Physics, Boulder, Colo., June 15-17. **March 1** is deadline for submission of abstracts and summaries to Stanley H. Autler, Code RRA, NASA-ERC, Cambridge, Mass. 02139.

Circle 27 on reader service card →

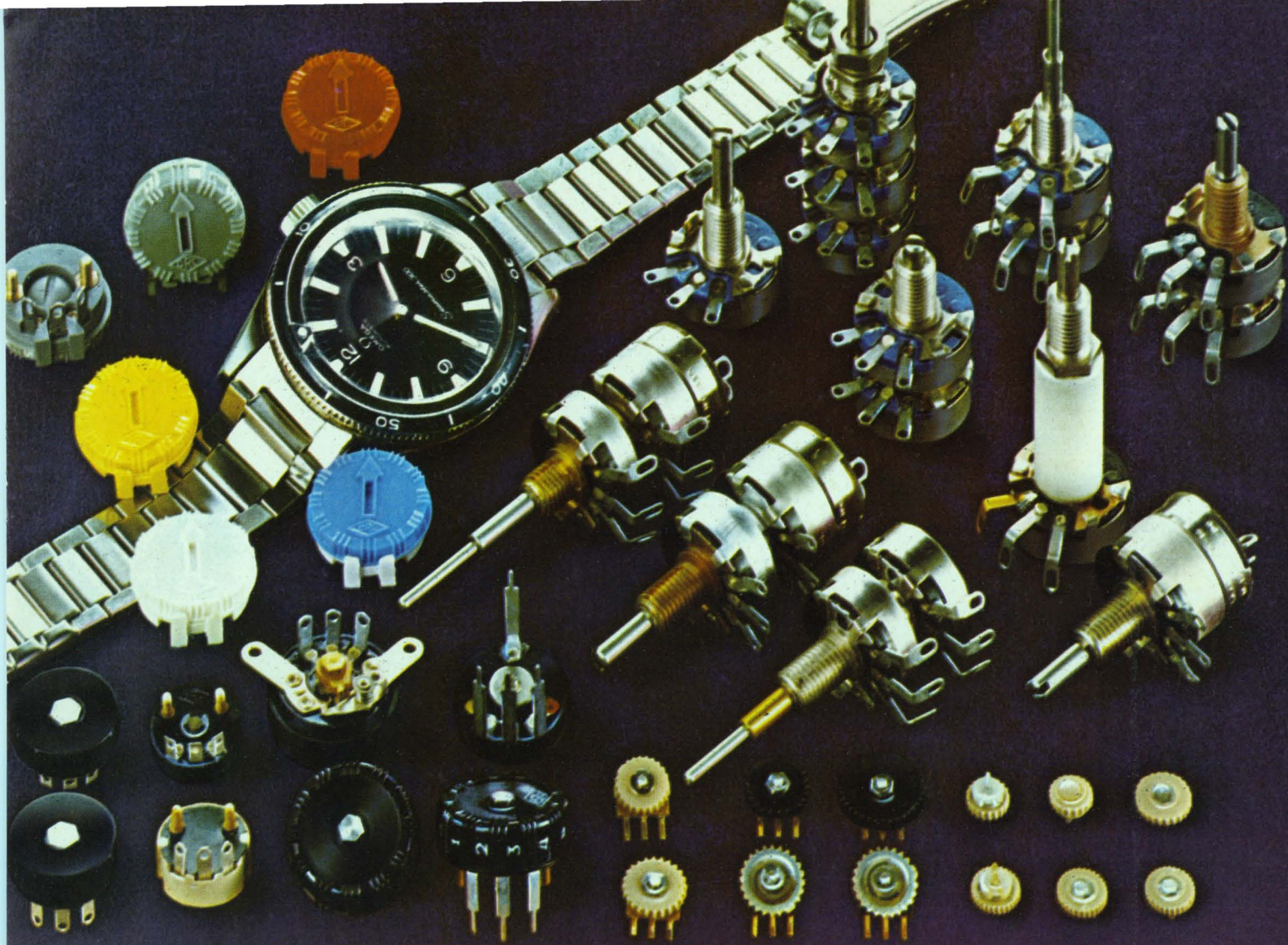

a little something special for everybody

Centralab designs miniature potentiometers to meet unique and exacting applications

Throughout our more than 20 years of experience in the development of miniature industrial potentiometers, we've found that many special purpose designs soon establish an array of standard applications. Today, Centralab pots are relied upon for test and measurement instrumentation, communications, medical equipment and other exacting applications.

Many of your present requirements might be satisfied by our

standard models which meet the following design parameters:

Wattage ratings: 1/10 to 2 watts
 Temperature range: -55°C to 120°C
 Resistance range: 4 ohms to 10 megohms

Size: 5/32" to 5/8" diameter

Carbon composition resistance. Bushing mounted units also available with wirewound resistance.

Some models provide switching capability.

Our miniature potentiometers represent just a small share of our entire capability, which includes custom designs for a wide variety of unique applications.

Simply tell us what you need. We'll customize a potentiometer to your mechanical and electrical specifications with your economics in mind. For additional information, write: Centralab Electronics Division.

CENTRALAB PRODUCTS ARE MARKETED THROUGH CENTRALAB INDUSTRIAL DISTRIBUTORS AND INTERNATIONALLY THROUGH GLOBE-UNION INC. - INTERNATIONAL DIVISION.



CENTRALAB

Electronics Division
 GLOBE-UNION INC.

5757 NORTH GREEN BAY AVENUE
 MILWAUKEE, WISCONSIN 53221



The industry's broadest line of

The CMC Model 905 Frequency Meter has already taken the country by storm. But why not. Where else can you get 15-MHz IC performance, 5-digit readout, a 1-MHz crystal oscillator, automatic trigger level, simplified controls, and a convenient tilt-up stand—all in a tiny package only 5-inches wide and 3½-inches high for only \$395?

But maybe a frequency meter is not for you, and what you need is a TIM. If so, why pay \$600 to \$800, when the CMC Model 915 Time Interval Meter is yours for just \$450? It offers the same 1-MHz temperature-compensated crystal oscillator as the Model 905. It triggers on positive or negative going pulses, and it can be operated in either a 1 μ s or 1 ms mode, with a range from 0 to 99,999. Measurement starts on the

A-input and stops on the B-input, and reset can be accomplished even during the measurement operation.

Or look at the third little member of this low-cost family—the Model 925 Electronic Totalizer. The 925 input frequency range is from dc to 100 KHz, and its totalizing range is from 0 to 100 KHz, or 0 to 100 Hz by internal switch selection. Trigger level is automatic, and a pushbutton switch on the front panel resets the count to "0." Price: only \$295 — \$200 less than the nearest major competitor!

And here's some really big news in low-cost electronic control counters. Now you may choose between CMC's Single Preset, Model 912, or Dual Preset, Model 913; and you don't have to pay the \$700 and \$1000 asked by the competitors. Pay only \$550



*Something
to write home
about...*



lowest cost counters!

for the 912 and \$650 for the 913, and get CMC's high quality performance as well.

The Model 912 limit function holds "output" at the preset number until reset manually, while it continues to count. Or, in the "recycle mode," it will hold the "pulse relay output" at the preset number, then reset to "0" and automatically resume counting. The Model 913 performs as the 912 except that it is equipped with two sets of limit switches for dual preset operation. Both units come conveniently packaged in boxes that are 19-inches wide for standard rack mounting and only 3½-inches high.

At last, here is a low-cost counter family that puts every primary counting function within the budget reach of every potential user. Buy one or buy a group.

The more you buy the more you save. But now you may select, buy, and pay for only those functions that you really need!

For full specs, just circle the reader service card; and for a demonstration of any or all of these products, contact your local CMC representative.

COMPUTER MEASUREMENTS



A DIVISION OF NEWELL INDUSTRIES

12970 Bradley / San Fernando, Calif. 91342 / (213) 367-2161 / TWX 910-496-1487

Circle 29 on reader service card

LSI/DRA



Wait no longer... LSI is here!

(And Texas Instruments brings it.)

Here's the dawn of a new day for electronics.

LSI/DRA (Large Scale Integration/Discretionary Routed Arrays) are here *now!* They are designed into the LSI computer shown (below left). This working computer was developed to demonstrate the practicality of LSI/DRA.

But it's more than just practical. LSI/DRA is already economically feasible for new designs.

TI engineers and scientists have solved the many manufacturing problems involved.

And they've been so successful that costs—already less than for similar functions built up from conventional military ICs—will be competitive with many industrial function costs within the span of the new product design time.

With both production and cost problems on the way to solution, it's time for forward-looking manufacturers to start learning how to work with LSI/DRA. Some have already started.

It's easier than it seems, too, be-

cause you don't have to start from scratch with a new design. TI offers standard products that you can evaluate as a starter. Here they are:

DRA 1001

Digital differential analyzer

This integrator features high speed (orders of magnitude above available competition), complete stability, and a one part in 2048 output resolution (10 bit binary plus sign).

Two DRA-1001s will provide the incremental solution to the sine and cosine functions.

They can operate with a typical clock rate of 2 MHz, and they can compute the magnitude of any angle in less than a millisecond. Power dissipation is only typically 2.5 watts per array.

DRA 2001 to DRA 2003 Serial-in serial-out static shift registers

These DC to 10 MHz TTL shift registers are available in three standard types—dual 253, dual 349, and dual 501-bit units. Special internal circuitry gives

greatly reduced power dissipation without loss of speed, and short internal connections minimize noise coupling.

Custom designs

You can evaluate LSI/DRA at low cost with standard units, but you'll undoubtedly require custom arrays to meet your individual design requirements. We can help you there, too.

Many special arrays may be made simply by providing custom interconnection patterns on one of the three standard logic wafers. Other requirements may be met with custom wafer designs as well.

Either way, TI's computer-aided design techniques reduce design costs and lead time to new lows.

Get the economic story



Since economics is the chief consideration in deciding when to go LSI, we've prepared a special bulletin that gives you all the

facts as they appear now. For your free copy, send a request for the LSI/DRA bulletin on your letterhead or business card to Texas Instruments Incorporated, P.O. Box 66027, M.S. 333, Houston, Texas 77006.



The TI LSI computer (below left), developed under Air Force contract, employs only 34 LSI arrays to perform the same functions as the standard TI 2502 (above left) which uses 1735 IC flat packs.

TEXAS INSTRUMENTS
INCORPORATED

Cermet

AND THE

Model 3252

TRIMPOT® POTENTIOMETER

Meets or exceeds MIL-R-22097, Style RJ-22
TC 100 PPM/°C over entire resistance and temperature range*

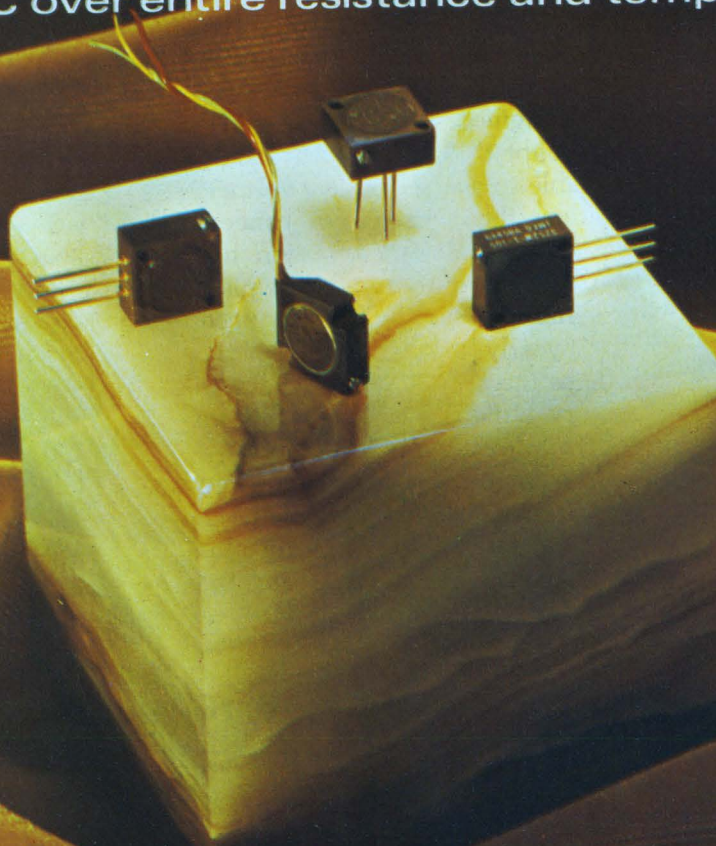

Why settle for less than the best in ½ inch square potentiometers? Specify units from the leaders in the field . . . potentiometers backed by years of engineering and manufacturing know-how . . . from Bourns, a company built on the concept of quality and service. Write or call the factory, your local field office or representative today for complete technical details.

*Resistance range: 10 Ω to 2 Megohms
Temperature range: -65°C to +150°C



BOURNS, INC., TRIMPOT PRODUCTS DIVISION • 1200 COLUMBIA AVE., RIVERSIDE, CALIF. 92507

Electronics Newsletter

January 5, 1970

NASA to deemphasize electronics in '70's

When NASA announced the closing of its Electronics Research Center in Cambridge, Mass., the official reason was economy. But there was yet another factor, perhaps more significant and certainly more ominous: in the words of the space agency's administrator, Thomas O. Paine, the closing reflects "a general deemphasis in the role of electronics in NASA's future plans." Other officials had nothing to add along this line, but James C. Elms, director of the center, noted by contrast that one of his prime goals would be to retain intact the skilled teams which had been built up during the center's brief history.

Whether NASA will save by closing the center is debatable. Its more than 800 employees are protected by Civil Service regulations, meaning that NASA will pay their salaries until they find new jobs. And the agency already is on record as wanting to retain almost all of the scientific and engineering crews as well as their equipment. Also, there is serious doubt that government facilities in the Massachusetts Bay area will be able to absorb lower level personnel.

Nor does the closing mean cancellation of the contracts, says Elms, only a transfer of administration to other centers. Finally, the center never was allowed to grow to its planned staffing level; it has remained the smallest of NASA's centers, accounting for only about 1% of the agency's yearly budget.

Perhaps the only immediate gain will be from sale of the \$36 million laboratory building—but even this may be too specialized a structure for quick sale to industrial users.

Aside from government officials, few area spokesmen are commenting on the closure. An indication of the generally apathetic public response was a local radio station's sandwiching of the announcement between news of a small tenement fire and the latest feats of the Boston Bruins hockey star Bobby Orr.

Cost-sharing rule draws industry fire

Alerted by the EIA Government Products division, some 40 defense contractors will be training their guns on some new language in the Independent Offices Appropriations Bill requiring cost sharing for all independent R&D. The idea, apparently, is to persuade Congress to amend the bill when it reconvenes January 19.

What rankles most about the new law is that it not only relates the amount of cost sharing to the "benefit accruing" from the work, but it requires cost sharing on all unsolicited proposals, industry's included.

For its part, NASA has already drawn up preliminary contracting instructions for its \$3 billion R&D allotment to comply with the new statute for all independent R&D proposals accepted, including such things as experiments which are not planned for specific satellite projects and other applied research. And while the new NASA rules are not specifically retroactive, extensions or supplements of existing contracts or grants which developed out of either solicited or unsolicited proposals will be considered new procurements within the new statute. NASA's new regulations would thus preclude profit payments.

The only area of the Defense Department affected by the new law is in civil defense. But should the initial mood of the 91st Congress prevail into its second session, cost sharing could become a fact of life for all agencies.

Electronics Newsletter

Tv X-ray labeling to start Jan. 15

January 15 will be anything but a red letter day for television set makers. That's the date after which every tv receiver made—black-and-white or color—will have to carry a label stating that it meets the new Federal standard of maximum allowable X-ray emission: 0.5 milliroentgen per hour measured two inches from any point on the outside of the set.

The standard, the first to become law under the Radiation Control for Health and Safety Act, becomes increasingly stringent with the passing of time. Sets produced after January 15, for example, must comply with the standard even if the viewer adjusts the set's external controls in such a way as to increase the set's capacity to produce the deadly rays. Sets made after June 1, on the other hand, must meet the standard even when both external and internal controls have been adjusted in this way. And finally, after June 1, 1971, all sets must meet the standard even under conditions of component or circuit failure and even if operated at up to 130 volts.

MOS tester features 2-Mhz data rate

An MOS/LSI tester that will do both d-c and functional testing at the wafer probe point will probably be the fastest available when it's unveiled next month by the Macrodata Co., a new firm in Chatsworth, Calif. President William C.W. Mow says the unit, which will cost \$235,000, gets repetition rates up to 2 megahertz down to the prober. Today's best for functional testing is about 30 kilohertz. The key to the big speed boost: putting the tester's driver/comparator only 2 inches from the probe head, reducing the noise that can degrade the performance of such testers. The 2 Mhz speed is faster than most metal oxide semiconductor logic. Mow says the unit will test a chip with 80% confidence.

It includes the testing station and all associated electronics (but not a probe head), an Interdata computer with 15,000 words of memory, plus an additional 2 million bytes of disk memory, and a teletypewriter setup.

Mow feels testing is the key to efficient MOS/LSI design, and once this tester is in production (shipments are expected to begin in April), Macrodata will turn more of its resources to an automated design system for MOS/LSI and a minicomputer that will probably reach the market in 1971.

Addenda

The FCC is holding hearings January 22 and 23 in Washington to hear arguments on two proposals to provide additional frequency space for land mobile radios. One is to share uhf-tv channels 14 through 20 in 25 major urban areas. The other would allocate a total of 115 megahertz of additional spectrum space in the 806 to 960 Mhz band—75 Mhz to common carrier systems and 40 Mhz to private systems—in major urban areas. . . . Manufacturers of air-ground radiotelephone equipment have something to cheer about. After a 12-year development phase, the FCC has finally decided such service is feasible. So as of Feb. 16 regular service will start with 12 channels in the frequency ranges 454.6625 to 455 Mhz and 459.6625 to 460 Mhz with 25 kilohertz channel spacing. Up to four channels will be permitted in some major air hubs, although only one licensee will be authorized in any one location.

TELEVISION

New phosphor system makes color bright 85® tubes brightest yet.

Improved dusting techniques and new phosphor system boost brightness to 30% greater than former industry standard.

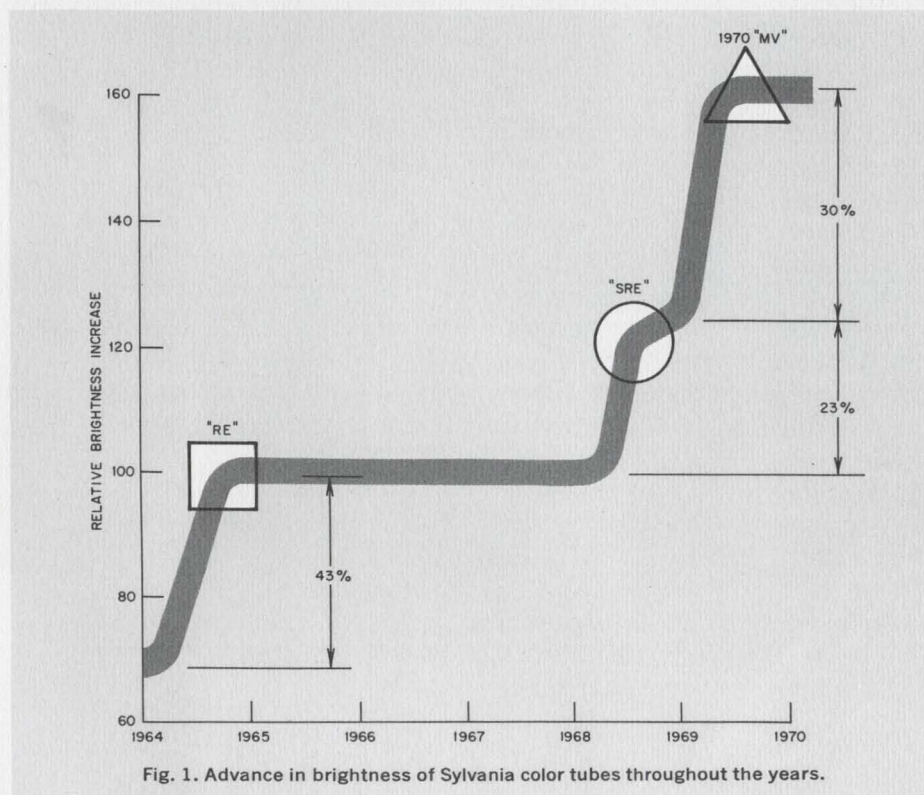

Fig. 1. Advance in brightness of Sylvania color tubes throughout the years.

Sylvania has traditionally led the way in color-tube brightness. Now we've done it again with a 30% increase in brightness at no increase in cost. The result is a tube that is competitive with recently announced "brighter" tubes, but without the added complexity and cost.

The new color bright 85® MV tube depends upon new developments in manufacturing processes and basic changes in the phosphor system to achieve its greater brightness.

In manufacturing color picture tubes, many other manufacturers use the slurry technique to deposit phosphors. This method inherently limits the size of the phosphor particles that

can be deposited. The result is that the density of the phosphor powder on each dot is not necessarily optimum for maximum brightness. It is also difficult to obtain a smooth, uniform coating.

Sylvania developed and patented the original dusting process many years ago. Now we've refined these techniques to provide an even more uniform distribution of Sylvania's larger phosphor particles. In dusting, the photolithographic material is applied as a thin uniform film on the face of the picture tube. While the film is still wet, the appropriate dry phosphor is injected into the system in the form of an air-dispersed particulate cloud.

The phosphor particles deposited on the film are absorbed by the wet photolithographic material. The result is, in effect, a rapid-drying mixture of uniform thickness and density. The overall effect of the differences in screening processes is an intrinsic brightness advantage for Sylvania's unique dusting system.

In phosphor technology, Sylvania has always been out in front. The increase in brightness of Sylvania color tubes over the years is shown in Fig. 1. Sylvania has now developed a europium-activated yttrium oxide phosphor that gives a net increase of more than 50% in red brightness over the pre-1968 Sylvania vanadate phosphor. This increase was obtained through the improvement of raw materials and carefully controlled manufacturing processes.

All color picture tubes use a zinc-cadmium sulfide as the basic green

continued on next page

This issue in capsule

Integrated Circuits

How to use full adders to make binary converters.

CRT Modules

Integrated display module line expands.

Circuit Modules

New techniques cut NAFI module cost.

Hybrid Microelectronics

How to use our versatile video amplifier.

Microwaves

These rugged tunnel diodes can really take it.

Diodes

Silicon high-voltage diodes can cut TV costs.

phosphor. Sylvania has achieved a substantial green brightness increase by optimizing particle size, changing the activator from silver to copper, and by changing the zinc-cadmium ratio.

The basic blue phosphor for all color tubes is zinc sulfide. By proper selection and control of the types and amounts of activators, Sylvania has been able to increase the brightness of the blue phosphor.

The net result of all of this development work is the new *color bright 85 MV*, a tube that offers you a choice of more brightness or more contrast than any competitive tube and a balance between the two that is competitive with any other tube on the market. Fig. 2 shows the white-field brightness as related to glass transmission characteristics. Note that the *color bright 85 MV* achieves a brightness level of 40 foot-lamberts with 60% transmission panel.

Other features of the MV tube include a temperature compensated shadow mask and Sylvania's sharp focus electron gun. But, and probably most important, all of these advances have been attained at no increase in cost over our previous tube. Isn't the *color bright 85 MV* the tube to consider in your next design?

CIRCLE NUMBER 300

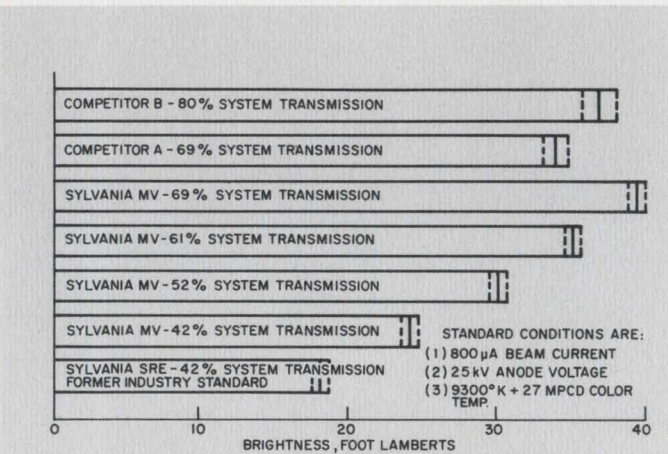

Fig. 2. White-field brightness of the *color bright 85 MV* as compared to competitive types.

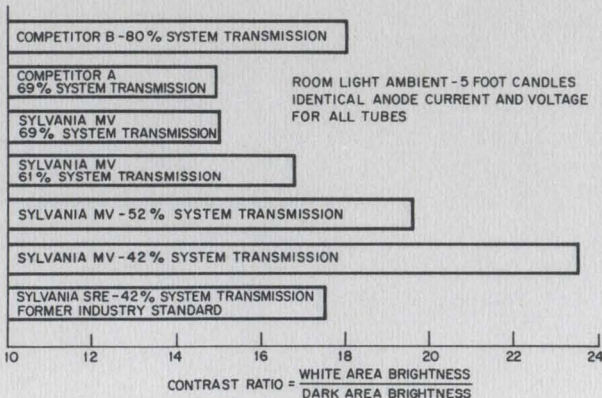

Fig. 3. Contrast ratio of the MV tube in comparison with other types.

INTEGRATED CIRCUITS

How to use full adders to make BCD-to-Binary converters.

Simple design gives high-speed operation, eliminates need for clock pulse.

Conversion of binary-coded-decimal (BCD) numbers to straight binary numbers can be simplified by using full adders instead of shift registers which require a clock pulse.

The design principle involved is easily understood once the basic notation is expanded in a certain manner. For example, the decimal number 79 can be expressed as 7×10 plus 9×1 . The $\times 10$ and $\times 1$ are implied by position. A complete expression for 79 in BCD is $(0111)_2 (10)_{10} + (1001)_2 (1)_{10}$.

This value can also be represented by $(0111)_2 (8+2)_{10} + (1001)_2 (1)_{10}$. It can be seen from this that the value of this number can be obtained by adding the BCD bits after they have been multiplied by the proper value of 2.

$$\begin{aligned} \text{That is: } & (1001)_2 (1)_{10} = 0001001 = 9 \\ & (0111)_2 (2)_{10} = 0001110 = 14 \\ & (0111)_2 (8)_{10} = 0111000 = 56 \\ & \hline & 1001111 = 79 \end{aligned}$$

A general expression for a BCD character is $A2^3 + B2^2 + C2^1 + D2^0$. If we use U to represent the units character and a T to represent the tens character, a BCD number may be expressed as $T_4 T_3 T_2 T_1 U_4 U_3 U_2 U_1$.

Applying these representations to the preceding table, we have:

$$\begin{array}{r} U_4 U_3 U_2 U_1 \\ T_4 T_3 T_2 T_1 0 \\ T_4 T_3 T_2 T_1 0 0 0 \\ \hline 2^6 2^5 2^4 2^3 2^2 2^1 2^0 \end{array}$$

where multiplication by the proper power of 2 is obtained by the positions of the T's and U's in the addition.

This notation is used in the diagrams of Fig. 1 and Fig. 2. Both of these logic diagrams are designed to convert BCD numbers to binary numbers.

The form of Fig. 1 makes use of eight/full SM-10 adders arranged as a ripple adder. The output of any one stage cannot begin to settle until all of its inputs have settled. Using ripple adders is a relatively slow technique, but the circuit is simple and its response is more than adequate when the inputs may be coming from BCD switches. Conversion time is typically less than 100 nanoseconds.

The circuit of Fig. 2 makes use of eight SM-30 independent-carry adders and 2 SM-40 carry decoders. In this configuration, the output of any stage can start to settle as soon as the independent carry from all preceding stages has settled. These independent carriers settle in parallel and thus the conversion time is faster, typically less than 70 nanoseconds.

Both of these systems make use of the fact that the 8th adder does not generate a carry out. This is because T_4 and T_3 can never be true at the same time in a BCD number. The same fact is also true of the last stage of the adder that produces the 2^6 output.

These methods of BCD-to-binary conversion have the advantages of high speed and simple design. In addition, a clock pulse or pulse train is not required.

When using BCD number of more than two characters, the procedure is the same. In this case, the hundreds character, H, is multiplied by $(64+32+4)$ and the thousand character, K, is multiplied by $(512+256+128+64+32+8)$.

CIRCLE NUMBER 301

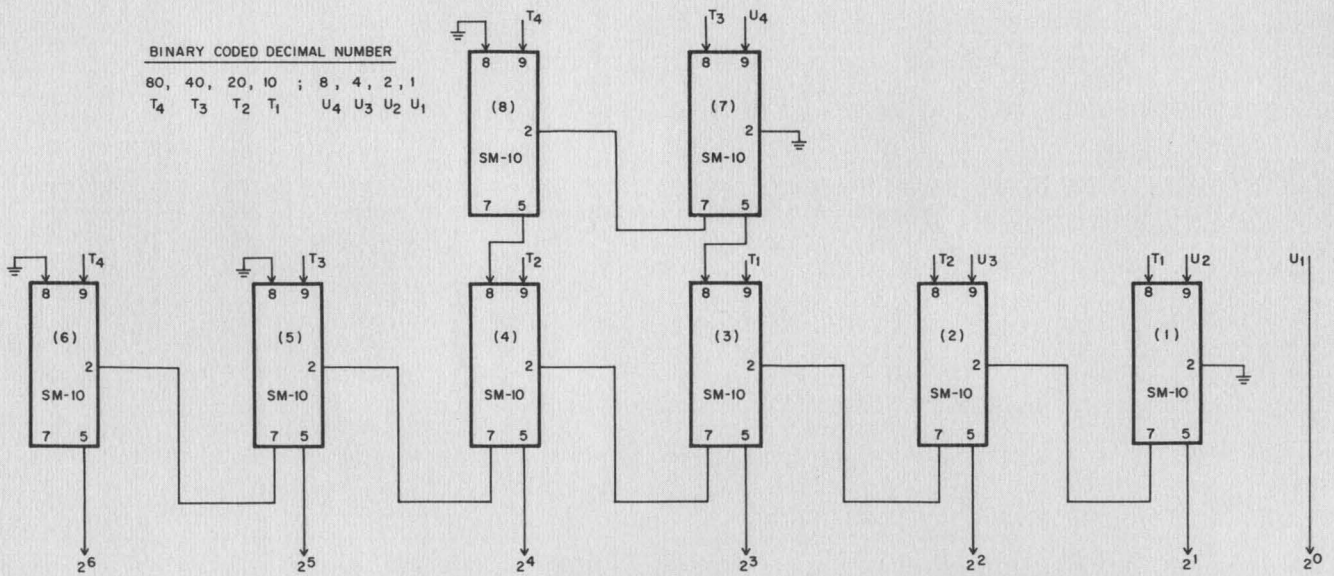

Fig. 1. Simplest form of BCD-to-binary converter uses 8 full adders in a ripple-carry circuit.

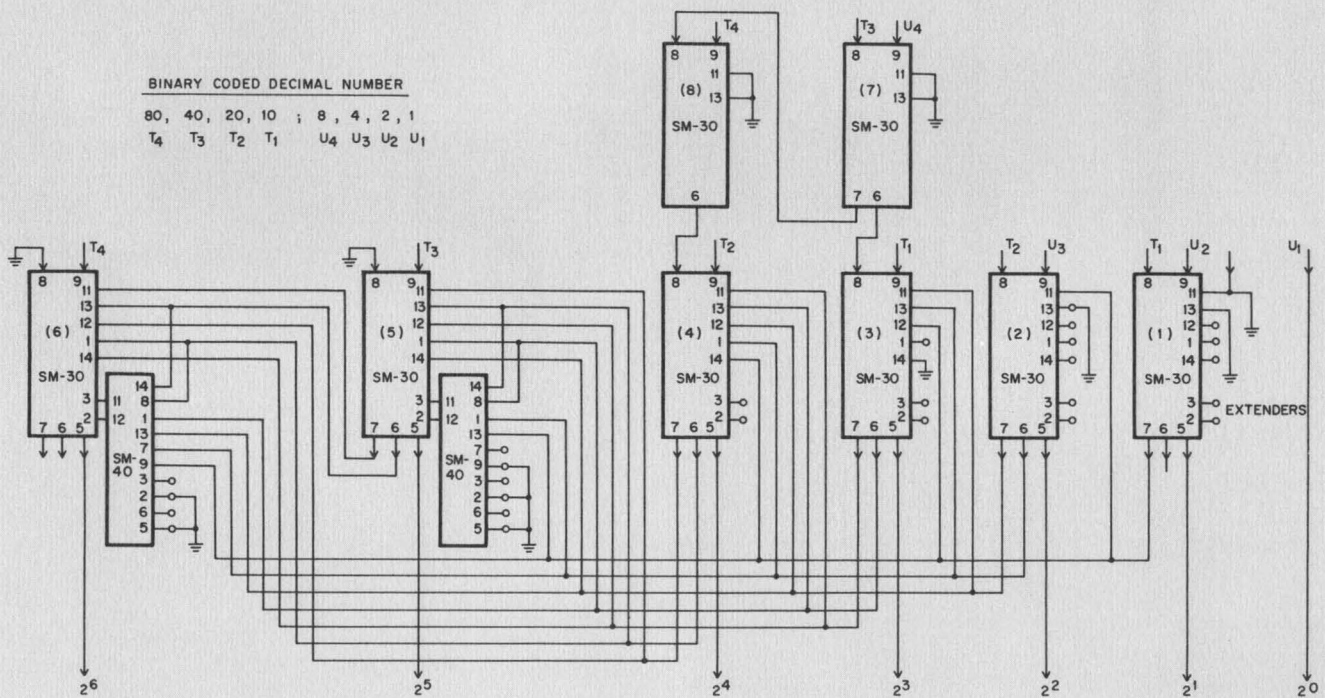

Fig. 2. More complex BCD-to-binary converter uses 8 independent carry adders and 2 carry decoders to obtain conversion time of less than 70 nanoseconds.

CRT MODULES

Integrated display module line expands.

We've added variety to our popular line of compact CRT readout systems.

A few issues ago, we introduced our new 12" CRT display module. This module contains all of the electronics needed to drive the CRT and is available with or without cabinet. Apparently, we introduced something a lot of people had been waiting for, because the response has been a pleasant surprise. So far, we've received individual orders for up to 1000 units.

Now, we've expanded the line still further to give you a wider range of 90° tube sizes, all in the same chassis, modified physically and electrically to fit the particular tube size chosen. The all-solid-state chassis contains circuits for tube electrode voltages, power supplies, and video or blanking amplifiers. All you supply are the input signals.

Our long experience with cathode-ray tubes and associated circuitry enables us to offer you a wide variety of options within a single standard package. For example, you can have your choice of tube phosphors, and we can provide anti-reflection panels bonded to the face of the tube selected.

Although the monitor chassis may look standard, we can also make many variations in the circuitry to adapt it to your particular needs including the addition of correction

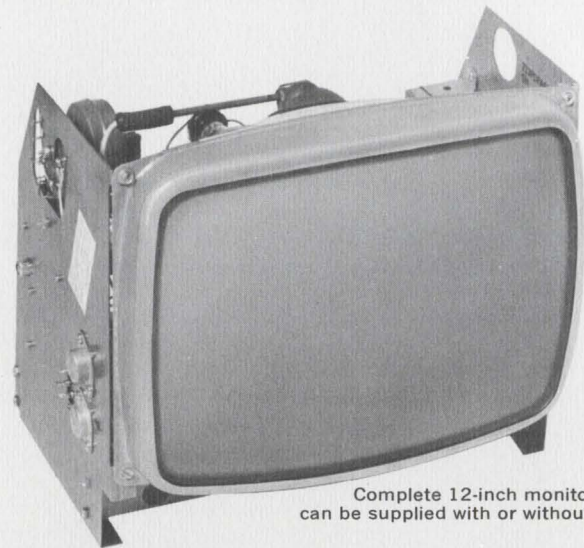

Complete 12-inch monitor module can be supplied with or without cabinet.

circuitry, for example. Systems are available for either AC or DC operation.

These monitors are suitable for rack, console or cabinet mounting. Units supplied with cabinet come complete with anti-reflection panel.

Price is another advantage of our new module line. We can probably supply a module tailored to your specifications at a price lower than it would cost you to build it yourself.

All you have to do is let us know the size tube you want and what your X, Y and Z input requirements are. We'll do the rest.

CIRCLE NUMBER 302

CIRCUIT MODULES

New techniques cut NAFI module cost.

Thick-film resistors are used in new modules to lower cost and increase reliability.

We've now expanded our line of NAFI modules to 82 types. Three of the latest types are the MDL line driver, MDM line receiver, and MDN line terminator.

In the line terminator we've combined Standard Hardware Program techniques with thick-film technology to obtain a compact, reliable unit that can be produced at lower cost.

The MDL line driver module consists of six driver circuits and a 1.3 μ s one-shot circuit. Each driver is capable of driving 500 feet of cable. When a logic "1" is applied to both timing inputs, a 5-Volt, 1.3 μ s pulse is generated at those output terminals whose corresponding data input terminals have been set to a logic "1". The timing output signal is a complementary 1.3 μ s pulse, approximately coincident with the other output signals.

The MDM line receiver module is designed to work with the line driver. The module consists of six receiver circuits with transformer coupled inputs. The output of each of these circuits drives a flip-flop. There are two ENABLE and two RESET inputs. Each services three of the receiver circuits. When the ENABLE circuit is set at logic "0", the flip-flops are independent of the transformer coupled input signals. Application of a logic "0" to the RESET terminals will clear the flip-flops. The test input terminals can be used as output terminals when use of the flip-flops is not required. Each receiver has a built-in propagation delay of 500 μ s so that the unit will not respond to transients.

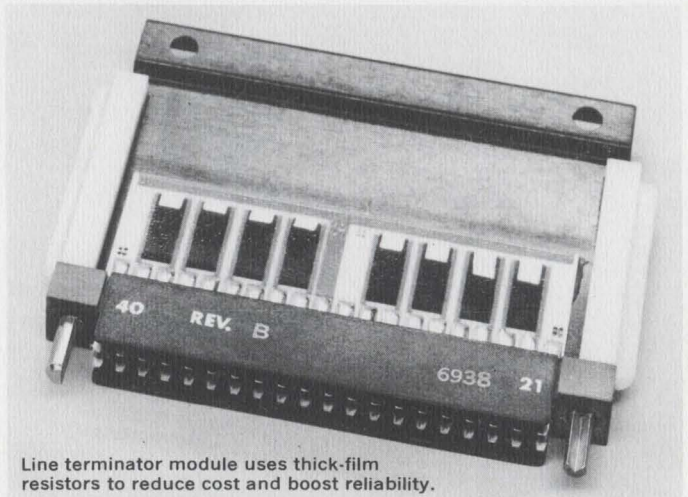

Line terminator module uses thick-film resistors to reduce cost and boost reliability.

The MDN line terminator is a module containing sixteen 75-ohm thick-film resistors. Each resistor is capable of dissipating an average power of 100 mW or a peak power of 430 mW with a 1.45 μ s duration.

Like the other modules in the NAFI series, these units meet the stringent requirements of the Navy's Standard Hardware Program. For example, reliability specifications for NAFI modules require a 30,000-hour minimum operating life. Also, makers of NAFI modules must maintain their qualification through periodic testing by government quality assurance personnel.

At our circuit assemblies facility at Muncy, Pa. we have produced over 25,000 NAFI modules to date. As a qualified supplier of NAFI modules for the Poseidon program, we have developed and manufactured a broad line of modules. We'd be only too happy to give you complete specifications on the entire line.

CIRCLE NUMBER 303

HYBRID MICROELECTRONICS

How to use our versatile video amplifier.

Here are three applications for Sylvania's wide-range MS-100A hybrid microelectronic unit.

Our MS-100A is a versatile 0 to 20 MHz video amplifier that packs 700 mW of output power (175 mA of output current) into a one-inch-square package. The three applications described here are only typical of the many uses for this microelectronic video amplifier.

In the application of Fig. 1, the problem was to design a unity-gain DC/video summing amplifier with 10 inputs. The amplifier had to be able to handle large-amplitude 100-ns pulses with fast risetime and low overshoot. The performance of the MS-100A in this application is shown in Fig. 1 and the accompanying waveforms.

The second application required a DC/video amplifier for a 50-ohm system. The amplifier had to have a 50-ohm input impedance and a voltage gain of 10. It was required that the circuit be capable of driving a 50-ohm load to ± 5 Volts. The solution was to use the MS-100A as a video power amplifier as shown in Fig. 2. The accompanying waveform shows the large-signal, high-frequency performance of the MS-100A. The signal shown is a 2-MHz sine-wave output into a 50-ohm load.

In the third design, a wideband DC/video amplifier was

required for a non-inverting unity-gain application. The system required that the amplifier have a high input impedance and a low output impedance at video frequencies. The solution to this design problem was to use the MS-100A in the non-inverting configuration shown in Fig. 3. The resulting circuit provided an input impedance of 5000 ohms and an output impedance of less than 2 ohms.

In addition to these applications the MS-100A has been used in many other ways; for example, as a low IM distortion preamplifier for 100-kHz RF signals. All IM products in the preamplifier were down 65 dB or more with the MS-100A driving two 1-Volt rms 100-kHz signals into a 50-ohm load.

Another application is the use of the MS-100A as a high speed sample-and-hold circuit with an FET gate. This circuit was capable of sampling 200-ns pulses to 10-mV accuracy.

A final example of the versatility of the MS-100A is its use as a wide dynamic range, ultra-linear AM detector for a 455 kHz IF system. This detector supplied an IF gain of 20 dB as well as 1 dB linear detection from 0 to -50 dBm at the input.

Although the MS-100A video amplifier is one of our growing list of off-the-shelf hybrid microelectronic devices, we are able to provide complete design facilities for custom devices as well.

We have the long experience in hybrid technology that allows us to make many variations on basic designs and to develop new designs to your specifications. Our design engineering team is ready and waiting to solve your microelectronics problems.

CIRCLE NUMBER 304

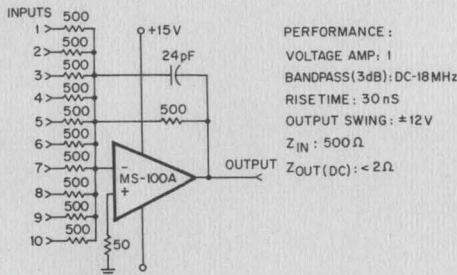

PERFORMANCE:
VOLTAGE AMP: 1
BANDPASS(3dB): DC-18MHz
RISETIME: 30 ns
OUTPUT SWING: ± 12 V
 Z_{IN} : 500 Ω
 $Z_{OUT}(DC)$: $< 2 \Omega$

Fig. 1. The MS-100A used as a summing amplifier.

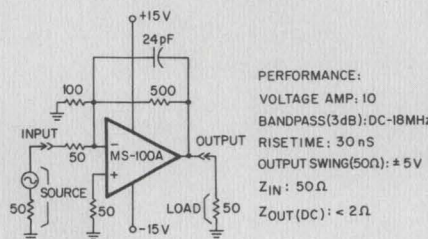

PERFORMANCE:
VOLTAGE AMP: 10
BANDPASS(3dB): DC-18MHz
RISETIME: 30 ns
OUTPUT SWING(50 Ω): ± 5 V
 Z_{IN} : 50 Ω
 $Z_{OUT}(DC)$: $< 2 \Omega$

Fig. 2. The MS-100A as a video power amplifier.

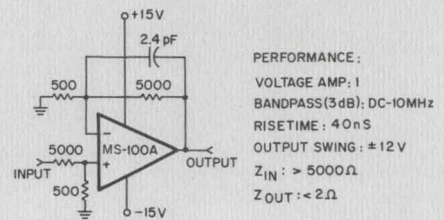

PERFORMANCE:
VOLTAGE AMP: 1
BANDPASS(3dB): DC-10MHz
RISETIME: 40 ns
OUTPUT SWING: ± 12 V
 Z_{IN} : $> 5000 \Omega$
 Z_{OUT} : $< 2 \Omega$

Fig. 3. MS-100A in the non-inverting configuration.

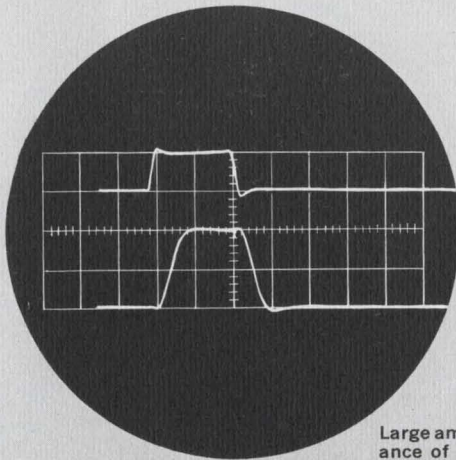

Large amplitude pulse performance of MS-100A. Input is the top scale and output is at the bottom. Vertical scale: 1V/cm (bottom). Horizontal sweep is 50 ns/cm for both traces.

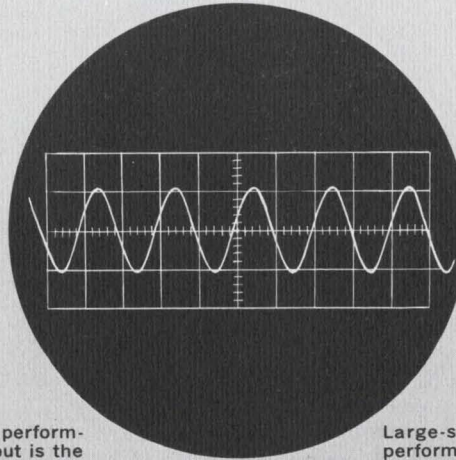

Large-signal, high-frequency performance of MS-100A. Signal shown is a 2-MHz sine-wave output into a 50-ohm load. Vertical scale: 5V/cm.

MICROWAVES

These rugged tunnel diodes can really take it.

Germanium diodes use solid-structure planar techniques to get high reliability.

We've got a complete line of planar tunnel diodes that can really stand up to rugged environments. They're ideal for use in microwave medium-noise amplifiers, oscillators and as RF amplifiers in phased array radars. Typical V-I characteristics and the small-signal equivalent circuit are shown in Fig. 1.

The planar construction contributes to the extreme ruggedness of these devices. All of these devices are capable

of withstanding the shock and vibration characteristics encountered in space applications. Silicon dioxide passivation is used on all junctions.

As an example of the ruggedness of these tunnel diodes, diode chips were subjected to cryogenic cycling. All electrical characteristics were tested after this treatment and were found to be unchanged.

Physically, the diode structure remained intact and the passivating oxide layer did not peel or crack. Temperature characteristics of these diodes from +135°C to -195°C are shown in Fig. 2.

All of the diodes in this family are available in packages, pin mounted, or in chip form. All diodes are fully tested at the factory before shipment.

If you have a tunnel diode application, why not investigate this rugged, low-cost family of diodes today?

CIRCLE NUMBER 305

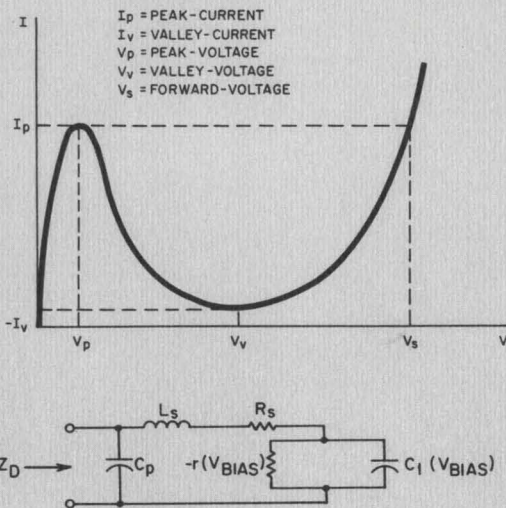

Fig. 1. Typical tunnel diode V-I characteristic and small-signal equivalent circuit.

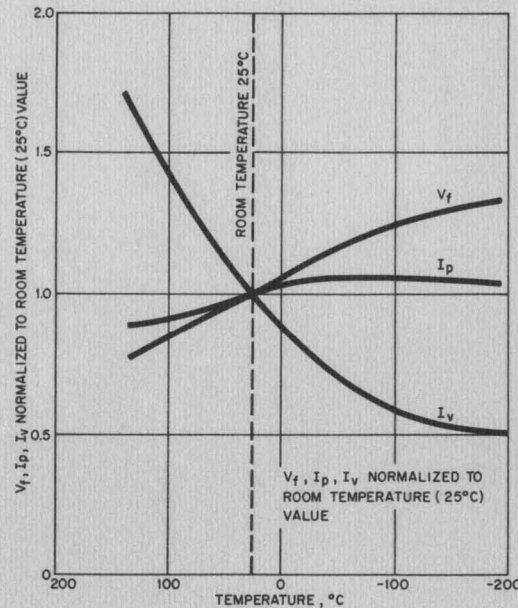

Fig. 2. Tunnel diode DC temperature characteristics normalized to 25°C room temperature value.

Characteristics of tunnel diode family

Line Number	Type* Number	Package Outline	Type Number	Package Outline	Type Number	Package Outline	I_p^1 ma ±20%	τ_j ohms typ.	R_s ohms max.	C_j pf max.	f_{ro} GHz min.
195	D5361	048	D5561	084	D5571	082	1.8	67	7.0	2.0	5.0
196	D5361A	048	D5561A	084	D5571A	082	1.8	67	3.0	0.60	25
197			D5561B	084	D5571B	082	1.8	67	6.0	0.70	15
198	D5362	048	D5562	084	D5572	082	2.7	44	6.0	3.0	5.0
199	D5362A	048	D5562A	084	D5572A	082	2.7	44	2.5	0.75	25
200			D5562B	084	D5572B	082	2.7	44	6.0	1.0	12
201	D5363	048	D5563	084	D5573	082	3.9	31	6.0	5.0	5.0
202	D5363A	048	D5563A	084	D5573A	082	3.9	31	2.0	1.00	25
203			D5563B	084	D5573B	082	3.9	31	6.0	1.60	10
204	D5364	048	D5564	084	D5574	082	5.6	22	6.0	7.0	5.0
205	D5364A	048	D5564A	084	D5574A	082	5.6	22	1.5	1.40	25
206			D5564B	084	D5574B	082	5.6	22	6.0	2.30	7.5
207	D5365	048	D5565	084	D5575	082	8.2	15	6.0	10.0	5.0
208	D5365A	048	D5565A	084	D5575A	082	8.2	15	1.0	2.00	25
209			D5565B	084	D5575B	082	8.2	15	6.0	3.30	5.5

*Three basic categories are specified for each value of peak current, the type number suffix indicates the category: Blank Suffix—General Purpose UHF "A" Suffix—High Cutoff Frequency "B" Suffix—Short Circuit Stabilized

DIODES

Silicon high voltage diodes can cut TV costs.

Diode tripler and quadrupler assemblies can provide the anode supply voltage needs of modern color sets with improved high voltage regulation.

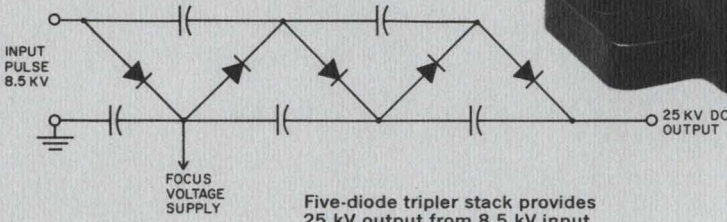
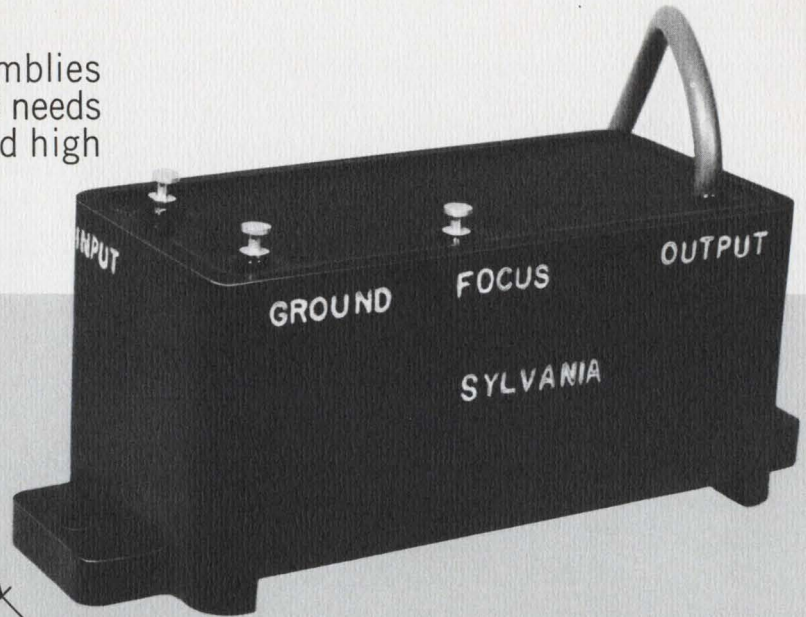

If you're trying to cut costs in TV set designs without cutting corners, you should talk to our diode engineers. They have developed high-voltage multiplier circuits that may be just what you need. They'll work with you to adapt these units to your design.

The big advantage of designing-in our HV multipliers is that you can eliminate the high-voltage cage and all of its associated hardware. You also get better high-voltage regulation since the loosely coupled tertiary flyback winding is eliminated.

The circuit of one of our triplers is shown in the illustration. With an 8.5 kV input from the flyback transformer it puts out 25 kV DC to the color tube anode and can be loaded up to 2.5 mA output current with minimal drop in

output voltage. Note that a suitable tap for focus supply voltage is provided.

Each diode stack in the tripler circuit is carefully matched and can be delivered molded along with the capacitors in a plastic package. The resulting unit will meet all the environmental requirements of solid state and hybrid color sets; such requirements include over-voltage surges, arcing, and ambient temperature conditions.

Since each application is unique, we aren't offering these voltage multipliers as off-the-shelf items. Our engineers will work with you to design a unit tailored specifically to your needs. And they'll show you how you can cut costs in the design of your high-voltage power supplies.

CIRCLE NUMBER 306



Use Sylvania's "Hot Line" inquiry service, especially if you require full particulars on any item in a hurry. It's easy and it's free. Circle the reader service number(s) you're most interested in; then fill in your name, title, company and address. We'll do the rest and see you get further information by return mail.

BUSINESS REPLY MAIL

No Postage Stamp Necessary if Mailed in the United States

FIRST CLASS
Permit No. 2833
Buffalo, N.Y.

POSTAGE WILL BE PAID BY

Sylvania Electric Products Inc.
Sylvania Electronic Components
1100 Main Street
Buffalo, New York 14209

Dept. E 1 1

MANAGER'S CORNER

The marketable advantage in color tubes.

Recently two major manufacturers almost simultaneously announced the development of "improved" color picture tube systems. Although the systems differ slightly, each achieves a substantial increase in brightness—and brightness has been the name of the claim-game for the past five years. More recently other manufacturers have announced production plans to switch to the new system to stay competitive.

For the first time since 1964 the Sylvania leadership in brightness appeared to have been dramatically challenged. This development confronted Sylvania with several problems. First of all, at the time of these developments, Sylvania was preparing to announce a new, even brighter *color bright 85*[®] tube which did not employ the new techniques. Secondly, and most important, there was the question of what would be the marketable advantages provided by the competing systems.

In 1964 Sylvania introduced the first rare earth europium phosphor screen which replaced the all-sulfide system and provided bright, rich reds that unleashed the then suppressed blues and greens. Although every other color picture tube manufacturer has since adopted this basic system, Sylvania has maintained a traditional leadership in brightness. In 1964 Sylvania announced a 42 percent increase in brightness and again in early 1968 another 23 percent white-field brightness increase was achieved.

For 1970 the new *color bright 85 MV* offers a 30 percent brightness increase over the 1969 version. More important, now that the industry has had time to compare the other new tubes to our new tube, it is apparent that the *color*

bright 85 MV offers certain distinct marketable advantages to the set manufacturer.

The first is flexibility in both brightness and contrast. The TV set manufacturer is not locked in on a standardized transmission panel. Where one manufacturer decides that maximum contrast is critical, a 42-percent transmission panel in conjunction with the new *color bright 85 MV* phosphor system will provide greater contrast than is attainable from any other available tube. Conversely, a 69-percent transmission panel on a *color bright 85 MV* tube will provide the brightest picture available to the industry. It should be noted here that an average transmission panel will provide brightness and contrast which are visually very close to the other new tubes.

There is an even greater benefit in cost to set manufacturers. The new *color bright 85 MV* is being offered at no increase in price because the vast improvements come from a new phosphor system and improved dusting techniques. The competitive tubes, on the other hand, require extra processing steps which add substantially to the cost of manufacturing. And this comes at a time when there is extreme pressure on manufacturers to lower set costs: at a time when cutting a nickel out of the price of a picture tube is considered significant.

While the competitive systems have allowed other manufacturers to be brightness competitive there is still no tube which offers a significant advantage over the *color bright 85 MV*. Sylvania believes our increased flexibility and lower unit cost outweigh the value of closing the brightness gap. The ultimate decision will, of course, be with our customers.

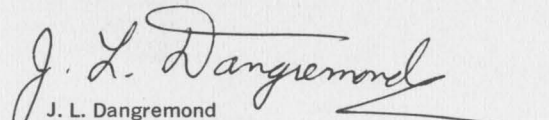
J. L. Dangremond
Product Sales Manager

This information in Sylvania ideas is furnished without assuming any obligations.

SYLVANIA

GENERAL TELEPHONE & ELECTRONICS

NEW CAPABILITIES IN: ELECTRONIC TUBES • SEMICONDUCTORS • MICROWAVE DEVICES • SPECIAL COMPONENTS • DISPLAY DEVICES

E1

NAME _____

PLEASE PRINT

TITLE _____

COMPANY _____

ADDRESS _____

CITY _____ STATE _____ ZIP _____

Circle Numbers Corresponding to Product Item

300 301 302 303 304 305 306

Please have a Sales Engineer contact me.

Visit Phone... Phone No. _____ Area Code _____



HOT LINE INQUIRY SERVICE

Need information in a hurry? Clip the card and mail it. Be sure to fill in all information requested. We'll rush you full particulars on any item indicated.

You can also get information using the publication's card elsewhere in this issue. Use of the card shown here will simplify handling and save time.

For continuous lacing...

* that **CABLE-LACER** brake speeds the work too!

The experienced harness worker can quickly guide the hooked needle of the Gudebrod Cable-Lacer* across narrow break-out points between pins to grasp the loop. This is where work is speeded first. But then, the pressure of four fingers on the lacing break allows a swift, single pull for firm knot setting—further speeding the job. No need for wrapping around the fist—no need for a second pull. It all becomes a naturally fast procedure. What's more, the special Gudebrod lacing tape bobbins are helpful when all-hand tying seems required! Use Gudebrod Cable-Lacer, Gudebrod's Bobbins for improved accuracy and time saving.

*T.M. Union Special Machine Co.

Save money & time with **GUDEBROD SYSTEM "C"**

For continuous lacing Gudebrod offers a four part system to reduce your harnessing costs. The Cable-Lacer and Bobbins are the first two parts. Add to them Gudebrod's specially made, case hardened, extra long, wire holding pins and the Gudebrod Swivel-Tilt Harness Board Mount. The pins make wire threading easier and sharply reduce the need for re-dressing. The Gudebrod Mount brings any part of the harness within easy reach. Gudebrod System "C" makes harnessing go faster, cost less. Write for details. (For spot ties, ask about System "S")

Gudebrod Swivel-Tilt
Harness Board Mounts
available in several sizes

GUDEBROD
Electronics Division

1870—100 Years of Quality—1970

GUDEBROD BROS. SILK CO., INC. Founded 1870, 12 South 12th Street, Philadelphia, Pa. 19107

Problem:
Resolve laser-stimulated pulses
as short as 10 nanoseconds.

Solution:
The PAR™
High Resolution
Boxcar Integrator.

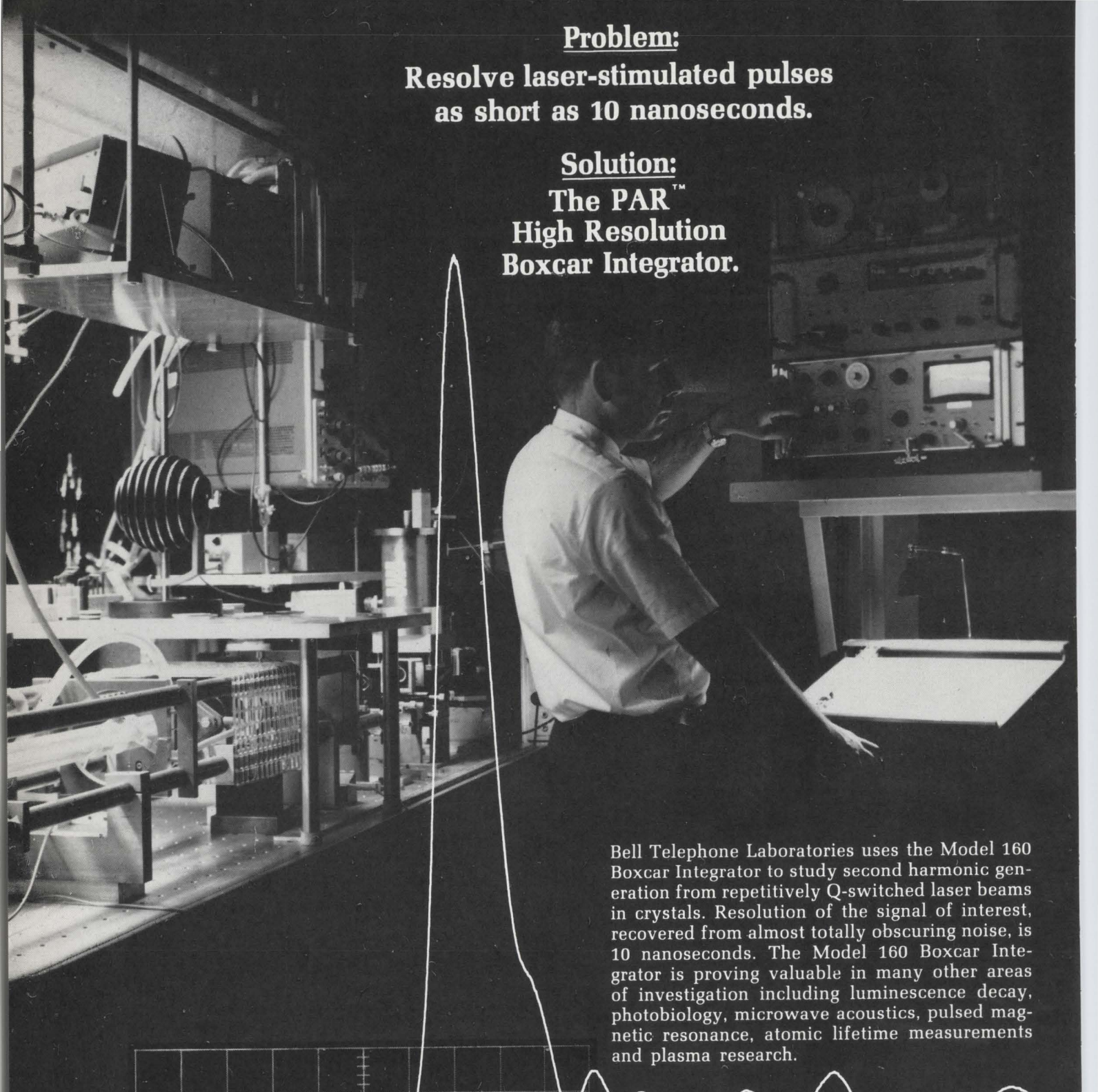

Bell Telephone Laboratories uses the Model 160 Boxcar Integrator to study second harmonic generation from repetitively Q-switched laser beams in crystals. Resolution of the signal of interest, recovered from almost totally obscuring noise, is 10 nanoseconds. The Model 160 Boxcar Integrator is proving valuable in many other areas of investigation including luminescence decay, photobiology, microwave acoustics, pulsed magnetic resonance, atomic lifetime measurements and plasma research.

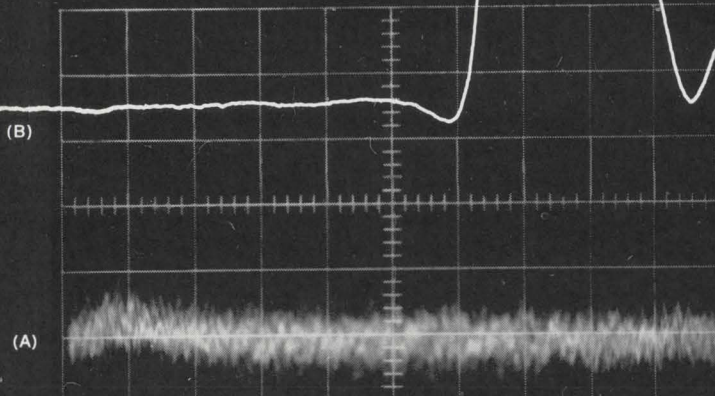

(A) Noisy signal to Boxcar Integrator.
(B) Recovered second harmonic signal at output of Boxcar Integrator.

If you have a problem where noise interferes with the recovery of repetitive complex waveforms, let us show you how you solve it with the Model 160 Boxcar Integrator (price: \$3,950) or another of our broad line of signal recovery instruments.

For information, write Princeton Applied Research Corporation, Box 565, Princeton, New Jersey 08540. Telephone: (609) 924-6835.



PRINCETON APPLIED RESEARCH CORP.

White House urges reorganization of telecommunications management

New agency would absorb National Communications System and FCC's frequency assignment role; Commerce would manage frequency

By Robert D. Westgate

Electronics staff

A new, stronger Office of Telecommunications Policy (OTP) to replace the Office of Telecommunications Management (OTM) is being proposed in a White House memorandum now being circulated quietly in the capital. The memo, signed by Peter M. Flanigan, special assistant to the President, is being sent to the agencies involved.

The proposed reorganization follows a number of studies of Federal communications organization, reorganizations, and shifts of responsibilities within the executive branch since World War II. The most recent included the December 1968 study by the Bureau of the Budget, and the Government Accounting Office report to Congress last summer.

Drop one job. As proposed, the OTM within the Office of Emergency Preparedness would be abolished and "all policy functions of that office not directly related to emergency preparedness should be transferred to the OTP, along with appropriate emergency planning functions, final spectrum management authority, and National Communications System responsibilities." William E. Plummer would lose one of the two hats he now wears in OEP. He serves as OEP acting assistant director and OTM acting director. The latter job has the rank of special assistant to the President, which also would be abolished.

The memo says that the OTM's record reveals that its attempts "... to exercise leadership in communications policy have been

largely ineffectual. The responsibilities and authority of the OTM are questioned by agencies with operating responsibilities," resulting "from a number of factors including organizational location, inadequate staff, and lack of clear authority."

The memo claims, "there is now no office in the Executive branch with the responsibility or the capability to review the whole range of national telecommunication policies as expressed in legislation and in FCC policies." It explains that the Antitrust division of the Department of Justice has occasionally filed briefs on the competitive aspects of decisions before the FCC, but these derive largely from antitrust considerations rather than from familiarity with communications issues.

Future aim. The Administration hopes that the new OTP would provide effective machinery for "dealing expeditiously with domestic telecommunications issues."

It admits the government had been "grappling for several years, with only limited success, with such issues as 'foreign attachments' to the public telephone network, cable tv, and pay tv, the possible uses and industry structure for a domestic satellite system communications system, and policies for computer communications."

During a 4-day hearing last month by the House subcommittee on space science and applications, its chairman, Rep. Joseph E. Karth (D., Minn.), continually led witnesses to say that they felt one of

the reasons satellite communications technology hadn't been used much domestically was the absence of a high-level (Presidential) communications policy statement. For example, the FCC now is awaiting a report being completed by a White House study group before it rules on applications for uses of communications satellites. The report will cover the directions the U.S. domestic satellite system should take.

The White House memo also suggests that the proposed reorganization might coordinate "procurement and use of telecommunications facilities by the Federal Government," which has been limited under the National Communications System, and make present procedures for spectrum allocation more flexible than they are, thus alleviating a spectrum shortage crisis—especially in the land mobile radio allocations area.

OTP duties. The director of the OTP, appointed by the President, "would have primary Executive branch responsibility for both national telecommunications policies and Federal administrative telecommunications," the memo states. The OTP's responsibilities would include:

- "Economic, technical, and systems analysis of telecommunications policies and opportunities in support of national policy formulation and U.S. participation in international telecommunications activities.

- "Developing Executive branch

U.S. Reports

policy on telecommunications matters including, but not limited to, industry organization and practices, regulatory policies, and the allocation and use of electromagnetic spectrum for both government and nongovernment use.

- "Advocating Executive branch policies to the FCC, and through the President to the Congress; and representing the Executive branch in FCC proceedings.

- "Exercising final authority for the assignment of the spectrum to government users, and developing with the FCC a long-range plan for improved management of the total radio spectrum.

- "Reviewing and evaluating the research and development for, and planning, operation, testing, procurement, and use of, all telecommunications systems and services by the Federal Government; developing appropriate policies and standards for such systems; and making recommendations to the Bureau of the Budget and responsible departmental officials concerning the scope and funding of competing, overlapping, or inefficient programs.

- "Exercising the functions conferred on the President by the Communications Satellite Act.

- "Under the policy guidance of the director OEP, coordinating plans and programs for testing of, and preparing for the use of, telecommunications resources in a state of national emergency.

- "Test, review, and report to the President, through the National Security Council, on the ability of national communications resources to meet established national security requirements efficiently and responsively.

- "Coordinating Federal assistance to state and local governments in the telecommunications field."

Top grads. The White House memo further recommends that the OTP be established with an initial strength of up to 30 professionals, including up to 15 at "super grade" levels (GS16 through GS18 with a salary range of \$25,049 to \$33,495). The director of the OTM would get \$40,000.

Commerce Secretary Maurice

Stans, President Nixon's old campaign manager, was thrown a bone which may make him happy after the rejection suffered at the hands of Defense Secretary Melvin Laird [*Electronics*, Nov. 10, 1969, p. 51], when he attempted a little empire building by trying to assume responsibility for national telecommunications affairs. The White House memo suggests "the major portion of frequency management direction of the OTM should be transferred to the Department of Commerce to provide the technical and clerical support functions" for a new Telecommunications Research and Analysis Center as a section under the Department of Commerce.

If the center were established in Commerce, 47-year-old Myron Tribus, assistant secretary for science and technology, would be in charge of its duties, including providing a centralized research, engineering and analysis capability in support of spectrum management, and—as the memo so bureaucratically puts it—"such other areas as may be required."

Last fall, Secretary Tribus let it slip [*Electronics*, Sept. 1, 1969, p. 14] that he thought Commerce was the only place for a Federal telecommunications authority to manage "electrospace." The White House memo states that Commerce now has a telecommunications research capability, but no responsibility or familiarity with communications policy. Neither the Council of Economic Advisers nor the Office of Science and Technology [within Commerce] are equipped to address the fundamental economic and institutional problems of the communications industry and its regulation by the FCC, or the problems of the government's own telecommunications."

Commercial electronics

Big squirt

While air pollution is an unnecessary and noxious evil, a group at Bendix Motor Components division has found what could be a silver

lining in the smoggy clouds. In fact, air pollution, or future state and Federal laws setting automobile exhaust emission levels, may open a veritable mother lode of a market for the Elmira, N.Y., facility—namely, electronic fuel injection.

According to Eugene Taurman, the division's manager of market planning, negotiations with Chrysler, Ford, and General Motors are in their final stages and Bendix expects to see its system riding on certain 1971 models, probably as an option [*Electronics*, Dec. 8, p. 33].

Deja vu. Electronic fuel injection is not new. In fact, it was this same division that eight years ago received patents on the basic electronic injection system, but shelved plans for a commercial system because the cost of the electronic components for the system was too high, and there was no real incentive to put such a system on cars.

Meanwhile, West Germany's Robert Bosch GmbH, under a Bendix license, introduced an advanced version of the original Bendix system on the Volkswagen 1600 series in 1968 [*Electronics*, March 17, p. 87].

The Bendix system is similar to Bosch's. In fact, it even uses several Bosch components—like the injectors, fuel pump, and pressure sensor.

In operation, fuel is pumped from the gas tank through a filter to a common rail, or metal tube, which runs around the top of the engine block and supplies all of the injectors. An electronic control unit varies the length of time the injectors are open by varying the width of a voltage pulse that triggers each injector's solenoid. A fuel-pressure control valve maintains a constant pressure in the rail. Further, there is a connection from the fuel pump to a so-called secondary, or return, fuel line which permits the pump to purge vapors from the system.

Checking. The injectors themselves are mounted at the intake valve of each of the engine's cylinders. The control unit determines the engine's fuel requirements from several sources, including a manifold pressure sensor, a full-load enrichment switch for acceleration,

ELECTRONIC CONTROL UNIT AND TRIGGER

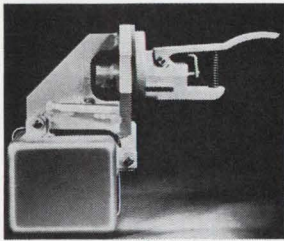

INJECTOR



THROTTLE BODY

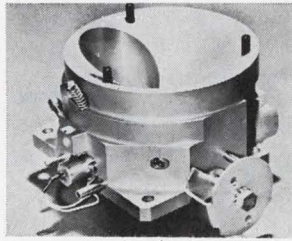

FUEL PRESSURE CONTROL VALVE

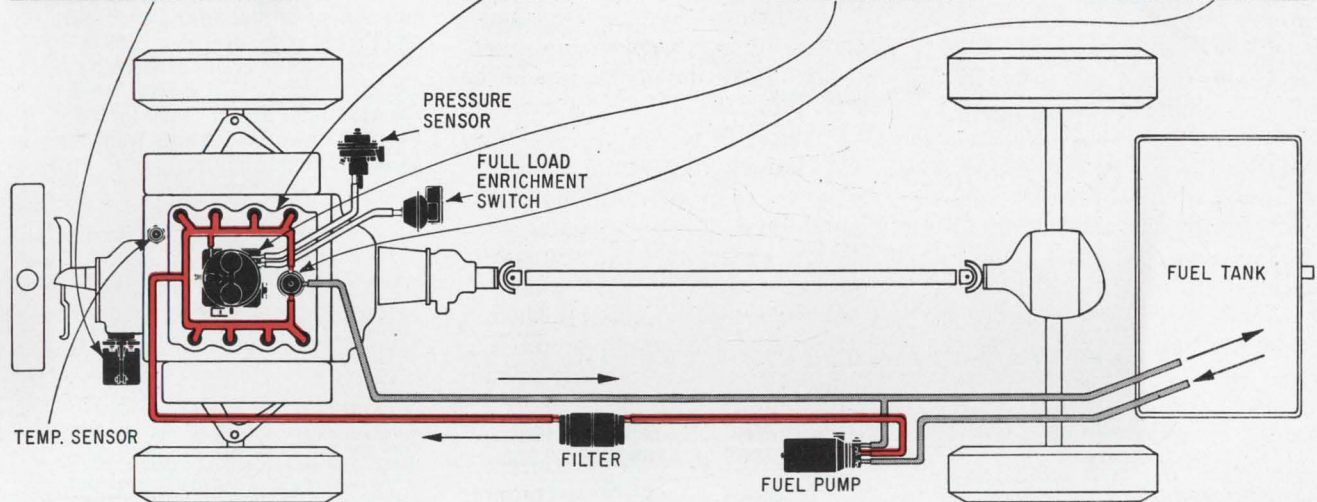
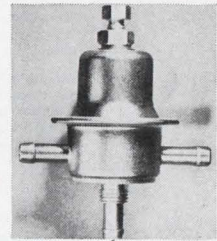

Gassed. Faced with ever-tightening antipollution laws, Detroit's automakers are warming to the virtues of electronic fuel injection. Pictured above is Bendix system now expected to ride on 1971 model cars as an option.

a coolant thermistor for warmup, and an engine speed sensing unit.

The major obstacle was the fact that "the engine compartment of a car is one of the meanest environments for electronic components," says Todd L. Rachel, staff assistant to the division's director of engineering. R-f generation, voltage transients, and voltage variation are just some of the terrors awaiting electronic components near an engine.

Transient voltages, for example, can go as high as 200 volts, so Bendix has tied all the electronics in its system directly to the battery, which effectively dissipates the transients. Also Bendix had to design all its circuits so that they would work with voltages that vary between 6 and 16 volts d-c. Further, all leads and the wiring harness must be far enough from the secondary ignition circuit. In addition, Rachel says, the entire system can take up to 10 G's of shock and that Bendix has estimated that there is a less than 1% rate of failure for solder joints as well as components for 50,000 miles of operation.

Heat's on. While Bendix makes no bones about drawing heavily on Bosch's experiences in designing such a system for the rear-engine, air-cooled Volkswagen, the division was pretty much on its own when it came to building a system for a front-engine American car, where temperatures are higher and moisture problems greater. Accordingly, all components are capable of operating at a minimum of 125°C and some as high as 200°C. Bendix also decided to remove the 5-ohm resistors that are in series with each injector from the control box to the wiring harness. In a car using eight injectors, that works out to 80 watts that don't have to be dissipated in the box.

Initially, the Bendix system will use discrete components, but Rachel says that several prototypes have already been built with integrated circuits, both digital and linear, with considerable success. Based on this success and the anticipated cost savings, Bendix anticipates using custom IC's—"probably diode transistor logic," says Rachel —by 1973.

Management

Who's the drummer?

Now that the long-simmering feud in the Electronic Industries Association has exploded into an open revolution, the issue to be settled is whether the members of the EIA's Consumer Products division receive full autonomy in all consumer activities or form their own association.

The conflict, brewing for some time before George Butler took office as EIA president last June, came to a head when Butler fired Jack Wayman, the division's staff vice president for seven years. Butler, annoyed by Wayman's alleged activities aimed at splitting the consumer group from the EIA, sacked Wayman without notifying division members. Many of those members, say industry sources, are angered by what they see as a new attack on their independence and are considering an association of their own.

With Butler seemingly moving toward a pool arrangement of divi-

Electronics Index of Activity

January 5, 1970

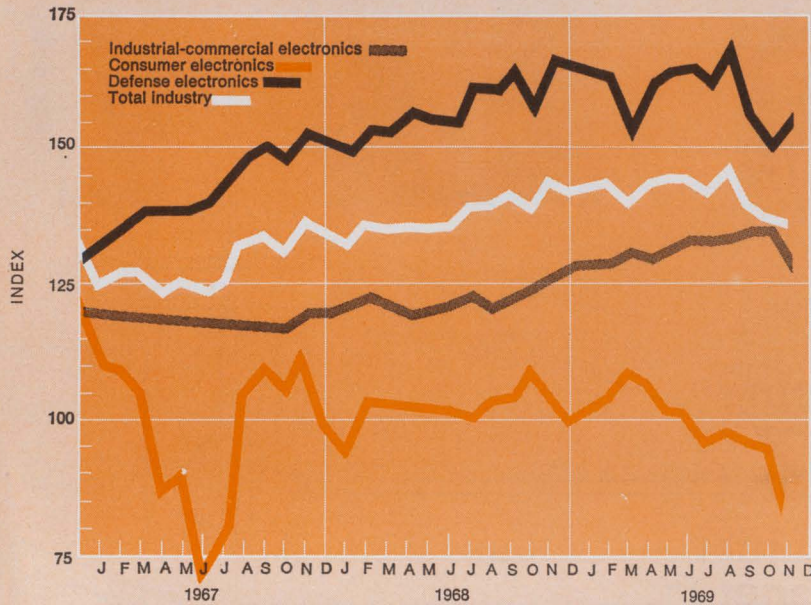

Segment of Industry	Nov. 1969	Oct. 1969*	Nov. 1968
Consumer electronics	84.9	95.0	105.7
Defense electronics	156.6	152.0	167.1
Industrial-commercial electronics	129.9	136.0	127.4
Total industry	136.5	137.5	145.0

Total electronics production continued downward in November for the third month in a row, dropping one full index point from the revised October figure to 136.5. It also was 8.5 points below the November 1968 total.

Defense electronics was the only component of the index to score a one-month gain, up 4.6 to 156.6. Industrial-commercial production lost a substantial 6.1 points, while the consumer sector really took a beating: down 10.1 points from the revised October figure.

Indexes chart pace of production volume for total industry and each segment. The base period, equal to 100, is the average of 1965 monthly output for each of the three parts of the industry. Index numbers are expressed as a percentage of the base period. Data is seasonally adjusted. *Revised.

sions through such things as an executive-level legislative council to set overall association policy, consumer members fear an end to the traditional independence of divisions. And other groups, notably parts and government products, are believed waiting to see if the consumer group can hold on to its autonomy within the EIA before making moves to strengthen their own independence. These groups, however, have little choice but to stay with EIA, because their membership is broad-based and overlaps other sectors of the industry.

Mitigating against a major split—even if consumer products makers want it—is the fact that many of the larger corporate members are also members of other EIA divisions, often several. Thus, consumer product members' anger leading to a possible split could well be cooled at higher management levels within their own companies. This could be a source of Butler's greatest strength.

The issues. At a series of meetings between EIA management and the consumer division's executive committee, the division added a stipulation to its old list—the right to hire and fire its own executives. The others: control over all division activities in legislative, marketing, engineering, and policy-making activities; reduction in dues paid by members to the EIA for basic membership; reduction of the EIA's seven divisions and two subdivisions to three broad groups (part of the EIA's reorganization plan of last June but never effected); a more independent title, such as the Consumer Electronics Association.

Unlike other divisions, the consumer group is a small, very close knit group, and considers itself a different breed from the government-industrial units. Thus, a decision to stay or split will be made without consulting the other groups. Butler himself is sure the Wayman supporters are pushing for a split, but doesn't see the effort

as any real threat to the association.

He points out that there are 24 companies in the consumer group—only two big ones, Zenith and Emerson, aren't among them—and “to be a viable group it would have to have 70% of them.” Butler also warns that the EIA will exert pressure to keep the sheep in the fold. He sums up the turmoil as “important, but it's certainly not a crisis.”

Scorecard. EIA officials speculate that leaning toward a split are RCA, Magnavox, Admiral, Philco-Ford, and Cortron Industries. Cortron employs chairman Charles Hoffman of the division's executive committee, and is to become a subsidiary of Admiral—one of the major companies believed threatening to resign. Expected to oppose a new trade group are Motorola and General Electric. The rest, notably Sylvania and Westinghouse, are on the fence. Those whose markets are mainly consumer-oriented, according to one industry source, will go

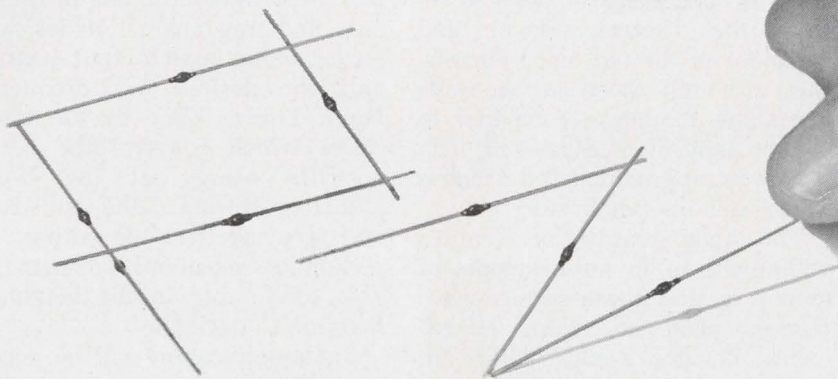

Introducing the PZ Zener

The new fused-in-glass
1 watt zener ...

Typical Unitrode fused-in-glass
stability and high-performance at
the price of an ordinary device

Order your free samples today

- Fills the bill from 400 mw thru 1 watt
- Voltages from 6.8 to 200 V
- 8 millisecond surges to 30 watts
- Low reverse current — to 500 nA
- A quarter the size of a conventional 1 watt
- Weighs less than 1/4 gram
- No plastics, epoxies, silicones, oxides, gases, or solders are used

580 Pleasant St., Watertown, Mass. 02172 • (617) 926-0404

UNITRODE

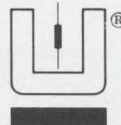

TOUGH AS ALL GET-OUT FROM THE INSIDE OUT

With the silicon die metallurgically bonded between terminal pins of the same thermal coefficient, the hard glass sleeve is fused to the entire outer silicon surface. Result — a voidless, monolithic structure.

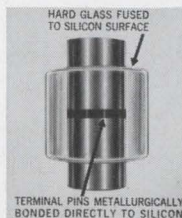

4 EASY WAYS TO GET FREE SAMPLES AND SPECS

1. Call Bud Anderson COLLECT, at (617) 926-0404.
2. Call your nearest Compar office.
3. Call your nearest Daniel & Co. office.
4. Check off the magazine Reply Card number.

U.S. Reports

with whomever has control of the consumer electronics show, held annually to preview consumer products wares. For Wayman, the show has been a one-man operation for three years, grossing about \$500,000 each year.

Wayman, who is using a desk and telephone in the office of one of Washington's prominent attorneys, has been asked by his backers not to make any decisions about his future until the split-or-stay decision has been made.

Whatever the decision, says Hoffman, "I believe we have to stick together to have a strong voice" in such matters as the ongoing industry problems over color tv X-radiation with the Department of Health, Education, and Welfare; the issue of color tv fires with the Product Safety Commission; and the fight against components makers for free trade and lower tariffs. This "strong voice" is an added incentive for smaller consumer makers, for whom strength is mainly in numbers, to go along with the majority decision.

Advanced technology

Let's hear it

Surface acoustic waves may get on television as integrated intermediate-frequency filters in color sets. At least Zenith thinks so, because it's working on a 40-megahertz sur-

face-acoustic-wave bandpass filter with the necessary i-f traps to replace the discrete inductor and capacitor of the old tuned circuits. But, although these surface-wave filters are miniature compared to the present filter coils—0.15 inch square vs. approximately 1.5 inches—size isn't the whole story.

The main reason for Zenith's willingness to lay out development money is that these surface-wave devices need no tuning adjustments. Besides, Zenith's filters are computer designed, allowing a vast combination of parameters to be analyzed. And better yet, once in the set the filters can't drift, the bugaboo of the coils.

How much? Cost may be an immediate factor in determining just how fast the new filters get into tv sets. New technologies are involved—methods of cutting piezoelectric substrates, techniques for depositing the metallic electrodes of the interdigital transducer pair—but they lend themselves to batch processing, especially for substrate handling. And batch-processed components mean big savings after the design becomes standard and Zenith can start turning out filters by the batch for color sets.

Zenith's filter works like this: An interdigital transducer pair—comb-like metallic arrays whose finger spacing determines the center frequency—is deposited on an acoustic substrate such as lead zirconate, Zenith's choice because of its temperature stability and good electro-

acoustic coupling. The transducer pair, besides determining the bandpass and trap characteristics, also serves as the input/output, passing only the desired radio-frequency band. This is done by the transducer which converts the r-f to acoustic energy at the input, launches it down the substrate, and recovers it at the output. Insertion losses can be made manageable, preferably in the neighborhood of 15 decibels.

But amplification will be necessary. Zenith has not announced plans to use surface-acoustic-wave amplifiers behind the filters, although as these new amplifier designs firm and their cost and reliability make them attractive, they could be employed in later circuits. In early models Zenith will probably use monolithic IC amplifiers, but hybrids are being considered.

Chain. In actual circuits, filters will have to be cascaded to synthesize the i-f response for color tv. One arrangement which Zenith is considering uses a video chain consisting of three surface wave video filters and a sound chain, which shares one filter with the video, along with an independent audio filter. The first filter in the chain provides both out-of-band video rejection and moderate attenuation of the sound carrier. The second and third filter provide a video notch at 41.25 Mhz, and together with the first filter, gives the proper bandpass, including a notch at 47.25 Mhz. Finally, in combination with filter 1, filter 4 provides the proper sound-picture level.

With this arrangement Zenith comes very close to fulfilling most of the specifications for a color i-f bandpass. In fact, when the surface wave chain was substituted for the standard i-f tuned circuit in a Zenith color set, picture quality was good.

Problems remain. Serious are the reflections between transducer pairs of each filter, reflections which show up as ghosts on the screen. Since this is a traveling-wave device, there's always some echo level, and its reduction requires new substrate and transducer designs. Various ways to make the transducer operate in one

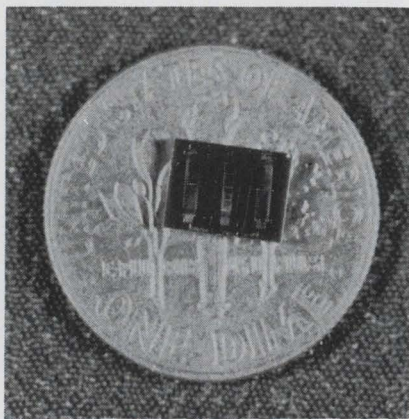
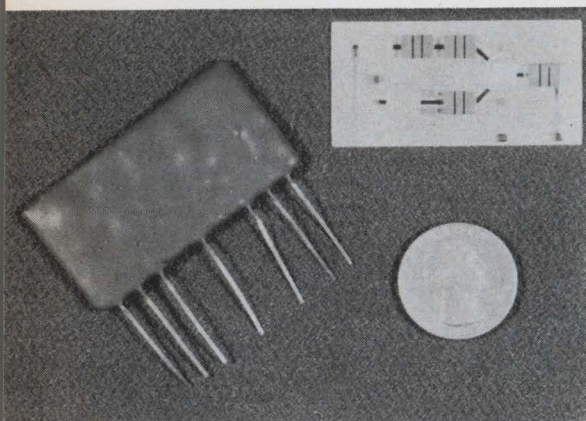

Waves. Encapsulated mock-up (left) shows surface wave filter for future tv. Circuit, with its i-f amplifiers, eliminates coils in old circuits. Each of three filters at right uses outer transducers in series or parallel, providing single input/output pair.

big cost-saver big size-shrinker

Sized right for high density pcb switching—as small as .145 cu. in.—the MicroClareed MR Relay adds a new dimension to Clare Sealed Contact Reed Relay capabilities. And it provides the low-cost, top quality combination you expect from Clare, the experienced volume producer. Design around 1 to 5 contacts in epoxy sealed and open coil modules. Take advantage of all of the inherent reliability of CLAREED Relays in only 1/5th the size.

Super-clean in construction, the 100% operation-tested, glass-encapsulated contacts never need maintenance or adjustment. Fast... with switching speeds in the low millisecond range. Complete input-output isolation and insensitivity to electrical transients provide high reliability with maximum circuit simplicity.

For information, circle Reader Service number, or, call your Clare Sales Engineer or local Clare Distributor. Or write for Data Sheet 961. C. P. Clare & Co., Chicago, Ill. 60645...and worldwide.



Length: 1 $\frac{1}{4}$ " max.

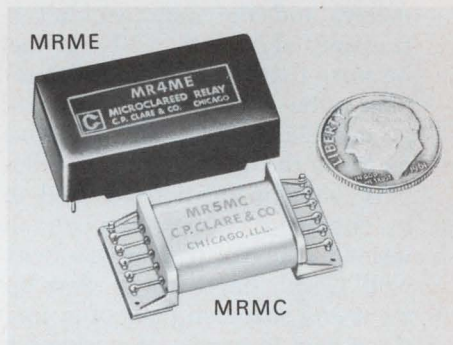

- Inherent reliability with no maintenance (Contacts sealed in glass)
- Switching times 0.5 to 2 ms
- Insensitive to transient electrical/electronic noises
- Contact load versatility—low level to 10 va
- Life:
 - .125 amp., 28 v: 10 x 10⁶ operations
 - low level: 100 x 10⁶ operations
- 1 to 5 contacts per module—open coil or molded epoxy modules

LOOK FOR



ON THE RELAY

a GENERAL INSTRUMENT company

U.S. Reports

direction only—normally interdigital transducers are bidirectional devices—may be the answer. Further, the use of lossy substrates could help. One problem—the back-wave launched by the transducer—can be solved by angle-cutting the substrate edges, a technique used successfully by Zenith.

Optoelectronics

Data bundles

When hard wires are used to extract test data from a hostile environment—such as r-f interference and electromagnetic pulse environments—unwanted interference often gets mixed with the signals to be monitored or recorded for later analysis, and it can disturb the test environment. But fiber-optic bundles, combined with solid state light emitters and sensors, provide a remedy for such transmissions by electrically isolating the hostile environment from the remote recording equipment.

Until recently, however, attenuation in the fiber-optic “light pipes” had hobbled efficient phototelemetry, and the data couldn’t be transmitted more than 20 or 25 feet, because that was about the longest fiber-optic bundle available with acceptable efficiency. Improvements in the quality of the bundles, plus some innovations cooked up by engineers at the Autonetics division of the North American Rockwell Corp., have led to development and successful use of at least three data-transmission systems in the Autonetics Navigation and Controls division (formerly Strategic Missile Systems division).

Lengthy link. The most sophisticated of these, in the opinion of Ralph Bradley, supervisor of the telemetry engineering unit, is a 70-foot-long data-acquisition link used to check the performance of a missile guidance and control system in a high-energy electromagnetic pulse environment.

The phototelemetry unit rolls analog and digital multiplexing into the same package with pulse-code-modulation techniques to transfer

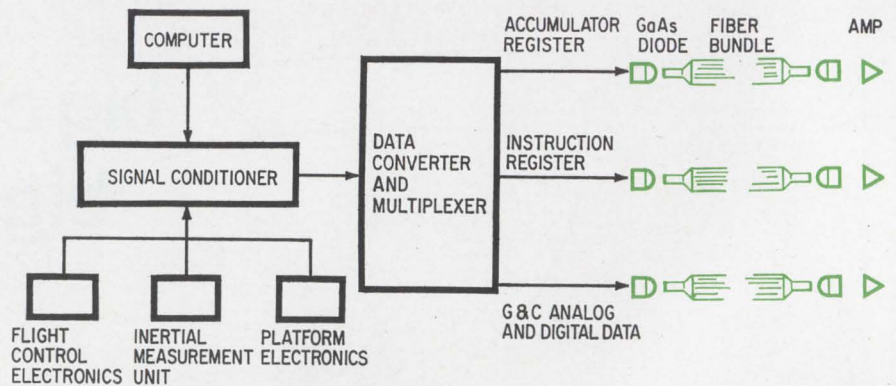

Linking the lines. Autonetics has used 70-foot-long fiber-optic bundles to move data in this guidance and control system in a high-energy electromagnetic pulse environment.

data at 345.6 kilobits per second over each of three fiber-optic bundles that are linked by gallium-arsenide infrared emitting diodes and p-i-n photodiode detectors. [*Electronics*, Dec. 22, 1969, p. 34]. Any one of these three bundles can handle up to 106 analog signals from the missile guidance system being tested, plus 49 discrete digital on-off signals. The data comes from the flight-control electronics, inertial measurement unit, platform electronics, and digital computer associated with the system. The signals include such things as a-c and d-c power supply monitors, thrust-vector commands, actuator position pickoffs, and gyroscope pickoffs.

The signals may vary in level from 0 to 100 millivolts for some subsystems, to 0 to 40 volts for others. This variance requires that signals be to levels between 0 and 5 volts before they can be accepted by the analog multiplexer which can handle 100 to 800 signal samples a second. Its single output is converted to an 8-bit digital signal by an analog-to-digital converter.

Digits. “The digital signals—the on-off data such as velocity meter outputs and other discrete events that cause a switch to toggle,” Bradley says, “are conditioned and multiplexed in a digital multiplexer in 16 digital words of 8 bits.” The sampling cycle is repeated every 16 words, and the words are fed to a data converter to be time-multiplexed with the analog data.

Two 8-bit encodings of analog information and 8 bits of discrete data are time-multiplexed into a 27-bit word: 8 bits of analog data, 8 of discrete or on-off data, then 8 more bits of analog information followed by 3 synchronization bits. Finally, the serial bit stream is converted into a special code for pcm transmission to the light-emitting diode associated with the light pipe for this data transfer.

The other two phototelemetry links are synchronized with the digital computer to continuously monitor the outputs of the accumulator and instruction registers. These two outputs let the person running the test know what the computer is doing at a given time (accumulator register) and compare it with what it was told to do (instruction register). These two outputs are also converted to a special code for pcm transmission.

Each of the three outputs, then, modulates one of the three light-emitting diodes. Signal conditioning is required to provide adequate drive current to excite the diodes to emit at approximately 9,000 angstroms. When the diode is on, a digital 1 is transmitted; when it’s off, a 0 is sent. This emission is carried through the light pipe, picked up by the p-i-n diode detector, and amplified by a linear integrated circuit operational amplifier. Then, the signal is either recorded on tape or sent to a “quick-look” ground station. So by immediately examining selected digital words that describe certain

How bright is a bright light?

*We make
a reflector
precise
enough
to light
a football
field*



Chicago Aerial Industries didn't ask us to invent a better way to illuminate football games. What they wanted was a three-dimensional, electroformed reflector head formed to incredibly precise specifications for a military contract. They decided we were the only people with the capabilities to produce what they needed.

They were right. No one can match Buckbee-Mears in the field of two or three dimensional precision electro-forming. Our mesh screens, for example, go down to four million holes per square inch with perfect accuracy. Line width tolerances of $\pm .0001$ are common.

A few of our standard products include evaporation masks, pin hole apertures, micro-mesh sieves, electron microscope

grids, optical wedges, zone plates and a variety of micro-miniature parts.

We're equally adept at electroforming gold, silver, copper and nickel. Any shape you want. Besides the reflector, we produce seamless tubing to a thickness of .005 inches for housing intricate electronic packages used in space vehicles. We make the carefully angled exhaust pipes for aircraft jet engines.

If it requires an intricate two or three dimensional shape with precision tolerances, just ask us. Call Bill Amundson, our Industrial Sales Manager, and tell him what you need.

If we can help one bulb light a football field, just think what we might be able to do for you!



BUCKBEE-MEARS CO.

245 E. 6th St., St. Paul, Minnesota 55101 / (612) 227-6371

The world leader in precision photomechanical reproduction

U.S. Reports

critical performance parameters of the system, it can be determined if the test is getting the needed data.

Better bundles. Bradley says the recent improvements in fiber-optics that have allowed longer data-transmission systems include availability of the longer bundles, plus improvements in the coating material for the bundles.

A highly reflective metal had been used to coat the fibers, but it absorbed too much light, destroying transmission efficiency. Now the bundles, which Autonetics buys from the American Optical Co., have a transparent dielectric glass coating. The glass has a different refractive index from the bulk bundle glass, giving better reflection.

Autonetics applies an end fixture to the bundles to act as a mechanical connector, and also to facilitate cutting and polishing the bundle ends, which further reduces reflection losses. Nevertheless, an emitter output of about 20 milliwatts will attenuate over the 70-foot bundle, leaving only about 0.03% of that output at the end of the bundle. Roughly 30% of the power is caused by bundle end losses, and there's attenuation along the bundle of 10% per foot, but the p-i-n diode detector can still sense the signal. "There's not much of a problem to detect this low-level signal," says Bradley, "and bring it quickly to a 1,000-times amplifier."

Memories

An nsec saved

Fast microprogramers are a must in third- and fourth-generation computers, where every nanosecond counts. Each nanosecond spent in manipulating instruction repertoires degrades overall system performance. Optical Memory Systems, a new Southern California firm, attacked the problem with an optical read-only memory that is arousing the interest of several computer manufacturers, including Xerox Data Systems.

Although intended primarily as a computer microprogramer, the memory also has code conversion and character generator applications. The first to be produced will have 102,400 bits, with a word size of 100 bits, parallel output. Other sizes, ranging from 4,096 to 262,144 bits and a 256-bit word length, also will be made. Access time is a conservative 70 nanoseconds. With a smaller number of outputs and multiplexing, considerably faster access times are possible, according to Robert L. Burr, general manager of the firm.

Infrared. The memory uses a 32-by-32 x-y matrix of 1,024 gallium arsenide diodes operating in the infrared, which are individually addressed and selected by the computer. The source diodes are driven by 64 decoder/drivers.

When a diode is turned on—only one source at a time is used—the light passes through an optical mask bearing the desired bit pattern. The mask is an ordinary high-resolution photographic plate, and the 0's and 1's are created by exposing a photo-emulsion on the glass, using integrated circuit mask-making techniques. Bit apertures in the mask are 15 mils square, with 5-mil separation and one-bit space between words. Opaque areas of the plate produce a 0 and clear portions register a 1. Opposite the source diodes, on the other side of the mask, is an array of 100 p-i-n diode sensors, all of which can receive light when a single source is turned on. Which sensors are excited depends on the individual gallium arsenide diode source selected and on the bit pattern on the program mask. This means that the total number of bits in the memory is the product of the total number of sources times the number of sensors.

Burr says proprietary optical devices are used as voltage multipliers to accomplish the high-energy transfer needed to excite the pin diode array with a single source. The secret, according to Burr, lies in increasing the output of the source diode to "hit" the p-i-n diode array harder than would otherwise be possible.

Thus the result, in the words of

COMES WITH EVERY
GE CAPACITOR

Dependable Distributor Service

General Electric Distributors help you solve the tough ones with capacitors from local stock:

EAST AND NORTHEAST
Cramer/Washington, Inc.
692 Loftstrand Lane
Rockville, Maryland 20850
Tel: 301-424-2700

Schweber Electronics, Inc.
Jericho Highway
Westbury, N. Y. 11591
Tel: 516-334-7474

5640 Fisher Lane
Rockville, Maryland 20852
Tel: 301-427-4977

213 Third Ave.
Waltham, Mass. 02154
Tel: 617-891-8484

Semiconductor Specialists, Inc.
2011 Waverly St.
Pittsburgh, Pa. 15218
Tel: 412-351-3611

SOUTHEAST
Cramer/Florida Electronics
4141 N.E. 6th Ave.
Ft. Lauderdale, Fla. 33308
Tel: 305-947-6517

Jackson Electronics Co.
P.O. Box 19837
Atlanta, Ga. 30318
Tel: 404-355-2223

Schweber Electronics, Inc.
2830 N. 28th Terrace
Hollywood, Fla. 33020
Tel: 305-927-0511

Southeastern Radio Supply Company
414 Hillsboro St.
Raleigh, N. C. 27603
Tel: 919-828-2311

MIDWEST
Electronics Marketing Corp.
814 W. 3rd Ave.
Columbus, Ohio 43212
Tel: 614-299-4161

Hamilton Electro Sales
920 S. Westwood
Addison, Ill. 60101
Tel: 312-543-8500

1400 W. 46th Ave.
Denver, Colorado 80216
Tel: 303-433-8551

Lew Bonn
7275 Bush Lake Road
Edina, Minn. 55435
Semiconductor Specialists, Inc.
P.O. Box 66125
Chicago, Ill. 60666
Tel: 313-255-0300

25127 W. Six Mile Road
Redford, Mich. 48240
Tel: 313-279-1000

SOUTHWEST
Arco Electronics, Inc.
P.O. Box 34772
Dallas, Texas 75234
Tel: 214-239-9123

Hamilton Electro Sales
P.O. Box 10227
Dallas, Texas 75207
Tel: 214-638-0900

1216 W. Clay St.
Houston, Texas 77019
Tel: 713-526-4661

1741 N. 28th St.
Phoenix, Arizona 85009
Tel: 602-272-2601

WEST & NORTHWEST
Elmar Electronics, Inc.
2288 Charleston Rd.
Mt. View, Calif. 94041
Tel: 415-961-3611

Hamilton Electro Sales
10912 W. Washington Blvd.
Culver City, Calif. 90230
Tel: 213-870-7171

2320 6th Ave.
Seattle, Wash. 98121
Tel: 206-442-2011

5567 Kearny Villa Rd.
San Diego, Calif. 92123
Tel: 714-279-2421

340 Middlefield Rd.
Mt. View, Calif. 94041
Tel: 415-961-7000

Kimball Electronics, Inc.
350 Pierpont Ave.
Salt Lake City, Utah 84101
Tel: 801-328-2075

G. S. Marshall Co.
9674 Telstar Ave.
El Monte, Calif. 91731
Tel: 213-686-1500

Electronic Capacitor & Battery Dept., Irmo, S. C.

GENERAL ELECTRIC

430-44A

COMES WITH EVERY GE
TANTALUM FOIL CAPACITOR

Meticulous quality control

Is it possible to test in reliability? Hardly. It must be built in — then tested for verification. There is no better example of this than the GE tantalum foil capacitor. To verify its design parameters every unit gets 382 quality control checks during its manufacture.

After uncompromising quality control . . . a dissipation factor reading, capacitance test and leakage current test at room and high temperature provide extra verification. Each production lot is then sampled for rugged environmental testing to add even more assurance of performance to product specification.

This adds up to a tantalum foil capacitor with: (1) low leakage current, (2) long, stable shelf life, (3) no limit on charge or discharge current, eliminating the need for external impedance limitation. Units available with standard elastomer seals or with high-reliability glass-to-tantalum hermetic seals.

GE tantalum foil capacitors meet or exceed the requirements of MIL-C-3965 and MIL-C-39006 and are available in all specified sizes.

Choose from many standard units

	<u>Tubular Type</u>	<u>Rectangular Type</u>
Voltage Ratings:	3VDC-450VDC	10VDC-150VDC
Capacitance Ratings:	.5uf - 1450uf	20uf - 3500uf
Temperature Ratings:	-55C to 125C	-55C to 125C

Call your GE Electronics Distributor or GE ECSSO District Sales Manager, or write Section 43037, General Electric Co., 1 River Road, Schenectady, N. Y. 12305

Electronic Capacitor & Battery Dept., Irmo, S. C.

GENERAL  ELECTRIC



See Litton first for miniature K-Band magnetrons.

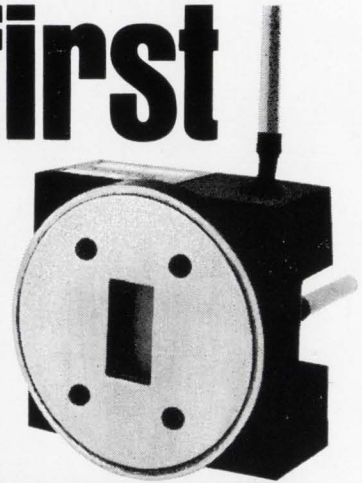
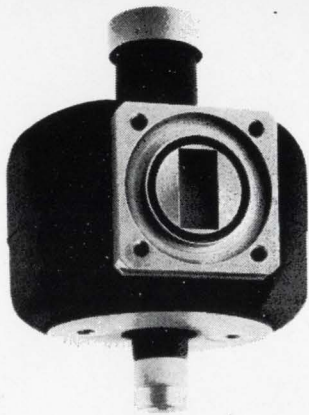

If your application involves missile guidance radar, beacons, airborne terrain-following radar, manpack radar, aircraft landing systems, transponders, fuzes, commercial weather avoidance radar or airborne doppler navigation radar — Litton offers you a complete line of miniature K-band magnetrons.

Our exceptionally broad line will fit into any system within all these applications and offers you unique performance characteristics. Qualities like low temperature coefficients. Short warm-up time. Very short pulse width capability. Long life expectancy and low RF interference. These features will ensure compatible operation in the most demanding K-band systems.

A few typical examples of our miniature line are given in the chart below. For full details contact: Electron Tube Division, 960 Industrial Road, San Carlos, Calif. 94070. Telephone (415) 591-8411.

Tube Type	Minimum Peak Power (Kw)	Frequency Range	Tuning
L-5048 coaxial	1.0	15,950-16,550	Mechanical
L-5112 coaxial	2.2	15,400-15,700	Mechanical
L-5113 coaxial	2.2	15,400-15,700	Mechanical
L-5013 coaxial	4.0	15,500-16,500	Mechanical
L-5035 coaxial	8.0	15,900-16,400	Mechanical
L-3958A coaxial	9.0	15,500 \pm 85	Fixed Frequency
L-3496A	1.0	16,000-16,500	Mechanical
L-5189	1.0	14,200 \pm 150	Fixed Frequency
L-4370	0.04	13,325 \pm 30	Fixed Frequency

 **LITTON INDUSTRIES**
ELECTRON TUBE DIVISION

U.S. Reports

Douglas Maure, engineering vice president, is that "you get the whole enchilada—100 bits of parallel output—in one shot."

Each sensor receives a 150-milliampere pulse from the light emitter, and a high-speed IC pulse amplifier for each sensor provides transistor-transistor-logic level output. The operational amplifier is a Fairchild μ A 733 and a-c preamplifier with a 15-decibel gain and a 6-nsec rise time.

Program masks are prepared by the company from paper or magnetic tape, or punched-card bit location specifications supplied by the customer. An important advantage over other read-only memories is that any desired mask can be inserted in the memory in the field for Fortran, Basic, or whatever language is being used. The quick-change capability is particularly advantageous at the computer design stage when mistakes within a large number of bits must be corrected. Individual bits on the mask can also be changed, using an x-y microscope positioner and an emulsion to dissolve or add bit locations.

The 12-by-12-by-14-inch memory costs about 2 cents per bit in quantities of 500, but could drop in extremely large memories, Burr says.

For the record

Moving. Motorola's Semiconductor Products division has given five men broader responsibilities and named three of them corporate vice presidents. They are: Thomas Connors, formerly vice president and director of marketing for the division, who became corporate vice president for marketing; John Welty, former vice president and director of operations and administrative services, who was named assistant general manager of the division; Jack Haenichen, former director of operations who assumes Welty's former duties; Patrick Lynch, former director of operations, who was chosen director of operations for all discrete products except optoelectronics, which re-

mains under Haenichen; and C.J. Goodman, former marketing manager for the U.S., who succeeds Connors as the division's director of marketing. Haenichen, Lynch and Goodman are the new vice presidents.

At the same time, Motorola Semiconductor announced formation of the office of general manager, including Welty and Stephen Levy, general manager, who is also a corporate vice president. For Welty, the move appears especially significant. He returned to Motorola shortly after C. Lester Hogan, Levy's predecessor, left for Fairchild with several associates. Welty had been general manager of Philco-Ford's Semiconductor operations, and now looks like the best bet as a successor if Levy is selected for greater responsibility.







Director. The Navy has named RCA prime contractor for its Aegis anti-aircraft missile system, formerly ASMS (for advanced surface missile system). The announcement was made with award of the \$252,930,400 engineering and development contract. The system will use a variation of the General Dynamics Standard missile from a standardized launcher that will also accommodate Asroc, the anti-submarine rocket. The Aegis radars will use Univac's AN/UYK-7 computer [*Electronics*, Sept. 22, 1969, p. 58].

Lighter, smaller. At about the same time it was celebrating its Aegis contract, RCA was saying that it has opened the door to a new generation of phased-array radars by reducing cost and size without sacrificing performance. The Missile and Surface Radar division in Moorestown, N.J., credits four innovations for making possible the deployment of portable tactical phased-array radars for land, sea, and air applications:

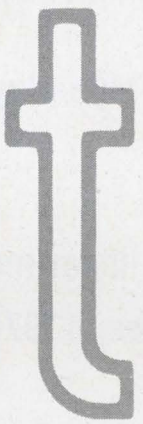
- A new feed using a parallel power divider that's just 1 inch deep. Normal depth previously, says RCA, was 28 inches.
- Smaller phase shifters attained through heavy dielectric loading.
- A hybrid IC phase-shifter.
- A new radome design.

The most wanted power supply... yours from TEC

TEC, the proven power supply manufacturer, now offers its PM series plug-in modular supplies most wanted for stringent design requirements in industrial/military applications. Attractively priced: dual outputs, \$59.00; single outputs, \$49.00; unregulated power supply, \$39.00. Complemented by equally reliable thick-film Hybrid Voltage Regulators. Check our custom capability, too.

	 <p>TEC PM Series Power Supplies 115 VAC input supplies. +5, \pm15, +200vdc output for logic, opamps, nixies. Totally encapsulated.</p>
 <p>TEC VR Series Hybrid Regulators Economy Price 2X-DIP package. Built-in fold back current limiting. Adjustable and fixed output voltages.*</p>	
	 <p>TEC VRH Series Hybrid Regulators High Performance coldweld Hermetic Seal, metal, Dual-in-Line package. Fixed output voltages.*</p>

*Plug-in connectors available for testing and bread-boarding.

See our ad in EBG . . . inside front cover
We're also in EEM . . .
pages 2120-2125



P.O. Box 910
Boulder Industrial Park
Boulder, Colorado
(303) 442-3837

- Q: What will be the real growth rate of the U.S. economy in the first half of 1970?** **A: - 0.8%**
- Q: What will be the capacitor market in consumer electronic equipment in 1972?** **A: \$22.3 million**
- Q: How many tape players for automobiles will be produced in 1970?** **A: 580,000**
- Q: How many linear monolithic microcircuits will be used in oscilloscopes in 1970?** **A: 544,000**
- Q: What is the best computer service market for the 1970's?** **A: Facility Management**
- Q: At what rate is the market for discrete semiconductors in computer equipment declining?** **A: 4.8%**

What's the source of those answers?

MAPTEK

What is MAPTEK?

MAPTEK *is your source of data* . . . the world's largest computerized commercial management information data base. MAPTEK forecasts the production of *all* electronic equipment (over 400 products) . . . *all* end markets for electronic components and hardware (over 350 products) . . . *total* markets as well as end markets for computer products and services . . . shipments and value added for 60 basic industries . . . and total U.S. economic outlook!

MAPTEK *interprets and forecasts* . . . the entire technological, competitive

and business environment and supports all of your tactical and strategic planning. It helps you to react to changing conditions, tells you how to enhance your company's share of a specific market, assists you in pricing strategies of your products, gives you thorough knowledge of individual end markets for your products and how to serve their needs.

If your company has an interest in the electronics industries or electronics technologies, MAPTEK is your ideal source of data and strategic guidance in these markets. We'll be happy to

show you how to utilize this new corporate planning tool, developed by a leading technological information company with a multi-million dollar investment. Call or write MAPTEK Administration, Quantum Science Corporation, 245 Park Avenue, New York (212) 986-4410 or 851 Welch Road, Palo Alto, California (415) 327-8400.

MAPTEK IS A REGISTERED TRADEMARK OF QUANTUM SCIENCE CORPORATION.



Quantum Science Corporation

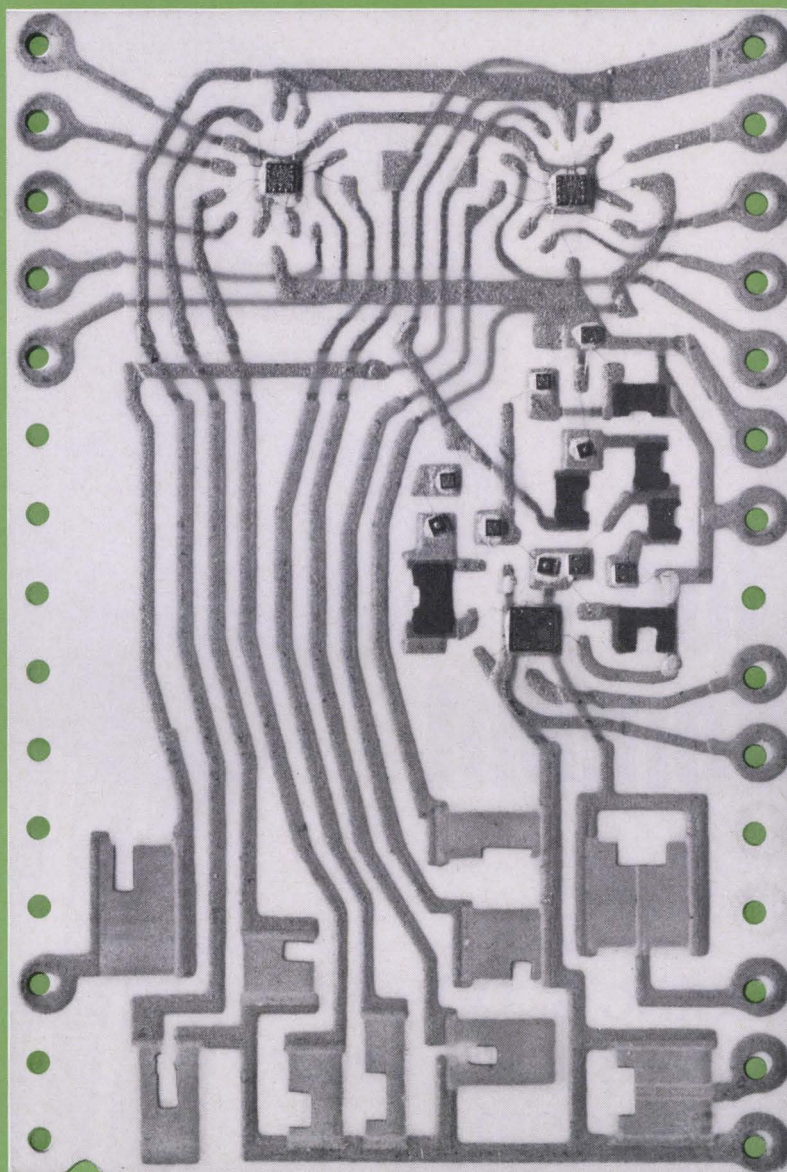

4 X Actual Size.

A complete 8-bit Digital-to-Analog Converter for \$75!

The new Helipot Model 845 is a thick-film, miniaturized hybrid digital-to-analog converter (DAC) that converts an 8-bit binary word into an analog output. The input gates, switches, resistor network, reference voltage, and output amplifier are all in the hybrid module.

Because of its operating temperature range (-20°C to $+85^{\circ}\text{C}$), Model 845 can be used for any industrial digital-to-analog conversion, process control being a typical application. Price is \$75/unit in 1-9

quantities (less in greater numbers). The package size is 1.0 inch x 1.5 inches x 0.170 inch. The unit accepts an 8-bit, parallel, binary word that is TTL- and DTL-compatible, and an enable gate is provided. Four different output-voltage ranges are available as standard models: two unipolar (0 to +5 v, 0 to +10 v) and two bipolar (-5 to +5 v, -10 to +10 v). Power-supply requirements are +15 v at 60 ma and -15 v at 10 ma. The output accuracy is $\pm 1/2$ least-significant bit at $25^{\circ}\text{C} \pm 1$ mv

per percent of supply-voltage variation. The output-current range is 0 to ± 2.5 ma, and the output slew rate is 0.3 v/ μsec .

And, it's available from stock.

Beckman[®]

INSTRUMENTS, INC.

HELIPOT DIVISION

2500 HARBOR BOULEVARD

FULLERTON, CALIFORNIA 92634

INTERNATIONAL SUBSIDIARIES: AMSTERDAM; CAPE TOWN; GENEVA; GLENROTHES, SCOTLAND; LONDON; MEXICO CITY; MUNICH; PARIS; STOCKHOLM; TOKYO; VIENNA

Circle 59 on reader service card

Room for improvement

General Electric's TO-5² transistor-size sealed relays give you more room for increased power, improved performance

We didn't cut any corners on this high-reliability, transistor-size sealed relay. We left them on so there'd be more room for a more powerful magnet—2½ times more powerful.

This added power means this type 3SBS, 2PDT, 1 amp relay gives you higher contact forces, larger contact gaps, and greater overtravel to minimize mechanical shifts. Shifts which usually increase early-in-life failures.

Though there's more room inside to give you all these advantages, the outside dimensions—top-to-bottom (.275") and side-to-side (.370")—are the same as any transistor-size relay.

So don't cut corners on your next transistor-size relay application. Specify GE's square Type 3SBS. For full details, write General Electric, Section 792-45, Schenectady, New York 12305.



GENERAL  **ELECTRIC**

write your own ticket



Program your measurement system: write your own ticket for fully automated testing and process control. You can direct, without expensive hardware changes, a test or process to proceed exactly as you like — under full computer control. Each test can be run exactly like the previous one, or changed incrementally by your program. You can measure voltages, frequencies, and resistances, getting processed data in formatted readouts as the test progresses. You can scan in a sequence and rate determined by the data itself. You can program to compare measurements against limits to actuate safety alarms, alter sequences, control or shut down a process.

It's all practical with the VIDAR 5206 Digital Data Acquisition System, which includes a mini-computer for measuring and controlling tests and processes — exactly as you want them, and far more accurately than you could do it yourself. The way you use one of these systems is limited only by your imagination. Important capabilities include speeds to 70 channels per second; measures signals from a few microvolts on up, with $0.1\mu\text{v}$ resolution; over 140 dB CMR at any frequency; scans up to 1000 channels; and has 32 control outputs as standard.

The VIDAR 5206 D-DAS tells you what's *really* happening now in your tests or processes. For the facts, send today for your copy of VIDAR Bulletin 104C.



VIDAR®

77 Ortega Avenue, Mountain View, California 94040 • (415) 961-1000

the automatic-measurement people

Circle 61 on reader service card

Tips on cooling off hot semiconductors

As power levels go up and up and package size shrinks, circuit designers are keeping semiconductors cool with IERC Heat Sinks/Dissipators. Reducing junction temperature gives many benefits: faster rise and fall times, faster switching speed and beta, fewer circuit loading effects and longer transistor life and circuit reliability.

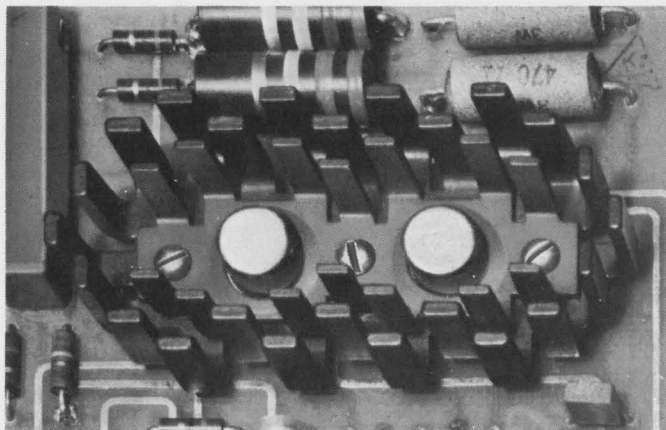

Thermal mating of matched transistors, such as these TO5's shown on a dual LP, maintains matched operating characteristics. The LP's unique multiple staggered-finger design (both single and dual models) maximizes radiation and convection cooling, results in a high efficiency-to-weight and -volume ratio.

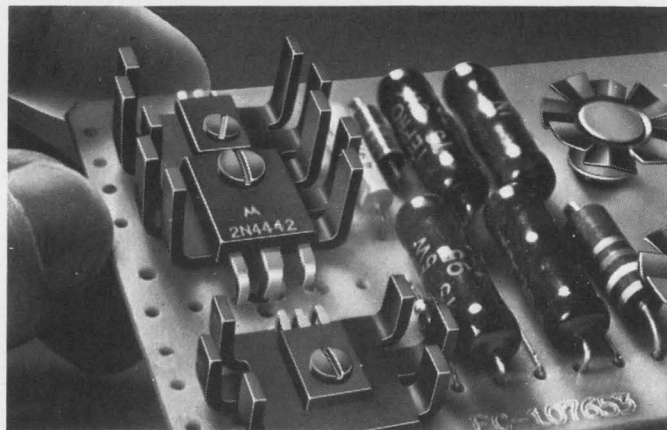

Power levels of plastic power devices such as X58's, MS9's, and M386's can be increased up to 80% in natural convection and 500% in forced air when used with PA and PB Dissipators. PA's need only .65 sq. in. to mount; PB's 1.17 sq. in. Staggered finger design gives these light-weight dissipators their high efficiency.

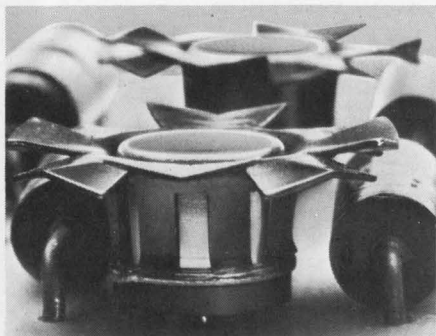

TO5's and TO18's in high density packages can be cooled off with efficient push-on Fan Tops that cost only pennies. T-shaped, need no board room, let other components snug-gle close. Spring fingers accommodate wide case diameter variations. Models for RO97's, RO97A and D-style plastic devices also.

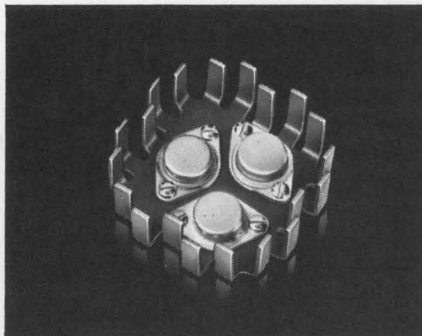

High power TO3's, TO66's, TO6's, TO15's, etc. can be operated with much more power when used with HP's. These compact, light-weight staggered finger devices accommodate from one to four TO3's. Provide the same heat dissipation as an extrusion that's three times heavier and one-third larger.

Heat problems? IERC engineers welcome the opportunity to help solve your heat dissipation problems. As the world's largest manufacturer of heat sinks/dissipators for lead and case mounted semiconductors, they can come up with a practical, low cost solution.

Free four-page Short Form Catalog. Send for your copy today.



Heat Sinks/Dissipators

IERC



TRW 5 watt 3 GHz S-band transistor

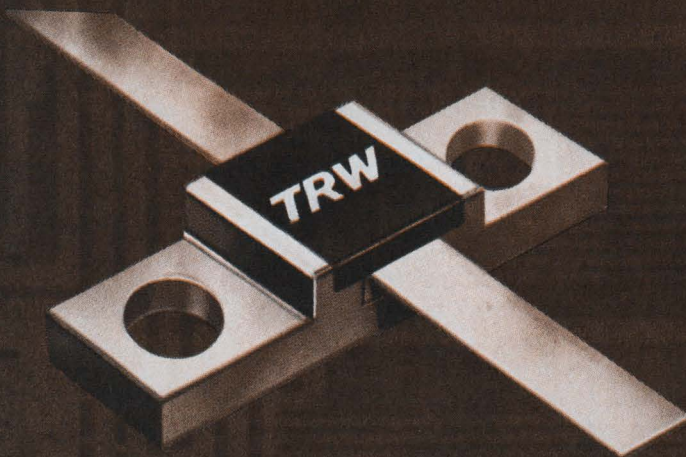

...New Broadband MIC package

The TRW Gigahertz Family takes another step forward in power and frequency: a new compatible series of microwave transistors, operating at 3 GHz—the heart of S-band. The new family includes four devices with the highest available output power bandwidth and gain at 3 GHz:

PT6669	300 mW	6 dB gain
PT6618	1.0 Watt	5 dB gain

PT6635	2.5 Watts	4 dB gain
PT6636	5.0 Watts	3 dB gain

This new common base series is consistent with microwave integrated circuits and/or conventional stripline. The package is also specially designed for low parasitics. Like the rest of the Gigahertz Family, they operate from a 28 volt source.

For complete information and

applications assistance, contact TRW Semiconductors Division, 14520 Aviation Blvd., Lawndale, California 90260. Phone: (213) 679-4561. TWX: 910-325-6206.



ACTUAL SIZE

TRW[®]

Time-share terminals can now draw their own conclusions.

Now you can get instant graphics. From the new Hewlett-Packard Graphic Terminal, the most functional advance in time-share capability since the Teletypewriter itself.

Feed standard EIA ASCII inputs to the Graphic Terminal and as the data arrives from the computer, it can be plotted right along with the Teletypewriter printing. When data transmission is finished, so is the graph. Plugged into the Teletypewriter, the Graphic Terminal will plot from keyboard inputs, or you can plot with the Teletypewriter silenced by a switch. No more waiting. No more wading through a swarm of digits. Clear, sharp graphs help you get the picture every time — on the spot. And give you faster, more direct comprehension of computer solutions.

The HP terminal is simple to operate but provides sophisticated results. No special programming knowledge is needed. Numbers become points, curves, circles, lines, ellipses, contours. Or business graphs like bar or pie charts. Check out trends, study the behavior of input functions, compare one result with another. Design graphically with figures from computer-resolved data.

Add a new dimension to your in-house capability. Put a Hewlett-Packard 7200A Graphic Plotter next to your Teletypewriter and draw a more functional picture of the cold hard data. Your time-share service has the facts. If they don't yet offer the 7200A, have them get in touch with us.

HEWLETT  **PACKARD**

GRAPHIC RECORDERS

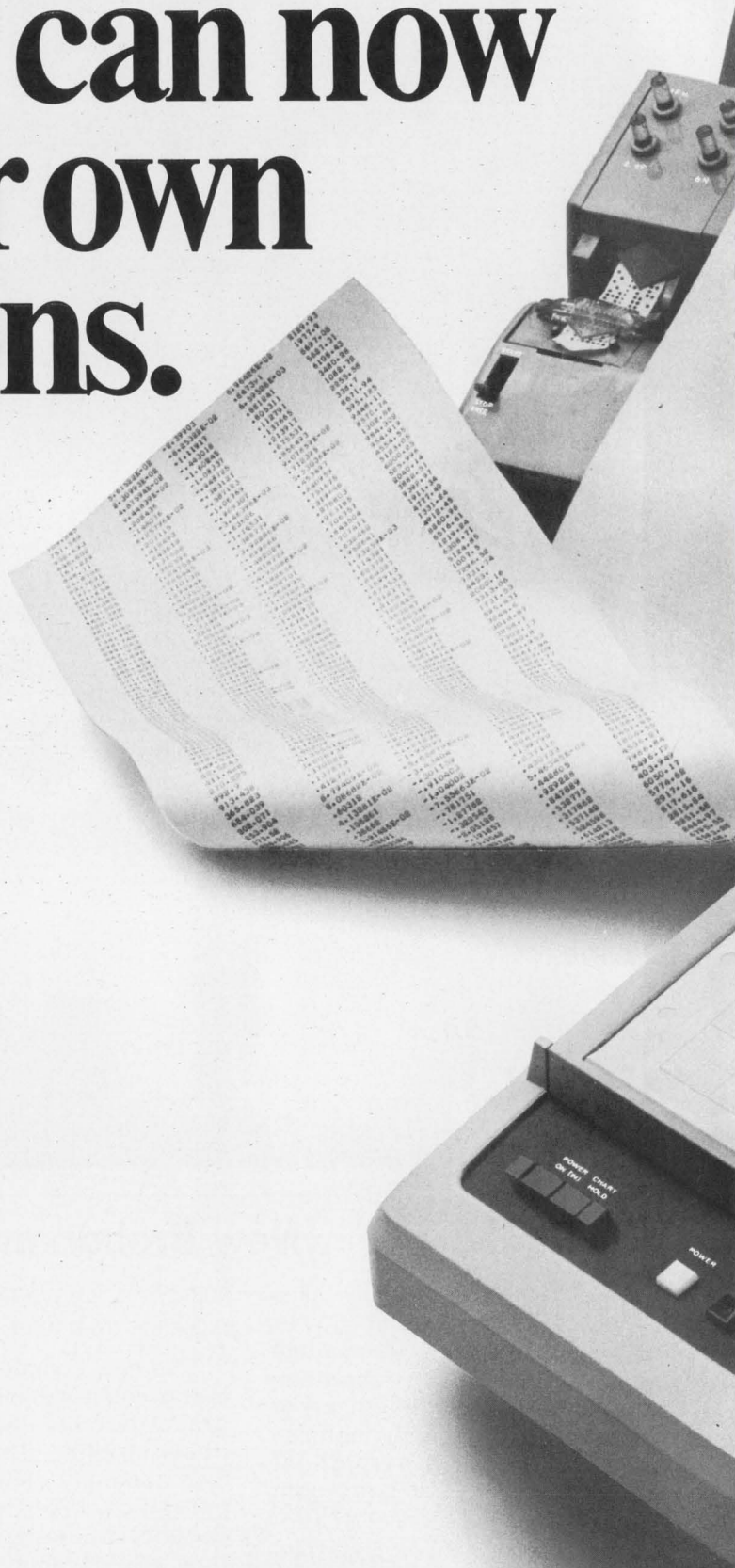

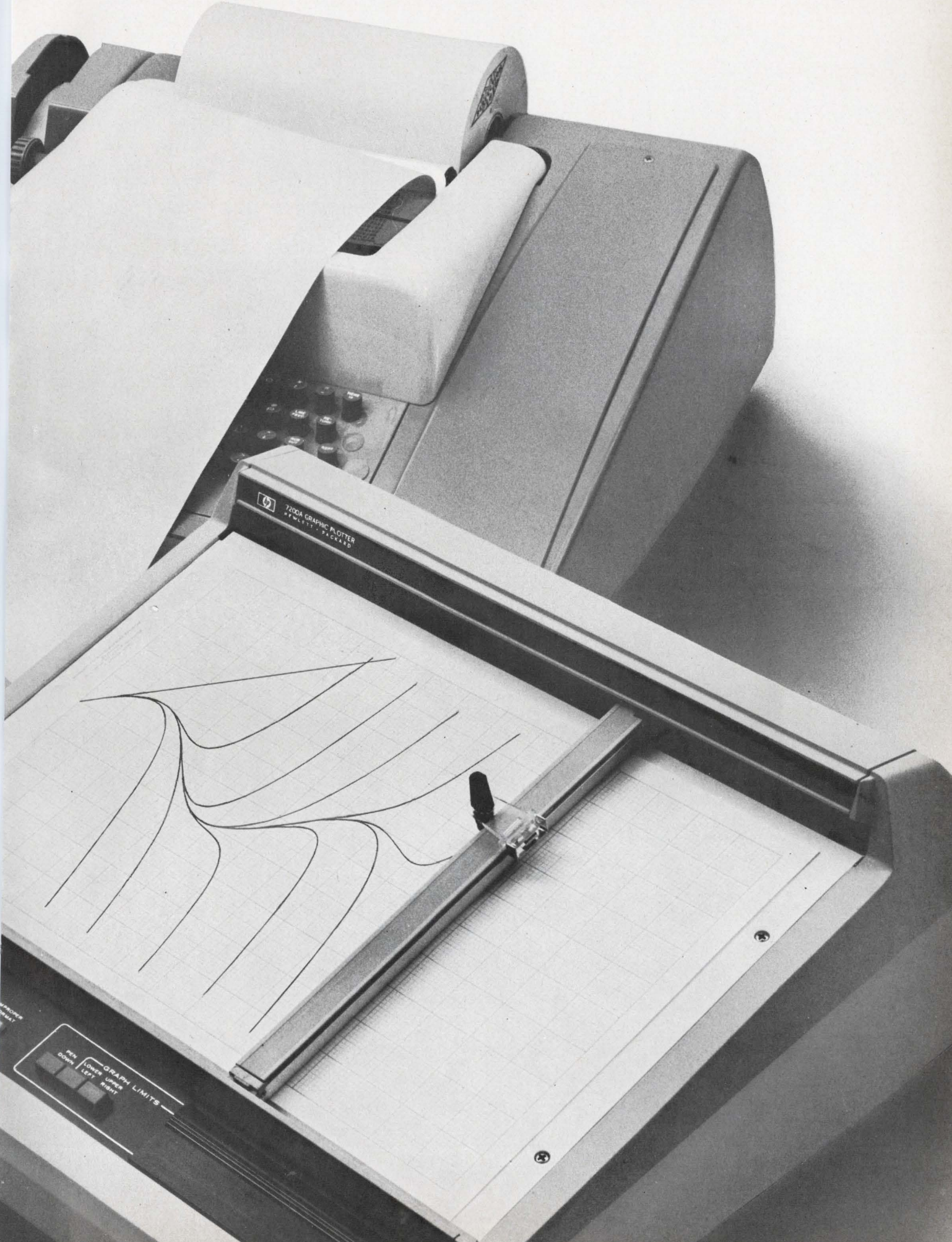

 7200A GRAPHIC PLOTTER
HEWLETT - PACKARD

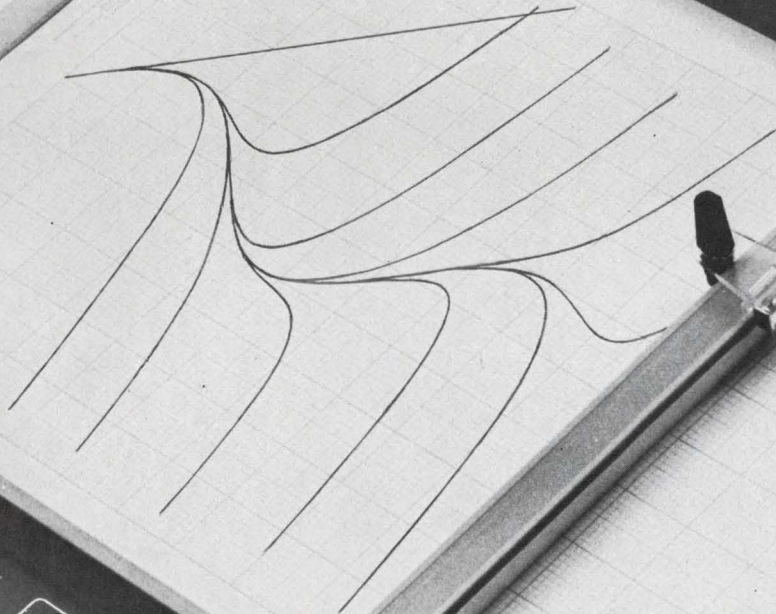

GRAPH LIMITS
PEN DOWN LOWER LEFT RIGHT

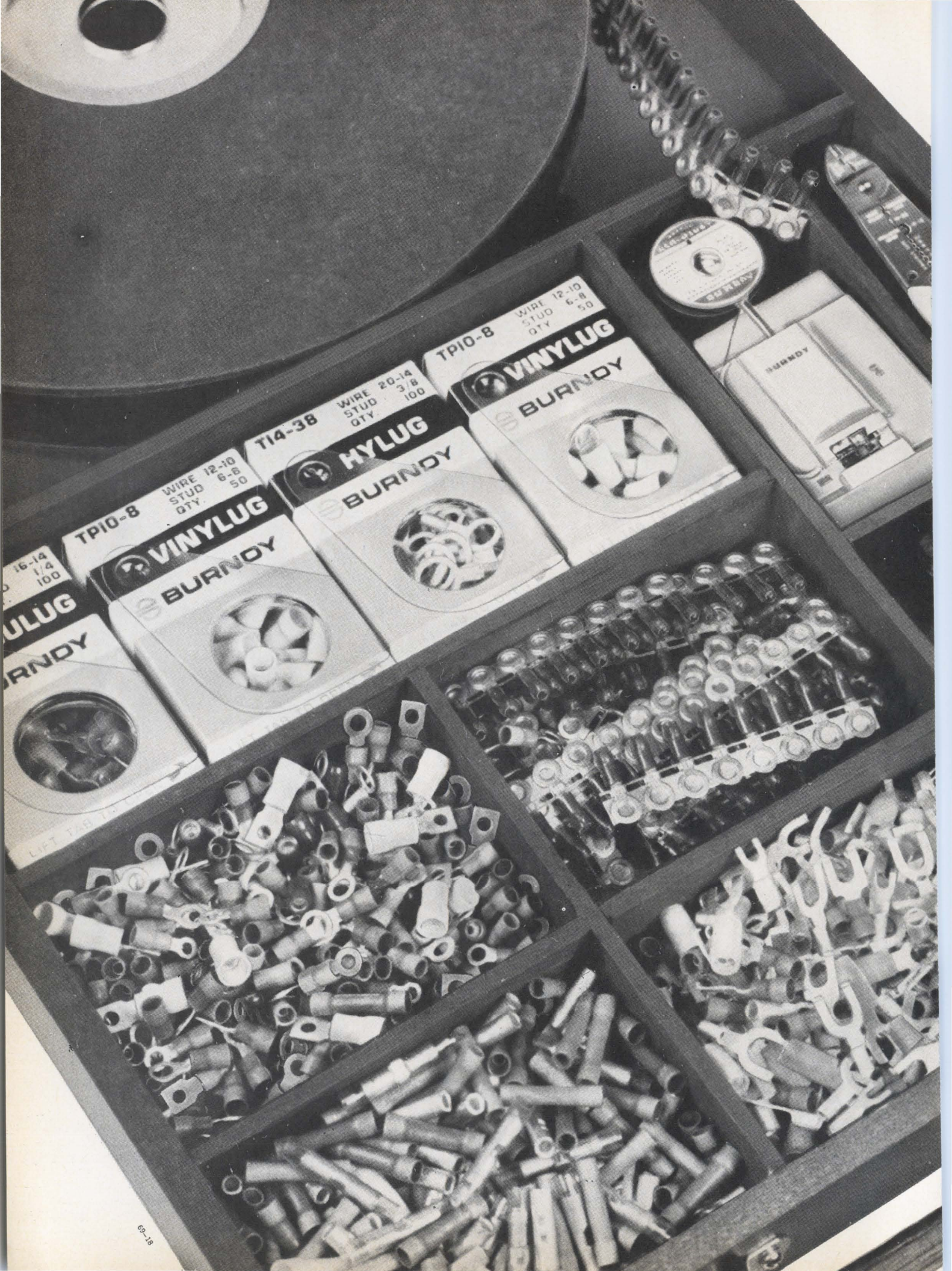

16-14
1/4
100

TPI0-8

WIRE 12-10
STUD 6-8
QTY 50

VINYLUG
BURNDY

T14-38

WIRE 20-14
STUD 3-8
QTY 100

HYLUG
BURNDY

TPI0-8

WIRE 12-10
STUD 6-8
QTY 50

VINYLUG
BURNDY



VINYLUG
BURNDY

VINYLUG
BURNDY

HYLUG
BURNDY

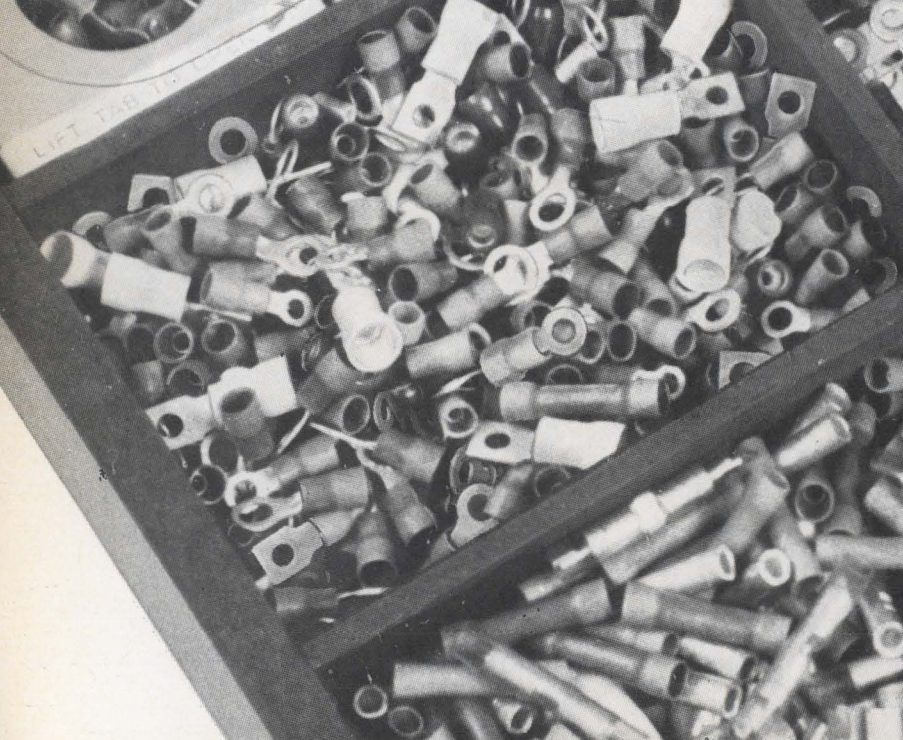

Burndy presents the complete terminal package.



Variety. Discover Burndy quality at competitive prices. Three full lines of compression terminals and splices: bare Hylug® with brazed seam; nylon-insulated Insulug®; and new Vinylug™, one of the best insulated lugs made at economical prices. All styles in inventory-cutting, range-taking sizes for #22-10 wire. Available in bulk or convenience type packaging for installation with *any type hand tools*, or on reels for automatic feed in crimping machines.

Fast, accurate hand tools that cut down on rejects, make quality control easy. Every crimp is perfect, no changing dies. Plier or ratchet-type, they install a full range, bare and insulated, sizes #22-10.

Our high-speed automatic machines install up to 2,000 per hour even with inexperienced operators. Here's the way to step up your assembly line—even die changes take no more than a minute.

Record-breaking delivery. Burndy has warehouses and distributors from coast to coast. Complete stocks are never more than a couple of hours away.

Service back-up. Burndy doesn't just sell you terminals. We have a force of factory-trained terminal specialists, experts on installation and tooling, too. Write today for samples, new catalog and/or a visit. See how Burndy's complete terminal package works to your advantage.

 **BURNDY**
Norwalk, Connecticut

INTERNATIONAL SALES HEADQUARTERS AND MANUFACTURING FACILITIES: CANADA: Ontario / ENGLAND: St. Helens, Lancs.
BELGIUM: Mechelen / MEXICO: Naucalpan de-Juarez / BRAZIL: Sao Paulo / JAPAN: Tokyo / Sales Offices in Other Major Cities

Circle 67 on reader service card



MICROWAVE IC MODULES PROGRESS REPORT #9: SWITCHING MODULE

Sperry Rand's PACT (Progress in Advanced Circuit Technology) program has taken a new look at microwave signal switching and developed the first complex circulator module.

It began with a major system contractor's effort to boost the reliability of a hand-held radar by providing redundant transmitters, receivers and local oscillators. Since a working radar set needs only one of each, the extras ride along as spares until a malfunction of a primary element calls them to duty.

Sperry's mission was to develop a super-reliable switching module capable of selecting either transmitter and either receiver and hooking them into the antenna duplexer circuit. Solid state was the only answer to the reliability requirement.

Sperry's solution is a single rectangular module, one inch by 1.8 inch, on a substrate 0.055 inch thick. Four circulators, a termination load and two DC blocking elements coexist on the module. One of the fixed circulators serves as the antenna duplexer, shunting transmitter and receiver signal paths. The other fixed circulator provides an antenna termination load to protect the downstream components against bursts of reflected transmitter energy.

Latching circulators allow operator selection of either of the two transmitters and receivers. Our latching circulators switch with as little as 200

microjoules of energy, a negligible drain on the power supply.

Sperry's circulators perform well. Measurements taken at 9.0 GHz show minimum isolation of 28 db and maximum insertion loss of 0.7 db at 27°C. And all four circulators do their jobs with negligible interaction even though they share a common substrate.

Sperry is the expert for integrated microwave modules and we welcome your system challenge. To help start a conversation, we have a new module planning sheet you can get free. Send for it, fill in the blocks to describe your requirement, then send it back and we'll be in business.

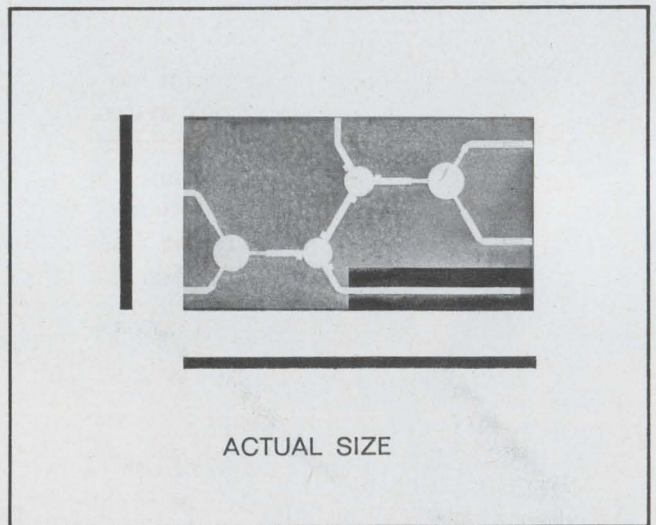

Sperry Microwave's solid-state switching module provides a common substrate for four circulators, two DC blocking elements and a termination load.

*For faster microwave progress,
make a PACT with people
who know microwaves.*

SPERRY
MICROWAVE ELECTRONICS DIVISION
CLEARWATER, FLORIDA

International Newsletter

January 5, 1970

U.S., France hold secret computer talks

French and U.S. negotiators are deep in secret talks that may set important new guidelines on an increasingly serious problem: **How far can the U.S. go in making private electronic firms the instruments of its foreign policy?** At issue in particular is whether Washington has the right to tell foreigners how they can use electronic products manufactured on their own soil by local subsidiaries of U.S. companies.

The new hassle stems from 1965, when Washington denied an export request for two big Control Data 6600 computers, which former President de Gaulle wanted to help develop his own independent nuclear strike force. The French promoters of that "Force de frappe" still want mammoth computers and the French are asking Washington to reopen the computers dossier. The reason: three months ago Control Data began making computers in its first Continental plant, in France near Geneva. It will start making the 6600 in a few months, turning out about 10 systems a year for Common Market customers. Since there will be no exporting from the U.S., can the U.S. still keep up its embargo?

Neither side will discuss the talks, though U.S. diplomatic sources concede they have been taking place. But they decline to say how far the French are asking the U.S. to go—whether Paris merely wants to get a Control Data giant for its military research or whether French officials are asking for a total suspension of the U.S. embargo in principle. Should the French win, the looser strings to Washington could start some U.S. electronics subsidiaries looking harder at the increasingly attractive, but restricted, Eastern European market.

Northrop to make British navigation and attack system

Ferranti has agreed to let Northrop produce the inertial navigation and attack systems for the Harrier vertical/short takeoff and landing (V/STOL) fighter when it is produced under license in the United States by McDonnell-Douglas. The U.S. Marine Corps is buying 12 of the Harriers, the only operational jet V/STOL in the free world today, from Britain's Hawker Siddeley Aviation for \$35.3 million, but only can do so if future purchases are made in America. The Ferranti system is a self-contained unit which allows the pilot to navigate and to find and attack targets with a wide variety of weapons. It also provides precision aiming with automatic weapon release at the appropriate point.

East Europe nations step up purchases of process control

The British push to sell computerized process control systems in Eastern Europe is showing results. The longtime marketing leader, GEC-Elliott Automation Ltd.—a division of the General Electric-English Electric combine—boosted orders in 1969 to \$17 million, over three times its 1968 sales. The company picks East Germany, Russia, Poland, and Rumania as biggest buyers. Ferranti Ltd., which started selling seriously in East Europe in March with appointment of exclusive Czech agents, expects its first big order, for over \$250,000, to be confirmed shortly. George Kent Ltd. expects two complete non-computerized steel and iron production control systems sold to Russia last year to be followed by bigger and better orders in 1970.

Behind the boost in sales are increased emphasis on productivity in current Eastern Bloc five-year plans and large investment in petrochemical and chemical refining plant requiring control systems beyond

International Newsletter

the present scope of native technology. Further, East Europeans tend to build large plants fully automated from scratch instead of in stages, and to place large equipment orders with single suppliers instead of distributing them widely as is Western practice. In East Germany, GEC-Elliott is supplying the complete computer control complex, worth \$92 million, for the Schwedt-on-Oder petrochemical plant, the biggest in East Europe. The master computer and two subsidiary systems were commissioned last year and another subsidiary system will be installed this year.

Japan first with quartz wrist watch

A Japanese company has beaten the Swiss to the market with the first crystal-controlled electronic wrist watch. The initial model, a gold-cased version, is now being sold for \$1,250, of which about half is for the case. The builder, Suwa Seikosha, claims accuracy is better than 5 seconds per month and is completely unaffected by motion of the wearer. A quartz crystal sealed in an evacuated tube oscillates at 8,192 hertz and its output fed to a cascade of 13 dividers, which give one pulse per second to a geared six-pole stepping motor.

But, Suwa Seikosha only has about a six-month lead over the Swiss. Longines and a 19-company collaboration will market quartz electronic watches this year. The Longines watch will have discrete components while the other, developed by an industry wide cooperative research effort, will use integrated circuits. Suwa Seikosha will use hybrid techniques in its integrated circuits.

Scandinavian bank EDP network to get GI MOS IC's

General Instrument has won an important entree into the European MOS integrated circuit market. Its British subsidiary has landed the contract to supply tailor-made circuits to Sweden's Facit for use in a \$40-million Scandinavian savings bank computer network [*Electronics*, Oct. 13, p. 9E]. Facit is contributing to the system all the cashier equipment, including input keyboards and information display screens.

Facit, despite its status as a leading European office equipment maker, has not yet decided on how fast to jump into electronic calculators. It does not now manufacture its own, but sells Japanese machines under its own label. While it will not give information on its plans for entering electronic calculator production, such calculators are understood to be on the drawing boards, and will be designed to use the General Instrument circuits. Facit's own electronics efforts mainly have been in manufacture of computer peripheral equipment, mostly tape punches and tape readers, which use bipolar integrated circuits.

Siemens and Fuji expand joint marketing plans

Look for increased German-Japanese cooperation in electronics as companies in both countries try to pry open new markets. Siemens AG and the Fuji Electric Co., two heavyweights in world markets, have just agreed to intensify their cooperation in the electrical-electronics field. During a recent visit by a seven-member Fuji delegation at the German company's Karlsruhe plant, talks centered on new Siemens developments which the Japanese firm will market in Eastern Asia. Involved primarily are industrial measuring devices and control equipment. The deal soon may be rounded out by a Siemens agreement to push new Fuji products on European markets.

Optical deflection addressing moves holographic memory closer to reality

Japanese researchers use single crystals of tellurium dioxide as the light-bending material; ultrasonic waves control the positioning of light from a helium-neon gas laser

Holographic memories show great promise as file memories, but so far there have been many practical difficulties blocking their realization. One of these—addressing—is on the way toward elimination. A team headed by Nobukazu Niizeki at the Electrical Communication Laboratory of the Nippon Telegraph and Telephone Public Corp. has developed an optical deflection system for addressing the memory.

The physical effect used has been known for about 30 years, but until recently no reliable device had been developed. Ultrasonic waves are launched inside the optical material making up the deflection unit and, because of the photoelastic effect, the material's refractive index is varied periodically by the ultrasonic waves. This forms the equivalent of a diffraction grating for light passing through the deflection unit. And deflection of an incident light beam can be varied by changing the frequency of the ultrasonic wave. Therefore, it's possible to obtain a one-dimensional scan by varying a transducer's driven frequency and a two-dimensional scan can be obtained by using two sweep generators to independently deflect the beam in horizontal and vertical directions.

Te time. The efficiency of light-bending usually is expressed as a figure of merit, generally quite large for liquids. But absorption of the ultrasonic waves by liquids is large, and their temperature characteristics are poor. Both ECL and Bell Telephone Laboratories Researchers have used water, but its structure becomes disarranged and results are poor.

The Japanese researchers, in their search for an efficient solid material for this application, have homed in on tellurium dioxide. Tests of the acoustic-optical properties of single crystals of TeO_2 showed that they are eminently suited for use in deflection systems. Large, uniform crystals can be readily fabricated. Philips' Gloeilampenfabrieken previously has grown crystals of this material and reported some data on their proper-



3-D. Cube of TeO_2 at center left is in optical path of laser beam coming from upper right. Acoustic transducers are attached to cube's top and side.

ties, but the researchers believe they are the first to use this material in an optical deflection system.

The deflection device for these experiments was built around a cube of tellurium dioxide approximately 10 millimeters on a side. On two perpendicular faces of this cube, lithium niobate ultrasonic transducers are attached for launch-

ing transverse ultrasonic waves inside the deflection crystal.

The light source used in these experiments is a 6328-Angstrom unit helium-neon gas laser. The beam from this laser passes through the cube approximately parallel to the third axis and is deflected in two dimensions by the ultrasonic waves.

Horizontal deflection repetition frequency is 1.8 kilohertz, and the vertical frequency is 50 hertz. Sweep is obtained by varying the ultrasonic transducer driving frequency linearly between 19 megahertz and 32 megahertz to vary deflection of the beam. Specific addresses are selected by an on-off pulse which amplitude modulates the frequency modulated signals. The data signal has a 57.6-kilohertz clock frequency—or 32 times the horizontal repetition frequency. That means the laser beam will be deflected to 32 discrete positions on a line. However, some time is required for transition to the next line because the sawtooth wave controlling horizontal deflection has finite fall time, and the system is designed to produce only 30 dots on a line. Similarly, there are 36 lines theoretically possible, but only 33 lines are used.

The ECL group has been able to obtain displays with up to 70-by-70 separate dots by this technique. They expect to increase the frequency to obtain greater bandwidth and work for a raster with up to 100 by 100 dots. The ultimate aim is a large-scale file memory, composed of holograph pages each having matrix of 100 by 100 bits. A beam directed at one of these



Display. Dot array projected on screen gives readout of experimental system.

pages would enable readout of information by photodiode or other sensor matrix located behind the holograph. Further, a 100 by 100 matrix of holograph pages would be located on one sheet of material, and individual pages would be addressed by deflection of laser beam to the desired page.

Great Britain

Organic MOS

For better or for worse, electronics has opened up the possibility of an organ in every home. Sales of electronic organs are showing healthy growth, especially in the less-expensive ranges. And to keep profits up, some manufacturers, notably Italians and Japanese, have switched to integrated circuits in the divider chains which produce the lower notes by continuous division by two of the output of a series of oscillators tuned to produce the high notes.

New Marconi-Elliott Microelectronics Ltd. is going one stage further with an MOS integrated circuit divider which allows the series of oscillators to be replaced by a single oscillator. M-E claims that this will cut costs in all organs except the cheapest, and at the same time make it impossible for the instrument to get out of tune with itself.

Currently, organs normally have 12 oscillators producing the 12 notes in the highest octave on the keyboard. Dividing each frequency

by two produces the octave below the highest octave, and so on. Though accurate division is simple enough, the oscillators obviously have to be carefully matched to each other and maintained in proper relationship, or the whole keyboard gets out of tune. Manufacturers say that in the least expensive organs this doesn't matter because they're only domestic novelties anyway. But for the serious musician it's a problem.

M-E plans to use a single oscillator to generate the highest note, and produce each note by division from the one above it; dividing the frequency of a note by the twelfth root of two gives the note below it. The only difficulty is to devise an integrated circuit which will divide by the twelfth root of two—which is 1.059463.

Fortunately, this figure is very close to the fraction 196/185; M-E men say the difference when dividing by the latter instead of the former is not audible. To divide by this fraction, Bill Betts of M-E has developed a chain-code generator based on an irregularly operating six-stage shift register. He proposes to put three chain-code generators on a chip about 80-mils square, using about 400 p-channel enhancement-mode MOS transistors. The outputs of the three generators give three adjacent notes, so that four chips in series driven from a master oscillator will give the 12 notes of the scale. To obtain a complete keyboard, either simple binary dividers can be used or the chain-code generator chips can be extended right down the keyboard, one generator for each note. The former will be cheaper, but the phase relationship between octave frequencies is fixed, producing an identical tone characteristic. The latter is more expensive, but the phase relationship throughout the keyboard is random. This provides a tonal variation similar to the pump-driven pipe organ and which many serious musicians prefer.

To divide successively by 196/185, Betts feeds the master oscillator output into a 63-stage shift register which jumps 14 stages so that it is effectively only a 49-stage register. He does this by detecting

a unique bit configuration once per cycle and using it to feed a jump start pulse into the register. The register output then is twice divided by two to produce a total division by 196. During the transition of these 196 states the following chain-code generator is fed only 185 states. Similarly, this second generator passes on to the third generator only 185 states for every 196 states.

M-E's chips still are in development and won't be ready for test for some months. But as far as can be seen, the price will be \$4.

France

Untangling the wires

Setting up wiring schemes for complex equipment is the worst kind of drudgery for most electronic engineers. Yet a machine or a technician has to be told to connect a wire from point A to point B to get the product to do what it's supposed to do.

Computer manufacturers have managed to automate this tedious job by programming it. A machine then lays out the wiring pattern for its new siblings. The result is quicker work and fewer errors—but computer makers jealously guard the complex programs involved. Other manufacturers have their own proprietary programs and have little reason to open them up to rival companies.

A Parisian software firm now has come up with new program that puts computer-aided wiring within the reach of small firms.

What's more, the program is available as a service or for purchase. The developed, Centre Lebel d'Etudes Scientifiques, charges about \$900 for a typical wiring job of 60 micromodules with 44 pins each. Lebel also will sell the entire program to volume wirers. The price tag would be about \$4,000 for the basic program, plus costs for individual tailoring.

On to America. Lebel hopes to find an American software firm to set up the service in the U.S., for clients too hurried to correspond

Electronics International

with Paris. The firm believes it is the first company anywhere to offer such a service to all comers.

The program for users of printed circuit micromodules, works like this.

A client first sends Lebel information on the type of component technology he uses—DLT, TTL, etc.—and gives fan-in and fan-out data. To help Lebel's computer pick the shortest route and wiring order for different wires, saving on wire costs and cutting crosstalk, the customer sends precise mechanical measurements of his modules and connectors, including number of pins and distance between them. This mechanical and electrical profile is used to build a "basic library" on a Lebel client.

Using the customer's circuit drawings, Lebel makes one perforated card for each module connector, indicating the pins requiring connections. A first reading sorts out possible design errors by telling the customer which pins have no connections indicated. Such an elementary check is rare with manual tables, says Lebel.

A second reading of the punched cards produces a wiring list, including orders on wire lengths and in which order they should be connected. In wiring tangles of more than one layer, it gives much more precise instructions on wiring order than is usual with manual lists, claim Lebel officials.

The entire operation takes the French firm about a week for a 60-module rack, compared with a bare-minimum three weeks for manually written lists. Moreover, the computer results also include a complete technical description of a product's wiring pattern, with signal designations, a step requiring extra work for technicians. For clients with automatic wiring machines, Lebel can supply a punched tape with the proper wiring instructions.

No absurd work. Lebel figures the cost of its computer-aided wiring is about the same as for a manual job, but claims its results are more accurate as well as quicker. "Errors in a wiring scheme almost always are caused by a technician confusing, misinterpret-

ing or misreading what a design engineer has drawn," claims Alain Schwartzmann, a Lebel sales engineer. "That's much less likely using a computer. Our program lets the design engineer be totally responsible for his wiring plan, without his having to do the absurd work of searching for pins to connect."

Fleeting image

Two French firms are mounting a frontal attack on the small but growing market for high-speed bi-planar electronic cameras—a market generally limited to basic research laboratories but now spreading into industrial R & D.

The companies, Thomson-CSF and Sodern, an affiliate of Philips' Gloeilampenfabrieken, are going after the American leader, the Beckman and Whitley division of Technical Operations, Inc. And they plan to compete in price, size, and speed.

A prototype of the newest French camera was unveiled at last month's Paris Physics Show by Thomson-CSE. The camera aims directly at the emerging industrial market by concentrating on easy handling and low price. The unit will sell in Europe for around \$10,000, about one-third less than a comparable Beckman and Whitley camera—and it is only half as big as the American competitor.

The French unit measures 14 by 7.9 by 10.5 inches and weighs 33 pounds. Unlike some cameras, it is contained in a single compact unit that can be easily mounted on a tripod. Like the competition, it receives a Poloroid camera back.

Bi-planar cameras don't take a series of rapid-fire shots on movie film as do high-speed electromechanical units. They take only one shot at a time—but they make it tell, by shooting at super-high speeds of up to 5 nanoseconds.

The bi-planar cameras are almost entirely electronic: A lens focuses

an image on a pulse-generating bi-planar photocathode tube. When a brief high-voltage pulse—10,000 to 15,000 volts—is switched across the tube, it allows the photons that make up the image pass through very briefly—like a shutter—and amplifies the photon, too.

Thomson-CSF has reduced the size of its camera by using a contact arc-gap switch to open and close the shutter. Competing cameras use such switches only to excite the tube. To time the brief exposure they use delay lines or cables whose length must be varied according to the desired exposure time. This contactless switching greatly simplifies the electronic circuitry that must produce a brief but steady high voltage, say Thomson-CSF engineers. A potentiometer replaces delay lines and cables.

The camera also boasts a new photocathode tube made by Philips' French Radiotechnique subsidiary, that gives a 29-photon gain against the 20-photon gain of now-standard tubes, plus wider spectrum response.

Since the Thomson-CSF camera is aimed at relatively leisurely industrial snap-shooters, its quickest exposure time is an unhurried 10 nsecs. Maximum exposure is 1 microsecond. The company expects to sell about 100 of the cameras in Europe over the next three years.

Sodern, which already makes what it claims is the world's fastest bi-planar camera with a 5-nsec minimum exposure, is working on a new model that will be close to five times faster. And it will use a new Radiotechnique photocathode

Snapshot. Thomson-CSF electronic camera operates as fast as 10 nanoseconds.

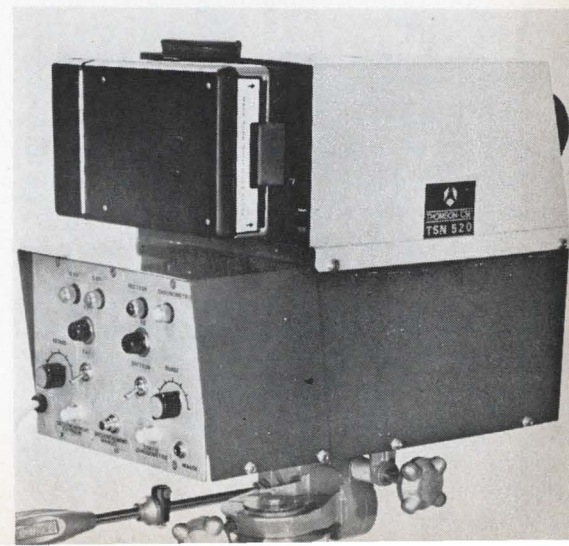

tube with the enormous gain of 600 photons. The company hopes to show this camera for the first time at a high-speed camera meeting in Denver next August. It would be available by the end of 1970, at a price the company declines to estimate.

West Germany

Blitzkrieg

Electronic flash units have brought a new convenience to amateur photography, and the competition for the consumer's dollar is as intense as the flash's output. Over the years one feature after another has been added—small size, sealed rechargeable batteries, unit construction, battery-saver circuits. The latest selling point is a purely electronic advance: automatic control of flash duration time, and hence of total exposure.

West Germany's Metz Apparatewerke even has made an advance on that. Its new Mecablitz 185 offers a control accuracy of $\pm 10\%$, regardless of whether the flash is 18 inches from the subject or 16 feet away. That's equivalent to only one quarter of a lens stop, hardly significant even in color photography. Some units on the market vary by as much as two lens stops.

As with other automatic flash units, the Mecablitz 185 frees photographers from the need to determine and set the camera aperture for each change in distance from the subject. All that's required is a one-time aperture setting corresponding to film sensitivity.

The heart of the new Blitz—German for flash—is what Metz likes to call an analog computer. This computer evaluates the light intensity reflected from the object and provides an output that kills the flash when the picture is properly exposed. The flash is shut down at any instant between 1 millisecond and 50 msec, depending on how much light the subject reflects, which is a function of its distance and its brightness.

In addition to the analog com-

puter, the Mecablitz 185 packs two ignition circuits, a flash tube, a flash capacitor, a photo diode and a power supply plus all the required control circuitry, into a case little larger than a pack of king-size cigarettes.

Just as in any electronic flash unit, a flash capacitor is charged either by rectified current coming from regular a-c power lines or stepped up to higher voltages from a battery. When the release button is pushed, the ignition circuit ionizes the flash tube so that the capacitor can discharge through that tube, thereby producing a flash.

In automatics, the light that bounces off the subject hits a photodiode and produces a signal proportional to light intensity. The output from the photodiode goes to the computing network, where it charges an integrating capacitor through its associated resistor. The voltage across the capacitor then is applied to the base of a transistor. When this voltage exceeds a specific threshold, current starts to flow through the transistor, switching on a thyristor. The thyristor causes a capacitor in a second ignition circuit to discharge through the primary winding of a coil. The high-voltage pulse induced in the secondary winding energizes a switching tube which short-circuits the parallel-connected flashbulb, extinguishing the flash.

Distortion. At short range, from 18 to 36 inches, delays in the circuit's response fool the computer and can cause the film to be overexposed. To prevent this Metz designers added a voltage proportional to the photodiode's current to the voltage across the integrating capacitor. The resulting higher voltage drop across the resistor of the RC network causes the switching tube that short-circuits the flashbulb to ignite earlier. As the light duration increases, as with greater subject distance, the added voltage becomes a smaller proportion of the total, thus maintaining the proper exposure.

Automatic light control isn't affected by other flashes set off in the vicinity, because the computing network starts operating only at the instant the camera release but-

ton is pressed. So, the computer can't be fooled by light pulses emanating from other sources. But once it's operating, the computer does take into account normal room lighting and the flashes coming from other sources.

Air power

In the highlands of Bavaria, about 50 miles west of Munich, construction crews are now busily at work on what will some day be one of the world's largest and most powerful short-wave radio stations.

When the first construction phase is completed—about five years from now—the station will comprise some 12 transmitters, each with an output power of 500 kilowatts. It will have antennas—both directional and omnidirectional—with some antenna supporting structures almost 400 feet tall. Another 12 transmitters with their associated antennas will be added to the station during subsequent construction phases some time in the late 1970's or early 1980's.

The agency that's going all out for such radio power is the German Post Office, which runs the country's various communication links. It will make the station available to the Deutsche Welle, a government-backed organization and the German equivalent to the Voice of America.

To spread the word about Germany around the world, the Post Office isn't pinching pennies. The initial construction phase will cost \$80 million, with more than half of that amount going for transmitters and related electronics equipment.

Five of the 12 transmitters are scheduled for completion in March 1972. They will be operational a few months later—just in time for broadcasting the Olympic Games from Munich.

Remotes. The sheer size of the installation and its total output power aren't the only things that make the new short-wave station stand out. It will also feature remote-controlled transmitter tuning—the first time ever, AEG-Telefunken says, that 500-kilowatt transmitters will be so tuned.

\$44,000,000

WILL BUY 1,000,000 TRIPLETT 310 VOM's
BUT YOU ONLY NEED ONE...AT \$44⁰⁰ THAT'S A BARGAIN

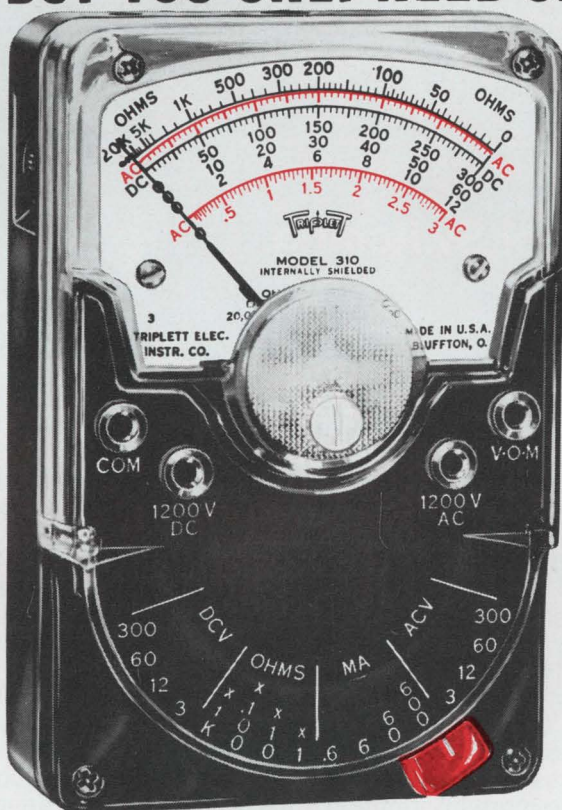

MODEL 310
World's Largest Selling
Volt-Ohm-Milliammeter
(SHOWN ACTUAL SIZE)

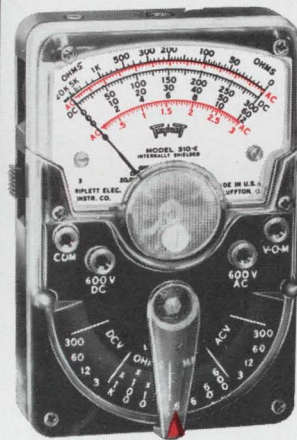

MODEL 310-C
Volt-Ohm-Milliammeter

- 1** HAND SIZE V-O-M WITH PROVISION FOR ATTACHING AC CLAMP-ON AMMETER.
- 2** 20,000 OHMS PER VOLT DC SENSITIVITY; 5,000 AC.
- 3** ONE SELECTOR SWITCH MINIMIZES CHANCE OF INCORRECT SETTINGS AND BURNOUTS.

310-C PLUS FEATURES

- 1** Hand size V-O-M with provision for attaching AC Clamp-on Ammeter.
- 2** 15,000 OHMS per volt AC sensitivity; (20,000 DC same as 310).
- 3** Single fully enclosed Lever Range Switch, plus DC Polarity Reversing.

MODELS 100 AND 100-C

Comprehensive test sets. Model 100 includes: Model 310 V-O-M, Model 10 Clamp-on Ammeter Adapter; Model 101 Line Separator; Model 379 Leather Case; Model 311 leads. (\$83.20 Value Separate Unit Purchase Price.)



MODEL 100 — U.S.A. User Net.....\$78.00
MODEL 100-C — Same as above, but with Model 310-C, Net.....\$88.00

SELF-SHIELDED Bar-Ring instrument; permits checking in strong magnetic fields. FITTING INTERCHANGEABLE test prod tip into top of tester makes it the common probe, thereby freeing one hand. UNBREAKABLE plastic meter window. BANANA-TYPE JACKS—positive connection and long life.

Model 310—\$44.00 Model 310-C—\$56.00 Model 369 Leather Case—\$4.40
All Prices are Suggested U.S.A. User Net, Subject to Change

TRIPLETT
CORPORATION BLUFFTON, OHIO 45817

**Our new
high energy
silicon power
transistors.
15 Amperes.
80 to 120 Volts.**

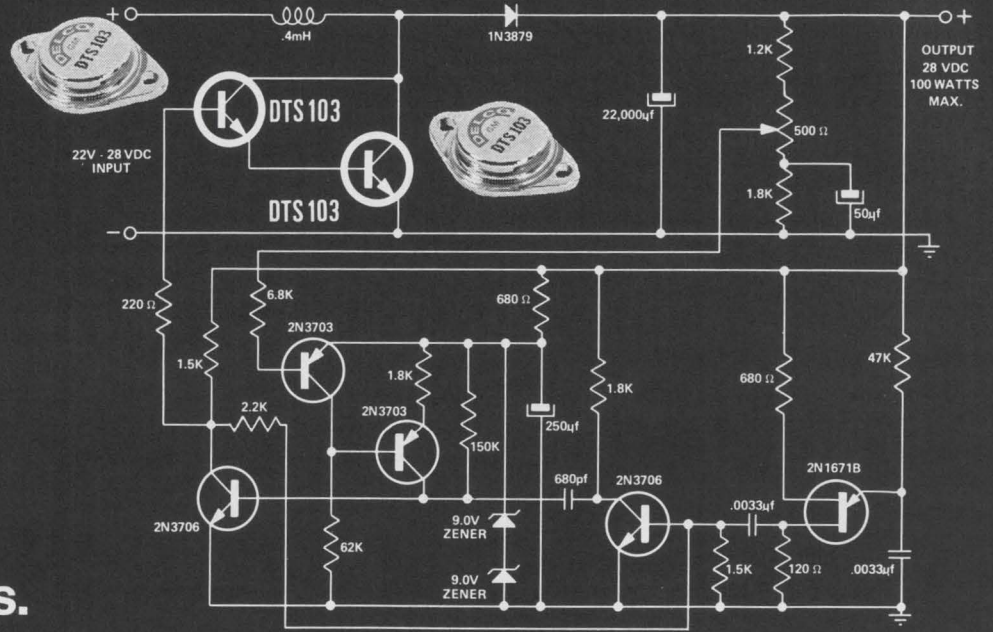

For Switching.

The Delco Radio DTS-100 series. NPN. Triple diffused. Rugged.

All the experience gained from our very high voltage silicon power line has gone into the development of these new transistors.

They were especially designed for the extreme under-the-hood environment of our I.C. voltage regulator. We found these devices ideal for applications requiring high efficiency switching or high power amplification.

The Delco triple sequential diffusion gives the DTS-100 series the high

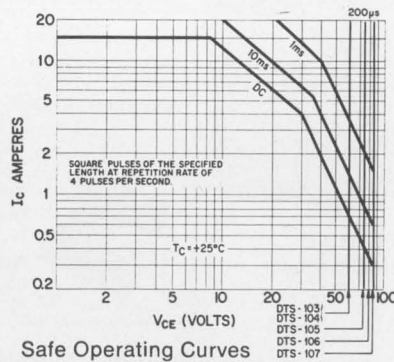

energy reliability that's needed for very tough switching jobs—resistive or inductive. The 28-volt shunt regulator above, for example, is amply handled by the DTS-103 (V_{CEX} of 80 volts). For complete data on this circuit, ask for our application note No. 42.

In the direct coupled audio amplifier above right, the DTS-107 displays the excellent frequency response, gain linearity and transconductance of this family. This circuit is covered in our application note No. 43.

Our solid copper TO-3 package provides maximum thermal capacitance to absorb peak power pulses. Its low thermal resistance ($0.75^{\circ}\text{C/W Max.}$) assures the extra reliability you expect from Delco.

Like more information? Just call us or your nearest Delco Radio distributor. All our distributors are stocked to handle your sample orders.

SEMICONDUCTOR DISTRIBUTORS

- ALA., BIRMINGHAM • Forbes Distributing Company, Inc. (205)-251-4104
- ARIZ., PHOENIX • Sterling Electronics, Inc. (602)-258-4531
• Hyer/Cramer Electronics, Inc. (602)-263-1112
- CAL., LOS ANGELES • Kierulff Electronics, Inc. (213)-685-5511
• Radio Products Sales, Inc. (213)-748-1271
- CAL., PALO ALTO • Kierulff Electronics, Inc. (415)-968-6292
- CAL., SAN DIEGO • Milo of California, Inc. (714)-232-8951
- COLO., COLORADO SPRINGS • L. B. Walker Radio Co. (303)-636-1661
- COLO., DENVER • L. B. Walker Radio Co. (303)-935-2406
- COLO., ENGLEWOOD • Hyer/Cramer Electronics Inc. (303)-771-5285
- FLA., MIAMI • Mountain Electronics, Division of Mountain National Co. (305)-634-4556

- FLA., WEST PALM BEACH • Mountain Electronics, Division of Mountain National Co. (305)-833-5701
- ILL., ROSEMONT • F-J-R/Midwest, Inc. (312)-678-8560
- ILL., SKOKIE • Merquip Electronics, Inc. (312)-282-5400
- IND., INDIANAPOLIS • Graham Electronics Supply, Inc. (317)-634-8486
- MD., BALTIMORE • Radio Electric Service Co. (301)-823-0070
- MASS., NEWTON • The Greene Shaw Co., Inc. (617)-969-8900
- MICH., KALAMAZOO • Electronic Supply Corp. (616)-381-4626
- MINN., MINNEAPOLIS • Stark Electronics Supply Co. (612)-332-1325
- MO., KANSAS CITY • Walters Radio Supply, Inc. (816)-531-7015
- MO., ST. LOUIS • Electronic Components for Industry Co. (314)-647-5505

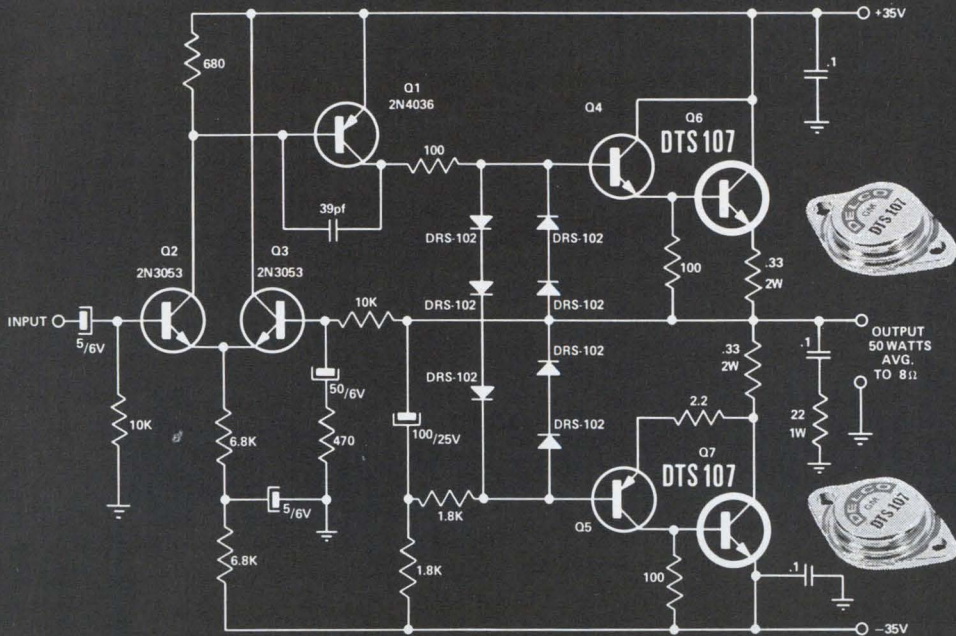

For Audio Amplification.

	I _c Cont. Amps.	I _c Pulsed Amps.	V _{CEX} @ .5mA Volts	V _{CEO} @ .25mA Volts	V _{CEO(SUS)} @ 250mA Volts	h _{FE} @ 5A	h _{FE} @ 20A (Min.)	V _{CE(sat)} @ 10A (Max.)	f _t MHz (Min.)	P _T Watts (Max.)
DTS-103	15	20	80	60	60	20-55	5	1.8	4	125
DTS-104	15	20	80	60	60	50-120	10	1.5	4	125
DTS-105	15	20	100	80	75	20-55	5	1.8	4	125
DTS-106	15	20	110	90	80	20-55	5	1.8	4	125
DTS-107	15	20	120	100	85	20-55	5	1.8	4	125

Kokomoan's Regional Headquarters

Union, New Jersey* 07083
Box 1018 Chestnut Station
(201) 687-3770

Santa Monica, Calif.* 90401
726 Santa Monica Blvd.
(213) 870-8807

Detroit, Michigan 48202
57 Harper Avenue
(313) 873-6560

Chicago, Illinois* 60656
5151 N. Harlem Avenue
(312) 775-5411

Kokomo, Ind. 46901
700 E. Firmin
(317) 459-2175 Home Office

*Office includes field lab
and resident engineer
for application assistance.



MARK OF EXCELLENCE



DELCO RADIO

DIVISION OF GENERAL MOTORS
KOKOMO, INDIANA

THE KOKOMOANS ARE IN POWER

N.J. CLIFTON • Eastern Radio Corporation (201)-471-6600
N.M., ALBUQUERQUE • Hyer/Cramer Electronics Inc. (505)-265-5767
• Sterling Electronics Inc. (505)-247-2486
N.Y., BINGHAMTON • Federal Electronics, Inc. (607)-748-8211
N.Y., NEW YORK • Harvey Radio Co., Inc. (212)-582-2590
N.Y., WOODBURY, L.I. • Harvey Radio Company, Inc. (516)-921-8700
OHIO, CINCINNATI • United Radio, Inc. (513)-761-4030
OHIO, CLEVELAND • The W. M. Pattison Supply Co., Industrial
Electronics Division (216)-441-3000
OHIO, DAYTON • F-J-R/Ohio, Inc. (513)-278-9411
OKLA., OKLAHOMA CITY • Radio, Inc. (405)-235-1551
OKLA., TULSA • Radio, Inc. (918)-587-9123

PENN., PHILADELPHIA • Almo Electronics, Division of
Sterling Electronics (215)-676-6000
PENN., PITTSBURGH • RPC Electronics (412)-782-3770
TEXAS, DALLAS • Adleta Electronics Company (214)-742-8257
TEXAS, FORT WORTH • Adleta Electronics Co. (817)-336-7446
TEXAS, HOUSTON • Harrison Equipment Co., Inc. (713)-224-9131
UTAH, SALT LAKE CITY • Hyer/Cramer Electronics Inc. (801)-487-3681
VA., RICHMOND • Meridian Electronics, Inc., a Sterling Electronics
Company (703)-353-6648
WASH., SEATTLE • Kierulff Electronics, Inc. (206)-763-1550
WASH., TACOMA • C & G Electronics Co. (206)-272-3181
CANADA, ONT., SCARBOROUGH • Lake Engineering Co., Ltd.
(416)-751-5980

THE 5000 PERM TOROID

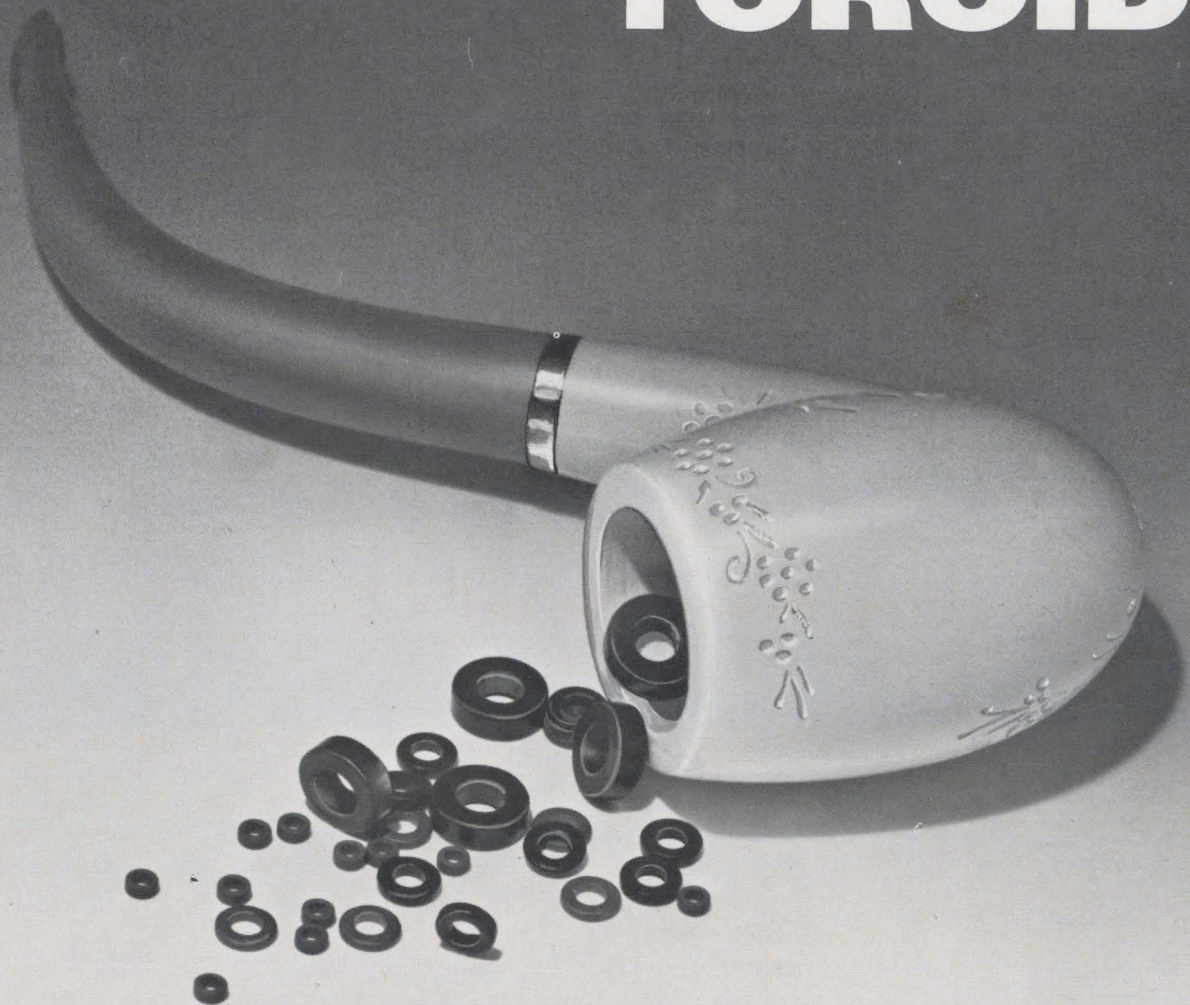

NO LONGER A PIPE DREAM

That's right. 5000 initial permeability. And we mean it!

Perhaps your designs for pulse transformers have gone up in smoke for want of a powerful enough material. Well, now you've got it. And then some. Stackpole Ceramag® 24H ferrite material.

Ceramag® 24H is a precision engineered product. Exact processing, density checks, rigid kiln controls and precise

sintering. You get more out of it simply because we put more into it.

Here are a few more conservative characteristics. Maximum permeability, 6900. Typical. Saturation flux density, 4100 gauss and residual magnetism of 850 gauss. If curie point is significant to your operation, how about one of 175° C. Then there's temperature coefficient. Ceramag® 24H goes + 0.700% / ° C at -25°

C to 25° C and -0.450% / ° C at 25° C to 75° C. And all of this with a disaccommodation factor of 1.4×10^{-6} .

Ceramag® 24H is ready. Are you? Drop us a line and we'll send you some even more interesting facts about this fantastic new material. And the charts to prove it. Stackpole Carbon Company, Electronic Components Division, St. Marys, Pa. 15857. Ph: 814-834-1521



STACKPOLE
Electronic Components Division

ALSO A LEADER IN THE MANUFACTURE OF QUALITY FIXED COMPOSITION RESISTORS

Washington Newsletter

January 5, 1970

All 1970 markets up except Government

Total U.S. market for electronics in 1970 will be \$25.5 billion, according to a preliminary forecast by the Electronic Industries Association. This is an increase of 1.4% over last year's \$25.1 billion, despite a predicted 3.5% decline in Government spending. Any future increases in Government spending will come in education, health, transportation safety, and air and water pollution, EIA says. The forecast adds that **the Government will place increased emphasis on R&D work**, on nondefense problems. The consensus in Washington is that the military R&D market for 1970 looks "grim."

Microelectronics and semiconductor makers should get in gear for huge increases. The EIA forecast says **microelectronics markets will be in for an increase of 58% to 750% million**, with the demand for semiconductor products up about 60% over last year.

Computer sales are the major factor in EIA's projected 1970 industrial market of \$7.6 billion, up 5.6%—with computers gaining 7.1% to \$4 billion.

Batelle Memorial Institute sees a \$200 million decline in Federal R&D spending in 1970 from 1969, with total funding at \$15 billion. Over the next 10 years, Batelle predicts, Government R&D spending will increase about 4% a year.

Whitehead leading list for chief of communications

Dr. Clay T. Whitehead, 31-year-old assistant to President Nixon, is regarded as the leading candidate to head the stronger, independent Office of Telecommunications Policy after a reorganization of the Office of Telecommunications Management [p. 45]. Whitehead, once reported in line for the chairmanship of the Federal Communications Commission prior to the appointment of Dean Burch, **headed the Nixon Administration's still unreleased study of telecommunications**. Whitehead's qualifications for the \$40,000-a-year post include an MSEE and a Ph.D in management, both from MIT, plus time in as consultant to the Bureau of the Budget and to the Rand Corporation.

Among other recommendations, the Whitehead study reportedly will suggest to the FCC who should own satellite earth stations.

Save Apollo 17-20, scientists urge

Scientists are furious, again, at NASA. George M. Low, new deputy administrator, has confirmed that the agency may cancel the last four Apollo moon landings [*Electronics*, Dec. 8, 1969, p. 66] to pick up about \$1 billion as a start on the \$10 billion space shuttle and station programs. Scientists meeting in Boston claimed such a sacrifice would be "tragic" and would result in "bitterness and frustration". Extensive experiments and instruments are being developed by scientists for use aboard the service module that will do double duty as a Scientific Instrument Module on Apollo 17 through 20.

F-15 radar contest due in six months

Either Hughes or Westinghouse will be selected to provide a modified fire-control radar for the F-15 after a "fly-off" which Brigadier General Benjamin N. Bellis—the F-15 program manager—says will come in about six months. McDonnell Douglas, successful bidder for the prime development contract for the air-superiority fighter [*Electronics*, Dec. 22, 1969,

Washington Newsletter

p. 61], was the only competitor not firmly committed to avionics subcontractors. Air Force Secretary Seamans says the company turned in a 43-page list of possible subs running to 4,000 names and located in 42 states. F-15 weapons payload will initially consist of the Sidewinder for close combat until the AIM-82 Dogfighter missile is developed, plus the AIM-7 for longer range. The AIM-7 is a variation of Raytheon's Sparrow series of which Gen. Bellis says, "We would like to increase reliability." Additionally, the aircraft will carry the M-51 Gatling gun now used in the F-4, pending development of a 25-millimeter model using caseless ammunition for which GE and Philco-Ford are now competing. Though the F-15 will still be somewhat slower than the Soviet Mig-23 Foxbat, some of which will be deployed this year, Secretary Seamans says the McDonnell Douglas plane's maneuverability is expected to give it air superiority.

Myers to head manned space flight

Dale D. Myers, 47, a veteran of 26 years in the aerospace industry, is set to head NASA's Office of Manned Space Flight. He will succeed George Mueller who resigned in November. Myers now is vice president of North American Rockwell's Space division and manager of its space shuttle program. In another change, NASA has announced that John A. Whitney, 37, has been appointed assistant general counsel for procurement.

Comsat imperils its Intelsat role, AT&T's Hough warns

The Communications Satellite Corp.'s "determination to interfere" in AT&T's overseas communications market is "seriously jeopardizing Comsat's role as manager" of the International Telecommunications Satellite Consortium, charges AT&T vice president Richard Hough in a letter to Comsat chairman James McCormack. AT&T says foreign communications authorities, with the FCC ruling on the submarine TAT-5 cable requiring an equal split between cable and satellite facilities for service between Rhode Island and the Iberian peninsula, feel the U.S. government is "challenging their sovereignty," and AT&T is finding it "increasingly difficult to pacify" its overseas partners and obtain support for Comsat's fight to retain Intelsat management.

Comsat has questioned if the mix of cable and satellite facilities makes sense. With future cable investment, "satellite capacity will be standing idle and satellite-per-circuit costs" forced higher, McCormack had said in a letter to FCC on the argument [*Electronics*, Oct. 13, 1969, p. 34].

Addenda

Salaries for engineers are on an upward trend, the Labor Department says, with an average increase in 1969 of 6%. Biggest gainers were college graduate trainees, making about \$9,600 a year, up 7.1%. Program managers, highest on the list at \$24,000 gained only 3.2%. . . . Interested parties have until Jan. 31 to file comments with the FCC on its proposed plan to make permanent its 1966 decision on the ownership of earth stations used in international satellite communication. That decision states that ownership should be divided between the Communications Satellite Corp. and the common carriers, including ITT World Communications Inc., Western Union International Inc., and American Telephone & Telegraph.

Performance / Efficiency / Size

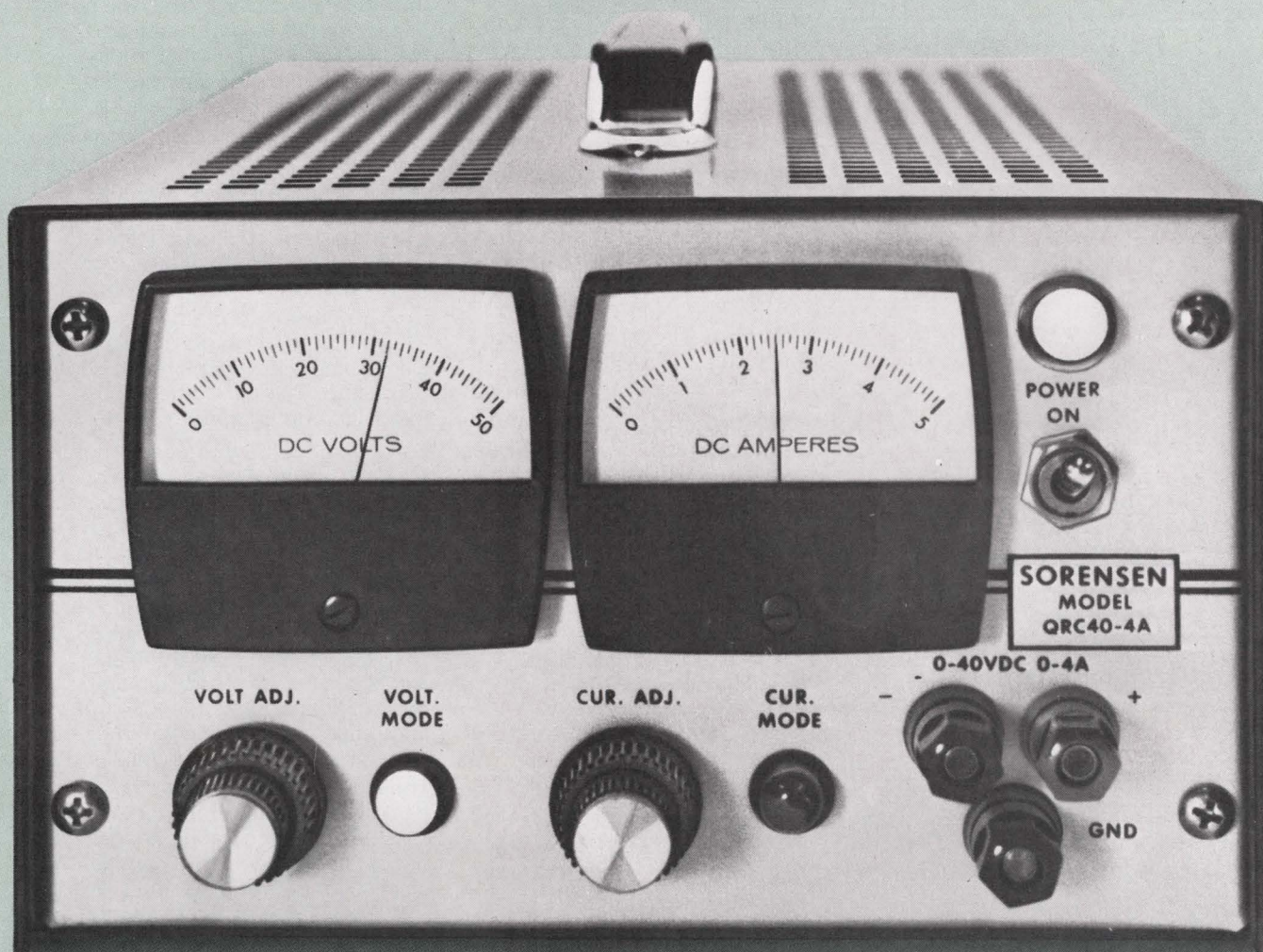

The QRC Series solves the specification/power/volume problem by utilizing all silicon, series regulator techniques with modern high speed transistor switching circuitry.

7 models, all available from stock, cover the voltage ranges of 0-20 and 0-40 Vdc at currents up to 30 amperes with prices starting at \$350 for model QRC 40-4A.

Features include: ■ $\pm 0.005\%$ voltage regulation for line and load changes combined ■ $< 1\text{mV}$ r.m.s. ripple (10Hz-7MHz)

■ 0.01% resolution ■ 25μ sec. response time ■ optional overvoltage protection ■ voltage and current regulation with automatic crossover ■ remote programming and remote sensing ■ -20 to $+71^\circ\text{C}$ operating temperature.

For more information contact your local Sorensen representative or; Raytheon Company, Sorensen Operation, Richards Avenue, Norwalk, Connecticut 06856.

Tel.: 203-838-6571;
TWX: 710-468-2940;
TELEX: 96-5953.

RAYTHEON



Learn how electronics is working to change the practice of medicine.

2nd National Conference & Exposition
on Electronics in Medicine.

February 12-13-14, 1970
Fairmont Hotel
San Francisco, California

Presented by
Electronics/Management Center
in association with
McGraw-Hill Publications

Electronics/Medical World News
Modern Hospital/Postgraduate Medicine

How much change will be brought about by the successful applications of the electronics technology to the modern needs of medicine?

Will the physician without a working knowledge of the employment of electronics as an administrative and clinical tool be obsolete in five years? Will the high efficiency, high reliability procedures predicted for the seventies increase or decrease the role of the individual physician? What will be its impact on the medical team and the medical center? Can electronics through automation improve the nation's overall health levels?

These are some of the questions now being answered by eminent physicians and technologists in many of our nation's most respected institutions where electronics is being actively applied to benefit hospital, doctor, and patient.

How well these programs are working, what's right and what's wrong with electronics will be explored in depth in the 2nd National Conference & Exposition on Electronics in Medicine.

The format of the three day program is based on the enthusiastic response to the First National Conference on Electronics in Medicine and the request by its attendees to provide for a broad interchange of ideas.

In morning sessions, authorities in both medical and electronic disciplines will present their knowledge and experience on subjects of major interest; instrumentation, computers, information systems, monitoring, diagnosis, therapy, and administration.

These meetings will provide the backdrop for afternoon work-sessions in which each attendee will become an active participant in the discussion of problems and solutions. All work sessions will be conducted to bring the maximum knowledge and experience of the group as a whole to each of the participants. Attendees will have the opportunity to join at least two of the six sessions being offered.

While meetings and work sessions will explore the most recent ideas with attendees, exhibits will present physicians and hospital administrators with the latest hardware available, providing an important opportunity for demonstration and a "hands-on" familiarization of the newest features and capabilities of electronics products designed specifically for medical application.

Meetings:

Keynote address

George Burch, M.D., Ph.D., Tulane University Medical School, New Orleans, La.

"Instrumentation and Common Sense"

Robert D. Allison, Ph.D., Director, Vascular Laboratories, Scott & White Clinic, Temple, Texas.

"Computers: A New Order for Medical Data"

Arnold Pratt, M.D., Director, Division of Computer Research & Technology, National Institutes of Health.

Address:

Hon. Roger O. Egeberg, M.D., Assistant Secretary for Health and Scientific Affairs, Dept. of Health, Education and Welfare.

"Medical Engineering: Problems and Opportunities"

George N. Webb, Asst. Professor, Biomedical Engineering, The Johns Hopkins University School of Medicine.

"The Medical/Engineering Interface"

Donald Lindberg, M.D., Chairman, Dept. of Information Science, University of Missouri.

"What's New in Medical Information Systems"

William Chapman, M.D., Palo Alto Medical Clinic (Selected films will be shown as part of Dr. Chapman's presentation.)

"Getting Medical Electronics from Research into the Real World"

Irving Selikoff, M.D., Director, Environmental Sciences Laboratory, Mt. Sinai School of Medicine.

Address:

"Is Science for Real? Or will the American public ever demand the medical care it deserves and find true happiness?"

Richard Bellman, Ph.D., Professor of Mathematics, Electrical Engineering and Medicine, University of Southern California.

How Hospitals Evaluate and Purchase Medical Electronic Equipment:

"Selection of cardiac care unit monitoring equipment"

James A. Stark, M.D.

H. Aileen Atwood, R.N.

"Data Processing Comes to Merritt Hospital"

Howard Scott, Hurdman & Cranstoun Penney and Co.

"Selecting Equipment for the Clinical Pathological Laboratory"

R. Thomas Hunt, M.D.

Floyd Oatman, A.T. Kearney & Co. Inc.

"Boosting Hospital Efficiency through Electronic Aids"

Oscar M. Powell, M.D.

S.R. Wickel

Work Sessions:

On-line Computer Applications.

The role of the computer in medical record-keeping, data analysis, and history-taking in the office and the hospital.

Automating the Clinical Laboratory.

This session will attempt to pinpoint the major test requirements of the clinical laboratory, evaluate the available equipment for automatic testing and determine future requirements.

Problems in Intensive Care Monitoring.

A discussion of problems in intensive care, available instrumentation, and what's needed for improved patient monitoring.

Multiphasic Screening: Pros and Cons.

How effective are automated screening techniques in preventive medicine for large groups? How much data is needed, and what associated hardware and software are required?

Problem Clinic.

A forum at which doctors and engineers will have the opportunity to discuss specific medical/

engineering problems and point the way to feasible solutions.

Buying, Selling and Maintaining Medical Electronic Equipment.

Marketing and maintenance are key problems in developing the role of medical electronics. On this panel, experts will discuss current practices and develop ways to improve them.

Exhibits:

This year, there is a new emphasis on exposition. One which reflects the increasing number of electronics products being accepted as practical, progressive, working tools by more and more hospitals and physicians.

Exhibits will include many products related to the program of discussions and work sessions. Demonstrations of product features will help attendees explore new applications for the latest electronics equipment.

Here is a partial list of the companies which will be presenting their most recent achievements.

Avtel Corporation • Bio-logics, Incorporated • Birtcher Corporation • The DeVilbiss Company • Federal Pacific Electric Company • General Electric Company • Graphic Controls Corporation • Honeywell, Incorporated • Mead-Johnson Laboratories • Laser Systems & Electronics, Incorporated • Medidata Sciences, Incorporated • Ohio Medical Products • Parke-Davis • Remler Company • Richard Manufacturing Company • Spacelabs Incorporated • Statham Instruments Incorporated • Technicon Corporation • Wang Laboratories, Incorporated •

Registrants of the 2nd Annual Conference & Exposition on Electronics in Medicine will be encouraged to invite their professional associates to regular exhibit sessions. Other members of the medical profession in the western region will also receive special invitations to visit the exhibits.

Registration Fee: \$150

(Includes all sessions, exhibits, luncheons, reception, and copy of the proceedings when published.)

Note: Only those fully paid in advance will be admitted to meetings and work sessions.

Mail registration and make checks payable to:

2nd National Conference and Exposition on Electronics in Medicine.
330 West 42nd Street, New York, New York 10036

A number of rooms is being held at the Fairmont Hotel for registrants. Make reservations directly with the hotel, identifying yourself as a Conference attendee.



Advance Registration

2nd National Conference & Exposition on Electronics in Medicine

February 12-13-14, 1970

Fairmont Hotel, San Francisco, California

Name _____ Title _____

Address _____

City _____ State _____ Zip _____

Hospital or Company affiliation _____

Check enclosed _____ Send invoice _____

**Pick the
biggest
winner yet.**

**We did.
i-3301**

New LSI memory is largest bipolar ever. A 1024-bit ROM with 60 nsec maximum access.

Introducing Intel Model 3301, a Schottky-process bipolar ROM memory with 256 x 4 organization. It's fully-decoded and dissipates only 0.5 mW/bit power. All inputs are Schottky diode clamped, and all outputs are capable of wired OR operation.

Two "chip select" leads permit expansion to a 1024 word memory without need for external decoding. Addition of two quad gates allows further expansion to 2048 words.

Memories offered as standard products will translate ASCII-8 to EBCDIC-8 and vice versa. Custom units to match your truth table can be delivered in 4 to 6 weeks.

Order now from over 40 locations. Phone your local Intel distributor: Cramer Electronics or Hamilton Electro Sales. Or phone us collect at Mountain View, California (415) 961-8080.

Intel Corporation is in production at 365 Middlefield Road, Mountain View, California 94040.

**Intel delivers.
Try us.**

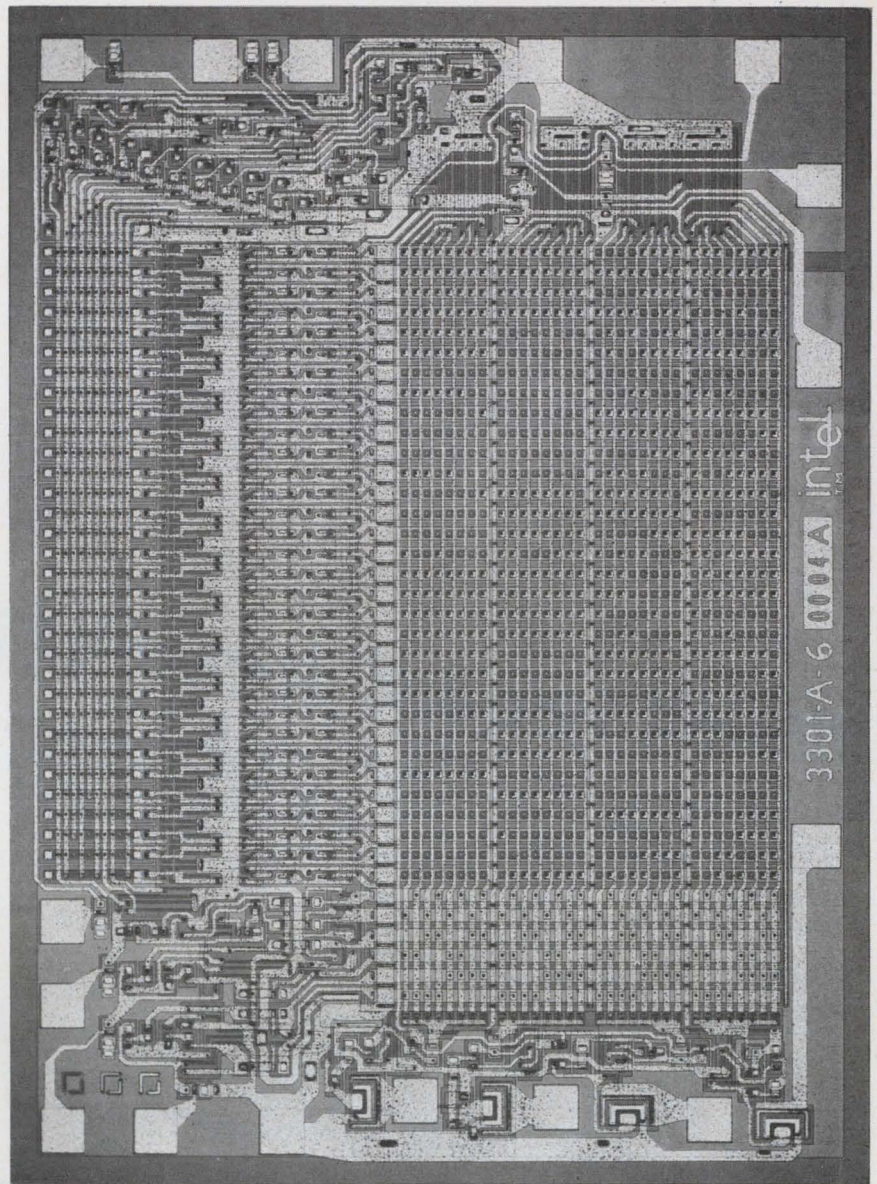

intelTM

BURROUGHS DEVELOPS... SELF-SCAN PANEL DISPLAY

the most significant development in electronic display

Burroughs, the originator of NIXIE® tubes, now revolutionizes display technology with the first commercially practical dot matrix display system. It took SELF-SCAN panel display, the remarkable Burroughs invention that takes the electronics out of the present electronic display ... reducing costly drive circuitry up to 90%.

With a minimum number of leads and drivers, Burroughs' system automatically scans data input into in-plane readout characters formed by glowing dots ... making possible a totally new combination of readability, minimal packaging and cost advantages.

The new flat-panel display is basically a matrix of small gas discharge cells hermetically sealed between heavy glass plates in a sandwich configuration. The matrix itself, formed of insulating material, has small grooves on its top surface to allow positioning of information anode wires which intersect each hole. Cathode conductors behind the center sheet intersect at each cavity with a second set of anode wires.



By utilizing the phenomena of preferential glow transfer and glow shifting, the initial glow caused by cathode ionization in the dot matrix may be moved through selected holes to a visible position on the top surface. A sequential flow of light is thus achieved without separate drivers for individual columns and rows.

Burroughs' alphanumeric SELF-SCAN panel displays are available with or without memory for any application requiring 16 or 18 digit readout.

Write today for descriptive brochure, Burroughs Corporation, Electronic Components Division, P. O. Box 1226, Plainfield, New Jersey 07061. Tel.: (201) 757-5000.

Burroughs



Electronic

Technical Articles

**Read-only memories
simplify logic design**
page 88

The truth table, originally the starting point for logic minimization, is becoming the end point, thanks to continued development of large-scale integration. This allows large read-only memories to be programmed with a truth table and dropped directly into a digital system. Designers used to sweat to reduce the number of costly diodes and transistors. But with integrated circuits, 10 transistors on a common substrate became as cheap as one, and logic designers can now afford to throw them in by shovelfuls, concentrating instead on interconnections and power dissipation. New read-only memories promise to throw miniaturization out the window altogether.

**Special report:
Starting a new
electronics decade
pacesetters**
page 101
Technology
page 105



Electronics technology in 1970 will bear the unmistakable stamp of the computer to an unprecedented degree, as exploding demand—particularly in the industrial and commercial sectors—creates new applications and markets. Closely allied with this demand will be increased versatility of computer equipment and peripherals. The Government and its agencies will continue to fund advances in technology, although probably at a reduced rate. One of the biggest impact areas for the computer will be manufacturing, where it will find applications in production, testing, and shipping. And circuit design also will reflect new and imaginative uses for the computer as it boosts technology.

**Symmetrical ECL
doubles NOR function**
page 142

Symmetrical emitter-coupled-logic IC's provide two NOR functions with much lower propagation delay and power dissipation than in standard ECL. When very fast switching is required in equipment design, SECL offers high packing density and reduced power consumption. Process technology is demanding, but not exotic. Shallow diffusion yields narrow base regions, and oxide sputtering substitutes for thermal growth to minimize emitter dip.

Coming

**Surface acoustic waves
simplify decoding**

Though still in its infancy, surface acoustic-wave technology can handle sophisticated microwave signal functions. The concluding article in *Electronics'* three-part series tells how some available devices, such as matched filters and variable-period transducers, do just that.

Standard read-only memories simplify complex logic design



Large-scale integration of semiconductors has made standard memories practical for use in implementing combinational and sequential logic; *Floyd Kvamme* of National Semiconductor explains how this is achieved

● Complex logic functions in control and arithmetic applications can now be implemented economically with semiconductor read-only memories, thanks to recent technological advances that make them mass producible with large capacities and good yields. These applications are in addition to their classic chores of microprogramming, table lookup, and data conversion. As implementations of logic functions, they replace arrays or assemblies of gates and flip-flops at lower cost and provide more efficient use of silicon real estate, without sacrificing the direct interface with the logic circuits in the data path. Furthermore, they're simpler to design than gate arrays, and can be manufactured and tested in the same way as read-only memories for conventional uses.

Of course, they have always been capable of acting as combinational and sequential logic networks, but past proposals often depended on core ropes, arrays of resistors, or the like. These complex structures, as logic networks, were economically and technically incompatible with the structure of then-conventional digital systems.

In general, digital systems comprise a series of registers that store data temporarily during the process, combinational logic that operates on the data as it passes from register to register, and control logic that determines both when data transfer occurs and what happens to the data during the transfer. When these systems were built with vacuum tubes or transistors, or even with indi-

vidual integrated-circuit gates, they had to be carefully designed to execute the desired functions, and only the desired functions, with a minimum number of components. The cost of these components, their physical arrangement in a machine, and other gross considerations imposed severe constraints on system organization—constraints that precluded the use of bulky and expensive read-only memory structures like core ropes.

Today, large-scale integration of both logic and memory circuits has removed this preclusion. With the metal-oxide-silicon process, read-only memories with capacities of up to 2,048 bits per chip are in mass production, and 4,096-bit units will be available soon. In these units the cost of individual components is almost negligible, and packaging constraints are more likely to involve interconnections a fraction of an inch long rather than to involve 50-foot cables under the floor.

Thus, economic incentive to reorganize systems now exists, because these memories provide the functional equivalent of 100 to 200 logic gates. And read-only memories are among the least expensive forms of LSI because they comprise arrays of identical cells instead of collections of miscellaneous gates randomly connected.

Nor do the technical barriers remain. MOS read-only memories can be an integral part of a logic system because they are electrically and physically compatible with logic ICs and have self-contained decoding and

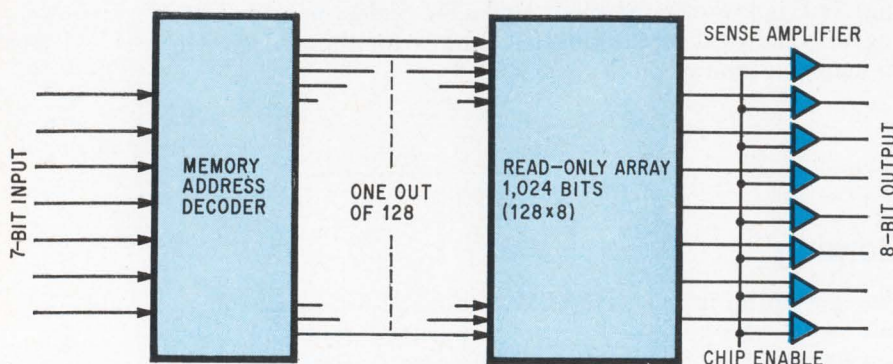

Logic or data. The seven-bit input can be regarded either as an address for one of the 128 eight-bit words, or as a combination of seven logic variables controlling eight independent functions.

GRAY	BINARY
0000	0000
0001	0001
0011	0010
0010	0011
0110	0100
0111	0101
0101	0110
0100	0111
1100	1000
1101	1001
1111	1010
1110	1011
1010	1100
1011	1101
1001	1110
1000	1111

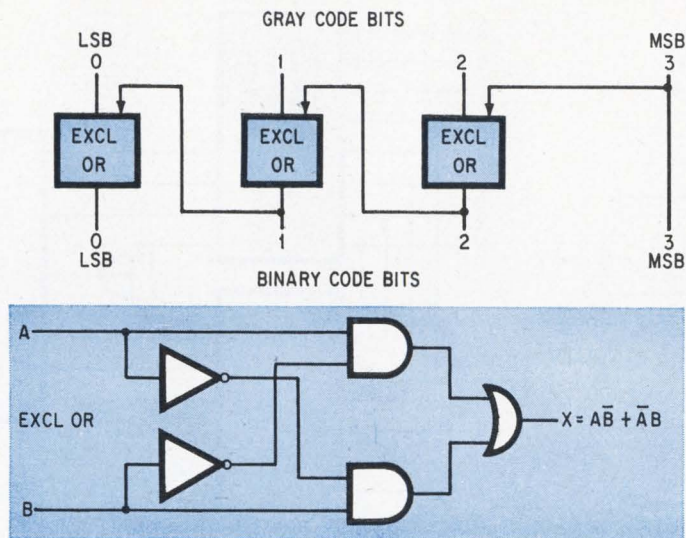

Conversion. A read-only memory containing 16 four-bit words can convert from the Gray code to binary code just as well as the logic network of three exclusive-OR circuits; the read-only memory contains merely the truth table for the conversion (left). This is a simple example, because both conversions require only a single chip—in fact, a chip with four exclusive-OR's is available, which would have a spare circuit left over in this application.

sense circuitry. Before MOS and LSI arrays became common-place, read-only memories were generally treated as subsystems because they required special control, sense and power-supply circuitry, and were assembled and packaged differently from logic circuits.

Although it is not a new idea, very little of a practical nature has been written about read-only memory logic. Therefore, the system designer will find little to guide him in this field. One pitfall to avoid is trying to force read-only memories into the established molds for relay and gate logic, by using, for instance, logic equations intended to minimize the number of gates or wiring cross-overs. These do not apply to MOS read-only memories.

In conventional logic design, redundancies cost money, and it's well worth the time and effort to eliminate them from the design. But the advantage offered by memory logic lies in the fact that redundancies add little to the cost; the designer is spared the effort and expense of trying to produce a read-only memory without redundancy. Traditional logic design techniques that delete storage elements within each memory must be dropped in favor of a method that reduces the number of read-only memory packages in a function. The cost of these individual packages, and therefore the cost of the system as a whole, is kept low by using standard production memories with standard capacities and custom internal wiring patterns, even though such a route would traditionally entail ex-

pensive or inefficient designs using arrays of gates.

System development usually can be divided into six steps: describing the system, designing the architecture, generating the truth tables, generating the logic equations and diagrams, building the hardware, and checking out the system. In this sequence of steps, the input for programing a read-only memory would be a truth table, which brings the memory's manufacturer into the picture after the third step. But at the outset of development, the system designer should decide where he can use the memories, and he should be definite about this before committing himself to a particular architecture—that is, before taking the second step. Otherwise, he will find himself asking the manufacturer for rush changes, at great expense.

In general, a truth table lists various combinations of a set of input variables, with one or more output functions for each combination; as such, it governs the locations of 1 and 0 bits stored in the read-only memory. Most memories contain standard groups of decode and sense circuits flanking a standard array of MOS field-effect transistors. Data is loaded into this array by etching away part of the gate oxide of MOS FETs corresponding to 1 bits, so that when they are selected, they begin to conduct and thereby produce a 1 output. The other MOS FETs in the array can't conduct even if selected—the unetched gate oxide at each transistor is thick enough to prevent the potential due to the gate voltage from opening a conducting channel in the transistor, thus producing a 0 output.

Using a read-only memory for logic requires only a different point of view, not a change in the hardware. Many classic read-only memory applications—for example, converting a word in one code to a word in a different code—are really combinational logic functions. A network that implements one of these functions generates a specific output for each specific combination of input variables, regardless of the network's past history. Viewed functionally, the memory's input is an address and its output is a bit or a word corresponding to the address; but the concepts in this memory-oriented terminology can be replaced one-for-one by combinational logic terminology.

This one-for-one replacement is apparent in the 1,024-bit memory shown opposite; it produces an eight-bit output word when one of 128 seven-bit addresses is re-

This is the 14th installment, and the 34th article, in *Electronics'* continuing series on memory technology, which began in the Oct. 28, 1968, issue.

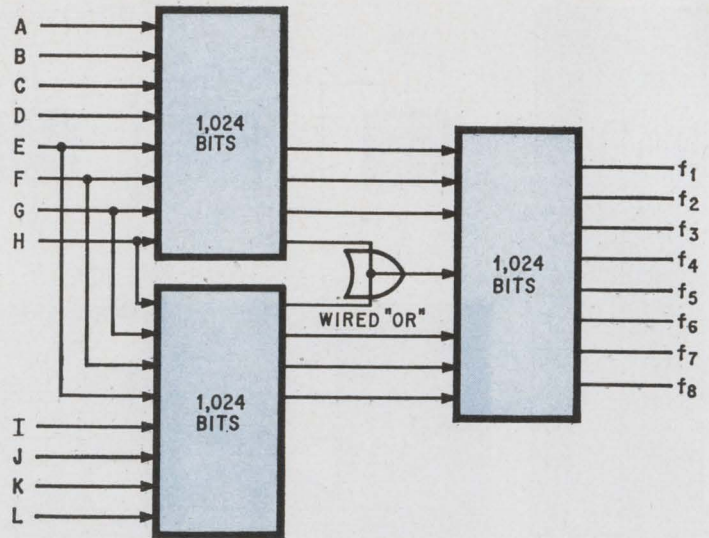
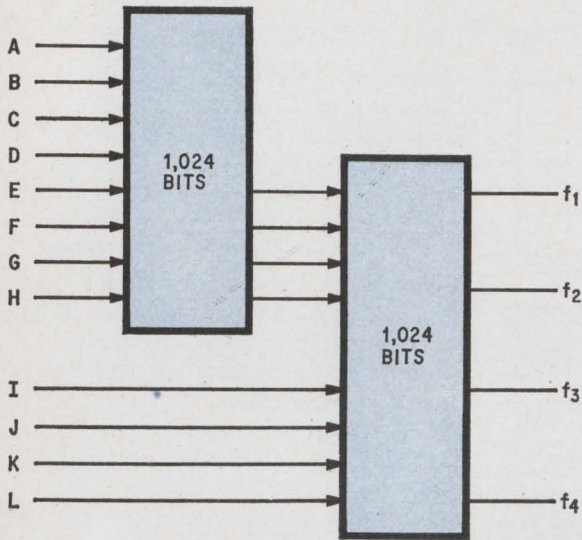

ceived. The seven bits in the address can be called seven variables and the eight bits in the output word can represent eight independent functions of these variables.

A programmer specifying data to be stored in a read-only memory thinks in terms of storing certain words in certain addresses. But a logic designer working with the same memory can think in terms of the output functions and ignore the fact that words are stored. These two viewpoints correspond to looking at the memory either horizontally or vertically [see tables, pages 92-93]:

► In the horizontal view (table 1) a word at the input produces a word at the output, and all bits in the input word are related to those in the output word. However, no output word is related to any other in the memory. Here, the read-only memory performs its classic function.

► In the vertical view (table 2), the output bits for a given input may be totally unrelated to one another. Instead, bits in corresponding positions for all the input combinations represent values of an output variable as a Boolean function of the inputs. Seen in this way, the memory is a bit-for-bit implementation of a truth table.

A third approach, partly horizontal and partly vertical, divides each input word into subwords (table 3). This viewpoint is more flexible than the other two aspects.

With programming variations, the horizontal view in table 1 could represent the conversion of a communications code such as the American Standard Code for Informa-

tion Interchange (ASCII) to a machine language such as the standard Hollerith punched-card code. Or, it could stand for the generation of an error-correcting code from binary-coded decimal numbers or represent a microprogram. For instance, the read-only memory can interpret keyboard instructions to a business machine or control how an "intelligent" computer terminal manipulates data when addressed by instructions from the central processor. In each example, the data in one form addresses the stored words representing the data in the converted form.

The vertical representation in table 2, a classic truth table, is generally useful in logic synthesis. A logic designer, beginning with a combinational function to be implemented or with an equation, makes a truth table that describes the function. Every combination of the input variables should be entered. The logic sum of those entries containing a 1 in the output column is the standard sum, which fully defines the function but is generally full of redundancies. Each term in the standard sum is called a minterm.

In conventional logic design the standard sum is the starting point for the logic designer's most exacting task—determining the least redundant sum. Its result, the minimum sum, is a sum of products; each product is implemented by an AND gate, and their sum by an OR gate. An exactly parallel procedure resulting in a product

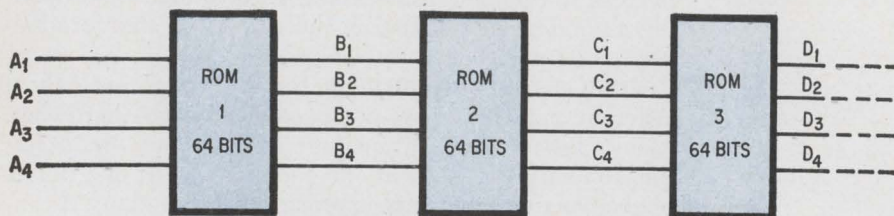

A ₁	A ₂	A ₃	A ₄	B ₁	B ₂	B ₃	B ₄	C ₁	C ₂	C ₃	C ₄
0	0	0	0	0	0	0	1	0	0	1	0	
0	0	0	1	0	0	1	0	0	0	1	1	
0	0	1	0	0	0	1	1	0	1	0	0	
0	0	1	1	0	1	0	0	0	1	0	1	
0	1	0	0	0	1	0	1	0	1	1	0	
⋮				⋮				⋮				

Brute force. A type of sequential operation is possible simply by stringing read-only memories together; the output of each is the input to the next, whose output is the next in the sequence. For a particular input A, all the outputs would remain fixed, and pseudo-sequential operation would require looking at the output of successive read-only memories.

Cascade. Complex logic functions can be executed simply when small memories are cascaded. Here (far left) only 2,048 bits define four independent functions of 12 variables each, a task that would require eight times as many bits in a single read-only memory, or in parallel read-only memories wired to act as a single array. At the left, 3,072 bits take the place of 32,768 in a similar layout.

of sums is also sometimes used.

But all this hard work is avoided when the minterms are programmed directly into a read-only memory. This can be done directly from the truth table, for each of several functions at once, bypassing the minimization process.

The vertical view in table 2 shows seven input variables, A through G, describing 128 different combinations of seven events, and eight possible output functions, shown as f_1 through f_8 , for each event combination. To realize a function of the seven variables the designer would simply place a 1 in the column corresponding to that function wherever the function was to contain a given minterm.

Each function thus contains a set of minterms that is different from the sets contained by the other functions and independent of them.

By using a truth table that is efficiently implemented in the read-only memory, the logic designer avoids not only the task of minimization but also minimization errors that might creep into a gate array. For example, a designer can save gates by reducing the expression

$$Z = \overline{A}\overline{B}\overline{C} + \overline{A}BC + A\overline{B}\overline{C} + A\overline{B}C$$

to

$$Z = \overline{B}\overline{C} + A\overline{B} + \overline{A}BC$$

In a read-only memory this expression, in its unreduced

form, can be implemented with eight bits—eight because the expression involves three binary variables, and $2^3 = 8$. Minimization produces no savings, because the minimized expression still involves three variables. On the other hand, even the minimized expression requires dissimilar gates—two ANDs and an OR.

Logically, if the number of minterms for a given function of n variables is greater than 2^{n-1} , it is easier to program the complement of the function and invert the read-only memory's output rather than program the function itself in the memory.

It is unlikely that very many terms would occur in an equation in practical applications. Because control functions vary widely, there is no agreement in the literature on a typical number of minterms in a control function. But functions like those in table 3 would probably take about 12 gates to implement, and eight such functions would therefore require about 100 gates. In other words, one 1,024-bit read-only memory is generally the equivalent of 100 gates; thus 10 bits in a read-only memory can generally replace a gate in combinational logic. However, this is a conservative estimate; it's easy to find examples in which three or four bits equal a gate.

One such example, which incidentally is also a simple example of the equivalency of conversion and logic, shown on page 89, is in changing a four-bit Gray code representation—one in which successive values differ in no more than one bit—into its binary equivalent. These representations are often used where a continuously varying quantity, particularly a mechanical one, is converted to digital form. When the conversion is implemented in conventional logic, it requires three exclusive-OR gates, or a total of 15 simple gates. But a read-only memory containing 16 four-bit words—64 bits in all—could be programmed to generate the corresponding binary output for any Gray-code input. In this case, 64 bits in the read-only memory replace 15 gates in the logic implementation, so that each gate is equivalent to approximately four bits.

Nearer to a logic designer's interest, perhaps, is an example such as the trigonometric lookup table (table 4). Read-only memories so programmed are made as standard components for signal processors and fast-Fourier-transform applications. In this table, an input word is a seven-bit binary fraction that represents an angle that is a multiple of 0.703125, which is $1/128$ of 90° ; the cor-

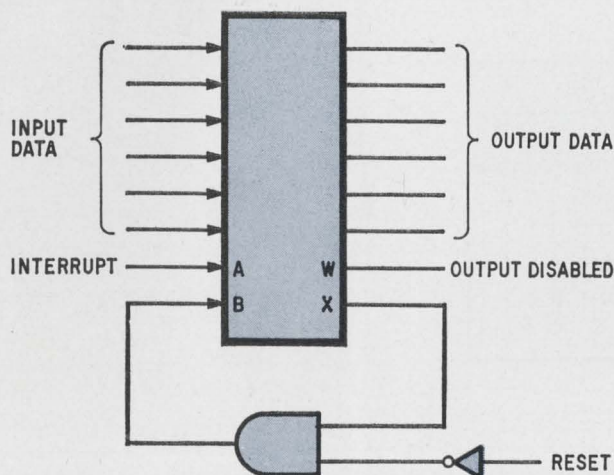

Truly sequential. A feedback loop from at least one output to the input is necessary for true sequential operation, which requires knowledge of the inputs' past history as well as their current state.

Table 1

INPUT WORD							OUTPUT WORD							
A ₁	A ₂	A ₃	A ₄	A ₅	A ₆	A ₇	X ₁	X ₂	X ₃	X ₄	X ₅	X ₆	X ₇	X ₈
0	0	0	0	0	0	0	1	1	1	1	1	1	1	1
0	0	0	0	0	0	1	0	1	0	0	1	0	0	1
0	0	0	0	0	1	0	0	1	0	1	1	1	0	0
0	0	0	0	0	1	1	0	0	0	1	0	0	0	0
0	0	0	0	1	0	0	1	0	1	1	0	0	1	1
0	0	0	0	1	0	1	1	0	1	1	0	0	1	1
0	0	0	0	1	1	0	0	0	0	1	1	0	1	0
0	0	0	0	1	1	1	1	0	0	0	0	0	1	0
0	0	0	1	0	0	0	0	1	1	0	1	0	0	0
0	0	0	1	0	0	1	0	0	0	1	0	0	1	0
⋮														

Table 2

INPUT VARIABLES							OUTPUT FUNCTIONS							
A	B	C	D	E	F	G	f ₁	f ₂	f ₃	f ₄	f ₅	f ₆	f ₇	f ₈
0	0	0	0	0	0	0	1	1	0	1	0	0	0	1
0	0	0	0	0	0	1	1	1	0	0	1	0	0	1
0	0	0	0	0	1	0	1	1	0	1	1	1	0	0
0	0	0	0	0	1	1	1	0	0	1	0	0	0	0
0	0	0	0	1	0	0	1	0	1	1	0	0	1	1
0	0	0	0	1	0	1	1	0	1	1	0	1	0	0
0	0	0	0	1	1	0	1	0	0	0	1	1	0	1
0	0	0	0	1	1	1	1	0	0	0	0	0	1	0
0	0	0	1	0	0	0	1	1	1	0	1	0	0	0
0	0	0	1	0	0	1	1	0	0	1	0	0	1	0
⋮														

responding output word is the binary representation of the sine of that angle.

In general, the number of inputs to a memory is the logarithm, base 2, of the number of words. Thus, doubling the number of words increases the number of address bits by one. When applied to read-only memories that replace logic networks, this rule seems to require a doubling of memory bits with every additional variable. Not so—several methods are available to significantly reduce the number of read-only memories needed to perform large combinational functions. One of the best methods is cascading them, as shown at the top of page 90, a technique that becomes more efficient as the number of variables increases.

A simple example is an AND function of four variables, ABCD. This function can be performed by 16 bits of one read-only memory, 15 of which are 0, or by 4 bits in each of three memories for a total of 12 bits. A 4-bit segment in one first-stage memory would form the AND function of A and B; the second memory would similarly form C and D. The A·B and C·D outputs of these read-only memories would then be the inputs to a third 4-bit read-only memory, producing a second-stage output representing A·B·C·D.

It's impractical actually to use read-only memories for four-input ANDs, but this example shows the technique. The progression in the number of bits as the number

of variables increases, shown in table 5, is much slower than the exponential growth of a single read-only memory. Note that the first of two read-only memory levels for a 7-input AND contains three read-only memories—two 4-bit and 8-bit.

The cascades accomplish, with 2,048 and 3,072 bits, functions that would require 16,384 and 32,768 bits, respectively, with a single read-only memory or with parallel memories. They also illustrate two other points: the flexibility of read-only memories following the log₂ capacity rule, and the efficiency of a few medium-sized memories relative to one giant—and expensive—special memory. In the three-memory cascades, two of the interim outputs are combined in an OR gate, which effectively “doubles” the second memory’s capacity by reducing the second-stage inputs from eight to seven. Truth tables permitting such combinations are easy to prepare when the first-stage read-only memories have input subwords in common. Either a hardware logic gate may be used or, as shown on page 90, the memory outputs can simply be mixed together. Another technique uses a logic gate at an input to “double” memory capacity; what is actually doubled is the system’s logical flexibility.

The cascade technique’s versatility is due to the fact that any large group of functions usually contains many common variables or minterms. This appears in table 3, for example, in which the most significant bits of eight

TABLE 4
1024-BIT SINE LOOKUP TABLE

ADDRESS	DEGREES	BINARY OUTPUT
0 0 0 0 0 0 0	0	0 0 0 0 0 0 0 0
0 0 0 0 0 0 1	0.7	0 0 0 0 0 0 1 1
0 0 0 0 0 1 0	1.4	0 0 0 0 0 1 1 0
0 0 0 0 0 1 1	2.1	0 0 0 0 1 0 0 1
⋮		⋮

Table 3

CHARACTER ADDRESS				LINE ADDRESS			OUTPUT CHARACTER								
A ₁	A ₂	A ₃	A ₄	B ₁	B ₂	B ₃	f ₁	f ₂	f ₃	f ₄	f ₅	f ₆	f ₇	f ₈	
0	0	0	0	0	0	0	1	0	0	0	0	0	0	0	1
0	0	0	0	0	0	1	1	0	0	0	0	0	0	0	1
0	0	0	0	0	1	0	1	0	1	0	0	0	0	0	1
0	0	0	0	0	1	1	1	0	0	1	0	0	0	0	1
0	0	0	0	1	0	0	1	0	0	0	1	0	0	0	1
0	0	0	0	1	0	1	1	0	0	0	0	1	0	0	1
0	0	0	0	1	1	0	1	0	0	0	0	0	1	1	1
0	0	0	0	1	1	1	1	0	0	0	0	0	0	0	1
0	0	0	1	0	0	0	1	1	1	1	1	1	1	1	1
0	0	0	1	0	0	1	1	0	0	0	0	0	0	0	0

input words are alike. Likewise, in the two-memory 12-input cascade, the shared terms combine with the unshared terms to drive the second memory. The principle of the three-memory arrangement is similar. It is most useful when a group of input variables, such as EFGH, are common to several output functions. But cascaded read-only memories, like cascaded logic gates, have a longer propagation delay than does a single rank.

Many variations of these basic cascades are possible, and they can be used in combination with read-only memories of different sizes. Determining the best way to rearrange the original truth tables is an ideal task for a computer, since a great many variables must be compared and shifted around to match common terms in a convenient order. These techniques stem from the table 3 approach, which the National Semiconductor Corp. uses to organize large conversion read-only memories and character generators for displays.

For example, National uses the three-memory cascade to translate from the 12-line Hollerith code to the 8-line ASCII. Read-only memories like table 3 serve as alphanumeric fonts, and read-only memory kits are available to generate 5-by-7 matrixes of 1 and 0 patterns, for example, from ASCII 6-line inputs for various types of displays and printouts.

In this approach, the 4-bit input subword would address a character, and the 3-bit subword would address

a row, line or column related to that character. The 1 bits in the first eight rows of the output matrix outline the letter N; these bits could display the character on a cathode-ray tube by gating the crt beam with output line-by-line or column-by-column.

Assume, however, that N represented a large group of functions containing the corresponding minterms in the first eight sets of input variables. If the letter M represented a different large group of functions, the f₁, f₂, f₃, f₄, and f₈ columns would be identical to those for the N-group. In this case a majority of the minterms that could be represented by the input variables are, in fact, common. These read-only memory minimization techniques do not recreate the design and debugging problems of gate-logic minimization. The validity of a truth table doesn't have to be checked out in prototype hardware, because it is easily verified with a computer. Programs are available to print out truth tables from logic expressions or vice versa, mechanizing an otherwise tedious manual process.

Also, standard read-only memories will generate all eight output functions for a given input combination in about 1 microsecond. As a result, delays found in large combinational nets are avoided, and therefore need not be compensated with high-speed logic, which brings in its own problems of noise, races and clock skew.

Read-only memories can also be programed to perform a sequence of logic events, or a mix of combinational and sequential events. Feedback makes the sequential operation possible.

Any series of read-only memories can simulate sequential logic in a straightforward manner. For example, the memories shown at the bottom of page 90 are merely programed to shift the binary value of each set of outputs up by one from stage to stage. The collection of read-only memories simulates a counter. Shift registers and other sequential functions could be implemented in this fashion, but the design would be inefficient because it would require many read-only memories.

But only one would be needed to make a counter if the output from the first read-only memory were returned directly to its input. A binary 0000 input would generate an output of 0001, changing the input to 0001 and the output to 0010, and so forth. To keep the read-only memory from rippling through all its states, at least one additional input is required for a clock pulse.

The memory is programed to generate an output for each clock pulse that matches the other 4 bits of the input. This match can be made to occur at the rise of the clock pulse, at its fall, or at both.

This highly efficient counting technique employing the clocking and feedback techniques was introduced a few years ago,² considerably ahead of its time. It was implemented with a small read-only memory—64 by 4—limiting the counter modulus to eight. Modern read-only memories make this counting technique much more powerful. Any arbitrary number of stages can now be implemented with memories of up to 2,048 bits, since additional inputs and outputs are available for carry, borrow, and special feedback functions.

Any design of a counter, or for that matter design of any sequential logic function, must answer several important questions. Where does the sequence start? Where does it stop? If it gets into a wrong or disallowed state because of noise or other perturbation, how can this condi-

TABLE 5 NO. OF INPUTS TO AND FUNCTION	BITS REQUIRED IN SINGLE ROM	BITS REQUIRED IN 2 CASCADED ROMs
4	16	12
5	32	16
6	64	20
7	128	24

tion be detected and how can the device be forced out of the wrong state loop?

With read-only memories these questions are answered more simply than with conventional logic design. In fact, starting the counter is easy—just force the address to its initial value and bring up the clock signal. This design avoids the additional reset input or its equivalent, required in conventional sequential circuits. And the counter stops whenever the clock signal stops or the events being counted stop happening; the only precaution is to make sure the counter counts every event, yet doesn't count a single event more than once. In designs that have many bits changing at nominally the same time, another problem is avoiding false sequences when the changes involve slight differential delays—as in fact they invariably do.

One way of solving these problems is to count in Gray code, which easily converts to straight binary, as was illustrated earlier. Gray-code counting is easy to accomplish with read-only memories, as are many of the arithmetic techniques developed in synthesizing relay-type logic and in avoiding race conditions that occur in asynchronous counter-type logic systems.

A simple design using a read-only memory is a counter that can count either up or down. Such a counter, shown below, can be built with a 1,024-bit memory, so that it has 16 stable states; it can be connected to similar units to

increase the number of states and the count range. Its two most significant input bits are the up/down controls. The two most significant outputs are the carry/borrow lines, which can be connected to the count-up and count-down lines of another read-only memory counter to expand the range. Stable states are reached as they are addressed, and the counter is drawn by feedback into the next stable state.

This design is basically the elementary sequential logic circuit proposed in 1967 for implementation with read-only memories—with two major improvements. First, it has additional capability for generating additional outputs, such as carry and borrow. Second, it takes advantage of a technology—MOS—that permits far more complex functions than this to be built monolithically, whereas the original design used up a whole bipolar memory for a simple counting operation. Bipolar technology's lower component density and more complex construction have yielded to MOS in this respect.

It is not necessary to feed back all output lines to form new inputs. Some outputs may represent combinational functions and some may be fed back for sequential functions. In addition, the feedback loops might themselves act as outputs to control subsequent circuits.

At first glance, these random-logic techniques seem to require asynchronous operation, which is difficult to control. But in read-only memories that have controls for

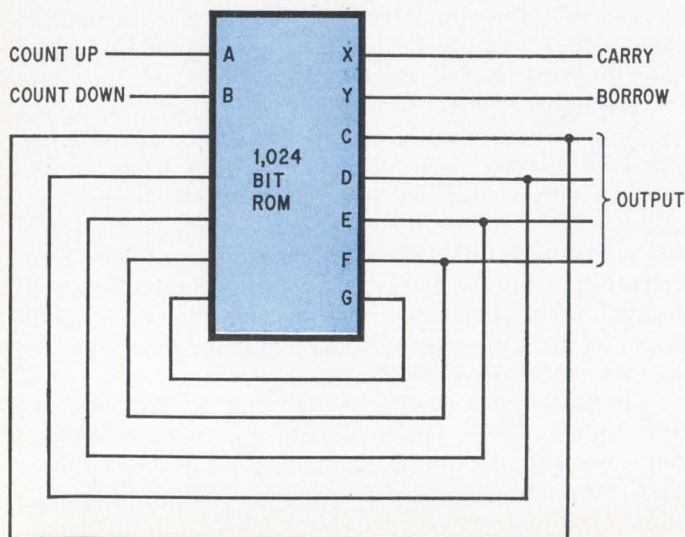

Up-down counter. This simple sequential circuit, essentially similar to one first proposed in 1967, offers two improvements: it generates additional outputs such as carry and borrow, and it has basic potential for considerably more complex functions than mere counting.

strobing or enabling, the strobe line can be used much like a system clock. For instance, the outputs can be disabled until all input transients have died away.

In a basic random-logic configuration, shown on page 91, the read-only memory performs combinational functions, such as code conversion, with the six data lines, while it can also perform control and sequential functions with the A and B inputs and the W and X outputs (or with some of the data lines as well). In normal operation, both the interrupt line A and the reset line B are at their 0 states. Thus, the W and X output lines are also at their 0 states. In this configuration, a 2,048-bit memory can store 256 words with 6 data bits and 2 control bits.

Now suppose an interrupt at the 1 level appears at the A input. This causes the W line to put out a 1, alerting the outside world that the read-only memory's output data is no longer valid. At the same time, the X line goes to its 1 state, if the reset is at 0, this drives the B input to its 1 state and causes the unit to latch. When the interrupt signal returns to 0, the outputs remain in their 1 states, due to the feedback loop, and the B line remains at 1. With the memory latched, a reset command is required before the other six outputs can represent the data or functions programed in that portion of the memory.

The gate driving the B input takes the place of an additional address or control line, and is the equivalent of a ninth input variable. With it, the 2,048-bit read-only memory has the same logic flexibility as one with 4,096 bits under the \log_2 rule. The single external gate makes the structure very easy to implement.

What the diagram shows is a normal combinational logic net acted upon by two sequential events—interrupt followed by reset—that stop it and then restart it respectively. The read-only memory's capacity can be used for combinational functions, sequential functions such as a modulus-16 counter, or in many other applications.

Many approaches have been championed as the most efficient implementation of LSI. One way to judge their economic merits is to compare the silicon chip areas they need to perform the average function. For example, a 2,048-bit read-only memory can be made on a 90-by-110-mil chip. According to our approximations, it is the equivalent of about 200 logic gates.

There are no LSI techniques today that can put a 200-gate random logic function on so small a chip. In fact,

no one would propose to put even 100 gates on such a chip. Thus chip economics favor the use of read-only memories even if our approximation were off by a factor of two. Forecasts of bipolar logic cells as small as 10 square mils have been made, but MOS FET storage elements have already gone beyond this level, to about 1 square mil per MOS FET. Of the 10,000 square mils on the chip in the photo about 65% is occupied by the wire-bonding pads, intraconnection wiring, and decode and sense circuits. Logic arrays require similar investments in area for input-output functions. Future improvements in process resolution and larger chip sizes will greatly increase read-only memory capacity because of the basic storage element's small size.

Moreover, semiconductor read-only memories require no custom engineering, wiring, packaging or testing on the part of the semiconductor manufacturer. Once the user submits his truth table to the manufacturer, no further negotiations are required. Only one mask, controlling the gate-oxide thickness, is altered to program a read-only memory. Logic arrays, by contrast, require the manufacturer to decipher logic equations and diagrams, to prepare a set of production masks based on these diagrams governing the type and chip location of logic cells and input-output devices, and to generate up to three metallization etching masks.

Differences in the gate oxide have virtually no effect on the production process; that is, read-only memories storing different data or implementing different logic designs are produced identically, so it is a standard production item. Its handling, flow, inspection, packaging, and testing are familiar to people on the production line, who thus don't have to learn the distinctions between different designs. Experience proves that this familiarity with a single design, or with a minimum number of designs, is not a minor point in the production of any IC. No special precautions or instructions are needed at any stage during the manufacturing process, from first diffusion to final test, and none need be paid for.

Perhaps the greatest benefit of read-only memory logic comes in testing. A device with 100 or 200 gates always poses severe testing problems: Every function that it should perform must be verified, and every incorrect function that it might perform must be weeded out. This complexity requires the logic-array manufacturer to develop either a special tester for each array that it builds, or a large general-purpose tester capable of testing virtually anything in digital circuitry. Either approach is expensive. But the read-only memory manufacturer can use a standard tester that rapidly checks out the memories in all applications—as memories or as logic.

Furthermore, the read-only memory need only be tested for its combinational functions, in addition to the usual electrical tests. Unlike an array of gates and latches, a read-only memory sequential-logic system can be checked out with the feedback loops open; then, if the combinational net functions properly, the sequential net will also work when the feedback loops are closed, because the loops simply change the output from one combinational function to another. ●

References

1. Samuel H. Caldwell, "Switching Circuits and Logical Design," Wiley, April 1959.
2. John L. Nichols, "A Logical Next Step for Read-Only Memories," *Electronics*, June 12, 1967, p. 111.

Designer's casebook

Designer's casebook is a regular feature in Electronics. Readers are invited to submit novel circuit ideas and unusual solutions to design problems. Descriptions should be clear. We'll pay \$50 for each item published.

Op amps reject line noise in a-d converter's input

By Dusan Velasevic and Srdan Stankovic

Institute of Nuclear Sciences, Belgrade, Yugoslavia

Line frequency noise from analog signals can considerably reduce the accuracy of output signals from an analog-to-digital converter. But two operational amplifiers can be used to separate and filter noise from analog signals before conversion without appreciably prolonging settling time.

The input signal, comprising the line frequency noise superimposed on the analog signal, is fed simultaneously into the two op amps. The high-

pass R_1C_1 network at the input of the first op amp filters out the analog portion and, with adjustment of R_1 and R_2C_2 keeps the phase shift of the noise through the first op amp constant. This op amp inverts the noise waveform.

The second op amp acts as a summing network for the analog input signal, its noise component, and the inverted noise component passed by the first op amp. The summing network thus actually subtracts out the noise component. Potentiometer R_3 can be adjusted to provide complete cancellation of the line frequency noise.

By comparison, when a Gaussian three-pole active filter is incorporated into an a-d converter to reject noise, the converter's settling time is 200 milliseconds at 0.01% of full scale. The op amp circuit's settling time is 40 milliseconds with the same rejection ratio and line frequency noise.

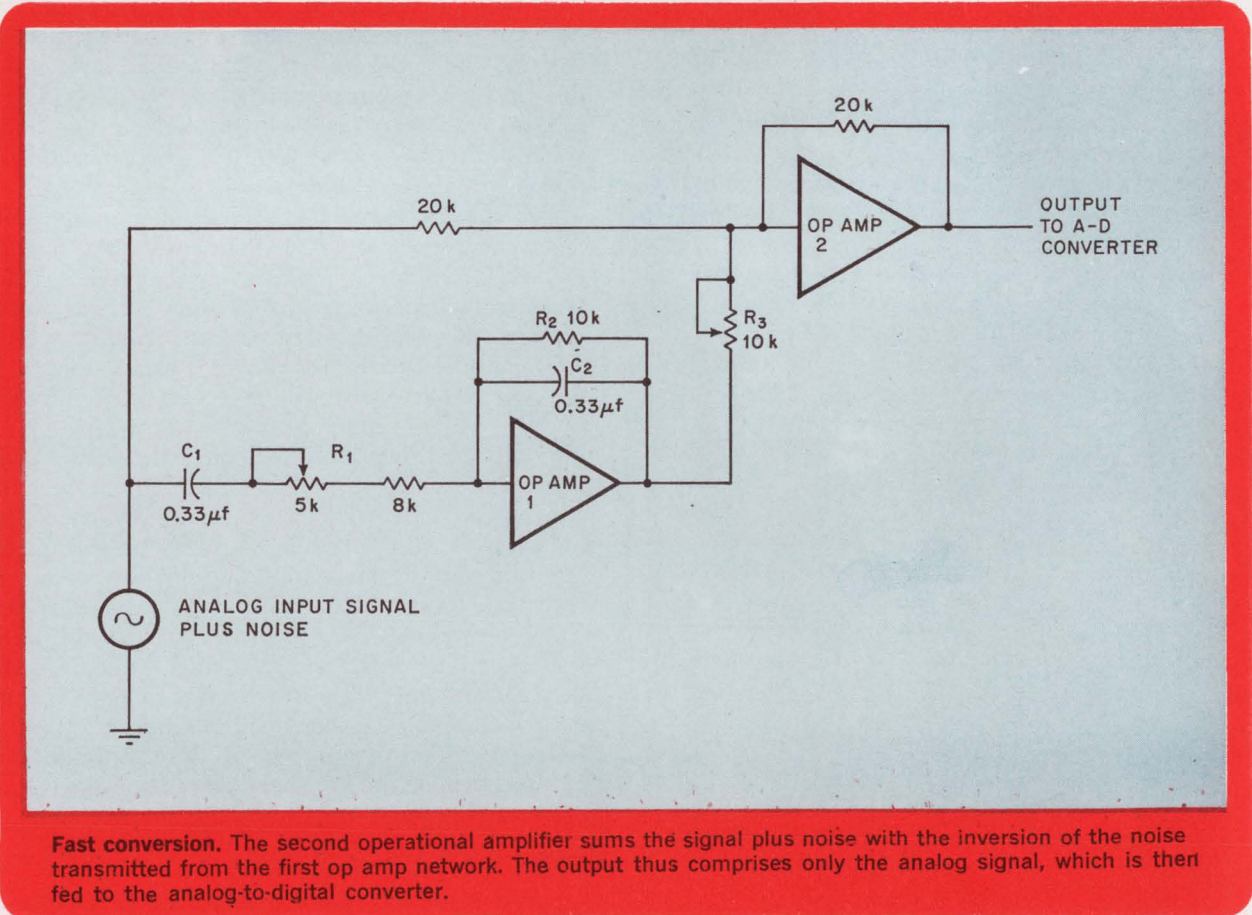

Resistors come to light in digital display system

By R.K. Sharma

Instrumentation Limited, India

A seven-segment digital display system built with a resistor matrix is less costly and far more reliable than a system built with a conventional diode matrix. Cost and reliability advantages are attributed to the fact that fewer components are used (21 resistors versus 49 diodes).

And unlike the conventional diode system, the newer system's lamps glow when there is no active input to the terminals. When a particular digit is

to be displayed, unwanted lamps are extinguished by a voltage applied to the digit's input terminal. In the conventional system, the diodes distribute the current needed to drive the transistors that turn on the lamps for the desired digit. But with the new system, high-value resistors are used so that the current delivered to undesired transistors are small enough to be negligible. The input terminals of the matrix take signals from a decoder that converts the binary-coded decimal numbers of a binary counter into decimal numbers.

To extinguish a digit's lamp, a voltage greater than the supply, V_b , must be applied at the digit's input terminal. The current generated by V_b and the input voltage passes through the resistors, R_b , and arrives at the bases of transistors, Q_1 , through the resistors R . Transistors not connected to the active input through an R resistor are unaffected. This current is enough to saturate the Q_1 's, whose

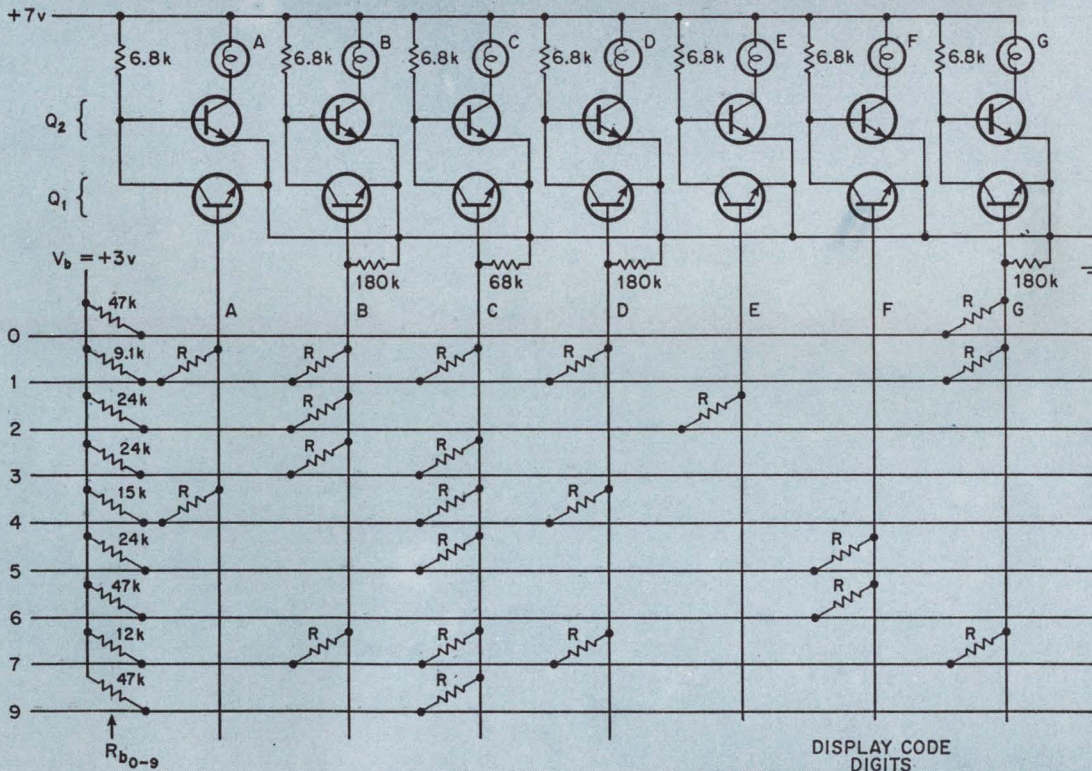

$R = 56k$
 Q_1, Q_2 - NPN SILICON SWITCHING TRANSISTORS

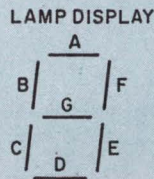

DISPLAY CODE DIGITS

	0	1	2	3	4	5	6	7	8	9
LAMP A		X			X					
LAMP B		X	X	X				X		
LAMP C		X		X	X	X		X		X
LAMP D		X			X			X		
LAMP E			X							
LAMP F						X	X			
LAMP G	X	X						X		

Resistive. The voltage applied at the input terminal turns on the transistors, Q_1 , connected to the terminal by the resistors, R . Transistors, Q_2 , turn off and extinguish the desired lamps. Below is the display code that shows which lamps must be out to display a particular digit.

low saturation voltage keeps the transistors, Q_2 , off and, consequently, the lamps off.

The remaining terminals are kept slightly below the threshold voltage of transistors Q_1 , since V_b by itself is not high enough for turn-on. Thus Q_1 's collector-emitter voltage in the off state saturates its respective Q_2 . Hence, these lamps all glow.

To display a 0, its input voltage is raised higher than the threshold of the input transistor to lamp G, turning it on. This, in turn, cuts off the following

transistor stages, extinguishing lamp G.

Input terminals 1 to 9 are at a voltage below threshold and, therefore, the current delivered to the corresponding transistor bases will be insufficient to drive these transistors into saturation. Therefore, the Q_2 's corresponding to these input terminals will be on. Thus, lamps A, B, C, D, E, and F keep glowing and the digit 0 is lit.

To light the digit 8, all lamps must glow. Thus, no input terminal is needed for this digit.

Unijunction controls oscillator in simple underwater pinger

By Frank Watlington

Columbia University Geophysical Field Station, Bermuda

An oscillator, timer, and switch connected to a transducer produce a simple device called an oceanographic pinger. The unit can be used to produce sound waves underwater.

A pulse from the unijunction transistor timing circuit turns on the 2N3055 transistor switch which applies power to the oscillator circuit. The timer controls the duty cycle (and, consequently, the

life of the flashlight batteries used to power the oscillator). The unijunction circuit's repetition rate is determined by the 100-kilohm resistor and the pulse length by the 560-ohm resistor in series with the unijunction's emitter resistance.

Oscillator pulses are applied to the inverter transformer which steps up their voltage and applies the pulses to the transducer. The unit is tuned through the two variable inductors.

The value of the components is for operation at about 2 kilohertz, but by varying the inductors in the feedback and transducer circuits, frequencies as high as 16 khz can be obtained. If a pressure potentiometer replaces the 100-k resistor in the timing circuit, ping rate can vary with water depth.

The transducer used is a double bilaminar piezoelectric ceramic unit.

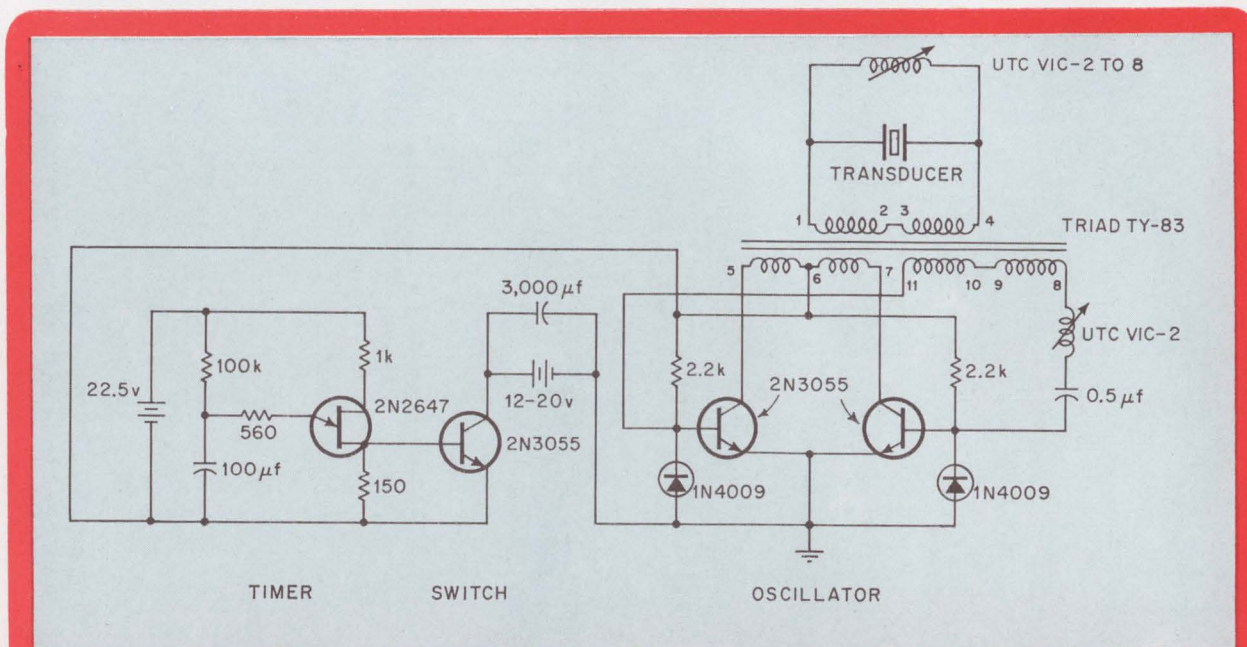

Making waves. The oceanographic pinger generates sounds underwater at a particular frequency. Pulses from the oscillator are stepped up in voltage to drive the transducer. Sound waves generated by the transducer have a frequency which can be adjusted by varying the inductors.

not just another calibrator... an AC voltage standard

(the first to 110 kHz)

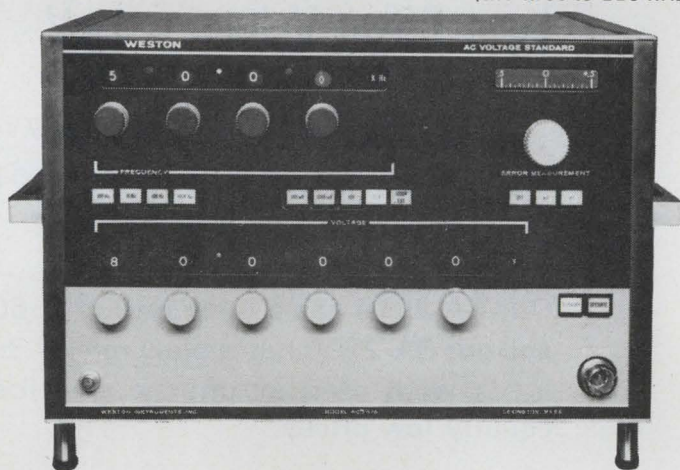

The **WESTON-LEXINGTON ACS-176 AC Voltage Standard** is the most accurate, most stable AC Voltage Standard produced.

Here, at last, is a laboratory instrument that combines the accuracy and stability of a primary standard with versatility and operating simplicity needed for the rapid, precision calibration of AC test instruments without external monitoring equipment. Wide voltage (0.1 μ V to 121 volts) and frequency (10 Hz to 110 kHz) ranges with in-line digital display provide broad test flexibility for use in production and incoming inspection. Direct indication of voltage, frequency, and % error simplify and speed operation while eliminating human error. Remote programming is available, including voltage and error measurement ranges, together with an error measurement output for data recording.

- 10 Hz to 110 kHz
- 0.02% + 2 μ V absolute accuracy of setting from 0.1 mV to 121 V (no need to worry about or look for additional adders or uncertainties; there are none)
- Direct indication of % error
- 0.01%/year amplitude stability
- Remotely Programmable
- Many other advanced features

Send for complete data and specifications on this extraordinary new instrument.

Weston Instruments Division,
Weston Instruments, Inc.
17 Hartwell Avenue, Lexington, Mass. 02173.
Tel: (617) 861-9000; TWX (710) 326-0596

a Schlumberger company

WESTON®

COMPARE!

Check the features below against any other 100kHz AC voltage standard.

Unparalleled performance

The ACS-176 offers the best overall accuracy available (0.02% + 2 μ V to 20kHz over its full voltage range) and the best frequency temperature-coefficient characteristic in its field. An important plus is its capability for calibrating phase-angle voltmeters with 0.1° accuracy to 10kHz. And it is available with a data acquisition system (Series 710).

Unique features:

From its human-engineered panel design to its exclusive convenience and safety features, the ACS-176 offers:

- Transient-free, rapid-settling voltage selection.
- Large in-line numerical readout for repeatable, accurate, frequency selection.
- In-phase and quadrature phase reference outputs for calibrating phase meters.
- Overload-memory circuit for safety.
- Totally fail-safe operation.
- Remote programming of ranges.

For the first time:

Now you can rely on a meaningful and useful *total* accuracy specification. Absolute Amplitude Accuracy, including: 90 day stability; all calibration uncertainties in traceability to NBS; all effects of noise, cycle-to-cycle instability, and distortion in calibrating average or rms-responding instruments; 0.1mV to 121V, all effects of line-voltage variation within the stated temperature limits.

1000 volt amplifier

Also available to expand these outstanding calibration capabilities to high voltage levels is the KVA-121 kilovolt amplifier. This all-solid-state add-on unit simply and conveniently extends the versatility of the basic instrument, providing full-range calibration voltages to 1000 volts from the *same* output connector.

You Can't Get This Kind of Performance From Any Other Op Amp: for **\$17.85***

RA-2600

Input Bias Current = 2nA

Input Impedance = 200 M Ω

Voltage Gain = 200,000 V/V
Slew Rate = ± 7 V/ μ s ($A_v=1$)
Input Offset Voltage = 2mV
Fully Compensated
Short Circuit Protected

for **\$27.25***

RA-2520

Slew Rate = ± 120 V/ μ s ($A_v=2$)

Input Offset Voltage = 4mV

Voltage Gain = 15,000 V/V
Large Signal Bandwidth = 200 kHz
Input Impedance = 100 M Ω

Our RA-2510 has a slew rate of ± 60 V/ μ s
and our RA-2500 has a slew rate of ± 30
V/ μ s with similar characteristics and
equally low prices.

*100 unit price

We're calling our linear line the no-compromise op amps because you don't have to compromise your design to stay within budget. In fact, with performance characteristics such as we offer, your design job is easier, and you end up with a more reliable circuit, too.

Get off-the-shelf delivery of these monolithic op amps that exceed hybrid performance. We build them to full military temperature range and to comply with MIL-STD-883. (If you don't need military temperature range, our commercial version, 0°C to +75°C, devices are available at even greater savings.)

Ask your nearest Radiation sales engineer about our no-compromise linear line. He'll help you *pick the best IC for the job.*

Lexington, Massachusetts (617) 862-1055
Norwalk, Connecticut (203) 853-3646
Washington, D.C. (202) 337-4914
Oaklawn, Illinois (312) 423-6010
Dallas, Texas (214) 231-9031
Albuquerque, New Mexico (505) 268-3549
Palo Alto, California (415) 321-2280
Long Beach, California (213) 426-7687
P. O. Box 37, Melbourne, Florida 32901 (305) 727-5430

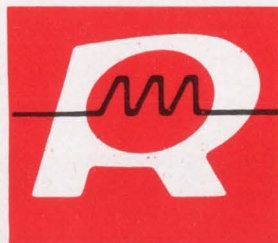

RADIATION
INCORPORATED
SUBSIDIARY OF HARRIS INTERTYPE CORPORATION
MICROELECTRONICS DIVISION

1970's market pacesetters

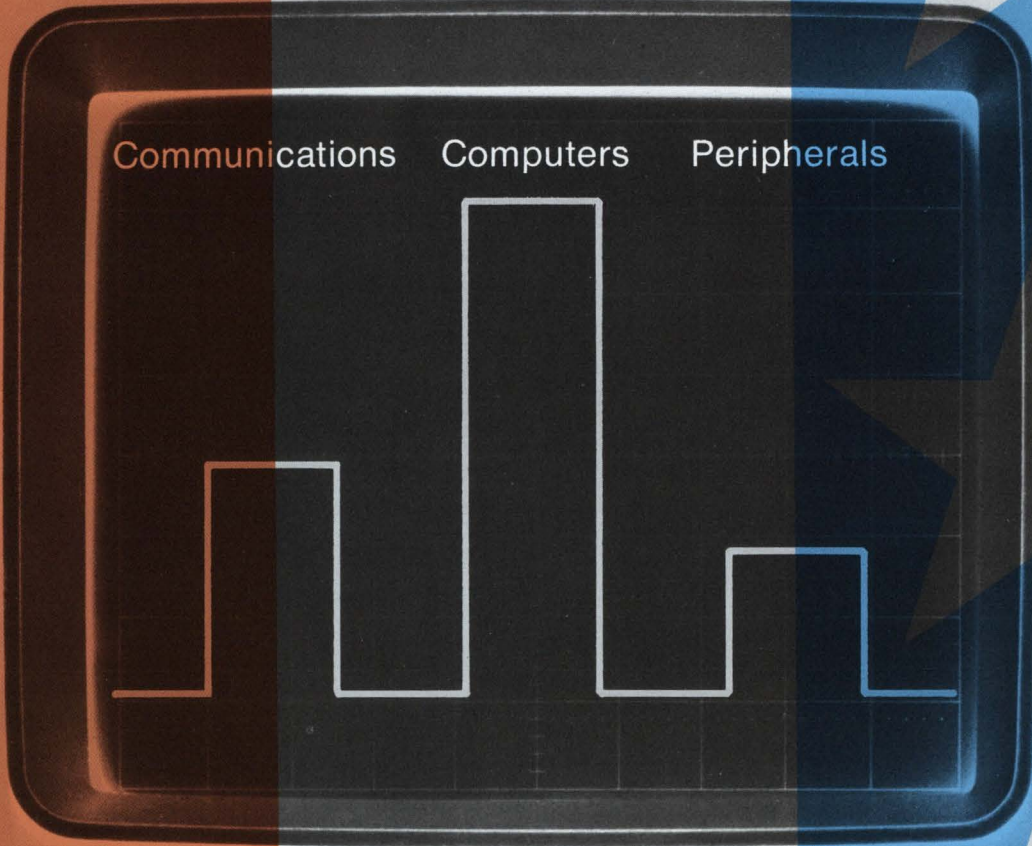

CAL. BEAM FINDER INTENS. FOCUS ILLUM. POWER ON

600 mV
2 kHz

A
OFF
A B

SHIFT

Electronics'
consensus
forecast
January 5, 1970

AC
0
DC

GAIN x1
x10

Y_A

Industrial and Commercial Markets

1973 (Dollars)		1969	1970	1973		1969	1970	1973
		(millions of dollars)				(millions of dollars)		
3,482.1	Therapeutic Equipment, total	31.9	36.9	51.5	Citizens Band Equipment	35.4	39.6	54.0
	X-Ray Equipment, Therapeutic	20.4	22.3	29.8	Navigation, total	152.0	164.7	310.2
1,058.1	Ultrasonic	5.1	6.4	9.2	Radar	93.4	99.7	190.2
22.5	Diathermy, shortwave & microwave	3.3	4.0	5.8	Other navigational aids			
25.6	Defibrillators	3.1	4.2	6.7	(Sonar, Loran, VOR)	58.6	65.0	120.0
11.4					Terminal & Switching	238.0	243.1	312.0
16.8					Carrier Current	25.7	28.0	51.2
31.2	Nuclear instruments & equipment, total	127.8	137.8	195.9	Intercom	103.2	105.7	116.0
21.0	Pulse analysis Instrumentation	18.8	20.2	24.1	Commercial Sound & P.A.	228.5	236.0	273.4
8.2	Power Supplies for Nuclear Equipment	9.2	10.0	17.6	A-M Station Equipment	16.4	17.3	19.0
49.8	Personal Dosimeters	2.7	2.9	4.0	F-M Station Equipment	12.3	14.0	21.5
97.8	Radiation Monitoring, Portable Survey				TV Station Equipment	136.0	141.2	156.8
60.7	Instruments	4.2	4.9	6.1	Facsimile	31.7	38.0	68.2
42.0	Radiation Monitoring, Fixed Position	4.9	5.4	8.0	Telemetry	217.3	230.4	293.0
18.7	Detectors (all, separate unit or part				Modems	78.8	90.0	171.9
17.1	of system), total	8.6	10.1	14.9				
	Solid state (Semiconductors, scintillation,				Lasers & equipment, total	64.4	75.2	134.2
16.2	crystals, and organic phosphors)	4.4	5.2	6.8	Gas Lasers	42.3	47.2	82.1
	Tubes (Geiger, gas flow, BF ₃)	3.2	3.7	6.0	Solid State Lasers, incl. Ruby Lasers	3.2	4.4	6.0
39.6	Ionization Chambers	1.0	1.2	2.1	Semiconductor Lasers	5.7	7.6	18.8
	Reactor Controls	24.3	26.0	31.0	Liquid Lasers	2.7	3.4	7.8
48.9	Nuclear Instruments & Equipment, other	55.1	58.3	90.2	Laser Power Supplies	4.8	6.1	9.7
11.4					Auxiliary laser equipment,			
18.3					incl. nonlinear crystals	5.7	6.5	9.8
23.7	Computers & related equipment, total	4,942.7	5,314.5	6,892.2				
148.6	Digital Computers, except process control	3,750.0	3,945.0	4,800.0	Closed circuit television, equipment, total	104.2	127.6	209.1
38.2	Analog Computers, except process control	62.4	71.5	86.0	Industrial CCTV	35.4	41.2	64.8
84.0	Hybrid Computers, except process control	43.6	48.1	69.5	Education CCTV	25.9	33.3	51.0
	Peripheral Equipment, total	1,039.9	1,192.3	1,849.7	Theater CCTV	3.9	5.2	9.3
46.3	Converters, A to D	25.4	31.7	42.2	Medical CCTV	7.7	9.3	16.0
77.6	Converters, D to A	18.3	20.9	27.3	CATV Equipment	31.3	38.6	68.0
10.0	Input-Output Equipment, total	434.9	492.5	776.4				
	Electromechanical Devices, total	233.8	270.3	358.8	Dictating devices (for business)	112.7	116.0	133.7
	Card Readers	74.2	80.4	102.3				
	Readers, paper tape	32.8	38.4	47.2	Power supplies, OEM type	83.4	91.2	117.3
	Card punchers	93.1	106.7	127.6				
	Impact Printers	24.3	32.0	63.0	Industrial Operations Electronic equipment,			
	Electromechanical readout devices	9.4	12.8	18.7	total	1,139.4	1,231.8	1,679.7
	Electronic Devices, total	201.1	222.2	417.6	Motor Speed Controls	59.4	64.8	86.1
	Digital Displays	27.6	31.5	49.8	Welding Controls	23.9	27.6	34.2
	CRT Displays	37.4	43.1	77.2	Power Supplies (complete equipment)	131.0	139.7	176.0
	Non-impact printers	8.0	12.3	26.1	Photoelectric gauges and controls	20.1	22.6	34.0
	Audio output equipment	1.8	2.3	7.5	Cryogenic Equipment	71.3	75.0	101.4
	Character recognition equipment				Ultrasonic Cleaning Equipment	18.4	21.0	29.5
	(optical, magnetic, etc.)	126.3	133.0	257.0	Ultrasonic Testing Equipment	22.7	25.4	39.9
	Mass Storage Memories, total	297.7	327.5	501.3	Infrared inspection and gauging equipment	45.3	48.0	61.2
	Core Memories	45.4	51.7	63.8	X-Ray inspection and gauging equipment	31.5	34.7	45.8
	Magnetic Tape Machinery	69.0	74.0	99.5	Nuclear Gauging and Processing	77.9	84.2	115.0
	Magnetic Drum Memories	36.3	39.5	48.0	Process Control Computer Systems, total	393.4	422.2	572.2
	Magnetic Disc Memories	147.0	162.3	290.0	Process Control Computer Systems, analog	98.7	107.4	158.0
333.1	Remote Terminal Equipment, total	263.6	319.7	502.5	Process Control Computer Systems, digital	254.0	267.3	349.0
252.0	Terminals	153.2	197.0	295.0	Process Control Computer Systems, hybrid	1.1	2.0	3.8
9.5	Couplers	110.4	122.7	207.5	Process control operator consoles complete	27.5	30.1	38.4
23.0	Electronic desk calculators	46.8	57.6	87.0	Production data-gathering systems	12.1	15.4	23.0
10.0					Machine Tool Controls, total	74.0	83.0	150.6
22.1					Point-to-Point Control Systems	41.2	46.3	77.6
16.5	Communications equipment, total	1,788.6	1,884.4	2,554.8	Continuous Contouring Systems	32.8	36.7	73.0
38.1	Radio, total	548.7	576.0	761.6	Electronic controllers and programmers	47.4	51.9	72.7
23.5	Airborne, including ground links	144.2	151.7	197.0	Electric actuators and solenoid valves	49.0	52.4	62.0
8.5	Land Mobile	205.6	210.0	239.4	Indicators	7.9	9.3	13.4
6.1	Marine Radio	23.5	25.2	33.7	Recorders	66.2	70.0	85.7
84.4	Microwave Relay	115.7	122.3	198.0				
70.0	Amateur Equipment	24.3	27.2	39.5				
14.4								

Continued

Cold Cathode Display Tubes	15.0	16.2	21.0
Rear Projection Readout Devices	4.8	5.4	8.1
Light-Emitting diode displays	0.8	1.5	4.0
Rectifiers, solid state, total	128.7	140.1	162.3
Rectifiers, silicon	97.8	107.2	124.5
Rectifiers, selenium and copper oxide	13.9	12.5	11.3
Rectifier assemblies	17.0	20.4	26.5
Switches, mechanically actuated, total	177.9	195.1	234.1
Coaxial Switches	9.6	10.8	14.0
Pressure Switches	21.2	23.0	26.1
Rotary Switches	41.2	46.4	60.0
Snap-action Switches	58.5	62.8	72.3
Toggle, mercury, knife, misc.	32.0	34.1	40.0
Stepping Switches	15.4	18.0	21.7
Transducers, total	112.7	120.5	155.4
Pressure Transducers	33.7	35.4	46.6
Position Transducers	32.3	33.7	43.0
Strain Transducers	33.0	36.8	49.2
Acceleration Transducers	13.7	14.6	16.6
Wire & cable, total	363.7	385.1	429.7
Coaxial Cable	73.4	75.4	85.8
Flat and Flexible Printed Circuit Cable	23.3	27.8	41.6
Hook-up Wire	163.8	169.9	155.3
Magnet Wire	103.2	112.0	147.0

Federal Electronics

(millions of dollars)	1969	1970	1973
FEDERAL ELECTRONICS, TOTAL	10,712	10,606	11,514
Department of Defense,			
electronics portion, total	9,044	9,209	10,062
Procurement, total	4,714	4,609	5,097
Communications	1,145	1,110	1,150
Aircraft	1,218	1,100	1,285
Missiles	1,493	1,528	1,725
Mobile and ordnance	260	266	290
Ships	598	605	647
Research, development, test, and evaluation	2,300	2,485	2,700
Operations and maintenance	2,030	2,115	2,265
NASA, electronics portion	1,486	1,210	1,178
FAA, electronics portion	110	118	197
AEC, electronics portion	72	69	77

Consumer Electronics

(millions of dollars)	1969	1970	1973
CONSUMER ELECTRONICS, TOTAL	4,570.0	4,819.8	5,492.4
Television receivers, total	2,708.0	2,828.0	3,175.0
Monochrome TV	522.0	478.0	385.0
Color TV	2,186.0	2,350.0	2,790.0
Radios, total	561.4	591.2	659.0
Home A-M and F-M radios	251.4	267.0	294.0
Automobile A-M and F-M radios	310.0	324.2	365.0
Tape recorders and players, total	431.0	493.1	641.5
Automobile cassette players	34.0	38.3	49.5
Automobile 4-track and 8-track players	37.9	40.1	47.2
Home/office cartridge players/recorders	118.3	124.0	155.8
Open reel tape recorders	96.8	103.7	139.0
Recording tape (non-industrial)	144.0	187.0	250.0
Video tape recorders	6.7	9.1	21.4
Hi-fi audio components	127.6	144.0	180.2
Phonographs	524.3	513.2	497.6
Electronic organs	98.3	102.4	114.7
Guitar amplifiers	37.2	40.3	46.0
Kits	57.9	64.7	80.2
Garagedoor openers (control devices only)	20.7	24.3	43.0
Automotive electronics	6.9	9.5	33.8

1969 1970
(millions of
INDUSTRIAL AND COMMERCIAL, TOTAL 9,483.4 10,207.8

Test and measuring instruments, total	773.0	843.8
Spectrum Analyzers, subaudio to 1GHz	14.6	15.8
Signal Generators, up to 1 GHz	20.8	22.0
Sweep Generators, up to 1 GHz	8.4	8.9
Pulse Generators, up to 1 GHz	11.2	13.8
Oscillators, up to 1 GHz	22.9	24.0
Waveform Generators, all shapes	14.7	15.6
Waveform Analyzers & Distortion Meters	5.9	6.5
Counters, time and frequency	36.1	39.7
Timers, electronic	78.0	81.3
Panel Meters, total	48.0	51.1
Analog	41.2	41.7
Digital	6.8	9.4
Noise Measuring Equipment, up to 1 GHz	12.7	14.0
Frequency Measuring Instruments, except counters	13.6	14.1
Voltmeters, Ammeters & Multimeters electronic, DC to 1 GHz, meter indicating	29.0	32.6
Digital Voltmeters, Ammeters & Multimeters DC to 1 GHz	32.1	36.7
Power Meters, DC to 1 GHz	6.8	7.9
Impedance Measuring Equipment, up to 1 GHz	14.7	16.0
Calibrators and Standards, active & passive	16.1	19.0
Oscilloscopes, main frame only	117.4	121.3
Oscilloscope Accessories and Plug-ins	27.8	30.5
Recording Instruments, digital & analog	65.3	69.7
Component Testers (capacitor, transistor, tube, integrated electronics, etc.)	26.8	30.8
Power Supplies, lab type	59.3	67.2
Amplifiers, lab type	7.8	8.3

Microwave measuring equipment (above 1 GHz), total 83.0 97.0

Microwave Phase Measuring Equipment	6.2	7.8
Microwave Impedance Measuring Equipment	13.7	14.9
Microwave Power Measuring Equipment	4.8	5.6
Spectrum Analyzers, above 1 GHz	12.3	14.0
Frequency Measuring & Analysis, above 1 GHz other	9.7	11.1
Microwave Noise Measuring Equipment	5.8	7.0
Signal Generators, above 1 GHz	13.6	15.1
Sweep Generators, above 1 GHz	9.1	12.0
Pulse Generators, above 1 GHz	4.8	5.9
Field Intensity Meters and Test Receivers	3.0	3.6

Medical equipment, total 347.2 385.5

Diagnostic Equipment, total	236.0	259.8
X-Ray, Fluoroscopic Equipment	183.0	199.3
Electroencephalographs	6.3	7.1
Electrocardiographs	16.8	18.4
Ultrasonic	5.8	6.9
Radioactive Tracer Equipment	13.7	16.0
Electron Microscopes	10.4	12.1
Patient Monitoring Systems, total	19.0	23.5
Cardiac	11.7	14.0
Respiratory	4.5	6.0
Blood Gas	2.8	3.5
Prosthetic/Orthotic Equipment, total	60.3	65.3
Hearing Aids	51.2	54.0
Pacemakers	9.1	11.3

Component Markets

	1969	1970	1973		1969	1970	1973
	(millions of dollars)				(millions of dollars)		
Antennas & antenna hardware	428.4	447.3	518.0				
Capacitors, total	427.3	456.0	515.5				
Paper Capacitors	53.7	55.2	57.7	Linear	22.4	27.8	43.0
Film Capacitors	67.8	74.5	98.9	Other Multicomponent Packages, total	39.6	45.3	60.1
Electrolytic Capacitors, total	182.4	193.7	210.5	Active	15.1	18.3	26.7
Aluminum	88.4	93.4	102.0	Passive	24.5	27.0	33.4
Tantalum	94.0	100.3	108.5	Printed circuits, total	271.0	303.3	379.4
Mica Capacitors	24.8	27.3	24.0	Single-layer Boards	101.2	104.7	121.0
Glass & Vitreous Enamel Capacitors	9.0	8.6	7.3	Two-layer Boards	107.5	118.2	142.4
Ceramic Capacitors	62.6	67.4	81.4	Multilayer Boards	62.3	80.4	116.0
Variable Capacitors	27.0	29.3	35.7	Quartz crystals (including mounts and ovens)	55.1	59.0	69.5
Connectors, total	376.5	396.2	471.8	Resistors, total	418.0	428.7	446.5
Coaxial Connectors, standard size	32.1	34.9	39.8	Fixed Resistors, total	220.8	225.2	233.8
Coaxial Connectors, miniature	22.4	24.1	33.6	Composition Resistors, fixed	84.3	85.5	82.6
Cylindrical Connectors	136.0	141.1	167.8	Deposited Carbon Resistors, fixed	17.8	16.3	14.5
Rack and Panel Connectors	79.4	82.5	91.9	Metal Film Resistors, fixed	55.3	58.4	68.8
Printed Circuit Connectors	52.5	57.2	73.2	Wirewound Resistors, fixed	63.4	65.0	67.9
Special Purpose & Fused Connectors	54.1	56.4	65.5	Potentiometers, total	170.9	175.5	178.8
Delay lines	18.8	20.2	26.7	Wirewound Potentiometers	80.7	82.9	84.0
Electromechanical devices, total	577.0	602.4	729.7	Non-Wirewound Potentiometers	90.2	92.6	94.8
Resolvers	9.1	10.3	12.1	Other Resistors (including varistors and thermistors)	26.3	28.0	33.9
Servo Motors	32.8	35.4	40.6	Relays, total	281.5	303.0	368.6
Synchros	25.9	24.3	23.6	Solid-State Relays	19.6	26.3	47.0
Rate Generators	5.2	5.4	6.2	Electromagnetic Relays, total	114.9	124.9	148.2
Motor Generators	16.5	18.1	21.4	Contact Meter Relays	6.0	5.7	5.0
Fractional Horsepower Motors	415.2	427.0	508.0	Crystal Can Relays	33.7	34.8	38.0
Solenoids	25.1	27.0	36.8	Dry Reed Relays	26.4	30.4	41.2
Encoders & Decoders	47.2	54.9	81.0	Mercury Wetted Relays	16.5	19.3	25.0
Electron tubes, total	1,387.5	1,405.2	1,473.7	Resonant Reed Relays	1.7	2.0	3.8
Receiving Tubes	191.0	174.3	133.7	Telephone Type Relays	26.4	27.7	29.0
Power and Special Purpose Tubes, total	353.5	361.1	377.3	Thermal Relays	4.2	5.0	6.2
High-Vacuum Tubes	62.8	60.7	57.0	Other Relays	147.0	151.8	173.4
Gas and Vapor Tubes	17.1	16.3	14.0	Semiconductors, total	1,282.9	1,317.8	1,640.7
Klystrons	40.4	39.5	36.3	Discrete, conventional devices, total	544.5	509.8	404.8
Magnetrons	38.7	37.9	36.0	Transistors, total	395.9	372.7	305.4
TWT's, including backward wave types	65.3	68.4	76.0	Transistors, silicon, bipolar	288.0	271.2	227.5
Light-Sensing Tubes	42.3	45.8	51.3	Transistors, germanium bipolar	81.3	67.4	30.7
Image-Sensing Tubes				Transistors, field effect	20.4	26.3	34.2
(Including TV Camera Tubes)	36.8	38.4	43.0	Transistors, unijunction	6.2	7.8	13.0
Storage Tubes	18.4	19.3	23.6	Diodes, total	148.6	137.1	99.4
Display Tubes, except cathode ray	11.9	13.0	16.4	Germanium diodes	20.0	18.1	9.0
Cathode Ray Tubes, except TV	19.8	21.8	25.7	Silicon diodes	128.6	119.0	90.4
TV Picture Tubes, black-and-white	92.0	91.3	88.7	Discrete, special devices, total	235.8	243.7	292.0
TV Picture Tubes, color	751.0	778.5	874.0	Thyristors (SCR's, 4 layer diodes, etc.)	65.2	69.8	93.7
Ferrite devices, total	331.6	345.7	416.0	Tunnel diodes	7.0	8.1	9.7
Computer Cores	20.7	24.8	38.5	Trigger diodes	48.7	45.3	40.2
Transformers & Chokes, except TV	217.4	221.0	261.2	Microwave diodes, total	13.4	16.3	26.2
TV Ferrite Components, including yokes, flybacks	82.3	87.2	98.0	Detector & Switching	13.1	15.7	24.0
Coils	11.2	12.7	18.3	Gunn	0.3	0.6	2.2
Filters, electronic, total	53.6	57.6	76.6	Varactor	8.7	9.8	14.7
Active Filters	4.6	6.5	21.2	Zener diodes	56.2	58.9	63.7
Passive Filters	49.0	51.1	55.4	Microwave transistors	7.9	9.0	23.0
Loudspeakers	113.0	120.2	134.7	Multiple devices (duals, diode arrays)	28.7	26.5	20.8
Magnetic tape, total	205.4	233.0	319.6	Integrated electronics, total	502.6	564.3	943.9
Audio Tape	61.3	70.2	99.5	Monolithic IC's Total	397.7	416.7	630.2
Computer Tape	77.4	89.0	121.8	Linear (less than 12 gates)	82.3	93.4	182.0
Instrument Tape	36.0	39.8	49.5	Digital (less than 12 gates)	315.4	323.3	448.2
Video Tape	30.7	34.0	48.8	Integrated arrays, total	74.0	110.4	255.6
Microwave components & hardware, total	119.0	126.3	182.5	MSI devices (12 to 100 gates)	67.8	98.3	206.6
(tubes and antennas excluded)				LSI devices (100 or more gates)	6.2	12.1	49.0
Microwave Ferrite Devices	22.6	25.7	34.2	Operational amplifiers, total	30.9	37.2	58.1
Multicomponent packages, total	251.6	290.0	407.1	Monolithic	27.2	32.2	45.8
(two or more separate active or passive components in a single package)				Hybrid	3.7	5.0	12.3
Logic Modules	153.6	168.5	232.0	Optoelectronic devices, total	51.9	61.4	91.7
Hybrid IC's Total (Semiconductor devices and thin or thick film components combined on a common substrate)	58.4	76.2	115.0	Photovoltaic (solar) cells	5.8	7.0	8.4
Digital	36.0	48.4	72.0	Photoconductive cells	9.0	10.1	14.2
				Light-emitting diodes	1.1	3.0	4.3
				Photodiodes	5.9	6.7	10.2
				Phototransistors	7.3	8.4	15.8
				Special optoelectronic devices (isolators, switches)	2.2	3.1	5.7

Continued

Technology/70: Bold new inroads for the computer as the digital era gets under way

Technology index

106	Computers
110	Military
112	Solid state
116	Components and Packaging
118	Microwave
120	Avionics
122	Space
124	Instruments
128	Communications
133	Industrial

● Electronics technology in 1970 will reflect the inroads of the computer as never before. This can be seen in the increasing demand—particularly in the industrial and commercial sectors—for computer peripherals, remote terminals, minicomputers, computer-controlled testing and manufacturing equipment, and data modems. And largely as a result of this demand, there is little question that this year will be one in which the versatility of such equipment will be improved steadily. The Government, too, will help underwrite technological advances, although funding will be below that of previous years.

NASA, though heavily committed to the Apollo missions, will sponsor advances in such areas as display technology, data processing, and laser communications.

In the communications sector, digital techniques will be used increasingly in the 1970's. Pulse-code modulation will be used in both satellite and millimeter-waveguide communications and there will be a growth in remote terminal-to-central processor communications. The Bell System's Picturephone service will begin in July and will include not only the Picturephone, but a data set for communicating with a computer; the data set will display computer outputs on the Picturephone screen, and, eventually, Picturephone signals will be transmitted digitally on megabit channels.

Minicomputers—aimed at applications in process-control systems, data-collection equipment, bulk memories, inventory control, and various industrial monitoring functions—will help push the semiconductor technology still further towards LSI and semiconductor memories.

The computer is also moving into the instrument field, where manufacturers must now produce equipment that is compatible with computers. Instrument makers will not only make computers but also offer software.

Unquestionably, the computer will have a tremendous impact on manufacturing. The machine will be used in production, testing, and shipping. And, the computer will even have an effect on how circuits are designed. Computer-aided manufacturing setups will have to feed easily inserted components. Beam leads, for example, are ideal for such setups. Thus the computer itself will contribute to technological advances.

In semiconductor technology itself, 1970 will mark the expansion of such new products as complementary metal oxide semiconductor circuits, Schottky-diode IC's, silicon-gate IC's, and optoelectronic circuits.

This will be the year of both the peripheral and the mini ...and, perhaps, even a fourth generation of computers

There's a consensus that most technological advances from here on out will fall into the evolutionary, rather than the revolutionary, category.

—*Electronics*, Jan. 6, 1969, p. 131

That statement may be just as true today as it was a year ago. Evidence of this can be seen in minicomputers and peripherals—two of the computer industry's fastest growing segments—both of which represent advances that are evolutionary in nature. But today the industry is at the threshold of other advances in the state of the art that are so radically different they could be considered revolutionary. And, conceivably, these revolutionary advances could herald the rise of a fourth generation of computers far more flexible and less costly than those of the earlier generations.

Laszlo L. Rakoczi, vice president of the Standard Computer Corp., sees sophisticated subroutines simplifying the use of the fourth-generation computer, just as microprograms simplified the design of the third-generation machine.

"Where the third-generation microprograms resided in a read-only memory," says Rakoczi, "the fourth-generation subroutines will operate in an inner computer; its place in the system is similar to that of the read-only memory, and its function combines those of the microprograms and the software subroutines in the third generation. In this inner computer, the 'firm' subroutines

will be available for a wide variety of applications, while the main processor utilizes 'soft' subroutines in specific programs—both replacing the fixed and invariable function of each bit in a microprogram."

Another company, which has expertise in both computer design and semiconductor technology, believes it is well on the road towards packing so much computing power in so few cubic inches with large-scale integration that conventional systems will look like Henry Ford's Model T by comparison.

Still another system in this fourth generation could be made up of a number of small specialized computers interconnected in a multiprocessing arrangement. Such a system could do the same job as one big processor, and thus could be very attractive for avionics applications, especially in a military environment.

"This means that a lot of little computers on the wing-tips, in the engines, and so on, can replace a rack full of equipment in the airplane itself," says Albert D. Goldstein of the Bunker-Ramo Corp.'s Defense Systems division. "LSI makes this possible because of its low cost and low power dissipation."

As for the market itself, last summer's ripples are still spreading as the result of the Great Unbundling. These ripples will probably continue through most of 1970.

The Great Unbundling got under way when the International Business Machines Corp. announced what it



New media. Punched cards produced by the keypunches in the background are gradually yielding to other media, such as this General Electric Datanet-760 terminal (shown in an Internal Revenue Service installation) for entering income tax data into a computer.

Back talk. With this compact IBM terminal (right), the machine-shop employee, or anyone lacking computer skills, can enter data into a remote computer, request information and obtain a computer-compiled spoken response on the telephone. Below, in a similar environment, a machine operator enters data through a terminal, part of IBM's new 2790 data communication system.

called a "change in marketing and pricing policies." This change, the separation of some software and other services from computer hardware as salable entities, was a radical departure from the company's previous policies; it was accompanied by a small reduction in the price of hardware. By the end of the year, several major computer manufacturers had followed suit. Just how much of an effect unbundling will have on the pricing of both hardware and software won't be known for some time yet. Price adjustments, especially by the independent software firms, are likely to occur as competition matures.

Although unbundling is primarily a marketing gambit, it could have some side effects on technology. For example, the far-out prophets of LSI have been talking for years about such things as hardware compilers that would translate programming languages into machine language—a task that thus far has been accomplished by software only. Further development of LSI, together with the fact that unbundled compilers are no longer free, could bring a hardware compiler closer to economic feasibility. One software function, sorting, has already been achieved with hardware. Astrodata, Inc. exhibited a sorter at the 1969 Fall Joint Computer Conference.

What also will affect the computer industry's growth will be a decision from Federal Communications Commission regarding the use of communication lines between geographically separated data processing systems. The decision should be handed down sometime this year.

"There are several directions that the FCC could take," says Curtis W. Fritze, vice president for corporate planning at the Control Data Corp. "Three independent networks probably will be allowed to develop. These would appear to be a community-antenna-television-like network that ultimately would transmit data to and from consumer-level terminals, a special-purpose data-transmission network for high-volume data transmission and a switched voice-grade common-carrier network for the occasional low-volume user of data communication services. In addition, a satellite-transmission network may take over some tv distribution, removing part of the load from the common-carrier network, whose capacity for data transmission thereby would be improved."

Over the years there has been a steady increase in the capability of large computer systems—as much as 40% per year, according to some observers. This growth is expected to continue through the introduction of new

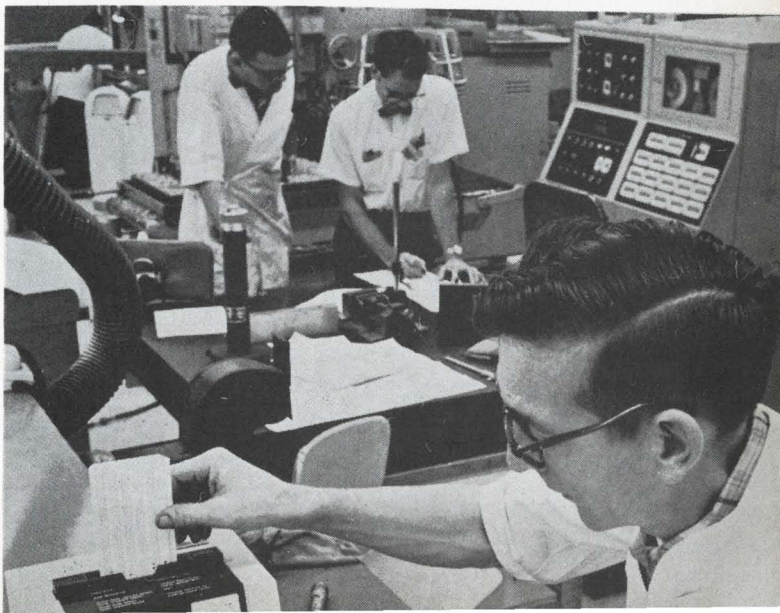

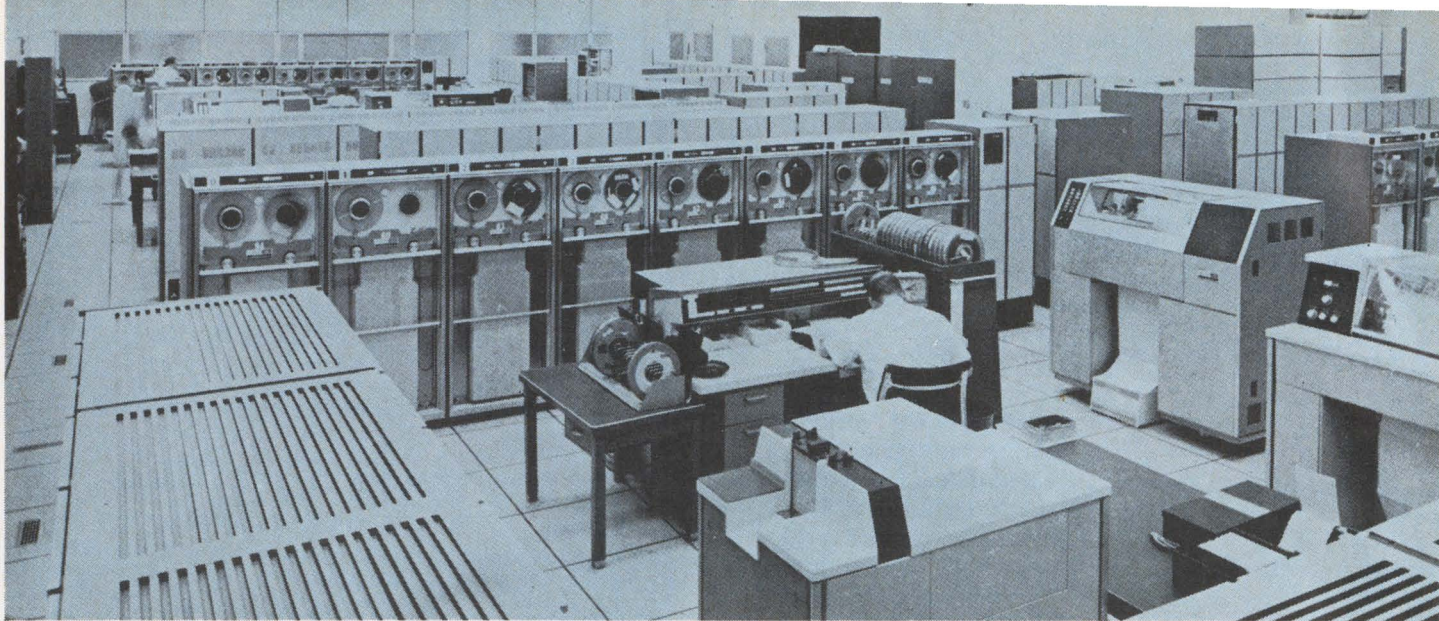

equipment and the upgrading of older machines with new software. Some of the improvement, of course, will be attributable to LSI.

"But customers buy throughput, not technology," says Control Data's Fritze. "They look for the most efficient system that can solve their problems, measured by their own bench-mark programs; they aren't interested in the technology with which the system is manufactured." General Electric takes the same view.

Analog computers make up just about the only segment that is yet to reap any benefit from LSI—and that's because no one seems to be doing any serious work on large-scale operational amplifier networks or arrays. Because analog computers are essentially interconnected networks of operational amplifiers—linear circuits with large gains—they rely primarily on individual IC op amps.

It isn't difficult to see why analog computers lag digital machines when it comes to LSI. Just as the development of linear IC's lagged digital IC's by several years because they required closer component control, so linear LSI circuits are lagging digital IC's.

Minicomputers will continue their mushrooming growth during 1970 and beyond. Some of the leading manufacturers—in particular, the Data General Corp., the Digital Equipment Co., Honeywell, Varian Data Machines, and the Hewlett-Packard Co.—are each talking in terms of turning out thousands of machines a year. And almost daily, newly organized firms have been entering the field. But because the supply of available engineering and management talent is limited, this trend toward more new firms may abate.

A substantial part of these companies' sales are to manufacturers who incorporate the minicomputers in their own products as subassemblies. These products include process-control systems, data-collection equipment with preprocessing capability, sophisticated displays and plotters with postprocessing capability, and various kinds of bulk-memory systems.

Data General says its Nova minicomputers are finding applications in areas previously untouched by computer technology. And, says the company, the impact of these new applications will begin to be felt this year.

Minicomputers are now handling such jobs as plant-facility control, life-test monitoring, and general baby-sitting for machines and processes; minicomputers now perform such tasks as turning lights on and off, and main-

taining optimum temperatures in factory areas as activity and environmental conditions change.

And thanks to minicomputers, traditional computer applications are being expanded. For inventory control, as an example, geographically separated warehouses previously depended on a central computer to keep track of their individual stock transactions. But this was at the expense of complexity in the central computer and costly or time-consuming data communications. Warehouses now are installing minicomputers, keeping track of their own inventories, and communicating with the central computer only for transactions involving other warehouses or for management information.

This is part of another continuing trend in data communications, which includes not only communications between computers, but also between a computer and remote peripherals, and between remote access stations and a computer operating in a time-shared or multiprogrammed mode.

"The Fall Joint Computer Conference displayed this trend very vividly," points out Douglas L. Powell, manager of General Electric's GE-600 product line sales. "Many of the 370 exhibitors there showed terminals and other data-communications equipment." So many of these exhibitors tried to demonstrate their equipment simultaneously, using connections to their home offices, that they overloaded the city's long-distance telephone facilities.

Inner space. This computer complex typical of many large installations, is a battery of Univac 1108's at NASA's Manned Spacecraft Center in Houston. They are used to monitor and predict occurrences during lunar flights and other missions.

Computer output microfilm is another area that will come on strong this year, and perhaps even stronger later in the decade. Computer output microfilm includes both bona fide microfilm—a sequence of images on a roll of 16- or 35-millimeter film—and microfiche, which records from a dozen to several hundred images on a rectangular sheet of film no larger than 6 by 8 inches, and often smaller. Several new models of equipment have recently appeared, and their prospects are excellent. They offer a practical way of overcoming the deficiencies of electro-mechanical line printers, which have been a roadblock in the production of hard copy for many years. Their chief disadvantage, however, is the need for special equipment to read them.

In addition to computer output microfilm and mini-computers as subassemblies, other kinds of peripheral devices are becoming practical, thanks to continued improvements in IC's. These devices are capable of performance more nearly matched to the high-performance central processor; they streamline the task of attaching a multiplicity of peripherals over communication lines; in some cases, they open the exit door for such electro-mechanical devices as card readers and paper-tape punches, which have monopolized the peripheral area since the dawn of the computer age; they permit the design of peripheral devices with some degree of "intelligence" that was not economically possible previously.

Data General's warehouse-inventory installations are good examples of these "intelligent" peripherals.

Another fast-growing area is that of semiconductor memories. Any prediction of what these devices are going to do in 1970 depends on who makes the prediction. Representatives of companies firmly committed to ferrite-core arrays and similar technology admit that semiconductor memories are making a strong challenge, but they claim that ferrite-core arrays will continue to dominate the market. But the National Cash Register Co. has a different view. NCR has been one of the leaders in magnetic memory technology with its rod memories, but is now moving rather rapidly toward both MOS and bipolar semiconductor arrays.

"Magnetic memory technology will mature in 1970," says Donald E. Eckdahl, vice president and general manager of NCR's Electronics division, "and the computer industry will begin a full-scale rush into large-scale integration in both processors and memories." Only time will tell whether semiconductor arrays will begin to displace core arrays.

Nevertheless, both forms of memory will certainly be affected by the growing interest in memory hierarchies, which incorporate a large and relatively slow main storage with a smaller and much faster buffer that cycles at the same speed as the central processor. This design approach offers a new lease on life to ferrite-core arrays as the main storage, or "backing store," as it is sometimes called; the buffer has been built with semiconductors at IBM and with small fast cores at Control Data.

As the interest in semiconductor memories grows, the interest in plated wire seems to fade somewhat. However, firms already committed to plated wire, or those intensively investigating it, aren't in any hurry to back off. "Research in planar thin films, laser techniques, and other main-memory media is also being carried forward at Honeywell," says Robert P. Henderson, vice president and general manager of that company's Electronic Data Processing division. His remarks doubtless apply to many companies. Plated wire is most likely to acquire or retain extensive applications in the avionics field, where the wire's capability for nondestructive readout and electrically alterable read-only operation are distinct advantages. Semiconductor arrays, on the other hand, suffer from a distinct disadvantage in this area because they lose their stored data if power fails. The nitride process, however, promises to offset this disadvantage but requires greater development if it is to have a significant effect on this year's market.

In the peripheral equipment area, further rapid growth of optical-character recognition apparatus is predicted by most observers. A number of such machines were introduced in 1969. And sooner or later, OCR will be available for remote connection over telephone lines. And the capability of recognizing handprinted characters, even cursive writing (connected letters), is expected within the next few years.

Further development of bigger and faster disk memories, particularly those with removable disk packs, will certainly be a factor in 1970 and beyond. However, the disk-pack market doesn't seem to be seriously affecting magnetic tape equipment. On the contrary, there appears to be a trend toward mixing disk and tape memories in a single system, something of a rarity in past years except in the largest installations.

Military electronics R&D will be feeling the pinch as tight budget squeezes major procurement runs

"Grim, very grim" is the outlook for new military electronics programs in 1970 and, perhaps, the next few years. This outlook, a consensus of Washington observers, is based on procurement and research and development spending levels of more than \$18 billion out of a total fiscal 1970 outlay of nearly \$70 billion. Of this \$18-plus billion, between 25% and 40% is pegged for high-technology areas led by electronics. Industry will have to rely on this figure through June 30, after which Congress presumably will have responded to the Nixon Administration's first defense spending request for fiscal 1971.

However, the consensus is that there'll be few big, new production runs in the near future. As one Pentagon source sees it, the Department of Defense will undertake "a lot of product improvement programs and some extended R&D in electronics" in the coming year. And it is likely to be "at the expense of some large procurements, mostly in the tactical area."

Just what is product improvement? Says one DOD man, it's "our word for making do with what we've got, for making systems in hand work better. Call it upgrading, if you like." The military, in DOD's opinion, has "too many systems that aren't performing as promised; that don't work well separately and sometimes don't work at all in combination."

Another DOD concern is electronics hardware complexity. One Army Materiel Command source notes: "Industry seems to have forgotten the old maxim that weapons are supposed to be 'designed by geniuses for use by idiots.' Some Government people have forgotten, too. Our orders are to change that."

Still another impulse to simplify comes from the military's desire to buy as much equipment as possible with their shrinking defense dollar. This was the reason behind the decision to simplify the avionics aboard the F-15 tactical air superiority fighter [*Electronics*, Dec. 22, 1969, 61]. But John J. Fischer, assistant to the vice president in Autonetics' Navigation Systems division, notes that some Air Force buyers would like to retain mission capability with lower-cost systems. "They're looking for ways to combine sensors and cut the number of black boxes. For example, they may want to derive doppler data from forward-looking radar," he says.

And the design of electronics equipment will have

to stress reliability and field maintainability even at the expense of size and weight. This is emphasized by Naval Air Systems Command's avionics chief, Joseph Kemp, who says he expects avionics to take a more total systems approach and "depart from requiring the best available in favor of the best in terms of operational cost."

While Navair will continue to do research in micro-miniaturization, IC's, and large-scale integration, the main task will be modernizing and updating such aircraft as the S-2 and F-4. Replacing analog circuitry with digital processors, displays, and instrumentation is in the cards. "Any new systems will go digital," says Kemp, particularly in antisubmarine warfare. Analog ASW sensors pose a problem, he says, because of electromagnetic interference.

One program that would have great significance later on involves Navair's desire to develop a single, basic digital computer configuration to meet all the Navy's airborne data processing and control requirements [*Electronics*, Sept. 29, 1969, p. 73]. At present, the Navy must maintain literally hundreds of different kinds of computers, many tied to an individual firm's technology. But the planned Advanced Avionic Digital Computer (AADC) will be built from a family of basic functional modules that could use any technology, whether already available or developed in the future, says project engineer A. David Klein.

The modules, which will perform a variety of tasks, could form an entire computer series—from the smallest special-purpose machine to the very largest general-purpose unit. And it will be possible to improve parts of the computer by substituting new modules as advanced designs become available, adds Klein.

In other areas, Navair will be moving toward low-light-level tv, infrared and laser sensors, in combination with its airborne radar equipment. This combination of different techniques, says Kemp, provides a better flight profile, real-time transmission of data to some ground or ship-based receiver as the key element.

But the \$101 million slash in Navy's current R&D budget, leaving little more than \$2 billion, contains a number of reductions in the electronics sector. For example, cuts were made in funds for the night vision system known as TRIM/combined sensor vehicle system, as well as for target development, search and res-

a \$54 million increase over last year—the only service thus blessed—and, excepting night vision and other electronic warfare systems, much of this is expected to go toward resolving problems in existing programs.

U.S. Air Force aircraft purchases will run to \$3.4 billion, just 10% below its request, for the remainder of this fiscal year. But that is \$425 million below last year, and estimates call for further cuts for fiscal 1971. Cutting one key program, the Advanced Manned Strategic Aircraft (AMSA) or B-1A, could do it, and sources strongly believe this program may be stretched out at least in these early development stages.

Some of these ideas can still be funded in R&D of course," the official explains, but, again, the service is going to be choosy with an RDT&E budget of \$3 billion, \$307 million less than last year even though this spending area could rise for the USAF in the second half under a larger fiscal 1971 budget.

There is, however, a trend in navigation systems toward augmented inertial units, with the Air Force concentrating on simplifying doppler, inertial, and loran sensors, integrating them, and coming up with a system that costs less than a pure inertial system but has equivalent performance.

Technology also seems to be catching up with inertial systems themselves. Strapdown guidance is beginning to take over from conventional gimbaled platforms and although strapdown techniques are in their operational infancy, they already have made a sizable penetration into the booster market, according to John W. Minor, chief engineer of the guidance and navigation group in Honeywell's Aerospace division.

In a strapdown system, accelerometers and gyros are mounted directly on, or strapped down to, the body of the vehicle. Gimbals, a major source of unreliability, are eliminated.

A strapdown system is going into the Air Force's Agena vehicle, another is proposed for the Delta. And in addition to launch vehicle use, strapdown systems could fit the requirements of spacecraft—Apollo backup guidance is strapdown—and air-launched missiles, says Minor.

Still greater reliability theoretically is possible when conventional motion-sensing components are replaced by laser rate sensors, eliminating all moving parts. Honeywell expects to flight-test a laser system later this year.

But, in general, "The technology limits for reducing navigation computer costs still aren't being approached in terms of the full implementation of LSI, computer memories, architecture, software and input/output," says Roy Kaufold, vice president and manager of Northrop Electronics' Navigation department.

Honeywell's Minor predicts that by 1975 a strapdown navigator for commercial aircraft would weigh eight pounds, cost \$20,000 (compared with the \$100,000 price tag now); for tactical aircraft, the price would be \$30,000.

Overall, the direction of military electronics technology tends to support the 1970 estimate of the Electronic Industries Association that new procurement and R&D market opportunities will be poor for major prime system contractors, average for associate primes and major subsystem makers, and good for suppliers of equipment, components and materials. What EIA left unsaid was that no one's chances are excellent.

cue systems, and advanced airborne reconnaissance.

Electronic countermeasures systems also are likely to be affected by the cuts. "I see less being spent on such equipment in 1970 than in the past two to three years," says Jesse R. Lien, senior vice president of Sylvania Electronic Products. He notes that this might not necessarily mean a less powerful ECM capability, however.

There'll be more R&D money to shore up areas that have been neglected because of critical Vietnam requirements, predicts John L. Grigsby, vice president and chief engineer at the Applied Technology division of Itek Corp. Particular attention should be paid to integrated electronic warfare systems controlled by their own airborne computers, he says. And he'd like to see funds for developing phased-array antennas that could be flush-mounted around the aircraft, eliminating the "bumps and lumps" needed now.

Any big changes in ECM during the 1970's will not necessarily occur in r-f techniques, but in LSI, Lien feels. "LSI continually gives us more active elements in smaller areas. I foresee the cost per bit falling by a factor of 10 every five years for more than the next decade."

"This obviously means we can economically do digitally things formerly only possible in analog formats," he adds. "Relatively simple digital processing techniques are going to enable things like adaptive ECM systems," says the Sylvania vice president.

Also sitting tight on proven technology is the Army Materiel Command. AMC's new commander, Gen. F.J. Chesarek, made clear not long after his appointment last year that he won't take chances on unproven technology such as that which led to cancellation of the controversial AH-56 Cheyenne helicopter gunship program with Lockheed.

Rapid technological advances Chesarek notes, "churn up demand for large quantities of special people, and the payoff has not been thoroughly thought out." Moreover, Chesarek points out that, "confidence in short-term add-on costs being quickly amortized has been shaken" in the electronics area. Translation: an end to quick-reaction programs.

Among the services, Army's procurement can be expected to decline most sharply this year. Nevertheless, its current \$1.5 billion RDT&E appropriation represents

C/MOS and silicon-gate IC's, as well as Schottky devices, could come into their own in solid state technology

The types of solid state devices that get designed into electronic equipment in 1970 will be strongly determined by two factors:

▶ New, controversial technologies—design engineers will have a chance to evaluate the merits of integrated circuits made by such diverse methods as complementary metal-oxide semiconductor, Schottky-diode, and silicon-gate technologies. This should help to resolve the conflicting opinions surrounding them and to determine whether their promise of performance, or economy, or both, will in fact be realized.

▶ Availability, at last, of highly touted older devices. Manufacturers of MOS IC's and optoelectronic devices, for example, have finally solved their manufacturing problems and geared up their production facilities to match the demand. The result: an estimated tenfold increase in sales of MOS IC's alone.

Complementary MOS IC's seem ripe for exploitation. Usually regarded as a memory device for military and space equipment, C/MOS is now being considered for commercial and industrial equipment and for linear and control-logic applications. CMOS offers the dual advantages of essentially zero power dissipation and high speed (5 to 10 megahertz, as high as many bipolar IC's).

However, some manufacturers feel the disadvantages of C/MOS outweigh the advantages. Tom Hyltin, manager of strategic marketing for advanced technology

at Texas Instruments, says the C/MOS advantage of extremely low power drain is offset by its complicated fabrication, which requires more steps than bipolar or single-channel MOS technology. Furthermore, C/MOS requires more chip area to perform a given function.

Hyltin feels that the National Aeronautics and Space Administration will be disappointed in its C/MOS development projects; he cites the hoggish area requirements of C/MOS circuitry. "NASA will be able to buy larger chunks of logic on a chip with other technologies," he predicts.

A more optimistic view comes from Gene Blanchette, group director for integrated circuits at Fairchild Semiconductor: The C/MOS industry "will start moving by the end of 1970." At first Fairchild will make memories and random logic, "and as I see it, linears will follow," Blanchette says. He sees C/MOS as primarily for the military and aerospace industries today, but he does not rule out eventual use in other more economy-minded market segments.

Motorola Semiconductor Products Inc. also has plans to get into C/MOS. During the year, Motorola will introduce basic logic building blocks including various gates and type D flip-flops, and also highly complex functions such as a 64-bit memory, multiplexers, and a quad eight-bit shift register. "Prices of C/MOS will remain higher than p-channel MOS, partly because C/MOS requires twice

Pattern of the future? Intricacy of Intel's silicon-gate mask may portend new levels of complexity—and economy—in IC's.

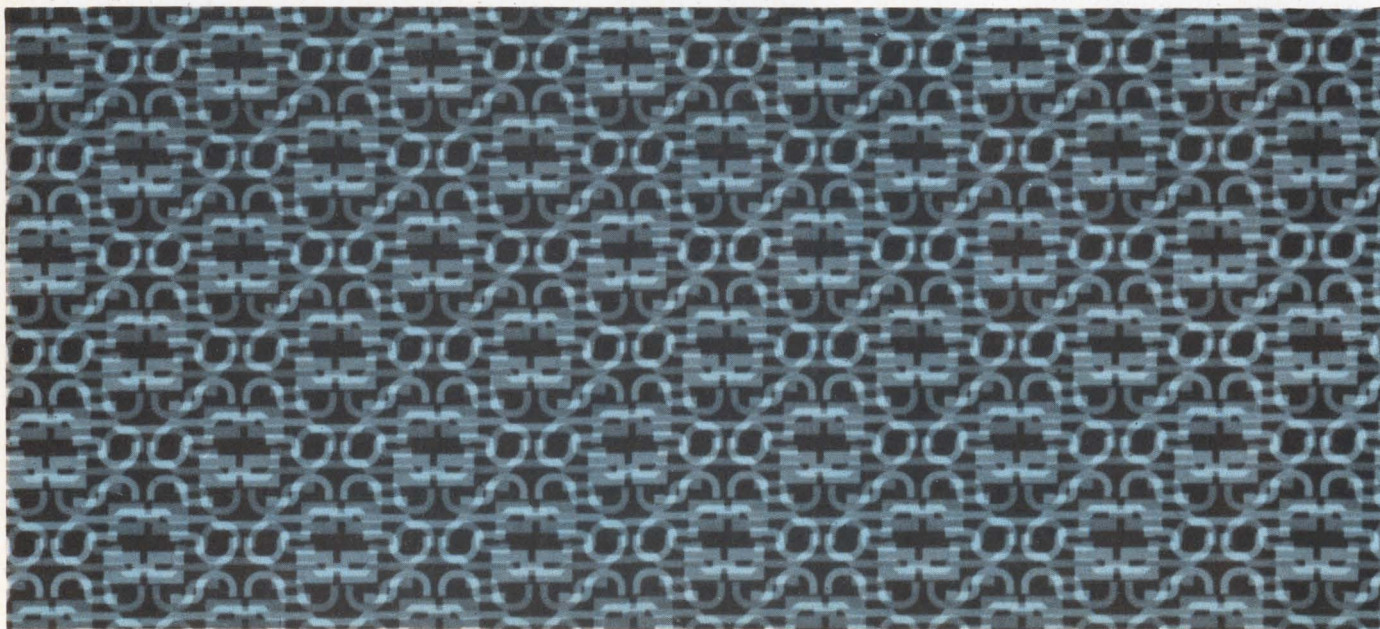

the silicon area," predicts Roger Helmick, Motorola's product planner for digital circuits. For the future, he sees prices dropping, becoming competitive with those of other logic families in many applications as C/MOS becomes widely accepted.

For Albert Medwin, Ragen Semiconductor's president, the day of CMOS in industrial and commercial applications is here already. "CMOS is already in nonmilitary applications in the data terminal field," he reports. "One firm is designing a CMOS mini-computer with a 4,096-word memory." Medwin believes that CMOS is not significantly more expensive than other circuitry, particularly when the overall system cost-saving advantages, such as noise immunity, and the use of a single power supply and clock are considered. And other firms share his view, he says; he expects six or eight semiconductor houses to get on the CMOS bandwagon this year.

RCA is another company that takes its C/MOS seriously. The company is gearing up for mass production for commercial and industrial applications, and predicts that C/MOS will account for a sizable portion of IC industry sales in a few years.

Silicon-gate technology, which became a commercial reality in 1969, should grow steadily in popularity during 1970. The technology affords much lower threshold voltages, higher speeds, and greater packing density in MOS IC's. Both Fairchild and Intel are producing MOS devices using the silicon-gate technique. Intel is shipping products and Fairchild is planning to get into full production when its new MOS facility is ready sometime in the first quarter of the year.

According to Intel's president, Robert Noyce, "The immediate market for silicon-gate devices is the second-source business. We can supply to present designs immediately; 1970 will be a year of prototype orders, and 1971 will be a production year." By then, the newer circuits will be part of the finished design and be needed in large quantities. Noyce sees silicon-gate devices taking over the MOS market in much the same way as "silicon took over germanium or as the planar process took over the mesa structure—not all at once, but at a steady, fast growth. Silicon gate will be the dominant technique, and that's why we're in it." The market for silicon-gate circuits will double every year for the next several years, Noyce believes.

Texas Instruments views the silicon gate as only part

of the broader technology of self-aligning gates. "There are other ways that look as good or better," Hyltin says, "and TI is trying to decide which one." The company is therefore investigating all self-aligning-gate processes, he reports, including the use of molybdenum as the gate material and ion implantation.

Other manufacturers view standard MOS technology—particularly on 1-0-0 crystal orientation silicon—as adequate for most present needs. Ken Moyle, in charge of MOS process development at the National Semiconductor Corp., reports that his company "is studying the silicon gate process in case there are certain circuits which would exhibit superior electrical performance. But compared to National's 1-0-0 processing for most standard products, silicon gate requires more processing steps, needs the same chip area per function, has a lower yield, costs more, has questionable stability and unconfirmed reliability—but does offer improved speed."

Sharing this view, Motorola is leaving the door open for silicon-gate but for the present the company is concentrating on standard low-threshold 1-0-0 silicon logic processes. Motorola's Helmick says: "Silicon-gate technology offers smaller geometries and minimizes Miller capacitances, permitting speeds of three times those of present p-channel MOS IC's."

Another major development of 1969, Schottky diode IC's, will become increasingly available to designers during 1970. Opinions differ, however, on the need for these new devices. Noyce of Intel—the first company to introduce them commercially—feels that Schottky IC's offer many advantages over conventional transistor-transistor logic in digital systems. "If you are going to redesign, or if you are just starting for the first time, you might as well use the best technique: Schottky diodes offer more design flexibility than gold-doped devices. And they provide extremely fast circuits—almost as fast as emitter-coupled logic." Because Schottky IC's don't need the gold doping ordinarily used to make TTL fast, device characteristics are improved—gain is larger for instance—and various kinds of devices slow and fast can be incorporated on the same chip.

Although much of the original development work on Schottky IC designs and processes was done at Fairchild, that company hasn't yet introduced commercial products. There is every indication that the company is gearing for production, but it hasn't announced any timetable of device availability. In Europe, however, Ferranti Ltd. has been quick to develop production capability. Ferranti is pleased with the performance of the prototype IC's that have been built, and expects to be in volume production by the middle of the year.

Other companies are more cautious. According to TI, it's too early yet to draw conclusions about the overall capability of Schottky diode IC's. "ECL has the edge," Hyltin says, "it's still the way to go when you want ultimate speed."

National Semiconductor and Motorola favor alternate approaches to using Schottky diodes for speeding up transistor-transistor logic. Helmick of Motorola acknowledges that his company is experimenting with Schottky IC's. "But they are not without problems," he cautions. "We have some questions about switching reliability and performance over a wide temperature range."

Conversion to the Schottky process isn't an easy task for manufacturers; environmental cleanness and material



purity are overriding problems. "For bipolar devices you need aluminum that is 99.0% pure, but for Schottky diodes, it has to be 99.9999% pure" says one manager.

Whatever the prospects for Schottky IC's, discrete Schottky devices are expected to flourish in such ordinary applications as uhf tv mixers, as rectifiers for computer power supplies and as metal plating equipment. The big advantage here of Schottky diodes over conventional p-n junction diodes is low forward voltage drop and high rectification efficiency at high frequencies.

An increasingly popular practice in digital systems is to use local regulation of voltage. Instead of a single central regulator, a monolithic IC regulator is included on each printed-circuit card in the system. Rough pre-regulation is used, and the voltage is distributed without excessive concern for line drop. The local regulators then smooth out the voltage variations due to line drop and absorb transients caused by the IC's switching.

Robert J. Widlar, National Semiconductor's advanced linear circuit designer, feels that the simplicity of using a fixed-voltage, no-external-component regulator IC "now makes on-card regulation quite attractive." However, some manufacturers believe that the current-output requirement is too variable from card to card to settle on a single local regulator design. According to H.B. Grutchfield, manager of technical development at Signetics, "If circuit cards had remained with nothing but TTL gates, then we would know what the current requirements are. But now with medium-scale and large-scale integration and memory devices appearing on the cards, it's hard to say what the current requirements are, and so it's difficult to design for a mass market. And that's what you have to do to get the price down."

Local regulation was one of the few linear-IC applications that showed some growth in 1969. "The overall linear market didn't do much in 1969 because the new devices were not new types, just a better this or better that," according to Mike Markkula, manager of linear IC marketing at Fairchild. The basic problem: "No new markets were created," he says. His figures show only a 10% growth in dollar volume for linear IC's, but a whopping 70% growth in unit volume for 1969.

Things look much better for 1970. Markkula expects a 15% to 20% growth in dollars. Much of this growth will come from the consumer communications market, Markkula believes. "Fairchild will be one of the prime

suppliers to the tv industry" this year, he claims. Three different tv models "will have three or so IC's each, and by 1971 it will be five or six chassis with five IC's." One of the main reasons for this growth, Markkula believes, is the increasing attention consumer manufacturers pay to reliability.

Another major trend in 1969 was for system houses—the end users—to take a more active part in design of integrated circuits. The design interface—the relationship between system maker and IC maker—can be expected to shift further toward the user in 1970, at least as far as MOS IC's are concerned. Many IC manufacturers are aiding their customers in developing their own design capability. Often the system house will go far beyond designing and will furnish the IC manufacturers with masks—the only manufacturing services that remain to be done are the diffusion and metalization of the wafers.

The desire of customers to do their own design may be largely induced by supply problems, one marketing expert believes. Because of the growth in demand for MOS circuits, manufacturers have not always been able to keep up with their commitments. Many users concluded that by doing their own design, they could at least avoid delay up to that point in the complicated fabrication procedure.

TI's Hyltin believes that there is an optimum cut-off point in customer participation. It's wise for the user,

Unquestioned credit. Data terminals are a burgeoning application of digital IC's. Digital Data Systems' credit-card verifier is just one of the uses of terminal equipment of the contenders for the market

he says, "to generate the logic layout in computerized form." Beyond this point, however, the user may save money by letting the IC vendor take over. "In the long term," Hyltin says, "the vendor can do the artwork cheaper because he's better instrumented for it."

Basically, of course, costs are the only factor limiting the growth of IC applications, and 1970 may see two promising low-cost fabrication techniques, base-diffusion isolation and collector-diffusion isolation, become practical. These techniques, which eliminate one or more masking steps and therefore reduce costs and increase yield over standard bipolar fabrication, were described by Bell Telephone Laboratories several years ago, but have never been exploited to any extent by commercial of the division, it's in being able to fabricate huge manufacturers.

Fairchild's Blanchette says that BDI and CDI will become significant in 1970. One of the first applications will be bipolar memories, and these will be in production this year, because BDI and CDI are "another step that will get the costs down so that semiconductor memories will be competitive with cores."

Sylvania's Semiconductor division also shows a strong interest in BDI and CDI. What's the main appeal of these techniques? According to Brian Dale, chief engineer of the division, it's in being able to fabricate huge quantities of switching IC's for operation in the 2 to 3 volt range. With BDI or CDI such IC's can be manu-

factured in huge quantity at extremely low cost, and since high performance isn't required of the circuits, the processes are entirely adequate. And such circuits are the type used by the thousands by Bell Telephone and by Sylvania's parent company, General Telephone and Electronics.

However, Dale cautions, "You can't make a direct one-to-one replacement" for conventional IC's. The standard process will always give better performance. "The new technique isn't going to sweep the industry," he says.

MOS technology is preferable, says National's Ken Moyle. "Bell Labs BDI and CDI offer high packing density but not speed. We can do the job with MOS," according to Moyle.

In semiconductor memories, designers are moving toward MOS for the main frame and bipolar IC's for scratch-pads, buffers and cache memories. "The bipolar scratch-pads and buffers will get larger and larger in capacity but they can't catch up with MOS memories in terms of packing density and power dissipation," according to D.C. McKenzie, manager of the MOS department at Signetics.

The increasing importance of semiconductor memories, whether bipolar or MOS, will precipitate some major changes in the semiconductor industry. "Gradually we will see ourselves moving into the memory system business," says McKenzie. Moyle agrees; in read-only memories, he says, "the future is in packaged functions—the computer terminal business," rather than in individual IC's. "Soon the buyer is going to want 4,096-bit memories and that's what we're working on."

Moyle predicts that read-only memories will exceed random-access, or read-write, memories this year. "Some companies are looking for random-access memories to take off" this year, he says, "but it's not going to happen that fast. We don't see it now." When it does happen, there will be a significant effect, according to predictions: "Eventually the core memory companies will take over some semiconductor houses and produce the random-access memories, Moyle says.

Optoelectronic devices are expected to take a big leap forward as devices that have been available—in theory—for years are finally being produced in volume and at substantially lower prices than before. Optical couplers, for example, composed of a gallium arsenide light emitter and a silicon detector, have great appeal because of the electrical isolation they provide. Such couplers have been "available" for five years. But at \$50 to \$100 per coupler, they've been too expensive for ordinary application. Now says Hyltin, they are "coming down to a price area under \$10, where just about every digital interface can use one" instead of an electromechanical device.

Peter Polgar, operations manager for optoelectronic products at Motorola, concurs, noting that "1970 will be the year when optoelectronics takes off." Polgar says that "with many large-volume suppliers entering the field, and prices falling to economically practical levels, we'll see wide expansion of optoelectronic applications and sales."

Monolithic arrays of sensors, for example, will be used in character recognition equipment and tv cameras, Polgar predicts. Growth in light-emitter applications will be even more dramatic, chiefly in display.

Huge computer growth will sustain the demand for discrete components and denser packaging

Components and packaging, sometimes considered the most prosaic of electronics sectors, are experiencing significant changes. Though IC's offer lots of circuitry in a small package, customers still demand complete, working equipment, and IC's are only one element of that equipment. The major trends in 1970 will be continued steady use of discrete components, new wiring schemes, greater use of multilayer printed-circuit boards, and computer-aided design applied to board layouts.

If discrete component manufacturers owe any debt for continuing growth in the face of the mushrooming IC market, it should be paid to the computer industry. Computers, the fastest-growing segment of the electronics industry, consume 12% of all components, according to Maptek, a service of Quantum Science Corp., New York, that provides data based on electronic component and equipment.

Many engineers still use fixed-carbon composition, carbon film, metal film, and cermet resistors, primarily because they haven't been able to get enough power capability in IC's. The Quantum Science study predicts use of these components will remain at the predicted 1970 level of \$14.8 million through 1972. This relative market stability can also be attributed to increased production of remote terminals, which will reach \$3.2 million in 1972, up \$1.1 million during 1969. Remote terminals, with an average of 633 resistors in each unit,

are expected to reach 254,000 units in 1972 (exclusive of teletypewriters), and thus will rescue almost 161 million resistors.

Remote terminals also will create a big market for aluminum electrolytic capacitors. The value of these capacitors used in remote terminals is expected to nearly quadruple from \$1.1 million in 1968 to \$3.9 million in 1972.

However, IC's will take over at least one more function previously found in hybrid form. Up to now operational amplifiers have incorporated some IC chips as hybrid circuits, but low cost and better performance are spurring an all-monolithic trend for 1970.

One such monolithic op amp is a comparator module available from Analog Devices in a T-100 case. Priced in lots of 100 or more at \$7.85, the unit, Model 351, is designed for instrumentation applications, with an open loop d-c gain of 60,000 and a 2-milliampere output current capable of driving at least one logic load.

There is still plenty of action in such basic components as switches. Low-energy circuits that usually require reed-relay switches for reliability and precision soon may be using new gold contact switches. In one switch, designed by Cherry Electrical Products Corp., two gold-contact prisms, welded at right angles to each other, offer high force per unit area and eliminate contact closure interference from foreign particles. Operating life

already has been measured in millions of closures, and they offer extremely low insertion resistance. The switch is in the Hewlett-Packard 9100-A desk top calculator.

Although much component development centers on integrated-circuit improvements, changes are coming in package design. For example, sales of flat-ribbon cable used in computer equipment will more than double, rising from \$10.9 million in 1968 to \$24 million in 1972.

A trend toward usage of more multilayer printed-circuit boards also is emerging. In fact, 1970 may be the year when multilayer p-c boards outstrip single-layered boards, especially as computers start to require high circuit densities. Multilayer board usage will account for about half of the total p-c boards used in computer equipment in 1972. Although engineers still will use single-layer p-c boards, in computer equipment, doubling their use by 1972, use of multilayer boards will more than triple in the same period. This will be due mainly to increased computer capacity, larger instrumentation systems and data processing equipment, and new construction techniques, such as a conical-shaped fillet, that offer all the advantages of p-c board hole liners.

Better board layouts as well as better integrated circuits and integrated systems also are in store during 1970 because of improved computer-aided design programs. IBM, for example, uses the computer to automatically generate artwork used for producing p-c boards and IC designs. Programs soon will be available for working with nonlinear type semiconductors, one of the things not possible till now.

In the packaging and production outlook for 1970, the bright star may well be copper-to-aluminum connectors. Only the lack of suitable connectors has been holding back extensive use of aluminum wire as a replacement for copper. The scarcity of copper, its rising cost, and heavy weight are among the reasons bulk users such as telephone companies, automobile manufacturers and aircraft producers are interested in aluminum wire. Aluminum weighs half as much as copper and carries 80% of the current that the same size copper wire would. [*Electronics*, Dec. 8, 1969, P. 94.]

Several copper-to-aluminum connectors will be coming from AMP Inc. They will be applicable to solid and stranded wire, as well as, flat-wire ribbon cable used extensively in aircraft and computer applications.

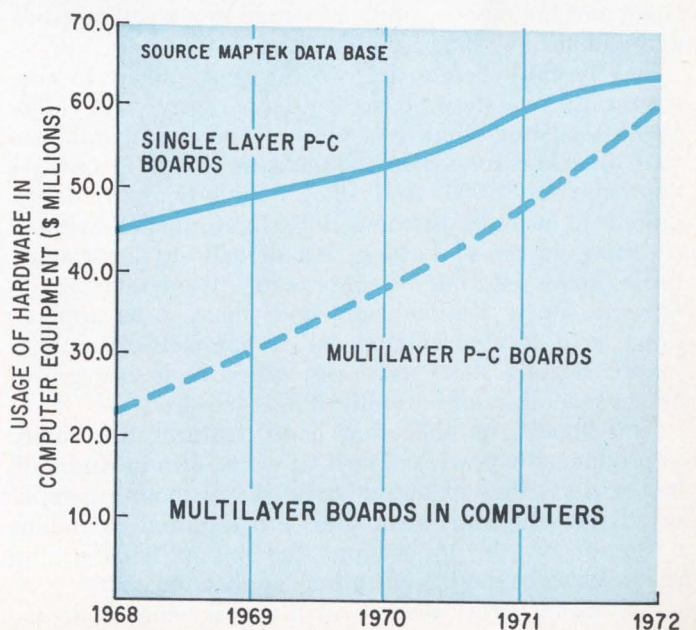
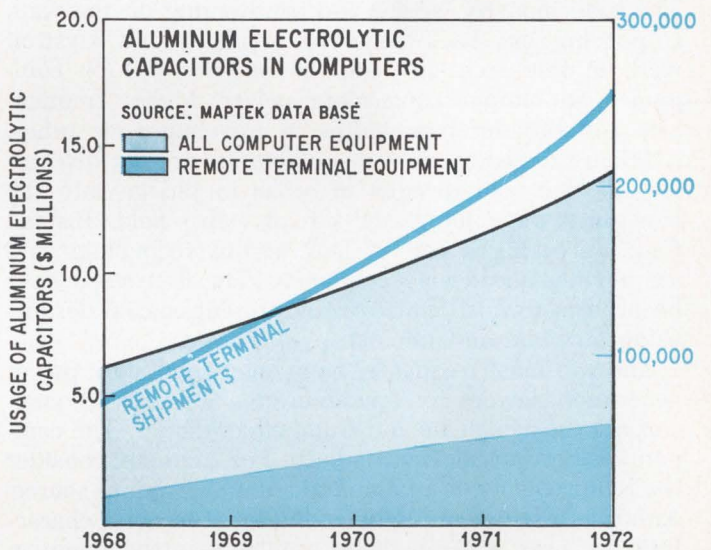
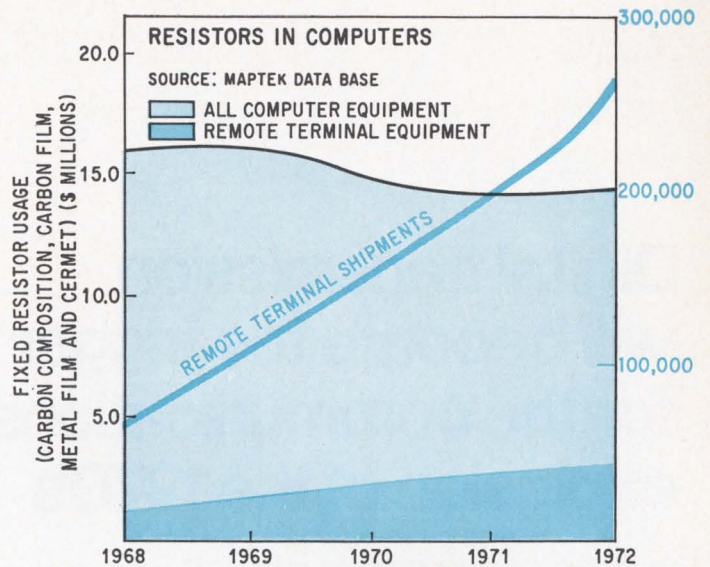

Digital transmission will become the trigger for the communications explosion of the 1970's

Rapid advances in solid state microwave power sources and amplifiers are sounding the death knell for medium-power microwave tubes at frequencies below C-band. The tube industry, seeing the handwriting on the wall, is phasing out backwardwave oscillator and klystron work in this area. Instead, the microwave tube companies are emphasizing more power, higher frequencies and broader bandwidths in traveling-wave tubes.

Microwave component manufacturers are not discarding all their old designs in order to plunge into the new microwave integrated circuit (MIC) field. Instead they are taking a careful look at this technology and are moving ahead very cautiously. The first steps have been taken toward miniaturizing present coaxial designs using stripline and microstrip techniques.

The two most frequently mentioned solid state power generation devices for operation at microwave frequencies are the avalanche and Gunn effect diodes. The competition between devices is keen. For example, consider the requirements of a parametric amplifier pump source. Airborne Instruments Labs, citing low f-m noise characteristics, uses a Gunn diode oscillator as the pump in its S-band paramp. On the other hand, American Electronics Labs claims its paramp, using an impatt diode pump, is best. AEL contends impatt noise can be overcome and the device can be mounted in a stripline package without any major problems.

The battle between the two devices is likely to continue until one shows a decided superiority. The Gunn-effect oscillator offers low noise output, comparable to that of a klystron when mounted in a high-Q cavity—approximately 1000. And since a high-Q cavity is required to achieve the low noise performance without reverting to phase locking, it's difficult to incorporate these diodes into microstrip circuitry. It operates at frequencies up to Ku-band and finds most of its applications as a local oscillator and a parametric amplifier pump. It falls short, however, when high c-w power above several hundred milliwatts, is required.

The **impatt**, on the other hand, features the ability to produce c-w powers of several watts, also in Ku-band, but at a sacrifice of output noise. Even though complicated phase-locking techniques are required to reduce noise for certain applications the impatt finds use in radar beacons and transmitter applications.

The Gunn effect diode and the avalanche diode are

progressing from the laboratory into production items. But the limited space-charge accumulation (LSA) diode and the avalanche diode operating in the sub-harmonic mode are still in the research stage.

The LSA diode, although it requires precise loading of the primary-resonant frequency circuit to allow the peak r-f amplitude to build up quickly, can also produce kilowatts of peak powers at fundamental frequencies. The limiting factors of these devices are materials and fabrication techniques, and until they are reliably and economically reproduced, they will continue to live in the lab. Frank Brand, chief of integrated electronics at the Army Electronics Command in Ft. Monmouth, N.J., expressed his disenchantment with LSA for high-power because of its extremely low duty cycle—.0001% during pulsed operation.

"1970 will be the year of the impatt," says Robert Angle, manager of the microwave and semiconductor operation at Varian Associates, "and we have developed an automobile braking radar using an impatt diode oscillator operating at a fixed frequency." Varian has sold 2,700 units to be installed in luxury automobiles in 1970. One spur to progress in this area is an FCC decision to license the owner, rather than the manufacturer, as the radar operator. Varian also is working the other side of the fence—it's developing a solid state traffic control radar using impatts, for police use.

"The Gunn-effect diode is best suited as a local oscillator in radar and communications systems," says Joseph F. White, chief engineer of Microwave Associates' solid state products division. "This is due to its low a-m and f-m noise, low drift, and low power requirements." White has built an X-band c-w Gunn oscillator featuring a 1-megahertz drift and 10-mw of output power. He sees no reason why units with less than 100 kilohertz drift can't be made using conventional techniques such as a constant-temperature oven.

However, microwave transistor technology is moving along, too. [*Electronics*, May 26, 1969, p. 84]. Power outputs of 5-watts c-w have been generated from individual transistor chips at 2 gigahertz at efficiencies better than 45%, while RCA is working on a 5-watt transistor at high S-band and TRW is offering 2.5 watts at 3 Ghz for \$170 each in lots of 100. [*Electronics*, Nov. 10, 1969, p. 33]. The octave bandwidth transistor amplifier operating from 2 to 4 Ghz already is providing a solid state replacement for the low-noise, low-power traveling wave tube amplifier. The Army's Brand feels transistors can be brought up to 10 Ghz without much difficulty.

Progress hasn't been confined to new solid state power sources. Higher output power at higher frequencies are being sought and attained in microwave tubes, and problems such as spurious response and band-edge oscillation are being eliminated. Paul A. Ridge, production manager of medium-power tubes at Varian, feels that solid state amplifiers have been too quick to take on jobs that they can't thoroughly handle, and customers are reverting back to twt's.

Traveling wave tube amplifiers capable of multi-octave bandwidths as well as twta's with c-w power of 500 watts at C-band and X-band are likely to debut in 1970. The biggest potential new market for twt manufacturers is the twta package that eliminates need for the user to provide a power supply. The amplifier's performance can be degraded when the twt power supply does not match the specifications set by the tube—ripple, load regulation, etc. "The twta manufacturer eliminates the problems associated with electrical, mechanical, and thermal interfacing for the purchaser by providing him with the complete package," says Ridge.

The klystron is not dead, either, says a Varian spokesman. And for evidence he cites the new Varian X-band klystron, which can generate c-w outputs of 1 mega-

watt. But the future of the low-power klystron and the backward wave oscillator isn't rosy. Ridge feels most of these low-power tubes will be replaced by solid state sources in five years. Martin Schilling, vice president for research and development at Raytheon, also isn't optimistic. He sees the reflex klystron restricted to spare-parts applications as soon as 1970.

Microwave integrated circuits are finding increasing applications—a trend that will continue into the 70's. Devices such as filters, couplers, mixers, amplifiers, oscillators, and similar active and passive components frequently appear on the market.

The reasons for this are many, but perhaps the ease of assembly of large quantities and reduced costs make the MIC an ideal replacement for conventional coax and waveguide circuitry wherever practical. "The low cost for large volumes will make MIC's the way to go in 1970," says Harlan Howe, engineering manager for components at Microwave Associates. According to Howe, so far there has been no big-volume production of hybrid lumped element circuits on microstrip, and unless size is the big factor, he feels there is no need to go that route.

Until an economical, high performance monolithic MIC hits the market place, the hybrid MIC will continue to be widely accepted for many active microwave components such as amplifiers, mixers, power sources, and limiters. The LEL division of Varian Associates is firmly committed to the merits of this technique, such as small size and low cost. It is using hybrid IC technology to manufacture decade bandwidth amplifiers from uhf to L-band, S-band log amplifiers, and constant phase limiters. According to Warren Roggenendorf, production manager at LEL, 1970 should see the development of an octave band hybrid IC amplifier for use above S-band.

There have been few dramatic improvements in active microwave components other than solid state amplifiers and sources; the mixers used today are very close to their theoretical limits. And only when manufacturers provide mixer diodes that have a constant impedance with frequency will the multi-octave mixers become a reality. But this isn't likely to occur in 1970.

Microwave ferrite is finding new uses and is improving performance in older devices, such as phase shifters and yig filters. "An electronically variable ferrite attenuator has found wide acceptance," says Perry Smith, marketing manager at Solitron Microwave. New materials are being developed that offer lower magnetic saturation to yield lower operating frequencies and narrower line-widths for higher Q's, all at a saving to the user.

Ferrite substrates offer the prospect of building both active and passive devices on a single substrate. Their use in MIC's promise better circulators and isolators.

Although still in the early stages of development, microwave acoustic devices are showing up in signal processing systems for radar, communications, and navigation. Accessibility to tapping off the surface wave makes them ideal for active delay lines and filters where narrow bandpass and low loss are required.

Autonetics, a major researcher in the area, is confident that microwave acoustic devices will replace electromagnetic counterparts in radar signal processing in the next few years. One of their most advanced developments to date is a 50-tap quartz delay line operating at 120 Mhz; bandwidth is 50 Mhz.

With increasing air traffic and narrowing safety margins, airlines will be investing heavily in electronic systems

Unless the Federal Aviation Administration and the airlines get moving—and very quickly—on drastically upgraded electronic systems for air traffic control and airport facilities, predictions of multiple midair collisions and mind-boggling ground congestion will be proven tragically correct. Both the FAA and the airlines will have to introduce “new” electronics systems—the ideas for some of which date back as much as 20 years—at an extremely rapid pace.

The airlines, despite a current profit squeeze, will have to shell out for several new communications and navigation systems. Some of these are:

▶ Area navigation systems, which relieve airplane congestion, particularly in crowded terminal areas, by opening up additional routes. These are calculated in the aircraft through signals from conventional very-high-frequency omnirange (VOR) and distance measuring equipment (DME) navigation stations on the ground.

▶ Digital data communications links, which greatly reduce routine voice communications between the pilot and the ground by coding the information and transmitting it digitally. Intracompany communications—a pilot reporting to his airline such data as the number of passengers he’s carrying, or the time he left the loading gate—will be automated first. Eventually, two-way digital communications also could be used for air traffic control information.

▶ Cockpit instrumentation to present information to the pilot in a form he can more easily see and understand. The cathode ray tube, with the ability, says its developers, to display just about anything demanding the pilot’s attention, will be the basic instrument.

▶ Clear air turbulence detection systems which indicate when an aircraft is in the vicinity of potentially dangerous air turbulence. Ground-based radar and airborne lasers have been tried but an infrared system may, after years of test and development, finally win out.

▶ Collision avoidance systems, being tested under the auspices of the Air Transport Association. Significant in the development of this sophisticated and expensive equipment is its use of time and frequency synchronization to locate an aircraft. This technique could begin to play a role in other areas of air traffic control by the end of the decade.

And of course there’s the continuing effort to make existing electronics systems more reliable and cheaper to build, a particular emphasis in the general aviation market. The current effort seeks to redesign systems with medium- and large-scale integration. In the process, functions that had hitherto been performed with analog circuitry are being handled digitally to take advantage of the digital nature of the IC’s.

Along with improvements made by the airlines will come FAA-sponsored improvements to ground-based air

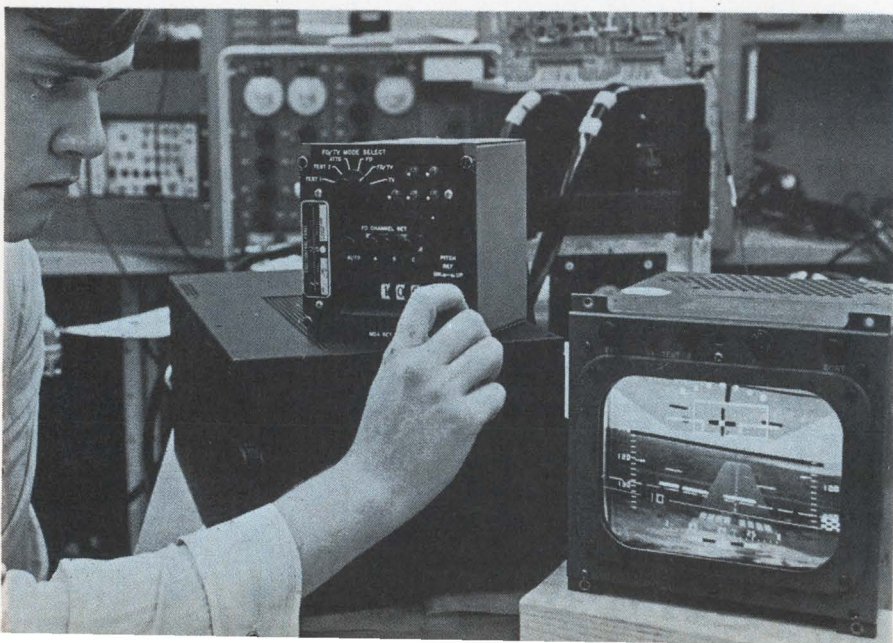

Picture this. First major assignment for cathode-ray tube displays is to do the job of a pilot’s electromechanical attitude director indicator. Combinations of attitude and flight director data are displayed on this Norden unit, superimposed on a television picture of an actual approach to a runway. The big future advantage of crt’s: they can be programed to display any information a pilot requires.

traffic control hardware and procedures. Many specific recommendations for updating present equipment were contained in the report prepared last fall by the Air Traffic Control Advisory Committee for the Secretary of Transportation [*Electronics*, Oct. 27, 1969, p. 127]. Should sufficient funds become available, modifications, costing between \$4 and \$5 billion, likely will be made in such areas as the present radar beacon system, so that each beacon can be addressed discretely and handle digital data communications; phased-array antennas to replace the mechanically scanned antennas which interrogate the beacons; better use of computer programming techniques to space aircraft approaching terminal areas, and introduction of wide-angle, scanning-beam microwave landing systems.

It can be difficult for the pilot of a giant commercial airliner to pick out information from among the hundreds of dials and warning lights in his cockpit. Consequently, considerable effort is going toward improvement of data presentation.

Main targets of this streamlining are the many conventional indicating dials. Numerical readouts were added to some of the dials several years ago. And now vertical displays, which relate the value of a parameter to the height of a lighted, vertical scale, also are being developed. A pilot could, for example, quickly check a bank of four engine-temperature indicators by seeing whether all the strip-scales were lighted to the same height. An out-of-step parameter would be at a different height. Solid state light emitters, consisting of vertical arrays of gallium arsenide diodes, are feasible and could be ready in a few years.

But perhaps the biggest change in the cockpit will be the introduction of the cathode-ray tube, presently confined to weather radar. The crt can be driven by a programmable digital computer to display just about any kind of information.

Initially, crt displays are being developed—by such companies as Kaiser Aerospace and Electronics, and the Norden division of United Aircraft—to replace an aircraft's attitude director indicator, an electromechanical device that helps a pilot fly correctly.

The crt's great asset is its flexibility—once in place it can be used for a variety of tasks. Thus, it also could aid in instrument landings, display critical aircraft performance parameters, and act as a display for closed-circuit

tv systems in the airplane. And in the event of a malfunction, it could flash a warning to the pilot immediately and even, depending on programming, direct him out of a tight situation.

Traditionally, the airline industry has been a borrower of technology—weather radar and satellite communications, for example. "In just about every research and development project we've gotten involved with in the past, some organization has at least proved its feasibility," says B.F. McLeod, director of electronics engineering for Pan American World Airways.

But development of a system to detect clear air turbulence represents a marked departure from the way airlines usually handle new technology. No other user has proved feasibility of the passive infrared technique developed by Barnes Engineering and being tested by Pan American, Eastern, and Trans World Airlines.

In the spring, digital data links, one of the systems under consideration for at least 20 years, will undergo what could be its final round of testing before being introduced operationally. Prototype hardware will be flown between the West Coast and Hawaii by several airlines. Upon interrogation by ground stations, the test aircraft—Pan American plans to outfit several Boeing 747's for the purpose—will automatically transmit information on its identification, altitude, latitude, longitude, windspeed, and direction, and outside air temperature. Much of this will be available automatically from the aircraft's inertial navigation system. And in addition, the pilot will be able to insert preset messages.

Much of the work involved in specifying the system's overall signal characteristics—such features as message format and the scheme for amplitude-modulating the vhf carrier—has been completed. Main objective in the flight tests is to hit upon the final hardware specifications, particularly on the best way of digitizing the pilot's messages. The final specification that defines the system and hardware could be issued in time for production equipment to be ready by the end of the year.

The big milestone last year for area navigation, another 20-year-old brainchild, was the FAA's decision to set up 16 special routes over which the airlines could fly and evaluate equipment. Almost all the airlines are considering one of three types of area navigation systems, designated the Mark I, II and III, which are graded in increasing levels of complexity and cost.

Development of the Mark III system is, for example, spearheaded by users of the Boeing 747 who want area navigation for maneuvering easily in and out of terminal areas. The 747's on-board inertial navigation systems furnish the position information used to drive a pictorial display.

The Mark I system probably would operate on the same distance and bearing coordinates as does the present VOR/DME system. A simple pointer, driven by a course-line computer would indicate to the pilot the direction he's to fly. The Mark II system, basically a simplified inertial system that drives a map display, is based on what Lockheed is developing for its L-1011.

It will take another year to put together airline-approved specifications for area navigation systems, according to David H. Featherstone, executive secretary of the Airlines Electronic Engineering Committee. And production hardware won't be ready for another six months to a year.

Integrated systems and LSI rate high in NASA interest as the space effort moves ahead despite fiscal uncertainties

Despite the rosy glow at the National Aeronautics and Space Administration following two successful moon landings in 1969, the euphoria does not extend to fiscal matters for the new year. Currently operating on a budget under \$3.7 billion—about \$154 million less than the previous fiscal year—the civilian space program is hamstrung by factors beyond its control: nationwide inflation, plus commitment of most of its funds to future Apollo missions.

Still awaiting the White House signal on the direction of future space efforts, NASA officials are unsure of the prospects. The space agency would like a budget of at least \$4.1 billion in fiscal 1971, but this is unlikely to come about. Far more likely would be a NASA budget in the neighborhood of \$3.8 billion, a spending level that will buy no more than last year when inflation is taken into account.

In addition, a cost-conscious Congress, which didn't approve the 1970 fiscal year budget until almost half the year was gone, is unhappy over the actual benefits being derived from the space program and questions NASA's present balance of manned and unmanned space flights.

But regardless of the budgetary outcome, the broad scope of NASA's shopping list of space projects is impressive. While Apollo landings on the moon are slated to continue through a 20th mission, NASA is laying groundwork for manned earth-orbital space stations; unmanned probes to distant planets, and unmanned satellites that will orbit the earth collecting data on the planet's resources. And while these programs get started, NASA hopes to continue sending up improved versions of its earlier meteorological, astronomical, and advanced technology satellites.

In manned space flight this year, NASA hopes to emphasize both the Apollo Applications Program that aims to put a space workshop into orbit and the larger space station and shuttle.

If Congress elects to continue the workshop effort, the McDonnell Douglas-developed system will be put into orbit atop a Saturn 5 rocket in July, 1972. A three-man crew will follow it into space a day or two later, riding a Saturn 1B. The workshop, made from a dummy third stage of a Saturn 5 refurbished for use as living and working quarters, will orbit 235 miles up. It will contain a solar observatory—the Apollo Telescope Mount

—an airlock module, and an adaptor for multiple dockings, which are being developed.

NASA's space station, large enough for a 12-man crew, is slated for orbit in the late 1970's. Designed in separate modules, or sections, the station serves as a semipermanent space facility supplied by the space shuttle—a comparatively low-cost, earth-to-orbit-and-return vehicle that will be reusable. Eventually, it will be expanded by adding extra modules to house as many as 50 men.

Along with the station, NASA will develop the reusable space shuttle. The shuttle will deliver experiments and equipment to the station, rotate personnel, resupply expendables, and return cargo to earth.

Last fall, McDonnell Douglas and North American Rockwell began program-definition phase studies which should be completed in August. Almost half of the very broad studies cover a long look at the station as part of an eventual national research facility in earth orbit—a space base—its use in future planetary travel, and at the problems of interim and advanced logistics. Problem areas on which NASA hopes to concentrate this year include: reducing the number of interface connections between station modules, increased life and redundancy levels in the instrumentation, compatibility of integrated display systems in the shuttle and station, and techniques for converting nuclear reactor energy to usable power.

Electronics design in the space station and shuttle will mark the introduction of important new technologies to the program. "It offers the greatest opportunity and challenge of the space age to date for the electronics industry," explains Robert Lovett, a NASA systems engineer for the space station. "A lot of money will be spent to put 12 men into orbit around the earth; their time will be valuable, and we don't want them to do simple, mundane jobs. They also won't be supported by a large group of people on the ground telling them what to do, like the Apollo astronauts."

Thus the station will be designed to operate as automatically as possible, with its various tasks, such as arrival or departure of a logistics vehicle, or setting up experimental modules, performed independently.

The electronics in the space shuttle also will receive considerable attention. Four companies have already completed feasibility studies of the shuttle and requests for proposals are expected this month for follow-up studies. Present demands on avionics for the space

shuttle are within the state of the art, top Lockheed Missile and Space officials working in that program point out. "But it will take a helluva lot of engineering to adapt existing technology," they say.

Integrated electronic systems, foolproof, hardy enough for at least 100 missions, and costly—up to \$100 million each—will take over many of the duties now carried on by astronauts and ground control. Aim of this effort is to reduce overall costs and increase reliability.

The complexity of the integrated systems are apparent when all of the functions being considered for integration are listed: guidance, navigation and control, equipment checkout and fault warning, crew command and control displays, communication data link, target tracker and sensor, environment and electrical control, and data processing.

The next few years also will see the space electronics debut of large-scale circuit integration. In particular, LSI will make possible the high degree of on-board automation that's desired.

LSI also will be designed into the computer memories that will operate in the space environment, and will contribute heavily to the high degree of on-board data processing that will be designed into space hardware. The processing includes not only handling of experimental data but of information needed to check out the spacecraft before launch.

It's also expected that information will be multiplexed over a common set of wires from one part of a spacecraft to another. This would help reduce the overall weight of the craft by cutting down on the number of wires.

Laser communications with its potential for wide data bands is another new area that will get its day in space soon. Lifetimes are now long enough and power output high enough to make the laser a feasible space communications tool, says John A. Jamieson, director of product development and research at Aerojet General's Electronics division. Aerojet received a contract late last year to develop a communications system using a carbon dioxide laser; it will be tested aboard the ATS-F satellite. With continuous power output of 120 milliwatts, the laser should be adequate for space-earth data links, says Jamieson. And it will operate for up to 3,000 hours.

Other areas of electronics technology that could be applied to space uses during the next few years include

laser ranging; electronically steered antennas, with beam-pointing direction independent of a spacecraft's attitude; wide-bandwidth recording and reproducing; high-power, solid-state microwave devices, and cooling of integrated circuits with heat pipes.

As happened last year, there will be few surprises in NASA's Office of Space Sciences and Applications (OSSA). One of the most important programs to pick up speed this year will be the earth resources technology satellite (ERTS) [*Electronics*, May 12, 1969, p. 101, Nov. 10, 1969, p. 58], NASA should be receiving design studies in March from TRW Inc. and General Electric, in which they show how existing spacecraft—the Orbiting Geophysical Observatory and the Nimbus weather satellite, respectively—could be modified to meet ERTS requirements. The companies also are evaluating orbital and ground-based data processing requirements. By June or July, NASA could award a production contract worth perhaps \$80 million for two satellites and ground equipment.

The big uncertainty right now, says Theodore E. George, ERTS program manager, is design of the data collection and processing systems. "We only have an idea of what we want," he explains. Another problem area will be modification of state-of-the-art communications equipment to provide a wideband transmission system.

NASA hopes to continue its probe of the planets next year with orbital missions to Mars. Two Mariner spacecraft will be launched in May, 1971, arrive six months later and go into eccentric orbits around the red planet for three months to a year, taking the planet's temperature, checking its atmosphere, and mapping and photographing its surface.

The two Mariners also will provide data on Mars' gravity to prepare for the landing on Mars in 1973 of Viking—NASA's most expensive—at an estimated \$750 million—unmanned spacecraft.

Pioneer F is scheduled for a March, 1972 launch and Pioneer G for one a year later to explore interplanetary space, including the asteroid belt and the magnetosphere of Jupiter—a two-year trip, followed by an elliptical orbit of the sun. If impacts with the asteroids don't kill off the Pioneers, returned data on the properties of charged particles, magnetic fields and radio frequency emissions 200 million miles from earth will enable scientists at NASA to guide the design of spacecraft to be used on a proposed visit to the outer planets. This billion-dollar "grand tour" program needs a green light by next year if it's to meet a 1979 launch window. Communications problems will be especially troublesome. For example, out near Pluto it will take eight hours for data on the spacecraft's performance to be radioed to earth and for a reply to be returned. A prototype self-testing, self-repairing computer called Star has been designed by the Jet Propulsion Laboratory to run the flight and its experiments.

A Mariner-sized Venus-Mercury flyby is also being considered for a launch in 1973. Protection of the exterior solar panels and internal instruments from high temperatures—up to 1,000°C—is one of the most important problems to be solved. One proposed design suggests protection be provided by a metal "umbrella." Ultraviolet and tv pictures, atmospheric and ionospheric data, and thermal maps will be obtained from both planets.

Computerized control of test instrumentation is rapidly approaching near-universal acceptance

Everybody has a system—so much so that the drift toward computer-controlled test systems has turned into a stampede. Instrument makers who just recently argued that customers wouldn't spend the money for such systems now say the same customers are demanding the latest in computer-controlled gear. Companies that long have relied on the sales of bench-top instruments now say they have no choice but to either start making computer-compatible instruments or build computer-controlled systems themselves. And companies already in the systems business are talking about building their own computers, even though a major cause of systems' popularity has been lower small-computer prices.

Says one systems man: "People are starting to demand the whole package from you, including software, training, and repair. And you have a much better handle on these things if you're the one who makes the computer and writes the programs."

Another reason for the growing popularity of systems is that instrument buyers find they aren't so expensive after all. If a customer will be testing identical circuit boards and nothing else for the next 10 years, he's better off without a computer. But if his testing needs are in flux, it's a lot less expensive to change a program than to buy new hardware.

Companies already in the systems business are planning more-complex units. For example, until now the most complicated system made by Teradyne Inc. has been a computer-controlled integrated-circuit tester, the J259. But engineers at the Boston-based company are now readying a large-scale integration tester for introduction early in 1970. And Educational Computer Corp., already on the market with an LSI tester, will bring a new word-generator to the IEEE show in March. Priced at \$40,000, the generator has 48 output terminals, each capable of delivering formats of from 10 to 4,000 bits at frequencies up to 1.5 Mhz.

General Radio Co. provides a good example of what systems have done to the instrumentation business. The venerable Massachusetts firm made its reputation with highly accurate bridges and meters, packaged in characteristic black leather-covered boxes. And for General Radio to forecast their demise would be like Schlitz predicting everyone would be out of beer. Nonetheless, Richard Rogers, a General Radio product manager, says flatly: "The days of the black box are just about over.

You have to be in the systems business to survive." And others at General Radio say it won't be too far into the 1970's before more than half the company's business will be in systems.

Besides making their own computer-controlled systems, instrument houses also are making it easier for customers to build their own. Rare is the new counter, voltmeter, or other basic instrument that can't be remotely controlled and that doesn't convert its measurements into a binary-coded-decimal output. And even such sophisticated items as spectrum analyzers are being readied for programing.

Typical of the attitude among instrument makers are the sentiments of Bart Weitz, a marketing manager at Dana Laboratories Inc. "I don't think we'll ever again make an instrument that's not remotely programable," he asserts.

In a way, Hewlett-Packard Co. is forcing many companies to be systems-conscious. H-P's big commitment to systems has extended to setting up a separate division to build them.

Dana's Weitz reasons, "Every Hewlett-Packard division is making products programable. You see a digitally programable power supply that's made by a division (The Harrison division) that probably never even heard of a computer before. Their Moseley division is making digital plotters in place of x-y recorders. Every divi-

sion that wasn't involved in computer interfacing is thinking of it now. And this is going to have an effect on all of us because to be competitive everybody is going to have to consider how easily their equipment can be interfaced with computers or put into computer-controlled systems."

Robert Grimm, marketing director at H-P's systems division, seems to back this up. "All the new designs throughout the company are considering programability and adaptation for use in automatic test systems," he says. "This doesn't mean all the instruments are that way, because there's still a tremendous market for manual instruments. But I'd say that this is considered in each case. And if you look at the instruments being introduced, a much larger percentage are designed for easy inclusion into computer-controlled systems."

A list of system makers reads like a Who's Who in the instrument business. For example, Tektronix Inc. has started putting systems into its catalog. "Probably no one has ever bought one of these systems," says Lang Hedrick, instrument engineering manager, explaining that the listings are "just suggestive of the kind of thing we can do."

The John Fluke Manufacturing Co. is another established maker of bench-top instruments that's getting into the systems business. "We want our whole line computer compatible," says a Fluke spokesman.

Time for a change. The coming of solid state displays is paving the way for a generation of hand-size instruments. First to arrive is this stopwatch built with Hewlett-Packard's gallium-arsenide-phosphide numeric indicator.

Beckman Instruments Inc. has its own reason for moving into systems. "The instrument market isn't growing that much," says William Smith, marketing manager for the Electronics Instrument division. "So if what you're in isn't growing, you get into something that is, something that's a little more specialized."

The Cimron division of Lear Siegler Inc. is yet another company moving into systems. Gary Thomas, the division's marketing chief, reports that 25% of his business is in systems work.

The instrument that'll be most affected by the move to systems is the frequency synthesizer. In earlier days, synthesizers were valued for their precise outputs; but in the computer age another synthesizer virtue is getting attention—the ease with which they can be programed. Except in applications where a sweep generator is needed, the synthesizer will replace all other signal sources because it fits right into computer-controlled

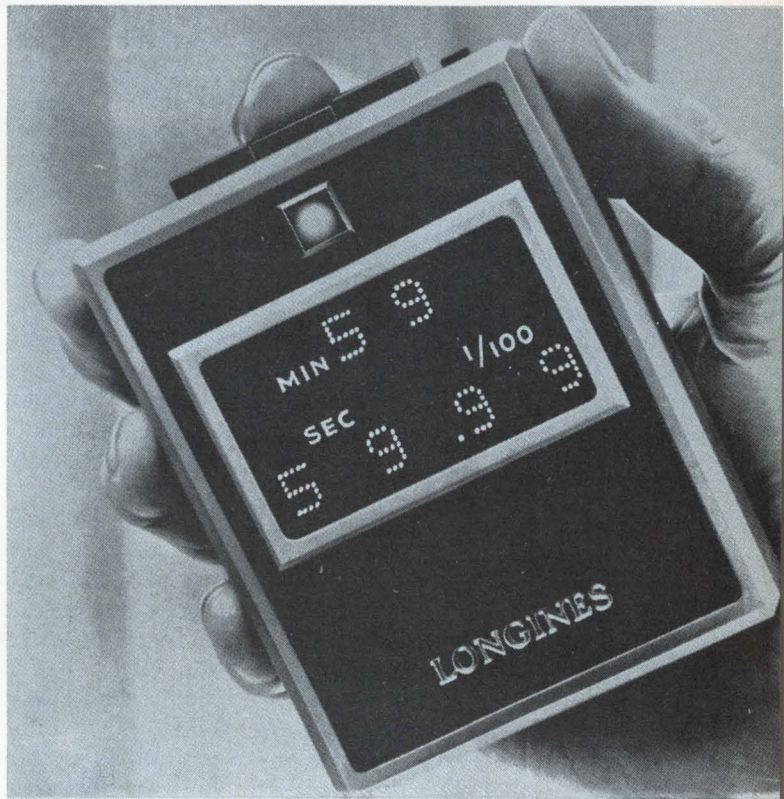

systems. What's keeping them out now is the price, which is in the \$7,000-and-up range. All the large instrument houses are working hard to bring that price down, and some are thinking of doing it by cutting down output purity.

"I thought synthesizers were going to sweep over the signal-generator market," says Philip Goodrich, manager of Dana's high-frequency division. "Now it seems that everybody underestimated the cost of developing and making these things as low-priced instruments. But the switch is inevitable."

A high-quality signal generator costs about \$2,000. Many instrument makers guess that a synthesizer in the \$3,000-to-\$4,000 neighborhood will take a big chunk of the signal generator market.

The growing popularity of systems isn't the only thing instrument makers have strong feelings about. There's a lot of conviction in what they say about prices,

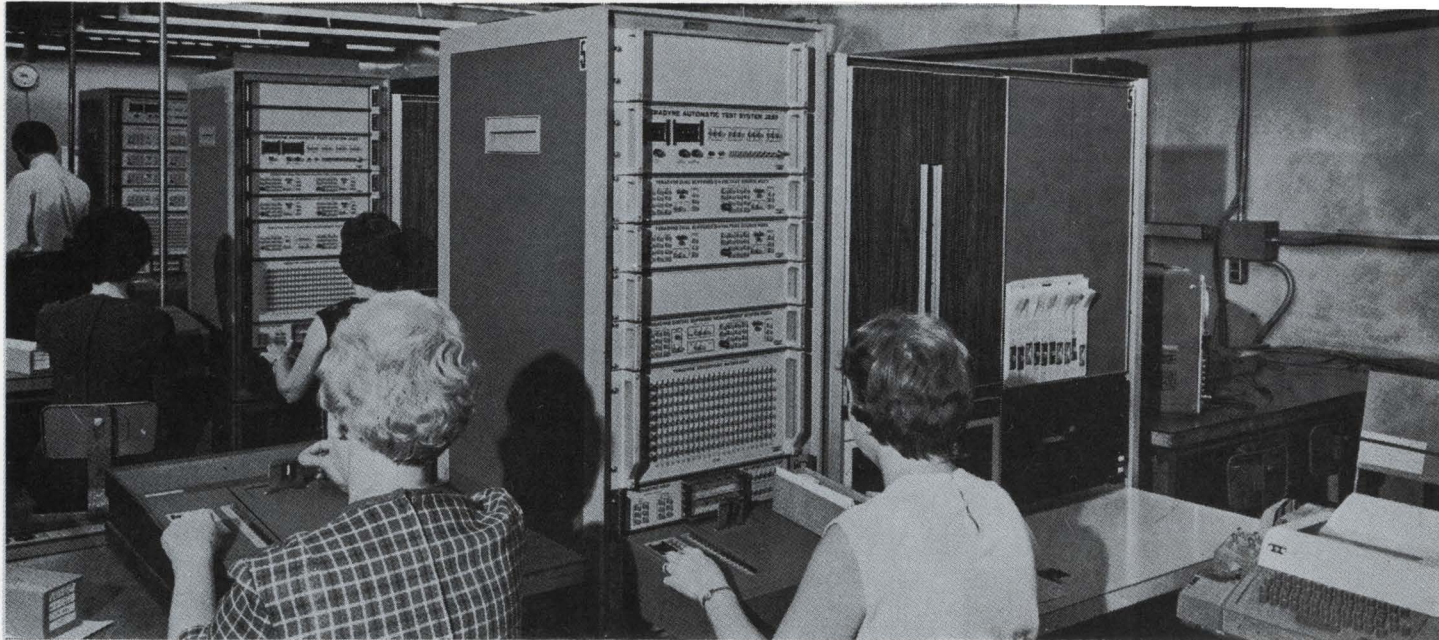

but very little agreement. Some see an inevitable drifting upward caused by inflation, while others say that with the growth of the instrument business slowing down, competition will be fiercer and prices will remain stable. Still others predict instrument makers will take a cue from Detroit and come out with economy models—instruments with not quite as many ranges or capabilities, and at commensurately lower prices.

Even in systems there's little agreement. H-P's Grimm says that prices will drop because computer prices are falling. But GR marketing manager Leo Chamberlain says prices can only go up. "Instrument makers are going to realize that they haven't been charging enough for systems engineering. It's going to make customers mad to see this kind of rise because they're used to adding up the price of the hardware."

As for individual instruments, many makers expect rising prices. "I don't see how you can come to any other conclusion," says Tektronix's Hedrick, who cites rising raw material costs. "An example of a component that's critical to our oscilloscopes is the new metal shield around the cathode-ray tube," he says. "That has a lot of nickel in it, and if you've been reading the papers, you know the nickel situation is pretty bad."

Even where prices have been dropping, as in the counter and digital-voltmeter market, there may be some leveling off. "We've rapped the price about as hard as we can," says Richard Hall, chief engineer in charge of counters at Systron-Donner Corp. "I don't see any real heavy price knockdowns in the instrumentation field, and in the counter field specifically," he asserts.

The surge toward digital displays will continue into 1970. Many makers are looking for something to replace the ubiquitous Nixie-type tube. Solid state displays are the best bet now. Monsanto already is building voltmeters and counters with its own solid state displays, but the price per digit of the Monsanto display still is high—\$48. Hewlett-Packard will get the price of its display down to \$50 a digit this year. And some of the bigger solid state houses, Fairchild and Texas Instruments in particular, will get into displays.

No one doubts that there's a large demand for solid state displays. Fred Katzmann, Monsanto's Electronic Instruments division chief, says that Monsanto's entire line will have them within 18 months. Says John Minck,

manager of H-P's solid state display department: "Our first display came out as a remarkably high-priced (\$75 per digit) unit and we were really surprised at how many people were willing to buy them. The thing that struck us is the variety of people willing to pay a rather high price; as you look through the customer list you see everything from machine-tool guys, to medical electronics, to the expected aerospace people."

With the introduction of its new display in 1970 H-P will retreat from the logic-with-display concept it embraced in 1968. The new unit will require the customer to supply his own logic to drive it.

Of course, one of the big advantages of solid state displays over tubes is that they draw far less power—in the low milliwatt region. So, combined with integrated circuits, particularly custom-designed MOS IC's, solid state displays portend entire new families of portable instruments, such as battery-powered slide rules.

Of course engineers at Burroughs Corp. aren't sitting around waiting for solid state displays to kill off the Nixie tube. Late in 1969 the company introduced a new display that uses plasma. Called Self-Scan, it's intended for large-capacity, stacked displays. Burroughs' initial target is the calculator industry.

The move to digital displays continues to put the squeeze on makers of analog-display instruments. Latest to feel the pressure are makers of multimeters in the

Fast and flexible. At Sylvania's Semiconductor division in Woburn, Mass. programable testers run complete d-c checks on IC's. Computer-controlled systems, such as these J259's from Teradyne Inc., are becoming increasingly popular because they're fast, accurate, and easy to modify for testing different circuits.

\$100 to \$200 bracket. Weston Instruments Div. introduced a \$400 digital multimeter [*Electronics*, Oct. 27, 1969, p. 149] recently, and other digital houses are readying their own versions.

Weston also is bent on bringing some pressure to bear on its fellow digital-meter makers. Last March Weston announced it had exclusive patent rights to the dual-slope integration technique, used for analog-to-digital conversion in most meters. Since then Weston has been quiet and just a few companies have bothered to pick up a license. Now Weston is beginning to stir; if its claims stick, a lot of instrument houses will have troubles.

Last year Fluke built its first digital meter, the 8300A multimeter. The company will expand its digital line, and plans to get into the already overcrowded digital-panel-meter market.

It seems anybody can build a dpm; it just takes some display tubes and a handful of IC's. The result is that everybody from the biggest houses down to mom-and-pop operations are turning out dpm's. The lure is the vast replacement market for analog meters. But nobody knows at what point customers will get rid of their \$10 analog meters and buy a dpm. Weston president Roger Swanson says people aren't going to pay much more than they pay now, while Beckman's William Smith feels the dpm's superior accuracy (10 times better on the average) will loosen purse strings. The least expensive

dpm's sell in the \$125 range, for a 3½ digit meter. Tyco will bring the price down to \$100 early this year.

Another group of instrument makers facing tough going are manufacturers of pulse generators. There the pressure is coming from data generators, which use digital circuits to generate pulses. In addition to doing everything a pulser does, a data generator puts out its pulses in an almost limitless number of formats, making it much more valuable for testing logic circuits. Until now though, data generators in the 10-to-40-Mhz class have cost between \$5,000 and \$8,000, four to five times more than equivalent pulse generators. But that's changing. For example, Tau-Tron Inc. is introducing a family of data generators priced from \$2,600 down.

No area of instrumentation has been more active in 1969 than the oscilloscope market. Tektronix, the king of the hill, came out with two new lines, the 7000 and the 5000 series which, among other things, feature character generation on the scope face and a fiber-optic display of scale settings. Hewlett-Packard, now the only hill-climber of any consequence, brought out a new scope of its own, the 183, whose 250-Mhz bandwidth makes it the fastest scope on the general-purpose market.

Harold Edmonson, marketing manager at H-P's scope division, says H-P has no immediate plans to match Tektronix's two display systems, although he is impressed with one of them. "The character generator in particular is an interesting item," he says. "I think it's a little more expensive than the world needs now (base price of 7000 mainframe is \$2,000). It's an indication of things to come. It could be the first stepping stone to a computing-type oscilloscope, one that would make some calculations and display an answer for you. But making the character generation available is, of course, the first step in getting some logic into oscilloscopes."

Tektronix, trying to pass Hewlett-Packard's 250 Mhz, is working on a faster scope. But manager Hedrick won't say when it'll be ready. "We'd be pretty irresponsible if we weren't working on something to fill that market need. It's a pretty broad usage area simply because devices that go as fast as the 183 will measure are readily available," he says.

Two other large instrument houses, Monsanto Electronic Instruments and Philips Electronic Instruments, made noises about challenging the leaders. Philips introduced a new 50-Mhz scope, and promised 100-Mhz and 150-Mhz units for 1970. But Philips imports its scopes from the company's ancestral home in Holland and can't respond quickly to changes in the U.S. market. However, Philips has bought the land for a U.S. scope facility. Monsanto also has a 50-Mhz scope, built under a military contract; division head Katzmann says that the company will start taking orders early this year.

Dumont Oscilloscope Laboratories also is in the market. "Dumont" was the name of the company that once ruled the oscilloscope business. It slipped, and was taken over by Fairchild, and then it slipped some more. The division recently was bought by an independent group, and rechristened Dumont. The company bought out its first new scope last year, the 1050, a 50-Mhz unit which has drawn considerable praise. But Dumont's ambitions are small. General manager Robert Coultas doesn't talk about challenging Tektronix and Hewlett-Packard but about filling the gaps in their lines.

Avalanche, Gunn diodes are coming on strongly in the quest for better microwave power sources

If a single word could describe what the mood of the 1970's will be, it would be communicate. In fact, the next ten years could well be labeled the "digital decade." The transmission of voice, data, and video through digital modulation of high-frequency radio waves eventually will become prevalent. Face-to-face communication will be ushered in with the introduction of Picturephone service in 1970, while information exchange will be greatly expanded through the use of pulse-code modulation, millimeter waves, and satellites.

The development of new systems for safely controlled traffic is within reach as is the ability to shrink present communication systems through solid state circuitry. Regulatory agency decisions have created new challenges for the community antenna and subscription television industries, and for microwave transmission firms.

The Bell System will offer Picturephone service in July 1970 between New York City and Pittsburgh to both homes and industry. The enormous interest in video telephone has occasioned a meeting of the Consultative Committee for International Telegraph and Telephone (CCITT) to be set for July to set worldwide standards for future videophones. Work on video telephone is underway in England, Germany, France, Sweden, Japan, and at independent telephone companies in the United States; Bell even anticipates that videophone instruments will be offered by other American or foreign com-

panies based on the Carterfone decision of 1968, but not in time for the New York-Pittsburgh offering. Coast-to-coast Picturephone service is not expected until 1975, and then only between 20 densely populated cities.

The coding format used for Picturephone transmission is differential pulse code modulation (pcm). This method yields good motion portrayal but limits the reading of alphanumeric characters to 14-point type or larger. "We are currently involved in looking for a tradeoff of motion portrayal for picture resolution," says Irwin Dorros, Bell Labs' director of network planning. "One method under consideration is to slow the scan rate and send fewer pictures per second within the 1 Mhz bandwidth."

A big feature of the July Picturephone offering will be inclusion of a data set, described by a Bell spokesman as a "casual crt terminal" for executive use. The 12-key Touch-Tone dial, part of the Picturephone set, uses an 8-bit code, permitting the user to communicate with a computer merely by pressing keys. The computer outputs are displayed on the screen. The busy executive, for example, can call on the computer to perform arithmetic computations or get stock market quotations with his Picturephone data set.

"There is exploratory work going on at Bell Labs on the next generation of Picturephone," says William Cagle, head of the video telephone department at Bell Labs. "These studies include the possibilities of color

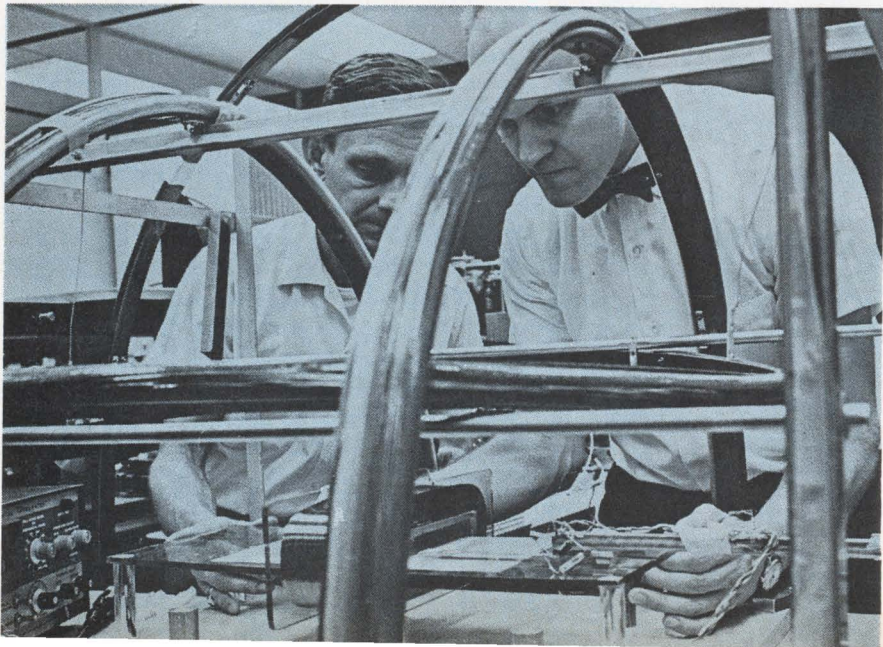

Memory protection. The curved metal structure shields the permanent memory sheet from the earth's magnetic field while being tested. The memory sheet, comprising many magnetic dots, is used in Bell's electronic switching system.

Mini-filter. The miniature crystal filter, left, is composed of four thin quartz layers and occupies only one cubic inch. It will replace its larger counterpart, right, in telephone carrier equipment.

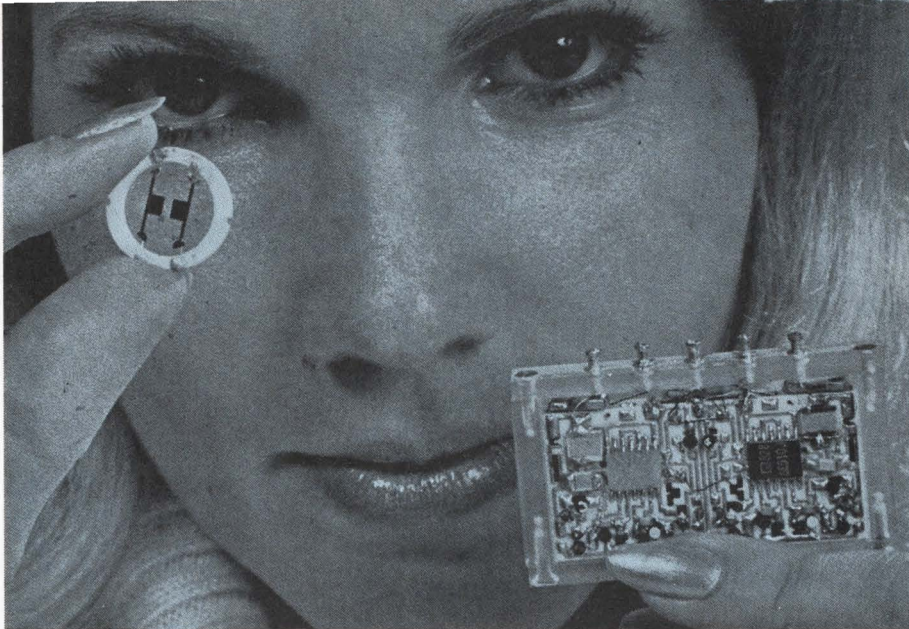

and slow scan. There are three basic problems that must be solved before color Picturephone becomes a reality," adds Cagle, "and they are a rugged color camera that doesn't need adjustment; the ability to transmit color pictures using the same bandwidth as in black-and-white Picturephone, and development of a receiver that will produce a picture bright enough for a lighted room. We see the development of such a Picturephone at least five to 10 years away," concludes Cagle.

"The computer people foresee tremendous growth in data traffic however I think their forecast is overly optimistic and I believe that we are successfully keeping up with the rate of growth," says Lee L. Davenport, president of General Telephone and Electronics Laboratories. He sees the telephone network expanding to accommodate the communications industry, and feels that one way to keep up with the growth of voice and data transmission is by faster electronic switching. Bell seems to be guided by this philosophy, too, since they already have delivered their 100th Electronic Switching System (ESS). GT&E has designed a system similar to ESS and calls it EAX, for Electronic Automatic Exchange; delivery of the first EAX is slated for 1971.

If there is a practical method of mixing voice, data, and video transmission, pcm seems to be it. GT&E's Davenport, however, feels the evolution will take quite some time. Bell's faith in the future of pcm is repre-

sented by its development of the T-5 digital coaxial cable system with 500-megabit capacity; T-5's projected introduction into the Bell System is the mid 1970's.

"The use of a truly digital line, such as T-5, will make it possible for Picturephone to displace only 96 voice channels rather than the 400 currently displaced when a digital picturephone signal is carried over the present TD-2 system," says Richard Boyd, head of the wire systems engineering department at Bell Labs.

The use of new digital filters such as polyolithic filters, and inclusion of medium-scale integration (MSI) will increase the number of channels and lower per-mile channel cost for wire line carriers. The polyolithic filter, composed of 4 thin layers of quartz mounted in a one-cubic-inch capsule, when used with frequency division multiplex will provide more available wideband channels and pack more voice channels side by side. The polyolithic filter is being developed by Lenkurt Electric Co., a GT&E subsidiary, and should be available throughout the GT&E system by 1971. Lenkurt feels that MSI should improve reliability and spur the development of pcm switching and long distance transmission systems.

An all solid state device called a digital adaptive equalizer has been developed at Lenkurt to correct high-speed data signals instantaneously. The new device employs large-scale integration and will operate at speeds up to 9,600 bits per second, four times the capability of the present GT&E system.

A thorn in the side of any global pcm system has been the different systems adopted by the U.S. and Europe [*Electronics*, June 23, 1969, page 94]. However, a step toward world compatibility has been taken by the International Telephone Union (ITU), which recently agreed on a standard of 8,000 samples/second using eight binary digits in a time slot.

Any worldwide pcm system will have to be successfully linked. The prime candidate for the job is the communications satellite, with the Intelsat 4 satellites slated to make the first global pcm tests late this year. The trial, called Spade, will use an 8,000-bit sampling rate and the A-law, the companding law accepted by Europe over Bell's mu-law. However, Comsat is sticking to a 7-bit word even though member nations of CCITT have agreed on an 8-bit word standard. Once a worldwide digital network is operating—10 to 15 years from

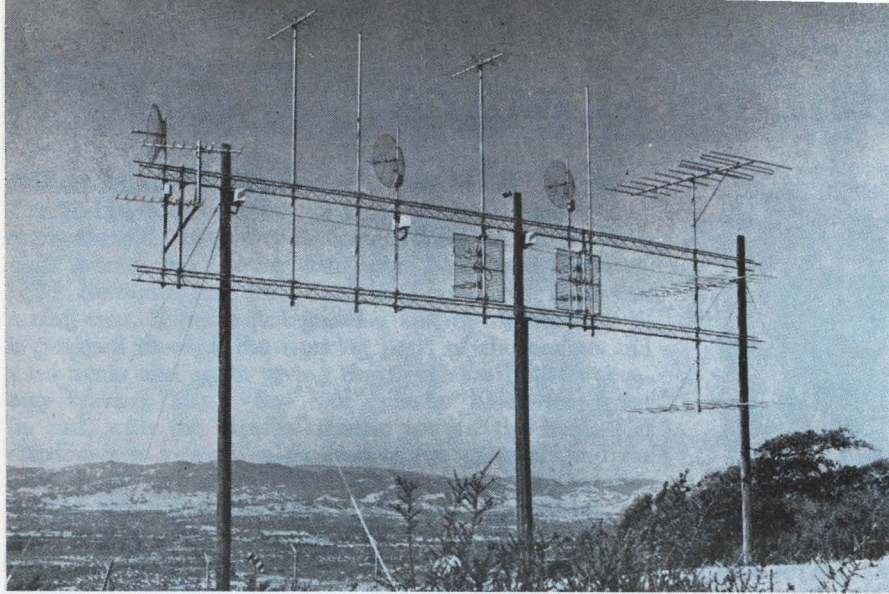

Pickup sticks. A multitude of CATV antennas for vhf and uhf signals are lined up for best reception.

now, according to a Comsat spokesman—Comsat will move toward a standing coding format.

Comsat also is building a time division multiple access (TDMA) system to complement Spade. The TDMA system with 8-kilobit sampling rate, will use the Bell-promoted the mu-law and an 8-bit word. According to Comsat, Spade is slated for areas with light traffic while TDMA is designed to handle medium to heavy traffic.

The satellite transmission system of the future, now under study at Bell Labs, will use a 30-gigahertz up-link and an 18-Ghz down-link. The capacity of such a system will be 40,000 voice circuit per ground station per satellite, and with an estimate of 50 ground stations, a satellite communications system would yield 2 million voice circuits, more than by any other transmission mode.

The satellite also is being geared for domestic use, as in the rush to provide communications to Alaska. A program, consisting of the Intelsat series as well as the Applications Technology Satellite series linked to earth stations and microwave radio links, appears to be the beginning of a domestic satellite experiment. The large commercial earth station located in the Talkeetna mountains in Alaska should be completed in 1970 and will provide the first live commercial tv in that state.

Satellite communications systems will expedite development of a space diversity system. This will use millimeter-wave transmission capable of bypassing bad weather zones, the cause of rapid signal attenuation.

The interest in millimeter-wave transmission has been spurred by the activity at Bell Labs, which is working on the introduction of a 40- to 110-Ghz system with more than 100 channels. The mode of propagation will be the TE_{01} ; transmission medium will be circular waveguide with an internal helical sheath to attenuate unwanted modes. Two methods of solid state power generation are under study at Bell Labs. One is the impatt diode, a transit-time device; the other is the limited space-charge accumulation (LSA) mode of the bulk-effect gallium arsenide diode. Scientists at Bell lean toward the impatt because of LSA material problems.

The potential of the millimeter wave transmission medium is quite high: its estimated capability is 232,000 voice channels is almost three times the capability of Bell's newest coaxial cable, the L-5, now under development. And in the future, perhaps by the 1980's, is the laser with a potential 25 million voice channels.

The future use of millimeter waves is relegated to the mid 1970's. The fact that some engineers have been moving higher up in the frequency spectrum has not deterred the great interest in microwave transmission. The first field trials of the Bell System's new TH-3 solid state transmitter-receiver link have begun with a 300-mile run, including 13 relays, between Dodge City, Ka., and Vega, Tex. The system includes a 6-Ghz repeater with six working channels and one spare, each capable of 1,800 message circuits for voice or data.

Microwave transmission is not limited to the telephone companies and the military, as witnessed by recent FCC decisions in the Microwave Communications Inc. (MCI) and the Community Antenna Relay Service (CARS) rulings. The MCI decision allows private carriers to compete with the telephone companies in microwave transmission while the CARS decision lets CATV companies transmit tv signals by either cable or microwave radio. It also allows them to originate programming and accept advertising.

MCI is in the process of setting up a Chicago-to-St. Louis microwave network for the primary purpose of data transmission. MCI feels that competition in the microwave carrier business will substantially reduce costs and provide better service. This opinion is not shared by the phone companies. Davenport of GT&E says, "The telephone companies are kept from competing with non-

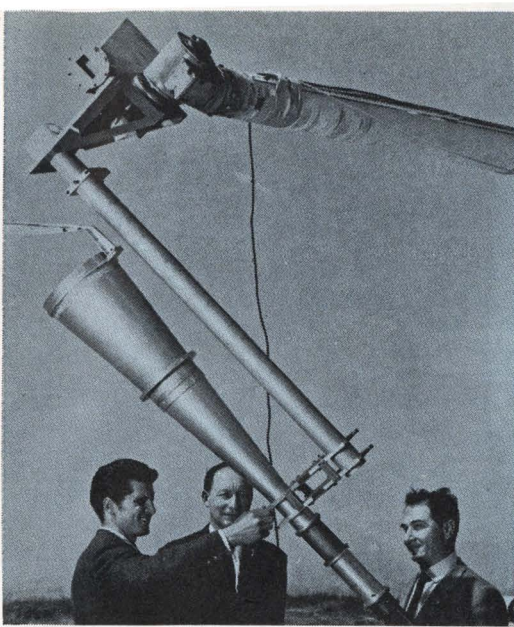

Horning in. These conical antennas will transmit downlink signals from Intelsat 4 to stations on earth. The satellite simultaneously will carry 6,000 telephone channels and 12 color tv programs.

regulated firms by the regulatory agencies and could offer far better service to the user if rate adjustments were allowed. The lowering of rates in high traffic areas, coupled with an increase in rates in low-traffic areas would allow the phone companies to complete more actively." Some telephone company engineers are doubtful that MCI can offer trouble-free service to its subscribers under its present set up.

The CARS decision probably will be felt by the general public more than the MCI decision in that a fourth network, the CATV network, is a distinct possibility. The ruling allowing program origination will result in a demand for microwave links as well as inexpensive studio equipment. Don Smith, product planning manager for Microwave Associates, says "The decision has produced an overwhelming reaction from the CARS people and the end is nowhere in sight. The innovations are coming along so fast that all microwave CATV equipment manufactured now will be obsolete in 10 years," adds Smith.

The enthusiasm of the CATV industry is reflected in its 25% subscriber growth rate per year and the increased channel capacity now available through the use of converters at the tv set. The "black box" converter will make as many as 20 vhf subchannels available for programing. Another boom for the CATV industry will be the leasing of channels to subscribers for industrial uses. In 1970 CATV will offer entertainment as well as local public service programing.

The tv surge does not stop with CATV: a recent FCC decision would result in pay tv in 1970. The Zenith Radio Co. has successfully tested its pay tv concept, Phonevision, from 1962 to 1968. The pay tv ruling limits the number of pay tv stations to one per city, and then only if there are at least four commercial stations in service. The CATV people think that pay tv already is obsolete and feel that by the time it gets going, CATV will be so far advanced that the public won't be interested in pay tv.

In the consumer area, vacuum tubes are being replaced by solid state circuitry in most new tv's, except for the high-voltage rectifier and picture tube. And Motorola says that its new Quasar chassis has a solid state high-voltage rectifier.

Many new circuits found their origins in limited edition tv sets, such as the RCA 2000 series. However, some 2000 series circuitry, such as the diode-switched electronic tuner and channel selection controlled by com-

puter-type logic should find their way into more of the manufacturer's receivers. At Zenith, some color sets have a monolithic IC color demodulator.

Some new ideas being studied this year are Zenith's acoustic wave filter to eliminate filter adjustments, flat picture displays to eliminate the cathode-ray tube, and a laser projection system for very large screen displays.

The impact of imported Japanese television sets has caused domestic manufacturers to lower prices but it hasn't had much effect on U.S. technology. For example, use of the single-gun color tube, Sony's Trinitron, has not stampeded U.S. tv makers. Rather, they intend staying with the black-masked color tubes introduced last year, such as the Zenith Chromacolor and the RCA Highlight 70. These two giants state that their tubes provide more than 100% greater brightness than their older color tubes and can't see using a tube that is basically found in small-screen sets—Sony's Trinitron is found only in 12" receivers.

The most comprehensive communications system ever built for commercial use will be ready for use in late 1970, when occupancy of New York's World Trade Center is scheduled to begin. Upon completion in 1973, the office building complex will contain an estimated 50,000 telephones. The gigantic communications effort, undertaken jointly by the New York Telephone Co. and RCA, will combine telephone, computer, television, radio and graphic information handling. Among the many services to be provided for WTC tenants are Picture-phone, overseas direct dialing, Bellboy personal signaling, high-speed facsimile transmission, data processing, time-sharing computer inputs, and closed-circuit tv. The heart of the telephone system will be an ESS office to be located in the second of the two-110 story towers.

Vehicular communications technology is being pushed forward at a rapid pace. "Raytheon is committed to a broad transportation systems and traffic control program as evidenced by our Merging Control and PAS-II programs for the Bureau of Public Roads," says Martin Schilling, vice president for research and development at Raytheon. Both systems use induction loop sensors buried in the road. Their output feeds into a Raytheon 703 computer. The Merging Control System, presently under test on Route 128 in the Boston area, allows cars to enter a limited access highway smoothly and safely. PAS-II is designed for installation on winding rural two-



Follow the sun. The 45-square-foot mirror, right, automatically follows the sun as it moves across the sky. The other equipment, left, gathers data on how rain effects the received signals.



Let it rain. This modified trash can is used by Bell Labs to determine the effects of rain density on microwave transmissions. The information gathered is sent over phone lines to a computer at the labs for analysis.

lane roads where passing is dangerous. The buried sensors will feed information to the computer through telephone lines; the computer will determine the position and closing velocity of each vehicle within the system's range and send out its commands via the sensors. The commands will actuate messages to be displayed on-board vehicles containing PAS-II.

Vehicle identity always has been a problem in large urban areas. Several systems attacking this problem are being studied and tested. Motorola has installed a bus-locating system in Chicago which can tell a controller the exact location of each vehicle in service. However, this system is limited to fixed-route vehicles. Raytheon is developing an identification system employing coded radio transmission. Operating at 450 Mhz, the system will be tailored for municipal vehicles such as police, fire, medical, and transportation. Schilling of Raytheon says the system will completely eliminate the need to ask, "Car 54, where are you?"

The problem of an acceptable standard for home video recorders still lingers. One industry spokesman sees two knights in armor, CBS and RCA, lances in hand jousting over this prize. Since the FCC has no jurisdiction here, it's anybody's guess who will win. In the wings stands Sony with its own machine, but most observers don't give it much chance against the two giants.

New uses for the laser are constantly popping up. The newest development is a color tv projection system using krypton and argon gas lasers to project color tv pictures filling an 8-by-10-foot screen, and in broad daylight, too. GT&E Labs' version is called "the only type of system that will do the job" by Davenport. The only bottleneck is achieving sufficient brightness from a single laser, which would be necessary for any future installations.

The boating public also is in for new equipment as a result of the FCC's decision that all ship-to-shore radios used in 1971 must operate on either single sideband or vhf with f-m and a 25-kilohertz bandwidth. This decision will make obsolete all presently used a-m and f-m transceivers and spur development of a new line of solid state boat radios. Raytheon isn't satisfied to let the boat owner off with only a radio; they are developing an all solid state boat radar for the small craft owner. Schilling feels that as soon as a good solid state oscillator is developed in production quantities, this radar will be feasible.

Computer-aided manufacturing, particularly of IC assemblies, will spur new applications for industrial-electronics gear

Up until now, the path of industrial electronics has been largely predictable: customers stated their needs and technology provided the answers. This has resulted in an annual growth of from 15% to 20%. Now, however, the picture is changing. And the real growth is difficult to predict because it will stem from a heretofore invisible sector—small, nonelectronic manufacturing companies.

Basically, these companies form an original-equipment market that will buy electronic packages and use them in their own equipment for resale to the ultimate user. Locating this invisible market won't be easy, says the industrial electronics market development manager of a large electronics company. It's a matter of electronic answers finding the unique problems of industry. By the end of the decade, though, he figures the industrial electronics field could be as large as \$30 to \$40 billion.

Making themselves felt in the industrial sector over the next few years will be electronic devices and systems that presently are confined to high-technology applications or to protected environments. Among these are laser-based sensors, optoelectronic components and systems, and customized IC functional arrays to program and control machinery. They will replace functionally limited electromechanical devices, they will provide solutions to problems that can't be tackled any other way, and will offer high-accuracy, high-resolution measurements of physical and chemical variables.

The laser has moved out of the laboratory and into manufacturing operations, for cutting materials to high accuracy, for aligning machine tools, and for welding and trimming. But its versatility continues to increase. For example, at Grumman Aerospace a laser sensor provides measurement and control of five degrees of freedom from one laser reference beam. This five-axis measuring system permits alignment of complex machinery fixtures and of mockups of large, full-scale physical models.

The laser also is finding its way into the real world of process control. One example is a laser-sensor particle-size analyzer now undergoing field trials at a copper mine. Recently introduced by the Procedyne Corp. of New Brunswick, N.J., the analyzer measures the statistical distribution of the size of machinery-ground copper-bearing ore particles.

Signals from the analyzer go through a computer system that in turn controls the ball mill that grinds the ore, thus maintaining proper size distribution. Following the ball mill operation, the ore enters the flotation equipment that separates particles rich in copper from those containing less of the metal. Particle size distribution thus sets the efficiency of separation and increases process yield.

A helium-neon laser, mounted in a sampling chamber at the process site, produces a pulse-signal whose duration is proportional to the random dimension of a particle as it passes through a sampling chamber and interrupts the laser beam. In each measurement cycle the laser scans 10,000 particles. The electronics portion of the analyzer—comprising buffer amplifier, input-pulse discriminator, logic and memory, and digital readout—separates the 10,000 counts, or pulse-width signals, into five classifications, between 3-micron and 2,000-micron sizes. Each classification represents a band of particle sizes.

Optoelectronic products, including cadmium sulfide and gallium arsenide devices, image sensors, and low-light-level tv assemblies, accounted for about \$60 million sales in 1969. And Ed Youch, optoelectronics marketing manager for Texas Instruments, predicts that total use of optoelectronics conservatively will reach \$460 million annually by the end of the decade. Proportionately, the military and aerospace use of optoelectronics will decrease, with the increased demand coming from industrial and related applications.

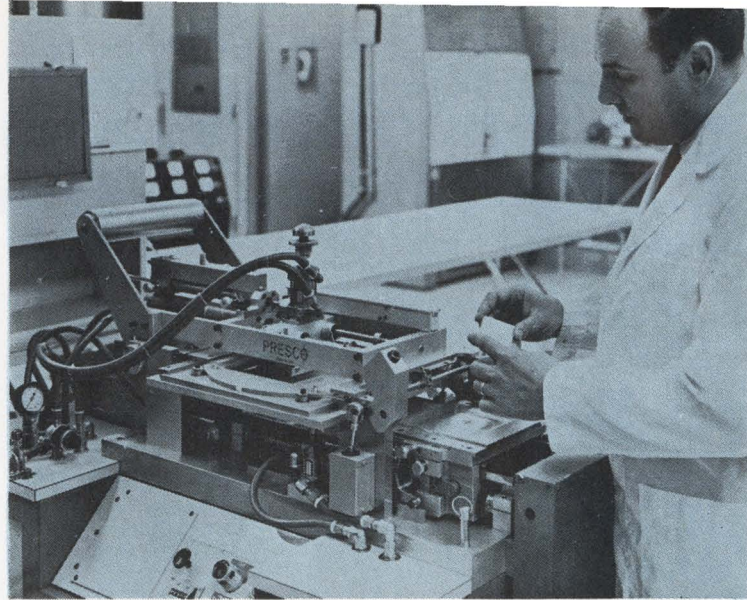
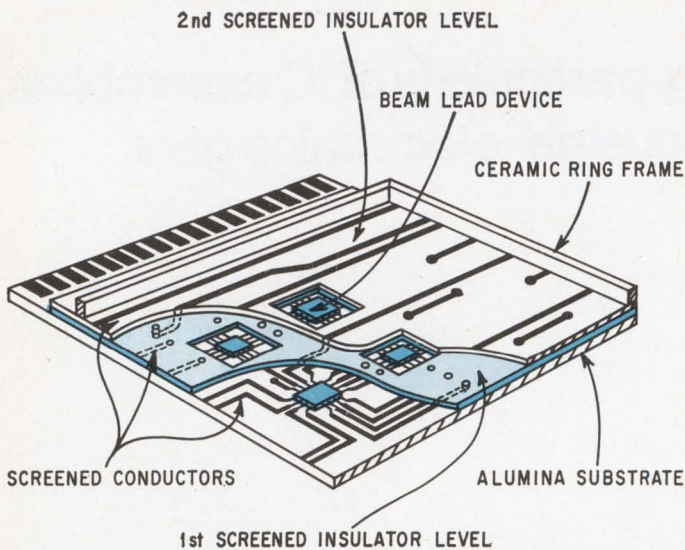

The spur to growth will not come from any particular breakthrough in optoelectronic technology, but from reduced prices as volume increases and—with lower prices—resulting opportunities to design these devices into new kinds of end-use equipment.

Right now, says Youch, a GaAs infrared emitter matched with a silicon detector—and mounted to form a usable light-sensing channel—sells for about \$5 a channel in 50,000-channel quantities. He predicts that with the expected increase in chip yield of GaAs devices, price will drop to \$3. Arrays will be denser, with emitter cells (and similarly, detector cells) separated 5 mils center-to-center. Then an emitter-detector array will be cheap enough to compete with fiber optic methods of bringing light to a detector. An added advantage to the user, says Youch, is that an array of such channels eliminates the production step of “tweaking” the fibers to get a multichannel system lined up.

Cheaper optoelectronic devices thus will evolve into more industrial and commercial equipment for mark sensing and pattern recognition. Among these applications are credit-card and identification-card verifiers, home and building security systems, visible displays, automobile headlight dimmers, vehicle hit-distance sensors, brushless commutators for d-c motors, shaft encoders, and safe optical transmission of on-off conditions in potentially explosive environments.

Building security systems may evolve into both an engineering challenge and a fruitful market for sensors, computers, and large-scale displays. An architect for a large building being designed is considering installation of optoelectronic sensors in about 500 doorways and along hallways. Object is to keep track of how many people are in the building at any time and to determine in which direction they’re traveling. With the optoelectronic sensors tied to a computer and display, a security guard could identify the presence of prowlers, and the computer could send advance signals to bring an elevator to a floor when a large group starts traveling toward the elevator bank. It also could turn off lights and other utilities when an office area is unoccupied.

The availability of lower-cost electronics components and subsystems will capture the attention of mechanically oriented machinery makers. Unfettered by such constraints as cam-switch arrangements of electromechanical types of control systems, machinery incorporating electronic systems will be less costly and capable of faster, more comprehensive operations. Furthermore, signals will be computer-compatible. Actually, this trend already has started. Most integrated circuit manufacturers are geared to work with end-product designers. They have established separate engineering marketing groups to exploit this fertile small-user industrial electronics market, particularly for the development and

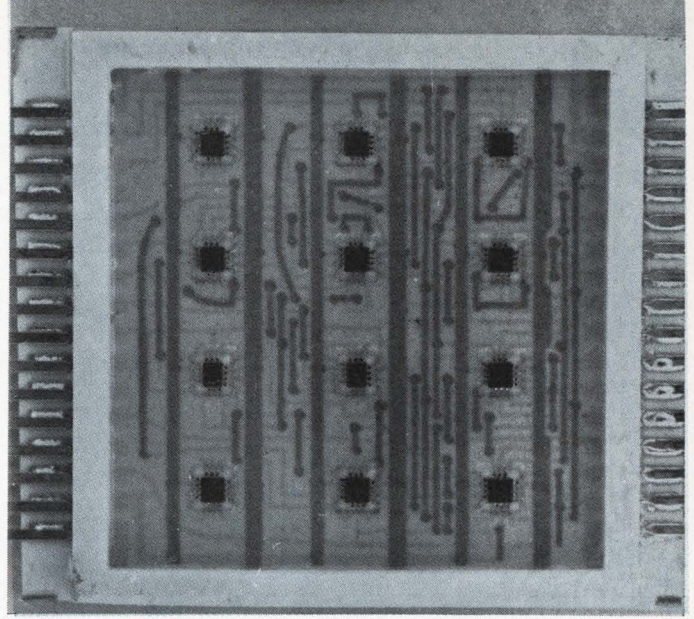
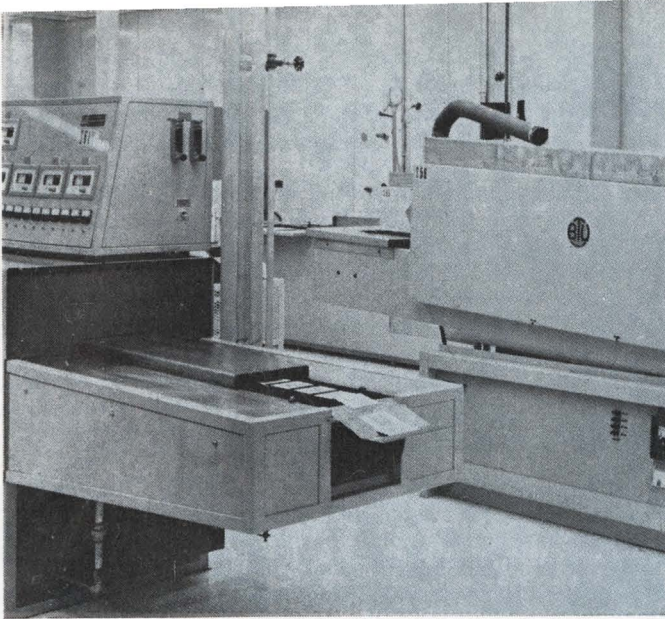

eventual production of functional arrays structured specifically for the customer's product.

It seems likely that going the electronics route—ramping products and betting on existing or upcoming electronic technology—will be a user-management decision. A wrong decision could put the product in jeopardy.

But user management will need good engineering advice. Generally, these machinery makers don't have electronic engineers on their staffs. And the electronics field is too complex, too fast-moving, to expect that a mechanical designer could generate the best answers. Right now, machinery-maker customers are being courted by semiconductor companies.

Eventually, though, the customer-executive may not want to put all his eggs in one basket by depending on the recommendations of a given IC maker. And he won't have enough work to keep an in-house staff tuned in on the rapidly changing electronics technology. Nor, it may turn out, will IC suppliers be able to handle the product-design demands of customers. Thus, the 1970's may well see the establishment of independent electronic-design consulting firms responsible for a customer's complete product design; for recommending the appropriate electronics technology; for evaluating IC suppliers; and for establishing efficient assembly and intermediate and final test procedures.

Computer-aided manufacturing—including production,

inspection, movement, storage, and shipment—is slated to become a way of industrial life. High-volume electronic-component production and a few other manufacturing operations already are being directed by digital computer systems.

Technically, the use of digital computers in manufacturing will be much simpler than using essentially the same computer system in the continuous-process industries—which have enjoyed about 10 years' experience in computer control. And financially, computer-aided manufacturing systems will be considerably cheaper.

What these systems can do is schedule and direct manufacture of parts and assemblies, and test them automatically. Interaction between machines along the production line is relatively well understood. Basically, what is involved is sequence and logic decisions for handling discrete parts and assemblies, a much simpler software task than the mathematical (polynomial and differential equation) modeling required for control of continuous-process plants like those found in the petroleum, chemical, and metal industries. And because of the step-by-step characteristics of the manufacturing operations and the go/no-go decisions of the computer, programming of product variations to meet customer needs will be simple and straightforward—thus saving time and money in changing the manufacturing line from one product to another, but similar, one.

Above, prototype of Univac's multilayer hybrid beam-leaded IC module typifies up-and-coming growth factors in industrial electronics. Units are produced by a semiautomatic process which includes thick-film screening and multizone furnace operations. Computer-controlled production line is slated.

Since most inputs to a CAM system will be high-level signals, primarily contact closures from the machines, electrical noise in the shop should give little trouble and thus eliminate some of the expensive electronic and computer niceties (shielding and filtering) found in low-level signal process computer systems.

Such simple hardware and software requirements cut prices drastically. According to William E. Ware, manager of product marketing of Systems Engineering Laboratories of Ft. Lauderdale, Fla., a digital computer control system for a manufacturing operation will cost only about one-half to two-thirds of an equivalent system for a continuous process. A modest CAM installation might run to about \$75,000, including the computer and its programming but not the cost of modifying the production line itself for computer control, he says.

While CAM is an up-and-coming technology that will engage the interest and enthusiasm of electronics engineers, again the largest application for such systems, including computers, displays, and other electronic gear, will be in the non-electronic industries. In the textile industry, for example, CAM will be used for directing and controlling weaving of patterns on looms, continuous dyeing of materials, and cloth-cutting.

Although CAM will improve production of non-electronic products, it will have little, if any, impact on the characteristics of the manufactured product. But when

CAM gains more of a foothold in the manufacture and assembly of electronic products, it will strongly affect the design and selection of components.

As an ultimate goal, what CAM can do is direct one manufacturing setup to produce variations in assemblies—essentially custom products on demand—by translating sales orders through the computer to the production machines. Thus, under computer direction, the machines would locate individual circuits on a substrate, make interconnections, perform intermediate and final tests, apply protective coatings, and package the final and complete unit.

But taking this route first means that a basic electronic design concept must be adopted that's amenable to computer-aided manufacturing. One contender is beam-lead hybrid integrated circuit construction. Here, hybrid means putting any combination of MOS and bipolar, thick or thin film, and linear and digital circuits on a substrate to produce the functional equivalent of a large-scale integrated circuit. Hopefully, production versatility will substitute for customized monolithic arrays.

At present, though, only a few modest-size circuits are available in beam-lead construction. Only a few companies make beam-lead IC's, and the cost of these devices is relatively high. Even so, Texas Instruments and the Univac division of the Sperry-Rand Corp. are betting on beam-lead IC's and beam-lead packaging for use in automatically assembled and tested functional arrays. They expect to accomplish comprehensive static and dynamic testing, improved assembly yields, and improved reliability because of the reduced number of connections that have to be made at assembly.

Ultimately, predicts Pat Carney, marketing manager for beam-lead hybrid circuits at TI, beam-lead IC chips will be put right on a printed circuit board, resulting in a functionally comprehensive assembly that looks like a flat-pack.

For the large industrial company that uses a lot of electronics in its own products, but isn't an IC maker, added advantages of hybrid beam-lead construction are that the company can retain in-house engineering competence and the functional security of their product design, can keep the "added-value" in the company by making, not buying, and can respond rapidly to variations in product demand.

A case in point is Univac. It doesn't make IC's but uses a lot of them in their computers. Under development are digital, multilayer, thick-film, ceramic modules using beam-lead devices to create high-speed, high-packing-density logic functions.

According to John Pastre, technical applications supervisor of Univac's digital equipment laboratory, it will be possible to start producing automatically a functional module in three or four days after a design is fixed—where a package might consist of 12 to 16 beam-lead devices per package and 70 or so packages per module. Pastre expects beam-lead devices and construction to become an industry standard.

Equipment manufacturers are starting to develop automatic beam-lead bonding by thermal compression techniques, and success in this area should lead to full-scale automated production processes. At present, though, Univac is producing prototypes of small quantities of its multilayer ceramic devices in a semi-automatic pilot plants. ●

**Electronics
guide**

Major 1970 confe

January

Computer Software & Peripherals Show & Conference (COMPSO East)
January 19-21
New York Hilton Hotel
New York City

February

Reliability Symposium
February 3-5
Biltmore Hotel
Los Angeles

Aerospace & Electronic Systems Winter Convention (Wincon)
February 10-12
Biltmore Hotel
Los Angeles

National Conference & Exposition on Electronics in Medicine
February 12-14
Fairmont Hotel
San Francisco

International Solid State Circuits Conference
February 18-20
Sheraton Hotel
University of Pennsylvania
Philadelphia

March

IEEE International Convention & Exhibition
March 23-26
Coliseum
New York Hilton Hotel
New York City

Annual Meeting of Association for Advancement of Medical Instrumentation
March 23-25
Statler-Hilton Hotel
Boston

International Symposium on Submillimeter Waves
March 31-April 2
Commodore Hotel
New York City

INFO-EXPO-70
March 23-25
Shoreham Hotel
Washington, D.C.



Details on reverse

General

IEEE International Convention & Exhibition

Mar. 23-26

IEEE

IEEE Hq., 345 E. 47th St.,
New York, N.Y. 10017

Electronic Components Conference

May 13-15

IEEE G-PMP, EIA

Darnall Burks, Sprague Electric Co.,
Marshall St.,
North Adams, Mass. 01247

Design Automation Workshop

June 21-25

IEEE G-C, ACM, SHARE

H. Freitag, IBM Watson Research
Center, P.O. Box 218,
Yorktown Heights, N.Y. 10598

Military/Aerospace

Aerospace & Electronic Systems Winter Convention (Wincon)

Feb. 10-12

IEEE G-AES

J. A. Jamieson, Electronics Div.
Aerojet-General Corp.
1100 W. Hollyvale St.,
Azusa, Calif. 91702

National ISA Aerospace Instrumentation Symposium

May 11-13

ISA Aerospace Industry Div.

Instrument Society of America
530 William Penn Place,
Pittsburgh, Pa. 15219

Aerospace Electronic Conference (NAECON)

May 18-20

IEEE G-AES, Dayton Sect.

IEEE Office, 124 E. Monument Ave.,
Dayton, Ohio 45402

Electronics guide

Details of major 1970 conferences Sponsors and program information

Communications & Microwaves

International Symposium on Submillimeter Waves

Mar. 31-Apr. 2

PIB, AFOSR, ONR, USARO, G-MTT, G-ED, OSA

Jerome Fox, Microwave Research
Institute, Polytechnic Institute of
Brooklyn, 333 Jay St.,
Brooklyn, N.Y. 11201

Frequency Control Symposium

Apr. 27-29

U.S. Army Electronics Command
AMSEL-KL-SP (Mr. J. M. Stanley)
Fort Monmouth, N.J. 07703

National Telemetry Conference & Exhibition

Apr. 27-30

IEEE G-AES, IEEE G-ComTech

A. V. Balakrishnan, NTC Program
Chairman, 3531 Boelter Hall, UCLA
Los Angeles, Calif. 90024

International Microwave Symposium

May 11-14

IEEE G-MTT

R. H. Duhamel, Granger Assoc., 1601
California Ave., Palo Alto, Calif. 94304

International Communications Conference

June 8-10

IEEE G-ComTech, San Francisco Sect.

A. M. Peterson, Stanford Research
Institute, Menlo Park, Calif. 94025

Computers

Computer Software & Peripherals Show & Conference (COMPSO East)

Jan. 19-21

Bernard Lane, Show World Inc.
37 W. 39th St.
New York, N.Y. 10018

INFO-EXPO-70

Mar. 23-25

Paul Zurkowski
Information Industry Association
1025 15th St. NW, Suite 705
Washington, D.C. 20005

Spring Joint Computer Conference

May 5-7

IEEE G-C, AFIPS

AFIPS Hq., 210 Summit Ave.,
Montvale, N.J. 07645

IEEE Computer Conference

June 16-18

IEEE G-C

G.L. Tucker, Office of Secy. of Defense,
Rm. 3E1014, The Pentagon,
Washington, D.C. 20301

Medical Electronics

Annual Meeting of Association for Advancement of Medical Instrumentation

Mar. 23-25

AAMI

John J. Collins, Jr., M.D.
67 Bay State Road,
Boston, Mass. 02215

National Conference & Exposition on Electronics in Medicine

Feb. 12-14

"Electronics", "Medical World News"
"Modern Hospital",
"Postgraduate Medicine"

S. Weber, E/MC, 330 W. 42nd St.,
New York, N.Y. 10036

Solid State

International Solid State Circuits Conference

Feb. 18-20

SSC Council, Philadelphia Sect.

University of Pennsylvania
T. Bray, General Electric Co., Bldg. 3
Rm. 261, Electronics Park,
Syracuse, N.Y. 13201

International Magnetism Conference, (INTERMAG)

Apr. 21-24

IEEE G-MAG

D. S. Shull, Bell Telephone Labs, 330
Lexington Ave.,
Winston-Salem, N.C. 27102

Conference on Solid State Devices in Industry

June 15-16

IEEE G-IECI, IEEE G-IGA, Cleveland Sect., ISA

Andy Humphrey, Reliance Electric &
Engineering Co., 24701 Euclid Ave.,
Cleveland, Ohio 44117

Solid State Sensors Symposium

June 18-19

IEEE G-ED, Twin Cities Sect., ISA

Dr. K. C. Nomura, Honeywell Inc.,
Solid State Electronics Center,
Plymouth, Minn. 55427

Reliability

Reliability Symposium

Feb. 3-5

IEEE G-R, ASQC, IES, ASNT

W. R. Abbott, D-60-01/B104, Lockheed
Missile & Space Co., P.O. Box 504
Sunnyvale, Calif. 94022

Reliability Physics Symposium

Apr. 7-9

IEEE G-R, IEEE G-ED

K. H. Zaininger, RCA Labs.,
Princeton, N.J. 08540

ferences: January-June

April

Frequency Control Symposium
April 27-29
Shelburne Hotel
Atlantic City

Reliability Physics Symposium
April 7-9
Stardust Hotel
Las Vegas

International Magnetics Conference (INTERMAG)
April 21-24
Statler-Hilton Hotel
Washington, D.C.

National Telemetry Conference & Exposition
April 27-30
Statler-Hilton Hotel
Los Angeles

May

Spring Joint Computer Conference
May 5-7
Convention Hall
Atlantic City

International Microwave Symposium
May 11-14
Newporter Inn
Newport Beach, Calif.

Electronic Components Conference
May 13-15
Statler-Hilton Hotel
Washington, D.C.

Aerospace Electronics Conference (NAECON)
May 18-20
Sheraton Dayton Hotel
Dayton

National ISA Aerospace Instrumentation Symposium
May 11-13
Washington Plaza Hotel
Seattle

June

International Communications Conference
June 8-10
San Francisco Hilton Hotel
San Francisco

Conference on Solid State Devices in Industry
June 15-16
Statler-Hilton Hotel
Cleveland

IEEE Computer Conference
June 16-18
Washington Hilton Hotel
Washington, D.C.

Solid State Sensors Symposium
June 18-19
Radisson Hotel
Minneapolis

Design Automation Workshop
June 21-25
Sheraton Palace Hotel
San Francisco

side.

WHATEVER YOU WANT IN A COATER

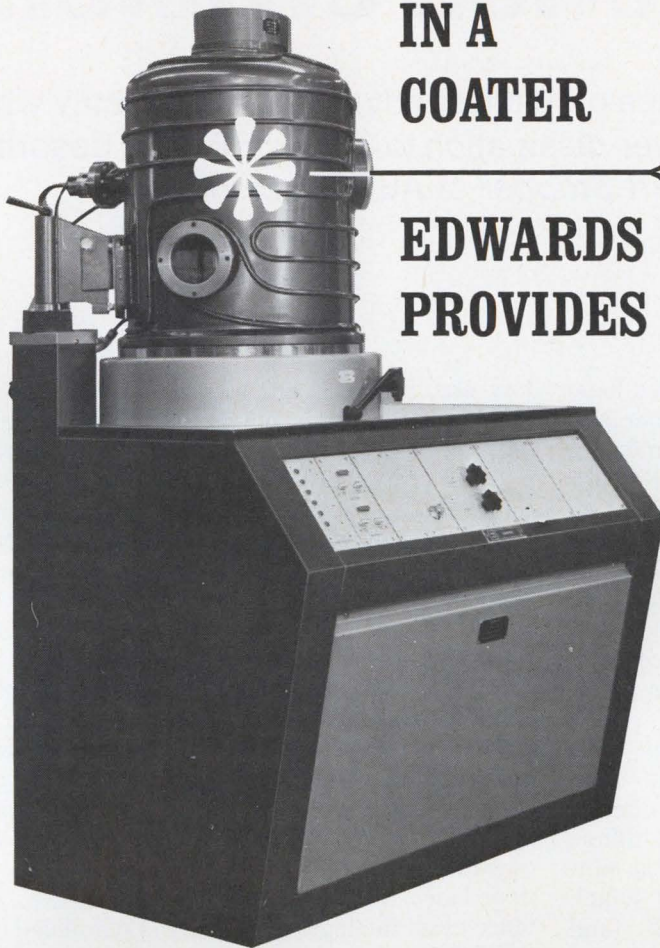

EDWARDS PROVIDES

These new Edwards systems are the ultimate in vacuum coat-ers. Designed to perform only as coat-ers, they do everything, do it better, and change over faster. Each component is an integral part of a complete, proven coating-system configuration. Matched modular accessories are accommodated in a free-standing console, allowing evaporator-top work space. Edwards pumping units achieve the lowest ultimate vacua in the bell jar, where it counts. And Edwards bell-jar tooling, unique in the industry, provides top coating versatility. Twelve patented design features contribute to the unparalleled performance of these systems.

Available in 12", 18", and 30" models, and the Edwards exclusive 19" model.

Technical Papers on Film Deposition, Vacuum Technology, and Freeze Drying gratis to interested persons. Request list of currently available material.

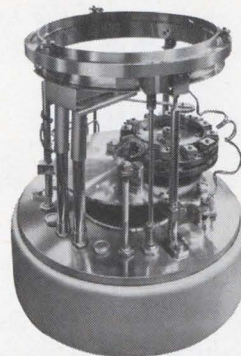

UNIQUE BELL-JAR TOOLING

Rotating and spherical workholders, largest available, provide complete uniformity, top production rate. For multi-layer films, sequential evaporation in a single pumpdown. Deposition by resistance, electron beam, or sputtering. Fittings include shielded glow-discharge rings, multiple sources, shutters, others.



THIN-FILM THICKNESS MONITOR

Measures film-deposition rate and thickness. Water-cooled crystal mounts.

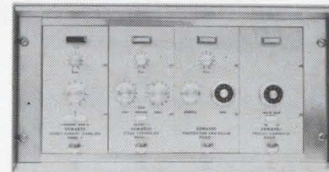

AUTOMATIC EVAPORATION AND RATE-CONTROL SYSTEM

Provides fully automatic cycling, while also allowing semi-automatic and manual control.



FILM-RESISTANCE CONTROL UNIT

Monitors resistance films during deposition, actuates an automatic source shutter at predetermined values.



MODULATED-BEAM PHOTOMETER

Provides control of optical thickness of multi-layer or single-layer depositions in transmission and reflectance modes.

EDWARDS HIGH VACUUM INTERNATIONAL LIMITED



High Vacuum, Inc.

GRAND ISLAND, NEW YORK 14072
IN CANADA: OAKVILLE, ONTARIO

EDWARDS HIGH VACUUM LTD.
Manor Royal
Crawley, Sussex, England

EDWARDS ALTO VUOTO S.p.A.
Via Pisacane ang. Via Dante
Pero (MI), Italy

EDWARDS HOCHVAKUUM GMBH.
Frankfurt/Main - Niederrad,
Hahnstrasse 46, Germany

Symmetrical ECL doubles IC NOR function efficiently

An extra function adds to the virtues of this fast advanced-logic family while holding delay to 0.9 nsec and power dissipation to 35 mw; SECL is described by *Hans-Wilhelm Ehlbeck* and *Herbert Stopper* of AEG-Telefunken

● Fast and frugal, the symmetrical emitter-coupled logic IC offers the user a two-for-the-price-of-one bargain. It can perform two NOR functions at only a minimal cost in propagation delay and power consumption for the extra function. In fact, on a per-gate basis, an SECL integrated circuit's propagation delay is about 0.9 nanosecond—comparable to that of advanced emitter-coupled-logic IC's—but the SECL's power consumption is only 35 milliwatts per gate, against 80 mw in ECL's. SECL is aimed at applications in large, high-speed computers and in shift registers and counters used in measuring equipment.

SECL is a development within the current-mode-logic series, and enjoys the extremely fast switching characteristic of other group members. SECL is directly evolved from emitter-emitter coupled logic. EECL differs from ECL in having input emitter-followers and an output current switch instead of an input current switch and output emitter followers. This gives EECL (and SECL) certain significant advantages over ECL integrated circuitry:

- ▶ They are exceptionally stable, for instance, since base-emitter voltage drift can't cause deterioration of output logic levels. The output logic levels depend only on the value of the output resistors and on the current fed to the resistors by the constant current source.
- ▶ An extra supply voltage and external bypass capaci-

tors aren't needed for transmission line terminations. ECL circuits, on the other hand, need an extra supply voltage because of the voltage drop created by the 50-ohm resistor in the emitter-follower output circuit. Since SECL doesn't have an emitter-follower output, there's no voltage drop to compensate for. By the same token, the bypass capacitors that an extra supply would need are eliminated.

▶ SECL is immune to damage even if the transmission lines and terminations are short-circuited. This is because the current through the output resistor is independent of the resistor value.

▶ There's no Miller effect, so input capacitance isn't multiplied by the IC. This is because there is no resistor in the collector circuit of the output transistors.

▶ Finally, in an EECL circuit the capacitance of only one inverting transistor is paralleled with the lowest impedance in the system, whereas in ECL, the capacitance of all the logic transistors is paralleled. As a result, the RC time constant is lower in EECL and the speed, therefore, is greater.

Because of these advantages, and in an effort to offer a distinctive product line in the highly competitive digital IC market, AEG-Telefunken has developed a SECL product line. Available are a multifunction gate and a line driver; other IC's of higher complexity are being developed.

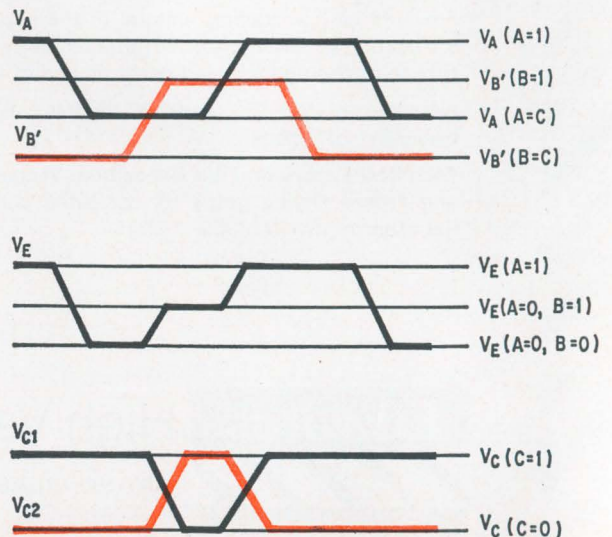
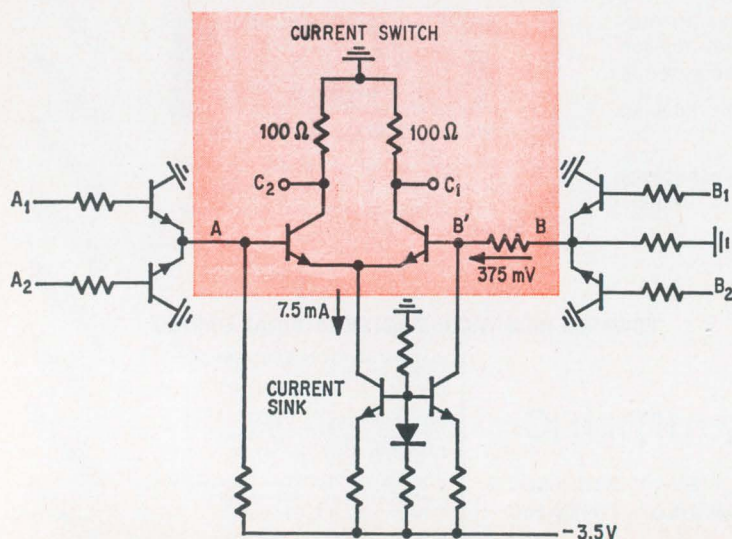

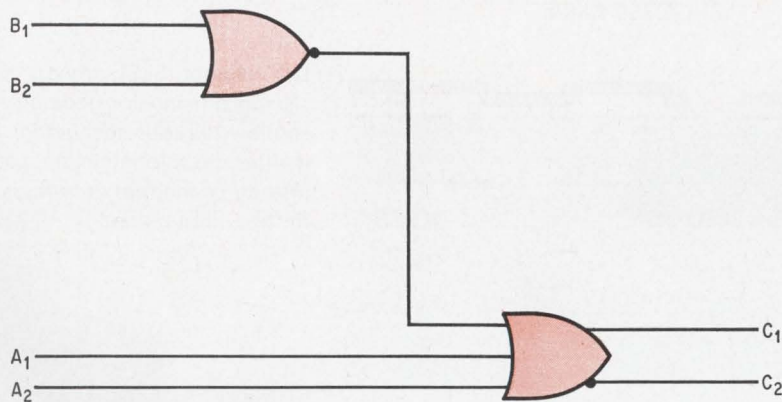

Logic. SECL circuit on opposite page provides the two NOR functions instead of one, as shown here, with very little increase in power or decrease in speed.

EECL and SECL have disadvantages, too, with respect to ECL. There can be no wired-OR function, and ability to drive capacitive loads is limited. And an ECL circuit, with its low-impedance emitter-follower at the output, can drive a larger load than can an EECL circuit with its 100 ohms impedance at each output. But the advantages—of SECL, at least—can more than compensate.

SECL differs from other EECL circuits in that a fixed reference voltage is replaced by a floating reference voltage in series with an additional logic input. The purpose is to gain logic capability without sacrifice of speed or power.

To understand this property of SECL, consider the current switch circuit indicated by the shaded portion of the diagram at left. A simple current switch—with a single input tied to a fixed reference voltage—can perform only the logic functions of assertion and negation: $C_1 = A$ and $C_2 = \bar{A}$. But the SECL current switch shown in the diagram can perform more complicated functions—the so-called logic implication and its negation:

$$C_1 = A + \bar{B}$$

$$C_2 = \bar{C}_1 = \bar{A}B$$

For the complete SECL gate on the opposite page, the logic equations are:

$$C_1 = A_1 + A_2 + \bar{B}_1 \bar{B}_2$$

$$C_2 = \bar{C}_1 = \bar{A}_1 \bar{A}_2 (B_1 + B_2)$$

In effect, these equations show that the SECL gate operates as two NOR gates connected as shown in the logic diagram above. If an ideal floating voltage source could be achieved, these two NOR functions could be obtained with no increase in power consumption or decrease in speed. In practice, of course, this isn't possible; with the source resistor and current sink in the real circuit some loss of speed and increase in power must be accepted.

The loss of speed is due to the additional resistor between points B' and B in the circuit diagram opposite, this resistor decreases the amount of current flowing into the base of the transistor (the right-hand transistor in the shaded portion of the diagram). The current sink is another delaying factor; it represents a capacitance which must be loaded by the driving current. And both the resistor and the current sink consume extra power as well.

Nevertheless, fabrication techniques are available to minimize these undesirable effects. In AEG-Telefunken's SECL gate, the primary NOR function is responsible for a propagation delay of 1.3 nanoseconds and power consumption of 55 milliwatts, from an A input to a C output. The additional NOR function associated

Symmetry. Heart of SECL multi-function gate is the current switch, which has a floating reference voltage B' and an extra logic input B. Voltage waveforms for various input conditions are shown at right of circuit.

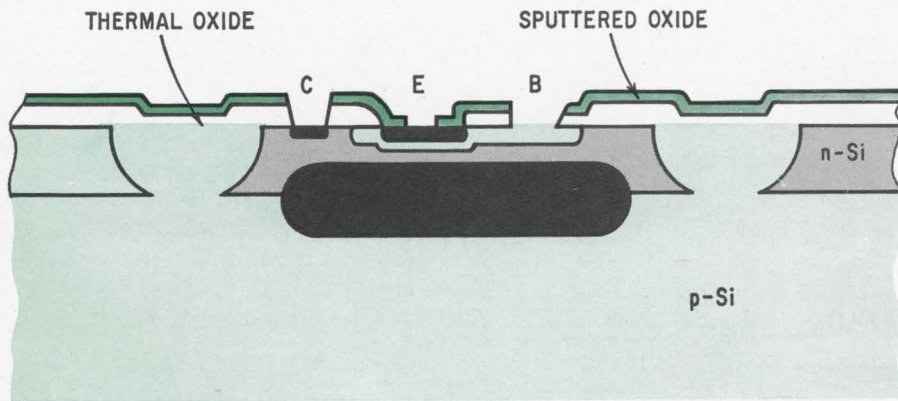

Little dipper. SECL process is based on standard transistor geometry, but uses shallow diffusion techniques. To keep emitter dip to a minimum, sputtering, instead of thermal growth, is used to form final oxide.

with the B inputs introduces an additional delay of 0.5 nsec and power consumption of 15 mw. The average performance of these two NOR functions is what counts: 0.9-nsec delay at 35 mw per NOR gate. Moreover, the process technology, while demanding, is not especially exotic.

The important fabrication step is base diffusion; it's necessary to keep the base extremely shallow. When AEG-Telefunken began its SECL development program, computer analysis called for rather high values of f_T , the frequency at which current gain equals one, and low values of r_{bb} , the base resistance. This could be accomplished only through an extremely shallow diffusion, but one with a high surface concentration of dopant so that the dopant concentration is high in the base region and terminates abruptly.

AEG-Telefunken obtained best results with a sheet resistivity between 200 and 300 ohms per square for the boron (base and resistor) diffusion, 0.2-micron base width, and a collector junction 0.8 to 1.0 micron deep. This produces transistors with f_T as high as 1.4 gigahertz at $V_{CE} = 2$ volts and $I_C = 5$ milliamperes.

Aside from the base width, the transistor geometry is not exceptional; it has two base contacts and an emitter 32 microns long and 10 microns wide.

With shallow diffusion and high surface concentration, an emitter-dip effect enters. As the n-type emitter

is diffused into the base, the boron dopant in the base acquires a high diffusion coefficient directly below the emitter. The base, therefore, tends to bulge out into the collector region, as shown above. The bulge becomes even more pronounced later on when the circuit is subjected to high temperature during the final oxide growth. To minimize emitter dip, AEG-Telefunken sputters the final oxide onto the silicon surface instead of growing it at high temperature; since sputtering is a low-temperature process, there's little additional diffusion.

Another important consideration in SECL circuits is stability. To prevent the oscillations that emitter followers with capacitive loads are prone to, each input is furnished with a 200-ohm resistor. This value gives the best compromise between speed and stability, and minimizes circuit input load. If the base resistors were omitted, the total propagation delay (that is, between A_1 and C_2 or A_2 and C_2 in the circuit diagram on page 142) would be reduced by 300 picoseconds.

The SECL two-NOR gate is intended to drive balanced or unbalanced printed-wiring transmission lines with characteristic impedances of 200 or 100 ohms, respectively. It also can drive very short wires, which act as an inductance, because the 100-ohm output resistors attenuate the ringing caused by the combination of wire inductance and load capacitance.

The SECL circuit family is packaged in 14-lead flat-packs. One package contains, for instance, two dual-NOR-gate circuits. With external wiring, this package could be operated as a clocked R-S flip-flop.

To accommodate the full range of transmission lines—flat cables, twisted pairs, and coaxial cables, as well as printed wiring—a special SECL line-driver was designed. This circuit has no built-in output resistors, but by connecting an external resistor to the current sink, it can be adapted to any load between 50 and 100 ohms per output. It is also compatible with the various termination schemes—terminations at the front end, rear end, or both ends (provided that the characteristic impedance is more than 100 ohms), or bus lines with high-source-impedance drivers.

Since the line driver is a differential amplifier, it can act as a line receiver as well. And with added resistors and supply voltages, it can be used as a lamp driver or as a level converter for interfacing with other kinds of integrated-circuit logic. ●

The test our tester flunked.

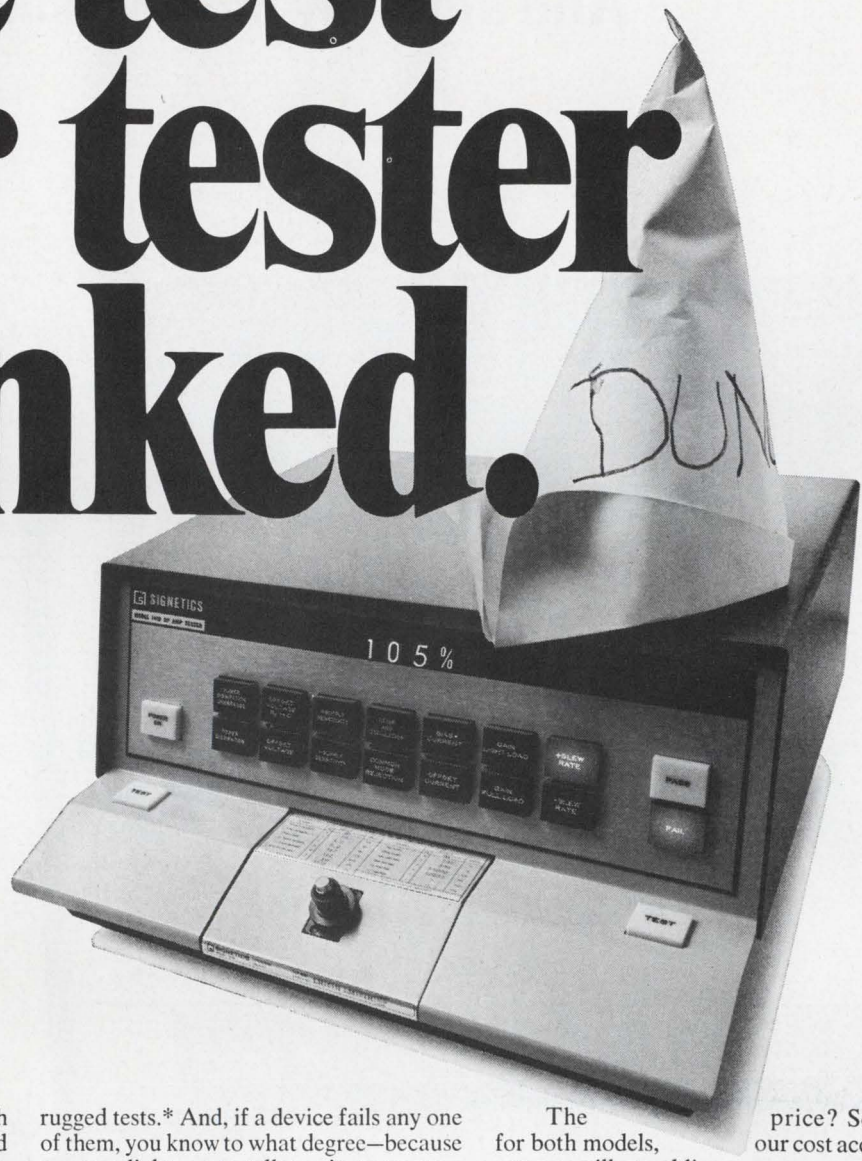

Six months ago, when we came out with our Model 1410 op amp tester, we called it "the most comprehensive, definitive, easy-to-use tester on the market today."

Which it was. And still is.

But: it couldn't test comparators.

So now we've come out with a brand-new tester. Which *can* test comparators. And we call it—with a burst of poetry—our Model 1420.

(The reason we don't bother showing the 1420 is this: it's almost a look-a-like for the 1410. Except it isn't blushing.)

Like the 1410, our 1420 is a snap to operate. You simply insert a program board, and push a button marked "test." Blink, blink, blink: the machine runs through 14

rugged tests.* And, if a device fails any one of them, you know to what degree—because a screen lights up to tell you in percentage figures!

No fiddly knobs, no mysterious meters. In fact, both testers are so easy to use, a secretary can handle them. Any secretary. Even yours.

If you don't care about comparators, the 1410 is your baby. (It'll handle 75% of the linear IC's around today.) Otherwise, you want the new 1420, which takes care of 90%. And if you opt for options, the 1400 series has a host: classification, data logging, automatic handling, computer calculated program values, 1% or 5% program boards, environmental testing.

The price? So low for both models, our cost accountants are still grumbling.

Put these statements to the test... by writing for specs, prices, addendum on the whole Signetics line of testers. Better yet, call collect to Marketing, Signetics Measurement Data Division, (415) 961-9384, for the name of our nearest distributor.

Please, please do it.

Otherwise, this ad will flunk.

*The fearsome fourteen... 1) power consumption (greater than 200%), 2) power consumption (less than 200%), 3) offset voltage (source resistance zero ohms), 4) offset voltage (source resistance programmed), 5) + supply sensitivity, 6) - supply sensitivity, 7) common mode rejection, 8) bias current, 9) offset current, 10) gain (programmed light load), 11) gain (programmed heavy load), 12) noise, oscillation, 13) + slew rate, 14) - slew rate.

Signetics

MEASUREMENT/DATA

Signetics, Measurement/Data, 341 Moffett Blvd., Mountain View, Calif. 94040/A subsidiary of Corning Glass Works

**Meet Datapoint.
It's 20 times faster
than other multipoint recorders.
And infinitely more versatile.**

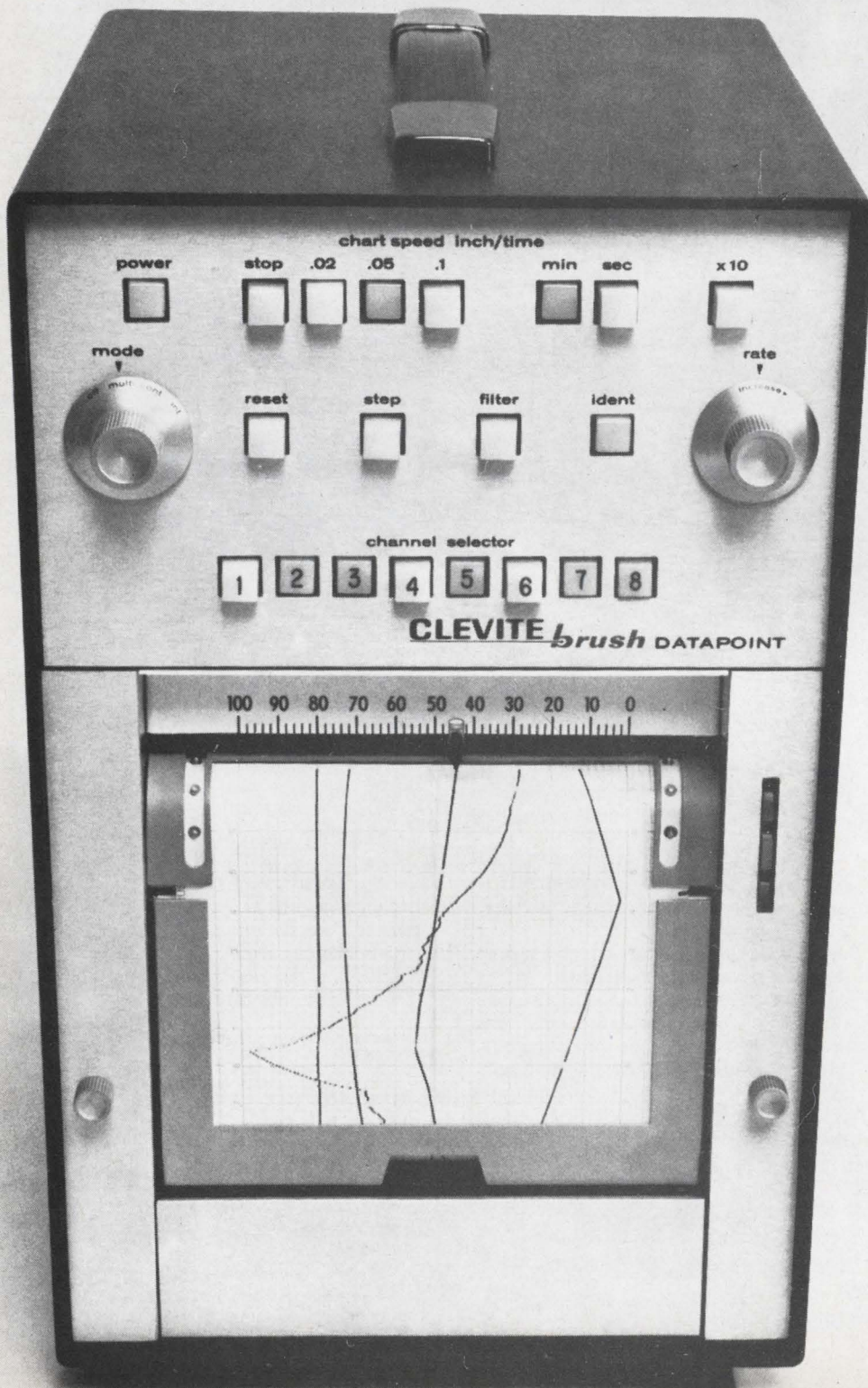

This new high-speed multipoint recorder by Brush runs off as many as 20 samples per second on 2 to 8 patients. So it's great for monitoring fast-changing variables in systemic and wound temperature, heart rate, ECG and the like.



Datapoint handles mixed inputs from high and low level inputs. All on one chart. Recordings come out clear, crisp, uncluttered. And Z-folded. You've got a choice of 12 chart speeds, pushbutton controlled.

About that versatility. Datapoint works in three modes: multipoint sampling, intensified sampling, for channels of high dynamic content, or continuous single channel recording. So you get much more than just a fast multipoint recorder. Without paying more to get it.

And Datapoint is accurate, too. A full 99.5%, enforced by a non-contact position-feedback system. It's a first in this type of recorder. (But a proven success in countless Brush direct writing oscillographs.)

Speed. Versatility. Accuracy. These make Datapoint a new concept in recording. There's never been anything like it. You'll find more proof in the Datapoint brochure. Send for your copy today. Brush Instruments Division, Gould Inc., 3631 Perkins Avenue, Cleveland, Ohio 44114.

GOULD BRUSH

Once pet of military and NASA, C/MOS is now wearing civvies

Complementary technology made its reputation in high-performance military and aerospace applications; however, manufacturers believe C/MOS can now compete on a cost basis in the commercial market

By Peter Schuyten and George F. Watson

Electronics staff

Complementary metal oxide semiconductors (C/MOS), with their low power dissipation, high noise immunity, and good switching speeds, have always looked attractive to the commercial user except for one thing—price. But the winds of change are blowing strong. As more and more work is being done on C/MOS, device yields continue to rise while costs come down, to the point where complementary circuits are now finding their way into commercial and industrial systems.

Since its development some three years ago, C/MOS had been the darling of the military and aerospace world. Incorporating both n and p channels on a single chip, it gave these users power dissipation in the nanowatt range, noise immunity of 40%, and speeds comparable to many bipolar devices—about 10 megahertz and more. And only the military and National Aeronautics and Space Administration could afford it.

Now, however, suppliers and commercial customers are starting to realize that they can afford to design complementary circuits into a broad range of commercial systems—everything from battery-operated instrumentation to large-scale computer memories.

Currently product planners at more than a few integrated circuit houses are putting pressure on their R&D operations to get C/MOS out of the lab and into a commer-

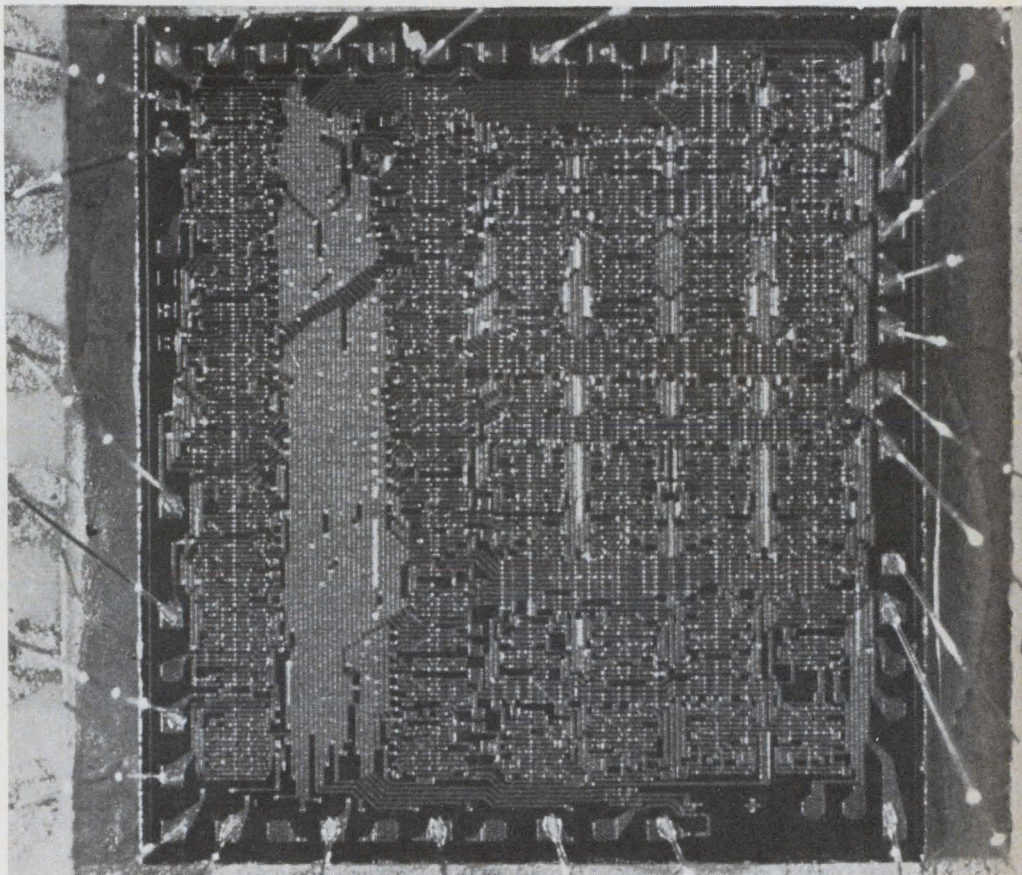

Massive potential. Low-power C/MOS allowed RCA to put 750 devices on 145-mil/155-mil parallel processor built for NASA's Goddard Space Flight Center.

cial line. Such firms as Hughes Aircraft, Motorola Semiconductor, General Instrument, Fairchild, and Union Carbide's Electronics division all appear to be trying to match RCA, Ragen Semiconductor, and Solid State Scientific, the three

firms generally accepted as the leaders in complementary work.

In terms of power dissipation, C/MOS derives some unique advantages over other IC technologies from the fact that it dissipates significant power only during a

change of state. One transistor in the complementary "node" is on and the other is off until a pulse arrives; then each of them changes state. The instant of change is the only time that significant current flows; and with proper design, even this current—and hence power dissipation—can be kept extremely low, on the order of microamperes. This transient power dissipation results from the charging of input and output capacitances.

The rest of the time, the node is in the quiescent state—the driver transistor is on, while the load transistor is off. In this state, the only power dissipation is caused by the leakage current of the off transistor. The dissipation is the product of supply voltage and leakage current and is on the order of nanowatts per gate.

In single-channel MOS circuitry, on the other hand, when a transistor is on, its load transistor is on too. There is, therefore, a significant power drain—a few milliwatts per gate. In bipolar IC's, dissipation per gate ranges from 1 mw for low power transistor-transistor logic to 80 mw for current-mode logic.

The complementary arrangement that makes C/MOS low in power consumption makes it fast too. C/MOS gate propagation delay is about one fourth that of single-channel MOS and clock rates as high as 20 megahertz should soon be possible with C/MOS.

The reason for this great speed is the absence of the conducting load transistor needed in p-channel MOS circuits. This transistor slows P/MOS switching because it charges and discharges very slowly compared to the driver transistor.

Good judgment enters into designing with C/MOS, however. It's necessary to be extremely careful about fan-in and fan-out. The speed advantage can easily be wiped out, according to one industry source, particularly if the fan-in is too great.

Noisy neighbors. One of the most appealing features of C/MOS to industrial users is its noise immunity—a particularly important characteristic in the electrically noisy environments of machine tools and numerical-control equipment. Noise voltages as large as 40% of the supply voltage won't affect C/MOS;

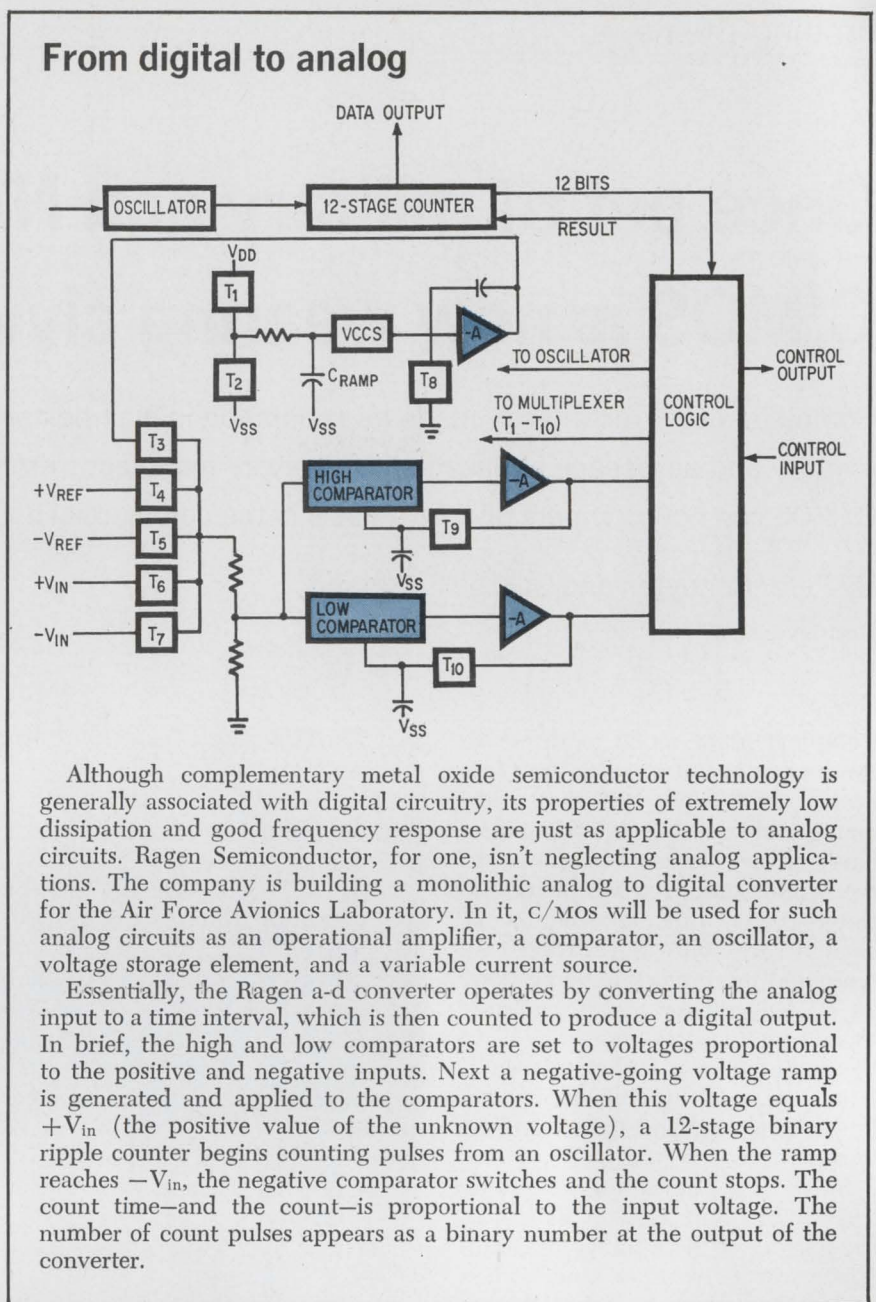

Although complementary metal oxide semiconductor technology is generally associated with digital circuitry, its properties of extremely low dissipation and good frequency response are just as applicable to analog circuits. Ragen Semiconductor, for one, isn't neglecting analog applications. The company is building a monolithic analog to digital converter for the Air Force Avionics Laboratory. In it, c/mos will be used for such analog circuits as an operational amplifier, a comparator, an oscillator, a voltage storage element, and a variable current source.

Essentially, the Ragen a-d converter operates by converting the analog input to a time interval, which is then counted to produce a digital output. In brief, the high and low comparators are set to voltages proportional to the positive and negative inputs. Next a negative-going voltage ramp is generated and applied to the comparators. When this voltage equals $+V_{in}$ (the positive value of the unknown voltage), a 12-stage binary ripple counter begins counting pulses from an oscillator. When the ramp reaches $-V_{in}$, the negative comparator switches and the count stops. The count time—and the count—is proportional to the input voltage. The number of count pulses appears as a binary number at the output of the converter.

thus for the maximum supply of 15 volts, noise immunity is 6 volts. This is comparable to the noise immunity of so-called "high-level" bipolar logic and considerably more than the 1-volt immunity of low-power TTL.

Tied to this behavior is the advantage of the insensitivity of C/MOS to variations in supply voltage. C/MOS can operate even if the supply is poorly regulated; what counts as far as switching is concerned is the relative threshold voltage between the n- and p-channel transistors.

There is no doubt in the minds of C/MOS makers that a big commercial market is in the offing for

the technology; doubts do exist, however, about exactly where the market lies and when it will materialize.

For its part, RCA, which is generally credited with performing the initial development work in complementary technology, sees a mass commercial market for C/MOS circuits, a market that could eventually grow to 60% or 70% of the low- to medium-speed digital circuits. This market includes battery-operated test equipment, electronic watches, low-power instrumentation, timers, and automobile electronics. "But it's going to take a lot of applications work with the customer to open this market up,"

says Elvet Moore, RCA's engineering manager for MOS integrated circuits.

Currently, the market is using everything from diode-transistor logic to P/MOS. According to RCA's Frank Rohr, who heads the company's market planning for digital IC's, C/MOS logic can do these jobs better and cheaper than the other technologies. "Of course, C/MOS won't compete with P/MOS and the others in every area. Rather, we view it as another kind of logic, and as such, it offers certain unique advantages you can't get from anything else," Rohr points out. RCA is planning to introduce a full line of commercial C/MOS devices later this year.

On the other hand, Ragen Semiconductor president Albert H. Medwin, who formerly worked at RCA on C/MOS, sees the market somewhat differently. According to Medwin, C/MOS will be the primary technology in large-scale memory arrays. "If the trend is truly toward larger and larger memory chips, and everything we've seen in the last year indicates that it is, then C/MOS is the technology to do the job," he says.

Medwin bases this forecast on the power dissipation characteristics of the technology. He says "You can concentrate more functions on a chip with C/MOS than with other technologies."

Backing Medwin up, Robert J. Lesniewski, Solid State Scientific's technical program manager, says: "C/MOS's greatest potential lies in large high density memories. It's the dynamic power dissipation that makes C/MOS attractive. If you use a complex DTL or TTL chip in a computer, it will begin to light up. And P/MOS will practically burn out. In order for semiconductor memories to be competitive with cores they're going to have to get denser and denser. In other words, high density requires low dynamic power, which is where C/MOS comes in."

But unlike Ragen, which is involved only in custom C/MOS work, Solid State Scientific, like RCA, is developing a stable of workhorse C/MOS logic devices.

At Motorola Semiconductor the C/MOS emphasis is also on MSI logic. According to Robert Frazier, manager of digital IC design in re-

Gentle slope. Deposition of metal over abrupt steps is avoided with RCA's graded-density oxide technique. Here, aluminum passes over 12,000-angstrom-thick oxide.

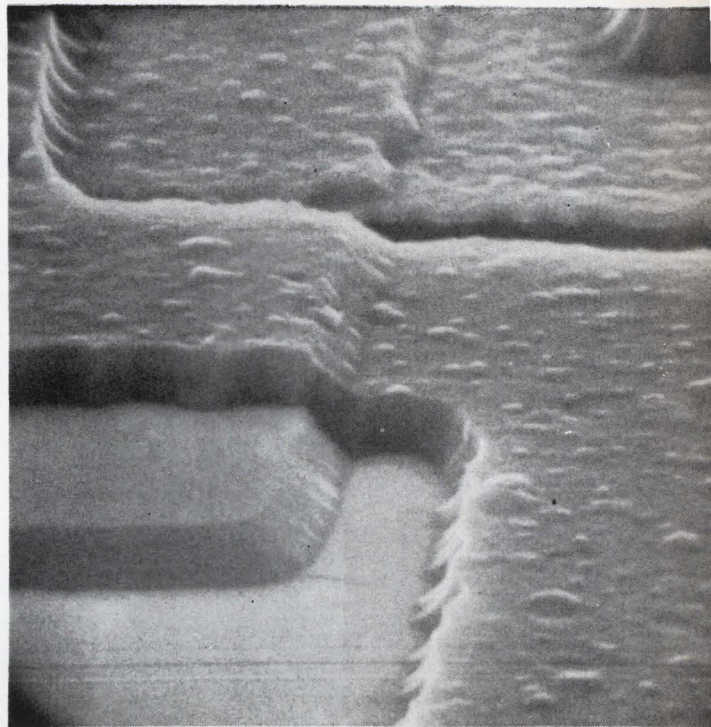

search and development, Motorola regards C/MOS primarily in terms of portable equipment applications because of the low power requirements and in industrial applications because of high-noise immunity. He says: "The main thing holding up the price of C/MOS is its newness. These are potentially low-cost units. The yields we're getting now with our process are better than they were with the simplest bipolar processing, and about the same as they are with p-channel MOS. It's just that there's not yet enough volume to justify price reduction."

Motorola expects to have four or five standard circuits—gates and flip-flops—ready for introduction in the next three or four months. These will be followed later in the year by more complex functions, possibly counter and analog-gate functions with 20 to 30 gates. They are also working on the design of a 64-bit C/MOS random-access memory, and Frazier expects it to be introduced as a product sometime in 1970.

In terms of battery-powered systems, Frazier cautions that C/MOS dictates a worry Motorola didn't have before with other technologies—nanoampere leakage. "Packaging has to be done more carefully because these are micropower parts, and this nanoamp leakage can run a battery down. The pack-

aging has to be even cleaner than in p-channel MOS."

Yet another caution comes from Hughes Aircraft, where Robert Bower, assistant manager of the MOS division says that in a memory, for example, if most of the bits are sitting idle most of the time, C/MOS will work well, but if the bits are changing state often, the lower power dissipation characteristic of C/MOS will be substantially reduced. Hughes is licensed by RCA to produce C/MOS. According to Jack Hirshon, Hughes' MOS division manager, the division got started in C/MOS by exactly duplicating RCA in both its processing and products; RCA wanted a second source and Hughes wanted to be that second source.

Nay sayers. For an opposing point of view, Robert Graham, vice president of marketing for the Intel Corp., talks about dynamic memory applications saying, "We have accomplished the same thing as C/MOS with regular p-channel devices." He does concede, however, that for low-power logic functions you almost have to go to C/MOS. "But we're not in that business." In conclusion, Graham says: "You can't bring the price down because there are too many steps and the chips are too big. But if the price did come down, there could be a commercial-industrial market for them in the

Why just hope for laminate consistency?

Call on the Lint-Pickers!

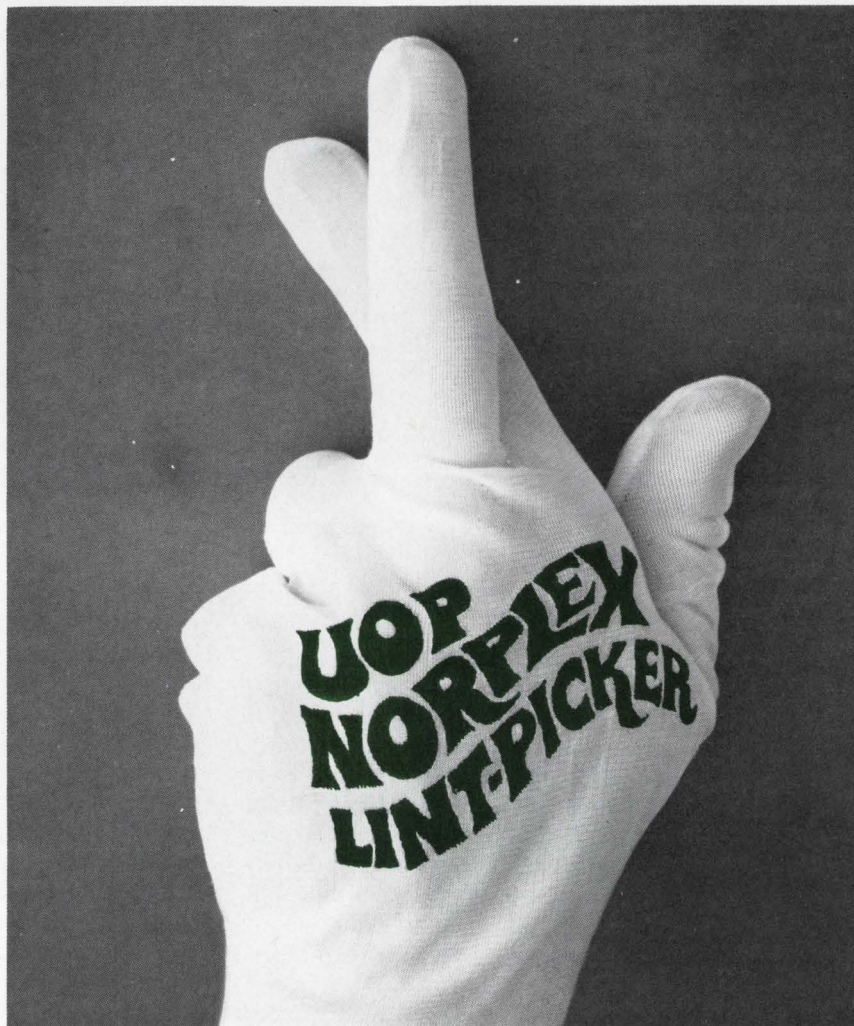

You hope your copper-clad laminates will be consistently perfect and perfectly consistent. And what you hope for, you get, from the "Lint-Pickers".

UOP Norplex is called that, you know, because we're the finicky-est folks in the laminating business. Our clean rooms, with precisely controlled temperatures and humidity, add to Norplex product dependability.

Special quality-control equipment, much of it designed by Norplex, helps assure reliable high-volume production. And assures the uniform quality that is guaranteed to meet

or exceed NEMA and MIL-P specifications. Our new, modern plant at Franklin, Indiana, opening soon, will add extra capacity to turn out and speed your orders.

Most important, though, are Norplex' skilled technicians and workers, proud of their products, proud to be called "Lint-Pickers".

UOP Norplex is a division of Universal Oil Products Company, a half-billion dollar company busy making life better through research and product innovation world-wide.

For our latest catalog, contact UOP Norplex Division, La Crosse, Wisconsin 54601. 608/784-6070.



Volume and surface resistivity testing of copper-clad laminates. Exterior control unit, designed by Norplex, gives fast, reliable readout.

 **NORPLEX**
LAMINATED PLASTICS

HANSEN'S NEW 900 SERIES

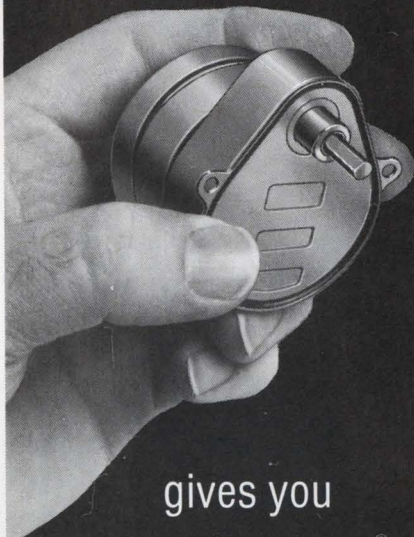

gives you
standard Synchron®
reliability with up
to 98 oz.-in. torque

Now, without sacrificing compact size, you can get high torque even at higher speeds—from 1 to 900 RPM. Synchron® 900 Series has thick, wide gears, specially designed to give the added gear strength that makes full use of its power increase. Highest quality instrument gear train for all speeds below 900 RPM.

The new self-starting hysteresis motor has positive direction of rotation—right or left hand. Plus extra heavy phenolic first gear for low noise level. It can be stalled continuously without electrical or mechanical damage.

Added strength in both the rotor and gear train enables 900 Series to handle your toughest timing and control jobs. Because of its compact dimensions, it is often interchangeable with motors of lower torque. To find out what 900 SERIES can do for you, write or phone today to have a representative contact you.



HANSEN MFG. CO., INC.
Princeton, Indiana 47570

HANSEN REPRESENTATIVES: CAREY & ASSOCIATES, Houston and Dallas, Texas; R. S. HOPKINS CO., Sherman Oaks, Calif.; MELCHIOR ASSOCIATES, INC., San Carlos, Calif.; THE FROMM CO., Elmwood Park, Ill.; JOHN ORR ASSOCIATES, Grand Rapids, Mich.; H. C. JOHNSON AGENCY, INC., Rochester, N.Y.; WINSLOW ELECTRIC CO., Essex, Conn.; Villanova, Pa., and New York, N.Y.

EXPORT DEPARTMENT: 2200 Shames Drive, Westbury, N.Y. 11590

small memory area—not dynamic memories.”

Also addressing himself to price considerations, Harry Neil, MOS product manager for Fairchild, says that the higher price of C/MOS is accounted for by the increased chip area which is due to the isolation, or channel separation, that is required to keep the n and p channels apart, and secondly, because the two devices that are used in C/MOS are larger than the two devices that are used in single-channel MOS. Fairchild, however, intends to eliminate this problem by combining C/MOS with the silicon-gate process. With it, the thick oxide that's used with silicon gates also separates the p and n regions.

Fairchild's C/MOS effort is still in the R&D stage, and it will be sometime before a product is ready, according to Neil. “Using silicon gate should bring the price down to the bipolar level,” he says.

But ultimately, it's the user that determines the market. One firm that went the C/MOS route after first working with P/MOS is Viatron Computer Systems Inc. “We chose C/MOS because it gives us more function for the dollar,” says Viatron's Laurence C. Drew, director of development engineering. Viatron needs speed in its devices. P/MOS can operate fast enough, but only with multiplexing techniques, Drew explains, but then design parameters become more critical, yields fall off, and P/MOS becomes an expensive circuit. With C/MOS on the other hand, he says: “You don't have to push the process as much. On this basis, we find it's very comparable in cost with single-phase p channel.” Viatron is currently using C/MOS supplied by Ragen and Solid State Scientific.

The Madatron Corp. decided on C/MOS because it did the job cheaper than other technologies, and at lower power. It is using Ragen-built custom complementary circuits in a decoder for a 2-inch drum memory in an alphanumeric display system. The 70 or 80 devices normally required for decoding were reduced to about 30 with C/MOS, and they interface directly with bipolar circuitry.

The addition of n-channel transistors and the need to isolate them electrically from the p-channel transistors requires two extra mask-

SCHAUER

1%

tolerance

1 WATT ZENERS ARE A REAL BUY!

ANY voltage from 2.0 to 16.0
at the industry's **LOWEST
PRICES!**

Quantity	Price each
1-99	\$1.07
100-499	.97
500-999	.91
1000-4999	.86
5000 up	.82



THE HI-RELIABLE!

No fragile nail heads.

Silicon junction aligned between two, parallel, offset tantalum heat sinks . . . great lead tension strength.

All welded and brazed assembly.

High pressure molded package.

Gold plated nickel-clad copper leads.

Write or phone for Form 68-4 for complete rating data and other tolerance prices.

Semiconductor Division

SCHAUER MANUFACTURING

CORP. 4514 Alpine Avenue
Cincinnati, O. 45242
Ph. (513) 791-3030

Electronics Profit.

How McGraw-Hill's new
Electronics/Management Center
can help you improve it.

We've created a unique information system for the management of companies in and around electronics.

We call it the Electronics/Management Center.

E/MC combines the specialized experience of the publishers of *ELECTRONICS Magazine*, with the broadly-based facilities of McGraw-Hill, one of the world's largest corporations devoted to increasing man's knowledge.

In thirty years of electronics experience, we've accumulated the background and talents to produce the problem-solving tools you need. The kind that are essential when living with lasers, making your way through the implications of Large-Scale Integration, and meeting the technical revolutions yet to come.

Supplement To Internal Systems

For your company, we'll plan, execute, and analyze custom projects—to meet an objective of general, technical, or marketing management. Or to establish a new objective.

Our system is sufficiently diverse to serve as a prime and total information source. Or, it can supplement the most sophisticated company capability. In fact, it may be more efficient to "buy" certain kinds of information from us than it is to "make" it yourself.

Often, we can be faster. Or less

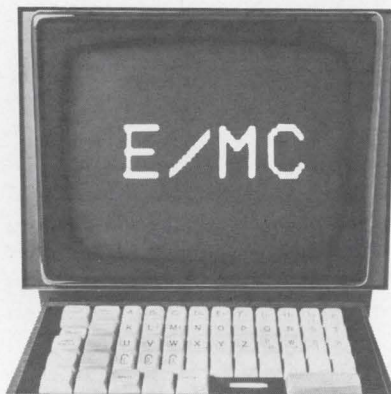

expensive. Always, we can be more objective.

Independent Technical Group

In technical matters, we can provide important assistance without adding overhead or over-loading your present staff. We offer the services of a national organization of university-based scientists and engineers with a long list of accomplishments.

Full Marketing Assistance

We can help you reduce marketing risks, too.

It's difficult to move around the electronics industry without bumping into both customers and competitors in the same corridor. We can probe new market potentials without revealing your identity. Or conduct research in an area not too familiar to your own staff.

We can do it in a neat package that combines access to the market with complete maintenance of confidence.

We can also supply those complex services you'd like to have created outside if you could find someone who speaks your language. Services like seminars, to educate customers, or train technical and marketing staffs, or develop management skills.

Weekly News Service

Management will also find our weekly news service an invaluable working tool. In minimum reading time each week, the *Electronics/Management Advisory Service* can keep your company current on the important electronics developments around the world. Market changes, prices, contracts, finances, significant trends, even a telephone number to call for person-to-person consultation—all the essentials to provide an information base on which to make top management decisions. For the next week. Or the next five years.

If you believe, as we do, that better information can help make your company more profitable, and you would like to know more about our services, write to: Electronics/Management Center, 330 West 42nd Street, New York, New York 10036.

E/MC

Electronics/Management Center
A McGraw-Hill Information Service

ing steps in C/MOS fabrication. Precautions for preventing contamination must also be more elaborate with C/MOS because of the extreme sensitivity of n-channel transistors to contamination.

Once these added requirements have been mastered, however, manufacturers claim, yields are extraordinarily high, and as such, the extra steps and attendant expense are more than compensated for. It is this high-yield potential that prompts visions of a mass C/MOS commercial market, whether logic, memory, or both.

At Ragen Semiconductor, for example, laboratory-style finesse is used routinely in production. Wafers are handled in laminar-flow boxes within laminar-flow clean rooms. Photoresists are filtered before they are applied to the wafers on a rotating turntable at precisely-controlled speeds.

RCA like other serious C/MOS contenders, has devoted special attention to its oxide process. The result has been a yield-improving technique that prevents sharp corners on the oxide step (as shown on p. 149).

Tough steps. Indeed, it's the oxide steps that have always presented the greatest problem in C/MOS fabrication. The oxide must be thin directly over the gate, but thick over other parts of the circuit to prevent parasitic transistors from forming between the metalization and the silicon. When metalization passes from the gate to the surrounding region, it has to climb a step several thousand angstroms thick, and it's difficult to deposit reliably over such a step.

RCA, however, eliminates the problem completely by changing the step into a slope. Oxide is deposited with a graded density; it, therefore, is etched more rapidly at the top than at the bottom of the layer. The result is a far more gentle transition between the thin and thick portions of the oxide, and a higher-yield fabrication process.

In short, C/MOS makers, almost without exception, are starting to master the various processing steps required for complementary technology. As one industry source puts it: "C/MOS is no longer a black art; it's a demanding, but controllable and reproducible procedure."

Solve all Resistor problems fast...

TALK TO THE SPECIALIST... LECTROHM

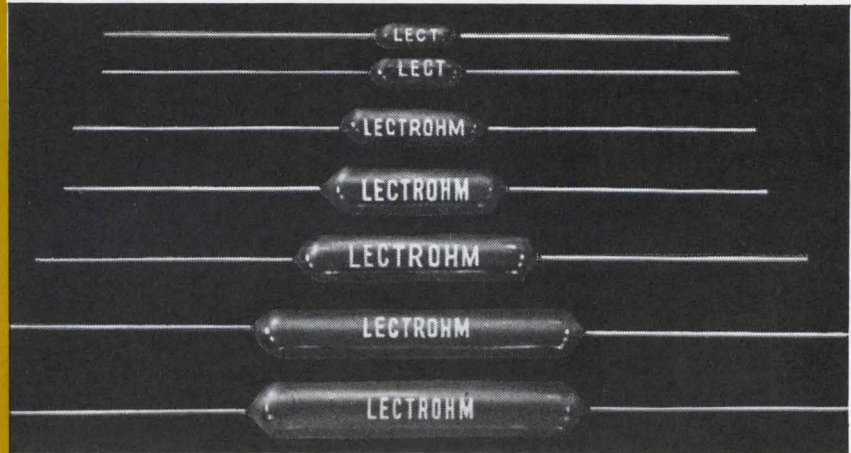

With LECTROHM's entire production facilities devoted to the manufacture of quality power, wire-wound resistors, we are in the unique position to provide quick, economical solutions to all resistor problems. As specialists in the field, LECTROHM knows resistors.

Whether your products require "standard" or "custom" styles — fixed or adjustable types, vitreous enamel or silicone coated — there is a LECTROHM resistor to match those needs precisely. To meet your production schedules, large stocks of standard styles in popular values are always available for immediate shipment, with special facilities geared to fast delivery on small orders of special values.

Whatever your resistor problems entail, you will do better talking to the specialist — talk to LECTROHM. You'll be time and money ahead, everytime.



Vitreous Enamelled Fixed Resistors



Vitreous Enamelled Adjustable Resistors



Type FP Resistors

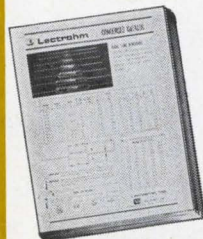

FREE!
Full line
LECTROHM
catalog.
Send for your
copy today!



Lectrohm, Inc.

a subsidiary of



COOK ELECTRIC

5562 Northwest Highway, Chicago, Ill. 60630

Mallory designed this DURACELL[®] for Bogen

We met their battery needs. What can we do for you?

When the Bogen Division of Lear Siegler Inc. designed its solid state Pagemaster—an ingenious pocket-sized device that enables a doctor on a call or a roving employee to be contacted wherever he may be—they needed a special kind of battery to power it. A battery tiny in size yet packed with energy. One that would far outlast ordinary batteries.

Naturally they turned to Mallory, makers of DURACELL, the amazing long distance power cell. And Mallory made it. A one-ounce DURACELL mercury battery that can last up to 1000 hours and can maintain about 80% of its energy up to two years in storage.

Among our 1000-plus existing battery types—one of which is our high-rate (HRA-2401) Alkaline battery series recently developed for high-drain, low temperature applications—there may be one ready to meet your specifications. If not, we'll design one that will.

As we did for Bogen.

For more information about Mallory battery systems, write: Technical Sales Department, Mallory Battery Company, a division of P. R. Mallory & Co. Inc., South Broadway, Tarrytown, New York 10591. Telephone: 914-591-7000.

(In Canada: Mallory Battery Company of Canada Limited, Sheridan Park, Ontario.)



MALLORY

® Registered trademark of P. R. Mallory & Co. Inc.

Radar braking is set for market debut

Practical, high-technology system for autos features doppler radar and IC's; may provide first big commercial break for Impatt diodes

By James Brinton

Electronics staff

It's unnerving to sit beside a driver as he accelerates his car hell-for-leather at a brick wall. But it's safer than it used to be—if he's driving a car equipped with a new radar-controlled vehicular braking system just developed by Bentley Associates of Chelmsford, Mass. It may be the first practical radar braking system ever made, and could be the first big commercial market for Impatt diodes. John B. Flannery, the 40-year-old president of Bentley, says the system already is back-ordered despite plans to build at least 2,500 units in '70.

The system features up-to-date technology—besides the Impatt diode microwave oscillators, there are doppler radar, signal processing that uses frequency division and integration over time, and IC's—and is sufficiently reliable and inexpensive to be a big seller and be safe. Earlier efforts in this field either were too costly to attract buyers—especially auto makers—or worked erratically.

"Sales are no problem," says Flannery, noting that his waiting line includes one of Boston's largest public utilities (with a fleet of 1,000 trucks), a major East Coast auto dealer, one of the country's biggest auto renters, as well as various bus and truck lines.

Railroded. The braking system grew out of work Bentley did for the Penn Central Railroad. Though it's a little-known fact, locomotive speedometers are wildly inaccurate because of the two-inch tolerances allowed on their wheels. Thus the axle pickoffs used to generate speed inputs often read very high or low, and in switching operations, for example, an incorrectly low

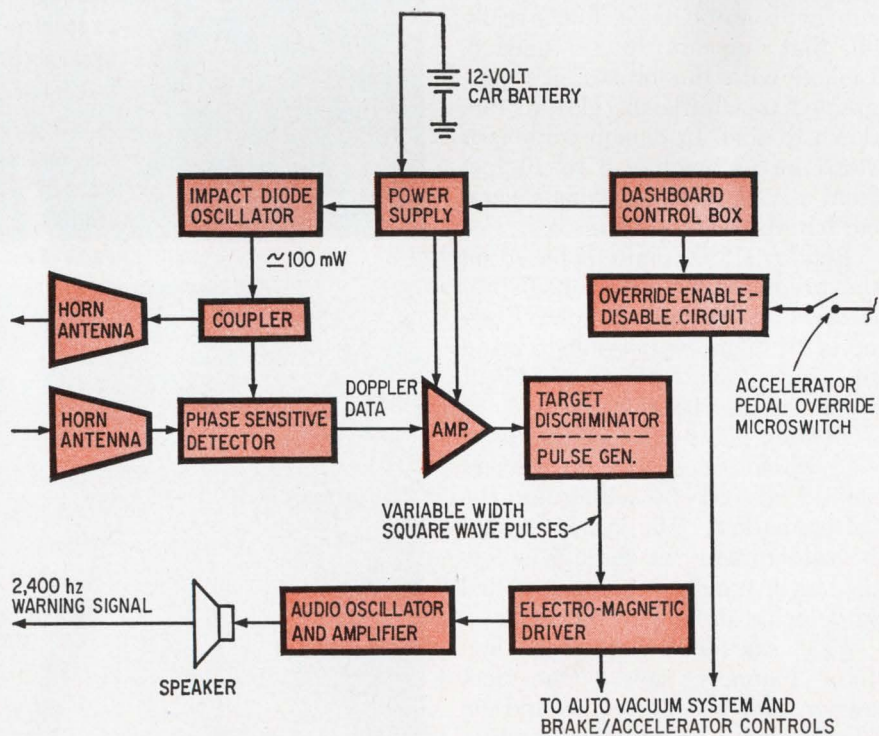

Halter for horsepower. Similar twin radar antennas (top) may appear in your rear-view mirror soon; behind them will be the system diagrammed above, a doppler radar braking system. First units should go on truck fleets next year, and the maker hopes for sales to automakers as well. Possibly a big new auto electronics market, the system also is the Impatt diode's first major appearance.

speedometer reading can cause damaged cargo. But Bentley came up with a doppler radar system that used the returns from railroad ties, and it worked well. And from rails to roads was a simple jump.

"Initially we were thinking of speedometers," says Paul D. Flannery, 33, vice president of the firm. "So we instrumented an automobile, and sure enough, we got fine returns from the pavement. But when we scanned other automobiles it quickly became apparent that we easily could measure the closure rate to the car in front of us. That's when we had the germ of a radar braking system."

As developed, the system uses an Impatt diode microwave oscillator generating about 100 milliwatts at 10.525 gigahertz—set by the FCC. Two horn-lens antennas are used.

The radar is pure doppler—no range-gating circuitry is needed—and this may account for its low cost, \$800 installed. The major auto makers have been working on radar braking programs for some time, but they appeared to insist on getting range information, a costlier approach.

Enough. While all the Bentley system can indicate is rate of closure with an obstacle, that's really all that appears to be needed. Linked with the brakes, it's programmed to whittle the closure rate down to zero. In demonstrations it stops an automobile 8 to 10 feet from a wall, and maintains several car lengths between cars.

Bentley's \$800 figure is based on the predicted 2,500-unit 1970 production. According to John Flannery, "It might be possible to bring the price down to \$400 or \$450 if we can make 50,000 per year."

Bentley plans to reach this level—at which sales to auto makers should take off—by selling into the "after market." The system would be sold directly or through a few dealers or franchisees, and installed in vehicles already on the road.

Fleet sales look most promising, John Flannery says. "One fleet owner said the system would be like having a third foot in situations where the driver of a heavy truck must brake and downshift, while double clutching and matching engine and gearbox rpm," he notes.

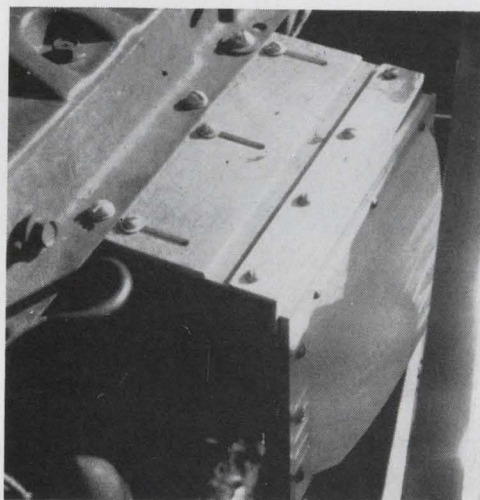
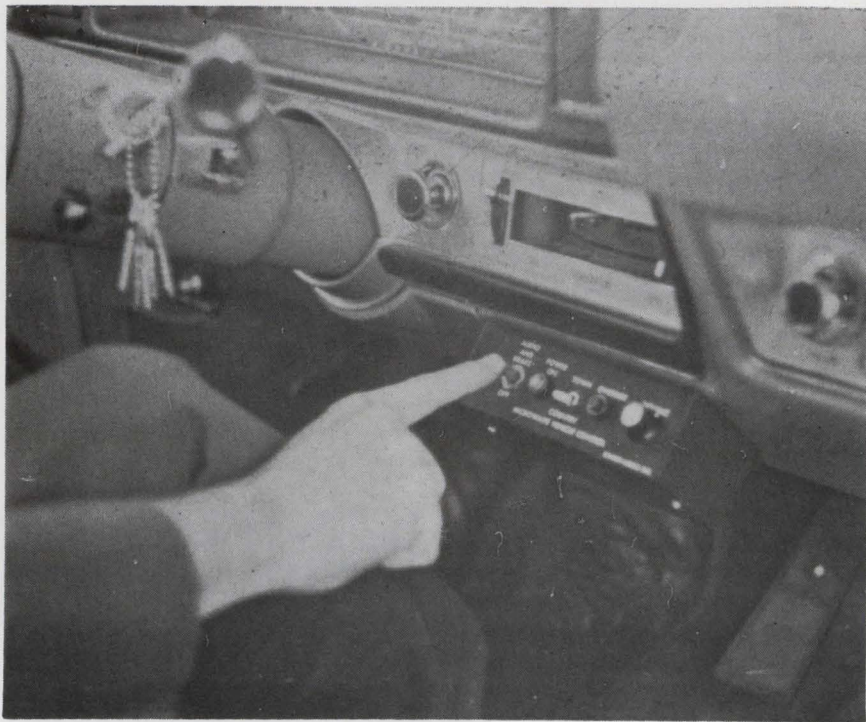

Radar control. Driver can disable automatic braking (above) and use his own judgment, as when on icy roads. The horn-lens antennas are mounted either in front of or behind the grill of vehicle (left). Builders report few blockage problems with concealed installations as most cars now use plastic grillwork. Mounted at apex of antenna held by Paul Flannery (below) is 100-mw Impatt oscillator.

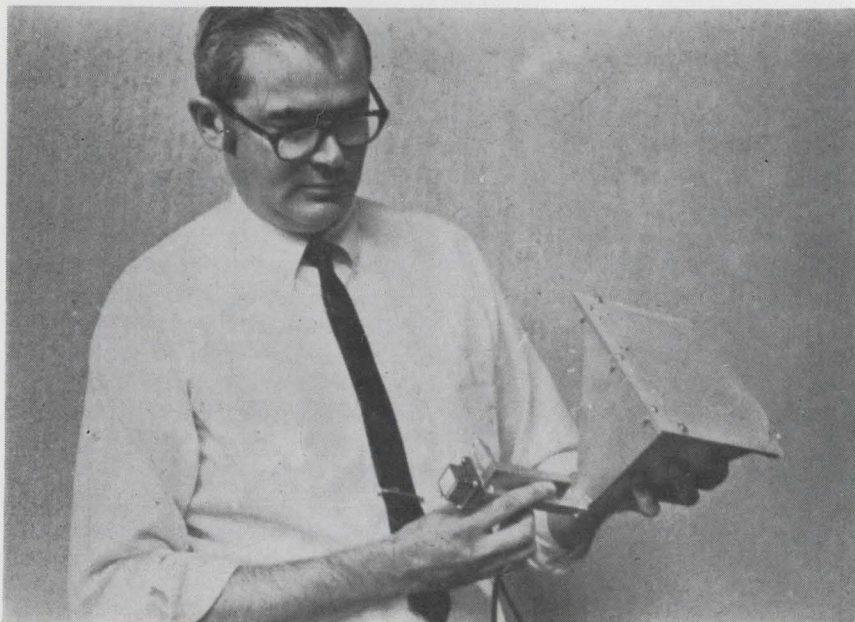

The after market colored Bentley's design approach. The system uses the vehicle's existing equipment as much as possible—for example, engine vacuum is used to pull or release cables which depress the brake pedal and control the throttle. "It would have been possible to have worked directly into the hydraulic system," says Paul Flannery, "but we wanted no safety or warranty problems."

How it works. The Impatt local oscillator supplies 100 milliwatts continuous X-band power to a coupler which transmits most of it to the transmission horn antenna after bleeding off a small amount for the mixer-detector. Returned radar pulses are picked up at the receive horn and mixed with the Impatt oscillator's signal in a phase-sensitive mixer-detector. Its output is higher if the vehicle ahead is getting nearer, and higher in proportion to the rate of closure with that vehicle.

This signal is amplified and fed to a target discriminator which uses some proprietary techniques. Its output triggers a pulse generator which yields pulses whose width is proportional to closure rate. These pulses trigger an electromagnetic driver that in turn operates the vacuum-powered controls for brake and throttle linkage.

Since higher closure rates make for wider pulses, the brakes are pumped for longer durations, slowing the vehicle more swiftly than if the rate of closure were lower. Meanwhile, the system also closes the throttle so that brakes and engine don't work at cross-purposes.

While all this is happening, the driver is warned of braking action by an audio beeper in the control module mounted under the dashboard. High closure rates are signaled by long, repeated beeps.

Do it yourself. A toggle switch on the small control panel can cut out all but the beeper, allowing the driver to brake at his discretion—on icy pavement, for example. There's also an override micro-switch on the accelerator pedal that allows the driver to momentarily override the system to get past objects—like detour signs or slow cars—with high closure rates, but which he'll swerve around.

There are two modes of opera-

What happened when doctors and engineers got together:

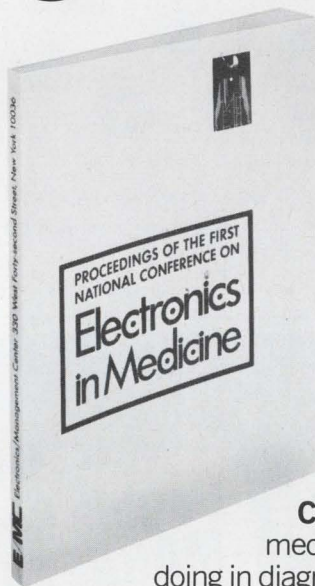

Doctors told engineers how they were using electronics and revealed their most urgent needs. Engineers described and demonstrated their newest equipment for diagnosis, treatment, and prevention. And hinted at things to come.

Their complete dialogue, with illustrations, makes pretty informative reading on a vital and growing market.

Here are some of the things it contains:

Computers: How they're joining the medical team. What computers are doing in diagnosis. In communications. The small computer as a paramedical aid.

Instrumentation: What's needed. What's available. Patient management. Protection. Standards and safety.

Electronics in the Hospital: The surgeon, the hospital, the instruments. What the administrator wants. Prescription for large-scale health care. The surgery department.

Electronics/Management Center
330 West 42nd Street, New York, N.Y. 10036

Enclosed is \$12 for a copy of the Proceedings of the First National Conference on Electronics in Medicine.

Send the Proceedings and bill me later. P.O. # _____

Name _____

Company _____

Address _____

City _____ State _____ Zip _____

Ferrite Shielded Air Core Yoke C5380. Designed for high speed precision character displays (nanosecond writing speeds). Undesirable magnetic coupling and stray fields eliminated by unique shield design.



DESIGN DEVELOPMENT FROM *syntronic* THE YOKE SPECIALISTS

Syntronic engineers and manufactures the most extensive line of deflection yokes available . . . and continually develops new designs to satisfy the ever increasing requirements of the display industry. For large production or custom applications get the engineering control and production experience that only SYNTRONIC, the yoke specialists, can provide.

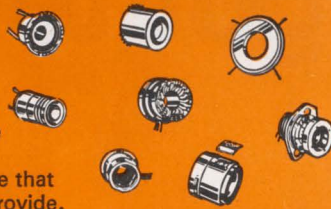

syntronic

INSTRUMENTS, INC.
100 Industrial Rd., Addison, Ill. 60101
phone 312-543-6444

Circle 215 on reader service card

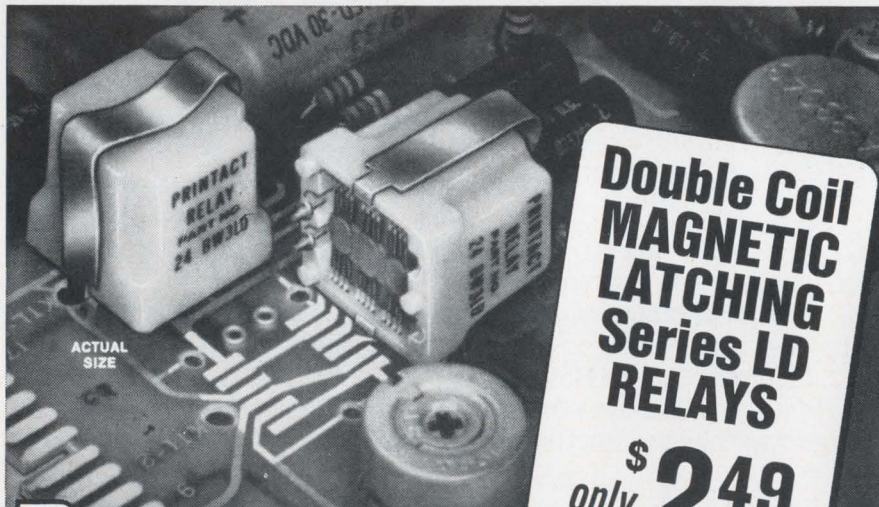

**Double Coil
MAGNETIC
LATCHING
Series LD
RELAYS**

\$249 EACH
(IN LOTS OF 5,000)

Printact®

Plugs into your PC board . . . mates with plated conductors

Where **memory without power** is a requirement in the design of control circuitry, the use of the "LD" relay results in a **compact-low cost module**. Reliability is assured by the unique design which includes, as standard, many features not generally available in commercial relays.

Encapsulated coil, bifurcated gold or palladium contacts, low thermal EMF, plug-in without sockets or soldering, low bounce and chatter, series-break switching eliminates pig-

tails, permanent magnet avoids return spring and mechanical linkage—all of which assures continuous performance for many millions of cycles.

Available with 6, 12 or 24 VDC 1 watt coil (AC operation with series diode) in 2, 3 and 4 pole configuration. Series break swingers permit each pair of fixed contacts to be etched with common (Form C) or isolated (Form A plus Form B) switching between make and break circuits.

For data write or call 212-EX 2-4800.

Printact Relay Division, Executone, Inc., Box 1430, Long Island City, N.Y. 11101

158 Circle 158 on reader service card

The indecisive impatt

The Bentley vehicular braking system may be the Impatt diode's first large-scale commercial market break. Ironically, it could penetrate one of the hardest markets for electronics to enter—the automotive field. But it almost didn't make it. Though Bentley was able to offer the prospect of a large market, the incentive almost didn't attract Impatt suppliers.

"Fifteen or 16 months ago, when our engineering effort began," says Paul Flannery, "Impatts were costly and available only in small quantities." Thus, when Bentley asked for quotes on quantities in the thousands, a few potential suppliers honestly didn't know whether they would be able to produce either the quantity he wanted, or whether they could meet the price he needed, he says.

But as a result of a concerted effort to develop an Impatt oscillator aimed directly at commercial applications and at low cost, Varian Associates' Solid State division in Beverly, Mass., was able to ride through the engineering phases with Bentley and also wound up with its first large order—for more than 2,500 Impatt oscillators, said to be the largest Impatt order yet.

While Varian isn't quoting the price offered Bentley, it's said to have been in the \$60-per-unit range. This represents quite a drop from the price just two years ago when a 100-milliwatt Impatt diode alone cost more than twice that figure without its mount.

tion. The "country" mode triggers braking at a distance of 150 feet for high-speed driving. The "city" mode cuts in the brakes at 30 to 40 feet for driving in congested traffic or at speeds of 25 miles per hour or less. Though the city mode cuts in later, the pulse generator emits pulses three times wider than in the country mode. Thus, Paul Flannery claims that "if your brakes are as good as those of the guy in front, you can't hit him even if you are only a foot away—the radar braking system's reflexes are measured in milliseconds." This is why he considers the system a potential aid to the old and infirm, a market scheduled for later penetration. What's more, the system works in rain, snow, and fog.

Electronics | January 5, 1970

CTS TRIMS CERMET INDUSTRIAL TRIMMER PRICES TO

50¢

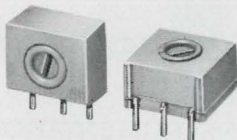

- 50¢ each in 50,000 quantity
- 65¢ each in 1,000 quantity
- \$1.14 each in 100 quantity

for $\pm 20\%$ Tolerance (Add 4¢ for 10% tolerance)

Series 360 single-turn cermet industrial trimmers provide...

- **Setability $\pm .03\%$**
- **Environmental performance requirements of characteristic C of MIL-R-22097D**

... plus!

- 1.5% average equivalent noise resistance
- 0.5% average contact resistance variation
- Compact, single-turn design

- Top or side adjust
- $\frac{1}{2}$ watt @70° C
- Tolerance to $\pm 5\%$
- TC ± 150 ppm/°C available at no extra cost over most of the resistance range.

Your CTS Distributor will have both styles in stock for fast, prototype delivery. Production quantities to you in 4 weeks.

See your distributor... call your CTS sales engineer... or write for complete data. We'll respond quickly. CTS of Berne, Inc., Berne, Indiana 46711. Phone: (219) 589-3111.

CTS CORPORATION

Elkhart, Indiana



Digitally Controlled Power Sources Include Added Systems-Oriented Functions

Digitally Controlled Power Sources (DCPS's) are complete digital-to-analog links between a computer (or other digital source) and any application requiring a fast, accurately settable source of dc or low frequency ac power. Such applications generally require more than a programmable power supply or D/A converter with a power amplifier — the DCPS's include these added functions in a single compact trouble-free package:

INTERFACE Customized plug-in interface cards match the Digitally Controlled Power Source to the computer (8421 BCD or Binary).

ISOLATION All digital inputs are floating and isolated from the floating analog output, thus avoiding troublesome loops between the output ground and computer ground.

STORAGE Inputs from all digital data lines are stored upon receipt of a gate signal from the computer. Output levels are maintained until a new gate signal is received — thus, the computer is free to perform other tasks in the interval between voltage level changes.

FUNCTION SELECTION Selects the output voltage range, and isolates the three input bits to the current limit D/A converter.

OUTPUT VOLTAGE D/A CONVERTER Converts one polarity bit plus 16 BCD voltage bits or 15 binary voltage bits to an analog voltage for input to the power amplifier. Thus, resolution is 0.5mV for straight binary and 1mV for BCD operation.

REFERENCES Provide voltage for the Output Voltage and Current D/A Converters.

CURRENT LIMIT D/A CONVERTER Sets current limit of power amplifier to one of eight values.

CIRCUIT POWER SUPPLIES Provide all the necessary dc power — no external power supplies are required.

FEEDBACK Informs the computer when each programming operation is completed and when the output current is overloaded.

BIPOLAR POWER AMPLIFIER Programs either side of zero or through zero without output polarity switches or "notch" effects, with an accuracy of 1mV, 5mV, or 10mV depending on range and model. Outputs from -100V to +100V with currents up to 1A are available.

all this

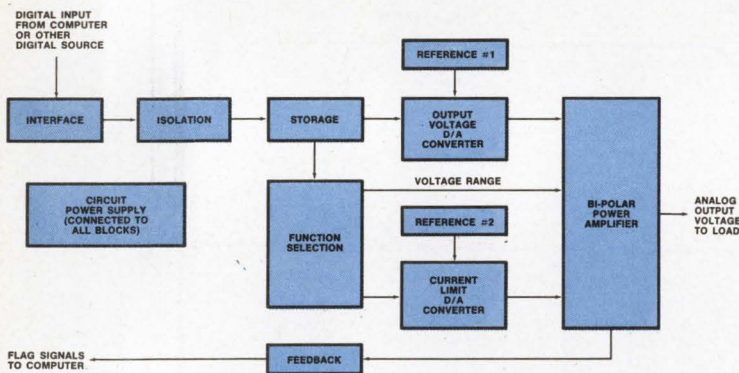

in one compact package

Write for Digitally Controlled Power Brochure.

21904A

HEWLETT  PACKARD

COMPUTER INSTRUMENTATION

100 Locust Avenue, Berkeley Heights
New Jersey 07922 • (201) 464-1234

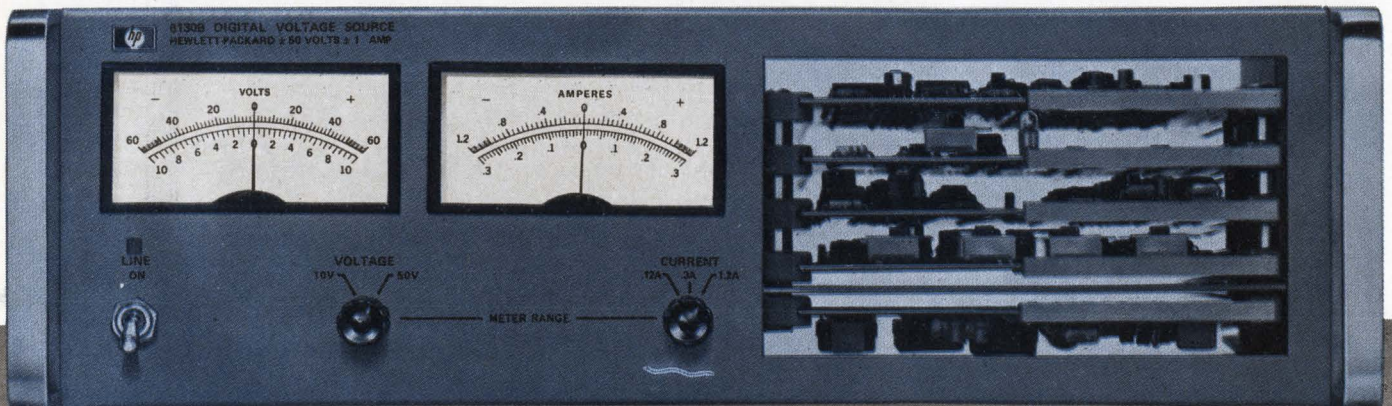

PDP-11 rides on a unibus

Modular 16-bit computer has subsystems strung in parallel on a single data-transfer trunk; this architecture seen as central design theme for family of DEC machines planned for 1970's

The PDP-11 is the Digital Equipment Corp.'s answer to the growing demand for 16-bit mini-computers. It also may be a hint of things to come from DEC in the 1970's.

The new machine is a modular computer with its parts strung in parallel on a single bus. With this sort of wide-open architecture, system parts as diverse as the arithmetic unit and teleprinter console are attached to the bus through buffers. Except for core memory, every part of the PDP-11 can directly address any other, using a scheme based on real and imaginary core locations. From the point of view of the central processor, for example, the teletypewriter is a location in memory with special properties, and the same is true of tape, drum, or disk stores, and digital/analog interfacing electronics for other peripheral gear. In a sense, everything is peripheral to the bus, which DEC calls unibus.

Modularity is physical as well as electronic. Major subassemblies, such as the arithmetic unit, can be removed and replaced in less than 3 minutes, and the computer put back on line when power and unibus connections are made. Minor subassemblies are on individual circuit boards—small ones for high-current circuitry, larger ones for integrated circuits and low-current circuits. Thus the machine is easily maintained as the parts most apt to fail are the smallest and easiest to remove.

Such modularity means the machine can be updated almost infinitely. According to a DEC spokesman, "DEC plans to use the modularity of the machine to take advantage of the most advanced technology as quickly as this technology becomes practical."

The fact that the unibus-based

machine is fully asynchronous helps. Because there need be no common clocks rate throughout the PDP-11 system, faster memories or processors can be added whenever necessary without upsetting operation. Also, slower subassemblies can replace faster ones to achieve a favorable cost tradeoff.

The Flexprint bus used in the PDP-11 could already carry 18-bit words, and there's little to prevent paralleling these Flexprint conductors to create machines of al-

most arbitrary word length. Nor is there any rule against applying this architecture to 8- or 12-bit machines. For the next few years DEC can be expected to introduce products with a family resemblance to the PDP-11's unibus form.

While the unified busing concept isn't new, only the PDP-11 seems to be using it specifically in the general-purpose commercial computer market. Variations of the concept are used for the Apollo guidance and navigation computer built

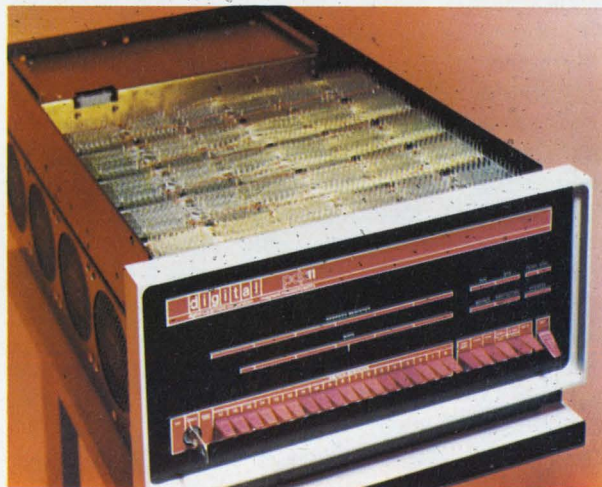

Expandable. The PDP-11, shown with top removed is modular in both physical and electronic design. Major subsystems such as the core memory, below, are easily removed and replaced.

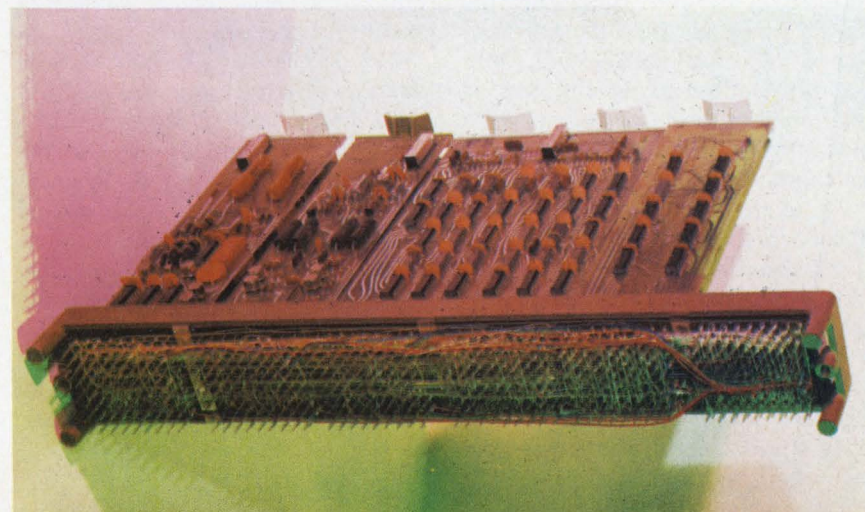

for the National Aeronautics and Space Administration by Raytheon Co. [*Electronics*, Jan. 9, 1967, p. 112], and the six-month-old GRI-909 aimed at the systems control market by its builder, GR Industries Inc. [*Electronics*, July 7, 1969, p. 14].

By contrast, the PDP-11 has a powerful central processor and arithmetic unit (the GRI-909 has no arithmetic unit in its standard model). The PDP-11's processor has the almost unheard-of total of eight general-purpose flip-flop registers, any one of which can be an accumulator, stack pointer, auto index register, or true 16-bit address register. In addition, the processor has two temporary storage registers.

Put to work. Not only does it have about twice the typical number of general-purpose registers of other 16-bit machines, but it appears to make better use of them, by allowing almost any system component on the unibus to have direct-memory access. Under the constraints of more common architectures, memory access is via the central processor, with data stopping over in the CPU's registers on the way into, or out of, memory. The PDP-11's almost unlimited memory access thus allows the CPU to operate with fewer interrupts.

The interrupts that do occur are adjustable through software; priorities can be controlled by the running program, and some interrupts disallowed. Some other situations which normally would cause interrupts don't arise. This is because instructions can operate directly on data in the registers at input and output devices—data can be transferred from one buffer register to another on the bus, bypassing the central processor (and its registers) completely. And since each sub-assembly attached to the bus is addressed in the same code used to spot core locations, no special I/O instructions are needed.

There are only slightly more than 60 software instructions in the PDP-11's instruction set, but DEC spokesmen like Andrew C. Knowles, product-line manager for the PDP-11, believe that the flexibility provided by the machine's general-purpose registers makes these 60 instructions equivalent to more than 400 hardwired instructions.

The rationale behind this is

DEC's statement that most data in a program are structured in tables, lists, tables of addresses, etc. Addressing modes have been engineered into the PDP-11 to deal with these common data structures. Thus the PDP-11 addressing modes include direct register addressing, sequential addressing, full address indexing, and others.

Another case in point is DEC's use of double operand instructions in the PDP-11, something which may be unique to a computer system this small.

In addition to the usual single-address instructions, the PDP-11 includes a repertoire of seven double-address instructions. Such double operand instructions can be very flexible; MOV (move) for example, can at various times replace any one or a combination of the following individual instructions: load, store, load from table, store in table, push down, pull up, load index register, and output to peripheral.

Thus, for at least part of its repertoire, the PDP-11's instruction set is a machine language as simple as many higher-level languages.

Catching the bus. With a large number of devices sharing a common data-transfer bus, how does the PDP-11 keep order? The umpire is a control and priority arbitrator included in—but electronically distinct from—the central processor unit. There's no polling of the system; a unit requests use of the unibus whenever it needs it.

When the request is made, the controller checks the central processor's status register, and if the processor is between bus cycles of an instruction execution, the requester at least has a chance of getting at the bus.

Nonprocessor requests—those from a disk memory, say—always have first crack at the bus. However, the software in use and the contents of the processor-status register interleave eight levels of processor priority between those of devices on various bus request lines. So the processor has the second-highest priority (and the lowest) plus six levels between the other priority levels of PDP-11 devices, such as peripheral equipment.

In response to a bus request, the controller sends out a "bus grant" pulse, and the device that

made the request prevents the grant signal from passing down the line to devices more distant from the controller. Thus, devices hardwired closer to the processor automatically have higher priorities than those further away.

Once a device has the bus, it holds it until its job is done, and meanwhile sends out a "bus busy" signal.

After a nonprocessor request is made, it takes a maximum 3.5 microseconds to catch the bus. And after the device has control, it can transfer data at more than 20 megabits per second if it has the capability.

Big fleas, small fleas. Some devices using the bus will require the aid of the processor in what are called device servicing programs. When such a bus request is made, the task under way in the processor is interrupted and the return address for the interrupted routine and the processor status word are held in a pushdown list, a combination of hardware and software also known as a last-in, first-out stack. In the PDP-11, the list is automatically maintained for interrupt processing, making it possible for higher priority interrupts to break into the processing of lower priority interrupt routines.

It takes 7.2 μ sec for the processor to get the interrupt command and fetch the first instruction in the new routine (assuming there are no nonprocessor bus requests). When the interrupt routine is done, the last instruction is "return from interrupt," and this returns the processor to the job next downward in priority—at the top of the pushdown list. That is, it restores former processor status and the contents of the registers. The return to a preinterrupt state takes about 4.5 μ sec to accomplish.

Even second and third level (and beyond) interrupts can in turn be interrupted by bus requests with high enough priorities. This nesting of priority interrupts, as DEC calls it, can go on until all available core memory is used up holding prior processor conditions.

Judging it. Since the PDP-11 is asynchronous, and has characteristics like multidevice direct-memory access, it's hard to compare it with other machines. Even standby

(Continued on p. 185)

*over 50% more
device area
in these
14 and 16 lead*

AlSiPak[®]
ALL CERAMIC
PACKAGES

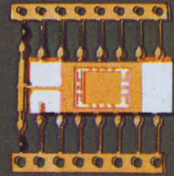

AlSiPak[®]
No. SZ-80107-AB
14 lead package
with device area
.170 x .200

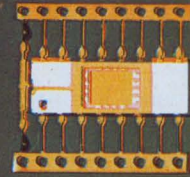

AlSiPak[®]
No. SZ-80108-AC
16 lead package
with device area
.170 x .220

SHOWN ACTUAL SIZE.
LEADS ON .300 ROW CENTERS.

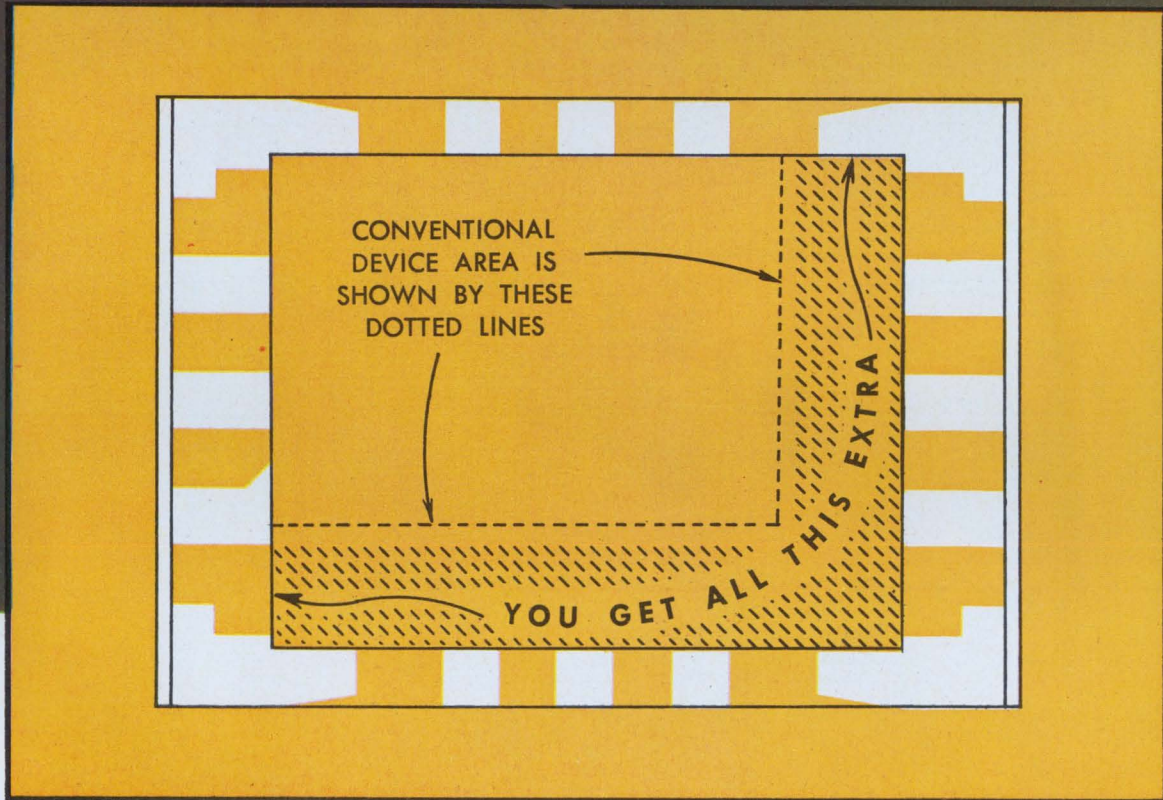

THIS 15X MOCK-UP SHOWS THE **BIG DIFFERENCE!**

Prices and Detailed Specifications on Request

CODE IDENT. NO. 70371

PHONE 615 265-3411 • CHATTANOOGA, TENNESSEE 37405, U.S.A.

American Lava Corporation **3M**
A SUBSIDIARY OF COMPANY

For service, contact American Lava representatives in Offices of Minnesota Mining and Manufacturing Company in these cities (see your local telephone directory): Boston: Needham Heights, Mass. • Chagrin Falls, Ohio • Chicago: Elmhurst, Ill. • Dallas, Tex. Indianapolis, Ind. • Laurens, S.C. • Los Angeles, Calif. • Metropolitan New York: Ridgefield, N.J. • Up-State New York and Canada: Phoenix, New York • Orange, Conn. • Philadelphia, Penna. • Roanoke, Virginia • St. Louis: Lee's Summit, Mo. South San Francisco, Calif. • International: c/o American Lava Corporation, Chattanooga, Tenn. 37405, U.S.A., TELEX 558432.



Inductors for all temperatures



UTC high Q coils give you better inductance stability over any temperature range

That's a tough claim to back up!

We do it by meticulously controlling every process variable that can affect temperature stability of an inductor. We pay special attention to every detail of design and manufacture—winding methods, materials compatibility, stabilization processes, assembly and impregnation—details other manufacturers ignore. Over any temperature range you specify, UTC inductors will outperform all others.

Available from our catalog are high Q inductors with guaranteed stability from -55°C to $+130^{\circ}\text{C}$. Adjusted inductance

tolerances are as tight as $\pm 1\%$ on standard inductors. Select from hundreds of inductors made to MIL-T-27C. If your specific need cannot be supplied, we'll tailor an item to your specifications.

When your designs call for better inductance stability, UTC is the answer. Check your local distributor for immediate off-the-shelf delivery or contact United Transformer Company, Division of TRW INC., 150 Varick Street, New York, New York 10013.

TRW
UNITED TRANSFORMER COMPANY

Photorelay drives IC directly

Module, available with lamp or GaAs diode as light source, can act as buffer between MOS and DTL-TTL circuits

A transducer's output often is too much for an integrated circuit to withstand. A thermocouple's signal, for example, may be too powerful, or there may be unwanted noise in the signal at the IC's input. Both problems can be solved by the isolation and electrical-output characteristics in Digit/Comtex Inc.'s quadruple photorelays, designated models L-911 and L-912.

Though intended as direct replacements for reed relays, the modules can prevent damage where large voltage differences exist between two systems, and they can provide up to 7500 volts differential isolation. They might, for example, act as buffers between a digital system and a signal contaminated with voltage spikes or r-f.

The modules have four optically

coupled relays which can interface directly with diode-transistor-logic and transistor-transistor-logic IC's over a temperature range of 0-75°C. Each relay can drive 15 1.6-milliamp loads, and outputs can be tied in parallel for wired-OR operation.

Incandescent or neon lamps, available in voltages of ± 5 volts d-c, ± 24 volts d-c, and 120 volts

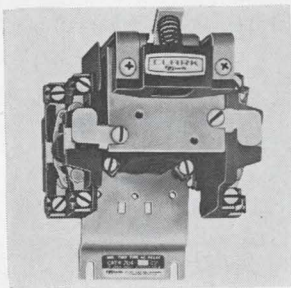

Relays designated bulletin 703, type KC are 15 amp, 600 v d-c control devices that may be equipped with either series or shunt coils and are available with 2, 4, 6 or 8 convertible contacts. The relays are completely assembled for direct mounting to metal panels without additional insulators or special hardware. A.O. Smith Corp., Clark Control Division, Cleveland 44110 [341]

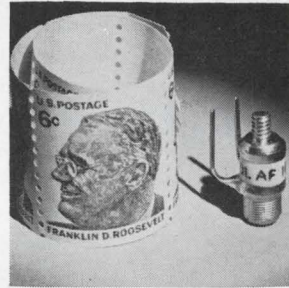

Two variable air dielectric trimmer capacitors feature a screw mounting for panel or p-c board mounting installation in h-f circuits. They are available in two ratings each—from below 0.8 pf to above 10 pf and from below 0.8 pf to above 14 pf. Q is guaranteed to exceed 4,000 at 100 Mhz. Price in lots of 100 is \$3.85 each. Voltronics Corp., West St., Hanover, N.J. [342]



Wirewound precision potentiometer series 9320 features a minimum practical resistance tolerance of $\pm 1\%$ and independent linearity of $\pm 0.4\%$. The 1 13/16 in. diameter series offers a standard resistance range of -65°C to $+85^\circ\text{C}$. Power rating is 3 w at 40°C . Price in lots of 1 to 9 is \$13.50 each. Beckman Instruments Inc., 2500 Harbor Blvd., Fullerton, Calif. [343]

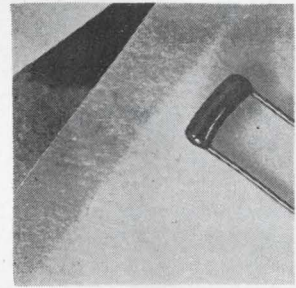

Tera-ohm resistor model 100 is available in the range from 10^8 to 10^{11} ohms. The subminiature devices provide controlled input resistance for source followers, amplifiers, JFET, IGFET, and MOS transistors. They also control the discharge rate of storage capacitors and crystal transducers. Price (1-15) is \$8. Eltec Instruments Inc., Box 46, Lancaster, N.Y. 14086 [344]

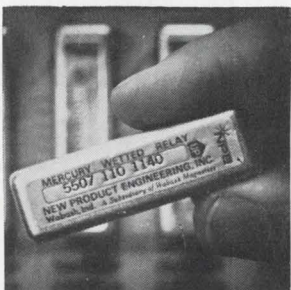

Low-profile, mercury-wetted relays offer unlimited life operations and bounce-free switching. Measuring 0.550 in. from mounting surface to top, they are designed for p-c board mounting. Switching time is comparable to conventional dry reed switch relays. They are suited for such applications as process control interfaces. New Product Engineering Inc., Wabash, Ind. [345].

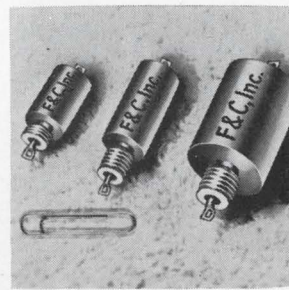

Miniature, tubular filters series 1400 are for use in aerospace or industrial radar, navigation, communication, fire control and other systems where emi/rfi energy must be eliminated. They come in L, Pi and T shapes, with voltage ratings from 50 v d-c to 120 v a-c. Price is from \$10 to \$30 each in small lots. Filters & Capacitors Inc., Box 1272, San Fernando, Calif. [346]

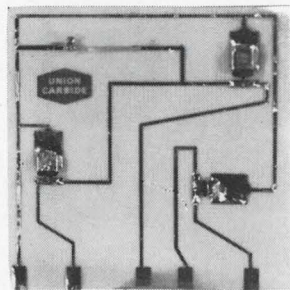

Solid tantalum chip capacitors series T411 feature assembly temperatures of 300°C and continuous operating temperatures to 175°C . This is achieved by use of a copper coating process that prevents degradation of the chip counter-electrode system at the temperature utilized in hybrid circuit and thick film technology. Union Carbide Corp., Box 5928, Greenville, S.C. [347]

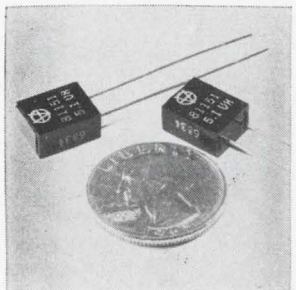

Variable toroids series 81 Varoid, tuning from minimum to maximum in 180° rotation of tuning core, is designed for use where high Q, low coupling and low temperature coefficients are required. Frequency range is 50 khz to 100 Mhz, with nominal inductance values from 0.1 to 1,000 μh . Volume price is about \$2 each. Vanguard Electronics, W. Hyde park, Inglewood, Calif. [348]



AN122

Dual Monolithic NPN-Silicon- Planar - Transistors

MATCHED PAIRS FOR DIFFERENTIAL AMPLIFIERS

Low Profile six lead TO-5 six lead epoxy

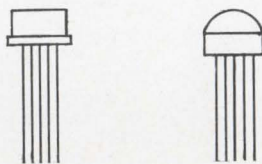

- HIGH h_{FE} AT LOW CURRENT > 200
- LOW OUTPUT CAPACITANCE < 2.0 pf
- h_{FE} MATCH < 10%
- TIGHT V_{BE} TRACKING < 5.0 $\mu V/^{\circ}C$ -55 $^{\circ}C$ to +125 $^{\circ}C$

PRICES

	1-24	25 up	100 up
\$	3.80	3.20	2.55

ANCRONA CORP.

65 East 55th Street • New York, N. Y. 10022
(212) 688-6285 • Telex 223 117 • TWX (710581 / 4513)

a-c, are used in the model L-911. Rise time is 75 milliseconds and fall time is 50 msec. This relatively slow-speed model is intended for machine tool applications, where substantial buffering between input signal and the machine is needed. By buffering, the software requirements of the machine can be simplified and memory requirements minimized, says Digit/Comtex.

The model L-912 uses a gallium arsenide light-emitting diode, with a 5-volt input, as a light source. With a maximum switching time

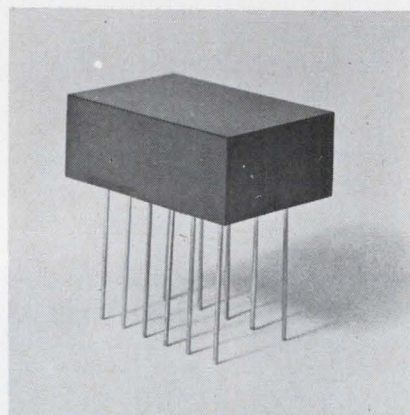

Buffer. Quadruple photorelay can be interface between systems of different voltage levels.

of 5 microseconds, the unit is intended for general-purpose high-speed data transfer. One application might be as an interface between metal oxide semiconductor circuits and diode-transistor-logic or transistor-transistor-logic voltage levels.

The company says that the modules are more reliable than reed relays because they have no moving parts and there are no metal connections between the relay and digital system. Also, lifetime may be considerably longer, since it depends on the lifetime of the light source (20,000 hours) rather than the number of cycles.

Price of the modules is \$20 each in quantities over 1,000. Delivery time is four weeks for the L-911 and 6-8 weeks for the L-912. It is expected that the principal customers will be makers of small computers, numerically controlled machines, and other industrial equipment.

Digit/Comtex Inc., P.O. Box 272, Weston, Mass. 02193 [349]

New components

Triac isolated by substrate

Alumina also provides
low thermal impedance
in plastic package

Washers or disks made of Mylar, mica, or a ceramic are used with standard industry packages to provide low thermal impedance and electrical isolation for triacs. A plastic package developed by the Electronic Control Corp. employs an alumina substrate for the semiconductor chip instead.

The company produces a line of devices, called Quadrac, in which electrical isolation is achieved by glass passivation. But these have been available only in higher-priced packages. The alumina substrate was used to obtain lower-cost plastic packages while still isolating the glass-passivated triac from the copper-tab heat sink.

This increases the cost of a plastic package by 20% to 25%, according to John Munson, product manager. He adds that the company expects to offset this through improved yield in its production of triac chips. The new package, called Thermotab, will compete with similar devices designated Powerpak by General Electric and Versatab by RCA.

With the package design, the company is announcing a new line of electrically isolated triacs with current ratings ranging from 1.6 to 16 amps. The line also has high-voltage capability ranging from 200 to 800 volts.

Typical prices, in quantities of 100, will be \$1.06 each for 1.6 amps, 200 volts at 10 milliamperes. A similar 25-ma device will sell for 81 cents each. At the higher-power end, a 16-amp, 200-volt, 50-ma device will sell for \$2.25 each. The same devices with built-in triggers will cost an additional 25 cents each. Delivery time for all units is 30 days.

Electronic Control Corp. 1010 Pamela Drive, Euless, Texas [350]

circuit problems?

***Signalite Glow Lamps have
solved problems in these areas:***

- Voltage Regulation & References • Photo-Cell Drivers • SCR Triggering
- Timing • Photo Choppers • Oscillators • Indicator Lights • Counters
- Voltage Dividers • Surge Protectors • Logic Circuits • Flip-Flops
- Memory • Switching • Digital Readouts

Signalite glow lamps combine long life, close tolerance and economy, and are manufactured with a broad range of characteristics to meet individual application requirements. For a creative approach to your design problem . . . contact Signalite's Application Engineering Department.



ULTRA HIGH LEAKAGE RESISTANCE. Devices with leakage resistance in excess of 10^{12} ohms are available for circuits requiring this property. Such applications would include sample and hold for A to D conversion, and capacitor memory systems.

**SEE Signalite Application News
for TYPICAL APPLICATIONS**



PHOTO-CELL APPLICATIONS

The A074 and A083 have been designed for use with Cadmium Sulfide or Cadmium Selenide photocells. Applications include photo choppers, modulators, demodulators, low noise switching devices, isolated overload protector circuits, etc. Speed of operation is limited only by the photo-cells.

**SEE Signalite Application News
for TYPICAL APPLICATIONS**

SIGNALITE APPLICATION NEWS



is used to communicate new and proven techniques and applications of Signalite's neon lamps and gas discharge tubes. Signalite Application News provides a forum for an exchange of ideas to keep the design engineer aware of the versatility of neon lamps and their many applications. Copies are available from your Signalite representative or by contacting Signalite.

CIRCLE 510 ON READERS SERVICE CARD



VOLTAGE REGULATORS BETTER THAN 1% ACCURACY These subminiature voltage regulators are used in regulated power supplies, as reference sources, photomultiplier regulators, oscilloscopes calibrators, etc. They are available in voltages from 82 to 143 V. They are used in multiples as regulators in KV ranges.

**See Signalite Application News
for TYPICAL APPLICATIONS.**



NEON TIMERS The bi-stable characteristics and high leakage resistance of Signalite's special glow lamps make them ideal as a component for timing circuits. The basic circuit resembles a relaxation oscillator network.

**SEE Signalite Application News
for TYPICAL APPLICATIONS**

Signalite

INCORPORATED
NEPTUNE, NEW JERSEY 07753
(201) 775-2490



A General Instrument Company

313

Thickness monitor has 0.05% accuracy

Intended for semiconductor work, instrument gauges aluminum thickness over a range of 1 to 200,000 Å

Digital circuits can take many bows for the performance of Granville-Phillips Co.'s new film-thickness monitor. Called the 219 FTM, the monitor basically is a counter that measures a crystal oscillator's period, converts it to a thickness reading, and shows the reading in angstroms on a digital display. Most monitors that use a crystal are analog instruments with analog dis-

plays, says Louis Rice, one of the engineers who designed the 219.

Digital display alone makes the 219 more accurate, Rice points out. Since the monitor measures period, and not frequency, its response is linear over a wide range of film thicknesses.

In use, the 219's crystal oscillator is placed next to the substrate onto which the film is to be deposited.

Thus the same thickness builds up on the crystal as on the substrate. And as the thickness increases, the crystal's frequency drops.

"The mass (hence the thickness) turns out to be a linear function of the period," says Rice. "With other instruments, the mass is a function of one over the frequency squared. So for a very small period of time these monitors will read

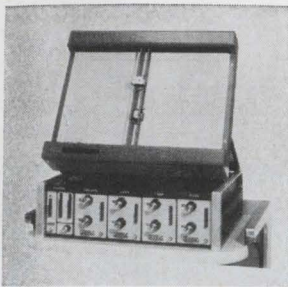

X-Y recorder called Plotamatic 901-2P is a high-speed unit. It features all plug-in electronics, a digital time base with 1% accuracy and sweep speeds from 0.2 sec/in. to 1,000 sec/in. Sensitivity down to 40 $\mu\text{V}/\text{in.}$, d-c common mode rejection in excess of 150 db, and automatic line coding are offered. Bolt Beranek and Newman Inc., McGaw Ave., Santa Ana, Calif. [361]

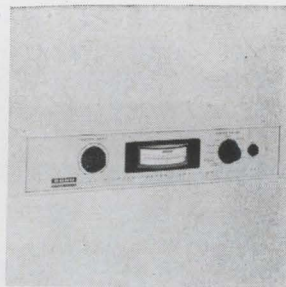

D-c microvoltmeter/amplifier model 207 is a solid state device designed for use in applications such as direct-reading voltage measurement, potentiometric voltage measurement or comparison; and noninverting d-c amplification. Accuracy is to within 3% of end scale. Price is \$825; delivery, from stock. Cohu Electronics Inc., P.O. Box 623, San Diego, Calif. 92112 [362]

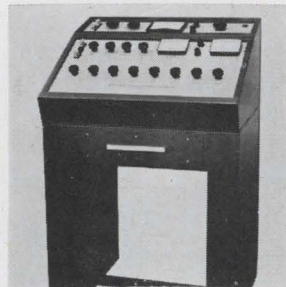

Tinsley inductively coupled double ratio bridge 5650 is for measuring the resistance of platinum resistance thermometers. It can be adjusted to 8 figures with an accuracy of ratio measurement to 1 in 10^7 . Temperature control of the unit is not required, as inductive ratios are not affected by temperature changes. Southfield Electronics, 10 1/2 Mile Rd., Southfield, Mich. [363]

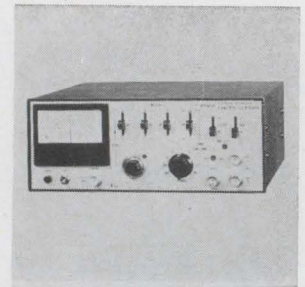

Phase sensitive detector model 822 has a frequency response of 1hz to 1 Mhz. Range is 100 μV resolution to 1 v full scale referred to input. It recovers signals 70 db below noise. Output stability is better than 0.005% of full output /°C. Time constant is 1 msec to 10 sec. Price is \$770. Keithley Instruments Inc., 28775 Aurora Rd., Cleveland, Ohio 44139 [364]

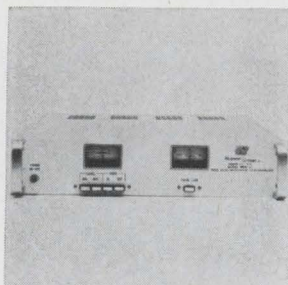

Wideband synchronizer model WBS was developed to meet the demands of precision swept measurements. Its combination of wide phase error correction voltage, and interface capability with all types of microwave oscillators allows measurements which were previously impossible or very costly. Microwave/Systems Inc., 1 Adler Drive, E. Syracuse, N.Y. 13057 [365]

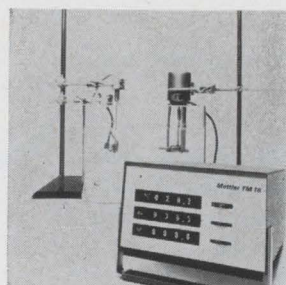

Direct-reading digital thermometer TM16 measures temperatures in the -20° to $+300^\circ\text{C}$ range with 0.05°C reproducibility and digital indication in 0.1°C increments. The temperature of liquids, vapors, and semi-solids such as greases and pastes can all be measured or controlled with the TM16. Price is \$895. Mettler Instrument Corp., Nassau St., Princeton, N.J. 08540 [366]

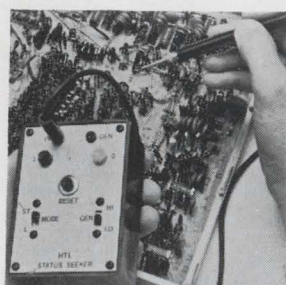

Status Seeker logic test set model ST-15 indicates logic levels and displays pulses as short as 40 nsec in a graphic manner. A latching mode is included to detect and capture noise spikes or a single pulse. The unit can both generate and detect pulses simultaneously. Price is \$95. Delivery is from stock. Dataprobe Inc., 290 Huyler St., South Hackensack, N.J. 07606 [367]

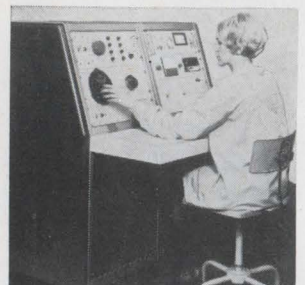

Emi filter insertion loss analyzer is for rapid rate testing to MIL-Std-220A. It reduces the time required to test emi filters for both filter manufacturers' production lines and for final quality control. It is also suited for incoming inspection and component evaluation laboratories. The unit also provides voltage drop for MIL-Std-202. Spectrum Control Inc., Fairview, Pa. [368]

Why National Semiconductor buys Teradyne J259's by the dozen

National Semiconductor can trace its considerable success as an IC manufacturer to many factors. One of the most important is the productivity of its testing facility, built around a lineup of 12 Teradyne J259 computer-operated test systems. "The Teradyne systems," according to Jeff Kalb, National's TTL product manager, "give us the economy of testing that is so important to profitable high-volume production."

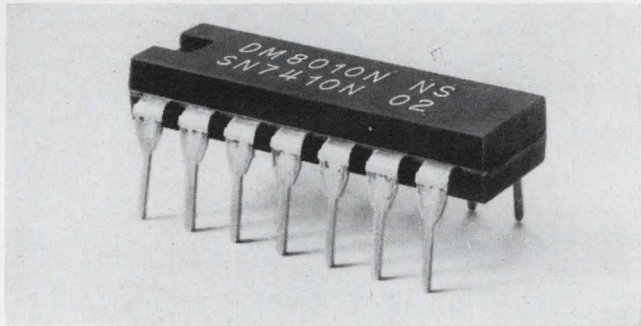

National, along with most other major IC producers, has found that the J259 boosts productivity in many ways. No other test system, for example, gives its user as much multiplexing freedom as does the J259, which lets National leverage its investment by making each J259 support several test stations doing several different jobs.

Reliability is another all-important key to productivity. National experiences minimal downtime with its J259's. This is as it should be; we design and build our equipment to work shift after shift, year after year, in *industrial* use. Teradyne systems are right at home on production lines like National's, where the workload is heavy and continuous. And operation never has to be interrupted for calibration; the J259 has no calibration adjustments.

The J259's great versatility is also put to good use at National. The same systems that test wafers and packages also generate the distribution and end-of-life data that engineers need to control production processes and ensure high device reliability. Production, engineering, QC, and final test – all share simultaneously in the benefits from National's J259's.

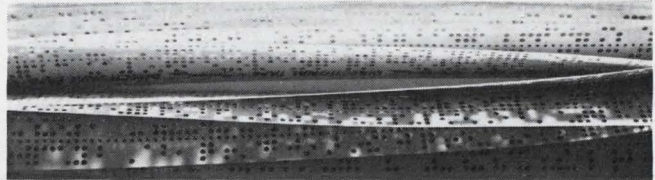

A computer-operated system is only as good as its software, which in the case of the J259 is the best there is. National's J259's are orchestrated by Teradyne-supplied master operating programs for datalogging, classification, and evaluation. As Teradyne updates and improves its software, National is kept fully informed.



National's array of J259's handle the testing of its digital IC's smoothly and economically. For its linear-IC testing, National has turned to Teradyne's J263 computer-operated linear-IC test system.

Teradyne's J259 makes sense to National Semiconductor. If you're in the business of testing circuits – integrated or otherwise – it makes sense to find out more about the J259. Just use reader service card or write to Teradyne, 183 Essex St., Boston, Mass.

Teradyne makes sense.

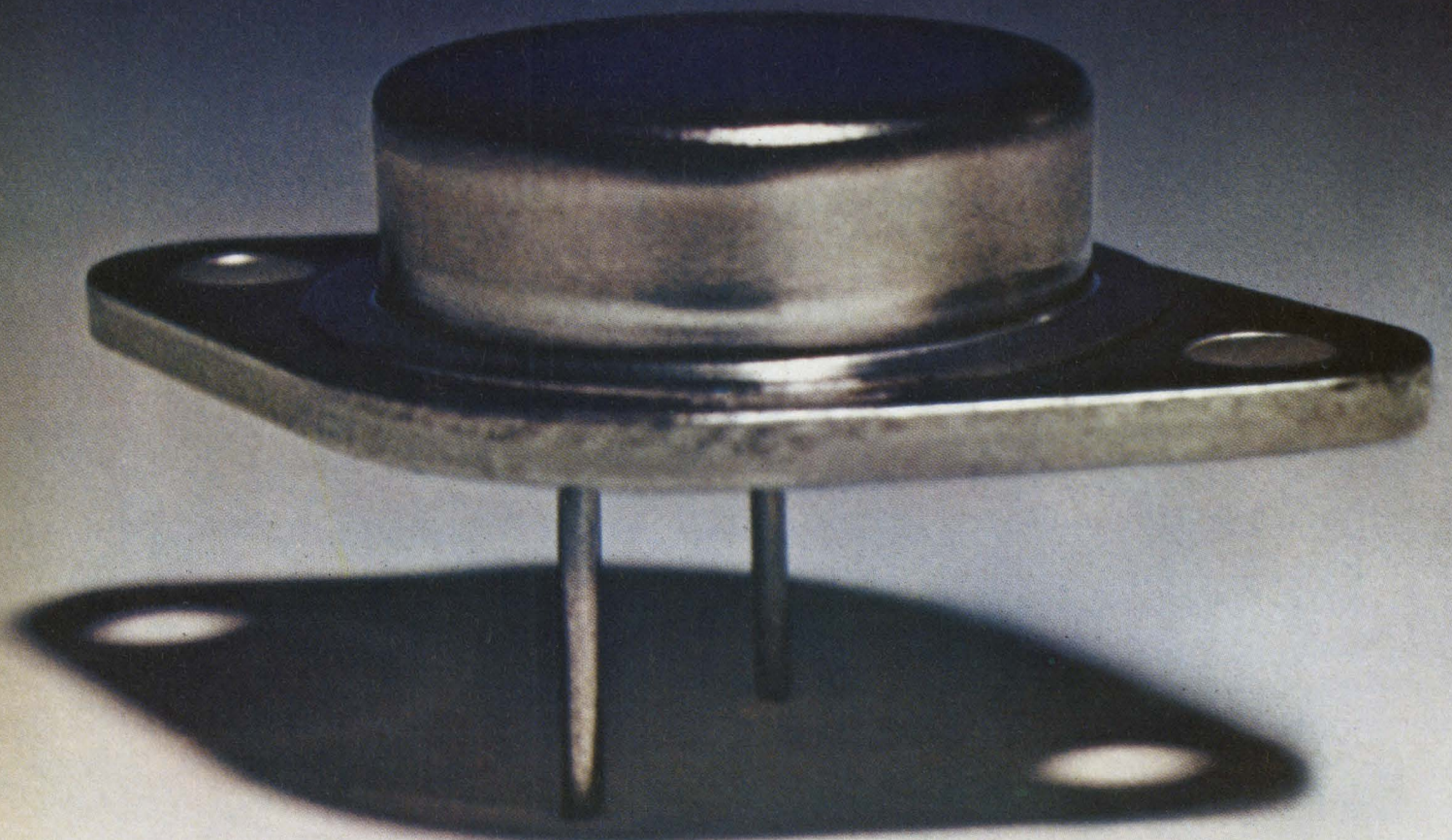

We're available—immediately

**Get up to 10,000 units
of 2N3773 transistors
immediately from
Westinghouse**

What's more, we'll also give you fast service on larger orders. As many as it takes to fill your total requirements.

Our 2N3773, 2, 1, (TO3) is a family of 30-amp diffused transistors for high power switching and amplifying applications. They offer a wide selection of

voltage and gain.

For complete data — and a large ready supply—of any and all these transistors, contact your local Westinghouse Distributor (see adjacent listing) or Westinghouse Semiconductor Division, Youngwood, Pa. 15697.

You can be sure ... if it's Westinghouse



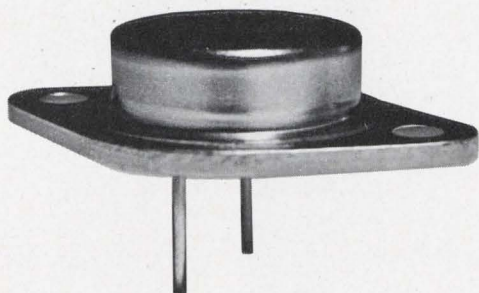

Westinghouse Industrial Semiconductor Distributors

Alabama

ACK Semiconductors, Inc.
Birmingham Phone: 205 322-0588
Electronic Wholesalers, Inc.
Huntsville Phone: 205 534-5722

Arizona

Hamilton Electro of Arizona
Phoenix Phone: 602 272-2601
Kierulff Electronics Corp.
Phoenix Phone: 602 273-7331

California

Newark Electronics
Inglewood Phone: 213 674-8440
Hamilton Electro Sales
Los Angeles Phone: 213 870-7171
K-Tronics
Los Angeles Phone: 213 685-5888
Elmar Electronics, Inc.
Mountain View

Phone: 415 961-3611

Hamilton Electro Sales—North
Mountain View

Phone: 415 961-7000

Hamilton Electro of San Diego
San Diego Phone: 714 279-2421

Colorado

Electronic Parts Co.
Denver Phone: 303 266-3755
Hamilton Denver
Denver Phone: 303 934-5508

Connecticut

Cramer Electronics, Inc.
North Haven Phone: 203 239-5641

Florida

Cramer Electronics, Inc.
Fort Lauderdale
Phone: 305 566-7511

Electronic Wholesalers, Inc.
Orlando Phone: 305 841-1550
Hall-Mark Electronics Corp.
Orlando Phone: 305 855-4020

Georgia

Specialty Distributing
Atlanta Phone: 404-873-2521

Illinois

Semiconductor Specialists, Inc.
Chicago Phone: 312 279-1000
Pace/Avnet Electronics
Schiller Park Phone: 312 678-6310

Indiana

Fort Wayne Electronics Supply, Inc.
Fort Wayne Phone: 210 742-4346
Ra-Dis-Co.
Indianapolis Phone: 317 637-5571
Radio Distributing Co.
South Bend Phone: 210 287-2911

Maryland

Pyttronic Inc.
Baltimore Phone: 301 727-5100
Hamilton Electro Sales
Baltimore Phone: 301 668-4900
Cramer Electronics, Inc.
Rockville Phone: 301 424-2700

Massachusetts

Cramer Electronics, Inc.
Newton Phone: 617 969-7700
Schweber Electronics
Waltham Phone: 617 891-8484

Michigan

Semiconductor Specialists, Inc.
Detroit Phone: 313 255-0300

Minnesota

Semiconductor Specialists, Inc.
Minneapolis Phone: 612 866-3434
Stark Electronic Supply
Minneapolis Phone: 612 332-1325

Missouri

Electronic Components for
Industry Co.
Kansas City Phone: 816 421-8400

Electronic Components for
Industry Co.

St. Louis Phone: 314 647-5505
Hall-Mark Electronics Corp.
St. Louis Phone: 314 521-3800

New Jersey

General Radio Supply Co., Inc.
Camden Phone: 609 964-8560
Angus, Inc.
Moorestown Phone: 609 235-1900
Sterling Electronics, Inc.
Perth Amboy Phone: 201-HI 2-8000

New Mexico

Kierulff Electronics Corp.
Albuquerque Phone: 505 247-1055

New York

Stack Industrial Electronics
Binghamton Phone: 607 723-6326
Summit Distributors
Buffalo Phone: 716 884-3450
Cramer/Eastern
East Syracuse Phone: 315 437-6671
Schweber Electronics
Long Island Phone: 516 334-7474
Milgray Electronics, Inc.
New York Phone: 212 989-1600

Ohio

Sheridan Sales
Cincinnati Phone: 513 761-5432
Sheridan Sales
Cleveland Phone: 216 524-8120
Hughes-Peters, Inc.
Columbus Phone: 614 294-5351
Mentronics, Inc.
Mentor Phone: 216 946-3058

Oklahoma

Hall-Mark Electronics Corp.
Tulsa Phone: 918 835-8458

Pennsylvania

Cameradio Company
Pittsburgh Phone: 412 391-4000

South Carolina

Sawyer Electronics Corp.
Greenville Phone: 803 235-0438

Texas

Hall-Mark Electronics Corp.
Dallas Phone: 214 231-6111
Midland Specialty Co.
El Paso Phone: 912 533-9555
Hall-Mark Electronics Corp.
Houston Phone: 713 781-6100
Lenert Company
Houston Phone: 713 225-1465
The Altair Co.
Richardson Phone: 214 231-5166

Washington

Hamilton Electro Sales of the
Pacific Northwest
Seattle Phone: 206 624-5930
Kierulff Electronics Corp.
Seattle Phone: 206 725-1550

West Virginia

Charleston Electrical Supply
Company
Charleston Phone: 304 346-0321

Wisconsin

Taylor Electric Company
Milwaukee Phone: 414 964-4321

Canada

Canadian Westinghouse
Hamilton, Ontario
Phone: 416 528-8811

European Headquarters

Westinghouse Electric
International, S.A.
London, S.W. 1
Phone: Whitehall 2704

Westinghouse Semiconductor Division
Youngwood, Pennsylvania 15697

an approximately linear output, but ours will read a linear output over quite a wide range."

The 219 has full-scale ranges of 2,000 and 20,000 and 200,000 Å; it resolves 1 Å. Accuracy is 0.05% of full scale or one digit, whichever is higher.

Although normally calibrated to read the thickness of aluminum, the 219 works with any material, such as gold or chromium, with a density between 2 and 20 grams per cubic centimeter. If the 219 is to be used mostly with a material other than aluminum, Granville-Phillips engineers will modify the instrument to read out the thickness of that material.

But even when the 219 is set for aluminum it can be used with other



Limit. When the displayed measurement equals the thickness set on the thumbwheel switches, a relay closes.

substances. "If you're going to take a one-time run," says Rice, "our instruction manual gives you a little formula that'll figure out what the reading will be for the new material, based on the relative densities of that material and aluminum."

Digital commands can remotely adjust any of the 219's controls, making it easy to fit the monitor into an automatic system. One of the monitor's front-panel controls is a set of thumbwheel switches with which the user specifies the film thickness he wants. When the 219 measures that thickness, it closes a relay. This closure can be used to shut off the deposition device or to start some other process.

Granville-Phillips' marketing people expect semiconductor houses to supply the largest market for the 219; but at \$1,355 the instrument is inexpensive enough for laboratory work. Delivery time is two to three months.

Granville-Phillips Co., 5675 East Arapahoe Ave., Boulder, Colo. 80303 [369]

Is your passive component supplier as reliable as his components?

He's fine at meeting industry specifications. Even exceeding them. But what about customer service? Does he sometimes act as if that's a necessary evil? And have you been telling yourself that you have to put up with this kind of an attitude in order to be sure of getting components that are truly reliable?

Then it's time you learned about us. We're one of the leaders in component reliability—and we deliver in every other area as well. You bet we meet deadlines—speed samples—maintain competitive prices—and provide prompt technical assistance. If this kind of extra reliability would be a nice innovation, why not put us to the test. Give us an urgent request for technical assistance. Or an urgent

order. Write AIRCO SPEER ELECTRONIC COMPONENTS, St. Marys, Pennsylvania 15857. Then watch us perform.

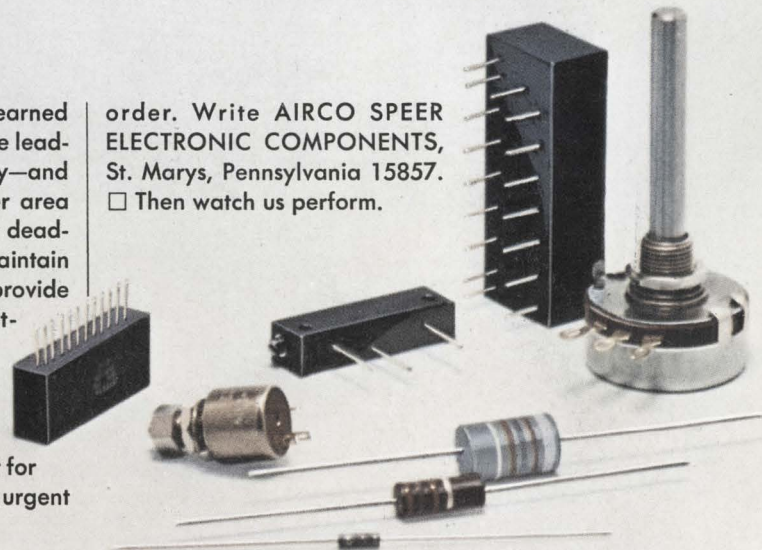

The passive innovators at **AIRCO** Speer

Speer resistors Resistor and conductor paste Jeffers JC precision resistors Jeffers JXP precision resistors and networks Jeffers inductors Jeffers capacitors PEC variable resistors and trimmer potentiometers. Circle 172 on reader service card

Massive core memory is fast, inexpensive

Access time is as low as 2 μ sec, price 1.5 cents per bit for units with capacity of 1 million or 2 million bytes

Speed costs plenty in large core-memory systems, and the marketing race doesn't always go to the swift. When a company comes along with a memory that is both faster and less expensive than its competition, it's a sales manager's dream come true.

That's the position, at least for now, of Data Products Corp. which has entered the fray against Am-

pex, Lockheed, and Fabritek with a core memory that costs about 2 cents per bit in full-core user configurations, and less than 1.5 cents per bit for the stripped versions with minimal control interface.

Model 1720-I has a capacity of 1 million bytes, 3-microsecond cycle time and 1.75 μ sec access time. Model 1720-II has 2 million bytes, a 2- μ sec cycle time, and 1.25- μ sec

access time. In order to keep down the cost of the Model I, 18 bits are internally multiplexed to get a 36-bit output, and this results in a slow speed. A 2-microsecond cycle time will later be offered as an option.

Fabritek and Ampex have large core systems of similar size, with cycle times of 2.75 and 2.7 μ sec respectively. Lockheed's models

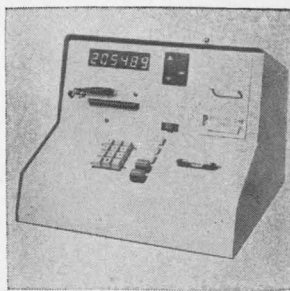

Data collection equipment SDA-770 is an industrial data acquisition system for nonclerical production workers. It is computer controlled with multiple terminals at remote sites for accurate and timely acquisition of data that is converted to machine readable form. Initial deliveries are projected for the summer of 1970. Sierra Research Corp., Bedford St., Burlington, Mass. [381]

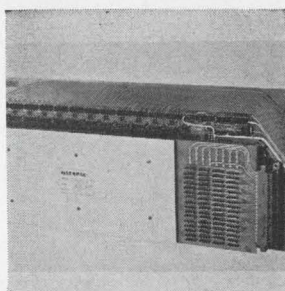

Low-cost memory system Mempac 100 packs 98,000 bits on an 18-in. p-c board. Designed as a read-only memory, it is for use in general computing and data processing systems where high speed and random access storage are required. Access time is 125 nsec. In quantity, price of large capacity units is about 1 cent per bit. Datapac Inc., 3839 S. Main St., Santa Ana, Calif. [382]



High-speed data acquisition system DRS-1168 is designed to meet the precision requirements of automatic and permanent logging of inputs from one or several sources, on smudgeless paper tape. Applications include component test and evaluation, biomedical instrumentation, etc. Price is \$1,995; delivery, 4 weeks. Electronic Micro Systems, 1672 Kaiser Ave., Santa Ana, Calif. [383]

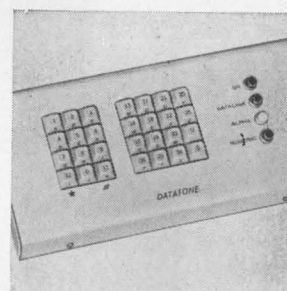

Solid state Datatone KTCT (keyboard tone calling terminal) offers complete alphanumeric capabilities for computer input, punched card and control operations. Supplied with encoders and power supply, the unit is designed for use with a data or acoustic coupler, and is compatible with all types of tone receivers. Trepac Corp. of America, 30 W. Hamilton Ave., Englewood, N.J. [384]

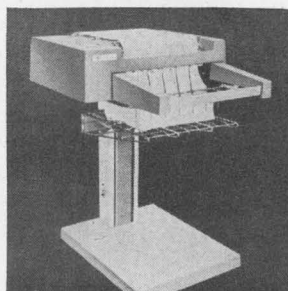

Form stacking unit model 401 handles the paper output of high-speed computer printers. It accepts any continuous fan-fold form at print rates to 2,000 lines a minute and skip rates to 80 inches a second. It takes any form, including 11-lb single-part paper, in widths from 4 to 18 inches. Price is \$1,600. Advanced Terminals Inc., 874 Welsh Road, Maple Glen, Pa. 19002 [385]

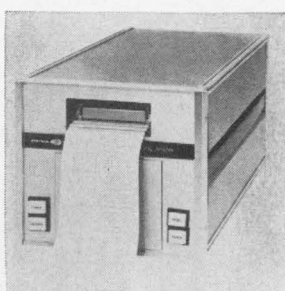

Digital printer model 5103 can be actuated by virtually any type of digital measuring instrument (counter, dvm, multimeter, etc.) regardless of BCD data format. Operation allows an A and B or A or B source control. Each source can be a different BCD input code. Each source can have either negative or positive logic. Systron-Donner Corp., 888 Galindo St., Concord, Calif. [386]

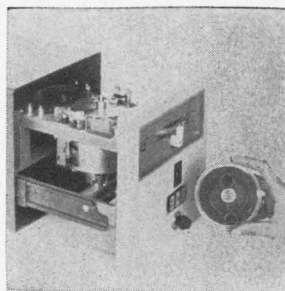

Magnetic tape system CONCEPT is a modular automatic system for electronic data processing peripherals. It employs a self-threading enclosed reel of 1/4-in. tape called the Neopaq. When inserted and locked in place, the tape is in direct contact with the central capstan, the only driven member in the system. Newell Industries Inc., 795 Kifer Rd., Sunnyvale, Calif. 94086 [387]



Disk memory M200C is a head-per-track type mass memory for small computers. It comes in 4 capacities ranging from 426,000 to 3,408,000 bits and average access time is 8.7 msec. Number of data tracks vary from 16 to 128 with 26,624 bits per track. Three timing racks are included, providing a bit clock, sector and origin pulse. Applied Magnetics Corp., Goleta, Calif. [388]

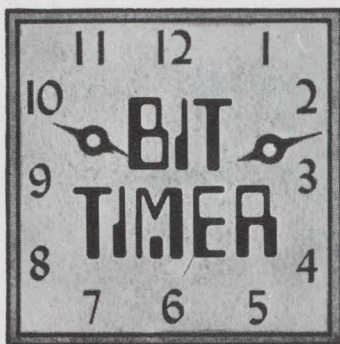

**Bliley
CLOCK
OSCILLATORS
use Bliley
Crystals
to Insure
System
Reliability**

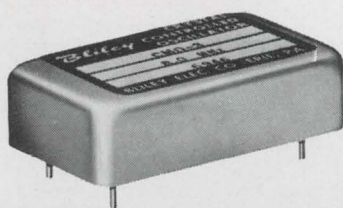

Our New CMO Series offers

- Frequency Range 50 Hz-25 MHz
- Custom Stability per your Specs
- TTL Compatible Output
- Operation on 5 VDC
- PC Board Mounting
- Low Profile Packaging

Call or write us today
with your specification requirements

Bliley if you buy quality

BLILEY ELECTRIC COMPANY

2545 W. Grandview Blvd.
Erie, Pa. 16512

... four large-capacity memories can be connected in parallel to provide 8.3 million bytes ...

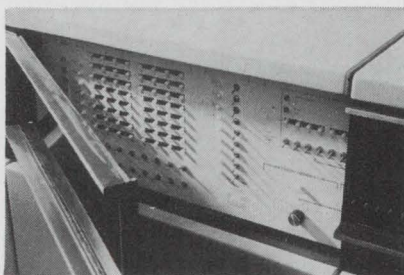

Topside. Control panel sits atop cabinets containing huge memory.

310 and 320 have a 3.2- μ sec cycle time, and IBM's model 2361-I and 2361-II cycle at 8 μ sec.

The Data Products random-access memory is plug- and software-compatible with the IBM 360 series, including the 2361 large core-storage unit. It is directly addressable from the computer program, and functions as an extension of the main CPU memory. As many as four 1720-II memories can be connected in parallel for up to 8.3 million bytes of storage. The smaller 1720-I provides 262K 36-bit words when used with the IBM 360/50, and 131K 72-bit words with the 360/65, 67, and 75. The 1720-II has 524K 36-bit words and 262K 72-bit words. Both are field-adjustable to 72 or 36-bit word sizes.

Storage protection is provided by dividing the memory into 2,048-byte blocks, with a total of 512 blocks in the 1720-I and 1,024 blocks in the 1720-II. Four-bit keys corresponding to each block are stored in an auxiliary storage protect memory, and the correct key must be supplied by the program in order to write new information during a store cycle, or access data during a fetch. This prevents loss of stored information, and allows control of core-storage data access.

Timing is adjustable to permit operation with the IBM 360/50, and the faster 360/65, 67 and 75.

One key to the relatively low bit cost lies in core production methods, says John Guyett, marketing manager for mass storage systems. A "cookie-cutter" technique automatically punches out the 22-mil lithium cores from continuous

strips of material.

"We get a higher volume than with powder press methods, better uniformity in core thickness and better than 95% yields," he says.

"Magnetics are about 80% of manufacturing costs, and we have been very stingy about the stack organization, using very close physical spacing on the cores and stringing to reduce the drive line length," he adds.

A proprietary decode network gives an improved signal-to-noise ratio, and an isolation transformer is used for balanced input to the drive lines, Guyett says. The decode network also permits multiplexing, or overlapping, the addresses for cycle times as fast as 1 μ sec in some OEM applications where sequential data from disk or remote storage memories is used.

Organization is two-wire, 2 $\frac{1}{2}$ D, with switching of the addressed core by half-select currents in the addressed x-line and y-line pair for each bit. Each core stack module has a capacity to 262,144 words of 40 bits, with an array of 4,096 by 2,560 cores 0.020 inch apart along both x and y lines. A full drive current of 850 milliamps is needed for the core, which has a 220 nanosecond switching time.

The stack is physically laid out to permit easy access to all selection diodes without dismantling the system. Cores are bonded to the ground plane with a silicon-based material that is impervious to solvents. This permits cleaning the stack to avoid contamination. The bonding also gives precise physical alignment of the cores, resulting in fewer production-line errors and reducing rework as much as 60%, according to Data Products. In addition, thermal transfer from core to ground plane is improved. Transistor-transistor logic IC's are used for all system logic. For off-line testing of functions, the maintenance panel has storage register, data and mark register, storage protection key register, pattern generator and power supply displays, and related controls.

Data Products Corp., 6219 DeSoto Ave., Woodland Hills, Calif. 91364 [389]

Oh, you'll put it together, all right, and after a while, it'll work, more or less. Then you'll take the prototype to engineering for board design, get it back, attach the components, test it, make a few compromises, try it again. What you have then is an engineering model.

Then the manufacturing design. Back to engineering for debugging. More testing. Parts procurement. Incoming inspection. Telephone calls. Late deliveries. More testing. Heartache. Final release and the module is ready for manufacture. Maybe.

All this time, an already designed, fully debugged, guaranteed, computer-tested, solid state module sits on Digital's shelf. Fifty engineers in offices around the country wait for your call to help. Application notes, installation drawings, catalogs sit in our mail room.

Power supplies, hardware, racks are piled high in the stock room.

M Series modules are the most complete, fully compatible, fast, all IC, TTL, inexpensive solid state logic available anywhere. With a few million modules in our recent history, and a few million dollars worth of test equipment, we really know how to put them out.

Read all about them in the new Logic Handbook. Free.

digital
COMPUTERS · MODULES



Hold it, right there.

DIGITAL EQUIPMENT CORPORATION,
Maynard, Massachusetts 01754. Telephone:
(617) 897-5111 / Cambridge, Mass. / New
Haven / Washington, D.C. / Parsippany, Palisades
Park, N.J. / Princeton, N.J. / Rochester, N.Y. / Long
Island, N.Y. / Philadelphia / Pittsburgh / Cleveland /
Dayton / Huntsville / Cocoa, Fla. / Chicago / Denver /
Ann Arbor / Salt Lake City / Houston / Albuquerque /
Los Angeles / Palo Alto / Seattle. INTERNATIONAL,
Carleton Place and Toronto, Ont. / Montreal,
Quebec / Edmonton, Alberta, Canada / Reading and
Manchester, England / Paris, France / Munich and
Cologne, Germany / Oslo, Norway / Stockholm,
Sweden / Sydney and West Perth, Australia.

Guess what our new TWIN-LEAF[★] connector saves besides space?

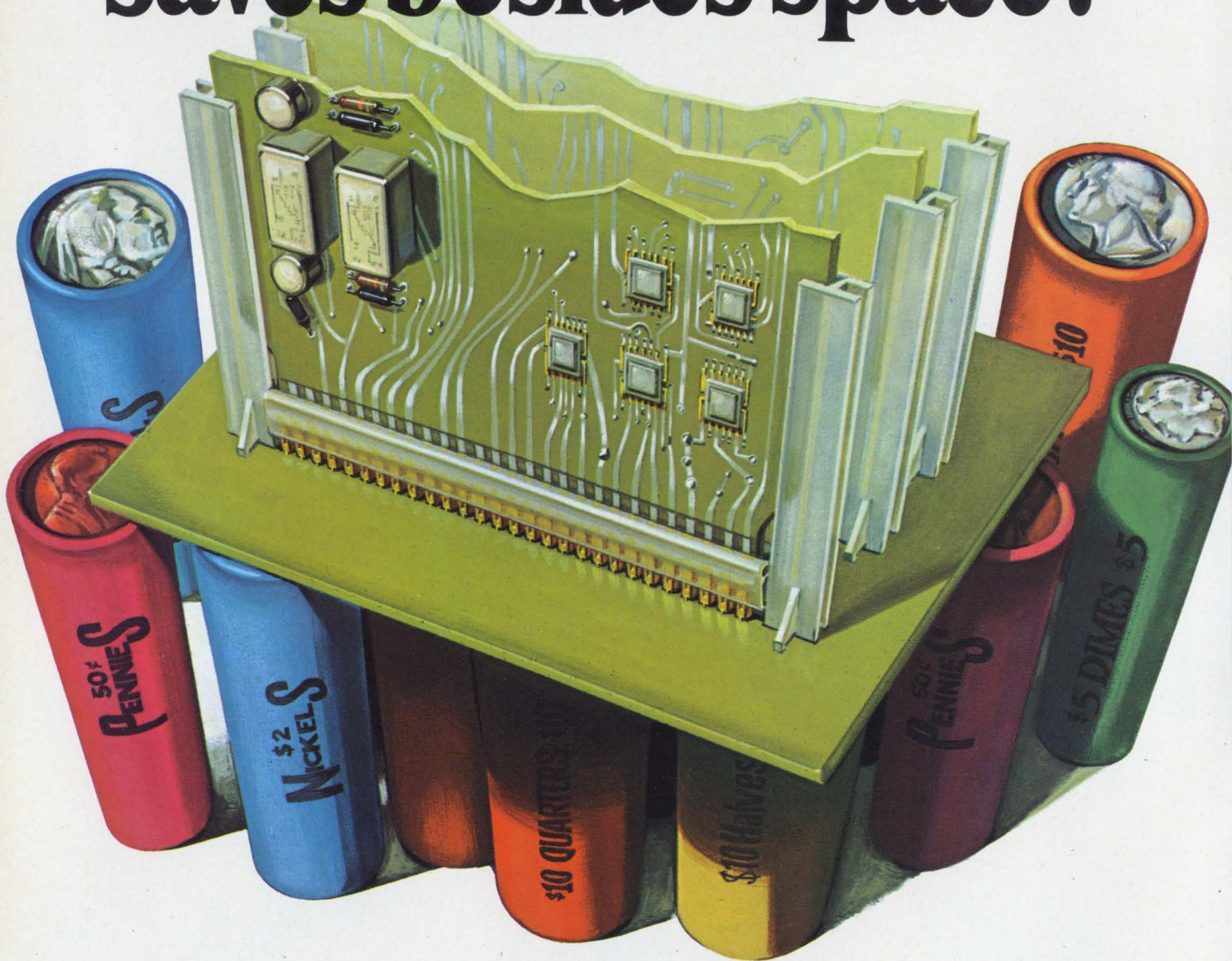

That's right. This new connector takes up very little space. For very little money.

You can choose from four different centerline spacings. Two of them—.100" and .125"—nobody else makes. And the other two—.150" and .156" with *bifurcated* contacts—are the same spacings as anyone else's.

But that's all that's the same. You can get from 6 to 100 contacts (by 2's) per connector. Contacts are phos-

phor bronze with gold over nickel plating on contact area, and bright tin plated solder posts. Our card guides can handle two adjacent cards at the same time. There's also the unique stand-off feature of the connector housing. It exposes the contacts so you can make electrical continuity probes without damaging the contact area.

This pre-loaded TWIN-LEAF[★] connector has proven to be adaptable to every mother-daughter board appli-

cation known. And its future applications wait only for your imagination.

For more information on how you can save money and space on all your mother-daughter board applications write to **Industrial Division, AMP Incorporated, Harrisburg, Pa. 17105.**

AMP
INCORPORATED

Circle 176 on reader service card

Process instruments keep the operator in mind

Using Monsanto design ideas, valve-maker Fisher Controls jumps into the electronics business with a complete control line

Even before the Monsanto Co. merged with the Fisher Governor Co. last August, users and makers of process instrumentation suspected Monsanto engineers in St. Louis were developing a line of electronic controllers. Speculate no longer. The Fisher Controls Co., Fisher Governor's new name, has introduced a full line of electronic process instrumentation based on

the Monsanto design. Available now is a family of instrumentation for the control room—indicator-controllers, indicators, recorders, and annunciators — all mechanically compatible to fit into modular assemblies, and electronically compatible to work with any of the several industry-accepted signal levels.

To beat the high cost of control

room space and to ease the process operator's task of checking a large group of instruments, the designers opted—as have some other instrument companies—for the high-density and deviation-controller concepts. But Fisher has taken the high-density concept a step further. Instead of the customary 2- or 3-inch width for a controller, Fisher's units are only 1 inch wide by

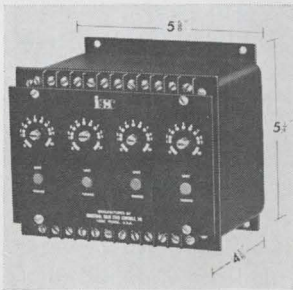

Solid state programmer 1044 is a flexible and compact time based unit suited for industrial applications. Four independently adjustable time periods can be arranged for sequence, parallel and repeating functions. Repeat accuracy is $\pm 1/2\%$ of setting. Time period adjustments are from 0.02 to 500 seconds. Industrial Solid State Controls Inc., 435 W. Philadelphia St., York, Pa. [421]

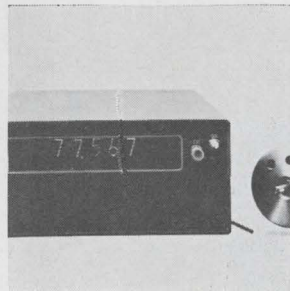

Digital readout system is manufactured for OEM's. The bidirectional counter displays the position of an incremental encoder. The encoder can be used to translate virtually any motion in the measurement of force, displacement, speed, flow, etc. The readout then displays this measurement with Nixie tubes. Data Graphics Corp., P.O. Box 18324, San Antonio, Texas 78218 [422]

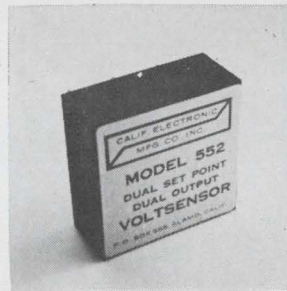

Voltage sensitive, precision relay driver called model 552 Volt-sensor is a bistable voltage comparator with dual set points and dual outputs. It can be used as an alarm or precision controller in petrochemical and steam power installations and is suited for small precision "bang-bang" servos. California Electronic Mfg. Co., P.O. Box 555, Alamo, Calif. 94507 [423]

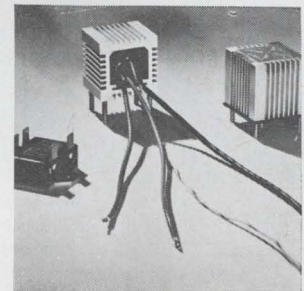

Solid state drivers function as d-c control relays for uses where induction loads and heavy arcing shorten electrical life of electro-mechanical control components. Standard devices, rated at 6, 12, 24 and 36 v d-c to 8 amps, are available in either a phenolic enclosure with aluminum mounting plate or aluminum case. Cutler-Hammer Inc., 4201 N. 27th St., Milwaukee, Wis. [424]

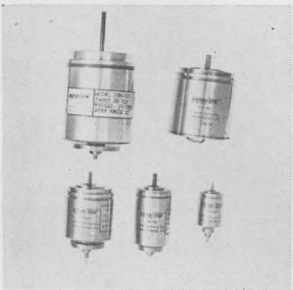

Resonance-Free and jitter-free 15° variable reluctance step motors are announced. Rated at 28 v d-c, the 4-phase motors come in sizes 8, 11, 15, 18, 20 and 32, offer running torques up to 35 oz. in., damping torques to 70 oz. in., and bidirectional speeds up to 1,400 pps. Synchronous slow speeds are up to 2,600 pps. Computer Devices Corp., Santa Fe Springs, Calif. [425]

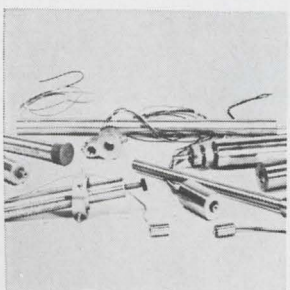

Linear variable differential transformers are for operational use in OEM and industrial applications where a voltage output directly proportional to displacement is required. The line is designed to withstand the adverse industrial environments of dirt, oil, intense heat or cold. Prices range from \$15 to \$190. Columbia Research Laboratories Inc., Woodlyn, Pa. 19094 [426]

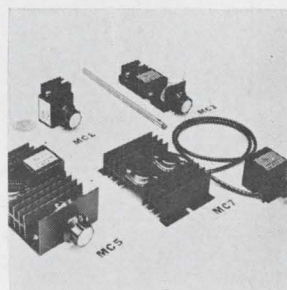

D-c motor controller to 1/2 h-p series MC-1 through MC-8 is for use with permanent magnet or shunt d-c motors. Each control features speed ranges from 0 to 110% of rated speed, elimination of high current inrush per cycle thus increasing brush life, reducing motor heating and avoiding motor clogging. Power Concepts Corp., 20 Broad St., Binghamton, N.Y. 13902. [427]

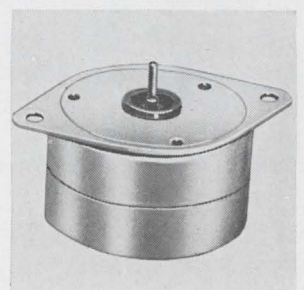

Low-cost 5-v permanent magnet stepper motor and logic drive model ID07 is designed to meet industrial and commercial instrumentation requirements. It has a starting rate of 450 steps/sec and a slow rate of 1,000 steps/sec. It has a step angle of 7 1/2° increments and develops a torque of 0.83 oz.-in. The A.W. Haydon Co., 232 North Elm St., Waterbury, Conn. 06720 [428]

ECCOAMP

ELECTRICALLY CONDUCTIVE ADHESIVES & COATINGS



New four page folder describes materials from 0.0001 to 100 ohm-cm. Adhesive pastes to replace hot solder, thin liquids, silver lacquer in aerosol spray, glossy coatings, etc.

CIRCLE 516 ON READERS SERVICE CARD

CRYSTAL CLEAR EPOXIES, SILICONES, ETC. FOR ELECTRONICS & DISPLAY



ECCOCLEAR designates a broad line of transparent casting resins useful for visual display and inspection of electrical/electronic components. New folder presents 11 systems, including dig-out & repair types, complete with properties selector chart.

CIRCLE 517 ON READERS SERVICE CARD

THERMAL CONDUCTIVE DIELECTRICS



Electrically insulating, thermally conductive . . . for bonding, encapsulating, coating or sealing heat sinks, components or cryogenic devices where rapid heat transfer is desired. New four-page folder describes materials and applications.

CIRCLE 518 ON READERS SERVICE CARD

Emerson & Cuming, Inc.



CANTON, MASS.
GARDENA, CALIF.
NORTHBROOK, ILL.
Sales Offices
in Principal Cities

EMERSON & CUMING EUROPE N.V., Oevel, Belgium

. . . high-density grouping, setpoint design provide quick alert when variables go awry . . .

6 inches high and 18 inches deep. Thus, for example, a dozen instruments can be stacked side-by-side and take up only 12 inches. The product line includes a 12-unit case that's prewired to accept any unit, among them the TL101 three-mode (universal) process controller, the TL102 flow controller, the TL103 level controller, and the TL111 service transfer station for maintaining the customer's control center.

In deviation control, the controller's movable scale is adjusted so that the setpoint, the desired value of the controlled variable, appears at the instrument's center. When the measured variable is at the setpoint value, the moving pointer is at midscale. But when any change occurs, the pointer moves away from its midpoint and the color that

of the controlled variables has gone awry.

Trend recorders also are included in the new line. Permanently wired to 12 inputs, six of them can be recorded simultaneously on a consistent time base. Selection of any recorded input is done through an integral selector switch. This switch contains two extra positions to allow, for example, recording of high and low calibration signals whenever recorder accuracy is to be checked.

The case in which individual instruments are mounted has quick-connect terminals that are color coded and labeled. The junction boxes mounted in the field to accept the process transducer signals use the same coding scheme. And so does the 25-pair cable that connects the field junction box to the control room instruments. This unique field wiring scheme, says Don Munger, sales manager of electronic products, cuts down on installation costs and reduces wiring "goofs" to a minimum.

Fisher will make its instruments at the main plant in Marshalltown, Iowa. It has selected vendors for electronic components and mechanical pieces and is setting up a 13,000-square-foot area to assemble, solder, and calibrate the units. Control computation and amplification for the instruments is done with integrated-circuit operational amplifiers and with discrete transistors.

All are mounted—along with necessary range switches—on a printed-circuit board. The company expects to be in volume production by February. It will market the instruments through Fisher's existing distributors, who up to now have sold control valves. But in December Fisher started training its 120 sales representatives on the new electronics line.

Price? "We'll be competitive, on the low side," says Don Munger. What this probably means is that, while there will be a price list, Fisher may well follow industry custom of negotiating a sale.

Fisher Controls Co., Marshalltown, Iowa 50158 [429]

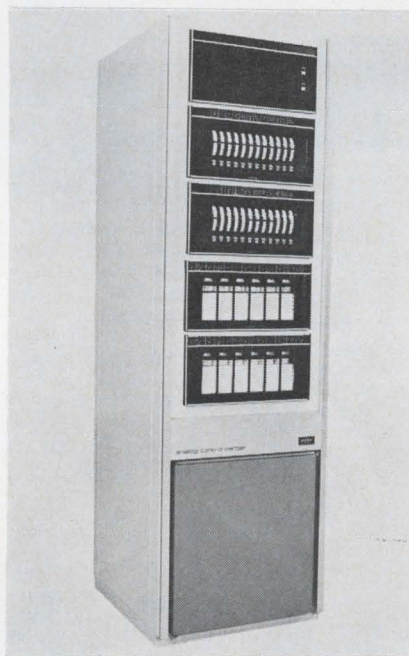

Control center. An annunciator panel is at the top, then two banks of indicators and controllers, and two banks of trend recorders.

is observed by the operator will change, say from green for normal operating conditions to red, indicating trouble.

The combination of high-density grouping and all normal operating values set at mid-scale will tell the operator at a glance if one or more

FOR EXCELLENCE IN ROTARY SWITCHES SPECIFY GRAYHILL

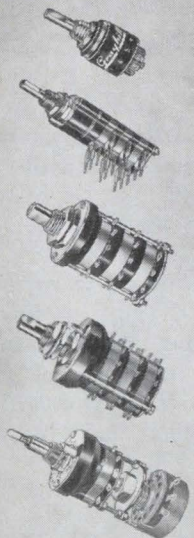

- 15°, 30°, 36°, 45°, 60° or 90° Angle Of Throw
- 2 To 24 Positions Per Pole
- Ratings Up To 15 Amps.
- 1 To 6 Poles Per Deck
- 1 To 12 Decks
- Diameters 1/2" To 2 1/4"
- Shorting Or Non-shorting Contacts
- Explosion Proof
- Military Or Commercial Styles
- Single Or Concentric Shafts
- Solder Lug Or Printed Circuit Terminals
- Switch And Potentiometer Combinations
- Key Lock Option
- Homing Rotor (Bridging And Shorting) Option
- Spring Return Option
- Power or Signal Switching
- Isolated Position (Pull-To-Turn) Option
- Adjustable Stop Option



For your Grayhill Engineering Catalog offering complete technical data—contact

523 Hillgrove Avenue
LaGrange, Illinois 60525
Area Code 312, Phone 354-1040



... the Difference Between Excellent and Adequate

Circle 216 on reader service card

For maximum frequency stability, get Motorola oscillators.



Currently available in production or prototype quantities.

When the maximum in frequency stability is required, choose from Motorola's line of proportional ovenized precision oscillators. All are enclosed in an ovenized housing where the quartz crystal and its oscillator circuit are held to temperature changes of small fractions of a degree.

High Stabilities. To parts in 10⁻¹⁰ vs. environmental factors.

Wide Frequency Range. From 60 KHz to 20 MHz normal. Extended ranges available on special order.

Wide Temperature Range. From -55° C to +125° C.

Low Aging. Less than 5 x 10⁻¹⁰/day.

And if you need a non-standard oscillator, let us know your requirements. We'll design one specifically to meet your needs.

For complete information send for your free copy of Bulletin TIC-3401 today. Write Component Products Dept., Motorola Communications & Electronics Inc., 4501 W. Augusta Blvd., Chicago, Illinois 60651.



MOTOROLA

Circle 217 on reader service card

LSI

The Changing Interface

Medium and large scale integration are slated to have major impact on the electronics industry. The effects are already being felt — not only on systems and component design — but on fundamental, traditional relationships between equipment builders and component suppliers.

Important trends that will affect your profession, your job, your company, are explored in THE CHANGING INTERFACE, a 150-page illustrated volume to be published shortly by McGraw-Hill's Electronics/Management Center.

In THE CHANGING INTERFACE, leading design engineers and managers, the men responsible for guiding their companies through the next generation of electronics, discuss the problems that LSI/MSI are stirring up — and offer their solutions.

Here are some of the vital topics covered.

- Implications of LSI on the Electronics Market
- The Rationale for an In-House IC Capability
- The Component Maker's Responsibility vs. the System Builder's Responsibility
- Masks and Computer-Aided Design at the Interface
- The Testing Interface
- How IBM and Bell Laboratories Deal with the Interface Problem
- Controversies and Future Trends in LSI

You can reserve a copy of THE CHANGING INTERFACE now at the special pre-publication price of \$6.50 by returning the coupon below. If you send a check now, we'll pay the cost of postage and handling.

Electronics/Management Center
330 West 42nd St.
New York, N.Y. 10036

Attn. Mr. Wayne Cowart

Please reserve my copy of THE CHANGING INTERFACE at the prepublication price of \$6.50.

Name _____ Title _____

Company _____

Company Address _____

City _____ State _____

Check enclosed for \$6.50 Bill me
 Bill Company P.O. Number _____

Circle 179 on reader service card

179

Schottky diode has 0.5-volt drop at 50 amps

High efficiency achieved principally through use of chrome electrode; device designed for rectification of power supplies in computers

When you think of using Schottky-barrier rectifier diodes, rectification of microwave devices probably comes immediately to mind. But now Motorola engineers have come up with what they think is a completely new kind of device: a Schottky-barrier diode for rectification of power supplies, particularly those used in computers.

Further, its developers cite the

MBD5500's rating of 50 amperes; previous hot-carrier diodes have been doing well to reach 50 milliamps, they say. Art Mouyard, project manager for hot-carrier devices at the Semiconductor Products Division, believes the unit's efficiency and speed will be its strongest features. He explains that efficiency is best measured in a Schottky device in terms of its forward voltage

drop. At 50 amps, the MBD5500 has a drop of just 500 millivolts, compared with 1.2 volts to 1.4 volts for a standard p-n junction rectifier diode.

As for speed, Mouyard is hard-pressed to assign a value to this device. "Speed seems important to a designer when he hears of a Schottky-barrier diode," Mouyard says, "because speed has been

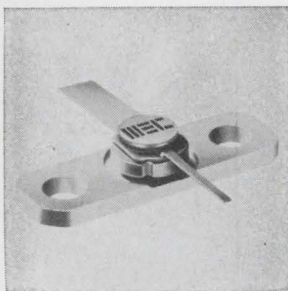

Epitaxial npn small L&S band transistor model MSC2010 can deliver 10 w at 2 Ghz with 5 db power gain at 35% efficiency, 20 w at 1 Ghz with 10 db gain at 60% efficiency and 50 w at 1 Ghz in pulsed operation. Unit is housed in the Stripac package which provides low input Q making it ideal for broadband circuits. Microwave Semiconductor Corp., Somerset, N.J. 08873 [436]

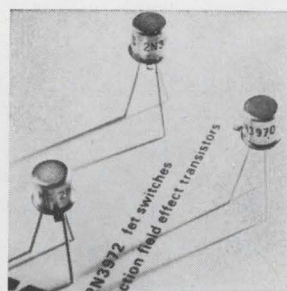

FET choppers series 2N3970, 2N3971 and 2N3972 may be used as switches in digital applications such as in multiplexers, commutators or analog applications like tv equipment or oscilloscopes. Devices offer low leakage of 250 pa, fast switching and low pinch-off voltage. Price (100 up) is from \$2.60 to \$3. National Semiconductor Corp., 2975 San Ysidro Way, Santa Clara, Calif. [437]

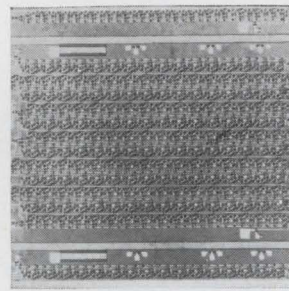

Monolithic triple 66-bit dynamic shift register MC1141 contains 1,191 p-channel enhancement-mode MOS FET's. It is designed to operate from 10 khz to 1 Mhz in the temperature range of 0° to 75° C, and features a power dissipation of 1 mw per bit at 1 Mhz, typical clock input capacitance of 80 pf. Motorola Semiconductor Products Inc., Box 20924, Phoenix [438]

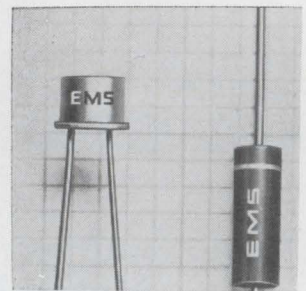

Silicon passivated diode controlled switches serve as direct replacements for four-layer pnpn diodes. The two-terminal devices feature excellent temperature stability in switching voltage, switching current, and holding current, with temperature coefficients in the order of 0.09%/° C in all characteristics. Electronic Micro Systems, 1672 Kaiser Ave., Santa Ana, Calif [439]

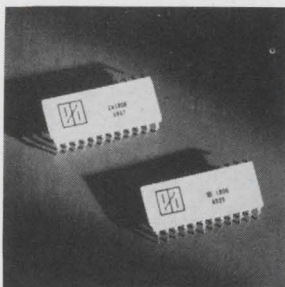

Standard MOS logic arrays are available in two types. The 1806 variable hex gate array has a typical propagation delay of 250 nsec; the 1808 fixed logic array, 150 nsec. Both come in 24 pin metal-ceramic hermetically sealed dual-in-line packages. In 100 lots, the 1806 costs \$16.20 each; the 1808, \$14.10 each. Electronic Arrays Inc., 901 Ellis St., Mtn. View, Calif. [440]

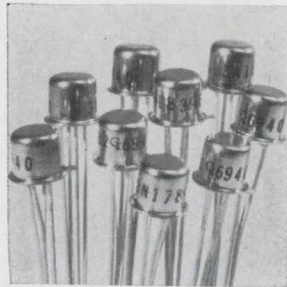

Nine N-and P-channel enhancement mode silicon insulated gate FET's are designed for chopper applications and for low power (3N175, -6 and -7), medium-power (3N181, -2 and -3), and high-voltage (3N178, -9 and -80) switching. Features are square law characteristics and a high ratio of off-to-on resistance. General Instrument Corp., 600 W. John St., Hicksville, N.Y. [441]

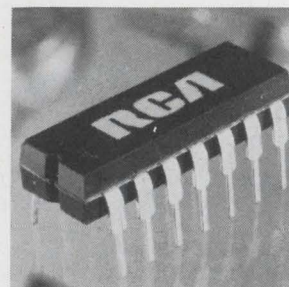

Monolithic IC zero voltage switch CA3059 is for 50 to 400 hz thyristor control applications. It includes threshold detector and trigger circuit that pulses the triac gate at the zero-voltage point for reduction of rfi. The unit, in a 14-lead dual-in-line plastic package (0° to +70° C), costs \$1.95 each in 1,000 lot quantities. RCA/Electronic Components, Harrison, N.J. [442]

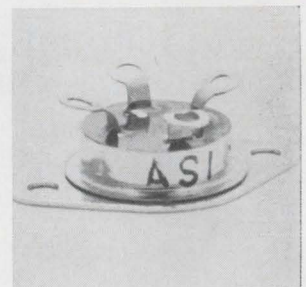

Bridge rectifier can be supplied at a cost less than that required for four similar rectifiers and assemblies. It has a 10-amp continuous rating with a standard JEDEC TO-3 mounting case, the rectifier being isolated from the case. Prv rating is from 50 to 600 v. Higher voltages are available as special orders. Atlantic Semiconductor, 905 Mattison Ave., Asbury Park, N.J. [443]

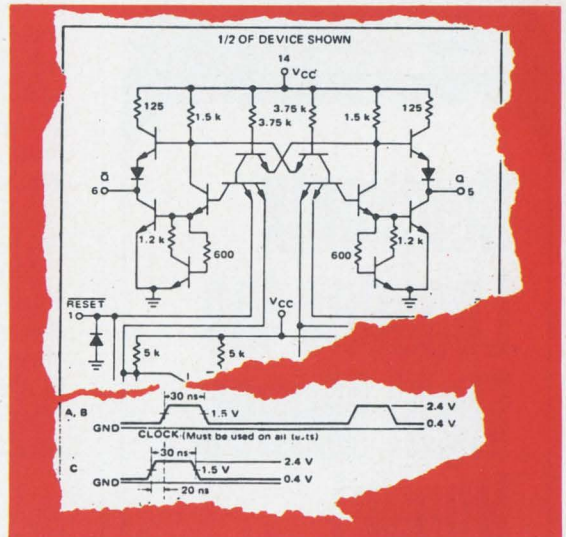
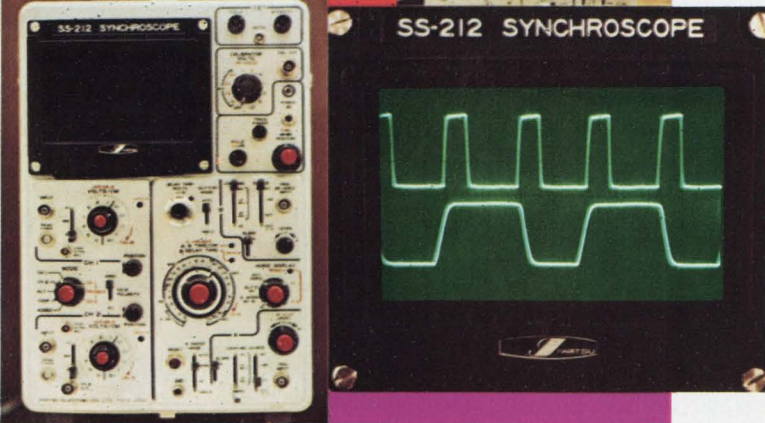
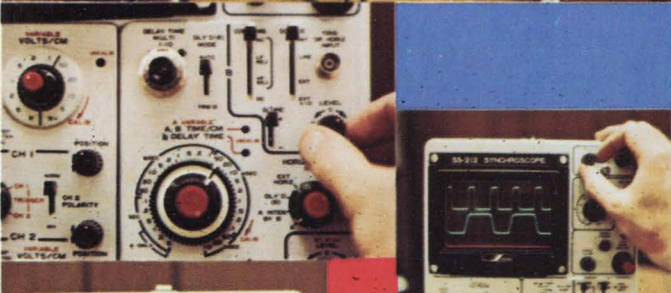
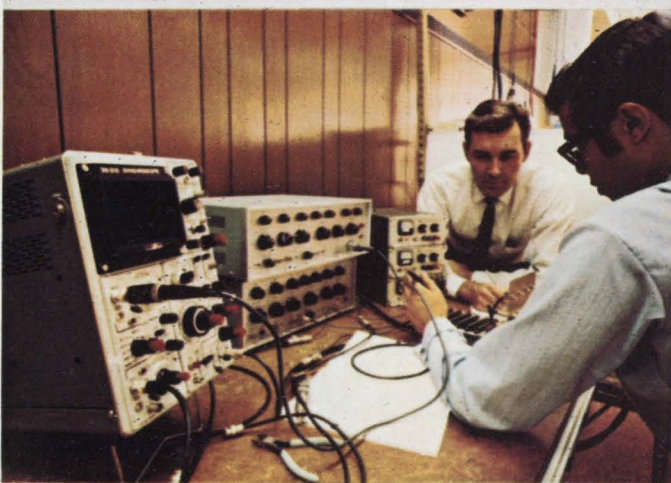

E-H the logical solution

The E-H Research Laboratories, Inc., America's leading designer and manufacturer of pulse generators and other measurement instruments, has teamed up with the Iwatsu Electric Company, Ltd., Japan's foremost manufacturer of oscilloscopes. Together they make an ideal team to solve any of your logic problems.

For example, the **E-H 137 pulser** is an ideal stimulus source offering a source impedance of 50 ohms, fast, ultra-clean, adjustable leading and trailing edge ramps, all the output levels you need for TTL and ECL logic and 100 MHz pulse repetition frequency.

Team this up with the **Iwatsu 212 oscilloscope** and you've got a team that'll perform to your utmost satisfaction for years to come. The Iwatsu 212 is the ideal wide-band scope featuring bandwidth in excess of 200 MHz, with sweep speeds and writing rate to match. One MΩ input impedance matches directly with the impedance level of circuitry under test. This is the only 200 MHz bandwidth oscilloscope featuring 1ns/cm and delayed sweep in one instrument. Big, bright 6x10 cm display is another feature.

These are only two instruments from a broad line of E-H and Iwatsu instrumentation exclusively available from E-H. So whatever your logic problems are, contact an E-H representative today for the most logical solution.



E-H RESEARCH LABORATORIES, INC.

515 Eleventh Street • Box 1289, Oakland, California 94604 • Phone: (415) 834-3030 • TWX 910-366-7258
 In Europe: E-H Research Laboratories (Ned) N.V., Box 1018, Eindhoven, The Netherlands, Telex 51116
 In Japan: Iwatsu Electric Company, Ltd., 7-41, 1-Chome Kugayama Suginami-Ku, Tokyo 167, Japan

Rentronix Loosens the Tight Money Noose!

Rentronix reduces the tight money squeeze considerably by providing you name-brand electronic instrumentation and small computers on a short-term rental basis.

Rented instrumentation means specific equipment costs can be charged to the individual project. Rentronix has the right equipment for any project!



FREE

48-page catalog covering hundreds of electronic instruments and small computers available for short-term rental.

Rentronix

A Division of Inmark, Inc.
11501 Huff Court
Kensington, Maryland 20795

pushed in microwave applications. But this device is fast, too. It will be even faster than a fast-recovery rectifier diode." Mouyard adds that to test speed, Motorola reached the limit of the best test equipment available, and the device showed no change in rectification efficiency out to 500 kilohertz.

Motorola achieves the low forward voltage drop chiefly through the use of chrome metalization; the chrome allows a lower drop than molybdenum or other metals. "We've used this metal system for seven years or so in zener diodes,"

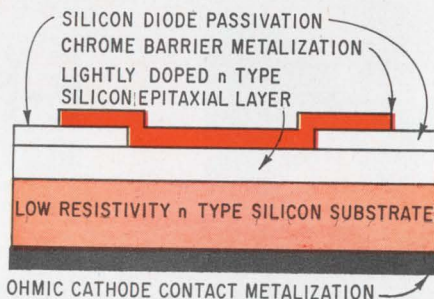

Efficient. Chrome electrode is key to low forward-voltage drop.

Mouyard points out, "and we know how to etch it. In essence, it gives us the best forward voltage drop with the greatest productibility."

Gold is evaporated atop the chrome, which also is evaporated onto the wafer rather than being diffused. The gold provides a good ohmic layer for soldering. The silicon dioxide, chrome, and gold are laid down in that order atop a low-resistivity epitaxial layer that enhances the unit's turn-on voltage in comparison to standard rectifier diodes. Mouyard says the latter devices don't turn on until the level is about 0.6 volt because they're high-resistivity devices; the MBD-5500 turns on at 200 mv.

The hot-carrier diode dissipates about 25 watts in the forward direction vs. 60 watts for a standard rectifier diode. But Mouyard cites some tradeoffs. The MBD5500's peak operating voltage is about 20 volts; leakage at that level is 200 milliamps. In comparison, a standard p-n rectifier diode shows just one microamp of leakage at 400 volts. This tradeoff was made to get the low forward-voltage drop.

But the 20-volt rating still is well-suited to rectification of computer

and mobile power supplies where size is a consideration, Mouyard says. Because of the unit's low dissipation, he foresees uses in aircraft power-supply rectification. The lower dissipation means less heat-sinking is required, keeping size and weight down. It fits into a pressfit DO-21 package, which Mouyard describes as a rugged, hermetically sealed, gold-plated copper package.

Power loss in the reverse direction has to be considered in a hot-carrier diode, but even with a greater reverse dissipation, the MBD5500 is better than a standard p-n rectifier diode for total dissipation. With the 200 ma leakage at 20 volts, the power loss in the reverse direction is 4 watts. "That's worst case," Mouyard stresses. "It might be more like 1 watt, but this has to be added to the forward loss of 25 watts. So you have a total of about 30 watts dissipation, which is still only half that of the standard p-n device, even with its negligible power loss in the reverse direction."

The MBD5500 is priced at \$8.50 in quantities of 100-999; from 1,000 to 5,000, the price drops to \$7.65.

Motorola Semiconductor Products Inc., Box 20912, Phoenix, Ariz., 85036 [444]

New semiconductors

Thyristor controls 2,000 volts

Device features high
surge current and dv/dt ,
300-milliamp firing current

Low component count is as much an advantage in power equipment as it is in computer circuitry: the fewer the number of components, the greater the reliability and the smaller the assembly costs, regardless of application. So Westinghouse's 2,000-volt thyristor should be welcome news to power-system designers; its high voltage rating makes it possible to reduce—by as much as 50% in some cases—the number of series thyristors in mo-

tor controls, starters, and directly controlled power systems.

According to the manufacturer, the device is the first available domestically with such a high voltage rating. D.P. DelFrate, marketing manager for the Semiconductor division, claims that, although higher voltage ratings are specified by non-U.S. manufacturers, other important parameters are compromised. The Westinghouse device, however, can withstand surge current of 6,000 amperes and a voltage increase (dv/dt) of 300 volts per microsecond. In addition, the thyristor requires a gate current of no more than 300 milliamperes to fire, and the half-wave average current is 300 amps.

The thyristor is made by diffusion techniques, rather than by alloying. The silicon chip is mounted in the package by the manufacturer's spring-loaded compression bonding technique, which helps to assure uniform post-encapsulation characteristics and eliminates failure by thermal fatigue.

There are two package versions: 286-Y30 contains an integral heat sink, 270-Y30 is a stud-mount design. For either package, delivery is in two to three weeks. Price, in quantities of 10 to 99, is \$320 for the integral-heat-sink package and \$300 for the stud-mounted unit.

Westinghouse Semiconductor Division,
Youngwood, Pa. [445]

New semiconductors

IC op amp has FET input stage

Unit for industrial market
is one of 8 linear circuits
introduced by Fairchild

At high temperatures, junction field effect transistors don't do very well. But in the industrial temperature range, they have a high input impedance and in other ways perform better than bipolar devices. And this is the market—industrial process control and instrumentation—that Fairchild Semiconductor has

in mind for its $\mu A740$ operational amplifier, one of eight devices that the company says have been requested by customers since it launched its family of linear integrated circuits. [*Electronics*, July 21, 1969, p. 144].

Besides op amps, the new IC's include intermediate-frequency amplifiers, modulators-demodulators, and analog multipliers.

"With the $\mu A740$ we've made things easier for industrial customers who formerly used a 709 op amp with a pair of external FET's for the input," says Mike Markkula, Fairchild marketing manager for linear IC's. The 740 has a junction-FET input stage.

All specifications for the 740 equal or exceed those of the 741—the input current is down in the picoamp range, and input impedance is about 10-12 ohms.

Two of the new circuits are for communications, and they make Fairchild a second source for the Motorola MC1495 4-quadrant analog multiplier and the 1496 modulator-demodulator. The 795 analog multiplier will sell for \$12 and is intended for displays and "anywhere you have to multiply two analog signals," says Markkula. The 796 modulator-demodulator for a-m systems costs \$4.95.

Another new device is the $\mu A757$ i-f amplifier. Jerry Zis, senior marketing engineer, says its most important characteristic is that its input and output impedance remain constant with changing automatic-gain-control voltage. This is due, he says, to the unusual circuit that is used as the load for the agc signal. "We use a transistor emitter-base junction as a resistive diode load. The agc signal controls a current source which varies this resistance," says Zis, "and the over-all effect is that the input and output tank circuits don't detune."

Because too much gain in one block could make the circuit unstable, the 757 has two gain sections and the agc can be applied to each or both. The over-all gain is 75 decibels, and the agc range is 70 db. The 757's price, \$4.85, and its 50 db intermodulation distortion make it suitable for use in stereo f-m receivers.

Fairchild Semiconductor Division, 464
Ellis St., Mountain View, Calif. 94040
[351]

New printer beats interface problems.

\$995



This newly-designed printer provides sophisticated performance at an unusually low price.

Model 5103 accepts 4-line BCD codes and prints up to 21 columns as fast as three lines per second. Options include built-in clock for time print-out, and selectable input code: 8-4-2-1 or 4-2-2-1 or 2-4-2-1.

The printer will accept data from two sources, printing each on the same or separate lines. Reliability is enhanced by permanently lubricated ball bearings and a continuously rotating print drum that eliminates the wear caused by start-stop mechanisms.

Print-out may be on pressure-sensitive paper or in ink with remote selection of black or red characters.

Price is \$995 for basic 5-digit printer, and the design facilitates later expansion in the field.

Digital clocks.

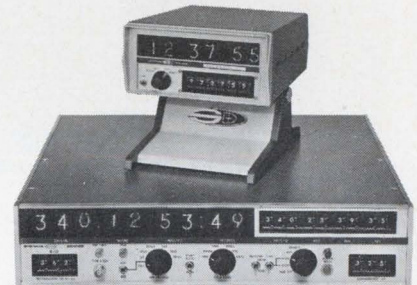

Full line of digital clocks ranges from a compact \$675 model to sophisticated calendar-clocks with stability of 5 parts in 10^9 per day and provision for synchronization with WWV and WWVH.

All clocks use proven integrated circuits and all-silicon solid-state components in order to maximize reliability. All are designed to be integrated into systems with remote control. Time data is available on parallel BCD outputs, and output time pulses occur at intervals ranging from 0.1 second to 1 hour.

A unique warning device prevents erroneous readings after power interruptions.

Send for literature.

SYSTRON  DONNER

Data Products Division,
Systron-Donner Corporation,
888 Galindo Street,
Concord, California 94520.
Phone (415) 682-6161.

The Standard of Excellence

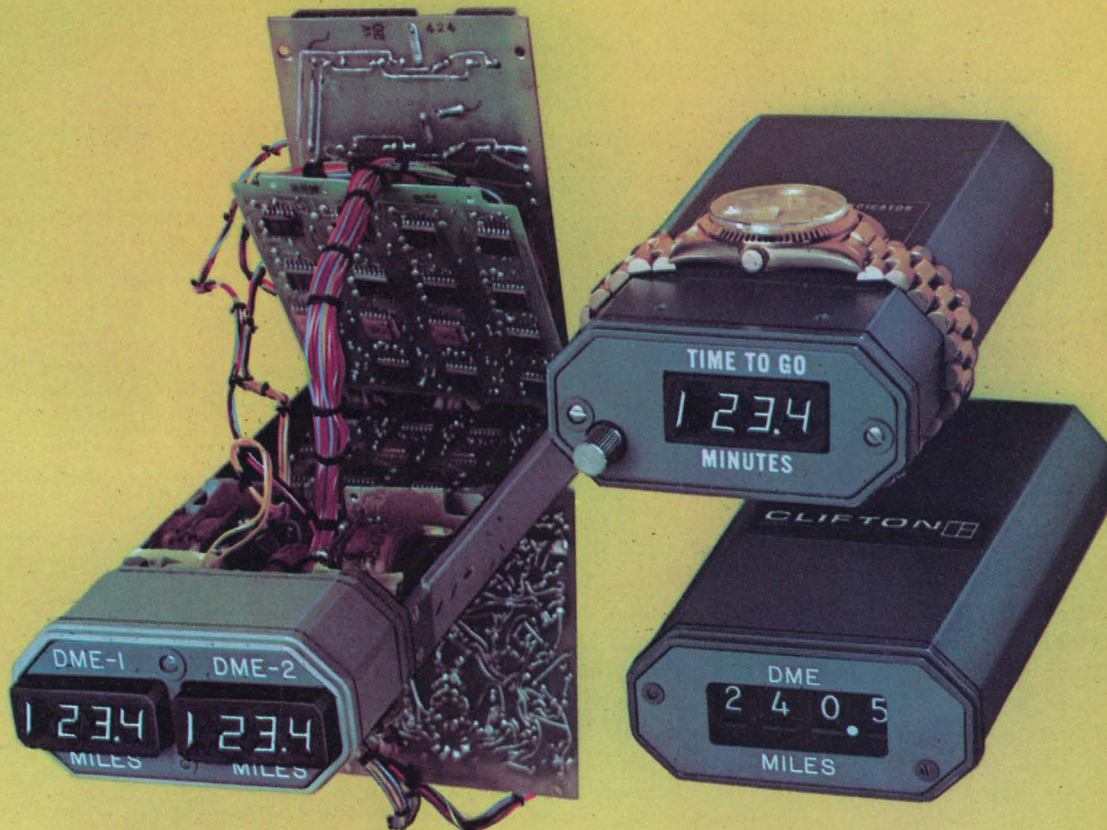

Digital Indicators by Clifton

In the Clifton family of ARINC type, solid state, Time-To-Go, INS and DME indicators, we are proud to have anticipated and produced advanced cockpit hardware for the new generation of commercial transports.

Important design advances in the areas of fault monitoring and detect circuitry plus central dimming capabilities are incorporated into the basic design.

In operation, each indicator recognizes the address of a specific function pa-

rameter, decodes the serial BCD data, and provides a digital display of the information. Each basic indicator in the family has the capability of being converted to any other indicator format by simply changing a lightplate and programmable connector. Seven segment lamp or magnetic wheel readouts are available for most designs.

Two basic display families, a 4 Digit and Dual 4 Digit configuration, are included in the INS and DME indicator product line. Sim-

ilar indicators are available for AIR DATA applications. A variety of indicator readout configurations meet all INS, DME or AIR DATA indicator requirements.

You can obtain full information on this advanced line of indicators which is available and now flying by calling your Local Clifton Sales Office or area 215 622-1000; TWX 510 669-8217.

CLIFTON 
DIVISION OF LITTON INDUSTRIES

Chronometer and Band from J. E. Caldwell Co., Philadelphia—\$1200.

specifications like cycle time don't mean much in the Unibus format. DEC claims, however, that in benchmark tests against other machines, the PDP-11 is faster on the average. "Some competing machines do some operations faster," says a spokesman, "but when all task times are added and averaged out, we come out ahead."

For engineers who want numbers, the PDP-11's standard 4K memory module (the MM11-E) cycles in 1.2 μ sec and has a 500-nanosecond access time. The MR 11-A read-only memory module also has a 500-nsec access time, and with it comes the MW11-A, a 128-word, 2- μ sec-cycling read-write memory.

Direct-memory access can occur at the full speed possible with the main core memory since the Unibus scheme makes multiplexing unnecessary; the rate is 833,000 words per second. Maximum latency time is 3.5 μ sec for highest-priority bus users.

The amount of time saved by direct-memory access, and by direct data transfer between parts of the PDP-11 system without involving the general registers, is not specified, and probably varies with the individual system and application. But it exists, and may be the factor that allows the PDP-11 to come out ahead in DEC's benchmark tests.

The PDP-11 initially is going to be available in two models; the PDP-11/20, which uses the 4K core memory and comes equipped with an ASR-33 teletypewriter, at \$10,800, and the PDP-11/10 "dedicated controller," equipped with read-only memory and a small amount of read-write core. The 11/10 substitutes a turnkey console for the full operator's console of the 11/20. Its \$7,700 price doesn't include a teletypewriter.

Knowles says both machines already are back-ordered. Initial deliveries of 11/20's to customers already on the books should be in the second quarter of 1970 with mass deliveries early in the third quarter. The PDP-11/10 should be ready for deliveries late in 1970.

Digital Equipment Corp., 146 Main St., Maynard, Mass. 01754 [338]

\$1495.
\$1495?
\$1495!



We kid you not. That's our price . . . unbelievably low—without a micron loss of quality or efficiency. Our philosophy's simple: no over-engineering, no idle parts sitting—and costing—till user requirements catch up. No wonder our display terminals lead the entire field in price-performance. For further details, write for our free brochure or call collect.



Infoton

Infoton Incorporated, Second Ave., Burlington, Mass. 01803 (617) 272-6660
Incorporating Information Research Associates, Inc.

Circle 185 on reader service card

XENON corporation DC XENON & KRYPTON ARC LAMPS

39 commercial street • medford, massachusetts/02155 • (617) 395-7634

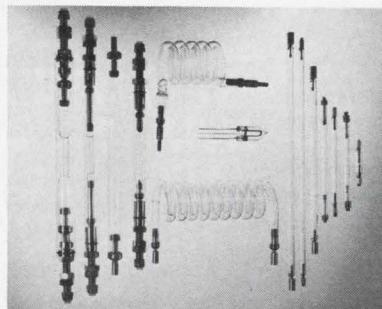

FLASHTUBES & ARC LAMPS

TYPICAL DESIGNS:

- Linear
- "U" Shaped
- Air Cooled
- Helical
- Water Cooled
- Annular

TYPICAL APPLICATIONS:

- Strobe Photography
- Copying Machines
- Computer Printing
- Pulsed "UV" Bleaching, Fusing & Curing
- Laser Pumping
- Beacon Lights
- Photo Chemistry

AVAILABLE IN SOLDER SEAL OR GRADED SEAL PACKAGE

- **FREE FLASHTUBE CATALOG ON REQUEST •**

Specialists in the Generation of Light

STABILITY & QUALITY

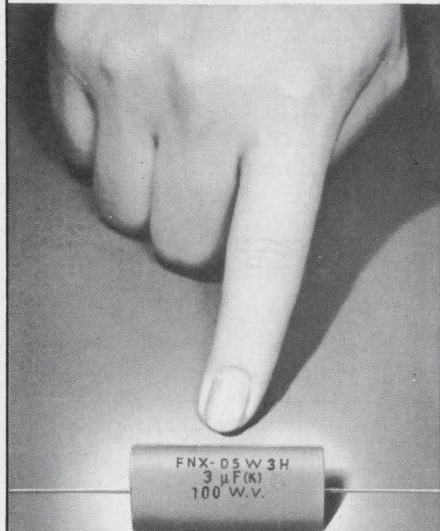

MATSUO

METALLIZED POLYESTER FILM CAPACITOR -"TYPE FNX-H"-

Sub-miniature size and oval section ideal for space economy. Lightweight, self-healing and with high insulation resistance. Capacitance values up to 10 MFD. Outer wrap of tough polyester protects against moisture. Perfect in both transistorized and low voltage tube circuits and others where size and cost are paramount.

Specifications:

- Operating Temperature Range: -40°C to +85°C
- Standard Voltage Rating: 100, 200, 400, 600VDC
- Standard Capacitance Value: .1 MFD to 10 MFD.
- Standard Capacitance Tolerance: ±20% (available ±10%)

MATSUO'S other capacitors include:

Solid Tantalum Capacitors: MICROCAP

for hybrid ICs, Type TAX hermetically sealed in metallic case, Type TSX encased in metallic case and sealed with epoxy resin, Type TSL encased in metallic case and sealed with epoxy resin

Polyester Film Capacitors: Type MFL epoxy dipped, Type MFK epoxy dipped, non inductive, Type MXT encased in plastic tube, non inductive.

For further information, please write to:

MATSUO ELECTRIC CO., LTD.

Head Office: 3-5, 3-chome, Sennari-cho, Toyonaka-shi, Osaka, Japan
 Cable: "NCCMATSUO" OSAKA Telex: 523-4164 OSA
 Tokyo Office: 7, 3-chome, Nishi-Gotanda, Shinagawa-ku, Tokyo

New materials

Low-weight fabric acts as absorber

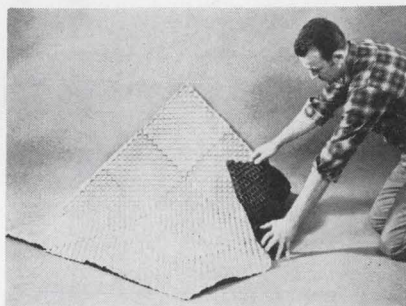

Eccosorb FBC is a low-weight, surface-resistive fabric that has been formed into an array of pyramids, thus creating a drapable microwave absorber. The fabric construction permits sewing together large blankets for easy handling when used to cover sensitive electronic gear, antennas, radomes, etc. First member of the new series of absorbers is useful above 2.4 Ghz, weighs 0.1 lb/sq ft. in quantity. The material is in the \$10-per-sq-ft. price range. Emerson & Cuming Inc., Canton, Mass. 02021 [491]

Solder creams are now available in curable and noncurable formulations in a large selection of standard and special alloy compositions, viscosities, and powder mesh sizes, with rosin and acid flux bases in all degrees of flux activation. Typical uses include the attaching of feedthroughs and dividers; bonding of IC's to p-c boards; mounting of discrete components to hybrid substrates; selective tinning of component pads; and for making contacts to the metallized area of passivated silicon device chips. Alpha Metals Inc., 56 Water St., Jersey City, N.J. 07304 [492]

Silver-coated ceramic powder Silclad G-100 may be substituted for pure silver in conductive gaskets, coatings, plastics, etc. Typical resistance is 0.008 ohm at room temperature and less than 0.040 ohm after 1,000 hours at 500°F. Particle size of Silclad G-100 is less than 44 microns and its density is 1/3 that of pure silver. Cost is approximately 25% that of pure silver. Sigma-tronics, Box 105, Moorestown, N.J. 08057 [493]

Easy-to-use nonflammable cleaner and lubricant for electrical switches and contacts is available in aerosol form. Sprayed on electrical contact points, it forms a long-lasting, protective film that cleans, lubricates, and extends the life of electromechanical components, reducing maintenance time and expense. The thin film formed has low dielectric properties. Crown Industrial Products Co., Hebron, Ill. 60034 [494]



**NORTON®
MAGNETIC
HEADS**

**MULTITRACK
ERASE
RECORD
PLAY**

Send now for complete technical literature.

NORTON

ASSOCIATES, INC.

10 Di Tomas Court, Copiague, N.Y. 11726
 Phone: 516 598-1600

Circle 218 on reader service card

GRC® Intermold®



**die cast
ZINC ALLOY**

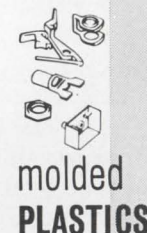

**molded
PLASTICS**

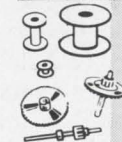

Coil Bobbins
Gears & Pinions

**Samples Show How
NEW MOLDING PROCESS
JOINS 2 DIFFERENT
PLASTICS IN A
SINGLE SMALL PART**

- Combine different colors, physical, chemical properties of different plastics in a single tiny component.
- Movable-element parts, separable parts, two-color parts, numbered and lettered parts, combination-of-materials parts.
- Saves assembly costs, enhances appearance, performance of your product.

Write today for "inter-mold" samples and detailed bulletin.



GRIES REPRODUCER CO.

Division of Coats & Clark Inc.

World's Foremost Producer of Small Die Castings
 151 Beechwood Ave., New Rochelle, N.Y. • (914) 633-8600
 Plants in: New Rochelle, N.Y.; Warren, R.I.; Toccoa, Ga.

Circle 219 on reader service card

New Books

On the beam

Quantum Electronics, Vols. 1 & 2
V.M. Fain and Ya. I Khanin
MIT Press, Vol. 1: 314 pp., \$16.50.
Vol. 2: 312 pp., \$16.50

Since the birth of quantum electronics as an independent engineering field about 10 years ago, few authors have been able to combine a clear treatment of the theory with a compendium of applications useful for laser design. Too often the theory bogs down in detail irrelevant to applications, while the applications themselves are too brief to be generally useful.

This has been avoided in this two-volume edition. The first volume comprises the theory and the second, applications. Both complement each other; taken together they offer an unusually complete and readable treatment. The authors, both Soviet physicists writing with the laser designer in mind, expand the theory only when its bearing on applications warrants the detail, and keep all applications relevant to current systems. Moving from the paramagnetic maser amplifier as an example of the earliest realized simulated emission, the authors discuss microwave molecular oscillators, including the molecular beam oscillator, and wind up with crystal, solid state, and gas laser systems.

Particularly good is the chapter on lasers, which comprises almost half of the second volume. Starting with the methods of obtaining population inversion by optical excitation, the chapter moves into the important area of pumping, with a discussion of the pulsed xenon lamp system. In this section, as well as throughout the book, the authors include helpful design information that balances the more theoretical material. For example, the pumping section includes a design for a laser with a spiral lamp circumscribing the crystal mounted in the axis of the spiral. This is a common arrangement for most pulsed-lamp designs which allows most of the illumination to the crystal to be emitted from the surface of the lamp facing the axis. The authors note that this method

provides a more uniform excitation of a crystal than a straight lamp employing reflectors to concentrate the pumping energy on the crystal. There is also a discussion of the inherent remaining non-uniformity due to the focusing properties of the crystal itself, an important pumping consideration often omitted from general discussions.

The section on solid-state lasers begins with the familiar ruby laser and the conditions for lasing. Included in the ruby theory is its oscillation threshold dependence on mirror angle and the emission line-width growth with increasing temperature, two important design parameters rarely discussed outside of the journals.

The treatment of gas lasers is equally complete, offering infrequently-discussed design details. Included is a very complete table of transitions in gases at which laser action is observed; this is hard-to-get design information compiled in a concise form that itself could be worth the price of this volume.

The other sections on gas lasers are equally design-oriented. Included are a design of a gas-discharge helium-neon laser with an internal mirror configuration, several mirror layouts with and without prisms, and a layout of a caesium-vapor laser with optical excitation, unique among gas lasers because of its methods of pumping. Pumping is accomplished with caesium-vapor by containing it in a closed glass tube and heating it to a temperature of 448 degree Kelvin, at which time it is excited by the light of a helium gas-discharge lamp.

Recently Published

Computer Oriented Circuit Design, ed. F. Kuo, W. Magnuson Jr., 561 pp., \$14.50

Explores different aspects of the design of electronic circuits using a digital computer. Discusses network topology, numerical analysis, state space techniques, modeling of solid state devices, graphic data processing, optimization techniques and automated circuit layout.

The first plug-in curve tracer costs 1/3 less!

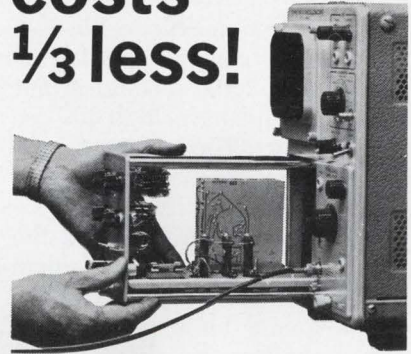

With U-Tech's plug-in and console units, any X-Y oscilloscope becomes a curve tracer displaying the dynamic characteristics of both NPN and PNP transistors, N Channel and P Channel junctions, FET's, MOS-FET's, bipolars, unijunctions, diodes, tunnel diodes and SCR's. You have curve tracer capabilities, without buying a complete curve tracer unit. In so doing you pay up to:

1/3 less!

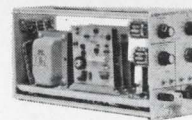

U-Tech plug-in **MODEL 681**: \$655.00*. For use with Tektronix† 560 Series Oscilloscopes.

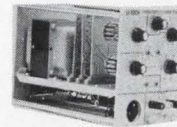

U-Tech plug-in **MODEL 682**: \$675.00*. For use with Tektronix† 530, 540, 550, 580 Series Oscilloscopes.



U-Tech console **MODEL 683**: \$685.00* For use with any X-Y Oscilloscope.

Ask your distributor about these U-Tech curve tracer units or order direct from:

U-TECH

A DIVISION OF INDUSTRIAL PHYSICS AND ELECTRONICS COMPANY
4190 SOUTH STATE STREET,
SALT LAKE CITY, UTAH 84107
(801) 262-2663

†Registered trademark Tektronix Inc.
*Prices apply to purchase and shipments within U.S.A. fob Salt Lake City, Utah

More bits to the inch

Monolithic sequential magnetic memories
R.J. Spain
Sylvania
Waltham, Mass.

Photolithographic techniques for defining paths of domain propagation in thin magnetic films opens the door for manufacturing monolithic sequential memories that are reliable and have high bit density at low cost. The advantage of thin-film sequential memories over other memory systems is that they greatly reduce the electronics and the interconnections usual in random-access magnetic memory systems.

Magnetic thin-film memories and shift registers use easily prepared materials which can be deposited over large surfaces easily. Bit densities at present are about 2,000 to 3,000 bits per inch with stepping or shifting rates above 500 kilohertz. Increasing the bit density by a factor of 5 seems possible before reaching limitations posed either by the increase in propagation field resulting from channel width reduction or by the definition of drive conductor patterns. Increasing storage density should make possible even higher frequencies of operation to be reached.

Storage and retrieval of information is effected through controlled displacement of magnetic domain walls. In a thin-film magnetic shift register, for example, binary information is stored as the presence or absence of domains of reversed magnetization within an initially saturated magnetic stripe. Domains are shifted along the stripe via specially arranged drive conductors. Information enters by formation of a domain at the input location; the output signal can be obtained at the readout location by inductively sensing the movement of the domains.

When these devices first were made, the paths of information flow were defined by the edges of the stripes, which were vacuum deposited through an evaporation mask. However, this method greatly limited the storage area. With photolithographic techniques

for defining domain paths, much higher densities became possible and more complex information paths could be formed. This made possible shifting devices of much greater propagation channel length to be constructed by winding the paths back and forth across the substrate in a zigzag manner and by shifting in any given direction. In addition, various channel shapes could be used to perform logic functions within the film.

Recent developments in the application of controlled domain wall motion in the rare-earth orthoferrites have extended the range of possibilities still further. With thin platelets of orthoferrite, it is possible to obtain cylindrical domains which exist in, and tend to stay in, a minimum energy state, thereby making it possible to induce motion of the whole domain by passing a magnetic field gradient across the domain. Such gradients can be produced by the action of a uniform magnetic field on specially shaped patterns of soft magnetic materials. Information flow thus can be directed and driven along any given direction in the memory plane through a time-varying uniform magnetic field, reducing the number of high definition conductor lines needed.

Under the shift register approach, using platelets of orthoferrites, bit densities on the order of 10^4 bits per inch and shifting rates exceeding 100 khz have been achieved. Storage densities above 10^5 bits per square inch and shifting rates from 1 to 10 megahertz will be likely.

Presented at Nerem, Boston, Nov. 5-7.

Sowing an ion

Implanted components in microcircuits
J.D. Macdougall and K.E. Manchester
Sprague Electric Co.
North Adams, Mass.

Injecting dopants into semiconductors by ion bombardment rather than by diffusion has several advantages. It permits fabrication at low temperatures, precise control of shallow doped layers, and elimi-

nates lateral diffusion. Ion implantation has been successfully demonstrated with silicon planar boron resistors, boron-phosphorus compensated resistors, and insulated gate field effect transistors (IGFET).

In the ion implantation process ions are accelerated and focused by electrodes; uniform large-area exposure of the substrate is achieved by sweeping the ion beam while moving the sample beneath the beam. Conventional photolithographic masking techniques are used to define the device geometries.

Boron implanted resistors have been fabricated with very precisely controlled doping levels. For a 50 kilo-electron-volt boron implant, approximately 90% of the dopants lie within a layer less than 0.2 micrometer thick. Thus, for similar doping levels the implanted layers yield sheet resistance roughly 20 times higher than diffused resistors. The sheet resistance depends on the ion dose and changes less rapidly than the inverse dose. Since this behavior is consistent with variation of carrier mobility with dopant concentration, the ion dose need only be controlled to $\pm 10\%$ in order to yield precisions on the order of $\pm 6\%$ for the sheet resistance of the implanted resistors.

Close temperature tracking between diffused resistors and implanted resistors is achieved because average doping levels in both implanted and diffused layers are similar. The resistor substrate reverse breakdown characteristics of ion implanted devices normally are sharp and uniform across a given wafer; breakdown voltage for a resistor fabricated in 10 ohm-centimeter n-silicon is 60 ± 10 volts.

The presence in a silicon crystal of comparable amounts of p and n type dopants considerably changes the carrier scattering mechanisms which determine the variation of resistance with temperature. Superimposing a 110-keV implant of phosphorus atoms on a previously implanted 40-keV boron distribution will increase sheet resistance as the phosphorus dose is increased. There is a marked increase

Chief Engineer for

Small but sophisticated design group involving design problems on TV Video—Color Cameras—Pulse and Digital Equipment—Microwave—etc.

Requires strong technical ability coupled with ability to motivate and channel efforts of 15 man engineering group.

Send resume or contact:



B. Presti
Sarkes Tarzian, Inc.
Bloomington, Ind. 47401
Area Code 812/332-7251

Circle 220 on reader service card

FREE! HOW TO HANDLE WAFERS, CHIPS, SUBSTRATES, MASKS

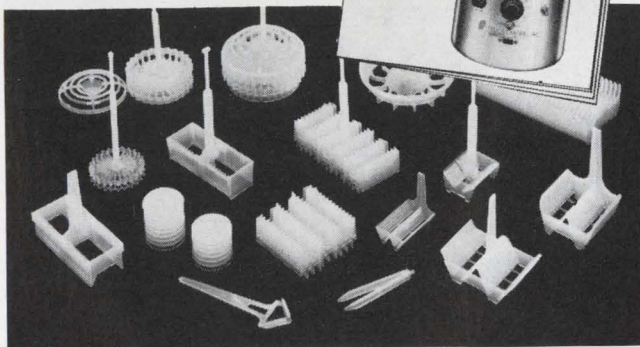

FEP Teflon* precision-molded into baskets, carriers, and trays — perfect for processing and handling semiconductor materials. The FEP material is virtually inert and useable at extreme temperatures. Hundreds of types, designs and sizes.

Write for 28-page catalog containing complete specifications and technical data.

*DuPont Trademark

FLUOROWARE
Chaska, Minnesota 55318 • Phone 612-448-3131

Circle 221 on reader service card

Technology Consultants, Inc. has the **TALENT** for helping your company profit!

Profitable growth to a position of industry leadership is often the result of ideas developed to maximum usefulness. But finding the skilled resources or time to move ideas into the money market could be a problem. TCI can help.

TCI provides a team of electronic specialists from a vast talent pool to extend your technical capability. They can help you solve critical technical problems when in-house resources may be limited. Or, guide your existing capabilities into new directions for growth. They assume overall job responsibility. And they relieve the financial burden of carrying a full-time technical staff on your payroll.

A TCI team of experts...with appropriate analytical and technical talent...and with direct support of all Electronics/Management Center resources is ready to help you by participating in:

- Systems design & analysis
- Search for new products
- Research & development
- Technical proposals
- Seminars for up-dating technical staffs
- Product feasibility studies
- Literature searches



Ask for our brochure or call direct and arrange for a preliminary meeting now.

Technology Consultants, Inc.

An Exclusive Technical Affiliate of

E/MC

Electronics/Management Center
330 West 42nd Street
New York, N.Y. 10036
(212) 971-3485



Circle 189 on reader service card

189

The Complete Line of Signal-Indicating Alarm-Activating Fuses

For use on computers, microwave units, communication equipment, all electronic circuitry.



BUSS GLD- $\frac{1}{4}$ x $1\frac{1}{4}$ in. Visual-Indicating, Alarm-Activating.



BUSS Grasshopper Fuse, Visual-Indicating, Alarm-Activating.

BUSS GBA- $\frac{1}{4}$ x $1\frac{1}{4}$ in. Visual-Indicating.



BUSS MIC- $\frac{13}{32}$ x $1\frac{1}{2}$ in. Visual-Indicating, Alarm-Activating.



BUSS ACH Aircraft Limiter, Visual-Indicating.

BUSS MIN- $\frac{13}{32}$ x $1\frac{1}{2}$ in. Visual-Indicating.



FNA FUSETRON Fuse $\frac{13}{32}$ x $1\frac{1}{2}$ in. slow-blowing, Visual-Indicating, Alarm-Activating. (Also useful for small motors, solenoids, transformers in machine tool industry.)

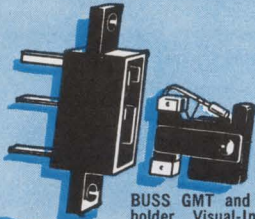

BUSS GMT and HLT holder, Visual-Indicating, Alarm-Activating.

Write for BUSS Form SFB

INSIST ON

BUSS QUALITY

FUSES

BUSSMANN MFG. DIVISION, McGraw-Edison Co. St. Louis, Mo. 63107

Circle 222 on reader service card

The Complete Line of Fuses For The Protection of Semi-Conductor Rectifiers

TRON Rectifier Fuses

Provide extremely fast opening on overload and fault currents, with a high degree of restriction of let-thru current. Many types and sizes available. Ampere ratings from $\frac{1}{2}$ to 1000 in voltage ratings up to 1500.

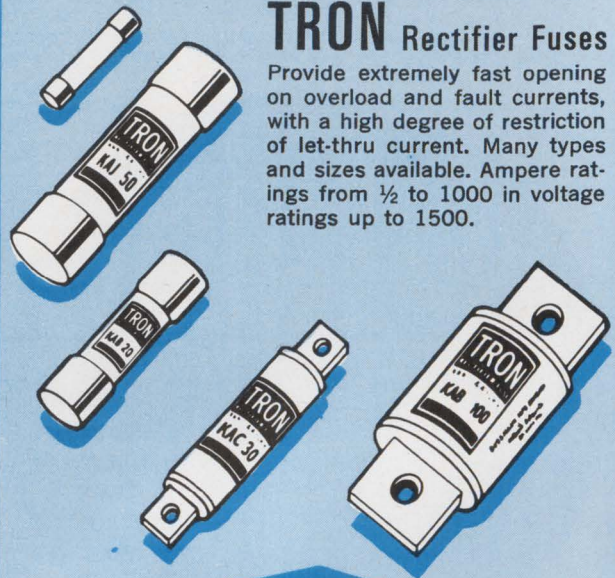

Write for BUSS Form SFB

INSIST ON

BUSS QUALITY

FUSES

BUSSMANN MFG. DIVISION, McGraw-Edison Co. St. Louis, Mo. 63107

Circle 222 on reader service card

BUSS: The Complete Line of Fuses and . . .

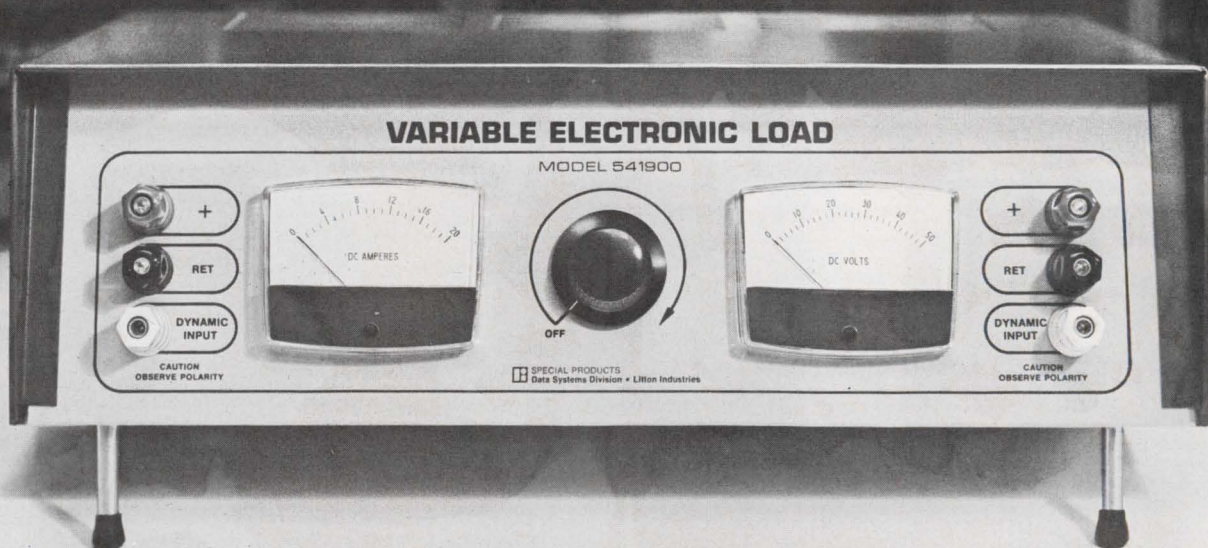

A new concept in laboratory load simulation featuring...

- Instant dial-a-load control
- Static and dynamic load simulation up to 100 watts
- Front panel voltage and current read-out
- Light weight, compact, and portable
- Available in rack mount or bench configuration
- Immediate delivery

Constant current, non-inductive load characteristics make the VEL ideal for testing transformers, inductors, relays, etc. Send for FREE application notes. Use the inquiry card in this magazine for additional technical data or call direct.

 SPECIAL PRODUCTS
Data Systems Division • Litton Industries
9001 Fullbright Ave., Chatsworth, Calif. 91311

Circle 190 on reader service card

Technical Abstracts

in resistance at low temperatures for the most highly compensated resistors. Other than temperature compensation and sheet resistance, the addition of phosphorus to the boron resistor left the electrical parameters unchanged.

Presented at NEC, Chicago, Dec. 8-10.

Laser machine shop

Applications to microelectronic and silicon wafer dicing

Glenn A. Hardway
Spacerays, Inc.
Burlington, Mass.

Lasers are being used to perform many material processing tasks for the electronics industry, such as hole drilling, resistor trimming, scribing of silicon wafers, helixing cylindrical resistors, controlled fracturing, welding, and dynamic balancing.

Hole drilling and material removal is best achieved with the pulsed ruby laser since this type is capable of producing 150 joules at 1 pulse per second. When properly focused, a 30 joule ruby-laser beam can remove material 0.1 inch thick from alloys in only two shots. The ruby-laser equipment needed to carry out this task consists of a high-average-power pulsed laser, a 30-kilowatt power supply, an automatically controlled table, optics, and closed circuit tv for viewing the drilled hole.

When laser welding is required, the equipment must be more flexible than that used for material removal. Miniature welding requires a table top mount, a microscope, as well as an eye protecting shutter.

For microminiature welding, such as welding fine wires or materials of thicknesses less than .003

inch, a neodymium doped YAG device is recommended, since the YAG laser is capable of operation at very low output energies. YAG's with outputs of less than 100 millijoules can, for example, weld micro-miniature wires of .0005 inch diameter and trim thick and thin film resistor elements, performing both operations with high precision.

Controlled fracturing of ceramics is best achieved with a CO₂ laser system by means of localized heating. The semiconductor industry uses this technique to adjust thick and thin film resistor elements and to slice silicon wafers.

The YAG laser can both scribe and cut during silicon wafer dicing. The low-power pulsed YAG laser can scribe a channel that is .0025 inch across; all the heat is contained within the channel.

Presented at NEC, Chicago, Dec. 8-10.

Fuseholders of Unquestioned High Quality

SUB-MINIATURE FUSES

Ideal for space tight applications, light weight, vibration and shock resistant. For use as part of miniaturized integrated circuit, large multi-circuit electronic systems, computers, printed circuit boards, all electronic circuitry.

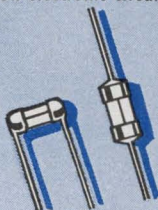

TRON Sub-miniature Pigtail

Fuses — Body size only .145 X .300 inches. Glass tube construction permits visual inspection of element. Hermetically sealed. Twenty-three ampere sizes from 1/100 thru 15.



BUSS Sub-miniature GMW Fuse and HWA Fuseholder

Fuse size only .270 X .250 inches. Fuse has window for visual inspection of element. Fuse may be used with or without holder. 1/200 to 5 amp. Fuses and holders meet Military Specifications.

Write for BUSS Form SFB

INSIST ON

BUSS QUALITY

FUSES

BUSSMANN MFG. DIVISION, McGraw-Edison Co. St. Louis, Mo. 63107
Circle 191 on reader service card

THE COMPLETE LINE OF *Small Dimension* FUSES

For The Protection of All Types of Electronic and Electrical Circuits and Devices . . .

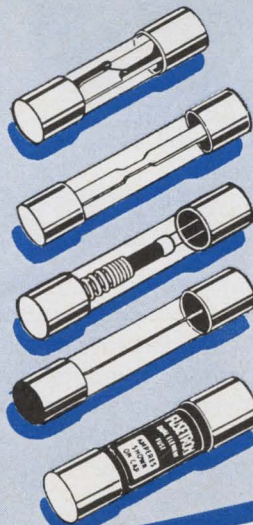

. . . includes dual-element "slow-blowing", single-element "quick-acting" and signal or visual indicating types . . . in sizes from 1/500 amp. up.

For special fuses, clips, blocks or holders, our staff of fuse engineers is at your service to help in selecting or designing the fuse or fuse mounting best suited to your requirements.

Write for BUSS Form SFB

INSIST ON

BUSS QUALITY

FUSES

BUSSMANN MFG. DIVISION, McGraw-Edison Co. St. Louis, Mo. 63107
Circle 191 on reader service card

DOUBLE YOUR FUSE FUNCTION

In the design of high-powered solid state equipment there often occurs the need for equalizing resistors. Consider the case of parallel series pass elements in a regulated power supply. It may not have occurred to the designer that a Littelfuse 275 Series Picofuse will fulfill a dual purpose, in that the voltage drop across the fuse is in the approximate range necessary for equalization purposes, in addition to the provision of over-current protection. Picofuses are now available with ratings from 1/16 through 15 amps.

Write for a free copy of our 275000 Series Resistance Data Chart.

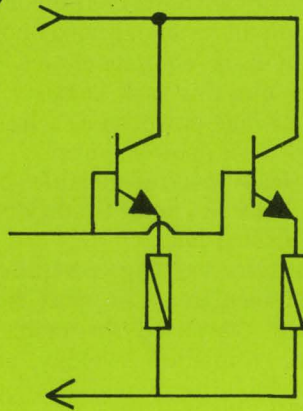

LITTELFUSE

DES PLAINES, ILLINOIS

Circle 192 on reader service card

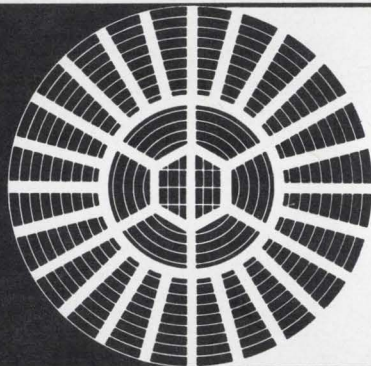

ANTENNA ENGINEERS

Antenna design, development and test including large aperture unfurlable antennas. Background in electromagnetic theory, with experience in the design and development of sophisticated, broadband feed systems. Knowledge of computer programming and applications of computer techniques to antenna problems is desirable. For more information write to Mr. H. W. Bissell, Professional Placement Manager, P.O. Box 504, Sunnyvale, California 94088. Lockheed is an equal opportunity employer.

LOCKHEED
MISSILES & SPACE COMPANY
A GROUP DIVISION OF LOCKHEED AIRCRAFT CORPORATION

New Literature

Industrial connectors. Amphenol Industrial division of the Bunker-Ramo Corp., 1830 S. 54th Ave., Chicago 60650. Two popular families of high-density microminiature circular connectors are described in a 16-page catalog.

Circle 446 on reader service card.

Hybrid dividers. GPS Instrument Co., 14 Burr St., Framingham, Mass. 01701. A two-page color brochure details a series of new hybrid dividers ranging in price from \$65 to \$305. [447]

DIP socket boards. Robinson-Nugent Inc., 800 E. Eighth, New Albany, Ind. 47150. Catalog 0969 illustrates and describes a line of high-density DIP socket boards. [448]

Photoresist spinners. Headway Research Inc., 3713 Forest Lane, Garland, Tex. 75040. A six-page brochure covers a line of photoresist spinners for coating silicon and germanium wafers, and large glass and ceramic substrates with photosensitive material. [449]

Equalized bandpass filters. Communication Devices, 4180 Courtrai, Montreal, Quebec, Canada, offers a data sheet describing group delay and amplitude equalized bandpass filters intended for high-capacity radio relay systems. [450]

Keyboard data entry system. Systems Engineering Laboratories, 6901 W. Sunrise Blvd., Ft. Lauderdale, Fla. 33313. A four-color brochure describes Key-Tran, a new computer based keyboard data entry system that employs a new concept of direct data entry from keyboard to magnetic tape. [451]

Precision potentiometers. Bourns Inc., 1200 Columbia Ave., Riverside, Calif. 92507. A six-page brochure outlines all configurations of the Bee-Line series of precision potentiometers. [452]

Stray current meter. Owen Laboratories, a division of Berktronics Inc., 1221 S. Shamrock Ave., Monrovia, Calif. 91016. A single-page bulletin discusses the model 110 Straycheck, a small stray current meter for use in checking medical instruments before connection to the patient. [453]

F-m mobile radio. Motorola Communications and Electronics Inc., 1301 E. Algonquin Rd., Schaumburg, Ill. 60172, offers brochure TIC 3531 on the solid state Mark-12 uhf multichannel f-m mobile radio. [454]

Silicon oxidation. International Plasma Corp., 25222 Cypress Ave., Hayward, Calif. 94544, has available a product bulletin entitled "Oxidation of Silicon During Photoresist Stripping." [455]

Computer programs. Time/Ware, 688

LAUNCHING
THE SPECTACULAR



IN ELECTRICAL and
ELECTRONICS ENGINEERING



4 Floors of Exhibits

NEW YORK COLISEUM / 10 a.m.-8 p.m. 4 Days.

50 Technical Sessions

NEW YORK HILTON / 10:00-12:30; 2:00-4:30 5 Days.

Registration — Good all days — Technical Sessions and exhibits. In and out privileges. IEEE Members \$4.00. Non-members \$8.00. Ladies \$2.00. High School Students \$3.00 if accompanied by adult (One student per adult). Thursday only — limit of 3 students per adult.

IEEE INTERNATIONAL
CONVENTION and EXHIBITION
MARCH 23-26, 1970



IEEE
70

Circle 223 on reader service card

EASY OPERATION COMPACT, LOW COST



MODEL 553 (133mm) DUAL-TRACE OSCILLOSCOPE

The "KIKUSUI Triggerscope. Model 553" is a dual-trace oscilloscope incorporating a trigger sweep system features light-weight compact, easy operation as well as high reliability by employing a highly sensitive 5 INCH Cathode-ray tube and numerous solid state designs.

This oscilloscope is of 2 channel operation mode, providing a vertical differential DC amplifier for bandwidth of DC~7 MHz, where-

by the dual-trace system displays either channel separately, alternates between channels, or choppers between channels. With a wide sweep range, further, extending from 1 sec~1 μ s, this model is advantageously suited for many measurement uses and waveform monitoring.



kikusui

KIKUSUI ELECTRONICS CORP.

3-1175, SHINMARUKO-HIGASHI, KAWASAKI-CITY, KANAGAWA-PREF., JAPAN
TELEPHONE: (044) 41-0111, CABLE ADDRESS: "KIKUSUIDE" KAWASAKI

Circle 224 on reader service card

Token is either the world's first or second largest maker of ferromagnetic pot cores.



Token couldn't care less.

It's not making more pot cores than anybody that's important to us—it is making them **better** than anybody else that matters.

This is the way we feel about each of our products, from metal magnetic and ferrite cores right on up to memory systems. You could say that the history of magnetic material manufacture in Japan is the history of Token—a good reason to want to keep our reputation as Japan's largest and most advanced magnetic material manufacturer.

Let us send you products brochure: Token, suppliers of quality materials to the electronics and communications industries.

Token

Tohoku Metal Industries, Ltd.

Koei Bldg. 13-10, 7-chome, Ginza, Chuo-ku, Tokyo, Japan

Telephone: Tokyo 542-6171 Cable Address: TOHOKUMETAL TOKYO

Main Products: Ferrite Cores, Memory Cores, Memory Matrices, Ferrite Magnetostrictive Vibrators, Pulse Transformers, Permanent Magnets (Cast, Ferrite), Tape Wound Cores, Bobbin Cores, Magnetic Laminations, Fe-Co Alloys, Sendust Cores

Circle 193 on reader service card

193

...not a

SHADOW

of a doubt...

BURNS & TOWNE EPOXYS

Burns & Towne has a wide selection of reliable low cost NPN and PNP Silicon Planar Epitaxial Transistors for amplifier and switching applications

- SMALL-SIGNAL
- HIGH-SPEED
- MEDIUM-POWER
- HIGH-FREQUENCY

SMALL-SIGNAL		
NPN		PNP
2N3565	2N4967	2N4248
2N3691	2N4968	2N4249
2N3692	2N5127	2N4250
2N3693	2N5131	2N4964
2N3694	2N5132	2N4965
2N4966	2N5133	2N5138
		2N5139

MEDIUM-POWER			
NPN		PNP	
2N3566	2N4227	2N3638	2N4228
2N3567	2N4969	2N3638A	2N4971
2N3569	2N4970	2N3644	2N4972
2N3641	2N5128	2N3645	2N5142
2N3642	2N5129	2N4142	2N5143
2N3643	2N5135	2N4143	
2N4140	2N5136		
2N4141	2N5137		

HIGH-SPEED	
NPN	
2N3646	2N4275
2N4274	2N5134

HIGH-FREQUENCY	
NPN	
2N3563	
2N3564	

CALL OR WRITE FOR FULL SPECIFICATIONS AND PRICE DATA



CONTACT FRED SEIGEL
BURNS & TOWNE, INC.
 550 OLD COUNTRY ROAD
 HICKSVILLE, L.I., N.Y. 11801 TEL (516) 935-0522

Circle 225 on reader service card

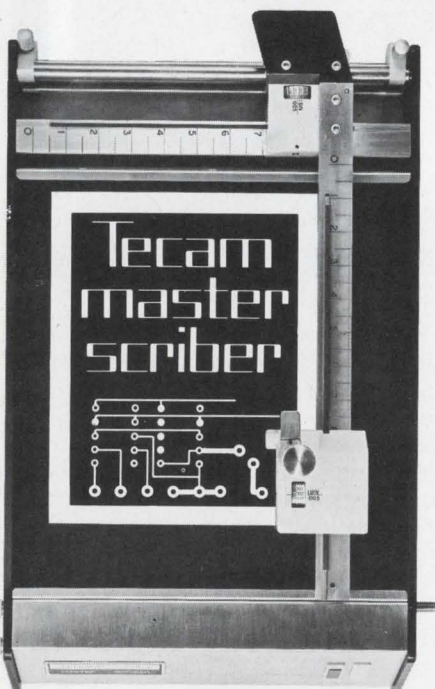

the quick way to printed circuits
 for full details write to

Techne Incorporated 661 Brunswick Pike
 Princeton New Jersey 08540
 Telephone (609) 452-9275

ECONOMICAL Thin Film!

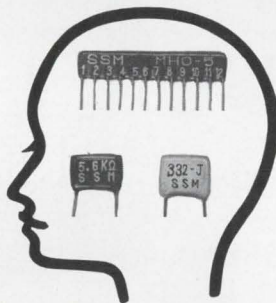

What's needed for memory system is everlasting high accuracy. SSM's components are the very ones satisfying superior reliability.

- Plate-ohm: evaporated metal film resistor.
- Pla-module: thin film modulated C-R circuit.
- Pla-con: organic thin film capacitor by plasma reaction.

SUSUMU INDUSTRIAL CO., LTD.

Minami Bldg. 1-12 Ebisuminami
 Shibuya-ku, Tokyo, Japan.
 TEL: Tokyo (03) 712-5990
 TELEX: No. 246-6270

New Literature

Main St., Redwood City, Calif. 94063, has available detailed literature on a series of 30 computer programs designed for quality engineering and statistical analysis. [456]

Instruments. Greibach Instruments, division of Solitron Devices Inc., 37-11 47th Ave., Long Island City, N.Y. 11101. A catalog utilizing a basic format for ease of reference is broken down into two instrument sections, analog and digital. [457]

ECL systems. Texas Instruments Inc., P.O. Box 5012, Dallas 75222. Twelve-page application report discusses the effect of temperature on logic levels in emitter-coupled logic circuits and describes a method of designing an air-cooled ECL system. [458]

I-O typewriters. Electronic Engineering Co. of California, 1601 E. Chestnut Ave., Santa Ana, Calif. 92702, has released a four-page brochure describing the type 1651 computer I-O typewriters. [459]

D-a converters. Computer Products, 2709 N. Dixie Highway, Ft. Lauderdale, Fla. 33307. A six-page folder covers the DA-035 series digital-to-analog converters, offering 40 models with 8, 10 or 12-bit resolution, with or without data storage. [460]

Portable data terminal. Technitrend Inc., 7300 N. Crescent Blvd., Pennsauken, N.J. 08110. Systems information bulletin 170 contains an illustrated description of a new portable data terminal. [461]

Interference microscope. Hacker Instruments Inc., Box 646, West Caldwell, N.J. 07006, offers a four-page brochure on an interference microscope that measures the thickness of thin film layers, coatings, platings, etc. [462]

R-f sputtering units. Varian, Vacuum Division, 611 Hansen Way, Palo Alto, Calif. 94303. Three r-f diode sputtering units for thin film coating work are described in an eight-page brochure. [463]

Electronic drafting aids. Circuit Aids Inc., 172 Walker Lane, Englewood, N.J. 07631, has released a comprehensive catalog describing a full line of pressure-sensitive, pre-cut electrical and electronic drafting aids for printed-circuit draftsmen, engineers, and artists. [464]

Ultrasonic wire bonder. Mech-EI Industries Inc., 73 Pine St., Woburn, Mass. 01801. Model TU-900 ultrasonic wire bonder for use in manufacturing hybrid circuits, as well as integrated circuits and transistors, is described in a single-page data sheet. [465]

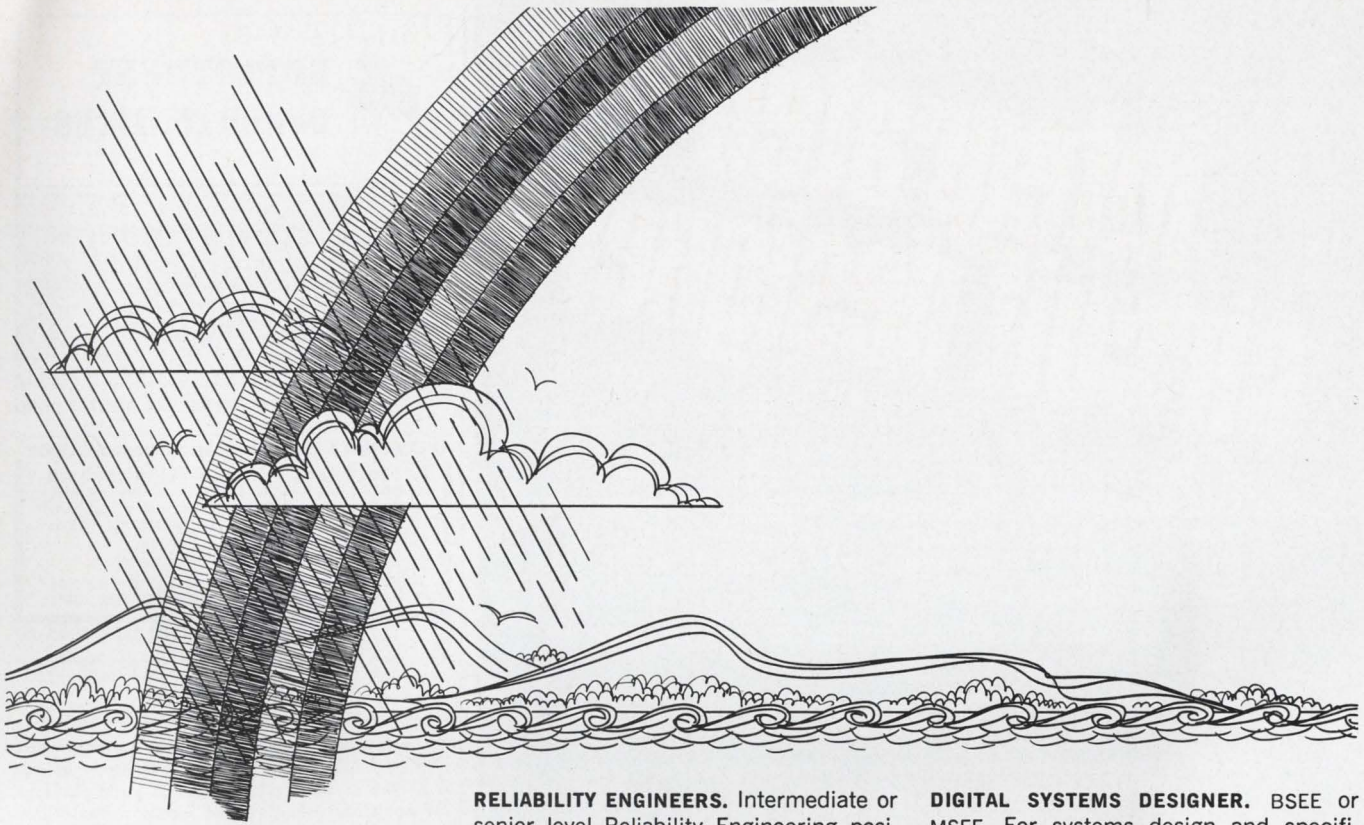

How much opportunity can you find under one roof?

At Electronics Division, probably all you're looking for. Everything from aircraft ground equipment to ASW to Communications and Avionics to Operations Research to Product Assurance Engineering, all comfortably housed in one plant in Rochester. (The living is great here, too.)

If you like the idea of being comfortably close to opportunities in your specialty—and others—check the openings listed, and send us a resume. Address J. P. O'Reilly, Dept. 151

QUALITY CONTROL ENGINEERS. BS in EE, ME or equivalent, with 2 to 10 years quality assurance experience. Background in military electronics desirable. Experience required in inspection planning, documentation review, configuration control, material review or project quality engineering with wired assemblies, micro-electronic devices or systems.

RELIABILITY ENGINEERS. Intermediate or senior level Reliability Engineering positions. BS in EE or Science plus two or more years experience in any of the following: circuit design, circuit analysis, reliability predictions (manual or computerized), failure reporting, analysis and corrective action, reliability test planning, reliability program planning, demonstration testing, reliability proposal preparation and design review. Assignments will involve the performance of all functions associated with a MIL-STD-785 reliability program. Senior level positions require a working familiarity with the above items. Emphasis is required in the planning stages of Hi-Rel programs to ensure demonstration of contract specified requirements.

MAINTAINABILITY ENGINEERS. BSEE plus 2 or more years experience in maintainability engineering—establishment of qualitative and quantitative maintainability requirements (maintenance concepts, throwaway vs. repair, maximum repair time, maintenance down time per operating hour, maintenance man-minutes per operating hour, etc.). Positions involve design analysis, design review, maintenance engineering analyses, and demonstration testing. Task flexibility is enhanced by participation in cost effectiveness/integrated logistics support studies, proposals, and other research activities.

DIGITAL SYSTEMS DESIGNER. BSEE or MSEE. For systems design and specification of digital data acquisition, data processing and data reduction systems. Experience in special purpose computer design, general purpose computer interface and peripheral equipment specification, digital data transmission systems and digitally driven display systems.

SHIPBOARD SYSTEMS DESIGNER. BSEE or MSEE. For systems design and specification for shipboard instrumentation systems with experience in shipboard sonar, stabilization and fire control, communication, navigation and data acquisition systems. Emphasis is on analog signal acquisition storage, processing and display.

TRANSDUCER DESIGN/DEVELOPMENT ENGINEERS. BS in EE, ME or Physics. Minimum 2 years experience in underwater transducer development, vibration technology, or airborne acoustics.

AEROSPACE GROUND EQUIPMENT ENGINEERS. BSEE or MSEE with 2 or more years experience in electronics support of airborne weapons systems. Two types of assignments requiring: (a) System engineering with specific experience in one or more of the following: RF, video, pulse techniques, computer and digital techniques, operations analysis, attack radar, penetration aids, flight control systems; (b) Design experience in AGE radar (indicator, synchronizers), IF, video, RF and ECM (threat simulation).

GENERAL DYNAMICS

Electronics Division

1400 N. Goodman St., Rochester, New York 14601

An Equal Opportunity Employer (M&F)

Integrated Circuit Designer

An opportunity in our Microelectronics Research Group exists for an individual experienced in the design, debugging and testing of integrated circuits. Minimum of 2 years experience required. MSEE or BSEE degree required.

We can offer excellent employee benefits and liberal starting salary.

Please forward your resume in confidence to
Mr. R. C. Davis, Employment Mgr.



SPERRY RAND

RESEARCH CENTER

SUDBURY, MASSACHUSETTS 01778

An Equal Opportunity Employer

CIRCLE 967 ON READER SERVICE CARD

SEARCHLIGHT SECTION

AUTOTRACK MOUNT

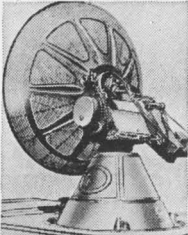

360 degree azimuth, 210 degree elevation sweep with better than 1 mil. accuracy. Missile velocity acceleration and slewing rates. Amplidyne and servo control. Will handle up to 20 ft. dish. Supplied complete with control chassis. In stock—immediate delivery. Used world over by NASA, USAF, MP-61-B. Type SCR-584. Nike Ajax mounts also in stock.

PULSE MODULATORS

250 KW HARD TUBE PULSER

Output 16 kv 16 amp. Duty cycle .002. Pulses can be coded. Uses 5D21, 715C or 4PR60A. Input 115 v 60 cy. AC \$1200 ea.

MIT MODEL 9 PULSER 1 MW—HARD TUBE

Output 25kv 40 amp., 30kv 40 amp. max. Duty cy. .002. .25 to 2 microsec. Also 5 to 5 microsec. and .1 to .5 microsec. Uses 6C21. Input 115v 60 cycle AC. Mfg. GE. Complete with driver and high voltage power supply. Ref: MIT Rad. Lab. Series, Vol. 5, p. 152.

1.2 MEGAWATT HARD TUBE

0-40 KV at 0-30 amp. 20-5,000 pps. .5-5 microsec. Input 208V. AC, 60 cycle, Levinthal mod. 333M. Price \$4400.

2 MEGAWATT PULSER

Output 30 kv at 70 amp. Duty cycle .001. Rep. rates. 1 microsec. 600 pps. 1 or 2 msec. 300 pps. Uses 5948 hydrogen thyratron. Input 120/208 VAC 60 cycle. Mfr. GE. Complete with high voltage power supply.

18 MEGAWATT PULSER

Output 150KV at 120 amps. Rep. rate: 50-500 PPS. Pulse length: 5 msec. 15 KV 120 amp. into pulse transformer. Rise time 1.5 msec. Filament supply 5V 80 amp. incl. 17.5KV 1.5 amp DC power supply. Input: 220V 60 cy AC.

SCR 584 AUTOTRACK RADARS

Our 584s in like new condition ready to go, and in stock for immediate delivery. Ideal for telemetry research and development, missile tracking, satellite tracking. Fully Desc. MIT Rad. Lab. Series, Vol. 1, pps. 207-210, 228, 284-286. Comp. Inst. Bk available \$25.00 each.

ANTI-AIRCRAFT GUN MOUNT

Will handle 6,000 lbs. rapid slew through 360° azimuth, 180° elevation. Mobile.

MICROWAVE SYSTEMS

200-2400 mc. RF PKG

Continuous coverage, 30 Watts Cw nominal output. Uses 2C39A. Price \$575.

L BAND RF PKG

20 KW peak 990 to 1040 MC. Pulse width .7 to 1.2 micro sec. Rep. rate 180 to 420 pps. Input 115 vac incl. Receiver \$1200.

200-225 mc RADAR SYSTEM

1 Megawatt output, 200 nautical mile range for long range detection of medium and high altitude jet aircraft as well as general search. AN/TPS-28.

AN/GMD-1B RAWIN RADAR

L-Band Radiosonde Tracking System. Complete, new cond. in stock for immed. del. AN/GMD-2 computer mfg. Gen'l Mills also in stock.

5 MEGAWATT C-BAND

Klystron RF package delivering nominal 5 megawatt pulse RF. Complete with pulser and power supply.

500 KW L BAND RADAR

500 kw 1220-1359 msc. 160 nautical mile search range P.R.I. and A scopes. MTL thyratron mod 5J26 magnetron. Complete system.

C BAND AUTOTRACK

1 Megawatt 10 ft. Parabola. Sperry.

AN/GPG-1 SKYSWEEP TRACKER

3 cm. automatic tracking radar system. Complete package with indicator system. Full target acquisition and automatic tracking. Input 115 volts 60 cycle Nw. In stock for immediate delivery. Entire System 6' long, 3' wide, 10' high. Ideal for Infrared Tracker, Drone Tracker, Missile Tracker, R. & D.

INDICATOR CONSOLES

AN/SPA-4A, PPI 10", range to 300 mi.
VJ-1 PPI 12", Range to 200 mi.
VL-1 RH1 12" to 200 mi. 60K ft.

40 KW TRANSMITTER

4 to 21 MHz, 40 kw Telegraphy, 30 kw Voice, can be SSB. New condition. Two systems in stock. Excellent rf source, broadcast or point-to-point.

3 KW TRANSMITTER

2-30MHz. Phone or CW. 208V 3 PH 60 cy. AC input. MFR-RCA.

HUNDREDS MORE IN STOCK
LARGEST RADAR
INVENTORY
IN WORLD.
WRITE
FOR
CATALOG
ON YOUR
LETTERHEAD

Radio-Research Instrument Co.

45 W. 45th St., New York, N.Y. 10036 ■ 212-586-4691

CIRCLE 970 ON READER SERVICE CARD



EMPLOYMENT OPPORTUNITIES



We have been placing B.S., M.S. and Ph.D.

ELECTRONIC ENGINEERS

in fee paid positions throughout the U.S. since 1959. Send resume today or request confidential application. We are graduate engineers, working full time . . . for you.

ATOMIC PERSONNEL, INC.

Suite L, 1518 Walnut St., Phila., Pa. 19102
AN EMPLOYMENT AGENCY FOR ALL TECHNICAL FIELDS

CIRCLE 968 ON READER SERVICE CARD

PERSONALIZED (not computerized) SERVICE

ONE knowledgeable, ethical, service-motivated consultant is more valuable to the job-seeking electronic engineer than a computer and 87 affiliated agencies. Especially when his service is nationwide and employer fee paid.

You write. I'll respond. Then you decide.

JOSEPH P. CORCORAN, Personnel Consultants
505B Germantown Pike, Lafayette Hill, Pa. 19444

215/825-0848

CIRCLE 969 ON READER SERVICE CARD

POSITION VACANT

Electrical-Electronic Engineers. Salaries \$10-\$25,000. We specialize in developing nationwide job search programs to fit your particular position objective and location flexibility. Project, Design, R&D, and management openings in all fields. Fees Company Paid. 85 affiliate offices to serve you. Send resume in confidence with present and desired salary, reason for desiring change and location flexibility to Leonard Personnel, 310 Empire Bldg., Pittsburgh, Pa. 15222.

TEST EQUIPMENT New - Used

HP, Tek GR etc. . . . examples: HP 410B \$135; HP 400D, \$95; Tek 123 preamp, \$25; Tek Z plug-in, \$295. All models of EXACT line (Function generators) at very large reductions.

LABORATORY EQUIPMENT SALES

16210 May Creek Rd. Renton, WA 98055

CIRCLE 971 ON READER SERVICE CARD

*Somebody—
Somewhere*

needs your idle equipment!

Reach that buyer quickly and economically thru the

**“SEARCHLIGHT
SECTION”**

*The meeting place of Used
Equipment Buyers and Sellers*

Electronics index

Volume 42, 1969

NOTES: ED (Editorials); EI (Electronics International); NP (New Products); USR (U. S. Reports)

- AIR NAVIGATION** See Avionics; Navigation Systems
- AMPLIFIERS**
- Absolute value circuit needs only one op amp p. 89 Jan. 20
- Active filters—Part 6: The op amp saves time and money p. 82 Feb. 3
- Part 7: Analog blocks ensure stable design p. 100 Feb. 17
- Adapter lets digital IC tester check on operational amplifiers p. 94 July 21
- Amplifier modules deliver 250-watt pulses NP p. 186 Nov. 10
- Amplifier offers 10^{12} ohms isolation NP p. 153 Sept. 29
- Amplifier with 2-decade range NP p. 212 Mar. 3
- Amplifiers low in cost, drift NP p. 179 Sept. 15
- Amplifiers put out 10 watts NP p. 160 Sept. 29
- Another entrant in op-amp sweepstakes NP p. 139 Apr. 28
- Automatic attenuator rapidly changes signal level p. 120 Sept. 15
- Broadband power amps can be combined NP p. 133 Sept. 1
- Buffer amp provides stability over wide temperature range p. 107 Nov. 24
- Common-mode rejection ratio: what the spec sheet doesn't say p. 116 June 23
- Designing lumped elements into microwave amplifiers p. 100 Apr. 14
- 'Everything on amp' NP p. 159 May 26
- Fairchild introduces family of linear IC's NP p. 144 July 21
- FETs protect differential amplifiers p. 88 Jan. 20
- Great Britain: Beating the heat—pdm for 30-watt audio amplifier EI p. 240 May 12
- High accuracy obtained from peak detector using op amp p. 94 Mar. 17
- High power r-f amplifier operates at 100°C NP p. 183 June 23
- Hybrid op amp challenges the discretely NP p. 153 Aug. 18
- Hybrid op amps offer low drift NP p. 162 Oct. 13
- Hybrid power amp put out 100 watts NP p. 157 Oct. 27
- It's the heat—hybrid IC power-switching amp USR p. 46 Oct. 13
- Log amp has 80 Mhz bandwidth NP p. 192 Dec. 8
- Loop gain measurements made with paired amplifiers p. 92 May 26
- Lower price widens amplifier's uses NP p. 136 July 21
- Minimizing common-mode errors in a variable-gain amplifier p. 104 June 23
- Monolithic IC puts out 18 watts NP p. 185 Mar. 17
- Navy—MAIR starts USR p. 82 Sept. 15
- 19 op-amp gains are switched without offset p. 94 Mar. 3
- Op amp betters price-performance ratio NP p. 163 Feb. 3
- Op amp log circuit eliminates diode bulk-resistance effects p. 101 June 9
- Op amp settling time is 80 nsec for gain of 1 NP p. 161 July 7
- Op amp sine wave oscillator uses diodes for stability p. 97 Mar. 17
- Op amp tester analyzes the no-go NP p. 171 Aug. 4
- Op amp trimming done internally NP p. 157 Mar. 17
- Op amps replace transformer in phase detector circuit p. 109 May 12
- Op amps speed cockpit control NP p. 165 Aug. 18
- Oscilloscope: Helical transmission lines bend the beam p. 90 July 7
- Q-multiplier circuit uses op amp with LC feedback p. 92 May 26
- Signals shifted 180° as amplitude remains constant p. 110 May 12
- Silicon avalanche diodes amplify at sub-harmonics of X-band frequency USR p. 39 Feb. 3
- A simplified design approach for hysteresis circuits p. 106 Nov. 10
- Team work streamlines differential amplifier tests p. 132 Sept. 15
- Trading stability for better noise protection—solid-state differential amplifier NP p. 169 June 9
- Unity-gain amplifier in probe needs only two conductors p. 99 June 9
- Video i-f amplifier goes on a chip NP p. 197 Aug. 4
- ANTENNAS**
- Airborne phased-array antenna for communicating with military satellites USR p. 56 Jan. 20
- Chop talk—Satellite antenna for helicopters USR p. 38 Sept. 1
- Japan: Low-cost circulator for tv antenna connections EI p. 203 Mar. 17
- Phased-array satellite antenna pops up when orbit is reached USR p. 53 Feb. 17
- West Germany: Dishing it up—SAFE antenna EI p. 200 Sept. 29
- West Germany: System that checks surface deviations of parabolas may spur new design for large antennas EI p. 218 Feb. 17
- West Germany: Transistorized antennas headed for production EI p. 232 Aug. 4
- West Germany: Where's the antenna? Meinke antenna EI p. 224 Sept. 15
- ASTRONOMY**
- New directions—NASA astronomy program USR p. 46 Nov. 24
- Technique for predicting proton showers 4 to 14 hours before they occur USR p. 62 Jan. 6
- AUTOMOTIVE**
- Australia: Fare enough—electronics in taxicabs EI p. 186 July 7
- Detroit puts electronics in the driver's seat p. 84 Mar. 17
- German car market opening up p. 155 May 12
- Great Britain: Closely watched buses EI p. 204 Oct. 27
- Great Britain: Valve-cap oscillator signals flat tire EI p. 200 Jan. 20
- Great Britain: Yig-based system checks auto exhaust gases EI p. 222 Apr. 14
- Japan: Parking lights EI p. 81 Feb. 3
- Regulated sales for Motorola voltage regulators USR p. 71 Sept. 15
- Road open for highway automation p. 138 Aug. 18
- Vehicle-locator inquiry—Finding the way USR p. 58 May 12
- West Germany: Electronic cashier—coin-operated self-service fuel pumps EI p. 199 Jan. 20
- West Germany: Streamlining the flow—electronic data-processing systems for controlling traffic EI p. 196 Aug. 18
- West Germany: Truck gear shift system EI p. 168 Dec. 22
- West Germany: Where's the antenna? Meinke antenna EI p. 224 Sept. 15
- AVALANCHE EFFECT**
- Avalanche source puts out 250 mw NP p. 195 Dec. 8
- Silicon avalanche diodes amplify at sub-harmonics of X-band frequency USR p. 39 Feb. 3
- Single transistor divides frequency in avalanche mode p. 96 Sept. 29
- AVIONICS**
- ARTS-3—State of the ARTS USR p. 50 July 7
- Air Force awards contract-definition phase of the ZF-15A (FX) advanced fighter development program p. 54 Jan. 20
- Air Force awards contracts for Geans USR p. 66 Nov. 10
- Air operations planning goes automatic p. 117 May 26
- Air traffic control: Hits and misses USR p. 60 Aug. 18
- Air traffic control: Industry proposals USR p. 59 Aug. 18
- Air traffic control for the 1980's: Survival to cost billions of dollars p. 127 Oct. 27
- Aircraft spending sliced USR p. 38 July 21
- Big Boeing proposed for Awacs USR p. 82 Sept. 15
- Caught in the crunch—vidicon for a military infrared avionics system USR p. 56 Jan. 6
- Chop talk—Satellite antenna for helicopters USR p. 38 Sept. 1
- Complex monitoring—AIDS unit would monitor 300 to 400 test points USR p. 53 Mar. 17
- Computer navigates helicopters USR p. 46 Feb. 3
- DC-10's air data system casts a long shadow p. 125 Mar. 17
- Digital readout with backup NP p. 158 Feb. 17
- Digital torquerer—ground checkout of inertial instrumentation USR p. 58 Aug. 4
- Drone on—Nite Panther USR p. 50 Jan. 20
- EDP for all hands wanted by Navy USR p. 52 July 21
- Electronic pressure sensor slated for DC-10's air data computer USR p. 43 Jan. 20
- Electronics Markets 1969: Commercial markets starts to soar p. 122 Jan. 6
- Elf to the rescue—finding downed pilots USR p. 50 Jan. 20
- FAA adds automatic altitude readout to its Common Instrument Flight Rules Room at Kennedy Airport USR p. 58 June 23
- Flights of fancy—TI studies state of the future art USR p. 48 Mar. 31
- France: Sensitive radar keeps helicopters in the clear EI p. 221 Apr. 14
- France: Supersonic circus EI p. 186 May 26
- Great Britain: Digital approach—aircraft instrument landing systems EI p. 230 Aug. 4
- Head-up hologram enables pilot to "see" carrier's deck despite zero visibility USR p. 46 June 23
- High stakes on Capitol Hill p. 171 Jan. 6
- I/CNI hanging by a thin thread p. 115 July 21
- In-flight recorders will give additional data USR p. 48 Feb. 3
- Jumbo-jet age means airlines must take electronic route on the ground, too p. 129 Nov. 24
- L-1011's flight plan USR p. 54 Aug. 4
- LSI takes off—avionic computer USR p. 56 Apr. 14
- Light loran USR p. 46 Dec. 8
- Little loran—6-pound loran receiver, Litcom USR p. 53 May 12
- Little Rascals—Manpack version of carrier landing system USR p. 46 July 21
- Lufthansa ready to fly its Boeing 707's with domestic throttle-control system EI p. 201 Mar. 17
- NAS contract slippage—At the crossroads USR p. 54 Oct. 27
- Navy contract for Cains—Beyond Cains USR p. 47 June 23
- Navy gets a new airborne watchdog—the E-2C p. 133 July 7
- Omega: Worldwide system or backup—which role will Omega play? p. 153 Nov. 10
- One if by land—converting inertial navigation systems USR p. 44 Dec. 8
- Op amps speed cockpit control NP p. 165 Aug. 18
- Performance monitor USR p. 61 Aug. 18
- Practical research gains emphasis at NASA's ERC p. 149 Dec. 8
- Quick frisk—electronic means to thwart would-be hijackers USR p. 56 Mar. 31
- Radiation-hardened IC's go commercial NP p. 137 Feb. 3
- Shear look—Doppler radar techniques spot wind vortex patterns USR p. 46 Mar. 31

Short subject—NASA's V/STOL avionics program USR p. 58 July 7
 TSW-7 portable control tower USR p. 68 Feb. 17
 U. S. SST USR p. 58 Oct. 13
 VAST gets vaster USR p. 46 Jan. 20
 West Germany: Breaking a log jam—Airlong for testing small sounding rockets and military missiles EI p. 209 Oct. 13
 West Germany: Computer polices airport noise EI p. 183 July 7
 Wild blue data—Paces ADA for Airborne Data Automation USR p. 45 Mar. 31

BUSINESS
 Autonetics, Act 2—Microelectronics Products division to be spun off USR p. 54 Oct. 13
 Autonetics arrays its MOS forces p. 103 Apr. 28
 Bechtel Corp. moving into the microwave power business USR p. 62 Mar. 3
 Before you start your own company . . . p. 110 Aug. 18
 Bendix Corp. sells semiconductor operation to Solitron Devices USR p. 58 June 23
 Boeing brings electronics work in-house USR p. 50 Dec. 22
 Building a business in the ghetto spells Progress with a capital letter 'P' p. 165 Jan. 6
 The business to be in ED p. 31 Jan. 20
 Capital expenditures by electronics firms USR p. 53 Apr. 28
 The case for an open market ED p. 31 June 23
 Computer exports—Feast or famine USR p. 60 Aug. 18
 Data General expanding Novas USR p. 50 Aug. 4
 EDP Technology will buy Cornell Aeronautical Laboratory USR p. 68 Oct. 27
 Eastern Europe: Horse traders EI p. 12E Oct. 13
 Electronics companies' capital spending plans USR p. 82 Sept. 15
 EE's—names to conjure with p. 139 Aug. 4
 Electronics firms' capital expenditures USR p. 66 Nov. 10
 Electronics markets—a midyear report p. 107 Aug. 4
 Electronics Markets 1969: The new math of growth p. 111 Jan. 6
 Advanced projects begin to take shape p. 112 Jan. 6
 IC makers' surge to continue p. 114 Jan. 6
 Sweet notes in instrumental theme p. 118 Jan. 6
 Long-term prognosis still favorable p. 121 Jan. 6
 Commercial markets start to soar p. 122 Jan. 6
 Changing of the guard makes civilian agencies cautious p. 125 Jan. 6
 Growth signal is loud and clear p. 126 Jan. 6
 Still dancing to Pentagon's tune p. 130 Jan. 6
 Gravy train still rolling along p. 131 Jan. 6
 Technology gains to outstrip the growth in dollar volume p. 134 Jan. 6
 Strong demand to continue for high-performance items p. 136 Jan. 6
 IC's to gain a foothold p. 138 Jan. 6
 NASA tightens its belt another notch p. 141 Jan. 6

European electronics markets: 1970 p. 79 Dec. 22
 Another good year p. 85 Dec. 22
 West Germany p. 86 Dec. 22
 Great Britain p. 89 Dec. 22
 France p. 92 Dec. 22
 Italy p. 94 Dec. 22
 Sweden p. 96 Dec. 22
 Netherlands p. 98 Dec. 22
 Belgium p. 99 Dec. 22
 Switzerland p. 100 Dec. 22
 Spain p. 102 Dec. 22
 Denmark p. 103 Dec. 22
 Norway p. 103 Dec. 22

Ex-TI team makes MOS deal with Sprague USR p. 56 July 7
 Fairchild Alumni Assoc. at new company Advanced Micro Devices Inc. USR p. 53 Apr. 28
 Fairchild's Hogan, phase two USR p. 52 Mar. 17
 Fairchild returns to power transistors USR p. 56 Feb. 17
 Federal budget: Fiscal 1970 spending plan bears LBJ brand p. 117 Feb. 3
 Federal budget has something for everyone . . . ED p. 31 Feb. 3
 Ford Instrument division shutdown USR p. 52 Apr. 28
 France: Calculated risk—Exactionique aims at undercutting Japanese calculators EI p. 202 Sept. 29
 France: Cartel blanche—giants divide market EI p. 185 July 7
 France: Components shortage EI p. 205 June 9

Grass Valley Group: Bigtime profits in a rural setting p. 129 Mar. 31
 Guidelines needed ED p. 31 Jan. 20
 High stakes on Capitol Hill p. 171 Jan. 6
 IBM and the antitrust suit USR p. 44 Feb. 3
 IBM faces antitrusters USR p. 54 Jan. 20
 IBM: Heading off IBM ED p. 39 Feb. 17
 IBM may soon plunge (without splash) into the 'third-plus' generation USR p. 51 Mar. 17
 International: Union label—American union mounts campaign to stem the flow of US companies to the Far East EI p. 180 Feb. 3
 Japan's goals are defined ED p. 31 Sept. 1
 Japan: Land of rising exports ED p. 33 Aug. 18
 Johnson, Nicholas, a man with a mission p. 134 Oct. 27
 Logitron Inc.: Young EDP executives find their youth a liability on backers' balance sheets p. 123 Nov. 24
 Mexico: Climate friendly in Mexican border zone p. 151 Mar. 3
 Monsanto purchases The Fisher Governor Co. USR p. 62 Mar. 3, USR p. 58 June 23
 National Semiconductor: Charting a course to high profits p. 129 Oct. 13
 Neustein, Joseph, president of Electro-Optical Systems USR p. 65 May 26
 1969 outlook is bright ED p. 31 Jan. 6
 Packard's choice USR p. 45 Jan. 20
 A question of bad business ED p. 31 July 21
 Scientific Data System merger with Xerox Corp. USR p. 67 May 26
 Signetics-GI licensing deal—Licking the platter USR p. 53 June 9
 Sprague Electric goes into power transistors USR p. 66 Feb. 17
 Sweden: Nordic conglomerate EI p. 181 Feb. 3
 Sweden: Trouble ahead EI p. 184 July 21
 Sweden: Vikings, modern style—AGA to build in U.S. EI p. 210 Oct. 13
 SDC means business—in software p. 151 Sept. 15
 To thread maze of export rules, start at the Commerce Dept. p. 139 Feb. 17
 Upbeat outlook favors industry p. 131 Feb. 3
 Viatron—vibrant and probably viable p. 141 June 23
 Wall Street hunts for systems to keep up with volume growth p. 143 Mar. 3
 West Germany: Components booming EI p. 232 Aug. 4

CAPACITORS
 Adding capacitance by the strip NP p. 155 Feb. 17
 Capacitor discharge sets shape of ramp function p. 90 Dec. 8
 Coater speeds capacitor line NP p. 135 Apr. 28
 Electronics Markets 1969: Strong demand to continue for high-performance items p. 136 Jan. 6
 Identical resonators cut ceramic I-f filter cost p. 102 May 26
 Japan: Film making—yttrium-oxide thin films EI p. 197 Aug. 18
 Touch-activated switch built with copper-plated board p. 79 Sept. 1

COLOR TELEVISION
 Apollo: Signal filter to improve color tv from the moon, but not until next trip USR p. 39 Nov. 24
 Cat's eyes for military—Low-light-level tv systems p. 64 Sept. 1
 IDA's Biberman sees sec tube as a workhorse p. 66 Sept. 1
 Army seeks more light on low-level tv p. 68 Sept. 1
 Color tv gets a badly needed face-lift p. 102 Aug. 4
 Color-tv wheel takes a spin in space p. 114 July 7
 Factory approved—HEW teams to check X-ray emission USR p. 48 July 7
 Germany: Five IC's for color-tv sets get warm reception EI p. 237 May 12
 Hot colors—thermoplastic display device projects real-time wall-size pictures in color or b&w USR p. 74 Sept. 15
 IC processes color signals NP p. 201 Aug. 4
 Japan: On the spot—simplified convergence board EI p. 160 Apr. 82
 Logic circuits improve tv color mix NP p. 169 Feb. 17
 New circuits brighten color tv picture p. 133 June 9
 No doubt about Apollo fallout ED p. 31 Aug. 4
 Pay tv gets in the broadcast picture p. 123 May 26
 Picture image?—RCA and Zenith tubes are strikingly similar USR p. 52 June 23
 Portable color tv camera uses digital multiplexing techniques USR p. 56 Apr. 14

'Pressing' pictures on holographic tape is fast, inexpensive p. 108 Nov. 10
 Radiation revisited ED p. 31 Sept. 1
 Showdown for tv—safety standards for color tv receivers USR p. 45 Sept. 1
 SCL's in tv USR p. 60 Jan. 6
 Solar color—color tv for the sun USR p. 58 Nov. 10
 Sweden: Dimming the color EI p. 198 Aug. 18
 West Germany: convergence circuit for 110° color tv EI p. 169 Dec. 22
 West Germany, where linear IC's reign: When it comes to color tv, the outlook is bright indeed p. 111 Sept. 15

COMMUNICATIONS SATELLITES
 ATCS-F—Laser loot USR p. 58 Dec. 8
 ATCS-5—L-band experiments USR p. 53 Dec. 8
 ATCS-5—L-band satellite plan hits a tail-spin USR p. 53 Oct. 27
 Aeronautical services satellite system USR p. 58 May 26
 Air Force's 621B tactical navigation satellite program—Salesmanship USR p. 63 June 9
 Computer simulation plays key role in design of satellite earth stations p. 120 June 23
 Crash program to complete a satellite communications earth station on Guam by Nov. 1 USR p. 60 Aug. 4
 DSCS-2 awarded to the TRW Systems Group USR p. 64 Mar. 17
 GE vs. AT&T USR p. 60 Mar. 17
 Intelsat catches its breath p. 111 Apr. 23
 Intelsat plots a course for the future p. 133 Feb. 17
 Intelsat 3: Second satellite orbited USR p. 66 Feb. 17
 Intelsat 3A: Relaying greetings USR p. 58 Jan. 6
 One vs. many—multipurpose domestic satellite likely USR p. 58 May 12
 NASA ray—ATCS-F to have 30-watt laser USR p. 79 Sept. 15
 Off the ground—switching to synchronous satellites to relay information to mission control USR p. 52 Sept. 29
 PCM: A global scramble for systems compatibility p. 94 June 23
 Phased-array satellite antenna pops up when orbit is reached USR p. 53 Feb. 17
 Son of ATCS—operational in the '70's: the synchronous meteorological satellites USR p. 42 July 21
 Tactical Communications Satellite could see duty in Vietnam USR p. 68 Feb. 17
 Tacsat flight-control programmer USR p. 39 July 21
 TacSat 1 really works USR p. 52 Nov. 10
 Tomorrow's communications—report p. 73 Nov. 24
 The goals: a communications system that replaces person-to-person. The tools: satellites, facsimiles, computers, telephones, microwaves . . . p. 80 Nov. 24

U.S. changes COMSAT's Intelsat role USR p. 48 June 23
 West Germany: Dishing it up—SAFE antenna EI p. 200 Sept. 29
 West Germany: System that checks surface deviations of parabolas may spur new design for large antennas EI p. 218 Feb. 17

COMMUNICATIONS
 Active filters sift sounds NP p. 194 Jan. 6
 Administration fighting delays improved frequency management USR p. 51 Nov. 10
 Airborne phased-array antenna for communicating with military satellites USR p. 56 Jan. 20
 Antenna duplexer is miniaturized NP p. 157 Sept. 29
 Australia: Fare enough—electronics in taxicabs EI p. 186 July 7
 Australia: Outback changeover—single side-band for flying doctor network EI p. 217 June 23
 Brave new network—EIA talks broadband USR p. 54 Nov. 10
 Brazil works on that busy signal p. 133 Mar. 17
 Bulk delay line reveals its secrets USR p. 47 Aug. 18
 Canned heat—"Hot plate" controls temperature inside TO-5 or TO-8 can USR p. 44 Mar. 31
 Centralization cuts costs in tv data display character generation for London Stock Exchange members and Japanese telephone subscribers EI p. 157 Sept. 1
 Communications takeover ED p. 31 Nov. 24
 Computer designed specifically to handle communications input and output problem USR p. 62 Mar. 17
 Computer directs in-out traffic NP p. 154 Mar. 31
 Controlling power without interference NP p. 140 Jan. 20

Curve fitter aids the measure of rms by overruling square-law slowdowns p. 98 Sept. 29
 Data-communications terminal prints fast, quietly NP p. 174 Apr. 14
 Digging in—tests of underground millimeter-wave communications USR p. 58 Sept. 29
 Digital common carrier? USR p. 50 Dec. 8
 Dissent on telecommunications report USR p. 60 June 9
 Electronics Markets 1969: Growth signal is loud and clear p. 126 Jan. 6
 F-M stereo: IC does four jobs NP p. 171 Jan. 20
 France: Laying cable to rest—microwaves for telephone system EI p. 185 July 7
 France: Officials ponder solutions for data transmission explosion EI p. 252 Mar. 3
 France: Pretty fair exchange—IBM electronic telephone exchange links 750 push-button telephones to a central computer EI p. 158 Apr. 28
 Germany: Detached—cordless telephone EI p. 238 May 12
 Getting link going—MCI to establish a commercial microwave link between Chicago and St. Louis. USR p. 40 Sept. 1
 Great Britain: Filtering the surface waves EI p. 184 Nov. 24
 Great Britain: Gunn channel—British army line-of-sight communications EI p. 206 June 9
 Great Britain: Small talk—world's smallest one-piece radio-telephone EI p. 230 Aug. 4
 Hamming it up—CSP-11 speech processor USR p. 72 Sept. 15
 Hear this now—digital ship-to-ship talk USR p. 51 June 9
 Help on the way for teleprocessing? p. 133 Sept. 29
 How's that again?—speech synthesizer for computers USR p. 54 Sept. 29
 I/CNI hanging by a thin thread p. 115 July 21
 Identical resonators cut ceramic I-f filter cost p. 102 May 26
 IBM stakes out bigger share of modem market NP p. 152 May 26
 Japan: New from old—railroad communications twist EI p. 186 July 7
 Johnson, Nicholas, a man with a mission p. 134 Oct. 27
 Keeping in touch—Whatever happened to NCS? USR p. 56 Aug. 4
 Kit provides acoustic terminal NP p. 170 Nov. 10
 Limiters minimize phase distortion NP p. 154 Nov. 24
 Little loran—Litcom, a 6-pound loran receiver USR p. 53 May 12
 Making ripples—acoustic surface-wave transducer USR p. 51 May 26
 Making the scene—computerized dispatch system for police departments USR p. 58 Oct. 27
 Mallard, Radas killed USR p. 42 Dec. 22
 A matter of poor communications . . . that could get better ED p. 31 Oct. 13
 Millimeter waves for ships p. 108 May 26
 Navy's Project Sanguine aetling pale USR p. 52 June 23
 Navy's Sanguine politics USR p. 48 Nov. 24
 Navy transceiver—What if . . . ? USR p. 52 July 7
 OTM's give and take USR p. 53 Dec. 8
 Omnibus chip—f-m telemetry transmitter USR p. 50 Apr. 28
 PCM: a global scramble for systems compatibility p. 94 June 23
 PRBS can fool the system p. 82 Apr. 28
 Phase locking: integrated tuned circuits made easy p. 94 Apr. 28
 Photo Magnetics Systems suing several of the Goliaths in the communications/computer field for infringing on patent USR p. 82 Sept. 15
 Piezoelectric power source—It's a snap USR p. 58 May 12
 Pinpointing whispers—60 gigahertz transceiver USR p. 49 Mar. 3
 Q-multiplier circuit uses op amp with LC feedback p. 92 May 26
 RADA data USR p. Apr. 28
 R-f pollution: a rising concern ED p. 31 Dec. 8
 Speed merchant—ultrahigh-speed a-d converters USR p. 56 June 9
 Switch in time—two-channel video signal selector USR p. 55 Oct. 27
 Tapping microwave acoustics for better signal processing p. 94 Nov. 10
 Applying surface wave acoustics p. 97 Nov. 10
 Amplifying acoustic surface waves p. 102 Dec. 8
 Telegram by pcm USR p. 62 Feb. 17
 Time-division multiplex-demultiplex system NP p. 160 Apr. 14
 Time-sharing traffic cop NP p. 152 Oct. 27

Tomorrow's communications—report p. 73 Nov. 24
Six ages view the future of communications p. 76 Nov. 24
The goals: a communications system that replaces person-to-person contact. The tools: satellites, facsimiles, computers, telephones, microwaves . . . p. 80 Nov. 24
Black boxes that changed communications p. 93 Nov. 24
No more pencils, no more books—write and read electronically p. 94 Nov. 24
Showmanship in communications p. 97 Nov. 24
Picture this: point-to-point paper from the next big-time black box p. 98 Nov. 24
Misusing computers in communications p. 102 Nov. 24
Three influential communicators p. 104 Nov. 24
Turning on—meter-polling system via telephone USR p. 42 Sept. 1
Utopia—Field-replaceable modules USR p. 54 Aug. 18
Vehicle-locator inquiry—Finding the way USR p. 58 May 12
White-noise set tests radio networks NP p. 151 Feb. 3
World pcm standards discord USR p. 40 Dec. 22

COMPUTERS
Active filters see Filters
Air traffic control for the 1980's: Survival to cost billions of dollars p. 127 Oct. 27
All-IC hybrid computer eliminates the patchwork from programming p. 100 Mar. 17
Analyzer checks computer operation NP p. 174 Oct. 27
Analyzer zips through complex logic NP p. 149 Aug. 18
Another from DEC USR p. 53 Apr. 28
Automating Congress: caveat vendor USR p. 41 Dec. 8
Bit by bit—18-bit model smaller than 8-bit machines USR p. 56 Oct. 27
British IC's technology—special report I "The American Challenge" on a chip p. 74 Jan. 20
II Metalization is designed quickly and inexpensively p. 78 Jan. 20
III Laser cuts masks to size, eliminating most errors p. 81 Jan. 20
IV Glow-discharge unit makes multilayer deposition easy p. 84 Jan. 20
Building blocks are two-based hit for analog control computers p. 96 Aug. 4
Calculator is interruptible NP p. 198 Nov. 10
Can the computer manage? ED p. 31 Jan. 20
The case for patenting software p. 96 July 7
Cellular redundancy brings new life to an old algorithm p. 98 July 21
Centralization cuts costs in tv data display character generation for London Stock Exchange members and Japanese telephone subscribers EI p. 157 Sept. 1
China poised for 'great leap' into the forefront of science EI p. 251 Jan. 6
Cogito, cogitas, cogital . . . calculators with MOS LSI USR p. 56 May 12
CAD: A quantum pump for CAD ED p. 33 Mar. 17
Computer-aided design, act two: Admission price exceeds forecasts p. 90 June 9
Computer aids instruments in tasks from a to d NP p. 165 July 7
Computer designed specifically to handle communications input and output problem USR p. 62 Mar. 17
Computer directs in-out traffic NP p. 154 Mar. 31
Computer display is highly readable NP p. 161 Jan. 20
Computer display is a speedy writer NP p. 209 Mar. 3
Computer simulation plays key role in design of satellite earth stations p. 120 June 23
Computer with a heart, at last—PDP-12 design to lower the barriers between men and computers NP p. 179 Jan. 6
Computers make a big difference in MOS designs p. 82 Oct. 13
Converting 10 bits in 1 microsecond NP p. 199 Jan. 6
Cutting tape—preprocessing bandwidth analog data USR p. 62 May 26
DC-10's air data computer shadow p. 125 Mar. 17
Data General expanding Novas USR p. 50 Aug. 4
Digital signal processors go to market NP p. 159 Apr. 14
Disk pack drives USR p. 64 May 12
Display-terminal prices trimmed to fit into more schools, offices NP p. 119 Apr. 28
EDP for all hands wanted by Navy USR p. 52 July 21

Electronic pressure sensor slated for DC-10's air data computer USR p. 43 Jan. 20
Electronics Markets 1969: Gravy train still rolling along p. 131 Jan. 6
Electronics markets—a midyear report p. 107 Aug. 4
Engineer in the loop—CAD scheme complement the engineer USR p. 54 Jan. 6
Europe: Computer makers look East p. 103 Sept. 1
Europe: Cooperative effort seen as key to building giant European computer EI p. 237 Dec. 8
Europe: A gap is a gap EI p. 183 July 21
Exports—Feast or famine USR p. 60 Aug. 18
Fingering the ailment—computerized ECG system USR p. 52 Aug. 18
Fourier analyzer is also computer of all trades NP p. 154 May 26
France: Calculated risk—Exactronique aims at undercutting Japanese calculators EI p. 202 Sept. 29
France: Officials ponder solutions for data transmission explosion EI p. 252 Mar. 3
France: Pretty fair exchange—IBM electronic telephone exchange links 750 push-button telephones to a central computer EI p. 158 Apr. 28
German IC's
Generating IC artwork automatically saves time, prevents costly errors p. 117 Nov. 24
Germanium IC's point the way towards picosecond computers p. 88 Mar. 3
Getting more mileage from computers p. 117 Jan. 20
Great Britain: Graphics design aids for computers EI p. 158 Apr. 28
The Hill wants a computer—but whose? USR p. 51 June 9
How's that again?—speech synthesizer for computers USR p. 54 Sept. 29
Hybrid computers
IV Analog-plus-logic system gets into the control stream p. 98 Jan. 6
Illiac 4: short circuits snag program USR p. 47 Apr. 14
In the factory—digital computer called the PDP-14 USR p. 52 Mar. 3
In this case too ED p. 31 Nov. 10
Industrial FFT computer bows NP p. 171 Oct. 27
IBM: Heading off IBM ED p. 39 Feb. 17
IBM may soon plunge (without splash) into the 'third-plus' generation USR p. 51 Mar. 17
IBM reveals some details about the most powerful computer it has ever developed USR p. 39 Sept. 1
Isolating acoustic signals in real time NP p. 181 Mar. 17
Japan: Computer for doctors will come with special package of software EI p. 251 Mar. 3
Japan: Cutting cost of DDC . . . and an end to hunting EI p. 237 Nov. 10
Japan: Fare game—Computer controls electrostatic printer that issues RR tickets EI p. 199 Jan. 20
Japan: LSI calculator EI p. 204 Mar. 17
Japan: Thinking small—minicomputers EI p. 197 Aug. 18
Japanese show off calculators some with program, others low-priced EI p. 203 June 9
Key-to-tape unit to KO cards? NP p. 171 Sept. 29
LSI takes off—avionic computer USR p. 56 Apr. 14
Limac—largest fixed-wire ECL IC's USR p. 39 Dec. 22
Magnetic bubbles—a technology in the making p. 83 Sept. 1
Magnetic card unit for low-cost processing NP p. 149 May 26
Making a minicomputer superfast p. 116 Nov. 10
Maryland moves to reorganize and streamline its data-processing activities USR p. 80 Sept. 15
A matter of poor communications . . . that could get better ED p. 31 Oct. 13
Memories
All-IC hybrid computer eliminates the patchwork from programming p. 100 Mar. 17
Altered to suit—simulator in attache case USR p. 41 Nov. 24
Associative memories USR p. 44 Jan. 20
Associative memory on a chip NP p. 166 Aug. 4
Boosting reliability of disk memories p. 88 Oct. 27
Core memory speeds IC tests NP p. 192 May 12
Core memory tester has low price tag NP p. 175 May 12
Coupling sets thin magnetic films on closed flux path p. 118 May 12

Digging in data: nonvolatile and alterable semiconductor memory USR p. 50 Apr. 14
Disk memory runs on air NP p. 149 Oct. 13
5-wire organization cuts core memory price NP p. 151 Mar. 31
Flat display has inherent memory NP p. 133 Mar. 31
400-nsec ROM sells for 3.5 cents per bit NP p. 143 Apr. 28
Glass semiconductor read-only memory USR p. 58 Mar. 3
Great Britain: Down to the wire—Ferrite plus platinum wire for memories EI p. 182 July 21
Hughes sets new kind of trap to weed MOS to silicon nitride USR p. 39 Apr. 28
Japan: Diodes galore—photodiode matrices for holographic memories EI p. 159 Apr. 28
Japan: high-density plated-wire memory matrix EI p. 167 Dec. 22
Japan: Mass-produced read-only memory is custom wired after assembly EI p. 195 Aug. 18
Japan: A powerful memory EI p. 223 Apr. 14
Memory cycles in 200 nsec NP p. 168 Oct. 13
Memory designed for peripherals NP p. 160 Nov. 24
Memory has unforgeable price USR p. 53 Jan. 6
A memory to build on NP p. 180 May 12
Memory within a memory NP p. 184 June 9
MOS kits produce display signals NP p. 196 Sept. 15
MOS read-write memory goes to market NP p. 193 June 23
Monolithic memories carry five-year warranty NP p. 165 Oct. 13
NASA expects GOTS to resolve problems of man-machine interface USR p. 51 May 12
New beam-lead connection boosts semiconductor memory yields p. 105 Dec. 22
160-kilobit core memory has low profile NP p. 171 Apr. 14
Radiating confidence—hardened plated-wire USR p. 54 July 7
Read-only memory adds to calculator's repertoire p. 70 Feb. 3
Read-write memory dissipates only 315 mw NP p. 190 Sept. 15
Remember the mainframe—modular answer to all questions USR p. 60 Oct. 27
Rotating disks and drums set peripheral memories spinning p. 96 May 26
Silicon gates opening up for MOS USR p. 67 Sept. 15
Taking the bit—Low-cost disk for mini-computers USR p. 46 Sept. 1
Two firms enter MOS read-only memory race NP p. 189 Apr. 14
200-kilobit read-only memory is fast NP p. 177 Sept. 15
Unicon ordered USR p. 52 Feb. 3
Westinghouse takes another look at MONOS USR p. 62 Jan. 6
Woven-wire memories go commercial NP p. 157 Nov. 24
Memory technology—special report
IX Semiconductor arrays get bigger and denser p. 100 Jan. 20
X MOS random-access arrays p. 102 Jan. 20
XI Cutting systems costs with MOS p. 105 Jan. 20
XII Getting more speed from MOS p. 106 Feb. 17
XIII COS/MOS the best of both worlds p. 109 Feb. 17
XIV SOS brings new life to read-only units p. 114 Feb. 17
XV Optical techniques light the way to mass-storage media p. 108 Mar. 3
XVI Optoelectronic memories: light to read out by p. 113 Mar. 3
XVII Cryoelectronic memories: best hope for large and fast storage units p. 108 Mar. 17
XVIII Sonic film unit is a sound bet p. 90 Apr. 14
XIX Ferroelectric memories for special applications p. 116 May 12
XX Coupling sets thin magnetic films on closed flux path p. 118 May 12
XXI Delay lines—key to low cost in keyboard machines p. 114 June 9
XXII For sophisticated calculators, core arrays are worth the price p. 118 June 9
XXIII Exotic storage applications often revive old memories p. 119 June 9
XXIV Military masses its cores for battlefield conditions p. 122 June 9
XXV Memory testing is a task that comes in layers p. 88 Sept. 1

XXVII Computers for core tests p. 90 Sept. 1
XXVIII Exercising memory systems with worst case bit patterns p. 93 Sept. 1
XXVIII Boosting plated-wire yield: which knob to adjust? p. 95 Sept. 1
XXIX A choice for serial memories p. 122 Sept. 15
XXX Controlling creep and skew in thin-film memories p. 125 Sept. 15
XXXI Packing data tightly in thin-film memories p. 129 Sept. 15
XXXII 'Cache' turns up a treasure p. 105 Oct. 13
XXXIII Speeding up ferrite-core memories p. 108 Oct. 13
Merchandise tag reader—Game of tags USR p. 50 July 7
Mini-computer permits the user to do his own customizing USR p. 67 May 26
Mini machine USR p. 54 Mar. 3
A miniprinter for minicomputers NP p. 153 Oct. 13
Modem on a card NP p. 165 Nov. 10
More merrily—small computer for large fast Fourier analysis USR p. 50 July 21
Multistable logic simplifies man-machine interface p. 105 Aug. 18
NASA expects GOTS to resolve problems of man-machine interface USR p. 51 May 12
Naval Supply Systems Command is buying 14 IBM 360 computers to keep track of its massive inventory of aircraft parts USR p. 82 Sept. 15
OCR reader weighs in at modest price NP p. 165 Sept. 29
Photo Magnetics Systems suing several of the Goliaths in the communications/computer field for infringing on patent USR p. 82 Sept. 15
Point of purchase: Up-to-the-minute inventory figures can be calculated with this system USR p. 44 Jan. 20
Printer to be used by computers over conventional voice-grade phone lines USR p. 60 June 23
Quick EXAM—experimental aerospace multi-processor USR p. 50 Mar. 31
RCA installs computer controlled production system USR p. 60 June 23
Raytheon's RAC-251 computer: off we go—into LSI USR p. 56 Oct. 13
Redefining computer goals ED p. 39 Oct. 27
Remote computer terminal is portable NP p. 171 Aug. 18
Rugged Nova in uniform NP p. 169 Nov. 10
Self-cycling display is processor too NP p. 161 Nov. 10
A shoe drops—IBM's System/3 USR p. 48 Aug. 18
Simulating MOS USR p. 41 Feb. 3
Single building block proves logical choice for custom IC's p. 88 Apr. 28
Small computer is expandable NP p. 193 Nov. 10
Software: Granting of software patents still 'iffy' USR p. 37 Sept. 1
Software for low-cost system includes PDP-8/I computer and a new graphics display terminal USR p. 62 Jan. 6
Soviet Union: The computer mess EI p. 239 May 12
Supernova is order of magnitude faster than it parent; fits in same size box NP p. 119 Sept. 1
Survey of EDP occupations shows priorities for systems analysts and programmers USR p. 82 Sept. 15
SDC means business—in software p. 151 Sept. 15
System speeds digital filtering NP p. 178 Feb. 17
Taking the mess out of design NP p. 151 Jan. 20
TAPE deal USR p. 64 May 12
3-D guidance—Missile computer has 3-D coaxial interconnections USR p. 52 Aug. 4
Time-sharing of hybrid computers NP p. 173 Feb. 17
Time-sharing traffic cop NP p. 152 Oct. 27
Tomorrow's communications—report p. 73 Nov. 24
The goals: a communications system that replaces person-to-person contact. The tools: satellites, facsimiles, computers, telephones, microwaves p. 80 Nov. 24
Misusing computers in communications p. 102 Nov. 24
Turning on—meter-polling system via telephone USR p. 42 Sept. 1
Unbundling sets up new deal—new IBM policy USR p. 45 July 7
Univac looking for additional buyers of its new computer developed for the Navy USR p. 58 Sept. 29
Users' choice is name of keyboard game p. 145 Nov. 10
Viatron lengthening line USR p. 66 Sept. 29

Viatron—vibrant and probably viable p. 141 June 23

Videofile concept for law enforcement USR p. 61 Apr. 14

West Germany: Computer plots profiles of river bottoms EI p. 181 Feb. 3

West Germany: Computer polices airport noise EI p. 183 July 7

West Germany: Fast needlework—P-251's printing mechanism EI p. 185 May 26

West Germany: Streamlining the flow EI p. 196 Aug. 18

West Germany: \$20,000 terminal turns tracings into computer inputs EI p. 250 Mar. 3

Wild blue data—Paces ADA for Airborne Data Automation USR p. 45 Mar. 31

CONFERENCES

Electronics guide—Major 1969 conferences: January-June p. 143 Jan. 6

Electronic Industries Assn. is going to reorganize USR p. 56 Mar. 31

Ending conference boredom ED p. 31 July 21

IEEE needs money ED p. 39 Feb. 17

IEEE Show

Instruments win top billing with IC's p. 98 Mar. 3

Counters, testers, an in-between source, a dvm calibrator, and a signal generator p. 101 Mar. 3

International Solid State Circuits Conference USR p. 58 Mar. 3

WESCON '69 product preview NP p. 163 Aug. 4

CONSUMER ELECTRONICS

Cassettes: Kit provides self-reversing for cassettes NP p. 167 Oct. 27

Color tv gets a badly needed face-lift p. 102 Aug. 4

Electronics markets—a midyear report p. 107 Aug. 4

Electronics Markets 1969: Technology gains to outstrip the growth in dollar volume p. 134 Jan. 6

F-M stereo: IC does four jobs NP p. 171 Jan. 20

Factory approved—HEW teams to check X-ray emission USR p. 48 July 7

Fingertip control—tv sets with electronic tuning USR p. 60 Jan. 6

Hi-fi radio/audio field: IC's still stalled in audio outlets p. 145 June 9

Japan: Direct drive for hi-fi EI p. 216 June 23

Lighting the way to flat-screen tv p. 114 Mar. 17

Maxi coat—magnetic oxide for recording tape USR p. 48 Nov. 24

Overcoming design problems in varactor-diode tuners p. 88 Jan. 6

'Pressing' pictures on holographic tape is fast, inexpensive p. 108 Nov. 10

Pushing buttons: detent uhf tuners gains USR p. 58 Feb. 17

SelectaVision: willing, able, not yet ready USR p. 43 Oct. 13

Stretch: tape machine uses Dolby system USR p. 52 Apr. 14

Tape equipment fights for markets p. 139 June 9

U.S. lights fire under microwave ovens p. 123 Oct. 13

West Germany: Peltier plaques cool rooms in summer and heat them in the winter EI p. 219 Feb. 17

COUNTERMEASURES

Air Force: SRAM missile test USR p. 58 Sept. 29

Caught in the crunch—vidicon for a military infrared avionic system USR p. 56 Jan. 6

Drone system—\$50 million off the shelf USR p. 41 Dec. 8

Navy gets a new airborne watchdog—the E-2C p. 133 July 7

Package deal for ECM firms NP p. 151 Jan. 20

SAM faces life USR p. 63 Nov. 10

Technique for predicting proton showers 4 to 14 hours before they occur USR p. 62 Jan. 6

Whither ABM? USR p. 56 Mar. 31

CRYSTALS

Crystalline units delay Ghz signals NP p. 186 Jan. 6

Foot step—crystals of lithium niobate USR p. 40 Nov. 24

German IC's—Growing silicon on spinel adds up to high isolation, fast switching in IC's p. 113 Oct. 27

When does it pay to customize IC's? p. 116 Oct. 27

Great Britain: Prospects bright in U.K. for glow-diode displays EI p. 249 Mar. 3

Monolithic crystal filter vaults to eight poles NP p. 172 Mar. 3

Piezoelectric power source—It's a snap USR p. 58 May 12

West Germany: Curie-point cure—ferrite IC's EI p. 223 Apr. 14

West Germany: Filtering up—filter uses polycrystalline spheres EI p. 160 Sept. 1

DETECTION

Air pollution: Jumble of electronics, instruments keeps air pollution monitoring hazy p. 137 Dec. 8

Army's radar device can detect and chart underground tunnel complexes USR p. 52 Apr. 28

Backscattering thickness gage USR p. 60 Apr. 14

Color scanning technique for detection of cancer of the pancreas USR p. 61 Apr. 14

Detector covers 1,100-6,000 A NP p. 178 June 9

Detector spots fast-rising spikes NP p. 179 Apr. 14

Elf to the rescue—finding downed pilots USR p. 50 Jan. 20

Eye that bonds—i-r detects bonding flows USR p. 42 July 21

Fast bounce: laser scanning system USR p. 56 Apr. 14

Great Britain: Mixing it up—detectors and mixers for submillimeter wavelengths EI p. 180 Mar. 31

High accuracy obtained from peak detector using op amp p. 94 Mar. 17

Infrared detector chart outlines materials and characteristics p. 91 Jan. 20

IC-size phase detector doesn't need any inductors p. 91 Aug. 4

Open and shut case—sonic underwater valve locator USR p. 50 Mar. 3

Package deal for ECM firms NP p. 154 Jan. 20

Photodiodes' dark current is lightened NP p. 173 Sept. 29

Pinholes: Finding pesky flaws in oxide USR p. 45 June 23

Pocket-size detector can find static charges or leakage current in medical electronic equipment USR p. 60 June 23

Safeguard watcher—microwave pulse height detector USR p. 44 Apr. 28

Seeing in the dark is aim of r-f holography p. 110 Nov. 24

A self-adjustable bandpass filter picks off weak signal despite noise p. 104 Sept. 29

Taking the heat off thermocouple failures p. 96 Oct. 13

West Germany: Infrared indium—room temperature infrared detectors EI p. 201 Sept. 29

Zener circuit detects transients in power lines p. 111 May 12

DIODES

Color from the II-VI's USR p. 40 Feb. 3

Cooler LSA diodes USR p. 64 Feb. 17

Diode controls speed of fan that cools a thyatron p. 95 Jan. 6

Electronics Markets 1969: Strong demand to continue for high-performance items p. 136 Jan. 6

FLD-100 light-emitting diode USR p. 62 July 7

Faster than ECL—high-speed digital logic USR p. 56 Feb. 17

First GaAsP—continuous-wave pumping of a neodymium-doped yag laser USR p. 40 Apr. 28

Focus on diodes—yag laser forms diodes USR p. 51 May 26

Great Britain: Gunn channel—British army line-of-sight communications EI p. 206 June 9

Great Britain: Mixing it up—detectors and mixers for submillimeter wavelengths EI p. 180 Mar. 31

Great Britain: Prospects bright in U.K. for glow-diode displays EI p. 249 Mar. 3

Gunn diodes shoot for new jobs in high-speed digital systems EI p. 201 Oct. 27

Japan: Diodes galore—photodiode matrixes for holographic memories EI p. 159 Apr. 28

Japan: Guarding the gates EI p. 216 June 23

Japan: Gunn for hire EI p. 254 Jan. 6

Japan: Mass-produced read-only memory is custom wired after assembly EI p. 195 Aug. 18

Japan: Odd batch of light-emitting diodes yields a bonus: negative resistance EI p. 229 Aug. 4

Japan: Schottky barrier devices show current increase under pressure EI p. 223 Sept. 15

Light-emitting diode seeks mass market NP p. 159 Oct. 13

Log diodes can be counted on p. 104 Mar. 31

Monsanto is going into the microwave diode business USR p. 66 May 26

Op amp log circuit eliminates diode bulk-resistance effects p. 101 June 9

Op amp sine wave oscillator uses diodes for stability p. 97 Mar. 17

Overcoming design problems in varactor-diode tuners p. 88 Jan. 6

Passing marks—reliability of nitride-passivated diodes USR p. 46 July 7

Photodiodes' dark current is lightened NP p. 173-Sept. 29

Power zener dissipates 100kw NP p. 165 May 26

Rectifier diodes have 100-amp rating NP p. 161 Nov. 24

Schottky diode without a guard ring USR p. 56 Nov. 10

Semiconductor device symbols—special guide p. 115 Nov. 24

Silicon avalanche diodes amplify at subharmonics of X-band frequency USR p. 39 Feb. 3

Simpler digital circuits in a snap p. 105 June 9

Switzerland: Watch out—light-emitting diodes produce readout in stop watch EI p. 204 June 9

Three-barrier Schottky diode reaches S band NP p. 157 Feb. 3

Tuner diodes get 'Made in U.S.' label NP p. 163 May 26

Varactor diodes tune over octave band NP p. 181 Sept. 15

Varian doubles its impatts' power NP p. 158 Feb. 3

Zener in preregulator limits series transistor dissipation p. 98 Oct. 27

DISPLAYS

All-IC hybrid computer eliminates the patchwork from programming p. 100 Mar. 17

Analyzer zips through complex logic NP p. 149 Aug. 18

British IC's technology—special report Integrated solid state display needs no complex circuitry p. 100 Feb. 3

Centralization cuts costs in tv data display character generation for London Stock Exchange members and Japanese telephone subscribers EI p. 157 Sept. 1

Color from the II-VI's USR p. 40 Feb. 3

Computer display is highly readable NP p. 161 Jan. 20

Computer display is a speedy writer NP p. 209 Mar. 3

Digital readout with backup NP p. 158 Feb. 17

Display-terminal prices trimmed to fit into more schools, offices NP p. 119 Apr. 28

Display tube for starglight scope is easy on the eyes USR p. 47 Sept. 29

Ferrite dots create displays NP p. 163 Aug. 18

Flat crt with large screen around the bend in Britain EI p. 197 Jan. 20

Flat display has inherent memory NP p. 133 Mar. 31

Great Britain: Prospects bright in U.K. for glow-diode displays EI p. 249 Mar. 3

Head-up hologram enables pilot to "see" carrier's deck despite zero visibility USR p. 46 June 23

Hot colors—thermoplastic display device projects real-time wall-size pictures in color or b&w USR p. 74 Sept. 15

Japan: Signed up—a fluorescent mosaic display EI p. 224 Apr. 14

Japan: Solid state numerology EI p. 186 Nov. 24

Japan: Vtr runs radar autoplotter EI p. 185 Nov. 24

MOS kits produce display signals NP p. 196 Sept. 15

Navy wants a large-screen display system for its war rooms USR p. 55 Oct. 27

On the beam for sharp crt character displays p. 109 Sept. 29

Oscilloscope's changing face—red, green and blue traces p. 84 Aug. 4

Printer, dvm in thrift pack NP p. 166 Aug. 4

Put your display on television NP p. 188 Sept. 15

Readout says it big and wide NP p. 162 July 7

Road open for highway automation p. 138 Aug. 18

Self-cycling display is processor too NP p. 161 Nov. 10

7-beam crt gives brighter display NP p. 174 Aug. 18

Six-decade display tube for advanced dvm's NP p. 175 June 9

Software for low-cost system includes PDP-8/I computer and a new graphics display terminal USR p. 62 Jan. 6

Solar color—color tv for the sun USR p. 58 Nov. 10

'Sound pen' provides display input NP p. 151 Dec. 22

Teacher in a tube—video portion of school audio-visual tape system USR p. 63 May 12

Tektronix terminal running late USR p. 52 Apr. 28

Thick-film IC is total d-a converter NP p. 185 Sept. 15

Through a glass, lightly NP p. 174 Dec. 8

EDITORIALS

Advanced technology helps chart growth p. 31 Aug. 4

Are we ready for IC standards? p. 35 June 9

The business to be in p. 31 Jan. 20

... but NASA is not rewarded p. 31 Feb. 3

Call for objectivity p. 31 Jan. 6

Can the computer manage? p. 31 Jan. 20

The case for an open market p. 31 June 23

Circumventing incompetence p. 35 May 26

Communications takeover p. 31 Nov. 24

Doing what comes naturally . . . in this case, too p. 31 Nov. 10

Ending conference boredom p. 31 July 21

Europe measures the gap . . . while the U.S. widens it p. 31 May 12

Exploiting expert advice and opinion p. 31 Nov. 24

Federal budget has something for everyone . . . p. 31 Feb. 3

Great expectations . . . and a fourth dimension p. 31 July 7

Guidelines needed p. 31 Jan. 20

Heading off IBM p. 39 Feb. 17

IEEE needs money p. 39 Feb. 17

It's no laughing matter p. 31 Apr. 28

Japan's goals are defined p. 31 Sept. 1

Japan: Land of rising exports p. 33 Aug. 18

A matter of poor communications . . . that could get better p. 31 Oct. 13

1969 outlook is bright p. 31 Jan. 6

No doubt about Apollo fallout p. 31 Aug. 4

The numbers game, again p. 37 Mar. 3

Product planning aids West German IC effort p. 43 Sept. 15

A quantum jump for CAD p. 33 Mar. 17

A question of bad business p. 31 July 21

Radiation revisited p. 31 Sept. 1

Redefining computer goals p. 39 Oct. 7

R-f pollution: a rising concern p. 31 Dec. 8

Safety in the streets p. 35 June 9

Teamwork for hospital safety p. 37 Mar. 3

Toward better communication p. 33 Mar. 31

Trial balloon—maybe. Hot air—no! p. 31 Sept. 29

When it pays to do it yourself p. 33 Mar. 31

A widely absurd proposal p. 35 May 26

EDUCATION

Displays—terminal prices trimmed to fit into more schools, offices NP p. 119 Apr. 28

Europe measures the gap . . . while the U.S. widens it ED p. 31 May 12

Great Britain: High school electronics EI p. 185 Nov. 24

Lectron's electronics kit leaves the toy box p. 147 Apr. 14

Teacher in a tube—video portion of school audio-visual tape system USR p. 63 May 12

ELECTRON BEAMS

Great Britain: Frame up—image converter camera EI p. 158 Sept. 1

Masked marvel—electron-beam masking machine USR p. 50 Aug. 4

Making ripples—acoustic surface-wave transducer USR p. 50 May 26

FIELD EFFECT TRANSISTORS

BIFET circuit yields time delays up to 30 hours p. 94 May 26

FET's help to spot the spikes NP p. 129 Sept. 1

FET links oscillator to TTL circuit p. 97 Feb. 17

FETs protect differential amplifiers p. 88 Jan. 20

FET's tune RC oscillator over decade range p. 96 Feb. 17

FET varies Q of tuned circuit by several thousand p. 95 Sept. 29

Great Britain: gallium-arsenide FET's EI p. 170 Dec. 22

Hybrid FET switch turns on in only 50 nanoseconds NP p. 189 Mar. 3

Japanese take two steps forward in MOS-bipolar compatibility EI p. 207 Oct. 13

Linearity corrector does double duty p. 110 June 9

Matching FET's by design is faster and cheaper than by pick and choose p. 114 Dec. 8

MOS FET prevents loading by a pulse stretcher p. 95 Mar. 3

MOS FET stabilizes oscillator's output p. 80 Feb. 3

MOS FET's switch in 3 nsecs NP p. 206 May 12

Semiconductor device symbols—special guide p. 115 Nov. 24

Squelch acts faster with FET gate p. 96 Mar. 17

Toshiba joins consumer FET race NP p. 174 Jan. 20

FILTERS

Active filters

Part 6: The op amp saves time and money p. 82 Feb. 3

Part 7: Analog blocks ensure stable design p. 100 Feb. 17

Part 8: Positive results from negative feedback p. 96 Mar. 31

Part 9: Applying nonlinear elements p. 116 Apr. 14
 Part 10: Synthetic inductors from gyrators p. 118 July 7
 Part 11: Varying the approach p. 86 July 21
 Part 12: Short cuts to network design p. 82 Aug. 18
 Part 13: Narrowing the choice p. 106 Oct. 27
 Active filters sift sounds NP p. 194 Jan. 6
 Apollo: Signal filter to improve color tv from the moon, but not until next trip USR p. 39 Nov. 24
 Charting a simpler course to the design of yig filters p. 118 Mar. 3
 Designing mismatched low-pass filters graphically—special guide p. 123 Nov. 10
 Feedback sharpens filter response p. 102 Sept. 29
 Great Britain: Filtering the surface waves EI p. 184 Nov. 24
 Hybrid ladder networks aimed at low-cost jobs NP p. 183 May 12
 Identical resonators cut ceramic i-f filter cost p. 102 May 26
 IC filter goes broadband NP p. 180 Nov. 10
 Monolithic crystal filter vaults to eight poles NP p. 172 Mar. 3
 Nomograph charts a fast way to build a notch filter p. 119 Sept. 15
 Pulse-train duty factor controls RC filter p. 93 Aug. 4
 A self-adjustable bandpass filter picks off weak signal despite noise p. 104 Sept. 29
 24 active filters a wide choice for the designer p. 87 July 21
 Universal graphs map direct route to mismatched pi and tee filters p. 121 Nov. 10
 West Germany: Filtering up—filter uses polycrystalline spheres EI p. 160 Sept. 1

GENERATORS
 Comb generators cover 3-40 Ghz NP p. 186 Feb. 17
 Converted generator drives heavy logic loads p. 97 Feb. 17
 Data generator logically copes with MSI NP p. 201 Mar. 3
 Data generators aimed at wider market NP p. 137 Nov. 24
 Diode generator yields complex functions p. 95 Oct. 13
 4-pulse sequence generator built with 1 hex inverter p. 79 Feb. 3
 High-voltage source has split personality NP p. 171 Sept. 15
 Low frequency waveform generator uses 3 op amps p. 98 Apr. 14
 Pulse generator triggered by a step function p. 87 Mar. 31
 Pulses come cheap from small source NP p. 156 Jan. 20
 Sawtooth generator delivers constant peak voltage p. 97 Mar. 3
 Signal generator comes under digital control NP p. 152 July 21
 Signal generator for all NP p. 121 Sept. 1
 Simple gating yields phase-locked pulse bursts p. 96 Jan. 6
 Source delivers a couple of extra waves NP p. 161 Mar. 17
 Sweeper goes from 10 Mhz to 18 Ghz NP p. 191 Dec. 8
 Teamwork streamlines differential amplifier tests p. 132 Sept. 15

GUIDED MISSILES
 Air Force: SRAM missiles test USR p. 58 Sept. 29
 SAM faces life USR p. 63 Nov. 10
 3-D guidance—Missile computer has 3-D coaxial interconnections USR p. 52 Aug. 4

GUNN EFFECT
 Great Britain: flash Gunn radar EI p. 170 Dec. 22
 Great Britain: Gunn channel—British army line-of-sight communications EI p. 206 June 9
 Great Britain: Gunn diode and yig sphere make up bwo EI p. 250 Mar. 3
 Gunn diodes shoot for new jobs in high-speed digital systems EI p. 201 Oct. 27
 Japan: Gunn for hire EI p. 254 Jan. 6
 Monsanto is going into the microwave diode business USR p. 66 May 26
 Yig-tuned Gunn oscillators sweep X band NP p. 189 June 23

HALL EFFECT
 Active filters: Part 9 Applying nonlinear elements p. 116 Apr. 14
 Japan: On the square—IC device can square or cube an analog input function EI p. 253 Jan. 6

INDUSTRIAL ELECTRONICS
 Advanced technology helps chart growth ED p. 31 Aug. 4
 Air pollution: Jumble of electronics, instruments keeps air pollution monitoring hazy p. 137 Dec. 8

Analog-plus-logic system gets into the control stream—Hybrid Computers IV p. 98 Jan. 6
 Calculator is interruptible NP p. 198 Nov. 10
 China poised for 'great leap' into the forefront of science EI p. 251 Jan. 6
 Computer-aided design, act two: Admission price exceeds forecasts p. 90 June 9
 Crime fighting: Safety in the streets ED p. 35 June 9
 East Germany: Government planners set 13% as growth goal for electronics industry in '69 EI p. 198 Jan. 20
 EE's—names to conjure with p. 139 Aug. 4
 Electronics Markets 1969: IC's to gain a foothold p. 138 Jan. 6
 Electronics markets—a midyear report p. 107 Aug. 4
 European electronics markets: 1970 p. 79 Dec. 22
 Another good year p. 85 Dec. 22
 West Germany p. 86 Dec. 22
 Great Britain p. 89 Dec. 22
 France p. 92 Dec. 22
 Italy p. 94 Dec. 22
 Sweden p. 96 Dec. 22
 Netherlands p. 98 Dec. 22
 Belgium p. 99 Dec. 22
 Switzerland p. 100 Dec. 22
 Spain p. 102 Dec. 22
 Denmark p. 103 Dec. 22
 Norway p. 103 Dec. 22
 France: Calculated risk—Exatronique aims at undercutting Japanese calculators EI p. 202 Sept. 29
 Grass Valley Group: Bigtime profits in a rural setting p. 129 Mar. 31
 High stakes on Capitol Hill p. 171 Jan. 6
 In the factory—digital computer called the PDP-14 USR p. 52 Mar. 3
 Japan: All wound up—video tape copying equipment EI p. 181 Mar. 31
 Japan: Cutting cost of DDC . . . and an end to hunting EI p. 237 Nov. 10
 Japan: Fare game—Computer controls electrostatic printer that issues railroad tickets EI p. 199 Jan. 20
 Japan: Fluorescent mosaic display for outdoor signs EI p. 224 Apr. 14
 Japan: Keeping track of Japan's high-speed passenger trains p. 124 May 12
 Jumbo-jet age means airlines must take electronic route on the ground, too p. 129 Nov. 24
 Law enforcement: videofile concept USR p. 61 Apr. 14
 Lectron's electronics kit leaves the toy box p. 147 Apr. 14
 Making the scene—computerized dispatch system for police departments USR p. 58 Oct. 27
 Merchandise tag reader—Game of tags USR p. 50 July 7
 Microwave kiln for curing tanak USR p. 54 Jan. 20
 Packard's choice USR p. 45 Jan. 20
 Picking up the chips—Catalogues listing many new standard chip types USR p. 44 Sept. 1
 Point of purchase: Up-to-the-minute inventory figures can be calculated with this system USR p. 44 Jan. 20
 Printer to be used by computers over conventional voice-grade phone lines USR p. 60 June 23
 Printer with burning prose NP p. 178 May 12
 Printing: Display-terminal prices trimmed to fit into more schools, offices NP p. 119 Apr. 28
 Printing: A miniprinter for minicomputers NP p. 153 Oct. 13
 Putting products in their place NP p. 205 Nov. 10
 RCA installs computer controlled production system USR p. 60 June 23
 Road open for highway automation p. 138 Aug. 18
 Sweden: Trouble ahead EI p. 184 July 21
 Sweden: Vikings, modern style—AGA to build in U.S. EI p. 210 Oct. 13
 SDC means business—in software p. 151 Sept. 15
 Taking the heat off thermocouple failures p. 96 Oct. 13
 To thread maze of export rules, start at the Commerce Dept. p. 139 Feb. 17
 Turning on—meter-polling system via telephone USR p. 42 Sept. 1
 Users' choice is name of keyboard game p. 145 Nov. 10
 Vending machines—The buck stops here currency-note acceptor built into vending machines USR p. 48 Oct. 13
 Videofile puts lawmen in the picture p. 131 Aug. 4
 Wall Street hunts for systems to keep up with volume growth p. 143 Mar. 3
 Welding—Two out of three—system monitors welding operation USR p. 53 May 12
 West Germany: Components booming EI p. 232 Aug. 4

West Germany: Electronic cashier—coin-operated self-service fuel pumps EI p. 199 Jan. 20
 X-Ray spectrometer puts the fix on the mix NP p. 207 Dec. 8

INFORMATION RETRIEVAL
 Acoustic terminal adds and records NP p. 172 Nov. 10
 Acronyms—antic abbreviations p. 111 Sept. 1
 Computer aids instruments in tasks from a to d NP p. 165 July 7
 Controller features a stored program NP p. 172 Oct. 13
 Data generators aimed at wider market NP p. 137 Nov. 24
 Hello, moon—Sprague's Microperm process to store records USR p. 48 Aug. 4
 The Hill wants a computer—but whose? USR p. 51 June 9
 Kit provides acoustic terminal NP p. 171 Nov. 10
 Maryland moves to reorganize and streamline its data-processing activities USR p. 80 Sept. 15
 A matter of poor communications . . . that could get better ED p. 31 Oct. 31
 Microfilm printer takes direct route NP p. 194 Nov. 10
 Printer with burning prose NP p. 178 May 12
 Punchless cards—binary-coded magnetic dots system USR p. 52 May 12
 Remote computer terminal is portable NP p. 171 Aug. 18
 System speeds digital filtering NP p. 178 Feb. 17
 Terminal does double duty NP p. 166 Sept. 29
 Two-gap head verifies recorder data NP p. 177 Nov. 10

INSTRUMENTS
 A-d converter has keyed clock timer NP p. 188 Dec. 8
 Added flip-flop stabilizes a-d converter output p. 76 Dec. 22
 Air pollution: Jumble of electronics, instruments keeps air pollution monitoring hazy p. 137 Dec. 8
 Analyzer adapts to impedance NP p. 184 Apr. 14
 Analyzer zips through complex logic NP p. 149 Aug. 18
 British pair checks radiation levels NP p. 175 June 23
 Calibrator booster reaches 1 kv over range of 10 hz to 110 khz NP p. 168 Aug. 4
 Canada: Telling volumes—electronic volume measure for railroads EI p. 231 Aug. 4
 Ceramic steadies reference unit NP p. 143 Dec. 22
 Common-mode rejection ratio: what the spec sheet doesn't say p. 116 June 23
 Controllers have built-in safety NP p. 158 July 7
 Converter—\$1,000 converter tells all the angles NP p. 129 Apr. 28
 Converters—Getting from a to d in less time NP p. 161 Aug. 18
 Correlation comes to Everyman NP p. 145 Sept. 29
 The correlator that came in from the sea NP p. 147 Nov. 24
 Counters cover 0.05 hertz to 500 Mhz NP p. 157 July 7
 Curve fitter aids the measure of rms by overruling square-law slowdowns p. 98 Sept. 29
 Cutting tape—preprocessing bandwidth analog data USR p. 62 May 26
 Digital differential analyzer—Unquestionably LSI NP p. 145 Aug. 18
 Designers of medical instruments face serious questions on safety p. 92 Feb. 17
 Digital coupler gives 100,000-megohm isolation NP p. 169 June 23
 Digital signals rule programmable ratio box NP p. 141 July 21
 Digital torquer—ground checkout of inertial instrumentation USR p. 58 Aug. 4
 Dopant profile plotted in seconds NP p. 167 Sept. 15
 Echoes at sea are weeded out NP p. 163 June 9
 Electronics Markets 1969: Sweet notes in instrumental theme p. 118 Jan. 6
 Electronics markets—a midyear report p. 107 Aug. 4
 500-watt inverter protects itself NP p. 146 Dec. 22
 France: Oscilloscope—Scooped on scope EI p. 159 Sept. 1
 Great Britain: Portable X-ray unit weighs only 25 pounds EI p. 200 Jan. 20
 High-speed recording USR p. 60 Feb. 17
 Infrared detector chart outlines materials and characteristics p. 91 Jan. 20
 IC's shrink digital printer's size, weight NP p. 193 Aug. 4
 IEEE Show: Counters, testers, an in-between source, a dvm calibrator, and a signal generator p. 101 Mar. 3

IEEE Show: Instruments win top billing with more IC's and digital designs p. 98 Mar. 3
 Know your d-a converter's capability p. 129 Nov. 10
 Low-cost counters have premium specs NP p. 131 July 21
 NAND gate counter is cheaper to make p. 87 Jan. 20
 Navy study of mean time between failures USR p. 57 June 23
 On the beam for sharp crt character displays p. 108 Sept. 29
 Oscilloscope can be a storage scope NP p. 187 Dec. 8
 Oscilloscope's changing face—red, green and blue traces p. 84 Aug. 4
 Oscilloscopes: Chopper network fights scope drift NP p. 165 Aug. 4
 Oscilloscopes: Helical transmission lines bend the beam p. 90 July 7
 Oscilloscopes: Scopes to take product spotlight when curtain lifts for WESCON '69 NP p. 163 Aug. 4
 PRBS can fool the system p. 82 Apr. 28
 Plug-in breadboard for designers NP p. 151 Jan. 20
 Relays upended to save space NP p. 143 Feb. 3
 Security system gets your number NP p. 134 Sept. 1
 Simplifying crt character generation p. 72 Dec. 22
 A single-channel 'multitrace' scope p. 113 Sept. 29
 Spectrum analyzer goes to 1,250 Mhz NP p. 196 Jan. 6
 Switch protects uhf transmitters NP p. 184 May 12
 Taking the heat off thermocouple failures p. 96 Oct. 13
 Teamwork streamlines differential amplifier tests p. 132 Sept. 15
 Thickness gage gives digital answer NP p. 208 Dec. 8
 Transmitters accurate to 0.1% NP p. 186 June 23
 Uncased resistors and inductors offered NP p. 125 Sept. 1

INTEGRATED ELECTRONICS
 Active filters: Part 8 Positive results from negative feedback p. 96 Mar. 31
 Part 9 Applying nonlinear elements p. 116 Apr. 14
 Adapter lets digital IC tester check on operational amplifiers p. 94 July 21
 Air makes the going great for IC slices NP p. 211 Jan. 6
 All-IC hybrid computer eliminates the patchwork from programming p. 100 Mar. 17
 An extra card, and dvm measures low resistance NP p. 181 Mar. 3
 Are we ready for IC standards? ED p. 35 June 9
 At last, a bipolar shift register with the same bit capacity as MOS p. 84 Dec. 8
 Attractive coat—plastic films called parylenes USR p. 68 Sept. 15
 Beam-lead IC plans: Motorola to market fallout from its Safeguard effort USR p. 48 Apr. 14
 Beam-lead IC's push sparks demand for special bonders USR p. 47 Mar. 3
 Bonding—Bumping the substrate USR p. 63 May 12
 British IC's technology—special report I "The American Challenge" on a chip p. 74 Jan. 20
 II Metalization is designed quickly and inexpensively p. 78 Jan. 20
 III Laser cuts masks to size, eliminating most errors p. 81 Jan. 20
 IV Glow-discharge unit makes multi-layer deposition easy p. 84 Jan. 20
 V Electron-beam testing: gentle and fast p. 92 Feb. 3
 VI Bulk-effect modules pave way for sophisticated uses p. 94 Feb. 3
 VII MOS frequency soars with ion-implanted layers p. 96 Feb. 3
 VIII Integrated solid state display needs no complex circuitry p. 100 Feb. 3
 Changing times—IC's to set artillery fuses USR p. 41 Apr. 28
 Checking for leaks in IC's USR p. 56 Mar. 17
 Cogito, cogitas, cogitat . . . —calculators with MOS LSI USR p. 56 May 12
 Computers make a big difference in MOS designs p. 82 Oct. 13
 Cooling dual in-lines with dissipator/clip NP p. 173 June 23
 Core drivers are IC-compatible NP p. 192 Mar. 3
 Curve tracer improves indication of IC performance p. 93 May 26
 D-bugger tests IC's in-circuit NP p. 172 Sept. 15
 Detroit puts electronics in the driver's seat p. 84 Mar. 17
 Dielectric isolation is design key in IC line NP p. 168 July 7

- Electronics Markets 1969: Strong demand to continue for high-performance items p. 136 Jan. 6
- Fairchild introduces family of linear IC's NP p. 144 July 21
- A faster generation of MOS devices with low thresholds is riding the crest of the new wave, silicon-gate IC's p. 88 Sept. 29
- Flexible tester for digital IC's NP p. 163 Mar. 31
- German IC's
Growing silicon on spinel adds up to high isolation, fast switching in IC's p. 113 Oct. 27
When does it pay to customize IC's? p. 116 Oct. 27
Generating IC artwork automatically saves time, prevents costly errors p. 117 Nov. 24
Multi-emitter IC's stabilize voltages in solid state tuners p. 91 Dec. 8
- Germanium IC's point the way towards picosecond computers p. 88 Mar. 3
- Germany: Five IC's for color-tv sets gets warm reception EI p. 237 May 12
- Getting the MOST—Hughes goes with I (for ion implantation) MOS
USR p. 52 Oct. 13
Government-industry cooperation bears fruit in IC mil specification p. 125 Dec. 22
- Great Britain: Beating the heat—pdm for 30-watt audio amplifier
EI p. 240 May 12
- Great Britain: Hybrids with beam-lead ECL chips are bet for mid-70's MSI
EI p. 183 May 26
- Hi-fi radio/audio field: IC's still stalled in audio outlets p. 145 June 9
- How reliable are MOS IC's? As good as bipolars, says NASA p. 106 June 23
- Hybrid breadboard technique cuts costs
USR p. 70 Sept. 15
- Hybrid IC lines move into production
NP p. 149 July 7
- Hybrid-IC transistors served in ceramic cup
NP p. 141 Sept. 1
- Illiac 4: short circuits snag program
USR p. 47 Apr. 14
- IEEE Show: Instruments win top billing with more IC's and digital designs p. 98 Mar. 3
- IC circuit measures speed of switches p. 108 May 12
- IC device reads wire memories
NP p. 183 Oct. 13
- IC does four jobs in f-m stereo
NP p. 171 Jan. 20
- IC filter goes broadband
NP p. 180 Nov. 10
- IC flip-flops accurately control motor rotation p. 94 Aug. 18
- IC handler adds no electrical noise with fluidic logic in control
NP p. 133 May 26
- IC light-sensitive switch can handle 5 ma
NP p. 179 Oct. 13
- IC processes color signals
NP p. 201 Aug. 4
- IC produces i-f on the spot
NP p. 185 Jan. 6
- IC regulator rides easy on high voltage
NP p. 181 June 9
- IC-size phase detector doesn't need any inductors p. 91 Aug. 4
- ICs are checked faster with audible voltmeter p. 88 Jan. 20
- IC's are tailored to consumer jobs
NP p. 163 Nov. 24
- IC's break through the voltage barrier p. 90 Mar. 31
- IC's help simplify multimeter
NP p. 167 Aug. 4
- IC's shrink digital printer's size, weight
NP p. 193 Aug. 4
- IC's slim flight-line meter
NP p. 172 Aug. 4
- IC's take the "bounce" out of switches p. 91 Aug. 4
- It's the heat—hybrid IC power-switching amp
USR p. 46 Oct. 13
- Japan: Alumina enhancement for IC fabrication
EI p. 208 Oct. 13
- Japan: Close quarters—better IC isolation
EI p. 181 Mar. 31
- Japan: Noncontact IC printer loads manually
NP p. 201 Nov. 10
- Japan: On the square—IC device can square or cube an analog input function
EI p. 253 Jan. 6
- LSI and systems: the changing interface p. 78 Mar. 31
- Limac—largest fixed-wire ECL IC's
USR p. 39 Dec. 22
- Masking camera for LSI circuits focuses on speed and resolution
NP p. 153 June 9
- MERA fallout helps prove IC's can be used in microwave
USR p. 42 Apr. 28
- Mil Std 883—a real test case p. 131 Aug. 18
- Monitor protects IC-header bond
NP p. 133 Dec. 22
- Monolithic IC puts out 18 watts
NP p. 185 Mar. 17
- Monolithic regulator stands alone
NP p. 141 Sept. 29
- MOS IC adder handles 4 bits
NP p. 179 Oct. 27
- MOS moves onto high-speed track
USR p. 49 May 26
- Motorola puts its mark on MOS
NP p. 194 Sept. 15
- NASA's "line certification" program
USR p. 54 July 21
- National Semiconductor's IC's available off the shelf
USR p. 54 July 21
- Negative signals converted to positive logic p. 97 Mar. 17
- New circuits brighten color tv picture p. 133 June 9
- No tuned circuits in IC wide-range f-m discriminator p. 108 Nov. 24
- No West German 'creativity gap' where linear IC's are concerned p. 104 Sept. 15
- When it comes to color tv, the outlook is bright indeed p. 111 Sept. 15
- IC's enter the picture for automatic cameras p. 113 Sept. 15
- For noisy environments, why not low-speed logic? p. 115 Sept. 15
- Off with the on—switching circuit for d-a converter
USR p. 50 Sept. 29
- Omnibus chip—f-m telemetry transmitter
USR p. 50 Apr. 28
- One-way road—CMOS a-d converter
USR p. 54 June 9
- Phase locking: integrated tuned circuits made easy p. 94 Apr. 28
- Photolithographic masks: taking a close look
NP p. 145 May 26
- Plastic IC's demand new physical p. 147 May 12
- Power-module line is keyed to IC's
NP p. 164 July 21
- Printing active devices
USR p. 65 Oct. 27
- Product planning aids West German IC effort
ED p. 43 Sept. 15
- Radiation-hardened IC's go commercial
NP p. 137 Feb. 3
- Regulated sales for Motorola voltage regulators
USR p. 71 Sept. 15
- Silicon gates opening up for MOS
USR p. 67 Sept. 15
- Single building block proves logical choice for custom IC's p. 88 Apr. 28
- Smog gets in your IC's
USR p. 48 June 23
- Solo road—interfacing system house
USR p. 50 Aug. 18
- Sorting IC's economically p. 74 Sept. 1
- Soviet Union: Russians launch IC sales campaign with ambitious exhibit at Paris Salon
EI p. 157 Apr. 28
- Thick-film IC is total d-a converter
NP p. 185 Sept. 15
- Timer turns back the clock
NP p. 161 Feb. 17
- Tiny supply for IC's delivers 5 watts
NP p. 145 Oct. 27
- West Germany: Curie-point cure—Ferrite IC's
EI p. 223 Apr. 14
- When it pays to do it yourself
ED p. 33 Mar. 31
- Yig plus new substrate equals microwave IC's
USR p. 37 Dec. 22
- LARGE SCALE INTEGRATION**
Autonetics, Act 2—Microelectronics Products division to be spun off
USR p. 54 Oct. 13
- Autonetics arrays its MOS forces
p. 103 Apr. 28
- British IC's technology—special report
Glow-discharge unit makes multilayer deposition easy p. 84 Jan. 20
- Cellular redundancy brings new life to an old algorithm p. 98 July 21
- Cogito, cogitas, cogitat . . . —calculators with MOS LSI
USR p. 56 May 12
- Digital differential analyzer—Unquestionably LSI
NP p. 145 Aug. 18
- France: LSI halves price of multimeter
NP p. 151 Mar. 17
- Japan: Illogical logic
EI p. 182 July 21
- Japan: LSI calculator
EI p. 204 Mar. 17
- LSI and systems: The changing interface p. 78 Mar. 31
- LSI takes off—avionic computer
USR p. 56 Apr. 14
- LSI under discussion
USR p. 58 Mar. 3
- Masking camera for LSI circuits focuses on speed and resolution
NP p. 153 June 9
- MOS random-access arrays p. 102 Jan. 20
- Raytheon's RAC-251 computer: off we go—into LSI
USR p. 56 Oct. 13
- Remember the mainframe—modular answer to all questions
USR p. 60 Oct. 27
- Setting a standard: 42-lead package functions both as a planar and plug-in unit
USR p. 48 Mar. 3
- Tacsat flight-control programmer
USR p. 39 July 21
- Viatron—vibrant and probably viable
p. 141 June 23
- LASERS**
ATS-F—Laser loot
USR p. 58 Dec. 8
- British IC's technology—special report
Laser cuts masks to size, eliminating most errors p. 181 Jan. 20
- Circuit monitors energy of laser photo-coagulator
p. 110 July 7
- Compact laser puts out 1 kw
NP p. 154 Sept. 29
- Fast bounce: laser scanning system
USR p. 56 Apr. 14
- First CaAsP—continuous-wave pumping of a neodymium-doped yag laser
USR p. 40 Apr. 28
- Focus on diodes—yag laser forms diodes
USR p. 51 May 26
- Great Britain: Mixing it up—detectors and mixers for submillimeter wavelengths
EI p. 180 Mar. 31
- He-Ne laser gets fine-tuning jobs
NP p. 189 Aug. 4
- Hologram system for fast fingerprint identification
USR p. 44 Mar. 31
- How deep is the ocean?
USR p. 64 Sept. 29
- Japan: In the loop—laser rangefinders can handle short distances
EI p. 186 May 26
- Laser-scanning system for military photo transmission goes civilian
USR p. 46 June 23
- Liquid laser goes commercial
NP p. 169 Dec. 8
- Light squeeze—500-picosecond pulses compressed to 270 psec
USR p. 50 May 26
- Long may it live—injection laser at room temperature
USR p. 44 Nov. 24
- Metal-vapor laser goes commercial
NP p. 177 Aug. 4
- NASA ray—ATS-F to have 30-watt laser
USR p. 79 Sept. 15
- New tune—parametric oscillator tuned with optics
USR p. 52 May 26
- 'Pressing' pictures on holographic tape is fast, inexpensive p. 108 Nov. 10
- Ruby laser produces as many as nine discrete colors simultaneously, six of them tunable
USR p. 62 Mar. 17
- SelectaVision: willing, able, not yet ready
USR p. 43 Oct. 13
- Short tube
USR p. 60 July 7
- Sounding a light note—holographic memories
USR p. 54 May 26
- Switch in time—q-switch without moving parts
USR p. 52 May 26
- Union ordered
USR p. 52 Feb. 3
- Wattmeter measures laser output
NP p. 157 Aug. 18
- Yag laser delivers 250 watts c-w
NP p. 172 June 9
- Yag laser shows power, versatility
NP p. 133 Apr. 28
- MAGNETICS**
Coupling sets thin magnetic films on closed flux path p. 118 May 12
- Czechoslovakia: Magnetic field varies turn-on time of "Timistor"
EI p. 182 Mar. 31
- Depositing ferrite films
USR p. 46 Oct. 13
- Ferrite dots create displays
NP p. 163 Aug. 18
- Follow the bouncing bubble
USR p. 51 Aug. 18
- Great Britain: Down to the wire—Ferrite plus platinum wire for memories
EI p. 182 July 21
- Great Britain: Rigged with yig
EI p. 222 Apr. 14
- Japan: On the spot—simplified convergence board
EI p. 160 Apr. 28
- Japan: A powerful memory
EI p. 223 Apr. 14
- Magnetic bubbles—a technology in the making p. 83 Sept. 1
- Magnetic card unit for low-cost processing
NP p. 149 May 26
- Memory technology report
XVIII Sonic film unit is a sound bet p. 90 Apr. 14
- XXXIII Speeding up ferrite-core memories p. 108 Oct. 13
- Oscilloscope's changing face—red, green and blue traces p. 84 Aug. 4
- Punchless cards—binary-coded magnetic dots system
USR p. 52 May 12
- Read-only memory adds to calculator's repertoire p. 70 Feb. 3
- Samarium cobalt permanent-magnet material
USR p. 64 Mar. 17
- Slim magnetic modules keep company with IC's
NP p. 139 Mar. 31
- West Germany: Curie-point cure—ferrite IC's
EI p. 223 Apr. 14
- West Germany: Device changes its I-V curve in magnetic field
EI p. 202 Mar. 17
- MAINTENANCE**
Smog gets in your IC's
USR p. 48 June 23
- VAST gets vaster
USR p. 46 Jan. 20
- MANPOWER**
Allen-Bradley battles U.S. on hiring Negroes
USR p. 48 Jan. 20
- Before you start your own company p. 110 Aug. 18
- Building a business in the ghetto spells progress with a capital 'P'
p. 165 Jan. 6
- Circumventing incompetence
ED p. 35 May 26
- Doing what comes naturally . . . in this case, too
ED p. 31 Nov. 10
- EE's—names to conjure with p. 139 Aug. 4
- Engineers accept the risk of layoffs as part of the game in defense field p. 122 Jan. 20
- Exploiting expert advice and opinion
ED p. 31 Nov. 24
- For EE's the party's over p. 139 Aug. 4
- Great expectations . . . and a fourth dimension
ED p. 31 July 7
- International: Union label—American union mounts campaign to stem the flow of U.S. companies to the Far East
EI p. 180 Feb. 3
- IUE tries to stem outflow of jobs p. 123 Mar. 31
- Keeping spin-offs in-house: a new approach to an old problem p. 127 Sept. 29
- Logitron Inc.: Young EDP executives find their youth a liability on backers' balance sheets p. 123 Nov. 24
- Mexico: Climate friendly in Mexican border zone p. 151 Mar. 3
- Miss Bell to you
USR p. 60 Aug. 4
- On the wing
USR p. 54 July 21
- Survey of EDP occupations shows priorities for systems analysts and programmers
USR p. 82 Sept. 15
- MARINE ELECTRONICS**
Great Britain: Schools systems—digital sonar finds schools of fish
EI p. 252 Jan. 6
- Hear this now—digital ship-to-ship talk
USR p. 51 June 9
- Millimeter waves for ships p. 108 May 26
- MEASUREMENTS**
Adapter lets digital IC tester check on operational amplifiers p. 94 July 21
- Air pollution: Jumble of electronics, instruments keeps air pollution monitoring hazy p. 137 Dec. 8
- An extra card, and dvm measures low resistance
NP p. 181 Mar. 3
- Analyzer adapts to impedance
NP p. 184 Apr. 14
- Automatic attenuator rapidly changes signal level p. 120 Sept. 15
- British pair checks radiation levels
NP p. 175 June 23
- Calibrator booster reaches 1 kv over range of 10 hz to 110 khz
NP p. 168 Aug. 4
- Canada: Telling volumes—electronic volume measure for railroads
EI p. 231 Aug. 4
- Cermet potentiometers are not driftless, but they drift less
NP p. 141 Feb. 3
- Counters cover 0.05 hertz to 500 Mhz
NP p. 157 July 7
- Digital multimeter, designed for Hawk tests, is built rugged
NP p. 164 Feb. 17
- Digital panel meter: Two more dpm's sign up for IEEE
NP p. 165 Mar. 17
- Dvm nudged into market
NP p. 164 Oct. 27
- Fluke's dvm
USR p. 58 June 23
- Four-digit voltmeter shows a low price
NP p. 145 Feb. 3
- France: LSI halves price of millimeter
NP p. 151 Mar. 17
- Gaussmeter priced for repair shop
NP p. 191 May 12
- Great Britain: Low-cost instrument plots impurity profiles of semiconductors
EI p. 179 Mar. 31
- IEEE Show
Small counter aims high p. 101 Mar. 3
- The 'compleat' counter, without plug-ins
p. 103 Mar. 3
- Add IC's, subtract cost p. 105 Mar. 3
- IC's are checked faster with audible voltmeter p. 88 Jan. 20
- IC's help simplify multimeter
NP p. 167 Aug. 4
- IC's slim flight-line meter
NP p. 172 Aug. 4
- Japan: Rubbed out—wiperless potentiometer
EI p. 215 June 23
- Japan: Wire-sleuthing—tracking wear on overhead railway wires
EI p. 202 Oct. 27
- Know your d-a converter's capability p. 129 Nov. 10
- Load current monitor doesn't break circuit p. 93 Oct. 13
- Loop gain measurements made with paired amplifiers p. 92 May 26
- Low-cost counters have premium specs
NP p. 131 July 21
- Magnetometer is accurate, stable
NP p. 143 May 26
- Meter divides or subtracts a-c and d-c
NP p. 189 May 12
- Meter has 0.1% accuracy
NP p. 149 Oct. 27
- Meter has 7-segment readout
NP p. 155 Dec. 22
- Meter maker goes digital, but . . .
NP p. 182 Apr. 14
- A microvolt potentiometer
NP p. 191 Jan. 6
- Pair of source followers keep a voltmeter steady p. 103 June 23
- Phase comparator yields digital output p. 118 Sept. 15

Photolithographic masks: taking a close look NP p. 145 May 26
Picoammeter: Holdout joins digital crowd NP p. 186 Mar. 3
Pot stays steady in changing climate NP p. 172 Mar. 17
Potentiometer promises 0.01 ppm accuracy NP p. 163 Oct. 27
Printer, dvm in thrift pack NP p. 166 Aug. 4
Reference waveform adds to scope's measuring capability p. 77 Dec. 22
Rms measuring time cut to 300 msec NP p. 165 June 23
Sighting irregularities in small shafts p. 96 Oct. 27
Six-decade display tube for advanced dvm's NP p. 175 June 9
Spectrum analyzer operates on battery NP p. 162 Sept. 29
Teamwork streamlines differential amplifier tests p. 132 Sept. 15
Tiltmeter goes to the field NP p. 147 Feb. 3
2-stage peak-holding circuit stores sub-microsecond pulses p. 105 Nov. 10
Voltmeter performs double duty NP p. 141 May 26
Voltmeter tells all—for \$650 NP p. 161 Oct. 27
A wattmeter for r-f and another for light NP p. 157 Aug. 18
X-Ray spectrometer puts the fix on the mix NP p. 207 Dec. 8

MEDICAL ELECTRONICS
Circuit monitors energy of laser photo-coagulator p. 110 July 9
Color scanning technique for detection of cancer of the pancreas UR p. 61 Apr. 14
Designers of medical instruments face serious question on safety p. 92 Feb. 17
Electronics Markets 1969: Long-term prognosis still favorable p. 121 Jan. 6
European pacemaker's a pace setter EI p. 215 June 23
Fingering the ailment—Computerized ECG system UR p. 52 Aug. 18
Great Britain: Long lived a pacemaker EI p. 180 Mar. 31
Japan: Computer for doctors will come with special package of software EI p. 251 Mar. 3
On the cuff—measure blood pressure with ultrasound UR p. 43 Dec. 8
Permanently implantable artificial heart, complete with computer control logic UR p. 58 Dec. 8
Pocket-size detector can find static charges or leakage current in medical electronic equipment UR p. 60 June 23
Safely isolated—circuit isolation for medical instrumentation UR p. 38 Sept. 1
Soviet Union: An on-board computer will keep medical tabs on cosmonauts in space stations EI p. 179 Feb. 3
Teamwork for hospital safety ED p. 37 Mar. 3
Xeroradiography to detect breast cancer in women UR p. 42 Feb. 3

METEOROLOGY
Shear look—Doppler radar techniques spot wind vortex patterns UR p. 46 Mar. 31
Son of ATS—operational in the '70's: the synchronous meteorological satellites UR p. 42 July 21
West Germany: Radar rain check EI p. 182 Mar. 31

MICROELECTRONICS
Adding capacitance by the strip NP p. 155 Feb. 17
Autonetics, Act 2—Microelectronics Products division to be spun off UR p. 54 Oct. 13
Great Britain: Hybrids with beam-lead ECL chips are bet for mid-70's MSI EI p. 183 May 26
Masked marvel—electron-beam masking machine UR p. 50 Aug. 4

MICROWAVE
Air traffic control for the 1980's: Survival to cost billions of dollars p. 127 Oct. 27
Amplifiers put out 10 watts NP p. 160 Sept. 29
Antenna duplexer is miniaturized NP p. 157 Sept. 29
Avalanche source puts out 250 mw NP p. 195 Dec. 8
Bechtel Corp. moving into the microwave power business UR p. 62 Mar. 3
British IC's technology—special report Bulk-effect modules pave way for sophisticated uses p. 94 Feb. 3
Bulk delay line reveals its secrets UR p. 47 Aug. 18
Coaxial switches isolate parts by 60 db NP p. 183 Feb. 17
Cystalline units delay GHz signals NP p. 186 Jan. 6
Depositing ferrite films UR p. 46 Oct. 13
Designing lumped elements into microwave amplifiers p. 100 Apr. 14

Digging in—tests of underground millimeter-wave communications UR p. 58 Sept. 29
Digital common carrier? UR p. 50 Dec. 8
Electronics Markets 1969: Still dancing to Pentagon's tune p. 130 Jan. 6
Foot step—crystals of lithium niobate UR p. 40 Nov. 24
France: Laying cable to rest—microwaves for telephone system EI p. 185 July 7
Getting link going—MCI to establish a commercial microwave link between Chicago and St. Louis UR p. 40 Sept. 1
Great Britain: Out of GaAs EI p. 203 Oct. 27
Help on the way for teleprocessing? p. 133 Sept. 29
IC produces i-f on the spot NP p. 185 Jan. 6
Japan: Gunn diodes shoot for new jobs in high-speed digital systems EI p. 201 Oct. 27
Japanese take two steps forward in MOS-bipolar compatibility EI p. 207 Oct. 13
Kiln for curing tanoak UR p. 54 Jan. 20
Little Rascals—Manpack version of carrier landing system UR p. 46 July 21
Log amp has 80 Mhz bandwidth NP p. 192 Dec. 8
A matter of poor communications . . . that could get better ED p. 31 Oct. 13
Micrometer tunes coax attenuator NP p. 190 Nov. 10
Millimeter waves for ships p. 108 May 26
Mini-magnetron delivers 1-kw pulses NP p. 165 Jan. 20
Mixers have low intermodulation distortion NP p. 185 Aug. 4
Mixers suppress unwanted signals NP p. 160 June 9
Motorola launches low-price transistor line NP p. 157 June 9
R-f connector extends upper frequency range NP p. 195 Mar. 3
R-f pollution: a rising concern ED p. 31 Dec. 8
Receiver/transmitter aimed at 960-Mhz band NP p. 199 May 12
Safeguard watcher—microwave pulse height detector UR p. 44 Apr. 28
Semiconductor microwave sources go off-the-shelf at more makers NP p. 149 Feb. 17
Signal generator comes under digital control NP p. 152 July 21
Silicon avalanche diodes amplify at sub-harmonics of X-band frequency UR p. 39 Feb. 3
Solid state microwave leaves lab p. 86 Feb. 17
Spectrum analyzer operates on battery NP p. 162 Sept. 29
Sweeper goes from 10 Mhz to 18 GHz NP p. 191 Dec. 8
Tapping microwave acoustics for better signal processing p. 94 Nov. 10
Applying surface wave acoustics p. 97 Nov. 10
Amplifying acoustic surface waves p. 102 Dec. 8
Three-barrier Schottky diode reaches S band NP p. 157 Feb. 3
Tomorrow's communications—report p. 73 Nov. 24
The goals: a communications system that replaces person-to-person contact. The tools: satellites, facsimiles, computers, telephones, microwaves p. 80 Nov. 24
Uncased resistors and inductors offered NP p. 125 Sept. 1
U.S. lights fire under microwave ovens p. 123 Oct. 13
Utopia—Field-replaceable modules UR p. 54 Aug. 18
Varactor diodes tune over octave band NP p. 181 Sept. 15
Varian doubles its impatts' power NP p. 158 Feb. 3
West Germany: Curie-point cure—ferrite IC's EI p. 223 Apr. 14
West Germany: Filtering up—filter uses polycrystalline spheres EI p. 160 Sept. 1
Yig plus new substrate equals microwave IC's UR p. 37 Dec. 22
Yig-tuned Gunn oscillators sweep X band NP p. 189 June 23

MILITARY ELECTRONICS
Air Force: Air operations planning goes automatic p. 117 May 26
Air Force avionics computer: LSI takes off UR p. 56 Apr. 14
Air Force awards contract for Geans UR p. 66 Nov. 10
Air Force: Big Boeing proposed for Awacs UR p. 82 Sept. 15
Air Force: Bulk delay line reveals its secrets UR p. 47 Aug. 18
Air Force: I/CNI hanging by a thin thread p. 115 July 21
Air Force: SRAM missile test UR p. 58 Sept. 29

Air Force's 621B tactical navigation satellite program—Salesmanship UR p. 63 June 9
Army purchasing—Harsha treatment UR p. 58 June 9
Army's radar device can detect and chart underground tunnel complexes UR p. 52 Apr. 28
Army's Stano field tests—Trying before buying UR p. 48 Dec. 8
Cat's eyes for military—Low-light-level tv systems p. 64 Sept. 1
IDA's Biberman sees sec tube as a work-horse p. 66 Sept. 1
Army seeks more light on low-low-level tv p. 68 Sept. 1
Caught in the crunch—vidicon for a military infrared avionics system UR p. 56 Jan. 6
Changing times—IC's to set artillery fuzes UR p. 41 Apr. 28
Digital multimeter, designed for Hawk tests, is built rugged NP p. 164 Feb. 17
Display tube for starlight scope is easy on the eyes UR p. 47 Sept. 29
Drone system—\$50 million off the shelf UR p. 41 Dec. 8
Electronics Markets 1969: Advanced projects begin to take shape p. 112 Jan. 6
Great Britain: Gunn channel—British army line-of-sight communications EI p. 206 June 9
Laird's lard UR p. 60 Apr. 14
Little Rascals—Manpack version of carrier landing system UR p. 46 July 21
Mallard, Radas killed UR p. 46 Dec. 22
MIT panel ponders university's role in military R&D UR p. 64 May 12
McLucas, John L. Undersecretary of AF: Robes of office UR p. 60 Mar. 3
Mil Std 883—a real test case p. 131 Aug. 18
Military budget takes it on the chin UR p. 37 July 21
Millimeter waves for ships p. 108 May 26
Memory technology—report XXIV Military masses its cores for battlefield conditions p. 122 June 9
Naval Supply Systems Command is buying 14 IBM 360 computers to keep track of its massive inventory of aircraft parts UR p. 82 Sept. 15
Navy—MAIR starts UR p. 82 Sept. 15
Navy: Drone on—Nite Panther UR p. 50 Jan. 20
Navy: Hear this now—digital ship-to-ship talk UR p. 51 June 9
Navy: VAST gets vaster UR p. 46 Jan. 20
Navy asks to be cut in on early design review conferences for new hardware systems UR p. 54 June 9
Navy contract for Cains—Beyond Cains UR p. 47 June 23
Navy gets a new airborne watchdog—the E-2C p. 133 July 7
Navy hopes to award a production contract for micro-miniature digital TACAN navigation systems UR p. 64 June 9
Navy plugs in—replacing high-power rectifier tubes UR p. 60 Oct. 27
Navy study of mean time between failures UR p. 57 June 23
Navy transceiver—What if . . . ? UR p. 52 July 7
Navy's coherent X-band power source—Solid high power UR p. 54 May 12
Navy's Project Sanguine getting pale UR p. 52 June 23
Navy's Sanguine politics UR p. 48 Nov. 24
Navy's SHP program—under full sail UR p. 43 Dec. 8
Navy wants EDP for all hands UR p. 52 July 21
Navy wants a large-screen display system for its war rooms UR p. 55 Oct. 27
Packard's choice UR p. 45 Jan. 20
Radiation-hardened IC's go commercial NP p. 137 Feb. 3
SAM faces life UR p. 63 Nov. 10
Soldiers and spacemen—NASA getting more involved in military business UR p. 76 Sept. 15
Strategic projects get green light p. 119 Feb. 3
Stubbing report: Silent treatment UR p. 60 Feb. 17
The numbers game, again ED p. 37 Mar. 3
Trial balloon—maybe. Hot air—no! ED p. 31 Sept. 29
Utopia—Field-replaceable modules UR p. 54 Aug. 18

MULTIVIBRATORS
Free-running multivibrator is made with a NAND gate p. 95 Jan. 6
Full duty single shot recovers fast p. 89 Mar. 31
Multivibrators separate pulses according to their widths p. 88 Dec. 8

One-shot multivibrator requires no standby power p. 91 May 26
One-shot multivibrator yields division up to 12 p. 96 Apr. 14
Positive or negative pulses trigger one-shot multivibrator p. 94 Aug. 18
A single-channel 'multitrac' scope p. 113 Sept. 29
Transformerless d-c voltage converter is 70% efficient p. 95 Apr. 14
Two one-shots control waveform's pulse width p. 93 Jan. 6

NAVIGATION SYSTEMS
ATS-5—L-band satellite plan hits a tail-spin UR p. 53 Oct. 27
Air Force awards contract for Geans UR p. 66 Nov. 10
Air Force's 621B tactical navigation satellite program—Salesmanship UR p. 63 June 9
Computer navigates helicopters UR p. 46 Feb. 3
Doppler sonar sensor with an inertial navigation system UR p. 60 May 26
I/CNI hanging by a thin thread p. 115 July 21
L-1011's flight plan UR p. 54 Aug. 4
Light loran UR p. 46 Dec. 8
Little loran—Litcom a 6-pound loran receiver UR p. 53 May 12
Lockheed-California selects four companies to help develop a modular navigation system for the L-1011 TriStar UR p. 66 Sept. 29
Navy contract for Cains—Beyond Cains UR p. 47 June 23
Navy hopes to award a production contract for micro-miniature digital TACAN navigation systems UR p. 64 June 9
Omega: Worldwide system or bankup—which role will Omega play? p. 153 Nov. 10
One if by land—converting inertial navigation systems UR p. 44 Dec. 8
Road open for highway automation p. 138 Aug. 18
Seeing in the dark is aim of r-f holography p. 110 Nov. 24
Tapping microwave acoustics for better signal processing p. 94 Nov. 10
Applying surface wave acoustics p. 97 Nov. 10
Amplifying acoustic surface waves p. 102 Dec. 8

NUCLEONICS
European pacemaker's a pace setter EI p. 215 June 23
Factory approved—HEW teams to check X-ray emission UR p. 48 July 9
Radiation-hardened IC's go commercial NP p. 137 Feb. 3
Radiation revisited ED p. 31 Sept. 1
R-f pollution: a rising concern ED p. 31 Dec. 8
Showdown for tv—safety standards for color tv receivers UR p. 45 Sept. 1
Transistors are radiation-hard NP p. 193 Apr. 14

OCEANOGRAPHY
Doppler sonar sensor with an inertial navigation system UR p. 60 May 26
Echoes at sea are weeded out NP p. 163 June 9
Great Britain: Schools systems—digital sonar finds school of fish EI p. 252 Jan. 6
Lasers—How deep is the ocean? UR p. 64 Sept. 29
Open and shut case—sonic underwater valve locator UR p. 50 Mar. 3
"Net NASA"—the National Oceanic & Atmospheric Agency UR p. 56 Jan. 20

OPTOELECTRONICS
Cat's eyes for military—Low-light-level tv systems p. 64 Sept. 1
IDA's Biberman sees sec tube as a work-horse p. 66 Sept. 1
Army seeks more light on low-low-level tv p. 68 Sept. 1
Caught in the crunch—vidicon for a military infrared avionics system UR p. 56 Jan. 6
Focusing in—solid-state tv cameras UR p. 54 Feb. 17
Hologram systems for fast fingerprint identification UR p. 44 Mar. 31
IC light-sensitive switch can handle 5 ma NP p. 179 Oct. 13
Japan: Diodes galore—photodiode matrices for holographic memories EI p. 159 Apr. 28
Memory technology XV Optical techniques light the way to mass-storage media p. 108 Mar. 3
XVI Optoelectronic memories: light to read out by p. 113 Mar. 3
Merchandise tag reader—Game of tags UR p. 50 July 7
Mix 'n' match—OCR that can 'read' variety of type fonts UR p. 52 Sept. 29
New tune—parametric oscillator tuned with optics UR p. 52 May 26

OCR reader weighs in at modest price
 NP p. 165 Sept. 29

Optical isolator speeds digital data transmission
 p. 104 Nov. 10

Photodiodes' dark current is lightened
 NP p. 173 Sept. 29

Security system gets your number
 NP p. 134 Sept. 1

Seeing in the dark is aim of r-f holography
 p. 110 Nov. 24

Strobing signal smooths data rate
 NP p. 167 July 7

Switch in time-q-switch without moving parts
 USR p. 52 May 26

Up goes production, down go prices . . . and here comes optoelectronics!
 p. 117 Dec. 22

OSCILLATORS

Avalanche source puts out 250 mw
 NP p. 195 Dec. 8

British IC's technology—special report
 Bulk-effect modules pave way for sophisticated uses
 p. 94 Feb. 17

FET links oscillator to TTL circuit
 p. 97 Feb. 17

FET's tune RC oscillator over decade range
 p. 96 Feb. 17

Great Britain: Gunn diode and yig sphere make up bwo
 EI p. 250 Mar. 3

Japan: Gunn diodes shoot for new jobs in high-speed digital systems
 EI p. 201 Oct. 27

Japan: Gunn for hire
 EI p. 254 Jan. 6

Low frequency waveform generator uses 3 op amps
 p. 98 Apr. 14

MOS FET stabilizes oscillator's output
 p. 80 Feb. 3

New tune—parametric oscillator tuned with optics
 USR p. 52 May 26

Op amp sine wave oscillator uses diodes for stability
 p. 97 Mar. 17

Oscillator has a transfer as the resonant device
 p. 78 Feb. 3

Power oscillator tests equipment for rf
 NP p. 177 Mar. 17

Retriggerable one-shots form delayed-key oscillator
 p. 96 Sept. 29

Single-sweep oscillator has multioctave range
 NP p. 147 Mar. 31

Stable f-m oscillator offers sensitivity and linearity
 p. 95 Aug. 18

Varian doubles its impatts' power
 NP p. 158 Feb. 3

Yig-tuned Gunn oscillators sweep X band
 NP p. 189 June 23

PACKAGING

Attractive coat—plastic films called parylenes
 USR p. 68 Sept. 15

Cooling dual in-lines with dissipator/clip
 NP p. 173 June 23

Multichip triac package replaces relays
 NP p. 205 Jan. 6

Multiplexers double as logic circuits
 p. 100 Oct. 27

Plastic bags change resistance tolerances
 USR p. 66 Oct. 27

Plastic IC's demand new physical
 p. 147 May 12

Setting a standard: 42-lead package functions both as a planar and plug-in unit
 USR p. 48 Mar. 3

Slim magnetic modules keep company with IC's
 NP p. 139 Mar. 31

Sorter handles 5,000 IC's an hour
 NP p. 206 Mar. 3

Terminal helps stamp out stampings
 NP p. 154 Mar. 17

PATENTS

The case for patenting software
 p. 96 July 7

Patently weaker—legislation
 USR p. 51 Aug. 18

Photo Magnetics Systems suing several of the Goliaths in the communications/computer field for infringing on patent
 USR p. 82 Sept. 15

Reforms urged by Tribus
 USR p. 37 Sept. 1

Software: Granting of software patents still 'iffy'
 USR p. 37 Sept. 1

PATTERN RECOGNITION SYSTEMS

Centralization cuts costs in tv data display character generation for London Stock Exchange members and Japanese telephone subscribers
 EI p. 157 Sept. 1

How's that again? speech synthesizer for computers
 USR p. 54 Sept. 12

MOS kits produce display signals
 NP p. 196 Sept. 15

Mix 'n' match—OCR that can 'read' variety of type fonts
 USR p. 52 Sept. 29

On the beam for sharp crt character displays
 p. 109 Sept. 29

OCR reader weighs in at modest price
 NP p. 165 Sept. 29

Punchless cards—binary-coded magnetic dots system
 USR p. 52 May 12

Simplifying crt character generation
 p. 72 Dec. 22

PHOTOGRAPHY

Great Britain: Frame up—image converter camera
 EI p. 158 Sept. 1

Head-up hologram enables pilot to 'see' carrier's deck despite zero visibility
 USR p. 46 June 23

Hologram system for fast fingerprint identification
 USR p. 44 Mar. 31

Japan: Diodes galore—photodiode matrices for holographic memories
 EI p. 159 Apr. 28

Japan: Tv facsimile for the home
 EI p. 200 Sept. 29

Laser-scanning system for military photo transmission goes civilian
 USR p. 46 June 23

'Pressing' pictures on holographic tape is fast, inexpensive
 p. 108 Nov. 10

Seeing in the dark is aim of r-f holography
 p. 110 Nov. 24

West Germany: where linear IC's reign: IC's enter the picture for automatic cameras
 p. 113 Sept. 15

Xeroradiography to detect breast cancer in women
 USR p. 42 Feb. 3

POWER SUPPLIES

A-C source drives tape-stepping motor
 p. 109 Nov. 24

Amphenol invades SMA connector market
 NP p. 143 Nov. 24

Amplifier modules deliver 250-watt pulses
 NP p. 186 Nov. 10

Cable connectors trim out the fuss
 NP p. 153 July 7

Cable weight takes a dive
 NP p. 147 Jan. 20

Control current slows pulse's leading edge
 p. 96 Aug. 18

Controlling power without interference
 NP p. 140 Jan. 20

Core-memory driver runs cooler
 p. 102 Oct. 13

D-a converter improves accuracy of thermal unit
 p. 88 Mar. 31

European pacemaker's a pace setter
 EI p. 215 June 23

Fast switching in the K-band
 NP p. 208 Jan. 6

Four-pole relays fit in TO-5 can
 NP p. 179 Dec. 8

France: Solar power from CdT
 EI p. 238 Nov. 10

High-voltage source has split personality
 NP p. 171 Sept. 15

Hybrid power amp puts out 100 watts
 NP p. 157 Oct. 27

IC regulator rides easy on high voltage
 NP p. 181 June 9

Inverter delivers 300 watts at 60 Hz
 NP p. 202 Jan. 6

Line-operated relay uses isolated actuating input
 p. 78 Feb. 3

Modified regulator yields variable d-c reference
 p. 78 Apr. 28

Monitor guards three ways against power failures
 p. 97 Oct. 27

Monolithic regulator stands alone
 NP p. 141 Sept. 29

NAND gate inputs expanded by adding resistor
 p. 95 Mar. 17

A negative-resistance circuit doubles for V or I control
 p. 78 Apr. 28

Negative signals converted to positive logic
 p. 97 Mar. 17

Nonstop limiter absorbs transients
 p. 106 May 26

Pick-hold coil driver recovers quickly
 p. 96 Apr. 14

Piezoelectric power source—It's a snap
 USR p. 58 May 12

Power-module line is keyed to IC's
 NP p. 164 July 21

Power supply breaker acts in 100 microseconds
 p. 79 Feb. 3

Power supply regulator uses fewer parts
 p. 94 Jan. 6

Proximity switch sets new limits
 NP p. 182 Dec. 8

Reed with a twist has longer life
 NP p. 177 Mar. 3

Sawtooth generator delivers constant peak voltage
 p. 97 Mar. 3

Spray-on battery
 USR p. 44 July 21

Sweep circuit triggers on only 200 millivolts
 p. 96 Mar. 3

Switch has lever action
 NP p. 167 Apr. 14

System steps in when power fails
 NP p. 200 Jan. 6

Thick-film voltage regulators given muscle
 NP p. 160 July 21

Time-delay relays are miniaturized
 NP p. 151 Nov. 24

Tiny supply for IC's delivers 5 watts
 NP p. 145 Oct. 27

Touch-activated switch built with copper-plated board
 p. 79 Sept. 1

Transmit-receive switch exceeds 60-db isolation
 p. 93 Aug. 18

2-pound battery delivers 100 amps
 NP p. 184 Nov. 10

Two zeners set limits of voltage range gate
 p. 98 Feb. 17

West Germany: Welded connections brace solar cells for longer life
 EI p. 183 Nov. 24

Zener circuit detects transients in power lines
 p. 111 May 12

PRINTED WIRING

Cone-shaped fillets hold parts for soldering
 NP p. 165 Apr. 14

Follow the recipe—circuit board lamination
 USR p. 42 Nov. 24

A memory to build on
 NP p. 180 May 12

Plug-in switch is rugged
 NP p. 142 Mar. 31

P-c artwork generated automatically
 NP p. 175 Oct. 13

Taking the picture out of p-c boards
 NP p. 153 Feb. 3

PROCUREMENT

Aircraft spending sliced
 USR p. 38 July 21

Army purchasing—Harsha treatment
 USR p. 58 June 9

Contracts—Shorten the overruns
 USR p. 60 May 12

Defense budget cuts restored
 USR p. 52 Nov. 24

Defense contractors' profits
 USR p. 52 Apr. 28

DOT budget—Escape mechanism
 USR p. 46 Apr. 28

Dissat on telecommunications report
 USR p. 60 June 9

Electronics Markets 1969: Changing of the guard makes civilian agencies cautious
 p. 125 Jan. 6

Mallard, Radas killed
 USR p. 42 Dec. 22

Military budget takes it on the chin
 USR p. 37 July 21

NASA funds cut
 USR p. 48 Apr. 28

NASA nervously eyes post-Apollo void
 USR p. 54 Apr. 14

Pentagon budget cuts
 USR p. 42 Dec. 22

Strategic projects get green light
 p. 119 Feb. 3

Stubbing report: Silent treatment
 USR p. 60 Feb. 17

The numbers game, again
 ED p. 37 Mar. 3

Trial balloon—maybe. Hot air—no!
 ED p. 31 Sept. 29

Upbeat outlook favors industry
 p. 131 Feb. 3

PRODUCTION TECHNIQUES

Air makes the going great for IC slices
 NP p. 211 Jan. 6

Backscattering thickness gage
 USR p. 60 Apr. 14

Beam-lead IC plans: Motorola to market fallout from its Safeguard effort
 USR p. 48 Apr. 14

Beam-lead IC's push sparks demand for special bonders
 USR p. 47 Mar. 3

Belgium: Aluminum's on the beam
 EI p. 217 June 23

Bonder searches automatically
 NP p. 217 Jan. 6

Bonding—Bumping the substrate
 USR p. 63 May 12

Bonding: Heavy-duty bonding automated
 NP p. 172 Aug. 4

British IC's technology—special report
 I "The American Challenge" on a chip
 p. 74 Jan. 20

II Metallization is designed quickly and inexpensively
 p. 78 Jan. 20

III Laser cuts masks to size, eliminating most errors
 p. 81 Jan. 20

IV Glow-discharge unit makes multilayer deposition easy
 p. 84 Jan. 20

V Electron-beam testing: gentle and fast
 p. 92 Feb. 3

VI Bulk-effect modules pave way for sophisticated uses
 p. 94 Feb. 3

VII MOS frequency soars with ion-implanted layers
 p. 96 Feb. 3

VIII Integrated solid state display needs no complex circuitry
 p. 100 Feb. 3

Cable connectors trim out the fuss
 NP p. 153 July 7

Checking for leaks in IC's
 USR p. 56 Mar. 17

Clean break—wafer division
 USR p. 68 Sept. 15

Coater speeds capacitor line
 NP p. 135 Apr. 28

Computers make a big difference in MOS designs
 p. 82 Oct. 13

Cone-shaped fillets hold parts for soldering
 NP p. 165 Apr. 14

Connecting aluminum wire reliably
 p. 94 Dec. 8

Darlington transistors offer low leakage
 NP p. 189 Feb. 17

Depositing ferrites films
 USR p. 46 Oct. 13

Dielectric isolation is design key in IC line
 NP p. 168 July 7

Etching—New etchant puts dielectric isolation in the groove
 p. 112 May 12

Eye that bonds i-r detects bonding flaws
 USR p. 42 July 21

Focus on diodes—yag laser forms diodes
 USR p. 51 May 26

Follow the recipe—circuit board lamination
 USR p. 42 Nov. 24

Free-standing transistor socket has no insulator
 NP p. 125 Apr. 28

German IC's
 Growing silicon on spinel add up to high isolation, fast switching in IC's
 p. 113 Oct. 27

When does it pay to customize IC's?
 p. 116 Oct. 27

Generating IC artwork automatically saves time, prevents costly errors
 p. 117 Nov. 24

Germanium IC's point the way towards pico-second computers
 p. 88 Mar. 3

Getting the MOST—Hughes goes with 1 (for ion implantation) MOS
 USR p. 52 Oct. 13

Good, bad, and pad—discretionary wiring technique
 USR p. 44 Oct. 13

Great Britain: Ball-bearing checker
 EI p. 202 Mar. 17

Great Britain: Down to the wire—Ferrite plus platinum wire for memories
 EI p. 182 July 21

Great Britain: Hybrids in a hurry—semi-automatic bonder
 EI p. 218 June 23

Great Britain: Hybrids with beam-lead ECL chips are bet for mid-70's MSI
 EI p. 183 May 26

Great Britain: Theory and fact—bistable circuit
 EI p. 184 July 7

Hughes sets new kind of trap to wed MOS to silicon nitride
 USR p. 39 Apr. 28

Hybrid breadboard technique cuts costs
 USR p. 70 Sept. 15

Hybrid IC lines move into production
 NP p. 149 July 7

IC's break through the voltage barrier
 p. 90 Mar. 31

IEEE Show: Vertical epitaxial reactor for silane deposition, and barrel reactor
 NP p. 170 Mar. 3

Italy: Plane MOS
 EI p. 239 Dec. 8

Japan: Alumina enhancement for IC fabrication
 EI p. 208 Oct. 13

Japan: Close quarters—better IC isolation
 EI p. 181 Mar. 31

Japan: Film making—yttrium-oxide thin films
 EI p. 197 Aug. 18

Japan: Mass-produced read-only memory is custom wired after assembly
 EI p. 195 Aug. 18

Japan: Noncontact IC printer loads manually
 NP p. 201 Nov. 10

Japan: Planting bears fruit—ion implantation technique for transistor
 EI p. 226 Sept. 15

Japan: Rubbed out—wiperless potentiometer
 EI p. 215 June 23

Japanese take two steps forward in MOS-bipolar compatibility
 FI p. 207 Oct. 13

Leave the storing to us—"fusion bank" concept for marketing products
 USR p. 49 Sept. 29

Log diodes can be counted on
 p. 104 Mar. 31

Masked marvel—electron-beam masking machine
 USR p. 50 Aug. 4

Masking camera for LSI circuits focuses on speed and resolution
 NP p. 153 June 9

Matching FET's by design is faster and cheaper than by pick and choose
 p. 114 Dec. 8

Mesa technique: Cooler LSA diodes
 USR p. 64 Feb. 17

MOS array tester is run by computer
 NP p. 202 Dec. 8

MOS moves onto high-speed track
 USR p. 49 May 26

Microwave kiln for curing tanoak, a hardwood
 p. 54 Jan. 20

Monitor protects IC-header bond
 NP p. 133 Dec. 22

Monolithic crystal filter vaults to eight poles
 NP p. 172 Mar. 3

Netherlands: Stacking up chips—IC's in TV sets
 EI p. 218 Feb. 17

New beam-lead connection method boosts semiconductor memory yields
 p. 105 Dec. 22

New twist to flip chips—Hughes' back-etched flip chips
 USR p. 46 Sept. 1

Nitride deposited uniformly
 NP p. 174 Aug. 4

Nitride passivation links TTL, MOS
 p. 117 Mar. 31

No West German 'creativity gap' where linear IC's are concerned
 p. 104 Sept. 15

When it comes to color tv, the outlook is bright indeed
 p. 111 Sept. 15

IC's enter the picture for automatic cameras
 p. 113 Sept. 15

For noisy environments, why not low-speed logic?
 p. 115 Sept. 15

Photolithographic masks: taking a close look
 NP p. 145 May 26

Pinholes: Finding pesky flaws in oxide
 USR p. 45 June 23

P-c artwork generated automatically
 NP p. 175 Oct. 13

Printing active devices
 USR p. 65 Oct. 27

Relay analyzer tests and tells
 NP p. 197 Dec. 8

Seaming flaw—cracks in aluminum interconnect strips USR p. 40 Apr. 28
 Semiconductor whodunit: Who's to blame for failures? p. 98 Aug. 18
 Smog gets in your IC's USR p. 48 June 23
 Solo road—interfacing system house USR p. 50 Aug. 18
 Sorter checks 5,600 epoxy transistors an hour NP p. 136 Sept. 1
 Sorting IC's economically p. 74 Sept. 1
 Spray-on battery USR p. 42 July 21
 Sputtering system coats 90 wafers NP p. 214 Jan. 6
 Taking the picture out of p-c boards NP p. 153 Feb. 3
 Terminal helps stamp out stampings NP p. 154 Mar. 17
 Thickness gage give digital answer NP p. 208 Dec. 8
 Thin lines—method to pack more semiconductor chips on a ceramic substrate USR p. 66 May 12
 Up goes production, down go prices . . . and here comes optoelectronics! p. 117 Dec. 22
 Varying interface charge for MOS USR p. 65 Oct. 27
 Want to be a good loser? go about it systematically p. 112 Apr. 14
 A weight-and-see approach to stress testing NP p. 157 July 21
 Welding—Two out of three—system monitors welding operation USR p. 53 May 12
 West Germany: Ceramic tip heats soldering iron and holds it at the right temperature EI p. 251 Mar. 3
 West Germany: Fast way to test for flicker noise EI p. 181 July 21
 West Germany: A lighter contact—solar cells made with solderless contacts EI p. 253 Jan. 6
 West Germany: Welded connections brace solar cells for longer life EI p. 183 Nov. 24
 Yag laser shows power, versatility NP p. 133 Apr. 28

PULSE TECHNIQUES
 Asynchronous pulse gives tape's data signal p. 80 Sept. 1
 Control current slows pulse's leading edge p. 96 Aug. 18
 Core-memory driver runs cooler p. 102 Oct. 13
 D-c restorer clamps random pulses to a reference p. 106 July 7
 4-pulse sequence generator built with 1 hex-inverter p. 79 Feb. 3
 Great Britain: Beating the heat—pdm for 30-watt audio amplifier EI p. 240 May 12
 Light squeeze—500-picosecond pulses compressed to 270 psec USR p. 50 May 26
 Multivibrators separate pulses according to their widths p. 88 Dec. 8
 Nomograph simplifies finding one-shot's pulse width p. 97 Sept. 29
 Positive or negative pulses trigger one-shot multivibrator p. 94 Aug. 18
 Pulse generator triggered by a step function p. 87 Mar. 31
 Pulse modulator regulates pneumatic valve closure p. 80 Sept. 1
 Pulse-train duty factor controls RC filter p. 93 Aug. 4
 Pulse train frequency varied as duty cycle stays constant p. 84 July 21
 Pulse width varied by a "switched ground" p. 77 Apr. 28
 Pulses come cheap from small source NP p. 156 Jan. 20
 Simple gating yields phase-locked pulse bursts p. 96 Jan. 6
 Simpler digital circuits in a snap p. 105 June 9
 Switch in time—q-switch without moving parts USR p. 52 May 26
 Telegram by pcm USR p. 62 Feb. 17
 Two one-shots control waveform's pulse width p. 93 Jan. 6
 2-stage peak-holding circuit stores sub-microsecond pulses p. 105 Nov. 10

RADAR
 Adding dimensions—millimeter-wave radar USR p. 56 May 12
 Army's radar device can detect and chart underground tunnel complexes USR p. 52 Apr. 28
 Converters—Getting from a to d in less time NP p. 161 Aug. 18
 France: Sensitive radar keeps helicopters in the clear EI p. 221 Apr. 14
 Great Britain: flash Gunn radar EI p. 170 Dec. 22
 Greece to get latest radars USR p. 50 Dec. 22
 Japan: Vtr runs radar autoplotter EI p. 185 Nov. 24
 Navy—MAIR starts USR p. 82 Sept. 15
 Package deal for ECM firms NP p. 154 Jan. 20
 Phased array's analog method keeps antenna beam shaped up USR p. 43 Mar. 31

Safeguard watcher—microwave pulse height detector USR p. 44 Apr. 28
 Shear look—Doppler radar techniques spot wind vortex patterns USR p. 46 Mar. 31
 Solid high power—coherent X-band power source USR p. 54 May 12
 Tapping microwave acoustics for better signal processing p. 94 Nov. 10
 Applying surface wave acoustics p. 97 Nov. 10
 Amplifying acoustic surface waves p. 102 Dec. 8
 West Germany: Taking a rain check EI p. 182 Mar. 31

RAILROADS
 Canada: Telling volumes—electronic volume measure for railroads EI p. 231 Aug. 4
 Japan: Fare game—Computer controls electrostatic printer that issues railroad tickets EI p. 199 Jan. 20
 Japan: Keeping track of Japan's high-speed passenger trains p. 124 May 12
 Japan: New from old—railroad communications twist. EI p. 186 July 7
 Japan: Tokyo subway tries trains with chopper control and regenerative braking that cuts power costs EI p. 217 Feb. 17
 Japan: Wire-sleuthing—tracking wear on overhead railway wires EI p. 202 Oct. 27
 Metroliners: It's no laughing matter ED p. 31 Apr. 28

RECEIVERS
 1-watt 60-gigahertz transceiver studied for a satellite application USR p. 66 Feb. 17
 Pinpointing whispers—60 gigahertz transceiver USR p. 49 Mar. 3

RECORDERS
 Acoustic terminal adds and records NP p. 172 Nov. 10
 Cassettes: Kit provides self-reversing for cassettes NP p. 167 Oct. 27
 High-speed recording USR p. 60 Feb. 17
 In-flight recorders will give additional data USR p. 48 Feb. 3
 Japan: Straining to hear—strain gage phono cartridge EI p. 225 Sept. 15
 Maxi coat—magnetic oxide for recording tape USR p. 48 Nov. 24
 Multipoint recorder serves as time-shared amplifier p. 111 July 7
 Stretch: tape machine uses Dolby system USR p. 52 Apr. 14
 Strobing signal smooths data rate NP p. 167 July 7
 Thick-film IC is total d-a converter NP p. 185 Sept. 15

RECTIFIERS
 Navy plugs in—replacing high-power rectifier tubes USR p. 60 Oct. 27
 Rectifier diodes have 100-amp rating NP p. 161 Nov. 24

RELIABILITY
 Attractive coat—plastic films called parylenes USR p. 68 Sept. 15
 Boosting reliability of disk memories p. 88 Oct. 27
 Navy study of mean time between failures USR p. 57 June 23
 Plastic IC's demand new physical p. 147 May 12
 Semiconductor whodunit: Who's to blame for failures? p. 98 Aug. 18

RESEARCH & DEVELOPMENT
 Acronyms—antic abbreviations p. 111 Sept. 1
 Australia: Back talk—industry official railing at the government's record in R&D EI p. 184 May 26
 Call for objectivity ED p. 31 Jan. 6
 Canada's new satellite projects shake up research establishment p. 143 July 7
 China poised for 'great leap' into the forefront of science EI p. 251 Jan. 6
 Classified research presents problems for universities USR p. 54 May 26
 Europe measures the gap . . . while the U. S. widens it ED p. 31 May 12
 France: Solar power from CdTe EI p. 238 Nov. 10
 Government: Research money USR p. 50 Feb. 3
 Great Britain: Rumbles over R&D EI p. 184 May 26
 Great expectations . . . and a fourth dimension ED p. 31 July 7
 Lectron's electronics kit leaves the toy box p. 147 Apr. 14
 Magnetic bubbles—a technology in the making p. 83 Sept. 1
 NASA budget in holding pattern p. 125 Feb. 3
 Practical research gains emphasis at NASA's ERC p. 149 Dec. 8
 R&D performance by electronics firms will rise 10% this year USR p. 67 May 26
 Safety in the streets ED p. 35 June 9
 Science secretary? USR p. 56 Aug. 18
 Strategic projects get green light p. 119 Feb. 3

Technology expenditures reduced USR p. 38 July 21
 A wildly absurd proposal ED p. 35 May 26
 Year of the application USR p. 55 Mar. 31

SATELLITES
 Aeronautical services satellite system USR p. 58 May 26
 Canada's new satellite projects shake up research establishment p. 143 July 7
 Earth Resources Technology Satellites A and B request for proposal USR p. 56 May 26
 ERTS—At long last, ERTS is on the way p. 98 May 12
 ERTS—Request for proposal USR p. 56 May 26
 ERTS—Waiting for program to get under way USR p. 58 Mar. 17
 ERTS gaps USR p. 60 Nov. 10
 ERTS project—bidders USR p. 62 July 7
 Tactical Communications Satellite could see duty in Vietnam USR p. 68 Feb. 17

SEMICONDUCTORS
 Active filters: Part 9 Applying nonlinear elements p. 116 Apr. 14
 Advanced technology helps chart growth ED p. 31 Aug. 4
 Another entrant in op-amp sweepstakes NP p. 139 Apr. 28
 Associative memories USR p. 44 Jan. 20
 At last, a bipolar shift register with the same bit capacity as MOS p. 84 Dec. 8
 Attractive coat—plastic films called parylenes USR p. 68 Sept. 15
 Autoneutronics arrays its MOS forces p. 103 Apr. 28
 Beam-lead IC plans: Motorola to market fallout from its Safeguard effort USR p. 48 Apr. 14
 Beam-lead IC's push sparks demand for special bonders USR p. 47 Mar. 3
 Circuit improves thermistor's linearity and boosts output p. 99 June 9
 Computers make a big difference in MOS designs p. 82 Oct. 13
 Bonding: Heavy-duty bonding automated NP p. 172 Aug. 4
 Detroit puts electronics in the driver's seat p. 84 Mar. 17
 Dielectric isolation is design key in IC line NP p. 168 July 7
 Digging in data: nonvolatile and alterable semiconductor memory USR p. 50 Apr. 14
 Electronics markets—a midyear report p. 107 Aug. 4
 Ex-TI team makes MOS deal with Sprague USR p. 56 July 7
 Fairchild's Hogan, phase two USR p. 52 Mar. 17
 Fairchild introduces family of linear IC's NP p. 144 July 21
 Fairchild returns to power transistors USR p. 56 Feb. 17
 A faster generation of MOS devices with low thresholds is riding the crest of the new wave, silicon-gate IC's p. 88 Sept. 29
 French MOS dda circuit enters European market EI p. 6E Aug. 4
 Getting the MOST—Hughes goes with I (for ion implantation) MOS USR p. 52 Oct. 13
 Glass semiconductor read-only memory USR p. 58 Mar. 3
 Great Britain: British IC's technology report MOS frequency soars with ion-implanted layers p. 94 Feb. 3
 Great Britain: Hybrids in a hurry—semi-automatic bonder EI p. 218 June 23
 Great Britain: Low-cost instrument plots impurity profiles of semiconductors EI p. 179 Mar. 31
 Great Britain: Mixing it up—detectors and mixers for submillimeter wavelengths EI p. 180 Mar. 31
 Great Britain: Out of GaAs EI p. 203 Oct. 27
 How reliable are MOS IC's? As good as bipolars, says NASA p. 106 June 23
 Hughes sets new kind of trap to wed MOS to silicon nitride USR p. 39 Apr. 28
 Hybrid FET switch turns on in only 50 nanoseconds NP p. 189 Mar. 3
 IC device reads wire memories NP p. 183 Oct. 13
 IC does four jobs in f-m stereo NP p. 171 Jan. 20
 IC light-sensitive switch can handle 5 ma NP p. 179 Oct. 13
 IC processes color signals NP p. 201 Aug. 4
 IC's are tailored to consumer jobs NP p. 163 Nov. 24
 International: OECD prescribes remedy for the gap between the U.S. and Europe in semiconductor technology EI p. 220 Feb. 17
 Italy: Plane MOS EI p. 239 Dec. 8

Japan: On the square—IC device can square or cube an analog input function EI p. 253 Jan. 6
 LSI under discussion USR p. 58 Mar. 3
 Leave the storing to us—"fusion bank" concept for marketing products USR p. 49 Sept. 29
 Masked marvel—electron-beam masking machine USR p. 50 Aug. 4
 Memory designed for peripherals NP p. 160 Nov. 24
 Memory technology—special report IX Semiconductor arrays get bigger and denser p. 100 Jan. 20
 X MOS random-access arrays p. 102 Jan. 20
 XI Cutting systems costs with MOS p. 105 Jan. 20
 MOS FET stabilizes oscillator's output p. 80 Feb. 3
 MOS FET's switch in 3 nsecs NP p. 206 May 12
 MOS IC adder handles 4 bits NP p. 179 Oct. 27
 MOS kits produce display signals NP p. 196 Sept. 15
 MOS moves onto high-speed track USR p. 49 May 26
 MOS read-write memory goes to market NP p. 193 June 23
 Monolithic memories carry five-year warranty NP p. 165 Oct. 13
 Motorola puts its mark on MOS NP p. 194 Sept. 15
 Multichip triac package replaces relays NP p. 205 Jan. 6
 National Semiconductor: Charting a course to high profits p. 129 Oct. 13
 New beam-lead connection method boosts semiconductor memory yields p. 105 Dec. 22
 Nitride deposited uniformly NP p. 174 Aug. 4
 Nitride passivation links TTL, MOS p. 117 Mar. 31
 One-way road—CMOS a-d converter USR p. 54 June 9
 Op amp betters price-performance ratio NP p. 163 Feb. 3
 Picking up the chips—catalogues listing many new standard chip types USR p. 44 Sept. 1
 Read-write memory dissipates only 315 mw NP p. 190 Sept. 15
 Semiconductor device symbols—special guide p. 115 Nov. 24
 Semiconductor microwave sources go off-the-shelf at more makers NP p. 149 Feb. 17
 Semiconductor whodunit: Who's to blame for failures? p. 98 Aug. 18
 Signetics-GI licensing deal—Licking the platter USR p. 53 June 9
 Silicon gates opening up for MOS USR p. 67 Sept. 15
 Simulating MOS USR p. 41 Feb. 3
 A solid look for vidicons NP p. 191 Apr. 14
 Soviet Union: Russians launch IC sales campaign with ambitious exhibit at Paris Salon EI p. 157 Apr. 28
 Switch and trigger functions built into one chip NP p. 203 May 12
 Toshiba joins consumer FET race NP p. 174 Jan. 20
 Toward better communication ED p. 33 Mar. 31
 Two firms enter MOS read-only memory race NP p. 189 Apr. 14
 Varying interface charge for MNOS USR p. 65 Oct. 27
 Viatron—vibrant and probably viable p. 141 June 23
 West Germany: Device changes its I-V curve in magnetic field IE p. 202 Mar. 17
 West Germany: Peltier plaques cool rooms in summer and heat them in the winter EI p. 219 Feb. 17
 Westinghouse takes another look at MONOS USR p. 62 Jan. 6

SILICON CONTROLLED RECTIFIERS
 Japan: Schottky barrier devices show current increase under pressure EI p. 223 Sept. 15
 SCR's in tv USR p. 60 Jan. 6
 SCR shift register can take a lot of noise p. 104 June 23

SIMULATORS
 Computer simulation plays key role in design of satellite earth stations p. 120 June 23
 Data generators aimed at wider market NP p. 137 Nov. 24
 Read-only memory simulator in attaché case USR p. 41 Nov. 24
 Simulating MOS USR p. 41 Feb. 3

SOLID STATE DEVICES
 Amplifiers put out 10 watts NP p. 160 Sept. 29
 At last, a bipolar shift register with the same bit capacity as MOS p. 84 Dec. 8

British IC technology—special report
I "The American Challenge" on a chip p. 74 Jan. 20
II Metalization is designed quickly and inexpensively p. 78 Jan. 20
III Laser cuts masks to size, eliminating most errors p. 81 Jan. 20
IV Glow-discharge unit makes multilayer deposition easy p. 84 Jan. 20
VIII Integrated solid state display needs no complex circuitry p. 100 Feb. 3
Converter—\$1,000 converter tells all the angles NP p. 129 Apr. 28
DC-10's air data system casts a long shadow p. 125 Mar. 17
Differential unit compares well NP p. 175 Mar. 3
Electronics Markets 1969: IC makers' surge to continue p. 114 Jan. 6
Etching—New etchant puts dielectric isolation in the groove p. 112 May 12
A faster generation of MOS devices with low thresholds is riding the crest of the new wave, silicon-gate IC's p. 88 Sept. 29
Faster than ECL—high-speed digital logic USR p. 56 Feb. 17
First GaAsP—continuous-wave pumping of a neodymium-doped yag laser USR p. 40 Apr. 28
Focusing in—solid-state TV cameras USR p. 54 Feb. 17
German IC's
Growing silicon on spinel adds up to high isolation, fast switching in IC's p. 113 Oct. 27
When does it pay to customize IC's? p. 116 Oct. 27
Generating IC artwork automatically saves time, prevents costly errors p. 117 Nov. 24
Multi-emitter IC's stabilize voltages in solid state tuners p. 91 Dec. 8
Glass semiconductor read-only memory USR p. 58 Mar. 3
"Hot plate" controls temperature inside TO-5 or TO-8 can USR p. 44 Mar. 31
Improved Miller sweep uses an active load p. 86 Mar. 31
IC's break through the voltage barrier p. 90 Mar. 31
Inverter delivers 300 watts at 60 Hz NP p. 202 Jan. 6
Japan: Array of dual-gate MOS transistors successfully generates tv picture EI p. 199 Sept. 29
Japan: Solid state numerology EI p. 186 Nov. 24
Line-operated relay uses isolated actuating input p. 78 Feb. 3
Microwave line from MERA project NP p. 210 May 12
NAND gate inputs expanded by adding resistor p. 95 Mar. 17
New beam-lead connection method boosts semiconductor memory yields p. 105 Dec. 22
Nitride passivation links TTL, MOS p. 117 Mar. 31
No West German 'creativity gap' where linear IC's are concerned p. 104 Sept. 15
When it comes to color tv, the outlook is bright indeed p. 111 Sept. 15
IC's enter the picture for automatic cameras p. 113 Sept. 15
For noisy environments, why not low-speed logic? p. 115 Sept. 15
Piezoelectric power source—It's a snap USR p. 58 May 12
Redesigned converter thinned, price trimmed NP p. 169 Mar. 17
Regulated sales for Motorola voltage regulators USR p. 71 Sept. 15
Relay has wide trigger-range NP p. 137 May 26
Rx for r-f power transistors p. 84 May 26
Seaming flaw—cracks in aluminum interconnect strips USR p. 40 Apr. 28
Simpler digital circuits in a snap p. 105 June 9
Single building block proves logical choice for custom IC's p. 88 Apr. 28
Solid high power—coherent X-band power source USR p. 54 May 12
Solid state microwave leaves lab p. 86 Feb. 17
Solid state switch handles 14 amps NP p. 155 July 7
Sweeper goes from 10 Mhz to 18 Ghz NP p. 191 Dec. 8
Trading stability for better noise protection—solid-state differential amplifier NP p. 169 June 9
Users' choice is name of keyboard game p. 145 Nov. 10
SPACE ELECTRONICS
And now, aiming beyond the moon—NASA's list of goals for the next decade USR p. 47 Aug. 4
Apollo: Signal filter to improve color tv from the moon, but not until next trip USR p. 39 Nov. 24
Apollo 8: shot seen 'round the world USR p. 58 Jan. 6

Apollo 11 will include RCA vhf communications setup and a collapsible dish antenna USR p. 62 July 7
... but NASA is not rewarded ED p. 31 Feb. 3
Canada's new satellite projects shake up research establishment p. 143 July 7
Color-tv wheel takes a spin in space p. 114 July 7
Contract for homing device for the Advanced Surface Missile System USR p. 66 Feb. 17
ERTS—At long last, ERTS is on the way p. 98 May 12
ERTS—Request for proposal USR p. 56 May 26
ERTS—Waiting for program to get under way USR p. 58 Mar. 17
ERTS project—bidders USR p. 62 July 7
Electronics markets—a midyear report p. 107 Aug. 4
Electronics Markets 1969: NASA tightens its belt another notch p. 141 Jan. 6
Hello, moon—Sprague's Microperm process to store records USR p. 48 Aug. 4
High stakes on Capitol Hill p. 171 Jan. 6
Intelsat catches its breath p. 111 Apr. 28
Italy: Lost in space?—ELDO's woes may lead to national space program EI p. 180 Feb. 3
Laird's lard USR p. 60 Apr. 14
Lunar labors USR p. 47 Aug. 4
Mariners 6 and 7: Late show will put Mars on tv p. 121 July 21
MOL cancellation wrapped in politics USR p. 50 June 23
Moon measure USR p. 57 June 23
NASA budget in holding pattern p. 125 Feb. 3
NASA funds cut USR p. 48 Apr. 28
NASA nervously eyes post-Apollo void USR p. 54 Apr. 14
NASA ray—ATS-F to have 30-watt laser USR p. 79 Sept. 15
NASA's space tours tailored to the budget p. 145 Sept. 15
New directions—NASA astronomy program USR p. 46 Nov. 24
No doubt about Apollo fallout ED p. 31 Aug. 4
Off the ground—switching to synchronous satellites to relay information to mission control USR p. 52 Sept. 29
1-watt 60-gigahertz transceiver studied for a satellite application USR p. 66 Feb. 17
Picking a path—Task Group takes pragmatic view USR p. 48 Sept. 29
Practical research gains emphasis at NASA's ERC p. 149 Dec. 8
Proposed national space station will put electronics to the test p. 149 June 23
Quick EXAM—experimental aerospace multi-processor USR p. 50 Mar. 13
Radiation-hardened plated-wire memory for space USR p. 54 July 7
Smooth sailing—Mariner's landfall USR p. 49 Aug. 18
Solar color—color tv for the sun USR p. 58 Nov. 10
Soldiers and spacemen—NASA getting more involved in military business USR p. 76 Sept. 15
Soviet Union: An on-board computer will keep medical tabs on cosmonauts in space stations EI p. 179 Feb. 3
Speed merchant—ultra-high-speed a-d converters USR p. 56 June 9
Tacsat flight-control programmer USR p. 39 July 21
Viking—Valhalla for hardware USR p. 54 June 23
Vikings embark USR p. 64 Mar. 17
West Germany: Lighting the way—Siemens material for Apollo EI p. 222 Apr. 14
West Germany: Welded connections brace solar cells for longer life EI p. 183 Nov. 24
STANDARDIZATION
Are we ready for IC standards? ED p. 35 June 9
Government-industry cooperation bears fruit in IC mil specification p. 125 Dec. 22
Mil Std 883—a real test case p. 131 Aug. 18
NASA's "line certification" program USR p. 54 July 21
Pay tv gets in the broadcast picture p. 123 May 26
Showdown for tv—safety standards for color tv receivers USR p. 45 Sept. 1
Toward better communication ED p. 33 Mar. 31
U.S. lights fire under microwave ovens p. 123 Oct. 13
World pcm standards discord USR p. 40 Dec. 22
SYSTEMS ENGINEERING
Computer simulation plays key role in design of satellite earth stations p. 120 June 23
What is a 'systems' approach? It's just the name of the game p. 68 Apr. 28
TELEVISION
Cat's eyes for military—Low-light-level tv systems p. 64 Sept. 1

IDA's Biberman sees sec tube as a work-horse p. 66 Sept. 1
Army seeks more light on low-level tv p. 68 Sept. 1
Centralization cuts costs in tv data display character generation for London Stock Exchange members and Japanese telephone subscribers EI p. 157 Sept. 1
Fingertip control—tv sets with electronic tuning USR p. 60 Jan. 6
Focusing in—solid-state tv cameras USR p. 54 Feb. 17
Grass Valley Group: Bigtime profits in a rural setting p. 129 Mar. 31
Great Britain: Flat crt with large screen around the bend EI p. 197 Jan. 20
Isocons make their move NP p. 181 Jan. 6
Japan: Array of dual-gate MOS transistors successfully generates tv picture EI p. 199 Sept. 29
Japan: Close quarters—better IC isolation EI p. 181 Mar. 31
Japan: Comfortably close—flat-screen tv EI p. 224 Apr. 14
Japan: Low-cost circulator for tv antenna connections EI p. 203 Mar. 17
Japan: Sharp-eyed—motion-stopping tv EI p. 238 Dec. 8
Japan: Tv facsimile for the home EI p. 200 Sept. 29
Lighting the way to flat-screen tv p. 114 Mar. 17
Mariners 6 and 7: Late show will put Mars on tv p. 121 July 21
Multi-emitter IC's stabilize voltages in solid state tuners p. 91 Dec. 8
Netherlands: Monolithic IC handles tv signal processing EI p. 218 Feb. 17
Overcoming design problems in varactor-diode tuners p. 88 Jan. 6
Pay tv gets in the broadcast picture p. 123 May 26
Pushing buttons: detent uhf tuners gains USR p. 58 Feb. 17
Put your display on television NP p. 188 Sept. 15
Seeing in the dark is aim of r-f holography p. 110 Nov. 24
SelectaVision: willing, able, not yet ready USR p. 43 Oct. 13
Silicon sec—secondary electron conduction (sec) vidicon USR p. 56 Sept. 29
A solid look for vidicons NP p. 191 Apr. 14
STV on the air USR p. 58 Oct. 13
Teacher in a tube—video portion of school audio-visual tape system USR p. 63 May 12
Video i-f amplifier goes on a chip NP p. 197 Aug. 4
West Germany: Silicon-target video tube moves toward commercial market EI p. 235 Nov. 10
TESTING
Adapter lets digital IC tester check on operational amplifier p. 94 July 21
Army's Stano field tests—Trying before buying USR p. 48 Dec. 8
Checking fluidics the easy way NP p. 178 June 23
Common-mode rejection ratio: what the spec sheet doesn't say p. 116 June 23
Complex monitoring—AIDS unit would monitor 300 to 400 test points USR p. 53 Mar. 17
Core memory speeds IC tests NP p. 192 May 12
Core memory tester has low price tag NP p. 175 May 12
Data generator logically copes with MSI NP p. 201 Mar. 3
Debugger tests IC's in-circuit NP p. 172 Sept. 15
Flexible tester for digital IC's NP p. 163 Mar. 31
Great Britain: Ball-bearing checker EI p. 202 Mar. 17
High-voltage source has split personality NP p. 171 Sept. 15
IEEE Show: A trio of testers p. 103 Mar. 3
IC handler adds no electrical noise with fluidic logic in control NP p. 133 May 26
ICs are checked faster with audible voltmeter p. 88 Jan. 20
Low-price tester sorts transistors NP p. 164 Mar. 31
Memory technology—special report
XXV Memory testing is a task that comes in layers p. 88 Sept. 1
XXVI Computers for core tests p. 90 Sept. 1
XXVII Exercising memory systems with worst-case bit patterns p. 93 Sept. 1
XXVIII Boosting plated-wire yield: which knob to adjust? p. 95 Sept. 1
Mil Std 883—a real test case p. 131 Aug. 18
MOS array tester is run by computer NP p. 202 Dec. 8
Op amp tester analyzes the no-go NP p. 171 Aug. 4
PRBS can fool the system p. 82 Apr. 28
Plastic bags change resistance tolerances USR p. 66 Oct. 27

Plastic IC's demand new physical p. 147 May 12
Power oscillator tests equipment for rf NP p. 177 Mar. 17
Probe costs—and does—less NP p. 187 Mar. 17
Radiation revisited ED p. 31 Sept. 1
Relay analyzer tests and tells NP p. 197 Dec. 8
Safeguard watcher—microwave pulse height detector USR p. 44 Apr. 28
Semiconductor whodunit: Who's to blame for failures? p. 98 Aug. 18
SCR shift register can take a lot of noise p. 104 June 23
Sorting IC's economically p. 74 Sept. 1
Taking the bit—Low-cost disk for mini-computers USR p. 46 Sept. 1
Taking the heat off thermocouple failures p. 96 Oct. 13
Teamwork streamlines differential amplifier tests p. 132 Sept. 15
VAST gets vaster USR p. 46 Jan. 20
Voltmeter performs double duty NP p. 141 May 26
A weight-and-see approach to stress testing NP p. 157 July 21
West Germany: Breaking a log jam—Alr-log for testing small sounding rockets and military missiles EI p. 209 Oct. 13
West Germany: Fast way to test for flicker noise EI p. 181 July 21
White-noise set tests radio networks NP p. 151 Feb. 3
Zipping through the harness maze NP p. 135 Jan. 20
THIN FILMS
Coupling sets thin magnetic films on closed flux path p. 118 May 12
Designing lumped elements into microwave amplifiers p. 100 Apr. 14
Focusing in—Solid-state TV cameras USR p. 54 Feb. 17
German IC's—Growing silicon on spinel adds up to high isolation, fast switching in IC's p. 113 Oct. 27
Germanium IC's point the way towards pico-second computers p. 88 Mar. 3
Hybrid FET switch turns on in only 50 nanoseconds NP p. 189 Mar. 3
Japan: Film making—yttrium-oxide thin films EI p. 197 Aug. 18
Japan: Straining to hear—strain gage phono cartridge EI p. 225 Sept. 15
MERA fallout helps prove IC's can be used in microwave USR p. 42 Apr. 28
Memory Technology—special report
XVIII Sonic film unit is a sound bet p. 90 Apr. 14
XXX Controlling creep and skew in thin-film memories p. 125 Sept. 15
XXXI Packing data tightly in thin-film memories p. 129 Sept. 15
Omnibus chip—f-m telemetry transmitter USR p. 50 Apr. 28
Redesigned converter thinned, price trimmed NP p. 169 Mar. 17
Spattering system coats 90 wafers NP p. 214 Jan. 6
TIMERS
Czechoslovakia: Magnetic field varies turn-on time of "Timisto" EI p. 182 Mar. 31
Digital clock operates in low megahertz range p. 87 Jan. 20
Equipment timer plugs into line NP p. 168 Aug. 18
Switzerland: Watch out—light-emitting diodes produce readout in stop watch EI p. 204 June 9
Timer turns back the clock NP p. 161 Feb. 17
TRANSDUCERS see INSTRUMENTS
TRANSISTORS
Aluminum replaces gold in radiation-resistant transistors USR p. 38 Dec. 22
Core drivers are IC-compatible NP p. 192 Mar. 3
D-a converter switches digital inputs with TTL gates p. 89 Dec. 8
Darlington transistors offer low leakage NP p. 189 Feb. 17
Dual transistor reduces error of track and hold circuit p. 94 Mar. 17
Fairchild returns to power transistors USR p. 56 Feb. 17
Free-standing transistor socket has no insulator NP p. 125 Apr. 28
Hybrid-IC transistors served in ceramic cup NP p. 141 Sept. 1
Inverted transistor switches precision d-c voltage p. 92 Aug. 4
Japan: Array of dual-gate MOS transistors successfully generates tv picture EI p. 199 Sept. 29
Japan: Guarding the gates EI p. 216 June 23
Japan: Planting bears fruit—ion implantation technique for transistor EI p. 226 Sept. 15
Japan: Schottky barrier devices show current increase under pressure EI p. 223 Sept. 15
Ladder network converts binary input to a-c output p. 106 July 7

Low-price tester sorts transistors
NP p. 164 Mar. 31

Microwave line from MERA project
NP p. 210 May 12

Multi-emitter IC's stabilize voltages in solid state tuners
p. 91 Dec. 8

Nonstop limiter absorbs transients
p. 106 May 26

Oscilloscope: Helical transmission lines bend the beam
p. 90 July 7

Phototransistor gives coupler high gain
NP p. 181 Aug. 4

Pnp power transistors in r-f band
NP p. 138 Dec. 22

Ring-type barrier cuts power transistor leakage
NP p. 159 Mar. 31

Rx for r-f power transistors p. 84 May 26

Single transistor divides frequency in avalanche mode
p. 96 Sept. 29

Smog gets in your IC's
USR p. 48 June 23

Sorter checks 5,600 epoxy transistors an hour
NP p. 136 Sept. 1

Sprague Electric goes into power transistors
USR p. 66 Feb. 17

TTL surge
USR p. 60 July 7

Transformer is eliminated in transistor chopper
p. 76 Dec. 22

Transistor "zener" has zero dynamic impedance
p. 86 Mar. 31

Transistors are radiation-hard
NP p. 193 Apr. 14

Transistors improve high-frequency limiter
p. 94 Oct. 13

UJT gives frequency divider an immunity to input jitter
p. 105 July 7

Unijunction circuit prevents damage to transistors
p. 100 June 9

West Germany: Fast way to test for flicker noise
EI p. 181 July 1

Zener in preregulator limits series transistor dissipation
p. 98 Oct. 27

TUBES

Caught in the crunch—vidicon for a military infrared avionics system
USR p. 56 Jan. 6

Great Britain: Flat crt with large screen around the bend
EI p. 197 Jan. 20

Isocons make their move
NP p. 181 Jan. 6

Low-light-level tv—IDA's Biberman sees sec tube as a workhorse
p. 66 Sept. 1

Mini-magnetron delivers 1-kw pulses
NP p. 165 Jan. 20

Navy plugs in—replacing high-power rectifier tubes
USR p. 60 Oct. 27

New circuits brighten color tv picture
p. 133 June 9

Oscilloscope: Helical transmission lines bend the beam
p. 90 July 7

Oscilloscope's changing face—red, green and blue traces
p. 84 Aug. 4

Photomultiplier's gain is temperature compensated
p. 97 Apr. 14

Picture image?—RCA and Zenith tubes are strikingly similar
USR p. 52 June 23

7-beam crt gives brighter display
NP p. 174 Aug. 18

Silicon sec—secondary electron conduction (sec) vidicon
USR p. 56 Sept. 29

Simplifying crt character generation
p. 72 Dec. 22

Six-decade display tube for advanced dvm's
NP p. 175 June 9

Through a glass, lightly
NP p. 174 Dec. 8

West Germany: Silicon-target video tube moves toward commercial market
EI p. 235 Nov. 10

ULTRASONICS

Bonder searches automatically
NP p. 217 Jan. 6

On the cuff—measure blood pressure with ultrasound
USR p. 43 Dec. 8

UNDERWATER ELECTRONICS

Echoes at sea are weeded out
NP p. 163 June 9

Open and shut case—sonic underwater valve locator
USR p. 50 Mar. 3

West Germany: Computer plots profiles of river bottoms
EI p. 181 Feb. 3

VARACTORS

Varactor diodes tune over octave band
NP p. 181 Sept. 15

VIDEO RECORDERS

Japan: All wound up—video tape copying equipment
EI p. 181 Mar. 31

Japan: And another vtr from Sony
EI p. 236 Nov. 10

Japan: Color by cassette—cassette for color vtr
EI p. 239 May 12

Japan: Toward compatible vtr's
EI p. 236 Nov. 10

Japan: Video tape recorders record stills
EI p. 160 Apr. 28

Japan: Vtr runs radar autoplotter
EI p. 185 Nov. 24

'Pressing' pictures on holographic tape is fast, inexpensive
p. 108 Nov. 10

SelectaVision: willing, able, not yet ready
USR p. 43 Oct. 13

Tape equipment fights for markets
p. 139 June 9

Unicon ordered
USR p. 52 Feb. 3

Video analyzer enhances pictures
NP p. 183 Mar. 17

Videofile concept for law enforcement
USR p. 61 Apr. 14

Author Index

Aaronson, G., Active filters: part 10
Synthetic inductors from gyrators
p. 118 July 7

Adby, P. R., Sawtooth generator delivers constant peak voltage
p. 97 Mar. 3

Aiken, W. E. & P. A. Dickson, Acronyms—antic abbreviations
p. 111 Sept. 1

Aldrich, R. A., Curve tracer improves indication of IC performance
p. 93 May 26

Allison, D. F. et al, New etchant puts dielectric isolation in the groove
p. 112 May 12

Alon, Y. & M. Jonas, Diode controls speed of fan that cools a thyatron
p. 95 Jan. 6

Altman, E., Tapping microwave acoustics for better signal processing
p. 94 Nov. 10

Anderson, J. L., Multiplexers double as logic circuits
p. 100 Oct. 27

Arnold, W. F. & A. Rosenblatt, Strategic projects get green light
p. 119 Feb. 3

Barber, B., A self-adjustable bandpass filter picks off weak signal despite noise
p. 104 Sept. 29

Barney, W., Nitride passivation links TTL, MOS
p. 117 Mar. 31

Basu, D. K. & B. Nag, Improved Miller sweep uses an active load
p. 86 Mar. 31

Belecki, W. B. & R. A. Hughes, Sorting IC's economically
p. 74 Sept. 1

Bertram, U. et al, When does it pay to customize IC's?
p. 116 Oct. 27

Biberman, L. M., Sees sec tube as a workhorse
p. 66 Sept. 1

Bisey, R., No tuned circuits in IC wide-range f-m discriminator
p. 108 Nov. 24

Black, G. & K. C. Smith, BIFET circuit yields time delays up to 30 hours
p. 94 May 26

Blatchley, W. R., Memories XXVI Computers for core tests
p. 90 Sept. 1

Blue, M. D. & D. Chen, Memories XV Optical techniques light the way to mass-storage media
p. 108 Mar. 3

Boisvert, R. & S. A. Lambert, Boosting reliability of disk memories
p. 88 Oct. 27

Boysel, L., Memories XI cutting systems costs with MOS
p. 105 Jan. 20

Brinton, J., Air operations planning goes automatic
p. 117 May 26

Core memory tester has low price tag
NP p. 175 May 12

Data generators aimed at wider market
NP p. 137 Nov. 24

Liquid laser goes commercial
NP p. 169 Dec. 8

Low-cost counters have premium specs
NP p. 131 July 21

Mil Std 883—a real test case
p. 131 Aug. 18

A miniprinter for minicomputers
NP p. 153 Oct. 13

Monitor protects IC-header bond
NP p. 133 Dec. 22

Practical research gains emphasis at NASA's ERC
p. 149 Dec. 8

Viatron—vibrant and probably viable
p. 141 June 23

Young EDP executives find their youth a liability on backers' balance sheets
p. 123 Nov. 24

Broch-Toniolo, F., A negative-resistance circuit doubles for V or I control
p. 78 Apr. 28

Brown, N. H., MOS FET stabilizes oscillator's output
p. 80 Feb. 3

Bucci, W., PCM: A global scramble for systems compatibility
p. 94 June 23

Buckland, N. M., Two zeners set limits of voltage range gate
p. 98 Feb. 17

Budlong, J. P., UJT gives frequency divider an immunity to input jitter
p. 105 July 7

Burkart, G. L., Optical isolator speeds digital data transmission
p. 104 Nov. 10

Camenzind, H. R. & A. B. Grebene, Phase locking: integrated tuned circuits made easy
p. 94 Apr. 28

Camenzind, H. R., et al, IC's break through the voltage barrier
p. 90 Mar. 31

Campeau, J. O., Cellular redundancy brings new life to an old algorithm
p. 98 July 21

Caulton, M. & W. E. Poole, Designing lumped elements into microwave amplifiers
p. 100 Apr. 14

Chang, H., Coupling sets thin magnetic films on closed flux path
p. 118 May 12

Chen, D. & M. D. Blue, Memories XV Optical techniques light the way to mass-storage media
p. 108 Mar. 3

Chernov, G., Memories XXVIII Boosting plated-wire yield: which knob to adjust?
p. 95 Sept. 1

Christensen, R. & D. Wollesen, Matching FET's by design is faster and cheaper than by pick and choose
p. 114 Dec. 8

Collins, J. H. & P. J. Hagon, Applying surface wave acoustics
p. 97 Nov. 10

Amplifying acoustic surface waves
p. 102 Dec. 8

Connolly, R., Administration infighting delays improved frequency management
USR p. 51 Nov. 10

Air traffic control for the 1980's: Survival to cost billions of dollars
p. 127 Oct. 27

Help on the way for teleprocessing?
p. 133 Sept. 29

Cooke, W. A., Pulse modulator regulates pneumatic valve closure
p. 80 Sept. 1

A simplified design approach for hysteresis circuits
p. 106 Nov. 10

Corey, F., DC-10's air data system casts a long shadow
p. 125 Mar. 17

Pay tv gets in the broadcast picture
p. 123 May 26

Cowdell, R. B., Universal graphs map direct route to mismatched pi and tee filters
p. 121 Nov. 10

Cupp, F., 4-pulse sequence generator built with 1 hex-inverter
p. 79 Feb. 3

Curran, L., Autonetics arrays its MOS forces
p. 103 Apr. 28

Computers make a big difference in MOS designs
p. 82 Oct. 13

Late show will put Mars on tv
p. 121 July 21

Plastic IC's demand new physical
p. 147 May 12

Up goes production, down go prices . . . and here comes optoelectronics!
p. 117 Dec. 22

Dance, E. A. & C. R. Elles, Memories XXVII Exercising memory systems with worst-case bit patterns
p. 93 Sept. 1

Danielsson, P., Added flip-flop stabilizes ad-converter output
p. 76 Dec. 22

D' Cunha, J. A., Negative signals converted to positive logic
p. 97 Mar. 17

DeCicco, M. & J. Durnin, Unijunction circuit prevents damage to transistors
p. 100 June 9

Delagrance, A. D., Low frequency waveform generator uses 3 op amps
p. 98 Apr. 14

DeVilbiss, A. J., Helical transmission lines bend the beam
p. 90 July 7

Dickson, P. A., IUE tries to stem outflow of jobs
p. 123 Mar. 31

Intelsat catches its breath
p. 111 Apr. 23

Intelsat plots a course for the future
p. 133 Feb. 17

NASA budget in holding pattern
p. 125 Feb. 3

Proposed national space station will put electronics to the test
p. 149 June 23

Road open for highway automation
p. 138 Aug. 18

Dickson, P. A. & W. E. Aiken, Acronyms—antic abbreviations
p. 111 Sept. 1

Dickson, P. & A. Rosenblatt, At long last, ERTS is on the way
p. 98 May 12

Dickson, T. C., III & J. P. Shea Jr., Analog-plus-logic system gets into the control stream
p. 98 Jan. 6

Downey, J., Capacitor discharge sets shape of ramp function
p. 90 Dec. 8

Doyle, O., Designers of medical instruments face serious questions on safety
p. 92 Feb. 17

Instruments win top billing with more IC's and digital designs
p. 98 Mar. 3

'Pressing' pictures on holographic tape is fast, inexpensive
p. 108 Nov. 10

Rms measuring time cut to 300 msec
NP p. 165 June 23

Semiconductor whodunit: Who's to blame for failures?
p. 98 Aug. 18

Drummond, J. D., Color-tv wheel takes a spin in space
p. 114 July 7

Detroit tunes electronics in the driver's seat
p. 84 Mar. 17

Dunn, R. & G. Hartsell, At last, a bipolar shift register with the same bit capacity as MOS
p. 84 Dec. 8

Durnin, J. & M. DeCicco, Unijunction circuit prevents damage to transistors
p. 100 June 9

Eckstein, D. & H. Schmidt, German IC's—Multi-emitter IC's stabilize voltages in solid state tuners
p. 91 Dec. 8

Elles, C. R. & E. A. Dance, Memories XXVII Exercising memory systems with worst-case bit patterns
p. 93 Sept. 1

Faggi, F. & T. Klein, A faster generation of MOS devices with low thresholds is riding the crest of the new wave, silicon-gate IC's
p. 88 Sept. 29

Fehr, K., Loop gain measurements made with paired amplifiers
p. 92 May 26

Feuer, E., Sweep circuit triggers on only 200 millivolts
p. 96 Mar. 3

Field, R. K., Nicholas Johnson a man with a mission
p. 134 Oct. 27

Tomorrow's communications
p. 73 Nov. 24

Fields, S. W., Charting a course to high profits
p. 129 Oct. 13

Hybrid IC lines move into production
NP p. 149 July 7

Monolithic regulator stands alone
NP p. 141 Sept. 29

Fisher, R. A. & D. J. Gawlowicz, Ladder network converts binary input to a-c output
p. 106 July 7

Flemming, J. P., Electron-beam testing: gentle and fast
p. 92 Feb. 3

Flint, O. Q., Jr., Free-running multi-vibrator is made with a NAND gate
p. 95 Jan. 6

Franco, S., Op amp log circuit eliminates diode bulk-resistance effects
p. 101 June 9

Frank, R. L., NAND gate inputs expanded by adding resistor
p. 95 Mar. 17

Freeman, J. H. et al., MOS frequency soars with ion-implanted layers
p. 96 Feb. 3

French, M., Rotating disks and drums set peripheral memories spinning
p. 96 May 26

Fritsch, R. J. & J. M. Nemohik, Circuit improves thermistor's linearity and boosts output
p. 99 June 9

Gange, R. A., Memories XVII Cryoelectronic memories: best hope for large and fast storage units
p. 108 Mar. 17

Gangi, A. F., Op amps replace transformer in phase detector circuit
p. 109 May 12

Gans, F., Common-mode rejection ratio: what the spec sheet doesn't say
p. 116 June 23

Gawlowicz, D. J. & R. A. Fisher, Ladder network converts binary input to a-c output
p. 106 July 7

Gerdes, R. C., Q-multiplier circuit uses op amp with LC feedback
p. 92 May 26

Gibson, D. H. & W. L. Shevel, Memories XXXII 'Cache' turns up a treasure
p. 105 Oct. 13

Ginsberg, E. L., IC's enter the picture for automatic cameras
p. 113 Sept. 15

Gosch, J., Electronics kit leaves the toy box
p. 147 Apr. 14

German car market opening up
p. 155 May 12

No West German 'creativity gap' where linear IC's are concerned
p. 104 Sept. 15

Graham, I. C. & C. S. L. Keay, FET links oscillator to TTL circuit
p. 97 Feb. 17

Grebene, A. B. & H. R. Camenzind, Phase locking: integrated tuned circuits made easy
p. 94 Apr. 28

Gruner, R. H., Phase comparator yields digital output
p. 118 Sept. 15

Gundlach, R., Rx for r-f power transistors
p. 84 May 26

Guyton, R., 19 op-amp gains are switched without offset
p. 94 Mar. 3

Hagon, P. J. & J. H. Collins, Applying surface wave acoustics
p. 97 Nov. 10

Amplifying acoustic surface waves
p. 102 Dec. 8

Hamilton, L. L., Pulse-train duty factor controls RC filter
p. 93 Aug. 4

Hamiter, L. C. Jr., How reliable are MOS IC's? As good as bipolars, says NASA
p. 106 June 23

Hargrove, A. H., IC-size phase detector doesn't need any inductors
p. 91 Aug. 4

Harmon, R. S., Taking the heat off thermocouple failures
p. 96 Oct. 13

Hartley, C., Oscillator has transfer as the resonant device
p. 78 Feb. 3

Hartsell, G. & R. Dunn, At last, a bipolar shift register with the same bit capacity as MOS
p. 84 Dec. 8

Herzog, G. B., Memories XIII COS/MOS the best of both worlds
p. 109 Feb. 17

Hills, M., Active filters: part 13 Narrowing the choice
p. 106 Oct. 27

Hoehne, W. & E. Witzenzeller, For noisy environments, why not low-speed logic?
p. 115 Sept. 15

Hoffman, E. J. One-shot multivibrator requires no standby power
p. 91 May 26

Hoffmann, H. et al, When does it pay to customize IC's?
p. 116 Oct. 27

Holland, J., MOS FET prevents loading by a pulse stretcher
p. 95 Mar. 3

Horan, F. H., Load current monitor doesn't break circuit
p. 93 Oct. 13

Hornak, T., Control current slows pulse's leading edge
p. 96 Aug. 18

Horsley, A. W., Glow-discharge unit makes multilayer deposition easy
p. 84 Jan. 20

Hoss, R. J., Pulse generator triggered by a step function
p. 87 Mar. 31

Hughes, R. A. & W. B. Belecki, Sorting IC's economically
p. 74 Sept. 1

Hull, R. W. & K. Simonyan, Log diodes can be counted on
p. 104 Mar. 31

Hurtig, G., Active filters: part 8 Positive results from negative feedback
p. 96 Mar. 31

Iltis, R., IC circuit measures speed of switches
p. 108 May 12

Jackson, T. M. & T. J. Rowe, Laser cuts masks to size, eliminating most errors
p. 81 Jan. 20

Johnson, J. B., Line-operated relay uses actuating input
p. 78 Feb. 3

Jonas, M. & Y. Alon, Diode controls speed of fan that cools a thyatron
p. 95 Jan. 6

Kalal, T. T., Pulse width varied by a "switched ground"
p. 77 Apr. 28

Kalisz, J., Simple gating yields phase-locked pulse bursts
p. 96 Jan. 6

Kanner, M., Nonstop limiter absorbs transients
p. 106 May 26

Karp, H. R., Magnetic bubbles—a technology in the making
p. 83 Sept. 1

Kass, S., NAND gate counter is cheaper to make
p. 87 Jan. 20

- Kaufman, A. B., Ferroelectric memories for special applications p. 116 May 12
- Keay, C. S. L. & I. C. Graham, FET links oscillator to TTL circuit p. 97 Feb. 17
- Keay, C.S.L. & J.A. Kennewell, D-a converter switches digital inputs with TTL gates p. 89 Dec. 8
- Kedson, L. & A. M. Stoughton, Memories XXV—Memory testing is a task that comes in layers p. 88 Sept. 1
- Keller, H., Overcoming design problems in varactor-diode tuners p. 88 Jan. 6
- Kennewell, J.A. & C.S.L. Keay, D-a converter switches digital inputs with TTL gates p. 89 Dec. 8
- Kestenbaum, R., What is a 'systems' approach? It's just the name of the game p. 68 Apr. 28
- King, G. & J. S. Heeks, Bulk-effect modules pave way for sophisticated uses p. 94 Feb. 3
- Klien, T. & F. Faggi, A faster generation of MOS devices with low thresholds is riding the rest of the new wave, silicon-gate IC's p. 88 Sept. 29
- Knauer, P. & G. McLin, Color tv gets a badly needed face-lift p. 102 Aug. 4
- Koch, G. & U. Mocchi, Dual transistor reduces error of track and hold circuit p. 94 Mar. 17
- Kocsis, J. et al, IC's break through the voltage barrier p. 90 Mar. 31
- Koller, K. & A. K. Pascher, Generating IC artwork automatically saves time, prevents costly errors p. 117 Nov. 24
- Kurokawa, K., All-IC hybrid computer eliminates the patchwork from programming p. 100 Mar. 17
- Lambert, S.A. & R. Bolsvert, Boosting reliability of disk memories p. 88 Oct. 27
- Latham, G.R., 4th., Inverted transistor switches precision d-c voltage p. 92 Aug. 4
- Lauffer, D.K., Single building block proves logical choice for custom IC's p. 88 Apr. 28
- Law, C., Canada's new satellite projects shake up research establishment p. 143 July 7
- Lehner, G.S., Sighting irregularities in small shafts p. 96 Oct. 27
- Lisee, B. & M. Nougaret, D-a convert improves accuracy of thermal unit p. 88 Mar. 31
- Liu, A., Retriggerable one-shots form delayed-key oscillator p. 96 Sept. 29
- Luisi, J.A., Memories XIV SOS brings new life to read-only units p. 114 Feb. 17
- Magill, L., Users' choice is name of keyboard game p. 145 Nov. 10
- Marley, J. & G. Trolsen, New beam-lead connection method boosts semiconductor memory yields p. 105 Dec. 22
- Marso, R. & A. Mondloch, Millimeter waves for ships p. 108 May 26
- Marsocci, V.A., Active filters: Part 9 Applying nonlinear elements p. 116 Apr. 14
- Martens, A.E., Photomultiplier's gain is temperature compensated p. 97 Apr. 14
- Martin, A.J., PRBS can fool the system p. 82 Apr. 28
- Math, I., IC flip-flops accurately control motor rotation p. 94 Aug. 18
- McCormick, R.E., Oscilloscope's changing face—red, green and blue traces p. 84 Aug. 4
- McDonald, J. & A. Pinkerton, Two-stage peak-holding circuit stores submicrosecond pulses p. 105 Nov. 10
- McIntyre, R., Adapter lets digital IC tester check on operational amplifiers p. 94 July 21
- McLin, G. & P. Knauer, Color tv gets a badly needed face-lift p. 102 Aug. 4
- Messina, F.J., Power supply regulator uses fewer parts p. 94 Jan. 6
- Miller, W.D., Minimizing common-mode errors in a variable-gain amplifier p. 104 June 23
- Minder, F., Touch-activated switch with copper-plated board p. 79 Sept. 1
- Mittleman, J., Computer-aided design, act two: Admission price exceeds forecasts p. 90 June 9
- Connecting aluminum wire reliably p. 94 Dec. 8
- Mocchi, U. & G. Koch, Dual transistor reduces error of track and hold circuit p. 94 Mar. 17
- Moiraghi, A., Single transistor divides frequency in avalanche mode p. 96 Sept. 29
- Molyneux, L., Op amp sine wave oscillator uses diodes for stability p. 97 Mar. 17
- Mondloch, A. & R. Marso, Millimeter waves for ships p. 108 May 26
- Mosca, V., One-shot multivibrator yields division up to 12 p. 96 Apr. 14
- Mueller, F.E., Pick-hold coil driver recovers quickly p. 96 Apr. 14
- Mullaney, J.W., Active filters: part 11 Varying the approach p. 86 July 21
- Muller, W., Positive or negative pulses trigger one-shot multivibrator p. 94 Aug. 18
- Nag, B. & D.K. Basu, Improved Miller sweep uses an active load p. 86 Mar. 31
- Near, C.W. & R.E. Watson, Read-only memory adds to calculator's repertoire p. 70 Feb. 3
- Nemohik, J.M. & R.J. Fritsch, Circuit improves thermistor's linearity and boosts output p. 99 June 9
- Neuhaus, H. et al. When does it pay to customize IC's? p. 116 Oct. 27
- Nichols, J.L., Reference waveform adds to scope's measuring capability p. 77 Dec. 22
- Nougaret, M., Multipoint recorder serves as time-shared amplifier p. 111 July 7
- Nougaret, M. & B. Lisee, D-a converter improves accuracy of thermal unit p. 88 Mar. 31
- O'Brien, T.E., Automatic attenuator rapidly changes signal level p. 120 Sept. 15
- Ochs, G. & P. Richman, Curve fitter adds the measure of rms by overruling square-law slowdowns p. 98 Sept. 29
- Osborne, T.E., Memories XXII For sophisticated calculators, core arrays are worth the price p. 118 June 9
- Overn, W.M., Memories XXX Controlling creep and skew in thin-film memories p. 125 Sept. 15
- Pascher, A.K. & K. Koller, Generating IC artwork automatically saves time, prevents costly errors p. 117 Nov. 24
- Pastoriza, J.J. & D.R. Weller, Know your d-a converter's capability p. 129 Nov. 10
- Pataki, S., Multivibrators separate pulses according to their widths p. 88 Dec. 8
- Payne, M., "The American Challenge" on a chip p. 74 Jan. 20
- Pearl, J., Memories XXXI Packing data tightly in thin-film memories p. 129 Sept. 15
- Pech, E. & R. Suhrmann, When it comes to color tv, the outlook is bright indeed p. 111 Sept. 15
- Perkins, J.F. & E. Segarra, Building blocks are two-base hit for analog control computers p. 96 Aug. 4
- Peterson, W.E., D-c restorer clamps random pulses to a reference p. 106 July 7
- Diode generator yields complex functions p. 95 Oct. 13
- Piatkowski, T.F., ICs are checked faster with audible voltmeter p. 88 Jan. 20
- Pinkerton, A. & J. McDonald, Two-stage peak-holding circuit stores submicrosecond pulses p. 105 Nov. 10
- Pitzalis, O., Jr., Zener circuit detects transients in power lines p. 111 May 12
- Plumb, J., Teamwork streamlines differential amplifier tests p. 132 Sept. 15
- Pohl, P., Zener in preregulator limits series transistor dissipation p. 98 Oct. 27
- Polata, B. et al, IC's break through the voltage barrier p. 90 Mar. 31
- Poole, W.E. & M. Caulton, Designing lumped elements into microwave amplifiers p. 100 Apr. 14
- Popper, H.R. & M.I. Rackman, The case for patenting software p. 96 July 7
- Priel, U., Memories IX Semiconductor arrays get bigger and denser p. 100 Jan. 20
- Rackman, M.I. & H.R. Popper, The case for patenting software p. 96 July 7
- Radley, P.E., Metalization is designed quickly and inexpensively p. 78 Jan. 20
- Raghavan, K.V., Two one-shots control waveform's pulse width p. 93 Jan. 6
- Reichard, R.W., Memories XXIII Exotic storage applications often revive old memories p. 119 June 9
- Reid, M., Climate friendly in Mexican border zone p. 151 Mar. 3
- Reisman, A., Germanium IC's point the way towards picosecond computers p. 88 Mar. 3
- Richman, P. & G. Ochs, Curve fitter adds the measure of rms by overruling square-law slowdowns p. 98 Sept. 29
- Rickard, B.W., Memories XXIV Military masses its cores for battlefield conditions p. 122 June 9
- Riddle, H., Transformer is eliminated in transistor chopper p. 76 Dec. 22
- Riley, W.B., Getting more mileage from computers p. 117 Jan. 20
- Through a glass, lightly NP p. 174 Dec. 8
- Robertson, G.I. & C.P. Sandbank, Integrated solid state display needs no complex circuitry p. 100 Feb. 3
- Rosenblatt, A., Cat's eyes for the military p. 64 Sept. 1
- I/CNI hanging by a thin thread p. 115 July 21
- Navy gets a new airborne watchdog p. 133 July 7
- Rosenblatt, A. & W.F. Arnold, Strategic projects get green light p. 119 Feb. 3
- Rosenblatt, A. & P. Dickson, At long last, ERTS is on the way p. 98 May 12
- Ross, W., Pulse train frequency varied as duty cycle stays constant p. 84 July 21
- Rowe, T.J. & T.M. Jackson, Laser cuts masks to size, eliminating most errors p. 81 Jan. 20
- Saffir, O.S., Memories XII Getting more speed from MOS p. 106 Feb. 17
- Salerno, J., Active filters: part 7—Analog blocks ensure stable design p. 100 Feb. 17
- Samuelson, D., Before you start your own company... p. 110 Aug. 18
- Sandbank, C.P. & G.I. Robertson, Integrated solid state display needs no complex circuitry p. 100 Feb. 3
- Sauerland, F.L., Identical resonators cut ceramic i-f filter cost p. 102 May 26
- Schlotterer, H., Growing silicon on spinel adds up to high isolation, fast switching in IC's p. 113 Oct. 27
- Schmidt, H. & D. Eckstein, German IC's—Multi-emitter IC's stabilize voltages in solid state tuners p. 91 Dec. 8
- Schuyten, P.J., Building a business in the ghetto spells Progress with a capital letter 'P' p. 165 Jan. 6
- EE's—names to conjure with p. 139 Aug. 4
- For EE's the party's over p. 139 Apr. 14
- Jumbo-Jet age means airlines must take electronic route on the ground, too p. 129 Nov. 24
- Keeping spin-offs in-house; a new approach to an old problem p. 127 Sept. 29
- Wall Street hunts for systems to keep up with volume growth p. 143 Mar. 3
- Scribner, E.J., Circuit monitors energy of laser photocoagulator p. 110 July 7
- Segarra, E. & J.F. Perkins, Building blocks are two-base hit for analog control computers p. 96 Aug. 4
- Seligman, L., Making a minicomputer superfast p. 116 Nov. 10
- Selph, R., SDC means business—in software p. 151 Sept. 15
- Worldwide system or backup—which role will Omega play? p. 153 Nov. 10
- Shahbender, R., Memories XVIII Sonic film unit is a sound bet p. 90 Apr. 14
- Shannon, J.M. et al., MOS frequency soars with ion-implanted layers p. 96 Feb. 3
- Shapiro, P., Infrared detector chart outlines materials and characteristics p. 91 Jan. 20
- Shea, J.P., Jr. & T.C. Dickson III, Analog-plus-logic system gets into the control stream p. 98 Jan. 6
- Shepard, R.R., Active filters: part 12 Short cuts to network design p. 82 Aug. 18
- Shevel, W.L. & D.H. Gibson, Memories XXXII "Cache" turns up a treasure p. 105 Oct. 13
- Shin, J.J., Signals shifted 180° as amplification remains constant p. 110 May 12
- Stegal, B., Simpler digital circuits in snap p. 105 June 9
- Silverman, J.H., A-C source drives tape-stepping motor p. 109 Nov. 24
- SCR shift register can take a lot of noise p. 104 June 23
- Simonyan, K. & R.W. Hull, Log diodes can be counted on p. 104 Mar. 31
- Sitnikov, L.S. & L.L. Utyakov, Multistable logic simplifies man-machine interface p. 105 Aug. 18
- Skole, R., High stakes on Capitol hill p. 171 Jan. 6
- Upbeat outlook favors industry p. 131 Feb. 3
- Slate, M.W., Want to be a good loser? Go about it systematically p. 112 Apr. 14
- Smith, D.K., Monitor guards three ways against power failures p. 97 Oct. 27
- Smith, K.C. & G. Black, BIFT circuit yields time delays up to 30 hours p. 94 May 26
- Spani, W., Absolute value circuit needs only one op amp p. 89 Jan. 20
- Stadler, H., Transistor "zener" has zero dynamic impedance p. 86 Mar. 31
- Steinman, A., Modified regulator yields variable d-c reference p. 78 Apr. 28
- Stephen, J. et al., MOS frequency soars with ion-implanted layers p. 96 Feb. 3
- Stewart, R.D., Memories XVI Optoelectronic memories: light to read out by p. 113 Mar. 3
- Seeing in the dark is aim of r-f holography p. 110 Nov. 24
- Stoughton, A.M. & L. Kedson, Memories XXV—Memory testing is a task that comes in layers p. 88 Sept. 1
- Stranddorf, S.P., FETs protect differential amplifiers p. 88 Jan. 20
- Suhrmann, R. & E. Pech, When it comes to color tv, the outlook is bright indeed p. 111 Sept. 15
- Teixeira, J.F., Unity-gain amplifier in probe needs only two conductors p. 99 June 9
- Thompson, P., A single-channel "multi-trace" scope p. 113 Sept. 29
- Tong, D.A., Squelch acts faster with FET gate p. 96 Mar. 17
- Toy, S., LSI halves price of multimeter NP p. 151 Mar. 17
- Tracy, R.A., Memories XXI Delay lines—key to low cost in keyboard machines p. 114 June 9
- Trolsen, G. & J. Marley, New beam-lead connection method boosts semiconductor memory yields p. 105 Dec. 22
- Tunzi, B.R., Memories X MOS random-access arrays p. 102 Jan. 20
- Turner, R.J., Buffer amp provides stability over wide temperature range p. 107 Nov. 24
- Feedback sharpens filter response p. 102 Sept. 29
- Stable f-m oscillator offers sensitivity and linearity p. 95 Aug. 18
- Transistors improve high-frequency limiter p. 94 Oct. 13
- Uimari, D.C., Memories XXIX A choice for serial memories p. 122 Sept. 15
- Ulrick, C.J., Core-memory driver runs cooler p. 102 Oct. 13
- Power supply breaker acts in 100 microseconds p. 79 Feb. 3
- Underwood, R.K., Converted generator drives heavy logic loads p. 97 Feb. 17
- Utyakov, L.L. & L.S. Sitnikov, Multistable logic simplifies man-machine interface p. 105 Aug. 18
- van der Geer, Kees, FET's tune RC oscillator over decade range p. 96 Feb. 17
- Transformerless d-c voltage converter is 70% efficient p. 95 Apr. 14
- Vander Haagen, G.A., FET varies Q of tuned circuit by several thousand p. 95 Sept. 29
- Velsink, W.B., Simplifying crt character generation p. 72 Dec. 22
- Venator, W., Charting a simpler course to the design of yig filters p. 118 Mar. 3
- Vermillion, L., Jumble of electronics, instruments keeps air pollution monitoring hazy p. 137 Dec. 8
- Vinatzter, A.E., High accuracy obtained from peak detector using op amp p. 94 Mar. 17
- Vogel, P., Bigtime profits in a rural setting for Grass Valley Group p. 129 Mar. 31
- Engineers accept the risk of layoffs in defense field p. 122 Jan. 20
- Wadsworth, D.F., Pair of source followers keep a voltmeter steady p. 103 June 23
- Walczak, M.W., Nomograph simplifies finding one-shot's pulse width p. 97 Sept. 29
- Wanek, P.V., Nomograph charts a fast way to build a notch filter p. 119 Sept. 15
- Transmit-receive switch exceeds 60-db isolation p. 93 Aug. 18
- Warren, L., Brazil works on busy signal p. 133 Mar. 17
- Watson, G.F., LSI and systems: the changing interface p. 78 Mar. 31
- Radiation-hardened IC's go commercial NP p. 137 Feb. 3
- Solid state microwave leaves lab p. 86 Feb. 17
- Watson, R.E. & C.W. Near, Read-only memory adds to calculator's repertoire p. 70 Feb. 3
- Weller, D.R. & J.J. Pastoriza, Know your d-a converter's capability p. 129 Nov. 10
- Welling, B., Active filters: part 6 The op amp saves time and money p. 82 Feb. 3
- Westgate, R.D., Government-industry cooperation bears fruit in IC mil specification p. 125 Dec. 22
- U.S. lights fire under microwave ovens p. 123 Oct. 13
- Westphal, P., Digital clock operates in low megahertz range p. 87 Jan. 20
- Whalen, R.M., Memories XXXIII Speeding up ferrite-core memories p. 108 Oct. 13
- Williams, J.H., Full duty single shot recovers fast p. 89 Mar. 31
- Williams, J.H. & J.W. Wolf, On the beam for sharp crt character displays p. 109 Sept. 29
- Williams, R., Linearity corrector does double duty p. 110 June 9
- Wintriss, V., IC's take the "bounce" out of switches p. 91 Aug. 4
- Witzenzeller, E. & W. Hoehne, For noisy environments, why not low-speed logic? p. 115 Sept. 15
- Wohler, J.E., Asynchronous pulse gives tape's data signal p. 80 Sept. 1
- Wolf, J.W. & J.H. Williams, On the beam for sharp crt character displays p. 109 Sept. 29
- Wolff, H., To thread maze of export rules, start at Commerce Dept. p. 139 Feb. 17
- Wollesen, D. & R. Christensen, Matching FET's by design is faster and cheaper than by pick and choose p. 114 Dec. 8
- Wong, T.H. et al, New etchant puts dielectric isolation in the groove p. 112 May 12
- Lighting the way to flat-screen tv p. 114 Mar. 17
- Youmans, A.P. et al, New etchant puts dielectric isolation in the groove p. 112 May 12
- Zahalka, L.B., Computer simulation plays key role in design of satellite earth stations p. 120 June 23

For the tough L-1011 wiring job, TEFLON puts on its toughest overcoat: liquid polyimide.

Start with the basic, high-reliability wire insulation of Du Pont TEFLON fluorocarbon resins — proved for over 20 years in the most critical applications. Then, if you need to push the reliability up another notch, overcoat TEFLON with the new, high-performance polyimide enamel that gives you extra protection against cut-through and abrasion over an extended range of mechanical and thermal requirements.

That's what designers of the Lockheed 1011 TriStar jet transport did. They specified the composite construction of TEFLON plus polyimide coating (TFE/H) for a portion of the general-purpose airframe wire in each of the new jetliners. As Lockheed engineers put it, the TriStar has been designed for 99% dispatch reliability and 99.8% operational reliability.

In other electronic and aerospace applications, this tough, lightweight, very thin insulation of TEFLON plus a polyimide jacket has proven itself repeatedly in critical service, as in major systems of the Apollo program.

Wire insulated with TEFLON plus polyimide provides optimum dielectric quality, superb mechanical properties, extremely long life at high temperatures, nonflammability, chemical resistance and easy handling, printing and potting.

TFE/H: a tough combination to beat. Look into it. Write us for more specific information: Du Pont Company, Room 7775-C, Wilmington, DE 19898.

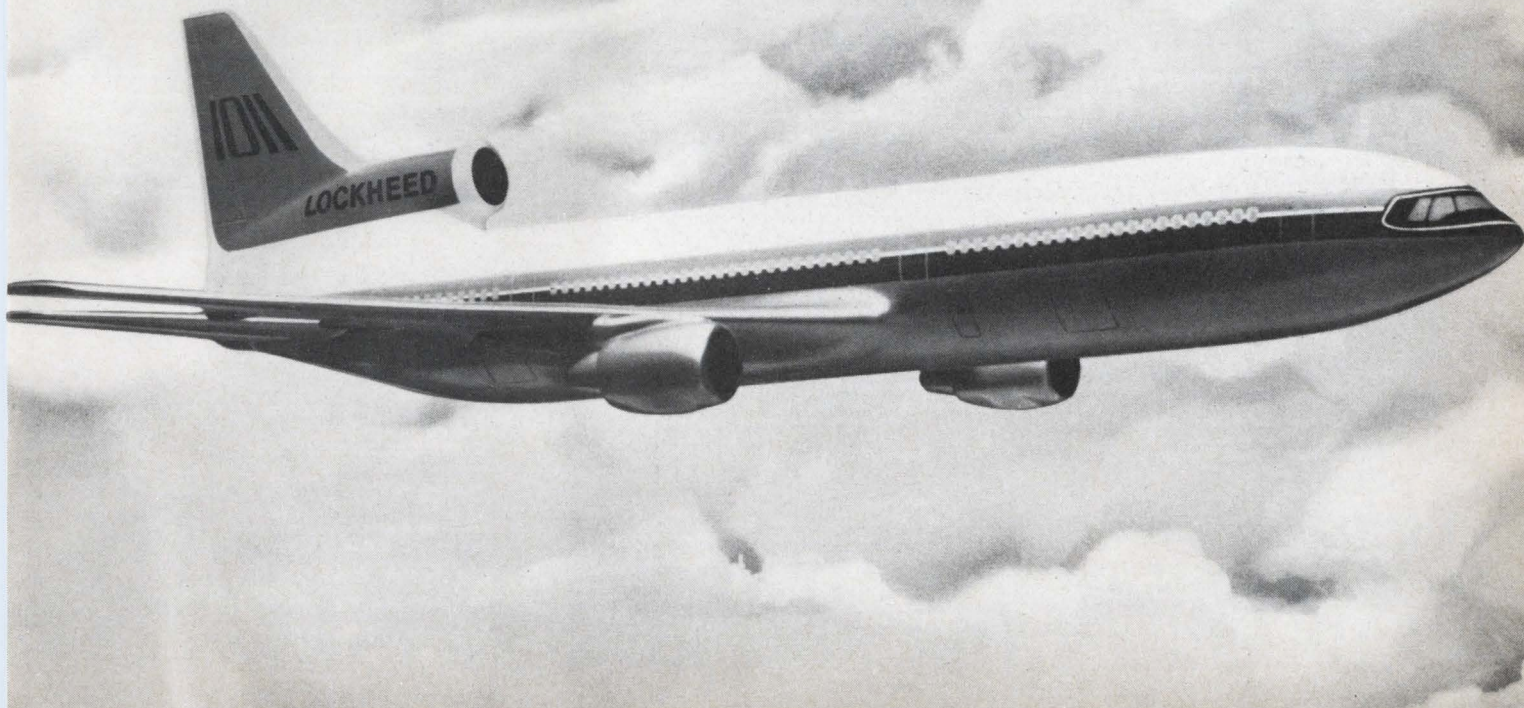

Electronics advertisers

January 5, 1970

Airco Speer Electronic Components	172	Hansen Mfg. Co.	151	Susumu Industrial Co. Ltd.	194
Hazard Adv. Co., Inc.		Kelley-Crescent Co.		Kyokuto Kikaku Co. Ltd.	
Airpax Electronics, Inc.	2nd Cover	Hewlett Packard, Loveland Div.	1	Syntron Instruments, Inc.	158
Tech Communicators, Inc.		Tallant/Yates Adv.		Burton Browne Advertising	
Allen-Bradley Company	23	Hewlett Packard, New Jersey Div.	160	Systron Donner Corporation	183
Hoffman-York, Inc.		McCarthy Scelba, and Di/Biasi Adv. Agcy., Inc.		Bonfield Associates Inc.	
American Lava Corp., Sub. of Minnesota Mining & Mfg. Co.	163	Hewlett Packard San Diego Div.	64, 65	Sprague Electric Company, The	7
Designers, Inc.		Lennen & Newell, Inc.		Harry P. Bridge Company	
AMP, Inc.	176	IEEE (Institute of Electrical & Electronic Engineers)	193	Sylvania Electric Products Inc., Electronic Components Group	35 to 42
Garceau, Hallahan & McCullough, Inc.		Alpaugh Advertising		Doyle Dane Bernbach Inc.	
Ancrona Corp./Neumuller & Co.	166	Infoton, Inc.	185	Techno Cambridge Ltd.	194
Wilhelm Bacher Werbung		Maslow, Gold and Rothschild, Inc. Adv.		Harrison Wright Associates Ltd.	
Barnes Corporation	211	Ing. C. Olivetti & C. Spa.	7E	Teradyne Inc.	169
Industrial Public Relations, Inc.		Studio Giuliano Blei		Quinn & Johnson Advertising Inc.	
Beckman Instruments, Inc., Electronic Instrument Div.	15	Integrated Circuit Engineering Corp.	26	Texas Instruments Incorporated Components Group	30-31
Hixson and Jorgensen, Inc.		N. A. Winter Adv.		Albert Frank-Guenther Law Inc.	
Beckman Instruments, Inc., Heliport Div.	59	Intel Corp.	84, 85	Tohoku Metal Industries Ltd.	193
N. W. Ayer/Jorgensen/MacDonald, Inc.		Bonfield Associates		Hakuhodo Inc.	
Bendix Corp., Electrical Components Div.	16, 17	International Electronic Research Corp.	62	Tripplitt Electrical Instrument Company	75
MacManus, John & Adams, Inc.		Van Der Boom, McCarron, Inc.		Byer and Bowman Advertising	
Bliley Electric Co.	174	JFD Electronics Co., Components Div.	13	Transformer Electronics Company	57
Barber and Drullard, Inc.		Delphi Adv., Inc.		Wolff & Weir	
Bourns, Inc., Trimpot Div.	32	Keithley Instruments, Inc.	24	TRW Semiconductors Inc.	63
The Lester Company		Bayless-Kerr Co.		Fuller & Smith & Ross Inc.	
Buckbee-Mears Co.	53	Kikusui Electronics Corp.	193	United Transformer Company, Division of TRW Inc.	164
Midland Associates, Inc.		General Adv. Agcy., Inc.		Fuller & Smith & Ross Inc.	
Burndy Corp.	66, 67	Lectrohm, Inc., Sub. of Cook Electric Co.	153	Unitrode Corporation	49
The Gravenson Group, Inc.		Sander Rodkin Adv., Ltd.		Silton Brothers Inc.	
Burns & Towne, Inc.	22, 194	Littelfuse, Inc.	192	Universal Oil Products, Norplex Division	150
Impact Adv. Inc.		Burton Browne Advertising		Campbell-Mithun Inc.	
Burroughs, Corp., Electronic Components Div.	86	Litton Industries, Inc., Electron Tube Div.	56	U-Tech, A Division of Industrial Physics and Electronics Company	187
Conti Adv. Agcy., Inc.		MacManus, John & Adams, Inc.		Ross Clay Advertising	
Bussmann Mfg. Div. of McGraw Edison Co.	190, 191	Litton Ind., Inc., Data Systems	190	Vidar Corporation, Instrumentation Division	61
Henderson Adv. Co.		Lockheed Missiles and Space Co.	192	Bill Fisher Advertising	
Carpenter Technology Corp.	25	McCann-Erickson, Inc.		Weston Instruments Inc. Lexington Division	99
Beaumont, Heller & Sperling, Inc.		Mallory Battery Co., Div. of P. R. Mallory and Co., Inc.	154	Larcom Randall Adv. Inc.	
Centralab Div. of Globe Union, Inc.	27	Needham, Harper and Steers, Inc.		Westinghouse Electronic Tube Division	20-21
The Brady Co.		Matsuo Electric Co., Ltd.	186	Ketchum, MacLeod & Grove Inc.	
Clairex Corp.	212	Daiko Adv., Inc.		Westinghouse Semiconductor Division	170-171
Michel-Cather, Inc.		Minelco, a Subsidiary of General Time	2	Ketchum, MacLeod & Grove Inc.	
Clare & Co., C.P.	51	Alden Adv. Agency Inc.		Xenon Corporation	185
Reincke, Meyer & Finn Adv., Inc.		Motorola Communications and Electronics Inc.	179		
Clifton Precision Products Co., Div. of Litton Industries	184	Brand Adv. Inc.			
Ivey Adv., Inc.		National Semiconductor Corporation	10-11		
Computer Measurements Co., Div. of Newall Industries	28, 29	Hall Butler Blanderwick Inc.			
Jones, Maher, Roberts, Inc.		New Hermes Engraving Machine Corporation	211		
Cosmicar	8E	Lester Harrison Advertising Inc.			
CTS Corporation	159	Norton Associates Inc.	186		
Reincke, Meyer & Finn, Inc.		J. J. Coppo Company			
Dale Electronics, Inc., Sub. of Lionel Corp.	3rd Cover	Omron Tateisi Electronics Co.	18-19		
Swanson, Sinkey, Ellis, Inc.		Dai-Ichi International Inc.			
Delco Radio Div.	76, 77	Philips N. V. Pit/Tmi Division	2E		
General Motors Corp.		Marsteller International S. A.			
Cambell-Ewald Company		Princeton Applied Research Corporation	44		
Digital Equipment Corp.	175	Mort Barish Associates Inc.			
Kalb & Schneider, Inc.		Quantum Science Corporation	58		
DuPont de Nemours Co., Teflon Div.	209	Hetcher-Walker Gusell, Inc.			
Batten, Barton, Durstine & Osborn, Inc.		Radiation Incorporated	100		
Edwards High Vacuum, Inc.	141	W. M. Zemp and Associates Inc.			
B. P. Myer Assoc., Inc.		Radio Corporation of America	4th Cover		
E-H Research Labs., Inc.	181	Al Paul Lefton Company			
Steedman, Cooper and Busse Adv.		Rentronix Incorporated	182		
E/MC Electronics/Management Center	157, 179, 189	E. G. White Advertising Inc.			
Ries Cappiello Colwell, Inc.		Romohawk Electronics Corporation	12		
E/MC Medical Electronics Seminar	82, 83	Lesserauz and Tandler Inc.			
Ries Cappiello Colwell, Inc.		Rohde & Schwarz	3E		
Emerson Cuming, Inc.	178	Sage Electronics Corporation	14		
Edwin F. Hall		Mathison Adv. Inc.			
Executone, Inc., Printact Relay Div.	158	Saches Tarzian Inc.	189		
J. A. Richards		Macgill/Ross Inc.			
Fluoroware	189	Schauer Manufacturing Corporation	151		
Colle & McVoy Adv. Agcy., Inc.		Nolan, Keelor & Stites			
General Electric Co., Capacitor Div.	60	Sescosem	4E		
Robert S. Cragin, Inc.		Signalite Inc. Sub. of General Instrument Corporation	167		
General Electric Co., Capacitor and Battery Department	54, 55	McCarthy, Seelba, DeBiasi Adv. Agcy, Inc.			
Robert S. Cragin, Inc.		Signetics Corp. Sub. of Corning Glass Works	145		
General Instrument Europe S.P.A.	5E	Cunningham & Walsh Inc.			
Studio Cigiemme		Siliconix Inc.	6		
General Radio Co.	8	Robertson West Inc.			
Horton, Church and Goff, Inc.		Sorensen Operation Raytheon Company	81		
Gould, Inc./Brush Instruments	146	Fred Wittner Company			
Carr Liggett Adv., Inc.		Sperry Rand Corporation, Sperry Microwave Electronics Division	68		
Grayhill, Inc.	179	Neals & Hickok Inc.			
Carr Liggett Adv., Inc.		Stackpole Carbon Company, Electronic Components Division	78		
Gries Reproducer Co.	186	Thomas Farragher and Associates Inc.			
Harold Marshall Adv.					
Gudebrod Bros Silk Co., Electronics Div.	43				
Ramsdell, Buckley & Co., Inc.					

Classified & Employment Advertising

F.J. Eberle, Manager
212-971-2557

EMPLOYMENT OPPORTUNITIES . . . 195-196

Atomic Personnel Inc. 196
Sperry Rand Research Center 196

EQUIPMENT (Used or Surplus New) For Sale

Laboratory Equipment Co. 196
Radio Research Instrument Co. 196

■ For more information on complete product line see advertisement in the latest Electronics Buyer's Guide

□ Advertisers in Electronics International

Electronics Buyers' Guide

George F. Werner, Associate Publisher
[212] 971-2310

Robert M. Denmead,
Midwest Regional Manager
[312] MO 4-5800

Cliff Montgomery,
New York District Manager
[212] 971-3793

Regina Hera, Directory Manager
[212] 971-2544

Thomas M. Egan, Production Manager
[212] 971-3140

Carol Gallagher,
Assistant Production Manager [212] 971-2045

Circulation Department

Isaaca Siegel, Manager [212] 971-6057

Research Department

David Strassler, Manager [212] 971-6058

Advertising Sales Staff

Dan McMillan III [212] 971-3468
Associate Publisher

Wallis Clarke [212] 971-2187
Advertising Sales Service Manager

Warren H. Gardner [215] LO 8-6161
Eastern Advertising Sales Manager

Atlanta, Ga. 30309: Michael H. Miller, 1375
Peachtree St. N.E.
[404] 892-2868

Boston, Mass. 02116: William S. Hodgkinson
McGraw-Hill Building, Copley Square
[617] CO 2-1160

Cleveland, Ohio 44113: William J. Boyle, 55
Public Square, [216] SU 1-7000

New York, N.Y. 10036
500 Fifth Avenue
James R. Pierce [212] 971-3615
John A. Garland [212] 971-3617
Michael J. Stoller [212] 971-3616

Philadelphia, Pa. 19103:
Jeffrey M. Preston
Warren H. Gardner,
6 Penn Center Plaza,
[215] LO 8-6161

Pittsburgh, Pa. 15222: Jeffrey M. Preston,
4 Gateway Center, [412] 391-1314

Rochester, N.Y. 14534: William J. Boyle,
9 Greylock Ridge, Pittsford, N.Y.
[716] 586-5040

Donald R. Furth [312] MO 4-5800
Midwest Advertising Sales Manager

Chicago, Ill. 60611: Kenneth E. Nicklas
Ralph Hanning 645 North Michigan Avenue,
[312] MO 4-5800

Dallas, Texas 75201: Richard P. Poole, 1800
Republic National Bank Tower,
[214] RI 7-9721

Houston, Texas 77002: Robert Wallin,
2270 Humble Bldg. [713] CA 4-8381

Detroit, Michigan 48226: Ralph Hanning,
856 Penobscot Building
[313] 962-1793

Minneapolis, Minn. 55402: 1104 Northstar
Center [612] 332-7425

St. Louis, Mo. 63105: Kenneth E. Nicklas,
The Clayton Tower, 7751 Carondelet Ave.
[314] PA 5-7285

James T. Hauptli [415] DO 2-4600
Western Advertising Sales Manager

Denver, Colo. 80202: David M. Watson,
Richard W. Carpenter
Tower Bldg., 1700 Broadway
[303] 266-3863

Los Angeles, Calif. 90017: Ian C. Hill,
Bradley K. Jones, 1125 W. 6th St.,
[213] HU 2-5450

Portland, Ore. 97204: James T. Hauptli,
Don Farris, 218 Mohawk Building,
222 S.W. Morrison Street,
Phone [503] 223-5118

San Francisco, Calif. 94111: James T. Hauptli,
Don Farris, 255 California Street,
[415] DO 2-4600

Pierre Braude Tel: 225 85 88: Paris
International Director

Paris: Denis Jacob
17 Rue-Jeorges Bizet, 75 Paris 16, France
Tel 727 33 42, 727 33 60

United Kingdom and Scandinavia

London: Oliver Ball, Tel: Hyde Park 1451
34 Dover Street, London W1

Milan: Robert Saldel, Roberto Laurer Jr.
1 via Baracchini Phone 86-90-656

Brussels: Denis Jacob
27 Rue Ducale Tel: 136503

Frankfurt/Main: Hans Haller
Elsa-Brandstroem Str. 2
Phone 72 01 81

Geneva: Denis Jacob
1 rue du Temple Phone: 31 95 60

Tokyo: McGraw-Hill
Publications Overseas Corporation,
Kasumigaseki Building 2-5, 3-chome,
Kasumigaseki, Chiyoda-Ku, Tokyo, Japan
[581] 9811

Osaka: Akihiko Kamesaka, McGraw-Hill
Publications Overseas Corporation, Kondo
Bldg., 163, Ume-gae-cho Kita-ku [362] 8771

Australia: Warren E. Ball, IPO Box 5106,
Tokyo, Japan

Business Department

Stephen R. Weiss, Manager
[212] 971-2044

Thomas M. Egan,
Production Manager [212] 971-3140

Maury D'Gongora,
Assistant Production Manager [212] 971-2045

Dorothy Carmesin, Contracts and Billings
[212] 971-2908

Frances Vallone, Reader Service Manager
[212] 971-2865

CRITIC'S CHOICE!

CHOOSE INTERCON- NECTION OPTIONS WITH NEW BARNES BREADBOARDS FOR DIP, FLAT-PACK AND "TO" PACKAGES

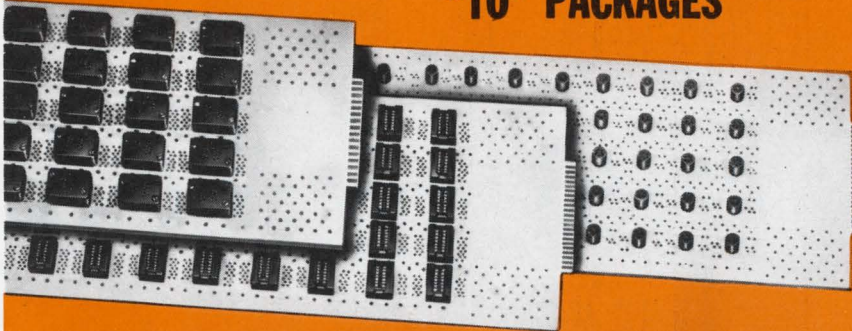

Take the "task" out of breadboarding. New Barnes 030 Series Breadboards offer you a choice of interconnection options for maximum design flexibility. Available with wiping action spring jacks for simple lead insertion without special interconnection jumpers, or turret lugs for soldering. Two jacks or lugs for each device lead. Boards available with 5 to 75 socket positions depending upon device type. Write or call us today for complete information.

barnes
CORPORATION

Lansdowne, Pa. 19050 • 215/MA2-1525

barnes / THE FIRST WORD IN CARRIERS, CONTACTORS AND SOCKETS FOR I.C.'S

Circle 227 on reader service card

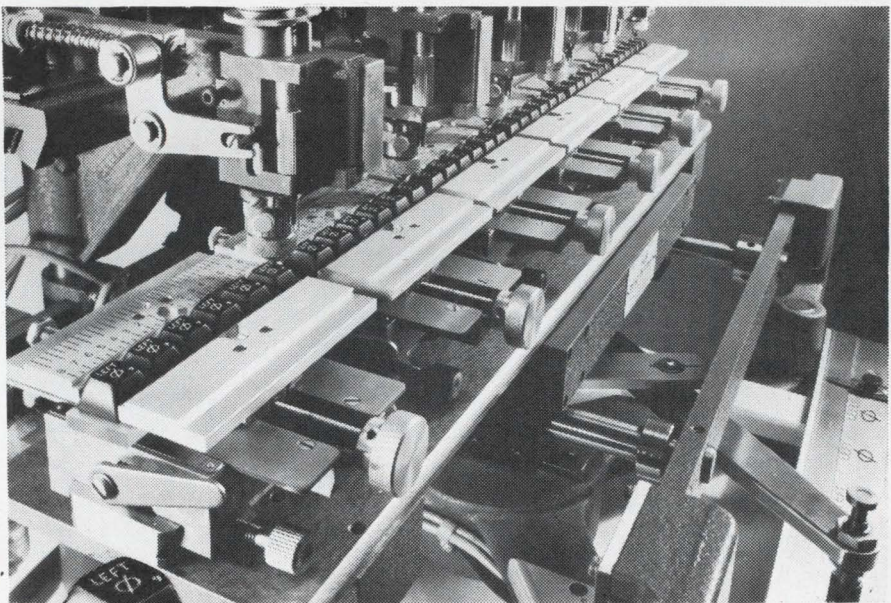

6 will get you 36

Now, new 6-spindle New Hermes engravings up to 36 machine keys with one set-up.

Any unskilled worker simply guides the pantographic tracer on this pneumatically-operated engraving

machine. Each spindle has an automatic depth-regulator, guaranteeing uniform depth and width of engraving over the complete contour of the key.

Write for detailed brochure No. 197.

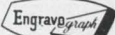
new hermes engraving machine corp. 

20 Cooper Square, New York, N. Y. 10003

Chicago, Atlanta, Los Angeles, Dallas, Montreal, Toronto, Mexico City

Why buy only photocells from us,

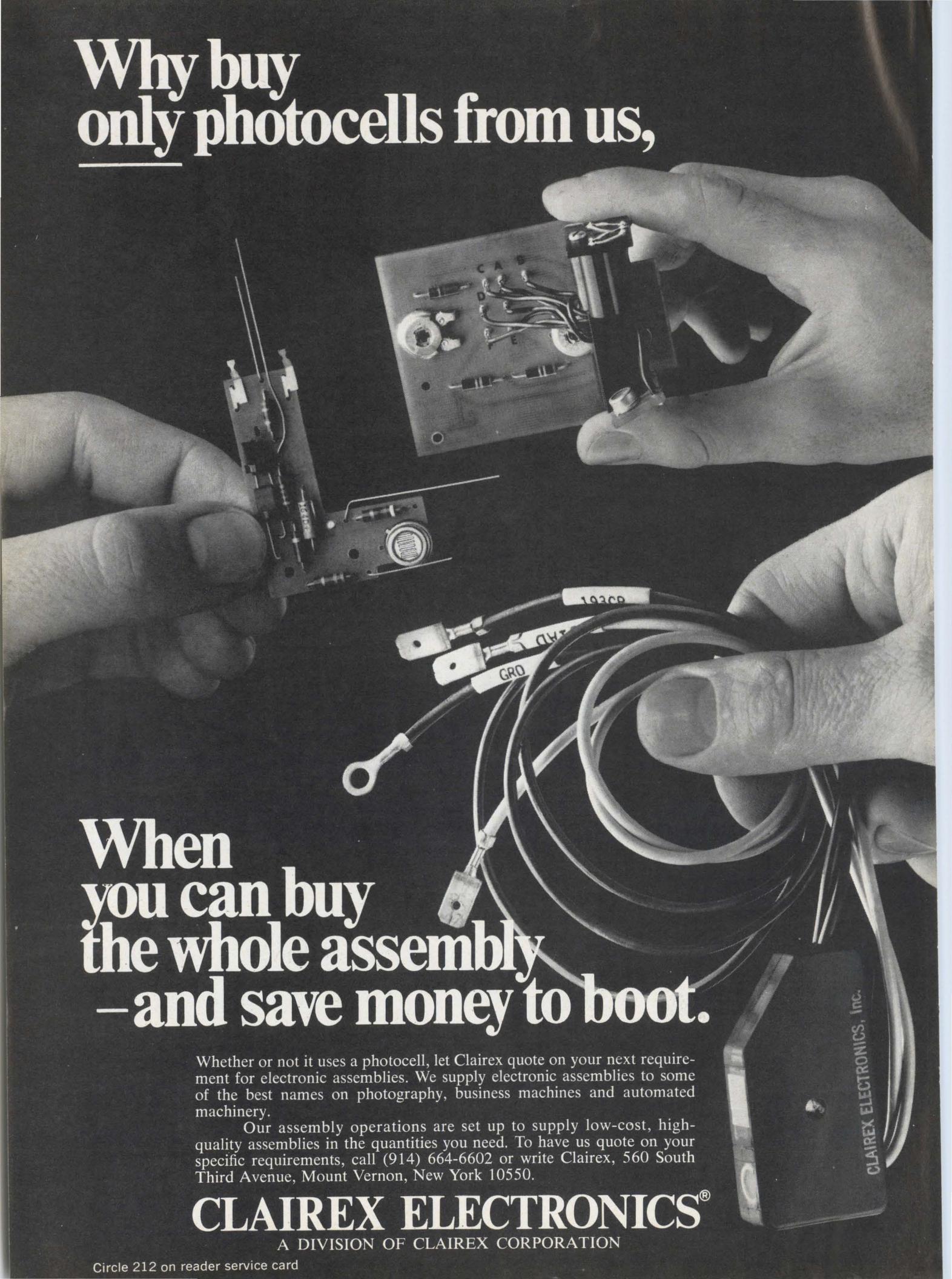

When you can buy the whole assembly —and save money to boot.

Whether or not it uses a photocell, let Clairex quote on your next requirement for electronic assemblies. We supply electronic assemblies to some of the best names on photography, business machines and automated machinery.

Our assembly operations are set up to supply low-cost, high-quality assemblies in the quantities you need. To have us quote on your specific requirements, call (914) 664-6602 or write Clairex, 560 South Third Avenue, Mount Vernon, New York 10550.

CLAIREX ELECTRONICS®

A DIVISION OF CLAIREX CORPORATION

General Railway
Signal Company
uses both silicone
and vitreous coated
Dale Resistors



Now...rugged Dale Wirewounds with your choice of coatings!

Coating makes a difference in the performance of industrial power wirewounds. That's why it's easier to call Dale when you're not sure what's best for your application. We make both silicone (HL) and vitreous (VL) coated models. Before coating they're identical. HL models receive multi-layer coatings of a special silicone formulation. This low-temperature process has less effect on resistor windings—and we sell more HL resistors where customers are primarily concerned with maintenance of tolerance and low TC. Our vitreous enamel coating is baked on to provide maximum resistance to moisture and chemical action—and VL sales are highest where these conditions are a factor. Today many companies—like General Railway Signal—make good use of Dale's single-source capability for power resistors. You can, too.

12 Different Silicone (HL) and Vitreous (VL) Models



HL/VL 3-225 watts, .1 ohm
to 1.3 Meg., $\pm 5\%$ tol.*



HLT/VLT 11-225 watts,
.1 ohm to 1.1 Meg., $\pm 5\%$ tol.



HLW/VLW 3-20 watts, .1 ohm
to 80K ohms, $\pm 5\%$ tol.*



HLZ 40-375 watts, .13 ohm
to 25 ohms, $\pm 10\%$ tol.



HL/VL Flat 24-95 watts,
.1 ohm to 150K ohms, $\pm 5\%$ tol.*

MIL. SPEC. All HL and VL
models meet or exceed the
requirements of MIL-R-26 and
MIL-R-19365C where applicable.



HLM/VLM 10-20 watts,
.1 ohm to 51K ohms, $\pm 5\%$ tol.

* $\pm 10\%$ below 1 ohm



HLA 10-225 watts,
1 ohm to 100K ohms, $\pm 5\%$ tol.

*For fast price and
delivery information,
phone 402-564-3131.*



DALE ELECTRONICS, INC.

1300 28th Ave., Columbus, Nebr. 68601
In Canada: Dale Electronics Canada, Ltd.

Circle 901 on reader service card

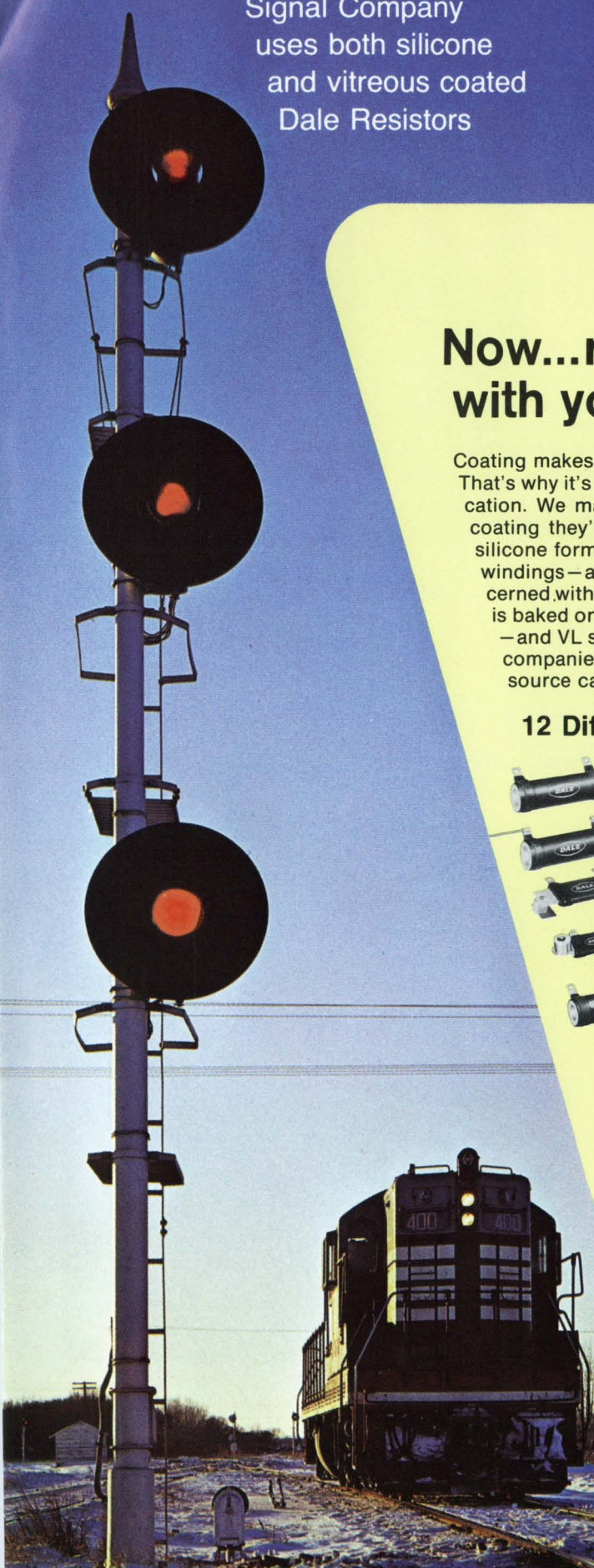

RCA DISPLAY TUBES DELIVER CLEAR,

BRIGHT VISUAL INFORMATION . . . LOOK:

USE RCA DISPLAY TUBES FOR ALL TYPES OF VISUAL INFORMATION: ALPHA-NUMERIC -- WAVEFORMS -- PICTORIAL -- AND COMBINATIONS. READOUT IN 2-COLORS PLUS IN-BETWEEN SHADES ON I-GUN CRTS. THEY EXPAND COMMUNICATIONS POSSIBILITIES IN AIR TRAFFIC CONTROL SYSTEMS, MILITARY IFF SYSTEMS, STOCK MARKET QUOTATION DISPLAYS, TRANSPORTATION STATUS BOARDS, TEACHING MACHINES AND ELECTRONIC TEST INSTRUMENTS.

Ask your local RCA Representative or RCA Industrial Tube Distributor for more information on these tubes which add new dimension to computer readout. For technical data, write: RCA Electronic Components, Commercial Engineering, Section A-19/ZC-3, Harrison, N.J. 07029. In Europe, contact: RCA International Marketing S.A. 2-4 rue du Lièvre, 1227 Geneva, Switzerland.

RCA