

Piping away heat for reliability 94
LSI: determining optimum complexity 126
Federal budget puts crunch on electronics 141

\$1.00 A McGraw-Hill Publication

February 16, 1970

Electronics®

**MOS memory:
new design
makes it
big**



**WHAT'S THE
POINT OF
MEASURING
CAPACITANCE
HERE?**



**Use the 1682 1-MHz Automatic
Capacitance Bridge
from General Radio--
with accuracy specified
at the unknown!**

At 1-MHz, the typical 3-terminal capacitance tester, with a 4-foot cable to a 1000-pF unknown, adds about a 4-percent error to the readout. GR's 1682 has four-terminal Kelvin connections that minimize lead-impedance effects and preserve the accuracy of the bridge *at the component*, even with low-impedance unknowns. And an additional guard terminal provides a similar safeguard for high impedances, whose measurement might be affected by stray capacitance to ground.

The true accuracy of the 1682 is 0.1% of the unknown value from 1 to 2000 pF and 1% up to 20 nF. Conductance accuracy is 1% from 1 to 2000 μ mhos; 10% up to 20 millimhos. The front panel displays 5 digits of capacitance and 4 digits of conductance simultaneously, plus automatic decimal points and units of measurement.

**IF
ACCURACY IS
SPECIFIED
HERE!**

20 measurements per second can be made for $\pm 10\%$ -of-full-scale differences in unknowns, and up to 50 per second for closer tolerance components.

An internal bias of 0 to 100 V is supplied; up to 200 V can be applied externally. Low-level or high-level BCD output and remote programmability can be added. Test fixtures are available for axial leads and GR900® or GR874® terminals. Prices in U.S. start at \$3940; quantity discounts are available for lots of two or more. For more information write General Radio Company, West Concord, Mass. 01781 or telephone (617) 369-4400. In Europe write Postfach 124, CH 8034 Zurich, Switzerland.

GENERAL RADIO



The best gets better.

The HP 5248 General-Purpose Counter can now measure to 3 GHz with a single plug-in — without any gaps. This is made possible by our new 150 MHz to 3 GHz Heterodyne Converter, Model 5254C, and by extending the direct counting range of the 5248 counter mainframe to 150 MHz.

There's another benefit unique to these instruments that's not immediately apparent. Converter and counter ranges actually overlap so you derive the final answer by merely adding the converter dial reading and counter reading. There's no need to remember to subtract readings over any part of the frequency range.

Even before the latest improvements, no other counter could match the

usefulness and flexibility of the 5245 Series. We now offer fourteen different plug-ins to help you make all the measurements you need. These include six frequency converters; transfer oscillator to 18 GHz; two time interval units; two prescalers; video amplifier; DVM; and preset unit.

And you can't beat the 5245 line for reliability either. Its remarkable dependability has made it extremely popular, particularly with rental firms — some of our best customers. When their clients rent an HP counter, rental firms know they won't lose rental fees because of downtime.

The price of the new 5254C Heterodyne Converter is \$825. The

5248L counter is \$2900. You won't find a more economical single-package solution to your dc to 3 GHz counter needs. Your local HP field office has all the details. Give them a call. Or write to Hewlett-Packard, Palo Alto, California 94304; Europe: 1217 Meyrin-Geneva, Switzerland.



HEWLETT  **PACKARD**

ELECTRONIC COUNTERS

02918

Circle 1 on reader service card

**There's a
new reason why
this continues to be
the world's most popular
counter line.**

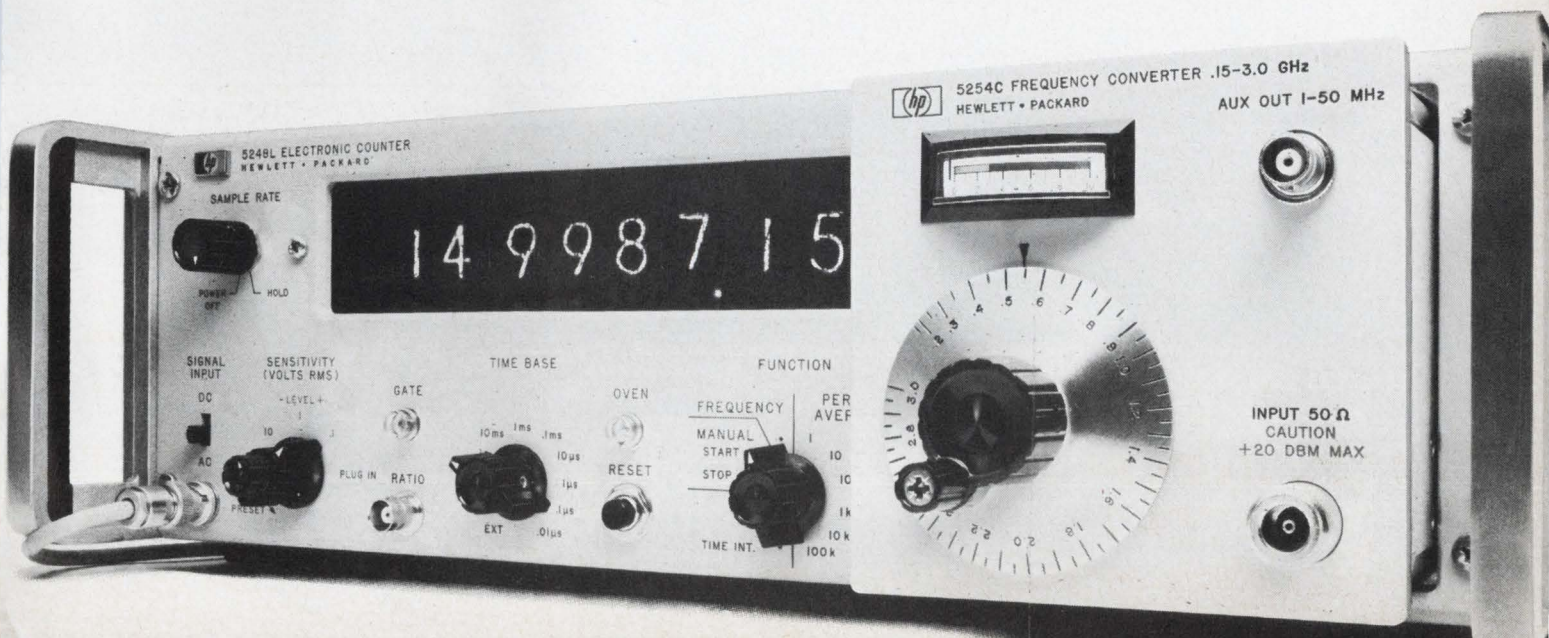

Now you can make frequency measurements *instantaneously*.

You're looking at the frequency of an information-carrying pulse measured the instant it occurred. Another important breakthrough made possible by the HP 5360A Computing Counter.

This counter is ideal for measuring the frequency profile of even the most advanced communications systems, such as chirp radar and other pulse compression types. As well as pulsed RF, tone bursts and transient signals.

You can measure the Doppler effect on a pulse, and check the incidental FM within the burst. And do it all with accuracy.

Unlike other methods, measurement with the 5360A is not duty-cycle-limited. So you can catch a single pulse, like the one pictured below. And even in short bursts of a microsecond, four digits of frequency information can be obtained.

You can measure the frequency of an RF burst automatically. Also, by triggering the counter, direct instantaneous measurements may be made anywhere within the RF envelope. This feature allows, for example, the frequency profile of a Doppler radar pulse to be measured with ease and accuracy.

With the 5360A mainframe, you can measure from .01 Hz to 320 MHz. Add plug-ins from the popular 5245 counter series, and you can go all the way to 18 GHz. And if you wish, order the 5375A Keyboard which adds extra versatility in programming the counter and in computation involving the measurements as variables.

And the 5379A plug-in affords unprecedented versatility and accuracy

in time interval measurement, with resolution to 100 picoseconds.

If you'd like to see how easily the 5360A Computing Counter can handle your frequencies for \$6500, just call your local HP field office. Or write to Hewlett-Packard, Palo Alto, California 94304; Europe: 1217 Meyrin-Geneva, Switzerland.

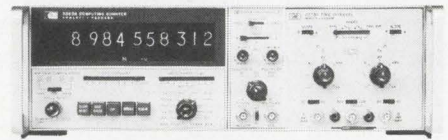

HEWLETT *hp* PACKARD
ELECTRONIC COUNTERS

02919

Circle 2 on reader service card

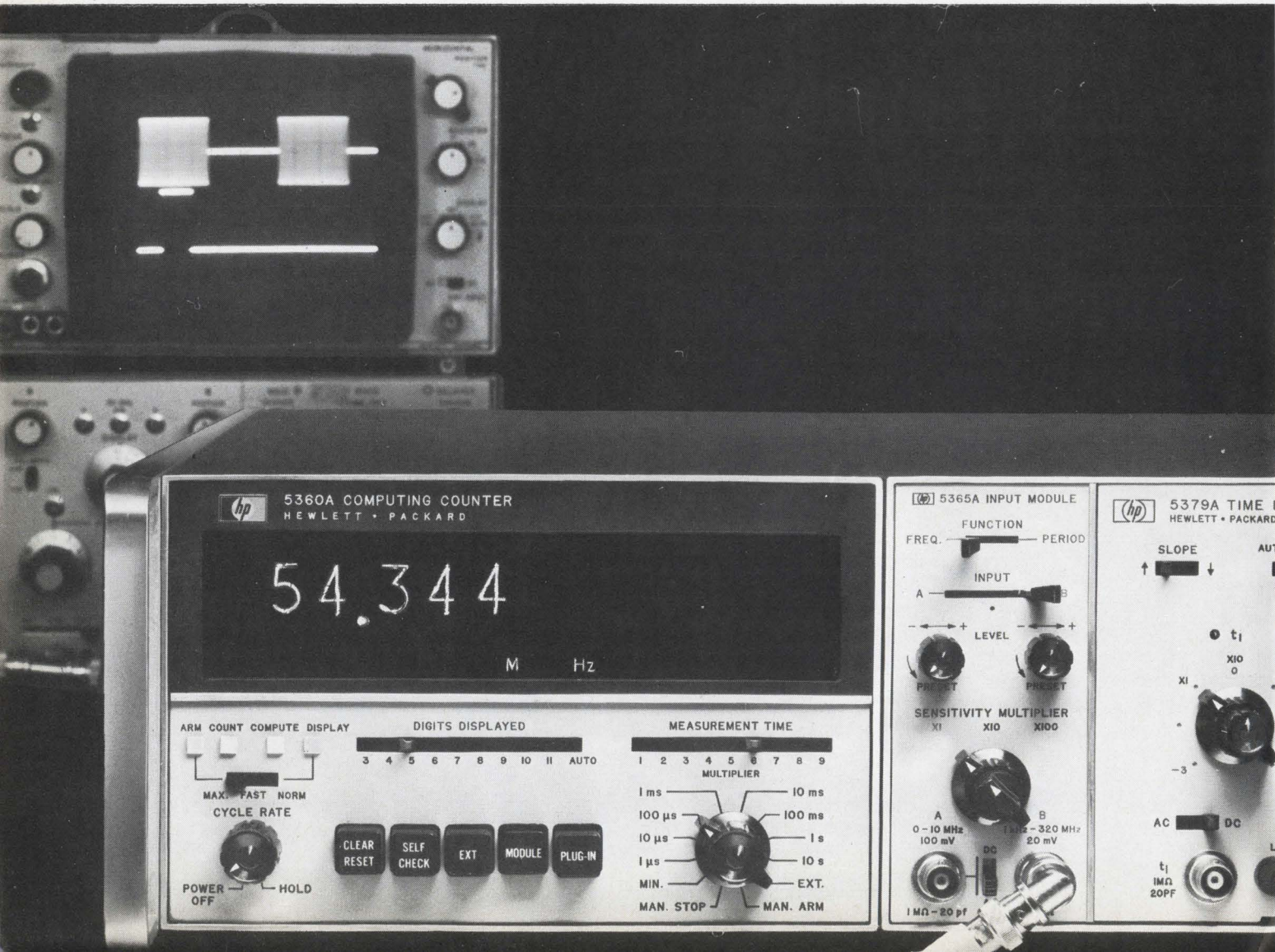

Features

Probing the News

- 141 **Federal budget:** Fiscal 1970 plans will cut deeply into electronics
- 142 **Military electronics:** Politics, inflation to take heavy toll in defense spending
- 146 **Space electronics:** Space age shifts into a lower gear
- 159 **Government electronics:** Best bets are police and air traffic control

U.S. Reports

- 43 **Computers:** Memory goes step past mainframe
- 44 **Space electronics:** Millimeter-wave experiment for ATS-F
- 45 **Memories:** Unique technique for encoding information
- 46 **Medical electronics:** Ultrasonic tooth decay detector
- 48 **Commercial electronics:** Sensors to measure water pollution
- 50 **Displays:** Circuitry for flat-faced cathode-ray tube
- 52 **Communications:** FCC rulings boon to private CATV operators
- 54 **Components:** Detector diode with wide temperature range
- 57 **For the record**

Electronics International

- 71 **Japan:** Radiation and electricity alter MAS memory
- 72 **France:** Fashioning a model
- 73 **Great Britain:** Two crt's help read the stars
- 73 **West Germany:** Fast printout
- 74 **Poland:** Reckoning on computers

New Products

- 157 **In the spotlight**
- 157 Analyzer bares junctions' secrets
- 163 **Production equipment review**
- 163 Compact CO₂ laser delivers 300 w
- 168 Probe checks flatness of substrate
- 170 **Subassemblies review**
- 170 Mask aligner accurate to 1 micron
- 175 **Instruments review**
- 175 Counters measure up to 500 Mhz
- 178 Modulator, synthesizer combined
- 181 **Semiconductor review**
- 181 MOS memory is bipolar-compatible
- 184 Scratchpad outputs to TTL, DTL
- 188 **New materials**

Title R registered U.S. Patent Office; © copyright 1970 by McGraw-Hill Inc. All rights reserved, including the right to reproduce the contents of this publication in whole or in part.

Articles

- Industrial electronics** 94 **Heat pipes—a cool way to cool circuitry**
Heat transfer devices rely on vapor heat transfer and capillary action
C.H. Dutcher Jr. and M.R. Burke,
Electronic Communications Inc.
- Data processing** 101 **Laser recorders pick up where magnetic machines leave off in speed, capacity**
Capable of recording 21.8 million bits per second, laser systems promise to have a strong impact on high-volume data processing
Stanley Parnas of Synergistics,
and C.J. Peters
- Circuit design** 104 **Designer's casebook**
- Feedback circuit checks thermal resistance
 - Zener diode in op amp's loop allows symmetrical clipping
 - IC's gate FET's for roll rate data
- Memories** 109 **Random-access MOS memory packs more bits to the chip**
Eliminating separate feedback for each bit in the design of a 1,024-bit memory leads to major cost reductions
Lee Boysel, Wallace Chan, and Jack Faith,
Four-Phase Systems
- Packaging** 116 **Multilayer p-c boards are both rigid and flexible in all the right places**
Available materials, including polyimide films, can open up new design options
Raymond A. Grueninger,
International Business Machines Corp.
- Instrumentation** 122 **Frequency meter, comparator, phase meter in one box**
Crystal-controlled unit for calibration and measurement is portable and compact
Arthur Delagrange and Robert Davis,
Naval Ordnance Laboratory
- Integrated electronics** 120 **What level of LSI is best for you?**
Mathematical models can determine what's best suited for your design
G.E. Moore,
Intel Corp.
- ### Departments
- | | | | |
|----|--------------------------|-----|--------------------------|
| 4 | Editorial Comment | 69 | International Newsletter |
| 5 | Readers Comment | 83 | Washington Newsletter |
| 9 | Who's Who in this issue | 190 | New Books |
| 14 | Who's Who in electronics | 194 | Technical Abstracts |
| 22 | Meetings | 199 | New Literature |
- 33 Electronics Newsletter

Electronics

Editor-in-Chief: Donald Christiansen

Senior staff editors

Technical: Stephen E. Scrupski

News: Robert Henkel

International: Arthur Erikson

Art director: Gerald Ferguson

Assistant managing editors: H. Thomas

Maguire, Howard Wolff, William Buccì,

Richard Gundlach, Frederick Corey

Special projects editor: Roger Kenneth Field

Senior staff writer: John Johnsrud

Reader communications manager: John

Drummond

Department editors

Senior associate editors: Joseph Mittleman, Harry R. Karp; Advanced technology: Laurence Altman; Communications: Leon M. Magill; Computers: Wallace B. Riley, George Weiss; Design theory: Joseph Mittleman; Industrial electronics: Harry R. Karp; Instrumentation: Owen Doyle; Military/Aerospace: Alfred Rosenblatt; New products: William P. O'Brien; Solid state: George Watson, Stephen Wm. Fields

Copy editors: Edward Flinn, William S. Weiss

Assistant art director: Charles Ciatto

Production editors: Susan Hurlburt, Arthur C. Miller; Editorial research: Virginia Mundt; Editorial secretaries: Claire Goodlin, Bernice Pawlak, Barbara Razulis, Vickie Green, Terri O'Neill.

Field bureaus

Boston: James Brinton, manager; Gail Farrell; Los Angeles: Lawrence Curran, manager; Ralph Selph; New York: Peter Schuyten; San Francisco: Stephen Wm. Fields, Marilyn Howey; Washington: Ray Connolly, manager; Robert Westgate, Lois Vermillion; Frankfurt: John Gosch; London: Michael Payne; Paris: Arthur Erikson; Tokyo: Charles Cohen

Reprints: Virginia Mundt; Circulation: Isaaca Siegel

Publisher: Gordon Jones

Associate publisher: Dan McMillan

Assistant to the publisher: Wallace C. Carmichael

February 16, 1970

Japan: Down with rice, up with computers

● Japan's successes in the electronics markets it already has tackled are spurring the country to even more ambitious plans. In just a few years, Japan expects to supply nearly all of its large-scale computer requirements; it already produces three-quarters of the computers for its domestic market, representing about half the dollar volume. And the nation hopes to enhance its worldwide position in consumer electronics, and to penetrate industrial markets.

Among the major factors that suggest Japan's ambitious goals will be fulfilled are these:

▶ The Japanese Finance Ministry favors sharply increased military spending as well as substantial outlays for developments in science and technology.

▶ The government continues its strong role in defining major technological goals and takes a hand in guiding those developments aimed at meeting them. It wants to spend less money to subsidize production of such traditional products as rice (which for years has been in excess supply), and spend more to develop products with high-technology content.

▶ Japan has embarked upon a government-supported super-computer project whose charter is to develop high-performance computers that make extensive use of integrated circuits. The project is expected to set the pace for computer developments, if not lead to a commercial large-scale computer.

▶ Japan continues to strongly support protection of its electronics industry, particularly computers, IC's, and defense-related products.

The proposed boost in military spending to \$1.6 billion, while a pittance by U.S. standards, nevertheless represents a significant 17.7% increase over the 1969 outlay. This

could portend important developments in surface-to-air missiles, naval vessels, aircraft, and tanks.

In the consumer sector, Japan continues to push state-of-the-art boundaries by assigning its top-notch engineers to equipment design. As the nation advances into new consumer areas, it should not be surprising to find Japanese engineers leap-frogging U.S. designs.

Clearly, these factors represent a strong challenge to the U.S. electronics business. In particular, the burning desire of the Japanese to spend their limited funds wisely and apply their resources efficiently should give pause to many a U.S. technologist.—D.C. ●

Sermon on the launchpad

● Back in 1938, Franklin D. Roosevelt called the concentration of economic power in the U.S. a threat to the nation. And in so doing, he aligned himself with those whose "basic thesis is not that the system of free private enterprise for profit has failed in this generation, but that it has not yet been tried." FDR addressed those words to America's industries. But apply those words to America's governmental bodies at every level and they come close to the views of the present White House occupant. Richard Nixon contends he wants to break down "big government," with its associated inefficiencies, over-regulation, and expense.

One significant step back from excessive regulation has just been taken in the Administration's recommendation to the Federal Communications Commission that domestic

Published every other Monday by McGraw-Hill, Inc. Founder: James H. McGraw 1860-1948. Publication office 99 North Broadway, Albany, N. Y. 12202; second class postage paid at Albany, N. Y. and additional mailing offices.

Executive, editorial, circulation and advertising addresses: Electronics, McGraw-Hill Building, 330 W. 42nd Street, New York, N. Y. 10036. Telephone (212) 971-3333. Teletype TWX N. Y. 710-581-4235. Cable address: MCGRAWHILLN.Y.

Subscriptions solicited only from those professionally engaged in electronics technology. Subscription rates: qualified subscribers in the United States and possessions and Canada, \$8.00 one year, \$12.00 two years, \$16.00 three years; all other countries \$25.00 one year. Non-qualified subscribers in the U.S. and possessions and Canada, \$25.00 one year; all other countries \$50.00. Air freight service to Japan \$50.00 one year. Single copies: United States and possessions and Canada, \$1.00; all other countries, \$1.75.

Officers of McGraw-Hill Publications Company: Joseph H. Allen, President; John R. Emery, J. Elton Tuohig, Senior Vice Presidents; Gordon L. Jones Jr., Group Vice President; Vice Presidents: John R. Callahan, Editorial; John M. Holden, Marketing; David G. Jensen, Manufacturing; Jerome D. Luntz, Planning & Development; Robert F. Marshall, Administration; Robert M. Wilhelmy, Finance; Director of Circulation: Ralph Blackburn.

Officers of the Corporation: Shelton Fisher, President and Chief Executive Officer; John J. Cooke, Senior Vice President and Secretary; Gordon W. McKinley, Vice President and Treasurer. Title © registered in U.S. Patent Office; © Copyright 1970 by McGraw-Hill, Inc. All rights reserved. The contents of this publication may not be reproduced either in whole or in part without the consent of copyright owner.

Subscribers: The publisher, upon written request to our New York office from any subscriber, agrees to refund that part of the subscription price applying to copies not yet mailed. Please send change of address notices or complaints to Fulfillment Manager; subscription orders to Circulation Manager, Electronics at address below. Change of address notices should provide old as well as new address, including postal zip code number. If possible, attach address label from recent issue. Allow one month for change to become effective.

Postmaster: Please send form 3579 to Fulfillment Manager, Electronics, P.O. Box 430, Hightstown, New Jersey 08520.

In search of quality

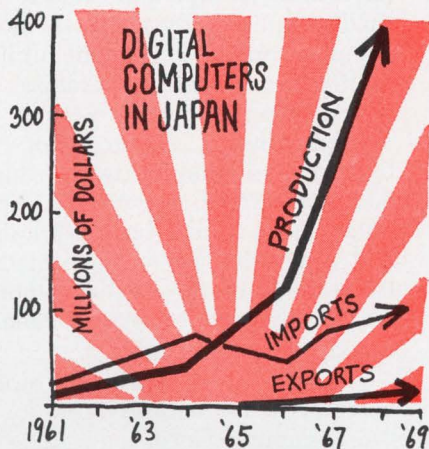

satellite systems be opened to competitive development.

Except for the Communications Satellite Corp., just about everyone in the communications industry hailed the White House proposal. General Electric's Richard P. Gifford, one of industry's leading communications planners, called it "a breath of fresh air." The American Telephone & Telegraph Co. deigned to call the White House view "consistent" with its own, and indicated it plans to file for a satellite system, pending FCC approval. Broadcasters indicated similar plans for tv-signal transmission using their own satellite, and the Electronic Industries Association praised the White House statement as one with "sound philosophic and economic underpinnings."

Clearly, the White House recommendation seems to be a good one. Assuming the FCC will adopt it as policy for the three-to-five-year interim period proposed, the Administration might do well to look at the commission that will administer the plan. The undermanned, underfunded FCC is badly in need of reorganization itself. Though chairman Dean Burch has said he recognizes this need, a successful revamping requires the broader perspective that only the White House can give it.

The need to bring a moribund FCC into the space age deserves the serious and outspoken consideration of the communications industry, too. It's no secret that the commission has long been alleged to be the tool of the industries it serves.

Obtaining freedom from the bonds of excessive regulation is one thing. But substituting another, and, hopefully, better system is something else.—R.C. ●

McGraw-Hill News Service

Director: Arthur L. Moore; Atlanta: Fran Ridgway; Chicago: Robert E. Lee; Cleveland: Arthur Zimmerman; Dallas: Marvin Reid; Detroit: James Wargo; Houston: Barbara LaRoux; Los Angeles: Michael Murphy; San Francisco: Margaret Drossel, Tyler Marshall; Seattle: Ray Bloomberg; Washington: Charles Gardner, James Canan, Herbert W. Cheshire, Seth Payne, Warren Burkett, William D. Hickman; Bonn: Robert F. Ingersoll; Brussels: James Smith; Hong Kong: Kate Mattock; London: John Shinn; Mexico City: Gerald Parkinson; Milan: Jack Star; Moscow: Jack Winkler; Paris: Robert E. Farrell, Stewart Toy; Tokyo: Marvin Petal

To the Editor:

I found your special feature on communications [Nov. 24, 1969, p. 73] very interesting. All the dreams described were great. But, why do I have so much trouble finding a communications receiver to replace my National NC 57? It is now 20 years old, with a FET Q multiplier, and still does the job. By contrast, I had to return a "modern" receiver for unsatisfactory performance. Even if I were to spend \$1,600 for a National HRO 500, some important features would still be missing.

This general falloff in quality was highlighted recently by a notice from one of my favorite suppliers that the Drake SPR-4 has been delayed in manufacture due to the lack of quality components. It isn't necessary to have an engineering degree to realize that if good components can't be located, good circuits can't be built—at any price.

I believe this to be a sorry situation. What is the value of all this new technology, if the end product is just about worthless.

James E. Davis

Washington

Unknown to many

To the Editor:

In your examination of technology in the 1970's [Jan. 5, p. 105], you say that only when mixer diodes have a constant impedance with frequency will the multi-octave mixers become a reality. You further add that this isn't likely to occur in 1970.

I would like to point out that this projection is incorrect as RHG Electronics Laboratory developed such a mixer in 1969 and is currently promoting this device. The beam-lead Schottky diodes used in this mixer are being provided by Sylvania and are being manufactured to specifications jointly arrived at by RHG and Sylvania.

Ronald B. Hirsch

President,
RHG Electronics Laboratory Inc.
Farmingdale, N.Y.

▪ Communications engineers interviewed for *Electronics'* technology report were not aware of RHG's multi-octave mixer, which operates between 0.5 and 8 gigahertz. A 0.5-to-12-GHz mixer is now in the works at RHG.

Arithmetic, too

To the Editor:

Your new products section announced a new computer, DEC PDP-11 [Jan. 5, p. 161], using a common bus structure upon which subsystems are connected. While the article (continued on p. 6)

Instant module time check

**CURTIS 620-PC
ELAPSED TIME
INDICATOR**

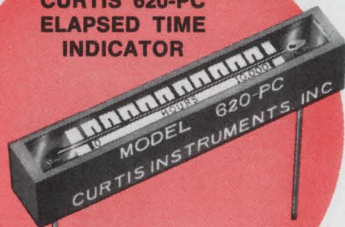

**SHOWN 1½ TIMES
ACTUAL SIZE**

Increasingly important in military equipment philosophy is the field or line replacement module.

With this Curtis Elapsed Time Indicator mounted on each functional replaceable module of your system you have an accurate record of operating hours for each individual module regardless of its installation history. Operating time record becomes part of module. Unit is extremely small, weighs little, uses little power, and is not expensive! For full details, ask for information on Model 620-PC. Meets requirements of MS 3311 (AS).

WRITE OR CALL

Curtis

INSTRUMENTS, INC.

200 Kisco Avenue

Mount Kisco, N.Y. 10549

(914) 666-2971

Readers Comment

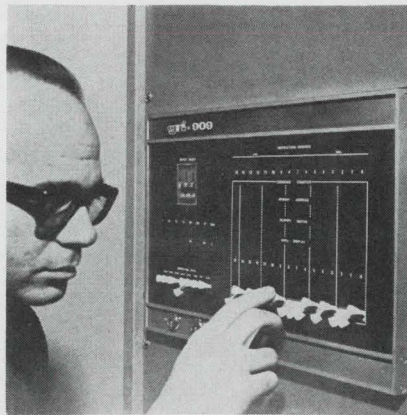

The GRI 909—aimed at OEM market.

references the contributions made to this concept by our own GRI-909 computer, I feel the statement, "the GRI-909 has no arithmetic unit in its standard model," is misleading. Indeed, in most configurations multiple or special arithmetic, or both, and logic operators are included with considerably more computing power than is found in most computers in the miniclass.

The GRI-909 actually represents a full family of computers. The version we define as standard contains two arithmetic units. One performs simple arithmetic operations on data being transferred on the fly from register to register. The other unit contains two independent registers that allow arithmetic and logical operations to be performed without altering the input operands. In its most basic form, the GRI-909 can be provided without the latter arithmetic operator for control operations involving limited or no arithmetic—such as in

communication terminals.

It is not necessary to purchase an arithmetic operator unless actually required. By contrast, more complex operations might utilize multiple arithmetic operators or special plug-in operators such as multiply/divide, square root or byte manipulation hardware which add instructions to the basic computer on a modular basis, and also add computing power. The modular concept of the GRI-909, therefore, allows the user to choose exactly what he needs.

Irwin M. Stone

Director of marketing,
GRI Computer Corp.
Newton, Mass.

Profit motive

To the Editor

When the Soviet Union wishes to advance economically, it looks to the West for technological assistance. Now, Soviet planners are looking to increase the state of automation in their country by purchasing modern computing machinery from Western companies [Jan. 19, p. 137]. I don't believe that businessmen in Western countries should be so eager to sell their equipment—thereby rendering assistance to the Soviet Union—when that country seems to ignore the individual rights of its people. I think that these profit-oriented businessmen should also consider whether it is morally correct to sell their equipment to the Soviet Union.

Ernst F. Germann

Austin, Texas

SUBSCRIPTION SERVICE

Please include an Electronics Magazine address label to insure prompt service whenever you write us about your subscription.

Mail to: Fulfillment Manager
Electronics
P.O. Box 430
Hightstown, N.J. 08520

To subscribe mail this form with your payment and check new subscription renew my present subscription

Subscription rates: qualified subscribers in the U.S.: 1 year \$8; two years, \$12; three years, \$16. Non-qualified: 1 year \$25. Subscription rates for foreign countries available on request.

CHANGE OF ADDRESS

ATTACH LABEL HERE If you are moving, please let us know five weeks before changing your address. Place magazine address label here, print your new address below.

name _____

address _____

city _____

state _____

zip code _____

ALL POWER TRANSISTORS LOOK ALIKE... BUT THEY'RE NOT EQUAL

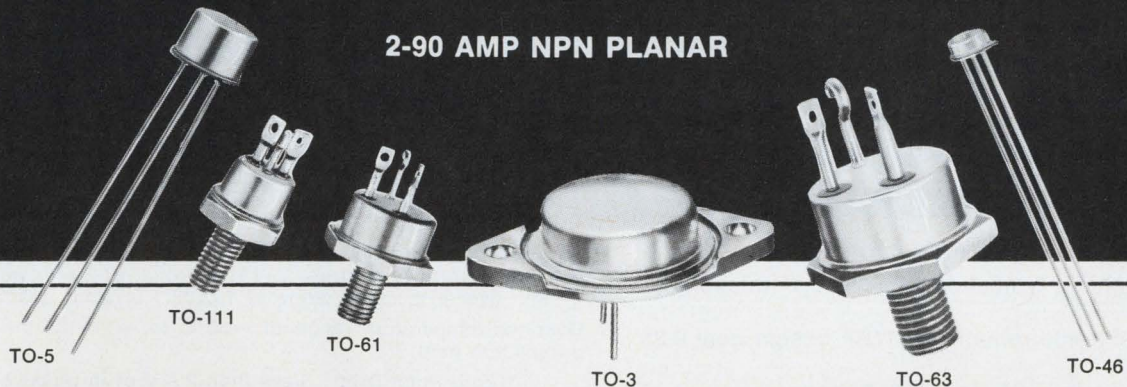

To the eye, the only difference between Pirgo power transistors and other makes is the name behind them. But that's quite a difference.

Pirgo is a new company—not committed to old ways of doing things. We have the most modern equipment and quality control facilities for the production of NPN and PNP planar silicon transistors rated from 2 thru 90 amps.

Pirgo's management group grew up with the semiconductor industry. We are staffed with skilled management and engineers of the highest technical capability.

Pirgo is an affiliate of the Sprague Electric Company, and draws upon the full resources and sales staff of Sprague.

All of this translates to high reliability, outstanding service, and on-time delivery. Even our low price policy is unusual.

Don't take our word for it. Ask for a copy of our new catalog, then send us your toughest spec. Or contact your local Sprague Electric sales engineer. We'll show you what a difference a name makes.

Pirgo products are available from authorized Sprague semiconductor distributors.

PIRGO  **ELECTRONICS INC.**
A Sprague Electric Company Affiliate

**130 CENTRAL AVENUE
FARMINGDALE, NEW YORK 11735
Tel.: 516-694-9880**

more functions in less space

radiation hardened magnetic Flat Pak modulators, analog multipliers, demodulators mount directly on IC cards.

- Flat Pak design only 0.1" thick.
- Zero Hysteresis.

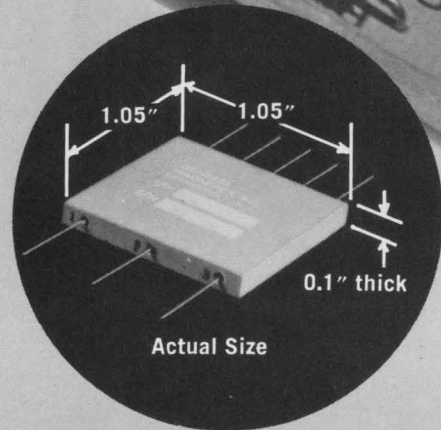

Accuracy 1% absolute or 2 MV whichever is greater

- Hybrid assemblies mount directly on IC cards.
- Space saver design . . . typical dimensions 0.1" thick x 0.5" x 0.75".
- Rugged design, extreme reliability. MTBF design goal 0.25 per million hours.
- Extremely low drift over -55° to $+125^{\circ}$ C range.
- Not affected by high intensity nuclear radiation.
- Capable of operating on carrier frequencies as high as five Mhz.
- One or more isolated or floating input signals may be used for modulating, multiplying, dividing, squaring or extracting a root.
- No external nulling or offset adjustments.
- No additional components or compensation required.
- No external operational amplifiers required.
- Standard ± 15 V DC power supplier unless otherwise specified.

As an Analog Multiplier of a Bipolar DC signal times an AC signal, the output **product accuracy** is 1% of point, or 2 MV, whichever is greater over a dynamic range of 10,000:1 in each quadrant.

Over the temperature range of -55° C to $+125^{\circ}$ C, the following parameters hold:

- 1) Zero Point Drift: ... Less than 2 MV of in phase component
- 2) Gain Slope Stability: Less than 2% change
- 3) Dynamic range and output wave quality independent of temperature variations

Typical input/output parameters:

X Signal: 0 to ± 5 V
 Y Signal: 0 to ± 5 V
 Output: 0 to 5V RMS across 5K or greater load impedance

Magnetic DC x DC Multiplier

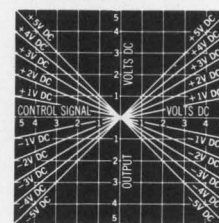

Squaring

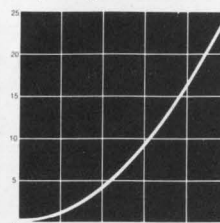

Square Root

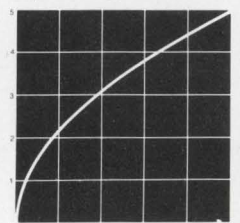

Division

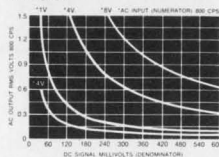

Amplitude Modulation

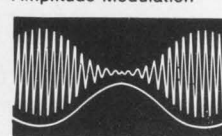

Balanced Modulator

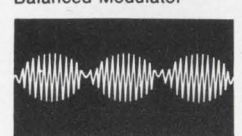

MAGNETIC MULTIPLIERS

Dynamic Product Range

80 db

Magnetic Modulators

Dynamic Range:

60 db



There is No Substitute for Reliability
GENERAL MAGNETICS, INC.
 135 Bloomfield Avenue,
 Bloomfield, New Jersey 07003

Who's Who in this issue



Burke

Dutcher

A varied background is one of the strongest assets of Clinton H. Dutcher Jr., author of the article that begins on page 94. A group leader at Electronic Communications Inc.'s R&D division, Dutcher worked on spectral analysis of f-m noise at Bell Labs prior to earning a Ph.D. from Florida University. Co-author Michael R. Burke, who holds a degree from the University of Illinois, now is with Honeywell's Aerospace division.



Moore

Firsts have been a specialty of Gordon E. Moore, author of the article starting on page 126. Under his direction, the Fairchild Semiconductor R&D laboratory scored several firsts, including planar ICs. Moore is now an Intel vice president.



Grueninger

A stickler for selecting the right materials and processes for multi-layer circuit boards is Raymond A. Grueninger, who wrote the article starting on page 116. He's with IBM's Electronics Systems Center, and studied chemical engineering.



Boysel

Chan

Faith

The art of the possible isn't confined to politics alone, as Lee Boysel, Wallace Chan, and Jack Faith point out in the article beginning on page 109. All three delved into the possibilities inherent in MOS/LSI at Fairchild Semiconductor before moving to Four-Phase Systems. Boysel, president, founded the firm in 1968. Then he recruited Chan, who heads the MOS/LSI design section, and Faith, who is Four-Phase's chief engineer.

Stanley Parnas and **Jack Peters**, authors of the article beginning on page 101, both are veterans of Sylvania's Applied Research Laboratory. When Synergistics bought the lab in 1969, Peters left to form a consulting firm, while Parnas stayed on. Peters joined Sylvania in 1957; Parnas signed on in 1968.

Arthur Delagrange and **Robert Davis**, who wrote the article that starts on page 122, met at MIT, where they received MS degrees in electrical engineering. Both men returned to the Naval Ordnance Laboratory, where they had worked as students. Now they work on digital and analog design at NOL.



California builds a giant water faucet and F&M Systems turns it on...

with 7,000 logic assemblies from TI Supply.

California is building a gigantic "water faucet." It's a statewide, 444-mile aqueduct utilizing a complex control system to govern the delivery of water down the fertile San Joaquin Valley to the Los Angeles basin.

F & M Systems Co. (Dallas), a division of Fischbach and Moore, Incorporated, is prime contractor for the major portion of the control system for the California Aqueduct of the State Water Project. This portion includes 37 remote, unmanned sites and two area control centers, each of which will scan all functions at the remote sites under its jurisdiction in less than a minute.

For so complex a control system, F & M Systems not only needed a dependable supply of electronic components but also a reliable source for assembling the 7,000 logic cards.

Photo courtesy State of California, Department of Water Resources.

They found it at TI Supply. From stock, we furnished DTL integrated circuits, discrete semiconductors, capacitors and resistors, removing the inventory burden from F & M Systems. We also provided the capability for testing all components, assembling them on P/C boards, testing the completed assemblies and delivering on time. On budget.

If that's your idea of service, then call on us. For we offer more.

Custom-marking and connector assembly to save time and money.

"Burn-in" services to assure high-reliability semiconductors.

In-depth stocks of electronic components and industrial supplies that keep what you need on our shelves and not on yours.

The point is, we're out to solve your problems and help you grow. And we've got 51 world-wide locations to back up our promise.

Isn't that worth a call?

At TI Supply: a DTL reservoir.

Tap it, like F&M Systems did, to start a stream of DTL ICs flowing your way. All you want, in the quantities you want at the time you want.

Our pipelines keep our reservoir full to the brim on all of TI's 33 DTL functions.

That's a broad choice that makes selection simple; delivery that saves time, trouble and money. Even more money when you order DTL ICs from us in the economical, reliable plastic dual-in-line package.

And if you want technical literature, cross-reference data, application assistance or other problem-solving help, you can get that, too.

To tap TI Supply call your nearest branch office or write TI Supply Co., P.O. Box 35486, Dallas, Texas 75235.



TI SUPPLY.. the problem solvers.

EAST
Boston (Canton), Mass. (617) 828-5020
Clark, New Jersey (201) 382-6400
New York, New York (212) 895-0803
or (516) 488-3300
Philadelphia (215) 664-1132

MIDWEST
Kansas City, Missouri (816) 753-4750
Minneapolis (Edina), Minn. (612) 941-5020
Chicago (Rosemont), Ill. (312) 296-7187
Wichita (Derby), Kansas (316) 788-1714

SOUTHWEST
Austin, Texas (512) 454-2531
Dallas, Texas (214) 357-6121
Fort Worth, Texas (817) 332-9361
Houston, Texas (713) 785-4800
Tulsa, Oklahoma (918) 437-4555

WEST
Los Angeles, California (213) 776-4490
Denver, Colorado (303) 757-7671
San Francisco (Sunnyvale), Calif. (408) 732-5555
CANADA
Montreal (St. Laurent), P.O. (514) 332-3550
Toronto (Richmond Hill), P.O. (416) 889-0844
Ottawa, P.O. (613) 825-3716

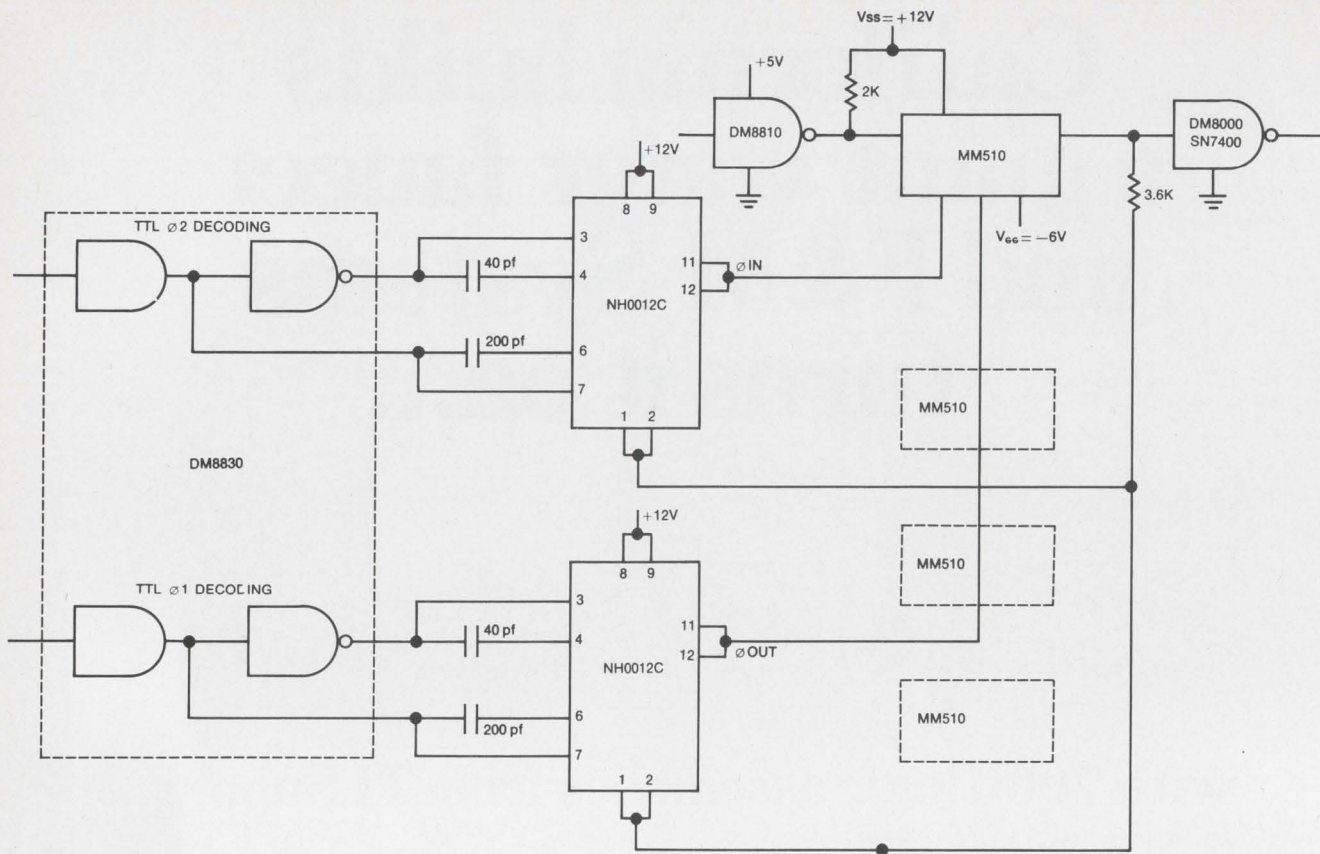

HIGH SPEED MOS CLOCK DRIVER

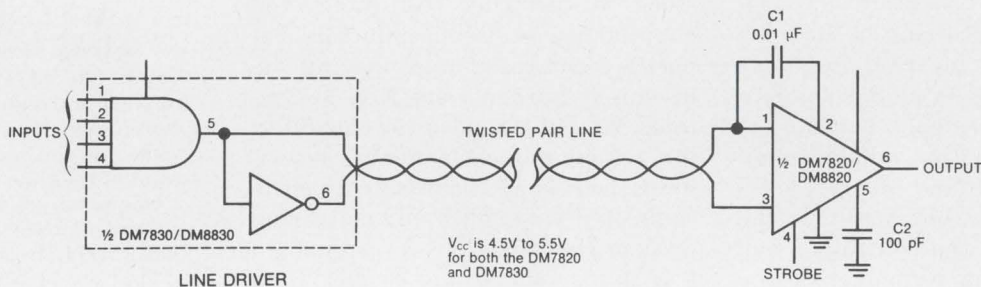

LINE DRIVER

LINE RECEIVER

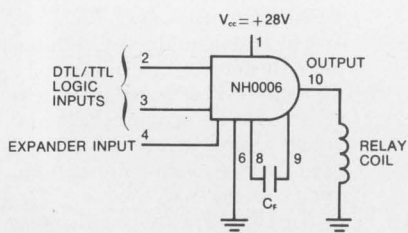

RELAY DRIVER

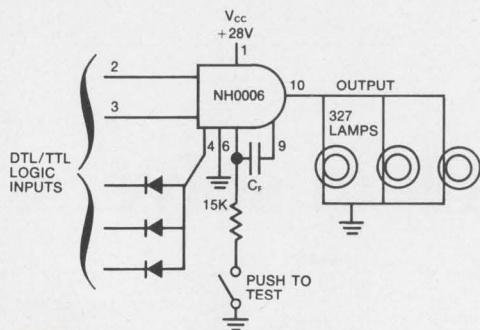

LAMP DRIVER WITH EXPANDED INPUTS

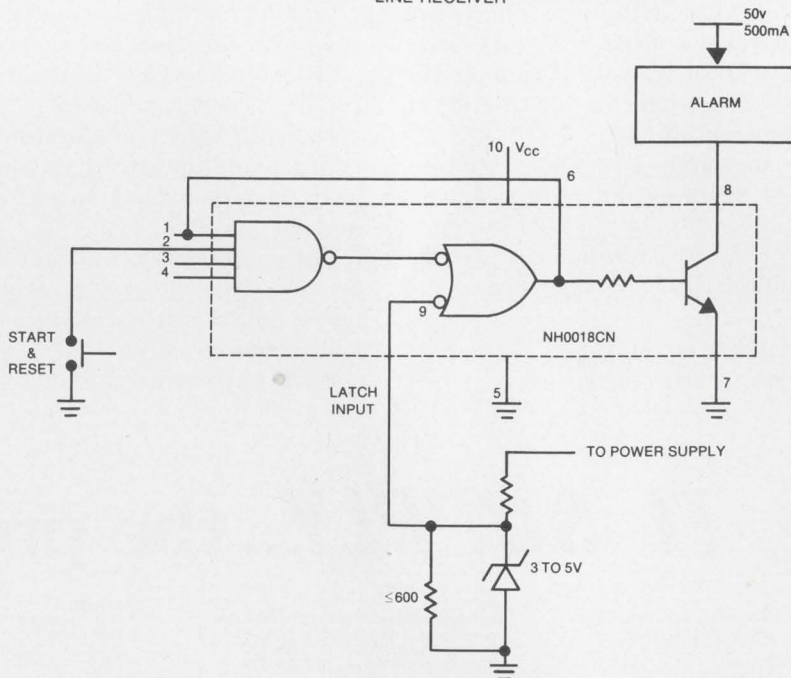

POWER SUPPLY MONITOR

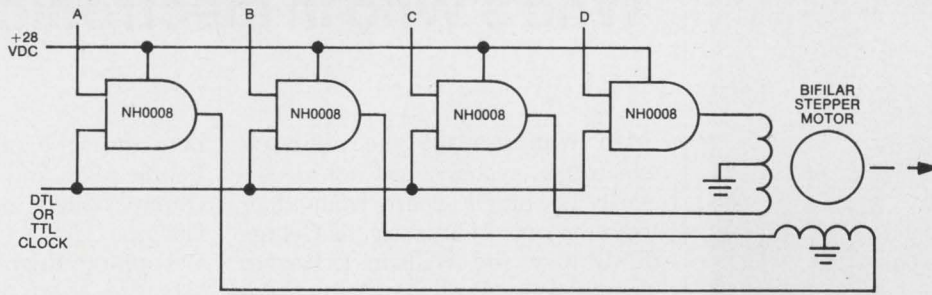

CONTROLLER FOR CLOSED LOOP STEPPER MOTOR

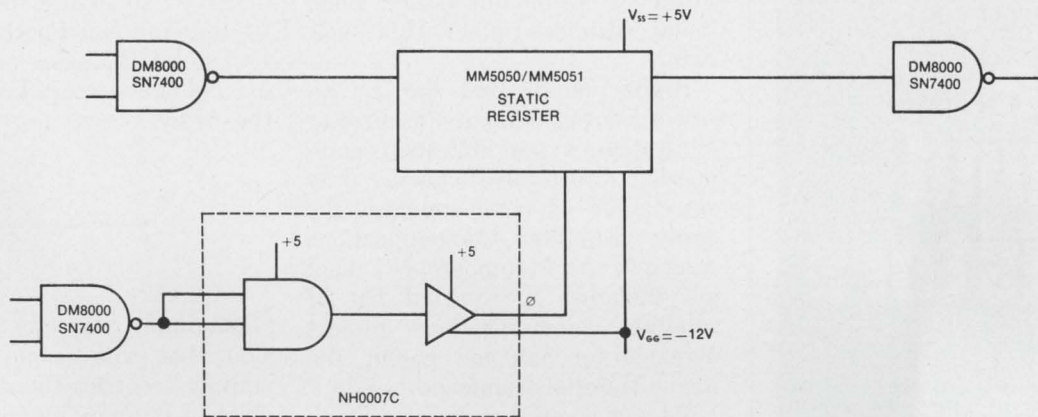

DRIVING STATIC MOS REGISTERS

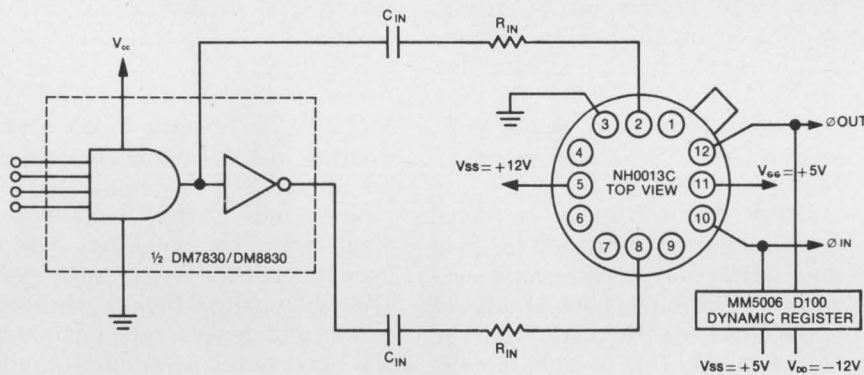

DRIVING DYNAMIC MOS REGISTERS

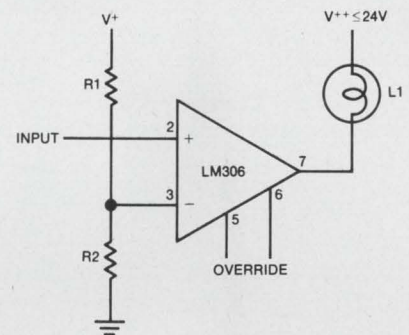

LEVEL DETECTOR AND LAMP DRIVER

Leave the driving to us.

Interface at the output of a TTL system calls for circuits capable of handling up to 1 amp or 100 volts. From there, you can drive a line, trigger a relay, control a motor or light your lamps. Similarly, your MOS memory requires MOS clock drivers to deliver precision pulses to registers for a completely compatible TTL system (our registers are already TTL compatible at data input/output).

For total digital systems—DTL, TTL or MOS, National drivers come in TO-5s or molded silicone dual in-lines.

They're part of the National scene, low cost and ready to go from distributors' stocks.

Call, write, TWX or honk for our drivers guide with charts, specs and applications notes. National Semiconductor, 2900 Semiconductor Drive, Santa Clara, California 95051 (408) 732-5000 TWX: 910-339-9240 Telex: 346-353 Cables: NATSEMICON.

National/Digital



RCL

wire wound resistors

- Standard Temperature Coefficient ± 10 PPM
- Standard Tolerance $\pm 1\%$
— available to $\pm .002\%$
- Sub-Miniature Series available at no extra charge
- 22 Special Temperature Coefficients available from -50 PPM to $+6000$ PPM
- Available in Standard Wattages $\frac{1}{2}$ Watt through 50 Watts
- Resistance Values from .01 ohms to 275K
- Special Silicone Coating impervious to all cleaning solutions without exception!
- **DELIVERY — IN QUANTITY WITHIN TWO WEEKS**

RCL

General Sales Office
RCL ELECTRONICS, INC.
700 South 21st Street
Irvington, New Jersey 07111

Who's Who in electronics

Men who manage the military's electronic systems are not necessarily a breed apart from their counterparts in industry, as George E. Rippey and William J. Regner demonstrate. Both are Army colonels, and have assumed new middle management posts with the Strategic Communications Command (Stratcom) at Ft. Huachuca, Ariz.

Rippey, an EE from the University of Kansas, takes over as director of Stratcom's communications engineering directorate following duty since 1967 as commander of the Army Satellite Communications Agency at Ft. Monmouth, N.J. That job included the second hat of satellite communications project manager for Satcom's parent, the Army Materiel Command.

Regner is chief of staff for Stratcom's Safeguard Communications Agency, succeeding Col. Paul C. Day, who moves up to agency deputy commander. Here, Regner finally should be able to capitalize on his University of Oregon business administration degree after 25 years of service—largely as an infantry commander.

Greek honor. Rippey, a Signal Corps alumnus, continued his field duty after the second world war with a 1949 tour as signal advisor to the Greek 9th Mountain Division, an assignment that brought him the Greek War Cross. After that, he moved into Army communications management posts, including two in Washington—one as chief of the Defense Communications Agency's systems engineering division.

Both Regner and Rippey have put in time on the R&D side of military systems development. Stratcom chief Regner served three years as an instructor and later was chief of weapons research and analysis at Ft. Benning, Ga., while communications specialist Rippey has been cited by Who's Who in Engineering as a leader and teacher in that field, as well as for outstanding contributions in research and development. Rippey's other claims to fame are two daughters—Sandy, a graduate of the American University in Washington, D.C., and

now the wife of a Marine Corps fighter pilot, and Lorraine, recently commissioned in the Army Nurse Corps.

Topping Regner's outside interests are sports. At golf he once achieved a 386-yard hole-in-one. Equally intriguing is the way he managed to escape being drafted by the National Football League's Philadelphia Eagles at the end of his college career: he enlisted in the Army.

"Sometimes people get the impression that this is an anti-patent activity," worries Richard H. Stern, chief of the new patent unit in the Justice Department's antitrust division. "We're here to protect the patent system, not attack it," he asserts.

The patent unit was set up by Assistant Attorney General Richard McLaren in January to fill a void existing in the Justice Department for 15 or 20 years since the old Patent and Cartel Section was abolished. "The field has sort of been ignored for years," says Stern. This will change, though, he notes, as the unit makes sure businesses don't take unfair advantage of other businesses by abusing the patent system.

Stern, 38, is an honors graduate of the Yale Law School and holds a BSEE from Columbia University. He values his engineering degree, because "I don't see how anyone could do work in the patent field without some kind of technical background." Of the five other staff attorneys in the unit, four are engineers in various fields.

Restraint. The new Justice unit will be handling cases where a patent-holder attempts to place unreasonable restrictions on how licensees use the patent rights, or where the holder tries to restrict use of the patented product after sale. As an example, Stern recalls the case of a patented coffin lid in which the holder licensed the lid

- Five full digits plus "1" for 20% overranging
- Basic unit measures 0 to 1100 volts dc in three ranges
- Auto ranging and polarity with active 3-pole switchable filter
- 25 millisecond sampling speed
- Full systems capability with timing signals and ready indicator
- Low cost options include ac voltage, millivolt-ohms, external reference (ratio) and fully isolated remote programming and data output.



The first really new DVM in a decade

Announcing the Fluke 8300A, a 0.005% digital voltmeter with full systems capability for \$1295

There are a lot of good DVM's around. All but one share a common set of faults—overwhelming complexity and high cost. And as you might guess, the DVM that beats the others cold is the new Fluke 8300A.

Why?

Because Fluke uses a new A to D technique which reduces componentry by up to 500 percent. Obviously, when components are eliminated, good things happen. Power requirements go down, reliability goes up, circuitry is simplified, troubleshooting is speeded and reduced. Most important to the system

designer, lowered costs mean we can invest some of the savings in features you need in a DVM.

With all its features and accuracy, the Fluke 5-digit DVM sells for less than many 4-digit units. We price the options low, too. A fully loaded Fluke 8300A sells for \$2995. Comparable but not equal competitive instruments cost as much as \$5000.

And when the Fluke name goes on the front you know you're getting quality instrumentation... in keeping with the Fluke philosophy of bringing you standards lab performance in portable instrumentation.

Fluke, Box 7428, Seattle, Washington 98133. Phone: (206) 774-2211. TWX: 910-449-2850. In Europe, address Fluke Nederland (N.V.), P.O. Box 5053, Tilburg, Holland. Phone: (04250) 70130. Telex: 884-50237. In the U.K., address Fluke International Corp., Garnett Close, Watford, WD2 4TT. Phone: Watford, 27769. Telex: 934583.



SEE US AT IEEE

Sweeping superiority

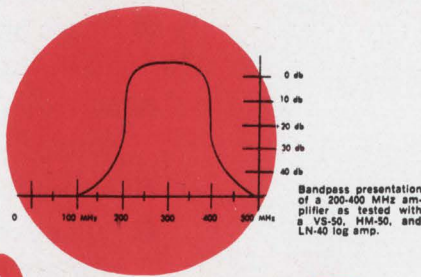

THE UNIQUE VS-50 SOLID-STATE SWEEP GENERATOR 2-500 MHz

Master of hundreds of applications in the FM radio, VHF TV and TV IF, and most communication bands, the Texscan VS-50 can cover the 200-400 MHz range in a single sweep—and add 300 MHz of extra coverage. As the above frequency plot of a 200-400 MHz amplifier bandpass presentation shows, the oversweep permits out-of-band tune-ups and slope characteristics to be measured easily in a single test. Descriptive literature covering all technical details of this unique instrument—available only from Texscan—is yours for the asking, free on request.

STATE-OF-THE-ART LEADERSHIP

RF Output: RF output is at least 1 vrms into a 50 ohm load.

Sweep Width: The sweep width is continuously variable from 500 KHz to 500 MHz at any center frequency, but the unit will not sweep above 500 MHz at rated output. The unit is also provided with a CW output mode for signal generator applications.

Frequency Range: The unit can be centered at any frequency between 2 MHz and 500 MHz and sweep anywhere within that range.



Texscan

CORPORATION

2446 NORTH SHADELAND AVENUE
INDIANAPOLIS, INDIANA 46219

Who's Who in electronics

to persons who agreed not to sell it for use within 50 miles of Boston. He had sold someone else the rights in Boston, thereby eliminating competition. The same principle applies to electronic inventions, says Stern, though there are no such cases on file with the unit now. But he emphasizes that this could change soon, because "when you get a fast technology area generating more patents, you get more licensing and, thereby, more illegal licensing."

Most cases now on file with the unit are chemical, "which I regret," says Stern. With his technical background, he would feel more at home with cases involving electronics.

Solomon on the Potomac. An example of the kind of case that might come before the unit is one in which a patent holder of a microcircuit which is adaptable to television, radio, or sound production, grants rights to one manufacturer of tv's costing less than \$200, other rights to a maker of sets over \$200, and so on into the radio and sound equipment. On the other hand, an inventor with an antenna adaptable to tv, citizens' band, and f-m might be allowed to restrict use to CB and f-m, since breaking into the commercial tv market is so expensive. In a case like this, "where it's the only way to get the product or new technology on the market," the practice is acceptable, he says.

The unit's effort is aimed at preventing industrial enterprises that use patents from hampering free enterprise, an area which Stern concedes could fall under the jurisdiction of the Federal Trade Commission. The Sherman Antitrust Act and the Federal Trade Commission Act cover much the same ground in different language, he says, but the FTC is not likely to be very active in patent litigation.

Stern, who is married and has five children, was most recently director of the compliance division of the Commerce Department's Office of Foreign Direct Investments. Prior to that he was a trial attorney in the Justice Department's anti-trust division.

Several hundred thousand unfair advantages.

There you are, busting your back trying to beat another company to market with a new, improved electronic Thing.

Everything looks good — up to the point where sub-assembly X has to be connected to board B. And you've never seen a connection like that before.

Sweat not. We're sitting over here with several hundred thousand different connectors. Most were specials, once. Many are patented. All of them are ready. Now.

Card edge connectors. Two-piece PC connectors. Board-to-board connectors. Miniatures. Sub-

miniatures. Dual-in-Line receptacles. Back panel metal plates. Rack and panel connectors. Mil spec cylindrical connectors. Tube and transistor sockets. Even new Mojo™ modular card edge connectors which you sort of invent as you go along. All available with the respected Varicon™ metal-to-metal connection that fully meets Mil-E-5400.

Because they're ready, you get a jump on your competitor. Because they're standard, you put your Thing together for less money than he can. It's unfair, but it's fun. And profitable.

But what if we *don't* have a

standard for you? Still no problem. With hundreds of thousands of different connectors already behind us, your special will just be a not-quite-standard.

We have several pounds of catalog, containing more information about connectors than you probably care to have. So don't just send back a reader information card. Call, write, wire, or TWX us, and tell us either your specific problem or your general field of interest. We'll send you the pertinent few ounces.

Elco Corporation,
Willow Grove, Pa. 19090.
(215) 659-7000 TWX 510-665-5573.

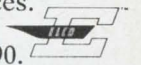

ELCO Connectors

See us at IEEE '70.

Booth 4G07-4G09.



**One of these panels
any capital**

This one.

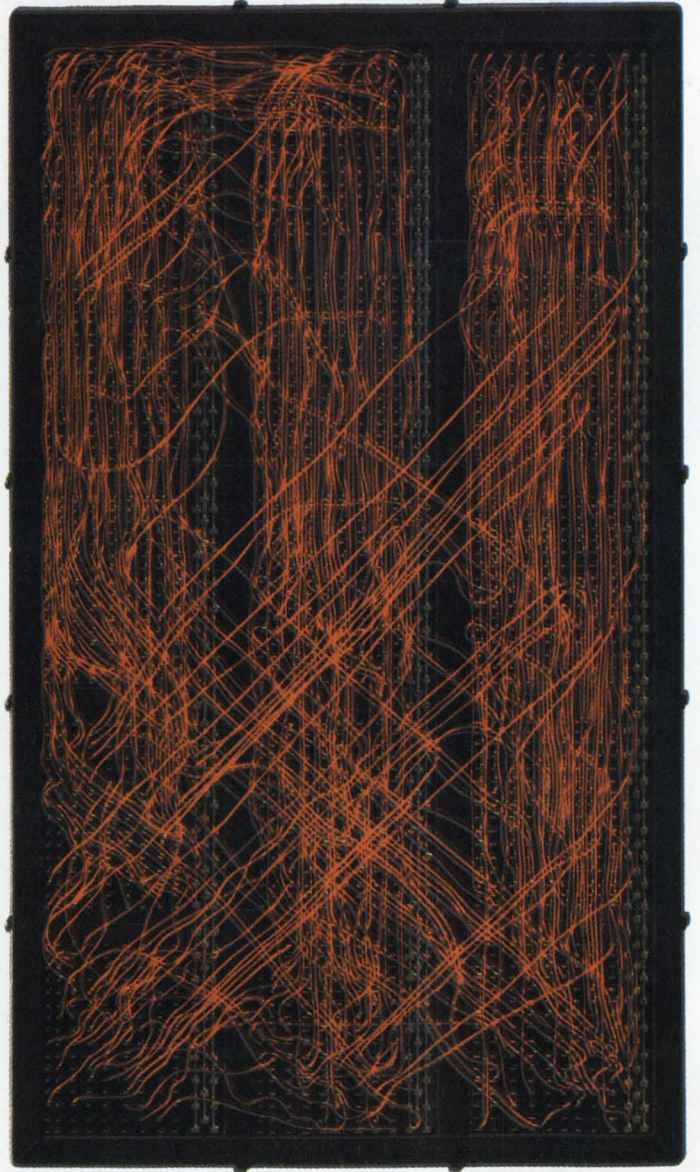
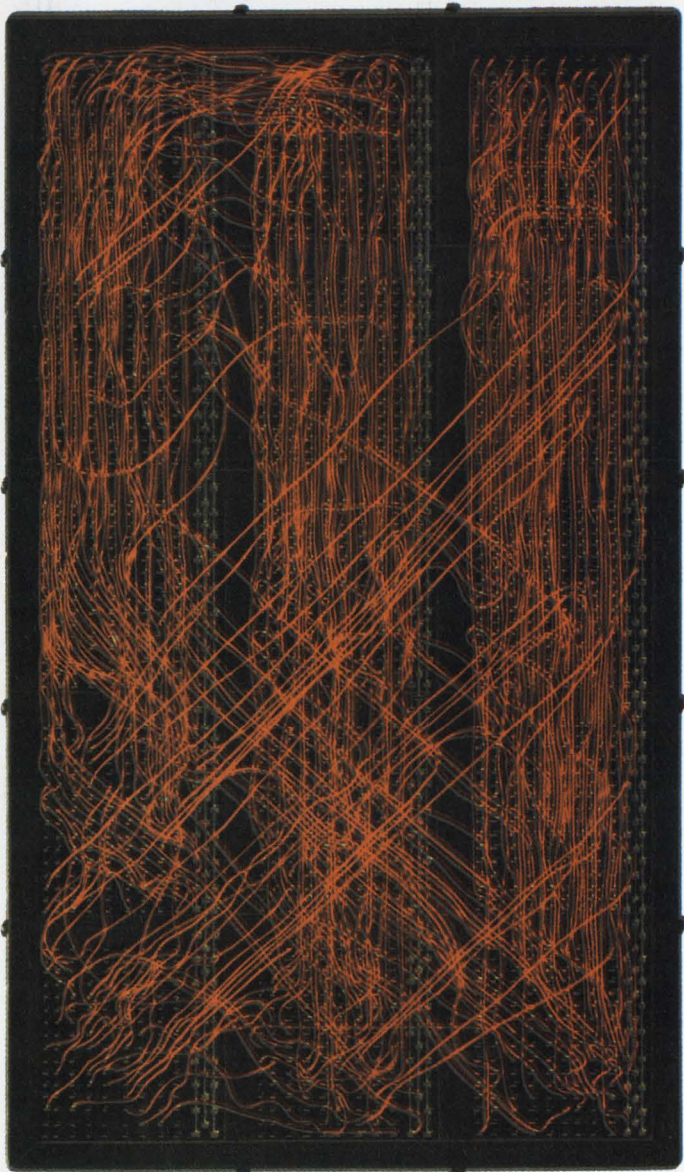

was wired without investment.

It was wired with AMP's unique TERMI-POINT★ point-to-point automatic machine wiring.

The other panel was wired with wrap-type terminations. Which required a considerable capital investment.

There's no capital investment with the AMP method because you don't have to buy any wiring machine. And the system is faster, more reliable, and easily maintainable.

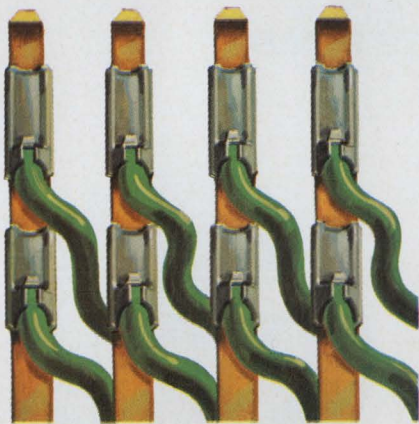

Metal clips swage the wire against the post

And the wire can be either solid or stranded. The clips are fed from one reel; the wire from another. They're applied to the post simultaneously. The clips hold with a spring action. The stored energy of this clip keeps the connection gas tight. And compensates for conductor creep. The clip keeps resistance low, too, because of the high force it exerts on the wire. In short, the clip assures greater reliability.

★Trademark of AMP Incorporated

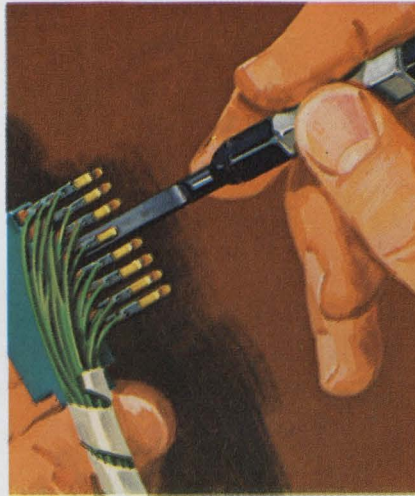

TERMI-POINT terminations are easier to test, maintain and service

The termination can be inspected visually. And the tensile strength is tested (non-destructively) using a simple spring force gauge. There can be up to three terminations per post. Yet you can remove any one without disturbing the others. A simple hand extraction tool makes it easy.

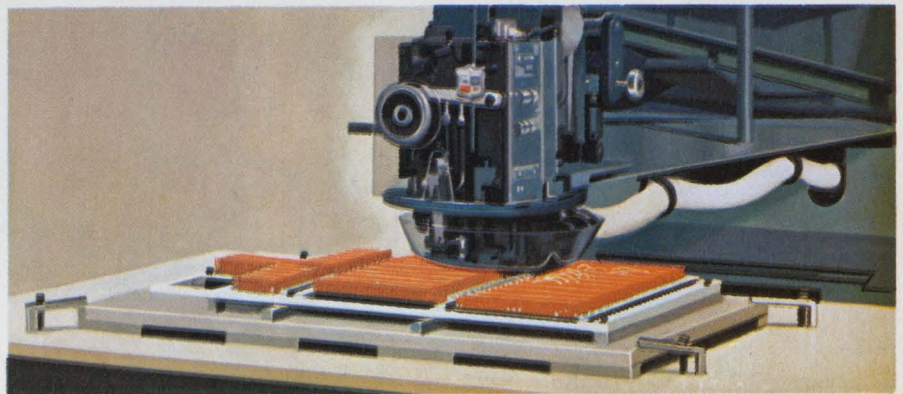

You'll need to know more

If the lower costs and greater reliability of our point-to-point wiring system makes sense to you, learn more about it and its associated connectors and accessories. Write to Industrial Division, AMP Incorporated, Harrisburg, Pa. 17105.

Two types of AMP application tools

One is a numerically controlled and fully automated machine. It wires panels on a pre-determined pattern by means of a programmed tape. On a grid of .001". For example, on a .156" by .188" edge connector cabled to an IO connector having .200" by .200" grid. This machine can duplicate your present wire routings and produce up to 1000 leads per hour. The other tool is a hand gun. It holds a reel of clips and operates pneumatically. It's ideal for prototype, standard production, or on-the-spot servicing.



AMP
INCORPORATED

TI's quiet revolution in Linear ICs



Here's your biggest choice for system interface design—10 sense amps, 2 memory drivers, 6 line circuits.

System interface designers have long needed an IC line big enough to work with. TI's quiet revolution in Computer Interface has provided the answer—the biggest family now available. Choose from 18 proven functions—all in stock.

The 10 sense amps (Series 7520N) offer you a selection of three basic circuit designs—three versions of dual preamplifiers driving common-output circuits, or two complete sense amps in a single package. You gain low propagation delay, fast overload recovery, high d-c noise margin, individual channel strobing, TTL compatible out-

puts—and substantial cost savings.

From the group of six drivers and receivers, you can pick dual line receivers which translate transmission line signals to logic signals or perform level shifting operations (SN75107/SN75108). Or receivers which can be applied as differential or single-ended receivers or as comparators (SN75100/SN75120). Or pick dual channel line drivers useful in balanced, unbalanced and party line systems (SN75109/SN75110).

Of the two memory drivers, the SN75303—a 150 mA transistor array—interfaces between bipolar

logic levels and magnetic memory systems. The SN75324 replaces traditional discrete high-current transistor-transformer circuits in magnetic memory systems.

If you're ready to whip interface problems the IC way, we'll send you our new brochure on our Computer System Interface Circuits. Circle 288 on the Reader Service Card or write Texas Instruments Incorporated, P.O. Box 5012, M.S. 308, Dallas, Texas 75222. That's where the quiet revolution is going on. Or call your authorized TI Distributor.



TEXAS INSTRUMENTS INCORPORATED

design inspirations

*Prices shown are single lot.
Inquire about quantities.

Keyboard Switch Bank

Utilizes reliable reed switches. Mechanical lockout feature allows simplified circuitry. 11 keys 0-9 and period. SB-033



CIRCLE NO. 325 28.50 *

ELFIN® Readout Neon Indicator

Single plane 9-segment neon for brighter, wider viewing. 0.41" dia. Has mount for PC wiring. Displays 0-9, +, -, some alpha & decimal. Long-life operation. MG-19. \$4.95

2.99 each, in 1000 lots
CIRCLE NO. 326



Transistorized Neon Logilite

4.85 *

Neon pilot operates from low-voltage 5VDC supply. Self-contained transistorized generator provides hi-voltage to excite neon. Bushing 3/8". LVN-ML.

CIRCLE NO. 327



Terminal Strip Kit

10.95 *

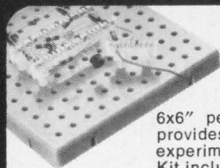

6x6" perforated board provides the base for experimental designs. Kit includes board & 16 CB-2 ceramic plug-in strips.

CIRCLE NO. 328

Remote Control Relay

For safe, shock-free remote control circuit operation. Compact plastic case. 115 VAC input 5A capability. FR-101.

3.85 *

CIRCLE NO. 329



Straight Knurl Aluminum Knobs

55¢ *

High lustre, machined aluminum knobs with smooth, precision serrations. Natural satin finish. KN Series. 1/2" dia. 55¢, 1" dia. 70¢ ea.



70¢ * CIRCLE NO. 330

Immediate Deliveries on Above Items

ALCO®

ELECTRONIC PRODUCTS, INC.
Lawrence, Massachusetts 01843

Meetings

Look out, 1970's, here comes the IEEE

For the electronics engineer, the seventh decade of the 20th Century will start in New York on March 23. That's when the IEEE International Convention and Exhibition opens, and that's what the IEEE ambitiously declares on the cover of the advance program for its annual four-day meeting. For the skeptics, the IEEE can point proudly to sessions such as those on electro-acousto-opto-magneto-elasto interactions (as 1970ish as a title can get), satellite communications, and computer techniques in urban management.

But the strong point of the meeting—putting aside the restaurants, theaters, museums, and other fringe benefits—will be the tutorial sessions, an area that each year has continued to gain in emphasis. Dubbed the technical applications program, the sessions will be offered this year at the Coliseum rather than the New York Hilton Hotel, a few block to the south. Beginning with a timely and ambitious discussion—"How to Get Started in Hybrid IC's"—the subjects range from "Design and Application of Microstrip Circuits," to "Applications of Microwave Semiconductor Devices," "How to Reduce Interference in Electronic Equipment," "Applications of Infrared Radiation," "Time-Shared Computer-Aided Circuit Analysis," and "Using Small Computers."

Touching the bases. The sessions will be thorough. For example, the hybrid IC section, organized by D.W. Cottle of Raytheon, will cover

almost everything except how to arrange financing. Listed are sub-sessions on how to get started with a vendor and the experience of one user in that direction, what's needed to get into thick and thin films; how to prepare low-cost artwork and masks; handling of active elements; packaging; and the experience of a user in getting started with thick films.

In setting the convention's theme—"Launching the Spectacular '70's in Electrical and Electronics Engineering,"—the IEEE has tried to project the device technologies that the EE will have to deal with into the next 10 years. Thus, it will cover silicon IC's, memory systems, microwave devices, and consumer IC's. Of course, the bread-and-butter subjects will not be ignored—power high-speed circuits, for instance, or oceanography.

The winner of the IEEE's medal of honor will be Dennis Gabor of London University, generally acknowledged to be the father of holography.

And what about that electro-opto-magneto etc.? Well, it's Session 1A, scheduled for the Hilton's Trianon Ballroom on March 23 at 9:30 a.m. It will delve into Bell Labs' magnetic bubble domains [*Electronics*, Sept. 1, 1969, p. 83], applications of nonlinear optics, what RCA's lab terms a new technique for converting infrared to visible image called "upconverting," and acoustoelectric interactions.

For further information contact IEEE Headquarters, 345 E. 47th St., New York, N.Y. 10017.

Calendar

International Solid State Circuits Conference, IEEE, University of Pennsylvania; Sheraton Hotel and University of Pennsylvania, Philadelphia, Feb. 18-20, 1970.

Scintillation & Semiconductor Counter Symposium, IEEE; Shoreham Hotel, Washington, March 11-13.

International Seminar on Digital

Processing of Analog Signals, IEEE; Swiss Federal Institute of Technology, Zurich, Switzerland, March 11-13.

Symposium on Management and Economics in the Electronics Industry, IEE; University of Edinburgh, Scotland, March 17-20, 1970.

International Convention, IEEE; New

(Continued on p. 24)

from Bourns

A DIAL T TO C UNT N

New, High-Quality 1 $\frac{3}{8}$ " Diameter Turns-Counting Dial with Readability of a 1 $\frac{13}{16}$ " Dial

SEE WHAT YOU GET

White on black set points pop right out at you. No misreading. Ten turns setable to one part in a thousand. Same readability as 1 $\frac{13}{16}$ " dial in a third less panel space.

Tough cast aluminum housing with only 4 moving parts. Newly developed dial changeover can't foul. Smooth as it looks. Zero backlash.

1 $\frac{3}{8}$ " diameter for mounting on $\frac{1}{4}$ " and $\frac{1}{8}$ " diameter shafts. Simple to do; no special panel holes required.

ONLY \$3.99 in 1,000 lots

Send for data on H-510 Turns-Counting Dial or ask your nearest Bourns sales office or representative.

Available through your Bourns distributor.



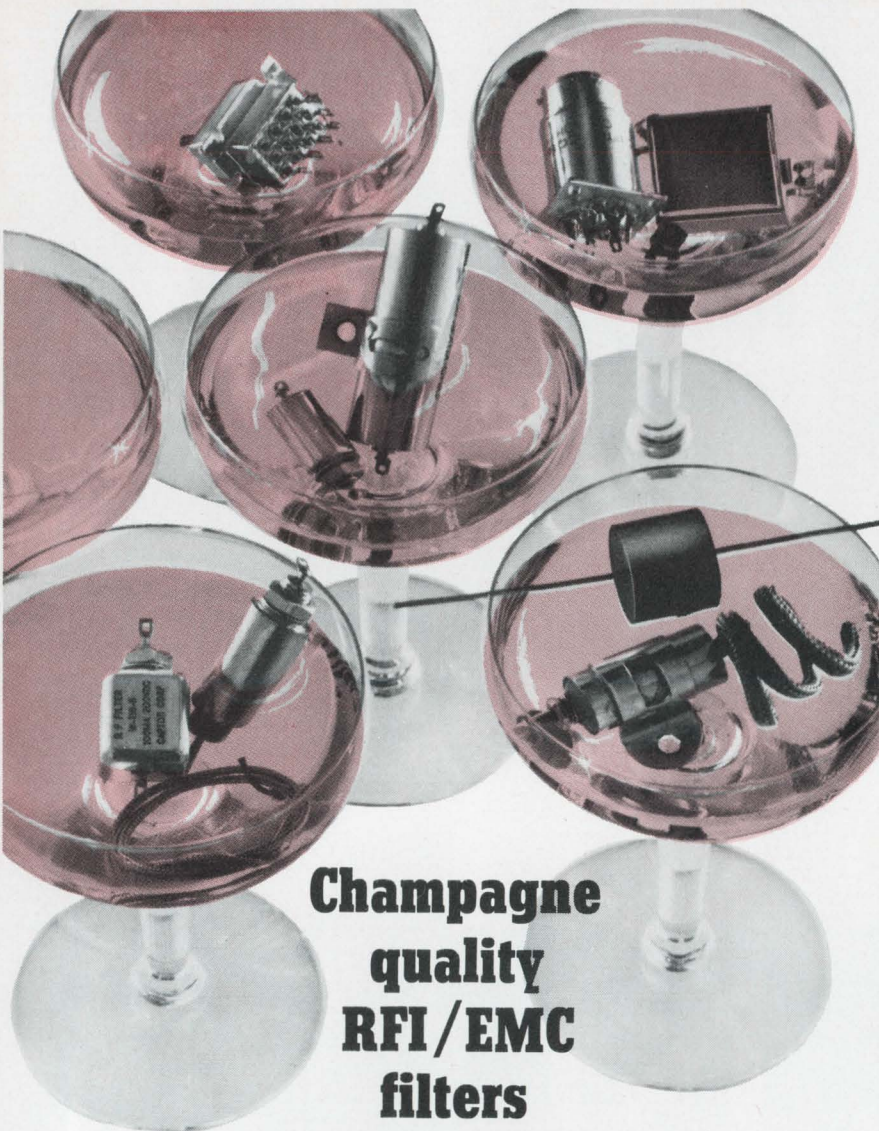

**Champagne
quality
RFI/EMC
filters
at beer prices**

A toast! May you and your products benefit from finer, lower-cost filters from Captor Corporation. Captor combines knowledgeable application engineering with a quality assurance program that extends through every manufacturing step from order entry to final packaging. Costs are closely controlled because production is geared to a specific electronic components family: miniature RFI/EMC filters, communications and security filters, and custom designed filters and assemblies. Captor's new environmentally conditioned plant is designed expressly for fast, efficient manufacture of this integrated product line. Write for our capabilities brochure today and drink in the whole story.



5040 Dixie Highway, Tipp City, Ohio 45371, Phone: (513) 667-8484

Meetings

(Continued from p. 22)

York Hilton Hotel and the New York Coliseum, March 23-26, 1970.

Meeting of the Association for the Advancement of Medical Instrumentation, Statler Hilton Hotel, Boston, Mar. 23-25, 1970.

Symposium on Submillimeter Waves, IEEE, Polytechnic Institute, Brooklyn, New York, March 31-April 2, 1970.

Communications Satellite Systems Conference, American Institute of Aeronautics and Astronautics; International Hotel, Los Angeles, April 6-8, 1970.

Reliability Physics Symposium, IEEE; Stardust Hotel and Country Club, Las Vegas, Nevada, April 7-9, 1970.

Meeting and Technical Conference, Numerical Control Society; Statler Hilton, Boston, April 8-10, 1970.

Computer Graphics International Symposium, IEE; Uxbridge, Middlesex, England, April 13-16, 1970.

International Geoscience Electronics Symposium, IEEE; Marriott Twin Bridges Motor Hotel, Washington, April 14-17, 1970.

USNC/URSI-IEEE Spring Meeting; Statler Hilton Hotel, Washington, April 16-19.

American Power Conference, IEEE; Sherman House, Chicago, April 21-23, 1970.

International Magnetics Conference (INTERMAG), IEEE; Statler Hilton Hotel, Washington, April 21-24, 1970.

Southwestern IEEE Conference & Exhibition; Memorial Auditorium, Dallas, April 22-24.

Annual Frequency Control Symposium, U.S. Army Electronics Command; Shelburne Hotel, Atlantic City, N.J., April 27-29, 1970.

National Telemetry Conference, IEEE; Statler Hilton Hotel, Los Angeles, April 27-30, 1970.

National Relay Conference, Oklahoma State University and the National Association of Relay Manufacturers; Oklahoma State University, Stillwater, April 28-29, 1970.

Transducer Conference, IEEE; National Bureau of Standards, Washington, May 4-5, 1970.

National Appliance Technical

(Continued on p. 26)

another
A-B resistor
enters the

exclusive
circle

Here's the latest Allen-Bradley resistor—the Type BB 1/8 watt—to meet the requirements of MIL-R-39008 Established Reliability Specifications at the highest level—the S level. Now, A-B provides this “peak” performance in all four ratings—the 1 watt, 1/2 watt, 1/4 watt, and 1/8 watt. A clear demonstration of the type of leadership you've come to expect from Allen-Bradley.

An exclusive Allen-Bradley hot-molding technique ensures high uniformity from resistor to resistor—billion after billion. Their predictable performance makes them ideal for critical military applications.

For immediate delivery at factory prices, call your authorized A-B Industrial Electronics Distributor. For technical specifications write Marketing Dept., Electronics Div., Allen-Bradley Co., 1201 South Second Street, Milwaukee, Wis. 53204. Export Office: 1293 Broad Street, Bloomfield, N. J., U.S.A. 07003. In Canada: Allen-Bradley Canada Limited.

A-B hot-molded fixed resistors are available in all standard resistances and tolerances, plus values above and below standard limits. Meet MIL-R-39008 at S level for all values from 2.7 ohms to 22 megohms, except Type BB which is from 10 ohms to 22 megohms. Shown actual size.

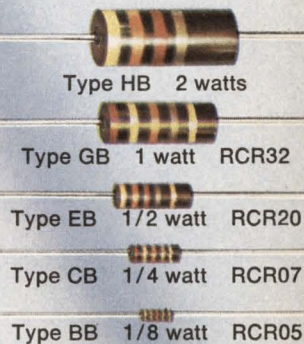

© Allen-Bradley Company 1969



ALLEN-BRADLEY
QUALITY ELECTRONIC COMPONENTS

THE New GENERATION SCR



DISC PACKAGED REGENERATIVE GATE SCR's

Operation to 20 KHz with low switching losses
⊕ di/dt capability to 800 A/μsec. ⊕ low power
gate drive ⊕ dv/dt capability to 500 V/μsec.
⊕ 175 and 370 amperes RMS ⊕ turn-off time
capability to 10 μsec. ⊕ also available
in stud type package to 470 amperes RMS.

For additional information and application assistance,
write or call National Electronics, Inc.,
a varian subsidiary, Geneva, Ill. 60134,
phone (312) 232-4300.

NATIONAL ELECTRONICS, INC.

a varian subsidiary

1969 COMPETITION WINNER
Cited by Industrial Research Inc.
as one of the 100 most
significant technical products of the year.



A NATIONAL® exclusive,
Patent Pending.

Meetings

(Continued from p. 24)

Conference, IEEE; Leland Motor Hotel, Mansfield, Ohio, May 5-6, 1970.

Short courses

Safe-Life Design Practices: Practical Applications of Fracture Mechanics, Engineering 879.4; Boelter Hall, Room 4442, University of California, Los Angeles, March 16-20, \$285 fee.

Thermal Pollution Seminar, Institute of Environmental Sciences; Sheraton-Plaza Hotel, Boston, April 16-18. \$150 fee.

System Engineering, Engineering and Physical Sciences Extension University Extension, University of California at Los Angeles, April 20-24. \$285 fee.

Laser Fundamentals and Communications; Rice University, Houston, Texas, May 4-6. \$300 fee.

Call for papers

Government Microcircuit Applications Conference: GOMAC, U.S. Army Electronics Command, Ft. Monmouth, N.J., Oct. 6-8. March 18 is deadline for submission of summaries and abstracts to Robert D. Larson, Air Force Avionics Laboratory, Wright-Patterson AFB, Ohio 45433.

Conference on Applications of Simulation, IEEE, Association for Computing Machinery, American Institute of Industrial Engineers, The Institute of Management Science; Waldorf-Astoria, New York, Dec. 9-11. March 31 is deadline for submission of papers to Michel Araten, Celanese Chemical Co., 245 Park Ave., New York 10017.

Fall Joint Computer Conference, IEEE, American Federation of Information Processing Societies; Astorhall, Houston, Nov. 17-19. April 10 is deadline for submission of papers to L.E. Axson, Chairman, Technical Program Committee, 1970 Fall Joint Computer Conference, P.O. Box 6-449, Houston 77061.

Systems Science and Cybernetics Conference, IEEE Systems Science and Cybernetics Group; Pittsburgh, Pa., Oct. 14-16. April 15 is deadline for submitting abstracts to Prof. A. Lavi, Carnegie-Mellon University, Pittsburgh, Pa. 15213.



ERIE

When you want radar as pure and coherent as a laser beam...

Symbolic electronic signal undistorted by EMI —
photographed by Howard Sochurek

bring ERIE in early.

31,000 feet...heavy traffic...ugly weather over the Plains. This isn't the time for "noise" in the radar. But, no sweat! RCA's exciting new AVQ-30X Weather Radar is up front, sweeping the sky...protected from EMI by 39 special ERIE filters. No other airborne radar has ever approached the single or dual system reliability of the AVQ-30. From the start, RCA has called on the outstanding research and component capability of ERIE TECHNOLOGICAL to help in the development of this great new unit. Proof, once again, that it pays to bring ERIE in early.

ERIE TECHNOLOGICAL PRODUCTS, INC.

644 West 12th Street, Erie, Pennsylvania 16512
(814) 456-8592

Circle 27 on reader service card

To make Decoders that can drive every major display device,

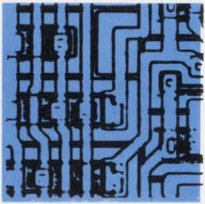

Three Fairchild MSI decoder/drivers cover the requirements of every major military and industrial display device on the market. The 9315. The 9317. And the brand new 9327. Each device has a built-in driver stage—an important feature that means smaller, lower-cost systems with higher reliability.

NIXIE—The 9315 One-of-Ten Decoder/Driver accepts decimal inputs and provides ten mutually exclusive outputs which directly drive NIXIE* tubes. Stable high-voltage output characteristics also make the 9315 ideal for driving relays, lamps and similar devices.

SEVEN-SEGMENT—Fairchild's 9317 and 9327 Seven-Segment Decoder/Drivers convert 4 inputs in 8421 BCD code into appropriate outputs for driving seven-segment numerical displays. The 9317 is designed for use with incandescent lamps, neon, electroluminescent and CRT displays, as well as light emitting diode indicators. The 9327 is used for DIGIVAC S/G** vacuum fluorescent readouts. Both devices feature automatic ripple blanking, lamp intensity modulation, lamp test facility, and blanking output. Outputs are disabled by codes in excess of binary 9. Flags are removed on the 6 and 9, which reduces the number of ambiguous states.

*NIXIE is a registered Trademark of Burroughs Corporation.
**DIGIVAC S/G is a registered Trademark of Wagner Electric Corporation.

To order these Decoder/Drivers, call your Fairchild Distributor or ask for:

PART NUMBER	PACKAGE	TEMPERATURE RANGE	(1-24)	PRICE (25-99)	(100-999)
U4L931551X	Flat	-55°C to +125°C	\$22.00	\$17.60	\$14.65
U4L931559X	Flat	0°C to + 75°C	11.00	8.80	7.30
U6B931551X	DIP	-55°C to +125°C	20.00	16.00	13.30
U6B931559X	DIP	0°C to + 75°C	10.00	8.00	6.65
U4L9317513	Flat	-55°C to +125°C	28.00	22.40	18.70
U4L9317593	Flat	0°C to + 75°C	14.00	11.20	9.35
U7B9317513	DIP	-55°C to +125°C	25.40	20.30	17.00
U7B9317593	DIP	0°C to + 75°C	12.70	10.15	8.50
U4L9327591	Flat	0°C to + 75°C	13.05	10.50	8.80
U7B9327591	DIP	0°C to + 75°C	11.90	9.55	8.00

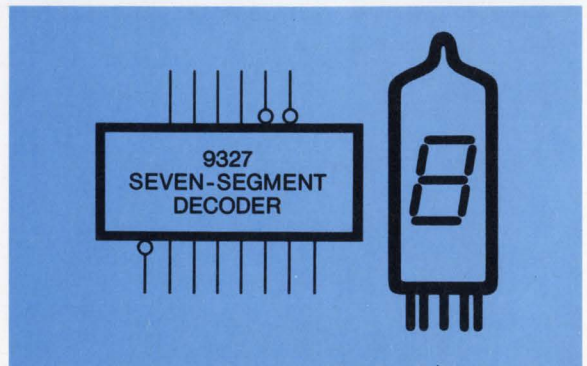
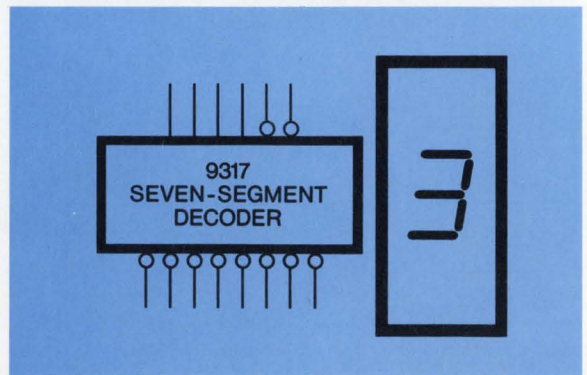
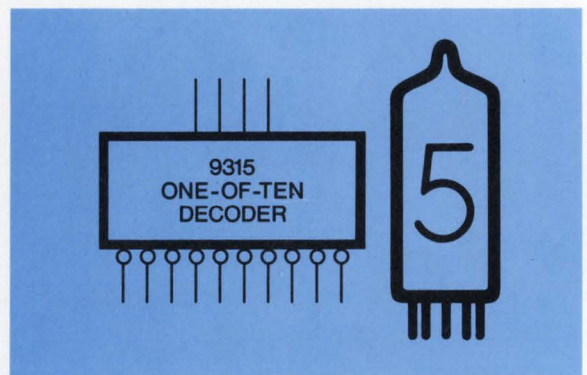

you have to get serious about MSI family planning.

We put together a family plan by taking systems apart. All kinds of digital systems. Thousands of them.

First we looked for functional categories. We found them. Time after time, in a clear and recurrent pattern, seven basic categories popped up: Registers. Decoders and demultiplexers. Counters. Multiplexers. Encoders. Operators. Latches.

Inside each of the seven categories, we sifted by application. We wanted to design the minimum number of devices that could do the maximum number of things. That's why, for example, Fairchild MSI registers can be used in storage, in shifting, in counting and in conversion applications. And you'll find this sort of versatility throughout our entire MSI line.

Finally, we studied ancillary logic requirements and packed, wherever possible, our MSI devices with input and output decoding, buffering and complementing functions. That's why Fairchild MSI reduces—in many cases eliminates—the need for additional logic packages.

The Fairchild MSI family plan. A new approach to MSI that's as old as the industrial revolution.

It started with functional simplicity, extended through multi-use component parts, and concluded with a sharp reduction in add-ons.

Simplicity. Versatility. Compatibility.

Available now. In military or industrial temperature ranges. In hermetic DIPs and Flatpaks. From any Fairchild Distributor.

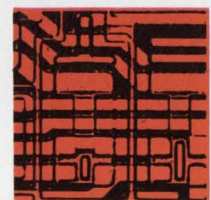

OPERATORS
9304 - Dual Full Adder/Parity Generator

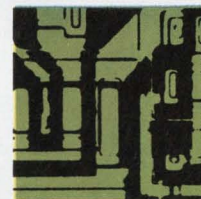

LATCHES
9308 - Dual 4-Bit Latch
9314 - Quad Latch

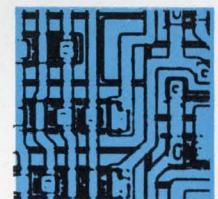

DECODERS AND DEMULTIPLEXERS
9301 - One-Of-Ten Decoder
9315 - One-Of-Ten Decoder/Driver
9307 - Seven-Segment Decoder
9311 - One-Of-16 Decoder
9317 - Seven-Segment Decoder/Driver
9327 - Seven-Segment Decoder/Driver



REGISTERS
9300 - 4-Bit Shift Register
9328 - Dual 8-Bit Shift Register

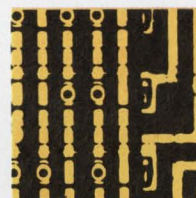

MULTIPLEXERS
9309 - Dual 4-Input Digital Multiplexer
9312 - 8-Input Digital Multiplexer

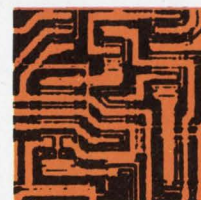

COUNTERS
9306 - Decade Up/Down Counter
9310 - Decade Counter
9316 - Hexadecimal Counter

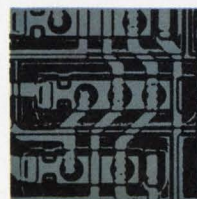

ENCODERS
9318 - Priority 8-Input Encoder

FAIRCHILD
SEMICONDUCTOR



Branching and looping flexibility provided by "IF" keys expands programming capability.



Trig functions covering all quadrants and any size angle in degrees or radians.



Complex and vector arithmetic simplified with coordinate transformation keys, rectangular-to-polar and vice-versa, in milliseconds.

754.8367 z temporary
5.336 845 815 05 y accumulate
33.50 x keyboard

Dynamic range 10^{-99} to 10^{99} , nearly 200 decades. Observation of math operations on 3 displayed registers. Up to 16 more registers for data storage.



Hewlett-Packard
 P. O. Box 301
 Loveland, Colorado 80537

Please send:

- 22-page, Full-Color Brochure on HP 9100 Calculator System.
- 6-Page Brochure, "Can a computing calculator make your operation more profitable?"

Name _____

Title _____

Company _____

Address _____

City _____

State _____

Zip _____

Now the emancipator...
 computes, plots and

Prints Quietly

The HP 9100A/B Calculator frees you from the drudgery of complex problem solving.

The HP 9125A Plotter frees you from the tedium of hand-plotting graphs.

And now, the quiet HP 9120A Printer frees you from the manual transfer of data.

Add up these three capabilities, and what do you have?

THE ONLY TOTAL GRAPHIC COMPUTING SYSTEM AVAILABLE TODAY FOR \$204 PER MONTH!

With this new electro-sensitive printer you speed up your computations by eliminating the need to record results. You get a permanent record of all inputs—a record that makes error tracing quicker and easier. And, you have printed proof of all your computations.

The 9120A printer gives you maximum flexibility in what you print. You can print all of the displayed information; a complete listing of the program instructions stored in memory; or only the information you specify. The 9120A does this printing at the rate of 3 lines per second—without the distracting noise of a mechanical printer.

You get completely documented calculator programs that are specifically designed for use with the plotter and printer. And, you can put this system to work for you today, not sometime in the distant future.

If you want a printer that operates quietly in an office environment—if you want a low-cost system that gives you total graphic solutions—call for a quiet demonstration of the complete emancipator today.

To put this total system to work for you even faster, send your purchase order to any Hewlett-Packard Sales and Service office (located in principal cities throughout the world). For a 22-page brochure, write Hewlett-Packard, P. O. Box 301, Loveland, Colorado 80537. Europe: 1217 Meyrin-Geneva, Switzerland.

Price: HP 9100A Calculator, \$4,400; HP 9100 B Calculator, \$4,900; HP 9120A Printer, \$975; HP 9125A Plotter, \$2,475. Lease/rental plans start as low as \$1.50/computing hour based on average usage.



Program from the keyboard. Record and store 196-step programs on credit-card-size magnetic cards for repeated use.



Edit programs easily. Single-step through programs to check and de-bug. Address an individual step and make corrections without re-entering the entire program.

099/32A

HEWLETT  PACKARD

Circle 31 on reader service card



Ultramation: the digital controller you can build with your bare hands.

Honeywell's new H112 digital controller is made of simple, basic components. Just pick out the ones you need and plug them in.

Start with the basic 12-bit H112 controller – 4K ICM-160 core memory, control logic, power supply and drawer. Costs under \$5K.

Need more? Add on μ -PAC logic modules.

Extra memory. A/D converters. Digital subsystems. A unique control panel – great for unattended installations. It moves from controller to controller for start-up, service, or

reprogramming. Unplug the panel and nobody can tinker with the operation.

Since all components are Honeywell's, they all go together. No need to engineer your own interfaces. No repackaging.

That's Ultramation – the ultimate in controller adaptability from Honeywell.

Find out more. Write for the new H112 Technical Bulletin. Honeywell, Computer Control Division, Framingham, Massachusetts 01701.

The Other Computer Company:
Honeywell

Electronics Newsletter

February 16, 1970

Viatron, AMI sign \$21 million MOS deal

In what may be the largest single semiconductor contract in the history of electronic data processing, American Microsystems Inc. has agreed to make \$21 million worth of metal oxide semiconductor LSI devices for Viatron Computer Systems over the next year to 18 months. But an even larger deal may be brewing: Texas Instruments president Mark Shepard is said to be negotiating with Viatron on a contract involving both MOS and discrete semiconductors.

Furthermore, Viatron also is said to be on the verge of a \$15 million contract with Fairchild Semiconductor for MOS and discrete devices. Finally, it's believed that Steven Levy, vice president and general manager of Motorola's semiconductor operation, already has signed a \$9 million deal, mostly for discretely and some MOS.

Asked for confirmation, Viatron spokesmen admit only that the company's relationship with North American Rockwell's Autonetics division has broken down "because of Autonetics' dramatically rising prices," and the firm is turning to its list of second sources. Confirming this is a change in the arrays Viatron is putting into its System 21 data entry consoles—instead of the four-phase MOS to have been supplied by Autonetics, the arrays now are two-phase MOS—the type made by AMI, Motorola, Fairchild, and TI.

Siliconix to offer microwave devices ...

Siliconix is entering the microwave semiconductor field. The first devices will be field effect transistors that can handle 10 to 12 watts at 2 gigahertz or one watt at X band. The chips for these new devices, however, are existing units that will be recharacterized and repackaged for microwave applications. Down the road are new FET's and bipolar devices, and a line of multiplier varactors and tuning varactors.

Also in the works at Siliconix is a new type of device—a binary varactor. It replaces p-i-n diodes in phased-array radars and requires much less power—a 40,000-element array using p-i-n's needs about 2,000 watts for switching power, but with binary varactors, only 10 watts is needed.

Siliconix has been working on microwave devices for some time; but the pace was increased in November when Robert Johnson and Bernard Siegal went to Siliconix from Microwave Associates (West) after that firm transferred its California operation to Burlington, Mass.

... as instrument makers add lines

Three instrument makers—Datapulse, Dana, and Tektronix—are moving into new areas. Long a manufacturer of pulse generators, the Datapulse division of Systron-Donner will bring its first function generators, the \$400 model 401 and the \$1,000 model 410 to the IEEE show in New York, March 23-26. Hewlett-Packard and Wavetek have had the function-generator business to themselves.

Dana, known as a maker of \$1,000-and-up digital voltmeters, will go after the low-price market with its \$400 model 3800, a 3½-digit multimeter.

Tektronix, which has quietly been building up its systems section, will show at IEEE the S-3150, a computer-controlled unit that runs static and dynamic tests on digital integrated circuits. And back at Beaverton, Ore., Tektronix engineers are building a prototype of a metal oxide semiconductor IC test system.

Hughes prepares to sell I/MOS

Hughes Aircraft is ready to graduate from R&D to production with ion implantation to boost the speed of MOS devices. A dual 64-bit dynamic shift register using ion implantation (I/MOS) is set to be introduced next month; quantity price will be about 20% to 25% more than that of conventional p-channel devices. Hughes will probably specify the unit at a minimum of 10 megahertz. The fastest conventional p-channel shift registers on the market are rated at 5 Mhz.

Hughes introduced its first I/MOS unit, a single 64-bit dynamic shift register, last fall [*Electronics*, Oct. 13, 1969, p. 52], but that device was available only in sample quantities; the new shift register will be a production item.

Meanwhile, back in the lab, the Hughes MOS division is working on an I/MOS 2,048-bit read-only memory with an access time that Hughes predicts as between 100 nanoseconds and 200 nsec. Most conventional MOS read-only memories run at 1 microsecond, with some faster units on the market at about 500 nsec. But Hughes will come in significantly under that speed. The device, strictly a research and development item now, is expected to be available in sample quantities sometime in the second half of the year.

Budget pinching accelerates layoffs

As the Nixon Administration's fiscal policies begin to take hold, and as the Federal budget reflects resulting slashes [see p. 141], more and more electronics facilities engaged in Government-funded activities are being forced to pare work complements.

For example, the Sandia Corp. is preparing for what may be the first layoffs in its history. Reacting to decreased Federal R&D outlays, Sandia plans to use attrition, retirement, and then outright layoffs to cut the payrolls at its Albuquerque, N.M., and Livermore, Calif., research facilities by at least 5%.

Personnel cutbacks at EG&G in Bedford Mass., another casualty of Federal budget balancing, are to reach between 200 and 300 within weeks. Many of those laid off will be leaving the Bedford headquarters and research layout, but more are slated to go when EG&G closes its Laboratory Products division in Goleta, Calif., and its Santa Monica, Calif., division. The latter, formerly E. H. Plesset, is heavily involved in classified optical research. There also was some shrinkage when only a few of the 50 employees at a Bedford support operation moved with it to Los Alamos.

NASA cuts require revised ATS bids

General Electric and Fairchild-Hiller have been ordered back to the drawing boards by NASA to revise proposals for the F and G models of the Applications Technology Satellite. The companies are being asked to reflect the fiscal 1971 budget cutting the program 20% to \$31 million and delaying launches to 1973 and 1975. John E. Naugle of NASA's Office of Space Sciences and Applications says proposal revisions should take four weeks with four to six weeks more for NASA reevaluation, followed by a contract award about May instead of this month. At the same time, NASA put down rumors of slippage in the Earth Resources Technology Satellite. An ERTS program official says contracts will be on schedule in late June or early July if GE and TRW are on time with their Phase B and C studies.

ERTS funds are scheduled to double to \$52.5 million in fiscal 1971 and the 1972-73 launch dates for the satellite are unchanged.

**Integrated
Circuit**

IDEAS

FROM
SYLVANIA

How SUHL circuits improve avionics systems.

Computer family uses our ICs and functional arrays to obtain powerful, compact, airborne navigation package.

A small, lightweight, computer using Sylvania SUHL circuits has been selected for use in the navigation system of the new Lockheed TriStar passenger jet. The computer is a member of Micro-D family designed and developed by the Arma Division of Ambac Industries. Both computers in the family depend on SUHL logic for high-speed operation and design flexibility.

One of the computers, a serial type, is being used in inertial navigation systems, airborne loran receivers and cockpit displays for area navigation systems. The computer uses 342 Sylvania SUHL circuits of 10 different types. Arma selected SUHL TTL circuits for their design because they offered high noise immunity, excellent fan-out/fan-in capability and high reliability. On the latter point, Arma is assuring a MTBF of 10,000 hours on every computer.

The computer operates at 1.5 MHz clock speed, weighs 5.7 pounds and occupies less than 0.1 cubic foot of space. An optional high-speed clock provides a 50% increase in computation speed.

Packaging of the computer uses nine multilayer circuit boards that plug into a multilayer mother board. The memory stack and associated electronics occupy five of the nine boards, three boards are used for logic and control operations, and the last includes clock and timing circuitry. The rugged package can withstand 35 g's in all three axes. *(continued on next page)*

This issue in capsule

MSI Applications

Read-only memory features on-chip decoding.

IC Specifications

Where we stand on MIL-STD 883.

IC Applications

Interface family solves transmission-line noise problems.

LSI Developments

Uni-Cell LSI flies high in airborne computer.

Manager's Corner

Where will the next price break come in ICs?



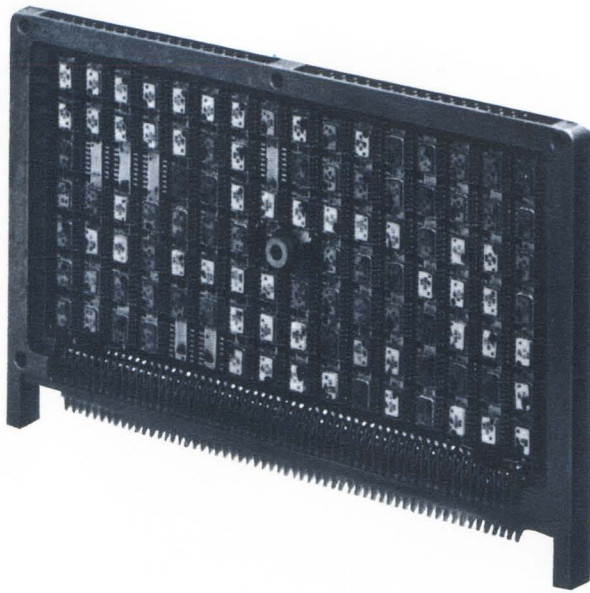

The second SUHL equipped Arma computer is an 18-bit word, parallel-organized system that weighs in at 9 pounds and takes up 0.2 cubic foot of space. This is the computer selected for use in the area navigation system of the new Lockheed L-1011 TriStar passenger jet. This computer uses 495 SUHL circuits of 9 different types, including a number of functional arrays. Again, Arma selected SUHL TTL circuits for their high noise immunity, fan-in/fan-out capability and high reliability.

According to Arma, the liberal use of Sylvania functional arrays provides an extra measure of flexibility in speed and architecture. The multiplicity of flip-flops and gates in the MSI packages permits compact packaging without compromising reliability and economy.

The central processor contains 13 registers for manipulation of instructions and data. Two 18-bit registers form a double-length accumulator to provide double precision computation. Three 15-bit registers are also available to insure efficiency of programming and memory conservation.

Like all of the SUHL TTL circuits used in these computers, both systems are available off-the-shelf.

CIRCLE NUMBER 300

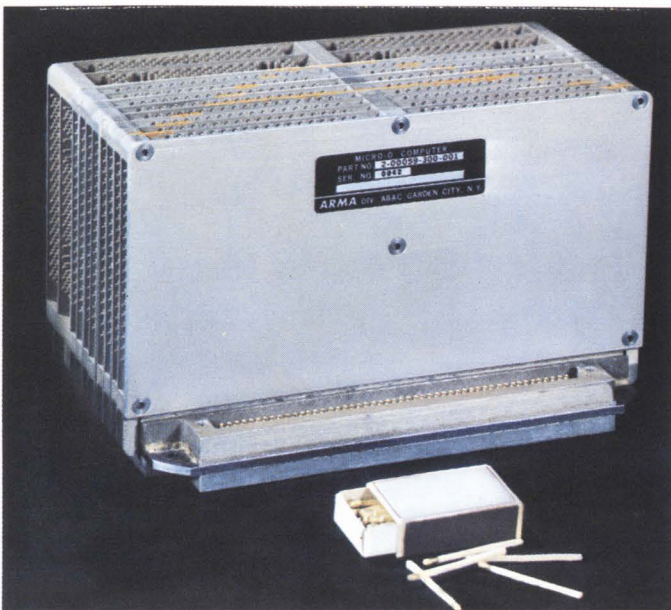

Read-only memory features on-chip decoding.

Single-chip 256-bit device has typical access time of 35 ns.

Sylvania's new SM-320 read-only memory has a 256-bit capacity arranged in 32-word x 8-bit format. All decoding is done directly on the chip. The outputs have free collectors, thus making it easy to parallel devices to expand system capacity. A 5-bit address code enables the selection of any one of 32 8-bit words stored in the memory.

The SM-320 read-only memory is shown in block diagram form in Fig. 1. The input address gates and chip enable gate are located in section A, the address decoder matrix (5 bits for 32 words) is located in section B, and the memory storage area (256 bits) is located in section C. Section D contains the output transistors which have open collectors to facilitate feeding data onto a common bus. Pull-up resistors can be added externally.

Operation of the memory can be seen from Fig. 2. Selection of any one of the 32 8-bit words stored in the memory is implemented by 32 5-input emitter selector transistors. Only one word may be selected at a time. The chip enable signal controls selection or inhibition of all words in the memory.

In a larger system using more than one device, the chip enable can be used to select individual units or groups of units. In this manner, for example, data in multiples of 8 bits can be sequenced onto a serial bus line. Decoding of appropriate units, as in character generation, can also be implemented in this manner.

The 5 emitters of each selector transistor accepts appropriate inputs from the address gates. In the unselected state, at least one emitter on all 32 decoding transistors will be at logic "0" due to the chip enable inhibiting that particular address bit. If, for example, the network Q_1, Q_2, Q_3 is considered, the emitter of Q_1 , which has a logic "0" presented to it, will allow current to flow through it to ground. This insures, through the V_{BE} drops of Q_1 and Q_2 , that Q_3 is turned off. Therefore, no current will flow in any of the 8 emitters of Q_3 . Thus, transistors Q_4 through Q_{11} will be turned off, causing a logic "1" condition to appear at the outputs. In the "selected" state all 5 emitters of Q_1 would go to a logic "1" condition by appropriate application of input signals and by the chip enable line enabling the address gates. This causes Q_3 to turn on, allowing current to flow in all 8 emitters. In turn, transistors Q_4 through Q_{11} turn on, setting all 8 outputs to the logic "0" state.

This condition would be true, however, only if all 8 emitters of the word selected are connected to their individual bit lines. If any emitter is not connected, no current will flow into the base of its corresponding output transistor. That transistor will not turn on and a logic "1" will appear at the output. Thus, to set up a logic "1" in any of the 8-bit positions in a word, the appropriate emitter connection must be broken or etched away. A logic "1" is obtained by breaking the connection between the emitter and the bit line, and a logic "0" is obtained by allowing the linkage to remain intact.

The SM-320 read-only memory has a typical access time of less than 35 ns and provides an output current of 10 mA at 450 mV. Input load current is typically 1.4 mA. The SM-320 comes in a 16-lead dual in-line package using ceramic or CerDip construction.

CIRCLE NUMBER 301

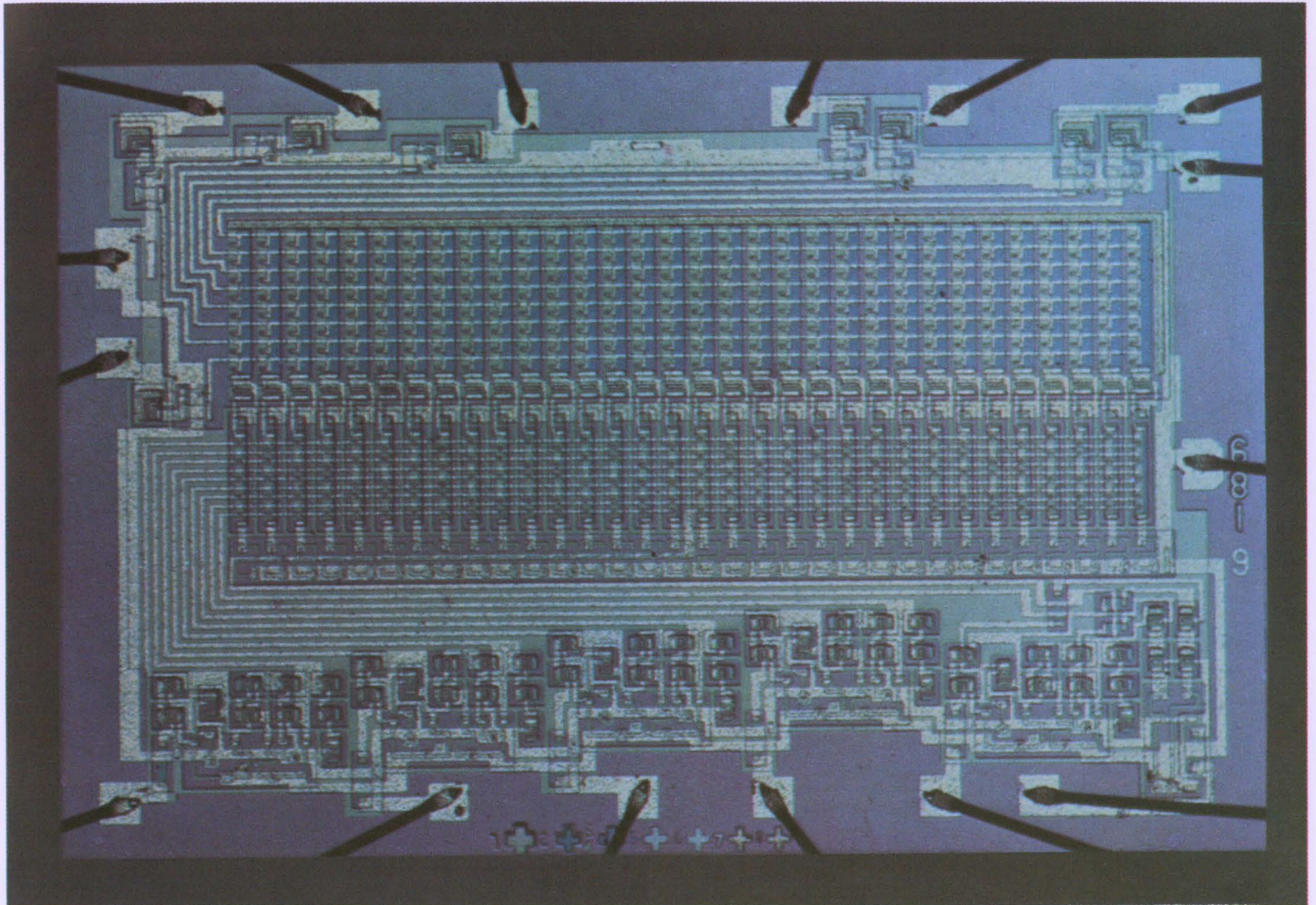

SM-320 read-only memory

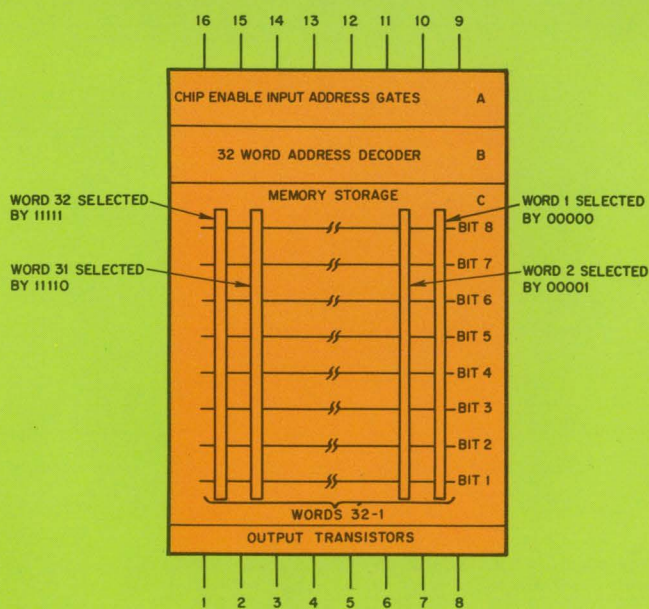

Fig. 1. Organization of SM-320 read-only memory in block form.

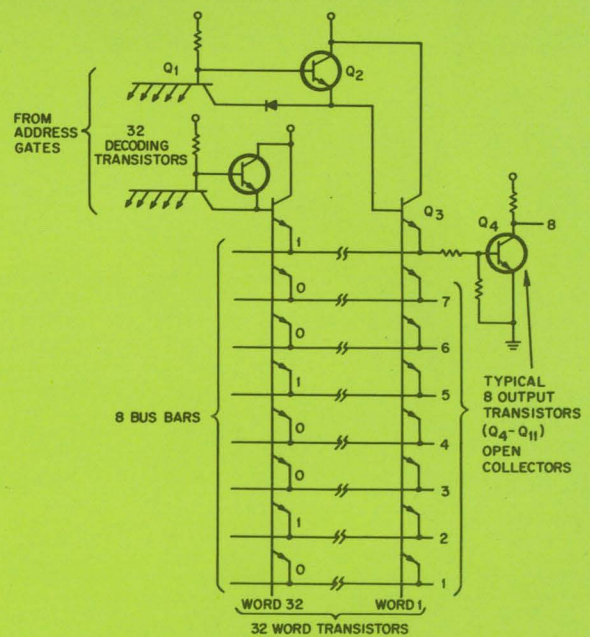

Fig. 2. Circuit configuration of SM-320 read-only memory.

Where we stand on MIL-STD-883

There has been a lot of confusion about MIL-STD-883. Here's a chart that will clarify Sylvania's position on this important document.

Like its predecessors, MIL-STD-883 contains a wide variety of options as to stress levels and methods of testing. The chart shown here gives Sylvania's standard reliability specifications for the three reliability levels called for in

MIL-STD-883. The five-digit numbers shown in many of the boxes refer to specific sections of Sylvania's standard reliability manual where full test procedures are detailed.

Of the three levels of reliability, option A is the most stringent and is designed for circuits to be used where repair is difficult or impossible and where high reliability is imperative. Option B circuits are intended for applications where repair is less difficult to perform but high reliability is still required.

The standard reliability level is actually the test procedures applied to all off-the-shelf Sylvania SUHL logic circuits. These circuits should be selected where repairs can readily be made but high reliability is desirable.

CIRCLE NUMBER 302

Table 1. General Reliability Specification

I. Production Screens	Option A	Reliability Level Option B	Standard Sample	Remarks
Pre-seal Visual Inspection	100% (91-928)	100% (91-917)	(91-910/91-913)	91928 identical to 883 Method 2010 Test Cond. A except for 1 level 75X mag.
Stabilization Bake	48 hours (91-176)	24 hours (91-176)	16 hours (91-176)	All 200°C
Temperature Cycle	20 Cycles (91-205)	10 Cycles (91-205)	5 Cycles (91-144)	All -65 to +200°C 10 cycles 91-205 meets 883 Method 1010 Cond. D
Constant Acceleration	30K 6's; Y1 and Y2 (91-194)	30K 6's; Y1 only (91-194)	None	Meets 883 Method 2001 Cond. E
Electrical Screen	DC, (Go/No-go at temp. extremes)	DC, (Go/No-go at temp. extremes)	Specified DC, & AC Go/No-go tests	Per test spec. sheet for appropriate type
Burn-in	RL to simulate 15 (RL—270 ohms) 168 Hrs., 125°C (91-929)	RL to simulate 7 (RL—470 ohms) 96 Hrs., 125°C (91-929)	None	Same as 888 Method 1015, Cond. D (flip-flops) or Cond. E (gates) except no. of gates not limited to 21 in Cond. E
Electrical Screen	DC, Go/No-go at temp. extremes; AC at 25°C	DC, Go/No-go at temp. extremes; AC at 25°C	None	Per test spec. sheet for appropriate type
Fine Leak Screen	5 x 10 ⁻⁸ cc/sec. (91-163)	5 x 10 ⁻⁸ cc/sec. (91-163)	None	Meets 883 Method 1014
Gross Leak Screen	(91-162)	(91-162)	(91-162)	Same as 883 Method 1014 except omit Step 1 & vacuum sequence

Table 2. Product Acceptance Tests

Inspection	Acceptance Criteria LTPD/a (max)*			Remarks
	Reliability Level			
	A	B	Std.	
Electrical Verification DC at 25°C AC at 25°C DC at High Temperature DC at Low Temperature	5 / 2 5 / 2 10 / 3 10 / 3	10 / 3 10 / 3 Not Required Not Required	10 / 3 10 / 3 Not Required Not Required	Conditions and limits on test spec sheet for appropriate type
Mechanical Verification	5 / 2 (91-908)	10 / 3 (91-908)	10 / 3 (91-908)	Meets 883 Method 2009
Fine & Gross Leak Verification	10 / 1 (91-911)	Process Control	Process Control	883 Method 1014 (See Table 1)

Table 3. Design Assurance Tests (for information only)

Test	Acceptance Criteria per Subgroup LTPD/a (max)*			Remarks
	Reliability Level			
	A	B	Std.	
88-200 Group B	10 / 3	10 / 3	10 / 3	Individual tests per appropriate methods in 883
88-200 Group C	10 / 3	10 / 3	10 / 3	

Table 4. Traceability

Reliability Level		
A	B	Std.
Lot travel card from pre-seal visual inspec.	Lot travel card from pre-seal visual inspec.	Date code

*LTPD = Lot tolerance percent defective
a (max) = Maximum acceptance number

Interface family solves transmission-line noise problems.

Line driver and two receivers are completely compatible with SUHL logic and other types of TTL.

Here is a family of circuits specifically designed for digital data transmission in high-noise environments. The family consists of a quad logic-level driver to transmit digital signals and two types of receivers. One receiver is a quad single-ended type and the other is a dual differential receiver.

When used together, these devices provide high system noise immunity due to an increased logic "1" level of the driver and increased thresholds of the receivers.

The two receivers feature diode decoupling of the inputs

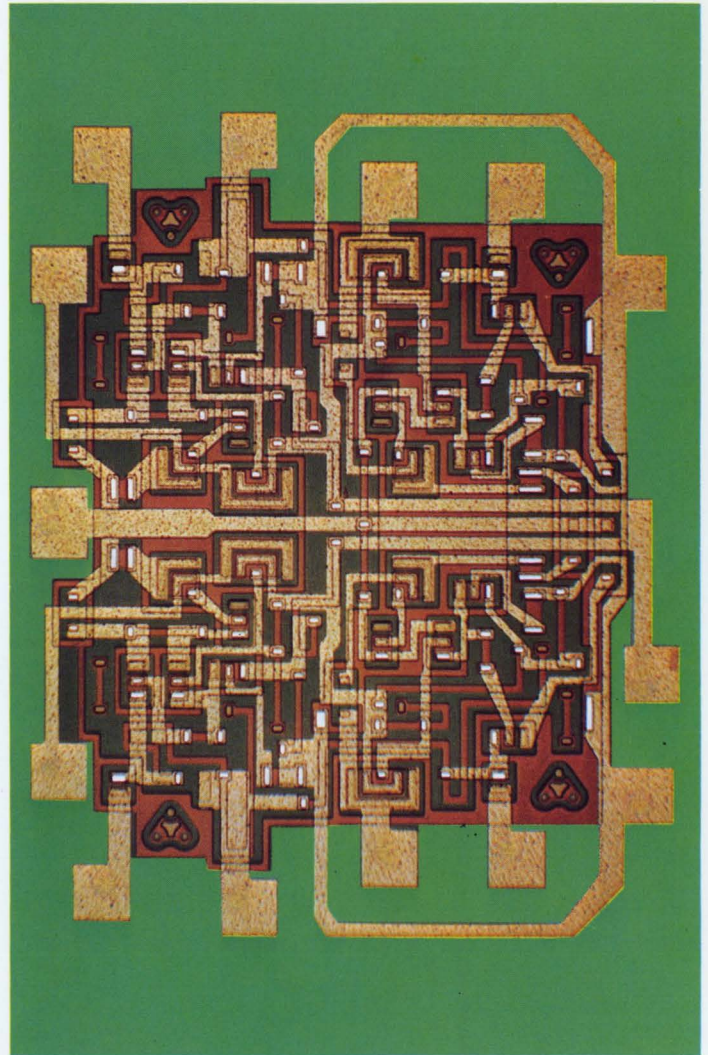

SS-342 series quad high-threshold logic receiver.

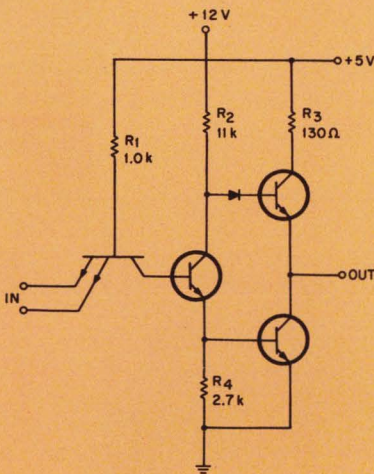

Fig. 1. Single transmitter unit of quad logic-level driver.

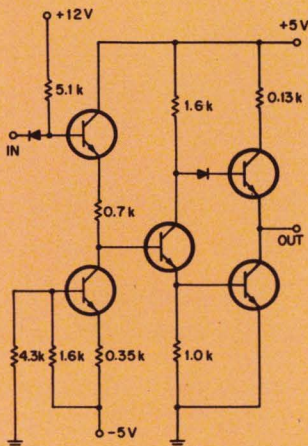

Fig. 2. Receiving element used in quad logic-level receiver.

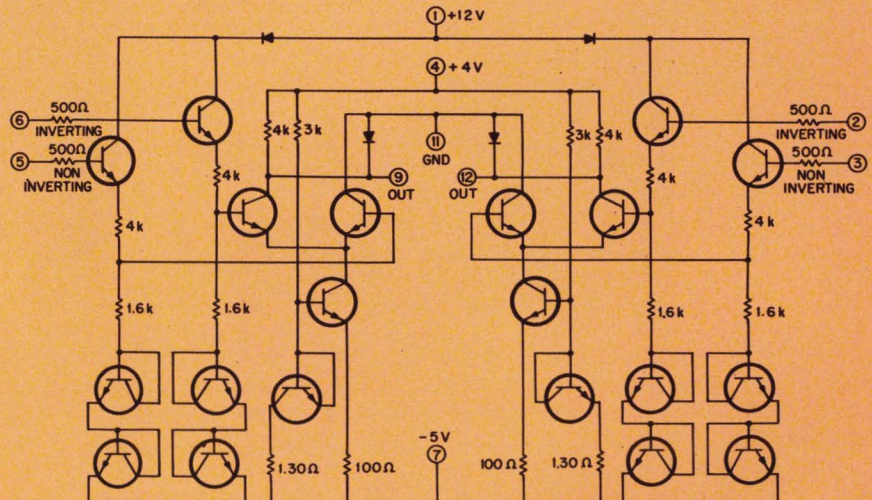

Fig. 3. Complete circuit of dual differential receiver.

to protect against power-down conditions. Thus, if driver power is turned on before receiver power, the devices will not be damaged by transmitted levels of up to +11 V referenced to receiver ground.

The SS-207/-208 logic-level driver, shown in Fig. 1, consists of four identical inverters integrated on one monolithic chip. The main advantage of this driver over a typical TTL integrated-circuit gate is that it has a high logic "1" level, allowing greater system noise immunity.

Each inverter is capable of driving six single-ended receivers or four differential receivers while maintaining a logic "1" level of 4.5 V. Input loading of each device is equivalent to four SUHL I gates and is typically 4.0 mA at logic "0" and 160 μ A maximum at the logic "1" level.

Although the input threshold of the logic-level drivers is approximately the same as SUHL I, the output logic "1" is about 1 V higher than TTL logic. This is achieved by two variations from conventional TTL circuitry. First, the base of the upper cascode is returned to +12 V through R_2 , resulting in a high static logic "1". Second, the ratio of collector-to-emitter resistor is about 5 to 1 virtually eliminating the "1" level sag observed in typical TTL logic.

The logic-level receiver package, SS-209/-210, contains four independent single-ended receivers. (Fig. 2) When used with SS-207/-208, logic-level driver, this design allows ± 1.5 V of noise rejection. Output circuitry of the receivers is similar to SUHL I circuitry and displays the same basic

characteristics. The input circuitry is a departure from TTL design that provides higher thresholds. Basically, the input threshold is established by a current source which is compensated to obtain a stable transfer characteristic over the temperature range. The receiver is designed to drive directly SUHL logic and other types of TTL.

The design of the SS-194/-206 dual differential receiver allows for large shifts in ground and V_{cc} levels between the line driver and receiver. The input of each of the two independent differential switches can swing from +11 to -5.25 V, referenced to receiver ground. The differential receiver is normally driven by two complementing logic signals. These could be derived from the Q, \bar{Q} outputs of a flip-flop, the input and output signals of a NAND gate or the input and output of a logic-level driver.

The output of the receiver will go to a logic level "1" when the non-inverting input voltage is at least 1.5 V more positive than the inverting input voltage, within specified input voltage limits. Conversely, a logic "0" will appear at the output when the inverting input is at least 1.5 V more positive than the non-inverting input voltage. Thus, the receiver responds to the difference between the two input signals rather than their absolute magnitudes. This is especially valuable in high-noise environments.

All three devices in our interface family come in 14-lead flat packs and are available in both commercial and military temperature ranges.

CIRCLE NUMBER 303

Uni-Cell LSI flies high in airborne computer.

Adaptive four-bit shift register replaces 28 standard ICs in compact lightweight system.

Sylvania's approach to LSI, Uni-Cell, got its first real test in Raytheon's new AS-80 airborne computer. And it came through with flying colors.

The compact computer uses a Sylvania-designed adaptive four-bit shift register. Using only three control lines, the register can shift right or left, count up or down, clear, hold, read-in paralleled data and complement.

Raytheon designed the AS-80 computer to make use of the latest state-of-the-art LSI and MSI circuits. The result is a small, high-speed fourth generation machine.

The unit is a high-speed 16-bit parallel processor incorporating a 32-word 100 ns scratchpad memory, programmed input-output channel and a convenient repertoire of 25 instructions. The unit weighs only 10 pounds and occupies 0.3 cu. ft. of space.

The four-bit shift register made for the Raytheon computer consists of 20 Uni-Cells—the equivalent of 80 logic gates. This LSI package replaces 28 discrete ICs and reduces external connections from 292 to 28. Inside the device, the reduction of wire bonds from 586 to 56 enhances system reliability. Other advantages gained over the use of discrete

ICs are a reduction in clock interval from 125 ns to 60 ns, a decrease in power from 1.4 W to 0.75 W, and a speed-power product lowered from 175 ns-W to 45 ns-W.

Sylvania's Uni-Cell design is a highly flexible approach to LSI. A typical uncommitted Uni-Cell wafer is shown in Fig. 1. Each basic Uni-Cell element contains the equivalent of four gate functions and a sufficient number of components to permit metallization of any one of eight different logic functions.

When you use the Uni-Cell approach, all you have to do is define the logic function you want, partition the system and deliver the functional logic diagrams to our semiconductor facility at Woburn, Mass. We'll take it from there.

Our engineers will convert your diagrams into Uni-Cell groups and determine the minimum array size. Then they will prepare the metallization patterns. The first layer of metallization interconnects the Uni-Cell components to define the lowest sub-logic to be performed. The second layer metallization (Fig. 2) defines cell interconnections in the horizontal direction. The third metallization layer (Fig. 3) defines the signal paths in the vertical direction and brings terminal points to bonding pads for connection to package leads. A typical Uni-Cell device mounted in a 28-lead package is shown in Fig. 4 ready for testing and capping.

If you think LSI is the way to go in your next project, show us your logic diagrams and we'll show you what Uni-Cell can do for you.

CIRCLE NUMBER 304

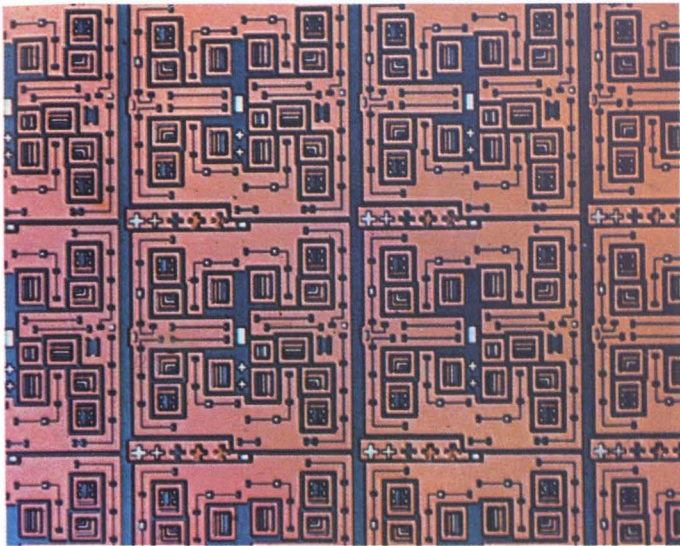

Fig. 1. Section of an uncommitted Uni-Cell wafer ready for metallization.

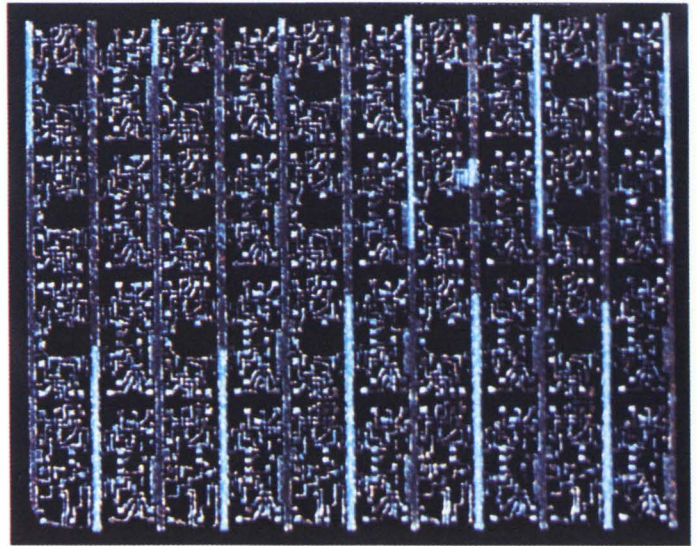

Fig. 2. Uni-Cell wafer with first and second metallization steps completed.

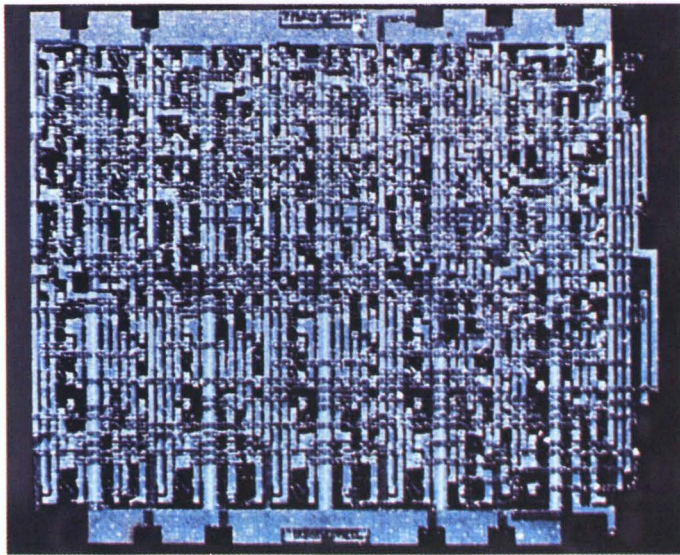

Fig. 3. Third metallization step brings connections out to bonding pads.

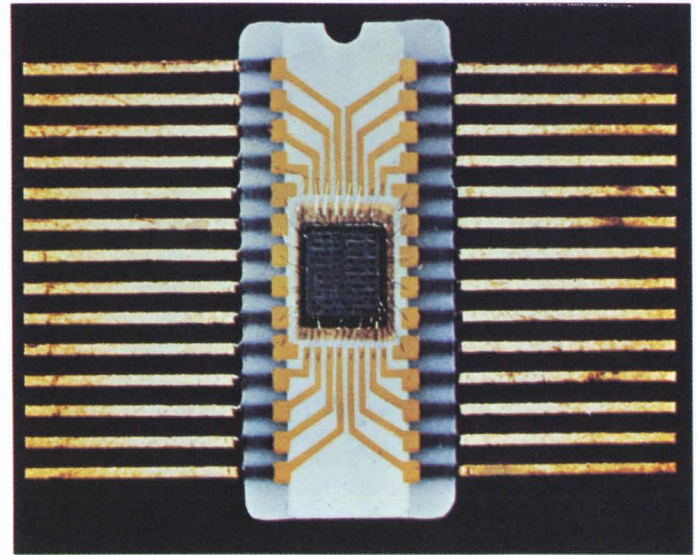

Fig. 4. Completed Uni-Cell circuit mounted in 28-lead package ready for testing and capping.



HOT LINE INQUIRY SERVICE

Need information in a hurry? Use Sylvania's "Hot Line" inquiry service. It's easy and it's free. Just circle the reader service number(s) you're most interested in. Then fill in your name, title, company and address. We'll do the rest and see that you get further information by return mail.

You can also get information by using the publication's inquiry card elsewhere in this issue. However, using the card shown here will simplify handling and save time.

SEE OUR SPECIFICATIONS IN
VSMF
 MICROFILM CATALOG FILE

FIRST CLASS
 Permit No. 2833
 Buffalo, N. Y.

BUSINESS REPLY MAIL
 No Postage Stamp Necessary if
 Mailed in the United States

POSTAGE WILL BE PAID BY
 Sylvania Electric Products Inc.
 Sylvania Electronic Components
 1100 Main Street
 Buffalo, New York 14209

Dept. E 2 2

Fold and seal with tape or glue. (Do not staple.)

Fold here

MANAGER'S CORNER

Where will the next price break come in ICs?

Higher yields and improved technology have been instrumental in knocking down the prices of integrated circuits to their present low levels. But, there is a limit as to what can be done in these areas to further improve the price picture.

One of the key cost factors remaining in the present state of the IC art is the cost of connecting the chip to the outside world.

In the vast majority of circuits produced today, thermo-compression or ultrasonic bonding techniques are used. Both of these methods involve high labor cost because of the skill required by the operator and the fact that each pad on the chip must be connected individually.

The fact that many manufacturers use overseas plants in low-cost labor areas indicated the importance of this step in the overall IC cost picture.

Obviously, the area of chip mounting and bonding is ripe for technological advances. And there are a number of these advances now in the development stage. Among these techniques are flip-chip, spider bonding and beamleading.

All three methods place some restriction on the layout of the chip and all three are only suitable for high-volume production.

Beamleading promises to be one of the most effective approaches to the problems of lower device cost and greater design flexibility.

Unlike flip-chip, beamlead devices are mounted face-up thus making testing easier. Beamleads also have a limited degree of flexibility that permits bonding to surfaces that are not perfectly flat.

Because of advanced masking techniques and the perfection of batch processing methods, it is easier to attain exacting precision with beamleads than with spider bonds.

Sylvania has been working on the beamlead process for over three years and has developed many special pieces of equipment for handling and mounting these devices. We see beamleading as a major answer to lower costs in automated high-volume production runs.



H. K. Ishler
Director, Integrated Circuit Engineering

This information in Sylvania ideas is furnished without assuming any obligations.

SYLVANIA

GENERAL TELEPHONE & ELECTRONICS

NEW CAPABILITIES IN: ELECTRONIC TUBES • SEMICONDUCTORS • MICROWAVE DEVICES • SPECIAL COMPONENTS • DISPLAY DEVICES

I am especially interested in ICs for following application(s) _____

NAME _____

TITLE _____

COMPANY _____

ADDRESS _____

CITY _____ STATE _____ ZIP _____

Circle Numbers Corresponding to Product Item

300

301

302

303

304

Please have a Sales Engineer contact me.

Visit Phone ... Phone No. _____ Area Code _____

Memory hops one step past mainframe

Semiconductor—to compete with big ferrite-core arrays—functions much like a drum but cuts waiting time dramatically

While semiconductor manufacturers churn out memory modules for scratch pads and high-speed buffers, they confidently predict—and some ferrite-core stack makers reluctantly agree—that semiconductors will be a major factor in computer mainframe memories in two or three years.

But one semiconductor house has taken a different route. Advanced Memory Systems Inc. of Sunnyvale, Calif., has neatly leapfrogged all the others to bring out a semiconductor mass memory, one step beyond the mainframe memory, in the area now occupied almost exclusively by large and slow ferrite-core arrays. Furthermore, the new unit, dubbed the semiconductor storage unit, or SSU, will sell for less than a cent a bit in large quantities, instead of the 3 to 5 cents for present-day mass core memories.

The SSU has an average access time of 131 microseconds, and a maximum access time of 525 μ sec, following which it produces or accepts data in sequential locations at the rate of 16 bytes every μ sec. This contrasts with a typical extended core memory, which has a uniform access time of about 4 μ sec and a cycle time of 8 μ sec for all data, whether in sequential or random locations; and with typical 1 μ sec or less for mainframe memories.

A lot in a hurry. Typical applications for the SSU are the same as those for extended core units—where large blocks or programs or data are needed quickly and often. For example, in a time-shared system, programs in active use are kept in the main memory; but whenever a user finishes with a major part of his program and requests another, or requires tem-

porary use of a subroutine or compiler, these large programs are interchanged rapidly with segments in the main memory. Disks and drums are sometimes used directly for such storage; but because these electromechanical devices have long intrinsic delays, they are more often used as a backup store for inactive programs—such as those of users who are not “on the air” at a particular time—while the active swapping or “sloshing” takes place between the main memory and a mass memory.

The SSU is based on a continuously operating shift register that rotates data from its output back to its input. The access time, required for the desired data to appear at the output, averages half the length of time to traverse the full length of the shift register. This access time is never more than half a millisecond, and is usually much less. Thus, functionally, the SSU looks much like a drum; but a drum's access time is much longer—sometimes 30 msec or more. Once the access time has elapsed, both the drum and the SSU can transfer data rapidly until the capacity of the track or of one shift register is exhausted.

MOS circuits. Each shift register in the SSU is a dynamic metal oxide semiconductor circuit driven by a 1-megahertz clock. Each register contains 1,024 bits continuously cycling through it at the 1-Mhz rate; 128 registers operate in parallel to provide 128 bits, or 16 eight-bit bytes, at the output every μ sec. In the smallest SSU model, with a capacity of about two million bytes, there are more than 16,000 of these 1,024-bit shift registers all chugging along together.

But they're not necessarily all in step—and therein lies one of the

great advantages this unit has over an electromechanical magnetic drum. Any 128-register clock can operate at either of two frequencies, and can change from speed to speed almost instantly. No magnetic drum can do this; the drum always works at constant speed.

But the operating frequency of a dynamic MOS shift register need only be sufficient to restore the charge on the leaky capacitances that store the data in such a register; any frequency higher than this minimum, up to a point, works just as well as the minimum. So the 1-Mhz rate is only for the convenience of the user; the registers can loaf along at as little as 10 kilohertz and still keep the data valid and conserve power.

Staying in shape. Thus, those 16,000 shift registers merely jog along at 10 khz until a request to read or store data is received. Then a block of 128 out of the 16,000 suddenly begins sprinting at 1 Mhz—100 times the jogging speed—until the desired location appears at the shift register outputs. After transferring the first group of 16 bytes, the shift registers return to the jogging rate—that is, they effectively stop and wait for the next data transfer time. If the computer is fast enough, the sprinting continues until the operation is complete. But few computers can match the maximum 16-bytes-per μ sec rate of the SSU, so the registers usually revert immediately to the jogging rate, to await the next group of bytes. It's unlikely that they'll have to take more than one jogging step, because few computers are so slow that the next data location will pass them by at the 10-khz rate.

The SSU comes with a controller that is tailor-made to match the

U.S. Reports

storage unit with the computer—be it an IBM System 360, Univac 1108, Control Data 6600, or what have you. Two million, four million or eight million bytes come with the controller; up to eight million more can be connected externally to the controller, and up to eight controllers—128 million bytes—can be connected together on one channel. No commercially available system today can handle 16 bytes at a time; one of the controller's functions is to match the computer's channel speed to that of the SSU. But if anybody invents a computer that can inhale 16 bytes at a time without strangling, the SSU is ready for it.

A disadvantage of the SSU not suffered by conventional extended core units or magnetic drums is that its contents must be dumped onto some other memory medium—core or drum, for example—before power is shut down. This could be a real nuisance in installations where everybody goes home every night, or over the weekend. But, installations big enough to justify using a mass memory are usually on the air 24 hours a day, seven days a week, so that the dump would have to occur only for maintenance or in an emergency situation.

Space electronics

Finding a place

Crowding of the frequency spectrum isn't exclusively a terrestrial problem. It's a growing concern in space communications, with potential users struggling to get frequencies assigned in existing bands up to 12 gigahertz. So NASA is going to two regions that aren't fully allocated—20 Ghz and 30 Ghz—for an advanced millimeter-wave communications experiment that will be part of the mission of the ATS-F satellite scheduled to be launched in 1973.

The Hughes Aircraft Co.'s Space System division will build the 85-pound millimeter-wave experiment package, which includes four transmitters, two operating at 20 Ghz

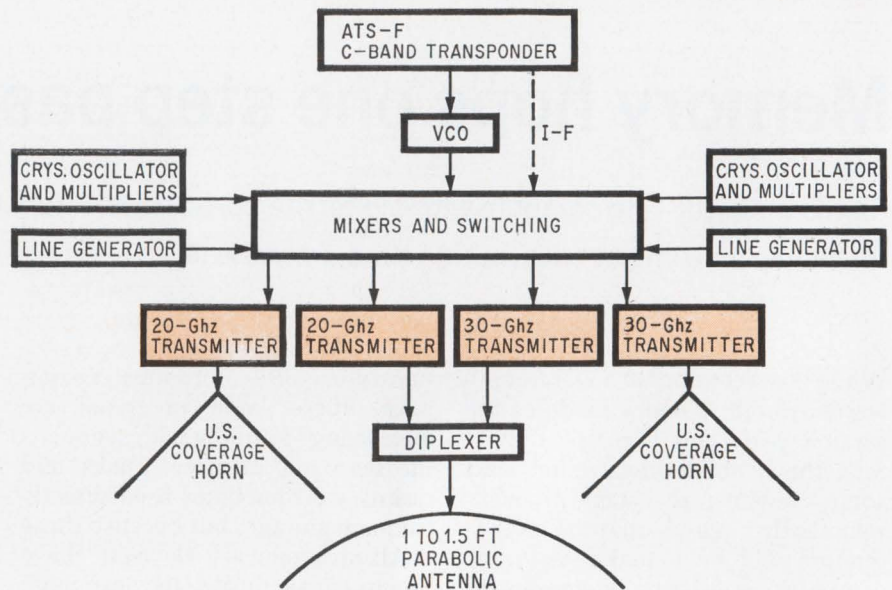

Flying high. The millimeter-wave communications experiment for ATS-F is more sophisticated than the one aboard the currently orbiting ATS. Hughes package includes a high-gain parabolic dish to beam wideband signals back to earth after giving transmission area propagation profile. Redundant multiplier chains, line generators, and transmitters will be included at the two frequencies.

and two at 30 Ghz. NASA's Goddard Spaceflight Center has awarded Hughes the contract, worth \$2.83 million, which is intended to develop a model of the reflection characteristics of the atmosphere at these two frequencies in various kinds of weather. NASA is particularly interested in finding out how badly heavy rainfall attenuates signals at these frequencies.

More to come. The experiment will be more ambitious than a similar one aboard ATS-5 (known as ATS-E before orbit). That satellite has been returning some useful millimeter-wave communications data even though it went into an undesirable spin after launch last fall. However, the ground receiver can only lock onto the signal for about 40 milliseconds during a 780-msec revolution of the antenna. So a good deal of data is being lost. In addition, when that experiment was designed by Martin-Orlando for a space-to-ground (or down-link) frequency of 15.3 Ghz, spaceborne solid state circuit technology wasn't able to deliver enough power at higher frequencies. To cope with this problem a ground-to-space link (or uplink) at 31.65 Ghz was used from NASA's facility

at Rosman, N.C., to measure propagation characteristics at that frequency, using a 1-kilowatt ground transmitter.

However, use of the uplink, in addition to tying up the ground transmitter, dictates data analysis aboard the satellite. This analysis won't be necessary with the Hughes experiment on ATS-F. On the preceding ATS, the experiment provided for a minimum of 200 milliwatts that could be beamed from the satellite on the 15.3-Ghz down-link because of the desire to stick with solid state circuitry. Ben V. Thompson, project manager for the millimeter-wave experiment at Hughes, says the components, including waveguides and antennas, can be made small and light enough to provide good gains at these shorter wavelengths. By going to 20 Ghz (15 millimeters) and 30 Ghz (10 mm).

Thompson is going to be teamed with Louis Ippolito, the principal investigator for this experiment at Goddard. Thompson says the Hughes system will operate in three modes. In the continuous-wave mode, the output will be 2 watts from traveling wave tubes that serve as the final stage in the transmitters, feeding two kinds of

antennas. One will be a high-gain (38 to 40 decibels) parabolic dish that will be 1 foot to 1.5 feet in diameter. One of the 20-Ghz transmitters and one of the 30-Ghz units will feed this antenna.

Countrywide. Another of the 20-Ghz transmitters will feed a horn antenna covering the U.S., with a gain of 27.5 db, and the other 30-Ghz transmitter will feed the same kind of horn. In the continuous mode, two unmodulated crystal-controlled carriers can be sent, one at each frequency, to obtain propagation measurements. There's a water-vapor absorption band between 20 and 30 Ghz, but there are windows at each end of that range.

In the modulated (or multitone) mode, as Hughes calls it, the horns will become a nine-line spectrum of signals spaced 187.5 megahertz from each other across 1.5-Ghz bands centered at 20 Ghz and 30 Ghz. The power output at each of these sidebands will be 60 milliwatts. "They're far enough apart," Thompson says, "so that the ground equipment [Rosman again will be the prime site] will be able to pick them out and measure fading at selected frequencies."

The propagation characteristics will be correlated with observed and measured weather conditions along the satellite's path (90° to 100° west longitude). Finally, after the synchronous-orbiting satellite has been up long enough to get baseline information on propagation characteristics through the atmosphere, especially in heavy rainfall, comes the proof of the pudding. This calls for the third mode and will include the actual beaming of wideband communications (40-Mhz bandwidth) at 20 Ghz and 30 Ghz using the high-gain dish antenna putting out 2 watts. This is a bonus not included in the ATS-5 millimeter-wave experiment.

Gamut. In the communications mode using the high-gain antenna, such signals as video, wideband data, "and other representative signals that might be used in a wideband communications link might be used," Thompson says. The wideband communications signal will be sent to the satellite probably on a C-band (4 to 8 Ghz) uplink to

be used with ATS-F. On the return trip, two routes are open. It could be sent either at baseband from the C-band transponder through a voltage-controlled oscillator, or at an intermediate frequency, then put through the mixer and switching circuitry.

Thompson expects that all the data the ATS-F millimeter-wave experiment should generate, especially wideband data, will aid a systems designer who wants to design a satellite communications link. He should be able to do so anticipating the amount of reflection and scattering caused by heavy rain at these frequencies.

All of the circuitry is solid state, up to the traveling-wave tubes, which are being built by the Hughes Electron Dynamics division. Thompson says a space-qualified 2-watt twt at these frequencies is something new. A crystal-controlled oscillator is the initial source of energy, and its 5-Mhz output is multiplied up through several stages of a multiplier chain to 10 Ghz. The Schottky-barrier diodes are used as two times and three times multipliers to get on to 20 and 30 Ghz.

Memories

Gate code

When Electronic Arrays Inc. announced its 4,096-bit read-only memory last month, the chip's small dimensions—94 by 88 mils—were characterized as good design practice, which usually indicates efficient arrangement of devices on the chip. But with Electronic Arrays, it also means an unusual method of encoding information in the memory.

In most metal oxide semiconductor read-only memories, the gate regions of the transistors lie between a grid of p-channel lines (or columns) and metal lines (or rows). The oxide over each gate region is thinned even if it is not going to hold a bit of information. Coding is done by depositing metal—which contacts the metal rows—over the thinned gate region; thus,

when the device is addressed, it turns on, representing a 1. The gate metal and the metal rows are defined at the same time. Devices which are to remain off have no metal over their gate regions.

According to Michael McCoy, manager of advanced product development at Electronic Arrays, this process requires lots of chip area because space is needed for the gate metal, and to reduce the surface charge. "Since all of the devices have a thin gate region," McCoy says, "they may inadvertently be turned on—even if they do not have metal over their gates—if adjacent devices are on." This is due to surface-charge buildup and can be eliminated by spacing the transistors farther apart.

Skinny digit. Electronic Arrays' approach is to put the gate regions under the metal rows, and to code the memory by thinning the gate oxide only on the devices that are

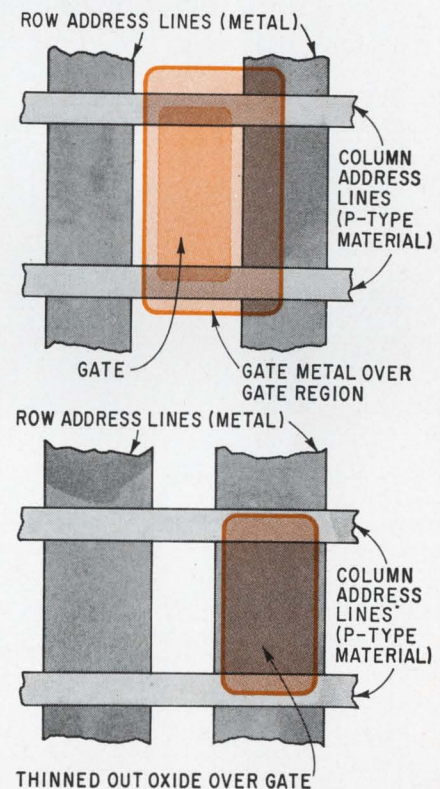

Slim. Denser, smaller chips are made (bottom) by thinning oxide only over devices where 1 is to be stored. Metal connection between gate area, row isn't needed. Usual method (top) thins oxide over all transistors, stores 1 by depositing metal over device.

to represent a 1. Because the oxide is thick over the 0 or off devices, they are immune to the surface-charge problem and thus remain off. And because the space between the rows and columns isn't needed for the gate area, the rows and columns can be closer together, resulting in a smaller chip.

McCoy says, "We don't fight the area battle just to fight something. It's because we can pack in more bits, and our yields are higher with the smaller chips." This is also in line with Electronic Arrays' philosophy of sticking to only one process—high-threshold MOS. "Others," according to McCoy, "say that high-threshold MOS is

dead, but we think that there is a lot more we can do with it, and this is one example."

The EA3300 is now being sampled in the form of an ASCII to EBCDIC, and an EBCDIC to ASCII converter—both on the same chip. According to Earl Gregory, vice president of marketing at Electronic Arrays, this converter is available elsewhere in one form or the other—two packages are needed to go both ways. Gregory says that in addition to the demand for the converter, "it demonstrates that we really can produce the device." He adds that the 3300 is the most complex chip available. In volume production, Gregory expects to sell

the memory for less than a penny a bit, and volume production will begin soon.

Medical electronics

Sound of a hole

Can sound waves detect unsound teeth? Dr. Sidney Lees, head of the bioengineering department of Boston's Forsyth Dental Center, thinks so, and is using ultrasonics to study tooth decay. "By finding out what happens during decay we may speed up the procedure for evaluating dental treatments," says Lees. Also, his study may lead to a more precise definition of a cavity. "Right now it's difficult to get two dentists to agree on what a cavity is," he says. "Opinions are subjective."

Ultrasonic reflections from healthy and demineralized tooth enamel—enamel about to decay—differ, and Lees wants to find out why. Healthy enamel consists of calcium crystals surrounded by a layer of organic matter, which can replace minerals if they are lost. Without this network, demineralization eventually becomes decay. But the earliest stages of decay may be reversible if detected in time, since the enamel is in chemical equilibrium with the so-called oral environment.

Rod. Lees' ultrasonic system uses a piezoelectric transducer of lead zirconate titanate. In experiments, a sonic pulse at 7.5 to 15 megahertz originates in the transducer and is sent through an aluminum rod to a layer of tooth enamel mounted on it. Lees hopes to work on living teeth in the future.

The pulse is reflected by the enamel and reenters the rod, and returns to the transducer, generating an electrical signal corresponding to the echo. This output is displayed on an oscilloscope and the wave shapes photographed.

The high-energy pulses formerly used to study teeth have been at frequencies over 30 megahertz, and were hard to achieve efficiently. And since the long-term effects of frequency and wave shape on teeth are unknown, Lees prefers pulses

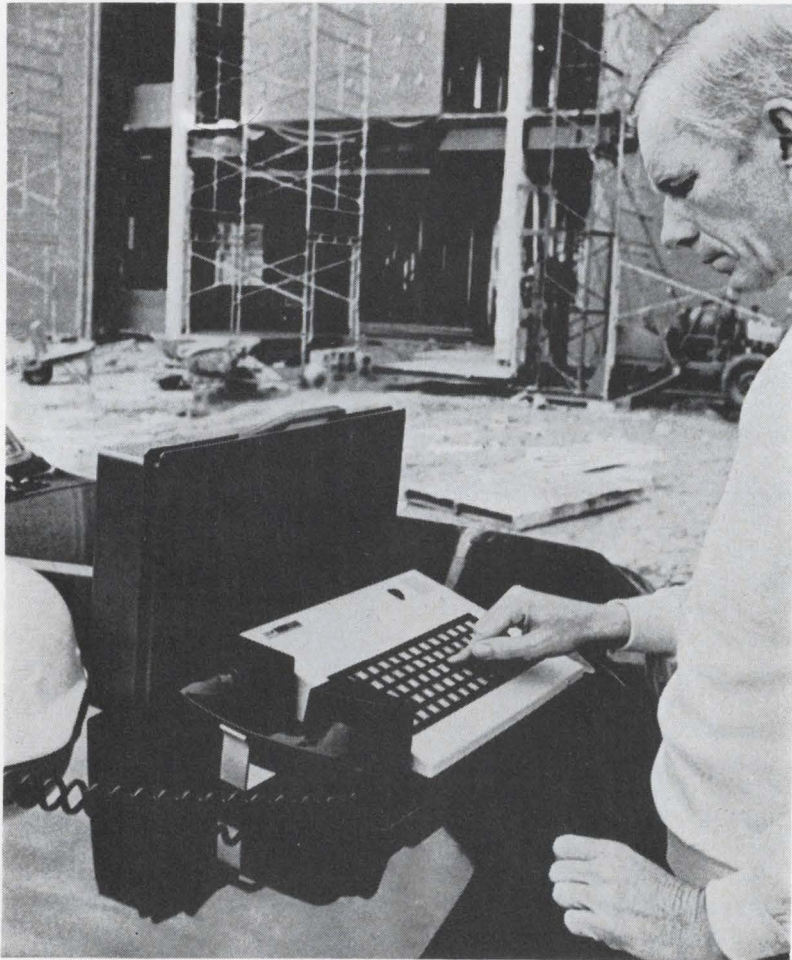

Small talk. IBM is offering this portable audio computer terminal that rents for \$20 a month. Compatible with IBM's System 360 and labeled the 2721, it will accept alphanumeric data and can be used with any standard phone line. The keyboard—60 flat, pressure-sensitive keys—can be customized simply by slipping a plastic matrix atop the standard arrangement. And the 2721 fits into an attache case.

You can't get this kind of performance

(from any other Op Amp)

RA-2600 **for \$17.85***

Input Bias Current = 2nA

Input Impedance = 200 M Ω

Voltage Gain = 200,000 V/V

Slew Rate = ± 7 V/ μ s ($A_v=1$)

Input Offset Voltage = 2mV

Fully Compensated

Short Circuit Protected

* 100 unit price

RA-2520 **for \$27.25***

Slew Rate = ± 120 V/ μ s ($A_v=2$)

Input Offset Voltage = 4mV

Voltage Gain = 15,000 V/V

Large Signal Bandwidth = 2000 kHz

Input Impedance = 100 M Ω

Our RA-2510 has a slew rate of ± 60 V/ μ s and our RA-2500 has a slew rate of ± 30 V/ μ s with similar characteristics and equally low prices.

We're calling our linear line the no-compromise op amps because you don't have to compromise your design to stay within budget. In fact, with performance characteristics such as we offer, your design job is easier, and you end up with a more reliable circuit, too.

Get off-the-shelf delivery of these monolithic op amps that exceed hybrid performance. We build them to full military temperature range and to comply with MIL-STD-883. (If you don't need military temperature range, our commercial version, 0°C to +75°C, devices are available at even greater savings.)

Ask your nearest Radiation sales engineer about our no-compromise linear line. He'll help you *pick the best IC for the job.*

Lexington, Massachusetts (617) 862-1055
Norwalk, Connecticut (203) 853-3646
Frederick, Maryland (301) 862-5400
Oaklawn, Illinois (312) 423-6010
Dallas, Texas (214) 231-9031
Albuquerque, New Mexico (505) 268-3549
Palo Alto, California (415) 321-2280
Long Beach, California (213) 426-7687
P. O. Box 37, Melbourne, Florida 32901 (305) 727-5430

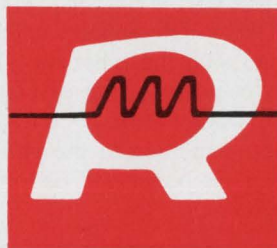

RADIATION
INCORPORATED

SUBSIDIARY OF HARRIS INTERTYPE CORPORATION
MICROELECTRONICS DIVISION

using less energy and lower frequencies.

The enamel layer on the rod will be immersed in a weak acid, which demineralizes it, so the wave shape before and after demineralization can be compared. "We can see a change in pulse shape due to the acid," says Lees, "but we want to find out why it changes. Nobody has had a dynamic situation where you can see what actually happens as the surface is etched away." Therefore, Lees also plans to bounce sound waves off the enamel while it is in the acid, simulating the environment in the mouth.

Making changes. Reflections from the enamel might be changed in several ways. "When a tooth is etched with acid, the nature of the reflecting surface changes," says Lees, "which means that the wave shape and amplitude of the pulse change. And if the transducer is rotated in relation to the enamel, the wave shape changes according to the molecular configuration, and

this enables you to see the nature of calcium formations at the tooth's surface."

By finding out what happens to enamel it will be possible to see how and why fluoride treatments work, and determine the effects of foods and food additives. "If we could add the right things to food," Lees says, "we could prevent cavities."

The measurement system is intended as a laboratory tool for now, and not for the dentist's office. Lees thinks that if more funds for development were available, ultrasonic instruments could be sold to dentists within 2 or 3 years. But little money is available for dental research. He feels fortunate to have received \$247,435 from the John H. Hartford Foundation in New York.

Lees says that it will take two years to develop his system and another three or so before it is accepted by the dental profession. The total system cost may be between \$50,000 and \$100,000. Lees

finds the general lack of financial support frustrating, since he says, "a pay-off is imminent; we have ideas on how to look into teeth and we know what to do."

Commercial electronics

Bye-bye bucket

Sensor makers will find a growing market at the Interior Department as the Federal Water Pollution Control Administration (FWPCA) moves toward use of more electronic sensors—replacing "glorified bucket" samplers and wet chemistry sensors—in its water-quality monitoring network. The funding request for FWPCA's pollution control operations and research budget, a large part of which is spent on pollution surveillance and aid to state and local agencies, is up to \$98 million in fiscal 1971 from \$86 million in fiscal 1970.

The network, with monitoring stations in all major streams and rivers across the country, will be similar to the air-quality monitoring system set up by the Department of Health, Education, and Welfare's National Air Pollution Control Administration [*Electronics*, Dec. 8, 1969, p. 137] when completed. The network is a Federal-state effort, with greatest funding coming from the states. The tentative target date for completion of the water-monitoring program is 1974.

Subdivisions. The FWPCA has divided the country into nine regions, each to set up a monitoring system with a central data bank. The Federal Government hopes to build some 2,400 monitoring stations also feeding water-quality information into the network, says William Sayers, chief of the Water Quality Surveillance Systems of the FWPCA. Currently, the Government operates about 700 stations, such as those on rivers and streams which are on state lines and in coastal waters. Federal stations operate, for example, on the Potomac, Missouri, and Mississippi Rivers, and in the Great Lakes. The states are required to set up their own sta-

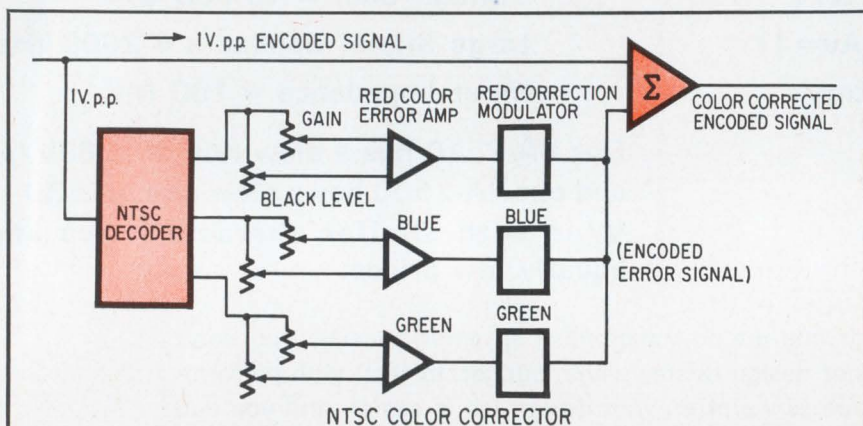

Shade of meaning. CBS Laboratories has developed a device designed to correct color variations in tv programs after they have been encoded and before transmittal to viewers. Differences caused by use of different cameras, changes in lighting, and mixing of video tape and film would be balanced out by adjusting each of the three primary colors—red, blue, and green—rather than by adjusting one at the expense of the other two. The Color Corrector, as it's called, has five controls: for highlighting, lowlighting, red and blue midrange, amount of color, and intensity of all colors without affecting white balance. The encoded signal is divided into two parts, 1 volt peak-to-peak. One part is decoded. A correction vector is added to each color signal in a differential amplifier. Each signal is then remodulated and combined with the other two. The encoded error signal is fed into a summing circuit—a grounded base amplifier—as is the original encoded signal, where error is canceled. Corrections can be fed into a small computer, and then to the unit to correct programing color variations. The Color Corrector will be available to the tv industry in April for under \$3,000.

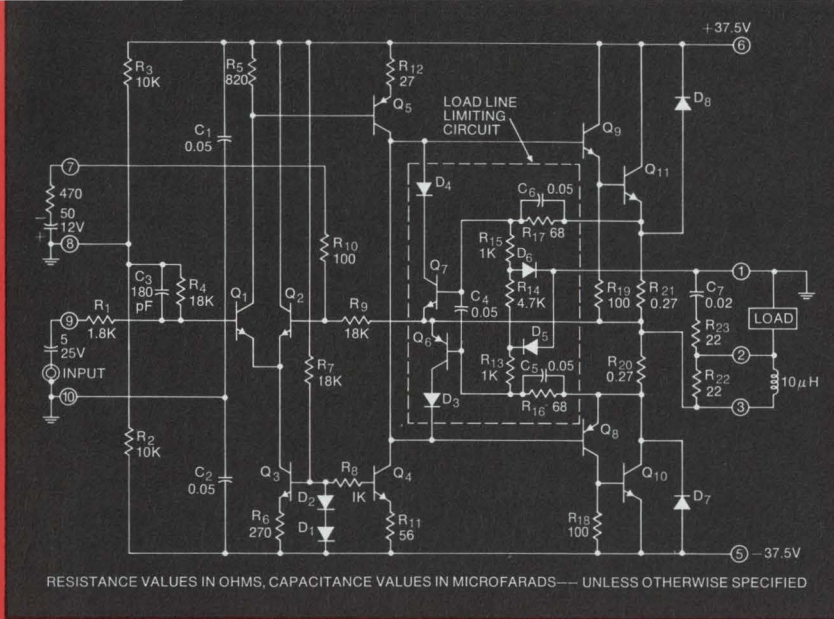

Schematic diagram of unencapsulated TA7625

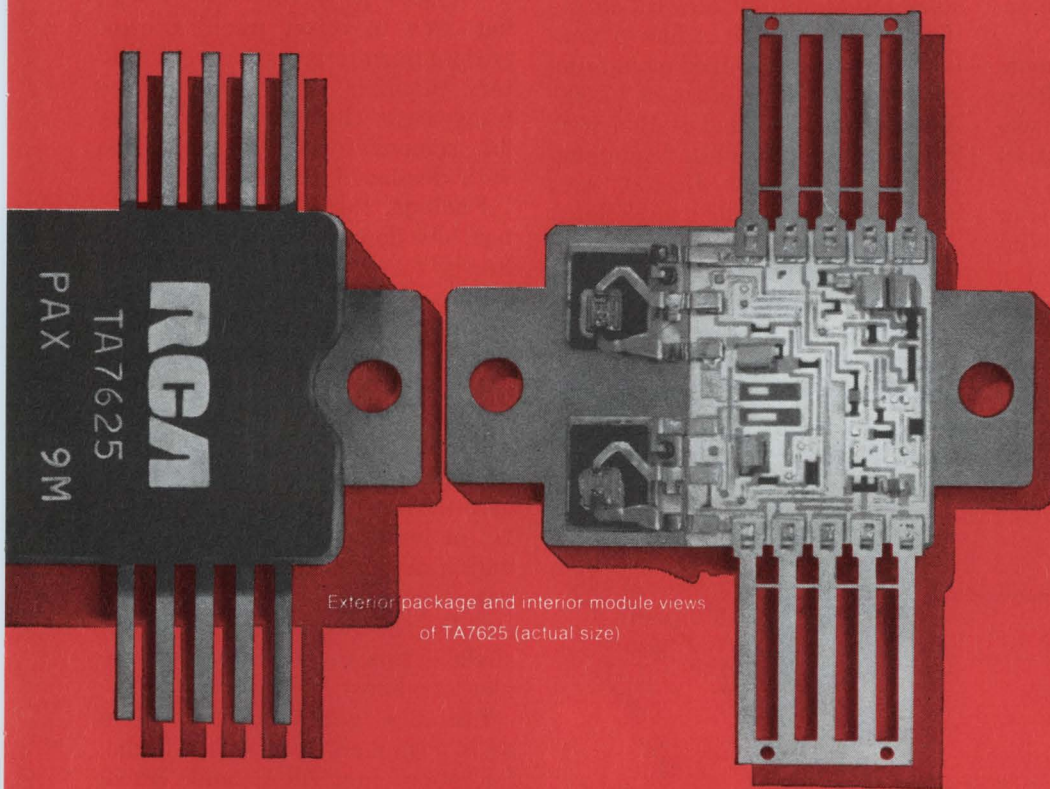

Exterior package and interior module views of TA7625 (actual size)

New—from the industry leader in Solid-State Power:

TA7625 Hybrid Power Circuit

From the latest advances in power hybrid technology, RCA introduces the TA7625 7A linear amplifier—a complete, all-silicon power module for industrial, military and commercial applications.

The solid-state TA7625 is ruggedly packaged...so small it fits in the palm of your hand. It will offer you new opportunities in design—new economies in systems production. As for design features:

- 7 amperes of peak load current capability
- single or split power supply (30-75 volts)
- load line limiting
- > 60 dB power gain
- provision for external feedback control

The RCA developmental TA7625 is now available for your engineering evaluation. Its potential uses are numerous and challenging:

- servo-motor driver (AC, DC, or pulse-width modulated)
- positive and negative output power supply
- self-excited and driver inverter
- linear amplifier
- power Op Amp
- bridge amplifier
- audio power amplifier

For more information on RCA Hybrid Power Circuits, see your local RCA Representative. For technical data, write RCA Electronic Components, Commercial Engineering, Section I-N-2/UC1, Harrison, N. J. 07029. In Europe: RCA International Marketing S.A., 2-4 rue du Lièvre, 1227 Geneva, Switzerland.

RCA

U.S. Reports

tions on estuaries flowing through a state.

About 350 of the current stations are equipped with electronic sensors, but there is an increasing need for electronics in the system. The need increases directly with the need to monitor water quality at shorter intervals of time—or with the inevitable increase in pollution potential from more power plants.

The tradeoff is in cost. If a government has to send a man on a boat with his glorified bucket to sample water more than two or three times a day, increasing also the required number of laboratory personnel to analyze the water sample, it becomes more economical to use electronic sensors and telemetering equipment, says Sayers.

Water quality sensors at remote sites, housed in protective shelters, consist of a flow chamber for water intake, an analyzer, and output phase.

A to d. To measure the pH factor in water, the sensor package consists of a glass electrode and a silver-silver chloride reference electrode plus an automatic temperature compensator, active analyzer, and panel meter. The measured analog signal of unfiltered river water, for example, is converted to a

digital signal and transmitted via phone lines or radioed to a central data unit.

The FWPCA is using IBM 1130's in its nine regional centers, with the larger IBM 360/65 at Washington processing data from all nine regions. Water quality data travels at extremely slow rates. In the Ohio Basin, for example, water quality data from the Great Miami and Little Miami Rivers travels at only about 40 bits per second to the central data unit in Cincinnati.

Each monitoring station measures eight pollution factors: acidity, temperature, dissolved oxygen, conductivity, chlorides, turbidity, oxidation reduction potential, and solar radiation that directly affects the activity of algae. A four-parameter electronic-equipped monitoring station costs an average of \$7,000. A more sophisticated station with telemetry equipment and pumping intake would cost \$15,000, says Sayers. Major suppliers are Schneider Instruments in Cincinnati, Automated Environmental Systems Instruments, and Fairchild.

The FWPCA and the states would welcome development of a cheaper monitor—buoy-type, battery-operated, or, better yet, one which would float, says Sayers.



Wet regions. Of these nine water quality regions, the Ohio Basin, Middle Atlantic, and Pacific Northwest (including Alaska) have submitted plans to the FWPCA for a five-year program to complete the monitoring system. Data banks will be set up in each of the cities shown, transmitting water quality data to Washington. The FWPCA hopes to have its national water quality net fully operational by 1974.

Displays

Straight faced

There's a good reason for the scarcity of cathode-ray tubes with flat faces—the electron beam that excites a display tube's phosphor must play over a spherical surface lest pictures, alphanumeric, and graphics be distorted. On a flat face, a square comes out looking like a pillow or pincushion; hence the name, pincushion distortion.

But the interest in flat-faced crt's is growing. Phototypesetters need a flat face from which to transfer copy without losing resolution; computer engineers would like to combine data entry tablets with flat crt's to offset parallax error or data misinterpretation; and military planners would like to lay transparent charts or graphs over flat screens for easy comparison with displayed data.

Footage. But pincushion distortion has slowed these applications. For a faceplate to be large, the electron beam deflection has to be narrow, say less than 50°, necessitating a very long tube. And for many uses, 2 or 3 feet of cathode-ray tube is simply 1 or 2 feet too much.

Intronics Inc. of Newton, Mass., may have enlarged the small market in wide-angle, flat-faced tubes with a new circuit which, the company says, can compensate for pincushion distortion even in very shallow tubes with deflection angles of almost 140°.

Intronics got interested when such customers as Collins Radio, Radiation Inc., RCA, and Brush Instrument said they wanted large-area, flat-faced crt's. They added that, while the tubes could be custom-built, pincushion distortion was a problem.

Much of the problem is caused by the old method of correcting for pincushion distortion. Some flat displays used cumbersome magnetic field coils or plates to twist the electron beam back into position. A more common approach is to use analog circuitry to distort the deflection signal so that the physical and electronic distortions cancel and pincushion disappears;

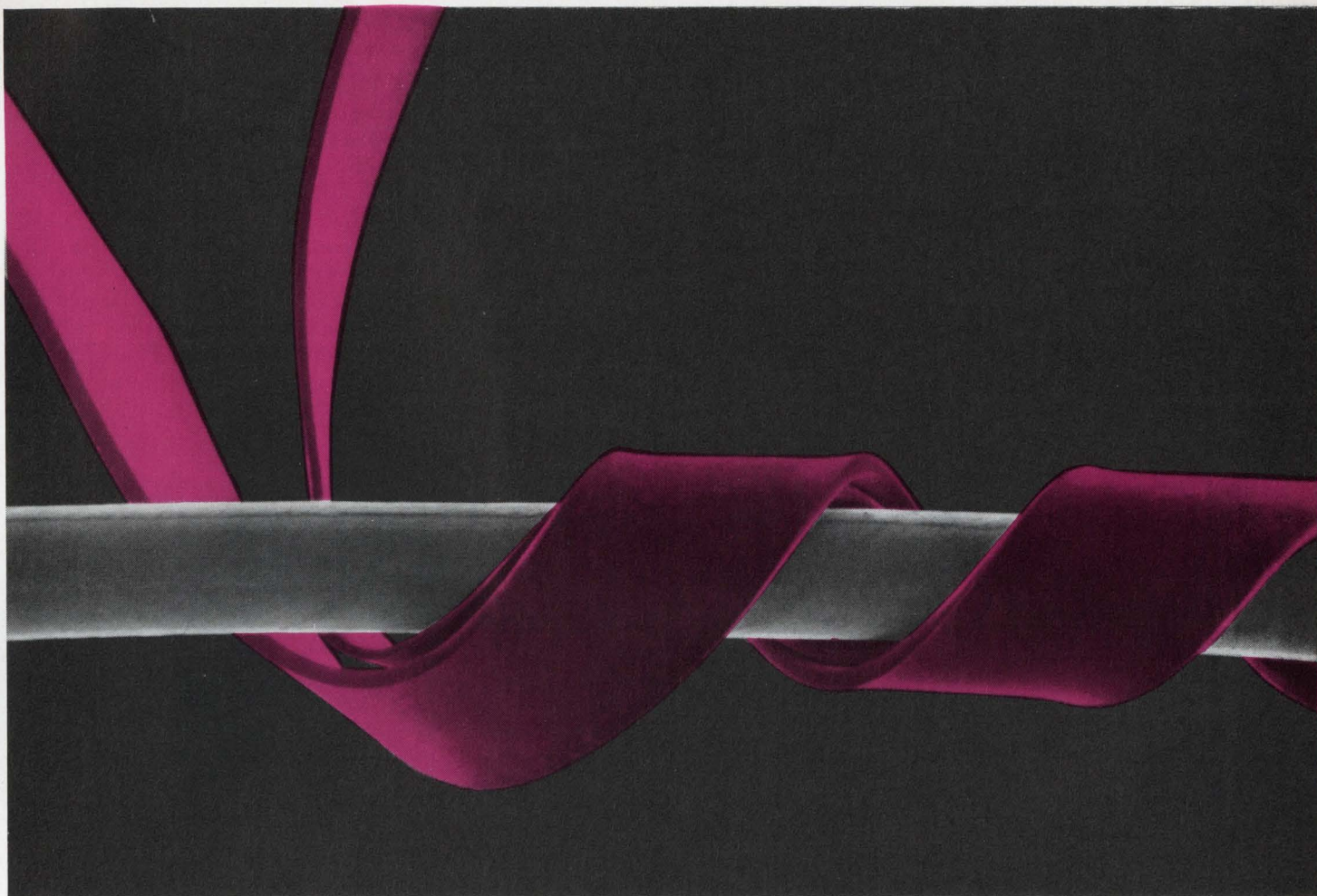

Customizing a magnetic alloy

Bell Laboratories scientists have custom tailored a magnetic alloy for the "piggyback twistor," a memory device used in electronic switching systems.

In this device, metal tapes (enlarged 225 times above) are wound into a tight spiral—subjecting them to considerable mechanical stress. The magnetic properties of the alloys must be essentially independent of such stress. That is, they must have low magnetostriction. In addition, the outer tape must be magnetically "hard"—with high coercive force (resistance to change in direction of magnetization). And finally, it must be ductile enough to be formed into tape. No known alloy had this combination of properties. So, E. A.

Nesbitt, G. Y. Chin, and D. Jaffe of Bell Laboratories made one to order.

Tailoring the new alloy for the outer tape required a precise knowledge of the relationship between the magnetic behavior of materials and their structure. So, the Bell Laboratories scientists began with 90% cobalt and 10% iron, a composition they knew had the necessary ductility and low magnetostriction—two of the essential requirements. But, since the coercive force of the composition was inadequate, they were faced with another knotty problem.

To solve it, they went back again to a basic principle—a precipitate in an alloy impedes the motion of magnetic domain walls when a field is applied to reverse the magnetic

polarity. With that foundation, the scientists formulated a composition of 4% gold, 84% cobalt, and 12% iron. (The gold is the precipitate.)

When this new alloy was cold-drawn to produce a 97.5% reduction in cross section and then heat treated, its coercive force increased to the point required for piggyback twistors.

By simplifying the manufacture of piggyback twistors for use in the electronic switching systems now being built by Western Electric, the new magnetic alloy puts basic research in metallurgy at the service of telephone customers.

From the Research and Development Unit of the Bell System—



Bell Labs

WHAT?

Still chopping light
with a wheel?



Hey Mister, get a FORK!

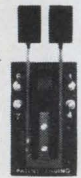

Many engineers already use Bulova/American Time Products tuning forks to chop light and similar energy beams. Those who are not are a bit behind the times, and should know the fork's tremendous advantages over motor-driven light choppers —

- No wearing parts / No lubrication needed
- Low power requirements / Much longer life
- More efficient light handling / Smaller and lighter

How is all this achieved? By attaching to a fork's tines a pair of vanes — slotted, notched, or pierced, to suit the need. Then the vibrating fork chops light or similar energy beams to produce optical effects never before achieved. What's more, it's all done in a very, very small package. For example, a 2 cubic inch package can chop 1,000 times per second!

Another variation is a scanner that uses a torsional fork scanning at a uniform repeat rate. A mirror or other optical device can be attached to vibrate the device torsionally.

Whatever your application, from burglar alarms to infrared spectrophotometers, if you've got some light to chop or scan, call American Time Products 212-335-6000, see EEM Section 3800, or write —



Electronics Division of Bulova Watch Co., Inc.
61-20 Woodside Ave., Woodside, N. Y. 11377
(212) 335-6000

Go Bulova, and leave the designing to us!

U.S. Reports

unfortunately, this solution hasn't worked well for wide deflection angles.

Tough cure. One of the most widely used schemes is approximation through linear segments—adding a little more correction for each added amount of x or y axis deflection. Electronically, this means a diode-resistor ladder network—simple in concept but redundant, very complex, and costly for high accuracy.

The other major method uses a mathematical model. It's an approximation to an infinite power series—the quantity $x^2 + y^2$ raised to ever increasing powers. This was harder to conceptualize but easier to build, consisting mostly of analog multipliers and so-called squarers in combination.

The flaw in this approach is that it simply can't correct for deflection angles of 80° to 90° or more.

Intronics' approach, developed by James B. Knitter, analog design manager, is still being patented, so he's not saying much about hardware. He admits, however, that he works not only with the deflection values of x and y, but also with I, or dynamic focus. Thus his module not only corrects for pincushion, but keeps phosphor dot brightness and size constant over the entire tube face.

Omnibus. He calls the heart of his circuit a "square-rooter," a piece of hardware he specifically developed to manipulate the sum of x^2 , y^2 , and I^2 as a single quantity—not handling the terms separately as do other circuits.

Whatever the electronics, the results claimed are impressive. Knitter says that his circuitry can erase pincushion distortion 10 to 15 times more accurately than former techniques used with narrow-scan tubes. And for wide deflections—about 100°—there's no real competition, he says. And it's about 20 times more accurate than no correction at all.

First units will be sold to purchasers with special applications, and Knitter estimates that his breadboard will translate into production units at about \$400 each. But he's hopeful that once quantity increases, and tube makers

find that they can take advantage of the easier way to make a flat-faced tube, Intronics' circuit could even find its way into consumer products.

"The combination of curved face and curved shadowmasks—plus convergence problems—is largely what causes so much 'off-color' tv," he says. "A flat face could simplify design, and keep color true at the picture edges, too."

Communications

A bit more cable

The FCC, in three decisions on cable television, has opened new market possibilities through a move toward competitive networks. Two of the rulings favor community antenna tv carriers over regulated phone companies, while the third permits transmission in the 4 to 6 gigahertz bandwidth in areas where there is no foreseeable spectrum congestion.

In one ruling, the Federal Communication Commission holds that telephone companies cannot own CATV systems, either directly or through an affiliate, in areas where they are providing local telephone service, though they can still lease distribution facilities to independent operators on a nondiscriminatory basis. Telephone companies now providing such service have until 1974 to discontinue operations. The only exception, the FCC says, will be in sparsely populated areas where CATV systems could not exist without the local phone company.

Monopoly. One reason for the action is the favoritism the companies sometimes display for their own CATV affiliates in providing access to telephone poles. The FCC says it fears the phone companies might be tempted to extend the monopoly to other cable uses, such as data transmission.

Industry sources say the action encourages development of independent CATV and microwave networks that will buy equipment from suppliers other than AT&T. And, as these networks develop to the

Buy a whole ADAC...

or a choice cut

This new, computer-controlled Astrodata Data Acquisition and Control system is a low-cost, expandable unit based on over ten years of Astrodata experience in data systems. A basic ADAC system will accept up to 10 low-level signals (expandable to 500), amplify, filter, condition, multiplex, convert, compute, control and record them, for less than \$30,000.

What's also convenient about the ADAC concept is that you buy only as much system as you need now, with low-cost plug-in expandability for future functions. Or perhaps your requirements are for ADAC components only. Look at the selection:



1. "Front-end" Equipment



Astrodata 889 Low-level amplifiers; wide band, differential, high gain and compact. Astrodata 889-900 Filters, low pass 3-pole devices with 3dB cutoff

points at 9 frequencies plus wide band. Astrodata 889-600 Signal Conditioners which include isolated power supplies and bridge completion networks for transducer excitation and signal conditioning.

2. Low-Level Multiplexing



With the ADAC, you have a choice of Astrodata's Model 960 Low-Level Multiplexer which can accept 10 to 100 inputs (using 10-channel cards), has 5 gain ranges from ± 5 to ± 100 mv, with speeds up to 10 kHz, OR Astrodata's new Model 990 featuring wider dynamic range and speeds to 40 kHz. Either can be provided with programmable offset voltage.

3. Analog to Digital Conversion

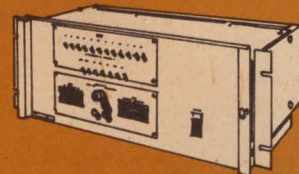

The ADC in this system is an ASTROVERTER data converter—and does it perform! Throughput rate is 100 kHz with an accuracy of $\pm 0.06\%$ full scale $\pm \frac{1}{2}$ least significant digit. Output is eleven binary bits plus sign. But the ASTROVERTER is much more than an ADC. By merely replacing a few cards, the ASTROVERTER becomes a DAC, or a 128-channel high-speed multiplexer, or a simultaneous sample-and-hold device. It can also be used as the total interface between analog and digital signals. Its great flexibility, high speed (5 μ sec digitizing) and low cost provide a panacea for the system designer.

4. Computation



The selection of a computer allows the ADAC system to be fitted more precisely to the application. By having more than 40 computing devices from which to select, Astrodata engineers can supply exactly what's required, allowing for future expansion, and reducing overall system cost. If you already have a computer at your installation, so much the better, interfacing is our middle name.

5. Software

With a staff of nearly 100, Astrodata's software group can develop any, yes any, type of program your application may require, from simple data acquisition to a highly involved control complex.

That's ADAC—its parts and its entity, all products of Astrodata, its people and its resources. Call us now if you want more data, write for the ADAC brochure, or request information on specific system components.

U.S. Reports

point where they begin to interconnect, microwave equipment suppliers will find a new market.

In another action, AT&T, General Telephone & Electronics, United Utilities Inc., and the Continental Telephone Corp., were told to delay planned substantial increases in CATV distribution charges until the FCC has time to decide whether a formal filing is required.

Opening the band. The final decision permits CATV microwave common carriers to operate in the 4 to 6 Ghz bandwidth—they were formerly restricted to 10.7 to 11.7 Ghz. The deciding factors in the ruling were the possible development of a microwave network for CATV systems, development of domestic satellite communications programs sharing the 4 to 6 Ghz bands, development of additional nationwide networks for data and other specialized services such as the MCI network, and new facilities for cheaper educational television relay.

This is not the FCC's final action, however, as it plans to make what it calls a "more intelligent determination" on the use of these bands within the next year, as development of microwave and satellite networks progresses. CATV carriers operating in 4 to 6 Ghz will have equal status with general common carrier operations and satellite earth stations in the same band until the decision is made, preferably before Feb. 1, 1971, the FCC says, when the CATV carriers may be pushed down to secondary status in the band.

Components

Solution seeking problem

What do you do with a detector diode that works from liquid-nitrogen temperatures all the way up to metal-melting heat? NASA's Electronics Research Center is trying to find out.

The device, called a backward diode, is made of silicon carbide. And although its semiconductor qualities are poor compared to those of silicon semiconductors, it can't be

touched for temperature range. At room temperature, says its developer, NASA engineer Richard Farrell, it can detect 15 megahertz r-f with 585 millivolts/milliwatt sensitivity.

Losing cool. Cranking the temperature to 700°C drops sensitivity by two-thirds to about 190 mv/mw. Beyond this temperature, the package parts begin to melt. Cooling the detector to the 77°K temperature of liquid nitrogen doubles sensitivity.

Farrell says that the diode has worked up in X band (8 Gigahertz to 12.4 Ghz), too. He's measured room temperature sensitivities of 110 mv/mv at 50 Mhz and 0.5 mv/mw at 8.8 Ghz. But extrapolating from these measurements, he figures the diode's usefulness should cut off in L band, between 1 and 2 Ghz.

Making them sounds simple. Farrell takes a chip of silicon carbide and deposits a lump of silicon on top. He then heats the combination to about 2,100°C in an atmosphere of pure nitrogen.

The heat liquifies the silicon lump and some of the silicon carbide, and the liquid takes nitrogen from the atmosphere, creating a junction during regrowth and cool-down.

Packaging looks standard, but isn't. The usual whisker contact is used to pin out from the silicon lump, but instead of gold, it's made of copper-plated molybdenum to withstand operating temperatures.

Unfortunately, the waveguide and other r-f conducting components available don't withstand heat as well as the diode and this is sure to limit its usefulness—for instance, to Venus-probe radiometry or radar applications. It is also possible that high-temperature process-control sensors might use the diode, and it also might find its way into re-entry vehicles in spots where insulation isn't practical.

More needed. But wide application appears to await development of other high-temperature components—passive components like resistors and capacitors—and active ones like transistors. As yet, there's little to match the diode's tempera-

COMES WITH EVERY
GE CAPACITOR

Dependable Distributor Service

General Electric Distributors help you solve the tough ones with capacitors from local stock:

EAST AND NORTHEAST
Cramer/Washington, Inc.
692 Loftstrand Lane
Rockville, Maryland 20850
Tel: 301-424-2700
Gerber Electronics, Inc.
652 Providence Highway
Dedham, Mass. 02026
Tel: 617-329-2400
Rome Electronics, Inc.
108 Spring St.
Rome, N. Y. 13440
Tel: 315-337-5400
Schweber Electronics, Inc.
Jericho Highway
Westbury, N. Y. 11591
Tel: 516-334-7474
5640 Fisher Lane
Rockville, Maryland 20852
Tel: 301-427-4977
213 Third Ave.
Waltham, Mass. 02154
Tel: 617-891-8484
Semiconductor Specialists, Inc.
2011 Waverly St.
Pittsburgh, Pa. 15218
Tel: 412-351-3611
Standard Electronics, Inc.
1501 Main St.
Buffalo, N. Y. 14209
Tel: 315-883-5006

SOUTHEAST
Cramer/Florida Electronics
4141 N.E. 6th Ave.
Ft. Lauderdale, Fla. 33308
Tel: 305-947-6517
Jackson Electronics Co.
P.O. Box 19837
Atlanta, Ga. 30318
Tel: 404-355-2223
Schweber Electronics, Inc.
2830 N. 28th Terrace
Hollywood, Fla. 33020
Tel: 305-927-0511
Southeastern Radio Supply Company
414 Hillsboro St.
Raleigh, N. C. 27603
Tel: 919-828-2311

MIDWEST
Electronics Marketing Corp.
814 W. 3rd Ave.
Columbus, Ohio 43212
Tel: 614-299-4161
Hamilton Electro Sales
920 S. Westwood
Addison, Ill. 60101
Tel: 312-543-8500
1400 W. 46th Ave.
Denver, Colorado 80216
Tel: 303-433-8551
Lew Bonn
7275 Bush Lake Road
Edina, Minn. 55435
Semiconductor Specialists, Inc.
P.O. Box 66125
Chicago, Ill. 60666
Tel: 312-255-0300
25127 W. Six Mile Road
Redford, Mich. 48240
Tel: 313-279-1000

SOUTHWEST
Arco Electronics, Inc.
P.O. Box 34772
Dallas, Texas 75234
Tel: 214-235-9123
Hamilton Electro Sales
P.O. Box 10227
Dallas, Texas 75207
Tel: 214-638-0900
1216 W. Clay St.
Houston, Texas 77019
Tel: 713-526-4661
1741 N. 28th St.
Phoenix, Arizona 85009
Tel: 602-272-2601

WEST & NORTHWEST
Elmar Electronics, Inc.
2288 Charleston Rd.
Mt. View, Calif. 94041
Tel: 415-961-3611
Hamilton Electro Sales
10912 W. Washington Blvd.
Culver City, Calif. 90230
Tel: 213-870-7171
2320 6th Ave.
Seattle, Wash. 98121
Tel: 206-442-2011
5567 Kearny Villa Rd.
San Diego, Calif. 92123
Tel: 714-279-2421
340 Middlefield Rd.
Mt. View, Calif. 94041
Tel: 415-961-7000
Kimball Electronics, Inc.
350 Pierpont Ave.
Salt Lake City, Utah 84101
Tel: 801-328-2075
G. S. Marshall Co.
9674 Telstar Ave.
El Monte, Calif. 91731
Tel: 213-686-1500

Electronic Capacitor & Battery Dept., Irmo, S. C.

GENERAL  ELECTRIC

430-44

COMES WITH EVERY GE
METALIZED POLYESTER
CAPACITOR

Rigorous testing

General Electric is a hard school for metalized polyester capacitors. GE gives diplomas in high reliability and long operating life only to those graduates of a rugged three-stage test prior to shipment for use in your electronic circuit.

A curriculum of three quality measurements is required of every unit: (1) Capacitance measurement for tolerance spread and correct nominal value, (2) Dissipation factor measurement to assure conformance to standard specifications, (3) Dielectric withstand voltage measurement that assures total reliability (example, a 100-volt design is checked at 200 volts withstand).

Choose from standard ratings of Metalized Polyester Capacitors

Voltage Ratings: 100V and 200V DC at + 85C

Capacitance Ratings: .01uf to 10uf

Temperature Ratings: - 55C to + 85C (and + 125C with proper derating) or let GE's 20 years of experience special-design metalized polyester capacitors to fill your need for reliable, long-life performance.

Call your GE Electronic Distributor or GE ECSO District Sales Manager, or write Section 43040, General Electric Co., 1 River Road, Schenectady, N. Y. 12305.

Electronic Capacitor & Battery Dept., Irmo, S. C.

GENERAL  ELECTRIC



If your product has to be cleaned completely, safely, efficiently, you should be using FREON[®] cleaning agents.

Here's why...

- 1. Low boiling point (under 120° F)** for low-temperature vapor degreasing. Eliminates cooling time for post-cleaning processes...no damage to heat-sensitive parts. Minimal heat passed into work environment.
- 2. High density combined with low surface tension** evacuates soil from pores, crevices and cracks—floats away contaminants.
- 3. Clean without damage.** Compatible with widely used materials of construction. Clean completed assemblies instead of individual parts.
- 4. Chemically pure and stable.** No acid acceptance and scratch tests necessary. No inhibitors needed. Parts dry residue-free.
- 5. Safe to people,** as well as to material—nonflammable, nonexplosive, low order of toxicity.
- 6. Lower overall cleaning costs possible.** FREON solvents are recoverable for reuse indefinitely. Very low power requirements in vapor degreasing because of a low heat of vaporization. Better cleaning results in fewer production rejects.

Du Pont FREON cleaning agents have been used to solve critical cleaning problems in the electronics and aerospace industries for many years. If you have a critical cleaning problem, or are looking for a better cleaning system, write today to Du Pont Company, Room 8703-F, Wilmington, Delaware 19898.



U.S. Reports

ture range in any of these categories.

Why no silicon carbide transistors? "Mobility in silicon carbide is two to three times lower than that for silicon," says Farrell, "and the same is true of carrier effective mass—it's two to three times higher than for silicon."

That's the rub. Until the material problems are solved, Farrell won't be holding his breath awaiting a silicon carbide transistor.

There's hope, however, in research at the Air Force Cambridge Research Labs and at the Stanford Research Institute. These and other labs are trying to develop what's called beta silicon carbide, a material with much more favorable mobility and carrier mass characteristics. Data on beta silicon carbide isn't sidewalk conversation material yet, though, and the probability of its soon becoming available in amounts large enough for widespread research is low.

For the record

Bienvenu . . . willkommen . . .

The Electronic Industries Association has started smoothing the way for foreign companies to participate in its statistical programs. Noting that a U.S. corporation manufacturing electronic products in this country is eligible for EIA membership even though it might be foreign owned, the EIA's board of governors has approved statistical participation. But foreign companies will be allowed to take part only if the governors and the EIA division responsible for a particular program both give their okay.

Come and see. Optical character readers, limited to the large corporations that can afford to spend half a million dollars and up for the equipment, are finding favor with smaller firms. But they don't have to buy or even rent the gear because of the proliferation of service centers that provide readers on a piecemeal basis. One of the biggest makers of optical character readers, Recognition Equipment,

Looking for an economical system building block?

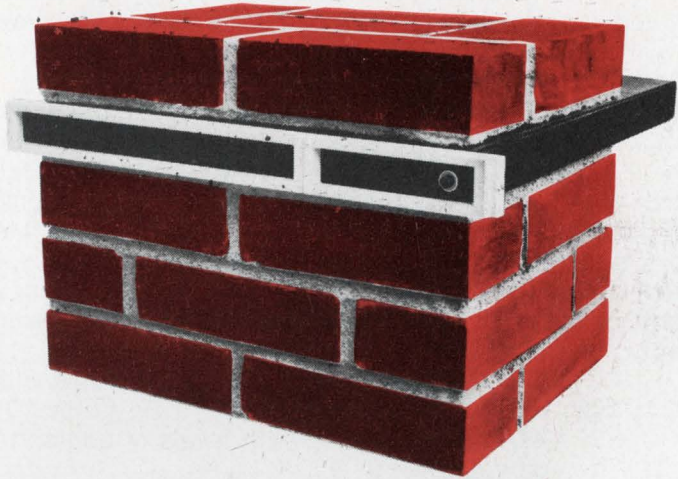

REDCOR 720 MUX/A-D CONVERTER

REDCOR's Model 720 Multiplexer/A-D Converter is an economical and versatile system-building block that accepts up to 32 channels of analog data. Time-shared multiplexing and successive approximation analog-to-digital conversion are utilized to process the analog input data into a format suitable for inputting directly into a computer. The basic 720 contains modular multiplexers, high-input impedance buffers, a sample and hold, an ADC, power supplies, and a voltage reference.

The 720 Multiplexer/A-D Converter offers distinct cost-performance advantages for a wide variety of data-acquisition problems where high resolution and attendant accuracy must be compared to system cost and throughput rates. The 720 is available in 8 to 12 bits binary, with system throughput rates ranging from 40 KHz to 20 KHz. Either single-ended or differential inputs are provided, with full-scale input ranges from 5v to 20v in bipolar or unipolar configurations.

The 720 is completely self-contained in a forced-air-cooled 19-inch chassis that requires only 1¼ inches of panel space. Modular concepts are employed throughout the instrument, with all circuitry contained on plug-in circuit modules that are removable from the master interconnect mother PC board. All test points required for system test calibration and maintenance are available from the swing-out front panel. The modular structure of the 720 ensures ease of maintenance and simplifies field expandability of channels.

Simplified operation, low-cost, ease of interfacing, and guaranteed system performance specifications make the Model 720 Multiplexer/A-D Converter attractive for any computer-controlled data-acquisition or process-control application.

R **REDCOR**
C **CORPORATION**

Complete Systems Capability / 7800 Deering Avenue, P.O. Box 1031,
Canoga Park, California 91304—(213) 348-5892

READOUTS

New! The Bright One.

The new TEC-LITE TSR-71 Series is designed for exceptional readability — bright, wide viewing angle and large segmented incandescent characters (.61") that come on strong, even in direct sunlight.

Operates from IC signals — and keeps operating — minimum life is 100,000 hours. Features include low voltage supply (3.5 to 5.0 volts dc), unlimited filter color selection and four logic function options: (1) decimal decoder/driver logic only (2) decoder/driver plus buffer memory (3) decoder/driver, memory and decade counter (4) decoder/driver plus decade counter. Each of these options is also available with blanking zero.

There are two basic models: TSR-71A with input logic levels of Logic "1" 0V to +0.4V, Logic "0" +1.5V to +4.0V. And TSR-71B with levels of Logic "1" +2.0V to +5.0V, Logic "0" 0V to +0.8V.

Readability is the big news. But the price is newsworthy, too: as low as \$16.85 in quantities of 100-499. For complete information on the TSR-71 — or any member of the TEC family of readouts, switches, indicators, display panels, keyboards or data terminals — write: TEC, Incorporated, 6700 So. Washington Avenue, Eden Prairie, Minnesota 55343. (612) 941-1100.

NEW!

TEC[®]

INCORPORATED

U.S. Reports

now has a dozen such centers operating; it plans to have 26 to 28 open by the end of the year with more to follow. The centers, planned for Europe and Canada as well as most major U.S. cities, will be equipped with Recognition Equipment's Input-2 systems. At the same time, the company has changed its marketing approach. The idea is to push the Input-2, a half-million-dollar version of its original gear that costs about a million dollars, to small and medium-size users. Rental for Input-2 is \$13,000 a month; its big brother rents for \$18,000.

Into business. The North American Philips Corp. has formed a separate corporation to widen its push into the business products field. Arthur L. Hanrahan has been named president of the new company, to be called Philips Business Systems Inc. North American Philips, a subsidiary of Philips Gloeilampenfabrieken of the Netherlands, makes Norelco systems. Last year, the company introduced two integrated-circuit calculators—the P-251 and the P-350. The latter series of small computers is designed to replace accounting and invoicing equipment.

Bumpy road. System Development Corp., which shed its non-profit status last August and became a for-profit, taxpaying company [*Electronics*, Aug. 18, 1969, p. 36], almost immediately ran into a roadblock called the Association of Independent Software Companies. The association claimed that SDC was unfair competition because of tax benefits plus Air Force guidance and supervision available through its previous nonprofit status. It maintained that all Air Force contracts given earlier to SDC should be rebid. However, the Pentagon has pointed out that SDC won the contracts in bidding against other firms in the first place. And, although about 100 employees have been laid off in the past six months, mainly because of cutbacks in air defense activities, SDC vice president Charles A. Alders says operations are "very stable."

TRW

10 WATT 2 GHz

HIGH GAIN

Broadband Transistor

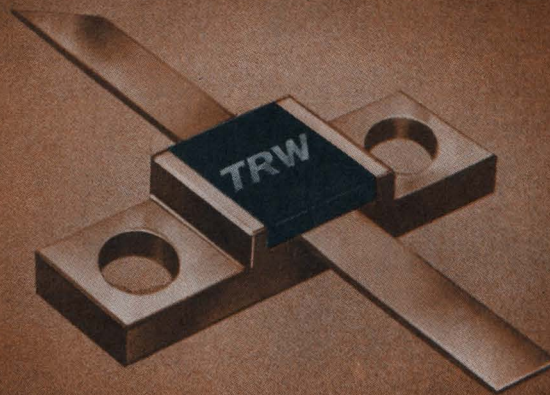

... higher power for telemetry, ECM, NAVAIDS, Radar

TRW has added still another member to its Gigahertz family. PT8610 provides 10 watts output power at 2 GHz, with 7dB gain and 15% bandwidth. It is a single-chip device in a new low parasitic MIC package.

The broadband capability of the device provides circuit design simplicity and insures repeatable system-to-system per-

formance with a minimum of circuit tuning elements.

Designed for use in common-base circuits, PT8610 can be cascaded with other TRW broadband devices to extend reliable solid state power at 2 GHz. Companion transistors are the 5 watt 2N5768, 2.5 watt 2N5767 and the 1 Watt 2N5766.

For further information contact

any TRW distributor or TRW Semiconductor Division, 14520 Aviation Boulevard, Lawndale, California 90260. Phone (213) 679-4561. TWX: 910-325-6206.

Actual Size



TRW®

T²L procurement problems? Look to Motorola for a first choice or second-source answer. Five T²L families offer packaging variety, function selectivity, and availability to meet your schedules.

Choose from M TTL Families I and II, interchangeable with SUHL I and II. Or consider Motorola's M TTL III, the advanced form of high speed T²L, completely compatible with MDTL and SN54H/74H Series devices. Economize with MC4000 MSI complex functions to lower overall system costs. And Motorola's comprehensive selection of 5400/7400 devices are all interchangeable with Series 54/74 types.

MC1000	MC1001	MC1002	MC1003	MC1004	MC1005	MC1006	MC1007	MC1008	MC1009	MC1010	MC1011	MC1012	MC1013	MC1014	MC1015	MC1016	MC1017	MC1018	MC1019	MC1020	MC1021	MC1022	MC1023	MC1024	MC1025	MC1026	MC1027	MC1028	MC1029	MC1030	MC1031	MC1032	MC1033	MC1034	MC1035	MC1036	MC1037	MC1038	MC1039	MC1040	MC1041	MC1042	MC1043	MC1044	MC1045	MC1046	MC1047	MC1048	MC1049	MC1050	MC1051	MC1052	MC1053	MC1054	MC1055	MC1056	MC1057	MC1058	MC1059	MC1060	MC1061	MC1062	MC1063	MC1064	MC1065	MC1066	MC1067	MC1068	MC1069	MC1070	MC1071	MC1072	MC1073	MC1074	MC1075	MC1076	MC1077	MC1078	MC1079	MC1080	MC1081	MC1082	MC1083	MC1084	MC1085	MC1086	MC1087	MC1088	MC1089	MC1090	MC1091	MC1092	MC1093	MC1094	MC1095	MC1096	MC1097	MC1098	MC1099	MC1100	MC1101	MC1102	MC1103	MC1104	MC1105	MC1106	MC1107	MC1108	MC1109	MC1110	MC1111	MC1112	MC1113	MC1114	MC1115	MC1116	MC1117	MC1118	MC1119	MC1120	MC1121	MC1122	MC1123	MC1124	MC1125	MC1126	MC1127	MC1128	MC1129	MC1130	MC1131	MC1132	MC1133	MC1134	MC1135	MC1136	MC1137	MC1138	MC1139	MC1140	MC1141	MC1142	MC1143	MC1144	MC1145	MC1146	MC1147	MC1148	MC1149	MC1150	MC1151	MC1152	MC1153	MC1154	MC1155	MC1156	MC1157	MC1158	MC1159	MC1160	MC1161	MC1162	MC1163	MC1164	MC1165	MC1166	MC1167	MC1168	MC1169	MC1170	MC1171	MC1172	MC1173	MC1174	MC1175	MC1176	MC1177	MC1178	MC1179	MC1180	MC1181	MC1182	MC1183	MC1184	MC1185	MC1186	MC1187	MC1188	MC1189	MC1190	MC1191	MC1192	MC1193	MC1194	MC1195	MC1196	MC1197	MC1198	MC1199	MC1200	MC1201	MC1202	MC1203	MC1204	MC1205	MC1206	MC1207	MC1208	MC1209	MC1210	MC1211	MC1212	MC1213	MC1214	MC1215	MC1216	MC1217	MC1218	MC1219	MC1220	MC1221	MC1222	MC1223	MC1224	MC1225	MC1226	MC1227	MC1228	MC1229	MC1230	MC1231	MC1232	MC1233	MC1234	MC1235	MC1236	MC1237	MC1238	MC1239	MC1240	MC1241	MC1242	MC1243	MC1244	MC1245	MC1246	MC1247	MC1248	MC1249	MC1250	MC1251	MC1252	MC1253	MC1254	MC1255	MC1256	MC1257	MC1258	MC1259	MC1260	MC1261	MC1262	MC1263	MC1264	MC1265	MC1266	MC1267	MC1268	MC1269	MC1270	MC1271	MC1272	MC1273	MC1274	MC1275	MC1276	MC1277	MC1278	MC1279	MC1280	MC1281	MC1282	MC1283	MC1284	MC1285	MC1286	MC1287	MC1288	MC1289	MC1290	MC1291	MC1292	MC1293	MC1294	MC1295	MC1296	MC1297	MC1298	MC1299	MC1300	MC1301	MC1302	MC1303	MC1304	MC1305	MC1306	MC1307	MC1308	MC1309	MC1310	MC1311	MC1312	MC1313	MC1314	MC1315	MC1316	MC1317	MC1318	MC1319	MC1320	MC1321	MC1322	MC1323	MC1324	MC1325	MC1326	MC1327	MC1328	MC1329	MC1330	MC1331	MC1332	MC1333	MC1334	MC1335	MC1336	MC1337	MC1338	MC1339	MC1340	MC1341	MC1342	MC1343	MC1344	MC1345	MC1346	MC1347	MC1348	MC1349	MC1350	MC1351	MC1352	MC1353	MC1354	MC1355	MC1356	MC1357	MC1358	MC1359	MC1360	MC1361	MC1362	MC1363	MC1364	MC1365	MC1366	MC1367	MC1368	MC1369	MC1370	MC1371	MC1372	MC1373	MC1374	MC1375	MC1376	MC1377	MC1378	MC1379	MC1380	MC1381	MC1382	MC1383	MC1384	MC1385	MC1386	MC1387	MC1388	MC1389	MC1390	MC1391	MC1392	MC1393	MC1394	MC1395	MC1396	MC1397	MC1398	MC1399	MC1400	MC1401	MC1402	MC1403	MC1404	MC1405	MC1406	MC1407	MC1408	MC1409	MC1410	MC1411	MC1412	MC1413	MC1414	MC1415	MC1416	MC1417	MC1418	MC1419	MC1420	MC1421	MC1422	MC1423	MC1424	MC1425	MC1426	MC1427	MC1428	MC1429	MC1430	MC1431	MC1432	MC1433	MC1434	MC1435	MC1436	MC1437	MC1438	MC1439	MC1440	MC1441	MC1442	MC1443	MC1444	MC1445	MC1446	MC1447	MC1448	MC1449	MC1450	MC1451	MC1452	MC1453	MC1454	MC1455	MC1456	MC1457	MC1458	MC1459	MC1460	MC1461	MC1462	MC1463	MC1464	MC1465	MC1466	MC1467	MC1468	MC1469	MC1470	MC1471	MC1472	MC1473	MC1474	MC1475	MC1476	MC1477	MC1478	MC1479	MC1480	MC1481	MC1482	MC1483	MC1484	MC1485	MC1486	MC1487	MC1488	MC1489	MC1490	MC1491	MC1492	MC1493	MC1494	MC1495	MC1496	MC1497	MC1498	MC1499	MC1500	MC1501	MC1502	MC1503	MC1504	MC1505	MC1506	MC1507	MC1508	MC1509	MC1510	MC1511	MC1512	MC1513	MC1514	MC1515	MC1516	MC1517	MC1518	MC1519	MC1520	MC1521	MC1522	MC1523	MC1524	MC1525	MC1526	MC1527	MC1528	MC1529	MC1530	MC1531	MC1532	MC1533	MC1534	MC1535	MC1536	MC1537	MC1538	MC1539	MC1540	MC1541	MC1542	MC1543	MC1544	MC1545	MC1546	MC1547	MC1548	MC1549	MC1550	MC1551	MC1552	MC1553	MC1554	MC1555	MC1556	MC1557	MC1558	MC1559	MC1560	MC1561	MC1562	MC1563	MC1564	MC1565	MC1566	MC1567	MC1568	MC1569	MC1570	MC1571	MC1572	MC1573	MC1574	MC1575	MC1576	MC1577	MC1578	MC1579	MC1580	MC1581	MC1582	MC1583	MC1584	MC1585	MC1586	MC1587	MC1588	MC1589	MC1590	MC1591	MC1592	MC1593	MC1594	MC1595	MC1596	MC1597	MC1598	MC1599	MC1600	MC1601	MC1602	MC1603	MC1604	MC1605	MC1606	MC1607	MC1608	MC1609	MC1610	MC1611	MC1612	MC1613	MC1614	MC1615	MC1616	MC1617	MC1618	MC1619	MC1620	MC1621	MC1622	MC1623	MC1624	MC1625	MC1626	MC1627	MC1628	MC1629	MC1630	MC1631	MC1632	MC1633	MC1634	MC1635	MC1636	MC1637	MC1638	MC1639	MC1640	MC1641	MC1642	MC1643	MC1644	MC1645	MC1646	MC1647	MC1648	MC1649	MC1650	MC1651	MC1652	MC1653	MC1654	MC1655	MC1656	MC1657	MC1658	MC1659	MC1660	MC1661	MC1662	MC1663	MC1664	MC1665	MC1666	MC1667	MC1668	MC1669	MC1670	MC1671	MC1672	MC1673	MC1674	MC1675	MC1676	MC1677	MC1678	MC1679	MC1680	MC1681	MC1682	MC1683	MC1684	MC1685	MC1686	MC1687	MC1688	MC1689	MC1690	MC1691	MC1692	MC1693	MC1694	MC1695	MC1696	MC1697	MC1698	MC1699	MC1700	MC1701	MC1702	MC1703	MC1704	MC1705	MC1706	MC1707	MC1708	MC1709	MC1710	MC1711	MC1712	MC1713	MC1714	MC1715	MC1716	MC1717	MC1718	MC1719	MC1720	MC1721	MC1722	MC1723	MC1724	MC1725	MC1726	MC1727	MC1728	MC1729	MC1730	MC1731	MC1732	MC1733	MC1734	MC1735	MC1736	MC1737	MC1738	MC1739	MC1740	MC1741	MC1742	MC1743	MC1744	MC1745	MC1746	MC1747	MC1748	MC1749	MC1750	MC1751	MC1752	MC1753	MC1754	MC1755	MC1756	MC1757	MC1758	MC1759	MC1760	MC1761	MC1762	MC1763	MC1764	MC1765	MC1766	MC1767	MC1768	MC1769	MC1770	MC1771	MC1772	MC1773	MC1774	MC1775	MC1776	MC1777	MC1778	MC1779	MC1780	MC1781	MC1782	MC1783	MC1784	MC1785	MC1786	MC1787	MC1788	MC1789	MC1790	MC1791	MC1792	MC1793	MC1794	MC1795	MC1796	MC1797	MC1798	MC1799	MC1800	MC1801	MC1802	MC1803	MC1804	MC1805	MC1806	MC1807	MC1808	MC1809	MC1810	MC1811	MC1812	MC1813	MC1814	MC1815	MC1816	MC1817	MC1818	MC1819	MC1820	MC1821	MC1822	MC1823	MC1824	MC1825	MC1826	MC1827	MC1828	MC1829	MC1830	MC1831	MC1832	MC1833	MC1834	MC1835	MC1836	MC1837	MC1838	MC1839	MC1840	MC1841	MC1842	MC1843	MC1844	MC1845	MC1846	MC1847	MC1848	MC1849	MC1850	MC1851	MC1852	MC1853	MC1854	MC1855	MC1856	MC1857	MC1858	MC1859	MC1860	MC1861	MC1862	MC1863	MC1864	MC1865	MC1866	MC1867	MC1868	MC1869	MC1870	MC1871	MC1872	MC1873	MC1874	MC1875	MC1876	MC1877	MC1878	MC1879	MC1880	MC1881	MC1882	MC1883	MC1884	MC1885	MC1886	MC1887	MC1888	MC1889	MC1890	MC1891	MC1892	MC1893	MC1894	MC1895	MC1896	MC1897	MC1898	MC1899	MC1900	MC1901	MC1902	MC1903	MC1904	MC1905	MC1906	MC1907	MC1908	MC1909	MC1910	MC1911	MC1912	MC1913	MC1914	MC1915	MC1916	MC1917	MC1918	MC1919	MC1920	MC1921	MC1922	MC1923	MC1924	MC1925	MC1926	MC1927	MC1928	MC1929	MC1930	MC1931	MC1932	MC1933	MC1934	MC1935	MC1936	MC1937	MC1938	MC1939	MC1940	MC1941	MC1942	MC1943	MC1944	MC1945	MC1946	MC1947	MC1948	MC1949	MC1950	MC1951	MC1952	MC1953	MC1954	MC1955	MC1956	MC1957	MC1958	MC1959	MC1960	MC1961	MC1962	MC1963	MC1964	MC1965	MC1966	MC1967	MC1968	MC1969	MC1970	MC1971	MC1972	MC1973	MC1974	MC1975	MC1976	MC1977	MC1978	MC1979	MC1980	MC1981	MC1982	MC1983	MC1984	MC1985	MC1986	MC1987	MC1988	MC1989	MC1990	MC1991	MC1992	MC1993	MC1994	MC1995	MC1996	MC1997	MC1998	MC1999	MC2000	MC2001	MC2002	MC2003	MC2004	MC2005	MC2006	MC2007	MC2008	MC2009	MC2010	MC2011	MC2012	MC2013	MC2014	MC2015	MC2016	MC2017	MC2018	MC2019	MC2020	MC2021	MC2022	MC2023	MC2024	MC2025	MC2026	MC2027	MC2028	MC2029	MC2030	MC2031	MC2032	MC2033	MC2034	MC2035	MC2036	MC2037	MC2038	MC2039	MC2040	MC2041	MC2042	MC2043	MC2044	MC2045	MC2046	MC2047	MC2048	MC2049	MC2050	MC2051	MC2052	MC2053	MC2054	MC2055	MC2056	MC2057	MC2058	MC2059	MC2060	MC2061	MC2062	MC2063	MC2064	MC2065	MC2066	MC2067	MC2068	MC2069	MC2070	MC2071	MC2072	MC2073	MC2074	MC2075	MC2076	MC2077	MC2078	MC2079	MC2080	MC2081	MC2082	MC2083	MC2084	MC2085	MC2086	MC2087	MC2088	MC2089	MC2090	MC2091	MC2092	MC2093	MC2094	MC2095	MC2096	MC2097	MC2098	MC2099	MC2100	MC2101
--------	--------	--------	--------	--------	--------	--------	--------	--------	--------	--------	--------	--------	--------	--------	--------	--------	--------	--------	--------	--------	--------	--------	--------	--------	--------	--------	--------	--------	--------	--------	--------	--------	--------	--------	--------	--------	--------	--------	--------	--------	--------	--------	--------	--------	--------	--------	--------	--------	--------	--------	--------	--------	--------	--------	--------	--------	--------	--------	--------	--------	--------	--------	--------	--------	--------	--------	--------	--------	--------	--------	--------	--------	--------	--------	--------	--------	--------	--------	--------	--------	--------	--------	--------	--------	--------	--------	--------	--------	--------	--------	--------	--------	--------	--------	--------	--------	--------	--------	--------	--------	--------	--------	--------	--------	--------	--------	--------	--------	--------	--------	--------	--------	--------	--------	--------	--------	--------	--------	--------	--------	--------	--------	--------	--------	--------	--------	--------	--------	--------	--------	--------	--------	--------	--------	--------	--------	--------	--------	--------	--------	--------	--------	--------	--------	--------	--------	--------	--------	--------	--------	--------	--------	--------	--------	--------	--------	--------	--------	--------	--------	--------	--------	--------	--------	--------	--------	--------	--------	--------	--------	--------	--------	--------	--------	--------	--------	--------	--------	--------	--------	--------	--------	--------	--------	--------	--------	--------	--------	--------	--------	--------	--------	--------	--------	--------	--------	--------	--------	--------	--------	--------	--------	--------	--------	--------	--------	--------	--------	--------	--------	--------	--------	--------	--------	--------	--------	--------	--------	--------	--------	--------	--------	--------	--------	--------	--------	--------	--------	--------	--------	--------	--------	--------	--------	--------	--------	--------	--------	--------	--------	--------	--------	--------	--------	--------	--------	--------	--------	--------	--------	--------	--------	--------	--------	--------	--------	--------	--------	--------	--------	--------	--------	--------	--------	--------	--------	--------	--------	--------	--------	--------	--------	--------	--------	--------	--------	--------	--------	--------	--------	--------	--------	--------	--------	--------	--------	--------	--------	--------	--------	--------	--------	--------	--------	--------	--------	--------	--------	--------	--------	--------	--------	--------	--------	--------	--------	--------	--------	--------	--------	--------	--------	--------	--------	--------	--------	--------	--------	--------	--------	--------	--------	--------	--------	--------	--------	--------	--------	--------	--------	--------	--------	--------	--------	--------	--------	--------	--------	--------	--------	--------	--------	--------	--------	--------	--------	--------	--------	--------	--------	--------	--------	--------	--------	--------	--------	--------	--------	--------	--------	--------	--------	--------	--------	--------	--------	--------	--------	--------	--------	--------	--------	--------	--------	--------	--------	--------	--------	--------	--------	--------	--------	--------	--------	--------	--------	--------	--------	--------	--------	--------	--------	--------	--------	--------	--------	--------	--------	--------	--------	--------	--------	--------	--------	--------	--------	--------	--------	--------	--------	--------	--------	--------	--------	--------	--------	--------	--------	--------	--------	--------	--------	--------	--------	--------	--------	--------	--------	--------	--------	--------	--------	--------	--------	--------	--------	--------	--------	--------	--------	--------	--------	--------	--------	--------	--------	--------	--------	--------	--------	--------	--------	--------	--------	--------	--------	--------	--------	--------	--------	--------	--------	--------	--------	--------	--------	--------	--------	--------	--------	--------	--------	--------	--------	--------	--------	--------	--------	--------	--------	--------	--------	--------	--------	--------	--------	--------	--------	--------	--------	--------	--------	--------	--------	--------	--------	--------	--------	--------	--------	--------	--------	--------	--------	--------	--------	--------	--------	--------	--------	--------	--------	--------	--------	--------	--------	--------	--------	--------	--------	--------	--------	--------	--------	--------	--------	--------	--------	--------	--------	--------	--------	--------	--------	--------	--------	--------	--------	--------	--------	--------	--------	--------	--------	--------	--------	--------	--------	--------	--------	--------	--------	--------	--------	--------	--------	--------	--------	--------	--------	--------	--------	--------	--------	--------	--------	--------	--------	--------	--------	--------	--------	--------	--------	--------	--------	--------	--------	--------	--------	--------	--------	--------	--------	--------	--------	--------	--------	--------	--------	--------	--------	--------	--------	--------	--------	--------	--------	--------	--------	--------	--------	--------	--------	--------	--------	--------	--------	--------	--------	--------	--------	--------	--------	--------	--------	--------	--------	--------	--------	--------	--------	--------	--------	--------	--------	--------	--------	--------	--------	--------	--------	--------	--------	--------	--------	--------	--------	--------	--------	--------	--------	--------	--------	--------	--------	--------	--------	--------	--------	--------	--------	--------	--------	--------	--------	--------	--------	--------	--------	--------	--------	--------	--------	--------	--------	--------	--------	--------	--------	--------	--------	--------	--------	--------	--------	--------	--------	--------	--------	--------	--------	--------	--------	--------	--------	--------	--------	--------	--------	--------	--------	--------	--------	--------	--------	--------	--------	--------	--------	--------	--------	--------	--------	--------	--------	--------	--------	--------	--------	--------	--------	--------	--------	--------	--------	--------	--------	--------	--------	--------	--------	--------	--------	--------	--------	--------	--------	--------	--------	--------	--------	--------	--------	--------	--------	--------	--------	--------	--------	--------	--------	--------	--------	--------	--------	--------	--------	--------	--------	--------	--------	--------	--------	--------	--------	--------	--------	--------	--------	--------	--------	--------	--------	--------	--------	--------	--------	--------	--------	--------	--------	--------	--------	--------	--------	--------	--------	--------	--------	--------	--------	--------	--------	--------	--------	--------	--------	--------	--------	--------	--------	--------	--------	--------	--------	--------	--------	--------	--------	--------	--------	--------	--------	--------	--------	--------	--------	--------	--------	--------	--------	--------	--------	--------	--------	--------	--------	--------	--------	--------	--------	--------	--------	--------	--------	--------	--------	--------	--------	--------	--------	--------	--------	--------	--------	--------	--------	--------	--------	--------	--------	--------	--------	--------	--------	--------	--------	--------	--------	--------	--------	--------	--------	--------	--------	--------	--------	--------	--------	--------	--------	--------	--------	--------	--------	--------	--------	--------	--------	--------	--------	--------	--------	--------	--------	--------	--------	--------	--------	--------	--------	--------	--------	--------	--------	--------	--------	--------	--------	--------	--------	--------	--------	--------	--------	--------	--------	--------	--------	--------	--------	--------	--------	--------	--------	--------	--------	--------	--------	--------	--------	--------	--------	--------	--------	--------	--------	--------	--------	--------	--------	--------	--------	--------	--------	--------	--------	--------	--------	--------	--------	--------	--------	--------	--------	--------	--------	--------	--------	--------	--------	--------	--------	--------	--------	--------	--------	--------	--------	--------	--------	--------	--------	--------	--------	--------	--------	--------	--------	--------	--------	--------	--------	--------	--------	--------	--------	--------	--------	--------	--------	--------	--------	--------	--------	--------	--------	--------	--------	--------	--------	--------	--------	--------	--------	--------	--------	--------	--------	--------	--------	--------	--------	--------	--------	--------	--------	--------	--------	--------	--------	--------	--------	--------	--------	--------	--------	--------	--------	--------	--------	--------	--------	--------	--------	--------	--------	--------	--------	--------	--------	--------	--------	--------	--------	--------	--------	--------	--------	--------	--------	--------	--------	--------	--------	--------	--------	--------	--------	--------	--------	--------	--------	--------	--------	--------	--------	--------	--------	--------	--------	--------	--------	--------	--------	--------	--------	--------	--------	--------	--------	--------	--------	--------	--------	--------	--------	--------	--------	--------	--------	--------	--------	--------	--------	--------	--------	--------	--------	--------	--------	--------	--------	--------	--------	--------	--------	--------	--------	--------	--------	--------	--------	--------	--------	--------	--------	--------	--------	--------

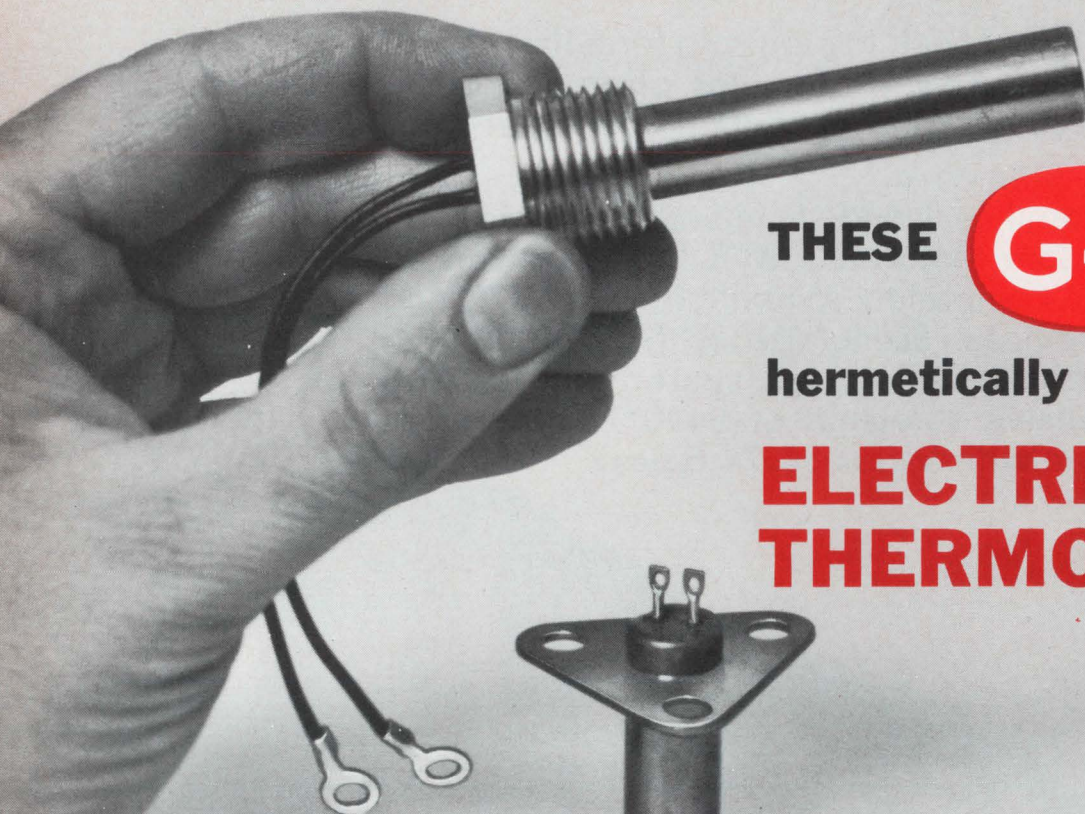

THESE



hermetically sealed

ELECTRICAL THERMOSTATS ...

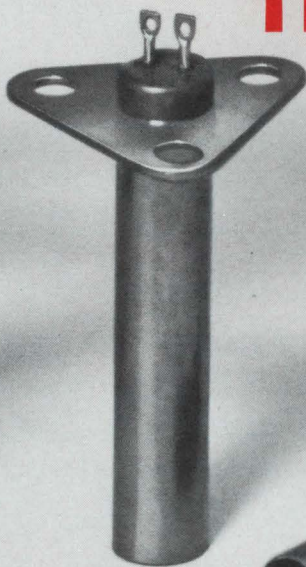

***QUICK CONNECT TYPE INDUSTRIAL THERMAL RELAY**

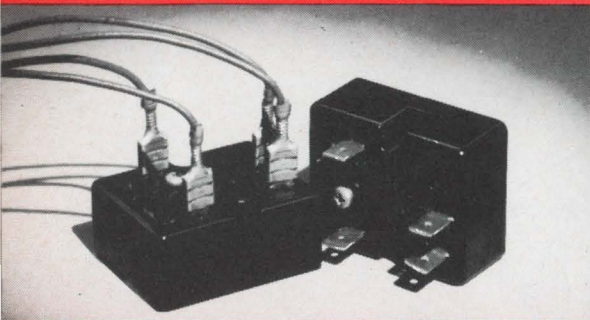

The Quick Connect thermal relays are designed to withstand the most demanding industrial applications. They reduce installation time and cost. Require only two mounting screws. Eliminates need for brackets, sockets, retainers. **Features:** time delays, 2 to 180 sec.; contacts, SPST, NO/NC; heater voltages, 6.3, 26, 115V AC or DC; resistive rating, 2A 115V AC or 1A 28V DC; mounts in any position.

*Recognized Under The Components Program Of Underwriter's Laboratories, Inc.



CIRCLE 332 ON READERS SERVICE CARD

***RED LINE INDUSTRIAL THERMAL TIMING DEVICES**



Designed to meet the most demanding applications. They are housed in shatter-proof, dust-proof metal enclosures and feature stainless steel mechanisms and encased heaters for reliable, quiet operation in any plane. **Features:** delays up to 3 minutes, operating voltages 6.3 to 115V, AC or DC.

*Recognized Under The Components Program Of Underwriter's Laboratories, Inc.



CIRCLE 333 ON READERS SERVICE CARD

***THERMETTE 9 PIN RELAY**



Metal enclosed thermal time delay is dust proof and shatter proof — designed for industrial applications requiring reliable operation and long life. **Features:** temp. compensated; time delays, 2 to 180 sec.; heater voltages, 6.3, 26, and 115V. AC or DC; contacts, SPST, NO or NC.

*Recognized Under The Components Program Of Underwriter's Laboratories, Inc.



CIRCLE 334 ON READERS SERVICE CARD

solve temperature control problems

OFFER PRECISE TEMPERATURE CONTROL, RAPID RESPONSE, MINIMAL DIFFERENTIAL . . . *from G-V*

G-V offers a wide selection of electrical thermostats for over and under temperature indication, alarm or cut-off service. They are designed to meet the rugged and precise requirements of both military and commercial applications including missiles, data processing equipment, etc. Both surface sensing and immersion types are available. For surface temperature sensing, crystal can size VE Series features a tolerance of $\pm 3^{\circ}\text{C}$, a differential of $\pm 1.5^{\circ}\text{C}$. Various models cover settings between -55°C and $+150^{\circ}\text{C}$. The C8 Series cartridge immersion or air sensing thermostats are available with a variety of mounting brackets and terminals. They are supplied with a setting tolerance of $\pm 5^{\circ}\text{F}$ ($\pm 3^{\circ}\text{C}$), and repetitive operation within $\pm 1^{\circ}\text{F}$ can be expected. These units will withstand indefinite exposures to temperatures of -65°F to $+300^{\circ}\text{F}$ without damage. The C8 Series can be adjusted without damage to the hermetic seal. Contact ratings: VE Series, up to 3 amps; C8 Series up to 5 amps.



G-V CONTROLS INC.
LIVINGSTON, NEW JERSEY 07039
(201) 992-6200

CIRCLE 331 ON READERS SERVICE CARD

*AIR FLOW SENSING SWITCH



A new design concept and technique is utilized to monitor presence of air flow. When air flow drops below a safe level, it operates an alarm or automatic shut-off. Used in electronic equipment, cooling packages, air conditioners, computers, etc.
Features: Operates in any plane, no moving parts. No special adjustments.

*Recognized Under The Components Program Of Underwriter's Laboratories, Inc.

only from 

CIRCLE 335 ON READERS SERVICE CARD

*ELECTRICAL THERMOSTATS FOR INDUSTRIAL USE

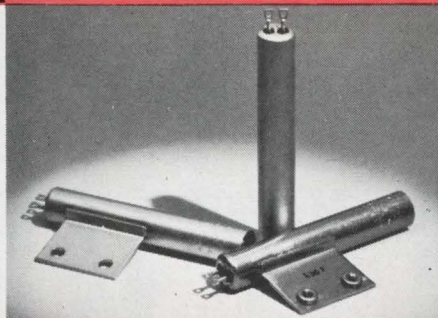

The D8 Series is suitable for a wide range of temperature control applications, offering exceptional stability. Since the encasing shell is the temperature sensing element, response to temperature change is very rapid.
Features: contact ratings up to 5 amps, operating range -65° to $+300^{\circ}\text{F}$.

*Recognized Under The Components Program Of Underwriter's Laboratories, Inc.



CIRCLE 336 ON READERS SERVICE CARD

DIRECT-LINE FIELD ENGINEERING SERVICE



G-V assistance is always available to help you design and produce a better product. G-V Regional Field Engineers in your area will assist you and your design group in new applications and proper selection of your controls. G-V Product Engineers will help you with special applications. When you require experience, products and services in electro-mechanical and solid-state controls . . . call your man from G-V.



CIRCLE 337 ON READERS SERVICE CARD



Data survival kit

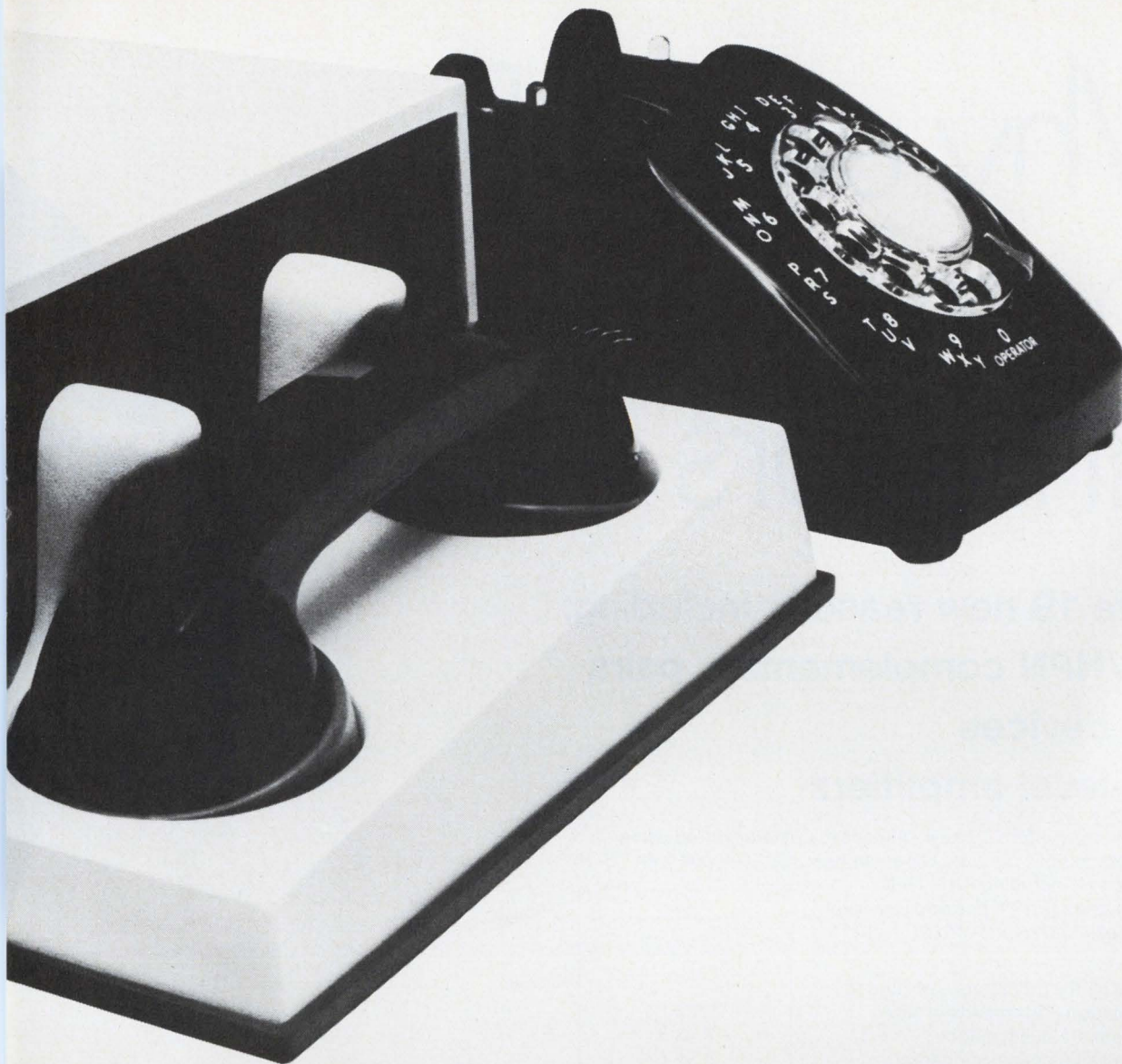

This new acoustic coupler delivers data alive and well over lines noisier and 10 times weaker than other couplers can tolerate.

We've found a way to virtually eliminate a problem that has been plaguing acoustic couplers for years—second harmonic distortion.

This means you no longer have to worry about the transmit signal generating interference with the receive signal. We've all but cancelled that problem by adding a signal component that offsets distortion, bringing harmony to data transmission.

As a result, we can transmit at higher power than other couplers. And we can receive much weaker signals than other couplers.

One or two other things. Normally, a computer has no way to verify the accuracy of its transmission to a remote teletype. With our remote echo option, the coupler will send received data back to the computer for verification. This option operates under direct computer control. If there is an error, the computer will let you know. Also, with our parallel input/output option, the interface between our acoustic coupler and your equipment may be parallel, rather than our standard TTY or EIA serial data interfaces.

In short, there is no longer any reason for your data not to survive. Perish the thought.

Another innovation from the company that specializes in data communications systems.

ADDS
Applied Digital Data Systems, Inc.

Patents pending

Mr. Richard Kaufman, Dept. 24
Applied Digital Data Systems, Inc.
89 Marcus Boulevard
Hauppauge, New York 11787

Please send more information.

Name _____

Title _____

Company _____

Address _____

City _____ State _____ Zip _____

Circle 65 on reader service card

Why use GE epoxy TO-18 transistors?

Here are 19 new reasons including:

- PNP/NPN complementary pairs
- PNP devices
- Low-level amplifiers

General Electric now offers 19 new reasons to get *you* started using epoxy transistors in your circuits. Nineteen new JEDEC types with TO-18 lead configuration—including PNP/NPN complementary pairs, PNP types and low-level amplifiers, *all designed for industrial applications.*

Each one offers all the advantages of rugged epoxy encapsulation. This means greater resistance to damage due to shock, acceleration and similar environmental stresses. In addition, GE's new epoxy transistors will cost you less than metal case devices.

General Electric's epoxy package can dissipate up to 500 mW and offers breakdown voltages as high as 60 volts. These new designs feature excellent beta linearity from 1 to 750 ma. with a saturation voltage of .75 volts at 500 ma.

With the introduction of these 19 new types, General Electric provides you with a selection of TO-18 based epoxy transistors superior to any other encapsulated device you may have used previously. If you need more proof, order a sample from the table at right, and prove to yourself that GE's new epoxy transistors meet your application requirements. You'll soon be "designing in" these new devices all the way from input to output. And you'll find that they're readily available off the shelf at your authorized, full-line General Electric semiconductor distributor.

If you'd like more information about GE's (TO-18) epoxy transistors or GE's "specials" capability, or if you desire a sample device for testing, write on your firm's letterhead to General Electric Company, Section 220-80, 1 River Road, Schenectady, New York 12305. In Canada: Canadian General Electric, 189 Dufferin St., Toronto, Ont. Export: Electronic Sales, IGE Export Division, 159 Madison Avenue, New York, N. Y. 10016.

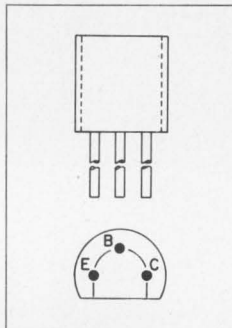

GENERAL  **ELECTRIC**

220-80A

Circle 66 on reader service card

- 60 volt PNP and NPN
- Collector currents up to 1 ampere
- Tight beta limits (2 to 1 spread)
- Guaranteed beta at 500 ma
- 500 mW power dissipation

		COMPLEMENTARY PAIRS						
NPN	PNP	Voltage Rating (V _{CEO})	Beta (h _{FE})		Power Dissipation (P _c)	Max. Cont. Collector Current (I _c)	Saturation Voltage at 500 ma (V _{CE(SAT)})	
			Min.	Max.				
2N5810	2N5811	25V	60	200	500mW	750mA	.75V	
2N5812	2N5813	25V	150	500	500mW	750mA	.75V	
2N5814	2N5815	40V	60	200	500mW	750mA	.75V	
2N5816	2N5817	40V	100	300	500mW	750mA	.75V	
2N5818	2N5819	40V	150	120	500mW	750mA	.75V	
2N5820	2N5821	60V	60	200	500mW	750mA	.75V	
2N5822	2N5823	60V	100	200	500mW	750mA	.75V	
		LOW-LEVEL AMPLIFIERS						
2N5824		40V	60	180	360mW	100mA	.125V	
2N5825		40V	100	200	360mW	100mA	.125V	
2N5826		40V	150	300	360mW	100mA	.125V	
2N5827*		40V	250	500	360mW	100mA	.125V	
2N5828*		40V	400	800	360mW	100mA	.125V	

*low-noise types available approximately 2/1/70

HELIAX COAXIAL CABLE...

unique design
and performance



The coaxial cable with the corrugated outer conductor.

Better than braided coax because HELIAX has perfect shielding, precise electrical characteristics, lower attenuation and freedom from age deterioration.

Better than smooth wall coax because HELIAX is more flexible, easier to install, stronger, lighter, free from differential expansion and comes in extremely long continuous lengths.

Available from stock in 35 types and sizes down to 1/4". Foam or air dielectric. Teflon too. Connectors for all standard interfaces.

For full details, communicate with Andrew.



ANDREW

ANDREW CORPORATION, 10500 W. 153RD STREET,
ORLAND PARK, ILLINOIS 60462, PHONE (312) 349-3300

International Newsletter

February 16, 1970

New Toyota changes gears electronically

Electronic controls are taking over more and more work in automobiles. Now, even that bastion of mechanical and hydraulic ingenuity, the transmission, is falling to electronics. Last week, Toyota's new Corona cars arrived on the market with an electronically controlled automatic transmission.

The major advantage that Toyota claims for the new control system is that it makes possible more than one speed pattern for shifting. The new transmissions have two patterns, one with conventional speed shift points and one for sport, high-performance driving. In the sport pattern, the second gear range is much wider and only shifts into drive gear at high speeds. This sport pattern is also advantageous in mountain driving and other situations where an ordinary hydromechanical transmission might tend to hunt.

Developed in cooperation with Nippon Denso Ltd., which also makes the electronic components, the transmission costs about \$55 more than a regular automatic. The electronic package replaces about half the hydraulic components usually needed. Its computer section uses five monolithic IC's and seven hybrid IC's. At present, there are no plans to export cars with the new transmission to the United States.

BBC tests pcm to send tv audio

The British Broadcasting Corp.'s technique for carrying a television audio signal in pulse-code modulated form within the video wave form [*Electronics*, Sept. 30, 1968, p. 11E] will go into operation on a trial basis in May. If the trial on the cable distribution link between London, Birmingham and Manchester is successful, the system will be extended to include the whole BBC tv distribution network between studio and final broadcast transmitter. Costs can be cut because, by combining audio and video signals, only one distribution cable or r-f frequency carrier is required.

The BBC has granted a manufacturing license for the instruments to Pye TVT Ltd. of Cambridge, a Philips subsidiary, and is negotiating with others. Pye expects to charge up to \$7,500 for an input-output equipment set. Likely customers are Britain's commercial television stations, and many European networks—the system has been tested and recommended by the European Broadcasting Union.

Sanyo to supply GE with personal tv's

General Electric, in the latest of a series of moves to strengthen its consumer electronic position, is close to signing a contract with Japan's Sanyo Electric Co. for small portable television sets. Sanyo says it expects to clinch the deal this week and will supply 30,000 transistorized tv sets—both 9-inch and 12-inch models—to GE. Last November Sanyo and General Electric concluded an agreement under which the Japanese company will supply General Electric with cassette-type audio tape recorders.

Yugoslavs eye role as world supplier

Yugoslav firms are trying hard to cut themselves in on a larger share of electronics markets around the world. Radio Industries of Zagreb (RIZ), for example, is now readying four radio transmitters and related gear for shipment to Saudi Arabia, India, and Ceylon. This multimillion

International Newsletter

dollar shipment comes hard on the heels of deliveries of \$2 million worth of similar equipment to other countries, mainly West Germany. This year RIZ also expects to export 40,000 tape recorders and intends to soon enter foreign markets with color tv sets built under license from West Germany's Blaupunkt GmbH.

Equally active in sales abroad is Nikola Tesla, another Zagreb-based firm. Last year the company delivered \$6 million worth of telecommunications equipment to the Soviet Union. A new agreement calls for the shipment of \$6.5 million worth of similar gear to the Soviet Union this year and \$7.5 million next year.

Okinawa's newest industry: IC's

There's a buildup afoot in the manufacture of semiconductors on Okinawa. Latest to apply for permission to set up production is National Semiconductor, which reportedly requested government approval for both manufacture and export of IC's as well as other semiconductor products. Initial investment would be on the order of \$1.9 million. Local estimates put annual business after five years at \$14.5 million and employment at more than 1,000 Okinawans. The move is even larger than last year's startup of semiconductor operations by Fairchild, which planned initial investment only about one third that of National.

Elliott to build flight data computer

Though British avionics products are fairly advanced, so far no English company has put its chips on a digital air data computer. Now, though, Elliott Flight Automation, armed with a government contract, will take the plunge. Its airborne computer system will process most of the inputs needed for navigation and flight control. It will borrow some of the digital technology the company has acquired in other avionics contracts, particularly on the LTV A-7 Corsair. The transducers, however, will be new; Elliott claims they are much simpler than those commonly used.

Elliott sees two big markets for its computer system. The first is the United States, where the company has already established a solid foothold. But even more significant is the European market, and Elliott is keeping a sharp eye on the British-German-Italian multi-role combat aircraft. Elliott's system almost certainly will be the only digital air data computer both suitable for the MRCA and originating from within the cooperating countries.

Canadians develop flat-screen tv

When flat-screen tv displays come of age, Canada may be one of the suppliers. A flat screen has been developed jointly by Autotelic Industries Ltd., Fort Erie, Ont., and the University of Waterloo's Industrial Research Institute. The first pilot model for tv manufacturer evaluation should be available in from three to six months. Both Canadian Motorola and Canadian General Electric have expressed an interest in the device, says Autotelic.

The company's display uses a deposited gold grid, which it says is similar to the Panasonic unit but not as complex. Instead of one video amplifier per line, the Canadian unit requires just a diode and a resistor for each line. For computer read-out and video-phone applications, the developers are currently building up solid state boards for a 6-inch square panel.

Radiation and electricity can alter MAS read-only memory from Japan

Key is positive shift of threshold voltage when gate bias exceeds a critical voltage; team at Nippon Electric used metal alumina semiconductors to form tightly packed 256-bit memory with high mutual conductance, 50 nsec cycle time

MAS transistors form the basis for a read-only memory, which is alterable both electrically and by radiation, being developed in Japan.

A Nippon Electric Co. team under Sho Nakanuma, using a three-dimensional wiring scheme, has built a 256-bit memory using only 256 metal-alumina-semiconductor transistors for storage. Another 16 transistors are used in the reading circuit to improve the signal-to-noise ratio. Nonetheless, the Japanese approach allows reading and writing selection of any one of the 256 bits with only 34 terminals.

The alumina film has a higher dielectric constant than many other oxides, and, therefore, the mutual conductance of the MAS transistors is nearly twice as large as it is in conventional MOS transistors. This, in turn, means that circuit components can be tightly packed into a structure that allows high-speed operation. A cycle time of 50 nanoseconds for reading out data has already been achieved.

Shifty. The key to the memory's storage ability lies in the fact that the threshold voltage of the MAS transistors shows a positive shift when gate bias exceeds a critical voltage. What's more, the gate voltage can be negative, positive, a-c, d-c or pulses. Although the shifted threshold voltage decays, it decays so slowly—its half life is 10^{14} hours—that the shift is essentially permanent. However, X rays can cancel the shift in voltage with no damage to the silicon-alumina interface properties. This ability to be altered by radiation indicates that the threshold voltage shift is probably

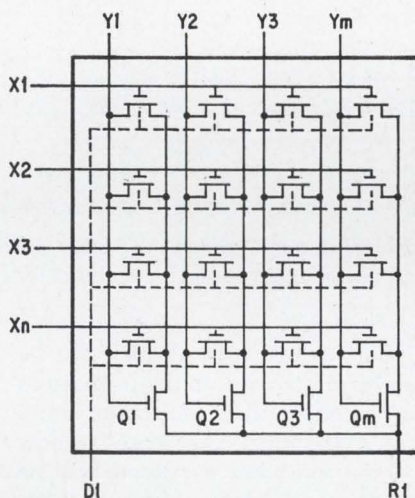

3-D. Wiring scheme for MAS memory needs only one terminal per line plus a read and a write terminal.

not caused by ionic charge phenomena, but by electron activity. Most likely, says the team, electrons from the metal or silicon are captured by traps in the alumina.

The mechanism of writing selection and the actual writing itself are fairly simple. For channel writing, +30 volts is applied to the selected X terminal, and -30 volts is applied through a resistor to the selected Y terminal. The X voltage is applied to all gates in a row; but, it cannot write information into the transistors because the voltage is below the critical value. The voltage does, however, cause formation of an n channel under all gates connected to the selected X line. Since D1 terminal connected to the substrate is at 0 volts, it is not possible to maintain the selected Y line at -30 volts. Current

flows in the forward-biased diodes between the n sources of transistors connected to Y lines and the p substrate. Hence, source-to-substrate voltages are less than 1 volt.

To store a 1, the potential of the D1 terminal is maintained at 0 volts and no change takes place. To store a 0, a -30-volt pulse is applied to the D1 terminal. Both substrate and selected Y line fall to -30 volts, because there is no longer any source-to-substrate current flow. Since the -30 volts connected to the source extends under the gate via the channel, voltage difference between the gate and channel is 60 volts—which is sufficient to write in a zero.

Other transistors connected to the selected Y line, but not connected to the selected X line, have a potential of 0 volts on their gates. The only voltage connected to these transistors is the -30 volts on their sources and on the substrate, which is below the critical value.

Other transistors connected to the selected X line, but not connected to the selected Y line, have a potential of 0 volts on their sources. This potential extends under the gate via the channel, and, thus, shields the alumina under the gate from the -30 volts connected to the substrate. Thus, the potential difference across the alumina remains below the critical voltage.

For readout, 5 volt pulses are supplied to selected X and Y lines. The 5 volts on the X line is applied to the gates of selected transistors. This is more than the threshold voltage if stored information is 1. The readout voltage on the Y line

is applied to the gates of the readout transistors and the sources of the selected storage transistors. Since 5 volts is applied to both gate and source of selected transistor, it conducts, and a positive voltage is applied to source of the readout transistor. Since positive voltages are applied to gate and source of the readout transistor, it also conducts, and a positive voltage pulse appears across a load resistor connected between terminal R1 and ground.

France

The inside story

The semiconductor industry has parlayed its products into the backbone of modern technology, while knowing precious little about the innards of the tiny chips it churns out by the millions.

Until the integrated circuits era, precise insights into the role of a transistor's physical characteristics in producing a given electrical output were not so important. Transistors were cheap enough that manufacturers could toss out those that didn't perform right. Lack of knowledge "troubled the human spirit," but not corporate profits, says Gérald Rey, a French solid state researcher.

However, the spirits of Rey and a colleague, Henri Martinot, were troubled enough to make them give semiconductors a long and penetrating look. The result is new mathematical models that tie electrical characteristics of a single transistor or a complex integrated circuit to precise physical parameters. And, the equations used with the models are simple enough to be solved without a computer. Engineers of French semiconductor firms say they know of no other model so simple to apply yet so accurate in dissecting a transistor.

Two-year job. Working at a space automation laboratory in Toulouse, Rey, Martinot and a team of more than a dozen researchers have been puzzling over transistor models for close to two years. So far they've developed a-c and d-c models for

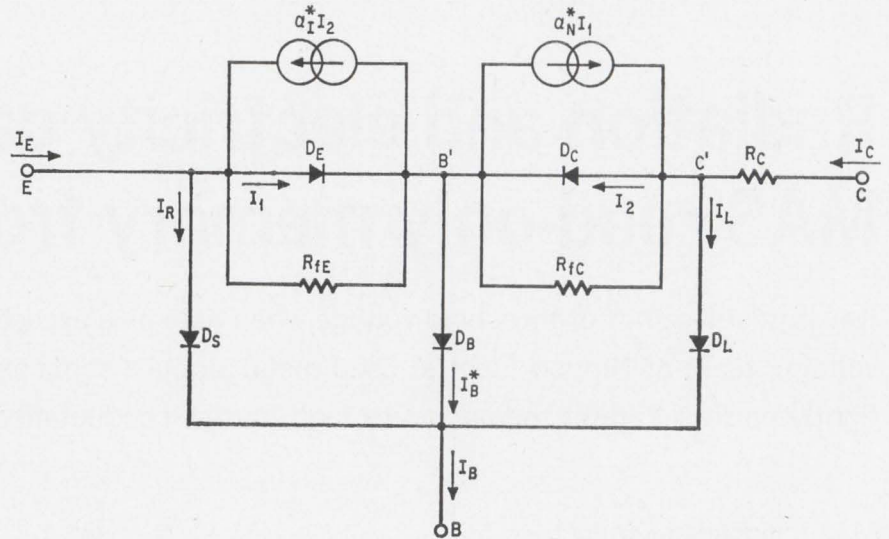

- α_N^* : INTRINSIC CURRENT GAIN AT FORWARD BIAS.
- α_I^* : INTRINSIC CURRENT GAIN AT REVERSE BIAS.
- D_E : INTRINSIC EMITTER-BASE DIODE (ACTIVE ZONE).
- D_C : INTRINSIC COLLECTOR-BASE DIODE (ACTIVE ZONE).
- D_S : DIODE REPRESENTING SURFACE RECOMBINATION PHENOMENA.
- D_L : DIODE REPRESENTING PASSIVE COLLECTOR-BASE JUNCTION & SURFACE RECOMBINATION PHENOMENA.
- D_B : DIODE REPRESENTING STATIC BASE RESISTANCE.
- R_{fC} AND R_{fE} : EARLY-EFFECT RESISTANCE.
- R_C : OHMIC RESISTANCE OF COLLECTOR ZONE.

Fashioning a model. Toulouse team views a transistor along lines of this model and ties physical to electrical characteristics with 12 formulas.

bipolar transistors. Both can be used equally well on the transistors and diodes that constitute integrated circuits. The team is now working on what it expects will be the first complete model of MOS circuits, to be ready next year.

The Toulouse group has tested the d-c bipolar model against some 50 transistors of major manufacturers. These test transistors covered a power range of 1 watt to 10 milliwatts, a cutoff frequency range of 30 megahertz to 2 gigahertz and included rectangular, circular, star, and other mask shapes. Electrical parameter curves predicted by the model, based on the transistors' physical characteristics, hit actual curves right on the nose in most cases. At worst, error went to only 10%, which compares with an error margin of up to 50% for other models, says Rey.

La Radiotechnique, the French components subsidiary of Philips Gloeilampenfabrieken, plans to use the bipolar model to control quality on its transistor assembly line. The model ties each electrical parameter to a physical characteristic and, hence, to a technological process. Radiotechnique engineers will know, for example, that if a tran-

sistor's gain measures wrong, the culprit is the diffusion oven's temperature, a low-quality chip, or some other precise problem. Radio-technique design engineers also plan to use the model to simulate TTL-gate and multi-emitter IC's.

Thomson-CSF is using the Toulouse model to develop tiny "nano transistor" IC's, 1,000 times smaller than standard circuits, to cut power consumption and speed access time in computers.

Mathematical models of semiconductor components are not new, of course. A basic transistor model was developed way back in 1954 by J.J. Ebers and J.L. Moll of Bell Telephone Laboratories. A uni-dimensional model concerned only with a transistor's depth profile, it was modified in 1966 by an IBM team led by H.N. Ghosh, who added the transversal currents that also greatly affect performance.

Too raw. The IBM model, while a big improvement, is highly complex. Designers must feed lengthy raw equations into a computer each time they want to conjure up an imaginary transistor. Designing an IC this way makes the computer work long hours. And since results may be only approximate, designers

must couple this theoretical work with deductive juggling.

The Toulouse team boiled down such equations into relatively simple formulas that can be solved manually. The bulk of mathematical calculation has been done "once and for all," says Rey, who thinks it is "ridiculous" to make a computer solve the same equations each time a parameter is changed.

The number of essential parameters that must be fed into the model is only 12, half a dozen less than most other models require. These parameters are all constant and are tied to physical characteristics. The model, thus, follows a set of tidy laws: the saturation current of diode D_B is proportional to the base doping, and so forth.

Though parameters are fewer, the model gives all the information of earlier models, and then some. Rey says it is the only one that furnishes data on current gain variation as a function of the bias current and simulates output characteristics.

Big role. Rey forecasts a big role for the Toulouse models in studying the physical parameters that set the upper limits on transistor power and frequency. For example, impedance saturation problems that crimp the signal amplitude a transistor can put out at high frequencies will now be much easier to study than in the past. And, the lab is using the model to see how radiation affects different transistor parameters, under a French military contract.

Great Britain

Seeing stars

Astronomers spend precious little time actually looking through telescopes. In fact star-gazing for many astronomers amounts to laborious analysis of photographs. A photo covering an area a few times the size of the moon contains tens of thousand of stars, most of which have to be ignored in studies of star motion, fluctuations in brightness and other changes.

Now the Royal Observatory at

Edinburgh has automated the chore of star-field analysis. In collaboration with Faul-Coradi Scotland Ltd., the observatory has developed a completely automatic computer-controlled analyzer that has pinpointed and measured the brightness of 1,000 stars an hour. During its first three months of operation, it has fixed the position of over a quarter million stars. What's more, it has measured the brightness and temperature—deduced from star color, using different filters—of about 40,000 stars.

The system, which Faul-Coradi plans to market for about \$300,000, is called Galaxy. Galaxy works by scanning each photograph twice. During the first scan, a precision spot on a cathode-ray tube, is further focussed down—to about 16 microns—and scanned across the photo, which is actually a negative. When a star image is encountered—the image may be anything from tens to hundreds of microns across—a photocell behind the plate detects a reduction in incoming light, and triggers an x-y coordinate recorder.

The coordinate measuring system uses conventional glass gratings and, with a 16-micron spot, gives a first-stage position accuracy

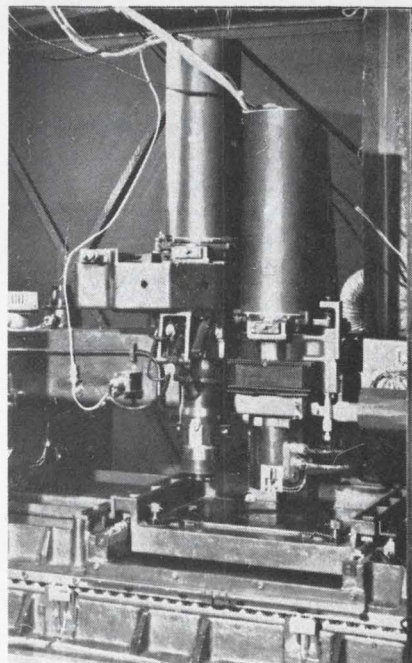

Tabled. Motion of star photo and crt scan give position to 0.5 micron.

to 32 microns. The plates are searched at the rate of 30 square millimeters per minute, equivalent to fixing the positions of about 10,000 stars in an hour. The search is effected by combining linear scan on the crt and mechanical indexing of the base carriage. The recorder punches out the coordinates on eight-channel paper tape.

Taped out. This tape controls the second, more complex, scan, which measures precise position and brightness. The plate is rescanned using a 1-micron spot generated in a second crt. Every pair of tape coordinates is read, in turn, by a photoelectric tape reader, which brings the relevant image under a concentric circular grid containing 256 circles with one-eighth of a micron between adjacent circles.

Initially the image probably will be off-center, and a photomultiplier registers the error against the circles. The carriage is shifted until the image is centered, while the necessary movement is measured. Checking experiments at the observatory show that absolute image position is fixed to within 0.5 micron. At the same time, the density and profile of the image in the circles is compared with 1,024 reference profiles stored in the Elliott computer that controls the system. By this method image size accuracy is refined to one-quarter of a micron, says the observatory. The code of the matching profile and precise position coordinates are punched out on a second eight-channel tape. This second scanning pass takes a maximum of four seconds, allowing about 1,000 measurements in an hour. The data output is so great, says the observatory, that the problem now is to devise computer programs to process it for further study.

West Germany

Head start

A relatively unknown West German company will soon give both foreign and domestic producers of data-printout equipment a run for their money. HCH-Electronic, a

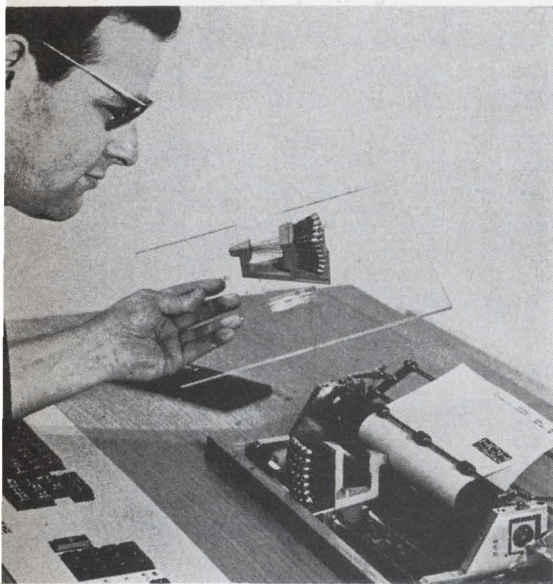

Type cast. An array of solenoids at one end of type head push pins at other end to generate characters.

small firm in Bavaria, is now preparing to market a printer that can produce characters at a rate of 100 per second—the highest rate yet achieved with a serial-type printing device, although electrostatic printers work much faster. At that speed, the new printer is 2.5 times faster than the one introduced by Texas Instruments last year [*Electronics*, May 12, 1969, p. 178].

At its present state of development, the printer is only slightly faster than the printing mechanism Philips designed for its P251 desk calculator [*Electronics*, May 26, 1969, p. 185]. However, the HCH device can be modified for printing up to 300 characters per second, its developer says. Also, while the Philips unit produces only numerical symbols, the HCH unit prints both letters and numbers.

HCH-Electronic is a 24-man company founded last year in Vilshofen, a small town on the Danube river not far from the Czech border. The company, which is financially backed by two Americans, is headed by D.J. Hueppe, who invented the new printer. The company's work force is likely to triple, Hueppe says, when orders start to pour in.

At the fair. The new printer, which is already being produced in small runs, will debut at the

Hanover Fair in May. It will be marketed throughout Western Europe and overseas by Controls and Instruments GmbH, German subsidiary of the American firm. Hueppe says a follow-up model that can produce characters at the 300-per-second clip may be introduced at next year's Hanover Fair.

The printer's key part is its printing head, a 290-gram plastic device that moves along a sliding mechanism just in front of the paper. Installed on this unit are 35 solenoid coils which activate steel pins set in a five by seven plastic matrix. Each pin travels forward through a small hole at the tip of the unit, producing a dot on the paper. The pin, which travels only 1.2 millimeters, is pulled back into its channel by spring action. When a combination of pins shoot forward, a complete character composed of an arrangement of dots is generated.

Although the head's basic mechanical principles are roughly the same as those in the Philips printer, the Philips device generates each symbol in steps as its printing head moves in small increments from left to right. In the HCH device complete characters are produced in one step, with all pins necessary for generating a character hitting the paper at the same time.

Quiet. The plastic construction of the head not only makes for almost noiseless operation, but also reduces wear. The head has shown only negligible wear even after 10⁸ steps in a durability test. The printer's small number of moving parts—only 11—also contribute to noiseless operation.

Characters are produced on pressure-sensitive paper as the head moves along the sliding mechanism. Regular paper can also be used, but a carbon ribbon is necessary. The force behind the pins—about 300 grams—is enough to produce several carbon copies.

The head's control circuitry uses conventional digital techniques, with coding and decoding units supplying the necessary inputs—0 and 1 levels originating at a computer, for example—for the printer's power unit. This unit contains 35 driver stages, one for each solenoid.

In addition to the control circuitry the printer has two stepping motors; one moves the printer head along the slide, the other advances the paper on the cylinder.

Poland

Reckoning on computers

In Poland computers are a growth industry, at least by East-Bloc standards. Despite a pressing need to develop more sophisticated electronics hardware including components, the Poles have, nevertheless, been remarkably successful in producing commercial computers. Now they are generally considered well up front in this field among eastern nations.

At Wroclaw, on the country's western border, the Polish government has been building a computer manufacturing complex that is now one of the largest in the Soviet Bloc. Here, at the Elwro Works, some 4,000 people are busy turning out the ODRA-1204, a second-generation, general-purpose machine widely used in the East. The Poles, who at present have an estimated 170 systems in use, are now planning to complete this year a country-wide computer network comprising 27 data processing centers with a total of 57 computers. Eager to maintain their growth rate, officials are currently negotiating with the French for a license to produce integrated circuits.

Parallel with their efforts in the general-computer field, the Poles are developing machines aimed at special functions and applications. Work in this area is concentrated largely at the Computer Development Institute of Warsaw's Technical University. The institute, before turning its attention to special machines, concerned itself mainly with designing commercial systems for the industry.

Of the special computers the institute has built so far, two systems stand out. One, dubbed Anops, is designed for biomedical applications, and the other called GEO-2, is used for solving mathematical problems encountered in geodesy.

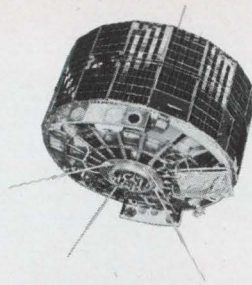

FROM

Weather "Bird"

TO

Tropo-scatter

in one quick

frequency change

MCL's 2-1/2-KW PLUG-IN CAVITY

Giving a big assist to the Department of Commerce's Satellite tracking command is MCL's 2.5KW plug-in amplifier, an integral part of the up-link command transmitter. This high-powered cavity unit supplies the signal power so vital to the telemetry communications of the ESSA Satellite (Environmental Survey Satellite) or the Weather Bird.

Adaptability to a wide range of frequencies gives the MCL amplifier system almost limitless applications in other command communication channels.

Tropo-Scatter, for example, is used by oil companies as a communications' link in the Sahara desert. Other applications include testing equipment for checking out antennae, laboratory and field testing.

A conference call to MCL engineers just might put you on the right wave length regarding your application needs.

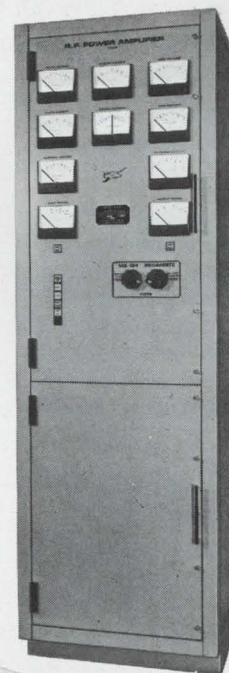

Call (312) 354-4350 or send for MICROWAVE MARKETPLACE CATALOG—Edition "A".



MICROWAVE CAVITY LABORATORIES

DIVISION OF KMS INDUSTRIES, INC.

10 North Beach Avenue, LaGrange, Illinois 60525

RCA Solid-State Data for Designers

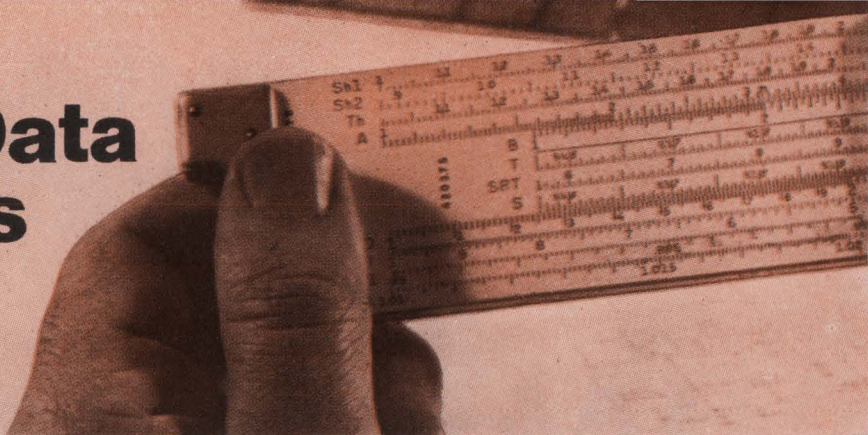

Switching regulator offers high efficiency

Where space and weight are important factors, the switching regulator has some impressive advantages. Here's why:

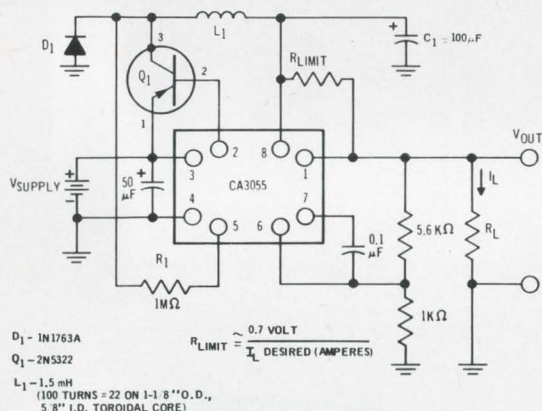

SWITCHING REGULATOR USING RCA-CA3055

The switching regulator is basically a relaxation oscillator (positive feedback is introduced via R_1) and, unlike conventional Class A dc regulators, it's either in the "Off" state—with essentially zero internal dissipation—or saturated in the "On" state with low dissipation. Thus the operating efficiency is high.

The regulator's state is determined by the voltage difference between the internal reference (pin 5) and the sense input (pin 6). When the sense input is more negative than the reference, the regulator is on. Conversely, if the reference is more negative, the regulator is off.

The RCA-CA3055 makes an excellent switching regulator. Its load and line regulation capability is 0.025% and it can deliver up to 100 mA. It has an input voltage range of 7.5 V to 40 V and an adjustable output from 1.8 V to 34 V.

Circle Reader Service No. 315.

Typical operating characteristics:

Output Impedance	<0.15Ω
Line Regulation	.03%
Efficiency	76.5%
Rise Time	1 μs
Switching Frequency	60 kHz
Output Voltage	11 V
Output Current	400 mA

No trade-off on power capability with two new high voltage types

RCA's 2N5804 and 2N5805 are two new triple-diffused silicon n-p-n transistors that offer the best in high-voltage, high power characteristics ($P_T = 110 \text{ W}$)—in an economical TO-3 package. Especially useful in efficient power conversions, the 2N5804 and 2N5805 will find design applica-

tion in switching inverters, series regulators, linear amplifiers, deflection amplifiers, and motor controls.



Designed primarily for use in the industrial and military markets, these devices round out a line that already makes RCA the silicon power leader in the industry.

The 2N5804 features V_{CE0} (sus) of 225 V (max.), while 2N5805 offers V_{CE0} (sus) of 300 V (max.). Both silicon power transistors have a current capability of 8 A and are beta controlled at 5 A.

Circle Reader Service No. 316.

New COS/MOS 4-Bit Full Adder is significantly faster than P-MOS adders

RCA's CD4008D is a new generation 4-Bit Full Adder featuring a fast look-ahead carry capability. The CD4008D combines low quiescent power dissipation—5 μW (typ)—with high-speed operation where sum propagation delay is typically 400 ns and carry-in to carry-out delay is 50 ns. This rapid carry feature is especially valuable in assembling multiple adder stages such as a 16-bit full adder where all sum outputs will settle to final values in 660 ns.

The new COS/MOS adder will operate with a single power supply over a wide voltage range—6 to 15 V—and with power consumption sev-

eral orders of magnitude lower than bipolar adders.

The circuit shown here is a typical computer application of a CD4008D. It also incorporates two other COS/MOS integrated circuits—the CD4013D Dual D-Type Set/Reset Flip/Flop and the Developmental TA5652 Quad AND/OR Select Gate.

Registers "A" and "B" are each 4-bits long. The true complement select gate gates information from the "A" register to the four "A" inputs of the adder. The Bus/B register select gate

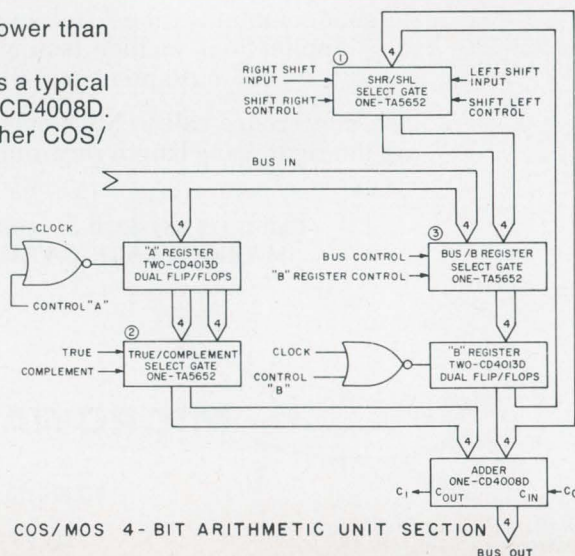

③ feeds the "B" register with information from either the Bus line or the SHR/SHL select gate ① and the "B" register, in turn, passes this information to the four "B" inputs of the adder. The select gate ① provides a means for shifting the "B" register information one position either left or right, thus permitting multiplication or division by two.

The CD4008D adder's output is the sum of its "A" and "B" inputs. When the "A" input from true/complement select gate ② is true, the adder's output is "A" plus "B"; conversely, when the "A" input from the true/complement select gate is the complement, the adder's output is "B" minus "A".

Circle Reader Service No. 317.

Ultra reliable: RCA's radiation-hard transistors

Reliability was the hallmark of the successful lunar landing of Apollo 12's "Intrepid" and the redocking maneuver with the "Yankee Clipper." One of Apollo's most important systems—the Rendezvous Radar—uses an ultra-high-reliability version of RCA's 2N2857 family of radiation-tolerant, low-noise UHF amplifiers.

For applications demanding radiation-tolerant devices, RCA's pioneering low-noise, ultra-high frequency 2N2857 family has demonstrated its

tolerance to a severe radiation environment consisting of steady-state fast-neutron radiation with near-fission spectrum ($E > 0.1$ MeV); fluence 1.2×10^{14} n/cm² accompanied by reactor gamma radiation ($E \approx 1.0$ MeV); gamma dose 1.5×10^7 rads. Peak primary photo current (I_{pp}) for a dosage rate of 10^9 rad/sec is about 0.006 ampere.

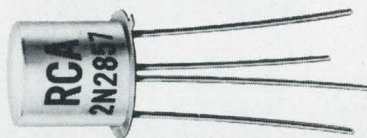

The following table depicts the survivability of the 2N2857 family:

Device unbiased during irradiation				
Parameter	Test Condition	Pre-Irradiation	Post-Irradiation	
h_{FE}	$V_{CE}=1$ V, $I_C=3$ mA	80	20	
h_{fe}	$V_{CE}=6$ V, $I_C=5$ mA $f=100$ MHz	18	18	
I_{CBO}	$V_{CB}=15$ V, $I_E=0$	0.008 nA	0.35 nA	
$V_{(BR)CBO}$	$I_C=1$ μ A, $I_E=0$	33 V	36 V	
$V_{(BR)CEO}$	$I_C=3$ mA, $I_E=0$	20 V	27 V	
V_{CE}	$I_C=10$ mA, $I_B=1$ mA	0.16 V	0.37 V	
G_{PE}	$V_{CE}=6$ V, $I_C=1.5$ mA $f=450$ MHz	13.4 dB	13.0 dB	
NF	$V_{CE}=6$ V, $I_C=1.5$ mA $f=450$ MHz	4.4 dB	4.5 dB	
C_{obo}	$V_{CB}=10$ V, $f=1$ MHz	1.1 pF	1.1 pF	

Contact your local RCA Representative who will be pleased to work with you on your high-reliability requirements.

For further data on the 2N2857 family, circle Reader Service No. 318.

For price and availability information on all solid-state devices, see your local RCA Representative or your RCA Distributor. For specific technical data, write RCA Electronic Components, Commercial Engineering, Section B19-3/UM4, Harrison, N.J. 07029. In Europe: RCA International Marketing S.A., 2-4 rue du Lièvre, 1227 Geneva, Switzerland.

The key to intrusion alarms—RCA GaAs laser diodes

Alarms using RCA's developmental type TA7699 (or its TA7699R reverse polarity counterpart) gallium arsenide (GaAs) laser diodes disclose many intruders. These laser diodes are designed into protective systems for both military and commercial applications.

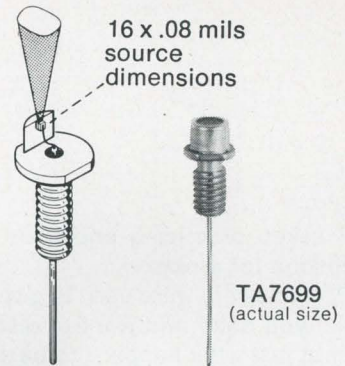

Single laser diode assembly

The TA7699 and TA7699R are "Close Confinement" laser diodes. (Close Confinement is a manufacturing technique that limits radiation to the junction area and results in lower threshold currents and greater efficiency.) They operate in the near infrared region (9050 angstroms), and are capable of 15 watts (minimum) output.

Here are three big reasons for using the TA7699 and TA7699R: 1) operating range in excess of 1000 feet; 2) readily available silicon photodetectors can be used for receivers; 3) relatively low drive current required—so battery life can be a year or more.

Also available are selected RCA GaAs "CC" diodes that have outputs up to 25 watts at the same low drive current as the TA7699—as well as the following "CC" diode types:

Characteristics	TA7606	TA7608	TA7610
High Radiant Peak Power Output (Watts)	1 (min.)	5 (min.)	10 (min.)
Source Dimension (Mils)	3	6	9
Typical Threshold Current, I_{th} (Amperes)	4	7	10
Low Drive Current, I_{FM} (Amperes)	10	25	40

Circle Reader Service No. 319.

What do you really want in your scope?

HP asked practicing engineers this question for a reason.

The answers were used to give you what you need and want in a scope... not just what happens to be available. The result is the 180 Scope System.

Some of your suggestions... like infinite bandwidth... were impossible to meet. But as a result of trying, HP did hit 250 MHz, about twice the real-time frequency of any other general-purpose scope available today!

And, by carefully screening the many suggestions, a definite pattern of preference emerged. Most engineers wanted:

1. Highest possible performance.
2. Plug-in versatility.
3. Ease of operation.
4. Capability of future expansion, to prevent early obsolescence.
5. The smallest possible package, with largest CRT display.

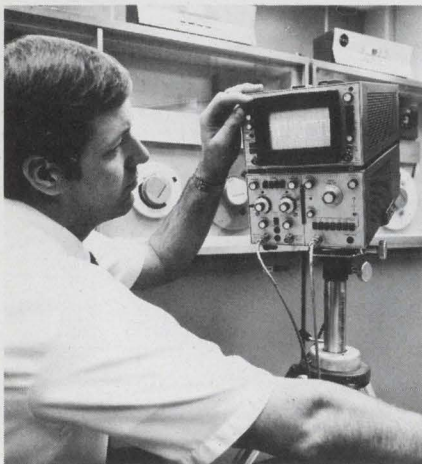

Naturally, we feel that 180 scope system is today's best answer to these requirements. However, you may want more information before

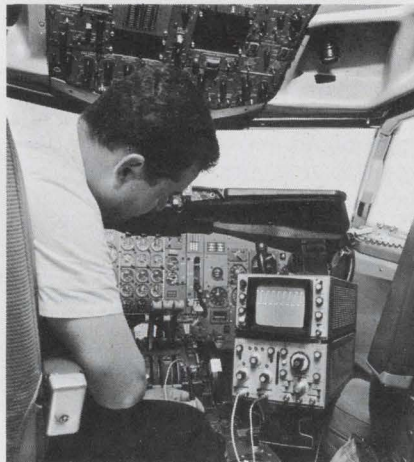

making your decision. Consider the following facts.

"We want performance."

The introduction of the **183A scope**—with its 250 MHz **real-time** bandwidth and 10 mV sensitivity—gives you the undisputed leader in high-frequency, real time measurements. The true performance champ!

But 250 MHz real-time is only part of the story. With the 180 series you start with a choice of three mainframes, in either rack or cabinet configuration.

The **HP 180A Mainframe** is designed for general use through 100 MHz real-time and 12.4 GHz sampling. You have your choice of 9 plug-in units. With this combination you can tailor a 180 to meet your present requirements—and still have the ability to expand in the future.

Big picture CRT display is a full 8 x 10 cm. Yet, front-panel size is no larger than this page. (Small package to eliminate clutter—big CRT to increase measurement accuracy.)

The **HP 181A Mainframe** brings storage to the 180 System. It is the only mainframe that offers both variable persistence, and storage—and it is the only storage scope in the 50 or 100 MHz range. For versatility, the 181A accepts all plug-ins that the 180A uses.

The **HP 183A Mainframe CRT** is an HP exclusive. Utilizing a unique transmission line deflection system in the CRT, the mainframe provides real-time bandwidth beyond 500 MHz.



This means you will not be mainframe-limited tomorrow, when new, state-of-the-art plug-ins become available. Right now, all 11 of the present 180 series plug-ins operate in the 183A mainframe, at their specs. (Another example of HP's fight against obsolescence.)

"We want easy operation."

As for ease of operation, a quick glance at the front panel is your best assurance of that. The 180 system is

The Performance Champs

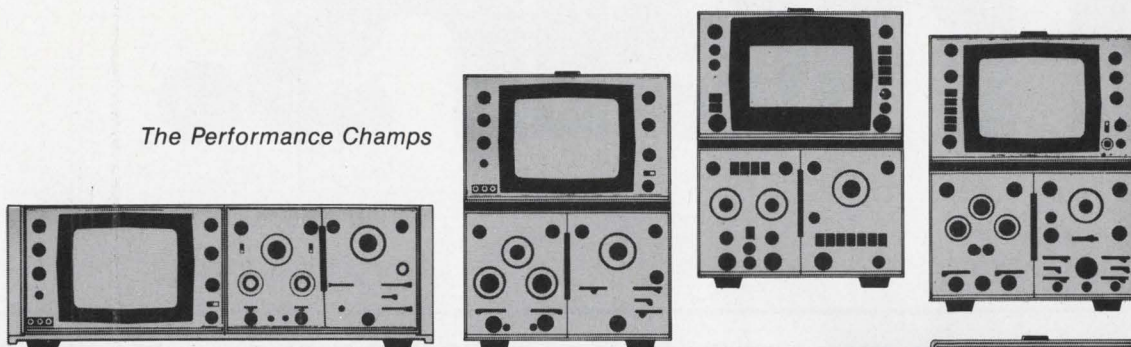

human-engineered to give you maximum performance with minimum confusion. Significant contributions have been made in simplifying controls: Single-control triggering for the 250 MHz time base; selective use of push-buttons; single-switch signal averaging in the sampling plug-in to reduce noise and jitter. Exclusive HP



mixed sweep control lets you expand a selected portion of the signal for precise measurements in areas of critical importance.

Carry the rugged 180 Scopes anywhere you need it—with plug-ins, weight is only 30 to 35 pounds. Put it on your bench without crowding—takes only 8" x 20" of space. Use it in racks where space is at a premium—rack version is only 5¼" high.

"We want plug-in versatility."

Plug-in compatibility is one of the many plus features you suggested. All the high-performance capabilities of the 11 plug-ins can't be covered in

a short space. But just to give you an idea of system versatility, you can get:

Calibrated time domain reflectometry with 35 ps risetime.

12.4 GHz sampling with 28 ps risetime.

Choice of regular or delayed sweep time bases.

50 MHz four-channel with 20 mV/div sensitivity.

100 MHz dual-channel with 3.5 ns risetime, no capacitive distortion and

250 MHz real-time dual-channel with 10 mV/div sensitivity.

"Now, and in the future..."

To prevent mainframe obsolescence in the 180 Series, HP has adopted a design philosophy of driving the CRT vertical plates directly from the vertical plug-in. This design approach keeps the full capability of the CRT available to future plug-ins, so you can take advantage of tomorrow's technology in today's mainframe. (The 183A Mainframe is an example of this philosophy in action—when 500 MHz vertical amplifiers are designed, they will work in this existing mainframe.)

Today oscilloscope technology is at a crossroads. The system you choose now is the one you will have to live with for a good many years to come.

The HP direction points to getting the best, now; at a low price; with assurance of increased measurement capabilities down the road, using existing mainframes.

If you have read this far, you probably agree with at least some of the

points mentioned. If you are not completely convinced, we're willing to rest our case on a side-by-side comparison with any other high-frequency scope you may be considering. If you think the other scope is better... buy it! Conversely...

To arrange a comparison, call your local HP field engineer. Ask him about HP's new concept of oscilloscope service... have him show you HP's video training tapes.

Or, for a complete full-color 180 system brochure, write to Hewlett-Packard, Palo Alto, California 94304. Europe: 1217 Meyrin-Geneva, Switzerland. Price examples: 50 MHz system, \$2065; 250 MHz system, \$3150.

080/2

HEWLETT *hp* PACKARD

OSCILLOSCOPE SYSTEMS

Theirs.

SERIES 7400 PRICING GUIDE*

PART	TEXAS INSTRUMENTS		SIGNETICS		MOTOROLA	
	NUMBER	PRICE	NUMBER	PRICE	NUMBER	PRICE
Quadruple 2 Input Positive NAND Gates	SN 7400N	1.26	N7400A	1.20	MC7400P	1.10
Quadruple 2 Input Positive NAND Gates (w/open col)	SN 7401N	1.26	N7401A	1.20	MC7401P	1.10
Quadruple 2 Input Positive NOR Gates	SN 7402N	1.45	N7402A	1.38	MC7402P	1.26
Quadruple 2 Input Positive NAND Gates (w/open col)	SN 7403N	1.26	—	—	—	—
HEX Inverter	SN 7404N	1.58	—	—	MC7404P	1.36
HEX Inverter (w/open-col)	SN 7405N	1.58	—	—	MC7405P	1.36
Quadruple 2 Input Positive AND Gate	—	—	—	—	—	—
Triple 3 Input Positive NAND Gates	SN 7410N	1.26	N7410A	1.20	MC7410P	1.10
Triple 3 Input Positive AND Gate	—	—	—	—	—	—
Dual 4 Input Positive NAND Gates	SN 7420N	1.07	N7420A	1.02	MC7420P	1.10
8 Input Positive NAND Gates	SN 7430N	1.07	N7430A	1.02	MC7430P	1.10
Dual 4 Input Positive NAND Buffers	SN 7440N	1.45	N7440A	1.38	MC7440P	1.26
BCD-to-Decimal Decoder/Driver	SN 7441AN	7.03	N7441B	6.70	MC7441AP	6.20
Expandable Dual 2-Wide 2 Input AND-OR-INVERT Gates	SN 7450N	1.26	N7450A	1.20	MC7450P	1.10
Dual 2-Wide 2 Input AND-OR-INVERT Gates	SN 7451N	1.26	N7451A	1.20	MC7451P	1.10
Expandable 4-Wide 2 Input AND-OR-INVERT Gates	SN 7453N	1.26	N7453A	1.20	MC7453P	1.10
4-Wide 2 Input AND-OR-INVERT Gates	SN 7454N	1.26	N7454A	1.20	MC7454P	1.10
Dual 4-Input Expander	SN 7460N	.94	N7460A	.90	MC7460P	.88
Positive Edge-Triggered JK F.F. (AND Inputs)	SN 7470N	1.90	N7470A	1.81	—	—
J-K Master Slave F.F. (AND Inputs)	SN 7472N	1.77	N7472A	1.69	MC7472P	1.50
Dual J-K Master Slave Flip Flops	SN 7473N	2.91	N7473A	2.77	MC7473P	2.55
Dual D-Type Edge-Triggered Flip Flops	SN 7474N	2.52	N7474A	2.40	—	—
Dual J-K Master Slave F.F. w/Preset & Clear	SN 7476N	3.06	N7476B	2.92	MC7476P	2.70
Dual J-K Master Slave F.F. (Vcc-14, Gnd 7)	SN 74107N	2.91	—	—	—	—

*DIP 0°C to 70°C. Prices as of January 10, 1970.

Ours.

FAIRCHILD

NUMBER	PRICE
--------	-------

U6A740059X	.85
U6A740159X	.85
U6A740259X	.97
U6A740359X	.85
U6A740459X	1.07
U6A740559X	1.07
U6A740859X	1.10
U6A741059X	.85
U6A741159X	1.10
U6A742059X	.85
U6A743059X	.85
U6A744059X	.97
U6B744159X	6.65
U6A745059X	.85
U6A745159X	.85
U6A745359X	.85
U6A745459X	.85
U6A746059X	.77
U6A747059X	1.41
U6A747259X	1.31
U6A747359X	2.15
U6A747459X	1.88
U6B747659X	2.28
U6A7410759X	2.15

This looks like an ad about prices. It isn't. It's an ad about production.

Mechanized, high-yield production.

Production that is turning out 2-million Series 7400 circuits per month.

Production that allows us to price our Series 7400s far below anybody else in the business.

And production that allows us to promise that you can get the 7400s you need, in the quantity you need them, delivered when you need them,

from any Fairchild Distributor. Today.

FAIRCHILD
SEMICONDUCTOR

Fairchild Semiconductor / A Division of Fairchild Camera and Instrument Corporation / Mountain View, California 94040, (415) 962-5011 / TWX: 910-379-6435.

For Distributor Listing, turn page.

FAIRCHILD STOCKING DISTRIBUTORS

ALABAMA

SCHWEBER ELECTRONICS
Huntsville
Tel: 205-539-2756

ARIZONA

HYER ELECTRONICS COMPANY
Phoenix
Tel: 602-263-1112

HAMILTON ELECTRO OF ARIZONA
Phoenix
Tel: 602-272-2601

CALIFORNIA

AVNET ELECTRONICS
Culver City
Tel: 213-836-7200

HAMILTON ELECTRO SALES
Culver City
Tel: 213-870-7171

HAMILTON ELECTRO SALES—NORTH
Mountain View
Tel: 415-961-7000

HAMILTON ELECTRO OF SAN DIEGO
San Diego
Tel: 714-279-2421

G. S. MARSHALL COMPANY
El Monte
Tel: 213-579-1500

G. S. MARSHALL COMPANY
San Diego
Tel: 714-278-6350

G. S. MARSHALL COMPANY
Sunnyvale
Tel: 408-732-1100

COLORADO

HAMILTON ELECTRO SALES
Denver
Tel: 303-433-8551

HYER ELECTRONICS COMPANY
Englewood
Tel: 303-771-5285

CONNECTICUT

CRAMER ELECTRONICS, INC.
North Haven
Tel: 203-239-5641

FLORIDA

POWELL-FLORIDA
Orlando
Tel: 305-423-8586

CRAMER FLORIDA, INC.
Fort Lauderdale
Tel: 305-566-7511

HALL MARK ELECTRONICS
Orlando
Tel: 305-855-4020

SCHWEBER ELECTRONICS
Hollywood
Tel: 305-927-0511

GEORGIA

CRAMER ELECTRONICS, INC.
Atlanta
Tel: 404-451-5421

ILLINOIS

F-J-R ELECTRONICS
Rosemont
Tel: 312-678-8560

PACE/AVNET ELECTRONICS
Schiller Park
Tel: 312-678-6310

SEMICONDUCTOR SPECIALISTS, INC.
Chicago
Tel: 312-279-1000

INDIANA

SEMICONDUCTOR SPECIALISTS, INC.
Indianapolis
Tel: 317-243-8271

KANSAS

AVNET ELECTRONICS
Prairie Village
Tel: 913-362-3250

LOUISIANA

STERLING ELECTRONICS CORPORATION
New Orleans
Tel: 504-522-8726

MARYLAND

HAMILTON ELECTRO SALES
Baltimore
Tel: 301-796-5000

SCHWEBER ELECTRONICS
Rockville
Tel: 301-427-4977

CRAMER/WASHINGTON
Rockville
Tel: 301-424-2700

MASSACHUSETTS

CRAMER ELECTRONICS, INC.
Newton
Tel: 617-969-7700

SCHLEY ELECTRONICS CORP.
Watertown
Tel: 617-924-1500

SCHWEBER ELECTRONICS
Waltham
Tel: 617-891-8484

MICHIGAN

SEMICONDUCTOR SPECIALISTS, INC.
Detroit
Tel: 313-255-0300

SHERIDAN SALES CO.
Southfield
Tel: 313-358-3333

MINNESOTA

PAGE/AVNET—MINNEAPOLIS
Minneapolis
Tel: 612-920-5866

SEMICONDUCTOR SPECIALISTS, INC.
Minneapolis
Tel: 612-861-3400

MISSOURI

HAMILTON ELECTRO SALES
Hazlewood
Tel: 314-731-1144

SEMICONDUCTOR SPECIALISTS, INC.
St. Louis
Tel: 314-423-6500

NEW JERSEY

HAMILTON ELECTRO SALES
Cherry Hill
Tel: 609-662-9337

SCHLEY ELECTRONICS CORP.
Rutherford
Tel: 201-935-2120

NEW MEXICO

HYER ELECTRONICS CO.
Albuquerque
Tel: 505-265-5767

NEW YORK

CRAMER ELECTRONICS
Rochester
Tel: 716-275-0300

CRAMER ELECTRONICS, INC.
Syracuse
Tel: 315-455-6641

SUMMIT DISTRIBUTORS, INC.
Buffalo
Tel: 716-884-3450

HAMILTON ELECTRO SALES
Syracuse
Tel: 315-437-2641

SCHWEBER ELECTRONICS
Westbury, Long Island
Tel: 516-334-7474

TAYLOR ELECTRONIC CORPORATION
Baldwin, Long Island
Tel: 516-223-8000

NORTH CAROLINA

HAMILTON ELECTRO SALES
Greensboro
Tel: 919-275-9969

OHIO

F-J-R ELECTRONICS
Dayton
Tel: 513-278-9411

SCHWEBER ELECTRONICS
Cleveland
Tel: 216-333-7020

SHERIDAN SALES CO.
Cincinnati
Tel: 513-761-5432

SHERIDAN SALES CO.
Cleveland
Tel: 216-524-8120

OREGON

HAMILTON ELECTRO SALES
Portland
Tel: 503-255-8550

PENNSYLVANIA

POWELL ELECTRONICS, INC.
Philadelphia
Tel: 215-724-1900

SHERIDAN SALES CO.
Pittsburgh
Tel: 412-243-6655

TENNESSEE

POWELL ELECTRONICS, INC.
Fayetteville
Tel: 615-433-5737

TEXAS

ARCO ELECTRONICS INC.
Dallas
Tel: 214-239-9123

HAMILTON ELECTRO SALES
Houston
Tel: 713-526-4661

NORVELL ELECTRONICS, INC.
Dallas
Tel: 214-357-6451

NORVELL ELECTRONICS, INC.
Houston
Tel: 713-774-2568

UTAH

HYER ELECTRONICS CO.
Salt Lake City
Tel: 801-487-3681

WASHINGTON

HAMILTON ELECTRO SALES
Seattle
Tel: 206-624-5930

KIERULFF ELECTRONICS
Seattle
Tel: 206-763-1550

CANADA

AVNET ELECTRONICS OF CANADA, LTD.
Toronto
Tel: 416-789-1838

AVNET ELECTRONICS OF CANADA, LTD.
Montreal
Tel: 514-381-9126

R.A.E. INDUSTRIAL ELECTRONICS, LTD.
Vancouver
Tel: 604-253-8494

SCHWEBER ELECTRONICS
Toronto
Tel: 416-925-2471

Washington Newsletter

February 16, 1970

Congress docile on tight Nixon rein for communications . . .

Little Congressional opposition is forecast for President Nixon's plan to replace the Office of Telecommunications Management with a stronger Office of Telecommunications Policy [*Electronics*, Aug. 4, 1969, p. 56]. OTP will be directly responsible to the President; it will be his "principal adviser on telecommunications policy;" and will make policy for the National Communications System—a responsibility now held by the Secretary of Defense.

The reorganization is being handled under provisions of the U.S. Code, which requires no new legislation. Only a negative action on Capitol Hill can prevent the White House plan from going into effect. This is highly unlikely despite some criticism of the President's aggregation of additional direct power and his unwillingness to spell out the cost.

. . . Commerce Dept. gets research role

The Nixon reorganization proposal paid off only slightly for the Commerce Department, despite its effort to achieve total telecommunications authority in the Executive Branch [*Electronics*, Nov. 10, 1969, p. 51]. What Maurice Stans's department will get is a role supporting OTP by coordinating Federal frequency uses and assignments through a central research and engineering capability; providing telecommunications research and analysis; and developing and operating a National Electromagnetic Compatibility Analysis Facility. Money for NECAF already is requested in fiscal 1971 budget (see p. 150).

May we compete with Ma Bell? irate Comsat asks

Obviously displeased with the White House recommendation for competitive development of domestic satellite systems [*Electronics*, Feb. 2, p. 125], the Communications Satellite Corp. is reorienting its technological, political, and economic outlook to compete in the U.S. systems market. Comsat operations vice president George P. Sampson says the company is prepared to place in synchronous orbit "a multiple purpose system or . . . a series of special-purpose systems—each geared to the peculiar needs of a single user or several users." Previously, Comsat was firm in calling for a multipurpose system for all tasks except aircraft navigation.

On the political side, Comsat is suggesting—but will not directly ask—for a Congressional look at the White House ruling. For example, Sampson notes the 1962 satellite act creating Comsat requires competitive procurement, division of Comsat stock ownership, and—by FCC order—limiting its services to common carriers and NASA. Citing the White House recommendation for competition without restriction, Sampson asks, "Are these restrictions now lifted from us?" And in an obvious reference to AT&T's announced domestic satellite plan, Sampson raises this question: "If others may now go into the satellite business domestically, is Comsat free to enter competitively into the terrestrial communications business?"

Earth station radomes doomed

Radomes that protect ground station antennas for satellite communications are hindering reception of color-television signals and are on their way out. This is one reason for Communications Satellite Corp.'s request for proposals from 35 antenna companies for a new 97-foot-diameter

Washington Newsletter

dish at Andover, Me., to replace the pioneering horn installation developed in 1962 by AT&T for use with its Telstar satellite. Though Comsat won't admit it, the Andover horn was receiving smeared signals or losing pictures altogether when its radome was wet with rain or snow. Specifications for the new antenna, to be ready for operation in the spring of 1971, call for de-icing equipment but no radome.

Economics is a second element in the Comsat Andover plan. The original AT&T installation cost about \$15 million and required a staff of more than 50, but Comsat estimates that new stations with greater capabilities now cost about \$3.5 million and need a crew of 12 to 14. For a simple, unmanned, receive-only earth station in a domestic system, Comsat predicts costs will drop to \$65,000.

Intelsat parley frets over manager issue

The issue of who shall manage the International Telecommunications Satellite Consortium is a prickly one at the 73-country Intelsat negotiations for a permanent agreement, now underway in the Capital. High-technology countries, mostly European, are still adamant that the **Communications Satellite Corp. be dumped from the management role.** The Nixon Administration appears to have backed off from the firm position of its predecessors that Comsat be retained as permanent manager. Now the U.S. position is that Comsat should continue as technical manager until an international study can survey the options and report in a couple of years. France, Germany, and Switzerland, however, want to specifically exclude Comsat as permanent manager.

Agency war looms over pollution battle

An administrative war will probably break out in this session of Congress over management of President Nixon's environment cleanup programs. The work should be combined in an independent Environmental Quality Administration, says Senate Minority Leader Hugh Scott (R., Pa.). Scott is pushing legislation creating an EQA to combine the 90-plus Federal programs now dealing with environmental preservation. Obvious agencies are the National Air Pollution Control Administration in the Department of Health, Education, and Welfare, and the Interior Department's Federal Water Pollution Control Administration, both of which have electronic pollution-surveillance programs.

Other operations that might be in the EQA, and which Scott's staff concedes were not included in the proposal due to oversight, are NASA's environmental aerial-mapping program and air-pollution activities in the Commerce Department's ESSA.

Though the Government will spend less in fiscal 1971 on pollution-control R&D than it did in 1970, the share for electronics will rise \$1.4 million, to \$59.1 million.

FCC's Burch unplugs maverick Johnson

Ask Federal Communications commissioner Nicholas Johnson why he is conspicuously absent from FCC's latest list of committee assignments, and his own suggestion is that he has become overly outspoken. Johnson seems to have been effectively unplugged by chairman Dean Burch from participation in any of the 10 committees. At the same time, Burch's own assignments give a good reading of his interests. His committees include space, the chairmanship of the telephone and telegraph unit, and FCC representative to the executive committee of the National Association of Railroad and Utilities Commissioners.

Our package deal is a complete fabrication.

We make every part of our hermetic integrated circuit packages in our own plants.

We have to.

It's the best way we can be sure that every one will measure up to specs. Both ours and yours.

Take, for example, our off-the-shelf dual inline package. It uses our own special blend of hard glass and alumina to get the best properties. High electrical insulation, thermal shock resistance, hermeticity, and a thermal expansion that matches the metal alloy parts.

It meets Mil-specs and can be plated to your requirements.

If this package doesn't suit your needs, we'll design one to your specs.

Each hermetic package gets to you in first-class condition. No bent or shorted leads. No excess glass-ceramic flow.

In short, the perfect package deal.

*Sylvania Metals & Chemicals, Parts Division,
Warren, Pa. 16365.*

SYLVANIA
A SUBSIDIARY OF
GENERAL TELEPHONE & ELECTRONICS



Introducing The Electronics Network.

Channel 1: Sells the decision-making market.

Electronics is the worldwide electronics marketing channel. Use it to build a market position for your products. To create acceptance for your advanced technology. Or simply to sell ideas.

Many of Electronics 81,000 subscribers cannot be reached through any other publication. Sixty-seven per cent buy anywhere from \$10,000 to over \$1,000,000 worth of products each year. And many of them never see salesmen.

40 skilled editors located in the key market areas and an annual editorial budget in excess of \$1,000,000 provide Electronics readers with broadband technical information to help them do their jobs better.

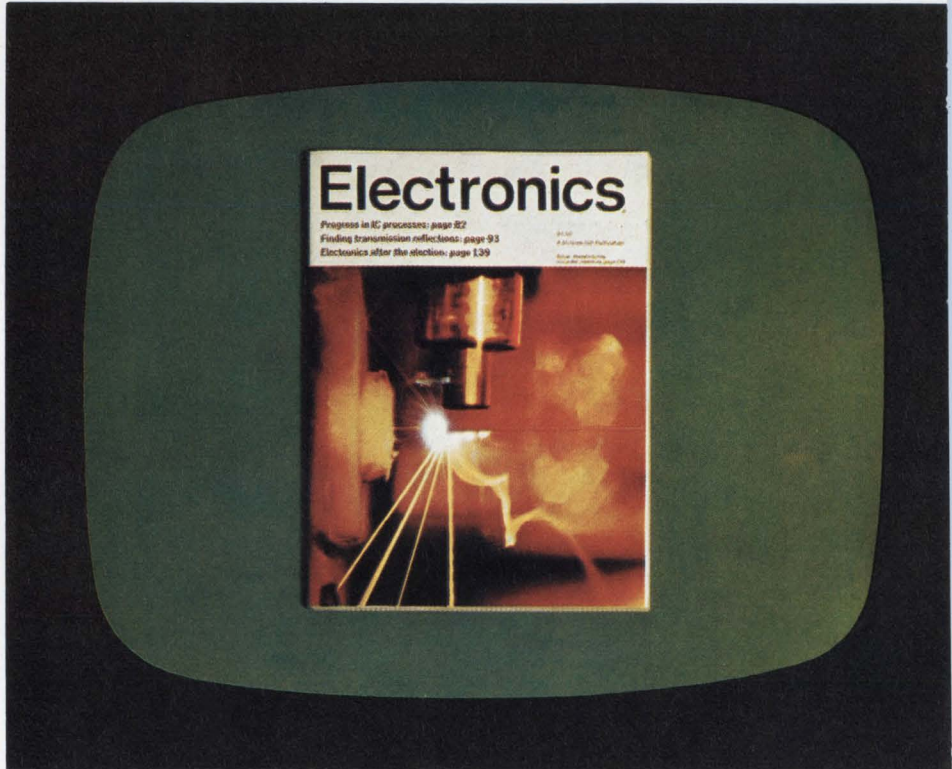

Channel 2: Covers the mass market.

Electronics New Product Preview is the low-cost, mass-coverage channel to the U.S. market (where approximately 70% of the worldwide market is located). Use it as cooperative direct mail to merchandise off-the-shelf products, promote established low profit-margin items. Or use it to generate quick inquiries for your catalogs and specification sheets. (Our first issue produced over 50,000 inquiries.)

ENPP reaches 100,000 U.S. recipients (without duplicating the circulation of Electronics). It publishes more new-product information than any other electronics publication and presents it in ten product sections.



Four channels
designed to work together
to make your
advertising budget
go farther.

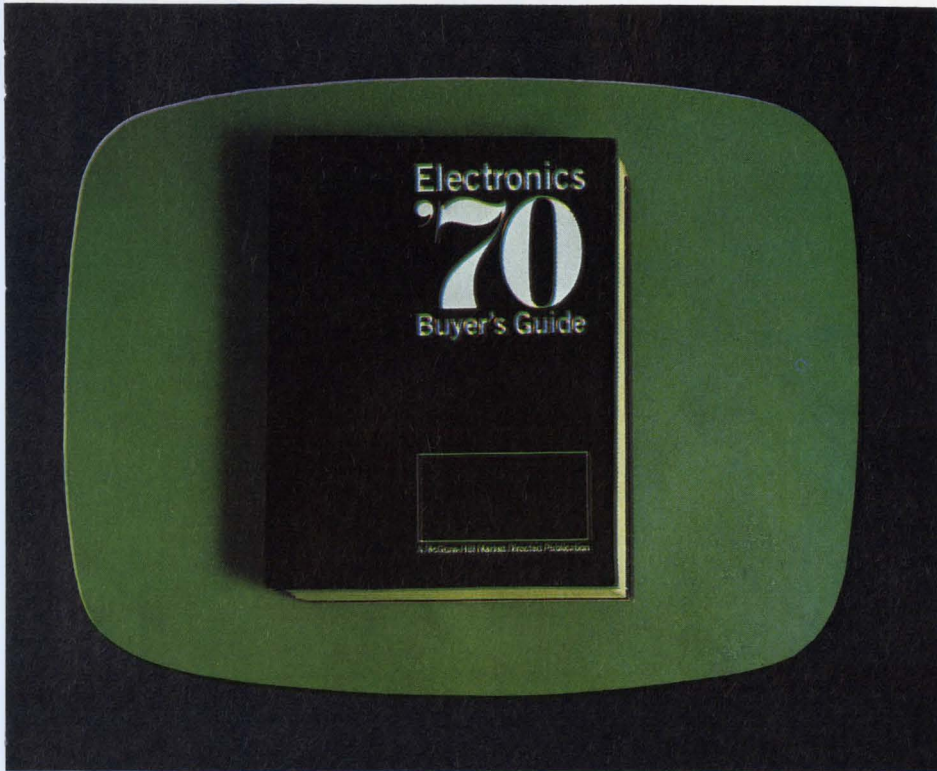

**Channel 3:
Reaches the ready-to-buy market.**

Electronics Buyers' Guide is the channel to use for reaching customers who are actively seeking sources of supply. EBG goes to 85,000 engineers and purchasing men, but is used by more than 375,000 of them. (It's borrowed a lot.) The "yellow pages" gives the buyers all the information they need in one reference: sources, product and advertisements. Prime users tell us they prefer EBG two to one over all other directories, catalogs and registers because it is so complete and easy to use.



**Channel 4:
Provides custom marketing services.**

Electronics/Management Center can develop a customized information program to help you reach your markets. It can probe market potentials, test new product ideas, improve old products, even design a complete marketing strategy.

Electronics/Management Center has the people and facilities to provide you with custom-information in the areas of management, marketing and engineering consultation.

Write for the E/MC brochure, "A full-circle information resource."

*The Electronics Network.
A market-directed communications
service from McGraw-Hill.
Electronics. Electronics New Product Preview.
Electronics Buyers' Guide.
Electronics/Management Center.
330 West 42nd Street, New York, N. Y. 10036.*

Top of the ops

10 MEG Ω *

741 & 748

(TOA 7741) (TOA 7748)

Internal or external compensation? . . . Use either of these high input impedance op amps with no compromise of other performance characteristics.

Building from the 741, the best all-around op amp previously available, Transistron now offers the broadest range of derivatives available . . . families that let you match the op amp to your design, instead of vice versa. Dual units, special input configurations and compensation arrangements, and a variety of temperature ratings and package configurations (dual-in-line, TO-5, flat pack) are available.

Need a 741 with internal compensation, plus 20X lower input bias current, 20X lower input offset current, 10X higher input Z? The basic **TOA 7741** gives you min. input Z of 3 megohms, max. input bias current of 30nA, max. input offset current of 10nA.

Need a 741 with variable bandwidth to 5 MHz and variable slew rate to 10V/ μ s, PLUS 20X lower input bias; 20X lower input offset current; 10X higher input Z? The incomparable **TOA 7748** does the trick, with an external capacitor for performance flexibility, plus input characteristics equal to the TOA 7741.

*** Typical input impedance**

ALSO . . . Transistron manufactures all these popular industry linear IC types, each available in both military and industrial temperature ratings, and representing a broad family of derivative types:

709 (including duals)	Op amp
741 (including duals)	Op amp
748 (including duals)	Op amp
710	Differential comparator
711	Dual differential comparator
8711	Dual output dual differential comparator
723	Voltage regulator
TVR2000...	Highest performance voltage regulator
SN7524	Dual sense amplifier

Send for your FREE copy of Transistron's new, complete LINEAR IC INDUSTRY INTERCHANGEABILITY CHART.

Transistron
 electronic corporation
 168 Albion Street, Wakefield, Mass. 01880

EVEN SQUINTING WON'T HELP.

No use, fellas. You need a microscope to see the world's most densely packed LSI circuit.

That's what Electronic Arrays has done this time.

4692 transistors (4096 bits of memory) on a single 88 x 94 mil chip.

Since that kind of density is not available elsewhere, may we take this hallowed moment to proudly proclaim our EA 3300 (a 512 word, 8 bit/word ROM) the champion of the LSI world.

We didn't, however, design the EA 3300 this way just to show off.

EA 3300 has the most functional complexity of any product available today in a 24 pin package.

That reduces cost.

A smaller die further reduces costs by giving you higher yields and greater product performance and reliability.

Our entire line of Registers, ROM's, Read/Write RAM's and Logic circuits is made in *production quantities* with the same close-tolerance MOS technology as the EA 3300.

And all products are available *immediately* from 24 distributors nationwide, and 6 international distributors.

To see is to believe. Do both by addressing your purchase orders to your nearest EA distributor or to Electronic Arrays, Inc., 501 Ellis Street, Mountain View, California 94040. (415) 964-4321.



**electronic
arrays, inc.**

Proven MOS products delivered in volume.

Forms for your specialized bit patterns are available from any of our representative offices or directly from the factory. The EA 3307, which is an EA 3300 already programmed to be an EBCDIC to ASCII and ASCII to EBCDIC code converter, is available from distributor and factory stock. Features include two output inhibit controls that give 1024 4/bit words; nine input addresses; all decoding on the chip; power requirements less than 100 milliwatts; synchronous 2-phase clock, 24 pin hermetic dual-in-line package.

Circle 89 on reader service card



check out

ELECTRO'S New Low Cost

MINI-PROX

**Compact Proximity Sensing System
for Non-contact, Detection and Control
of Ferrous and Nonferrous Metals**

- LOW COST
- ASSURED SENSING DISTANCE ACCURACY
- TEMPERATURE-STABLE
- NO MOVING PARTS IN ELECTRONIC OUTPUT MODEL
- PLUG-IN CONVENIENCE

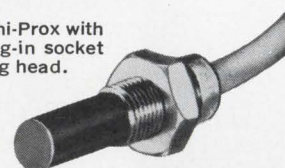
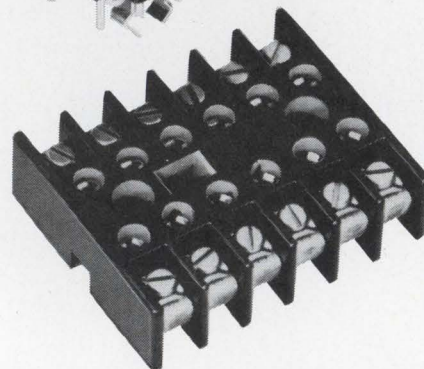
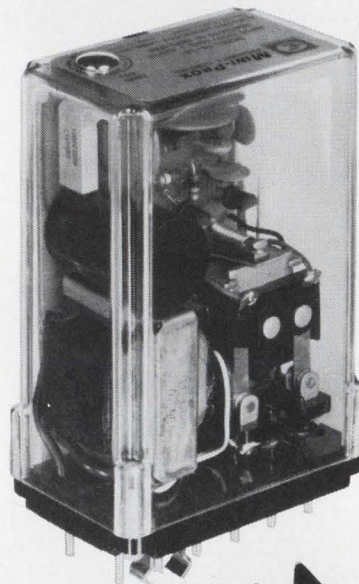

Model 55125 Mini-Prox with Model 41060 plug-in socket and 4943 sensing head.

ELECTRO representatives are experienced in assisting with proximity switch applications. Most carry local stocks to service your requirements immediately.

Write for bulletin giving complete specifications and the name of your nearest EPL representative.

MANY MONEY SAVING APPLICATIONS

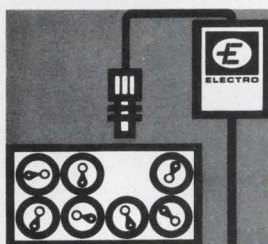

PACKAGING

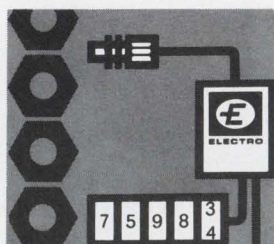

COUNTING

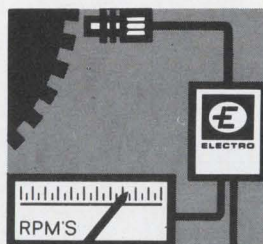

SPEED CONTROL

Conveyor Control • Cut-Off Control • Missing Parts Detection • and many others

Accuracy of sensing distance is often a critical factor in sensing and control applications. Mini-Prox accuracy can be depended upon in any environment; heat to +160°F or cold to -30°F at either probe or control. Line voltage variations from 105 to 130 volts—dust—moisture—vibration, none of these affect its accuracy. You can set it and forget it.

Plug-in design provides for easy wiring. Unitized construction eliminates soldering or wiring of sensitivity controls. Connections for power, sensing head and relays are made to screw-type socket terminals. Operations up to 600 per minute may be controlled or monitored by the Model 55125 illustrated. Electronic output models for higher speeds are also available. Five standard sensing heads are presently available with sensing ranges of .050" to .250", .100" to .500", .300" to 1.000".

ELECTRO with 15 years field experience in proximity switches has designed-in reliability, assuring you of years of trouble-free performance. Compare with others of similar size and price. One look at the quality of construction tells the difference.



ELECTRO
PROXIMITY SWITCHES

ELECTRO PRODUCTS LABORATORIES, INC.
6125 West Howard St., Chicago, Ill. 60648 • 312/647-8744



Our MD 200 is the finest MOS/LSI tester available!

"We have the capability of conducting on-wafer tests, both digital functional and parameter, at speeds to 2MHz . . . prior to packaging. The MD200 is able to do this because the analysis is done at the probe head, not in a computer 30-50 feet away. With as many as 16 stations of 64 probe pins controlled by a single computer, we've had to automate everything . . . including mechanical functions such as probe down sensing, off-wafer detection and inking; making our MD200 the fastest fully-automated system available.

"To simplify programming, and significantly reduce test time, we've created TOIL (Test-Oriented, Interactive Language). Included in TOIL are all the necessary parameter and functional tests to evaluate both the logic and the circuits on the wafer. Most importantly, programming is reduced to a series of questions and answers.

Therefore, minimal training of personnel is required.

"Macrodata's MD200 has the capability of performing a detailed analysis of your complete MOS/LSI design and production cycle . . . based on factual test results. Additionally, we've included a complete complement of test aids . . . test generation programs, and yield evaluation mapping programs, to reduce total test and evaluation time.

"The MD200 is available now. We'll be delighted to demonstrate it for you. Or write for our 16 page brochure describing Macrodata's MD200 Diagnostic Test System in detail."

Dr. William C. W. Mow
President
Macrodata Company

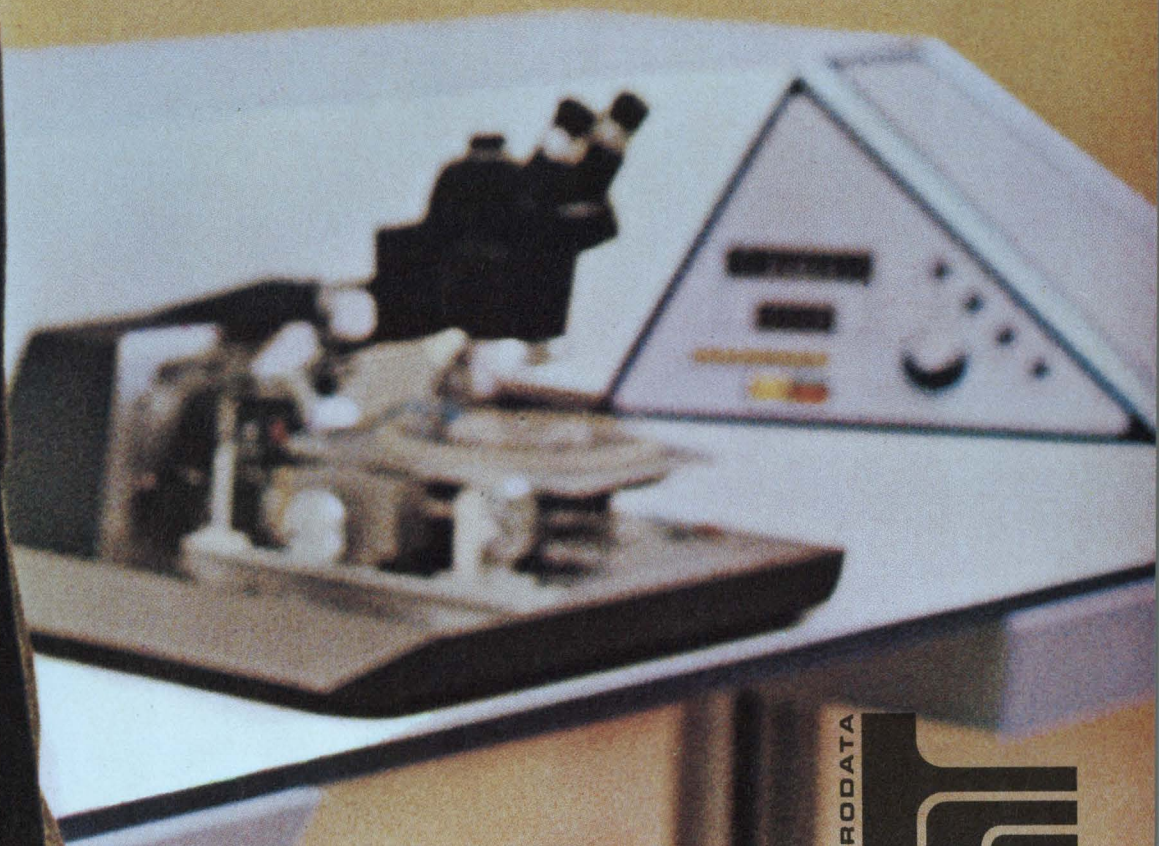

Macrodata Company Test Systems Division
20440 Corisco Street, Chatsworth, California 91311



There isn't another like it. A 1/4-inch, single-pole, six position, 28-vdc. Helipot switch for PC boards.

Beckman® INSTRUMENTS, INC.

HELIPOT DIVISION

Fullerton, California 92634

INTERNATIONAL SUBSIDIARIES: AMSTERDAM; CAPE TOWN;
GENEVA; GLENROTHES, SCOTLAND; LONDON; MEXICO CITY;
MUNICH; PARIS; STOCKHOLM; TOKYO; VIENNA



Model 374H \$3.00 (1-9 pieces)

Model 374 \$2.75 (1-9 pieces)

Technical Articles

**Heat pipes—
a cool way
to cool circuitry**
page 94

Need a new method of removing heat from electronic components and systems? Try the heat pipe, which works on the principles of evaporation and condensation to provide thermal stability in electronics. Available in various shapes, they've operated in a range of -200°C up to $+2,000^{\circ}\text{C}$.

**Laser recorders
boast high speed
and big capacity**
page 101

With magnetic recorders already pushed to the limit of their storage capability, laser machines, which store much more data and transfer it faster, look like the wave of the future. They split the beam of a c-w gas laser into 36 units, modulate each one, and shine the modulated beams onto films.

**Random-access
MOS memory packs
more bits to the chip**
page 109



An MOS random-access memory that packs 1,024 bits plus decoding circuitry on a chip 150 mils square achieves its density by eliminating the separate feedback required to refresh each bit. A modified version of a dynamic one-bit shift register, the new design shares the refresh portion of the memory cell among many bits, leaving more room for strictly data-storing circuitry. In three years, the cost of this dense array is projected to dip to a fraction of a cent per bit. Cover photo by Henry Reis.

**Multilayer p-c boards
are rigid, flexible**
page 116

Innovation in electronics extends to packaging, too. Thanks to new fabrication techniques and films, multilayer printed-circuit boards can be built that are both rigid and flexible wherever the user wants these properties.

**Frequency meter,
comparator, and
phase meter in one box**
page 122

For only about \$150 worth of parts, an instrument can be built that acts as a frequency meter, a comparator, and a phase meter. The crystal-controlled calibration-measurement device packs all these functions into a portable and compact box that weighs only two pounds.

**What level of LSI
is best for you?**
page 126

IC prices can be accurately predicted from mathematical models based on the density and distribution of reject-causing defects, and how fast defects are diminishing as the process matures. With these models, designers can select IC's now that will be economical when production starts.

Coming

Alphanumeric displays

Alphanumeric displays are being revolutionized as equipment designers turn to new and improved digital readout devices. In the next issue *Electronics* will present articles on a GaAsP dot-matrix; a GaAsP seven-segment character, and two updated versions of the glow-discharge tube.

Heat pipes—a cool way to cool circuitry

These heat-transfer devices can solve thermal problems in many applications, say *C. H. Dutcher Jr.* and *M. R. Burke*,* both of Electronic Communications Inc.; vapor heat transfer and capillary action combine to pipe heat away from circuits

● Out of the laboratory little more than a year, heat pipes—thermal conductance devices—are now moving into production. And once these devices become available in sizeable quantities, electronics engineers will be able to take advantage of the devices' capabilities and avoid, in some cases, the use of liquid or forced-air cooling. Yet another advantage would be smaller packaging.

Heat pipes have operated at temperatures ranging from -200°C to $+2,000^{\circ}\text{C}$, and have transported as much as 25 kilowatts per inch square of heat flux. This capability stems in large part from the use of new internal structures and a variety of fluids that range from liquid nitrogen to liquid silver.

Although these devices can, and often do, act as heat radiators, they are usually used as transporters of heat to an external heat sink. Thus, they allow the engineer to place the sinks in locations that can be far more desirable.

An r-f power transistor for example, can be mounted, without cooling fins, on a flat heat pipe and the heat sink can be located at the edge of the circuit module.

There are, of course, other examples of where heat pipes are advantageous. In some instances: traveling-wave tubes will no longer require cumbersome liquid cooling; flat packs will be mounted directly on flat heat pipes; high-power tetrodes will no longer need bulky cooling fins; printed-circuit boards can be kept cool by

ringing them with small tubular heat pipes; and whole structures, such as microwave antennas, can be built with heat pipes serving a dual purpose—heat transfer and structural support. In effect, just about every type of electronic device that has to be cooled can be cooled with heat pipes.

There is yet another advantage to using heat pipes, one that is very dear to the hearts of electronic engineers—reliability. By keeping temperature virtually constant, heat pipes eliminate thermal gradients that cause mechanical stresses, which, in turn, cause interconnection failures in electronic devices. The elimination of these gradients can lead to as much as an eightfold improvement in device reliability.¹

As for the heat pipes themselves, there are but two types—one that transports heat only and one that maintains a constant temperature while it transports heat. Both types, however, employ the same basic principles of physics—vapor heat transfer and capillary action.

The basic heat pipe, or transport-only type, is made up of a containment vessel (usually made of copper, nickel, or stainless steel) and a porous wick structure (such as a wire mesh made of either copper or nickel) that lines the containment vessel. The wick is saturated with a liquid, the most common being water or methanol.

When heat is applied by conduction at one end of

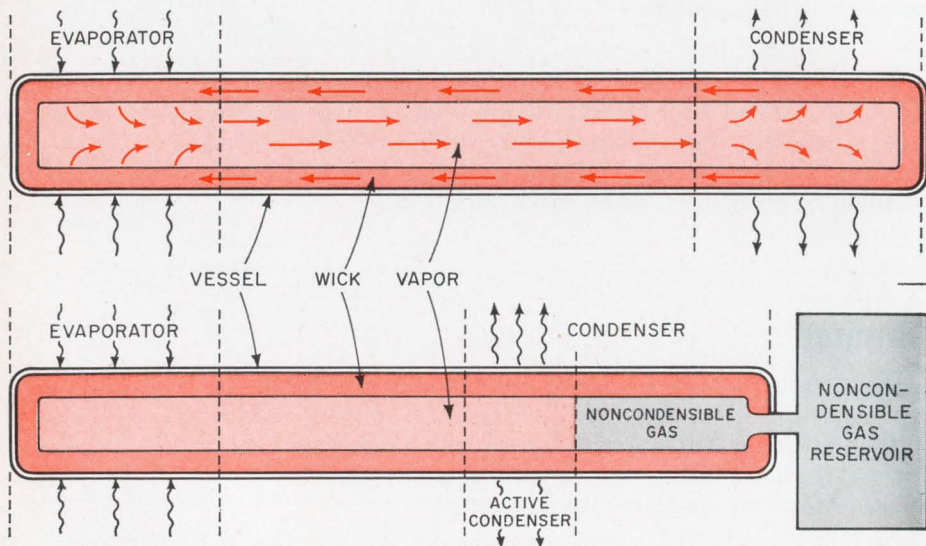

* Mr. Burke is presently employed by Honeywell Inc.'s Aerospace division.

Capillary action. Attractive forces between the liquid and vessel combine with surface tension to move the liquid back to the evaporator section of the heat pipe.

Temperature leveler. The noncondensable gas in the constant temperature heat pipe effectively shortens the condenser section by creating a gas-vapor interface to provide temperature stabilization.

the heat pipe, the evaporator section, the liquid vaporizes and the heat is carried down the length of the vessel to the other end of the pipe, the condenser section. Condensation then occurs and the heat is transferred out of the pipe by conduction. The working fluid is drawn back along the wick to the evaporator section by capillary action. Since the latent heat of the working fluid's evaporation is carried by the vapor from the evaporator section to the condenser section, heat transfer is achieved with almost no temperature drop across the heat pipe.

The constant temperature heat pipe differs from the transport-only type only in that it includes a reservoir attached to the condenser section. This reservoir holds a noncondensable gas, which provides temperature leveling. The gas is distributed uniformly with the working fluid vapor throughout the heat pipe. When heat is applied to the evaporator, both the working fluid's vapor and the noncondensable gas are driven toward the condenser. However, the working fluid has a return path while the noncondensable gas does not and an interface is established between the two, thus, dividing the condenser into two sections.

Temperature leveling comes about because heat pipes are designed to operate on the exponentially shaped portion of the working fluid vapor-liquid equilibrium curve, while the pressure of the noncondensable gas is

Cooling. The rectangular heat pipe, left, cools the 25-watt uhf thin-film amplifier by carrying its heat to the flat heat sink.

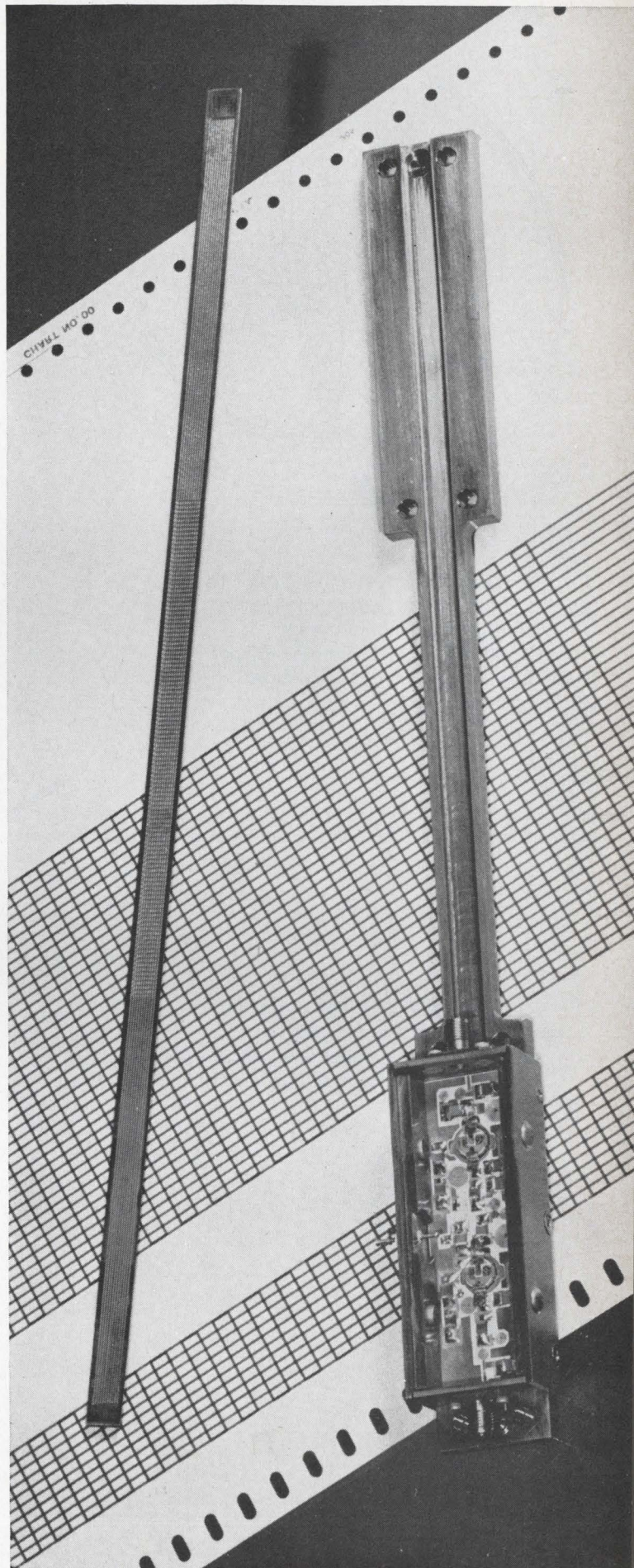

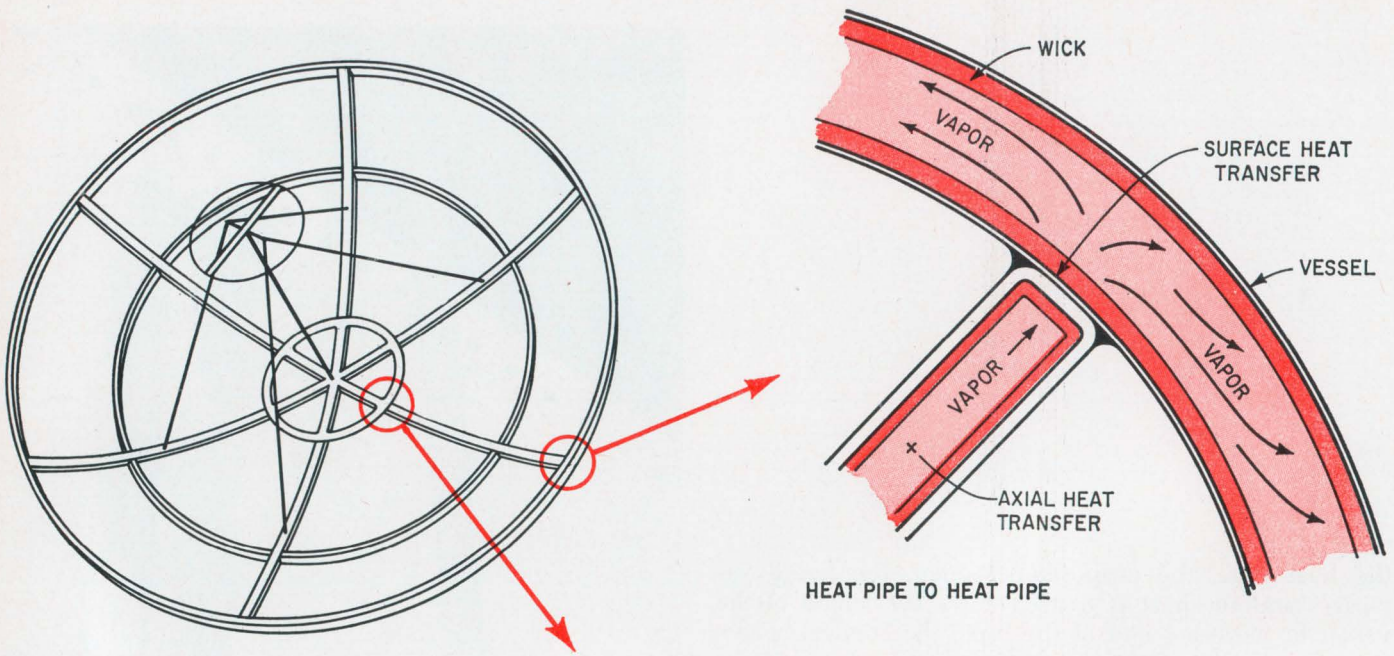

Heat pipe system. An antenna structure is constructed of many heat pipes for isothermalization and strength. Open-channel and heat pipe-to-heat pipe interconnections are utilized in this design.

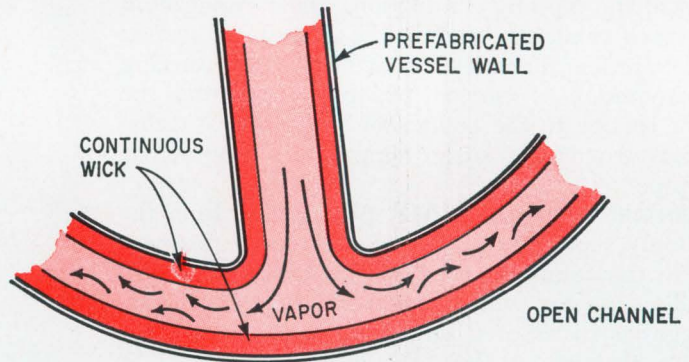

Flat pack cooler. Heat pipes support the flat packs and transfer their heat to other pipes in the main frame, which, in turn, transfers the heat to an external heat sink.

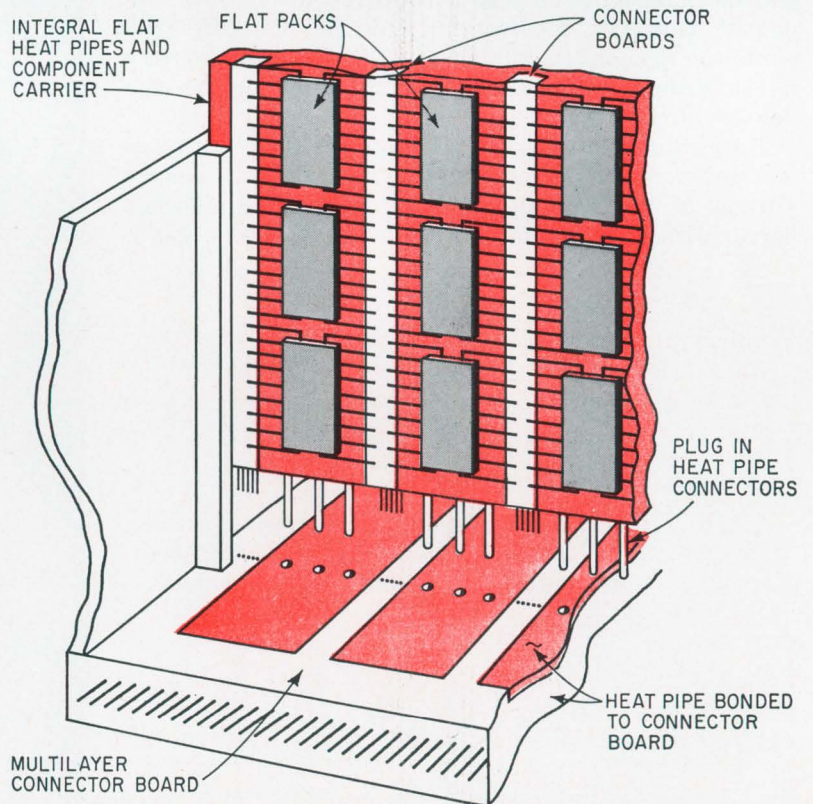

by the substrate, P_v and P_a are the heat powers generated per unit volume and area, respectively, and A is the area of interface between the substrate and the heat pipe.

Substituting P/P_a into the volume equation for the combination yields

$$V = \frac{P}{P_a} \tau + \frac{P}{P_a} t$$

The power density of the package is finally written as

$$\frac{P}{V} = \frac{P_v WL\tau}{WL\tau + WLt} = \frac{P_v}{1 + \frac{P_v L}{P_a}}$$

governed by the linear ideal-gas law. Thus, a small change in temperature has a large effect on the effective condenser area, which tends to level the heat pipe's temperature.

In one version of the constant-temperature device, the noncondensable gas reservoir is placed in contact with the heat pipe's center section. Called the variable-conductance, constant-temperature heat pipe, this device serves a dual purpose—it carries away the waste heat of device being cooled, and performs a temperature regulation function. The latter function, however, depends upon the ratio of the reservoir volume to the effective condenser volume. For example, if the power into a variable-conductance heat pipe varied from 70 to 320 watts, the temperature variation would be 2.18°C for a ratio of 5. But for a ratio of 100, the variation would be 0.06°C.

Thus, because of both its flexibility and capability, the heat pipe is a logical substitute for the solid conductor wherever heat is to be transferred; the heat pipe is far more efficient. A heat pipe 2 feet long and 0.5 inch in diameter for instance, can handle 200 watts at 100°C with a temperature drop during heat transfer of 0.5°C. If a solid copper bar of the same dimensions were used to perform this function, it could transport only 5 watts if both ends of the bar were kept at a temperature differential of 70°C. Should 200 watts be forced through it, the copper bar's temperature differential would rise to 2,550°C. And if the bar diameter were increased to handle the 200 watts at the 70°C differential, the bar would weigh 53 pounds. The heat pipe would weigh but 12 ounces.

The question that must be answered, of course, is: How is the best device-heat pipe combination selected? For the best combination, the heat pipe must be designed so that the requirements of the device are accommodated. The limits on linear heat transfer set the limits on the size of electronic modules, or alternatively, their packaging densities. Thermal limits depend upon the volume and power density of the electronics package.

For example, consider a substrate mounted on a flat heat pipe. The dimensions of the substrate are W , L , and τ while those of the heat pipe are W , L , and t . The volume of the substrate-heat pipe combination is $V = WL\tau + WLt$, while the maximum power transfer is $P = P_v V = P_a A$, where P is the total power generated

and it is readily seen that neither the volume of the package nor its power density can be optimized without reducing the substrate dimension to zero.

The design objective is to mount the electronics onto the heat pipe in such a manner so that the heat enters the pipe directly. An unfortunate characteristic of heat transfer from a device to a transfer element which could be either a heat pipe or a heat sink, is that an interface exists between the two objects. This interface has a thermal resistance, which causes a drop in the temperature across it. Even if thermal grease is used to lower the thermal resistance, the temperature drop across the interface will fall between 0.05° and 0.20°C-inch²/watt. The heat pipe does not lower the interface temperature drop. But by allowing the sink, together with its fins, to be moved away from the electronics module, the heat pipe leads to a more efficient electrical and thermal design.

Components, such as power transistors, can be screwed onto flat heat pipes directly. Threaded inserts are placed into the heat pipe prior to the working fluid. And Teflon insulating plugs can be used as inserts for TO-3 and TO-5 packages to accept electrical connections. This method of interfacing doesn't pose major problems for wiring and interconnecting components. Nevertheless, care must be taken to prevent fluid leakage from the heat pipe, for just one leak is sufficient to halt heat transfer. Rigorous checking for leaks is therefore of paramount importance during fabrication.

Another example of electronic package-to-heat pipe design is the interlacing of heat pipes with the electronics package. Flat packs can be mounted directly on a flat heat pipe that has plug-in connectors. These plug-ins, themselves heat pipes, fit into flat heat pipes that are mounted on the main frame. Channels are formed in the flat pipes to accept connector boards; the flat pack leads attach to these connector boards that plug into multilayer boards in the main frame.

Some electronics applications require the use of heat pipes that are shaped differently, but are connected in series. Consider the removal of heat from an electronics module used in a satellite. A rectangular shaped module, measuring about 10 by 3 by 7.5 inches, is mounted on a large flat ring that is a heat pipe in itself. A cylindrical heat pipe is inserted into the edge of the ring, connecting the ring to a rectangular heat pipe radiator mounted outside of the satellite. The cylindrical heat pipe is called a heat pipe extender, and the rectangular

Warming up to heat pipes

Headed by George M. Grover, one of the leading exponents of heat pipes, the Los Alamos, N.M. Scientific Laboratory is perhaps furthest ahead in the development of these thermal-conductance devices. The lab has been doing a great deal of work on high-temperature heat pipes, using liquid metals as the working liquid. But primarily because of lab's association with the Atomic Energy Commission, most of the work has dealt with reactor cooling. Other applications, however, are also being studied—among them, the use of heat pipes for rocket cooling.

But where Los Alamos is primarily concerned with using heat pipes as cooling device, others—notably Energy Conversion Systems Inc. of Albuquerque, N.M.—are using the pipes to add heat. In fact, ECS is manufacturing a heat-pipe device called the Thermal Magic Cooking Pin. As implied by its name, the device is used for cooking. The pin is inserted into meat, which when placed into an oven, cooks from the inside out.

But by and large, cooling—particularly of electronics—is probably the most far reaching application of heat pipes.

At the Hughes Aircraft Co. in Torrance, Calif., heat pipes are used to cool printed-circuit boards. In fact, Hughes is also experimenting with dielectric heat pipes to cool traveling-wave tubes. At TRW Systems in Redondo Beach, Calif., power transistors are cooled by placing the chips inside finned heat pipes. And at Electronic Communications Inc. in St. Petersburg, Fla., power amplifiers have been mounted on flat heat pipes.

Another company that's moving ahead in its development of heat pipes is RCA, which has already developed a 250-ampere silicon rectifier that employs an integral heat pipe to cool the chip. The heat pipe eliminates the need for forced air cooling. Besides the rectifier, RCA has also developed a transmitter that is cooled by heat pipes. The transmitter was designed for use on the C-5A transport.

And the list of companies working on these devices goes on and on. Varian Associates' Eimac division in San Carlos, Calif., uses heat pipe principles to cool a 50-kilowatt tetrode, while Litton Industries Electron Tube division, also in San Carlos, uses heat pipes to cool high-power vacuum tubes. And McDonald Douglas' Donald W. Douglas Laboratory in Richmond, Wash., used heat pipes to cool an electronics deck on an Advanced Technology Satellite. Isotopes Inc. of Middle River, Md., is also

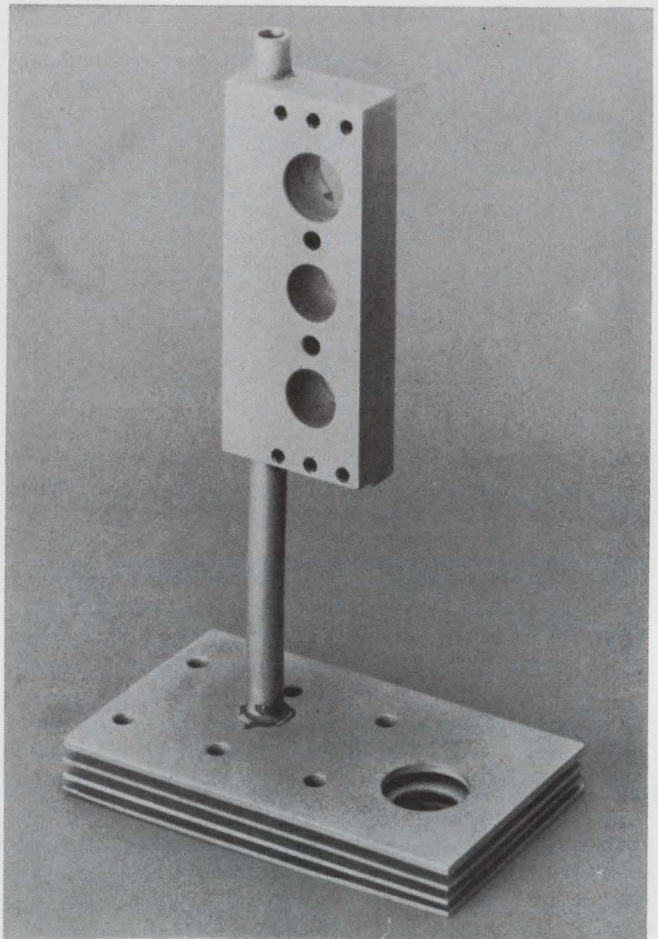

Heat pipe flies on the C-5A.

using heat pipes to cool spacecraft systems. Long heat pipes were wrapped around an Atlas rocket to cool its equipment. Also involved in heat-pipe work for spacecraft is the Jet Propulsion Laboratory in Pasadena, Calif.

Philco-Ford's Aero-Nutronics division in Newport Beach, Calif., uses heat pipes to cool high performance automatic weaponry for the military.

Some electronics applications require the use of heat pipes that are shaped differently, but are connected in series.

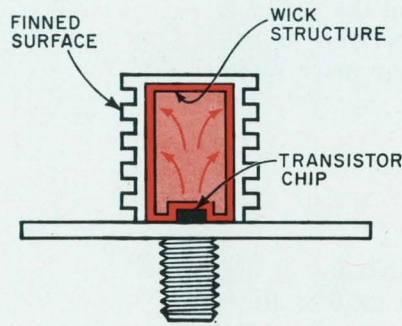
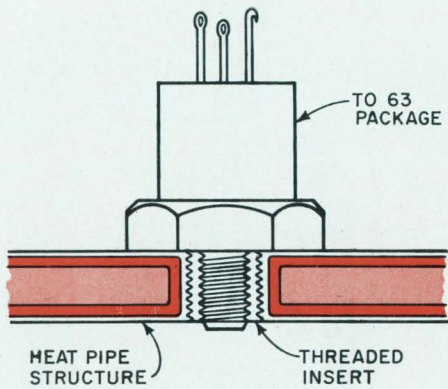

Eliminating bulk. TO-63 package, is screwed directly into a flat heat pipe, which cools the package, while the power-transistor chip is mounted inside a heat pipe for thermal reliability.

Data furnished by K.T. Feldman of Energy Conversion Systems.

Operating values of heat pipes

Temperature Range in °C	Working Fluid	Vessel Material	Measured Axial ¹ Heat Flux in Kilowatts/square inch	Measured Surface ¹ Heat Flux in watts/ square inch
-200 to -80	liquid nitrogen	stainless steel	0.431 @ -163°C	6.5 @ -163°C
-70 to +60	liquid ammonia	nickel, aluminum, stainless steel	1.9	19
-45 to +120	methanol	copper, nickel, stainless steel	2.9 @ 100°C ³	487 @ 100°C
+5 to +230	water	copper, nickel	4.3 @ 200°C	942 @ 170°C
+190 to +550	mercury ² + .02% magnesium + .001% tantalum	stainless steel	162 @ 360°C ⁴	1,170 @ 360°C
+400 to +800	potassium ²	nickel, stainless steel	36 @ 750°C	1,170 @ 750°C
+500 to +900	sodium ²	nickel, stainless steel	60 @ 850°C	1,443 @ 760°C
+900 to +1,500	lithium ²	niobium +1% zirconium	13 @ 1,250°C	1,334 @ 1,250°C
1,500 to +2,000	silver ²	tantalum +5% tungsten	26	2,665

¹Varies with temperature

²Tested at Los Alamos Scientific Laboratory

³Using threaded artery wick

⁴Measured value based on reaching the sonic limit of mercury in the heat pipe

heat pipe radiator is the heat sink.

The temperature of the ring-shaped device must be determined from the temperature of the heat sink, which must operate at a fixed temperature if all the power is to be passed. This fixed, radiated temperature is calculated from Stefan's law—assuming deep space radiation to be 0° Kelvin.

$$T_{\text{radiator}} = \left[\frac{\dot{Q}}{\epsilon\sigma A} \right]^{1/4}$$

where Q = power radiated, ϵ = emissivity of the radiator; σ = Stefan-Boltzmann Constant (36.6×10^{-12} watts/in²°K⁴); and A = radiator area.

For example, if the power radiated is 120 watts, the radiator emissivity is 0.9, and the radiator area is 144 inches square. The resulting radiator temperature is 398°K or 125°C. However, the heat flow from the module to the radiator will cause temperature drops at the interfaces of the heat pipes themselves.

In this example, all the heat pipes are considered to be copper-water, with a thermal resistivity of 0.18°C inch²/watt. The significant thermal drops in a copper water heat pipe are across the liquid-wick matrix interfaces. Summing the thermal drops of all the heat pipes results in a total thermal resistance of 0.084°C/watt. And, when the total power to be removed in the form of heat is 120 watts, the temperature difference between the heat-pipe ring and the heat-pipe radiator will be 10°C. This means that the heat-pipe ring must be designed to operate at 135°C.

Basically, to form a heat-pipe system, there are but two methods of interconnection—open channel and heat pipe to heat pipe. With the former, two heat pipes use a common wick and vapor transport channel to yield a single, long heat pipe that has a complicated geometry. This approach, although advantageous in that it has vapor heat transfer between the two pipes, is not without drawbacks. For one thing, the capillary pumping length is increased; for another, the common wick requires a porous conformal coating to provide continuity of the wick structure. This can be difficult to achieve.

With a heat pipe-to-heat pipe interconnection, an interface—rather than a common wick and vapor channel—is used, with the contact area made large enough so that the interface thermal drops are small. One way to increase the contact area is to remove part of each heat pipe using an axial slice, where each is to be joined. But like the open-channel method, this, too, is not without its drawbacks.

Because a part of each pipe is cut away, the cross-sectional area of each heat pipe is reduced by half. Moreover, the effective length of the heat pipe combination is also shortened. The combined two-pipe system thus does not use the full cylindrical-surface area available to transfer heat.

There is, however, a heat pipe-to-heat pipe interconnection method that both maintains effective length and provides good heat transfer. But this approach requires a third heat pipe. Two heat pipes are butted together, end to end, and the third pipe, in the form of an annulus, is placed in a manner surrounding the junction. In such a configuration, it is at the interface of the two joined heat pipes' outer diameters and the

annular-shaped pipe's inner diameter that the greatest temperature drop occurs.

For example, two heat pipes whose outer diameters measure 0.75 inch are ringed by a third annular heat pipe that is 8.5 inches long (4.25 inches on each side of the butt joint), and the air gap between the annulus and the two joined pipes is 0.0005 inch. With an input power of 100 watts, the temperature difference for a typical copper-water heat pipe is about 15°C between the input surface temperature and the output surface temperature. It is important to note that no thermal grease is used.

If a solid copper connector were used in place of the third heat pipe, the temperature difference would be 45°C.

An entire heat pipe system can be envisaged with this heat pipe-to-heat pipe configuration. Consider, for example, the cooling of electronic equipment in a van. Here, the ultimate heat sink would be an air conditioner located atop the van—an optimal location since all heat sources are located below the final heat sink. Gravitational forces would aid the capillary pumping in all vertical flow paths. A number of "trunk" heat pipes would interface with the electronics equipment and interconnect with the ultimate heat sink, thus removing the heat and cooling the equipment. ●

References

1. Grumman Aerospace Corp., "Effects on Electronic Equipment Reliability of Temperature Cycling in Equipment," 1969.

Bibliography

K.T. Feldman and G.H. Whiting, "The Heat Pipe," Mechanical Engineering, February 1967.

G.Y. Eastman, "The Heat Pipe," Scientific American, May 1968.

T.D. Sheppard, "Heat Pipes and Their Application to Thermal Control in Electronic Equipment," Proceedings of Nepcon West, February 1969.

Laser recorders pick up where magnetic machines leave off in speed, capacity

They record 21.8 million bits/second; Stanley Parnas of Synergistics and C.J. Peters tell what laser systems mean to high-volume data processing

● Because computer designers are demanding data transfer rates beyond the capabilities of magnetic recorders, an increasing share of the digital-data storage work now done magnetically will be taken over by laser recorders. Moreover, the laser recorder's high-storage densities should appeal to people, such as research engineers and insurance executives, who have plenty of data to permanently store and don't want rooms filled with reels of tape.

For a number of years, engineers have been building experimental models of laser recorders; some have found their way into in-house systems and a few recorders have been sold. But million-dollar price tags have kept them out of all but the most eager hands. Things are changing though, at least where fast access times aren't needed. Laser recorders of the non-scanning variety are coming to market with prices that are within hailing distance of magnetic-recorder prices.

Magnetic recorders put around 7,200 bits onto an inch of tape by laying down nine tracks, each with 800 bits per inch. Some advanced machines double this density by recording at 1,600 bits per inch. The best transfer rate is about 1 million bits per second. Chances are small that these figures will improve by much.

On the other hand, laser recorders store hundreds of thousands of bits per inch, and their transfer rates go up to millions of bits per second. They're improving,

too. Within five years a storage density of millions of bits per inch and transfer rates of 30 or 40 million bits per second will be seen.

Two types of laser recorders have evolved. First to appear were scanning recorders which store data by shooting their laser at a sheet of some transparent material, such as Mylar, on which is a thin film of metal. The sheet sits up like a target on a rifle range, allowing the laser to quickly zero in on any point on the sheet; hence, recorders of this type have fast access times. The beam burns 5-micron-wide holes in the metal; the presence or absence of a hole at a particular spot is interpreted as a 1 or a 0. Scanners store about 20 million bits per square inch, transfer data at a rate around 800,000 bits per second, and have access times in the 50-millisecond range.

But because the circuits and mechanical gear that aim the laser are expensive, scanning recorders have a high price—\$500,000 up to a few million dollars.

Non-scanning recorders, in which photographic film moves through a stationary beam, offer a less expensive alternative. Their storage capacity is as good as and their transfer rate is better than those found in scanning units, and their price is much closer to the \$25,000 that a high-quality magnetic recorder costs. For example, Synergistics Inc.'s PDR-5, the first non-scanning laser recorder to be commercially available, sells for \$65,000. It uses commercial laser film, such as Agfa makes, which costs \$60-a-reel to buy and \$1 to develop. By way of contrast, sheets for a scanning laser cost about 25¢ per square inch, and magnetic tape costs \$15 to \$20 for a 2,400-foot reel.

Access time is the one area where non-scanning units can't match the scanners. Since they look for data by searching through a reel of film, much like a magnetic recorder searches through a reel of tape, a non-scanning recorder has an access time that ranges from a few milliseconds to a few minutes.

But on the plus side, non-scanning recorders can look and, in many ways, act like a magnetic recorder, making it easy to train people to use them. The PDR-5 strongly resembles the upright two-reel recorders found on the floors of most computer centers. Its controls are almost identical, and its operation appears to be similar. Film, mounted on standard-size reels, moves past what could be called the record-reproduce head,

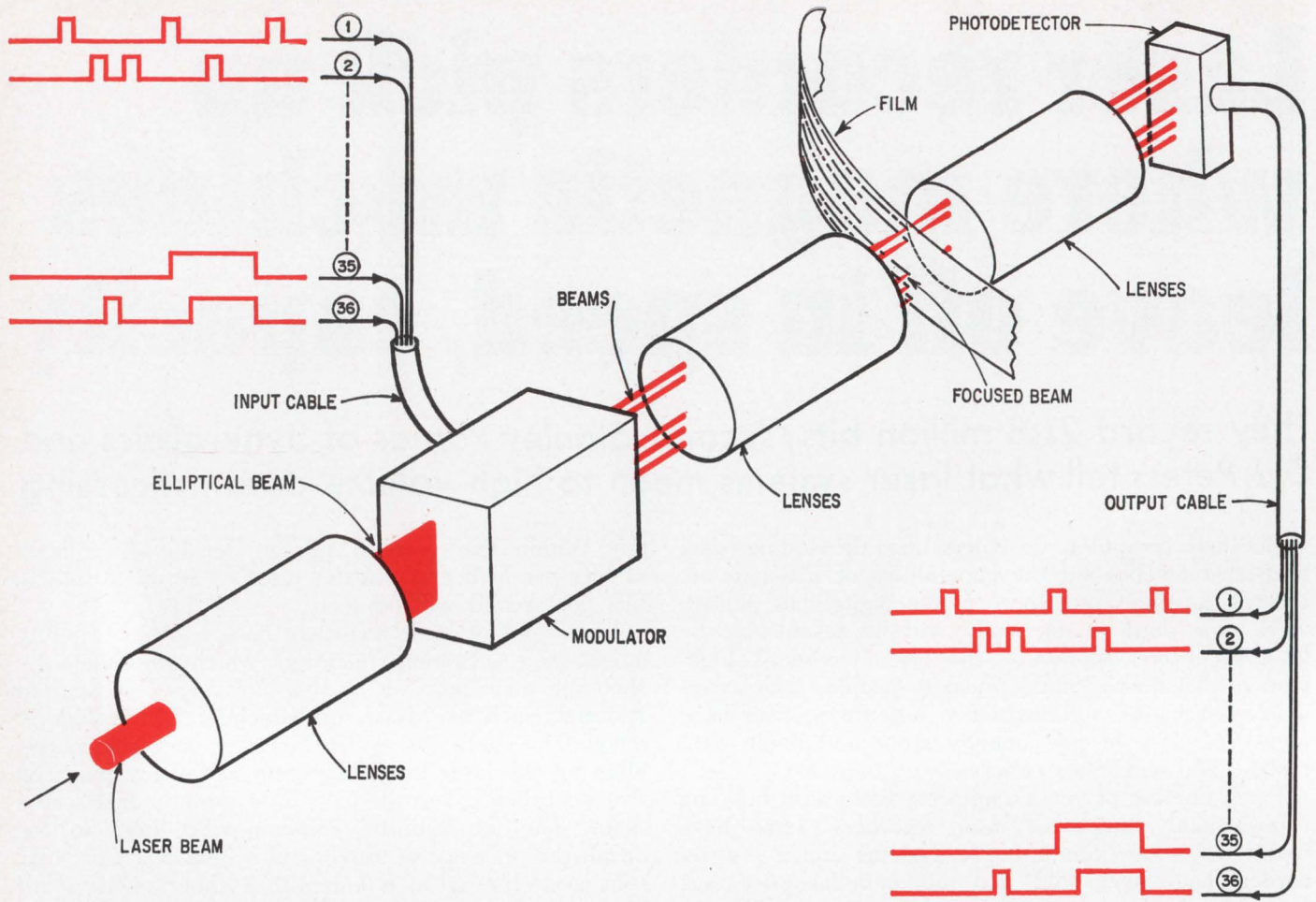

Bits onto film. Driven by the recorder's 36 input signals, the modulator converts a single laser beam into 36 information-carrying beams, which are focused onto the film.

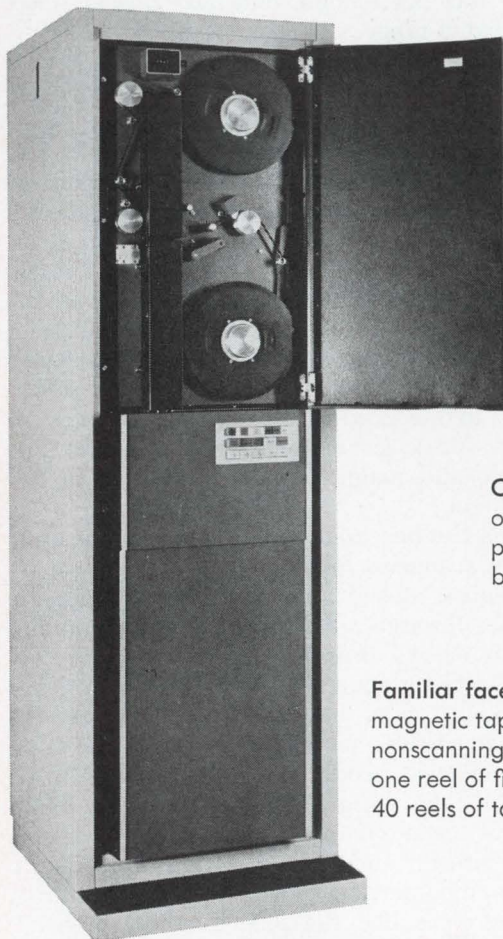

One beam; one diode. With its column of 36 GaAs diodes, the recorder's photodetector turns the incoming beams into 15-mv outputs.

Familiar face. Looking much like a magnetic tape recorder, this non-scanning laser recorder puts onto one reel of film enough bits to fill 40 reels of tape.

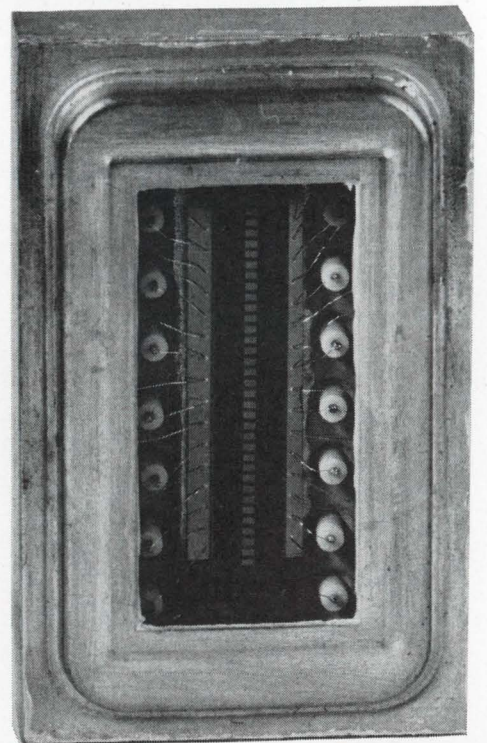

which actually is the spot where the laser beam is focused on the film.

The differences show up in performance. The PDR-5 can put as much as 360,000 bits onto an inch of film; it records 36 tracks on film about as wide as standard magnetic tape; and its top transfer rate is 21.8 million bits per second. Put another way, a 2,000-foot reel of film holds 8.6 billion bits, which is enough data to fill 40 reels of magnetic tape.

Another big difference is that, like all laser recorders, the PDR-5 has a frequency response that's flat from d-c out to 600 kilohertz, per track. Magnetic digital recorders have a much narrower bandwidth and are never flat down to d-c. Because of its flat response, the PDR-5 can record at one speed and playback at another. Thus, it can accept data that comes in slowly, as it does from a communications line, and then feed the data directly to a computer as quickly as the computer can accept it. There's no need for a buffer memory.

It works the other way too. At intelligence installations, transmitted information arrives in high-speed bursts and is then analyzed at slower speeds. Magnetic recorders that store this incoming data have to play it back into a memory which then feeds it to the analysis equipment at the slower speed. The laser unit can do the whole job by itself.

The PDR-5 uses a continuous-wave gas laser that puts out 15 milliwatts. The beam, red in color and 0.8 millimeters in diameter, passes through a series of lenses which flatten it into an upright rectangle, 18 mm by 0.5 mm. The flattened beam goes to the modulator, a KD*P (deuterated potassium dihydrogen phosphate) crystal, whose window is as high and as wide as the incoming beam. The crystal electro-optically splits this beam into a stack of 36 beams, each 0.5 mm high and 0.5 mm wide, and each with an equal share of energy. Although the beams have no gaps between them, they do have 40 decibels of isolation.

The crystal modulates each beam by changing or not changing its polarity in response to a signal coming from one of the recorder's 36 input terminals. Connecting each terminal to the crystal is a drive circuit, which sends 100-volt pulses to the crystal when triggered by the input. Whenever a driver sends a pulse, the crystal changes the polarization of the beam associated with that driver.

In effect, the single KD*P crystal acts as if it were 36 separate electro-optic crystals. A pulse coming from a drive circuit changes the crystal's index of refraction in only a localized region, and just the light in that region has its polarization changed.

Coming out of the modulator is what appears to be a single beam, 18 mm by 0.5 mm, but which actually are 36 smaller beams, some with their polarization changed. This stack of beams strikes a piece of polarized glass, which, depending on its orientation, either passes those beams with changed polarization and absorbs the others, or vice versa. The beams that do get through are focused onto the film. If, for example, all 36 beams are passed, the stack that hits the 8-mm high film is 6 mm high and 0.005 mm (5 microns) wide.

Since the film is transparent, the beams pass through it, and travel on to another series of lenses, which focuses each of the beams onto one of 36 gallium-arsenide diodes in the recorder's photodetector. When a beam hits a diode, it sends a 15-millivolt signal to one of the recorder's 36 output terminals, giving the recorder a real-time readout. Even though the diodes share the same substrate, the isolation between channels on the photodetector is 60 db.

The final recording step is to develop the film, which is done by standard photographic means. A developer, designed to handle PDR-5's film, processes a 2,000-foot reel in less than a half hour. Any spot a beam struck is transparent on the developed film.

Playback differs little from recording. The laser beam, flattened, split but unmodulated, is focused onto the film. The beams passing through transparent areas go onto the photodetector, generating the output signals.

A popular use for these signals is reloading a multi-billion-bit disk memory after a power failure or computer malfunction has emptied it. For a tape recorder, this is a three- or four-hour job; the laser recorder does it in 30 minutes without help from a computer.

Film holds more data than tape for two reasons: a given width of film has more tracks, and a given length of a film's track hold more data.

More tracks can be squeezed onto film because film is bothered less by crosstalk. Isolation between tracks on the PDR-5's film is 40 db, about what it is for tape. Yet the film tracks have a center-to-center distance of 7 mils, 10 to 15 times less than that for tape.

The tracks being so close results in another benefit, besides the obvious one of more tracks. In much the same way that magnetic tape moves past a head, film moves through the laser beam always slightly skewed, or tilted. As a result data is recorded at one point on one track slightly before or after data is recorded at an adjacent point on another track. During playback, all bits supposedly recorded at one time should arrive at the output simultaneously. But they don't because of this skewing effect.

Although the exact differences in arrival times can't be predicted, the peak difference for bits from adjacent tracks is directly proportional to the center-to-center distance. Engineers usually eliminate the effects of skew by making the minimum pulse length for a bit several times longer than this peak difference. Since film tracks are 10 to 15 times closer, the recording pulses can be similarly shorter. This allows 10 to 15 times as many bits to fit onto a given length of track. ●

Designer's casebook

Designer's casebook is a regular feature in Electronics. Readers are invited to submit novel circuit ideas and unusual solutions to design problems. Descriptions should be clear. We'll pay \$50 for each item published.

Feedback circuit checks thermal resistance

By Paul Cade

International Business Machines Corp., Essex Junction, Vt.

Thermal resistance between two points usually can be determined by measuring the power dissipated through the thermal path and the temperatures at the path's two end points. But gauging a transistor's junction-to-case thermal resistance presents a problem: although collector dissipation and ambient temperature can be measured easily, checking the actual junction temperature is difficult. This measurement can be avoided if two, instead of one, ambient temperatures and associated power dissipation readings are taken under a constant junction temperature.

Thermal resistance in this case is

$$\theta_{jc} = \frac{T_{A1} - T_{A2}}{I_e(V_{cb2} - V_{cb1})}$$

where T_{A1} and T_{A2} are ambient temperatures, I_e is emitter current and V_{cb2} , and V_{cb1} are collector-base voltages.

With constant current, the voltage drop across a forward-biased p-n junction (in this case, the transistor's base-emitter junction) is a decreasing function of temperature. However, if voltage is kept constant through a feedback arrangement, the base-emitter junction temperature of the transistor will remain constant, regardless of ambient temperature changes, as will the temperature of the nearby collector-base junction.

Thus, by varying collector voltages to maintain constant emitter voltage on the transistor in different temperature environments, junction temperature can be maintained fairly accurately and the thermal resistance can be determined from the given equation.

In the feedback circuit, both the constant-current supply and the reference voltage are adjusted for the desired emitter current and voltages for a particular transistor family. The transistor is immersed in a temperature-regulated water or oil bath and V_{cb} is noted. Then the transistor is immersed in a second bath, the new V_{cb} is noted, and the tempera-

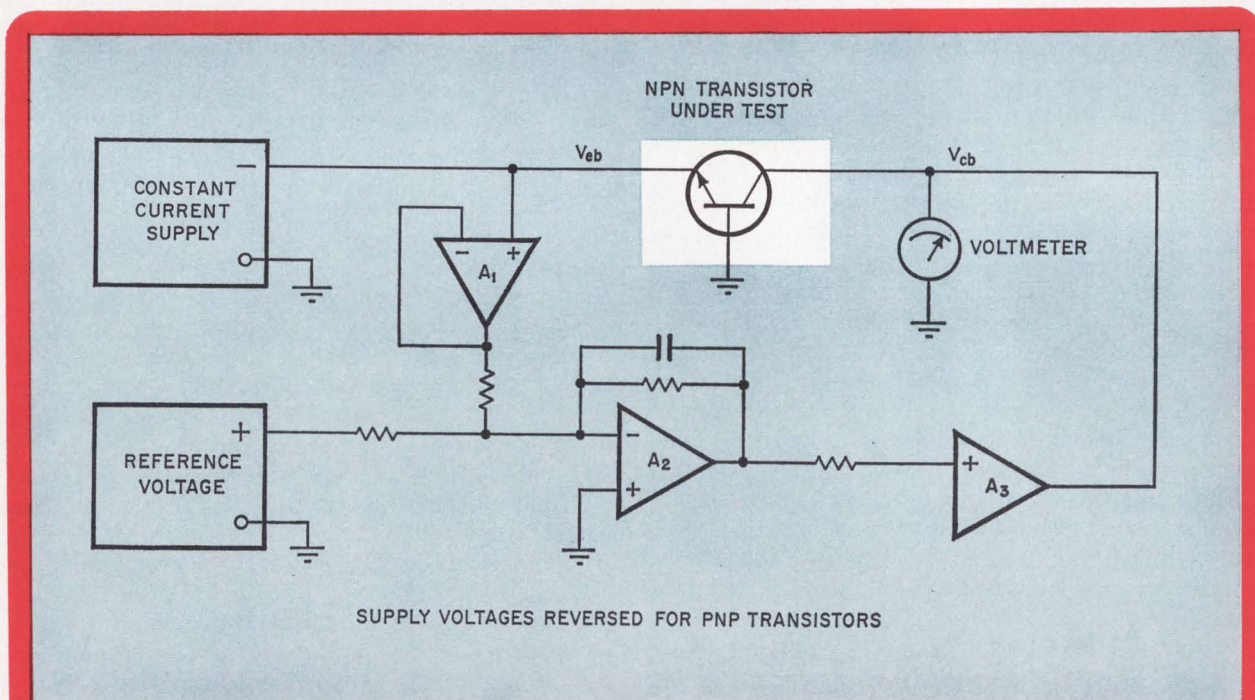

Measuring up. The transistor is immersed in two different temperature baths while maintaining a constant emitter current. The feedback circuit senses changes in V_{eb} from the reference voltage, driving V_{eb} so that it increases the collector-base junction temperature. This, in turn, drives V_{eb} back to nominal value.

tures and voltages are substituted into the equation to obtain θ_{jc} .

A decrease in the emitter-base junction temperature will cause a rise in V_{eb} , which is sampled by a high input-impedance, unity-gain amplifier, A_1 . This, in turn, feeds the summing junction of A_2 , where the signal is compared to the reference voltage. The error between the reference voltage and the increasingly negative V_{eb} (when $T_{A1} > T_{A2}$) is inverted by A_2 . A_2 's signal drives a power am-

plifier, A_3 , which drives V_{eb} to a greater positive voltage. The increasing V_{eb} causes an increase in the collector-to-base junction temperature, due to greater power dissipation. This, in turn, drives the emitter-base temperature up and V_{eb} back to its nominal value. The operator does not have to readjust the V_{eb} each time the transistor is placed in a new temperature environment.

Large batch-type measurements can be automated by recording the V_{eb} on tape or cards.

Zener diode in op amp's loop enables symmetrical clipping

By Raymond Liu

Perkin-Elmer Corp., Norwalk, Conn.

An operational amplifier, with a bridged zener diode network in its feedback loop, clips and squares the edges of a-c inputs with fast transitions each time the zero crossover of the a-c input signal is detected. The circuit is especially useful in phase-sensitive demodulation networks.

The common approach that employs back-to-back zener diodes in the feedback path of the op amp is less effective because of the decreased circuit gain that occurs when the diodes operate below the knee of the zener curve at low input signals. Often, the pulse transitions are unsymmetrical for leading and trailing edges, and the rise and fall times are slower.

In the bridged network, positive amplitudes of the input generate a negative pulse, while negative inputs generate a positive voltage level.

The zener diode provides a stable floating-reference voltage with the aid of the positive and negative supply voltages and the two 6.8-kilohm resistors. When the amplifier saturates, the two terminals of the zener are connected to the summing node and output of the op amp. Since a

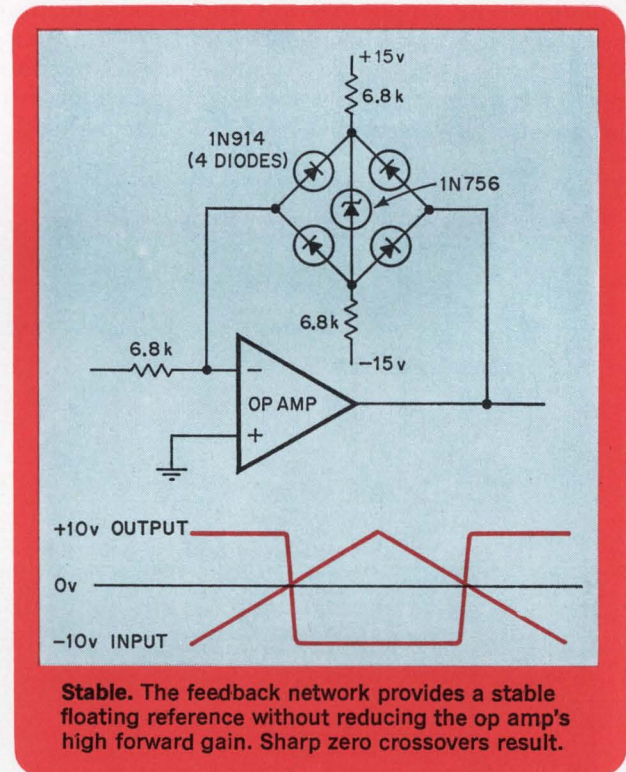

Stable. The feedback network provides a stable floating reference without reducing the op amp's high forward gain. Sharp zero crossovers result.

stable voltage across the zener can always be established without reducing the op amp's high forward gain, the circuit will produce symmetrical hard-amplitude clipping with sharp zero crossover, even at low input signals.

IC's gate FET's for roll rate data

By W.A. Cooke

Lockheed Missiles and Space Co., Sunnyvale, Calif.

Electromechanical gyroscopes, used to stabilize the flight of space vehicles, are expensive and consume a great deal of power. An electronic counterpart, made of reference sensors, IC amplifiers, and field effect transistors, eliminates these two problems. In addition, the electronic version is a much lighter package.

The circuit, called a derived-rate circuit, gen-

erates an output voltage that corresponds to the roll rate of the vehicle. Sensors—either solar cells or magnetometers—provide input information for the circuit. As the vehicle rolls, the sensors, which are located in quadrature around the perimeter of the vehicle, generate a sinusoidal wave whose frequency is proportional to the roll rate of the vehicle. The waveforms are combined and converted to yield an output voltage with a scale factor of 0.1 volt per radian per second.

In the derived-rate circuit, the sinusoids arriving at the S_1 and S_2 inputs are 90° out of phase with each other and have constant amplitudes. Two input signals are differentiated to produce new signals whose amplitudes are proportional to the angular frequency ω and shifted 90° . Hence, this voltage is dependent on input frequency or spin rate of the vehicle. Only the negative-half cycles are inverted by an amplifier and then summed with

the positive-half cycles to produce the output waveform shown below.

The two input IC's, MC1519's, are differential amplifiers which clip the input sinusoids and use them as gating signals to the field effect transistors, Q_1 and Q_2 . At the same time, the two sinusoids from S_1 and S_2 are differentiated by the networks, R_1-C_1 and R_2-C_2 , to generate the frequency-dependent relation. The differentiated signals are delivered to the source of the dual FET's. The positive-half cycles of the differentiated S_1 and S_2 signals are channelled by Q_1 and Q_2 directly to the output amplifier A.

Negative-half cycles of the differentiated signals are channelled by Q_1 and Q_2 through inverting amplifier A_3 . The amplifier inverts the negative cycles of the differentiated signals and feeds them to the output amplifier where they are summed with the positive cycles.

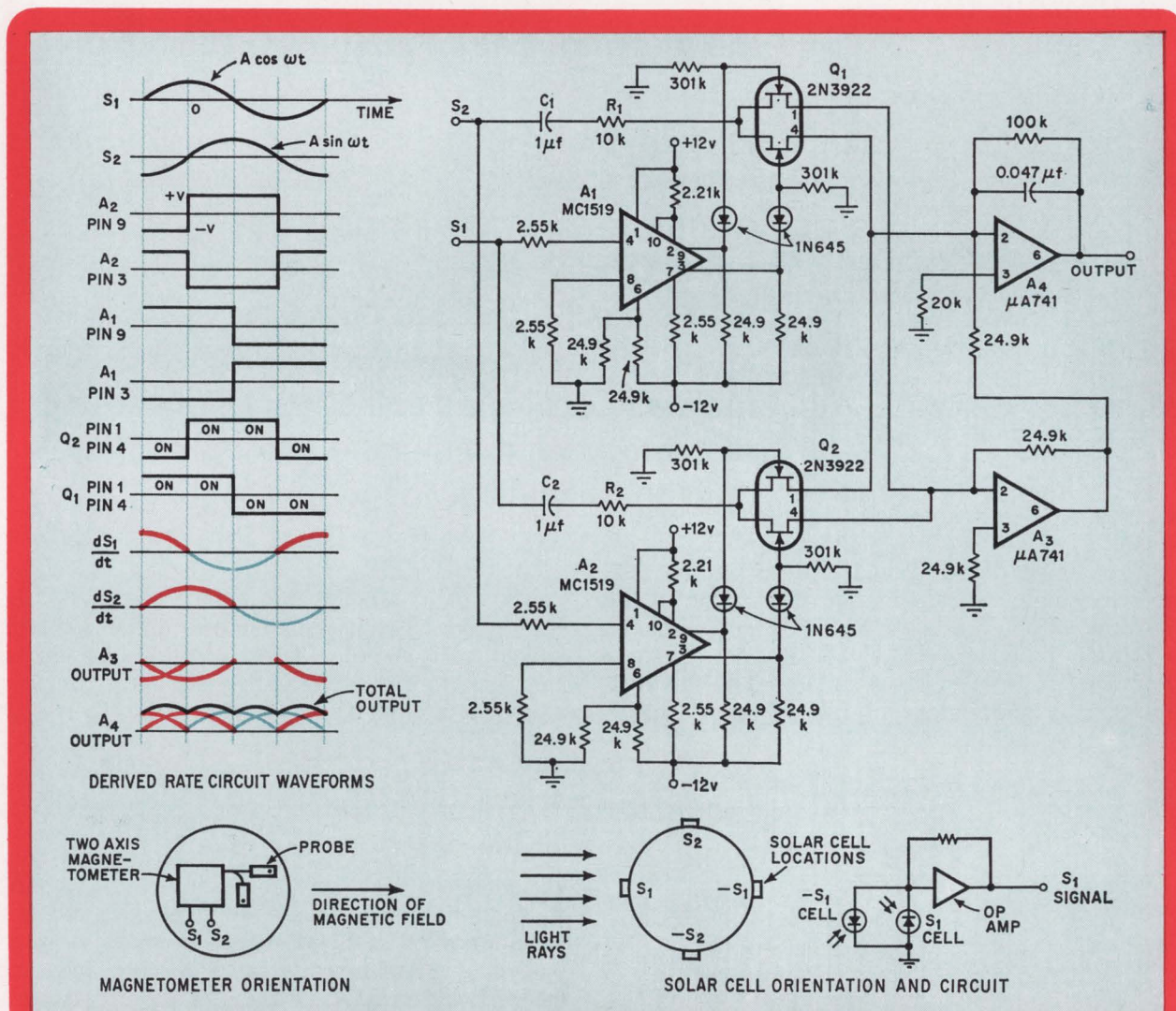

In a spin. Sensors located on the rocket's periphery generate input sinusoidal waves which are amplified and gated to produce a nearly constant output voltage corresponding to the rocket's roll rate. The output is made up of positive- and negative-half cycles of the input after they are differentiated and rectified by the circuit.

Look at the screen, not the knobs.

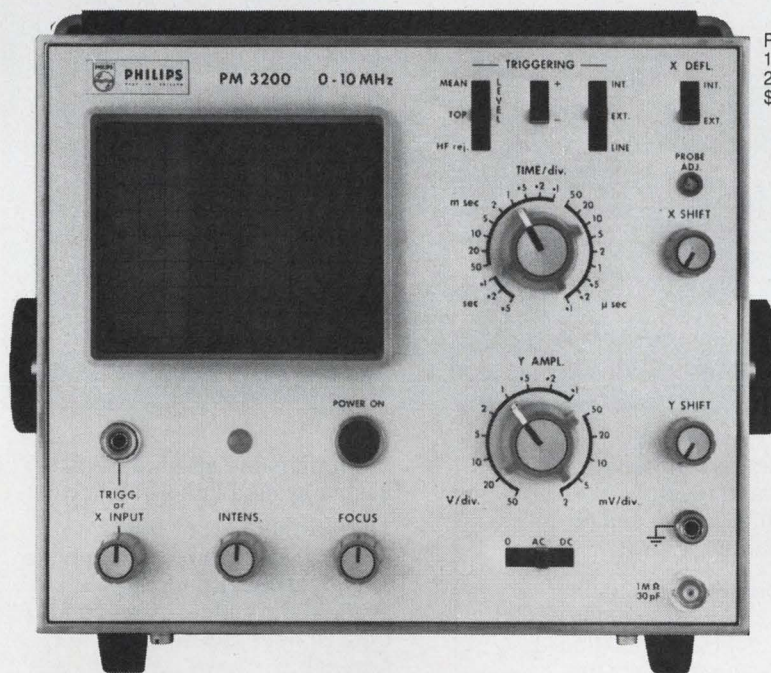

PM 3200
10MHz
2mV/div
\$480

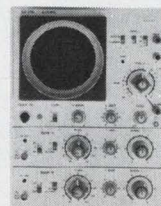

More of the Unbeatable
Philips Scopes

PM 3231
15 MHz: 10mV
Dual Beam Delay Lines
\$975

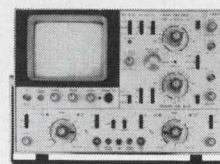

PM 3250
50 MHz: 2mV
Dual Trace
\$1995

Three fewer controls mean you spend more time measuring, less twiddling. Dc balance, trigger stability and manual level are out. So triggering is fully automatic.



Explanation. When waveforms start looking like this: all other automatic trigger circuits stop triggering. So you have to switch to manual and start knob twiddling. With the PM 3200 you switch from "mean" to "top" and stay with signal-derived, fully automatic triggering.

In either position automatic means automatic over the whole of the 10MHz range. And then on to at least twice this nominal bandwidth figure.

This unique Philips circuit has yet another feature. Whatever the signal, even no signal and whatever the sweep speed, the trace is always clearly visible.

There's no dc balance control because none is needed. Drift is feedback and virtually eliminated. (At max. sensitivity (1/4div/24hours).

The PM 3200 is highly portable (11.7 lbs.). Battery pack optional.

For information, contact:
Philips Electronic Instruments, 750
S. Fulton Ave., Mt. Vernon, N.Y. 10550

**PHILIPS
ELECTRONIC
INSTRUMENTS**

750 S. FULTON AVE., MT. VERNON, N.Y. 10550
A DIVISION OF PEPI, INC.

Signal Innovator



SG-1000 Uniqueness in Signal Generation

Singer has advanced the state-of-the-art with a signal generator so New it almost requires a new name.

The Model SG-1000 obsoletes every other signal generator within its frequency range . . . singly or in combination. Its performance is so superior that no other instrument available can equal or even approach it.

That's why we call it the Innovator.

Here's why you'll call it unbelievable . . .

- Digital readout of frequency.
- Broadband frequency coverage from 61kHz to 512MHz (to 1024MHz with a simple passive doubler) in a small 5¼" high package.
- Exceptional frequency accuracy and resolution . . . typically 0.005% . . . and no human readout errors.
- Full modulation capability AM FM Pulse Video Internal 1,000Hz modulation . . . and combinations of the above.
- Output levels from +20dBm to -146dBm.
- An automatically leveled output . . . within ± 0.5 dB over the entire frequency range.
- Use it as a 2MHz counter for counting modulating signals or rep rates directly.
- A spectrally pure output signal approaching that of a crystal . . . extremely low residual and incidental FM.
- Total elimination of dial tracking errors.
- The availability of BCD frequency output and a

programmable attenuator to assure system integration.

This is only part of the SG-1000 story. A more complete technical description is available in Singer Application/ Data Bulletin SG-10 upon request.

For additional information contact your local Singer Representative, or write or call —

The Singer Company
Instrumentation Division
915 Pembroke Street
Bridgeport, Conn. 06608.
203-366-3201.

In Europe contact: Singer
Sewing Machine Company,
Instrumentation Division, P.O.
Box 301, 8034 Zurich, Switzerland,
Telephone: (051) 47 25 10
TWX 710-453-3483

SINGER
INSTRUMENTATION

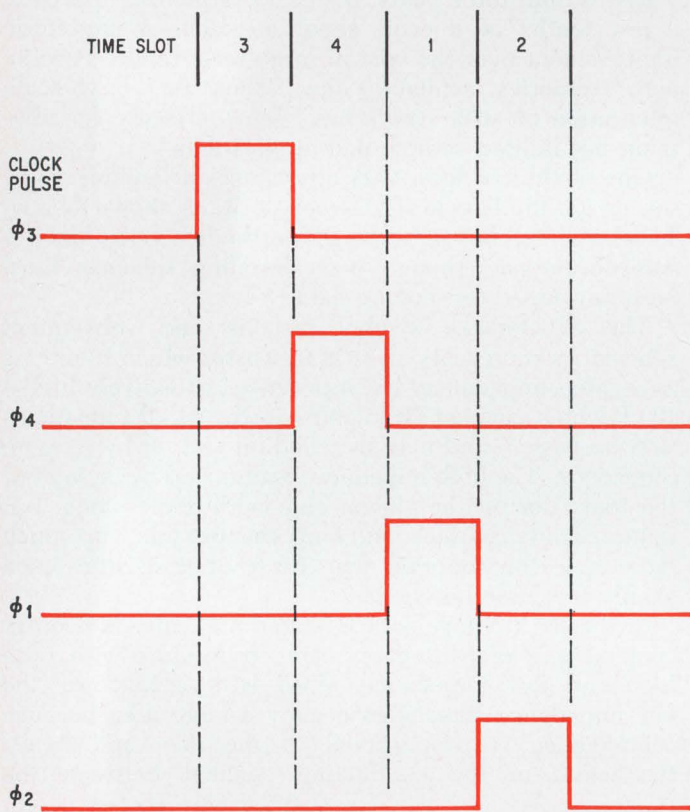
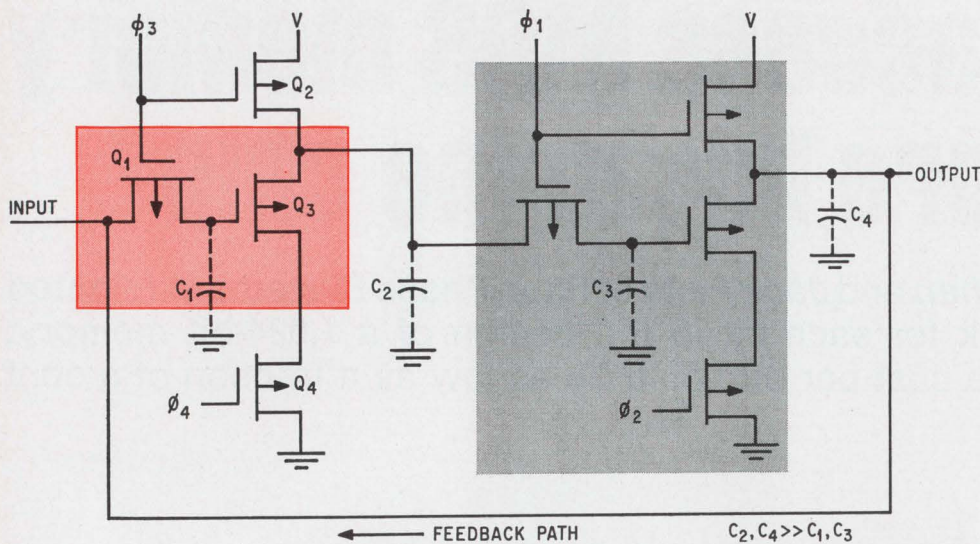

Dynamic standard. Feeding back one bit of a dynamic MOS shift-register cell yields a dynamic memory cell. Data held on capacitor C_1 (and redundant data on C_3) is refreshed by charge from the large output capacitors C_2 and C_4 . The four clock pulses occur during a single memory cycle. Color tint block identifies the basic storage unit; gray tint identifies the feedback circuit that refreshes the charge on the data-holding capacitor, C_1 .

source and drain. This type of cell also dissipates a lot of power and requires high-voltage and high-current line drivers to get data in and out in a typical coincident-current memory scheme. These factors, combined with the requirement for external decoding, drive, and sense circuits, appear to limit at 256 the number of bits on a chip, and the cost from going much below 2 to 3 cents per bit.

To break this price barrier, Four-Phase Systems' new design approach is based on the dynamic storage scheme found in a conventional MOS shift-register cell, shown at the left with the four-phase clocking waveform needed for operation. In a dynamic cell data, stored in the form of a charge on a parasitic capacitor, must be periodically refreshed because it tends to leak off. But the big advantage is offered by relatively high transistor impedances so the area occupied by each transistor is small.

(In this and in the figures to follow, capacitors drawn with dashed lines are parasitic. Capacitors drawn with solid lines, although also technically parasitic, have been purposely augmented to increase their value by enlarging the $p+$ region of the silicon in their vicinity.)

The operation of this shift register cell, which actually consists of two inverter stages, starts with the pre-charging during the first phase of the four-phase clock cycle of capacitors C_1 and C_2 . These capacitors are discharged later in the cycle, but the discharge is con-

Reading and writing. A row-address decoder selects the row in the memory that's to be read out. This read-row signal also triggers a delayed write row circuit that rewrites the readout data, restoring the voltage level of the signal on the storage capacitor.

Sharing the stage. The redundant stage of the dynamic shift register memory element is shared among more than one data-holding capacitor in Four-Phase Systems' design. The feedback stages refresh the charge levels on capacitor C_0 , C_1 , C_2 , and C_3 , each storing one information bit within a memory cell containing three active elements. Color and gray tints identify storage and feedback circuits as in the dynamic cell shown on page 110.

ditional—whether they are discharged depends upon the data stored in the memory cell.

The precharging occurs during the first clock pulse, ϕ_3 . Transistor Q_1 is turned on and capacitor C_1 is charged to the input signal voltage level—either a logic 1 or a 0. Simultaneously, Q_2 is turned on and C_2 , the output signal-holding capacitor of the first inverter stage, is charged to the supply voltage level, V .

Conditional discharging occurs next. When clock pulse ϕ_3 goes to 0, pulse ϕ_4 comes up, turning on Q_4 . If the charge on C_1 is at the high, logic-1 level, Q_3 turns on and C_2 discharges to ground through Q_3 and Q_4 . But if the input and the charge on C_1 had been a logic 0, capacitor C_2 would not have discharged; a charge equivalent to a logic 1 would have remained.

Passing the signal on C_2 through the other half of the cell reinverts it, restoring the original signal level at the cell's output. And tying the output back to the input, as shown by the solid feedback line in the schematic shown on page 110, converts this one-bit shift register into a binary memory element—a dynamic flip-flop that stores one bit of information.

However, there's a basic information redundancy in this flip-flop cell—the basic information bit held on C_1 is also held on C_3 , although in complement form. C_3 and the second half of the flip-flop bit keep restoring or refreshing the charge on C_1 , which otherwise would

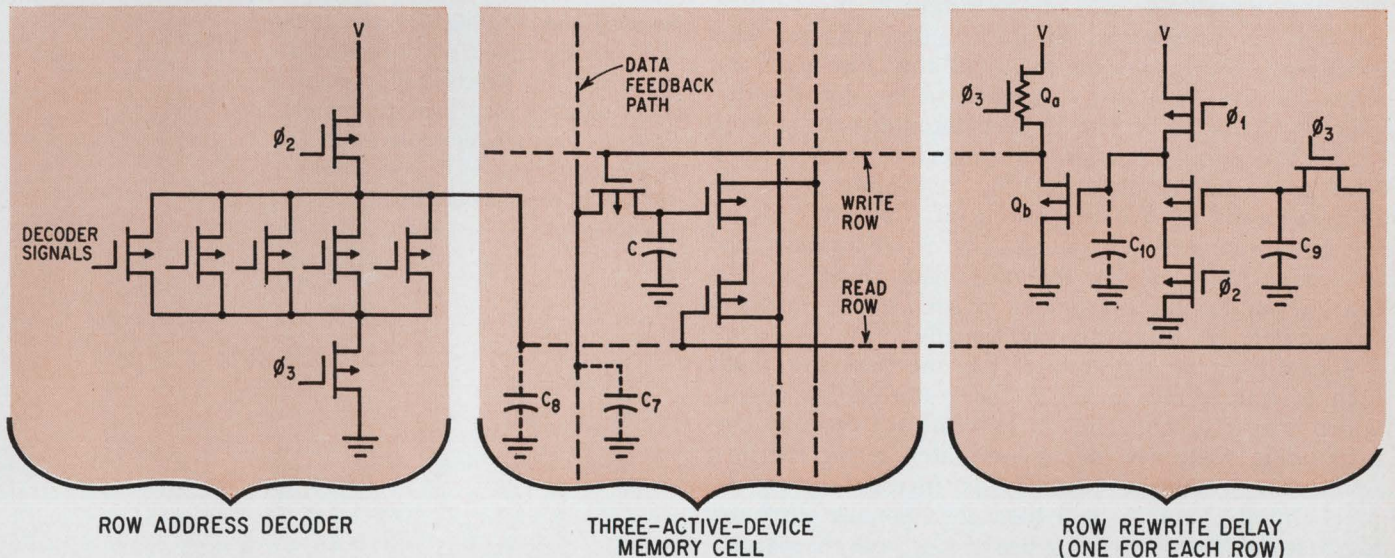
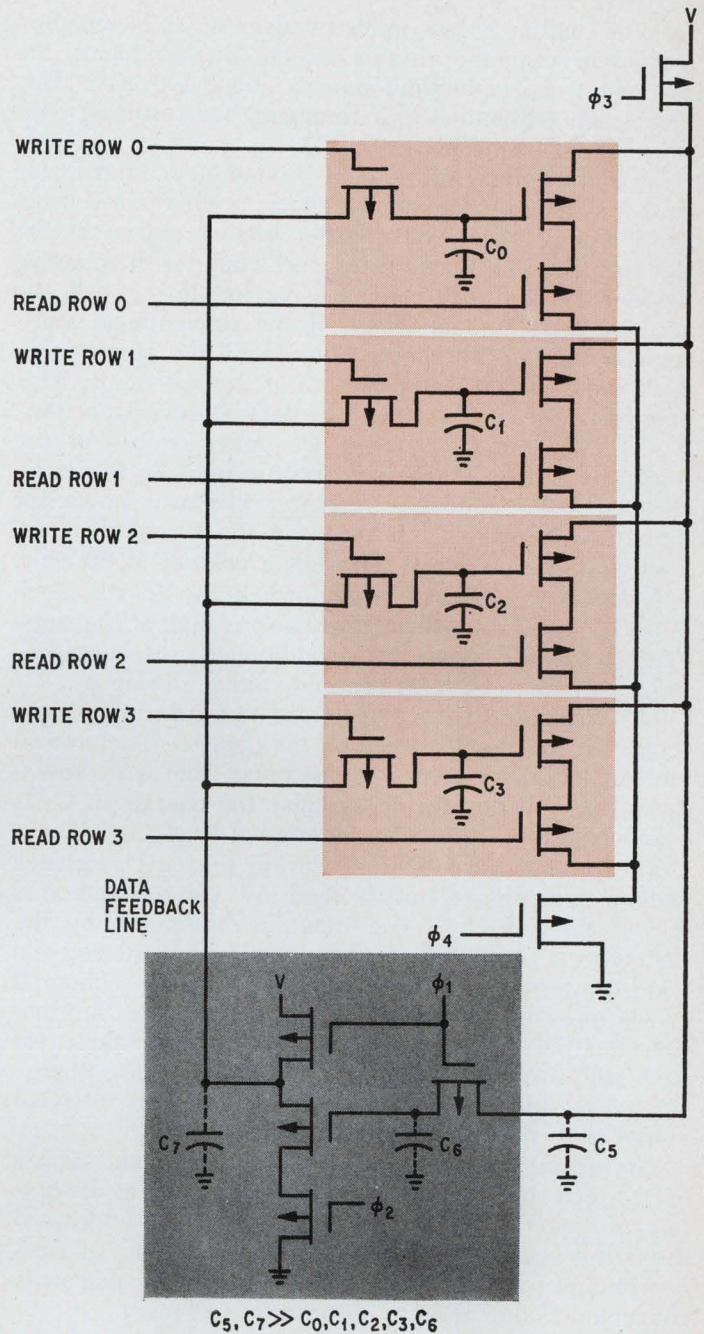

leak off within a few milliseconds. For shift registers and other dynamic circuits on the market today, the maximum charge-holding time is about 100 μ sec. This means the minimum clock frequency for restoring data must be 10 kilohertz.

To reduce this information redundancy, Four-Phase Systems shared a common feedback, or charge-restoring, stage among many shift-register bits as shown at the right of page 111. Each memory cell contains three active devices and one data-holding capacitor. In this cell, the second, or redundant, stage of the conventional shift-register flip-flop has been replaced by the single feedback stage shown at the bottom of the schematic. This stage refreshes each of the four data-holding capacitors, C_0 , C_1 , C_2 , and C_3 in sequence under control of the read row gates, which have been added to the basic dynamic cell. Only four memory cells are shown for illustrative purposes. However, in the actual memory, a single feedback stage refreshes a column of 32 cells.

A memory sequence begins when the fourth clock pulse, ϕ_4 , comes up. Read row 0 also is high at the same time, so that the signal on C_0 conditionally discharges C_5 previously charged to the supply voltage during ϕ_3 .

The charge on C_5 is transferred to C_6 during ϕ_1 and then is inverted and placed on the data feedback-return line capacitor, C_7 , during the ϕ_2 pulse. The write row 0 line rises, and during the ϕ_3 pulse the charge on C_7 is transferred to C_0 , restoring its original level.

The process repeats itself during the next sequence of four clock pulses. But the read row 1 line is activated during ϕ_4 , and C_5 is conditionally discharged by the data-storing capacitor, C_1 . This sequence, restoring the last bit interrogated and reading out the next sequential bit, is repeated continually. Thus, four bits of information can be stored with only 18 transistors—three for each cell, five in the feedback stage, and one to charge C_5 at ϕ_3 —rather than the 32 required if each bit were stored in a single shift-register cell.

The actual circuit mechanism that generates signals on the read row and write row lines is shown at the bottom of page 111. Each of the 32 rows is addressed through a standard decoder network consisting, at each row line, of five transistors in parallel. Each transistor is connected to one address bit or its complement.

When the ϕ_2 pulse is present, the output of the parasitic capacitance, C_8 , at the output of the decoder network⁵ is precharged to the supply voltage. This precharge is retained on the read row line until ϕ_3 , when the five-bit address supplied to the decoder discharges C_8 on 31 of the 32 lines through one or more of the five parallel transistors connected between each read row and ground. On the remaining row, the address keeps all five transistors off. Capacitor C_8 on this row retains its charge, and the corresponding read row stays high. During the next clock pulse, ϕ_4 , the charge enables the capacitors in each of the memory storage cells to discharge conditionally.

Also during ϕ_3 , the state of the one read row that's high is transferred to C_9 in the restore-delay circuit, which stores it long enough to bring up the one corresponding write row line 1 μ sec later during the next cycle. The read row actually is inverted twice, by precharging C_{10} at ϕ_1 and then conditionally discharging it at ϕ_2 . At the next ϕ_3 pulse, if C_{10} were discharged,

Write the first time. To change the contents of the memory, new data is placed on the data feedback path through this feedback circuit, which replaces the feedback stage shown at the right of page 111.

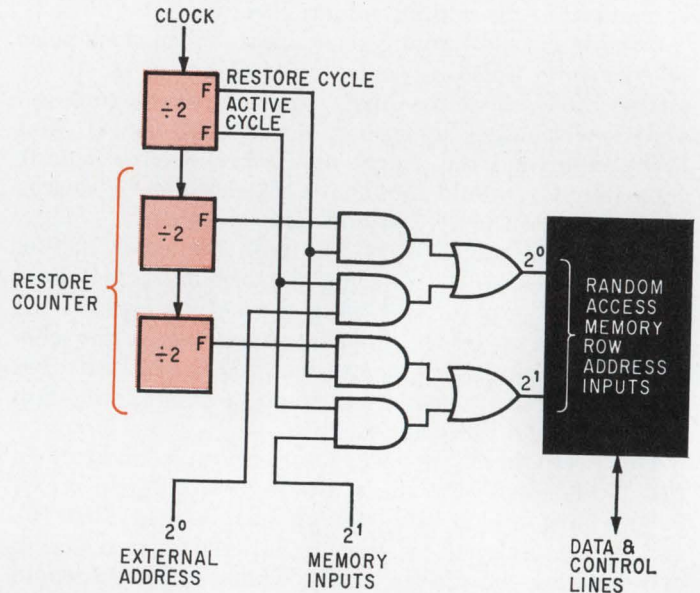
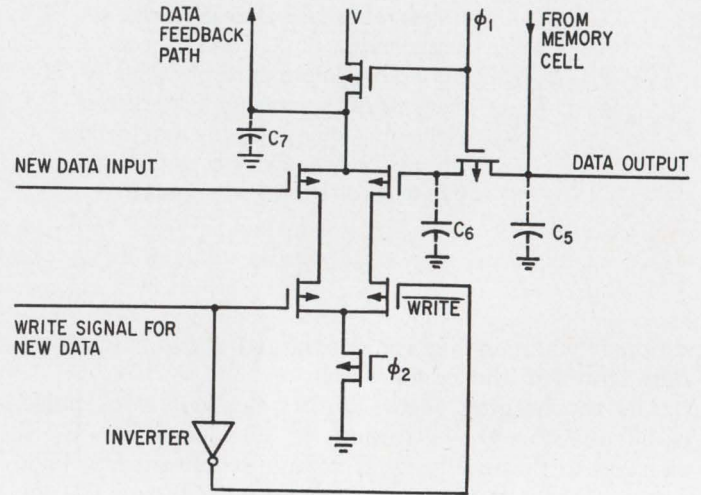

Reading and restoring. Charges on the data-holding capacitors are restored periodically by switching the memory's row inputs to a binary refresh counter. Restore cycles are alternated with command cycles which come to the random-access memory from the computer.

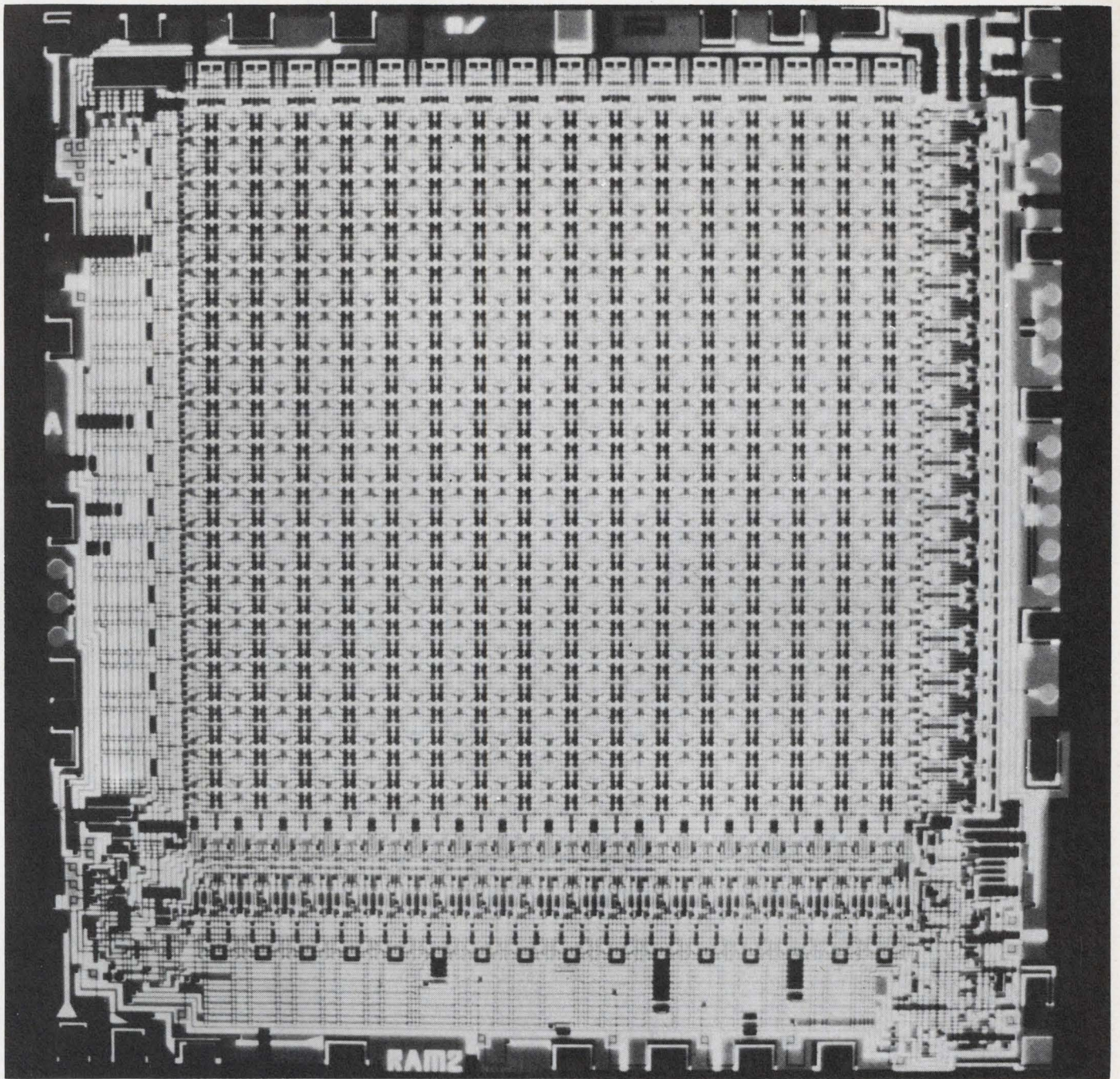

Full chip. Some 4,500 devices squeezed into a 150-by-150-mil-square silicon chip form a complete 1,024, 1-bit-word, four-phase random-access memory. Included on the chip are full binary decoding, chip selection gates, and read-write circuits. 3,072 8-bit-bytes of memory fit on a single 8-by-11-inch printed circuit card (see cover) that includes clock generation and driver circuitry and memory-buffer registers. At a 1-megahertz clock rate, the card dissipates only about 7 watts of power, low enough so that the memory can be driven by a battery in the event of a power failure. Entire computer for which the memory is designed will dissipate only 10 to 15 watts.

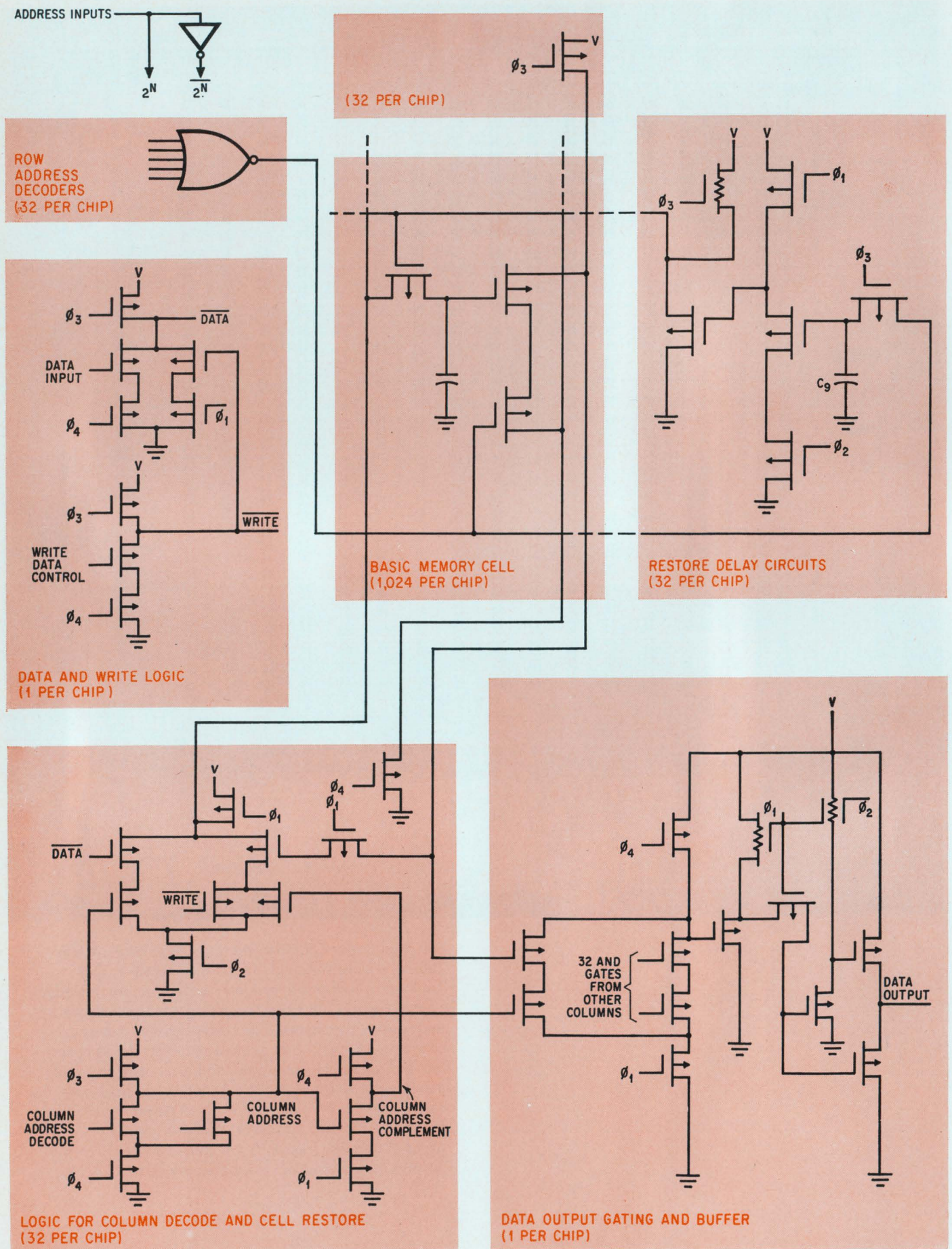

One-chip design. The memory contains all of the circuits required for a 32-row by 32-column random-access memory on a single silicon chip—including one write data input logic stage, one output buffer, and 64 row- and column-selection gates.

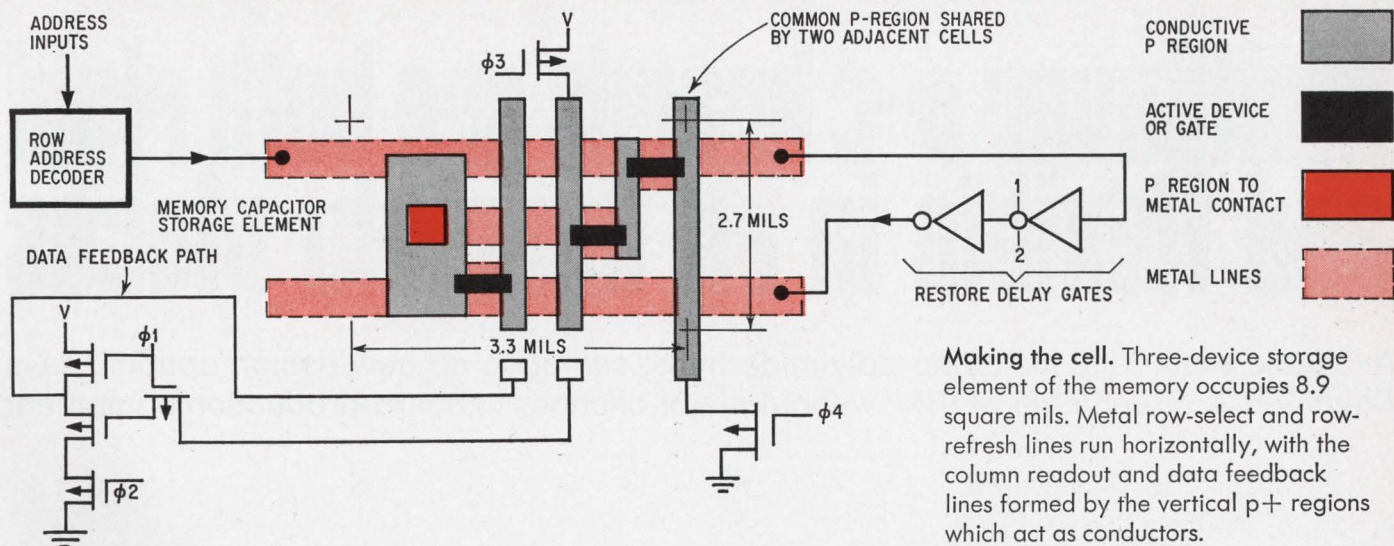

Making the cell. Three-device storage element of the memory occupies 8.9 square mils. Metal row-select and row-refresh lines run horizontally, with the column readout and data feedback lines formed by the vertical p+ regions which act as conductors.

the write row line would rise to restore the charge in the memory cell. If C_{10} were not discharged the write row line would stay down. The line's level is controlled by the 30:1 ratio of impedances Q_a to Q_b , which form a voltage divider.

This voltage-divider or ratio circuitry depends on the ratio of two MOS impedances; it's an old form of MOS logic. It takes up more room than four-phase logic because the different impedances are obtained by varying the chip area occupied by the individual transistors. However, the ratio circuitry is needed to control the write row lines in spite of the extra space it occupies. This is because the write row lines cannot be controlled by precharging, as are the read row lines, during the four-phase clock times. The memory system would need either extra clock phases, or additional logic to insure that precharging the write rows would not interfere with other aspects of the memory's operation. The ratio logic approach actually is the simplest way to control the write row line. And there are so few of the circuits on the chip—32 out of thousands—that the extra space required is negligible.

New data may be written into the memory merely by putting it on the feedback path using the circuit shown at the top of page 112. With this circuit, the memory could perform all of the functions of a true random access memory. The integrity of the stored data

levels must be assured by interrogating and then refreshing each row at least once every 100 μ sec.

To make certain the data will be restored within the allotted 100 μ sec each active random-access cycle consisting of the four clock pulses ϕ_1 thru ϕ_4 is followed by a row-restore cycle. Over a long period, data is available from the memory only half the time. It's similar to the situation in a destructive readout core memory, where full cycle time is twice as long as access time—the dead time is needed to rewrite the data that was held in the core location.

In the Four-Phase MOS memory, this dead time—during which the next four clock pulses occur—is used to refresh the data somewhere in the memory. Successive rows are refreshed in successive restore cycles. And these are alternated with random-access cycles.

The addresses of the rows to be refreshed are generated by alternately switching the memory's row inputs between a binary restore counter and the actual address input coming from the computer, as shown on page 112.

The entire memory contains 32 vertical columns, with 32 memory cells in each column. Every column is self-contained and automatically restores its own bits. An entire horizontal row of 32 cells is refreshed during every refresh cycle. This also applies to multiple-chip configurations where chip-select lines are used. Write data input logic and the output buffer appear only once on the chip. There are 32 row address decoder gates, 32 column decoders and 32 restore-delay circuits. Since only rows are refreshed, one five-stage binary counter connected to the row address is all that is needed to cycle through the rows, irrespective of the number of words in the memory.

The memory cell is laid out with the metal row lines running left to right and the p regions, which act like another conductor strip, running up and down, as shown above. Cell size is about 9 square mils, compared to 20 to 30 square mils for a shift register bit. ●

References

1. Lee Boysel, "Cutting system cost with MOS," *Electronics*, Jan. 20, 1969, p. 105
2. Jack Schmidt, "Integrated MOS Transistor Random Access Memory," *Solid State Design*, January 1965, p. 21.
3. Jack Schmidt, T. Asai, and J. H. Freidrich, "Hybrid LSI Memory," *IEEE Computer Convention*, Los Angeles, June 1968.
4. Lee Boysel and Joe Murphy, "100-Nanosecond Memory: 4 ϕ Techniques Used in High Speed Logic," *EDN*, June 1968.
5. Lee Boysel, "Memory on a chip: A step toward LSI," *Electronics*, Feb. 6, 1967, p. 92.

Multilayer p-c boards are both rigid and flexible in all the right places

Available materials, including polyimide films, can open up new design options, says *Raymond A. Grueninger* of IBM, without major changes in board-production equipment

● Unquestionably, a multilayer circuit board with rigid and flexible sections would be far more versatile than a conventional, all-rigid board. Yet, for all its advantages—low weight, high package density, and reliability superior to that of all-rigid boards—the composite unit has made little headway within the electronics industry. This is despite the feasibility that was made possible several years ago by the availability of copper-clad flexible dielectric films.

A pioneer in the development of multilayered composite boards, the International Business Machines Corp.'s Electronics Systems Center in Owego, N.Y., has built a variety of large and complex packages—including rigid back panels and integral flexible cable extensions, and others with rigid connector areas and flexible sections mounted in radial bends. IBM also has developed integral-cable multilayer interconnection boards—a board is rigid for mounting rows of circuit-module connectors. The unbonded cable extensions remain flexible to a large, round plug-in connector, to which they are bonded and rigidized.

In effect, these boards are proof of the composite board's versatility; sections on the same board can be made rigid or more flexible where needed.

Compared with all-rigid boards, composite boards weigh as much as 30% less because the flexible film is less dense and thinner than rigid epoxy glass. An

0.002-inch-thick flexible polyimide film, for example, is used in place of a 0.004-inch-thick epoxy-glass layer. In some designs it's possible to eliminate connectors at what would have been the board-cable interface. This, too, cuts down on weight. And by eliminating the need for interface connectors, both the packaging density and circuit reliability can increase by up to 50%. Even manufacturing costs can be trimmed by as much as 30%, because of lower inspection and wiring costs, particularly if the design eliminates a discrete-wire harness.

Finally, the availability of some flexible materials in roll form could justify high-volume, high-speed continuous production over present batch fabrication methods.

To take advantage of the virtues of these boards, the jumping-off spot is selection of a flexible dielectric laminate material. Mechanical, electrical, and processing performance characteristics must be considered. Among the mechanical factors that must be weighed are degree of flexibility, tensile and impact strength, tear initiation resistance, and ease of machining. Electrical considerations include dielectric constant, dissipation factor, and volume and surface resistivity. Processing factors are resistance to solvents and other process solutions, platability, and adhesive bonding characteristics.

Of the flexible substrate materials available commercially, polyimide films are best for meeting such a

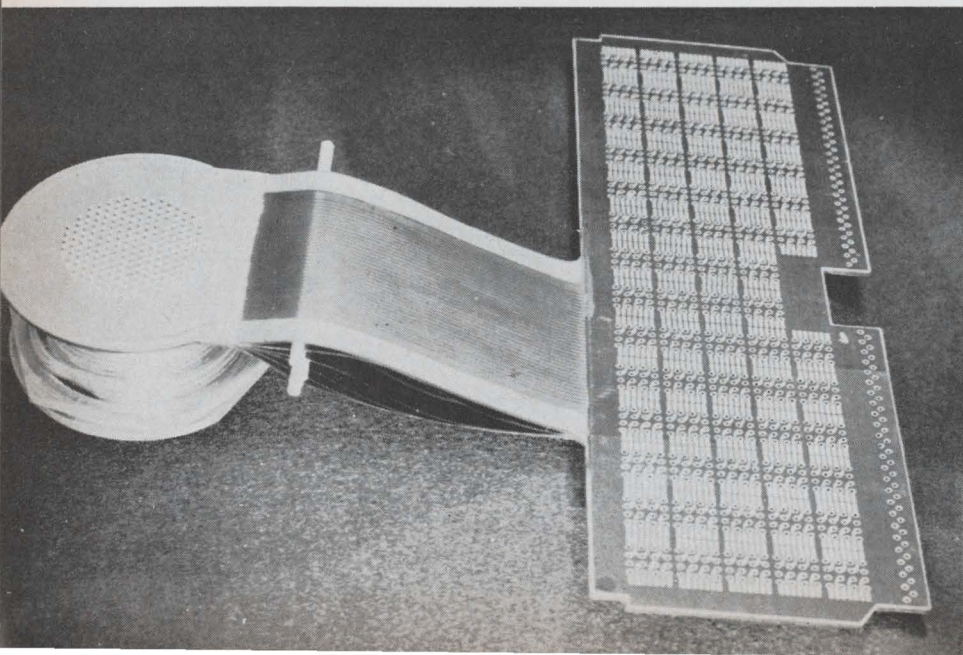

Interconnector. Rigid for mounting rows of small connectors, this integral cable multilayer board has unbonded cable extensions that remain flexible to round connector, where they are bonded and rigidized.

broad range of requirements. Copper-clad polyimides used as circuit layers come in a variety of film thicknesses and copper weights, and employ various adhesive materials to bind the copper to the film. Glass-fabric-supported copper-clad polyimide substrates, a newer material, should be useful for high-temperature circuit operation.

Interlayer materials available for joining polyimide laminates include polyimide films coated with B-staged (mixed, semicured, and ready for thermosetting) adhesives such as modified epoxies and polyesters; glass-supported epoxy preimpregnated (preg) adhesives; and unsupported B-staged adhesive films such as polyvinyl butyl.

Unsupported adhesive films and B-staged adhesive coatings may soften from the heat generated during drilling of the through holes. Since the adhesive is extremely difficult to remove, plating of the through-holes in the laminated composite can be complicated. The epoxy glass prepreg adhesive layers perform better in drilling and plating—and epoxy smear can be removed fairly easily with an acid solution.

But using an epoxy-glass prepreg as an interlayer adhesive in a multilayer hybrid construction does have some disadvantages. The prepreg's operating temperature is less than that of the polyimide layers in a composite. And overall stiffness increases as the number

Lay up. Layers of polyimide film, interlayer adhesive, and epoxy glass are assembled, then squeezed under heat and pressure to form a multilayer circuit board like the one shown at the bottom. Note how sections of the rigid epoxy-glass layers have been removed to form a flexible area.

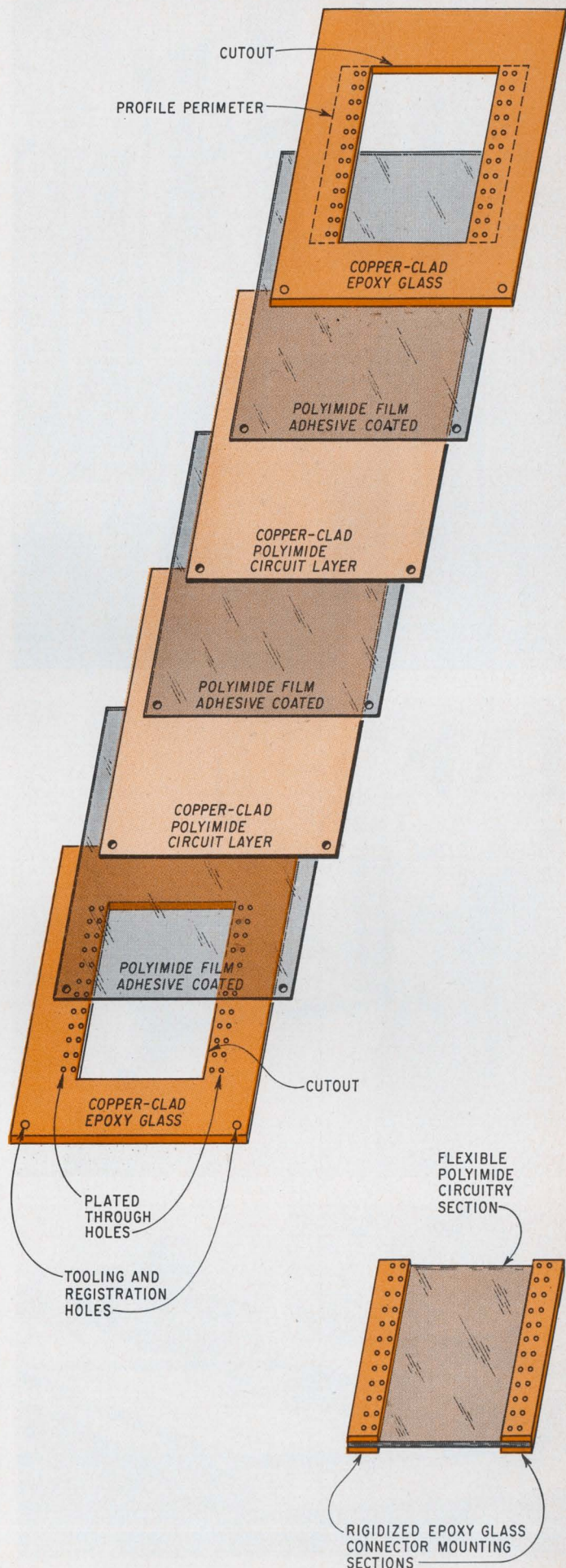

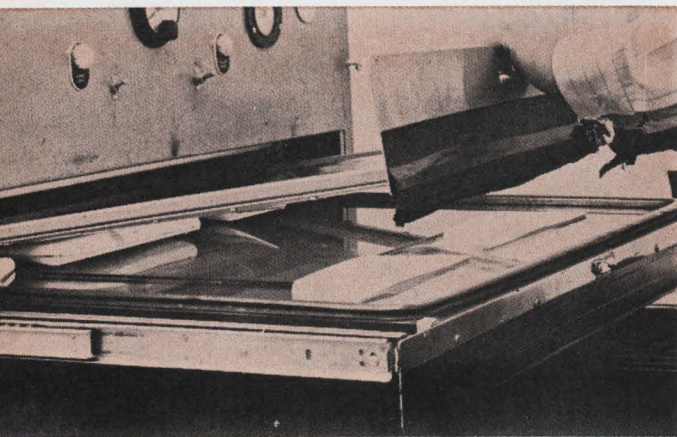
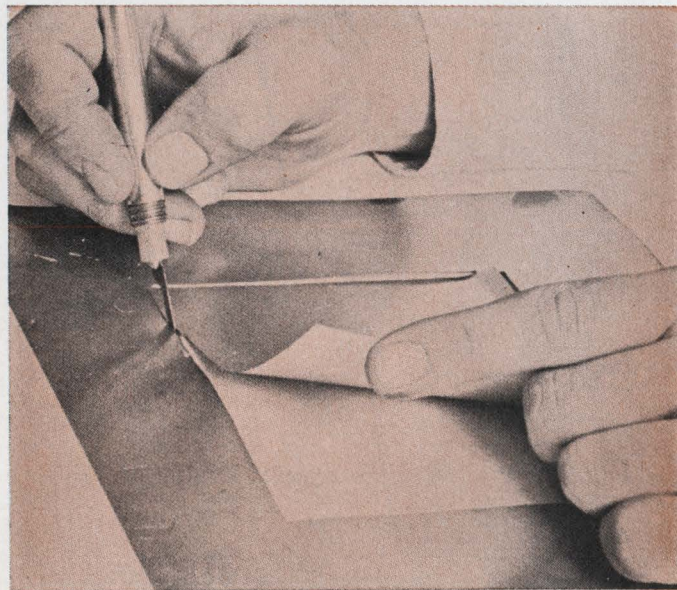
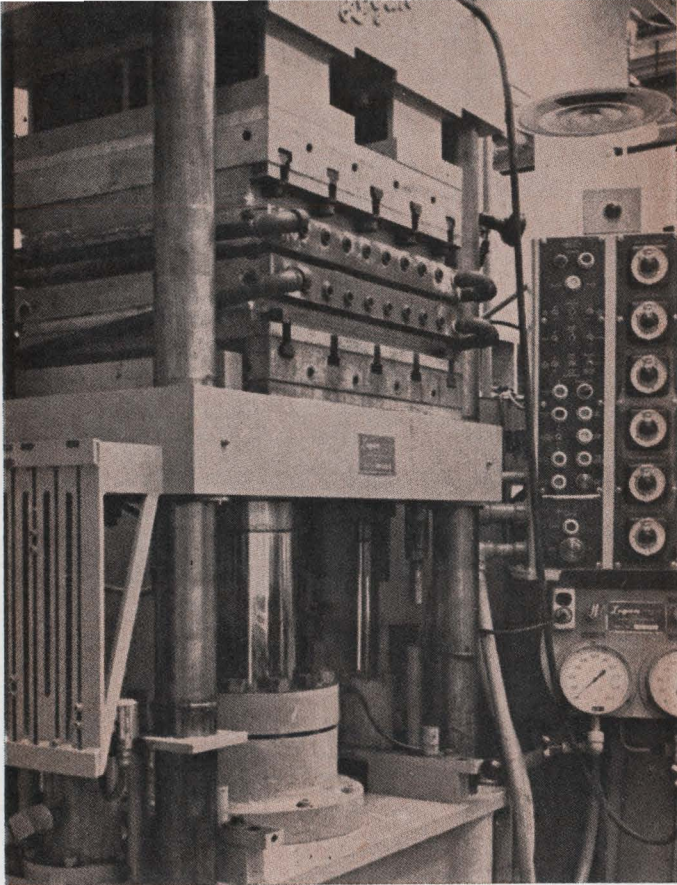

Eight steps. Fabricating a multi-layer flexible-rigid printed circuit board involves few changes from the conventional techniques. Two of the first three steps, destressing and cutting the epoxy-glass layers, are routine, while applying the conductor patterns requires special care, as does . . .

of epoxy-glass prepreg layers increases.

Conventional copper-clad, glass-supported epoxy laminates can be combined with copper-clad polyimides and adhesive-coated polyimide films. This can be accomplished without incurring major modifications in the standard, plated-through-hole multilayer circuit board fabrication process. The same is true for unsupported adhesive films or epoxy prepreps.

A typical processing sequence for fabricating a flexible-rigid hybrid multilayer composite applies to those employing copper-clad polyimide film with a cladding adhesive, adhesive-coated polyimide interlayer bonding, and copper-clad G-10 epoxy glass rigidizing layers. With modifications, the sequence also applies to composite structures consisting of copper-clad polyimide layers employing cladding adhesive and epoxy glass prepreg interlayer adhesive.

The flexible-rigid fabrication process requires eight steps: destressing the film, cutting the epoxy glass, applying the conductor patterns, laminating the layers, drilling the through holes, plating the through holes, personalizing, and profiling. Most of these are straightforward, but a few, such as applying the conductor patterns on flexible films and drilling and plating of through holes, are more complicated. The eight steps, with emphasis on the factors that distinguish them from the fabrication of all-rigid multilayer circuit boards, are:

- ▶ **Destressing the film.** Most copper-clad polyimide laminates are produced by roll-lamination and are stocked in roll form. Then layers are cut to size from the roll, and are heated and pressurized in a flat-bed hydraulic lamination press to release the cladding adhesive bond. Cooling the laminate while it's still under pressure re-establishes the bond, but with minimum stress.

- ▶ **Cutting the epoxy glass.** Copper-clad epoxy-glass circuit layers make the composite rigid. But, all intended flexible areas of the composite are cut from the epoxy-glass layer. Then registration holes are punched into all composite layers.

- ▶ **Applying the conductor patterns.** Photoresist techniques for rigid and flexible layers in a composite board are similar to those used on all-rigid units, but flexible polyimide layers require special care. Positive or negative liquid resists or negative film resists are used. And film or glass artwork yields the conductor pattern.

... laminating the layers in a hydraulic press under controlled pressure and temperature. Drilling the through holes must be done carefully to avoid adhesive smear which could affect the bonding of the electroplated copper to the hole walls and to the copper layers...

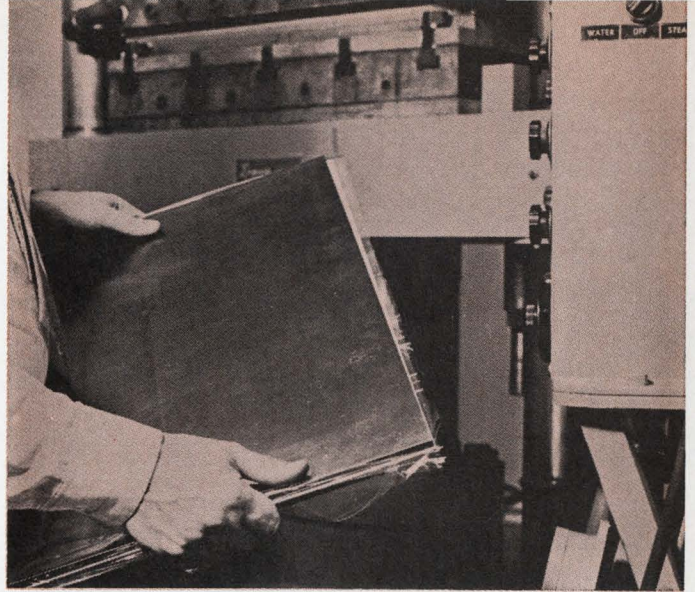

First the layers are chemically cleaned to remove surface contaminants and to aid adhesion of the photoresist material, applied next. Then, after exposure to high-intensity light the image is developed and etched to remove unwanted copper. Finally, the remaining photoresist is removed by a solvent.

To obtain smooth, clean edges for polyimide films, particular attention must be paid to resist-pattern touch-up. Otherwise, manual removal of excess copper after etching may cause permanent damage to the polyimide layer.

These layers also require care while they're in the solvent, particularly if the solvent is chlorinated. Solvent-immersion time must be controlled closely because the cladding adhesives in copper-clad polyimide materials can soften and swell. If left in the solvent too long, the copper circuit could lift right off the substrate. And the solvent must be completely removed by air drying or baking to avoid blistering and poor bonding later.

One side of each of the two circuit layers that will form the composite's outside surface is not photoresisted at this stage. Instead, the conductor patterns are photoetched after the through-hole-plating operation.

► Laminating the layers. Lamination is the most critical production step. Lamination pressure must be closely controlled—too-low pressures cause voiding, while under too-high pressures, circuit shifting or conductor fracturing can occur.

Because sections representing flexible areas were cut from epoxy-glass rigidizing layers, in their place sections of a nonbonding fluoroplastic, such as Teflon, must be inserted. These inserts, identical in thickness and size to the removed epoxy-glass sections, will not stick to the interlayer adhesive and can be extracted from the composite after profiling. When epoxy-glass rigidizing layers are not used and flexible and unbonded composite sections are desired, areas of the interlayer adhesive are removed prior to lamination. Then fluoroplastic release sheets are inserted to maintain uniform thicknesses.

All composite layers are chemically cleaned prior to layup to remove surface contaminants and insure adhesion. Layup is performed under semi-clean-room conditions.

After layup, the composite goes into the press, where pressure and heat are applied immediately. The flow

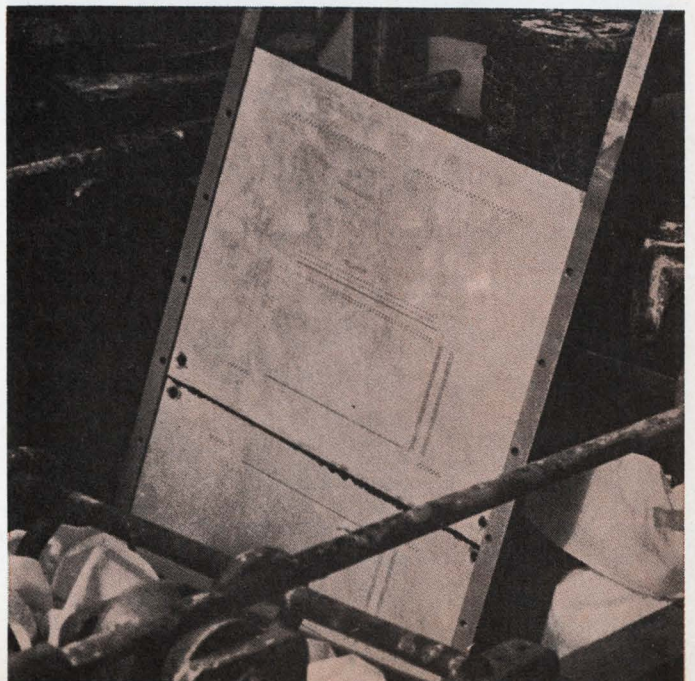
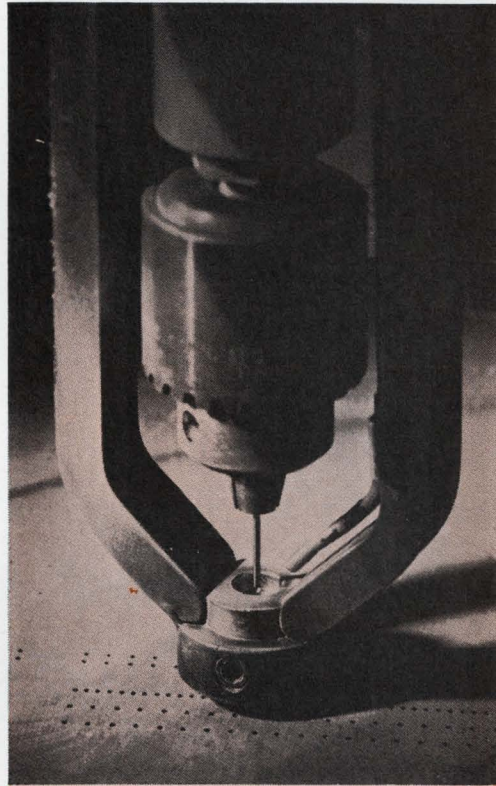

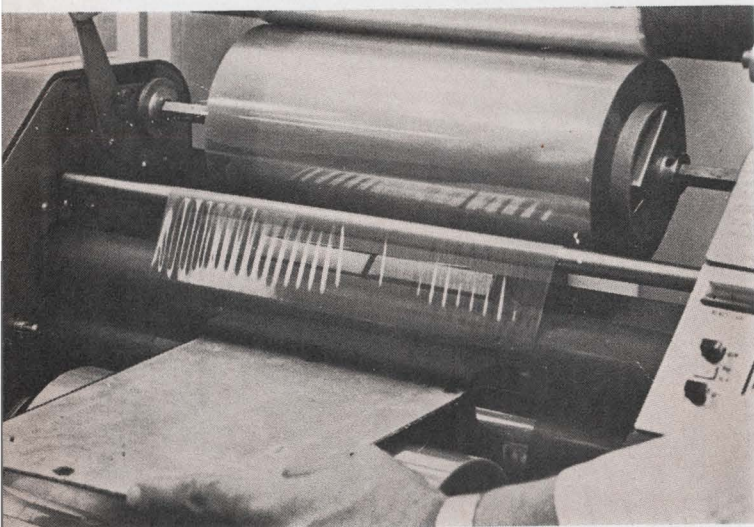

... and to the outer pattern of conductors that are photoetched during the personalizing step. The final step, profiling, involves shearing, milling, and drilling. The result is, for example, a composite (bottom) that's flexible enough to be bent radially but rigid enough to prevent stress at connector pins.



characteristics of the selected interlayer adhesive determine the rate of increase in pressure and heat. For high-flowing adhesives, a short minimal pressure may be used to flow before full pressure is applied. For low- or non-flowing adhesives, a rapid rise to maximum pressure is recommended.

The composite remains under maximum pressure and temperature for as long as it takes to achieve full cure of the interlayer adhesive, generally not more than two hours. Then the press is cooled, but the highest lamination pressure is maintained until the press reaches room temperature to avoid warping.

► **Drilling the through holes.** After lamination, the composite is drilled to the required through-hole pattern. Unlike all-rigid boards, flexible-rigid units require experience and trial-and-error procedures to determine the drill speed that will produce smoothest through holes with minimum adhesive smear. Through-hole quality is affected by the relative number of polyimide and adhesive layers in the composite, as well as by the nature of the interlayer adhesive. Numerically controlled drills with variable rotation speeds have been successfully used here. As in all-rigid assemblies, all copper burrs must be removed from drilled hole rims mechanically. Then the composite is vapor blasted to remove loose material from inside the drilled holes and to prepare its two outside copper-clad surfaces and the through holes for copper plating.

► **Plating the through holes.** Three essential modifications to through-hole copper plating operations for epoxy-glass must be made to achieve acceptable plating of a polyimide hybrid structure.

The first, alkaline cleaning before through-hole-plating of polyimide structures, serves two purposes: removal of organic contaminants from the copper surfaces, and formation of irregular surfaces—etch backs—so the plating will better adhere to the walls. The operation requires a weak alkaline solution and a carefully timed cleaning cycle so that etch back doesn't eat away too much of the polyimide. The polyimide could be cleaned in an acid bath, but etch back wouldn't occur because polyimide is impervious to acid.

Then, electroless (chemical) copper deposition must be used to plate the walls, because the polyimide doesn't conduct electricity. The electroless deposition operation essentially is the same as that used for plating holes in

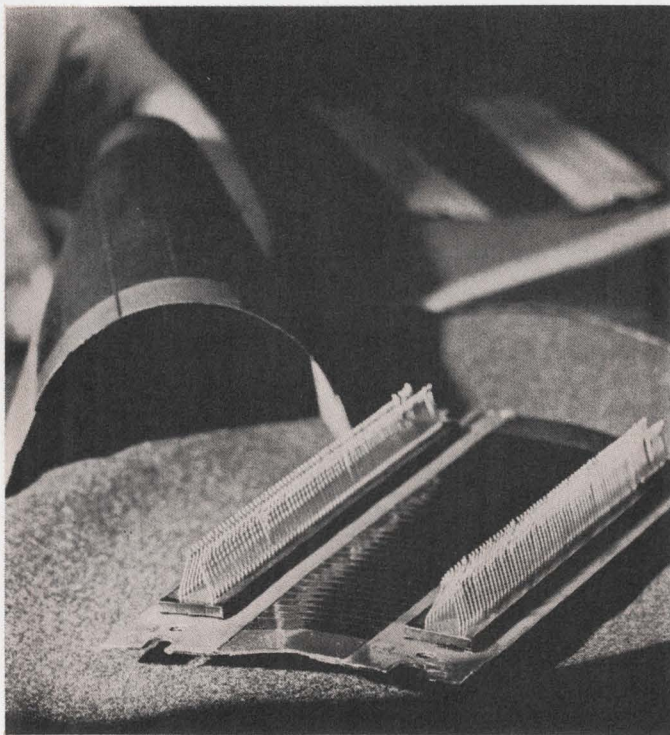

epoxy-glass layers. The main difference is that for polyimide films such chemical-bath parameters as temperature and pH must be closely controlled—to within 2%, compared with the conventional 5%. And deposition of copper in polyimide holes takes about twice as long as in epoxy-glass holes.

Next, copper electroplating is accomplished through an acid-copper bath at room temperature. The acid bath's parameters must be more carefully controlled than the alkaline bath that has been used with epoxy-glass layers. A major consideration in using acid-bath electroplating is that the plating tanks must be able to withstand any attack by the acid solution. Thus existing tanks of stainless steel, fiberglass, or similar materials may have to be replaced or coated with a material impervious to the acid. One type of tank that will perform satisfactorily consists of a fiber-glass body lined with polyvinyl dichloride.

► **Personalizing.** The two outside surfaces of the laminated composite, which still are completely copper coated, are photoresisted, developed, etched, and cleaned to produce the personalized conductor patterns that interconnect the plated through holes.

► **Profiling.** Finally, the hybrid multilayer board is shaped and completed by shearing to approximate size, milling to exact size and shape, and drilling to provide mounting holes or to reduce weight. ●

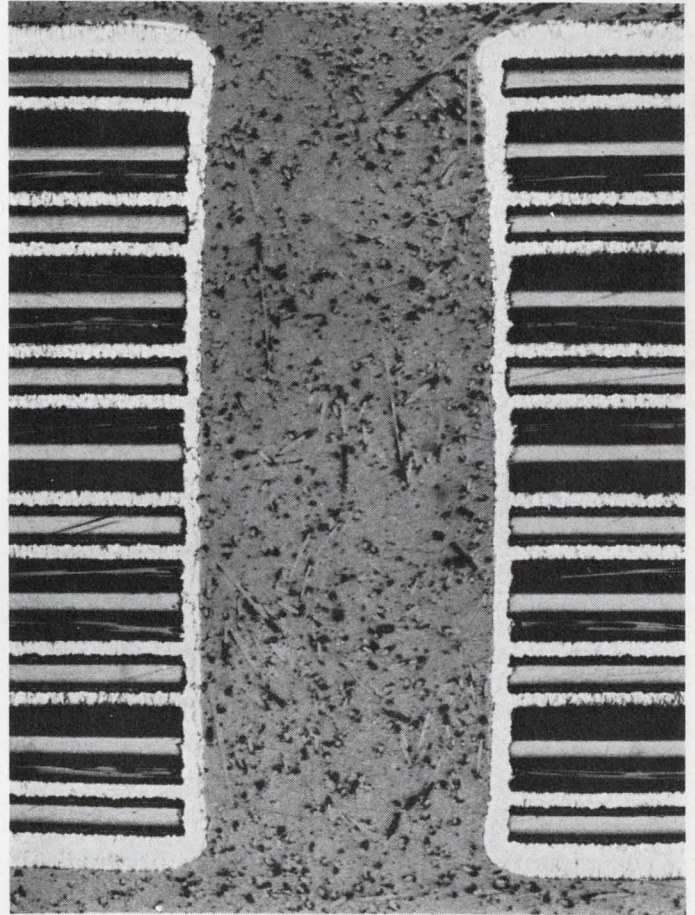

Smooth or smear. Plated-hole wall (top) through six copper-clad circuit layers and 10 epoxy-glass adhesive layers, is fairly smooth because adhesive doesn't extrude during drilling. But smear occurs (below) in sandwich consisting of one polyimide circuit layer between two epoxy-glass layers. Hole diameter is 0.028 inch. White surfaces in cross section are clad or electrodeposited copper.

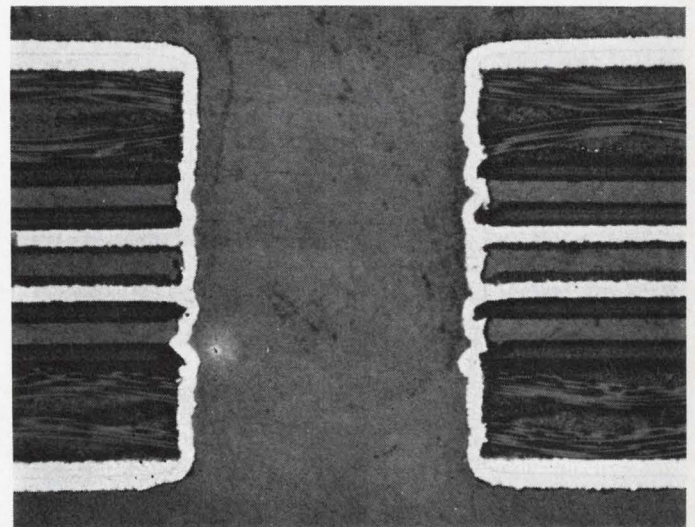

Frequency meter, comparator, phase meter -- three in one

Arthur Delagrance and Robert Davis of the Naval Ordnance Lab tell how they designed a crystal-controlled unit for calibration and measurement that's portable, compact and, versatile and costs only about \$150 to build

● Combining versatility and low cost in a calibration-measurement instrument is nice work if you can get it—and you can get it for only \$150 in parts and some assembly time. The fruit of your labor will be a battery-powered, fist-size device that can compare unknown frequencies against accurate reference frequencies; determine frequency or phase; compare two unknown frequencies with each other; and supply many different reference frequencies. Furthermore, the accuracy and stability of these reference frequencies depends on only one crystal.

The instrument originally was designed for calibrating carrier oscillators in f-m tape recorders. However, its multiple capabilities and its portability allow the device to be used in the field for such jobs as checking signal sources, synchronizing generators, and adjusting filters.

The instrument has four sections: an input network, comprising an operational amplifier and a differentiating circuit; a comparator; a frequency divider made of J-K flip-flops; and a crystal-controlled oscillator. The divider and oscillator act as a synthesizer. They put out a number of reference frequencies whose accuracy and stability are governed by a single crystal. One reference frequency is compared with the unknown frequency of the signal fed to the instrument's input jack. The instrument can handle almost any waveform; however, the signal to be processed must be periodic.

The input signal goes through a blocking capacitor and a current-limiting resistor to the operational amplifier, which is protected by back-to-back diodes. The signal overdrives the amplifier, causing it to put out a square wave whose frequency is equal to the unknown frequency.

At the amplifier's output is a resistance-capacitance network, buffered on each side by a gate. The first gate inverts the square wave. Then it is differentiated by the RC network, producing a train of alternately positive and negative pulses. The second gate blocks the positive pulses and inverts the others. The result is a train of positive pulses, one of which occurs each time the input to the instrument goes negative. These pulses feed one side of the comparator.

Fed to the other side is a similar pulse train generated by the reference signal, which originates in the crystal-controlled oscillator. The oscillator's output passes through a gate to the divider, comprising a chain or chains of J-K flip-flops. These produce the reference frequencies. In the simplest example, a series of flip-flops each dividing the frequency of its input by 2, a switch connected to the outputs of all the flip-flops could pick a reference frequency equal to $f_c/2$, $f_c/4$, down to $f_c/2^N$, where N is the number of flip-flops in series and f_c is the frequency of the crystal-controlled oscillator.

In the beginning. Although it can measure frequency and phase, the instrument was first built to calibrate carrier oscillators in f-m tape recorders. When the crystal's frequency, f_c is 5.184 Mhz, the reference frequency, f_R , is either a center frequency or a —40% deviation frequency associated with one of the seven standard tape speeds. In this example the comparator's R-S flip-flop is made from two gates to ensure a sufficient voltage swing across the meter.

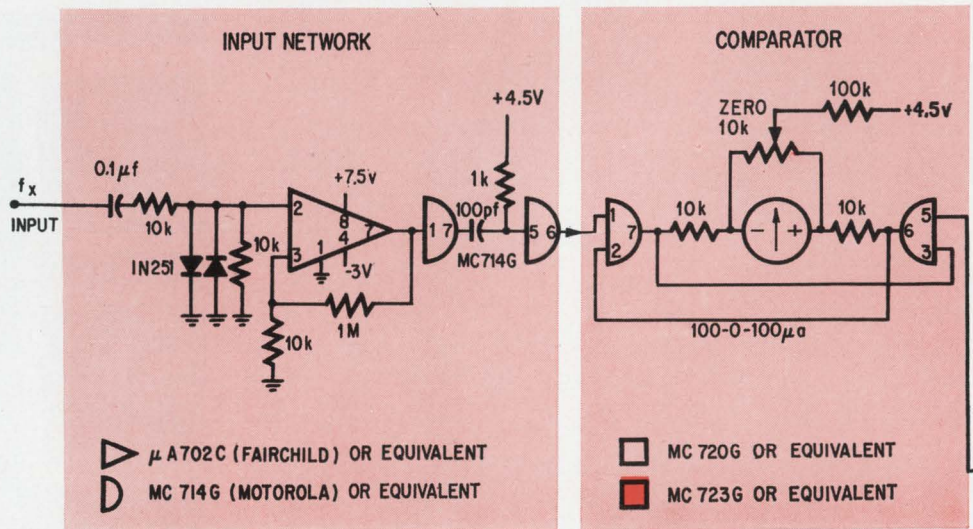

The original. The first device built around the synthesizer-comparator scheme shown at the bottom is this calibrator for the oscillators in f-m tape recorders. But the instrument also measures frequency or phase, or compares two unknown frequencies.

The selected reference goes through a buffered RC network, identical to the one that handles the input signal, and into the comparator, which consists of an R-S flip-flop and a zero-center d-c meter. There the two pulse trains—one generated by the unknown frequency and the other by the reference frequency—are compared. The unknown-frequency pulses set the flip-flop; the reference-frequency pulses reset it. The meter is connected between the flip-flop's output terminals so that when the flip-flop is set, the meter's pointer moves to the right of zero and when it's reset, the pointer moves to the left of zero.

If the unknown frequency is higher than the reference frequency, the comparator receives more set than reset pulses, and the pointer moves to the right a distance related to the difference between the unknown and the reference frequency. And if the unknown is lower than the reference, the pointer shifts to the left. When the frequencies are within a few hertz of each other, the instrument, in effect, switches from a coarse- to a fine-adjustment mode. The pointer starts oscillating about zero, indicating that the frequencies are close. As the unknown is brought yet closer to the reference, the pointer oscillates at a slower speed. The idea is to slow down the pointer as much as possible. When this is done, the unknown frequency is within a fraction of a percent of the reference. For example, if the reference

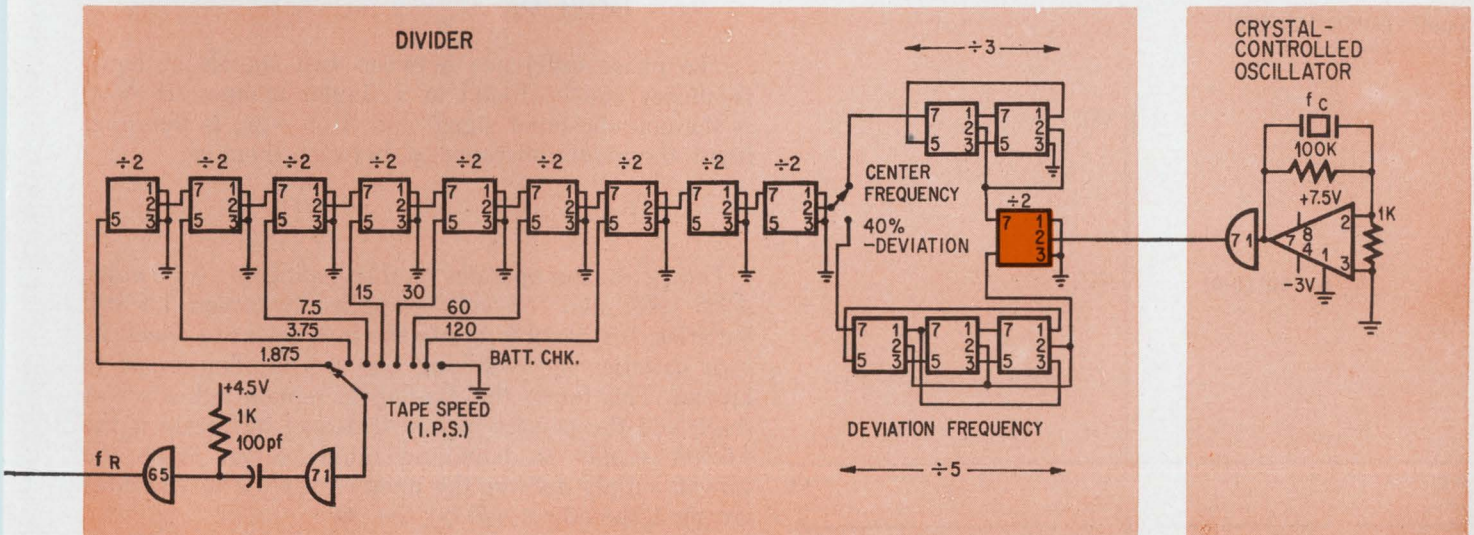

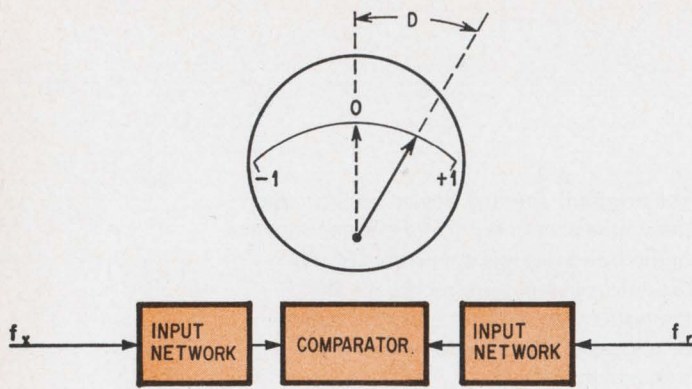

Frequency or phase. When an unknown and a reference frequency go to the comparator, the amount of meter deflection is proportional to the unknown frequency. If the inputs to the comparator have the same frequency, the deflection is a measurement of the phase difference.

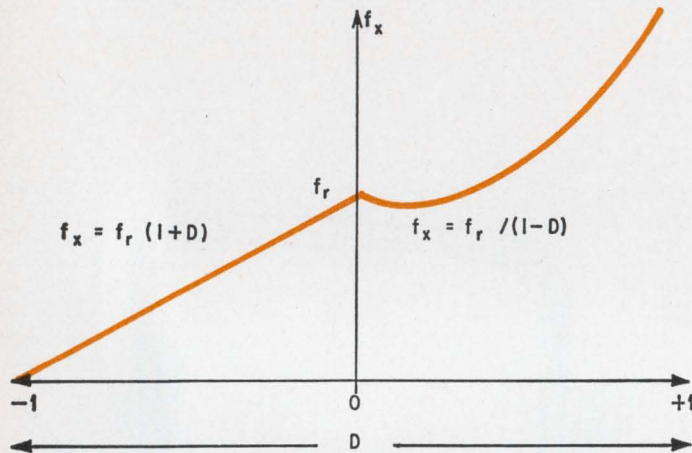

is 100 kilohertz, the unknown can be brought to within 1 hertz, or 0.001%, of it; on the other hand, if the reference is 1 khz, the unknown can only be brought to within 0.02%.

In the ideal case, when the unknown frequency is exactly equal to and in phase with the reference, the pointer comes to rest at zero.

If, as in synchronizing generators, two unknown frequencies are to be compared, an additional input network is connected to the comparator in place of the oscillator-divider network. After the second unknown frequency signal is fed to this input network, the user synchronizes one of the unknowns to the other by adjusting either frequency while looking at the meter.

The instrument also yields an approximate measurement of the value of a frequency not equal to a reference. With the synthesizer connected to the comparator the user selects the reference frequency that causes the smallest meter deflection. Calling the distance between zero and either end of the scale ± 1 , the user measures the deflection, D . With the right-hand deflection ($0 \leq D \leq 1$) indicating that the unknown frequency, f_x , is greater than the reference, f_r , f_x is

$$f_x = f_r / (1 - D)$$

If the deflection is to the left ($-1 \leq D \leq 0$), f_x is

$$f_x = f_r(1 + D)$$

The phase difference between two signals of equal frequency can be found in a similar manner. If $A(\omega t)$ is the periodic input signal and $A(\omega t + \phi)$ is the other input, the phase difference, ϕ , between them is

$$\phi = 180^\circ(1 - D)$$

The instrument operates on three voltages—+4.5 volts, +7.5 volts, and -3 volts—supplied by seven 1.5 volt batteries. It's possible to use the instrument to check its own batteries by switching one R-S flip-flop input to ground. This forces the flip-flop to remain either set or reset, and the pointer then will deflect full scale if the 4.5-volt supply is delivering rated power. Since the 4.5-volt supply delivers the most current, if its batteries are good, the others will be, too. ●

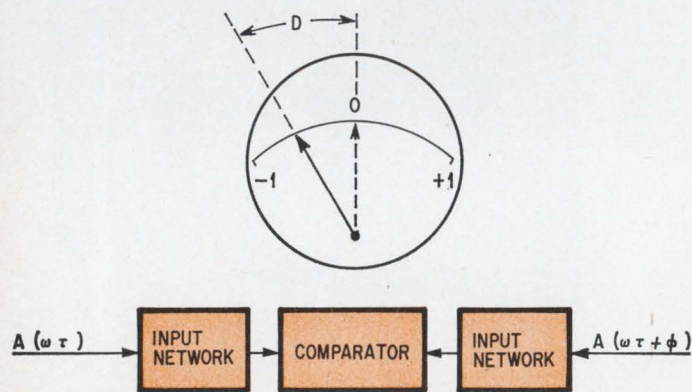

$A(\omega\tau)$ = PERIOD FUNCTION
 ϕ = PHASE ANGLE

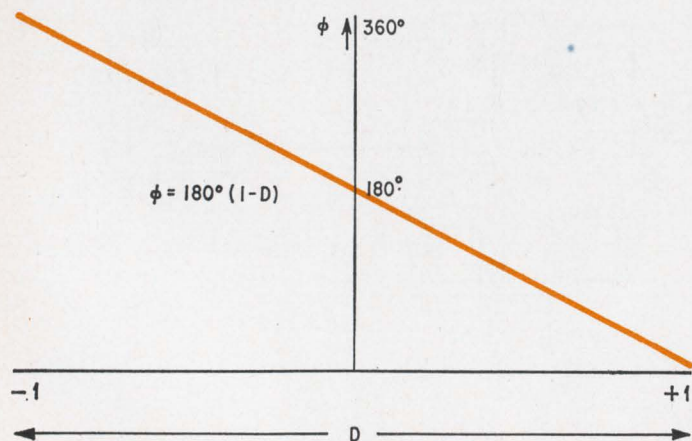

Auto Scale- Factor Readout

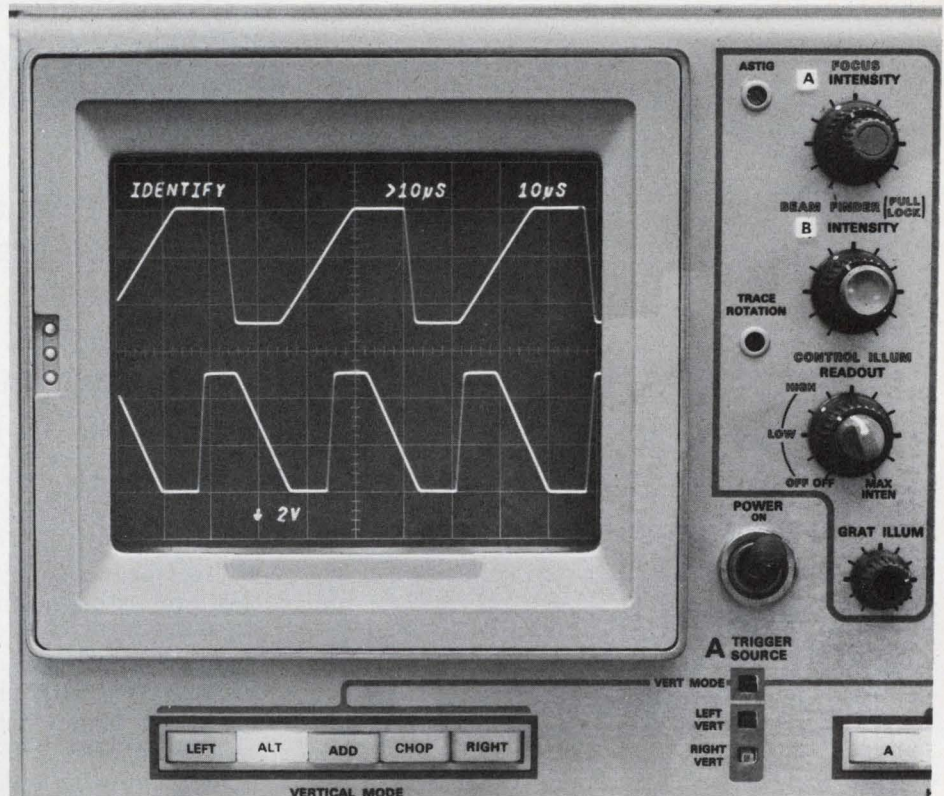

means faster measurements with fewer errors

The New Tektronix 7000-Series Oscilloscope System has AUTO SCALE-FACTOR READOUT—just one of many new convenience features which refine waveform measurement ease. Auto Scale-Factor Readout labels the oscilloscope graph with deflection factors and sweep speeds, invert and uncalibrated symbols, and identifies the trace and its data. When magnified sweeps and the New P6052 or P6053 10X probes are used, the readout is automatically corrected. Press either a probe-tip or front-panel switch, the trace shifts vertically and its deflection factor is replaced by the word IDENTIFY to associate waveforms with scale factors. Scale factors of *inverted* and *uncalibrated* displays are prefixed by invert (\downarrow) and uncalibrate ($>$) symbols. Now, you can forget the inconvenience of hand labeling photographs. With AUTO SCALE-FACTOR READOUT you look in only one place for accurate data. On the CRT where it's displayed automatically . . . with the waveforms!

New Convenience, a Wider Performance Spectrum, and Four Plug-In Flexibility are some factors which make the New Tektronix 7000-Series Oscilloscopes an asset to your measurement capabilities.

Prices of Instruments shown:

7704 DC-150 MHz Four Plug-In Oscilloscope	\$2500
7A12 Dual-Trace Amplifier Plug-In	\$ 700
7A16 Single Trace Amplifier Plug-In	\$ 600
7B71 Time-Base Plug-In	\$ 685
7B70 Time-Base Plug-In	\$ 600

Note: 7504 DC - 90 MHz Four Plug-In Oscilloscope with Auto Scale-Factor Readout \$2000

U.S. Sales Prices FOB Beaverton, Oregon

For information, call your local Tektronix Field Engineer or write: Tektronix, Inc., P. O. Box 500, Beaverton, Oregon 97005.

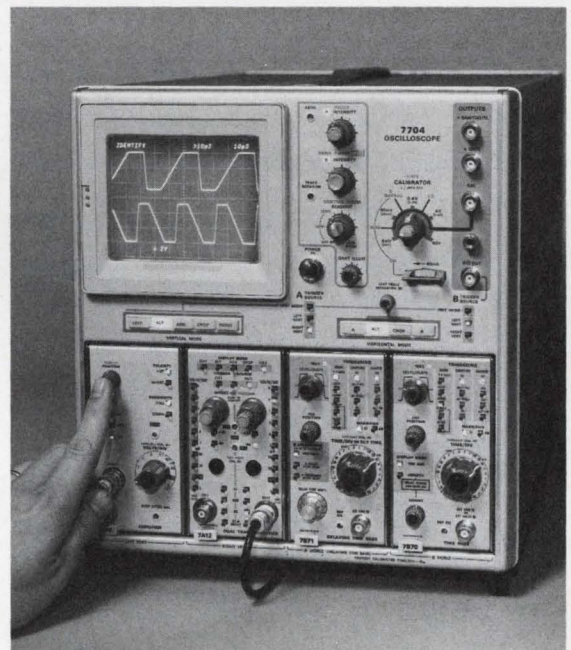

The Readout System presently displays up to 49 symbols and responds to various functional instructions. Less than half of the symbols are needed for today's plug-ins.



Tektronix, Inc.

committed to progress in waveform measurement

What level of LSI

You don't need a crystal ball to help you decide, says Intel's *G. E. Moore*; mathematical models can determine what's best suited for your design by forecasting the cost per function well in advance of your actual production

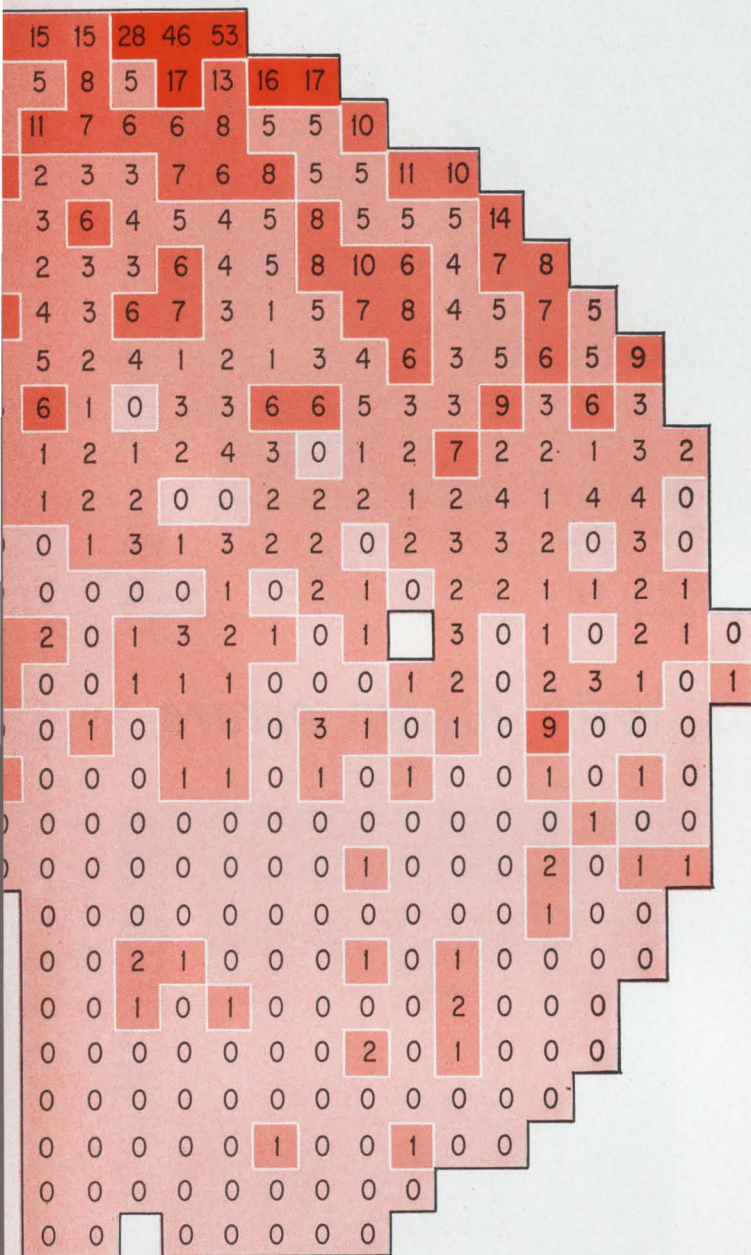

● Everyone agrees that the cost of an integrated circuit will drop as the manufacturer gains experience in making it. But how much will the cost drop? This is a crucial question to the IC user—the equipment or system manufacturer—who must choose circuits for a product years before it's in production. Is it better to select IC's of great complexity and hope for reasonable costs by the time quantity orders are placed? Or should the user play it safe and design with simpler IC's whose cost is already known?

Fortunately, a method of prediction has been devised to eliminate the guesswork from such decisions. Working with IC manufacturers, the user can plot cost per function for integrated circuits of various complexities over the next several years. On the basis of these plots, the user can then decide which IC will give minimum cost per function when the equipment design is ready for production.

Such forecasts can have profound and far-reaching effects. In memories, for example, the designer can now make a rational choice between cores and IC's, between 64-bit arrays and 256-bit arrays.

The IC manufacturer, too, has a vital interest in forecasting. It helps to resolve the dilemma of setting a price for a significantly new product: a safe, overly conservative quote can make customers disappear; on the other hand, an overly optimistic, unrealistically low estimate

Top to bottom. Distribution of defects on a half-wafer after a single critical process operation shows a gradient from top to bottom. The gradient varies in magnitude and orientation with the operation, so it's difficult to decide on an overall defect distribution. Numbers indicate defects in the area that a single IC will occupy. The empty space near the center is occupied by a test pattern.

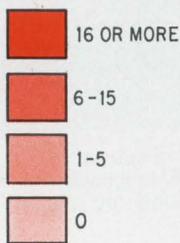

is best for you?

can lead to financial loss.

Briefly, the forecast procedure is as follows:

► The IC manufacturer determines the number of defects that occur on the silicon wafers during the production process, how they are distributed on the wafers, and how the number and distribution of defects are varying with time.

► From this data, an equation for IC chip yield as a function of chip area is developed. From the equation, a plot of yield versus area is made for each year in the forecast period.

► Next, a curve of yield versus time is drawn for various IC's of different complexity. These plots are based on the yield-versus-area plots—knowing the chip area of an IC, one can find its estimated yield at any given time.

► Finally, the plot of cost versus time is drawn for each IC by converting yield to cost (this takes into account chip processing cost and packaging cost, and obviously only the manufacturer can do it). For a comparison of alternatives, this can be reduced to a plot of cost per function (i.e., cents per gate, cents per bit, etc.).

To understand the nature of the prediction procedure, it's necessary to go back to the basic factor affecting IC costs and prices—yield, the percentage of acceptable IC's produced by the process.

An IC chip could be discarded for having pinholes in oxide layers, extra metal resulting from scratches in masks, or any variety of defects formed during the growth of epitaxial films—a complete list of possible defects would fill a library. Each process in the complicated IC fabrication sequence can introduce defects, and if these are of a serious type and fall in an active portion of the structure, they make the IC a reject.

Not all loss of yield results from defects. The IC design may require a tolerance on resistance or beta that the process can't maintain, for example. Such designs can result in vanishingly small yields even though no processing defects whatsoever occur. Then there are the mistakes that can wipe out an entire local population: a process can be omitted, a mask misaligned, or a wafer left in the etch bath too long. But, these are the kind of normal design and manufacturing problems that are universal in industry. The special problems of the IC manufacturer relate to yield-limiting, process-induced flaws.

Incidentally, there is no fundamental reason why

$$D_0 \text{ AND } D = f(x)$$

1

$$Y = f(A/A_0)$$

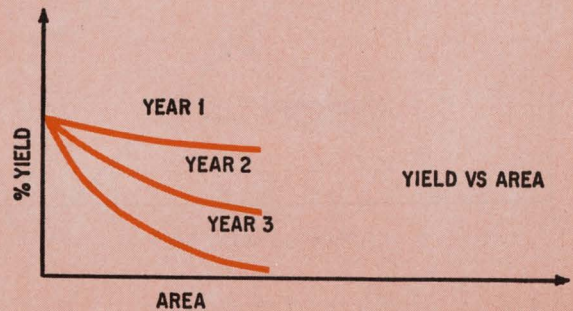

2

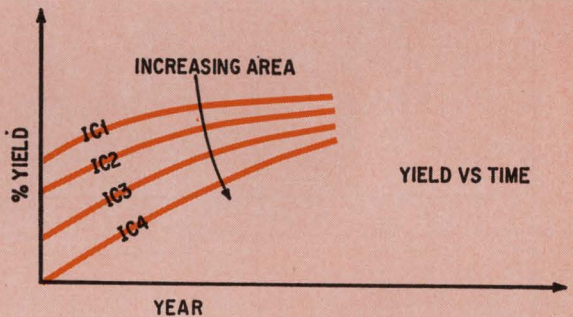

3

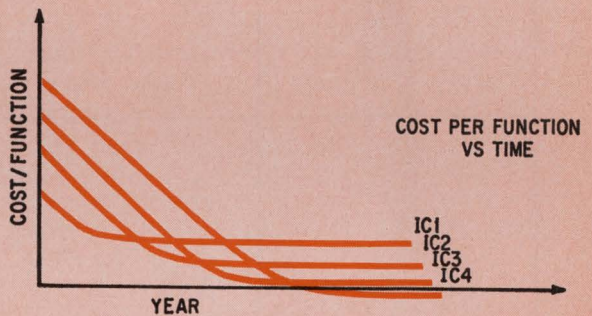

4

Silicon crystal gazing. To forecast IC cost, average defect density and defect density distribution (1) are used to develop equation and plot for yield as a function of relative chip area (2). Knowing the chip area of various IC's, it's possible then to draw yield curves for them as a function of time (3). Finally, from process and packaging data, cost per function is plotted against time for each IC (4). The equipment designer should select the IC that gives the lowest cost per function at the time the equipment goes into production.

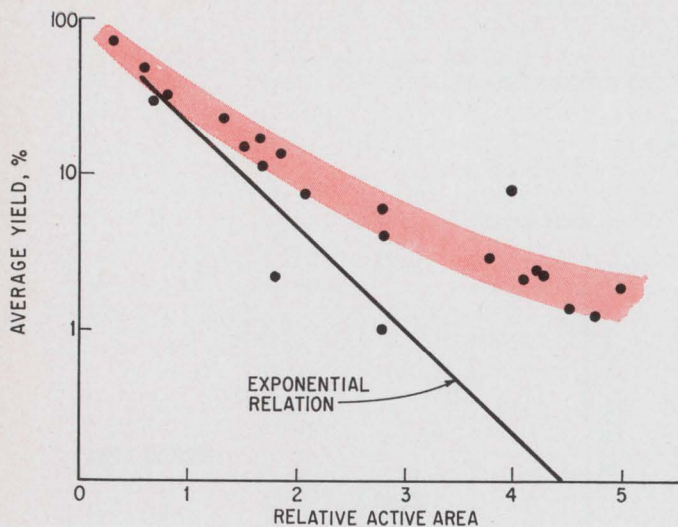

Less than exponential. For the vast majority of IC's yield falls off at a less-than exponential rate as active area increases. This indicates that the defects are clustered on the wafer, not distributed at random.

yield should not be 100%. IC manufacturing isn't like chemical manufacturing where the laws of thermodynamics limit the yield for converting one material to another. Instead, every rejected IC represents a flaw that theoretically could have been avoided.

The relationship of IC yield to wafer defects depends on IC area. Consider an IC production line—a sequence of fixed processes—turning out a family of circuits that differ only in the photolithographic masks employed. The number of potential flaws a circuit is exposed to is a function of the area it occupies on the wafer or, more precisely, a function of the active area exclusive of borders and other nonsensitive regions. In other words, the more complex members of a given family, because they occupy a larger area, are more likely to include defects and, therefore, are prone to lower yields.

A plot of yield versus active area reveals the crux of IC cost prediction. If defects were randomly distributed over the wafer surface, yield would drop off exponentially as active area is increased. But, this is not the case; as shown at top left, yield drops off, but at a rate considerably less than exponential. In real life, therefore, the defects are not distributed randomly over the wafer. Cost prediction hinges on the determination and description of this distribution.

Adding to the overall difficulty of this task is the fact

Models. To account for the nonrandom occurrence of defects, several defect-density probability distribution functions have been proposed. The bell-shaped curve developed by Murphy is a compromise between rectangular and triangular distribution. Seeds' distribution, at the bottom, is based on the premise that the probability is greatest of finding no defects, and that the curve decreases exponentially as the defect density increases. D_0 represents the average deleterious defect density.

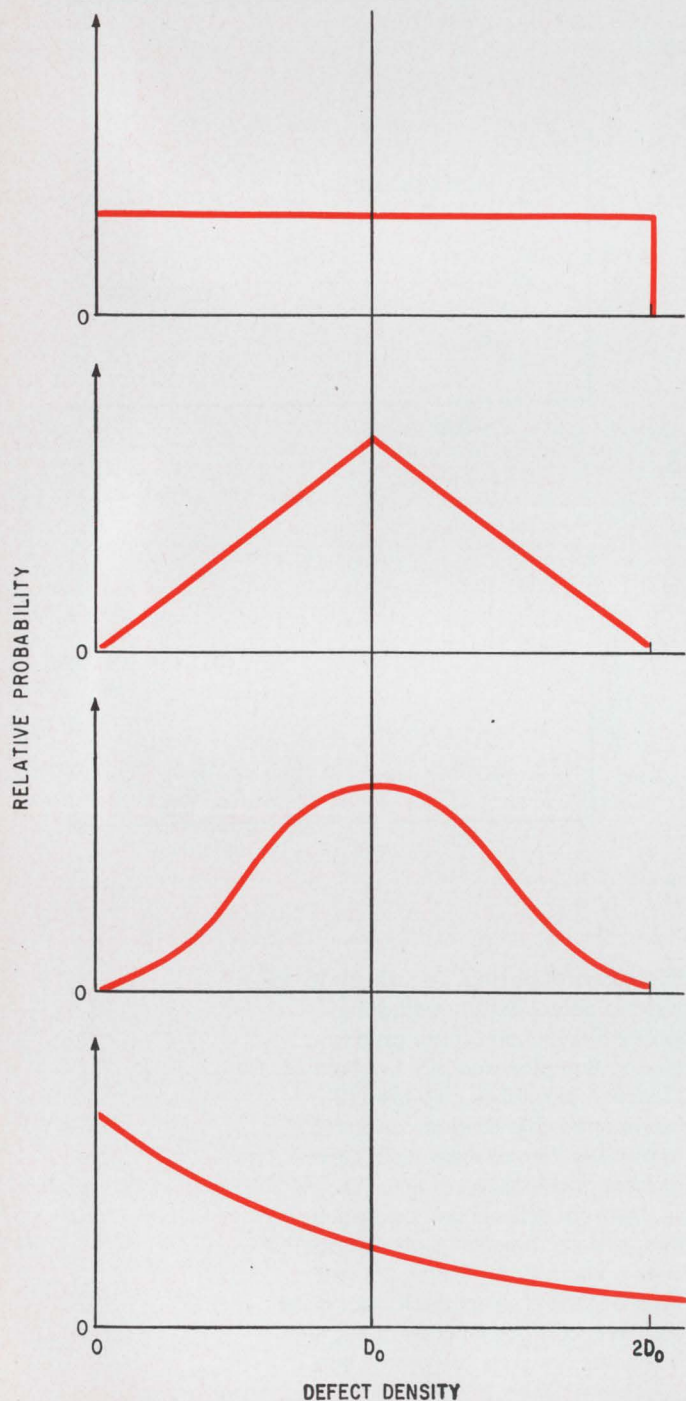

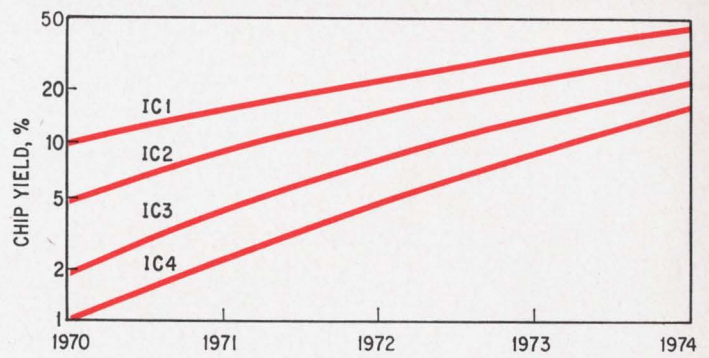
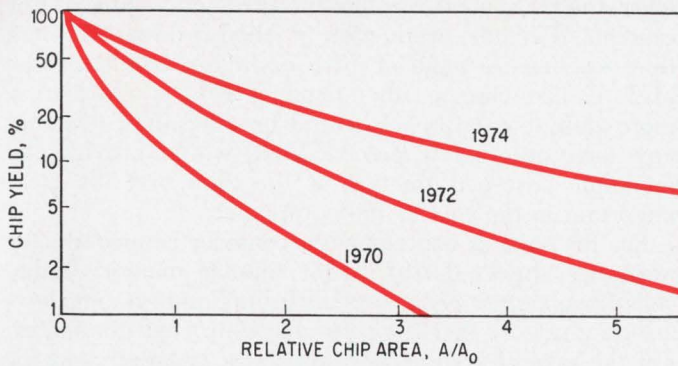

Year by year. Right now, yield is related to chip area as indicated by the 1970 curve, which is based on Intel's mathematical model. The other curves are predictions for two and four years from now based on the model and a 40% per year decrease in defect density.

Another slice. The lower the initial yield, the more the yield improves. IC 4, for example, increases 15 times in yield over a four year period, but IC 1 increases only 4.5 times. IC's 1, 2, 3, and 4 are circuits of increasing complexity and, therefore, increasing chip area.

that the orientation of the wafer as it goes through a certain process may affect the distribution of flaws that result from that process. There may be a top-to-bottom gradient of defects, as shown on page 126—a systematic variation in defect density produced by one critical process. Subjecting the wafer to an additional process can superimpose another such defect-density gradient. The combined defect distribution depends on the relative orientations of the crystal during the processes, and it can be drastically different from either distribution.

In spite of the difficulties, it's possible for a manufacturer to arrive at an average deleterious defect density by observing the production line over a period of time, taking into account wafer-to-wafer and day-to-day variations. At the same time, the manufacturer can also come up with a model that relates yield to the probability distribution function for various random defect densities. Then, by observing the longer-term variation in average defect density, the manufacturer can establish a trend for yield as process technology matures and can use this trend in the model to predict yields and costs years in advance.

What models are appropriate? If the probability of a defect occurring in any part of a processed wafer is constant, there is equal probability that two areas of the same size will not contain a defect. For twice the

area, the probabilities for no defects are multiplied; the net probability is therefore smaller since the quantities multiplied are less than unity. Yield therefore drops off with increasing active area according to the equation $Y = Y_0^{A/A_0}$, where A_0 is the original area corresponding to yield Y_0 and A is the new area. For a yield of $1/e$ for A_0 , the equation becomes the familiar exponential model $Y = \exp(-A/A_0)$.

But, the unrandomly distributed defects demand more realistic description. Available models are attempts to do this. In his model, B.T. Murphy of Bell Telephone Laboratories decided that, for constant area, the probability of finding a given defect density is somewhere between the extremes of constant probability and a triangularly distributed probability about the mean, as shown on the opposite page.¹ In Murphy's view, a bell-shaped curve most accurately depicts the defect-density probability distribution.

Taking another tack, R.B. Seeds of Fairchild Semiconductor assumed in his model that the probability is greatest for finding no defects in a given area; the probability of finding a higher defect density decreases exponentially as the magnitude of the defect density increases, as shown opposite.² Seeds refined his model by considering the possibility that several process steps, each with an independent probability distribution that varies exponentially with the defect density, contribute to yield loss. Further, he assigned weighting factors to each step according to the importance of the defects it causes. The detailed assumptions in his model were adjusted to fit empirical data.

A.G.F. Dingwall of RCA Electronic Components introduced an adjustable parameter in his model; this parameter can be used to vary the probability distribution curve.³ Dingwall's model rests on much more complex statistical mathematics than the other models.

In any case, all the models can be scaled by means of the average deleterious defect density D_0 (the total number of deleterious defects in the population divided by the total silicon area) combined with a probability distribution function to suggest how the defects spread geometrically. These relationships are then used to calculate the curve of expected yield versus chip size.

In the model used at the Intel Corp., for the large areas occupied by LSI chips, yield drops off exponentially with the square root of increasing relative area:

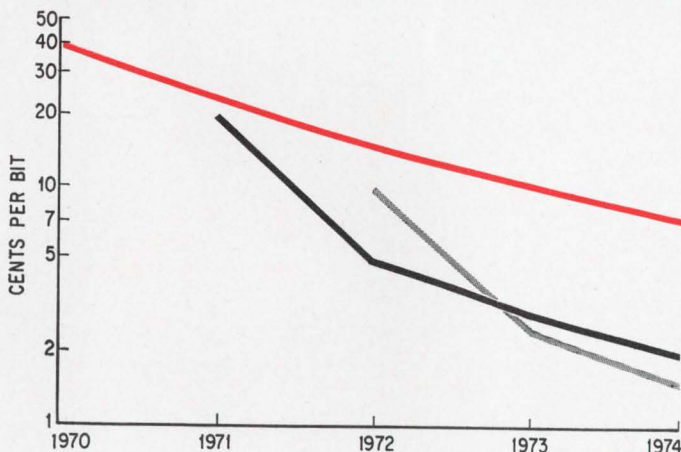

It takes time. Larger, more complex chips will cost less per function—less per bit for the memory circuits illustrated here—but this lower cost will be attained at a later time.

$Y \approx \exp(-\sqrt{A/A_0})$. The model was selected as the most representative of Intel's processing. The corresponding defect-density probability distribution is complicated, but it approximates that selected by Seeds, on the opposite page.

The curve must be calculated often as the technology evolves because both the defect density distribution and the average defect density are dynamic functions. In particular, the distribution is always strongly influenced by the process step that introduces the dominant number of defects. An improvement in that step can greatly reduce defect density and completely change the defect distribution.

For the purpose of discussion, a value for the rate-of-change of the average deleterious defect density can be estimated from the increase in IC complexity over the last few years. It works out to a decrease of about 40% per year, if it's assumed that improvements in defect density account for half the observed increase in IC complexity. (The other half is attributable to greater packing density.)

Using the Intel model for yield versus area and extrapolating at the 40% per year rate-of-change of defect density, it's evident that a rapid improvement can be expected for products that presently have low yields, as shown on the preceding page, top left.

In fact, the lower the initial yield, the greater the improvement will be. To illustrate this point, the diagram shown on the preceding page, top right, cuts the yield-versus-area-versus-time pie another way; it shows the increase of yield with time for four different products. The yield improvement for the product with 10% yield in 1970 is something over fourfold in 1974. But in the same period, yield of a product with 1% yield in 1970 would increase fifteen times.

To figure the overall cost decrease, the packaging cost is also taken into account. When the yield is very low, the cost of the silicon chip completely dominates the cost of the IC. As higher and higher yields are obtained, the cost of packaging (including testing) becomes an increasingly larger fraction of the total cost. In the vicinity of 20 to 30% yield, usually, the chip and packaging costs are about equal, and cost per function drops to a minimum level.

The equipment designer should then try to use IC's that will be in the minimum cost per function range

when the equipment reaches the production phase. For example, if volume production is scheduled for 1972, IC's that now have a yield of 10% or higher would be the likely choice. On the other hand, if 1974 is the date, a more ambitious approach would be advisable; IC's that now have only a few percent yield would provide the minimum cost per function at the time that it's most important in the cost of the equipment.

For the sake of concreteness, consider semiconductor memories. Intel's i-3101 64-bit bipolar memory today sells for about 40 cents per bit in moderate quantities—a high unit cost that suggests that chip cost dominates. For the sake of argument, suppose the present yield for this circuit is 5%.

The yield-versus-year plot shown on the preceding page predicts that over the next four years, yield will increase some six times, and chip cost will, therefore, decrease by the same amount. So in 1974, the i-3101 will decrease in price to about 7 cents per bit as shown at bottom of preceding page.

Based on experience, it's reasonable to assume that the functions that can be packed into a unit area should roughly double during the same time period. In four years, the chip that now holds 64 bits should be able to accommodate 256 bits of fully decoded memory, for a price per bit of about 2 cents.

A somewhat more complex IC, perhaps one with 512 bits on a chip, would extrapolate to still lower price, although the chips would be larger than in the 3101.

The same mathematical model can be used to predict MOS memory prices. The MOS i-1101, for instance, contains 256 bits of fully decoded random-access memory on the same size chips as the 64-bit bipolar memory. Since the 1101 now costs about the same as the bipolar IC, the cost per bit is about one-quarter that of the bipolar circuit. This extrapolates to one-half cent per bit in 1974 for a MOS random-access memory of 1,024 or 2,048 bits per chip. ●

References

1. B.T. Murphy, "Cost-Size Optima of Monolithic Integrated Circuits," *Proc. IEEE*, Vol. 52, pp. 1537-1545 (1964)
2. R.B. Seeds, "Yield and Cost Analysis of Bipolar LSI," *IEEE International Electron Devices Meeting*, Washington, October 1967.
3. A.G.F. Dingwall, "High-Yield-Processed Bipolar LSI Arrays," *IEEE International Electron Devices Meeting*, Washington, October 1968.

Three ways to make more sense:

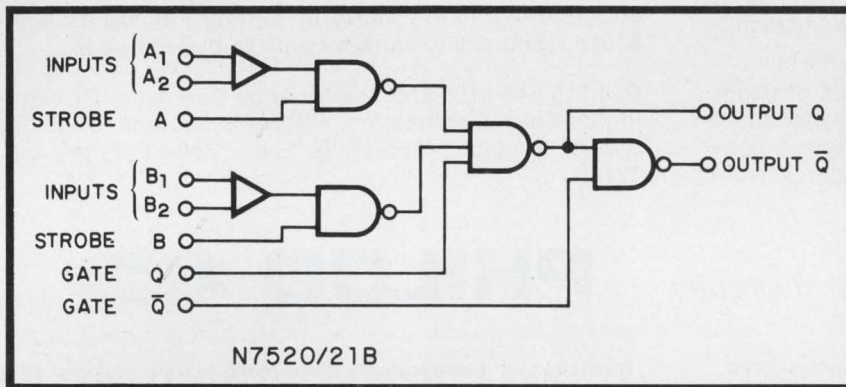
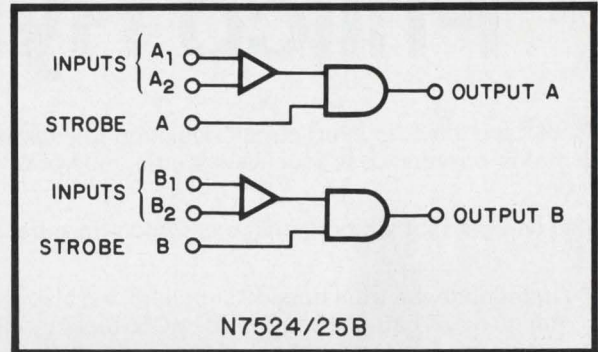
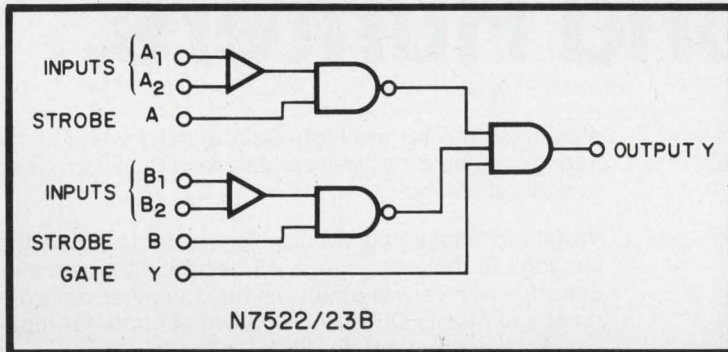

Starting today, E.D.P. makes more sense than ever—with these dual core memory sense amplifiers.

They're all second-generation. All just arrived. And they're all from Signetics.

7520/21... dual pre-amplifiers connected to a common output stage. They have both Q and \bar{Q} outputs to allow flip/flop or register functions.

7522/23... a dual pre-amplifier which has a common open collector output stage that permits collector logic and use as an expander for the 7520/21.

7524/25... with two completely independent sense channels. Both feature a common threshold adjustment, separate outputs and strobe inputs.

All of these new sense amplifiers feature high speed and full TTL compatibility. (Incidentally, the even numbers boast $\pm 4\text{mV}$ threshold uncertainty; odd numbers, $\pm 7\text{mV}$.)

For specs, more data, applications, we hope you'll write or call us. Now; today.

In fact, with linears like these, we think it makes all sorts of sense!

Signetics

Signetics Integrated Circuits, 811 E. Arques Ave., Sunnyvale, Calif. 94086 / A subsidiary of Corning Glass Works

Hybrids in a hurry... from the Philco Hybrid Hunters.

We'll have a hybrid microcircuit designed to *your* specifications on your desk four weeks after receipt of your order.

You can get that kind of service at Philco-Ford because of...

... Independence from outside suppliers: we also manufacture a broad line of Philco® MOS, bipolar, microwave, and electro-optical devices as well as the packages to put them in. This device technology coupled with our *thick-* and *thin-*film capability results in an unbeatable team.

... State-of-the-art achievements: we're proud of things like saying, "Yes," to guaranteed 1% resistor tolerances; putting 21 1% resistors in a package; and, by means of our MLI (multilayer interconnect) tech-

niques, achieving the highest in density while eliminating bonded crossovers which results in increased overall reliability.

... Variety in packaging: to us this means tailoring the package to the job... from all-hermetic flatpacs or cans for highest reliability in the toughest environments, to plastic DIP's and conformal coats for high-volume industrial applications.

So, get a hybrid in a hurry by putting Philco-Ford's in-house resources to work for your in-house needs.

Call 215-646-9100 and ask for Dick Sorensen. Or, write Philco-Ford Corporation, Microelectronics Division, Hybrid Products Marketing, Blue Bell, Pennsylvania 19422.

The better idea people in hybrid circuits.

PHILCO 

5-channel TTL-to-MOS interface: triple, dual-in-line, molded epoxy package.

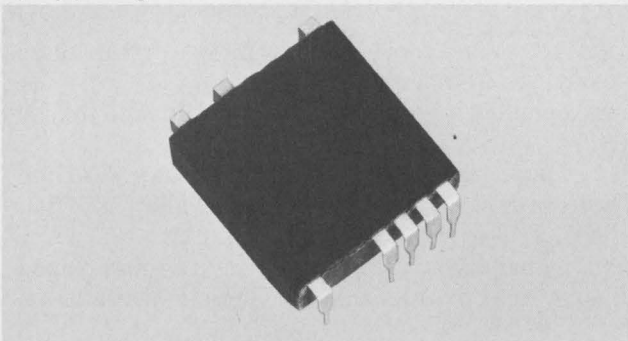

Dual-channel comparator with three-substrate design, MLI techniques, in modified TO-8 case.

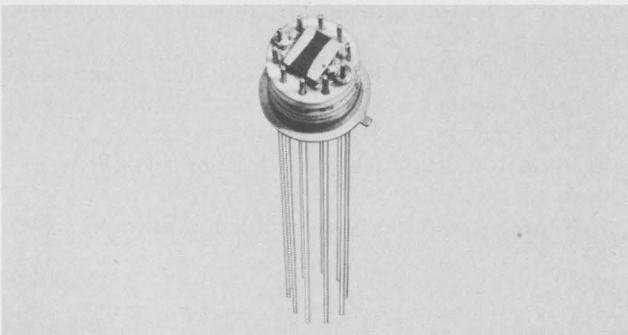
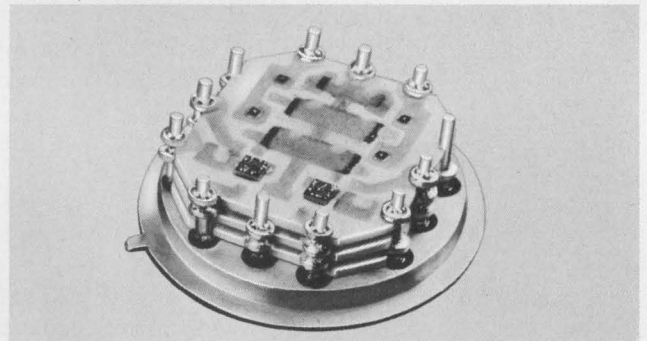

Butler oscillator: multiplate, TO-5 package.

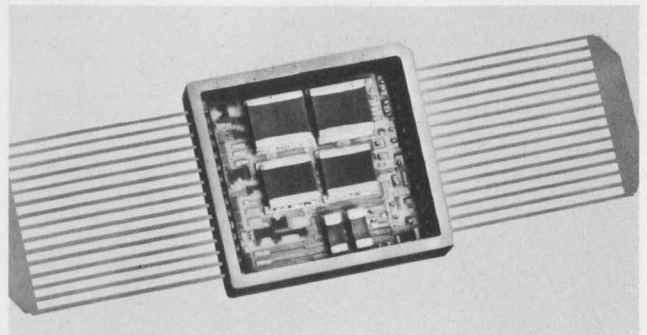

Triple detector with MLI conductors, 13 1% resistors, 6 capacitors with 1% tracking over temp. range, 19 active devices in 1 x 1-in. hermetic flatpack.

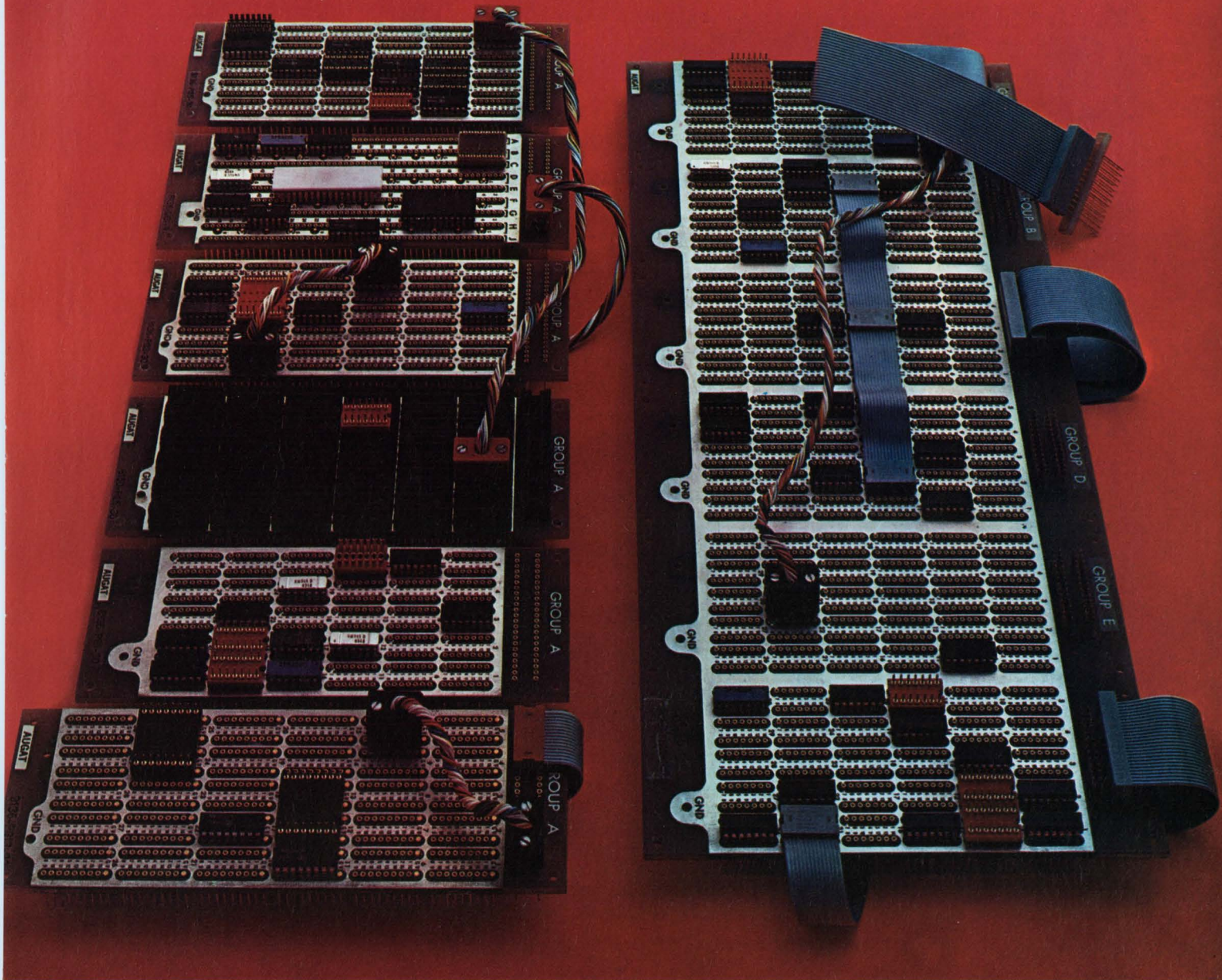

6x30=180

Now – specify 30 pattern panels, or any multiple up to 180 patterns – all standard catalog items.

Unique new I.C. packaging concept results in far greater flexibility, plus sizeable savings in space, time and money.

Modular panels are available in continuous rows of contacts for universal use, as well as 14 and 16-pin configuration.

Accessories include plugs with cable for interfacing and I.O. connections, and adaptors for mounting discrete components.

Close tolerances permit simplified mounting of single or multiple panels automatically wire wrapped on one plane – a service provided by Augat.

Let us show you the new approach to breadboarding, prototyping and production. Call us, (617) 222-2202, or write for new Catalog No. 266, Augat, Inc., 33 Perry Avenue, Attleboro, Massachusetts 02703.

AUGAT inc.

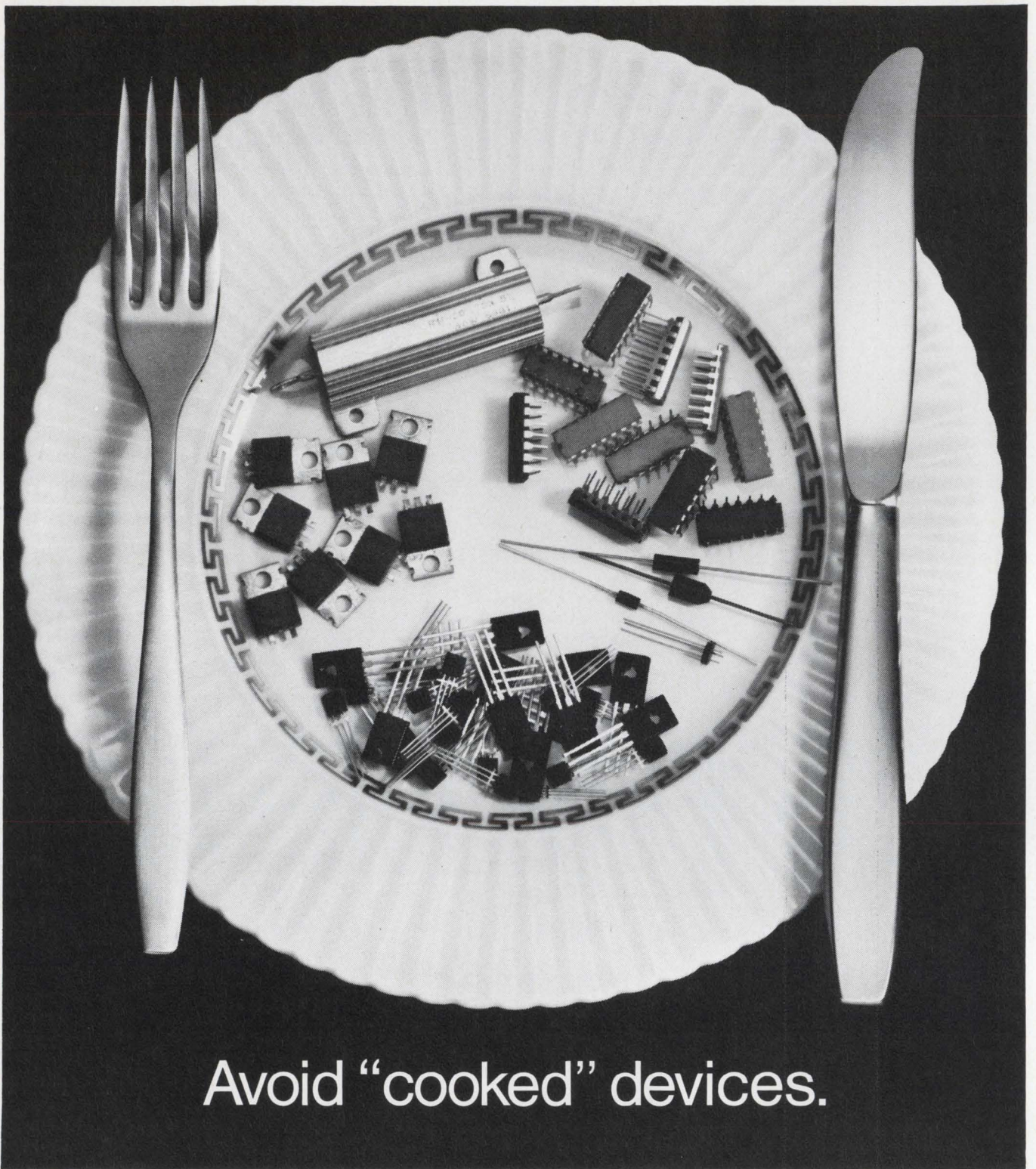

Avoid "cooked" devices.

Heat, built up by high-frequency voltage variations, can melt molding compounds made of organic plastic. So the semiconductor devices they enclose can fail. But they won't fail if they're encapsulated in Dow Corning® silicone molding compounds.

Dow Corning silicone molding compounds are stable over a wide range

of temperature and humidity conditions. Dielectric losses at high frequencies, junctions operating at high temperatures and soldering baths are not a problem with Dow Corning molding compounds. They are stable over a wide range of frequencies and temperatures, and are self-extinguishing, chemically compatible and easy to mold. They can make a significant contribution to your product's reliability.

For more information, write Dow Corning Corporation, Dept. B-9356, Midland, Michigan 48640.

Molding Compounds from

DOW CORNING

DOW CORNING

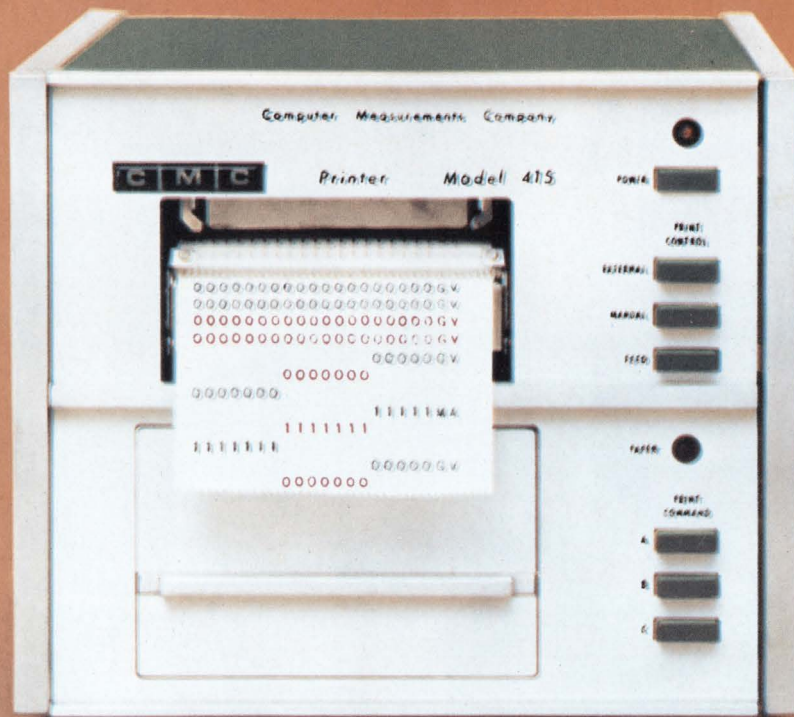

*Now take a peek
at the world's
greatest printer...*



Outclasses the competition ten ways!

This new CMC Model 415 Printer is so good, we don't want to obscure the facts with advertising rhetoric, so here are ten reasons why the 415 is your best buy:

1. The mechanical printing mechanism is good for more than 5,000,000 cycles without an adjustment, is replaceable in the field, and provides legibility of an electric typewriter.
2. Floating decimal point and automatic zero suppression are standard features.
3. Line capacity from 7 to 21 columns is offered; and red/black printing with color selection by numerical field is provided.
4. Internal programming is included to allow printing any input data character into any printed column.
5. Controls can be programmed remotely.
6. Unique "print-command" feature allows priority control over the 3 input channels
7. Prints 3 lines-per-second—more speed than needed for
8. Full IC design provides accurate reliable performance, and IC sockets make maintenance easier.
9. Measuring only 8½" w x 7½" h x 17½" d, this handsome, lightweight instrument is designed for a vast diversity of data logging applications.
10. And to top it all—this great little printer sells for as low as \$1295!

For the full specs, circle the reader service number; and for a demonstration, contact your local CMC representative.

COMPUTER MEASUREMENTS



A DIVISION OF NEWELL INDUSTRIES

12970 Bradley / San Fernando, Calif. 91342 / (213) 367-2161 / TWX 910-496-1487

Circle 135 on reader service card



**You'll get
the direct print paper
on the right faster.**

There's no need for "hurry" stamps on Astroprint oscillographic papers. Easy ordering and direct delivery are part of the package.

You also get a direct print, orthochromatic paper unsurpassed for

trace density, instant pop-up (less than 1 second), excellent image stability and sharp contrast. On mercury vapor, Xenon, and cathode ray light sources.

Astroprint DP 90 (for open magazine applications) and DP 80 (for closed magazines).

As a starter, test us for delivery and cost. Just call your local Xerox Product Specialist or write to Xerox Corporation, Dept. HL, Rochester, New York 14603.

The paper will prove itself.

XEROX

Xerox and Astroprint are registered trademarks of Xerox Corporation.

You get all these design choices

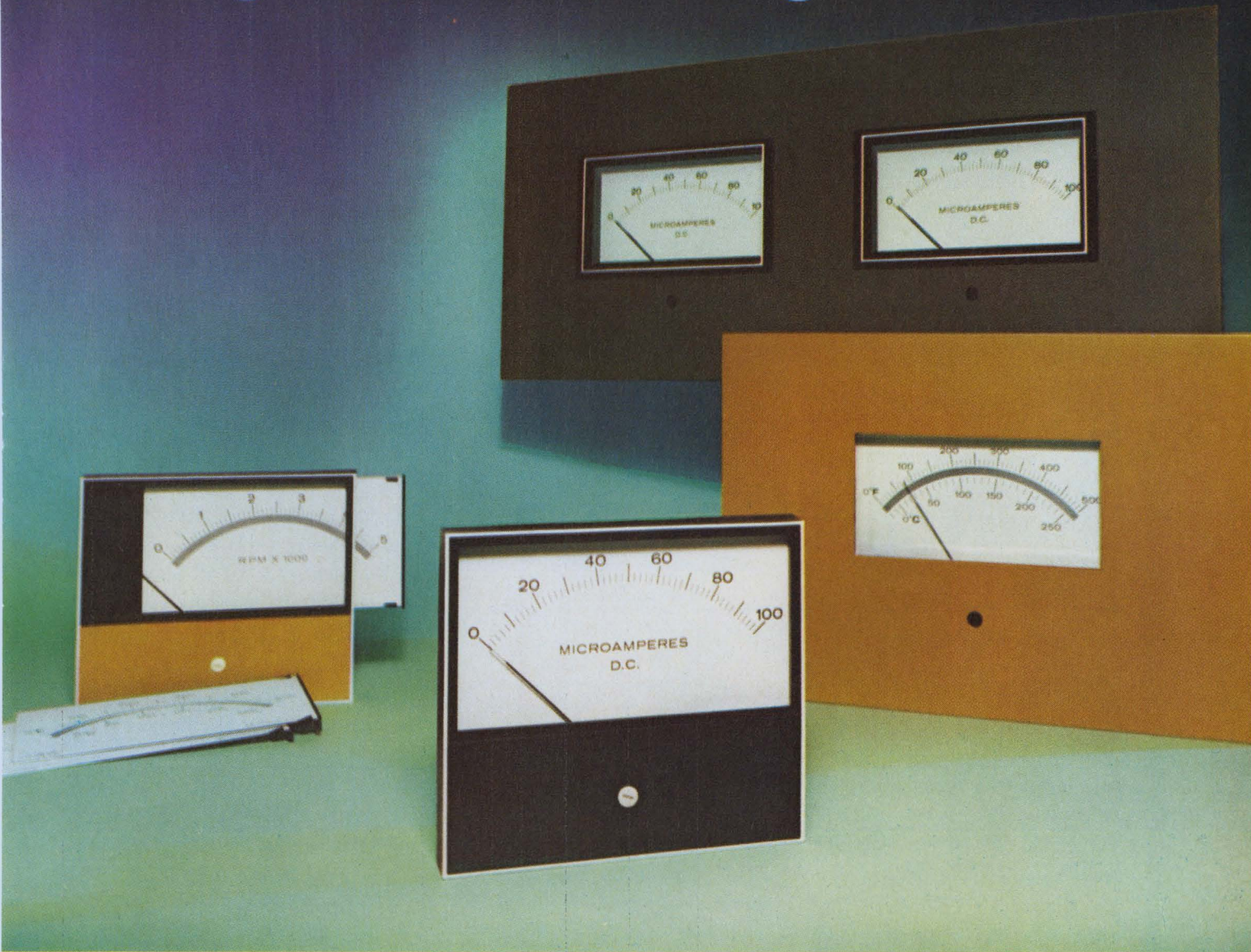

...with one new API meter

■ API Series 7000 panel meters, styled for the '70s, offer the greatest versatility ever built into a single meter design. You can front mount, bezel mount or lens mount. Change the slide-in scale in the field, without damage, to reduce inventory requirements. Enhance your panel design with "stick-on" front color plates. ■ Taut band and 1% tracking are standard in the most popular DC ranges. Phenolic cases incorporate glass windows that are scratch-proof, free of static electricity. Low OEM quantity prices. ■ **Ask for Bulletin 67.**

First showing—IEEE Booth Nos. 2G34-36

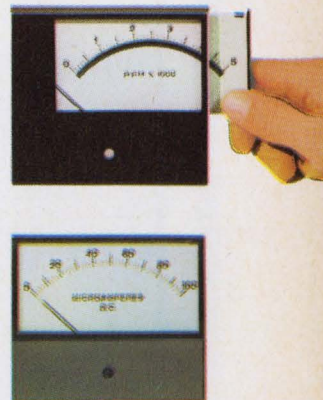

api

INSTRUMENTS COMPANY

Chesterland, Ohio 44026

(216) 729-1611

Circle 137 on reader service card

New S. S. White system trims microelectronic hybrid resistors at 1,000 per hour...or more

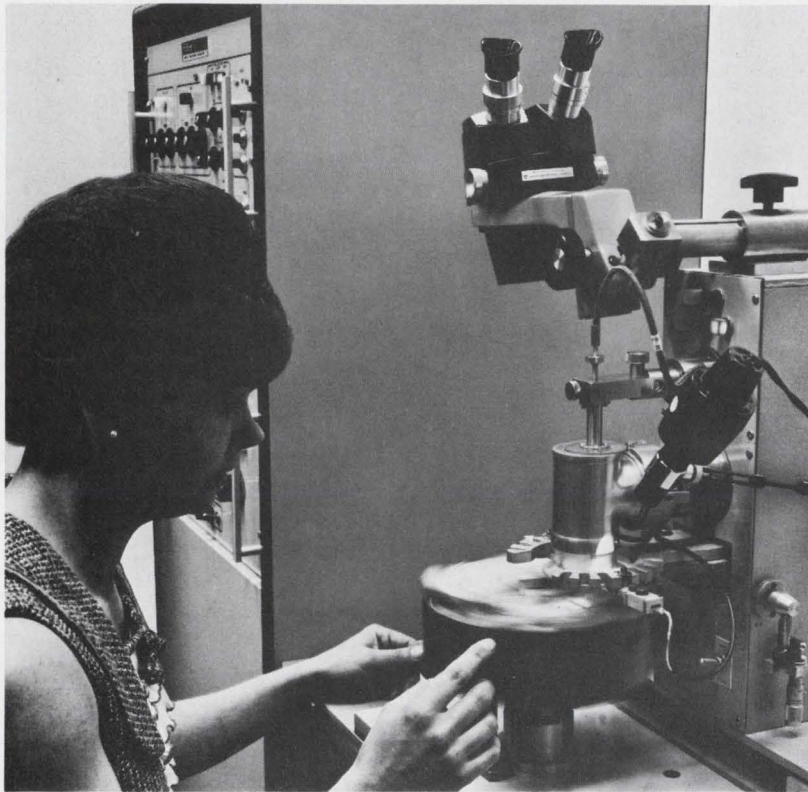

If you're into hybrid circuitry in a big way, or hope to be, our Model AT-701AR may be just what you need. It offers high capacity, accurate trims, high yield — or, just what you need to keep your customers and your comptroller happy.

Model AT-701AR is similar to our highly successful Model AT-701A, but with the addition of a rotary feeding system which lets operator load and unload substrates during the machine's trimming cycle. Capacity is limited only by the man-

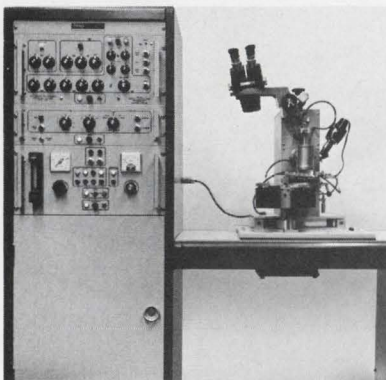

Model AT-701AR

ual dexterity of your operator.

Accuracy of the AT-701AR is guaranteed—within 0.5%. 0.1% is attainable with care and some sacrifice of speed. Trimming is monitored by a precision system of electronics featuring a four-wire Kelvin bridge, and tolerances may be programmed from $\pm 0.1\%$ through $\pm 11\%$. (No use making them better than the specs require!)

But suppose the Model AT-701AR is too big or too small for you?

Call us anyway. If you can get by with something like 600 accurate trims an hour, we can offer you our Model AT-701A, to which you can add the turntable feature later. If you're still experimenting, we have Model LAT-100 for breadboarding. It is accurate to 1% better, takes substrates up to 4 x 4 inches and sells for only \$5,950. If you're *really* big, there's the Model AT-704A, a rotary-feed

machine that trims four resistors simultaneously, monitors, and inspects them at the breathtaking rate of 4,000 per hour. And if *that's* not fast enough for you, buy two.

All the S. S. White resistor trimming systems are based on the proven Airbrasive® method of removing resistance material which produces neither heat nor shock, does not alter the substrate.

Call 212-661-3320 to arrange for a live demonstration. Speak to Hal Skurnick or Nick LaCourt. These same gentlemen will be demonstrating the Model AT-701AR and the Model LAT-100 at major electronics trade shows around the country, and if that's not quick enough for you, we will arrange for you to visit our factory. We have also prepared an extensive technical bulletin on this equipment, called, rather cryptically, the "RT-14", a copy of which is yours for the asking.

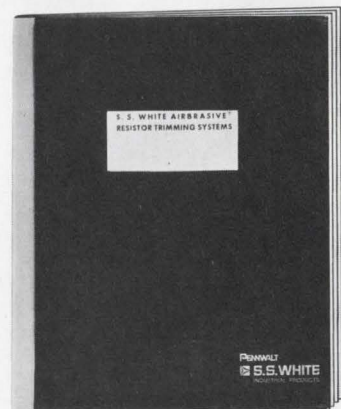

RT-14

Write to S. S. White Division, Pennwalt Corporation, Dept. R, 201 East 42nd Street, N.Y., N.Y. Tel.: 212-661-3320

**SEE US AT BOOTH 362
NEPCON WEST**

PENWALT
S.S. WHITE
INDUSTRIAL PRODUCTS

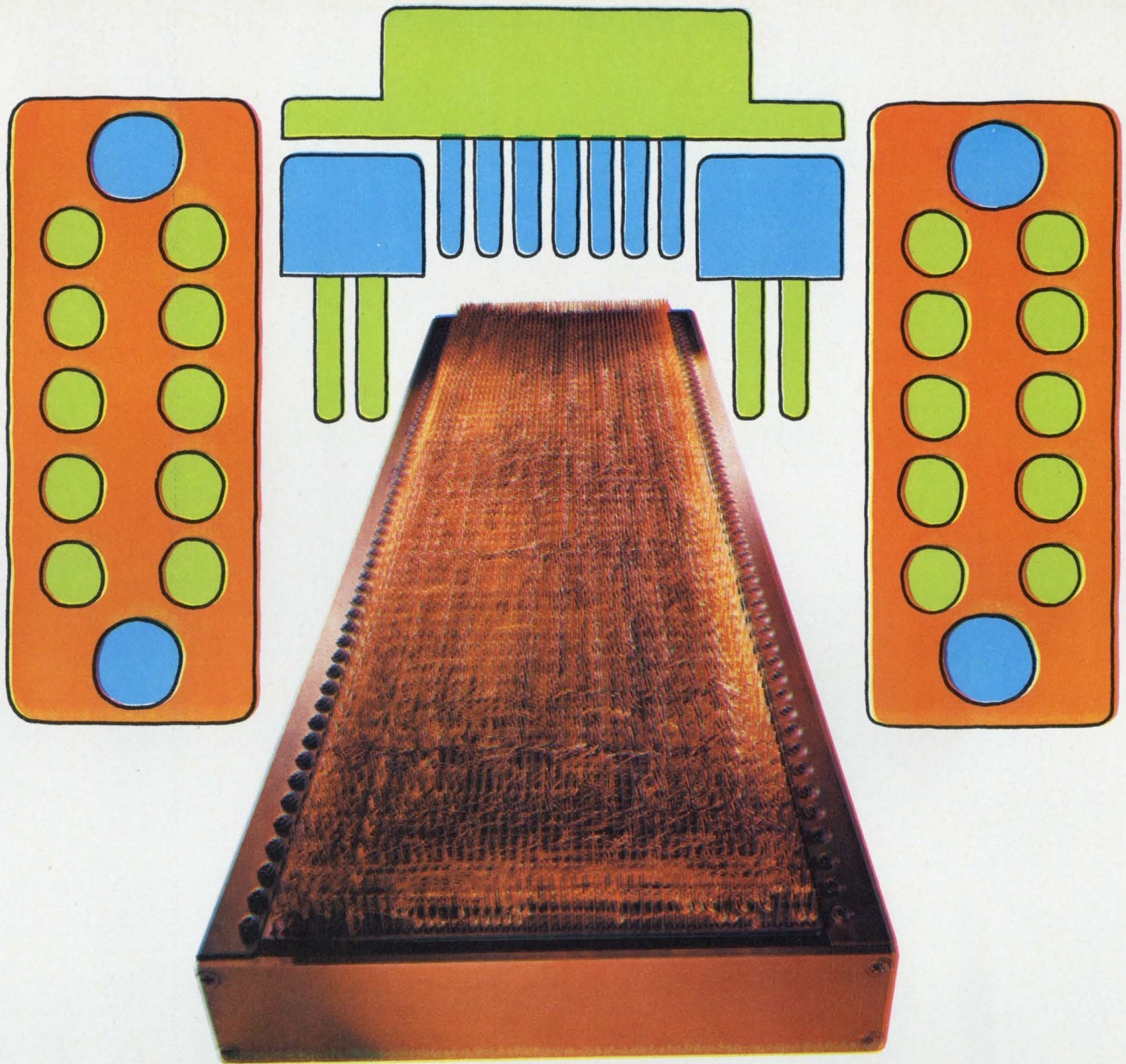

Winchester Electronics

— their obsession with precision is solving tomorrow's problems today.

Problems—like connectors requiring post true positioning to within a mere .020 of an inch—won't stump Winchester Electronics. They've been making AccurFrame® as close to perfection as modern wire terminating machines demand.

And this fact proves the point: Of the various types of wire terminating connectors, only the HW Series by Winchester Electronics, positioned in AccurFrame,

consistently meets the contact true position tolerances required by automatic wire terminating machines.

Now, if that doesn't say something for Winchester Electronics' AccurFrame, perhaps you have a connector requirement that does. Want to take us up on it? Write or call Winchester Electronics, Main Street and Hillside Avenue, Oakville, Conn. 06779.



**WINCHESTER
ELECTRONICS**

DIVISION OF LITTON INDUSTRIES

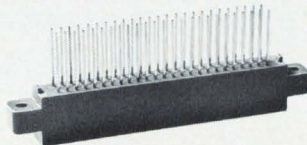

Need a helpful ally, taking on Mil-Spec contracts?

When it comes to military contracts, Brand-Rex can make getting the proper wire and cable the easy part of the job.

We offer an unusually broad range of products from tiny hook-up wires to mighty umbilical cables. Polyethylene, PVC, Kapton, Kynar, Teflon TFE and FEP are a few of the insulations we use regularly.

Brand-Rex's quality control procedures, well-known and accepted by military and aerospace

people, simplifies meeting MIL, NAS and other requirements.

Need an ally in a tough market? Contact the people who've been there for years, supplying cable for practically every major missile system and space shot. Whether your cable requirements are large or small write for the new Brand-Rex Military Specification Wire and Cable catalog.

Brand-Rex Division, American Enka Corp., Willimantic, Conn. 06226, (203) 423-7771

Connect for tomorrow.

BRAND-REX

Circle 140 on reader service card

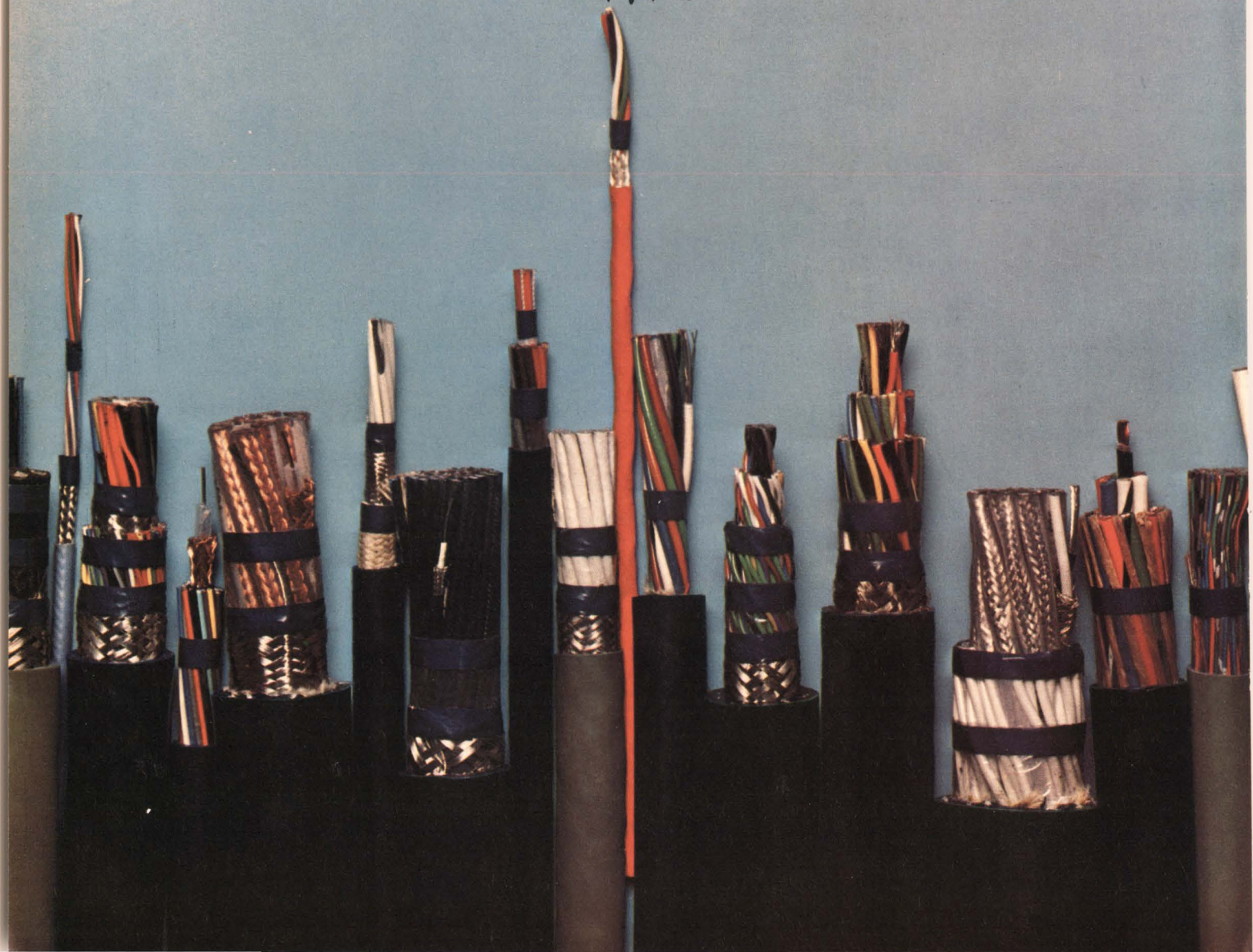
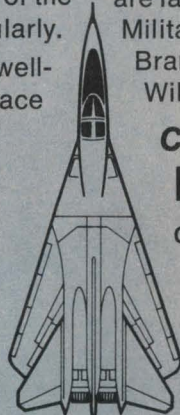

Nixon's budget scalpel cuts electronics deeply

Caught between inflation and election-year politics, Nixon's first budget, the biggest ever, also is a tight one; electronics, with few exceptions, will feel the pinch

● Electronics companies will be taking their share of the lumps dealt out in the fiscal 1971 budget. At \$200.8 billion, President Nixon's first budget generated from scratch is the biggest ever—and one of the tightest as well. Drafted with one eye toward stopping inflation and the other toward the legislative penny-pinching that is certain in a Congressional election year, the new budget offers slimmer pickings for sales of electronics to government agencies.

But among the proposed sharp cuts in defense and space spending some conspicuously outstanding increases are being sought. Democratic Majority Leader Mike Mansfield already has risen to the \$1.5 billion bait proposed to expand the Safeguard anti-ballistic missile defense system. Broad Democratic opposition to the Army's ABM plan—which slipped through the Senate last year on Vice President Agnew's tie-breaking vote—already is evident. And the suspicion has been raised that these funds are being sought to divert Congress' attention from other programs sought by the Pentagon.

Similarly, Secretary of Defense Melvin Laird's request to program money for the Navy's third Nimitz-class nuclear carrier and a final purchase of the Air Force's ill-starred F-111 interceptor tends to support the view that such controversial and highly visible programs may be negotiable during the tough legislative infighting ahead.

Though Safeguard is one system on which the President and Con-

gress are certain to go to the mat, one of Richard Nixon's overall advantages lies in the sharp cuts he has made already in Melvin Laird's defense spending and in Tom Paine's NASA request as well. Another advantage may be realized from his clever consolidation of virtually every spending program other than defense and space into a new, all-purpose "Human Resources" category. Thus the Administration is able to demonstrate its "changing priorities" where 41% of the Federal spending plan tops defense outlays for the first time in recent history.

From the view of the electronics industry, 1970 has truly become a year of changing priorities. The National Aeronautics and Space Administration's programs were cut sharply in the budget battle to \$3.6 billion and then cut again the last minute to \$3.3 billion, forcing stretchouts and cancellations in virtually every area. The Department of Defense is launching some new programs, but the gradual withdrawal from Vietnam—coupled with a prolonged inflation affecting equipment costs that has not been matched by comparable gains in performance—has inevitably produced a high degree of caution among military customers. That combination of events will result in some 640,000 fewer jobs among defense suppliers in the 24 months ending July 1, 1971.

Both corporate and academic engineers and scientists face at least as tough a year in terms of Federal funding as do production special-



ists. Last year's Congressional requirement that military R&D relate directly to a military requirement continues in effect, eliminating a great deal of basic research.

And though the President has programmed new and larger funds to cope with such urban ills as crime and pollution, they hardly compensate for the reduction in military and aerospace.

But the President has made it clear that his desires to control inflation and broaden his political base have priority over everything else. Thus does the Federal budget for fiscal 1971, with its promise "to meet today's needs and to anticipate tomorrow's challenges," read like the opening speech in a year-long campaign.

Politics, inflation taking a heavy toll in defense spending

● Sensing a moment of economic truth added to strong Congressional pressures, President Nixon has turned in a fiscal 1971 defense budget that calls for outlays of \$71.79 billion, 12% below the last LBJ defense budget submitted a year ago. And the administration itself trimmed that budget by \$4.6 billion before Congress took out its own ax.

From research to production, every level of the defense electronics community will feel the pinch. Even before the Democratic-controlled Congress performs the surgery likely in a campaign year, the Nixon-Laird package calls for a manpower reduction of 1.3 million in the 24 months ending June 30, 1971. This figure includes 640,000 jobs at Defense Department contractors. Layoffs to date have only reached the 40,000 level, but defense officials indicate this figure will begin to rise sharply sometime this summer as contracts are completed and not replaced.

The total projected job decline represents about 30% of the defense industry labor force. Adding military and civilian personnel to be dropped by the Pentagon in the same period, the military-industrial complex will put manpower back into the labor market equivalent to a staggering 1.6% of the nation labor force.

But significant increases are proposed for the controversial Safeguard ballistic missile defense system; a variety of Navy ships, including long lead-time items for a third Nimitz-class nuclear carrier, CVAN-70, plus the Navy F-14 and Air Force F-15—replacements for the trouble-plagued General Dynamics Corp. swing-wing fighter. Eleven other major weapons systems are slated for significant funding increases, too, while an equal number will experience sharp cuts. The

F-111 itself falls into the latter category; it's programmed for \$567 million or \$364 million less than in the current budget. But defense officials suggest that all F-111 money may be withdrawn pending another study of the effort. Secretary Melvin Laird has tied a string to the F-111 money, officials say, noting that he is not committed to buy any additional planes.

Whether or not the F-111 is cancelled is not a critical factor in an industry anxious for new ground electronics and avionics business in what is sure to be a lean year. The more than 50% budget increase—to \$1.5 billion—for moving Safeguard from the first to second phase with acquisition of new sites in the northeast, northwest, the Washington, D.C., area, and at the Minuteman ICBM site at Whiteman Air Force Base is sure to create a Congressional uproar.

Escalation of the Safeguard request in the new fiscal year from the currently approved \$892 million is not all bricks-and-mortar

money, however. Defense officials say about \$600 million of the new funds will go toward phase 2 start-ups which Laird plans to outline shortly. Much of the remainder will go for new hardware and hardware studies of such items as Raytheon's Missile Site Radar (MSR); an increased effort on GE's Perimeter Acquisition Radar (PAR) for long-range tracking; Burroughs' displays for both radars; Sperry Univac's high-speed data processors for the radars, plus continued development and evaluation of large-scale integrated circuits being produced by RCA, Motorola and Texas Instruments. Advanced electronic data processing studies also are expected to mean fresh money as well for IBM Federal Systems Division and Control Data Corp. if funding is approved.

Excepting the B-1A advanced strategic bomber, which will be held at the \$100 million level under the new budget proposal, only a handful of other strategic systems have got Nixon approval for spend-



ing increases.

Though Boeing, North American Rockwell, and General Dynamics are still expected to come up with B-1A designs within two to three months, potential avionics suppliers are not optimistic about prospects over the short or long hauls. Leading the latter group are IBM Federal Systems and North American Autonetics division, with Hughes and a handful of others coming on. As an official at one of the companies expresses it, "The outlook isn't good for the plane and we're not counting on it. Congress isn't convinced we need it, and I'm suspicious that it's being held back for bargaining at the upcoming Vienna arms limitation talks."

The prospects are somewhat better for the Airborne Warning and Control System (AWACS), for which new budget funding is nearly doubled to \$87 million. Nevertheless, the program has been moving slowly in the past two years and has been seven years in development. It suffered at the hands of Congress in the last session, and Air Force officials are unhappy that they did not get substantially more money than the Pentagon finally allotted. Nevertheless, USAF still wants to fly a brassboard radar this year and Westinghouse is said to have the inside track.

Coming along steadily and quietly is the Navy's Underseas Long-Range Missile System (ULMS), which grew from \$10 million to \$24 million this year with reprogrammed money and is up for \$44 million in the new budget. Still studied as a follow-on to the Poseidon/Polaris program, a new class of bigger and more expensive ULMS submarines would carry missiles with 5,000-plus-mile range, and would have multiple warhead capa-

Department of Defense: Where procurement dollars go

(Millions of dollars)

	Fiscal 1969	1970	1971
Aircraft	8,008	6,449	6,327
Missiles	3,282	3,203	3,670
Ships	1,070	2,632	2,579
Tracked combat vehicles	542	359	330
Ordnance, vehicles, and related equipment	6,603	4,488	3,260
Electronics and communications	1,514	1,147	893
Other procurement	2,090	2,022	1,590
Total procurement	23,108	20,300	18,649

bilities. Hughes and Lockheed Missiles & Space are expected to push for further study money even though no contract timetable is scheduled yet. Though there is Congressional opposition to this program, too, it could be held as a good bargaining element in the Administration's arms limitation negotiations.

Support for this argument is being read into the Nixon request to convert six more Polaris submarines to accept the Poseidon missile and its controversial multiple warheads. This is double the fiscal 1970 figure and it's suggested that the Pentagon wanted to proceed even faster—the \$1.68 billion approved for the program represents a cut of \$33 million. Total cost of the eventual conversion of 31 of the 41 Polaris boats is figured at \$5.6 billion, including Lockheed's missile costs. The conversion effort is expected to continue to help contractors ranging from Texas Instruments, the prime component supplier, up through Control Data's fire-control computers in the General Electric fire-control system.

Though money for the new high-speed, deep-diving attack sub dubbed SSN688 was cut back by \$147 million to \$476 million, the Pentagon says the Navy has enough for three more boats, whose design has been completed by General Dynamics/Electric Boat division.

Six subs out of a planned 10 are now budgeted.

Also in the anti-submarine warfare (ASW) market, DOD raised funds for the Mark 48 antisubmarine rocket by some \$6 million to \$160 million—an indication of the Navy's concern for what it believes is a rising Soviet underseas threat. Funded for the Naval Ordnance Systems Command effort are prime contractor Honeywell Inc., using GE's torpedo, General Precision/Librascope's fire control and Sangamo Electric's sonar subsystems.

For surface ships, Laird wants to fund six more DD-963 class destroyers above the three already budgeted, and has scheduled \$119 million more than last year for a \$460 million total in fiscal 1971. Scheduled to run to 30 ships, the award may be split between the Bath Iron Works in Maine and Litton's Ingalls division in Mississippi. A \$150 million budget for a second nuclear-powered frigate of the DLGN-38 class also was authorized to follow Newport News Shipbuilding's first ship. Advance funds for a third CVAN-70 carrier are also programed, but are being held back pending Congressional and DOD studies of the long-range need and value of carriers in general.

As a weapons category, fixed- and rotary-wing aircraft are likely to generate the least flak on Capitol Hill, as well as offering the greatest avionics opportunity in fiscal 1971. Though the number of planes purchased will drop to 456 from 676 last year, and helicopters will fall to a neat 1,000 from 1,259, some of these dips represent completely normal procurement cycles, such as the highly successful McDonnell Douglas F-4J for the Navy. No purchases are planned next year, and the Air Force is cutting back on its acquisition of the E model.

Similarly, the Boeing Vertol CH-46 helicopter is being dropped. But

Where defense research dollars go

(Millions of dollars)

	Fiscal 1969	1970	1971
Military sciences	599	557	585
Aircraft	1,161	1,598	1,624
Missiles	2,518	2,284	2,230
Military astronautics	1,074	674	481
Ships and small craft	354	297	379
Ordnance, vehicles, and related equipment	366	323	321
Other equipment	1,178	1,106	1,163
Program management and support	507	525	514
Emergency fund	—	75	50
Total research, development, testing, and evaluation	7,756	7,439	7,346



**Cinch introduced 39 new products last year
...but we won't sell you any of them.**

**because every one
was custom designed
for a Cinch customer.**

And each one was designed to meet a special requirement. It may have been an extra-tight tolerance, unusual plating configurations, or even price. No matter what your special requirement might be, Cinch can not only design the connector you need—but we can build it too—on dependable delivery schedules. Cinch production capabilities, in plastic molding, selective plating and assembly are unequaled.

Why not let us build a connector for you that we won't sell to anyone else?

Contact any Cinch Electronics Group sales office or Cinch Manufacturing Company, 1501 Morse Ave., Elk Grove Village, Illinois, 60007 (312) 439-8800

C-6916



DIVISIONS OF TRW INC.; CINCH MANUFACTURING, CINCH-GRAPHIK, CINCH-MONADNOCK AND CINCH-NULINE



A DIVISION OF TRW INC.

the upswing in such new programs as the Lockheed S-3A ASW aircraft for the Navy, the Grumman F-14 replacement for the Navy's cancelled F-111B, and the McDonnell F-15 air superiority fighter for the Air Force will help take up the technological slack in the fixed-wing market. But the amount of tactical helicopter systems will decline as Vietnam activity declines and military inventories continue to rise.

The Marine Corp's drive for vertical/short takeoff and landing strike aircraft has led DOD to approve the purchase of 18 more Hawker Siddeley Harriers. Total value of the British order in the new fiscal year now stands at \$118 million, or \$61 million more than a year ago when a first purchase of 12 planes was approved. Two U.S. avionics producers are profiting from the program, however. Hoffman Electronics is supplying the AN/ARN-91 Tacan navigation package while Sperry Rand's U.K. affiliate—Sperry Gyroscope Co.—is providing automatic stabilization as well as other avionics instrumentation packages.

Though new avionics potential appears relatively bright, it's only because other military electronics procurement and the research, development, test and engineering area look so grim. Though the Nixon Administration boasted major savings on the personnel and logistics sides as the pace of Vietnam activity diminishes, there are some significant cuts in hardware, too.

DOD purchases of communications and electronics systems, for example, are being chopped 22% to \$893 million compared with \$1,147 billion this fiscal year. As for distribution throughout the services, the Air Force takes the

Budget for aircraft and missiles		
(in millions of dollars)		
Maker, model and mission	Fiscal 1971	Change from fiscal 1970
Aircraft		
LTV A-7D light attack	253	0
McDonnell F-4E interceptor	76	+ 50
McDonnell F-4J fighter	0	-146
Grumman F-144A/C fleet defense	938	+496
McDonnell F-15A air superiority	370	+195
Lockheed S-3A antisubmarine warfare	310	+160
LTV A-7D light attack	254	-143
LTV A-7E light attack	133	- 31
Grumman EA-6B electronic warfare	198	- 40
B-1A strategic bomber	100	0
Hawker Siddeley P.1127 V/STOL fighter	118	+ 61
LTV-A-7D light attack	253	-143
LTV A-7E light attack	133	- 31
Lockheed C-5A cargo	624	-285
General Dynamics F111F air defense	567	-364
Bell UH-1H tactical helicopter	21	- 40
Boeing CH-46F aircontrol and support helicopter	0	- 33
Missiles		
Boeing/TRW Minuteman 2/3 ICBM	797	-151
*Lockheed Polaris/Poseidon ballistic missile (SLBM)	1,680	- 33
Hughes Phoenix long-range air-to-air	100	+ 82
NAR Condor (AGH-53A) tactical standoff	52	+ 44
Hughes Phoenix (AIM-54A) long-range air-to-air	100	+ 82
RCA Aegis surface fleet defense	75	+ 40
AT&T Safeguard antiballistic missile	1,450	+598
ULMS Advanced SLBM	44	+ 20
Martin Shillelagh (MGM-51A) anti-tank	6	- 50
* includes submarine modifications.		

biggest lumps, though the Army runs a closed second. Its procurement requirements are expected to drop as sharply as they grew during the Vietnam escalation.

Army's C&E funding is pegged at \$273 million, compared with its \$315 million procurement budget this year. Navy drops to \$305 million from \$385 million while USAF—the only service to get more money in the current year—is budgeted for \$128 million slash, to \$301 million. Defense agencies such as the Directorate of Defense Research and Engineering (DDR&E), Advanced Research Projects Agency (ARPA) and others under the purview of the Secretary are scheduled for no more than \$13 million in the new fiscal year.

Though the procurement totals are bolstered in the DOD category

of "other equipment"—an area heavily oriented to electronics generally and data processing systems in particular—the money sought for this equipment is down markedly, too, from more than \$2 billion to a sum of less than \$1.6 billion.

The thrust of this cutback will affect major efforts in the area of electronic warfare, for example, and night vision in particular as well as tactical processing, airborne warning and control, undersea surveillance and laboratory hardware purchases for Federal contract research centers and military in-house operations.

Though major prime contractors will find tough competition for the relatively limited number of new starts, there will be opportunities for suppliers of military subsystems in DOD's plan to improve the performance of existing military inventories. Tactical missile guidance, airborne search and fire control radars, laser and infrared homing systems all require improvement, in the view of defense project managers. Industry suppliers may find new bidding opportunities, either in production or final development phases where they believed competition was already foreclosed.

Military research, development,

Defense budget by mission

(Billions of dollars)

	Fiscal 1969	1970	1971
Strategic forces	8.6	7.5	7.9
General-purpose forces	30.7	27.8	24.7
Intelligence and communications	5.8	5.6	5.2
Airlift and sealift	1.6	1.7	1.5
Guard and reserve forces	2.1	2.5	2.5
Research and development	4.7	4.8	5.4
Central supply and maintenance	9.4	9.4	8.4
Training, medical, etc.	12.4	13.0	12.6
Administration and associated activities	1.3	1.5	1.5
Military assistance	2.2	2.4	2.5
Total obligational authority	78.7	76.4	72.3

test, and evaluation presents a significantly smaller and very mixed bag. While fiscal 1971 RDT&E funding requests are off only \$93 million from last year, the \$7.35 billion total is sure to buy less in the marketplace under present inflationary conditions.

RDT&E money for military sciences—a category embracing everything from the related areas of oceanography, submarines and ASW systems to “electronics research to increase performance and reliability” of systems and components—is up significantly to \$585 million. Most of the money is being held at the DOD level, although each service’s share is also slightly higher. The same can be said for aircraft, with a \$26 million boost to \$1.6 billion covering beginning pro-

grams such as F-14 and F-15. Though Navy’s share of RDT&E money is off nearly \$100 million to \$695 million, it still has \$274 million programmed for continued F-14 development.

A sharp decline in astronautics RDT&E stems largely from last year’s cancellation of the Air Force Manned Orbiting Laboratory. But the cut of nearly \$200 million still leaves more than \$480 million—a figure most defense officials believe is sufficient to continue with few changes the development of secondary power sources, navigation and guidance systems, sensors, and re-entry and missile propulsion systems.

Comparisons of these programs show clearly that there will be a large gap in overall Federal R&D

that cannot be filled by increases in nonmilitary budgets. Military and aerospace contract researchers, for example, can find little solace in Presidential science adviser Lee DuBridge’s hailing a \$73 million increase in fiscal 1971 for the National Science Foundation. The money will be used for environmental studies at the university level.

DuBridge anticipates a continuing downward trend in military R&D. And a senior DOD official concedes that any so-called “peace dividend” achieved by a cutback in Vietnam outlays will not work its way back into other military programs. “Chances are we’ll never see any of it, if there is any,” says another highly-placed Pentagon staffer.

Space age shifts into a lower gear

● The National Aeronautics and Space Administration “is putting into motion . . . a program which does not advance toward a single climactic event,” said NASA administrator Thomas O. Paine, introducing the agency’s \$3.33 billion budget for fiscal 1971 at a press conference. With these words, Paine officially marked the end of an era whose single-minded and costly dedication to a goal in space—landing men on the moon—is unlikely to be duplicated in this country again.

The new budget’s austerity results from White House and Budget Bureau directives that chopped NASA’s initial \$4.1 billion request at the very last minute. What’s left is the lowest space agency budget since fiscal 1962; NASA contractors may lay off as many as 45,000 people by June, 1971.

Action on major programs in the coming fiscal year is described in slowdown terms—words such as “reduced,” “suspend,” and “defer,” appear everywhere. Thus, decisions have been made to:

▶ Defer the Apollo Applications

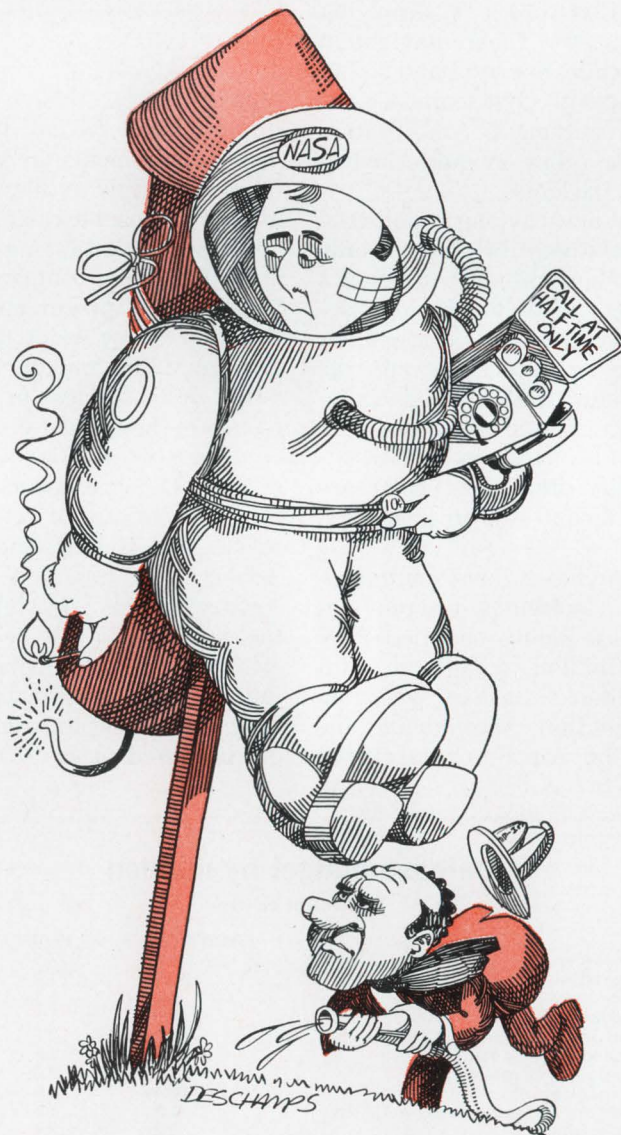

Program three-man space workshop six months to a launch in late 1972. The program's budget is up \$64.2 million to \$346.3 million and the initial launch will be followed in 1973 by three visits by astronaut teams.

▶ Defer Project Viking, the effort to orbit and then land on Mars, to 1975 as announced earlier. However, asked when NASA plans to actually land on Mars, Paine replied that the agency has no target date "whatever." Although the prime contractors—NASA's Langley Research Center for the lander, and the Jet Propulsion Laboratory for the orbiter and space bus—will be able to keep busy, Martin-Marietta, the prime systems contractor, may have to lay off people in Denver as its project integration contract is stretched out.

▶ Defer the launch of Advanced Technology Satellites F and G by one year to 1973 in the wake of an \$8 million fund reduction to \$31.1

million. The choice by NASA between Fairchild Hiller and General Electric to fabricate the satellites is imminent.

▶ Suspend production of Saturn 5 launch vehicles after the 15th unit is produced, as well as Apollo spacecraft. Although the production halt was expected many months ago, many contractor employees will be affected, especially those at Boeing, McDonnell Douglas, North American Rockwell, and Grumman Aerospace—the major contractors—and the chief electronics suppliers—AC/Electronics, Raytheon, and IBM. NASA had hoped that after the original production order for Apollo Spacecraft was completed it could buy long lead items for three Apollo launches during the year after Apollo 19 was sent off. But next year's pinched budget quashed that possibility.

▶ Stretch out lunar missions to five or six month intervals following the launch in April of Apollo 13.

Original plans were to launch missions every three to four months. Lunar missions also will be suspended during the Apollo Applications Program, cutting Apollo costs during this period almost in half (to \$956.5 million).

▶ Reduce NASA's operational base by closing the Electronics Research Center by June 30, as reported earlier. However, most of the 800-plus employees are expected to be able to continue their projects—such programs as navigation satellites and electromagnetic compatibility—at other government agencies and NASA centers. Also to be closed: the Michoud Assembly Plant in Mississippi and the Mississippi Test Facility, with still other centers also under consideration.

Space program budgets for other Federal agencies, led by the Department of Defense, will drop somewhat in fiscal 1971 to \$1.8 billion. Of this, \$1.67 billion will go for military reconnaissance, and navigation and communications satellite programs, including launch vehicle and range-operation costs. For companies already sharing in the military satellite work, business probably will keep up with last year's pace. TRW Systems Group, feels that none of its on-going satellite projects will be affected by cuts in the fiscal 1971 budget. However, one program that TRW had high hopes for in 1970—the tri-service, navigation satellite system (Navsat)—appears headed for more delays before it moves into the hardware stage. Technical problems as well as insufficient funds are cited as reasons for the delay.

Still more funds for space developments will be available from the Environmental Science Services Administration, which wants \$26 million to cover meteorological satellite activity. And the Atomic Energy Commission is budgeting \$99 million to develop the Nerva nuclear rocket engine and nuclear space power sources.

Whatever light shines through the budget-cutting figures centers around NASA's desire, according to Paine, to preserve "a strong future capability in space." A critical factor will be development of a "re-usable space transportation system, including the space shuttle, the

NASA space science and applications

(Thousands of dollars)

	Fiscal 1969	1970	1971
Physics and astronomy	128,850	111,835	116,000
Supporting research/technology	22,497	17,500	17,500
Airborne research	1,000	1,600	3,000
Data analysis	3,412	3,000	3,000
Sounding rockets	19,234	18,500	18,500
Solar observatories	13,812	14,700	16,100
Astronomical observatories	36,392	31,600	27,100
Geophysical observatories	13,072	6,000	5,200
Explorers	19,431	18,935	25,600
Lunar and planetary exploration	87,923	151,013	144,900
Supporting research/technology	18,571	17,980	17,400
Data analysis	2,337	2,600	3,900
Pioneer	4,700	20,800	32,900
Mariner-Mars 1969	26,130	4,491	200
Mariner-Mars 1971	20,058	60,342	29,600
Viking	12,427	40,000	35,000
Mariner-Mercury 1973	—	1,000	21,100
Planetary astronomy	3,700	3,800	4,800
Bioscience	37,900	19,670	12,900
Supporting research/technology	8,900	11,170	9,400
Planetary quarantine	1,300	2,500	2,000
Biosatellites	27,000	6,000	1,500
Space applications	98,655	128,400	167,000
Supporting research/technology	19,600	24,900	25,900
Tiros/TOS improvements	5,800	3,700	3,200
Nimbus	31,800	27,300	28,000
Meteorological soundings	3,000	3,000	3,100
Cooperative applications satellite	100	100	100
Applications technology satellites	24,700	39,000	31,100
Geodetic satellites	2,465	1,700	3,500
Earth resources survey:	11,200	26,000	52,500
Aircraft program	(8,900)	(11,000)	(11,000)
Earth resources technology satellite	(2,300)	(15,000)	(41,500)
Synchronous meteorological satellites	—	2,700	15,600
Navigation and traffic control satellite studies	—	—	3,000
Global atmospheric research program study	—	—	1,000
Launch vehicle procurement	99,900	108,800	124,900
Support research/technology	4,400	4,000	3,000
Scout	12,600	13,700	15,100
Delta	24,300	32,100	34,000
Agna	11,300	5,300	—
Centaur	44,200	50,000	68,100
Titan 3 C	3,100	3,700	4,700
Total	453,238	519,718	565,700

space station, and the reusable nuclear rocket," he says. In addition, NASA is continuing a broad unmanned space exploration program—a Mariner Mercury-Venus flyby for 1973 received strong support—and is expanding its work in the Office of Space Science and Applications, a reaction, in part, to Congressional criticism that space technology isn't being used for the public good. OSSA's budget request for the next fiscal year is up \$26 million to \$565.7 million, the largest in four years.

NASA is allocating some \$110 million for the development of the space station and shuttle, up more than six-fold over the year-ago figure. McDonnell Douglas and North American Rockwell already are working on \$2.9 million contracts awarded last July for the 12-man phase B, or design definition, earth-orbiting station; request for proposals on phase B studies on the space shuttle are expected soon. "So far the general feeling is that the space shuttle program is going to receive sufficient support," says a source at Lockheed Missiles & Space, a team leader in the space shuttle bidding. He cites the elimination of one "and possibly two Apollo flights" in favor of funding for the space shuttle.

But funding soon will have to jump drastically if the shuttle is to move into the hardware stage.

"Hundred-million-dollar studies sound impressive, but with a program like this they can go on for years without resulting in anything flyable," says one space program consultant. "The feasibility of the reusable shuttle is at the same level of uncertainty as was the development of Saturn 5 when it was begun in 1960." Development and flight of the space shuttle could take more than \$5 billion, he notes, adding that this kind of money just isn't available right now.

Some of the larger NASA prime contractors see little immediate impact from the agency's reduced fiscal 1971 budget in terms of ongoing development and production work. Others want to wait and see what Congress finally does to the budget. A spokesman at North American Rockwell's Space divisions says the funding cutback itself won't have a noticeable effect, explaining that the company has been in a gradual decline for the past couple of years as work on Saturn and Apollo has decreased. "We plan to decrease employment for the foreseeable future, but don't know exactly now what this will mean in terms of people," he notes.

The official says the company is now studying the number of people that will be required for the S-2 Saturn and Apollo support effort. Indications are that support programs will be required in those

areas through 1974. North American still has five lunar mission spacecraft to be completed at its Downey, Calif., plant, and four Apollo Applications Program spacecraft. Two already are at Cape Kennedy, and a third is awaiting shipment.

Another spokesman says most subsystems for the current Apollo program already have been delivered by subcontractors, but adds that some undelivered systems may be affected by the planned program stretch-out.

Subcontractors who might be affected include Collins Radio, supplier of the communications system; Honeywell, which produces an electrical system for manually flying the spacecraft; and Dalmo Victor, maker of the high-antenna.

At the Jet Propulsion Laboratory, delay of the Viking Orbiter-Lander launch until 1975 will have only a minor impact on work levels, primarily because most of the slack will be taken up by the 1973 Mariner Mercury-Venus flyby. The Viking program stretchout will result in a personnel reduction of about 100 in the laboratory's 4,200-man work force, according to a JPL spokesman. It's too early to say which subcontractors may benefit from the Mariner Mercury-Venus project, since the project office still is being set up and no subs have been selected, they indicate.

The newest NASA program with the most immediate potential benefit to the civilian sector is the Earth Resources Technology System program. Both General Electric and TRW are working on design studies for the ERTS A & B satellite systems and the necessary ground equipment. With a budget request for next year of \$52.5 million, double the fiscal 1970 funding, ERTS is well on its way to launches in 1972 and 1973. The satellites will survey the earth, through a Hughes Aircraft multispectral scanner and RCA return-beam vidicon cameras, seeking out resources in and on the land and seas. There is also \$2.1 million available for a national earth resources laboratory to be established at Goddard Space Flight Center.

Weather satellite programs also are receiving support in the budget for the Synchronous Meteorological Satellite, stepped up to almost \$13

NASA research and development

(Thousands of dollars)

	Fiscal 1969	1970	1971
Manned space flight	2,177,500	2,031,745	1,474,200
Apollo	2,025,000	1,686,145	956,500
Space flight operations	150,000	343,100	515,200
Advanced missions	2,500	2,500	2,500
Space science and applications	453,238	519,718	565,700
Physics and astronomy	128,850	111,835	116,000
Lunar and planetary exploration	87,923	151,013	144,900
Bioscience	37,900	19,670	12,900
Space applications	98,665	128,400	167,000
Launch vehicle procurement	99,900	108,800	124,900
Advanced research and technology	278,220	272,302	264,200
Basic research	20,220	18,902	17,600
Space vehicle systems	31,349	30,670	30,000
Electronics systems	34,460	33,500	22,400
Human factor systems	19,402	21,900	17,900
Space power/electric propulsion systems	38,787	34,450	30,900
Nuclear rockets	33,502	36,500	38,000
Chemical propulsion	25,752	20,480	20,300
Aeronautical vehicles	74,748	75,900	87,100
Tracking and data acquisition	279,672	278,000	298,000
University affairs	9,000	7,000	—
Technology utilization	3,800	5,000	4,000
Total new obligational authority	3,201,430	3,113,765	2,606,100

million, after last year's \$2.7 million start. The first SMS could be Delta-launched late next year and take position 23,000 miles up over the equator and above the eastern Pacific ocean; a second launch is planned for 1972. Eventually, the SMS will be operated by the Environmental Sciences Services Administration. Contracts worth about \$20 million for design, testing and production should be awarded soon after the new fiscal year starts.

The pace on the Nimbus program also will pick up—to the tune of \$28 million—and so will work on the geodetic satellites, budgeted at \$3.5 million. Two new efforts will begin in fiscal 1971 with \$3 million for navigation and air traffic control satellites and \$1 million for a Global Atmospheric Research Program (GARP) study. Requests for

studies on phase B feasibility, definition and design studies should go out sometime this year for both programs. Eventually, GARP—sponsored by the World Meteorological Organization and the International Council of Scientific Unions—may launch two satellites to study techniques for long-range weather prediction. In navigation and air traffic control, studies will continue on the capability of two satellites over the Atlantic to serve as relays for these services, which are needed by both American and European airlines.

NASA's efforts in planetary exploration, other than Viking, will be backed by a smaller \$109.9 million budget. Although funds for the Mariner-Mars orbiter in 1971 were cut by more than half, to \$29.6 million, most of the contracts already had been awarded. The orbital

spacecraft still will be launched next year to relay photographic, spectrographic and radiometric observations of the red planet's temperature, atmosphere, surface, and weather. Some insight into the "wave of darkening" that spreads over the Martian surface and a better knowledge of the planet's gravity may be obtained. JPL is the prime contractor; GE and Honeywell's Radiation Center are developing attitude scanners, Motorola, the radio subsystems and Litton, data automation.

The space agency has also asked for almost \$33 million for the Pioneer F&G voyages to Jupiter in 1972 and 1973 which will explore interplanetary space. The flights will gain data that could be helpful to engineers designing spacecraft for the outer-planet "grand tour."

Bleak budget's best bets: Police, air traffic control

● The departments of Justice, Transportation, and Health, Education, and Welfare will be making important commitments to new and improved electronic systems and hardware in the fiscal year beginning July 1. However, overall sales to each of these agencies will be limited by the stern constraints outlined in President Nixon's first budget. Anxious to control inflation but unwilling to impose new taxes in a Congressional campaign year, the Administration had no choice but to limit the funds available for applying new technology to resolve the problems facing a troubled nation.

These troubles may be reflected in the fact that electronics technology will make perhaps its greatest new impact in the Department of Justice. Attorney General John Mitchell's agency is scheduled for a \$279 million budget boost in the Nixon budget, raising its total funding to \$1.12 billion. Potentially the largest electronics customer within Mitchell's bailiwick is the Law Enforcement Assistance Admini-

stration (LEAA), with a proposed \$480 million program, double that of the current fiscal year. But some of this largess will be forthcoming at state and municipal levels under LEAA's matching grant program. Most of the matching grants go to police departments on a 60-40 basis, with the Federal Government supplying the larger share. The money for matching grants—\$285.9 million in the new budget, up \$97.5 million—will help improve law-enforcement methods, including police communications equipment such as radios and teleprinters, and to establish computer systems for allocating manpower and other services.

At \$11.3 million, the funding request for the LEAA's National Institute of Law Enforcement and Criminal Justice is almost triple the \$4 million received in fiscal 1970. The institute hopes to develop improved police detection and apprehension equipment, including night-viewing devices, voice-print gear, and better police radio and communications equipment. Re-



search also will continue on development of compact teleprinters that could fit into police cars.

Project SEARCH (System for Electronic Analysis and Retrieval of Criminal Statistics)—a multi-state project for sharing criminal case histories—is budgeted for \$3 million in fiscal 1971. SEARCH is a prototype for a future national system with each state filing its own cases and providing them on request over interstate data links. Ten states—Arizona, California, Maryland, Michigan, Minnesota, New York, Connecticut, Florida, Texas, and Washington—are participating.

LEAA plans to bring in from three to five more states during the next fiscal year, probably including Pennsylvania, Ohio and Illinois. Although the SEARCH program is slated for a final feasibility demonstration in late spring or early summer, LEAA already is con-

fidant it will be successful. Eventually the system will tie together 40 of the nation's highest-crime states. Each state system office will have a computer with capability at least equal to a Burroughs 5500 or an IBM 360/40 and their associated hardware and software.

Also in the Justice department, the Federal Bureau of Investigation plans to expand its computer-based (IBM 360/50) national crime information center, which provides data on stolen items and at-large criminals, by adding more interfaces with state law-enforcement agencies. Expansion of the information center generally results from state agencies replacing manual criminal-filing systems with computerized operations. And, in addition, some states want to expand their criminal file operations to service more of their own agencies. The FBI data bank, with 24 computer interfaces, is slated to double

in size by December. But the interstate expansion eventually will open up access to the data bank to "hundreds more agencies," says the FBI.

The Treasury Department also has begun installing a criminal information network as part of its operation to halt marijuana and drug smuggling from Mexico. A \$2 million Burroughs B5500 computer system, tied to teletype terminals set up on roads leading from the California-Mexico border, will be installed by the Bureau of Customs in San Diego. The system, which also will communicate with the FBI's data bank, will supply information on wanted criminals and stolen motor vehicles based on license plate numbers and personal identification data supplied by customs officers. Eventually, the system may be expanded to cover the Texas-Mexico and Canadian borders.

FCC and OTM: managing the spectrum

A modest \$925,000 increase in the perennially underfunded Federal Communications Commission budget has been requested by the White House, raising the FCC's bankroll to \$24.9 million in fiscal 1971. At the same time, the Administration wants to nearly double the budget of the Office of Telecommunications Management to \$3.3 million. Both budgets—which have important implications for the communications industry—are likely to pass Congress easily because of their relatively small size and the haste with which the legislators will be obliged to move on appropriations in this election year. However, if Congressmen take the time to look carefully at the duplication of effort implicit in the spending plans of the two independent offices, one agency could find some of its appropriations scrubbed.

The proposed doubling of OTM's funding, officials say, is based almost entirely on its plan to create a National Electromagnetic Compatibility Analysis Facility (NECAF) to "provide for more emphasis on radio-frequency analysis." The facility's tasks resemble those of the Defense Department's Electromagnetic Compatibility Analysis Center at Annapolis, Md. And, says one Washington communications

specialist, "it sounds to me like an FCC function."

But "NECAF will only be dealing with problems in government," an OTM official explains. More specifically, they will be only those compatibility problems not related to Defense. Typical NECAF customers will be the Federal Aviation Administration, the Environmental Science Services Administration, the Atomic Energy Commission, the Forest Service, and agencies dealing in electric power distribution, and in communication systems associated with combatting air and water pollution.

Using \$906,000 of its requested funding increase, OTM expects to add 40 people to NECAF's staff in fiscal 1971, building toward a total of approximately 100 employees within two years. The facility's ultimate size and structure "will be determined by the volume of problems that come to it," the OTM official says. The staff will consist of communications and electronics engineers, computer programmers, mathematicians, and specialists in electromagnetic compatibility.

Along similar lines, the FCC says that with its \$925,000 increase it will "continue development of a prototype radio spectrum management center to relieve congestion

and interference in mobile communications." The program was recommended by Stanford Research Institute in its contract study to FCC last year. FCC chairman Dean Burch indicates the commission plans to make the prototype center do double duty as the first regional spectrum-management center.

The center will develop systems engineering and spectrum management procedures for boosting the useful efficiency of the land mobile spectrum. These techniques could be applied, it's hoped, to other frequency users. An important part of the center's initial work, the FCC says, will be development of a data base for the land mobile service. Initially, the center will be based in FCC headquarters in Washington but a new center will be built in 1972, probably in the Washington-Baltimore area, says the FCC. Eventually, the center will be staffed by 25 to 35 people, mostly engineers and data processing experts, with some attorneys, and the usual clerical support.

Congress is expected to approve the center, though a fight is called likely from those on Capitol Hill who think the problem can be solved by moving parts of land mobile communications to the UHF sector.

**A cross-section
of DuMont Customers:**

AEL Products Inc.
American Airlines
Applied Device Corporation
Applied Technology Inc.
Atlantic Technology
Ball Brothers Research Corporation
Barnes Engineering Company
Bell Aero Systems Company
Bell Telephone Labs
Bendix Corporation
Beta Instrument Corporation
Bunker Ramo Corporation
Burroughs Corporation
Collins Radio Company
Computer Industries Inc.
Computer Micro Data Systems
Conductron Inc.
Control Data Corporation
Datascope Corporation
Defense Electronics Inc.
Digital Equipment Corporation
E. I. DuPont de Nemours Company
Eagle Signal
Eastman Kodak Company
E G & G
Electronic Associates Inc.
Elliott Brothers Ltd.
Finnigan Instruments Corporation
Fisher Scientific Company
General Dynamics
General Electric Company
General Electrodynamics Corporation
General Precision Systems Inc.
General Time
Goodyear
Hamilton Standard
Harshaw Chemical Company
Hazeltine Corporation
Heath Company
Honeywell Inc.
Hughes Aircraft Corporation
IBM Corporation
Interstate Electronics Corporation
Itek Corporation
ITT Federal Labs
LTV
Litton Systems Inc.
Lockheed
Loral Electronics
Magnavox Company
Mann Russell Electronics Inc.
Martin Marietta
McDonnell Douglas Corporation
Medical Electronics
Melpar Inc.
Motorola
National Cash Register Company
Norden
North American Rockwell Corporation
Northwest Orient Airlines
Nuclear Chicago Corporation
Nuclear Corporation of America
Packard Instrument Company
Perkin Elmer
Sanders Associates Inc.
Sandia Corporation
Sperry Gyroscope Company
Stewart Warner
Sylvania
TRW Systems
Taylor Winfield Corporation
United States Government
Univac
Watkins Johnson Company
Western Electric Company
Xerox Corporation

where the tube action is



Air Sockets
Cathode Ray Tubes
Custom Power Tube Connectors
Direct View Storage Tubes
Display Tubes
Electrical Readout Storage Tubes
Electron Multipliers
Fiber Optic Face Plate Tubes
Flying Spot Scanners
Image Converters
Image Intensifiers
Instrument Tubes
Ionization Gauges
Microwave Source Holders
Noise Sources
Oscilloscope Tubes
Particle Detectors
Photomultiplier Tubes
Power Diodes
Power Triodes
Scan Converters
SPM Structures
Thyratrons

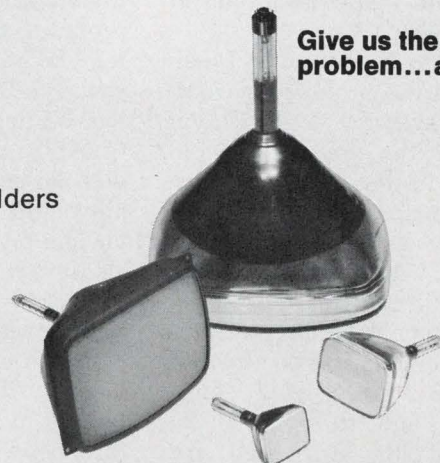

**Give us the
problem...and see**

For immediate action, call, write or TWX. (201) 773-2000.
750 Bloomfield Ave., Clifton, N. J. 07015 TWX 710-989-7149.

Air traffic control may get off ground

A chronically underfunded Federal Aviation Administration at last may start to get the money it claims is needed to breathe life into the shaky air traffic control system. The Nixon budget alone calls for \$1.76 billion and the FAA's parent, the Department of Transportation, has \$10 million for R&D in air traffic control plus \$57.5 million that may be available from supplemental fiscal 1970 funds. The total FAA bankroll could reach more than \$1.83 billion—up \$500 million from the agency's total in the current fiscal year. Added to this record-setting figure could be the proceeds of an airport user tax incorporated in special legislation pending before Congress.

The new budget request calls for FAA outlays of \$276 million for new facilities and equipment—much of it to complete the 21 control centers that make up the semi-automated en-route air traffic control system. Delays in making the system operational are expected to draw heavy fire from Congress. Chief sharpshooter is likely to be Texas Democrat Jack Brooks, whose subcommittee on government activities is investigating the progress, or lack of it, in completing the computerized National Airspace System. According to Brooks, the FAA's troubles in implementing the national air traffic control system are due not only to lack of funds but to unsolved technical problems and "inadequacies in contractor support."

The Congressman undoubtedly has in mind the problems encountered by Raytheon in developing displays for the en-route system, and by IBM in developing software for the system.

In addition to the en-route automation, FAA will be anxious, if user tax money becomes available, to install instrument landing systems at commercial airports, to add more distance measuring equipment sites, and to upgrade the accuracy of the very-high frequency omnirange (VOR) navigation stations. The agency also will be examining ways to extend data

processing in the National Airspace system, trying to place under computer control such functions as the flow of aircraft approaching a terminal, and handing over flight plans from one en-route center to the next.

The new budget also seeks \$231 million for grants-in-aid to airports—largely for construction programs—and a total of \$90.5 million for R&D. A big chunk of this money—\$34.2 million—will go to upgrading the en-route and terminal air traffic control system. For the future, the FAA is studying the requirements of the air traffic control system of the 1980's, concentrating on scanning beam microwave instrument landing systems, an addressable radar beacon system, and time-frequency techniques for controlling aircraft [*Electronics*, Oct 27, 1969, p.127].

The supersonic transport again will be delayed due to lower funding in the new fiscal year. The SST is slated for \$290 million, a goodly sum by most standards but less than the \$314 million the FAA requested. The result: prime contractor Boeing may have to stretch out the flight of the first prototypes by four months to the first quarter of 1973. However, there's hope that if budgets are increased in subsequent years, the first operational model could be delivered in 1978 or 1979.

The Coast Guard also has a few items of interest to the electronics industry in its \$24 million R&D budget, up more than \$9 million from a year ago. Most of the funds—\$13.5 million—will go to the advanced development of the national oceanographic data buoy program, with \$5 million slated for the buoy's communications and sensors. The first prototype buoys will be deployed by 1973. Another Coast Guard development program with sizable market potential is an all-weather harbor approach and navigation system. The Guard will also evaluate airborne systems for measuring the extent, thickness, and movement of polar ice.

Electronics equipment procurement by the service includes shipboard and navigation electronics for a new polar icebreaker, avionics for six Sikorsky HH-3F helicopters, and \$5.65 million for updating loran navigation stations.

HEW's big ticket: Air-pollution control

In the Department of Health, Education and Welfare the most promising area for electronics lies in air pollution controls [*Electronics*, Dec. 8, 1969, p. 137]. The development and installation of such equipment is budgeted in fiscal 1971 for \$106 million, up \$10.4 million from fiscal 1970. Most of this increase is in the National Air Pollution Control Administration's (NAPCA) R&D budget, at \$62.3 million. This sum is allocated for development of technology for controlling sulfur oxides in the atmosphere. Research also will be performed on more efficient combustion of fuels and also into the fast-growing field of new, cleaner vehicular power.

President Nixon could request additional funding in his upcoming message on the environment, but he'll likely seek to strengthen enforcement authorities. This approach will require that polluting industries and state governments, rather than the Federal Government, buy control and measurement devices. And there will be increased activity in developing economic incentives to stop industry and consumers from polluting the environment.

The Clean Air Act of 1967 places emphasis on regional, not Federal, control of air pollution. Federal action is only involved in designating the cooperating regions and in assisting the development of state enforcement standards and procedures.

NAPCA's program also proposes to help the states establish effective control programs, and to designate 23 more air quality control regions in fiscal 1971. Each region will have to buy sensing, telemetry, and data-processing equipment to tie into the National Air Pollution Control Administration's national monitoring network.

The National Institute of Health's Library of Medicine will further develop its Medical Literature Analysis and Retrieval System (MEDLARS), with part of a \$7.6 million operational budget. MEDLARS, a computer-based bibliographic in-

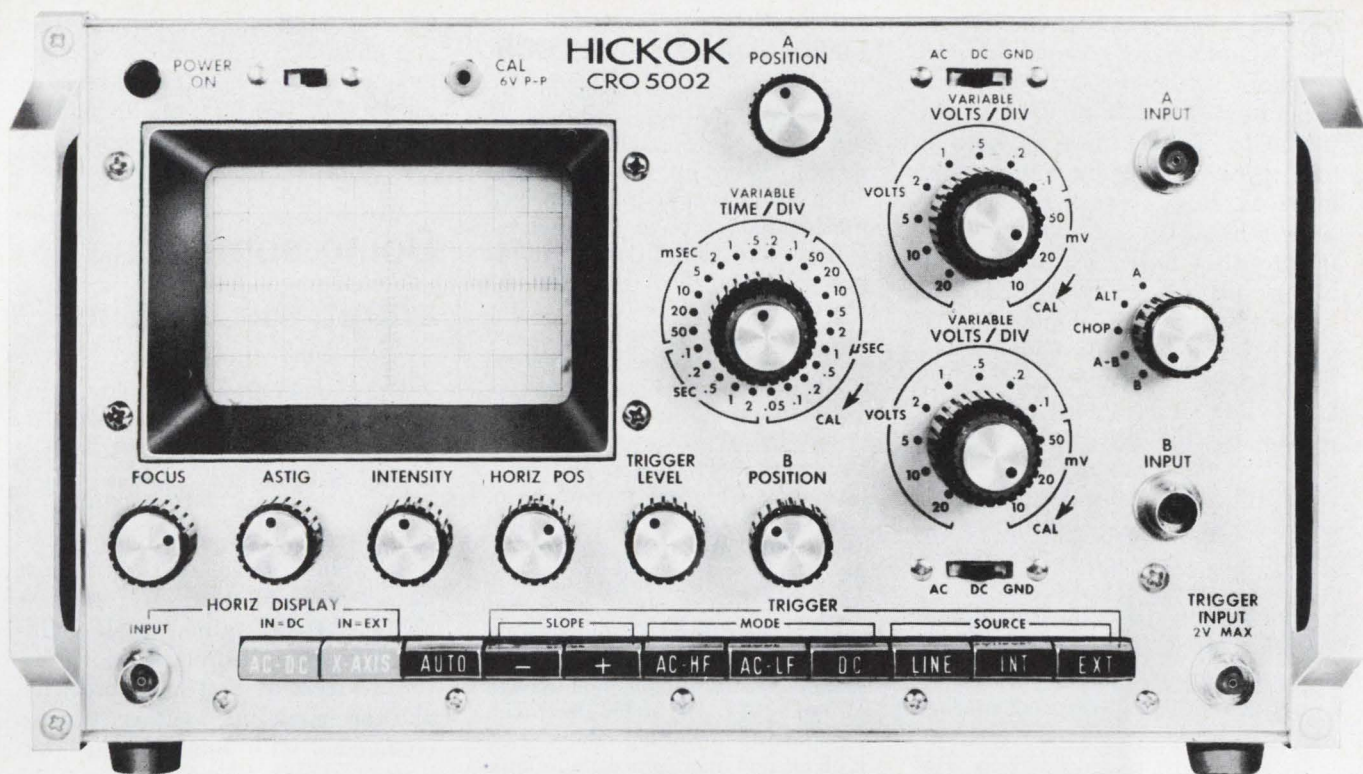

DUAL TRACE MODEL ILLUSTRATED

SINGLE TRACE

\$725

CRO-5000

DUAL TRACE

\$995

CRO-5002

- DC to 25MHz
- All Solid State
- Vertical Delay Line
- Light, Portable, Reliable

These new oscilloscopes give you the most for your dollar. No frills. Just performance. You owe it to your budget to see Hickok before you buy any other. In stock at franchised electronic distributors. Call the one nearest you for a detailed brochure and a demonstration.

The Hickok Electrical Instrument Company
 10514 Dupont Avenue • Cleveland, Ohio 44108

HICKOK

formation storage and retrieval system, is undergoing conversion from a Honeywell 800-200 to a third-generation IBM 360/50. The system ties in 10 medical libraries, both at universities across the country and overseas. Some expansion is foreseen in fiscal 1971 but officials hesitate to offer firmer estimates. The library also has budgeted \$906,000 to continue the development of a national biomedical communications network that will deliver data to doctors and other health professionals. Included is a remote access device linking the physician's office to a central information source. This source will allow the physician, for example, to receive programs for diagnostic and therapeutic procedures by telephone. The development of such a system, experts agree, could provide a lucrative medical electronics market in the future.

In other NIH research areas, the National Institute of Environmental Health Sciences plans to spend a small part of its \$19.8 million budget request on biomedical instrumentation. The National Heart and Lung Institute, with a \$171.7 million budget, seeks an extra \$10 million for R&D in artificial hearts, drug studies, blood resources, and other organic studies. NH&LI also will spend a small amount on instrumentation to diagnose heart and lung diseases.

In all, NIH plans to spend \$165 million on collaborative R&D projects—those conducted by NIH people and researchers in other institutions and drug companies. Grants will total \$546.4 million, more than requested in fiscal 1970, but less than the actual 1969 outlay of \$555.3 million.

Total health research funding requested for all Federal agencies is \$1.66 billion, with 72% from HEW. Only 12% of this is available to industry. The bulk of Federally funded health research is performed by universities, medical schools, and non-profit institutions.

HEW's Hill-Burton program for hospital construction and modernization is budgeted at \$30 million for grants to publicly owned hospitals. The program is still in a House-Senate conference. It contains a \$5 million request for an interest-subsidy program for privately owned hospitals, expected to

Merry mailmen—with OCR

With White House plans for restructuring the postal system in the works, the Post Office Department is saying little about its fiscal 1971 plans, awaiting an expected Presidential message to Congress. Guesses are that the restructured postal system—including rate increases—will not go as far as the private postal corporation proposed in a task force study completed under former President Johnson.

Whatever President Nixon proposes, the department's spending for electronics research and engineering is expected to rise. As of last month, the department had 192 active research contracts in force, and it is seeking \$55 million for research in the new fiscal year—an increase of \$13.3 million. And about 10% of the department's planned \$221 million procurement in fiscal 1971 will be for electronics equipment, including about \$2.5 million for data processing units.

The biggest single segment of the R&D funds will go for improved optical character readers which scan and distribute letters and packages whose addresses are printed in a wide variety of type faces. So far, more than \$15 million has been spent on developing the systems. Study contracts continuing in 1970 include those held by Burroughs, Philco-Ford, IBM, and Recognition Equipment. The department also will take a closer look at encoding systems which put letters in the sequence in which a carrier walks his route.

generate some \$400 million worth of loans. Only about 15% of the total program is slated for equipment, with a lesser percentage going for computer billing services, patient monitoring, and closed-circuit television systems. An HEW official says hospitals tend to buy the "newest, shiniest and jazziest" equipment with their money.

The new budget request for HEW's Office of Education contains little for electronics. Equipment and construction programs were cut in both fiscal 1970 and 1971 budgets, largely due to priorities in other areas and inflation, HEW says. A small fraction of the \$1.3 billion requested for elementary and secondary education may be spent on computer aids for deprived children. The Education

Office's \$186 million R&D budget contains \$25 million for experimental schools and individualized instruction, but little of this will go for sophisticated equipment.

Doing something about the weather

The Commerce Department's Environmental Science Services Administration (ESSA) wants to spend almost \$40 million more in fiscal 1971. A total of \$208.2 million is requested for its efforts to do something about the weather, or at least to better predict it. The request includes \$146.7 million—a \$16.7 million increase—primarily for improved weather and flood forecasts, and for expanding weather services connected with handling air pollution. Also included are \$29.7 million for R&D—a \$4.2 million rise—in improved severe-storm forecasting techniques and investigation of weather modification effects due to air pollution; \$6 million for replacement of equipment and expansion of observation and analysis capabilities; and \$25.8 million—a big boost of \$18.4 million—for continued support of the weather satellite program.

In addition, ESSA will purchase some of the IBM 360/30 computers it is renting at its National Meteorological Center in Suitland, Md.

Although NASA provides much of the technical management and all of the procurement for ESSA's satellite operations, the weathermen want to take over some of these functions themselves. They have asked for \$25.8 million to buy two improved-Tiros operational satellites (ITOS) and a Geostationary Operational Environmental Satellite (GOES). Included in both these purchases will be command and data-acquisition ground equipment for these satellites and for ATS satellites already in orbit.

This special report was written by Electronics' Washington bureau: Ray Connolly, manager, Robert Westgate and Lois Vermillion. It was edited in New York by Alfred Rosenblatt, military/aerospace editor.

EAGLE

*...where the
state of the art
is the standard
of the industry*

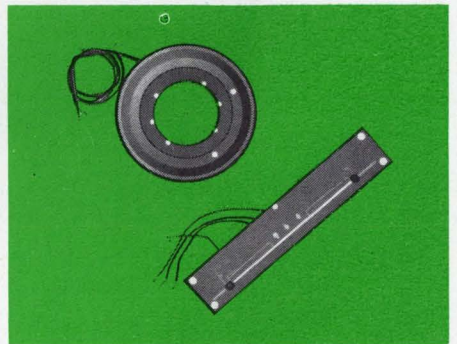
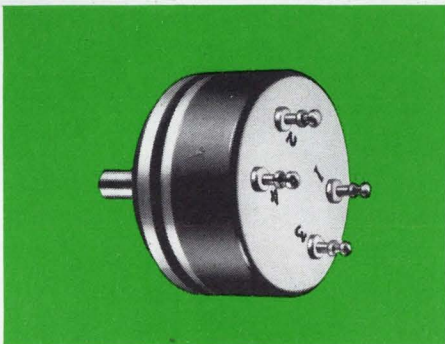

Specialists in Precision Potentiometers and Elements

Gamewell® Rotary Potentiometers

Precision conductive plastic, resistance element potentiometers with metal housings and side or rear terminals in diameters of 1/2" to 3". Exceed the most demanding specifications of industry and the military. Available in both linear and non-linear outputs. Also available: A wide variety of physical configurations including sub-assemblies which mate them with other components for greater packaging and operating efficiency. For virtually infinite resolution, extremely long life, excellent output smoothness, almost unlimited accuracy without catastrophic failure, negligible phase shift. And we offer a wide variety of wirewound styles, too!

Gamewell® Translatory Potentiometers

For military and industrial control applications requiring highly accurate measurement of linear motion. Available with single or dual resistance, wirewound or conductive plastic elements with separate contacting brushes and terminals. Stainless-steel shaft can be rotated 360° without affecting operation. Rigid housings of anodized aluminum withstand vibration, shock. Contacting elements are of precision metal. Both linear and non-linear resistance elements available in standard configurations; special configurations for special requirements. Taps supplied if desired. Standard stroke lengths 1/2" to 24". Non-standard also available.

Gamewell® Resistive Elements

The single most important components in a potentiometer. Gamewell conductive plastic elements are carefully molded from resins and powders as one-piece units. Production is strictly controlled in our own facility. Wirewound elements use alloys with resistivities ranging from 29 to 800 ohms/cir. mil. ft., wound on insulated copper mandrels using Class F insulation for operation up to 150°C.

GET THE SPECS and full details... more than \$1 million in Eagle time/count controls, relays, Gamewell potentiometers... waiting to serve you in 35 major areas throughout the world... including U.S.A., S.A., Europe, U.K., Canada and Australia.



Eagle Signal

a systems division of

GULF + WESTERN INDUSTRIES, INC.
925 Lake St./Baraboo, Wisc. 53913

Completely programmable waveforms
from 1 MHz to 300 MHz with accuracy up to 1 part in 100 K.

Model 1001:
0.5 MHz to 300 MHz;
a sweep and signal
generator; 5 kHz
stability; calibrated
output attenuator;
frequency, amplitude
and sweep width are
analog programmed;
perfect for use in auto-
matic, closed-loop
systems. \$995



Model 155:
Has Model 150 features
with addition of front-panel
control of all functions;
both units need contact
closures for programming;
or use TTL logic with
standard interface options.
\$1195.

Model 150:
0.1 Hz to 1 MHz;
Frequency, function
and amplitude
programmed by
8421 BCD code;
frequency can
be swept or dc-
modulated;
output may be
continuous or
triggered. \$995



Model 157:
100 μ Hz to 1
MHz - accuracy
of 0.01%; may
be triggered
and frequency
is compatible
modulated,
with TTL inputs; ideal alternative for
expensive frequency synthesizer. \$2995

9045 Balboa Ave., San Diego, Calif. 92123; Tel. 279-2200
P.O. Box 651, San Diego, Calif. 92112; TWX 910-335-2007

See Us at IEEE Booth 2E45 thru 49

Analyzer uncovers junctions' secrets

By detecting 'undetectable' radiation, noncontact instrument spots current bunching, shallow diffusions, and other faults in IC chips; failure analysis seen as initial application

By James Brinton

Electronics staff

Some of today's integrated circuits are more complex than most earlier devices that required a chassis full of space, and the reduction in size has complicated the test process. Testing an IC is largely a matter of noting whether it works or not; the "why" is much harder to get at because there is nothing like a tube or transistor tester that can be used on individual junctions in an IC. What's needed is equipment capable of tracing a signal from junction to junction and noting how each one performs.

Vanzetti Infrared & Computer Systems Inc. is introducing an instrument that may fill this requirement. It's the first piece of test gear that can inspect junctions without the possibility of damaging them. Electron microscopes and laser inspection tools can change the operating characteristics and make the data suspect.

Company president Riccardo Vanzetti calls the instrument a semiconductor junction analyzer, and says that it takes advantage of faint infrared emissions called recombination radiation.

These emissions are given off when a carrier electron loses energy, drops out of its excited state, and recombines with an atom. And, since the number of excited electrons is a direct function of applied current, recombination radiation should give investigators at least a qualitative reading of applied current, current density, and other current-related parameters.

Less intense. Because recombination radiation is about 10^{-5} less intense than thermal infrared emissions, Vanzetti had a hard time

convincing his onetime superiors at the Raytheon Co. that it could be detected. But he got some NASA research funding and built a crude demonstrator that worked [*Electronics*, Nov. 25, 1968, p. 51]. The production model is the grandson of this device. Both reject the longer-wavelength thermal IR in favor of shorter-wavelength recombination radiation.

There's still some question as to whether the instrument is detecting so-called true recombination radiation, or is picking up an emission caused by some other poorly understood mechanism. But nevertheless, what it detects varies proportionally with current and, thus, is useful (see panel, p. 159).

The analyzer is a benchtop unit with micrometer positioning controls that can spot a junction or part of a junction below the instrument's infrared detector system. The business end of the detector is a metal-sheathed optical fiber that is positioned a few thousandths of an inch (or less) above junctions, and can be passed back and forth along their length.

The chip to be inspected is mounted and connected but not covered or encapsulated. Either cans or flatpacks can be plugged into the analyzer with their contacts piped out to a back-panel connector where signals can be fed in to stimulate operation.

For the maximum degree of sensitivity, pulse repetition rates of

Inspection. Fiber-optic probe reaches down to chip (atop red fixture) to pick up IR emissions.

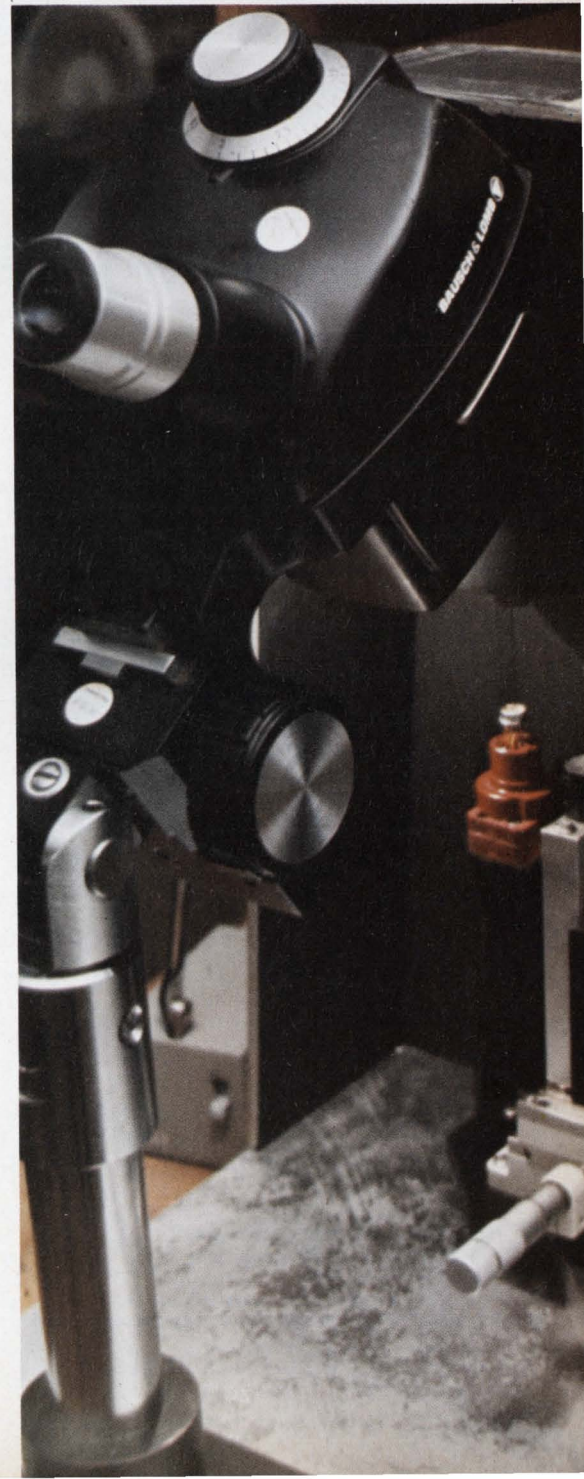

MICROWAVE IC MODULES PROGRESS REPORT #9: SWITCHING MODULE

Sperry Rand's PACT (Progress in Advanced Circuit Technology) program has taken a new look at microwave signal switching and developed the first complex circulator module.

It began with a major system contractor's effort to boost the reliability of a hand-held radar by providing redundant transmitters, receivers and local oscillators. Since a working radar set needs only one of each, the extras ride along as spares until a malfunction of a primary element calls them to duty.

Sperry's mission was to develop a super-reliable switching module capable of selecting either transmitter and either receiver and hooking them into the antenna duplexer circuit. Solid state was the only answer to the reliability requirement.

Sperry's solution is a single rectangular module, one inch by 1.8 inch, on a substrate 0.055 inch thick. Four circulators, a termination load and two DC blocking elements coexist on the module. One of the fixed circulators serves as the antenna duplexer, shunting transmitter and receiver signal paths. The other fixed circulator provides an antenna termination load to protect the downstream components against bursts of reflected transmitter energy.

Latching circulators allow operator selection of

either of the two transmitters and receivers. Our latching circulators switch with as little as 200 microjoules of energy, a negligible drain on the power supply.

Sperry's circulators perform well. Measurements taken at 9.0 GHz show minimum isolation of 28 db and maximum insertion loss of 0.7 db at 27°C. And all four circulators do their jobs with negligible interaction even though they share a common substrate.

Sperry is the expert for integrated microwave modules and we welcome your system challenge. To help start a conversation, we have a new module planning sheet you can get free. Send for it, fill in the blocks to describe your requirement, then send it back and we'll be in business.

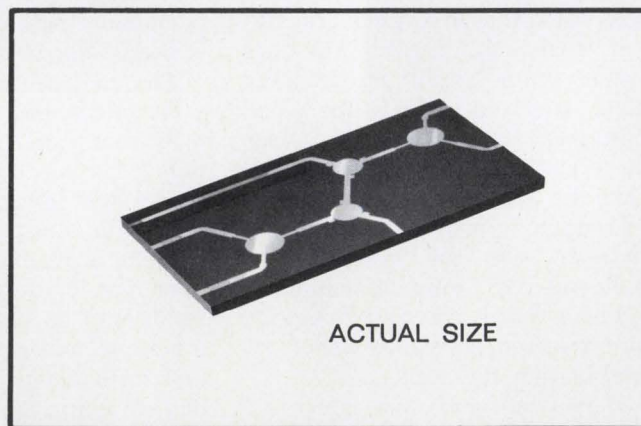

Sperry Microwave's solid-state switching module provides a common substrate for four circulators, two DC blocking elements and a termination load.

*For faster microwave progress,
make a PACT with people
who know microwaves.*

SPERRY
MICROWAVE ELECTRONICS DIVISION
CLEARWATER, FLORIDA

... electronics for signal processing may be included in later models ...

1 to 2 kilohertz are recommended, and pulse widths of 2 to 100 microseconds. But, the bandwidth of the detector circuitry is wide enough to accommodate repetition rates up to about 350 khz and narrower pulses. Sensitivity on the job will vary with these values and, to a degree, with the optical fiber used; but, detection of emissions from junctions running at about 10 to 100 microamperes is par.

Behind the optical fiber is a proprietary diode detector. The original device used a cryogenically cooled avalanche photodiode; but the production unit doesn't need to be cooled and is said to be two orders of magnitude more sensitive.

The detector's output is fed to a FET-input amplifier with a gain of about 10; this amp is a customized unit and is followed by a Fairchild 751C wideband op amp with a gain of about 500. The 751C feeds a Fairchild 715 (gain is about 10), which in turn outputs to another amp used primarily to load the 715 (gain is 2 to 4) and then to

a sample-and-hold network. This integrating sample-and-hold circuit settles in about 100 microseconds—a time that's the result of a tradeoff between noise and pulse response. The readout is a digital panel meter that displays the amplitude of the detector's output, and thus gives a reading of pulse amplitude as indicated by infrared emissions.

Basic black. This is the basic model, and Vanzetti expects many users to get along without anything more complex. But those who want more than a numerical readout of pulse amplitude can use an analog output jack on the front panel to feed what's called a waveform eductor. The eductor is a specialized integrating device that subtracts much of the noise from the faint signal and yields a cleanly defined pulse shape suitable for oscilloscope display. There are hints that some such signal-processing electronics will be included in later versions of the junction analyzer.

For testing, the instrument is a

... by any name

Solid state specialists don't agree about what it is that Vanzetti's detector detects. Vanzetti believes it is recombination radiation emitted by carriers throughout the volume of the junction; but a former colleague from Raytheon insists that, in theory, recombination radiation in silicon should be too weak to find. However, the same engineer admits that Vanzetti is looking at something that fits the classic description.

The body of theory and math which would either support or deny Vanzetti's contention doesn't exist. But Vanzetti has proven experimentally that the radiation he's working with is proportional to current density. And, for most applications, he feels this is all the data needed to make the technique useful.

Mrs. Jayne Partridge, an engineer at MIT's Draper Laboratory who is a specialist in the physics of failure in semiconductors, has a hunch that Vanzetti may be detecting a surface-state emission.

"Mobility, trapping and activation sites, and recombination itself, each differ slightly at the surface from the same things in the bulk of the material," she says, hinting that this may be how the analyzer beats the odds against it. Existing theory says that recombination radiation should be soaked up within the junction in phonon, or thermal interactions. What's needed, she adds, is a more accurate mathematical model of the junction, not just to explain Vanzetti's results but also to make them more useful. She says the difficulty now entailed in the precise computation of carrier lifetimes would be eased considerably—if the exact nature of Vanzetti's detected emissions were known.

Meanwhile, Mrs. Partridge hopes that the analyzer will prove helpful in semiconductor research. It may help measure the relative radiation hardness of semiconductor devices, and determine why transistor characteristics drift with time.

BUG KILLER

FACT® (Flexible Automatic Circuit Tester), Hughes' random access system hunts down electronic "bugs:" shorts, opens, defective insulation, poor solder connections.

In any type system: spaceborne, airborne, underwater communication, control, computer, support, telephonic switching. In any type assembly. And to insure the results are always accurate, FACT "de-bugs" itself.

FACT. Quick delivery. Order now. Lease/rental plans available. Contact:

L. W. Risner
FACT Systems
Hughes Aircraft Company
P. O. Box 92904
Los Angeles, California 90009
(213) 670-9040



HUGHES
HUGHES AIRCRAFT COMPANY
FACT SYSTEMS

EMI*

$$\lambda = 1,650-8,500 + A^\circ$$
$$ENI = 2 \times 10^{-13} \text{ Im.}$$



The 9558Q Photomultiplier eliminates

...the nuisance of multiple detectors! One EMI photomultiplier type 9558Q covers UV, visible and infra red. The 9558Q is a two inch diameter end window tube with eleven venetian blind dynodes having highly stable CsSb secondary emitting surfaces. The Spectrasil window gives better transmission of UV than natural quartz. The photocathode is the S-20 (tri-alkali) type employing unique EMI geometry. The results are high quantum efficiency (23-25% at peak) and exceedingly low dark current, (typically .002uA. at 200 A/L). Where the exact wavelength is unknown, or the entire spectrum is under investigation, the 9558Q enables the work to proceed without changing detectors.

Where the red sensitivity of the tri-alkali photocathode is most important, and the UV region is not, the 9558B, with a pyrex window (but all the other desirable characteristics of the 9558Q) may be substituted at much lower cost. Tubes can be specially selected for difficult astronomical tasks, laser range finders, red channels of flying spot scanners, etc.

Write for details on S-20 tubes in a complete range of sizes.

GENCOM DIVISION varian/EMI

80 EXPRESS STREET, PLAINVIEW, N. Y. 11803
TELEPHONE: (516) 433-5900

... for incoming inspection purposes,
analyzer can spot variations within lots ...

very intimate tool, says Vanzetti. The optical fiber is from 0.0005 to 0.0025 inch in diameter, with the finest commonly used fiber 0.001 inch in diameter. This means that the analyzer can easily view junctions only 0.001 inch wide, and track along their length to detect variations in performance. Vanzetti figures that dimensional resolution already is good enough for most anticipated LSI checkout applications.

At first, he expects the analyzer to be used in failure analysis to probe for faults, junction by junction, throughout an IC. Quality con-

Benefits. "For the first time," says Vanzetti, "design engineers will be able to detect crosstalk, proximity effects, and (with waveform eductors) pulse distortion. Large-scale integrated circuits tell us less about their internal operation than almost any other electronic assembly. With only a transfer characteristic to work on, lots of questions about inner workings are left unanswered. Perhaps the analyzer can be of some help in clearing things up."

Vanzetti expects that eventually pulse shape analysis and junction performance studies will be made

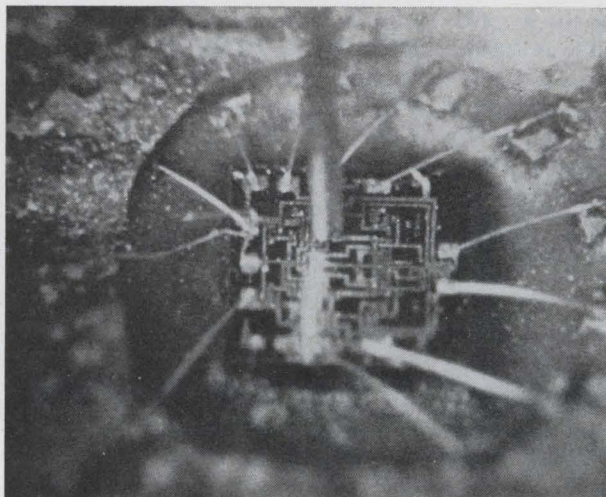

On site. Optical fiber sheathed in metal detects IR radiation from a section of IC chip.

trol engineers should also be interested in the instrument since recombination radiation is higher as current density is increased. Thus it becomes possible to detect shallow diffusion or bunching of current into small areas within a junction. This application has already helped a maker of microwave switching diodes. Using Vanzetti's prototype, the maker inspected a new p-i-n diode and found 80% of the applied current bunching into only 20% of the length of the junction. The product was pulled out of the production schedule as a result; if the diode had been built in quantity, this bunching could have led to widespread unreliability due to a failure mechanism nearly impossible to track down by normal means.

as a matter of course before new circuits or devices are released for production. This should be especially true of large digital circuits which clock at high rates; with engineers moving to coaxial or strip transmission line to preserve pulse shape, Vanzetti figures that they'll be just as eager to spot degradation within LSI devices themselves. The analyzer can be an incoming test device, checking vendors' products against one another by spotting semiconductor-junction variations within lots.

The price is \$9,850 for a single analyzer; in lots of 50, the price falls to \$8,350. Delivery time is three months.

Vanzetti Infrared & Computer Systems Inc., 515 Providence Hwy, Dedham, Mass. 02026 [338]

We're right on the edge of something small!

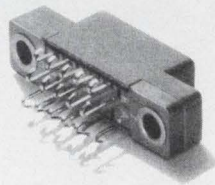

Finding just the right edge-board connector for your sub-miniature pc boards can be a very small matter once you decide which type of connector in our TRIAC-50 Series can do the best job for you. Standard units feature 20, 40, 60 or 80 contacts on .050 centers for 1/32" or 1/16" double-sided boards. "Bellows" design

 maximizes contact area, and triple spring action assures firm electrical connections and minimizes board wear. (There's practically no limit to the number of insertions and removals possible.) The special body design guards contacts against harm from mis-aligned insertions, too. Available either with solder hooks or straight pin terminals.

You say you need a more exotic configuration? Then call or write us today—our custom-designers have some good news for you!

 **FABRI-TEK**
NATIONAL CONNECTOR DIVISION

9210 Science Center Drive Minneapolis, Minn. 55428
Phone 612-533-5361 TWX 910-576-2866

Computer Controlled FM Demodulator System

provides the data acquisition/reduction community with the following advanced features . . .

- System is capable of demodulating "any" FM format up to 1.5MHz.
- Front panel programmable or computer interfaced for automatic operation.
- Excellent adjacent channel rejection characteristics . . . greater than 40dB at three deviations from center frequency for all constant bandwidth channels.
- Only FM demodulator capable of reducing a data channel where the wow and flutter components exceed the actual data bandwidth.

■ Unique internal crystal standardization negates the need for system recalibration.

■ Lower harmonic distortion than any other available tunable FM demodulator . . . typically less than 0.5% at a modulation index of 5.

These features and many others are explained in detail in a new Application / Design Bulletin. For your copy, contact: Data-Control Systems, Inc., Commerce Park, Danbury, Conn. 06810



DATA-CONTROL SYSTEMS, INC.

Feed it just about anything



Compact CO₂ laser puts out 300 watts

In modular design, tubes are stacked in oscillator pairs for desired power; first models used to cut ceramic substrates for hybrid circuits

The customary way of boosting the power output of a carbon dioxide laser is to make the tube longer, since the power goes up at about 60 watts per meter of length. A new heat-transfer technique announced last year allows higher output per unit length [*Electronics*, Sept. 29, 1969, p. 154]. Now, the Korad department of Union Carbide Corp. takes a third approach—a two-tube

version in which the tubes are stacked one above the other and connected optically in series by two 45°-angle mirrors in a machined mirror mount.

Each of these mirrors bends the beam, turning it around and sending it back through the other tube. These two tubes act as an oscillator pair, their 50-watt outputs combining to give a 100-watt out-

put. Two or more tubes, each five feet long, are housed in a compact head that measures 67 inches in length. In this modular approach, the head can be made wider to accommodate additional tubes, and as many as six are used in one model. The first four models in the new series have outputs ranging from 50 to 300 watts.

Besides being compact, one of the



Real-time tape control automates production of IC and LSI step-and-repeat photomasks in any pattern. Placement of images is fully automatic in both the X and Y axes and may be programed as desired on 1-mil centers. Mixed arrays of different images with random periodicity between image centers can be produced automatically. The Jade Corp., Huntingdon Valley, Pa. 19006 [421]

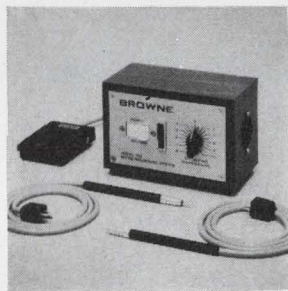

Autopulse soldering system model 150 is for delicate hybrid IC soldering processes. It is supplied complete with a stepless variac power supply, foot switch actuator, micro-loop hand probe, microgap tungsten resistance hand probe, and a full assortment of replacement tip elements. Price is \$175. Browne Engineering Co., Coast Village Circle, Santa Barbara, Calif. [422]

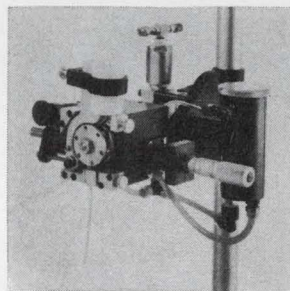

Designed for the automated dispensing of 500 micrograms to 500 milligrams of reactive resins and chemicals, the Picoshot adapter is for precision bonding, potting, and junction coating in the semiconductor and components industry, and for precision application of adhesive products in assembly operations. Fluidyne Instrumentation, Mt. Diablo Blvd., Lafayette, Calif. [423]

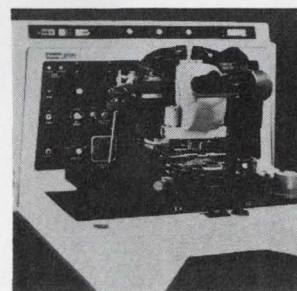

Fully automatic mask alignment system called Autolign 2686 is designed for integrated circuit production. It accommodates wafers up to 3 in. in diameter and positions mask-to-wafer with an accuracy of better than 1 micron. Typical alignment time is 4 to 6 seconds versus the conventional 20 to 30 seconds. Price is \$29,750. Kulicke & Soffa Inc., Fort Washington, Pa. 19034 [424]



Screen printer model 1200-TT is a fully automatic machine tooled for high speed printing of conductor and resistor patterns on ceramic substrates. It screens fine lines—down to 0.003 in.—at rates up to 1,600 pieces per hour with ±0.001 in. repeatability, even on substrates with a 20% variation in thickness. Wells Electronics Inc., 1701 S. Main St., South Bend, Ind. 46623 [425]

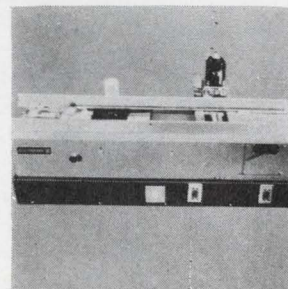

Bench type wave-soldering system model 94 is designed for fully automated production of chips, substrates, micromodules, flat-packs, or p-c boards up to 6 in. wide. It consists of a foam fluxer, preheater, soldering unit, board-holder carrier and conveyor. It operates at temperatures up to 600°F. Price is under \$3,000. Electrovert Inc., 85 Hartford Ave., Mt. Vernon, N.Y. [426]

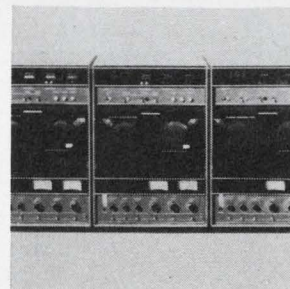

Automatic plasma machine IPC 2003 is designed for wafer stripping and photoresist removal. It contains two 3-x-6-in. plasma reactors, and a single reactor window covers both reactors. It has three automatic cycles, each of which can be set at 0-300 watts, 0-900 cc per minute gas flow, and 0-99 minutes. Monte Tool Associates, 25222 Cypress St., Hayward, Calif. [427]

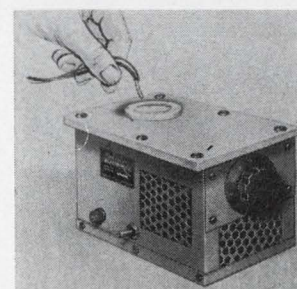

High-temperature (in excess of 1,300°F) silver soldering pot eliminates need for chemical or abrasive removal of film insulation and use of soft solder and soldering iron when joining magnet wires to leads. Dipping wires into molten solder simultaneously strips insulation and encases them in a permanent silver solder coating. Precision Electronics Corp., Marshfield, Mass. [428]

more than a power supply

You get more than a power supply when you specify this or any Hewlett Packard power supply. An international network of 220 sales/service offices are at your disposal . . . the most comprehensive service manuals detailing every aspect of the supply from theory and operation to troubleshooting . . . protection circuitry including an internal overvoltage "crowbar" to safeguard delicate loads, standard on this Low Voltage Rack (LVR) Series. OUTPUTS: 10V @ 20, 50, or 100A; 20V @ 10, 20, or 50A; 40V @ 3, 5, 10, 30, or 50A; 60V @ 3 or 15A. RIPPLE AND NOISE: typically 200 μ V rms, 10mV p-p. Remote Programming and lots more. Prices start at \$350.

and you can customize it with these options . . .

- 10-Turn Output Voltage and Current Controls
- Chassis Slides
- 3-Digit Graduated Decadial for Voltage or Current
- 115V, 208V, or 230Vac Inputs
- 50Hz Input.



HEWLETT  PACKARD

POWER SUPPLIES

Over 100 power supplies are described in the 1970 HP Electronics Catalog. Write for your copy.

100 Locust Avenue, Berkeley Heights, New Jersey 07922 (201) 464-1234

hp DC POWER

From 10 μ V to 4000V

From 1 μ A to 2000A

From \$90 to \$3,500

From manual to computer controlled.



LOW COST SUPPLIES

Compact laboratory power supplies can be stacked or rack mounted. Choose from 6 well-regulated models: 10V @ 1A; 25V @ .4A; 50V @ .2A. Three Constant Voltage/Current limiting models — \$90. Three Constant Voltage/Constant Current models — \$115.

Constant Voltage/Constant Current with Automatic Crossover, Remote Programming, Remote Sensing, Auto-Series or Parallel, Optional Internal Over-voltage "Crowbar"

MEDIUM POWER / TRANSISTOR REGULATED

Precisely regulated. Programming speeds as fast as 500 μ s. 20 models: 7.5V @ 3 or 5A; 10V @ 10A; 20V @ 1.5, 3, 5, or 10A; 30V @ 1A; 40V @ .75, 1.5, 3, or 5A; 60V @ 1 or 3A; 100V @ .75A; 160V @ .2A; 320V @ .1A. \$144 to \$395.



MEDIUM POWER / SCR REGULATED

8 models: 20V @ 15 or 45A, 40V @ 10 or 25A; 60V @ 5 or 15A, 120V @ 2.5A; 600V @ 1.5A. \$360 to \$550.

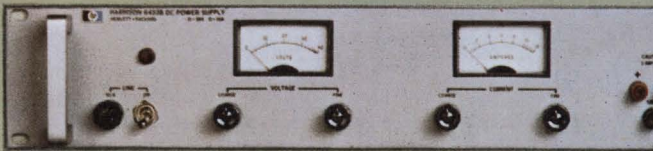

HIGH POWER/SCR REGULATED

12 Models: 4V @ 2000A; 8V @ 1000A; 18V @ 500A; 36V @ 300A; 64V @ 150A; 110V @ 100A; 220V @ 50A; 300V @ 35A; 600V @ 15A. \$1275 to \$3500.

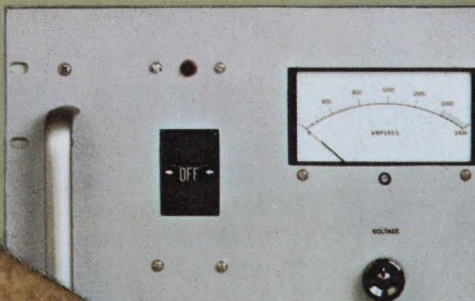

Korad units, the KG-26, is said to be the most powerful CO₂ laser operating in the fundamental mode (single mode) that is commercially available. Its continuous-wave output is 300 watts in the fundamental mode, which is designated by the expression TEM 00. Brian Woodcock, Korad product line manager for gas lasers and the designer of this new series, says the closest commercially available competitor is a laser made by Coherent Radiation Laboratories that puts out 200 watts c-w in the fundamental mode, and is 10 feet long.

Woodcock says he decided that if the laser tubes could be built in pairs, the power could be boosted by linking up additional frames of two-tube units. Thus Korad settled on a basic two-tube design, and incorporated it in the KG22, a unit that puts out 100 watts c-w in the fundamental mode (each model in the series has about 25% greater power in multimode operation) for an input of 50 amperes. Beam diameter is 8 millimeters and beam diver-

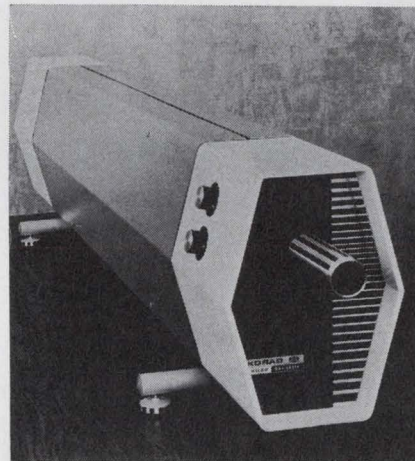

Power pack. Gas laser head houses tubes stacked in oscillator pairs for compact power.

gence is just 2 milliradians in the fundamental mode. The KG22 sells for \$12,550.

A one-tube version has been housed in the same head as the KG22. It's designated KG21, puts out 50 watts c-w in the fundamental mode with a 30-amp input, and costs \$8,200.

Adding up. The KG24 has a frame of four tubes and is mounted in a head 24 inches wide vs. the KG22's 12-inch width. The KG24's c-w output in the fundamental mode is 200 watts with a 70-amp input. Its beam diameter is 8mm and beam divergence is 2 milliradians. The price is \$21,400. The most powerful in the series, the KG26, is the 30-watt unit (100-amp input) that requires six tubes, is 26 inches wide, has a 9-mm beam diameter and a beam divergence of less than 2 milliradians. It costs \$28,500.

This modular approach is unusual in lasers, says Woodcock, who maintains that the design is stable enough to go to 500 watts. "Which is about as much as anyone needs in industrial applications," he says. Mechanical stability is critical to the Korad "add-a-frame" approach to boosting laser power. "To be able to line up a number of tubes this way," Woodcock explains, "we need very stable mirror

BUGS ARE BIG BUSINESS

Every year a million dollars go down the drain because "bugs" are big business in components. Buggy coils and transformers can cause many costly breakdowns. It's enough to bug anyone! And it's about time bugs were stamped out. For years Delevan has been waging an intensive campaign to exterminate this threat. That's why Delevan uses X-Ray and fluoroscopic equipment to insure consistent quality and long life in its magnetic components. Long ago, Delevan adopted rigorous manufacturing controls in order to meet stringent military standards. A continuous audit of these controls is conducted by our Defense Supply Agency approved environmental laboratory. That's why Delevan is testing to the latest revision on Mil C 15305 rev. D—testing that includes 2,000 hr. life test, 15 g force vibration, 50 g force impact, 10 day moisture resistance, and temperature cycling. And that's how Delevan catches the bugs before they catch you. Send for a Catalog of Our "bugless" Products.

Delevan  **AMERICAN
PRECISION
INDUSTRIES INC.**
Division

270 QUAKER RD. / EAST AURORA, N. Y. 14052
TELEPHONE 716/652-3600 TELEEX 091-293
OTHER DIVISIONS OF AMERICAN PRECISION INDUSTRIES INC.: BASCO • DUSTEX •
MOELLER INSTRUMENT CO. • OXFORD CORP. • TRUCK EQUIPMENT CO.

mounts and a minimum of adjustments. We've built a very rigid framework for the section holding the tubes."

Woodcock singles out two other features for the series as being significant. It uses electrically isolated power supplies; and a versatile electronic controller enables the series to have a wide range of pulse lengths and repetition rates. The controller also helps adjust the current "to get maximum benefit from short pulses," Woodcock notes. He says electrically isolated power supplies—isolated from each other and from ground—are important because the gas discharge in a CO₂ laser is an unstable phenomenon. "We have to isolate the tubes from each other because we want to pulse them and control the tube current accurately," he says. When a gas laser is pulsed, the gas must break down instantaneously; and, if the tube is producing coronas, they can cause timing problems and variability in performance. "Grounding one end of the tube eliminates the coronas," Woodcock asserts, "and also contributes to greater operator safety."

Cut-up role. The units have been used by Korad to cut apart ceramic substrates bearing thin film Ni-chrome resistors and gold interconnects. These are substrates up to 2 inches square (some as large as 6 inches square) in which the passive component pattern is repeated in much the same way as it is on a silicon wafer for integrated circuits. The laser cuts the substrate into its smaller parts, on which active semiconductor dice can be mounted. Korad officials maintain that laser cutting gives better yields than diamond cutting, and offers lower hourly operating costs than diamond cutting, even though the latter is less expensive initially.

Korad is also working with customers in an application that uses the lasers to weld hybrid circuit lids to the packages, with no heat reaching the components.

The units all have a wavelength of 10.6 microns, a pulse length from 200 microseconds to 1 second, and a pulse repetition rate from one to 5,000 pulses per second.

Korad Department, Union Carbide Corp., 2520 Colorado Ave., Santa Monica, Calif. 90406 [429]

RCA COS/MOS makes MSI also mean multiple-saving integration

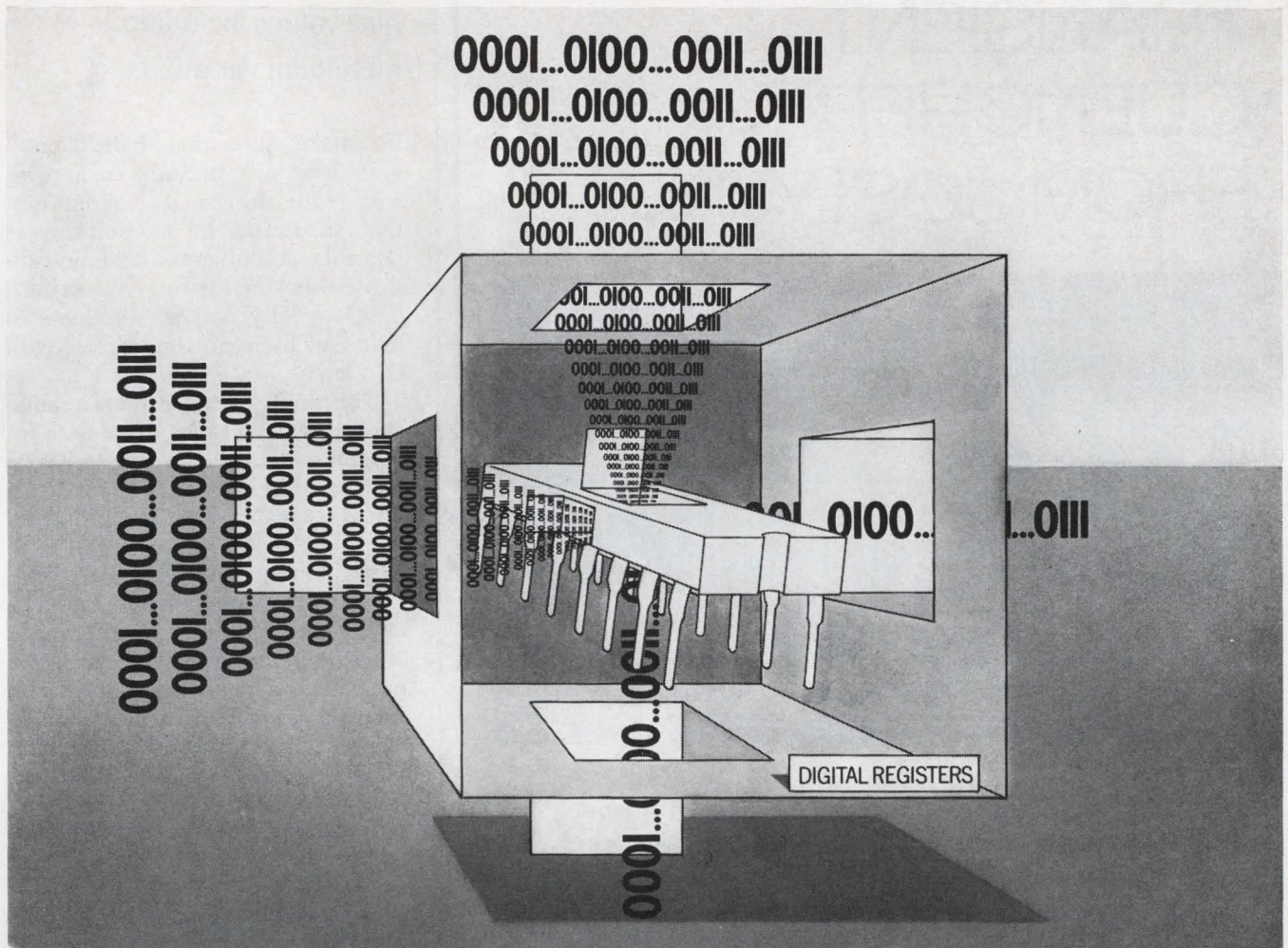

New CD4014D and CD4015D COS/MOS Registers provide cost-saving benefits of MSI

RCA COS/MOS digital IC's provide:

- Operation from a single power supply—6 to 15 V
- Low quiescent power dissipation—5 μ W (typ)
- High noise immunity—45% of V_{DD} (typ)

Think of these characteristics in terms of system reliability, minimum package size and elimination of extra circuits and components. Low power means simpler, less expensive power supply circuits; tighter packaging density (no special cooling devices required). COS/MOS IC's mean greater tolerances to power-supply voltage and signal amplitude variations. And the high noise-immunity characteristic eliminates the need for special noise-suppressing circuits. COS/MOS has other logic system design advantages, too: medium speed operation [f_{CL} = 2.5 MHz (typ) at V_{DD} - V_{SS} = 10 V]; fully static operation; full military temperature range, and single phase clocking.

CD4014D (formerly Dev. No. TA5578) is an 8-stage synchronous parallel-input/serial-output register; CD4015D (formerly Dev. No. TA5579) is a dual 4-stage serial-input/parallel-output register. Each device is available in 16-lead DIL ceramic packages at \$13.60 (1000 or more units).

For further details on the two new COS/MOS Registers and RCA's growing COS/MOS line, see your local RCA Representative or your RCA Distributor. For the technical data bulletins on the new Registers (File Numbers 415 and 416) and a new COS/MOS Reliability Report (RIC-101), write to RCA Electronic Components, Commercial Engineering, Section ICN2-2, Harrison, N. J. 07029. In Europe: RCA International Marketing S.A., 2-4 rue du Lièvre, 1227 Geneva, Switzerland.

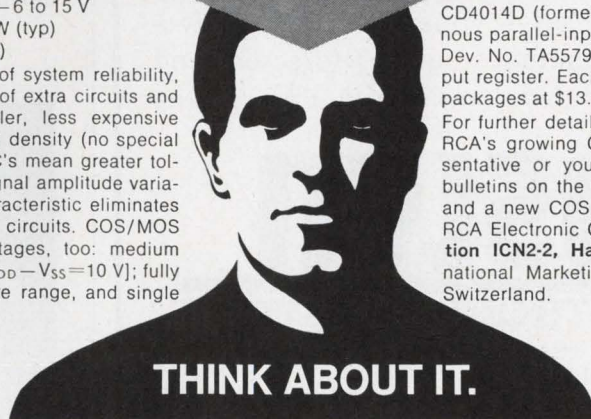

THINK ABOUT IT.

RCA Integrated Circuits

THE COCKY LITTLE TRANSIENT QUENCHER FROM JOSLYN

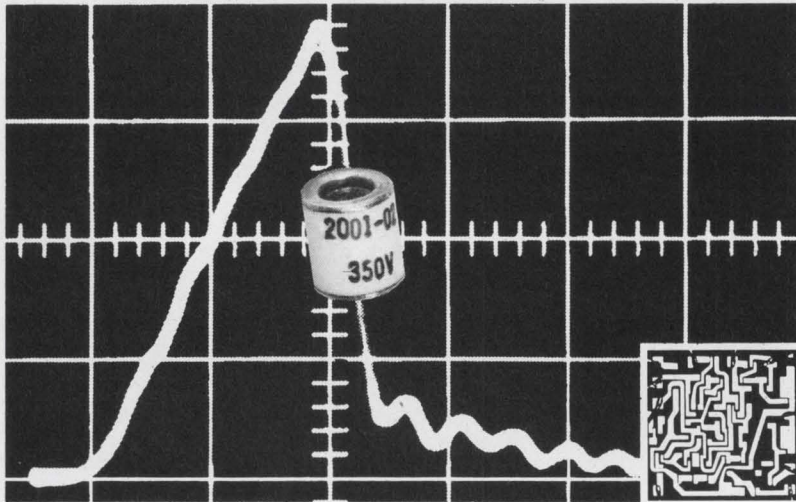

2001-01 350V Transients have never been able to knock off solid-state electronics when Joslyn precision protection devices are on guard duty. *Never! They quickly extinguish damaging transients with extreme accuracy, nano-second response, and high repeatability over an unequaled period of time. Ideal for protecting AC and DC input lines, RF systems (transmitting or receiving), balanced and unbalanced transmission lines, radar modulators, traveling wave tubes, and cathode ray tubes. Contact Joslyn today for full information and delivery from stock for the field-proven cocky little spark gap that will solve your particular protection problem. Full line includes surge protectors and lightning arresters. *when properly selected and connected



JOSLYN

ELECTRONIC SYSTEMS

Joslyn Electronic Systems Santa Barbara Research Park
P.O. Box 817 Goleta, Calif. 93017 Tel. (805) 968-3551

1813

Production equipment

Substrate flatness, thickness checked

Instrument can measure
nine values including
metal-film variations

To make sure that hybrid integrated circuits perform in accordance with design, it is important that substrates be as uniform as possible. A universal ceramic-substrate checking instrument has been developed by Aremco Products to help microcircuit engineers with this job.

The unit, called the Cerama-Probe 118, consists of a dial indicator capable of reading to 0.0001 inch, a vacuum manifold for holding the ceramic substrate, and an x-y table used to move from point to point in increments of 0.001 inch.

In a few minutes, the microcircuit engineer can check: thickness of a substrate, variation of thickness over the surface of the substrate, relative flatness, or camber; thickness of thick-film metalization, variation of thickness, hole locations, line widths and variation of thick-film metalization, spacing of metalization thickness, and variations of thickness.

The model 118-A, which permits checking all of these values, is priced at \$545. The 118-B, which sells for \$285, does not have the micrometer-controlled x-y platform and is used primarily for rapid checking of substrate and metalization thickness.

Aremco Products Inc., P.O. Box 145,
Briarcliff Manor, N.Y. 10510 [430]

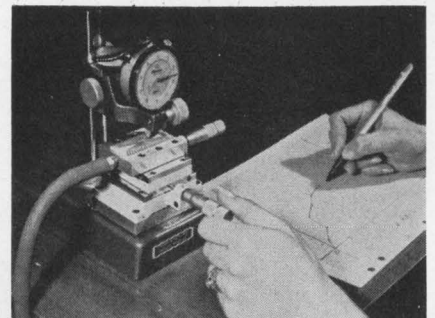

If all systems aren't "GO"
after the computer's moved,
you know who's going to hear about it.



If you'd just as soon skip a spicy conversation with the Data & Systems people, have a quiet one with Allied instead.

Allied Van Lines has highly-trained professionals who know just how to move your electronics equipment—safely and on schedule.

And our Electronic Vans are just as good as our personnel. They have a special bracing that keeps your computer from shifting . . . an air suspension system that soaks up jolts and bumps along the way.

Call the highly-trained Allied Agent in your area.



ALLIED VAN LINES®

**We make the kind of moves
you never hear about**

Circle 213 on reader service card

Automatic mask aligner is accurate to 1 micron

Electronic technique for production of integrated circuits eliminates operator error, does job in a few seconds

In the photochemical process of manufacturing integrated circuits, one of the toughest decisions an operator faces is determining when the mask is properly aligned with the wafer. For each layer, the operator inserts a mask that contains the electrical pattern to be deposited, and clamps the mask to the wafer when he thinks the mask is correctly aligned with the other de-

posited layers. At best, this method is limited by operator skill.

But an automatic mask aligner, called the Autolign 2686, removes the inconsistency and error due to the operator's judgment and skills. Besides speeding the operation—a mask can now be aligned in a few seconds, compared to the 30 seconds required in manual methods—the Autolign guarantees align-

ment to within 1 micron.

The Autolign was developed by the Computer Vision Corp. of Burlington, Mass., and is marketed by Kulicke and Soffa.

Mask alignment is similar to multicolor printing where several colors are positioned with respect to a registration mark to produce a composite picture of color patterns. In IC manufacturing the elements or

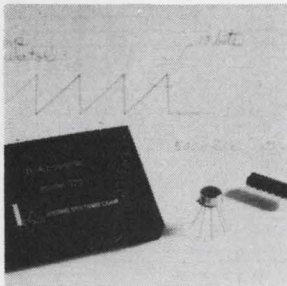

D/A converter model 320 contains a complete set of switches and a resistance ladder. Full scale output is 15 ma which may be converted to a voltage by means of a resistor to ground. The unit's fast settling of 750 nsec for 10 bits and 200 nsec for 8 bits makes it suitable for use in graphic display systems. Hybrid Systems Corp., 95 Terrace Hall Ave., Burlington, Mass. 01803 [381]

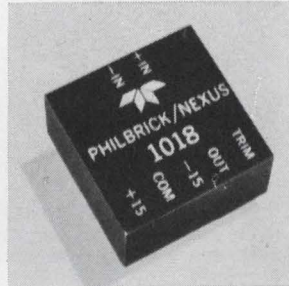

Chopperless, differential operational amplifier model 1018 features low drift. It employs dual-input transistors with a precision metal-film resistor and a bias current compensation network. This results in high thermal stability and low static offsets. Typical gain is 2,000,000; output, ± 3.5 ma at ± 13 v. Philbrick/Nexus Research, Allied Dr. at Route 128, Dedham, Mass. [382]

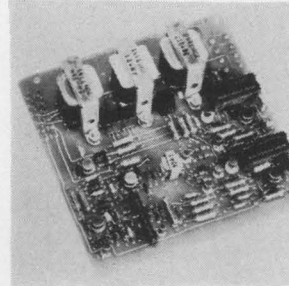

Synchro-to-sine/cosine converter series 421 features automatic voltage compensation. It will accept the output of a standard three-wire synchro and provide two isolated d-c voltages: one corresponding to the sine of the rotor shaft angle, and one corresponding to the cosine. Price is about \$400-\$450. Natel Engineering Co., 8944 Mason Ave., Canoga Park, Calif. [383]

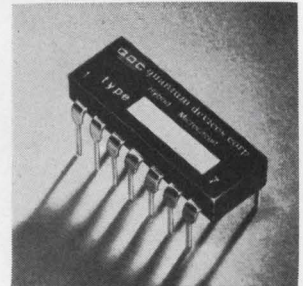

Operational amplifier OA201 features a 150-ma output at 10 v. Packaged in dual in-line configuration it is also available as a hermetically sealed unit. The amplifier is short circuit proof. It operates at a very low input bias current, 200 na. Offset voltage is $25 \mu\text{v}/^\circ\text{C}$, and open loop gain is greater than 100,000. Quantum Devices, 15 W. Main St., Bergenfield, N.J. [384]

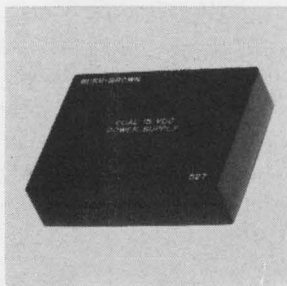

Encapsulated power supply model 527 provides two 15 v power supplies capable of common external connections with an accuracy of 1%. Each separately regulated supply provides a full 50 ma of output current. Output regulation, line or load is $\pm 0.2\%$. Temperature stability is $\pm 0.02\%$ / $^\circ\text{C}$. Price is \$39; delivery, stock to four weeks. Burr-Brown Research Corp., Tucson [385]



High input impedance, wideband video amplifier 4376 offers high gain and low equivalent input noise. It is useful for amplifying signals from high impedance sources and for increasing the sensitivity of lab instruments such as a wideband oscilloscope or an r-f voltmeter. It features built-in protection circuitry. Price is \$395. C-Cor Electronics Inc., State College, Pa. [386]

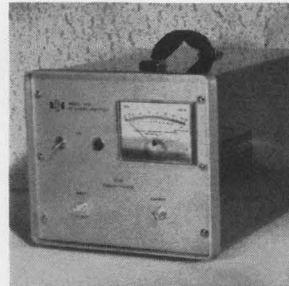

Power amplifier model 310L can provide over 10 watts of r-f power output from 250 khz to 110 Mhz. Its flat 50 db gain permits it to be driven to its full power output by all signal and sweep generators. Applications are in antenna testing, transmitter design, laser modulation and rfi/emf testing. Electronic Navigation Industries Inc., Main St. East, Rochester, N.Y. [387]

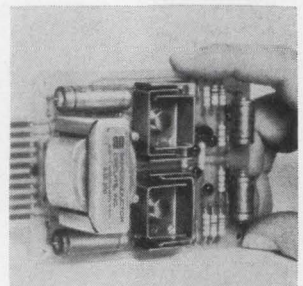

Plug-in power supplies series J feature an isolation factor of 10,000 megohms with 1 pf maximum capacitance. They are for use with medical instruments, machine tool controls, strain gauge bridges, and transducers. Series includes both single and dual d-c outputs at 10, 12, and 15 v and 50, 100 and 200 ma. Semiconductor Circuits Inc., Merimac St., Woburn, Mass. [388]

Hugle Industries offers unequalled capacity and performance in silicon epitaxial reactors.



Fulfill your silicon epitaxial production requirements with Hugle Industries VERTICAL BARREL REACTORS.

The Hugle Industries Vertical Barrel Reactor has the proven combination of high production rates and close tolerances required for modern semiconductor operations.

UNIFORMITY The unique flow pattern of the Hugle Industries Vertical Barrel Reactor has provided remarkably uniform silicon epitaxial deposits. In evaluation tests for a leading semiconductor manufacturer at the Hugle Industries Applications Laboratory, the reactor pictured above produced silicon epitaxial deposits with better than 3% average thickness deviation at 7 microns and better than 12% average resistivity variation at 11 ohm-cm on a full 40 wafer susceptor load.

FEATURES The Hugle Industries Vertical Barrel Reactor incorporates several unique features such as Reactor Control Unit which permits virtually 100% time utilization of the generator and programmer through its unique pre-purge and post-purge system Water-cooled stainless steel shell which absorbs 100% of the radiated energy, thus reducing the air conditioning requirements to less than 25% of competitive units Injection Block System which provides rapid gas change, low maintenance, and independent vent/deposit capability for each flowline A newly updated Real Time Automatic Program Controller which permits program changes in any time interval without affecting the remaining time intervals.

CAPACITY Each susceptor of the Hugle Industries Vertical Barrel Reactor will hold 40 two-inch wafers in outward facing pockets designed for easy wafer removal. With automatic pre-purging and post-purging of N₂ and H₂ programmed

by the Hugle Industries Reactor Control Unit, a dual barrel system is capable of 120 two-inch wafers per hour with a 15 minute deposition time. This high capacity is available with only 75 KW of 10 KHz power. No additional air conditioning is required because the entire deposition system is contained within a water-cooled stainless steel bell-jar.

Make an appointment! Bring your samples to the Hugle Industries Applications Laboratory for demonstration on our Vertical Barrel and Horizontal Epitaxial Reactors.

750 North Pastoria Avenue, Sunnyvale, California 94086, (408) 738-1700.

Other Hugle Industries products include Diffusion Doping Systems Model 100 Infrared Microscope Model 1350 Ultrasonic Wire Bonder Model 1400 Beam Lead Bonder Model 2100 Universal Assembly Machine Model 2000 Flip Chip Bonder Die Attachers Fully Automated Assembly Lines.

 **Hugle Industries, Inc.**

First in service to semiconductor manufacturers

How Small is Big Enough?

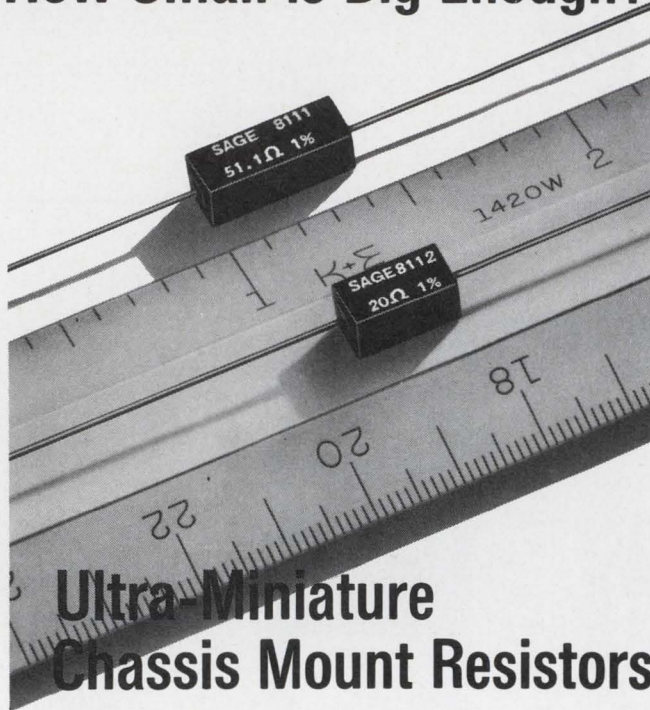

Ultra-Miniature Chassis Mount Resistors NEW from SAGE!

PROBLEM: To produce, for aerospace application, out-board resistive components for use with hybrid and/or integrated circuits which combine minimum size with maximum efficiency and reliability; also to provide mounting ease and flexibility using component clips, clamps or high temperature epoxy bonding materials

SOLUTION: The new Sage Ultra-Miniature Chassis Mount Resistors shown here!

STYLE 8111: 7 WATTS CHASSIS MOUNTED—3.5 WATTS FREE AIR—LESS THAN 0.015 IN³ VOLUME

STYLE 8112: 5 WATTS CHASSIS MOUNTED—2.5 WATTS FREE AIR—LESS THAN 0.009 IN³ VOLUME

Part	Length	Width	Height	Standard Ranges Resistance
8111	0.430" ± 0.015"	0.156" ± 0.005"	0.165" Max.	.05Ω-13KΩ
8112	0.305" ± 0.015"	0.156" ± 0.005"	0.165" Max.	.05Ω-6KΩ

ACCURACY: Tolerance to ± 0.05%

PERFORMANCE: Meet or exceed all applicable requirements of MIL-R-18546

Free air rating is based on maximum surface hot spot temperature of 275° C.

Chassis mount power rating is based on maximum surface hot spot temperature of 150° C when mounted on 4" x 4" x 0.040" aluminum chassis.

For complete engineering data on these new Sage achievements in miniaturized electronic products, write . . .

**SAGE ELECTRONICS CORP. • BOX 3926
ROCHESTER, N. Y. 14610 • Phone: (716) 586-8010**

Precision Power Resistors

SAGE
ELECTRONICS
SUBSIDIARY OF GULTON INDUSTRIES, INC.

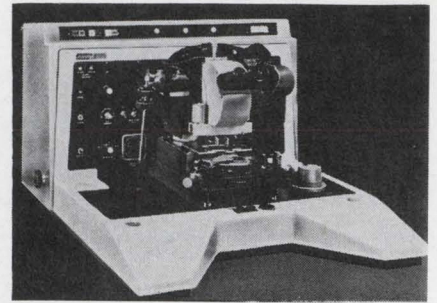

Arranger. Instrument aligns mask and wafer for manufacture of IC's

layers that are applied are the conductor wiring patterns and component parts such as collector and emitter junctions. As many as nine layers are used to build IC's.

In the Autolign process, a special recognition pattern is impressed on a small amount of silicon, typically less than 1%. This pattern serves as the registration mark and enables the machine to align each mask by scanning the marks and converting the information received from the scan into x, y, and angular error signals corresponding to cartesian and polar coordinates. The error signals drive servo motors which position the mask until the error is nulled and proper alignment is achieved.

The first layer of the IC need not be positioned very precisely—it is not being aligned with respect to any other layers. On this layer are deposited, typically, 500 identical patterns which eventually will become part of the IC. In two of these 500 positions, special machine patterns are substituted. When the machine scans the next layer, it looks only for the two special patterns and disregards the other 498 patterns. When it recognizes the two patterns, it generates signals corresponding to their location. Once the pattern is recognized, it takes only a few seconds to align the mask to within 1 micron of its proper position.

After the mask is aligned, the Autolign exposes the wafer to prepare it for the diffusion and metalization processes; the wafer is withdrawn and a new one substituted; and the process is repeated.

Price of the Autolign 2686 is about \$30,000.

Kulicke and Soffa, PLP Division, 135 Commerce Drive, Fort Washington, Pa. [389]

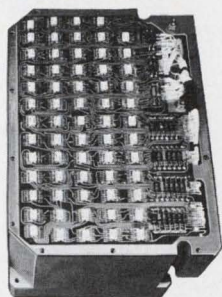
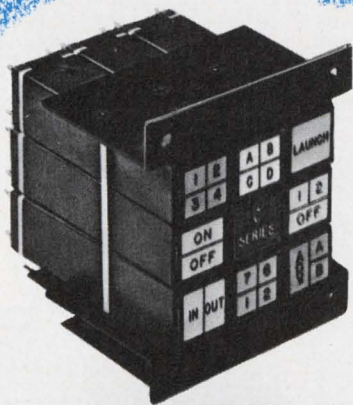

Avionic Assemblies

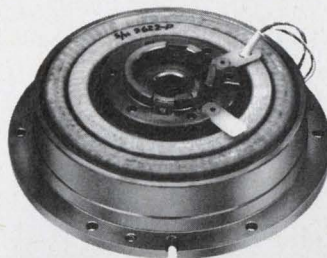

Servo Motors

Synchros and Resolvers

When it comes to Components and Avionic Assemblies

You Name It!
We have it or we'll make it



From the most basic rotating components to complex avionic assemblies, you can depend on Clifton quality, versatility and variety.

In synchros, what do you need in the way of accuracy, size, type, temperature, radiation or corrosion resistance, terminals or leads, double ended shafts, tandems, gyro pick-off or BuWeps types? We have everything!

In servo motors (AC, DC or stepper) and sophisticated motor rate tachometers, Clifton is an acknowledged leader.

In avionic assemblies, we use quality components coupled with creative design and

offer sophisticated avionic systems, actuators, analog computers, simulators, switches, and indicators.

Finally, in the solid state technologies which are in some cases replacing electro-mechanical assemblies, look to Clifton for the latest in A/D Converters, digital readouts, solid state servo repeaters.

For a willing response to your inquiry, contact your Local Clifton Sales Office or (215) 622-1000, Clifton Heights, Pa.

CLIFTON
DIVISION OF LITTON INDUSTRIES



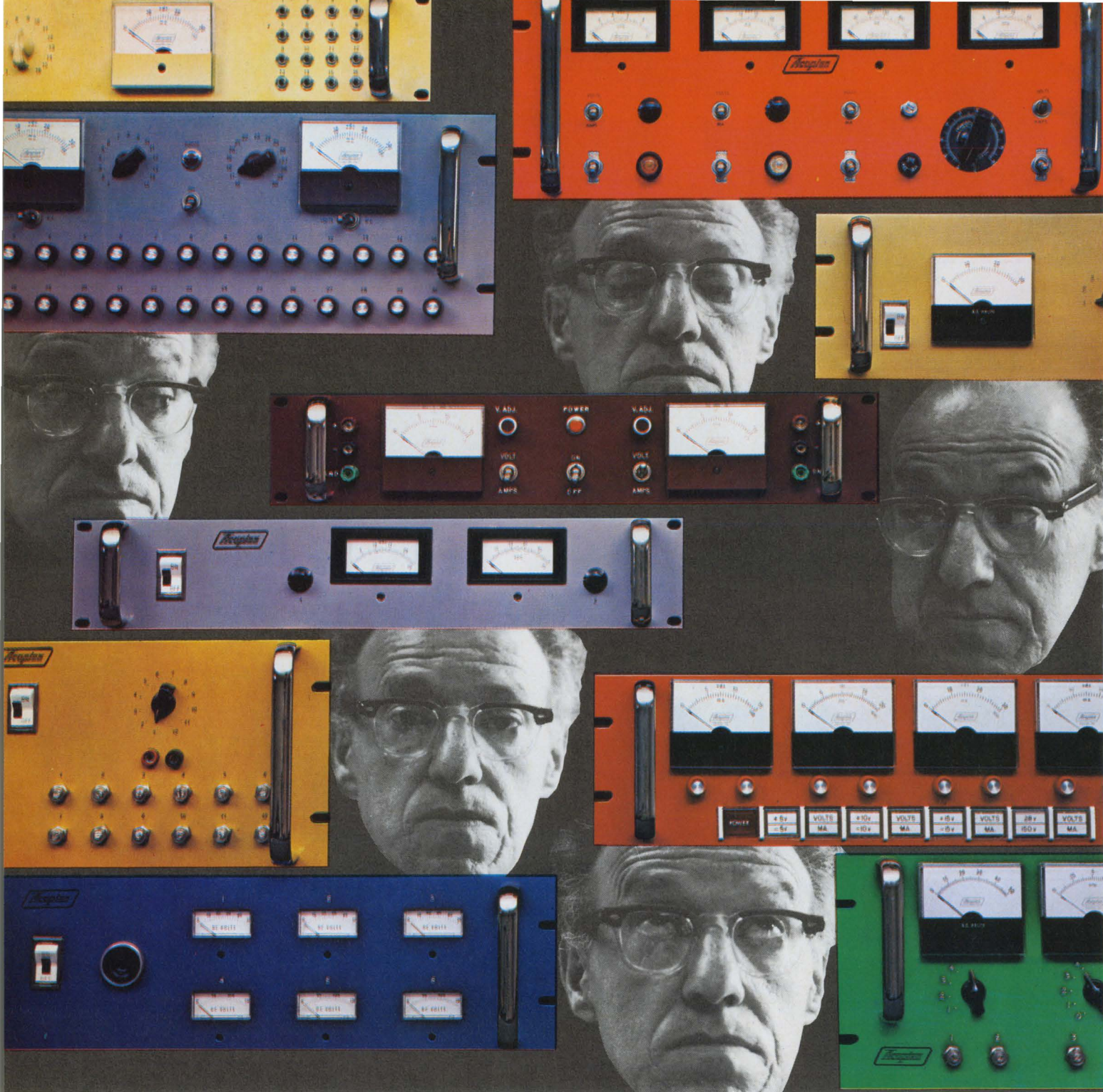

**Looking for a special power supply system?
Acopian will ship it in just 9 days!**

When you're looking for a multiple-output power supply system, and you need it in a hurry, look no further. Acopian will design it, build it, test it, and ship it...fully wired...in just 9 days!

Call 'hot line' 215-258-5441. Simply tell us the DC voltages and currents you need. We'll discuss—the power modules, the panel size, accessories such as meters, terminations, test jacks, rotary

switches or any other feature you feel is important. Then—on the phone—we'll give you a firm price—and get the order going for guaranteed 9-day shipment.

Others make promises. Acopian makes power supplies. Power modules in 3 days, and now power systems in 9 days. For immediate service, call 215-258-5441. For literature, write Acopian Corporation, Easton, Pa. 18042.



Circle 174 on reader service card

Counter line measures up to 500 Mhz

Dana Laboratories enters manual-control market with 5 models; top-of-line has sensitivity of 500 microvolts, 10-nsec resolution

Last summer, Dana Laboratories introduced its series 8100 automatic counters, designed for users who require more performance than a low-cost manual counter can offer, but don't need as much as the higher-cost automatic counters can supply. It was Dana's first entry into the counter business. Now the firm is invading the market for manual counters, too, with the in-

roduction of five models in a series designated 8000.

The aim is to offer instruments that compete with the lower-cost manual counters. The top-of-the-line model 8035 measures frequencies up to 500 megahertz, has a sensitivity of 500 microvolts and a time-interval resolution of 10 nanoseconds.

Dana says that competing units

measure up to 512 Mhz with a 10-nsec time interval resolution, but their sensitivity is listed at 50 millivolts, significantly higher than the signals at which the Dana unit will trigger. In addition, Dana spokesmen say, the competing machines require two plug-ins to achieve the 10-nsec time interval resolution while also measuring up to 512 Mhz; the Dana model 8035 offers

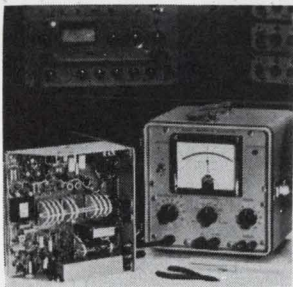

Phase angle voltmeter model 210 adds flexibility to field testing. It measures a-c voltages from 3 mv to 300 v full scale, in the range 20 hz to 40,000 hz. It also splits total input voltage into in-phase, quadrature, and fundamental voltage components, and measures phase angle between input and an arbitrary reference signal. North Atlantic Industries Inc., Plainview, N.Y. [361]

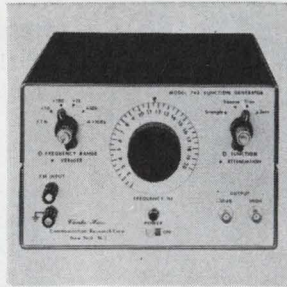

Function generator model 743 provides low distortion sine, square, and triangular waves over a dial-controllable range reaching 2 megahertz, with an output of up to 20 v p-p from a 50-ohm source impedance. In the frequency-modulation mode it is possible to sweep from 1 hz to 4 Mhz. Clark-Hess Communication Research Corp., 43 W. 16th St., New York 10011 [362]

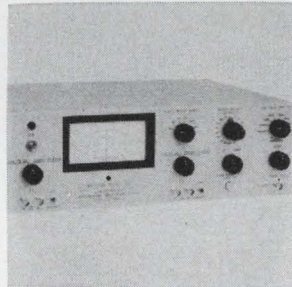

Audio-video phase meter model 352 has an extended low frequency response down to 0.5 hz with a high frequency response of 2 Mhz. A phase reference switch permits positive or negative phase measurements about 0° or 180° without phase discontinuities. Phase reading discrimination is 0.1°. Price is \$1,190. Wiltron Co., 930 E. Meadow Dr., Palo Alto, Calif. [363]

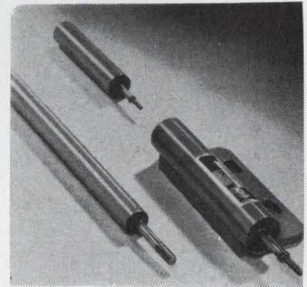

Miniature transducers models 3-120, 3-131, and 3-143 sense rectilinear displacements with an accuracy of 0.5%. They range in size from 3/8 to 3/4 in. o-d and have a life up to a million cycles and a resolution to 0.0006 in. Rugged and insensitive to shock and vibration, units are suited for military applications. Edcliff Instruments, 1711 S. Mountain Ave., Monrovia, Calif. [364]

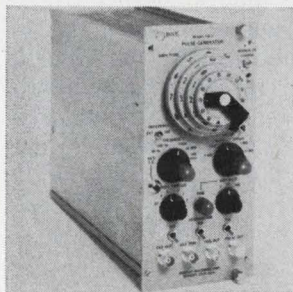

Pulse generator model PB-3 is designed to test amplifiers, analog-digital converters, and multi-channel pulse height analyzers. It offers $\pm 0.005\%$ integral linearity, ± 10 ppm/°C stability and operates at a repetition rate up to 100 khz. It features adjustable rise time from 50 nsec to 2 μ sec. Price is \$1,150. Berkeley Nucleonics Corp., 1198 Tenth St., Berkeley, Calif. [365]

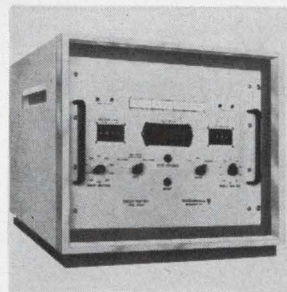

Automatic circuit test set AP-503 is for both production line and maintenance applications to reduce test labor costs by providing quick and accurate checks of cable conductors. Test ranges include 1 to 99 ohms for continuity checks, and 10 to 90 megohms at voltages to 1,500 v d-c for hipot/insulation resistance checks. TeleSciences Inc., Moorestown, N.J. [366]

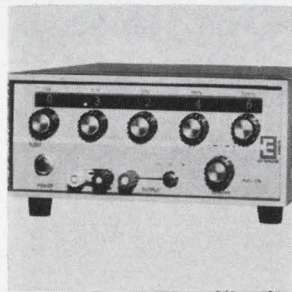

Variable d-c voltage standard model V-2000 features 1 μ v resolution and 0.005% accuracy. Output range is up to ± 11.1110 v in 5 decades. Front-mounted rotary switches control illuminated readout. A ± 1 mv vernier switch aids range control. Output current of 50 ma increases versatility. Price is \$625. Esterline Angus Division of Esterline Corp., Box 24000, Indianapolis 46224 [367]

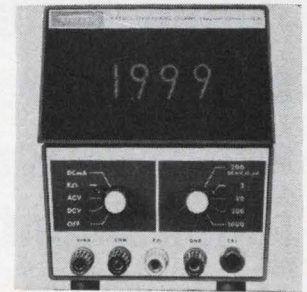

Digital multimeter model 262 is a complete test instrument with a basic d-c accuracy of 0.1% of reading. Nineteen ranges are available to measure d-c volts, a-c volts, d-c current and ohms. All d-c ranges are autopolarity for in-circuit testing convenience. The small and lightweight unit is priced at \$375. United Systems Corp., 918 Woodley Rd., Dayton, Ohio 45403 [368]

VACTEC

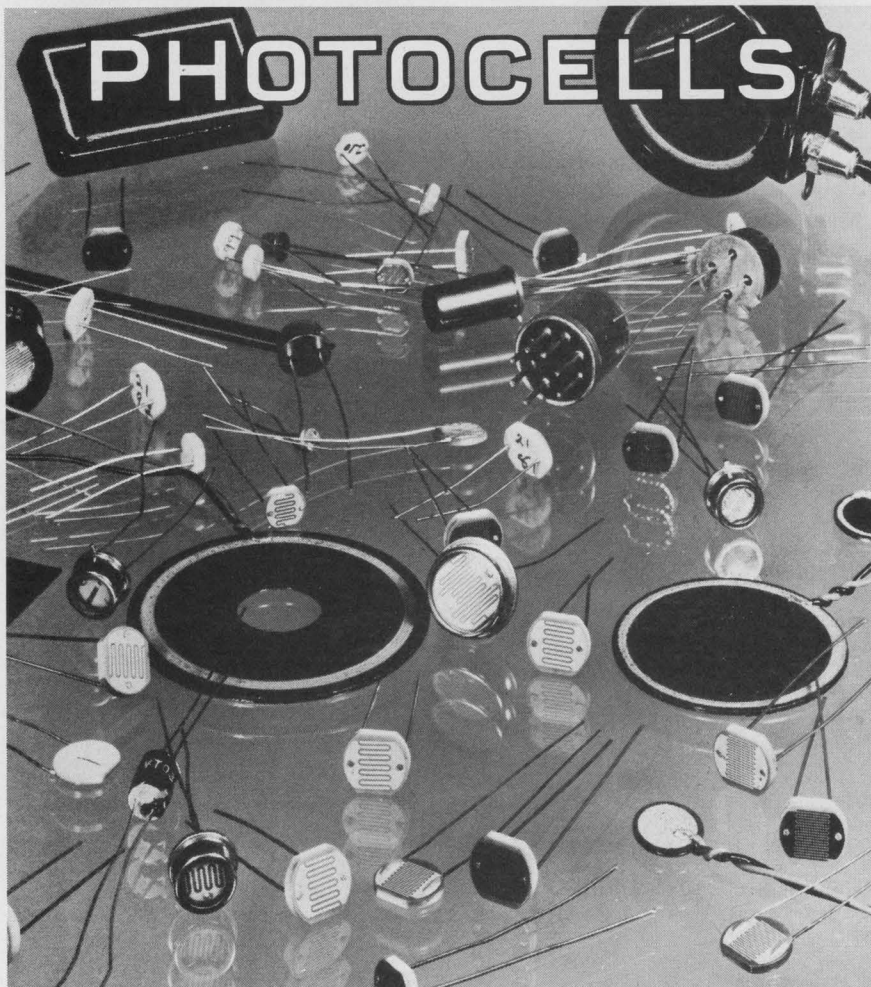

The world's most un-diversified company manufactures a standard or custom size and type for every requirement.

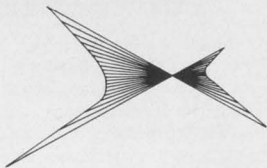

VACTEC, INC.

2423 Northline Ind. Blvd.
Maryland Heights, Mo. 63043
Phone (314) 872-8300

Write for Bulletin PCD-4 describing CdS and CdSe cells; for photocell lamp or LED modules request Vactrol Bulletin SPV-4A for Se types; or see EBG under "Semi-Conductors" or EEM Sec. 3700.

... automatic-gain feature
permits signal tracking ...

both features built in, and costs \$3,095 vs. a price of \$3,800 for two of the best known competitors in the industry.

Dana models 8020 and 8030 also offer frequency measurement to 500 Mhz with a sensitivity of 500 μ v. The 8020 sells for \$2,295, and the 8030 has a price tag of \$2,595.

The lowest-cost Dana model is the 8010, a counter-timer that measures up to 120 Mhz with a time-interval resolution of 100 nsec, sells for \$1,495, and will compete with at least five other instruments. But Dana spokesmen claim its 50mv sensitivity is better than all but one of the competitors, and its oscillator stability of three parts in 10^9 per day is better than three of the others and equal to that of the other two.

Resolution. The model 8015 is the other Dana instrument that offers a



Accurate count. New series measures frequencies up to 500 Mhz.

10-nsec time-interval resolution, the same as its principal competitors. Dana's unit is rated at 120 Mhz. It has a sensitivity of 50 mv and includes a highly stable trigger amplifier. Dana is specifying a stability for this amplifier of 5% full-scale. The stability is achieved partly through the use of differential amplifiers that are temperature-compensated for low drift under changing temperature conditions, and partly by employing low-leakage clamp diodes on the input. The model 8015 sells for \$2,095.

An automatic gain feature on the three 500-Mhz machines allows them to track signals varying between 500 μ v and 300 mv. Delivery takes 90 to 120 days after receipt of order.

High-Frequency Division, Dana Laboratories Inc., 2401 Campus Drive, Irvine, Calif. 92664 [369]



Winter on Colorado's front range?

No. Winters on Colorado's Front Range of Science and Technology – the 150-mile span where the high plains meet the mountains – are dry, mild, sunny and warm.

What you are seeing here is 50 miles away, in the higher elevations of the Rocky Mountains . . . where "Ski Country, USA" is the world's winter playground.



It's something else.

While skiers are on the slopes, there's shirtsleeve golf and tennis in Metro Denver and other Front Range communities. There's more sunshine than most places. It's a great place to be. And that's part of the reason that IBM, Kodak, Honeywell, Western Electric, Martin Marietta,

Hewlett-Packard, Sundstrand, Litton, Monsanto, Beech Aircraft, Ball Corporation, Bell Telephone Laboratories, Gulf & Western, and other blue-chip companies are here.

WRITE TODAY – There's a very pleasant economic climate, too. If you are looking for a single location for a new plant site, research facility, administrative headquarters, or distribution center . . . or for a large unit tract of land . . . Forward Metro Denver will give you complete information. Everything in absolute confidence. Write Manager, Forward Metro Denver, Department 264, 1301 Welton Street, Denver, Colorado 80204. Phone: (303) 534-3211.



DENVER IN WINTER: WARM, DRY, SUNNY. HOW IS IT WHERE YOU'RE AT?

	Maximum Daily Temp. Average	Average Mo. Precipitation	Average Pct. Available Sunshine
October	66.6	1.01	75
November	51.6	.69	66
December	45.2	.47	68
January	42.1	.55	73
February	44.6	.69	71
March	49.9	1.21	71
	50.0°F	4.62	70.6%

Source: National Weather Record Center, Asheville, North Carolina



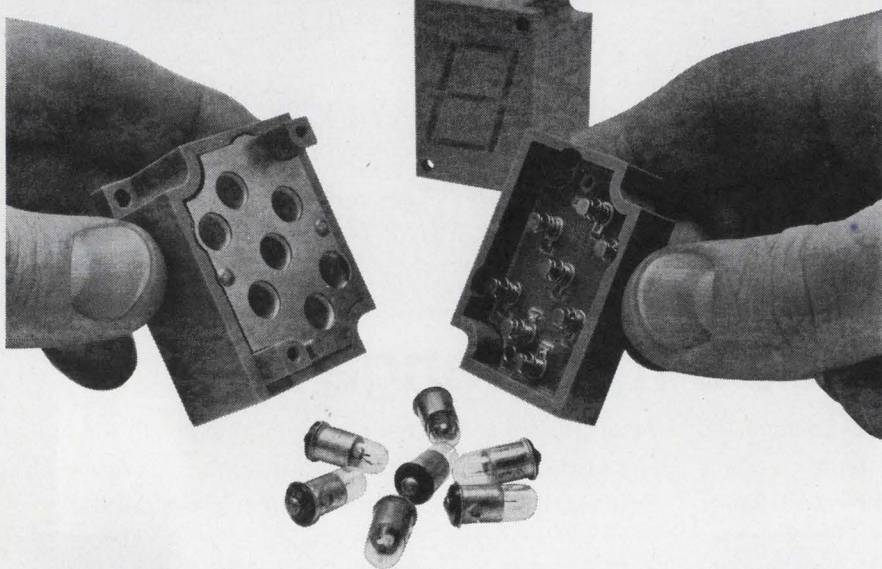

What makes low-cost Dialight readouts so reliable and easy-to-read?

Reliable because of simple module construction and long life lamps. Designed for use with neon or incandescent lamps to meet circuit voltage requirements. Easy-to-read from any viewing angle. 1" high characters are formed by unique patented light-gathering cells, and may be read from distances of 30 feet. Sharp contrast makes for easy viewing under high ambient lighting conditions.

Dialight Readout Features

1. Operate at low power.
 2. 6V AC-DC, 10V AC-DC, 14-16V AC-DC, 24-28V AC-DC, 150-160V DC or 110-125V AC.
3. Non-glare viewing windows in a choice of colors.
 4. Available with RFI-EMI suppression screen.
5. Available with universal BCD to 7 line translator driver.
 6. Can be used with integrated circuit decoder devices now universally available.
7. Caption modules available; each can display 6 messages.

Send for catalog

Catalog-folder contains complete specifying and ordering data on numeric and caption modules, translator drivers, mounting accessories. Dialight Corporation, 60 Stewart Avenue, Brooklyn, New York 11237. Phone: (212) 497-7600.

DIALIGHT



DT-126

New instruments

Modulator combines with a synthesizer

Unit for measurements
in communications systems
covers 10 khz-100 Mhz range

For testing and calibrating high-accuracy communications equipment, you need a frequency synthesizer, an a-m/f-m modulator, and an attenuator. The Rohde and Schwarz Co. thinks the most economical way to provide the required capabilities is to put all of these instruments in one package—as it does in its MS100M a-m/f-m signal generator.

The unit delivers crystal-controlled frequencies from 10 kilohertz to 100 megahertz and permits both a-m and f-m operation. Frequency adjustment can be remotely programmed, and sweep operation is possible.

The MS100M supplies frequencies in 1-hz steps through eight decade switches. If output frequency is to be controlled by a program, the adjustment of all decade steps is connected by a common switch to the program lines of the eight multipoint connectors at the rear of the set. By simple contact closing, individual decades can be remotely controlled in the 1-out-of-10 code via a common return circuit.

Amplitude- and frequency-modulation of the output signal can be accomplished over the instrument's entire range. Output can be amplitude-modulated up to a maximum of 95%, and the percentage, continuously adjustable by a control knob, is indicated by a panel meter. The modulation signal is either fed from an external source with a frequency of 20 hz to 20 khz or is derived from an internal 1-khz generator. Simultaneously a-m and f-m is possible.

The MS100M, which is expected to be used principally for narrow-channel measurement, is priced at \$7,650.

Rohde and Schwarz Co., 111 Lexington Ave., Passaic, N.J. 07055 [370]

R.M.S. VOLTS -- the scale says -- but what about the circuits behind that scale?

All of us have been making rms readings of ac voltages for years. We know we have, it says so right on the front of the meter.

If someone were to ask what we mean by rms voltage, we could quickly explain the concept of "root mean square." In the interest of accuracy we might add that the rms voltage indication on most meters is true only for a sinusoidal wave. Unfortunately, most measurements are not made on true sinusoidal waves. However, for many applications, average responding meters are adequate.

But it would seem logical, where accuracy is important, to use a meter that measures true rms voltage no matter what the wave shape—a true rms voltmeter.

Why isn't this done more often? Well, until recently, most true rms voltmeters were expensive, limited

in capability and rather slow responding.

Now Hewlett-Packard has adapted the thermocouple concept used in standard laboratories; added protective amplifiers to insure overload protection (800 V p-p); and reduced final-value step function response to less than 5 seconds.

When you combine these features with a low price of \$575, it adds up to the HP 3400A—the first practical true rms voltmeter for general use in the 10 Hz to 10 MHz range. And, a high crest factor (ratio of peak to rms) allows you to measure noise and other non-sinusoidal wave forms at a ratio of 10:1 full scale or 100:1 at 10% of full scale. You get accurate noise and pulse measurements — without having to make non-standard corrections.

The 3400 isn't just a fine true rms

voltmeter—although that's plenty in itself. It can also be used as an ac/dc converter and a current meter. Typical dc output accuracy is 0.75% of full scale from 50 Hz to 1 MHz. Use the HP 456A AC Current Probe (\$250) and you get quick dependable current measurements. The 456A probe has a 1 mA to 1 mV conversion allowing direct readings up to 1 amp rms.

So, if all your measurements aren't made on true sinusoidal wave shapes and if you like direct accurate rms voltage indication no matter what you're measuring, it's time to check into the HP 3400A true rms voltmeter. For more information, contact your local HP field engineer. Or, write to Hewlett-Packard, Palo Alto, California 94304. Europe: 1217 Meyrin-Geneva, Switzerland.

099/19A

HEWLETT  PACKARD
ANALOG VOLTMETERS

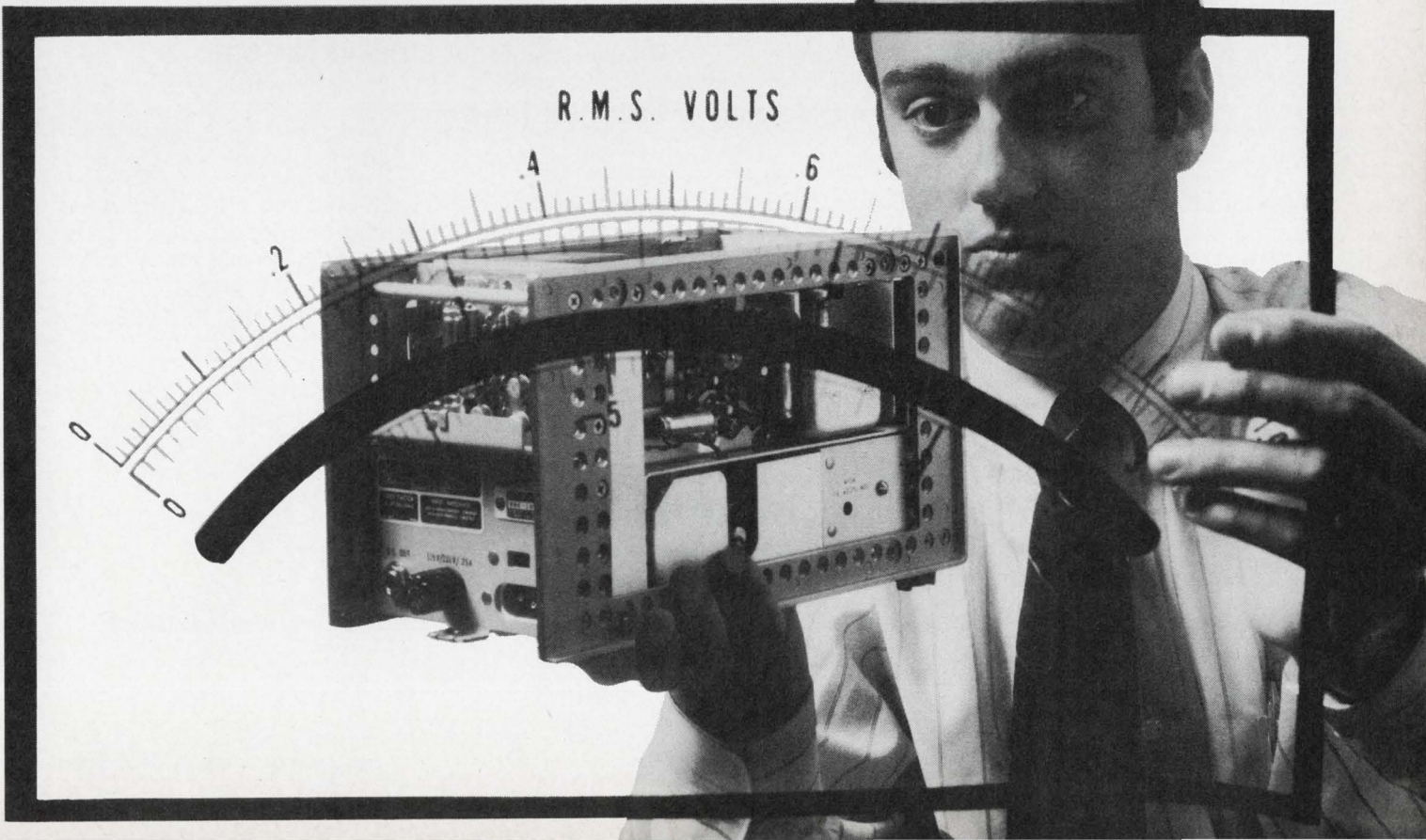

Another new trio of VHF power transistors from United Aircraft

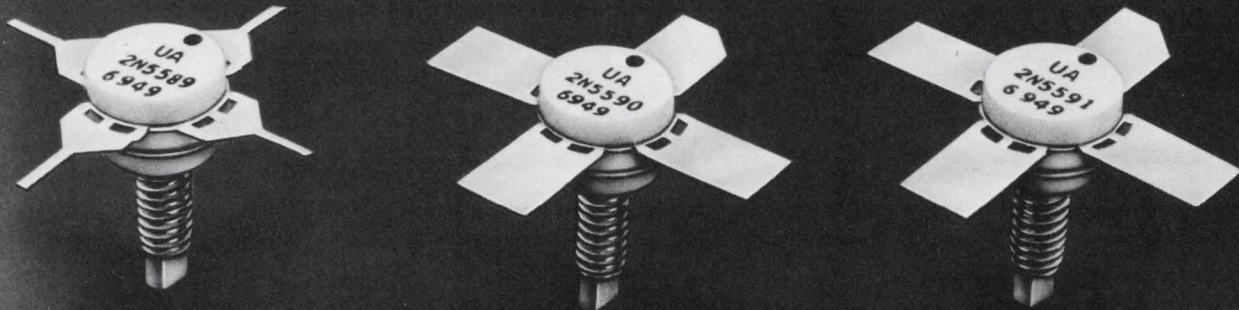

APPLICATION	DEVICE	FREQUENCY (MHz)	MODULATION	POWER OUT (WATTS)	POWER GAIN (MIN. dB)	EFFICIENCY MIN. (%)	T _i	V _{cc}	CASE	
Class AB, B, & C VHF Amplifiers	2N5589	175	FM	3.0	8.2	50	200	13.6	TO-71	
	2N5590	175	FM	10.0	5.2	50	200	13.6	TO-72	
	2N5591	175	FM	25.0	4.4	50	200	13.6	TO-72	
	2N5641	175	FM	7.0	8	60	200	28	13.6	TO-71
			AM	5.0 Typ.						
	2N5642	175	FM	20.0	8	60	200	28	13.6	TO-72
			AM	10.0 Typ.						
	2N5643	175	FM	40.0	7.5	60	200	28	13.6	TO-72
AM			20.0 Typ.							

- Large signal specifications
- Low inductance stripline packages
- Tantalum nitride emitter ballasting resistors

These latest members of the growing family of United Aircraft RF power transistors have been optimized for peak performance at 13.6 volts. Like the three models we introduced in November (see chart), these new devices—the 2N5589, 2N5590, and 2N5591—are designed for FM/VHF mobile communications equipment.

Also available: 2N4429, 2N4430 and 2N4431 RF power transistors in stripline and hermetic packages. **Our latest RF catalog** lists data on these and other devices in our line including: 2N3553, 2N3632, 2N3866, 2N5090, 2N3375, 2N3733, 2N4440, 2N5016, 2N4428, and 2N4012.

For RF power transistors for all VHF, UHF and microwave applications, write or call:

Electronic Components DIVISION OF **United Aircraft**

TREVOS, PENNSYLVANIA Tel. 215-355-5000 TWX: 510-667-1717
West Coast Office: 128 E. Katella Ave., Orange, Calif. (714) 639-4030

DESIGNERS AND PRODUCERS OF • RF AND MICROWAVE TRANSISTORS • CUSTOM HYBRID CIRCUITS • MONOLITHIC INTEGRATED CIRCUITS • SEMICONDUCTOR DICE

MOS memory is bipolar-compatible

Static read-only unit of 1024 bits has typical access time of 500 nsec, can drive standard TTL and DTL circuits without additional components

It's fairly routine for an MOS read-only memory to be compatible with typical input/output levels of bipolar logic circuits, but not so routine for an ROM to be compatible even with worst-case situations.

That's the claim that Solitron Devices makes for its new ROM, designated model UC 6525/7525. It has an access time of 500 nanoseconds, and is directly compatible

with bipolar circuits without the need for translators or external pull-on resistors. It can drive, or be driven from, standard series 54/74 transistor-transistor logic and series 830/930 diode-transistor logic circuits. With the addition of external resistors, most ROM's can handle bipolar output, but can't accommodate bipolar input logic levels, says Robert S. Goldin, man-

ager of MOS products at Solitron's San Diego plant.

Worst-case compatibility (logic 1 input 2.4 volts minimum, and logic 0 input 0.4 volt maximum) is achieved by optimization of a low threshold p-channel enhancement mode technology, according to Goldin. The threshold is held to between -1.4 volts and -2.2 volts. Process control parameters and

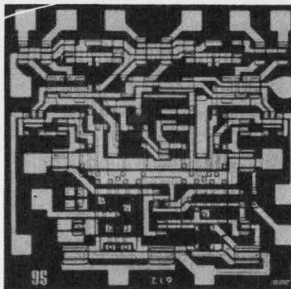

Sense amplifiers series 7520 offer typical threshold voltage temperature coefficient of $-15 \mu\text{V}/^\circ\text{C}$ over the full military range. Units are in wide use for design of core memories. They detect bipolar differential-input signals from core arrays and provide logic-level outputs for interfacing with TTL or DTL logic. Silicon General Inc., Bolsa Ave., Westminster, Calif. [436]

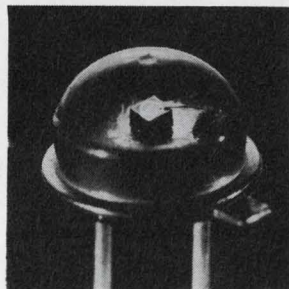

Gallium arsenide i-r emitting diode FLD 100 is suited for use in conjunction with silicon photo sensors since their spectral peaks are closely matched. Forward voltage is 1.35 v; reverse voltage, 8.3 v; wavelength at peak, 9,000 angstroms; angle between half intensity points and peak axis, 65° . Fairchild Microwave and Optoelectronics, 2513 Charleston Rd., Mtn. View, Calif. [437]

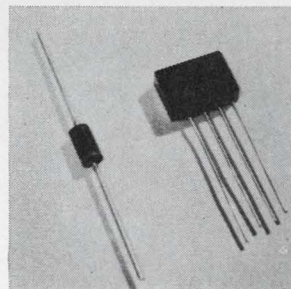

Silicon rectifier series MHR can handle 300 amp surges at 100°C . Voltage ratings at 100-1,000 v piv are standard. Units meet or exceed requirements of Mil-Std-202B method 103A and all other specifications of NEMA-EIA Class A2. Prices start at 23 cents each in 1,000 lot quantities for the MHR100. Micro Semiconductor Corp., 11250 Playa Court, Culver City, Calif. 90230 [438]

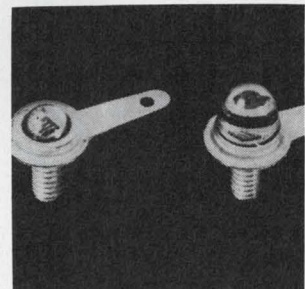

High-power light-emitting diodes series ME2 and ME5 are large area, gallium arsenide units with spectral emissions in the near infrared range peaking at 9,000 angstroms. At 1 ampere continuous input current they have a total radiated minimum output power of 10 mw from a 50-x-50-mil emitting area. Monsanto Electronic Special Products, 10131 Bubb Rd., Cupertino, Calif. [439]

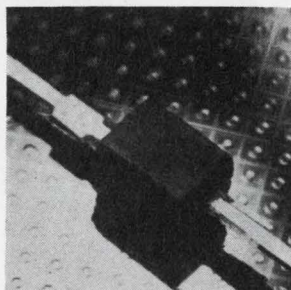

Low-cost varactor diodes with high Q, linear response and a spread of 5 to 1 at 3 to 30 v are for use in solid state tv tuners, instrumentation, and microwave circuits. The completely passivated devices provide superior mechanical shock resistance through solid junction-to-lead construction. Kollstan Semiconductors, 111 New York Ave., Westbury, N.Y. [440]

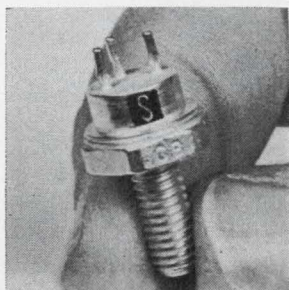

R-f power transistor type 2N5016 is a silicon npn interdigitated device. It is capable of 15 w output power at an operating frequency of 400 Mhz. It can dissipate 30 w at case temperature of up to 50°C and has a saturated output power of 21 w. Price is \$35.10 each in quantities of 1 to 99. Solitron Devices Inc., 1177 Blue Heron Blvd., Riviera Beach, Fla. 33404 [441]

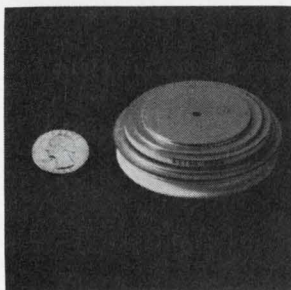

Silicon controlled rectifier called Astro-Pack, with a 48-mm pellet diameter, can supply up to 1,500 amps and up to 1,200 v. It offers I^2T up to 1 million. It supplies up to 2,000 amps rms in an a-c switch in a water cooled configuration. Applications include motor controls and electromechanical power supplies. Power Semiconductors Inc., 90 Munson St., Devon, Conn. 06460 [442]

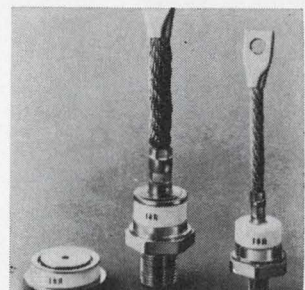

Fast recovery 100-ampere rectifiers series 101KL and 101KLR come in a DO-8 Rock-top package. Reverse recovery times are $1.5 \mu\text{sec}$ and $2 \mu\text{sec}$ with up to 100 amps at voltages from 400 to 1,300 v. Applications include inverters, phase-controlled SCR assemblies, and other areas requiring h-f fast recovery rectification. International Rectifier, El Segundo, Calif. [443]

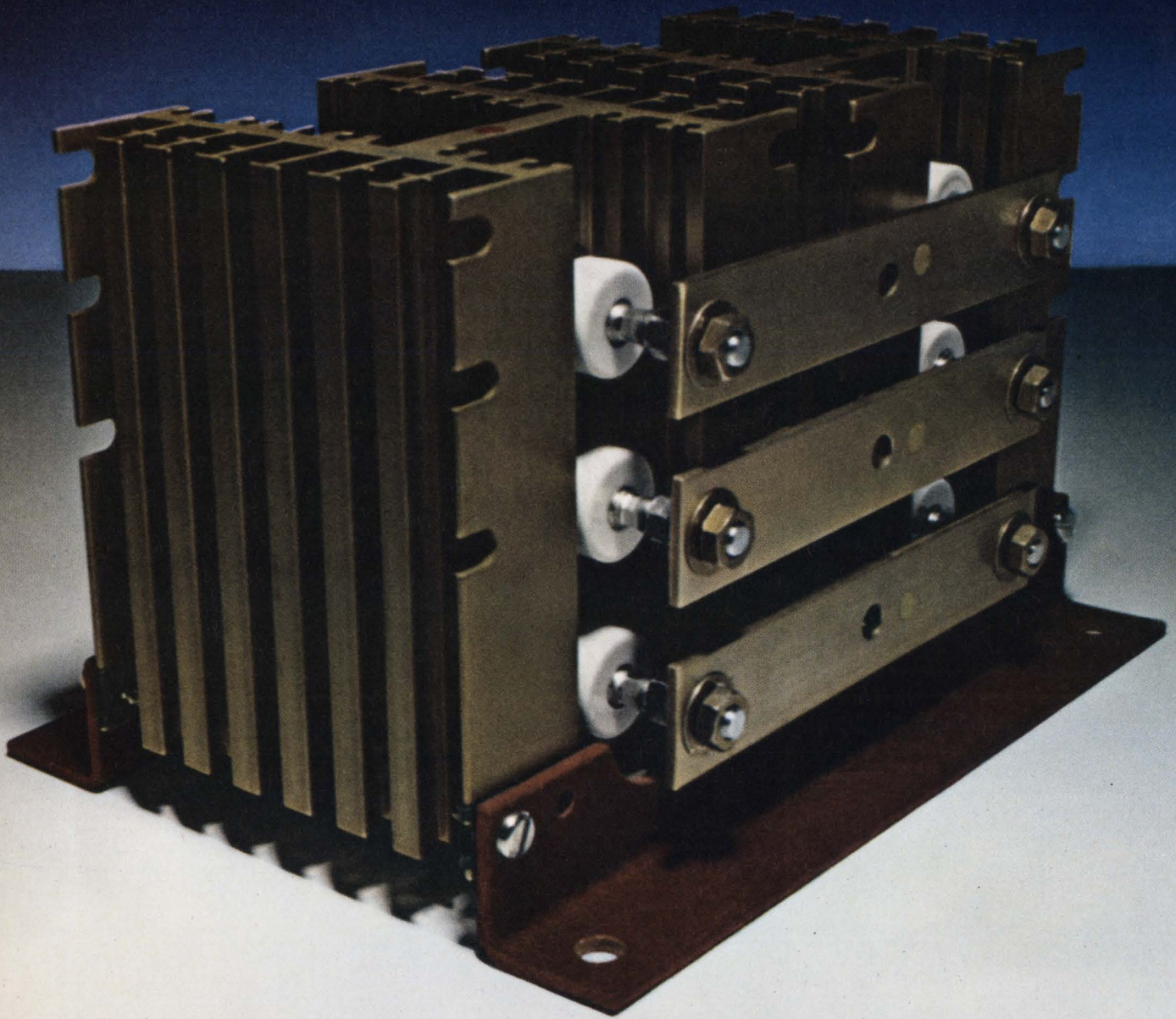

Try me.

Whether you build stacks or buy 'em... we'll show you how Westinghouse Gold-Line rectifier assemblies yield more power per dollar.

Send for the proof.

After you've tried our assemblies, you'll ask yourself why you bother to build.

Because Westinghouse Gold-Line rectifier assemblies give you simplified design and standardization; fewer parts; bonus output amps.

And you'll save on inventories, parts, labor, testing, rejects and down-ratings. What's more, we guarantee the current rating of Gold-Line rectifier pre-assembled packages. They're compact in de-

sign with a wide range of distinct current and voltage ratings and circuit configurations.

Let us analyze your real costs, and prove that Westinghouse can save you money. But first write for our 54-300 catalog and our 54-021 price list. You'll see how our stacks stack up. Then you'll try us. Write Westinghouse Semiconductor Division, Youngwood, Pa. 15697.

You can be sure... if it's
Westinghouse



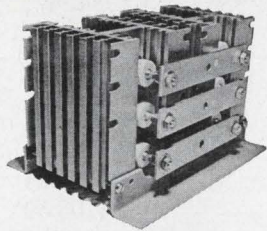

Westinghouse Industrial Semiconductor Distributors

Alabama

ACK Semiconductors, Inc.
Birmingham 205 322-0588
Electronic Wholesalers, Inc.
Huntsville 205 534-5722

Arizona

Hamilton Electro of Arizona
Phoenix 602 272-2601
Kierulff Electronics Corp.
Phoenix 602 273-7331

California

Newark Electronics
Inglewood 213 674-8440
Hamilton Electro Sales
Los Angeles 213 870-7171
K-Tronics
Los Angeles 213 685-5888
Elmar Electronics, Inc.
Mountain View 415 961-3611

Hamilton Electro Sales—North
Mountain View 415 961-7000

Hamilton Electro of San Diego
San Diego 714 279-2421

Colorado

Electronic Parts Co.
Denver 303 266-3755
Hamilton Denver
Denver 303 934-5508

Connecticut

Cramer Electronics, Inc.
North Haven 203 239-5641

Florida

Cramer Electronics, Inc.
Fort Lauderdale 305 566-7511
Electronic Wholesalers, Inc.
Orlando 305 841-1550

Georgia

Specialty Distributing
Atlanta 404-873-2521

Illinois

Semiconductor Specialists, Inc.
Chicago 312 279-1000
Pace/Avnet Electronics
Schiller Park 312 678-6310

Indiana

Fort Wayne Electronics Supply, Inc.
Fort Wayne 210 742-4346
Ra-Dis-Co.
Indianapolis 317 637-5571
Radio Distributing Co.
South Bend 210 287-2911

Maryland

Pyttronic Inc.
Baltimore 301 727-5100
Hamilton Electro Sales
Baltimore 301 796-5000
Cramer Electronics, Inc.
Rockville 301 424-2700

Massachusetts

Cramer Electronics, Inc.
Newton Ctr. 617 969-7700
Schweber Electronics
Waltham 617 891-8484

Michigan

Semiconductor Specialists, Inc.
Detroit 313 255-0300

Minnesota

Semiconductor Specialists, Inc.
Minneapolis 612 866-3434
Stark Electronic Supply
Minneapolis 612 332-1325

Missouri

Electronic Components for
Industry Co.
Kansas City 816 421-8400

Electronic Components for
Industry Co.
St. Louis 314 647-5505
Hall-Mark Electronics Corp.
St. Louis 314 521-3800

New Jersey

General Radio Supply Co., Inc.
Camden 609 964-8560
Angus, Inc.
Moorestown 609 235-1900
Sterling Electronics, Inc.
Perth Amboy 201-HI 2-8000

New Mexico

Kierulff Electronics Corp.
Albuquerque 505 247-1055

New York

Stack Industrial Electronics
Binghamton 607 723-6326
Summit Distributors
Buffalo 716 884-3450
Cramer/Eastern
East Syracuse 315 437-6671
Schweber Electronics
Long Island 516 334-7474
Milgray Electronics, Inc.
New York 212 989-1600

Ohio

Sheridan Sales
Cincinnati 513 761-5432
Sheridan Sales
Cleveland 216 524-8120
Hughes-Peters, Inc.
Columbus 614 294-5351
Mentronics, Inc.
Mentor 216 946-3058

Oklahoma

Hall-Mark Electronics Corp.
Tulsa 918 835-8458

Pennsylvania

Cameradio Company
Pittsburgh 412 391-4000

South Carolina

Sawyer Electronics Corp.
Greenville 803 235-0438

Texas

Hall-Mark Electronics Corp.
Dallas 214 231-6111
Midland Specialty Co.
El Paso 912 533-9555
Hall-Mark Electronics Corp.
Houston 713 781-6100
Lenert Company
Houston 713 225-1465
The Altair Co.
Richardson 214 231-5166

Washington

Hamilton Electro Sales of the
Pacific Northwest
Seattle 206 624-5930
Kierulff Electronics Corp.
Seattle 206 725-1550

West Virginia

Charleston Electrical Supply
Company
Charleston 304 346-0321

Wisconsin

Taylor Electric Company
Milwaukee 414 964-4321

Canada

Canadian Westinghouse
Hamilton, Ontario 416 528-8811

European Headquarters

Westinghouse Electric
International, S.A.
London, S.W. 1 Whitehall 2704

**Westinghouse Semiconductor Division
Youngwood, Pennsylvania 15697**

... 4 types of word-bit organization offered ...

other processing steps also "were held just a little tighter," he says.

While the static ROM takes more power—240 milliwatts compared with as little as 80 mw for some dynamic ROM's—it also avoids the timing restrictions imposed by externally generated clock inputs required for dynamic systems, according to Goldin. "You also have to consider the power consumed in the clock generations themselves; the power advantage is with the dynamic ROM only when a large number of memories is being used," he says.

Takes the heat. Dynamic ROM's now on the market are temperature-limited to a maximum of 85°C, and have outputs that are true only during specified clock-phase periods. In contrast, the static ROM

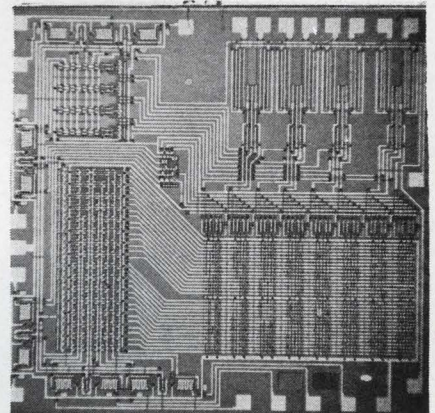

Accommodating. MOS memory is compatible with bipolar logic.

(UC 6525) built to meet military specifications has an operating temperature range of from -55°C to +125°C. Both ceramic dual-in-line and rectangular flatpack 24-lead configurations are available. Basic chip size is 110 by 113 mils.

Four different memory organizations are offered, including 128 words by eight bits, 256 words by four bits, 512 words by two bits, and 1024 words by one bit. Word expansion is provided by four programmable chip-select inputs, which can be specified by the buyer. Up to 16 ROM's of 128 words by eight bits each can be arranged in a wired-OR fashion to make a 2048-word by eight-bit system that

Does
H_(BEEP)P_(BEEP)
really lose
sleep
over us?

They would
if they knew
about the
1028.

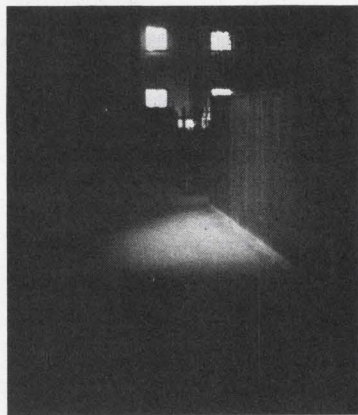

Our new 1028 is the world's lowest priced frequency synthesizer. For \$1990, it does virtually everything their \$8000 model does. Frequency and amplitude are fully programmable. Sine wave and square wave output may be used simultaneously. Five digit frequency resolution



PACIFIC
MEASUREMENTS

is constant over the 1 Hz to 12.9 MHz range. The price is guaranteed to give you-know-who insomnia. For specs on the 1028 Frequency Synthesizer, write:

Pacific Measurements Inc.,
940 Industrial Avenue,
Palo Alto, California 94303.
We gotta be better.

doesn't require an external decoder.

A one-time masking charge of \$400 covers the cost of generating a gate oxide mask to meet a customer's program requirements. The minimum order is 15 pieces; the UC6525 Mil Spec version costs \$103.50 in quantities under 25; \$95.40 for under 100; and \$82.00 for under 1,000. In the same lots, the UC7525 commercial model sells for \$67.00; \$56.25; and \$47.75, respectively. Delivery time is four weeks.

Solitron Devices Inc., 8888 Balboa Ave.,
San Diego, Calif. 92123 [444]

New semiconductors

Scratchpad memory is TTL-compatible

64-bit random access unit
has 40-nsec access time;
can be used as buffer

Semiconductor memories for main-frame computer applications may be about a year away, but according to Dave Conrad, vice president of marketing at Computer Microtechnology Inc., there are many applications that can benefit now from a new semiconductor memory—the bipolar scratchpad. One of the newest scratchpads is CMI's model CM2100.

The CM2100 is a 64-bit device organized in a 16-word by four-bit configuration. It can be used as a high-speed scratchpad memory—40-nanosecond access time—or as a buffer memory. The buffer, or cache as IBM calls it, is a small, fast memory placed in front of the slower main memory. It's used to store information that the computer processor uses frequently. The total computer system looks faster than it really is because the buffer supplies its information at a much faster rate than the main-frame core memory [*Electronics*, Oct. 13, 1969, p. 105].

Another application for the CM2100 is in computer peripheral equipment and instrumentation. Conrad says that the "smart" ter-

Our center of attraction.

We're the only ones with .050 centers in our flat conductor cable connectors. We're the only ones with a metal shell to protect that fragile connector. And the only one whose connector will mate with any existing version. (No matter what type of wire is used.) Interchangeable. Intermountable. You can use them with any of your retrofit projects. And should repair be necessary, modular construction makes them easily repairable in the field. They can even be potted for environmental sealing. It's the newest idea yet in flat cable connectors. One more thing. We're trying to come up with a name for this connector. Something better than Flat Conductor Cable Connector. If you can think of a name we can use, it's worth a case of booze. And even if you don't win the booze, we'll be happy to send a genuine certificate recognizing your idea.

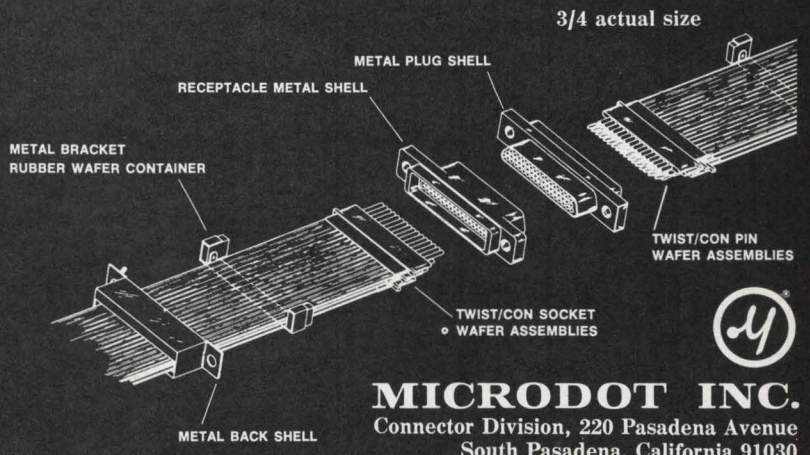

MICRODOT INC.
Connector Division, 220 Pasadena Avenue
South Pasadena, California 91030



**NOW...
YOU CAN
PUT THEM
TO WORK IN
MORE
PLACES**

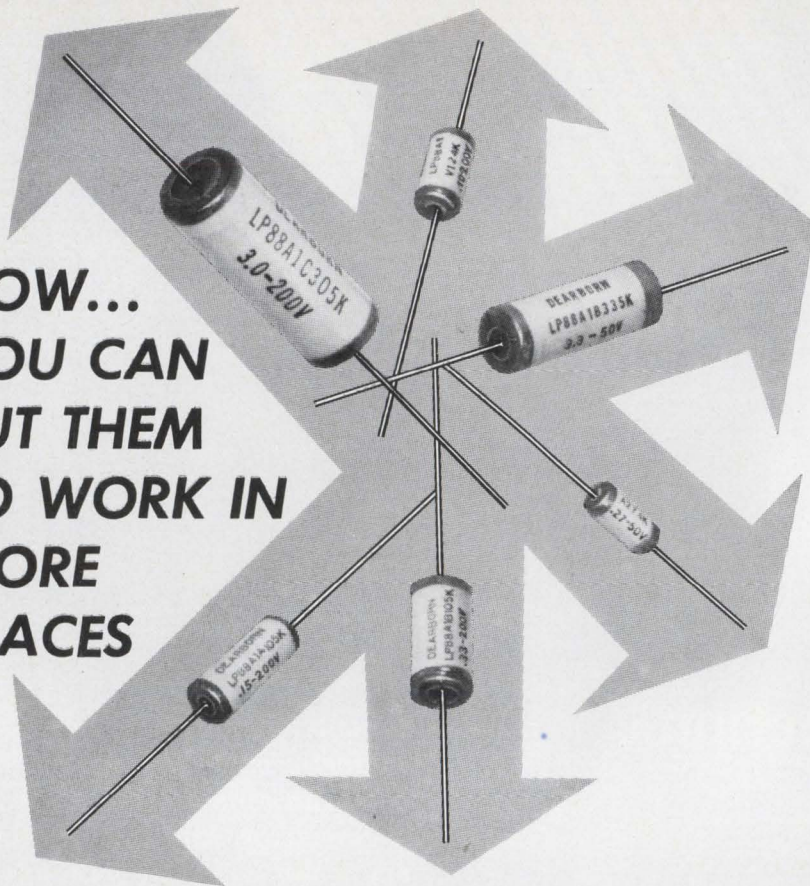

DELTAFILM® LP88 POLYCARBONATE CAPACITORS

now available with capacitance values up to 9 times higher!

get the big advantages of metallized polycarbonate-film in smaller capacitors!

- **EXCEPTIONAL PERFORMANCE:** Extended life characteristics. Very low temperature coefficient. High insulation resistance. Low dissipation factor (high Q). Excellent resistance to shock and vibration.
- **FUZ-ION SEALED®:** Heat-shrinkable plastic case is fused to epoxy for

maximum seal efficiency. Casing is nonconductive, fungus-proof, corrosion-proof, and humidity resistant.

- **OPERATING TEMPERATURE RANGE:** -55 C to +125 C
- **CAPACITANCE VALUES:** from .027 to 50 μ F.
- **VOLTAGE RATINGS:** 50, 75, 100, 150, and 200 VDC.
- **IDEAL FOR A-C AND D-C APPLICATIONS**

For complete technical data, request Engineering Bulletin 154A by writing to Dearborn Electronics, Inc., Box 530, Orlando, Fla. 32802.

Dearborn Electronics, Inc.
(a subsidiary of the Sprague Electric Company)

FOREMOST IN FILM CAPACITORS

**... unit provides storage
for peripheral devices ...**

minimal is becoming more popular and so are "smart" instruments. "The storage requirements of these devices are increasing and they are becoming intelligent systems."

Memories larger than 64 bits can be set up by using the CM2100 as a building block. Conrad says it's relatively easy because of the chip-select input and the fact that the outputs can be connected to make a wired-OR function.

Total power dissipation for the CM2100 is 360 milliwatts, and it is compatible with diode-transistor and transistor-transistor logic—the outputs can drive 10 unit loads. In-

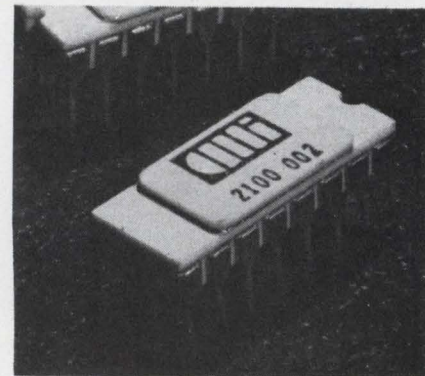

Scratchpad. Semiconductor memory stores data until system needs it.

put clamp diodes reduce line ringing to a minimum and input leakage current is 40 microamperes maximum. Other specifications include an output leakage current of 100 μ a; operating temperature range of 0° to 70°C; recovery time from chip enable input of 30 nsec; and a minimum write pulse width of 12 nsec. The package is a standard 16-pin ceramic dip.

The 64-bit random-access device comes complete with address buffer, decoder, and write- and sense-amplifier. Computer Microtechnology expects that the scratchpad memory will be used principally to buffer mainframe core memories and as storage for peripherals.

Delivery time is one week after receipt of order. The memory costs \$38.50 in quantities of 100.

Computer Microtechnology Inc., 610 Pastoria, Sunnyvale, Calif. 94086 [445]

The Hickok digital measuring system has a big hole in it.

It's designed that way. With one end always open.

You buy only the Main Frame and a plug-in unit for whatever it is you want to measure. Volts, Capacitance, Frequency, Time. Whatever your project calls for.

The plug-in determines the application. The Main Frame shows you the reading digitally.

When you want to measure something else, ohms, for instance, you don't buy everything all over again. You buy just the individual ohmmeter and plug it into your Main Frame.

That's the beauty of plug-ins. They bring the cost of digital readout down to where it should be.

The system isn't obsolete when new plug-ins are developed. Just plug them in as they come.

There's now a total of ten. For DC volts, events, period, frequency, ohms, time interval, capacitance, DC microvolts, AC volts and DC current.

The system can also drive a digital printer. As well as a set-point controller.

When the system's got a hole in it, it does a lot more than what you'd expect. In a smaller space and for a lot less money.

Contact your Hickok distributor for more information and a demonstration or write us at 10514 Dupont Avenue, Cleveland, Ohio 44108. Overseas, write to Hughes Aircraft Company, International Sales, P.O. Box 92927, Los Angeles, California 90009, U.S.A.

Hickok

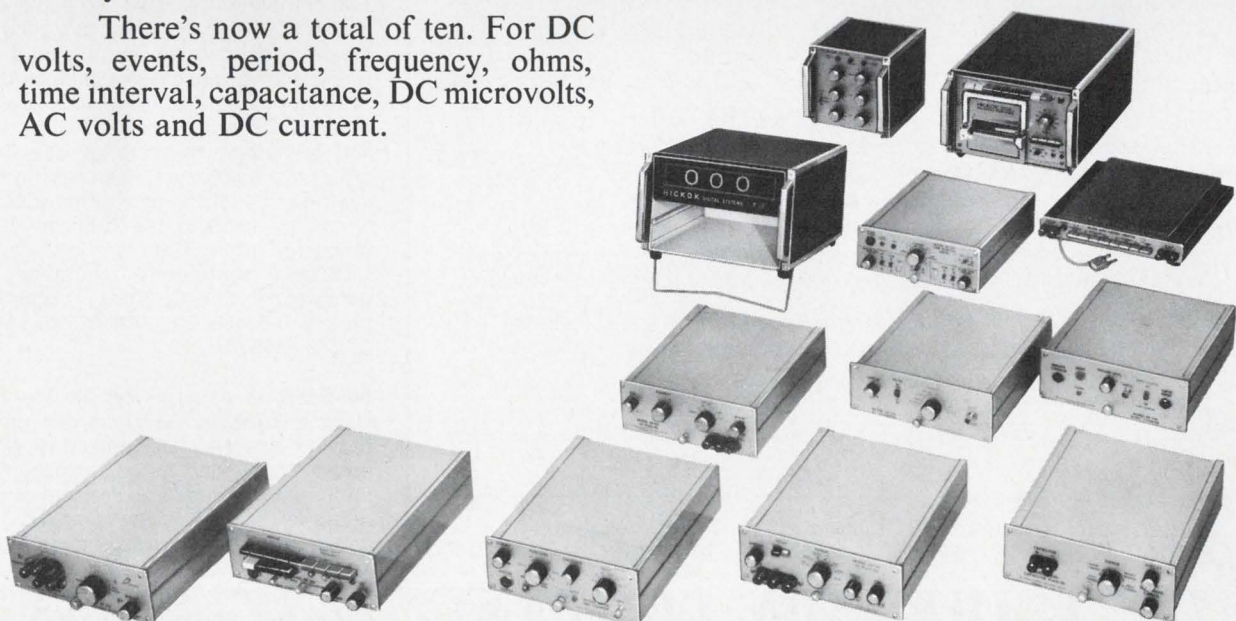

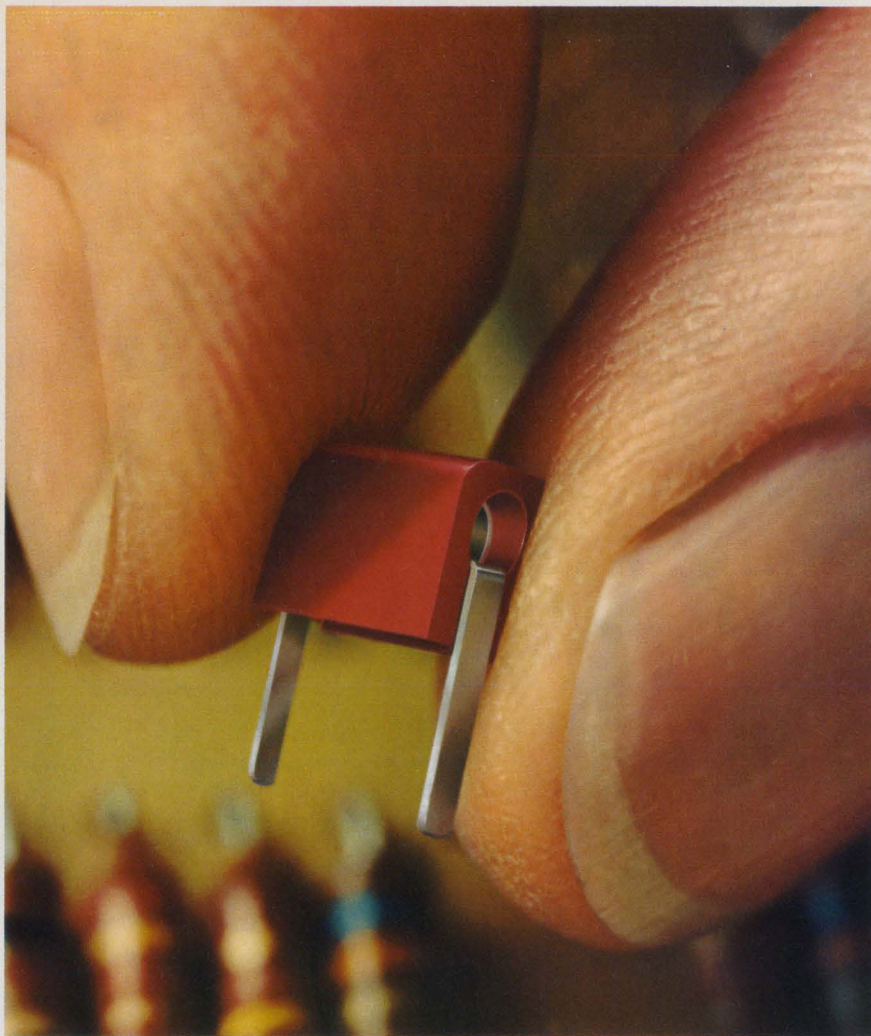

Looking for a little jack? ()
 How's this for size? (Actual Size)

We've been making miniature jacks for over 10 years. But this new one is half again as small as any horizontal mounting type we've offered before. It accepts a 0.080" diameter tip plug on either end and has a maximum current capacity of 5 amperes. Operating voltage is 1500 volts RMS at sea level, 350 at 50,000 feet. Contact resistance is less than 2 milliohms. Capacitance between adjacent jacks is less than 1 pF at 1 MHz. Comes in 10 colors meeting Federal Standard #595.

Johnson makes hundreds of different jacks and plugs . . . and carries most of them in stock for immediate delivery. Or perhaps you have a unique need. Our engineers will work it out for you. Just give us a call. Meanwhile, return the coupon.

E. F. JOHNSON COMPANY/3002 Tenth Ave. S.W./Waseca, Minnesota 56093

- Send me a sample of your new miniature jack and complete design details.
- Send me information on your complete connector line and other Johnson components.

NAME _____ TITLE _____

FIRM _____ ADDRESS _____

 CITY _____ STATE _____ ZIP _____

E. F. JOHNSON COMPANY

New materials

Epoxy bonds device, substrate

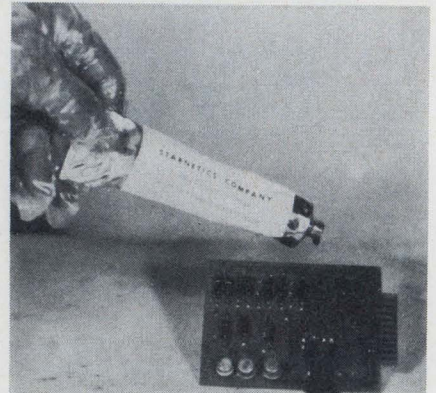

Fritz-Copper is a two-component, air-drying, copper-epoxy adhesive developing a tensile strength of 5,000-6,000 psi. Designed for hybrid IC's, it can be used to attach active devices to passive, metalized alumina substrates. Production quantities are available at approximately 60 cents per oz. Starnetics Co., 10639 Riverside, N. Hollywood, Calif. 91602 [341]

Single-component, silver-filled epoxy ink designated SS-570 serves as a conductive resin. The liquid material can be silk-screened directly onto matrix boards and ceramic wafers to provide conductive paths. It can also be sprayed or brushed on for shielding and grounding applications. It features low-temperature cure cycles (94° to 160°C), low resistivity (less than 0.01 ohm-cm) and up to 12-month shelf life. Sample 2-oz jars or syringes are available at \$15. Rogers Corp., Rogers, Conn. 06263 [342]

Two-component, silver-filled epoxy compound Epo-Tek H21 is designed for bonding of passive components and leadless inverted devices in hybrid circuit fabrication. It is a 100% solids system with properties permitting rapid and reliable positioning of chip resistors, chip capacitors, leadless inverted devices, inductors and other devices. It can be used in the 300° to 400°C range for intermittent service, and will withstand continuous operating temperature of 250°C. Epoxy Technology Inc., 65 Grove St., Watertown, Mass. 02172 [343]

Absorb-R is a series of flexible foam sheet microwave absorbers designed to provide less than 1% reflection, over a broad frequency range, occupying a minimum of space. Performance is relatively insensitive to polarization, or angle of incidence. Useful temperature range is -70° to +150°C. Custom Materials Inc., Alpha Industrial Park, Chelmsford, Mass. 01824 [344]

Heat-shrinkable, electrically-conductive tubing is constructed of spirally wound vacuum-metalized Mylar, and is available with inside diameters from 0.09 to 1 in., and in lengths of 36 in. An insulating layer of Mylar or other desired film can be wound on the inside of the conducting layer, on the outside, or both. Niemand Bros. Inc., 45-10 94th St., Elmhurst, N.Y. 11373 [345]

Silicone molding compounds MS2644, MS2646E and MS2647E are designed for use with transfer molding equipment to encapsulate semiconductors, resistors, capacitors and other electronic devices. Their fast cure suits them for use with multicavity molds where high production rates are required. Temperature range is -65° to +350°C, with extreme resistance to thermal shock. Midsil Corp., Box 475, Emerson, N.J. 07630 [346]

Single-crystal gallium phosphide is available in either Czochralski ingots (undoped or tellurium or sulfur doped), or dendrites grown from solution. The ingots are available in sizes ranging from 10-100 grams, sometimes larger. The dendrites measure from 5-12 mm² x approximately 1 mm thick. Single-crystal gallium phosphide is priced from \$50-\$100 per gram depending on sizes and quantity ordered. Atomergic Chemicals Co., 584 Mineola Ave., Carle Place, N.Y. 11514 [347]

Flexible electrical conductive coating called Polycomp 21-301 can provide shielding for substrates subject to flexural stresses, such as tubing and flat-ribbon cable. It also can serve as a general-purpose conductive coating with high impact resistance. It may be applied by brush, spray, or dip coating. The material is available in 3-oz. jars and 1-, 2-, and 5-lb cans. Polymer Composites, 1068 Clinton Ave., Irvington, N.J. 07111 [348]

Precision gauged polyurethane film is available 18 and 36 in. wide in thicknesses of 0.010 to 0.030 in. in continuous length rolls. The film has all of the outstanding properties of thermoplastic polyurethane, including outstanding resistance to low temperatures, abrasion, cutting, weather, oils, fuels and most chemicals. It contains no plasticizers. Molded Products Co., Easthampton, Mass. 01027 [349]

High dielectric constant casting resin called Stycast HiK Castable can be cast in place into circuit modules, antenna cavities, transmission line components and other electrical/electronic devices. It is available in a wide range of dielectric constants and is extremely low in loss. Dielectric constants from about 3 to 20 are available. Loss tangents are below 0.002. Price is about \$20 per pound depending on quantity ordered. Emerson & Cuming Inc., Canton, Mass. 02021 [350]

What happened when doctors and engineers got together:

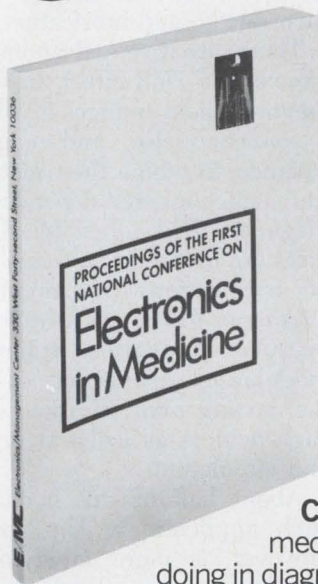

Doctors told engineers how they were using electronics and revealed their most urgent needs. Engineers described and demonstrated their newest equipment for diagnosis, treatment, and prevention. And hinted at things to come.

Their complete dialogue, with illustrations, makes pretty informative reading on a vital and growing market.

Here are some of the things it contains:

Computers: How they're joining the medical team. What computers are doing in diagnosis. In communications. The small computer as a paramedical aid.

Instrumentation: What's needed. What's available. Patient management. Protection. Standards and safety.

Electronics in the Hospital: The surgeon, the hospital, the instruments. What the administrator wants. Prescription for large-scale health care. The surgery department.

Electronics/Management Center
330 West 42nd Street, New York, N.Y. 10036

Enclosed is \$12 for a copy of the Proceedings of the First National Conference on Electronics in Medicine.

Send the Proceedings and bill me later. P.O. # _____

Name _____

Company _____

Address _____

City _____ State _____ Zip _____

**Find it fast!
in the
FREE
NEW
1970
Newark
industrial
electronic
catalog**

A \$9,000,000 INDUSTRIAL ELECTRONIC INVENTORY
720 PAGES • OVER 70,000 ITEMS; 500 MAJOR LINES

Eliminate line transients, noise and even
arrest lightning with the

WANLASS PARAFORMER™



MODEL NO. PEC-60
ONLY \$95.00

FOR 60 VA OF
WANLASS
PARAMETRIC
POWER

AND ALSO GET
0.25% AC REGULATION!

THE WANLASS PARAFORMER is the revolutionary power transfer component that effects parametric transfer of power without solid-state or mechanical elements. Standard units rated from 60 to 5000 VA in stock.

Immediate delivery from stock—factory OEM prices
—fast efficient service from 11 Newark warehouses.

One source for the products
you need, in the quantities
you need.



For your free catalog write to:

Main Office & Warehouse

NEWARK ELECTRONICS CORPORATION

500 North Pulaski Chicago, Illinois 60624
(312) 638-4411

WAREHOUSES IN

- * Minneapolis, Minn. (612) 331-6350
- * Cincinnati, Ohio (513) 421-5282
- * Denver, Colorado (303) 757-3351
- * Detroit, Michigan (313) 548-0250
- * Los Angeles Area (213) 678-0441
- * Grand Rapids, Michigan (616) 452-1411
- * Dallas, Texas (214) 271-2511
- * Houston, Texas (713) 782-4800
- * New York City (212) 255-4600

New Books

Magnetism and semiconductors

Structure and Application of
Galvanomagnetic Devices
H. Weiss
Pergamon Press, 362 pp., \$18.

Galvanomagnetism was an effect looking for an application up until recently. But now that semiconductor materials such as indium antimonide, indium arsenide, and indium phosphide are readily available, new uses for galvanomagnetism are continually being found. This book explores these applications at length, after explaining the basic physics of galvanomagnetic devices, their characteristics, and their design and fabrication.

There are two galvanomagnetic effects: the Hall effect, in which a magnetic field induces a voltage in a semiconductor, and magnetoresistance, in which the resistance of the semiconductor depends on the magnetic field intensity. Both effects are being utilized in a variety of applications—measurement of magnetic fields, measurement of material properties, transducing, modulation, conversion of d-c to a-c, analog multiplication, and for such devices as isolators, gyrators, and circulators.

About half of this book covers such applications. The approach, however, is more satisfying than simple case histories because underlying principles are analyzed to indicate more general applications and pitfalls in reducing physical effects to practice.

A section on contactless signal generation, for example, discusses ways of using the Hall effect to obtain information about the relative positions of two moving objects. Such diverse applications are described as a scheme for routing pneumatic-tube mail carriers and a method for automatically positioning car bodies for production-line operations. For all applications, the relation of the geometrical arrangement of Hall device and magnetic field to the nature of the output signal is discussed. Thus the equipment designer can select a geometry that will be most useful in his application—a sharply peaked, sin-

gle-polarity electrical output, for example, or perhaps one that gives a large positive pulse preceded and followed by smaller negative pulses. Such factors as the required magnetic field intensity and temperature variations also are considered.

Fitting machine to man

Man-machine Simulation Models
Arthur I. Siegel and J. Jay Wolf
Wiley-Interscience, 177 pp., \$9.95

During the past few years development of various systems of extraordinary size and complexity has been almost staggering. Included are airplanes that carry 500 people, spacecraft to carry men to the moon, systems for military offense on the national, as opposed to the battalion, level, and many others. Expensive as these have been, they have cost much less than they would have if designers had not learned to compute the systems' response to various stimuli before actually building them, and to alter design in line with simulation results.

But after having built such systems, the designers occasionally discovered that their simulation had omitted an important factor—the shape, size, and behavior of the people who use the system. Recognizing this, the authors have undertaken to show how these factors can and should be included in a simulation.

They describe models that include one or two operators, and those that include groups of people. They take into account two dozen or more factors that affect or are involved in human performance. For single operators they include such items as stress threshold and individuality factors; for groups they include capability of cross-training for more than one specialty, morale threshold, pay level, and sickness.

One-man examples described in detail include landing an airplane on an aircraft carrier and launching an air-to-air missile; two-man examples are in-flight refueling and

Hughes introduces the all-in-one aircraft-spotting, target-identifying, target-tracking, missile-shooting, low-level navigating, and terrain-mapping storage tube.

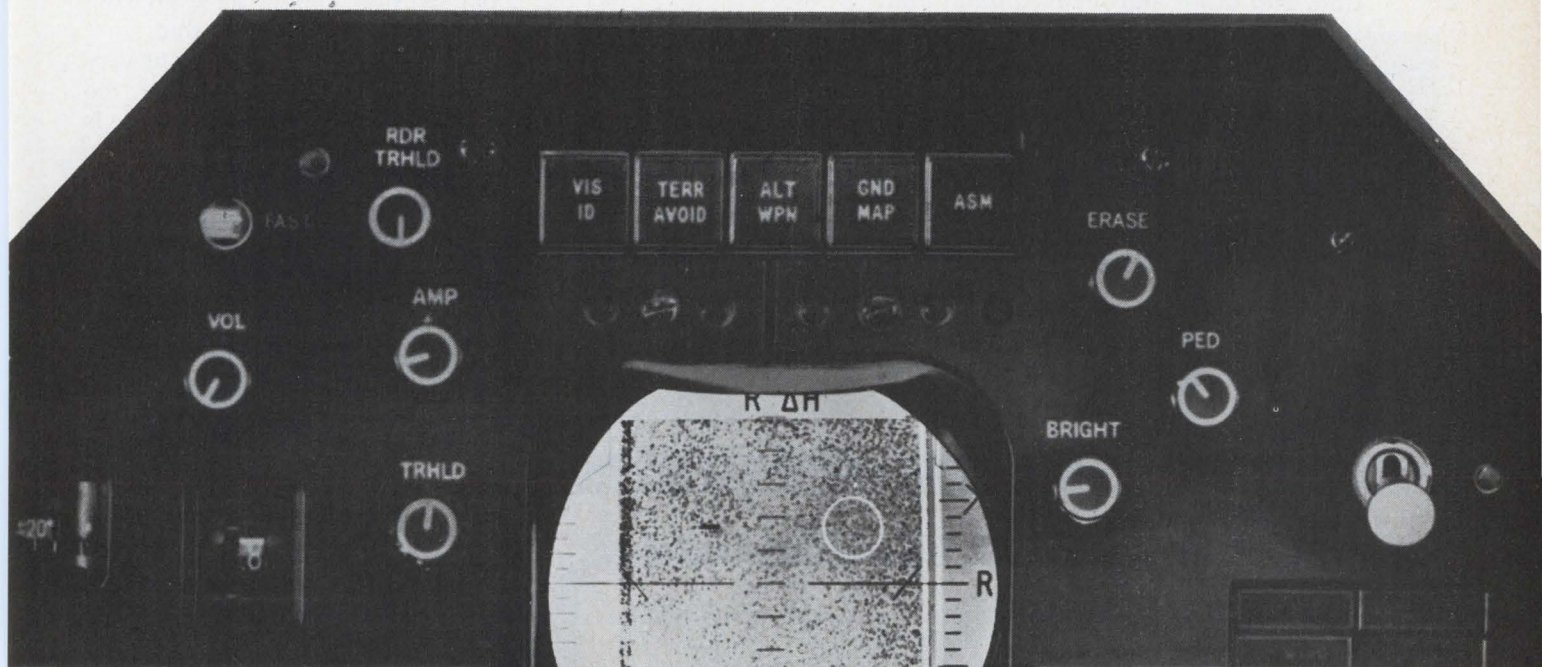

How can one storage tube perform the combined duties of an observer, navigator and gunner in a jet fighter's cramped cockpit?

The Hughes Multi-Mode TONOTRON* tube does because it's unique.

One difference: selective erasure. Any portion of the image can be wiped out at will.

The pilot has continuous viewing at maximum brightness. Stored information is retained without fading until new data are presented. And write-through information can be provided in a non-stored presentation.

Another difference:

simultaneous presentation of new and stored information.

Still another difference: high-resolution writing. And display tones are reversible without affecting contrast and resolution.

See why we call it a new-generation storage tube?

Product advances like our Multi-Mode Tonotron help explain why we're No. 1 in direct-view storage tube sales.

Reliability is part of it, too. We've proved ours by building

14,000 Hughes guidance and control systems for jet fighters and missiles. And weather radar tubes for commercial aviation.

We offer application engineering and system design assistance, in addition to advanced products. May we send you more information? Our all-in-one reference catalog describes the broad Hughes line of storage tubes, plus related systems.

Write: Hughes, Vacuum Tube Products Division, 2020 Oceanside Blvd., Oceanside, California 92054.

HUGHES

HUGHES AIRCRAFT COMPANY
VACUUM TUBE PRODUCTS DIV.
OCEANSIDE, CALIFORNIA

*TONOTRON is a trademark of Hughes Aircraft Company

Circle 191 on reader service card

OPTICAL SCANNING ?

Convert Your TV Camera (or ours) into a highly Versatile computer input device with the CVI model 321 Video Analyser!

Sampling bandwidth compression allows convenient low rate digitization of wide band video signals with line or raster scanning, X-Y-Z point analysis, noise reduction, and other significant operations.



cvi COLORADO VIDEO, INCORPORATED

P O BOX 928 • BOULDER, COLO. 80302 • PHONE (303) 444-3972

Video Data Acquisition — Processing — Display — Transmission

Circle 214 on reader service card

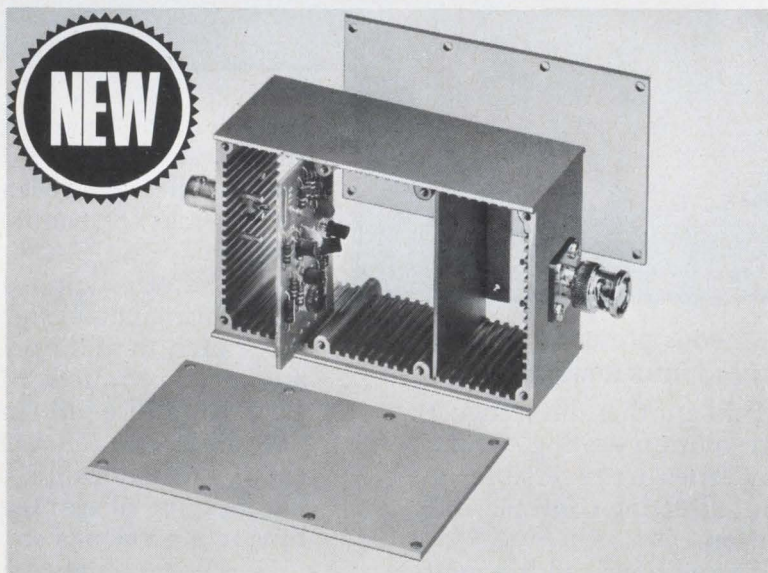

SHIELDED BOXES with CARD GUIDES

Rugged die-cast aluminum boxes, slotted to accept $\frac{1}{16}$ " circuit boards and shielding dividers. Excellent for packaging electronic circuitry. Boxes have removable top and bottom covers. Useable inside space: 4"x2"x1 $\frac{1}{2}$ ". Several models with various connectors.

Write for 1969 Catalog



POMONA ELECTRONICS CO., INC.
1500 E. Ninth Street, Pomona, California 91766

New Books

intercepting an intruding aircraft. The group example is a nuclear submarine with ballistic missiles and its crew; a 22-page flow chart describes the submarine simulation.

Readers who habitually skip prefaces will, in this case, fail to learn that the U.S. Navy paid for the research described in the book. But by the time they finish the examples, they should have guessed where the money came from.

The book is interesting, but very impersonally written—it has too many passive verbs—and this is unfortunate, considering the personal factors which make up the subject matter.

Sensor selections

Handbook of Transducers for Electronic Measuring Systems
Harry Norton
Prentice-Hall Inc., 704 pp., \$26.00

One of the most important requirements for any book designed to be used as a reference is organization—the reader must have information at his disposal quickly, and in an immediately recognizable format. Happily, organization is a strong point of this valuable reference.

For example, the author devotes the first 100 pages to general descriptions of measuring systems and transducers, and then organizes the remaining 600 pages into 14 chapters broken down alphabetically according to what's being measured. Thus chapter 7 covers light, chapter 8, liquid level, and chapter 9, nuclear radiation.

He also subdivides each chapter into sections covering basic concepts and methods of design, operation, calibration, and testing of various transducers and of special measuring devices. And he follows each chapter with two or three pages of bibliography.

The book does have some shortcomings for those who will want to use it as a text as well as a reference. The chapter on sound, for instance, begins with three pages of definitions that are quite distracting. Most readers won't wonder what peak sound pressure or free-field normal incidence re-

sponse means until they encounter these terms in a paragraph. At that point, they'd tend to flip to the back for definitions.

Otherwise, this chapter shares all the virtues of the book. It follows the definitions with a brief but adequate explanation of the physical laws of sound and of the basic measurement units. Then it describes the five types of sound transducers — capacitive, electromagnetic, inductive, piezoelectric, and reluctance—discusses the applications each was designed for, and offers tips on selecting and calibrating the right transducer for a particular job. Discussions are compact and informative—just right for the working engineer.

Illustrations are ample and well done, as are the photographs. A bonus for anyone who ever had trouble remembering how to convert a temperature from one scale to another is the nine-page table showing the centigrade, Fahrenheit, Kelvin and Rankine equivalents from absolute zero (-495.7°F) to well over the melting point of tungsten ($3,653^{\circ}\text{K}$).

Appendices contain a discussion of units, a collection of symbols, and an 11-page glossary.

Recently Published

Design of Resonant Piezoelectric Devices, Richard Holland and E.P. Eer-Nisse, MIT Press, \$12.50

Emphasis of the book is on mathematical techniques. Many of the discussions pertain to ferroelectric ceramic devices, the simplest device class to represent analytically.

Matrix Analysis of Discontinuous Control Systems, P.V. Bromberg, American Elsevier, \$18.75

Aimed at graduate-level students, the book discusses the application of matrix algebra to the solution of linear differential and finite-difference equations with constant coefficients.

Formal Languages and their Relation to Automata, John E. Hopcroft and Jeffery D. Ullman, Addison Wesley, \$11.95

This volume covers concepts of a language, its finite representations and grammars as well as types of automata. It is intended for use in graduate-level courses.

**The thermistors VECO produces
Will suffer a lot of abuses.
They quickly defeat
Any problems of heat
In Mil. & Industrial uses.** *



Got a special thermistor application problem? Victory Engineering's complete lines of thermistor disks and rods are manufactured to meet or exceed MIL-T-23648 standards. Instant response coupled with precision measurement makes them ideal for temperature control uses, such as transistor circuitry. VECO produces positive and negative temperature coefficient thermistors in a wide range of body styles and resistance values. Every Victory thermistor is backed by a long-held reputation as the industry leader solely devoted to the research, development and manufacture of temperature and voltage sensitive components.

*ENGINEERS ARE INVITED TO SUBMIT VECO LIMERICKS. BEST WILL RECEIVE A VECO THERMISTOR DESIGN KIT AND/OR HAVE LIMERICK APPEAR IN FUTURE ADVERTISING.

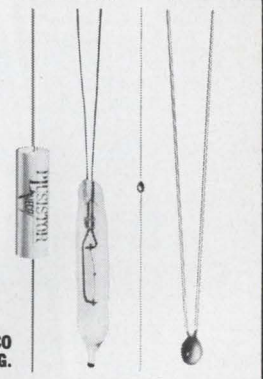

VICTORY ENGINEERING CORPORATION

VICTORY ROAD, SPRINGFIELD, NEW JERSEY 07081 • (201) 379-5900 • TWX 710-983-4430

Circle 215 on reader service card

UNBELIEVABLE ADHESIVE



It's a fact: EASTMAN 910® Adhesive can form remarkably strong, long-lasting bonds between just about any materials you can think of — and do it with surprising speed, without the need for any mixing, heat, solvents, catalysts or more than contact pressure.

Hard to believe? Find out for yourself what this unique adhesive can do, and how it can help you cut assembly costs. Get your copy of the EASTMAN 910 Adhesive information kit by writing to Chemicals Division, EASTMAN CHEMICAL PRODUCTS, INC., Kingsport, Tennessee.

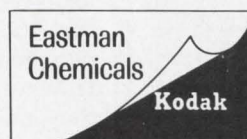

Circle 193 on reader service card

NEW! from starmark

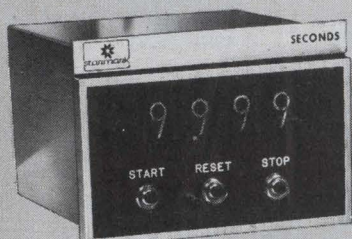

DIGITAL STOP WATCH

With data (BCD)
output and resolution to .001
seconds!

The series 200 models are available in a wide range of full scale values and resolutions. They feature easy-to-use remote control provisions plus convenient front panel controls. Standard models come equipped with either a precision internal oscillator or external 60 HZ time base. Design is such that the user can cascade multiple units.

- COMPACT
- LOW PRICE

Part of a full line of elapsed time or time of day monitoring and display instruments made and marketed by Starmark Electronics. For further information, call Bob Rush or Bob Lynn (816) 931-7367.



T.M.

3710 Main Street
Kansas City, Missouri 64111

Technical Abstracts

Sharing the tasks

Design of digital filters using read-only memories
Allen D. Sypherd
Autonetics division of North American
Rockwell Corp.
Anaheim, Calif.

Read-only memories have capabilities that make them particularly suited to the addition, multiplication, timing, and control functions needed to build digital filters. The one-word delay, also needed in digital filters, is more readily implemented with a shift register. Although these same functions can be performed by standard integrated circuits, the read-only memory offers improved performance and versatility with reduced hardware. The digital filter implements the transfer function representing any of a variety of analog filters. (See "Happy algorithm", *Electronics*, Dec. 22, 1969, p. 160.) Basically, the analog transfer function is converted into discrete, or digital, form using, for example, z-transform notation. Then, to ease design, the digital transfer function is converted, by partial fraction expansion, into a sum of first-order z-transform terms:

$$G(z) = \sum_{k=1}^n \frac{R_k}{1 - B_k z^{-1}}$$

The z-term represents a one-word delay, done in a shift register. The R- and B-terms are coefficients, which more than likely have a different value at each discrete interval for each of the summed factors. In that event multiplication by variable coefficients would be called for, and this can be accomplished in the read-only memory. The summation of all the terms, from 1 through n, requires a multiple-input adder, and a ROM can also carry out this task.

Read-only memories perform many types of tasks, such as code conversion, microprogramming, function generation, and table lookup. However, the operation is always the same: an address is sent to the ROM, and the output is a preprogrammed word corresponding to the

input address.

As a multiple-input adder, consider a 1,024-bit ROM organized into 256 words of 4 bits. The eight address bits ($2^8 = 256$) represent the numbers to be added. The output will be the sum plus carries. If the number of inputs to be summed is five or less, the read-only memory is encoded to output the sum and three carries of an 8-bit input, 3 bits of which are delayed carry-in bits. Using standard integrated circuits, such a multiple-input function would require seven full adders and six delay units.

As a multiplier, the ROM can take on three different configurations: parallel-parallel for fixed coefficients; parallel-parallel for variable coefficients; and serial-parallel for slower-speed, minimum hardware, multiply-variable-coefficient applications.

The ROM serial-parallel multiplier is probably the most interesting form. It can be used, for example, in applications where the multiplier is time-shared with multiple inputs and multiple outputs. A variable-pole filter is a case in point. Time delay through such a filter is not critical, so inputs can be switched into the filter, processed and stored in a feedback register, circulated internally over and over again by the properly timed switching of inputs and outputs as needed to obtain the desired response, and switched to the output at the proper time. Different poles can be realized at each pass of the digital information within the filter by using a read-only memory coefficient store that modifies the serial-parallel ROM multiplier.

Presented at NEC, Chicago, Dec. 8-10, 1969.

Illuminating

A silicon-diode camera tube
Thomas R. Kohler, Joze Kostelec
Edward Stupp, Egons Rasmanis
Philips Laboratory; Amperex Electronic
Corp.
Briarcliff Manor N.Y.; Slatersville R.I.

A television camera tube using an array of discrete, reverse-biased silicon diodes as the image sensing target shows significant improve-

ments over current vidicon-type tubes for applications in low-light-level tv and near-infrared tv. The silicon-camera tube has a wider spectral response and higher quantum efficiency, and isn't damaged by bright lights.

The silicon tube differs from the Plumbicon and conventional vidicons in that the sensing element is an array of planar diodes fabricated in a wafer of single-crystal silicon, instead of a deposited layer of lead oxide or antimony trisulfide. The array consists of a matrix of about 500,000 p-type islands diffused into n-type silicon.

The diodes are fabricated by planar-silicon technology, and therefore, the surface between the diodes is passivated with a thermally grown silicon-dioxide layer. This oxide also serves to prevent the electron beam from striking the n-type substrate. To prevent the silicon-dioxide insulator from excessively charging negatively (and therefore preventing the beam from landing properly on the diodes), a resistive sea is deposited over the whole surface. This resistive layer is critical to the tube's operation since it must be low enough to prevent excessive surface charging yet be high enough to prevent resolution deterioration arising from conductivity between the diodes.

The photolithographic process for forming the diode pattern on the wafer consists of coating the surface of an oxidized wafer with a photoresist material, followed by the conventional photographic procedures. The exposure of the photosensitive film is generally accomplished by exposure to ultraviolet light through a photomask. The photoresist is then developed, the oxide etched, and the resist stripped off.

Then the p-n junctions are formed by boron diffusion. Boron is diffused through the windows in the oxide, which were opened in the photolithographic process. Subsequent to this diffusion, the imaging area of the wafer is thinned to the desired thickness. The n+ layer for reducing surface recombination is then formed by phos-

Pert Mag, the PERMAG girl, says:

"Handling is chore-less with Magnets!"



And Permag has just the right magnet for your material handling problem. Permag offers permanent magnets, assemblies, electrical alloys, flexible magnets, soft magnetic materials and ferrites. Also, special precision grinding and cutting. And full magnetizing and engineering facilities. Distributor of Gordos Reed Switches.

Permag

PERMAG SIERRA CORP. 3721 HAVEN AVENUE, MENLO PARK, CALIFORNIA 94025 • (415) 369-0303
 PERMAG PACIFIC CORP. 5441 WEST 104th ST., LOS ANGELES, CALIF. 90045 • (213) 776-5656 • TWX [910] 328-6547
 PERMAG SOUTHWEST CORP. 2720 TAYLOR STREET, DALLAS, TEXAS 75226 • (214) 748-6909
 PERMAG CENTRAL CORP. 1213 ESTES AVE., ELK GROVE VILLAGE, ILL. 60007 • (312) 956-1140
 PERMAG MAGNETICS CORP. (formerly EMPIRE MAGNETICS) 3130 SOUTH AVE., TOLEDO, OHIO 43609 • (419) 385-4621
 PERMAG NORTHEAST CORP. 50 THAYER ROAD, WALTHAM, MASSACHUSETTS 02154 • (617) 484-0550
 PERMAG CORP. 88-06 VAN WYCK EXPRESSWAY, JAMAICA, N.Y. 11418 • (212) 657-1818 • TWX [710] 582-2952

Circle 216 on reader service card

This announcement is neither an offer to sell nor the solicitation of an offer to buy any of these securities. The offering is made only by the Prospectus.

320,000 Shares

Wang Laboratories, Inc.

Common Stock
 (\$.50 Par Value)

Price \$43.25 per Share

Copies of the Prospectus may be obtained in any State only from such of the several underwriters as may lawfully offer the securities in such State.

White, Weld & Co.

Blyth & Co., Inc.

Tucker, Anthony & R. L. Day

Eastman Dillon, Union Securities & Co.

Glore Forgan Staats
 Incorporated

Goldman, Sachs & Co.

Kidder, Peabody & Co.
 Incorporated

Lehman Brothers

Salomon Brothers & Hutzler

Smith, Barney & Co.
 Incorporated

Stone & Webster Securities Corporation

Wertheim & Co.

January 28, 1970

NEW PACKAGING STANDARD FOR RADIAL LEAD COMPONENTS

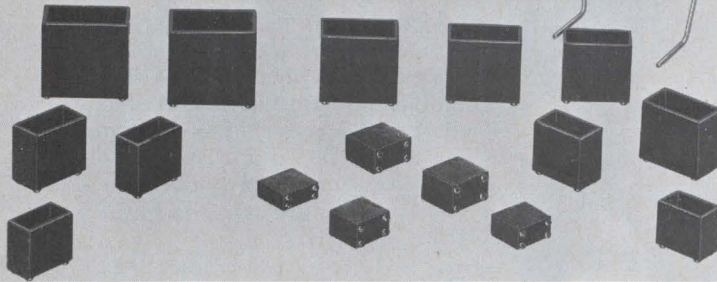

If you've been looking for packaging improvement in radial lead components, here is an answer to your problem....An expanded family of radial lead component encapsulation shells available from Robison Electronics. Produced from glass-filled Diallyl Phthalate, these shells range in size from .100 Wide x .250 Long x .250 Deep to 1.200 Wide x 2.400 Long x 1.350 Deep. All shells in this family incorporate two holes for lead ter-

mination and stand-off feet for PC mounting to allow solder fillet formation and flush cleaning of flux residues after leads are soldered. Precision molding assures consistency of size and appearance throughout the range of shells. Perfect for packaging resistors, capacitors, inductors, and other miniature components. Available from stock or within 2 weeks ARO. Contact factory for complete information.



ROBISON ELECTRONICS, INC.

2134 W. Rosecrans Ave., Gardena, Calif. 90249, ph. (213) 321-0080, 327-5661

Technical Abstracts

phorus diffusion.

Two films are deposited after another oxide etching is made to open the contacts. One is an anti-reflection coating which minimizes the reflection losses, and the other is the resistive sea which completely covers the oxide surface and the diodes. The wafer is then tested and mounted in the tube structure.

The silicon tube has promise in color tv applications. The spectral sensitivity of the silicon tube is such that a much improved red response is possible over conventional tubes. In theory, the silicon tube's response in the red channel is better than the XQ1023 Plumbicon by a factor of three. Since the luminance signal is composed of signals from the red, green, and blue channels, an improved signal-to-noise ratio as well as better color reception is assured. The tube also makes an excellent receptor when coherent sources such as lasers are used as illuminators.

Presented at NEC, Chicago, Dec. 8-10.

Tv and the 3 R's

Transmitting audio-visual information on f-m subcarriers
Harold R. Walker
Educating Systems Inc.
New York, N.Y.

Standard television equipment operating at standard scan rates is used in a new educational-tv system in which video information is sampled and transmitted on f-m subcarriers at a reduce frame rate, conforming to any allowable bandwidth. The system was approved by the FCC for experimental use and was tested in Flint, Mich.

The most difficult aspect of any slow-scan tv system is synchronization of camera and receiver. In this system, a local tv station with good area coverage is used as the unknown helper. A receiver at the educational tv transmitter picks up the local high-energy vertical and horizontal pulses. These are used to generate the camera deflection voltages and drive the sampling circuits. Interlaced scanning is automatically provided to the low-cost camera used in the system.

Horizontal pulses from the syn-

Circle 217 on reader service card

PRECISION

MILLIVOLT SOURCE

\$195



An accurate, compact, battery operated source of DC Millivolts suitable for general calibration and testing.

SPECIFICATIONS:

- **Full Scale Output Voltage: Resolution**
0 to ± 1000 mv full scale ... < 1 mv
0 to ± 100 mv full scale ... < 0.1 mv
0 to ± 10 mv full scale ... < 10 μ v
- **Open Circuit Accuracy:** 0.20% + drift
- **Open Circuit Linearity:** 0.1%
- **Open Circuit Stability:** 0.5% max. from turn on, 0.1% max. per 8 hours in continuous operation after 2-hour warm-up, 0.25% max. per 1 week in continuous operation.
- **Output Impedance:** 0 to 100 ohms maximum (derived from drop across a 100 ohm ten turn potentiometer.)

M
E
MONROE ELECTRONICS, INC.
5 VERNON STREET MIDDLEPORT, NEW YORK
DEVELOPMENT AND MANUFACTURE OF ELECTRONIC INSTRUMENTS AND SYSTEMS
Area Code 716, REpublic 5-3721

196 Circle 196 on reader service card

FREE SAMPLES



Printed Wiring Shapes and Patterns for Artwork Accuracy in Seconds

Yours — free for the asking — a trial sample packet of By-Buk time saving pressure sensitive printed wiring drafting aids. Discover the efficiency of this partner to faster, more accurate artwork production. By-Buk offers thousands of ideas in printed wiring shapes, patterns and tapes. Individually die cut on quick release backing paper. Easy to apply. Available in opaque black, transparent red and transparent blue.



See these cost savers for yourself. Send for your free samples, plus 20 page product line catalog.

BY-BUK COMPANY

4326 W. Pico Blvd.
Los Angeles, Calif. 90019
(213) 937-3511

Circle 218 on reader service card

Opportunities for CIRCUIT DESIGNERS

Expanding activity on long-range programs and advanced projects has created many stimulating growth-assignments for Circuit Designers at Hughes.

Some of our most urgent requirements exist in the following areas:

- Development of high-power airborne radar transmitters, the design of which involves the use of the most advanced components
- Design of low-noise radar receivers using parametric amplifiers and other advanced microwave components
- Design of digital radar signal processing subsystem circuits, including range and speed trackers, doppler filter banks and a variety of display circuits
- Design of high-efficiency power supplies for airborne and space electronic systems
- Development of telemetering and command circuits for space vehicles and communications satellites

Requirements: an accredited Engineering degree, a minimum of two years of directly relatable experience and U.S. citizenship.

For immediate consideration, please airmail your resume to:

MR. ROBERT A. MARTIN
Head of Employment
Hughes Aerospace Divisions
Dept. 54
11940 W. Jefferson Blvd.
Culver City, Calif. 90230

HUGHES

HUGHES AIRCRAFT COMPANY
AEROSPACE DIVISIONS

An equal opportunity employer—M & F

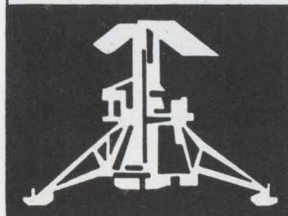

Technical Abstracts

Chronizing receiver are applied to a sawtooth generator in the transmitter. Then an emitter follower reduces loading on a bypass capacitor and drives an operational amplifier. Vertical pulses are applied to a digital countdown circuit whose output generates another sawtooth. This second waveform may be 266 to 152 times slower than the vertical scan rate. The two sawtooth waveforms are compared in an operational amplifier and used to generate a 0.2-microsecond pulse when coincidence occurs. This pulse samples the video signal from the camera; it is held by a boxcar detector for 63 μ sec until the next sample is received. The output of the boxcar detector is filtered and delayed so that the video emerges as a 7,875-hertz sine wave with amplitude modulation. This is the signal sent to the receiver.

The receiver has similar circuits to generate the sampling pulse, and because of the positive synchronization, the sample pulse will appear at the receiver at the transmitter. The video is delayed by 63 μ sec, one horizontal line, causing the displayed data to appear one scan line lower on the screen.

Because of the slow scan rate—one picture occurs every 8-10 seconds—some storage method is necessary. A tv camera with an r-f output views the receiver with its normal P4 phosphor—both are placed in a light-tight box. The output of the vidicon—in this case a Westinghouse Permacon—is fed to ordinary receivers in classrooms.

“Educating” uses a special purpose f-m/f-m multiplexer with four subcarrier channels centered at 23.375, 55.125, and 70.875 kilohertz. The upper two channels are used for voice. The fact that synchronization pulses are not carried with the video allows the use of two clear sound channels. The synchronization information, obtained from the local tv station, is transmitted at 39.375 khz and tone bursts used to erase the images are carried at 23.625 khz. A single-side band system could have been used advantageously had the FCC allowed it.

Presented at NEC, Chicago, Dec. 8-10, 1969.

the most popular ALCOSWITCH®

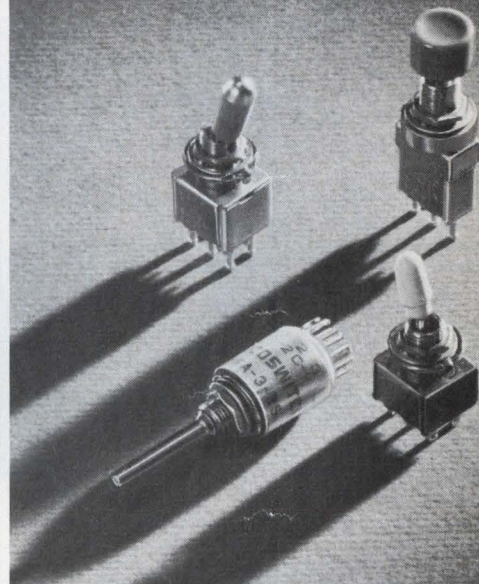

WE'RE
NOT
NO. 1, 2 OR 3

But we are popular in the miniature switch field.

You'll find our ALCOSWITCH® in test equipment, medical equipment, electronic controls, computers, and in thousands of installations where design engineers want the best without having to pay outrageous prices.

We're popular too, because ALCOSWITCH® has one of the broadest lines available in miniatures — toggles, push buttons, rotaries, locking, slide, and rockers, along with a host of needed accessories.

ALCOSWITCH® is made for engineers — and you can fill your immediate requirements from our stocks or from one of our many ALCOSWITCH® stocking distributors in your area.

ALCO®

ELECTRONIC PRODUCTS, INC.

Lawrence, Massachusetts 01843

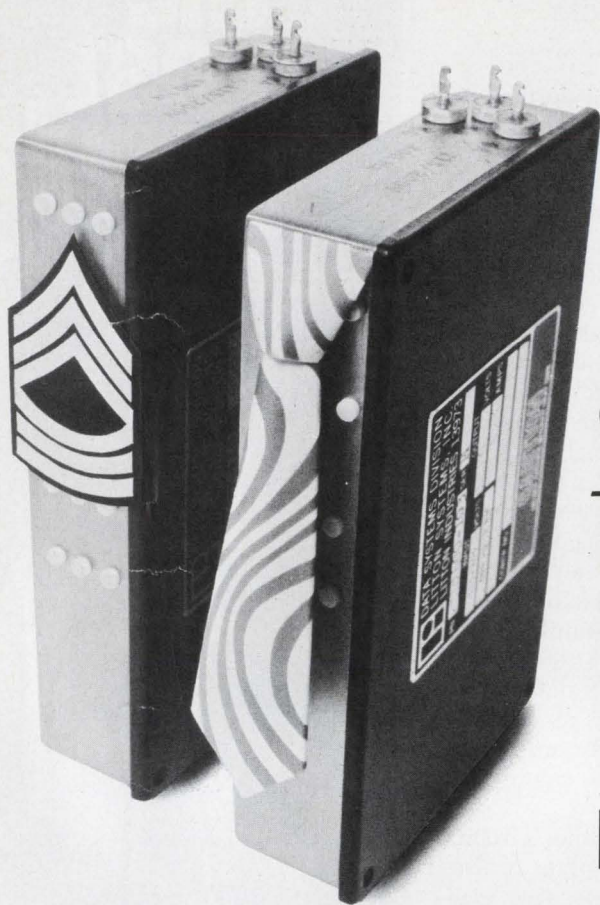

Commercial & military

THE LEADER in power conversion designs for every application.

Off-the-shelf, custom-tailored or complete power systems... economy with high reliability.

Our applications engineers will be happy to assist you. Phone, write or use inquiry card in this magazine.



SPECIAL PRODUCTS
Data Systems Division • Litton Industries
9001 Fullbright Ave., Chatsworth, Calif. 91311 (213) 781-8211

Circle 220 on reader service card

Custom Thick Film Hybrid Microcircuits

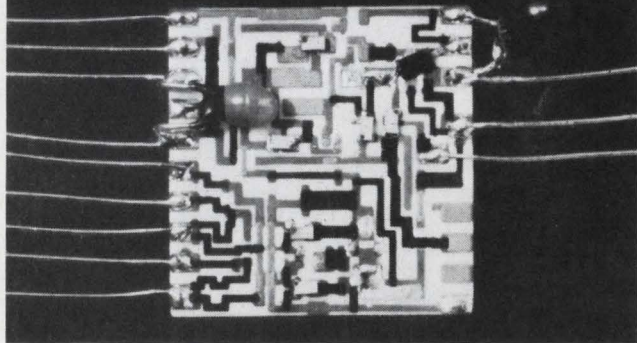

Complete services are offered to repackage and manufacture your discrete circuit in hybrid thick film form or manufacture your thick film design in production quantities.

Printed and fired thick film circuits feature:

- Miniaturization
- High Reliability
- Low Cost

Fast turn around prototype capability allows quick evaluation of your requirement.

Astro-Space Laboratories, Inc.



110 Wynn Drive, N.W. / Huntsville, Alabama 35806
205/837-5830

198 Circle 198 on reader service card

OVER
1,000,000 SIZES
MILITARY CASES
COMBINATION • TRANSIT • INSTRUMENT

MIL-T-945A, T-4734, T-21200, STD-108, C-4150



Choose from over 1,000,000 variations in dimensions, proportions, metals, finishes, and custom accessories. Whatever your need, the MM (multi-measure) method gives you high production savings even on custom runs as low as 25 units. Send your print or requirements. Manufacturers representatives in all major cities.

SEND FOR FREE CATALOG & DIMENSION SPECIFICATION SHEETS.

••MM ELECTRONIC ENCLOSURES, Inc.

111 Bloomingdale Rd., Hicksville, N.Y. 11801 • 516-935-9400

Circle 221 on reader service card

New Literature

Indicator selection. Dialight Corp., 60 Stewart Ave., Brooklyn, N.Y. 11237, announces a 56-page product selector guide that aids in the selection and procurement of more than a million and a half indicator lights, readouts, and illuminated push-button switches. Circle 446 on reader service card.

Power supplies. Trygon Electronics Inc., 111 Pleasant Ave., Roosevelt, L.I., N.Y. 11575, has published a 16-page new product supplement to its power supply handbook 269. [447]

Operational amplifiers. Torque Systems Inc., 225 Crescent St., Waltham, Mass. 02154, has available data sheets and application notes on the PA-100 series of high performance operational amplifiers. [448]

Tachometers. Dynalco Corp., 4107 N.E. 6th Ave., Fort Lauderdale, Fla. 33308. Short-form data sheet Dynaform 1 describes the various electronic tachometer types and their main applications and characteristics. [449]

Logic assemblies. Cambridge Thermionic Corp., 445 Concord Ave., Cambridge, Mass. 02138, offers a condensed catalog describing new TTL and analog circuit assemblies that have been added to its inventory of logic cards. [450]

Portable strip printer. Dataline Inc., 181 South Boro Line Rd., King of Prussia, Pa. 19406. Bulletin 100 describes the model 5064 portable strip printer, a digital impact unit that can be incorporated into data communications systems to provide hard-copy readout. [451]

Data set. Tel-Tech Corp., 9170 Brookville Rd., Silver Spring, Md. 20910. Data set TT-201, a compact modem compatible with the Bell 201 and very low in price, is described in a four-page folder. [452]

Resistor networks. Vishay Resistor Products, 63 Lincoln Highway, Melvern, Pa. 19355. An application engineering bulletin describes 2- and 4-element resistor networks that can be used to extend the performance of amplifiers, voltage dividers, and R-2R ladder networks. [453]

Power converters. Arnold Magnetics Corp., 11264 Playa Court, Culver City, Calif. 90230, offers a four-page condensed catalog describing the features, specifications, modifications, and mounting dimensions for a line of miniature and subminiature power conversion equipment. [454]

Thermistors. Keystone Carbon Co., St. Marys, Pa. 15857. A 56-page catalog on

disk-type thermistors contains 34 full-page graphs showing resistance-temperature curves and tabulated charts, enabling determination of the resistance value of any unit at specific temperatures. [455]

Rotary pulse generators. Trump-Ross Industrial Controls Inc., 265 Boston Rd., N. Billerica, Mass. 01862. A six-page shortform catalog describes TRUROta rotary pulse generators. [456]

Connectors. Dale Electronics Inc., P.O. Box 609, Columbus, Neb. 68601, has published a 48-page catalog listing its full line of connectors. [457]

Torque motor guide. Aeroflex Laboratories Inc., South Service Rd., Plainview, N.Y. 11803, has available a comprehensive guide to its line of brushless d-c torque motors, d-c moving coil torque motors, d-c tachometers, d-c torquer/tachometers, and d-c torquer amplifiers. [458]

Thick-film resistors. Cermetrics Inc., 113 E. 16th St., New York 10003. Bulletin CM351 provides specifications on a series of ultrahigh value thick-film resistors, ranging up to 1,000 megohms. [459]

Lighted pushbutton switches. Arrow-Hart Inc., 103 Hawthorn St., Hartford, Conn. 06106, has prepared a 12-page catalog section describing the Adapt-a-Switch line of lighted pushbutton switches. [460]

Plastic thyristors. Transatron Electronic Corp., 168 Albion St., Wakefield, Mass. 01880, has available a 24-page reliability report on plastic encapsulated thyristors. [461]

Epoxy molding compounds. Rogers Corp., Rogers, Conn. 06263, has published data sheets on mineral-filled, encapsulation grade epoxy molding compounds RX2200 and RX2210. [462]

Tape heads. Nortronics Co., 8101 Tenth Ave. North, Minneapolis 55427. A 24-page catalog presents detailed specifying information about a comprehensive line of magnetic heads for audio, mastering, duplicating, instrumentation, and minidigital applications. [463]

Precision potentiometer. Beckman Instruments Inc., 2500 Harbor Blvd., Fullerton, Calif. 92634. A two-page catalog sheet describes the series 7620 servo mount precision potentiometer. [464]

Ratio meter system. Weinschel Engineering, Gaithersburg, Md. 20760. An application note describes a ratio meter system for making accurate, broadband, r-f swept-frequency microwave parameter measurements. [465]

brite glo[®] ALCOLITE

Alco's new Brite Glo[®] miniature lamp series is achieved through painstaking workmanship that assures the best pilot assembly on the market.

The new T-1 3/8 MNE neon series has an exclusive ring electrode construction that glows on the entire surface with direct current. Available as individual lamps or as miniature panel assemblies.

All our miniature incandescent pilot assemblies contain the most popular and long-life MIL-grade T-1 5 volt lamps. Choice of domed or cylindrical assemblies, in a variety of colors.

Our standard neon series are all equipped with NE2 lamps and are available in many lens styles and colors, with or without built-in series resistors.

For design-service assistance and price quotations, call (Area 617) 686-3887.

SEND FOR COMPLETE
ALCOLITE
CATALOG



ALCO

ELECTRONIC PRODUCTS, INC.

Lawrence, Massachusetts 01843

The Material of Unlimited Uses...

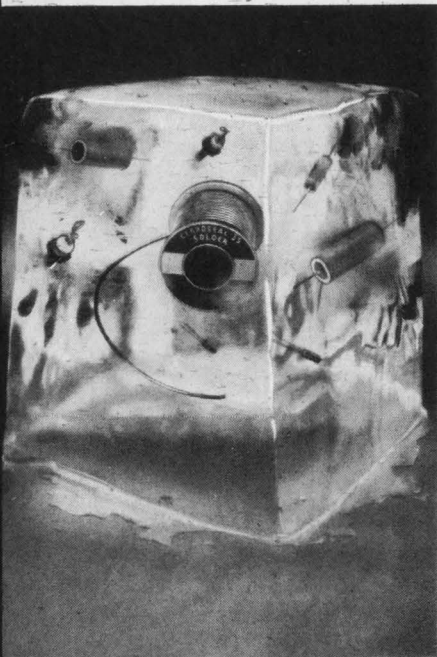

SOLDERING "UNSOLDERABLES"

...is but one of the thousands of uses for advanced low-melting-temperature alloys such as Cerroalloy® 35. Cerroalloy 35 melts between 238° and 260° F., and can be used with ordinary soldering techniques. When soldered with this versatile alloy, "toughies" such as glass-to-metal, ceramic-to-metal and metal-to-metal seals stay tight even in a deep vacuum. Other Cerro® Alloys, including specials made to your individual specs, are perfect for joining ultra-delicate parts like integrated circuits which cannot be heat-sunk during soldering. Low-temperature soldering as cool as 117° F. can also be accomplished with certain Cerro Alloys.

For detailed information contact Cerro Alloy Dept., Cerro Copper & Brass Company, Bellefonte, Pa. 16823 ... (814) 355-4712.

In Europe, contact Mining & Chemical Products Ltd., Alperton, Wembley, Middlesex, England.

CERRO®

200 Circle 200 on reader service card

New Literature

Digital counter multipliers. High Frequency Engineering Co., 2626 Frontage Rd., Mountain View, Calif. 94040, offers a specification sheet describing a line of three solid state pre-scalers designed to extend the frequency capability of existing digital counters. [466]

Pressure sensitive transistors. Stow Laboratories Inc., Hudson, Mass. 01749. The combination of physical sensing and transistor characteristics of the Pitran pressure sensitive transistor is described in an eight-page brochure. [467]

Vitreous enamel resistors. Sprague Electric Co., 35 Marshall St., North Adams, Mass. 01247. Bulletins 7400C and 7410E contain updated technical information on Blue Jacket vitreous enamel resistors. [468]

Wire strippers. Ideal Industries Inc., 5180 Becker Pl., Sycamore, Ill. 60178. A full line of hand and bench mounted wire strippers is illustrated and described in an eight-page brochure. [469]

Torque measurement. Waters Mfg. Inc., Wayland, Mass. 01778. Precision torque measuring instruments are illustrated and described in a 10-page brochure. [470]

Pulse modulators. Bertan Associates Inc., 15 Newtown Rd., Plainview, N.Y. 11803. High-power pulse modulators that are fully solid state and computer-controllable are described in technical bulletin 6901. [471]

Voltage standard. Esterline Angus Division of Esterline Corp., Box 24000, Indianapolis 46224. A variable d-c voltage standard is described in a two-color catalog sheet. [472]

Audio equalizers. Melcor Electronics Corp., 1750 New Highway, Farmingdale, N.Y. 11735, offers a six-page catalog covering a complete line of audio equalizers. [473]

Polycrystalline materials. Aremco Products Inc., P.O. Box 145, Briarcliff Manor, N.Y. 10510, has available product bulletin 537 describing high purity polycrystalline materials. [474]

Instrumentation. Honeywell Test Instruments Division, P.O. Box 5227, Denver, Colo. 80217. Catalog D-2000 illustrates and describes a line of electronic test and measuring instruments. [475]

Motors, gearmotors, converters. Carter Motor Co., 2711 W. George St., Chicago 60618. Bulletin 969 illustrates and describes a line of motors and gearmotors, and d-c to a-c converters. [476]

Communications equipment and systems. Racal Communications Inc., 8440



EMPLOYMENT OPPORTUNITIES

PERSONALIZED (not computerized) SERVICE

ONE knowledgeable, ethical, service-motivated consultant is more valuable to the job-seeking electronic engineer than a computer and 87 affiliated agencies. Especially when his service is nationwide and employer fee paid.

You write. I'll respond. Then you decide.

JOSEPH P. CORCORAN Personnel Consultants
505B Germantown Pike, Lafayette Hill, Pa. 19444
215/825-0848

CIRCLE 966 ON READER SERVICE CARD

ADDRESS BOX NO. REPLIES TO: Box No.

Classified Adv. Dept. of this publication.

Send to office nearest you.

NEW YORK, N. Y. 10036: P. O. Box 12

CHICAGO, Ill. 60611: 645 N. Michigan Ave.

SAN FRANCISCO, Cal. 94111: 255 California St.

POSITION VACANT

Wanted—Electrical or electronics engineer with five or more years experience needed to teach in the area of electronics technology. Applicant must have B.S. degree (M.S. preferred). Salary commensurate with qualifications. Excellent future. Send resume to: Dr. A. A. Paloumpis, Dean of Instruction, Illinois Central College, P.O. Box 2400, East Peoria, Illinois 61611.

EMPLOYMENT SERVICE

Resume Guide—Authentic writing instructions, clear, examples: \$2. Executive Resumes, Box 246EL, Montclair, N.J. 07042.

BUSINESS OPPORTUNITY

Capital Contacts—Before you try Public or Private Placements to Underwriters, Investment Banking Houses, write for helpful information to Confidential Consultant 817 - 51st St., Brooklyn, N.Y.

CLASSIFIED ADVERTISING

SEARCHLIGHT SECTION

BUSINESS OPPORTUNITIES
USED OR SURPLUS EQUIPMENT

LARGEST INVENTORY OF U.S. MILITARY RADARS IN THE WORLD

TRACKING—SEARCH—AIRBORNE
WRITE FOR FREE 16-PG. CATALOG

RADIO RESEARCH
INSTRUMENT CO.

45 W. 45th ST., N.Y., N.Y. 10036
212-586-4691

CIRCLE 967 ON READER SERVICE CARD

Sold!

"Please discontinue our ad in "Searchlight" as we have sold the equipment through this advertising."

Can "Searchlight" Serve You?

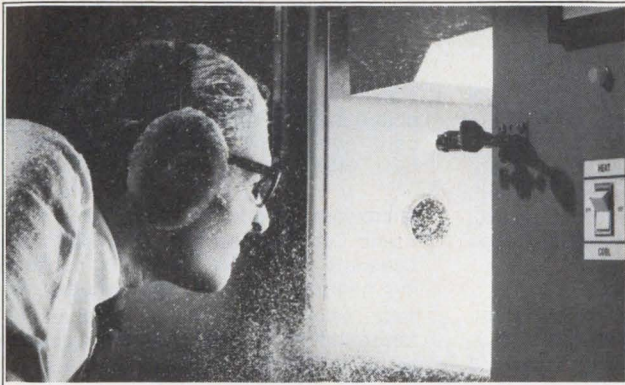

THE CHILLER

Cold. Calculating. Mechanically refrigerated. Yet, at times, warm . . . even hot. Called by those who know . . . Tenney Jr. Inside 1¼ cu. ft. of emptiness waiting for you and yours. Get it. Sit it on your bench-top. Watch it pull down from ambient 75°F to -120°F in 55 minutes. Or, if heat is your hang-up, watch it zoom to +350°F in 35 minutes. Either way with ±¼°F control and no RFI. Write or call us about Tenney Jr. today. We'll see that you get yours.

T Jr: \$1080 — Available immediately from stock. Also ask about the Tenney SST, only \$890.

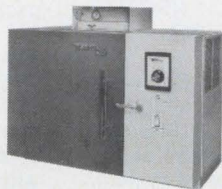

Tenney
ENGINEERING, INC.

1090 Springfield Rd., Union, New Jersey 07083 • (201) 686-7870
Western Division: 15721 Texaco St., Paramount, Calif. 90723

606

Circle 222 on reader service card

SWITCH/INDICATORS

Super-compact 5 & 15 amp models.

Alternate or momentary action. Push-on, push-off power switch mounts in a ¾" hole on centers as close as 1½" (5 amp model) and 2½" (15 amp). Minimum life: 100,000 cycles.

Independent, isolated incandescent lamp (neon optional). Match other TEC-LITE indicators for panel design harmony. Switch contact rating: 5 or 15 amps at 115 VAC, 60 Hz or 28 VDC resistive. Available in 14 lens colors. As low as \$3.85 in quantities of 100 - 499.

For more information on PBL-PBS switches — or our complete line of display/control products and systems — write: TEC, Incorporated, 6700 So. Washington Avenue, Eden Prairie, Minnesota 55343. (612) 941-1100.



TEC
INCORPORATED

Circle 223 on reader service card

LSI

The Changing Interface

Medium and large scale integration are slated to have major impact on the electronics industry. The effects are already being felt — not only on systems and component design — but on fundamental, traditional relationships between equipment builders and component suppliers.

Important trends that will affect your profession, your job, your company, are explored in LSI: THE CHANGING INTERFACE, a 100-page illustrated volume published by McGraw-Hill's Electronics/Management Center.

In THE CHANGING INTERFACE, leading design engineers and managers, the men responsible for guiding their companies through the next generation of electronics, discuss the problems that LSI/MSI are stirring up — and offer their solutions.

Here are some of the vital topics covered.

- Implications of LSI on the Electronics Market
- The Rationale for an In-House IC Capability
- The Component Maker's Responsibility vs. the System Builder's Responsibility
- Masks and Computer-Aided Design at the Interface
- The Testing Interface
- How IBM and Bell Laboratories Deal with the Interface Problem
- Controversies and Future Trends in LSI

Copies of LSI: THE CHANGING INTERFACE are available now at \$10 per copy. Fill in and return the coupon below. If you send a check now, we'll pay the cost of postage and handling.

Electronics/Management Center
330 West 42nd St.
New York, N.Y. 10036

Attn. Mr. Wayne Cowart

Please send _____ copies of LSI: THE CHANGING INTERFACE at \$10 per copy.

Name _____ Title _____

Company _____

Company Address _____

City _____ State _____

Check enclosed for _____ Bill me
 Bill Company, P.O. Number _____

Circle 201 on reader service card

201

New Literature

Second Ave., Silver Spring, Md. 20910. A short-form catalog provides specifications on a broad line of equipment such as receivers, panoramic adapters, frequency measuring systems, and man-pack transceivers. [477]

Digital computer. GRI Computer Corp., 76 Rowe St., Newton, Mass. 02166. A 12-page booklet provides complete information about the 909 digital computer, a direct function processor. [478]

Operational amplifier. Analog Devices Inc., 221 Fifth St., Cambridge, Mass. 02142, has issued a fold-out data sheet giving description, specifications and application guidance for model 153 low drift, battery powered, differential operational amplifier. [479]

Coiled cords. Adirondack Wire & Cable Co., New Britain Ave., Farmington, Conn. 06032, has published an informative catalog giving specification data and prices for coiled cords in varying lengths. [480]

Voice response. Voice Response Systems Inc., Six Westchester Plaza, Elmsford, N.Y. 10523. How to provide immediate dialog between man and computer with computer-generated real

time voice response, is described in a four-page illustrated brochure. [481]

Data sets. Rixon Electronics Inc., 2120 Industrial Parkway, Silver Spring, Md. 20904. Modem short form catalog No. 4 deals with data sets up to 9,600 bps over voice grade lines. [482]

Electromechanical devices. Singer, Diehl division, FINDERNE Ave., Somerville, N.J. 08876. A 16-page catalog covers a broad range of precise electromechanical devices and equipment, and spans the product alphabet from a-c tachometers to vortex blowers. [483]

Vacuum/coater systems. Norton Co., 160 Charlemont St., Newton, Mass. 02161. A 20-page illustrated brochure, written for those using vacuum deposition equipment, describes the NRC3117 vacuum/coater systems. [484]

Digital signal processing. Computer Signal Processors Inc., 209 Middlesex Turnpike, Burlington, Mass. 01803, has available an eight-page brochure on the CSS-3 digital signal processing system. [485]

Single cycle clutch. Automated Business Systems, 600 Washington Ave., Carlstadt, N.J. 07072, has available

specification sheets on a single cycle clutch that simplifies paper tape/edge card punch and reader system interface. [486]

Microwave products. American Electronic Laboratories Inc., P.O. Box 552, Lansdale, Pa. 19446. A catalog containing nearly 100 pages, color-coded for easy selection, provides detailed information on a wide line of microwave products. [487]

Semiconductors. Sprague Electric Co., 35 Marshall St., North Adams, Mass. 01247. Forty-page short form catalog WR-125A gives salient information on TTL and high-speed TTL IC's as well as compatible MSI IC arrays, linear IC's, thin-film hybrid circuits, transistors, transistor chips, and flatpack hermetic packages. [488]

Thermometry. Doric Scientific Corp., 7969 Engineer Rd., San Diego, Calif. 92111, offers a six-page report giving a comprehensive comparison of a popular system using a quartz thermometer with a system using platinum thermometers. [489]

Laser data. Laser Diode Laboratories, 205 Forrest St., Metuchen, N.J. 08843. Gallium-arsenide laser diodes, diode



2 4 1 0 : 2 1 AM * 3 9 5 +

2 4 1 0 : 2 1 AM * 3 9 5 +

Print your blessings.

Count 'em. Code 'em. Time 'em.
Add 'em. Cost 'em. Read 'em. Keep 'em.

arrays, pulse generators, and d-c/d-c converters are detailed in a newly published data file. [490]

Glass digital memories. Corning Glass Works, Raleigh, N.C. 27602. Application note No. 7 describes how low-cost, high-speed glass digital memories can be used economically in low-speed applications. [491]

Digital multimeter. Dana Laboratories Inc., 2401 Campus Dr., Irvine, Calif. 92664. Data sheet 958 describes the model 5700 digital voltmeter, a premium five-digit, with sixth-digit 10% overrange, instrument. [492]

Test sockets. Robinson-Nugent Inc., 800 E. Eighth St., New Albany, Ind. 47150. Catalog 0769 covers a line of test sockets for integrated circuits. [493]

Modular power supplies. Analog Devices Inc., 221 Fifth St., Cambridge, Mass. 02142. A 12-page catalog presents specifications and applications on eight different modular d-c power and reference sources. [494]

Control systems. Motorola Instrumentation and Control Inc., P.O. Box 5409, Phoenix, Ariz. 85010. Bulletin 203A de-

scribes Veritrak electronic control instrumentation for industrial processes. [495]

Mica paper capacitors. General Laboratory Associates Inc., Norwich, N.Y. 13815, offers a brochure describing a line of custom, high temperature, mica paper capacitors. [496]

Electrical impulse counters. Kessler-Ellis Products Co., 120 First Ave., Atlantic Highlands, N.J. 07716. Six-page catalog 1200 covers a complete line of electrical impulse counters, accessories, and drivers. [497]

Regulated supplies. Quindar Electronics Inc., 60 Fadem Rd., Springfield, N.J. 07081. A four-page accessory specification sheet describes the company's selection of a-c/d-c and d-c/d-c regulated power supplies. [498]

Resistive pastes. Electro-Science Laboratories Inc., 1133 Arch St., Philadelphia 19107, has issued a 16-page technical paper on thick-film resistor pastes for high performance use, and a four-page catalog on the series 3800 resistive pastes. [499]

Power supply. California Electronic Mfg. Co., P.O. Box 555, Alamo, Calif. 94507.

Data sheet 32 contains technical information on the model 222A dual ± 15 v regulated power supply. [500]

Reliability report. Unitrode Corp., 980 Pleasant St., Watertown, Mass 02172. Reliability report R-169 covers a line of fused-in-glass zener diodes, rectifiers and rectifier assemblies, thyristors, and microwave p-i-n diodes. [501]

Rectangular connectors. Burndy Corp., Norwalk, Conn. 06852. Miniature rectangular connectors with crimp-removable contacts are featured in 24-page catalog MS-69. [502]

Connectors. ITT Cannon Electric, Humboldt St., Los Angeles 90031, has available a catalog describing its line of Micro-D Mark II rugged and moisture-sealed connectors. [503]

Laser measurement guide. International Light Inc., Dexter Industrial Green, Newburyport, Mass. 01950. A brochure describes various aspects of laser power and energy measurement. [504]

Neon lamps. Signalite Inc., Neptune, N.J. 07753. A 12-page technical brochure contains application ideas for neon glow lamps as circuit components and voltage regulators. [505]

3 .1 A 2 1. 9 Ω .7 F 3 8

3 .1 A 2 1. 9 Ω .7 F 3 8

It's hard to find an end to what our MULTI-PRINTER™ can do. And no other does so much, so accurately and reliably.

For the record, a Multi-Printer gives you visual and electrical readout of serial/parallel data input from an electrical or electronic source. At its heart is the decade, a 10 or 12-character magnetic printing device, complete with its own printed and electrical readout. And because our decades are made of quality glass fiber circuit boards and solid steel frames, you can depend on long-lasting and trouble-free performance. One Multi-Printer can take up to 30 decades to spell out information with whatever symbols or characters you choose.

It'll do your ticketing, billing, timing and production monitoring, or give

you remote readouts of recording instruments. It prints on pressure-sensitive paper rolls or ticket card forms — without smudges or ink splashes, on as many as seven copies.

In short, there's no typical application for our Multi-Printer — just an uncommonly large number of time and money saving uses. And since it's so beautifully modular, we can build it with just the number of decades and symbol types you want.

For full details, write to Product Manager, ITT General Controls, 1838 Flower Street, Glendale, Calif. 91201. International Telephone and Telegraph Corporation. You can really count on our Multi-Printer.

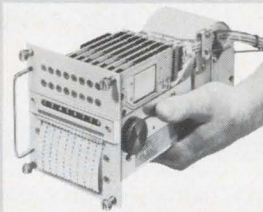

COUNTERS **ITT**

How to dodge 5 common design ruts with miniature reed relays

DEEP RUTS: only 0.35" high, encapsulated, 1, 2, 4 poles. Bulletin B/3124.

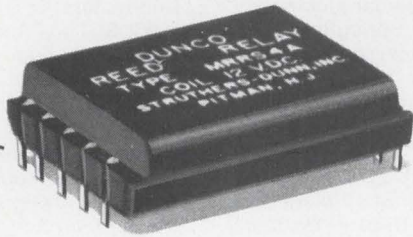

DAMAGING RUTS: sealed case protection at "open-type" cost. 9 internally shielded models. Bulletin B/3330.

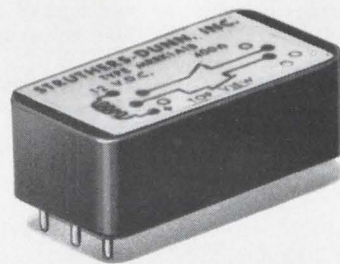

WIRY RUTS: axial lead, molded types, for point to point or P/C wiring. 1-12 Form A contacts. Catalog C/3030.



COSTLY RUTS: 9 low-cost open types, snap-on magnetic shields. Bulletin B/3113.

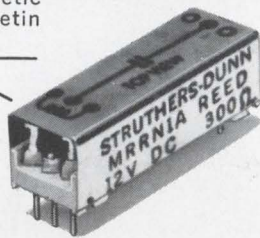

NARROW RUTS: just .75 by .30 by .45" high, encapsulated, 1 Form A or 1 Form C contact. Bulletin B/3210.

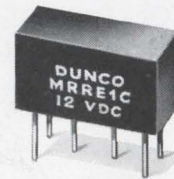

DETOUR ALL RUTS by letting Struthers-Dunn take your problem in tow. As one of the pioneers in reed relays, chances are we've already produced a special similar to your needs—in size, shielding, contact configuration, terminal arrangement, operating characteristics, and delivery.

RUT-LEVELING DATA

Check these numbers on Reader Service Card for any or all of the Bulletins.

- #320 Bulletin B/3124, Low-Profile types.
- #321 Bulletin B/3210, Subminiature types.
- #322 Bulletin B/3113, Open types.
- #323 Catalog C/3030, Axial lead types.
- #324 Bulletin B/3330, Plastic case types.



STRUTHERS-DUNN, INC.

PITMAN, NEW JERSEY 08071

Canada: Struthers-Dunn Relay Div., Renfrew Electric Co., Ltd.

Electronics advertisers

February 16, 1970

Acopian Corp.	174	E/MC Electronics/Management Center	189, 201	Microwave Cavity Laboratories	75
Mort Barish Associates		Ries Cappiello Colwell, Inc.		Don Z. Advertising	
Alco Electronics Products, Inc.	22, 197, 199	Erie Technological Products Co., Inc.	27	MM Electronic Enclosures, Inc.	198
Marketronics Advertising		Walker, Schmidt & Mackall, Inc.		Berlin/Pecor, Inc.	
Allen-Bradley Co.	25			Monroe Electronics, Inc.	196
Hoffman-York, Inc.				Ruda Adv. Assoc.	
Allied Van Lines, Inc.	169			Motorola Semiconductor Products, Inc.	60, 61
Young & Rubicam, Inc.				Lane & Wampler Adv., Inc.	
American Electronics, Inc.	206			Multicore Solders, Ltd.	10E
Durel Advertising				Jefferies Harper & Partners, Ltd.	
AMP, Inc.	18, 19	Fabri-Tek Instruments, Inc.	161		
Aitkin-Kynett Co., Inc.		Kerker Peterson, Inc.			
AMP Europe	11E, 12E	Fairchild-Dumont	151		
Allardyce, Palmer, Ltd.		Josephson, Cuffari and Co.			
Andrew Corporation	68	Fairchild Semiconductor, Inc.	28, 29, 80, 81, 82		
Fensholt Adv., Inc.		Chiat Day, Inc.			
A.P.I. Instruments	137	Ferisol	17E		
George Z. Griswold Advertising		Agence Domenach			
Applied Digital Data Systems, Inc.	64, 65	Fluke Mfg. Co., John Bonfield Associates	15	National Electronics, Inc., Sub. Varian Associates	26
Shaw Elliott, Inc.		Forward Metro Denver	177	Connor-Sager Assoc., Inc.	
Astrodata, Inc.	53	Broyles, Allebaugh & Davis, Inc.		National Semiconductor Corp.	12, 13, 16E
Jansen Assoc., Inc.				Hall Butler Blatherwick, Inc.	
Astro Space Laboratories	198			Newark Electronics Corp.	190
Basinger and Sankey, Inc.				Stral Adv. Co.	
Augat, Inc.	133				
Horton Church & Goff, Inc.					
		Gencom Division—Varian/Emi	160		
		A.D. Adams Adv., Inc.		Oak Mfg. Co., a Division of O/E/N	207
		General Electric Co., Capacitor and Battery Department	54, 55	Buchen Adv., Inc.	
		Robert S. Cragin, Inc.			
Beckman Instruments, Inc., Helipot Div.	92	General Electric Co., Semiconductor Products Div.	66, 67		
N.W. Ayer/Jorgensen/McDonald, Inc.		Robert S. Cragin, Inc.		Pacific Measurements, Inc.	184
Bell Telephone Laboratories	51	General Instrument Europe S.P.A.	18E	Jack Herrick Adv., Inc.	
N.W. Ayer & Sons, Inc.		Studio Cigiemme		Permag Corp.	195
Bourns, Inc., Trimpot Div.	23	General Magnetics	8	Schneider, Allen, Walsh, Inc.	
The Lester Co.		McCarthy/Scelba/DeBiasi Adv. Agcy., Inc.	2nd Cover	Philco Ford Co., Microelectronics Div.	132
Brand-Rex	140	General Radio Co.		The Aitkin-Kynett Co., Inc.	
Creamer, Trowbridge, Case & Basford, Inc.		Horton, Church and Goff, Inc.		Philips Electronics Instruments	107
Bulova Watch Co., Electronics Div.	52	G-V Controls, Inc.		Marsteller, Inc.	
Caroe Marketing, Inc.		M.S.D. Advertising Agency, Inc.		Philips N.V. Pit/Tmi Division	2E
By-Buk Company	196			Marsteller International S.A.	7
J. R. Bloome Co.				Pirgo Electronics, Inc.	
				Herbert Lindauer Associates	
		Hewlett Packard Colorado Springs Div.	78, 79	Pomona Electronics Co.	192
Captor Corp.	24	Tallant/Yates Adv., Inc.		Buxton Adv. Agcy.	
Weber, Geiger & Kalat, Inc.		Hewlett Packard, Loveland Div.	30, 31, 179	Power Designs, Inc.	208
Cerro Copper & Brass Co.	200	Tallant/Yates Adv., Inc.		Samuel H. Goldstein	
Sykes Adv., Inc.		Hewlett Packard, New Jersey Div.	164, 165		
Cinch Mfg. Co.	144	McCarthy Scelba and Di Biasi Adv. Agcy., Inc.			
Stral Adv. Co., Inc.		Hewlett Packard, Santa Clara Div.	1, 2		
Clifton Precision Products Co., Div. of Litton Industries	173	Lennen & Newell, Inc.		Radiation, Inc.	47
Ivey Adv., Inc.		Hickok Electrical Instrument Co.	153, 187	W.M. Zemp and Assoc., Inc.	
Colorado Video, Inc.	192	Parsells Adv. Service		Radio Corporation of America	4th Cover, 49, 76 77, 167
Wolff & Weir		Honeywell Computer Control Div.	32	Al Paul Lefton Co.	
Computer Measurements Co., Div. of Newell Industries	135	Creamer, Trowbridge, Case & Basford, Inc.		RCL Electronics, Inc.	14
Jones, Maher, Roberts, Inc.		Hughes Aircraft Co.	159, 191, 197	Morvay Adv. Agcy.	
Cosmicar	16E	Foote, Cone & Belding		Redcor Corp.	57
C.P. Clare International	9E	Hugle Industries, Inc.	171	Management Communication Consultants, Inc.	
C.R.C.	8E	Tom Jones Adv. & Packaging		Robison Electronics	196
SPI				Rob's House of Marketing	
Curtis Instruments, Inc.	6			Rohde & Schwarz	21E
Knudsen-Moore, Inc.					
		ITT General Controls	202, 203		
		MacManus, John & Adams, Inc.		Sage Electronics Corp.	172
		I.E.R.	22E	Mathison Adv., Inc.	
		PEMA		Schlumberger Ltd., EMD	3E
Data Control Systems	162			T.B. Browne, Ltd.	
Technical, Industrial & Scientific Marketing, Inc.		Johnson Co., E.F.	188	Schlumberger Ltd., SIS	5E
Dearborn Electronics, Inc., Sprague Electric Co. Div.	186	Martin Williams Advertising		T.B. Browne, Ltd.	
Harry P. Bridge Co.		Joslyn, Inc.	168	Signetics Corp., Sub. Corning Glass Works	131
Delevan Electronics Corp.	166	Chace Co. Adv., Inc.		Cunningham & Walsh, Inc.	
Stahlka, Faller & Klenk, Inc.				Singer Co., The Instrumentation Div.	108
Dialight Corp.	178			Technical, Industrial and Scientific Marketing, Inc.	
Michel Cather, Inc.		Lambda Electronics Corp.	3rd Cover, 211, 212	Sogie	6E
Dow Corning Corp.	134	Michel Cather, Inc.		Etudes et Creations Publicitaire	
Ketchum, MacLeod and Grove, Inc.		Litton Ind., Inc., Data Systems	198	Solartron Electronics Group, Ltd.	4E
DuPont de Nemours & Co., Freon Div.	56	LTT	14E, 15E	T.B. Browne, Ltd.	
N. W. Ayer & Son, Inc.		Publibel		S.P. Electronica	7E
				Studio Sergio Rosata	
		Macrodata, Inc.	91	Sperry Rand Corp., Sperry Microwave Electronics Div.	158
Eagle Signal Div. of Gulf & Western Co.	155	Alden Adv. of California, Inc.		Neals & Hickok, Inc.	
Feeley & Wheeler, Div. of Geyer, Oswald, Inc.		Masineport	207	Starmark Electronics, Inc.	194
Eastman Chemical Products, Inc.	193	Publicom Romanian International Publicity Agency		Martin Fromm and Assoc., Inc.	
Fred Wittner Co.		Microdot, Inc.	185	Struthers Dunn, Inc.	204
Elco Corp.	17	Gumpertz, Bentley and Dolan Advertising		Harry P. Bridge Co.	
Schaefer Adv., Inc.				Sylvania Electric Products, Inc., Electronic Components Group	35 to 42
Electronic Arrays, Inc.	89			Doyle Dane Bernbach, Inc.	
Hal Lawrence, Inc.				Sylvania Electric Products, Inc., Parts Div.	85
Electronics Network, The	86, 87			Doyle Dane Bernbach, Inc.	
Ries Cappiello Colwell, Inc.					
Electro Products Laboratories, Inc., Transducer Div.	90				
Grant Wright & Baker, Inc.					

NEW NEW NEW



**Size 9
and 13**

Permanent Magnet DC Motors at New, Low Prices

Now, automatic production equipment allows American Electronics, Inc. to reduce the prices of Size 9 and 13 permanent magnet dc motors by 40%. And every AEI dc motor still has precision ball bearings, a dynamically balanced armature, long lasting brushes and powerful Alnico V magnets.

These motors are available with ratings from 0.8 ounce-inch and from 4,000 to 20,000 RPM. Accessories tailored to fit your application.

Circle the Reader Service number now, and we'll send you our short form catalog and our Design and Applications booklet. Or call today for prices. Phone (714) 871-3020. TWX 910-592-1256.



AMERICAN ELECTRONICS INC.
1600 East Valencia Drive
Fullerton, California 92634

Tec, Inc.	58, 201
Stevenson and Assoc., Inc.	
■ Tektronix, Inc.	125
Dawson, Inc.	
Tenney Engineering, Inc.	201
Keyes Martin & Co.	
Texas Instruments Incorporated, Components Group	20, 21
Albert Frank-Guenther Law, Inc.	
■ Texscan Corp.	16
MacGill/Ross, Inc.	
TI Supply Company	10, 11
Albert Frank-Guenther Law, Inc.	
Transitron Electronic Corp.	88
Larcom Randall Adv., Inc.	
TRW Semiconductors, Inc.	59
Fuller & Smith & Ross, Inc.	
United Aircraft Electronic Components	180
Cunningham & Walsh, Inc.	
■ Vactec, Inc.	176
Coleman and Associates	
■ Victory Engineering Corp.	193
A.D. Adams Adv., Inc.	
Wavetek	156
Chapman Michetti Advertising	
Westinghouse Semiconductor Div.	182, 193
Ketchum, MacLeod and Grove, Inc.	
White, S.S., Div., Penwalt Corp.	138
W.L. Towne Co., Inc.	
White Weld & Co.	195
Doremus & Company	
Winchester Electronics, Div. of Litton Industries	139
Wilson, Haight & Welch, Inc.	
Xerox Corporation	136
Hutchins Adv. Co., Inc.	

Classified & Employment Advertising

F.J. Eberle, Manager
212-971-2557

EMPLOYMENT OPPORTUNITIES 200

Joseph P. Corcoran,
Personnel Consultants 200

EQUIPMENT
(Used or Surplus New)
For Sale
Radio Research Instrument Co. 200

■ For more information on complete product
line see advertisement in the latest **Electronics Buyer's Guide**

□ Advertisers in **Electronics International**

Electronics Buyers' Guide

George F. Werner, Associate Publisher
[212] 971-2310

Robert M. Denmead,
Midwest Regional Manager
[312] MO 4-5800

Cliff Montgomery,
New York District Manager
[212] 971-3793

Regina Hera, Directory Manager
[212] 971-2544

Thomas M. Egan, Production Manager
[212] 971-3140

Carol Gallagher,
Assistant Production Manager [212] 971-2045

Circulation Department

Isaaca Siegel, Manager [212] 971-6057

Research Department

David Strassler, Manager [212] 971-6058

Advertising Sales Staff

Dan McMillan III [212] 971-3468

Associate Publisher

Wallis Clarke [212] 971-2187

Advertising Sales Service Manager

Tomlinson Howland [212] 971-6792

Promotion Manager

Warren H. Gardner [212] 971-3139

Eastern Advertising Sales Manager

Atlanta, Ga. 30309: Charleton H. Calhoun, III
1375 Peachtree St., N.E.
[404] 892-2868

Boston, Mass. 02116: William S. Hodgkinson
McGraw-Hill Building, Copley Square
[617] CO 2-1160

Cleveland, Ohio 44113: William J. Boyle, 55
Public Square, [216] SU 1-7000

New York, N.Y. 10036

500 Fifth Avenue

James R. Pierce [212] 971-3615

John A. Garland [212] 971-3617

Michael J. Stoller [212] 971-3616

Philadelphia, Pa. 19103:

Jeffrey M. Preston

6 Penn Center Plaza,

[215] LO 8-6161

Pittsburgh, Pa. 15222: Jeffrey M. Preston,

4 Gateway Center, [412] 391-1314

Rochester, N.Y. 14534: William J. Boyle,

9 Greylock Ridge, Pittsford, N.Y.

[716] 586-5040

Donald R. Furth [312] MO 4-5800

Midwest Advertising Sales Manager

Chicago, Ill. 60611: Kenneth E. Nicklas

Ralph Hanning 645 North Michigan Avenue,

[312] MO 4-5800

Dallas, Texas 75201: Richard P. Poole, 1800

Republic National Bank Tower,

[214] RI 7-9721

Houston, Texas 7702: Richard P. Poole

2270 Humble Bldg. [713] CA 4-8381

Detroit, Michigan 48226: Ralph Hanning,

856 Penobscot Building

[313] 962-1793

Minneapolis, Minn. 55402: 1104 Northstar

Center [612] 332-7425

St. Louis, Mo. 63105: Kenneth E. Nicklas,

The Clayton Tower, 7751 Carondelet Ave.

[314] PA 5-7285

James T. Hauptli [415] DO 2-4600

Western Advertising Sales Manager

Denver, Colo. 80202: David M. Watson,

Richard W. Carpenter

Tower Bldg., 1700 Broadway

[303] 266-3863

Los Angeles, Calif. 90017: Ian C. Hill,

Bradley K. Jones, 1125 W. 6th St.,

[213] HU 2-5450

Portland, Ore. 97204: James T. Hauptli,

Don Farris, 218 Mohawk Building,

222 S.W. Morrison Street,

Phone [503] 223-5118

San Francisco, Calif. 94111: James T. Hauptli,

Don Farris, 255 California Street,

[415] DO 2-4600

Pierre Braude Tel: 727 73 01: Paris

International Director

Paris: Denis Jacob

17 Rue Georges Bizet, 75 Paris 16, France

Tel 727 33 42, 727 33 60

United Kingdom and Scandinavia

London: Oliver Ball, Tel: Hyde Park 1451

34 Dover Street, London W1

Milan: Robert Saldel, Roberto Laurerl Jr.

1 via Baracchini Phone 86-90-656

Brussels: Denis Jacob

27 Rue Ducale Tel: 136503

Frankfurt/Main: Hans Haller

Elsa-Brandstroem Str. 2

Phone 72 01 81

Geneva: Pierre Braude

1 rue du Temple Phone: 31 95 60

Tokyo: Noboru Matsumoto, McGraw-Hill

Publications Overseas Corporation,

Kasumigaseki Building 2-5, 3-chome,

Kasumigaseki, Chiyoda-Ku, Tokyo, Japan

[581] 9811

Osaka: Akihiko Kamesaka, McGraw-Hill

Publications Overseas Corporation, Kondo

Bldg., 163, Umegae-cho Kita-ku [362] 8771

Australia: Warren E. Ball, IPO Box 5106,

Tokyo, Japan

Business Department

Stephen R. Weiss, Manager

[212] 971-2044

Thomas M. Egan,

Production Manager [212] 971-3140

Maury D'Gongora,

Assistant Production Manager [212] 971-2045

Dorothy Carmesin, Contracts and Billings

[212] 971-2908

Frances Vallone, Reader Service Manager

[212] 971-2865

ELECTRONIC CONTROL SYSTEMS

DATA LOGGERS

(manufactured under HOKUSHIN License — JAPAN)

TRANSISTORIZED
ACCURACY
RELIABILITY
LITTLE POWER CONSUMPTION
EASY OPERATION
EASY MAINTENANCE
DESIGNED FOR INTEGRATED AUTOMATION

GENERAL SPECIFICATIONS

- Unified signal 2... 10, 4... 20, 0... 5, (Input—Output) 0... 10, 0... 20 mA etc.
- Load resistance 0... 3 Kohms
- Ambient temperature -10°... +60°C (for field instruments)
-10°C... +45°C (for panel instruments)
- Power supply 200 or 220 V (+10... -15%) (A.C. or 60 c/s)

ELECTRONIC CONTROL SYSTEMS INCLUDE:

- Temperature transmitters with
 - thermoreistance (-200... +500°C)
 - thermocouples (0... +1600°C)
 - radiation pyrometer (+600... +2000°C)
- Pressure transmitters with
 - bourdon tube (0... 350 kgf/cm²)
 - capsule (0... 1 kgf/cm²)
 - bellows (0... 1000 mm Hg)
- Differential pressure transmitters with
 - bell (0... 100 mm H₂O)
 - bellows (0... 400 mm H₂O)
 - bellows (0... 35000 mm H₂O)
- Area type flow transmitters: 0, 24... 54, 94 m³/h
- Electromagnetic flow transmitters: 0, 41... 1770 m³/h
- Displacement type liquid level transmitters: 0... 2000 mm
- pH transmitters: 0... 12 pH
- Water quality psychrometer, mol. ratio concentration transmitters
- Miniature indicators
- 120 and 250 mm scale one and two point recorders
- Multipoint (2, 3, 6, 12) recorders
- Calculators and accessories: square root extractors, multipliers, dividers, adders-subtractors setters, program setter, integrators, signal limiters, manual control stations etc.
- Controllers
 - (PI-PID) with and without indicators
 - Multipoint on-off controllers
 - Relay amplifiers

MASINEXPORT

Bucharest Matei Millo 7
Cables: MASEXPORT — Bucharest
Telex: 216

Oak
Versatility



Now! One new exclusive switch replaces seven
You can easily eliminate tedious design engineering problems—just use versatile Multidex® switches. They're available in thousands of variations...are smaller than the switches they replace...yet provide more contacts (up to 36) at no additional cost. Crisp Detenting... the patented Unidex™ detent offers uniform "feel" for long life in choices from 10° to 36° throw. Meets MIL-S-3786, SR32 requirements.

Superb Insulation... molded diallyl phthalate meets MIL-M-14 requirements and guarantees electrical continuity between mounting and housing. Glass-alkyd insulation available on request. Special contacts and clips... Oak-pioneered, double-wiping, self-cleaning contacts assure trouble-free operation. Special AF clips with large windows speed wiring.

What's more, Multidex switches meet commercial and military environmental requirements. Special options available on request. For full details, write today for Bulletin SP-324.

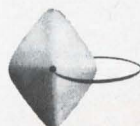

OAK MANUFACTURING CO.
A Division of OAK ELECTRO/NETICS CORP.
Crystal Lake, Illinois 60014
PHONE: 815-459-5000 TWX: 910-634-3353

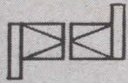

PRECISION IN MINIATURE

REMOTE CONTROLLED HIGH VOLTAGE POWER SOURCE

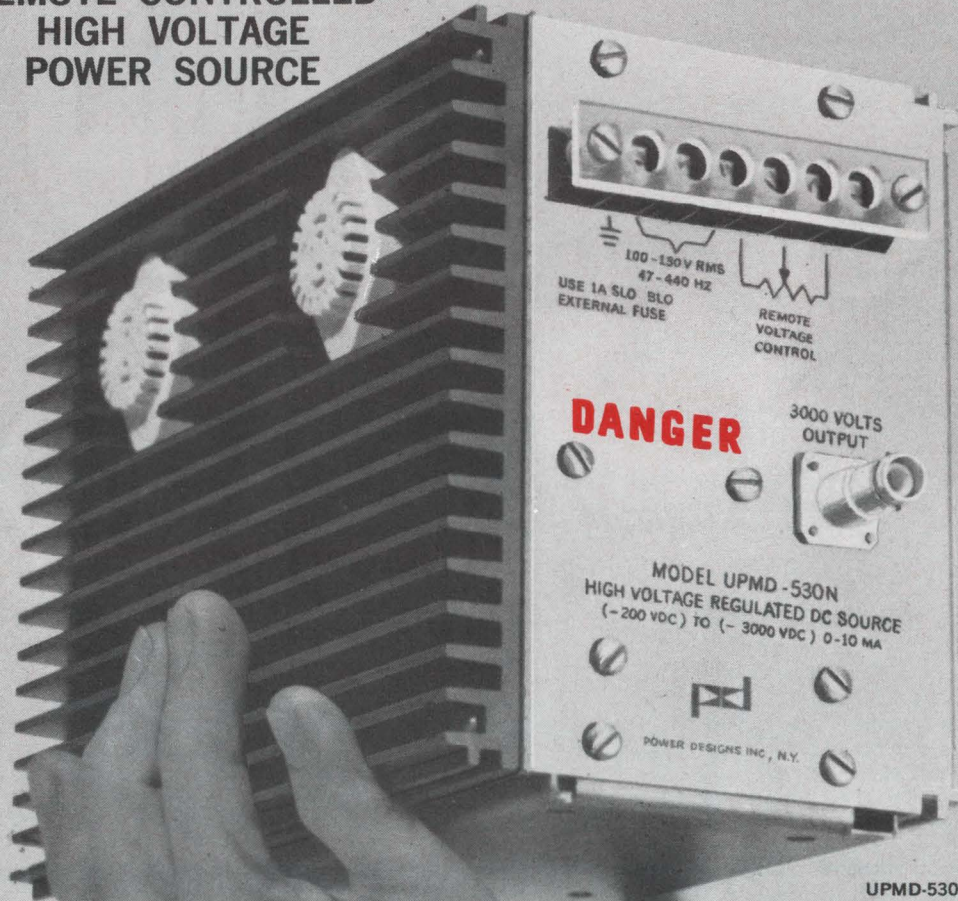

UPMD-530N \$385.00
Negative output polarity

UPMD-530P \$420.00
Positive output polarity

Output: Remotely resistance programmed over a 200 to 3000 VDC range at 10ma. No high voltage potentials at programming terminals (15V max)

Stability: 0.01%

Ripple & Noise: 10mv p-p

Regulation: 0.0025% +5mv

T.C.: 50 ppm/°C

Size: 6h x 4½w x 7½d

Ideally suited for Photomultiplier, small CRT display, Electron Microscope, Mass Spectrometer, Electron Probe and Ion Probe Applications.

fob westbury, n.y.

WRITE FOR DETAILED SPECIFICATIONS

POWER DESIGNS, INC.

3381 MIRANDA AVE. • PALO ALTO, CALIFORNIA

415-321-6111 TWX: 910-373-1251

1700 SHAMES DRIVE • WESTBURY, N.Y.

516-333-6200 TWX: 510-222-6561

Here's the first I-C regulated bench power supply to give you 0-10 volts at 1 amp for \$75.00

Also available 0-20, 0-40, 0-120 vdc

Regulation

line 0.01% + 1mv
load 4 mv

Ripple and noise

250 μ v rms; 1 mv p-to-p

All silicon DC power supply using integrated circuits to provide regulation system

except for input and output capacitors, rectifiers and series regulation transistors

Multi-position operation

lies flat or stands erect

AC input

105-132 vac 47-440 Hz (Current ratings based on 57-63 Hz.)

Weight

less than 5 lbs.

Output

5-way binding posts

Ambient operating temperature

0-50°C

Temperature coefficient

0.015% + 300 μ v/°C

Adjustable current limiting

0% to 110% of rating

Storage temperature

-40°C to +85°C

Convection cooled/ Die-cast aluminum construction

No overshoot

on turn-on, turn-off or power failure

Controls

coarse voltage adjust, fine voltage adjust, current adjust, ON/OFF switch, meter function switch.

Indicators

power ON light and dual-function meter

Overvoltage protection

available as an option up to 70 vdc

LC-OV-10 adj. volt range 3-24 vdc **\$20.00**

LC-OV-11 adj. volt range 3-47 vdc **\$20.00**

LC-OV-12 adj. volt range 3-70 vdc **\$25.00**

Guaranteed for 5 years material and labor

LL series bench-type supply 5 $\frac{5}{8}$ " x 5 $\frac{1}{2}$ " x 3 $\frac{5}{8}$ "

Model	ADJ. VOLT RANGE VDC	CURRENT RANGE ⁽¹⁾	Price ⁽²⁾
LL-901	0-10	0-1.0 amp	\$75
LL-902	0-20	0-0.65 amp	85
LL-903	0-40	0-0.35 amp	85
LL-905	0-120	0-65 ma	99

NOTES:

(1) Consult factory for operation at 50 Hz or temperatures above 50°C. Ratings apply 0-50°C.

(2) All prices F.O.B. Melville, N. Y.

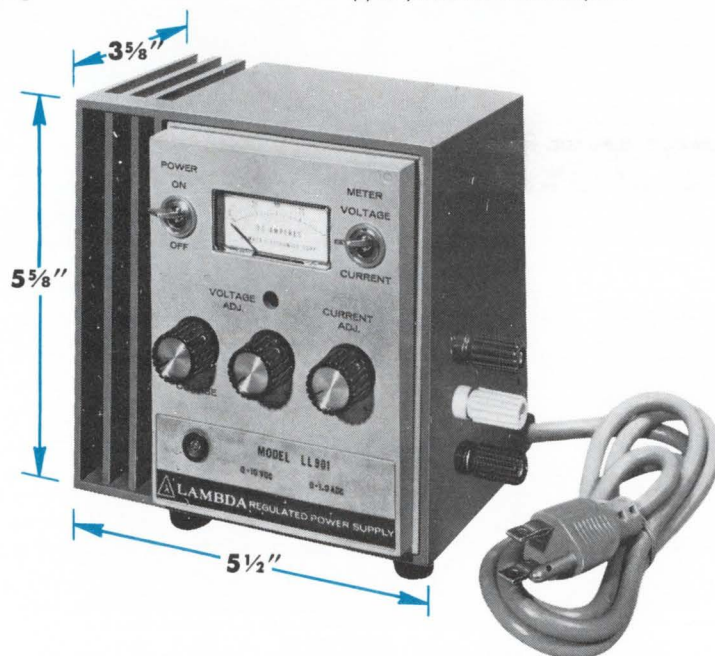

Lambda Electronics Corp., 515 Broad Hollow Road, Melville, L. I., New York 11746 • Tel. 516-694-4200.

Two instruments in one. High-precision differential voltmeter and high-precision power supply.

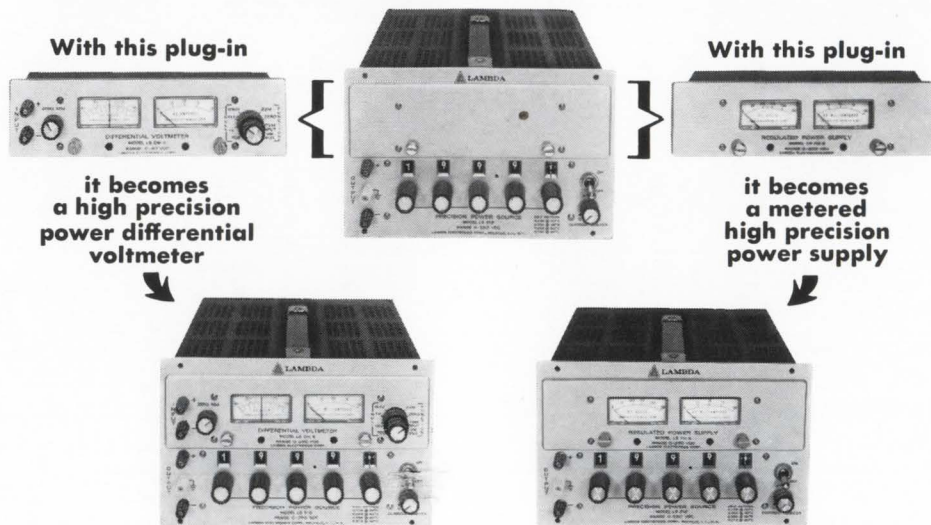

Features of the high-precision, power, differential voltmeter:

Draw power as you measure voltage...

The first and only differential voltmeter to furnish high stability power output while being used as a voltmeter ... no need for a separate power supply.

Plus all power supply specifications.

Features of the metered, high-precision power source:

Regulation 0.0005% plus 100 μ V

best of any high-stability power supply in this price range.

Ripple

35 μ V rms; 100 μ V p-to-p.

Accuracy

0.01% + 1mv.

2 Meters

monitor voltage and current simultaneously and continuously.

Illuminated digital readout

Remotely programmable

1000 ohms/volt nominal, or volt/volt

Constant voltage/constant current

Multi-current-rated

for 30°C, 40°C, 50°C, 60°C

Only 5¼" high

convenient half-rack size for rack or bench use.

Stability

0.001% + 100 μ V over 8 hour period.

Convection-cooled

no blowers, no external heat sinks.

Auto series/auto parallel

with Master-Slave tracking.

AC input

105-132VAC, 47-440 Hz (derate dc output current 10% at 50 Hz) 205-265vac "V" option at extra charge of 10%.

Twice the power

in a convenient ½-rack package.

All silicon semiconductors

for maximum reliability.

Completely protected

short-circuit proof; continuously adjustable current limiting.

Fungus-proofing option

add suffix "R" to model number and add \$20.00 to price.

Basic Non-Metered Model	VOLTAGE RANGE	MAX. AMPS AT AMBIENT OF (1)				Price ²	Metered Accessory		Diff. VM Accessory		Over Volt. Protect. Adj. V.		
		30°C	40°C	50°C	60°C		Model	Price ²	Model	Price ²	Model	Range	Price
LS-511A	0-10VDC	2.8A	2.5A	2.1A	1.7A	\$375	LS-FM1	\$55	LS-DM1	\$85	LHOV-4	3-24	\$35
LS-512A	0-20VDC	1.8A	1.6A	1.3A	1.1A	375	LS-FM2	55	LS-DM2	85	LHOV-4	3-24	35
LS-513A	0-40VDC	1.0A	0.9A	0.75A	0.6A	375	LS-FM3	55	LS-DM3	85	LHOV-5	3-47	35
LS-515A	0-120VDC	0.33A	0.29A	0.25A	0.21A	375	LS-FM5	55	LS-DM5	85			
LS-516A	0-250VDC	0.1A	0.09A	0.08A	0.07A	380	LS-FM6	55	LS-DM6	85			

NOTES: 1. Current rating applies over entire voltage range. Ratings based on 55-65 Hz operation. Derate current 10% for 50 Hz.
2. This price is for non-metered Precision Power Source. Addition of Metered Accessory Plug-In (next two columns) is necessary to have Metered High Precision Power Supply. Addition of Differential Voltmeter Accessory Plug-In to the basic model is necessary for the unit to function as a High Precision Differential Voltmeter.

Lambda Electronics Corp. 515 Broad Hollow Road, Melville, L. I., New York 11746. Tel. 516-694-4200.

To get a high-current power supply with **80% efficiency** ...get Lambda's LB Series.

Convection-cooled 7-inch panel
Only 10 mv ripple, up to 300 volts; up to 300 amps.

Up to 80% efficiency

Low ripple
 10 mv rms max.

Regulation
 line .05% + 6 mv.
 load .01% + 10 mv.

AC input
 208 ± 10% vac; 57-63 Hz, 3 phase 4 wire.

All silicon semiconductors
 for maximum reliability

Convection cooled
 no blowers, no external heat sinks

Overvoltage protection
 standard on all models up to 70 vdc

Remotely programmable

Remote sensing

Transformer
 designed to MIL-T-27C Grade 6

Completely protected
 Short circuit proof. Continuously adjustable
 automatic current limiting.

Constant voltage/constant current
 by automatic crossover

Temperature coefficient
 0.03% + 0.5 mv/°C

Series/parallel operation

Fungus proofing option

Add suffix "R" to model number and add \$25.00 to price.

Multi-current-rated

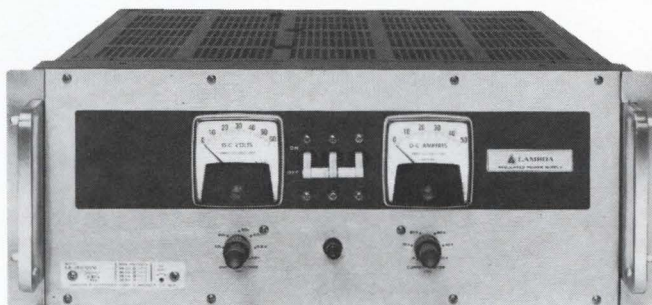

LB Series, metered, full-rack

Size: 7" x 19" x 20 1/16"

Model	VOLTAGE RANGE	CURRENT (AMPS) AT AMBIENT OF: (1)				Price (2)
		40°C	50°C	60°C	71°C	
LB-701-FM-OV	0-7.5	300	270	235	200	\$1,450
LB-702-FM-OV	0-15	180	170	160	150	1,450
LB-703-FM-OV	0-36	80	75	70	65	1,200
LB-704-FM-OV	0-60	50	47	44	40	1,300
LB-705-FM	0-125	25	22	19	16	1,100
LB-706-FM	0-300	10	9.5	9.0	8.0	1,250

NOTES:

- (1) Current rating applies over entire voltage range.
- (2) Prices include meters. LB Series models are not available without meters. Prices for all models up to and including 60 vdc include built-in overvoltage protection. Prices and specifications are subject to change without notice.
- (3) Chassis Slides: Add suffix (-CS) to model number and add \$100.00 to price.

Lambda has over 10,000 power supply units on-the-shelf for 1-day delivery.

Every one fully guaranteed for 5 years... material and labor.

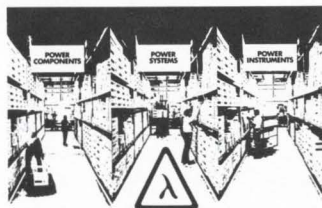

LAMBDA
 ELECTRONICS CORP.
 A **Veco** Company

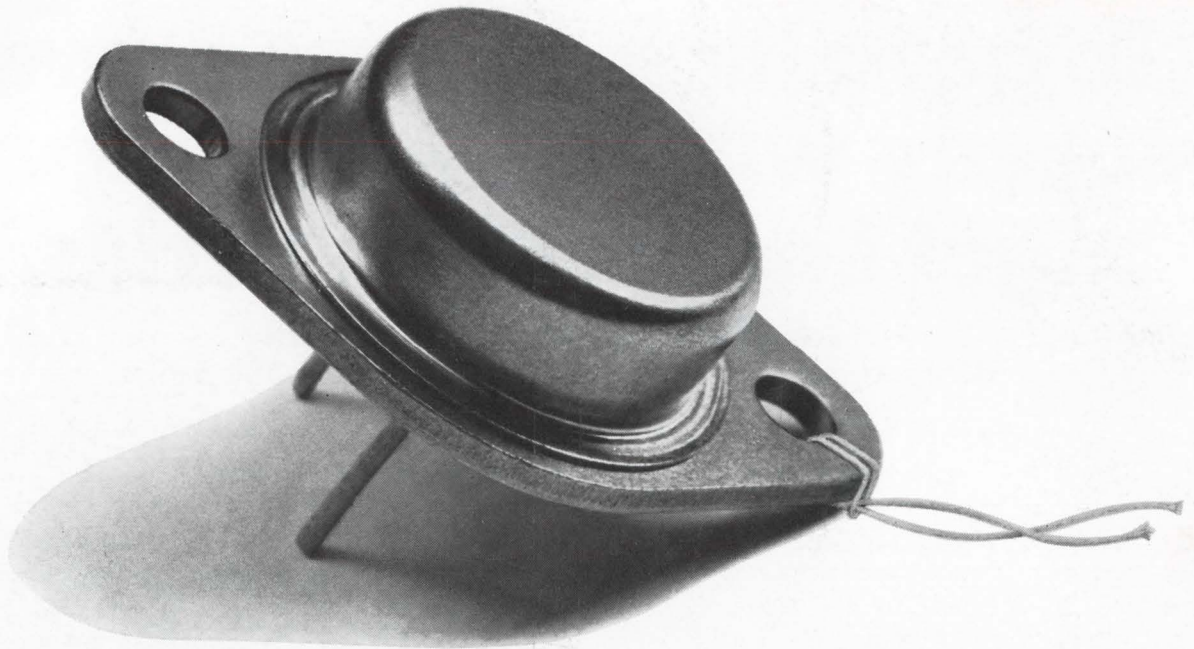

RCA's ESP (Exceptional Switching Performance) type 2N5805 and its companion 2N5804 are veritable "switch hitters" through an unusual combination of capabilities: *both transistor types have excellent current handling—at high voltage—in economic TO-3 packages.* For example, the 2N5805 can switch 375 volts and 5 amperes in less than 2 μ s.

You'll find that for efficient and economical power conversions, these two new triple-diffused n-p-n units will excel for use in military and industrial applications.

Rounding out a transistor line that already makes RCA the industry leader in silicon power, these ESP devices—the 2N5804 (formerly TA7130) and 2N5805 (formerly TA7130A)—feature:

- Current capability to 8 A
- Controlled beta at 5 A
- V_{CEX} — 375 V (2N5805); 300 V (2N5804)
- V_{CEO} — 300 V (2N5805); 225 V (2N5804)
- Fall time — 2 μ s @ 5 A
- Full safe area operating protection

If your requirements are for a high-voltage transistor family that has more than ordinary power, try RCA's new 2N5804 and 2N5805. As switch hitters,

they're ideally suitable for such applications as: switching inverters, switching regulators, converters, solenoid and relay drivers, modulators, deflection amplifiers, and motor controls.

For more information on these and other RCA silicon power transistors, just contact your local RCA Representative or RCA Distributor. For technical information, write: RCA Electronic Components, Commercial Engineering, Section 1-N-2-16/UT6, Harrison, N. J. 07029. In Europe: RCA International Marketing, S. A., 2-4 rue du Lièvre, 1227 Geneva, Switzerland.

RCA

