

November 9, 1970

\$1.00 A McGraw-Hill Publication

Electronics in Vietnam Part II 70

Recording transients on magnetic disks 82

Fly-by-wire flight control systems 87



LIBRARY
STATE TECHNICAL INSTITUTE
MEMPHIS

Electronics[®]

**LSI boosts
minicomputer
performance**

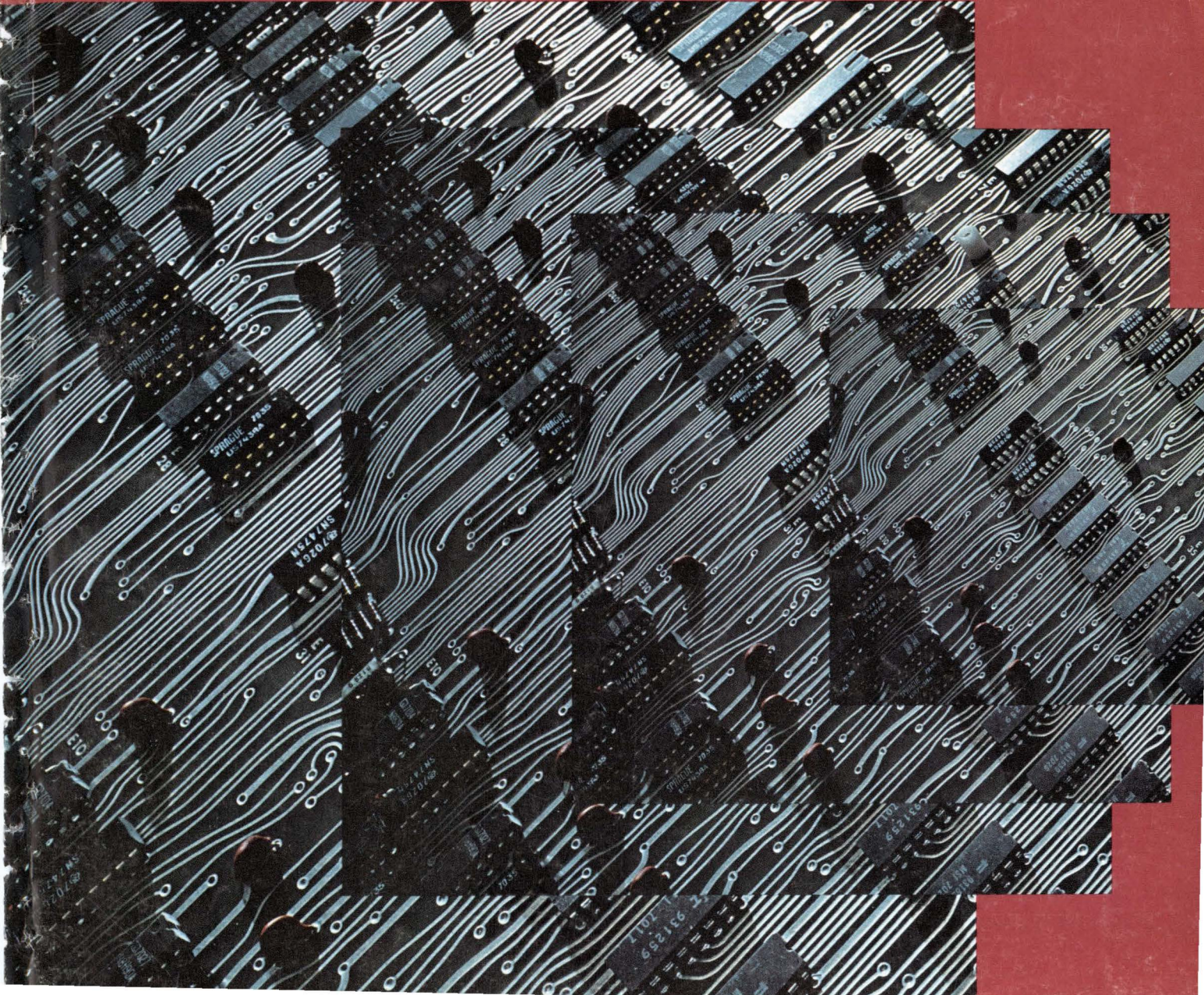

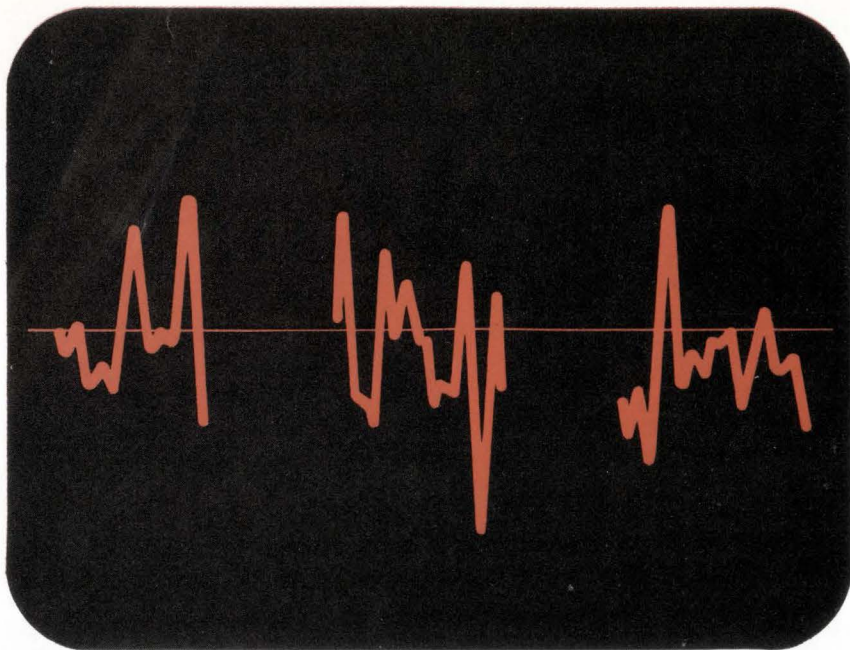

can you afford to miss part of your data?

At Time/Data, *real-time signal analysis* means continuous processing of your data – all of your data, all of the time – for maximum statistical accuracy. We offer three systems fast enough to guarantee real-time analysis whatever your needs. But speed isn't all. Our task-oriented systems are also easy and fast to use, reducing set-up costs and true processing time. They feature:

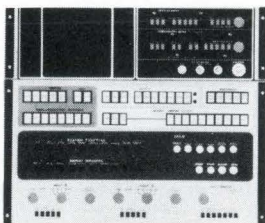

- User-designed controls and alphanumeric displays – eliminates complex sequence of button-pushing or tedious programming via teletype.
- The speed of the hard-wired, digital processor combined with the flexibility of the general-purpose computer.
- Complete software package for true “one-button” operation. No need to know or learn computer programming.

Time/Data Signal Analysis Systems

	1923C	1923B	1923A
Maximum Frequency Range	0-50 kHz	0-50 kHz	0-50 kHz
Maximum <i>Real-Time</i> Frequency Range	0-500 Hz	0-18 kHz	0-30 kHz
Power Spectrum Processing Time (for 1024 points)	1 sec	28 ms	17 ms
Price (FOB Palo Alto, Calif.)	\$43,500	\$65,000	\$85,000

All three systems also provide Fourier Transforms, Cross Spectrums, Transfer Functions, Coherence Functions, Correlations, Convolutions, Cepstrum, Averaging – and much more. May we discuss these systems with you in terms of your measurement needs?

Call your nearest GR District Office or write to General Radio, 300 Baker Avenue, Concord, Massachusetts 01742, or Time/Data, 490 San Antonio Road, Palo Alto, California 94306. In Europe, write to Postfach 124, CH 8034, Zurich, Switzerland.



Time/Data
A GR COMPANY

BOSTON 617 646-0550 / CHICAGO 312 992-0800 / DALLAS 214 637-2240
LOS ANGELES 714 540-9830 / NEW YORK (N.Y.) 212 964-2722 (N.J.) 201 943-3140
SAN FRANCISCO 415 948-8233 / SEATTLE 206 747-9190 / WASHINGTON, D.C. 301 881-5333
TORONTO 416 252-3395 / ZURICH (051) 47 70 20

Today, fast, low-cost pulses with variable rise and fall — tomorrow, a system!

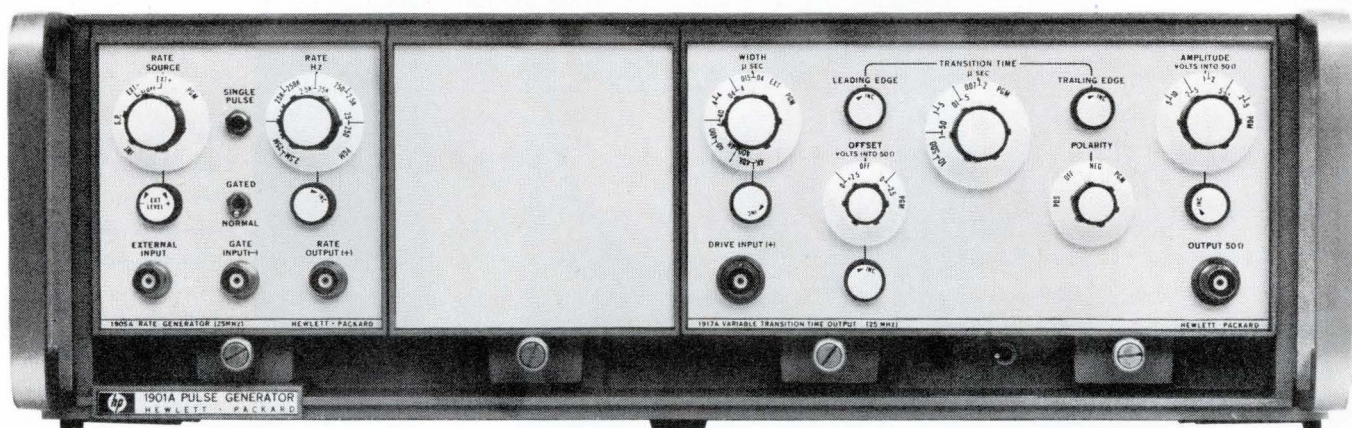

HP's new, all-solid-state 1900 Pulse System gives you the best of two worlds. **For only \$1195, you can get a 7 ns variable rise and fall generator, right away.** Then, as your needs and/or funds increase, plug-in capability allows you to get additional features, without having to buy a whole new generator.

Our basic package consists of a rate generator, a pulse shaping output, and a mainframe.

The 1917A pulse shaping output provides 10 V pulses with variable rise and fall times as short as 7 ns, **reversible polarity, and dc offset.** It takes up only half of a mainframe, and can handle rep rates of up to 25 MHz. A unique external-width function allows the 1917A to be used as a **pulse amplifier**, also, maintaining

width and spacing of externally-supplied pulse trains.

The 1905A Rate Generator ("clock") is a quarter-size plug-in. It provides output triggers at repetition rates from 25 Hz to 25 MHz in six decade ranges. Rep rate can be determined internally, by external triggering, or by single-pulse push-button. **Gating feature allows pulse bursts.**

The 1901A Mainframe is a standard rack size unit, and contains power supplies that can be used to power other 1900-series plug-ins. **Built-in EMI and RFI shielding are standard.**

Price of this three-part package (including a blank plug-in) is only \$1195. As your needs change, available plug-ins include a 350 ps output, **a 16-bit (RZ, NRZ) word generator**, variable delay generators, fan-in and

fan-out generators, and optional analog programming — plus a high power pulse-shaping output (1 A, 50Ω) and mainframe.

Call your local HP field office for ordering. For further information on the HP 1900 Pulse System, see pp. 254-261 in your 1970 HP catalog, or send for our new free brochure on pulse generators. Hewlett-Packard, Palo Alto, California 94304. In Europe: 1217 Meyrin-Geneva, Switzerland.

080/10

HEWLETT  **PACKARD**
S I G N A L S O U R C E S

We built these tape recorders to play, not to play with!

When you're recording data, you don't want to waste time playing nursemaid to a temperamental tape machine. So we built the HP 3950/3955 Analog Recorders to play tape, not games.

Through simple design and rugged construction, we cut out almost all of the finicky adjustments and maintenance operations required for most recorders.

Routine maintenance on the HP 3950/3955's runs less than one/fifth of that needed for most of the machines you might be considering.

The HP 3950/3955's low initial price, plus the sharply reduced operating costs that come with minimum downtime, make it an attractive buy for a wide variety of scientific, medical and

industrial applications.

If up to five times less tape recorder maintenance and downtime looks good to you, ask your local HP field engineer about our HP Model 3950 and 3955 Analog Recorders. Or write Hewlett-Packard, Palo Alto, California 94304; Europe: 1217 Meyrin-Geneva, Switzerland.

Misalignments that might interrupt your work on other machines are eliminated by a cast aluminum frame, machined to precise dimensions on a numerically controlled milling machine. Tape transport components are mounted to this frame on precisely indexed bosses, and neither shimming or other adjustments are required in the field.

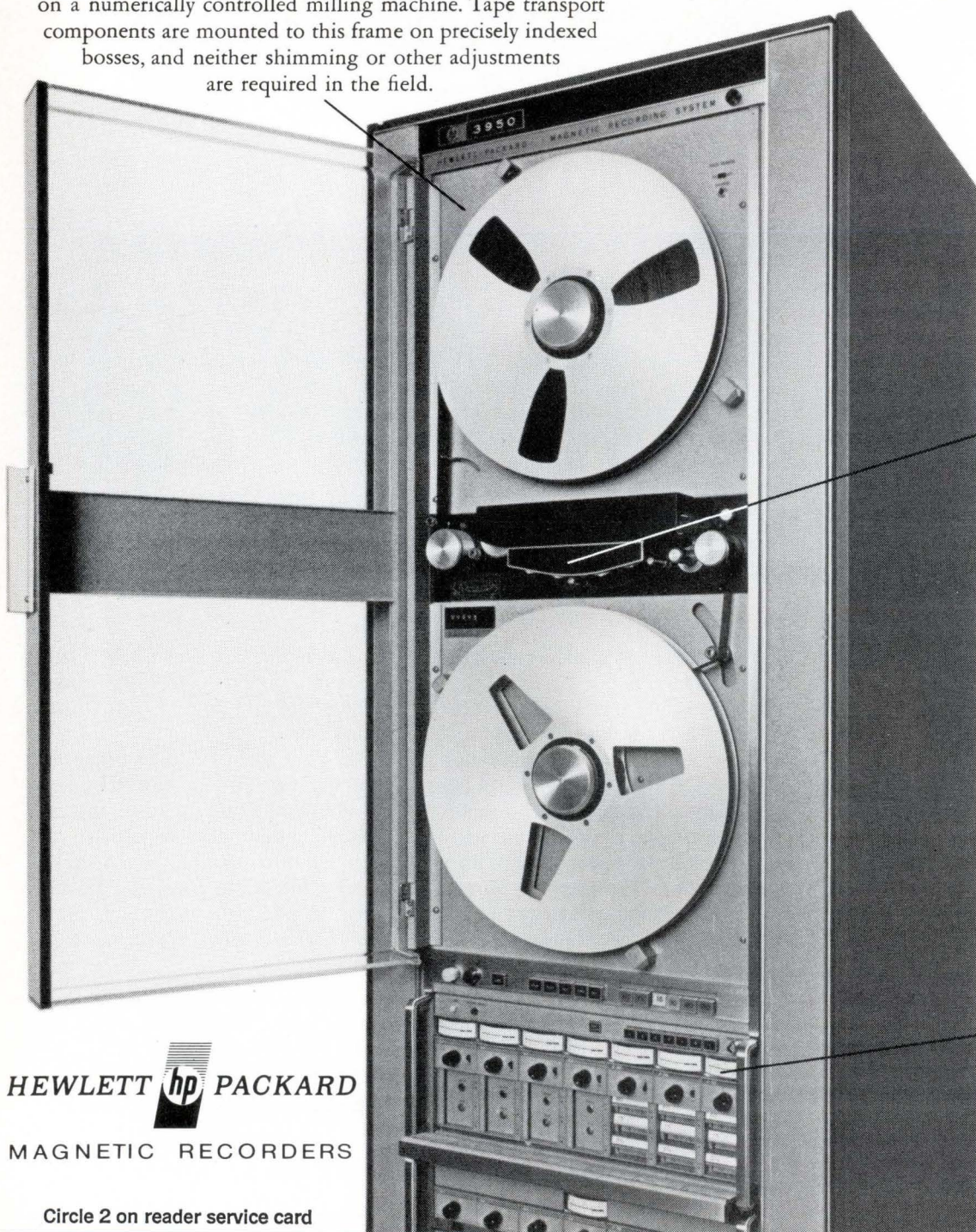

An instrumentation quality, open loop tape drive ends the need for complex servo systems and vacuum or blower buffer chambers. The simple, uncluttered tape path assures easy cleaning and loading. Both IRIG 7 and 14 channel models are available, with the 7 channel model expandable to 14.

Front panel monitor meters, test signal selectors and test I/O connectors for all record and playback electronics are readily accessible.

HEWLETT  **PACKARD**
MAGNETIC RECORDERS

Circle 2 on reader service card

Features

Probing the News

- 103 **Solid state:** Avalanche diodes get big boost of identity
- 105 **Engineers and careers:** IEEE: crisis
- 109 **Components:** Sum of Sprague's parts equals new business
- 112 **Communications:** AT&T sweetens satellite plan
- 115 **Consumer electronics:** Fire safety proposals burn TV set makers

Electronics Review

- 33 **Meetings:** Electron Devices sessions feature light valve, charge-coupled device, reliable plastic transistor package, Gunn diodes in local oscillators
- 35 **Computers:** IBM unveils new machine, new series
- 36 **Military electronics:** Tubes called answer to EMP
- 36 **Integrated electronics:** Slight change increases breakdown voltage
- 38 **Companies:** How to succeed in buying a business
- 41 **Budgets:** Two years of defense cuts forecast
- 42 **Government electronics:** Postal system automates parcel post
- 42 **Medical electronics:** Patient monitoring goes digital
- 42 **Instrumentation:** Computer system watches diodes
- 45 **For the record**

Electronics International

(follows page 24)

- 7E **Sweden:** The Carlsson sound
- 8E **Great Britain:** LEDs ride the rails; IR camera tube
- 9E **France:** All-in-one flight display
- 10E **West Germany:** Audio tape tensioning
- 10E **Japan:** Curved Schottky diodes; alumina for multilayers
- 23E **New Products International**

New Products

- 119 **Computer conference preview**
- 119 Core pattern increases versatility of memory stack
- 120 Capacitive key enters data
- 122 Disks expand minicomputers
- 122 French terminal is interactive
- 124 MOS chip contains keyboard code
- 124 Printer priced under \$6,000
- 126 Terminal rents for \$39 a month
- 129 **Instruments review**
- 129 Computer checks linear ICs
- 133 **Data handling review**
- 133 A-d converter resolves 15 bits
- 134 ROM programmer saves time, costs
- 139 **Semiconductor review**
- 139 Hybrids reduce board density
- 142 **New materials**

Title R registered U.S. Patent Office; © copyright 1970 by McGraw-Hill Inc. All rights reserved, including the right to reproduce the contents of this publication in whole or in part.

Articles

- Computers** 64 **Standard LSI chips breed a fast new series of minicomputers**
Built with an eye to technological trends, the new Nova family proves capable of absorbing benefits of LSI without requiring a radical redesign
Ronald Gruner, Lawrence Seligman, Jonel Sutton
Data General Corp.

- Military electronics** 70 **Armed forces rely on communications to fight and survive in Vietnam**
South Vietnamese are being trained to take over \$333 million network that links grunts with generals: beacons rescue downed pilots

- Circuit design** 78 **Designer's casebook**
 - Symmetry principle eases design of summing op amp
 - Single IC pulser eliminates contact bounce
 - Zener diodes reset sampling gate automatically

- Instrumentation** 82 **Need accurate recordings of fast transients? Try disks**
Disk technique, always ready to record random transients, offers better signal-to-noise ratio than tape units and avoids single-event limitation of camera-oscilloscope setups
R.W. Calfee, E. Troy Hatley, Pete Kauffman
Data Disc Inc.

- Avionics** 87 **Electronic flight control is getting set to take off**
Fly-by-wire systems can achieve reliabilities far superior to those of mechanical aircraft control systems, and will eventually permit greater aircraft maneuverability
J.P. Sutherland and R.C. Hendrick
Honeywell Inc., Aerospace division

- Departments**
 - 4 About this issue
 - 6 Readers Comment
 - 12 Who's who in electronics
 - 20 Meetings
 - 25 Electronics Newsletter
 - 35 Index of Activity
 - 53 Washington Newsletter
 - 144 New Books
 - 146 Technical Abstracts
 - 149 New Literature
 - 151 International Newsletter

EDITOR-IN-CHIEF: Kemp Anderson

EXECUTIVE EDITOR: Samuel Weber

MANAGING EDITORS: Robert Henkel, News;
Arthur Erikson, International

SENIOR EDITORS: H. Thomas Maguire,
Stephen E. Scrupski

ASSOCIATE EDITORS: William Bucci, Richard
Gundlach, John Johnsrud, Howard Wolff

DEPARTMENT EDITORS

Communications & Microwave: Leon M. Magill;
Components: George F. Watson; *Computers*:
Wallace B. Riley; *Consumer*: Gerald M. Walker;
Industrial Electronics: Alfred Rosenblatt;
Instrumentation: Owen Doyle; *Military/*
Aerospace: Herman Lowenhar; *New*
Products: H. Thomas Maguire (Mgr.),
William P. O'Brien, George Weiss; *Packaging*
& Production: Stephen E. Scrupski;
Solid State: Laurence Altman

COPY EDITORS: William S. Weiss, Chief;
Margaret Eastman

ART: Fred Sklenar, Director
Charles D. Ciatto, Assistant Director

PRODUCTION EDITORS: Susan Hurlburt,
Arthur C. Miller

EDITORIAL SECRETARIES: Claire Goodlin,
Vickie Green, Terri O'Neil,
Bernice Pawlak, Patricia Ritter

FIELD EDITORS

Boston: James Brinton (Mgr.), Gail Farrell;
Los Angeles: Lawrence Curran (Mgr.);
New York: Peter Schuyten (Mgr.); *San*
Francisco: Stephen Wm. Fields (Mgr.),
Marilyn Howey; *Washington*: Ray Connolly
(Mgr.), Jim Hardcastle, Lois Vermillion;
Frankfurt: John Gosch; *London*: Michael
Payne; *Paris*: Arthur Erikson; *Tokyo*:
Charles Cohen

McGraw-Hill WORLD NEWS

Director: Walter A. Stanbury; *Atlanta*: Stan
Fisher; *Chicago*: Robert E. Lee; *Cleveland*:
Arthur Zimmerman; *Dallas*: Marvin Reid;
Detroit; James Wargo; *Los Angeles*: Michael
Murphy; *San Francisco*: Margaret Drossel,
Tyler Marshall; *Seattle*: Ray Bloomberg;
Washington: Charles Gardner, James Canan,
Herbert W. Cheshire, Seth Payne, Warren
Burkett, William D. Hickman; *Bonn*: Robert F.
Ingersoll; *Brussels*: James Smith; *London*:
Marvin Petal; *Milan*: Jack Star; *Moscow*:
Axel Krause; *Paris*: Robert E. Farrell, Stewart
Toy; *Tokyo*: Mike Mealey

PUBLISHER: Dan McMillan

ASSISTANT TO THE PUBLISHER: Wallace C.
Carmichael

PLANNING & DEVELOPMENT MANAGER:
Donald Christiansen

ADVERTISING SALES MANAGER: Pierre Braudé
CIRCULATION MANAGER: George F. Werner

RESEARCH MANAGER: David Strassler

PROMOTION MANAGER: Tomlinson Howland

ADVERTISING SALES SERVICE MANAGER:
Wallis Clarke

Engineer power hasn't yet joined the growing list of slogans scrawled on the walls of the nation's establishments, but it's not far away, if the discontent evident in the ranks of the Institute of Electrical and Electronics Engineers is anything to go by. There are proposals that the IEEE enroll itself as one of the Washington lobbyists and play whatever politics it must to insure a healthy supply of engineering jobs and a healthy respect for the engineer's status. There are even demands that the IEEE establish a "portable pension," a topic that would not even have been considered a couple of years ago, and become active in environmental issues.

Inheriting IEEE's current problems, which are compounded by its geographical dispersity and its technical diversity is incoming president James H. Mulligan Jr., who takes over the post at the beginning of the year. Covering the story [page 105]—and slowing down the peripatetic Mulligan, now IEEE vice president, long enough for interviewing—fell to Peter Schuyten, manager of *Electronics*' New York bureau, home city for the IEEE. Schuyten says: "It finally took three interviews, one in a New York cab before a meeting, to get a good picture of Mulligan's plans—and his reactions to members' reactions to what he said."

The geographical scattering of the IEEE's chapters and sections—and critics—posed no barrier to reporting. Schuyten called on the

magazine's bureaus in Boston, Los Angeles, San Francisco, and Washington, plus McGraw-Hill World News bureaus in Chicago and Cleveland. Contributing were Jim Brinton, Larry Curran, Gail Farrell, Marilyn Howey, Jane Shaw, Lois Vermillion, and Art Zimmerman.

Perhaps the best analysis of the IEEE's current round of introspection is provided by Mulligan himself, who says: "We aim to find out not only what the IEEE is doing wrong, but what it should be doing that it isn't doing at all."

Companies do listen to customers' suggestions, particularly when the customers start implementing their own proposals. A case in point is the instrumentation disk recorder described in the article beginning on page 82. Data Disc Inc. was in the digital disk-recorder business when customers started asking the firm to add analog capability to its basic recorder. Some customers were even buying the digital units and adding converters themselves to come up with analog disk recorders.

Therefore in 1968, when Richard W. Calfee and E. Troy Hatley moved to Data Disc from IBM, they were charged with the job of building an analog unit. Calfee, now vice president of the video division, and Hatley, manager of the video systems department, pooled talents with H.R. Kauffman, product manager, to describe today's instrumentation disk recorders.

November 9, 1970 Volume No. 43, Number 23—88,952 copies of this issue printed

Published every other Monday by McGraw-Hill, Inc. Founder: James H. McGraw 1860-1948. Publication office 330 West 42nd N.Y., N.Y. 10036; second class postage paid at New York, N.Y. and additional mailing offices.

Executive, editorial, circulation and advertising addresses: *Electronics*, McGraw-Hill Building, 330 W. 42nd Street, New York, N.Y. 10036. Telephone (212) 971-3333. Teletype TWX N. Y. 710-581-4235. Cable address: MCGRAW HILL N. Y.

Subscriptions limited to persons with active, professional, functional responsibility in electronics technology. Publisher reserves the right to reject non-qualified requests. No subscriptions accepted without complete identification of subscriber name, title or job function, company or organization, including product manufactured or services performed. Subscription rates: qualified subscribers in the United States and possessions and Canada, \$8.00 one year, \$12.00 two years, \$16.00 three years; all other countries \$25.00 one year. Limited quota of subscriptions available at higher-than-basic rate for persons outside of field served, as follows: U.S. and possessions and Canada, \$25.00 one year; all other countries \$50.00. Air freight service to Japan \$60.00 one year, including prepaid postage. Single copies: United States and possessions and Canada, \$1.00; all other countries, \$1.75.

Officers of McGraw-Hill Publications Company: Joseph H. Allen, President; John R. Emery, J. Elton

Tuohig, Senior Vice Presidents; Donald B. Gridley, Group Vice President; Vice Presidents: Ralph Blackburn, Circulation; John R. Callahan, Editorial; William P. Giglio, Administration; David G. Jensen, Manufacturing; Jerome D. Luntz, Planning & Development; Joseph C. Page, Marketing; Robert M. Wilhelm, Finance.

Officers of the Corporation: Shelton Fisher, President and Chief Executive Officer; John J. Cooke, Senior Vice President and Secretary; Gordon W. McKinley, Vice President and Treasurer.

Title registered in U.S. Patent Office. © Copyright 1970 by McGraw-Hill, Inc. All rights reserved. The contents of this publication may not be reproduced either in whole or in part without the consent of copyright owner.

Subscribers: The publisher, upon written request to our New York office from any subscriber, agrees to refund that part of the subscription price applying to copies not yet mailed. Please send change of address notices or complaints to Fulfillment Manager; subscription orders to Circulation Manager, *Electronics* at address below. Change of address notices should provide old as well as new addresses, including postal zip code number if possible, attach address label from recent issue. Allow one month for change to become effective. Postmaster: Please send form 3579 to Fulfillment Manager, *Electronics*, P.O. Box 430, Hightstown, N.J. 08520.

SOLID TANTALUM CAPACITORS



BOARDABLE & AFFORDABLE

RIGHT ON THE MONEY
FOR PRINTED WIRING BOARDS
IN INDUSTRIAL, COMMERCIAL,
AND ENTERTAINMENT
ELECTRONICS

Sprague Type 196D Dipped Solid-Electrolyte Tantalex® Capacitors cool the performance/budget argument. Newly broadened line—now available in all popular 10% decade values between 0.1 μF and 330 μF . Voltage range: 4 to 50 vdc. Hard insulating resin coating is highly resistant to moisture and mechanical damage. Straight or crimped, long or short leads. Operate to 125C with only $\frac{1}{3}$ voltage derating. Write for Engineering Bulletin 3545A.

Technical Literature Service
Sprague Electric Company
35 Marshall Street
North Adams, Mass. 01247

SPRAGUE[®]
THE MARK OF RELIABILITY

THE BROAD-LINE PRODUCER OF ELECTRONIC PARTS

45M-0139

INTERNATIONAL frequency meter

- Tests Predetermined Frequencies 25 to 1000 MHz
- Extended Range Covers 950 MHz Band
- Pin Diode Attenuator for Full Range Coverage as Signal Generator
- Measures FM Deviation

MOBILE

FM-2400CH

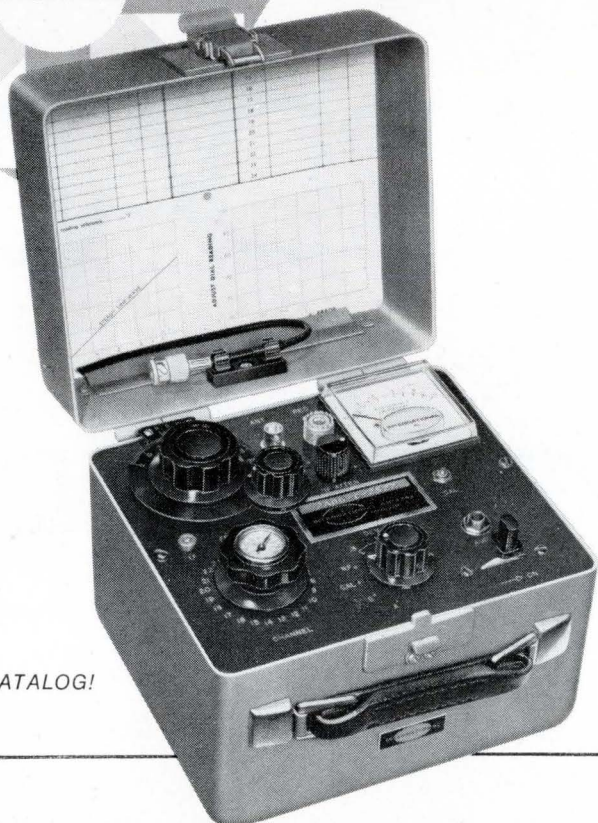

WRITE FOR CATALOG!

The **FM-2400CH** provides an accurate frequency standard for testing and adjustment of mobile transmitters and receivers at predetermined frequencies.

The **FM-2400CH** with its extended range covers 25 to 1000 MHz. The frequencies can be those of the radio frequency channels of operation and/or the intermediate frequencies of the receiver between 5 MHz and 40 MHz.

Frequency Stability: $\pm .0005\%$ from $+50^\circ$ to $+104^\circ\text{F}$.

Frequency stability with built-in thermometer and temperature corrected charts: $\pm .00025\%$ from $+25^\circ$ to $+125^\circ$ (.000125% special 450 MHz crystals available).

Self-contained in small portable case. Complete solid state circuitry. Rechargeable batteries.

FM-2400CH
(meter only).....\$595.00
RF crystals (with temperature correction)..... 24.00 ea.
RF crystals (less temperature correction)..... 18.00 ea.
IF crystals.....catalog price



CRYSTAL MFG. CO., INC.
10 NO. LEE • OKLA. CITY, OKLA. 73102

Readers comment

Availability

To the Editor: We appreciate the attention given to Fairchild's new approach to high-speed multiplication ["Parallel multiplier gets boost from IC iterative logic," Oct. 12, p. 89].

However, we would like to correct one misunderstanding to avoid any confusion. The 9344 circuit discussed is not currently available. Our present plans call for introduction of the 9344 circuit in production quantities in January 1971.

Gene Selven
Director of product marketing
Fairchild Semiconductor
Mountain View, Calif.

Interface systems

To the Editor: The Sept. 28 issue carried a news item on interface systems for electronic calculators [Electronics Newsletter, p. 34]. Apparently you must have missed our news release which described the complete line of interfacing systems our company manufactures for the Wang Laboratories Inc.'s 700 series electronic desk calculators.

Our company has developed a wide range of interfacing systems for electronic desk calculators designed to allow them to be used for data acquisition, process control, and other applications where minicomputers are presently employed.

Our emphasis has been particularly heavy in the process control field where the rapidity and simplicity with which the calculator can be programed vis-a-vis the conventional minicomputer allows the new system to be used for the development of direct digital process control systems at the pilot plant level.

We have also developed a drum memory system, as well as a tape drive, for Wang Laboratories' calculator line.

Roger Jennings
Fluidyne Instrumentation
Lafayette, Calif.

5 ways to kill Trigger Trauma without killing your budget.

Only DUMONT's extraordinary new independent, setable triggering kills trigger trauma. Now you can choose from five models and get just the scope you need starting at \$1845.00 complete for unsurpassed 50 MHz, dual channel performance.

Write or call for details now.

DUMONT OSCILLOSCOPE LABORATORIES, INC.
40 Fairfield Place, West Caldwell, N.J. 07006
(201) 228-3665/TWX (710) 734-4308

DUMONT
OSCILLOSCOPE LABORATORIES, INC.



THE

END

**CORES LOSE
PRICE WAR
TO NEW CHIP**

ASK INTEL FOR

PROOF

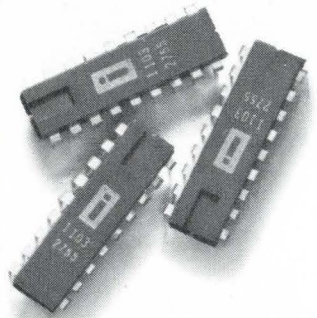

Intel introduces Type 1103, a history-making 1024-bit RAM made by our silicon-gate MOS process at such high yields that the cost dips below cores.

Just tell us what core memories cost you, and we'll tell you how to build operational Type 1103 memories for less cost in any size from 50,000 bits to 10,000,000 bits.

The Intel 1103 makes a fully assembled memory system that has a maximum access of 300 nanoseconds and a total cycle time of 600 nanoseconds. The chip is fully decoded and dissipates only 100 microwatts per bit, permitting dense packing in compact configurations.

For proof of the cost advantage, phone your Intel representative or call us collect at (415) 961-8080. For immediate delivery phone your local Intel distributor, Cramer Electronics or Hamilton Electro Sales. If your distributor isn't stocked, call Intel collect for immediate same-day shipment.

Intel Corporation is in high-volume production at 365 Middlefield Road, Mountain View, California 94040.

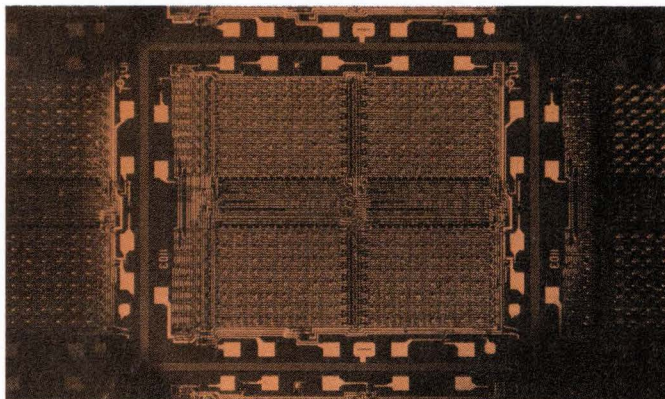

intelTM
delivers.



It's not rain or snow that's holding up your mail.

It's eighty-two billion pieces of mail every year.

Knowing the volume is going nowhere but up, the U.S. Post Office has asked our Electro Dynamic Division to explore the possibility of electronic transmission of some of the mail to help lighten the load.

In addition to an analysis of satellite, microwave and laser sending methods, the in-depth study is investigating delivery by in-home printing devices.

We think it will be possible one day to send a million letters coast to coast every minute without anyone but the correspondents knowing what's been written.

The day of the electronic post office hasn't arrived. But for now, electronics can help move the mails in another way. In a San Diego test, we're posting electronic letters.

These letters are printed circuit cards. They're enclosed in envelopes and packages that you can't tell apart from ordinary mail.

The printed circuit has no power, but when it passes a monitor, it immediately identifies itself, so we know when and where it's been mailed and where it's going.

With this kind of information, we'll know more about what happens to a letter that becomes part of the mail.

Sorting out eighty-two billion pieces of mail is a problem. But we put technology to work solving problems from the bottom of the sea to outer space...and a good bit in between.

GENERAL DYNAMICS

1 Rockefeller Plaza, New York, N.Y. 10020



MOS FET SWITCHES from Siliconix

Here's a quick look at what's happening with our more popular devices and an introduction to a couple of new ones:

DEVICE	$R_{DS(ON)}$	$\frac{BV_{DSS}}{BV_{SDS}} \frac{BV_{DSS}}{BV_{SSS}} \frac{I_D=10\mu A}{V_{GS}=V_{BS}=0}$
M163 —New, low C_{RSS} , 0.35 pF typ. 3N163 equiv., no zener diode.	250 Ω $V_{GS}=-20V$ $I_D=100\mu A$ $V_{BS}=0$	-40V
M103 —Low $I_{D(OFF)}$, low $I_{S(OFF)}$.	100 Ω $V_{GS}=-20V$ $I_D=100\mu A$ $V_{BS}=0$	-30V
M511A —New, equiv. to MEM511	300 Ω Max. $V_{GS}=-15V$ $I_D=-100\mu A$ $V_{BS}=0$	-30V
M107 —Dual Monolithic FET	120 Ω	-30V
M119 —Very high BV_{DSS} , BV_{SDS} , BV_{SSS}	125 Ω $V_{GS}=-60V$ $I_D=100\mu A$ $V_{BS}=-20V$	-75V
3N167 $R_{DS(ON)} < 20\Omega$	20 Ω $I_D=1mA$ $V_{GS}=-20V$	-30V
M116 —Low I_{GSS} , N-channel enhancement mode.	200 Ω $I_D=100\mu A$ $V_{GS}=10V$ $V_{BS}=0$	+30V

There's much more to the Siliconix MOS FET switch story, so write or call for instant information and assistance.

Siliconix
incorporated

2201 Laurelwood Rd. • Santa Clara, Calif. 95054
(408) 246-8000 Ext. 201 • TWX: 910-338-0227

Who's who in electronics



Harwood

From resistors and capacitors to integrated circuits—that's the transition made by Charles C. Harwood, the newly named president of Signetics Corp., Sunnyvale, Calif. Harwood had been a vice president of Corning (Signetics' parent) and the general manager of the company's Electronic Products division, makers of resistors and capacitors, before he replaced James F. Riley at the helm of Signetics. Riley left to become president of Intersil Inc.

Although resistors and capacitors are very different from ICs, Harwood doesn't expect the transition to be too difficult. For one thing, when he came aboard, Signetics was in the middle of a reorganization whereby each group—MOS, linear, bipolar, digital, advanced products, and product marketing—is set up as a separate company. "These decisions were in the works before I came," says Harwood. "I've had a chance to participate."

Basically, says Harwood, the changes will allow each product manager to run his own business, and now that the company is expanding into MOS and linear, this

decentralization may be needed. It's this expansion that Harwood hopes will allow Signetics to do better than the industry next year.

"Percentagewise, the industry will be flat this year and there will be a slight growth next year, but we hope to do better because of new product introductions." Since Harwood arrived, Signetics has introduced about 12 new linears and 10 MOS products.

"The idea that research and development wastes money is nonsense," says Robert S. Pepper. Pepper is corporate manager of the Sprague Electric Co.'s functional circuit design and technology operation, and he's out to prove his point [see p. 109].

"This may be the first internal R&D facility with a profit and loss statement, but if it is, that's exactly what I want. With the functional circuits operation, I'm laying it on the line."

In 1964, Pepper came out of the University of California's Berkley faculty as the Ford Foundation's first resident in engineering practice. His role was supposed to have been similar to that of a medical resident, except that after watching how things worked in the real world of industry Pepper was supposed to have returned to his students and help them prepare for it. But the competitive bug bit, and as Pepper says, "I went over the hill and stayed there. It almost sank the residency program—it looked as if its only result would be the exodus of teachers to private industry." But the residency idea prospered and now is sponsored by the National Science Foundation.

Pepper's lust for a profit and loss statement has been with him ever since he began doing some linear IC design for the semiconductor department during his residency. But even though he eventually became director of semiconductor R&D for Sprague, he has never settled the profit and loss question to his satisfaction. Now he may.

"The original idea behind the

Take a look at these typical **C**omplementary Symmetry MOS IC dissipation: *gates—10 nW/pkg; counters, registers, decoders—10 μ W ($V_{DD} = 10$ V).* You'll see why RCA COS/MOS saves design dollars by cutting system size. It does so by eliminating the need for forced cooling systems; using smaller, less expensive power supplies and enabling higher packing densities.

RCA's broad line of COS/MOS ICs — gates, flip-flops, hex buffer/logic-level converters, multiplexers, static-shift reg-

isters, counters, adders and memories — offers many more unique performance features for logic systems.

Immediately available in production quantities are:

- CD4000 and CD4000D Series — 28 ceramic-packaged devices at new low prices

- CD4000E Series — 19 new economy-priced plastic-packaged ICs

RCA will also custom tailor COS/MOS ICs for your special digital-circuit applications. Ask your RCA Representa-

tive about this service.

For price, delivery or technical information on COS/MOS ICs, see your local RCA Representative or RCA Distributor. And, for more information on COS/MOS performance features, request bulletin ST-4001, "COS/MOS ICs," from RCA, Commercial Engineering, Section 70K-9/CD50, Harrison, N.J. 07029. International: RCA, 2-4 rue du Lièvre, 1227 Geneva, Switzerland, or P.O. Box 112, Hong Kong.

RCA COS/MOS ICs: microwatt power consumption significantly reduces system size...and cost.

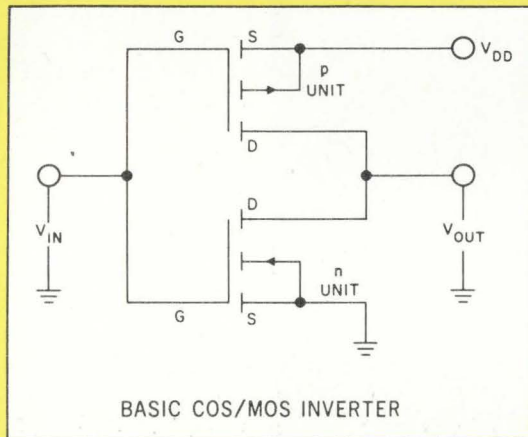

The unique design of the basic inverter circuit in RCA COS/MOS ICs limits the quiescent power consumption to nanowatts.

In most logic systems, the majority of the circuitry changes logic state at only a portion of the clocking rate. Therefore, the quiescent power consumption between switching periods is the major factor in determining total power consumption. Dynamic power consumption is a function of switching frequency.

In either logic state, one transistor of the basic COS/MOS inverter circuit is ON and the other is OFF. A very high OFF-impedance between the supply voltage line and ground limits the quiescent current of the OFF transistor to a very low value (0.3 nA typ at $V_{DD} = 10$ V).

RCA

Integrated Circuits

It took a new generation to bridge the gap

Delevan's Micro-i® Series 155

A new generation of low-cost, miniaturized inductors that is the long-sought transition between discrete and monolithic IC circuits.

HIGH RELIABILITY AND VERSATILITY

Originally designed to meet the rigorous standards of DOD and NASA specifications, Micro-i Series 155 inductors are perfect for communications applications and the computer field where performance is critical and ownership costs are a consideration. Proven successful for choke and filter applications.

SUPERIOR FEATURES

Ruggedly constructed with internal connections, thermo-compression bonded for high temperature processing.

RF Inductor Epoxy-molded to meet MIL-C-15305, Rev. D, Grade 1, Class A.

Miniaturization and low profile give improved compatibility with hybrid ICs.

Four separate leads are readily adaptable for solder reflow connections. Eliminates costly body tie-down, reduces lead fatigue caused by vibration and is easily adaptable to tuned circuits by means of outboard chip capacitor.

Write for complete technical data.

Delevan
Division



**AMERICAN
PRECISION
INDUSTRIES INC.**

270 QUAKER RD. / EAST AURORA, N. Y. 14052
TELEPHONE 716/652-3600 TELEEX 091-293

OTHER DIVISIONS OF AMERICAN PRECISION INDUSTRIES INC.: BASCO • DUSTEX •
MOELLER INSTRUMENT CO. • OXFORD CORP. • TRUCK EQUIPMENT CO.

Who's who in electronics

functional circuits operation was that bringing all of Sprague's technology to a single point of access would be good for Sprague's existing divisions," he says. "But I asked for my own P&L and got it."

Has Theodore Brandt been hired as Monsanto Electronic Instruments' new marketing manager to start the company on the road to oscilloscope power? Brandt himself says not, though he did spend his last 11 years at Tektronix, rising to field marketing manager.

"They [Monsanto] were looking for someone who had a good marketing and business background, and who could grow with Monsanto as a company," he states, "but they weren't looking for someone to solve the problem of 'How do we get into the oscilloscope business?'" Monsanto currently produces only low-frequency units for the military.

Maybe it is just a coincidence that Brandt is a former Tek man. But Monsanto spokesmen have long been making noises about challenging Hewlett-Packard Co. and Tek in the oscilloscope market. And Brandt sounds as though he likes the idea. "The ability to display a waveform," he says, "is very important in the instrument business. An oscilloscope is one of the key elements in a product line."

As his immediate task, however, Brandt puts top priority on setting up "a distribution system that can handle our product line."

Like most other instrument-house executives, Brandt wants his firm to go after new markets. "I'd like the company to become really responsive to the changing industry needs that require electronic instrumentation," he declares. "The people who study the human body, who manufacture automobiles, and who are engaged in the chemical business are getting more involved in measuring and controlling things that have electrical characteristics."

Although going after nonelectronics industry business presents marketing problems, Brandt believes that an electronics salesman can make the switch.

Expand your Measurement Horizon

with a Beckman 525 MHz Frequency Meter.

That's right...525 MHz direct count. Now, there is no lost time waiting for prescaling, or the need to manually tune and interpret the heterodyne unit. The Model 6421 lets you read frequencies to one Hertz in one second. It's the perfect instrument for commercial communications frequency measurements. □ Easy to use in a system, you can order your 6421 with programmable inputs and BCD outputs at no extra cost. It's portable too, only 15 pounds complete with built-in carrying handle, and there's an optional battery pack. □ There's more. The 6421 has a wide dynamic range of better than 26 dB, 50 mV

to 10 V without adjustments. (No need for external attenuators or dividers to make accurate measurements.) And an input impedance over the entire range of the instrument of one megohm...greater than any other frequency meter available. □ With all these outstanding features the Model 6421 is only \$1,575*. And as with all Beckman EID products the 6421 is available through our new factory direct rental and lease program. Ask your local Beckman representative for details or call us direct (312) 671-3300.



Beckman

INSTRUMENTS, INC.
ELECTRONIC INSTRUMENTS DIVISION
Schiller Park, Illinois 60176

Helping science and industry
improve the quality of life.

**When you build
a product last,
you better
build it better.**

Now, that may sound like sour grapes. So we'll just give you the facts:

All our competitors beat us to market with their industrial/lab supplies. They became entrenched. (Sure, we've pioneered most of the major innovations in the power supply industry—such as our DCR series—but we're not always first.) So before we began our design, we talked with the people who were using these kinds of power supplies. What did they like? What didn't they like? Any changes they'd like to see made? Any features added?

Here are the results:

1. Our new SRL line has a special circuit which allows you to check overvoltage setpoint instantly, and easily change settings without removing the load from the supply.
2. Complete line features new small-sized SRL units available in 14 models in voltage ranges from 0-10 Vdc to 0-60 Vdc and current ranges up to 100 amps.
3. High stability and reliability through use of integrated circuitry.
4. These supplies all feature an adjustable built-in SCR crowbar and adjustable current limiting circuitry as standard.
5. We have the fastest response time over full load range.
6. These supplies give you less than 1 millivolt RMS ripple.

Now, those are just a few of the reasons you may want to consider Sorensen the next time you consider buying industrial/lab power supplies. For more reasons and complete information on these or any of our power supplies (we manufacture and inventory more power supplies than any one else in the world), please call our Applications Engineering Manager, Norbert Laengrich (collect) at (203) 838-6571, or write him at Sorensen, Richards Avenue, Norwalk, Connecticut 06856. He will also send you our 124 page Power Supply Handbook and Catalogue. Or circle 200 on the inquiry card.

Sorensen
POWER SUPPLIES

AN OPERATION OF RAYTHEON CO.



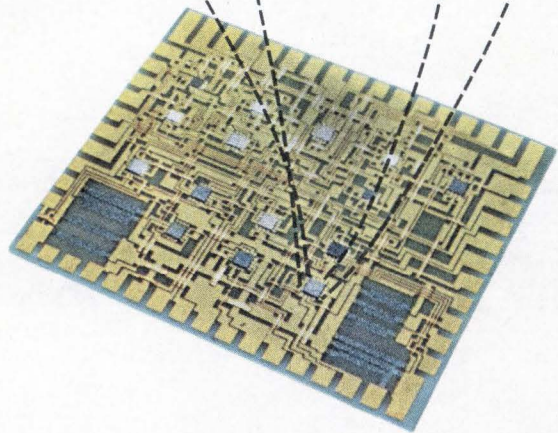
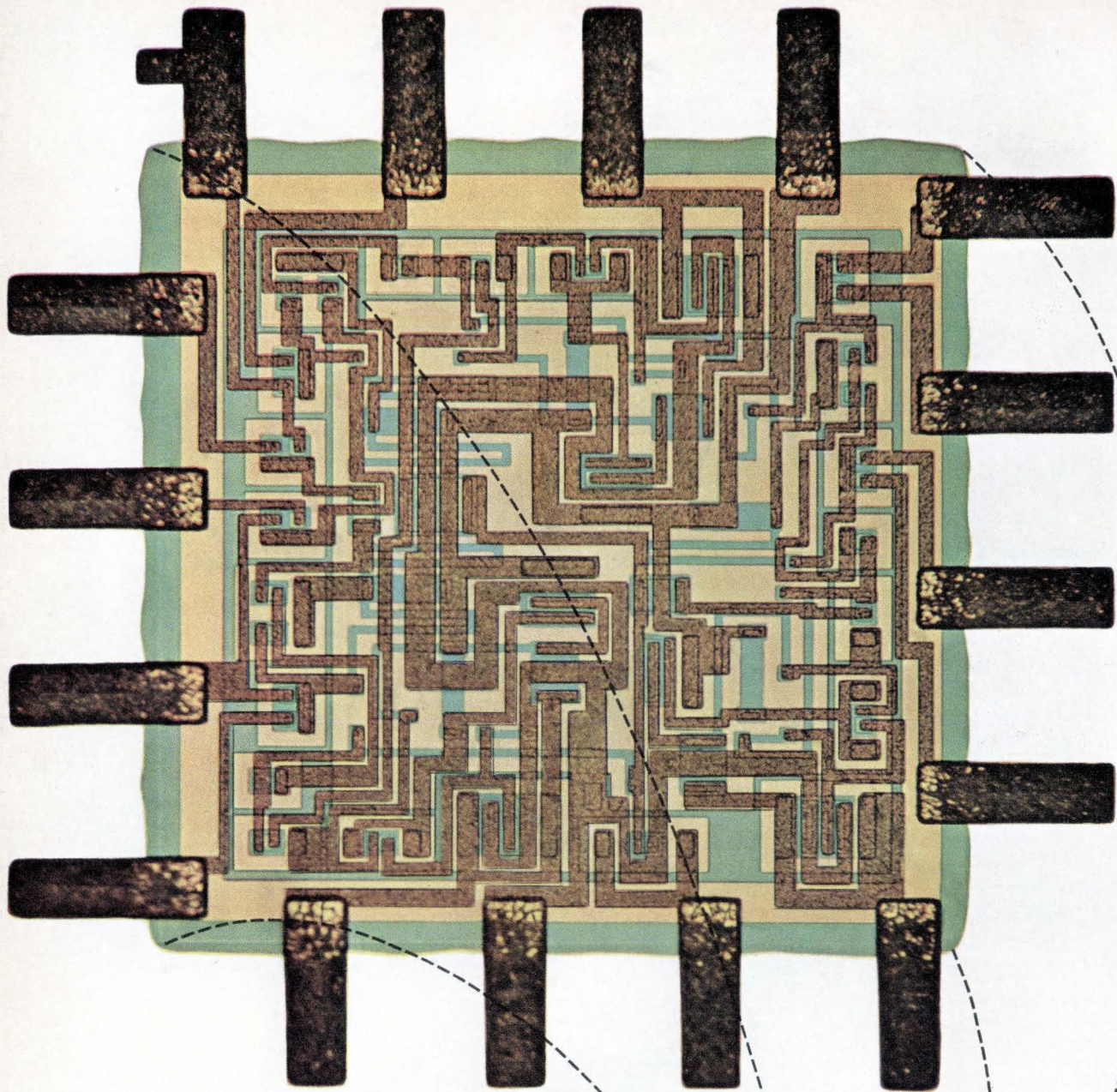

Circuits and synergy

To fill a variety of communications needs, Bell Labs and Western Electric have worked together to develop a special kind of integrated circuit. Based on two compatible and complementary technologies—silicon and tantalum—this “hybrid integrated circuit” is hundreds of times smaller and more reliable than circuits using discrete solid-state components.

The silicon portions of the circuit contain active components such as diodes and transistors; some low-precision resistors and the necessary interconnections are also formed on the tiny silicon chips. Hundreds of these chips are fabricated on one silicon slice. Tiny gold conductors—“beam leads”—are formed on each chip at the same time. Then the chips are separated and the beam leads bonded to tantalum thin-film circuits. Typically no more than one or two square inches, tantalum circuits contain precision resistors, capacitors, and interconnections etched into the metal film, previously deposited on glass or ceramic substrates.

Hybrid integrated circuits open new opportunities for circuit designers in many areas of communications systems engineering—telephone equipment, transmission, switching.

In this hybrid integration technology, design and manufacturing are intimately related. Designer and maker must work closely together. The Bell System fosters this concerted action—this synergy—with Bell Labs, for research and development, and Western Electric for manufacturing and supply. At several plants Bell Labs and Western Electric engineers work together in Process Capability Laboratories, speeding new designs into manufacture.

Here are a few examples of their teamwork.

The tantalum portion of a hybrid circuit starts as a 2000-Angstrom layer of tantalum, deposited on glass or ceramic. This process, invented at Bell Labs, was first carried out in a vacuum under bell jars. Western Electric designed and built “open ended” machines.

Now, deposition takes place as the glass or ceramic chips move through the machine on a chain.

For highest precision, newly formed tantalum thin-film resistors require adjustment. This is done by removing, electrochemically, just the right amount of tantalum to raise the resistance to the required value. Bell Labs devised the process; Western Electric computerized and automated it.

Silicon circuits are sensitive to impurities such as sodium ions in the air. So, they used to be sealed into expensive evacuated cans. But now, a gold and silicon-nitride shield gives the required protection at low cost. Originated by Bell Labs, it was put to work by Western Electric.

Making connections to integrated circuits once called for individual attachment of fine gold wires. Then Bell Labs came up with “beam leads”: gold conductors plated into place on silicon circuits. In addition to being conductors, the leads also give mechanical support. Western Electric developed methods for bonding them to circuits.

Beam leads are fabricated as part of the silicon circuit but their free ends must be attached to other circuitry. Bell Labs and Western Electric have developed thermocompression bonding techniques for this job. With the proper combination of time, temperature, and pressure all leads on the silicon circuit are bonded simultaneously to a thin-film circuit.

In the future, we hope to get more circuitry into less space and to find new functions for the technology. The circuit shown here, for instance, is one of some 200 logic “building blocks” for use in private branch exchanges, data sets, and other customer telephone equipment. It could not have been built with “discrete-component” technology. And we will not stop with silicon and tantalum. For other jobs, other materials may be better. Bell Labs and Western Electric are working together to find and apply them.



Bell Labs
Western Electric

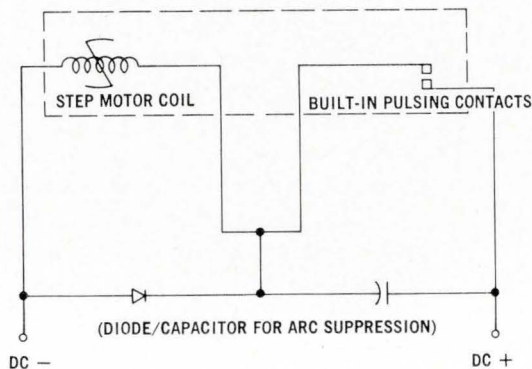

Pulsing circuitry inside motor. No external pulser or logic network necessary.

NEW SELF-PULSING STEP MOTORS ELIMINATE COSTLY CIRCUITRY.

Because the new Ledex Series 50 12-position step motors have pulsing contacts built in, they need no external pulsers or expensive logic circuitry. You get important savings because in many cases, pulsing circuitry can cost as much as or even more than the motor itself.

There are two self-pulsing models on the shelf. One steps as long as you apply power. The other has a control deck, so you can command it to self-step to any of 12 positions. It includes a 2-inch flatted shaft so you can add rotary switches and have a combination power positioner and self-homing stepping switch.

Also New

Two other new Series 50's are 10- and 24-position stepping motors. For use wherever you need dependable remote positioning . . . counting, sequential switching, tape advancing, cam cycling, printer driving and automatic testing. These respond to simple square wave DC pulses . . . still no expensive logic circuitry.

Other Series 50 stepping motors include 12- and 18-position models. All have an exclusive tooth clutch that puts out high torque for size. You can get a breakaway torque of up to 172 ounce inches . . . or drive a constant friction load of up to 64 ounce inches. Life is 3 million steps minimum — each way for bidirectional models. Step accuracy $\pm 1^\circ$, non-accumulative. 60 stock models available from the shelf.

For complete data on the new Ledex self-pulsing stepping motors and other high torque Series 50 models, write for Catalog D-7000 or call us at 513/224-9891.

Specialists in remote positioning



LEDEX DIVISION, LEDEX INC.

123 Webster Street, Dayton, Ohio 45401 phone (513) 224-9891

Meetings

Calendar

Symposium on Man-Machine Systems, IEEE; Langford Hotel, Winter Park, Fla., **Nov. 12-13.**

Symposium on Communications, IEEE; Queen Elizabeth Hotel, Montreal, Canada, **Nov. 12-13.**

Magnetism and Magnetic Materials Conference, IEEE; Diplomat Hotel, Hollywood Beach, Fla., **Nov. 15-19.**

Fall Joint Computer Conference, IEEE; Astro Hall, Houston, **Nov. 17-19.**

Conference on Display Devices, IEEE; United Engineering Center Auditorium, New York, **Dec. 2-3.**

Conference on Vehicular Technology, IEEE; Statler-Hilton Hotel, Washington, **Dec. 2-4.**

National Electronics Conference, IEEE; Conrad Hilton Hotel, Chicago, **Dec. 7-9.**

International Symposium on Circuit Theory, IEEE; Sheraton Biltmore Hotel, Atlanta, Ga., **Dec. 14-16.**

Reliability Symposium, IEEE; Sheraton Park Hotel, Washington, Jan. 12-14. Optics in Microelectronics, Optical Society of America, Stardust Hotel, Las Vegas, **Jan. 25-26.**

International Solid State Circuit Conference, IEEE; Sheraton Hotel, University of Pennsylvania, **Feb. 17-19.**

Call for papers

G-MTT International Microwave Symposium, IEEE; Washington, May 17-20, 1971. **Jan. 3** is deadline for submission of summaries and abstracts to Mr. Robert V. Garver, Chairman, Technical Program Committee, Harry Diamond Laboratories, Washington, D.C. 20438.

Temperature, its Measurement and Control in Science and Industry, American Institute of Physics, Instrument Society of America, National Bureau of Standards; Washington, June 21-24, 1971. **Jan. 4** is deadline for submission of abstracts to Dr. H.H. Plumb, National Bureau of Standards, Room B222 Physics Bldg., Washington, D.C. 20234.

Joint Automatic Control Conference, IEEE; Washington University, St. Louis, Mo., Aug. 11-13, 1971. **Jan. 8** is deadline for submission of papers to Dr. John Lewis, Department of Electrical Engineering, The Pennsylvania State University, University Park, Pa. 16802.



We met the challenge... We beat it

Basic challenges often call for elegant solutions. In our case it was bringing metallic oxide semiconductors (MOS) from laboratory curiosities to dependable electronic hardware.

We did it. And we emerged as an undisputed leader in MOS technology.

Our championship in the MOS arena is already putting MOS devices to work for our customers profitably in calculators,

computers, peripherals, communications systems, and other electronic products.

Our expertise can be your expertise. If your company manufactures anything with electronic parts, the chances are good that MOS devices from AMI can put you ahead of your competition. So hop a jet to our Santa Clara headquarters and see firsthand what we're doing with microscopic chips of silicon.

And then? Well, we have a plant in Tijuana, Mexico. If you take in the bullfights instead of us, we'll never tell.

American Micro-systems, Inc.

3800 Homestead Road, Santa Clara, Calif. 95051 Phone: (408) 246-0330



THE LEADING
MOS COMPANY,
WITH FACILITIES IN
CALIFORNIA, MEXICO
IDAHO & KOREA

How to evaluate DEC and SYSTEMS and other small real-time computers.

Go to a company that makes a complete line for the OEM and end-user markets. Which leaves only DEC and SYSTEMS.

Forget everything you've heard. Take a hardnosed look for yourself. Compare dollars against performance—right down both lines.

If you need large memory, compare SYSTEMS 72 with the PDP-8 and PDP-11. You'll find the SYSTEMS 72 has a little more speed and a lot more memory (max. 65,000 words of programmable memory—almost twice as much as the other two). On many applications, this will cut cost as much as 40%.

If you need more speed, you'll find the SYSTEMS 82 is 4-5 times faster than the PDP-8 or 11. And because it's designed for real-time systems use, you can hang on a wide variety of analog front ends and peripheral equipment.

If you need even faster speeds and heavier software, check out SYSTEMS 810B—the fastest field-proven 16-bit machine in the business. It comes with a whole library of software including FORTRAN IV and a foreground-background-midground programming system called Real-Time Executive.

SYSTEMS also makes some very large, very fast real-time computers. But that's another story.

As far as small real-time computers go, don't take our word for it. Send the coupons.

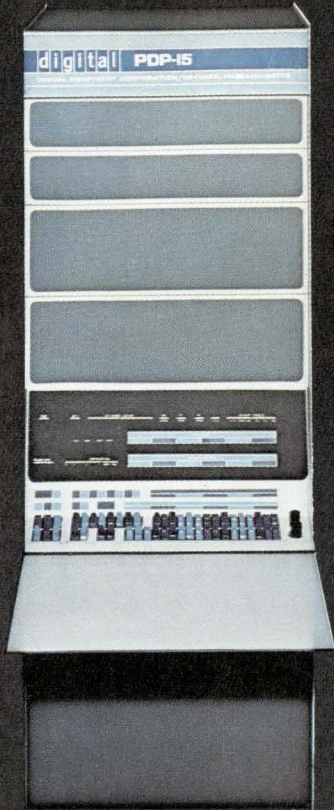

PDP-15

Word length—18-bit
Cycle time—800 nanosec.
Maximum core memory—131

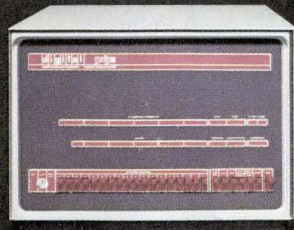

PDP-11

Word length—16-bit
Cycle time—1200 nanosec.
Maximum core memory—32

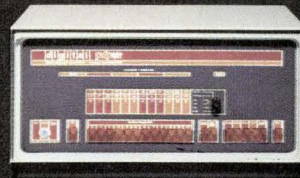

PDP-8 Series

Word length—12-bit
Cycle time—1200-1600 nanosec.
Maximum core memory—32

1

Digital Equipment Corp.

146 Main Street
Maynard, Mass. 01754

I'd like to compare the DEC and SYSTEMS lines of small real-time computers. Please send me more information.

Name _____

Title _____ Tel. _____

Company _____

Address _____

City _____ State _____ Zip _____

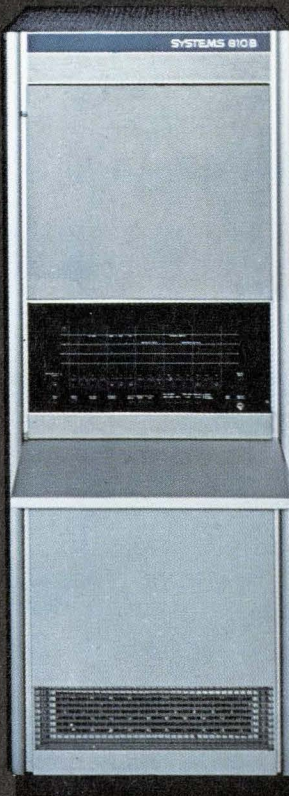

SYSTEMS 810B

Word length—16-bit
Cycle time—750 nanosec.
Maximum core memory—32

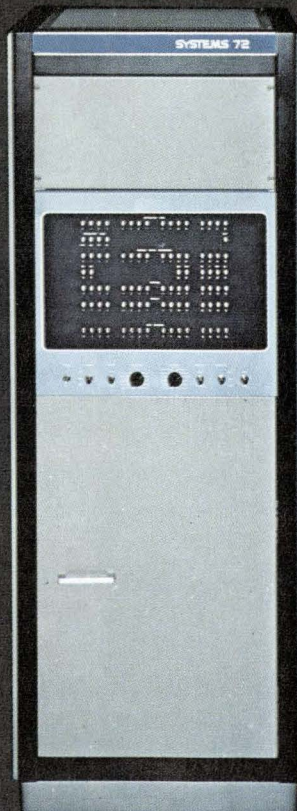

SYSTEMS 72

Word length—16-bit
Cycle time—880 nanosec.
Maximum core memory—65



SYSTEMS 82

Word length—16-bit
Cycle time—900 nanosec.
Maximum core memory—16

1

SYSTEMS Engineering Laboratories

6901 West Sunrise Blvd.
Ft. Lauderdale, Fla. 33313

I'd like to compare the SYSTEMS and DEC lines of small real-time computers. Please send me more information.

Name _____

Title _____ Tel. _____

Company _____

Address _____

City _____ State _____ Zip _____

"n" Key Rollover. It remembers your every touch.

Our new "n" key rollover solid state keyboard has a memory like an elephant.

Data bits from the first key depressed are stored in our MOS memory until a second key is activated... even though the first key is still depressed. So any number of keys can be depressed without interfering with the sequence of data entry.

Which makes operator error practically nil. Tests have indicated up to 30% fewer errors than with two-key rollover keyboards.

And no special training is needed to switch from an electric typewriter. In fact, most any secretary can sit down and start operating.

Our "n" key rollover is also more reliable. Because pulse output is part of the solid state chip within the key, rather than a pulse network of discrete components.

For even more things you'll want to remember for your next keyboard application, call or write your MICRO SWITCH Branch Office.

MICRO SWITCH

FREEPORT, ILLINOIS 61032
A DIVISION OF HONEYWELL

NOV. 9, 1970

Electronics

International

Japanese focus on one-tube
color tv cameras: page 23E



Omnidirectional speakers launch Swedish company
in European hi-fi markets: page 7E

Automatic counting to 800 MHz

Plug-in to hands-off, high frequency operation

Fully-automatic counting from DC to 800 MHz is just one of the plug-in capabilities of Philips PM 6630 counter/timer system.

With the main unit you get the usual multifunction measurements on sine-waves and pulses. Plus exceptional

10 ns resolution, foolproof triggering, pulse spacing and trigger output facilities.

In addition, PM 6630 has a unique direct reading of pulse-width.

Plug-in to increased versatility and flexibility. 800 MHz counting at 50 mV. Extra sensitivity of 1 mV up to 160 MHz. Two channel time interval measurements. (Plug-in microwave converters are on the way too.)

And you've a choice of main unit. Higher stability remote control and BCD output with 8-digit PM 6630A.

More economy, the same versatility in frequency and time measurements with 6-digit PM 6630B.

Find out more about our counter/timer system by reading our comprehensive brochure. Contact your local Philips organisation or write to:

Test and Measuring Instruments Dept.,
N.V. Philips Gloeilampenfabrieken,
Eindhoven, The Netherlands.



TEST AND MEASURING INSTRUMENTS

PM 6630
160 MHz : 1 or 50 mV
800 MHz : 50 mV
10 ns
1 M Ω or 50 Ω

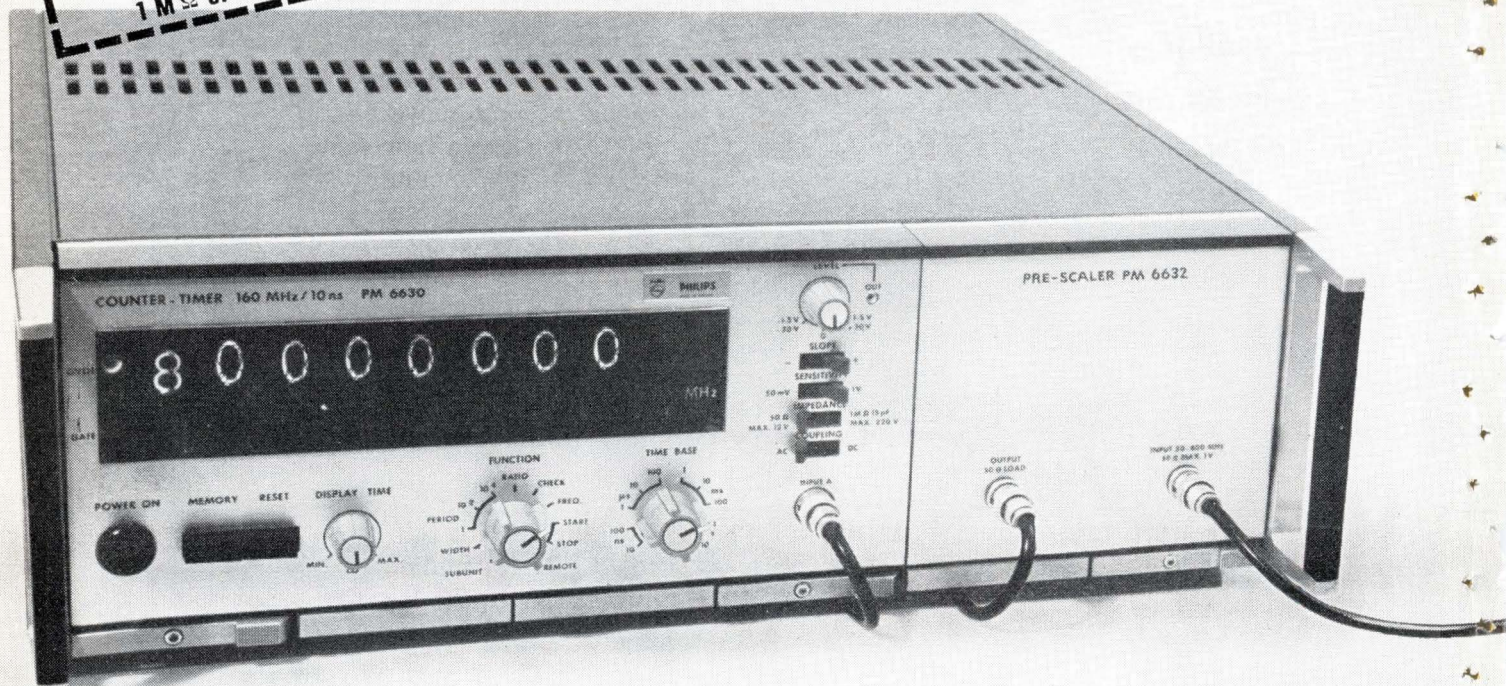

PHILIPS

International Newsletter

November 9, 1970

Lash-up of European computer makers challenges U. S.

Europe has long sought a counter to American dominance in the computer industry. And a new European computer consortium, set up to bid on the largest data processing project ever conceived in France, may prove the nucleus for just such an international group. Its members are Britain's International Computers Ltd., Holland's Philips Gloeilampenfabrieken, and France's Cie. Internationale pour l'Informatique.

The consortium would jointly install a \$16 million air freight customs control system at the new Paris airport being built at Roissy-en-France for 1973 use. The system, on which IBM and Honeywell-Bull are also bidding, will be similar to one ICL is installing at London's Heathrow Airport. A CII Iris 80 computer, Europe's biggest machine, would be the central processor. ICL would contribute know-how and some peripherals, Philips other peripherals.

The French government's close ties with CII makes the new group the likely winner. In fact, it is thought the French government asked Philips and ICL to participate as a way of luring them into permanent links with CII. For two years ICL and CII have been negotiating a joint research and marketing deal, possibly with America's Control Data Corp. as a participant.

Seven electronic systems for cars offered by Lucas

Automotive markets for electronics keep growing and Joseph Lucas Ltd., which supplies more than half the automotive electrical equipment used by British auto manufacturers, plans to move into auto electronics in a big way. The company is offering seven new systems using electronics: fuel injection; anti-skid protection; monitoring of braking and lighting systems and all fluid levels; a steady cruising speed controller; an engine speed limiter; a breakerless ignition distributor, and a permanent magnet alternator with bridge rectifier output control.

Most likely to be taken up first is the fuel injection system, which uses a novel sensing method. In the injector, voltages proportional to the throttle butterfly-valve angle and engine speed, which is read off the distributor, are converted to digital signals, combined, and matched with references in a semiconductor read-only memory.

Sweden to start satellite project

Sweden has decided to take the plunge into satellites. The Board for Technical Development has asked for \$1.4 million in fiscal 1971/72 to start the project definition of a Swedish research satellite. The request followed the board's proposal that Sweden invest \$64 million in the next five years for space projects [*Electronics*, Oct. 12, p. 128]. The board's timetable calls for startup of the development phase—including production of prototypes and subsystems—by Jan. 1, 1973.

The satellite will circle in polar orbit, at a height of 700 kilometers. Launched by a Scout rocket, the cylinder-shaped satellite will handle ionosphere and meteorological studies. An onboard computer will store and treat data before transmitting it to earth. The computer, which would have an 8,000 word memory, will be a "further development" of the central computer developed by SAAB-Scania for the new Swedish supersonic military jet, the Viggen, according to the board.

The communication system would include vhf links for transmission of processed data from the computer; a microwave link in the 2.2- to

International Newsletter

2.3-gigahertz range for transmission of raw data from the satellite when needed; vhf links for command and tracking, and a microwave link for reprogramming the computer.

**British IR imager
is portable,
sells for \$5,000**

A battery-powered infrared thermal imager developed by Britain's state-owned electricity utility, the Central Electricity Generating Board, for detecting hotspots in overhead transmission lines will be made commercially. Pye TVT Ltd., a Philips subsidiary, will sell the imager for less than \$5,000, which is between a quarter and a half the cost of established thermal imagers on the British market. Low price and small size—the unit measures 8 by 9 by 12 inches and weighs 15 pounds—has been obtained by using a Nipkow disk mechanical scanning system, similar to the original mechanical TV scanners. This approach gives a 30-line picture at 18 frames a second on a built-in 2.5-inch diagonal screen, which CEGB men say gives a clear picture of hotspots from the ground. Field of view is 6° vertical and horizontal, and thermal resolution is 1°C from the nitrogen-cooled indium-antimonide detector.

**Viggen production
under way in Sweden**

The first Viggen aircraft and supersonic jet engine have rolled off the production lines in Sweden, both on schedule. The aircraft is built for the Swedish Air Force by SAAB-Scania, the engine by Volvo-Flygmotor, on license from the United States' Pratt and Whitney. Another American company, the AIL division of Cutler-Hammer, has just been awarded a \$6 million contract for the attack version's instrument landing system, which will be made in the U.S.

The Swedish air force has contracted for 175 attack and two-seat trainer aircraft and for 195 engines, which are a military supersonic variant of those found on the DC-9 airliner. Only about 20% of the original engine design is left, the rest being Swedish redesign.

**Transmission
system uses coated
glass for laser beam**

A laser-based optical transmission system, on which researchers at West Germany's AEG-Telefunken are currently working, may some day be used in telephone communications without the need for switching centers. In such a system the information would be accompanied by special addresses that could be identified by correlators at the receiving end. The company is concentrating its more immediate efforts, however, on a simpler system—the transmission medium itself, plus the receiver and transmitter. An experimental version of this will probably be ready within the next three years, AEG-Telefunken says.

Instead of using a gradient-type glass fiber, in which the index of refraction varies from the center towards the periphery [*Electronics*, Sept. 14, p. 201], the German firm employs a dielectric glass fiber with a 1-micron-diameter glass core surrounded by a 50-micron-diameter glass coat. Since the coat's index of refraction is different from that of the core, the information-carrying light beam stays within the core. With core diameter on the order of magnitude of the light wave length, delay distortion is practically eliminated. This, in turn, makes for good broadband transmission characteristics and also allows a relatively small bending radius to be used. One problem at present is the fiber's high attenuation—1 decibel per meter. But AEG-Telefunken researchers say better fibers will give a value of 0.1dB per meter.

Test equipment off the line...

...for example UHF Wattmeter NAU, Precision Sound-Level Meter ELT and IC Tester ISP, the Frequency & Time Standard CAQA as well as Capacitance and Inductance Meters KRT and LRT or the Level Recorder ZSW. Not to mention wideband, two-channel frequency-response display units and frequency synthesizers, noise generators, bandpass filters and RC oscillators, field-strength meters and signal generators – in short, all the equipment illustrated and even more is available from stock.

Speedy delivery on a second, large group of precision test instruments. Among these are digital multimeters, milli- and microvoltmeters, VHF amplifiers and monitoring receivers, SHF test receivers, UHF attenuator sets and pads, transistor test sets, impedance and admittance meters, crystal measuring sets, Z-g diagraphs, reflectometers and programmed controllers,

plus UHF modulators, pulse & bar signal generators, UHF and SHF resonance frequency meters, frequency standards, frequency-comparison oscilloscopes and receivers, phase recorders, TV demodulators, frequency counters, digital clocks and power supplies.

For many special areas of application Rohde & Schwarz can also supply specialized equipment, which because of its sophisticated design cannot be kept on stock, but is all the more worth waiting for.

Contact your nearest R&S agency.

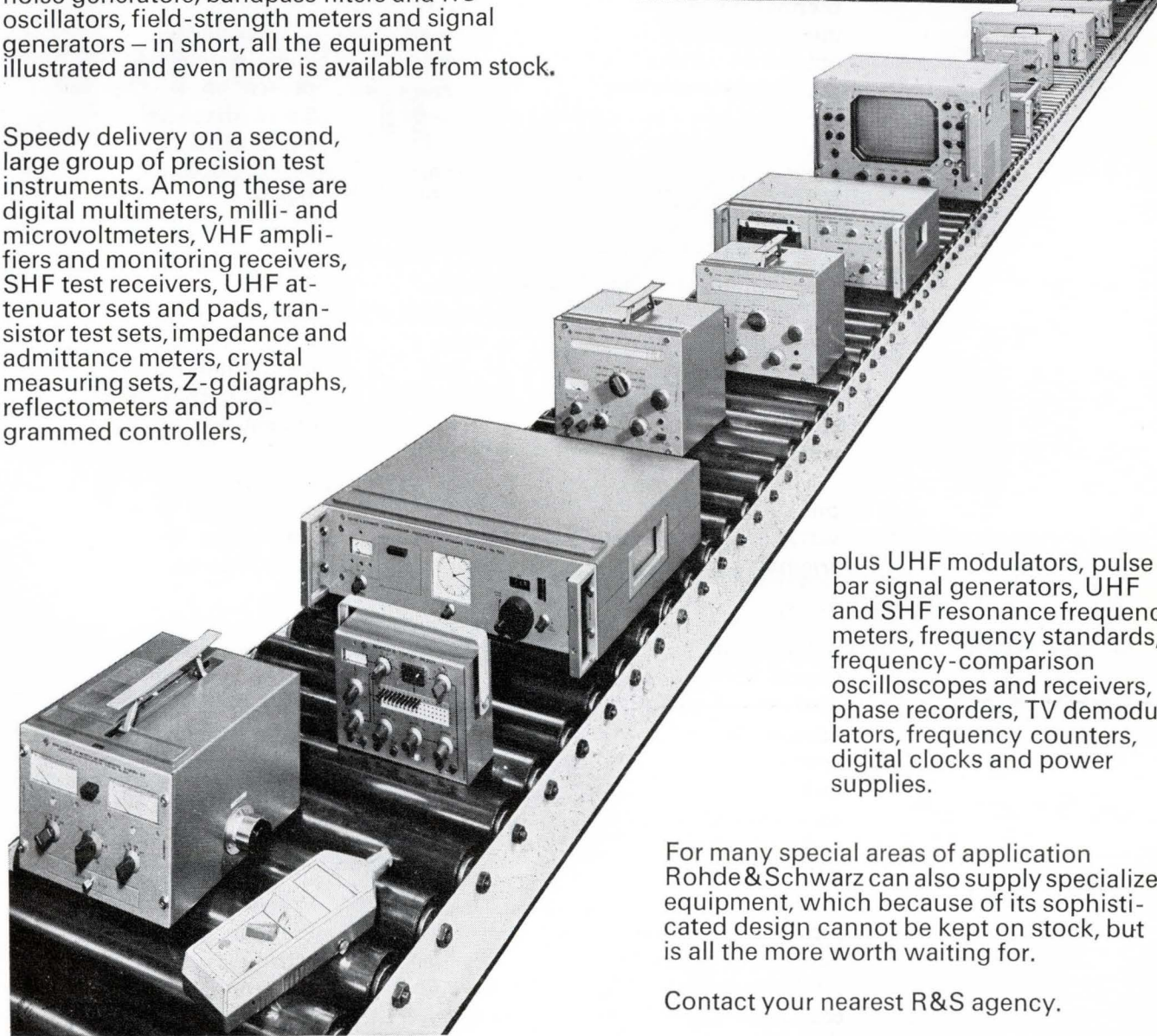
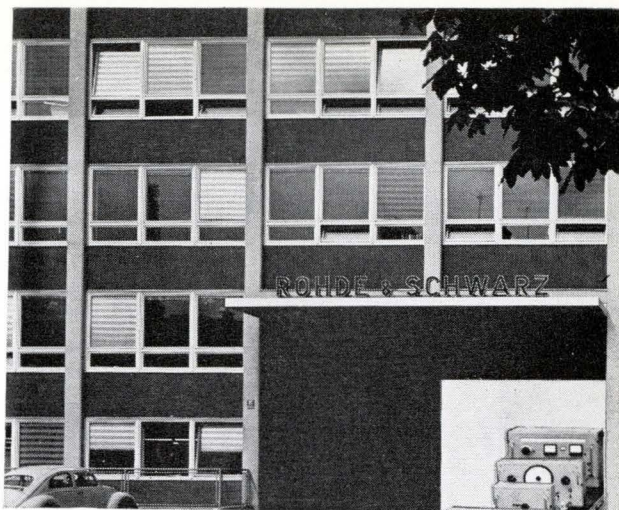

ROHDE & SCHWARZ

8000 München 80
Mühlhofstraße 15
West Germany
Tel. (08 11) *41 29-1
Telex 5 23 703

Distributors in: Addis Abeba, Athenai, Auckland, Bangkok, Bern, Bogotá, Bombay, Brno, Bromma, Brussels, Budapest, Buenos Aires, Caracas, Djakarta, Dublin, Guayaquil, Helsinki, Istanbul, Karachi, København, Lima, Lisboa, Madrid, Melbourne, Mexico, Milano, Montevideo, Nairobi, Nicosia, Osaka, Oslo, Ottawa, Paris, Passaic (N. J.), Pretoria, Reykjavik, Rijswijk, Rio de Janeiro, Santiago de Chile, Seoul, South Ockendon, Teheran, Tema, Wien

We've got the answer
to all your problems with

high speed power diodes

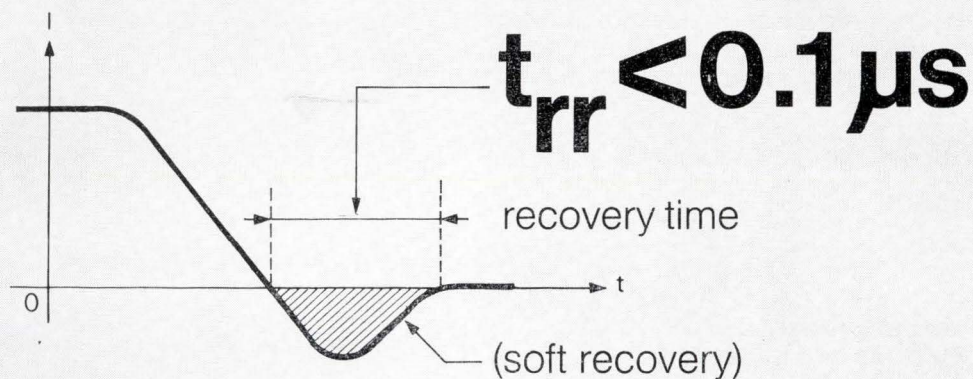
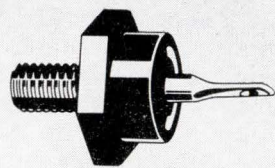

- booster diodes
- limitation of over-voltage
- low switching losses
- low radio-TV interference

from 0.4 A to 30 A
from 50 volts to 1000 volts

DO 5 package

Belgium

Thomson S.A.
196 A, avenue Louise
B - 1050 - Bruxelles 5
Tel. : 49.29.54 Twx : 23.113

Denmark

EV Johanssen A/S
Scherfsgvej 1
DK 2100 - Copenhagen Ø
Tel. : 29.56.22 Twx : 2771

Finland

OY Suflra AB
Ruusulankatu 20 A 12 Helsinki 25
Tel. : 49.01.37
Tlg : Pierrejoly - Helsinki

Great Britain

Thomson - CSF UK Ltd
Bilton house, Uxbridge road
Ealing, London W5
Tel (01) 579 1857/8/9 - Twx 25659

Holland

Compagnie Générale d'Electricité
Koninginnegracht 64 La Haye
Tel. : 60.88.10 Twx : 31.045

Mijnssen & Co N.V.
Keizersgracht 369 Amsterdam C
Tel. : 23.95.43 Twx : 14.065

Italy

Mistral s.p.a.
Via Melchiorre Gioia, 72
20 125 Milano
Tel. : 68.84.103 Twx : 31.042

Norway

Feiring A/S
Sandakervein 46 b Oslo 4
Tel. : 21.82.12 Twx : 16.435

Sweden

Elektroholm AB
Dalvagen 12 S - 171 03 Solna 3
Tel. : 82.02.80 Twx : 1389

Switzerland

Modulator S.A.
Fischerweg 11-13
3000 Berne 9
Tel. : 23.77.85 Twx : 32.431

Western Germany

Sesosem Halbleiter GmbH u. Co KG
8000 München 25 Fallstrasse 42
Tel. : 811.73.10.42 Twx : 522.916

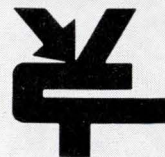

sesosem

THOMSON-CSF

Carlsson sound making noises across Europe

State-owned Swedish firm girds for tough marketing battle in competitive European hi-fi market

For the past dozen years, the Carlsson sound was music to the ears of Swedish hi-fi buffs only. Now it's starting to waft across the rest of Europe, and electronics executives are hearing the overture to what could be a David-Goliath marketing battle.

Behind the skirmishing is Sonab, a company which, like the Carlsson sound, was unknown outside Sweden—until now. The state-owned Sonab is one of the fastest-growing electronics firms in Scandinavia, if not in Europe. Whereas most hi-fi equipment makers have started from the electronics end—tuners and amplifiers—Sonab started through the back door with speakers. It has now broadened its line and has an fm tuner-amplifier and a turntable—both made by Japan's Yamaha to Sonab designs.

Sonab was formed in 1966 to develop, manufacture and market a stereo loudspeaker system designed by Stig Carlsson, an electronics engineer and faculty member of the Royal Institute of Technology of Stockholm. Carlsson's omnidirectional speakers, with flat frequency response, were patented in the early 1950s, and small marketing efforts were launched in the middle of the decade.

Lack of financing and laggard management prevented the speak-

ers from getting into the real hi-fi competition that was developing in Sweden. However, the Swedish government got involved with the company through a state institute that held some shares, and in 1966 Sonab was formed with the state holding half interest. During the next several years, the state acquired full control.

Sonab this past year has been on an aggressive marketing drive in Sweden—and has gained a healthy 20% of the speaker market in the face of extremely tough competition from European, Japanese and American makers. Sales this year will total about \$2 million and the company aims at doubling sales in Sweden next year.

In recent months Sonab has established sales and marketing subsidiaries in West Germany, Britain, and Holland. This month it starts a subsidiary in Switzerland. Although all these nations have well-established domestic industries, Sonab very confidently estimates that its total sales will reach \$20 million within five years.

Managing director Hans Wagner, a marketing specialist who previously worked for several industrial firms in the Wallenberg banking-industrial group, has spent considerable time studying the American market, but has decided not to tackle it—at least not immediately. One reason is that the audio tastes of American hi-fi enthusiasts appear to be much different from the Carlsson sound.

The Carlsson speakers use an unconventional multi-driver array. For the most popular models, these

include one base/mid-range speaker and four tweeters. They are mounted in the top of the cabinet, facing different horizontal directions and upward. Sonab says its speakers provide the same tonal balance 180° around the speaker.

Sonab's most expensive speaker—retailing in Sweden for about \$300—also has a bass speaker, with its own transistorized amplifier in the cabinet. This woofer is located at the bottom of the cabinet, pointing toward the floor.

The company says that the Carlsson sound is the closest thing to the original sound. Sonab marketing people bluntly say that their speakers are definitely not for the hi-fi enthusiast who demand bass that rattles the china, one reason why they don't intend to tackle the American market now.

When in the summer of 1969 the company decided to produce its own tuner/amplifier design, electronics companies in Europe were so occupied with color tv production that no firms could be found to take on the job. Nils Maartensson, president of the subsidiary Sonab Development AB, who designed the fm tuner, says the com-

Top view. Mid-range speaker points up and four tweeters aim at central post.

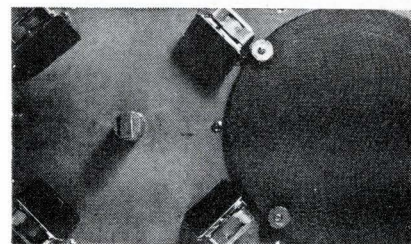

pany would have preferred to have had it manufactured in Sweden—or at least, Europe—to simplify communications and control. Sonab engineers completed the design in three months, Yamaha took on the production job, and first production models were in Sweden in less than a year. In spite of the rather high price—\$440—and the fact that it was a brand-new competitor on the market, the series was entirely sold out as soon as it was announced. The Carlsson/Sonab identity was enough.

Just six months ago, Sonab Development employed three engineers. Today, there are 50 and the firm could use still more, says Maartensson, who notes he has hired a few British engineers to fill specialized posts. Maartensson was previously with Svenska Radio AB, a subsidiary of the telecommunications giant, L M Ericsson, where he worked on military and commercial radio communications systems.

Exactly what's next for Sonab is being held closely. Broadly speaking, the company says it plans to get into professional electronics, communications systems, audio and video products and components. On the components side, Sonab already represents Ferranti of England for semiconductors and microwaves tubes, and has signed an agreement with Ferranti for development of monolithic circuits.

Great Britain

Light-emitting diodes ride the rails

A driver's display in the prototype of British Railways' automatically controlled train, due to start trials next year [*Electronics*, Sept. 28, p. 125], is likely to provide one of the first operational applications for solid state light-emitting diodes.

A feature of the system will be a speedometer indicating actual speed by a conventional pointer and maximum permissible instantaneous speed by illuminated diodes radiating around the speedometer's circumference. Bars made

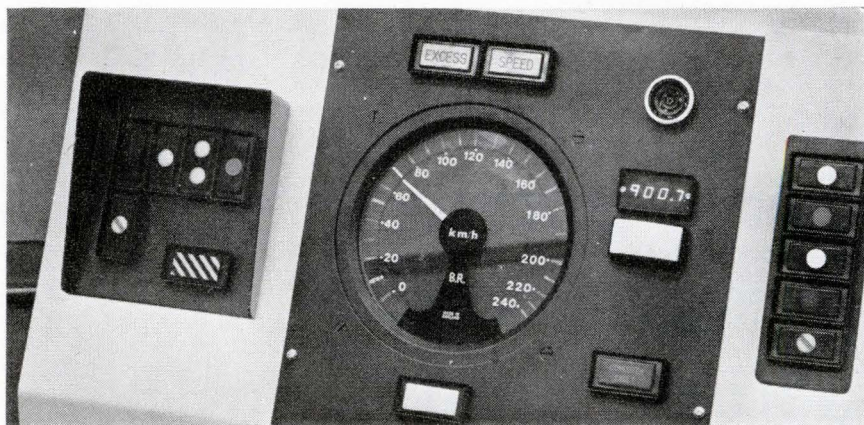

Prototype. Light-emitting diodes form rays, showing maximum permissible speed, around dial and form number display, showing distance to next speed change.

up of four Monsanto MV-50 gallium arsenide-phosphide red-light diodes with a common lens are placed at 10 kilometer-per-hour intervals around the dial. If the pointer goes above the illuminated bar, an alarm sounds. If the driver does not respond within five seconds, the brakes are applied automatically.

Next to the speedometer is a numeric readout made up of Monsanto MAN-1 seven-segment arrays which indicates the distance in meters to the point where the maximum speed will change.

British Rail is using the solid state light emitters to achieve maximum reliability by minimizing the risk of a display failure. For the same reason, the input electronics are triplicated and operate through a voting system.

The display is driven by a special-purpose computer developed at British Rail's Derby technical center. Permanent train data—such as its length, weight and braking characteristics—fed in before the journey starts are integrated during the trip with local information, including upcoming signal status, gradient, speed restrictions and other conditions, to calculate maximum permissible speed.

The local data originates in rail-side transmitters and travels to the train in two parallel cables mounted between the rails and inductively coupled to sensors mounted underneath the train. One cable carries variable data such as signal status in the form of audio tones fre-

quency modulated onto a carrier normally between 45 and 60 kilohertz. The other cable carries permanent data, such as distances and gradients, in binary-coded form using 62.5 kHz to denote binary 0 and 67.5 kHz to denote binary 1. Messages are 256 bits long, organized in 16-bit words at a data rate of about 600 bauds.

These two carriers allow the train to look ahead through up to four sets of signals. They can also be used to provide a two-way secure speech link between the train and a controller. Two trains will be fitted with the system. Trials will be carried out near Manchester to see how well the approach improves train regularity, safety and track capacity.

Great Britain

Pyroelectric target tried for IR TV tube

A target sensitive to visible light is essential to optical TV camera tubes. But a TV tube with an infrared sensitive target is still not available in a production model. Many companies are working on it, though, and English Electric Valve Co., with the support of Britain's Ministry of Defence (Navy) may be getting somewhere.

Commercial thermal imagers do, of course, exist. But they work by scanning the scene with oscillating mirrors and revolving prisms

arranged to focus the radiation on to a point-sensitive IR detector. This makes them bulky, and when indium antimonide is used as the detector, liquid nitrogen cooling is necessary.

The British company's aim is to produce a room temperature IR camera tube in a vidicon envelope, giving an IR imaging system that would look and operate much like closed-circuit TV. Its research has produced some tubes with pyroelectric targets, though thermal resolution is poor and they need a mechanical chopper spinning in front of the lens. However, the team leader, Michael Wreathall, claims that resolution can be improved to practicable levels. He described the work at last month's Electron Devices Meeting in Washington. In France, Thomson-CSF has experimented on the same lines, and the Russians are known to be interested.

Wreathall's tube is laid out much like a vidicon, except that the target is made of the pyroelectric material, triglycerine sulphate (TGS), the front window is made of silicon or arsenic trisulphide which absorbs little IR radiation. So far, however, the tubes can only pick out objects more than 25°C above the ambient temperature—and to be practicable, resolution has to be better than 1°C. Current medical thermal imagers claim resolutions of 0.2° to 0.125°. But Wreathall believes that optical changes he has in mind will improve resolution to about 3° and development of the target assembly will further cut it to 1°. He plans to use a frame rate of 12.5 frames per second and 100 lines per frame.

TGS works as a target material because an infra-red pattern produces a corresponding differential charge pattern in the slice. If the target is prepolarized by applying a field of 3 V or 4 V of either polarity, incident radiation will reduce the charge in proportion to its intensity. Though the effect is straightforward, obtaining a usable, corresponding signal from the output is not.

There are two possible modes

of operation: with the target stabilized at the 0-volt cathode potential, or at the anode potential—typical +300 V to +400 V. Though Wreathall is investigating both, he has greater hopes of the cathode potential stabilized mode.

In either mode, however, there is a problem: the successive output signals from a given point on the target are proportional not to the absolute level of incident radiation but to change in the level since the last scan. Therefore a stable radiation pattern produces no signal. The solution is to chop incoming radiation at a frequency that is high compared to the rate of change of the thermal pattern, and as a result any point on the target is undergoing constant heating and cooling. The chopping rate may be about one-eighth of the scanning frequency, but is not critical.

During the warming-up phase, the beam has a new positive signal at every point on the scanned face to charge down to zero in the CPS mode but during the cooling phase the scanned surface goes negative so that the beam cannot land. Wreathall solves this by utilizing the residual gases in the tube to carry a small positive bias current to the scanned face, increasing all charge amplitudes by that amount, and raising the cooling phase charge levels above zero.

France

Flight data display opens avionics battle

A French company is trying to crack the American hold on the world's civil avionics business. The flight should be tough even in its home market, where Air France, like most of the world's airlines, traditionally has favored U.S. equipment. But the French firm, Thomson-CSF, is laying down an even brasher challenge: it wants to win a share of the U.S. market.

"An attack on the civil avionics market starts in the U.S.," declares Yves Brault, marketing manager of

Thomson-CSF's avionics division. "We've got to establish ourselves there." Brault made his first foray into that market in September to show off a new flight data display. Aside from a civilian head-up display unit that the company adapted from a military gunsight, the new device is its first civil avionics product. The firm's 1969 military avionics sales volume was \$65 million. From the reaction of U.S. aircraft builders and airlines, the French display could be a winner.

Though military aircraft use displays that convert flight data to visual—often pictorial—images, commercial airliners' instrument panels remain a jungle of dials and gauges that can pare crucial seconds from a pilot's judgment time. Aviation experts figure slow or inaccurate dial reading has caused more than one air crash, and the faster reaction times required by supersonic jetliners like the Anglo-French Concorde will heighten the risks. Sperry, Honeywell, Norden and Kaiser in the U.S.—and now Thomson-CSF in France—thus are racing to develop a display for the supersonics and possibly for retrofit into existing airliners. Such pictorial displays have been dubbed "electronic attitude director indicators" by a special ARINC committee that began studying specs last June.

The French EADI projects flight information on a 7-inch-diagonal color cathode-ray tube. Using inputs from standard instruments it forms a picture of the area toward which the plane is heading—coloring the ground red and sky pale yellow, with a green line separating the two. "Some American airlines asked us for a blue sky, but it's too difficult," says Brault.

When the plane approaches its landing strip, the strip is simulated on the screen so the pilot doesn't have to make mental calculations based on instrument readings of his speed, rate of descent, and so forth. The screen also displays figures and color symbols on acceleration, altitude, glide scope, and other parameters.

Mounted on the instrument

panel in its 11-pound, 7.2-by-6.5-by-11-inch box, the display replaces seven standard dials. In addition, it furnishes information on three new parameters—speed vector, potential flight path, and slope of descent.

An electronic control box containing a signal generator and monolithic integrated circuit logic for interfacing with standard instruments takes up a 22-pound box, measuring 10 by 7.6 by 19.5 inches.

Thomson-CSF had to design a special CRT with high brilliance and reliability characteristics. The ARINC committee, in which Thomson-CSF is represented, is aiming at a 4,000-hour CRT lifespan. "We think we'll make it," says Brault.

West Germany

Photoresistor controls audio tape tension

A tape recorder performs best when the tape bears down on the recording or playback heads with a specific uniform pressure. For pressure control most tape recorder makers use a simple mechanical method, a felt-coated device pressing the tape against the head. The results are good, but, for the audiophile, far from ideal.

Now West Germany's Braun AG, a big name in the audio and electrical appliance field, has turned to electronics to control tape pressure. In its latest tape recorder—the TG 1000, intended for both home and professional uses—tape tension, and thus pressure, is controlled on both sides of the drive capstan by a photoelectronic technique. While a mechanical device senses the variations in tape tension, a photocircuit/bridge circuit combination acts on the recorder's drive mechanism to maintain proper tape tension. Basically, tape tension on both sides of the capstan is equalized so that the tape bears down on the heads with a uniform pressure.

Braun engineers have succeeded in keeping tape drift to a value considerably less than that obtained

by conventional means. Wow and flutter are held at 0.05% at tape speeds of 7.5 inches per second, which is better by a factor of two than other tape pressure controls.

So far, only expensive professional tape recorders employ electronics for tape tension control and their methods are fairly complicated and elaborate, Braun says. With the TG 1000, on the other hand, the controlling function is kept simple and overall price is held to less than \$500.

The mechanical sensing elements are spring-controlled levers mounted near the magnetic head assembly. When tape tension decreases, the spring pulls the lever outward. This opens an aperture between a small lamp and a photoresistor.

The photoresistor is in parallel with a balancing resistor which is connected between the collector and the base of a control transistor. This transistor is in the direct-current path of a dc bridge circuit. When the photoresistor's values decrease the resistance on the transistor's collector-emitter path also decreases. The ac current flowing through the bridge and then through the motor becomes greater, thereby increasing the electrical moment of the motor and increasing tension on the tape.

Japan

Curved Schottky electrode handles high forward current

Schottky barrier diodes that can easily be fabricated on transistor or IC chips and still retain pure Schottky characteristics at high forward currents have been developed at Kyodo Electronic Laboratories Inc. A curved metal electrode in the Kyodo diodes eliminates the electric field concentration that degrades the performance of diodes fabricated in windows of the silicon dioxide layer.

First device to be fabricated commercially will be a 300-milliwatt discrete pnp transistor with a

Schottky diode clamp to reduce collector charge storage. The device answers the need for a pnp unit with low storage time that can handle moderate amounts of power.

In principle, Schottky diodes are extremely simple to fabricate. A suitable metal with appropriate work function is deposited on a clean semiconductor surface. Actual fabrication of course brings with it some problems. But aside from any metallurgical problems encountered during fabrication, diodes fabricated merely by depositing metal through a window in the oxide passivation coating will not operate satisfactorily. Field concentration along the edges of the metal will cause breakdown at very low reverse voltages. Metal deposited over the surrounding oxide improves the field distribution and gives some improvement in performance, but is not wholly satisfactory.

Kyodo engineers, who developed the new Schottky configuration while designing a new type of integrated circuit, find it is suitable for use with high-current discrete devices. Field concentration around the edges is kept small by using a rounded electrode structure similar in shape to the base-to-collector junction in a planar transistor. Only one extra step is needed. The semiconductor region to be used for the Schottky diode is etched to a depth of about 1 micron, using the oxide window as a mask, before deposition of the diode metal electrode. A moat with the desired rounded inside corners is automatically formed during the etching process. Since the depth of the moat is in general less than the thickness of the metal subsequently deposited, no trouble is encountered with breaks in the metal.

An added bonus of this configuration is that the series resistance of the diode is reduced because the etching process reduces the thickness of the high-resistivity epitaxial layer in series with the Schottky barrier junction. Typical value of epitaxial layer thickness is 4 microns and of etch depth, 1 micron.

The most common method now used to prevent breakdown on Schottky diodes at low reverse voltage is diffusion of a p^+ guard ring around the periphery of diodes fabricated on n-type substrates [*Electronics*, July 21, 1969, p. 74]. This type of structure gives the desired increase in reverse breakdown voltage, and permits the fabrication of stable and reproducible Schottky diodes. Although it does add a pn junction diode in parallel with the Schottky diode, no problems other than an increase in capacitance are encountered as long as current densities are kept at moderate levels.

But as current through the Schottky diode increases, its voltage drop increases above the level required for conduction in the parallel junction diode, and part of the current is carried by the junction diode. The junction diode normally will exhibit storage, and thus current flow through it will negate the advantages of the Schottky diode. A double diffused guard ring has been developed to eliminate this unwanted current flow, but a simpler structure is still desirable to avoid adding to the already complex production process.

A further application might be in making junction field effect transistors using compound semiconductors. With these materials, JFETs with semiconductor junction gates are difficult to fabricate because selective diffusion is difficult. JFETs with Schottky gates using guard rings cannot be fabricated because the ring is where the source and drain should be. But it should be possible to fabricate the transistors with curved Schottky gates.

Japan

Alumina replaces aluminum in multilayer wiring method

Conversion of aluminum metalization to alumina insulation is the key to an improved method of making multilayer connections de-



**WHERE
PRECISION
AND
RELIABILITY
ARE
VITAL**

electronica

**POTENTIOMETERS
AND TRIMMERS
ARE
SPECIFIED**



electronicaspa

via Carlo Pisacane 10/4 - 20016 Pero (Milan)
☎ 35 30 241/2/3/4 - TWX 32242

AUSTRIA WIEN
Dipl. Ing. N. BURISCH

BELGIUM BRUXELLES
AVI-ELEC S.A.

DENMARK KOPENHAGEN
E. V. JOHANSEN A/S

ENGLAND WELLING-Kent
NOBEL ELECTRONICS

FINLAND HELSINKI
ELEKTROTJANST

FRANCE CITE BRUYERES-SEVRES
TECHNIQUE ET PRODUITS S.A.

GERMANY STUTTGART
TEKELEC-AIRTRONIC GmbH

GREECE ATHINAI
STYLVA CO.

HOLLAND ROTTERDAM
UNI-OFFICE N.V.

ISRAEL RAMAT-GAN (Tel-Aviv)
ELINA LTD

ITALY FIRENZE
P. SEBASTIANI

ROMA
Comm. C. BAGNULO

NORWAY OSLO
HENACO A/S

PORTUGAL LISBOA
RUALDO L. DA

SPAIN BARCELONA
MICRO ELECTRONICS S.A.

SWEDEN SOLNA
ELEKTROHOLM AB

SWITZERLAND ZURICH
BAERLOCHER AG

TURKEY ISTANBUL
HUSNU ERTUNA

Manufactured under license from Spectrol Electronics Corporation

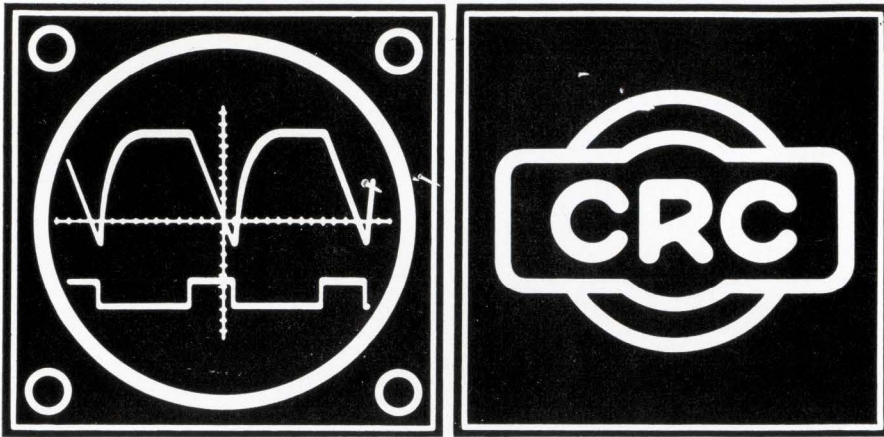

highly competitive

50 MHz - 5 mV/div. Dual trace

OCT 569



Ref. 7042

- Display area 8 x 10 cm - accelerating voltage: 10 kV • Deflection factor max.: 0,5 mV ch A and B cascaded • X horizontal, Y vertical 5 mV/div. 5 MHz • Calibrated sweep delay 10 ns/div. to 0.5 s/div. • Compact.

CRC - siège social : rue Daguerre - 42 SAINT-ÉTIENNE - France - Tél. (77) 32.39.77 - Téléx : 33 696

Agences PARIS et EXPORT BORDEAUX GRENOBLE RENNES MARSEILLE STRASBOURG TOULOUSE
Tél: 655.62.22-Télex: 27676 Tél: 92.61.40 Tél: 87.64.28 Tél: 36.41.98 Tél: 48.68.00 Tél: 32.51.86 Tél: 80.04.09

veloped by Nippon Electric Co. The process, applicable to both IC chips and to ceramic substrates for mounting ICs in forming hybrid LSI arrays, makes for more reliable devices and permits fabrication of additional interconnection layers than was possible before.

The new method starts with a layer of aluminum deposited in the usual manner. But instead of etching off the aluminum where wiring is not needed, the metal is converted by electrochemical oxidation to alumina, an excellent insulator.

The deposited aluminum surface is first oxidized lightly in a bath that does not oxidize deeply. Then the circuit is masked using photoresist, and portions of the aluminum that normally would be etched away are completely anodized so that only the desired wiring pattern remains as a conductor. Then photoresist is stripped away and an approximately 0.5-micron-thick layer of silicon dioxide is deposited to complete the layer.

Because the excess aluminum is converted into oxide rather than removed, the surface of the chip remains planar. Thus the process can be used to form multilayer wiring without risking open circuits because each layer forms a flat substrate for the next layer. The improved reliability prompted Nippon Electric to use the process even on some chips with only a single wiring layer. Fabrication of the second and succeeding layers starts with etching of through holes and then repeats the process.

Nippon Electric has displayed a hybrid LSI multi-access register with CML IC chips using the technique. Beam lead chips have two layers of wiring, and a 40-by-50-millimeter substrate has three layers of wiring, for a total of five layers of wiring. The 15 chips which form the LSI circuit have a total of about 300 gates.

The non-threshold logic circuits that Nippon Electric made for the Electrical Communications Laboratory of the Nippon Telegraph and Telephone Public Corp. [*Electronics*, July 6, p. 7E] use this method of forming wiring patterns.

connector serie 254 double sided

CCTU 08-13 HE 902
2.54 mm (0.1") pitch edge connector

split-face contacts
removable beryllium copper
solder tails wrap termination
solder spigots for
printed circuit boards

polycarbonate moulding
2 versions:

monoblock
for CCTU arrangements

trunkated
(with a fixing lug)
up to 2 x 49 contacts on request

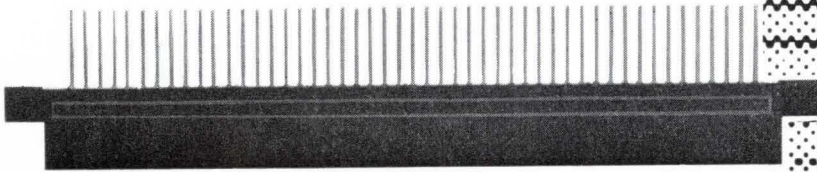

for your double sided
2.54 mm (0.1") pitch
printed circuit connectors
gardez le contact avec la qualité socapex

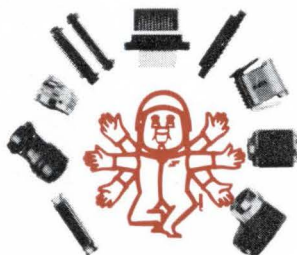

SOCAPEX
THOMSON-CSF

9, RUE EDOUARD NIEUPORT 92 SURESNES FRANCE TEL. 506.20.40 ET 506.65.45

BELGIQUE : J.P. LEMAIRE, Rampe Gauloise, 1 A - 1020 - BRUXELLES — DEUTSCHLAND : THOMSON-CSF GmbH, Fallstrasse 42 - 8 MÜNCHEN 25 (Postfach 469 - 8000 MÜNCHEN 25) — DANMARK : POUL SABROE, Skodsborgvej 142 - HØLTE — ENGLAND : THOMSON-CSF UNITED KINGDOM, 1 Cadogan Place - LONDON, SW 1 — ESPANA : Mr. POU-LAIN, Avenida Generalísimo Franco 381 - BARCELONA — ISRAEL : CIDEV - 47, Rothschild Boulevard - TEL-AVIV (P.O. Box 2024 - TEL-AVIV) — ITALIA : MISTRAL SpA - Via M. Gioia 72 - MILANO — NEDERLAND : N.V. TEHAGES - Smaragdhorst 64 - DEN HAAG (Postbus 2153 - DEN HAAG) — NORGE : J.M. FEIRING A.S., Sandakerveien 46 B - OSLO 4 (P.B. 4376) — REPUBLIC OF SOUTH AFRICA —

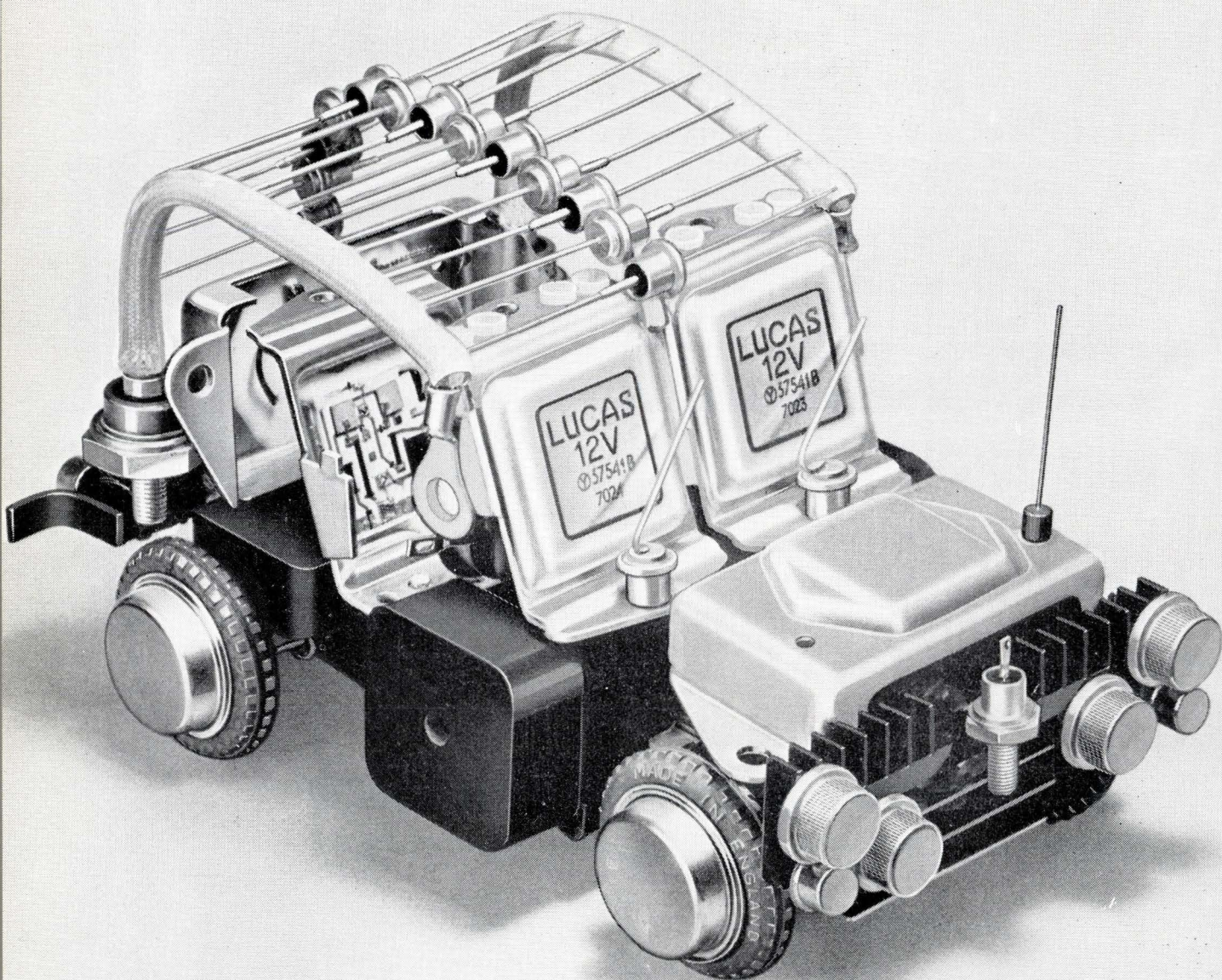

Who in the world of semiconductors are LUCAS?

We're BIG – in fact the largest suppliers of semiconductors to the U.K. Motor Industry.

Beneath the bonnet of a car is a particularly arduous environment for our devices, especially in a Grand Prix or rally. We've proved their reliability and over the years achieved more than our share of successes in Formula 1 racing, the 1969 London-Sydney race and the Mexico 1970 World Cup Rally. Our research and development efforts have twice earned us the Queen's Award to Industry for technical innovation, the first time was for a high-voltage transistor and the latest has been for a micro-circuit voltage regulator.

Apart from the hybrid thick film circuits and rectifiers we make for the Motor Industry we make over 1,200 different types of devices in quantities ranging from a few hundred to millions. Applications include Telecommunications, Industrial Equipment, Aircraft & Military uses.

If you design electronic equipment or purchase components why not contact us for details of our devices.

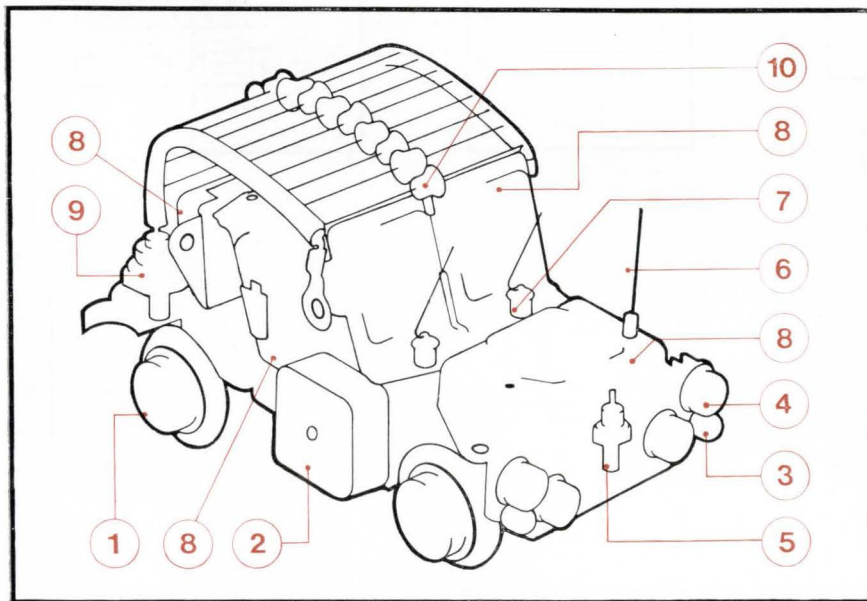

1. DT4300 Series 500V Silicon N.P.N. Power Transistors.
2. 2DS2000 Series 2-4A 'Potted' Rectifier Assemblies.
3. T05 Homogeneous Base 5W Transistors.
4. DD5620 Series 18A, 100 – 400V 'Pressfit' Silicon Rectifiers.
5. DD4020, DD4060 & DD4520 Series 6-10A, 50-1350V Silicon Rectifiers.
6. DA000 Series 0-5A, 80-200V Avalanche Diodes for Telecommunications applications.
7. ZC2000 Series 1-8W 5% Voltage Regulator Diodes.
8. Thick Film Hybrid Microcircuit Regulators.
9. DD710 Series 35A, 50-400V Silicon Rectifiers.
10. DA2068 1-0A 1250V Controlled Avalanche Rectifiers.



LUCAS

semiconductors

Joseph Lucas (Electrical) Ltd., Mere Green Road, Four Oaks, Sutton Coldfield, Warwickshire, England. Tel: 021-308 3501

Integrating colour television

a total approach

first from Europe's strongest group
in solid-state devices

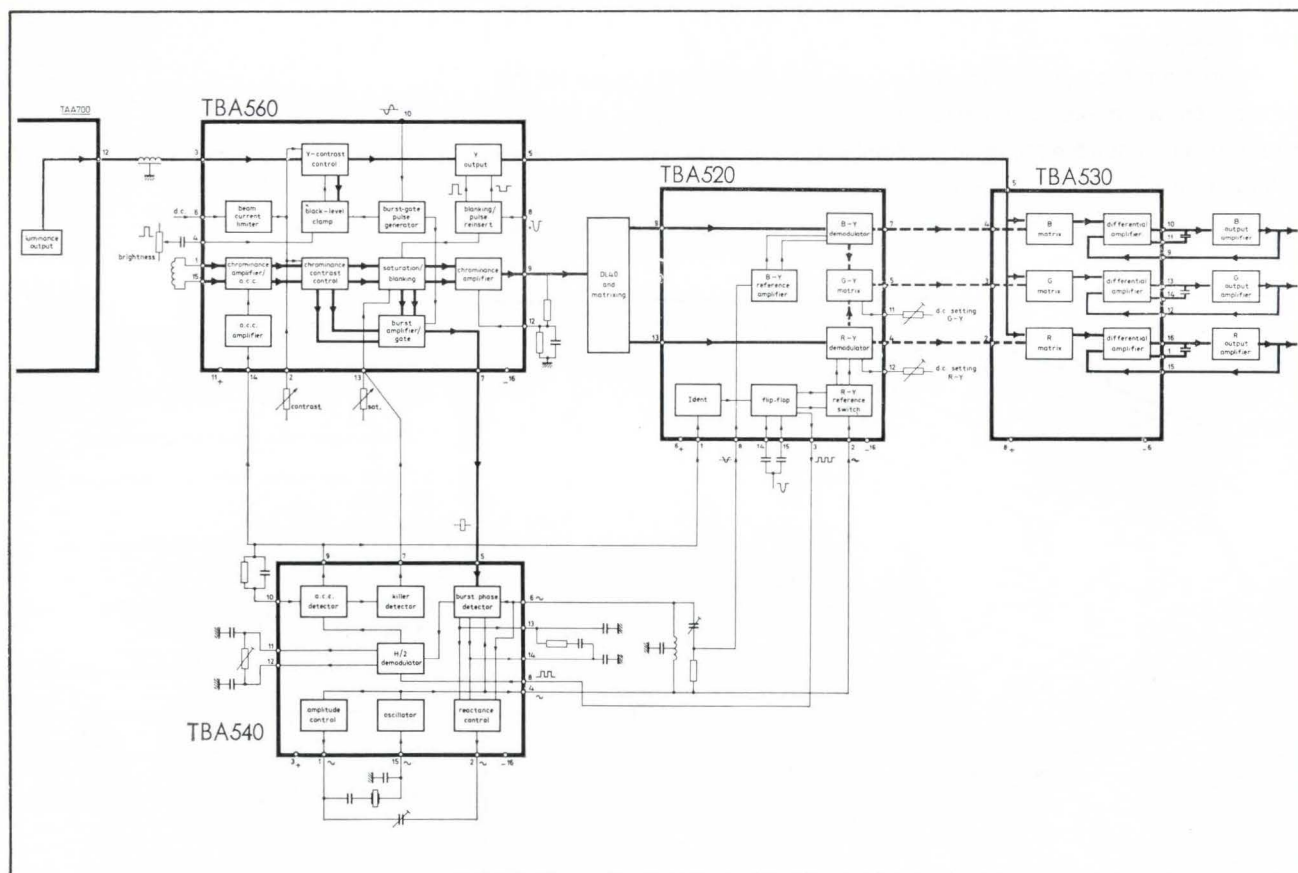

PHILIPS

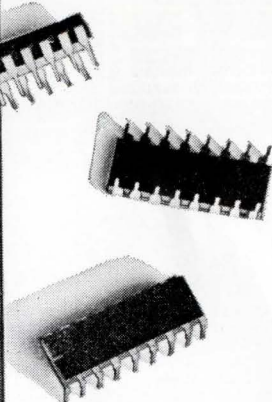
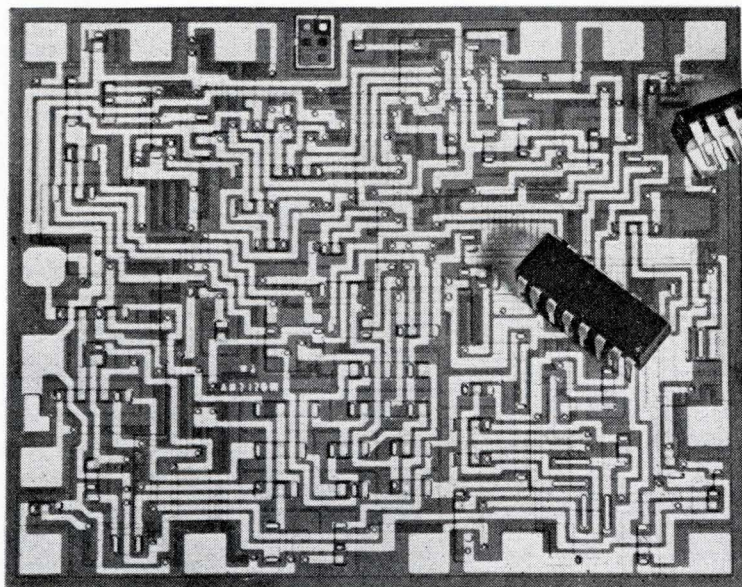

It had to come . . . integrated circuits for colour TV. There are just too many practical benefits that have made their arrival inevitable. Greater reliability comes first, along with improved performance at no extra cost. Development and assembly time is drastically cut. There are significant savings in component handling and stocking. Altogether IC prices compare favourably with the total cost of discrete circuitry. And think what IC's can do for a truly modular TV concept.

All this can be yours now, thanks to Philips' total approach.

So far attempts to integrate television circuitry have been rather haphazard . . . particularly where colour was concerned. Then Philips engineers began looking at PAL colour TV circuitry in terms of functions rather than circuit elements. Making the best use of today's IC techniques, they developed a range of only four and fully matched integrated circuits.

Look at the typical colour block diagram. The framed areas are now on four IC chips!

The number of extra discrete components has been reduced to the bare minimum. Circuit tuning is virtually a thing of the past - most of it is integrated now and you know what that means in time and cost savings. The four new devices together with the three television types announced earlier, make a complete range of Philips IC's for colour television. The time to get integrated is now... with Philips. Send for full information.

N.V. Philips' Gloeilampenfabrieken
Eindhoven - the Netherlands



electronic components
and materials

ATES

SILICON NPN HIGH POWER TRANSISTORS

Type	V _{CBO} (V)	V _{CEO} (V)	I _{Cmax} (A)	h _{FE}	P _T (W)	T _S (°C)	T _J (°C)	θ _{J-c} (°C/W)	Case
2N 3055	100	60	15	20-70 (4V; 4A)	117	-65 +200	200	1.5	TO-3
2N 3442	160	140	10	20-70 (4V; 3A)	117	-65 +200	200	1.5	TO-3
2N 4347	140	120	5	20-70 (4V; 2A)	100	-65 +200	200	1.5	TO-3
2N 3054	90	55	4	25-100 (4V; 0.5A)	29	-65 +200	200	6	TO-66

ABSOLUTELY FREE FROM SECOND BREAKDOWN

HOMETAXIAL



RELIABLE INEXPENSIVE

ATES COMPONENTI ELETTRONICI S.p.A.

Management and Sales Dept.: 20149 MILAN (Italy) - 2, Via Tempesta - Phone 4695651 (4 lines) - telex 31481

UK: ATEs ELECTRONICS LTD. - Mercury House, Park Royal - LONDON W. 5 - Phone 01-998.6171 - telex 262401

What counts most is what you mostly count.



(Don't pay too much!)

Société d'Instrumentation Schlumberger's new range of 12.5 MHz counters do practically all your counting jobs yet cost so little to buy.

The basic FM 2503 version measures frequency and counts events. It has an optional 5 digit readout with the clock locked on to mains frequency, and good sensitivity.

The FM 2501 is a universal frequency counter-timer (with a 1μ resolution), which also measures period and ratio. It has crystal-controlled

stability of 5 ppm per month and a 5 digit non-blinking display.

The FM 2502 has the same fundamental features *plus* 2 inputs with shaping networks and amplitude adjustment as well as a time base divider (up to 999) which make it particularly suitable for tachometry and pre-set time base measurement.

All the counters have TTL integrated circuits and BCD 1248 outputs and any two can be linked to give a reading of up to 10 digits.

So don't pay the earth for a complex counter whose capabilities you'll rarely use. Our new counters will do most of your work and save you lots of money besides.

Whatever your needs in frequency measurement, contact us today or any one of the Schlumberger agents throughout the world.

**Société d'Instrumentation
Schlumberger**

Société d'Instrumentation Schlumberger, 10 rue Nieuport, 78 Velizy-Villacoublay, France. Tel: 946 9650

speed and reliability with **SODECO** *print*

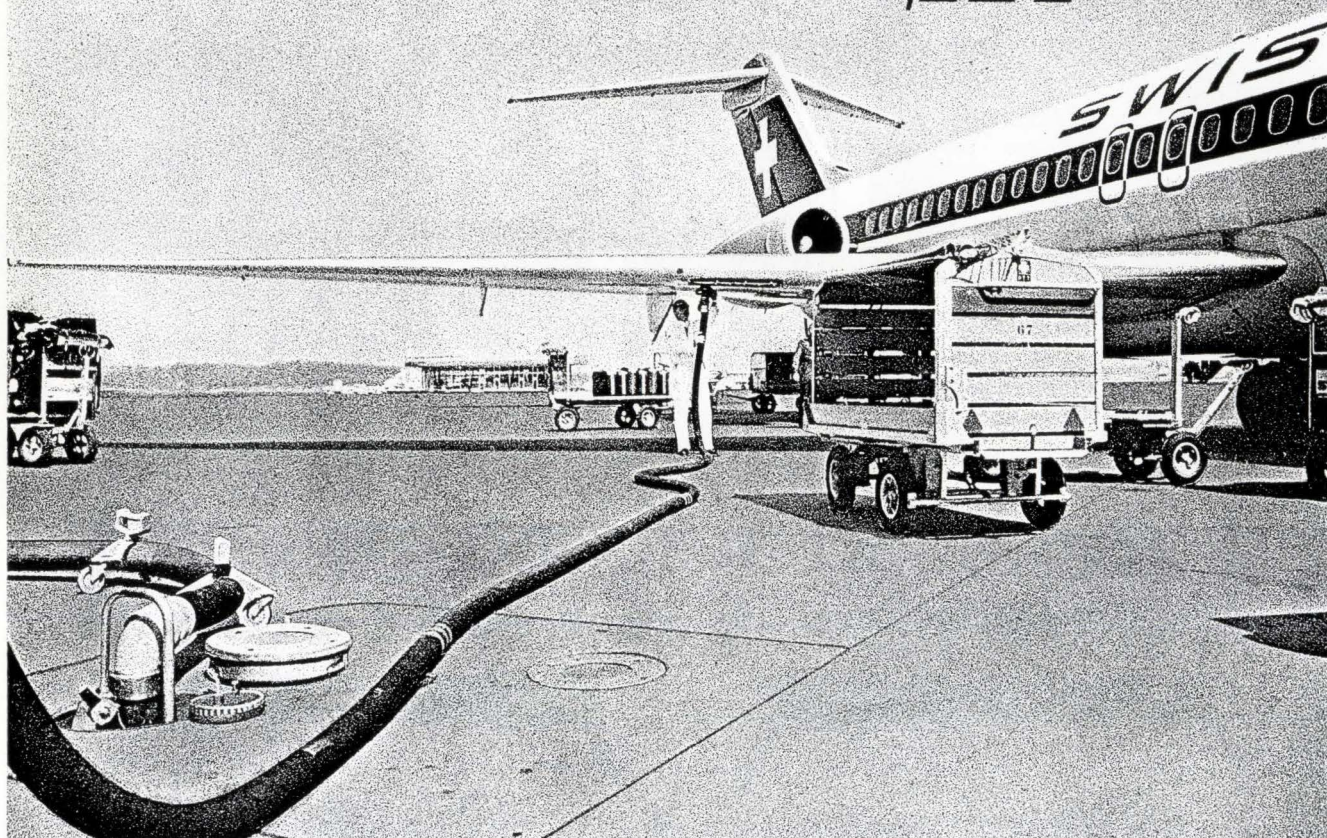

Even though SODECO-print printing impulse counters have no direct connection with jet aircraft, the following example shows how one of the many operations connected with air transport can be carried out quickly and reliably.

As part of the extensions made at Geneva airport, the refuelling installations have also been modernised and rationalised. Among other apparatus, the central control desk is equipped with a SODECO-print for recording on cards. This comparatively small and compact apparatus records all the necessary data, such as quantity, type of fuel, etc., including date and time, on a card as soon as the latter is inserted into the slot on the front plate. The necessity for taking meter readings, together with the subsequent clerical work, are obviated, as the printer delivers in a fraction of a second a record of all the data required for subsequent billing operations.

This case is one of many in which SODECO printing impulse counters can be called upon to solve counting and metering problems. The apparatus are very adapt-

able in application and are used in all branches of industry, transport and research. The four following basic units are available: a 6-digit counter with decade transfer, a timing element, a time and date printing unit with or without self-contained synchronous motor, and

a counter comprising 1-5 monodecade elements. Combinations of up to four units are possible. Printing of the results can be carried out either on a continuous paper chart or on a card. All the functions within the apparatus are controlled electrically, permitting fully automatic operations of all the phases in a cycle e.g. counting, printing, resetting, counting, etc.

It is certain that the SODECO-print can be adapted to the specific requirements of your problem. Write for complete technical data. Or let us have

details of your problem and our specialists will be glad to send you particulars of the most suitable solution.

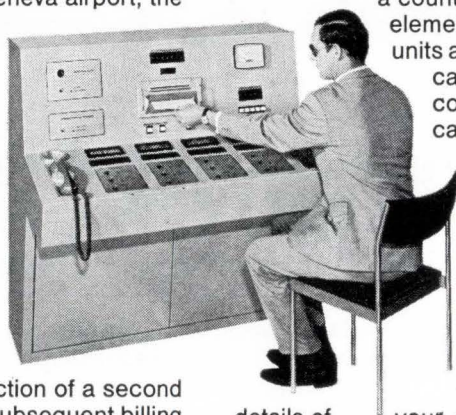

When quality counts—specify SODECO

SODECO Grand-Pré 70
1211 Geneva 16
(Switzerland)
Tel. (022) 33 55 00
Telex 22 333

SODECO

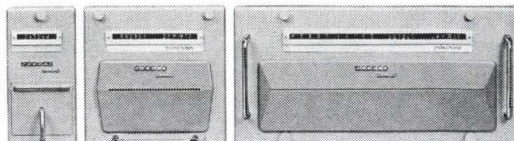

Introducing the most advanced DVM in the world.

Solartron's new LM.1490 speaks for itself.

Scale length: 250,000.

Auto calibration: (the DVM literally calibrates itself).

Sensitivity: 100 nano volts.

Variable integration time.

Infinite mains frequency rejection—on demand.

Remote command of all parameters.

You pay that much more for the LM.1490, naturally. But if your needs are less demanding, choose one of our 14 other DVMs and get the best price performance in Europe.

Whatever your needs in digital measurement, contact us today or any one of the Schlumberger agents throughout the world.



SOLARTRON
Schlumberger

The Solartron Electronic Group Ltd Farnborough Hants England Tel: 44433

NEW

low cost sealed wirewound potentiometer

borel saint-martin cb

8

standard versions.
Single, double or triple
serial mounting
possibility on one shaft.
Order assembled units or
"do it yourself kit"
for having every
possible version
on hand in
your lab.

TRIM
POT

Resistance
range: 10Ω to $50\text{K}\Omega$.
Power rating: 2 W at
 40°C .
Max. operating temp.:
 125°C .
Linearity: better 1%.
Basic model:
 20×10 mm.

For detailed technical data write to

CONTELEC

rte de Port 38, 2500 Bienne (Switzerland), tel. 032/3.10.31, telex 34.397
or your representative.

Japanese color tv cameras grow simpler and simpler

Optical systems in the newest three models move stripe filters next to color tube faceplate

Most color tv cameras now in use have three or four color tubes, as well as large, complex optical systems for color separation between the main lens and these pickup tubes. Simpler cameras, aimed mainly at closed circuit tv and other markets less demanding than professional broadcasting, have been developed using special stripe filters, which allow one- or two-tube color discrimination. Now a new batch of simplified cameras is headed for market, pushed by the development of methods that put the stripe filters in the plane of the tube's faceplate, further reducing optical system complexity.

Two of the new tubes, by Nippon Columbia Co. and Hitachi Ltd., were discussed at last month's International Electron Devices Meeting in Washington. Hitachi plans to use its tube in what it calls the world's smallest color camera, which will go on sale in June at a target price of \$5,500. Nippon Columbia is expected in the near future to announce a commercial camera using its filter integrated color vidicon. A third camera, by Sony, has a second tube for luminance-signal generation and is already on the market. Though all three cameras will find their first buyers in the professional and semiprofessional area, they repre-

sent important steps toward inexpensive color cameras for consumer use with video tape recorders.

The Nippon Columbia system is based on frequency separation of color signals. In its filter integrated color vidicon, the glass faceplate has a series of blue reflecting stripes, separated by equally wide clear stripes, with a pitch of 47 microns. Another series of red reflecting stripes has a pitch of 61 microns.

As its electron beam scans the photoconductive layer, the vidicon produces three output signals. The alternating presence and absence of red information on the photoconductive layer gives a red signal modulated onto a 3.9-megahertz carrier. Blue information is similarly modulated onto a 5.1-MHz carrier. The unmodulated green information, plus half the blue and red information, forms a baseband video signal that supplies the luminance information. A low-pass filter with a 3.3-MHz bandwidth separates the luminance signal. Filters with a bandwidth of 0.5 MHz and detectors are used to obtain the blue and red signals. These signals are then matrixed and processed to obtain luminance, red, blue, and green outputs.

If the stripes in both filters are vertical, nonlinearities in the vidicon will cause an interfering beat to be generated at the 1.2-MHz difference frequency. By tilting both sets of stripes in opposite directions, the beat signal reverses phase for succeeding lines on the sweep and forms a low visibility pattern.

The dichroic filters are prepared by vacuum evaporation and photo-etching on the inside of the vidicon faceplate glass. Actual thickness of each filter is on the order of 1 micron. The two stripe filters are covered with a 20-micron thick glass layer applied by a proprietary process. The glass both protects the filters from physical damage in later processing steps and provides an optically smooth surface for fabrication of the photoconductive layer. In this vidicon an In_2O_3 layer is used as the transparent electrode; the usual coating cannot be used because of the high temperature needed for its heat treatment.

Spurious color is minimized by a doubly refracting plate of quartz, about 6 millimeters thick, which is cemented to the outside of the vidicon faceplate glass. When light from a repetitive pattern with a pitch of 47 microns hits quartz of this thickness, the transmitted normal and abnormal rays at the faceplate side will be displaced just half of this pitch and the image will be cancelled out. Thus the quartz acts as a lowpass filter with a sharp null at 3.9 MHz. A similar filter is not needed at 5.1 MHz because at that frequency the response through the optical system is low.

Aside from decreasing the size and cost of a camera by eliminating relay-lens and field-lens optics, the use of the filter integrated color vidicon also improves performance. Although optical definition ahead of the stripe filters does not affect the camera's color response, optical definition after the filters does matter because color information is

New products international

high-frequency spatially modulated information. Since relay lenses have better definition at their centers than edges, they are apt to produce color shading at the edges of the picture. The relay lens optics also increase light loss.

A team at the Central Research Laboratory of Hitachi has been working on a camera that is essentially a modification of one-tube color ideas already made public by Columbia [*Electronics*, Jan. 23, 1967, p. 235]. Although Hitachi is also working on a vidicon with color stripes deposited on its glass faceplate, its present system brings the stripes into contact with the photoconductive layer indirectly. Hitachi's present faceplates are made of glass fibers, about 5 microns in diameter, which transmit light without allowing it to spread and thus effectively provide a "zero-length" optical path between the inner and outer faceplate surfaces. The dichroic filter is made with two overlapping sets of stripes, in the same way as the Columbia filter, and then assembled so that it is in contact with the fiber faceplate—and in effective optical contact with the photoconductive layer.

The Hitachi design includes another innovation that allows it to eliminate the low-pass filter in the luminance channel. Each set of stripes is individually set at a large enough angle with the vertical for the phase of each of the two color carrier signals to change individually on succeeding lines. As in the Columbia version, proper design also permits cancelling out the difference beat, but the smaller angle between scanning lines and stripes makes for smaller stripe pitches in the Hitachi filter—44 and 52 microns.

Since the phase of the color carrier signals reverses on adjacent lines, color carrier signals can be removed from the luminance signal by adding the signal from a given horizontal line to the signal from a previous line that has been delayed by precisely one horizontal period. Subtraction of the direct and delayed signals doubles the

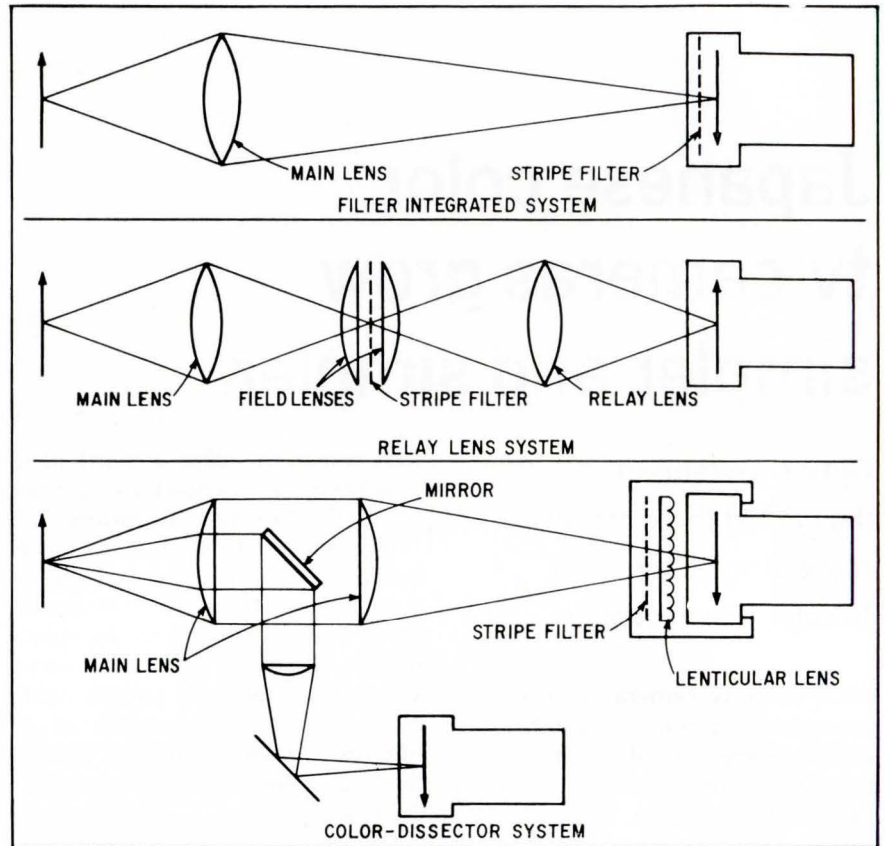

Of the same stripe. Nippon Columbia's new design (top) supersedes relay lens approach. Hitachi's is similar but uses fiber optic faceplate. Sony's two-tube camera has fully silvered mirror (here exaggerated) to split light.

values of the color carriers, which are selected by bandpass filters. Detection and subsequent signal processing is the same as in the Columbia camera.

Sony has based its color camera on an earlier two-tube unit developed by NHK, Japan's public service broadcasting system [*Electronics*, Feb. 6, 1967, p. 103], but has added important innovations. In contrast to the frequency division scheme used in the Columbia and Hitachi cameras, Sony's calls its design a phase-division method. All three primary signals produce signals that have the same frequency but differ in phase. Though the camera has been on the market for about a year now, Sony says it has never publicly explained its tube and forced color correction.

Sony's camera has two vidicon tubes, one for chrominance, one for luminance. The zoom lens is a special unit with a beam splitter

at its center to provide two optical outputs. The color dissector vidicon assembly is a standard vidicon, factory assembled with a color stripe and lenticular lens unit.

The color dissector vidicon has a tricolor and black stripe filter, in which one cycle of red, green, blue, and black stripes measures 300 microns. A glass spacer maintains a 6-mm center-to-center distance between the stripe filter and a lenticular lens. The center of the lenticular filter is about 3 mm from the vidicon photoconductive layer.

The main lens focuses light rays on the photoconductive layer of the vidicon. In between, the light rays pass through the stripe filter and lenticular lens. The lenticular lens has an auxiliary focusing action which assures that rays of light passing through a given color stripe are always focused on one stripe on the photoconductive layer.

The output of the color dissector

General Electric's C106D... a plastic SCR for 240 volt line operation

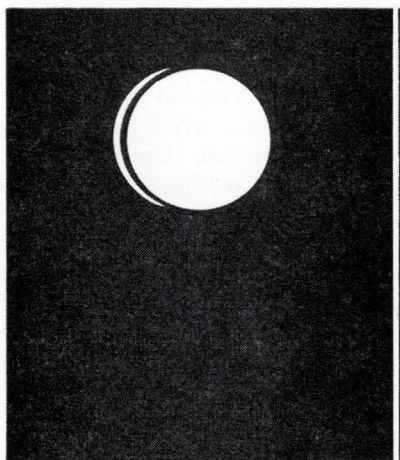

**C106
C107**
15-400 volts
4 amps RMS

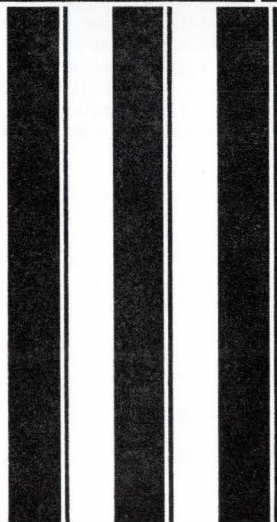

General Electric's C106/C107 Silicon Controlled Rectifier family now has a 400 volt member . . . more than enough for 240 volt line operation. The universal motor speed control circuit below is one example of the C106D's direct design capabilities.

Typical applications include virtually any low-current sensing job. Appliances to light industrial. Automotive to heavy industrial.

RELIABLE The plastic encapsulated device utilizes the proved planar passivated process . . . all junctions are protected with a silicon-dioxide layer.

SENSITIVE Four amp RMS C106 series operates directly from low signal sensors such as thermistors and photo-conductive cells. More sensitive than many higher-priced units, the C106 requires a maximum trigger current of only 200 micro-amps.

VERSATILE Flat power tab package is designed for a variety of mount-down methods—printed circuit, plug-in socket, screws or point-to-point soldering.

RUGGED, COMPACT C106 uses a solid plastic encapsulant for rigid pellet support and protection from moisture.

For lower cost applications, GE's 4-amp C107 may be ideal. Housed in the same strong package, the C107 requires slightly greater trigger current (500 μ A) and can handle a one-cycle, forward surge of 15 amps (vs 20). Check your local General Electric distributor for C106/C107 prices in your quantity. For more information, write *General Electric Company, Dept. 40-32CI, 159 Madison Avenue, New York, N.Y. 10016 U.S.A.*

40-32

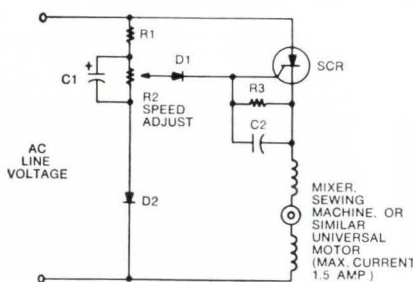

Line Voltage	240V
R ₁	100K
R ₂	20K
R ₃	1K
C ₁	1 μ F, 100V
C ₂	0.1 μ F, 50V
D ₁	1N5060
D ₂	1N5060
SCR	C106D1

GENERAL  **ELECTRIC**[®]

New products international

vidicon is a dot-sequential color signed and time-sequential sampling is used to separate the three color signals. Since every fourth stripe on the filter is black, this provides a reference for accurately timing the sampling pulses and also for correcting the linearity of the sweep generator. The sampling circuits convert the dot-sequential chroma signal from the vidicon into narrow band R, G, and B signals.

The forced color corrector is an important feature of the Sony camera since it can correct for many shortcomings in the chrominance signal. The forced corrector is referenced to the wide-band luminance signal. The luminance chan-

nel delivers a high resolution signal that is unaffected by zooming and other aspects of the optical system. Rather than being a half-silvered mirror, there is actually a small diameter mirror, which diverts only light rays from the center sector of the lens to the luminance vidicon. Thus the luminance vidicon always operates with a small effective lens aperture, and has great depth of focus and high resolution.

The forced corrector compares the resulting wideband luminance signal with a narrowband luminance signal obtained by mixing the three color signals, and then multiplies each of the individual color signals by the ratio of the

wide-band to the narrow-band luminance signals. This processing produces three wideband color signals, which are then encoded into the NTSC color signal.

Sony is proud of the fact that the camera only has three adjustments, instead of 30 or more as in some other color cameras. Color balance is adjusted merely by focusing the camera on a white card and pushing a button. Gain is adjusted merely by pushing another button. Although designed primarily for closed circuit tv systems, many of these cameras are in use in commercial television—especially for sports and for special applications including transmission from helicopters.

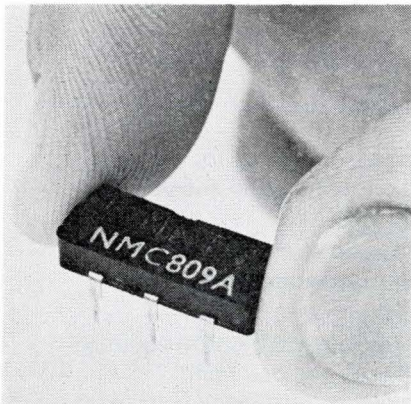

Thick-film hybrid, wideband i-f amplifier NMC 809A uses dual in-line construction with mounting pins on a standard 0.1-in. pitch. Gain is integrally controlled between 20 and 24 dB. Newmarket Transistors Ltd., Newmarket, Suffolk, England. [249]

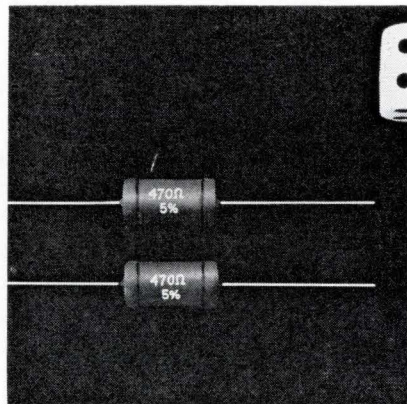

Carbon resistors type SK8 are available with values from 10 ohms to 10 megohms. Tolerances are either 2% or 5%. Limiting voltage is 750 volts and wattage, 1 watt. Resista GmbH, 83 Landshut, Ludmillastrasse 23, West Germany. [250]



Digital static strain indicator PS7/D is for measuring many physical quantities in various industrial fields. Accuracy is $\pm 0.2\%$ full scale, ± 2 digit. Shinkoh Communication Industry Ltd., 1-12-10 Sakurayama, Kanagawa-ken, Japan. [251]

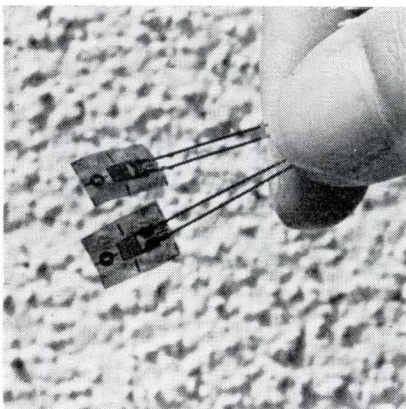

Moisture-proof strain gage (Polymicron) has a measuring range of approximately 5-7% strain. It can be used for a temperature up to 200°C. Shinkoh Communication Industry Co. Ltd., 1-12-10 Sakurayama, Zushi-shi, Kanagawaken, Japan. [252]

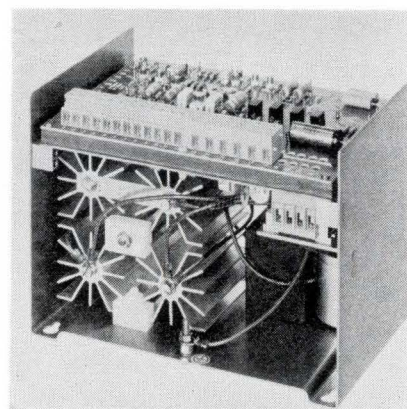

Current rectifier unit type CCB is for rpm control of dc current motors with and without dynamos or as field winding power supply. Dc current is 12A and maximum dc output voltage is 330 V. Brown, Boveri & Cie, 68 Mannheim 1, W. Germany. [253]

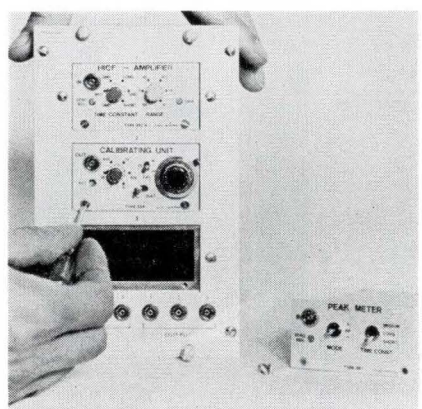

Minimodular system combines sensitive amplifier, a calibrating unit and a peak meter—all used for piezoelectric measurements. Amplifier has open-loop gain of 70 dB. Hellige GmbH, 78 Freiburg, Heinrich-von-Stephan-Str. 4, W. Germany. [254]

The 4 advantages offered by SGS

- New IC's for radio, tv and hi-fi**
- TAA 611 Audio amplifier for radioreceivers, varcaps in TV-tuners
 - TAA 621 Audio amplifier with low noise, high output power up to 4 W
 - TAA 661IF FM amplifier and detector, supply voltage range from 6 to 15 V
 - TAA 661IF FM amplifier with low noise, high output power up to 4 W
 - TBA 231 Dual preamplifier for driving varcaps in TV-tuners
 - TBA 271 Voltage stabiliser for driving gain, and wide supply voltage range

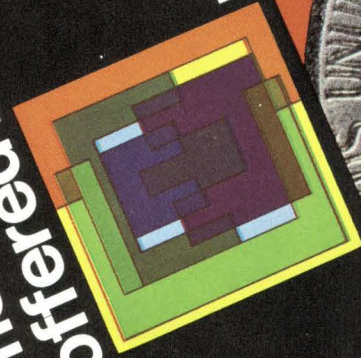

Availability
Price
Quality
Range



The high accuracy of SGS production combined with the efforts of its R&D laboratories have made it possible to realise large scale production of these devices at high quality levels, extremely competitive prices and immediate availability.

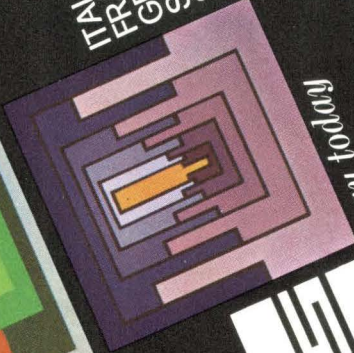
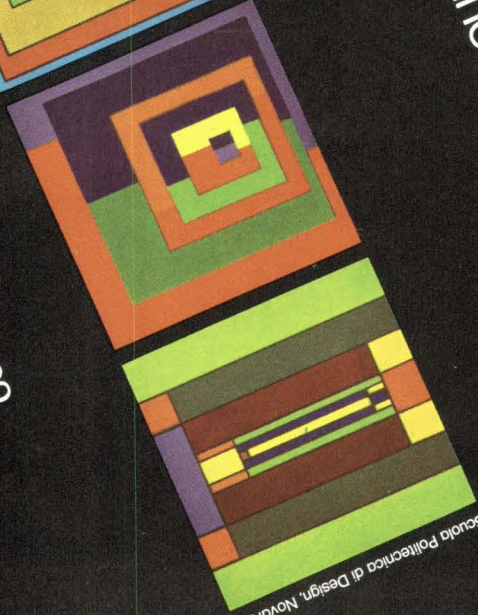
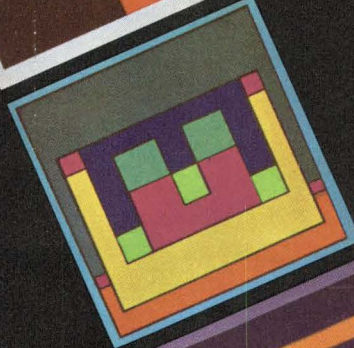
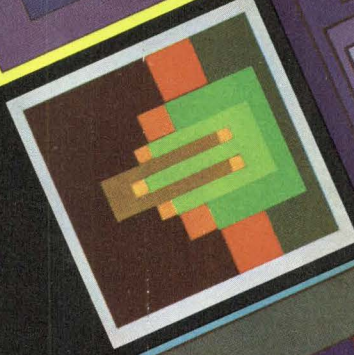
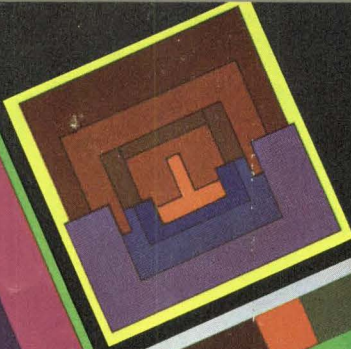
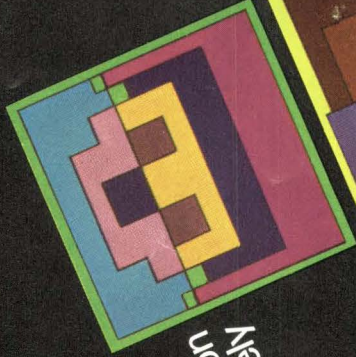

Scuola Politecnica di Design, Novara

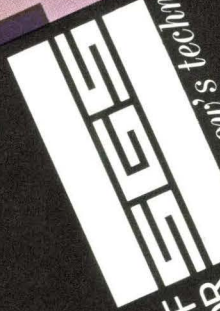

SEMICONDUCTOR
GROUP OF
COMPANIES

Tomorrow's technology

UK
GERMANY
FRANCE
ITALY
SINGAPORE
SWEDEN

99¢

Hooray! Price reductions for both red and amber GaAsLITEs.

Effective immediately, prices (suggested resale in 1,000 quantities) on our red light-emitting diodes MV 50, MV 10B and our amber GaAsLITE MV 1, have been cut to 99¢. Smaller quantity prices have gone down, too. Get the details from your distributor.

If you've been considering GaAsLITEs in sockets where you need good brightness, low power drive, high reliability, and ready availability, it's time to stop thinking and send a P.O. Wow! 99¢.

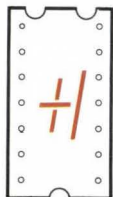

MAN 1001

New: Polarity and overflow display

Customers who have bought and used our MAN 1 displays asked us to build a ± 1 device to integrate into digital readout displays, cockpit instruments, and industrial controls.

Voila! the MAN 1001. Same size and package as the MAN 1 GaAsLITE display. Same high brightness (typ. 350 ft-L @ 20 mA) and IC-compatible power requirements (3.4V typ. forward voltage per segment @ $I_F = 20$ mA).

Suggested resale price, 100's: \$11.50 each.

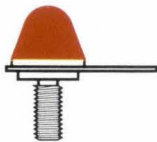

Meet Big Red, the MV 4

The GaAsLITE becomes an illuminator

Photography fans will be delighted to hear that we've developed the MV 4 series of light-emitting diodes. They put out 5,000 ft-L @ $I_F = 1.0$ A in the 6700 Å region, well above the sensitivity range of most photographic emulsions. Mounted in a TO-5 stud-type header, the MV 4 can take up to 1A continuous current in an efficient heat sink.

MV 4's will also serve well as high intensity locators and warning indicators when pulsed. They will handle peak currents of 25A at 1 μ sec, 300 pps limits.

Price: (resale, 100's) \$9.25.

Delivery: off the shelf.

GaAsLITE Update

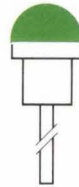

MV 2:

The green GaAsLITE is GO...

We are now in full production with our green solid-state light, the MV 2. Its active gallium phosphide puts out a very bright 300 ft-L in the 5600Å range @ 650 mA.

Packaged in a TO-18 header, the MV 2 completes the stop-wait-go color choices that display designers have been looking for.

Suggested resale price, 1,000's: \$3.75.

... and it's in our new GaAsLITE Answer Kit.

Creative display designers want new answers for panel indicator light problems. They'll find them, complete with applications ideas and design help, in our GaAsLITE Answer Kit, available from any Monsanto distributor worldwide for only \$9.95. Contains a volume of GaAsLITE Tips, two MV 50 and MV 10B red GaAsLITEs, two MV 1 amber solid-state lights, and one of our new green answers, the MV 2.

Get out a purchase req and start working with all kinds of GaAsLITEs now.

Monsanto

For additional technical information write
Monsanto Electronic Special Products
10131 Bubb Road, Cupertino, California 95014
(408) 257-2140

New products international

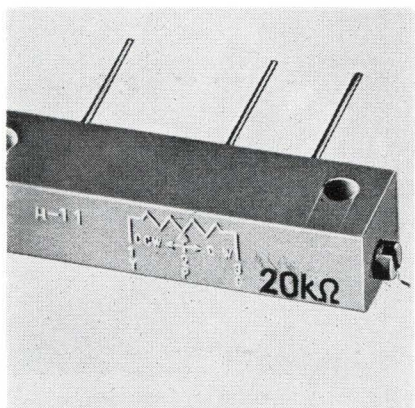

Twenty-two turn potentiometer type 1211P has a range from 10 ohms to 50 kilohms and a tolerance of +5%. It can be loaded with 0.75 W at 85°C. Temperature range is -55° to +150°C. Resista GmbH, 83 Landshut, Ludmillastr. 23, W. Germany. [255]

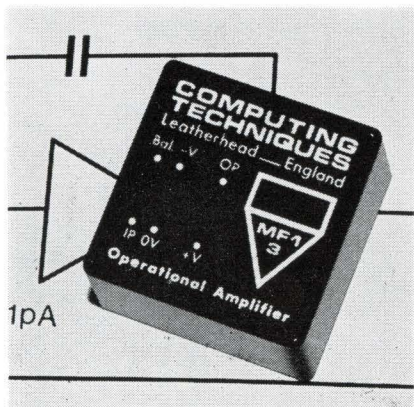

Electrometer amplifier MF1-3 operates from 6V supplies and draws a quiescent current of 750 μ A. It has input impedance of 10^{12} ohms and draws a bias current of 0.01 pA. Computing Techniques Ltd., Bridge St., Leatherhead, Surrey, England. [256]

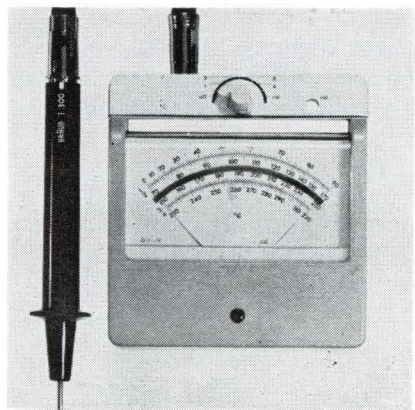

Testatherm P3, for measuring temperatures in systems engineering, is based on resistance change principles. Used with thermistor probe, it can be used for measurements from -50° to +300°C. Braun AG, Postfach 115/116, W. Germany. [257]

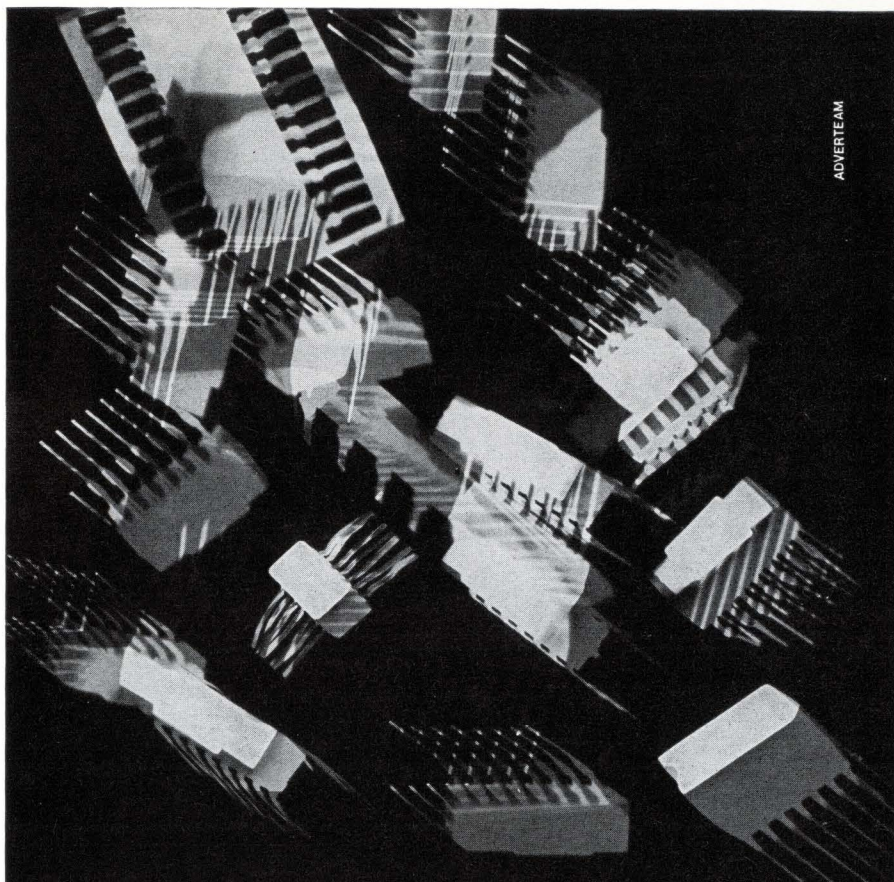

ADVERTISING

MOS MTOS MTNS

General Instrument Europe has standard MOS transistors and LSI circuits available ex-stock. We are producing in large quantities single and dual MOS transistors, frequency dividers, multiplexers, shift registers, counting systems. Prices are economic even to small user.

New GIANT/MTNS series is directly compatible with DTL/TTL



GENERAL INSTRUMENT EUROPE S.p.A.

Pizza Amendola, 9 - 20149 MILANO - Tel. 469.77.51/2/3/4/5
Cable: GINEUR MILANO - Telex: GINEUR 31454

GENERAL INSTRUMENT FRANCE - 11/13 Rue Gandon - 75
PARIS 13e - telephone: 588.74.31 - telex: 26.766

GENERAL INSTRUMENT U.K. Ltd. - Stonefield Way - RUISLIP
Middlesex - HA4 OJT. - telephone: 01-845.12.88 - telex: 22.623

GENERAL INSTRUMENT DEUTSCHLAND GmbH - Neumarkter
Strasse, 61 - (8) MÜNCHEN 80 - telephone: 448.566 - telex: 523.769

Agents: Austria, Belgium, Denmark, Holland, Israel, Norway,
Sweden, Switzerland

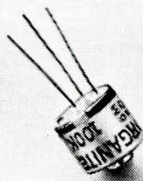

Crash Dive

This was a Morganite type 81E Cermet Trimming Potentiometer that didn't make it.

Shame really. The more so because this particular specimen had already survived several rigorous mechanical and electrical tests. But then, we are unusually strict at

Morganite, because our customers like it that way.

Another thing they like is having the right products at the right time, complete with full technical information to match. So our constant research and development is more than an ivory-tower luxury—it's a common-sense necessity.

We reckon that reliable delivery makes sense too. As you'll see when you ring us for samples for evaluation or development projects. Then you can put our Cermet Trimming Potentiometers through *your* test routine and watch how they stand up to it.

You'll like what you see.



MORGANITE RESISTORS LIMITED

Bede Industrial Estate, Jarrow, County Durham

Telephone: Jarrow 897771 Telex: 53353



New products international

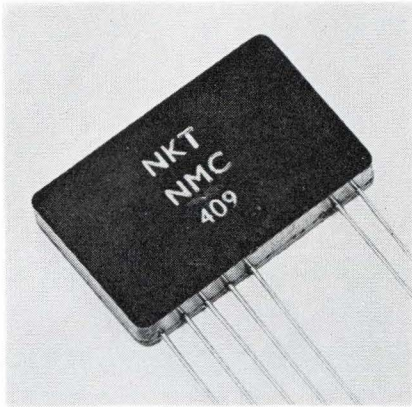

Low-frequency, thick film hybrid flip-flop NMC409 is designed to work in conditions of high electrical interference with minimal risk of false triggering. Newmarket Transistors Ltd., Pye Group, St. Andrew's Road, Cambridge, England. [258]

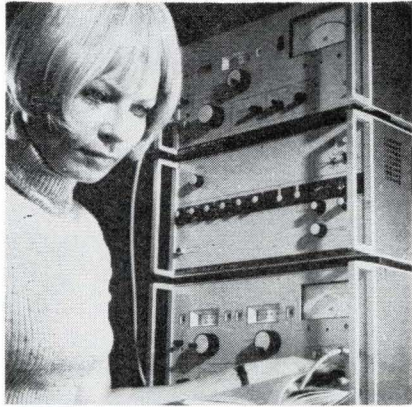

Quartz-controlled measuring generator G2006 operates on the frequency-synthesis method and is designed to determine frequencies from 0.1 to 100 megahertz in steps of 1 hertz. Accuracy is 5×10^{-5} . Siemens AG, 8 Munich 1, West Germany. [259]

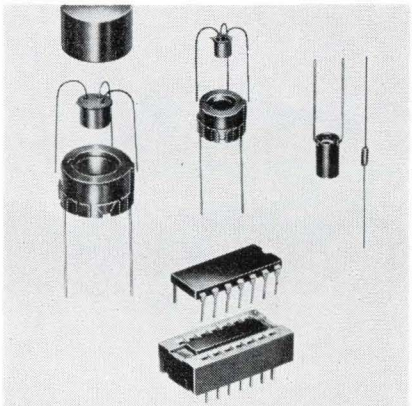

Subminiature component ovens use the self-regulating characteristics of polycrystalline semiconductor materials. They may be operated from various supplies up to 24 V dc or rms. Jermy Industries, Vestry Estate, Sevenoaks, Kent, England. [260]

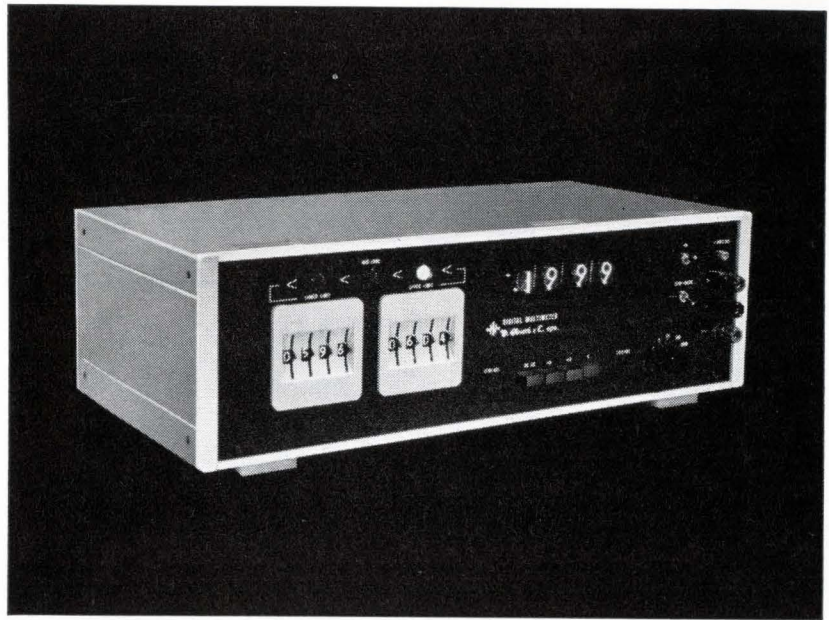

digital instruments

These instruments are designed to measure voltages, currents (AC and DC), and resistances, with the results displayed directly in numerical form.

The units of measurement are in Volts, mA, Kohms, and have five ranges from 0.2-2000 with a precision in the order of 0.1%.

The measurements are displayed with 4 or 5 decimal indicator tubes and the selection of a range establishes the position of the decimal point.

These instruments are available as multimeters, or for measurement of only voltages, currents, or resistances.

Panel instruments, with 3 or 4 decimal figures display, are available for the measurement of only one electrical quantity on one range.

All the instruments can be optionally supplied with digital output.

DIGITAL INSTRUMENT WITH PRESET

These digital instruments allow the numerical preset of two limits with in which the quantity to be measured is compared.

Contact closures and lamps provide output signals that indicate whether the result of the measurement is below, above, or within the two preset limits.

These limits are preset by manual positioning of rotating decimal commutators.



D. Olivetti e C. spa

Factory: Aprilia (CAP 04011) - SS. 148 - Km. 43^o
Strada Pontina - Tel. 924361/2/3

Sales Office: Milano (CAP 20149)
Corso Sempione, 73 - Tel. 335830 - 345178 - 342989

Digital voltmeters and multimeters, level analyzers, preset counters, digital printers, encoders, power supplies, data loggers and systems.

Thin film networks, hybrid circuits, silicon controlled rectifiers, triacs, high precision photographic products.

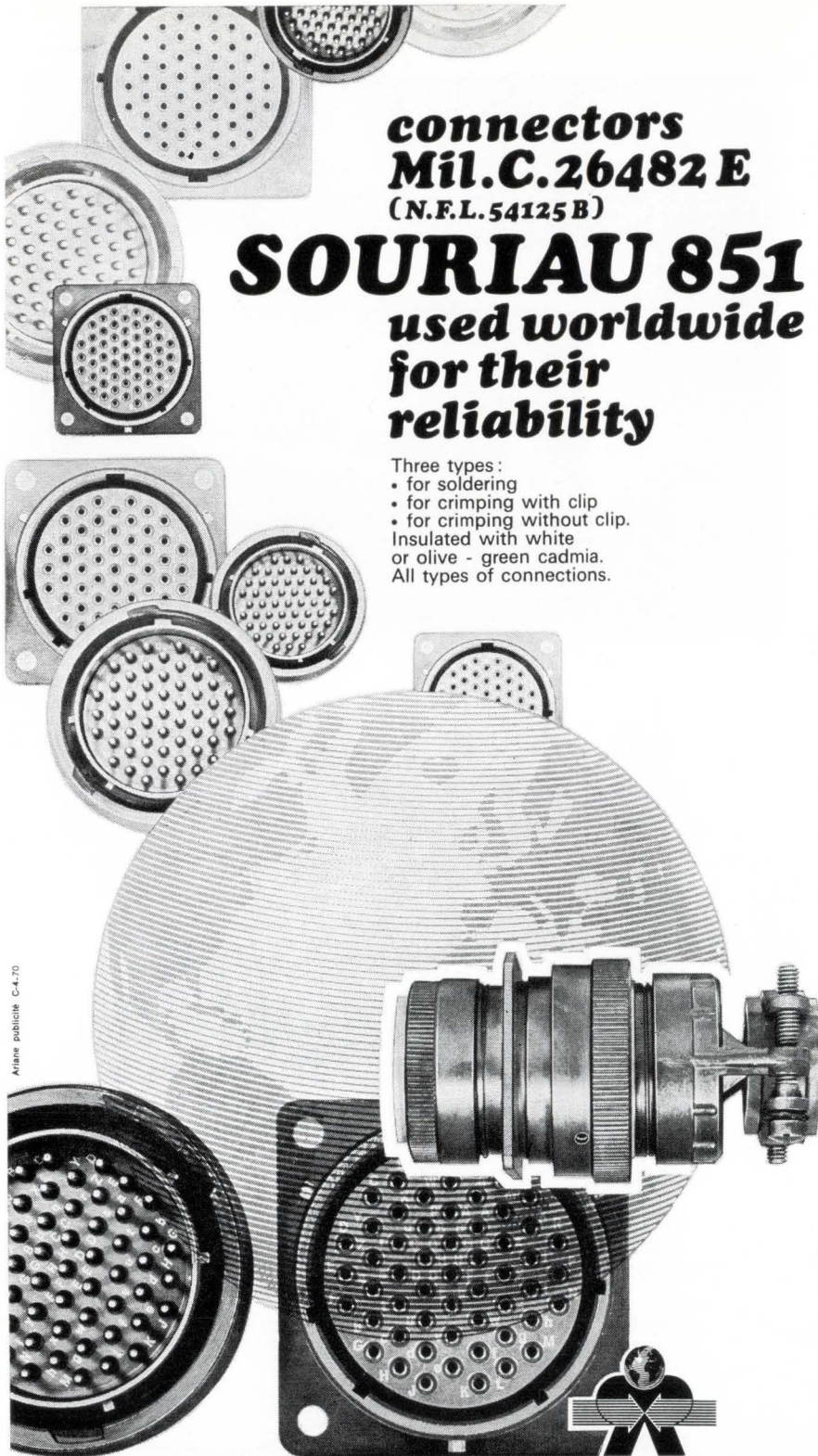

connectors
Mil.C.26482 E
 (N.F.L.54125 B)

SOURIAU 851
 used worldwide
 for their
 reliability

Three types:
 • for soldering
 • for crimping with clip
 • for crimping without clip.
 Insulated with white
 or olive - green cadmia.
 All types of connections.

Ariane publicité C-4-70



SOURIAU ET C^{IE}

Head-Office, 9, rue Galliéni, 92-Boulogne-Billancourt - France Tél: 603.96.23 604.20.00
 Plants: Boulogne-Billancourt - La Ferté Bernard - Champagné - Cluses

Branch-Offices: Lyon: 231, Avenue Jean-Jaurès - France - Tél: 72.14.91 et 92
 Toulouse: 10, Boulevard Griffoul-Dorval - France - Tél: 52.51.35

SOURIAU ELECTRIC G.m.b.H DUSSELDORF Western Germany - Tél: Sa-Nr-10373
 SOURIAU ITALIANA S.p.A. MILAN Italy - Tél: 688.7407

SOCIÉTÉ ÉLECTRIQUE BENELUX SOURIAU BRUXELLES Belgium - Tél: (02) 41.64.54

SOCIÉTÉ ÉLECTRIQUE BENELUX SOURIAU NEDERLAND ROTTERDAM Netherlands - Tél: (010) 13.25.64

SOURIAU ELECTROPON Windsor Berks Great Britain - Tél: Windsor 69471

Agents in all countries

New products international

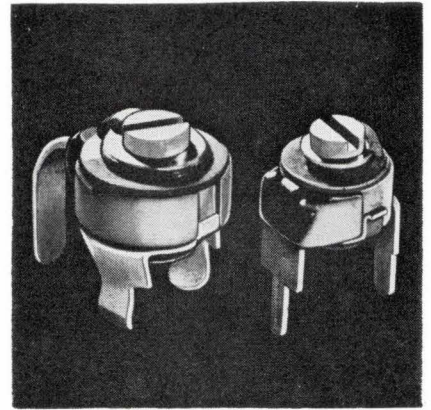

Ceramic dielectric trimmer capacitors are for printed circuit applications. They are available in two configurations with capacitance ranges from 1.7 pF to 18 pF. Tekelec Airtronic, Cite des Bruyeres, Rue Carle Vernet 92, Sevres, France. [261]

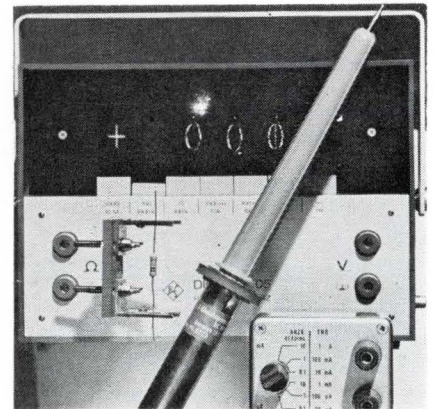

Digital multimeter UGWD, with switchable shunt, measures dc and ac in 6 ranges. Lowest range is 0 to 10 μ A with resolution of 10 μ A. Used with probe, dc voltages up to 30 kV can be determined. Rhode & Schwarz, 8 Munich 80, W. Germany. [262]



Miniature spdt coaxial switch provides 60 LB minimum isolation to 18 GHz. VSWR from 0 to 18 gigahertz is less than 1.5:1, to 12.4 GHz is less than 1.4:1 and 8 GHz is less than 1:3:1. Amphenol, Thanet Way, Whitstable, Kent, England. [263]

The part it played in developing the seismograph could shake up your product development

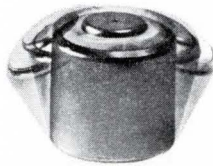

A seismograph powerful enough to get the measure of underground tremors? Hardly possible without the Mallory standard of battery performance.

The Mallory Duracell qualities are well-known. Long life. Steady, fade-free performance throughout. Power that stays fresh in the cell for years because it is automatically preserved when not actually working. Built-in protection against leakage.

Those are the Duracell qualities which have helped to find new applications for measuring instruments. Like light meters. And underwater equipment.

Instrumentation and beyond, Mallory leads the way in miniature and special batteries of all kinds.

Just get in touch with us and we'll help you turn your product development into a landslide victory.

MALLORY BATTERIES LIMITED. Gatwick Road, Crawley, Sussex.

MALLORY DURACELL®

You could not possibly have told me all there is to know about Mallory and Duracell in this advertisement. Please tell me more.

Name _____ Company _____

Address _____

Position _____ Principal field of interest _____

England

The Marketing Manager,
European Headquarters,
Mallory Batteries Ltd.,
Gatwick Road,
Crawley, Sussex.

W. Germany

The Marketing Manager,
Mallory Batteries G.m.b.H.,
5023 Weiden bei Köln,
Aachener Strasse 274.

France

The Marketing Manager,
Mallory Batteries S.A.,
5 Rue Vauthier,
92-Boulogne-sur-Seine,

Italy

The Marketing Manager,
Mallory Batteries S.r.L.,
Via Catone 3,
20158 Milano.

Denmark

The Marketing Manager,
Raaberg & Co. A.S.,
37 Bredgade,
Copenhagen K.

E/7

The best place to reach your local market is in this foreign publication.

It doesn't matter where a magazine comes from. What matters is how far it reaches.

The fact is, the international edition of Electronics is the worldwide magazine that's more consistently read than any other electronics publication in more than 46 countries.

Electronics' Men of Action study reveals that 9 out of 10 subscribers read at least 3 out of 4 issues. These subscribers are the chief engineers, research directors, project managers, corporate officers, scientists and all the other decision-makers who recommend, approve, or specify your products and services.

In fact, Electronics International helps you enlarge your "home market" better than any other electronics publication. Because we actually have an editorial staff there. As well as in 63 other countries. All combined, they provide readers with the most complete, up-to-date and accurate coverage of all the new and exciting developments in electronics.

Wherever you are in the world of electronics, the best place to reach your local market is in the international edition of Electronics magazine.

For more information, check with the Electronics representative for your country.

Electronics.

A McGraw-Hill Publication
330 West 42nd Street/New York, N.Y. 10036

New products international

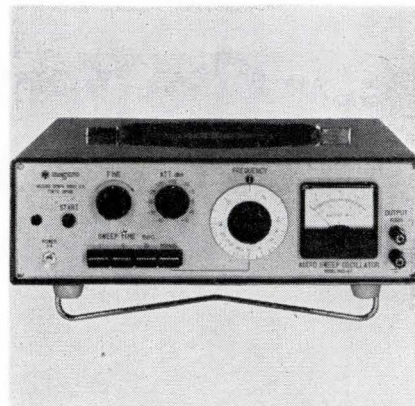

Audio sweep oscillator MAS-411 is for lab and production line in the rapid determination of the response characteristics of tape recorders, amplifiers and other audio reproducing equipment. Merguro Denpa Sokki K.K., 2-5-1 Chou-ku Tokyo. [264]

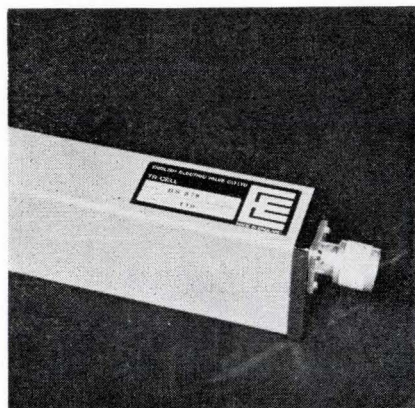

TR coaxial cell BS876, which operates at L-band frequencies, has applications for the protection of parametric amplifiers and traveling-wave tubes. Peak operating power is 10 kW. English Electric Valve Co., Chelmsford, Essex, England. [265]

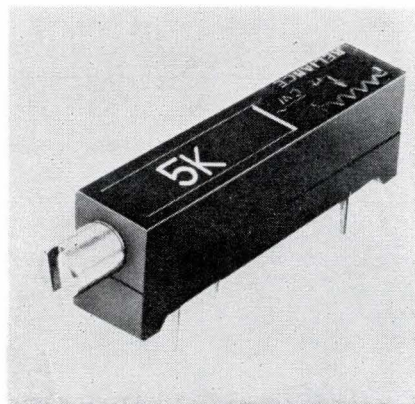

Fully sealed, cermet miniature trimmer type CC151 has terminals suited for pc mounting. Resistance tolerance is $\pm 20\%$ and wattage rating 1 W at 40°C derating to 0 at 125°C. Reliance Controls Ltd., Swindon, Wiltshire, England. [266]



Slide-rule L C R Bridge has ten overlapping ranges for rapid 1% measurements of any component, also tolerance and phase angle. Switch selects 1kHz or 100/120Hz operation. 2, 3 and 4-terminal connections. Adjustable overall sensitivity, special 'search' facility, and automatic increase of detector gain as balance is approached.

B 500



Universal Bridge for 0.1% measurements of any LCR combination from 2 micro-ohms to 500 gigohms. Source/detector (1592Hz) operate from a.c. or internal rechargeable battery. Sockets for external 200Hz - 20kHz. Display gives units, zeroes and decimal point. Four-terminal connections for accurate low impedance measurements.

B 224

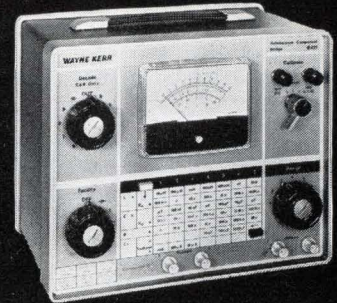

Autobalance Component Bridge for immediate readout of resistance, capacitance and shunt loss, inductance and series loss. C and R comparisons from -25% to +25%. Electrolytics tested with d.c. Accuracy 0.25% (R & C), 2% (L). Internal 1kHz source/detector.

B 421



Autobalance Universal Bridge for continuous 0.1% readout of in-phase and quadrature terms, with analog outputs of both. Backing-off facilities, DVM connections, optional BCD outputs. Push-buttons for optimum discrimination up to five figures. Illuminated readout.

B 641



Autobalance Universal Bridge gives four-figure readout on all ten ranges covering every practical value of L, C, R & G. Sensitivity increases automatically when decade back-off controls are used but can be selected manually. External Standards sockets permit comparative measurements and increase discrimination to 5 or 6 figures. Accuracy 0.1%.

B 642

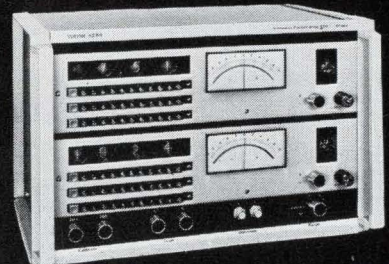

Autobalance Precision Bridge accurate of 0.01% though simple to operate. It measures virtually any meaningful impedance in any quadrant. Automatic compensation for measurement lead impedance. Six-figures discrimination. Analog outputs.

B 331 MkII

Wide range A.F. Bridges

Wayne Kerr Bridges provide accurate measurement of L, C and R values over an unusually wide range. They employ a minimum number of fixed stable Standards in association with precision tapped transformers giving voltage and current ratios. Speed and ease of operation are assured by functional styling.

WAYNE KERR

THE WAYNE KERR COMPANY LIMITED,

Roebuck Road, Chessington, Surrey. Tel: 01-397 1131. Cables: Waynkerr, Chessington. Telex 262333

PARIS: TECHNIQUE ET PRODUITS 626-02-35 LORRACH: BRINDI GMBH 07621-5742 STOCKHOLM: SCANTELE AB 24 58 25 OSLO: FEIRING INSTRUMENTS A/S 23 11 80
BRUXELLES: ETABLISSEMENTS MIRAVOX S.P.R.L. 35.41.73.35.41.74 KOBENHAVN NV: HANS BUCH & CO A/S TAGA 5170 RIJSWIJK (Z.H.): C. N. ROOD N.V. 99.63.60.

New products international

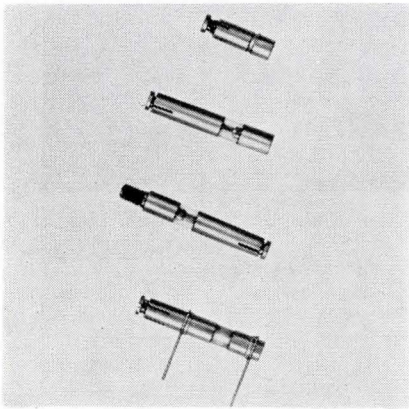

Tiny trimmer capacitor is suited for hybrid circuits, uhf oscillators, strip-lines, and balancing of semiconductors and microwave components. It features low losses. Tekelec Airtronic, Cite des Bruyeres, Rue Carle Vernet, Sevres, France. [267]

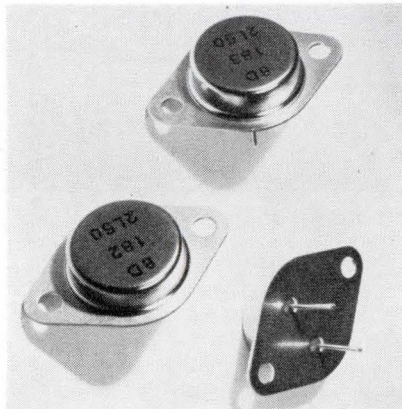

Power transistors types BD181, BD182, and BD183 combine high gain with a minimum level of distortion, low losses, excellent thermal stability, and increased power bandwidth factor. N.V. Philips, P.O. Box 523, Eindhoven, The Netherlands. [268]

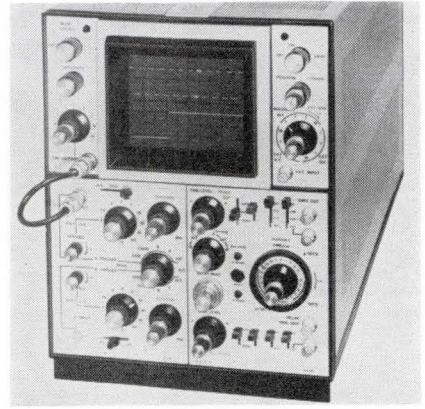

Oscilloscope RO70 is a 90-MHz unit that features 5-mV sensitivity, a bright, 10 x 8 cm display, dual channel inputs with signal delay, and comprehensive trigger facilities. Roband Electronics Ltd., Charlwood, Horley, Surrey, England. [269]

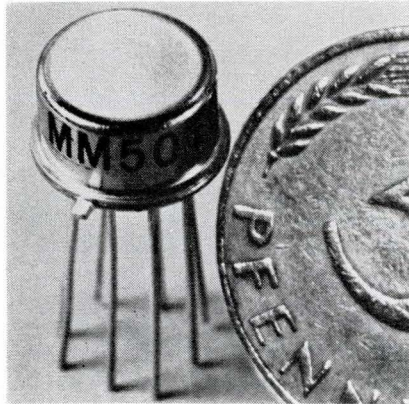

Model MM5016 512-bit MOS shift register operates on +5 V and -12 V and is bipolar compatible. Operating frequency is 600 Hz. Price is \$5.20 each in lots of 100 and up. National Semiconductor GmbH, 891 Landsberg, Lechstr. 255, W. Germany. [270]

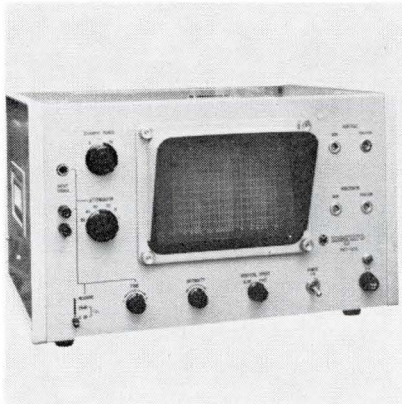

Audio frequency response tracer MAT-141A speeds up testing time in determining response characteristics of audio equipment such as tape recorders, amplifiers, loudspeakers, and pickups. Meguro Denpa Sokki, K.K., 2-5-1 Chou-ku, Tokyo. [271]

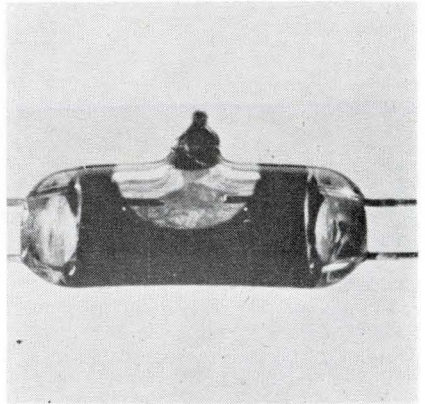

Miniature electrolytic level EP-304 is used to measure deviations from horizontal positions in control and measuring equipment. Typical voltage change is 20 mV/arc minute. Amphenol-Tuchel GmbH, August-Haeussler-Str. 10, W. Germany [272]

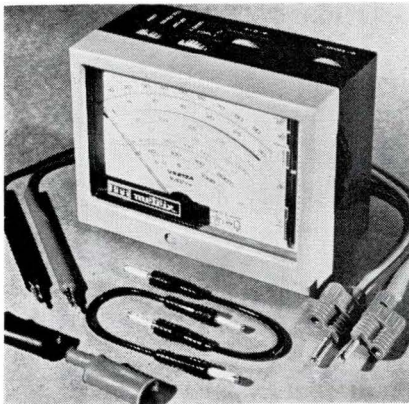

Millivoltmeter VX213A measures dc voltages and currents; ac voltages up to 1 MHz directly, up to 30 MHz with a probe, up to 1,000 MHz with a measuring tee; and resistances to 100 megohms. ITT Metrix, Edinburgh Way, Harlow, Essex, England. [273]

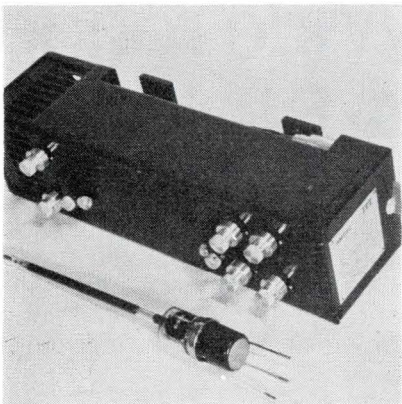

Traveling-wave tube W5/4G, for systems operating from 5.85 to 7.2 GHz, has output power of 10 W and maximum noise factor of 26 dB. Maximum amplification is 42 dB. Standard Elek-trik Lorenz AG, 85 Nuernberg, Platenstr. 66, W. Germany. [274]

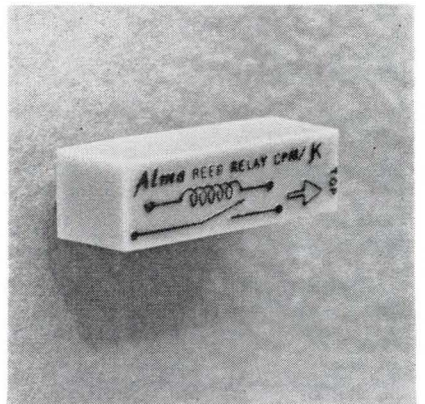

Four types of mercury wetted reed relays have been added to the CPR range. Contacts are rated at 50 W impedance of 10^{12} ohms and draws a contact resistance of about 50 milli-ohms. Alma Components Ltd., Park Road, Diss, Norfolk, England. [275]

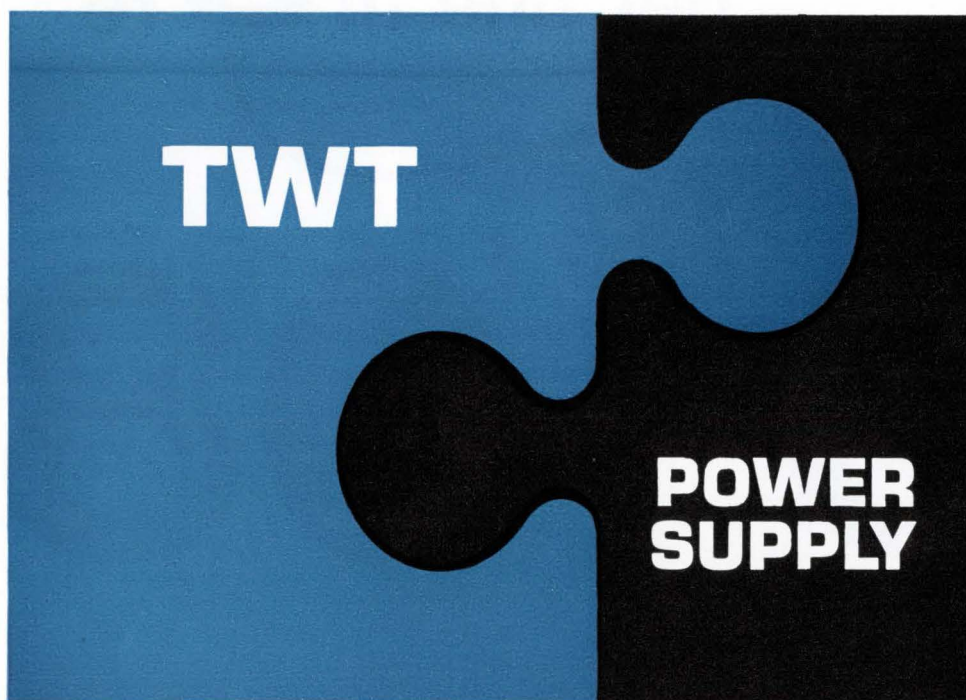

From 4 to 18 GHz Sperry gets it together

Of course you could buy your traveling wave tube and its power supply separately and endure the interface problems yourself. You could, but why would you bother?

Sperry has the industry's top capability for matching tubes with their power supplies. You can get light weight, high efficiency and no problems by buying the package from Sperry.

Pick any of Sperry's trend setting TWT's from 4 to 18 GHz. Then let Sperry engineers provide the appropriate power supply, along with whatever options you want.

The combination can be fully circuit protected. Sperry will add an RF signal source, BITE circuits can be included, and you may have liquid,

forced air, or conduction cooling. Operating mode can range from very narrow pulses all the way to CW. Additional RF hardware can be integrated into the package and all these options can be mixed and matched to fit your application.

To put Sperry experience to work on your tube/power supply interface problem, contact one of these Regional offices:

NEW YORK
(516) 574-1435

LOS ANGELES
(213) 641-8821

DALLAS, TEXAS
(214) 424-5851

S. LYNDEBORO, N. H.
(603) 654-9564

Or Sperry Electronic Tube Division, Sperry Rand Corporation, Gainesville, Florida 32601.
Phone (904) 372-0411.

SPERRY
ELECTRONIC TUBE DIVISION

Sperry could be working on the Package you need.

Circle 194 on reader service card

get one m **0** re

.0008%

with the Sercel VM2700 multimeter



The SERCEL VM 2700 brings a new dimension to digital measurement. It combines multimeter versatility with the accuracy (.0008% per day), resolution, speed (130 measurements per second) and long term stability (.005% per year) of the highest grade of laboratory DVM.

To further extend the utility of this remarkable instrument, a range of plug-in options is available, which includes a unique arithmetic unit.

With this unit, digital measurement of deviation (ΔV) and percentage deviation ($100 \Delta V/V$) on both AC and DC volts can be made for the first time.

- 6 digits, scale length 200 000, automatic ranging, automatic zero reset
- 45 ranges: dc volts — ac volts — dc mA — ohms — dc ratio — ac ratio, deviation and percentage deviation on both AC and DC volts
- dc volts: 200 mV, 2 V, 20 V, 200 V, 1000 V full scale
- resolution: 10 microvolts, or 1 microvolt (optional)
- accuracy: $\pm .0008\%$ of reading $\pm .00025\%$ of full scale per DAY
- stability: $\pm .005\%$ of reading $\pm .001\%$ of full scale per YEAR
- input impedance: $> 10\,000$ megohms (.2 V — 2 V — 20 V ranges)
- offset current: 100 picoamperes
- conversion time: 7.5 milliseconds (130 measurements per second at full accuracy)
- filter: 40 db at 50 Hz (settling in 100 ms)
80 db at 50 Hz (settling in 500 ms)
- complete isolation between analogue input and digital output
No end of conversion signal is given until reading is stable.

GREAT BRITAIN
GERMANY
ITALY
NETHERLANDS
DENMARK
SWEDEN
PORTUGAL

BRITEC Ltd
Josef LIEBERT
3 G ELECTRONICS
DE BUIZIERD
PRINS
TRANSFER AB
Soc. Com.
MATOS TAVARES

LONDON tel. WHI 3070
KREFELD tel. 42721
MILANO tel. 54.42.91
THE HAGUE tel. 83.10.00
GLOSTRUP tel. 96.88.44
VALLINGBY tel. 87.02.50
LISBOA tel. 36.11.01.16



division mesure
12 rue Léonidas - Paris 14^e
Tél: 273.01.42 FRANCE

Electronics Newsletter

November 9, 1970

Bucket brigade cuts flat screen circuitry

The complexity of the external circuitry required by solid state "flat" display and imaging devices is a big obstacle to their further development. But engineers at RCA's David Sarnoff Laboratories have built a self-scanning device that doesn't need external addressing and driving circuits because it's based on the charge transfer idea [see p. 33].

The 15-by-32 array of light-sensing cells uses what they call the "bucket brigade" approach. In it, MOS transistors on the monolithic silicon chip have sources and drains that act as photodiodes. A light pattern on the chip is read out when the charge pattern representing the image is transferred, diode to diode, to the edge of the array. While the chip incorporates only horizontal bucket brigades at present, the goal is to include vertical scanning and build a 500-element array on a 1-inch-diameter wafer, perhaps using silicon-on-sapphire technology.

Cw high power in C band attained from GaAs diode

Bell Laboratories engineers appear to have licked the problem of obtaining continuous high-power operation of solid state devices at microwave frequencies. Using gallium arsenide in a conventional three-layer diode structure, they have attained almost 3 watts output at 6.1 gigahertz. The single, Schottky-barrier GaAs Impatts are mounted on copper studs.

The power exceeds that obtained by both silicon and germanium, even when those materials are mounted on diamond heat sinks. Since GaAs already is known for its low noise output, the new power levels make it a double threat. Noise figures remained low even at these output levels, the Bell researchers report—in the 25-decibel range for unoptimized diodes, 3 to 7 dB lower than for comparable silicon structures.

Transistor offers delay, amplification

A new acoustic delay device, offering the simplicity of a transistor and both the delay and amplification characteristics of more complex surface wave devices, has been developed by the Hughes Research Laboratory. Up to now, fabrication difficulties with the interdigital acoustic transducer needed to launch the wave along the substrate had held up the development of acoustic delay lines at microwave frequencies.

The Hughes device, an acoustic analogue of the standard three-terminal transistor, relies on the current induced by the bulk acoustic waves in epitaxial gallium arsenide to produce rf power gain of 20 decibels, with delays up to 10 microseconds. With signal routing, Hughes is confident that delays up to 100 μ s are in the offing. Hughes is working at 1 to 3 megahertz, but with better electro-mechanical coupling material, such as zinc oxide or silicon lithium niobate, X-band frequencies are feasible. What's more, input signals from watts up to kilowatt pulses can be handled, making possible for the first time high-power, solid state delay devices.

Univac joins parade with new machines

The Univac division of Sperry Rand Corp. is finally introducing its 1110 computer, thus joining IBM, NCR, Burroughs, and RCA in the recent parade of announcements. A logical extension of the 1100 line, Univac's new machine has three to five times the computing power of the 1108.

The improvement is due partly to a faster computational speed and

Electronics Newsletter

partly to a technique that, notably with the aid of what Univac calls a communications/symbiont processor, permits concurrent computation on several different tasks. This processor, which Univac is introducing at the same time as the 1110, will execute subroutines that involve peripheral equipment and communications lines, without loading the central processor.

The big machine has a ferrite-core memory; the smaller one, like Univac's 9000 series, has a plated-wire memory.

H-P to buck Tek with service scope

Hewlett-Packard is preparing to challenge Tektronix Inc.'s dominance of the portable oscilloscope business. Around January, H-P will introduce a new line of service scopes that are expected to be very light, easy to repair, and easy to calibrate.

According to an industry source, the basic model will be called the 1701, will have a 30-megahertz bandwidth, and will sell complete with ac/dc supply for "well below what Tek charges for the 422 without a battery pack." The 422, a 15-MHz unit, lists for \$1,500. A second model, 1702, will go to 50 MHz, while other scopes in the new series will have bandwidths up to 150 MHz.

Tektronix also has something new planned—the 423, an updated version of the 422, which will reportedly feature a built-in battery pack and a display area larger than the 422's 8 by 10 centimeters. The new scope may be ready by March's IEEE show.

Computer to use planar coaxial pack

The planar coaxial packaging developed at Bunker-Ramo Corp.'s Electronic Systems division [*Electronics*, Aug. 4, 1969, p. 52] for air-to-surface missile computers has spawned a processor occupying only 67 cubic inches.

The basic computer has a 4,096-word, 18-bit plated-wire memory, uses medium-scale integrated MOS arrays in its central processor, and has a multiply time of 33 microseconds and a divide time of 43 μ s. Initial use is expected to be in missile and torpedo guidance, but the firm is also eyeing process and production control applications. Preproduction units will cost about \$30,000, but the price will drop to about \$5,000 for the 4.5-pound machine in quantities of 1,000. Though plated wire was chosen for the initial units because military users are interested in nonvolatile, nondestructive readout, the design can accept other memory types, such as semiconductor.

ITT takes over satellite terminal work for Navy ships

After two years of hard work on the design of shipboard communications satellite terminals, ITT's Defense Communications division has been selected by the Navy to build the next generation shipboard terminal. Designed to operate with DCS-2, the defense communications satellite now being built by TRW Systems, the system—designed around a 4-foot-diameter dish—will be built under a \$6 million contract.

A major part of ITT's design efforts went into the antenna mount, which can give trouble when a terminal on a pitching ship tracks a satellite low in the sky. Still the biggest problems in ship-board terminal design, however, is electromagnetic interference from other emitters such as radar and the communications systems crammed into Navy combat ships.

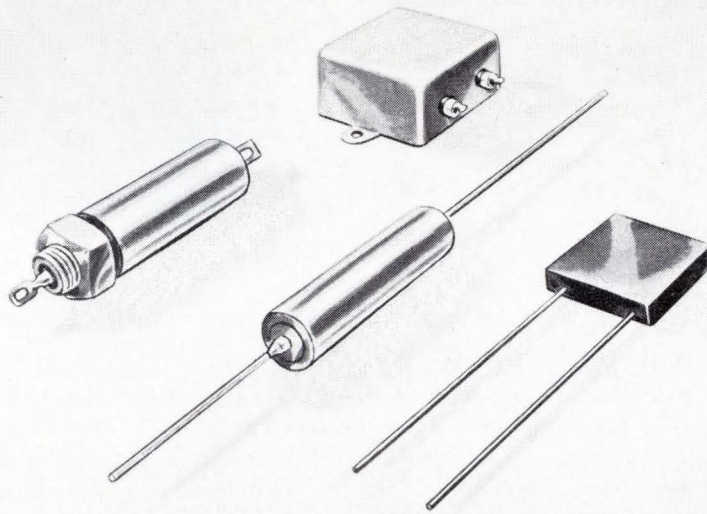

The only things passive at Aerovox are the capacitors we make

Manufacturing capacitors is a fast moving business where "state-of-the-art" is almost yesterday's news. At Aerovox we've developed the ability to achieve technical and design advances with a minimum amount of time lag . . . making us the fastest moving company in the passive component field. And we probably make more types and more capacitors than anyone else in the industry.

We've been at it for almost fifty years now, but we don't believe that age alone is reason enough to choose Aerovox capacitors. You can't buy leadership by just putting in time. You have to go out and win it . . . with a product that's better than the other guy's . . . and with service that the customer can depend on. Let us prove it . . . contact Aerovox for your next capacitor requirement and let us show you how fast we move.

AVX Aerovox®

AEROVOX CORPORATION, NEW BEDFORD, MASSACHUSETTS 02741 • TEL. 617-994-9661
PLANTS IN: NEW BEDFORD, MA., OLEAN & FRANKLINVILLE, N.Y., MYRTLE BEACH, S.C. AND HAMILTON, ONT., CANADA

RCA Solid-State Data for Designers

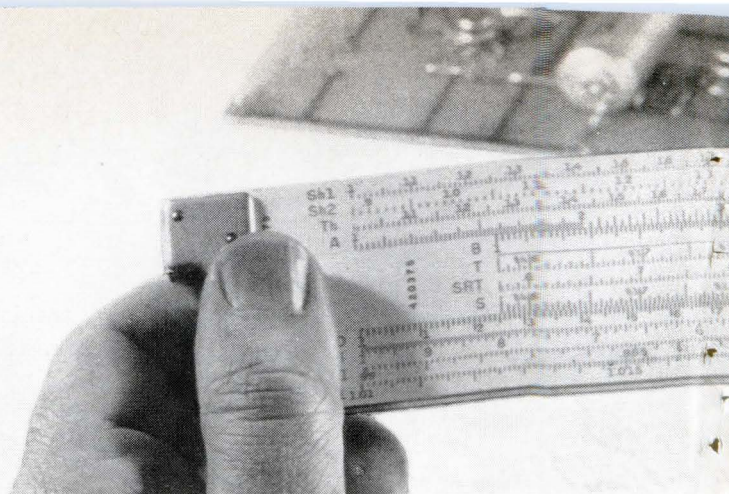

Profit makers: RCA's power transistor families

Here are two established families of RCA low-power transistors—the 2N5320 and its companion type, the 2N5322—that can help you increase profit margins from your equipment sales.

These extremely reliable devices are suitable for a myriad of general-purpose industrial applications. To name just a few: industrial controls, test instrumentation and control equipment, and power amplifier drivers.

The n-p-n 2N5320 and its p-n-p complement, the 2N5322, are double-diffused epitaxial planar tran-

sistors in hermetic TO-5 cases that feature 1 A current capability. They are big brothers to RCA's 2N2102 (n-p-n) and 2N4036 (p-n-p) transistors that have 0.5 A current capa-

bility. Examine their performance curves. You'll find they have the characteristics you need for your circuit application.

Circle Reader Service No. 305.

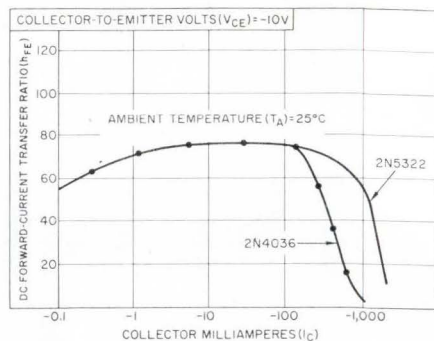
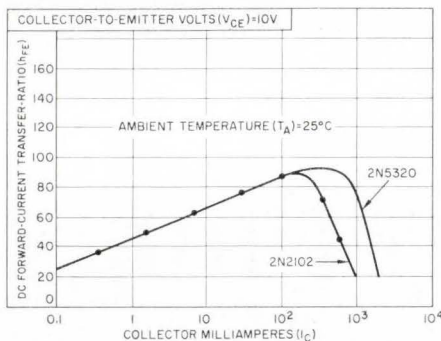

TYPICAL STATIC BETA CHARACTERISTICS FOR TYPES 2N5320, 2N2102, 2N5322, AND 2N4036.

Application	MOD. or CW	Room Temperature Devices			
		Emitter	Laser Diode	Laser Diode Stack	Laser Array
Paper Tape Reader	CW	40736R			
Card Reader	CW	40736R			
Shaft Encoder	CW	40736R			
Keyboard	CW or CODED	40736R			
Circuit Isolator Coupler- "DC Transformer"	MOD	40736R			
Data Transmission	MOD	40736R TA7762R			
Line Finder/ Edge Sensor	CW or PULSE	40736R	TA7606, 7, 8, 9, 10, TA7699, TA7925		
Intrusion Alarm	MOD or PULSE	40736R TA7762R	TA7606, 7, 8, 9, 10, TA7699, TA7925, TA7763, TA7864	TA7764 TA7765	
Remote Control Signalling	MOD	40736R TA7762R	TA7606, 7, 8, 9, 10, TA7699, TA7925, TA7763, TA7864	TA7764 TA7765	
Voice Communications	PULSE		TA7606, 7, 8, 9, 10, TA7699, TA7925, TA7763, TA7864		
Ranging	PULSE		TA7699, TA7925, TA7763, TA7864, TA7705, TA7787	TA7764 TA7765	TA7687-92 incl.
Night Vision Applications	PULSE		All types above plus TA7867*		TA7924†

*GaAlAs—wavelengths from 800 to 880 nm

†77° K

Looking for GaAs lasers and IR emitters? RCA has the devices to meet your requirements

Gallium-arsenide lasers and/or IR emitters are now being designed into a wide range of signaling and illumination equipment. For such applications, RCA offers a broad line of lasers and emitters—well-suited to meet these requirements.

RCA injection lasers feature high peak powers, low drive currents and proven reliability. Because of their simplicity, ease of drive, and covert wavelength, they are naturals for in-

trusion alarms, ranging, data-link communications and secure illumination. RCA IR emitters feature small size and high efficiency. Their pre-focused, high brightness beam pattern allows optimum performance in card readers, shaft encoders, short range intrusion alarms and data-link communications. Finally, RCA lasers and emitters are compatible with most photodetector systems.

Try RCA's superior GaAs lasers and IR emitters in *your* system. You'll beam!

Circle Reader Service No. 306.

RCA Thyristors expands its triac line to 600 volts

RCA announces a new line of 600 V triacs available now for industrial control manufacturers. These new triacs have a 600-V peak repetitive rating at a maximum rated junction temperature of 100° C.

In difficult industrial applications where ac power sources demand

600 VOLT TRIACS				
Package	10 A	15 A	30 A	40 A
Press-Fit	40795	40797	40671	2N5443
Stud	40796	40798	40672	2N5446
Isolated Stud	40801	40804	40807	40690

added safety margin, this group of RCA triacs can be used to assure reliable equipment operation.

These new triacs (as the chart illustrates) range from 10 amperes, with availability in press-fit, stud and isolated stud packages.

Circle Reader Service No. 307.

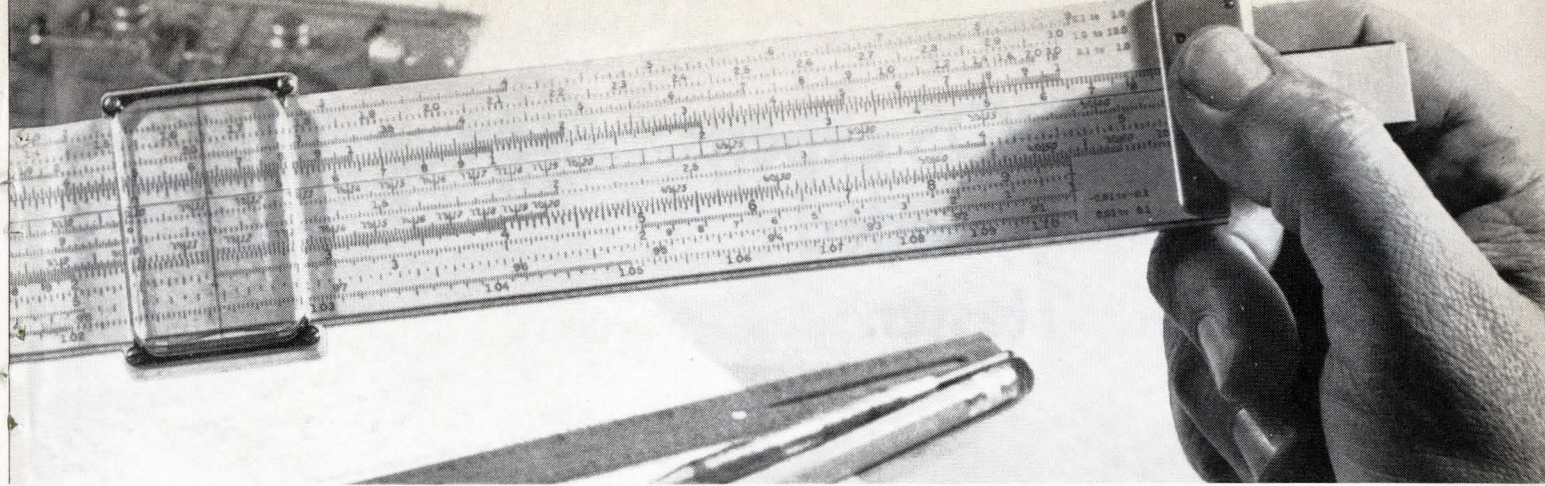

TA7625A: a new high power op amp

RCA's new TA7625A plastic power hybrid amplifier is capable of handling 7 amperes peak current. It is a modification of RCA's well known TA7625 linear amplifier, and thereby

terminal 3 and 4) can be varied to minimize distortion at low frequencies.

What does this mean to the designer? It means that he is better able to use the hybrid as a current source. It also means that the TA7625A has greater capability and

is constant within 1 dB over the full -55°C to $+125^{\circ}\text{C}$ temperature range. With slide rule and bread-board you can custom-tailor this circuit to your own specifications.

RCA's CA3018 and its companion type, the CA3018A, are well suited to a variety of applications in low power systems in the dc through VHF range. The CA3018 provides a V_{BE} match of $\pm 5\text{ mV}$. In the CA3018A, V_{BE} is matched within 2 mV and performance characteristics are controlled from $10\ \mu\text{A}$ to 10 mA. You can purchase the CA3018 for just 98¢, the CA3018A for \$1.35 (at 1000-unit levels).

The circuit shown here may also be built with the five-transistor CA3045 in a DIC package or the CA3046 in a DIP package.

For Application Note ST-3895, "Design Ideas for RCA Linear Arrays," circle Reader Service No. 309.

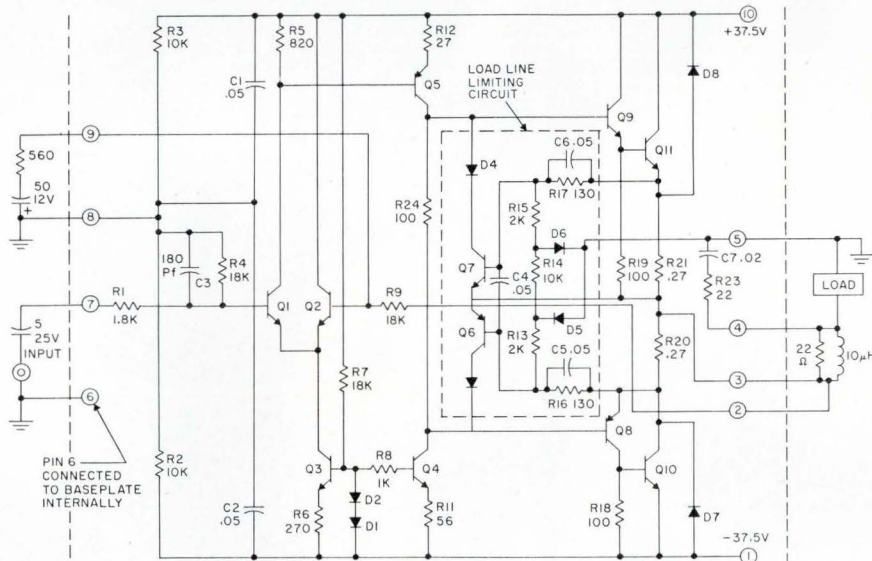

SCHEMATIC OF TA7625A HYBRID POWER MODULE.

provides added versatility. With minor circuit changes, the TA7625A can replace the TA7625.

The TA7625A has both short-circuit protection and reactive load-fault protection. Its inverting terminals are external. Thus the feedback resistor (22 ohms across

versatility in servo-amplifier applications, in voltage-regulator circuits, inverters, and in deflection-amplifier circuits ($V_S = \pm 37.5\text{ V max.}$).

Contact your local RCA Representative for planned price reductions.

Circle Reader Service No. 308.

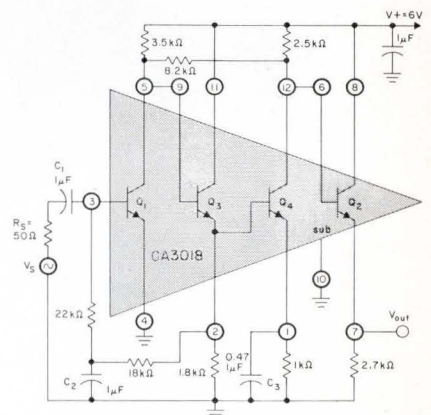

SCHEMATIC OF WIDEBAND VIDEO AMPLIFIER USING THE CA3018.

Custom design your own 30 MHz broadband amplifier with IC's transistor array

RCA's CA3018—monolithic, four-transistor array—offers the circuit designer a best-of-both-worlds approach. Here you have the economy, compactness, and device matching and temperature tracking you expect of IC's, combined with accessibility and design freedom that

normally require discrete transistors. In the CA3018, two independent transistors and two Darlington-connected transistors are housed in a 12-lead TO-5 style package.

The wideband video amplifier shown here (in the schematic at right) utilizes the CA3018 to provide a 30-MHz bandwidth and a gain of 49 dB—with two feedback loops for excellent stability across the full frequency range. Gain of the amplifier

For price and availability information on all solid-state devices, see your local RCA Representative or your RCA Distributor. For specific technical data, write RCA, Commercial Engineering, Section 70K-9/UM6, Harrison, N. J. 07029. International: RCA, 2-4 rue du Lièvre, 1227 Geneva, Switzerland, or P.O. Box 112, Hong Kong.

**We asked 37 MOS experts
what they really needed
in a high speed tester.**



When Xintel decided to build the best MOS tester in the world, we knew there was only one way to go about it.

First—find out what the industry really needed by talking to the experts at the manufacturing and large user level.

Then—and only then—would we put our engineers to work designing the product.

So we pooled our Hertz, Diners, Am Ex, Air Travel Cards and took to the road, interviewing every MOS/LSI maker and user we could find.

Our tour took us to National Semiconductor, Fairchild, Intersil, 4-Phase Systems, Signetics, Electronic Arrays, American Microsystems Inc., Motorola, Mostek, Semiconductor Electronic Memories Inc., Advanced Memory Systems, Raytheon, Intel, Monolithic Memories, IBM, Cogar, Philco, General Instruments, MOS Technology, Garrett, Uni Sem, General Digital, RCA, Computer Microdevices . . .

Most of these companies were eager to discuss the problems of testing RAMs, ROMs and complex arrays.

Here is what they told us.

"Building MOS Testers isn't for the Weak, Faint Hearted, or Inexperienced"

No argument here. That's why we put together a team of practical, no-nonsense, systems-oriented guys who know their way around MOS testing like an experienced airline pilot knows his way around the sky.

Men such as Bill Ackley, John Coons, Rod Mack, Ken Watanabe, and Ed Edwards. That's the Xintel MOS squad. A group of real heavy-weights. And each is capable of wearing a number of different hats.

"It should test MOS and Bi-Polar Devices"

Ours will. We can generate and measure a wide range of positive and negative voltages to handle P-channel and N-channel MOS/LSI chips and wafers plus all types of bi-polar ICs.

We can handle Random Access and Read Only Memories, Shift Registers and Random Logic Arrays. Those now in production and those that are just a gleam in the eyes of MOS designers.

"We need to make three kinds of tests"

We coined a new word—Dy-metric®—to describe the operation of the Xintel MOS tester which makes parametric, functional and dynamic tests. Most of them simultaneously.

Because timing is so important, our tester uses a fast mini-computer for loading and translating data—plus additional high speed memory capable of outputting complete word patterns at megacycle rates.

"Make it flexible—yet economical"

No monster here. Our survey helped separate the wheat from the chaff, the real from the imaginary. Instead of chasing rainbows we designed a reliable, flexible MOS test system. It has many data logging modes for wafer probe, final test, device classification or engineering analysis. Our tester will be working when many of the high priced monsters are dead in the water.

"Keep the software simple"

We've developed a language so your engineers and techs can type, edit, compile and execute tests directly from the Teletype keyboard—using simple English source statements. They can concentrate on testing—not programming.

"Give us plenty of peripherals"

And we have. Disc and core memory for supplying data to the computer—high speed paper tape punch and reader—hard copy output from a TTY or a high speed line printer—plus computer control of functions such as probe-down sensing, off-wafer detection, inking, sorting . . .

"No relays, please"

Reliability and speed of testing of LSI devices requires new methods of switching. Reed relays just won't hack it.

Xintel's MOS tester will use solid-state electronic pin drivers to switch and measure voltages and currents at high speed. And they'll be far more reliable than mechanical switches.

Here Comes Spectrum I. The MOS Tester That 37 Experts Helped To Design!

Here comes Spectrum I—the sensible MOS tester. It should be. After all, 37 MOS experts helped in the design concept. We'll be conducting special industry showings this fall. In the meantime, for more of the exciting Xintel story just write or circle the reply card.

Xintel
Corporation

20931 Nordhoff • Chatsworth, California 91311 • (213) 882-8811

Circle 31 on reader service card

THE ONLY THING YOU LOSE WITH THIS NEW POWER SUPPLY IS A LOT OF EXTRA FAT



Compact new "Cube-Pacs"™ offer complete power supply packages at a fraction of the size and weight of conventional power supplies.

The inside secret: a network of unique Powercube® modules that provide just the power supply you need in as little as 7.2 cubic inches and 7 ounces. Weigh that against the power supply you're now using!

"Cube-Pac" design flexibility permits innumerable output combinations up to 100 volts. These new power packages also give excellent heat transfer... input-output isolation... line and load regulation... high efficiency... all in an RFI/EMI shielded enclosure. All the more reason to write for complete information today.

And take pounds off your power supply.



POWERCUBE CORPORATION

214 CALVARY STREET, WALTHAM, MASS. 02154 (617) 891-1830

SUBSIDIARY OF UNITRODE CORPORATION

Light valve is bright spot for liquid crystals

New Bell Labs unit described at Electron Devices Meeting can amplify and project low-level image signals

Putting liquid crystal materials into useful devices hasn't been easy. In fact, the future has brightened only lately due largely to the formulation of compounds which are stable over practical temperature ranges. But difficult as the materials were to handle, there's never been a lack of schemes for using them—ranging from numeric indicators and clocks with no moving parts to optical terminals for computers. Now Bell Labs has come up with another one.

The device, described at the recent Electron Devices Meeting in Washington, was one of several developments that came out of the meeting. These will be described on the two following pages.

Called a light-activated light valve, the Bell device takes an image and (via some simple, noncritical optics) amplifies its intensity up to 100 times, while projecting it from a two-inch square onto a room-sized screen. The Bell System is eyeing the valve for possible picturephone service, but clearly the valve may find applications wherever low-level signals are played.

Selenium photoconductors are now being used. However, Bell will switch to cadmium sulfide to increase brightness by a factor of 100.

The heart of the device is a pho-

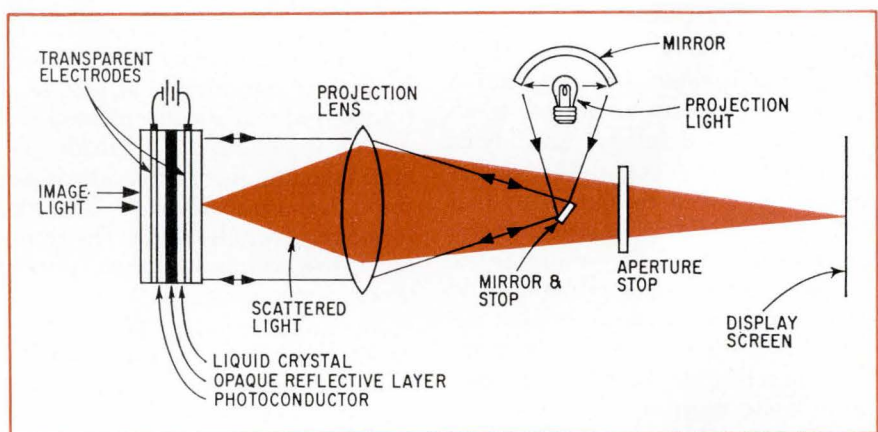

Light traffic. Bell Laboratories' new light valve could find its way into low-level signal applications—for example, CRTs.

toconductor-liquid crystal pair sandwiched between two transparent electrodes, with an opaque reflective layer optically separating the photoconductor and liquid crystals. This structure forms the image plane of a projection system—a lens, light source, mirror and stop, and display screen.

Right now, resolution is 250 lines per inch. This can be increased to 500 lines with no problem at all, says Bell. Moreover, the developers see no screen size limitation.

In operation, an image light falls on the photoconductor-liquid crystal cell, which is biased with dc voltage. The voltage is arranged so that when no image is present, most of the voltage goes across the photoconductor; the voltage across the liquid crystal stays below the switching threshold. But when an image is present, the photoconductor transports current to the liquid crystal, creating dynamic

scattering at the conduction points.

Meanwhile, on the other side of the cell, the projection lamp source is focused onto the liquid crystal. When no image is present the projection light is simply reflected by the liquid crystal and blocked by the stop from reaching the screen. However, when the image is present and the dynamic scattering exists in the liquid crystal, the projection light is scattered past the stop and reaches the screen, where it is displayed. Since the projection light can be many times brighter than the image, amplification can be enormous—a thousand times.

Overlap key to GE's charge-coupled device

When Bell Laboratories developed a new type of MOS structure that operated by transporting a charge across an insulator-semiconductor

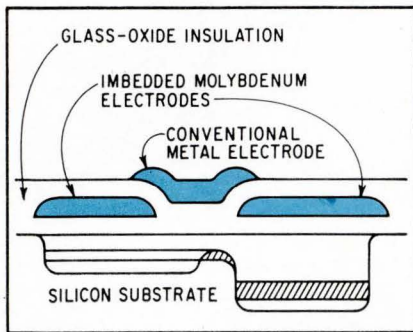

Key. GE device features overlapped molybdenum electrodes.

interface [*Electronics*, May 11, p. 112], few people realized that a simpler, more sophisticated semiconductor technology had been launched. Now General Electric has come up with a development that may well move charge-transfer technology out of the laboratory.

Unlike conventional bipolar and MOS structures, charge-coupled devices require no diffusion regions or contacts into the silicon to perform shift register functions. The key to the construction of the new GE device—called a surface-charge transistor by its inventors—is an overlapping double-layer molybdenum metalization process previously developed by GE for fabrication of self-aligned gates and MOSFETs.

In the GE process, the transfer gate electrodes overlap the source and receiver electrodes so that mask alignment is not critical, as it is with Bell Lab's single-layer metalization CCDs. Moreover, the active portion of the transfer gate is automatically aligned with the spaces between the previously formed storage electrode, allowing fabrication of very narrow transfer gates and resulting in higher transfer speeds.

The self-registration feature, together with the inherent simplicity of the GE approach, makes possible densities on the order of several million transistor elements per inch. This density is high enough for a self-scanned video device, and may permit information storage density of 1 million bits per square inch—at least 10 times better than present

MOS shift registers. With this potential, the surface charge transistor could become the building block for computer mainframes.

The GE circuit provides amplification of both voltage and electrical charge, while performing the charge transfer function. This means the new element provides both MOSFET and CCD functions simultaneously.

The surface-charge transistor is similar in concept to the MOS device. It has three electrodes—source, transfer gate and receiving (drain). In shift register operation, the source and receiving electrodes have the same area, and charge is transferred via locally created depletion regions from the oxide surface beneath the source electrode, through the transfer gate electrode, to the receiver electrode. The transfer gate's voltage controls charge flow.

To obtain voltage gain, the receiving electrode is made smaller than the source electrode, so that the transfer charge occupies a smaller depletion region.

Plastic package called better than TO-18

A low-cost plastic transistor package that has demonstrated greater reliability than the expensive hermetically sealed TO-18 can is in mass production at Western Electric's Allentown, Pa., plant. D.M. Sutter and R.D. Wasser, Bell Laboratories engineers at Allentown who helped develop the package, reported at the Electron Devices Meeting that the transistors have a mean time between failure of 10^8 hours at 125°C , the normal junction operating temperature.

The MTBF figure is based on 30,000 hours of accelerated life testing in which the transistors stood up to 10^4 hours at 300°C junction temperature. What's more, lead pulling and bending tests also have shown that the plastic package offers mechanical performance that's equal to that of the TO-18.

To get this kind of reliability in a plastic package, the Bell engi-

neers use a transistor chip with silicon nitride coating and gold-platinum-titanium alloy contacts instead of the usual aluminum. The nitride blocks impurities; the contact resists corrosion.

The silica-filled silicone encapsulating material was selected because it offers ease of flow into the encapsulating molds, low dielectric loss, resistance to high temperatures, and purity, Wasser says. The nickel leads were chosen because the corrosion-resistance metal has a high thermal expansion that matches that of the plastic and is ductile and bondable, and is compatible with metal stamping techniques.

Gunn fights way into local oscillator

In scoring impressive performance gains across the frequency band [see p. 103] the avalanche oscillator would seem to leave little room for the Gunn diode, except perhaps in certain X-band local oscillator applications, where low noise is the prime requirement. But don't count them out yet. Just developed by Varian Associates in Palo Alto, Calif., is a series of moderate power Gunn oscillators for the 40 to 60 gigahertz range that will give any Impatt a good fight.

In fact, in Pasadena, Calif., Jet Propulsion Laboratory is using some of them as local oscillators in key systems, and has already logged 1,000 hours on the devices with good results. Moreover, JPL reports that the noise figures on the Varian Gunns are as low as those of commercially available klystrons in this frequency range.

Power output is moderate, but Varian feels it is sufficient for most low applications in the 40 to 60 gigahertz range. For example, at 40 GHz, the device produces 8 milliwatts of output power at 3% efficiency; at 55 GHz it puts out 18 mW. Most important, supply voltages are very low: the unit uses 3.8 volts d-c and 450 milliamps for 55-GHz operation. Moreover, it's also temperature compensated, so

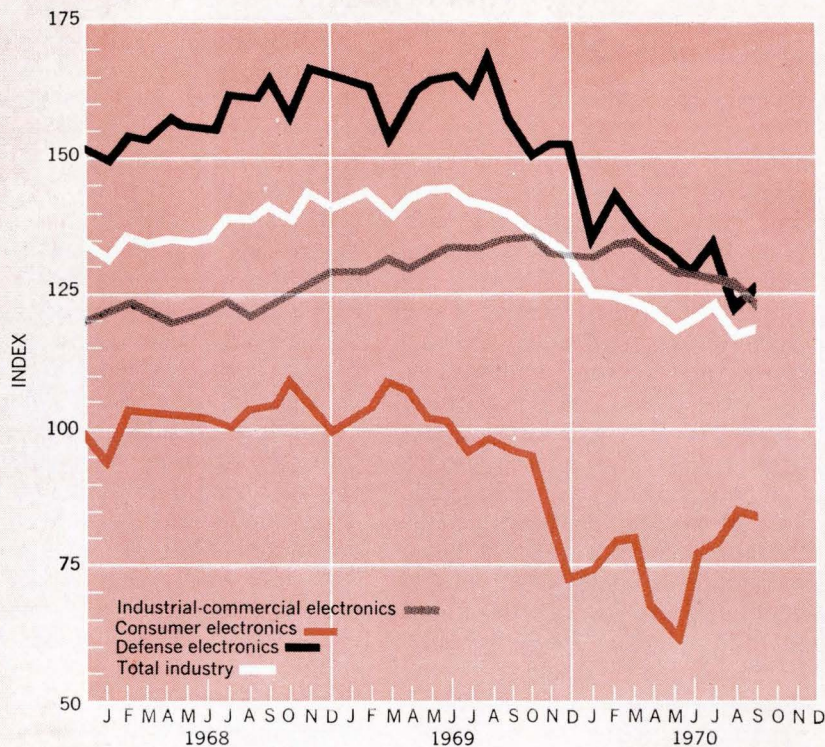

Segment of Industry	Sept. '70	Aug. '70*	Sept. '69
Consumer electronics	85.0	86.2	96.8
Defense electronics	127.1	124.1	157.8
Industrial-commercial electronics	124.8	127.3	135.8
Total industry	118.9	118.2	140.9

Electronics Index of Activity

Nov. 9, 1970

The index inched upward in September for the second straight month, reaching 118.9 from August's downward-revised 118.2. However, the figure is still a whopping 22 points behind the year-ago total.

The only individual component of the index to rise in September was defense electronics, up 3 points to 127.1, but it's still down 33.7 points from the September 1969 figure. The other two sectors fell, though not by enough to bring down the total index. The industrial-commercial area declined 2.5 to 124.8, while consumer electronics dipped 1.2 to 85.

Indexes chart pace of production volume for total industry and each segment. The base period, equal to 100, is the average of 1965 monthly output for each of the three parts of the industry. Index numbers are expressed as a percentage of the base period. Data is seasonally adjusted. *Revised.

that frequency variations are tiny—only 20 parts per million over a 0 to 50°C range.

The oscillators are hermetically sealed packages designed into standard rectangular cavities, with iris coupling to output waveguides.

Computers

New IBM minis to hasten shakeout

The minicomputer shakeout may be about to intensify significantly. And the cause of this trend, as of most trends in the computer industry, is International Business Machines Corp.—or, more precisely, IBM's introduction of the System 3 model 6 and the System 7. While this announcement may not sink the well established firms like Digital Equipment Corp., Hewlett-

Packard, and Data General, it will definitely manure many small, undercapitalized firms hanging on by their long and strong fingernails.

The System 3 model 6 upstages the company's year-old System 3 [*Electronics*, Aug. 18, 1969, p. 48], now known as the model 10. Both units are intended for the customer who is utterly lacking in any technical expertise. The model 6 includes as an optional feature a high-speed wire matrix printer similar to one offered on the System 370 model 155, capable of printing at 85 characters per second both left-to-right and right-to-left—the reverse printing is in lieu of a carriage return function for continuous printing. And like the older model 10, the new machine can use the small, 96-column punched cards—but card-handling hardware is an optional extra. The system's basic input medium is the keyboard and an integral disk

drive. First shipments to customers will be in 60 days.

The System 7 is "sensor-based"—an IBM neologism that is supposed to include process control, data acquisition, laboratory instrumentation, and all other environments in which measurements are combined and computed. It uses an all-semiconductor memory, as did the System 370 model 145 [*Electronics*, Oct. 12, p. 125]; the memory is made with the same technology but packaged differently than in the model 154. The System 7 is IBM's least expensive computer, renting for as little as \$352 a month, and selling for a minimum of \$16,060—thus getting into the price area first opened in 1965 by Digital Equipment Corp.'s PDP-8, and since abandoned by DEC for the \$5,000 to \$10,000 sector.

DEC doesn't seem to be particularly worried. "We had expected something more spectacular and

competitive," says Nicholas J. Mazzaresse, DEC vice president for small computer products, "say, a machine selling in a full-fledged system configuration for about \$16,000. By the time you add enough options to make up a decent system, IBM's new baby costs over \$20,000. I can't foresee any pinch except maybe in rentals—and that's less than 10% of our business."

Although System 7's memory cycle is 400 nanoseconds, substantially faster than the 1.2 microseconds of DEC's PDP-11, Mazzaresse says DEC will have a high-speed memory module available well before IBM's first deliveries, in November 1971. "This makes the System 7's cycle time a little academic," he says.

Data General also doesn't have too much to worry about; its Supernova SC clips along at 300 nsec. None of the minicomputer manufacturers seem to be worried about losing business to IBM; on the contrary, they figure IBM will bring new and unsophisticated users into the computer market, skim off some for itself, and increase business for firms like Data General and DEC. IBM's traditional price umbrella will help.

One advantage IBM System 7 customers will enjoy is service. "Most minicomputer manufacturers have poor service arrangements," says Milton Collins, head of computer engineering and programming at Teradyne Inc. "As a result, firms like Teradyne, which uses small computers in semiconductor test systems, have to do their own servicing. IBM's extensive service network and good reputation for service obviously will improve the situation."

IBM didn't say anything about a core memory as an optional extra or replacement for the semiconductor memory. One observer who is familiar with the System 7's market area found this surprising. "People worry about volatility of data in the control applications market," he says, "and a core backup could be a valuable option." Perhaps IBM will offer such an option soon.

Military electronics

DASA wants tubes to counter EMP

After government and industry investments of billions of dollars and uncounted engineering man-hours in the research, development, and production of solid state circuits, the Defense Atomic Support Agency is recommending reversion to the tube for some military electronics systems. The reason: tubes are better able to resist overvoltages created by intense electromagnetic pulses created by explosion of nuclear warheads outside the atmosphere. The DASA recommendation is contained in an EMP handbook, prepared by the Illinois Institute of Technology Research Institute, that's designed to tell managers how to protect military electronic systems.

The DASA handbook, when released, will stand as one of the rare unclassified documents on EMP. It flatly states that EMP is a "threat to nearly all sophisticated military systems." It explains that a 1-megaton burst outside the earth's atmosphere could rain gamma rays over a 1,000-mile circle. These rays, in turn, dislocate valence electrons from air molecules when they penetrate the atmosphere. Thus, a cloud of fast-moving electrons is created that generates intense electromagnetic fields when it is bent by the earth's magnetic field.

Because the rise time of the initial signal pulse is in the 10-nanosecond range, frequencies as high as 100 megahertz are produced. The free electrons then oscillate for several milliseconds as they are drawn back to their matched ion pairs, generating enormous amounts of radiation that cover the frequency spectrum.

The fields are incredibly intense. The handbook says that while nearby communications transmitters might generate fields of 10 volts per meter or adjacent radar might emit 100-volts-per-meter fields, electromagnetic pulse fields

can pack up to 100,000 volts.

To test EMP countermeasures, DASA and the Air Force are building simulators to test components. One such facility just completed is the Advanced Research Electromagnetic Simulator, A \$6.5 million EMP generator located at Kirtland Air Force Base, N.M.

The ARES, designed and built by EG&G Inc., can be used only to test EMP resistance of the weapon itself; it cannot be used to test missiles and their command electronics buried in silos. For siloed missiles, the Air Force Weapons Laboratory is asking industry for bids on airborne simulators that can be towed over hardened sites. Two solicitations have been sent out to date. One asks for bids on a 3,000-foot glider that would contain an antenna and a 25-megavolt capacitive generator, capable of storing 625 kilojoules of energy; the other seeks bids on a 1,000-foot dirigible 45 feet in diameter that would carry similar equipment.

Integrated electronics

Slight change increases breakdown voltage

One of the main circuit limitations of MOS field effect transistors is that they have a fairly low breakdown voltage—on the order of 30 volts. But by making a slight modification to its standard MOS process, National Semiconductor has been able to increase this to above 100 volts.

When a MOSFET is turned off and the drain voltage increased, becoming more negative, three things happen.

- First, the p-n junction depletion layer increases in width but bends toward the p region at the surface. This causes a critical field to be reached near the surface of the silicon, where the depletion region is narrowest. Therefore, avalanche breakdown occurs.

The degree of bending and the depletion width are functions of substrate resistivity, junction depth, and gate voltage. Theoretically, a

portable
from any viewpoint

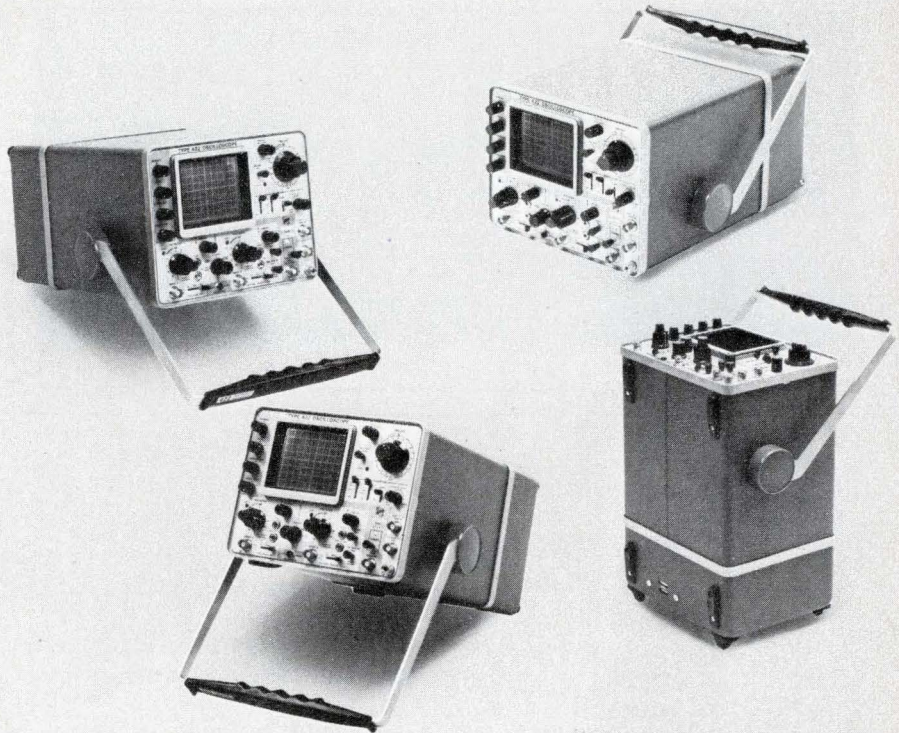

Tektronix 422 Oscilloscope

The 422 isn't portable as an afterthought—it was designed that way for your convenience. It's designed to travel in your car, aboard airplanes and boats, in mobile electronic facilities—anywhere you have room for a small 22-pound package. When you reach your destination, simply remove the panel cover and the ruggedized 422 is ready to display waveforms with laboratory precision. Dual channel, 10 mV/div (ch 2 is 1 mV/div AC), 50 ns/div sweep rate with X10 mag, 15-MHz performance in a "portable designed" package. Take along a 422 when you need a truly portable, high-performance oscilloscope.

The 422 is available in AC and AC/DC models. The AC model operates from 115 or 230 VAC, 45 to 440 Hz; the AC/DC model operates from AC, an internal rechargeable battery pack or from external 11.5 to 35 VDC.

For a demonstration of the 422 in your application call your Tektronix Field Engineer or write, Tektronix, Inc., P. O. Box 500, Beaverton, Oregon 97005.

422 AC Model \$1500—422 AC/DC Model with batteries \$1990,
FOB Beaverton, Oregon.

Available in U.S. through the Tektronix lease plan

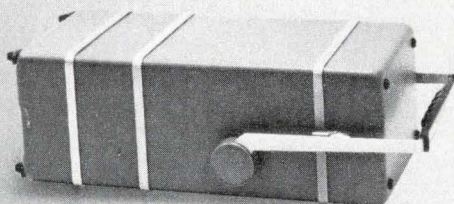
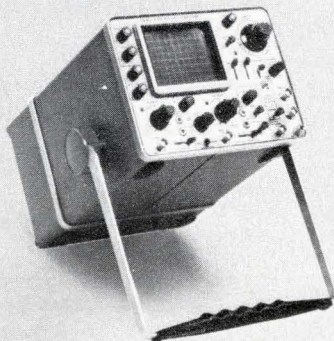
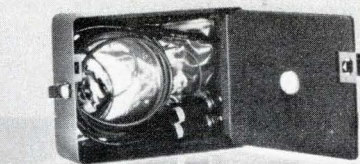

AC/DC Model



TEKTRONIX®

committed to progress
in waveform measurement

See The Tektronix Display At *FJCC*

Circle 37 on reader service card

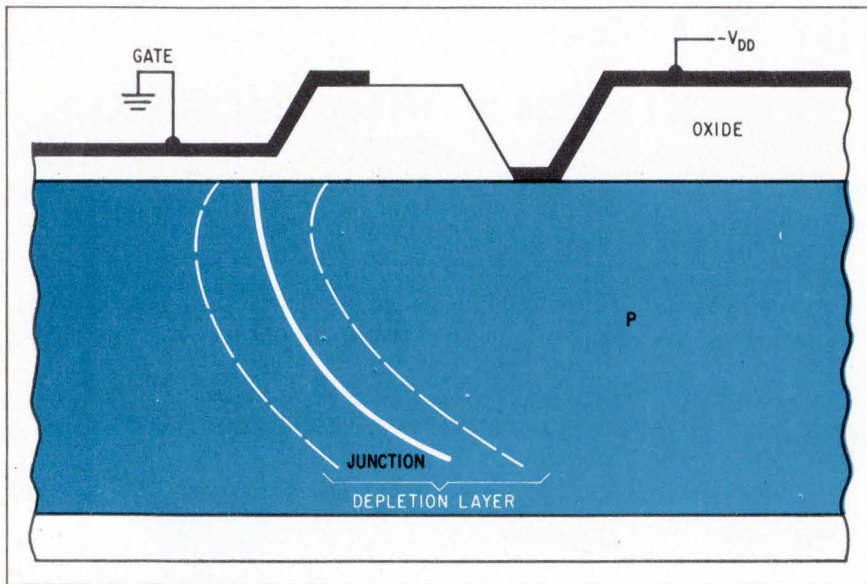

Presto. National Semiconductor, by modifying MOS IC silicon process has achieved a structure that limits depletion-layer curvature.

junction may withstand 120 V, but the bending causes a drastic reduction, to as little as 30 volts. And though the breakdown is not destructive, the device malfunctions.

- Second, if the drain-source spacing is narrow and the gate is biased slightly negatively, the increased drain voltage will cause the depletion layers of the drain and source to meet in the channel region of the substrate. This is called punchthrough, which is also not destructive—but also causes the device to malfunction, by creating the effect of a p-type channel in the normally n-type substrate.

Punchthrough voltage depends on drain-source spacing, the impurity gradient in the p regions, and substrate resistivity, as well as drain and gate-voltages. The spacing is very narrow in logic ICs for high gain and high component density. Heavy doping of the p regions forces almost all the depletion-layer width to be in the substrate. A gate bias that is slightly negative, but not negative enough to invert the substrate under the gate from n-type to a p-type channel, is not uncommon. When it occurs, it enhances punchthrough by allowing the source depletion layer to extend along the silicon surface toward the drain depletion

layer. Consequently, punchthrough can also occur at voltages as low as 30 volts.

- Third, since the gate is almost at substrate potential, increased drain voltage causes a field to develop within the thin oxide, isolating the gate electrode and drain. If the critical field of the oxide is reached, it will rupture. At oxide thicknesses necessary for reasonable gain (about 1,000 to 1,200 angstroms), practical rupture potentials are about 70 to 100 V. Theoretically, very pure and defect-free silicon oxide can withstand higher potentials, but defect sites are created by the doping and oxidation processes. The oxide typically ruptures near the p-n junction, which, as noted, is under the thin oxide and formed by heavy doping.

Standard processes do not offer much relief from these breakdown modes. Widening the channel does raise the punchthrough voltage, but does not solve the other problems, and furthermore negates the chief advantage of MOS, high component density.

But all of these problems can be prevented by a structure that limits the depletion-layer curvature and moves much of the layer under thick oxide at high voltages. This structure can be achieved with a simple modification of the (100)

silicon process that National has used to make MOS ICs for several years.

The basic requirement of the structure is that the p-n junction have a linear gradient, so that the depletion width will spread into both sides of the junction, and so that junction breakdown voltage is increased because of the decreased concentration gradient at the junction and better junction curvature. This structure is achieved by making a deep diffusion into a substrate of relatively low resistivity. It relieves the three breakdown modes as follows:

- The linearity and improved curvature of the junction increases p-n junction breakdown voltage to 100 V or better. Typically, the new devices can stand off a drain voltage of -110 V.
- While the substrate resistivity is kept high enough to maintain the 100-V breakdown voltage, it is reduced somewhat to limit the extension of the depletion region into the channel. This increases the punchthrough voltage to better than 100 V.
- And finally, oxide rupture is prevented by the fact that about half the potential between the drain and the gate electrodes must be dropped across the drain-to-substrate depletion layer. Thus the stress on the oxide is relieved by about 40% to 60% and the structure is able to withstand more than 100 V.

Companies

How to succeed in buying a business

Underlining the drive to catalog lines of large-scale integrated circuits is the Kenics Corp.'s quick move into the business—a move with a twist. Though planning to sell standard products to the commercial market, it initially acquired an operation that was making custom devices to military specifications for in-house projects.

Now, its wholly owned subsidi-

Now, Pixiepot® precision 10-turn wirewound pots priced as low as \$3.25



Now, you can order new, improved Pixiepot® 10-turn wirewound potentiometers directly from this data sheet at the lowest pot prices anywhere!

For as little as \$3.25 (see price schedule), you get the world's smallest precision mini-pots for commercial and industrial applications, with all these special high performance features available: • High torque 2 to 8 oz. — in., • Custom bushing length, shaft configurations and lengths, • Any resistance within the range, • Linearity tol. $\pm 0.1\%$, • Resistance tol. $\pm 2\%$. Standard features include: • Newly developed superior high impact plastic housing, $\frac{3}{4}$ " length and $\frac{7}{8}$ " diameter size. • Gold-plated terminals, welded terminations and slotted stainless steel shaft with bushing mounting. Call your nearest Pixiepot distributor listed on the opposite side of this page for fast off-the-shelf delivery of standard models.

PRICE LIST FOR PIXIEPOT POTENTIOMETERS

DESCRIPTION	1-9	10-24	25-49	50-99	100-249	250-499	500-999	1000-2499	2500-4999	5000-9999	10,000 UP
Model 3253, Std. Res.	4.95	4.90	4.80	4.70	4.50	4.30	4.10	3.90	3.65	3.47	3.25

SPECIAL FEATURES (ADDITIONAL CHARGES)

	1-9	10-24	25-49	50-99	100-249	250-499	500-999	1000-2499	2500-4999	5000-9999	10,000 UP
$\pm 2\%$ Res. Tol.	5.00	3.00	2.00	1.50	1.00	.75	.60	.50	.45	.40	.35
Hi-Torque (HT)	.95	.85	.75	.65	.60	.55	.50	.45	.40	.35	.30
Ind. Lin. $\pm 0.1\%$	5.00	3.00	2.50	2.25	2.00	1.75	1.60	1.50	1.50	1.50	1.25
Shaft Lock	.50	.45	.40	.35	.30	.25	.25	.25	.25	.20	.20
Spec. Res. (1)	Min. quan.	3.50	1.60	1.05	.65	.30	.20	N/C	N/C	N/C	N/C

(1) Any value between 100 Ω and 100K other than standard values shown in table. For resistance values outside this range, contact factory.



SPECIFICATIONS

ELECTRICAL

Actual electrical travel ($+10^\circ - 0^\circ$) 3600°
 Normal resistance range 100 Ω to 100K
 Extended resistance range 25 Ω to 150K
 Resistance tolerance, standard $\pm 5\%$
 special $\pm 2\%$
 Power rating at 20°C derating to 0 at 85°C2
 End resistance within linearity tolerance or 0.1 Ω whichever is greater
 Linearity, independent, tolerance, standard $\pm 0.25\%$
 special $\pm 0.1\%$
 Equivalent noise resistance, max. (ohms) meas. per VRCI stds. 1,000
 Insulation resistance at 500 VDC, min. (megohms) 100
 Dielectric withstanding voltage (volts RMS) 1,000

MECHANICAL

Total mechanical travel ($+15^\circ - 0^\circ$) 3600°
 Mechanical life, shaft revolutions, normal conditions 500,000

Cups, max. number 1
 Moment of inertia, approx. (gm-Cm²) 0.3
 Weight (oz) 0.5
 Stop strength, static (oz-in)50
 Torque: Standard starting, Max. (oz-in) 1.0
 Special (designated H.T.) (oz-in) 5 ± 3

ENVIRONMENTAL

Temperature range, standard -25° to $+85^\circ$ C
 Humidity and dust protection enclosed construction
 Vibration 10G to 2,000 cycles
 Shock 50G

TYPICAL SPECIAL FEATURES AVAILABLE

Shaft lock • Any resistance within the range • High Torque • Resistance Tol. $\pm 2\%$ • Linearity Tol. $\pm 0.1\%$.

CUSTOM FEATURES AVAILABLE

• Bushing length • Shaft configurations and length

Pixiepots are also available in a combination package with Model 61 miniature turns-counting dials at one super-budget price! Example: 5,000 ... \$6.95

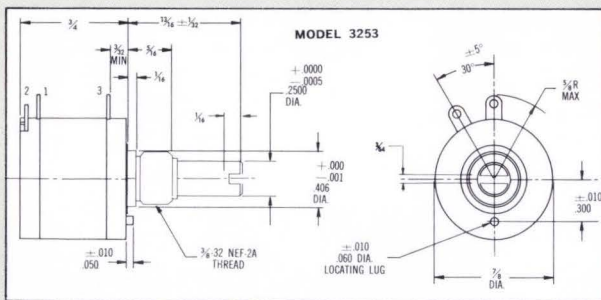

NOTE: Lock washer and hex nut supplied with each unit. Design details subject to change without notice. Certified Drawings available on request. Tolerances unless otherwise specified: Fractional: $\pm \frac{1}{4}$ " Decimal: $\pm .005$ " Angular: $\pm 1^\circ$

Talk to Duncan engineers direct for immediate answers to your special requirements. You can use this toll-free telephone number from anywhere in the nation: 800-854-3252. (California residents, call collect (714) 545-8261)

DUNCAN ELECTRONICS
SUBSIDIARY

SYSTRON + DONNER

2865 FAIRVIEW ROAD COSTA MESA, CALIFORNIA 92626

TYPICAL COIL CHARACTERISTICS FOR STANDARD RESISTANCES

Standard Resistance (Ohms)	Theoretical Resolution Nominal (%)	Max. Appl. Voltage (Volts DC)
100	.051	14
200	.042	20
500	.036	32
1K	.025	45
2K	.023	63
5K	.021	100
10K	.016	140
20K	.015	200
50K	.011	316
100K	.008	447

All resistances shown are manufactured with resistance wire with temperature coefficient of .002%/°C (20 ppm) nominal.

HOW TO SPECIFY

When ordering a PIXIEPOT, indicate the model number, resistance, linearity tolerance and any additional special features. The letters "R" and "L" precede the resistance and linearity respectively.

Example: 3253 R1K L.25 HT
 Model Number _____
 *Resistance (Standard Tolerance) _____
 Linearity Tolerance (\pm) _____
 Code letter SL Shaft Lock / HT High Torque _____

*If the resistance tolerance is $\pm 2\%$ show the tolerance in parenthesis () after the resistance. E.g. R1K(2) designates a 1K resistance with a tolerance of $\pm 2\%$. For resistance values less than 1,000 ohms (1K), show the actual value omitting the letter "K". E.g. 3253R100L.25 is a 100 ohms resistance.

Duncan Model 3253

Call your nearest distributor for fast delivery of in-stock Pixiepots

Duncan Model 3253



DISTRIBUTORS

Akron Elect. Supply Co. Akron, Ohio 44306 (216) 762-8818

John A. Becker Elect. Co. Dayton, Ohio 45402 (513) 224-1071

Bodelle Co., Inc. Chicago, Ill. 60627 (312) 468-1017

Bodelle Co., Inc. Detroit, Mich. 48235 (313) 273-6920

Bodelle Co., Inc. Fort Wayne, Ind. 46815 (219) 485-3929

Mace Electronics Erie, Pa. 16505 (814) 838-3544

Radar Electric Co. Seattle, Wash. 98119 (206) 282-2511

Richey Elect., Inc. North Hollywood, Ca. 91601 (213) 877-2651 (213) 761-6133

*San Diego, Ca. 92103 (714) 291-4955

*Las Vegas, Nev. 89102 (702) 870-5996

*Agents of Richey Elect.

Solid State Electronics Dallas, Texas 75220 (214) 352-2601

Southwest Elect., Inc. Houston, Texas 77036 (713) 782-3060

Sterling Electronics Watertown, Mass. 02172 (617) 926-9720

Perth Amboy, N.J. 08861 (201) 442-8000

South Norwalk, Conn. 06854 (203) 853-3153

Terminal-Hudson Elect., Inc. Mountain View, Ca. 94040 (415) 969-9240

M. Leff Radio Parts Co. Braddock, Pa. 15104 (412) 271-2800

SALES REPRESENTATIVES

FLORIDA & P.R.

Orbe, Inc. St. Petersburg, Fla. 33733 (813) 894-0687

Orlando, Fla. 32804 (305) 425-9004

METRO. NEW YORK & NO. NEW YORK

Sencor, Inc. Albertson, L.I., N.Y. 11507 (516) 747-1273

Montclair, N.J. 07042 (201) 783-5990

MIDWEST STATES

Carlson Elect. Sales Co. Chicago, Ill. 60648 (312) 774-0277

St. Louis, Mo. 63141 (314) 991-0262

Exon Electronics Minneapolis, Minn. 55421 Tel: (612) 788-4111

MICHIGAN

Elko Sales Corp. Grosse Pointe Woods, Mich. 48236 (313) 884-7893

Grand Rapids, Mich. 49506 (616) 949-1451

SOUTHERN STATES

Grady Duckett Sales Co. Atlanta, Ga. 30329 (404) 451-3529

Greensboro, N.C. 27420 (919) 273-4617

Huntsville, Ala. 35804 (205) 881-1213

WASH., OREGON, IDAHO & MONTANA Reeve Mktg. Assoc. Seattle, Wash. 98133 (206) 542-5889

ARIZONA & UTAH Southwest e/m Eng., Inc. Phoenix, Az. 85020 (602) 944-1521

OHIO, KY. & W. PENNA.

Rockford Cont. Ohio Dayton, Ohio 45414 (513) 278-7362(3)

Euclid, Ohio 44132 (216) 731-5250 Columbus, Ohio 43209 (614) 231-5890

TEXAS, OKLA. ARKANSAS & LA.

Kemp Engring. Co., Inc. Dallas, Texas 75220 (214) 357-6663

Houston, Texas 77023 (713) 928-5426

COL., WYOMING & NEW MEXICO

Waugaman Assoc., Inc. Wheatridge, Colo. 80033 (303) 423-1020

MID-ATLANTIC STATES

Marktron, Inc. Rockville, Md. 20850 (301) 762-6210

Towson, Md. 21204 (301) 825-8222

S. NEW JERSEY & E. PENNA.

Sencor, Inc. Philadelphia, Pa. 19152 (215) 342-0223

NEW ENGLAND STATES

Gerber Sales Co., Inc. Waltham, Mass. 02154 (617) 891-8040

New Haven, Conn. 06515 (203) 777-6279

East Longmeadow, Mass. 01028 (413) 525-3059

NO. CALIF. (RENO) Jack Pyle Company San Mateo, Ca. 94402 (415) 349-1266

SO. CALIF.

Factory Sales Office Costa Mesa, Ca. 92626 (714) 545-8261

UPSTATE NEW YORK

Reed Electronics, Inc. Rochester, N.Y. 14618 (716) 473-2767

Vestal, N.Y. 13850 (607) 748-7391

East Syracuse, N.Y. 13057 (315) 463-8955

INTERNATIONAL REPRESENTATIVES

AUSTRALIA

Rutherford Imports Pty. Ltd. E. Doncaster, 3109 848-3033

BELGIUM & LUXEMBOURG

N. V. Nijkerk S.A. Brussels 2, Belgium 28.20.70 (2 1.)

CANADA

Aero Sales Eng. Co. Rexdale, Ontario (416) 743-9130

Ottawa, Ontario (613) 828-8560

ENGLAND

Steatite Insulations Ltd. Birmingham EDG 6961/2

FRANCE

Radio TV Francaise 92 Neuilly-Sur-Seine, (Paris) 722-70-40

GERMANY (WEST)

Elektronik Bauelemente GMBH 46 Dortmund 1 (231) 528065

HOLLAND

Nijkerk's Handelsonderneming N.V. Amsterdam (020) 428933

ISRAEL

STG Int. Ltd. Tel-Aviv 53459

ITALY

Ingg. S. & Agostino Belotti Milano 54 20 51

JAPAN

Shoshin Shoji Kaisha Ltd. Tokyo (270) 5921-6

NEW ZEALAND

P. H. Rothschild & Co. Ltd. Lower Hutt 63-581

NORWAY

J. M. Feiring A/S Oslo 4 21 82 12

PORTUGAL

Sociedade Comercial Romar Lda. Lisbon 672161

SPAIN

REMA Leo Haag S.A. Madrid 3 253.40.03

SWEDEN

ALLHABO 10028 Stockholm 49 224600

SWITZERLAND

E. Fenner 4450 Sissach (061) 853385

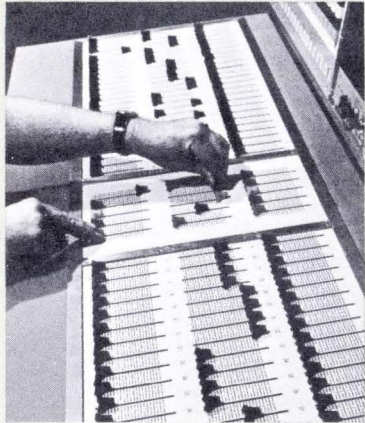
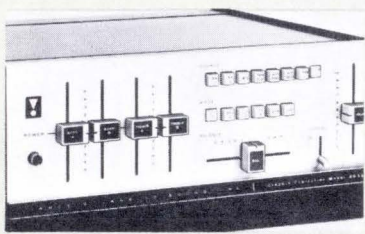

NEW! DUNCAN FADERS

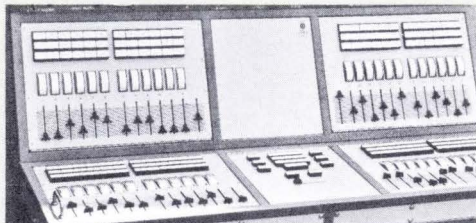

Slide actuated pots

The Duncan KP 200 series precision slide actuated potentiometer provides users with a 2 3/4" linear travel featuring essentially infinite resolution at low cost. The KP 200 series also provides: • Single or dual resistive elements • Linear or audio tapers • Standard tap positions • All metal housing and complete electrostatic shielding. Primarily used in the broadcast and recording industries, special applications in SCR lighting controls and commercial sound systems also have been numerous.

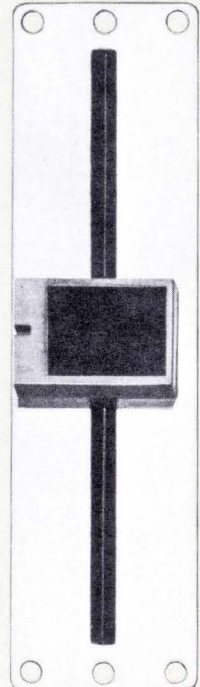

Send today for free catalog with complete specs.

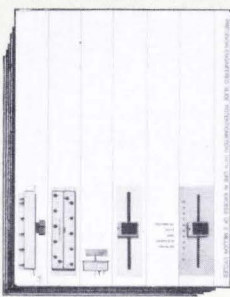

Contact factory direct for information on Duncan faders — call toll-free from anywhere in the nation: 800-854-3252. (California residents, call (714) 545-8261 collect.)

DUNCAN ELECTRONICS SUBSIDIARY



2865 FAIRVIEW ROAD □ COSTA MESA, CALIFORNIA 92626 PHONE: (714) 545-8261 □ TWX 910-595-1128

ary, Kenics Electronics Inc. of Largo, Fla., is selling a catalog of bipolar LSI devices which may be the most complex available over the counter. They may also be the largest—up to a quarter of an inch on a side, a size usually associated with MOS. Among them is a 1,536-bit read-only memory.

If the Largo address is familiar—it once was the home of the Honeywell Aerospace division's in-house LSI facility. When Honeywell decided to move the facility to Minneapolis, it found that only part of the staff would transfer. It also felt that buying new equipment was more feasible than transporting the old gear to Minnesota.

Earlier this year, Joseph D. Sabo, president of another Kenics subsidiary, Kenics Electronic Systems Corp., Cambridge, Mass., entered the picture. From 1965 to 1969, Sabo had been manager of the Poseidon guidance program at MIT's Instrumentation Laboratory, and was in a position to keep close tabs on the IC industry.

Sabo was able to snap up the plant as a going operation, and including about half the old Honeywell staff. Now Honeywell is a Kenics customer for some circuits.

Honeywell had been absorbing the plant's output in its avionic and military data processing programs, and had bought some experimental arrays for its Computer division. But the Largo plant wasn't producing anything commercial. And at first glance this may have looked like a liability. But gearing up to produce high-quality LSI circuits for aerospace applications forced the Largo operation to shake down tightly, speeding up the transition to commercial.

Sabo gives most of the credit to Herschel T. Hochman, formerly a staff consultant and supervisor for Honeywell, and now Kenics Corp. president. "Herschel applied the production control others just seem to talk about," says Sabo, "and he makes sure that his staff is just as careful as he is."

Hochman's tight controls probably helped make it possible for Kenics Electronics to announce its

first commercial products after only about seven months. It isn't a one-product company; backing up the 1,536-bit ROM are 1,120- and 1,024-bit ROMs, a one-of-32 decoder, an eight-bit timing generator, a programmable modular counter, and a 10-bit parallel-access shift register. There's also a 16-bit logic family which includes gated and addressable latch chips, a 16-bit power inverter, and a zero-to-16-position shifter available with or without end-around connection.

For now, all Kenics' products are bipolar, heavy-current-sinking TTL circuits. The 1,536-bit ROM, for example, can sink 0.5 milliamperes at 0.5 volt at each of its 24 output pins. By contrast, it needs only 0.3 mA at its inputs, making it fully compatible with low-level TTL.

MOS-LSI devices are in the works. A 2,240-bit ROM, a 2,048-bit ROM, and a dual 50-bit serial shift register probably will appear first. These high-threshold devices will be followed by TTL-compatible circuits in the same configurations, plus a 256-bit random access memory.

Budgets

EIA sees 2 more years of defense cuts

Defense budgets will continue their downward slide for two more fiscal years before beginning to recover in fiscal 1974. Then they will rise during the last half of the decade. That's the estimate of 19 manufacturers who took part in an Electronic Industries Association forecast of the next 10 years of Federal spending and its impact on industry. "All in all, it's a pretty flat curve," explains Cliff Bean of Sylvania Electronic Systems, who coordinated the study, because "we're talking in terms of inflated dollars," he adds. That's the bad news in the study.

The good news for some manufacturers will be a change in the military electronics mix. In the next two fiscal years of constrained defense budgets, the EIA forecasters say that "procurement in general

will decline, but research and development will increase somewhat, particularly as Southeast Asia activity diminishes." Following the general pattern of the cold war in the 1950s, EIA sees growth in "requirements and funding for intelligence, reconnaissance, and communications, as manpower restrictions require improved information and data handling."

The average EIA estimate of fiscal 1972 military spending is \$69 billion, with the electronics content expected to slip fractionally from 15.6% to 15.4%. The following year, however, the analysis shows electronics content at around 15.8% on a smaller budget, estimated on average at \$68.4 billions.

On publication of the study in a few weeks, after EIA's Requirements Committee has completed its correlation of the raw data gathered for the forecast, readers will find that "essentially level funding is predicted for the next few years" for the civilian space programs; the averaged estimate is \$3.3 billion in fiscal 1972 dollars—"with a possible gradual increase toward the end of the forecast period as the space shuttle program moves closer to fruition." Right now, however, it should be noted that the future of the shuttle is as much a matter of politics as it is technology.

For other nondefense markets, EIA's analysts are reduced pretty much to guesswork. While the data shows "appreciable growth" in spending for civil aviation and urban mass transit, as well as the education, environmental pollution control, law enforcement and health systems, Bean concedes that no more than five or six EIA members were able to come up with figures for these areas. Is industry uninterested in these new markets? "No," says Bean emphatically, "it's simply that no one had the information" at the industry level. While industry's market researchers have developed years of expertise in analyzing budgets and expenditures for military and space electronics, the nonmilitary side has been largely neglected.

Government electronics

**Computers replace clerks
in parcel post prototype**

Keeping manpower down while providing more service is a tricky task—but it's what the reorganized U.S. Postal Service was chartered to do. To pull it off, the service is eyeing computer-controlled, self-service stations that will eliminate the need for window clerks to handle parcel post at new locations.

Field tests of prototype hardware, which Design and Development Inc. of Cleveland built under a \$325,000 contract, are scheduled to begin in November, says Thomas Lanyi, the program manager for the parcel post mailing facility. If they support the claim that the program will pay for itself in five years, postal engineers will next attempt to simplify the machine to reduce its cost and only then turn to industry for production. Ultimately, he adds, "a very large market for the units could result."

To use the prototype, the customer places his package on a built-in scale and punches in the parcel post code of the package's destination. The postage required is then displayed on cold cathode readout tubes and the customer inserts either coins or bills into the machine. A printer developed especially for this application then prints three copies: one for postal records, another that serves as the customer's receipt, and a third that is affixed to the package as postage. Postal rates are stored in one quarter of a custom-built computer's 4,096 words of 16-bit core.

Lanyi says that special postal restraints required a custom machine. One was that postal rates are nonlinear and could not be calculated with each use, so that special features had to be added for efficient table look-up. The other restraint was that rates change about once or twice a year. Since postal workers are at best semi-skilled repairmen, the unit had to be easily reprogramed with available manpower. This was achieved

by adding mechanical switches that change the values of the rates stored in memory.

Lanyi notes that the prototype is a "Cadillac" unit that will have to be simplified if it is to be widely used. But reducing unit cost—at present \$40,000 in small quantities—will be easy, he feels. For one thing, the Design and Development machine offers seven types of special service, including the capacity to handle special delivery mail. Chances are good that the machine's cost can be lowered by dropping some of these little used services. The use of newer technology, such as MOS for the computer's logic circuits and programmable read-only memories for storing rates, should also reduce its cost. Finally, Lanyi says, the 5-megahertz computer has excess capacity to share. If each computer were time-shared between a number of stations, the unit cost of the stations would drop sharply.

Medical electronics

**A digital advance
in patient monitoring**

Changes have come slowly to patient monitoring systems. But this month a system is being introduced that radically departs from older designs. Developed by Abbott Medical Electronics Co. (a joint venture of a pharmaceutical giant, Abott Laboratories, and an aerospace firm, SCI Systems Inc.) it is digital. The system multiplexes to reduce cables, and has a minicomputer to process data and control bedside equipment. In addition, the system's modules are in plastic chassis to reduce shock hazards.

In layout, Abbott's system resembles older units. At each bed is a console containing modules for taking cardiograms and measuring and displaying blood pressure and other physiological parameters. Signals from all the consoles in a ward are fed back to a central station along a single pair of wires, thanks to the fact that each console multiplexes its outputs. Normally,

in similar layouts, as many as 50 leads come out of a single console.

At the central station the mini-computer reduces the data, does trend analysis, and looks for the irregular heartbeats called arrhythmias. It can also control instruments or send information back to a physician at bedside. "The central station has the capacity for controlling as many as four activities at each of the bedside units," says Abbott Medical president Elliott Farmsworth.

Instrumentation

**Computer system
tests, matches diodes**

When diode maker KEV Electronics Corp. found that it couldn't check out its products with commercial production test equipment, it developed its own. Now the equipment, which tests the devices at operating frequencies instead of at dc or kilohertz, will be marketed.

KEV, in Wilmington, Mass., makes ion-implanted voltage variable capacitors for electronic tuning of TV and fm receivers. A major problem is selecting the three or more diodes needed for a tuner so that their capacitance changes match as tuning voltage varies. According to Jerome L. Hartke, technical director for device development, KEV's diodes have tightly controlled capacitance versus voltage curves, and are sorted into only 10 categories instead of the 1,000 typical for conventional double-diffused or epitaxial diodes. Nevertheless, they do have to be matched before shipment, so KEV put together its computer-operated system which is now matching diodes in pilot production lots.

KEV feels the system should interest other diode makers, too, but would rather make diodes than test equipment. So it developed the tester with Digital Equipment Corp.—partly because Hartke lives across the street from Roger Pyle, manager of DEC's custom software group. KEV makes the rf test head and analog circuitry, which DEC

PIN diodes

Industry's longest carrier lifetime
(typically 7 μ s)

Low series resistance
(typically 0.3 Ω at 100mA)

Available off-the-shelf

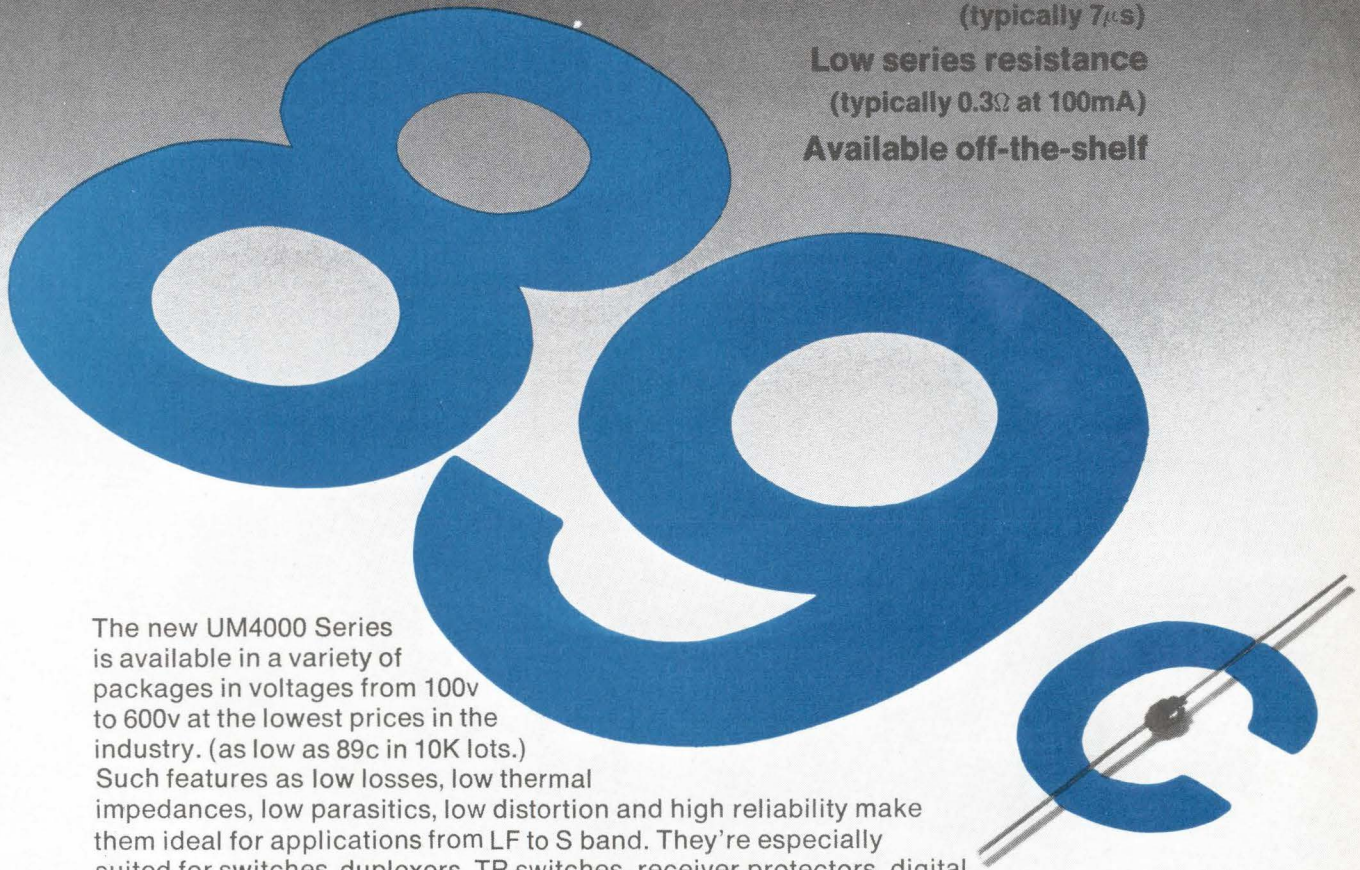

The new UM4000 Series is available in a variety of packages in voltages from 100v to 600v at the lowest prices in the industry. (as low as 89c in 10K lots.)

Such features as low losses, low thermal impedances, low parasitics, low distortion and high reliability make them ideal for applications from LF to S band. They're especially suited for switches, duplexers, TR switches, receiver protectors, digital phase shifters, attenuator circuits and AGC loops. For fast action, call Steve Nannis collect at (617) 926-0404.

Unitrode Corporation, 580 Pleasant Street, Watertown, Mass. 02172.

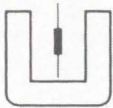

UNITRODE quality takes the worry out of paying less.

Unitrode Corporation

Inquiry Processing Dept.11B, 63 Atlantic Ave., Boston, Mass. 02110

Please send me free UM4001 sample as well as Application Bulletin and complete specs.

NAME _____ TITLE _____

COMPANY _____

ADDRESS _____

CITY _____ STATE _____ ZIP _____

Standard ARM Missile
Phoenix Missile System
Maverick Missile
Agena Launch Vehicle
E-2C Computer
DC-10 PE/PS System

Our Hybrid credentials: pretty fast company.

When it comes to hybrids, we like to think we've been around. Ours are reliable. And not just when the customer is the government.

In terms of dollar volume, we are among the largest producers in the field. And that is hardly surprising.

After all, in hybrids, we do it all. The simple. The complex. And in between. Everything from simple resistor networks to LSI hybrid circuits.

Hughes designs the circuits, develops the prototypes, manufactures the components. Assembles, tests and guarantees the total hybrid circuit package.

We make both thick and thin film hybrids. We use standard IC's. And we make the MOS devices and flip chips right here in-house.

If you like, we'll even make your hybrids with all-aluminum interconnect metallurgy.

When it comes to hybrids, it will pay you to think Hughes. We're experienced. For full details, write for our illustrated brochure. The address is: 500 Superior Avenue, Newport Beach, California 92663.



Circle 44 on reader service card

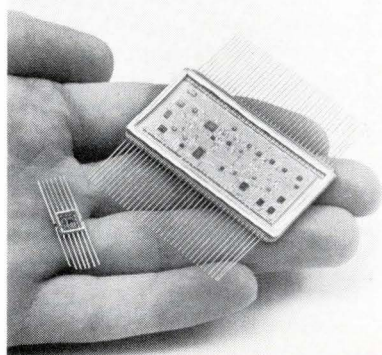

interfaces with a PDP-8/L minicomputer. DEC developed the software and will market the whole system with custom programing. Price should be around \$50,000.

KEV has applied for a patent on the operating-frequency test technique. The diode under test is placed in an oscillator phase locked to a reference oscillator controlled by a standard diode. These oscillators are swept together over the tuning voltage range while the voltage needed to keep the phase-locked oscillator on frequency is compared with up to 10 standard test curves stored in memory to find the best match. The system can match these curves to $\pm 0.1\%$.

In addition to tracking, the system also can test other parameters: DEC is developing software for testing leakage current, breakdown voltage, and forward voltage. KEV and DEC expect the system to test up to 10,000 diodes an hour when used with an automatic handler or wafer prober.

For the record

Lonely. While conventions have had a tough year in 1970, a new low may have been reached by the Eascon Conference Oct. 26-28 in Washington. Despite efforts by the sponsor, IEEE's Aerospace and Electronic Systems group, to broaden the subject matter, Eascon ended up being—as one engineer wryly described it—a wake for the military aerospace business.

Only 300 registered, and this included better than 85 authors and session chairmen. Attendance was less than half of last year's, which was in itself disappointing.

Exhibitors rattled around in one of the Sheraton Park Hotel's halls. Only 12 companies exhibited over and above the six military and NASA exhibitors that got in free. With virtually no attendees on the floor by early afternoon, fed-up exhibitors decided to close the hall two hours early one day, and four hours early on the last day.

Moves. It's musical chairs time at Fairchild Semiconductor again;

this time in the MOS group. A few weeks ago, Robert J. Schreiner, ex-general manager of Fairchild's Systems Technology division, was brought in as MOS marketing manager. Harry Neil, MOS and memory marketing manager until then, was due to move into MOS operations to fill the spot vacated when Jack Gates was let go. (Gates had been described as the man who made Fairchild MOS work.)

But Neil has moved to Intersil Memories Inc. in Cupertino, Calif. And with all the cuts in both people and money at Fairchild these days, Neil may have worked out the best deal of all. He's back in MOS and he's back in marketing.

Laser meets ultrasound. The first of a group of acousto-optic diffraction devices has arrived from Zenith's Acousto-Optic Development Group. It's an intensity modulator that uses interaction of laser light and ultrasound and operates over the entire visible and near-infrared spectrum. In operation, sound waves pass through the laser light beam, diffracting a portion of the light and causing it to change direction. Applications include read-out displays, laser beam communications for deep space, short-link video-rate communications, low-resolution scanner, doppler-shift optical frequency modulator, and video film and microfiche recording.

Glavin in. William Glavin, a 15-year veteran of IBM who came to Xerox Data Systems last April as executive vice president, is the new president in the wake of the abrupt resignation of Dan McGurk. McGurk left the company with no announced plans, and at a time when the firm's phenomenal growth has flattened out.

McGurk said earlier this year that XDS 1970 sales would, at best, be even with last year's \$125 million; the former Scientific Data Systems had been growing at a rate of 25% to 30% in recent years. Glavin's appointment could signify a speedup in Xerox Data System's plans to go after the business computer market.

Are you thinking Hughes is big in electronics?

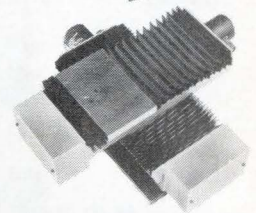
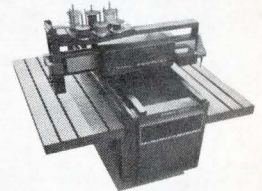
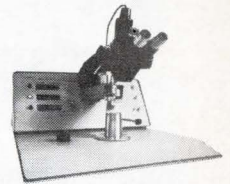

Good thinking.

Because Hughes put a lot of innovative thought into making better gas and solid state lasers (RS 293), micro-circuit production equipment (RS 294), high vacuum equipment (RS 295), semi-automatic wire terminating and harness laying equipment (RS 296), N/C positioning tables and systems (RS 297), and FACT Flexible Automatic Circuit Testers (RS 298).

HUGHES

HUGHES AIRCRAFT COMPANY
INDUSTRIAL ELECTRONICS GROUP

Circle appropriate Reader Service (RS) number

We make two 25MHz Oscilloscopes. Others make them, too...

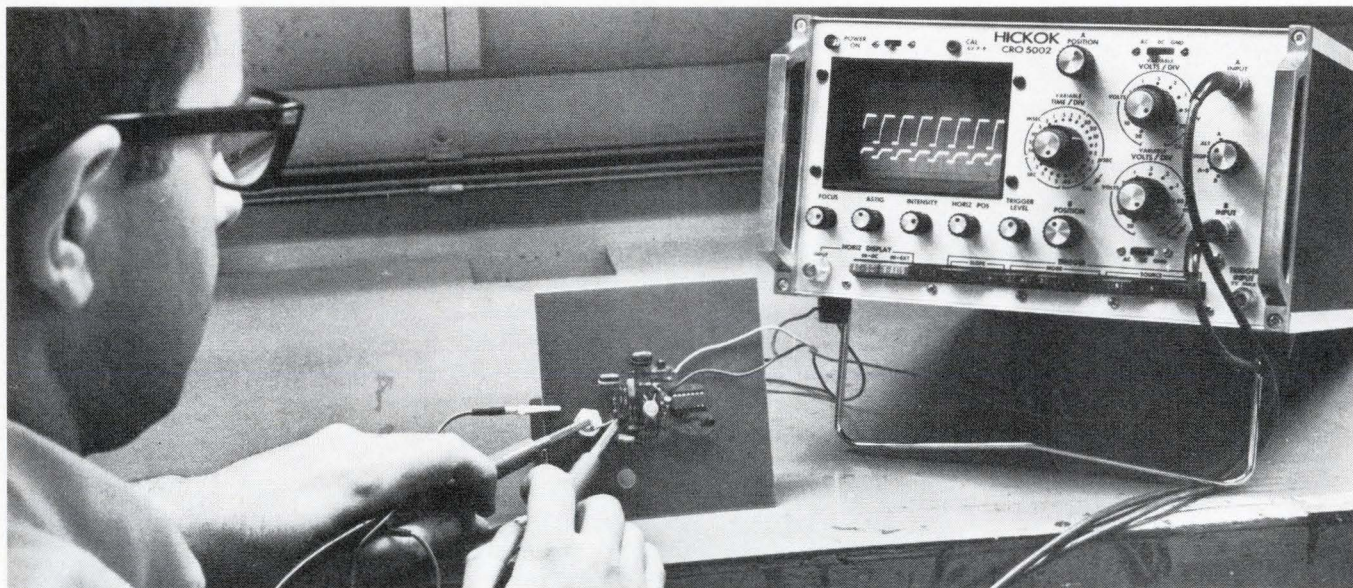

...so what's our bag?

First: price—\$725 for our single trace Model 5000, \$995 for our dual trace 5002. You pay only for precise measurement characteristics, not for fancy frills.

Second: special features—like ultra-stable triggering to 50MHz. A unique sweep circuit that lets you view any 10-division segment of over 40 calibrated divisions of sweep—a simplified, delayed sweep. Portable (about 25 lbs.). Solid-state reliable. Overload protected.

Third: your local Hickok man will gladly make a side-by-side competitive demo in your plant so that you can compare before you buy. Just ask him. Then decide.

There's more to tell. Circle Reader Service Card # **46** or call us for complete information.

HICKOK

INSTRUMENTATION GROUP
10514 Dupont Ave. • Cleveland, Ohio 44108
Phone 216-541-8060

Need an 80-db blast?

Actual size

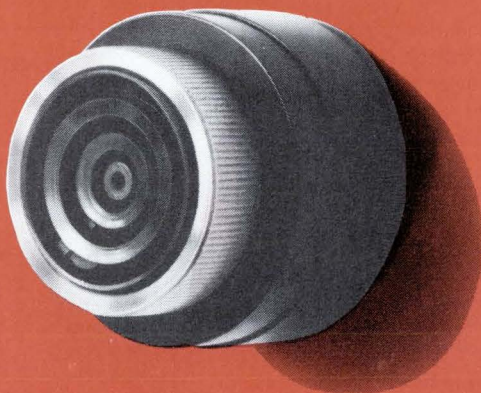

You'll get it from our 1¼-ounce Sonalert® electronic audible signal.

With as little as 6 VDC and 3 ma., Sonalert produces a piercing sound that's hard to ignore. Yet it weighs only a couple of ounces because it's all solid state. Even the transducer is a crystal. This makes Sonalert reliable, efficient and long lasting. And because it's solid state, there's no danger of arcing, no RFI or EMI noise, important considerations in computer and other control signal applications.

Standard units vibrate at a fixed frequency of 2900 ± 500 Hz or 4500 ± 500 Hz depending on model. In

® Registered trademark, P. R. Mallory & Co. Inc.

addition, pulsing, warbling and AC models are available. The penetrating sound covers a wider area than alarm lights and demands instant action. This makes Sonalert ideal where ignoring warnings would be hazardous or cause damage. Examples: aircraft fuel warning, electrical overload, computer error, automobile door ajar or headlights-on warning. Other applications include communications, shipboard, missile and medical electronics alarms.

For an informative 48-page booklet of projects and circuit ideas, write for folder No. 9-406. Address Mallory Capacitor Company, a division of P. R. Mallory & Co. Inc., Indianapolis, Indiana 46206.

MALLORY

MALLORY CAPACITOR COMPANY

a division of P. R. MALLORY & CO. INC.
3029 E. Washington St., Indianapolis, Indiana 46206; Telephone: 317-636-5353

Electrical and electronics components • sequence timers • metallurgical products • batteries

immediately available!...

GENERAL INSTRUMENT ADVANCED NITRIDE TECHNOLOGY

GIANT™ SHIFT REGISTERS IN PLASTIC DIPs... AT CAN PRICES

512-bit @ \$5.00 ea./100 pcs

Dual 256-bit @ \$6.00 ea./100 pcs

For the first time, the reliability of nitride and the economy of plastic packaging have been combined. The results of this GIANT (General Instrument Advanced Nitride Technology) development are the 512-bit and the dual 256-bit dynamic shift registers, the first in a new line of low cost plastic packaged GIANT devices. And, like all GIANTS, they are completely compatible with TTL/DTL and MOS, both electrically, through the use of low threshold nitride processing, and mechanically, through the use of the 14-lead plastic DIP. This unique nitride/plastic combination now makes possible the first LSI shift registers with all the advantages of the dual-in-line configuration, but at can prices... **approximately one cent per bit** at the 100 piece level. The low prices represent major cost savings over presently available ceramic dual-in-line packaged LSI.

It was predicted that because silicon nitride prevents ionic contamination, nitride devices could be put in plastic packages. Results of an intensive and continuing test program (available upon request) have confirmed this prediction. The units, subjected to a series of tests including those for moisture resistance (per method 1004-1 of MIL-Std. 883), thermal shock (per method 1011 condition A of MIL-Std. 883) and the "pressure cooker" (8 hours @ 240° F @ 20 psig in boiling water), showed no degradation of functional parameters or long term stability problems.

The GIANT 512-bit dynamic shift register (DL-7-1512) features two phase clocking, single input and output for data, and recirculation logic. Units may be combined in a system by means of two independent chip select controls.

The GIANT dual 256-bit dynamic shift register (DL-7-2256)

PLASTIC GIANT SHIFT REGISTERS

IMMEDIATELY AVAILABLE

DL-7-1512 DYNAMIC 512-BIT
DL-7-2256 DYNAMIC DUAL 256-BIT
DL-7-1200 DYNAMIC 200-BIT
SL-7-4032 STATIC QUAD 32
SL-7-4025 STATIC QUAD 25

AVAILABLE WITHIN 30 DAYS

DL-7-2100 DYNAMIC DUAL 100-BIT
DL-7-2100A DYNAMIC DUAL 100-BIT
DL-7-0406 DYNAMIC DUAL 100-BIT
SL-7-2128 STATIC DUAL 128-BIT
SL-7-2064 STATIC DUAL 64-BIT
SL-7-2050 STATIC DUAL 50-BIT
SS-7-8212 STATIC DUAL 16-BIT
SS-7-8211 STATIC DUAL 16-BIT
SS-7-2004 STATIC DUAL 4-BIT
SS-7-1032 STATIC VARIABLE LENGTH

is composed of two independent 256-bit shift registers with common clocking.

Both GIANTS, DL-7-1512 and DL-7-2256, are immediately available from your authorized General Instrument distributor.

For full information write General Instrument Corporation, Dept. P, 600 West John St., Hicksville, N.Y. 11802, or call in New York: 516-733-3333; in Chicago: 312-774-7800; in Los Angeles: 213-873-6500. (In Europe, write to General Instrument Europe S.P.A., Piazza Amendola 9, 20149 Milano, Italy; in the U.K., to General Instrument U.K. Ltd., Stonefield Way, Victoria Road, South Ruislip, Middlesex, England.)



GENERAL INSTRUMENT CORPORATION • 600 WEST JOHN STREET, HICKSVILLE, L. I., NEW YORK

HANDY

Handy by virtue of its operating convenience and its small size, Triplet's Model 310 V-O-M is no miniature when it comes to rugged capability on the job.

With outstanding readability from 0.05 to 1200 V DC in 5 ranges at 20,000 ohms per volt . . . 0.05 to 1200 V AC in 5 ranges at 5,000 ohms per volt . . . 5 ohms to 20 megohms in 4 ranges . . . 10 μ A to 600 mA DC . . . 0.1 to 300 A AC with the optional Model 10 clamp-on adapter . . . the Model 310 can handle practically every electrical measurement you'll need to make. Accuracy on the DC ranges is 3%—4% on AC.

For all its conveniences and features, this great Triplet instrument . . . the World's most popular miniature V-O-M . . . is only **\$44** suggested USA user net. If you'd rather have a high voltage range of 600 V (AC and DC) and an AC sensitivity of 15,000 ohms per volt, ask for the Triplet Model 310-C at \$56 suggested USA user net. See them both at your local Triplet distributor or, for more information, call him or your Triplet sales representative. Triplet Corporation, Bluffton, Ohio 45817.

TRIPLET

The World's most complete line of V-O-M's . . .
choose the one that's just right for you

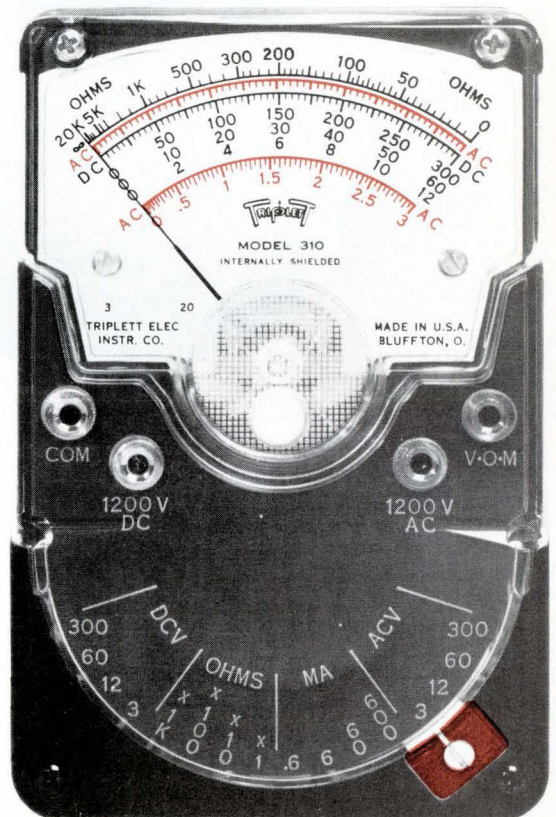

1. Hand size V-O-M with provision for attaching AC clamp-on ammeter.
2. 20,000 Ohms per volt DC sensitivity 5,000 AC.
3. One selector switch minimizes chance of incorrect settings and burnouts.

Shown actual size

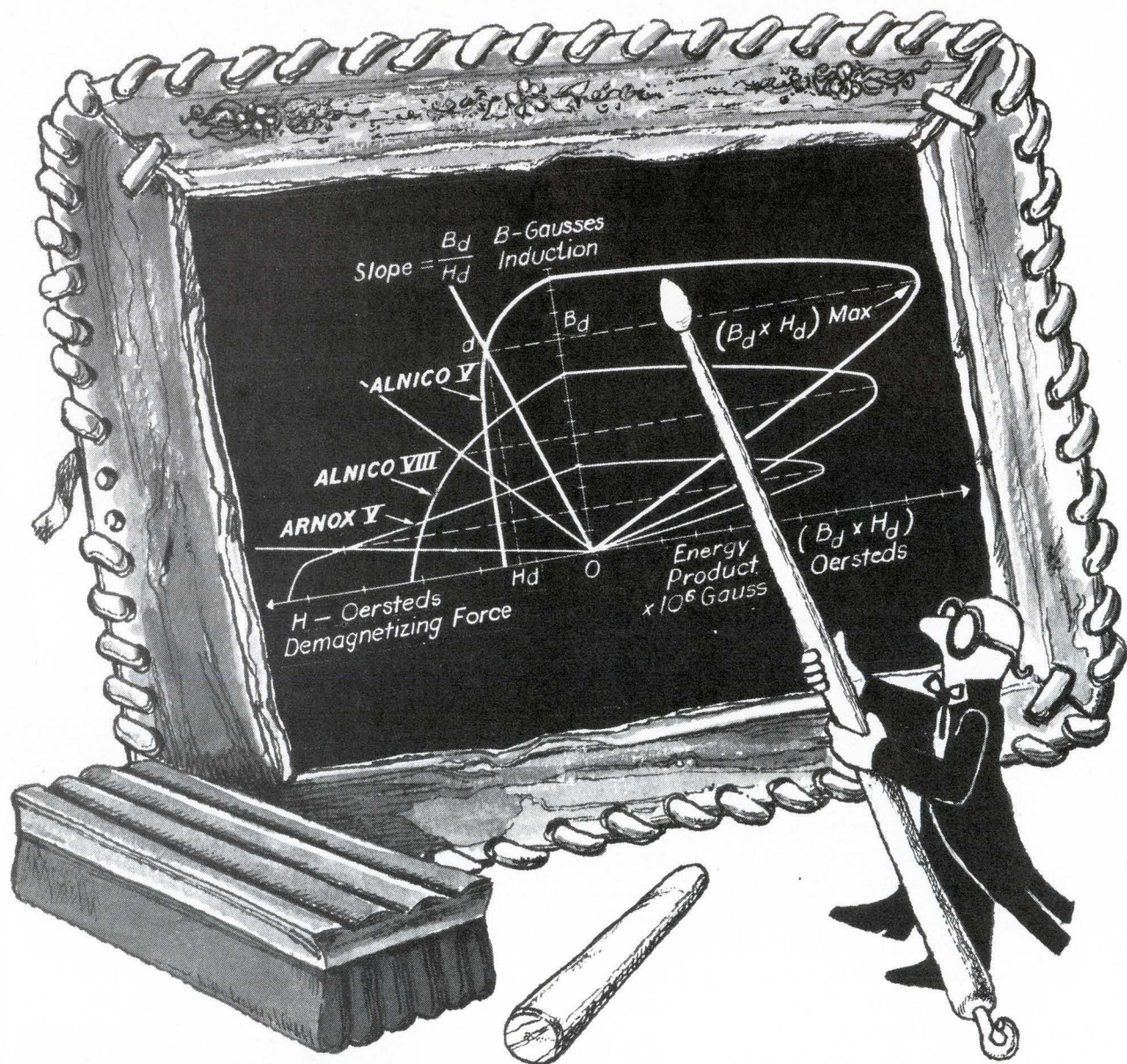

Energy product.

Choose: Maximum in cast or sintered Alnico. Or as much as you need in Arnox ceramic. Both from Arnold.

Seeking a top-quality source of supply and service for permanent magnets for anything from mikes to meters to motors to magnetos? Arnold's the answer. Examples: Our cast Alnico magnets with maximum energy product per unit volume. Our sintered Alnico—same maximum energy product in homogeneous, close-tolerance magnets available in intricate shapes.

And our Arnox[®] hard ferrite magnets, made from non-strategic materials, with a variety of energy products, in non-oriented or highly oriented configurations.

Trust the Arnold reputation for the newest and the best in permanent magnets. At measurable cost savings, too. Call or write for the convincing details.

ARNOLD
SPECIALISTS IN MAGNETIC MATERIALS

The Arnold Engineering Co., Dept. E2, Marengo, Illinois 60152 • Member Company of Allegheny Ludlum Industries • Branch Offices and Representatives in Principal Cities

Price Breakthru!

Now, on FET switches, drivers for industrial use (-20°C to $+85^{\circ}\text{C}$)

\$3/channel* buys you 6 channels of MOS switching complete with DTL/TTL compatible drivers.

Package is hermetic seal, ceramic dual-in-line.

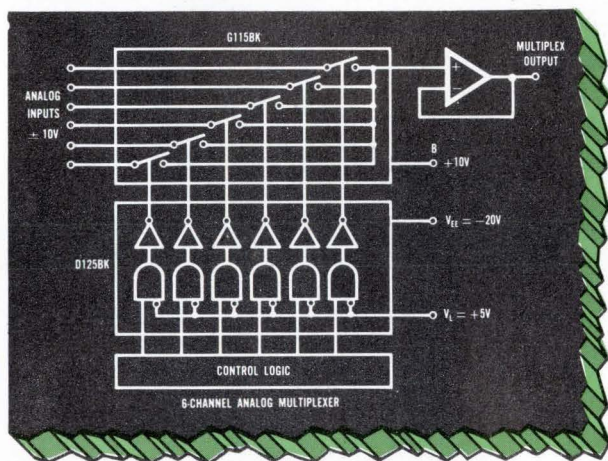

Use them for:

- Multiplexing 1 mV-10 V
- Sample-and-hold
- D/A converters
- General switching
- Interfacing low level logic to MOS or JFET switches

For complete information on the D125BK, G115BK or others in this series, call any of the offices listed below.

* 100 piece price

New York: Sy Levine (516) 796-4680
New England: Al La Croix (617) 762-8114
St. Louis: Jim Spicer (314) 291-3616
Minneapolis: Ed Koelfgen (612) 920-4483
Southern California: Dave Ferran (213) 420-1307
Northern California: Chuck Brush (408) 246-8000

 **Siliconix incorporated**
2201 Laurelwood Road • Santa Clara • California 95054
Telephone (408) 246-8000 Extension 201 • TWX: 910-338-0227
Great Britain: Siliconix Limited, Saunders Way, Sketty, Swansea
West Germany: Siliconix GmbH, 7024 Bernhausen, Postfach 1340
France: Siliconix, 9, Avenue d' Arromanches, 94-Saint-Maur



a "NEW" Generation of Multimeters at a "NOW" Price



Unique
self-check
calibration

- AC, DC, volts and current, Ohms
- .1% basic accuracy
- 100 μ V resolution, AC and DC
- Auto-Polarity on DC ranges
- Automatic zero correction
- Self-contained Battery Pack, Optional

\$375

DIGI/EC®

by **UNITED SYSTEMS CORPORATION**

918 Woodley Road • Dayton, Ohio 45403 • (513) 254-6251

For complete specifications request catalog

Representatives throughout the World

Washington Newsletter

November 9, 1970

Labor unions renew efforts to organize engineers . . .

The increasing number of unemployed defense electronics and aerospace workers is encouraging organized labor to mount a fresh drive to bring engineers into its fold. Competing in the effort are the United Auto Workers, to which the late Walter Reuther unsuccessfully sought to add an engineering arm in the early 1960s, and four of the 18 member unions of the AFL-CIO Council of Scientific, Professional and Cultural Employees. The latter group consists of the Communications Workers of America, the International Association of Machinists and Aerospace Workers, the International Brotherhood of Electrical Workers and the International Union of Electrical, Radio and Machine Workers.

Though engineers tend to reject unionization because of their strong sense of individuality, organization efforts inadvertently got a boost from a major aerospace executive. He recently told the Electronic Industries Association that federal suppliers should begin to view themselves not as manufacturers but as contractors, obliged to hire and fire on the basis of whether they win or lose a contract competition.

. . . and support retraining bills as an option

The AFL-CIO's support of the legislation of Sen. Edward M. Kennedy (D., Mass.) and Rep. Robert N. Giamo (D., Conn.), under which defense industry professionals would be retrained for civilian programs, is likely to meet with more success than its organizing efforts, say Capitol Hill observers. Congress is expected to undertake something comparable to Kennedy's three-year, \$450-million program, since DOD's own estimate is that aerospace and electronics industry layoffs will continue to rise in 1971 [*Electronics*, Sept. 14, p. 67]. As one industry executive says of labor's organization plans: "What help can a union give engineers if the jobs don't exist in the first place?"

U.S. mail automation market draws ITT

With the outlook bright for a growing postal automation market [*Electronics*, Sept. 14, p. 125], the battle lines are beginning to form. International Telephone and Telegraph is shortly about to show how serious it is by announcing a new division aimed solely at the U.S. postal equipment market—and at capturing 50% of the business.

With its equipment in service or on order for more than 50 cities around the world, the telecommunications giant has been a pioneer in the international market. And it isn't a stranger to this country either, having designed and built the first, and only, automated post office in Providence, R.I., 10 years ago. But ITT has been out of the domestic market in recent years because of the Post Office's "Buy America" policy. Instead it has built up experience abroad with hardware designed by its overseas companies, such as Standard Elektrik Lorenz, Stuttgart, and Bell Telephone Manufacturing Co., Antwerp. Now ITT will use its capability in the U.S. to build its entire line of foreign-designed electromechanical and electronic postal equipment.

White House limits on funding stall four FAA programs

Four Federal Aviation Administration development programs—all scheduled to go out to industry for bids in November—have been stalled by an Office of Management and Budget order requiring the FAA to have money on hand for the programs. The OMB order came down after

Washington Newsletter

industry complaints that companies had invested large sums preparing for programs that failed to materialize. Stalled by the directive are: a phased-array radar with discrete addressing capability; a scanning microwave instrument landing system; collision avoidance system ground stations; and a pilot warning indicator—a low-cost CAS which tells of other aircraft nearby.

The delay is expected to last for some months because the FAA will not have an opportunity before January to ask Congress for \$8 million in new funds in a fiscal 1971 supplemental appropriation. No money for the programs can be wrung from the FAA's \$45 million R&D appropriation expected to clear Congress when it reconvenes after the election recess.

IBM avionics unit seen as precursor of optical computer

Introduction of an optical system for replacing cable in aircraft uses may mean that IBM's program to develop an optical computer is gaining steam. Called the Light Interface Technology System, the IBM package uses light-emitting gallium arsenide diodes as transmitters and silicon photodiode receivers. Light can be sent without a repeater as far as 25 feet through a fiber optic pipe, which IBM claims is several times cheaper than cable. LITS is also said to reduce the problems of electro-magnetic interference and radiation protection that plague designers of conventional avionics hardware.

Medical device safety program head named at HEW

The first of several steps toward tighter safety standards for medical electronic devices has been taken by the Food and Drug Administration. Former Hewlett-Packard medical electronics engineering manager, David M. Link, has been named special assistant to the FDA commissioner for medical devices. Link will head a cautious program spelled out by a Department of Health, Education and Welfare committee. His first job will be to ask industry for information on medical devices, a job he hopes to complete within six to nine months. After that, Link says the controversial task of identifying potentially hazardous devices will begin. Chances are that this will be done by a top level panel selected by a group such as the National Academy of Sciences. Then legislation will be required to authorize the secretary of HEW to set up pre-marketing clearance procedures.

Packard proposes contractor pay shift to aid cash flow

The Department of Defense, suffering from the same economic pressures as its contractors, wants to cut back some of its \$8 billion in annual progress payments to primes for work in progress. Instead, DOD would permit them to charge off the interest on the private financing that would take the place of the payments. The idea comes right from Deputy Secretary David Packard, who notes the change "would give us an extra \$3 billion under Congressionally imposed expenditure limitations for use on other programs."

Bankers, reluctant in the past to lend money on major weapons systems contracts because of their uncertain profit potential, have shown some interest in the scheme when approached by the Pentagon. Packard now wants the Defense Industry Advisory Council to conduct a special study to see if this idea will overcome the reluctance and lure more private capital into defense work.

The first monolithic dual J-FET: A standard 2N package with the right answer to $\frac{\Delta(V_{GS1} - V_{GS2})}{\Delta T}$

The trouble with most dual J-FETS is that they're actually two J-FETS. Or two J-FETS with an extra P channel tossed in to provide isolation.

The one practically assures you of poor thermal tracking. The other means you can't get the dual J-FET in a standard 6-lead 2N package. (The lead from that extra P channel has to go somewhere. Where? That's your problem, not the J-FET-makers.)

Because the NPNPNPN construction uses up a lot of silicon real estate, good thermal tracking is hard to come by there, too.

Enter our monolithic dual J-FET, the first monolithic dual J-FET.

As you can see, we build it differently.

We lay down SiO₂ boats in the chip and build our J-FETS in there: for the first time, you get a dual J-FET

with dielectric isolation. No P channel. No seventh lead. Higher isolation. Lower cross talk. Lower noise.

And, because we use less chip to build in, you get thermal tracking values of 5 $\mu\text{V}/^\circ\text{C}$ or better, without fuss.

If all this sounds like the answer to a differential amplifier problem or two, it's because we planned our dual J-FET that way.

We have other J-FET answers to any problems you might be facing with AC, DC, high frequency, or low noise amplifiers; analog or digital switching; or high-voltage hangups. All in our new J-FET spec sheet. Write, and we'll have one in the next mail.

Can't wait that long? Call (215) 355-5000 and ask for Marty Kiouis. Unisem Corporation, P.O. Box 11569, Philadelphia, Pennsylvania 19116.

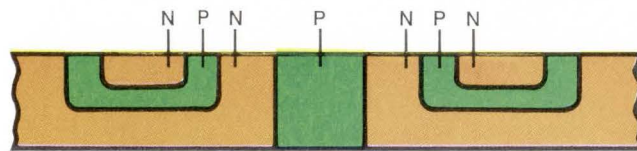

Them.

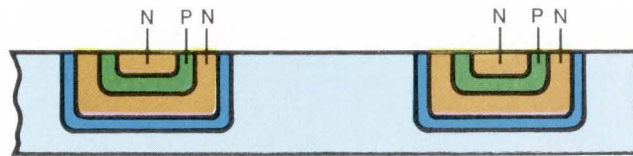

Us.

Another Unisem first: the dielectrically isolated monolithic dual J-FET.

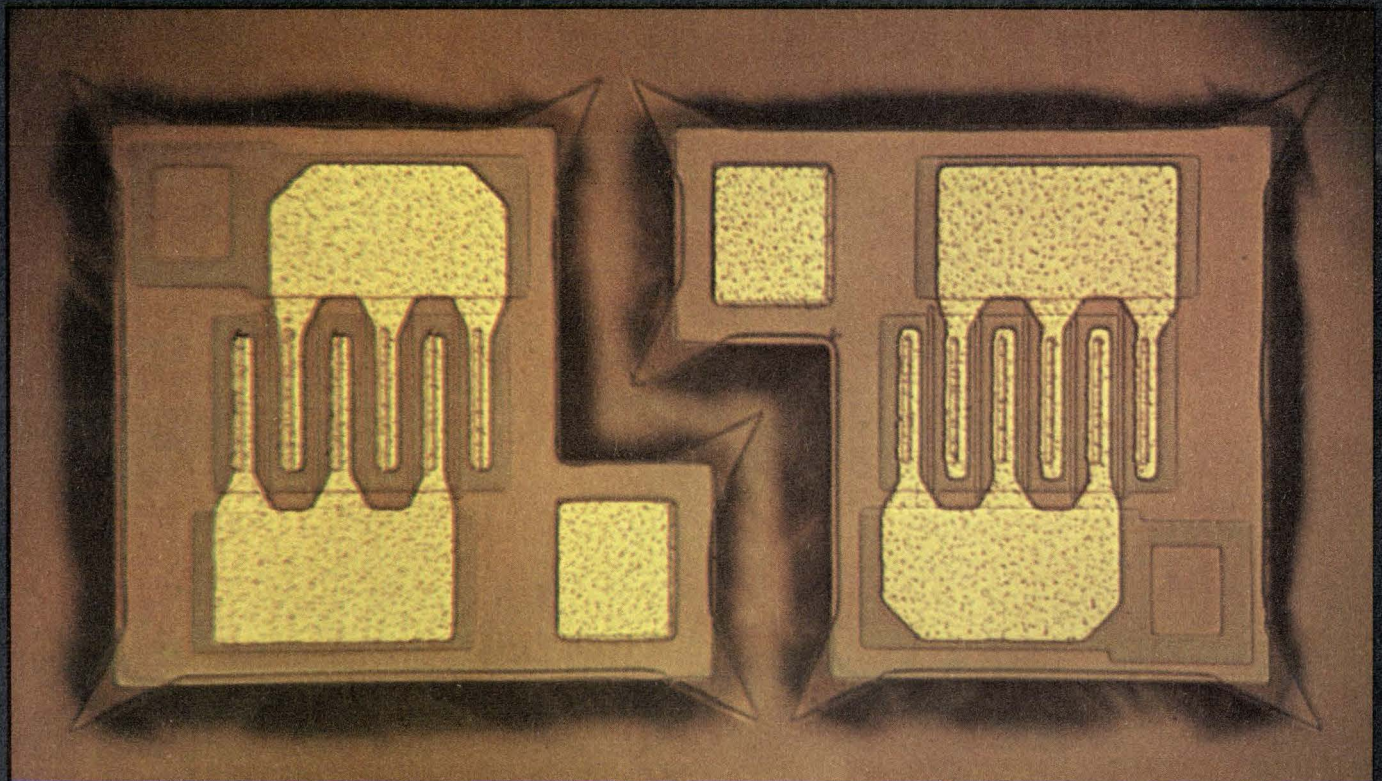

Unisem

SUBSIDIARY OF UNITED AIRCRAFT CORPORATION

U
A

A brief word about P.C. connector

No one connector supplier offers the variety of printed circuit types and configurations that AMP does. This fact translates in benefits to you of 1) greater design freedom, 2) selection of your own degree of reliability, and 3) a total termination capability that can fit the largest or smallest of your production needs. These benefits are what we call AMP **Economation**.

All three types of wiring techniques

We offer a choice of wiring techniques for crimp snap-in, point-to-point, and solder termination.

Crimp — AMP pioneered the *crimp snap-in* contact featuring the advantage of selective random wiring and partially filled housings. We still have the broadest selection for this type of application.

Point-to-Point — Our connectors for point-to-point wiring include both the A-MP TERMINPOINT★ clip-type and the wrap-type with .025 square posts. AMP terminating tooling includes manual, semi-automatic, and completely automatic X-Y wiring machines.

Solder—Most of our mother/daughter connector types and many of our board-to-wire connectors are available in solder tab or eyelet styles.

Biggest variety of contact types and plating

Because of your need to suit a variety of design parameters, AMP offers bifurcated contacts, leaf type, cantilever and

Connectors for point-to-point wiring

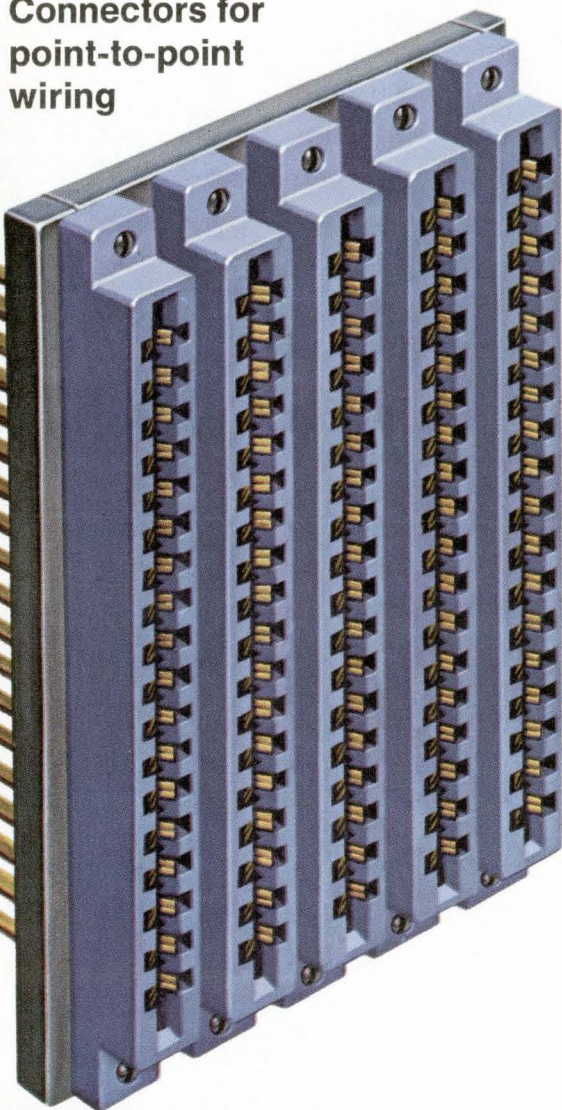

Random wiring with crimp snap-in contacts

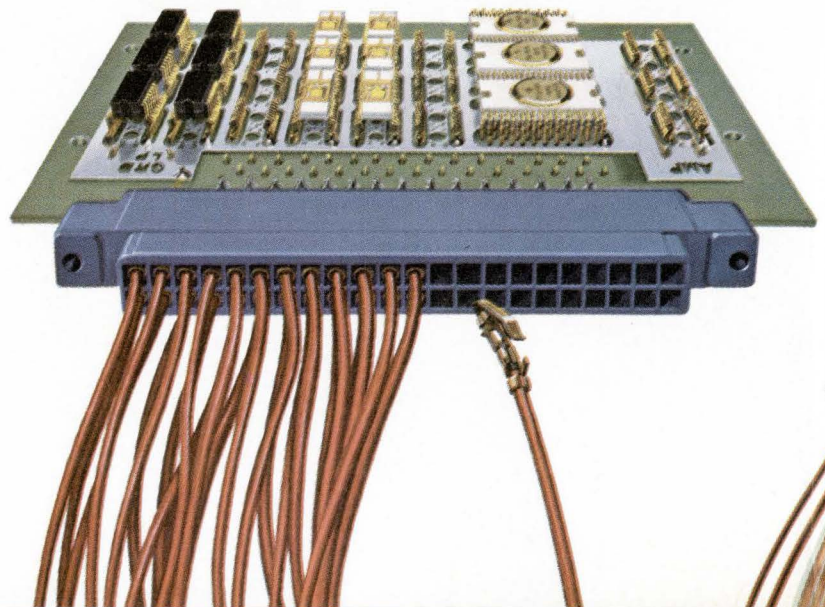

the world's broadest line...AMP

fork type. These contacts are available in a variety of platings to accommodate different degrees of reliability and economy.

Center line spacing and positions

Our commercial printed circuit connectors cover grid and staggered center-to-center spacings of .050 to .156 and positions variations—from 3 to 50 dual. The sheer variety of our P.C. connector types covers practically all your requirements. Our engineering staff will work with you on custom designs.

Variety of housing materials

Our plastic technology gives you a broad choice of housing

materials in thermosetting and thermoplastic materials.

Flexible Flat Cable

AMP has the most reliable and quickest method for mechanically attaching contacts to flat cable—automatically by machine. And A-MP contacts can even be applied in the middle of the cable, or anywhere in between. Housings are available for cable-to-board or cable-to-cable applications. Round wire can also be used in combination with flat cable.

Substrate Connectors

AMP has a variety of designs for connecting various styles of substrates including zero-force and high density connectors for MSI and LSI circuitry. Talk to us about your requirements.

We'd like to enlarge upon this brief description of our P.C. line in person, or in printed form in our new printed circuit connector catalog. For more words and some fast action write: **AMP Incorporated, Industrial Division, Harrisburg, Pa. 17105**

AMP

INCORPORATED

See us at booth #1311
Fall Joint Computer Conference
Nov. 17, 18, 19.

Mother/Daughter applications

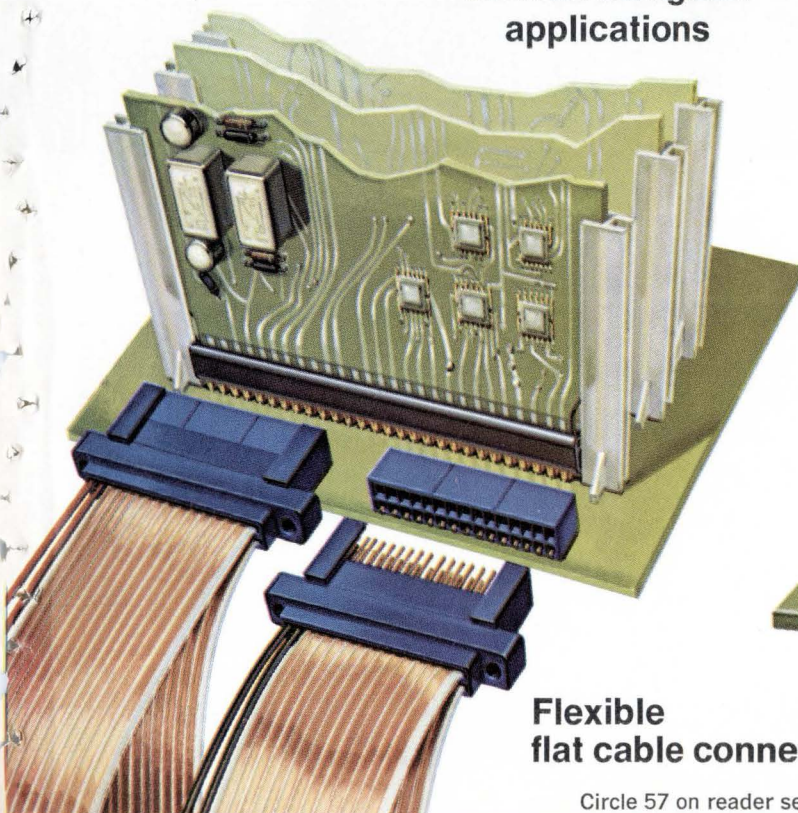

Flexible
flat cable connectors

Zero-force entry and withdrawal connectors

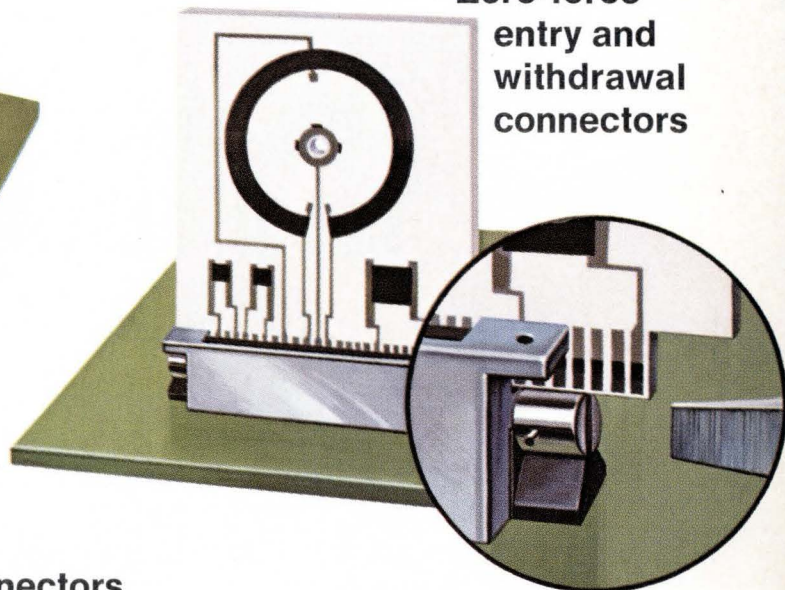



Southwest

**The place to be
for electronics.**

We asked one of the top executives at Honeywell Inc., why his division was consolidating in Southeast Pennsylvania: "We're in the electronic instrument business," he said. "We've got to have trained, skilled people, and lots of them. Nowhere in the country are there as many electronics and instrument people as there are here in Southeast Pennsylvania."

Philadelphia Electric
AN EQUAL OPPORTUNITY EMPLOYER

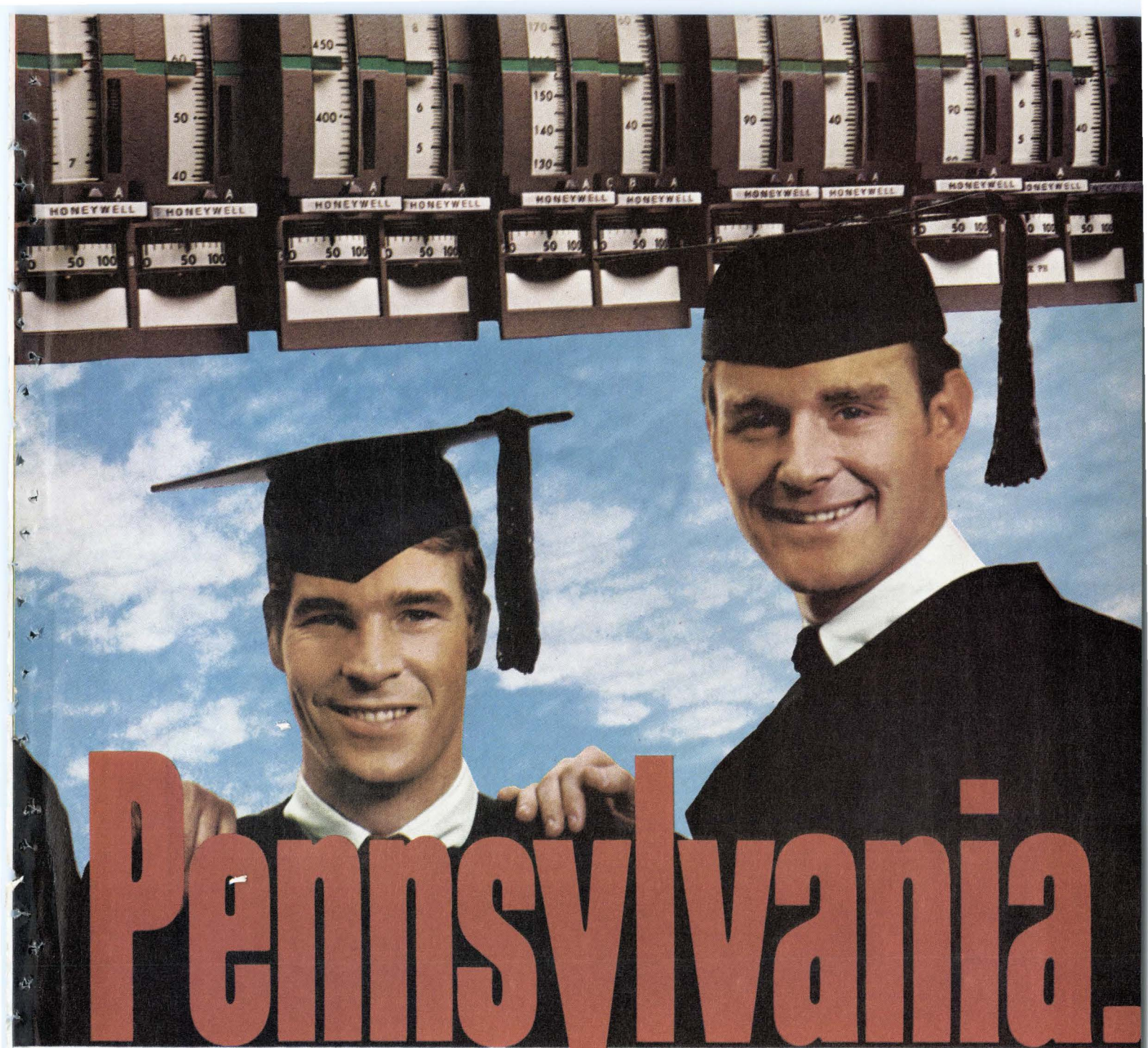

"For the record there are 30,000 professional scientists currently working in this area. This gives us the richest brain pool in the nation.

"And our business isn't standing still. It's growing larger and more complex every year. By consolidating, and consolidating here, we stand a much better chance to meet this demand."

He also knew Southeast Pennsylvania is a thriving

market — 26 million people within a 100-mile radius. Close to suppliers. And convenient to a network of superhighways. Very important when you're trucking material in and out.

There's really too much happening in Southeast Pennsylvania to discuss in an ad: the availability of 100% financing for qualified companies. The more than 400 plant sites, plus 63 industrial parks; the

easy accessibility to a major sea and airport. To name a few more things.

For the full story, get in touch with William Taylor, Jr., Manager, Area Development Department, Philadelphia Electric Company, (215) WA 2-4700, Ext. 570. Bill can tell you just about anything you'd like to know about Southeast Pennsylvania. And if he can't, he can direct you to people who can.

Company • Serving 4 million people in a 7-county area.

1000 CHESTNUT STREET,

PHILADELPHIA, PA.

19105

Circle 59 on reader service card

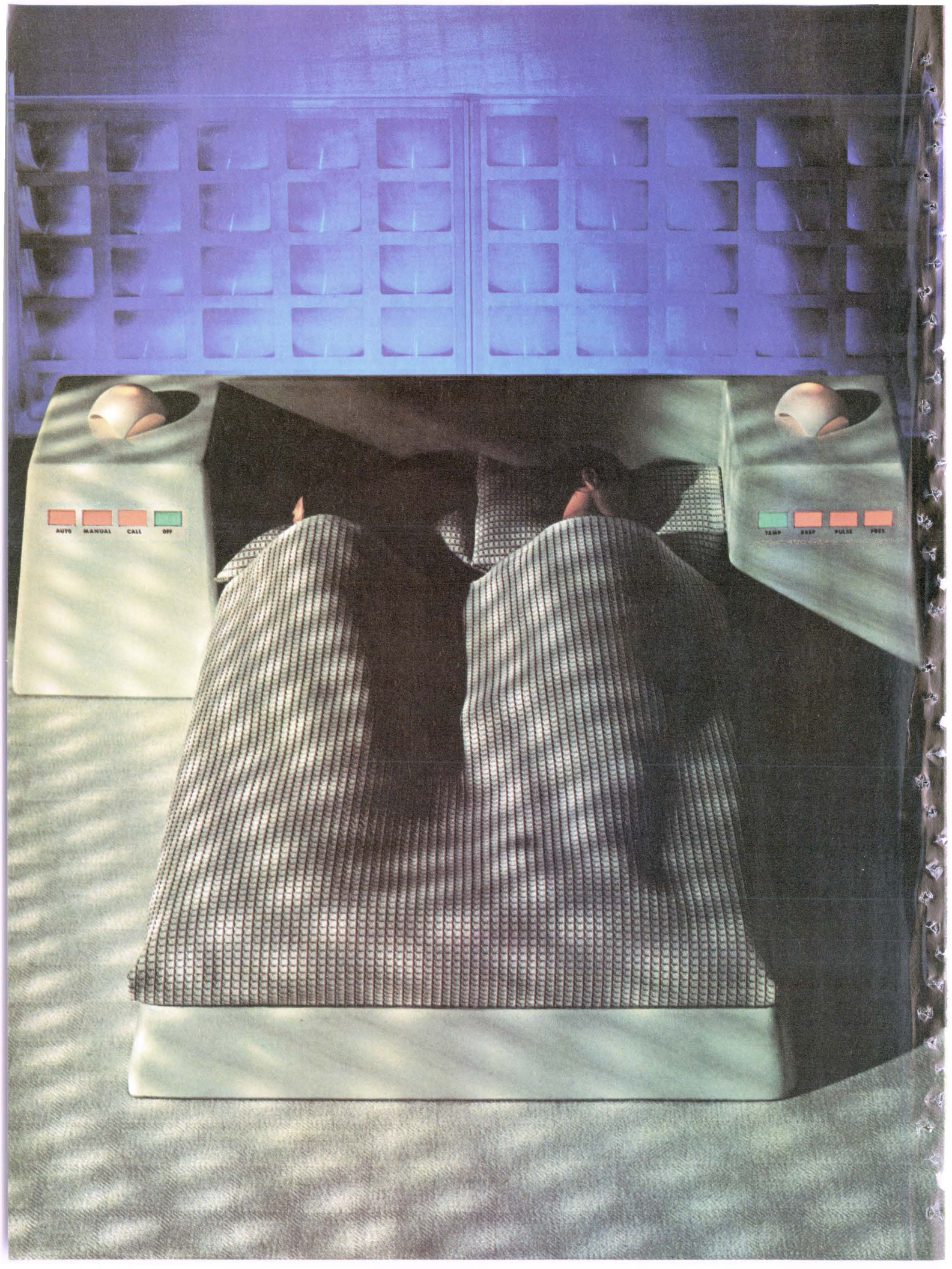

AUTO MANUAL CALL OFF

TEMP RESP PULSE PRES

By 1979, your bed will take you to your doctor.

Electronics will be giving your doctor a lot of new tools in the decade ahead. Your bed, for example, may save you from weekly visits to his office.

Part of a remote monitoring system, the bed would contain instruments to keep a regular check on patients with chronic conditions. Cardiac patients, for example, would periodically have the ECG data tapes transmitted to hospital diagnostic centers. These centers, in turn, would process and transmit the data to a terminal right in the doctor's office.

And along with helping patients lead normal lives outside the hospital, these medical-electronic devices will be assisting doctors and nurses inside the hospital; taking care of routine follow-up work such as verifying that prescribed medication has been administered.

The fact is, products of electronics technology will be doing more for our lives tomorrow than electricity does for us today.

Our daily newspapers will be automatically printed in our living rooms. Home computers will cook the food and wash the clothes. Automated highways will do the driving.

Who are the master minds masterminding these changes?

Our readers.

The men who are helping to advance medical care through electronic innovations. (Interested in this fascinating field? We'll be glad to send you a reprint on our Medical Electronics series.)

Every two weeks, Electronics presents its readers with a complete up-to-the-minute picture of the state of technology. Plus all the fast-changing developments in their particular fields of interest. Industry-wide and world-wide.

Readers and advertisers use Electronics for the same reason. It helps keep their business lives healthy.

Electronics, a McGraw-Hill market directed publication.

Our readers are changing the world.

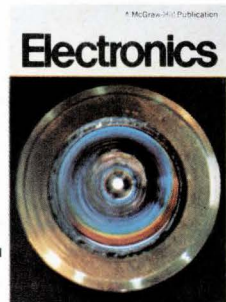

TRY TO MATCH THIS

for size and reliability

you can't!

For their size, Type BB resistors pack a tremendous power dissipating ability. Rated 1/8 watt at 70°C in a 0.0004375 cu. in. volume.

And miniaturization has not reduced reliability. Tests prove it. They satisfy the highest level—the S level—of the latest MIL-R-39008 Established Reliability Specifications in all resistance values.

The key is hot molding—the Allen-Bradley way. A-B developed and built the machines. Only A-B uses them. They're fully automatic. Built-in precision control. A high degree of uniformity. Predictable performance from resistor to resistor—year after year.

For immediate delivery at factory prices call your authorized A-B industrial electronics distributor. Or write Marketing Dept., Electronics Division, Allen-Bradley Co., 1201 South Second St., Milwaukee, Wis. 53204. Export Office: 1293 Broad St., Bloomfield, N.J., U.S.A. 07003. In Canada: Allen-Bradley Canada Limited.

© Allen-Bradley Company 1969



Exclusive

Only A-B Type BB
RCR05 meets MIL-R-39008
ER (established reliability)
for 1/8-watt resistors
at the S level.
Shown actual size.



ALLEN - BRADLEY
QUALITY ELECTRONIC COMPONENTS

EC69-80

Article Highlights

**LSI boosts
minicomputer
performance**
page 64

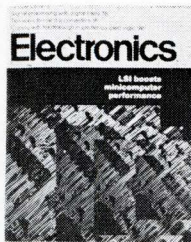

Forward-looking computer engineers do well to take into account emerging technological trends when designing machines. A case in point is the Nova series of minicomputers. Initially designed to take advantage of the availability of MSI at competitive prices, the original Novas were able to offer performance features usually found only in larger machines. Now the

latest series of Novas has proven capable of absorbing LSI technology, achieving even higher performance levels while still maintaining compatibility with its predecessors.

**Armed forces rely on
communications to fight
and survive in Vietnam**
page 70

As part of President Nixon's Vietnamization program, the South Vietnamese are being trained to take over at least part of the sophisticated electronic gear that serves U.S. armed forces, including a \$333 million communications network that's capable of linking GIs on patrol with generals in the Pentagon. In the second of a two-part series, *Electronics* examines this and other electronic equipment, including new beacons which can bring help fast to downed pilots, and better air traffic control radar.

**Need accurate
recordings of fast
transients? Try disks**
page 82

Magnetic tape and camera-oscilloscope setups, the usual methods of recording transient waveshapes, encounter barriers that restrict their performance. But disk recording can get around these limitations and offer better performance in many applications. Always ready to record random transients, disks offer better signal-to-noise ratios than tape recorders while avoiding the single-event limitation of camera-scope setups.

**Fly-by-wire
flight control
systems stir interest**
page 87

Though they're still proving themselves operationally, fly-by-wire systems, which operate an aircraft's control surfaces by electrical wiring instead of mechanical linkages, are attracting considerable interest. FBW systems offer the potential of being simpler, lighter, and more reliable than mechanical units.

Point-of-sale gear

Coming

The conventional cash register is getting a facelift as electronics companies develop new terminals to be used in retail stores. In its next issue, *Electronics* looks at the terminals and how they fit into new management information systems.

Standard LSI chips breed a fast new series of minicomputers

Originally built with an eye to technological trends, the new Nova family proves capable of absorbing the benefits of LSI without requiring radical redesign

By Ronald Gruner, Lawrence Seligman, and Jonel Sutton, *Data General Corp., Southboro, Mass.*

□ Designing today's minicomputers requires more than just using current technology inexpensively. The designer must provide the capability to accommodate technology that may only be emerging now but is likely to be standard within a few years. In doing so, he will be assured of a family of computers that will offer state-of-the-art performance while continuing to maintain compatibility with earlier models.

A noteworthy embodiment of this design philosophy is the Nova series of minicomputers, which has proved capable of absorbing large-scale integration, the latest component technology to be entering the volume market.

LSI refers to any whole-function subsystem on a single chip, capable of operating independently of other parts of a system, and so goes beyond the medium-scale integration of complex functional units that perform a single specific function in a system. For example, an adder on a single chip would be MSI; an adder with its associated registers would be LSI.

In fact, it was in anticipation of the availability of MSI at competitive prices that the original Nova was designed. Thanks to MSI, it was able to incorporate features until then found only in larger computers, such as multiple accumulators, indexing, powerful sets of arithmetic and logical instructions.

Then, the Supernova, introduced a year later, used additional MSI to get more speed. It had a fully parallel 16-bit design, while the Nova had a quasi-serial layout, which processed 16-bit words four bits at a time. Though such a change would require four times as many gates in the data paths, plus perhaps a few more or less in the control logic, the extra MSI meant that the Supernova needed only 50% more parts than the Nova—yet the whole machine would fit in the same size package.

Now a new line of Novas—the Supernova SC, the Nova 1200, and the Nova 800—extends the original design concepts to achieve higher levels of performance and lower cost through the use of still higher level circuit integration, with some LSI in both memory and processor. All three new machines are compatible with each other and with their precursors; they run with the same software and have interchangeable input-output interface hardware. [See "LSI in the Novas," p. 66.]

The series takes advantage of several new LSI cir-

cuits that have recently become available as standard products. For example, there is a 64-bit scratchpad memory capable of accepting or reading out four bits at a time, on a chip that is compatible with TTL circuitry. The chip may be considered functionally a complete 16-by-4-bit memory system. There is also a 256-bit read-only memory on a chip that reads out eight bits at once and is also TTL-compatible. And at the largest scale is a 1,024-bit chip that functions as a very fast 1K-by-1-bit random access memory, but which requires extensive analog circuitry to interface with the TTL logic of digital processors.

All of these standard LSI devices are essentially memory systems. The Supernova SC, in fact, uses several 1,024-bit chips for all or part of its memory. But LSI in the processor is something else again—for three reasons.

First, it's difficult to specify the function of a complex logic circuit array in such a way as to make the array standard. On the other hand, memory devices, like those mentioned, can be characterized exclusively by size and speed, and usually fit the needs of many computer manufacturers.

Second, the design cost of processor LSI is higher than the design cost of a memory array. Unlike memory chip design, where a single cell design can be duplicated many times with uniform interconnections, processor design requires interconnecting many hundreds of separate gates in a nonrepetitive metalization pattern.

Third, the required power level per function in a memory array is much smaller than in logic; it can easily be less than one milliwatt per bit within an LSI array, as contrasted with a standard flip-flop package that dissipates about 100 milliwatts. The power level can be smaller in a memory array, particularly in very large ones, because it is economical to make the individual cells operate with nonstandard low-voltage levels and to include peripheral circuitry to boost the signals to TTL-compatible levels.

It is therefore logical that the first processor application of LSI should be memory-like functions within the processor—such as a set of general registers or an internal scratch pad. Indeed, to a large extent, this is exactly how LSI is applied in the processors of two of the new computers. The 64-bit scratchpad and the 256-bit read-only memory mentioned previ-

ously are used respectively as the accumulators in the Nova 1200 and to hold an automatic program load routine in the Novas 1200 and 800. (The Supernova SC has no processor LSI, but does use the 1,024-bit MOS chips in its memory, whereas Novas 1200 and 800 have core memories.)

Obviously, designers of the Nova line couldn't have had these specific kinds of LSI in mind while working on the original Nova. Rather, they knew that increasingly sophisticated circuitry would become available as time went by, and tried to make a design that would be easy to redesign when the new circuits became available.

For example they thought—correctly—that sooner or later a semiconductor memory would become available, and expected—but only partly correctly—that it would probably be suitable for a machine like the Supernova before it was cost-effective for either the slower Nova or a larger, more powerful system.

As things turned out, semiconductor technology for bona-fide memory applications, as opposed to memory-like functions in the processor, was until recently applied only in special-purpose designs, and in fast buffers in the largest computer systems. Its application to minicomputers has awaited an increase in production, and a corresponding reduction in cost, to the point where the technology could become competitive with core memories. Applying the technology too soon—in an attempt, for example, to obtain performance with only secondary concern for cost—would have been risky when technological standardization hasn't yet been clearly defined.

But once standardization is defined, the intrinsic speed advantage of semiconductor memory makes it

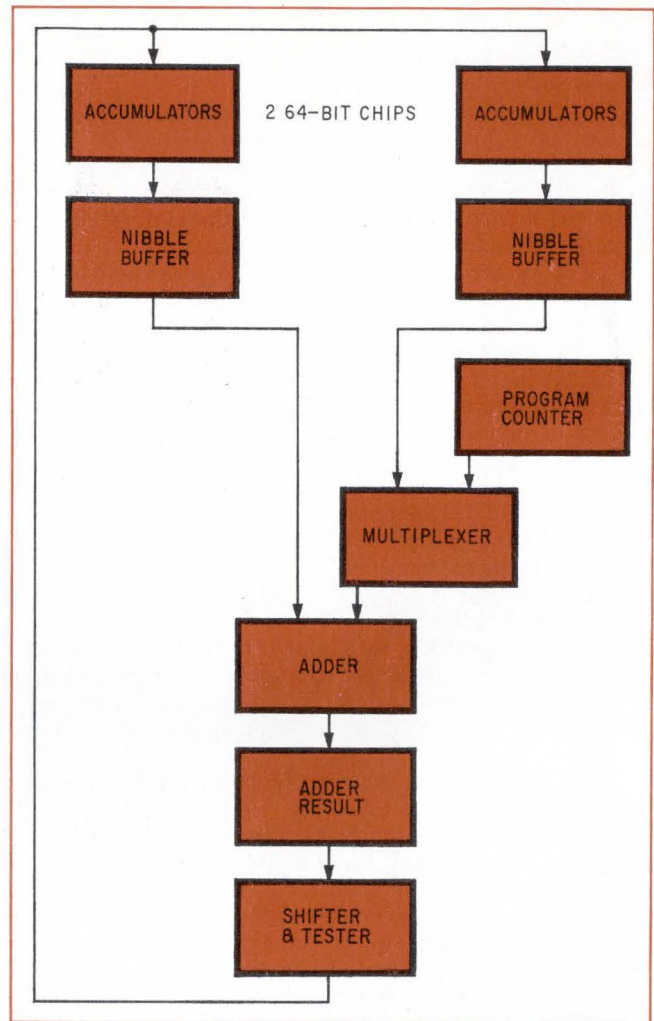

1. Overlapping. At the same time as the current instruction is being fetched and the program counter incremented for the next instruction, the result of the previous instruction is being returned to the accumulator, in the Nova 1200.

2. Twins. Two identical sets of four 16-bit accumulators halve access time for instructions with two operands. The multiplexer permits the same adder to be used both for incrementing the program counter and for processing data.

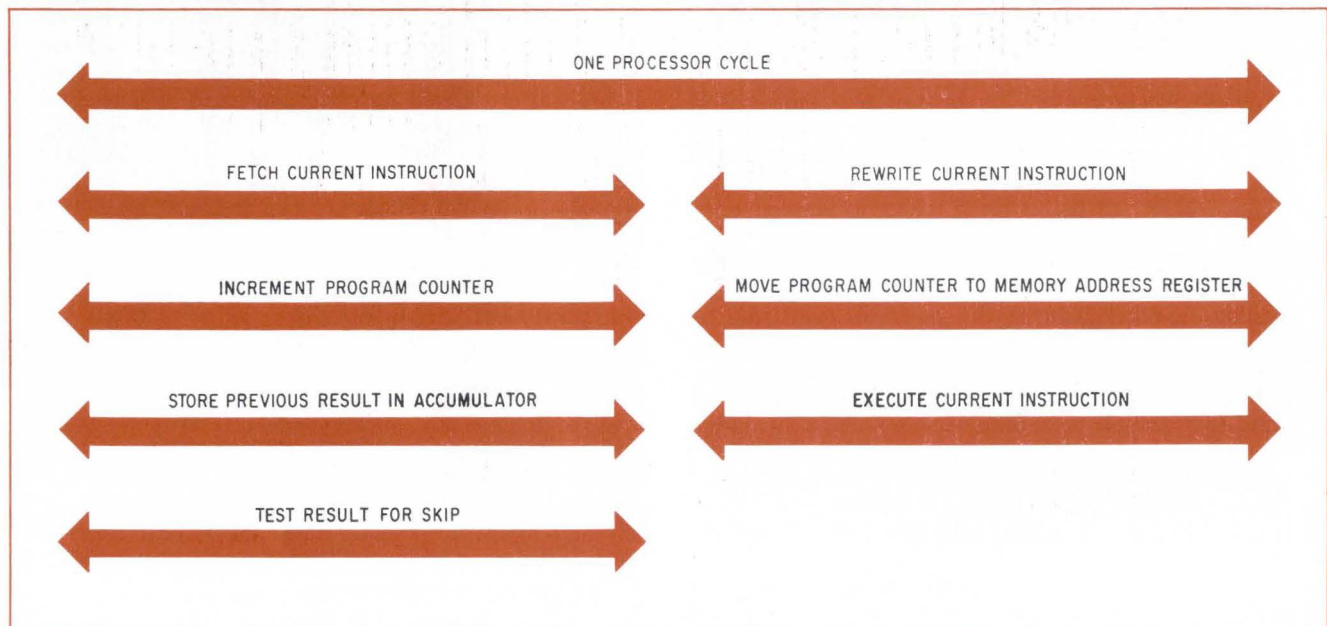

LSI in the Novas

The design of Data General's new line of three small computers had two dominant aims:

- To make use of the most advanced components readily available off the shelf, especially LSI, since LSI would reduce the parts count and the number of interconnections, and so increase reliability.

- To achieve a low price/performance ratio by concentrating on simplicity and efficiency. More specifically, mechanical construction costs were to be kept down by simple packaging, and electronic construction costs minimized by simple internal design and extensive use of MSI. Furthermore, efficient use of components not only kept component costs down, but also cut space requirements and therefore construction costs.

These aims were applied to different degrees in the computers. The Supernova sc, for instance, realizes the full potential of the first Supernova by taking advantage of advances in technology that were anticipated, but not yet available for production use, when the original model was designed.

The Nova 1200 was intended to be both less expensive and faster than the original Nova, and in fact its processor executes instructions at two and a half times the speed of its predecessor but requires only half the space.

Finally the Nova 800 matches the 800-ns cycle time of the original Supernova, but occupies only two-thirds its space and costs one-fourth less.

The price, performance and size of the three new computers are directly related, whereas the use of LSI in the processor is inversely related to these parameters. Thus, every memory fits on a single 15-inch-square board, regardless of speed or type.

In the Nova 1200, which costs about \$5,500, the processor also fits on one circuit board of the same size. It has the slowest basic cycle time—1,200 nanoseconds, matching that of its core memory. A single 64-bit LSI package contains its four 16-bit accumulators. Two of these packages are used, making two complete sets of accumulators that always contain identical data. Thus two operands can be taken simultaneously from the accumulators, cutting the retrieval time in half.

The adder in the Nova 1200, which is four bits wide, is also a single LSI chip; besides addition and subtraction, it can execute all 16 Boolean functions of two variables.

Finally, its processor also contains two 256-bit read-only memory chips. They store a program load routine that is automatically transferred to the main core memory when the load switch is pressed. This read-only memory is not to be confused with the braided transformer read-only memories that could replace sections of core memory in the original Nova and Supernova; instead, it represents a way to implement the program loading function right in the processor, with the LSI storage taking the place of logic hardware.

In the Nova 800, which costs about \$7,000, the processor is mounted in two boards, not one, and also contains two 256-bit read-only memory chips. Its adder is similar to that in the 1200, but because the 800 is fully parallel four of the 4-bit adders are used instead of one. The 800's basic processor cycle time is 400 ns, and it operates with a ferrite-core memory whose cycle time is 800 ns.

At the top of the line is the Supernova sc, whose price

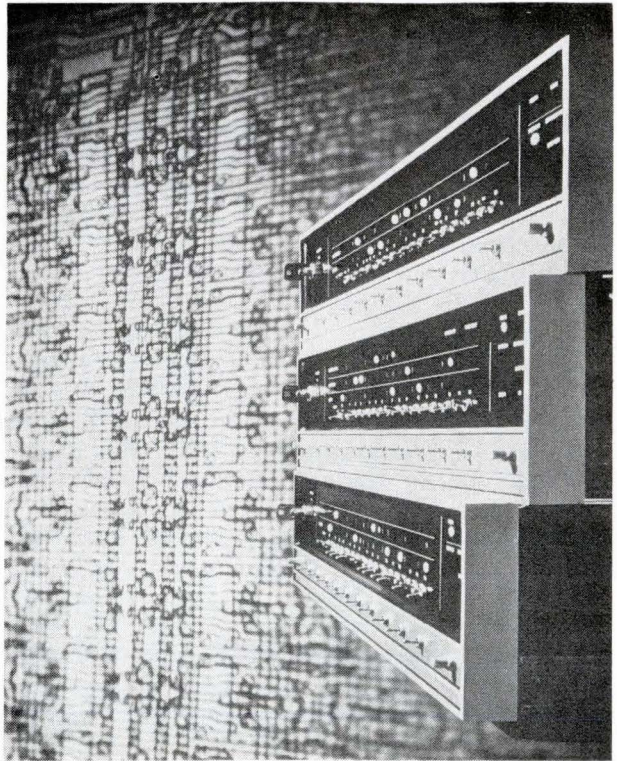

Stacked. Shown against an enlargement of a semiconductor memory mask are, bottom to top, the Nova 800, the Supernova SC, and the Nova 1200.

tag is about \$12,000. Its processor takes three boards, has a basic cycle time of only 300 ns, and uses no LSI. But the great speed of the Supernova processor makes a semiconductor memory practical and economical, so that the Supernova sc as a computer uses the most LSI even though its processor uses none.

The three new machines are compatible with each other and with the two older models, so any collection of input-output equipment that works with one of the machines will work with any other. Although this capability was considered a design constraint, it permitted considerable simplification of Nova 1200 and 800 packaging, thus reducing the cost of parts and of assembly labor. All internal connections are made through printed wiring; the processor, memory, and input-output interface boards plug into a printed back panel, and all cables are eliminated.

Even the slowest of these machines is quite fast by the standards of only a few years ago. As a result, although minicomputers have traditionally been sold for industrial control to scientific laboratories, or as sub-assemblies in other manufacturers' products, by now small computers are quickly becoming cheap enough for on-line business applications. They are fast enough to be used without special hardware in processing applications like text-editing or typesetting as opposed to simple integer arithmetic. They also have a general-purpose structure that's modifiable by suitable programs for the business environment.

instantly applicable in such a machine as the Supernova SC. The Supernova SC has a dynamic metal oxide semiconductor main memory that cycles at 300 nanoseconds. At this speed it keeps up with the processor and doesn't need the braided read-only memory in which programs for its predecessors resided. The memory requires very little power to operate, is relatively easy to manufacture, and occupies very little volume.

Its speed arises primarily from four characteristics:

- ▶ A semiconductor memory cell's state can be sensed without changing it—that is, its readout is inherently nondestructive.

- ▶ This nondestructive readout saves time in any system, because the system need not stop to rewrite data in the memory that has just been read out.

- ▶ The power required to drive the memory is relatively low.

- ▶ The power available in the sense signal is high compared to core memory.

These advantages of semiconductor memory contrast sharply with the several disadvantages of continued use of core memories. For one thing, core speeds are limited; a reduction in size from the standard 18 mils to 14 mils, for the sake of higher speed, presents serious problems in manufacturing core planes and stacks due to the difficulty of stringing them. It's unlikely that such small cores will ever be used in minicomputers, because the stringing and other costs would be so high that semiconductor memories would easily undercut them.

For another thing, a core memory readout is inherently destructive; the time to switch the core to determine its state prior to switching, and the time then to switch it back, will always occupy a significant fraction of the total cycle time. And the switching has other disadvantages. Not only does it soak up lots of power from the input, and generate very little at the output, but this mismatch of input and output power levels also creates a poor signal-to-noise ratio that isn't present in semiconductor memories.

The decision to adopt a semiconductor memory for the new Supernova, however, entailed another choice. The goal before integrated circuit memory technology is the largest chip size—both in mils and in bit capacity—at which a reasonable yield can be maintained. Today, this means either 256 bits of TTL-compatible bipolar memory or 1,024 bits of dynamic MOS memory not directly compatible with TTL circuitry. To the Supernova SC designers, the value of the four-fold increase in bit density compensated for the extra analog circuitry required for a TTL interface. They felt that the dynamic MOS approach, even though it requires additional interfacing circuitry, is the cheaper way to build fast memories at least for the next few years.

The degree of compatibility among various manufacturers of dynamic MOS chips is not clear yet, however, and the details of memory design depend very much on the chips. The chip chosen for the 4,096-word Supernova SC memory, with 16 bits per word, is a 1,024-bit dynamic MOS chip manufactured by Intel Corp., because it was judged likely that this tech-

PULSE	INSTRUCTION FETCH REWRITE	NIBBLES FROM ACCUM	PROCESS NIBBLES	NIBBLES TO ACCUM
8		3rd	2nd	
9		4th	3rd	
1			4th	
2				1st
3				2nd
4				3rd
5				4th
6		1st		
7		2nd	1st	
8		3rd	2nd	
9		4th	3rd	
1			4th	
2	NEXT FETCH			1st

3. At their heels. Pipelining each operand, nibble by nibble, through the adder reduces the number of execution steps required from eight to five. Steps relating to current instruction are in color; those relating to the previous instruction are in black.

nology and this particular chip design within that technology would be adopted as an industry standard. In other words, the computer's designers felt that the dynamic MOS technology—at least for a 4,096-by-16 bit memory—has reached a state that makes it economically justifiable in the memory of a machine with the speed of the Supernova SC. Furthermore, adopting it is the beginning of a cycle that will bring down the price still further.

Of course, for smaller memories other methods may be preferable. For example, in a 1,024-by-16-bit memory a simplified interface might compensate for the increased bit cost of another technology.

When a semiconductor memory is incorporated in a computer, the processor has to be changed to enable it to make efficient use of the memory. The most obvious requirement is faster processor logic: the basic processor cycle must match the basic memory cycle if the memory is to be kept busy. Historically, processor cycles have usually been faster than memory cycles, and sophisticated designs were necessary to make the memory keep pace with the processor. Now that their cycles match, the old sophisticated designs are no longer needed; new designs, also perhaps sophisticated, must replace them.

The first step toward higher speed is to make the processor entirely parallel internally. It also follows that the processor cannot be microprogramed. A microprogram is a series of instructions—microinstructions, if you will—that defines the routing of data step by step from the main memory through various registers and functional units in the processor. The microprogram is often stored in a read-only memory, although recent advances in technology have made alterable "read-only" memories possible. Since, in

general, there are many steps in the routing of each word from the main memory, the use of microprogramming assumes that the processor's internal speed is much faster than its main memory speed.

Another necessity, if the processor is to use the memory efficiently, is to overlap the execution of each instruction with the fetching of the subsequent instruction from the main memory. This requirement stems from the semiconductor memory's nondestructive readout capability. In a core memory the act of sensing a 1 bit destroys it, and must be followed by its regeneration. But sensing in a semiconductor memory does not alter its contents, and the time needed to read the memory—its access time—is essentially the same as its full cycle time. Conventional processor designs for minicomputers, however, call for most of the internal operations to occur during the rewrite portion of the core memory cycle. If this conventional design were retained with a semiconductor memory, even if the processor cycle were exactly the same length as the memory cycle, the memory would remain idle about half the time.

This overlapped execution and fetch had, incidentally, been a feature of the original Supernova processor, in which the programs could be stored in a braided-wire transformer read-only memory. Such a memory has the same essential characteristics as a semiconductor memory—high speed and nondestructive readout.

The new Supernova SC's memory is a significant improvement, however, since the speed can be achieved in an alterable memory. The fetch and execution portions of all the arithmetic and logical instructions are overlapped. The memory does not require a rewrite cycle, so that the processor can begin to fetch any subsequent instruction from the memory immediately after it has fetched the preceding arithmetic or logical instruction.

But not every instruction may be overlapped; for example, the Jump instruction's execution determines the address of the subsequent instruction, which therefore cannot be fetched until the Jump has been executed. A Jump therefore takes two 300-ns cycles—two, because of the time required for the calculation of the next address. Nevertheless, the bulk of the instructions are in the arithmetic and logical class; the overlapping technique executes them at the full rate of one per 300-ns cycle.

A different kind of overlapping is used in the Nova 1200, which is the least expensive of the new computers. Its use of LSI made possible the design of the entire central processor on a single pc board carrying fewer than 115 integrated circuit packages. It's more than twice as fast as the original Nova, having a 1.2 microsecond cycle time as against 2.6 μ s.

The 1200 uses overlapping when the processor is executing a string of arithmetic instructions in which the result produced is also to be tested for a skip—a condition that determines whether the computer will get its next instruction from the adjacent memory location or from the next one beyond. As shown in Fig. 1, in the first half of the cycle the processor fetches the current instruction, increments the pro-

gram counter to the address of the next instruction, stores the result of the previous instruction in the appropriate accumulator and checks the result for a skip. In the second half, the processor rewrites the current instruction into the memory—a necessary step here because the memory is made of cores, not semiconductors—performs the actual operation required for it, and also moves the contents of the program counter to the memory address register in preparation for fetching the next instruction.

It is evident from the diagram that to fetch an instruction, execute it, and return the result to the accumulators requires one and a half cycles; but overlapping the result-return with the fetching of the next instruction reduces the net time to one cycle.

In addition to instruction overlapping, the Nova 1200 employs pipelining to speed up processing. The pipeline process operates on four-bit groups—called "nibbles" to distinguish them from the eight-bit bytes used in the larger computers. Processing in nibbles permits the use of LSI in standard packages of 14, 16, or 24 pins, which in turn keeps the packaging costs within reason. The chips used contain the accumulators and the adder.

In a pipeline operation, one or two nibbles are brought out in parallel from the accumulators to buffers, transformed in the adder in a manner that depends on the particular instruction being executed, and returned to the accumulators, as shown in Fig. 2. The complete operation on a 16-bit word requires four passes through the adder.

Without pipelining, these four passes and their subsequent returns would require eight steps; but with pipelining, as each nibble passes through the adder, the next nibble is fetched from the accumulator, so that a total of only five steps is required, as shown in Fig. 3.

The overlapping and pipelining in the Nova 1200 are examples of improvements to the original Nova design that the designers felt weren't suitable in 1968 because of the complex logic design they required, but that were readily included in an improved design as parts became available. Obviously the additional control logic takes more space. But the objective in using LSI is to utilize space more efficiently—in fact, one major design goal for the Nova 1200 was to get the processor on one 15-inch-square circuit board. Using two boards would not only decrease performance as signals were sent between the two boards, but would also result in an unacceptably higher cost. But using LSI in the accumulators and the adder saves enough space to add the logic for overlapping and pipelining and still put the entire processor on one board.

These techniques of overlapping and pipelining result in vastly increased performance of the Nova 1200 over the original Nova. The rate at which the Nova 1200 executes instructions is two and a half times as fast as the old Nova, even though its machine cycles are only slightly more than twice as fast, and its basic clock rate is only 25% faster.

The Supernova SC and the Nova 800 don't use pipelining—they are fully parallel machines, in which

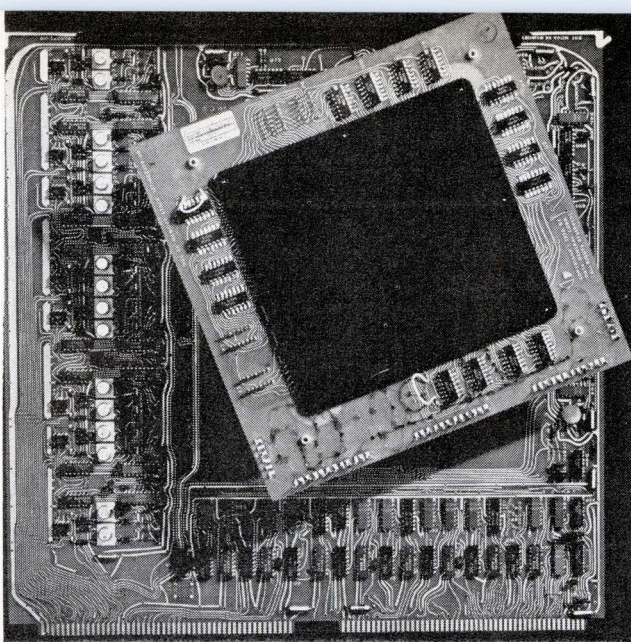

Baby. The new core memory design for the Nova 800 and 1200 has the core mat wired directly on a baby board, which then is plugged into the large 15-inch-square board. The remaining components are assembled on the large board before the core mat is attached, permitting them to be wave-soldered.

the processor actually operates internally on 16-bit words. Hence the typical LSI circuits that supply four bits at a time can't be used.

The TTL compatible 256-bit read-only memory chip is useful in a parallel machine, however, as it is fast enough to implement the automatic program load feature in both the Nova 800 as well as the slower Nova 1200. Their use here saves processor circuitry without requiring any tradeoff in performance. The Nova 800, the middle member of the series, has a ferrite-core memory that cycles at 800 ns—hence its name—and is designed to be particularly useful in heavily input-output oriented applications, such as data concentration or fast analog-to-digital conversion.

The design of a new line of computers depends only partly on any new technology. Improving the product and bettering the price/performance ratio still depend in large measure on improvements in traditional technologies, design ingenuity in using traditional components in more efficient ways, and simplification in the computer's construction and the circuits' packaging.

For example, although semiconductor memory is now available on the Supernova SC, the other two new computers still utilize core memory—and core is also available for mixing with the volatile semiconductor memory in the Supernova SC. This mixed-memory option is available as a way of cutting cost substantially with only a marginal decrease in performance. However, users who choose it are faced with the rather sticky programing job of putting frequently used instructions in the semiconductor portions and seldom-used data in the core portion. Thus, for both new Novas and for the Supernova core-memory option, another major design goal was

to greatly simplify core memory construction to reduce cost, and decrease the space required so more logic could be added.

Until recently only discrete components were available for the drive functions associated with core memory. But now there are complete sets of four monolithic drive circuits on a single chip for the X and Y drivers, and better transistors for inhibit current driving have simplified the inhibit drive circuit. This use of MSI produces a significant reduction in the space requirements of the memory drive.

The chip itself is bipolar and contains a decoding network so the memory address lines can be connected directly to it. It also has a resistive divider that biases the stack, replacing the discrete components formerly used. With simplified geometry and the introduction of monolithic drive circuits, only one drive voltage is necessary for both inhibit and read-write windings, instead of the two that were formerly required.

The great reduction in circuit packages associated with driving the core memory left room for more logic on the memory board. For example, in the new Novas the memory is connected to both the processor-memory bus and the input-output bus. This means that data channel operations bypass the processor, permitting a faster data-transfer rate in input-output operations.

The construction of the new core memories was also improved. Formerly the core mats had to be wired directly onto the memory board, and then all components had to be hand soldered. Now the core manufacturer wires the core mat onto a baby board. The remaining components are wave-soldered onto large 15-inch memory board which then undergoes preliminary test; lastly, the baby board with the core mat is simply plugged into the big board for final test and shipment.

The same memory board with a pluggable mat of 18-mil cores is used in both the Nova 1200 and Nova 800. The old Supernova's core memory is used in the Supernova SC if the user wants a part-core, part-semiconductor memory. The different cycle times are achieved entirely through the use of faster, more expensive drive circuitry in the Nova 800 than in the Nova 1200.

Of the three new models, however, the Supernova SC is definitely the most distinguished. Its combination of an LSI mainframe memory with the original Supernova processor result in a minicomputer system with processing speeds greater than those traditionally associated with minicomputers. This means that minicomputers can expand into new areas of use, particularly into business applications and others with stringent real-time processing requirements. □

Bibliography

- Edson D. deCastro, Henry Burkhardt, and Richard G. Sogge, "Nova can't lose its instructions," *Electronics*, Dec. 9, 1968, p. 76.
 Lawrence Seligman, "Making a minicomputer superfast," *Electronics*, Nov. 10, 1969, p. 116.
 M.E. Hoff, Jr., "Silicon-gate dynamic MOS crams 1,024 bits on a chip," *Electronics*, Aug. 3, 1970, p. 68.

Armed forces rely on communications to fight and survive in Vietnam

South Vietnamese are being trained to take over \$333 million network that links grunts with generals; beacons bring help to downed pilots

By Arthur Erikson, *managing editor, international*

□ U.S. armed forces in Vietnam depend on a sophisticated panoply of electronics gear, as well as sheer manpower superiority, to contain the enemy in Vietnam. Essential to the war effort is the latest in communications equipment, ranging from man pack radios, to beacons that bring help fast to downed pilots, to a vast backbone network that could link the Pentagon to GIs in combat. As part of President Nixon's Vietnamization policy, a good deal of this equipment is slated to be turned over to the Vietnamese.

Thus, an ambitious effort is under way to train Vietnamese operators and maintenance men for the hardware they can expect to inherit from the U.S. And at headquarters of the Military Assistance Command-Vietnam (MACV), communications and electronics specialists are poring over equipment rosters, sorting out what they feel the Vietnamese could master and what seems beyond their ken for the foreseeable future.

One essential system that's destined to go native—at least partly—is the Defense Communications Agency's backbone Integrated Communications System (ICS) network. Largely made up of troposcatter links, the network is crucial to the \$333 million Vietnam telephone-telegraph system operated by the U.S. Army's First Signal Brigade.

Still to be decided is exactly how this system will be split up. A.L. Van Boskirk, a U.S. aid official who's a communications adviser to the Vietnamese government, expects part will be held by whatever

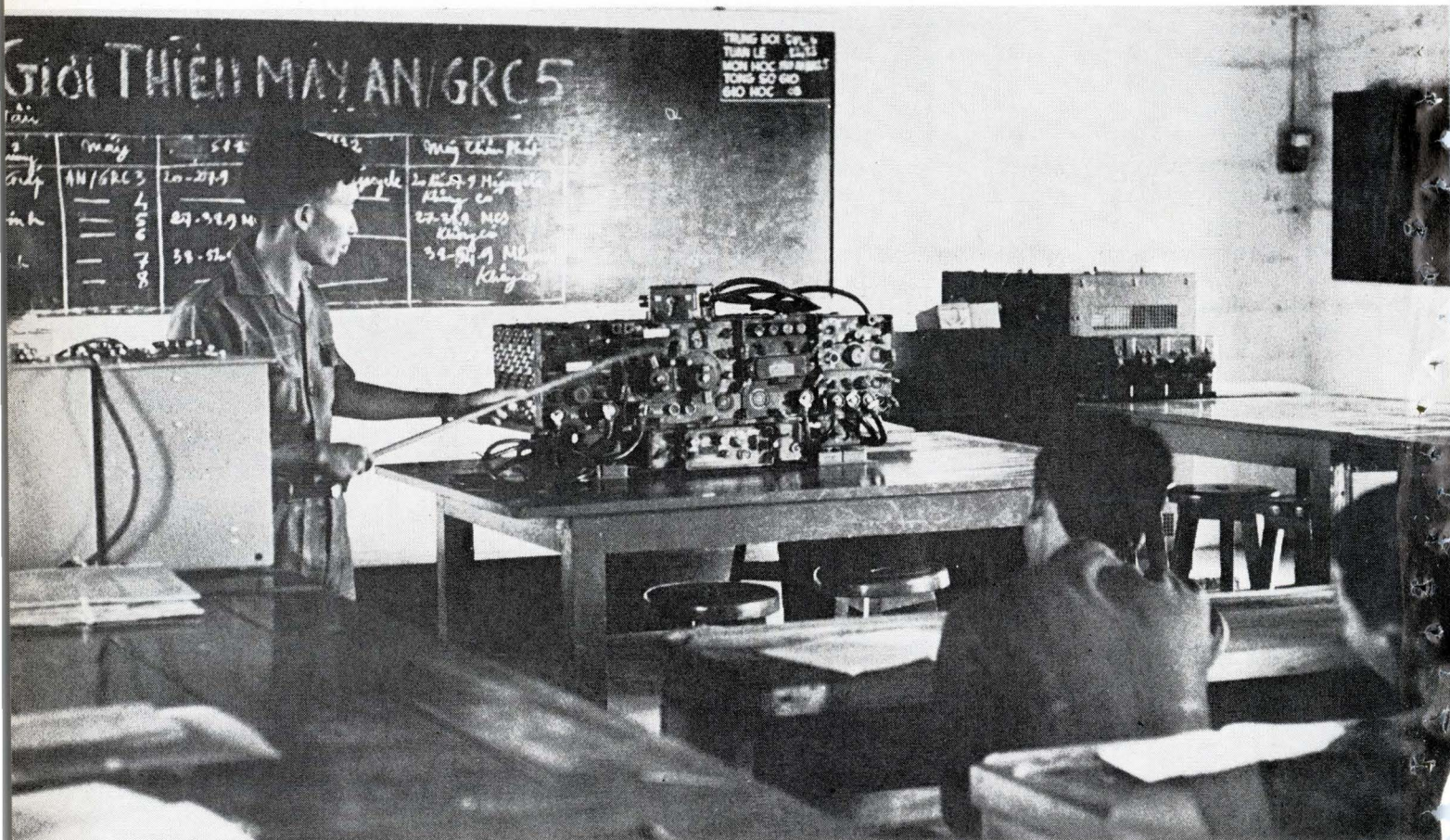

1. Bright students. An instructor at the Vietnam signal school at Vung Tau explains the GRC-5 radio set.

U.S. forces stay in the country, part will go to the Army of the Republic of Vietnam, and the balance to an autonomous telecommunications authority. At MACV, a general working on the program predicts the Vietnamese will wind up with "a greatly shrunk ICS." The reason: the troposcatter links cost too much to be run as a viable commercial operation.

School days

Nevertheless, the Vietnamese are confident they'll be able to operate it and keep it running with little outside help. "Our goal," says ARVN Col. Vu-Duy Tao, who heads the Signal school at Vung Tau, "is to be able to handle the system in about three years." After that, it's hoped, the system and the men who run it will get into mufti.

To meet this still unofficial goal the school will have to turn out 1,700 highly skilled maintenance men and an additional 1,900 men with lesser skills. It's a tall order, especially since the school has to train operators and repair men for tactical equipment as well (Fig. 1). Along with the new ICS section, Tao's outfit runs 56 other training programs lasting from eight weeks to 11 months.

Page Communications Engineers, the Northrop Corp. subsidiary which installed the ICS network, will be on hand to aid Tao's instructors. Limited to volunteers with at least a ninth-grade education, the program first provides a course in English that lasts from 24 to 39 weeks. Then Page instructors give enrollees 16 weeks of basic electronics, modeled, says Page systems engineer Robert Drake, on one given to Signal Corps students at Fort Monmouth, N.J. Formal training ends with up to 16 weeks more of specialized instruction in microwave, carrier equipment, or central dial exchange repair.

Although Vung Tau has the largest contingent of student electronics technicians, smaller groups turn up at other bases. The Vietnam Air Force (VNAF) operates a maintenance school at Nha Trang. And at Da Nang, VNAF technicians trained both in the U.S. and at Nha Trang are maintaining most of the communications and navigation gear on VNAF aircraft—mainly observation planes, helicopters, Cessna A-37 attack planes, and the Northrop F-5 fighter.

Six months of on-the-job training follows (Fig. 2). And if gauged by their enthusiasm, the Vietnamese promise to be top-notch ICS repair men. "We had to chase them off the equipment after dinner," says Signal Corps 1st Lt. John Sandberg, who worked with a score of trainees at Phan Thiet, an ICS site that's slated to be turned over to ARVN. In Sandberg's view, the Vietnamese he trained (undoubtedly hand picked) were better than the average GI.

They have another edge on the average GI in Vietnam: they are not rotated after 12 months, just

Second of a two-part series. In the Oct. 26 issue, Electronics examined the use of computers, night vision gear, and personnel radar in Vietnam.

when they've begun to know their gear.

There are problem areas, too. One of the biggest is a lack of repair manuals in Vietnamese. MACV has a group at work on the problem, and so does the ARVN signal school at Vung Tau, where instructors have even put together from English and French textbooks a Vietnamese primer in pulse techniques. But much of the time, technicians with little grasp of English have to puzzle out instructions in manuals that sometimes stump the GIs.

All told, it seems certain that ARVN and VNAF technicians will be able to field-maintain the gear they'll get. For extensive repair, though, they'll need backup by U.S. depots or perhaps by companies like Page, Philco-Ford, and others already in the country to handle jobs that military personnel can't.

The ICS that the Vietnamese will inherit, albeit in abbreviated form, now is the equivalent of two statewide Bell Telephone systems. But where a two-state Bell System would use microwave links and cables for its trunk lines, for the most part ICS uses tropospheric scatter links—Radio Engineering Labs' REL 2600 (Fig. 3). This is because allied forces relinquish control of much of the countryside to the Viet Cong after sundown. This situation rules out microwave towers, of course, except in the secure areas south of Saigon. The few line-of-sight hops in the ICS net are handled by AN/FRC-109 equipment.

Even using mainly hilltop sites, there's a problem with outages caused by sporadic attacks on tropo installations and telephone switching centers. At 1st Signal Brigade headquarters atop a red-dirt rise at Long Binh, there's a status board that keeps track of circuit outages, much as planes are tallied at Air Force control centers. "It's a rare day that we don't get a few rounds through a switchboard somewhere," says Gen. Matthew Rienzi, who until a few months ago was commander of 1st Signal, the top electronics job in Vietnam.

Communist fire isn't the only cause of outages. There's a constant rotation of Army personnel at ICS sites and some strange things have happened since Page Communications turned ICS over to Army maintenance men 15 months ago. The site at Vung Tau, for example, had to run without half its channels for more than a month early this summer because the crystals for its REL 2600 failed and the replacements were 12 kilohertz off standard.

ICS maintains reliability despite the difficulties. Its Tan Son Nhut satellite terminal, an AN/MS-46 made by the Ground Systems Group of Hughes Aircraft Co. went on the air in December 1966, and has been operating at 99.9% reliability, says its current keeper, Warrant Officer W.O. Beeler. The terminal has a 40-foot dish a 10-kilowatt transmitter operating at 8 gigahertz and a 7-GHz receiver with a sensitivity of -120 dBm. Beeler insists that the few problems encountered have been mechanical, mostly in the refrigeration equipment for the receiver that runs at 42°K. He's particularly happy with the transmitter klystrons, Varian VA-876S; they've been running for as much as 8,000 hours although their design life is only 2,000 hours.

From grunts to generals

While the Army runs ICS for all the services, it has its own unique communications problems—and solutions. Communications channels for the U.S. Army in Vietnam extend from search-and-destroy patrols all the way back to Washington. Army patrols seldom get out of radio contact with their company commander, who keeps in touch with their fire base. The fire base, in turn, is linked to battalion headquarters, where the commander has a tie into division headquarters. The divisions have access to a corps area “tactical” communications network, actually a permanent installation of troposcatter and microwave links that could be moved if necessary. Finally, there’s the backbone ICS tied by cable and satellite to the continental U.S., operated by the Defense Communication Agency and shared by all three services.

Out where the rifles are crackling, one common manpack radio is the AN/PRC-25, which the Army has been using for more than five years. The Army fights on frequency modulation as well as its stomach—the RPC-25 operating in the 30–76 megahertz band is an fm set.

The PRC-25, one of the first solid state radios to get into the field, was not blessed with a transistor output stage. When a grunt does call on his PRC-25, he’ll likely be packed up back at company headquarters on an AN/PCR-77. It’s an ultrareliable version of the PRC-25 and does have a power transistor, rather than a tube, in the transmitter output stage. The PRC-77, a two-year field veteran, is “a very fine set,” reports the Signal Corps colonel charged with keeping the communications working for the Americal division based at Chu Hai-an, the largest infantry outfit

2. **On-the-job training.** Vietnamese soldiers help operate ICS switchboards which they may eventually run alone.

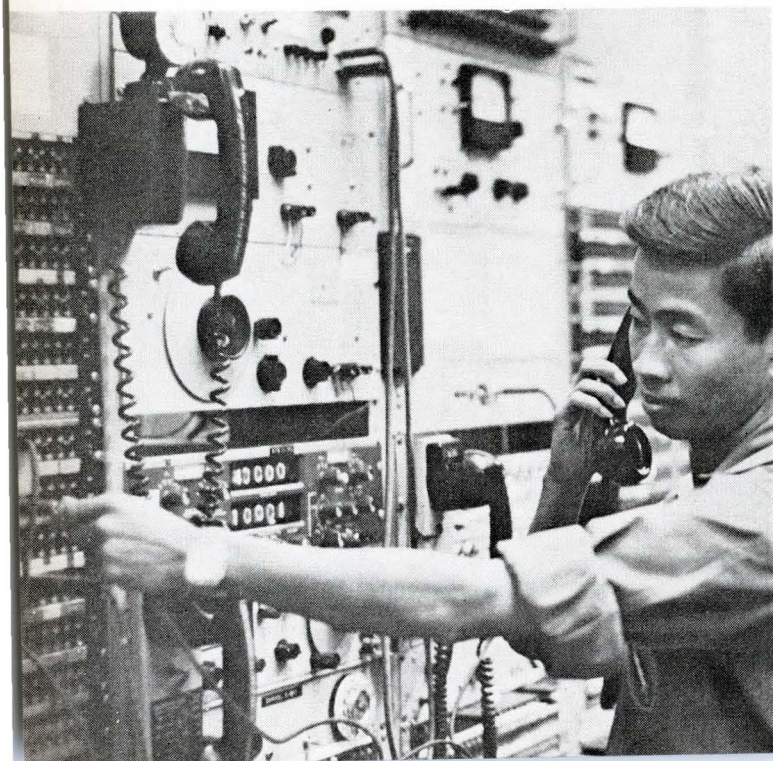

in Vietnam. The radio’s range is up to 5 kilometers with a whip antenna and 8 km with a long-ground-plane antenna.

Rare is the U.S. soldier who understands Vietnamese, but such is the esteem held by U.S. military commanders for the linguistic abilities of enemy troops that the PRC-77s in the field generally work with an AN/KY-28 digital scrambler. This requires a pair of men—one for the radio itself and one for the scrambler—to lug the packs. When two men under fire dive for cover, the tie that binds scrambler and radio generally breaks. Thus, one of the many small but vital improvements made because of such Vietnam experience is an automatic disconnect for the radio-scrambler cable.

Next step in the grunt-to-general-staff hierarchy of radio communications is the AN/GRC-163 that turns up at fire bases and battalion headquarters. Part of the veteran AN/VRC-12 series of vehicle-mounted hardware, the jeep-mounted GRC-163 can get a signal out to troops up to 50 miles away if it’s driving the AS-2169 log periodic antenna. With a whip, range is 8 to 12 miles. Output is 35 watts and, as an Army set, it’s frequency modulated.

The GRC-163 handles up to four voice channels and has a voice scrambler for security. It’s made a big hit with signal corpsmen since its arrival in Vietnam 17 months ago: before, they had to work in vans bearing the much heavier, though transportable, AN/TRC-24, a 12-channel set that operates in the 50-100 MHz band.

The GRC-163 hasn’t been a perfect performer. The set’s multiplexer, Canadian developed and designated the AN/TCC-70, develops occasional ringer module trouble. But the biggest problem is dust that fouls the generators.

Brigade commanders receive orders from division headquarters through the TRC-24 and the divisions tie into one of three Corps Area networks. So far, these “tactical” networks have been based mainly on 12-channel TRC-24 equipment, but new hardware is coming in as the systems shift to pulse code modulation. One set going operational is the AN/GRC-50, which operates from 1.3 to 1.8 GHz. Though it offers PCM, the GRC-50 still uses vacuum tubes. So it’s being supplemented by the solid-state AN/TRC-111, which operates at 4.5 to 6 GHz. “One TRC-111 can handle as much traffic as three GRC-50s,” reports Capt. Kent Seiler of the First Signal Brigade’s 2nd Group, which runs one of the Corps Area networks. The network comprises 84 systems and some 1,700 voice circuits.

Though a tube set, the GRC-50 will be in the Army’s radio arsenal for a long time given the approximately 15-year procurement cycle for heavy communications equipment. Thus the set is slated for improvements. For example, the Electronics Command at Fort Monmouth, N.J., has designed a new mixer that uses a tunnel diode instead of the original tube to boost the receiver’s sensitivity.

Seiler’s group has wrought an improvement of its own. The usual GRC-50 comes with a ridge-loaded horn antenna with a 17-dB gain. In Vietnam, though,

many sets use 8-foot dishes rather than horns. The dishes, cannibalized from deactivated AN/TRC-29 sets, boost antenna gain to 35 dB.

The higher-gain dish antennas have occasioned an associated improvement. The horn antenna must be fed through a coaxial cable that has a loss of 6 dB for each 80 feet of run. The dishes are fed by "G" lines—surface wave transmission line—[*Electronics*, April 1954, p. 180]; their loss is 6 dB per 150 ft.

Although the 2nd Group's main job has been to keep communications open between divisions and to tie them into the backbone ICS network, during the past year it's been supplying communications aid to combat-unit commanders who moved out so fast they get out of range of their base radios. To serve them, 2nd Group flies airborne relay stations, military versions of the Beech Queen Air twin turboprop aircraft. They carry three AN/ARC-149 radio sets, which cover the 30-100 MHz range.

Air Force talks it up

Like the Army, the Air Force has its own (mainly a-m) communications chain extending from the firing lines on up to the ICS. The latest Vietnam manpack radio, in fact, is the Air Force's AN/PRC-66, produced by Collins Radio Co. "We're tickled to death about it," reports Staff Sgt. Henry Schaeffer, who handles manpack maintenance at the Tan Son Nhut air base. "It's picked up planes 90 miles out," says Schaeffer's boss, Senior Master Sgt. James Nelson. The radio is used mainly by forward air controllers to guide fighter aircraft.

The PRC-66's output is 2 watts PEP (peak envelope power) and it can select from as many as 3,500 channels in the 225-400 MHz band, double the number available to FACs on the PRC-66's predecessor, the AN/PRC-41. That's important in Vietnam's heavy radio traffic. Better still, the PRC-66, weighs in at 16 pounds, about one-third the weight of the PRC-41. And it's one tenth the size. In fact, most of the PRC-66's weight and size are represented by its battery and case—the set itself only weighs 5 pounds.

These features cost money. The transceiver goes for \$6,000; the dry-cell battery pack—good for eight hours' use on a one-to-nine transmit-receive ratio—cost \$87. And it's not perfect even at that price. The battery contacts broke off one of the first sets that saw service in Vietnam late this spring. And the handset is a drawback; the FAC can't hear unless he's holding it up to his ear. Then, too, the tuning knobs and controls, lined up on the upper edge of the set, are too exposed to stand up under tough field use, says maintenance-man Schaeffer. What's more, since the PRC-66 has no guard receiver, FACs are not alerted when a pilot comes up on the 243-MHz distress frequency.

These shortcomings are soon to be corrected. "There's room for an additional plug-in module," Schaeffer notes, "and I expect we'll get a guard receiver unit." As for the exposed knobs, Schaeffer

already has designed a protective cover. And he's mulling replacement of the handset with a headset, possibly even a speaker. However, the Marine Corps already has found its own solution. In its version of the PRC-66, the AN/PRC-75, the receiver is helmet mounted. The balance of the set is hand held, while the battery is in a back-pack.

For its long-haul transmissions, the Air Force, like the Army, has to use a lot of tropospheric scatter gear. Tactical tropo mainstays in Vietnam are the AN/TRC-66A and the AN/TRC-97A. Despite its 2,500-pound weight, the TRC-97A is considered a lightweight set by Air Force standards. Even so, there's concern over its mobility, and USAF's Rome Air Development Center in New York will shortly call for proposals on a 500-pound set. It is to operate in the 4.4-to-5-GHz band with peak power of 1 kw and carry 60 voice channels or 24 PCM channels.

The system, thus far dubbed "lightweight tropo" or "tactical tropo," will use frequency-division or time-division multiplexers. It may also feature some form of signal sampling or redundant coding to match the reliability of standard frequency-diversity systems. This level of sophistication is needed to pare weight: current tropo systems use both frequency diversity and path diversity to thwart fades, but the path-diversity hedge is achieved at the cost of an additional dish.

Also due is a replacement for the AN/TRC-103, an Air Force standby for long-haul traffic in Vietnam. The successor is the AN/MRC-113, a super-reliable version of the all-solid state TRC-103. Built by General Dynamics, the MRC-113 is a fully mobile (not just transportable) tropo system with a 3,000-hour MTBF and a 15-minute MTTR. Along with the actual tropo gear, REL's AN/FRC-123, there's a microwave relay terminal, Motorola's AN/TRC-92, that provides

3. **On the beam.** 120-foot-high troposcatter antennas of the ICS often are targets of enemy rockets and mortars.

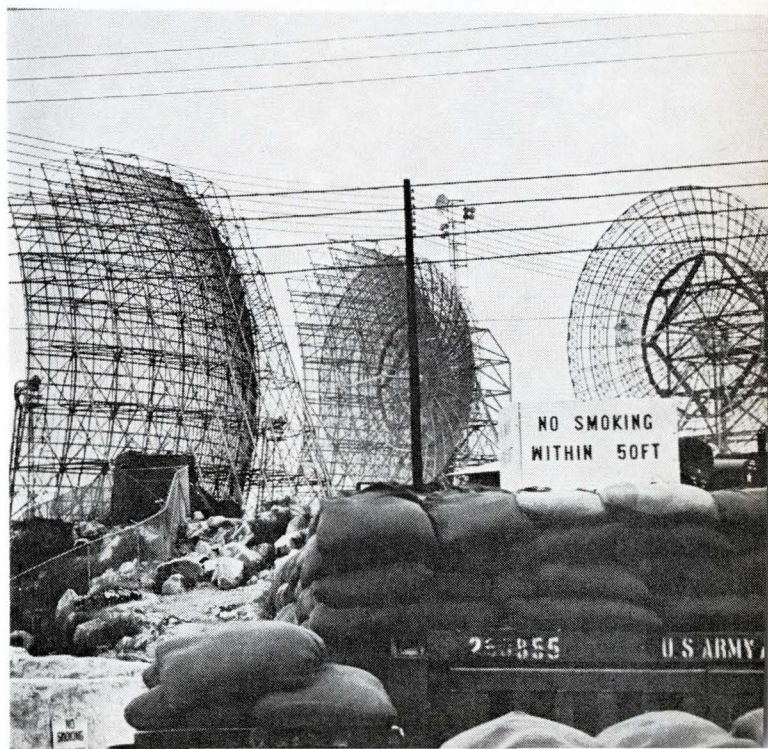

a short-hop voice link into the tropo system. The main antenna, a 28-foot dish, is segmented for mounting on a 30-ft. trailer-truck bed.

At the installation site, typically a hilltop, the crew assembles the antenna and then tilts up the trailer, which becomes an elevated base for the dish. The TRC-92 is set up alongside and is used as a down-hill link to a second TRC-92. The FRC-123 has a 10-kw output in the 775-985 MHz band. The TRC-92, intended for short hops, puts out a mere 125 mW in the 7-to-8.5-GHz band. Page Communications is prime contractor for the system, which will cost about \$400,000 each in quantity.

Army men say Vietnam is an fm war. But the Air Force works on a-m, usually single sideband. How do the twain meet? Through a proliferation of airborne radios and a jeepload full of hardware called the AN/MRC-108, from Collins Radio. This package comprises a 618-T a-m ssb transceiver for the 2-to-30-MHz band, a GRC-125 fm rig for the 30-to-76-MHz band, a 618M-1C a-m ssb transceiver for the 116-to-156 MHz band, and an a-m ARC-51 BX for 225 to 400 MHz. Another version uses an ARC-58 for 116 to 156 MHz.

Down, but not out

With the toll of downed aircraft at more than 7,200, survival equipment has taken on added importance. Aloft, U.S. pilots lose much of their effectiveness if their radios go out; downed—and some are every day—pilots are generally helpless without a radio beacon to guide search and rescue missions. Pilots who survive crashes have a good chance of getting back, thanks to better beacons.

4. Pipsqueak. The URT-33 beacon, its parachute attachment cord dangling, being used in conjunction with the URC-64.

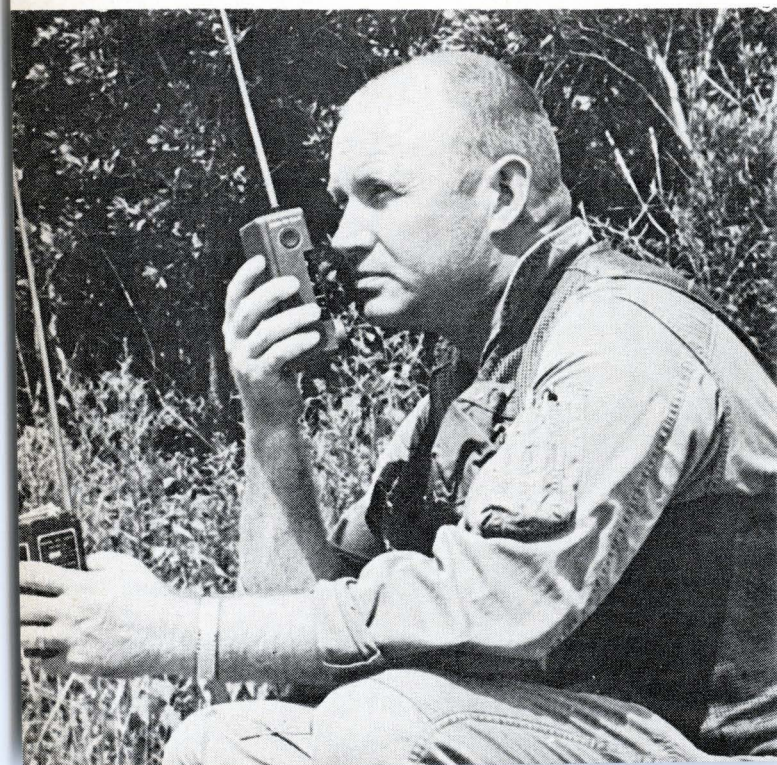

But at night, when the Viet Cong take over much of the countryside, rescue operations cease. And Air Force officers candidly admit that night-rescue hardware is lacking.

In its simplest version, a survival beacon is merely a transmitter that chirps away on the 243-MHz emergency guard channel, alerting rescue teams that a friendly plane is down in the area. The 243-MHz signal, too, can be used for direction finding. But to further help pinpoint a downed pilot a voice radio must supplement the chirper to “talk” rescue planes in. The latest survival radios combine the chirper and the voice radio; one even adds a Tacan signal.

Workhorse of the chirpers is the AN/URT-33 (Fig. 4), which puts out a downward-sliding chirp from 1,000 to 300 hertz at a 2.5-Hz repetition rate. About 20,000 have been produced, and one is routinely included in every parachute pack. The radio weighs one pound and costs about \$80.

Chute packers lash the radio's antenna to the parachute riser cord, so that the antenna is extended and the chirper goes on even if the pilot is unconscious. The antenna also actuates the on-off switch, but the National Cash Register Co., which produces the URT-33, backs it up with a separate manual switch. This addition is important: in earlier survival chirpers, the single antenna-actuated switch often was disabled by a bent, jammed or broken antenna. (Air Force survival kits, in fact, include an alligator clip and a short length of wire so a substitute antenna can be jury-rigged.)

Battery life also has been improved to 26 hours, 10 hours longer than in the earlier AN/URC-21. To supplement the URT-33 chirper with a companion voice-communications set the Air Force combined both capabilities in a unit called the AN/URC-64, produced by the Magnavox Co. A 24-month Vietnam veteran, it is, in the words of a Seventh Air Force colonel, “one of the most significant pieces of hardware developed for Southeast Asia.”

What makes the URC-64 significant is its triple-threat capability as a chirper, as a keyed-cw set, or as a voice unit. It can use four channels—the 243-MHz guard channel and three others—and has a fairly long battery life of nine hours. Thus, it can serve as a beacon for direction finders on search-and-rescue planes when the mini-chirper's batteries have run down.

Voice communications range is about 60 miles (to high-flying planes) and over 100 miles in keyed-cw operation. Any of the four channels (selected by plug-in crystal) can be used for voice or keying, but only the guard channel can chirp. As soon as he establishes contact on the 243-MHz band, the downed airman switches to another channel to free the guard frequency for other distress calls.

Although the URC-64 has won wide Air Force acceptance the Navy has something better: the AN/PRC-90, produced by Sylvania Electric Products Inc., a subsidiary of General Telephone & Electronics Corp. The Air Force, in fact, is switching to the PRC-90 and has ordered 8,700 units from Sylvania at

about \$500 each. By the year-end, Sylvania will have produced a total of 13,000 sets.

The **PRC-90** is a two-channel set, and, at 27 cubic inches and 24 ounces, is somewhat smaller and lighter than the URC-64. What's more, the PRC-90 is more rugged than the URC-64: it can survive a rapid decompression during a fall from 40,000 feet, and withstand a plunge of 50 feet in salt water. Best of all, its quarter-wave length, rubber-impregnated, flexible whip antenna is practically unbreakable and won't short-circuit when wet. The antenna is not pulled up to switch the set on as in the URC-64; there's a separate on/off switch.

The PRC-90 is built around six, modular thick-film circuits. Peak effective power is 500 mW in both beacon and keyed-CW mode, 200 mW in voice mode. Its chirping beacon, as usual, operates at 243 MHz as does the keyed-cw mode. Voice communications can be either at 243 or 282 MHz. If the set is used in beacon mode alone, the mercury battery provides a 15-hour operating lifetime at a 25°C ambient.

In addition to the U.S. Navy and U.S. Air Force, the Australian Air Force already has bought 260 PRC-90s and production forecasts for the set run to a total of 30,000 units. This prediction could be off the mark since it assumes that Honeywell Inc.'s AN/PRC-95 (Fig. 5) will not, in turn, supplant the PRC-90.

With first deliveries slated for January (several months late because of transponder delay problems), the PRC-95 is the latest of the rugged, immersible air-sea rescue radios developed for the Navy. It will have two channels for voice communications, with a line-of-sight range of up to 120 miles as well as a conventional chirping beacon. The real innovation, though, is the set's L-band Tacan distance measuring equipment. This feature permits Tacan-equipped aircraft to pinpoint a downed airman's location within 0.1 nautical mile.

There's a noteworthy innovation, too, in the PRC-95's power supply. It's the first survival radio to use a lithium battery. Largely because of its dry active region, the battery has an estimated shelf life of at least five years. Electrolyte doesn't start working until the user activates the battery by pulling a ring. Once in operation, the battery should power the radio beacon for 18 hours under ambient temperatures of 25°C. The set weighs 2 pounds and measures 30 cubic inches.

The Navy also expects great things from a new chirper, the AN/PRT-5. It's a 16-inch-long by 6-inch-diameter 15-pounder with simultaneous 8.36-MHz and 243-MHz outputs. It floats alongside a life raft and has 500-mW PEP at 8.36 MHz, good for a range of several thousand miles to a land-based network of sensitive monitoring stations. The network will localize the beacon to a sector 50-miles in diameter. Rescue aircraft sent there will home on the 243-MHz beacon from about 160 miles away using their direction finders. The PRT-5 has a 9-foot antenna for the lower-frequency link and a 12-inch uhf antenna. The battery is expected to power the equipment for 72 hours, long enough for rescuers to reach a downed aircrew anywhere in the world, in any kind of weather.

Radar, as well as radio, can come to the aid of parties downed in Southeast Asia. The Avion Division of Dewey Electronics Corp. in Paramus, N.J., for example, has carried development of an X-band crash-location beacon through to the penultimate stage, preproduction models under an Air Force contract. The beacon uses a crystal-video receiver to instantaneously cover the 8.5-9.6 GHz band with sensitivity of at least -50 dBm. Interrogated by any friendly airborne X-band radar, the unit responds with a 9.31-GHz single or double-pulse reply. Peak output power is 150 watts.

Another candidate for this business is Motorola's Government Electronics division. That company has two commercial X-band beacons, one much larger than Dewey's, the other about half the latter's size. Output power is lower in both, 50 W peak for the larger one, the SST-119X, and 5 watts for the other, the SST-201X. Non-Mil-spec construction and parts are further drawbacks of the Motorola beacons.

X marks the spot

The Dewey survival beacon is a cousin to the company's AN/PPN-17 (Fig. 6), the latest paratroop beacon in Vietnam. Weighing in at about 16 pounds, it's an inline tubular combination of battery and transmitter/receiver sections plus a top-mounted slotted-waveguide antenna. The beacon operates at X band, has a tunable preselector, and a four-bit reply message. Peak power is 400 W.

Though the PPN-17's output is high, in Vietnam a beacon may have to operate under a heavy cover of jungle vegetation, which can attenuate signals as much as 1 dB for each meter of foliage traversed. With the shallow angles involved in paratroop operations, total attenuations of 25-30 dB are not uncommon. One solution would be to mount the antenna on a mast. But with manpack equipment like the PPN-17, all that can be supplied, considering the weight limitation, is a 3-foot mounting spike.

At one time, the Air Force was pondering an air-dropped version of the PPN-17 in which blades folded flat against the sides would open when the beacon was dropped and pinwheel it down to an acceptably soft landing. But now the Air Force seems to be leaning toward a combination X/Ku-band beacon, the AN/TPN-23 fitted with aerodynamic blades and an imbedment spike, developed by Vega Precision Labs Inc., Vienna, Va.

The basic beacon is somewhat heavier than the PPN-17 (20 pounds vs. 16 pounds) but offers simultaneous operation in both X band and Ku band. Output elements are limited-space-charge-accumulation (LSA) diodes that generate 100-W peak output in each band. The beacon can transmit and receive simultaneously in both bands or it can transmit in one band and reply in the other.

Also available for remote control is a uhf command circuit. Thus a beacon dropped well in advance of a strike can lie silent until switched on to guide planes

on a mission. Another possibility would be to add sensors, such as footfall detectors, for surveillance of unsecured terrain. Then the beacon could be interrogated by overflying aircraft. This way, battery life can run to several weeks.

On-the-spot practice may not make perfect hardware for Vietnam, but it helps. An occasional feature of U.S. Army installations in the combat theater is a Quonset hut or two with "Activ" painted on the door. Inside, the people could be working on almost anything relating to Army operations in Southeast Asia. For "Activ" is the acronym for Army Concept Team in Vietnam. Its main role is to apply the lessons learned in Vietnam as soon as possible.

One of the group's major jobs is putting new electronics equipment to its ultimate test: letting GIs operate it. Another main job is assessing the evolution of broad categories of equipment. For example, one study under way is a hard look at fast-proliferating avionics equipment as the Army's largely whirlybird air armada gets more sophisticated. Then there's on-the-spot research and development. Finally, there's Activ's part in Vietnamization: like almost every other Army unit, Activ is trying to pass along its essential skills to its Vietnamese counterpart, the Combat Development Test Center-Vietnam.

Although Army procurement procedures usually proceed at a stately pace, Activ can move fast on small, but nonetheless badly needed items. "As long as we don't spend more than \$50,000 and can get a prototype into the field within nine months, we don't have to go through channels, all we need is an okay from Fort Monmouth," says Col. Richard L. Clarkson, the group's commanding officer. The funds come from a program known as Vlapa (for Vietnam Laboratory Assistance Program, Army), funded at \$1 million yearly. For costlier hardware, there's a special fast-procurement cycle, too; but it goes through channels.

Quick fix

Thus it was Activ that put into the field in a few months a quick-disconnect for the cable that links AN/KY-28 secure voice gear, lugged by one grunt, to the AN/PRC-25 or AN/PRC-77 radio carried by another. Without the disconnect, the cable often is ripped out of the set. Activ also drummed up a makeshift log-periodic antenna when ground troops moving into Cambodia found they were getting out of range of their bases. The antenna was a 5-foot-square lashup of bamboo poles with scrap wire taped to it. Linked to transceiver antennas through a coke-bottle-based balun, it outperformed the whip antenna by 4 db.

Such on-the-spot development work is limited to fairly simple items because Activ is a small group—about 100 people—without a whopping research budget. But for evaluations Activ can lay its hands on some of the most sophisticated Army gear.

At midyear, evaluations were under way on man-pack and long-range personnel radars; base-defense listening devices; a quick-erect base station, antenna

tower and an auxiliary generator for powering helicopter electronics while the aircraft is on the ground. Also in progress is work on night-vision equipment; a petroleum-jelly-filled, self-waterproofing telephone cable; a helmet radio receiver, (the AN/PRR-9) incorporating ICs, and a commercial, British-built 9-pound hf a-m transceiver (Rank Bush Murphy Electronics' Model A 16) that the Green Berets think may suit them better than what's now available from the U.S.

Ask any of the project officers running evaluations of new hardware (or, for that matter, Clarkson himself) why equipment so often fails in Vietnam after it's passed field trials in the U.S., and you get a variant of the same reply: it's the way troops handle equipment. "The initial reaction is shock," says Clarkson, speaking of test engineers who come out to Vietnam to see equipment they've helped develop get put through its paces. "Back there," he continues, "jeep-mounted equipment is tested with the jeep crawling. In combat, though, the accelerator's on the floorboard whenever there's enemy fire."

Anything that protrudes from a combat vehicle is a potential trouble spot—whip antennas, for example. Activ has worked out a spring-mounted telescopic whip that will give, rather than break, when it catches on jungle foliage. And an Activ test team had to send back for redesign a land navigation system that pairs magnetometers and an odometer to develop the basic inputs for computing position coordinates. The magnetometers were slung outboard on an armored personnel carrier, and didn't last long in the jungle.

Still another problem is battery trouble. There's electrolyte spillage, for one thing. For another, the battery contacts break, even on some of the latest equipment. And, as any grunt who's had his radar run out of power at night will attest, changing batteries noiselessly with no light is not the same as changing them in a well-lit test shop where nobody's outside ready to shoot at anything that rustles. What's more, there's a proliferation of battery types, sizes, and voltages. Here, though, the Army is making a start. The AN/PPS-9, currently under evaluation, uses one of an upcoming family of standard batteries, says Maj. Ralph Badger, who heads Activ's research and development section. Even more important is a program to standardize battery compartment sizes, so that a variety of batteries can be used interchangeably.

Radio antennas, too, are a continuing preoccupation because of attenuation of signals by foliage. "We've had four different projects to find ways to get antennas up above the foliage," says Badger, "and none worked." In one try, Activ lifted antennas by moored balloons—much to the dismay of helicopter pilots. There's no more formal work on radio antennas under way in Vietnam, he adds.

But work continues on foliage penetration by radars. Among the sets under evaluation is base defense hardware that uses anti-clutter circuitry, developed by the Limited Warfare Laboratory at Aberdeen, Md. Also under evaluation is a long-range ground surveillance radar, the AN/TPQ-34. The set's performance is classified, but presumably its designers have addressed themselves to foliage penetration.

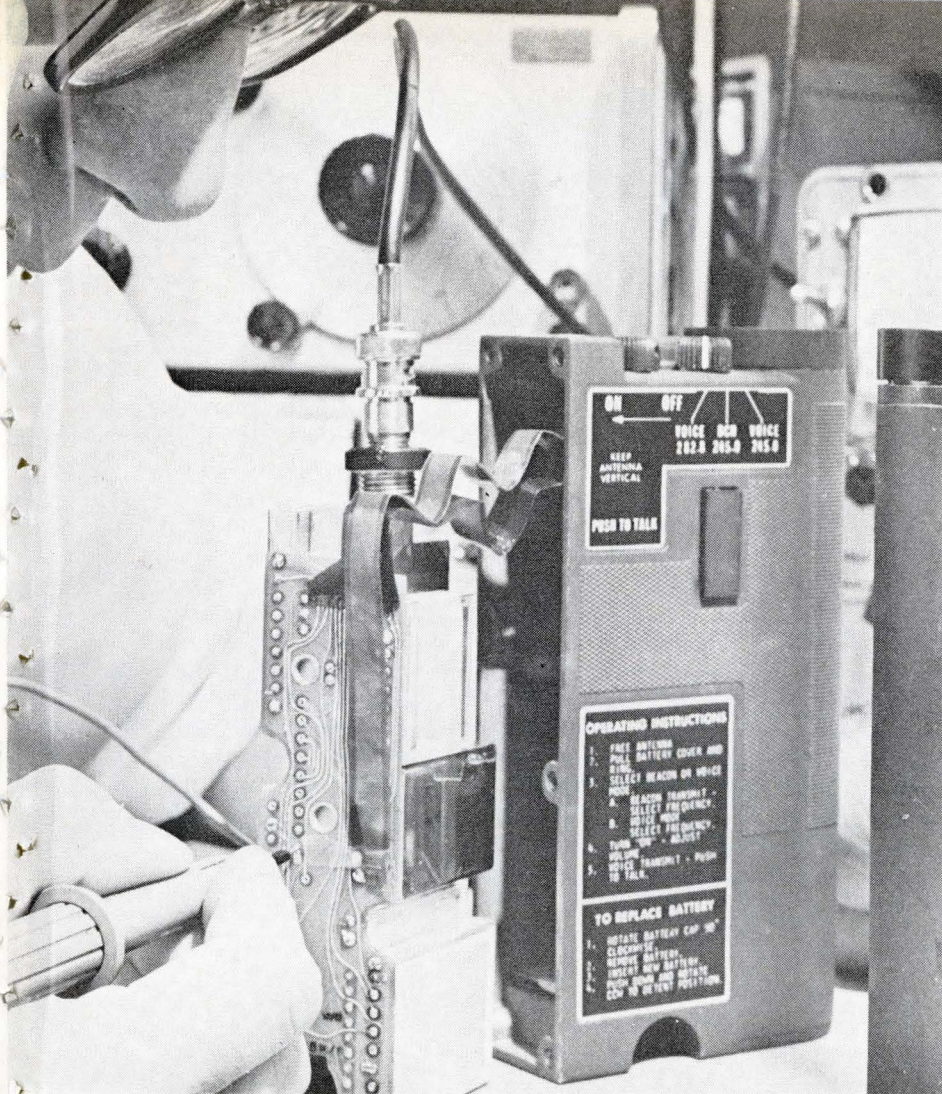

5. **All in one.** The PRC-95, latest of the personnel-survival beacons that were developed for use in Southeast Asia, combines chirper, voice and Tacan modes, may supplant the PRC-90.

6. **In production.** The PPN-17 paratroop beacon, already deployed in Vietnam, features a four-bit reply message and 400-W output power.



Radar Riders

Other radar problems remain Air Force concerns. Although it's running two of the world's busiest airports, Tan Son Nhut and Da Nang, the Air Force has still to set up truly permanent air-traffic-control radar installations in Vietnam: the Korea-vintage sets in use are operated from bunkered-in vans. In fact, traffic is so heavy (although down from the peak of 11,000 radar-controlled movements in a month at Da Nang during the Tet offensive of 1968) that the Air Force has doubled up the number of operators' vans that work with each radar. One van houses five surveillance controllers, the other has three approach controllers. This has boosted the radars' capacity from 7,000 operations per month to more than 10,000.

However, reports Lt. Col. John Monk, chief of Navaid operations for the 7th Air Force, the two-van solution creates a problem: the surveillance operators have to phone the approach operators every time they turn a plane over for a landing. In the Air Force's latest air-traffic-control radar, Raytheon's AN/TPN-19, the two-operator teams work side by side. This new radar also will meet a requirement that the Air Force didn't know it needed before Vietnam—the ability to

paint targets in heavy monsoon rains. And temperature inversions and screening problems are other main radar headaches in Vietnam, Monk feels.

One of the most effective airstrike control radars has been the AN/TPQ-10, a General Electric Co. product. This X-band radar has been a mainstay in "blind" bombing operations—strikes against targets like camouflaged enemy batteries that pilots can't see.

To pinpoint targets, photoreconnaissance planes like the RF-105 Thunderchief and the RF-4C Phantom overfly enemy positions and pick off their coordinates through inertial and loran navigation. With this data fed into its computer, along with information on ballistics, plane velocity and altitude, weather conditions and the like, the TPQ-10 guides fighter-bombers to the drop point. Initially, circular probable errors of 150 meters were obtained, but during the Khe Sanh defense in 1968 ballistics tables were refined to achieve 50-meter CEPs.

But the military wants to do even better. RCA is developing the AN/TPQ-27 for the Marines under a Navy contract. Although most pilots don't like to relinquish control of bomb release, the TPQ-27 likely will have an automatic-operation mode in which the system's ground-based computer triggers the bomb release through a uhf control link. This could slice between 15 and 25 meters off the CEP. □

Designer's casebook

Symmetry principle eases design of summing op amp

By Brock Dew
MIT, Cambridge, Mass.

Computing resistor values for differential summing of voltages into operational amplifiers needn't be complicated if the principle of symmetry is employed. With this technique the task is accomplished virtually by inspection—even when several signals must be weighted with different gains and polarities. Moreover, this method can be extended to reactive elements, such as capacitors, in design summing integrators and filters. And scaling is easier because a single gain multiplying the sum allows over-all gain to be changed easily.

First, select a base value of resistance, R , usually 20 kilohms for IC op amps. The signals then are

summed through resistors whose admittance is proportional to the desired weighting, and whose connection to the op amp depends on polarity. A resistor whose admittance is proportional to the reciprocal of the over-all gain weights the feedback. Weighting is accomplished by selecting the absolute magnitude of the desired gains, G .

Note that for every resistor weighting an input or feedback signal, a complementary resistor must be added to ground on the other side of the differential op amp. This is required to maintain symmetry.

The differential op amp action drives e_2 until it almost equals e_1 . This permits modeling to be realized. Both individual and over-all gains should be apportioned to prevent e_1 and e_2 from exceeding the amplifier's common-mode operating range. Maintaining resistor symmetry also equalizes the dc resistance to ground at the two op amp inputs, and minimizes offsets due to leakage current. It also tends to balance the two inputs' sensitivity to pickup and prevents amplifier input impedance from affecting the validity of the summing equations.

Simple summing. System block diagram (left) demonstrates weighting of signals with gains of either polarity. Circuit diagram (right) shows that feedback is weighted with a resistance proportional to over-all gain; the summing resistor values are inversely proportional to absolute magnitude of desired gains.

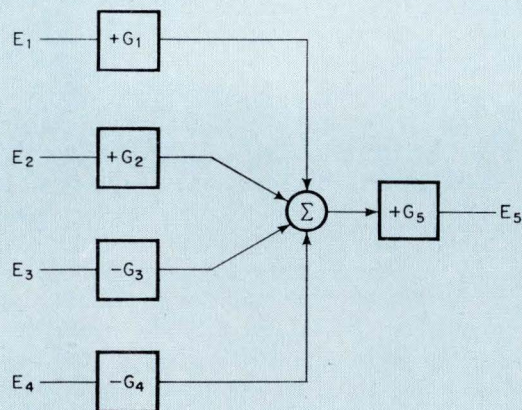

$$E_5 = +G_5 (E_1 G_1 + E_2 G_2 - E_3 G_3 - E_4 G_4)$$

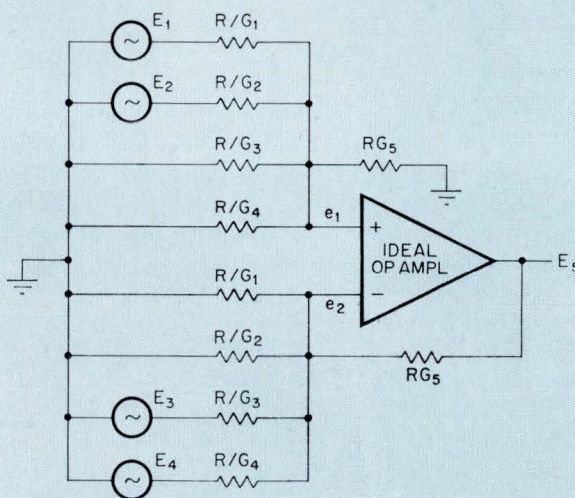

$$e_1 = \frac{E_1 \frac{G_1}{R} + E_2 \frac{G_2}{R}}{\frac{G_1}{R} + \frac{G_2}{R} + \frac{G_3}{R} + \frac{G_4}{R} + \frac{1}{G_5 R}} \approx e_2 = \frac{E_3 \frac{G_3}{R} + E_4 \frac{G_4}{R} + E_5 \frac{1}{G_5 R}}{\frac{G_1}{R} + \frac{G_2}{R} + \frac{G_3}{R} + \frac{G_4}{R} + \frac{1}{G_5 R}}$$

$$E_5 \approx G_5 (E_1 G_1 + E_2 G_2 - E_3 G_3 - E_4 G_4)$$

Single IC pulser eliminates contact bounce

By A. James Laurino
Cambridge, Mass.

Contact bounce encountered when mechanical switches are interfaced with high-speed logic circuits can cause errors. An economical anti-bounce circuit using a single integrated circuit does the job without large, expensive filter capacitors.

The circuit comprises a quadruple dual-input positive NAND gate; gates 3 and 4 form a set-reset flip flop.

When a break-before-make switch is in the normally closed position, one input to gate 3 is grounded and the voltage to gate 1 is positive. This causes the output of gate 3 to go low and the output of gate 1 to go high. Thus, with one input to gate 2 high and the other low, the gate's high.

When the switch is reversed, one input to gate 3 rises to a positive voltage and the input to gate 1 goes to zero. This causes the output of gate 3 to remain high and the output of gate 1 to go high. With both inputs to gate 2 high, its output goes low, thus initiating the pulse.

The pulse's leading edge then resets the flip flop, which causes gate 3's output to go low until the switch again is returned to the normally closed position. When gate 3's output goes low, gate 2's output is forced to go high, and the pulse is discontinued.

Since the pulse is completed within a time much shorter than the period of one contact bounce, the circuit is desensitized to any changes at the output of gate 1. Thus the effect of contact bounce is eliminated. Of course, it's assumed that contact bounce is about one contact and never between two.

When the switch is returned to the normally closed position, the input to gate 1 first rises to positive voltage, causing its output to go low, followed by one input of gate 3 going to ground. This sequence, which results from the break-before-make action of the switch, prevents a false output.

Pulse width is determined by the time it takes the pulse's leading edge to propagate from the output of gate 2 through gates 4, 3 and 2. To lengthen the pulse width, a capacitor must be connected from the output of gate 4 either to the input of gate 3, if TTL circuitry is used, or to ground if DTL is used. A 220-picofarad capacitor provides a 150-nanosecond pulse.

Testing the circuit is quite simple. With the input of gate 3 disconnected from the switch and connected to the output of gate 1, a square wave applied to the input of gate 1 should produce an output pulse.

Bounceless. This circuit produces a negative-going pulse whose minimum width is approximately equal to three gate delays. The pulse width, however, can be increased by adding a capacitor. If a TTL IC is used, the capacitor is placed between the outputs of gate 4 and gate 3; for DTL, it's connected from the output of gate 4 to ground

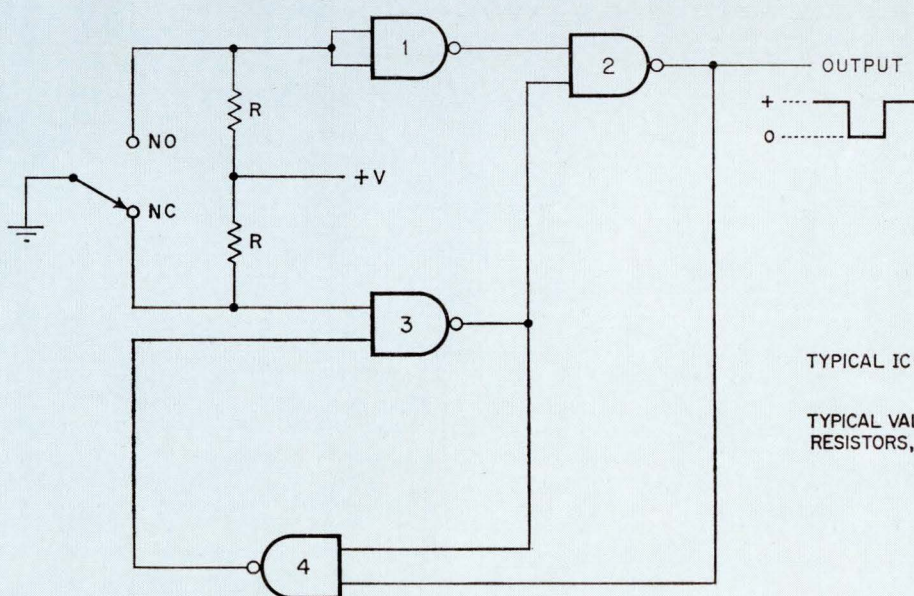

TYPICAL ICs: SN7400N (TTL)
MC846P (DTL)
TYPICAL VALUE FOR PULLUP
RESISTORS, R: 470 OHMS, 1/4 WATT

Zener diodes reset sampling gate automatically

By Ronnie W. Camp
Georgia Tech, Atlanta, Ga.

With their low impedance when conducting, zener diodes make fine candidates for diode gate samplers where simple structure and low power consumption are desired. Power is consumed only during sampling, and the gate automatically resets at the end of the sampling pulse when the zeners turn off. Furthermore, because of the low series on impedance, only relatively short sampling times (as low as 0.25 microsecond) are needed to acquire new samples.

A gate pulse of proper magnitude and polarity delivered to the primary winding of the balanced transformer reverse biases the zener diodes into breakdown and forward biases the signal diodes. The peak current, I_p , depends on the applied voltage and the series resistance of the transformer primary.

When all diodes are conducting the impedance around the secondary loop becomes quite small. Equal voltages are generated on both sides of the balanced transformer secondary. If the diode voltages are well

matched, the output terminal is effectively connected to the analog input. Impedance usually is a few ohms when 6- to 9-volt zeners and high-conductance signal diodes are used.

For most 6-V-or-greater zeners, reverse leakage is low enough to allow long retention of the sample on the output capacitor without significant loss. If the signal and zener diodes are well matched, very low offset can be realized at the output with minimal sampling pulse feedthrough.

When wideband analog signals are handled, the diodes' parasitic capacitance will allow some feedthrough of the analog input, which ultimately limits maximum operating frequency. This is especially true when operated with a fairly high impedance-resistive load. Typical zero bias capacitance values for the zeners are in the tens of picofarads.

In addition to sampling and sample-and-hold circuits, the gate also can be used as a shunt switch, where it has performed well because of the very low diode impedances. Typical peak gating currents in the 100-milliampere range have been used for the 1N4739A, a 9.1-V zener. The 1N4149 signal diode was selected because it has very low forward impedance at the selected gating currents.

Designer's casebook is a regular feature in Electronics. Readers are invited to submit novel circuit ideas and solutions to design problems. Descriptions should be brief. We'll pay \$50 for each item published.

Direct route. A sampling pulse at the input to the transformer's primary reverse biases the zener diodes and forward biases the signal diodes, resulting in very low on-impedance for the transformer's secondary loop. The analog input is effectively connected to the output until the sampling pulse is terminated.

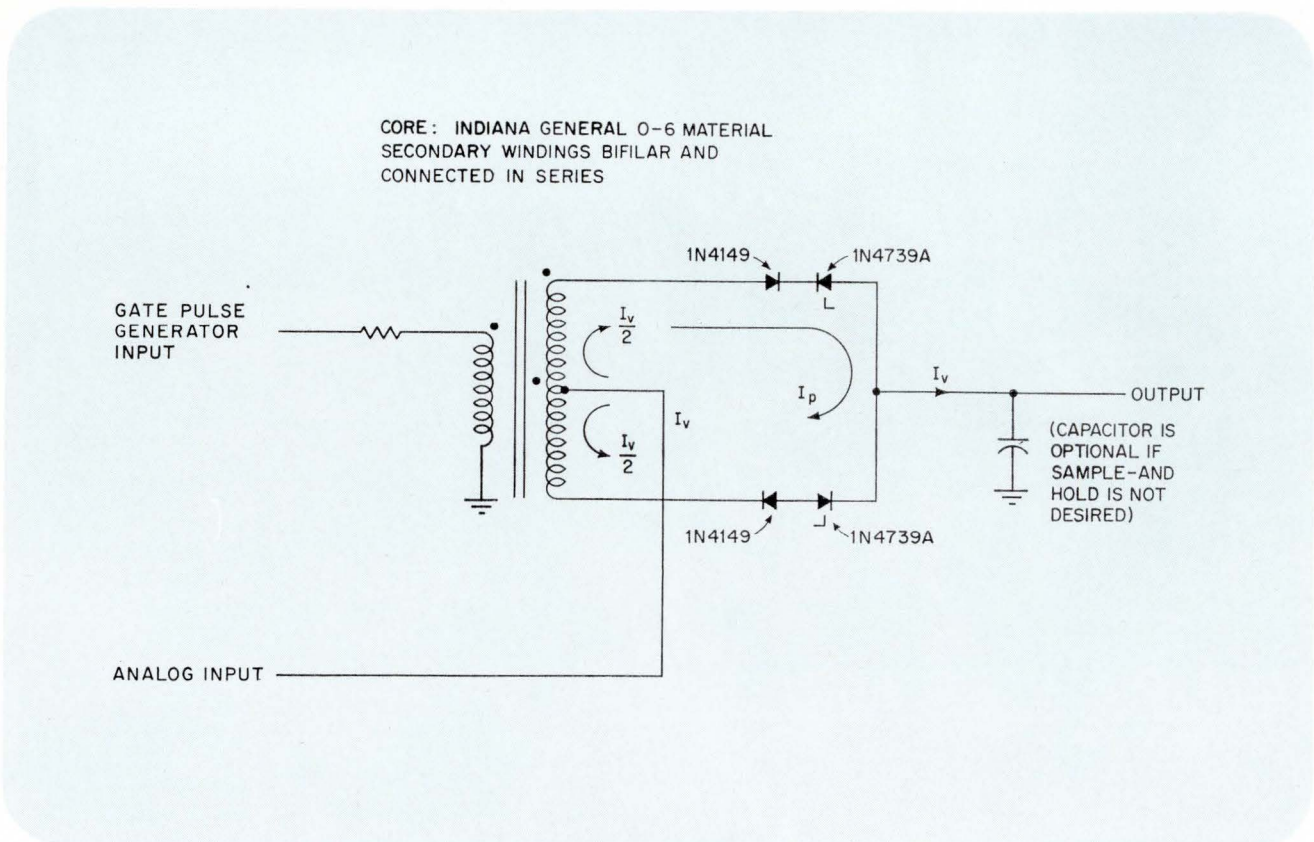

A unique pair of Planar Triodes

40 kW peak at 1500 MHz -15 kW peak at 3000 MHz

The TH 318, specially designed for pulsed oscillator service, delivers up to a 40 kW peak power output at 1500 MHz with a duty cycle of .003. Its pre-stretched grid structure completely eliminates grid resonances; and all-metal-and-ceramic construction assures exceptionally long service life, as demonstrated by hundreds of tubes in field use.

The TH 6886 delivers up to 15 kW peak at 3000 MHz with a duty cycle of .001. Its planar structure,

similar to the TH 318, gives it the same ruggedness and resonance-free operation.

Both tubes are particularly suitable for doppler radar applications because of their very low noise level. And they join the most comprehensive line of triodes and tetrodes developed for operation up to 20 kW CW at 1000 MHz. For more specific information, please circle the appropriate number on the Reader Service Card or contact us directly.



THOMSON-CSF

Thompson-CSF Electron Tubes, Inc./50 Rockefeller Plaza/New York, N.Y. 10020/(212) 489-0400

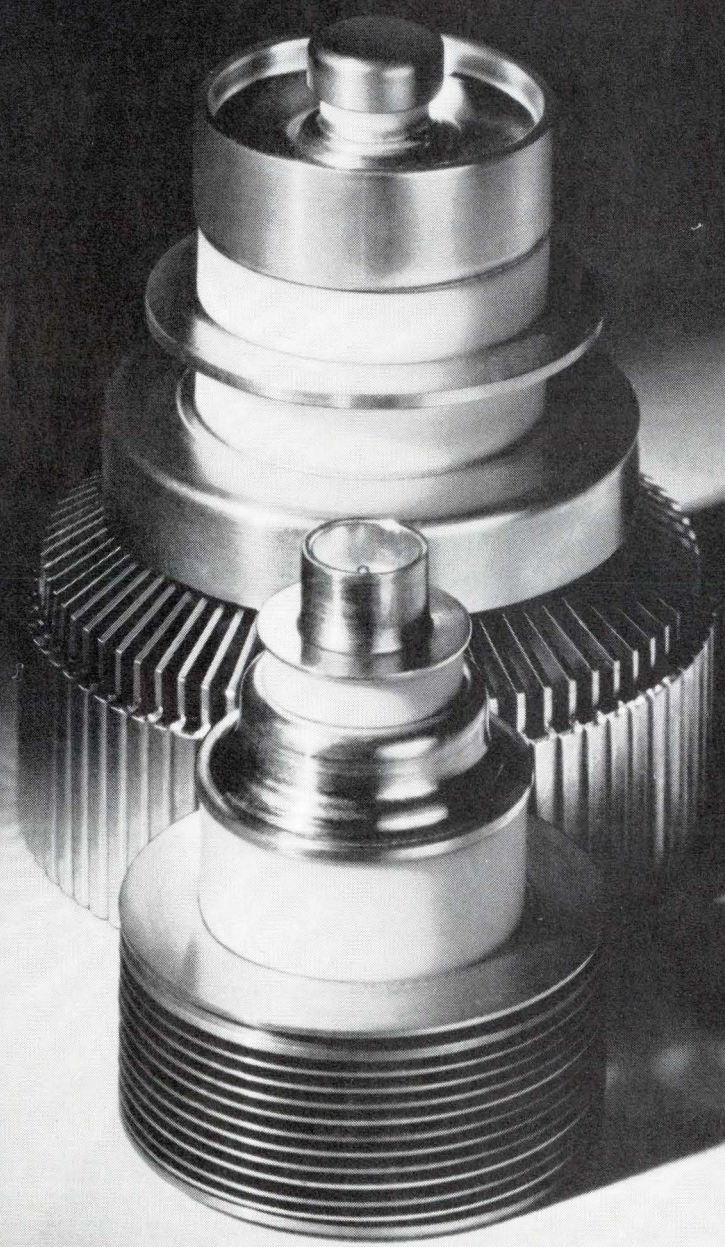

Need accurate recordings of fast transients? Try disks

Disk technique, always ready to record random transients, offers better signal-to-noise ratio than tape recorders and avoids single-event limitation of camera-scope setups

By Richard W. Calfee, E. Troy Hatley, and Pete Kauffman, *Data Disc Inc., Palo Alto, Calif.*

□ Disadvantages plague the usual methods of recording transient waveshapes for later analysis. Magnetic tape encounters track-to-track time-base errors; greatly increased noise and distortion occur whenever high-frequency data are played back at speeds slower than their recorded rate. On the other hand, a camera-oscilloscope setup photographs only a single event unless complicated resetting techniques are used; what's more, results can be interpreted only by manual techniques.

Disk recording generally outclasses either approach. Long used in video and digital work, such recorders allow transients to be played back repetitively—a must for automated signal analysis. No longer are expensive high-speed analog-to-digital converters needed; low-speed a-d units can convert high-frequency data at rates up to 100 megabits per second without any need for slowing down the replay rate. Also, since the disks may rotate continuously, they are always ready to record random transients. And disks come out on top, too, with a high signal-to-noise ratio and minimal interchannel time base error.

Disk recording systems for instrumentation are particularly convenient in monitoring setups where spikes, short-term radio frequency interference, or other forms of transient distortion must be located and recorded. Being multichannel instruments, they're also valuable in such areas as nuclear and physiological experimentation, where many transient events must be recorded simultaneously. And the repetitive playback feature makes them suitable for signal-analysis applications like telemetry, one-shot phenomenon studies, time-correlation work, and power-line transient recording, to name just a few.

One computer manufacturer, for example, already uses a 32-channel disk recorder on his production line to monitor the output amplitudes of recording heads in tape systems. Whenever sensors detect that a head isn't performing to specification, the disk unit turns off the recording channel connected to that head. As a result, that channel's track contains the last few milliseconds of output before the unacceptable signal appeared, and this can be used to determine the cause of failure.

In monitoring jobs like this, where signals of interest appear infrequently, tape recorders are unsuitable because their tapes have constantly to be changed,

which slows down the production line. Moreover, often the output on the recording channel is high-frequency information which tape recorders can't pick up because of their limited bandwidths.

The ways in which a disk recorder helps to cut the cost of performing nuclear experiments, as well as the time involved in analyzing the data, are rather different. Principally, by having to be placed only half a mile away from ground zero, where the sensors are, a disk recorder cuts cabling costs. Formerly, data from the sensors were fed into oscilloscopes equipped with single-event-triggered cameras; but because of the film's susceptibility to radiation and the need for last minute manual adjustments, recording equipment had to be least a mile from the explosion. In addition, the disk system records data over parallel channels, and passes it on serially over a single cable to a distant processing station, where data reduction is done electronically. This is both more efficient than taking film from cameras and more accurate than manually analyzing the photographs.

In instrumentation work, the disk recorders are similar to those used in the computer field for fast-access digital storage and in broadcasting for slow-motion and stop-action recording. They fall into two basic categories: fixed head and movable head.

A typical fixed-head unit has 32 record/playback heads, each of which records on only one track. For a given disk size, the recording time for each track depends on the speed of the disk. At 1,800 revolutions per minute, for example, the tracks on a disk 16 inches in diameter are 33 milliseconds long; however, a signal that lasts as little as 1 microsecond can be recorded.

Each head is mounted independently and has its own record and playback amplifiers, which function independently of the other amplifiers. As a result, some channels can record while others play back. This isn't possible in most tape recorders, in which all the heads are mounted in a single bar.

The second type of disk recorder has one or more heads that are moved from one track to the next. While typically having only a few channels, units of this type can record for longer periods because a head will move from track to track recording one signal. Again, recording time depends on disk speed, but for an 1,800 rpm rate, a movable-head unit can record for up to 20 seconds.

If a transient event longer than the maximum recording time is to be captured and the time at which it may occur is unknown, an instrumentation disk recorder can be combined with a tape recorder to get the best of both instruments. The disk unit, which is always ready to record, can capture the first several seconds of the transient, and then turn on the tape recorder to finish the task.

Usually, disk systems are designed with a building block approach, which permits a wide range of configurations. Input and output switches allow a number of input/output formats. A serial in/parallel out setup is a case in point. It can be used for signal correlation studies, where a single source provides data which are stored on different tracks for later parallel readout and analysis. Parallel in/serial out, as mentioned, is used in nuclear-weapons testing to save on cable costs while permitting electronic data reduction far from ground zero. With a serial in/serial out setup, the unit may record a transient on one channel and then move on to the next to await another transient; data can then be played back sequentially. Finally, parallel in/parallel out may be used for signal correlation systems in which any two of the recorded channels have to be related to each other.

Excellent playback fidelity results from a number of factors, among them the linearity of disk recorders' phase response and a signal-to-noise ratio that's typically 40 decibels.

The disk recorders' large bandwidth results primarily from the high disk speed. At a rate of 3,600 rpm, for example, the linear velocity of the disk

relative to the head is 3,000 inches per second, compared with a top speed for tape of 120 in./s.

The bandwidth of instrumentation disk recorders is typically dc to 6 megahertz. In the works are machines that'll go to 8 MHz and 10 MHz.

Because of the rigidity of the disk and the accuracy with which its speed can be controlled, both inter-channel and absolute time-base errors are very low—20 and 50 nanoseconds respectively. As a result, the recorded signals can usually be correlated with each other or with external signals without requiring special synchronizing circuitry.

In contrast, tape has track-to-track time-base errors of as much as 2 microseconds, and absolute time-base errors that are even higher. These errors are large because tape is a flexible and stretchable medium, the linear speed of which may vary. Also, tape may pass the recording head at a continually varying angle.

Another problem is that tape must run at high speed to record high-frequency data. However, the signal has to be replayed at a much slower speed when it's analyzed, for otherwise, expensive, high-speed processing equipment would be needed. Unfortunately, reducing the speed magnifies noise and distortion. And to minimize these effects, additional electronics (equalizing channels for linear recording, a modulator and demodulator for each speed in fm recording, filters) are needed.

With disk recorders there's no such problem because the recorded signal can be played back over and over, and at the recording speed, so that it ap-

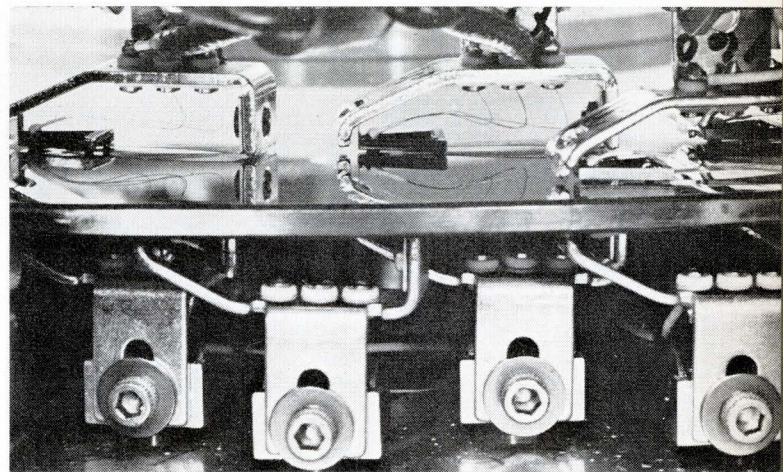
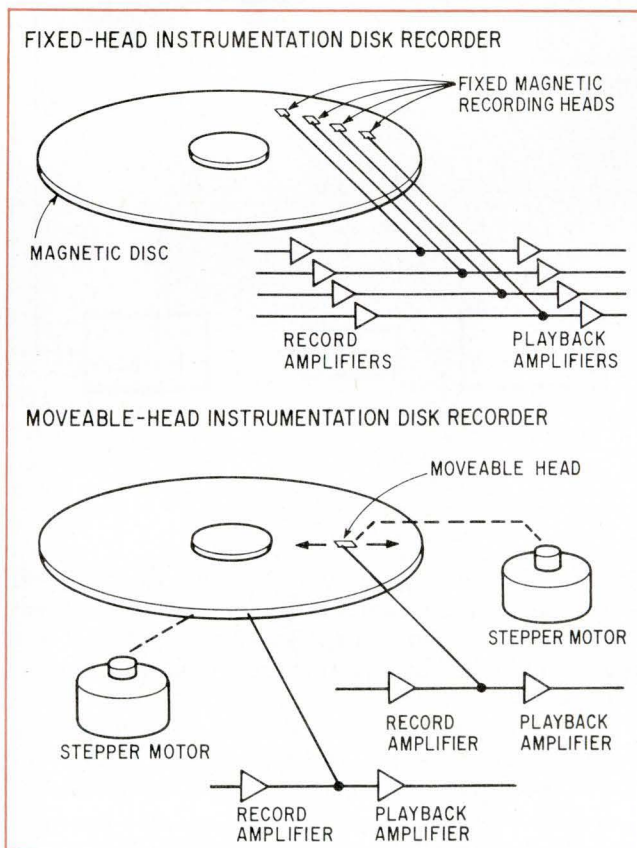

1. Two choices. A disk recorder may be either a fixed-head or a multiple-head unit. The former can record many inputs simultaneously, having a record/playback head for each of its many channels. The latter has far fewer channels, and is more suited to recording longer-lasting transients. In the two-channel version, the top head records on 300 concentric tracks on the upper side of the disk while a second records on another 300 on the under side. In both types of units, the record/playback heads ride only 7 to 10 microinches away from the disk. The narrowness of this gap helps give the recorders a bandwidth of dc to 6 megahertz.

Onto the disk

The modem system in Data Disc instrumentation disk recorders provides the recording head with a square wave whose period varies linearly with the amplitude of the analog input to the recorder.

Before the input arrives at the head, however, it has already gone through a low-pass filter, which has a linear phase-to-frequency ratio. The filter's job is to remove high frequencies, which would otherwise beat with the carrier sampling signal, and cause spurious modulation products.

After the filter, the processing and pre-emphasis circuits clip the signal to limit its positive and negative excursions and so prevent overmodulation. A pre-emphasis amplifier in the circuit increases the signal amplitude by 6 db per octave of frequency.

Next, the period modulator converts the pre-emphasized analog signal to a period-modulated square wave. The analog input to the modulator generates a current which is compared with the constant current going to a linearly charging capacitor. When capacitor current exceeds analog-signal current, the comparator switches. This simultaneously changes the level of the comparator's output voltage and starts a linear discharge

of the capacitor. When the voltage reaches a predetermined value, the comparator switches back, and the process is repeated. The output of the comparator triggers a JK flip-flop whose outputs are taken through line drivers to the record amplifiers. Saturation recording, like that used in digital recording, is used to put the signals on the disk.

The head that's used for writing is also used for replaying data. The playback amplifier sends its output to a limiter, which squares off the period-modulated signal. The demodulator, using delayed and nondelayed versions of its input to control the charging and discharging of a pair of capacitors, recovers the analog signal. The signal then passes through a 7-pole, maximally flat, time delay filter prior to de-emphasis and amplification. The de-emphasis network has the inverse characteristic of the pre-emphasis network, and the 7-pole, maximally flat, time delay, low-pass filter has a 3-dB bandwidth identical to that of the modulator filter. The combination of these two filters provides a linear phase response for the entire system. The detected analog signal is then amplified to drive a 75-ohm output impedance.

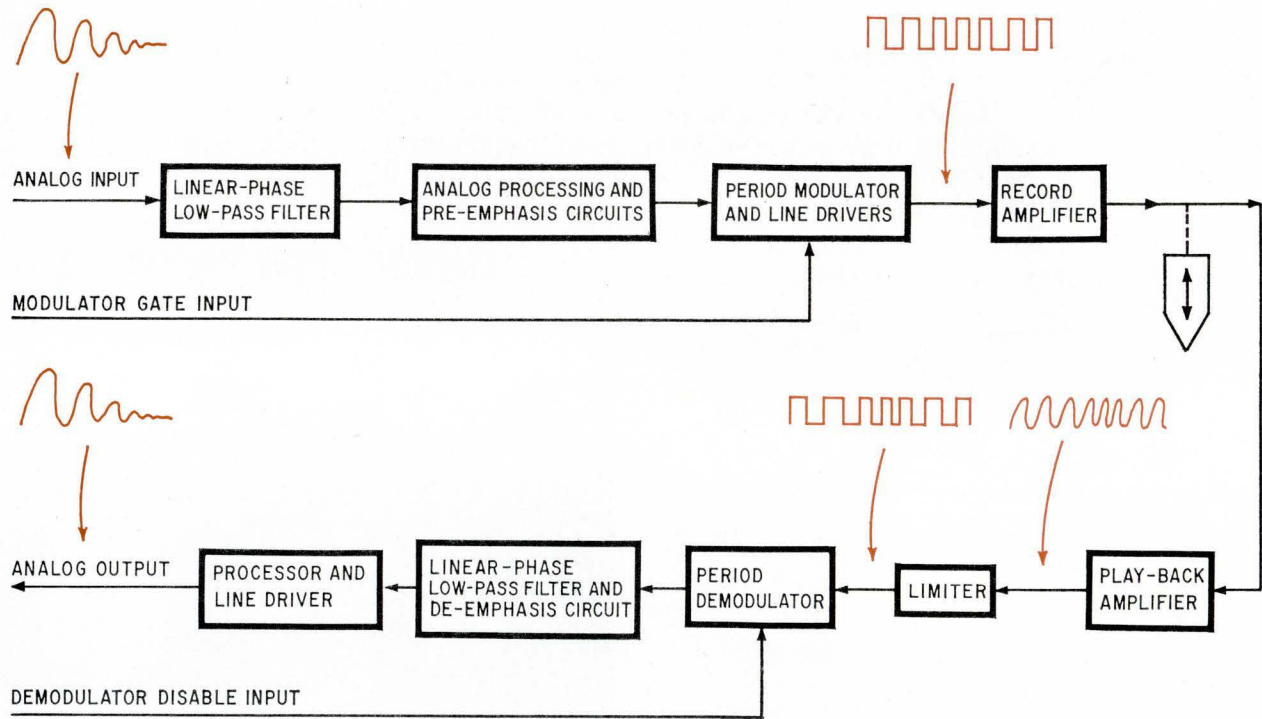

appears a periodic signal. It can then be analyzed by sampling techniques implemented with inexpensive, low-speed circuitry.

A tape recorder, too, can replay data repetitively if a loop of tape is made to continuously pass by the playback heads. However, the repetition rate is limited by the maximum speed of the recorder and the length of the tape required for the loop. Or a tape recorder with a scanning head could repetitively replay a transient by reading a stationary tape segment over

and over. But then the drawback is that the tape will deteriorate because it's not made for continuous direct contact with a head. And with either approach, the user is still limited by tape recorders' relatively narrow bandwidths.

The ease with which disk systems can repetitively playback data permits analog-to-digital conversion that is both fast and economical. A conventional sample-and-hold circuit can sample an analog output once per disk revolution, have it digitized during the

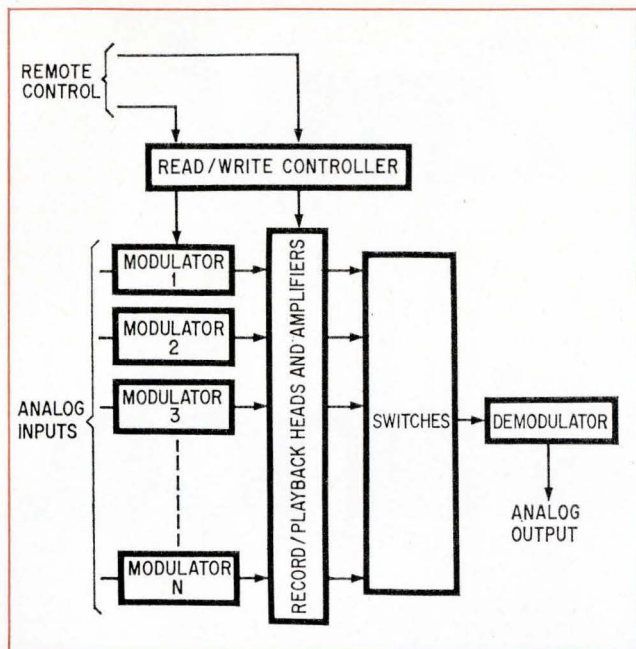

2. **Many in, one out.** Here an N-channel disk recorder records in parallel and plays back serially. The modulators convert the analog inputs into period-modulated pulse trains, which are stored on the disk. These digitally recorded signals are then switched to the demodulator, which reproduces the original analog signals.

conversion rate is 10^8 bits per second, i.e. $(10 \text{ bits/point} \times 10^2 \text{ points}) / (10^{-5} \text{ s})$. In addition, the actual conversion time is less than 2 s, which is not excessively long.

Despite all these useful characteristics, there are tradeoffs involved with disk systems. A maximum recording time of 20 seconds limits these recorders to transient work. Also, if information is to be permanently stored, it must be taken off the disk, which isn't removable, and put onto some other medium, such as tape.

Finally, instrumentation disk recorders are relatively expensive—\$10,000 to \$45,000. Some wideband tape units can cost this much, but when the recording bandwidth doesn't have to be particularly wide, and more than 7 channels aren't needed, the price for tape recorders drops off considerably. Units in the 1-MHz range, for example, typically cost less than \$10,000.

The Polaroid camera and an oscilloscope seems the most common, inexpensive (around \$3,000) method for capturing transients. However since data reduction must be done manually, inaccuracies as large as 10% may be introduced. In addition, the longer the duration of the transient to be photographed, the slower the oscilloscope's sweep rate must be. Therefore the bandwidth of the camera-oscilloscope setup goes down as the transient's length goes up. □

same revolution, and be ready to take another sample during the next revolution. If, for example, a transient lasting $10 \mu\text{s}$ is to be processed this way, it can be broken up into a maximum of 100 points, each 100 ns apart. If the disk speed is 3,600 rpm (600 revolutions, and hence 600 samples, per second), an a-d converter that runs at a rate of only 600 hertz can be used. These can be inexpensive items, even with 10-bit accuracy. What's happening then is that a signal $10\text{-}\mu\text{s}$ long is being broken up into 100 points, each of which is being digitized with 10-bit accuracy; so, the effective

COMPARISON CHART OF INSTRUMENTATION RECORDERS

Type	No. of Channels	Band Width	SNR (dB)	Recording Speed (in./s)	Recording Time	Time-Base Error	Interchannel Time-base Error	Typical Costs
Tape Recorder (Direct Recording)	14	dc-2MHz	28	120	18 minutes (max) for 10,800 foot tape	fair	good	\$25,000 to \$40,000
Rotary (Quad) Tape Recorder	1 or 2	To 6MHz	40	1,500	1 hour (max) 3,800 foot tape	very good	very good	\$70,000 to \$115,000
Helical Scan Video Tape Recorder	1	2-3MHz	28	240	1 hour (max)	poor	poor	\$1,000 to \$12,000
Tape Loop	14	dc-2MHz	25	120	0.4 s to minutes	fair	good	\$25,000 to \$40,000
Fixed-Head Disc Recorder	2 to 32	dc-6MHz	40	2,000	1 μs to 1 s (max)	very good	very good	\$10,000 to \$45,000
Moveable-Head Disc Recorder	1 or 2	dc-6MHz	40	2,000 to 3,000	1 μs to 20 s (max)	very good	very good	\$15,000 to \$35,000
Oscilloscope & Camera	1 to 4	dc-250MHz	10	—	100 ns to 50 s	excellent	excellent	\$3,000 to \$4,000

50 MHz/2mV. No drift. No DC balance.

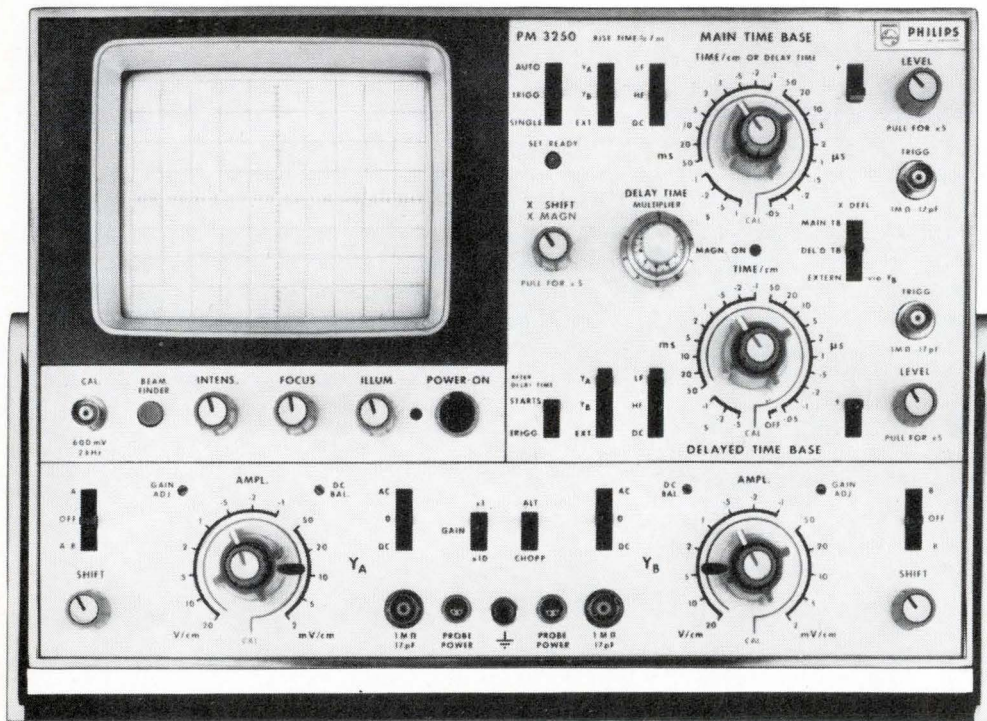

PM 3250
50 MHz: 2mV
Dual Trace
\$1995

More of the Unbeatable
Philips Scopes

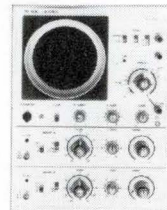

PM 3231
15 MHz: 10mV
Dual Beam
Delay Lines
\$1,050

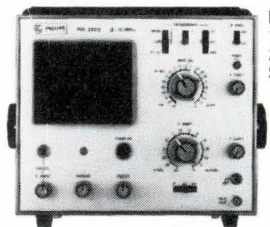

PM 3200
10MHz
2mV/div
\$495

Where wide bandwidth and/or high sensitivity are required, PM 3250 fits the bill. 50 MHz at 2mV/cm or 5 MHz at 200 μ V/cm.

No drift—We've eliminated it by a solid state chopper compensation network.

No dc balance—We've eliminated that too. As well as a number of formerly significant knobs.

Unique? How about PM 3250's ability to display a differential signal (A-B) and the original signal simultaneously. Or, how about a simple rearrangement of the conventional switching circuit so that

the dc positioning range is 160 divisions for x10 sensitivity gain.

Versatile? Other features include a delay line in the vertical channel which lets you see leading edges properly with high speed sweep circuitry. Only 35 ns is lost from a total delay of 65 ns which minimizes signal distortion.

A specially designed front panel simplifies complex operation.

So, if your requirement is for a wide bandwidth/high sensitivity scope, fill it with our PM 3250.
Call Dick Rude 914-664-4500.

**PHILIPS
ELECTRONIC
INSTRUMENTS**

750 S. FULTON AVE., MT. VERNON, N.Y. 10550
A DIVISION OF PEPI, INC.

Electronic flight control is getting set to take off

Fly-by-wire systems can achieve reliabilities far superior to those of mechanical aircraft control systems; currently in the flight-test stage, they will eventually permit greater aircraft maneuverability

By J. P. Sutherland and R. C. Hendrick, *Honeywell Inc., Aerospace division, Minneapolis, Minn.*

□ To most people, fly by wire may suggest Mary Martin in a Peter Pan costume. But to the aircraft industry and the armed services, it describes any system for controlling the actuators of an aircraft's ailerons, flaps and other control surfaces by electrical wiring instead of mechanical linkages.

Though still in the process of proving themselves operationally, FBW systems are attracting a lot of interest. To any user, such systems offer the advantages of being lighter and potentially more reliable than their conventional mechanical counterparts. To the armed services, since it's easy to make the systems redundant and disperse their circuitry throughout an aircraft, they promise greater combat survivability. To the aircraft manufacturer, FBW represents a possible alternative to complex mechanical systems.

Further, by incorporating feedback from sensors, an FBW system will enable a pilot to control an aircraft far more easily and with greater precision than has

been possible until now. Above all, FBW offers the potential of radically new airframe designs (Fig. 1).

The trouble with traditional flight control systems is that they've grown too complex. Even a casual glance at the enormous wings of the new airliners, drooping when on the ground and slowly flapping when airborne, suggests the problems involved in mechanical control and actuation of the ailerons, flaps, spoilers, and trim tabs. In the struggle to meet rigid performance and environmental specifications, designers have been forced to replace the simple manual control of earlier systems with complex nonlinear linkages, mixing assemblies, power actuation devices, and active artificial feel systems containing hundreds of different parts and interconnections. Their task has been further complicated by the often contradictory requirements for low weight and high reliability. As a result, their designs have been compromises that at best prevent realization of the aircraft's full po-

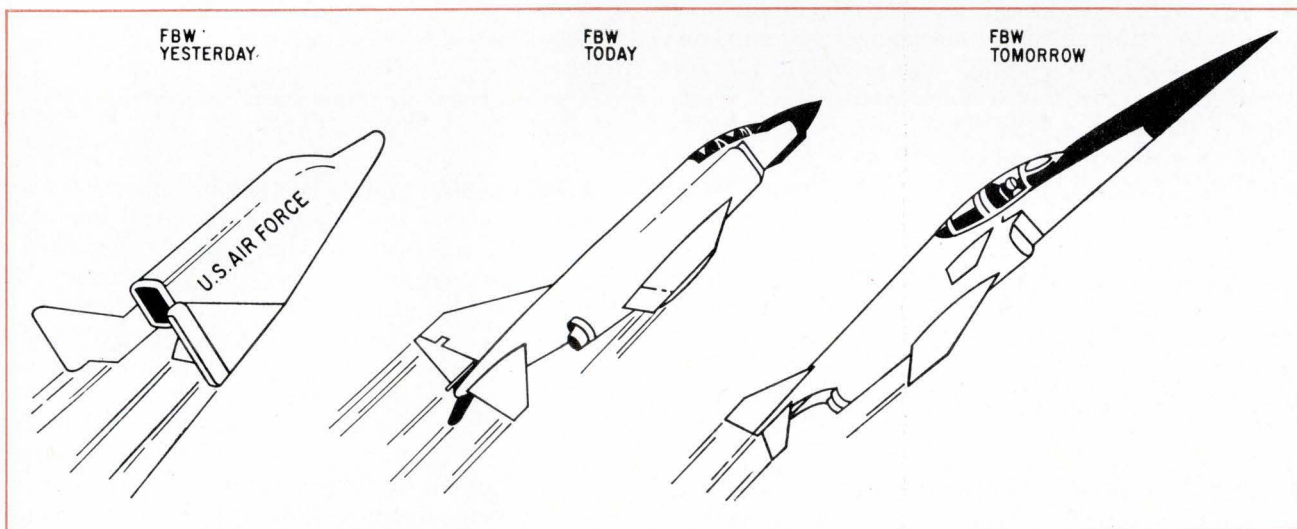

1. History and prophecy. Fly by wire, past, present, and future is illustrated here. The X-20 re-entry research vehicle, doomed by budgetary cuts, had an FBW flight-control system with dual and partially triple redundancy. The F-4 fighter, now being used by the Air Force as an FBW testbed, will have a quadruply redundant system with majority-voting logic: two of its channels can fail before the airplane must return to base. Eventually FBW will offer the aircraft designer a new freedom, permitting construction of radically new aircraft known as control-configured vehicles. In a sharp departure from traditional designs, which normally depend on the airframe configuration for unaugmented stability, the flight-control system of a CCV will be used for active, automatic stabilization.

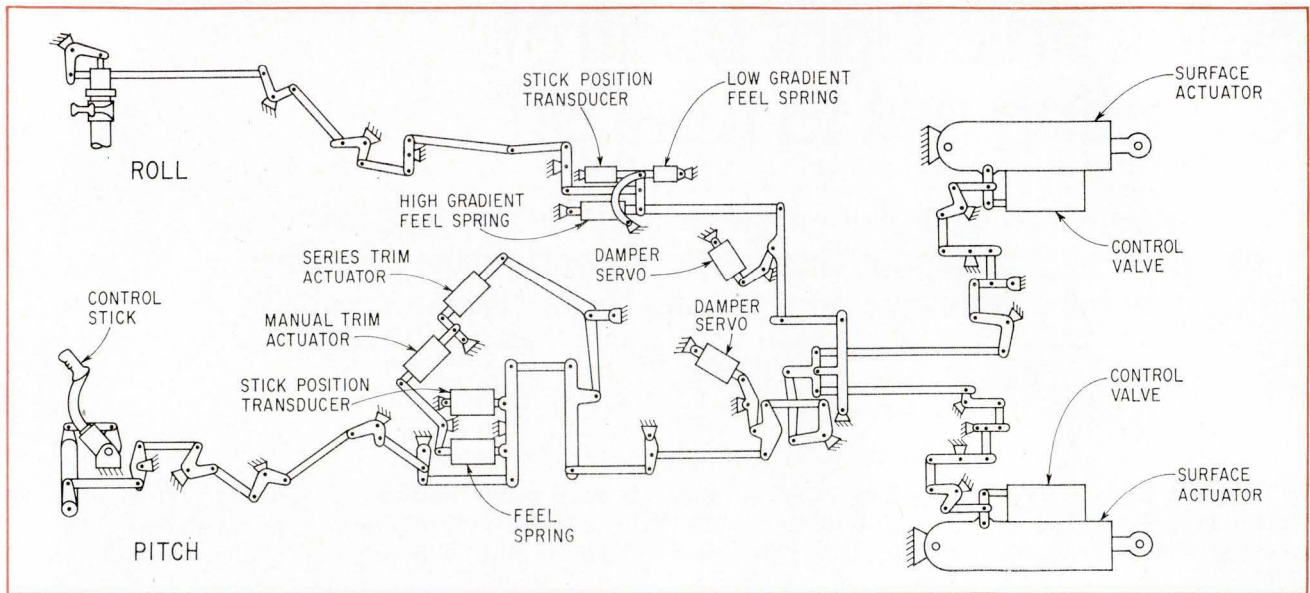

2. Mechanic's nightmare. The flight control system for a typical modern tactical fighter is a maze of heavy push rods and bell cranks. It costs \$70,000 to \$100,000 and weighs nearly 500 pounds.

tential and at worst severely limit its performance.

Figure 2 shows part of the flight control system of a typical high-performance tactical fighter aircraft. This maze of components and linkages has a total of 114 bearing points, each of which is a source of friction and possible failure.

FBW systems stand in sharp contrast to these. They are flexible, indifferent to the expansion and contraction caused by changes in temperature, need no lubrication or bearing points, can be looped in hairpin turns, and, best of all, easily can be made redundant.

Figure 3 illustrates what a simple, nonredundant version might look like. This system is functionally comparable to the complex mechanical system shown in Fig. 2, yet it is far lighter and permits a far more flexible layout. Not that a nonredundant FBW system should ever be used—its reliability is simply inadequate. But the redundancy necessary for a highly reliable system can be added without a severe weight penalty.

The main concern of would-be users, however, is not whether FBW is at all better than conventional systems, but how much better it is. The many tradeoff studies conducted during the past five years by flight control system vendors and aircraft manufacturers, therefore, have all attempted to quantify FBW manufacturing benefits. In general, the conclusions seem to be:

- ▶ The weight of an FBW system for a tactical aircraft would be about 60% less than that of a conventional system, for a large helicopter about 80% less.
- ▶ It would occupy about 150 fewer cubic feet in a bomber or jetliner.
- ▶ It would need 10% fewer manhours of maintenance in a bomber or jetliner.
- ▶ Its design and installation per large aircraft would take up to 5,000 fewer manhours, and effect major cost savings.

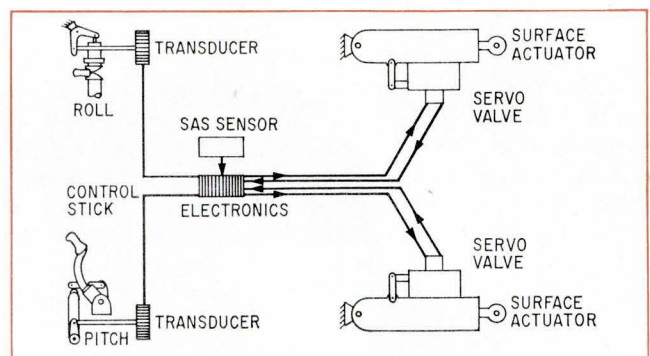

3. Wired for flight. This simple, nonredundant system is the FBW equivalent of Fig. 2. An operational system would be triply or quadruply redundant.

A flight control system is a combination of sensors, signal processors, and actuators designed to execute a particular control law, which may be regarded as a desired relationship between the pilot's commands, airframe motion variables, and airframe forcing elements (e.g., control surfaces). And the development of the control laws enforceable with FBW is another area of great current interest.

With FBW, control laws can be configured to optimize performance for a given mission while offering the pilot options in the form of alternative aircraft response characteristics. Although the optimum relationships between airframe motions and control requirements for various missions tasks (e.g., gunnery, bomb delivery, reconnaissance) are still imperfectly known, it seems likely that a mission-variable control law can sharply boost performance.

For this purpose, closed-loop control in the FBW system is essential. By utilizing the well-established servomechanism principles of sensing, signal amplifi-

How FBW evolved

Despite its revolutionary implications fly-by-wire has a readily traceable history of evolution (successive steps are illustrated above). Early aircraft used manual control exclusively. Then when the pilot could no longer move the control surface, a hydraulically boosted system much like automotive power steering, was added.

The next major step was to fully powered controls; the mechanical linkage moves only the valves on the hydraulic actuators. The pilot is no longer mechanically connected directly to the control surface, and must rely entirely on hydraulic power. In this case, he has to be artificially provided with stick "feel" through such devices as springs, bob weights and "q" bellows, which generate the desired handling qualities for the particular type of aircraft. Virtually all modern, high-performance military aircraft have fully powered flight control systems, as do several commercial aircraft (Boeing's

747 and 2707 SST and the Concorde, for example).

From power augmentation the next step was to stability augmentation systems (SAS), where feedback of aircraft motion damps out unwanted motion or oscillations of the aircraft. A control augmentation system (CAS) combines the damping function with an electrical feed-forward control signal, allowing the use of higher feedback gain (or a more sensitive damper).

Adding a clutch or other means of disconnecting the mechanical system provides pseudo-FBW; removal of the mechanical linkage transforms the system into FBW.

Dampers or SAS are in common use in all modern commercial and military aircraft, to provide better handling qualities and a smoother ride. CAS is being used successfully in several modern military fighters and the Concorde SST is an example of the successful application of pseudo FBW.

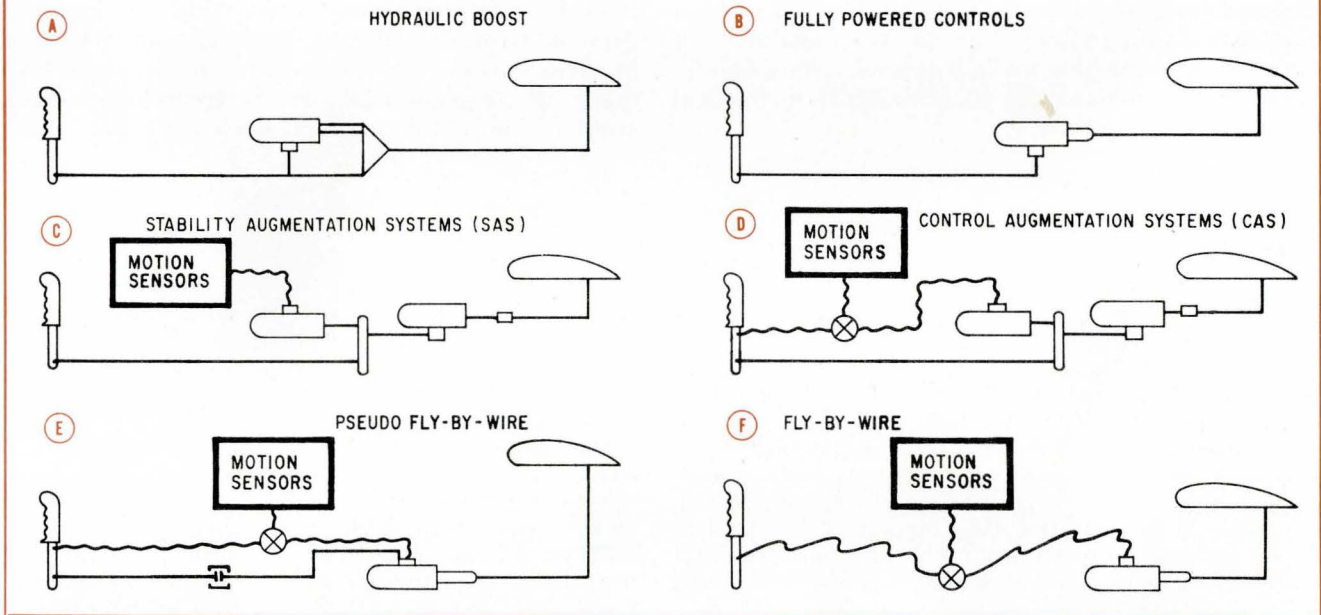

cation, filtering, and actuation, such a system can realize major handling-quality and performance improvements. Fig. 4 illustrates a typical FBW application to a high-performance military aircraft. Here, the pilot inputs his commands through a control stick and rudder pedals. The associated feedback variables reflect the major degrees of freedom to be controlled; for the pitch and yaw axes, the feedback variables involve both angular rate and linear acceleration.

This example shows each surface actuator associated with a single control axis. Such a one-to-one allocation is not the general rule, however; an actuator might affect multiple degrees of freedom (e.g., a differential tail providing both pitch and roll control or a helicopter swashplate actuator) and hence be driven by multiple control channels. Applying FBW to such an actuation set is quite simple, whereas a comparable mechanical control system is a veritable nightmare of complexity.

The ability of the feedback control system to pro-

duce a selected vehicle response is manifest in its ability to absorb changes in vehicle stability and control properties such as those which occur as fuel tanks are emptied (or refilled in flight), bombs are released, etc. In principle, FBW can improve performance, add maneuver capability, combine direct lift and elevator forces to ease the landing approach, compensate variable loads and both alleviate and stabilize structural loads and bending modes. The latter three capabilities have already been extensively studied and demonstrated in flight. Control system configurations which offer all the above features are likely in the future, but the current state of FBW development has far less comprehensive scope.

However, even if such FBW systems were flying today, a major concern remains. Before all of an aircraft's vital control functions can be delegated to an FBW system, that system must be clearly matched to all potential operating states of the airplane, including extreme maneuvers such as stalls and spins. The cur-

rent solution recognizes the present imperfect state of the art and returns full control to the pilot in these unusual maneuvers. But automatic recovery procedures may be an outgrowth of an FBW development contract that the Air Force recently awarded to Honeywell. Among other things the contract calls for investigation of control criteria during abnormal flight attitudes.

For the present, however, the overriding concern in FBW design is reliability. This has two major goals. (1) safety of flight, i.e. the minimization of the probability of aircraft loss, and (2) mission accomplishment, i.e., minimization of the probability of mission abort. Although numerical values for each are often difficult to determine, a popular figure used in assessing flight safety is a maximum allowable rate of failure (loss of control) of 2.3×10^{-7} per hour. This figure is derived from reports of those commercial aircraft accidents which were attributed to the flight control system. Figures for mission reliability may be deduced from overall aircraft availability and mission objectives. For example, an abort probability of 5×10^{-4} per hour (due to flight control system failure) might be an operationally effective figure for tactical purposes.

Since even major improvements in the available components of FBW systems would not do enough to raise reliability, FBW reliability boils down to the need for redundancy. The state-of-the-art failure rate for a single-channel (nonredundant) FBW system similar to that shown in Fig. 3, calculated on the basis of the component failure rates listed in Table 2, works out at something on the order of 8×10^{-4} failures per hour. Compared to the 2.3×10^{-7} failure rate needed for flight safety, this figure indicates an inadequacy of about 3000 in the reliability of a single channel system.

Selecting a redundant design involves many trade-offs. Among the basic questions that must be resolved are the number of channels and the types of monitoring required, mission flight time, since the likelihood of malfunction is proportional to flight duration, and the consequences of control loss and mission abort.

Table 1 shows the type of comparisons typically made between different potential system configurations. It hypothesizes three systems with varying numbers of identical channels, each channel having a predicted failure rate of 3×10^{-4} failures per hour due to its complement of sensors, control electronics, actuators and power supplies. Each system is further

In the works

Every major aircraft manufacturer in the United States and virtually every aircraft automatic flight control system supplier has performed or is performing some type of fly-by-wire study or development effort. This is broadening the technological base for FBW and overcoming the obstacles to its application.

Last year, the Air Force awarded a \$16.2 million FBW R&D contract to the McDonnell Aircraft division of the McDonnell Douglas Corporation for developing and flight testing a quadruply redundant FBW flight control system on an F-4 aircraft. The F-4 was chosen as a test bed to demonstrate the advantages of such a system on a current high-performance tactical fighter aircraft. During the second phase of this program the mechanical flight control system will be permanently disconnected and the FBW system used without backup.

The Air Force has also just completed another important but less ambitious program at Wright-Patterson Air Force Base. A nonredundant pseudo-FBW system—that is, an FBW system in parallel with a mechanical control system that may be disconnected—was installed and flight tested on a B-47 aircraft to demonstrate how FBW can improve the performance of a large flexible aircraft. The advantages of using a side-stick controller in conjunction with an FBW flight control system were also demonstrated during this program. Test pilots were surprised at the ease of control, particularly during turbulent instrument landing approaches. Even those unfamiliar with the B-47 had little difficulty flying it with the new control system.

The success of the B-47 FBW program has encouraged USAF to continue its R&D FBW efforts on large transport aircraft. The Air Force Flight Dynamics Laboratory at Wright-Patterson AFB is currently planning a FBW flight test program on a C-141 aircraft. As in the

case of the B-47 program, its main objectives will be, first, to demonstrate how much better a large aircraft performs with the FBW flight control system and, second, to dispel the doubt which still exists among USAF pilots unfamiliar with FBW.

FBW techniques also have potential for helicopters, and the U.S. Army is currently conducting a joint development program called Tactical Aircraft Guidance System (TAGS) with the Canadian government. Using a CH-47 as a test vehicle, they plan to fly a quadruply redundant control augmentation system in conjunction with a new type of hand controller and guidance system. This system will function essentially as an FBW flight control system, except that the mechanical control linkages will not be removed or disconnected.

The Navy is currently planning to include FBW in future airplanes. Its RA-5C which has been flying since 1958, is essentially FBW, and the success of that aircraft's electrical control system provides the Navy with a good precedent for eventual acceptance of FBW. Its F-14A already uses SAS and CAS (Fig. 5).

NASA has, of course, used FBW on all man-rated spacecraft since Gemini, and will very probably use it on the space shuttle. But the high quality of this equipment and the exceptional care with which it is installed and maintained are impractical for ordinary aircraft.

Besides the U.S., other countries are interested in FBW. The Concorde SST is flying today with a pseudo-fly-by-wire flight control system developed by Elliot Brothers (London) Ltd. The Royal Air Force has an FBW development program well underway at the Royal Aeronautical Establishment in Farnborough, England, and plans to start flight tests this fall of a quadruply-redundant FBW flight control system on a Hawker Hunter test aircraft.

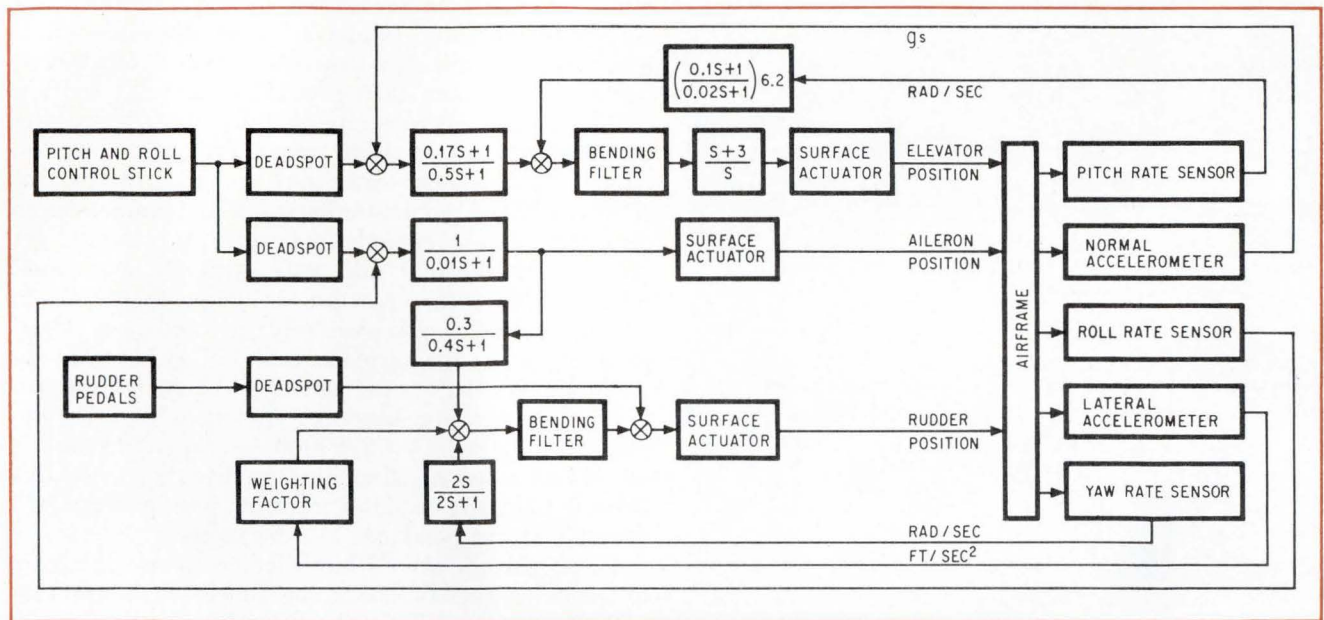

4. Take control. FBW control laws (shown here are a tactical aircraft's) must be matched to airplane's potential responsiveness, yet prevent instability. Controls have "dead spots"—neutral positions on either side of which FBW system is engaged. Bending filters remove normal airframe flexure signals from control loop, to prevent oscillatory buildup.

Table 1—Redundancy Comparisons—Two-Hour Mission

Channels of Redundancy	Monitoring Concept	Performance Under Sequential-Like Failures	Probability of Total Axis Failure (Pitch, Roll, or Yaw)	Failure After Which Mission Is Aborted	Probability of Mission Abort
3	Majority vote	Fail-operational, fail-off	3.2×10^{-6}	First	5.4×10^{-3}
3	Majority vote plus self-check to 95% confidence	Fail-operational, quasi fail-operational, fail-off	1.6×10^{-7}	Second (in the same axis)	3.2×10^{-6}
4	Majority vote	Fail-operational, fail-operational fail-off	2.6×10^{-9}	Second (in the same axis)	6.5×10^{-6}

Table 2—Component Failure Rates

Component	Failures Per Hour
3 Axes of electronics	18×10^{-5}
1 Control stick	3×10^{-5}
3 Rate sensors	21×10^{-5}
2 Linear accelerometers	6×10^{-5}
3 Electrohydraulic actuators	30×10^{-5}
1 Hydraulic supply	3×10^{-5}
1 Electrical supply	1×10^{-5}
Total failures per hour	82×10^{-5}

presumed to include three control axes (pitch, roll and yaw), each of which is vital to continued flight.

In the first, the "majority vote" concept compares like signals from three or more channels and rejects the odd man out, thus automatically disregarding faulty units ("fail-operate"). When only two channels remain, one can't outvote the other and the system is considered to have failed. The majority vote technique offers relatively thorough failure detection and has a history of successful use. However, the need for an extra channel for voting is a hardware extravagance, and techniques for channel conservation through some form of self-test are attractive alternates.

The second configuration shown in Table 1 assumes such a self-test capability for selection of a functioning channel after a second, similar failure (two failures

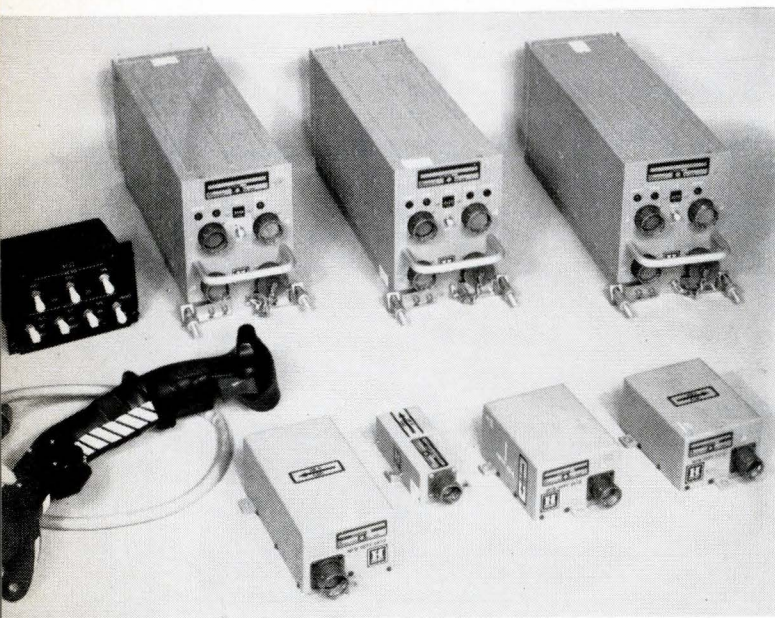

5. **Sized up.** Components of the control and stability augmentation system made by Honeywell for Grumman Aerospace Corporation's F-14A—the Navy's new air-superiority fighter. Similar components could be used in FBW designs.

in the same axis). Here a “fail-operational” performance, despite the second failure, is assumed with only a limited probability, since only a 95% self-check confidence is available.

However, with the third, a four-channel system, a 100% fail-operational performance under the second similar failure can be achieved through the majority vote monitor, though at the expense of an extra control channel.

These safety and mission reliability probabilities, computed for each system configuration for a two-hour flight, are only “rough-cut” numbers, but they offer clear-cut guidance to system designers. The three-channel majority-voted system is clearly inadequate in terms of current safety goals. Further, its potential for mission abort also appears excessive. The three-channel system with majority vote plus self-check surpasses current safety goals and, because it has less hardware than the four-channel system, has twice the mission reliability. However, since the four-channel system offers safety and mission reliability orders of magnitude in excess of current design goals, it is the choice for current FBW designs.

Of course, redundancy of the FBW system alone will not suffice to achieve the necessary reliability of the overall flight control system. The aircraft electrical power system will also have to be redundant, and a back-up battery-powered emergency system may be required. The power system must be at least as reliable as the control system itself.

The effect of radiation environments on tactical and strategic FBW systems seems at first sight to be another problem area. FBW might be faulted, in principle, for its susceptibility to radiation damage—a problem that cannot trouble purely mechanical sys-

tems. Further, circumvention—briefly shutting off susceptible circuitry during radiation exposure—seems impractical for a highly responsive aircraft. However, the hazard is more theoretical than actual. Neutron radiation and electromagnetic pulse (EMP) are the products of a nuclear burst, and therefore are accompanied by a shock wave and the intense thermal effects of X and gamma radiation. Blast overpressures of a few psi are enough to destroy an aircraft, yet the neutron fluences and EMP typically associated with such overpressures are far below the levels to which electronics can currently be hardened. Thus, in most cases, the airplane will fail structurally in environments that would not even begin to compromise the electronic systems. Instances can be hypothesized in which an aircraft is flown through a mushroom cloud or other burst debris, but since this is likely to fatally dose the crew, mission briefings will certainly stress avoidance of such tactics.

These considerations have led systems designers to begin to specify hardening levels commensurate with the weakest link, the aircraft structure itself, levels that can be achieved with relatively simple and inexpensive circuitry.

FBW shares with every physical system the statistical probability of abrupt and unforeseeable failure. However, the principle of redundant design, far simpler to implement with electronics than with mechanical systems, can make such a likelihood vanishingly small. Human error is a far more likely cause of trouble and FBW designs, like their mechanical predecessors, will have to cope with this.

Significant as is the increase in safety with FBW, however, it represents only the most obvious improvement in flight control and hardly suggests what the future may bring. For FBW could revolutionize airframe design, by making it possible to build aircraft in which the flight control system automatically compensates for airframe instabilities. By relying largely on automatic electronic stabilization, such control configured vehicles (CCV) could circumvent many of the inherent airframe stability requirements that today add to weight and drag and limit performance. Other possibilities with CCV are: constant-attitude lift, structural-vibration and load-distribution control.

The ultimate effects of this new design approach are difficult to predict, since imagination tends to extrapolate from established design concepts. However, even from today's obscure vantage point, it seems clear that by making CCV possible, FBW will have as revolutionary an effect on airframe design as semiconductors have had on electronics. Obviously, it will also require a radically new outlook from avionics designers, who have traditionally regarded an airplane as a container with power and signal sockets, hold-down clamps and wings. Now they will have to view the aircraft as an organic whole, controlled, guided, even kept aloft by their equipment. □

Bibliography

“Proceedings of the Fly-By-Wire Flight Control System Conference,” Dec. 1968, USAF Report AFFDL-TR-69-58, Wright-Patterson AFB, Dayton, Ohio.

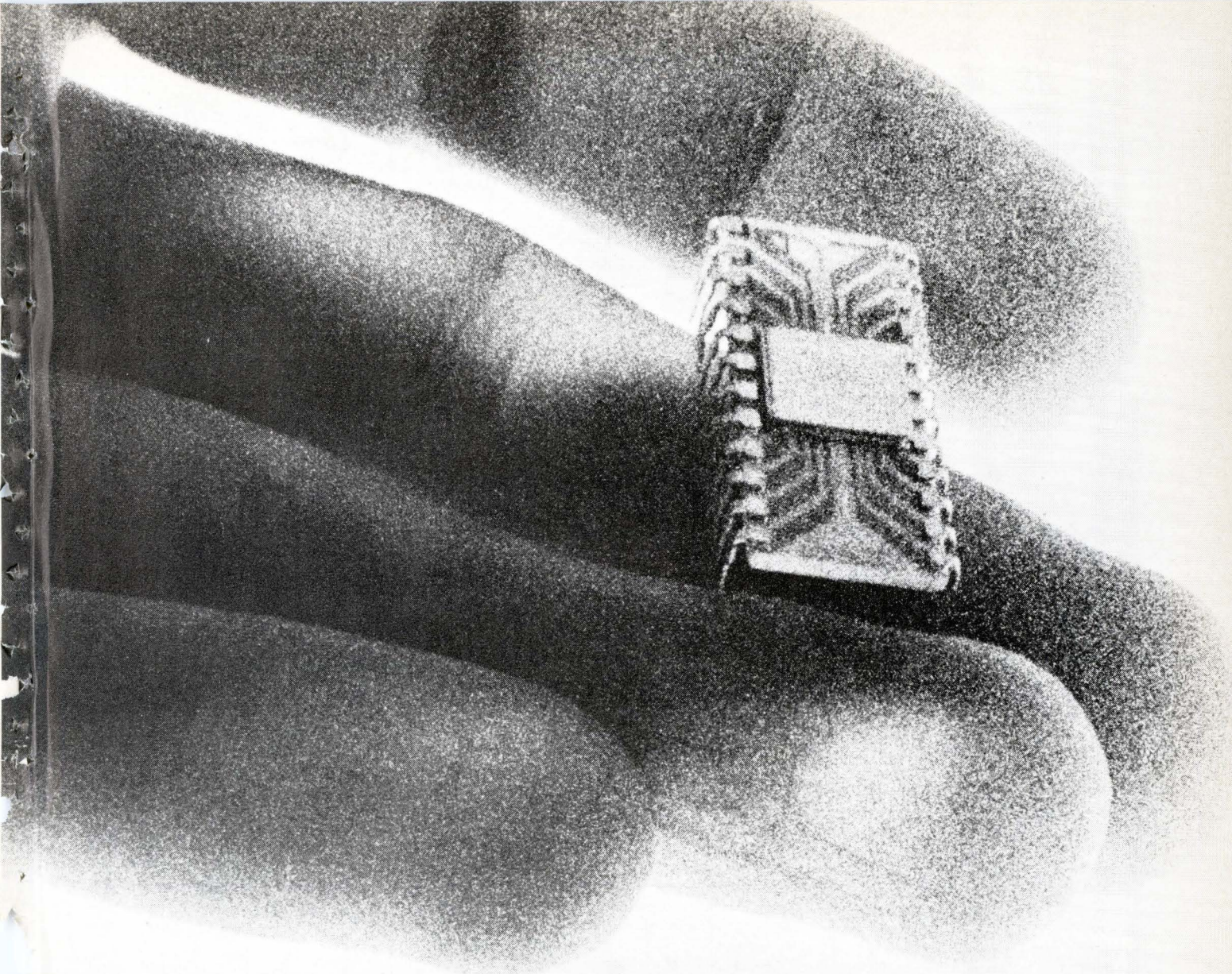

MOS. Ours today. Yours tomorrow.

We're there. Just like you. Up to our oxides in MOS technology. In active production, meeting demand with give-a-damn delivery.

Example: our MOS Read Only Memories, built for extraordinary flexibility in design. Ready for logic-programming to your specs, right on the chip. Just slap a truth table onto a deck of IBM cards and turn us on.

Our 24-pin ROMs don't settle for dinky single-line chip-select either. You can control 1 to 8 devices through our three chip-select terminals—a three-line binary coded function strictly exclusive with us. Access time, 550ns. Power dissipation, 150mW.

Optional output programming too: either bare drain or MOS pull-up resistor. Turn-around time from receipt of deck to delivery, competitive, of course.

Example: a salt-of-the-earth dynamic Random Access Memory. Completely characterized, in high volume MOS production longer than any similar device. Anywhere.

A remarkable RAM. With five chip-select inputs, permitting expansion to 8K—a capability ours alone. And unique 2.5 milliamp outputs for fast, inexpensive sensing. Fully decoded. Cycle time, 650ns. Access time, 400ns.

2410 Series	256x4 Static ROM	16-pin Ceramic DIP
2420 Series	128x8, 256x4 Static ROM	24-pin Ceramic DIP
2430 Series	256x8, 512x4 Static ROM	24-pin Ceramic DIP
N2301	256-bit Dynamic RAM	24-pin Ceramic DIP

In-depth applications info available. In person. Just call George Rigg (408) 739-7700, and let's discuss it man to man. Data sheets and price lists for the whole MOS batch, ready too. Along with our ROM Selection Chart, listing ten option combinations. Call and let George do it too, or write Signetics Corporation, 811 E. Arques Avenue, Sunnyvale, California 94086. A subsidiary of Corning Glass Works.



Signetics

MARKEL EXCELLENCE



it's worth more than it costs

For nearly half a century, Markel insulations have been engineered and manufactured with one overriding objective: to produce a line of products built up to the highest standard, not down to the lowest price. As a result, Markel products have earned a solid reputation as the *line of excellence*.

Buyers too often shop for the lowest price, failing to consider *value*. You cannot pay a little and get a lot. When you specify Markel, you get the extra value that goes with excellence: superb quality, outstanding engineering capability, complete and dependable customer service. We invite you to inspect the Markel line. Ask for a free copy of our new Materials Selector and Sample File, containing data and actual sample lengths of 18 Markel tubings and sleeveings.

ONE SOURCE FOR EXCELLENCE
in Insulating Tubings and Sleeveings
High Temperature Wire and Cable



L. FRANK MARKEL & SONS, INC., NORRISTOWN, PA. 19404 • PHONE: 215/272-8960

Facts.

The Brush 260 delivers more of them...with less fuss, bother and cost...than any other oscillograph you can buy.

Facts start with accuracy.

And the Brush 260 is about as accurate as you can get. We *guarantee* 99½% linearity. So when you're looking at the chart of a Brush 260, what you see, is fact. We owe it all to a fool-proof position feedback system that enforces pen position all the way across the chart. There are no springs, no strings. Or any of the other tricky mechanisms that you'll suffer with in other recorders.

Those traces you see are a lot more than just accurate. They're crisp and clear and reliable from one edge of the chart to the other. They won't smudge or smear. (And you can chalk

that up to a patented pressurized ink-writing system that puts the trace into the paper and not just on it.)

You can forget about recalibration problems, too. We took care of that little nuisance at the factory. So change those settings to your heart's delight. The Brush 260 will keep right up with you. And save you piles of time and piles of chart paper in the bargain.

That's what you get with a Brush 260. It's the go-anywhere, do-anything 6-channel recorder by Brush. At a price per channel that will surprise you.

More facts. Less fuss, bother and cost.

Ask your Brush representative for a demonstration. Or write for Brush 260 Bulletin 942-2: Brush Division, Gould Inc., 3631 Perkins Avenue, Cleveland, Ohio 44114.

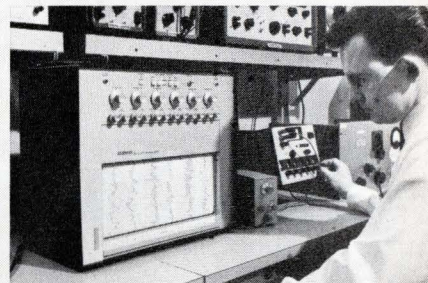

 **GOULD BRUSH**

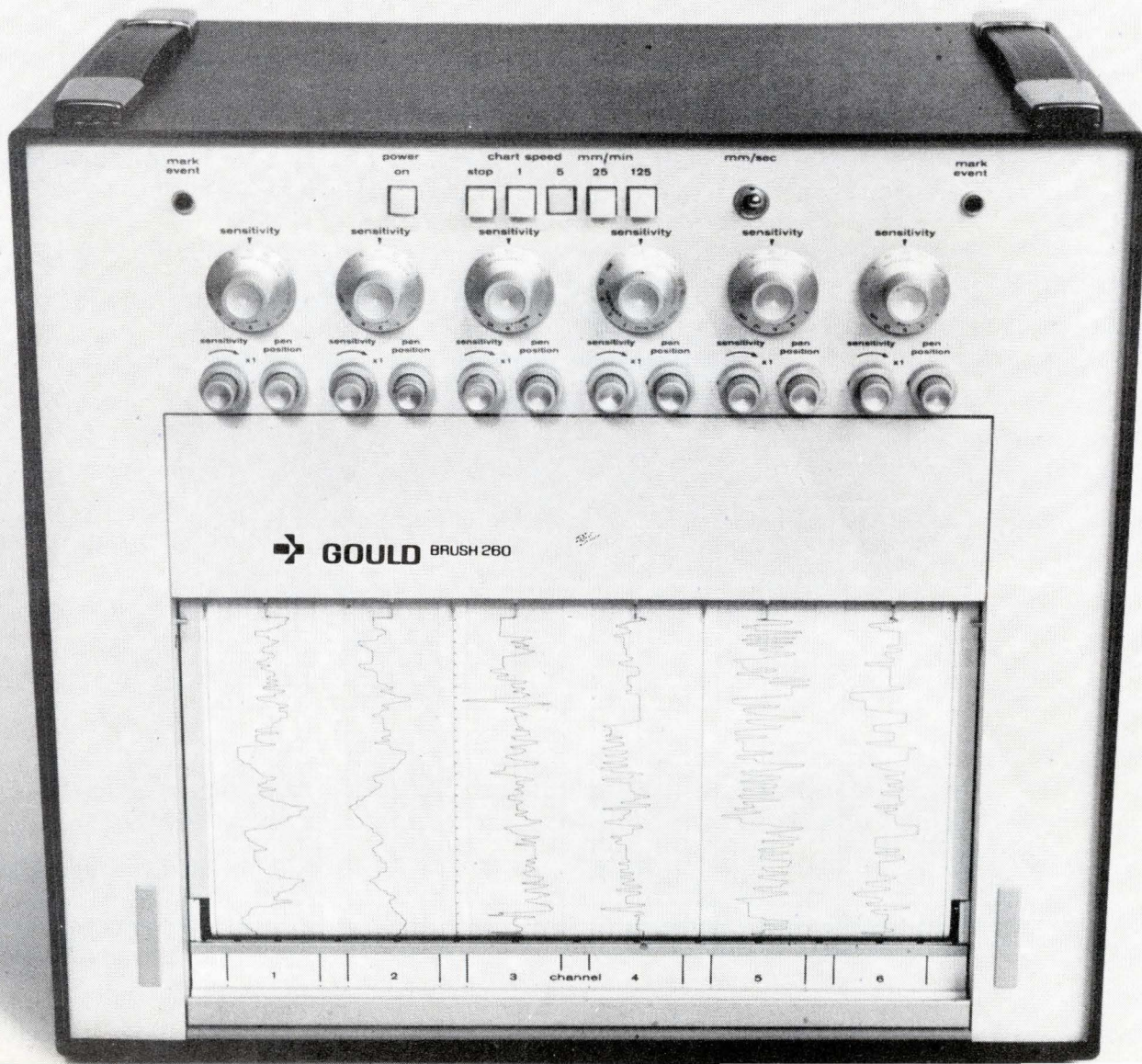

Easy as building blocks when you use **SOLID STATE ELECTRONIC CONTROLS** from **Struthers-Dunn**

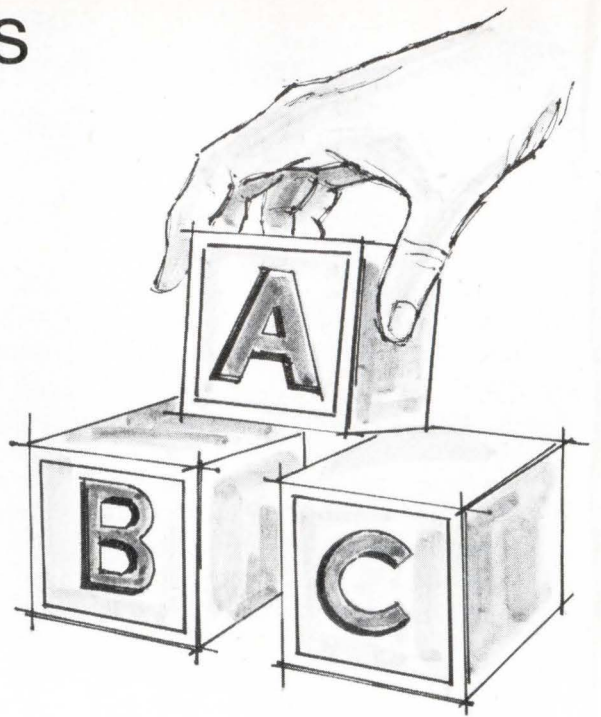

Select from standardized PC boards—each a functional subsystem—to be used as building blocks to assemble your own control system.

Or—let us design and furnish your complete electronic industrial control system in standardized card file enclosures using the same building blocks.

Struthers-Dunn systems engineers—electronically oriented, but with industrial control experience—have solved the problems caused by transients, voltage

swings, temperature variations, and environment common to industrial machinery and processes, but detrimental to electronic switching.

Learn of the Struthers-Dunn functional concept by circling the number below on the reader service card to receive Catalog C/70100.

STRUTHERS-DUNN, INC., SYSTEMS DIVISION
1114 State Street, Bettendorf, Iowa 52722

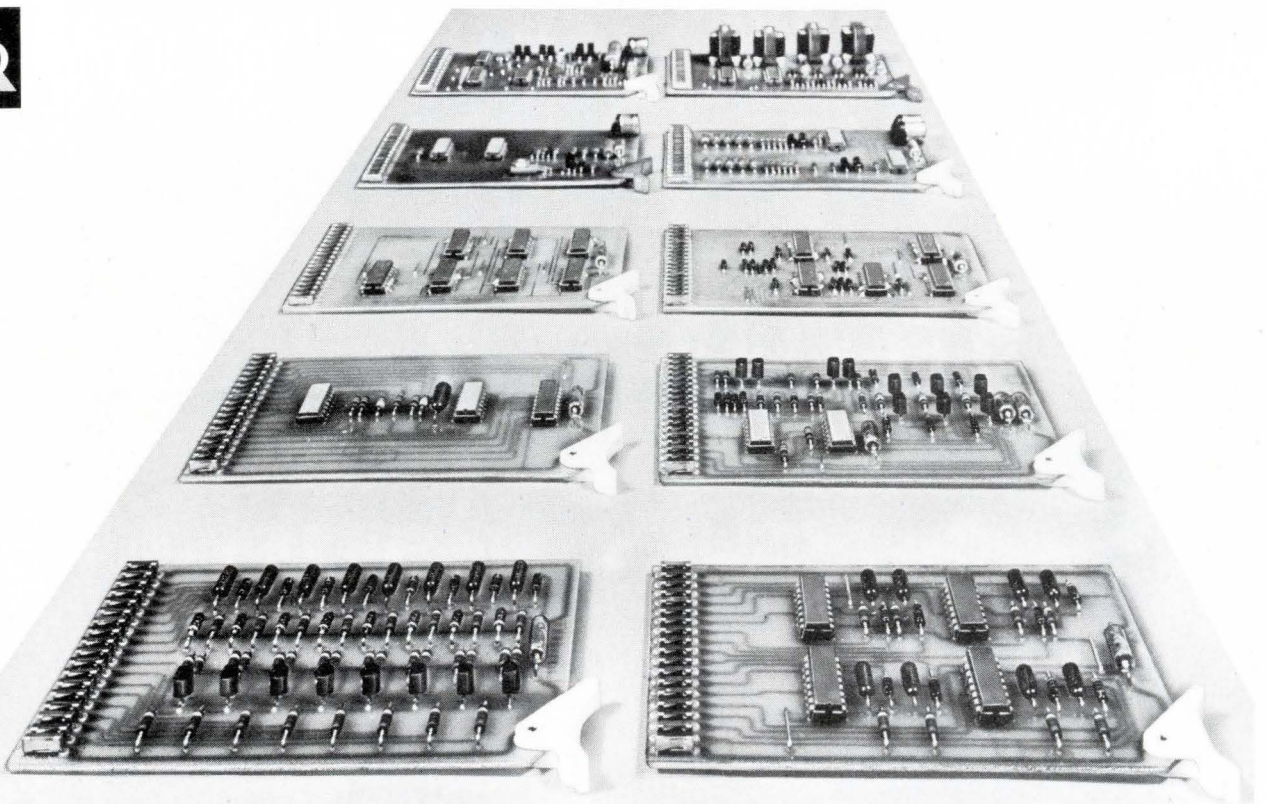

A NEW FIELD-OF-ONE IN LIGHTED PUSHBUTTON SWITCHES.

Switchcraft's "PUSH-LITE" switch offers reliable leafspring switching in a neat little package.

This whole new field of compact (1" x 1 1/8" x 1 3/4") pushbutton switches reduces the size of your control panels, consoles—and cost, too! Our new field-of-one consists of 6 series—including non-illuminated and illuminated single and twin-lamp units in two housing colors (black or grey). Up to 4PDT switching in momentary and push-lock/push-release functions. Ratings range from dry circuit switching, up to 3 amps., A.C., non-inductive load.

A rugged molded housing encloses the highly reliable leafspring switching and protects against dust, dirt and mishandling.

Pick from flange or barrier mounting—individually or in matrix configurations. Series PL "PUSH-LITE" switches mount from front of panel with clamp brackets, simply and quickly. No mounting screws show!

Design with up to two lamps and either full or split display screens—vertically or horizontally. Full display provides up to 3 lines of 6 characters each. Virtually unlimited lighting versatility

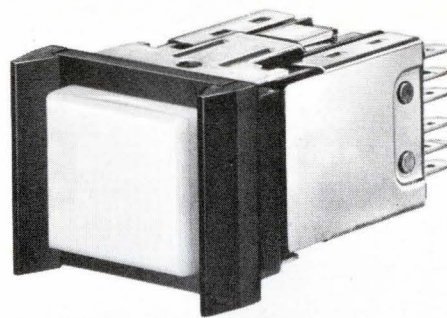

ACTUAL SIZE

provided by 7 different colors of pushbuttons, insert filters and silicone boots.

For additional information, contact a Switchcraft Representative or write for Catalog S-345. SWITCHCRAFT, INC. 5529 N. Elston Avenue Chicago, Illinois 60630

SWITCHCRAFT
INC.

Circle 97 on reader service card

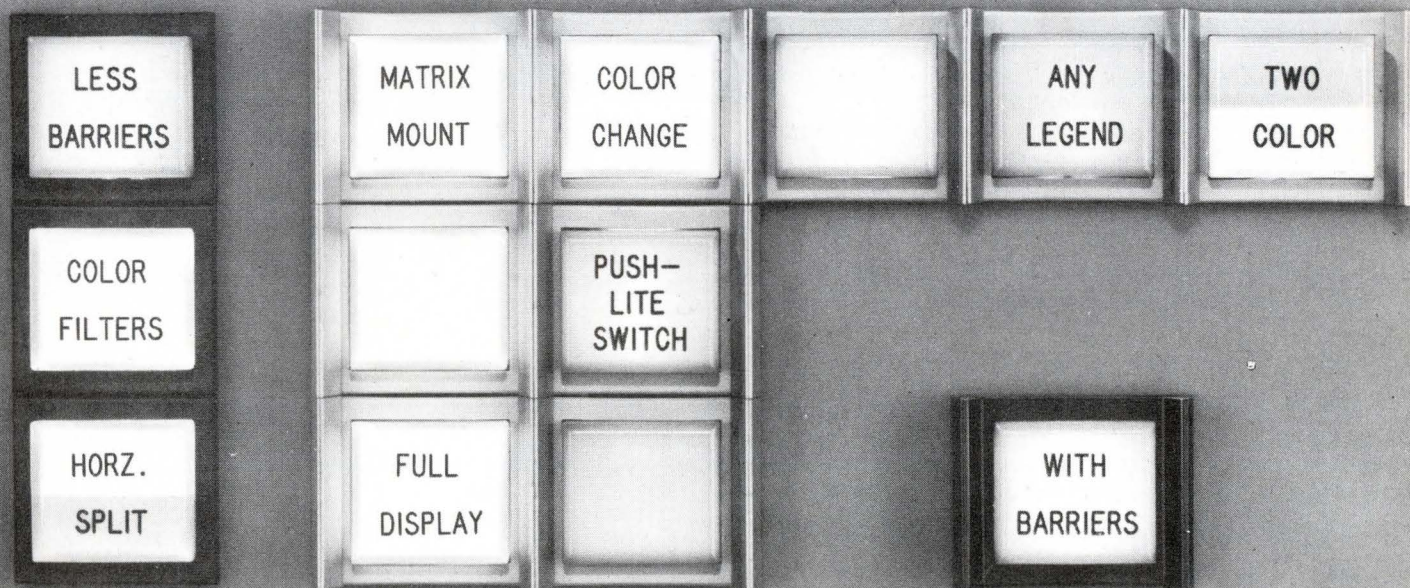

Tips on cooling off hot semiconductors

As power levels go up and up and package size shrinks, circuit designers are keeping semiconductors cool with IERC Heat Sinks/Dissipators. Reducing junction temperature gives many benefits: faster rise and fall times, faster switching speed and beta, fewer circuit loading effects and longer transistor life and circuit reliability.

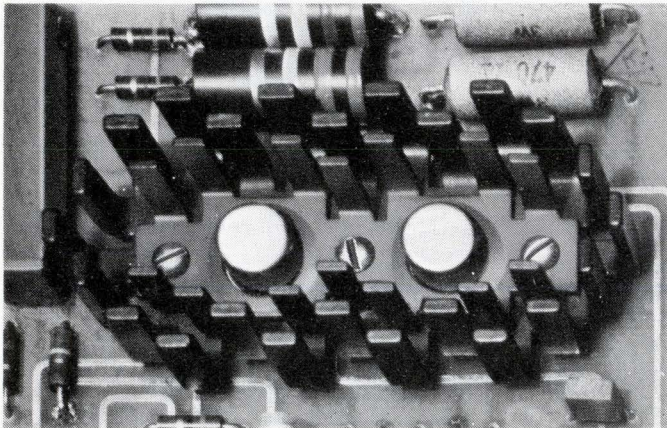

Thermal mating of matched transistors, such as these TO5's shown on a dual LP, maintains matched operating characteristics. The LP's unique multiple staggered-finger design (both single and dual models) maximizes radiation and convection cooling, results in a high efficiency-to-weight and -volume ratio.

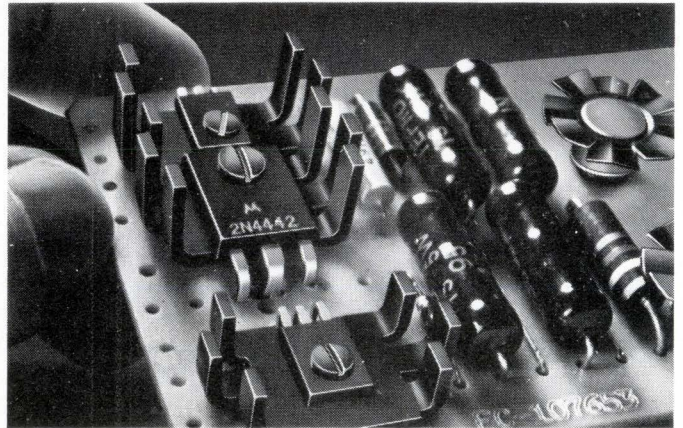

Power levels of plastic power devices such as X58's, MS9's, and M386's can be increased up to 80% in natural convection and 500% in forced air when used with PA and PB Dissipators. PA's need only .65 sq. in. to mount; PB's 1.17 sq. in. Staggered finger design gives these light-weight dissipators their high efficiency.

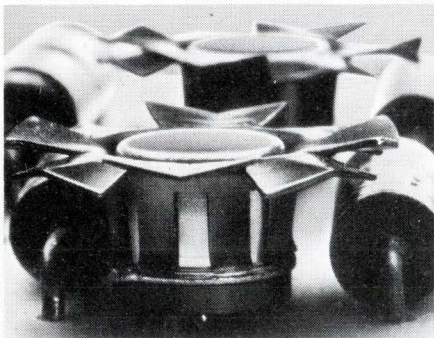

TO5's and TO18's in high density packages can be cooled off with efficient push-on Fan Tops that cost only pennies. T-shaped, need no board room, let other components snuggle close. Spring fingers accommodate wide case diameter variations. Models for RO97's, RO97A and D-style plastic devices also.

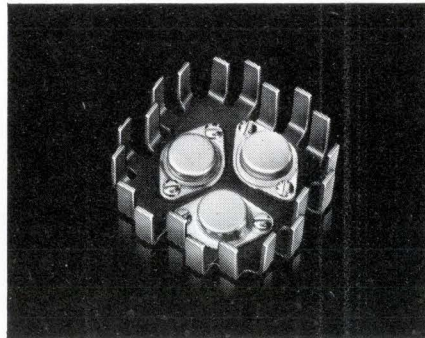

High power TO3's, TO66's, TO6's, TO15's, etc. can be operated with much more power when used with HP's. These compact, light-weight staggered finger devices accommodate from one to four TO3's. Provide the same heat dissipation as an extrusion that's three times heavier and one-third larger.

Heat problems? IERC engineers welcome the opportunity to help solve your heat dissipation problems. As the world's largest manufacturer of heat sinks/dissipators for lead and case mounted semiconductors, they can come up with a practical, low cost solution.

Free four-page Short Form Catalog. Send for your copy today.



Heat Sinks/Dissipators

IERC



There is our foam dielectric coax with a new copper corrugated outer conductor. We call it Cuflex.TM The same cable in aluminum sheathing is famous Foamflex. Spirafil II is our aluminum sheathed air dielectric cable. With a corrugated copper outer conductor it answers to the name Cufil.TM We have connectors to match all four.

In coaxial cable, whatever your needs, we probably have it. In stock, in all popular sizes, in warehouses across the country.

Let us tell you more. Write today for details: Phelps Dodge Communications Company, 60 Dodge Avenue, North Haven, Connecticut 06473.

**phelps
dodge**
Communications Company

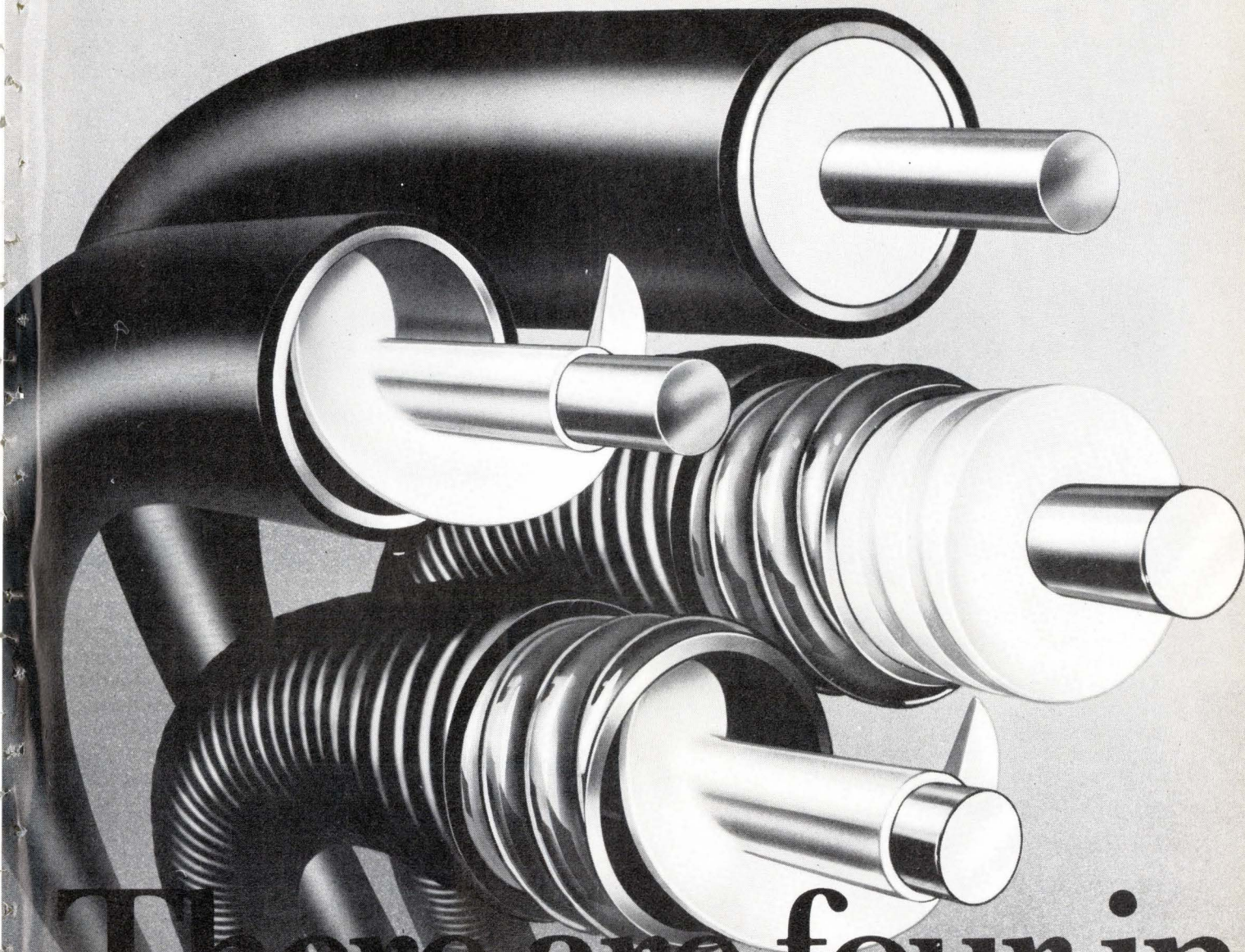

**There are four in
this family.
For every coaxial
cable need.**

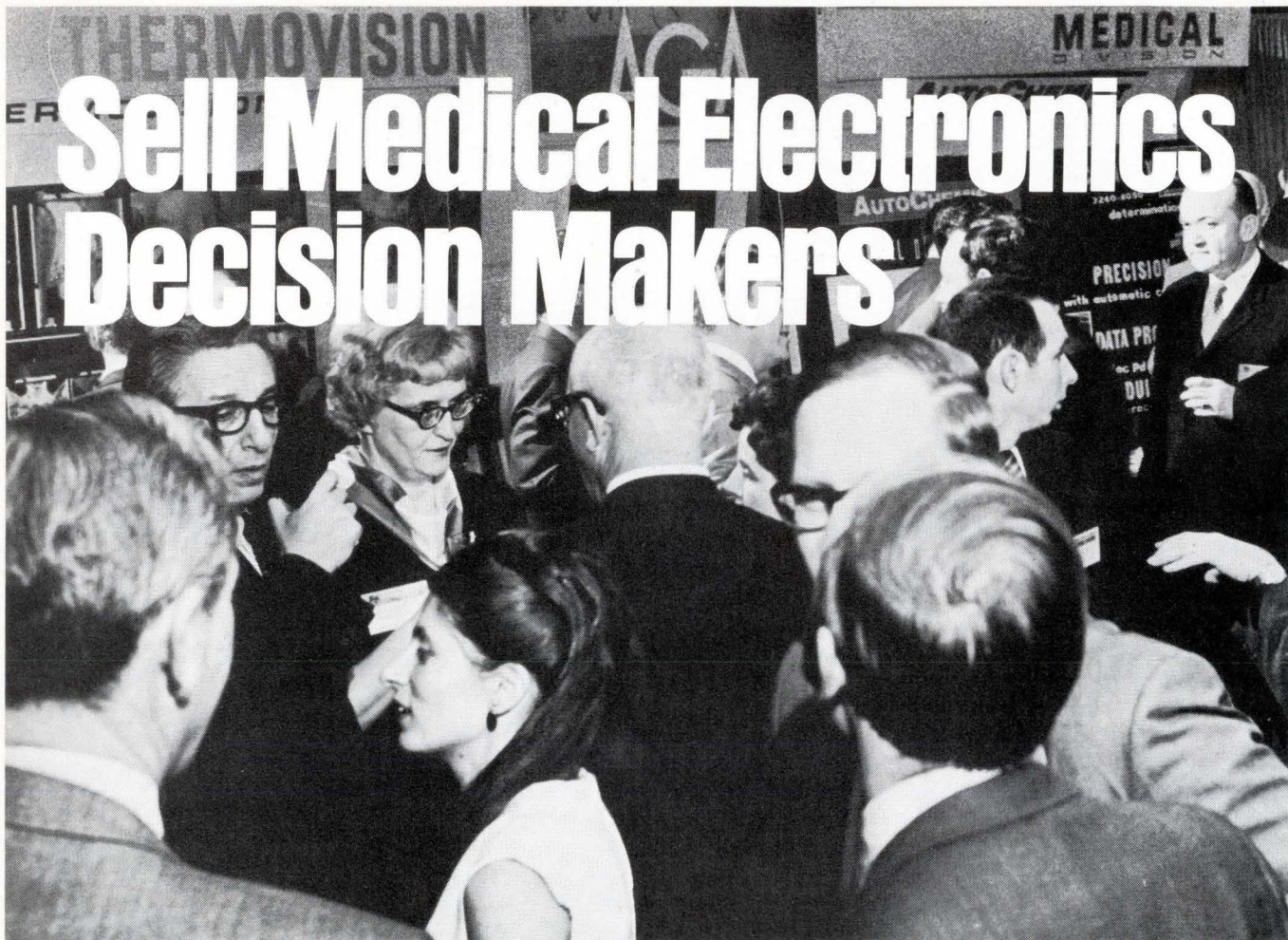

Sell Medical Electronics Decision Makers

The ELECTRONICS IN MEDICINE Conference & Exposition is different. Unlike every other medical show, it concentrates solely on medical electronics. It brings together only the manufacturers of medical electronics gear and the buyers and specifiers of such equipment—physicians, hospital administrators, biomedical engineers, educators, researchers and system design engineers.

Effective Sponsorship

ELECTRONICS IN MEDICINE is co-sponsored by Medical World News, Modern Hospital, Postgraduate Medicine and Electronics. The combined know-how and circulation of these major publications assure exhibitors of a highly qualified national audience.

On-Target Conference

A carefully crafted series of sessions, designed to attract only buyers and specifiers of medical electronics equipment and services, will be created by the editors of the co-sponsoring publications in conjunction with Dr. John Truxal, Institute Professor, Polytechnic Institute of Brooklyn. Dr. Truxal has long been concerned with the inter-play of engineering with biology and medicine and chaired a committee of the National Academy of Engineering on that topic.

Aggressive Promotion

The conference and show will be broadly promoted by the co-sponsoring publications, which have a combined

circulation of 400,000. A massive direct mail campaign and public relations campaign will be undertaken. Full page ads, well in advance of the event, will appear in all magazines. Direct mailers will repeatedly find buyers and specifiers wherever they work—hospital, private or group practice, clinic, research lab, and university.

Exhibitors Sell

The 3rd National Conference & Exposition on ELECTRONICS IN MEDICINE will enable you to find and sell new customers, expose current customers to your new products, create impressive lists of new, valuable contacts and create significant penetration of this burgeoning multi \$million market.

Reserve Your Booths Today

There is no premium on corner or upfront booths. Excellent locations, at no extra cost, will go to those firms which act promptly.

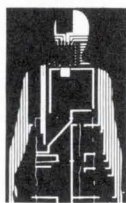

3rd National Conference & Exposition on Electronics in Medicine

Sheraton Boston Hotel / John B. Hynes Civic Auditorium
April 13-15, 1971

For space reservations, information:

Steve Miller, Exhibit Manager, National Expositions Company, Inc., 14 West 40th Street, New York, N. Y. 10018 • 212/564-8714.

the signal generator that's all things to all men



Constant Amplitude Generator

Automatically leveled outputs from 2.2 V (+20 dBm) to 0.01 μ V (-146 dBm) typically within ± 0.25 dB are provided—unobtainable from any other generator. . . Ideal for response testing of components (1 GHz) and to calibrate scopes, rf voltmeters, spectrum analyzers, etc.



FM Generator

Low distortion. Unique digital technique for adjusting deviation. At 500 MHz, deviation of 2.5 MHz is possible. Capable of handling FM stereo type signals.



RF Pulse Generator

Rise and fall times to 20 nanoseconds with a typical on-off ratio of 60 dB. Rep rates up to 500 kHz. Pulse widths as narrow as 4 microseconds are generated.



AM Generator

Covers the range from 61 kHz to 512 MHz in 1 unit. Has 100% modulation capability. AM bandwidth of DC to 200 kHz and lowest incidental FM available.



Video Generator

Can be video modulated over a bandwidth from DC to 100 MHz. Will simulate complex waveforms such as double sideband suppressed carrier.



Combination AM/FM Generator

No interaction between AM and FM. Use it for determining AM rejection of FM discriminators. Also apply it as a narrow band sweep generator with AM modulation for receiver testing.



and would you believe it's also a Counter

Reads generator output frequency to 5 places on a front panel Nixie readout. Also can be used as an external counter from DC to 2 MHz. Accurately monitors modulating rep rates.

A passive doubler raises output frequency to 1024 MHz.

The Singer Company
Electronic Products Division
915 Pembroke Street
Bridgeport, Conn. 06608.
203-366-3201.

In Europe contact: Singer
Sewing Machine Company,
Electronics Products Division, P.O.
Box 301, 8034 Zurich, Switzerland,
Telephone: (051) 47 25 10

it's the Model SG-1000

SINGER INSTRUMENTATION

new tektronix 7514 with write thru...

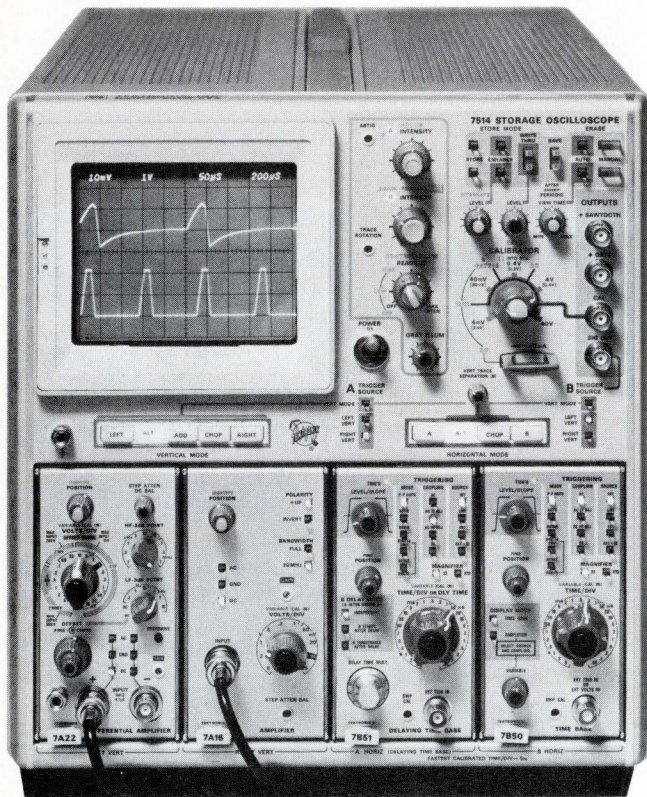

a significant advancement in storage oscilloscopes

WRITE THRU is the most significant advancement in storage scopes in several years. **WRITE THRU** allows simultaneous stored and conventional displays in the same area of the CRT . . . ideal for precise comparison of waveforms. Store a waveform, switch to **WRITE THRU** and the stored waveform then becomes a reference for all subsequent ones. Storage oscilloscopes are frequently used in the non-store mode, but until now, their usefulness has been limited due to a lack of trace brightness. Not so with the 90-MHz 7514! The 7514 has a conventional writing speed of $450 \text{ cm}/\mu\text{s}$. . . faster than any other storage oscilloscope. Set the focus control only once, and a new **auto-focus** circuit will take over, so that additional manual focusing is not required with changes in intensity.

The NEW 7514 uses rugged, bistable, split-screen storage which has a **high-burn resistance**. An auto-erase system with variable viewing time allows automatic erasure of either half of the screen after pre-selected view time. The extensive use of push-button controls make the 7514 very **easy to use**.

Seventeen plug-ins covering a wide performance spectrum are currently available, including the NEW 7D13 DIGITAL MULTIMETER, which measures voltage, current, resistance and temperature; and the NEW 7D14 500-MHz DIGITAL COUNTER. With vertical and horizontal mode switching in the mainframe, simultaneous measurements can be made by up to four plug-ins having widely different features.

For measurement ease, Auto Scale-Factor Readout, which is exclusive to Tektronix, labels the CRT with time and frequency; volts, ohms, temperature (C), and amps; invert and uncal symbols.

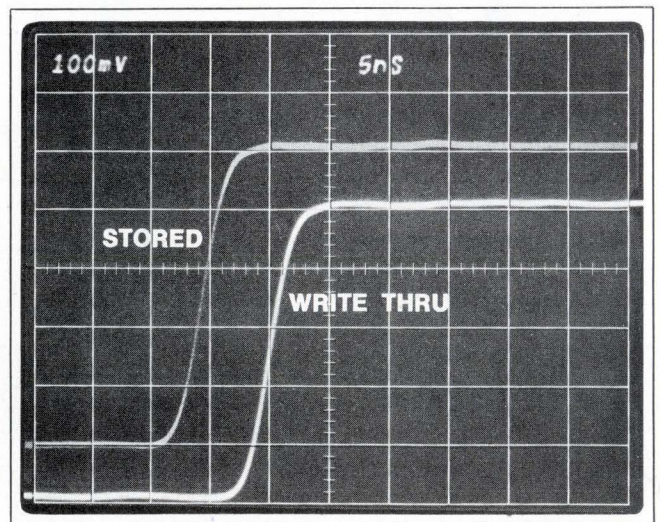

See your 1970 Catalog Supplement for complete specifications. Prices of instruments shown: 7514 Storage Oscilloscope \$3200, 7A16 Amplifier \$600, 7A22 Differential \$500, 7B50 Time Base \$450, 7B51 Delaying Time Base \$510.

U.S. Sales Prices FOB Beaverton, Oregon

Available in U.S. through the Tektronix lease plan



TEKTRONIX®

committed to
technical excellence

Avalanche diodes get big boost

Bell Labs' double-drift structure hikes outputs and efficiencies in microwave, millimeter wave regions; Gunns, LSAs could be overshadowed

By Laurence Altman, *Solid state editor*

The momentum in solid state power sources has taken a dramatic turn toward avalanche diodes recently. Providing the push is an important new development by Bell Laboratories: double-drift avalanche structures. Using ion-implantation fabrication, Bell Labs has added a second complementary drift space to the conventional silicon Impatt, resulting in a sharp performance improvement in the medium-to-high millimeter wave region: at 50 gigahertz, one double-drift diode can deliver 1 full watt of power with efficiencies above 14%, against 0.5 W at 10% efficiency for conventional diodes. What's more, the process has yielded c-w operation with useful power at microwave frequencies for the first time in the high-efficiency (Trapatt) mode (see panel).

Though they're only laboratory results now, these performance figures have tremendous implications for future research, perhaps even diverting shrinking R&D away from conventional Gunn and LSA diodes. And it's possible that the new double-drift devices will be used as the principal power sources for microwave and millimeter wave land and satellite communications systems as well as for many radars.

The performance of the 50-GHz device is "the highest power-frequency-squared figure—twice as high—reported for any c-w Impatt diode in any frequency range," says T.T. Seidel, a member of Bell Labs technical staff. And though the work is in the earliest stages, the diode's performance at higher frequencies—136 milliwatts at 92 GHz with efficiencies of 5.2%—already is better than that reported

for single-drift avalanche devices.

But an equally exciting breakthrough in solid state power sources is in the microwave region, where most applications lie. Until Bell Labs' development, Trapatt devices were limited to pulsed operation, drastically reducing usefulness. As with the Impatt, Bell credits the double-drift structure with the dramatic improvement in Trapatt performance. Moving up from the middle-megahertz range, Bell's best diodes to date show a continuous output of 1.5 W at X band with an efficiency of 20%. And these lab results "could be only the beginning," asserts W.L. Evans, a key member of the Trapatt development team.

Work in avalanche diodes is beginning to snowball. With the Trapatt, already there are reports of pulsed operation as high as 5 GHz with efficiencies as high as 30%, at both Sperry and Hughes. And RCA has shown pulsed outputs in the 30 W range at 13 GHz, but

at low efficiencies. In addition, recent computer simulations at Bell Labs suggest the feasibility of achieving c-w Trapatt efficiencies in the 40% to 50% range at frequencies as high as 10 GHz. Says Evans, "if we had to produce a good c-w Trapatt at 10 GHz with 5 W output we could do it. You might need diamond ring heat sinking at these outputs, but that's a known technology. You'd just have to put it all together."

News of the avalanche diodes has traveled fast throughout the solid state devices community, and its rapid development appears to have a significant effect on the direction of future work. Robert Ying, section head for silicon devices at Hughes Aircraft Co.'s Electron Dynamics division in Torrance, Calif., says the new Bell Labs diode "definitely" will affect the development of solid state oscillators. "With that kind of efficiency and power output," he says, "I guess everyone will go

Powerhouse. New double drift diode greatly enhances power by allowing in-phase drift of electrons across n region and holes across p region.

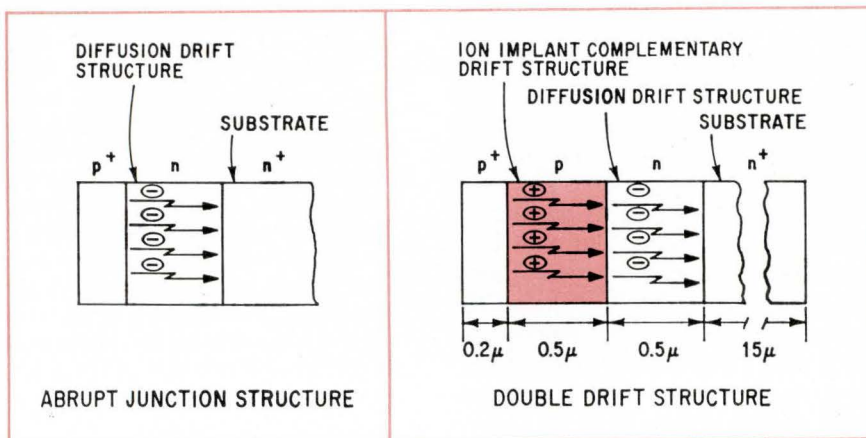

that route, especially at higher frequencies."

Ying reports his division, long in the vanguard of avalanche diode work, has been working on a double-drift silicon Impatt for about three months, achieving an output of 500 mW at Ku band (35 GHz) with 6% efficiency. Like Bell's silicon Impatt, this is an ion-implanted device, and Ying expects to approach Bell's performance figures within six months. And although the success of the double-drift structure has made a deep impression on Ying, he says Hughes probably won't abandon other single-drift work it has in the preproduction stage. Nor is Hughes irrevocably committed to ion implantation, in contrast to current thinking at Bell Labs, which takes the line that the ion-implant method is directly responsible for the success of the double-drift structure. In fact, Ying's group will use the double-drift technique to develop an X-band oscillator using double-epitaxial silicon growths. He estimates the effort should yield an oscillator with 2- to 3-W outputs at 10% to 15% efficiency.

Hewlett-Packard Associates also is keeping a sharp eye on avalanche developments. Michael Cowley, manager of applied research, says that most work is on the standard three-layer single-drift devices. "We are not doing anything with four-layer devices now," he says, "but we may look at them in the future." Cowley also is gauging the relative performances of Gunn and Impatt devices, noting that the traditional breakdown—low-power, low-noise applications filled by Gunn units and the higher-power applications by Impatt devices—is starting to change somewhat. "Some recent results we've obtained," he says "show that the Impatt is also good where low noise is a requirement," implying that the silicon Impatt may take over both high- and low-power applications. Furthermore, says Cowley, "the price advantage of the silicon Impatt will play an important role."

Also eyeing the double-drift Impatt is T.B. Ramachandran, senior

research engineer at Microwave Associates. He says flatly: "The double-drift Impatt could be a god-send to millimeter wave technology. So far there's nothing that can touch it." But Ramachandran notes that at lower frequencies where broader drift regions are needed, heat-sinking will be a problem that may require expensive fabrication techniques, so he isn't counting out the other diodes yet.

Ramachandran hopes to investigate the new double-drift device when research funding picks up. Further, he points out that right now, gallium arsenide Impatts achieve about two times the efficiency of silicon Impatts at X band; thus when Microwave Associates embarks on double-drift Impatt R&D, he'll try GaAs and even such materials as gallium arsenide phosphide and indium phosphide. In any case, for those with R&D money Ramachandran says the accent will shift away from LSA, Gunn and single-drift Impatts toward the double-drift device.

Interest in the avalanche diode is high in Japan. For example, although Nippon Electric Corp.'s device people are working with both Impatt and Gunn diodes, by far the greatest emphasis is on the Impatt. Nippon Electric feels single-drift structures will be sufficient below 50 GHz, but above that frequency double drift is needed. Nippon Electric flatly asserts that there is no communication application for

Gunn or LSA that Impatts could not achieve more easily. In fact, the company's engineers know of no method of obtaining the required high-frequency outputs from either Gunn or LSA units.

At Mitsubishi Electric Corp., work is proceeding on both Impatt and Gunn devices with the Impatt effort at about 20 GHz and the Gunn at X band. One Mitsubishi Gunn diode engineer says that Gunn will never achieve the Impatt's output and is perhaps fated to run one order of magnitude lower. But stating the case for Gunn diodes, he points out that Gunns have the advantage at X band, needing only about a 10-volt supply, while Impatts require perhaps 50 to 60 volts. And he feels the Gunn diodes' low-noise figures may always be lower than the Impatt's for the same Q-tuned circuit.

Furthermore, he says Gunn has a wider tuning range, important in some applications. For example, Gunns can easily be tuned over an 8-to 10-GHz band.

However, there is recent indication that the Gunn diode's greatest strength, as a low-noise oscillator, may be usurped by the avalanche diode. In fact, according to James Gewartowski, supervisor of the microwave source group at Bell Labs, avalanche diode amplifiers made with gallium arsenide have shown noise figures not very different from those of typical Gunn diode amplifiers.

Diode redoubled

The greater power available from the double-drift-space (2D) avalanche diode is due to the additional drift region that is implanted onto the conventional diode. The 2D structure has four layers instead of the usual three, and it is this double-drift region, together with the resulting bigger diodes, that is responsible for the power increase over the single-drift region.

Although the current Bell device uses an added p-drift region, either an n or p region can form the second drift region; the essential point is that each drift space in the active region must complement the other.

A conventional $p^{+}nn^{+}$ avalanche diode develops its rf power when electrons drift across the n region at avalanche. In a double-drift $p^{+}pnn^{+}$ structure, in addition to drifting electrons, holes drift across the added p region in phase with the electrons, resulting in greater power outputs.

When the avalanche diode is operated in the high-efficiency Trapatt mode, two frequencies are involved—the output frequency, which is the fundamental frequency of the device, and the Impatt frequency, which is the harmonic of the fundamental. The double-drift structure is ideal here because one side of the diode can be optimized for the fundamental Trapatt frequency and the other side for the necessary Impatt harmonics.

Engineers and careers

IEEE: crisis of identity

Radicalism in the ranks and conservatism at the top may be mediated by new lines of communication

By Peter Schuyten, New York bureau manager

To hear some members and ex-members tell it, there are more things wrong with the Institute of Electrical and Electronics Engineers than there are right with it. Admittedly much of the discontent with the IEEE has surfaced because of the recent surge of unemployment among its members. After years of "riding the gravy train," one member notes, "out-of-work electrical engineers are suddenly turning to the IEEE and saying, 'What are you doing for me now that I need you?'" And they are discovering, as one disenchanted ex-member says that "the IEEE has no real power."

But the general unhappiness has thrown up other complaints, too. Members are starting to accuse the institute's board of directors of everything from being slow and unresponsive to change to ignoring environmental issues.

In essence, the question on the minds of most members, including many on the board of directors, is: what role should the institute play in the coming decade? Should it remain strictly a technical, professional organization? Or should it act as a lobby group, working for the economic betterment of its members? Or should it do both?

Canvassing of grass roots opinion indicates some members actually favor changing the institute into a lobbying organization. As one member puts it, "The IEEE can't just be a professional group. As far as the membership is concerned, it must have influence in both areas—that is, it must work on behalf of the engineer, lobby for and protect him if necessary, and act as a professional society."

One man at the top, however, is more moderate in his views. Harold Chestnut, vice president in charge of technical activities and chairman of the IEEE's technical activities board says: "The whole situation is one of dynamics and change at the moment. If the subject [of the institute acting as a lobbying group] had been broached a couple of years ago, it would have been written off immediately. Now the board is looking into what we can and cannot do. There is definitely a limit to what we can accomplish—after all, our thing really is changing the technological frontier."

Caught in the middle of all this, at least come January 1 when he assumes the presidency of the IEEE, is James H. Mulligan Jr. (*Electronics*, Oct. 12, p. 14). Says a chairman of one of IEEE's local

chapters, "We're cheerfully waiting for Mulligan to show up here where he'll be shelled out of the room by questions and demands of unemployed engineers."

In fact, this has already happened in Columbus, Ohio at a joint meeting in September of the Group on Antennas and Propagation and the International Scientific Radio Union. Supposed to end at nine o'clock in the evening, the meeting didn't break up until one in the morning. There, Mulligan found himself peppered with questions and statements from angry engineers, one of whom was Victor Galindo, senior staff scientist for TRW Systems in Redondo Beach, Calif. Galindo contended that the IEEE was "prostituting itself to industrial and commercial interests," and doing nothing for its members.

Further evidence of the yawning

Hail to the chief. James Mulligan Jr., who becomes IEEE president Jan. 1, sees "nothing inherently unwieldy" about the organization.





What makes low-cost Dialight readouts so reliable and easy-to-read?

Reliable because of simple module construction and long life lamps. Designed for use with neon or incandescent lamps to meet circuit voltage requirements. Easy-to-read from any viewing angle. 1" high characters are formed by unique patented light-gathering cells, and may be read from distances of 30 feet. Sharp contrast makes for easy viewing under high ambient lighting conditions.

Dialight Readout Features

1. Operate at low power.
 2. 6V AC-DC, 10V AC-DC, 14-16V AC-DC, 24-28V AC-DC, 150-160V DC or 110-125V AC.
3. Non-glare viewing windows in a choice of colors.
 4. Available with RFI-EMI suppression screen.
5. Available with universal BCD to 7 line translator driver.
 6. Can be used with integrated circuit decoder devices now universally available.
7. Caption modules available; each can display 6 messages.

Send for catalog

Catalog-folder contains complete specifying and ordering data on numeric and caption modules, translator drivers, mounting accessories. Dialight Corporation, 60 Stewart Avenue, Brooklyn, New York 11237. Phone: (212) 497-7600.



DIALIGHT

DT-126

gap between the top and the bottom levels of IEEE lies in the reluctance of one chapter chairman to identify himself. As he puts it, "to do so would impair what little political maneuverability within the IEEE I now have. Frankly," he continues, "you're going to see a lot of the really committed people in this organization saying some innocuous things for a while because they realize how fast New York [IEEE headquarters] would squash them if they made a loud noise right now."

Aggravating the dissension is the IEEE's unwieldy structure. It's organized both on a geographical and on a technical basis.

Geographically, it comprises 10 regions, each with its own director who is also a member of the IEEE board. Each region contains a different number of sections, within which are grouped the local chapters. All of this means that communications between the board, the section officers, the local chapter chairman, and the individual member are not what they ought to be.

In theory, any member may also belong to one or more of the 31 technical groups. Yet, suprisingly for a technical society, these groups have not automatically been represented on the board of directors.

Consequently, Mulligan's reaction to all the brouhaha is to insist, first and foremost, on better lines of communication throughout the various chapters, sections and regions of the IEEE. "Today I feel that, largely because of the need for improved communications we are not making full use of the total resources of the institute currently provided in its structure," he says. "Once communications are in better shape, then we might make some changes. But communications, on the whole, are so bad right now that it would be foolish to make any changes."

To this end, he and the board have been working on programs to create a better two-way flow of information. One of them is quite an innovation for the IEEE. As explained by Seymour Cambias, director of the Southeast region

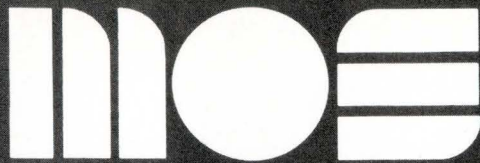

MOS TECHNOLOGY, INC.

○ it's a small world.

Conceived in the mind of man . . . created precisely to his specifications. A universe built on the technology of the infinitesimal . . . where a single chip the size of a pencil diameter and as powerful as ten thousand transistors is born and brought to maturity under the magnifying eye of the microscope.

A mini-world . . . of controlled environments, computer-aided design and test techniques, complete photomask facilities . . . that when mated with the capabilities of today's most highly qualified engineers and technicians serves to produce the most competent standard and custom MOS arrays attainable. MOS TECHNOLOGY, INC. . . . meeting your specs . . . modeling your package . . . merging time, space and money into savings for today's small world.

WE'VE TURNED
A TECHNOLOGY
INTO A COMPANY

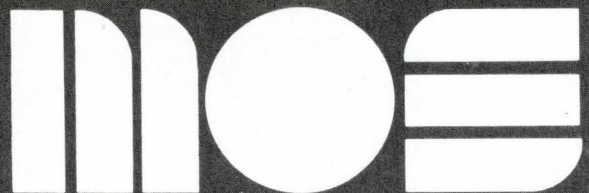

MOS TECHNOLOGY, INC.

VALLEY FORGE INDUSTRIAL PARK, VALLEY FORGE, PENNA. 19481 215-666-7950

a proud affiliate of Allen-Bradley Co



EASTERN REGION

Mr. Bill Whitehead, Sales Director, MOS Technology Inc., 88 Sunnyside Blvd., Suite 307, Plainview, N. Y. 11803 • 516-822-4240 • REPRESENTATIVES—Michael Scott Co., Inc., 20 Walnut St., Wellesley Hills, Mass. 02181 • 617-235-0102 • Ossmann Component Sales Corp., 280 Metro Park, Rochester, N. Y. 14623 • 716-442-3290 • Bob Jackson, Mfr.'s Rep., P.O. Box 17484, Charlotte, N. C. 28211 • 704-366-6678 • Falk-Baker Associates, 382 Franklin Ave., Nutley, N. J. 07110 • 201-661-2430 • Atlantic Component Corp., 1331 Harbor Lake Dr., Largo, Fla. 33540 • 813-584-8257 • C. H. Newson & Associates, Inc., 711 Bethlehem Pike, Philadelphia, Pa. 19118 • 215-248-3377.

CENTRAL REGION

Mr. Al Mattal, Sales Director, MOS Technology Inc., 10400 W. Higgins Rd., Suite 631, Rosemont, Ill. 60018 • 312-298-2035 • REPRESENTATIVES—Norvell Associates, P.O. Box 20279, Dallas, Texas 75220 • 214-357-6451 • John Grey Associates, 3957 Denley Ave., Suite 206, Schiller Park, Ill. 60176 • 312-671-3258 • Hastings Inc., 249 Winding Way, Dayton, Ohio 45429 • 513-771-5674 • Special Electronic Sales, 8053 Bloomington Freeway, Bloomington, Minn. 55420 • 612-884-4317 • Harlan J. Weisler & Associates, Inc., 2050 Woodson Rd., St. Louis, Mo. 63114 • 314-428-3934 • R. C. Merchant & Co., Inc., 18411 W. McNichols, Detroit, Mich. 48219 • 313-535-6000.

WESTERN REGION

Mr. Jack Turk, Sales Director, MOS Technology Inc., 2172 Dupont Dr. (Patio Bldg.) Suite 221, Newport Beach, Calif. 92660 • 714-833-1600 • REPRESENTATIVES—Hunter Associates, 1208 Fox Plaza, San Francisco, Calif. 94102 • 415-626-8576 • W. B. Knight Co., Inc., P.O. Box 400, 112 Glasgow Ave., Inglewood, Calif. 90301 • 213-678-4711 • J. A. Tudor & Associates, Inc., 2605 Western Ave., Seattle, Wash. 98121 • 206-682-7444 • Checkmate Sales, P.O. Box 22411, Denver, Colo. 80222 • 303-771-4920 • Toward Engineering Associates, Inc., P.O. Box 15268, Arcadia Station, Phoenix, Ariz. 85018 • 602-955-3193.

We can make anything by photo chemical machining. Not just 2 million color TV masks a year.

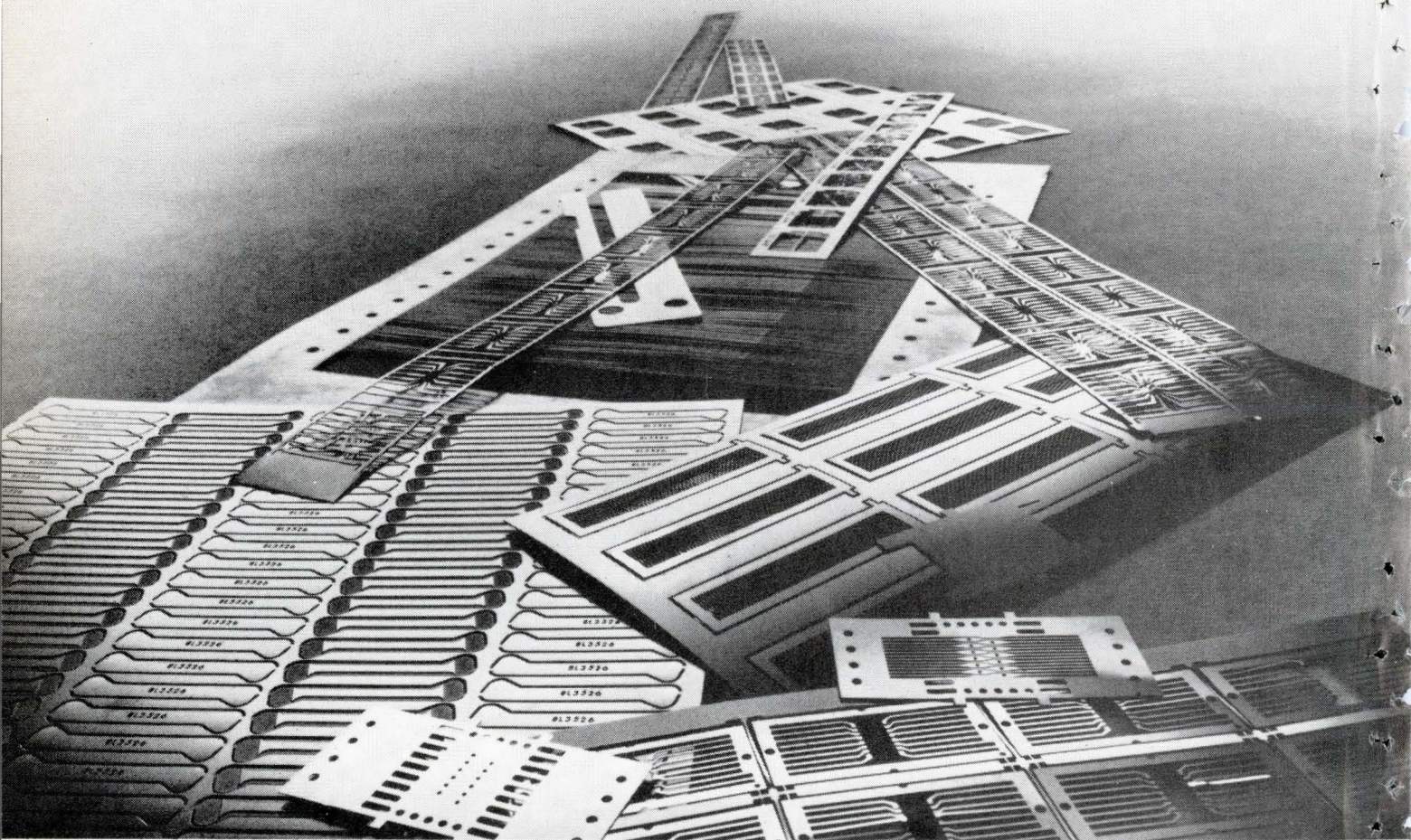

Anyone can handle a run-of-the-mill chemical milling job. But if you're going crazy with frustration, we've got answers not everyone can give you.

Like the time we rescued a whole integrated circuit production line that was shut down because a part kept failing. Our metallurgists found the "insignificant" change in metal grain structure that a metal supplier had introduced.

Or the time somebody needed a metal part that could pass a very nasty bending test. We whipped up a nickel alloy that did the job, though a lot of people on the sidelines said it couldn't be done.

Where do we get the experience? We've been through the mill with a huge, continuous photo chemical machining operation that has turned out millions of aperture masks (500,000 perfectly formed holes per mask).

We make all sorts of other complex things by photo chemical machining. (You see some of them here.) IC lead frames. Display tube numbers. Grids. Heaters. Electric razor cutter heads. Computer card guides.

We start them out in our big artwork shop and end up by plating them with nickel, gold, or silver.

Now we're expanding our photo chemical machining operations with a lot of automatic machinery. So we can handle more work.

If you need something special, come to us.
Instead of just milling around.

*Send for our brochure. Write to: Marketing Department,
Sylvania Precision Materials, Chemical and Metallurgical
Division, Towanda, Pa. 18848.*

SYLVANIA
GENERAL TELEPHONE & ELECTRONICS

where the plan was put into operation: "To understand the experiment, one first has to understand how this region is organized. It comprises 38 sections, 12 subsections, and assorted student branches. Basically what we've done is to appoint six area chairmen to deal closely with the seven or so sections assigned to them. While this may not sound like much on the surface, we've found that the setup has paid handsome dividends in terms of more communications and motivation on the part of the membership. It seems to have sparked more interest in IEEE affairs. Further, and perhaps equally important, the plan has put each section on a more businesslike basis, where objectives are set up and funds allocated instead of on a catch-as-catch-can basis."

The plan began last February, and has been so successful that the board has recommended its extensive adoption elsewhere.

Another positive step in the making, according to Mulligan, concerns the 31 technical groups. By the end of next year, they will have been reformed into six technical sections each with its own director.

Implicit in this move is a restructuring of the IEEE's board of directors. Traditionally the board has been made up of the 10 regional directors, assorted officers, and six directors-at-large. It is these last six who will eventually be replaced by the six technical directors, thus assuring the technical groups automatic representation on the institute's governing body.

Two of the six sections—the computer and power groups—will take on society status Jan. 1, a change that should also help meet members' needs as well as extend membership requirements to non-EEs.

As to the question of whether the IEEE is simply too unwieldy an organization ever to function effectively for its members, Mulligan is adamant in his conviction that "if we can get communications going the way we plan, and if our regional and divisional directors are committed to this two-way communications concept, then no, I don't think this will be the case. There is nothing inherently unwieldy about the IEEE."

Probing the news

Components

Sum of Sprague's parts equals new business

Divided, Sprague had been losing profits and business; united, it hopes to compete in the systems market

By James Brinton, *Boston bureau manager*

With its integrated circuit division losing money and its once-dominant position in the tantalum capacitor market slipping away, Sprague Electric Co. has turned to a new functional circuit design and technology operation. Sprague's management found that business was being lost due to uncoordinated sales efforts between departments with heavy investments in specific technologies, and it felt that more and better technology was on the shelf than in the market. The new operation, they hope, will rectify the situation and at the same time try for a more homogeneous image of the company as a producer of subsystems.

The word "functional" is important, for, unlike Sprague's other divisions, the operation is not committed to any one technology. Says Robert S. Pepper, corporate manager of the operation, "We're putting it all together. Because our group will apply all of the company's technologies (to a given problem), we are going after business that Sprague has never sought before."

Pepper expects the operation to gross about \$3.5 million next year, and perhaps even make a profit. If he succeeds, it could spell the end of the usual writeoff for corporate R&D, and maybe the beginning of a trend.

One of the few operations similar to Pepper's is Texas Instruments' customer engineering center, which was started late in 1967. However, while Sprague theoretically would use technology ranging from can capacitors on pc boards

to LSI, TI's operation usually fulfills customers' needs with semiconductors only.

Pepper has a strong component base to work from. Shipping more than a million units weekly, Sprague may be the country's largest hybrid circuit supplier. Its digital IC lines range from low cost and complexity 5400/7400-type TTL circuits to custom arrays—and even MOS arrays—through its part ownership of Mostek. And besides making some transistors of its own, it has a foothold in the high power transistor field through its investment in Pirgo.

Among the 15 or so companies for whom the new operation is "researching and developing" system subassemblies are Delco, NCR, Hewlett-Packard, Litton, Digital Equipment, Bendix, AirResearch, Hughes, GE, and Harris Semiconductor. All were signed up since it began in March.

So far the functional circuits group could be mistaken for a coordinated sales organization—something different from Sprague, which admits to internal communications problems. But it's more: The charter of Pepper's operation includes development of standard products (including a new line of advanced operational amplifiers, analog to digital converters, digital to analog converters) and service to custom LSI and linear circuit markets. So Pepper thinks of his group largely in terms of R&D. Because he feels that R&D can be a profit maker, he insisted on having a profit and loss statement, "partly as incentive for the group, but

60% less cavity!



This MCM* now does the same job in less than half the space! Size and weight reduction is one of many packaged advantages that General Electric MCM's provide for advanced microwave systems. For instance, the new C-2003E

*Microwave Circuit Module is a master-oscillator and power amplifier — using GE planar ceramic tubes — for IFF or ATC pulsed transponder applications. It's the electronic equal of the larger version we developed to give high RF gain, high power and unmatched stability under the most adverse environments and under severe load mismatch. General Electric combines research with production know-how to provide systems designers with one efficient source for high performance planar tubes and toughly packaged circuits. For more information, circle the appropriate number on the reader's service card, or write MDBS, Tube Department, Owensboro, Kentucky. 272-12



GENERAL ELECTRIC

Probing the news

mostly to show that R&D can pay its way."

But the group will also enhance the profitability of other Sprague divisions and departments. It's happening already at the ceramic products operation, which is supplying \$1 million worth of hybrid circuits to NCR in 1971. Without applications engineering and some specialized monolithic circuit design, the group would have had to no-bid the contract. As it was, Pepper's men talked to NCR, came up with the needed IC in about eight weeks, got production started and handed the business to ceramic products.

The group's product planning manager, William T. Campbell figures that, even with a "just fair" economy, functional circuits could add 10-30% to the growth rates of Sprague's divisions, just by finding new business that uses multiple technologies and turning it over to the appropriate division. By 1975, he reckons the operation could be responsible for as much as \$50 million in added business.

Meanwhile, Pepper's profit-minded researchers are laying it on the line. For example, they are re-designing the arithmetic unit of an aircraft fuel control computer. Instead of a 30-chip hybrid, Pepper hopes to produce a one-or-two chip device.

"On some simple circuits, we can get to 10X artwork in half a day," says Pepper. The operation has been equipped for this with a high-speed pattern generator, which calls on a library of monolithic circuit part shapes and comes up with artwork about 100 times faster than commercial artwork generators, according to Pepper. And to speed over-all design of LSI devices, there's also a library of digital building blocks; gates, flip-flops, registers, and so on, of various sizes, which the group claims it can combine to form nearly any digital function.

But not in any quantity. "We're production limited," says Pepper, "we have what amounts to an all-purpose pilot line, but its throughput is finite. As soon as quantity

rises and price falls, we'll hand the business over to one of the other divisions."

To all appearances, the earliest beneficiaries of this policy will be the IC and ceramic products groups. The functional products operation already has had a hand in developing the hybrid circuit modules to be used in RCA's new line of solid state television sets. "We make more of them than RCA does," says a Sprague spokesman. And this is only the beginning, because Sprague plans to develop standard modules for nearly all parts of television and high-fidelity equipment.

By the end of 1970, five or six such modules should be ready, among them units for color processing, a sound channel with audio i-f strip included, an audio amplifier, and a video signal processor. Upcoming on a custom basis will be video i-f modules and a complete television front end. Thus Sprague plans a major penetration of entertainment electronics markets through the functional circuits operation.

Despite his access to all of Sprague's varied technologies, Pepper is continually sniffing around for more. Recent additions to his list of techniques include a positive temperature coefficient ceramic which could be used as a substrate material and would act as a temperature stable oven when current is passed through it. [*Electronics*, Oct. 26, p. 33] Called PTCR, it promises ultra-high-accuracy voltage references in hybrid or monolithic form.

Scheduled for some commercial modules is a technique which eliminates the low-yield step of adjusting an rf or i-f coil.

Pepper also intends to utilize some of the advanced work done at the company's research and development laboratories. High on his list are ultra-high-value ion-implanted resistors for monolithic circuits. Pepper claims these can reach values at least 10 times greater than diffused resistors, achieve accuracies of 5% or less, and have temperature coefficients of only 50 to 100 parts per million per degree centigrade at values of about 4,000 ohms per square.

Neither heat,
nor cold,
nor any other adversity
can keep our new RAM
from meeting Milspec 883.

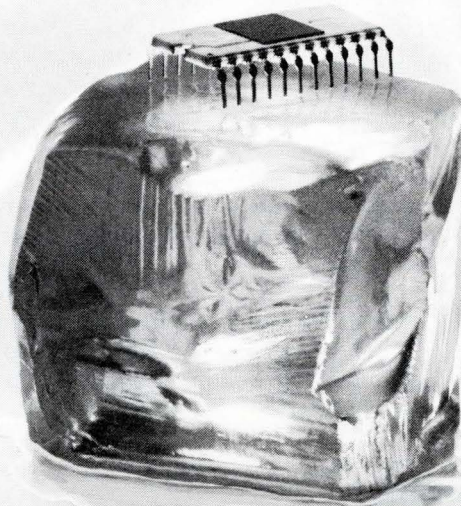

It's the first MOS RAM of its size and type that will hold its electrical characteristics from -55°C to $+125^{\circ}\text{C}$. And it's designed to meet all the other requirements of Milspec 883, too. The UC6550/7550 comes in a 64 word by 4 bit configuration. Four chip-select lines let you expand up to a 1024 word by n bit memory without external decoders. It's bipolar compatible too. Typical access time is 600ns. Single phase clocked operation lowers average power dissipation. Total input lockout simplifies timing

requirements. No maximum rise time requirements. No possibility of address racing. Memory elements are self-sustaining flip flops; no "refresh address" is needed. The read/write cycle is non-destructive.

We're already shipping parts for military and commercial applications. Contact us for full specs and prices.

Solitron Devices, Inc., P.O. Box 1416
San Diego, California 92112
Telephone 714/278-8780
TWX 910-335-1221

Solitron DEVICES, INC.

For custom designs or standards, contact Solitron, leader in semiconductors:

SAN DIEGO, CAL.
8808 Balboa Avenue
FET & Dual FET Transistors
MOS/FET Devices
MOS Memory Arrays
Shift Registers
Monolithic IC's

RIVIERA BEACH, FLA.
1177 Blue Heron Blvd.
Hi Rel Power Transistors
Si & Ge Power Transistors
RF & small Signal Transistors
PNP-NPN Industrial Transistors
PORT SALERNO, FLA.
Cove Road
Microwave Connectors

LONG ISLAND CITY, N.Y.
37-11 47th Ave.
Microwave Components
Bolometer Elements
Ferrite & Ferrite Devices
Microwave Semicond.
Plaxial (R) Cable
Precision RF Coax.

TAPPAN, N.Y.
256 Oak Tree Road
Diodes & Rectifiers
Zeners
High Voltage Assemblies
Power Rectifiers
Thick Film Hybrid Circuits

KENT, ENGLAND
Tubs Hill House
London Road, Sevenoaks
Solidv, Ltd.
Full line of
Solitron devices

BEN BAROQ, ISRAEL
51 Hayarkon Street
AEL Israel, Ltd.
Full line of
Solitron devices

TOKYO 105, JAPAN
NO. 5, 3-Chome
Shibahamamatsu-cho
Minato-ku
Matsushita Electric Trading
Full line of
Solitron devices

Communications

AT&T sweetens satellite plan

Filing for satellite leasing from Comsat promises wide range of services; critics say digital system is extraterrestrial expansion of carrier monopoly

By Jim Hardcastle, *Washington bureau*

An early full-scale initiation of Picturephone service and more digital circuits to serve data users are some of the promises the American Telephone and Telegraph Co. is holding out as it begins an extensive effort to rally support for its domestic satellite application. Waiting in ambush, however, are a number of prospective carriers who feel that the domestic satellite is just another tool in AT&T's plan to maintain its monopoly of the common carrier industry.

The filing, which came six weeks before the Federal Communications Commission's deadline for domestic satellite systems applications, calls for AT&T to lease two

satellites from Comsat, each with twice the capacity of Intelsat 4, and to build five ground stations. To sweeten the package and improve the chances of FCC approval, something has been added for just about every Bell System user.

According to Richard Hough, president of AT&T's long lines division, the prospects for an early approval seem bright. He notes that the White House in January called for an "open-skies" policy, which would permit any firm with solid financial backing and technical capability to loft a communications satellite. Hough further believes that America's problems over its national image—the results of its

late start in domestic satellites—and the large number of users to be served by the AT&T system should encourage FCC support.

AT&T competitors, though less sure of the plan's chances, will find opposition a difficult fight. William McGowan, president of Microwave Communications of America Inc., says that the questions most likely to hang up the application relate to antitrust. "At first blush," he says, "the AT&T filing seems like an attempt by Bell to maintain monopoly. It effectively removes AT&T's strongest competitor in the field—Comsat—from offering any services directly competitive with Bell."

When coupled with Western Union's more austere proposal for a dedicated satellite, Bell's plans will also provide a major obstacle to firms seeking to become a common carrier's common carrier, McGowan adds. For with most of the nation's communications traffic flowing through dedicated systems, fledgling carriers would probably not be left with enough to justify a system competitive with Bell's.

David Foster, president of Data Transmission Co., says his firm will not file against the AT&T proposal. He joins McGowan, however, in the view that the proposal was motivated by a desire to maintain Bell's stranglehold on the data communication services market. He charges that the satellite application is another means for Bell to cloud the data communications issue and forestall the FCC from giving the green light to specialized data carriers.

Comsat officials, however, deny AT&T's proposals would preempt

'Instant data network'

Bell's engineers dub AT&T's satellite proposal "instant data network"—and for good reasons. One of the system's most important roles would be in interconnecting the digital carrier systems Bell plans to use for both its Picturephone and digital data services. Since 1962, Bell has been installing 1.54-megabit (T-1) digital cable systems; 6.54-megabit (T-2) carrier will be put in by late 1972. Both systems will be used extensively to provide the wide variety of digital data services AT&T intends to offer by late 1973; T-2 also will be used for Picturephone loop service to subscribers.

If Bell sticks to its schedule it will be offering Picturephone service between Los Angeles and San Francisco, between Houston and Dallas, and among a number of cities in the Midwest and East when the satellites go up around 1974.

Cable systems with enough bandwidth to interconnect areas where the Picturephone and data services will be available will not be in the ground at that time, however. As a result, much of the satellite's digital capacity will be used to link up regional Picturephone and data networks. Later, advanced cable systems, such as the 46-megabit (T-3) and 600-megabit (T-5) will be used for that purpose, Bell engineers say. AT&T notes that in many cases, local loops for the digital data services will be analog. Modems installed at branch offices will convert the analog signals into a digital format before they are relayed to a T-1 system. Bell officials say a large number of data speeds will be available with the digital service but decline to specify what they will be.

them from domestic satellite service. They say they will most likely file for a second satellite system that would serve TV networks, independent telephone companies, and possibly CATV operators, and specialized data networks. Right now, the feasibility of their systems hinges on Western Union's success in courting the TV networks. If Western Union, which is counting on the networks for half of its satellite revenues, fails, and the networks decide to go with Comsat, prospects for its system look bright.

Bell, naturally, has different views and makes different claims. For data and Picturephone users, it says, it will dedicate half the transponders on either satellite to digital traffic. This would enable AT&T to add the equivalent of 64,000 miles of 6.3 megabit-per-second carrier, which could be used to unite regional grids of T-1 and T-2 digital carrier systems into a national network with each satellite. The remaining transponders would be analog, for the benefit of the ordinary telephone user. These could provide 5,400 voice circuits to lighten the load of terrestrial systems during peak traffic and to provide backup service during emergencies.

In a move designed to build political support, Bell also proposes to include the capability for extending service to parts of Alaska. Finally, the satellites would each be equipped with an experimental package, to provide propagation statistics on the 20 and 30 gigahertz bands. University researchers would monitor the package's beam over long periods to determine how much it was affected by extreme atmospheric conditions.

In its filing [*Electronics*, Oct. 26, p. 60] AT&T says that two synchronous satellites—one for operational use, the other for backup—would be leased from Comsat for \$29 million a year, and could be in operation 30 months after approval. They would be similar in design to Intelsat 4 satellites, but would have a narrower beamwidth and carry twice the traffic. Since the total bandwidth of 24 radio channels, each occupying a 40-MHz band, exceeds the 500-MHz width

of the 5,925- to 6,425-MHz up-link and the 3,700-MHz to 4,200-MHz down-link, the satellite would divide the 24 channels into two interleaved groups of 12. One would be transmitted by vertical polarization, the other by horizontal polarization.

To ease the problem of separating the channels, the satellite would carry two 6-GHz receiving antennas and three 4-GHz transmitting antennas. Each of the latter would transmit vertical and horizontal polarization simultaneously, and different antennas would transmit adjacent channels of the same polarization, AT&T says.

Under the AT&T-Comsat arrangement, Comsat would act primarily as an administrative agent and financier. The three satellites, one of which would remain on the ground as a spare, would be built by the winner of a competition to be held if FCC approval can be secured. And in the competition for the \$41.8 million satellite procurement, Hughes Aircraft Corp., the builder of the Intelsat 4 series, is holding all the cards, other satellite builders concede.

Five earth stations, located at Deluz, Calif., Mena, Ark., Hanover, Ill., Woodbury, Ga., and Hawley, Pa., would be built by AT&T and would be interconnected with terrestrial facilities by microwave hops. All stations would be equipped with two 100-foot antennas, so that both satellites could be used simultaneously if necessary. Both antennas will have slewing motors that will permit them to rapidly shift one satellite to another.

But all this is contingent on the approval of the FCC, which is gearing up to give prompt consideration to Bell's filing. FCC Common Carrier Bureau officials say the authorization for satellite systems should begin to roll out before the end of next summer, an unusually quick turnaround time for the procedurally bound agency. What its decision will be is hard to tell because the commission has declined to go beyond asking for domestic satellite applications. But the issue is clear, says one top FCC official. "It's how many satellite carriers should there be?"

SCHAUER

1%

tolerance

**1 WATT ZENERS
ARE A REAL BUY!**

ANY voltage from 2.0 to 16.0
at the industry's **LOWEST
PRICES!**

Quantity	Price each
1-99	\$1.07
100-499	.97
500-999	.91
1000-4999	.86
5000 up	.82



**THE
HI-RELIABLE!**

No fragile nail heads.
Silicon junction aligned between two, parallel, offset tantalum heat sinks . . . great lead tension strength.
All welded and brazed assembly.
High pressure molded package.
Gold plated nickel-clad copper leads.
Write or phone for Form 68-4 for complete rating data and other tolerance prices.

Semiconductor Division

**SCHAUER
MANUFACTURING
CORP.**

4514 Alpine Avenue
Cincinnati, O. 45242
Ph. (513) 791-3030



Bell & Howell & Jon Wells & The Simple Folk

Some people asked our guys how come we didn't turn out a recorder/reproducer that simple folk could use. At a simple price. Something that was production line oriented for a bunch of industries across the board.

We bounced that problem to Jon Wells who just recently came up with the remarkable, hi-rel VR3700B series.

Back Jon came with a little number called the VR3500. Although it's not as esoteric as the B model, it does have a lot of its features.

He used a modular concept with functions being grouped according to use. Linear IC's to get the bulk down. And large cards so any trouble shooting that needed to be done could be done fast.

Transport and electronics are set up so they can be easily repaired or modified. There's a closed loop tape path so you get real accuracy. Bi-directional speeds for versatility. A fail-safe phase lock DC capstan drive so you won't lose a smidgen of information. And very gentle tape handling.

As far as time base error and dynamic skew and flutter, they're fantastically low.

And so's the price.

Another thing. You don't have to be an engineer to run it. The how-to's are decaled right on the equipment.

That's the VR3500. An industrial recorder/reproducer. Brand new. And ready.

For all the specs, write its father, Jon Wells, Bell & Howell, Instruments Division, 360 Sierra Madre Villa, Pasadena, California 91109.

INSTRUMENTS DIVISION

 **BELL & HOWELL**

Circle 114 on reader service card

© Copyright 1970 Bell & Howell

Consumer electronics

Fire safety proposals burn TV set makers

TV firms are caught between deadlines in UL revisions and threat of Government action; costs are sure to rise

By Gerald M. Walker, *Consumer editor*

A safety squeeze is putting television set manufacturers under severe pressure. From one side, Underwriters' Laboratories has proposed extensive revisions of its testing standards, with deadlines that many in the industry feel will be impossible to meet. From the other side, it's felt that the Federal Government may step in with even tougher regulations unless the industry does a better job of policing itself. One thing is certain: any new standard is going to be costly.

UL's changes in its testing standards for radio and television receivers, UL 492, concentrate almost exclusively on fire safety. The date proposed for making most of the changes effective is Jan. 1, 1971. Others will become effective in June 1971, and January 1972. Included in the 17-page revision are requirements for steel or noncombustible high-voltage component enclosures; new spacing rules for arc tests; definitions of noncombustible parts and flammability classifications; tighter power supply checks; a new high-voltage short-circuit test, and numerous new definitions for flaming tests.

As a nonprofit, independent testing organization accepted by producers and consumers, UL swings a lot of weight on its own. But some companies regard the revisions as a direct response to the harsh publicity focused on manufacturers and UL by the National Commission on Product Safety's controversial report which cited allegedly widespread fire hazards in color sets [*Electronics*, Aug. 3, p. 54].

Others see the UL move as too late to head off Government safety standards. No legislation pertaining to consumer electronics safety standards appears to have a chance of passage this year, but some form of regulation is almost certain in the next session, they state. All of this adds even more confusion to an issue that is already charged with controversy and concern.

One of the most controversial aspects of UL's proposals is the timetable for compliance. All manufacturers that submit products to UL for tests under 492 have had the proposed revisions for some time. But due to confusion over UL's test procedures, and the give-and-take that characterizes relations between the voluntary standards group and its clients, it may be the beginning of December before industry's comments can be evaluated.

Those engineers who assert that UL's deadlines are impossible to meet say they will have to qualify noncombustible parts, redesign some high-voltage circuits, and institute new in-house test procedures on a very short lead time.

Sets made offshore, in countries such as Taiwan, may have an even harder time complying with the new standards. A leading company's engineering vice president complains, "We have to come to some agreement with UL on overseas assemblies. If we want to make a change as small as substituting a 1,400-ohm resistor for 1,200-ohm unit at our Taiwan plant, and everything works right on schedule, which it never does,

Bell & Howell & Tape. & Tape?

Right. We're in the magnetic tape business. Very seriously.

No, we don't buy it out. We make it. And darn well, too. For instance, the way we formulate and lay down the oxide makes it a really superior performer. No joke. Its sensitivity is so good it'll give your recorder a 2-3 dB better SNR than is possible with any other tape commercially available.

It's also the smoothest tape going. Like .5 micro inches peak to valley. Which gives you a much longer head life.

Then there's the fantastic consistency of our runs. Not just from beginning to end of reel, but from one reel to another, so you don't have to run around adjusting recorders all the time.

For all that, you'd expect to pay a little more, right? Well, chances are, our tape costs less than the one you're buying now.

Types? A full range. Wide-band with a 2 mHz response. Mid-band with a 600 kHz response. Standard telemetry. And instrumentation audio.

Want to try it? You can—at an introductory 20% discount. Now. But for a limited time. Get full details by calling your local Bell & Howell office, or write Instruments Division, Bell & Howell, 360 Sierra Madre Villa, Pasadena, California 91109.

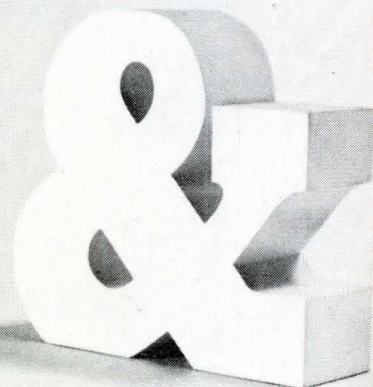

INSTRUMENTS DIVISION

 BELL & HOWELL

BUSS QUALITY

SMALL DIMENSION FUSES AND FUSEHOLDERS

For The Protection of All Types of Electronic and Electrical Circuits and Devices...



includes dual-element "slow-blowing", single-element "quick-acting" and signal or visual indicating types... in sizes from 1/500 amp. up.



HKA lamp-indicating, signal activating holder.



HMR RE shielded holder for 1/4 x 1 1/4 in. fuses.

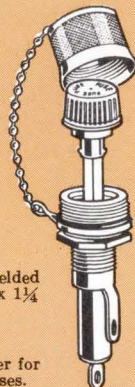

HKP panel mounted holder for 1/4 x 1 1/4 in. fuses.



TRON Rectifier Fuses For the Safe Protection of Solid State Devices.

Provide extremely fast opening on overload and fault currents, with a high degree of restriction of let-thru current. Many types and sizes available. Ampere ratings from 1/2 to 1000 in voltage ratings up to 1500.



Circle 116 on reader service card

GROOVY CLIPS for TESTING DIPS

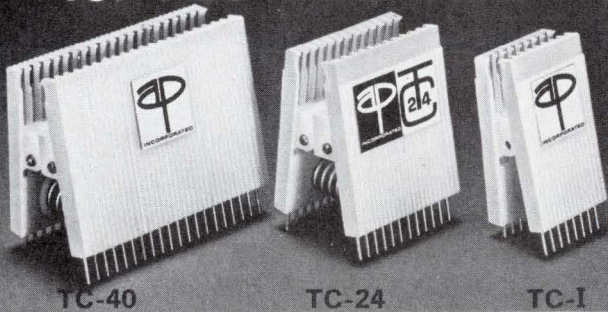

Permits quick attachment of test probes
Eliminates shorting between DIP leads
Excellent DIP removal tool
Eight sizes available:

- TC-I* fits 16-pin DIPS with .3" centers
- TC-II* fits 16-pin DIPS with .5" or .6" centers
- TC-8 fits 8-pin DIPS with .3" centers
- TC-14* fits 14-pin DIPS with .3" centers
- TC-24* fits 24-pin DIPS with .5" or .6" centers
- TC-28 fits 28-pin DIPS with .5" or .6" centers
- TC-36 fits 36-pin DIPS with .5" or .6" centers
- TC-40 fits 40-pin DIPS with .5" or .6" centers

Mating connectors available for all clips *Immediate delivery (Others 3 weeks)

SEND FOR **AP INCORPORATED DATA SHEET**
72 Corwin Drive, Painesville, Ohio 44077

ORDER DIRECT FROM



COMPAR FACILITIES

(201)473-2660 (301)484-5400 (505)265-1020 (617)969-7140
(203)288-9276 (303)757-7621 (513)878-2631 (713)667-3420
(205)539-8476 (312)775-0170 (518)489-7408 (714)279-9280
(206)822-4191 (313)357-5369 (602)947-4336 (716)271-2230
(213)843-1772 (314)542-3399 (607)723-8743 (801)364-1163
(214)363-1526 (315)471-3356 (609)429-1526 (919)723-1002
(216)333-4120 (415)347-5411 (612)922-7011

Circle 163 on reader service card

To pinpoint a cosmopolitan Texas location convenient to R & D capabilities, brainpower and productive labor:

ASK INSTA-SITE

The answers to specific Texas plant location questions and impartial site selections are instantly available from the nation's most comprehensive industrial computer program. Write or call for detailed Insta-Site information and your free copy of the Texas Fact Book.



TEXAS INDUSTRIAL COMMISSION
Capitol Station — Box 12728-E
Austin, Texas 78711 — 512/475-4331

Circle 164 on reader service card

Probing the news

it would take at least four months because of the acceptance tests, shipping, and communications delays. Six to eight months would be average." Practically all manufacturers of small screen receivers depend on offshore facilities for complete sets or subassemblies.

Exactly what the proposed UL revisions will cost an industry hit hard in a year of sales decline is anybody's guess. Says Zenith's safety engineer Ron Wilhelm, "Anyone who tells you that he can put a dollar figure on these changes is kidding. Costs involve engineering time and preparation for new test procedures which cost money just to set up."

Richard Sanderson, manager of product safety for Sylvania, notes that estimates on cost increases have to cover many variables. For example, he points out that the new fire-retardant wire requirement

throughout the set probably would add five cents to every dollar of Sylvania's wire purchases. But next year's model will not use as much wire overall as this year's. Another product safety engineer feels his firm will have to spend 15 cents more per switch and up to 50 cents more on printed circuit boards.

The parts companies also are facing higher costs to meet expensive standards. Many suppliers already have received copies of the UL revisions through EIA's Parts division and were asked by staff vice president Tyler Nourse to comment directly to UL. Nourse says the parts firms feel the new flame-retardant tests are important because they will accelerate specifications and tests of new and often unfamiliar materials.

T. Odon Mathews, director of product approval for AMP Inc., explains that the proposed revision may better define the differences among such terms as noncombustible, flame-retardant, and self-

extinguishing. "We hope that this is the beginning of a philosophy that relates the materials test to the application. A strip of fire-retardant material may have one characteristic and a component insulated with this same material another," he asserts.

Underlying all of the industry's comments on the fire safety push is the unmistakable feeling that television receivers got a bum rap in the government's product safety report. A spokesman for a Midwestern firm bitterly points to the difference in safety records between TV sets and automobiles. Another man quotes a recent electrical inspectors association survey, revealing that of a sample of 7,800 fires in homes reported nationally in 1969, 0.66% were traced to television receivers, against 4.11% in 1968. "We are making sets safer without the safety report," he maintains. "The report was only a prod to what the industry was already doing."



FNA FUSETRON
Fuse 13/32 x 1 1/2 in. slow-blowing, Visual-Indicating, Alarm-Activating. (Also useful for protection of small motors, solenoids, transformers in machine tool industry.)



BUSS MIC-13/32 x 1 1/2 in. Visual-Indicating, Alarm-Activating.



BUSS GLD-1/4 x 1 1/4 in. Visual-Indicating, Alarm-Activating.

BUSS GBA-1/4 x 1 1/4 in. Visual-Indicating.

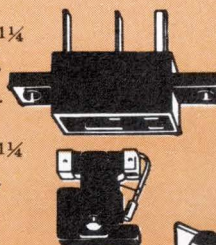

BUSS GMT and HLT holder, Visual-Indicating, Alarm-Activating.

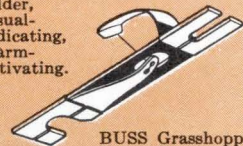

BUSS Grasshopper Fuse, Visual-Indicating, Alarm-Activating.

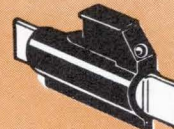

BUSS ACH Aircraft Limiter, Visual-Indicating.

The Complete Line of Signal-Indicating Alarm-Activating Fuses

For use on computers, microwave units, communication equipment, all electronic circuitry.

SUB-MINIATURE FUSES

Ideal for space tight applications, light weight, vibration and shock resistant. For use as part of miniaturized integrated circuit, large multi-circuit electronic systems, computers, printed circuit boards, all electronic circuitry.

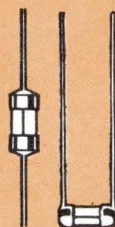

TRON Sub-Miniature Pigtail

Fuses—Body size only .145 x .300 inch. Glass tube construction permits visual inspection of element. Hermetically sealed. Twenty-three ampere sizes from 1/100 thru 15.



BUSS

Sub-Miniature GMW

Fuse and HWA Fuseholder
Fuse size only .270 x .250 inch. Fuse has window for visual inspection of element. Fuse may be used with or without holder. 1/200 to 5 amp. Fuses and holders meet Military Specifications.

BUSSMANN MFG. DIVISION,
McGraw-Edison Co., St. Louis, Mo. 63107

For fuses and fuseholders of unquestioned high quality for every protection need . . .

SUPPLIED THE ECONOMICAL WAY
THRU DISTRIBUTORS

BUSS QUALITY

FUSES

OUR ANGLE: angle position indicators that do more and cost less

SHOULDN'T YOU TAKE A NEW READING ON THIS COST-PERFORMANCE ANGLE?

For better ways to measure synchro and resolver data, North Atlantic offers the best of both worlds: budget prices for the popular API-8025; superior performance and increased capability of the new 8525. • Both are interchangeable without any mechanical or wiring modifications. North Atlantic's solid-state 8525 offers an accuracy of 0.05° (3 minutes). Following a 180° step input, it synchronizes a five-digit NIXIE readout in 1/2 second flat. And it tracks at up to 1000° per second. Where cost can be traded against performance, the proven electromechanical API-8025 . . . a recognized indus-

MODEL 8525



MODEL 8025

try workhorse . . . is available with its 6 minute accuracy, 25°/second slew speed, and many options. • Input of the 8525 is any 60 or 400Hz resolver/synchro data from control instrumentation. The patented servo design eliminates all inertia and improves dynamic performance many times over. Its digital outputs are especially suited to the computer-oriented requirements of today's automatic test systems. The 8525 . . . priced at \$2475 . . . and the API-8025 priced at \$995 actually cost less because they perform more functions per dollar. And with greater reliability. ®

For complete information on the cost-performance angle, please write or phone now.

NORTH ATLANTIC
industries, inc.

200 TERMINAL DRIVE, PLAINVIEW, NEW YORK 11803
cable: noatlantic / twx: 510-221-1879 / phone: (516) 681-8600

Core pattern makes stack more versatile

By Lawrence Curran, *Los Angeles bureau manager*

New mounting technique cuts costs, assembly problems; memory to make debut at Fall Joint Computer show

Cores in a memory stack are usually mounted on edge at right angles to each other, and on centers no closer than the equivalent of one core diameter apart. Designers at Ampex Corp.'s computer products division, however, have designed an interleaved herringbone-like pattern, in which the cores may be mounted on centers one-half their outside diameters. This technique allows the division to offer up to 21 different word and bit variations on one standard planar pluggable board.

The stack will be introduced at the Fall Joint Computer Conference, Nov. 17-19 in Houston. The

stack offers 1,024, 2,048, or 4,096 words on the same board, and bit lengths of 6, 8, 9, 12, 16, 17, and 18, although any other bit length from 6 to 18 may also be obtained.

Using 18-mil-diameter cores, the stack has a cycle time of 700 nanoseconds; with 22-mil cores, that speed is 900 ns. The stack is intended for use in computers in the mini- to medium-size range, and measures 8 by 7½ by ½ inch.

Victor Sell, product manager for cores and stacks, says one side of the circuit board will be etched to accommodate 4,096 words by up to 18 bits, while the opposite side will be etched to accept either 1,024 or 2,048 words by up to 18 bits. "When the edge connector is wired," Sell says, "the customer needs to do it only once, no matter whether he has 1,024, 2,048 or 4,096 words, because the drive and sense lines are on the same pins of the board regardless of

which way he goes."

Sell says one advantage of the Ampex variable-word, variable-bit planar stack is that all 75,000 cores are placed on the plane by one operator at the same time, all are strung at the same time, and all are inspected at the same time. Older methods required one plane or array per bit in a stack, to get bit variation. If it was to be a 4,096-word by 18-bit stack, 18 planes had to be assembled, each with 4,096 cores. This meant the cores might come from different lots, be assembled onto a plane by different operators, and be tested by different people before being combined into a stack. "But they were all driven from the same source by the customer—he needed them all to be playing the same tune to the same conductor," Sell says.

If a core, or several, with a wider than acceptable tolerance turned up in testing, the whole plane had

Packing them in. Cores in Ampex memory stack are mounted in a pattern suggestive of the herringbone stitch. Shorter address and sense wires made possible by this arrangement help to reduce noise.

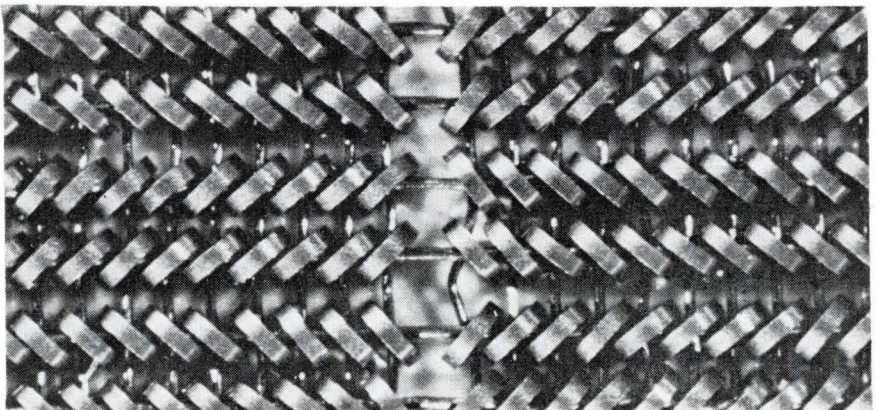
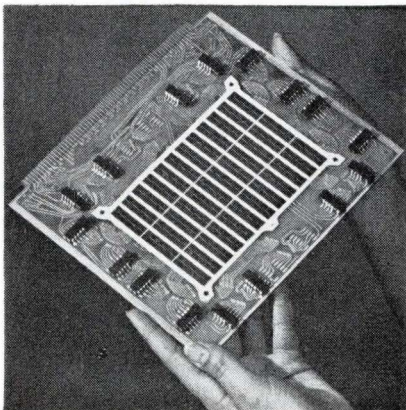

New products

to be discarded.

With the new mounting pattern, because the cores are much closer together than with other patterns, a virtual core-tunnel is created. This means that during stringing, there's no chance the needle will slip outside and maybe also chip the cores, as it often did when they were farther apart.

Sell points out further that wire lengths in the three-dimensional, three-wire design are at least half those in stacks with cores mounted on wider centers. "The sense in-

hibit line, which threads all the cores in a bit, can be up to 22 feet long," he notes. With the greater packing density, twice the number of cores can be put on it as was possible previously. "We've halved the core signal delay time," Sell says. Because the drive and sense links are also shorter, both the inductive coupling between drive lines and the impedance of the drive and sense lines are reduced, so that 25% less power supply voltage is required.

Ampex uses 16 diodes per dual

in-line package instead of the single-junction glass diodes that are still widely used. The DIP diodes require only 10 solder joints per 16 diodes versus two per diode with the single-junction type.

Ampex is quoting 10-week delivery on the new stack. Prices aren't firm, but it's estimated the cost per bit with 22-mil cores will be a little less than one cent in quantities of 1,000 or more.

Computer Products division, Ampex Corp., 9937 West Jefferson Blvd., Culver City, Calif. 90230 [338]

Capacitive key enters data

Coding scheme requires only 13 junction FETs

A simple mechanical key and an unusual coding scheme have been united in a new data entry keyboard. The coding arrangement for an 87-key assembly with eight bits per key requires only 23 junction field effect transistors, rather than 360 diodes necessary in most coding matrices. The key is capacitive, so that closure causes a change in capacitance to the coding circuit, resulting in an electrostatic impulse to the logic. And it's reliable: "We've tested our keys to 18 million closures and they're still going strong," says Walter Pound, product marketing manager at Colorado Instruments Inc., which developed the keyboard. It will be introduced at the Fall Joint Computer Conference.

The mechanical keys are based on the principle of a toy "cricket" that produces an audible snap when squeezed. With this human engineering feature, the keyboard user feels the snap-back in his finger.

The main elements of the key are a circular ceramic conductor and a dome spring, which together make an electrical capacitor. Depressing the key causes the dome

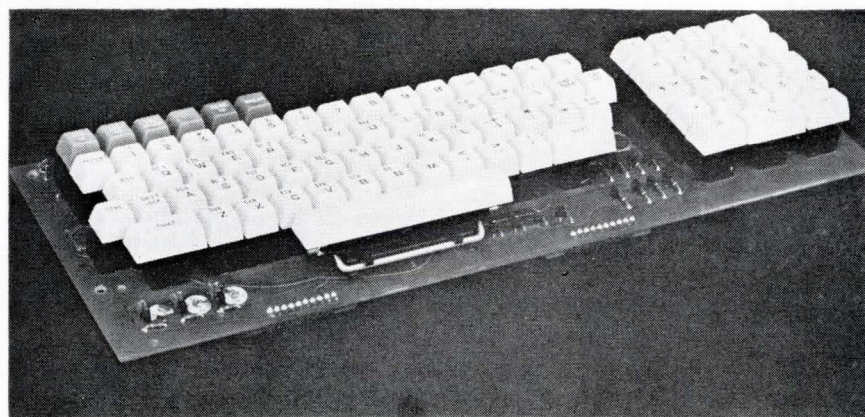

Contactless keys. No mechanical closure is involved in new keyboard. Depressing a key increases capacitance, driving junction FET into conduction.

to buckle, increasing the capacitance sharply and driving a J-FET into conduction. For alphanumeric keys, this yields a 0.5 microsecond pulse to the logic circuitry. What's more, a succession of characters can be generated while previously struck keys are still depressed, similar to N-key rollover.

In the control and shift modes, where the key must produce an output until it's released, a balanced-bridge approach is used. The key's static capacitance balances the bridge; when the key is struck, the bridge unbalances and a steady signal is delivered to the logic. When the key is released, the bridge becomes balanced and the signal stops.

The coding scheme defines each alphanumeric key in terms of its X, Y, and Z address coordinates, each of which represents portions of the outgoing bit pattern generated

by the key. Its circular ceramic conductor is divided into three sectors, each assigned to one of the coordinate lines on a printed circuit board. This approach requires only a few transistors for a large number of keys. For example, only 13 J-FETs are required in a 90-key American Standard Code for Information Interchange (ASCII) coded keyboard.

Thanks to the J-FETs' low impedance output, the keyboard is compatible with diode-transistor and transistor-transistor logic. The full 87-key unit with logic draws less than 1 watt total power and can be operated at temperatures from 0 to 70°C.

A full 87-key unit, without logic, is priced at less than \$100 when purchased in quantity. Delivery time is 6-8 weeks.

Colorado Instruments Inc., 1 Park St., Broomfield, Colo. 80020 [339]

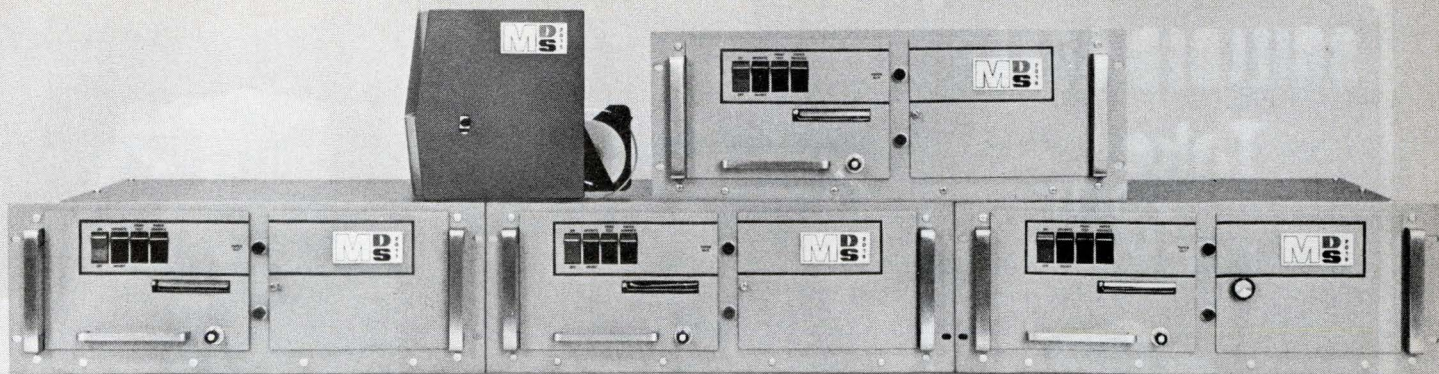

Five new printers from Mohawk.

These 5 new printers plus the 6 original Franklin printers give MDS a product line of strip and lister printers that can fill any requirement.

Our five new printers are the 2015 through the 2019. They're all fully buffered, asynchronous, have ultra-reliable TTL integrated circuits, and can operate on either 50 or 60 cycles. The lister printers range from 8 columns to 20 columns with printing rates from 10 to 20 lines per second. While the 2016 and the 2018 are numeric, the 2017 and 2019 are alpha-numeric. All four have programmable zero suppress and format control. And two of them, the 2018 and 2019, are character-serial. The 2015 strip printer features first character readability and a full 96 character ASCII font.

Our six original Franklin printers, the 800, 1200, 1600, 2200,

and 3200, add more capabilities to our line. Such as speeds up to 40 lines per second, a range of positive and negative interfaces, synchronous operation, and capacities up to 32 columns.

And, of course, all these printers are in production and are available for immediate delivery.

For more information about these MDS/Franklin digital printers, or about special printers like airline ticket printers, boarding pass printers, and card serial printers, call your nearest MDS salesman.

Mohawk Data Sciences Corp.
King of Prussia, Pa.



SHIELDED BOXES

Take
your
pick.

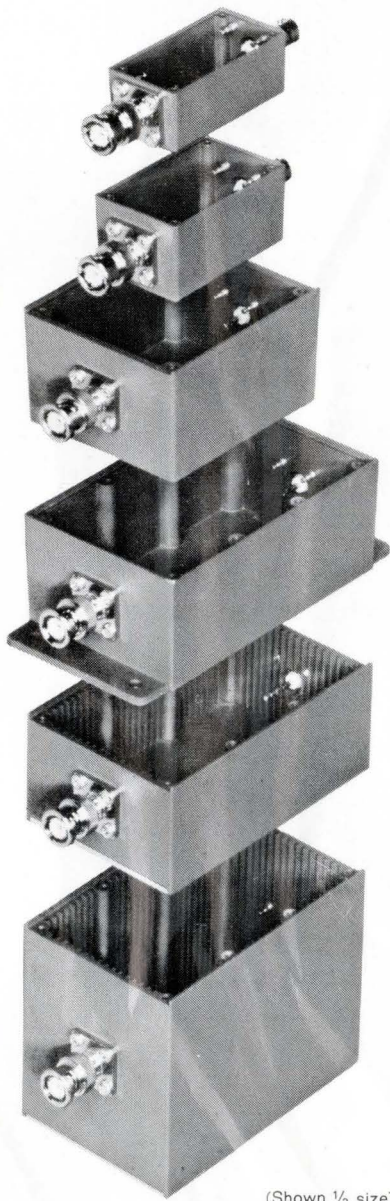

(Shown 1/3 size)

The newly expanded line of Pomona Shielded "Black Boxes" now comes in six different sizes; in cast or extruded aluminum; some slotted to accept circuit boards; in a broad choice of connector combinations or no connectors. There's bound to be one to meet your requirement. Write for complete information in our General Catalog.

**POMONA
ELECTRONICS**

1500 E. Ninth Street • Pomona, California 91766

New products

Disks expand minicomputers

Drive-controller system fits most 12-, 16-bit machines

Although the minicomputer user can choose from a few disk systems that are available for his machine, generally these are not in the same class as the large IBM type 2314 units and they are not in a single package. But at the FJCC, Information Storage Systems Inc., will show a data storage system that combines an 11-high 2314-type disk drive and a file control unit. The disk drive is the company's model 714, an IBM 2314 replacement.

According to Robert Daniel, manager of planning at ISS, the 714 is tailored to provide system expansion for a wide variety of minicomputers and proprietary systems. ISS worked with Hewlett-Packard to design the disk system's controller, and, says Daniel, "The design is generalized enough so we can interface with almost any 12- or 16-bit machine." Unlike most systems that require a controller from one company and a drive from another, Daniel adds, "we've designed both parts of the system so we know it's a good marriage. All that the designers of the central processing unit have to do is design the interface card, and we'll help them if they wish." ISS is not supplying separate interfaces for each minicomputer because, says Daniel, "we're not selling to the end user, we're selling to the OEMs. It's much easier for them to do one design than for us to do 100."

Data is organized as 92,000 individually addressed 256-byte records on a single model 2316 disk pack. This is equivalent to 23.5 million bytes or 188 million bits of usable data storage. Cost per bit is less than 0.01 cent. Average access time is 32 milliseconds, and start and stop times are about 20 seconds.

In addition to the read, write, and

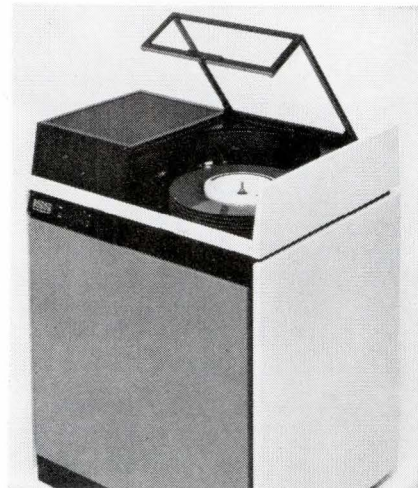

Added storage. Disk system enlarges memory capacity of small computers.

seek instructions, an expanded set of 10 instructions permits pack formatting, address comparison, address skip, position recalibration, cyclic check, and status check operation. Self-check logic also is incorporated in the drive to monitor unsafe conditions caused by improper write or erase current, excess temperature, and speed variations.

Delivery time is 90 days and the price is \$18,000 in quantities of 100.

Information Storage Systems Inc., 10435 North Tantau Ave., Cupertino, Calif. 95104 [340]

French display is interactive

Individual graphic elements stored, erased at any location

A conversational graphic display terminal to be introduced at the Fall Joint Computer Conference by a French company is designed to offer major features of high-cost systems such as the IBM 2250 at a lower price.

Sintra is offering its interactive graphic display terminal, named GIDI, for a price ranging between \$8,000 and \$18,000 in France. The

price in the U.S. has not yet been fixed. Sintra says the French price is less than half that charged for other terminals with similar capabilities. Unlike some of the inexpensive display terminals, this unit has a delay-line memory in addition to its cathode ray display tube. This permits the operator to store and erase individual graphic elements anywhere on the screen. The terminal can be connected directly to a computer or linked via standard telephone lines with transmission speeds up to 2,400 baud.

Available with the terminal are an alphanumeric keyboard, a function keyboard with 64 combinations, a light-pen tracking system, and a variety of interface connections.

The memory consists of up to seven modules of 1,024 bytes each. The terminal has a 12-inch CRT with a definition of 512 individually addressable positions along both axes. Vectors have random orientation and a maximum segment length of 15 units with a trace time of 19 microseconds.

Monolithic integrated circuits perform logic functions, and discrete components are used in the amplification circuitry. Company officials say that metal oxide semiconductor memories will replace the delay lines in models now being planned.

Sintra is aiming at such markets as system monitoring and process control, air and ground traffic systems, and various types of computer-aided design projects.

Sintra, 26, Rue Malakoff, 92-Asnieres, France [421]

Design tool. Terminal's memory allows user to remove graphic elements without erasing entire screen.

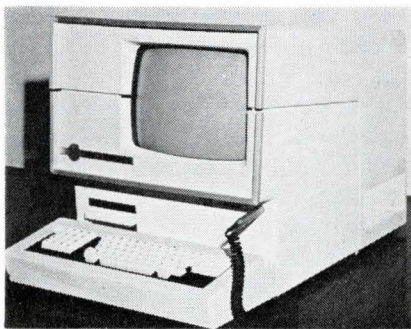

How would you like to have the best work force in your field?

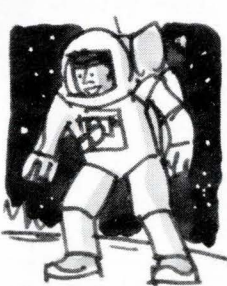
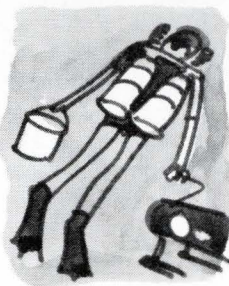
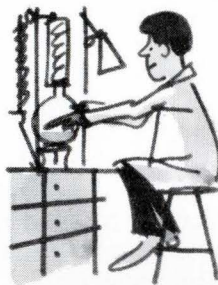

Drucker

In Florida we can show you how to have profits... performance... productivity!
Here's why Florida can deliver:

- We can out-recruit anyone for skilled labor. We'll show you proof of 10-to-1 superiority in competitive recruitment.
- Our skilled work force is growing faster than in any state in the Southeast.

- We now have in Florida a larger working age population (18-65) than any other Southeastern state.

Florida is a great place to work and live. Won't you let us reveal the hidden profit potential in Florida's remarkable labor picture? Just phone (904) 224-1215 or write in confidence.

Dept. D-4
Please send information about:

- Manufacturing plant
- Headquarters office
- Research
- Warehouse
- Other _____

NAME _____
 TITLE _____
 COMPANY _____
 ADDRESS _____
 CITY _____ STATE _____ ZIP _____



**THE -100°F. TO +400°F.
CHAMBER
WE WON'T
SELL TO
JUST ANYONE**

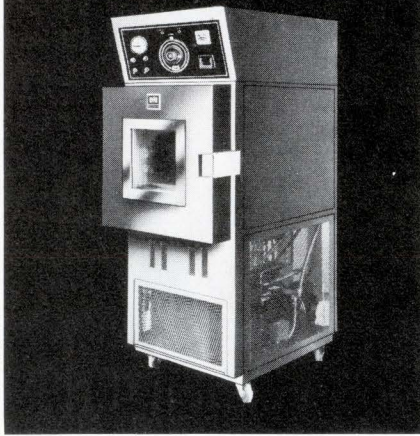

**(IT'S TOO MUCH UNIT
FOR ORDINARY WORK)**

It's a fact: Blue M Versa-Range Test Chambers are too much unit for run-of-the-mill needs. There are many, cheap, mass-produced chambers that can meet average requirements adequately. *But*, if you have really tough requirements, then consider these Versa-Range facts: They meet your needs because they meet the specifications we quote. When we say -100°F., for example, we mean -100°F. Not -95°F. or -88°F.

Our chart recordings are correct. Our pull down rate of 60 minutes or less to -100°F. is exact at nine points, not just one.

Versa-Range Chambers feature the patented POWER-O-MATIC 60® Proportioning Control for straight-line performance . . . not low-cost, on-off controls.

Blue M's mechanical refrigeration features long lasting continuously operating compressors — not the slam-on, cut-off, cycling type you find in cheaper chambers.

Versa-Range Chambers come with two different ranges in five sizes to 64 cu. ft. Accessories include programming.

If you want fine, reliable performance without a lot of parts failure, costly maintenance, and service calls, a Versa-Range Chamber is your best buy. Send for complete details: Blue M Engineering Company, A Division of Blue M Electric Company, Corporate Headquarters, Blue Island, Illinois 60406.



New products

Chip contains keyboard code

Interchangeable LSI units provide several formats

Versatility and low power drain are features of a data entry keyboard that uses a single LSI/MOS chip for all coding functions. The chip accomplishes up to nine bits and four levels of encoding and, since chips are available in several formats, all that need be done to change from one code to another is to switch to a new chip.

The keyboard, made by Clare-Pendar, a division of General Instrument Corp., employs a scanning technique to search for closure of the dry-reed switch keys. A basic scanning frequency of 50 kilohertz allows a scan rate of 20 microseconds. The clock circuit is contained in the LSI/MOS chip, as is the cir-

cuitry to detect switch closure. The chip also contains a 2,000-bit read-only memory to generate the output code. This is compatible with transistor-transistor logic.

Stephen Meyer, Clare-Pendar marketing manager, says the use of reed switches instead of—for example—Hall-effect keys means a savings in power. "Our keyboard draws 200 milliwatts, while the principal Hall-effect unit on the market draws 5 watts," he states.

The Clare-Pendar keyboard is available with any number of keys up to 88. It's also a three-mode unit—the logic can handle shift, control, and character. Other features are two-key rollover, positive or negative logic, and double shot-molded keys. A strobe that can be programed up to a two-millisecond rate signals valid data and prevents bounce.

Price of the keyboard is about \$250 in small quantities, and is expected to drop below \$100 in production volume.

Clare-Pendar Co., P.O. Box 785, Post Falls, Idaho 83854 [422]

Printer priced under \$6,000

Electrostatic unit operates at 300 lines per minute

Quiet operation is one of the attractions that electrostatic printers have over impact types. Cost and reliability also are desirable factors, says Milton Reid, vice president of marketing at Versatec Inc. His company will introduce at the FJCC an electrostatic printer that will sell for \$5,995.

The machine, designated the Matrix 300, can print at up to 300 lines per minute on fan-fold paper. Contributing to this speed is top-of-the-page formatting. When the job calls for printing on only part of a page, the Matrix 300 can slew to the top of the next page at the equivalent of 1,200 lines per minute.

A speed option on the motor and a photoelectric sensor allow the paper to advance to the next page when a form-feed command is given.

Input to the Matrix 300 is serial or parallel ASCII, accepted synchronously or asynchronously. A read-only memory helps to decode inputs to 5-by-7-matrix characters, and printout is in 80-character lines on 8½-by-11 fanfold paper.

With no moving parts other than the paper transport, the machine has inherent reliability as well as virtually silent operation, Versatec points out. In addition to applications for computer system printout and for use with display terminals, the machine can be linked to communications lines operating at speeds up to 4,800 baud. Versatec will supply interfaces for most of these applications.

Delivery time is 30 days after receipt of order. Quantity and OEM discounts will be offered.

Versatec Inc., 10100 Bubb Road, Cupertino, Calif. 05014 [423]

FROM THE WAVE MAKERS:

FUNCTION GENERATORS FOR SQUARES...AND MUCH ELSE

And much less expensive, to boot. Krohn-Hite's new line of function generators give you solid versatility, performance, and operating convenience. Two brand new models covering the frequency range of 0.002 Hz to 5 MHz. Each gives you wavemaking capability for sine, square, triangle, plus and minus ramps, and additional simultaneous square wave outputs. Ultra-fast risetimes. Provision for external V.C. of 1000:1 over the full range. D-C offset control. Adjustable symmetry on square wave for pulse operation. Best of all, we do everything with fewer components.

NEW MODEL 5100 FUNCTION GENERATOR,

0.002 Hz, to 3 MHz



Simultaneous auxiliary square wave

VCO 1000:1 sweep capability

Price: \$375.00.



NEW MODEL 5400 FUNCTION GENERATOR,

0.002 to 5 MHz



Symmetry offset provides pulse and sawtooth

VCO 1000:1 sweep capability

Price: \$550.00

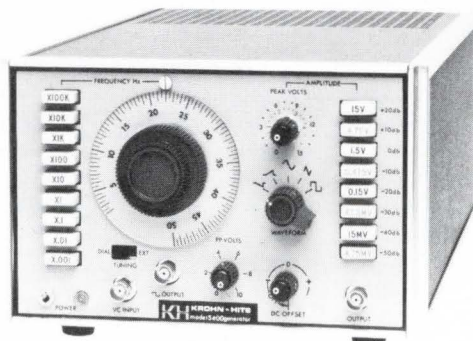

If you would like to know much more about much else, drop us a line: The Wavemakers, Krohn-Hite Corporation, 580 Massachusetts Avenue, Cambridge, Mass. 02139

KH **KROHN-HITE**
CORPORATION

OSCILLATORS / FILTERS / AC SOURCES / FUNCTION GENERATORS / AMPLIFIERS

OVERSEAS SALES OFFICES: BELGIUM, C. N. Rood s. a.; DENMARK, SC Metric A/S; FRANCE, Antares; GERMANY, Nucletron Vertriebs-GMBH; HOLLAND, C. N. Rood n. v.; ITALY Dott. Ing. Mario Vianello; SWEDEN, Teleinstrument; ISRAEL, R. D. T. Elect. Eng. Ltd.; JAPAN, Shoshin Shoji Kaisha, Ltd.; AUSTRALIA, Sample Electronics (Vic.) Pty., Ltd.; G. B., B & K Inst. Ltd.

Circle 125 on reader service card

How to put GE SSL's to work.

At General Electric, we make a dozen solid state lamp products (previously called light emitting diodes). All of them tiny. All super-tough. All withstand shock and vibration far better than any incandescent lamp. So they last far longer. And practically eliminate your maintenance problems.

But probably one of the nicest things about them from your point of view is that there are so many ways you can profitably use them.

Indication: If you want to be *positive* that your system is working, use GE's red SSL-22 indicator light. Now in use as on-off indicators, on maintenance panels and for information displays. Or use GE's green SSL-3 as an indicator, or for film marking.

Isolation: For electrical isolation and high-speed switching, we have delivery-ready stocks of two photon couplers. The PC4-73 has the highest transfer ratio (125%) of any coupler on the market. Both PC4-73 and PC15-26 will isolate up to 2,500 volts.

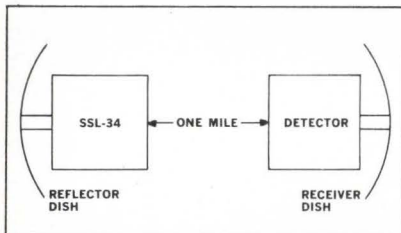
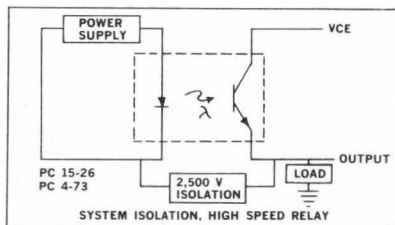

Communication: GE's SSL-34 has successfully transmitted (FM modulation, 10.7 MHz subcarrier, 2W transmitter) infrared signals *over a mile* through fog, rain and snow. Several of GE's infrared SSL's, operative in D.C. or pulsed modes, can be used in data transmission, communication links and remote telemetry applications.

Detection: Eight different GE SSL lamps are already designed into detection systems, such as level indicators, indexing tables, intrusion alarms, choppers, smoke detectors, size monitors, card and tape readers and for edge tracking.

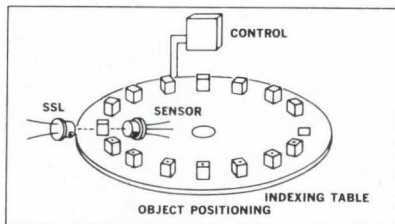

We'll be happy to send you free technical information on all of our SSL products. Or, for \$2.00, we'll send you the most complete SSL manual available. Covers theory, characteristics and applications, with 108 pages of diagrams and circuits.

General Electric Company, Miniature Lamp Department, M-E, Nela Park, Cleveland, Ohio 44112.

GENERAL  ELECTRIC

New products

Terminal rents at \$39 a month

CRT data unit designed for on-line operation

"Low-cost-display for a broadening market is definitely the trend in terminals," says Guy Mallery, vice president of Bunker-Ramo's business and industry division. The company will exhibit at the FJCC a cathode ray tube terminal that will rent for \$39 a month and is aimed at jobs at bank teller windows, factory work areas, hospital nursing stations, credit departments, and other places where non-typists interact with computers.

Mallery says the low price is due to volume production and standardization of a product line. "We've built about 20,000 CRT terminals," he points out.

The \$39 lease fee is for the BR-2210 terminal only, and includes maintenance anywhere in the U.S. In a typical installation, a complete work station can be outfitted on-line for about \$55 per month, including terminal, communications unit and control unit.

Operating features of the BR-2210 include protected format, variable layout, tab, skip, computer call, and conversational mode. The terminal's keyboard contains all alphanumeric characters, plus programmable function keys.

Delivery time is 90 days.

The Bunker-Ramo Corp., Business and Industry division, 445 Fairfield Ave., Stamford, Conn. 06904 [424]



Cut yourself in.

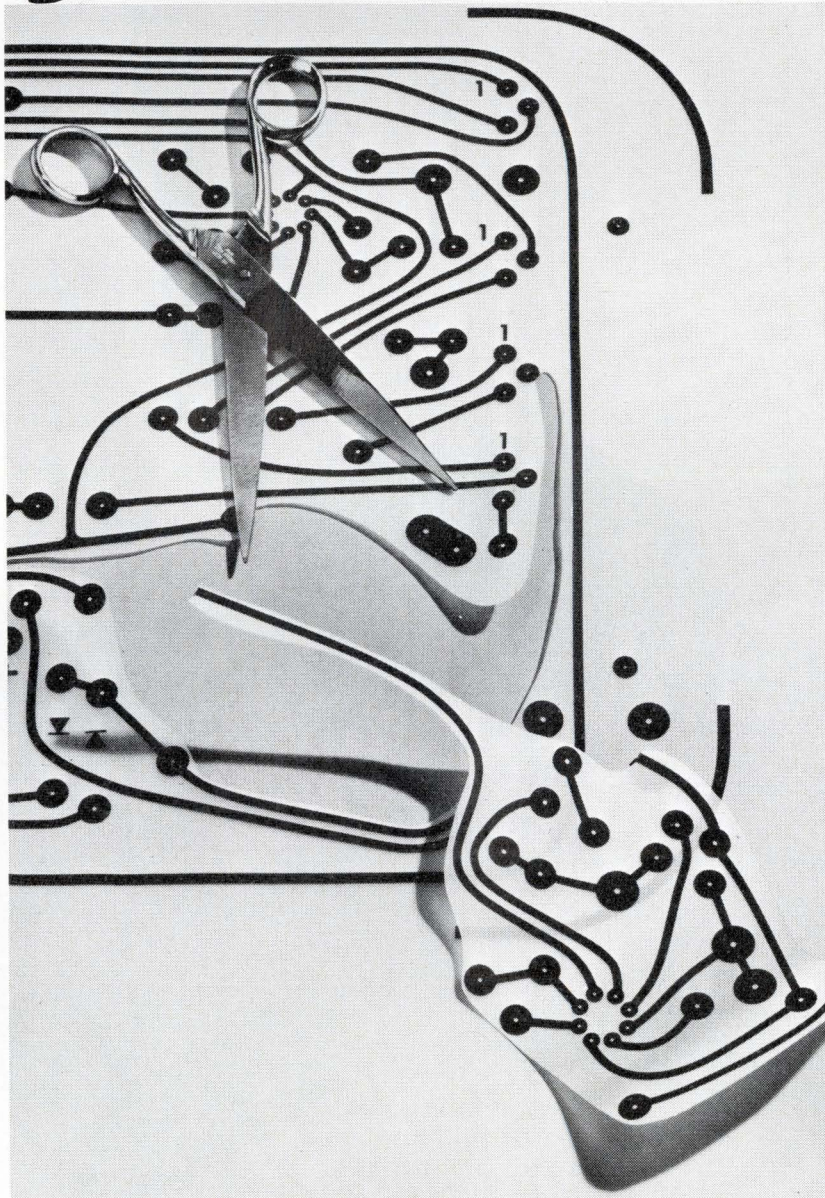

“Scissors draft” your way to increased production with KODAGRAPH Films and Papers.

Why retrace an entire drawing needing only revision? Instead, copy your original photographically on KODAGRAPH Film or Paper. Cut out the unchanged portions (often much of your drawing), mount them on a new drawing form, have a second original made on KODAGRAPH Film, and make your revisions on that.

For more on “scissors drafting” and other time-saving techniques, contact your Kodak Technical Sales Representative, or write Eastman Kodak Company, Business Systems Markets Division, Dept. DP 825, Rochester, N.Y. 14650

DRAWING REPRODUCTION SYSTEMS BY KODAK

Kodak

How to improve your test equipment without blowing your budget.

Simply use Hewlett-Packard's new family of high-performance, wideband general-purpose power amplifiers and preamps. These low cost RF amplifiers improve the sensitivity of your scopes, spectrum analyzers, counters, network analyzers — anywhere you need low-noise, high-gain amplification. These amplifiers are the result of

HP's hybrid thin-film microcircuit technology.

The table below gives frequency ranges, prices and performance of the six basic configurations. Dual channel versions of the preamps can also be supplied to improve the performance of 2-channel instrumentation.

They're ready for delivery now.

A call to your HP field engineer will bring you the details of how these amplifiers can help enhance the test equipment you're using now. Or write to Hewlett-Packard, Palo Alto, California 94304; Europe: 1217 Meyrin-Geneva, Switzerland.

HEWLETT  PACKARD

04021

HEWLETT-PACKARD 8447 SERIES LAB AMPLIFIERS

	HP 8447A Preamp	HP 8447B Preamp	HP 8447C Pwr. Amp.	HP 8447D Preamp	HP 8447E Pwr. Amp.	HP 8447F Preamp/Pwr. Amp.
Frequency Range	0.1-400 MHz	0.4-1.3 GHz	30-300 MHz	0.1-1300 MHz	0.1-1300 MHz	0.1-1300 MHz
Nominal Gain	20 dB	22 dB	30 dB	23 dB	22 dB	45 dB
Gain Flatness	±0.5 dB	±1 dB	±1 dB	±1.5 dB	±1.5 dB	±3 dB
Noise Figure	<5 dB	<5 dB to 1.0 GHz <6 dB, 1.0-1.3 GHz	<10 dB	<8 dB	<10 dB	<8 dB
Output Power @ 1 dB Gain Compression	>+7 dBm	>-3 dBm	>+19 dBm	>+7 dBm	>+14 dBm	>+14 dBm
Price	\$550	\$600	\$450	\$700	\$800	\$1225



Circle 128 on reader service card

New products

Instruments

Computer tests linear ICs

Programable benchtop unit combines with a Nova for 2½-second throughput

Linear integrated circuits don't sell in anywhere near the volume of digital ICs. So, while computer-controlled digital IC testers abound,

a lot less money and effort have gone into developing automated test systems for the linear units.

One company moving to fill the void is Microdyne Instruments, Inc., a long-time maker of benchtop LIC testers. Scheduled for its first showing in February, Microdyne's system will log data, have complete software packages, and be able to run dc tests on any 14-pin linear circuit. But the features Microdyne general manager Robert Therrien stresses are that his system can be bought and built in pieces, and that it retains its benchtop capability.

Since the system doesn't have to be purchased all at one time, a cus-

tomers can spread his costs out. The key to the modularity is the 735—a manually operated LIC tester which Microdyne recently introduced. Although it looks much like most other benchtop checkers, the 735 differs in one important respect—it's completely programable. So Microdyne engineers can interface the 735 with a minicomputer and with various input and output devices to build up the system. Thus a customer can start out buying just the 735 for \$7,850, and later add parts as he needs them.

Once a system is built up, says Therrien, the 735 can still be disconnected and used as a benchtop unit. The feature, he says, comes in

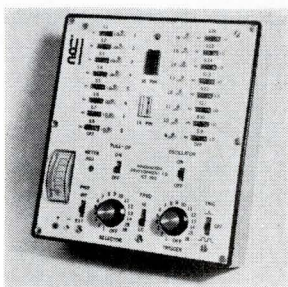

Portable integrated circuit tester model ICT-200 not only provides dc component testing, but has provisions for functional verification of the IC's operation. It allows digital engineers to test, on-the-spot, a suspected dual in-line IC. Test points are provided at each pin for oscilloscope monitoring. Unit price is \$199. Innovation Development Co., Box 7, Azusa, Calif. [361]

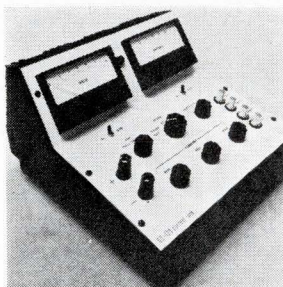

Current sink CS-125 rapidly and exhaustively determines the static and dynamic performance of low voltage dc power supplies, circuit breakers, amplifiers, and similar power devices. It will dissipate up to 125 watts in free air at a maximum ambient temperature of 95°F, and has maximum ratings of 60 V and 25 A. Price is \$295. Microcomp Inc., P.O. Box 181, Newtown, Conn. 06470 [362]

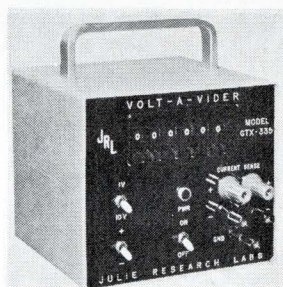

Dialable voltage sources called Volt-A-Viders bring 1 ppm technology to users of 10 ppm instrumentation. One of the first three in the series is the GTX-335 which provides an accuracy of ±0.005%. The GTX-331 provides ±0.001% accuracy; the 332, an accuracy of ±0.0025%. All are for use with loads requiring up to 10 V dc. Julie Research Laboratories Inc., W. 61st St., N.Y. [363]



Digital microvoltmeter model 2400 features sensitivity of 1μV/digit and long-term accuracy of 0.01%. Reading ±19.999 mV full scale, the chopper-stabilized unit is practically not affected by temperature and aging. Zero stability is 0.15 μV/°C. Price in single quantity is \$585; delivery, stock to 4 weeks. Newport Laboratories Inc., 630 E. Young St., Santa Ana, Calif. [364]

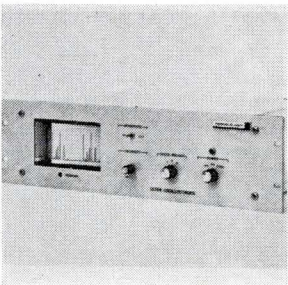

Single channel, strip-chart recorder designated Oscillocorder uses a heated stylus writing method so there are none of the usual problems associated with conventional ink recorders. Writing speeds of 1, 5, or 10 mm/s are selectable from the front panel. Vertical sensitivity is 10 V or 2.5 V full scale. Price is \$985. Ultek Div. Perkin-Elmer, Box 10920, Palo Alto, Calif. [365]

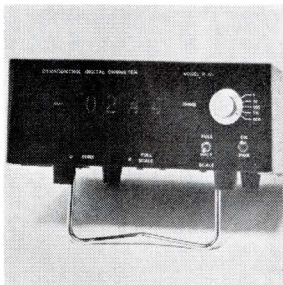

Solid state, lightweight digital ohmmeters can be used over a dynamic range of 100 micro-ohms to 20 megohms with maximum resolution of 100 micro-ohms or 1 milliohm, depending on the model. Units feature a full range scale of 1 ohm to 10 megohms or 0.1 ohm to 1 megohm on eight decade ranges. General Oceanology Inc., 27 Moulton St., Cambridge, Mass. 02138 [366]



Fourier analyzer model 825A is a solid state instrument for analyzing the frequency components of any periodic waveform applied at its input. The frequency analysis is performed in two quadrature channels so that phase information can be measured as well as amplitude information. Price is \$3,850. Progress Electronics Co. of Oregon, 5160 N. Lagoon Ave., Portland, Ore. 97217 [367]



Portable digital multimeter has BCD output and remote program options. Base price of the LX-2 DART is \$795, which includes automatic range and polarity selection, and four automatically selected ranges of ac and dc voltage from 100 μV to 1,000 V and resistance from 100 milliohms to 1.250 megohms. Non-Linear Systems Inc., Del Mar, Calif. [368]

If you'd like to make your FM radio 20 times smaller, we've got just the filter for you.

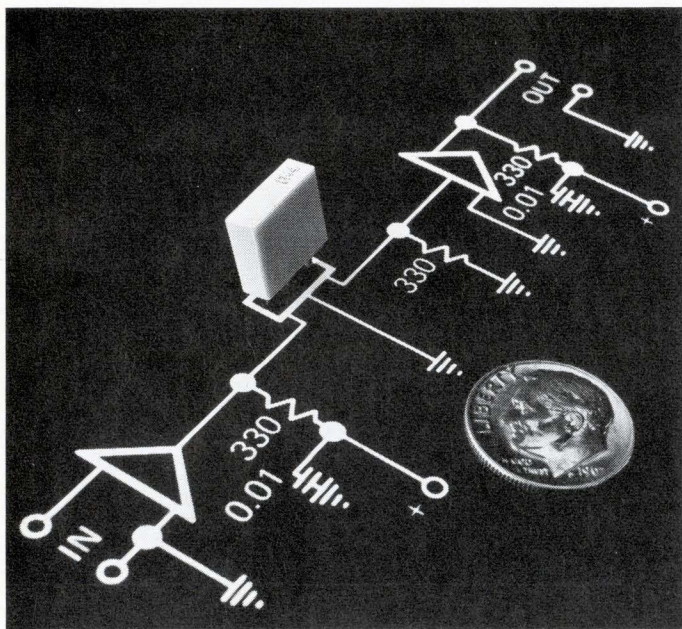

Our new 10.7 megahertz FM filter — the FM-4 — measures only 0.016 cubic inches in volume. But it replaces four tuned circuits more than twenty times its size. Price is competitive with IF cans, and it saves additional dollars by reducing the number of components and interconnections in your IF strip. It's just a sample of what Vernitron can do in piezoelectric filters — in which we've done the lion's share of development.

The FM-4 is based on the coupled-mode monolithic technique developed for our quartz filters. Result is a new level of performance — higher adjacent channel rejection, distortion less than ½ percent, bandwidths characteristically 235 kHz at 3 dB and 825 kHz at 40 dB. Insertion loss about 3.5 dB. It's just a sample of what we can do in piezoelectric filters — in which we've done the lion's share of development.

So, if you're on a size-reduction kick — or a cost reduction kick — our neat little FM-4 is a good place to start. In fact, for high-quality filters for almost any kind of communication equipment — military, commercial or consumer — get in touch.

Vernitron Piezoelectric Division, 232 Forbes Road, Bedford, Ohio 44146. Or: Vernitron (U.K.) Limited, Southampton, England.

New products

handy for running unanticipated tests or for filling in when a program has bugs or the computer malfunctions.

The 735 itself comprises a mainframe, a "performance board", and a test socket. The board adapts the mainframe circuits so that they can test a specific class of LICs. Only one board comes with the unit, but it covers better than half the LIC types available, says engineering manager John Leatherman.

The 735 can run through all tests and give a go/no go reading; stop at the test where an IC fails; or step through the 14 tests one at a time. Designers and troubleshooters should value this last mode. Combined with the 735's digital readout of the measured value and the limit for a test, the step-by-step mode allows a close examination of an LIC's performance.

For a system, the minimum price will be about \$23,500—almost \$8,000 for the 735, \$12,000 for the computer, and \$3,500 for the interface circuitry and controls. The computer is a Data General Corp. Nova—a 16-bit machine capable of running up to eight test stations. Leatherman estimates that the price for a system complete with input and output devices will run from about \$40,000 up.

The computer completely controls the 735, including the setting of limits. Thus the user can program his system to test an LIC, reset the limits, and test again. Or he can tell the system to judge an LIC on the basis of how close it comes to failing certain tests. Such programs allow the system to classify.

The basic output device will be a line printer, whose high speed will allow throughputs of up to one device every 2½ seconds. The bottleneck in many systems, says Leatherman, is not the tester but a slow-running teletypewriter. Leatherman expects the most popular input device to be a cathode-ray tube terminal, but all common output devices will be offered by the company.

Microdyne Instruments, Inc., 203 Middlesex Turnpike, Burlington, Mass. 01803 [369]

 **Vernitron Piezoelectric Division**
232 Forbes Road / Bedford, Ohio 44146 / (216) 232-8600

WHEN THE HEAT'S ON TO CUT COSTS, GENAL[®] SAVES THE MAKERS OF THESE PARTS A COOL \$112,000 PER YEAR.

Credit GENAL, the injection moldable phenolic from General Electric. It saves two manufacturers a grand total of \$112,000 a year. And gives them a combination of performance properties that no thermoplastic can touch.

Midwest Electric Products slashed cycle times by 50% on their fuse boxes and receptacles. And productivity was increased 56% on the housing for the Rotron* Muffin* fan.

It all adds up to \$112,000 worth of benefit. All because of the processing economies of injection moldable GENAL.

Now for the bonuses.

Heat resistance and rigidity to 450°F or higher. UL recognition to 165°C. SE-0 flammability. Arc resistance to 180 seconds. All at incredibly low material costs of only 1.16 to 1.36 cents per cubic inch.

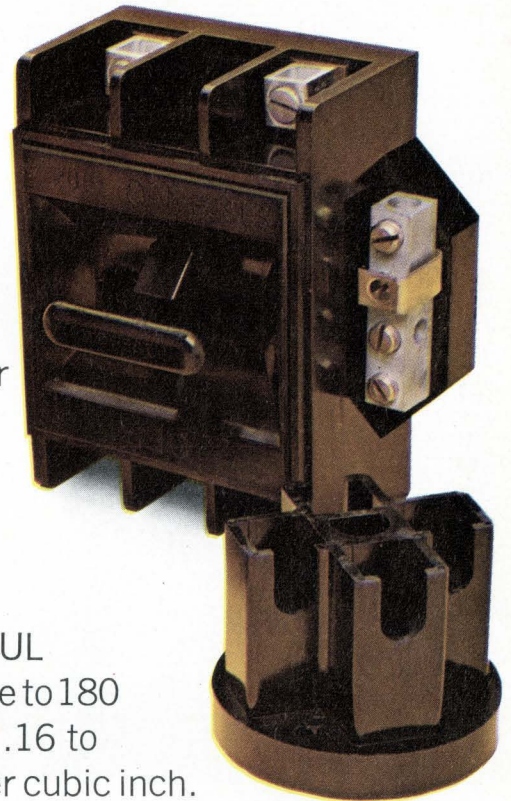

Any way you figure it, GENAL gives thermoplastics a run for the money. To help prove the point, we'll send you a handy 3-in-1 cost calculator. It's free, along with more data on GENAL injection phenolics. Write Section Plastics Dept., General Electric Co., One Plastics Avenue, Pittsfield, Mass. 01201.

*REGISTERED TRADEMARKS OF ROTRON INCORPORATED

Leader in Engineering Plastics
LEXAN[®] NORYL[®] GENAL[®] PHENOLICS

GENERAL  ELECTRIC



naturally.



Cintra Scientist 909

Language: math Operation: programmable

Price: \$3,780 Delivery: now

440 Logue Avenue / Mountain View, California 94040 / (415) 969-9230
Cintra Incorporated—a subsidiary of Physics International Co.

New products

Data handling

A-d converters resolve 15 bits

Linearity, conversion rate and word length can be controlled by user

As users of 12-bit minicomputers upgrade to 16-bit machines, they are also upgrading their analog-to-digital converters to obtain the

higher resolution and dynamic range possible with 15-bit a-ds. And then, many new systems start with 16-bit computers and 15-bit converters.

Entering this growth part of the a-d field is the Analogic Corp. Its AN2715M is priced at \$2,000, in contrast with the \$4,000-\$5,000 for some competing devices, and takes up only one-fifth its rivals' 19-inch rack-mount volumes.

Absolute accuracy is 0.01% of full scale—on a par with competing devices—but linearity is a controlled variable, as are conversion rate and word length. This allows the user to optimize the device for either speed or linearity, or even

a median amount of both.

This kind of user control is an unusual feature, but Analogic makes it available with a simple potentiometer adjustment. Fastest conversion rate is 6 microseconds per 15-bit word, but linearity here is $\pm 0.01\%$ of full scale. While this is good enough for many applications, the user can tighten up linearity to as little as 0.002% of full scale by slowing conversion to a 17 μ s per word rate. And, since word lengths of from two to 15 bits can be selected with the aid of a patch panel on the mother board of the assembly, still another level of control is added.

Analogic specifies the noise in

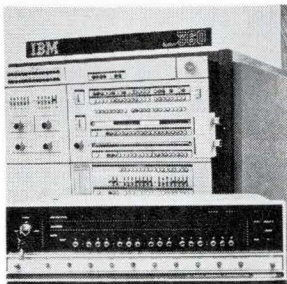

General purpose 360 interface makes it possible for a Nova or Supernova computer with appropriate software to emulate standard IBM peripheral controllers, including the 2803 magnetic tape controller, the 2703 communications processor, and the 2840 graphic display controller. Basic price of the interface unit is \$5,000. Data General Corp., Southboro, Mass. [381]

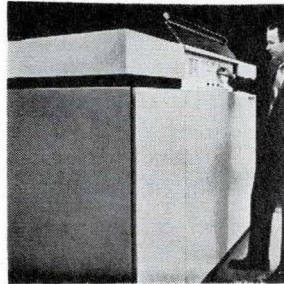

Large core store system 6000 is a mass core memory totally compatible with the IBM system 360. It allows a 360 to be used in many on-line, real-time applications, including time sharing and communications switching. Cycle time of the 6000 is 2 or 4 μ s. System is available in configurations of 1,048,576 and 2,097,152 bytes. Data Products Corp., Woodland Hills, Calif. [382]

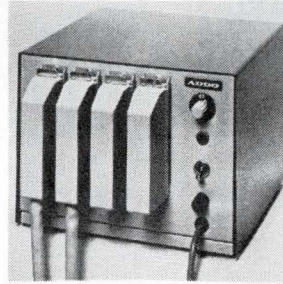

BCD decoder model 47-1321-00 makes possible automatic data recording through a direct connection between measuring devices with analog-digital converters and digital printers or adding machines with printout capability. Capacity is 8 BCD and 12 decimal positions. The unit has a capability of approximately one print-out/s. Addo-X Inc., 437 Madison Ave., N.Y. [383]

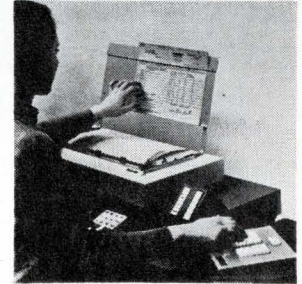

Numeric input device, called Novar 5-02, is for data communications terminals. It is equipped with an adding machine keyboard layout with numbers 0 through 9, and with additional keys for decimal point, plus sign, minus sign, asterisk, pound sign, field tab and line return. It is connected to a terminal by a six-foot cable. Novar Corp., Charleston Rd., Mountain View, Calif. [384]

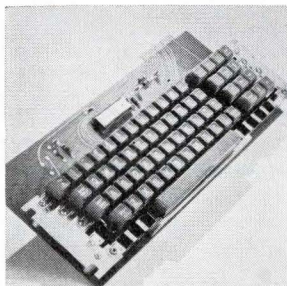

IC magnetic core memory system ICM-100 is a 1,000-word unit that measures 9 x 4 x 1 in. It comes in 8-, 9- and 10-bit formats to handle various combinations of read, write, restore, modify and clear functions in mini-computer-based random access systems. It operates at a 1 μ s full cycle time with an access time of 310 ns. Honeywell Inc., Framingham, Mass. [385]



Two new families of data communications products are announced: the 4800 data modem, and the 800 time division multiplexer. The type 4800 gives error-free performance in the 4,800 b/s speed class. The type 800 allows the user to buy only the modules required for his immediate 50 to 1,800 b/s requirements. Codex Corp., 150 Coolidge Ave., Watertown, Mass. 02172 [386]

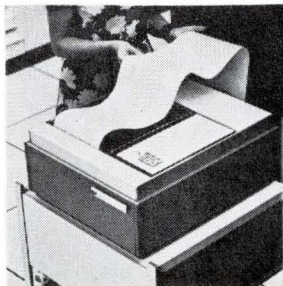

Computer output, hard copy printer Statos 21—four times faster than existing mechanical line printers—operates on-line at 5,000 lines/min (an entire page of computer-generated text every second) and costs \$15,300 in a complete configuration. It uses 640 writing heads across an 8 1/2-in. page width. Varian Associates, 611 Hansen Way, Palo Alto, Calif. [387]



Punched card data entry and program assembly capability is now available for the Comfile line of computing batch terminals. The new peripheral, Comfile 88-130, is a vacuum feed, optical card reader with a speed of 300 cards per minute. It permits the user to assemble programs written for the 88-23's 4K x 16 computer. Compat Corp., 177 Cantigue Rock Rd., Westbury, N.Y. 11590 [388]

STABILITY & QUALITY

High quality capacitors unrivalled in the precision, dependability and compactness. Quality is recognized by ever wider use in measurement equipment, computers, and automatic controllers. "LEAF" the matter of capacitors to MATSUO ELECTRIC CO.

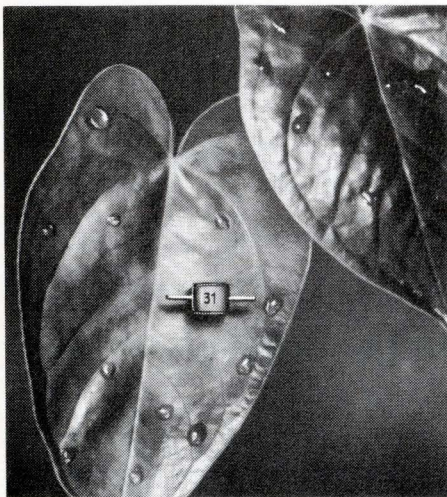

MATSUO

SOLID TANTALUM CAPACITORS FOR HYBRID ICs - "MICROCAP"

Specifications:

Operating Temperature Range: -55°C to $+85^{\circ}\text{C}$
Standard Voltage Rating: 6.3, 10, 16, 20, 25, 35 VDC
Standard Capacitance Value: .001 to 22MFD (E6 series)
Standard Capacitance Tolerance: $\pm 20\%$ (M)

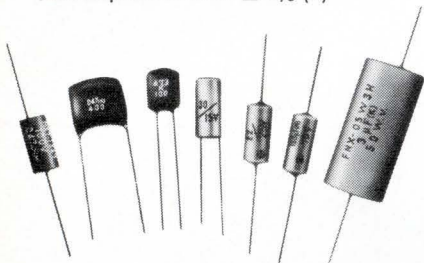

MATSUO'S other capacitors include:

Metallized Polyester Film Capacitor: Type FNX-H mylar wrapped.

Solid Tantalum Capacitors: Type TAX hermetically sealed in metallic case, Type TSX encased in metallic case and sealed with epoxy resin, Type TSL encased in metallic case and sealed with epoxy resin. **Polyester Film Capacitors:** Type MFL epoxy dipped, Type MFK epoxy dipped, non inductive, Type MXI encased in plastic tube, non inductive.

For further information, Please write to
Manufacturers and Exporters—

MATSUO ELECTRIC CO., LTD.

Head Office: 3-5, 3-chome, Sennari-cho, Toyonaka-shi, Osaka, Japan
Cable: "NCCMATSUO" OSAKA Telex: 523-4164 OSA
Tokyo Office: 7, 3-chome, Nishi-Gotanda, Shinagawa-ku, Tokyo

New products

its unit: at 300 microvolts full-scale peak-to-peak, the maximum noise-induced error of the AN2715M is equivalent to about one-third of a bit. Analogic claims that the noise of some competing units blurs their accuracy by as much as 1.5 bits.

Because noise is low, the company claims a dynamic range greater than 100 decibels without pre-ranging electronics or amplifiers at input. For firms with broader requirements, there's an optional op amp input with a bias of only 50 picoamperes and more than 10^{11} -ohm input impedance. It costs the user only about 0.001% in linearity, and settling time for $+10$ to -10 V swing is specified as a maximum of 1.5 μs .

But even with all the extras, it is the basic accuracy of this converter that Analogic expects to be its telling point—although the company isn't telling much about how it's achieved.

Analogic traditionally takes an "error budget" approach to design—individual component specifications are honed as tightly as possible to minimize error in the final assembly.

In the AN2715M, the engineers appear to have taken a new approach to design of the resistive ladder network, current steering switching componentry and voltage reference.

The voltage reference is servo-controlled and temperature-compensated, and the resistor net takes

Compact. A-d converter resolves 15 bits, yet takes up small volume as a system subassembly.

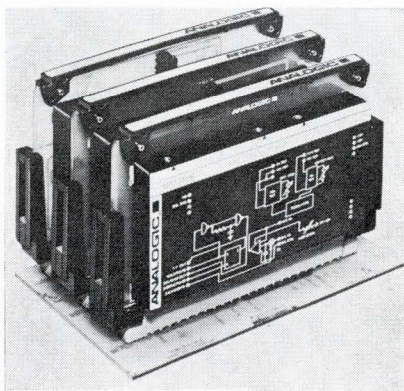

far fewer than the usual 30-odd units needed for an R2R configuration. Finally, a special method is used to compensate for beta changes with temperature in the switching transistors.

The converter is built as a printed circuit mother board and three smaller boards, taking up a volume of only 48 cubic inches.

The AN2715M is available from stock to 30 days. Price is \$2,000 for single units, \$1,800 in lots of ten.

The Analogic Corp., Audubon Rd., Wakefield, Mass. 01880 [389]

Read-only memory programmer saves time and mask cost

A do-it-yourself programmer for read-only memories now lets a user buy programmable PROMs off-the-shelf, pattern a memory within 15 minutes instead of waiting six to eight weeks for the manufacturer to do it, and eliminate the \$1,000 mask charge. What's more, duplicates of the memory can be made in seconds.

The programmer, said to be the first commercially available unit of its kind, is marketed by Spectrum Dynamics in several versions, called the 400 series, to be used with any of the PROMs now available.

The program is penciled in on a special card, used as a guide to enter logical 1s into the correct bit positions of each word in memory. Each word is addressed by an up/down counter actuated by a toggle switch. Each bit position (there are eight to a word) is addressed by a toggle switch which, when activated, stores the binary information in a register before it is delivered to the PROM. With this capability the operator can check and verify the entered data with a set of lamps on the panel. If a bit has been incorrectly entered, it can be erased by flipping the toggle switch to the erase mode.

Voltage, current, and pulse wave-shapes are internally adjusted and carefully controlled, so the fusible links on the PROM do not splatter or damage the chip when

Bench or System — the HP 3450A gives you maximum performance in a minimum space.

A quick look at the unfolding dodecahedron shows each of the 12 functions the Incredible Dodecameter performs. What it doesn't show is just how well this 5-digit multifunction meter performs each function.

For instance, you not only get true rms capability—you also get value-plus features like true 4-terminal ac ratio testing and 4-terminal ohms measurements.

And, accurate, fast measurements in each of these twelve categories is

only the start. You can add digital output and directly control external equipment like a printer. Or, add remote control and get full programmability for system use.

No matter what the application, you get more for your money with the HP 3450A.

This Incredible Dodecameter lets you start with the basic dc meter and add the capability that best fits your requirements. If your needs change, any of the options (except the rear

input terminals) can be easily installed in the field.

For more information on this outstanding 12 in 1 bargain, just call your local HP field engineer. Or, write Hewlett-Packard, Palo Alto, California 94304. Europe: 1217 Meyrin-Geneva, Switzerland.

Price Basic HP 3450A, \$3300; AC Option 001, \$1250; Ohms Option 002, \$425; Limit Test Option 003 \$375; Digital Output Option 004, \$190; Remote Control Option 005, \$245; Rear Input Terminal Option 006, \$70.

090/8A

The Incredible Dodecameter — A 12-in-1 way to better measurements!

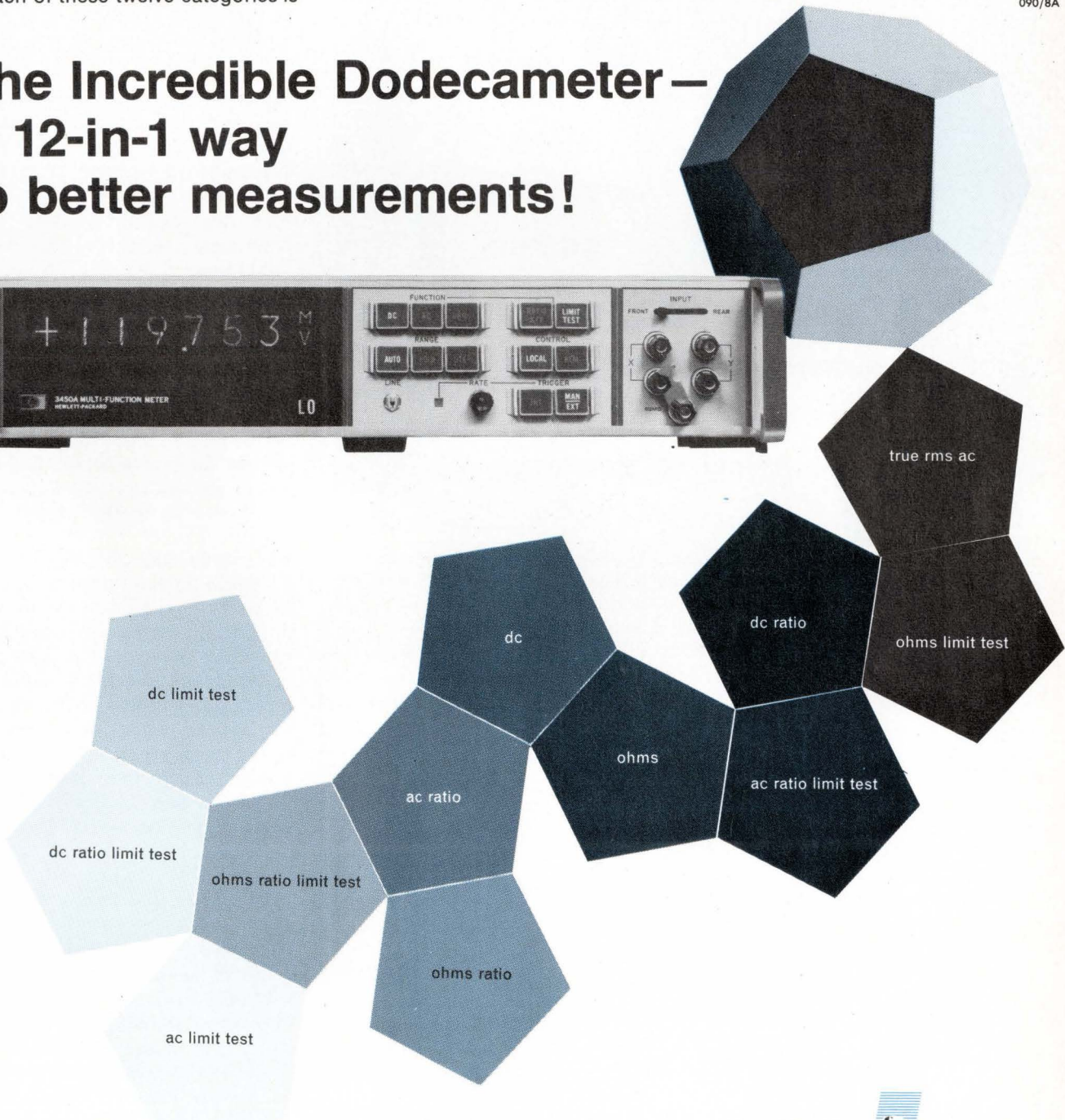
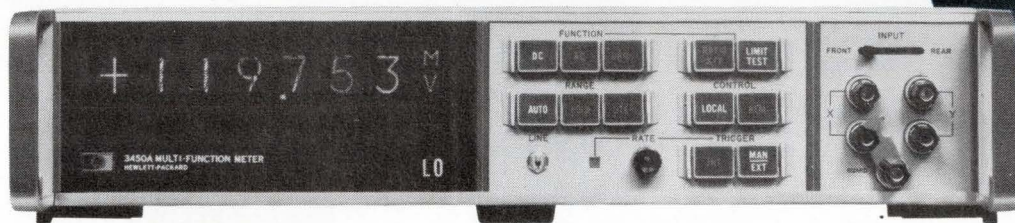

HEWLETT *hp* PACKARD
DIGITAL VOLTMETERS

FOR THE WIDEST RANGE OF HIGH PURITY ELEMENTS

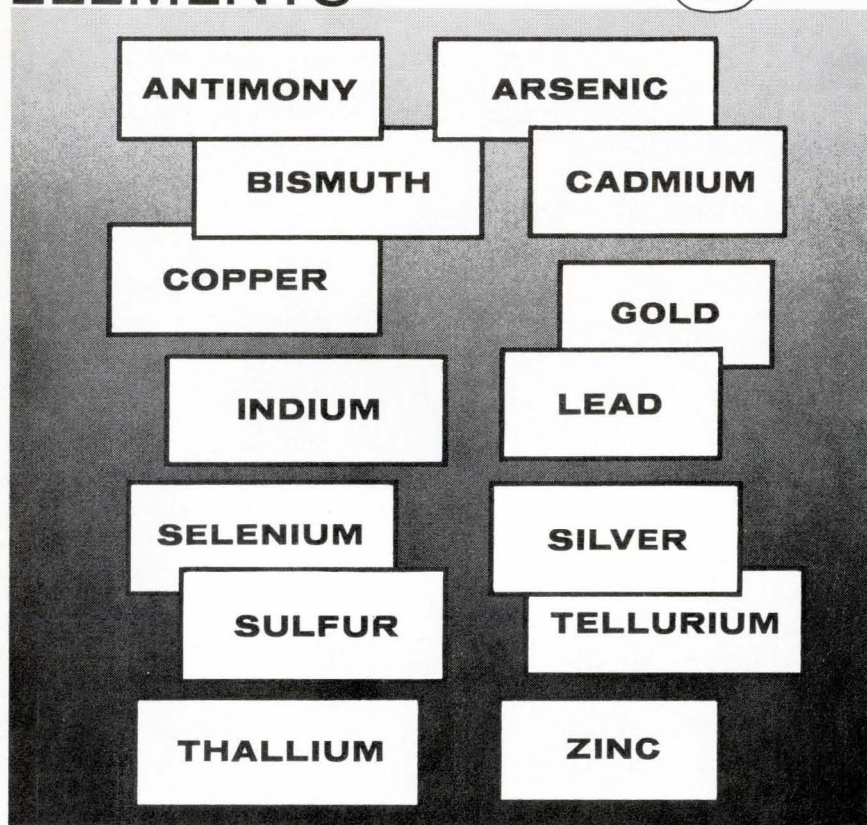

Asarco offers the largest selection of high purity elements for metallurgical research, electronic and other applications.

To meet the increasing demand for high purity elements, Asarco has expanded its production capabilities with the building of a new and modern facility at its Globe plant in Denver, Colorado. This new center permits us to supplement your research needs with the same high quality specifications on an as-required commercial quantity basis.

For data sheets on Asarco high purity elements, write to our By-Products Department.



AMERICAN SMELTING AND REFINING COMPANY
120 BROADWAY, NEW YORK, N. Y. 10005

Circle 136 on reader service card

$$E = \frac{3IC}{2} X$$

Last year, Electronics magazine supplied its readers with 67% more information on the subject of integrated circuits than the next leading electronics publication.

If you don't have your own subscription to Electronics, maybe you don't have the best formula for keeping yourself abreast of the industry's technology.

New products



Quick and easy. Switches permit up to eight logical 1s per word. Indicators display program logic as it is stored in programmer's memory.

they are opened. Another safety feature: all test socket pins are inactive, assuring that no spurious signals reach the package's leads or get to the memory. And as a further precaution, the operator can run a zero check on the PROM to see that all bit positions in memory initially read zero.

Additional features of the programmer include a three-digit read-out of the address location, and a word capacity switch which limits the number of addressable locations to 64, 128, 256, or 512.

Once a unit has been programmed, it can serve as a master from which duplicates may easily be patterned. Even the initial unit can be automatically programmed. A 50-pin connector on the back of the machine can be used to hook up card readers or punched paper tape readers.

Although the most popular types of PROMs use fusible links, other devices require several pulses to build the logical 1 into memory. For these as well as other variations of the PROM, Spectrum Dynamics indicates it will also build programmers.

The programmer handles memories with up to a 512-word capability in various packages such as 16- and 24-pin dual in-lines and 24-pin flatpacks. The programmer measures 12 x 10 x 5 inches and is priced at \$945.

Spectrum Dynamics, P.O. Box 23599, Fort Lauderdale, Fla. 33307 [390]

Stay where you are.

We'll bring the 39 best office and industrial sites in New Jersey to you.



Free.

Here is a great way to handle the research and details that can slow down preliminary site selection: Our latest Industrial Parks Kit. 39 of New Jersey's finest sites *come to you* with complete information on each. You get a full-color aerial photo of each site, its exact location, distance from major markets in New York City and Philadelphia, transportation facts, utilities available, lease or purchase requirements, zoning, and a lot more. Send for your free kit today. After you've made your preliminary choices, call us. Without charge or obligation, we'll assign a highly qualified Sitefinder to you who will make arrangements for your close-up inspection of the sites and

provide additional help or information. If you wish, he'll even arrange a tour by helicopter.

After all, you can't stay at home forever.

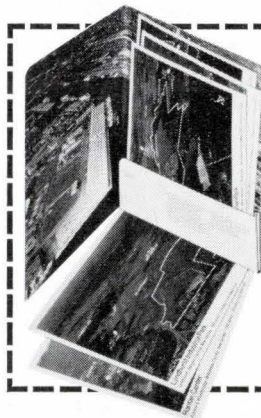

FILL IN THIS COUPON AND MAIL TODAY!

Public Service Electric and Gas Company
Box CBE, 80 Park Place, Newark, N.J. 07101
Gentlemen:

Send the new Industrial Parks Kit to me at the address below:

Name _____

Company _____

Address _____

City _____ State _____ Zip _____

**PUBLIC SERVICE
ELECTRIC AND
GAS COMPANY**

Plug in to big savings with GLASKYD[®]

alkyd molding compounds



Viking Industries did. Viking insists on GLASKYD for its line of "Vikom" commercial printed circuit connectors, many of which are used in giant computers. The reason is simple. It costs only $\frac{1}{4}$ as much as DAP.

But that's not the only reason Viking and many other manufacturers specify GLASKYD. It has superior moisture resistance, dielectric strength, arc and track resistance, dimensional stability and heat resistance. Non-burning properties, as deter-

mined by the most stringent military and commercial specifications, can also be obtained with a specialized formulation - Glaskyd 4000.

Smart designers using "value analysis" get optimum performance out of GLASKYD. Let us show you the advantages of a molding operation with GLASKYD molding compounds. Write American Cyanamid Company, Plastics Division, Wallingford, Connecticut 06492.

New products

Semiconductors

Hybrids reduce board density

Driver circuits for high-current, high-voltage jobs boost design flexibility

When sizable current and voltage are needed in a digital system, monolithic integrated circuits just won't turn the trick. To drive a

display or relay, for example, or to provide the clock signal for an entire system, 50 or more volts are needed, as well as a current of 100 milliamperes to 1 A.

Ordinarily, these levels would be provided by discrete components mounted on a printed circuit board. But Texas Instruments has introduced three hybrid circuits for this type of high-current, high-voltage function. They replace the four or five discrete active devices and four or five passive components that at present make up circuits linking TTL and DTL logic to power devices. TI's hybrid circuits reduce printed circuit board density by up to 60 percent, are more economical,

and offer improved reliability and flexibility over the discrete devices, the company says.

Model HIC040 is best suited for systems requiring high-current capability and fast switching speeds, such as a systems master clock driver. It has a high-speed SN54H00 gate that drives four 2N3725 high-current, high-voltage, and fast switching transistors. Voltage breakdown is 50 V and collector current per transistor is 1 A. The HIC040 is available in a 14-pin flat-pack and costs \$12.70 each, in lots of 1,000.

The HIC067 is for use in lamp and relay drivers. Its high output current drive capability is 150 mA and

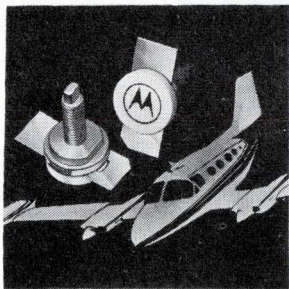

Silicon rf power transistors, types MM1552 and MM1553, are for vhf power amplifier applications to 175 MHz. They utilize balanced emitter construction for extreme ruggedness. They can withstand load mismatch conditions of a 10:1 VSWR at 75 W. The 1552 is rated at 90 W peak power output for 18 W max input at 150 MHz. Motorola Semiconductor Products Inc., Phoenix [436]

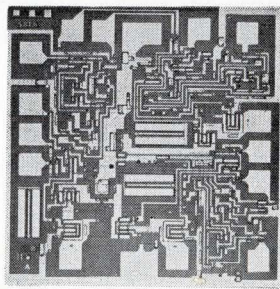

Triple line receiver IC 8T14 receives high-speed digital information that has been transmitted over long lengths of coaxial cable, strip line, or twisted-pair transmission lines. It is immune to line signal noise because hysteresis is employed in the input structure. Device is useful in signal squaring from dc to 50 MHz. Signetics Corp., E. Arques Ave., Sunnyvale, Calif. [437]

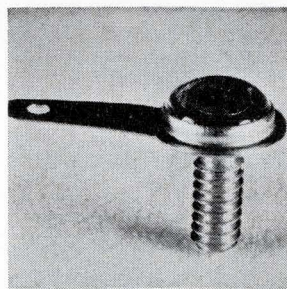

Red light-emitting diodes series MV4 feature typical output levels of 5,000 foot-lamberts at 2 volts, 1 ampere. The light output wavelength (6700 angstroms) is controlled to ± 200 angstroms, keeping it well above the sensitivity range of most photographic films. Price in lots of 1 to 9 is \$13.50 each. Monsanto Electronic Special Products, 10131 Bubb Rd., Cupertino, Calif. [438]

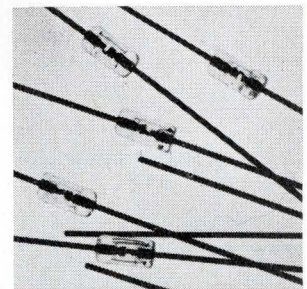

Lf attenuator diode type MA-47600 functions as an inexpensive silicon p-i-n device designed for use as a current-controlled resistor. It operates within the 10 MHz to 10 GHz frequency range, providing low capacitance of 0.35 pF and low series resistance for fast switching applications. Minimum breakdown voltage is 100 V. Microwave Associates, Burlington, Mass. [439]



Light activated phototransistor STPT60 is capable of 50 mW dissipation. It provides designers with high illumination sensitivity and stable electrical characteristics for applications such as punched-hole tape and card readers, lighting controls, counters and sorters, inspection and process controls. Sensor Technology Inc., 7118 Gerald Ave., Van Nuys, Calif. 91406 [440]

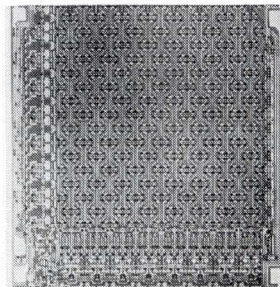

Bipolar 256-bit random-access LSI memory operates with a companion decoder to make mainframe memories with 120 ns maximum access time. Type 3102 memory unit works with type 3202 decoder to form fully decoded memories storing up to 4,096 words of any length. Memory price (1-24) is \$80 each; decoder, \$20. Intel Corp., Middlefield Rd., Mtn. View, Calif. [441]

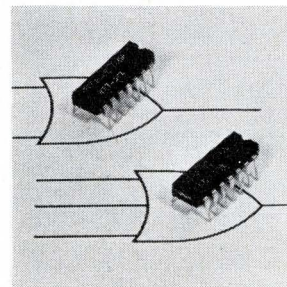

Design versatility of the 7400 series of TTL IC logic has been extended with the addition of two OR gates: the US7418A triple 3-input OR gate and the US7432A quad 2-input OR gate. Typical propagation delay and power dissipation are 15 ns and 55 mW, respectively, per gate function. Price (100-999) is \$1.58 each for both types. Sprague Electric Co., North Adams, Mass. [442]

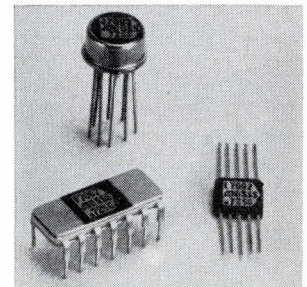

Monolithic instrumentation operational amplifier model SSS 725C may be specified to replace a discrete or hybrid module. Input offset voltage is 1.3 mV maximum; offset voltage drift, 1.5 $\mu\text{V}/^\circ\text{C}$ max; input offset current, 13 nA max; voltage gain (large signal), 500,000; common mode rejection ratio, 100 dB. Precision Monolithics Inc., 1500 Space Park Dr., Santa Clara, Calif. [443]

Varo Integrated Bridge Rectifiers offer a sizeable advantage.

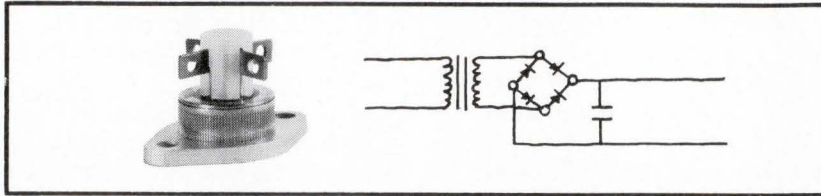

Varo's Integrated Bridge Rectifier requires just one-half to one-twentieth as much space as its competition. Saves design and installation time and reduces error.

Our IBR[®] is available as a 10-Amp, 10-Amp fast recovery and 25-Amp full-wave bridge rectifier, 200V, 400V and 600V controlled avalanche ratings. Electrically insulated case for direct chassis mounting. Three mountings op-

tions: Press mount, TO3 flange, single stud.

25-Amp IBR[®] only \$3.05*

10-Amp fast-recovery IBR[®] only \$4.75*

10-Amp IBR[®] only \$2.35*

*In 200V rating and quantity of 1,000 (press mount).

Write for complete information on Varo IBR[®] products. It could solve problems you didn't even know you had. Available now from Allied Electronics.



VARO

*Registered trademark of Varo, Inc.

SEMICONDUCTOR DIVISION, 1000 N. SHILOH ROAD, GARLAND, TEXAS 75040 (214) 272-4551

Circle 165 on reader service card

Perfect mate for integrations— Micro-Vectorbord[®] Tenth-Tenth Pattern "P"

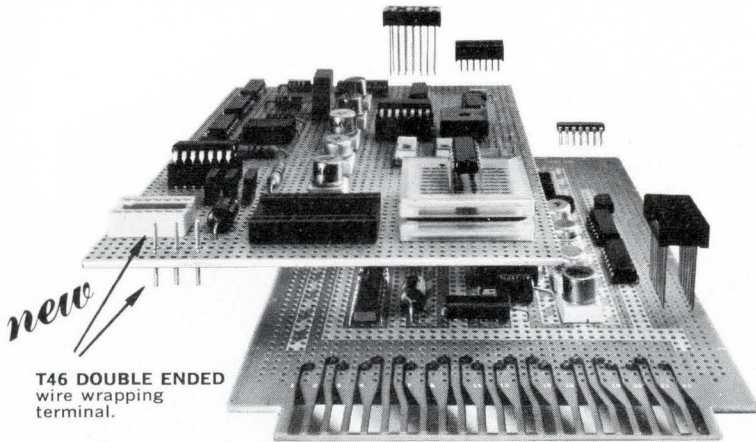

T46 DOUBLE ENDED
wire wrapping
terminal.

Precision punched .042" holes spaced .1" x .1" available in sheets of various sizes up to 8½" wide by 35" long, ¼" thick Epoxy Glass, Epoxy Paper, Phenolic.

Copper Clad and Non-Clad. Also available in Plugboards with etched or Elco Varicon contacts, buses, ground planes.

MINIATURE PUSH IN TERMINALS FOR .042" HOLES.



T44 MINIWRAP .025" Square, for wire-wrapping.



K27 .042" Diameter



T42-1 Micro-Klip

Vector

Send for complete literature

ELECTRONIC CO., INC.

12460 Gladstone Ave., Sylmar, California 91342
Phone (213) 365-9661 • TWX (910) 496-1539



New products

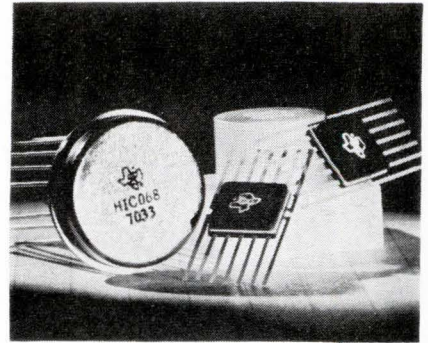

Drivers. Hybrids link logic with display and control functions.

its standby power dissipation is less than 20 milliwatts. It has an SN54100 gate that drives four 2N2222A medium current, high-voltage switching transistors. With a voltage breakdown of 40 V, the HIC067 also comes in a 14-pin flat-pack, and is available in lots of 1,000 at \$12.90 each.

In addition to driving lamps and relays, HIC067 units can be used as high-power buffers, dual and quad phase clock drivers, line drivers, memory drivers, and level shifters.

The high voltage capacity of TI's HIC068 makes it suitable for driving high-voltage tubes and displays; it has a breakdown voltage of 180 V. The circuit's high speed SN54H00 gate drives four high-voltage transistors, and the collector current is 100 mA. It is packaged in a 16-lead TO-92 metal can, and may be purchased in lots of 1,000 for \$11.65 each.

Typical applications of the HIC068 include Nixie tube drivers, relay drivers, and level shifters.

Microminiature components for each of these circuits are mounted on a ceramic substrate, and gold-wire bonding is used.

Operating temperature range of the devices is -55° to +125°C, and storage temperature range is -65° to +150°C.

Operating specifications are easily met with all three devices. The supply voltage is only 7 volts, while the input voltage for A and B inputs is 5.5 volts.

Texas Instruments, Inc., Inquiry Answering Service, P.O. Box 5012, M/S 308, Dallas, Texas 75222 [444]

We packed even more circuitry into CTS cermet resistor networks.

*New 8 and 18-lead styles added to 14 & 16-lead
Series 760 Dual In-Line Packages.*

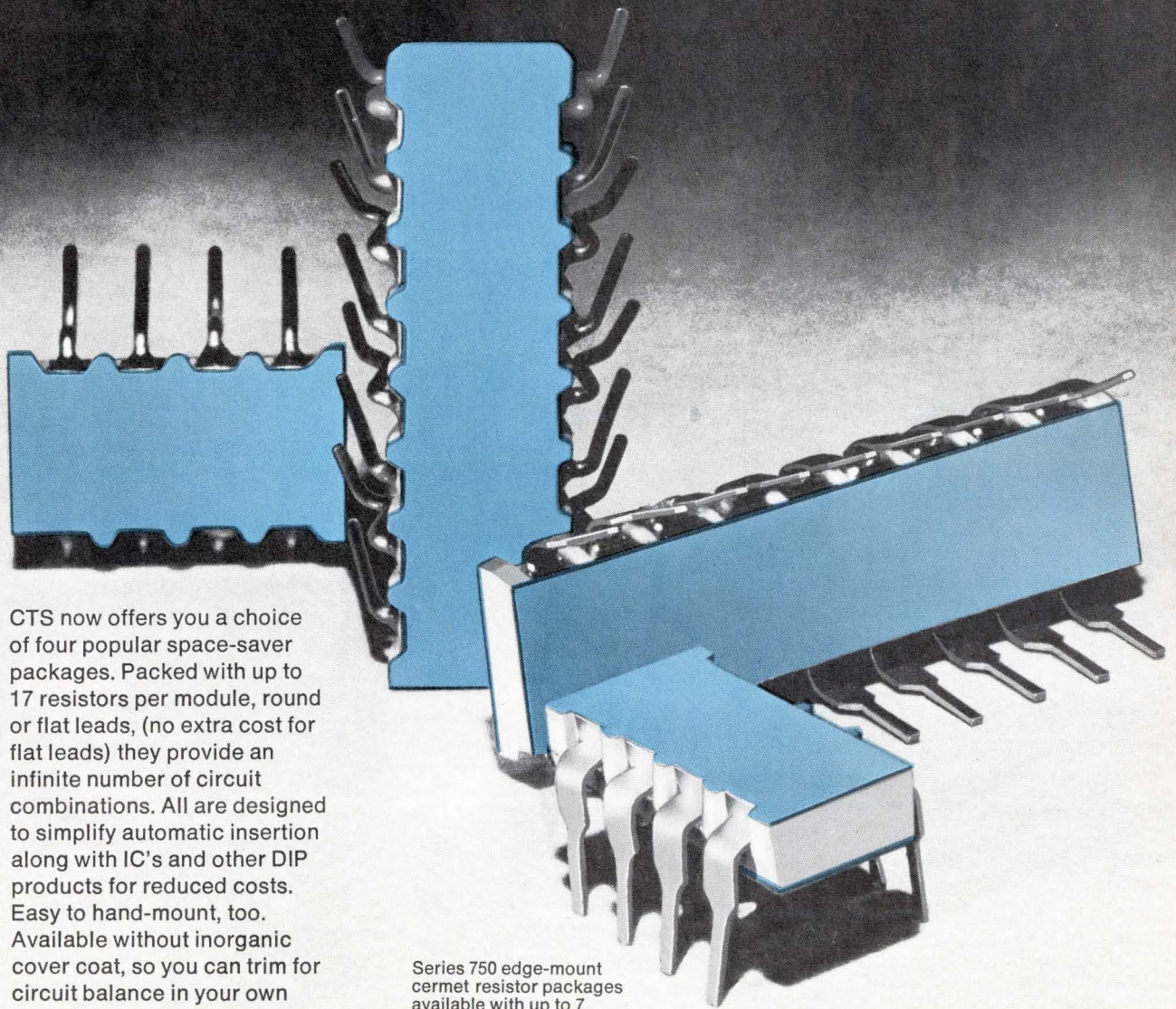

CTS now offers you a choice of four popular space-saver packages. Packed with up to 17 resistors per module, round or flat leads, (no extra cost for flat leads) they provide an infinite number of circuit combinations. All are designed to simplify automatic insertion along with IC's and other DIP products for reduced costs. Easy to hand-mount, too. Available without inorganic cover coat, so you can trim for circuit balance in your own plant. 5 lbs. pull strength on all leads; .100" lead spacing; rated up to 2 watts on 18 lead style.

CTS of Berne, Inc., Berne,
Indiana 46711. (219) 589-3111.

Series 750 edge-mount
cermet resistor packages
available with up to 7
resistors per module in
9 package configurations.

CTS CORPORATION
Elkhart, Indiana



YOUR CTS ANSWER
MAN will be glad to
work with you to pack
maximum circuitry
into your compact
design with this
expanded line of dual
in-line packages.

"OUR HERO"



5 VDC @ 3 AMPS - \$24.95 12 VDC @ 12 AMPS - \$75.00

JAY HOLSAPPLE, POWERTEC'S PRODUCT MANAGER, HAS A POWER SUPPLY SOLUTION FOR MOST REQUIREMENTS. CALL AND ASK JAY WHAT HE WOULD RECOMMEND FOR YOUR REQUIREMENTS. WIDE VARIETY OF OEM, MODULE AND RACK MOUNT, MILITARY, ULTRA MINIATURE HIGH PERFORMANCE SUPPLIES OFF THE SHELF.

CALL JAY COLLECT (213) 882-0004

POWERTEC A DIVISION OF
AIRTRONICS INC.
9168 DESOTO AVENUE
CHATSWORTH, CALIFORNIA 91311
(213) 882-0004 TWX 910-494-2092

Circle 166 on reader service card

AN INSTANT CIRCUIT BOARD™ SYSTEM!

CIRCUIT-STIK'S system of component sub-elements and materials produce circuit boards that are as durable and reliable as conventional printed circuit boards.

CIRCUIT-STIK ELIMINATES: design • drilling • art work • photo work • etching

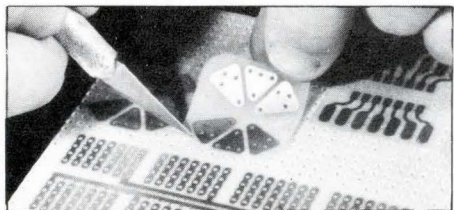

CIRCUIT-STIK sub-elements are pressure sensitive and offer exceptionally good adhesion strength, withstands soldering temperatures and yet may be removed for easy circuit design modifications.

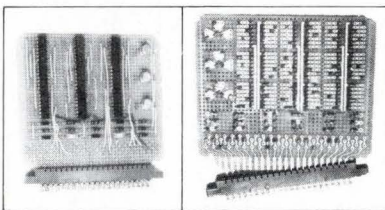

All types of circuit-element configurations may be mixed and combined on the same board.
SEND FOR YOUR FREE CATALOG AND SAMPLES.

CIRCUIT-STIK'S EVALUATION KIT FOR LARGE SYSTEMS APPLICATIONS
PART #8951-G, \$110.00 VALUE FOR \$89.50 (Plus \$1.00 shipping per kit).

circuit-stik INC.

PATENT PENDING

1518 W. 132nd ST., GARDENA, CALIFORNIA 90249

New products—Materials

IR-absorbing glass aids hermetic sealing

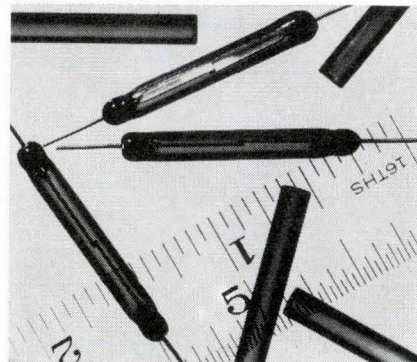

Encapsulating glass designated Code 9362 seals rapidly while minimizing oxide sublimation. It is a low-transmission, infrared-absorbing material designed specifically for making hermetic seals to 52% nickel alloy, Dumet, and other high-expansion materials. Because the glass offers good absorption coefficients at IR energy peaks, sealing can be accomplished with as much as 20% less power than with previously available materials. IR sealing-glass tubing is available in a wide range of outer and inner diameters and lengths. Corning Glass Works, Corning, N.Y. [341]

Rosin-based soldering fluxes are available with noncorrosive activation. Stabilres fluxes will not attack copper or copper oxide until they approach soldering temperatures. They can be activated to much higher levels than previously possible with safety. Further, extremely fine and delicate wires can be soldered with active rosin flux while heavily oxidized surfaces may be soldered with similar safety. Redox Co., 70 Blanchard St., Newark, N.J. 07175 [342]

Thermally-conductive epoxy designated Epo-Tek H74 has been developed for bonding substrates in hybrid IC packages. Electrical specifications include volume resistivity of 2.5×10^{15} ohm-cm; dielectric constant (1 MHz) of 5.5; and dielectric strength of 470 V/mil. Lap shear strength is 3,500 lb/in.² A trial evaluation kit is available at \$15. Epoxy Technology Inc., 65 Grove St., Watertown, Mass. 02172 [343]

Ulanocron RX200 is red-presensitized screen-printing photofilm. It possesses extremely long-running characteristics coupled with the ability to print fine-line and halftone details. It is available on 2- or 3-mil polyester support. The material is suited for dials and printed circuits. J. Ulano & Co., 210 E. 86th St., New York 10028 [344]

*State-of-the-art
in counting...*

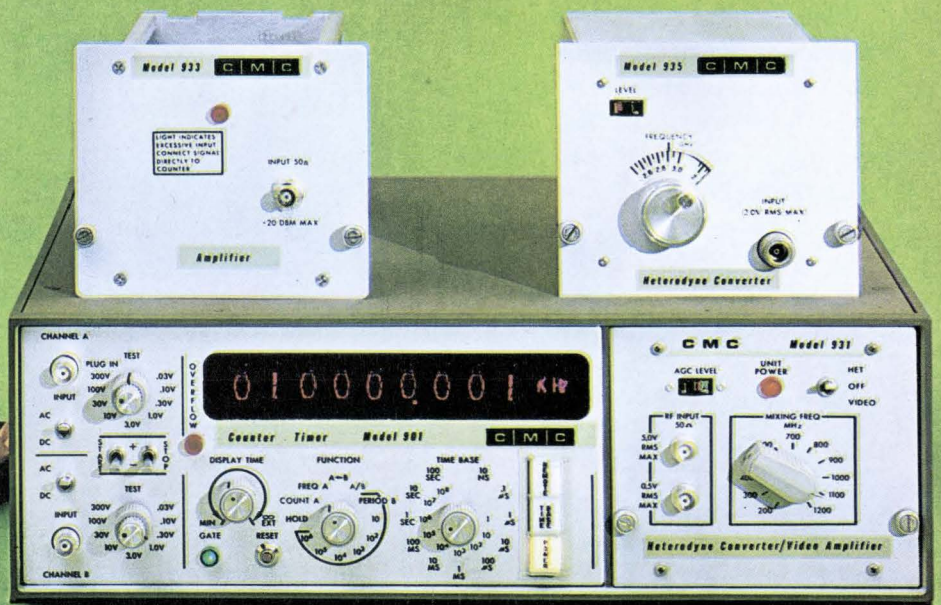
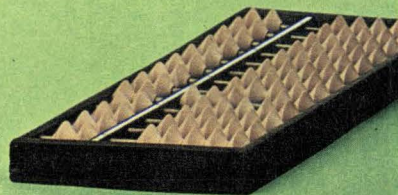

The CMC 901 with plug-ins that do it all!

For some applications, the abacus has been state-of-the-art for 5000 years, but if you want to count directly to 200 MHz or heterodyne to 3 GHz...or if you want to resolve time intervals to 10 nanoseconds...and if you're looking for input sensitivity values to 350 microvolts—there's only one state-of-the-art universal counter-timer for you—the CMC Model 901. This counter, complete with its family of plug-ins, does it all.

It not only counts to 200 MHz directly, but it also scales signals, measures time interval, period, and multiple period average. It provides frequency and multiple frequency ratios as well as total count; and, as an optional extra, it can be operated by remote control. No wonder our 901 customers are saying, "this is the last word in counting!" But it's also where counting's going; because, with its plug-in capability, there's no limit to the future direction that the 901 can take. Here's a counter that will remain state-of-the-art for years to come.

Can you afford to pass it by in favor of a poorer performer at a higher price when the 901 is available now, right off the shelf, for only \$2475? Just \$3300 buys both the Model 901 and the 1.3-GHz Model 931; and for less than \$3600 you can have the 901 with the 3-GHz Model 935. Or if you're looking for microvolt sensitivity, for less than \$2850 you can have the 901 with the 933 Video Amplifier that gives you 30-times gain.

For the full facts, and how to arrange for a free demonstration, circle the reader service card.

COMPUTER MEASUREMENTS COMPANY



A DIVISION OF NEWELL INDUSTRIES

Everything's clearer with the flat one!

Letters! Digits! Symbols! Equations! All varieties of data are displayed as undistorted images on Zenith Flat-Face Metal CRTs. Ideal for light pen operations, alphanumerics and analog presentations — they're even available with a rear port for optical chart projection. When you need CRTs, face up to the flat one. Write for details.

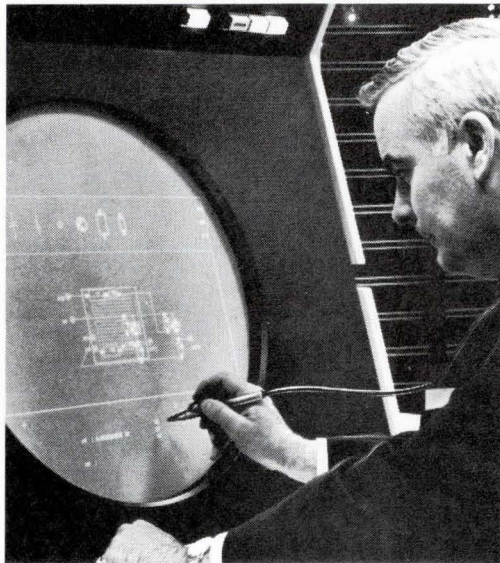

ZENITH RADIO CORPORATION
THE RAULAND DIVISION

5614 W. JARVIS AVE. • CHICAGO, ILL. 60648 • 312-647-8000

Circle 167 on reader service card

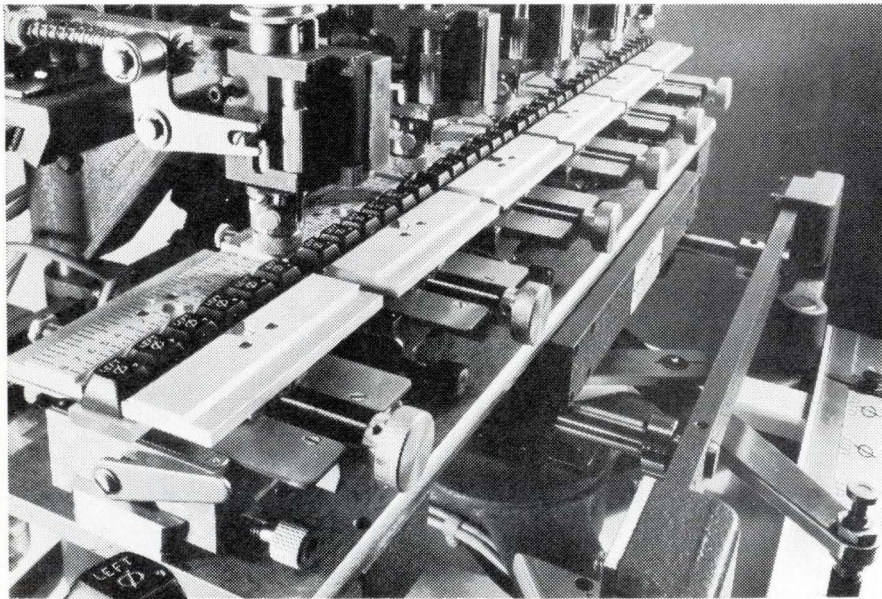

6 will get you 36

Now, new 6-spindle New Hermes engraves up to 36 machine keys with one set-up.

Any unskilled worker simply guides the pantographic tracer on this pneumatically-operated engraving

machine. Each spindle has an automatic depth-regulator, guaranteeing uniform depth and width of engraving over the complete contour of the key.

Write for detailed brochure No. 197.

new hermes engraving machine corp.

20 Cooper Square, New York, N. Y. 10003

Chicago, Atlanta, Los Angeles, Dallas, Montreal, Toronto, Mexico City



New Books

Recap on ECAP

Introduction to Computer Analysis: ECAP for Electronics Technicians and Engineers
Herman Levin, Prentice-Hall, 256 pp., \$14.65

ECAP—Electronic Circuit Analysis Program—is as good a circuit design program as any to use as a first step in getting into the computer-aided design game. Developed as a joint effort of IBM and the Norden division of United Aircraft, it is a general purpose program used in time-shared systems because it's uncomplicated and offers flexibility for device modeling.

There's generally little doubt that circuit designers should at least be on speaking terms with computer-aided design procedures.

And this is perhaps the only book available that could give him a solid foundation in the subject, no matter which of the many available circuit design programs he uses. It grew out of a course given to technicians, and moves rather slowly in circuit theory. But this should be a welcome change of pace for an engineer—he can skim over certain portions but can also slow down on points that aren't quite clear at first and be assured that he's getting a clear logical description.

The book covers basic dc analysis with a good discussion of modeling active components, transient response, frequency response, sensitivities and worst-case analyses, and various computer output options. It also has a useful appendix, containing sample ECAP formats and a list of the capabilities of ECAP when used with any of several IBM computers—1620, 1130, 7040, 7090, and several versions of the 360.

The level of detail is more than adequate. For the frequency response of a single-stage amplifier, for example, the author presents the circuit, its ac equivalent, the input form with all the necessary statements (only 16 in this analysis), the printout of the input data and the command statements, and the printout of the results of the ac analysis.

To help the self-teacher, problems are given at the end of each chapter and answers are provided.

**A major
breakthrough!**

**Buckbee-Mears
research has
found a way to
produce small
holes in thick
metal!**

*Our secret is to
laminate metal*

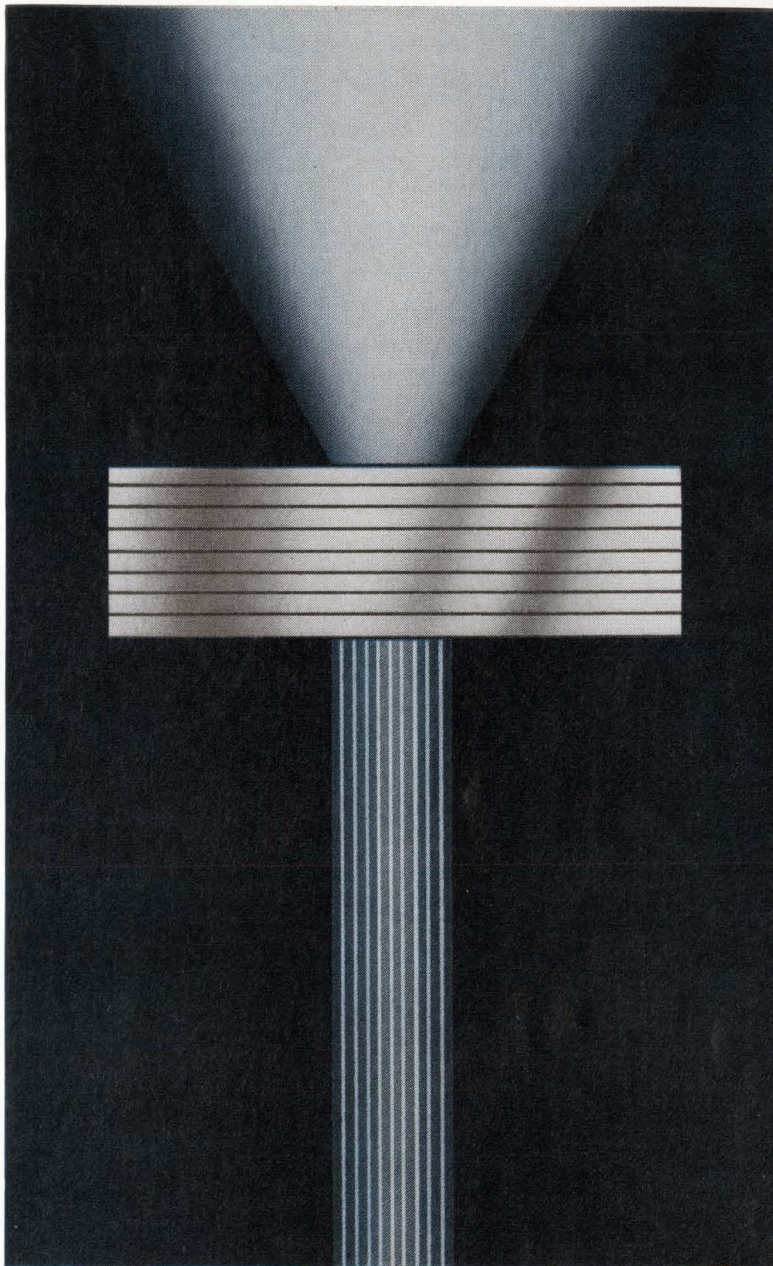

Until now, no one has been able to produce holes in thick metal at anything smaller than a one-to-one ratio. We put our world leading technology in photomechanical reproduction to work and came up with a way to laminate sheets of etched metal in perfect register. We can produce sharply cornered holes of any design in metal much thicker than the width of the hole.

The trick was to eliminate the radii in the corners caused by the laminating process. Our scientists succeeded so well that Buckbee-Mears can accurately register 10,000 holes per square inch over an 11" by 11" area. We can even register up to 40,000 holes per square inch if you need it!

Tolerance on registry is $\pm .0005''$. Tolerance on hole size

is $\pm .0002''$. We are able to laminate up to 1,000 layers of .005" thick material in accurate collimation.

There are countless applications for small holes in thick metals. A few examples might be core nests, fluid amplifiers and collimator screens. Buckbee-Mears can produce masters and the actual laminated metal parts. Either or both.

If you need small holes at better than a one-to-one ratio in any type of metal, any thickness, talk to Buckbee-Mears. We've got a capability to solve your problem.

Solving people's problems is the way we became the world's leader in photomechanical production. Call or write Bill Amundson, our industrial sales manager, and tell him what you need. His number is 612-227-6371.

PRECISION METAL AND GLASS ETCHING • ELECTRO FORMING • AUTOMATED DESIGN
bmc BUCKBEE-MEARS COMPANY
SAINT PAUL, MINNESOTA 55101

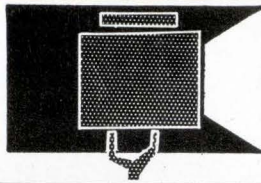

SEARCHLIGHT SECTION

- CLASSIFIED ADVERTISING • BUSINESS OPPORTUNITIES
- USED OR SURPLUS EQUIPMENT

AUTOTRACK MOUNT

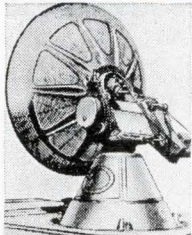

360 degree azimuth, 210 degree elevation sweep with better than 1 mil. accuracy. Missile velocity acceleration and slewing rates. Amp/dyne and servo control. Will handle up to 20 ft. dia. Supplied complete with control chassis. In stock—immediate delivery. Used world over by NASA, USAF, MP-61-B. Type SCR-584. Ideal satellite tracking. Large spare parts inventory for back-up.

ANTI-AIRCRAFT GUN MOUNT

Will handle 6,000 lbs. rapid slew through 360° azimuth, 180° elevation. Mobile.

COUNTERMEASURES SIMULATOR

Covers L-band, S-band, X-band, all radars. Tacan, UHF drone control, VHF drone control, Communications band. All housed in shelter.

FIBERGLASS RADOME Will handle 20 foot antenna. Easily erected & shipped. \$4800.

B-58 BOMBER ELECTRONICS

Ku band search radar, Ku doppler radar, Ku altimeter, all jamming countermeasures.

PULSE MODULATORS

MIT MODEL 9 PULSER 1 MW—HARD TUBE
Output 25kv 40 amp., 30kv 40 amp. max. Duty cy. .002. 25 to 2 microsec. Also 5 to 5 microsec. and 1 to .5 microsec. Uses 6C21. Input 115v 60 cycle AC. Mfg. GE. Complete with driver and high voltage power supply. Ref: MIT Rad. Lab. Series, Vol. 5, p. 152.

2 MEGAWATT PULSER

Output 30 kv at 70 amp. Duty cycle .001. Rep. rates. 1 microsec. 600 pps. 1 or 2 msec. 300 pps. Uses 5948 hydrogen thyratron. Input 120/208 VAC 60 cycle. Mfr. GE. Complete with high voltage power supply.

SCR 584 AUTOTRACK RADARS

Over 584s in like new condition ready to go, and in stock for immediate delivery. Ideal for telemetry research and development, missile tracking, satellite tracking. Fully Desc. MIT Rad. Lab. Series, Vol. 1, pps. 207-210, 222, 224-226. Comp. Inst. Bk available \$25.00 each.

HUNDREDS MORE IN STOCK
LARGEST RADAR
INVENTORY
IN WORLD.
WRITE
FOR
CATALOG
ON YOUR
LETTERHEAD

AUTOMATIC TRACKING SYSTEM

Sct. Atl. Mod. 3101-J70 Antenna Pedestal. AZ-EL 15 deg. per second rated speed. 23 inch dia. bearing. Complete w/control console & mag. amplifiers. Also in stock complete G10-track receiving system for 200-400 MHz telemetry band including 12' square quad. Helix. All part of Atlas missile instrumentation system

MICROWAVE SYSTEMS

SPARE PARTS IN STOCK

Nike Ajax, Nike Hercules, M-33, MPS-19, TPS-ID, TPS-10D, FPS-6 SPSS, SCR-584, MPQ-18. From Largest Inventory in World

KU BAND RF HEAD

16.5 GHz, 50 KW, .001 duty cycle, 45 Watts avg. compl. W/50 22 modulator compl. recv. Mfr. Emerson Electric.

L BAND RF PKG

20 KW peak 990 to 1040 MC. Pulse width .7 to 1.2 micro sec. Rep. rate 180 to 420 pps. Input 115 vac

MICROWAVE LINKS

C BAND Philco CLR6, CLR7, CLR9. Radar video length Motorola MRR-4.

X BAND FIRE CONTROL SYSTEM

MD-4, A5, A1g 32 system. 50 KW Autotrack, complete system, all cables etc., incl. gun turret if desired.

AN/GMD-1B RAWIN RADAR

L-Band Radiosonde Tracking System. Complete, new cond. in stock for immed. del. AN/GMD-2 computer mfg. Gen'l Mills also in stock.

500 KW L BAND RADAR

C BAND 1220-1359 msc. 160 nautical mile search range P.R.I. and A scopes. MTI. thyratron mod 5J26 magnetron. Complete system.

C BAND AUTOTRACK

1 Megawatt 10 ft. Parabola. Sperry.

AN/GPG-1 SKYSWEEP TRACKER

3 cm. auto. tracking radar system. Comp. pkg. w/indicator sys. Full target acquisition & auto. tracking. Input 115v 60 cy. new. In stock for immed. del. Entire sys. 6' x 3' x 10'. Ideal for infrared tracker, drone tracker, missile tracker, R & D

INDICATOR CONSOLES

AN/SPA-1A, PPI 10", range to 300 mi. VJ-1 PPI 12", Range to 200 mi. VI-1 RHI 12" to 200 mi. 60K ft. FPS-6 RHI. FPS-8 PRI. CPS-6B PPI. plus many more.

Radio-Research Instrument Co.

45 W. 45th St., New York, N.Y. 10036 • 212-586-4691

CIRCLE 966 ON READER SERVICE CARD

free catalog

POTTING APPLICATORS MANUAL AND DISPOSABLE

6cc 12cc 30cc

FOR POTTING, ENCAPSULATING, AND SEALING OF MINIATURE COMPONENTS

PHILIP FISHMAN COMPANY

7 CAMERON ST., WELLESLEY 81, MASSACHUSETTS

CIRCLE 967 ON READER SERVICE CARD

WELDING HAND TOOL

TW 17 A

\$ 48.00

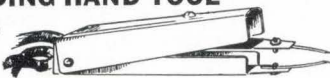

Replaceable Tips—Adjustable Pressure
AC and Stored Energy Power Supplies

EWALD Instruments Corporation

Route 7E, Kent, Conn. 06757

CIRCLE 968 ON READER SERVICE CARD

Sold!

"Please discontinue our ad in "Searchlight" as we have sold the equipment through this advertising."

Can "Searchlight" Serve You?

"SEARCHLIGHT"

IS

Opportunity Advertising

—to help you get what you want.

—to help you sell what you no longer need.

Take Advantage Of It

"Think Searchlight First"

For Every Business Want

LSI gets uniform

Application of custom LSI to the DTAS data transmission and switching system
C.E. Benson
Litton Industries
Van Nuys, California

Because small size and light weight were essential for a tactical field communication system required by the Marine Corps, metal oxide semiconductor, large scale integration modules were used in the modems and digital message entry devices (DMED) that comprise the data transmission and switching (DTAS) system.

It was early realized that careful organization of system logic, packaging, and programing was needed to get around the packaging and partitioning constraints imposed by LSI. To minimize LSI inputs and outputs, time division multiplex was used to provide multiple use of leads.

The basic system concepts settled, all related functions were grouped by partitioning the functional block diagram of the modems and DMED. Priority was given functions with critical timing relationships and then to functions with numerous interconnections, so the result would be devices with few timing constraints between signals.

The next step was to define the functional requirements of the LSI devices. Voltages and clock waveforms, among others, were unspecified to permit bipolar or MOS techniques, and were written as black box requirements.

Breadboarding of a device occurred simultaneously with its specification. The DMED breadboarding used MOS logic while the modems employed combinations of DTL logic to simulate MOS cells.

The final specifications were tailored to clock waveforms, voltages, and MOS-to-MOS interfaces. In the modem, each interface to a non-MOS circuit was made compatible with DTL logic.

The final LSI devices were realized with low voltage p-channel MOS processes, and operated with single-phase clock inputs at frequencies up to 1.6 megahertz.

Presented at COMAC, Fort Monmouth, October 6-8.

Low energy switching problem? Leave it to our "GOLDIE"...



"Goldie"—the new Cherry gold crosspoint contact switches solve practically every low energy switching problem. They do it with a contact design innovation that helps prevent the two main causes of contact failure:

1. Formation of insulating chemical films on contacts
2. Mechanical interference of foreign particles on contacts.

Our new "Goldie" switches combine a solid layer of gold alloy (69% gold, 25% silver, 6% platinum) contact material

with a crossed knife-edge configuration. These provide interfaces inert to chemical action and virtually eliminate contact closure interference from foreign particles. Low contact resistance is maintained throughout the switch lifetime, which is measured in millions of operations. Initial insertion resistance is below 50 milliohms.

Take a closer look at our problem-solving "Goldie" switches. Send for the sample of your choice today.



Hewlett-Packard Desk Top Calculator uses 63 Cherry "Goldies"

FREE SAMPLE SWITCH



E69 Push Button
Circle Reader
Service No. 300



E53 Low Torque
Circle Reader
Service No. 301



E63 Subminiature
Circle Reader
Service No. 302



S31 Open Miniature
Circle Reader
Service No. 303



E21 Miniature
Circle Reader
Service No. 304

Makers of patented Leverwheel/Thumbwheel Switches, Matrix Selector Switches, Snap-Action Switches and Keyboards.

CHERRY

CHERRY ELECTRICAL PRODUCTS CORP. • 3608 Sunset Avenue, Waukegan, Illinois 60085

Interactive Graphics

for the Tektronix T4002

Graphic Computer Terminal

With the introduction of the 4901 Interactive Graphic Unit and Joystick accessory, graphic input capability is now available for the Tektronix T4002 Computer Terminal. The Interactive Graphic Unit is a valuable aid wherever graphic analysis of statistical data is fundamental to: thorough scientific investigation—effective computer-aided instruction—informed decision making.

The 4901 and optional Joystick are *software* supported. The software permits coordinate identification, display rotation and overlaying, menu picking and other frequently repeated functions in graphic formatting.

The new 4901 generates a bright, no parallax, orthogonal crosshair cursor. The cursor is easily and accurately positioned with the desk-top Joystick. You enter data points and instructions through the T4002 keyboard. This means complete graphic interface without removing your hand from the Joystick.

PERMANENT COPY—when a copy is needed, the Tektronix 4601 Hard Copy Unit will produce an 8.5 x 11-inch permanent, reproducible copy in seconds without tying up your computer.

With this new hard copy capability and the T4002, your computer may seldom have to write the same display more than once. A T4002 demonstration provides an excellent opportunity to discuss software support, machine compatibility, interface options and maintenance. Contact your nearby Tektronix Field Office or write: Tektronix, Inc., Box 500, Beaverton, Oregon 97005. See your 1970 Tektronix catalog for specifications.

	U.S. Sales Prices FOB Beaverton, Oregon	U.S. Lease Prices per month
T4002	\$8800	\$340
Interface	600	24
4901	450	20
Joystick	250	10
4601	3750	145

The new, no parallax crosshair cursor is positioned with the desk-top Joystick.

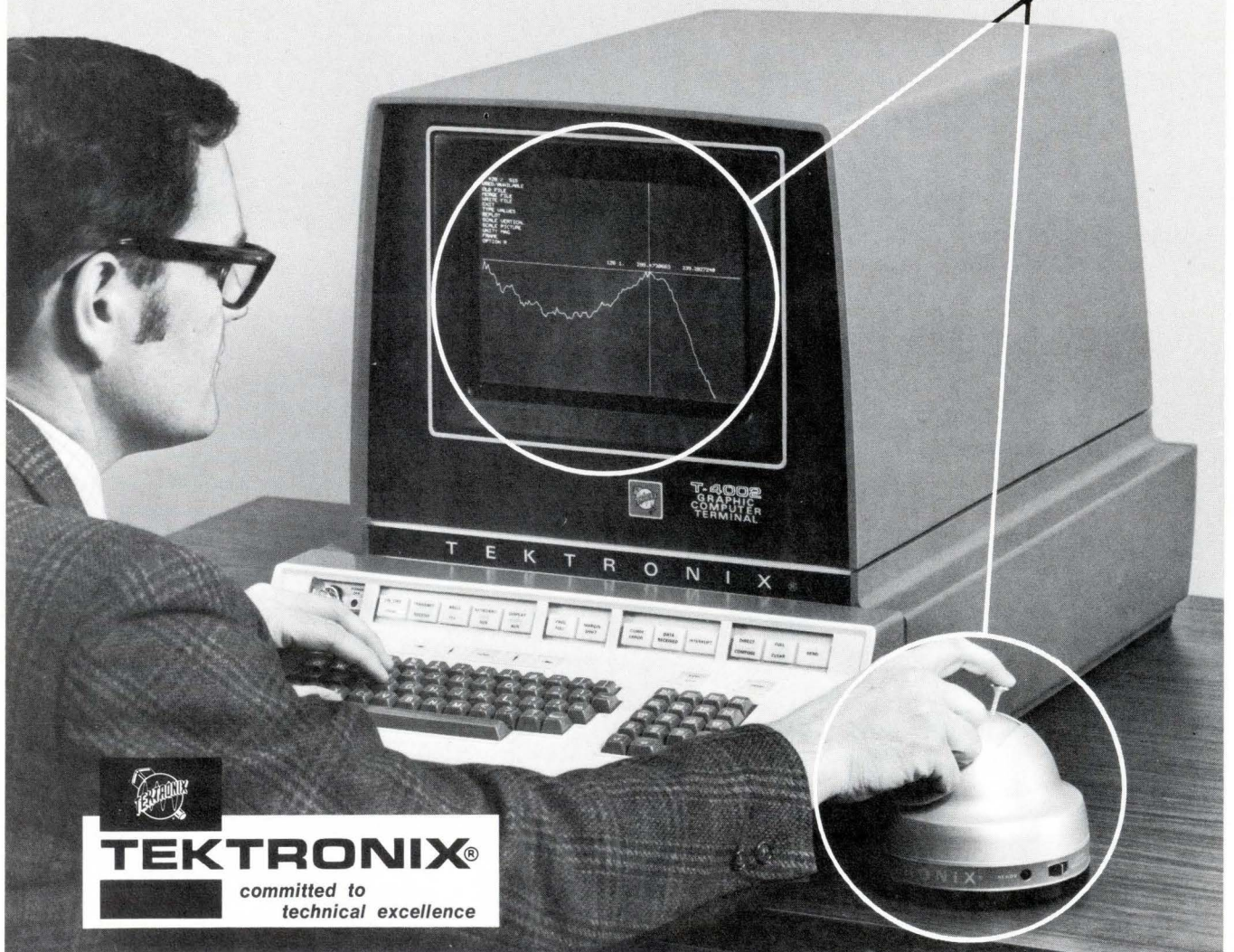

TEKTRONIX®
committed to
technical excellence

See The Tektronix Display At FJCC



NORTON[®] MAGNETIC HEADS

**MULTITRACK
ERASE
RECORD
PLAY**

Send now for complete technical literature.

NORTON
ASSOCIATES, INC.

10 Di Tomas Court, Copiague, N.Y. 11726
Phone: 516 598-1600

Circle 168 on reader service card

WIRE WOUND RESISTOR

SILICON INSULATED SMALL SIZE,
HIGH STABILITY, LOW T.C.R., LOW PRICE.

TOL	PRICE 100 Pz., US \$	TOL	PRICE 100 Pz., US \$
5%	6,00	5%	10,00
2%	8,00	2%	12,00
1%	10,00	1%	15,00
0,5%	12,00	0,5%	18,00
0,2%	20,00	0,2%	22,00

1 W at 5%
0,2 W at 0,2%
100 μ Max.
0,1 μ Min.

2 W at 5%
1 W at 0,2%
250 μ Max.
0,1 μ Min.

Price F.O.B. Mexico City
5 Free samples for anybody who
writes on Co. letter.
Call or write L. Michel Kun Pres.

SPECIAL T.C.R. AVAILABLE.
We also make:
All types of wire wound,
ceramics and fiber glass
from $\frac{1}{2}$ W to 1 000 W.
Metal oxide resistors from
 $\frac{1}{2}$ W to 10W. Down to 1%.
Thick film circuitry, passive
and active.
Load resistor assembly up
to 20 Mega watts.
Edge wound, punched grid
etc. etc.

LEMEX

LEMEX, S.A., - San Esteban No. 23, - MEXICO 16, D.F.
MEXICO CITY TEL. 561-30-00

Circle 169 on reader service card

New Literature

Dry reed relays. C.P. Clare & Co., 3101 Pratt Blvd., Chicago, Ill., 60645. Engineering data sheet 971B contains 17 pages of detailed specifications, complete with drawings and graphs, explaining how to choose the new metal-covered Picoreed relay. Circle 446 on reader service card.

Rf generators. Westinghouse Electric Corp., Box 2278, Pittsburgh, Pa. 15230. Brochure DB28-150 describes 25-to-50-kW, 250-to-450-kHz rf generators for a wide range of applications where heating of metals or semiconductors is required. [447]

Component ovens. Oven Industries Inc., 1106 E. Simpson Rd., Mechanicsburg, Pa. 17055. A designer's handbook provides accurate definitions of oven terminology to clarify the terms most often misconstrued. Included are illustrations depicting the most preferred thermal assemblies. [448]

Analog current monitor. Beta Corp., P.O. Box 20427, Dallas, Texas 75220. A versatile analog current monitor that may also be used in conjunction with a transistorized annunciator system is described in catalog 1030. [449]

Absolute shaft encoder. Veeder-Root, 70 Sargeant St., Hartford, Conn. 06102. A technical bulletin gives complete information on an optical absolute shaft encoder that counts chronologically. [450]

A-d-a products. Analogic Corp., Audubon Rd., Wakefield, Mass. 01880 offers a short-form catalog summarizing a complete line of analog-digital-analog conversion, signal conditioning, and digital display products. [451]

Attenuator catalog. Hyletronics Corp., Newtown Rd., Littleton, Mass. 01460, has published a six-page brochure describing its complete line of series 500N solid state attenuators (reflective) and series 500P spst nanosecond switches. [452]

Insulated strip terminals. Kent Corp., 169 N. Lake St., Mundelein, Ill. 60060. Six-page catalog KM-4 deals with a line of PVC and nylon insulated strip terminals for making completely insulated connections by automatic machine. [453]

Torque motors. Aeroflex Laboratories Inc., South Service Rd., Plainview, N.Y. 11803. A four-page brochure is devoted to a new line of brushless, wide-angle rotation, dc torque motors. [454]

Video amplifier. Computer Measurements Co., 12970 Bradley Ave., San Fernando, Calif. 91342, has available a data sheet outlining key features and giving complete specifications of the model 933 video amplifier. [455]

centre de recherches de la compagnie générale d'électricité
91 - MARCOUSSIS (FRANCE) - Tél. 920.82.50 - Telex : 26 877 LABMARCO



RANGE : 1 nsec. to 999 msec.
1 nanosecond RESOLUTION
Crystal aging rate : 1 part in 10⁹/day
Internal MIPAP logic

**NANOSECOND TIME INTERVAL METER
MODEL CC20**

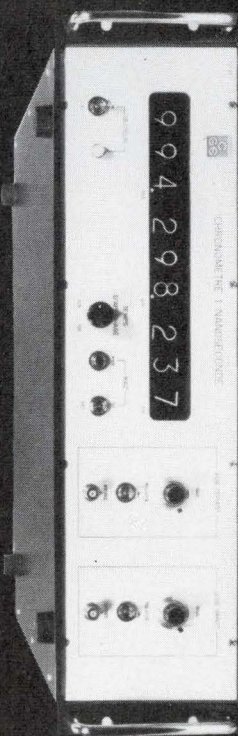

2B - Paris 131

Circle 149 on reader service card

149

□ OPERATING LIFE OF 10 YEARS □ PROVIDES 107 CFM AT FREE DELIVERY □ LOWEST NOISE LEVEL OF ANY 100 CFM FAN □ COMPACT—JUST 1½" DEEP □ IMPEDANCE PROTECTED □ U.L. YELLOW CARD RECOGNITION □ AVAILABLE FROM STOCK.

**Compare it!
Install it!
Forget it!**

The Rotron MUFFIN[®] FAN



Need price, delivery or other information? Call 914-679-2401 for immediate service, or write Rotron Incorporated, Woodstock, N.Y. 12498

Circle 150 on reader service card

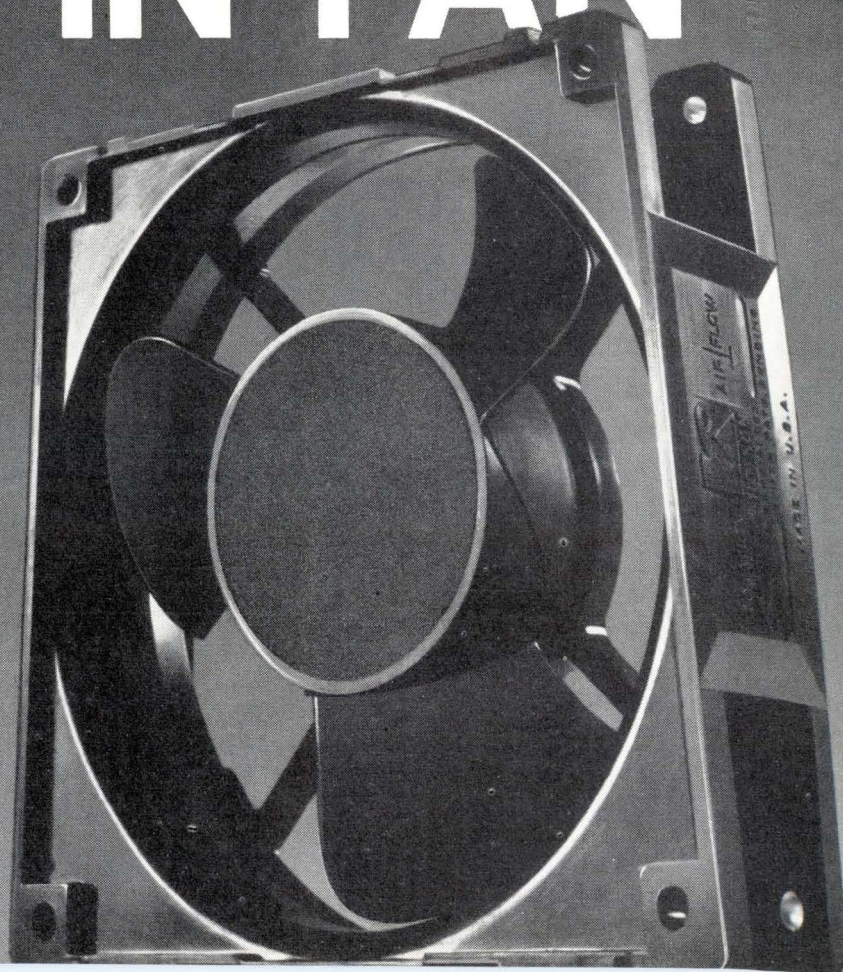

Advertising Sales Staff

Pierre J. Braude [212] 971-3485
Advertising Sales Manager

Atlanta, Ga. 30309: Charlton H. Calhoun, III
1375 Peachtree St., N.E.
[404] 892-2868

Boston, Mass. 02116: William S. Hodgkinson
607 Boylston St.
[617] 262-1160

Chicago, Ill. 60611: Ralph Hanning,
Kenneth E. Nicklas, 645 North Michigan
Avenue, [312] MO 4-5800

Cleveland, Ohio 44113: William J. Boyle,
[716] 586-5040

Dallas, Texas 75201: Richard P. Poole,
1800 Republic National Bank Tower,
[214] RI 7-9721

Detroit, Michigan 48226: Ralph Hanning,
2600 Penobscot Building
[313] 962-1793

Houston, Texas 77002: Richard P. Poole,
2270 Humble Bldg. [713] CA 4-8381

Minneapolis, Minn. 55402: Kenneth E. Nicklas,
1104 Northstar Center [612] 332-7425

New York, N.Y. 10036
500 Fifth Avenue
James R. Pierce [212] 971-3615
Warren H. Gardner [212] 971-3617
Michael J. Stoller [212] 971-3616

Philadelphia, Pa. 19103:
Jeffrey M. Preston
6 Penn Center Plaza,
[215] LO 8-6161

Pittsburgh, Pa. 15222: Jeffrey M. Preston,
4 Gateway Center, [412] 391-1314

Rochester, N.Y. 14534: William J. Boyle,
9 Greylock Ridge, Pittsford, N.Y.
[716] 586-5040

St. Louis, Mo. 63105: Kenneth E. Nicklas,
The Clayton Tower, 7751 Carondelet Ave.
[314] PA 5-7285

James T. Hauptli [415] DO 2-4600
Western Advertising Sales Manager

Denver, Colo. 80202: Richard W. Carpenter
Tower Bldg., 1700 Broadway
[303] 266-3863

Los Angeles, Calif. 90017: Robert J. Rielly,
Bradley K. Jones, 1125 W. 6th St.,
[213] HU 2-5450

San Francisco, Calif. 94111: Don Farris,
James T. Hauptli, 425 Battery Street,
[415] 362-4600

Paris: Denis Jacob
17 Rue-Georges Bizet, 75 Paris 16, France
Tel 727 33 42, 727 33 60

Geneva: Denis Jacob
1 rue du Temple

United Kingdom and Scandinavia
London: Keith Mantle, Tel: Hyde Park 1451
34 Dover Street, London W1

Milan: Robert Saidel, Roberto Laureri Jr.
1 via Baracchini Phone 86-90-656

Brussels: Denis Jacob
22 Chaussee de Wavre
Brussels 1040, Belgium

Frankfurt/Main: Fritz Krusebecker
Elsa-Brandstroem Str. 2
Phone 72 01 81

Tokyo: Masaru Wakeshima, McGraw-Hill
Publications Overseas Corporation,
Kasumigaseki Building 2-5, 3-chome,
Kasumigaseki, Chiyoda-Ku, Tokyo, Japan
[581] 9811

Osaka: Akihiko Kamesaka, McGraw-Hill
Publications Overseas Corporation, Kondo
Bldg., 163, Umegae-cho Kita-ku [362] 8771

Australasia: Warren E. Ball, IPO Box 5106,
Tokyo, Japan

Business Department

Stephen R. Weiss, Manager
[212] 971-2044

Thomas M. Egan,
Production Manager [212] 971-3140

Dorothy Carmesin, Contracts and Billings
[212] 971-2908

Frances Vallone, Reader Service Manager
[212] 971-6057

Electronics Buyers' Guide

George F. Werner, Associate Publisher
[212] 971-3139

Regina Hera, Directory Manager
[212] 971-2544

the new Bausch & Lomb StereoZoom 7 Coaxial Illuminator (Patented)

You're looking at a major advancement in microelectronics cost reduction and quality assurance

Now—speedily, surely—you can examine reflective micro-objects for the first time *as they really are*. Full-color definition. Without flare, glare, shadowy ambiguity. With image quality comparable to the best monobjective microscope . . . and in 3-D.

One-step visual quality control is now possible, for example, in assembling microelectronics. And quality assurance checking of multi-layer elements is swift and conclusive. Results: significant time and cost reductions.

New, unique, vertical illumination is the reason. The Bausch & Lomb StereoZoom 7 Coaxial Illuminator supplies uniform-intensity, full-aperture, on-axis illumination to both sides of the optical system. Better than ring lighting. Better than ordinary vertical and incident light systems.

But words can only hint. See it for yourself. Ask for Catalog 31-2368 and a demonstration of the Bausch & Lomb StereoZoom 7 Microscope with Coaxial Illumination . . . now.

BAUSCH & LOMB 
SCIENTIFIC INSTRUMENT DIVISION

99735 Bausch St., Rochester, N. Y. 14602



Electronics advertisers

November 9, 1970

Aerovox Corporation	27	Circuit-Stik Inc.	142	□ General Instrument Europe S. P. A.	29E
Lescabourra Advertising Inc.		Haaga Advertising		Studio Hedy	
Allen Bradley Company	3rd Cover, 62	Computer Measurements Company	143	General Instrument Corporation	
Hoffman York Inc.		Jones, Maher, Roberts Inc.		Semiconductor Products Division	48
American Cyanamid Co.,		□ Contelec	22E	Norman Allen Associates	
Plastic & Resins Division	138	Maison Daniel Borel		General Radio Company	2nd Cover
Wilson, Haight & Welch Inc.		□ CRC	12E	GRAD Associates	
American Microsystems	21	SPI		Gou'd Brush Instruments Division	95
Jordan Advertising		CTS Corporation	141	Carr Liggett Advertising Inc.	
American Smelting and		Reincke Meyer & Finn Inc.		Grayhill Incorporated	D.4
Refining Company	136			Carr Liggett Advertising Inc.	
Clyne Maxon Inc. Advertising		■ Delevan Electronics Corp.	14		
AMP Incorporated	56-57	Stahlka, Fallier & Klenk Inc.		■ Hewlett Packard Colorado	
Aitkin-Kynett Co. Inc.		Dialight Corporation	106	Springs Division	1
A P Incorporated	116	Michel Cather Inc.		Tallant Yates Advertising Inc.	
Howard Joseph Venaleck Advertising		Dumont Oscilloscope Laboratories	7	■ Hewlett Packard Loveland Division	135
Arnold Engineering Company	50	Keyes Martin & Company		Tallant Yates Advertising Inc.	
Brand Advertising Inc.		Duncan Electronics Inc.		■ Hewlett Packard	128
□ Ates Componenti Elettronici, S. P. A.	18E	Sub. of Systron Donner Corp.	39-40	Lenner & Newell Inc.	
Publicitas		Enyart & Ross Advertising Inc.		■ Hewlett Packard	2
				Lenner & Newell Inc.	
Bausch & Lomb Incorporated	D1	Eastman Kodak Company		■ Hickok Electrical Instrument Company	46
Wolff Associates Inc.		Business Systems Markets Division	127	Key Marketing Associates	
Beckman Instruments Inc.		J. Walter Thompson Company		■ Hughes Aircraft Company	44-45
Electronic Instrument Division	15	Electrostatics	D-4	Footo, Cone & Belding	
N. W. Ayer/Jorgensen/MacDonald Inc.		The Philips Agency of California Inc.			
Bell & Howell Electronics &		Electronics	60-61, 100	Intel Corporation	8-9
Instruments Group	114-115	Ries Cappiello Colwell Inc.		Bonfield Associates	
Coordinated Communications Inc.		Florida Dept. of Commerce, Division of		■ International Crystal Mfg. Co.	6
Bell Telephone Laboratories	18-19	Commercial Development	123	Robert V. Freeland & Associates	
N. W. Ayer & Son Inc.		Williams Cook Advertising Inc.		International Electronic Research Corp.	98
■ Blue M Electric Company	124			Van Der Boom, McCarron Inc.	
South Suburban Advertising		General Dynamics Corp.	10, 11	Advertising	
Buckbee-Mears Company	145	Young & Rubicam Inc.		International T. V. Symposium	D-4
Midland Associates Inc.		□ General Electric Company	25E	Publicitas Service International	
■ Bussmann Mfg. Division of		Robert S. Cragin Inc.			
McGraw Edison Company	116-117	General Electric Company,		Krohn Hite Corporation	125
Henderson Advertising Company		Miniature Lamp Division	126	Ingalls Associates Inc.	
		Batten, Barton, Durstine & Osborn Inc.		Ledex Inc.	20
C. G. E.	149	General Electric Company,		Yeck & Yeck Inc.	
Edition 2B Publicite		Plastics Dept.	131	Lemex S. A.	149
■ Cherry Electrical Products Corp.	147	Ross Roy of New York Inc.		□ Joseph Lucas Ltd.	14E-15E
Kolb/Tookey and Associates, Inc.		General Electric Company,		□ Mallory Batteries Ltd.	33E
Cintra	132	Tube Department	110	S. H. Benson Ltd.	
Bonfield Associates		Robert S. Cragin Inc.		Mallory and Co., P. R. Mfg. Division	47
				Aitkin Kynett Company	

a good rule to follow...

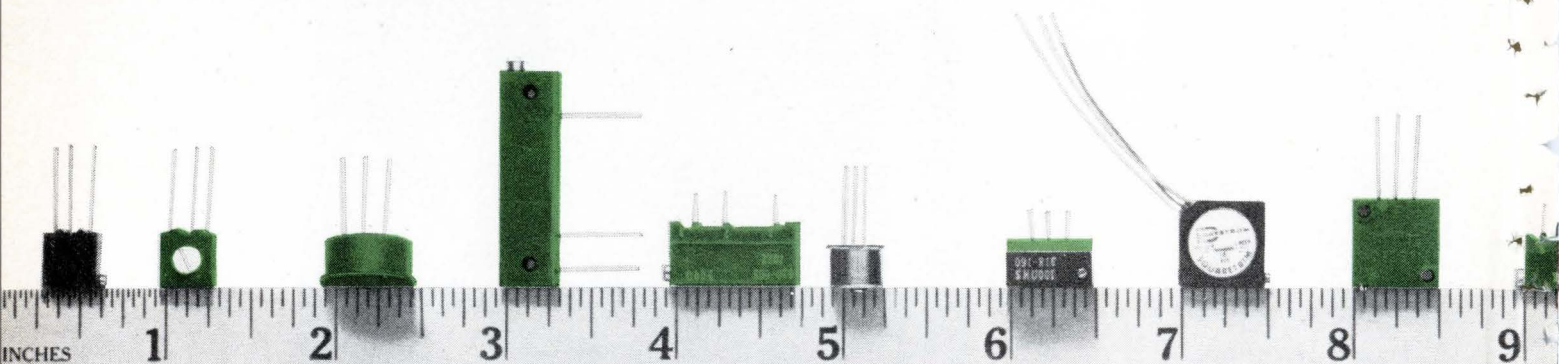

Markel and Sons, L. Frank George Moll Adv. Inc.	94	Rotron Incorporated Lescarboura Adv. Inc.	150	Texas Industrial Commission	116
■ Matsuo Electric Co., Ltd. Daiko Advertising Inc.	134	Schauer Manufacturing Corp. Nolan, Keelor, Stites	113	Thomson-CSF Electron Tubes, Inc. Mohr & Co., Inc.	81
■ Micro Switch Division of Honeywell N. W. Ayer & Son Inc.	24	□ Schlumberger SIS T. B. Browne, Ltd.	19E	Triplett Electrical Instrument Co. Byer and Bowman Advertising	49
■ Mohawk Data Sciences Corporation The Lampert Agency Inc.	121	□ Sercel Termont Technique	38E	UNISEM, Subsidiary of United Aircraft Corp. Schaefer Advertising, Inc.	55
□ Monsanto Company Michel Cather	28E	□ SESCOSEM Perez Publicite	6E	United Systems Corp. Advertising & Merchandising, Inc.	52
□ Morganite Resistors Ltd. Scientific Advertising & Marketing Ltd.	30E	□ SGS Scuola Di Design Di Novara	27E	■ Unitrode Corp. Impact Advertising, Inc.	43
■ Mos Technology Inc. Henry S. Goodsett Advertising Inc.	107	Signetics Corp. Sub of Corning Glass Works Hall Butler Blatherwick, Inc.	93	■ Varo, Inc. Tracy-Locke, Inc.	140
New Hermes Engraving Machine Corporation Bishopric Lieberman Harrison	144	Siliconix, Inc. Robertson West, Inc.	12, 51	Vector Electronics Co., Inc. Buck Advertising	140
■ North Atlantic Industries Inc. Helme Associates Inc.	118	Singer Company, Electronic Products Div. Technical, Industrial and Scientific Marketing, Inc.	101	Vernitron Piezoelectric Division Deborah Advertising, Inc.	130
■ Norton Associates Inc. J. J. Coppo Company	149	□ Socapex S.P.I.	13E	□ Wayne Kerr, Ltd. W. S. Crawford Ltd.	35E
□ D. Olivetti & C. SPA Studio ECO	31E	□ Sodeco Dumensil Publicite	20E	Weston Instruments, Inc., Archbald Div. Michel Cather	D2, D3
Phelps Dodge Communications Company Smith, Dorian & Burman Inc.	99	□ Solartron Electronics Group, Ltd. T. B. Browne, Ltd.	21E	Xintel Corporation Larry Courtney Co.	30, 31
Philadelphia Electric Company Al Paul Lefton Company Inc.	58-59	Solitron Devices, Inc. The Phillips Agency of California, Inc.	111	Zenith Radio Corporation Mills, Fife & Mac Donald, Inc.	144
□ Philips Gad-Elcoma Media International	16E-17E	Sorensen Operation Raytheon Co. Fred Wittner Co.	16, 17		
Philips Electronics Instruments Marsteller Inc.	86	□ Souriau & Cie Ariane Publicite	32E		
□ Philips N. V. Pit / Tmi Division Marsteller International S. A.	2E	□ S.P. Elettronica Studio Sergio Rosata	11E		
Pomona Electronics Company Buxton Advertising Agency	122	□ Sperry Rand—Sperry Tube Div. Neals & Hickok, Inc.	37E		
Powercube Corporation Div. of Unitrode Advertising Assistance Inc.	32	Sprague Electric Co., The Harry P. Bridge Co.	5		
Powertec Division of Airtronics PAC Advertising Agency	142	Struthers Dunn, Inc. Harry P. Bridge Co.	96		
Public Service Electric & Gas Company Williams and London Advertising	137	Switchcraft, Inc. Buti-Roberts Advertising	97		
RCA Electronics Components Al Paul Lefton Company	4th Cover, 13, 28-29	Sylvania Electric Products, Inc., Chemical & Metallurgical Div. Doyle Dane Bernbach, Inc.	108		
Rohde & Schwarz	5E	Systems Engineering Laboratories Shaw Elliott, Inc.	22, 23		
		■ Tektronix, Inc. Dawson, Inc.	37, 102, 148		

Classified & Employment Advertising

F.J. Eberle, Manager 212-971-2557

EQUIPMENT (Used or Surplus New) For Sale	
Ewald Instruments Corp.	146
Philip Fishman Co.	146
Radio Reaserch Instrument Co.	146

- For more information on complete product line see advertisement in the latest Electronics Buyer's Guide
- Advertisers in Electronics International

when ordering pots.

Weston Components, a Schlumberger company
Archbald, Pennsylvania 18403

Gentlemen:

- Please send me a copy of your new catalog of Weston trimming potentiometers.
- Please have a salesman call to discuss samples and prices.

Name _____ Title _____
 Company Name _____ Mail Station _____
 Street Address _____ City _____ State _____ Zip _____

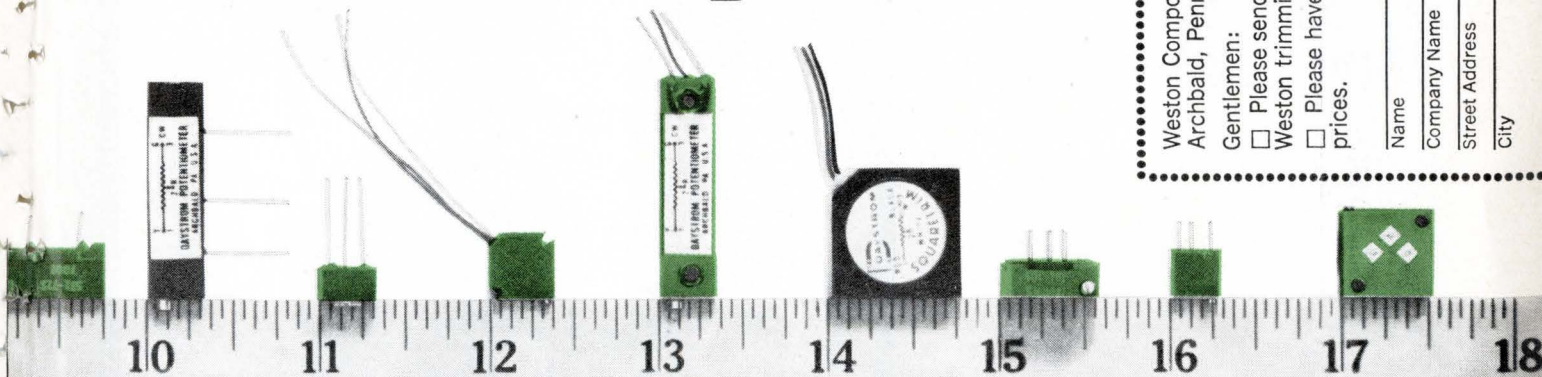

WESTON®

FOR EXCELLENCE IN TERMINATION HARDWARE SPECIFY GRAYHILL

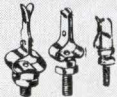

Test Clips

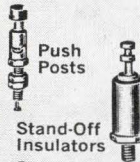

Push Posts

Stand-Off Insulators



Binding Posts

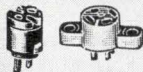

Sockets



Plastic Molded Parts



Test Clips

Adjustable tension, threaded studs or plug in bases, various sizes.

Push Posts

Plunger action lets you connect and disconnect quickly and easily, assures positive contact.

Binding Posts

Screw type or spring loaded, banana plug or stud mounting, single or multiple units, with various colors for circuit identification.

Stand-Off Insulators

High dielectric strength, low loss insulation, low moisture absorption, various mounting styles.

Sockets

Lamp or transistor, various colors, various mountings including printed circuit.

Custom Molded Parts

Tight tolerances provide you with "assembly ready" units. Thermosetting plastics to meet most specifications.

For your Grayhill Engineering Catalog offering complete technical data—contact



523 Hillgrove Avenue
LaGrange, Illinois 60525
Area Code 312, Phone 354-1040

... the Difference Between Excellent and Adequate

Circle 170 on reader service card

The power supply you plan to build is built!

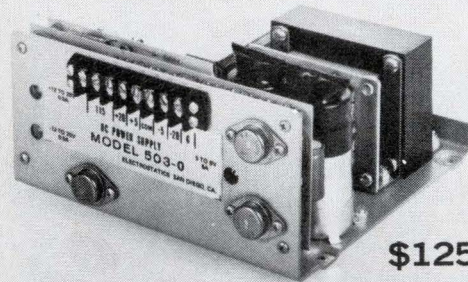

\$125 each

It's on the shelf, ready for immediate delivery from Electrostatics. With specs proven in service. Low cost. Brief specs on our Model 503:

- 3 DC Voltages
- All in one DC power supply
- + or - 4.5 to 6.5 at 5A
- +12 to 20V at 0.5A
- -12 to 20V at 0.5A
- Input 105-125V, 47-420 Hz
- Regulation: Line 0.01%
Load 0.1%
- Ripple: 500 μ V max.
- Temp: -20 to +71°C operating
- Foldback current limiting
- Size: 8" W x 4" H x 8" L

(\$150 with overvoltage protection)
For full information call Robert McCartney, Manager of Application Engineering, (714) 279-1414. Or circle the number below for our latest data sheet.

Electrostatics, inc.

7718 Clairemont Mesa Blvd., San Diego, California 92111

DEPT. 121

Circle 171 on reader service card

7th International Television Symposium Montreux Switzerland May 21 to 27 1971

This biennial event has become
a worldwide meeting place for the top men
in the technical fields of television.

Over 40 leading personalities serve on the Patrons' Committee, under the chairmanship of Mr. F. Locher, Director-General of the Swiss PTT-Enterprises
Symposium Chairman: Mr. W. Gerber, Berne
Corresponding members:
Mr. F. E. Borgnis, Zurich, and Mr. R. Theile, Munich

Highlights of the programme

International Review (progress reports)
Audio-Visual Systems for the Consumer
Round Table Conference on the New
Audio-Visual Era
New Products (exhibition and lectures)
Studio Automation
Satellite Communication
Broadcasting in Band VI
Cable TV, Electric Journal

Exhibition

The following firms have already expressed intention to take part in the 1971 exhibition:

- | | |
|--|---------------------------------------|
| AEG Telefunken (Germany) | Gates Radio Company (USA) |
| Ampex International (USA & GB) | Gretag AG (Switzerland) |
| Ets. P. Angenieux (France) | International Video Corporation (USA) |
| Autocue (GB) | Marconi Co. Ltd. (GB) |
| Balzars AG (Liechtenstein) | Memorex (GB) |
| Boston Insulated Wire & Cable Co. Ltd. (USA) | 3M Company (Germany & USA) |
| Co. B.A.R. Electronic SA (Belgium) | Norddeutsche Mende Rundfunk (Germany) |
| Cremer (France) | N. V. Philips (Holland) |
| Data Memory Inc. (USA) | Rank Precision Industries (GB) |
| Decca Radio & Television (GB) | RCA International Marketing (USA) |
| Dynair Electronics Inc. (USA) | Rohde & Schwarz (Germany) |
| Dynamic Technology Ltd. (GB) | Schlumberger (France) |
| EDS Engineering Design & Supplies Ltd. (GB) | Jos. Schneider & Co. (Germany) |
| Electromechanical Enterprise (Hungary) | Siemens AG (Germany) |
| English Electric Valve (GB) | Sondor (Switzerland) |
| EMI Electronics Ltd. (GB) | Sony (GB & Japan) |
| Felten & Guilleaume AG (Germany) | Stellavox (Switzerland) |
| Fernseh GmbH (Germany) | Thomson-CFS (France) |
| | Vitronic - P. Albrecht (Germany) |

For detailed information, contact:
7th Int. TV-Symposium,
box 97, 1820 Montreux,
Switzerland
Phone 021/61 33 86.
Telex 24471 Festimont.