

- 67 EE recruitment from minority groups steps up
- 97 Scan converter captures fast transients for analysis
- 125 A roundup of products bowing at Wescon

The changing face of  
Western electronics  
**A WESCON PREVIEW**

# Electronics

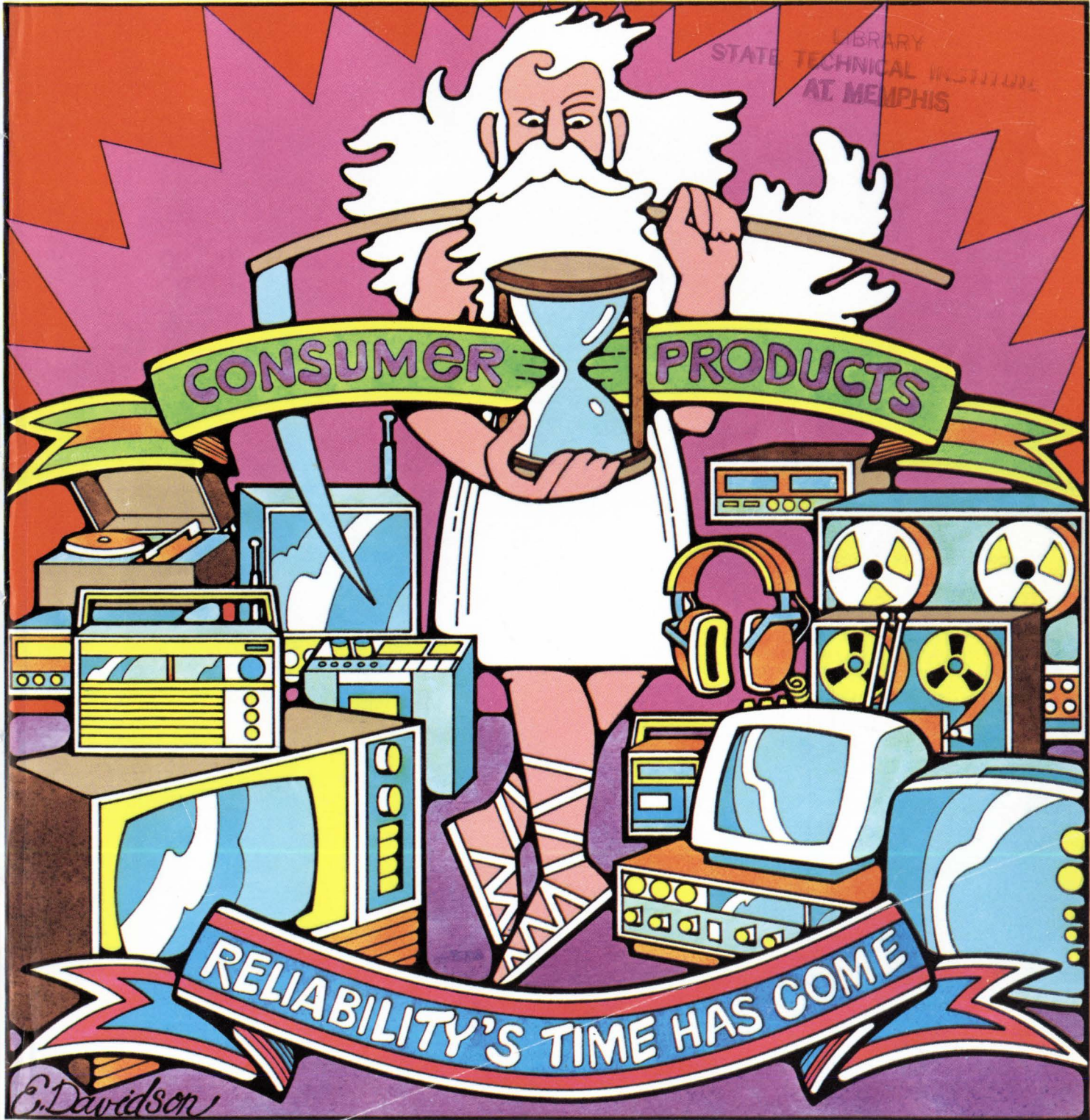



# Burroughs panel displays help you sell your products

"The SELF-SCAN<sup>®</sup> panel display provides a *CompuWriter*<sup>®</sup> feature never before available. . . now an average typist can set quality typography with ease because the SELF-SCAN panel displays each character and function as she keyboards so that she can verify or make corrections by individual character, word, or complete line. Burroughs panel displays DO help you sell your product." — Mr. John Peterson, Vice President, Domestic Marketing, for Compugraphic Corporation, 80 Industrial Way, Wilmington, Massachusetts 01887.

Helping you to sell your product helps us sell our product. That's why Burroughs family of panel displays is designed to provide the most pleasing, most readable character available today. Whether your application is for 8, 16, 32, 80, or 256 alphanumeric characters, Burroughs SELF-SCAN panel displays provide an economical approach to your readout requirement plus offer the extra advantage of adding aesthetic quality to your product.

Ask a Burroughs salesman to drop by and demonstrate his terminal in a briefcase. His SELF-SCAN panel display demonstrator is our best salesman.

Write or call  
Burroughs Corporation,  
Electronic Components  
Division, Box 1226,  
Plainfield, N.J. 07061  
(201) 757-3400



SELF-SCAN PANEL

**Burroughs**



"See us at Wescon Booth # 1622-1626"

Only Burroughs manufactures NIXIE<sup>®</sup> tubes, SELF-SCAN<sup>®</sup> panel displays and PANAPLEX<sup>™</sup> numeric panel displays.

Circle 900 on reader service card



# mighty mods...



## Now . . . High Efficiency, Switching Regulated Power Supplies

The new Switching Regulated Series is the most recent addition to the expanding line of Hewlett-Packard Modular Power Supplies. The MIGHTY MODS started with the 62000 Series — a complete line of modular power supplies with coverage from 3 to 48 volts, up to 192 watts.

The new Switching Regulated Supplies, Series 62600, feature advanced transistor switching design with up to 80% efficiency. You get more power in a smaller, cooler operating package . . . with 4 to 28 volts, up to 300 watts, 0.2% combined line and load regulation, 20mV rms/30mV p-p ripple and noise. And, HP thinks ahead to give you all the protection you need: overvoltage, overcurrent, over-temperature, reverse voltage and protected remote sensing. What it all adds up to is: selection, performance, reliability plus competitive pricing (with quantity and OEM discounts). Whether it's a modular, laboratory, or digitally programmable power supply — be confident when you specify . . . specify HP.

For detailed information, contact your local HP field engineer. Or write: Hewlett-Packard, Palo Alto, California 94304. In Europe, Post Office Box 85, Meyrin-Geneva, Switzerland.

HEWLETT  PACKARD

21303

Circle 1 on reader service card



# Self-Test Plus Sample And Hold... Now You Get Them Both In HP's 3490A.

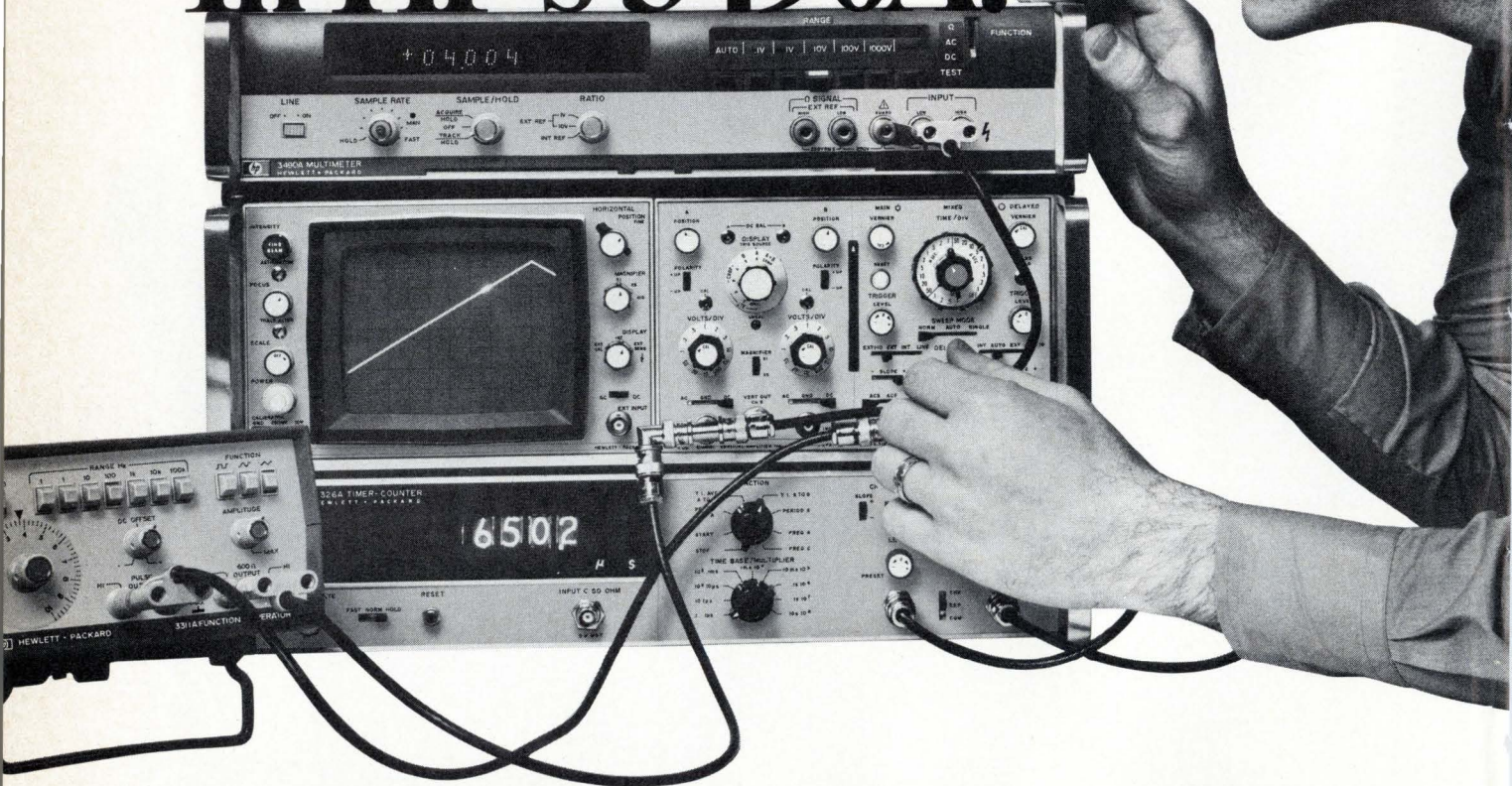

By adding a Sample and Hold option to our Self-Test 3490A, we've made a good DMM even better. And more accurate. Now, you'll be equipped to test ramp linearity; and pulse droop; and hysteresis; and peak amplitude — all at 0.01% resolution.

The Sample and Hold operates in either of two modes: **Track and Hold**, triggered from an external input; or **Acquire and Hold** that offers a built-in delay before reading. You'll find both modes valuable for testing network performance and production line testing.

**We Put It To Work**  
At HP, the 3311A Function Gen-

erator was one of the first instruments to benefit from the new Sample and Hold capability. We knew the 3311A offered exceptional value for the money — but we suspected that in some ways it was even better than we'd claimed. So we used the 3490A equipped with Sample and Hold to give us a much more accurate measurement of the 3311A's ramp linearity. The results: linearity was nearly ten times better than we'd originally spec'd it (triangle waveform mode). And while we were at it, we resolved the square wave flatness within 1mV.

So when you talk to our HP field engineer about the capable new

Sample and Hold option for the 3490A (base price \$1,650\*. Sample and Hold \$450\* extra), why not ask him to give you details on the better-than-we-thought 3311A. It was a bargain at \$249\* — now it's even more so when you consider the excellent ramp linearity.

\*Domestic USA Prices Only

**For new standards in digital voltmeters and signal sources, think HP.**

093/49

**HEWLETT  PACKARD**

Sales, Service and support in 172 centers in 65 countries. Palo Alto, California 94303. Offices in principal cities throughout the U.S.



## 29 Electronics Review

COMMERCIAL ELECTRONICS: Mitrix beamed at CATV market, 29  
LASERS: Lasers hold key to fusion energy systems, 30  
TRADE: Hong Kong booms out ICs and electronic products, 31  
AVIONICS: Univac gives voice to FAA experiment, 32  
GOVERNMENT ELECTRONICS: Railroad lab seeks test systems, 32  
COMMUNICATIONS: OTP tells FCC how to slice land-mobile band, 34  
SOLID STATE: Commercial CCD camera introduced, 36  
INSTRUMENTATION: Low-cost probe seeks hazards, bugs, 38  
AEROSPACE ELECTRONICS: Vulcan tests radiation hardening, 41  
NEWS BRIEFS: 42  
MILITARY ELECTRONICS: F-111 countermeasures funds sought, 42

## 52 Electronics International

JAPAN: Scriber uses laser for positioning, 52  
FRANCE: Birth pangs for cable TV, 52  
AROUND THE WORLD: 53

## 67 Probing the News

MANPOWER: Engineering schools court minority groups, 67  
COMPONENTS: Circular connectors—a start on standards, 70  
COMPANIES: AMS rolls with the punches and moves ahead, 74  
GOVERNMENT: Who watches the GAO as it watches you? 78

## 83 Technical Articles

CONSUMER ELECTRONICS: Factor reliability into design costs, 83  
DESIGNER'S CASEBOOK: Discriminator has one-shot, flip-flop, 92  
C-MOS counting circuit accumulates 2<sup>70</sup> pulses, 93  
Simple logic arrangement identifies first event, 94  
INSTRUMENTS: Silicon-target tube captures transients, 97  
ENGINEER'S NOTEBOOK: Power-supply design simplified, 103  
Table of conversion factors for ac waveform values, 104  
WESCON: Coast firms exploit consumer, commercial markets, 108  
Program reflects hot technology, sales boom, 116

## 125 New Products

WESCON '73 PRODUCT PREVIEW:  
Calculator controls instrument systems, 125  
Modular package permits fast breadboarding, 127  
Ease of operation built into 60-MHz scope, 127  
Function generator offers 100-microsecond response, 128  
Converter digitizes radar and TV signals, 130  
Pulse amplifier is versatile, 130  
IN THE SPOTLIGHT: 4,096-bit RAM uses one-transistor cell, 143  
INSTRUMENTS: Pulse generator offers six modes, 144  
PACKAGING & PRODUCTION: Test system checks up to 360 pins, 151  
COMPONENTS: Printed-circuit connector is gold-free, 156  
MATERIALS: 164

## Departments

Publisher's letter, 4  
Readers comment, 6  
40 years ago, 8  
People, 14  
Meetings, 20  
Electronics newsletter, 25  
Washington newsletter, 49  
Washington commentary, 50  
International newsletter, 55  
Engineer's newsletter, 107  
New literature, 165

## Highlights

### The cover: Reliability's hour has come, 83

The longer warranties now popular on consumer products are raising field-service costs, and this in turn is arousing new interest in component reliability. It's now the designer's job to learn how to trade off the price of this extra reliability against the likely service costs. Cover is by illustrator Everett Davidson.

### Military begins to standardize its connectors, 70

The armed forces have started to reduce to a precious few the accumulation during the past dozen years of a variety of connector types. The new specs apply principally to rear-release, circular, environmental connectors in standard, medium, and high densities. But manufacturers disagree on the probable effects of this standardization.

### Tube with silicon target stores fast transients, 97

An array of silicon diodes, serving as a target in a double-ended scan-converter tube, provides writing-charge gains of 2,000. With the aid of high-performance reading and writing guns, single-shot signals at up to 2-GHz frequencies can be displayed, and slightly slower ones can also be digitized.

### The West—and Wescon—go commercial, 108

With the move away from dependence on Government contracts well under way, the scene out West is wilder than ever, says this special report on Wescon. Suppliers are tangling with customers in the scramble for new commercial markets, business is booming, and technology is advancing smartly.

### And in the next issue . . .

Special report on medical electronics . . . a 4,096-bit RAM with only one transistor per cell . . . the spread of minicomputer networks



EDITOR-IN-CHIEF: Kemp Anderson

EXECUTIVE EDITOR: Samuel Weber

MANAGING EDITORS: Lawrence Curran, *News*;  
Arthur Erikson, *International*

SENIOR EDITORS: John Johnsrud,  
H. Thomas Maguire, Laurence Altman  
Ray Connolly

ART DIRECTOR: Fred Sklenar

ASSOCIATE EDITORS: John N. Kessler,  
Howard Wolff, Gerald M. Walker

#### DEPARTMENT EDITORS

*Aerospace*: William F. Arnold  
*Circuit Design*: Lucinda Matterna  
*Communications & Microwave*:  
Lyman J. Hardeman

*Components*: Joel DuBow  
*Computers*: Wallace B. Riley  
*Consumer*: Gerald M. Walker  
*Industrial*: Alfred Rosenblatt  
*Instrumentation*: Michael J. Riezenman  
*Military*: Ray Connolly

*New Products*: H. Thomas Maguire  
*Packaging & Production*: Stephen E. Grossman  
*Solid State*: Laurence Altman  
*Special Issues*: Harry R. Karp

COPY EDITORS: Margaret Eastman,  
Everett C. Terry

ASSISTANT EDITOR: Marilyn Offenheiser

ART: Charles D. Ciatto, *Associate Director*  
Patricia Cybulski, *Assistant Director*

PRODUCTION EDITOR: Arthur C. Miller

EDITORIAL SECRETARIES: Janet Annunziata,  
Julie Gorgoglione, Penny Roberts

#### FIELD EDITORS

*Boston*: Gail Farrell  
*Los Angeles*: Paul Franson (Mgr.)  
*Midwest*: Larry Armstrong (Mgr.)  
*New York*: Alfred Rosenblatt (Mgr.)  
*San Francisco*: George Sideris (Mgr.),  
Judith Curtis  
*Washington*: Ray Connolly (Mgr.),  
William F. Arnold  
*Frankfurt*: John Gosch  
*London*: Michael Payne  
*Paris*: Arthur Erikson  
*Tokyo*: Charles Cohen

#### McGRAW-HILL WORLD NEWS

*Director*: Walter A. Stanbury  
*Bonn*: Robert Ingersoll;  
*Brussels*: James Smith;  
*London*: Marvin Petal;  
*Milan*: Peter Hoffmann, Andrew Heath;  
*Moscow*: Axel Krause;  
*Paris*: Michael Johnson, Richard Shepherd;  
*Stockholm*: Robert Skole;  
*Tokyo*: Mike Mealey

PUBLISHER: Dan McMillan

ADVERTISING SALES MANAGER: Pierre J. Braudé  
ADVERTISING SALES SERVICE MANAGER:  
Wallis Clarke

BUSINESS MANAGER: Stephen R. Weiss

CIRCULATION MANAGER: George F. Werner

MARKETING SERVICES MANAGER:  
Tomlinson Howland

**W**escon is, for us, a good time to look at electronics technology and marketing in the West. You'll find, beginning on page 108, a special report on what's happening as the Sept. 11-14 show nears. The report was put together by our San Francisco bureau chief, George Sideris, and his Los Angeles counterpart, Paul Franson.

Some trends at Wescon time:

■ Vertical integration, such as the move by semiconductor makers into the systems market with microcomputers, is on the move.

■ Aerospace companies are not just adjusting to having to compete in commercial and consumer markets, but competing with gusto.

■ That old taboo—that components makers dare not compete with their subsystem and system customers—is crumbling fast as ways are found to shoot for specialized markets.

You'll also find in the Wescon pages a preview of the show's professional program, with its focus on components, instruments, medical electronics and market methods.

**T**he West is not the only place where electronics progress can be seen. Indeed, there's just about no place where the imprint of electronics is not being felt. So pervasive has electronics become that we've decided to devote an entire issue to detailing how the men and products of the electronics industries are having an ever greater impact—in some cases the deciding influence—on all the other activities that make up our technological society. Watch for our special October 25 issue.

**T**he time appears to be past when the mention of "a GAO investigation" can generate both fear and

fury in Federal electronics contractors. But the General Accounting Office run by Comptroller General Elmer B. Staats is still seen as an effective tool of the Congress in running down inefficiency that shortchanges Uncle Sam. As Senior Editor Ray Connolly points out in a look inside the GAO beginning on page 78, Staats' reputation for integrity and shrewd management has led Congress to grant him a great deal of freedom in redirecting GAO's efforts.

GAO still has many critics. However, their number seems to be increasing in Federal departments, where Staats has redirected the investigative spotlight, while electronics contractors see some relief from the earlier harsh tones of GAO reports that predated the Staats' era. Some manufacturers selling technology to the Government find it easier to deal with GAO since Staats has expanded his professional staff to include engineering, economics and management specialists as well as accountants and auditors.

"The increased use of science and technology," contends Staats, "has increased the imbalance in the roles of the executive branch and the Congress to the point where many students of government have begun to question seriously whether the Congress has the machinery to exercise adequately its responsibilities. Our objective is to recommend ways of making both proposed and ongoing Federal programs work better and to make the results of our studies known before decisions are reached."



August 30, 1973 Volume 46, Number 18  
91,625 copies of this issue printed

Published every other Thursday by McGraw-Hill, Inc. Founder: James H. McGraw 1860-1948, Publication Office 1221 Avenue of the Americas, N.Y., N.Y. 10020; second class postage paid at New York, N.Y. and additional mailing offices.

Executive, editorial, circulation and advertising addresses: Electronics, McGraw-Hill Building, 1221 Avenue of the Americas, New York, N.Y. 10020. Telephone (212) 997-1221. Teletype TWX N.Y. 710-581-5234. Cable address: MCGRAW HILL N.Y.

Subscriptions limited to persons with active, professional, functional responsibility in electronics technology. Publisher reserves the right to reject non-qualified requests. No subscriptions accepted without complete identification of subscriber name, title, or job function, company or organization, including product manufactured or services performed. Subscription rates: qualified subscribers in the United States and possessions, Canada, and Mexico \$6.00 one year, \$12.00 two years, \$16.00 three years; all other countries \$25.00 per year, except Japan \$50.00 per year and Brazil \$40.00 per year, including air freight. Limited quota of subscriptions available at higher-than-basic rate for persons outside of field served, as follows: U.S. and possessions and Canada, \$25.00 one year; all other countries \$50.00. Single copies: United States and possessions and Canada, \$1.00; all other countries, \$1.75.

Officers of the McGraw-Hill Publications Company: John R. Emery, President; J. Elton Tuohig, Executive Vice President-Administration; Gene W. Simpson, Group Publisher-Vice President; Senior Vice Presidents: Ralph Blackburn, Circulation; John B. Hoglund, Controller; David G. Jensen, Manufacturing; Gordon L. Jones, Marketing; Jerome D. Luntz, Planning & Development.

Officers of the Corporation: Shelton Fisher, President; Wallace F. Traendly, Group President, McGraw-Hill Publications Company and McGraw-Hill Information Systems Company; John J. Cooke, Senior Vice President and Secretary; Ralph J. Webb, Treasurer.

Title registered in U.S. Patent Office; Copyright © 1973 by McGraw-Hill, Inc. All rights reserved. The contents of this publication may not be reproduced either in whole or in part without the consent of copyright owner.

Subscribers: The publisher, upon written request to our New York office from any subscriber, agrees to refund that part of the subscription price applying to copies not yet mailed. Please send change of address notices or complaints to Fulfillment Manager; subscription orders to Circulation Manager, Electronics, at address below. Change of address notices should provide old as well as new address, including postal zip code number. If possible, attach address label from recent issue. Allow one month for change to become effective.

Postmaster: Please send form 3579 to Fulfillment Manager, Electronics, P.O. Box 430, Hightstown, N.J. 08520.



If you want  
a systems power supply for  
your system, one that you can  
plug and unplug with ease,  
look into

**KEPCO**

**OPS-II**

for an uncommitted  
amplifier

**CC**

for stabilized  
current

**PCX-MAT**

for stabilized  
voltage

**These three groups, all approximately  
20 watts in six voltage ranges,  
0-7 to 0-100V, are produced in  
a one-sixth rack format—  
really skinny supplies**

And they really do plug in—riding on guides to mate with a connector carrying source power and control signals and d-c output—yet, on that one-sixth width panel we've got two meters, 10-turn control, on/off switching, pilot, etc. (The OPS has a 10-terminal patch board for "doing your own thing".) There is a 3-unit rack housing and a 6-unit housing, (both 5¼" high x 19" wide) or you can choose between several bench-top housings. There is a digital programmer in compatible format too.

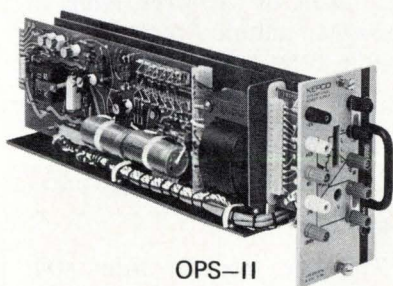

OPS-II

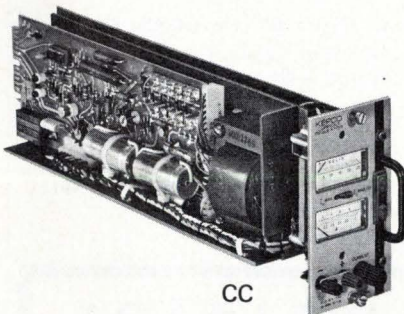

CC

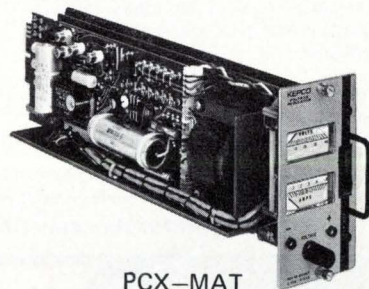

PCX-MAT

**KEPCO**®

Ask your Kepco man for details about the Kepco plug-in system supplies. If you don't know who he is, call (212) 461-7000 collect, or write Dept. AD-14 and we will be glad to direct you to the skinniest power supplies around.

KEPCO, INC. • 131-38 SANFORD AVENUE • FLUSHING, N.Y. 11352 • (212) 461-7000 • TWX #710-582-2631 • Cable: KEPCOPOWER NEWYORK



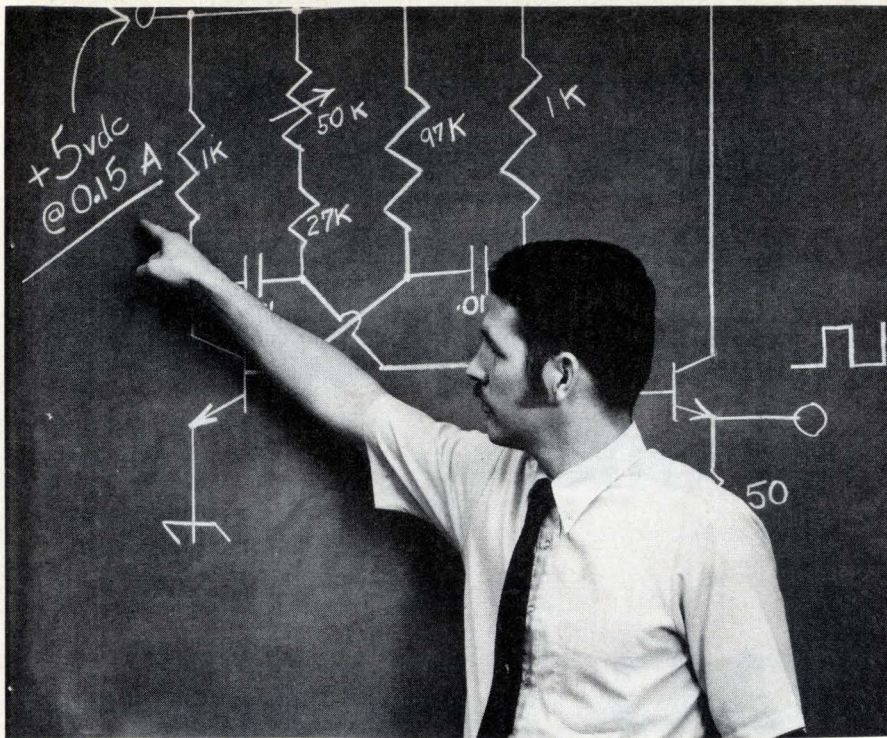

## How to Design Your Power Supply for \$66

You get the **complete schematic diagram, and parts list** with operating and installation instructions when you spend \$66 for an Abbott Model "RN" power supply. Two years in development, this model represents the latest state of the art in power module design. It features close regulation (0.1%), low ripple (0.02%), automatic short circuit and complimentary overvoltage protection and continuous operation in a 160°F ambient.

Abbott Engineers followed specific design criteria in engineering these modules. First, the electrical design was carefully engineered to insure that all components operate well within their limits, under "worst case" operating conditions. Second, the thermal design, including case construction, was carefully made to insure that the maximum temperature limits of all components are never exceeded. Then the size and weight of these modules were controlled to a minimum, without sacrificing reliability. Finally these units were thoroughly tested to make certain that all design and performance specifications were met.

So, you can build your own power supply using our schematic diagram if you want to—but we think we can build it more

Please see pages 686 to 699 of your 1972-73 EEM (ELECTRONIC ENGINEERS MASTER Catalog) for complete information on Abbott modules.

Send for our new 56 page FREE catalog.

reliably and for less cost, simply because we have been doing it for ten years. Put our power supply in your system first and try it. Examine its performance. We think you will be pleasantly surprised at the quality, adherence to specifications, and the reliability you find in the Abbott Model "RN".

Any output voltage from 5 to 100 volts DC with current from 0.15 to 20 amperes is available. **Many of the popular voltages are carried in stock for immediate delivery.** Please call us for attractive O.E.M. discount prices.

Abbott also manufactures 3,000 other models of power supplies with output voltages from 5.0 to 3,650 volts DC and with output currents from 2 milliamperes to 20 amperes. They are all listed **with prices** in the new Abbott catalog with various inputs:

- 60  $\Delta$  to DC, Hermetically Sealed
- 400  $\Delta$  to DC, Regulated
- 28 VDC to DC, Regulated
- 28 VDC to 400  $\Delta$ , 1  $\phi$  or 3  $\phi$
- 24 VDC to 60  $\Delta$ , 1  $\phi$

**abbott**

**t r a n s i s t o r**

**LABORATORIES, INCORPORATED**  
general offices

5200 W. Jefferson Blvd./Los Angeles 90016  
(213) 936-8185 Telex: 69-1398

**LABORATORIES, INCORPORATED**  
eastern office

1224 Anderson Ave./Fort Lee, N.J. 07024  
(201) 224-6900 Telex: 13-5332

## Readers comment

### In defense of bipolar

**To the Editor:** The article on semiconductor memories [*Electronics*, Aug. 2, p.75] was misleading in its comparison of bipolar and MOS. Among the errors that give a distorted picture of bipolar are:

- In the table on page 76, you list average price in large quantity of p-MOS at 0.4 cent/bit and 25 cents to 50 cents/bit for bipolar. Actually, bipolar prices are less than 2 cents/bit in quantity.

- You say that "these new methods [passive isolation by Fairchild and Raytheon] permit a maximum of 1,024 bits [in bipolar technology]." I'm sure no one sees the end of bipolar technology at a 1,024-bit RAM.

- You mention that Intersil Inc. is promising a 4,096-bit PROM by year-end. You failed to note that Monolithic Memories has been shipping a 4,096-bit PROM since the beginning of this year.

- You say programing (of PROMs) with fusible links takes several hundred milliseconds per fused location or 10 minutes per large array. Typically, Monolithic Memories programs fusible links in under 100 microseconds and programs 1,024 arrays in under 3 seconds.

- On p.80, you refer to the grow-back phenomenon that has plagued nichrome links and state that this phenomenon is not well understood. Actually, we can completely explain it and how to test for it. It is the result of having several volts across a fuse gap measuring several hundred angstroms, resulting in an intense, highly directed electrical field, causing migration in those fuses. This occurs for any fuse material, nichrome, silicon, or whatever. None of the new Monolithic Memories programmable ROMs have this problem.

Joseph J. McDowell  
Monolithic Memories Inc.  
Sunnyvale, California

### Correction

The 715 X-Y recorder from MFE Corp., Salem, N. H., is priced at \$1,060 with seven time sweeps. The published price was incorrect [*Electronics*, Aug. 2, p. 117].



# Save 37 weeks on your next microwave amplifier design— with MICroAMPs

Send for this. Read it. You'll be convinced.

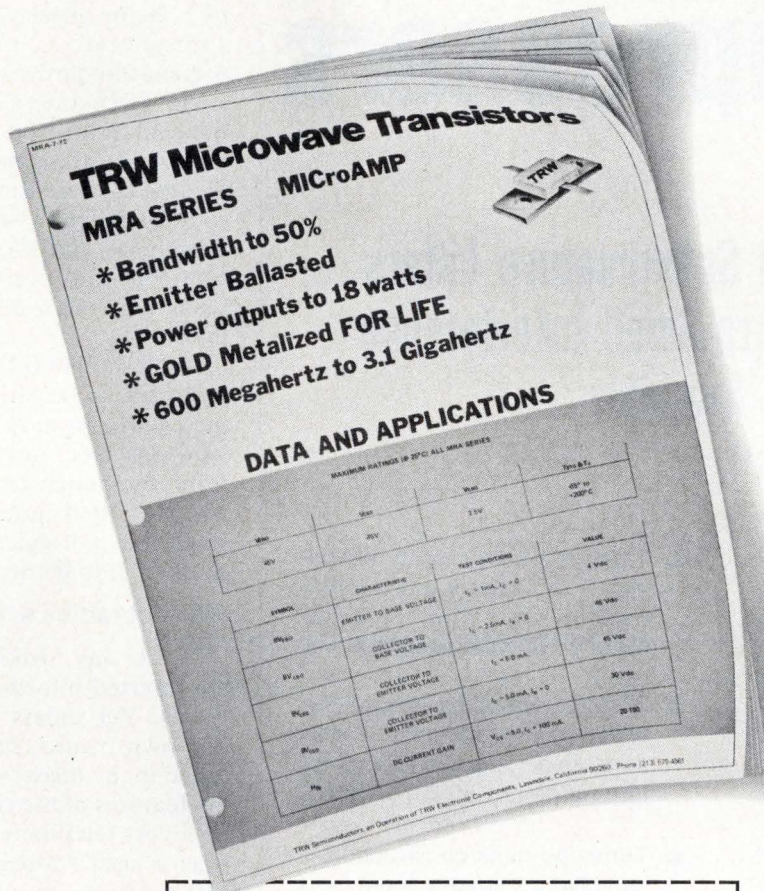

OK, convince me. Send your data and applications booklet on TRW MICroAMPs. Show me how input matching can help my broadband design go from paper to hardware in just 2 weeks.

Name \_\_\_\_\_ Title \_\_\_\_\_

Company \_\_\_\_\_

Address \_\_\_\_\_

City \_\_\_\_\_ State \_\_\_\_\_ Zip \_\_\_\_\_

Clip coupon and mail to Sales Manager, TRW Semiconductors, an Electronic Component Division of TRW Inc., 14520 Aviation Blvd., Lawndale, Ca. 90260. If you can't wait, phone: (213) 679-4561.

**TRW** SEMICONDUCTORS



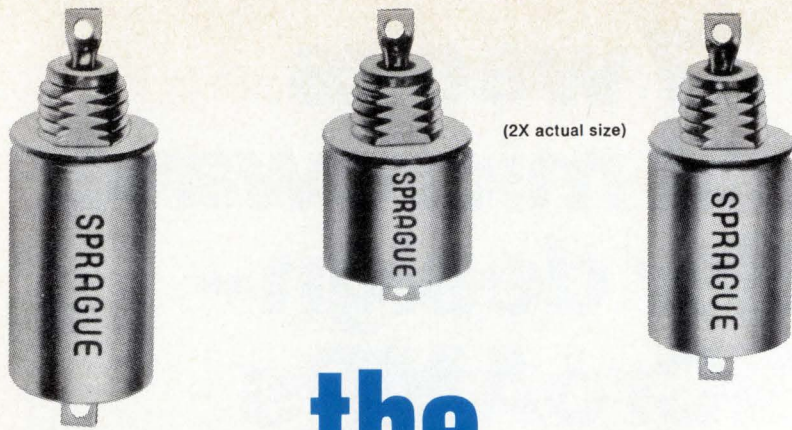

# the EMI suppressors

**Series JX2000/3000 Subminiature Filters . . .  
Broadest Line of Ultra-Small Interference  
Control Components Available . . .  
in 4 weeks or Faster!**

- High performance filters available in 5 different circuits—Feed-thru, L, PI, T, 2L . . . for a wide variety of applications, including power and control lines.
- High insertion loss characteristics . . . based on requirements of MIL-F-15733.
- Hermetically-sealed . . . with glass-to-metal seals in corrosion resistant metal cases.
- Small in size yet big in reliability . . . particularly useful for industrial and military high-density packaging applications.
- Excellent stability, even under adverse environmental conditions, over operating temperature range of  $-55\text{ C}$  to  $+125\text{ C}$ .
- Threaded-neck construction . . . effectively isolates input and output terminals.

**selected units NOW available  
OFF-THE-SHELF from your  
Sprague Industrial Distributor**

For complete information, write for our new 16-page Engineering Bulletin 8132 to: Technical Literature Service, Sprague Electric Company, 35 Marshall St., North Adams, Mass. 01247.



THE BROAD-LINE PRODUCER OF ELECTRONIC PARTS

## 40 years ago

From the pages of *Electronics*, August 1933

### Did they know how small?

"Under demand from the automobile manufacturers for smaller radio sets for installation on cars, tube engineers have gone into huddles to see what can be done. In this issue of *Electronics* will be found a description of laboratory types of tubes directly aimed at very short wavelengths. The dimensions of these new tubes have been reduced by a factor of ten; but the electrical characteristics are as good as present standard sized tubes. . . .

"In Germany, a new core material containing iron is being used for interstage transformers, reducing the size of these components. In this country Polyiron seems to be winning more and more recruits. Iron core coils and iron core tuning will reduce the size of radio sets further. . . .

"And so the tuning mechanism of radio sets is steadily being reduced in size. Time may come when the loud speaker must be separated from the tuner because the latter will be fitted into dimensions so small that not even a poor speaker could go into the space."

### Why not radios with a ringer?

"Each day striking news events are inserted into the broadcast programs. Yet unless the listener has his own radio set continuously tuned in, he misses these most thrilling features of the radio day.

"Every telephone has a bell to attract a user's attention. Without a bell a telephone would be only 50 per cent as useful.

"Yet the average radio receiver is like a telephone without a bell.

"The listener misses some of the best things on the air because he has no way of being notified. If there were some way of calling him to his radio set by means of a bell or signal light, he would be able to enjoy special features.

"A low frequency control tone on the station's carrier wave, inaudible to the ear, but capable of operating a signal relay, might be one way to do the job. Clock control for special periods would be another solution."



## Another FIRST from DDC...

The smallest glitchless DAC is also the fastest! . . . 13 bit resolution, settling time 50 ns per bit . . . in the first hybrid glitchless DAC. From DDC, of course. DDC, the leader in data conversion, has done it again! This time with the first hybrid deglitched digital-to-analog converter. So you could have the benefits of high speed plus compact size for critical CRT displays and precise testing applications.

The new Model DDAC hybrid features a 13 bit monotonic output, with programmable output of  $\pm 2.5V$ ,  $\pm 5V$ , or  $\pm 10V$  and 300mA coax drive capability. Other features include internal or external reference, 150 mV•ns glitch, and short circuit protected output. It's available as a complete two channel P.C. card assembly, a set of 3 hybrid modules or individual DAC, deglitcher, and coax driver.

And it's from DDC. The data conversion people who have made a habit of being first.

For product or technical applications information, write or call Steve Muth or Jim Sheahan. They're engineers, so they talk your language.

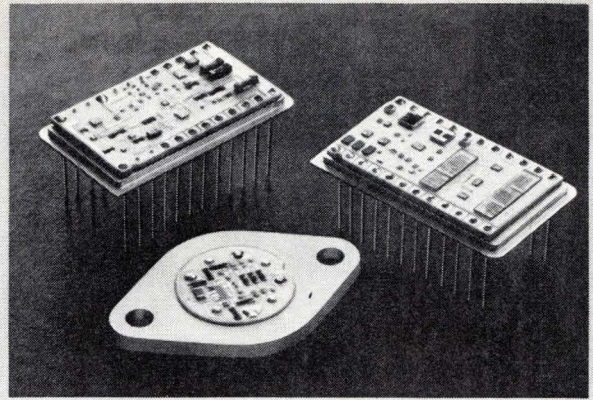

# DDC

A subsidiary of ILC Industries, Inc.

## ILC DATA DEVICE CORPORATION

100 TEC STREET, HICKSVILLE, N. Y. 11801 • PHONE: (516) 433-5330

Shaping the future of data conversion.

APPLICATION CENTERS

Long Beach, Calif.  
(213) 597-5744

Washington, D. C.  
(703) 536-2212

Bruxelles, Belgium  
Tel. 62.01.59

# Shaping the future of Display DACs

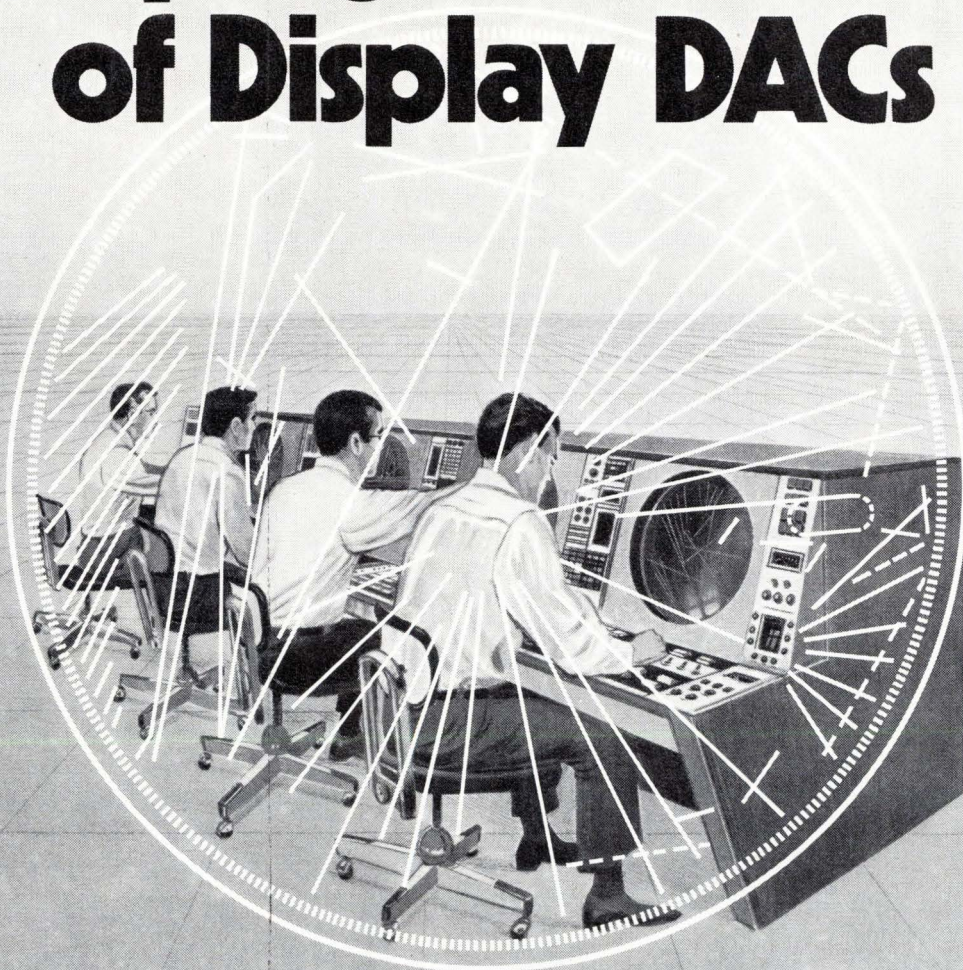

Circle 9 on reader service card



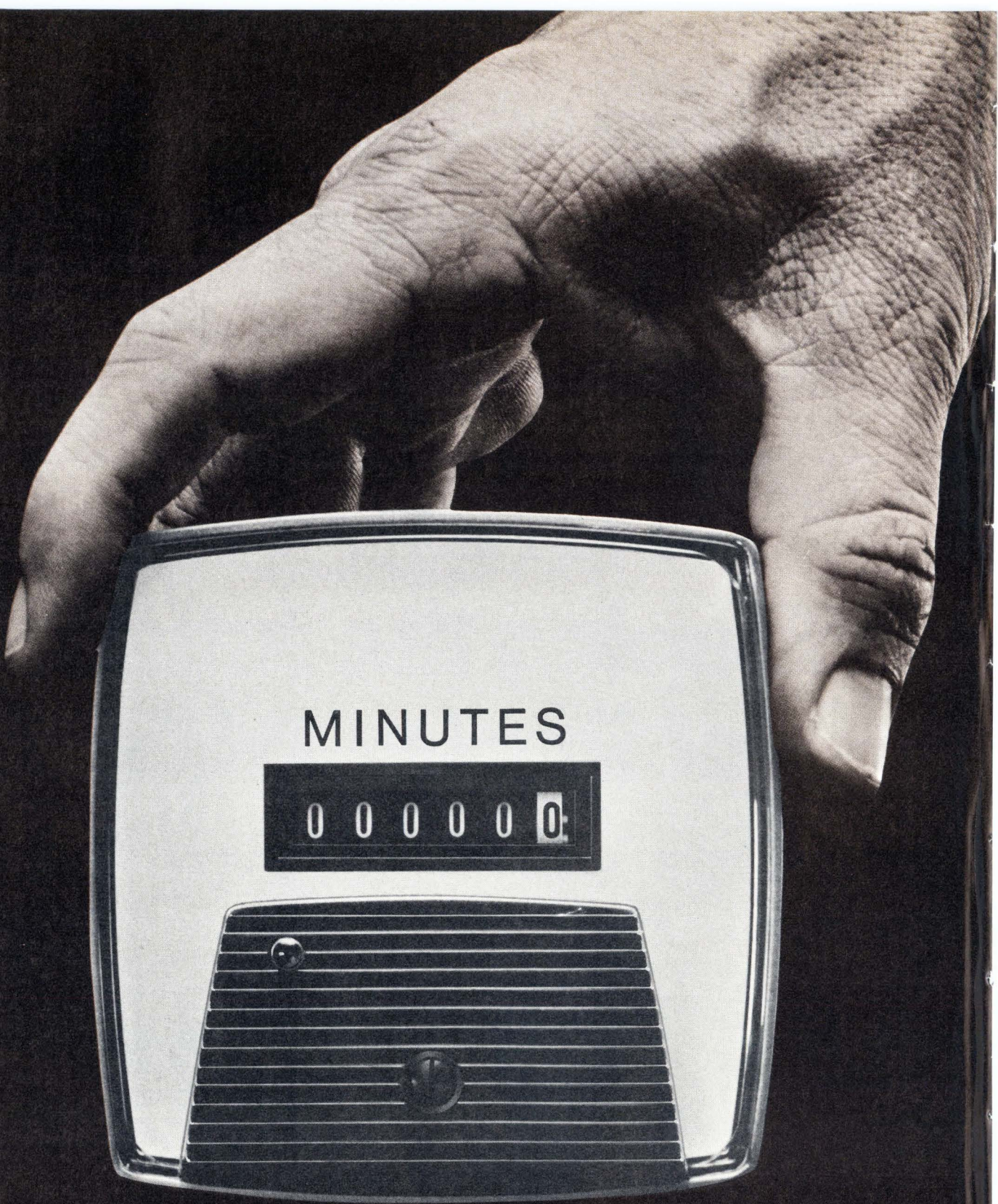

MINUTES

0 0 0 0 0 0

GENERAL  ELECTRIC



# All Time Meters are not created equal.

Only General Electric gives you  
reliability like this . . .



Our new Type 240 elapsed-time meters are recognized under the Component Program of Underwriters' Laboratories, Inc. Inside is a GE Telechron synchronous motor with proven dependability, and the all-new time-keeping mechanism never requires maintenance. Even the outside case is made of tough GE Noryl® for impact resistance. When you specify GE time meters, you can stop worrying about reliability.

Resetting is easy . . . just push  
the button.

Reset your hours or minutes indicator to zero simply by pushing the button. No knobs. No wasted motion. Just fast and accurate resetting every time. Push-button reset is available on Type 240 in behind-panel or BIG LOOK® style in 2½" and 3½".



GE time meters go where you want.

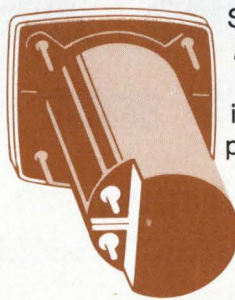

Slip the new Type 240 into *existing* mounting holes . . . just order from a variety of optional mounting-stud positions. And no new punching or dimensional drawing changes are needed to replace older GE Type 235 or 236 time meters. You can replace whatever you're using with new Type 240's. And get crisp, readable style to improve your panel or equipment.

The time meter you need is ready.

There's the all-new, behind-panel model (with glass window) for a neat, trim look. Or the wide-eyed BIG LOOK style that matches your other GE panel meters. Or choose the weather-proof conduit case, the round case, the square case, or the portable-stand case. In 120, 208, or 240-volts a-c and 50 or 60 Hertz. No one can match your design requirements like General Electric.

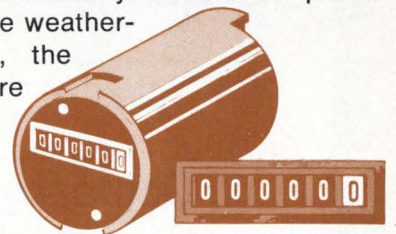

For a catalog of GE's full line of panel meters, contact your nearby authorized GE Distributor, Modification Center, or GE Sales Office. Or write to General Electric Company, Section 592-46, One River Road, Schenectady, N.Y. 12345.

## Specify General Electric... just for good measure.

Circle 11 on reader service card



# \$5,600 BUYS A NEW 16K NOVA 2.

Data General Corporation  
Southboro, Massachusetts 01772

Department E

- Please send me more information on Nova 2.
- Please have a salesman call on me.
- Please add my name to your mailing list.

---

Name

---

Title

---

Company

---

Street

---

City

---

State

---

Zip Code

---

Telephone

---



Nova 2 is so inexpensive that it even looks good with a quantity-one price tag of \$5,600\*. And after our liberal quantity discounts are applied, the price looks even better. Especially when you consider what your money buys.

It buys a Nova 2 that includes a high-speed, multi-accumulator central processor unit, a 16-bit word length, I/O system with programmed data transfer, 16-level programmed priority interrupt, high-speed Direct Memory Access data channel, programmer's console, 4-slot mainframe, and power supply.

It buys 16,384 16-bit words of 1000-nanosecond memory. That's twice the memory of other computers with comparable price and performance.

It buys a product concept whose reliability has been proven in over 7,000 installations around the world.

It buys a Nova 2 that's backed by a comprehensive customer-support organization that can provide documentation, training, field and factory service, and applications know-how.

It buys a Nova 2 that's entirely compatible with Data General's options, peripherals, interfaces and software.

\$5,600. You get a lot for your money.

\*Minimum order, five systems.

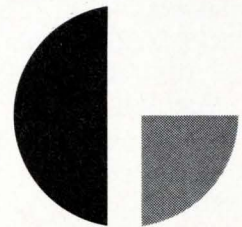

DATA GENERAL  
CORPORATION

Southboro,  
Massachusetts 01772  
(617) 485-9100



# FREE Engineering Handbook from RCL Electromagnetic Delay Lines

Including Dual-In-Line  
(DIP)

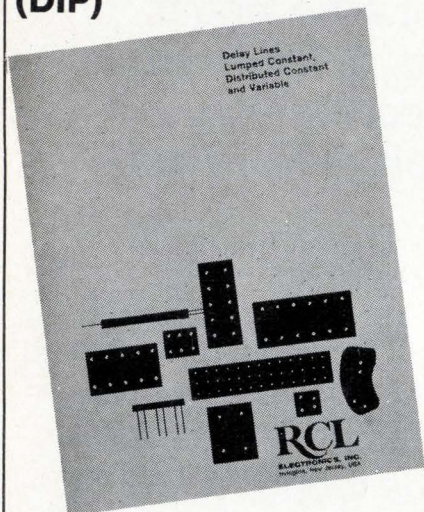

**NEW  
'73**

**EDITION**

Terms... engineering definitions... test methods ... how to specify delay lines ... characteristics of various types... specifications ... they're all included in this concise, easy-to-read handbook... yours for the asking.

**LUMPED CONSTANT ...  
DISTRIBUTED CONSTANT  
... VARIABLE**  
all three types are covered  
in this reference  
handbook.

# RCL

RCL ELECTRONICS, Inc.,

General Sales Office:

Seven Hundred  
South Twenty First Street  
Irvington, New Jersey 07111

## People

Simmers now pitches  
automated testers

David F. Simmers, who once pitched for the Penn State baseball team, may envy his teammates who went on to play professional ball. But Simmers is playing in yet another major league—the design of automated test systems—in his new job as chief engineer of Instrumentation Engineering Co. in Franklin Lakes, N.J.

In the three years since this company conceived and designed its model 390 automated test system, it has sold some two dozen of them to such companies as Xerox, Western Electric, and also to Sperry Gyroscope. Recently, Siemens AG in Munich ordered a system with a price tag of well over \$750,000.

Simmers will be responsible for all engineering activities relating to the 390 systems. He joins I-E after 13 years with RCA, where most recently he directed automated-test activities at the Astro-Electronics division in Princeton, N.J. "I learned in the mid-1960s that I really enjoy working with computer-based test equipment," he says.

After earning his BSEE at Penn State in 1959, Simmers joined RCA in Camden. "Those were the days when you designed digital circuits with discretes. Germanium transistors were on the wane, and silicon devices were taking their place. There was no such thing as a digital IC. You built flip-flops from scratch with discretes and some resistors."

Simmers shifted to RCA in Hightstown, N.J., where he worked for a time on spacecraft testing and automated test equipment. He found time amid these changes to earn his MSEE from the University of Pennsylvania in 1962.

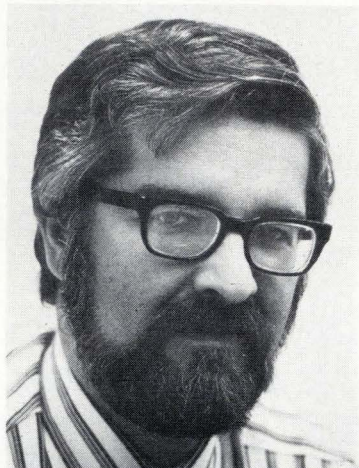

**New chief engineer.** Dave Simmers heads ATE effort at N. J. firm.

**The way to go.** "The nice part of being in automatic test equipment is that your customer usually convinces himself that automated testing is the way to go—that it's cost-effective. Often he is seeking our 390 system as a means of testing sophisticated pc boards." The 390 is a computerized circuit-board tester that uses an English-language test program, and Simmers says it offers universality in that it promises to test every printed-circuit board in a company's inventory on the same test station.

Simmers plays tennis regularly, but says it has been a while since he has squeezed in a round of golf.

Simmers has one regret: "If I had it to do over again, I would have attended a small college. I could have gotten in more innings on the mound. Who knows—maybe I would have thrown that elusive no-hitter."

Edelson sees move  
to higher frequencies

It almost seems as though Burton I. Edelson's career and the fortunes of the Communications Satellite Corp. were fated to merge. As a Navy communications officer assigned to the White House in 1962, he helped draft the legislation creating Comsat. And after retiring from a 20-year Navy career, Edelson helped start up Comsat's laboratories in Clarksburg, Md. Now, as the new acting director, he oversees the labs' transition to an applications-oriented role.

"Our major effort now is to define the Intelsat-5 system" in an in-house study covering earth stations for space communications, he says. Due in October for the International Telecommunications Satel-



# What this country needs is a good \$1,000 full-scale computer.



Introducing the computer for everybody. NAKED MINI™/LSI.

It's the computer for people who never thought they could afford a computer for their product.

It's also for people who have always been able to afford more, but have always gotten less computer than this.

NAKED MINI/LSI is the first OEM mini-computer designed for widespread, multi-level use. The first computer able to do more jobs than any computer could ever do before.

To do this, we had to give it an unheard of combination: extensive 16-bit computing power, large memory, and a small price tag. Specifically, NAKED MINI/LSI is the first computer powered to satisfy 90% of all potential minicomputer applications—and yet be priced as low as \$990 in OEM quantities of 200. And that price includes 4K words of memory.

Imagine it. For a price less than most hardwired circuitry or even a microcomputer,

your product can benefit from a general purpose computer having powerful arithmetic capabilities, up to 256K 16-bit words of memory, both byte and word processing, and uniquely flexible input/output.

Without going into all the jazzy widget features, let's just say that the NAKED MINI/LSI gives your product all the performance it could need to monitor, sequence, and control effectively. Which means your product will be more competitive, more flexible, and more immune to obsolescence.

And because we used LSI technology to make our new computer, you can add all this clout simply by plugging in a single card that measures 1" x 15" x 17" and weighs only 4 pounds.

For full details on the NAKED MINI/LSI (or its stand-alone counterpart, ALPHA/LSI), write Computer Automation, Inc., 18651 Von Karman, Irvine, Calif. 92664. Or call: (714) 833-8830. TWX 910-595-1767.

## The NAKED MINI™/LSI from Computer Automation.

Circle 15 on reader service card



# A leader in everything new in electrical measuring instruments, Simpson Electric.

## And Plenco has a part in it.

## Over 500 parts.

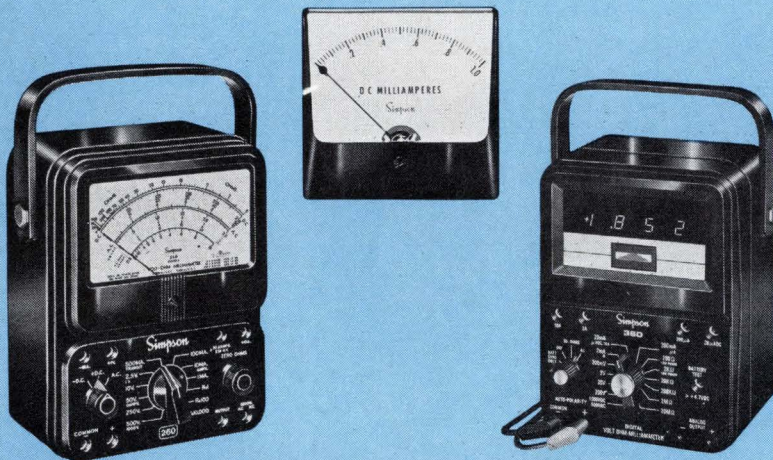

The widely-accepted new digital VOM 360®, popular Wide Vue Panel Meter, and the famous 260® Series 6 you see here are made by Simpson Electric Company, Chicago, the world's largest manufacturer of panel meters and electrical/electronic measuring instruments. They have to withstand tough service yet assure accuracy and sensitivity.

Plenco is able to contribute by providing molding materials for intricate internal components (plus housings, covers and knobs) that are dimensionally stable to meet Simpson's exacting requirements. Materials as high in electrical, impact and heat resistance as

specified, and offering molding characteristics to permit the close tolerances called for at any given check point.

Simpson has specified these Plenco materials in more than 500 separate instances. That's a lot of tests to pass.

Try us with yours.

**PLENCO**  
THERMOSET PLASTICS

PLASTICS ENGINEERING COMPANY  
Sheboygan, Wis. 53081

Through Plenco research . . . a wide range of ready-made or custom-formulated phenolic, melamine, epoxy and alkyd thermoset molding compounds, and industrial resins.

## People

lite Consortium network, which Comsat manages, Edelson adds, "It's a massive study calling on all parts of the company, and the labs are leading the effort." The "5" system will be based on present technology but include time-division multiple-access capability and a move to higher frequencies. The launch might be as early as 1978 or as late as 1982.

**Power vs capacity.** Citing the "bad tradeoff" between added capacity and more power of the Intel-sat-4 models, Edelson rejects "brute-force increases in power and size." Instead, increasing the bandwidth seems to be the answer—"we'll most likely go to 14 and 11 gigahertz."

However, higher frequencies bring other problems. "There is more attenuation in higher frequencies due to rainfall," he says. But this is "what advanced technology encompasses—interconnectivity." He explains that with higher-frequency, narrower "spot" beams, spacecraft require more precise stabilization systems, and this requires development of better sensors, thrusters, and memories.

**Odyssey.** If Edelson has the look of a man confident of the future of communications, maybe it's because, in a sense, he's been there already. One of his last Navy jobs was technical advisor to Arthur C. Clarke for the film "2001—A Space Odyssey."

He was also scientific and technical officer for missile and space technology at the Office of Naval Research in London. A U.S. Naval Academy graduate, he has MS and Ph.D. degrees in metallurgy from Yale University, and is a Senior Member of IEEE and a Fellow of the British Interplanetary Society.

**Former naval person.** Burt Edelson directs Comsat's laboratories in Clarksburg, Md.





# Boost memory speed and capacity to new heights.

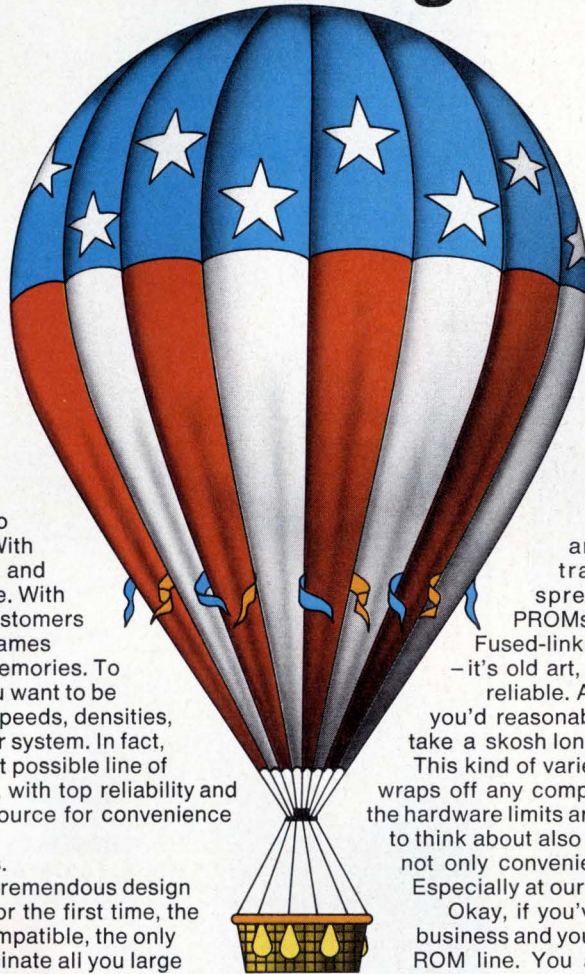

## PROMs to 15nS, ROMs to 4096 bits.

We hear you talking: you want to design a more powerful machine. With faster access times, more memory and more kinds of memory in less space. With programming tricks that let your customers abbreviate instructions and play games between several processors and memories. To get that kind of machine power, you want to be able to mix and match all kinds of speeds, densities, and organizations to maximize your system. In fact, what you really want is the broadest possible line of fast and dense PROMs and ROMs, with top reliability and lowest cost, preferably from one source for convenience and compatibility.

Now you've got it, from Signetics.

In our PROMs alone, look at the tremendous design possibilities. You're seeing here, for the first time, the brand new 15nS 10139. It's ECL compatible, the only one in the world. That ought to fascinate all you large main frame builders. Now, go over to TTL and Schottky TTL and you'll see six more PROMs. Fast ones, from 25nS to 40nS, in organizations from 32 x 8 to 256 and either tri-state or open collector. Which should turn on you fellows who work with all those peripherals.

In ROMs, when large production runs and few patterns make them a good tradeoff, Signetics gives you a wide spread, with speeds comparable to our PROMs, and densities even higher.

Fused-link PROM construction is used throughout - it's old art, at Signetics, and proven to be utterly reliable. And you can get PROMs in any pattern you'd reasonably want, without delay. ROM patterns take a skosh longer.

This kind of variety and performance ought to take the wraps off any computer designer's imagination, because the hardware limits are essentially wiped out. What you want to think about also is that when you field program you get not only convenience and flexibility, but cost savings. Especially at our low prices. So, think PROMs.

Okay, if you've read this far, you're in the memory business and you need more information on the PROM/ROM line. You also deserve a reward, we think, for professional diligence. We're happy to provide you both... an armload of backup data plus a FREE sample of any unprogrammed PROM or random pattern ROM listed in the chart. Simply do the obvious things with the coupon below. And we'll do the rest.

PROMs			
Device Organization	Typical Access Time	Device #	Type
32 x 8	15nS	10139	New unique, ECL 10K
32 x 8	25nS	82S23	Schottky TTL open collector
32 x 8	25nS	82S123	Schottky TTL (tri-state)
32 x 8	35nS	8223	TTL open collector
256 x 4	40nS	82S26	Schottky TTL open collector
256 x 4	40nS	82S29	Schottky TTL (tri-state)
ROMs			
256 x 8	35nS	8204	Schottky TTL (tri-state)
512 x 8	35nS	8205	Schottky TTL (tri-state)
1024 x 4	50nS	8228	Schottky TTL, totem pole

Attach this coupon to company letterhead and send to:

Signetics - PROM/ROM 811 East Arques Avenue Sunnyvale, California 94086		
About PROMs and ROMs, please send me your handbook, applications memos, ROM programmer brochure, and a list of your distributors. Also, send me one (1) free sample unit of the # _____ listed in the table.		
Name	Title	
Company		
Address		
City	State	Zip
<small>Signetics Corporation. A subsidiary of Corning Glass Works.</small>		

## signetics



# Growing with the

**Amphenol's new telephone connector system saves space, saves time, saves material.**

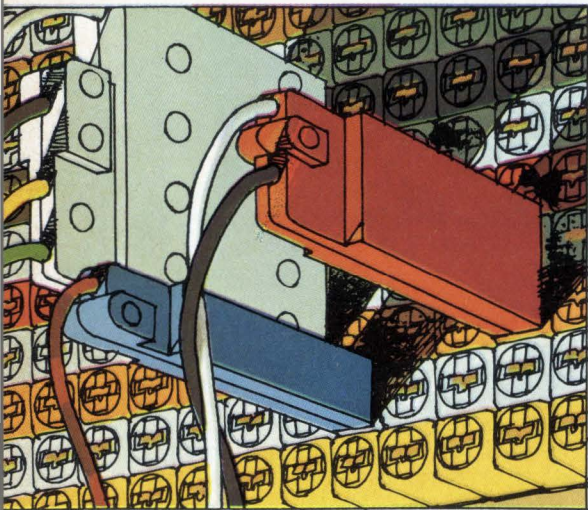

It's called Circuit Concentration Bay (CCB) and was first used to alleviate the problem of overcrowded distributing frames in a major Colorado telephone company central office. More than five miles of cable were actually eliminated in this installation. Floor space requirements were reduced by 80 per cent.

As more and more phone companies gain experience with CCB, it is also becoming clear that the savings in labor are at least as great as the space savings. Instead of the tedious, time-consuming job of hand soldering each connection, the craftsman uses color-coded miniature patchcords to complete circuits in about one-twentieth the time. And circuit interruptions found in normal distributing frames are virtually eliminated.

The savings in space, materials and labor due to Amphenol's CCB system are adding up to tremendous cost reductions and improved service for phone companies across the country.

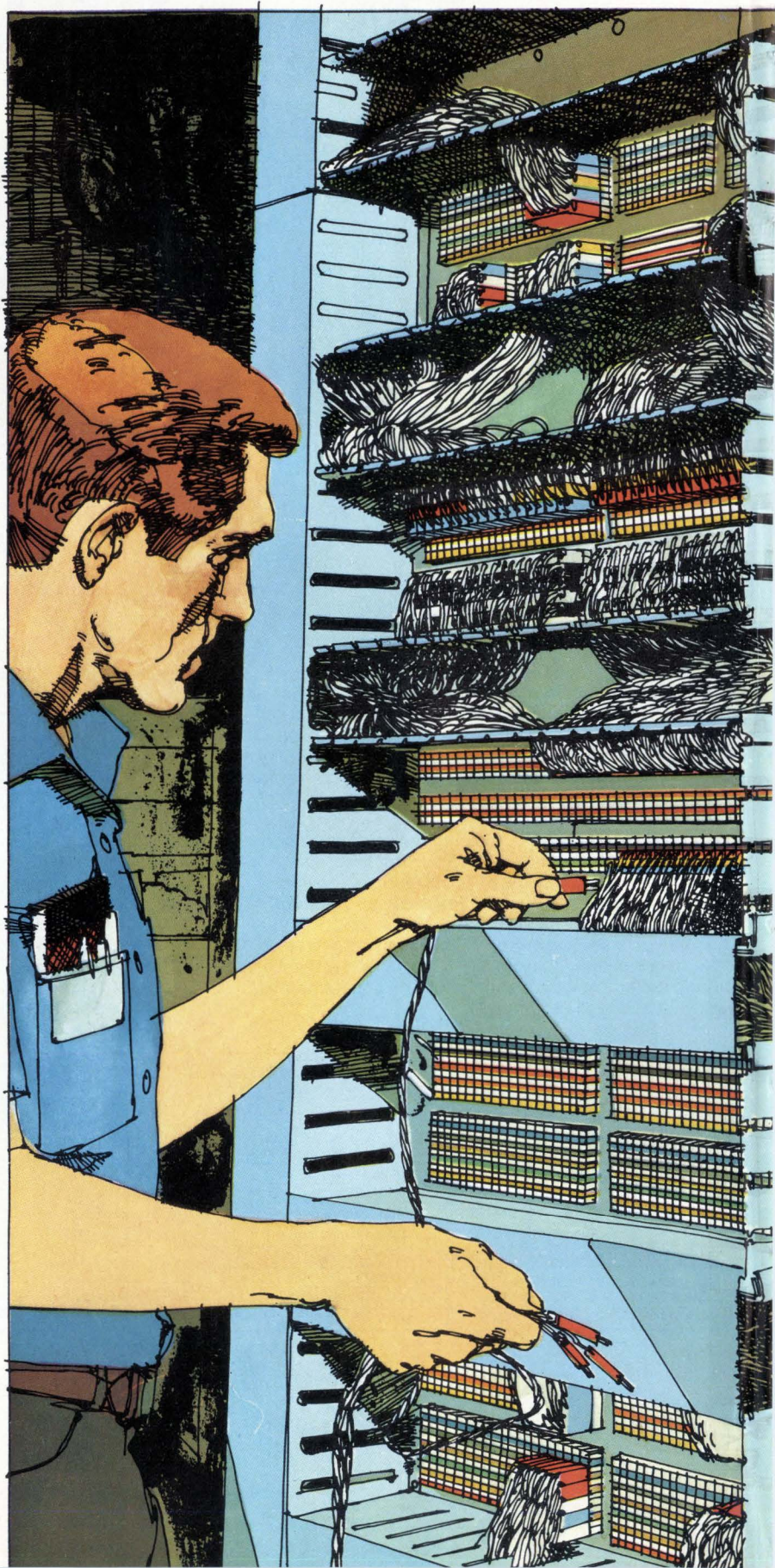



# new electronics

**Amphenol connectors help a mini-computer control a 70,000 vehicle intersection.**



A sophisticated traffic control computer was installed last year to tame an unusually busy intersection in Campbell, California.

Environmental problems are tough because the controller is located right at the intersection. It must remain unaffected by temperature variations between 0 and 120°F. and by voltage variations of plus or minus 10 per cent. It must perform faithfully for years to come.

That's why Amphenol's 5015 series connectors were selected. Our "Old Vet" has a service record in tough environmental conditions that no one can match. Some "Old Vets" are in service after over 30 years on the job.

That's important to Campbell, California because their traffic controller has a lot of work ahead of it.

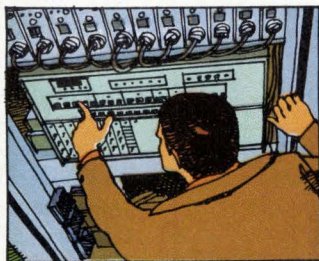

**Amphenol digital turns-counting dials help load a ship by computer.**

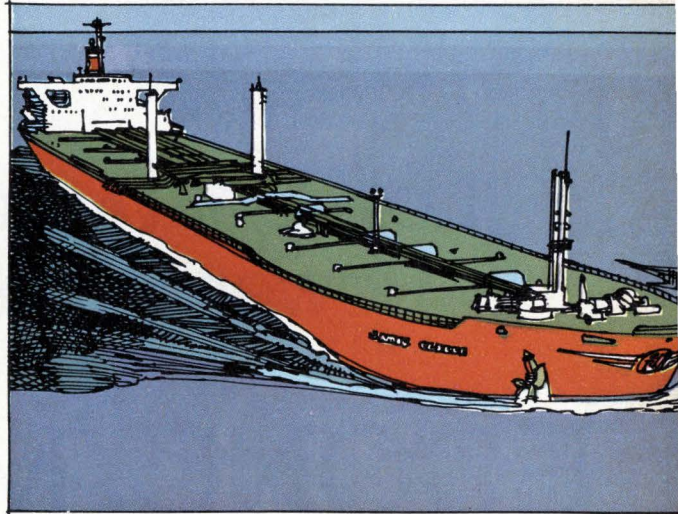

Unless a ship's cargo is distributed just right, stresses can cause extensive hull damage. So proper load distribution is critical. That's why one of the world's largest shipbuilders has developed an electronic cargo distribution computer. It presents cargo placement and hull stress information continuously.



The Swedish manufacturer selected Amphenol dials for this computer because they're so easy to read. A magnifying window significantly enlarges the numerals and vernier scale, and digital readout is angled to the perpendicular for easy viewing from all positions.

Easy readability of the computer input devices is essential because a misread digit, when fed into the computer, could cause a disastrous error in loading.

**BUNKER  
RAMO**

# AMPHENOL

For more information, contact these manufacturing/sales facilities. **United States:** Amphenol Sales Division, 2875 S. 25th Av., Broadview, Il. 60153 **Canada:** Amphenol Canada Ltd., 44 Metropolitan Rd., Scarborough, Ont. **Great Britain:** Amphenol Ltd., Thanet Way, Tankerton, Whitstable, Kent, England **West Germany:** Amphenol-Tuchel Electronics GmbH, 8024 Deisenhofen bei Munchen, West Germany **France:** Usine Metallurgique Doloise, 92a98 Avenue de Gray, 39100—Dole, France **Australia:** Amphenol Tyree Pty. Ltd., 10-16 Charles St., Redfern, N.S.W. 2016, Australia **India:** Amphetronix Ltd., 105 Bhosari Industrial Area, Box 1, Poona 26, India **Japan:** Daiichi Denshi Kogyo K.K., 20, 3-Chome, Yoyogi, Shibuya-ku, Tokyo, Japan 151

Circle 19 on reader service card



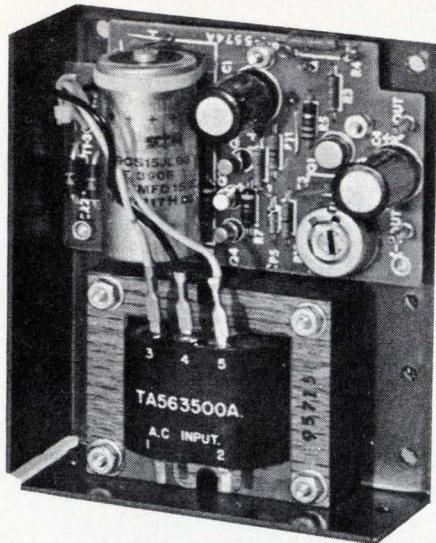

FROM  
**\$19<sup>95</sup>\***

# Low Cost Modular Power Supplies New **ECONO/MATE**

Model	DC Output		Only
	Voltage	Amperes	
EM-5B	5	3.0	\$39.95
EM-6B	6	2.4	39.95
EM-12B	12	1.5	39.95
EM-15B	15	1.3	39.95
EM-24B	24	1.0	39.95

Model	DC Output		Only
	Voltage	Amperes	
EM-5D	5	12.0	\$99.95
EM-6D	6	10.0	99.95
EM-12D	12	6.5	99.95
EM-15D	15	6.0	99.95
EM-24D	24	5.0	99.95

Model	DC Output		Only
	Voltage	Amperes	
EM-5C	5	6.0	\$59.95
EM-6C	6	5.0	59.95
EM-12C	12	3.0	59.95
EM-15C	15	2.8	59.95
EM-24C	24	2.3	59.95

**ECONO/MATE  
 SINGLE OUTPUT  
 SAME DAY SHIPMENT**

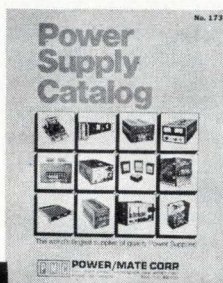

WRITE FOR FREE  
 CATALOG GIVING FULL  
 MODEL SPECIFICATIONS



\*QUANTITIES OF 1000

# POWER/MATE CORR

514 S. River Street, Hackensack, N. J. 07601 / Phone (201) 343-6294  
 TWX 710-990-5023

## Meetings

**European Microwave Conference:** IEEE, IEE, Brussels University, Belgium, Sept. 4-7.

**Western Electronic Show & Convention (Wescon):** Wema, Civic Auditorium and Brooks Hall, San Francisco, Sept. 11-14.

**Indian Electronics Trade Fair:** Trade Development Authority, Taj Mahal Inter-Continental, Bombay, Sept. 15-17.

**Electronic and Aerospace Systems Convention (Eascon):** IEEE, Twin Bridges Marriott, Washington, Sept. 17-19.

**Third European Solid-State Device Research Conference:** IEEE et al., Munich Technical University, West Germany, Sept. 18-21.

**International Conference on Engineering in the Ocean Environment:** IEEE, Washington Plaza, Seattle, Sept. 25-28.

**Semicon East:** SEMI, Holiday Inn and Nassau Coliseum, Westbury, N.Y., Oct. 2-4.

**International Exhibition of Industrial Electronics (Elettronica 2):** Turin, Italy, Sept. 29-Oct. 8.

**National Electronics Conference:** IEEE, Regency Hyatt O'Hare Hotel, Chicago, Oct. 8-10.

**Optical Society of America Annual Meeting:** OSA, Holiday Inn—Downtown, Rochester, N.Y., Oct. 9-12.

**International Telemetry Conference/USA:** ITC, Sheraton Northeast, Washington, D.C., Oct. 9-11.

**Canadian Computer Show and Conference:** CIPS, Exhibition Park, Toronto, Oct. 16-18.

**American Society for Information Science Annual Meeting:** ASIS, Hilton, Los Angeles, Oct. 21-25.

**Connector Symposium:** Connector Study Group, Cherry Hill Inn, Cherry Hill, N.J., Oct. 24-25.



# Celanex. It even sounds electrical.

For electrical-electronic applications, Celanex thermoplastic polyester performs small wonders. One reason is that glass-filled Celanex combines all the advantages of DAP, alkyds and phenolics. With none of their disadvantages.

The parts illustrated feature some other good reasons for choosing Celanex. In the Airpax slide switch (a), for example, Celanex SE-O grade combines excellent electrical properties with wear resistance, low coefficient of friction. And it received sole support approval from UL.

In the Permonite TV cathode ray tube socket (b), Celanex 3310 replaced polysulfone. Celanex withstands high voltage and high temperatures. Remains dimensionally stable. Replacing alkyds and nylons, Celanex combines fine electrical properties with fast

cycling and ease of molding in this high voltage contactor coil (c) by Essex International Controls Division, Inc. And the small grey TV tuner shaft (d) takes good advantage of another Celanex property—the lowest moisture absorption of any high-strength engineering plastic.

Celanex is also the high-strength insulating material for Magnum Electric Corporation's new, slimmer terminal strips (e). And Celanex's high dielectric strength assures an RMS breakdown voltage of more than 3,000 volts for the thin barriers between terminals. Celanex also contributes high arc track resistance and chemical inertness.

Plus all that, Celanex is one of the most processable plastics available. Molding is easier. Cycles faster. Which adds up to a very remarkable, performance-

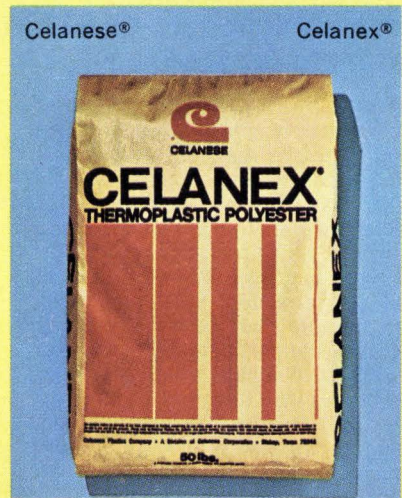

boosting, cost-saving engineering resin. Get the facts on Celanex. And on Celcon and Celanese Nylons. Write Celanese Plastics Co., Dept. X-607, 550 Broad Street, Newark, N. J. 07102.

Celanese Plastics Company is a division of Celanese Corporation, Canadian Affiliate: Celanese Canada Ltd. Export: Amcel Co., Inc., and Pan Amcel Co., Inc., 522 Fifth Ave., New York 10036.

## Celanex: the original thermoplastic polyester

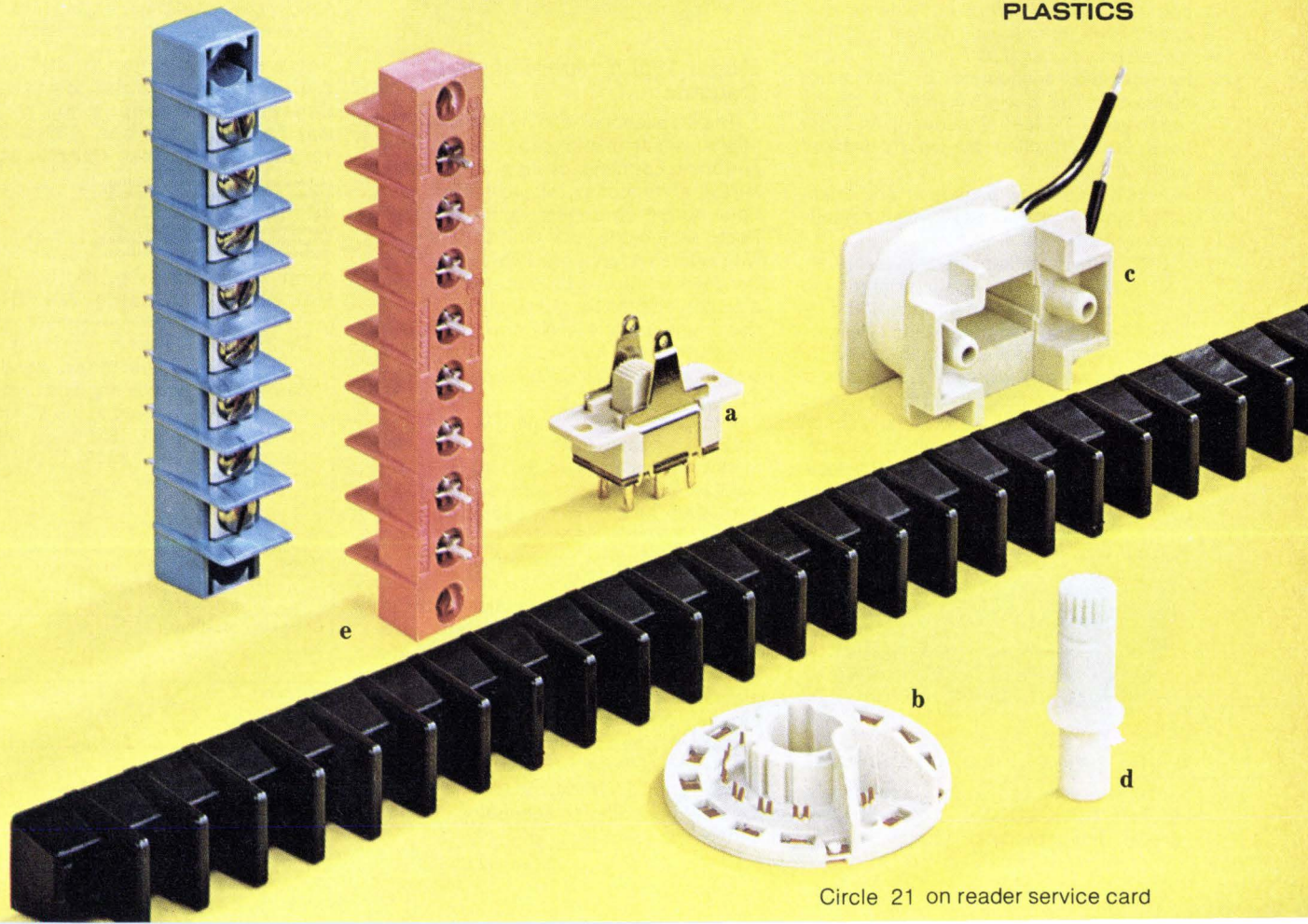

Circle 21 on reader service card



**\* Model 1941A**  
A 40 MHz unit for only \$299.

**\* Model 1952A**  
A seven function do-all 80 MHz instrument for \$695.

Now there is a new and exciting alternative to the counters you've been thinking about buying.

Fluke gives you a choice. Four superb counters designed to meet most applications over a wide frequency range.

For maximum reliability we pretest all IC's, crystal oscillators, LED's and Nixies. Instruments are "burned-in" at elevated temperatures to eliminate marginal parts. We virtually eliminate infant mortality. Each of these instruments is backed with a solid, no-nonsense one year warranty through the worldwide network of Fluke Technical Centers.

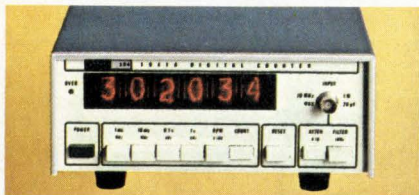

**Model 1941A Digital Frequency Counter**

Here's an outstanding low priced performer. It's unique among low frequency counters with unmatched features and capabilities. Frequency, rpm and totalize modes let you use it as a frequency monitor, precision tachometer or flow meter calibrator. The 6 digit display is clearly readable at 20 feet (7 meters). All functions are controlled by clearly marked pushbuttons.

A switchable low pass filter and attenuator simplifies operation in electrically noisy environments.

BCD output, a field installable option, interfaces easily with digital printers and automated test equipment providing 4-line 8-4-2-1 TTL compatible logic. A connector cable is all that is required to interface with Fluke's 2010A Digital Printer. No external circuitry is needed.

A programmable offset input option eliminates the need for manual calculations in measuring frequency offsets in receivers, as well as crystal oscillator and filter production.



**Model 1952A Universal Counter**

The versatile one from Fluke. Counting from DC to 80 MHz in the standard version, this precision counter can be

**\* Model 1950A**  
A super stable 50 MHz field or bench machine for \$445.

**\* Model 1980A**  
A portable 515 MHz telecommunications performer for \$795.

expanded in the field to cover telecommunications applications to 515 MHz.

Capabilities include frequency, frequency ratio, single period, period averaging, time interval measurement, totalizing and gateable totalizing. Matched input channels feature full control of coupling slope and trigger level. The standard display is 7 LED digits. 8 and 9 digits are available. Status lamps indicate units annunciation, overflow, gate and trigger level.

Ready to use when turned on, a standard 1952A performs to specifications that meet or exceed FCC requirements. An optional computer designed TCXO improves stability, reduces the aging rate and operates from  $-20^{\circ}\text{C}$  to  $+60^{\circ}\text{C}$ !

For data an optional BCD 8-4-2-1 parallel TTL compatible output is offered.



**Model 1950A Multi-Function Counter**

The economical one from Fluke. The 1950A, a full five-function counter, outperforms counters costing much more. Measure frequency, single period, multiple period averages, ratios or totals. Features include a 6 digit LED display with automatic annunciation, variable trigger level control with status lamps and a switch selectable attenuator for operation in electrically noisy environments.

An ideal field instrument, the 1950A weighs only 5 pounds and operates from 12 Vdc.

Available with optional TCXO's, that meet or exceed FCC requirements, the 1950A will operate in the lab or in the field as soon as it is turned on. Fluke's -04 TCXO gives you an operating range from  $-20^{\circ}\text{C}$  to  $+60^{\circ}\text{C}$ !

Other low cost counters use preset trigger levels subject to noise spikes and ringing, which causes false readings. The 1950A uses a variable trigger level control which can be quickly set to the correct level by looking at the LED trigger status lamps. Testing high speed digital circuitry is no problem.

Record data easily with an optional BCD output. Fluke's Model 2010A Digital Printer cables directly to the 1950A. No external decoding and encoding circuitry is needed.



**Model 1980A VHF, UHF, Telecommunications Frequency Counter**

The portable one from Fluke. The 1980A is a precision telecommunications counter designed to service mobile land, sea and air communications systems quickly, accurately and dependably. Ready to use instantly, this performance engineered counter operates under conditions that leave other counters out in the cold. With an optional TCXO the 1980A can be van or field operated, to specifications that meet or exceed FCC requirements, from  $-20^{\circ}\text{C}$  to  $+60^{\circ}\text{C}$ !

For total portability, a snap-on battery pack and carrying case provide 4.8 hours of operation.

With a variable trigger level control the 1980A can count ringing square waves and sine waves with noise spikes.

**For a demonstration or full details, call your Fluke Sales Engineer today. Fill in the coupon below or dial our toll free number, 800-426-0361 for the name of your nearest source.**



John Fluke Mfg. Co. Inc.  
P.O. Box 7428, Seattle, WA 98133

**Dear Fluke folks,**

I want a demo today. Send my nearest Fluke sales engineer out. I'm especially interested in the  Model 1941A,  Model 1950A,  Model 1952A,  Model 1980A,  All four,  Send data only.

Name \_\_\_\_\_

Company/Location \_\_\_\_\_

Address \_\_\_\_\_ City \_\_\_\_\_

State or Province \_\_\_\_\_ Zip \_\_\_\_\_

Phone \_\_\_\_\_



# Fluke counterattack



A brand spanking new line  
of digital electronic counters from those  
value conscious folks who blasted their way into the DVM market.

Circle 23 on reader service card





You don't have  
to give up  
carbon composition  
performance to  
save space.

If you're really  
serious about cost,  
be serious about quality.

Are you cramped for board space but not in power handling capabilities? Is reliable performance vital? Then use Allen-Bradley 1/8 watt carbon composition resistors. Get the pulse handling and overload capabilities that are superior to resistors manufactured by other technologies. Exclusive hot molded construction for a

dense resistance element which reduces noise, and results in a consistent performance. Most importantly, our 1/8 watt resistors have all of the quality and reliability common to our larger sizes. Quality that really can cut your fixed resistor costs. If you think resistors are identical, write for "7 Ways to Tell the Difference in

Fixed Resistors." Available from your Allen-Bradley Electronic Distributor, or: Allen-Bradley Electronics Division, 1201 South Second Street, Milwaukee, Wisconsin 53204. Export: Bloomfield, N.J. 07003. Canada: Allen-Bradley Canada Limited, Cambridge, Ontario. United Kingdom: Jarrow, Co. Durham NE32 3EN.

Actual size



Circle 24 on reader service card



**Allen-Bradley**  
Milwaukee, Wisconsin 53204



## **Semiconductor market exceeds growth predictions**

Surprising even the most bullish early-year forecasters, **the semiconductor market is expected to exceed \$1.9 billion in U.S. factory sales in 1973 and could climb to an astonishing \$2 billion**, according to updated estimates from key industry executives. This represents a growth rate of 30% to 35% over 1972 sales and will mean the industry is growing twice as fast as predicted at the beginning of the year.

Tom Longo, vice president of Fairchild Semiconductor's Digital Products and MOS Products group, says the semiconductor market is having its fastest year-to-year growth in its history, and he adds that the big push came "when the computer industry turned on in October and November of 1972." Both digital bipolar logic and memory will profit, "with TTL growing at a rate that exceeds the market," says Longo, "and it could end up this year with a 40% increase."

Adding to the digital bipolar thrust is the increased demand for consumer circuits, especially those for TV, automobiles, personal calculators, and watches. Bernard Vonderschmitt, vice president and general manager of RCA's Solid State division, predicts **the market as a whole will grow 32% in 1973, C-MOS sales will almost triple, and sales of silicon power devices will grow 30% this year**. But Vonderschmitt cautions against uncontrolled expansion. He forecasts a sharply reduced, 8%, growth rate in the over-all market in 1974.

## **RCA schedules four-character LCD modules**

RCA will announce 15 liquid-crystal-display modules by the end of this year. **Eleven will operate in the dynamic-scattering mode and four in the field-effect mode**. The modules will come in units of four characters each, and larger units can be made by stringing together these modules. Character heights will range from 0.2 to 1 inch.

**One-third of the RCA effort is aimed at the time piece market, and the rest is directed toward such digital-instrument applications as television-channel indicators**. The initial announcement will be a 0.6-in. dynamic-scattering clock display, consisting of four digits plus an indicator for a.m. and p.m. Under development is a C-MOS-chip driver to be mounted directly on the display glass. These display/driver combinations should become available by mid-1974.

## **National readies \$39 calculator marketing plan**

**National Semiconductor's \$39 calculator is ready for market**. The new six-digit, four-function, hand-held calculator will be marketed through National Semiconductor Electronics, which is a marketing arm of the Systems division that builds the unit from components supplied by the components division. The calculator is the second product NS Electronics is marketing; the other is the company's Data-Checker p-o-s terminals. **The calculator will be sold through stores such as Liberty House in San Francisco and Bambergers in the East**.

## **Motorola's VIP to arrive more than a year late**

The first Motorola product to use the VIP high-density bipolar process will be introduced shortly, nearly a year and a half later than originally planned. **The 256-bit TTL random-access memory had been scheduled for April, 1972**. Now, a 256-bit ECL RAM is due in October, and the more-desirable 1,024-bit ECL memory is set for a mid-1974 debut. **The long delay is likely to subject the RAMs to competition from MOS RAMs having silicon-on-sapphire substrates**, which offer similar performance and density, but much lower power dissipation.



## Super-speed cores picked for Illiac IV upgrading

A superfast core memory will help bring the Illiac IV computer and the Unicon laser memory up to their data-handling capacities next June at NASA Ames Research Center, Moffett Field, Calif. It will be the central memory of the computer complex in which the Illiac IV is the principal number cruncher and the laser memory is the principal mass storage unit. **By accessing 28 words every 650 nanoseconds, the \$700,000 memory will support a data-transfer rate of some 42 million words a second.**

The conventional core memory used to start up the system transferred 1 million words a second. **A core design was chosen over a solid-state memory to assure reliability and because of doubts that a semiconductor memory could be delivered in view of chip shortages,** says Michael Levitt, president of Systems Concepts Inc., of San Francisco, the firm that will develop the memory. Electronic Memories & Magnetics Corp., Los Angeles, will supply the core assemblies.

## TI to introduce LSI TTL product

Capping a trend to more complex transistor-transistor logic, Texas Instruments has developed a truly large-scale integrated TTL standard product—a 4-bit binary accumulator on a chip. **The 24-pin package, which is equivalent to 115 to 120 gates, is aimed at the intelligent terminal, and high-performance processor market.** With the ability to reduce package count and system costs, it will go a long way toward doing for digital TTL equipment what LSI has done for digital MOS. **The package, which will become available in September, combines the three functions (arithmetic logic unit, shift/shortage matrix, and multiplexing) that form the heart of a minicomputer's logic unit.** It can be expanded to handle n-bit words.

## Clairex plans to announce new photoconductors

Clairex Electronics plans to announce this fall and early in 1974 three new developments in photoconductors. **One is an ultraviolet photoconductive cell with an order-of-magnitude improvement over its current UV unit.** The new cell is aimed at pollution-monitoring and control applications. The company plans to test the cell with a new type of glass window that will be sensitive at wavelengths below 3,000 angstroms, where glass tends to absorb and sapphire is too expensive. Clairex will also announce a dual LED-photoconductor isolator with differential outputs for low-noise and bridge-type applications.

Clairex also plans to market more versions of its new type-9 material, **a CdS-based photoconductor that has higher speed and temperature stability than pure CdS and CdSe photoconductors.** The new material, which is proprietary, is not CdSSe, says Robert Farrall, company president.

## Motorola tries to turn tables in Far East TV sales

Motorola has decided that its premium-price **Quasar color television can help counter the one-way flow of Japanese color-TV sets to the U.S.** Aiwa Co. Ltd. will act as Motorola's agent in Japan for line of 21- to 25-inch color sets. Edward P. Reavy Jr, vice president and general manager of Motorola's Consumer Products division, predicts that, within two to three years, his company will capture about 1% of the Japanese market, which he estimates at 60,000 sets with a factory value of \$140 million. **Motorola's sets will retail in Japan for \$760 to \$1,250.**



# Q-LINE SCRs

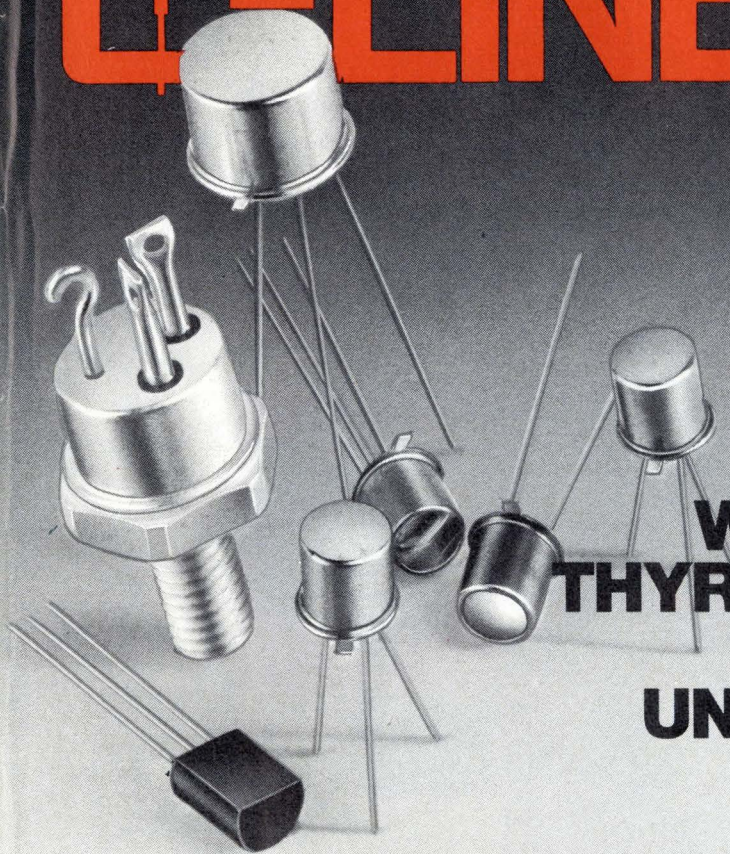

**WE PUT 14 YEARS OF  
THYRISTOR EXPERIENCE  
INTO EVERY  
UNITRODE SCR.**

And that means a better industrial product. Our performance record proves it. In industrial/commercial applications, the use of Unitrode SCRs doubled last year and has doubled again this year. For the military, Unitrode supplies more lead-mounted SCRs than everyone else combined. Unitrode is the only SCR supplier with Military Qualification Approval on all TO-5 and TO-18 mil. specs. Why this kind of acceptance? Our experience. It means a lot to people who've had experience with less.

Our broad line of SCRs including plastic and hermetically sealed metal types offers a wide range of choices for literally hundreds of applications. The Unitrode SCR product line ranges from our very popular, rugged

0.8 amp TO-92 plastic package and TO-18 hermetically sealed series to our 1.6 amp TO-5 and TO-39 series and 5 amp TO-59 stud series. Some series are available to 600 volts.

It's what you would expect from a company that makes thyristors a major part of its effort — not just a sideline.

For fast action, call Sales Engineering collect at (617) 926-0404 Unitrode Corporation, Dept. 15 Y, 580 Pleasant St., Watertown, Mass. 02172. For the name of your local Unitrode representative, dial (800) 654-9200 toll free or in New York State (516) 294-0990 collect. Check listing below for your nearest Unitrode distributor.



**UNITRODE** quality takes the worry out of paying less.

**Unitrode Franchised Distributors:** ARIZ., Kierulff, Phoenix (602) 273-7331; CAL., Kierulff, Los Angeles (213) 685-5511, Palo Alto (415) 968-6292, San Diego (714) 278-2112; CANADA, Schweber, Toronto (416) 925-2471; COLO., Kierulff, Denver (303) 343-7090; FLA., Schweber, Hollywood (305) 927-0511; GA., Schweber, Atlanta (404) 449-9170; ILL., Schweber, Elk Grove (312) 593-2740; MD., Schweber, Rockville (301) 881-2970, Technico, Baltimore (301) 828-6416; MASS., Schweber, Waltham (617) 890-8484; MICH., Schweber, Troy (313) 583-9242; N.J., Schweber, Somerset (201) 469-6008; N.M., Kierulff, Albuquerque (505) 272-1055; N.Y., Schweber, Rochester (716) 328-4180, Westbury (516) 334-7474; N.C., Schweber, Raleigh (919) 832-8881; OHIO, Schweber, Beachwood (216) 464-2790; TEX., Kierulff, Garland (214) 271-2471, Hamilton-Avnet, Dallas (214) 638-2850, Houston (713) 526-4661, Lenert, Houston (713) 225-1465; UTAH, Alta Electronics, Salt Lake City (801) 486-7227; WASH., Kierulff, Seattle (206) 763-1550.

See EEM Section 4800 and EBG Semiconductors Section for more complete product listing.

Circle 27 on reader service card



# Which air movers for your system?

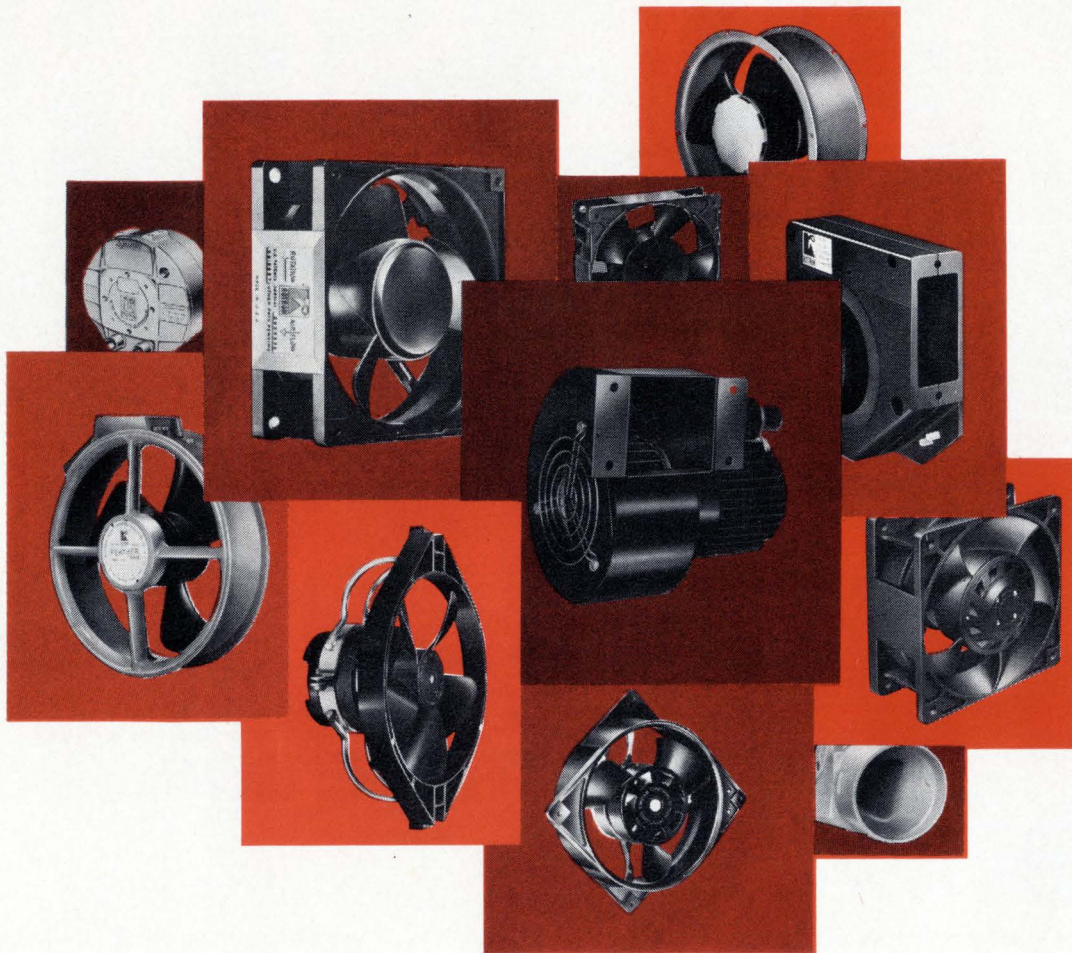

## Rotron® has the answer.

There are at least three major reasons why you can rely on Rotron to provide the best possible answer to your air moving need.

1. Rotron makes the widest selection of fans and blowers in the industry.
2. Rotron has a reputation for producing only the finest air movers. It's a reputation well earned, and one Rotron intends to keep.
3. Rotron offers you this superior selection and quality at hard-nosed competitive prices.

What's more, Rotron field application engineers will be glad to work directly with you where custom solutions may be required. You get the benefit of more than 20 years experience in developing specific answers to specific air moving problems.

Finally, Rotron products are available through a large, nationwide network of stocking distributors, to meet your needs in fast off-the-shelf delivery time.

Next time an air moving question arises, check Rotron. You'll like the answer. Get more information now by writing for Rotron's Quick Reference Catalog.

*Why settle for less when the best costs no more?*



**ROTRON INC.**, Woodstock, N. Y. 12498 ☐ 914 • 679-2401 ☐ TWX 510-247-9033  
Pacific Div., Burbank, Cal. 91506, 213•849-7871 • Rotron B.V., Breda, Netherlands, Tel • 79311, Telex: 844-54074



## Mitre's interface adapts CATV to digital terminals

Mitrix gear can be overlaid on a standard CATV system to transmit and receive digital communications

**Never mind the wired city**—Marshall McLuhan's "global village" is on the way. Cable television is seen by the Mitre Corp. as the "next ubiquitous communication system," and it looks as if Mitre's interface system, Mitrix, could add a new level of versatility to CATV [*Electronics*, Aug. 16, p. 29]. Mitrix is ready for full-scale development, either by the Government or by private industry, via licensing agreements, says Mitre.

The interface, which can be added to any standard CATV installation without modifying it or affecting normal services, provides communications to and from such diverse digital terminals as cathode-ray-tubes, teletypewriters, facsimile machines, and even braille embossers.

Mitrix, which operates full-duplex for simultaneous transmission and reception, can take simultaneous input from digital terminals running at different bit rates, and messages can be simultaneously broadcast, sent from subscriber-to-subscriber, or even sent from several subscribers to, say, a polling center.

**Transparent, yet private.** CATV is ideal for digital use, says Mitre, since typically less than half of a system's capability is used for TV and fm-radio signals. Mitre claims that the system is completely "transparent"—capable of transferring data without altering it at any

point—and that subscribers can be assured of privacy.

Basically, Mitrix is a high-speed, time-ordered, burst-transmission system. During transmission, the serial data stream is broken into repeatable frames 2.56 seconds long. Each frame has 8,192 slots, each containing 256 bits. The use of 17 address bits per slot allows the system to identify a maximum of 131,072 terminals ( $2^{17}$ ). Since Mitrix is time-shared, as many as 8,000 subscribers can be accommodated simultaneously. Rates from 70 to 30,000 bits per second are available, and the subscriber is assured of any chosen rate,  $\pm 1\%$ .

It has been three years since a team of Mitre engineers set out to develop the cable-based two-way digital-communications system, and Mitrix has been in operation in Mitre's Bedford, Mass., headquarters for the past two years.

**Mitrix equipment.** The Mitre demonstration two-way CATV network consists of a head-end and cables for transmitting and receiving,

but a single two-way cable can be used. A subscriber's digital interface unit (SDIU) connects subscribers' terminals—commercially available digital equipment—to the cables. The cables are connected through a central digital interface unit (CDIU) to a Digital Equipment Corp. PDP-15/20 minicomputer with 4,096 words of memory at the network-control center, which acts as the traffic manager. Mitrix could, however, be expanded hierarchically, with the network-control center of a lower-order network becoming a "subscriber" to a higher-order network.

Mitrix project leader David G. Willard says the SDIU can be hooked up to just about any terminal, as long as its output can be digitized. The SDIU itself can even act as a convertor for some simple applications. Simply by changing one input/output card, the SDIU can accept synchronous, asynchronous, serial, or parallel output at any rate. Willard suggests that, in the future, an SDIU might contain three differ-

### Mitrix: genie in the home

Believing that "any type of communications we can now conceive can potentially be carried by cable," Mitre set out to design Mitrix so that it imposes "the fewest possible limitations on the form or type of information it will carry." Therefore, the system was built with off-the-shelf components and is fully compatible with existing cable facilities, as well as all foreseeable cable uses. Mitre claims its applications are limited only by the terminals used with it.

Among the uses of Mitrix that Mitre envisions are such information-gathering applications as credit-card validation, meter-reading, shopping from home, and area surveillance. Electronic mail might be possible through use of facsimile machines. In the broadcast mode, Mitrix could deliver newspapers and periodicals, weather forecasts, and public-safety information. In the classroom, students could communicate with time-shared computers via Mitrix. And computers could communicate directly with one another, freeing humans from such tasks as inventory control.



ent I/O cards that could be switch-selectable.

**No noise.** The full Mitrix system occupies less than 2% of existing cable bandwidth, or about 1 bit per cycle of bandwidth. The rf signal, which requires only about 2 magacycles, can be anywhere on the cable. Mitrix is now using bandwidth slightly below Boston's channel 2. As far as the CATV system is concerned, the SDIU appears to be a modem and the CDIU as another off-the-air broadcast-signal input. Mitrix introduces no noise or crosstalk to the CATV system.

Willard says, "We believe strongly in the wired city"—and he believes Mitrix is a big step in that direction. If Mitre's estimates are correct, two-way cable transmission can be much less expensive than common-carrier data service. Using what Mitre calls "dynamic allocation," the network-control center

gives subscribers time slots only when needed and for as long as needed. This provides for the subscriber to be charged only for information moved, rather than on the basis of installed communications capacity. And the SDIUs themselves show promise of being cheap. Mitre used all off-the-shelf equipment in building its demonstration system, but Willard thinks that by using LSI technology, 1,000 SDIUs could be built for less than \$500 each.

Now that Mitrix is proven and ready for development, Mitre reports that already there have been about a dozen inquiries from interested companies. While Willard foresees many applications for Mitrix, he predicts it will first be used in a military or business environment as a closed loop, rather than in a city-link cable network combining both television and digital communications. □

## Lasers

### Lasers may unlock door to controlled-fusion systems

The high-power laser is a key—and possibly the key—to successful development of controlled thermonuclear-fusion systems that could provide an ecologically sound solution to the energy crisis. This was the view of researchers at the Workshop on Laser Interaction and Related Plasma Phenomena, Aug. 13 to 17 at Rensselaer Polytechnic Institute, Troy, N. Y.

Participants included representatives of Government research organizations and universities in the United States as well as experts from Germany, France, Great Britain, the Soviet Union, Canada, Poland, India, Israel, Ireland, Japan, Italy, and Australia. Although engineers and scientists from private industry, such as the Westinghouse and General Electric research laboratories, were present, the only private company now dedicating an effort to the development of controlled thermonuclear fusion is

KMS Fusion, Ann Arbor, Mich.

Keith A. Brueckner, executive vice president and technical director of KMS Fusion, discussed his company's project of achieving a "break-even" condition—with laser energy in equal to fusion energy out—by the end of this year.

Basically, a laser-induced thermonuclear-fusion system would produce energy by imploding a pellet of deuterium-tritium with a compression of about  $10^4$  times solid density. Rather than using high magnetic fields, a mechanism called inertial confinement would contain the reaction.

While much of the work in this area is still theoretical, Richard Sigel, a scientist at the Max Planck Institute for Plasma Physics, Garching, West Germany, reported the direct measurement of compression of plexiglas and deuterium targets to three to five times normal density by laser irradiation. This is the first

time measurements have been made of a material that had been compressed to more than a fraction of its normal density.

Sigel and his co-workers used a neodymium-glass laser to implode the targets. A low-powered gas laser tracked the front of the shock wave as it moved across the plasma, and the wavefront-plasma interaction was photographed by a high-speed (picosecond) camera.

**Simulation.** KMS has performed a computer simulation of the full process of laser coupling for the 1.06-micrometer wavelength (from neodymium-glass), says Brueckner. This includes simulation of the thermal-energy flow, hydrodynamics, nuclear reactions, and the energy transport in the nuclear-reaction products and radiation. These results were confirmed through independent work by John Nuckolls, associate leader of the Nuclear Explosive Design division at the University of California Lawrence Livermore Laboratories.

In addition to the neodymium-glass lasers, the CO<sub>2</sub> laser and the chemical (such as the hydrogen-fluoride and iodine) lasers are considered potentially capable of producing the high power needed for controlled thermonuclear-fusion systems.

While there are many candidate lasers, it was generally agreed that an ideal laser for controlled thermonuclear fusion has not yet been developed, Richard L. Morse, head of the laser fusion group at Los Alamos Scientific Laboratory, Los Alamos, N. M., said he could conceive of a CO<sub>2</sub> laser a meter in diameter that might do the job. A major problem in these long fusion lasers is that the lifetime of excited states is so short that the states decay before they can produce gain. Morse says that this may be solved by pumping the medium ahead of the pulse, much like pumping electrons in travelling-wave-tube amplifiers.

**Beyond the ultraviolet.** Somewhat apart from development of lasers for thermonuclear fusion were proposals by Ben Lax, professor of electrical engineering at Massachusetts



Institute of Technology, and George Baldwin, professor of nuclear engineering at RPI, for X-ray and gamma-ray lasers. Baldwin, who recently visited the Soviet Union and heard Russian reports of research on gamma-ray lasers, contends that, theoretically, a gamma-ray laser could be built, but he did not propose a design.

Lax proposed that with laser powers of  $10^{15}$  watts per square centimeter, soft X-rays (about 10 angstroms) will be given off by such targets as aluminum or diamonds. There would be no laser cavity in the conventional sense, but rather, extremely excited states would cause emission of coherent "light" at X-ray wavelengths. □

## Trade

### Hong Kong product mix is changing

Integrated circuits, calculators, cassette recorders, and high-fidelity system components—these are Hong Kong's growing electronics-assembly markets as the British crown colony moves to diversify its export capabilities into areas beyond transistors, diodes, and transistor radios. In the diversification process, Hong Kong's export growth rate is experiencing a slowdown—dropping from an average increase of 30% a year in 1970–72 to a level of approximately 23% this year.

Details of the diversification move, led by the approximately 60 U.S.-owned or -controlled companies that dominate Hong Kong's electronics industries, are spelled out in an unreleased report delivered in mid-August to the Department of State in Washington by the colony's American consul.

Although the 1972 demand for electronics exports to the U.S. and Western Europe failed to expand as rapidly as in years past, the report notes some sharp gains by Hong Kong-owned companies in new business areas such as hand-held and desktop calculators. These ex-

HOW HONG KONG EXPORTS GROW (in thousands of U.S. dollars)				
	1969	1970	1971	1972
<b>Electronics exports, total</b>	<b>135,698</b>	<b>176,698</b>	<b>231,447</b>	<b>301,133</b>
(% change from prior year)	+43.9%	+30.2%	+31.0%	+30.0%
<b>Product / Market</b>				
<b>Integrated circuits</b>				
U.S.A.	N.A.	N.A.	754	8,117
Japan	N.A.	N.A.	19	325
Taiwan	N.A.	N.A.	1	1
Others	N.A.	N.A.	—	116
Total (% change)	N.A.	N.A.	774	8,559 (+1,009.8%)
<b>Transistors</b>				
U.S.A.	31,308	27,839	23,201	30,414
Taiwan	815	959	2,423	2,675
Japan	4,353	2,829	1,923	1,455
Others	1,562	3,065	3,934	5,978
Total (% change)	38,038 (+70.6%)	34,692 (−9.2%)	31,481 (−11.1%)	40,522 (+28.7%)
<b>Diodes</b>				
U.S.A.	N.A.	5,056	5,375	7,467
Japan	N.A.	2,701	436	370
Taiwan	N.A.	135	385	308
Others	N.A.	73	114	222
Total (% change)	N.A.	7,965	6,310 (−20.8%)	8,367 (+32.6%)
<b>Capacitors/condensers</b>				
U.K.	390	1,150	726	828
U.S.A.	411	443	670	1,162
Taiwan	212	288	127	169
Others	175	473	423	486
Total (% change)	1,188 (+56.4%)	2,354 (+98.1%)	1,946 (−17.3%)	2,645 (+35.9%)
<b>Computer components/parts</b>				
U.S.A.	N.A.	25,879	38,371	41,883
Taiwan	N.A.	49	4,922	795
U.K.	N.A.	946	1,052	1,293
Others	N.A.	1,979	3,451	5,564
Total (% change)	N.A.	28,853	47,796 (+65.7%)	49,535 (+3.6%)
<b>TV receiver parts</b>				
U.S.A.	7,982	5,139	8,810	8,923
Taiwan	329	952	3,038	3,281
Japan	114	84	133	13
Others	316	313	240	312
Total (% change)	8,741 (−24.7%)	6,488 (−25.8%)	12,221 (+88.4%)	12,529 (+2.5%)
<b>Transistor radios</b>				
U.S.A.	54,416	59,547	77,307	92,749
U.K.	4,085	6,131	11,491	21,002
W. Germany	4,744	7,041	8,613	13,573
Others	14,153	17,603	22,215	35,651
Total (% change)	77,398 (+43.6%)	90,322 (+16.2%)	119,626 (+32.4%)	162,975 (+36.2%)
<b>Transistor radio parts</b>				
Singapore	584	1,681	3,355	4,119
Taiwan	748	545	1,614	1,547
U.S.A.	435	293	394	1,675
Others	575	898	1,656	1,806
Total (% change)	2,342 (+158.0%)	3,517 (+49.6%)	7,019 (+99.6%)	9,147 (+30.3%)
<b>Transceivers</b>				
U.S.A.	196	180	569	649
Switzerland	14	1	13	—
Canada	—	—	10	31
Others	36	14	19	127
Total (% change)	246 (+86.7%)	195 (−20.7%)	611 (+213.3%)	807 (+38.1%)
<b>Mikes/speakers/amps</b>				
U.S.A.	29	76	67	474
Singapore	1	1	23	5
France	1	19	12	23
Others	15	44	59	73
Total (% change)	46 (−73.8%)	140 (+204.3%)	161 (+15.0%)	575 (+257.1%)

N.A. — Not available

Source: Hong Kong Trade Statistics

ports "leaped from \$150,000 in 1971 to \$3.7 million in 1972, with sales directed almost entirely to the U.S. and European markets," says the report. "The rapid increase in production is expected to continue into the foreseeable future."

**Shares.** Beyond dominating the 280 electronics manufacturing and assembly operations in Hong Kong, the U.S. also takes an increasingly larger share of the island's output.

Last year, for example, electronics exports to the U.S. rose 21% to \$215.7 million out of a total of \$301 million in shipments, increasing the American market share by 7% to 77% (see table).

Transistor radios still account for a significant share of exports to the U.S., rising 23% last year to \$163 million. And there is a definite trend toward upgrading the quality of these exports, according to the State



Department, with a rapid expansion of multiband, a-m-fm, and clock radios.

At the same time, shipments of transistors to the U.S. in 1972 expanded by 12% to 92.7 million units, accounting for 56% of the Hong Kong output. Sources outside of the State Department familiar with the study note that Japan is withdrawing from the Hong Kong market for transistors, diodes, and other discrete components, even though that nation is, along with the U.S., making and buying a rapidly increasing share of the island's new and booming integrated-circuit market.

Ever since IC data has been recorded in Hong Kong, output has shot from \$774,000 in 1971 to more than \$8.5 million in 1972—an increase of more than 1,000%.

Japan's withdrawal from the competition to turn out discretely is attributed to two things. First, Japanese manufacturers are turning away from transistors in favor of ICs at a faster rate than their U.S. counterparts. Second, Japanese manufacturers of transistors and other discrete components are expanding their offshore capacity in other Asian markets where labor and production space are not in such tight supply as they are in Hong Kong. □

## Avionics

### Univac gives voice to FAA experiment

Sperry Univac is building a system for the FAA that tells pilots, in so many words, where to go. Delivered this month to the Federal Aviation Administration's National Aviation Facilities Experimental Center (NAFEC) near Atlantic City, N.J., Univac's voice-response system will help the FAA evaluate the application of computer-controlled speech for advisory messages to visual-flight-rules aircraft. The VFR planes will need beacon trans-

ponders and will be advised of the location and altitude of other aircraft in the area, as well as fixed obstacles like mountain peaks, television towers, and buildings.

**Words digitized.** The Univac voice-response unit supplies computer-controlled, and not computer-generated, speech, emphasizes Donald E. Anderson of Univac's speech communications department, St. Paul, Minn. Although the approach is basically digital, all words in the vocabulary are spoken individually into a microphone, converted to digital form, and stored on a cartridge disk. That memory is then linked to the voice-response system: "We're using a modified Univac 1616 mini with an audio-output section—a digital-to-analog converter and some standard interface logic," he explains. When the controller computer asks for a message, the Univac mini retrieves the digitized word from storage, and sends it to the audio-output buffer. "The system has two-channel capability—it can drive two transmitters simultaneously with independent messages," he says.

"In order for voice-response to be accepted, we feel it must be accurate and sound good," Anderson continues. "Our system uses 48,000 bits per second of speech, equivalent to sampling the analog at a 6-kilohertz rate. That's more bits per vocabulary word than you need for intelligibility, but we splurge a little," he explains. "Bits are cheap and getting cheaper."

The digital approach also allows the memory to accommodate various word lengths, compared to typical analog systems on the market with fixed 0.5- or 0.6-second windows. The Univac mini also can add pauses for phrasing, and since it stores redundant vocabularies with flat and falling intonations, can end each phrase with the falling intonation that approximates normal speech.

Although Univac's first such system surfaced in an FAA test in Knoxville, Tenn., last year, that setup was pulled together in a hurry, Anderson says. Leased lines linked the FAA's borrowed U.S. Air



**Voicebox.** The heart of Univac's voice-response system is a Univac 1616 mini-computer with an audio-output section. The system is being tested by the FAA.

Force Staran IV computer with Univac's speech lab in St. Paul. While the Knoxville application used a 250-word vocabulary, the current system has a capacity of 1,200 words, and the succeeding unit will have twice that capacity, says Anderson.

**All automatic.** Radar tied into the system was able to detect all beacon-equipped planes and, within a 50-mile radius, smaller planes without the transponders. "Once the controller keyed the aircraft into the system, the pilot could fly through without manual intervention," Anderson says. Besides advising participating pilots of the location and altitude of nearby aircraft, the FAA system also stored the area's terrain, and warned pilots of local Smoky Mountain peaks as well as three television towers in downtown Knoxville.

The FAA's use of computer-controlled voice, at this time, is advisory only. Anderson emphasizes: "We're



# measurements on the move...

With TEKTRONIX you make your measurements quicker and with greater accuracy. The light-weight 465 and 475 portables combine ease-of-operation with laboratory precision to reduce your repair time at your customer's location.

Some of the functions that make the 465 and 475 value leaders are: push-button trigger view, ground reference button at probe tips, delayed and mixed sweep, CRT positioned between the vertical and horizontal controls, easy to interpret push-button mode selection, and more.

With 200 MHz at 2 mV/div, the 475 offers lasting measurement capability. A linear 8 x 10-cm display and one nanosecond sweep speed

illustrate the ability to make complex, precise time measurements.

The 465 with a bandwidth of 100 MHz at 5 mV/div and 5 ns/div qualify it for most of today's measurement needs.

A different approach to battery operation. A 12 and 24 VDC option combined with a detachable battery pack provide continuous operation under a variety of situations. Measurements can be made when power availability is restricted to 12 and 24 VDC, or when commercial power is limited, or when isolation from line or ground is desired. With the detachable battery pack you carry the weight of the batteries only when needed.

Also available are rackmount versions of both the 465 and 475.

465 Oscilloscope ..... \$1725  
(Includes delayed sweep and probes)

475 Oscilloscope ..... \$2500  
(Includes delayed sweep and probes)

DC Operation (Option 7) . Add \$75

1106 Battery Pack ..... \$250

Rackmount ..... Add \$75

Let us help you make your measurements. To see one of these scopes, call your local Tektronix field engineer, he'll be glad to demo one for you. If you prefer, for additional information write Tektronix, Inc., P.O. Box 500, Beaverton, Oregon 97005. In Europe, write Tektronix Ltd., P.O. Box 36, St. Peter Port, Guernsey, C.I., U.K.



**"the value leaders"**

U.S. Sales Prices FOB Beaverton, Oregon

For a demonstration circle 32 on reader service card

Circle 33 on reader service card





---

## Electronics review

---

not controlling them. It would seem that this would be evolutionary—we'll start with advisory, and move to directing." □

---

## Government electronics

---

### Railroad laboratory seeks test systems

The Federal Railroad Administration is turning to industry to supply electronic gear for its testing and simulation center in Pueblo, Colo. Industry responses for the integrated computer system are due Sept. 5, and an award is due in early January. The agency expects to let a single contract by the end of this year for the analog data-acquisition, communications and control system.

With its \$21.5 million Wheel/Rail Dynamics Laboratory, the agency hopes to find ways to improve comfort, economy, and efficiency by rigorously testing rail cars up to 285 miles per hour in all kinds of simulated conditions. The process is akin to testing autos on a dynamometer, except that for rail cars, the agency needs mammoth machinery and highly sophisticated monitoring and control equipment.

The computer system is a "network of minicomputers hooked together to handle the simulation data," says John C. Mould, project monitor in FRA's Advanced Systems division. The network consists of a profile-generator system that presents track characteristics to an analog control system, a monitor/diagnostic/prognostic system that monitors safety and corrects and updates errors, the data-acquisition system that digitizes and stores data, and the control system for the railroad car's wheel modules, called trucks.

**Words, words.** Ultimately, under the multiphase project, the network will include 13 general-purpose minicomputers with storage capacities of 131,073 16-bit words of magnetic core, 344,064 16-bit words of semiconductor memory, eight magnetic-tape units, 14 mass-storage

disks containing 1.2 million words each, and one mass-storage disk of 14.5 million words. Associated hardware includes printers, plotters, readers, punches, graphic and hard-copy displays, and digital input/output equipment.

The data-acquisition part of the package makes sure the test simulator is working well and also measures vibration, heat, stress, fatigue, noise, and other data from the car being tested. Key units are closed-circuit TV, photographic motion analyzer and the analog pickoffs from the sensing instruments. The control system drives the hydraulic actuators in the dynamic simulator,

---

## Communications

---

### OTP recommends that the FCC reallocate land-mobile spectrum

Land-mobile equipment makers have gained an influential ally in their battle to sell communications services to other established radio common carriers. The White House Office of Telecommunications Policy has recommended this month to the Federal Communications Commission that these manufacturers be allowed to operate their own systems and set their own system standards.

And although the FCC has given AT&T and other wire-line carriers 75 out of the available 115 megahertz, the OTP would reslice the 900-MHz spectrum to give AT&T only 14 MHz, leave the other mobile services with 40 MHz, and reserve 61 MHz for allocation in the future.

"The result over the long run would mean a bigger market," says Glenn R. Petersen, general manager of General Electric's Communications Systems division, Lynchburg, Va. OTP's allocation, he adds, "would remove one of the restrictions to growth in the market." Agreeing, John Sodolski, staff vice president of the Electronic Industries Association, notes that the OTP viewpoint generally follows EIA and industry recommendations before

and the communications system includes 62 hard-hat headsets for remote two-way communications throughout the lab.

The dynamics laboratory is part of the Department of Transportation's High-Speed Ground-Test Center at Pueblo, jointly used by FRA and the Urban Mass Transportation Administration. Prototype cars under test there include Boeing-Vertol's state-of-the-art passenger car, Grumman's 300-mph tracked air-cushion vehicle, Garrett AiResearch's linear induction-motor research vehicle and Rohr Industries' urban passenger tracked air-cushion vehicle. □

the FCC's land-mobile hearings last May [*Electronics*, May 10, p. 29].

**Will AT&T pull out?** In making the same point, an FCC staff member comments, however, that "if the Commission buys that approach [giving AT&T 14 MHz], AT&T probably will stay out of the business."

And AT&T may be thinking just that. In an official statement, the company says that, "the frequency assignments and provisions recommended by the OTP would, if adopted by the FCC, require AT&T to review its position to determine whether we can proceed with the development" of its system.

**Justice enters its plea.** And, as if OTP's policy weren't enough, the Justice Department also wrote to the FCC, repeating its earlier objections to a possible AT&T monopoly in the land-mobile market and questioning whether or not AT&T should even be in the business.

Motorola, the giant land-mobile-equipment manufacturer, applauded both the OTP and Justice Department positions, saying, "We anxiously await the FCC's final rule-making in this matter."

Just what effect OTP's recommendations will have on the FCC—whose



# Who's afraid of the big backlog?



## EA expands to double IC production.

Like a lot of firms in the semiconductor business, Electronic Arrays has a big backlog of orders.

So we're boosting production rapidly to make deliveries on time.

In May we started up a new production facility—built especially to manufacture

N-channel MOS RAMs.

In June we added another 40,000 square feet of space, occupying a facility that will double total production of MOS ICs by year's end. Calculator circuits, RAMs, ROMs and shift registers, both P-channel and N-channel, will be coming off the line in

unprecedented quantities.

That means you can count on EA for big deliveries when you move into high-volume production.

Electronic Arrays, Incorporated, 501 Ellis Street, Mountain View, California 94040. Phone (415) 964-4321.

electronic arrays 



decision is due shortly, say staffers—can't be determined, but the OTP approach to maximize competition while minimizing regulation in the mobile-communications industry is expected to find favor with chairman Dean Burch and other FCC members. OTP wrote the commission it "believes that the needs of the mobile-communications users can best be made by an approach which enables customers themselves to determine, through market mechanisms, the most efficient and cost-effective use of the spectrum resource."

**OTP proposes.** In proposing that manufacturers and suppliers be permitted to operate dispatch systems, however, OTP, "to assure full and fair competition," calls for interchangeability of all equipment with any base station, but says that the specific compatibility in standards should be left up to the industry. OTP also urges that all land-mobile-radio systems be guaranteed access to the public switched-telephone network.

Among its other recommendations, OTP:

- Shoots down AT&T's proposed national mobile-telephone network based on its "cellular" approach [*Electronics*, Jan. 3, 1972, p. 100] as too unproven to tie up 75 MHz, but suggests that the FCC set aside some frequencies to test the market demand.
- Calls for local governments to pool their mobile services on a single shared-trunk system to conserve spectrum space.
- Urges the FCC to authorize production by numerous competing service suppliers, "upon a showing of minimum technical and financial qualifications," so that competitive pricing obviates "the need for rate regulation."
- Says that AT&T and other wire-line carriers "should not be permitted to participate in the non-regulated portion" of land-mobile, but should be allowed to provide rate-regulated mobile-telephone service as an extension of their national public switched-telephone network.
- Suggests that the FCC and the

Justice Department make sure that equipment giants don't leverage their way into predominant positions in the growing land-mobile market.

The FCC's decision is eagerly awaited by equipment makers and suppliers, who have been clamoring to get that 900-MHz spectrum allocation changed ever since about two years ago, when the FCC gave AT&T and other wire-line carriers the 75-MHz between 806 MHz and 881 MHz. A step toward developing a nationwide broadband common-carrier mobile service gave the remaining 40 MHz to the private land-mobile radio users. □

### Solid state

## Commercial CCD camera introduced

Charge-coupled devices are continuing to make steady progress on the imaging scene. Fairchild Camera and Instrument Corp. is now offering a monochrome camera that has an area array of 10,000 CCD elements as its basic sensor. The company also expects to develop a color camera within two years.

The new pocket-size MV-100 camera is not designed to meet television broadcast standards. Rather,

Fairchild is aiming it at the less demanding requirements of surveillance, medical instrumentation, and process control. And with it, the company hopes to gauge the market potential for a camera with the unique features provided by charge-coupled devices—exceptionally small size, low power consumption, and operation over a broad range of light conditions.

The MV-100 is the first in a series that Louis H. Pighi, vice president and general manager of Fairchild's Federal Systems group, says will eventually replace vidicon-tube TV cameras. "Within the next few years, Fairchild plans to introduce both color and monochrome cameras for a wide range of commercial, industrial, and military applications," Pighi says. In particular, he predicts that the forthcoming CCD cameras will have a significant impact on the closed-circuit and broadcast-television industries.

Fairchild's introductory camera, about the size of a cigarette pack, measure 3½ by 1½ by 2¼ inches and weighs six ounces. It consumes 1 watt and will operate in bright sunlight, as well as subdued room light. Power comes from a 115-volt ac line or a battery pack using a 12-volt rechargeable silver-zinc battery that will last for about three hours.

The scanning frequency is 15,750 lines per second in the horizontal axis (equivalent to a standard

**Replacement for vidicon?** Fairchild's MV-100 television camera, which uses charge-coupled devices, is aimed at security, surveillance, and instrumentation markets.





# Need a highly stable function generator? Digital synthesizer? Digital phase generator?

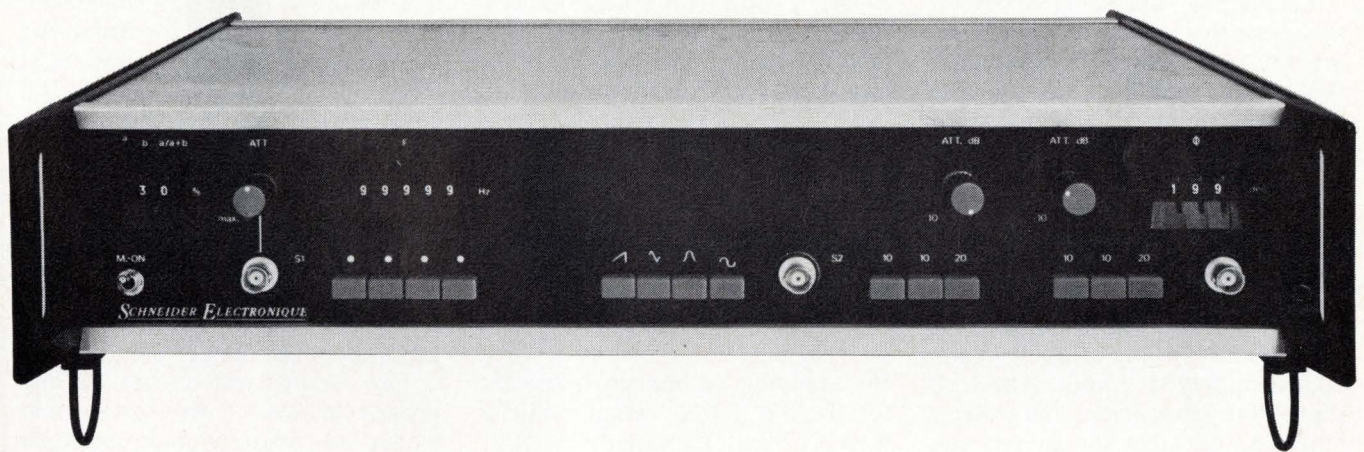

## Get all three in the GF106

which outperforms all others, while saving money in offering: Square, Sawtooth, Triangle, Squared Sine, outphased sine signals / Crystal-driven / Constant output level and phase throughout the range. / Three simultaneous outputs / Burst operation / Full programmability (option) / Automatic Frequency Scanning (option) / 0.001 Hz to 100 kHz Frequency Range. / Accuracy: 0.0001%. Sold and serviced throughout the U.S. and Canada. U.S. distributorships available.

LOOK FOR US AT  
WESCON  
BOOTH NOS.  
1023-1024-1032-1033

*Schneider Electronics*

c/o PERMAL INTERNATIONAL, 919 3RD AVE., NEW YORK, N.Y. 10022



broadcast camera) and 120 frames per second in the vertical axis. The vertical rate is four times the standard of 30 frames per second because, a Fairchild spokesman says, the CCD camera doesn't produce enough resolution elements to fill up a standard TV monitor. It produces about 80 TV lines per picture height, compared with 525 lines in a conventional broadcast camera. The bandwidth of the camera is only 1 megahertz, compared with broadcasting's usual 6 MHz. The spectral response of the camera ranges between 0.45 and 1.0 micrometer, well into the red portion of the spectrum. And the sensitivity is specified as 0.1 foot candle at the sensor.

The active sensor, contained in a 24-pin dual in-line package, consists of 10,000 elements in a 100 by 100 array. Each column of 100 light-sensitive elements is interspersed with a column of opaque CCD storage elements.

The charge accumulated in the light-sensitive elements, representing a frame of video information, is shifted and stored in the adjacent opaque columns. Then a line register at the bottom of the array shifts out the video, a line at a time, starting at the bottom of the frame. The electronics is arranged to shift and read out alternate lines per frame so that interlacing is automatically built in. The line register operates at twice the rate of the array elements, approximately 1.2 MHz. The CCD sensors are fabricated in bulk-silicon material that releases charge carriers in proportion to the amount of light reflected from the scene. These charge carriers are transferred by a clocking system and transmitted to a TV receiver as standard television signals.

Drive, scanning, and clocking circuits, made up mostly of discrete components, are separate from the sensor chips. Fairchild hasn't committed this part of the camera to integrated circuitry yet. But this may come with other cameras.

The camera results from Fairchild-developed CCD technology, augmented by work performed under ongoing U.S. Navy contracts aimed at developing low-light-level

imaging devices [*Electronics*, May 10, p. 25]. Included among the devices being developed for the Navy are a 100-by-100 area-imaging array and a 100-by-100 CCD TV camera. The MV-100 camera was developed by the Space & Defense Systems division, Syosset, N.Y., which has also built cameras using a linear CCD array [*Electronics*, Feb. 15, p. 31]. The sensor was developed by the Digital Products group of the Fairchild Semiconductor division, Mountain View, Calif. In April, this group introduced a charge-coupled linear image sensor, the first such product to be available commercially.

Firm pricing and availability of the MV-100 television camera will be announced before the end of the year, according to Fairchild. However, right now the company wants to negotiate with interested bidders.

Other companies are also involved in developing CCD cameras. Included are General Electric, Texas Instruments, Bell Laboratories, and RCA, which is expected to announce a CCD array on one of the largest MOS chips ever fabricated. □

## Instrumentation

### Low-cost probe seeks hazards, bugs

By applying technology perfected for the Air Force, General Microwave Corp., Farmingdale, N.Y., plans to cut sharply the price of instruments needed to measure microwave radiation. Commercial versions of the company's broadband

radiation-hazards meter will sell for about \$475. This is the mid-range of prices of narrow-band probes used to detect radiation at the 915 and 2,450 megahertz of microwave ovens, but it is less than a third the price of broadband devices, according to Sherman Rinkel, company president.

The General Microwave unit will have a frequency range of 300 MHz to 18 gigahertz with a flatness of  $\pm 1$  decibel. The unit, however, has been operating satisfactorily down to 50 MHz, Rinkel says. And it will come with selectable power density ranges of 2, 20 and 200 milliwatts per square centimeter.

In addition to making measurements on microwave ovens, the device could find use in general industrial areas and even as a "bug" detector which would detect the emissions from clandestine radio transmitters.

Rinkel says the commercial unit will resemble one originally developed by the company for Rome Air Development Center, Rome, N.Y. [*Electronics*, Sept. 27, 1971, p. 17]. One difference is that the military unit, which has a full-scale range down to 0.2 milliwatt per square centimeter, has a more sensitive, and more expensive, amplifier. Three engineering models are now being calibrated and subjected to acceptance tests for the Air Force at the National Bureau of Standards.

The broadband sensor in the probe consists of two orthogonal planes of resistive thermoelectric elements—some 75 pairs of hot and cold junctions on each plane deposited on a thin circle of Kapton, 1.25 inch in diameter. The elements are

**Bug catcher.** General Microwave Corp.'s new broadband radiation-hazards meter can be used to check microwave-oven leakage or detect hidden radio transmitters.

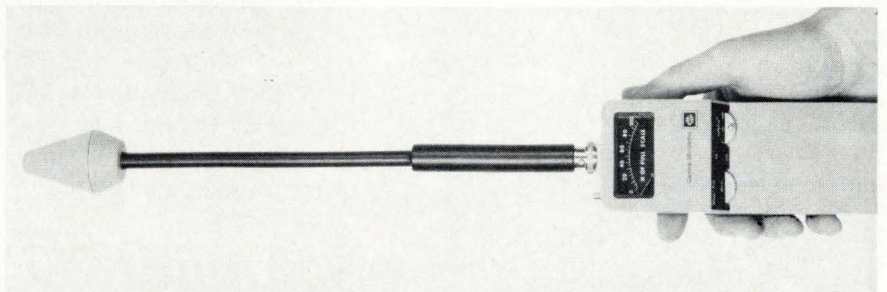



# Digitest 610. The digital multimeter that measures temperatures, too.

The Digitest 610 is a portable DMM that measures component temperature *plus* the usual volts, amps, and ohms. This feature gives you an added advantage when trouble shooting because defective components can now be more quickly identified through measurement of their surface temperature.

The light weight, compact Digitest 610 goes where it is needed. Where regular power sources are not available, it's built in nickel cadmium power pack provides many hours of reliable measurement, with recharging only an infrequent necessity. Bold bright planar gas discharge displays provide easy viewing, even at angles up to 130° and in direct sunlight. Data can be clearly read and understood at distances up to 40 feet.

The Digitest 610 is an 11,000 count unit and easy to operate push button switches enable rapid selection of mode and range from zero to full scale without further adjustment. The operational simplicity of the Digitest 610 allows non-skilled use with minimum training, but the precision design gives the trained technician and engineer the high degree of accuracy that he wants.

As well as AC and DC volts, AC and DC currents, the Digitest 610 can measure resistances from 0.1 to 5 megohms and temperature from -50°C to 200° C.

Sold and serviced throughout the United States and Canada. U.S. distributorships available.

## Schneider Electronics

c/o PERMAL INTERNATIONAL, 919 3RD AVE., NEW YORK, N.Y. 10022

LOOK FOR US AT  
WESCON  
BOOTH NOS.  
1023-1024-1032-1033

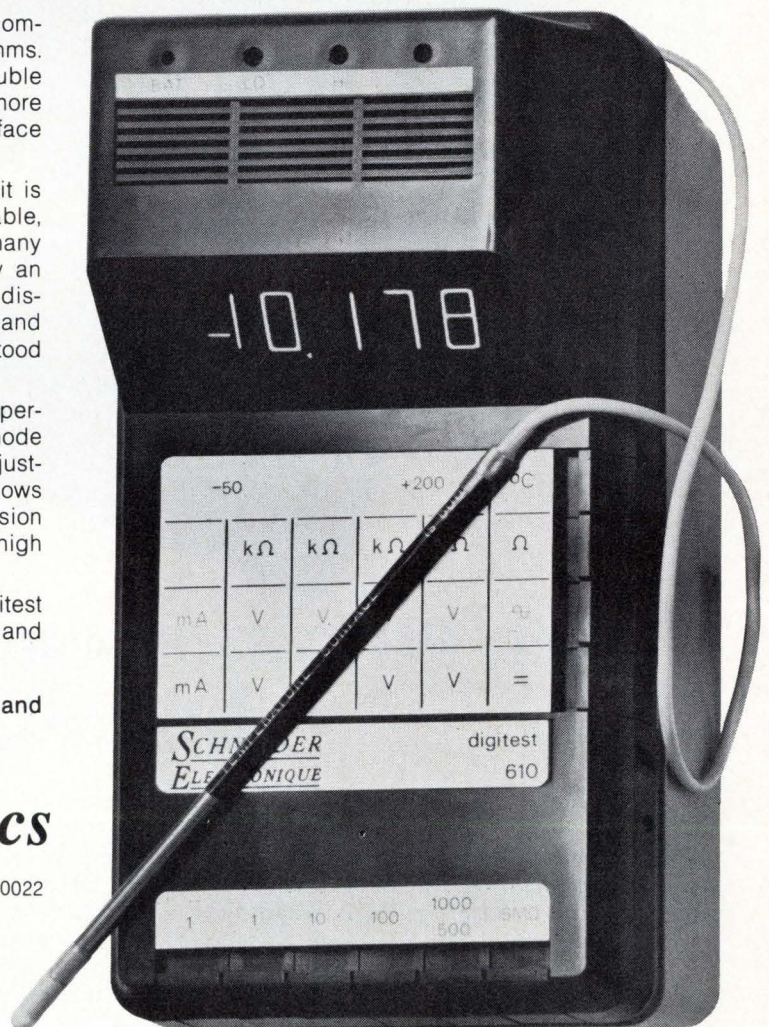



# SURPRISE!

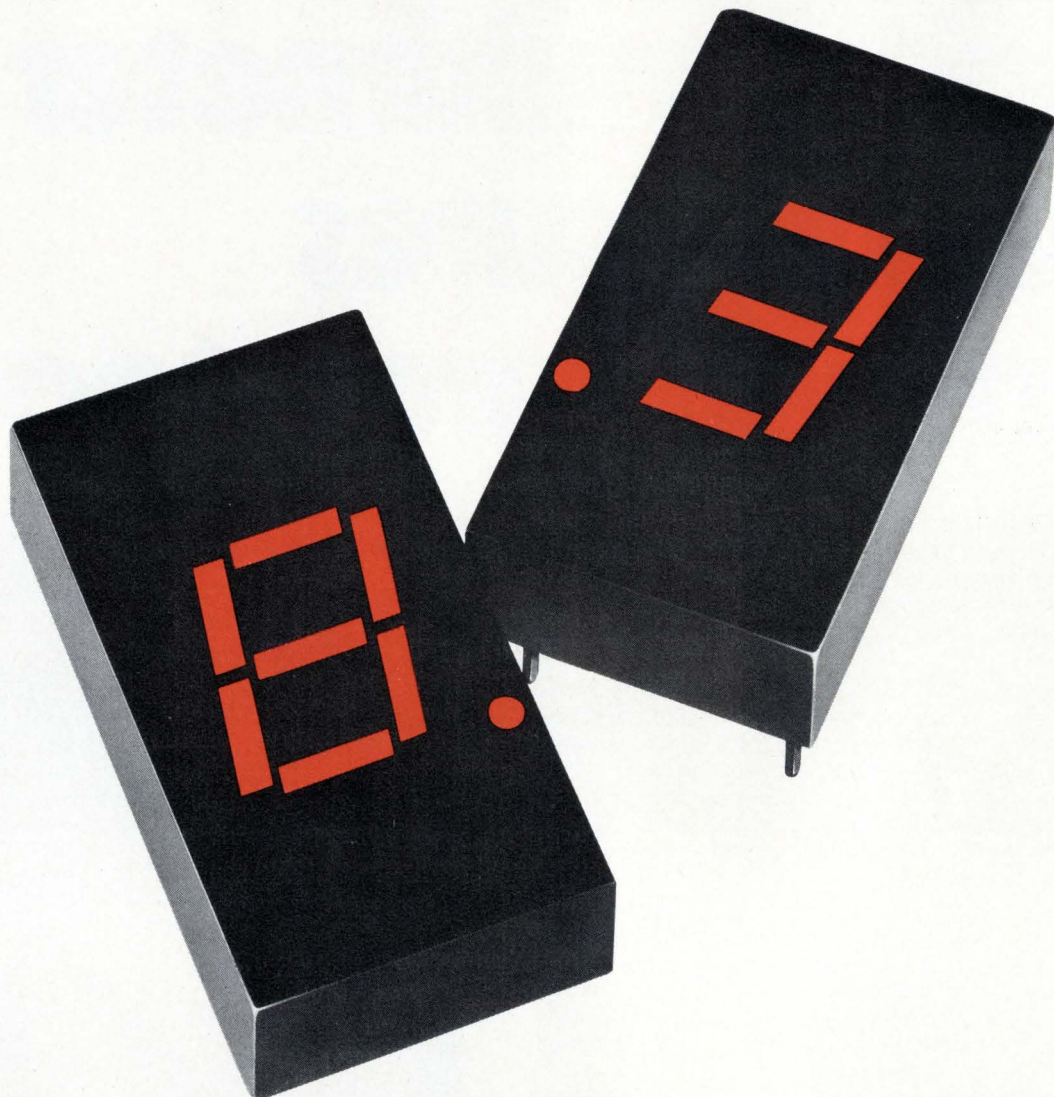

## New common cathode display just \$2.70\*

Now, the great-looking HP display is available in either common cathode and common anode configuration. Both at the new low price of just \$2.70\* in 1K quantities. Both have the same wide viewing angle and large 0.3 inch character and uniform segment illumination that assures excellent readability.

Specify either the 5082-7730 series (common anode) or -7740 (common cathode) for any commercial application. Reduce your display system costs by choosing the display that complements your drive electronics.

And get traditional HP quality.

Contact your HP distributor for immediate delivery. Or, write us for more details.

These displays are worth a closer look.

01332

\*1K quantity; Domestic USA Price Only.

40 Circle 40 on reader service card

HEWLETT  PACKARD

Sales, service and support in 172 centers in 65 countries.  
Palo Alto, California 94304. Offices in principal cities throughout the U.S.

Electronics/August 30, 1973



# SURPRISE! SURPRISE!

Now your HP distributor  
has still another way to keep  
you looking good.

Distributor Stocking Locations:

## HALL-MARK ELECTRONICS

Huntsville, Alabama  
(205) 539-0691

Lenexa, Kansas  
(913) 888-4747

St. Louis, Missouri  
(314) 521-3800

Raleigh, North Carolina  
(919) 832-4465

Tulsa, Oklahoma  
(918) 835-8458

Dallas, Texas  
(214) 231-6111

Houston, Texas  
(713) 781-6100

## SCHWEBER ELECTRONICS

Toronto, Canada  
(416) 925-2471

Hollywood, Florida  
(305) 927-0511

Elk Grove Village, Illinois  
(312) 593-2740

Rockville, Maryland  
(301) 881-2970

Troy, Michigan  
(313) 583-9242

Waltham, Massachusetts  
(617) 890-8484

Somerset, New Jersey  
(201) 469-6008

Rochester, New York  
(716) 328-4180

Westbury, New York  
(516) 334-7474

Beachwood, Ohio  
(216) 464-2970

## WYLE DISTRIBUTION GROUP

Liberty Electronics/Arizona  
Phoenix, Arizona (602) 264-4438

Liberty Electronics  
El Segundo, California (213) 322-8100

Elmar Electronics  
Mt. View, California (415) 961-3611

Western Radio  
San Diego, California (714) 235-6571

Elmar Electronics  
Commerce City, Colorado (303) 287-9611

Liberty Electronics/Northwest  
Seattle, Washington (206) 763-8200

## EUROPE

Celdis Ltd.

37-39 Loverock Road, READING, Berks, England  
Tel.: READING 58 22 11

I.S.C. France

20, rue Gambetta, 92-Boulogne, France  
Tel.: 604.52.75

Ingenieurbüro Dreyer

238 Schleswig, Flensburger Strasse 3, Germany  
Tel.: (04621) 2 31 21

EBV Elektronik

8 Munich 2, Gabriel-Max-Strasse 90  
Tel.: (0811) 644055-8

6 Frankfurt/Main 1, Myliusstrasse 54  
Tel.: (0611) 720416-18

B. V. Diode

Hollantlaan 22, Utrecht City, The Netherlands  
Tel.: (03088 42 14)

Interelko A. B.

Sandsborgsvagen 50, 12 233 Enskede, Sweden  
Tel.: (08) 49 25 05

HEWLETT  PACKARD

## Electronics review

thin films of bismuth and nichrome which operate as conventional thermocouples. The orthogonal orientation of the two planes makes the sensor sensitive to the elliptical polarization of the microwave energy fields to be measured.

**Broadband.** The effect is that of a broadband and sensitive absorber of microwave energy, with each junction pair adding its own small voltage, Rinkel points out. The summed voltages are then applied to a sense amplifier and eventually drive the indicating galvanometer. A 2-in.-high polystyrene foam cap protects the sensor and keeps it the requisite distance from the energy source when making measurements on microwave ovens.

General Microwave's first commercial probe will be an anisotropic device that is insensitive to energy in the plane of the probe. This is not much of a problem, according to Rinkel, because the hand-held unit, which weighs about 1.5 pounds, would be wiggled about by an operator until a maximum reading is obtained.

An isotropic model, suitable for unattended operation and sensitive to energy in all planes, will be available in six months to a year. It will cost "a couple hundred dollars more," estimates Rinkel. □

## Aerospace electronics

### TRW's Vulcan tests radiation hardening

The ban on atmospheric testing of nuclear devices by the U.S., USSR, and other signatories, while reducing radiation danger to inhabitants of the earth, complicates the testing of spacecraft containing radiation-hardened electronics. And underground testing, besides raising environmental questions, is "ridiculously expensive" says William C. Beggs, manager of a new flash X-ray facility that provides a fast high-energy burst of gamma radiation that simulates one component of a nuclear blast.

The 120-kilojoule machine, the largest commercial one in the country, has just gone on stream at TRW Systems, Redondo Beach, Calif., where it will be used to test components for satellites both for TRW and for other firms.

The Government has three larger machines of this type, including the mammoth 6-megajoule Aurora at Harry Diamond Laboratories in Washington D.C., and 1.5-megajoule and 500-megajoule facilities at Albuquerque, N. M. Beggs says that the largest machines, which can handle systems, as well as components, are kept busy.

The TRW facility was custom-built by Physics International Co., San Leandro, Calif., and PI also operates a smaller 95-kilojoule installation. The equipment supplies a short, high-energy X-ray burst. It can also provide heating, another important part of a blast, but its primary use is to check component performance under transient gamma radiation.

Called Vulcan the system is a high-energy-capacitor storage bank that is discharged rapidly by a field-emission vacuum target tube via a special transmission line. The storage bank is a Marx generator that consists of 50 0.5-microfarad 125-kilovolt capacitors that are charged in parallel, then discharged in series, providing up to 7 million volts at 100,000 amperes. Half-power pulse length is only 50 nanoseconds, and rms level is reproducible to 5%. The transmission line, nine feet in diameter, contains a Blumlein, (an oil-filled line) which stores and forms the pulse. The whole assembly is 50 ft. long, 11 ft high, and 11 ft. wide. The generator which moves on steel tracks to adjust the radiation level hitting the target, uses 28,000 gallons of transformer oil.

Dosage rate is up to 40,000 rads (in terms of silicon substrate), or as low as 3 rads (at the end of the 28-ft. target room). Maximum repetition rate is one pulse every 3 minutes.

This type of machine generates substantial electrical, as well as X-ray radiation. It is fully shielded—the target and instrumentation rooms are double-shielded in steel, and the whole assembly is in thick



### News briefs

#### Sperry acquires IteI subsidiary

Information Storage Systems, an IteI Corp. subsidiary that manufactures computer peripheral memories, has been acquired by Sperry Rand Corp. Sperry has made an initial payment of \$23 million to IteI, and additional payments will be contingent on, among other things, sales to customers other than Sperry during the balance of 1973 and through 1975.

ISS, to become a wholly owned subsidiary of Sperry Rand Corp., will operate as part of the Sperry Univac division. Also ISS will continue developing and manufacturing its products for IteI and other customers.

#### TI drops gold socket prices

Despite soaring gold prices, Texas Instrument is lowering the price of its low-profile IC socket, which has gold on the contact interface. The price cut, scheduled for September, will average 10%, and TI will reduce, for example, the price of a 14-pin connector in 25,000-lots from 21 cents to 18 cents. The reason for the cut, says the Attleboro, Mass., division, is a bonding technique that puts 100 microinches of gold on the contact, less gold than competing sockets, which are said to use about 10 microinches of electroplated gold.

#### Agency computer has 66 billion bits

A 66-billion-bit laser mass-memory system, made by Precision Instrument Co., Palo Alto, Calif., will be installed in April at the Social Security Administration's computer center in Baltimore, Md. Precision Instrument says this contract marks the memory's first business-data-processing application. The system, expandable to a trillion bits, will initially be used as a peripheral to a Univac 1108 computer. Another trillion-bit model has been at NASA's Ames Research Center since 1970, where it is used with the Illiac IV computer for scientific data processing.

#### \$10.4 million contract to AWACS

Electronic Communications Inc., a subsidiary of the National Cash Register Co., has received a \$10.4 million contract from the Boeing Aerospace Co. to provide radio equipment for the Air Force's Airborne Warning and Control System. The contract calls for the design, development, testing, and delivery of six types of equipment to be part of the AWACS ultrahigh-frequency radio complement. For the program's full-scale development phase, sufficient quantities of each unit will be delivered to equip three air laboratory systems for evaluation this fall. Factory production will begin early next year, and deliveries will start in mid-1974.

#### Top three military R&D vacancies filled

President Nixon has nominated two physicists and an aeronautical engineer to be assistant secretaries of research and development for the Air Force, Army, and Navy. The latter two posts have been vacant for nearly eight months.

Walter B. LaBerge, technical director of the Naval Weapons Center, China Lake, Calif., has been named assistant secretary of the Air Force for R&D. Norman R. Augustine, vice president for advanced development at LTV Aerospace Corp.'s Vought Missiles and Space Co., Arlington, Texas, has been chosen for the Army post, and David Samuel Potter, research director for the General Motors Corp. Detroit Diesel Allison division, is the Navy nominee.

#### U.S. sponsors Paris computer show

To help U.S. computer-equipment makers increase their sales to France, the Commerce Department will sponsor a show of computers and related equipment at the U.S. Trade Center in Paris Jan. 14-18, 1974. The department estimates that French imports of U.S. equipment will nearly double to \$211 million by 1977, keeping ahead of West Germany, the next largest foreign supplier.

concrete to protect against electromagnetic interference. Shielding is extensive to ensure that the instrumentation is not affected by the electrical noise.

The Vulcan installation, which was financed by TRW, has extensive instrumentation, but users may add their own. Because of the short length of the pulse, oscilloscopes and film are major instruments in monitoring results, and TRW has had to slightly modify the many units installed to give automatic and remote exposure. Full dosimetry is also provided. □

### Military electronics

#### AF seeks new funds for F-111 ECM

The Air Force is pushing Congress to begin funding research and development for a \$337 million procurement program to modify an undisclosed number of General Dynamics Corp. F-111 interceptors with ALQ-99 tactical jamming systems to give them a new electronic-warfare capability.

The program was disclosed in Congressional testimony by Brig. Gen. Lovic P. Hodnette Jr., AF director of reconnaissance and electronic warfare.

He detailed a reprogramming request for \$2.5 million in fiscal 1973 funds to outfit two of the existing planes as prototype EF-111A's by adding the ALQ-99 receiver, computer, and high-powered transmitters with directional/steerable antennas. The fiscal 1974 RDT&E budget request includes \$15 million for the EF-111A program, which could eventually have an estimated development cost of \$68.7 million before entering the procurement cycle.

**New jammer needed.** Hodnette explained that the Air Force had to scrap its original plans to upgrade its tactical-support jamming capability by using McDonnell Douglas F-4D Wild Weasel countermeasure planes to carry the ALQ-99 because



# $\Omega$ Micaply Ohmega™

## A new way to design with resistors.

We'll show you how at WESCON Booth 1309.

Micaply Ohmega is a unique resistor-conductor circuit material that provides circuit designers with a new way to design with resistors. It's available in 10" x 36" sheets with 25 or 100 ohms per square sheet resistivity.

This unique material is an epoxy glass substrate completely covered on one or both sides with a bi-layer cladding. The thin film type layer against the substrate is resistive, the top layer is copper. Using conventional printed circuit produc-

tion techniques, patterns of conductors and resistors can be etched to produce circuits complete with integral resistors. The entire process is subtractive—no screening, firing, or vacuum equipment is required.

Micaply Ohmega is ideally suited for high resistor density, low resistor value circuits; multilayer circuits where the resistors can be put between layers; circuits where economical step and repeat methods can be used on large sheets of Micaply

Ohmega; and designs previously impractical or uneconomical with other materials.

Let's talk about your potential applications.

**The Mica Corporation**  
Culver City, California  
(213) 870-6861 and  
Micaply International, Silloth, England

Circle 43 on reader service card

### We can assist in design and provide prototype circuit production.

*Multilayer printed circuit boards*

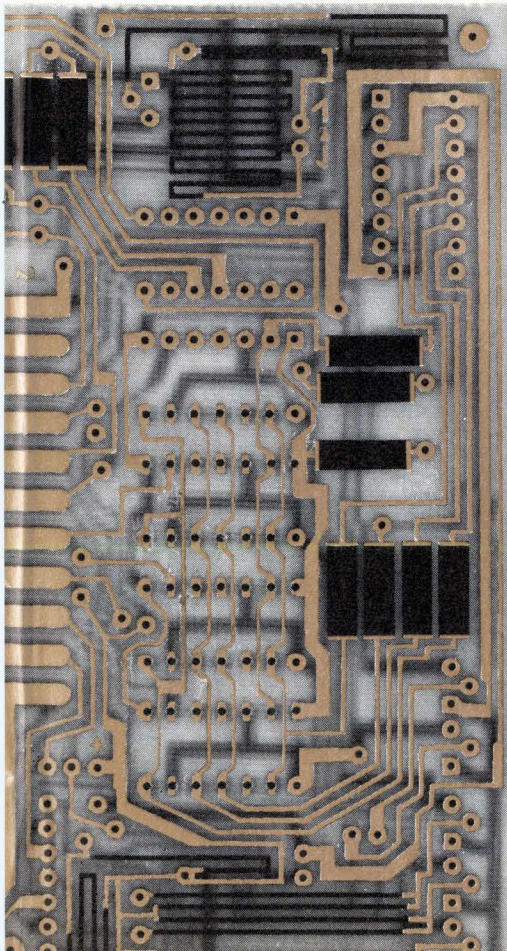

*High resistor density circuits*

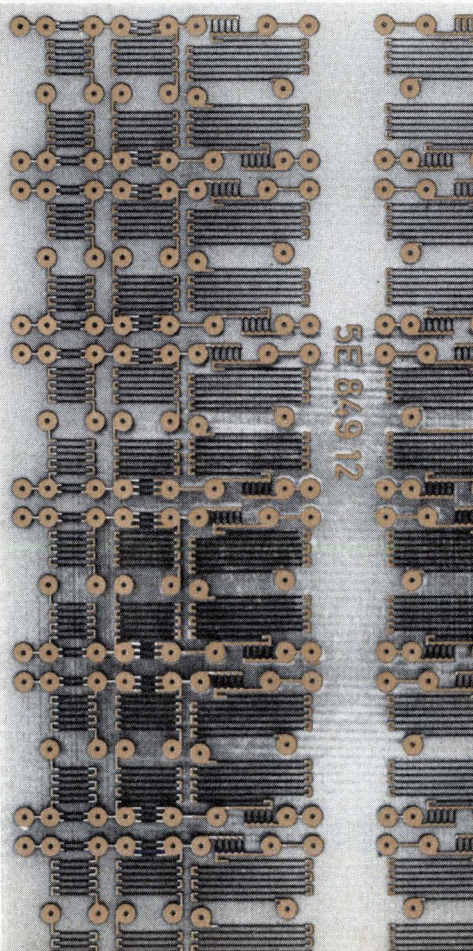

*Hybrid microelectronics*

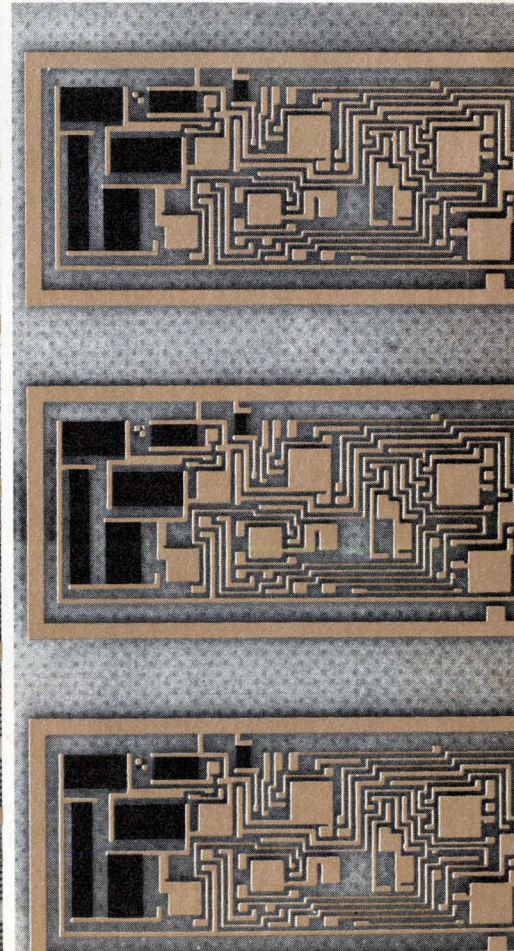



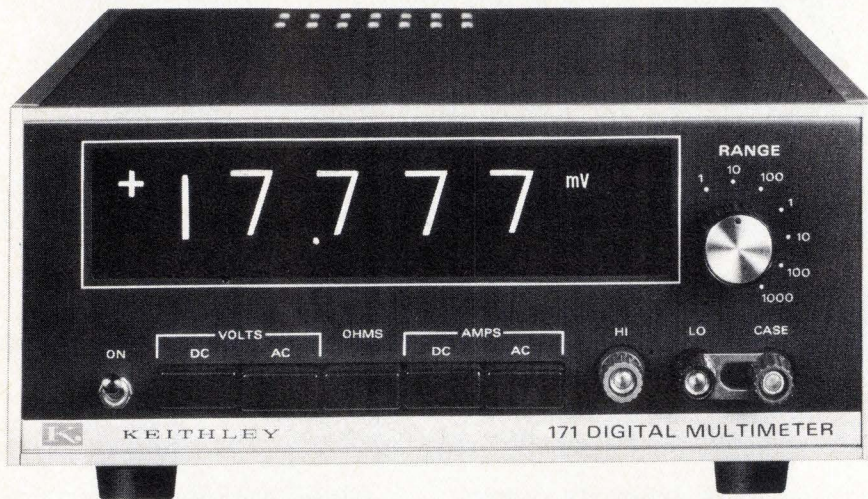

# NEW AC/DC Digital Multimeter has all the sensitivity, ranges and functions you need ... built in.

how sweet  
to have.

The new Keithley Model 171 Microvolt Digital Multimeter provides you with more measuring ranges than any other multimeter in its class. At only \$895 the 4½-digit Model 171 is the only multimeter you need whether it be for bench, systems, or servicing use — or all three.

This DMM eliminates the need for add-on preamps, plug-in circuit boards, hand-on shunts or other run-arounds. The only option we need offer is an easy-to-interface BCD output — and that's available built in.

The Model 171 measures

- dc voltage - from 1 microvolt to 1000 volts
- ac voltage - from 10 microvolts to 1000 volts
- ac & dc current - from 100 picoamperes to 2 amps
- resistance - from 100 milliohms to 2000 megohms

With all its capability this new Multimeter is really "sweet to have" . . . and our newest "how sweet" button proclaims just that. Get yours — and complete data or a demonstration of the Model 171 — today.



**KEITHLEY**  
INSTRUMENTS  
U.S.A. 28775 AURORA ROAD, CLEVELAND, OHIO 44139  
EUROPE: 14, AVENUE VILLARDIN, 1009 PULLY, SUISSE

SEE ALL OUR NEW MULTIMETERS AT WESCON BOOTH NO. 1522

"the technical risk . . . was exceedingly more difficult than we had anticipated." Another reason was that the existing EB-66 aircraft used for electronic countermeasures are old and becoming obsolete, according to Hodnette.

Asked if the Air Force could use the Navy's EA-6B plane, which is equipped with the ALQ-99 for the same purpose, Hodnette said "no," explaining, "It is an outstanding jammer in a protective environment," but "not as survivable an aircraft in a hostile environment," where the Air Force has an operational need. "An F-4 or an A-6 can maintain a station in a jamming role for two to two-and-a-half-hours," Hodnette said, "whereas the F-111 has about an eight-hour duration" on station.

**Congress cuts.** Prior to the \$2.5 million reprogramming request, Congress had already struck the same amount from the RDT&E budget request for fiscal 1973, cutting \$1 million for advanced aircraft avionics. This postpones flight tests of the forward-looking advanced multimode radar and drops another \$1 million for R&D on aerospace structural materials. It also excises another \$500,000 intended for flight-vehicle-subsystem concept studies on advanced life-support and avionics environmental-conditioning systems. The cut would also eliminate work on a single multimode matrix display for the cockpit to show data from multiple sources.

The ALQ-99 tactical jammer, developed by Cutler-Hammer's AIL division, Deer Park, N.Y., several years ago, consists of 15-foot long, low-drag pods, 15 inches in diameter, that are attachable to the belly or four pylons of a plane. The pods, powered by a 30-kVA, three-phase Garrett AiResearch ram turbine in the nose, has a 400-Hz output. As originally developed, each pod contained two Raytheon Co. transmitters and a single-track receiver that works with the pod's two antennas on a time-shared basis. The removable pods can cover differing or duplicate bandwidths, providing the capability of countering multiple threats. □



# 3 Wire Synchro to Linear D.C. Converter

ACCURACY 1/2 %



#MAC 1422-1

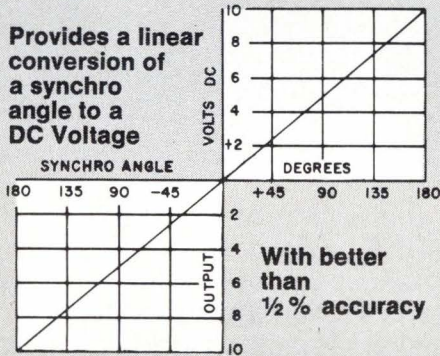

- Scaled for  $\pm 10V$  DC output
- Operates from  $\pm 15V$  supplies
- No external adjustments
- Hermetically sealed
- Output short circuit protected
- Units can be altered to operate with different L-L Voltages or frequency

## Specifications

**Accuracy:**  $\pm 1\%$  over temperature range

**Input:** 11.8V, 400HZ line to line 3 wire synchro voltage

**Output impedance:** less than 10 Ohms

**Input impedance:** 10K minimum line to line

**Reference:** 26V  $\pm 10\%$  400HZ (Unit can be altered to accommodate 115V if available at no extra cost)

**Operating temperature range:**  $-25^{\circ}C$  to  $+85^{\circ}C$

**Storage temperature range:**  $-55^{\circ}C$  to  $+100^{\circ}C$

**DC power:**  $\pm 15V \pm 1\%$  @ 75ma (approx.)

**Case material:** High permeability Nickel Alloy

**Weight:** 6 Ozs.

**Size:** 3.6" x 2.5" x 0.6"

## Precision Analog Components for Signal Manipulation and Function Generation

- Radiation Hardened Analog Multipliers and Modulators
- Linear DC to Synchro Converter
- Sine-Cosine to 3 Wire Converter
- 3 Wire to Linear DC Converter
- 3 Wire to Sine-Cosine Converter
- Sine-Cosine Generators
- Precision Modulators
- Precision Analog Multipliers
- Squaring/Square Root Modules
- Precision Analog Divider
- Precision A.C. Regulators
- Demodulators
- Transformers

## Analog Computing Applications

- Trigonometric Manipulations
- Multiplying
- Dividing
- Squaring
- Modulating
- Automatic Gain Control
- Demodulation
- RMS Computation
- Phase Measurement
- AC Amplitude Regulation and Modulation
- Linearizing
- Square Rooting
- Power Measurement
- Ratio Measurement

# 4 Quadrant Magnetic Analog Multiplier

DC x AC = AC Output

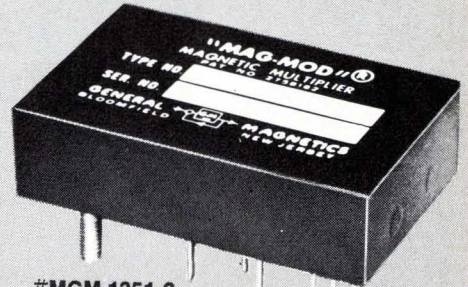

#MCM 1351-2

**Product Accuracy is  $\pm 1/2\%$  of all readings Over Full Temperature Range of  $-55^{\circ}C$  to  $+125^{\circ}C$**

- Product accuracy is specified in % of reading for all output analog voltage product points over the full military temperature range instead of % of full scale error giving superior results for small values.
- Linearity, product accuracy, and zero point virtually unaffected by temperature changes.
- All units are hermetically sealed and completely shielded from external electric or magnetic fields.

## Specifications Include:

**Transfer equation:**  $E = XY/3$

**X & Y input signal ranges:** 0 to  $\pm 3V$  Peak

**Maximum static and dynamic product error:**  $1/2\%$  of point or 2 MVRMS, whichever is greater, over entire temperature range

**Input impedance:** X = 10K; Y = 10K

**Full scale output:** 3 VRMS

**Minimum load resistance for full scale output:** 2000 ohms

**Output impedance:** Less than 50 ohms

**X input bandwidth:**  $\pm 0.5db$ , 0 to 200 hertz

**Y input bandwidth:**  $\pm 0.5db$ , 20 hertz to 1000 hertz

**DC power:**  $\pm 15V$  unless otherwise required @ 20 ma

**Size:** 1.8" x 1.1" x 0.5"

There is No Substitute for Reliability



**GENERAL MAGNETICS, INC.**

135 Bloomfield Avenue  
Bloomfield, New Jersey 07003  
(201) 743-2700

There is No Substitute for Reliability





**GENERAL MAGNETICS, INC.**

135 Bloomfield Avenue  
Bloomfield, New Jersey 07003  
(201) 743-2700



# FROM DELCO, THREE POWER TRANSISTORS.

	TYPE	V <sub>CEO</sub>	V <sub>CEV</sub>
	DTS-708	900V	900V
	DTS-709	900V	900V
	DTS-710	900V	—

We'd like to simplify your life while you simplify your high energy circuits.

These three new devices are all NPN,

triple diffused and packaged in Delco's solid copper TO-204MA packages (TO-3 to you old-timers) for man-sized power handling.

DTS-708 and 709 are designed for use in high voltage switching applications—where inductive loads or fault conditions may be giving you problems now. The DTS-710 is ideal for linear regulators and power amplifiers.

Safe Operating Curves on the data sheets let you know where it's at. And our applications engineering assistance is available, too.

You probably know about our reputation for making really tough transistors—for high peak energy handling. You'll find we can deliver, too.

All of the Delco distributors listed have the DTS-700 series in stock.

Give yours a call now for the prices you'll like and the data you'll need.

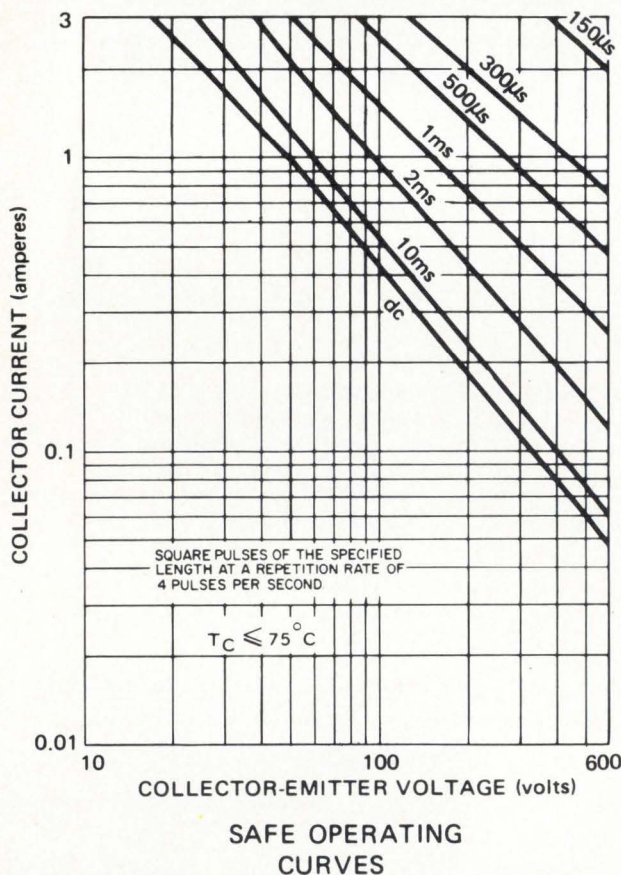

## NOW AVAILABLE FROM THESE DISTRIBUTORS IN PRODUCTION QUANTITIES.

**ALABAMA, Birmingham 35233**  
Forbes Distributing Co., Inc.  
1416 Fourth Ave., South  
(205) 251-4104

**ALABAMA, Huntsville 35807**  
Powell Electronics  
803 Oster Dr.  
(205) 539-2731

**ARIZONA, Phoenix 85005**  
Sterling Electronics, Inc.  
1930 N. 22nd Ave.  
(602) 258-4531

**CALIFORNIA, Goleta 93017**  
Radio Product Sales, Inc.  
350 E So. Kellogg Ave.  
(805) 964-4764

**CALIFORNIA, Los Angeles 90022**  
Kierulff Electronics, Inc.  
2585 Commerce Way  
(213) 685-5511

**CALIFORNIA, Los Angeles 90015**  
Radio Products Sales, Inc.  
1501 South Hill Street  
(213) 748-1271



# NEW 900-VOLT SILICON

V <sub>CEO</sub> (sus) IC = 1A	V <sub>CE</sub> (sat)	hFE Min/Max	IC
600V	2.0V (IC = 1A, IB = 250mA)	—	3A
600V	1.0V (IC = 2A, IB = 800mA)	—	3A
600V	—	10/50	3A

## CALIFORNIA, Palo Alto 94303

Kierulff Electronics, Inc.  
3969 East Bayshore Road  
(415) 968-6292

## CALIFORNIA, Redwood City 94063

Cramer/San Francisco  
695 Veterans Blvd.  
(415) 365-4000

## CALIFORNIA, San Diego 92123

Kierulff Electronics, Inc.  
8797 Balboa Avenue  
(714) 278-2112

## CALIFORNIA, San Diego 92111

Radio Products Sales, Inc.  
7889 Clairemont Mesa Blvd.  
(714) 292-5611

## COLORADO, Denver 80222

Cramer/Denver  
5465 E. Evans Place  
(303) 758-2100

## CONNECTICUT, Norwalk 06851

Harvey/Connecticut  
112 Main Street  
(203) 853-1515

## FLORIDA, Miami Springs 33166

Powell/Gulf Electronics  
1740 N.W. 69th Avenue  
(305) 885-8761

## FLORIDA, Orlando 32809

Powell/Gulf Electronics  
2032 Palm Ridge Way  
(305) 859-1450

## ILLINOIS, Rosemont 60018

Kierulff Electronics, Inc.  
9340 William Street  
(312) 678-8560

## ILLINOIS, Skokie 60076

Bell Industries  
Electronics Distributors Div.  
7701 N. Austin Ave.  
(312) 282-5400

## INDIANA, Indianapolis 46204

Graham Electronics Supply, Inc.  
133 So. Pennsylvania St.  
(317) 634-8202

## MARYLAND, Baltimore 21204

Radio Electric Service Co.  
1026 Cromwell Bridge Road  
(301) 823-0070

## MASSACHUSETTS, Needham Heights 02194

Kierulff Electronics, Inc.  
14 Charles Street  
(617) 449-3600

## MASSACHUSETTS, Newton 02195

The Greene-Shaw Co., Inc.  
Chapel Bridge Park  
70 Bridge Street  
(617) 969-8900

## MICHIGAN, Farmington 48024

Harvey/Michigan  
23461 Industrial Park Dr.  
(313) 477-1650

## MINNESOTA, Minneapolis 55401

Stark Electronics Supply Co.  
112 3rd Ave., North  
(612) 332-1325

## MISSOURI, North Kansas City 64116

LCOMP Kansas City  
1520 Taney Street  
(816) 221-2400

## MISSOURI, St. Louis 63144

LCOMP-St. Louis  
2605 S. Hanley Road  
(314) 647-5505

## NEW JERSEY, Clifton 07015

Wilshire Electronics/New Jersey  
312 Clifton Avenue  
(201) 365-2600 (212) 244-8930

## NEW YORK, Binghamton 13902

Harvey/Federal  
P.O. Box 1208  
(607) 748-8211

## NEW YORK, East Syracuse 13057

Cramer/Syracuse  
6716 Joy Road  
(315) 437-6671

## NEW YORK, Rochester 14623

Cramer/Rochester  
3259 Winton Road South  
(716) 275-0300

## NEW YORK, Woodbury 11797

Harvey/New York  
60 Crossways Park West  
(516) 921-8700 (212) 895-9260

## OHIO, Cincinnati 45237

United Radio, Inc.  
7713 Reinhold Drive  
(513) 761-4030

## OHIO, Cleveland 44125

Pattison Supply Co.  
Industrial Electronics Division  
4550 Willow Parkway  
(216) 441-3000

## OHIO, Dayton 45414

Kierulff Electronics, Inc.  
2030 Drill Avenue  
(513) 278-9411

## PENNSYLVANIA, Philadelphia 19114

Almo Electronics  
Roosevelt Blvd. at  
Blue Grass Road  
Northeast Industrial Park  
(215) 676-6000

## PENNSYLVANIA, Pittsburgh 15328

RPC Electronics  
620 Alpha Drive  
RIDC Park  
(412) 782-3770

## SOUTH CAROLINA, Columbia 29202

Dixie Radio Supply Co., Inc.  
1900 Barnwell Street  
(803) 253-5333

## TEXAS, Dallas 75201

Adleta Electronics Company  
1907 McKinney Ave.  
(214) 741-3151

## TEXAS, Fort Worth 76102

Adleta Electronics Company  
South Expressway at E. Vickery  
(817) 336-7446

## TEXAS, Garland 75041

Kierulff Electronics, Inc.  
2815 National Drive  
(214) 271-2471

## TEXAS, Houston 77004

Harrison Equipment Co., Inc.  
1616 McGowen St.  
(713) 224-9131

## UTAH, Salt Lake City 84115

Cramer/Utah  
391 West, 2500 South  
(801) 487-3681

## VIRGINIA, Richmond 23220

Meridian Electronics, Inc.  
1001 West Broad Street  
(703) 353-6648

## WASHINGTON, Seattle 98108

Kierulff Electronics, Inc.  
5940 6th Ave. South  
(206) 763-1550

## IN CANADA

ONTARIO, Scarborough  
Lake Engineering Co., Ltd.  
123 Manville Rd.  
(416) 751-5980

## Delco Electronics Regional Sales Offices

Union, New Jersey 07083  
Box 1018 Chestnut Station  
(201) 687-3770

El Segundo, California 90245  
354 Coral Circle  
(213) 640-0443

General Sales Office  
700 E. Firmin, Kokomo, Ind. 46901  
(317) 459-2175  
Operator (317) 457-8461



Delco Electronics, Division of General Motors.



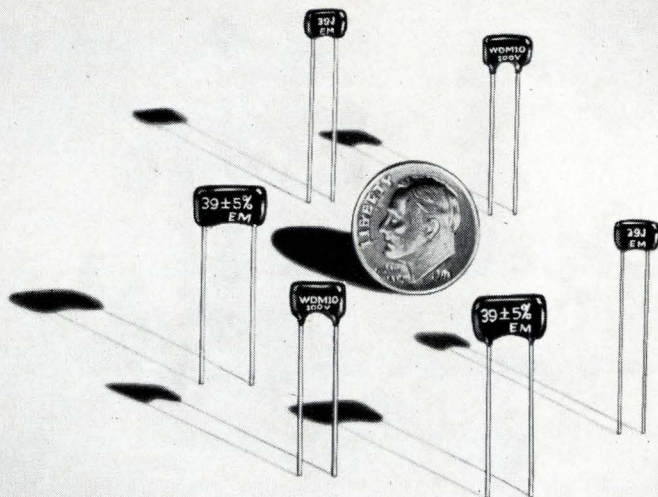

## They're Small and Reliable\*

### EL-MENCO DM5 — DM10 — DM15 — ONE COAT DIPPED MICA CAPACITORS

STYLE	WORKING VOLTAGE	CHARACTERISTIC	CAPACITANCE RANGE
DM5	50VDC	C	1pF thru 400pF
		D, E	27pF thru 400pF
		F	85pF thru 400pF
DM5	100VDC	C	1pF thru 200pF
		D, E	27pF thru 200pF
		F	85pF thru 200pF
DM10	100VDC	C	1pF thru 400pF
		D, E	27pF thru 400pF
		F	85pF thru 400pF
DM15	100VDC	C	1pF thru 1500pF
		D, E	27pF thru 1500pF
		F	85pF thru 1500pF
DM5	300VDC	C	1pF thru 120pF
		D, E	27pF thru 120pF
		F	85pF thru 120pF
DM10	300VDC	C	1pF thru 300pF
		D, E	27pF thru 300pF
		F	85pF thru 300pF
DM15	300VDC	C	1pF thru 1200pF
		D, E	27pF thru 1200pF
		F	85pF thru 1200pF
DM10	500VDC	C	1pF thru 250pF
		D, E	27pF thru 250pF
		F	85pF thru 250pF
DM15	500VDC	C	1pF thru 750pF
		D, E	27pF thru 750pF
		F	85pF thru 750pF

Where space and performance are critical, more and more manufacturers are finding that El-Menco miniaturized dipped mica capacitors are the reliable solution. The single coat is available in three sizes: 1-CRH, 1-CRT and 1-CE.

The 1-CRH DM "space savers" easily meet all the requirements of MIL and EIA specifications, including moisture resistance. The 1-CE and 1-CRT units also meet the requirements of MIL and EIA specifications, except that they have less moisture protection because of their thinner coating; these capacitors, therefore, are ideally suited where potting will be used. Note: DM10 and DM15 units are still available in the standard 4-CR size.

**Specify "El-Menco" and be sure . . .** the capacitors with proven reliability. Send for complete data and information.

\*Normally, El-Menco 39 pF capacitors will yield a failure rate of less than 0.001% per thousand hours at a 90% confidence level when operated with rated voltage and at a temperature of 85°C. Rating for specific applications depends on style, capacitance value, and operating conditions.

## THE ELECTRO MOTIVE MFG. CO., INC.

WILLIMANTIC, CONNECTICUT 06226

Dipped Mica • Molded Mica • Silvered Mica Films • Mica Trimmers & Padders  
Mylar-Paper Dipped • Paper Dipped • Mylar Dipped • Tubular Paper

West Coast Manufacturers contact: COLLINS & HYDE CO., 900 N. San Antonio Rd., Los Altos, California 94022  
5380 Whittier Blvd., Los Angeles, California 90022

ALSO SOLD NATIONALLY THROUGH ARCO ELECTRONIC DISTRIBUTORS



## Naval research claims battery breakthrough. . .

The customarily cautious Office of Naval Research is excited about development of what it calls **"a revolutionary, compact, high-powered electrochemical cell" having eight times the output of a conventional dry battery.** The experimental wet battery—small enough right now to power a watch—uses a lithium-metal anode, a carbon electrode, and an electrolyte of inorganic salts in an inorganic solvent. Energy is produced by decomposition of the solvent at the electrode and oxidation of the lithium during discharge, say the researchers.

**The battery is said to be immune to current leakage** because the fluid energy source is used only when the circuit is closed and the battery is discharging. In addition to the extended shelf-life this produces, the Navy says the unit's output of nearly 4 volts is so stable that a radio retains uniform tone quality for the battery's lifetime.

With basic research funded by the Navy, the cell was developed at GTE Laboratories, Waltham, Mass., by a group headed by Adam Heller and James Auburn.

## . . .with broad commercial use also seen

Potential military applications for the lithium-carbon wet cell are broad, the Navy believes, since the battery's demonstrated operating temperature ranges from  $-75^{\circ}\text{F}$  to  $+146^{\circ}\text{F}$ . Beyond the obvious tactical-radio applications, **the Navy envisions a need for the battery in submarines, mines, and missiles.** On the commercial side, GTE—which **has applied for patents on the battery and is evaluating its market potential—foresees applications in portable radios, television, cameras, and hearing aids, as well as watches and flashlights.**

Discovery of the principle behind the battery's development—that certain inorganic liquids can be used in alkali-metal batteries, both as solvents and oxidizers for the energy source, resulting in dense energy storage—came during GTE Labs' study for the Office of Naval Research of the electroluminescence properties of inorganic liquids.

## Computer-aided transcription system RFPs due

Development of a prototype computer-aided transcription system for courtrooms is the aim of a request for proposals coming out of the National Center for State Courts under a \$281,329 grant from the Law Enforcement Assistance Administration. **The system is to have CRT terminals for editing.** The center first would evaluate proposals from contractors and then choose a qualified source later this year to begin an 18-month project in a city to be selected. **Project goal is a basic fast, workable system that courts could use to cut down the laborious manual transcription** and ease their backlogs.

## AT&T protest may delay ship traffic systems

The Coast Guard's choice of Motorola to supply communications equipment for the Vessel Traffic System in the Houston Ship Channel is being investigated by the General Accounting Office **after a protest by AT&T's Southwestern Bell that procurement procedures may not have been proper.** AT&T contends that its proposal was more than double the winner's price, even though both were bidding to the same specifications. The Coast Guard answers that it acted properly, using equipment costs approved on General Services Administration lists.



## Expanding citizens' band: problems and politics

Politics and its considerations can be as much the bane of electronics technology as they can be its salvation. Consider, for example, the issue of expanding the congested citizens' radio service by adding new fm channels in the 224-225-megahertz band to create a new Class E service. While the proposal was finally compromised to the advantage of CB proponents before the Federal Communications Commission earlier this summer, the politics of the issue had stalled action on the plan for more than a year [*Electronics*, June 11, p.40; March 13, 1972, p.31].

When the FCC finally moved to resolve the case by allocating 40 new channels at 25-kilohertz spacing to establish a Class E service, the decision represented a neat political compromise of the positions of CB equipment makers and the Electronic Industries Association, on the one hand, who sought 2 MHz for 40 new channels, and their opponents among amateur broadcasters in the American Radio Relay League, on the other, who sought to keep all of the 220-225 MHz allocation they share equally with radiolocation services.

### Delays to come

In the months to come, ARRL can be expected to maintain at least a delaying action in the form of comments on the FCC decision, due to be received by Sept. 20, and replies to those comments, now scheduled for an Oct. 22 deadline. Yet implementation of Class E service seems inevitable.

Though the protective position of opponents of Class E is understandable, their struggle to preserve their small share of the limited spectrum is outweighed by the needs of citizens band service now jammed into the a-m band between 29.96 and 27.23 MHz. This Class D service suffers not only from overcrowding but abuse as well—because it is frequently used for unauthorized long-distance transmissions by employing the a-m signal reflection off the upper layers of the geosphere at that band.

But even proponents of Class E are quick to point out that the proposed fm allocation has definite limitations, most of them stemming from the Department of Defense. For example, the new service is likely to be useless along much of the northern and southern borders of the U.S. In those regions, particularly in the north central and northwestern areas, Class E service would be subject to interference from radiolocation services of Government agencies. Then there is the problem of some of DOD's

older coastal radars, which are likely to prove effective jammers of Class E transceivers in a few other areas.

### The good news

Nevertheless, U.S. equipment manufacturers are convinced that Class E service can be "far better than what we have with Class D" despite the FCC's caveats. The need is definitely there, as FCC's own figures show. Since the establishment of Class D service in 1958, the number of CB licensees has ballooned from 49,000 after the first year of operation to 868,013 in 1971.

While the retail potential for fm citizens' band equipment has been forecast at more than \$300 million a year—10 times its existing size—after a three-to-four-year startup, "there is more than 'greed' involved here," argues EIA's John Sodolski, vice president for communications and industrial electronics. That view is supported by manufacturer Gus Wirth of Echo Communications Inc., Cedarsburg, Wis. By modifying car radios "with one integrated circuit" to make them fm citizens' radio transmitters, Wirth contends, private industry could eliminate the requirement for expensive emergency highway broadcast systems now under consideration in the Department of Transportation.

Class E radios, costing \$200 each, installed in one out of every 10 cars in a 10-million car U.S. market would account for a \$200 million market, says Sodolski, while base-station sales to one of every two of these car owners would generate another \$100 million. Then there is the marine market, which would involve most pleasure-boat operators.

And if oil companies, motel operators, and others who are anxious to capitalize on the business of mobile users offer highway guidance, weather warning, and accident assistance services, as Sodolski and Wirth believe, the potential for Class E equipment could mount easily to \$500 million a year.

Without question a great deal of money is at stake. However, more is at stake. There is the obvious need to eliminate spectrum congestion, and here is a valuable opportunity for the private-communication-industry to provide new services without needless expenditure of Federal funds. Considering the tradeoff in which amateurs stand to lose no more than 20% of their allocation, the commission has only one viable course. It must act quickly and prevent a further delay in the expansion of CB in the public interest.

—Ray Connolly



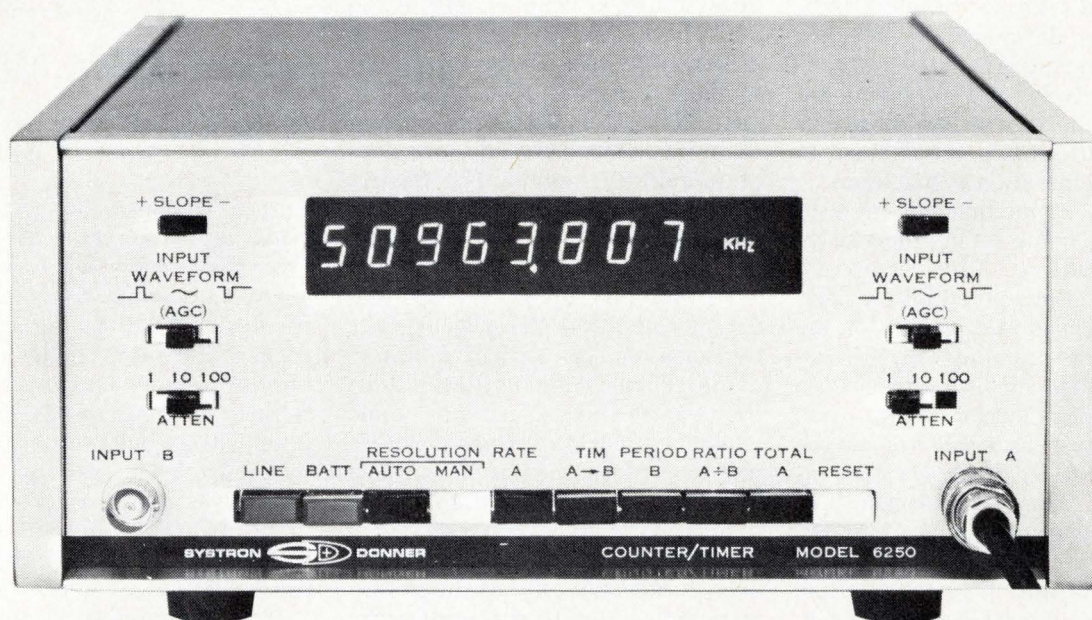

## 50 MHz automatic counter/timer

Frequency, TIM, period, ratio, totalize

Automatic gain control

Autoranging

Leading zero suppression

8-digit readout (standard)

25 mV input sensitivity

BCD output

### Model 6250 Options include:

Choice of 5 higher oscillator stabilities

Internal battery pack

Contact your Scientific Devices office or Concord Instruments Division,  
10 Systron Drive, Concord, CA 94518. (415) 682-6161

Europe: Munich, W. Germany, Leamington Spa, U.K.

**SYSTRON**  **DONNER**



## Wafer scriber uses laser for positioning

**Laser scribers** that also automatically position IC wafers may be coming along in the near future to add to the productivity of semiconductor plants. A group headed by Masayuki Ikeda in the manufacturing technology section of the Japanese government's Electrotechnical Laboratory has developed a complete system—including both experimental hardware and software—and is now talking with scriber manufacturers about adding this feature to their next generation of machines.

During the time that present laser scribers are being set up, their lasers are inoperative. This approach wastes the laser's potential for measuring the position of circuits on the wafer and for orienting the chip—especially since measurement is a leading application for lasers.

**Start.** Most laser scribers can be programmed to scribe between the individual IC chips if the spacings of the successive passes in the X and Y directions are fed into the system, and the starting point is located. Also a means must be provided to assure that the wafer and machine X-Y axes coincide. Now, adjustment for initial starting point and rotation of the table supporting the wafer must be performed manually.

In the experimental system, alignment of the axes is achieved by abutting the flat facet normally present on silicon wafers against a guide on the table. Precision is not always good enough, though, and it is sometimes necessary to rotate the table. Software has been developed to perform this rotation automatically, although the hardware is not implemented in the experimental unit.

The system operates under the control of a sequence controller with diode-matrix programming. About 150 steps are used, increasing to about 250 if rotation control is included. Spacing of cuts is fed man-

ually into the controller in the experimental setup, but with computer-controlled scheduling it would be simple to have the computer change these parameters as individual wafers arrive.

The special optical system produces a tubular beam of light. When the light is reflected from the chip, it travels up the tube—avoiding interference—to a four-sided prism. Images reflected from the four sides of the prism are reflected onto four photomultiplier tubes. The relative strengths of the four signals give an indication of the location of the pattern on the wafer.

In operation, the wafer is fed into the machine and clamped in place by vacuum. A capacitive sensor automatically finds the thickness of the wafer and adjusts the table height so that the reflected pattern will be in focus on the prism. The table is then slewed at a 45° angle, by feeding identical drive signals to the pulse motors controlling the two axes, to find the edge of the IC pattern. After the sensor locates the

pattern edge, the program, together with input information including spacing between scribed lines, enables the system to find the position of the starting corner. □

### France

## Government, industry spar over cable TV

France is taking its first cautious steps into the cable-TV business. Over the next few weeks, officials of a new state-owned company will put the finishing touches on a pilot program of local CATV networks in five provincial cities and two new Paris suburban communities. The program will try out alternative ways of managing CATV systems and will give private business its first taste of broadcasting in France. The first system should be operational sometime in 1974.

If the program works out well, the

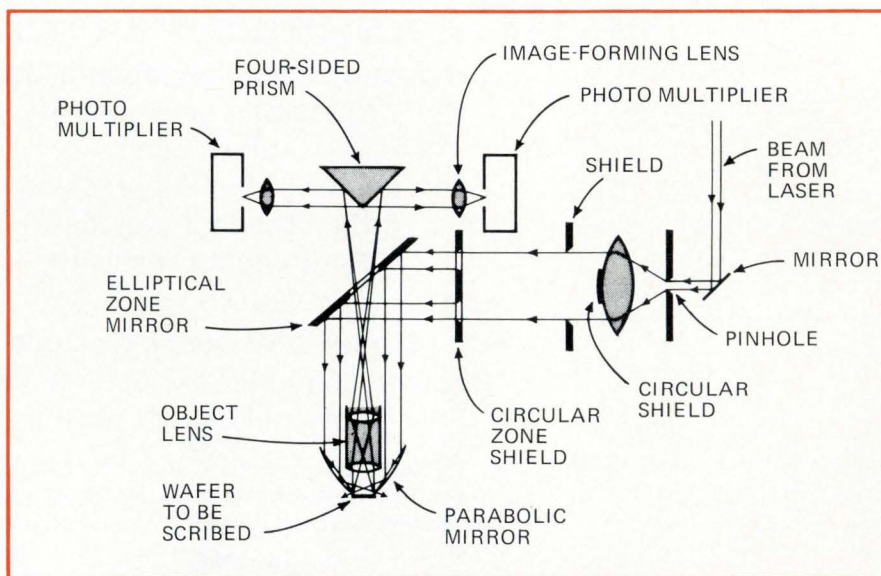

**In the fold.** Laser beam is bent by mirror before entering optical system that produces a tubular beam. Reflection from wafer goes to four-sided prism used to sense position.



market prospects for equipment producers will be bright in the late 1970s. Government estimates put investment costs for a CATV system serving half of all French homes at \$1.6 billion over the next 15 years—between \$100 and \$200 for each installation. What's more, U.S. companies are expected to pick up most of the hardware orders for at least the first half of this 15-year period. But French firms are bidding to grab control of CATV management and, eventually, the hardware.

**Opening.** The door to the private audio-visual interests was opened by a small clause in a law, passed last year, which redefined the state broadcasting monopoly. In the process, it allowed for certain exceptions to the exclusive broadcasting rights of the Office de Radio-diffusion Télévision Française and also set up a committee on new communications systems.

The first test of the more liberal attitude is likely to come in the Riviera resort of Nice. The issue at stake: who should control each local system. The private sector is being championed by a new company, Vidéo-Cités, a joint venture between Compagnie Générale d'Electricité, Compagnie Financière de Suez, a public utility company, and the Belgian company Coditel, already an experienced hand in CATV. Although it is unwilling to say so in plain terms, Vidéo-Cités plans to run the show—handling the engineering, design, and installation problems as well as the overall management of the system. For administrative reasons, Vidéo-Cités is proposing to work in partnership with the local city authority in Nice and anywhere else it may get involved.

**Snag.** All looked fine until the government became anxious over letting private companies take too much control. As a result, a new company has been set up this year to manage an experimental program in seven towns and cities. The company, Société Française de Télé-distribution, is run by the Posts and Telecommunications Ministry and ORTF, with the Ministry of Finance sitting in on the management.

Philippe Picard, SFT's vice presi-

dent, states bluntly: "I consider that the very creation of the SFT indicates the government's concern that the cable-TV networks should not pass entirely into the hands of private interests."

But whatever the formula finally agreed on for Nice, the partnerships are likely to take different forms in some of the other towns. SFT's idea is to try out various management combinations so that an initial decision on the overall pattern of CATV in the future can be taken around the middle of next year, with a more weighty assessment to follow.

In the northern provincial capital of Rennes, SFT is firmly in charge, in cooperation with the local city hall. The Rennes project will be the first to go into operation either late this year or early in 1974. In the first phase, costing about \$1.1 million, the network will be linked up to 10,000 subscribers. Later stages will add another 30,000.

A government laboratory and technical center in the city, the Centre Commun d'Études de Télévision et de Télécommunications, will use the Rennes project to try out hardware and has already sent out tenders for some equipment.

**Operation.** Just how the cable-TV networks will operate is not clear yet. Vidéo-Cités president Jean d'Arcy sees the system as being the big outlet for video cassettes. "For the first five years at least," he predicts, "the development of the big public market for video systems will be in institutional form using cable transmission"—as opposed to such alternatives as videoplayers installed in each home. In the Paris suburb of Creteil, however, city hall has a different idea. They want to use cable TV as a means of setting up a local educational, cultural, and news network to give a community flavor to one of France's largest new residential developments. □

## Around the world

### Germany ahead in entertainment IC use

In designing integrated circuits into entertainment electronic products, West German set makers are ahead of their counterparts in the Far East. American producers, on the other hand, are lagging behind West European manufacturers. These are the main conclusions of a report by Siemens AG.

In the study, Siemens uses a so-called "equipment unit" standard so as to have a uniform basis for comparing IC application in the individual market areas. According to this standard, a black-and-white TV receiver counts as one unit and a color set, because of its greater components consumption, as three units. A home radio and an automobile receiver each rate 0.3 unit and a portable radio 0.1 unit. Siemens calculates that last year 36 million equipment units were produced in Japan, 30 million units in the U.S., 8 million in West Germany and 17 million in the rest of Western Europe. These unit production figures are then related to the volume of ICs that radio and TV manufacturers in the four areas bought last year. Each area's IC-volume-per-unit figure, in U.S. dollars, is: 2.16 for West Germany, 1.39 for Japan, 1.15 for Western Europe, without West Germany, and 1.03 for the U.S.

### A videophone for private exchanges

It won't be until 1980 or so that video telephones will enter public service in West Germany, but at least one company is already getting set to produce them serially. Anticipating that a sizeable non-public market will develop within the next few years, Siemens AG has refurbished its original videophone model and come up with a commercial version, which will go into production at the company's Munich facilities. Designated the Videoset 101, it is the successor of the first European videophone, which Siemens introduced in 1967 and put into trial operations between Darmstadt and Munich in 1971. Compared with its predecessor, the Videoset boasts a larger screen, has better picture quality, and is much simpler to operate. The equipment is based on the internationally proposed 1-megahertz bandwidth standard and is compatible with the American norm.



# Here are two of the world's best oscilloscopes.

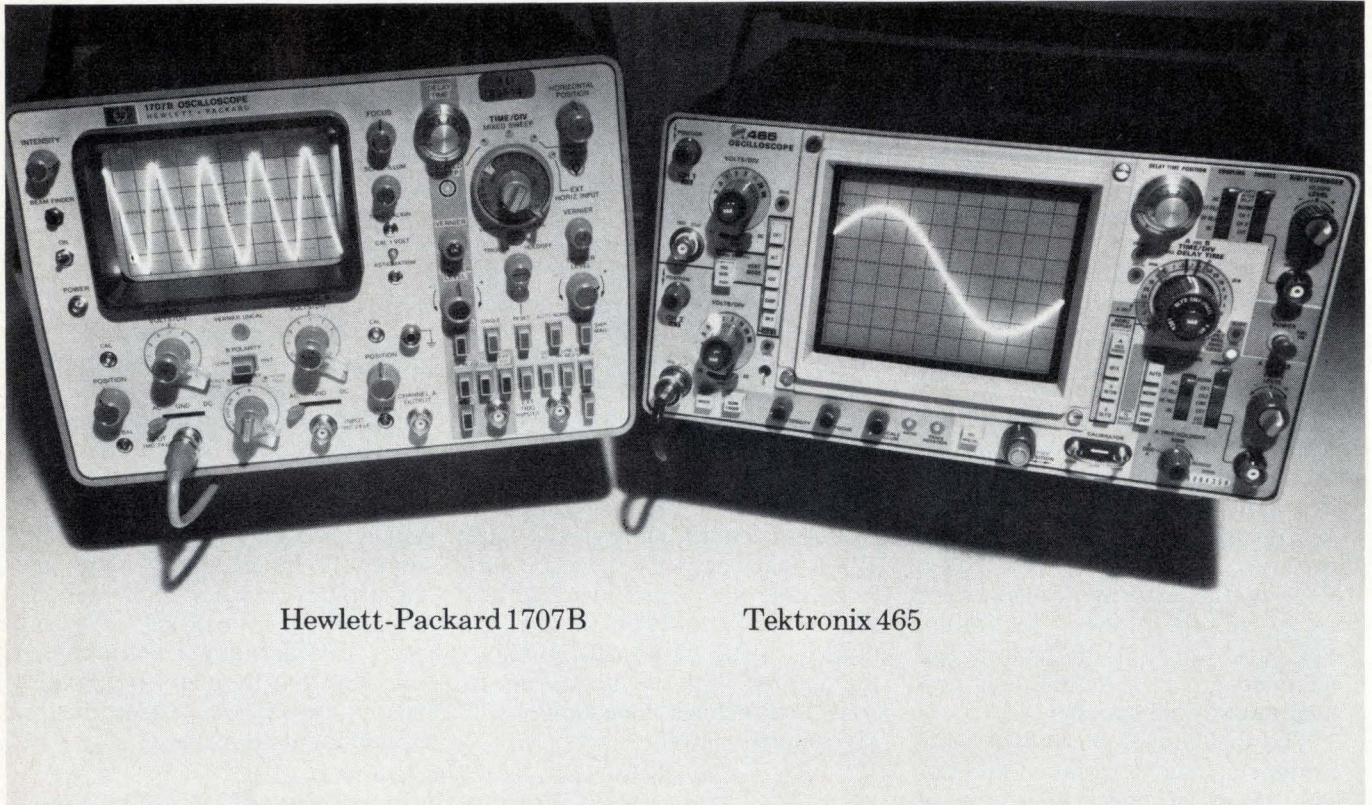

Hewlett-Packard 1707B

Tektronix 465

## Here's why you shouldn't own either one.

You can lease one for as little as \$45 per month.

We can give you immediate delivery on either the Hewlett-Packard 1707B or the Tektronix 465, in quantity.

The Hewlett-Packard scope lease is \$45 per month for 36 months. The Tektronix 465 is \$50 per month for 36 months.

Anyway you choose, leasing is the best thing that ever happened to a tight capital equipment budget. You pay for your scope as you use it ... and you pay for it out of the profits it generates.

Call your closest Instant Inventory Center and ask us about short term rentals, delivery, and other lease terms for scopes or any other electronic equipment you need, up to and including minicomputers.



Anaheim, California (714) 879-0561  
Dallas, Texas (214) 661-8082  
Fort Lauderdale, Florida (305) 771-3500  
Gaithersburg, Maryland (301) 948-0620  
Lexington, Massachusetts (617) 861-0667  
Mountain View, California (415) 968-8845  
Oakland, New Jersey (201) 337-3757  
Rexdale (Toronto) Ont., Canada (416) 677-7513  
Rosemont, Illinois (312) 671-2464

## Rental Electronics, Inc.

A **PEPSICO** leasing company.



## Will Chinese go for PAL?

There are strong indications that Red China may opt for the PAL color-TV transmission system. For one thing, **the Chinese are said to have bought PAL broadcast equipment both in Europe and Japan for test transmissions from Peking.** Furthermore, AEG-Telefunken, developer of PAL, confirms strong Chinese interest in the system. Numerous exploratory talks between the AEG-Telefunken and Red Chinese TV experts have already been held, the German company says. It stresses, however, **that no firm decisions have been made on whether the PAL system will be adopted or when regular color broadcasts will start in China.**

## Philips sees healthy rise in color-TV sales

On the eve of the big radio and TV show in West Berlin—August 31 to September 9—Philips Gloeilampenfabrieken has issued an optimistic forecast for 1973 sales of entertainment electronics equipment in Western Europe. In the color-TV sector, the Dutch company predicts total consumption **will reach 5.8 million sets, some 1.5 million more than last year.** By mid-1973, the firm's marketmen say, 11% of all West European households had color. Philips forecasts sales of 7.8 million black-and-white sets for this year, a decline from 1972, but a less dramatic one than originally expected. **The radio market is pegged at 39 million sets, with automobile radios going particularly strong.**

## Britain to buy lightweight airborne radar

**The British government will buy 100 units of a new lightweight search and tracking radar developed by Ferranti for navy helicopters.** It's claimed to weigh 140 pounds, about half the usual weight, including a scan-converted bright TV display with 8-inch screen. It's also frequency agile—successive pulses are at different frequencies—which reduces the intensity of clutter from sea waves while not affecting real target returns. First user will be a new Royal Navy helicopter called Lynx, due for service in two or three years. **It may also appear in U.S. Navy helicopters, as Raytheon Co. is interested in making it.**

## Nippon Electric unveils small computer

A goal of 5,000 systems in the five years starting this October has been set by Nippon Electric Co for sales in Japan of its NEAC System 100 small computer. The system comes in nine configurations, ranging from a punched-paper billing system through batch processing systems and multiwork systems with cassette tape, drum, or disk base. NEC president Koji Kobayashi **says the new system is designed for a much broader range of applications than any small computer system now available.**

**The major feature of new system is its design for use by people without computer experience.** Kobayashi says that a reasonably intelligent person can learn newly developed BEST—beginners efficient and simple translator—in between 30 minutes to an hour; also available is Aplika—application library by kit assembling. Moreover, it can use internationally standard Cobol and perform other operations formerly in the province of medium-sized computers. New peripheral equipment includes drum and disk memories, and a **line printer that has symbols embossed on a moving loop of steel—which looks like a band saw blade except it has raised symbols on its side rather than teeth on its edge.** System price ranges from a minimum of \$14,000 up to \$115,000.



### **British still worried over Japanese TV imports**

Sales of Japanese color-TV sets in Britain continue to grow steadily, while British TV-set makers continue to wonder what to do about it. **Japanese sets accounted for 7.2% of total color deliveries** to dealers in the second quarter of last year, **but this year it's 11.2% in the same quarter**, and it's certain to go higher when the autumn sales push starts. What worries British makers is that color-set supply in Britain is now solidly ahead of demand and, if present trends continue, there'll be between 500,000 and 1 million sets stockpiled by yearend, roughly equal to between three months and six months domestic production.

**As a result of discussions between Japanese and British industry leaders, the Japanese have offered to cut UK deliveries planned for this year by 25,000 sets** to a total of 275,000. But that is seen by Britain's industry as no more than a gesture and not in line with Japanese promises that they'll not go so far as to harm the British industry. Unlike most other Western European countries, Britain has no formal controls on Japanese imports, partly because the government thinks the industry is too sensitive and partly because it thinks the competition benefits the consumer.

### **Philips adds to VCR roster**

The Philips-developed video-cassette system is beginning to find support in Japan now that Philips and Hitachi Electronics of Tokyo have signed a VCR standardization agreement. This makes Hitachi **the first firm outside the U.S. and Europe to become a member** of Philips' VCR league. With that, Philips says, another step towards international VCR standardization and world-wide adoption of the system has been reached. So far, **some 14 audio-visual equipment makers in five European countries—West Germany, Great Britain, Italy, Switzerland, and Poland— and two in the U.S. have opted for the Philips system.**

### **Thorn cuts GT&E ties, joins with Ericsson**

Thorn Electrical Industries Ltd. is changing its tactics for breaking into telephone exchange manufacture. **It has dropped its three-year association with General Telephone and Electronics**, which has brought worthwhile orders only for GT&E's small-scale subscriber apparatus, and is talking with the Swedish telecommunications maker L M Ericsson. Meanwhile, Thorn has bought GT&E's share of their joint company and will keep making subscriber equipment.

**Even if the talks go well, Thorn's task will be difficult.** The only likely big money is in making public-exchange equipment for the post office, but Ericsson's equipment doesn't fit in too well. For one thing, its proven systems are crossbar-based, and present British domestic crossbar-making capacity is more than sufficient to satisfy post office demand till no more crossbar equipment is wanted for public networks. For another, the post office has already decided on its new-generation switching system to replace strowger and crossbar systems, so Ericsson's electronic systems are not candidates in the foreseeable future. Most likely, Thorn's plan is to try to use experience gained building Ericsson private automatic-branch, crossbar, and electronic exchanges, **to persuade the post office that it ought to have a share of the very large orders soon to be placed for the new-generation system**, called TXE-4. On present plans, these orders will be shared between Standard Telephones and Cables, General Electric Ltd., and Plessey.



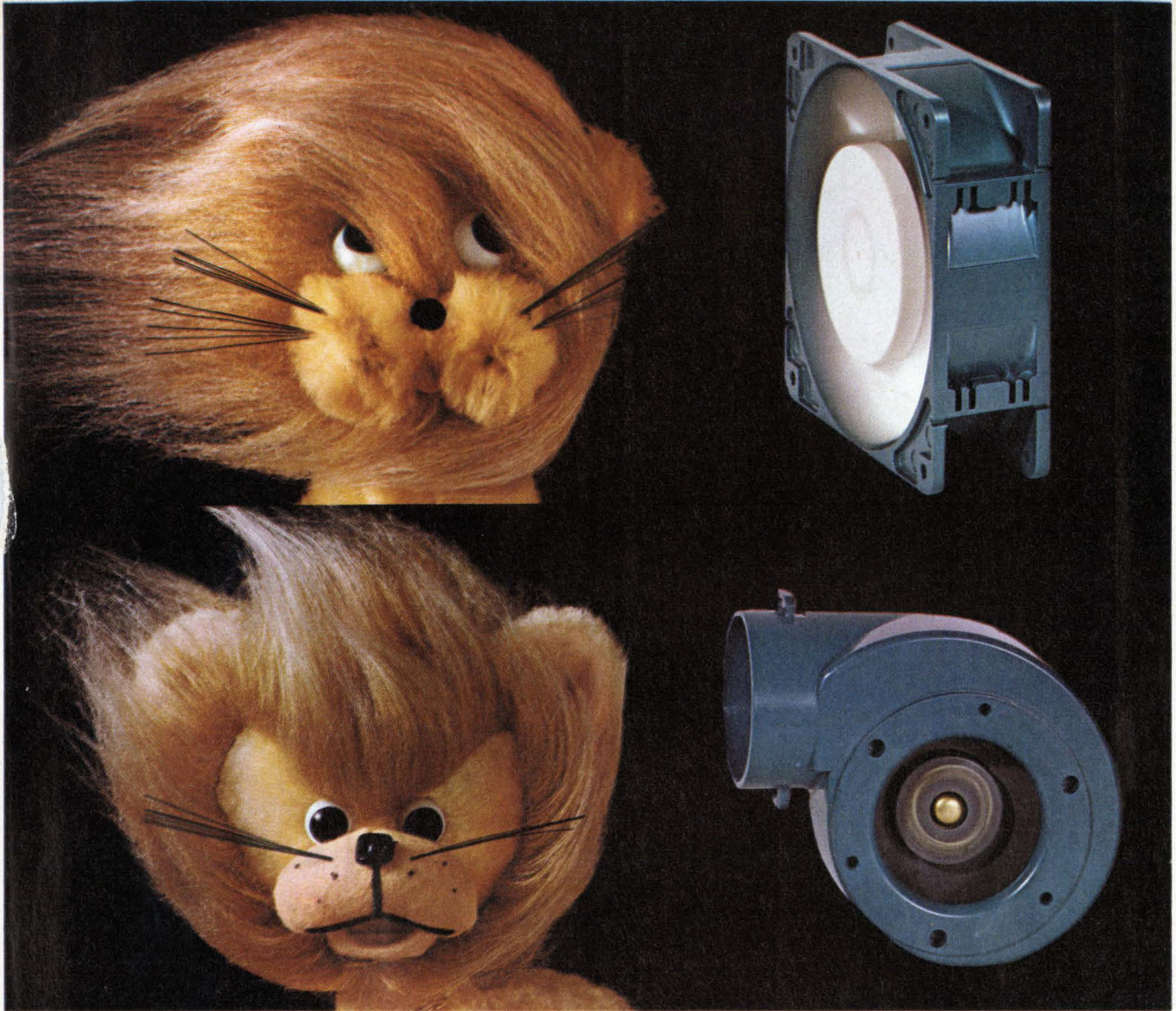

# Whoosh! or "pouf"

**Our little fans and blowers deliver just the air you need ... no more, no less.  
We guarantee it.**

The 105 cfm blast—or the 14 cfm gentle breeze—delivered by a Howard fan or blower is a matter of design. Designed to *your* performance parameters by Howard engineers who test and build these hardy little fans and blowers so carefully and to such exacting specifications that performance is guaranteed for 5 years in writing!

Air delivery tests to AMCA standards measure the air movement capabilities of each fan and blower. Dynamic and static air pressure tests assure that Howard

fans and blowers deliver just the amount of air your product needs—and continue to do so over their maximum life period.

More and more leading quality-minded firms are specifying Howard components. (Names on request). Can you afford less than the *guaranteed controlled air movement* of Howard fans and blowers?

**FREE Design Engineer's Manual and Guide** to help you design the ideal cooling systems for your products.



## HOWARD INDUSTRIES

DIVISION OF MSL INDUSTRIES, INC.

One Dixie Highway, Milford, Illinois 60953, Dept. EL

Phone: (815) 889-4105

FHP MOTORS GEARMOTORS FANS BLOWERS





## If you've been designing components good reasons to switch

**1. Excellent soldering:** CA 725 was developed for electronic application where soldering is important. After laboratory exposure at 150 F and 100% Relative Humidity for two years, CA 725 was still solderable.

**2. Overall gold plating has been eliminated:** CA 725 requires no special finishing. The need for gold plating in most applications can be reduced by 90%. Lets you put more gold where it is needed...at the contact point.

**3. Easier to fabricate:** CA 725 may be formed by conventional methods. For example, it is stamped and

formed on dies used for other copper alloys. Bend properties are excellent across the strip width. Even at harder tempers. That gives you additional freedom in die and part design.

**4. Excellent corrosion resistance:** CA 725 needs no protective coating. It resists tarnishing. Wire-wrap connectors can be made without any protective coating. CA 725 has excellent resistance to stress-corrosion cracking to boot.

**5. Greater fatigue strength:** Cold worked CA 725 has higher fatigue strength than similarly cold worked phosphor bronze.



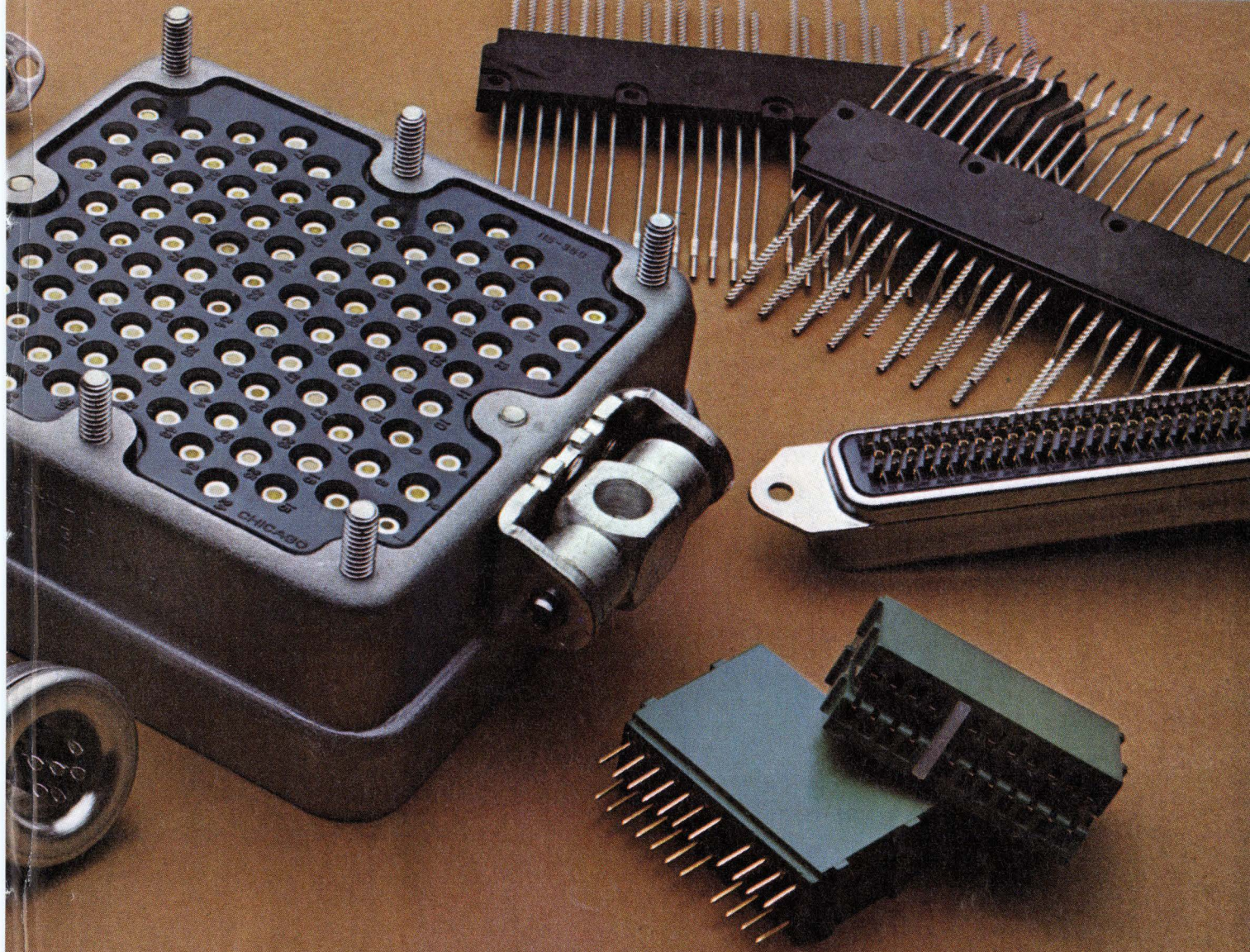

## with phosphor bronze, here are 8 reasons to Copper Alloy 725.

**6. Better stress relaxation performance:** CA 725 keeps its good spring properties at higher operating temperatures. This is especially important with today's increased packaging densities.

**7. Readily available:** CA 725 is not an exotic alloy in spite of its extraordinary properties. It is **an industry standard**. You can get it at most copper and brass wire and strip suppliers. If you can't, let us know.

**8. All this and economy too.** Because of CA 725's combination of properties, total material and finishing cost can be dramatically reduced. The

result for one component manufacturer was a superior product. And a 25% reduction in the cost of the part.

They switched from phosphor bronze. We have given you eight reasons why you should switch. Think about it. For more information on CA 725 call your local supplier, or write Department 3473, The International Nickel Company, One New York Plaza, New York, N.Y. 10004.

# INCO

THE INTERNATIONAL NICKEL COMPANY, INC., NEW YORK

Circle 59 on reader service card



**“Augat’s interconnection system appeared to have more advantages for use in the AN/TPX-42A Air Traffic Control System.**

**“Our extensive testing confirmed it.”**

Robert A. Mesard, Group Leader  
Transportation Systems Division  
A IL Division of Cutler Hammer.



"When work began on the AN/TPX-42A, we started looking for an interconnection system that offered high reliability and design flexibility, without sacrificing lower initial costs or low field maintenance.

"Our program staff ran detailed reliability and cost analyses of the four basic interconnection systems under consideration: P.C. boards, multi-layering, welded wire-stitching, and wire-wrapped plug-in panels.

"The system meeting all of our requirements was wire-wrapped plug-in panels. We compared several manufacturers of socket panels and selected the Augat panel based on overall quality, range of products, and their willingness to respond to our needs.

"Our findings were incorporated into our proposal to the Air Force. But as the wire-wrapped plug-in panel concept was comparatively untried in U.S.A.F. equipment, they requested additional testing. So we ran a series of in-depth reliability and stability studies and tests as part of our systems qualification and reliability demonstration program.

"After 13,200 test hours, we experienced no mechanical failure or intermittence with the Augat system.

"Electronic Systems Division of U.S.A.F. accepted these findings and approved the Augat system.

"We now have used substantial production quantities of Augat panels without a single contact failure."

Augat first pioneered the socket-panel concept in 1965, and the exclusive precision-machined tapered-entry contact has made Augat the reliability standard for the plug-in interconnection industry.

A I L's record of not a single contact failure is one of the reasons why Augat supplies more panels than all other manufacturers combined.

As the world's leading manufacturer of wire-wrapped panels and other IC interconnection products, Augat is ready and willing to help with all your interconnection requirements.

Call or write today for free brochure and complete product information. Augat, Inc., 33 Perry Ave., Attleboro, Massachusetts 02703. Represented and distributed internationally.

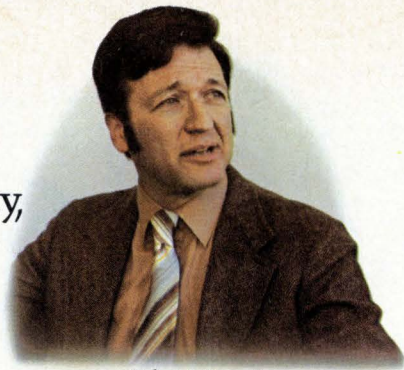

Robert A. Mesard

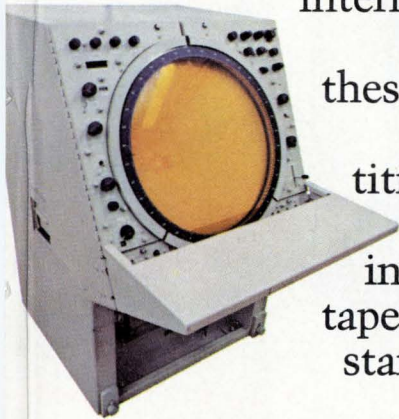

The AN/TPX-42A

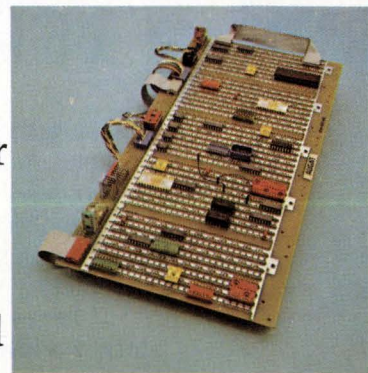

Augat I.C. Socket Panel

**Plug into Augat.® A I L did.**

"See us at WESCON, booths #1607-1608"

Circle 61 on reader service card



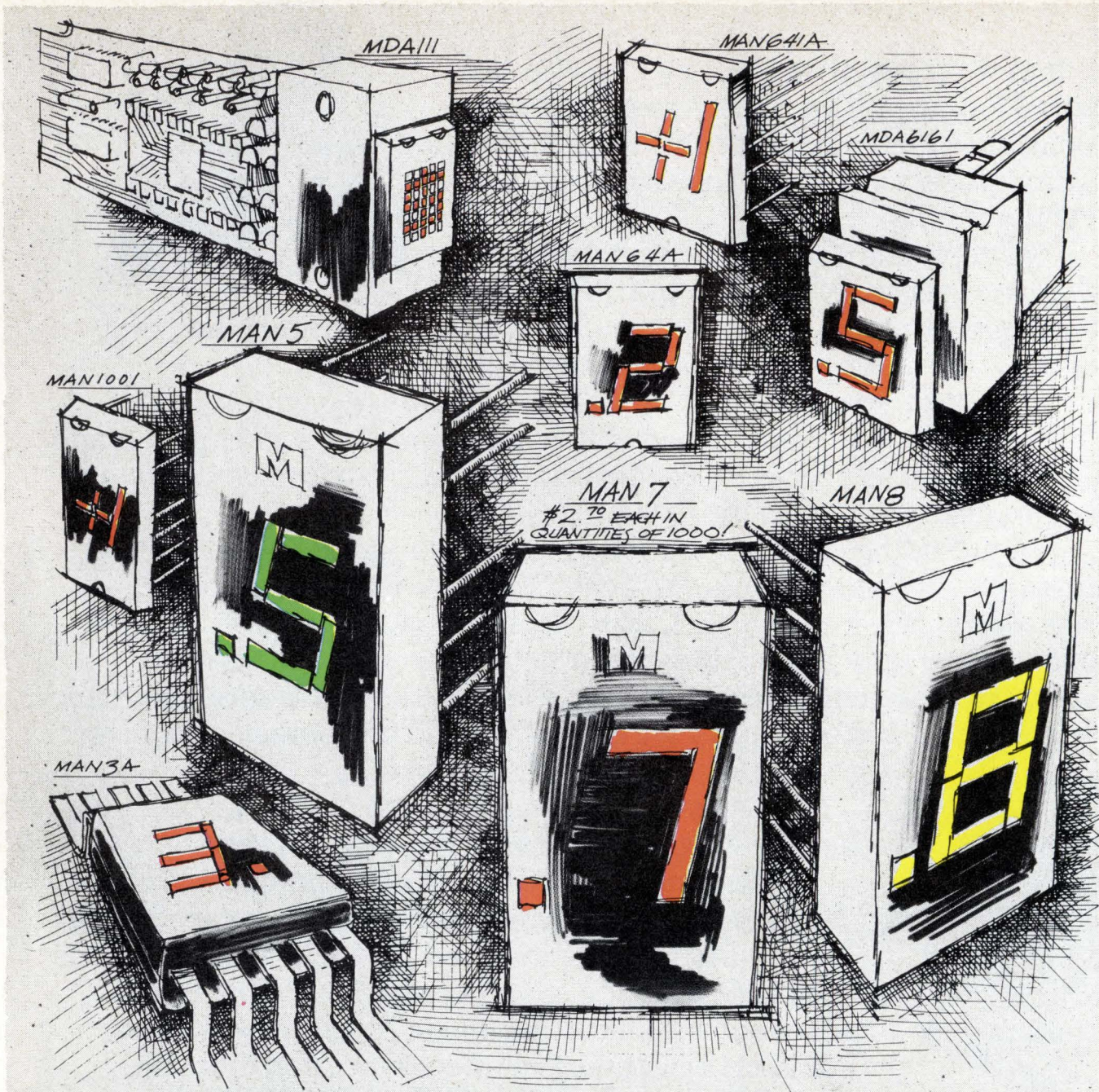

# Just a few reasons why we're

There they are, the biggest selection of LED displays in the business. And not just different sizes of red; green and yellow digits and alphanumerics, too. Plus all the backup IC's that can put them to work in your application at your logic level. Plus a whole line of prepackaged plug-in modules that let you unplug an un-LED and start getting Monsanto reliability in your socket. The GaAsLITE display was first announced here—in 1969. Now what you see is what you'll get—from stock, worldwide, at a distributor near you. Prices? We lead there, too!

Demand the LED displays with the reputation for quality.



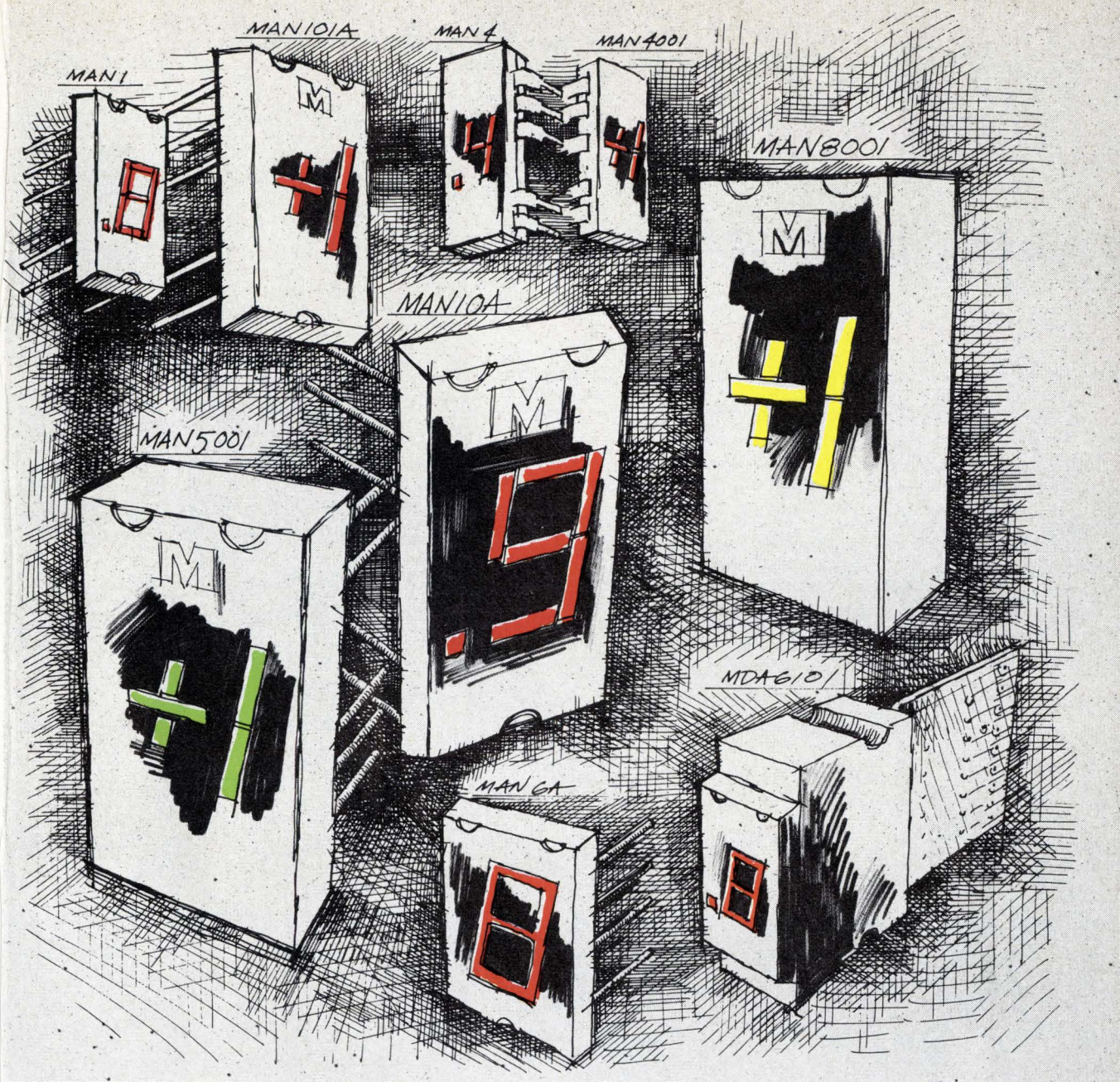

# first in Light Emitting Diodes.

Putting innovation to work.

Monsanto Commercial Products Co. Electronic Special Products  
 10131 Bubb Road, Cupertino, CA. 95104 (408) 257-2140  
 A unit of Monsanto Company

# Monsanto

**EASTERN HAMILTON/AVNET**, Atlanta, GA (404) 448-0800 Baltimore, MD (301) 796-5000 Boston, MA (617) 273-2120 Cedar Grove, NJ (201) 239-0800 Long Island, NY (516) 333-5800 Miami, FL (305) 925-5401 Mount Laurel, NJ (609) 234-2133 Syracuse, NY (315) 437-2642 KIERULFF ELECTRONICS, Gaithersburg, MD (301) 948-0250 Hicksville, NY (516) 433-5530 Rutherford, NJ (201) 935-2120 Paoli, PA (215) 647-2612 Needham Heights, MA (617) 449-3600 SCHWEBER ELECTRONICS, Atlanta, GA (404) 449-9170 Rockville, MD (301) 881-2970 Hollywood, FL (305) 927-0511 Raleigh, NC (919) 832-8881 Rochester, NY (716) 328-4180 Westbury, NY (516) 334-7474 Somerset, NJ (201) 469-6008 HAMMOND ELECTRONICS, Orlando, FL (305) 241-6601 SEMICONDUCTOR SPECIALISTS, INC., Pittsburgh, PA (412) 781-8120 MIDWEST HAMILTON/AVNET, Chicago, IL (312) 678-6310 Dallas, TX (214) 638-2850 Detroit, MI (313) 522-4700 Houston, TX (713) 526-4661 Kansas City, MO (913) 362-3250 Minneapolis, MN (612) 854-4800 St. Louis, MO (314) 731-1144 HARRISON EQUIPMENT, Houston, TX (713) 224-9131 KIERULFF ELECTRONICS, Garland, TX (214) 271-2471 SEMICONDUCTOR SPECIALISTS, INC., Dayton, OH (513) 278-9455 Chicago, IL (312) 279-1000 Detroit, MI (313) 255-0300 Indianapolis, IN (317) 243-8271 Minneapolis, MN (612) 854-8842 Kansas City, MO (913) 452-3900 St. Louis, MO (314) 428-6100 Dallas, TX (214) 358-5211 SCHWEBER ELECTRONICS, Elk Grove Village, IL (312) 593-2740 Cedar Rapids, IA (319) 366-0774 Beachwood, OH (216) 464-2970 Troy, MI (313) 583-9242 WESTERN ALTA ELECTRONICS, INC., Salt Lake City, UT (801) 486-7227 ELMAR ELECTRONICS, Mountain View, CA (415) 961-3611 Denver, CO (303) 287-9611 HAMILTON ELECTRO SALES, Culver City, CA (213) 870-7171 HAMILTON/AVNET, Denver, CO (303) 534-1212 Mountain View, CA (415) 961-7000 Phoenix, AZ (602) 269-1391 Salt Lake City, UT (801) 262-8451 San Diego, CA (714) 279-2421 Seattle, WA (206) 624-5930 KIERULFF ELECTRONICS, Palo Alto, CA (415) 968-6292 Phoenix, AZ (602) 273-7331 Denver, CO (303) 343-7090 Seattle, WA (206) 763-1550 San Diego, CA (714) 278-2112 LIBERTY ELECTRONICS, Phoenix, AZ (602) 264-4438 Seattle, WA (206) 763-8200 El Segundo, CA (213) 322-8100 WESCO ELEC., Los Angeles, CA (213) 685-9525 WESTERN RADIO, San Diego, CA (714) 235-6571 CANADA CANADIAN DYNAMICS, LTD., Vancouver, BC (604) 325-3201 Calgary, ALB (403) 265-6500 CESCO ELECTRONICS, LTD., Montreal (504) 735-5511 Ottawa (613) 729-5118 Toronto (416) 638-5250 Quebec (418) 524-4641 Vancouver (604) 433-7834 HAMILTON/AVNET, Montreal (514) 735-6393 Ottawa (613) 725-3071 Toronto (416) 677-7432 SCHWEBER ELECTRONICS, Toronto (416) 925-2471 SEMICONDUCTOR SPECIALISTS, Ontario (416) 678-1444



# New Tool New Board New Method

**it's part of the TY-RAP® System**

**Now tie quicker than ever before...**

Our new high speed tool does it all . . . feeds a TY-RAP tie around bundle, cinches to a preset tension, locks securely and trims evenly . . . all in  $\frac{1}{10}$  of a second. There is no tool adjustment needed regardless of bundle diameter from  $\frac{1}{32}$ " to  $\frac{5}{8}$ ".

The off-the-board harnessing method allows the tool optimum use. This technique utilizes our new harness board and harnessing aids. The board is reusable and reversible. It's modular too . . . snaps together for larger work areas. It's constructed of poly-ethene foam sandwiched between two metal screens — nails are pushed in by hand. It's all part of the TY-RAP System to lower your costs of harness fabrication.

Write for new catalog, The Thomas & Betts Company, Elizabeth, New Jersey 07207 (201) 354-4321. In Canada, Thomas & Betts Ltd., P. Q.

**Sold Only Through Authorized T&B Distributors**

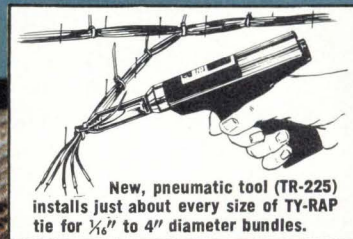

**THOMAS & BETTS**

Division of Thomas & Betts Corporation

517

Circle 64 on reader service card



# A Major Tooling Breakthrough in Production Wire Tying

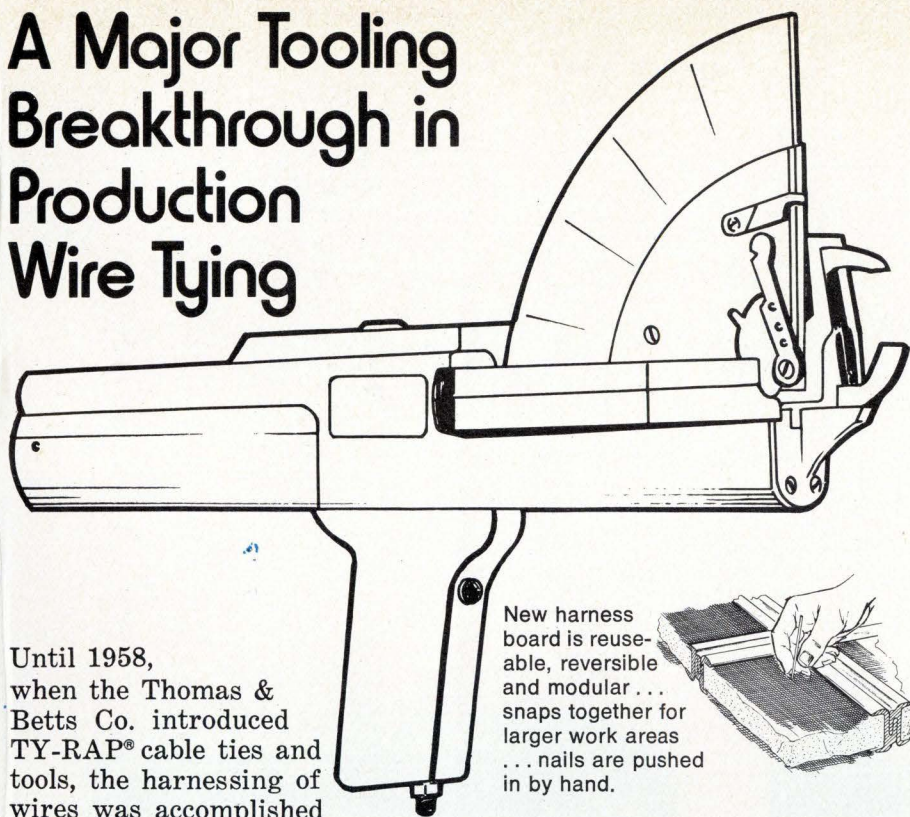

Until 1958, when the Thomas & Betts Co. introduced TY-RAP® cable ties and tools, the harnessing of wires was accomplished by either taping, lacing with string or spot tying. Today the TY-RAP system of harnessing has become the accepted way of handling wires — even in high volume production. The new T&B TR-300 automatic tying tool, the most recent addition to our tooling technology, has made harnessing a cost controlled proposition with measurable savings. With proper harness board preparation, the TR-300 tool can offer 4 to 5 times quicker installation than hand tying.

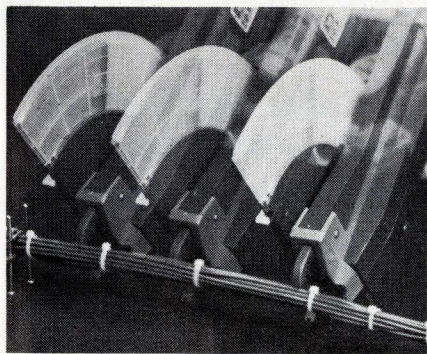

## How Do You Determine Your Tooling Needs?

The selection of the best TY-RAP tying system for your operation means evaluating:

- Volume of tying vs. costs
- Present harnessing methods
- Number of people involved
- Bundle diameters & breakouts

New harness board is reusable, reversible and modular... snaps together for larger work areas... nails are pushed in by hand.

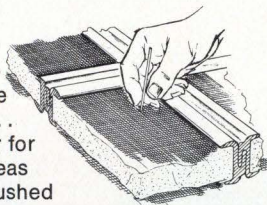

These and other considerations can be reviewed by your local T&B harnessing specialists. Your production rates, system flow and total installed costs are all of major concern to us. For example, we might recommend the New TR-225 pneumatic tool, a

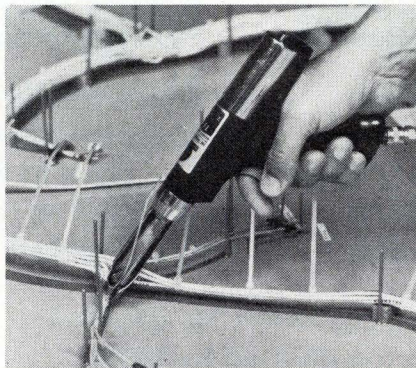

rugged design yet light weight and human engineered for both men and women operators. It was built to provide reliable performance day after day in a production environment... (has been test cycled 1,000,000 times per month without a failure). The tool accommodates most TY-RAP tie sizes... 16 in all... ranging from 1/16" to 4" bundle diameters. A further convenience is the long narrow nose that works easily at breakouts or in tight areas. If your production volume is such that it does not require the exclusive use of the TR-225, per-

haps the new WT-193 hand tool would supplement your operation.

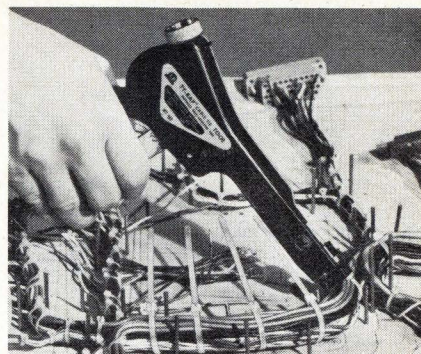

The WT-193 tool accommodates the same bundle range as the TR-225. With a similar narrow nose and long barrel, it is also well suited for tough to reach places. This particular design gives the operator the convenience of a long tying stroke with one squeeze of the trigger... the tie is cinched to a preset tension and trimmed flush with the head. The speed of tying is good for smaller volume tying as compared to the pneumatic TR-225.

Harnessing aids are available for your existing operation. The bundle shaper/retainer is effective in reducing the cost of routing wires. It shapes the bundles and holds them firmly above the surface of the board facilitating the ease of tying.

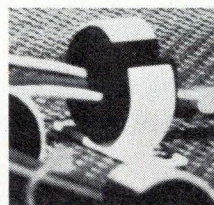

In our evaluations of harness fabricating techniques used across the country, operator performance, fatigue factors and process convenience appeared as major considerations in the cost structure of harnessing. Our harnessing specialists are equipped to study these costs as well as all pertinent factors involved in your wiring and harnessing operations. Write or call us today.

The Thomas & Betts Co., Elizabeth, New Jersey 07207, (201) 354-4321. In Canada, Thomas & Betts Ltd., P.Q.

530



Division of Thomas & Betts Corporation



# MONSANTO LAUNCHES NEW 50MHz COUNTER ATTACK



## New Model 100C

- 6 digit display
- Full-function to 50 MHz
- Priced at only \$565
- 7 digit option \$605



## New Model 101C with BCD

- 6 digit display
- 2 parts in  $10^8$  stability
- Priced at only \$695
- 7 digit option \$735

**When Monsanto first introduced these full-function 50MHz Counter-Timers we established the standards for the industry and caught our competition with their guard down.**

But our offensive couldn't be maintained by sitting on past successes. So, our NEW counter attack is again in your behalf, with new, realistic features and functional improvements. Contact your nearest Monsanto representative for a demonstration of our battle plan. Your reward will be a look at the best value on the market today.

For complete specifications request new brochure.

## United Systems Corp.

918 Woodley Rd.  
Dayton, Ohio 45403  
(513) 254-6251  
Subsidiary of

# Monsanto

**Monsanto: precision measurements to count on.**

All Monsanto instruments are available for rental or lease through Rental Electronics, Inc.



# Probing the news

Analysis of technology and business developments

## Engineering schools court minorities

With strong industry support, colleges seek to ease shortage by boosting enrollment of black, Hispanic, and Indian students to 15% from 1%

by Marilyn Offenheiser, Assistant Editor

As industry begins to feel more strongly America's shortage of engineering graduates, major corporations are joining colleges in accelerated programs to attract minority-group students to empty classroom seats. Recruiting is aimed across the board at all engineering disciplines. However, since about 25% of 1973's graduates were EEs, electronics engineering departments can be expected to wind up with about a quarter of black, Hispanic, and Indian students enrolled by the recruiters.

The shortage can be blamed on the recession of 1970-72. With many engineers out of jobs, students looked to other professions. Although the 1972 Manpower Report of the President estimates that 48,000 new engineers will be needed each year until 1980, only 44,000 entered the market this year. Consequently, employers snapped up all of them and are still looking for more.

Businessmen and academics think that minorities can provide the difference, and some signs indicate that their efforts are paying off. Both Columbia University and Rensselaer Polytechnic Institute report that more than half of all incoming minority students enter engineering, a figure disproportionate to the enrollment of the entire student body. But the success of the programs is also based on support from industry, as companies discover that minority engineers are more than mere tokens.

General Electric Co., for example, has been a prime mover in funding colleges and has also committed up to \$1 million to the Minority Engineering Effort of the Engineering

Council for Professional Development, which it and other firms established last December. ME3, as it's called, is staffed by four officers on loan from industry, who work with high-school students to encourage them to choose engineering careers.

Lionel Senhouse, director of ME3, who is on loan from AT&T, says that of last year's 44,190 engineering graduates in the U.S., only 600, or about 1%, were from minority groups. ME3's aim is to increase that percentage to 15%, equivalent to the percentage of minorities in the total U.S. population. However, those involved in increasing those numbers agree that the biggest problem is to convince minority students that engineering is a wide-open field.

"We have to deal with the black middle-class syndrome, which gears kids to achieve as doctors, dentists, and teachers," says Paul Zuber, di-

rector of the Graduate Center of Urban and Environmental Studies at Rensselaer and a leader in minority affairs on the campus. He adds, "They're not aware that engineering offers as many opportunities." F.S. Schutz, assistant dean of the School of Engineering at Georgia Institute of Technology, points out, "Since minority groups simply don't consider engineering, they cull themselves out."

**Through the mail.** The education and recruitment of the minority student into engineering is taking many forms. At ME3, direct mail has been emphasized. Last year, the group established communications with engineering schools around the country and then put together a list of about 10,000 likely candidates for these schools. Each student received a mailing that included a simple application form to be sent to the three colleges of his choice. About 500 replies were received. Now ME3 is

### MINORITY ENGINEERING GRADUATES

MINORITIES PRESENTLY CONSTITUTE 1% OF TOTAL ENGINEERING GRADUATES; THE GOAL FOR 1980 IS 15% OF TOTAL

1973



1980

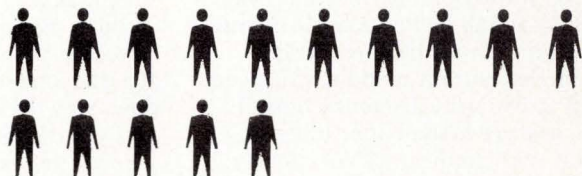



## Probing the news

surveying both schools and students to find out how effective the mailing was, and the organization plans a second mailing this October.

ME3 is also making for distribution in October a 27-minute film on minority groups in engineering. It plans minority-enrichment programs designed to place students in the laboratory, to set up a national system of recruitment programs, to possibly advertise through television and magazines, and to use task forces to deal with younger students, college guidance, and employment placement and guidance.

**"By example.** It is most important to show kids by example," asserts Senhouse, "that minority workers are already successful in engineering." However, Senhouse adds that companies don't realize they are not using minority engineers to full potential, and he aims to correct this. "It is our goal to achieve full utiliza-

tion of the minority engineer, who has a strong motivation for success going for him."

Industry leaders, however, are realizing more and more that minority engineers are assets and are beginning to pour more dollars into engineering schools. The list of contributors includes GE, Bell Laboratories, Singer, IBM, Westinghouse, Kodak, RCA, Hughes, Hazeltine, Honeywell, Monsanto, Motorola, McDonnell Douglas, Western Electric, DuPont, and Raytheon.

Because most of the money provides scholarships, and most minority students require financial aid, the recruiting programs are strengthened. Georgia Tech, for example, has received almost \$1 million in scholarship money from industry over the last five years.

Yet, says Howard L. Wakeland, associate dean of the College of Engineering of the University of Illinois, "although we receive about \$30,000 in support a year, we've been disappointed by the support

we have not gotten. Still in all, though, a few years ago, we didn't even get a cent from industry." Adds Rensselaer's Zuber, "If we had more money we could take in more than the 40 or 50 students that economics limits us to now."

**Help wanted.** But what industry puts in, it expects to get back as a finished product—the engineer. Almost every engineering school reports that minority graduates are being swept up as fast as they are graduated. Joseph Frisch, associate dean of engineering at the University of California at Berkeley, states that every minority graduate there has had at least two job offers. Wakeland states that there is a vast surplus of opportunity, and Georgia Tech's Schutz adds, "There is almost no hope in meeting industry's need for minority engineers."

As a result, engineering schools across the country are stepping up their programs, even as they find that traditional methods are not enough. For example, New York's

HP COUNTERS PROMISE A LOT — AND DELIVER IT ALL.

# The counter system that

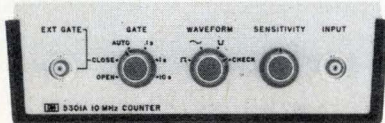

**5301A — 10 MHz Module:** 10 Hz to 10 MHz range. Direct counting and totalizing to over 10 MHz. Automatic or manual gating. Input waveform selector. External gate control. \$145.

The heart of HP's versatile frequency/time/volts/ohms measurement system is the sophisticated six-digit HP 5300A mainframe (\$395) which contains basic counting circuitry. Snap this mainframe onto the bottom module you need and it instantly becomes one of six feature-loaded instruments — each with traditional HP quality and ruggedness... each operating

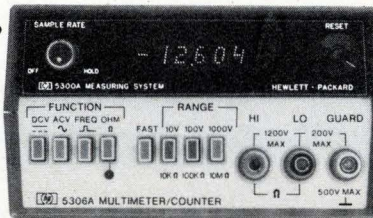

**NEW 5306A — Digital Multimeter/Counter Module:** Six-digit frequency readings to 10 MHz. Five full digits of AC/DC volts, ohms. Floating, guarded input. Automatic zero adjust. Up to 10 readings/sec. Overload protection. \$450.

from power line or optional battery pack.

Best of all, once you have the mainframe, it's the low cost way to build a complete workshop of first-line instruments.

It's the one system that truly does stay on top of your needs — and your budget.

Send for a free detailed brochure on HP's 5300 Series Counters.

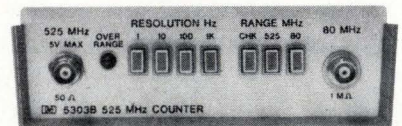

**5303B — 525 MHz Counter Module:** DC to 525 MHz range, burst or CW frequency. 50Ω or 1 MΩ input. Automatic gain control. Fuse protected front end. Optional high stability time base (FCC Type-Approved). \$800.



**Battery Pack Module:** Sandwiches in between any mainframe/module combination. Permits up to 5 hours of continuous operation. Battery level indicator. Recharge while in use. Carrying handles and shoulder strap. \$195.

02306

All prices domestic U.S.A. only.



City University and the University of Illinois bus students in for a day, weekend, or two-week program in engineering awareness. At UCLA, members of the Black Professional Engineers Society fan out and conduct dialogues in minority communities.

**MIT's tutoring aid.** Although the school of electrical engineering at MIT has no recruitment program of its own, MIT itself is actively recruiting minority students. Last year, 13 blacks were graduated with EE degrees, and Mildred Dresselhaus, associate head of the electrical engineering department, says the school would like to see that number increase. Dresselhaus emphasizes the fact that, since MIT is an academically exacting institution, a special tutorial service is offered to minority students.

Georgia Tech has set up a dual-degree program with the Atlanta University Center, which is composed of four predominately black Atlanta colleges. This allows a stu-

dent who completes three years at a black college and two years at Georgia Tech to earn both a liberal arts and a technical degree. The first group of minority seniors will be graduated in 1974; six black engineers are expected to be graduated where none has been graduated previously. At Rensselaer, seven blacks of an estimated 500 students received engineering degrees last year.

At this university, strong emphasis is placed on family relations, and director Zuber feels that family encouragement is essential to help a student in, through, and out of the college. "Also," says Zuber, "information gets back to the minority community through word-of-mouth. We give the kids all the help we can, we have a no-nonsense program. Pretty soon, a kid sees he can get As and Bs, and when he sees he is making it, his confidence grows, and this gets back to the community."

Taking another tack, the University of Michigan has outfitted a mobile home with a hands-on engi-

neering display. This exhibit, staffed by three students—one a black—from the School of Engineering, visits shopping centers, fairs, and schools. In addition, the university, which graduated 11 black engineers out of 630 last year, has established a minorities project office as a guidance, tutorial, and social center, and has formed a black engineers' club, which aids in recruiting.

Stanford University graduated 609 engineers in 1972, and 9% of them were from minority groups. The university also relies heavily on mailings of brochures to minority high-school students. And this year, department faculty members will hit the road on recruitment programs. Brochures are also used at Berkeley, where 20 blacks of a total of 180 students received engineering degrees.

As one recruiter says: "We're just beginning to do more than pay lip service to minority recruitment. We've a long way to go, but early results of the new programs are encouraging." □

# stays on top of your needs.

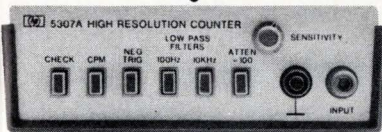

**NEW 5307A - High Resolution Module:** Range, 5 Hz to 2 MHz and 50 to  $1 \times 10^7$  counts/minute (CPM). Measures frequency and RPM much faster than conventional counters... 0.0001 Hz or 0.001 CPM resolution in less than 1 second. \$350.

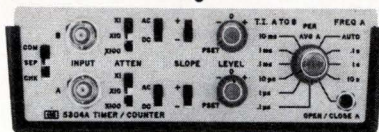

**5304A - 10 MHz Timer/Counter Module:** DC to 10 MHz range. 100 nsec. time interval accuracy. Unique "Time Interval Holdoff" ignores input ringing or contact bounce. Two DC coupled amplifiers with attenuators, slope, polarity and gain control. \$325.

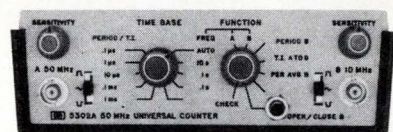

**5302A - Universal 50 MHz Counter Module:** 10 Hz to 50 MHz range. Automatic or manual gating. 100 nsec. time interval accuracy. Period, period average, ratio and totalize functions too. Input waveform selector. \$275.

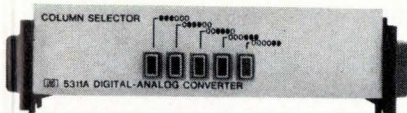

**Digital-to-Analog Converter Module:** Sandwiches in between modules—even with battery in place. Permits high resolution analog plots of digital measurements. Galvanometer and potentiometer recorder output. \$295.

HEWLETT  PACKARD

Sales, service and support in 172 centers in 65 countries. Palo Alto, California 94304. Offices in principal cities throughout the U.S.



Components

# Circular connectors: standards start

After a decade of almost uncontrolled proliferation, the military and industry have started on a program that promises to put an end to similar specs

by Larry Armstrong, Midwest bureau manager

The military is finally beginning to channel 10 to 12 years of state-of-the-art proliferation of circular connectors down a few standard lines. The effort, encouraged by component and original-equipment manufacturers, seeks to reverse a trend that one trade association official charges has largely been the fault of the makers themselves. Their goal, says the official, has been "to develop as many items as they could and then get them accepted as standard" to help sales. The result has been a Defense Department list of standard connectors—mostly circular—that runs a full page; by comparison, there are only two standards for tantalum capacitors and only one for composition resistors.

The military shares the blame, too. "Some of these specs have the soul and heart of some military service tied up in them," admits J. Roy Smith, director of engineering standardization at the Defense Electronics Supply Center. But reduced dollars for military programs have overcome much of the interservice rivalry that was a factor in the past, and in mid-August the three services incorporated industry recommendations into a program that takes them part of the way down the road to standardization.

The specifications principally address rear-release, circular environmental connectors in standard, medium, and high densities. They are being used in all new production and R&D programs that require circular connectors for power or signal distribution, such as the space shuttle.

DESC, serving as a parts-control advisory service to the three military departments since 1971, has made

dramatic inroads into the standardization of several categories of electronic components, including some connector types. "But high-density connectors was just a harder area to get into," remarks Robert W. Tonar, project engineer for electrical connectors at DESC. "The state-of-the-art plays a more pronounced role here—it moves a lot."

High-density connectors have pins with center-to-center spacing of less than 0.1 inch; medium-density connectors have 0.130-in. center-to-center pin spacing, and standard-density types have spacings of approximately 0.165 in.

Earlier this year, representatives from the three services sat down with DESC to solve a perplexing problem—to reach a coordinated military decision regarding duplication of procurement specifications among the four series in MIL-C-005015F, MIL-C-0026482F, and

MIL-C-83723B connectors. The group acted on five specs:

- MS3400 series (front release) of 5015 was canceled with the exception of the class D connector.
- MS3450 series of 5015 will be preferred for power applications over the 83723 series 2 connectors, made inactive for new design.
- Series 1 (solder and front release) connectors of 26482 were retained, but series 2 was canceled with the 83723 series to be used in its place. In mid-August, however, the group reversed those series; it now prefers 26482 series 2 over 83723 series 1.
- The services also came up with an abbreviated preferred parts list for new aerospace design that included only 83723 series 3 miniature connectors with bayonet and threaded couplings, and two high-density specs—MIL-C-38999 series 1 and 2, and MIL-C-81511 series 3 and 4. Connectors preferred for new

## Makers move into plastic

Concurrent with the military's attempts to standardize circular connectors is an industry trend to reduce the cost of the connector on its own. At the heart of the new connector designs is a one-piece molded thermoplastic contact retention disc that eliminates the need for individual metal retention clips for each contact.

Besides labor and material savings, the manufacturers are also claiming better performance: the polymer retention connectors are from 10% to 40% lighter than earlier designs, and almost a half-inch shorter than comparable mated pairs. With the polymer retention system, Amphenol's Terry F. Leen says, manufacturers can achieve a better contact density and still maintain the dielectric wall, which increases the connector life cycle by minimizing weight loss and outgassing caused by high temperatures.

Amphenol has announced expansion of the concept now used in Mil-C-0026482 parts to include Mil-C-83723 series 3, Mil-C-38999, and Mil-C-81511 specs by early 1975. Bendix has just changed its metal-clip version of the 26482 units to plastic, and probably will announce availability of 38999 with plastic retention shortly. Deutsch Co., Banning, Calif., which supplies 81511 connectors, uses the new system in that part, and is converting to plastic on 26482 connectors.



**This is TDK, maker of wide range of ferrite cores, fulfilling all needs as to size and characteristics.**



TDK specializes in the manufacture of magnetic materials. Since the invention of ferrite 38 years ago, TDK carried out its industrialization and has been engaged in further research and development in this field. We are specialists in the field of ferrites. No other party possesses the experience or can match the record we hold. Here, we introduce TDK's line of TV and radio ferrite cores. From the standpoints of rich variety of materials,

high level of processing techniques, diversification of forms and volume of production, TDK ranks No. 1 in the world. In recent days, the company is engaged in developing new processing techniques for the production, large size ferrite core of special shapes by slip casting method. These are now being made ready for commercialization. TDK's creed is to turn out products and do business in a manner to fulfill the requests of all customers.



**TDK**

**TDK ELECTRONICS CO., LTD.**  
 14-6 2-chome, Uchikanda, Chiyoda-ku, Tokyo 101, Japan  
**TDK ELECTRONICS CORP.**  
 LOS ANGELES BRANCH  
 931 South Douglas Street, El Segundo, California 90245  
 Phone: (213) 644-8625 Telex: 230653456 (TODENKA.ELSDI)  
 CHICAGO BRANCH  
 2906 West Peterson Avenue, Chicago, Illinois 60645  
 Phone: (312) 973-1222 Telex: 25910221421 (TDK CHGO)  
**TDK ELECTRONICS EUROPE GmbH**  
 4000 Düsseldorf 30 Gneisenaustrasse 51, FR. Germany  
 Phone: (0211) 44 56 46, 44 46 28, 44 61 03, 44 61 43  
 Telex: 8584136 TDK D

Circle 71 on reader service card



## Probing the news

ground-support applications were active series of 5015 and 26482.

"It's a list with teeth in it," one manufacturer says, to be implemented the second quarter next year.

Industry reacted, of course. The Society of Automotive Engineers, Aerospace Industries Association, and Electronic Industries Associ-

ation, in a letter to Richard A. Stimson, director of the Defense Supply Agency's Engineering Programs Division, Alexandria, Va., jointly requested that DESC standardize further and eliminate one of the high-density specs, preferably 81511. That letter also suggested that both series 1 and 3 of 83723 be listed under MIL-STD-1353, the new preferred-parts list. It didn't mention

that more manufacturers are tooled for series 1 than for series 3.

So the services met again, this time at DSA on Aug. 15, and agreed to agree. "We essentially made agreements to standardize on one of the high-density connectors, either 81511 or 38999, after the evaluation program at NAD Crane [Naval Ammunition Depot, Crane, Ind.] is completed," Tonar reports. That should happen in December 1974.

"We were hopeful that they'd end up with one medium-density spec and one high-density spec," says Terry F. Leen, aerospace marketing manager at Bunker Ramo's Amphe-nol Connector division, Chicago. "But as I read the current decision, they haven't accomplished any of that."

The military, manufacturers, and original-equipment manufacturers agree that standardization will lead to savings, but the question is how much. "The connector area is a big market to start with," Tonar says, "but at the same time, there are so many different styles and varieties that it's an expensive part to manufacture. Hopefully, by increasing the volume in a limited, standardized area that's also a state-of-the-art connector that OEMs will use, we can get the manufacturing costs down." One industry source pegs the market for circular environmental connectors at \$100 million to \$120 million per year, of which 60% is for military applications.

Industry reaction ranges from enthusiasm to downright disappointment. "This has been the biggest single breakthrough in the past decade," says William D. O'Hirok, manager of military marketing at ITT Cannon Electric, Santa Ana, Calif. "It's been an outstanding effort on the part of the military, and it shows that the military is trying to work with industry. Now we won't see new connector designs coming out of the woodwork all the time, so we won't have to worry about second-sourcing all of them," he adds.

As far as cost savings, "we won't need as many molds and piece parts, and we can increase volume in standard parts," O'Hirok says. But it won't reduce prices—the increasing cost of materials and labor will see to that, he adds. □

# CMOS/LSI SUBSYSTEMS CAN HELP YOU IMPROVE PRODUCT PERFORMANCE AND SLASH PRODUCTION COSTS.



## WE CAN HELP, TOO.

That's our business—helping our customers extend their design and manufacturing capabilities to include the most advanced semiconductor technologies.

Whether your product can be improved through the application of CMOS/LSI subsystems, the high precision of Bipolar linear circuits — or a combination of both — our people have the proven knowledge and access to the industry's most advanced processing equipment. This combination of skills and facilities just might enable us to help reduce your system costs.

Our customers choose to work with us because of the harmony and mutual integrity which characterize the close working relationship we feel is essential to doing a proper job.

We've helped develop some of the industry's most sophisticated integrated circuits for high-volume production, including High-Density CMOS (CMOS utilizing two separate layers of interconnect) and precision Bipolar ICs incorporating high-value thin-film resistors.

If you feel your products might benefit from the application of these advanced techniques, you should know more about us. Give us a call or drop us a line today. Call, write, or circle reader service number 245 today. If we can't help, we'll say so.

## MICRO POWER SYSTEMS

3100 Alfred Street, Santa Clara, CA 95050, Phone: (408) 247-5350, TWX: 910-338-0154  
Japan: Yas Kanazashi, 21 Mori Bldg., 2-2-5 Roppongi, Minato-ku, Tokyo, Phone: 586-0471



This is TDK, maker of ferrite cores  
with wide variety of material characteristics.

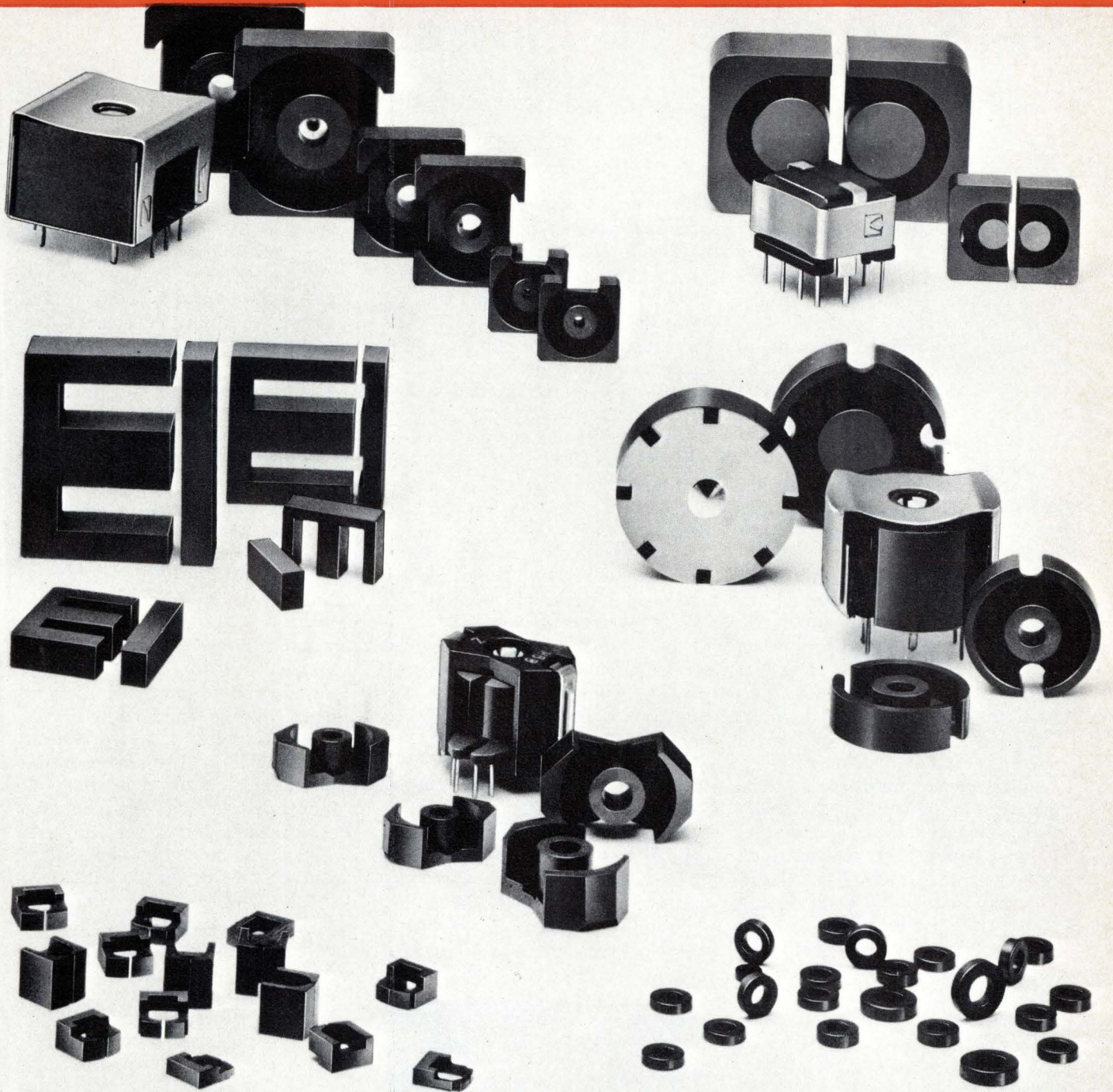

Our concern does not deal solely with ferrite cores for TV and radio use. TDK is ready to offer ferrite products covering any type of material characteristics. Ferrite is indispensable for the miniaturization and improvement of performance of equipment. Our products can be served in a wide range from low to high frequencies such as VHF, UHF and microwave. Through the development of diversified products such as RM core, Q

core and EP core which make high-density mounting possible, and as computer head core utilizing our exclusive high-density ferrite, TDK is making constant endeavours to improve the efficiency and level of its already high processing and designing techniques. TDK's creed is to turn out products and do business in a manner to fulfill the requests of all customers.



**TDK**<sup>®</sup>

**TDK ELECTRONICS CO., LTD.**  
14-6 2-chome, Uchikanda, Chiyoda-ku, Tokyo 101, Japan  
**TDK ELECTRONICS CORP.**  
LOS ANGELES BRANCH  
931 South Douglas Street, El Segundo, California 90245  
Phone: (213) 644-8625 Telex: 230653456 (TODENKA ELSJ)  
CHICAGO BRANCH  
2906 West Peterson Avenue, Chicago, Illinois 60645  
Phone: (312) 973-1222 Telex: 259102214211 (TDK CHGO)  
**TDK ELECTRONICS EUROPE GmbH**  
4000 Düsseldorf 30 Gneisenaustrasse 51, FR, Germany  
Phone: (0211) 44 56 46, 44 46 28, 44 61 03, 44 61 43  
Telex: 8584136 TDK D



Companies

# AMS brushes off blows

California firm claims 90% of add-on semiconductor memories sold into IBM market to date as it signs on new customers

by George Sideris, San Francisco bureau manager

**Though badly wounded** by reverses this summer, Advanced Memory Systems Inc. seems to be succeeding in its mission as the David of the solid-state-memory business. AMS has won a big chunk of the main-memory market from IBM, the Goliath, a feat that also has catapulted the Sunnyvale, Calif., firm into the front rank of memory-chip producers.

In the past few years, AMS has sold nearly 300 solid-state memories into the IBM add-on market, according to Robert H.F. Lloyd, president. (Add-ons are independently built memories attached to central processors sold by mainframe manufacturers.) That market base, totaling some 160 megabytes, represents 90% of semiconductor add-on installations to date and about half the total sales of both core and solid-state add-ons, Lloyd estimates.

**Adding on the profits.** And profits climbed, too. After losing \$1.8 million on meager sales of \$2.2 million in fiscal year 1971, AMS earned \$607,000 on \$13 million in sales in 1972, with most of the profit coming in the last quarter. The first six months of fiscal 1973, to March 30, brought an income of \$718,459 on \$13.7 million in sales.

Then, on Aug. 16, AMS announced a third-quarter loss of \$649,200 on sales of \$8.4 million. Half that loss was assumed with the acquisition on May 31 of Computer Microtechnology Inc., which was purchased to increase chip-production capacity. The other half was the result of an ill-timed buildup in system production capacity.

Since 1971, AMS' main outlet for IBM add-ons has been Intel Corp., a computer-leasing firm with head-

quarters in San Francisco. Intel and AMS successfully turned aside in court IBM's attempts to suppress their add-on business. Control Data Corp. also decided to compete head-on with IBM and, early this year, picked AMS to supply the semiconductor add-ons for the IBM system 370s that CDC would lease.

"We had to expand like hell to meet both our Intel contracts and the anticipated requirements of CDC," Lloyd says. "It was a calculated risk."

**Layoff helps.** But when CDC did not buy as many semiconductor add-ons as expected, AMS laid off 110 of its 800 employees. The result is that the reduction in overhead plus a \$12 million chip and memory backlog will recoup the loss this quarter, Lloyd predicts. What's more, Telex Corp. also has picked AMS as an IBM add-on supplier.

Lloyd is optimistic that, despite the setback, his company's momentum will enable it to command the rapidly growing semiconductor main-memory market. Counting both core and solid-state systems, he

**Ready to fight.** AMS president Lloyd says battle with IBM should be a long one.



pegs the IBM add-on market at about \$60 million this year. By 1975, some \$200 million in semiconductor add-ons will be sold to IBM customers— "if IBM allows it." He says IBM "has taken the gloves off" and is pricing systems more aggressively than ever to counter the invasions by AMS' customers.

**Long fight expected.** Lloyd explains that the leasing of IBM central processors with "foreign" main memories and peripherals probably represents the most serious threat to IBM's dominance of the computer market in history. It is a direct attack on IBM's traditional customer base, so the battle should be massive and prolonged.

AMS got hurt in a similar battle a few years after it was founded in 1968 by a group from IBM and Fairchild Semiconductor—Lloyd himself is from IBM. In 1970, AMS introduced a solid-state replacement for drum and disk memories—the SSU, for semiconductor storage unit, a shift-register memory. The orders began flowing in. But other firms, such as Memorex Corp., came out with low-cost magnetic peripherals and IBM slashed its lease charges; the SSU was squeezed out of the market. Lloyd expects the SSU concept to remain dormant until extremely low-cost shift-register memories emerge from development of magnetic-bubble and charge-coupled devices.

**False start.** The company also made a false start with production of high-speed bipolar scratchpad memories. Though they are still made by AMS, Lloyd believes they will remain a minor portion of the semiconductor memory market. He says the founders expected MOS







# NEW SHORTER CASE! SCHAUER 1-WATT ZENERS

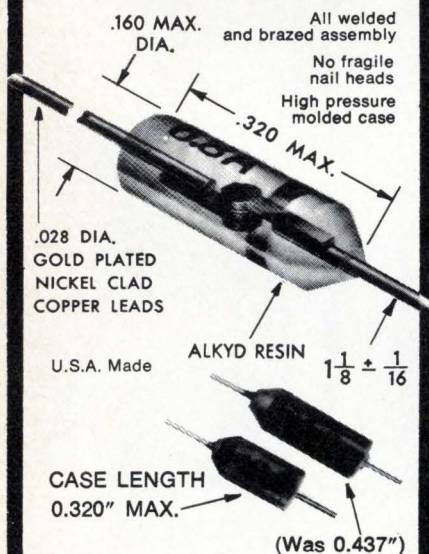

**SAME LOW PRICES FOR  
1% TOLERANCE ZENERS  
ANY VOLTAGE  
FROM 2.0 TO 18.0**

Quantity	Price Each
1-99	\$1.07
100-499	.97
500-999	.91
1000-4999	.86
5000 up	.82

**IMMEDIATE SHIPMENT**  
Send for rating data and  
20%, 10%, 5% and 2%  
tolerance prices.

Semiconductor Division

## SCHAUER

MANUFACTURING CORP.

4514 Alpine Ave., Cincinnati, Ohio 45242  
Telephone 513/791-3030

## Probing the news

main memories to capture the huge main-memory market eventually "but we badly overestimated the competition. We expected the big companies to become MOS competitors quickly, so we concentrated initially on exotic products."

AMS got back into the main memory stream in 1970 with the 6001, a 1,024-bit dynamic, p-channel MOS random-access memory. Lloyd says it was the first practical 1,024-bit MOS RAM, antedating Intel Corp.'s 1103 by six months.

But the 1103 won computer-industry acceptance [*Electronics*, April 26, p. 108]. It is produced by the millions today, while production of the 6001 has subsided to about 30,000 a month. Lloyd thinks Intel's prestige and superior financial backing tipped the scales to the 1103. "We were so broke we could afford only one advertisement for the 6001."

AMS countered the 1103 with the still-faster 6002 and set up Texas Instruments as a second source by providing TI with mask sets. The 6002 pulled AMS out of the red in 1972. It has been used in most of AMS' memory systems and is also bought by CDC, Varian, Interdata, Hitachi, and Fujitsu.

"The 1103 is still a thorn in our side, but the 6002 is clearly in second place," Lloyd contends. AMS has since put 2,048- and 4,096-bit p-channel RAMs into production [*Electronics*, March 15, p. 30]. Lloyd considers them interim products to be overtaken in the future by 4,096-bit n-channel MOS RAMs.

**Slow advance.** Lloyd is steering AMS into the n-channel RAM market cautiously. The firm is producing a 1,024-bit type, the 7001, which Motorola will second-source in the U.S. and Toko Inc. in Japan. "The 7001 gives us a six-month lead in systems and an edge in speed," Lloyd boasts. At 55 nanoseconds access time, the 7001 is faster than most large TTL RAMs and nearly as fast as emitter-coupled-logic.

AMS plans to withhold introduction of 4,096-bit n-channel RAMs until the industry standardizes on pinouts and until questions about their volatility—loss of data due to

charge leakage—are resolved. The latter issue was skirted in the 7001 design by making that RAM quasi-static rather than dynamic. It is continuously refreshed.

Lloyd concedes that new developments, such as Fairchild's isoplanar dielectric isolation process, might give bipolar RAMs an edge, but could just as well keep MOS RAMs in front. "Dielectric isolation may be the next major phase in MOS development," he says. N-channel MOS will win over bipolar, he argues, because it is fast and potentially 50% cheaper than bipolar.

He also believes that the first 4,096-bit n-channel RAMs on the market may prove too slow to win much of the market for large main memories from cores. None operates at the 200-150-ns access times he thinks necessary to achieve a clear cost-performance edge over large core memories.

"I am not one of those predicting the demise of core. People who back the 4,096-bit RAM as offering low cost at any speed may run head-on into core." He notes that many computer buyers want to purchase larger and larger core memories for less and less per bit, making high performance a prime requirement for the success of semiconductor memories. Speed increases processor throughput, thus offsetting high memory cost.

The core price trend also leads Lloyd to be conservative about the growth of the solid-state memory market. He estimates it will grow to about \$500 million—\$200 million for IBM and \$300 million for other systems—in 1975. Others have predicted as much as \$800 million in 1975, he points out.

Core price trends should bother AMS less than other chip producers because of AMS' lead in the add-on market, Lloyd figures. He reasons that the switches from core to semiconductor memories by IBM and other major computer companies reduce the competition from core-memory manufacturers. Memory builders without chip-production plants will find it impossible to compete in the semiconductor main-memory business, Lloyd expects, since chips represent the bulk of system costs. "It's really a components business," he says. □



# This is TDK, maker of a highly diversified line of ceramic capacitors of the High-K and TC types.



In addition to its production of ferrite cores and applied products, TDK is actively engaged in research and development of ceramic capacitors in respect to "C" characteristic. A rich variation is available—disc type, rectangular type, tubular type, feed-through type, trimmer type, etc. Naturally, those meet the MIL and UL standards are provided. In each and every case, they are a direct contribution to the development of electronics. In the making of ceramics as electronic ma-

terials, the selection of the raw materials and the processing techniques are of the highest importance. TDK employs an effective integrated production system embracing these aspects. Through its exclusive processing method, there are always provided perfect uniformity, trustworthiness and stable performance. TDK's creed is to turn out products and do business in a manner to fulfill the requests of all customers.

**TDK**  
**TDK ELECTRONICS CO., LTD.**  
 14-6 2-chome, Uchikanda, Chiyoda-ku, Tokyo 101, Japan  
**TDK ELECTRONICS CORP.**  
 LOS ANGELES BRANCH  
 931 South Douglas Street, El Segundo, California 90245  
 Phone: (213) 644-8625 Telex: 230653456 (TODENKA ELSJ)  
 CHICAGO BRANCH  
 2906 West Peterson Avenue, Chicago, Illinois 60645  
 Phone: (312) 973-1222 Telex: 259102214211 (TDK CHGO)  
**TDK ELECTRONICS EUROPE GmbH**  
 4000 Düsseldorf 30 Gneisenaustrasse 51, FR, Germany  
 Phone: (0211) 44 56 46, 44 46 28, 44 61 03, 44 61 43  
 Telex: 8584136 TDK D

Circle 77 on reader service card



Government

# Who watches ever-watchful GAO?

Comptroller General Staats enjoys wide freedom as head of agency that monitors Federal contracts—and even audits itself

by Ray Connolly, Washington bureau manager

The General Accounting Office hasn't been quite the same since 1966. Not only was that the year that Elmer B. Staats became GAO boss, but it's equally well remembered for implementation of new rules that directed the investigative spotlight of the Congressional auditors on Federal agencies instead of contractors and softened the tone of GAO's staff-initiated studies by including comments of the agencies and contractors under investigation.

To one old GAO hand, the change meant nothing more than "doing things a little differently" when writing reports with their familiar pale blue covers.

Their tough language usually guarantees nationwide headlines, and they have caught more than one Federal electronics contractor unprepared. To outsiders, the rules change seemed slight enough, but to Government vendors who had vigorously lobbied and testified a year earlier before Chet Holifield, the California Democrat whose House Government Operations Committee oversees the GAO, the switch was a distinct relief.

**A soothing pill.** As one corporate vice president in Washington colorfully put it, "the GAO used to be a big pain until Holifield's hearings got them straightened out. You might say those hearings were industry's Excedrin. Now, at least, we have a chance to defend ourselves, and most of the heat falls on the procurement people" instead of their contractors.

Although some staffers in the Congress—to which the GAO is solely responsible—scorn the altered operation as a sellout, few Federal electronics contractors view the GAO

as a soft touch. And Elmer Staats, whose large, well-tailored figure fits well with his imposing title of Comptroller General of the United States, makes it clear that he has no apologies for the 3,150 professionals he directs in monitoring government spending.

**Eyes niche.** At the end of his 15-year term in 1981, Staats would like to be remembered as the man who "gave leadership for the strongest influence for management improvement in the Federal government."

Staats views the changes by which

the findings of GAO staff-initiated studies are shared with the agency and contractor before publication as no more than a courtesy, an effort to strike a desirable balance. But such courtesies are not extended in investigations stemming from Congressional requests, now, despite what many people think, only 30% of GAO's output. Staats is quick to concede the validity of criticism by staffers in other agencies that GAO is guilty of applying a double standard. His employers in the Congress, he says, "have the right to

## One that got away

Some Congressional staffers are less than infatuated with GAO's performance, including the volatile Richard Kaufman, aide to Sen. William Proxmire, who has cited the auditors' blissful ignorance of the disastrous performance by Lockheed Georgia Co. on its Air Force contract to build the C-5A supertransport. That performance came to light when Proxmire's men turned up Air Force analyst A. Ernest Fitzgerald, who blew the whistle on the program. Kaufman has dubbed the GAO "the one-eyed watchdog" of the Congress.

At GAO's large, warehouse-like headquarters a short distance down from Capitol Hill, few staffers mention the C-5A slipup. Predictably, the auditors prefer to point with pride to their detailed reviews of military cost-effectiveness, including one that examined 16 programs—five Army, six Navy, and five Air Force. After studying a mixed bag of projects that included the Army's TOW surface-to-surface missile, the Heavy-Lift Helicopter, the Navy's troubled F-14 fighter, the DD-963 destroyer, the Air Force B-1 strategic bomber, and the Maverick air-to-surface missile, the auditors of the GAO concluded that cost-effectiveness is a valuable technique and advised the Congress that the Pentagon should apply it on a wider scale to other programs.

In another assessment of Pentagon test and evaluation of new weapons, the GAO examined 13 systems with an estimated total cost of \$46 billion and concluded that test objectives were generally adequate, but most of the managers didn't have adequate plans for conducting weapons tests, and, more important, T&E was not being completed in time for valid data to be available when binding procurement decisions had to be made.

Such judgments are often criticized as mealy-mouthed in arriving at some devastating conclusions, but, as the Ralph Nader task force's study of the Congress put it last year, "GAO walks a fine line between toadyism and giving offense, but it is still the most important investigative tool the Congress has."



# You have three choices in pressure transducers. Expensive. Inaccurate. Or National.

When we decided to go into the pressure transducer business we surveyed the existing products, and here's what we found.

At one end, there were inexpensive transducers that were too inaccurate to be of much interest to anyone. And at the other there were expensive, \$150-ish customized transducers.

Nobody was making a good, accurate transducer that you could pick up off the shelf for \$70 (\$40 in lots of 5,000). And nobody was making one with integrated circuits.

Somebody is now.

Our IC transducers are standardized hardware that can easily be adapted by you to your particular design. So you save lots of nice money.

But you don't sacrifice accuracy or field interchangeability, because our transducers are all calibrated by computerized laser trimming, for standardized outputs within a given band. And it also determines the temperature coefficients.

**You have three choices in our pressure transducers. Absolute, gage, differential.**

Our transducers come in three basic types, for measuring:

1. absolute pressure (pressure referenced to a self-contained vacuum, LX16XXA or LX17XXA).
2. gage pressure (all pressure signals referenced to room ambient pressure rather than vacuum, LX16XXG and LX17XXG).
3. differential pressure between two points or inputs (LX16XXD).

## Do it yourself.

Here's your chance to spend many fun-filled hours in creative tinkering.

Assemble your own controller from kit form.

The bread board kit is an analog output and low and high limit detector switch.

It can function as a display, control, alarm application, or all three.

If you like, we'll provide it in hybrid IC form.

For further information about our pressure transducers write

National Semiconductor Corporation,  
2900 Semiconductor Dr., Santa Clara,  
California 95051.

Expensive, inaccurate, or National. With a choice like that, you really don't have a choice.

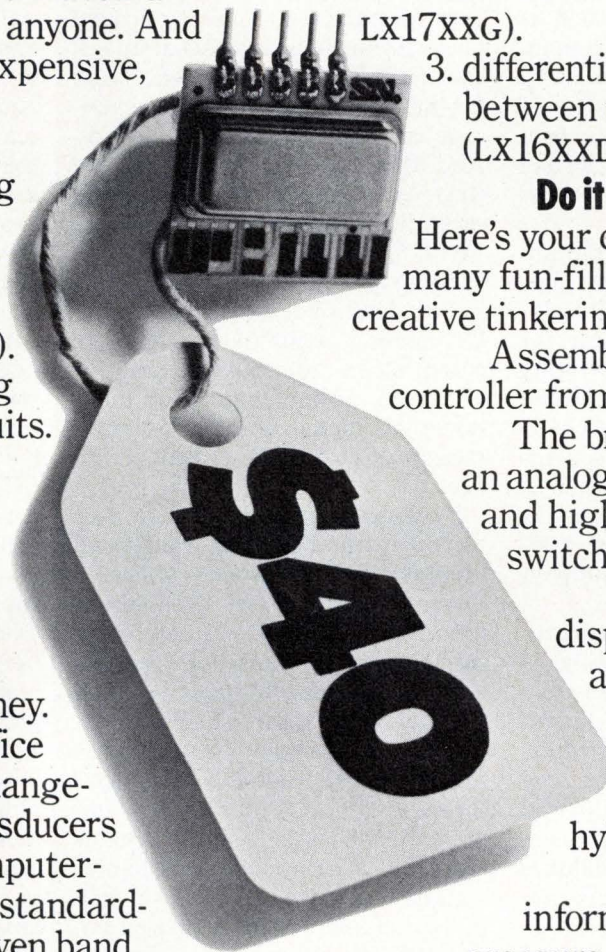

# National



make the ground rules" for the GAO.

Staats' caution is understandable. Although the Comptroller General is appointed by the President and is subject to Senate confirmation, he is responsible only to the Congress—the only body that can remove him from office "for specified causes or by impeachment." Because of the length of his term and the fact that he cannot be reappointed, the Comptroller General enjoys more freedom than any Federal official, with the possible exception of a justice of the Supreme Court.

**Self-audited.** Moreover, Staats enjoys the added and probably unique advantage that GAO audits itself, as well as the rest of the Government. Part of this stems, says one observer, from the notorious unwillingness of Congress to judge itself or its own, and part from the equally strong Congressional desire to keep GAO its own creature.

But credit is also given to the undisputed reputation of Staats himself as a person of unassailable integrity, plus his canny talent for satisfying equally the differing biases of such legislators as House Armed Services Committee chairman Edward Hébert, (D., La.), advocate of strong defense budgets, as well as Sen. William Proxmire (D., Wis.), chairman of the Joint Economic Committee and Pentagon critic.

Staats's reputation as the bureaucrats' bureaucrat is used less as a pejorative by those who know the man than as an accolade that describes the Government professional, who not only knows his way through the Federal and industrial maze, but also knows well the men who are responsible for building and changing it. Long service under four Presidents as the deputy in the old Bureau of the Budget proved valuable in acquiring that knowledge. Nevertheless, his reputation as a prudent man has not suffered by some major reorganizations undertaken within the GAO during his term. And the full effect of his second restructuring of the office last year has yet to be measured.

Staats last year turned the GAO divisional structure away from line

responsibilities on an agency-by-agency responsibility for defense, civil, and international affairs, and he reassigned audit and other responsibilities on a functional and program basis. Thus, one division that deals with all major Federal purchases carries the title of Procurement and Systems Acquisition, while others are functionally titled Financial and General Management, Logistics and Communications, and Federal Personnel and Compensation. Six other divisions deal with such internal GAO affairs as international and domestic field operations, resources and economic development, and manpower and welfare.

The new structure has served not only to make GAO larger and more powerful in Federal fiscal affairs, it also permits the people who work for Staats to gain broader experience as the organization expands. And there are definite signs that GAO will continue to grow, albeit carefully, under Staats's direction. "With 535 members, he can't please everybody" in the Congress, acknowledges one senior staffer for Holifield's committee, "but he comes closer than anyone else I've ever seen. So far, there is no question that Staats can have as much money as he wants" to run his office.

**Technically stronger.** While GAO recently gained prominence through investigations by its new Office of Federal Elections of Republican fund-raising in the 1972 campaign, the heavyweight division remains Procurement and Systems Acquisition. Its efforts trouble Federal electronics contractors most. Nevertheless, industrialists admit that GAO's technical expertise has improved substantially under Staats from the days when companies complained that the agency's staff of accountants regularly offered unsound technical judgments as part of their program audits.

Now, the GAO boasts that some 20% of its 3,150 professionals are neither accountants nor auditors but "engineers, economists, mathematicians, statisticians, attorneys, actuaries, and persons with academic backgrounds or experience in business and public administration."

The Electronic Industries Associ-

ation's vice president for government products, Jean Caffiaux, says his members' views of GAO are "ambivalent." The assessment sounds almost complimentary, compared with the pre-1966 period, when one could scratch a Federal electronics supplier on the subject and watch the vitriol run out. "Most of the time industry has an adversary relationship with the GAO," Caffiaux acknowledges, but he concedes there have been times when the agency's studies "have been supportive of industry positions."

**Case for industry.** Among the latter, he says, have been GAO's studies of independent research and development funding by the Defense Department, as well as the controversial 1971 defense-contract-profits analysis. The profit study was subject to varied interpretations, Caffiaux points out, "but if you just read the facts by themselves, you could make a case for industry" and its position that defense-contract profits are too low. Even GAO's disclosure of massive cost overruns on Washington's John F. Kennedy Center for the Performing Arts could be construed in a positive light, contends the EIA executive, "since it showed that defense contractors aren't the only ones who have overruns."

It surprises Caffiaux and many contractors, as well, that the GAO generates more than two-thirds of its own audit ideas, rather than responding to direct requests of the Congress, its committees, and members. The GAO contends that "audit planning is based largely on its own judgment of Congressional interest."

**Global input.** Part of that planning stems from the input of staff members stationed in some 50 Government departments and agencies in the Washington metropolitan area and in 15 regional offices and 29 suboffices throughout the country, plus overseas installations in Honolulu, Saigon, Bangkok, and Frankfurt. GAO's critics in the Government often fume that such staffers are no more than "spies," but the auditors see their assignment as no more than carrying out the Comptroller General's mandate from the Congress, as expressed in multiple laws passed since 1921. □



# Turn to page 7. Important? Sure...

By the time the office copy of ELECTRONICS gets to you, there's nothing left of page 7. It happens. Too often.

How often has ELECTRONICS wound up on your desk dog-eared and abused, with articles clipped out and ripped out? Or days, even weeks late?

How often has ELECTRONICS

never even made it to your desk?

You should be getting your copy of ELECTRONICS right off the press. You need it. Because it's important to stay on top of what's happening in your field. And ELECTRONICS is on top. ELECTRONICS is the Source. It's packed with up-to-date info, the breaking news of the electronic industries in the U.S. and worldwide.

You can get ELECTRONICS where you can find the time to read it—at home. Go to *the Source*, today. Fill out the subscription card enclosed in this issue, and send it off.

**Electronics** 7/13  
**IS THE SOURCE.** THE SOURCE





# Hard To Resist.

## *Hitachi Patents on Epoxide-Containing Polymers for Electron Beam Resists and Data Storage Now Available for Licensing.*

Hitachi is opening up thousands of its patents.

And, where it's needed, backing up the patents with the suitable technology.

We'd like to tell you about epoxide-containing polymers we've developed that may be of interest to you.

Hitachi's new epoxide-containing polymers are 50 to 300 times more sensitive to electron beams than conventional photoresists.

Used as resist films for manufacturing ICs or LSIs, patterns may be made with an electron beam drafting machine, and drafted directly by computer-controlled electron beam scanning. Therefore they allow

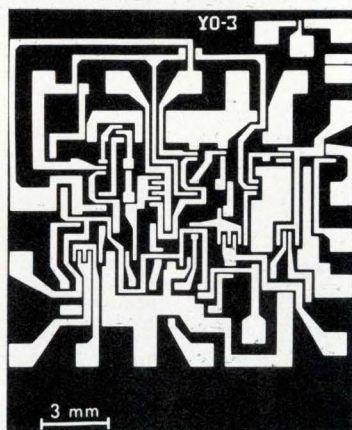

Chromium Mask for IC which is made with an electron-beam drafting machine, utilizing Hitachi's epoxide-containing polymers.

much greater miniaturization and accuracy.

Used as a medium for information storage, they will retain a considerably higher density of information.

To find out more about these patents, please contact us at the address shown.

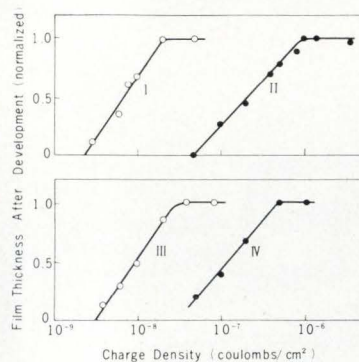

Exposure characteristics of epoxidized polymers and their starting polymers: I, epoxidized polybutadiene; II, polybutadiene; III, epoxidized polyisoprene; IV, polyisoprene.



## HITACHI

Hitachi, Ltd.

Area Section A (Patent Group)  
International Business Operations Division

6-2, 2-chome, Ohtemachi, Chiyoda-ku,  
Tokyo 100, Japan.



# For the real cost of a design, factor in reliability

Extended warranties, plus rising repair costs, are compelling consumer-product engineers to assess component reliability; here's a way to figure total reliability costs into design tradeoffs

by Erturk Deger and Thornley C. Jobe, *RCA Corp., Consumer Electronics, Indianapolis, Ind.*

□ Reliability, which used to be associated mainly with aerospace companies, has been pushed to the forefront in consumer electronics, right up alongside of price and quality [*Electronics*, Feb. 1, p. 78]. A competitive vogue for longer warranties, combined with extensive use of solid-state components in such products as color-television receivers, is making the cost of field service loom ever larger in the over-all financial position of a manufacturer—and effective management of this cost in turn swings the spotlight onto the designer of a product and what he does to improve reliability and prevent failure in the field.

Reliability differs from quality in that the quality emphasizes the initial performance of a component but reliability assures the continuation of performance over a period of time.<sup>1</sup> This distinction shows up in today's component specifications. Previously, designers had asked for quality control types of tests, which primarily assured that a part met all engineering specifications in a fairly straightforward manner. Now they specify accelerated life tests or reliability tests in addition to the quality tests, to ensure that the specs are not only met initially but also are maintained over some specified time.

The distinction has also changed the way we rate vendors. Previously we went on the basis of price, service, and quality, weighted 30%, 30%, and 40% respectively. Today reliability has been added to the scheme so that each of the four receive 25% weighting and reliability and quality now account for 50% of the total rating.<sup>2</sup>

With this shift in emphasis, vendors providing parts with high reliability are frequently paid a premium price, though this should not be construed as a blank check. The premium for reliability is paid to the extent that it reduces our field warranty cost—in other words, it must be accompanied by economic considerations and is not a leading independent concept.

### The economics of reliability

It is technically feasible to build every television set so that it will give failure-free service for many years. However, the cost of such a receiver would be so prohibitive that a firm attempting such an undertaking would be pricing itself out of the market. The total cost

of the product or part over its useful life span must be considered, rather than the initial part cost.

It is this "total reliability cost" that determines the selling price of the receiver. It consists of two variables: the cost of field service, and the initial cost of its part, which includes factory shrinkage. (The other elements of total product cost remain constant when one is evaluating reliability.)

Service cost may be reduced by improving part reliability, which is generally accomplished through derating the specifications. However, derating normally adds to part costs. Economics of reliability therefore refers to the design that ideally balances the increased part cost against the decreased service cost, thereby minimizing the total reliability cost.

As a design goal, the preceding point is akin to applauding motherhood and apple pie, and the critical question is how a designer should go about achieving this balance. To evaluate his design, an engineer needs measurement standards and guides to allow him to judge both the reliability performance and cost effectiveness of his design. Such a guide for discrete transistors that are used in color television circuits will be presented in this article.

Why is this guide needed? Historically, data collected from 90-day service-labor warranties have indicated that 90% of the field service problems for color television sets were related to deficiencies in parts quality and manufacturing operations. Under these conditions, design stresses did not significantly contribute to failures.

Under one-year service-labor warranty programs, however, our findings indicate that design stresses account for as much as 55% of all component failures in the field, so that component reliability now becomes an important factor to be optimized through design considerations. Moreover, the number and therefore cost of field failures due to stress failures grows dramatically under two-, three-, four-, and five-year warranties (Fig. 1).

Therefore, given the state of technology in the devices and components available for consumer products, it becomes the designer's responsibility to derate his parts to minimize total reliability cost to his company. Ob-



## How TV components fail

Time distribution of component failures in television receivers falls into three familiar, documented categories:

- Infantile failures, which occur when some part of the total population of a certain component is substandard. These parts will have substantially higher failure rates than the norm of the population, but they can be weeded out with burn-in testing. With no burn-in, more than 95% of the infantile failures occur during the first three months of the receiver. These potential infantile failures were not considered in the reliability guidelines, since they represent a portion of the population that falls outside the control of the design engineer.
- Random failures, which involve most parts during the life of a receiver. It is the random failure rate at which the reliability guidelines described here are directed. Determining the economic tradeoff between the cost of derating parts and the cost of servicing random failures is the designer's responsibility.
- Wear-out failures, which occur when the combination of stress level and time exceeds the normal life expectancy of the component. The wear-out failure rate rises abruptly when this point is reached. The design engineer must take these failures into account and compare them against the useful life of the set.

viously, the longer the warranty period, the more derating is required. What is considered to be the best cost design under one-year warranty may no longer be optimum under a two-year program. Specification changes may be needed to reduce stresses on components to bring the design into line.

Of course, not all component failures are within the realm of the designer. For example, the designer can do very little about infantile component failure, regardless of how much the device and component stresses are reduced. However, the intrinsic design of a component of its manufacturing process may influence infantile failures. (See "How TV components fail").

### Reliability data sources

Reliability cost estimates are based on our extensive examination and analysis of three sources of information: life test of television receivers, field service data, and vendor reliability tests.

The relationship between operating life and applied stresses was determined mainly by analysis of the history of component life in receivers. Millions of unit operating hours in TV sets, run under carefully controlled life test conditions, provided one source of data.

Additional data was derived by analyzing thousands of field service invoices and correlating these field experiences, component by component, with the life test histories. To make the correlation, it was necessary (1) to analyze thousands of components returned from television receivers in the field, (2) to tabulate the failure modes and frequency distributions of these failure modes for both the field returns and the data from the high-level stress tests, and (3) to compare the results and, where necessary, modify the tests to produce results the equivalent of the field experience.

Statistically valid and accurate field service data came

from the Reliability Serviceability Verification Program (RSVP), a computerized field reporting program implemented after two years of planning and design. Under RSVP, a minimum of 5% of the RCA television sales in the country is monitored through its warranty period. Field failures are broken down by components, workmanship, and alignment and adjustment for each chassis type. For each item, the rate of failure is determined, the distribution of failure with time is shown, and the corresponding mean time between failures (MTBF) of the chassis is computed.

Although field service data gives an accurate indication of warranty cost, it cannot be used directly in engineering decisions on the reliability of certain components, such as TV modules. This is because some failures, like false pulls by servicemen, are generated in the field and may have little or nothing to do with the actual reliability of the module or component.

Furthermore, information as to what has failed, and why, is needed before corrective action in design can be taken. To remedy this situation, therefore, an additional analytic step is introduced into the field feedback loop, and samples of the field-returned modules and some major component failures are periodically analyzed to determine the exact causes of failures. This analysis is carried out rapidly and economically by automated systems with minicomputer controllers, and the results are summarized for use by design engineers.

Finally, the data from the TV receiver environments has been supplemented by data from the component vendors that helps confirm life versus stress relationships. The high-level stress tests themselves have proved to be a valuable tool in assessing the quality and reliability of a supplier's product.

By using all these stress tests and reliability data, we have been able to upgrade the reliability of many of the components we purchase. When we have assured ourselves that the reliability of a component has been improved, we modify the numerical factors in our guidelines to circuit design engineers. As a result, the guidelines are periodically changed, and the circuit designers have access to the latest assessment of the data necessary to optimize their circuit designs.

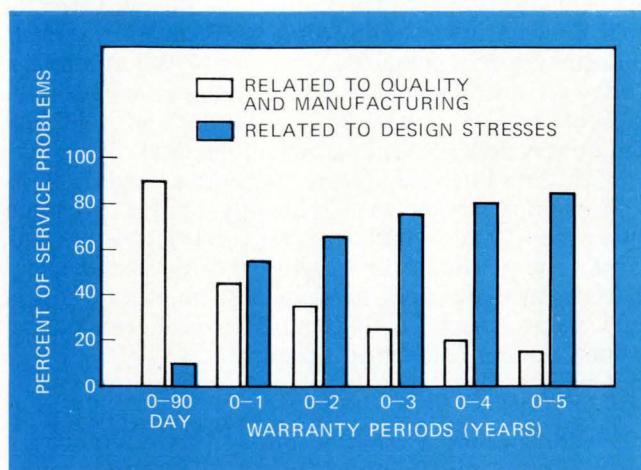

1. **Designer in the picture.** The growing importance of designing in reliability is dramatized by the rising impact of design stress failures on the cost of field service as warranties are extended.



## Part 1: Maximum stress limits on transistors

The following maximum stress limits go beyond the manufacturer's specifications, and they are intended to prevent excessive failures of transistors used in the television environment. Numerical values in this exhibit are not necessarily actual but are representative of the values RCA uses. This is done primarily because what works under our transistor specifications may or may not work under another firm's specifications.

- Collector-to-emitter voltage,  $V_{CE}$ . The peak collector-to-emitter voltage should not exceed 65% under normal operation and 90% under worst-case operation of the rated  $V_{CE0(SUS)}$ .
- Base-to-emitter voltage,  $V_{BE}$ . The peak reverse base-to-emitter voltage should not exceed 70% under normal operation and 90% under worst-case operation of the rated  $V_{BE}$ .
- Safe area operation. The peak power dissipated should be compared to the transistor's safe area operating curve. The peak power should not exceed 80% under normal operation and 90% under worst-case operation of that allowed by the curve.
- Junction temperature,  $T_J$ . This is to be calculated us-

ing the maximum rated thermal resistance ( $\Theta_J$ ).

For a transistor rated at less than 3 watts, it should not be within 25°C under normal operation (10°C under worst-case operation) of the maximum rated junction temperature ( $T_{JMAX}$ ).

For a transistor rated at 3 watts or more, it should not be within 40°C under normal operation (10°C under worst-case operation) of  $T_{JMAX}$ .

■ Thermal fatigue. RCA Solid State division publishes thermal rating cycling charts for its power transistors. To use these charts, the designer should determine the power dissipation and the case temperature excursion ( $\Delta T_C$ ) in his application. Then, by referring to those charts, he must assure himself that the thermal fatigue wear-out will not occur within the transistor's useful life.

According to field surveys, 95% of color TV receivers in the field experience 1,500 or fewer on-off cycles per year. Therefore, the designer should assure himself that the thermal fatigue will not occur within the first 7,500 cycles (corresponding to five-year period) under the normal operation of the receiver. Under the worst-case operation, the recommended minimum is 5,000 cycles.

STRESS LIMITS		
Parameter	Normal operation	Worst-case operation
$V_{CE-PEAK}$	65% $V_{CE0(SUS)}$	90% $V_{CE0(SUS)}$
$V_{EB-PEAK}$	70% $V_{EB-RATED}$	90% $V_{EB-RATED}$
Peak power	80% safe area	90% safe area
$T_J$	$T_J < T_{JMAX} - 25^\circ C (< 3W)$ $T_J < T_{JMAX} - 40^\circ C (\geq 3W)$	$T_J < T_{JMAX} - 10^\circ C$ $T_J < T_{JMAX} - 10^\circ C$
Thermal fatigue	7,500 cycles (5 years)	5,000 cycles (5 years)

What are these guidelines to engineers? The primary purpose of this article is to present one of our approaches to reliability and the specific technique we use with discrete transistors in color television receivers. Since no guide can cover all contingencies without severely restricting its usefulness, there will be situations to which it does not apply. Therefore, this guide is not a substitute for good engineering judgment—it is just a fairly accurate supplement based on our extensive examination of the sources described above.

### Guide to transistor reliability

The reliability guidelines are based on measurements taken under two sets of operating conditions: "normal" operating conditions, and "worst-case" conditions.

Normal operating conditions are a power-line voltage of 129 volts, room temperature of 20°C, and all controls adjusted for best picture and sound. Though 129 v is not the nominal power-line voltage, it ensures that the circuit designer avoids voltage thresholds, like the peak inverse voltage (PIV) of a diode, by very safe margins under normal viewing conditions.

Worst-case operating conditions consist of a power-line voltage of 135 v, 40°C room temperature, and misadjustment of all controls to maximize the stresses

on the component under investigation. We estimate that 135 v and 40°C represent the upper three-sigma limits of the distributions of line voltage and room temperatures experienced by TV receivers.

The transistor reliability guide has two sections:

■ "Maximum stress limits on transistors," Part 1, briefly lists and describes the maximum stress limits which must be observed in order to prevent excessive failures (see above). They are more restrictive than the limits recommended by the manufacturer.

■ The "Transistor derating model," Part 2, presents the circuit designer with a theoretical framework showing how the various stresses on transistors contribute to their failure rates (next page). Reduced to tabular form, the procedure is in day-to-day use by the TV designers at RCA Consumer Electronics division. The simplified tables make it unnecessary for the designer to worry about such non-design information as the average cost of servicing a transistor in the field, and enable him to estimate the total reliability cost of a proposed transistor application in a few minutes. They are updated periodically by the product analysis and control laboratory to reflect the latest available information and to take account of inflation of materials and labor costs.

Our approach to optimization in the procedure



## Part 2: A transistor derating model

If the maximum stress limits as listed in Part 1 are adhered to, and if the necessary precautions to protect the transistor from kinescope arc energy are taken, it's possible to estimate the rate of failure of a transistor fairly accurately. The predicted failure rate can then be used to estimate the total reliability cost (initial part cost plus field warranty cost) of a given application.

The failure rate model for a transistor application, and the discussion of the model parameters are:

$$\lambda = \lambda_B [K_{POW} K_{APP} FV_{CE} FT_J]$$

where

$\lambda$  = failure rate per  $10^6$  hours

$\lambda_B$  = base failure rate

$K_{POW}$  = power rating multiplier

$K_{APP}$  = multiplier, to indicate catastrophic or parameter shift type of failure

$FV_{CE}$  = failure contribution of  $V_{CE}$  stress

$FT_J$  = failure contribution of  $T_J$  stress

■ Base failure rate,  $\lambda_B$ . This is the failure rate when the transistor is operated at full rating along its critical parameters, such as  $V_{CE}$  and  $T_J$ . From life test experience and data, it works out at 12.5 per million hours.

■ Transistor power rating,  $K_{POW}$ . Higher physical stresses arise in power transistors than in a small-signal transistor because more current and higher temperature occur both at their bonds and in their semiconductor materials. RADC Reliability Handbook<sup>5</sup> suggests a multiplier of 1.0 for transistors rated from 0 to 1 W and a multiplier of 1.5 for power transistors rated between 1 W and 5 W. But extensive reliability analysis of the transistor applications in TV environment suggests the following values for this multiplier:

$K_{POW} = 1$ , when rated power is less than 1 W,

$K_{POW} = 2$ , when rated power is equal to or greater than 1 W.

■ Criticalness of application,  $K_{APP}$ . In certain applications, the functional operations of some transistors are not sensitive to parameter shifts and do not generate a failure (service call) until there is a catastrophic (open or short) condition. On the other hand, in some other applications a parameter shift (like a drastic change in beta,  $I_{CBO}$ , or  $V_{CBO}$ ) as well as a catastrophic condition will generate failures. In order to distinguish between these two cases in transistor applications, a criticalness factor ( $K_{APP}$ ) is incorporated into the model. The study of transistor applications suggests using the following values for this multiplier:

$K_{APP} = 1$  when a catastrophic condition causes a failure

$K_{APP} = 2$ , when both catastrophic and parameter shift conditions cause a failure

■ Collector-to-emitter voltage,  $FV_{CE}$ . Transistor failure

rates vary in direct proportion to the peak collector-to-emitter voltage over a fairly wide range of voltages. The reason for this is that, as  $V_{CE}$  increases, the likelihood that either primary or secondary breakdown will occur also increases. The expression for  $FV_{CE}$  is the following:

$$FV_{CE} = V_{CE\text{ pk}} / V_{CE(SUS)}$$

For peak collector-to-emitter voltages less than 33% of  $V_{CE(SUS)}$ , use  $FV_{CE} = 0.33$ .

■ Junction temperature,  $FT_J$ . According to semiconductor physics, the failure rate of the semiconductor as a function of junction temperature is given by the following Arrhenius model:<sup>6</sup>

$$\lambda = e^{A+B/T_J}$$

where

$\lambda$  = failure rate per million hours

$T_J$  = junction temperature in degrees Kelvin

A, B are material constants

A survey among our vendors has revealed that, over the operating range normally experienced in a television receiver, transistor failure rates are halved for each decrease of  $10^\circ\text{C}$  to  $30^\circ\text{C}$  in junction temperature. Therefore, the following linearized model can be used for transistor applications in TV receivers in place of the Arrhenius model. In this model, it was assumed that the failure rate is halved for each  $16^\circ\text{C}$ :

$$FT_J = (0.5)^{(T_{JMAX} - T_J)/16}$$

where  $F_I$  = failure rate per  $10^6$  hours, and  $T_{JMAX}$  = maximum rated junction temperature in  $^\circ\text{C}$ .  $T_J$ , in  $^\circ\text{C}$ , is the junction temperature calculated for the application using the maximum rated thermal resistance,  $25^\circ\text{C}$  room temperature, and 129-V line voltage. For junction temperatures below  $60^\circ\text{C}$ , use the  $FT_J$  value corresponding to  $T_J = 60^\circ\text{C}$ .

Once the failure rate per million hours is determined, the computations of the mean time to failure, percent of failure within the warranty period (F), and the corresponding service cost can be determined.

Mean time to failure:

$$MTTF = 1/\lambda \times 10^6 \text{ hours}$$

Percent failure within warranty period:

$$F = (Y \times 2,500 \text{ hours/year})(\lambda \times 10^{-6})100$$

where F = percent failure within the specified warranty period, Y = warranty period, in terms of number of years (2,500 hours corresponds to 1 year of customer operation), and  $\lambda$  = failures per million hours ( $\lambda \times 10^{-6}$  gives failures per hour).

Simplifying this expression yields:

$$F = 0.25(Y)(\lambda) \text{ percent failure per } Y \text{ years}$$

Service cost:

$$SC = 0.0025(Y)(\lambda)(C) \text{ dollars per set}$$

where C is the cost of servicing (part plus labor) a transistor failure in the field.

presented in the "Transistor derating model" is heuristic rather than rigorously mathematical. In other words, the procedure does not guarantee that the chosen least-cost design is the best of all possible choices. The answer is actually the best of only the proposed choices. There may still be other designs that may lower total reliability cost, but the art of providing suitable alternatives rests with the designer; the procedure only provides him with a tool with which to determine the best of his proposed alternatives.

The following is an example of how a circuit designer

determines which of three alternative transistor designs has the total reliability cost. In this hypothetical yet highly representative case the designer has the choice of:

- Using a transistor without heat sink, with a power rating of 1 watt, and with an initial part cost of 25¢, or
- Using the same transistor with a heat sink, yielding an initial part and assembly cost of 33¢, or
- Using a different transistor rated at 1.5 w, with an initial cost of 40¢.

It's assumed the conditions listed in Part 1, "Max-



TABLE 1. LEAST-COST ALTERNATIVES

Input data	1. Transistor No. 1 without heat sink	2. Transistor No. 1 with heat sink	3. Transistor No. 2 without heat sink
<b>SPECIFICATIONS:</b>			
Power rated	1 W	1 W	1.5 W
$V_{CE(SUS)}$ rated	40 V	40 V	60 V
$T_{JMAX}$ max. junction temperature	150°C	150°C	175°C
$\theta_{J-A}$ thermal resistance	250°C/W	125°C/W	160°C/W
<b>OPERATING CONDITIONS:</b>			
Power rating	0.25 W	0.25 W	0.25 W
$V_{CE-PEAK}$	24 V	24 V	24 V
$T_A$ measured	45°C	45°C	45°C
$T_J$ computed	108°C	76°C	85°C
$\Delta T_C$ measured	55°C	48°C	50°C
<b>SERVICE COST PER CALL:</b>			
Standard part cost/call	\$ 0.25	\$ 0.33	\$ 0.40
Service labor cost/call*	\$25.00	\$25.00	\$25.00
Total service cost/call	\$25.25	\$25.33	\$25.40
(*) Example for purposes of computation only.			

imum stress limits on transistor," for each of the three applications are already met.

Transistor specifications, operating conditions, and the cost data appear in Table 1. Table 2 shows failure rate and mean time to failure (MTTF) calculated from the procedure that is outlined in Part 2. Finally, at the end of Table 2, a total reliability cost is computed for each of the three designs under both one-year and two-year periods.

The total reliability costs of the three choices under a one-year warranty program are estimated at 55.8¢, 40.9¢, and 42.5¢, respectively. Therefore, the best design choice for the least total cost is the second one—the transistor with the heat sink. The third, while providing the highest reliability or lowest failure rate, is not acceptable because it costs more.

This example is also a good illustration of the difference between one-year and two-year warranties. Over two years, as shown on the table, the total reliability costs for the three options become 86.6¢, 48.8¢ and 45¢, respectively. In this case, therefore, the third design becomes the best choice.

As previously mentioned, there are additional unreliability costs—that is, deficiencies in parts quality and workmanship—over which the design engineer has no direct control. The predicted warranty cost in this illustration reflects only those factors over which the designer has direct control—its primary purpose is to serve as a vehicle to optimize the derating of the devices and components.

#### Adding components for lower total cost

Where the concept of total cost governs a circuit's design, some circumstances justify adding components to the circuit in order to increase its reliability and reduce its total cost.

For example, suppose the 1.5-w transistor in the first

example is used as a pulsed driver transistor with a transformer primary in its collector circuit. The problem for the circuit designer is to determine whether it is economical to add a diode to the circuit in order to clamp the collector to the supply voltage and keep the maximum collector-to-emitter voltage down to 18 v. Assume that a diode is available with a total purchase price, plus warranty cost, of 5¢. (The diode's warranty cost may be computed in the same way as a transistor's but from the reliability guidelines for diodes.)

The input data for this illustration (Table 3) shows the transistor specifications, assumed operating conditions, and the cost data. The procedure and the input data are used to compute the failure rates and MTTFs (Table 4) so that two total reliability costs are computed with and without the clamping diode in the circuit. The two figures work out at 51.9¢ without the diode versus the low 51.6¢ with the diode.

Once again, the estimated warranty cost in this illustration does not represent the total warranty cost, but represents only those factors over which the designer has direct control.

#### Guidelines in actual practice

One pertinent question about the use of the reliability guidelines concerns the accuracy of the estimates. Comparison with field data indicates that our estimates are fairly good, yielding an accuracy of  $\pm 20\%$  in general. Any significant difference between the predictions and the actual field experience need not indicate that the predictions are way off base—it could be a signal for taking a closer look at field failures. In other words, predictions can be used to serve as reliability standards. Just as the cost standards enable financial management to control cost, so reliability standards enable warranty management to monitor field performance.



In one recent case, use of maximum stress levels re-



TABLE 2. FIGURING THE OPTIMUM TRANSISTOR

Computations	Transistor No.1 without heat sink	Transistor No.1 with heat sink	Transistor No.2 without heat sink
$K_{POW}$ (power rating multiplier)	2	2	2
$K_{APP}$ (catastrophic and param. shift)	2	2	2
$FV_{CE}$ (voltage stress)	0.60	0.60	0.40
$FT_J$ (temperature stress)	0.162	0.040	0.020
$\lambda$ - (failures per $10^6$ hr)	4.86	1.22	0.40
MTTF (mean time to failure)	205,761 hr	833,337 hr	2,500,000 hr
Percent failures/year	1.22%	0.31%	0.10%
Warranty cost per set/year	30.8 ¢	7.9 ¢	2.5 ¢
Standard cost per set/year	25.0 ¢	33.0 ¢	40.0 ¢
Total reliability cost per set/year	55.8 ¢	<u>40.9 ¢</u>	42.5 ¢
Total reliability cost per set/2 years	86.6 ¢	48.8 ¢	<u>45.0 ¢</u>

 Transistor No. 1: 1 W without heat sink		 Transistor No. 1: 1 W with heat sink		 Transistor No. 2: 1.5 W without heat sink	
MTTF:	205,761 hr	MTTF:	833,337 hr	MTTF:	2,500,000 hr
Initial part cost	25.0 ¢	Initial part cost	33.0 ¢	Initial part cost	40.0 ¢
Warranty cost/1 yr	30.8 ¢	Warranty cost/1 yr	7.9 ¢	Warranty cost/1 yr	2.5 ¢
Warranty cost/2 yr	61.6 ¢	Warranty cost/2 yr	15.8 ¢	Warranty cost/2 yr	5.0 ¢
Total cost/1 yr	55.8 ¢	Total cost/1 yr	<u>40.9 ¢</u>	Total cost/1 yr	42.5 ¢
Total cost/2 yr	86.6 ¢	Total cost/2 yr	48.8 ¢	Total cost/2 yr	<u>45.0 ¢</u>

commended by the transistor guide pinpointed a certain small-signal transistor, which was failing more often than similar transistors in other applications. Immediately, samples of the transistors were taken to the failure analysis lab. At the same time, measurements were made to ascertain the stresses applied to the failing transistor, and these revealed that the transistor was being operated well within the manufacturer's specifications but beyond the maximum stress levels recommended by the guideline. This circuit, designed prior to our use of the guide, was quickly modified—but stress analysis of the circuit during the design cycle would have prevented the costly field repairs required to straighten out the situation.

In another case, the guidelines helped identify and control reliability problems associated with various vendors. This time, a certain component was failing in the field at about twice the predicted rate. Defective parts were collected and most were found to come primarily from one supplier. Follow-up showed that two suppliers shipped about the same number of parts to RCA, but failure analysis revealed a construction defect on one vendor's parts. When all the facts were in, we found that the better vendor's parts were failing at a rate

within 10% of the prediction, while the other vendor's parts were failing at four times the predicted rate.

### Reliability compared to modular design

Reliability and modular design are two different approaches to a solution for the same problem: how to reduce the maintenance cost of a television receiver to the customer. Reliability is intended to reduce the number of service incidents, while the modular approach seeks to reduce the service cost per failure incident. However, modularization does not come free, for labor saving which accrues to the consumer is partly offset by additional costs such as:

- A slightly higher replacement-part cost, due to the fact that good parts are discarded with bad parts when the entire module is yanked out.
- A slightly higher manufacturing cost, because additional assembly steps, parts, and materials are required in modular chassis.
- The introduction by modularization of extra parts and contact points that may themselves contribute to the field service incidents.
- Ease of replacing modules, which may encourage repairmen to pull out perfectly good modules.



TABLE 3. ADDING A COMPONENT

Input data	Without diode	With diode
<b>SPECIFICATIONS:</b>		
Rated power	1.5 W	1.5 W
V <sub>CE (SUS)</sub> rated	60 V	60 V
T <sub>JMAX</sub>	175°C	175°C
θ <sub>J-A</sub>	160°C/W	160°C/W
<b>OPERATING CONDITIONS:</b>		
Power dissipated	0.5 W	0.5 W
V <sub>CE-PEAK</sub> measured	36 V	18 V
T <sub>A</sub> measured	47°C	47°C
T <sub>J</sub> computed	127°C	127°C
ΔT <sub>C</sub> measured	60°C	60°C
<b>SERVICE COST PER CALL:</b>		
Standard part cost/call	\$ 0.40	\$ 0.45
Service labor cost/call*	\$25.00	\$25.00
Total service cost/call	\$25.40	\$25.45
(*) Example for purposes of computation only.		

On the other hand, the modular approach does increase the effectiveness of each service call, prolong set life, promote standardization, encourage the systems approach, and facilitate design changes in production.

Generally, the more reliable a set is, the less will be the need for modularization, so the two concepts are now accepted design tradeoffs. The ever-increasing reliability of television sets accompanied with the proper level of modularization should in the long run pay off in the customer's behalf.

**What we've learned in reliability**

By extending the warranty period for solid-state TV receivers to one year, consumer electronics companies have taken a significant step toward benefiting their customers. However, this move has also placed an added burden on each company's design engineering department.

No longer can a design engineer pat himself on the back when he has reduced a transistor's junction temperature or a resistor's power dissipation to the maximum rating values. He must now weigh the potential warranty cost of the stress he is applying to each component in his circuit, and compare these costs with those of alternate means of achieving the same performance.

For the design engineer to be able to perform this added task satisfactorily, he must have a more sophisticated measuring stick than has been available in the past for evaluating the cost-effectiveness of his design. Guidelines for circuit designers must be developed and updated periodically by each design engineering department, for one company's guidelines, when applied to another's product, may give a distorted picture of reliability. The differences exist because each manufacturer has its specifications for the components it uses.

These component specifications determine, to a large extent, the rate at which parts will be likely to fail in a given application. In addition, each manufacturer may experience different warranty or service costs depending

TABLE 4. COMPUTATIONS FOR DECISION TO ADD A DIODE

Computations	Without diode	With diode
K <sub>POW</sub> (power rating multiplier)	2	2
K <sub>APP</sub> (catastrophic and param. shift)	1	1
FV <sub>CE</sub> (voltage stress)	0.60	0.30 (use 0.33)
FT <sub>J</sub> (temperature stress)	0.125	0.125
λ (failures per 10 <sup>6</sup> hr.)	1.875	1.031
MTTF (mean time to failure)	533,333 hr	969,697 hr
Percent failures/year	0.4688%	0.2578%
Warranty cost per set/year	11.9 ¢	6.6 ¢
Standard cost per set/year	40.0 ¢	45.0 ¢
Total reliability cost per set/year	51.9 ¢	<u>51.6 ¢</u>

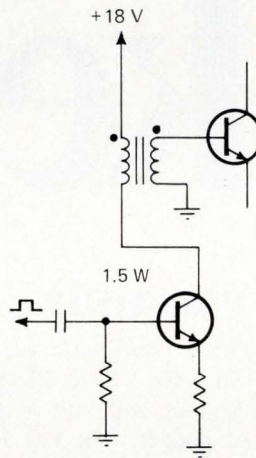

WITHOUT

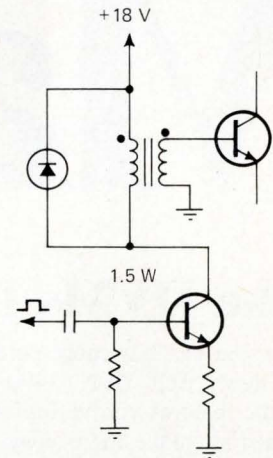

WITH

Circuit without diode

Circuit with diode

MTTF:	533,333 hr
Initial part cost	40.5 ¢
Warranty cost/yr.	11.9 ¢
Total cost	51.9 ¢

MTTF:	969,697 hr
Initial part cost	45.0 ¢
Warranty cost/yr.	6.6 ¢
Total cost	51.6 ¢

on its marketing strategy and warranty coverage. Therefore, each manufacturer's guidelines must be based on his own experience with the components he uses. □

**REFERENCES**

- Igor Bazovsky, "Reliability Theory and Practice," Prentice-Hall, 1965, pp. 279-280.
- RCA Suppliers Conference, "Purchaser Satisfaction through Product Superiority," Indianapolis, Ind., March, 1971.
- L.J. Gallace, V. Lukach, and D. Williams, "Thermal-Cycling Ratings of Power Transistors," RCA Solid State Division Application Note AN-4783, April, 1972.
- RCA Solid State Division, "Power Transistors," Technical Series PM-81, April, 1971.
- Rome Air Development Center, "RADCR Reliability Notebook," New York, October, 1967, p. 340.
- Rome Air Development Center, "RADCR Reliability Notebook," RADCR-TR-65-330, New York, October, 1965.



# The Same Technology Instruments Makes Them

## Take DVMs for example...

Today you can buy more performance for your dollar with HP's new "Self-Test" 3490 and "Snap-On" 3470. Both have the features you've told us you wanted, and both were designed to make them easy on your budget. The key is HP's advanced technology. Look what your dollars will buy with these four quality members of HP's DVM family.

**Self-Test 3490** makes double use of its internal ICs to bring you HP's exclusive "Self-Test" capability without extra cost. The basic 5-digit 3490, ready to measure AC, DC and Ohms sells for only \$1,650 (and at low added cost you can have isolated BCD output and isolated remote control, or the highly-useful remote control with ASCII bus). Compare the 3490 with any other multimeter in its class and you'll find an unusual blend of features and performance for the money.

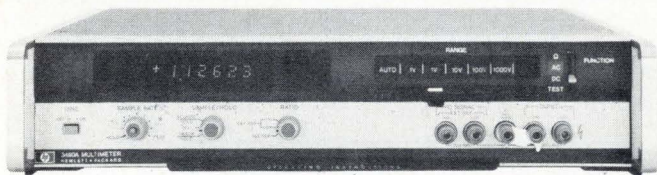

**Snap-On 3470** provides you with an economical 4-digit LED display unit that you can equip to meet your exact measurement needs. Get DC only for \$475 total, AC/DC/Ohms for \$600 total, or DCV/DCA/Ohms for \$875 total (5-digit versions are \$700, \$825 and \$1,100). Add on a battery pack center for \$200, BCD output center for \$175 or an exclusive





# HP That Makes Better... Now Cost Less

HP "Self Test" accessory for only \$50. You end up with a modern custom-tailored system for very little money.

**Multi-Mode 3450** lets you add up to 12 modes of high-accuracy measurement capability to your automated system. You can have true-rms, 4-terminal ratio, 4-terminal ohms and the unique limit test in addition to the usual functions. The 3450 is both fast and accurate, with 15 readings/sec. and accuracy to (0.008% of reading + 0.002% of range). Prices start at \$3,300 for the 5-digit DC volts and Ratio model, go to \$5,900 for total 12-mode capability.



Check your DVM measurement needs. You'll find that HP can fit them closely, whether they call for state-of-the-art performance or real economy. For more information on the entire HP family of DVMs and multimeters, contact your local HP field engineer. Or, write Hewlett-Packard, Palo Alto, California 94304. In Europe: HPSA, P.O. Box 85, CH-1217 Meyrin 2, Geneva, Switzerland. In Japan: Yokogawa-Hewlett-Packard, 1-59-1, Yoyogi, Shibuya-Ku, Tokyo, 151.



**Speed Star 3480** is systems oriented, but fine for the bench as well. This 4-digit,  $\pm 0.01\%$  unit delivers an unmatched 1,000 readings/sec. Get the exact capability you need by selecting plug-ins. For example, you can have DC, Ohms and true-rms AC for \$2,900 (isolated BCD output and isolated remote control are low-cost options). You can even turn the 3480 into an inexpensive A-to-D converter with a sample and hold option that also lets you take peak readings or do transient analysis. Or, add data storage that stores up to 50 readings or do transient analysis. Or, add data storage that stores up to 50 readings at the 1000/sec. rate and employ a low-cost printer to output the data.

Send for our 70-page Application Note 158, RS 91.



## Frequency discriminator uses one-shot and flip-flop

by Peter Alfke  
Fairchild Semiconductor, Mountain View, Calif.

A frequency discriminator that is accurate to within about 3% can be built inexpensively with only two integrated-circuit packages. The circuit, which is intended for industrial-control and communications applications, senses whether an incoming frequency falls within a predetermined band, or if the frequency is lower or higher than the band.

A dual retriggerable monostable and a dual flip-flop are the two IC packages. The positive-going edge of the incoming signal clocks both flip-flops and triggers the first monostable,  $M_1$ . When this monostable, which has an "on" time of approximately  $0.31R_1C_1$ , completes its timing cycle, it triggers the second monostable,  $M_2$ , which has an approximate "on" time of  $0.31R_2C_2$ .

For a low incoming frequency, both monostables have completed their timing cycles before the next positive-going edge of the input occurs. The next edge, then, sets flip-flop  $FF_1$  and resets flip-flop  $FF_2$  ( $Q_1$  and  $\bar{Q}_2$  outputs go high), indicating that the incoming frequency is below the design band:

$$f_L = 1/[0.31(R_1C_1 + R_2C_2)]$$

If the input frequency is increased, the next leading edge occurs while the output from monostable  $M_2$  is still high, so that both  $FF_1$  and  $FF_2$  are set ( $Q_1$  and  $Q_2$  outputs go high). This indicates the incoming frequency is within the design band.

Increasing the input frequency further causes the next leading edge to occur before monostable  $M_1$  has finished its timing cycle, beginning a new period for this retriggerable monostable. The continuing output from  $M_1$  prevents monostable  $M_2$  from triggering so that both flip-flops are reset ( $\bar{Q}_1$  and  $\bar{Q}_2$  outputs go high). This means that the incoming frequency is higher than the design band:

$$f_U = 1/0.31R_1C_1$$

The time constant (about 100 nanoseconds) established by resistor  $R_3$  and capacitor  $C_3$  makes the setup time of flip-flop  $FF_1$  longer than the trigger delay of monostable  $M_2$ . This assures that  $FF_1$  will change state at a frequency that is slightly below, rather than above, upper band limit  $f_U$ , thereby avoiding ambiguous output codes around  $f_U$ .

The circuit's frequency response is limited to a few megahertz because of the inherent delays of the monostables. Whenever the range of operating frequency permits, type 96L02 monostables should be used because they offer better temperature stability than the type 9602 devices. (The 74121 multivibrator cannot be used here because of its duty-cycle limitations.) □

**Monitoring frequency.** A couple of retriggerable monostables and flip-flops can be connected as a fairly accurate low-cost frequency discriminator. Lower and upper band limits are determined by the monostables' timing circuits. For in-band inputs, outputs  $Q_1$  and  $Q_2$  are high; for low frequencies,  $Q_1$  and  $\bar{Q}_2$  are high; and for high frequencies,  $\bar{Q}_1$  and  $\bar{Q}_2$  are high. The  $R_3C_3$  delay avoids ambiguity at the upper limit.

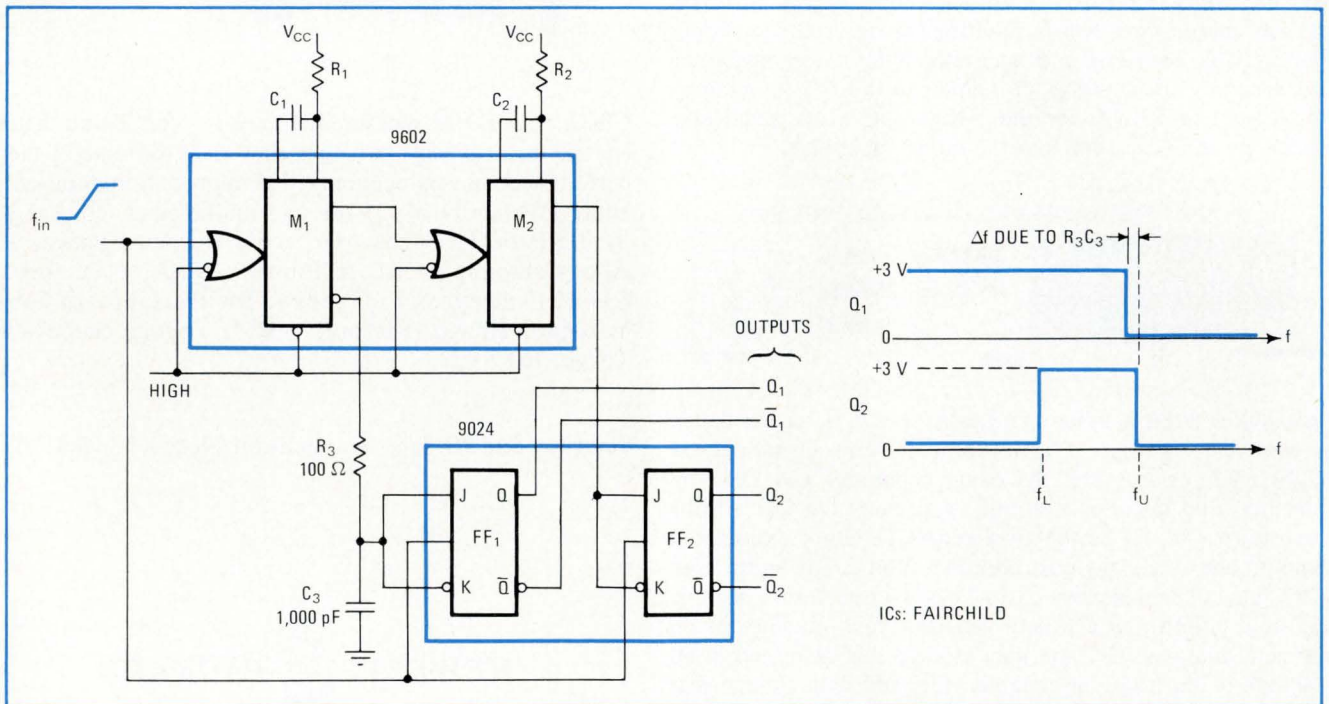



# C-MOS counting circuit accumulates $2^{70}$ pulses

by Robert M. Owens and Kenneth J. Hintz  
*Naval Weapons Laboratory, Dahlgren, Va.*

An easy-to-build counting circuit satisfies today's increasing need to monitor events or quantities over long periods of time. The circuit, which consists of only five ICs, can count to  $2^{70}$ —that's greater than a sextillion ( $1 \times 10^{21}$ )! It can be used in any situation where a large number of events must be counted.

Primarily, however, the circuit is intended to provide the integral of temperature over a 30-day period by counting the total cycles of a linear temperature-dependent oscillator. It employs complementary-MOS ICs to reduce power consumption to approximately 4.5 milliwatts for a supply voltage of 9 volts. This allows the circuit to be left unattended in the field for periods of longer than 30 days.

At first, the 64-stage static shift register is reset so that its  $\bar{Q}$  and the Q output of flip-flop FF<sub>1</sub> are high. The DATA input of FF<sub>1</sub> is high until a sync ("add one") pulse is generated by the  $\bar{Q}$  output of flip-flop FF<sub>2</sub> and the divide-by-64 binary counter, at its Q<sub>6</sub> output.

As the sync pulse goes high, FF<sub>1</sub>'s DATA input goes low. On the next clock pulse, then, FF<sub>1</sub>'s Q output goes

low, inverting the next bit in the shift register. Since the shift register's  $\bar{Q}$  output is high, FF<sub>1</sub>'s DATA input returns to its high state after the sync pulse occurs, and the rest of the bits in the shift register are recirculated unchanged. At its Q output, the shift register now contains the serial information, 100 . . . 000.

On the next sync pulse, the first register bit is again inverted, but since the register's Q output is low, as is FF<sub>1</sub>'s Q output, then FF<sub>1</sub>'s DATA input is held low, effectively implementing a "carry one." This "carry one" causes the second register bit to be inverted too. However, because the second bit goes from low to high ( $\bar{Q}$  output of the register goes high), FF<sub>1</sub>'s DATA input goes high, causing FF<sub>1</sub>'s Q output to go high so that the rest of the bits are recirculated unchanged.

The shift register now contains 010 . . . 000. The next sync pulse starts the inversion process again, incrementing the register by one, and resulting in an output of 110 . . . 000.

Essentially, the circuit provides a divide-by-n function, where n is the number of stages in the shift register. Since the register can store n bits of information, the circuit has an effective total count capability of  $2^n + n$ . The total count can be varied by adjusting the register length and by selecting the tap on the binary counter that provides one sync pulse for every register cycle.

For this circuit, the total count is  $2^{70}$ —a count that would require 37.4 million years to achieve if the circuit is clocked at a rate of 1 megahertz. The circuit's resolution for this period would be  $\pm 64$  counts. □

**A real old-timer.** Low-power counting circuit can keep track of more than a sextillion input pulses—a count that would take over 37 million years to attain at a clock rate of 1 megahertz. The circuit, which is made up of five C-MOS ICs, actually counts to  $2^{70}$ . It "slows" (for counting purposes) the incoming pulse train by combining a divide-by-64 binary counter with a 64-stage static shift register.

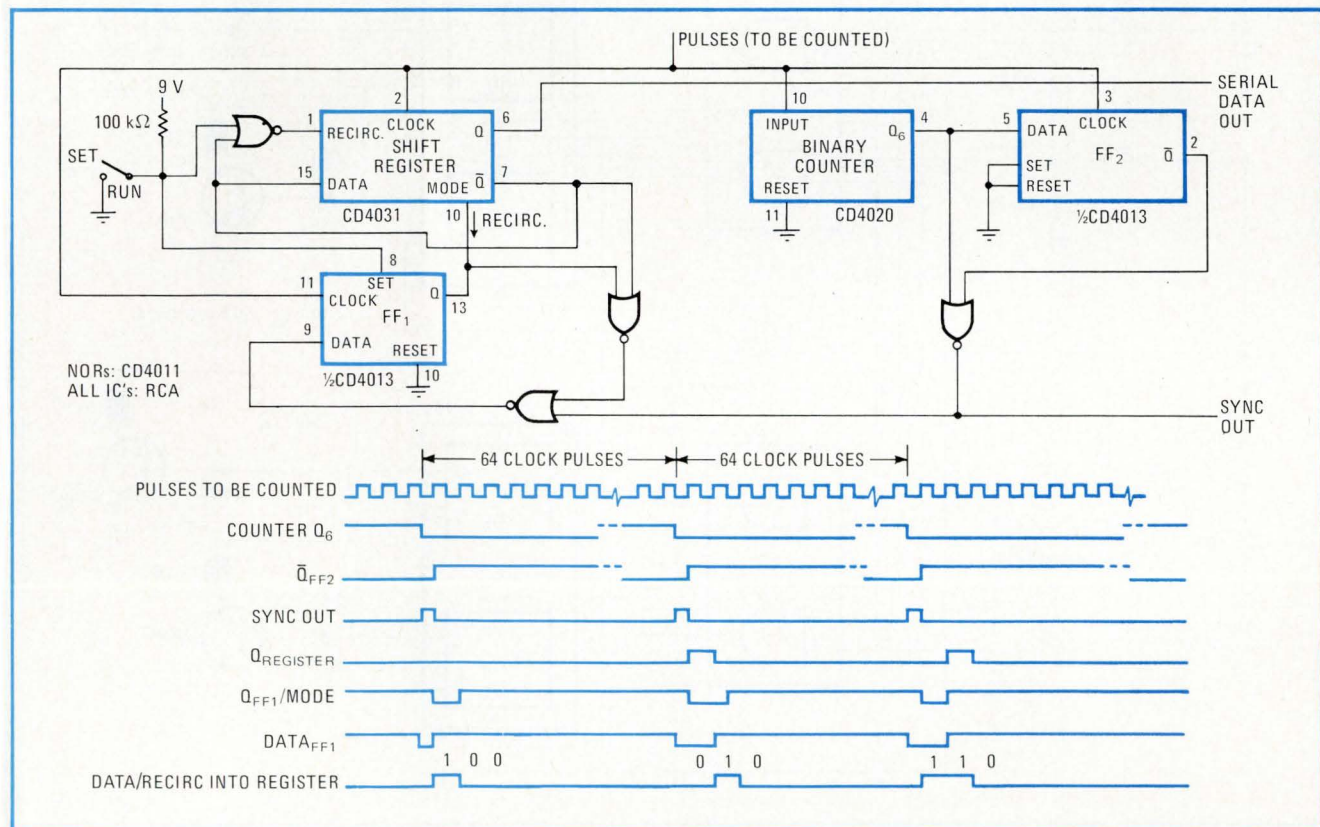



# Simple logic arrangement identifies first event

by Stephen Phelps  
Santa Fe Community College, Gainesville, Fla.

An inexpensive, straightforward circuit is capable of detecting and indicating which of four switches closes first. This first-response discriminator, which costs less than \$5 to build, can be operated from a 6-volt lantern battery. Since it is made up of TTL integrated circuits, it can resolve "ties" with nanosecond accuracy.

The circuit is useful in behavioral-science applications to determine the first response of any one of four subjects, or in scientific studies where it is important to pinpoint what event is occurring first. Another application, one of more popular interest, is eliminating ambiguity in various entertainment games by identifying which player reacts first or quickest.

Each of the circuit's four input switches,  $S_1$  through  $S_4$ , is initially open, keeping NAND gates  $G_1$  through  $G_4$  inhibited. Flip-flops  $FF_1$  through  $FF_4$  are initially reset by applying a logic 0 to each  $\overline{RD}$  input via switch  $S_5$ .

The Q output of each flip-flop is initially low, grounding the base current of the lamp-driver transistors so that all the lamps are dark. And the high  $\overline{Q}$  output of each flip-flop is applied to every NAND gate except the one associated with its own flip-flop.

The first switch to close enables its respective NAND gate, producing a low gate output, whose negative-going edge sets the corresponding flip-flop. The Q output of that flip-flop then goes high so that the associated lamp-driver transistor switches on and lights its lamp. Meanwhile, the  $\overline{Q}$  output of the triggered flip-flop goes low, inhibiting the other three NAND gates and preventing the second, third, and fourth switch-closings from propagating to the output.

Diode  $D_1$  is a high-current silicon device that is used primarily to drop the lantern-battery voltage to about 5.3 V to observe the limitation on TTL supply voltage of 5.25 V maximum. This diode also protects the logic in the event of a reversal of power-supply polarity. If a 5-V supply is used, the diode is not needed.

This first-response discriminating scheme may be extended to cover N inputs, as long as N N-input NAND gates are used, and TTL loading rules are observed. □

Designer's casebook is a regular feature in Electronics. We invite readers to submit original and unpublished circuit ideas and solutions to design problems. Explain briefly but thoroughly the circuit's operating principle and purpose. We'll pay \$50 for each item published.

**Finding the first.** Battery-operable logic circuit indicates which of its four input switches,  $S_1$  through  $S_4$ , closes first. All the flip-flops are initially reset (by switch  $S_5$ ) with their Q outputs low. The first switch to close enables its associated gate, which then sets the associated flip-flop. This lights the appropriate output lamp and inhibits the other NAND gates so that the other lamps remain dark.

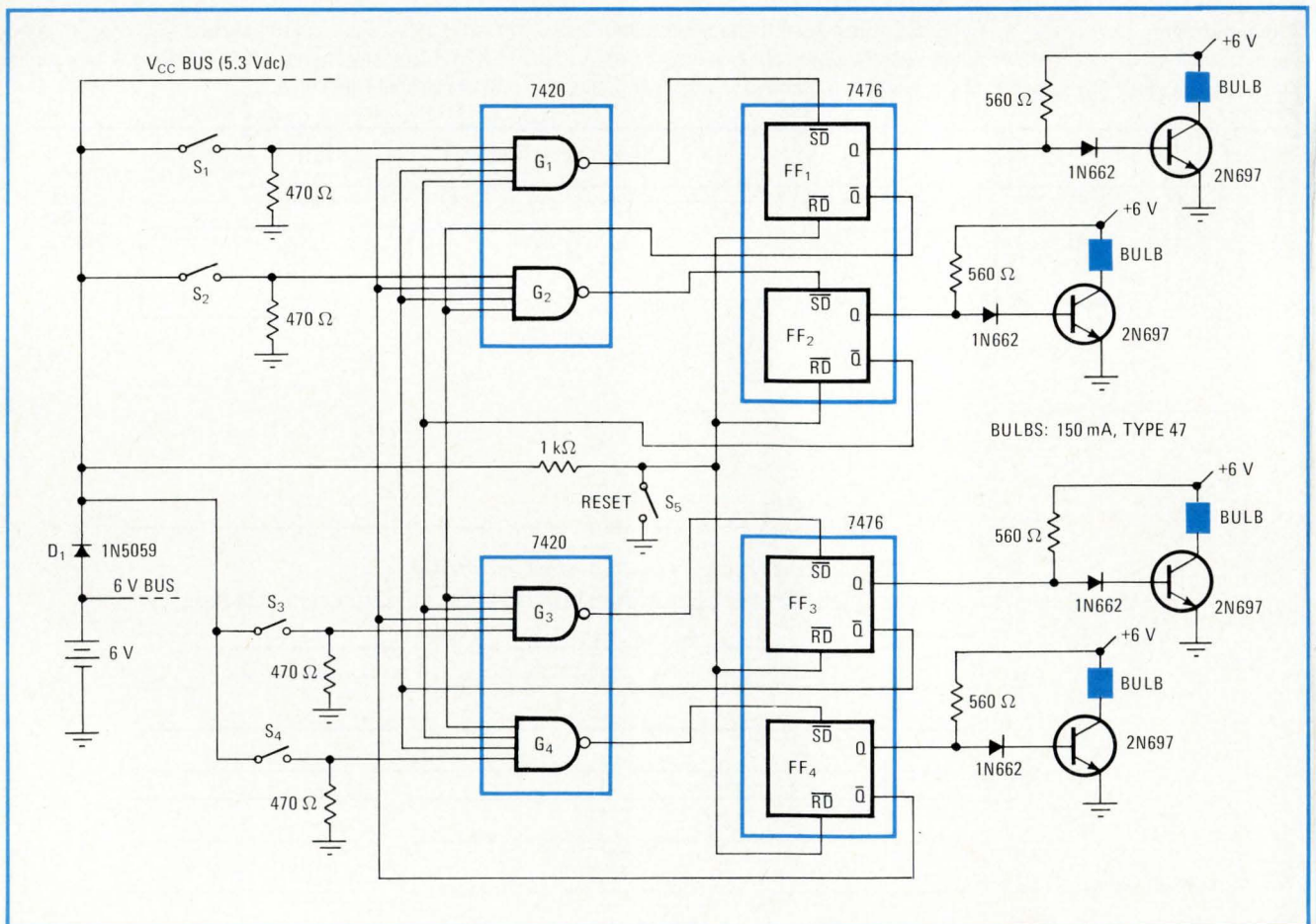



Meet our new series of  
high-frequency problem solvers . . .

# High-Performance VHF/UHF FET Family

Remember the U310? Some people call it the SuperFET. We introduced it a year ago: worst-case 75Ω input match VSWR of 1.25:1. Figure of merit  $2.35 \times 10^9$  typical. Third order intercept point of +29 dBm.

Now we've extended the U310 technology to produce an entire family of high-performance N-channel junction FETs. They're ideal for VHF/UHF applications such as the two circuits shown below:

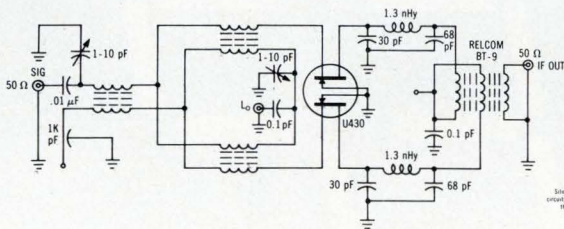

Single-balanced active mixer — 100 dB dynamic range,  
+2.5 dB conversion gain, +32 dBm intercept point, 50-250 MHz.

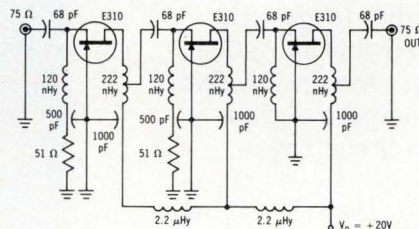

Wideband amplifier — 225 MHz center frequency,  
1 dB bandwidth of 50 MHz, 24 dB gain.

U310 family characteristics include:

- High power gain (common gate) — 16 dB at 100 MHz, 11 dB at 450 MHz.
- Noise figure = 3 dB typical at 450 MHz.
- High transconductance = 10,000 to 20,000 μmhos.

Select the right FET for your application from this array:

Type	Package	Feature	Applications	Price (1K units)
E308	Epoxy TO-106	$V_F = -1.0$ to $-6.0$ V $I_{DSS} = 12$ to 60 mA	High-frequency, small signal VHF or UHF source followers, amplifiers, mixers, or oscillators	\$ 0.57
U308	Metal TO-52			\$ 3.70
E309	Epoxy TO-106	$V_F = -1.0$ to $-4.0$ V $I_{DSS} = 12$ to 30 mA		\$ 0.75
U309	Metal TO-52			\$ 4.45
E310	Epoxy TO-106	$V_F = -2.0$ to $-6.0$ V $I_{DSS} = 24$ to 60 mA		\$ 0.75
U310	Metal TO-52			\$ 4.45
U310 family dual FETs have $V_F$ , $I_{DSS}$ , and $g_m$ parameters matched to 10%. Packages designed for easy insertion into printed circuit boards.				
E430	Epoxy Dual	$V_F = -1.0$ to $-4.0$ V $I_{DSS} = 12$ to 30 mA $g_m = 10$ to 20 mmho	VHF/UHF balanced mixers and cascode amplifiers	\$ 1.70
U430	Metal Dual			\$ 9.95
E431	Epoxy Dual	$V_F = -2.0$ to $-6.0$ V $I_{DSS} = 24$ to 60 mA $g_m = 10$ to 20 mmho		\$ 1.70
U431	Metal Dual			\$ 9.95

Get the complete story on this advanced high-frequency FET family.  
For application notes and technical information

## write for data

Applications Engineering: (408) 246-8000 Ext. 802



Siliconix incorporated

2201 Laurelwood Road, Santa Clara, California 95054



# Some of the best things about our new Digivac<sup>®</sup> 1000 are what you can't see.

When you look at our vacuum fluorescent readout, you won't see the low voltage requirements making it directly compatible with available MOS IC logic packages.

You won't see the exclusive mica substrate which supplies mechanical strength and helps emphasize lighted segments through a desirable halo effect.

You won't see the low cost, lower than competing readouts with fewer customer advantages.

Of course, there are things about our Tung-Sol<sup>®</sup> Digivac 1000 you can see.

Like the Digivac 1000's brightness. 50% more brightness and greater uniformity than ever before.

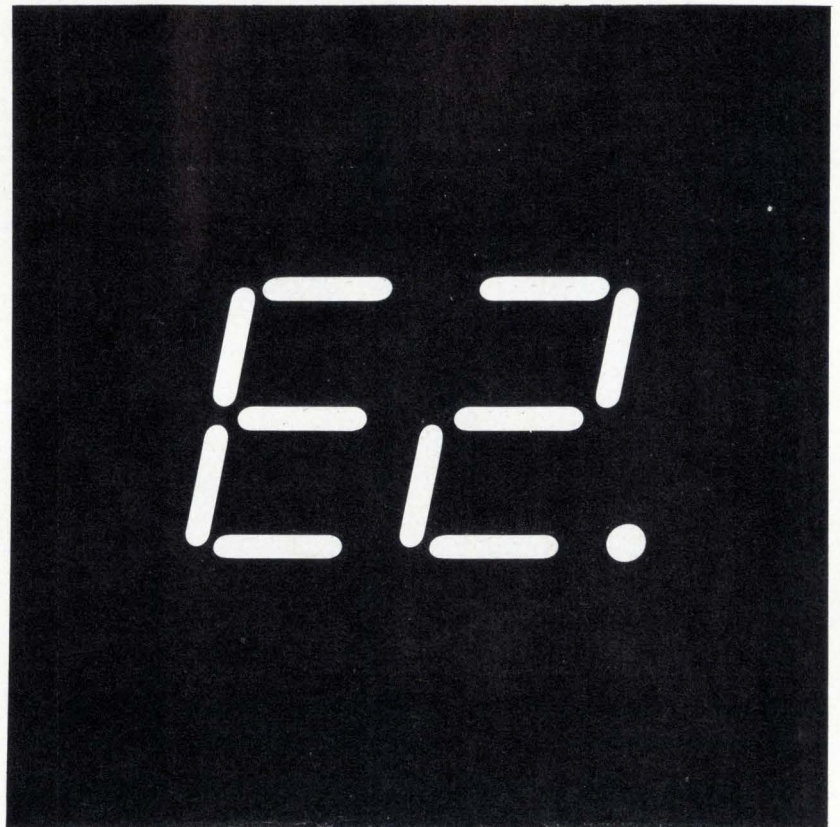
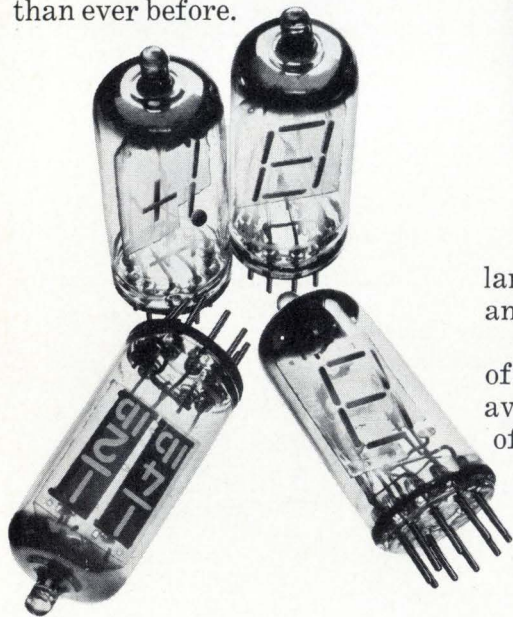

You can see the flexible language with alpha, numerical and symbolic figures.

You can see the wide range of colors, including white, available with common types of filters.

And because of the unique construction, you can see the accurate viewing assured from virtually any angle.

With the Digivac 1000 readout, whether you see it or you don't... it's still nice to know it's all there.

For additional information on the Digivac 1000, write to: Tung-Sol Division, Wagner Electric Corporation, 630 W. Mt. Pleasant Avenue, Livingston, New Jersey 07039.

*Wagner makes other quality products in volume for the electronics industry, including bridges, power supplies and subsystems, silicon rectifiers, resistors, miniature lamps and status indicators. And Wagner offers contract manufacturing.*

## **WAGNER<sup>®</sup>**

**We've got a lot more riding for you.**

®Trademarks Wagner, Tung-Sol and Digivac, Reg. U.S. Pat. Off. and Marcas Registradas



# Storage tube with silicon target captures very fast transients

High-performance read and write guns are combined with a highly sensitive silicon-diode-array target in a double-ended scan-converter tube that can acquire and store single-shot signals at frequencies up to 2 GHz

by Raymond Hayes, Robert G. Culter, and Kenneth W. Hawken, Tektronix Inc., Beaverton, Ore.

□ Before a fast transient can be studied in detail, it must be captured in an analyzable form, and the fastest of the breed will probably always stay just ahead of the advancing technology of this area. Still, a new type of double-ended scan-converter tube now makes it possible to store data at unprecedented speeds, partly because of a highly sensitive target—a silicon-diode array—and partly because of the excellent wideband deflection and resolution performance of the tube's read and write guns.

The new tube allows writing speeds as high as  $2 \times 10^{12}$  trace widths per second—fast enough for the full-screen display of a 2-gigahertz sine wave. Reliable digitization of the tube's output signal, however, demands a signal-to-noise ratio of about 20:1, a level of performance that the new tube reaches at a writing rate of  $5 \times 10^{11}$  trace widths per second. At that speed, the device

can resolve 400 TV lines per scan at a modulation level of 35%.

The need to record and analyze electrical transients from brief, single events occurs in a variety of applications—for example, in work with pulsed lasers for fusion studies, in infrared laser radar and meteorology, in nuclear and explosive testing, and in transient monitoring on data communications and power lines.

For recording transients in the microsecond to nanosecond range, the most common technique at present is high-speed photography of the face of a wideband oscilloscope. Commercially available scopes can produce useful records on fast film at writing speeds up to about 3 centimeters per nanosecond for an 8-by-10-cm display, or 5 cm/ns for an optimized 4-by-5-cm display. (This 5 cm/ns corresponds to an information writing rate approaching  $10^{11}$  trace widths/second, and, while

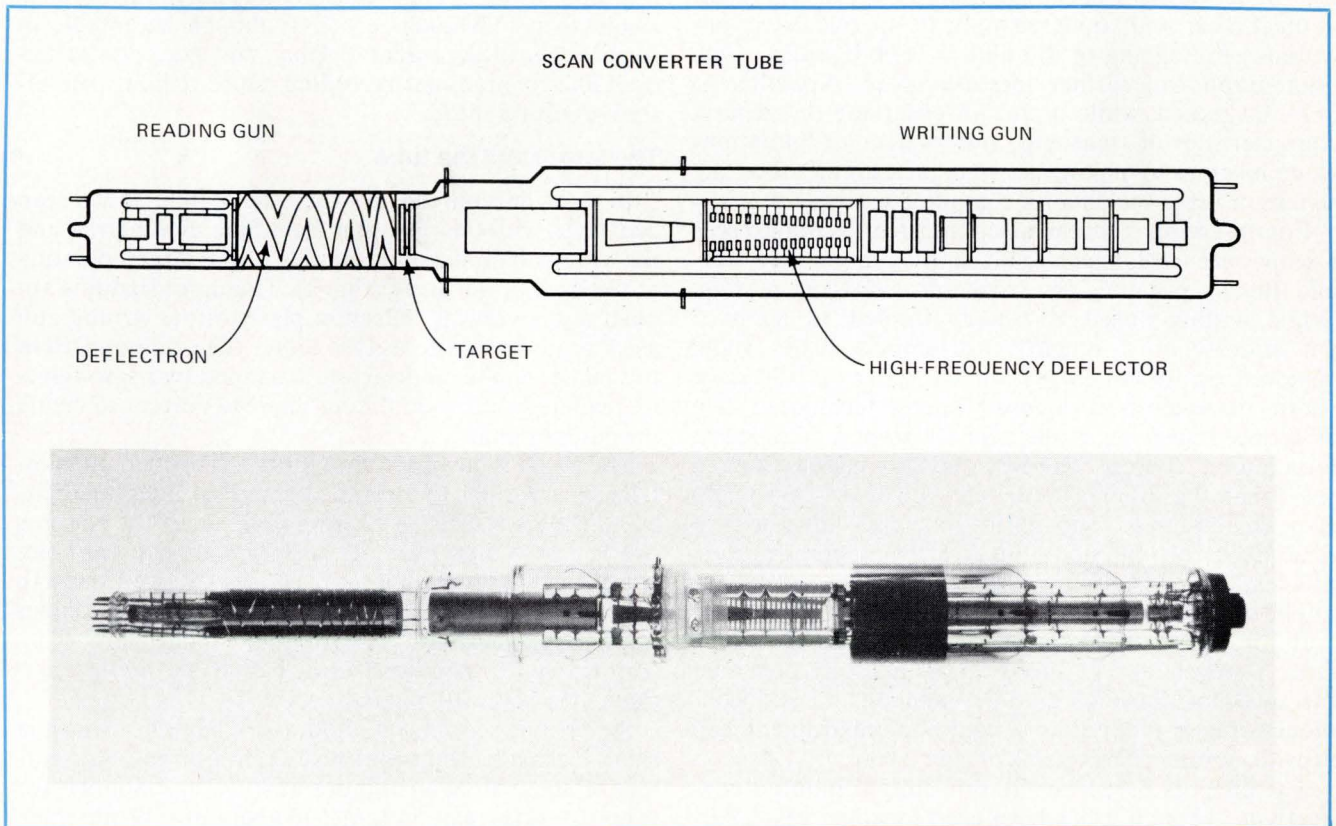

1. **Double header.** New scan-converter tube is double-ended in design. Target in center is an array of silicon diodes measuring  $\frac{3}{8}$  by  $\frac{1}{2}$  in. Note deflectron-type deflection system on read gun (left) and delay-line construction on extremely fast write gun (right).



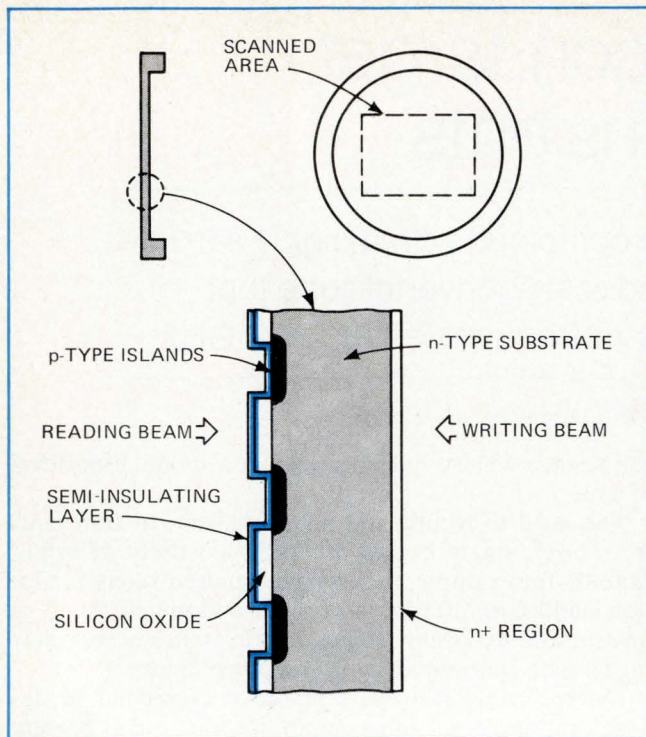

**2. The target.** Thinned n-type silicon substrate shown in the enlarged view is about 10 micrometers thick. Diffused into its back is a thin + layer that creates an internal field and repels carriers away from the surface. Over the front is a semi-insulating layer that prevents charging of the oxide web surrounding the diodes.

cathode-ray tubes have been built that are capable of  $10^{12}$  trace widths/second, such tubes have a very small vertical scan and are used only in specialized applications.) Prefogging of the film or back lighting of the photograph will further increase speed. Nonetheless, any film record, while useful for observing the general characteristics of transients, suffers definite limitations when it comes to making accurate measurements on the signals or using the data for computer analysis.

For observing medium-speed transients, storage oscilloscopes are used, which today employ direct-view storage tubes operating by secondary emission writing. While writing speed is usually limited to about 5 cm/microsecond, recently developed tubes have achieved up to 400 cm/ $\mu$ s (on the order of  $10^{10}$  trace widths per second) by the use of special techniques such as reduced scan or image transfer from a high-speed target to a slower, long-term-storage target. Such a speed handles 30-megahertz sine waves at 4-cm peak-to-peak amplitude. Though in some cases an electrical readout can be obtained from direct-view storage tubes, this feature is difficult to implement and in general has not been available.

If the target in a storage tube provides electronic gain, however, storage speed can be made greater than the speed of the photographic method—and a silicon-diode-array target under electron bombardment can provide writing charge gains of over 2,000.

The effect is based on the principle of induced conductivity. Though it has been used for some years, earlier scan-converter tubes used targets made of zinc sulphide or a similar amorphous photoconductor material.

## Tube at work

The scan-converter tube is the heart of the Tektronix R7912 transient digitizer. This instrument accepts fast single-shot or repetitive signals and converts them to much slower analog or digital signals. A TV and a digital operating mode are available.

In the TV mode, the target is scanned with a standard 525- or 625-line TV raster. The resulting signal is processed into a TV-compatible format which can then be displayed on a conventional TV monitor.

In the digital mode, the instrument functions as a fast analog-to-digital converter, converting an incoming waveform into 512 samples which are available as a direct output, or else may be stored indefinitely within the instrument in an optional digital memory.

After a transient signal has been recorded on the target, the target is scanned by the reading beam in a series of steps, 512 vertically and 512 horizontally. At each step a test determines if a signal is present. When one is present, its vertical position is given at an output connector as a 9-bit parallel word which is held until subsequent trace data is available. On completion of a vertical line, the scan moves one horizontal step to the right and is reset to the top of the next vertical line. During the reset, the horizontal position is given at the output connector, also as a 9-bit word. A 10th bit distinguishes between vertical and horizontal position data. The time needed for the complete scan is 65 milliseconds or less.

Such targets exhibit not only lower gain than the silicon-diode array but also considerable lag in the induced conductivity. This degree of lag, though acceptable in some applications (radar display, for example) is undesirable for transient recording, since it limits the effective writing speed.

## The target and the tube

In configuration, the new tube is a double-ended scan converter, with the read gun facing the diode array and the write gun on the opposite side of the target, pointing at the back of the array (Fig. 1). The input signal is applied to the vertical deflection plates of the writing gun as its beam sweeps across the target. The charge pattern this makes on the diode array is scanned by a low-velocity reading beam, modulating the read current to create the output signal.

The target is an array of pn junctions formed on an n-type silicon wafer by means of standard integrated-circuit techniques (Fig. 2). During fabrication the wafer is overlaid by a thermal oxide, in which an array of holes is etched by photolithography. Boron diffused through the holes forms the diodes. A density of 2,000 diodes per inch yields sufficient resolution for the  $\frac{1}{2}$ -by- $\frac{3}{8}$ -in. scan employed. A central area, 0.75 in. in diameter, is thinned to about 10 micrometers.

Reverse-biased silicon diodes do, however, have a small leakage current that results in a target dark current of about 15 nanoamperes at 30° C and doubles for every 10° C increase in target temperature. While some dark current is desirable to help bias the p region of the diode positive for reduced lag, high dark currents will



reduce the dynamic range of the target, limiting the maximum obtainable signal current. For the diode-array scan converter, the read beam's current saturation is 300 nA, so that dark currents much in excess of 100 nA cannot be tolerated. This limits the target's maximum temperature to about 60° C.

Increasing the applied target voltage does not increase the silicon array's gain—unlike in a photoconductive vidicon target—but it will reduce lag. On the other hand, dark current increases about 10% per volt in the range of 8 to 16 v, so a compromise must be obtained between dark current and lag. This translates into a compromise between maximum digitizable writing speed and maximum signal dynamic range, usually attained by setting the target voltage to obtain the required dark current at standard temperature (15 nA at 30° C).

In operation, the reading section functions like a vidicon camera tube's. The target substrate potential is held a few volts positive with respect to the reading gun's cathode. On being scanned by the reading beam, the target is charged negatively to the cathode potential, in which condition the diodes are reverse-biased.

During writing, 10-kilovolt electrons bombard the side of the target opposite the diodes and create many

electron-hole pairs near the surface. The holes diffuse through the target and drift across the depletion region formed by the reverse-biased diodes, causing the diodes to conduct and discharge in the written area. When the reading beam next scans this area, the diodes are recharged and a signal current is obtained in the target lead. This provides the output signal, which can be amplified for further processing.

Since the average energy required for the creation of an electron-hole pair in silicon is 3.6 electronvolts, roughly 2,780 electron-hole pairs are created by each incident 10-kv electron. Certain losses occur from the recombination of charge carriers and from the back scattering of some incident electrons, so that the effective charge gain in the target is about 2,000. This gain mechanism is responsible for the sensitivity of the target and the high-speed performance of the scan converter.

Because the penetration of the 10-kv writing-beam electrons is small, about 1  $\mu\text{m}$ , and the carriers they generate must diffuse through the wafer, causing losses in collection efficiency and deterioration in resolution, target thickness should be kept to a minimum. This is the reason the target is thinned in the center working region to about 10  $\mu\text{m}$ , a practical thickness.

To further assist collection efficiency, a thin

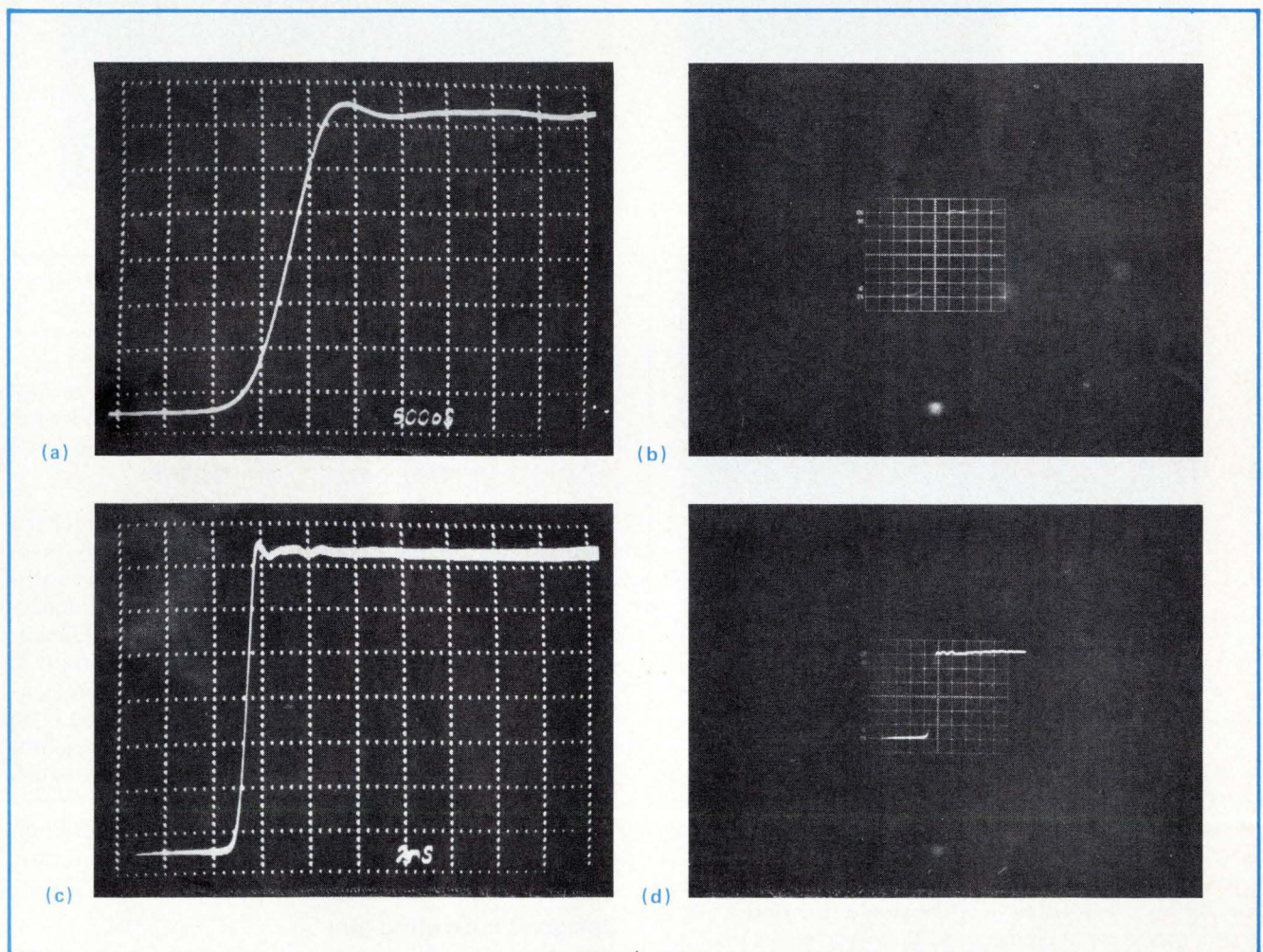

**3. Big and fast.** Large photos at left, (a) and (c), are taken from a 20-by-25-cm TV monitor displaying data captured by the scan-converter tube. Upper photo (a) has a horizontal calibration factor of 500 ps/div; lower photo (c) is 2 ns/div. The corresponding oscilloscope photos at the right were taken from the screen of a Tektronix 7904 with ASA 10,000 film. A reduced scan was used to increase brightness.



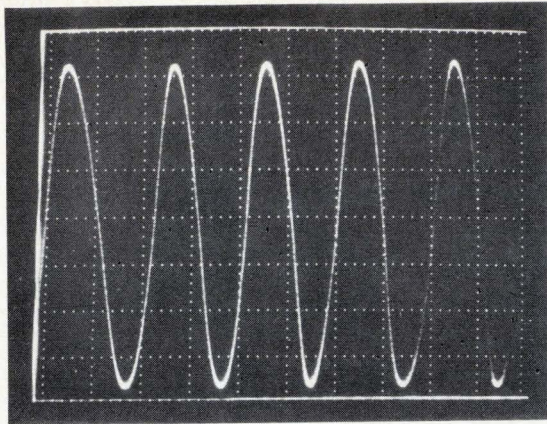

(a)

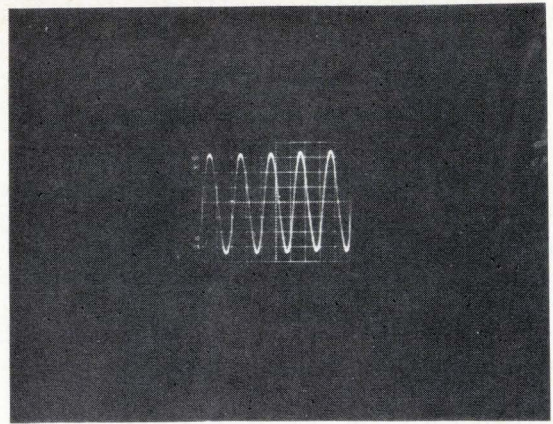

(b)

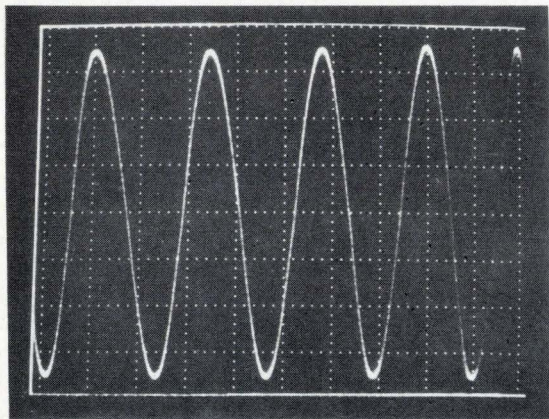

(c)

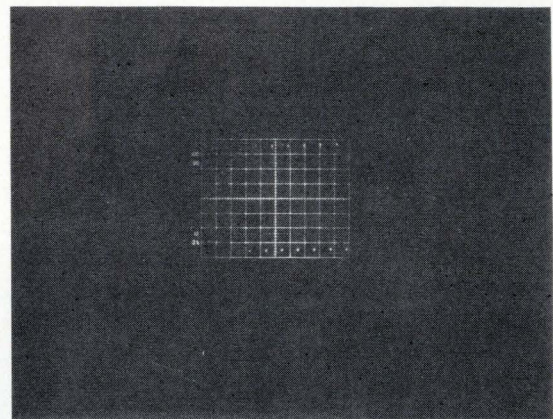

(d)

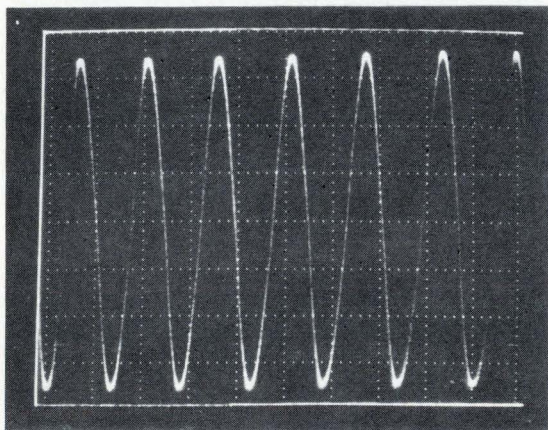

(e)

$n^+$  layer is diffused in this thinned region, to create an internal field and repel carriers away from the surface, where they could recombine. The design of diode-array targets has been described in the literature.<sup>1</sup>

In the targets used for the scan converter, a semiconducting layer is formed over the diode side of the target in order to prevent charging of the oxide web surrounding the diodes and consequent interference with the operation of the reading beam.

To achieve a large target gain, a high-energy writing

**4. Limitations.** At 100 MHz, top, both scan converter (a) and oscilloscope (b) give adequate performance. At 500 MHz, center, scan converter is still good (c), while scope has lost the fast-moving parts of the signal (d). Finally, at 2.4 GHz, the scan converter is still working (e), while no picture at all can be obtained from the scope. In the commercial instrument that uses the scan-converter tube, the dot-pattern graticule shown here and in Fig. 3 is generated by a special circuit and is written on the target by the writing beam.

beam is required, but for good deflection sensitivity the beam voltage at the deflector should be low. A post-deflection acceleration scheme would do, except that it would require a high voltage at either the beam deflectors or the reading section. Since the vertical deflector has a bandwidth of more than 2 GHz, it is important to keep the average potential near ground to facilitate connection to the vertical amplifier or signal source. The reading section handles signals as low as a few nanoamperes, and maintaining good signal-to-noise characteristics at an elevated voltage presents formidable practical problems. These considerations led to the adoption of a monoaccelerator writing gun, with both deflectors and reading section near ground potential.

#### Design of the writing gun

The writing gun was designed to achieve the best compromise between deflection sensitivity, resolution, accelerator voltage, and beam current. It was important



to design for high deflection sensitivity so that the tube could be used with available wideband amplifiers, which have only limited output voltage swing at frequencies above a few hundred megahertz. (Alternatively, such a tube could be used with direct access of the signal to the deflection plates.) But only a modest beam current is necessary when a high-gain target provides writing speed; the advantage is that the triode section of the gun can then be designed to maintain a small beam spot size at all grid drives, and tube resolution will not deteriorate at fast writing speeds.

Tradeoffs between the four parameters were optimized by means of a computer program. The best design consisted of a 10-kV mono-accelerator writing gun having a vertical deflection sensitivity of 24 v per scan, a beam spot size of .001 in., and a scan at the target of  $\frac{3}{8}$  by  $\frac{1}{2}$  in. The maximum beam current is in the range 3 to 10 microamperes.

At high frequencies, the transit time of the electron beam through the deflection plates becomes comparable to the period of the deflecting signal, and the deflection efficiency is decreased. To avoid this, the deflectors of high-frequency scan converters and cathode-ray tubes are usually made in the form of delay lines. For optimum performance, the delay line should have minimum dispersion and the phase velocity of signals on the line should match the electron velocity in the beam.

The vertical deflector used in the scan converter's writing gun consists of two helical delay lines assembled into a balanced deflection system. The deflecting field appears in the gap between the helices, which are contoured to provide the required sensitivity and scan. The final design has a deflection sensitivity of 24 v per scan and a bandwidth of 2.5 GHz as determined from risetime measurements. The delay line's impedance was set to 864 ohms line to line, to match the wideband deflection amplifier available.

### Reading the data

The reading section requires a low-velocity beam with minimum shading and good resolution. To accommodate variable scan rates, electrostatic deflection was preferred to the electromagnetic deflection common in vidicons. Generally, however, electron guns which use electrostatic fields also for focusing of the beam have poor shading characteristics.

Shading is caused by off-normal landing of the beam on the target and results in a variation in the level of the readout signal's base line. It is particularly objectionable in a measuring instrument, especially when the readout signal is to be digitized by a Schmitt trigger circuit. With appreciable shading, the Schmitt trigger level must be set high to avoid triggering off the uneven base line, which means that small signals cannot be detected and high-speed performance suffers.

To avoid this, a hybrid design was developed having an electrostatic deflection yoke immersed in an axial magnetic focusing field.<sup>2</sup> The yoke consists of a cylindrical electrode pattern containing a 90° twist about the axis between each end. This deflection pattern is photoetched on the interior all of the tube, the axial magnetic field being provided by an external solenoid.

For high-speed oscilloscope instrumentation, the pa-

rameters of most interest in a scan converter are writing speed, bandwidth, and resolution. For measurement purposes, good linearity and minimal distortion are also important.

### How fast can it write?

As the speed of the input signal increases, the writing beam spot must traverse the target at faster rates, thus depositing a decreased amount of charge. For a writing beam current  $I$ , the charge  $q$ , supplied to each resolution area of the target addressed by the writing beam, equals  $IG/s$ , where  $G$  is the effective target gain and  $s$  is the information writing speed in trace widths/second. The resulting change in the target surface potential  $v$ , as detected by the reading beam, is  $q/C$ ,  $C$  being the capacitance of the resolution element.

At high speeds, as  $v$  becomes small, the proportion of the reading beam current which lands on the target is reduced and the output signal is decreased.<sup>3</sup> Because of capacitive lag, several scans of the reading beam are required to completely resupply the charge  $q$  to the target. This lag is larger at small values of  $v$ , causing the signal current to drop. The limiting speed occurs when the signal-to-noise ratio falls below some useful value.

In a measurement instrument, the usual concern is with bistable operation—the presence or absence of a signal at each point on the target. If the signal is to be converted to digital form, reliable operation requires a peak signal-to-noise ratio of 20 or more. For direct viewing of the signal on a monitor, much lower ratios will still give acceptable displays. In situations where halftone signals are to be handled, a larger dynamic range is needed and the limiting speed is much lower.

Noise considerations for the readout resemble those for standard vidicons. To the video preamplifier, the signal source appears as a current generator in parallel with the stray capacitance between the target and surrounding components. Common input configurations are a load resistor across the signal source, followed by a voltage amplifier or a current amplifier in which a low input impedance is achieved by feedback. Sources for noise in the readout are shot noise from the target, leakage current, thermal noise in the load (or feedback) resistance, and noise contributed by the active devices in the amplifier.

To minimize all this noise the bandwidth of the amplifier should be kept as small as possible yet consistent with the resolution requirements of the system. The instrument in which the scan converter is presently used has a video bandwidth of 4.3 MHz, in which typical rms noise values are 0.13-nA target shot noise, 10-nA leakage current, and approximately 1-nA amplifier noise. Here, then, the preamplifier is the major source of noise and, to minimize it, the input capacitance was kept as small as possible by giving careful attention to the design of the target holder and output connection.

Noise in the writing beam's current only becomes important at the very high writing speeds possible with target gains well in excess of 2,000, where the charge deposited on each resolution element of the target is small enough for the statistical effects associated with individual electrons to show up.

The performance of the scan converter is probably



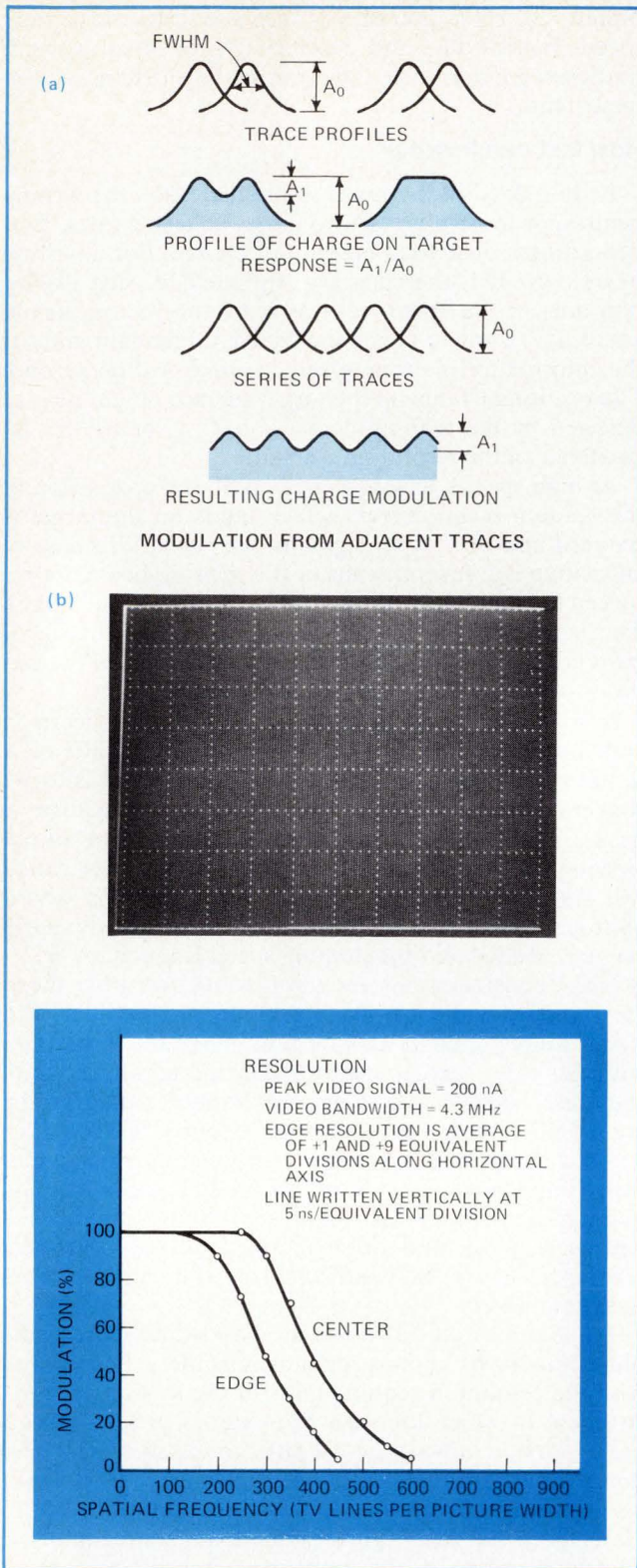

**5. Resolution.** Gaussian distribution of electron-beam intensity ultimately limits resolution. As beams get closer together, their profiles overlap and the modulation in the charge pattern is decreased. If they intersect at the full width at half maximum (FWHM) points, the modulation is completely lost (a). Resolution of 150 line pairs written at a speed of 200 divisions per microsecond demonstrates tube's performance (b). Resolution is better at the center than at the edges, having a value of approximately 400 TV lines per picture width at the center, and 300 lines per picture width near the edges (c).

easiest to appreciate when it is compared with that of a conventional high-speed CRT (Figs. 3 and 4). The leading edge of a single shot pulse recorded by the scan converter and displayed on a Tektronix 630 TV monitor is shown in Fig. 3a and c, which are reductions from a 20-by-25-cm monitor display. Similar pulses photographed with a 10,000 ASA speed film from the screen of a Tektronix 7904 oscilloscope are shown in Fig. 3b and d; in them, the CRT approaches its limit in writing speed, even though a small scan (4 by 5 cm) increases brightness.

Figure 4 illustrates the effect observed as the limiting writing speed is approached. The photographs were taken from single shot sweeps at various signal frequencies. With a 100-MHz signal, both devices have sufficient brightness for adequate film recording. At 500 MHz, the center portion of the sine wave is too fast to record on the CRT, and only the peaks of the waveform can be seen. The scan converter, however, gives a clear signal at 2.4 GHz, a figure that is at least five times better than the photographic writing speed of the CRT.

### Determining resolution

Good resolution is necessary for distinguishing closely spaced traces or small perturbations in a single trace. Electron beams in scan converters and CRTs normally have a Gaussian intensity distribution over the cross section (the size is generally specified as the full width at half maximum amplitude, or FWHM). As the distance between traces shortens and the beam profiles overlap, the modulation in the charge pattern deposited on the target decreases until it reaches zero and the traces cannot be distinguished (Fig. 5a). The fact that the modulation produced by adjacent traces is a function of the trace separation is the basis of the method used for measuring the scan converter resolution.

Signals written by the writing beam are subject to some resolution degradation in the target, both from lateral spreading of the charge carriers as they diffuse through the target and from spreading of the charge because of the discrete nature of the diodes. Consequently, resolution improves as the target is made thinner and the diode density is increased. A target thickness of about 10  $\mu\text{m}$  in the scanned area and a diode density of 2,000/in. give adequate resolution.

The resolution of the scan converter is measured by writing a series of vertical lines over the target and observing the readout response as the spacing between lines decreases. Figure 5b shows a photograph of 150 line pairs (black and white) or 300 TV lines written at a speed of 200 divisions/ $\mu\text{s}$ . A typical response curve is given in Fig. 5c. Resolution decreases at the edges of the scanned area because of deflection defocusing of the electron beams. Normally, of course, the focus is adjusted for the best compromise between center and edge resolution. □

### ACKNOWLEDGMENTS

The authors wish to thank B. Janko, R. Piazza, H. Cobb, and E. Ritz for their contributions to the design and development of the electron guns, and J. Bales for his assistance with device measurements.

### REFERENCES

1. M. H. Crowell and E. F. Labuda, *Bell System Tech. J.*, Vol. 48, pp. 1,481-1,528, May-June, 1969.
2. E. F. Ritz (to be published), *IEEE Trans. Electron Devices*, November, 1973.
3. R. W. Engstrom and J. H. Sternberg, *RCA Review*, Vol. 33, pp. 505-516, Sept., 1972.



## Power supply design made fast and simple

by Onis J. Cogburn  
Texas A&M University, College Station, Texas

A straightforward design technique lets you engineer a simple power supply quickly and easily and then check out the final circuit with only an oscilloscope. Since the design equations are based on the scope test display, there is no need for intermediate calculations. Checkout is further speeded because the percent ripple is determined directly from the peak value of the dc output voltage and the peak-to-peak value of the supply's output ripple voltage.

Figure 1 shows the schematic of a simple power supply along with a graph of its output voltage, which, in this case, is also the capacitor voltage. The percent ripple (% ripple) and ripple factor ( $f_r$ ) can be found from the scope display of output voltage:

$$\begin{aligned} (\% \text{ ripple}) &= (E_r/E_{o(pk)}) \times (100\%) \\ f_r &= (\% \text{ ripple})/(100\%) = E_r/E_{o(pk)} \end{aligned}$$

Also, since the voltage between time  $t_A$  and time  $t_B$  depends on the time constant set up by load resistor  $R_L$  and capacitor  $C$ , the output voltage at time  $t_B$  can be written as:

$$e_B = E_{o(pk)} \exp(-t_{(A-B)}/R_L C) = E_{o(pk)} - E_r \quad (1)$$

Dividing this equation by  $E_{o(pk)}$  yields:

$$(E_{o(pk)} - E_r)/E_{o(pk)} = \exp(-t_{(A-B)}/R_L C)$$

or:

$$(E_{o(pk)}/E_{o(pk)}) - (E_r/E_{o(pk)}) = \exp(-t_{(A-B)}/R_L C)$$

which can be rewritten as:

$$1 - f_r = \exp(-t_{(A-B)}/R_L C)$$

Inverting this equation and taking the natural

logarithm of both sides of the inverted equation gives:

$$\ln[1/(1 - f_r)] = t_{(A-B)}/R_L C$$

The value of capacitor  $C$  can now be computed:

$$C = t_{(A-B)}/R_L \ln[1/(1 - f_r)] \quad (2)$$

It is also possible to compute capacitance in terms of known (desired) quantities like output voltage, load current, and ripple. From the time period between point A and point C, ripple frequency  $F$  can be found:

$$t_{(A-C)} = 1/F$$

and:

$$t_{(A-D)} = 1/2F$$

Since the leading edge of the ripple voltage follows the dashed sine wave, angle  $\theta$  becomes:

$$\theta = \arcsin[(E_{o(pk)} - E_r)/E_{o(pk)}] = \arcsin(1 - f_r)$$

The time between points D and B is:

$$t_{(D-B)} = t_{(D-C)}(\theta/90^\circ)$$

and:

$$\begin{aligned} t_{(A-B)} &= t_{(A-D)} + t_{(D-B)} \\ t_{(A-B)} &= (1/2F) + (1/2F)[\arcsin(1 - f_r)/90^\circ] \\ t_{(A-B)} &= (1/2F)[1 + \arcsin(1 - f_r)/90^\circ] \end{aligned} \quad (3)$$

Combining Eqs. 2 and 3 permits capacitor  $C$  to be computed from given quantities:

$$C = (1/2F)[1 + \arcsin(1 - f_r)/90^\circ] / (E_{o(pk)}/I_L) \ln[1/(1 - f_r)] \quad (4a)$$

where:

$$E_{o(pk)}/I_L = R_L$$

For half-wave rectification, capacitor  $C$  can be expressed as:

$$C = (1/4F)[3 + \arcsin(1 - f_r)/90^\circ] / (E_{o(pk)}/I_L) \ln[1/(1 - f_r)] \quad (4b)$$

With these equations, the values of additional capacitors, such as those required by pi filters, can be deter-

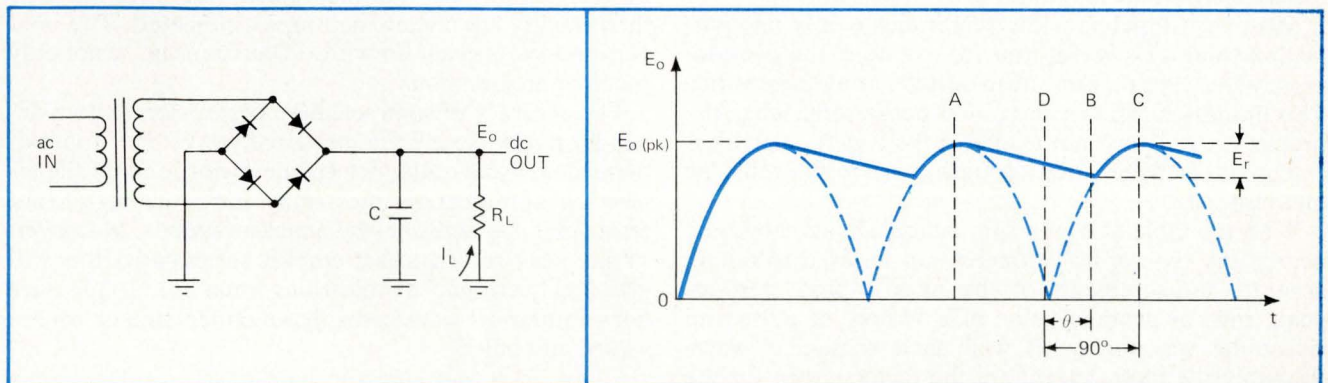

**1. Basic supply.** This simple power supply circuit can be checked out by observing a scope display of only the output voltage. The speedy design technique used to build the supply permits the value of capacitor  $C$  to be found easily from the desired supply specifications.



mined by using only capacitive reactances, series resistances, and a voltage-divider type of computation.

A typical shunt-regulated supply is drawn in Fig. 2; it employs a zener diode for regulation. The graph depicts a scope display of capacitor voltage,  $E_C$ . The guard voltage established by series resistor  $R_S$  and the zener assures that the ripple will not cause capacitor voltage to drop below the output voltage. An acceptable approximation for this guard voltage is  $V_Z/0.8$ , where  $V_Z$  is the zener voltage. The peak capacitor voltage can then be written as:

$$E_{C(pk)} = E_r + V_Z/0.8 \quad (5)$$

The output ripple voltage is:

$$E_{r(out)} = E_r r_Z / (r_Z + R_S) \quad (6)$$

where  $r_Z$  is the ac resistance of the zener. Series resistor

$R_S$  can be computed from this relationship:

$$R_S = (E_{C(pk)} - V_Z) / (I_L + I_{Z(min)}) \quad (7)$$

where  $I_{Z(min)}$  is the minimum current required to operate the supply above the knee in the zener's characteristic curve; an acceptable value is  $0.2I_{Z(rated)}$ . From the minimum value of zener current,  $0.2I_{Z(rated)}$ , and the maximum value,  $0.8I_{Z(rated)}$ , an appropriate guideline for zener power rating can be established:

$$P_Z \text{ must be greater than or equal to } V_Z I_L / 0.6 \quad (8)$$

Equations 1 through 8 make possible the rapid design of a fairly efficient power supply, one that can be quickly and easily checked out with a standard oscilloscope. Naturally, conventional design practices apply to the selection of all diodes and transformers. More complex supplies can also be designed this way. □

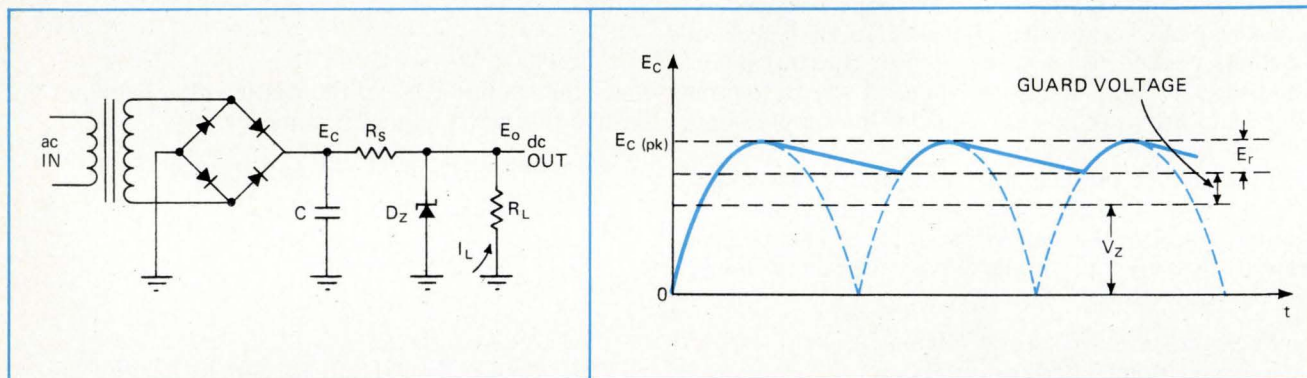

2. **Precaution.** Guard voltage of shunt-regulated supply prevents ripple voltage from dropping capacitor voltage below output voltage.

## Table of conversion factors for ac waveform values

by M.J. Salvati

Sony Corp. of America, Long Island City, N.Y.

You can enhance the usefulness of your ac voltmeter with a handy table of conversion factors. The table conveniently lets you employ any type of ac voltmeter to measure any value of a number of ac waveforms.

Most ac voltmeters accurately indicate only one particular value of a waveform, for example, the peak-to-peak, zero-to-peak, root-mean-square, or average value. This limitation can become rather bothersome when the proper meter is just not available for a particular measurement, or when nonsinusoidal waveforms must be measured.

With the table of conversion factors shown, however, nearly any type of ac voltmeter can be used to obtain accurate measurements of the peak-to-peak, zero-to-peak, rms, or average value of a variety of pulse and sinusoidal waveforms, as well as a triangular wave. Probably the most helpful are the factors given for the widely used average-responding rms-calibrated meter, since it causes the greatest confusion and error when it

is employed to measure nonsinusoidal waveforms.

To use the table, find the conversion factor that applies to the type of meter you are using and the desired value of the waveform you are measuring. Then simply multiply the meter indication by this factor.

For instance, suppose you want to determine the rms value of a sawtooth waveform and your ac voltmeter is the average-responding type, calibrated to indicate the rms value of a sine wave. The table shows the proper conversion factor to be 1.038. The reading on the meter is then multiplied by this number.







To measure rectangular pulses having a duty cycle of other than 50%, first find their actual duty cycle ( $D$ ) and then modify the meter reading as indicated. The conversion factors given for white (Gaussian) noise are only rough approximations.

The accuracy of some of these conversion factors depends on how closely the measured waveforms approximate ideal waveforms. Power-line distortion and the effects on non-ideal rectifiers may introduce significant errors into rectified sine-wave measurements. Moreover, simple peak rectifiers that employ series capacitors will give highly erroneous indications when used to measure nonsymmetrical waveforms like rectified sine or square waves, and pulses. □

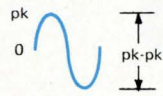
Engineer's Notebook is a regular feature in Electronics. We invite readers to submit original design shortcuts, calculation aids, measurement and test techniques, and other ideas for saving engineering time or cost. We'll pay \$50 for each item published.

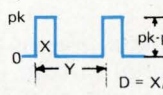

AC WAVEFORM CONVERSION

WAVEFORM	VOLTMETER TYPE						
		Peak-to-Peak	True Peak	Peak-Responding, rms cal for sines	True rms	Average-Responding, rms cal for sines	True Average
<b>SINE:</b> 	pk-pk	1.000	2.000	2.828	2.828	2.828	3.140
	0-pk	0.500	1.000	1.414	1.414	1.414	1.570
	rms	0.353	0.707	1.000	1.000	1.000	1.111
	avg	0.318	0.637	0.900	0.900	0.900	1.000
<b>RECTIFIED SINE: (FULL WAVE)</b> 	pk-pk	1.000	1.000	1.414	1.414	1.414	1.570
	0-pk	1.000	1.000	1.414	1.414	1.414	1.570
	rms	0.707	0.707	1.000	1.000	1.000	1.111
	avg	0.637	0.637	0.900	0.900	0.900	1.000
<b>RECTIFIED SINE: (HALF WAVE)</b> 	pk-pk	1.000	1.000	1.414	2.000	2.828	3.140
	0-pk	1.000	1.000	1.414	2.000	2.828	3.140
	rms	0.500	0.500	0.707	1.000	1.414	1.570
	avg	0.318	0.318	0.450	0.637	0.900	1.000
<b>SQUARE:</b> 	pk-pk	1.000	2.000	2.828	2.000	1.800	2.000
	0-pk	0.500	1.000	1.414	1.000	0.900	1.000
	rms	0.500	1.000	1.414	1.000	0.900	1.000
	avg	0.500	1.000	1.414	1.000	0.900	1.000
<b>RECTIFIED SQUARE: (HALF WAVE)</b> 	pk-pk	1.000	1.000	1.414	1.414	1.800	2.000
	0-pk	1.000	1.000	1.414	1.414	1.800	2.000
	rms	0.707	0.707	1.000	1.000	1.272	1.414
	avg	0.500	0.500	0.707	0.707	0.900	1.000
<b>RECTANGULAR PULSE:</b> 	pk-pk	1.000	1.000	1.414	$1/D^{1/2}$	$0.9/D$	$1/D$
	0-pk	1.000	1.000	1.414	$1/D^{1/2}$	$0.9/D$	$1/D$
	rms	$D^{1/2}$	$D^{1/2}$	$1.414 D^{1/2}$	1.000	$0.9/D^{1/2}$	$1/D^{1/2}$
	avg	D	D	$1.414 D$	$D^{1/2}$	$0.9 D$	1.000
<b>TRIANGLE AND SAWTOOTH:</b> 	pk-pk	1.000	2.000	2.828	3.464	3.600	4.000
	0-pk	0.500	1.000	1.414	1.732	1.800	2.000
	rms	0.289	0.577	0.816	1.000	1.038	1.153
	avg	0.250	0.500	0.707	0.867	0.900	1.000
<b>WHITE NOISE:</b> 	pk-pk	← See notes →					
	0-pk	← See notes →					
	rms	← See notes →			1.000	1.127	1.253
	avg	← See notes →			0.798	0.900	1.000

- NOTES: 1. Apparent pk-pk noise (scope trace width)  $\approx$  6 rms units (for 99.5% probability of instantaneous noise peak exceeding this level)
2. Tangentially measured pk-pk noise  $\approx$  2 rms units
3. Apparent pk-pk noise  $\approx$  3 tangentially measured pk-pk units



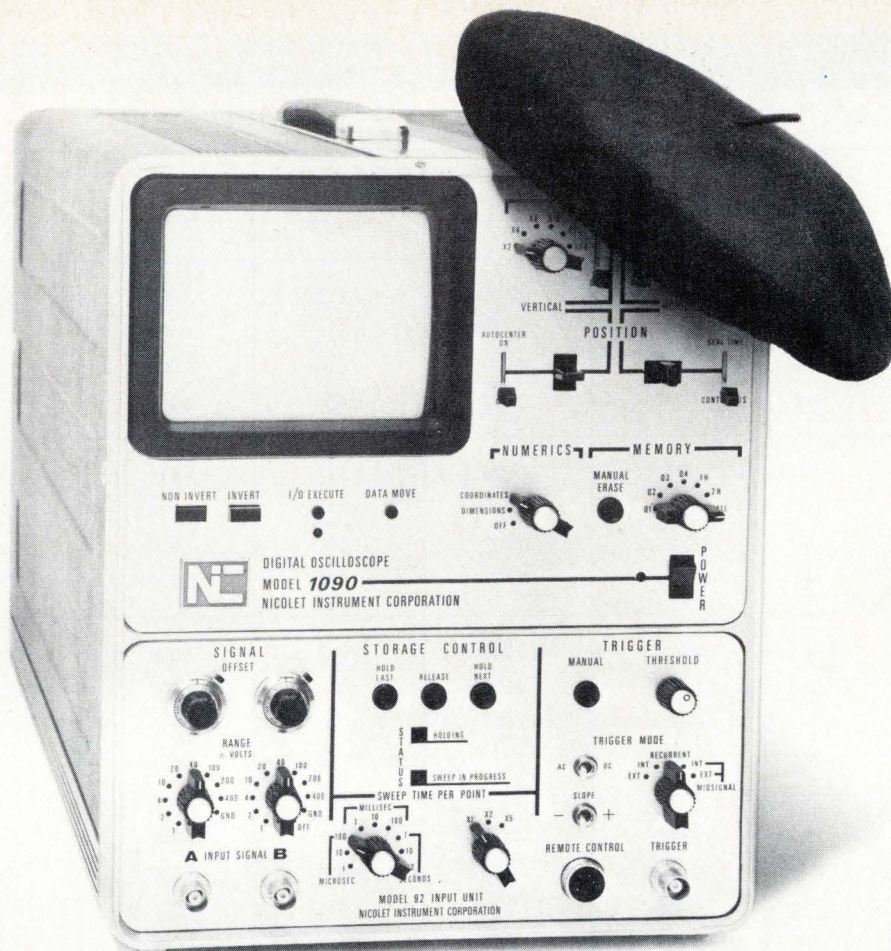

# VIVE LA DIFFÉRENCE!

## Storage is more than phosphor deep in the Nicolet 1090 Digital Storage Oscilloscope

At first glance the 1090 may look like a typical storage oscilloscope, but practically the only similarity is the presence of a CRT. The differences run the gamut from higher accuracy and resolution to much easier operation and the ability to look backward in time from the trigger.

The 1090 stores so much information about a waveform that it would take an analog storage oscilloscope with an enormous screen to show similar detail. Yet the 1090 does this by expanding any selected portion of the display on its screen up to 64 times, providing a display that is effectively 16 by 20 feet in size.

Moveable electronic crosshairs permit the selection of any data point on the waveform for normalized numerical readout of time and voltage values. There's no con-

version to do, thus no mental calculations.

If you wish, you can *look backwards* in time from the sweep trigger to observe conditions leading up to the trigger. This means, for example, that you can investigate the change in the air's electrical potential just prior to and just after a lightning bolt. Or you can record equal amounts of time on either side of nearly any *unpredictable trigger* and display the waveform with the trigger centered. Since the 1090's Model 92 plug-in unit has two inputs, you can also *compare cause-and-effect* relationships in great detail.

Ease of use is incomparable. Screen erasure is automatic. There's no mode switching and no need for intensity or enhancement adjustments. To capture a signal, just touch a button. To

release it and see each signal as it occurs, touch another button. You can choose to capture and hold the next signal, the previous signal, or the present one. Remote control is available for these functions.

Every captured signal may be inspected in ultra-fine detail for as long as you wish. You can even retain an older waveform for future comparison while you use the remaining 1/2 or 3/4 of 1090 memory for other measurements.

Write or phone for more details on use of a 1090 in your laboratory.

**NICOLET INSTRUMENT CORPORATION**

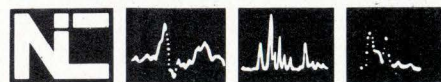

5225 Verona Road, Madison, Wisconsin 53711  
Phone: 608/271-3333 TWX: 910/286-2713



## Two capacitors may decouple better than one big one

Techniques for preventing amplifier instabilities and other problems like crosstalk, although not new, are often misused. For example, in selecting a capacitor for decoupling amplifiers you might assume that the bigger the capacitor, the more decoupling you get. That's true, but it ignores the fact that large capacitors have a high parasitic series inductance that does a far from effective job of bypassing high frequencies. **To bypass both high and low frequencies properly, two or more capacitors should be hooked up in parallel**—a large one for the low frequencies, and a smaller one for the high.

## Computer versus calculator tradeoffs to be discussed

Now that relatively inexpensive electronic calculators are bringing low-cost computing power to engineering departments, chief engineers are faced with a new dilemma: **is a time-shared computer or a programmable calculator more economical or efficient for engineering work?** There are tradeoffs that could make either the best route to take.

The question is important enough to be the subject of a seminar on Oct. 9 and 10 at the upcoming National Electronics Conference in Chicago. Matter for discussion will include the results of studies by several companies on how their decisions affected engineering staff efficiency.

## Cheap protection for audio amplifiers against shorts

The new, cheaper audio amplifiers are putting audio designers under pressure to think up equally cost-saving circuit tricks. Here's one idea for short-circuit protection. **On the output of the amplifier put two diodes in an anti-parallel configuration** as a feedback element on the ground leg of the load. If any overload condition (including a short) produces a higher-than-normal current through the load, **the diodes will conduct on alternate half-cycles, providing a high negative feedback** that effectively reduces the drive of the amplifier. For other amplifier tips, write for RCA's new Audio Power Amplifier Brochure, RCA Solid State division, Somerville, N.J. 08876.

## Take the pain out of measuring ac waveforms

Ac waveform measurements can be troublesome because there are four possible amplitude values from which to choose—peak-to-peak, zero-to-peak, root-mean-square, and average. And ac voltmeters are usually designed to measure only one of these. The table of conversion factors on page 104 lets you **use any one of several types of ac voltmeters to determine any of the four amplitude values** for sinusoidal, pulse, and triangular waves.

## Update your breadboards

If you're still using alligator clips in your breadboards, order a package of Clever Kleps. **These spring-loaded, push-to-seize, push-to-release test probes** come in all sizes and shapes—some with forked tongues, collets, or boathooks—to fit your test rig better. They're from Rye Industries, 130 Spencer Place, Mamaroneck, N.Y. 10543.

And for mounting TO cans, check out a line of insulating pads that make package holes easier to drill and also have **an exposed-lead feature that makes them easy to test**. Write to Tekna Products Co., 82 St. Paul St., Rochester, N.Y. 14604.



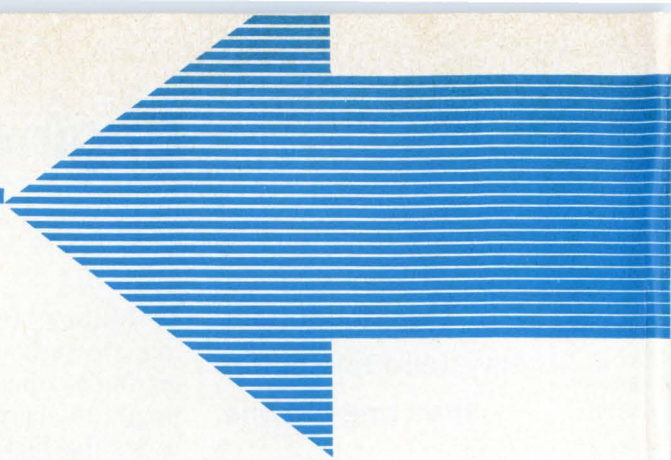

## West Coast electronics firms exploit consumer and commercial markets

---

Wescon time reflects vertical, forward, and horizontal movement into products that compete with many OEM customers, but aerospace manufacturers have lessened their dependence on Government contracts

---

by George Sideris, *San Francisco bureau manager*

□ The West Coast branch of the electronics community is coming into phase, at last, with the consumer and commercial markets that helped keep the East and Midwest relatively stable through the aerospace decline and the 1970-71 electronics recession. But even though the signs point to a steadier future, with less impact from Government electronics cycles on the region as a whole, the West is not yet ready to settle down as it readies for the Sept. 11-14 Wescon show in San Francisco.

Instrument firms are furthest through the transition, having cut their dependence on Government work through growth in industrial markets. But they are starting to lock horns with each other and computer-equipment manufacturers in data-processing markets. Aerospace firms are entering that fray and also competing with semiconductor suppliers for such huge markets as digital watches and calculators.

And the semiconductor industry is starting to compete, albeit gingerly, with its equipment-manufacturing customers. This latest move breaks the industry's first commandment: a component supplier shall not covet his customer's market (written, apparently, by systems manufacturers because vertical integration downward from systems to components is acceptable). But the losses—or, at best, slim profits—sustained during the recession put several companies in an ikon-breaking mood.

### More than diversification

The West's market-broadening efforts run much deeper today than the diversification attempts of the 1960s. In fact, the word "diversification" is going out of style in favor of such terms as upward or forward, vertical and horizontal integration, which loosely mean going from components to equipment production or from subsystems to systems, producing components as well as equipment, and opening new markets related to existing product lines. In contrast, diversification in the West has traditionally connoted the often random, usually abortive, attempts to force military/aerospace fallout on an unready civilian populace or to put together a conglomerate of unrelated subsidiaries.

One company after another has been restructuring itself to build up, down, or sideways on its established expertise. Even the brash semiconductor companies have learned after some sobering experiences that market research and marketing organization should precede product development.

"We have stopped inventing better mousetraps, only



to find there were no mice around," remarks Eugene White, vice president for the Commercial-Systems group at Fairchild Camera and Instrument Corp., Mountain View, Calif. "I think we all feel a sense of responsibility to plan products that satisfy our market needs in an evolutionary manner." His group is expanding into semiconductor-rich communications and optoelectronic equipment.

Nobody claims infallibility. Fairchild has sloughed off tube, bench-instrument, and graphics divisions as unsuited to its marketing goals. There are even a few skeletons in the closets of the area's biggest instrument firms, considered masters of horizontal integration, and the frustrations of aerospace companies trying to win such shy markets as medical instruments are now mostly legends.

Many of the region's electronics firms are enjoying the most profitable year in history. Few of the West's top executives doubt the boom will continue into next year, although the rate of growth is expected to ease [*Electronics*, June 21, p. 67]. There is considerable concern about the prospect of international trade restrictions, since both semiconductor and instrument companies count on overseas markets for up to 40% of their sales.

William R. Hewlett, president of Hewlett-Packard Co., Palo Alto, Calif., says he wouldn't mind a "breather" in the growth rate, but "everyone will be in trouble if the whole international-trade market is upset." He considers that a more "tangible worry" than a slowdown in the U.S. economy.

In general, optimism prevails. The Wescon program reflects that attitude. Panels on business opportunities have replaced discussions of employment opportunities aimed primarily at displaced aerospace engineers (see p. 116).

## Semiconductor firms swing out

A dusty tablet on a side street in Palo Alto says the modern communications industry started there in 1912 with Lee DeForest's audio amplifier. The East and Midwest captured most of that industry. Fifty years later, history repeated itself—the West's silicon planar transistors and integrated circuits fueled the data-processing industry.

Digital components became "jelly bean" commodities produced mainly in the West and shipped East at rapidly dropping prices. One of the first semiconductor firms to rebel against this exclusive devotion to compo-

nents was Advanced Memory Systems Inc., formed in 1968 by people from International Business Machines Corp. and Fairchild.

Robert Lloyd, president of AMS, Sunnyvale, Calif., says the firm's management intended from the start to compete with IBM by producing memory systems, as well as selling chips and subsystems to original-equipment manufacturers. The biggest system market would have to be found in add-on and replacement systems for IBM main memories.

"Value-added is the key to profitable sales," Lloyd states. "Memory systems are an ideal vehicle because most of their value is in the chips—60% and 80% in a few years. Memories are really a components business," he reasons.

### In the beginning

Lloyd also feared the young company would go broke waiting for the computer industry to adopt a standard chip design, citing the long gestation period of the Intel 1103 [*Electronics*, April 26, p. 108]. And after standardization, second-sourcing would depress the price.

AMS lost almost \$2 million a year struggling to develop chips and systems competitive with core memories before it turned the corner in 1972. It made almost 10% on \$5 million in sales in 1972 and built up a chip, OEM subsystem, and system backlog of \$12 million in the first half of this year.

The firm has sold more than 200 IBM add-ons, most

**Smart buffer.** Microcomputer in Fairchild's new teletypewriter buffer allows operator to edit copy before sending. Fairchild says the accessory pays for itself by cutting line charges by 12 to 1.





# Wescon

of them 1 million bytes or larger. The principal outlet is Intel Corp., San Francisco. Intel leases computer systems composed of its own peripherals and IBM mainframes. It competes with IBM by augmenting the speed of IBM processors with special peripherals. Starting in November, for example, it will replace the core memories in IBM 360/155s with MOS memories, speeding up the processor 20% to 50% without increasing the cost. Lloyd expects IBM's transition to solid-state main memories to increase AMS's business because those memories are too fast to be replaced by cores. Still perverse, AMS has developed chips faster than those in the original IBM memories.

The only major semiconductor supplier to compete head on with computer OEMs is Texas Instruments, Dallas. TI's moves have been the occasion for strong words in the West as well as the East.

Comments Lawrence Goshorn, president of General Automation Inc., an Anaheim, Calif., minicomputer-based automation company: "Companies like Texas Instruments, who are moving aggressively into minicomputers, calculators, peripherals, and large computers, are creating problems by alienating customers. Up to now, the components companies have been going after loose-tooth tigers—old mechanical industries, like calculators, meters, and watches.

"They won't find it so easy in the newer and more aggressive computer industry. The younger computer people are more competitive, with more systems capability than components suppliers have. They won't lie down and let components companies take the business," Goshorn concludes. As for his company, "we don't want

OEM customers with whom we compete. It creates an impossible dilemma."

National Semiconductor Corp., Santa Clara, Calif., agrees in principle with AMS and TI. "Components suppliers have been at the mercy of three levels of competitive pressure: other components suppliers, subsystems and subassembly producers, and systems manufacturers. A compo-

**Not that small.** First full micro-computer systems are as large as some minis. This is Intel's Intellec.

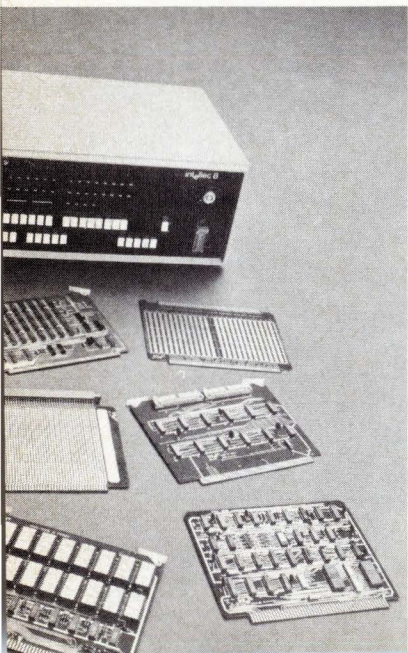

nents supplier can better control his profitability in a systems market," says Fred Bialek, head of National's new Systems division.

What of the risk of offending customers? "We took the position for a long time that we wouldn't get into systems," Bialek responds, "but since we make almost everything but mechanical parts, we finally decided we would be crazy not to do it."

National chose supermarket checkout systems for its entry. The choice followed a long search for a new market that demanded small, low-cost systems with a huge market potential, Bialek explains. Such a market would allow National to capitalize on its forte—frugality in mass production—while avoiding the need for extensive software support and competition with the large firms established in chain-store and other large point-of-sale systems.

The National systems stand alone in each store. A typical system, consisting of a small processor with a disk memory and eight checkout-stand terminals, costs \$28,800 with volume discounts. National has shipped 16 systems and is working on 13 orders. The second largest order is 60 systems for Alpha Beta Acme markets, a California food-store chain (Bialek won't identify the largest customer). The potential market over the next five years is \$1.5 billion to \$2.5 billion, Bialek estimates. In contrast, National's semiconductor sales are now \$100 million a year.

Bialek's division also assembles memory boards, calculator boards, and microcomputers for OEMs. However, the corporation's stance is that it is merely supplying a subassembly service to components buyers in the first two cases and prototypes to facilitate OEM-equipment design when it sells microcomputers. IC salesmen sell them, not the systems division.

National's only microcomputer at present is a bareboard, 16-bit model, the IMP-16. But it will soon be joined by an IMP-8, an IMP-P (a software-development unit), and a packaged OEM system, the IMP-L. Some of National's competitors say National has started making complete calculators. Bialek says only, "We have not decided our posture in the calculator market." He will not comment on reliable reports in the industry that National will have a \$39 calculator on the market in September, to be made by NS Electronics, a subsidiary. Among others, Macy's, Bambergers, Abraham & Strauss, and Liberty House of San Francisco are preparing to announce the product.

Motorola Inc., Phoenix, Ariz., is also skirting conflicts with computer manufacturers. While Motorola makes





**Super market.** National Semiconductor will soon have a smart-terminal version of this Datachecker cash register/accounting system.

interfaces, terminals, and other parts of a new hotel reservations and management system [*Electronics*, Aug. 2, p. 39], the system's processor is a PDP-11, bought from Digital Equipment Corp. The Holiday Inn chain is the first major customer. Another venture is a musical instrument priced well beyond the consumer mass market at \$6,000.

Fairchild is following a course similar to National's. Last month, a newly formed communications-equipment unit in White's Commercial Systems group introduced a solid-state teletypewriter terminal buffer. (TTB). And solid-state video cameras and optical character readers are being developed at Syosset, N.Y.

The buffers are the first in a planned line of communications-oriented memory products. Priced to pay for themselves in line-charge savings (they transmit at 12 times the standard teletypewriter speed), the TTBs have a potential market of 500,000 units at \$1,600 or \$2,200 each in the U.S. alone. A built-in microcomputer allows the operator to edit data, which is impossible with conventional tape-cassette buffers. The processor also "handshakes" with other teletypewriters and verifies transmission.

### Considering the competition

White, who has vetoed projects that would put Fairchild directly into competition with computer companies, says a communications-memory line avoids that problem and also such problems as obsolescence resulting from software changes. Communications formats are generally standardized; the computers interface with them.

Fairchild, incidentally, is not being doctrinaire about its suppliers. Although Fairchild makes many of the ICs in the buffers, the processor chip is supplied by Intel Corp., Santa Clara, Calif., and the 1,024-bit MOS shift registers were bought at distress prices from firms who overstocked in anticipation of a "silicon-disk" market that faltered. They will probably be replaced by Fairchild components in the future because the corporation's prime requirement for a system product is that it use large numbers of Fairchild parts.

The first video camera to come out of Fairchild's CCD (charge-coupled-device) image-sensor development project was introduced this month. It has an area array, rather than the linear array used in mechanically scanned prototypes [*Electronics*, Feb. 15, p. 31]. White says Fairchild will also make character readers and other systems with CCD arrays. A U.S. Postal Service contract to develop mail-sack readers is already being

implemented by the company.

The TTBs are being sold directly and through such distributors as Carterfone Communications Inc., of Dallas. Video products will be marketed through the Industrial Equipment division, which already sells audio-visual equipment through a distributor network. Two other divisions in the Commercial Systems group sell to Fairchild and other components manufacturers: Systems Technology, test systems; and Inland Manufacturing, molding machines, tooling, and molded parts.

Fairchild makes minicomputers for its own test systems and microcomputers for OEMs; it has also sold a few computers. But the latter were only component-development vehicles. Memories are also made, notably the Illiac IV's high-speed subsystem, but White says that Fairchild is only interested in component development or production of "carbon copies," not direct sales.

Fairchild's Bay Area neighbor, Intel Corp., also began producing memories because of the need to prove components. President Robert Noyce says that the Memory Systems division now produces for OEMs, bringing in 10% of Intel's total sales. The division has produced a few large IBM add-on systems, but Noyce says that doesn't pose a conflict with a customer because IBM makes its own memory chips.

Nor do Intel's new microcomputer systems [*Electronics*, May 24, p. 130] conflict, Noyce adds. They are intended to be used in OEM prototype systems as a guide to specifying chip sets, he says. "We are not supplying them to systems—we much prefer to participate with a broad customer base than turn off that base."

Digital watches are Intel's principal end-user product. Produced by a subsidiary, Microma Inc., acquired in 1972, they are expected to bring Intel rapid growth in the consumer market. The potential digital watch market is estimated to be as large as 100 million in 1980 if the average price drops to \$30.

Noyce is unconcerned that analog watches dominate the market now—"analog watches don't offer anything that looks new to the conspicuous consumer." The Microma watches have liquid-crystal displays; analog watches have conventional hands.

Nearby in Cupertino, Litronix Inc. is the newest contender for the pocket-calculator market. To get set, Litronix acquired an MOS firm, Advanced LSI, and a calculator assembly company, San Diego Electronics. It was already a leading producer of light-emitting-diode displays.

The first model, designed to retail for \$39.95, is being rushed into production for the Christmas season. The



move is intended to protect the firm against declines in display prices (*Electronics*, March 15, p. 65). Robertson Jones, vice president and treasurer, says that with the acquisitions, Litronix now produces 75% of all the parts in its calculators, further increasing profit potentials.

How will Litronix market them? "One thing is sure," Jones says, "we won't use our component reps." This month, the firm was still weighing the merits of direct or re-brand sales. Direct sales would be made through distributors and representatives already in the calculator business.

The next forward-integration effort may be digital watches, Jones indicates. Litronix makes LED watch displays and is developing watch-circuit modules. However, the latter are "exploratory—a decision on whether to produce them is months away." Litronix also became a supplier of LED materials to other LED firms recently. "That won't hurt our competitive position because the shortages are not so bad that our competitors would be unable to get materials elsewhere," he says.

The fast-growing firm had a profit of \$1.6 million on \$13 million in sales in the first half of this year, compared with a loss of \$239,000 on \$3.6 million sales in the first half of 1972.

---

## Aerospace firms go commercial

---

Aerospace companies in the West, seeking broader markets, are trolling in such flood tides as calculators, digital wristwatches, and automation. And they've found they can reach the necessary marketing depth by tying in with mass merchandisers.

The champion of up, down, and sideways integration is Rockwell International's Electronics group, which evolved out of the old Autonetics division of North American Aviation, Anaheim, Calif. The group expects sales around \$500 million this year, with 20% commercial—twice last year's percentage. A 50-50 mix is expected in five years.

The group's microelectronics divisions may be the world's largest MOS LSI producer. Production capacity is 500,000 complex arrays a month. The former division was recently split into two parts, one division for MOS-device production and the other for end-user equipment manufacturing [*Electronics*, Aug. 2, p. 48]. This will enhance the firm's posture in emerging markets, says R. S. (Sam) Carlson, president of both divisions. He predicts record sales of \$100 million this year for the two divisions.

Rockwell's calculator business dates to 1967, when a

contract for MOS chips came from Sharp Corp. of Japan (then Hayakawa Electric Co.). Last year, it started selling assembled calculators through mail-order houses and other mass distributors. Now, the equipment division has a backlog of 600,000, and it expects to produce 1 million in the fiscal year that started this month. Production capacity of 75,000 a month will be doubled by a new plant in Nogales, Mexico.

The Equipment division makes low-cost desktop calculators with eight-digit liquid-crystal displays—considered non-competitive with conventional calculators sold by the MOS Device division's chip customers. In the fall, however, several hand-held types will be made, including a low-cost battery model and an electronic slide rule. Plans for next year include digital watches designed to retail for less than \$50, with liquid-crystal displays and C-MOS (complementary MOS) circuits. The division also produces modem boards and controls for Rockwell's industrial equipment divisions.

Two other Rockwell activities are business machines and utility distribution-monitoring equipment. Last year, the Electronics group acquired Unicom Systems Inc., Cupertino, Calif., which distributes business machines and calculators through its own stores, other dealers, and department stores. In July, Rockwell bought the business-machines subsidiaries of Lamson Industries, an English calculator distributor. The monitoring equipment is made by the Systems Monitoring division.

Further, Rockwell has a large investment in Collins Radio Co. Collins may eventually become a part of Rockwell because it makes an attractive mix of military and commercial products.

Also in Southern California, Hughes Aircraft Co. has made a successful transfer of MOS technology into civilian markets. Hughes has produced many commercial systems, such as the DC-10 airliner's entertainment-multiplexing system, with MOS circuits made by the Microelectronics Products division in Newport Beach.

Two years ago, the firm found a fit between its micro-power C-MOS and the then-new electronic watch market. Production of C-MOS divider circuits for Timex analog watches (quartz-crystal watches with conventional faces) led to orders from Uranus Watch Co. for LED digital watch circuits.

Now, Hughes is producing hybrid-IC watch modules, including crystals made at Newport Beach, for Elgin Watch Co., Hudson-Harrison, a New York mail-order house, and others. W. H. Christoffers, vice president and group executive of the parent Industrial Electronics



group, says the division will soon swing into liquid-crystal designs. Christoffers considers LED watches, which sell for upwards of \$200, as novelty items. "Everybody wants one, but it may not last forever." Liquid-crystal watches are cheaper and can be viewed continuously without running down the battery.

In the air, Hughes is the acknowledged leader in commercial communications satellites. On the ground, the firm is expanding in cable television through subsidiary Theta-Com's combinations of cable TV and security systems, acquisition of cable plants and other parts of Kaiser Cable TV, and an experimental subscriber-response TV system in El Segundo, Calif.

Other aerospace companies with commercial ventures include Lockheed Electronics, Northrop Corp., and Boeing Co. Lockheed Electronics, Commerce, Calif., near Los Angeles, sells modular minicomputers to systems manufacturers. It is also moving vertically with a business system. That, too, is sold to OEMs.

Northrop's Electronics division, Palos Verdes, Calif., is also into data processing. Two years ago, it sold a minicomputer system for accounting and billing at medical laboratories. The customer also had a system from Berkeley Scientific Laboratories (BSL) that automatically compiled laboratory results. The two interfaced through a common digital recorder.

Last year, Northrop acquired BSL and formed two divisions: BSL Medical Data Systems, Hayward, Calif., and BSL Business Data Systems, Torrance, Calif. While the first pursues the lab market, the second is going after furniture manufacturers and other new markets.

George C. Chalmers, vice president, hopes the new ventures will gross \$25 million in five years. Sales are still small—but BSL leads the clinical-data-system market with 40 machines installed, and is probably the only supplier with interfaced lab and business processors.

### Tackling entrenched competitors

In the Pacific Northwest, the Boeing Co., Seattle, may become the exception to the rule against entering overcrowded markets. Boeing Electronics is attempting to crack two simultaneously—mobile communications and interconnect equipment, and alarm, security, and police electronics systems. Before producing any equipment, however, Boeing will first sign up and train a large network of sales, service, and stocking distributors and train their service personnel.

The marketing organization is being forged this year by Bruce Falkner, distributor-products sales manager. He and five regional managers expect to sign up 217 lo-

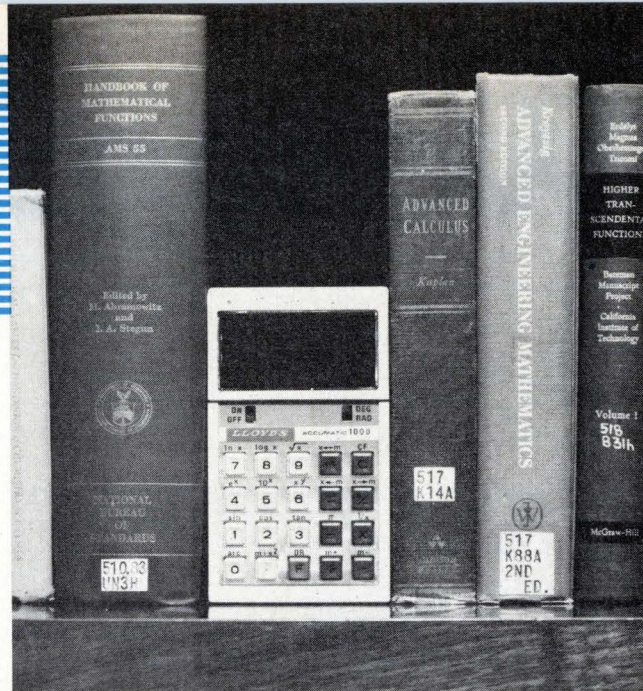

**Pocket filler.** Electronic slide rule for Lloyd's is one new calculator that will help hike Rockwell output to 1 million next year.

cal sales and service reps by year end and 70 zone (stocking) distributors in 1974. To have something for them to show and sell until production begins, Boeing has seven re-branded products—mobile and portable vhf transceivers, paging units and controls, a radio-message recorder and signaller, a hand-held radar, and a night-vision telescope.

Boeing's only commercial equipment at present, other than aircraft equipment, is a police communications scrambler. That won't be a distributor product because it requires sales-engineering support, but it has given Boeing an entry into the police and security market.

Meanwhile, Boeing Electronics is enjoying a boomlet in sales of hybrid ICs to other OEMs. Formed in 1970 with 600 employees, the division now has 1,400.

## Instrument, mini makers fight back

But the feverish quest for new markets isn't limited to aerospace and semiconductor firms. Several Western instrument companies have moved strongly into minicomputers, peripherals, and calculators. Initially, they did it to complement their instrument lines or to support digital-instrument-system requirements, but the trend is drawing these companies into business-data processing, computer-aided education, and other markets.

Hewlett-Packard Co. and Varian Associates, both of Palo Alto, Calif., started the trend in 1966 and 1967—one to support test instruments and the other because of its need for computers in scientific and analytical equipment.

H-P felt the market was ripe for minicomputers with enough input-output channels to control and process data from several instruments and thus take the drudgery out of making repetitive measurements, recalls William E. Terry, vice president of the Data Systems group. The economics were also ripe because low-



# Wescon

cost molded ICs were becoming available in large volume in the mid-1960s.

H-P has shipped more than 6,000 minicomputers. Terry believes H-P is now second in the minicomputer market, behind Digital Equipment Corp. He is certain H-P leads in computer-aided-education systems, and it has footholds in banking, police, and other markets.

Four years ago, H-P aborted a direct onslaught on the general-purpose, business-computer market. Engineers developed and management nixed a high-speed, medium-scale, 32-bit system called Omega. "It was a great leap forward, but it did not build on our strengths in logical progression," Terry explains.

In 1971, the engineers bounced back with the H-P 3000 16-bit "supermini." Though designed primarily for engineering, scientific and education use, it is a multi-lingual, multiprogramable, multiport system with up to 128,000 bytes of core memory, and can double as a general-purpose computer—for example, processing administrative data in an education application.

The H-P 3000 had a slow start because of software problems. The first customers encountered speed and reliability problems caused by flaws in the initial software. Revisions will be completed this fall, Terry says.

## Capitalizing on calculators

H-P has sold almost 20,000 desk calculators since 1969, and sales of the company's pocket slide rules are soaring around the 100,000 mark [*Electronics*, Feb. 1, p. 102; June 7, p. 42].

In the past year, H-P has been building a new class of engineering and data-acquisition and -processing equipment around desk calculators. In July, for ex-

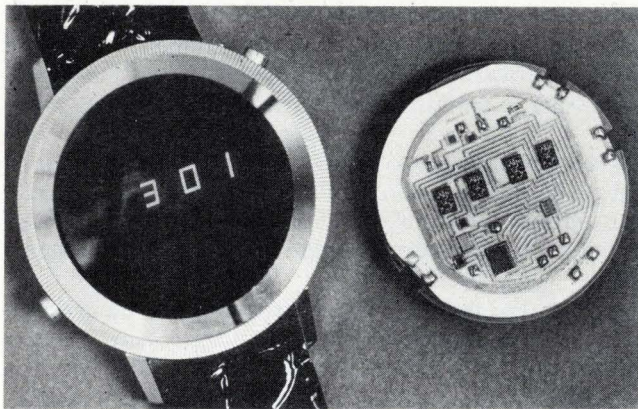

**Digital watchworks.** Hughes module for watchmakers has created new outlet for the firm's C-MOS circuits and crystal oscillators.

ample, a low-frequency network analyzer was introduced. With it, an engineer can design a circuit, calculate theoretical performance, test the network, and compare theoretical and test results. That's surely a better mousetrap, and, being a system, it commands a solid price—\$16,250.

Such variations on the digital-instrument theme have helped H-P cut dependence on Government markets from 40% to 25% in the past five years.

Meanwhile, across town, "Varian has been diversifying since the day it was founded in 1948," says Emmet G. Cameron, vice president for corporate development. Though Varian is generally identified in the electronics industry as a microwave components and subsystem manufacturer, the firm was actually founded by a group of Stanford University faculty members more interested in spectrometers, linear accelerators, and vacuum technology.

The klystron, invented by the Varian brothers, brought the firm financial success and led to almost \$100 million a year in microwave and power-device business—both tube and solid-state—and, recently, gas-discharge-display panels. This growth resulted from company developments, acquisition of companies in the device market and sponsorship of affiliates such as Communications Transistor Corp. [*Electronics*, May 10, p. 68].

Around \$100 million more in annual sales stems from dogged pursuit of the founders' scientific and vacuum interests. Hospitals, for example, have bought more than 150 linear accelerators for cancer therapy, and Varian claims to be the leading supplier of crystal pullers to the semiconductor industry. Pullers and other industrial vacuum systems stem from the invention of the vac-ion pump at Varian.

Computers and digital systems account for about \$35 million more. Cameron says the computer subsidiary, Varian Data Machines, down south in Irvine, Calif., became a "must" because of the need for signal processing and data enhancement in such analytical instruments as nuclear magnetic-resonance spectrometers.

Today, Varian Data Machines makes minicomputers and systems for many other applications. The V73 data-communications system is the subsidiary's newest. Other forays into the data market include electrostatic printers and electrophotographic systems (solid-state CRT and microfilm copiers). An affiliate, Varian Adco, tried, failed, and is now trying again to develop complete information-storage and retrieval systems. The electrophotography stems from Varian's development



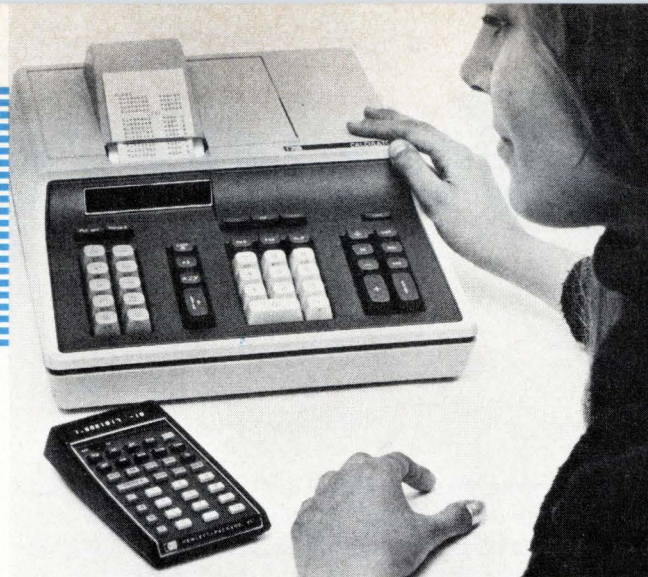

**Large and small.** Hewlett-Packard uses same basic chip set in desk and pocket versions of new scientific calculator.

of electrostatic graphic recorders for instruments.

Once dependent on the military market for 95% of its sales, Varian has cut that dependence to 25%. And it has strayed rarely into unrelated fields, although one such product is panel meters [*Electronics*, March 1, p. 111]. A group of engineers in a subsidiary wanted to make meters, "so we let them," Cameron says.

### Northwest expansion

Another Bay Area instrument maker, Systron-Donner Corp., Concord, Calif., also played out its charter-measuring instruments and transducers. For instance, the home burglar alarms made by the Security Devices division evolved out of aircraft fire detectors. In support of that product, a company making both fire and intruder detectors was acquired, and then an ultrasonic alarm was developed in-house.

Systron-Donner literally started in an attic in 1957, with a home-made product. The wife of one of the first three employees soldered the wiring and baked the paint on the cabinet in her oven. S-D's sales are more than \$40 million. Dependence on Government markets has dropped from the 90% to 95% range to 35-40%.

Farther north, Tektronix Inc., Beaverton, Ore., is rapidly casting off the image as an oscilloscopes-only manufacturer. The oscilloscopes led several years ago to computer-output monitors and formation of an Information Display Products division in 1970. The monitors evolved into computer-graphics terminals sold primarily in engineering, scientific, and educational markets using other Tektronix products. In June, the division entered the hundred-times larger market for low-cost alphanumeric terminals with television-tube displays.

Lawrence Mayhew, vice president and general manager of the division, explains that Tektronix salesmen call on many labs that buy alphanumeric rather than graphics terminals. Besides the waiting market, he adds, the new line also improves Tektronix's opportunities for future graphics terminals sales when customers upgrade to that type.

This month, Tektronix introduced a line of desk calculators. These, too, are complementary—aimed largely at the same customer base and designed to interface with terminals [*Electronics*, Aug. 2, p. 40]. Moreover, they are the kind of calculators that adapt easily to use in small instrument systems, Mayhew says.

The calculators could lead Tektronix into business markets. For example, business records can be keyed into the calculator's tape-cartridge memory for processing and to generate such displays as trend graphs on a

terminal. At Tektronix, the combination is called a "poor man's intelligent terminal."

The parent corporation is branching out into the billion-dollar general instrument market—a market five times larger than the one for oscilloscopes alone. Already involved in test systems, Tektronix is rapidly building a line of general-purpose test and measuring instruments [*Electronics*, Aug. 2, p. 111].

A much smaller firm than Tektronix, Wavetek, of San Diego, also found a way to evolve from instruments to data-processing equipment. Wavetek's experience in audio generation and detection led to voice-response communications systems that tie into IBM computers or stand alone. Using Touch Tone telephones as terminals, they generate spoken messages automatically.

The equipment replaces IBM 7770 systems (which IBM has stopped making). Wavetek got a request to build a voice-response system from Rohr Industries Inc., Chula Vista, Calif., and formed a subsidiary. The subsidiary isn't a money-maker yet but it has sold 40 systems in banking, credit, inventory and factory applications. Don Fleming, sales manager, predicts profitable growth. "We saw a small crack in the market that a small company could go after. It wasn't worthwhile for IBM."

### Making it in minis

Meanwhile, minicomputer firms are counterattacking. Most mini makers are moving into systems, impelled by competition, price erosion in the bare-bones OEM market, and the spectre of microcomputers capturing the system-control market [*Electronics*, March 1, p. 63]. OEMs can now buy bare minis for less than \$1,000 [*Electronics*, June 7, p. 109] from Computer Automation in Irvine, Calif.

Some firms, like Microdata Corp., also of Irvine, are making their own peripherals, as well. Microdata produces data-communications, education and micro-programming systems, and tape drives, and it has marketing rights on a disk drive made in Phoenix, Ariz., by Western Dynex.

General Automation perhaps has gone farthest along this route. Less than 20% of GA's sales are bare minis. "We aim at large end users and a limited number of



# Wescon



OEMs in synergistic industries like communications," says Lawrence Goshorn, president. One of the firm's largest markets is the automobile industry. Among GA's products are systems that test automobile electrical systems and exhaust emissions.

Goshorn believes minicomputers will retain an edge over microcomputers for another few years, but he warns that the computer industry had better integrate vertically to hold its position against the onslaughts of semiconductor manufacturers and other newcomers. □

## Wescon program reflects hot technology, sales boom

by Paul Franson  
*Los Angeles bureau manager*

The professional program for the Western Electronic Show and Convention, scheduled for San Francisco's Brooks Hall Sept. 11-14, is often a good economic barometer for the electronics community. Those sessions that haven't dealt with technology in recent years frequently went straight to the heart of problems troubling electronics executives. For instance, unemployment among aerospace engineers and proposals to solve it have been aired at length in the past few Wescons. But the barometer is rising this year as a reflection of record sales and demand in the electronics industries.

Entrepreneurship, a characteristic of electronics management in the San Francisco Bay Area, plus venture capital and guides to product marketing (including emphasis on international markets), have all but submerged yesteryear's preoccupation with retraining of displaced engineers in the non-hardware portion of the 33-session program. Most sessions, however, deal with technologies. Medical electronics gets considerable attention, and instrument technology and standards, plus careers in biomedical-engineering are highlighted.

### Stressing practicality

The technical topics are treated in ways that should be more useful to working engineers and managers than mere presentation of papers. Many of the most interesting sessions are devoted to panel discussions by knowledgeable experts with conflicting viewpoints, and some will even be hands-on workshops.

More sessions, 10 in all, are devoted to semiconductor components and their competitors than to any other

subject. Sessions are devoted to all the hottest topics—memories, microcomputers, displays, and high-speed as well as low-power logic circuits.

Two sessions, No. 2, "Readouts for instrumentation and test equipment," and No. 31, "LEDs and liquid crystals—facts and fancies," cover the controversial display field. The former will feature a panel of advocates from LED, liquid-crystal, gas-discharge, and even light-emitting thin-film companies, plus two users to add their views. Session 32, concentrating on LCDs and LEDs, features a more formal program, including discussions of measuring instruments and standards.

Perhaps the fastest-growing technologies in the whole churning semiconductor business are microcomputers and memories, with important new products appearing almost weekly. Session 11 will cover microcomputers, concentrating on the impact on the designer, as well as applications. This will be followed by a panel discussion featuring representatives from microcomputer companies, users, and the company that introduced a mini-computer that may stave off microcomputers a bit longer, Computer Automation Inc., with its under-\$1,000 mini.

The other hot topic, new semiconductor memories, will undoubtedly sharply focus on the new 4,096-bit MOS RAM devices. Other memory concepts, such as programmed logic arrays, will get attention, as well.

After memories and microprocessors, perhaps the most talked-about products in the field are the opposites of low-power logic, discussed by three manufacturers and three users in a panel in session 21, and high-speed logic, discussed by a panel composed of four circuit designers and three system designers in session 26. Session 8 is devoted to hybrid LSI, thought of as primarily a military interest, but the panel includes Motorola Communications, with its portable commercial-communications equipment, and Fairchild Semiconductor, with its heavy involvement in photographic and automotive consumer products.

Microwaves receive relatively good exposure at Wescon, with three sessions, but two are also on semiconductor components and systems—No. 15 deals with solid-state microwave sources for telecommunications, and No. 20 covers microwave transistors and transverse-electron amplifiers. Session 24, "Commercial applications for microwave technology," discusses requirements and applications, including those in automotive, intrusion-alarm and aircraft-landing systems.

Supporting these technology and product-oriented topics are the five sessions that feature marketing tech-



niques, venture capital, and entrepreneurship. The name of session 28 is "Techniques for conversion of technology into corporate and personal wealth." The session, chaired by Thomas A. Skornia of Skornia, Rosenblum and Gyement, will feature sections about patent and legal protection, venture capitalist views, and a personal look from Robert N. Noyce, president of Intel Corp.

### Technology into dollars

In the same vein, session 23 is a panel discussion on raising capital in Northern California. Once you have the organization and capital, however, the way you market and introduce new products can spell the success or failure. Session 3, organized by Donald M. Dible, author of "Up Your Own Organization," should help. Speakers tell how to evaluate the marketplace, plan strategy, secure publicity and place advertising, and build and motivate an organization of manufacturers' representatives or company sales force. Dible, whose second book, "21 Keys to Market Success," will be out this fall, says, "A big problem is not in getting started, but in making your company go. Not many engineering schools have good marketing departments—they're considered like oil and water, and I feel we need to homogenize them."

One topic, medical electronics, was picked for special

### Wescon's expectations

San Francisco's Brooks Hall, with its 489 booths, is sold out for the Sept. 11-14 Wescon show. But the sellout actually means there will be fewer booths than last year in Los Angeles and two years ago when booths were set up in the underground Brooks Hall and the street-level civic auditorium.

The Wescon board of directors decided to concentrate the exhibits in Brooks Hall this year, eliminating the booths in the auditorium, where many 1971 exhibitors expressed dissatisfaction at not being in the main traffic. Nor are Wescon officials looking for as many to attend as did last year—close to 30,000 in Los Angeles. The estimate this year is about 25,000, or just about the same as the San Francisco total in 1971.

Another move by the board this year clarifies Wescon's stand on sales. There will be no floor deliveries, and purchased products can't be brought back into the exhibit area, but they can be delivered to purchasers by qualified exhibitors who rent rooms on the upper floors of the civic auditorium.

emphasis by the Wescon program committee, headed by Thomas Magill, senior research scientist at Stanford Research Institute, and Dan S. Lansdon, administrative manager at Hewlett-Packard Laboratories. Again, the emphasis is on practicality. Session 5 is devoted to standards for medical devices. Federal standards are expected soon, says program organizer Michael J. Miller, executive director of the Association for the Advancement of Medical Instrumentation. Speakers will discuss proposed standards, legislation, and the role of such organizations as the medical devices technical advisory board in ANSI, the American National Standards Institute, which will act as a coordinating board.

A session on biomedical engineering is No. 7, "The electronic engineer's contribution to biomedical research." Organizer L. D. Prehn of the Pacific Telephone Co., believes the best way that EEs can contribute to research is to join in interdisciplinary teams with M.D.s and biologists in graduate research facilities. In the session, a practicing M.D. will tell "what electronic engineers can do for me."

### Instruments, workshop featured

Medical instruments aren't the only kind on the Wescon program, however. Two sessions, organized by Rudolph Panholzer at the Naval Postgraduate School in Monterey, Calif., discuss the growing complexity, even intelligence, in test instrumentation. Session 22 covers the role of computers in test systems; session 27 treats a similar topic, but with calculators as the focal point.

Session 18, providing a chance for participants to twiddle knobs, covers the multi-capability instrument with a number of functions in one box, which provide convenience and low cost, made possible by recent developments in tiny, low-cost semiconductors. A fourth session is devoted to computer-aided and computer-generated design of programs for testing digital and analog systems.

Two particularly timely sessions deal with point-of-sale systems, which finally seem to be growing at the rate anticipated for a number of years (session 6), and data distribution networks (session 29).

Concurrent with the show, a special two-day workshop on improving producibility will be held at the San Francisco Hilton Hotel. The workshop, which is sponsored by Wescon and the IEEE Manufacturing Technology group, will cover components and circuit-board manufacture, assembly, and testing. It has a separate \$100 registration fee, which also includes Wescon attendance. □



# FREE! 48-Page Booklet

**"How to write effectively"**

This time- and work-saving booklet can give your memos, letters, speeches, reports, a new clarity, brevity and impact. Included are guides to grammar, style vocabulary building... plus mistakes to avoid, and tips on organizing and outlining that make writing a breeze. Free when you order a free-trial copy of any book below.

WHEN YOU ORDER A FREE-TRIAL COPY OF ANY OF THESE **WILEY** BOOKS



① **All the Data You Need to Design the Best Possible Low-Noise Circuit**

## LOW-NOISE ELECTRONIC DESIGN

By Motchenbacher and Fitchen

See this practical guide on noise mechanism, noise models, and the analysis of noisy circuits and systems. This includes amplifier noise, and noise in sensors, transistors and ICs. It also helps you with design problems, and gives you new information on noise in passive components, biasing without noise, power supplies, and cascaded stages and feedback. And you'll see many design examples, information on computer-aided design, and noise measurement methods. **\$19.95**



④ **Over 200 Ready-Made Circuits To Save You Time and Work—Help Solve Design Problems**

## MODERN OPERATIONAL CIRCUIT DESIGN

By John I. Smith

You get a valuable collection of tested circuits and design techniques—complete with data, formulas, and graphs—involving the modern operational amplifier. You'll find many of the more advanced circuits completely new. Included are circuits for unity-gain inverter, inverting amplifier, dynamic error and stability, integrator and differentiator, follower, precision diode, instrumentation, voltage- and current-meter applications... plus data on circuits that enable you to construct autonomous electronic systems. **\$16.95**



② **Simplifies Analyses of Performance-Speed-Cost Trade-Offs for Optimum Device Selection**

## USER'S HANDBOOK OF INTEGRATED CIRCUITS

By Eugene R. Hnatek

To help you pick the best device for a given job, this guide gives you performance characteristics of bipolar ICs and MOS ICs, and how to combine them for maximum benefits from both. You'll also find details on structure and applications of operational amplifiers and voltage regulators, and design and applications of digital bipolar ICs. In addition, you'll get approaches to design of thin-film and thick-film hybrid circuits, and techniques of monolithic and hybrid packaging and assembling. **\$24.95**



⑤ **The Non-Specialist's Guide to Analysis, Design, and Application**

## OPTICS: A Short Course for Engineers and Scientists

By Williams and Becklund

This practical, instant-reference manual will give you a wealth of information on the properties of waves and optical materials, and ideal optical systems. Designed specifically for those with no experience in this area, it gives you details on such standard topics as radiometric and photometric units... diffraction... stops and pupils... lens aberrations... image "brightness"... evaluation of optical systems, and radiant energy detectors. You'll also get the math background you need, plus tables of typical optical quantities. **\$17.95**



③ **Proven Techniques to Pinpoint and Eliminate Noise Problems or to Design Around Them**

## GROUNDING AND SHIELDING TECHNIQUES IN INSTRUMENTATION

By Ralph Morrison

In this practical, detailed treatment you'll see what causes unwanted noise and why. The author gives you a complete rundown on noise sources, explains where the problems are, and offers you proven techniques for avoiding noise pickup. Using electrostatics and mutual capacitance as the basis, this realistic worksaver gives you general rules for shielding signal paths and grounding signal lines. It features the author's original treatments of the shield enclosure, the differential amplifier, and the use of multi-shielded transformers in instrumentation. **\$12.00**

⑥ **Instant Answers to 1,001 Questions—Those That Pop Up Daily in Actual Practice**

## THE ENGINEER'S COMPANION

By Mott Souders

**\$11.95**

⑦ **Ways to Solve Special-Purpose Digital Problems with Commercially-Available Micro-Digital Circuits**

## LOGIC DESIGN WITH INTEGRATED CIRCUITS

By William E. Wickes

**\$11.95**

----- MAIL COUPON TODAY FOR FREE BOOKLET -----

Please send me, to use FREE for 10 days, the book(s) I've circled below. For those I keep, I'll send the amount(s) shown, plus postage and handling. I'll owe nothing for any book(s) I return during the trial period. Include my FREE writing booklet, which is mine to keep whether or not I buy any books.

Bill me  Bill company

1 (1-61950-7)    3 (1-61617-6)    5 (1-94830-6)    7 (1-94275-8)  
2 (1-40110-2)    4 (1-80194-1)    6 (1-81395-8)

JOHN WILEY & SONS, INC., P.O. BOX 4192  
GRAND CENTRAL STATION, NEW YORK, N.Y. 10017

NAME \_\_\_\_\_

FIRM \_\_\_\_\_

ADDRESS \_\_\_\_\_

CITY \_\_\_\_\_

STATE \_\_\_\_\_ ZIP \_\_\_\_\_

Offer good in U.S.A. only.

063

A-4181 NP



The world leader in audio power ICs does it again.

# TBA 810 S

## first of a new

## protected

## generation

## of boosted power

## audio amplifiers.



### 7 watt now

SGS-ATES underlines its leadership in power amplifiers by launching its 2nd generation. Output power is increased, and a key new characteristic, protection, is designed-in. TBA 810S, the first into production, provides up to 7W (r.m.s. continuous) output over 4  $\Omega$  load. Ideal for car-radio applications, it features built-in

thermal protection which makes it completely resistant to unexpected variations in supply voltage, excessive increases in ambient temperature, or insufficient heat-sinking. Available in plastic quad in-line package with external cooling tabs, bent or flat, as illustrated.

Ask for the datasheet.

### 10 watt tomorrow

The TCA 940, currently in pre-production and shortly to be launched, provides full protection, both thermal and against permanent short circuit. Great for home-radio. More news soon.

### 20 watt coming up

The most powerful yet. Now in the final stages of development, this exceptional IC is designed as the real answer for hi-fi, with 100% protection. Look out for super-power.



# RELIABLE SPACE SAVERS...

*NEW! IMPROVED DESIGN*  
provides a longer life and greater dependability — check these outstanding features.

*"EXCLUSIVE"*  
**MOLDED-IN TERMINALS**  
eliminate staking and epoxy seals.

**LEVER STOP** feature prevents "push-in" of toggle, protects delicate parts.

**HIGH TORQUE BUSHING** withstands mechanical abuse.

**NEW FRAME DESIGN** allows use on 250VAC circuits.

**GOLD FINISH** on contacts and terminals for easier soldering and longer shelf life.

**FINE SILVER CONTACTS** and heat sinks provides a conservative 6 Amp rating.

**ISOLATION BARRIERS** between poles and terminals, inside and out.

**CASE MATERIAL** of D.A.P. for strength, better arc resistance and lower leakage.

These **STANDARD FEATURES** provide the ultimate in switching devices at competitive prices because there are no hidden added costs.

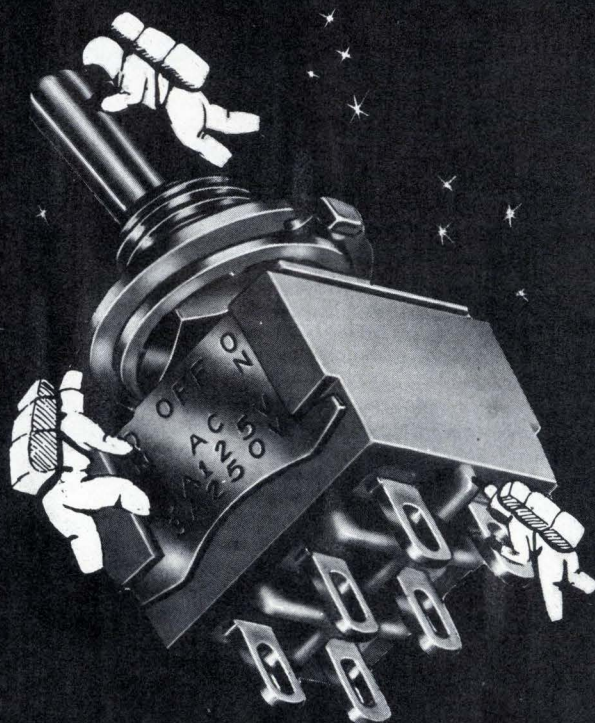

This complete new line of subminiature switches is now available from our authorized "Stocking Distributors". Write or call today and ask for an illustrated "NEW PRODUCT SELECTION GUIDE" — containing a detailed listing of all the series, options and pricing.

**INVESTIGATE & COMPARE**

# ALCOSWITCH

Mfd. by ALCO ELECTRONIC PRODUCTS, INC. NORTH ANDOVER, MASS.

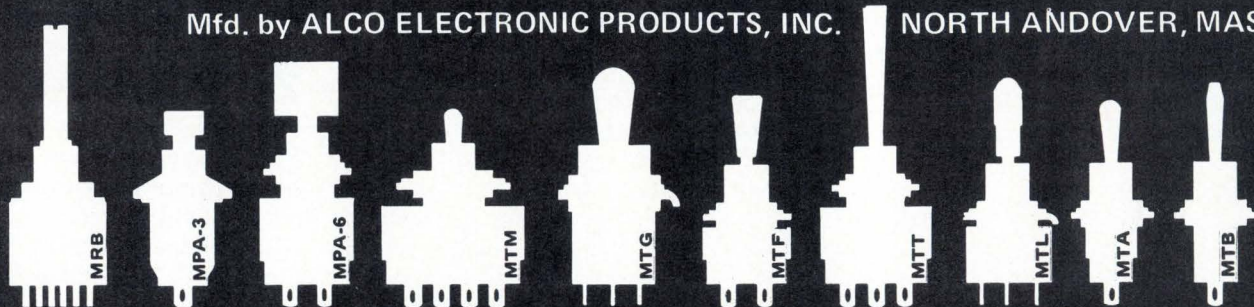

THESE OUTLINE ILLUSTRATIONS COMPRISE JUST A FEW NEW SERIES — SHOWN ACTUAL SIZE.



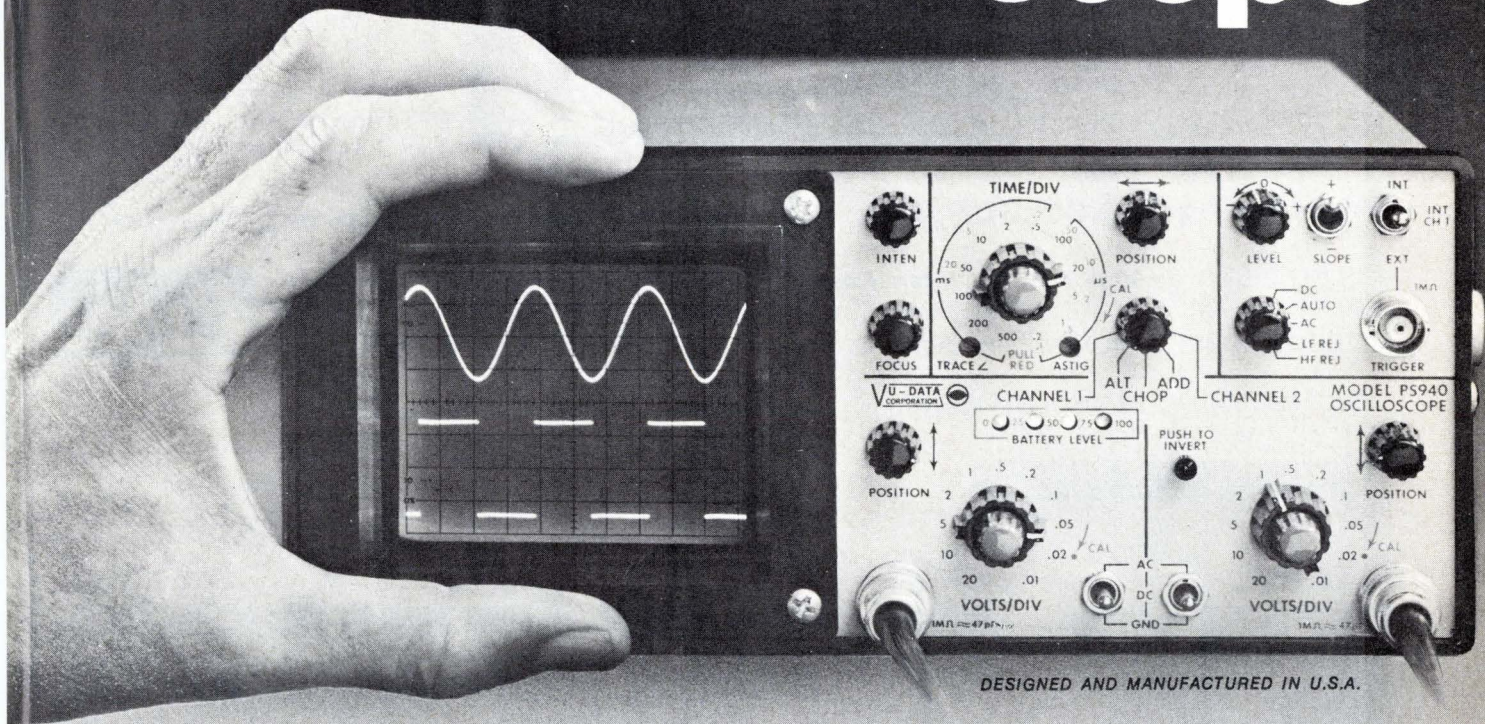

# a dual-trace "mini" that's really a scope





DESIGNED AND MANUFACTURED IN U.S.A.

 DC-20 MHz bandwidth  
21 sweep ranges to 100 nsec/div

 10 mV/div sensitivity  
Battery, AC or DC powered

 Fits in a tool kit or brief case  
Weighs only 10 lbs.

 8 x 10 div display area  
Delay line

 Calculated  
battery charge indicator

If you need a high-performance portable scope, but don't feel like lugging the weight around—or lack the space, then consider Model PS940A. This dual-trace mini-portable oscilloscope provides all the basic features and quality of a sophisticated laboratory oscilloscope, yet it adds a new dimension to portable scope applications. Its weight and size (10 lbs. and fits in a tool kit or brief case) make it easy to carry to every job, in the plant or in the field. It may not be

a lab scope, but it triggers like one—and in most applications it has the features to serve you well. With 20 MHz bandwidth, 100 nsec/div sweep rate and 10 mV/div sensitivity, Model PS940A is the dual-trace "mini-scope" to beat! Available now for only \$1,095.

Interested? Call Bob Mitchell at (714) 279-6572, or write to us at 7170 Convoy Ct., San Diego, CA 92111.

From a Leader in Mini-Portable Oscilloscopes

**VU-DATA**  
CORPORATION 

"See us at WESCON Booth No. 1221"

Circle 121 on reader service card



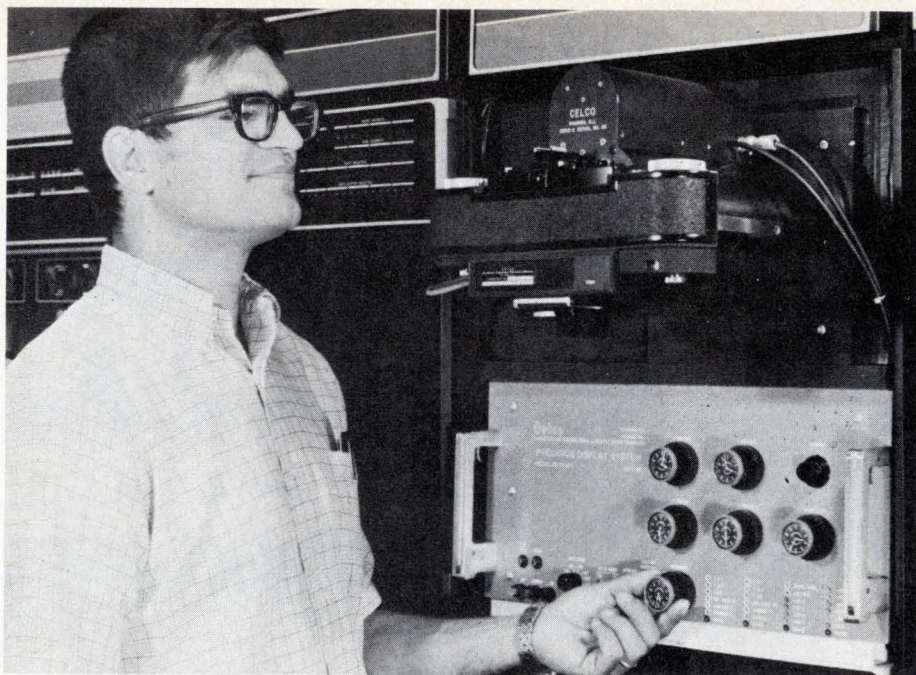

**CELCO**  
*makes CRT  
 Camera  
 Systems  
 that will  
 make  
 YOU Smile!*

Address inquiries to CELCO:  
 70 Constantine Drive, Mahwah, NJ 07430  
 1150 E. Eighth Street, Upland, CA 91786

**Introducing CELCO COF/FIC: Computer-On-Film/Film-Into-Computer**

- CELCO DSC I: to 1000 TV lines, 16mm Camera • Low-Cost & Compact
- CELCO DSC II: to 2000 TV lines, 35mm Camera • Ultra-High Stability
- CELCO DSC III: to 4000 TV lines, 70mm Camera • Ultra-Low Distortion to 0.05%



**CONSTANTINE ENGINEERING LABORATORIES COMPANY**

Circle 122 on reader service card



10 MHz to 18 GHz

**MCL is now a leader in solving your high power r-f and microwave testing problems.**

Many customers remember us for the "extras" engineered and built into our microwave cavities, e.g., our potted anode bypass assembly.

But some may not be aware that MCL currently offers one of the industry's largest and most diverse power oscillator, amplifier and systems lines.

The same extra margin of reliability and performance customers have learned to expect from our cavities is also a feature of our instrumentation products.

For a recommended solution to your high power testing problem—without obligation—write us today. MCL, Inc., 10 North Beach Avenue, La Grange, Illinois 60525. Or call (312) 354-4350.



See us in  
 EEM-Vol. 1 pp. 551-566



**This member  
of our family  
is still the  
thriftiest ASR  
terminal  
around. \$885.\***

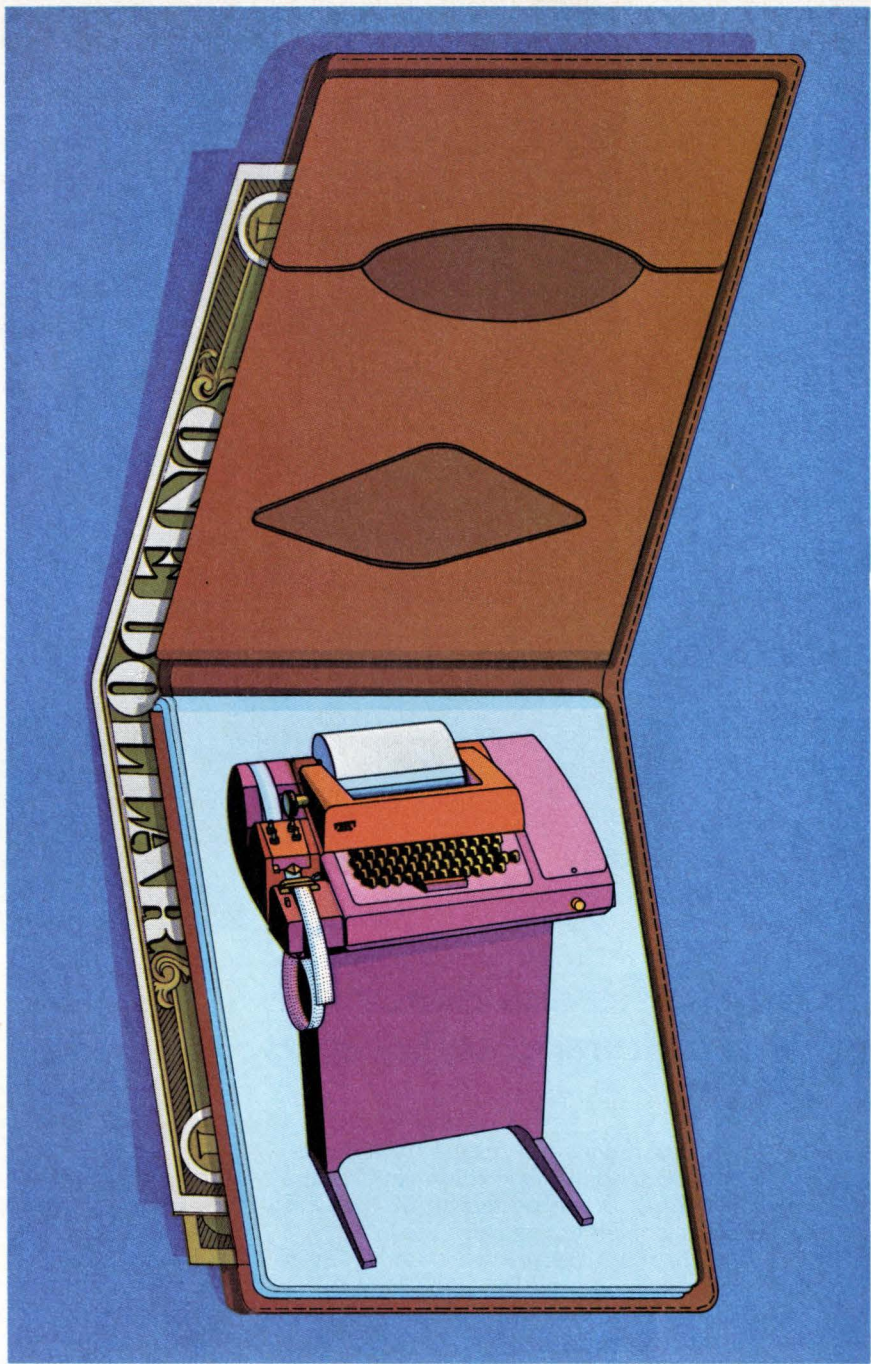

Teletype is a trademark registered in the United States Patent Office.

Dollar for dollar, the Teletype® model 33 is the least expensive, most reliable data terminal in its class. Because once you see how well it performs, you won't believe its price.

That's one reason why the model 33 is the most popular terminal in the industry. But it's hardly the only reason.

The model 33 is designed and built for extremely reliable operation at 100 wpm. And since it operates on the eight-level ASCII code, it speaks the language most computers understand. Both mini-computers and

maxi-computers. Which makes compatibility another reason behind its popularity.

Then there are some reasons you can't see. But they're there just the same. Like complete technical sales and service back-up to help you with installation and maintenance.

Available in three basic configurations, the model 33 is a lot of machine. At a very small price. Without pedestals, RO's start at \$551, KSR's at \$654 and ASR's at \$885.\* And for about \$200 more, you can equip any of them with a built-in, factory-tested modem.

It takes more than manufacturing facilities to build the machines Teletype Corporation offers. It also takes commitment. From people who think service is as important as sales. In terminals for message communications and computers.

That's why we invented a new name for who we are and what we make. The computercations people.



**The computercations people.**

For more information about any Teletype product, write or call: TERMINAL CENTRAL, Teletype Corporation, Dept. 53P, 5555 Touhy Avenue, Skokie, Illinois 60076: Phone 312/982-2500.

\*Prices subject to change without prior notice.



2001  
 2000  
 \$320

**The big difference between these high-frequency sweepers is \$320.**

The little differences are on the front panel (a start/stop mode of operation and a tape drive readout). Some people think they add up to \$320. For them, we built the 2001.

And for those people who don't require these features, we built the 2000. The 2000 is the only sweeper under \$1400 to offer frequency coverage of 1 MHz to 1.4 GHz, solid-state design, calibrated RF output from -80 to +10 dBm, P.I.N. diode leveling and a crystal-controlled marker system.

In addition, its frequency, bandwidth, and output level are programmable, making it ideal for production test and systems use as well as in the design laboratory. If you're still not sure which sweeper we built for you, send for more information. Just circle the reader service number or give us a call.

**WAVETEK®**

INDIANA INCORPORATED  
 P. O. Box 190, 66 North First Ave., Beech Grove, Indiana 46107  
 Tel. (317) 783-3221 TWX 810-341-3226

Model 2000  
 \$1375



Circle 124 on reader service card

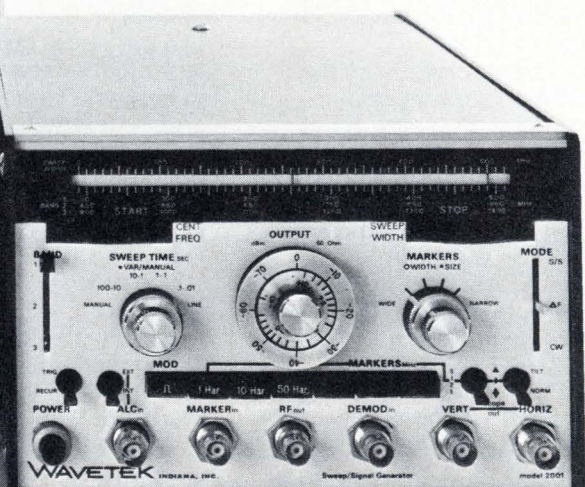

Model 2001  
 \$1695



## New products

# Wescon '73 to spotlight instrument systems with more self-control

Instruments have always been a Wescon mainstay, and this will be the case at the '73 show, Sept. 11-14 at Brooks Hall in San Francisco. But this year, showgoers will see more system-level exhibits—'smarter' instruments with built-in controls for handling more tasks. Following are some of the significant instruments and other products to be introduced at Wescon.

### Calculator controls instrument systems

**The fine line** between mini-computers and high-performance calculators will get a little finer at Wescon when Hewlett-Packard exhibits two new calculator-controlled instrument systems. The systems—one for automatic network analysis, the other for automatic data acquisition and analysis—both employ H-P's model 9820A programable calculator for processing data and for controlling programable instruments.

In addition to the calculator, the model 3043A low-frequency network analyzer contains a 3320B frequency synthesizer and a 3575A gain-phase meter. This instrument system has a frequency range of 1 hertz to 13 megahertz, and can resolve amplitude differences of 0.1 dB and phase angle differences of  $0.1^\circ$ . Input signal range of the gain-phase meter is 0.2 millivolt to 20 volts rms; input impedance is 1 megohm shunted by 30 picofarads. Output signal level of the synthesizer is 5 v rms maximum from either 50 or 70 ohms.

Manual setting of the controls on the frequency synthesizer and the gain-phase meter is not necessary as the instruments are automatically controlled by the calculator through an addressable-bus arrangement. A package of network-analysis programs is available as an extra-cost option for the 3043A. With these

programs or his own, the engineer can use the calculator to analyze a new circuit before it is built, and then use the full instrument system to verify the performance of the actual hardware later on.

U. S. price of the low-frequency network analyzer is \$16,250. The optional electrical engineering software package is an additional \$50. Delivery time is 90 days.

**Data acquisition.** By adding a scanner and a digital multimeter to the calculator, H-P has created an automatic data acquisition system

(see below) that can handle up to 100 channels at a reading rate of up to five readings per second. The model 3050A can either log data for later analysis or operate on it as it comes in. Statistical analyses, for example, can be performed after a batch of data has been acquired, while linearization of, say, thermocouple voltages can be done by the system in real time.

The measuring instrument in the data acquisition system is a 3490A DMM. It can measure both ac and dc voltage and resistance. Dc voltages





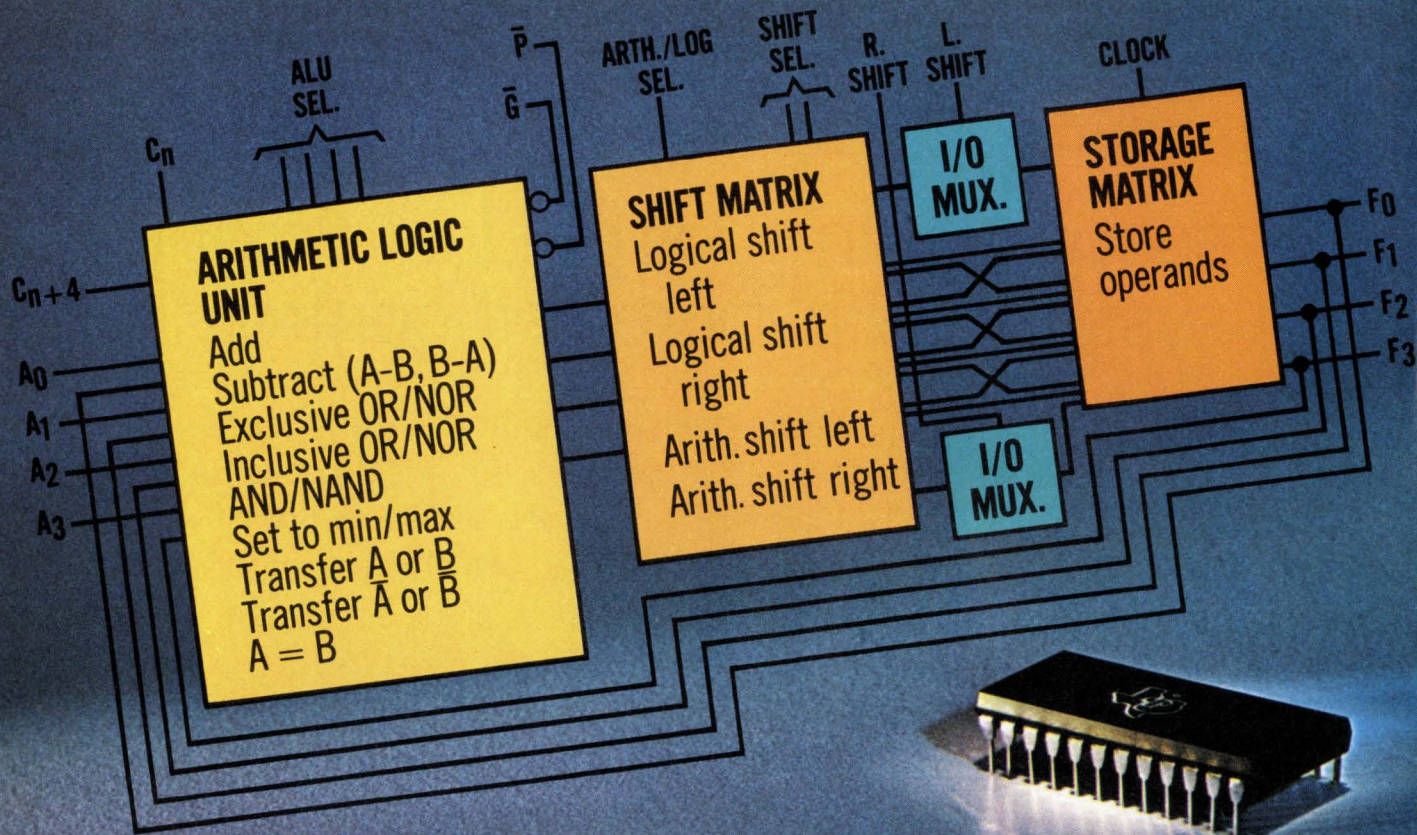

# SCHOTTKY LSI

## Processor Power

With TI's new SN54S/74S281 high performance monolithic accumulator.

Functionally, TI's new SN54S/74S281 Schottky LSI accumulator is the most powerful bi-polar monolithic IC available today.

Designed to operate as the "heart" of digital processors, the S281 integrates a 4-bit arithmetic logic unit/function generator with a universal left/right shift/storage matrix featuring multiplexed 3-state output/input cascading lines...all in a 24-pin package.

### Unmatched versatility, economy

We feel the S281 is a milestone device...with versatility and economy that cannot currently be achieved in any other way. The S281 can perform 20 arithmetic/logic operations on

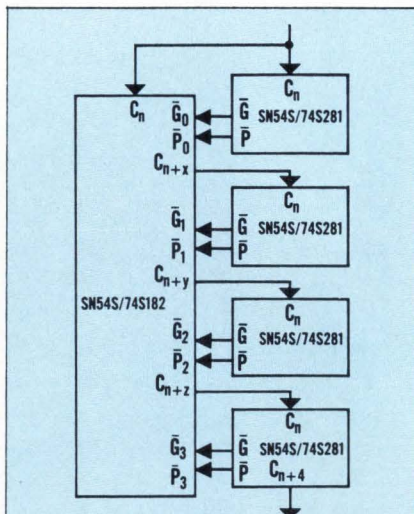

Fast, simultaneous carry generation over any bit length can be achieved by combining S281s and the 54S/74S182 look-ahead carry generator. 16-bit addition time is 27ns, typical.

two binary numbers (see above) and can be used in multiples of 4 bits to construct whatever system size desired. It can improve performance, lower costs and reduce board space in "intelligent" terminals, machine/process controllers, minicomputers, and specialized and medium-size main-frame computers.

And at \$15.23 in 100-piece quantities, the cost is lower than that of less complex ICs organized to perform similar functions. System level savings are even greater.

For data sheet, write: Texas Instruments Incorporated, P. O. Box 5012, M/S 308, Dallas, Texas 75222.



TEXAS INSTRUMENTS  
INCORPORATED



## New products

from 100 mV full scale to 200 V can be measured to 5-digit resolution. On the 100-mV range, this is a resolution of 1  $\mu$ V. Ac voltages from 20 Hz to 250 kilohertz can be measured on ranges from 1 V full scale to 200

V. And resistances can be measured from 100 ohms full scale to 10 megohms, with 1-milliohm resolution on the 100-ohm scale.

Price of the data acquisition system is from \$14,200 to \$19,600, de-

pending upon the number of channels. Deliveries will start in September.

Inquiries Manager, Hewlett-Packard Co., 1501 Page Mill Road, Palo, Alto, Calif. 94304 [371]

## Modular package permits fast breadboarding

**Breadboarding a circuit** is hardly ever a neat operation. Wires, terminals, components and soldered connections frequently spread out into a rat's nest of complexity ringed by a wall of instruments balancing precariously on the laboratory bench.

E&L Instruments Inc., Derby, Conn., however, has a neater and, more importantly, what it claims is a cheaper way to handle those breadboards—the ADAM I modular breadboarding system, which brings together all the elements needed for breadboard design in a single bench-top-sized package. Everything—solderless socket panels, power supplies and test and measuring instruments—are pluggable so that it's possible to choose just the right mix of devices.

"The system allows a circuit to be set up three times as fast as conventionally," declares E&L president Murray Gallant. "And because the sockets are solderless, there's no money lost because of heat damage to packages and components."

For \$395, a designer can have a quite sophisticated array of circuit options at his disposal. At the center of the system is a \$145 mainframe, with a front-panel area measuring 8.5 inches square into which the

other components are plugged. The mainframe also has a built-in power supply ("goof-proof," says Gallant) that is used to power the other plug-ins. It provides  $\pm 24$  volts dc unregulated power at 200 milliamperes,  $\pm 15$  V tracking power at 200 mA, and a +5-V, 1-A line.

Next, the designer plugs in a 2.8-by-8.5-in. solderless socket panel (\$30). Sockets are on 0.1-in. centers, and all components and connecting wires are plugged into it. The panel also has an on-off switch that can deactivate either a portion or all of the sockets.

Other plug-in modules, each measuring 1.4 in. high and 8.5 in. long, include:

- A \$55 signal source for digital circuitry that provides 0- and 5-v logic levels, one-shot logic outputs, two 10-kilohm potentiometers, and a BNC input connector.

- A \$115 function generator with a frequency range of 0.1 hertz to 100 kilohertz and an output amplitude of 0 to 10 V peak to peak and dc offset voltage between  $\pm 5$  V dc.

- A \$70 readout that incorporates a 10-megohm dc multimeter with full-scale ranges between 0.1 and 30 V, and light-emitting diodes to indicate logic levels; input currents may range from 0.1 to 30 milliamperes.

All signals can be brought to and from the socket panel using ordinary 22-gauge wire.

Gallant says, "Because we've eliminated separate sheet-metal fabrications and power supplies, instruments are available at half their usual cost. And it's a convenient way for a company to hold on to and save an original breadboard design."

Production will begin 30 days after Wescon. Thereafter, delivery time will be three to four weeks for the mainframe, from stock for the plug-ins.

E&L Instruments Inc., 61 First St., Derby, Conn. 06418. [372]

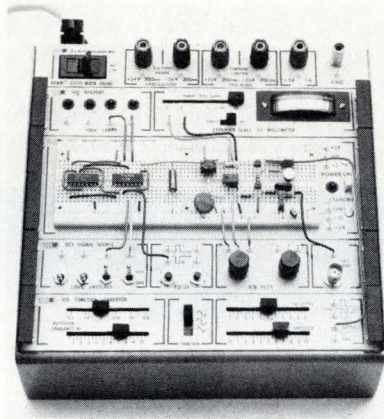

## Ease of operation built into 60-MHz scope

**With so many knobs** and buttons to handle, oscilloscopes often lend themselves to operator error. That's why ease of operation was one of the prime considerations in design of the Tektronix 5400 series, a 60-MHz general-purpose system aimed at users in engineering, manufacturing, servicing, and education.

To enhance the flexibility of the

three-plug-in mainframe of the 5400, 17 plug-ins are available that provide a wide range of measurement capability. ICs are used throughout to keep costs down and add to reliability, and the package includes a detachable display module that can be connected either to the top for a bench-mount configuration or to the side for a 5¼-inch-

high rackmount application. A large, bright CRT, cam switches, push buttons, and color-coded-front panels contribute to the ease of operation.

Also adding to easy use is an optional CRT readout of plug-in parameters. Previously available only on Tektronix's more expensive 7000 series, this CRT readout reduces



## New products

measurement time, because the operator can concentrate on the CRT display rather than having to watch the plug-in knobs. It also reduces errors by taking into account magnifiers and probe attenuators.

With the 5400 series, the CRT readout can also be accessed externally to read out such data as dates, picture numbers, digital clock times. The 5403-D40 oscilloscope, mainframe for the series, provides two amplifier compartments and one time-base compartment. Two plug-ins, the 5A48 dual-trace amplifier

and the 5B42 delayed-sweep time base, are now available and make full use of the bandpass and CRT-readout capability of the 5400 series. The 15 plug-ins available for the 2-MHz Tektronix 5100 series are compatible with the 5400 mainframe, but they do not have readout capability.

The mainframe, the 5403-D40 scope, is priced at \$1,175; without the CRT, it's \$825. Plug-ins range in price from \$115 to \$575.

Tektronix Inc., P.O. Box 500, Beaverton, Ore. 97005 [373]

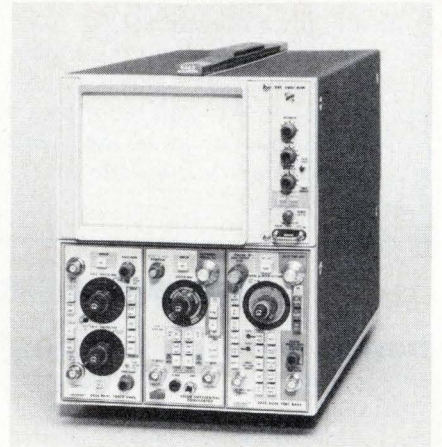

## Function generator offers 100- $\mu$ s response

**With a response time** of 100 microseconds and an estimated price of about \$1,600, a programmable function generator from Krohn-Hite will be among the fastest on the market and, in price, squarely in the mid-range of this type of instrument.

The model 5500R, a rack-mountable solid-state unit, which measures 3.5 by 14 by 19 inches, provides remote programmability of the positive time-duration of the waveform independently of the negative duration, which gives an additional pulse and sawtooth waveform when used in the square-wave and triangular-wave mode. Most benchtop relay systems have such a capability, but Krohn-Hite says this programmability is unique for a solid-state unit. Duration can also be selected manually with two rotary decade switches, providing resolution of one part in 100. Negative-waveform duration can also be selected individually.

Positive and negative waveform peaks can be controlled through a selection of positive, negative, or zero dc offset. For this peak control, the amplitude is halved, and the positive or negative peak is set at 0 v. With no waveform programed, a dc voltage of  $\pm 15$  v may be obtained, its value decreasing in proportion to the amplitude setting.

The frequency of the 5500R ranges from 0.0001 hertz to 5 megahertz; an analog frequency-control input permits frequency to be swept

over a range of 1,000:0 from dc to 1 MHz or to be varied around a programed frequency. Maximum resolution is one part in 5,000, allowing a maximum setting of 5.000. Amplitude can be as high as 30 v peak-to-peak, open circuit, with 0.01-v resolution. When set manually, amplitude has a maximum resolution of 0.01 v at a maximum setting of 15-v peak. Sine-wave distortion is less than 0.5%, and sine-frequency response is better than 0.05 decibel over most of the range.

The 5500R is split into two subassemblies—an analog board with

waveform-generating circuits and frequency-determining networks, and a digital board with optical couplers and field-effect transistors, where the program is brought in and switching is controlled. Forty-four bits of programing are required, and there is one programing ground return. The instrument is compatible with DTL, TTL, and RTL circuits.

Krohn-Hite is aiming the unit at OEMs who build automatic testing, analyzing, or calibrating units. Sales manager Ernest C. Lutfy notes that "speed is important to these users.

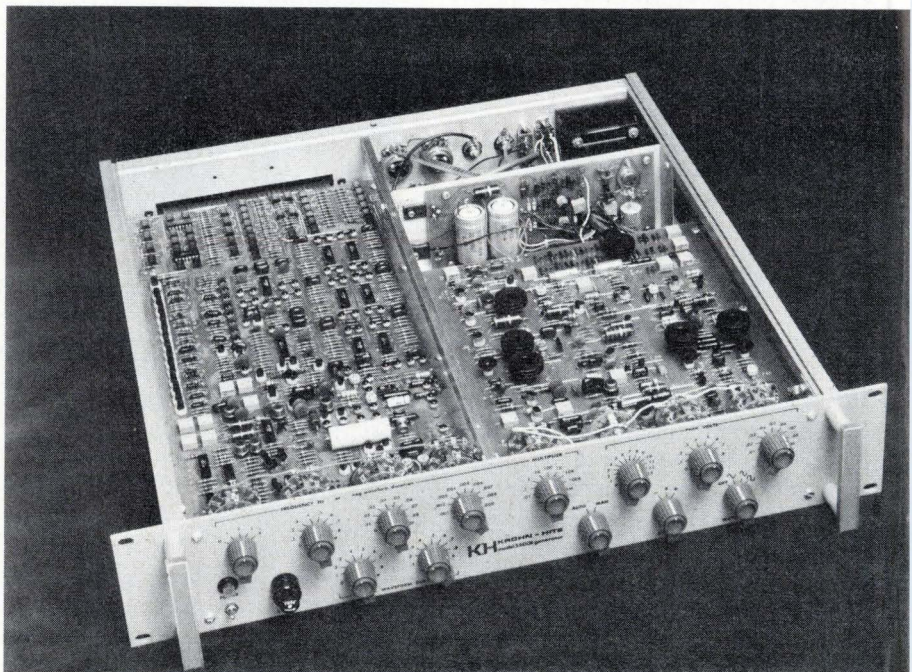



# BEST



Model 5100  
U.S. Pat. No. 3,735,269

## FREQUENCY SYNTHESIZER

- **\$2750**
- **0.001 Hz to 2 MHz Range**
- **0.001 Hz Resolution**
- **Full Programmability** BINARY OR BCD
- **No Switching Transients**
- **Direct Digital Techniques**  
NO MIXING OR PHASE LOCKING
- **High Spectral Purity** —70db SPURIOUS  
—55db HARMONIC
- **High Stability**  $\pm 2 \times 10^{-8}/^{\circ}\text{C}$  STANDARD  
 $\pm 2 \times 10^{-10}/^{\circ}\text{C}$  OPTIONAL
- **Precision Attenuator**  
0 TO 85db IN 1db STEPS PLUS CONTINUOUS CONTROL  
(PROGRAMMABLE ATTENUATION OPTIONAL)
- **High Output Voltage**  
10 VOLTS P-P, 50-OHM SOURCE IMPEDANCE

See us at Booth 1427  
**WESCON** SEPT. 11-14  
1973 WESTERN ELECTRONIC SHOW AND CONVENTION BROOKS HALL, SAN FRANCISCO

ROCKLAND SYSTEMS CORPORATION 230 W. Nyack Rd., W. Nyack, N.Y. 10994 • (914) 623-6666

# ROCKLAND



## New products

... When setting up a system that costs \$50,000 to \$100,000, it saves a lot of valuable computer time if you can run the tests quicker." And with a short transition time between fre-

quency changes, error is less likely to be introduced. Deliveries of the 5500R will begin in December.

Krohn-Hite Corp., 580 Massachusetts Ave., Cambridge, Mass. 02139 [374]

## Converter digitizes radar, TV

**Fast analog-to-digital** conversion suitable for digitizing television video signals or sampling short, fast radar pulses is a new and highly specialized technique, and manufacturers of such equipment include some small pioneering specialist companies. One such company is Micro Consultants Ltd., in England, which has a series of fast a-d and d-a converters.

Scheduled to be introduced at Wescon is a full-MIL-SPEC a-d module, intended primarily for digital removal of clutter from airborne radars. It will also digitize NTSC color video from  $-55^{\circ}\text{C}$  to  $+125^{\circ}\text{C}$ , and PAL color, as well, if a narrower temperature range is acceptable so that the sampling rate of the converter can be increased.

The radar moving-target-indicator function is performed by comparing digitized samples of consecutive returned pulses. The new unit will sample over the full temperature range at 12.5 megahertz so that pulse intervals down to about 80 na-

noseconds can be accommodated. Each pulse must be sampled at the same point, and the company claims it can place the sample center with a regularity to  $\pm 15$  picoseconds. Sample resolution is to 8 bits.

In television, a short sample period is important, and it can be as short as the time it takes the gate to open and then close immediately, which is about 200 ps.

The unit dissipates 10 watts. A preamplifier scales the input to  $\pm 0.5$  V or 1 V. Internal logic is nearly all Motorola's MECL 10,000. The hermetic aluminum casing measures 1.2 by 3.8 by 8.3 in.

Micro Consultants Ltd., Interface House, Croydon Rd., Caterham, Surrey, England [375]



## Pulse amplifier beefs up generator

**A good 50-megahertz pulse generator** with 5-nanosecond rise and fall times,  $\pm 10$ -volt outputs, and seven variable functions—repetition rate, pulse width, delay, amplitude, rise time, fall time, and offset—is an instrument that can easily cost \$2,000. And far from being rarely needed laboratory tools, such pulse generators are fast becoming necessities in today's world of mixed, and rapidly evolving, families of logic circuits.

One way to fight the high cost of these instruments is offered by E-H Research Laboratories in the form of its model 730 pulse amplifier.

This instrument can be used either to convert a simple no-frills pulser into a full seven-function machine, or it can be employed simply to beef up the low-level signal put out by a system clock while maintaining rise and fall times of as little as 5 ns. Since the 730 will be priced at \$400 when it is introduced at Wescon, and since a good bare-bones pulser—like E-H's model 710—costs about the same, a complete seven-function instrument works out to substantially less than \$1,000. And if the user already has a cheap pulser, the cost is reduced to that of the amplifier alone.

# Here's where you can get your 8000A today

**ALABAMA** Mobile (205) 342-9670, Huntsville (205) 881-6220. **ARIZONA** Scottsdale (602) 947-7841. **CALIFORNIA** Glendale (213) 245-9404, Santa Clara (408) 244-1505, San Diego (714) 565-2555. **COLORADO** Denver (303) 934-5505. **CONNECTICUT** Glastonbury (203) 633-0777. **FLORIDA** Orlando (305) 896-4881, Clearwater (813) 443-5854, Ft. Lauderdale (305) 735-7641. **GEORGIA** Atlanta (404) 874-9925. **HAWAII** Honolulu (808) 533-6095. **ILLINOIS** Des Plaines (312) 298-3600. **INDIANA** Indianapolis (317) 244-2456. **MARYLAND** Kensington (301) 881-5300. **MASSACHUSETTS** Lexington (617) 861-8620, Waltham (617) 899-1400. **MICHIGAN** Detroit (313) 892-2500. **MINNESOTA** Minneapolis (612) 884-4336. **MISSOURI** St. Louis (314) 423-1234. **NEW JERSEY** Union (201) 687-8737. **NEW MEXICO** Albuquerque (505) 299-7658. **NEW YORK** Rochester (716) 266-1400, Pleasantville (914) 769-1811. **NORTH CAROLINA** Greensboro (919) 273-1918. **OHIO** Cleveland (216) 267-0445, Dayton (513) 434-7500. **OREGON** Portland (503) 233-7151. **PENNSYLVANIA** Pittsburgh (412) 892-2953, King of Prussia (215) 248-5050. **TEXAS** Richardson (214) 231-2573, Houston (713) 621-0040. **VIRGINIA** Williamsburg (703) 229-5108. **WASHINGTON** Seattle (206) 762-2310, Vancouver (503) 283-3287. **CANADA** Mississauga, Ontario (416) 678-1500, Ottawa, Ontario (613) 725-3354, Longueuil P. Q. (514) 670-1212, Calgary, Alberta (403) 261-0780, Vancouver, B.C. (604) 253-7136.

Or dial toll free (800) 426-0361. If more convenient, simply write us directly or circle the reader service number below.

Address John Fluke Mfg. Co., Inc., P.O. Box 7428, Seattle, Washington 98133.





# Don't hang around waiting for delivery of a low-cost DMM



**Now you can get immediate delivery of the Fluke 8000A, the 3½ digit multimeter bringing new standards of excellence, reliability and value to the low cost field.**

With us, immediate delivery of the most popular digital multimeter ever made (over 15,000 delivered in less than a year), means now—often overnight! And that goes throughout most of the world.

For the name of your nearest source, check the adjacent column listing nearest local sales and service source in your part of the world. Order yours today on a 15-day no obligation trial basis. Use your American Express, BankAmericard, Mastercharge, company purchase order or check. And after you buy, remember we service what we sell. Fluke technical centers are conveniently located throughout the United States, Canada, Europe, and the Far East for fast 48-hour turn-around repair service. Off-the-shelf delivery means you won't be left at the station empty handed.

In the continental U.S., dial our toll free number 800-426-0361 for the name and address of your nearest local source. Or contact us directly by addressing, John Fluke Mfg. Co., Inc., P. O. Box 7428, Seattle, Washington 98133. Phone (206) 774-2211. TWX: 910-449-2850. In Europe, address Fluke Nederland (B.V.), P. O. Box 5053, Tilburg, The Netherlands. Phone 013-67-3973. Telex: 844-52237. In the U.K., address Fluke International Corp., Garnett Close, Watford, WD2 4TT. Phone, Watford, 33066. Telex: 934583. In Canada, address ACA, Ltd., 6427 Northam Drive, Mississauga, Ontario. Phone 416-678-1500. TWX: 610-492-2119.

At \$299 only the Fluke 8000A gives you 26 ranges ac/dc volts—100  $\mu$ v to 1200 v, current—100 na to 2A, resistance—200  $\Omega$  to 20 M $\Omega$ , 0.1% accuracy, rugged case with LED readout and two chip analog and digital LSI circuitry. Options include printer output, HV, RF, and 600A current probes and rechargeable batteries.



**FLUKE**®

Circle 131 on reader service card





## Now there is a choice.

DuPont calls their trichlorotrifluoroethane "FREON" TF. We call ours "BLACO-TRON" TF. So now you have a choice.

That's why BLACO-TRON precision cleaning solvent cleans the same as FREON: Their chemical formulas are identical.

If they're identical, why should you try BLACO-TRON? Service. The

service you get only from Baron-Blakeslee—for 38 years the accepted leader in advanced design precision cleaning equipment and the solvents to go in them.

### **BLACO-TRON**

FLUORINATED SOLVENTS—NOW THERE IS A CHOICE

Give BLACO-TRON—the new kid on the block—a fighting chance. Especially since the machines you are now using to clean with FREON were more than likely developed by Baron-Blakeslee in the first place. Pick up the phone and contact your BLACO-TRON Distributor now—he offers a full line of BLACO-TRON fluorosolvents.



**Baron-Blakeslee**

1620 South Laramie Ave., Dept. FE. Chicago, Ill. 60650—Offices in All Principal Cities.

\*FREON is DuPont's registered trademark for its fluorocarbon cleaning agents.

\*\*BLACO-TRON is Baron-Blakeslee's registered trademark for its fluorocarbon cleaning agents.

Circle 132 on reader service card





Now there is a choice.

**BLACOTRON**

## Call your nearest Baron-Blakeslee "BLACO" SERVICE CENTER for prompt Solvent Service

### New England

General Chemical Corp., Boston, Mass.  
(617) 872-1202  
The Hubbard-Hall Chemical Co.  
Waterbury, Connecticut  
(203) 756-5521

### Metro New York City, Northern New Jersey, Long Island

Baron-Blakeslee, Garden City, N.Y.  
(212) LE9-8680  
(201) 687-7383  
(516) 747-8460

### South New Jersey, Eastern Pennsylvania, Maryland, Delaware

Tri-State Chemicals, Inc.  
Blackwood, N.J. (Philadelphia)  
(215) LO3-5071

### Southeastern United States

Moreland Chemical Co. Inc.  
Spartanburg, S.C.  
(803) 583-8481

Moreland Chemical Co. Inc.  
Greenville, S.C.  
(803) 242-3727

Moreland Chemical Co. Inc.  
Augusta, Ga.  
(404) 722-3751

Moreland Chemical Co. Inc.  
Atlanta, Ga.  
(404) 457-4485

Moreland Chemical Co. Inc.  
Kingsport, Tenn.  
(615) 247-7149

Moreland Chemical Co. Inc.  
Charlotte, N.C.  
(704) 392-4301

Moreland Chemical Co. Inc.  
Greensboro, N.C.  
(919) 292-0624

### Upstate New York, Northwest Pennsylvania

Inland Chemical Corp., Syracuse, N.Y.  
(800) 348-4661

### Indiana, Ohio, Michigan

Inland Chemical Corp.  
Ft. Wayne, Indiana  
(800) 552-4605

Inland Chemical Corp., Toledo, Ohio  
(800) 348-4611

Inland Chemical Corp.  
South Bend, Indiana  
(800) 552-4605

Inland Chemical Corp., Cleveland, Ohio  
(800) 348-4611

Inland Chemical Corp., Lima, Ohio  
(800) 348-4611

### Illinois, Wisconsin, Minnesota, Iowa, Missouri, Nebraska

Baron-Blakeslee, Chicago, Illinois  
(312) 656-7300

Baron-Blakeslee, Milwaukee, Wisc.  
(414) 762-6850

### No. California, Nevada

Baron-Blakeslee, San Francisco, Calif.  
(415) 591-8237

### Oregon, Washington

Baron-Blakeslee, Portland, Oregon  
(503) 252-3468

### Southern California, Arizona

Baron-Blakeslee, Los Angeles, Calif.  
(213) 532-0730

### San Diego Area

Baron-Blakeslee, San Diego, Calif.  
(714) 295-0041

## New products

The 730, like most fast-pulse-out-put amplifiers, must work into a good 50-ohm termination. Some machines require that the user provide the termination; the 730 has a switch that gives the user a choice. Either a high-quality internal load can be put across the output, or the user can attach, say, a 50-ohm cable to the output and put his own termination on its far end.

The output voltage range of the 730 is  $\pm 1$  v to  $\pm 10$  v in two ranges. The voltages, of course, are developed across a 50-ohm load. Rise and fall times are continuously variable from 5 ns to 20 milliseconds. Further, up to  $\pm 5$  v of continuously variable dc offset is provided by the model 730.

Four output modes are provided: normal, complementary, and negative versions of each. Thus pulses



can go from 0 v to some positive or negative value, or they can go from those values to zero. Bipolar operation is provided by the offset control. A positive-going 10-v pulse, for example, starting from a  $-5$ -v baseline, will swing from  $-5$  v to  $+5$  v.

E-H Research Laboratories, 515 11th St.,  
Box 1289, Oakland, Calif. 94604 [376]

## A-d converter comes in small module

Using a lightweight, modular configuration, Datel Systems Inc. has developed an eight-bit analog-to-digital converter that has a conversion time of 200 nanoseconds, is accurate to within 0.4%, and carries a \$1,295 price tag. Datel was able to shave the ADC-VH8B down to a 3-by-5-by-1.5-inch module by combining parallel and serial conversion methods, converting the first four bits in parallel, then the second four bits. This reduces the number of components needed while retaining high speed.

The four most-significant bits are extracted from the analog input sig-

nal by a four-bit a-d converter and stored in an output register. This register controls a four-bit d-a converter that subtracts the analog value of the four most-significant bits from the analog input. The voltage difference is fed to a second four-bit a-d converter to determine the remaining four bits and complete the conversion cycle.

Long-term stability of the VH8B is within  $\pm 0.25\%$  a year. The unit also has a power drain of 8 watts, which Datel claims is much less than that of competing units. Input power requirements are  $\pm 15$  volts dc and  $\pm 5$  v dc. Input impedance is 100

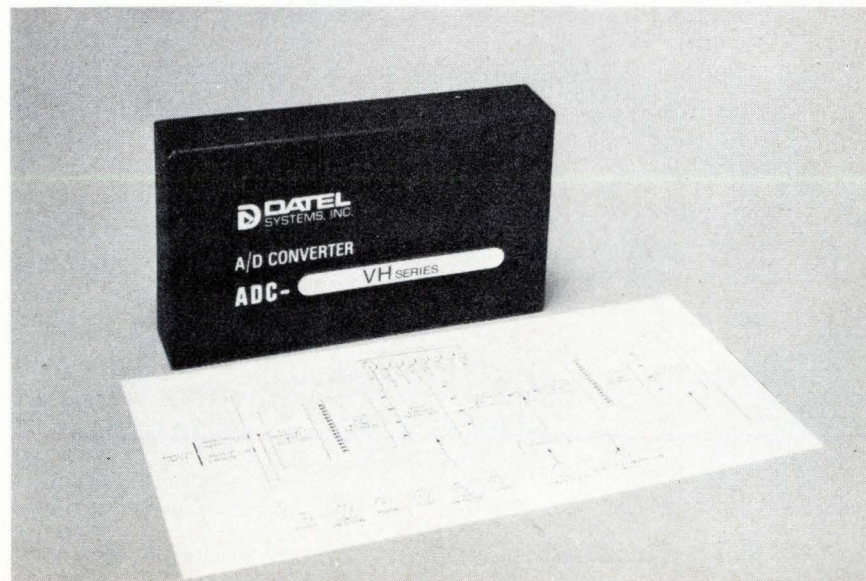





TRAVELING WAVE TUBE AMPLIFIER

HUGHES  
ELECTRON DYNAMICS DIVISION

POWER

RF

HELIUM CURRENT

RF INPUT

RF OUTPUT

POWER ON  
READY RF ON

ONE FULL YEAR WARRANTY.

**HOW DO YOU MEASURE QUALITY?**

In TWTAs, there are a lot of ways. You can measure them by product features.

(Hughes' TWTAs are lightweight, portable, feature interchangeable tubes, and cover 5 frequency ranges — 1 to 18 GHz in 2 power levels of 10 and 20 watts.)

You can measure them by how they're guaranteed. (Hughes' warranty is for one year — *with no hour limit.*)

You can measure them by industry position. (Hughes is No. 1 in the 10 and 20 watt fields.)

You can measure them by the kind of service that goes with them. (Hughes provides professional contact, application engineering, order follow through, on-time delivery, and — if needed — fast and complete warranty adjustments.)

Or you can simply measure them by the company that makes them. (Hughes.)



HUGHES AIRCRAFT COMPANY  
ELECTRON DYNAMICS DIVISION

Write for our catalog: Electron Dynamics Division, 3100 W. Lomita Blvd., Torrance, California 90509. Or call (213) 534-2121.

"See our complete line at WESCON '73 Booth #1226



## New products

ohms, and temperature coefficient is  $\pm 50$  ppm/ $^{\circ}$ C.

To obtain small size, however, the designers have not built in the power supply and sample-and-hold that are usually found in rack-mounted units. The VH8B requires a 5-v supply, and Datel can supply a sample-and-hold unit, the SHM-UH, with a 200-picosecond aperture time and a 50-decibel dynamic range, for \$350.

Datel is aiming the VH8B at the

radar and video markets in particular. The company notes that people in these markets "already have racks of large equipment so they don't care if the a-d converter is big, but a large one takes more power and can be four times as expensive." Also, many companies make high-speed a-d converters in-house, and Datel hopes to penetrate this market.

Datel Systems Inc., 1020 Turnpike St., Canton, Mass. 02021 [377]

## Relay-amplifier switches 10 A

An amplifier-driven general-purpose relay combines Magnecraft's model 388 relay with solid-state-amplifier circuitry to provide a full 10-ampere switching capability with extremely-low-power control, compatible with the low-power signal levels that are associated with integrated-circuit applications. A control power as low as 70 microwatts at 2.4 volts dc will signal the amplifier to energize the relay, which requires a driver-supply voltage of 24 v dc. Relay drop-out occurs when the control voltage decreases to 1.5 v dc or less.

Available in single-pole, double-throw and double-pole, double-throw configurations, the relay comes in plug-in and surface-mount versions. Gold-flashed silver alloy contacts that are 0.187 inch in diameter will switch resistive loads

of 10 A at 28 v dc or 115 v ac. Typical operating time is 12 milliseconds; typical release time is 25 ms. The 3-ounce W388SSC series operates from  $-10$  to  $+55^{\circ}$ C, and polarity and transient protection are standard.

The relays are available from stock at \$13.70 for the SPDT type and \$14.15 for the DPDT in quantities from 1 to 9.

Magnecraft Electric Co., 5575 N. Lynch Ave., Chicago, Ill. 60630 [378]

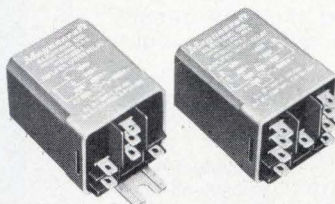

## Data mover lightens computer job

With introduction of the PDM70 (programmable data mover), Digital Equipment Corp. is taking data collection and distribution out of the computer.

The PDM70 can communicate among instruments or between computers and remote instruments via serial ASCII through 20-microampere current loops or EIA levels. It can also be slaved to a central processing unit or be used as a terminal. The unit can handle a variety of inputs to any computer.

The data mover comes in three

basic configurations—the PDM70-A includes a mounting chassis, power supply, and keyboard. The PDM70-B includes, in addition, a 32-character CRT, and the PDM70-C has only the mounting chassis and power supply. All three models have a programmable read-only semiconductor memory, Fairchild's FIFO, to decode incoming ASCII words that tell the module what to do. Another PROM in the control module can be designed to accept any 64-word combination of instructions that the customer desires. The PROM can also be

# Call Hughes for...

## Image Devices



Video storage units: scan conversion memory systems (RS 229)



Direct view and scan converter storage tubes and low light level devices (RS 226)

## Microwave Products



Millimeter-wave sweepers, sources, isolators, modulators, mixers, detectors and diodes (RS 220)

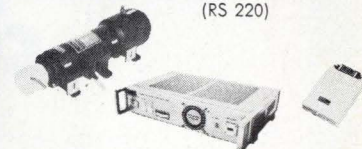

Microwave TWTs, TWTAs and solid state IMPATT and transistor amplifiers (RS 228)

## Lasers

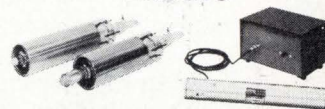

Gas lasers (RS 231)

## Thermal Products



Heat pipes (RS 237)

## Multiplex Systems

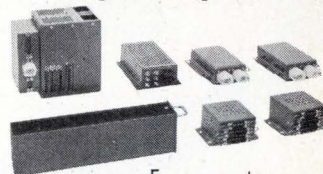

For remote communications/control (RS 230)

(213) 670-1515, Ext. 5964

Telephone for immediate information. For literature, circle reader service (RS) numbers, or write to Bldg. 6, Mail station D-135, Culver City, CA 90230.

# HUGHES

HUGHES AIRCRAFT COMPANY

Industrial Electronic Products



# Number one

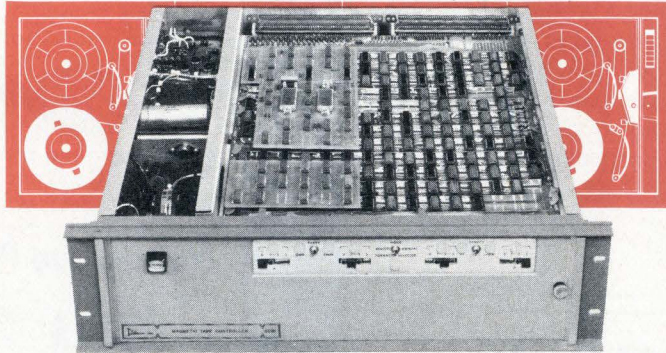

## in magnetic tape control!

DATUM 5091 Series Mag. Tape Systems, Controllers and Formatters outsell (1200 to date) and outperform any others available today. The result of years of developing minicomputer interface experience. Series 5091 consists of controls, cabinet, chassis, power supply, Formatter and Computer Adapter. The Series 5091 Input/Output System consists of a Controller, as many as four magnetic tape recorders, interconnecting cables and connectors.

Select NRZ or Phase-Encoded formats; control 7- and/or 9-track tape units; compatible with computer software while handling multiple-speed, multiple-density tapes; Formatters available if you want to design your own adapter.

It's your choice: complete System, Controller or Formatter.

*Off-the-shelf availability to match these computers:*

PDP8 E/M/I/L	IBM 1130	Honeywell 416
PDP 9	Micro Systems 810	Honeywell 124A
PDP 11	HP 2100	Honeywell 316
PDP 12	HP 2114	Honeywell 516
PDP 15	HP 2115	XDS CF 16
PDP 9L	HP 2116	XDS CE 16
NOVA 800	CAI 816	Univac 1616
NOVA 1200	CAI A16	Univac 1107
	Varian 620/i/L	

Write for specifications  
and prices

Peripheral Equipment Division

# Datum inc

170 East Liberty Avenue ■ Anaheim, California 92801 ■ 714/879-3070

programed through the keyboard. DEC says the bus structure simply consists of two 6-inch wires, R for receive, and T for transmit.

The PDM70 can handle both



analog and digital output data from sources such as balances, transducers, and voltmeters. The data is locally digitized, if necessary, and formatted into ASCII codes for serial transmission to a computer. On the return data loop, the computer's serial ASCII commands control and program remote devices. With a local memory and control option, the PDM70 can serve as a formatter, converting inputs into a form suitable for local output devices such as printers and oscilloscopes.

Control and input-output options are offered with the unit, including a processor interface for use without keyboard or display, and an 8-bit parallel input/output. Up to seven options in any combination can be used with a keyboard/display unit, and up to eight without a keyboard/display.

The system operates in three modes. In the programing mode, the user sets up and controls communications paths between the data source and destination options. Sources and destinations are selected in the addressing mode, and actual data transfer is effected in the



# FREE

## new Heath/ Schlumberger Electronic Instruments catalog

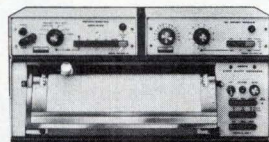

Gives complete details and specifications on hundreds of high performance, budget-conscious instruments for research and industrial applications. Here are just a few examples:

**Programmable strip chart recorder**... 1 mV to 500 V span, continuously adjustable... 23 chart speeds... 0.2% accuracy... floating input... fully programmable for all functions... easy conversion to metric work. \$675.\*

**New 110 MHz frequency counter**... 5 Hz — 110 MHz guaranteed, 2 Hz — 130 MHz typical... 15 mV input sensitivity guaranteed, 3-10 mV typical... input sensitivity control... autoranging with four automatically selected ranges... 1 MHz time base w/1 part in 10<sup>6</sup>/mo stability... 7-digit LED readout. \$325.\*

**Dual trace oscilloscope**... DC-15 MHz bandwidth w/ 24 nsec risetime... 50 mV/cm sensitivity... 200 nsec to 0.5 sec/cm sweep rates... triggered sweep... X-Y capability. \$595.\*

**For your free copy, mail coupon or use reader service number.**

HEATH  
Schlumberger

Heath/Schlumberger Scientific Instruments  
Dept. 531-287  
Benton Harbor, Michigan 49022

Please send new electronic instruments catalog.

Name \_\_\_\_\_

Title \_\_\_\_\_

Company/Institution \_\_\_\_\_

Address \_\_\_\_\_

City \_\_\_\_\_ State \_\_\_\_\_ Zip \_\_\_\_\_

\*Mail order prices; FOB factory.

EK-394



**WE'RE OLD HANDS**

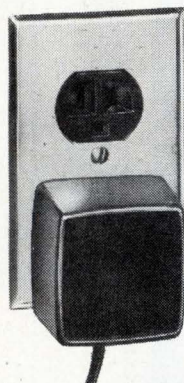
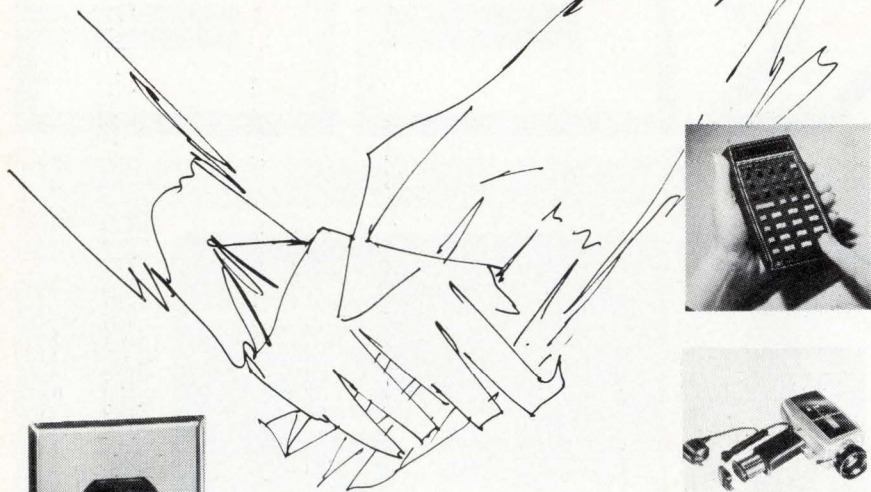

**AT DESIGNING  
AND BUILDING...**

## WALL PLUG-IN CHARGER/CONVERTERS

for all kinds of portable low-voltage operated equipment, i.e.: high-precision calculators, tape recorder/players, movie cameras, strobe lights, radios, monitoring devices, emergency equipment, toys, garden tools

— you name it, we've done it.

**DYNAMIC** has produced to the unique needs of literally hundreds of AC/DC and battery-powered units designed within U/L and CSA standards. Close cooperation with the battery manufacturers also keep **DYNAMIC** right up-to-the-minute on the latest characteristics of the many battery types available. Out of this long line of experiences and accomplishments has also come an expertise in low-cost mass production.

All of this know-how is at your service. Just call or write our Sales Engineering Staff and put-it-to-work for you. Literature available.

516 - 694-6000

**DYNAMIC INSTRUMENT CORP.**

MANUFACTURERS OF POWER CONVERSION AND BATTERY CHARGING SYSTEMS TO THE ORIGINAL EQUIPMENT MANUFACTURER

115 E. Bethpage Rd., Plainview, N. Y. 11803

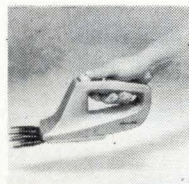
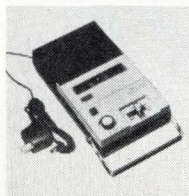
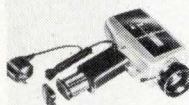
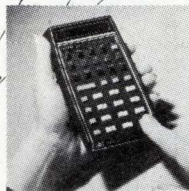

## New products

data mode. The PDM70 can operate at baud rates from 110 to 9,600, all of which are switch-selectable.

DEC plans to sell the PDM70 into laboratory and light industrial areas that use a variety of input and output equipment and need computer interfaces for them.

Delivery time on the module, 19.5 by 22 by 5.5 inches, is 60 days. The PDM70-A is \$1,550, the B model, \$2,050, and the C type \$950.

The Digital Equipment Corp., Maynard, Mass. 01754 [379]

## Multideck switch

A **multideck** rotary switch from Grayhill Inc. allows all its 12 terminal positions plus a common terminal for a switch deck to be terminated in a single printed-circuit board. Earlier designs permitted termination of only half the rotary-switch position on a board—the other half required either a parallel pc board or two decks to provide 12 position-per-pole switching.

The terminals are brought out in

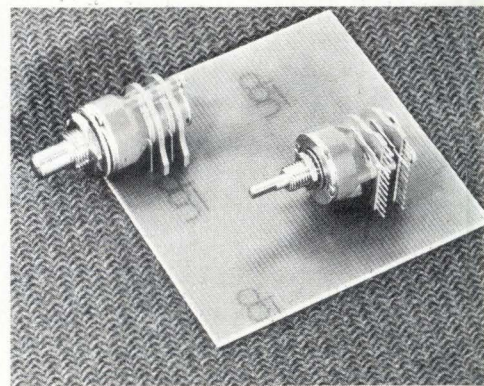

a straight line along one side of the switch and molded into a plastic support frame to eliminate flux contamination. For easy insertion, Grayhill designed the common terminal longer than the position terminal, and when mounted, the unit stands about 1 inch above the pc board. The contact system is rated to make and break 300 milliamperes through 10,000 operating cycles.

The switch will accommodate from two to 12 decks stacked in a single system. Other design vari-



To design engineers, she's  
a great mini-solution for  
instrument & system  
requirements.

To purchasing agents,  
she's a small blessing  
for big money savings.



*Duncan's  
little  
sweetheart  
has something  
for  
everyone.*



# PIXIEPOT<sup>®</sup>

For complete information, specs, prices  
or evaluation samples, call or write:

**DUNCAN ELECTRONICS**  
SUBSIDIARY

SYSTRON  DONNER

2865 FAIRVIEW ROAD • COSTA MESA, CALIFORNIA 92626  
PHONE: (714) 545-8261 TWX 910-595-1128

Circle 139 on reader service card



# DO YOU THINK YOU CAN CONSTRUCT THIS CIRCUIT IN 17 MINUTES\*?

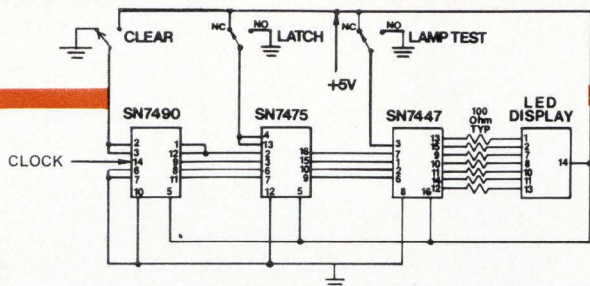

\*Circuit constructed by E&L Instruments Engineering Dept., using standard components and Elite-3, in 17 minutes, 8 seconds.

## YOU CAN WITH THE elite • 3 BREADBOARDING DESIGN SYSTEM

If time is valuable, the versatile ELITE-3 is a must for your lab. Test, design, layout any component combination, ICs, discretes, etc., *without soldering!* Eliminate expensive jumpers; use #22 gage solid wire. All components are reusable. The ELITE-3 includes independent circuit monitor logic lights, isolated toggles and pushbuttons, universal component acceptance, plus more . . . and costs only \$350.

Interested? Write or phone today for complete literature on ELITE-3 and other inexpensive, quality E&L circuit design aids.

See the Elite series, and new E&L products at WESCON Booth 1317

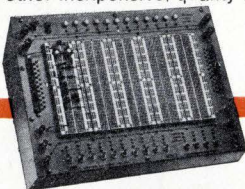

**ELI**

**E&L INSTRUMENTS, INCORPORATED**  
61 First St., Derby, Conn. 06418  
Telephone: 203/735-8774  
TWX: 96-3536 ELI DEBY

Circle 140 on reader service card

# IMMEDIATE DELIVERY! IN STOCK

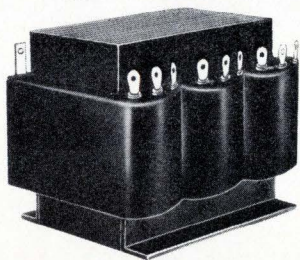
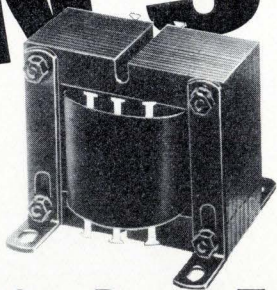

## Rectifier Power Transformers and Chokes

**SIGNAL HAS THE LARGEST SELECTION OF OUTPUT RATINGS AVAILABLE.**

- **Most Economical—No Minimum order Requirement.**
- Ideal for Single or Dual DC Supplies.
- Wide Diversity of Ratings—5 to 300V, 0.1A to 200 Amp.
- Very High Current Units Up to 1000 Amps, Single and 3 Phase.

**Signal transformer co. inc.**

1 Junius St., Brooklyn, N.Y. 11212  
Telephone (212) 498-5111

Send for Free Catalog also listing extensive lines of Printed Circuit Plug-In Transformers, Flat Plug-Ins and Constant Voltage Transformers.

140 Circle 186 on reader service card

## New products

ations include a choice of 30°, 12-position, or 36°, 10-position angles-of-throw, shafts 0.250 inch or 0.125 in. in diameter; and one or two poles per deck with either angle or throw. The switch operates through 360°.

Grayhill Inc. 561 Hillgrove Ave., La Grange, Ill. 60525 [380]

## DIP sockets

A **low-cost** line of DIP sockets is designed particularly for high-volume commercial use. Developed by Circuit Assembly Corp., the sockets have a low-profile cross-section, 0.145 inch above the printed-circuit board, with an over-all height above the board of 0.240 in.

They are available in a variety of sizes, including 8, 14, 16, and 18 pins on 0.300-in. centers; 22 pins on 0.400-in. centers; and 24, 28, 36, and 40 pins on 0.600-in. centers. They

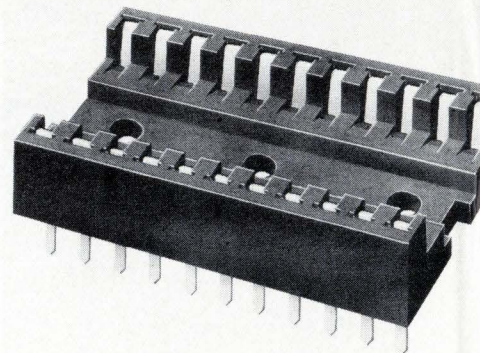

will accept both narrow IC chips and standard-width dual in-line package plugs and interconnects.

The standard line is furnished with tin-plated contacts, and gold-plated contacts can be supplied when the application requires them. The contacts are solder-tail length (0.145 inch) and are designed with a special configuration to prevent wicking during the soldering operation.

A single leaf spring provides contact with the mating plug or chip as well as providing a beveled entry.

Delivery is from stock.

Circuit Assembly Corp., 3169 Red Hill Ave., Costa Mesa, Calif. 92626 [442]



# For built-in reliability, design with "Scotchflex" Flat Cable/Connector Systems.

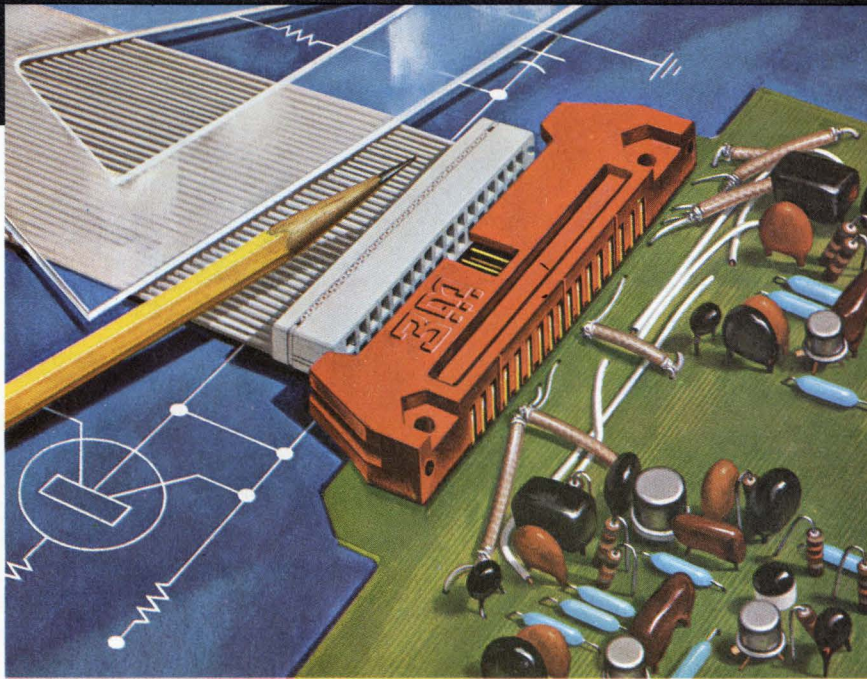

"SCOTCHFLEX" IS A REGISTERED TRADEMARK OF 3M CO.

"Scotchflex" Flat Cable and Connectors can offer you trouble-free packaging for your next generation equipment.

There's built-in reliability for your circuit inter-connects. Our flat, flexible PVC Cable has up to 50 precisely spaced conductors. The gold plated U-contacts are set into a plastic body to provide positive alignment. They strip through the insulation, capture the conductor, and provide a gas-tight pressure connection.

Assembly cost reductions are built-in, too. "Scotchflex" Connectors make up to 50 simultaneous connections without stripping or soldering. No special training or

costly assembly equipment is needed.

Off-the-shelf stock offers you flat cable in a choice of lengths and number of conductors from 14 to 50. Connector models interface with standard DIP sockets, wrap posts on .100 x .100 in. grid, or printed circuit boards. Headers are available to provide a de-pluggable inter-connection between cable jumpers and printed circuit boards (as shown). Custom assemblies are also available on request.

For full information on the "Scotchflex" systems approach to circuitry, write to Dept. EAH-1, 3M  
Center, St. Paul, Minn. 55101.

**3M**  
COMPANY





**DOWN GO COST, SIZE, WEIGHT, VOLUME.**

DESIGN SMALLER WITH  
NEW SANGAMO

**POWER  
Pack™**

TYPE 100 CAPACITORS

Imagine a much smaller, much lighter weight computer grade electrolytic capacitor. It's a breakthrough in technology that lets you break through in design.

You can use fewer capacitors at less cost because the Sangamo Type 100 features high ripple current capability up to 46 amps at 120 Hz @ 65°C. Regulate the power supply better thanks to ESR values ranging from .0062 ohms to .052 ohms at 120 Hz. And count on additional savings since you get no temperature or voltage derating with operating temperatures that range from -55°C to 105°C.

What's more, all-aluminum construction of the Type 100 allows higher internal temperature without

deterioration. And excellent impedance vs. frequency response over the entire temperature range means power supplies can operate more efficiently in the 20 to 40 KHz range.

For details on Type 100 Power Pack Capacitors, just write to Jim Dutton, Marketing Manager, Aluminum Electrolytic Capacitors, Sangamo Electric Company, Pickens, S. C. 29671, U.S.A. Or call him at (803) 878-6311 and ask for Bulletin 2271.

Then start thinking small.

**SANGAMO  
ELECTRIC COMPANY**

**TYPE 100 TYPICAL RATINGS**

Rated VDC	1-3/8" x 4-1/8"						2" x 4-1/8"						3" x 5-5/8"					
	Capacitance (mfd)	Max. ESR 120 Hz (Ohms)	Max. Ripple Current @ 120 Hz (rms amps)			Capacitance (mfd)	Max. ESR 120 Hz (Ohms)	Max. Ripple Current @ 120 Hz (rms amps)			Capacitance (mfd)	Max. ESR 120 Hz (Ohms)	Max. Ripple Current @ 120 Hz (rms amps)					
			65°C	85°C	105°C			65°C	85°C	105°C			65°C	85°C	105°C			
10	20,000	.0146	22.5	17.0	6.5	45,000	.0084	31.5	22.5	8.5	170,000	.0077	45.0	31.0	10.0			
15	14,000	.0147	22.0	16.5	6.5	32,000	.0087	31.0	22.0	8.5	110,000	.0079	45.0	30.5	10.0			
25	9,000	.0154	21.5	15.5	6.0	19,000	.0091	30.5	21.5	8.0	73,000	.0080	44.0	30.0	9.5			
50	4,400	.0168	19.5	13.5	5.0	9,800	.0101	29.0	20.0	7.0	36,000	.0087	42.0	29.0	9.0			

390



# 4,096-bit-RAM uses one-transistor cell

Memory offers small chip area, high production yield, and low cost; key to structure is on-chip sense amplifier to detect low logic signals

by Larry Armstrong, Midwest bureau manager

The 4,096-bit n-channel random-access memory products now going to market form a high mark in memory-component design. And the latest, the TMS4030, a 4,096-bit RAM from Texas Instruments, uses a single-transistor memory cell instead of three transistors per cell, thus offering small cell size and chip area, high yield, and low cost.

The key to implementing this simpler structure is a new on-chip sense amplifier that is capable of detecting the lower (200-millivolt) logic signals associated with one-transistor design, thus overcoming a major hurdle to high-density, low-cost RAM development.

**New workhorse.** The TMS 4030, the first of a class of RAMs combining high performance and high packing density, is considered by many designers of memory systems as the type of semiconductor device that will eventually deliver a mortal blow to the magnetic core as the workhorse component of the main-frame industry.

The 4,096-word-by-1-bit n-channel RAM has a maximum access time of 300 nanoseconds and a 710-ns read/modify/write cycle time. Timing waveforms for both read and write cycles are similar, with a minimum cycle time of 470 ns. The TI design team developed a novel input circuit to achieve full standard TTL-input compatibility without the use of pull-up resistors. To reduce overhead and simplify system design, says Daniel Baudouin, MOS marketing strategy manager, address registers and a chip-select input register are on the chip.

The TMS 4030 uses a single external clock, and that low-capacitance chip-enable clock input, which

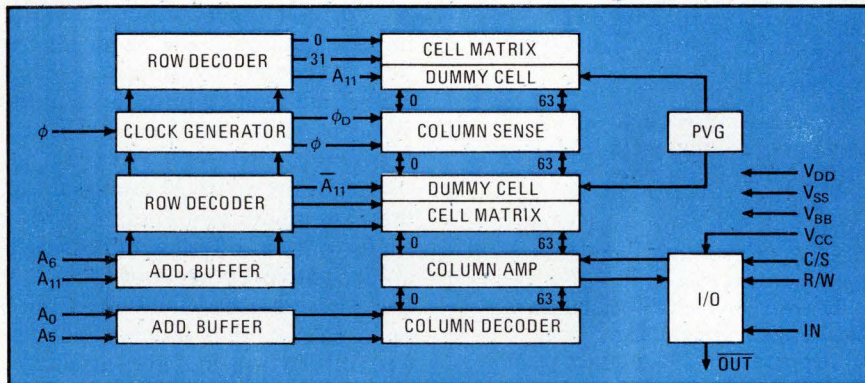

**Memory component.** Internally, the 4,096-bit random-access memory is a simple structure, organized in 64 columns by 64 rows, with columns and rows selected through a decoder.

acts as controlling clock to activate the chip operations and as a strobing pulse for the built-in registers, requires a positive voltage swing of 12 v.

"The output buffer, too, which provides direct TTL compatibility, features the three-state configuration and a fan-out of two TTL gates," Baudouin says. Output is in the high-impedance, or floating, state when the chip-enable clock is in the low state or when the chip-select input is in the high state. This, TI says, makes its RAM easy to expand in organization for a low-power memory system. The TMS 4030 dissipates 400 milliwatts in operation and 2 mw in standby. It must be refreshed every 2 ms.

TI uses a simple, single-transistor memory cell. The firm's Houston-based designers traded off the larger, more easily detected signals of the three-transistor cell for the easier process and layout rules, and therefore better yields, that TI says are possible with the smaller memory cell. Since the one-transistor cell size is determined by the sensitivity of the sense amplifier, the

design team accomplished a cell size of 2 square mils by developing the on-chip sense amplifier. Chip size is 160 by 180 mils.

Because of its simple timing requirements and on-chip capabilities, the TMS 4030 requires only a small number of supporting circuits. For example, a 4,096-word-by-17-bit minicomputer-memory design using TI's 4,096-bit RAM would require a single TTL-to-MOS converter/driver, while the same memory built with 1103-type 1,024-bit RAMs requires 39 converter/drivers and 17 sense amps. Also, unlike earlier 4,096-bit RAMs, TI's is priced at less than that of four 1103s, Baudouin says.

Available now from stock, the TMS 4030 is assembled in a standard 22-pin dual in-line ceramic package, "and will be available in plastic later this year." In 100-piece quantities, the device sells for \$26.35; 25-99, \$33; and 1-24, \$40. Pinout is similar, but not identical, to the recently introduced 600-ns Intel part [*Electronics*, July 19, p. 29].

Texas Instruments Incorporated, Inquiry Answering Service, P.O. Box 5012, M/S 308, Dallas, Texas 75222 [339]



# How to ship small packages in a big hurry.

## DELTA'S DASH

DELTA AIRLINES SPECIAL HANDLING

Delta guarantees delivery on the flight or routing you specify between most Delta cities.

Packages accepted up to 50 lbs. with length plus width plus height not to exceed 90" total, with only one dimension exceeding 30"

Delivery to Delta's passenger counter or air freight terminal at the airport at least 30 minutes prior to scheduled departure time.

Pick-up at DASH Claim Area next to airport baggage claim area 30 minutes after flight arrival at destination.

Charges for DASH shipments are nominal. Delta reservations will be pleased to quote actual charges between specific points.

Payments accepted in cash, by company check, most general-purpose credit cards, special credit arrangements or on government shipments by GBL. **DELTA**  
The airline run by professionals

### Rate examples (Tax included)

Atlanta-Washington . . . . .	\$21.00
Boston-Miami . . . . .	\$26.25
Cincinnati-Louisville . . . . .	\$21.00
Cleveland-Phoenix . . . . .	\$26.25
Los Angeles-New Orleans . . . . .	\$31.50
Dallas-Los Angeles . . . . .	\$26.25
San Francisco-Atlanta . . . . .	\$31.50
Philadelphia-Houston . . . . .	\$26.25
New York-Tampa . . . . .	\$26.25

For full details, call Delta reservations.



## Delta is ready when you are!

## New products

### Instruments

## Pulser offers six modes

50-MHz single-channel generator has variable rise/fall controls

A single-channel pulse generator has been added to the 50-megahertz line developed by Interstate Electronics and will be introduced at the Wescon show in San Francisco, Sept. 11-14.

Part of the series 20 family of IEC, the new model P24 operates with a single output offering offset-selectable positive or negative pulses. It has adjustable rise/fall times from 5 nanoseconds, plus independent rise and fall controls that are variable by as much as 100:1.

Single-channel performance lowers the P24's price to \$875, which is

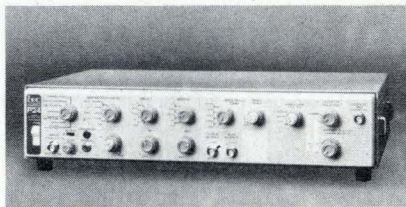

20% lower than the top-of-the-line model P25.

The new unit's master mode control determines any of six modes—single pulse, double pulse, trigger, gate, triggered double pulse, and pulse amplifier—as well as the constant-duty-cycle mode that is common to all models of the series 20. This last capability is designed for any system or circuitry application (transmission-line frequency-response analysis, for example) that requires a symmetrical pulse, regardless of frequency changes. The constant-duty-cycle mode sets a timing relationship between pulse width and period that stabilizes the duty cycle while repetition rates are varied.

As in other series 20 models, pulse rates are generated from 1 hertz to 50 megahertz, with ampli-

tudes to 10 volts across a 50-ohm load. Overshoot and ringing are specified at less than 5% of pulse amplitude, and jitter falls within 1%. A three-step attenuator with variable control provides maximum resolution at all signal levels. Interface features include a BNC connector for input signals, and separate signal level and slope adjustments. Delivery time, following Wescon, will be 45 days.

Interstate Electronics Corp., 707 East Vermont Ave., P.O. Box 3117, Anaheim, Calif. 92803 [351]

## Wave analyzer/recorder built for detailed noise studies

Designed for detailed noise-analysis studies, the model 1523-P4 wave analyzer plug-in is intended for use with General Radio's model 1523 graphic level recorder. The result is a compact instrument for narrow-band analysis/recordings, and, it can be used for high-resolution spectral analysis, swept-frequency analysis with a tuned detector, and measurements of amplitude versus time at selected frequencies. Bandwidth is 10 hertz and 100 kilohertz, dynamic range is 80 decibels, and analysis range is 10 Hz to 80 kHz. The 1523 recorder mainframe is priced at \$2,575 and the 1523-P4 plug-in at \$3,500.

General Radio, 300 Baker Ave., Concord, Mass. 01742 [353]

## Time-delay generators offer high-voltage output

Four time-delay generators are designated the models 453, 455, 436, and 438. The 453 and 455 feature high-voltage output greater than +100 volts into 50 ohms and offer

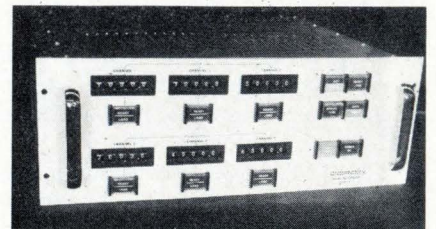



***CINCH CONNECTORS***

***IRC RESISTORS***

***UTC TRANSFORMERS***

***GLOBE MOTORS***

***HOLYOKE WIRE & CABLE***

***CINCH-GRAPHIK***

***IRC POTENTIOMETERS***

***SEMICONDUCTORS***

***SUPERMET PRODUCTS***

***CINCH-MONADNOCK***

***CAPACITORS***

***ELECTRONIC FUNCTIONS***

***CONSUMER INTERNATIONAL***

You know us well enough to call us by our first name...



# NEW IDEA!

## TIP-DIP™ DOUBLE-DENSITY

WIRE-WRAP®  
I.C. PANELS  
Pat. Pending

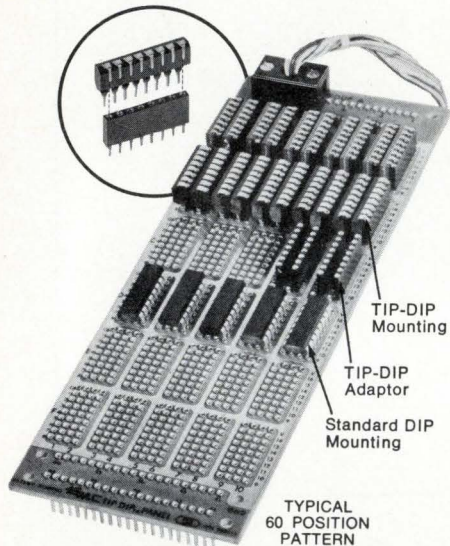
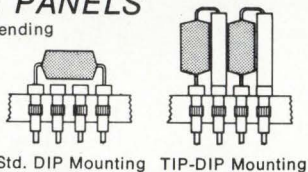

Add more IC's (up to twice as many) on Wire-Wrap panels that fit your present racks! The TIP-DIP concept: reformed DIP leads + Adaptor = more DIP's per inch and shorter wire lengths for faster switching. Standard or Custom Panels. Press available for bending leads.

**ELECTRONIC MOLDING CORP.**  
96 Mill St., Woonsocket, R. I. 02895  
(401) 769-3800



### New products

100-nanosecond increments of time delay. The model 453 has three channels and the 455 six channels, which can be triggered simultaneously, either by a common trigger or sequentially. The models 436 and 438 combine the high-voltage output with a low jitter—less than  $\pm 1$  ns referenced from either a trigger input to  $T_0$  or from  $T_0$  to the delayed outputs. The 436 is a three-channel instrument, while the 438 offers six channels.

Cordin, 2230 S. 3270 West, Salt Lake City, Utah 84119 [355]

Interval meter measures bounce time in relays

A digital meter for measuring the contact bounce time of a pair of closing contacts in relays, contactors, and switches can be used in-

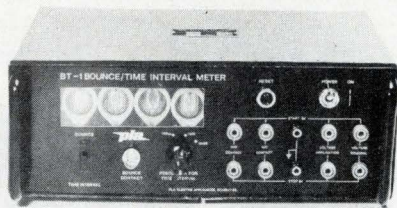

stead of an oscilloscope. Designated the model BT1, the time-interval meter measures bounce time from 50 microseconds to 99.99 milliseconds and measures operate-release time of relays, trip-on time of circuit breakers, or travel time of switch contactors from 100  $\mu$ s to 99.99 seconds. The crystal-controlled time-base generator has a maximum error of  $\pm 0.1\%$ .

PLA Electro Appliances, Thakor Estate, Kurla Kiroi Rd., Vidyavihar West, Bombay-400-086, India [357]

Function generator offers trapezoidal waveform

A function generator called the model 162 provides a trapezoidal waveform that features variable width and slope controls; thus, pulses may be generated with variable rise and fall times. There is also

a variable symmetry control which produces fixed rise- and fall-time pulses and sawtooth waveforms. The 30-megahertz instrument pro-

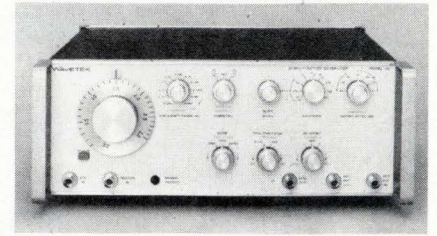

vides continuous operation and may be triggered or gated for single-cycle or tone-burst output by either an external voltage or a manual trigger. Wavetek, Box 651, San Diego, Calif. 92112 [358]

Strip-chart recorders measure dc to 100 Hz

The series GR-710C and GR-720C strip-chart recorders provide single- and dual-channel recording in compact packages designed to complement such systems as: pulmonary-function analyzers, industrial-noise monitors, and physiological-func-

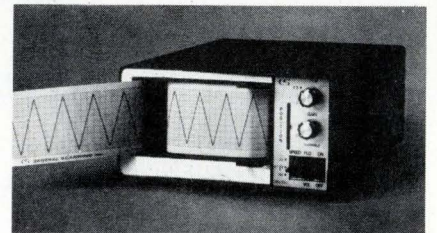

tion monitors. The motors in the recorders are designed for frequency responses from dc to 100 hertz and use magnetic circuits to permit tighter control of pen position. The recorders also have electromagnetically controlled damping for minimum square-wave overshoot.

General Scanning Inc., 80 Coolidge Hill Rd., Watertown, Mass. 02172 [359]

Sweeper covers the 0.5 to 500 MHz range

The Marka Sweep 9060 is a small instrument providing the features of a full-size sweeper. The frequency



**TRW<sup>®</sup> CINCH CONNECTORS**  
**TRW<sup>®</sup> IRC RESISTORS**  
**TRW<sup>®</sup> UTC TRANSFORMERS**  
**TRW<sup>®</sup> GLOBE MOTORS**  
**TRW<sup>®</sup> HOLYOKE WIRE & CABLE**  
**TRW<sup>®</sup> CINCH-GRAFIK**  
**TRW<sup>®</sup> IRC POTENTIOMETERS**  
**TRW<sup>®</sup> SEMICONDUCTORS**  
**TRW<sup>®</sup> SUPERMET PRODUCTS**  
**TRW<sup>®</sup> CINCH-MONADNOCK**  
**TRW<sup>®</sup> CAPACITORS**  
**TRW<sup>®</sup> ELECTRONIC FUNCTIONS**  
**TRW<sup>®</sup> CONSUMER INTERNATIONAL**

**We all have the same first name.**

More important, we all operate under the same philosophy, with the same standard of quality, reliability and service. Each of us specializes in a particular area of manufacturing. But not as separate companies. As the operating units of one entity. TRW Electronic Components.

That means you can enjoy all the unarguable advantages of having a single, reliable source for your electronic needs.

Between us, we make over 300 different kinds

of electronic components. And, among us, we have the ability to make whatever you want. High-technology, high-volume—or both. It's all in the family. Or can be.

So it will pay you to get familiar with us, to think of us on a first name basis. In this case familiarity breeds...contentment. With TRW reliability, quality, and service for the components you need. Because we can supply them.

And because we are TRW.

**TRW<sup>®</sup> ELECTRONIC COMPONENTS**

10880 Wilshire Blvd., Los Angeles, CA. 90024



**Finally!**  
**A filter so precise,**  
**filter characteristics**  
**for every setting**  
**are printed**  
**on top.**

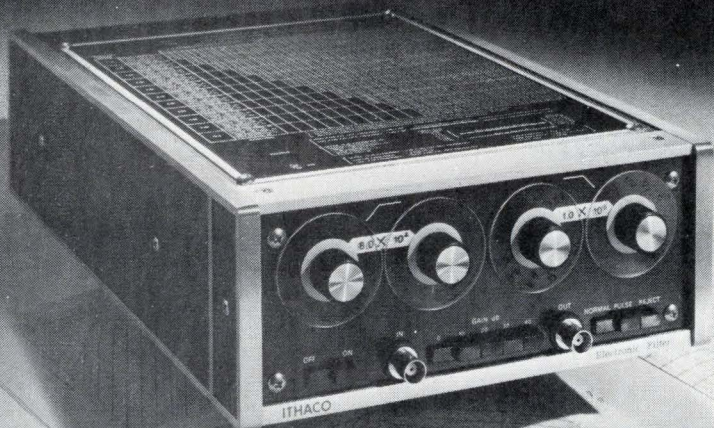

We've built a variable electronic filter that's so precise, it has enabled us to print the cutoff frequencies, center frequency, bandwidth, noise bandwidth and filter gain, for every setting, *on top of the instrument*. Besides being the easiest-to-use filters on the market, our 4200 series filters are twice as accurate, have less than half the self-noise, and provide 10 dB greater outband rejection than any other filters. Frequency coverage is .01 Hz to 1 MHz. Built-in selectable post-filter gain and remote preamplifiers are optional. A Butterworth response is used in the NORMAL mode and a Bessel response in the PULSE mode (transient response is superior to conventional "RC" or "Low Q" modes of other filters).

The price? \$695.

For complete specifications and your free copies of our variable electronic filter application notes, write to: Ithaco, Inc., Box 818-7R, Ithaca, New York 14850. For immediate response, call Don Chandler at 607-272-7640 or TWX 510-255-9307.

**ITHACO**

Visit us at Wescon September 11-14 Booth # 1028

## New products

range covered is from 0.5 to 500 megahertz, and sweep width is 500 MHz. The instrument also provides a 0.25-decibel flatness, as well as digital readout of center frequency, continuously variable control, and



continuously variable sweep-width control. Sweep repetition is alterable from 1 sweep per 10 seconds to 100 sweeps per second, and sweep duration (or scan rate) can be set from 2 to 5 milliseconds, thus permitting use in sweep-testing of CATV systems. Price is \$1,150.

Kay Elemetrics Corp., 12 Maple Ave., Pine Brook, N.J. 07058 [356]

## Sweeper-signal generator covers 1 to 18 gigahertz

Octave-band limitations and their associated problems are said to have been overcome by the model 9535 broadband sweeper-signal gener-



ator, which provides full-sweep coverage of L, S, C, X, and Ku bands in a single-range, self-contained instrument. The unit makes it possible to use a single setup to test over the range from 1 to 18 gigahertz or over any combinations of selected portions of these ranges.

Narda Microwave Corp., Plainview, N.Y. 11803 [360]



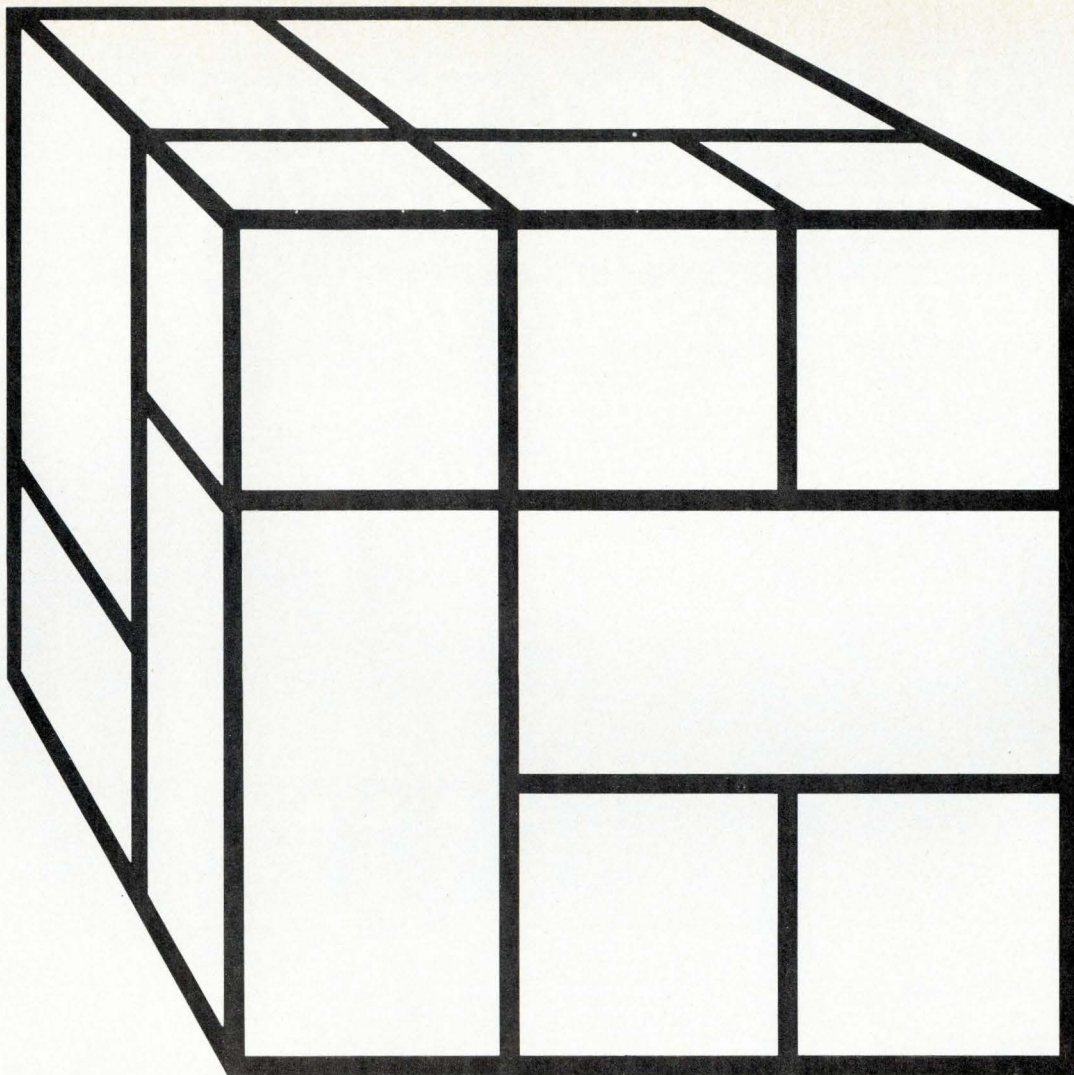

## E-H MODULAR SYSTEMS

**Building the solution to your measurement problem.**

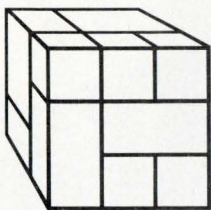

An E-H 4800 Series system is a collection of field-proven instrument modules that have been integrated to do a specific job. Jobs that are too large for our bench-top instruments, too small for

our large computer-controlled test system. The kind of system you would build yourself — if you had the time.

But E-H already has done most of the work for you.

We've designed a system that you can configure to suit your exact requirements. It contains the right stimulus and measurement modules for your applications, all controlled by a special-purpose, test-oriented system controller using a simplified test language.

A system like this can solve a variety of testing problems. It can handle measurement-only

applications, such as the measuring and interpreting of analog or digital signals, or the complete stimulus, interface, and measurement problem. This includes testing digital or analog ICs, PC boards, black boxes, passive components, delay lines, and instrument and module calibration. You can use it for engineering evaluation, incoming inspection or production line testing.

Write for our brochure; it contains an E-H 4800 system configurator to get you started. Then call our application engineers.

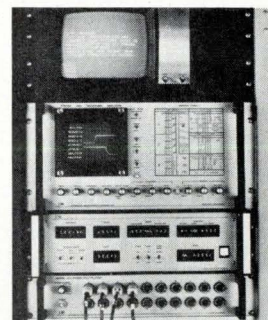

**E-H RESEARCH  
LABORATORIES, INC.**

515 11th Street, Box 1289  
Oakland, California 94604  
(415) 834-3030





# We packed even more circuitry into CTS cermet resistor networks.

8,-14,-16 and -18 lead styles  
Series 760 Dual In-Line Packages.

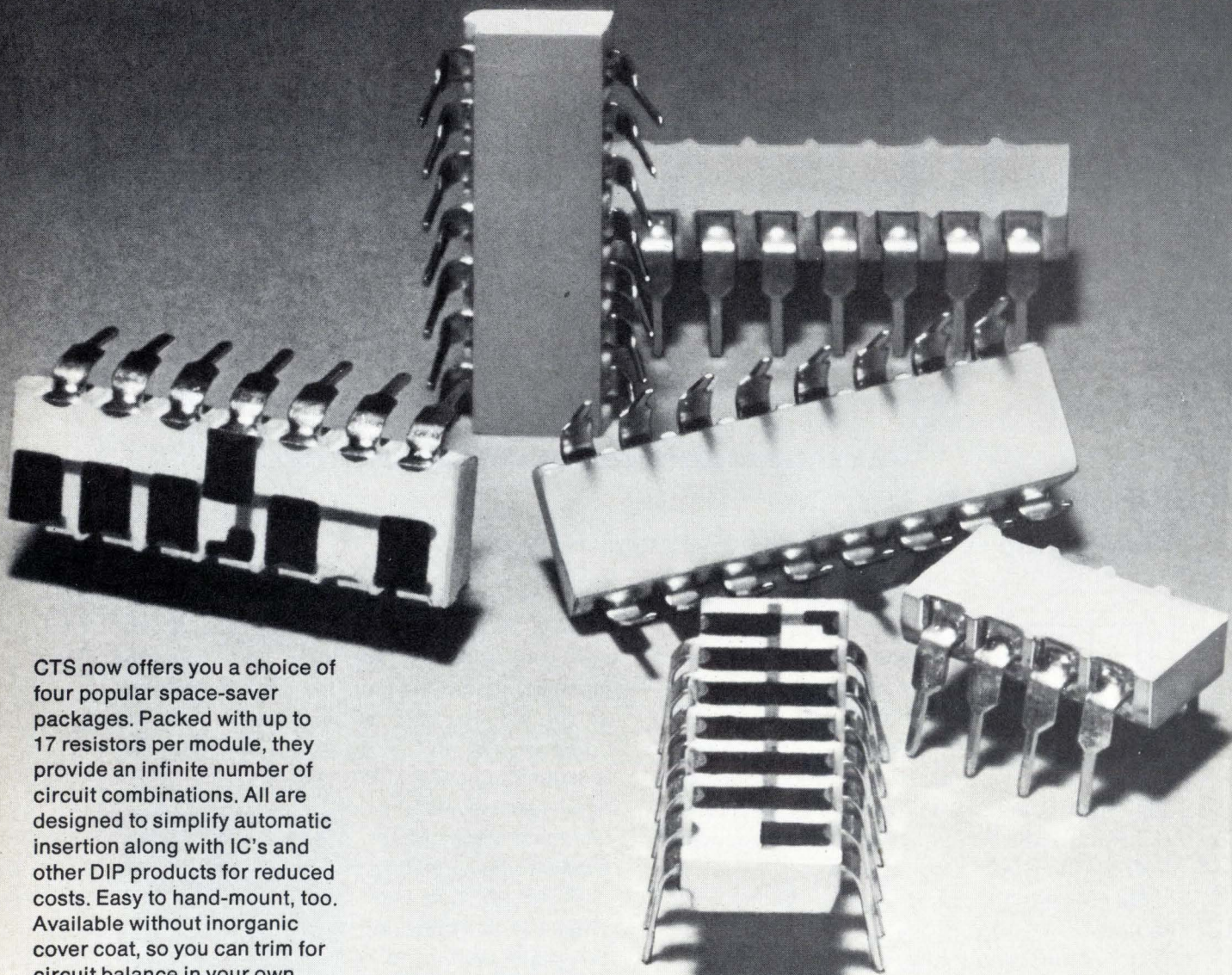

CTS now offers you a choice of four popular space-saver packages. Packed with up to 17 resistors per module, they provide an infinite number of circuit combinations. All are designed to simplify automatic insertion along with IC's and other DIP products for reduced costs. Easy to hand-mount, too. Available without inorganic cover coat, so you can trim for circuit balance in your own plant. 5 lbs. pull strength on all leads; .100" lead spacing; rated up to 2 watts on 18 lead style. Choose from standard circuit available for immediate delivery (see data sheet 3760... or custom design to specifications).

CTS of Berne, Inc., Berne, Indiana 46711. (219) 589-3111.

Series 750 edge mount cermet resistor packages available in infinite number of resistor patterns and wide selection of package configurations.

**CTS CORPORATION**

Elkhart, Indiana



A world leader in cermet and variable resistor technology



## New products

Packaging & production

### Tester checks up to 360 pins

Digital circuit system is expandable from 12-pin minimum by adding modules

An automatic digital-assembly-test system from Hewlett-Packard Co. checks digital circuits in any combination of input and output signals to a maximum of 360 pins.

Because the system, designated the model 9560, tests all pins of a unit under test simultaneously, it is fast. And it's flexible—different units under test can be handled without interface wiring because pins are set up as inputs or outputs by the test program. Users in manufacturing and maintenance fields can buy only the capacity needed, and then expand from a minimum 60-pin capability to 360 pins by adding 12-pin test modules.

Reference circuits are not required for the 9560 because testing is performed from stored test patterns or truth tables. The test rate can be as high as 22,000 patterns per second, depending on how many pins change state from one pattern to another.

The 9560 provides up to eight programmable digital input and output reference levels. It accommodates up to 10 programmable power supplies for unit-under-test power. These supplies also provide

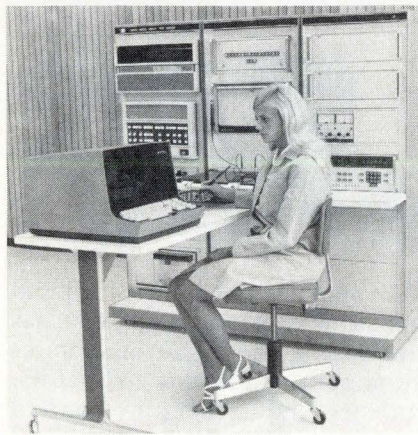

programmable current limits.

Test programs and fault diagnostics are written in H-P's ATS Basic language, a high-level interpretive language using English-like mnemonics. Computer-aided generation of test programs and fault diagnostics are available as services or can be purchased as a software package.

The 9560 is available in two versions: the B type is a paper-tape system, and the D type is a dual replaceable-disk-memory system. The disk memory offers immediate access to virtually unlimited storage of test and diagnostic programs, as well as storage of test data.

Prices for the 9560 system start at \$53,900.

Inquiries Manager, Hewlett-Packard Co., 1501 Page Mill Rd., Palo Alto, Calif. 94304 [391]

### Test system handles MOS and bipolar LSI devices

Capable of testing at the wafer level or completely packaged units at output speeds up to 10 megahertz, a cascaded-controlled system is designed for functional and parametric testing of both MOS and bipolar LSI devices.

Designated the MD-154, the system tests random-access and read-only memories, shift registers, and other standard products, as well as the new type of random-logic devices. It is designed for the LSI user as well as manufacturers, and it is easily programmed without operators' having to learn new languages. The system offers on-line front-panel programming capability, as well as the off-line technique of coding the test onto tapes. Engineering-characterization software is also available to specify the operating regions—including Schmoop plotting, rise-time and delay-time measurements—of both memory and random-logic devices.

Features of the MD-154 include testing up to 48 channels at data rates as high as 10 MHz; complete data analysis and device characterization; variable pin electronics that can be optimized for a single device;

and simultaneous or independent operation of dc parametric and high-speed functional tests.

Macrodata Corp., 6203 Variel Ave., Woodland Hills, Calif. 91364 [399]

### Delay-line winder offers automatic tap puller

The model BRS delay-line winder includes an automatic tap puller. The basic machine is a high-precision continuous-strip winder with speeds to 1,000 rpm and a feed rate from 10 to 2,000 turns per inch. The

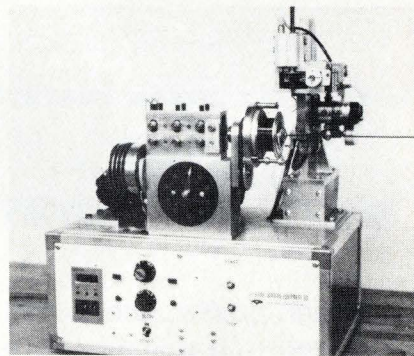

unit also has change gears that may be compounded to provide intermediate feeds in increments as small as 0.00001 inch. The machine head accepts flat, rectangular, or round forms as large as 1/2 inch in diameter.

Coil Winding Equipment Co., Railroad Plaza, Oyster Bay, N.Y. 11771 [393]

### Pc connectors are card-receptacle type

The GKD and GPC series of card-receptacle printed-circuit connectors are designed for industrial-electronics and office-machinery applications. Contacts are age-hardened beryllium-copper with bellows or

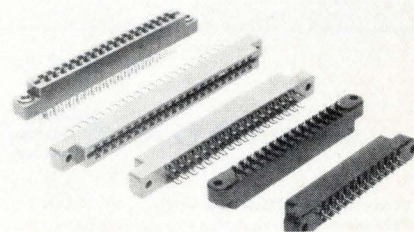



your best value is a

# TRYGON

**SYSTRON - DONNER  
POWER SUPPLY**

**QUALITY/RELIABILITY/SERVICE**

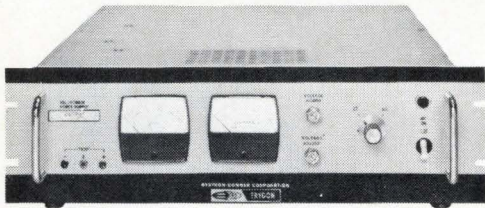

**VP Series  
\$595**

A high power, economical systems supply that powers and protects critical and sensitive IC circuits.

<sup>52</sup>  
Up to ~~30~~ <sup>52</sup>VDC Up to 135AMPS  
in your choice of ranges

- Adjustable current limiting
- Low Noise
- Meters and Overvoltage Protection optionally available

*expanded Series -  
New ratings added!*

**FEATURES** • Standard ratings are 5V/135A, 12V/90A, 15V/85A, 24V/60A, 28V/50A • automatic load share paralleling • low output impedance • remote sensing and programming • 0.02% line regulation • 0.05% load regulation • less than 1mV RMS ripple . . . all for only \$595.

*48V/30A 8V/115A*

Write directly or call your local Scientific-Devices sales office for complete specifications and applications.

**TRYGON ELECTRONICS**  
SUBSIDIARY

**SYSTRON**  **DONNER**  
CORPORATION

1200 Shames Drive, Westbury, N.Y. 11590 (516) 997-6200

The Systron-Donner Instruments Group:

Concord Instruments  Computer Systems  Datapulse  Kruse Electronics  Microwave  Trygon Electronics

## New products

cantilever configurations yielding an 8-ounce minimum holding pressure per contact pair. The GPC series has single readouts, and the GKD series has double readouts. Price ranges from 35 cents to \$1.69, depending on type of connector and options.

Positronic Industries, Connector Division, 1906 S. Stewart, Springfield, Mo. 65804 [394]

Multipin connectors offer from 2 to 10 contacts

Designed for a wide range of applications, a family of miniature multipin connectors provide from two to 10 contacts. The unit can be used in instruments, medical transducers, cameras, industrial controls, data-processing and communications equipment, and wherever a ruggedly constructed connector is desired. Further, the connector has a self-locking mechanism, which facilitates rapid engagement and disengagement. Typical price in 1,000-lots ranges from \$3.21 for a four-pin plug and \$6.62 for a 10-pin plug.

Lemo U.S.A. Inc., 2015 Second St., Berkeley, Calif. 94710 [395]

Thermal system is for C-V plotting of MOS

The model TP35 thermochuck is designed for C-V plotting and temperature cycling of MOS devices. The chuck reaches 300°C in 2½ minutes and cools down from 300°

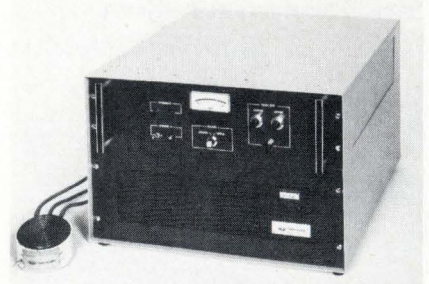

in 2½ minutes to ambient temperature without external liquid or gas supply. Low and high temperatures are presettable. Error is ±3°C at the extremes, and an optically coupled



# THE WORLD'S MOST POPULAR TRANSDUCER.

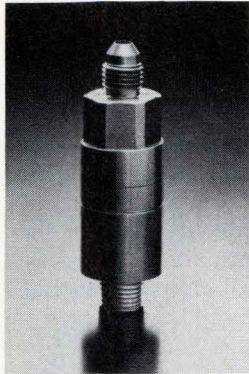

Take a look at the most popular transducer in the world. A pretty face with talent. Better known at Bell & Howell as "The Old Pro". And better known to our customers as 4-326.

By popular we mean most purchased. And most used. And most asked for by test and instrument engineers.

Does that make 4-326 the *best* transducer in the world?

In its field. In its range. Within its performance limits, test engineers in every industry say "Yes, it's the best."

Number 4-326 is one helluva transducer. A high performance, general purpose, unbonded transducer. With a 40 millivolt output and an uncanny ability to deliver superior performance in environments at temperatures ranging from  $-320^{\circ}\text{F}$  to  $+300^{\circ}\text{F}$ .

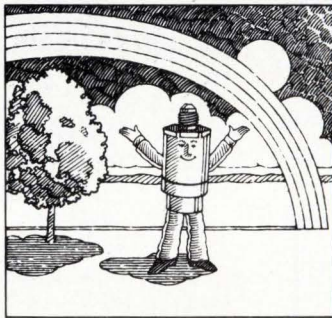

## Our transducers get around.

For over ten years, the "Old Pro", 4-326, has been satisfying customers in every field. In every test condition known to man: From below the earth's surface to the outer limits of space.

Yet for every "mister popular" with spectacular credentials, Bell & Howell has quite a number of not-so-well-known transducers with the same bloodline, the same impeccable credentials.

Each of our "lesser knowns" has made it through field-test conditions. Under fire. Under pressure. And each and every one of our transducers has passed the test expected of it by its user.

## Sometimes we go overboard.

Our transducers are no strangers to unusual environments. Take number 4-366, (also known as "Frogman"). This easy-to-install, easy-to-use, general purpose pressure transducer is totally at home under water. Its polychloroprene/polyolefin cable makes it completely waterproof to 600' depths.

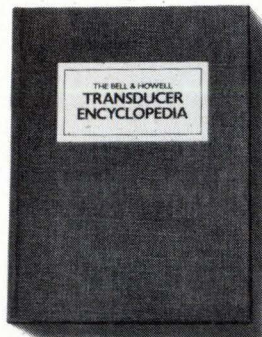

**BELL & HOWELL**

WE'RE REWRITING THE BOOK.

This little piece offers 40mV direct output, comes in an all-welded stainless steel case, and is salt water compatible. Naturally, it's been factory quality-control tested and comes with a calibration certificate.

## We'll go to any extreme.

Airborne missiles and rockets, test stands, aircraft maintenance and control, cryogenics— are the areas where you'll find number 4-356, our high accuracy transducer (0.25%).

Its wide temperature range, all-welded pressure cavity; and heat-treated, stainless steel case and diaphragm, make it impervious to harsh environments including corrosives. With this rugged little 2.5-ounce performer you can be damn sure of superior performance in the areas where it counts: accuracy, durability, size and weight.

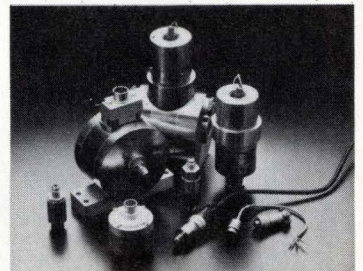

## Our long suit.

We make more than 400 types of transducers. That's right. More than 400. In every size, shape, mounting configuration, and pressure range.

You see, we've designed and produced transducers at every performance level including the highest level. And at every price level including the lowest low.

## We deliver. And we mean fast.

Perhaps the best news of all is our product availability story. Because, our story is short and sweet: Select any one of the 52 varieties of the 4-326, and we'll ship within 24 hours. To order, call collect, (213) 796-9381.

## We're rewriting the book.

It's true. We *are* rewriting the book, the Bell & Howell Transducer Encyclopedia Handbook, containing practical aids to help you select the best transducer for your project. Want to be a contributing editor? We'll pay \$25 for every article, case history, or personal experience accepted by the editor. Write, Encyclopedia, Bell & Howell, CEC/Instruments Division, 360 Sierra Madre Villa, Pasadena, CA 91109.



# SOLID RELIABILITY

## Micropackaged pulse transformers with outstanding performance.

Toko pulse transformers are proven performers in the electronics world, and are known for compactness, reliability and product quality which are hard to beat. Make your selection from our list of standard types or let us design a unit specifically for your application.

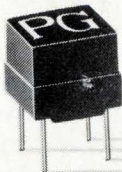

### Standard Types

Type	Turns ratio	Primary inductance	ET Constant (min.)	Leakage inductance (max.)	Interwinding capacitance (max.)	DC resistance (max.)	Connections
PGWB 4-1AA	1:1	1.8	1.2	0.10	8.0	0.20	A (LCED)
PGWB 10-1AA	1:1	11.0	2.5	0.15	12.0	0.20	A (LCED)
PGBB 8-1AA	1:1	38.0	3.5	0.15	8.0	0.20	A (LCED)
PGRB 10-1AA	1:1	134.0	5.0	0.15	12.0	0.20	A (LCED)
PGRB 16-1AA	1:1	340.0	10.0	0.15	18.0	0.30	A (LCED)
PGXB 22-1AA	1:1	1,400.0	20.0	0.20	25.0	0.35	A (LCED)

### Technical Data

- Operating temperature range: 0~70°C ● Storage temperature range: -40~+100°C ● Insulation resistance: (At 250 VDC) More than 10<sup>3</sup> M
  - Package: Transfer molding (epoxy) ● Environmental test: Units satisfy MIL-STD-202D
- For detailed information, please contact our sales department.



## TOKO, INC.

**Head Office:** 1-17, 2-chome, Higashi-Yukigaya, Ohta-ku, Tokyo, Japan  
**New York:** Toko New York Inc. 350 Fifth Avenue, New York, N.Y. 10001 U.S.A. Tel: 565-3767  
**Los Angeles:** Toko, Inc. Los Angeles Liaison Office 3440 Wilshire Blvd., Tishman Building, Suite 1106 Los Angeles, Calif. 90010, U.S.A. Tel: 380-0417  
**Düsseldorf:** Toko Elektronik G.m.b.H. 4 Düsseldorf, Lakronstrasse 77, W. Germany Tel: 0211-284211

Circle 154 on reader service card

## Heat Dissipating Components

In stock, a wide range of heat dissipating extrusions, including a 30-fin, 1.312" x 9.875" and a 3-sided heat sink chassis.

Custom engineering and design available for economic solutions to your thermal problems.

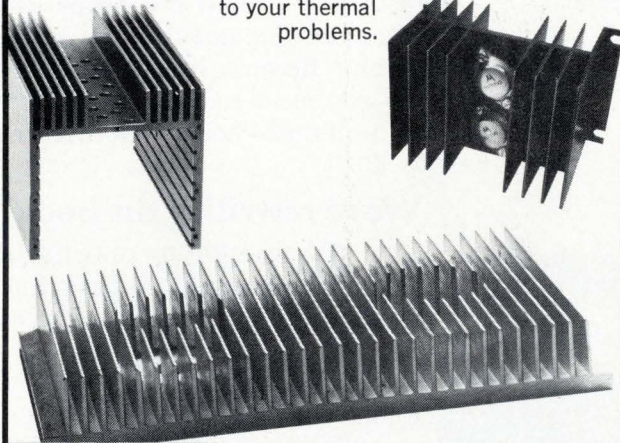

# WEI

"Natural and forced convection heat sink specialists"

## CORPORATION

2140 So. Santa Fe St., Santa Ana, Calif. 92705

Box 10577, 92711 TWX 910-595-1709 (714) 540-4688

## New products

zero-cross ac control provides fast response and low noise.

Tempronix Inc., 40 Glen Ave., Newton, Mass. 02159 [396]

## Audio connectors provide interchangeable inserts

Designated Slimline II, audio connectors are miniaturized units with interchangeable inserts that accept any plug or receptacle, male or female. Applications are in two-way and citizens-band radio, industrial

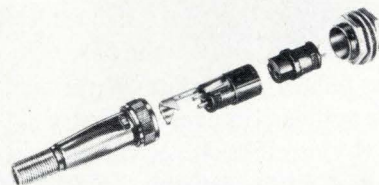

controls, and instrumentation, among others. The connectors, which can be retrofitted to existing systems, provide ground connections without using pin-contacts. Price ranges from \$2.50 to 80 cents each.

Switchcraft Inc., 5555 N. Elston, Ave., Chicago, Ill. 60630 [397]

## Wrapping tool makes solderless connections

A wire-wrapping tool is designed to make fast, solderless connections in assembly-line production of electronic equipment. The tool, which weighs under 13 ounces, responds to a light trigger pull, and it is said to operate on approximately 33% less air than other tools of comparable performance.

Standard Pneumatic Motor Co., Box 17500, 4980 Energy Way, Reno, Nev. 89510 [398]

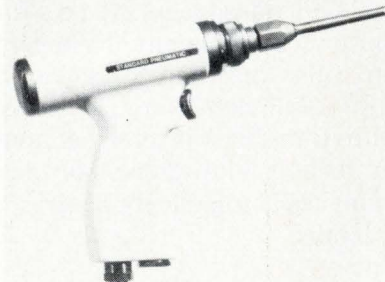



# THE FET CONNECTION

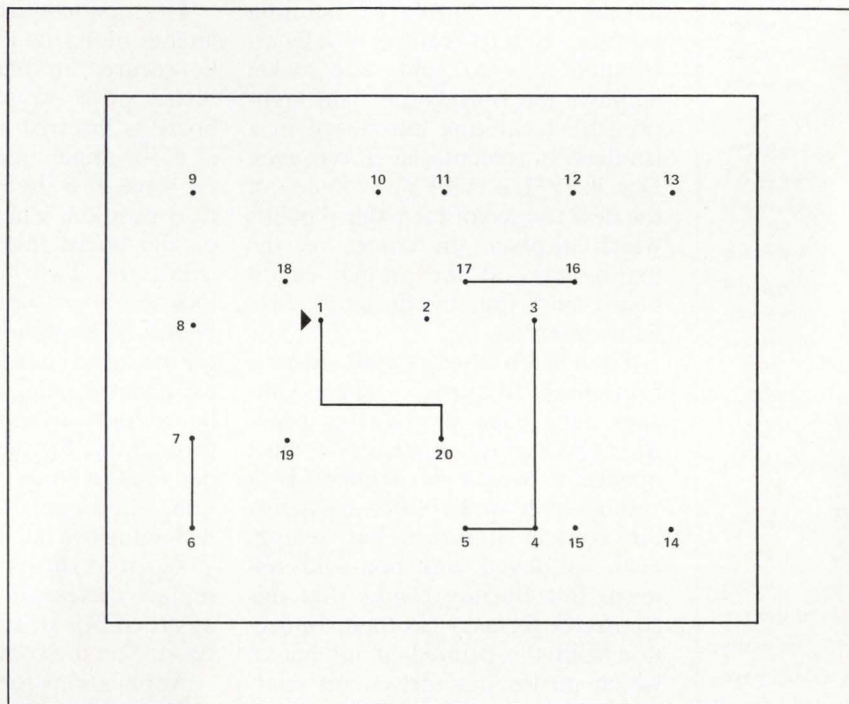

CONNECT THE DOTS TO IDENTIFY "THE FET CONNECTION" (START BY CONNECTING DOT #1 TO DOT #2 TO DOT #3 ETC.)  
CLUE: "THE FET CONNECTION" IS THE #1 SOURCE FOR MOSFETS.

The number to call for "THE FET CONNECTION" is 800-645-1247 toll free (In New York State call 516-733-3037). Besides full information, a dossier will also be provided to you on all 125 MOSFET types, the most offered by any source in the industry.

See the following page for "THE 42 OTHER FET CONNECTIONS."



THE 42 OTHER

# FET CONNECTIONS

(GENERAL INSTRUMENT'S  
AUTHORIZED DISTRIBUTORS)

## EAST

**ALABAMA, Huntsville**  
Cramer Electronics ..... (205) 539-5722

**CONNECTICUT, Stratford**  
Greene/Shaw ..... (203) 378-0485

**FLORIDA, Orlando**  
Cramer Electronics ..... (305) 894-1511

**Hollywood**  
Cramer Electronics ..... (305) 923-8181

**MARYLAND, Gaithersburg**  
Cramer Electronics ..... (301) 948-0110

**WASHINGTON, D.C., Hyattsville**  
Milgray ..... (301) 864-1111

**Baltimore**  
Resco ..... (301) 823-0070

**MASSACHUSETTS, Newton**  
Greene/Shaw ..... (617) 969-8900

**NEW YORK, Freeport**  
Milgray Electronics ..... (516) 546-6000

**Hauppauge**  
Semiconductor Concepts ..... (516) 273-1234

**Johnson City**  
Wilshire Electronics ..... (609) 797-1236

**Buffalo**  
Summit ..... (716) 884-3450

**Elmsford**  
Zeus Components ..... (914) 592-4120

**NORTH CAROLINA, Winston-Salem**  
Cramer Electronics ..... (919) 725-8711

**PENNSYLVANIA, Philadelphia**  
**SOUTH NEW JERSEY**  
Herbach & Rademan ..... (215) 426-1700

**Cherryhill**  
Milgray ..... (609) 424-1300

**Philadelphia**  
Philadelphia Electronics ..... (215) 568-8288

**Pittsburgh**  
Semiconductor Specialists ..... (412) 781-8120

## MIDWEST

**ILLINOIS, Elmhurst**  
Semiconductor Specialists ..... (312) 279-1000

**INDIANA, Indianapolis**  
Semiconductor Specialists ..... (317) 243-8271

**IOWA, Cedar Rapids**  
Daeco, Inc. .... (319) 365-7551

**KANSAS, Lenexa**  
Hallmark Electronics ..... (913) 888-4747

**MICHIGAN, Detroit**  
Semiconductor Specialists ..... (313) 255-0300

**MINNESOTA, Minneapolis**  
Hallmark Electronics ..... (612) 925-2944

**Minneapolis**  
Semiconductor Specialists ..... (612) 854-8841

**MISSOURI, St. Louis**  
Semiconductor Specialists ..... (314) 428-6100

**OHIO, Cincinnati**  
Hewark Electronics ..... (513) 421-5282

**Dayton**  
Semiconductor Specialists ..... (513) 278-9455

## WEST

**ARIZONA, Phoenix**  
Cramer Electronics ..... (602) 263-1112

**CALIFORNIA, San Carlos**  
Intermark Electronics ..... (415) 592-1641

**Santa Ana**  
Intermark Electronics ..... (714) 540-1322

**San Diego**  
Intermark Electronics ..... (714) 279-5200

**Culver City**  
Hamilton-Avnet ..... (213) 836-7200

**Los Angeles**  
Kierulff Electronics ..... (213) 685-5511

**Woodland Hills**  
Semiconductor Concepts ..... (213) 884-4560

**Newport Beach**  
Semcomp Sales ..... (714) 833-3070

**COLORADO, Denver**  
Intermark Electronics ..... (303) 936-8284

**TEXAS, Addison**  
Computer Components ..... (214) 239-0271

**Houston**  
Lener Co. .... (713) 225-1465

**Dallas**  
Semiconductor Specialists ..... (214) 358-5211

**UTAH, Salt Lake City**  
Alta Electronics ..... (801) 486-7227

**WASHINGTON-OREGON, Seattle**  
Intermark Electronics ..... (206) 767-3160

For full information and a dossier of all 125 MOSFET types (the most offered by any source in the industry), call 800-645-1247 toll free (In New York State call 516-733-3037) or write, Dept. M, General Instrument Corp., 600 W. John St., Hicksville, N.Y. 11802.

THE FET CONNECTION



## New Products

Components

### Pc connector is gold-free

Contact technique cuts cost of manufacturing printed-circuit boards

Although it is gold-free, a zero-entry-force printed-circuit connector developed by Burndy Corporation promises contact features usually attributed only to gold. The socket employs the Burndy gas-tight high-pressure technique introduced in a leadless IC receptacle [*Electronics*, Dec. 4, 1972, p. 139]. The contacts of the new connector have sharp points which displace the oxides on the mating tabs of the printed circuit board and thereby develop a reliable interface.

Though tin/contact systems have been used frequently, where voltages have been sufficient to penetrate the surface oxide, dry-contact operation—which is defined as a voltage of 20 millivolts or less across the contact interface—has seldom been employed with non-gold systems. But Burndy claims that this connector forms a gas-tight connection with the printed-circuit board, which means that dry-circuit operation can be employed with a high confidence in reliability.

The connector also offers a savings in the fabrication cost of the board because gold-plating the tab is not required. Solder tabs are used instead. Burndy estimates that this can effect a savings of two to four cents per tab depending on the thickness of gold. A solder tab also means dispensing with several steps in the fabrication of the board. In the conventional procedure, following solder plating of the pc board, a mask is applied and solder is stripped from the tab area to be plated. Then the mask is removed and the board is cleaned. It is remasked to slightly above the tab area, nickel-plated, and then gold-plated. Finally the mask is removed.

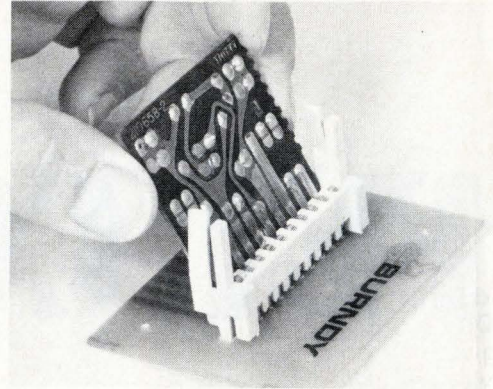

The new connector employs two latches along its base so that it can be secured in place on a mother board prior to soldering. The pc board is inserted into the connector at a 30° angle, encountering no entry force. It is then raised to the vertical position, which brings the tabs on the board into contact with the connector. Two latches deflect and lock the board into position. As the board is brought into the upright position, the contacts on the connector penetrate the solder tabs on the board. It is this motion which breaks through the brittle oxides on the solder tabs to form a reliable connection. The board can be removed by deflecting the latches.

Approximately 50 remove/replace cycles can be made without appreciably raising the contact resistance, the company says.

Applications for the connector include appliances, computer equipment, entertainment systems and electronic calculators.

Burndy Corp., Norwalk, Conn. 068567 [341]

Time-delay relay is accurate to within 0.001 s

Providing an accuracy to within 0.001 second at any setting, a precision time-delay relay, covering the range of 16 milliseconds to over nine hours, offers repeatability, regardless of setting, physical orientation, vibration, temperature variations, power-line transients and noise. Called Digilay, the units are digitally programed by setting the



# The CRT display isn't really obsolete. DIGIVUE® just makes it look that way.

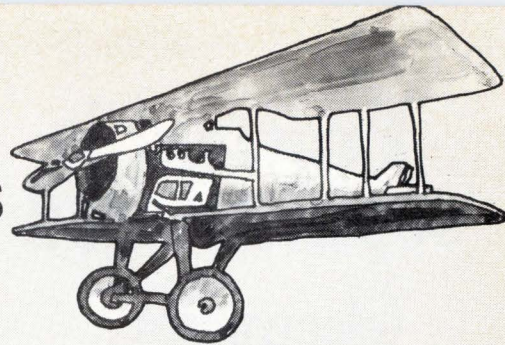

## And Rear Projection Capability One Reason Why . . .

Digivue is the plasma display device from Owens-Illinois that delivers computer-generated alphanumeric and graphic displays at microsecond speeds. Digivue provides drift-free images, selective write/erase, inherent memory, hard copy printout potential. And rear-projection capability.

You get coordinated computer-driven displays and optically projected images. Rear project a blank graph, chart, table, blueprint or cutaway drawing, for example, while computer-generated data fills in the blanks. Theoretically, anything that can be photographed can be rear-projected through a Digivue screen. From maps to the Mona Lisa.

Try that with a CRT.

If you'd like to know more about the next generation in display systems, take a look at tomorrow—take a look at Digivue.

Call or write:  
Electro/Optical Display Business  
Owens-Illinois, Inc.  
P.O. Box 1035, Toledo, Ohio 43666  
(419) 242-6543 Ext. 66-415

Circle 157 on reader service card



Simulation of rear projection on screen.



# Procond is sophisticated (electronics too)

Plastic film and electrolytic capacitors for entertainment and professional field.

Quadrangolo

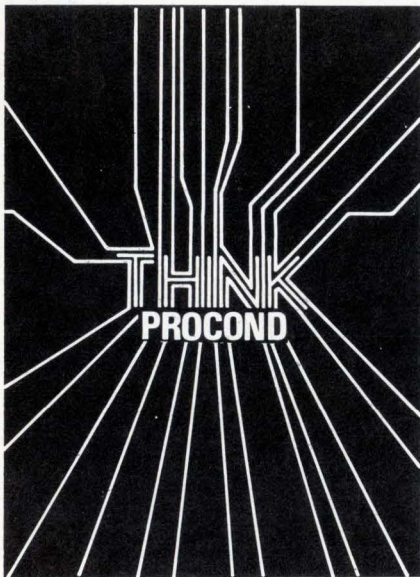

PROCOND S.p.A 32013 Longarone, Italy.

## New products

miniature rocker switches on their covers. Price is \$74.

Microtronics Corp., 203 Gateway Rd., Bensenville, Ill. 60106 [345]

Rectifier assemblies replace many types of vacuum tubes

A series of stud-mounted controlled-avalanche rectifier assemblies, designated 1N5595 through 1N5601, can replace more than 70



types of vacuum tubes. Tube-type bases and anode caps for the modules are available, allowing one or a stack of the modules to be assembled into a self-supporting package that fits into the socket of the tube being replaced, usually with no change in wiring. Price is \$32.

Solid State Devices Inc., 14830 Valley View, La Miranda, Calif. 90638 [343]

Ceramic resistors are flameproof

Ceron ceramic insulated wirewound resistors are flameproof and are designed for applications in digital-processing equipment and communications apparatus. The units are inert in the presence of heat or

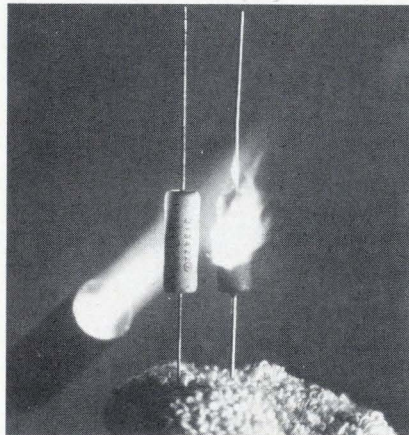

The U. S. Government does not pay for this advertisement. It is presented as a public service in cooperation with The Department of the Treasury and The Advertising Council.

# If you can't manage now, how are you going to manage later?

Money's tight. You feel pretty lucky if you can stretch your paycheck enough to meet all the everyday expenses. It's harder than ever to save a buck. And how are you going to take care of the future, when you've got enough trouble just taking care of the present?

But, you *can* manage to save—by joining the Payroll Savings Plan where you work. It's a sure way to get started on a nest egg that you can depend on in the future.

The amount you designate will be automatically set aside from your paycheck and used to buy U.S. Savings Bonds, *before* you get your check, and *before* you can spend it.

So, join the Payroll Savings Plan and start on your "secret stash" today. And then just relax and don't worry about tomorrow. You'll manage.



Now E Bonds pay 5½% interest when held to maturity of 5 years, 10 months (4% the first year). Bonds are replaced if lost, stolen, or destroyed. When needed they can be cashed at your bank. Interest is not subject to state or local income taxes, and federal tax may be deferred until redemption.

**Take stock in America.**  
Buy U.S. Savings Bonds.



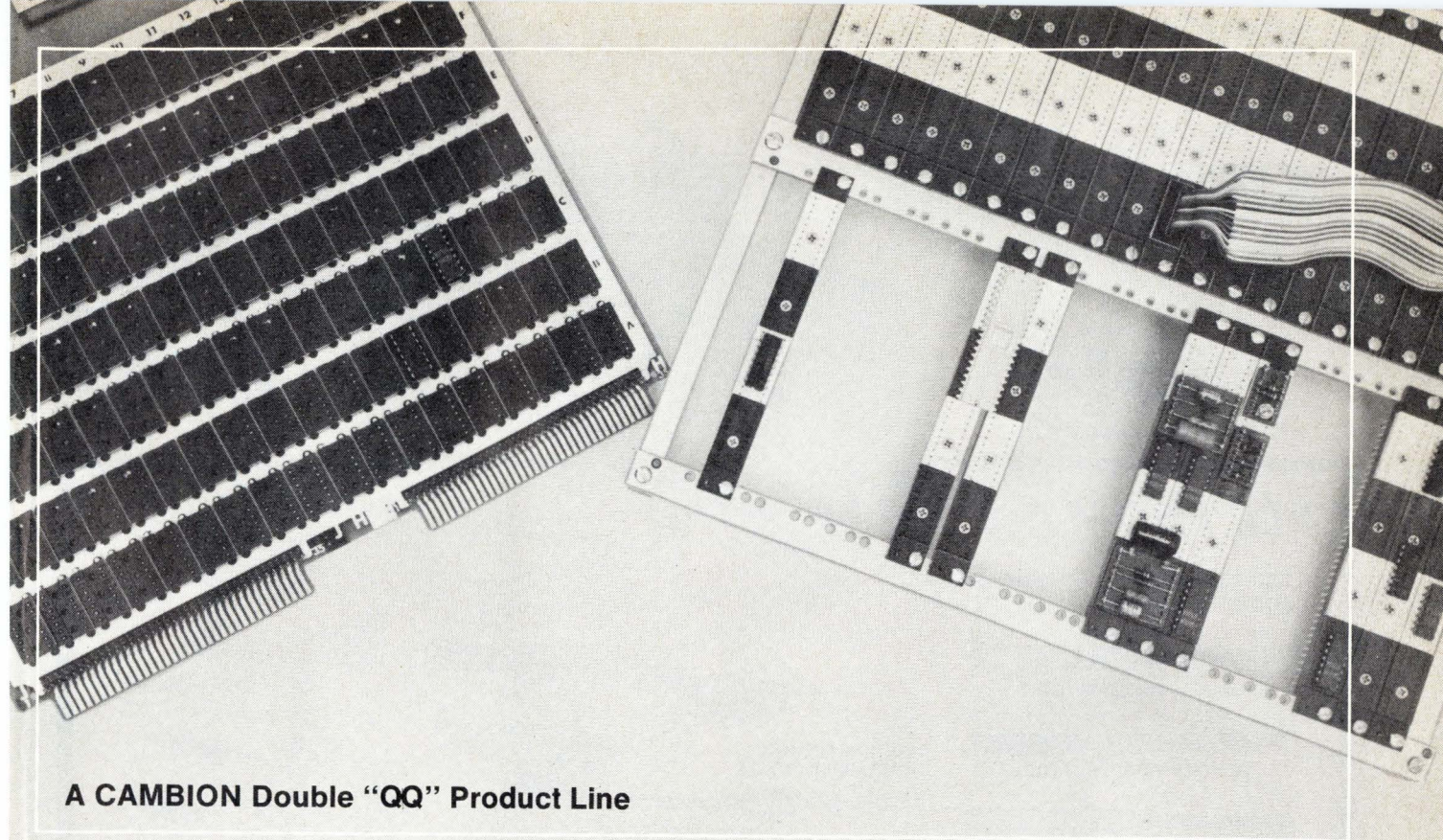

A CAMBION Double "QQ" Product Line

# Cambion presents the great debate.

## To Go Card File

Whatever the system you're building, you should consider cards as the best design concept, if:

1. Highly skilled technicians won't be around to service your system in the field.
2. Modularity offers your customer a benefit.
3. Your system needs good noise immunity.
4. Your system could make use of a wide variety of compatible printed circuit assemblies.
5. Your boss says to.

## To Go Integrated Socket Array

You should opt for Integrated Socket construction as the best design concept if:

1. Servicing can be done at the component level.
2. Time to layout and construct the system is important.
3. You want to minimize the total connections and the fabrication cost.
4. You have definite space limitations requiring the tightest packaging.
5. You and your boss have changed your minds.

## Rebuttal:

Cambion helps you keep your options open. With Cambi-Cards® you can have a modular Wire-Wrap\* system. With Cambion integrated arrays, you can have a mass-produced Wire-Wrap system to satisfy even the most exacting applications.

Before you get into the great debate (with your boss or the customer) let's discuss your projects. We have some typically Cambion thoughts designed to give you a quality product whether you go cards or integrated socket arrays or decide to mix the two.

At Cambion we take a Double "QQ" Approach – the

Quality stands up as the Quantity goes on. Why not give us a ring? Cambridge Thermionic Corporation, 445 Concord Avenue, Cambridge, Mass. 02138, Phone: 617-491-5400. In Los Angeles, 8703 La Tijera Blvd. 90045. Phone: 213-776-0472.

\*Trade mark, Gardner-Denver Company

Standardize on

# **CAMBION®**

The Guaranteed Digital Products  
Circle 159 on reader service card



# SPEED-WRAP®

*makes fast ...  
guaranteed perfect ...*

**SOLDERLESS, WRAPPED-WIRE  
ELECTRICAL CONNECTIONS**

*in less than 1/10th sec.*



PNEUMATIC AND ELECTRIC  
"SPEED-WRAP" TOOLS

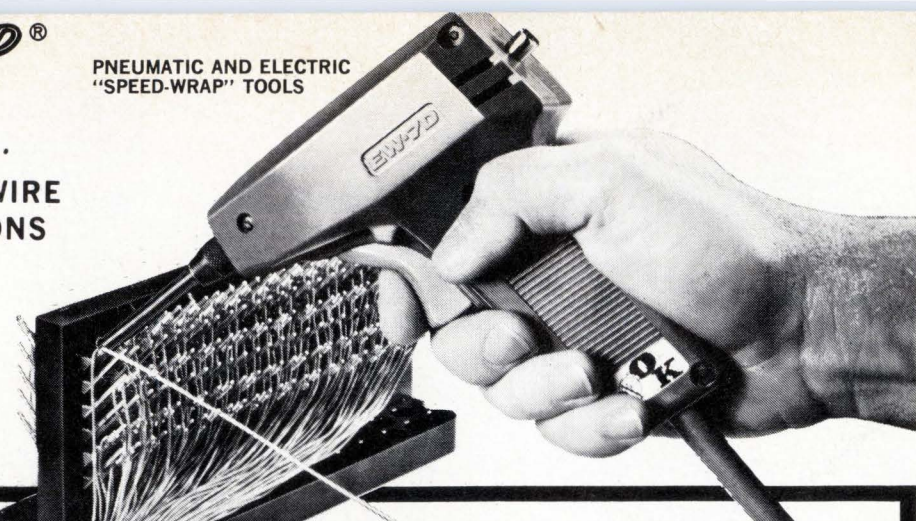

## ALL FROM OK

COILTITE® SLEEVES

COILTITE BITS



HAND WRAPPING TOOLS



HAND UNWRAPPING TOOLS



BARE GROUND WIRE STRAPPING TOOLS

HAND-WRAPPING—  
UNWRAPPING TOOLS



CONNECTOR  
PRESSER

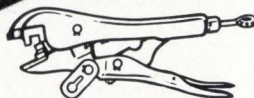

SPEED-SPLICE TOOLS

CABLE STRIPPING  
TOOL



WIRE  
STRIPPING  
TOOLS



CUT-  
STRIP  
TOOLS

FREE illustrated catalog  
available on request

**OK MACHINE AND TOOL CORPORATION**

3455 Conner Street, Bronx, New York 10475 / Phone: (212) 994-6600

Circle 160 on reader service card

THE MINIATURE  
PC ROTARY SWITCH.

**Very big in  
communications  
circuits.**

The screwdriver operated PC mount rotary is 0.6 inches in length. It's half that in diameter. (A shaft-actuated bushing-mounted version also available.)

Both provide a 36° angle of throw with one or two pole circuitry. Rated make or break 200 milliamps at 115 VAC resistive load for 5,000 cycles. (Or 50 milliamps at 25,000 cycles.)

For more information on all Grayhill products, write today for our newest Engineering Catalog. Grayhill, Inc., 523 Hillgrove Avenue, La Grange, Illinois 60525. (312) 354-1040.



**Best buy  
power  
module  
for  
op amps**



**± 15 V (tracking) @ 400 ma...\$85**

Line/load regulation of ±0.1% and ripple of 1.5 mv. 3.4"Hx5.1"Wx5.1"D. Order Model TD 15-40. For 1.0 amp outputs, specify TD 15-100. Price \$125. Other great buys are available to power balanced loads drawing from 25 ma to 8.5 amps.

Three day shipment guaranteed. Five year warranty.



Acopian Corp., Easton, Pa. 18042  
Telephone: (215) 258-5441



## New products

flame and will not ignite under any degree of overload. Their coating is also resistant to standard industrial cleaning solvents.

Sprague Electric Co., 35 Marshall St., N. Adams, Mass. 01247 [346]

Audio transformer is an ultraminiature device

Each of a series of ultraminiature audio transformers measures 1/4 inch in both diameter and height. Pri-

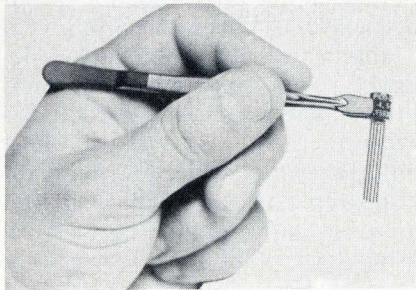

mary and secondary impedance ranges from 5 ohms to 30 kilohms, maintained within  $\pm 3$  decibels at 400 hertz to 250 kilohertz; maximum power is 100 milliwatts at 1 kHz. They are fabricated to military standards.

Pico Electronics, 316 W. 1st St., Mount Vernon, N.Y. 10550 [347]

Surge arrestors protect telecommunications lines

Solid-state electronic devices and telecommunications lines can be protected against transient voltage surges with a miniature two-electrode gas-filled surge arrestor called

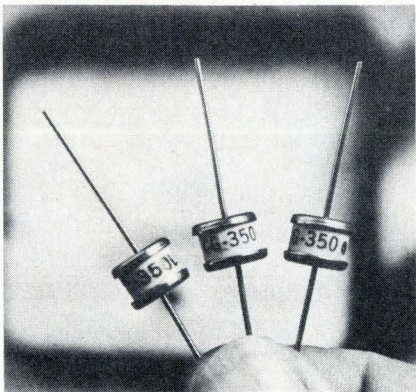

...switch, indicator, and circuit protector *all in a single compact package.*

## AIRPAX™ TYPE 203 Electromagnetic Circuit Protector

Airpax Type 203 Electromagnetic Circuit Protectors offer a choice of many mechanical and electrical configurations for maximum versatility. Series, shunt, and relay trip internal circuits are available and can be combined in single, two and three-pole versions. Current ratings from 0.02 to 20 amperes at 120V ac and 0.02 to 10 amperes at 250V ac. Inverse time delay or instant trip.



Photo courtesy of Kappa Scientific Corp.

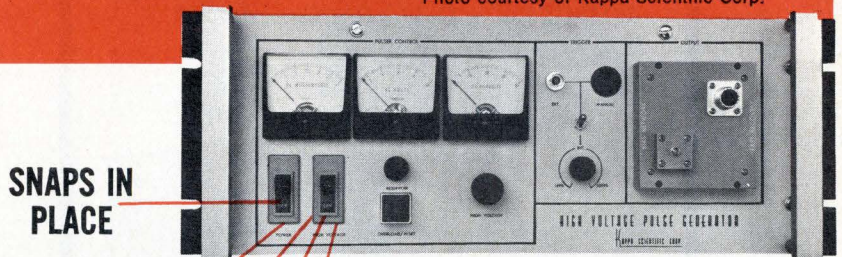

SNAPS IN PLACE

SAVES SPACE

STYLISH DESIGN

REDUCES COST

LOW MAINTENANCE

Here's why Kappa Scientific selected Airpax Type 203 Circuit Protectors for their new High Voltage Pulse Generator.

We quote: "... because it features a switch, indicator, and circuit protector all in a single compact package. This is an advantage because we require switching, indication, and protection for both input power and high voltage. Especially important is that total cost is competitive with individual switch, light, and fuse components. This approach eliminates unsightly fuseholders and fuse replacement, but better, prevents the not-uncommon practice of substituting high amperage fuses (the penny-in-the-fusebox remedy) with subsequent circuit damage."

**Shouldn't your next design include a Type 203?**

Write for full specifications.

Airpax Electronics / CAMBRIDGE DIVISION / Cambridge, Md. 21613 / Phone (301) 228-4600

# AIRPAX™

25 YEARS OF PROGRESS



# ASSOCIATED? ENVIRONMENTAL CHAMBERS?

## SYNONYMOUS!

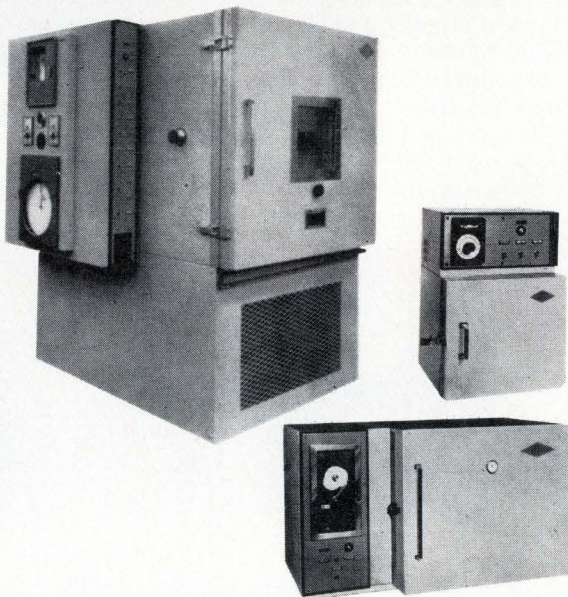

Associated manufactures a complete line of environmental chambers ranging from the smallest, lowest priced chamber available, Model RW-1100, to full size walk-in rooms.

The standards built into every Associated chamber probably exceed your day-to-day requirements, enabling you to purchase a reasonably priced standard unit rather than a customized special. In short:

**COST + QUALITY + DELIVERY = ASSOCIATED**

For details on the broadest standard line of environmental chambers, send immediately for our new, complete catalog.



**associated environmental systems**

360 MERRIMACK ST., LAWRENCE, MASS. 01802 • (617) 683-9501  
DIV: CRAIG SYSTEMS CORP.

### New products

the model CG-350L. The unit acts with a typical response of 800 to 1,000 volts for a 5-kilovolt-per-microsecond ramp and will withstand up to 750 surges of a 500-ampere, 10/1,000- $\mu$ s wavefront at 30-second intervals.

Signalite, 1933 Heck Ave., Neptune, N.J. 07753 [348]

Line of heat pipes has  
10- to 1,000-W capacities

A line of flexible heat pipes, constructed of stainless steel and with methanol as the working fluid, is designed for a range of applications where there is relative motion between the heat source and the heat sink. The pipes have a low temperature drop and long operating life-time. Several combinations of envelope and wick materials are available. The units also provide a heat-load capacity from 10 to 10,000 watts, depending on pipe material, working fluid, and size.

Hughes Aircraft Co., Box 90515, Los Angeles, Calif. 90009 [344]

Toggle switch offers  
quick actuation

A right-angle-mounting, double-pole, double-throw, subminiature toggle switch, when mounted in vertically stacked printed-circuit panels, extends outward to make the toggle easily accessible for quick actuation. Minimum electric life is 100,000 make-and-break cycles, and minimum insulation resistance is 1,000 megohms.

C & K Components Inc., 103 Morse St., Waretown, Mass. 02172 [349]

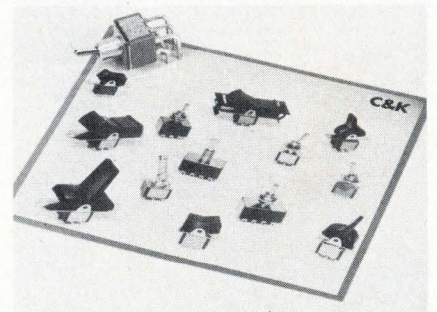



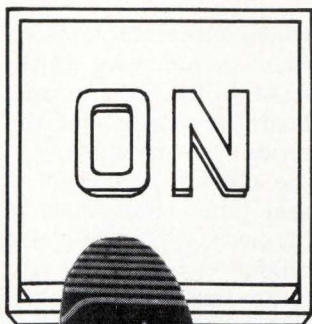

## Norplex...your reliable hand for multilayer circuits from prepreg preparation to push button performance

Thin-clad laminates or prepreg materials. Whatever your application calls for, it's the Norplex team reliability that can mean the difference at start-up time.

In thin-clad laminates, it's the reliability of optimum dimensional stability. Plus Norplex's ability to adhere to the many precise tolerances demanded by today's sophisticated multilayer circuits.

And in prepreg materials, it's the Norplex team effort to maintain quantity production under the strictest hygienic conditions... conditions that assure you prepreg which is clean, free of foreign particles and available in many varieties.

Finally, it's the pride of every plant worker, office employee and field representative... a team that serves every customer with 100% effort through Norplex's Quality Assurance program.

All together, this Norplex reliability spells out satisfaction for all your thin-clad laminates and prepreg needs... from plants in both La Crosse and Franklin, Indiana. Start the Norplex team working for you by writing or phoning for catalogs. Norplex Division, UOP (Universal Oil Products Company), Norplex Drive, La Crosse, Wisconsin 54601. Telephone: 608/784-6070.

Norplex<sup>®</sup> laminates  
by UOP



**CONTROL—precise**  
**SIZE—fits**  
**SUPPLY—fast**  
**PRICE—fine**

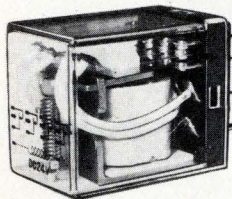

Miniature  
Relay Type  
MPM-100

- Available for various voltages AC & DC.
- Both 4PDT and DPDT contact switching requiring minimum driving power is available.
- Highly economical.
- Incorporates anti insulation fatigue device which prevents short-circuits.
- Uses UL-approved resin bobbin.

#### Digital Line Printer LP-108

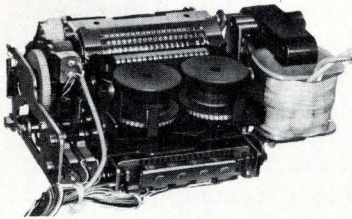

- Compact size with simplified mechanism.
- Up to 18 columns.
- 14 characters per column.
- High reliability.
- Red/black printing.
- Print rate of 2.5 to 3.0 lines/sec.
- Low cost

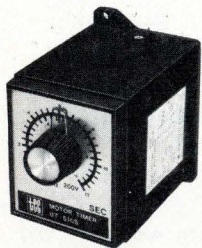

Miniature  
Motor Timer  
Type UT-500

- Smart surface design. Plug-in type terminal.
- Economical due to simplified pointerless mechanism.
- Available in a variety of types ranging from 10 seconds to 24 hours, surface-mounted or flush-mounted.

Whichever way you take the measure of TEC control instruments you're getting top value. They work longer; give you more reliable performance for your money.



**TOKYO ELECTRIC CO., LTD.**

14-10, 1-chome, Uchi-Kanda, Chiyoda-ku,  
Tokyo, Japan

#### New products/materials

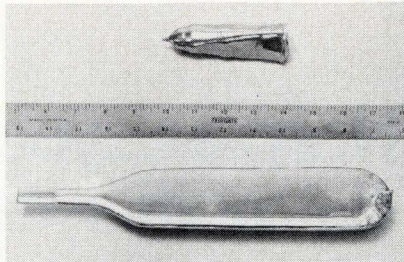

**Boat-grown gallium-arsenide** in ingots or slices is about five times the size of Czochralski-grown GaAs. The material features low density of etch pits, and is especially suited to microwave applications and where larger slices are desired. Horizontal or vertical GaAs is available.

Texas Materials Laboratories Inc., 2716 National Circle, Garland, Texas 75041 [476]

**A series of Uniset pellets** permits the use of automated assembly equipment and eliminates the need to meter and position small drops of liquid resins in production bonding, sealing, and insulation applications, which are impractical with liquid resins. Each pellet has a precise volume and shows no change in melting point or other characteristics after extended storage at room temperature. The pellets, however, melt and cure rapidly when heated above 200°F.

Amicon Corp., Polymer Products Division, 25 Hartwell Ave., Lexington, Mass. [477]

**MC18 is a clear transfer** molding compound for encapsulation of light-emitting diodes. The material, suitable for lead-frame devices and numeric displays, offers high-temperature color stability, resistance to moisture, and room-temperature shelf stability.

Hysol Division, The Dexter Corp., 211 Franklin St., Olean, N.Y. 14760 [478]

**Thin-film coatings** can withstand power densities on the order of 5 gigawatts per square centimeter in 3-nanosecond pulses for applications in laser-fusion programs. Center wavelength of the coatings is 1.06 nanometers, which is the emission-wavelength of neodymium-doped glass lasers.

Coherent Radiation, Optics Division, 3210 Porter Dr., Palo Alto, Calif. 94304 [479]

**Room-temperature etch-back** solutions for removing whiskered fibers from drilled holes in printed-circuit boards are designated the CEB 818 series. The materials will not affect the copper portion of the board, soak time is noncritical, and the solutions may be diluted to provide milder etches if desired. A chromium-free version is available for a still milder etch.

Coppertech Inc., Box 105, Flourtown, Pa. 19031 [480]

**A ruthenium-based resistor paste** called the 2800B series, is available in resistivity ranges from 10 ohms square to 1 megohm/square. The fired resistors exhibit good voltage stability and are laser-trimmable. The pastes can be fired over the temperature range of 750°C to 850°C, and are insensitive to firing variables. Price is \$30 to \$40 in quantity.

Electro-Science Laboratories Inc., 1601 Sherman Ave., Pennsauken, N.J. 08110 [409]

**A high-temperature alumina-glass** sealing material called Hybralox is used to seal glass and ceramic-to-metal hermetic packages. Available in paste form, the material can be tailored to customer applications, and can be screen-printed or brushed on. Three basic pastes are available for several applications. Price is \$25 per ounce in small quantities, and a kit is available for \$99.

Glass Beads Co., Box 266, Latrobe, Pa. 15650 [410]

**A low-solids, fine-line gold** paste, 06985-S, is capable of printing conductor thicknesses of 250 micrometers, using 325-mesh stainless-steel screens, while retaining a printing resolution of 3-mil lines on 6-mil centers. This is said to represent a material savings of over 35%, when compared to normal gold-conductor thicknesses of 0.4 mil to 0.7 mil processed under the same conditions. The pastes can be used for ultrasonic aluminum, TC gold, beam-lead, and die bonding.

Owens-Illinois Inc., Box 1035, Toledo, Ohio 43666 [475]



## MicroDevices Corp. Microtemp Safety Thermal Cutoffs

Micro Devices Corporation was founded in 1961 and began operations by supplying MICROTEMP Thermal Cutoffs to the aircraft industry. The market was quickly expanded to the appliance industry and then the electronics field. Today, MICROTEMP Thermal Cutoffs are found in an extremely wide range of products and applications; both nationally and internationally. The extensive variety of operating ranges, electrical characteristics, connecting terminals and mounting packages in which MICROTEMP Thermal Cutoffs can be obtained, delivers an application potential of endless possibilities.

**Test consoles.** A bulletin from Singer Instrumentation, 3211 S. La-Cienega Blvd., Los Angeles, Calif. 90016, describes 12 manual and automated systems for production testing of synchro and resolver components. Circle 421 on reader service card.

**Optical filters.** Thin Film Products Division, Infrared Industries Inc., 62 Fourth Ave., Waltham, Mass. 02154. A 28-page designer's guide and catalog on the company's line of optical filters also outlines other products and services offered by the division on a custom basis. [422]

**TWTs.** A 28-page catalog provides information on the traveling-wave tubes, amplifiers, and power supplies manufactured by Varian, 611 Hansen Way, Palo Alto, Calif. 94303. Operating characteristics and terminology are given, along with general information. [423]

**Video compressor.** An eight-page applications note from Colorado Video Inc., Box 928, Boulder, Colo. 80302, provides a description of and general information on the model 260 video compressor that can link television cameras to computers for image processing. [424]

**Thermal cutoffs.** Micro Devices Corp., 1881 Southtown Blvd., Dayton, Ohio 45439, is making available a six-page brochure giving an explanation of thermal cutoffs. The brochure cites applications, termi-

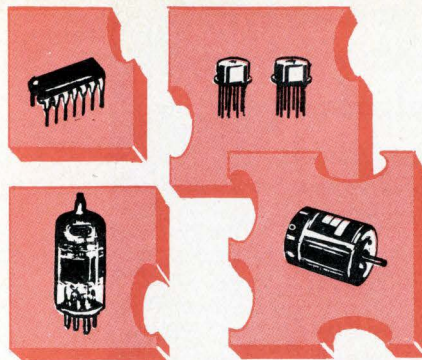

# TROUBLE?

finding components  
to solve your  
design puzzle ...  
**ADLAKE**  
has them!



### ADLAKE MERCURY WETTED RELAYS

Single side stable or bistable; multiple poles; sensitive form C, D, or K, or neutral form D; millions of trouble-free operations; low, stable contact resistance; plug-in or PC mountings.

### ADLAKE MERCURY DISPLACEMENT TIME DELAY RELAYS

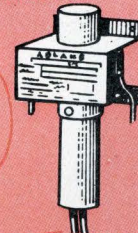

Time delays from 0 to 20 minutes; N.O. or N.C. slow "make" and N.O. slow "break" switching. AC and DC operated units, -37 to 200°F operating temperature range. 0.5-15 ampere ratings, non-inductive at 115 volts, 60Hz. Screw terminal or pigtail leads. U.L. listed types.

### ADLAKE LOAD RELAYS

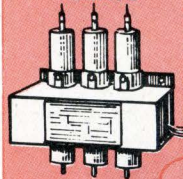

Light, medium, and heavy load switching; up to 3 poles. Screw or pigtail leads. Ratings from 35 to 100 amp, non-inductive at 115 volts 60 Hz. U.L. listed types. All popular coil voltages.

### ADLAKE DRY REED RELAYS



1, 2, 3, and 4-pole styles, hermetically sealed precious metal contacts, extended life, magnetic shielding, high operating speeds. Miniature, intermediate and standard sizes.

### ADLAKE HYBRID TIMERS



Highly reliable operation handles 35 amp loads. 12, 24, 32, 48 and 115 VAC or VDC inputs. Fast recycle time, fixed or adjustable timing from 100 msec. to 2+ minutes. Wide selection of N.O., N.C., On, Off, Delay, or Instant Close or Open switching.

### ADLAKE TRANSFER TIMERS, LATCHES

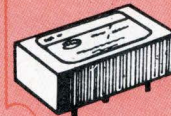

Transfer timers switch DC input to output with precise delay times. Close tolerance accuracy, wide operating temperature range, quick recycle, 1 amp rating. Pulse latch switches 2 amp (100% duty cycle) "off" and "on." Choice of packages.

*Adlake components are ideal interface timing and switching control components for the most modern and complete systems. Fast, stable, and reliable operation are prime features. Dry circuit to heavy current loads, input/output isolation, excellent environmental features, choice of packaging, terminations.*

**Let ADLAKE  
supply the  
missing piece!**

USE READER SERVICE NUMBER FOR COMPLETE INFORMATION

## THE ADAMS & WESTLAKE COMPANY



ELKHART, INDIANA 46514  
219 - 264 1141  
TELEX 25 8458  
CABLE ADLAKE



## The Brush 260 6-channel recorder. Precise data at low cost per channel.

Besides being an accurate, reliable instrument, the Brush 260 is also a real bargain.

You get six 40 mm analog channels and four event markers. Eight pushbutton chart speeds and built-in signal conditioners. Plus Brush exclusives like pressurized ink writing and Metrisite® servo-loop feedback system that assures 99½% linearity.

Write Gould Inc., Instrument Systems Division, 3631 Perkins Avenue, Cleveland, Ohio 44114. Or Kouterveldstraat Z/N, B 1920 Diegem, Belgium.

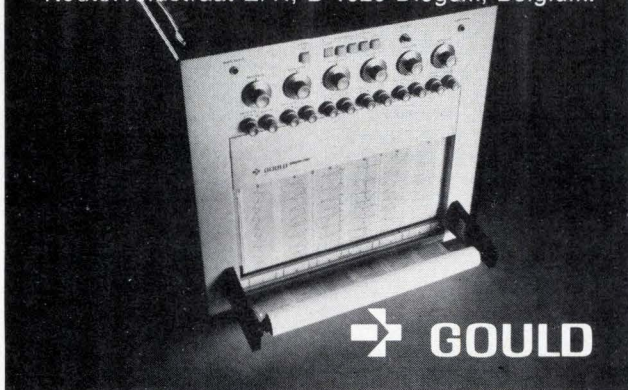

Circle 166 on reader service card

## Put .005% resolution in the palm of your hand



**\$295.**

Model 245 4½ digit DMM offers 21 range versatility, 100% overrange, line and battery operation, (DC and AC volts, ohms, DC and AC amps) .005% resolution with ±.05% basic accuracy for only \$295 including battery module, charger, input probes, carrying case and full documentation.

Truly portable, pocket-size  
1 3/4" X 3 1/2" X 5 1/2".

Simple, fool-proof and protected operation.

Data Precision Corporation  
Audubon Road, Wakefield, Mass. 01880

(617) 246-1600

**DATA PRECISION**  
...years ahead

Visit Us at WESCON, Booth 1334

### CALL YOUR LOCAL OFFICE FOR A DEMONSTRATION

AL	(205)536-1941
AZ	(602)946-7252
CA/S	(714)540-7160
CA/N	(415)321-7323
CO	(303)449-5294
CT	(203)527-1245
FL/S	(305)581-6611
FL/E	(305)622-6850
FL/W	(813)726-2373
FL/N	(305)727-3205
GA	(404)252-5360
IL	(312)593-0282
IN	(317)293-9827
MA	(617)273-0198
MD	(301)552-2200
MI	(313)482-1229
MN	(612)781-1611
MO/W	(913)236-6600
MO/E	(314)731-2331
NC	(919)275-3725
NJ	(215)925-8711
NM	(505)265-6471
NY/N	(315)446-0220
NY/S	(516)482-3500
OH/N	(216)243-7430
OH/S	(513)298-3033
TX/N	(214)234-4137
TX/S	(713)461-4487
WA	(206)767-4330

## New literature

nations, mounting techniques, and safety aspects. [425]

**Darlington amplifiers.** TRW Semiconductors, 14520 Aviation Blvd., Lawndale, Calif. 90260. Monolithic Darlington amplifiers are described in a data sheet containing rate information and operating curves. [427]

**Filters.** The Potter Co., Box 337 N. Highway 51, Wesson, Miss. 39191, has issued a catalog describing a line of over 30 standard EMI broadband, low-pass filters for general-purpose use. [437]

**Modules.** California Electronic Manufacturing Co. Inc., Box 555 Alamo, Calif. 94507. For engineers involved in instrumentation, control, or testing, the company has issued a 16-page catalog providing information on solid-state voltage-level detectors, power supplies, amplifiers, and industrially oriented detector packages. Specifications, block diagrams, operations curves, and prices are given. [438]

**Temperature controllers.** Oven Industries Inc., 1106 E. Simpson Rd., Box 229, Mechanicsburg, Pa. 17055. A series of compact ac temperature controllers that are insensitive to environmental changes is described in a six-page data sheet. [439]

**Miniprogramer.** A data sheet describes a remotely controlled miniprogramer available from Cole Instrument Corp., 2034 Placentia Ave., Costa Mesa, Calif. 92627. [440]

**Communications.** A 323-page handbook from Microdata Corp., 17481 Red Hill Ave., Irvine, Calif. 92705, can be used as an introductory text on data communications, as a reference manual for design, and as a guide in specifying typical communications systems. Price is \$2.50, plus 50 cents to cover postage and handling (California residents add 5% sales tax). [408]

**Transeiver.** A four-page brochure describes the operational features of the model SBT-22-18 paramilitary



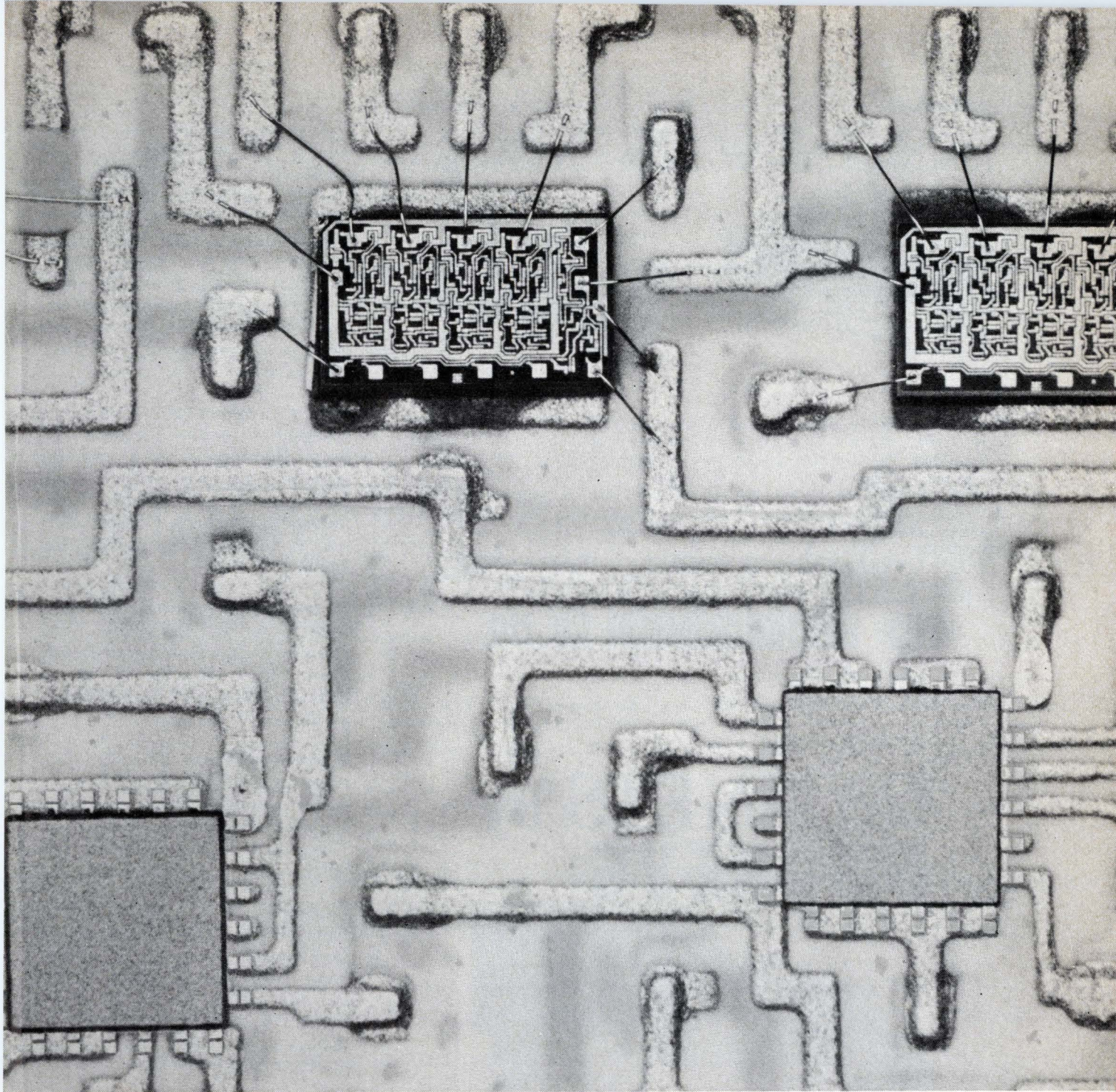

## Are beam-lead or chip-and-wire hybrids best for your circuits?

### Ask Raytheon.

Beam-lead hybrids for your circuits? Or chip-and-wire? If you're not sure which is the most *cost effective* for you, ask Raytheon. We've got extensive experience in both areas. In fact, no one can match our experience in packaging hybrids with beam-lead devices.

We can tell you when rugged, reliable beam-lead technology will

beat chip-and-wire hands down in overall circuit cost-effectiveness. Or we can tell you just as quickly when the lower unit cost of chip-and-wire is the best choice for greater short *and* long term savings.

Either way, Raytheon custom hybrids are the first choice for quality and reliability – in ECM, telemetry, radar, and medical electronics circuits.

And we have the applications, design, volume production, and quality assurance experience to back up the recommendation. Contact Raytheon Company, Industrial Components Operation, 465 Centre Street, Quincy, Mass. 02169.





**FUJI**

## 8K BYTES COMPLETE MEMORY CARD & 65K BYTES DRAWER FOR ADD-ON MEMORY



MB2000

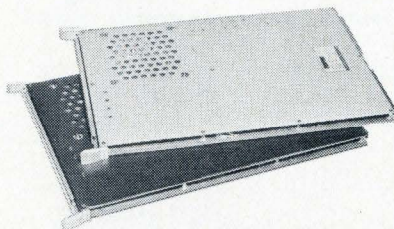

CMS2400 series

The CMS2401 and CMS2402 are 3 wire-3D core memory systems, fully contained on a single printed circuit card. The dimensions are 10" x 15" x 0.5". It mounts on 0.6" connector centers. The single memory card has a maximum capacity of 4096 words x 18 bits per word, smaller capacity by means of depopulation. Eight cards can be bussed to provide up to 32K words x 18 bits capacity. Also byte control is standard so that the 4K-18 can be logically alterable as 8K-9. Low power consumption, high reliability and rugged structure are key advantages of the CMS2400 series.

### SPECIFICATIONS:

	Access time	Cycle time	Temp. range	Power supply voltage
CMS2401	330 ns	1 μs	0°C to +50°C	+5V ±3% 1.6A max., -5V ±3% 0.2A max.
CMS2402	280 ns	750 ns		+15V ±3% 3.5A max.

## FUJI ELECTROCHEMICAL CO., LTD.

Head Office: Hamagomu Bldg., 5-36-11, Shinbashi, Minato-ku, Tokyo, Japan. TEL: 434-1271  
Overseas Office:  
New York, TEL: (212) 532-5630 / Los Angeles, TEL: (213) 620-1640 / Düsseldorf, TEL: (211) 89031

Circle 168 on reader service card

# CABINETS by BUCKEYE



## Designer's Instrument Series

Distinctive **style** for a professional-look in enclosures. Anodized aluminum extrusions give **strength**. Colorful suede-finish panels add **beauty**. Standard 19" front panels and heights from 12.25" to 28". Packaging **versatility** at a **budget price**. Slip-in front panels or models open with nut-tracks.

*Also Manufacturers of: quality cases, racks,  
P.C.B. guides, bails, knobs and indicator skirts.*

Write today for your free catalog.



the **BUCKEYE** stamping co.  
555 Marion Road, Columbus, Ohio 43207  
Quality Products Since 1902

168 Circle 191 on reader service card

## New literature

transceiver, with full break-in cw operation, manufactured by the Hallicrafters Co., 600 Hicks Rd., Rolling Meadows, Ill. 60008 [428]

**Circuit design.** E&L Instruments Inc., 61 First St., Derby, Conn. 06418. A catalog of circuit design and breadboarding equipment features sockets, socket boards, and pulse generators, among other products. [429]

**Printer.** Brochure DCP-1088A gives information on the TermiNet 300 data communication printer for OEM or end-user needs. It is available from General Electric, Communication Systems Division, Section P, Box 4197, Lynchburg, Va. 24502 [430]

**I-f amplifiers.** A short-form catalog from Pasternack Enterprises, 9562 Dumbreck Dr., Huntington Beach, Calif. 92646, describes its line of linear, limiting, and logarithmic i-f amplifiers. [431]

**Power supplies.** A four-page brochure providing information on power supplies is being offered by Computer Products Inc., 1400 N.W. 70th Street, Fort Lauderdale, Fla. [432]

**Capacitors.** A six-page brochure from Bell Industries, Electronic Components Division, 150 W. Cypress Ave., Burbank, Calif. 91502, describes radial- and axial-lead ceramic capacitors. Specifications, dimensional drawings, and working voltage ranges are provided. [433]

**Resistor.** The model 4002 SFR selectable fixed resistor is described in an applications brochure available from Bourns Inc., Trimpot Products Division, 1200 Columbia Ave., Riverside, Calif. 92507. [434]

**Product catalog.** Princeton Applied Research Corp., Box 2565, Princeton, N.J. 08540, has published a short-form catalog containing brief descriptions and key specifications of the company's products. [435]

**Components.** A 20-page condensed



Three Simple,  
Safe



## Temperature Indicators for Electronics

Let you know when rated temperature is reached . . . with an accuracy of  $\pm 1\%$

**1. TEMPILABELS<sup>®</sup>:** self-adhesive temperature monitors consisting of one or more heat-sensitive indicators sealed under transparent, heat resistant windows. The centers of the indicator circles turn from white to black irreversibly at the temperature ratings shown on the label. Tempilabels<sup>®</sup> are available in several sizes, and in single or multiple temperature ratings from 100° to 500°F. Accuracy is within  $\pm 1\%$  of the stated rating. They are particularly useful for monitoring operating temperatures of equipment or processes; obtaining temperature data of components as a guide to design and material selection; safeguarding temperature-sensitive materials in storage or transit. To serve as a permanent record, Tempilabels<sup>®</sup> can be removed from the surface and attached to a report.



**2. TEMPILAQ<sup>®</sup>:** materials of calibrated melting points suspended in an inert, volatile non-flammable vehicle. Available in over 100 systematically spaced temperature ratings from 100° to 2500°F. Tempilaq<sup>®</sup> indicates its temperature rating by liquefying within  $\pm 1\%$  of its rating. Available in bottles or spray cans.

**3. TEMPILSTIKS<sup>®</sup>:** temperature-indicating crayons of calibrated melting points. Available in over 100 systematically spaced temperature ratings. Tempilstiks<sup>®</sup> cover the range from 100° to 2500°F. Tempilstiks<sup>®</sup> indicate the specified temperature, by liquefying with a tolerance of  $\pm 1\%$  of its rating.

Detailed data and price sheets as well as samples are available upon request.

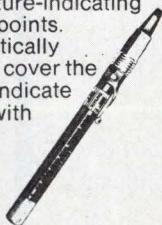

**Tempil<sup>®</sup>** DIVISION, BIG THREE INDUSTRIES, INC.

Hamilton Blvd., South Plainfield, N. J. 07080  
Phone: 201 • 757-8300 • Telex: 138662

Cut your helium  
leak testing costs  
by 50%  
using **TRACER-flo<sup>®</sup>** -  
the test you can trust.



**FACT 1** TRACER-flo performs **both** gross and fine non-destructive hermeticity testing on MOS, LSI, hybrids and semiconductors using non-toxic, inert Krypton 85 tracer gas. Helium won't work for gross leak testing.

**FACT 2** TRACER-flo performs gross production testing to  $1 \times 10^{-6}$  atm. cc/sec. and fine testing to  $1 \times 10^{-11}$ . Helium can't come near this sensitivity. We've found that an average of 38% of the helium rejects we retested on TRACER-flo are good!

**FACT 3** TRACER-flo's new low priced system sells for \$10,950. That's competitive with helium equipment.

**FACT 4** Facts 1, 2 and 3 add up to TRACER-flo production testing at an overall cost that's **half** that of helium even in moderate quantities.

Give us a chance to prove our claims. Get the facts. Call or write for a cost analysis comparison of TRACER-flo and helium testing. Or, call for a demonstration at either of our two facilities.



**TRIO-TECH, INC. OF CALIFORNIA**

2435 North Naomi Street, Burbank, Ca. 91504

(213) 846-9200

1954-M Old Middlefield Way, Mountain View, Ca. 94040

(415) 969-9600



# The long-billed heat sucker.

Cool bird. Reaches into tight places and sucks out heat. Does it with Hughes heat pipes.

Nesting places include transformer cores, solid state devices, tightly stacked circuit boards, electro-optical systems, and other congested hot spots. Any place the finned heat sinker can't nest.

Only Hughes has the long-billed heat sucker. Several

See our complete line at WESCON '73 Booth #1226



subspecies available: round and flat pipe bills, flexible round pipe bill, and the cold mounting plate bill. Strange bird, but very helpful.

Write or call: Hughes Electron Dynamics Division, Thermal Products, 3100 West Lomita Blvd., Torrance, California 90509. (213) 534-2121, Ext. 451.



Circle 170 on reader service card

## HAVE MINICOMPUTER? NEED MAG TAPE?



### NOVA PDP-8 PDP-11

Tell us what kind of mini you have and we'll send the details, along with our new short-form catalog describing our complete line of synchronous, incremental and low power tape units from \$2000.



## DIGI-DATA CORPORATION

4315 Baltimore Ave., Bladensburg, Md. 20710 • (301) 277-9378

How many tape drive manufacturers with over ten years' experience supply transports and mini-computer interfaces starting at \$4525 in single quantities? Digi-Data does . . . and offers generous OEM discounts besides. We're delivering both NRZI and 1600 BPI PE systems furnished with diagnostics and fully burned in on our own minicomputers . . . all transport sizes, and speeds to 45 ips.

170 Circle 193 on reader service card

## New literature

catalog details the complete line of components available from Centralab Electronics Division, Globe Union Inc., 5757 N. Green Bay Ave., Milwaukee, Wis. 53201 [436]

**Stepper motors.** A 12-page brochure on stepper motors and drivers has been issued by The Singer Co., Kearfott Division, 1150 McBride Ave., Little Falls, N.J. 07424. [401]

**Semiconductor fuses.** Semiconductor protective fuses with ratings of 250 volts, 10 to 600 amperes, are described in a data sheet from Semiconductor Division, International Rectifier Corp., 233 Kansas St., El Segundo, Calif. 90245. [402]

**Thermistor.** A four-page catalog from Victory Engineering Corp., Victory Rd., Springfield, N.J. 07081, provides information on the company's Thinistor line of thick-film flake thermistors. [403]

**Switches.** Cherry Electrical Products Corp., 3600 Sunset Ave., Waukegan, Ill. 60085. A handbook and catalog covers the line of gold cross-point switches for low-energy circuits. [404]

**Isolators.** A four-page bulletin containing details on the line of plug-in isolators and circulators is available from Raytheon Co., Special Microwave Devices Operation, 130 Second Ave., Waltham, Mass. 02154. Specifications, and installation details are provided. [405]

**Capacitors.** Engineering bulletin 3521.7 is a guide to MIL Style CSR91 nonpolarized solid electrolyte Tantalex capacitors available from Sprague Electric Co., 35 Marshall St., N. Adams, Mass. 01247 [406]

**Time-delay relay.** Struthers-Dunn Inc., Pitman, N.J. 08071. Data Bulletin B/91215 describes the model 45 delay-on-operate solid-state time-delay relay for industrial control applications. Diagrams of the timing operation and circuit are provided, along with circuit specifications. [407]

Electronics/August 30, 1973



We clamp all the way down  
on voltage drain, current  
drain, and heat emission...  
give you a single-plane  
phosphorescent display  
you can see across the room.

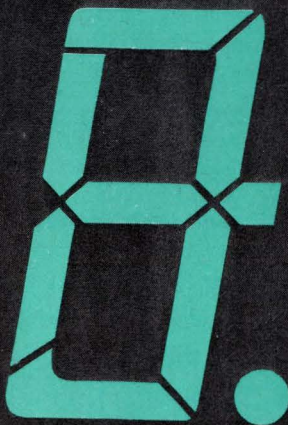

We clamp down fully  
on the disadvantages of other displays.

Our digital readouts,  
including the extremely lightweight,  
mini-size Multi-Numerical Indicator  
with 8, 10, and 12 digit readout,  
offer low-voltage,  
low-current drain,  
and stability advantages over  
conventional displays.

All have eye-easy phosphorescent  
segments with digits on a single-plane  
for optimal visibility  
under ambient light.

It's a natural green glow,  
so soft and clear you can see  
it across the room.

But the best comes last:  
They're competitively priced  
for all modern applications  
in calculators,  
digital clocks, voltmeters and counters,  
and a host of others.  
Count on us.

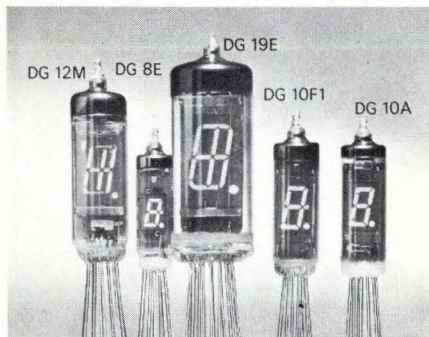
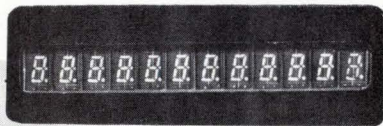
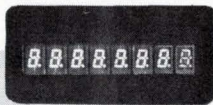

*The Brighter Side of Electronics*



**ISE ELECTRONICS CORP.**

P.O. Box 46 Ise City, Mie, Japan Tel: 05963-5-2121

*International Div.*

**ISE INTERNATIONAL CORP.**

Shinbashi Kokusai Bldg.  
No. 7-7-2, Higashi Shinbashi Minato-ku, Tokyo, Japan  
Tel: 433-6618 Cable: Iseworldrep  
Telex: J26546 Iseinter

*Representative:*

**ISE CORP. OF AMERICA**

(The former LEGI ELECTRONICS CORP.)  
1472 West 178th Street, Gardena California 90248  
Tel: (213) 532-0470, 0471



# Monsanto

ELECTRONIC SPECIAL PRODUCTS  
on the San Francisco  
Peninsula

## SEMICONDUCTOR ENGINEERS

THERE'S NEVER BEEN A  
BETTER TIME THAN NOW  
TO MOVE UP... to MONSANTO!

We are seeking creative,  
innovative Engineers to do  
packaging and Development  
in our Display, Discrete and  
Opto/Isolator Product  
Groups at our new world  
headquarters facility in  
Palo Alto.

OPENINGS EXIST IN THE  
FOLLOWING AREAS:

PACKAGING

SOLID STATE RELAY

MATERIALS

PRODUCT MARKETING

DESIGN/DEVELOPMENT

ELECTRONIC TEST

If your interests are more in  
the manufacturing side of  
the business, we also have  
several openings to provide  
Engineering support to  
Manufacturing. All these  
positions offer challenge,  
excitement and opportunity  
for some travel in both the  
United States and Overseas.

We are an equal opportunity em-  
ployer... a vigorous, growing lead-  
er in the Semiconductor Industry—  
allowing talented individuals full  
participation in our expanding  
activities. Excellent salary and  
benefits.

Please send your resume  
or contact Personnel  
Manager

## Monsanto

ELECTRONIC SPECIAL PRODUCTS  
10131 Bubb Road  
(408) 257-2140  
Cupertino, California 95014



## EMPLOYMENT OPPORTUNITIES

### RESUME KIT

Free Engineer's Resume Kit for Electrical,  
Mechanical and Industrial Engineers.  
Scientific Placement, Inc., Employment  
Service, 5051 Westheimer, Houston,  
Texas 77027.



CLASSIFIED ADVERTISING

## SEARCHLIGHT SECTION

BUSINESS OPPORTUNITIES  
USED OR SURPLUS EQUIPMENT

### BUSINESS OPPORTUNITY

Small Growing Company with calibration  
facilities seeks authorized repair center  
arrangement with manufacturer of control  
and measuring devices. Contact: Instru-  
ments East, 3301 Shipwright St., Ports-  
mouth, Va. 23703. 804-484-7239.

### IMMEDIATE DELIVERY

Minis & Peripherals  
DEC—HIS  
SEL—HP—MOHAWK

CPU, Card, Printer, Tape, Disk  
NEW • MOHAWK 4320 PRINTERS  
• DATA PRINTER V132  
• CENTRONICS 101A

**\$750 Minis**

TELETYPE 35 & 37

For Sale/Rent  
617/261-1100

Send for Free Report "Maintenance of Computers"

AMERICAN USED COMPUTER CORP.  
P.O. Box 68, Kenmore Sta., Boston, MA 02215

CIRCLE 952 ON READER SERVICE CARD

### PERFORMANCE AND RELIABILITY WITH ECONOMY

We Can Fulfill Your Needs!

Electronics and Electro-  
Optics For Laboratory  
Prototype, Production &  
Field Including

- RF Multimeters and Accessories
- RF Detectors
- Reflection Coefficient Bridges and Sets
- Terminations and Calibrated Mismatches
- Broadband RF Amplifiers and  
Multicouplers (2MHz to 1GHz)
- L-C and Crystal Filters
- Voltage Controlled RF Attenuators
- Opto-Electronic Detector/Amplifiers
- Active Probes and Adapters
- Peak-N-Notch Tunable Active Filters
- "500" Series Analog Modules (1 to 1MHz)
- Custom Engineered RF Signal Processing  
Subsystems

Call • Write • Circle-The-Number • Now  
For Data and Application Info

Radiation Devices Co.  
P.O. Box 8450  
Baltimore, Maryland 21234, U.S.A.  
Telephone (301) 665-2764



CIRCLE 953 ON READER SERVICE CARD

### ENTREPRENEURS WANTED

We are looking for aggressive entrepreneurs with five  
years of management experience who want to create and  
build substantial businesses and are willing to base them  
in Central Florida or San Antonio, Texas.

For the right entrepreneurs we offer help in putting  
their ventures together and access to start-up venture  
capital from our clients in the above areas. For further  
consideration write a letter outlining your qualifications  
and entrepreneurial accomplishments. Send it to:

Institute for  
New Enterprise Development

P.O. Box 27 M, Lincoln Centre, MA 01773

CIRCLE 954 ON READER SERVICE CARD

## free catalog

POTTING APPLICATORS  
MANUAL OR AIR OPERATED

2½cc 6cc 12cc 30cc  
FOR POTTING, ENCAPSULATING ETC.

PHILIP FISHMAN CO., INC.

7 CAMERON ST. WELLESLEY, MASS. 02181

CIRCLE 956 ON READER SERVICE CARD

RADAR SYSTEMS GROUND AND AIRBORNE. AUTOMATIC  
TRACKING ANTENNA SYSTEMS. NIKE AJAX. NIKE HER-  
CULES M-33. MSQ-1A. MPS-19. MPS-9. SCR 584. TPS-1D  
TPS-28. FAA-ASR-2. AIRBORNE SYSTEMS. APN-84. APN-102.  
APS-20. APS-27. APS-45. DPN-19. DIGITAL COMPUTERS  
IBM 650. IBM 704.

LARGEST INVENTORY OF RADAR AND  
MICROWAVE EQUIPMENT IN THE WORLD.  
RADIO RESEARCH INSTRUMENT CO.

3 QUINCY ST., NORWALK, CONN. 06850 (203) 853-2600

CIRCLE 957 ON READER SERVICE CARD

## HELP!

Q. How do I reply to a box number  
ad?

A. Address an envelope with the  
box number indicated in the ad,  
c/o Electronics, Class. Adv.  
Dept., P.O. Box 900, NY, NY  
10020

Q. Whom do I contact or call to re-  
new my classified ad or make  
corrections?

A. Write Electronics, Class. Adv.  
Dept., P.O. Box 900, NY, NY  
10020 or call: (212) 997-6585  
or 6586. Give full company  
name, size of ad, & date or dates  
it is scheduled to appear.



### Advertising Sales Staff

**Pierre J. Braudé** [212] 997-3485  
Advertising Sales Manager

**Atlanta, Ga. 30309:** Joseph Lane  
100 Colony Square, 1175 Peachtree St., N.E.  
[404] 892-2868

**Boston, Mass. 02116:** James R. Pierce  
607 Boylston St. [617] 262-1160

**Chicago, Ill. 60611:**  
645 North Michigan Avenue  
Robert W. Bartlett (312) 751-3739  
Paul L. Reiss (312) 751-3738

**Cleveland, Ohio 44113:** William J. Boyle  
[716] 586-5040

**Dallas, Texas 75201:** Charles G. Hubbard  
2001 Bryant Tower, Suite 1070  
[214] 742-1747

**Denver, Colo. 80202:** Harry B. Doyle, Jr.  
Tower Bldg., 1700 Broadway  
[303] 266-3863

**Detroit, Michigan 48202:** Robert W. Bartlett  
1400 Fisher Bldg.  
[313] 873-7410

**Houston, Texas 77002:** Charles G. Hubbard  
2270 Humble Bldg. [713] CA 4-8381

**Los Angeles, Calif. 90010:** Robert J. Rielly  
Bradley K. Jones, 3200 Wilshire Blvd., South Tower  
[213] 487-1160

**New York, N.Y. 10020**  
1221 Avenue of the Americas  
Warren H. Gardner [212] 997-3617  
Michael J. Stoller [212] 997-3616

**Philadelphia, Pa. 19102:** Warren H. Gardner  
Three Parkway,  
[212] 997-3617

**Pittsburgh, Pa. 15222:** Warren H. Gardner  
4 Gateway Center, [212] 997-3617

**Rochester, N.Y. 14534:** William J. Boyle  
9 Greylock Ridge, Pittsford, N.Y.  
[716] 586-5040

**San Francisco, Calif. 94111:** Don Farris  
Robert J. Rielly, 425 Battery Street,  
[415] 362-4600

**Paris:** Alain Offergeld  
17 Rue-Georges Bizet, 75 Paris 16, France  
Tel: 720-73-01

**Geneva:** Alain Offergeld  
1 rue du Temple, Geneva, Switzerland  
Tel: 32-35-63

**United Kingdom:** Keith Mantle  
Tel: 01-493-1451, 34 Dover Street, London W1

**Milan:** Robert Saidel  
1 via Baracchini Phone 86-90-656

**Brussels:** Alain Offergeld  
23 Chaussee de Wavre  
Brussels 1040, Belgium  
Tel: 13-73-95

**Stockholm:** Brian Bowes  
Office 17, Kontor-Center AB, Hagagarten 29,  
113 47 Stockholm. Tel: 24 72 00

**Frankfurt/Main:** Fritz Krusebecker  
Liebigstrasse 27c  
Phone 72 01 81

**Tokyo:** Tatsumi Katagiri, McGraw-Hill  
Publications Overseas Corporation,  
Kasumigaseki Building 2-5, 3-chome,  
Kasumigaseki, Chiyoda-Ku, Tokyo, Japan  
[581] 9811

**Osaka:** Ryji Kobayashi, McGraw-Hill  
Publications Overseas Corporation, Kondo  
Bldg., 163, Umegae-cho Kita-ku [362] 8771

**Australasia:** Warren E. Ball, IPO Box 5106,  
Tokyo, Japan

### Business Department

**Stephen R. Weiss, Manager**  
[212] 997-2044

**Thomas M. Egan,**  
Production Manager [212] 997-3140

**Carol Gallagher**  
Assistant Production Manager [212] 997-2045

**Dorothy Carter,** Contracts and Billings  
[212] 997-2908

**Frances Vallone,** Reader Service Manager  
[212] 997-6057

### Electronics Buyers' Guide

**George F. Werner,** Associate Publisher  
[212] 997-3139

**Regina Hera,** Directory Manager  
[212] 997-2544

## VIDEO analogue to digital converter systems for Colour TV and Radar

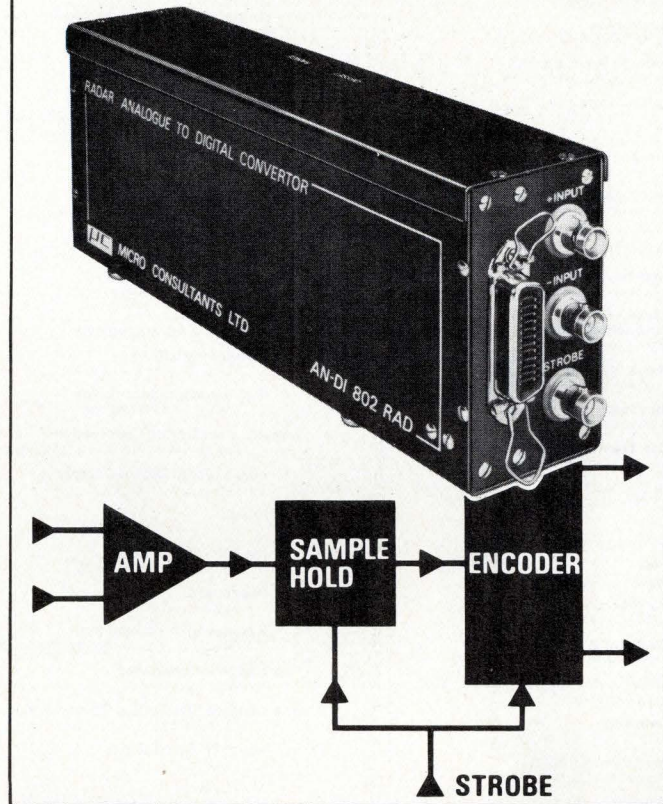

### AN-DI 802 RAD 'C'

<b>Resolution</b>	8 bits
<b>Throughput</b>	15 MHz
<b>Input</b>	$\pm \frac{1}{2}$ volt 50 $\Omega$ or 75 $\Omega$ diff.
<b>Sample Aperture</b>	100 picoseconds
<b>Output</b>	Parallel MECL balanced line drivers
<b>Size</b>	3.6 $\times$ 2.0 $\times$ 9.5 inches

### AN-DI 1002 VID

<b>Resolution</b>	10 bits
<b>Throughput</b>	4 MHz
<b>Input</b>	$\pm 1$ volt 50 $\Omega$ or 100 K $\Omega$ diff.
<b>Sample Aperture</b>	20 nanoseconds
<b>Output</b>	74 TTL
<b>Size</b>	3.6 $\times$ 2.0 $\times$ 9.5 inches

Also available is the DI-AN 1002 RAD, this is a complementary DIGITAL TO ANALOGUE CONVERTOR. Features include 15 MHz updating, 100 volt per  $\mu$  sec slew and < 100 pico volt second switching noise.



### WESCON - STAND 1355/56

If you can't make it, contact us for a demonstration, the week following exhibition

**MC MICRO CONSULTANTS LTD**

Interface House, Croydon Road, Caterham, Surrey, England  
Tel. Caterham 47201 (5 lines) Telex 946643



# Electronics advertisers

August 30, 1973

<b>Abbott Transistor Labs Inc.</b> Technical Adv. Agency	6	<b>General Magnetics</b> McCarthy/Scelba/DeBiasi Adv. Agcy., Inc.	45	<b>Rockland Systems</b> Rolf Johnsen, Inc.	129
<b>Acopian Corp.</b> Mort Barish Associates, Inc.	160	<b>* General Radio</b> Grad Associates	5E	<b>* Rohde &amp; Schwarz</b>	1E
<b>Adams &amp; Westlake Company Relay Division</b> Adwest Advertising	165	<b>* Goetz Electro GmbH</b> Dr. Heinrich Fuchs	57	<b>Rotron, Incorporated</b> Black-Russell-Morris	28
<b>Airpax Electronics</b> Welch, Mirabile & Co. Inc.	161	<b>* Gould, Inc./Instrument Systems Div.</b> Carr Liggett Adv., Inc.	166	<b>Sangamo Electric Company</b> Winius-Brandon Company	142
<b>Alco Electronic Products Inc.</b> Marketronics Advertising	120	<b>Grayhill, Incorporated</b> Carr Liggett Advertising, Inc.	160	<b>Schauer Manufacturing Corp.</b> Nolan, Keelor & Stites	76
<b>Allen-Bradley Company</b> Hoffman, York, Baker & Johnson, Inc.	24	<b>* Green International</b>	14E-15E	<b>‡ Schneider</b> N.A. Winter Advertising	37,39
<b>Amphenol Components Group - Bunker Ramo Corp.</b> Marsteller, Inc.	18-19	<b>Heath/Schlumberger Scientific Instruments</b> Advance Advertising Services	137	<b>SGS-ATES</b> Studio B Communications	119
<b>Associated Environmental Systems, Inc.</b> A. D. Adams Advertising, Inc.	162	<b>Hewlett-Packard</b> Richardson, Siegel, Rolfs & McCoy, Inc.	40-41	<b>Signal Transformer</b> Russell Technical Services, Inc.	140
<b>Augat</b> Creamer, Trowbridge, Case & Bastford, Inc.	60-61	<b>Hewlett-Packard</b> Tallant Yates Advertising, Inc.	2, 90-91	<b>Signetics Corp., Sub. of Corning Glass Works</b> Hall Butler Blatherwick, Inc.	17
<b>‡ Baron Blakeslee</b> Kolb/Tookey & Associates, Inc.	132-133	<b>Hewlett-Packard</b> McCarthy, Scelba, and DeBiasi Adv. Agcy., Inc.	1	<b>Siliconix</b> Robertson West, Inc.	95
<b>Bell &amp; Howell - Electronics &amp; Instruments Group</b> Boylhart, Lovett & Dean	153	<b>Hewlett-Packard</b> Richardson, Seigle, Rolfs & McCoy, Inc.	68-69	<b>‡ Sorensen Company, A Unit of Raytheon Company</b> 56A-56B, 80A-80B Provan die Eastwood & Lombardi, Inc.	56A-56B, 80A-80B
<b>The Buckeye Stamping Company</b> Wheeler Kight & Gainey, Inc.	168	<b>Hitachi, Ltd.</b> Dentsu Advertising, Ltd.	82, 175	<b>Sprague Electric Company</b> Harry P. Bridge Company	8
<b>Burroughs Corp.</b> Conti Advertising Agency, Inc.	2nd Cover	<b>‡ Howard Industries</b> Kolb/Tookey & Associates, Inc.	57	<b>Systron Donner Concord Instruments</b> Bonfield Associates	51
<b>Cambridge Thermionic Corporation</b> Chirurg & Cairns, Inc.	159	<b>Hughes Aircraft Company</b> Foote, Cone & Belding	134-135, 170	<b>* Takeda Riken</b>	106
<b>Celanese Corporation</b> D'Arcy-MacManus International, Inc.	21	<b>ILC Data Device Corporation</b> Marchin Weltman Advertising, Inc.	9	<b>T.D.K. Electronics Co., Ltd.</b> Chuo Senko Advertising Co., Ltd.	71, 73, 75, 77
<b>CELCO</b> Stano Advertising	122	<b>International Nickel Company</b> Ogilvy & Mather, Inc.	58-59	<b>* TEAC Corp.</b> Dentsu Advertising Ltd.	65
<b>* CIT Alcatel</b> Promotion Industrielle	16E	<b>* Intersil</b> Herrick Associates, Inc.	10E-11E	<b>Tektronix Inc.</b> McCann Erickson Inc.	33
<b>Clairex Corporation</b> Black-Russell-Morris	4th Cover	<b>Ise Electronics Corp.</b> Shinwa International, Inc.	171	<b>Teletype</b> N. W. Ayer & Son, Inc.	123
<b>Computer Automation</b> Cochrane Chase & Company, Inc.	15	<b>Ithaco, Inc.</b> Stahlka/Faller, Inc.	148	<b>Tempil Ind, Div. of Big Three Ind.</b> Black-Russell-Morris	169
<b>Constantine Engineering Laboratory Co.</b> Stano Advertising	122	<b>Keithley Instruments, Inc.</b> Chagrin Valley Marketing Associates	44	<b>‡ Texas Instruments Incorporated, Components Group</b> Tracy-Locke	126
<b>CTS Corporation</b> Reincke, Meyer & Finn, Inc.	150	<b>Kepeco Incorporated</b> Weiss Advertising	5	<b>‡ Thomas &amp; Betts Company</b> McCarthy, Scelba, DeBiasi Advertising Agency, Inc.	64-65
<b>Data General Corporation</b> The Advertising Group	12-13	<b>Lambda Electronics Corporation</b> Michel Cather, Inc.	3rd Cover	<b>Toko, Inc.</b> Hakuhodo, Inc.	154
<b>Data Precision</b> Allied Advertising Agency, Inc.	166	<b>* Magneti Marelli S.p.A.</b> Pulicor	52	<b>Tokyo Electric Co., Ltd.</b> PAL, Inc./Export Advertising	164
<b>Datascan, Inc.</b> McCarthy, Scelba, and DeBiasi Advertising Agency, Inc.	176	<b>M C L, Inc.</b> Carr Liggett Advertising, Inc.	122	<b>Trio-Tech Inc. of California</b> Robert A. White Advertising, Inc.	169
<b>Datum, Inc.</b> Data Advertising	136	<b>The Mica Corporation</b> Robert A. White Advertising	43	<b>TRW, Electronic Components Division</b> The Bowes Company	145, 147
<b>Delco Electronics Division, General Motors Corp.</b> Campbell-Ewald Company	46-47	<b>Micro Consultants Ltd.</b> Geoffrey Dadd Ltd.	173	<b>TRW Electronics, Semiconductor Division</b> The Bowes Company	7
<b>Delta Air Lines</b> Burke Dowling Adams, Inc.	144	<b>Micro Power Systems</b> Associated Ad Ventures, Inc.	72	<b>Trygon Electronic Subsidiary of Systron Donner Corporation</b> RAMA Advertising	152
<b>Digi-Data Corporation</b> R □ J Associates	170	<b>* Microwave &amp; Electronic Systems Ltd.</b> Hall Advertising Ltd.	8E-9E	<b>Tung Sol Division, Wagner Electric Corp.</b> CCI	96
<b>The DigiTran Company</b> Jansson Advertising, Inc.	20	<b>3M Electro Products Division</b> Batten, Barton, Durstine & Osborn, Inc.	141	<b>United Systems Corp., A Sub. of Monsanto Co.</b> Advertising & Merchandising, Inc.	66
<b>Duncan Electronics, Inc., Sub of Systron Donner Corp.</b> Enyart & Ross Advertising, Inc.	139	<b>Monsanto Commercial Products Co., Electronic Special Products</b> Advertising Promotion Services	62-63	<b>‡ Unirode Corporation</b> Impact Advertising	27
<b>Dynamic Instrument Corp.</b> Adrian E. Clark, Inc.	138	<b>National Semiconductor Corp.</b> Chiat/Day, Inc. Advertising	74	<b>Universal Oil Products, Norplex Div.</b> Campbell Mithun, Inc.	163
<b>E H Research</b> Hal Lawrence Incorporated	149	<b>‡ Nelson Ross Electronics, Div. Polarad Electronics</b> McCarthy-Scelba-DeBiasi Advertising Agency, Inc.	176	<b>Vu-Data</b> Manning/Bowen and Associates	121
<b>Electro Motive Mfg. Co., Inc.</b> Culver Adv., Inc.	48	<b>‡ Nicolet Instruments Corp.</b> Hagen Advertising, Inc.	106	<b>‡ Wavetek Indiana</b> Chapman Michetti Advertising	124
<b>Electronic Arrays, Inc.</b> Regis McKenna, Inc.	35	<b>* Nippon Kogaku K.K.</b> K & L Advertising Agency	132	<b>WEI Corp.</b> Advertiser's Services, Inc.	154
<b>Electronic Molding Corp.</b> ZThe Williams Company	146	<b>OK Machine &amp; Tool Corp.</b> Sales Promotion and Advertising	160	<b>‡ John Wiley &amp; Sons</b> 605 Advertising Group	118
<b>* Electro Scientific Industries</b> Com/Mark Communications Group	37	<b>Owens-Illinois, Inc. - Digivue</b> Howard Swink Advertising	157	<b>* Yokogawa Electric Works Ltd.</b> General Advertising Agency, Inc.	39
<b>EL Instruments, Inc.</b> Langelier-Stevens, Incorporated	140	<b>* Philips N. V. Pit/T &amp; M Division</b> Marsteller International S. A.	54		
<b>Fluke Manufacturing Co., John</b> Bonfield Associates	22-23, 130-131	<b>Plastics Engineering Company</b> Kuttner & Kuttner, Inc.	16		
<b>Fuji Electrochemical Co., Ltd.</b> General Advertising Agency, Inc.	168	<b>‡ Power/Mate Corporation</b> Spectrum Marketing Associates	20		
<b>* General Electric Company, Semiconductor Products Dept.</b>	7E	<b>1 PROCOND S.p.A.</b> QUADRAGONO	158		
<b>General Electric Company, Utility &amp; Process Automation Products Dept.</b> Robert S. Cragin, Inc.	10-11	<b>‡ Raytheon Company, Industrial Components Operation</b> Provan die Eastwood & Lombardi, Inc.	167		
<b>‡ General Instrument Corp Semiconductor Comp. Div.</b> Norman Allen Associates, Inc.	155-156	<b>* Raytheon Microwave &amp; Power Tube Division</b> Provan die Eastwood & Lombardi, Inc.	12E		
		<b>RCL Electronics, Inc.</b> Morway Advertising Agency	14		
		<b>‡ Rental Electronics, Inc.</b> Humphrey Browning MacDougall, Inc.	54		

## Classified & Employment Advertising

F. J. Eberle, Manager 212-971-2557

<b>EQUIPMENT (Used or Surplus New) For Sale</b>	
<b>Institute for New Enterprise Development</b>	172
<b>Monsanto</b>	172
<b>Radiation Devices Co.</b>	172

‡ For more information on complete product line see advertisement in the latest Electronics Buyer's Guide  
\* Advertisers in Electronics International only  
‡ Advertisers in Electronics domestic edition only



# Get what you want, when you want it.

Get absolute reliability, wide selection and quick delivery with Hitachi glass-sealed silicon diodes.

Hitachi quick deliveries are as reliable as Hitachi glass-sealed silicon diodes. And that's as reliable as diodes can get.

We make our diodes using a machine we designed, the world's only successful machine for mass-producing glass-sealed silicon diodes of uniform high reliability.

Our selection — always big — now includes many new types for specialized applications requiring fast recovery and high voltage. And our quality control is exacting.

Get what you want, when you want it. From Hitachi. You can count on us for quick delivery of any types of diodes. And, you can count on them.

## Rating of glass-sealed silicon diodes

HITACHI TYPE	V <sub>RRM</sub> (V)	I <sub>F(AV)</sub> (A)	I <sub>TSM</sub> (A)	T <sub>J</sub> (°C)	REMARKS	
W06 RECTIFIER DIODE	100	0.75 (T <sub>A</sub> = 40°C)	20	-40 +165		
	200					
V03 RECTIFIER DIODE	200	1.3 (T <sub>A</sub> = 25°C)	30			
	400					
	600					
V06 RECTIFIER DIODE	200	1.1 (T <sub>A</sub> = 20°C)	25			
	400					
	600					
V07 AVALANCHE RECTIFIER DIODE	400	1.3 (T <sub>A</sub> = 25°C)	30			AVALANCHE POWER 40W
	600					
	800					
V08 AVALANCHE RECTIFIER DIODE	400	1.1 (T <sub>A</sub> = 20°C)	25	AVALANCHE POWER 40W		
	600					
	800					
V09 FAST RECOVERY RECTIFIER DIODE	200	0.8 (T <sub>A</sub> = 40°C)	25	T <sub>rr</sub> ≤ 0.5 μsec		
	400					
	600					
V11 HIGH VOLTAGE & FAST RECOVERY RECTIFIER DIODE	800	0.4 (T <sub>A</sub> = 20°C)	25	-40 +125	T <sub>rr</sub> ≤ 0.4 μsec	
	1000					
	1300					
	1500					

HITACHI TYPE	V <sub>RRM</sub> (V)	I <sub>F(AV)</sub> (A)	I <sub>TSM</sub> (A)	T <sub>J</sub> (°C)	REMARKS
U05 RECTIFIER DIODE	100	2.5 (T <sub>L</sub> = 80°C)	100	-40 +175	
	200				
	400				
	600				
	800				
U06 FAST RECOVERY RECTIFIER DIODE	200	2.0 (T <sub>A</sub> = 40°C)	100	-40 +150	T <sub>rr</sub> ≤ 0.6 μsec
	400				
	600				
	800				
U07 HIGH VOLTAGE & FAST RECOVERY RECTIFIER DIODE	800	1.0 (T <sub>A</sub> = 40°C)	100	-40 +140	T <sub>rr</sub> ≤ 0.8 μsec
	1000				
	1300				
	1500				
Y16 HIGH VOLTAGE & FAST RECOVERY RECTIFIER DIODE	12000	0.002 (15.75KHz PULSE C-Load)	1.5	-40 +100	Recovery Current I <sub>rp</sub> = 2m A peak
AW01 ZENER DIODE	ZENER VOLT. 6~33V	PERMISSIBLE LOSS 1W		-40 +150	
AW03 ZENER DIODE	ZENER VOLT. 2~5V	PERMISSIBLE LOSS 1W			

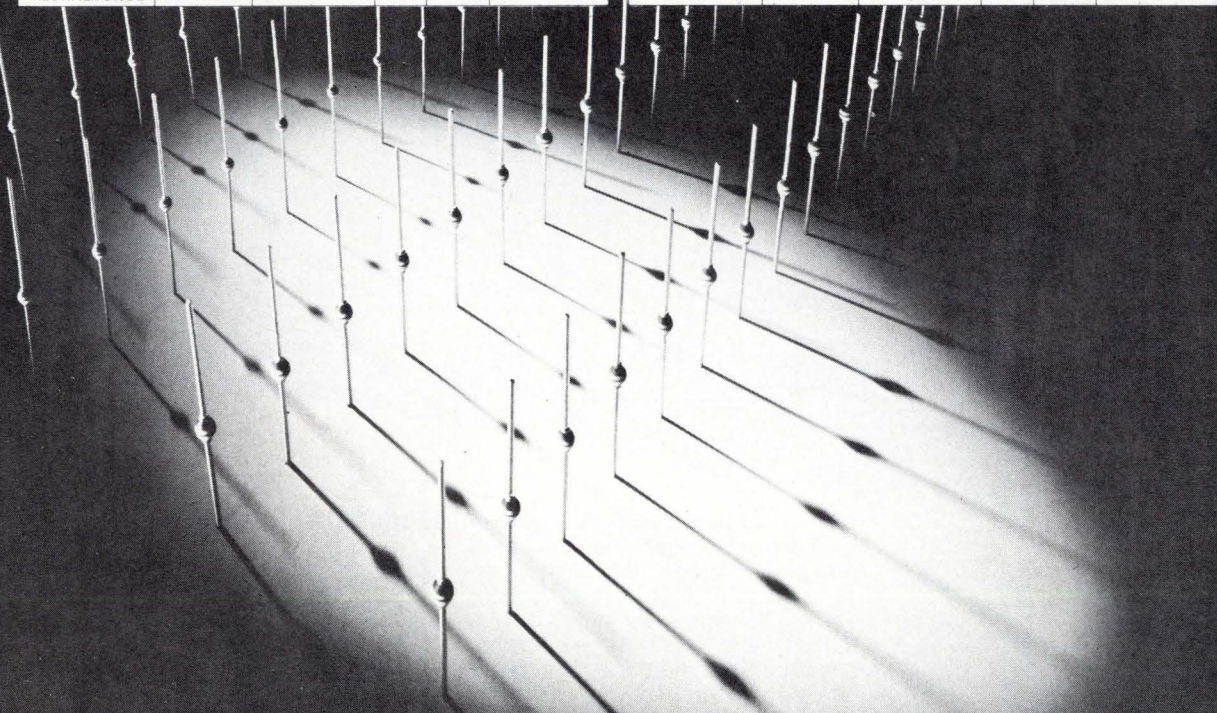

For further information, please contact:

Head Office (Section XME): 6-2, 2-chome, Otamachi, Chiyoda-ku, Tokyo 100 Argentina: Av. de Mayo 666, Piso 12, Buenos Aires Tel. 33-3201 Brazil: Av. Rio Branco 151, Grupo 1505, Rio de Janeiro-GB Tel. 231-1321 England: 2nd Fl., 11/12 Finsburg Sq., London E.C.2 Tel. 588-3275 West Germany: 4000 Düsseldorf, Graf-Adolf-Strasse 37 Tel. 10846 Hitachi America, Ltd.: New York: 437 Madison Av., New York, N.Y. 10022 Tel. (212) 758-5420 San Francisco: 100 California St., San Francisco, Calif. 94111 Tel. (415) 981-7871 Nissel Sangyo GmbH (Deutschland): 4000 Düsseldorf, Am Wehrhahn 41 Tel. 36 09 03 Nissel Sangyo Co., Ltd., Taipei Office: Nanking Bldg., No. 165, Sec., 2, Nanking East Rd., Taipei 104 Tel. 570704 Nissel Sangyo Co., Ltd., Hong Kong Branch Office: Watson's Industrial Estate Room No. 603 Block A 6th Floor, Watson Road, North Point, Hong Kong Tel. 5-784021-4, 5-784121 Nissel Sangyo do Brasil Ltda: Edifício Estrela, Av. Rio Branco 211, 9º-Andar Salas 96/99 São Paulo, Brasil Tel. 221-3011, 3805





# go portable

## Introducing THE Digital Panel Meter for Portable Instruments

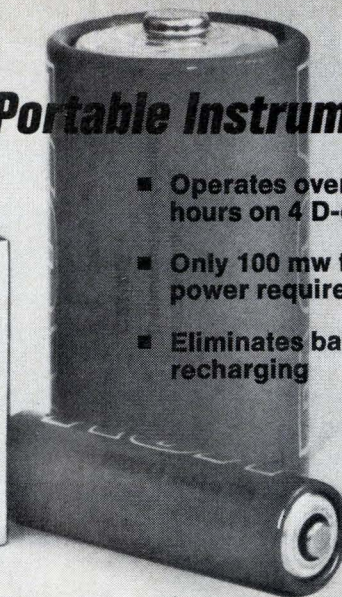
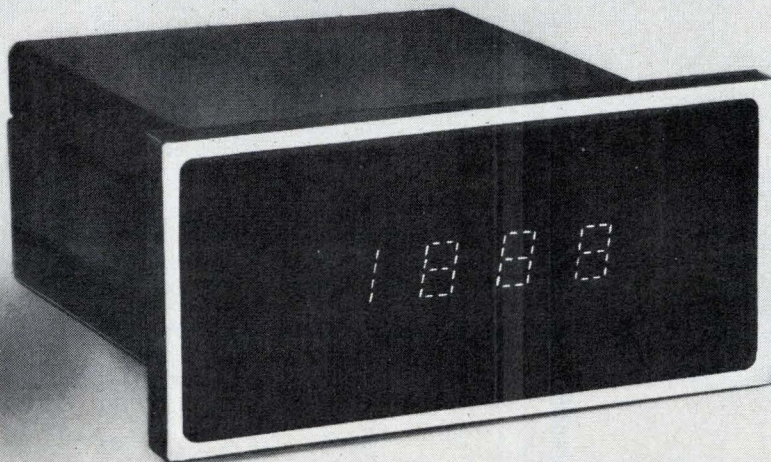

- Operates over 600 hours on 4 D-cells
- Only 100 mw total power required
- Eliminates battery recharging

NOW, make your portable instruments smaller, lighter, less expensive and more reliable. With the Datascan Model 820 battery powered DPM, you also get a bright, reliable and readable 3½ digit LED display, 0.1% (of reading) accuracy, battery input voltage from 4.8 to 8.0\* volts and an attractive miniaturized metal case that's only 3.5" deep x 2.5" wide x 1.3" high.

To get complete specs or to arrange for a demonstration, call or write. We're anxious to help you GO PORTABLE.

\*other ranges available.



Datascan  
Electronic  
Products

P.O. Box 785  
1111 Paulison Ave.  
Clifton, N.J. 07013  
Telephone: (201) 478-2800

### Datascan

Circle 176 on reader service card

## Fully Warranted Microwave Signal Generators... 1-21 GHz



GET YOUR POLARAD CATALOG, USE THE INFORMATION RETRIEVAL NUMBER.



Field test results are in. All the new "A" Series Polarad Signal Generators and Sources just keep operating; month after month after month. Therefore, we now provide a full, 1 year warranty — *without* the usual exception for microwave tubes. (Just compare our warranty with the ones for the generators you now use.)

### Only from Polarad:

Select from an array of rack/stack compact modular Generators and Sources. Get stable, spectrally pure outputs;  $\pm 0.5\%$  digital frequency readout; the most versatile FM, pulse, square wave modulation, and high output power.

# polarad electronic instruments

A Division of Polarad Electronics Corp.

5 Delaware Drive / Lake Success, New York 11040 / 516-328-1100 TWX 510-223-0414

176 Circle 194 on reader service card

Electronics/August 30, 1973