

- 75 AT&T takes another look at Picturephone
- 116 New 4,096-bit RAM features one-transistor cell
- 123 Minicomputer networks boost processor power

# Electronics®



**Is  
electronics  
making it  
in  
medicine?**

1470 TCH999 99SAB JUN74  
STATE TECHNICAL INSTITUTE  
LIBRARY PERIODICALS 0-10992  
38134  
MEMPHIS TN



# ENGINEER POWER

Engineering is the big difference in Power Supplies from Electronic Measurements . . . more power per cubic inch, more power per pound, higher efficiency (and less heat), ripple as low as 0.5 mV.

The table shows the 0.1%-regulation SCR models and 1%-regulation EM models, but Electronic Measurements has a full line, bench-type and modular, with single and multiple outputs, from 5V to 500V and from 2.5A to 650A.

And there's more: remote sensing and programming, automatic E/I crossover, stability within 0.05%, full overload protection, rugged construction that's easy to service, and a five-year guarantee.

In Power Supplies, the best is Engineer Power, from Electronic Measurements. For a short-form catalog, use the Reader Service card, or contact Electronic Measurements.

Rating	Price	
	EM	SCR
6V-600A	\$1,600	\$2,000
7.5V-300A	1,200	1,400
10V-250A	1,200	1,400
10V-500A	1,600	2,000
20V-125A	1,050	1,200
20V-250A	1,275	1,500
20V-500A	2,050	2,650
30V-100A	1,050	1,200
30V-200A	1,450	1,800
40V-60A	950	1,100

Rating	Price	
	EM	SCR
40V-125A	\$1,300	\$1,600
40V-250A	1,975	2,500
50V-200A	1,975	2,500
80V-30A	950	1,110
80V-60A	1,200	1,500
100V-100A	1,975	2,500
120V-20A	975	1,300
120V-40A	1,200	1,500

Rating	Price	
	EM	SCR
160V-15A	\$ 950	\$1,100
160V-30A	1,300	1,600
160V-60A	1,975	2,500
250V-10A	950	1,100
250V-20A	1,300	1,600
250V-40A	1,975	2,500
500V-5A	1,300	1,500
500V-10A	1,600	2,000

19" Rack, 20" depth. Voltage and current adjustable over wide range.

See EEM Vol.1-791, 1-792, 1-793 for additional information.



## ELECTRONIC MEASUREMENTS INC.

405 Essex Road, Neptune, N. J. 07753

Phone: (New Jersey) 201 - 922-9300 • (Toll-Free) 800 - 631-4298

Specialists in Power Conversion Equipment

# SURPRISE!



## Free! 100 page optoelectronic designer's catalog.

HP's new 100 page Optoelectronic Designer's Catalog is here! It's absolutely free and comes loaded with detailed specifications and complete application notes on our broad line of optoelectronic products, including our LED displays, LED lamps, high-speed optically-coupled isolator and PIN photodetectors.

Mail the coupon today so we can get your copy on its way to you now.



Sales, service and support in 172 centers in 65 countries.  
Palo Alto, California 94304. Offices in principal cities throughout the U. S.

Surprise me with your free 100 page HP Optoelectronic Designer's Catalog.

NAME \_\_\_\_\_  
 TITLE/POSITION \_\_\_\_\_  
 COMPANY \_\_\_\_\_  
 ADDRESS \_\_\_\_\_  
 CITY \_\_\_\_\_ STATE \_\_\_\_\_ ZIP \_\_\_\_\_  
 01331

# What's it worth to get lab capability

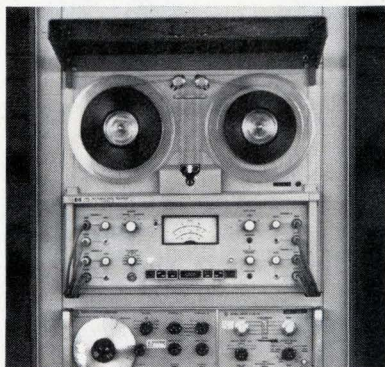

## in an instrumentation recorder with field portability?



**(\$4,270!)**

If you think you've got to sacrifice performance for portability, it'll be worth your while to price Hewlett-Packard's 3960 instrumentation recorder. At \$4,270, it gives you field portability along with performance and features found only in the most expensive laboratory machines.

Built on a precision milled alu-

minum casting, the 3960 weighs less than 50 pounds.

Signal-to-noise ratio is better than 46db when operating in the FM mode at 15/16 ips.

The 3960 Portable Instrumentation Recorder from Hewlett-Packard.

The one that you can pack off into

**pack it or rack it**

**HEWLETT *hp* PACKARD**

HP sales, service and support in 172 cities in 65 countries.

the field, or rack in the lab. From just \$4,270. And worth it. For complete details write Hewlett-Packard, 1501 Page Mill Road, Palo Alto, California 94304. In Europe, Post Office Box 85, CH-1217 Meyrin 2, Geneva, Switzerland. In Japan, Yokogawa-Hewlett-Packard, 1-59-1, Yoyogi, Shibuya-Ku, Tokyo, 151.

113-03

## 39 Electronics review

SOLID STATE: SOS array handles logic equations, 39  
Pad relocation revived at Hughes, 40  
Chips for Polaroid camera exposed, 40  
COMPANIES: 'Compatible' calculators start new era at Victor, 41  
GOVERNMENT ELECTRONICS: FBI to automate fingerprint system, 42  
AEROSPACE ELECTRONICS: FAA reopens ARTS-2 bids, 42  
COMPUTERS: Illiac 4 about to be unleashed, 44  
INDUSTRIAL ELECTRONICS: Software enhances numerical control, 46  
INDEX OF ACTIVITY: 48  
MILITARY ELECTRONICS: Poseidon failure laid to motors, guidance, 48  
NEWS BRIEFS: 50  
STANDARDS: U. S., EEC sharpen conflict on standards, 52

## 63 Electronics International

JAPAN: Color TV camera from Toshiba to cost \$770, 62  
FRANCE: Schneider sets up on its own in U. S., 62  
AROUND THE WORLD, 63

## 75 Probing the News

COMMUNICATIONS: Second thoughts about Picturephone, 75  
COMPUTERS: Network will conserve Belgium's water, 78  
INSTRUMENTATION: Will calculators replace minis? 80  
Weathermen look to Finland, 86

## 99 Technical Articles

MEDICAL ELECTRONICS: Doctors want better design approach, 99  
DESIGNER'S CASEBOOK: Adding automatic zeroing to ADC, 111  
Boosting IC regulator current with almost no power loss, 112  
Digital clock/calendar offers dual-mode display, 112  
SOLID STATE: Sense amp is key to fast 4,096-bit RAM, 116  
COMPUTERS: Standard interfaces promote minicomputer nets, 123  
ENGINEER'S NOTEBOOK: Choosing detector to measure rf power, 131  
Handy audio amplifier minimizes power drain, 132

## 145 New Products

IN THE SPOTLIGHT: Solid-state rf amplifier puts out 20 W, 145  
INSTRUMENTS: Low-priced multimeter has overload protection, 146  
SEMICONDUCTORS: Single-chip log amps use FET inputs, 150  
PACKAGING & PRODUCTION: Mask aligner boosts IC yield, 161  
SUBASSEMBLIES: Isolation amplifier's gain is variable, 171  
MATERIALS: 178

## Departments

Publisher's letter, 4  
Readers comment, 6  
40 years ago, 8  
People, 14  
Meetings, 30  
Electronics newsletter, 35  
Washington newsletter, 59  
Washington commentary, 60  
International newsletter, 65  
Engineer's newsletter, 134  
New literature, 182

## Highlights

### The cover: Medical electronics in operation, 99

New electronic equipment is urgently needed, not for exotic purposes, but with the basic capacity to survive brownouts, emergency medical situations, and electronically unsophisticated users. A dozen doctors suggest design improvements.

Center figure in cover photo, courtesy *Medical World News*, is noted heart surgeon Dr. Michael DeBakey, Baylor University, Texas, surrounded by electronic (and human) aids.

### Picturephones to gain new functions, 75

Experience in the field has taught AT&T that the Picturephone must expand its range of applications if it is ever to become profitable. Options under consideration for the second-generation model are a separable camera, a facsimile receiver, a video tape recorder, and a keyboard for data entry.

### The first one-transistor-per-cell 4,096-bit RAM, 116

Redesign of the on-chip sense amplifier, enabling it to pick up the low-voltage signals of one-transistor cells, overcame the main obstacle to exploiting these tiny cells in a high-density, low-cost memory chip.

### Minicomputer nets start a success story, 123

The availability of standard, low-priced interfaces adds economy to all the other good reasons—high reliability, fast throughput, and versatility—for realizing a processing system with a minicomputer network.

### And in the next issue . . .

Presenting the video disk recorder . . . microchannel plates upgrade low-light-level imagers . . . how to reduce trimmer sensitivity.

### Coming Oct. 25

A special issue devoted to the growing pervasiveness of electronics.

EDITOR-IN-CHIEF: Kemp Anderson

EXECUTIVE EDITOR: Samuel Weber

MANAGING EDITORS: Lawrence Curran, *News*;  
Arthur Erikson, *International*

SENIOR EDITORS: John Johnsrud,  
H. Thomas Maguire, Laurence Altman  
Ray Connolly

ART DIRECTOR: Fred Sklenar

ASSOCIATE EDITORS: John N. Kessler,  
Howard Wolff, Gerald M. Walker

#### DEPARTMENT EDITORS

*Aerospace*: William F. Arnold  
*Circuit Design*: Lucinda Mattera  
*Communications & Microwave*:  
Lyman J. Hardeman

*Components*: Joel DuBow  
*Computers*: Wallace B. Riley  
*Consumer*: Gerald M. Walker  
*Industrial*: Alfred Rosenblatt  
*Instrumentation*: Michael J. Riezenman  
*Military*: Ray Connolly

*New Products*: H. Thomas Maguire  
*Packaging & Production*: Stephen E. Grossman  
*Solid State*: Laurence Altman  
*Special Issues*: Harry R. Karp

COPY EDITORS: Margaret Eastman,  
Everett C. Terry

ASSISTANT EDITOR: Marilyn Offenheiser

ART: Charles D. Ciatto, *Associate Director*  
Patricia Cybulski, *Assistant Director*

PRODUCTION EDITOR: Arthur C. Miller

EDITORIAL SECRETARIES: Janet Annunziata,  
Julie Gorgoglione, Penny Roberts

#### FIELD EDITORS

*Boston*: Gail Farrell  
*Los Angeles*: Paul Franson (Mgr.)  
*Midwest*: Larry Armstrong (Mgr.)  
*New York*: Alfred Rosenblatt (Mgr.)  
*San Francisco*: George Sideris (Mgr.),  
Judith Curtis  
*Washington*: Ray Connolly (Mgr.),  
William F. Arnold  
*Frankfurt*: John Gosch  
*London*: Michael Payne  
*Paris*: Arthur Erikson  
*Tokyo*: Charles Cohen

#### McGRAW-HILL WORLD NEWS

*Director*: Walter A. Stanbury  
*Bonn*: Robert Ingersoll;  
*Brussels*: James Smith;  
*London*: Marvin Petal;  
*Milan*: Peter Hoffmann, Andrew Heath;  
*Moscow*: Axel Krause;  
*Paris*: Michael Johnson, Richard Shepherd;  
*Stockholm*: Robert Skole;  
*Tokyo*: Mike Mealey

PUBLISHER: Dan McMillan

ADVERTISING SALES MANAGER: Pierre J. Braudé  
ADVERTISING SALES SERVICE MANAGER:  
Wallis Clarke

BUSINESS MANAGER: Stephen R. Weiss

CIRCULATION MANAGER: George F. Werner

MARKETING SERVICES MANAGER:  
Tomlinson Howland

**I**nvariably, when Charles Cohen, our field editor in Tokyo, files a story, the story itself is accompanied by fascinating background information on the companies and individuals involved, notes on Japanese cultural and sociological factors that may perhaps be relevant, or an amusing anecdote of some tribulation in dealing with the Japanese technical community.

The Toshiba color vidicon story which leads off the Electronics International section in this issue is a case in point. In addition to the technical details of the development itself, Cohen cabled a detailed history of competing technologies, an analysis of the patent situation, and a critique on the shortcomings of Japanese publicity photos.

Cohen has been filing these colorful reports on the Japanese electronics industry for *Electronics* for almost a dozen years. He brings to the job a unique background that almost forms a specification for the ideal *Electronics* field editor in Tokyo. A native of Brooklyn, Cohen received a BEE degree from Cornell in 1953, then served in the Signal Corps for two years. Part of his service was in Japan, which he came to love, so after his discharge, he enrolled in the University of Tokyo and graduated with a masters degree in engineering. A little later, in 1962, he joined McGraw-Hill World News as a correspondent and then in 1969 became a full-time field editor for *Electronics*.

His technical knowhow and his fluency in the language are priceless assets that open many doors for him. Associate editor Jerry Walker, who annually visits Japan and makes the rounds with Cohen gathering inputs for our Japan market

report, was told by a Japanese electronics executive: "He speaks better Japanese than most of the engineers working for me."

**I**ncidentally, a Walker-Cohen reunion is scheduled in Tokyo next week in preparation for this year's Japan report which will appear in the Nov. 27 issue. This will kick off our series of year-end market and technology roundups and prognostications that have become traditional features of our coverage of the international electronics technology marketplace. The Japan report will be followed by the European report on Dec. 20. And the first issue of 1974, Jan. 10, will carry the 16th annual U.S. market forecast. Combined with our special issue of Oct. 25, which will be entirely devoted to an examination of the proliferation of electronics technology, this coverage should represent a powerful aid for electronics decision makers.

**A**nd in this issue you'll find a number of other stories reported by our network of international correspondents. Besides the Electronics International section, there are two Probing the News stories from overseas. One, by John Gosch, our man in Frankfurt, details the Belgian effort to build Europe's first computer-monitored network of waterways (see p.78). The other, from Martin Schultz, our man in Helsinki, chronicles the rise of a Finnish company to the heights of the balloon-borne radiosonde and rain-gauge business (see p.86).

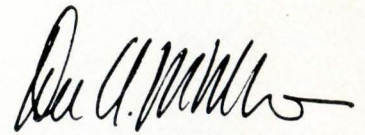

September 13, 1973 Volume 46, Number 19  
91,547 copies of this issue printed

Published every other Thursday by McGraw-Hill, Inc. Founder: James H. McGraw 1860-1948. Publication office 1221 Avenue of the Americas, N.Y., N.Y. 10020, second class postage paid at New York, N.Y., and additional mailing offices.

Executive, editorial, circulation and advertising addresses: Electronics, McGraw-Hill Building, 1221 Avenue of the Americas, New York, N.Y. 10020. Telephone (212) 997-1221. Teletype TWX N.Y. 710-561-5234. Cable address: MCGRAW HILL N.Y.

Subscriptions limited to persons with active, professional, functional responsibility in electronics technology. Publisher reserves the right to reject non-qualified requests. No subscriptions accepted without complete identification of subscriber name, title, or job function, company or organization, including product manufactured or services performed. Subscription rates: qualified subscribers in the United States and possessions, Canada, and Mexico \$9.00 one year, \$12.00 two years, \$15.00 three years; all other countries \$25.00 per year, except Japan \$50.00 per year and Brazil \$40.00 per year, including air freight. Limited quota of subscriptions available at higher-than-basic rate for persons outside of field served, as follows: U.S. and possessions and Canada, \$25.00 one year; all other countries \$50.00. Single copies: United States and possessions and Canada, \$1.00; all other countries, \$1.75.

Officers of the McGraw-Hill Publications Company: John R. Emery, President; J. Elton Tuohig, Executive Vice President-Administration; Gene W. Simpson, Group Publisher-Vice President; Senior Vice Presidents: Ralph Blackburn, Circulation; Walter A. Stanbury, Editorial; John B. Høglund, Controller; David G. Jensen, Manufacturing; Gordon L. Jones, Marketing; Jerome D. Luntz, Planning & Development.

Officers of the Corporation: Shelton Fisher, President; Wallace F. Traendly, Group President, McGraw-Hill Publications Company and McGraw-Hill Information Systems Company; John J. Cooke, Senior Vice President and Secretary; Ralph J. Webb, Treasurer.

Title registered in U.S. Patent Office; Copyright ©1973 by McGraw-Hill, Inc. All rights reserved. The contents of this publication may not be reproduced either in whole or in part without the consent of copyright owner.

Subscribers: The publisher, upon written request to our New York office from any subscriber, agrees to refund that part of the subscription price applying to copies not yet mailed. Please send change of address notices or complaints to Fulfillment Manager; subscription orders to Circulation Manager, Electronics, at address below. Change of address notices should provide old as well as new address, including postal zip code number. If possible, attach address label from recent issue. Allow one month for change to become effective.

Postmaster: Please send form 3579 to Fulfillment Manager, Electronics, P.O. Box 430, Hightstown, N.J. 08520.

# New function generator programs faster— functions better, longer.

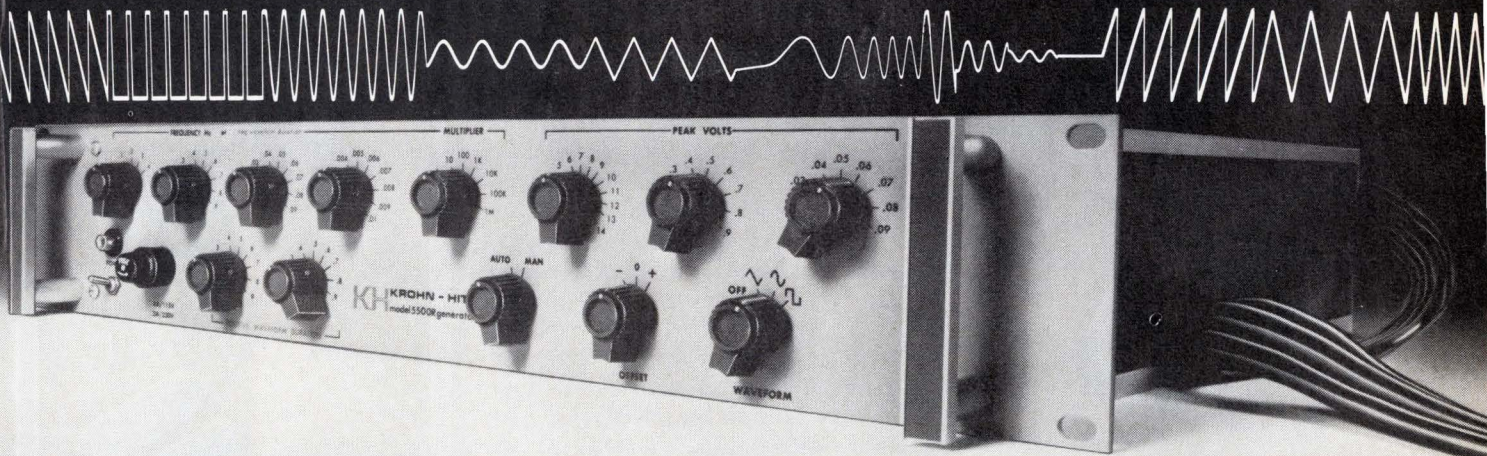

**The 5500R Programmable Function Generator utilizes high-speed FET switches for greater reliability and generates functions automatically in less than 100 $\mu$  sec.**

There are no relays to break down. And optical coupling assures high isolation between system and logic drive. Frequency range is 0.0001Hz to 5MHz. Sine, square, triangle, pulse and sawtooth waveforms, as well as frequency, amplitude, DC offset and pulse width control functions, can all be selected auto-

matically or manually. And the 5500R programming interface is compatible with DTL, RTL, TTL logic and relay closures. It's ideally suited for automatic calibration and test systems. For fast action, call (617) 491-3211, TWX 710 320 6583, or contact your local KH representative listed below.

**KH KROHN-HITE  
CORPORATION**

580 Massachusetts Avenue, Cambridge, Massachusetts 02139

SALES OFFICES: ALA., Huntsville (205) 534-9771; CAL., Santa Clara (408) 243-2891, Inglewood (213) 674-6850; COLO., Littleton (303) 795-0250; CONN., Glastonbury (203) 633-0777; FLA., Orlando (305) 894-4401; HAWAII, Honolulu (808) 941-1574; ILL., Des Plaines (312) 298-3600; IND., Indianapolis (317) 244-2456; MASS., Lexington (617) 861-8620; MICH., Detroit (313) 526-8800; MINN., Minneapolis (612) 884-4336; MO., St. Louis (314) 423-1234; N.C., Burlington (919) 227-2581; N.J., Bordertown (609) 298-6700; N.M., Albuquerque (505) 255-2440; N.Y., E. Syracuse (315) 437-6666, Rochester (716) 328-2230, Wappingers Falls (914) 297-7777, Vestal (607) 785-9947, Elmont (516) 488-2100; OHIO, Cleveland (216) 261-5440, Dayton (513) 426-5551; PA., Pittsburgh (412) 371-9449; TEX., Houston (713) 468-3877, Dallas (214) 356-3704; VA., Springfield (703) 321-8630; WASH., Seattle (206) 762-2310; CANADA, Montreal, Quebec (514) 636-4411, Toronto, Ontario (416) 444-9111, Stittsville, Ontario (613) 836-4411, Vancouver, British Columbia (604) 688-2619.

See us at WESCON, Booth 1333.

Circle 5 on reader service card

# Put on a great display...



## with Intronic's new, fast multiplying DACs.

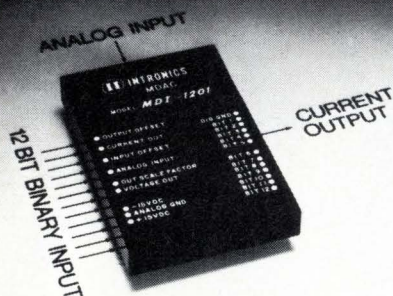

The first in a line of fast multiplying digital to analog converters from Intronic, specifically designed for high speed graphic display applications. The dynamic characteristics of models MDI 1201 & 1202 are optimized to ensure straight vector generation in your CRT displays, by minimizing delay time variation. And these models offer a fast settling time of 500ns, a wide bandwidth analog input of 4MHz, a low temperature drift of 5ppm/°C, and a high output impedance, all with no external trimming required.

Whether your application is graphic displays (generation of vectors and alphanumeric characters), scaling analog signals by digital command, synchro conversion, data normalization, or digital modulation systems, Intronic's fast multiplying DAC modules provide the speed and accuracy you require at the right price. Don't settle for less. Specify Intronic's MDI DACs for your high speed data conversion applications, they won't throw you a curve.



### intronic

57 Chapel Street, Newton, Massachusetts 02158 U.S.A.  
617-332-7350, TWX 710-335-6835

Overseas Call:  
Brussels, Belgium 35-97-91  
Helsinki, Finland 11-123  
Paris, France 9077844  
Munich, Germany 524181  
Tel-Aviv, Israel 53459  
Milan, Italy 9043983  
The Hague, Holland 678380  
Maidstone, England 54224

## Readers comment

### The whistler mode

**To the Editor:** Your article on hydrometeorological telemetry [*Electronics*, Aug. 2, p.61] leaves a misleading impression about the Stanford University vlf transmitter at Siple Station.

To the best of our knowledge, the first vlf transmitter to operate from the Antarctic was the 25-kilowatt-output transmitter used by the University of Washington for research with the Longwire (21 miles long, ice-supported dipole) antenna near Byrd Station.

This transmitter was primarily used for vlf ionospheric sounding, but early in 1966, it was used in a whistler-mode propagation experiment. We were able to transmit in the whistler mode to a polar orbiting satellite. Another program to record whistler-mode signals from the University of Washington vlf transmitter to the northern hemisphere was unsuccessful.

The Stanford 100-kw-input-power transmitter described in your article has a number of advantages over ours: its higher power, the greater efficiency of the Siple antenna, the lower geometric latitude of Siple Station, and particularly, an accessible conjugate near Roberval, Que. With these advantages, the Stanford University experiment may well yield a better understanding of whistler-mode propagation phenomena.

H. R. Willard  
W. J. Helms

Electrical Engineering Department  
University of Washington  
Seattle, Wash.

### EMC handbook item erred

**To the Editor:** The last notice in the Engineer's newsletter [*Electronics*, Aug. 16, p.121] contains a few errors. The number of the "Electromagnetic Compatibility Design Handbook" is Navair 1115, rather than 115, and the handbook may be obtained through normal Department of Defense channels.

Ernest R. Freeman  
President  
Sachs/Freeman Associates Inc.  
Hyattsville, Md.

# NEW SHORTER CASE! SCHAUER 1-WATT ZENERS

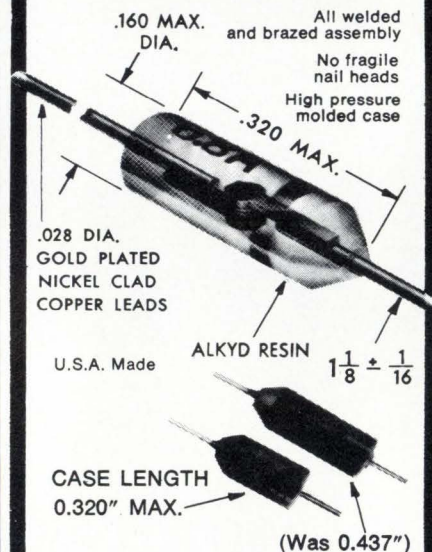

All welded and brazed assembly  
No fragile nail heads  
High pressure molded case

.028 DIA.  
GOLD PLATED  
NICKEL CLAD  
COPPER LEADS

U.S.A. Made

ALKYD RESIN

$1\frac{1}{8} \pm \frac{1}{16}$

CASE LENGTH  
0.320" MAX.

(Was 0.437")

**SAME LOW PRICES FOR 1% TOLERANCE ZENERS**

**ANY VOLTAGE FROM 2.0 TO 18.0**

Quantity	Price Each
1-99	\$1.07
100-499	.97
500-999	.91
1000-4999	.86
5000 up	.82

**IMMEDIATE SHIPMENT**

Send for rating data and 20%, 10%, 5% and 2% tolerance prices.

Semiconductor Division

## SCHAUER

MANUFACTURING CORP.

4514 Alpine Ave., Cincinnati, Ohio 45242  
Telephone 513/791-3030



# The first



## at this price!

**±1 $\mu$ V resolution**

**5 full functions**

**26 ranges**

**Lead-compensated ohms**

For immediate information on Systron-Donner's new Model 7205 5½-digit Multimeter, call us collect on our **Quick Reaction** line: (415) 682-6471. Or you may contact your Scientific Devices office or S-D Concord Instruments Division, 10 Systron Drive, Concord, CA 94518. **Europe:** Systron-Donner GmbH, Munich, W. Germany; Systron-Donner Ltd., Leamington Spa, U.K.; Systron-Donner S.A., Paris (Le Port Marly) France. **Australia:** Systron-Donner Pty. Ltd. Melbourne.

SYSTRON  DONNER

The Systron-Donner Instruments Group:

Concord Instruments  Computer Systems  Datapulse  Kruse Electronics  Microwave  Trygon Electronics

## 40 years ago

From the pages of *Electronics*, September 1933

The New Deal has restricted the hours of labor and thereby has introduced a tremendous amount of New Leisure. A current estimate places this sudden new recreation time at thirteen million hours per week.

Sooner or later this "Niagara of leisure" will have to be absorbed in part by amusements, sports and other recreations. A large part will be devoted to such electronic entertainment as radio, sound-pictures, home talkies, phonograph reproduction, synthetic musical instruments, and eventually, television.

Thus, suddenly our products are called upon to help shoulder the burden of the New Leisure. New markets are opened up for our entertainment carriers, multiplying their importance far beyond their former relationship in a world that worked long hours with little time for recreation. Now all forms of electrical entertainment find themselves in a new and rising market.

Whatever the restrictions placed on production and expansion in other industrial fields, under the new order of things, it is clear that a new boon and a new boom have been handed to the electronics industries of radio, sound pictures, and all associated fields. The far-reaching influences of these will be more apparent as the months of NRA roll on.

**Just fifty years ago**, in 1883, Thomas A. Edison discovered the flow of electrons across the vacuum of his early incandescent lamp, laying the foundation for the whole electronic industry, radio, and other applications of thermionic amplification.

And this month, appropriately enough, the radio industry starts its sales campaign, leading to Radio Progress Week, which will be celebrated Oct. 2 to 7. Radio Progress Week thus marks fifty years of the electronic arts, beginning with the first faint phenomena detected by Edison, which thereafter lay unused for almost a generation, but now expanded into services that span the earth.



## Stacked...with beautiful curves!

(stacked-foil construction with ultra-low impedance, ultra-low ESR, ultra-low inductance)

Revolutionary new Type 432D COMPULYTIC® Aluminum Electrolytic Capacitors offer capacitance values to 100,000  $\mu$ F with equivalent series resistance of typically less than 0.001 ohm and inductance of only 1 nH in a 3" x 5 $\frac{5}{8}$ " case. This same capacitor will handle 93 amperes of ripple current at 65 C and 1 kHz.

Impedance limits at 10 kHz are as low as 0.001 ohm with typical values of only half of the specified limits.

Now available in two additional smaller case sizes for space-saving applications in smaller-wattage power supplies, with typical impedance of five milliohms.

For complete technical data, write for Engineering Bulletin 3443 to: Technical Literature Service, Sprague Electric Co., 35 Marshall St., North Adams, Mass. 01247.

THE BROAD-LINE PRODUCER OF ELECTRONIC PARTS

Terminals are ideal for use with laminated-bus power distribution systems found in modern EDP equipment, where the low ESR and impedance of Compulytic capacitors help insure continued operation of logic circuits even during momentary power outages.

Sprague Type 432D Capacitors are available in nine voltage ratings from 5 to 50 volts d-c, and are designed for operation over the temperature range from -40 to +85 C.

45M-2122R1  
**SPRAGUE**  
THE MARK OF RELIABILITY

# How to get it all under control.

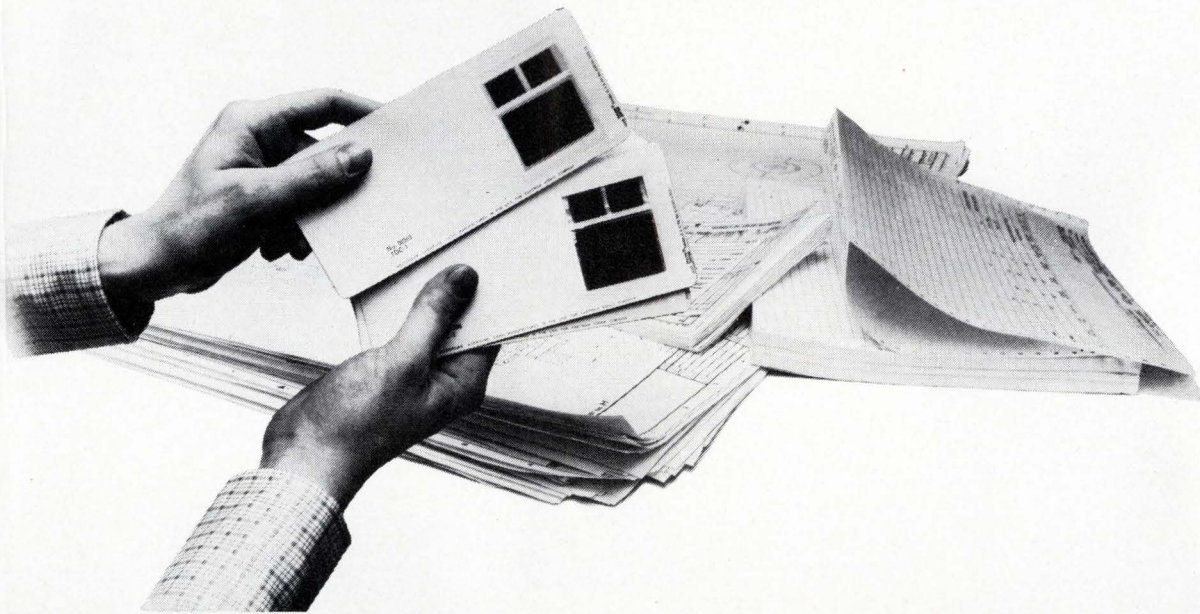

---

Looking for a better engineering document control program? Kodak can help you put the pieces together.

---

There's a new concept in engineering document control that uses microfilm as the key element in the filing, retrieval, and reproduction of engineering drawings.

You keep your engineering drawings as well as support data—change notices, specifications, parts lists, standards, etc—on microfilm, available for ready reference with microfilm readers.

Modern Kodak microfilming and photo-reproduction techniques let you go from the original drawing to microfilm, and then back to a full-size photographic blowback for revisions or for the production of inexpensive diazo duplicates.

You'll save filing space, reduce retrieval

time, and still have the capability of producing full- or reduced-size drawings of exceptional quality when desired. All it takes is the right equipment, materials, and know-how.

Kodak can help you with these. With microfilmers, film processors, readers, and reader-printers. With microfilm, and with drawing reproduction films and papers. And with the knowledge gained in more than 40 years' experience in microfilm.

---

Send for more information.

---

Just drop us a line for our brochure on the engineering document control concept, or request a sales representative to phone for an appointment. Eastman Kodak Company, Business Systems Markets Division, Dept. DP883, Rochester, N.Y. 14650.

**Kodak products for engineering data systems**



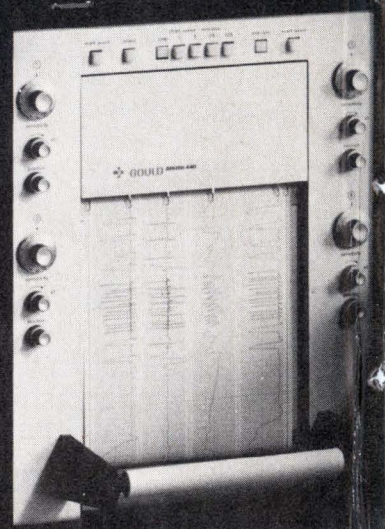
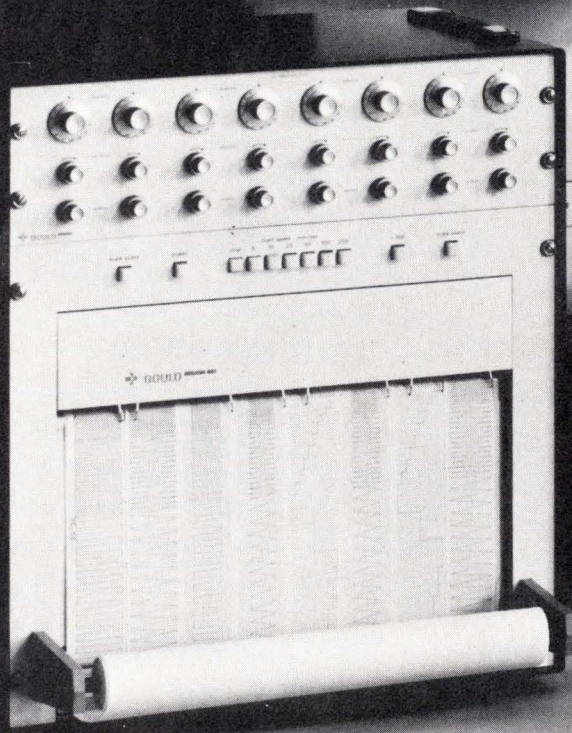
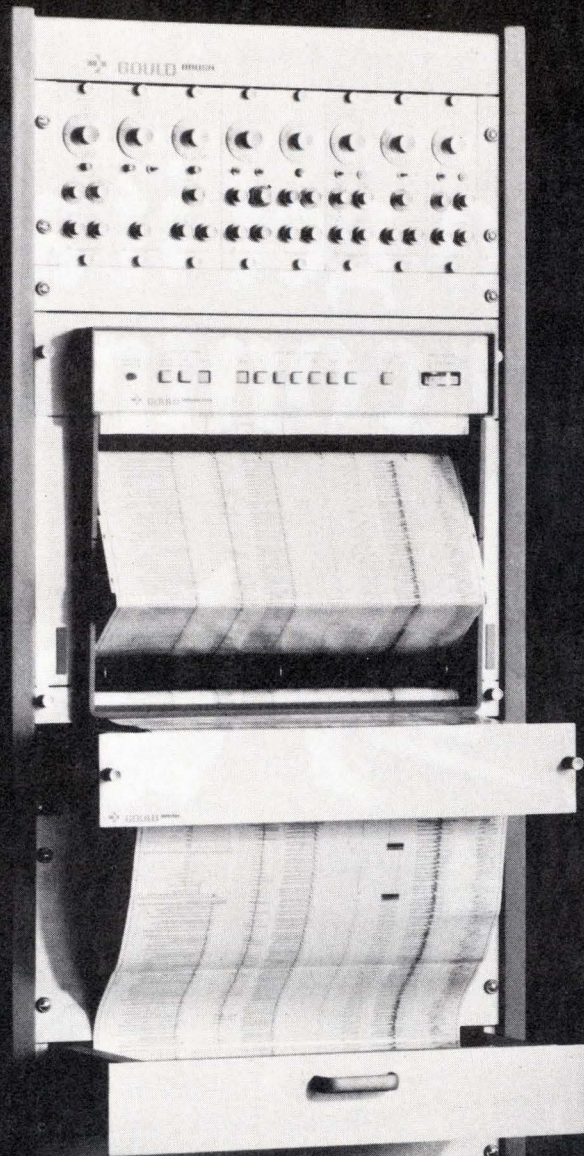

# Six good reasons why Brush recording systems are your best buy.

**1.** Brush has the broadest line in the industry.

We make a recorder/signal conditioner to meet just about any industrial or scientific application.

Choose from 1 to 8 channel direct writing recorders with or without built-in preamps; full scale frequency responses from 35 Hz to 55 Hz; 40 mm, 80 mm and 4½" wide channels; portable and rack mounted models.

**2.** Brush guarantees better than 99.5% linearity.

There are two reasons why we can guarantee such a high degree of accuracy. First, our Metrisite non-contact servo-loop feedback device. Second, our recorders have a rectilinear presentation which eliminates geometric errors.

**3.** The Brush pressurized inking system gives you the highest quality traces.

For twelve years, Brush traces have been the standard of the industry. Our pressurized inking system writes dry. It eliminates smudges, smears, skips and puddles. The record you get is crisp, clear and permanent.

**4.** Brush recording systems give you trouble-free operation.

All of our instruments require minimal maintenance. For example, our disposable ink supply usually lasts more than a year. And all of our electronics are solid state.

**5.** A Brush system is easy to operate.

All of our systems are self-calibrating. Controls are conveniently placed to give you maximum flexibility. Chart

paper can be replaced in seconds. Switching signal conditioners is a snap.

**6.** Brush is a single source for everything you need.

We offer custom financing and leasing plans. Our installation, training, and maintenance programs are geared to your needs. And our warranty and replacement parts packages are two of the best in the industry.

If you'd like to find out more, contact your nearest Gould Sales Engineer or Representative. Or write for detailed performance information and specifications. Gould Inc., Instrument Systems Division, 3631 Perkins Avenue, Cleveland, Ohio 44114. Or Kouterveldstraat Z/N, B 1920 Diegem, Belgium.

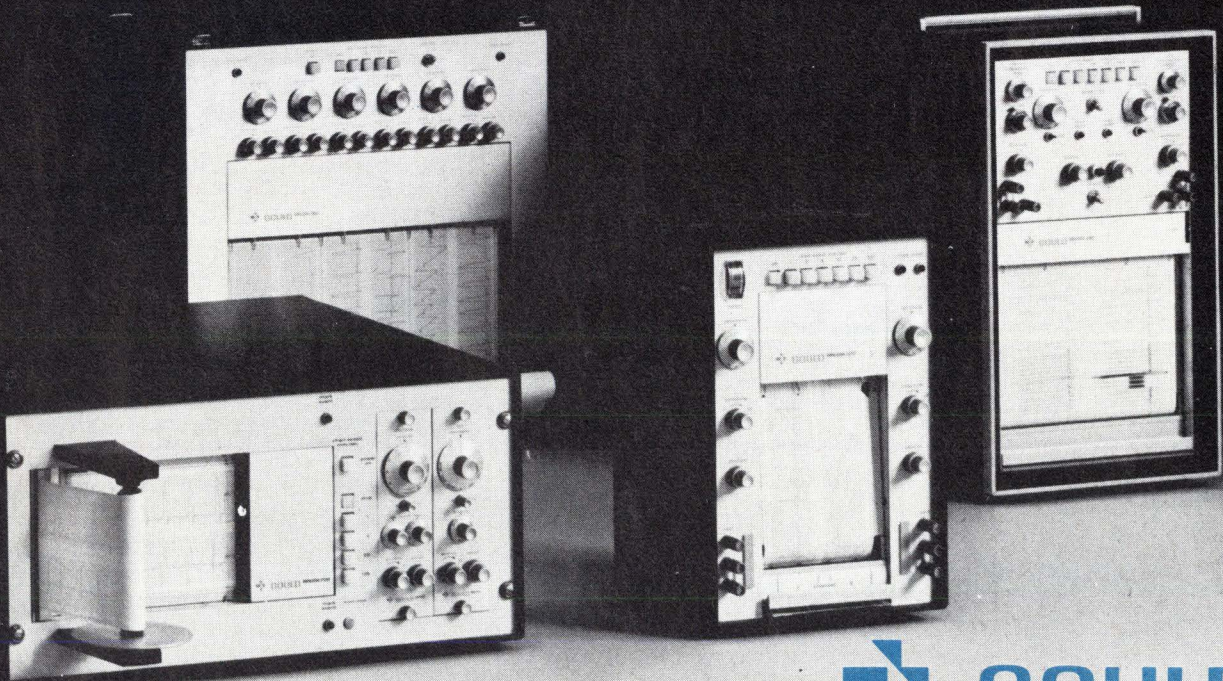

 **GOULD**

Circle 11 on reader service card



THE INCREDIBLY FAST 5900+. 100 READINGS PER SECOND IN THE  $4\frac{1}{2}$  DIGIT MODE.

**You can either make it better.  
Or you can make it cheaper.**

**Now, do both.**



*The challenge infuriates an engineer. Excellence cannot traditionally be compromised by economics. But if you can't afford it, you won't buy it. So sometimes we have to do both.*

*Above you see one of the "plus" machines from Dana. "Plus" because it is truly a better machine. And "plus" because it is priced to give you a new level of quality for the money.*

**The 5900+. A new standard.**

This new unit may well be the world's most accurate and stable 5-digit multimeter.

It delivers 0.001% total accuracy.

It has 350 volts RMS protection on all ohms measurements.

It provides true systems capability. It has 5 DC ranges, 60% overrange, and full ratio capability. Its basic price is \$1795. Nothing at that price is comparable in accuracy and quality.

**NOW WITH TRUE RMS CONVERTER**

**The 5000+ DVM. The price is lower. The standards aren't.**

This new DVM is the lowest priced 5-digit multimeter we've ever produced. Yet because it was engineered and built by men who have been dealing with units costing ten times as much, the 5000+ reflects their standards.

It is absolutely reliable. (Silicon solid state circuitry plus LED display.)

It has 5 DC ranges capable of measuring from 1  $\mu$ V through 1000V.

It offers autoranging in all functions and 100% overranging on all ranges.

It's available as a complete multimeter. Its basic price is \$995. Nothing with its features and its quality is available for the price.

Examine these products and study their incredible performance/price. Contact Cliff Hamilton at Dana Laboratories, Inc., 2401 Campus Drive, Irvine, California 92664. Or call collect at (714) 833-1234. Ask him about these plus machines.

**DANA**®

**Others measure by us.**

## If you want to hurt the 240L RF Power Amplifier

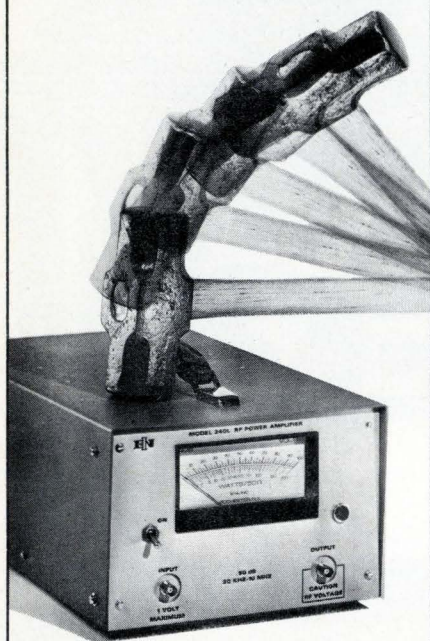

... you've got to do more  
than short circuit its output.

As a matter, of fact, this *brand new* instrument will deliver more than 40 watts of Class A linear power and up to 150 watts of CW and pulse power to any load impedance (from an open to a short circuit). Immune to load damage and unconditionally stable the 240L covers the frequency range of 20 KHz to 10 MHz with a flat 50 db gain. Completely *solid state* the 240L will faithfully reproduce input waveforms from any signal or function generator in its range.

If you need a transducer drive source for ultrasonics, RFI/EMI, biological research, electro or acousto optics the 240L was designed for you.

Solid state reliability is here  
at \$1450.00.

For further information or a demonstration contact ENI, 3000 Winton Road South, Rochester, New York 14623 (716) 473-6900 or  
TELEX 97-8283

# ENI

The world's leader  
in solid-state power amplifiers.

## People

Kelley to rely on  
electronics in FBI

As the new director of the Federal Bureau of Investigation, Clarence M. Kelley plans to streamline the venerated agency by using new electronics technology in much the same way he did as police chief of the in-



**G-man.** FBI chief Kelley says electronics is needed to streamline the agency.

novative Kansas City, Mo., department. "We have to gear our people to the use of all technologies, including electronics," to improve and update operations, the 61-year-old lawman says.

From his experience in Kansas City, Kelley foresees an increased use of computers in crime-fighting, especially as analytical and administrative aids. For example, the computerized criminal-history file in the National Crime Information Center (NCIC) network could become the basis for detailed studies about crime, he says. From that compilation of data, it might be possible to determine some causes of crime, and with that understanding, law-enforcement agencies might be able to predict crime patterns to improve assignment of personnel, says the director. Such studies are under way in Kansas City.

Also under study, Kelley says, is the feasibility of adding message-switching to the NCIC network, to speed queries among the various ju-

risdictions, and of finishing development of the Finder-automated fingerprint-reading project (see p. 42). But, since the FBI is an "after-the-fact type of agency," the silver-haired chief doesn't foresee the need for digitized mobile communications, one of his improvements for the Kansas City department [*Electronics*, Dec. 6, 1971, p. 39].

**Computers and privacy.** Kelley is attuned to the concern of civil libertarians about individual privacy with computerized police-data banks, such as the computerized criminal-history file. "The stir is well-founded," he says, "but it also must be recognized that the concern should be balanced against the benefits of a compilation such as this." He argues that an individual's criminal-history file would help a judge in making right decisions about a person's future. "I seriously question whether computerized criminal history will be used as much as NCIC" in police work, says Kelley.

Commenting on the close cooperation between the FBI and the Law Enforcement Assistance Administration, Kelley says that LEAA's grants to the states, "if used judiciously, should do a great deal of good" in also helping the states add new equipment to the bureau-run NCIC network.

After earning a B.A. at the University of Kansas and an LL.B. from the University of Kansas City, Kelley joined the FBI in 1940. Except for Navy service in World War II, he served in various FBI posts until he left to become Kansas City police chief in 1961.

Pritchard goes from  
R&D to domsat fray

Although Fairchild Industries started as an unknown quantity in the domestic-satellite business, the company has done several things to establish itself. One was to form the American Satellite Corp., a joint venture with Western Union International, to operate a domestic satellite system. Another was to organize its Space and Electronics Co. to



# MOSTEK WILL WORK WITH YOU. ASK HEWLETT-PACKARD.

"MOSTEK was . . . and still is . . . an important contributor to our hand-held scientific and business calculator line. Their extremely knowledgeable team makes interfacing a pleasant experience. Their engineers attack

the job with enthusiasm, propose creative alternatives and are able to implement difficult design concepts." — these words from Max Schuller, Section Manager of Technology, Advanced Products Division, Hewlett-Packard.

We take great pride in meeting the requirements of a company noted for its high standards and reputation for reliability, and it's more than satisfying when we're rewarded by such sincere comments, not only about our technical performance, but about our business attitudes as well. In reference to the latter, H-P says, "MOSTEK's frankness and honesty in their dealings with Hewlett-Packard are refreshing in the present business climate. This openness has given us the confidence that they will continue to meet their commitments to us."

At MOSTEK we're very much looking forward to working with H-P in the future. So, when you have a MOS requirement, problem, or just an idea, bring it to us and we'll work with you. Just ask H-P!



## **MOSTEK**®

1215 West Crosby Road  
Carrollton, Texas 75006  
(214) 242-0444  
TWX 910-860-5975  
TELEX 73-0423

© Copyright 1973 by MOSTEK Corporation

On one of the HEWLETT-PACKARD calculator assembly lines, Cupertino, California: Max Schuller, Section Manager of Technology, Advanced Products Division, HEWLETT-PACKARD; on the right, Robert Crawford, Senior MOS Design Engineer, MOSTEK Corporation.

**"Airpax UPL Series  
Circuit Protectors  
make our entire  
systems possible."**

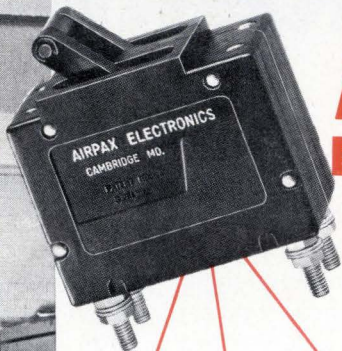

**AIRPAX™ TYPE UPL  
Electromagnetic  
Circuit  
Protectors**

Airpax Type UPL Circuit Protectors provide reliable, low cost power switching, circuit protection, and circuit control. UL Recognized, the UPL line offers many configurations including series, shunt and relay. Multipole assemblies are available with a mix of current ratings, delays, and internal configurations. Full load current ratings from 0.05 to 100 amperes.

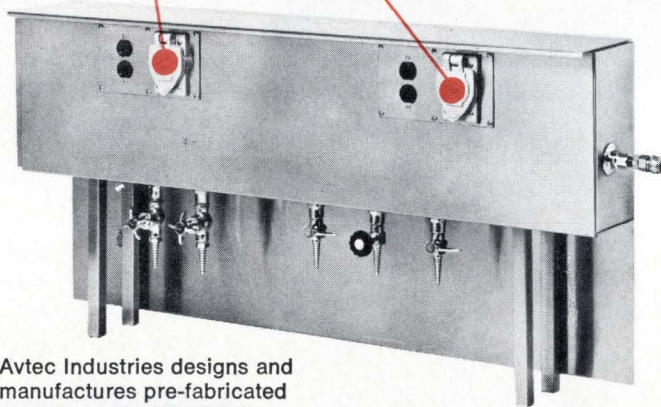

Photos courtesy of Avtec Industries

Avtec Industries designs and manufactures pre-fabricated modular Utility Distribution Systems for one-point connection to multiple-unit batteries of equipment or to special laboratory equipment; and Electra-Poles, unique systems that plug into the ceiling when power is needed and unplug when the equipment is removed. These systems require positive protection – AIRPAX protection!

In the words of Mr. Bruce A.

Zimmerman, Vice President of Avtec, "These entire systems are possible because we use Airpax UPL Series Circuit Protectors, which provide built-in 'point-of-use' protection and eliminate the need for running branch circuits from the panel box."

**Shouldn't you investigate Airpax Circuit Protectors for your next design?**

Write for specifications.

Airpax Electronics / CAMBRIDGE DIVISION / Cambridge, Md. 21613 / Phone (301) 228-4600



**People**

build such systems. To direct that effort, Wilbur L. Pritchard was chosen president.

A former vice president of the Communications Satellite Corp. and director of its laboratories, the 50-year-old electronics engineer plans a well-armed attack on the highly competitive market.

One place Pritchard foresees new customers is in the earth-station business, and Fairchild already has demonstrated a van-sized terminal at the recent National Cable Television Association meeting [*Electronics*, June 21, p. 72].

**Prospects bright.** To beef up its body-stabilized spacecraft technology, the company teamed with TRW Systems to bid on RCA Global Communications Co.'s domsat system [*Electronics*, June 7, p. 51]. More prospects are in sight, such as systems planned by Brazil and India and, of course, American Satellite Corp. The company also is building NASA's Applied Technology Satellite. Space and Electronics also has projects in automated data systems for military reconnaissance and is doing R&D work for postal-service automation, he adds.

Although the president's office in Germantown, Md., is only a few super-highway miles down the road from Comsat Labs, the difference is "like night and day," Pritchard says, obviously enjoying the competitive business environment. Fairchild is a "business-oriented company, while Comsat is a utility—secure, quiet, and prestigious." Comsat "was born with a silver spoon in its mouth," he adds. "Fairchild has to prove itself." After spending six years directing Comsat Labs' buildup to become a power in satellite research, "the next six years didn't seem quite so challenging," he reflects. "I needed to run something much more on my own with more freedom and scope."

Before joining Comsat, he was group director of Communications Satellite systems for Aerospace Corp., and director of engineering for Raytheon Co. His hobbies include restoring old pocket watches and playing the mandolin and banjo. He is married and has three children.

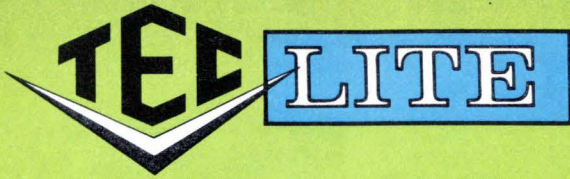

# YOUR COMPLETE SOURCE FOR INDICATING DEVICES

## READOUTS

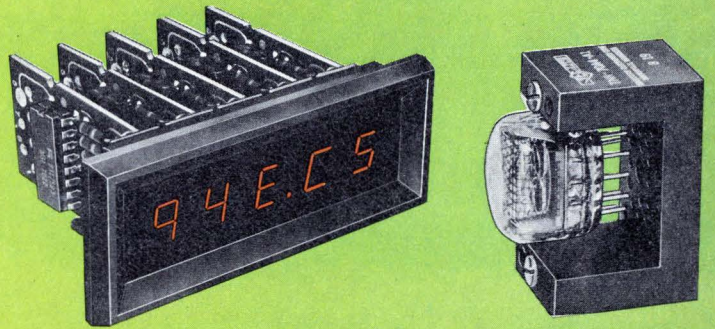

## LAMPS

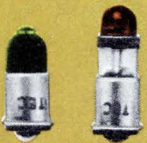

## INDICATORS

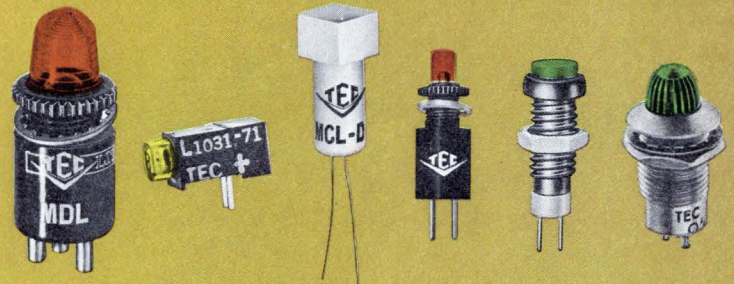

## DATA - LINE SYSTEMS

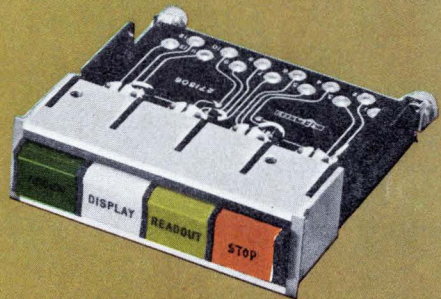

## SWITCHES & SWITCH/INDICATORS

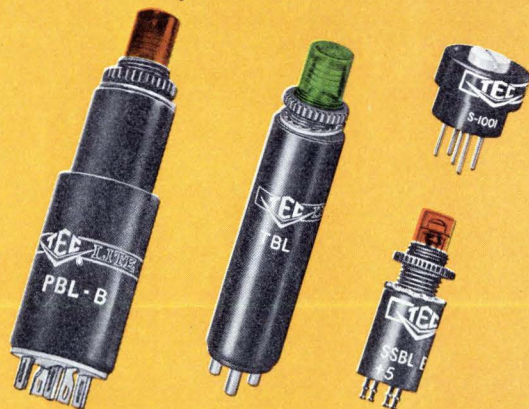

## DISPLAY PANELS



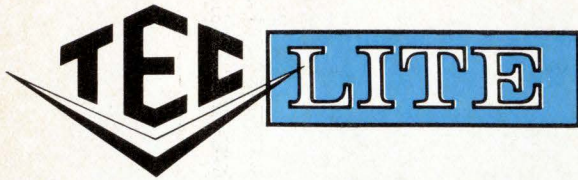

**ONE-STOP SERVICE FROM THE DISPLAY/CONTROL SPECIALISTS**

### **Complete Man-Machine Interface Line**

Highly reliable, economically priced devices for every information display and control need: computers and peripherals, industrial controls, communications, test equipment, aircraft and missiles, navigation, guidance/control systems, consumer products—TEC serves all, with over 15 years of proven performance.

Choose from a wide selection of body styles, terminal types, lens colors, mounting options, operating ranges, switch types, plus other options such as RFI shielding, waterproof units and engraved legends. Write for detailed specifications on all products listed in this brochure.

### **Custom Designed Displays and Controls**

And if what you need isn't in our inventory we'll custom build it for you at a surprisingly low cost. TEC has over 8,000 special designs on file—both electrical and mechanical—so let our innovative, problem-solving engineering staff help you with your unique requirements.

### **24-Hour Shipment on Many Devices**

One-day service on a variety of in-stock lamps, indicators, switches and readouts—including our broad line of LED's—for orders of 1 to 99. Ask for "QUICK DRAW" Catalog No. 955.

### **DATA-SCREEN™ TERMINALS**

TEC designed, built and delivered its first alphanumeric CRT terminals in 1963. More than a decade of experience serving countless businesses and industries has given TEC invaluable knowledge about interfacing CRT terminals with a host of business, scientific and process control computers. . .and at competitive prices.

Today, TEC's Series 400 DATA-SCREEN Terminals are available in 13 different models that offer screen capacities from 960 to 1920 characters and parallel, serial and teletypewriter replacement interfaces. Full edit capabilities in many models, plus buffered operation, allow off-line message composition and editing.

For more information on Series 400 DATA-SCREEN Terminals, write for 8-page, full-color brochure No. 884.



All devices shown approximately actual size, except where noted. Prices listed are unit prices in quantities of 100 (unless stated otherwise), F.O.B. factory, and represent the lowest-priced unit in a particular series. All prices and specifications subject to change without notice.

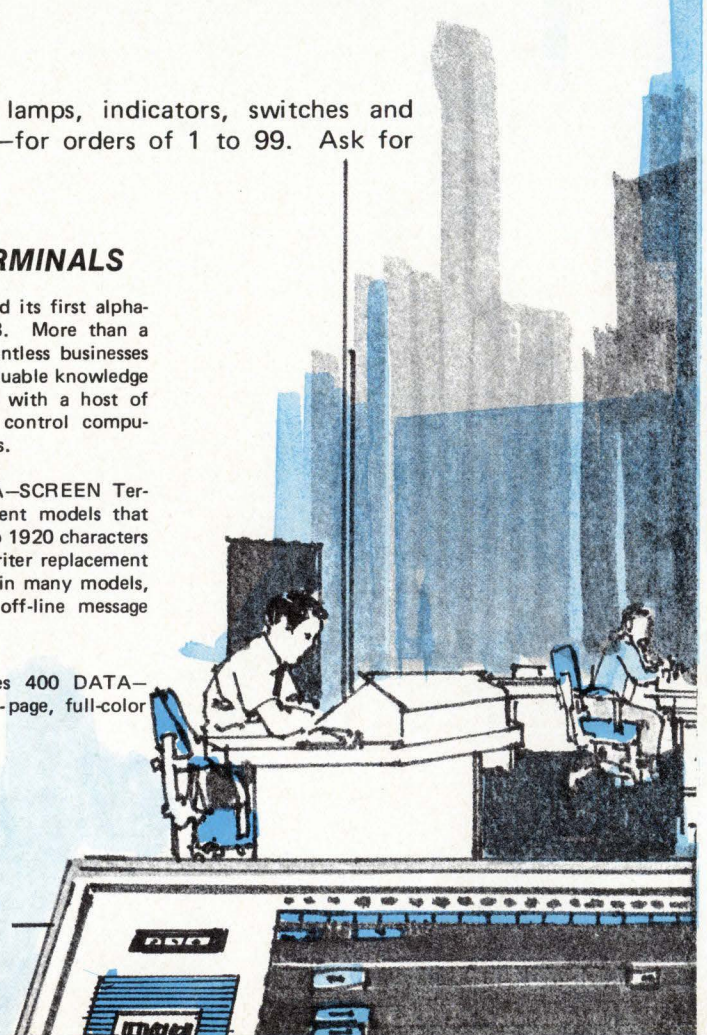

## LED INDICATORS, LAMPS, SWITCHES, SWITCH/INDICATORS & PANEL DISPLAYS

TEC-LITE solid state, IC-compatible LED indicating devices feature high reliability and long life, coupled with high brightness and low power consumption. Rugged units are also resistant to shock, vibration and extreme temperature changes. For applicable models, Fresnel rings in lens distribute light for maximum readability.

Items A through E are easily mounted, compact indicators that replace incandescent or neon cartridge lites in low current, solid state applications. All five have the following common features: black or clear anodized aluminum body; red or green LED; and internal resistor that adapts unit for 2 to 28 VDC operation (L-1016 and L-1021) or 5 to 28 VDC (L-1010, L-1015 and L-1020).

- A. **L-1010 Series.** Mounts in .290" hole on 1/2" centers in solderless cartridge holder or with Tinnerman clip (P/N 321212). . . . . \$1.25
- B. **L-1015 Series.** As above, but with flat top or spherical lens in red, green or clear. . . . . \$1.30
- C. **L-1016 Series.** Same as L-1015 above, but with .025" square Wire-Wrap® terminals . . . . . \$1.35
- D. **L-1020 Series.** Mounts in 5/16" hole on 5/8" centers in holder (P/N 781058-2) or lead wire connectors. . . . . \$1.65
- E. **L-1021 Series.** Similar to L-1020 above, but with turret lug terminals and flat top or spherical lens in red, green or clear. Mounts in 3/8" hole on 11/16" centers. . . . . \$1.70
- F. **LS/LL Series.** Direct replacements for flange-based T-1 1/4 incandescent or neon lamps. Internal resistors adapt units for 5 to 28 VDC operation. Red or green LED . . . . . \$1.25
- G. **L-1022 Series.** Indicator with red or green LED and aluminum body in black or clear anodized finish or optional irridite for RFI shielding. Operates from 2 to 28 VDC supply. Flat top or spherical lens in red, green or clear. Mounts in 3/8" hole on 9/16" centers. Other finishes available on special order . . . . . \$1.90
- H. **S-1022 Series.** Same features as L-1022 above, plus N.O. or N.C. switch with contact rating of 100 mA @ 115 VAC and life of 1 million operations at rated current. Flat top lens only . . . . . \$3.05

**NOTE:** All devices with green or yellow LED's are available only with 5-volt rating.

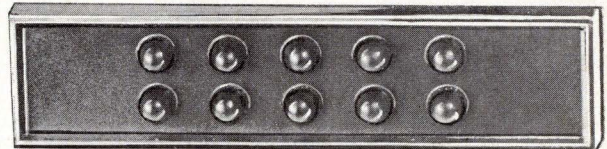
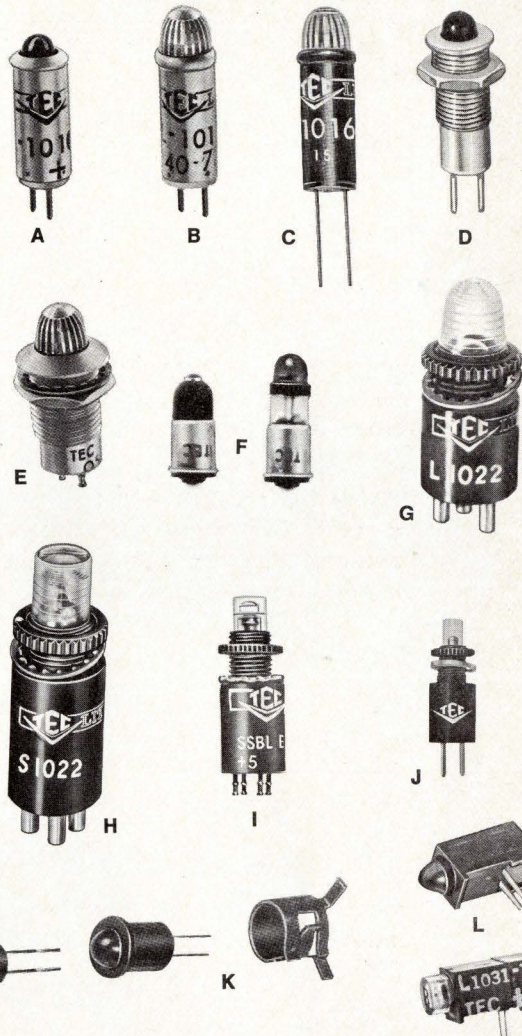

- I. **SSBL/SSIL Series.** Subminiature devices with red, green or yellow LED and red, green, yellow or clear lens. Anodized aluminum body in black or clear. Mounts in 1/4" hole on 3/8" centers. SSBL has SPST N.O. DB switch with contact rating of 100 mA @ 115 VAC and life of 1 million operations at rated current; uses 5 VDC supply. SSIL is indicator only and uses 5 to 28 VDC supply. SSBL. . . \$3.70 SSIL. . . \$2.70
- J. **L-1040 Series.** Ultraminiature indicator with red LED and red or clear lens. Uses 5 to 28 VDC supply. Black or clear anodized aluminum body. Mounts in .170" hole on .300" centers . . . . . \$2.65
- K. **L-1025 Series.** Panel-mounted, molded plastic indicator is only 21/64" long. Red diffusing LED appears black in "off" state. Mounts in 1/4" hole with clip provided. . . . . \$ .70
- L. **L-1030/L-1031 Series.** Compact, rugged plastic, PCB-mounted indicators solder directly to board in 1/32" holes. L-1030 has same LED as L-1025 above. L-1031 has red, green or yellow LED and red, green, yellow or clear lens. L-1030. . . \$1.25 L-1031. . . \$1.35
- M. **L-1050/L-1051 Series.** Panel display assemblies consisting of LED's mounted in handsome chrome-finished bezels. Mounts easily with two-push-on clips and protrudes a maximum of 1/2" behind panel. Red LED's appear black in "off" state. L-1050 (shown) holds up to 10 LED's; L-1051 holds up to 20 LED's. L-1050. . . \$6.30 L-1051. . . \$11.20



# TEC LITE DIGITAL READOUTS

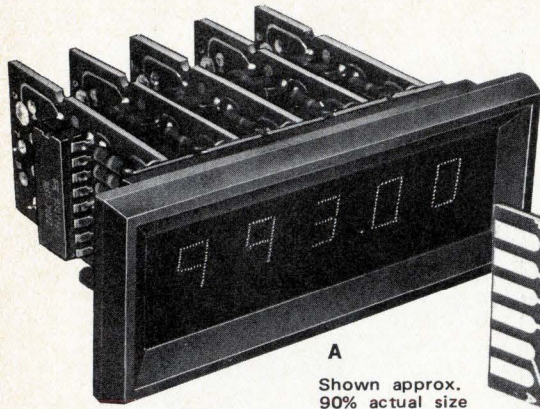

**A**  
Shown approx.  
90% actual size

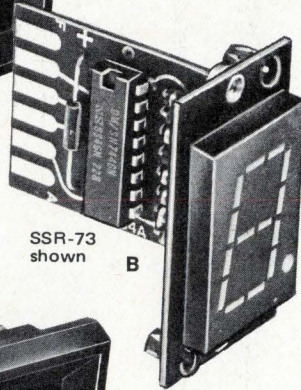

**B**  
SSR-73  
shown

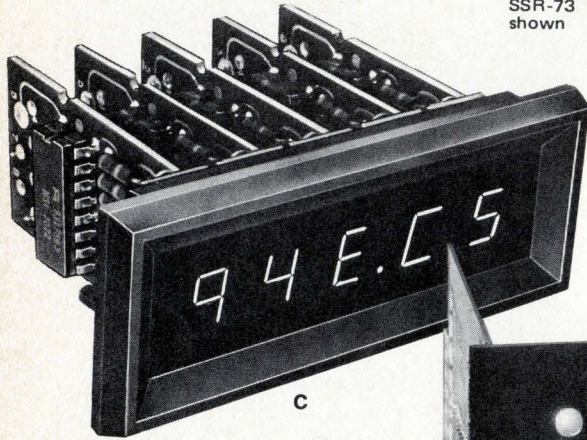

**C**  
Shown approx. 70%  
actual size (2" model)

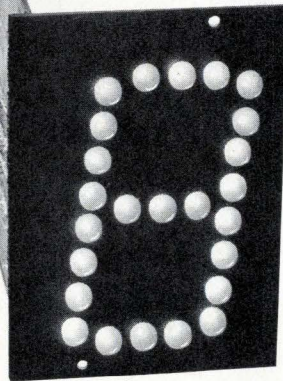

**D**

## LED DISPLAYS

IC-compatible readouts, controlled by DTL and TTL signal levels, feature bright, sharply defined characters in *eight* different sizes. Infinite life LED and solid state circuitry afford ruggedness and high reliability—even under adverse environmental conditions. All models have solid state, 7-segment decoder/driver and accept 1, 2, 4, 8 BCD inputs. Units include lamp test, nondriven decimal point, and provision for automatic blanking of leading and/or trailing edge zeros in a multidigit assembly.

Readouts A, B and D are also available with memory option; C is a hexadecimal display with an A-F character sequence in addition to 0-9 and has a built-in memory. Memory for all units has an IC buffer storage unit with four gated-latch circuits and a common gate driver. One-line clear and set feature reduces the number of input circuits required.

Input logic levels are 0 to 0.8 VDC for logic "0" and 2.5 to 5 VDC for logic "1". Supply is 5 VDC +5% @ 200 to 750 mA maximum, depending on model. Optional anodized aluminum bezel in clear or black finish is available to enhance panel appearance. Bezel includes red or neutral polarizing filter and holds from 1 to 10 readouts. Character heights for each series are listed below.

<b>A. SSR-70.</b>	Height, .270"	.....	\$14.65
<b>B. SSR-59.</b>	Height, .300"	.....	10.60
<b>SSR-71.</b>	Height, .334"	.....	14.50
<b>SSR-72.</b>	Height, .600"	.....	17.70
<b>SSR-73.</b>	Height, .770"	.....	20.20
<b>C. SSR-58.</b>	Height, .270"	.....	8.35
<b>D. R-1001.</b>	Height, 1"	.....	25.00
<b>R-1002.</b>	Height, 2"	.....	27.05
<b>R-1003.</b>	Height, 3"	.....	37.35

## TRANSISTORIZED DISPLAYS AND DECODER/DRIVER

**E. TSR-71 Series.** Bright, high-contrast segmented readout is clearly read even under sunlight conditions. Wide-angle, single-plane display uses RCA Numitron incandescent tube controlled by IC-compatible logic. MSI/IC logic provides BCD decoder/driver plus counter and buffer memory options. Driven decimal point or nonsignificant zero blanking (or ripple blanking for intensity control) are also offered. Input logic levels are 0 to 0.8 V for logic "0" and 2 to 5 V for logic "1". Display tube has 7-bar matrix .610" high and minimum life of 100,000 hours. Mounts on .90" centers. .... \$16.85

**F. TNR-70 Series.** UL listed, ultracompact readout with rugged, low-power neon NIXIE® tube offers two logic level options and four logic function options. Numeral display controlled by signals as low as 2 volts. Accepts 1, 2, 4, 8 BCD inputs and is available with memory and/or decade counter. Characters are .610" high. Mounts with just two screws on 1" centers. .... \$25.75

**G. TPD Series.** Display driver with solid state lamp control module designed for IEE Series 10 and 120H high-brightness projection readouts. Controls 6, 12 or 28 VDC incandescent lamps from logic levels as low as 1 mA. Other lamp supply voltages can be accommodated on special order. Also available as MTPD Series—designed to operate from low-level outputs of DTL and TTL IC modules. .... \$41.25

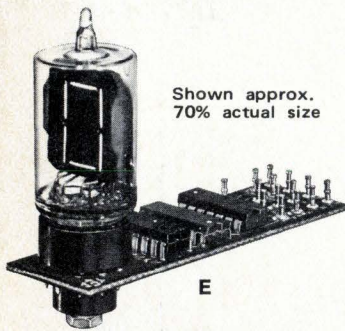

**E**  
Shown approx.  
70% actual size

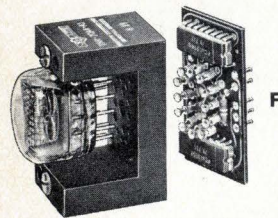

**F**

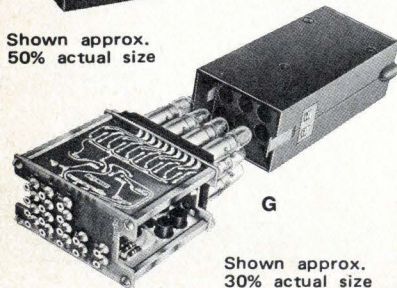

**G**  
Shown approx.  
30% actual size

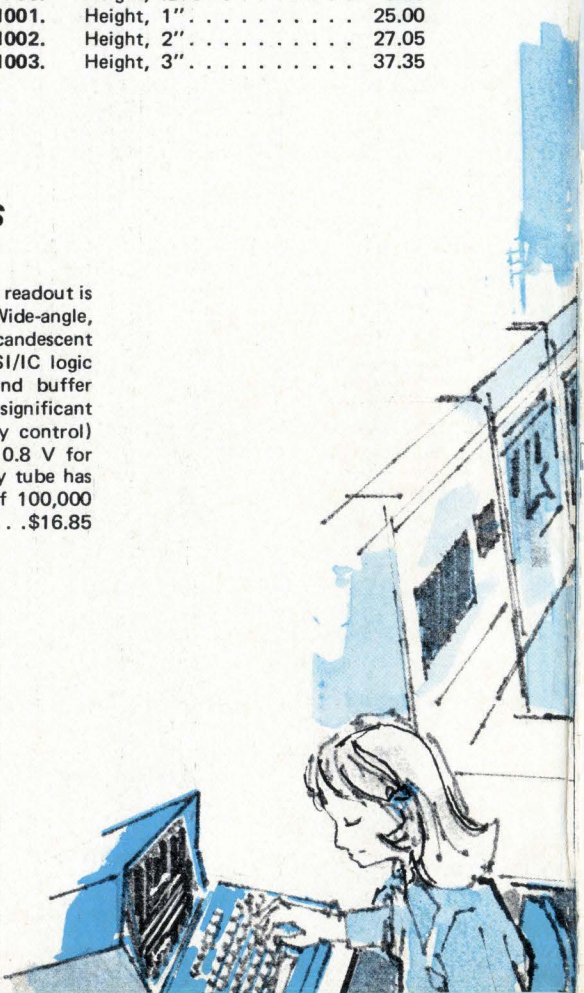

## TRANSISTOR CONTROLLED SWITCHES, INDICATORS & SWITCH/INDICATORS

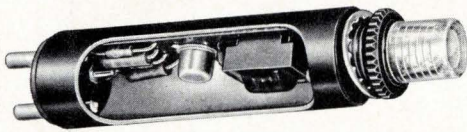

TEC—the originator and patentee of transistorized indicators—continues to lead the field in reliability, economy and variety. Our transistor controlled devices offer design advantages by confining high voltages and currents to the indicator and panel area. TEC-LITE transistorized units also eliminate the cost of designing, assembling and testing external lamp control circuits by providing lamp control logic *within* the indicator. All have aluminum bodies with black or clear anodized finish, plus Fresnel lenses for greater visibility (except STCL). Other colors and finishes—including irridite for RFI/EMI shielding—are available on special order.

- A. **TBL Series.** Switch/indicator with permanently wired neon lamp and N. O. or N. C. SPST or N. O. & N. C. SPDT momentary switch with contact rating of 100 mA @ 120 VAC. Lamp controlled by signals as low as 1.5 V. Red, amber, white or clear lens. Mounts in 3/8" hole on 5/8" centers. . . . . \$4.35
  - B. **TIB/TIL Series.** TIB is switch/indicator as above, but with replaceable incandescent lamp. TIL is indicator only. Both are controlled by signals as low as 3 mA. TIB . . . \$6.60 TIL . . . \$3.85
  - C. **TML Series.** An indicator with memory that turns on with signals as low as 2 us @ 0.5 mA. Has replaceable incandescent lamp and 5 indicator-switch options: no switch; N. O. SPST; N. C. SPST; N. O. & N. C. SPDT-DB; and reset/press-test. Switch contact rating is 100 mA @ 120 VAC. Red, amber, white or clear lens. Mounts in 3/8" hole on 5/8" centers. . . . . \$10.35
  - D. **MTL Series.** Miniature indicator with permanently wired neon lamp controlled by signals as low as 1.5 V. Flat top or spherical lens in red, amber, white or clear. Mounts in 3/8" hole on 5/8" centers. . . . . \$2.50
  - E. **STL Series.** Subminiature indicator with permanently wired incandescent or neon lamp controlled by signals as low as 1 mA. Red, amber, white or clear lens. Mounts in 1/4" hole on 3/8" centers. . . . . \$5.95
- Devices A through E are also available as IC-compatible units designed to operate from the low-level outputs of DTL and TTL IC modules. Write for Catalog No. 571, "Transistor Controlled Indicators and Readouts for Integrated Circuits."
- F. **STCL Series.** Subminiature indicator with replaceable incandescent lamp cartridge that plugs into logic section. Lamp is controlled by signals as low as 1.5 V and has flat top or spherical lens in translucent white, red, yellow or green. Mounts in 1/4" hole on 3/8" centers. . . . . \$4.65
  - G. **MTLED Series.** Indicator with long life, high brightness, red or green LED and red, green or clear lens. Interfaces directly with DTL and TTL IC logic. Ideal unit for airborne electronic systems and production/process equipment subjected to extreme and continuous vibrations. Uses 5 VDC supply. Mounts in 3/8" hole on 5/8" centers. . . . . \$3.05
  - H. **SSTL Series.** Subminiature version of MTLED above with same characteristics. Red LED only with red or clear lens, but can accommodate green or yellow LED by adding external resistor. Mounts in 1/4" hole on 3/8" centers. . . . . \$4.45
  - I. **L-1017 Series.** Cartridge indicator with red or green LED and flat top or spherical lens in red, green or clear. Acts as 1 unit load on DTL or TTL circuit instead of 10—or the entire circuit output—as would a normal LED. Supply is 5 VDC. Mounts in .290" hole on 1/2" centers with spring steel clip. . . . . \$2.30

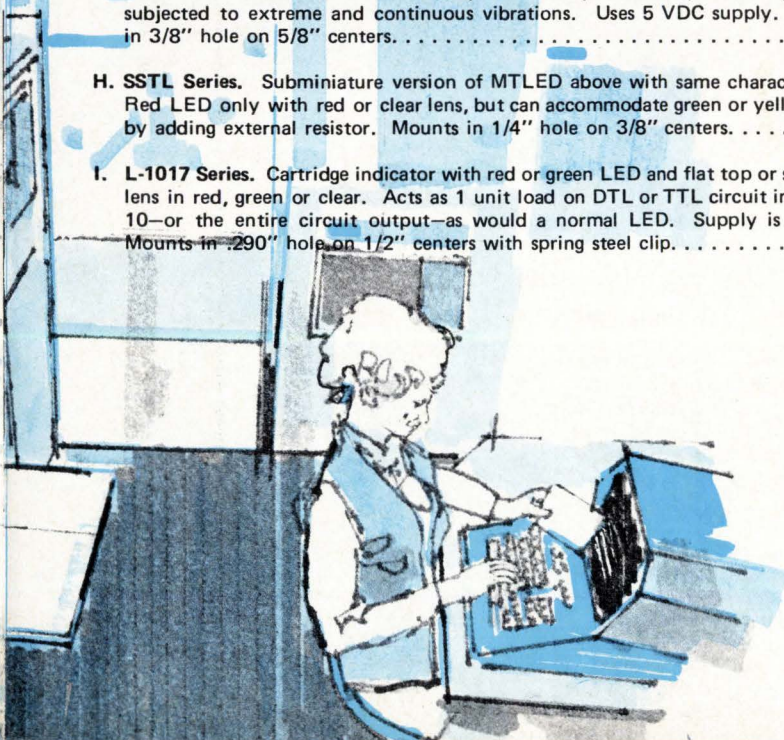
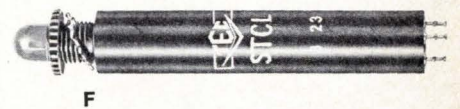
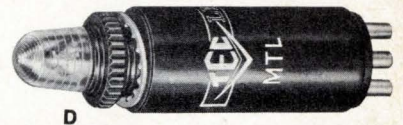
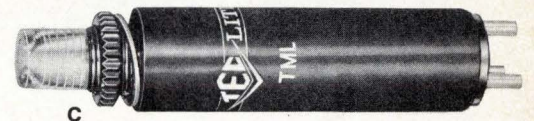
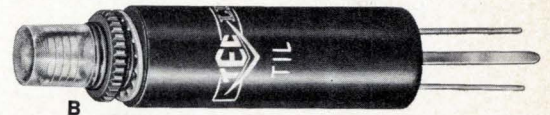



## CONVENTIONAL SWITCH/INDICATORS ... SWITCHES ... INDICATORS

Presented on these two pages are numerous devices that fill a variety of applications—from PCB-mounted switches for computers, amplifiers and tachometers to lite power supplies that power up to 400 indicators. Except where noted, all have aluminum bodies with black or clear anodized finish. Other colors and finishes—including irridite for RFI/EMI shielding—are available on special order. All indicators and switch/indicators are available with the following lens colors, unless specified otherwise: translucent red, amber, and green; translucent red and white; and clear. Other colors are available on special order.

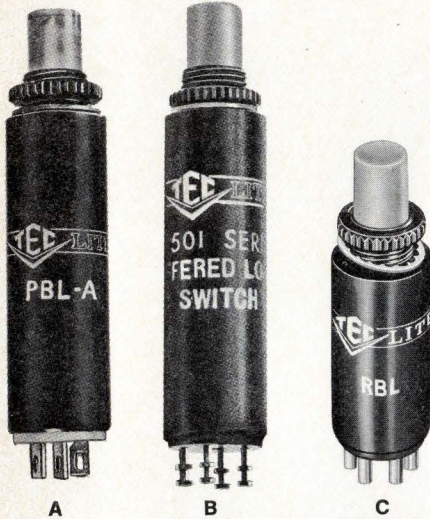

**A. PBL/PBS Series.** PBL is alternate or momentary snap-action, SPDT switch/indicator with three switch capacities—5 amp, 15 amp and 100 mA—and three replaceable lamp types: incandescent, neon or LED. PBS is switch only. Switch contact rating is @ 115 VAC or 28 VDC, with minimum life of 100,000 cycles at full rated current. Mounts in 3/8" hole on 5/8" centers (5 amp, 100 mA models) or 3/4" (15 amp). PBL. . . \$3.65 PBS. . . \$3.40

**B. S-501 Series.** Bounce free, buffered logic switch with momentary contact eliminates bounce inherent in any mechanical switch. Also, low output impedance of S-501 TTL buffer guarantees a much lower susceptibility to noise spikes. With translucent black, red, green or white lens. Mounts in 3/8" hole on 5/8" centers. Switch contact rating of 100 mA @ 115 VAC, with life of 1 million operations at rated current . . . . . \$5.45

**C. RBL Series.** Switch/indicator with replaceable incandescent or neon lamp is available with a variety of options: 1 amp, 2.5 amp and 100 mA switch capacities and four momentary contact switch types—N.O. SPST, N.O. DPST, N.O. & N.C. and SPDT. Switch contact rating is @ 115 VAC, with switch life of 1 million operations at rated current. Mounts in 3/8" hole on 5/8" centers . . . . . \$2.90

**D. MBL/MBS Series.** MBL is miniature switch/indicator with N.O. or N.C. momentary contact, permanently wired incandescent or neon lamp and standard lens colors stated above. MBS is switch only with N.O., N.C. or N.O. & N.C. contact and translucent black, red, orange or white lens. Switch contact rating for both devices is 100 mA @ 115 VAC, with life of 1 million operations at rated current. Mounts in 3/8" hole on 9/16" centers. . . . . MBL. . . \$2.00 MBS. . . \$1.45

**E. MDL Series.** Miniature indicator with permanently wired incandescent or neon lamp and flat top or spherical lens. Mounts in 3/8" hole on 9/16" centers. . . . . \$ .95

**F. RDL Series.** Indicator with replaceable incandescent or neon lamp in a variety of models: front and rear mounting; with or without bezel; and standard or wide diameter lens. Mounts in 3/8" hole on 9/16" centers or 15/32" hole on 11/16" centers . . . . . \$1.50

**G. PTL Series.** Indicator with replaceable incandescent or neon lamp and press-to-test feature—capability to test indicator lamp independent of external indicator circuit signals. Mounts in 3/8" hole on 9/16" centers. . . . . \$2.60

**H. S-105 Series.** Combines attractive panel appearance and large pushbutton surface with a variety of TEC-LITE indicators and switch/indicators—eight different models with various operating ranges and switch/terminal options. Fingertip grip affords easy removal of lens assembly for lamp replacement. Black cellulose acetate butyrate body. Easy snap-in mounting in .785" x .882" hole on 1" centers . . . . . \$3.50

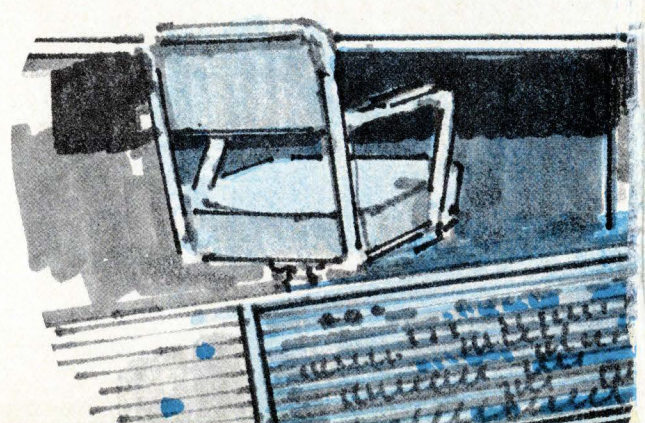
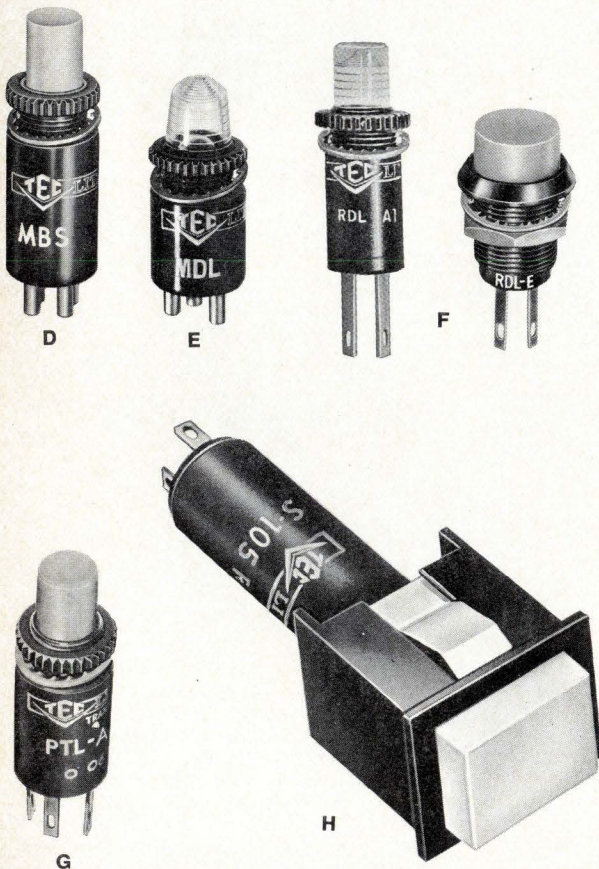



## ...LITE POWER SUPPLY... LAMPS & DISPLAYS

**A. FML Series.** Miniature front-mounting indicator with permanently wired incandescent or neon lamp is ideal where rear panel access is limited. Flexible nylon collet type body slides into panel mounting hole from the front and is locked firmly in place by slip-in lens. Flat top or spherical lens in transparent red, amber, and white; clear; and translucent white. Mounts in 3/8" hole on 1/2" centers. . . . . \$0.80

**B. SBL/SBS/SIL Series.** Space-saving subminiature devices. SBL is switch/indicator with permanently wired incandescent lamp and SPST-N.O.-DB momentary switch. SBS is switch only with N.O. momentary contact. Switch contact rating for both is 100 mA @ 115 VAC, with life of 1 million operations at rated current. SIL is indicator only. All mount in 1/4" hole on 3/8" centers. SBL... \$3.75 SBS... \$1.25 SIL... \$2.25

**C. S3L Series.** Tri-lite indicator offers three information display capabilities in one unit—three permanently wired incandescent lamps with red, amber and green filters are contained in this subminiature device for use in aircraft panels, EDP equipment, process control consoles, and instruments. Available with clear lens only. Mounts in 1/4" hole on 3/8" centers. . . . . \$6.50

**D. L-1003 Series.** Low-priced tri-lite indicator with same features as S3L. Clear flat top or spherical lens. Mounts in .290" hole on 1/2" centers. . . . . \$4.60

**E. S-1040 Series.** Ultraminiature switch for use with computer consoles and computer maintenance, test equipment, etc. Momentary N.O., N.C., or N.O. & N.C. contact with rating of 100 mA @ 28 VAC and life of 1 million operations at rated current. Lens available in white, red, orange, blue, yellow, green and black. Mounts in .170" hole on .300" centers. . . . \$1.70

**F. MCL Series.** Exceptionally low-priced miniature indicator with permanently wired incandescent or neon lamp and round or square lens. Economical, single-unit plastic lens and body in transparent red, amber and white; translucent white; and clear. Mounts in 5/16" hole on 1/2" centers. . . . \$0.20

**G. RCL Series.** Low-cost cartridge lite with replaceable incandescent or neon lamp and choice of three lens styles. Mounts in solderless cartridge holders or Tinnerman clip listed below or lead wire connectors. . . . . \$0.85

**H. SCL Series.** Subminiature cartridge lite with permanently wired incandescent lamp. One-piece, molded polycarbonate body and square or round lens in translucent white, red, green or yellow. Plugs into STCL Series or holder (TEC P/N 981364) which solders directly to PCB. . . . . \$1.45

**I. SDL Series.** Super-small indicator with permanently wired incandescent lamp mounts on 1/4" centers. Ideal for small information display panels and displays requiring many indications. Available with connector hookup (as shown) or 6" wire leads. . . . . \$2.10

**J. S-1001 Series.** Compact, N.O. maintained selector switch for CRT terminals, computers, stereo amplifiers, tachometers—virtually any application requiring a 4-position switch mounted on a printed circuit board. Detented for positive stop and retention, with life exceeding 25,000 operations. Current rating of 50 mA @ 30 VDC. Plastic body with molded standoffs. . . . . \$0.75

**RCLH Series Cartridge Holders.** These holders make mounting and hookup faster and easier for MCL and RCL Series above and L-1010, L-1015 and L-1020 Series on LED page. The RCLH-1 (K) and RCLH-2 (L) are for mounting lites to panels and attach from the rear. Part number 781402 (M) is a push-on connector for soldering to printed circuit boards, and part numbers 781056 (N), 781058-1 (O) and 781058-2 (P) are connectors for panel-mounted lites. . . . . \$0.75

**Q. Tinnerman Clip.** For mounting cartridge lites to panels. . . . . \$0.03

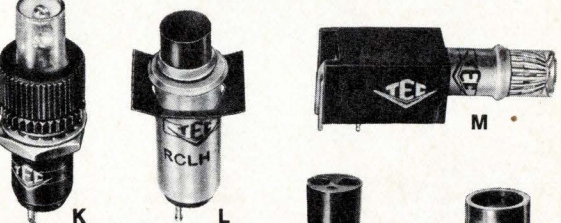
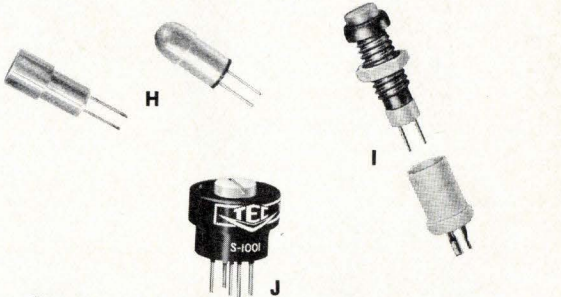
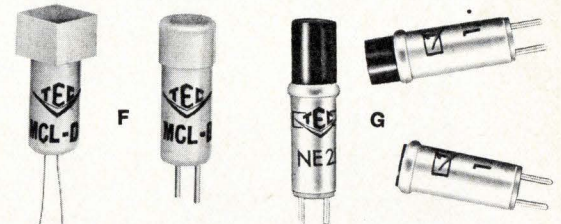
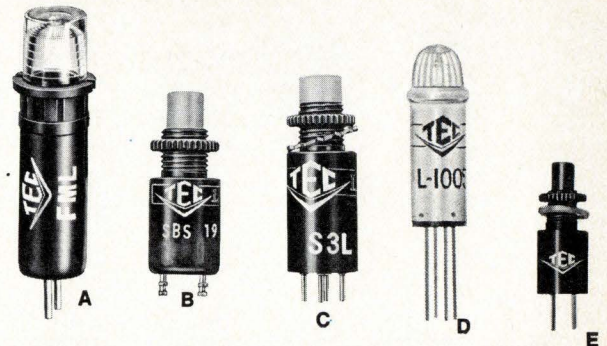

**R. LPS Series.** Light, compact and inexpensive, this unit provides a high quality, highly reliable power source for transistorized and conventional neon indicators and readouts—up to 400! A solid state, unregulated choke input supply, the LPS is designed to provide supply and bias voltages and operates from a nominal line input of 115 VAC, 60 to 400 Hz. Device is 3.50" high, 3.62" wide and 5.75" deep and can be placed in any convenient location. Requires no adjustment once installed. . . (10-49 qty.) \$57.80

**Lamps and Displays.** For your convenience, TEC makes available a variety of incandescent, neon and LED lamps—plus LED displays—at economical prices. Incandescents range in price from \$.33 to \$.83; neons are \$.10; LED's, \$.40 to \$1.60; and LED displays, \$6.65 to \$16.85. Handling charge of \$5 for orders under \$25. Send for "QUICK DRAW" Catalog No. 955 for complete listing.



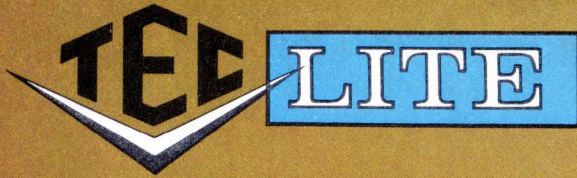

## DISPLAY SYSTEMS

### DATA-PANEL® DISPLAY SYSTEMS

These integrated displays cost less per point than individual indicators and cut installation work by 50% or more . . . arrive ready to install and operate. Messages and symbols are brilliantly and colorfully conveyed in a single viewing plane, and optimum use of IC's lowers cost and increases reliability. Maintenance is greatly simplified also, because all logic is placed in one assembly.

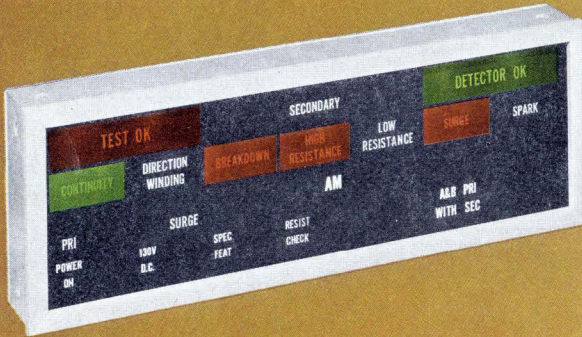

A DATA-PANEL Display System easily interfaces with *your* system, particularly if a computer is involved, and may be installed in consoles, racks or walls. Permanently visible legends, symbols, grid lines and graphic mimics can be provided for optimum user application; and, if desired, only the vital "on" or illuminated messages can be seen. Size limitation is 3 feet square.

Unit functions as a total input/output system, and is modular-designed to grow with your needs. Just a few applications are: data processing, communications, materials handling and dispatch.

A complete display system can be yours for less than \$20.

### DATA-LINE DISPLAY MODULES

Here is a versatile system that combines switches, indicators and message displays in an in-line modular package that complements our basic DATA-PANEL Display System design. Gives designers a new, completely modular information display device for computers, industrial control and guidance systems, peripheral equipment, etc.

Modular in-line design permits intermixing of message display, incandescent and neon functions. Function options may be arranged in any sequence on .7" centers in an extruded aluminum frame that is available in lengths to 4 feet. The frame forms the front bezel and provides panel mounting hardware. All lamps are replaceable from either the front or rear of panel. Modules can also be gang-mounted, as shown in the illustration at left.

A typical DATA-LINE Display Module with five switch/indicators, lamps and engraved legends is only \$15.75 in quantities of 50.

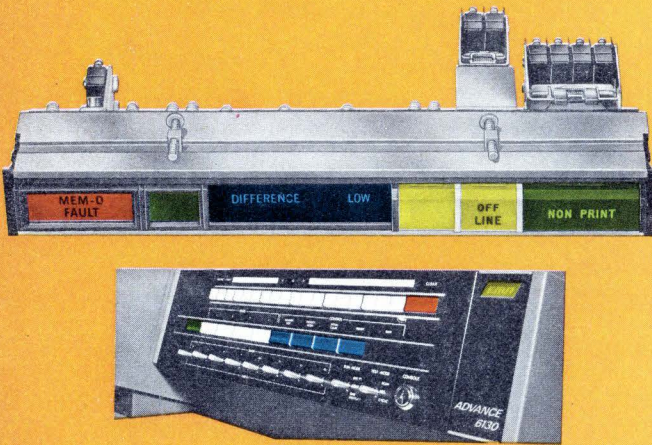

### DATA-MONITOR™ ANNUNCIATOR SYSTEMS

A natural extension of our DATA-PANEL Display Systems, these systems provide high-density alarm displays at 1/3 the cost and 1/9 the space of conventional annunciators. Solid state memory logic insures indication of passing alarms. Models range from simple visual indications of off-normal points to audible flashing alarm. All models include lamp test feature at no extra cost.

Compact device is only 6-1/2" high by 11" wide, including handsome anodized aluminum bezel that accommodates up to 10 printed circuit cards. Standardized cards contain 10 lamps (for redundancy) and logic control; supervised model has 20 lamps per card. For those units with audible flashing alarm, operator response to the problem turns off audible alarm; however, indicator remains on until off-normal condition is corrected.

A DATA-MONITOR Annunciator System with 5-point card and visual indication only is priced as low as \$145.

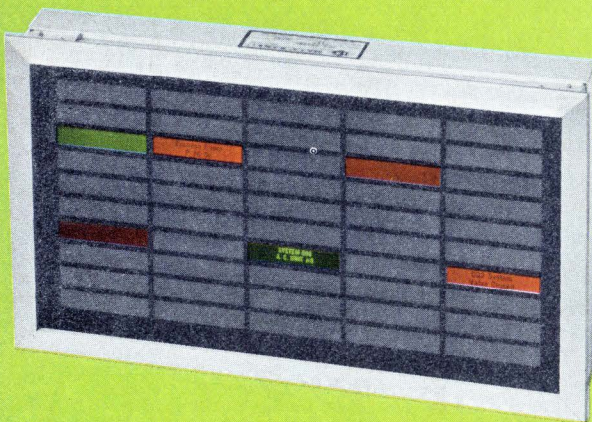

DATA-SCREEN™, DATA-PANEL®, DATA-MONITOR™, TEC, Incorporated; NIXIE®, Burroughs Corp.; Wire-Wrap®, Gardner-Denver Co. TEC-LITE indicating devices are protected by one or more of the following patents: United States, 2,985,874, 3,041,499, and 3,116,480; Australia, 244,756; Belgium, 604,246 and 637,379; Canada, 686,506 and 720,273; France, 1,291,911 and 1,365,693; Germany, 1,175,778; Great Britain, 978,436 and 1,003,994; Italy, 647,414 and 699,382; Switzerland, 376,541 and 392,687.



9800 NORTH ORACLE ROAD  
TUCSON, ARIZONA USA 85704  
(602) 297-1111  
TWX 910-952-1377

# Turn to page 7. Important? Sure...

By the time the office copy of ELECTRONICS gets to you, there's nothing left of page 7. It happens. Too often.

How often has ELECTRONICS wound up on your desk dog-eared and abused, with articles clipped out and ripped out? Or days, even weeks late?

How often has ELECTRONICS

*never even made it to your desk?*

You should be getting your copy of ELECTRONICS right off the press. You need it. Because it's important to stay on top of what's happening in your field. And ELECTRONICS is on top. ELECTRONICS is the Source. It's packed with up-to-date info, the breaking news of the electronic industries in the U.S. and worldwide.

You can get ELECTRONICS where you can find the time to read it—at home. Go to *the Source*, today. Fill out the subscription card enclosed in this issue, and send it off.

**Electronics**   
**IS THE SOURCE.**



# AMD:

**Tell us, Mr. Max. Do you use the AMD 2503 Successive Approximation Register in your A-to-D converters because it requires fewer packages? Because of its high speed? Or because its unique "single edge" triggering makes it refreshingly easy to use?**

Advanced Micro Devices, Inc. 901 Thompson Place, Sunnyvale, California 94086 / TWX 910-339-9280 / TLX 346306.  
For product or sales information, call the AMD sales representative nearest you. In Sunnyvale, Shel Schumaker at (800) 538-7904 (toll-free from outside California) or (408) 732-2400. In the eastern United States, Steve Marks or Bill Seifert at (516) 484-4990; in Washington/Baltimore, Ken Smyth at (301) 744-8233; in Boston, Paul Macdonald at (617) 273-1196. In Mid-America, Chuck Keough at (312) 297-4115. In the Los Angeles area, Steve Zelencik or Russ Almand at (213) 278-9700 or Larry Strong at (213) 870-9191. In the United Kingdom, Des Candy at Herne Bay (Kent) 61611; and in Germany, Hermann Lichotka at (0811) 594-680.

Advanced Micro Devices is distributed nationally by Cramer and Hamilton/Avnet Electronics.

# Mr. Max:

## Yes.

Solomon Max doesn't like to waste words. Or money. If you get the idea that we built exactly what he needed, you're right.

Besides our 8-bit Am2503, we've got a whole family of other successive

approximation registers available for immediate delivery. Eight to 12 bits. Serial or parallel data outputs. Standard or new low power.

All with all the logic for a cost-competitive A-to-D converter, ring counter or serial-to-parallel converter on a single chip. All MIL-STD-883. (We even have SAR "dice" available for the ardent do-it-yourselfers.)

It's all part of our master plan. By making exactly what people like Solomon Max want, we're going to be the sixth largest maker of integrated circuits in the U.S. by 1975.

DEVICE	FUNCTION	POWER		SPEED*	
		Std.	Low Power	Std.	Low Power
Am2502/25L02	8-bit SAR with serial or parallel data outputs	341mW	131mW	15MHz	3.5MHz
Am2503/25L03	8-bit SAR with expandable parallel output and input enable	315mW	115mW	15MHz	3.5MHz
Am2504/25L04	12-bit SAR with serial or parallel data outputs	472mW	157mW	15MHz	3.5MHz

\*Guaranteed minimum clock frequency

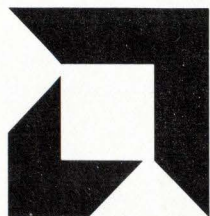

# Advanced Micro Devices, Inc.

(#15, going on #6.)

# FUJITSU Quality on Sale in Miniature Relays 153V & 473V series and High-power Relays 220 & 230 series

Fujitsu's 153V & **FUJITSU** 473V relay series are miniature, reliable, versatile and fully compatible with all standard-use relays. The 473V relay series is especially reliable, employing twin contacts.

Fujitsu's 220 & 230 relay series low in cost and small size for their contact rating, have been newly developed for use at high-power levels.  
220 Series — 230V AC 15A  
230 Series — 100V AC 8A

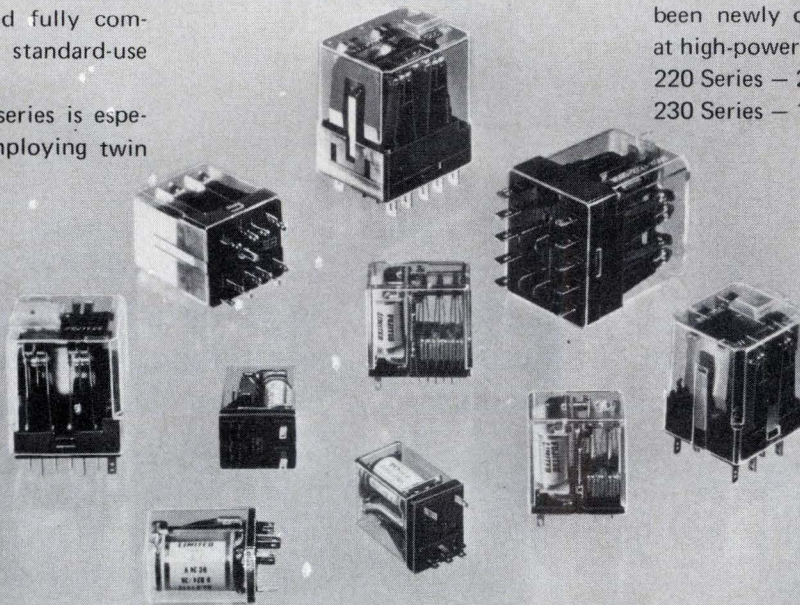

Relays	Contact Form	Contact Rating (Resistive Load)	Rated Voltage	Pick-up Current (Voltage)	Operate Time	Release Time	Initial Contact Resistance	Dielectric Withstanding Voltage	Remarks
153V 155V 156V	DPDT 4PDT	100V DC 0.3A 100V AC 1A	6~ 48V DC	5~ 58mA DC	10mS	8~15mS	150mΩ max.	500V AC (1 min)	
473V 474V	DPDT 4PDT 6PDT	30V DC 1A 100V DC 0.3A 115V AC 1A	6~ 100V DC	6~ 130mA DC	10mS(DC)	6mS	150mΩ max. (for general purpose) 50mΩ max. (for low level)	500V AC (1 min)	Twin contacts
FRL 233	2 PDT 4 PDT 6 PDT	AC 100V 8A	12~ 100V DC 24~ 200V AC	0.8 x (Rated Voltage) (Rated Voltage), DC	25mS(DC) max. 30mS(AC) max.	20mS max.	150mΩ max.	1500V AC (1 min)	
FRL 223	4 PDT	AC 230V 15A	12~ 100V DC 24~ 200V AC	0.8x(Rated Voltage), DC 0.85x(Rated Voltage), AC	25mS(DC) max. 30mS(AC) max.	25mS max.	150mΩ max.	2000V AC (1 min)	
473V 153V Plug-in with Socket		FRL 233 Solder Terminal/Plug-in with Socket							
474V 155V Printed Circuit Board		FRL 223 Solder Terminal/Plug-in with Socket							
156V Stud-screw/Solder Terminal									

**FUJITSU LIMITED**  
Communications and Electronics  
Marunouchi, Tokyo, Japan

For further information, please contact:  
Head Office: 6-1, Marunouchi 2-chome, Chiyoda-ku, Tokyo 100, Japan. Telex: J22833  
New York Office: 680 Fifth Avenue, New York, N.Y. 10019, U.S.A. Phone: (212) 265-5360  
Fujitsu California Inc.: 1135 East Janis Street, Carson, California 90746, U.S.A. Phone: (213) 636-0858, (213) 537-8930

**MAIN PRODUCTS** □ Telephone Exchange Equipment □ Carrier Transmission Equipment □ Radio Communication Equipment □ Space Electronics Systems □ Electronic Computers & Peripheral Equipment (FACOM) □ Telegraph & Data Communication Equipment □ Remote Control & Telemetering Equipment □ Electronic Components

# A tough little competitor.



**AMPSCO. American Power Systems Corporation.**

Maybe you heard of us when we were Armour Electronics. Maybe you didn't. Either way we're a scrappy little powerhouse you need to know now.

Because when your full time talents are needed in putting out a sophisticated, multi-thousand dollar unit, why waste even a little time designing its power supply? And since a reliable power supply is so critical, why buy it from a big company that spends only *some* of its time making it? Why not find yourself a sharp little outfit that spends *all* its time on power supplies? A company that stakes its entire reputation on *one* kind of product and has to do a mighty good job. For a mighty good price.

AMPSCO. O.E.M., off the shelf, slot and multiple power systems — When you make only one thing you make it better.

**Power Supplies by**  
**AMPSCO**  
**WWB&CO**

A Tough Little Competitor

American Power Systems Corporation 51 Jackson Street Worcester, Mass. 01608 (617) 753-8103

© 1973 Viacom International Inc.



**Siemens attention  
to quality  
is almost fanatical.**

**Advanced components  
is what it means to you.**



# SIEMENS

**Quality all the way.** The advanced components you buy from Siemens are the result of our almost fanatical attention to quality. And that goes for the selection of raw materials all the way to production supervision and final product testing.

**Investment in the future.** For many years Siemens has embarked on large-scale investment programs to cope with the demand for more components. We're constantly looking for new ways to eliminate order backlogs, without sacrificing product quality.

**Research and development.** Siemens spends over one million dollars every day on R & D, much of it in the component field. It's no wonder, then, that 90% of the components we offer today were unknown 10 years ago.

**Wide product spectrum.** Last year Siemens produced over 700 million components in more than 50,000 different shapes and sizes. These included capacitors, ferrites, transistors, diodes and microwave tubes. Plus a large variety of relays and surge voltage protectors.

Siemens Corporation, 186 Wood Avenue South, Iselin, New Jersey 08830. (201) 494-1000.

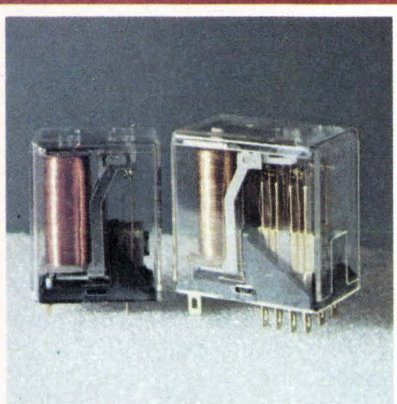

Relays

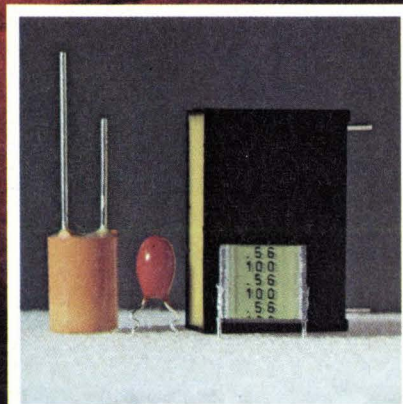

Capacitors

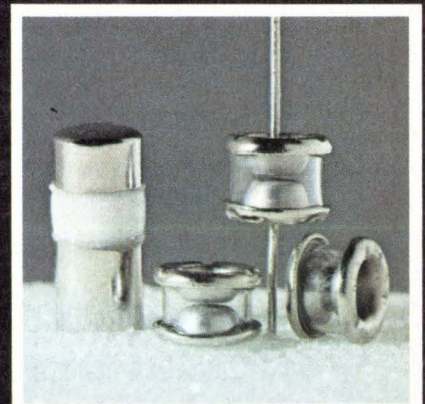

Surge voltage protectors

# How can you resist a 400% improvement in feedback stability?

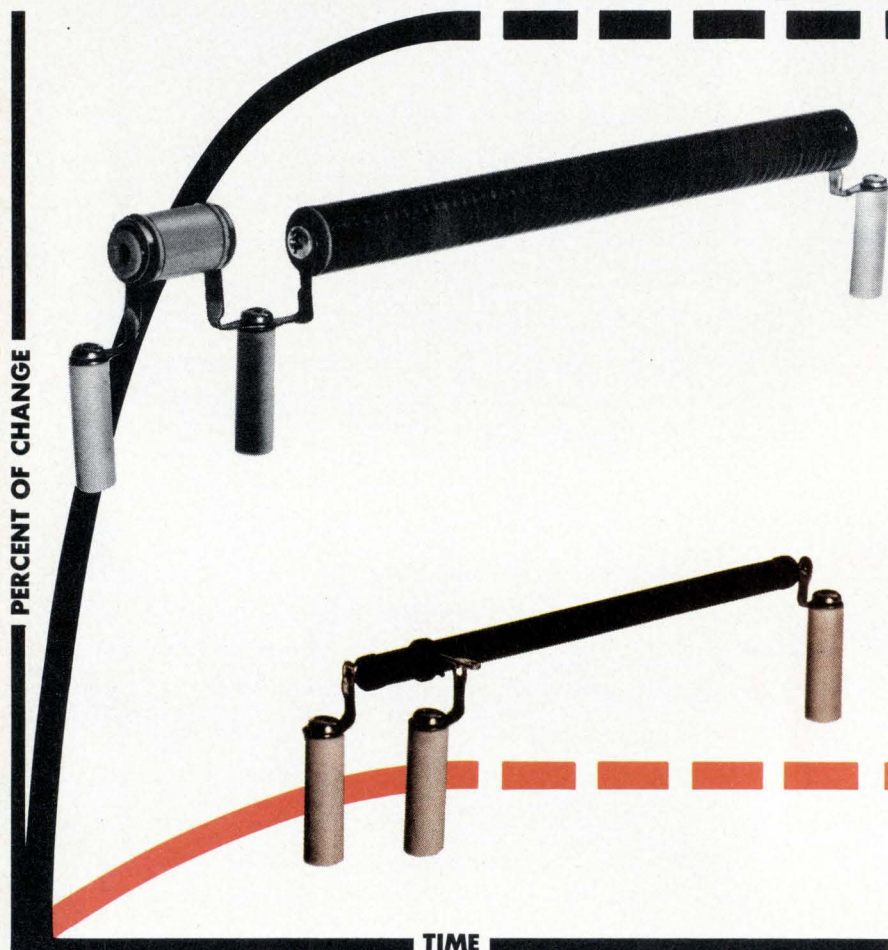

## So beautifully done!

With DIVIDER-MOX resistors, the effects of T-C matching, V-C, self-generated heat, and other control variables are minimized by a unique manufacturing process.

Precision is % allowable change over operating temperature range; DIVIDER-MOX resistors give 0.5% stability at 10% power dissipation over a temperature range of  $-55^{\circ}$  to  $125^{\circ}\text{C}$ .

And, along with precision and stability you also get size advantages as well . . . DIVIDER-MOX resistors are about  $\frac{1}{2}$  as large as the equivalent resistance carbon film.

Resistance ranges available from 25K to 2000 Megs with maximum power ratings up to 10W at 30kV. Customers may specify divider ratios in the range of 300:1 to 10,000:1.

Victoreen...where else can you get so many accurate ohms for your money:

VICTOREEN INSTRUMENT DIVISION  
VLN Corporation  
10101 Woodland Avenue  
Cleveland, Ohio 44104



## Meetings

**International Conference on Engineering in the Ocean Environment:** IEEE, Washington Plaza, Seattle, Sept. 25-28.

**Semicon East:** SEMI, Holiday Inn and Nassau Coliseum, Westbury, N.Y., Oct. 2-4.

**International Exhibition of Industrial Electronics (Elettronica 2):** Turin, Italy, Sept. 29-Oct. 8.

**Engineering in Medicine and Biology:** AEMB, Hotel Leamington, Minneapolis, Sept. 30-Oct. 4.

**Symposium on Semiconductor Memory Testing:** IEEE, Rickshaw Inn, Cherry Hill, N.J., Oct. 2-3.

**National Electronics Conference:** IEEE, Regency Hyatt O'Hare Hotel, Chicago, Oct. 8-10.

**Optical Society of America Annual Meeting:** OSA, Holiday Inn—Downtown, Rochester, N.Y., Oct. 9-12.

**International Telemetry Conference/USA:** ITC, Sheraton Northwest, Washington, D.C., Oct. 9-11.

**Instrumentation-Automation Conference:** ISA, Astrohall, Houston, Oct. 15-18.

**Canadian Computer Show and Conference:** CIPS, Exhibition Park, Toronto, Oct. 16-18.

**American Society for Information Science Annual Meeting:** ASIS, Hilton, Los Angeles, Oct. 21-25.

**Connector Symposium:** Connector Study Group, Cherry Hill Inn, Cherry Hill, N.J., Oct. 24-25.

**Northeast Electronics Research & Engineering Meeting (NEREM):** IEEE, Boston, Nov. 6-8.

**Conference on Magnetism and Magnetic Materials:** AIP, IEEE, Statler-Hilton, Boston, Nov. 13-16.

**National Telecommunications Conference:** IEEE, Hyatt Regency Hotel, Atlanta, Nov. 26-28.

# EMI FILTER CAPITAL OF THE WORLD

**FROM CERAMIC POWDER TO MIL-APPROVED TEST LAB...  
ERIE HAS IT ALL, UNDER ONE ROOF**

Only one company can deliver your total EMI Ceramic Filter needs . . . ERIE. We've been applying sophisticated ceramic and related technologies to developing superior filters for 35 years. Today ERIE has, by far, the broadest line of subminiature EMI Filters in the world. From tiny high frequency filters to broad band filters to custom filter assemblies, ERIE offers the ultimate in quality. And you get single-source responsibility too, for we build the complete filter in a plant devoted exclusively to the design and manufacture of EMI Filters. So come to ERIE for your filter needs. We'll put a team to work on your particular application. Aerospace. Communications. Avionics. Industrial Equipment. Whatever the market, we can help eliminate electromagnetic "noise" and emissions. In the meantime, write for our complete catalog . . . EMI Filters or call 613/392-2581.

**ERIE TECHNOLOGICAL PRODUCTS, INC.**  
Erie, Pennsylvania 16512

Circle 31 on reader service card

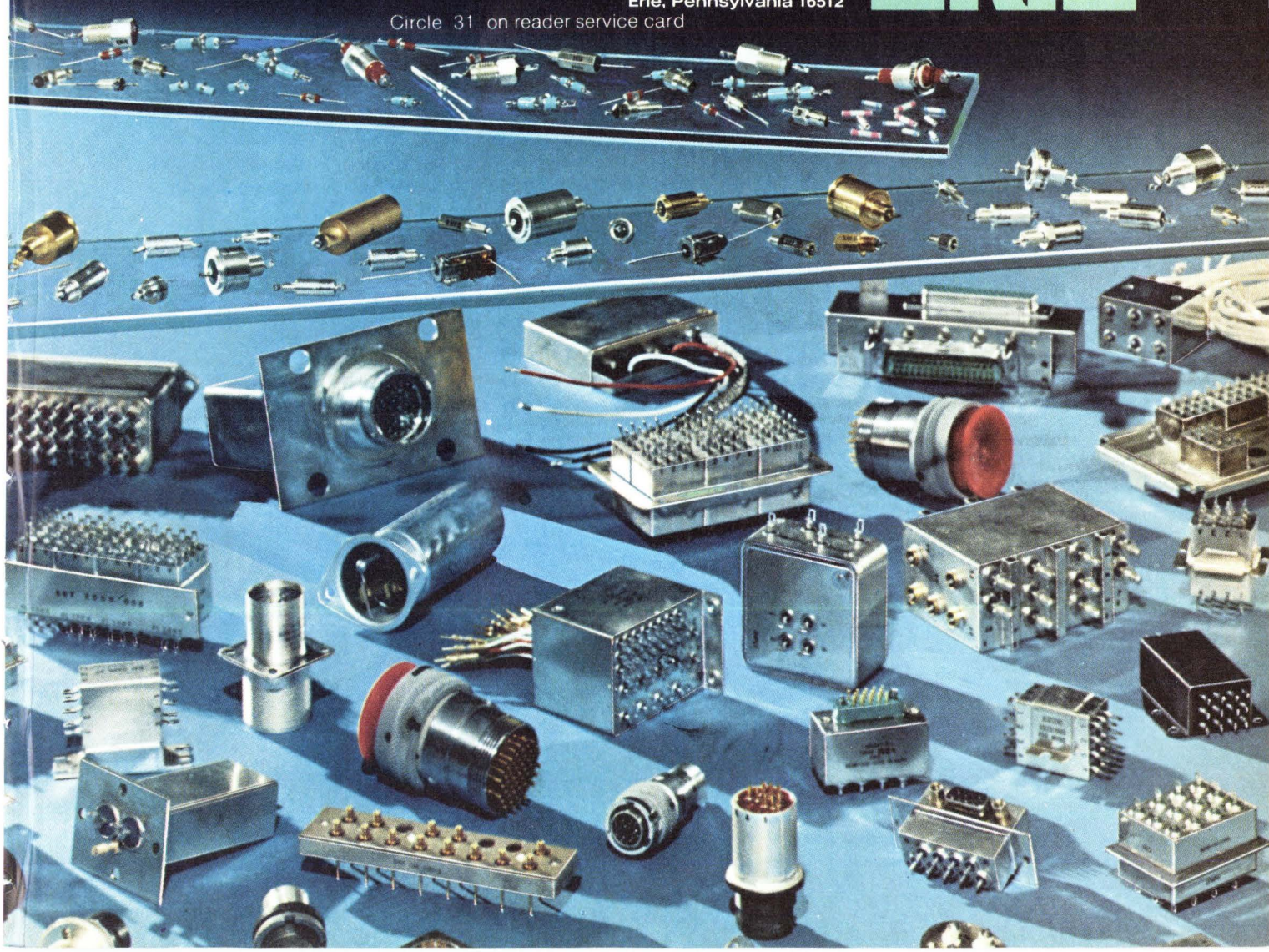
The logo for ERIE Technological Products, Inc. features the word "ERIE" in a bold, sans-serif font. The letter "I" is replaced by a stylized graphic of a sun or a light source, consisting of a yellow circle with a black outline, positioned above a horizontal line that passes through the center of the "I".

# 3 excellent reasons for you to investigate the new TEKTRONIX® 60MHz Oscilloscope

## It's flexible

Basic units are the 5403 three-plug-in Mainframe, D40 Display Module, 5A48 Dual-Trace Amplifier and 5B42 Delayed Sweep Time Base. The 5403/D40/5A48/5B42 gives you 60 MHz bandwidth at 5mV/div sensitivity (1 mV/div at 25 MHz) and magnified sweeps to 10 ns/div. Two 60 MHz 5A48s may be paired for four-trace displays. The 5A48 has 5 display modes (Channel 1, Channel 2, Added, Alternate, and Chopped). This performance is offered in an easy to move or carry 29 lb. package. Fifteen other plug-ins (w/o CRT READOUT) give outstanding versatility, including: simple to use, dual-trace DC to 1 GHz bandwidth, delayed sweep sampler and sweeps to 1ns/div; high-gain differential amplifier with 10  $\mu$  V/div sensitivity and 100k:1 CMRR for low-amplitude, low-frequency applications; differential comparator amplifier (accuracy to 0.20%) and CMRR of 10k:1; four-trace 1 MHz amplifiers offering up to eight traces; curve tracer for displaying semi-conductor characteristic curves.

## Easy to operate

The 5400 has it with a large (6½") bright CRT, pushbutton functions, beam finder, and color coded control panels making the operator's job straightforward. Optional CRT READOUT further enhances ease of operation. Added operator speed, perception and convenience advantages are realized with the CRT READOUT as it actively displays measurement parameters. Plus, a unique, programmable CRT READOUT offers the ability to identify tests and note conditions on the display. Easy determination of control display has been brought together in one highly visible area.

## Low cost

At \$2200 (\$1850 w/o CRT READOUT) the 5403/D40/5A48/5B42 is a very low priced 60 MHz, dual-trace, delayed sweep oscilloscope. Integrated circuits used wherever practical help keep reliability up and costs down. Maintenance costs are also low with Tektronix modular construction, fewer calibration points and ready access to circuits. CRT READOUT of plug-in parameters has never before been available at this price. The 5400 oscilloscope series provides versatility and excellent measurement value, with more on the way.

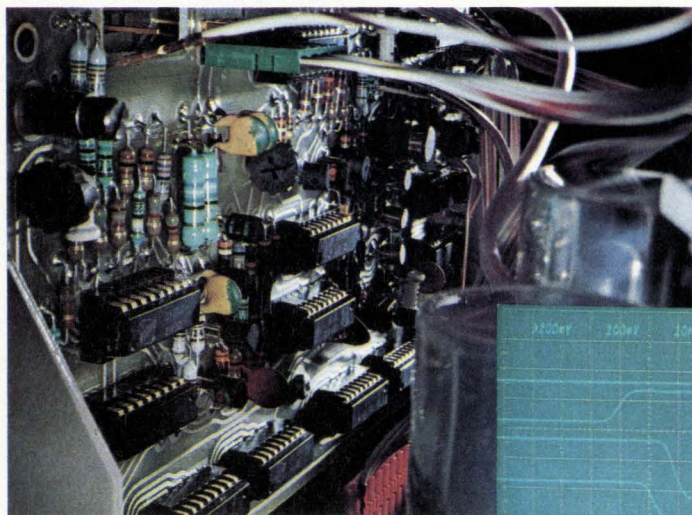

CRT READOUT circuit board

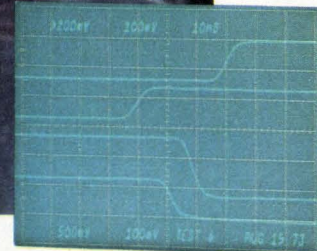

Quick, non-ambiguous  
measurement information  
at a glance.

For a demonstration circle 32 on reader service card  
Circle 33 on reader service card

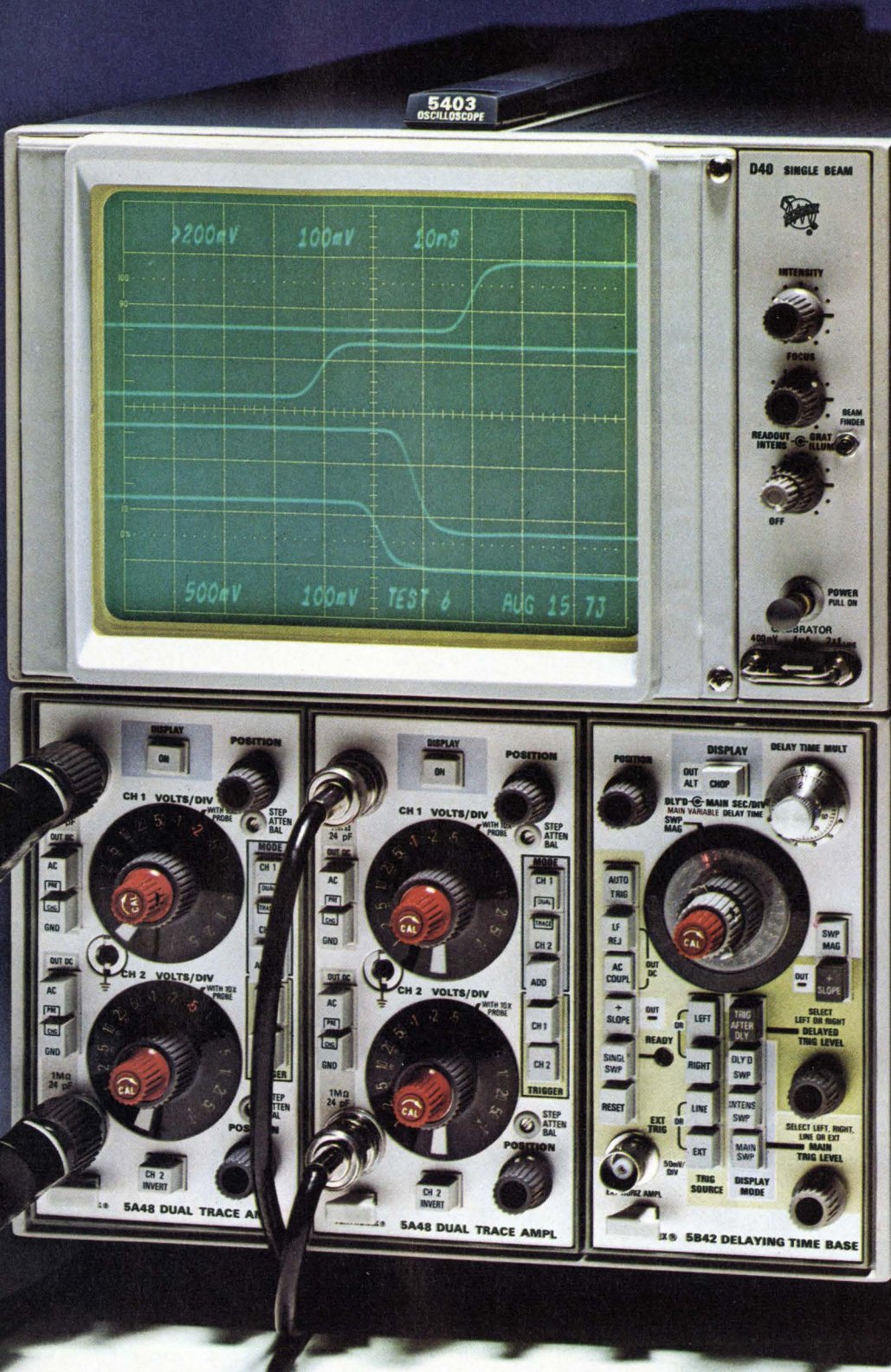

Expect  
new things from **TEKTRONIX®**  
committed to  
technical excellence

For complete details, mail to:

Tektronix, Inc.  
P.O. Box 500, Dept. 301  
Beaverton, OR 97005

(Europe: Tektronix, Ltd., P.O. Box 36,  
St. Peters Port, Guernsey, C.I., U.K.)

Name \_\_\_\_\_

Company \_\_\_\_\_ Dept. \_\_\_\_\_

Address \_\_\_\_\_

City \_\_\_\_\_ State \_\_\_\_\_ Zip \_\_\_\_\_

Telephone \_\_\_\_\_

Stable Trimmers  
Small Duals  
Rugged Pots

If you're really  
serious about cost,  
be serious about quality.

Type FD trimmer. Type GD pot. Ideal variable resistors for CATV attenuators. Or any Bridged-T or L pad application requiring minimum size, stability and long life in severe environments. Exclusive hot-molded composition resistance elements permit peak set-ability. Diameter 1/2

inch (12,70 mm). Immersion-sealed (can be potted). Standard resistance values from 100 ohms to 5 megs and many popular impedance values. Single turn. For complete technical details request Publication 5231 (FD trimmer), Publication 5213 (GD potentiometer), Publication 5221 (FD/

GD attenuators). Allen-Bradley Electronics Division, 1201 South Second Street, Milwaukee, Wisconsin 53204. Export: Bloomfield, New Jersey 07003. Canada: Allen-Bradley Canada Limited, Cambridge, Ontario. United Kingdom: Jarrow, County Durham NE32 3EN.

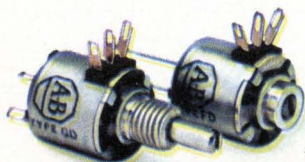

Actual Size



**Allen-Bradley**  
Milwaukee, Wisconsin 53204

Circle 34 on reader service card

## National's digital clock chips set to drive displays

In a few months, National Semiconductor Corp. expects to introduce an MOS LSI digital clock chip that will directly drive high-voltage, gas-discharge panel displays, eliminating interface circuits that usually couple MOS chips to these displays [*Electronics*, March 1, p.97].

**Gene Carter, National's IC marketing manager, says a second version of the design will directly drive light-emitting-diode displays.** Although standard MOS outputs can drive LEDs, Carter says interfaces have been required to control display brilliance. National and other firms already make chips that drive liquid-crystal displays directly [*Electronics*, Jan. 31, 1972, p.66].

**National has been showing customers a model of a clock with a liquid-crystal display,** arousing speculation the company intends to produce LCD displays.

## 4,096-bit RAM readied by Mostek in 16-pin DIP

Memory-system designers awaiting 4,096-bit RAMs for high packing density now have a package choice that can save them board space. Adding to the already available 22-pin products, **Mostek Corp. is sampling a 16-pin version of its 4,096-bit product.** Sources at the Dallas-based MOS house confirm that their 22-pin model, which had been scheduled for first-quarter 1974 introduction, has been shelved to allow the firm to announce the smaller package by year-end.

**Besides a 2-to-1 density advantage over 22-pin packages, the 16-pin RAM also has the potential for a lower price because of reduced packaging and bonding costs,** Mostek sources say. Both 16- and 22-pin versions are of the single-transistor contactless-cell design [*Electronics*, Dec. 18, 1972, p.30], are fully TTL-compatible, including clocks, and have access times in the 300-nanosecond range. The 22-pin model will be easier to use because multiplexed addresses on the 16-pin version will require two external clocks. However, the two clocks and multiplexed addresses permit a higher speed page mode, offering half the random access cycle time, or about 150 ns.

## Macrodata's Mow to exploit patent on memory testers

Since Macrodata Corp. has received a patent covering the basic techniques used in memory testing, company founder and president William C.W. Mow has decided to "protect his interest" in the field. **Mow says that competitors in memory-test equipment are violating the patent,** and he intends to make them either pay royalties or stop manufacturing. He adds that **Macrodata won't be unreasonable, but he hopes to use legal leverage to recover part of the money the company has invested in the technology.**

## I<sup>2</sup>L looks like logic of the future

The bipolar LSI of the future is emerging from a number of major semiconductor laboratories. It is called integrated-injection logic, or I<sup>2</sup>L, by some and merged transistor logic, or MTL, by others. **The new circuit technique is potentially capable of putting 1,000 gates or more on a single logic chip or 4,000 to 8,000 bits of random-access memory on a single memory chip.** This development could have as great an impact in the way bipolar logic and memory circuits will be built in the 1970s as DTL and TTL had in the 1960s.

Although there are different versions of I<sup>2</sup>L, they all use carriers injected directly into the switching transistor. In one version, complementary transistors are merged by tying the collectors of all npn units to a common potential. In this structure, the pnp transistor represents the emitter, the common region represents the base, and the npn transistor represents the collector. Significantly, the technique reduces the process complexity to that of a single planar transistor.

The technique is extraordinarily versatile. Already N.V. Philips, of Eindhoven, has built experimental digital-voltmeter chips containing a four-decade counter and seven-segment decoder, ROM stores, shift registers, control-logic for calculators, frequency dividers for electronic organs, and hammer-driver circuits. IBM in Germany is known to be working on logic and memory circuits.

Because of its very low speed-power product, (0.2 picojoule) others are applying I<sup>2</sup>L to watch and calculator chips. **Intel has quietly introduced the first I<sup>2</sup>L-type memory product—a 256-bit I<sup>2</sup>L RAM that is replacing its conventionally built T<sup>2</sup>L RAM, introduced last year. TI and Fairchild are working on the technique for a variety of applications.** Using an I<sup>2</sup>L circuit structure with an oxide-isolation technique, such as Isoplanar, could yield logic chips that are orders of magnitude denser, as well as faster and cheaper than any bipolar chips made today.

## Typewriters format corrected data for communication nets

Word-processing typewriters, which automatically type out edited information usually stored on magnetic cards or tape, are now taking on the characteristics of a communications terminal. Redactron Corp., Hauppauge, N.Y., has introduced **new communicating typewriters, which can format data so the typewriters can feed error-corrected information over phone lines and directly into teletypewriter lines** from one office to another. And the time-consuming step of retyping messages for teletypewriter networks—a step which may also introduce errors—is eliminated.

Applications described by Redactron for the typewriters include desk-to-desk transmission of correspondence and reports, as well as on-line interactive operation with computers. Speeds range as high as 2,400 bits per second. The equipment is compatible with EBCDIC, ASCII and Baudot codes. **The word-processing system is priced at \$7,200, including a modem, or rental starts at \$235 a month.**

## Heath does it itself in the auto test market

Recognizing the coming explosion in automotive electronics, the Heath Co. has decided to get into the service end of the business with a new line of assembled automotive test gear. Spurred by a request from **the Pontiac division of General Motors, Heath developed an analyzer for solid-state voltage regulators. Pontiac has classified it an "essential tool," requiring the \$119.95 instrument in all authorized service centers.**

To get a running start at the market, the Benton Harbor, Mich., kit maker will first begin selling assembled versions of its auto equipment—including engine and ignition analyzers—at prices ranging from 25% to 40% more than the kits. But to take on Sun Electric Co., the industry's giant, **Heath plans to add products to the assembled line that may not appear in kit form. Gear being considered includes 12-in. ignition scopes, digital tachometers, exhaust analyzers, and complete auto diagnostic centers.**



# C-LINE POWER DARLINGTONS

...how and where to use them

## new application notes contain more than 15 Power Darlington circuits

Here in one place is everything you've always wanted to know about Darlington... how to design for higher speed, lower saturation voltage and high gain in less space. Major applications include pulse and switching circuits, power supplies and linear amplifiers. Four typical applications are illustrated below.

### SWITCHING VOLTAGE REGULATOR

Unitrode Power Darlington's are optimized for switching-regulator service with very fast switching, very low  $V_{CE(sat)}$  and high current gain. In this circuit, the full load efficiency can be better than 95%.

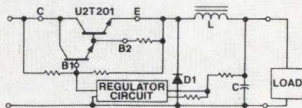

### PUSH-PULL INVERTER

The high current gain of the Unitrode Darlington allows it to be driven directly from a logic-level multivibrator. The low  $V_{CE(sat)}$  not only raises efficiency, but indirectly reduces the magnetizing inductance requirement of the transformer. At 10KHz and full load, the circuit attains an inversion efficiency of approximately 90%.

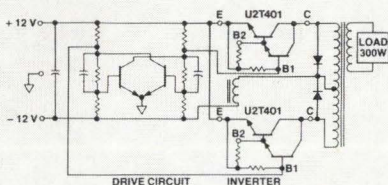

### HIGH SPEED SWITCH FOR INDUCTIVE LOADS

Used with loads such as solenoids, phase shifters and small DC motors, this circuit is not only a switch, but (in the ON state) a constant current source which can drive an inductive load to its steady-state current in less than the time constant of the load itself.

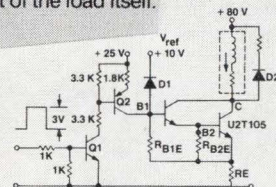

### MOTOR CONTROLLER

Unitrode Power Darlington's are most suited for applications where high-speed jogging, fast dynamic braking or high slew rates are required, and conventional power transistors will not satisfy the highest speed requirements.

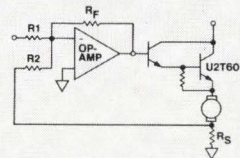

In all applications presented, the circuits have been proven with Unitrode's U2T Series Power Darlington's in both NPN and PNP types - from 2 to 20 amps, 60 to 150 volts in TO-33, 3 pin TO-66 and 3 pin TO-3 packages. 100 quantity prices for the series range from \$1.25 for 5A, 60V devices to \$5.40 for 20A, 150V types.

Unitrode Corporation, Dept. 16Y, 580 Pleasant Street, Watertown, Mass. 02172 Tel. (617) 926-0404

Use the Reader Service Card for your free copy of the new Power Darlington Application Booklet.

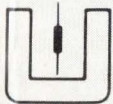

**UNITRODE** quality takes the worry out of paying less.

Unitrode Franchised Distributors: **ARIZ.**, Phoenix, KIERULFF (602) 273-7331; **CAL.**, Los Angeles, KIERULFF (213) 685-5511, Palo Alto, KIERULFF (415) 968-6292, San Diego, KIERULFF (714) 278-2112; **CANADA**, Toronto, SCHWEBER (416) 925-2471; **COLO.**, Denver, KIERULFF (303) 343-7090; **FLA.**, Hollywood, SCHWEBER (305) 927-0511; **GA.**, Atlanta, SCHWEBER (404) 449-9170; **ILL.**, Elk Grove, SCHWEBER (312) 593-2740; **MD.**, Rockville, SCHWEBER (301) 881-2970, Baltimore, TECHNICO (301) 828-6416; **MASS.**, Waltham, SCHWEBER (617) 890-8484; **MICH.**, Troy, SCHWEBER (313) 583-9242; **N.J.**, Somerset, SCHWEBER (201) 469-6008; **N.M.**, Albuquerque, KIERULFF (505) 272-1055; **N.Y.**, Rochester, SCHWEBER (716) 328-4180, Westbury, SCHWEBER (516) 334-7474; **N.C.**, Raleigh, SCHWEBER (919) 832-8881; **OHIO**, Beachwood, SCHWEBER (216) 464-2790; **TEX.**, Garland, KIERULFF (214) 271-2471, Dallas, HAMILTON-AVNET (214) 638-2850, Houston, HAMILTON-AVNET (713) 526-4661, Houston, LENERT (713) 225-1465; **UTAH**, Salt Lake City, ALTA ELECTRONICS (801) 486-7227; **WASH.**, Seattle, KIERULFF (206) 763-1550.

# 191 FLAVORS OF BECKMAN DIPS



All 191 flavors of RESNET™ DIPs offer system compatibility because we use the same packages you use for I.C.s; plus you get ceramic dependability at plastic prices.

Whether you're inserting resistors automatically or by hand — call your local Beckman/Helipot representative and ask how you can save money using RESNET DIPs. He stocks locally for immediate delivery.

If you need immediate technical literature or the telephone number of your local Beckman/Helipot representative, call H.E.L.P. (Helipot Express Literature Phone) toll-free (800) 437-4677.

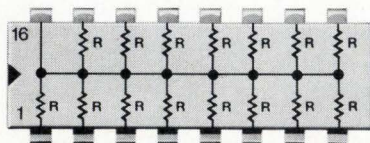

898-1 (15 resistors)  
Price (1,000-4,999) \$.85

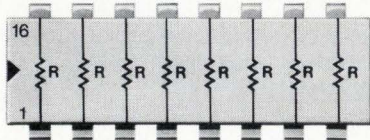

898-3 (8 resistors)  
Price (1,000-4,999) \$.76

**STANDARD RESISTANCE VALUES**  
(±2% or ±2Ω)

62*	110	330	1.0K	2.2K	6.0K	15.0K
68	150	470	1.5K	3.3K	6.8K	22.0K
100	220	680	2.0K†	4.7K	10.0K	

\* Standard in 898-3 only.  
† Standard in 898-1 only.

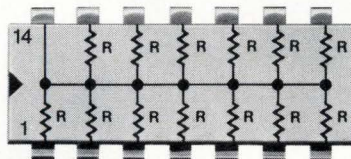

899-1 (13 resistors)  
Price (1,000-4,999) \$.81

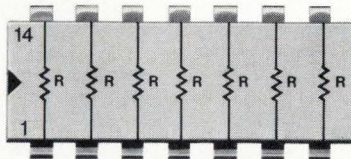

899-3 (7 resistors)  
Price (1,000-4,999) \$.72

**STANDARD RESISTANCE VALUES**  
(±2% or ±2Ω)

22	62	180	510	1.5K	4.3K	11K
24	68	200	560	1.6K	4.7K	12K
27	75	220	620	1.8K	5.1K	13K
30	82	240	680	2.0K	5.6K	15K
33	91	270	750	2.2K	6.0K	16K
36	100	300	820	2.4K	6.2K	18K
39	110	330	910	2.7K	6.8K	20K
43	120	360	1.0K	3.0K	7.5K	22K
47	130	390	1.1K	3.3K	8.2K	
51	150	430	1.2K	3.6K	9.1K	
56	160	470	1.3K	3.9K	10K	

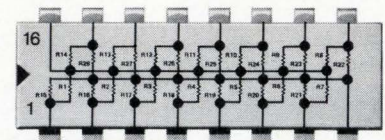

898-5-R220/330  
Pulse squaring TTL terminator.  
Price (1,000-4,999) \$1.45

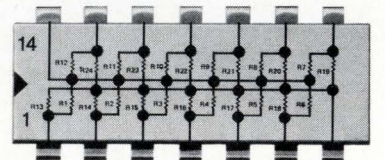

899-5-R220/330  
Pulse squaring TTL terminator.  
Price (1,000-4,999) \$1.35

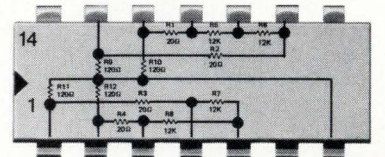

899-19  
DIP interface network providing resistors  
for μA711 core sense amplifier configuration.  
Price (1,000-4,999) \$1.18

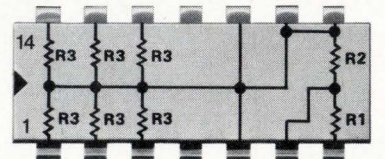

899-40  
DIP network provides six line terminators  
and the threshold setting divider for the Intel  
3208A sense amplifier.  
Price (1,000-4,999) \$1.35

**Beckman**  
HELIPOT DIVISION

## SOS array handles logic and acts as ROM

Rockwell's programmed logic array operates at 15 MHz and has a 4-million-bit storage capacity

Silicon-on-sapphire technology should receive a significant boost from a new SOS programmable logic array—or PLA—that can replace up to 400 eight-gate TTL ICs, yet operate at a speedy 15 megahertz. The new part is similar to some memory parts on the market—it can operate as storage equal to a 4-million-bit ROM—but it is designed to implement logic equations.

The array is made by Rockwell Microelectronics, which holds patents on the SOS process and devices. The Anaheim, Calif., company has been making an SOS 5,000-diode read-only memory. The only other company with announced SOS products is Inselek, Corp. with memories and C-MOS logic. Inselek has a technology license from Rockwell, and the two firms have just announced a second-source agreement, one that will become more significant when Rockwell announces its 60-nanosecond, 1,024-bit random-access memory late this year (see p.35).

Rockwell's new SOS PLA has 128 rows in 46 columns, so arranged that each row is effectively an AND gate of 45 potential input terms. It can implement logic equations directly, unlike a read-only memory, which simply stores all possible values of the variables. This greatly increases the amount of data or control logic that can be stored. For example, the SOS PLA can be used to compute the value of a function of

22 variables expressed as the sum of up to 128 products. A TTL version would require the 400 ICs mentioned, plus a power requirement of far more than the 300 milliwatts dissipated by the PLA.

**PLA acceptance.** The new part, like the earlier Rockwell ROM, is a diode array. ROMs and PLAs, implemented in MOS, use transistors for storage, but in the SOS technology, diodes are simpler to build, are smaller, and have equivalent or better performance. The earlier ROM has found relatively limited use, but Robert Koppel, manager of memory marketing at Rockwell, expects the new part to be much more widely accepted. "We're looking for wide application in the next year or two. I think it will play a major part in helping the PLA concept find acceptance. The device has much more significant capacity and is better packaged than the earlier part."

Koppel sees the broadest use of

the PLA in mechanizing general control-logic equations in digital systems, such as computers and test instrumentation. A PLA approach based on conventional silicon-gate MOS was used in the Computer Automation under-\$1,000 Naked Mini 16/LSI to greatly reduce internal program storage. [*Electronics*, June 7, p. 109]. The Rockwell part is much faster than typical MOS, however. The Computer Automation mini is significantly slower than conventional bipolar minicomputers, a handicap with conventional MOS compared to MOS devices on sapphire.

The PLA can also generate complex and exotic characters, such as Japanese symbols. In this application, the PLA stores the equations for all the lines displayed, whereas a conventional ROM approach must store all the spaces as well as the displayed areas.

A PLA can be considered a special

**PLA chip.** Rockwell's SOS programmable logic array contains 128 AND gates, each of 45 potential input terms. The actual circuit is at left, and magnification (below) is 30 ×.

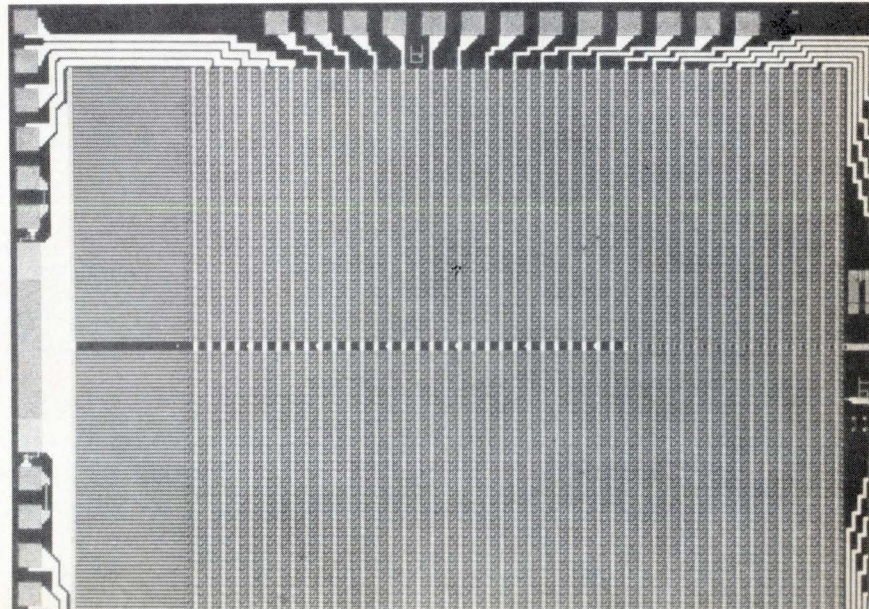
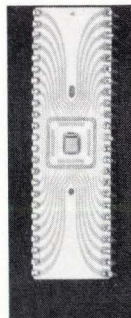

case of a read-only memory with added addressing and decoding. In this form, the PLA can also function as a variable-word-length 4,096-bit ROM exhibiting bipolar speeds. (A ROM implementation would require off-chip addressing, decoding, and sensing, probably with TTL parts; in PLA use, this is not necessary.)

Koppel mentions that there is considerable demand for a 1,024-word-by-4-bit ROM using the fast SOS technology, and the company is considering developing a version of the SOS PLA with on-chip addressing and decoding that would be more complex than the present array.

For small quantities of PLAs, Rockwell uses punched cards supplied by the user to control a laser encoding machine. For larger quantities, the same cards generate a mask pattern. The SOS PLAs, in 48-lead ceramic DIPs, cost about \$32 in quantities over 100. □

Solid state

'Pad relocation' revived at Hughes

LSI circuits using a full silicon wafer may have been abandoned by others in the semiconductor industry, but that hasn't deterred Hughes Aircraft Co. from taking on a \$428,000 contract for its own approach to full-wafer LSI. The contract, for parts used in high-frequency Codem (coded modulator-demodulator) data transmission equipment, comes from General Atronics Corp. of Philadelphia, a Magnavox subsidiary, for the U.S. Naval Systems Command. Delivery of the LSI will begin in January and continue through 1974.

The Hughes "pad relocation" technique [*Electronics*, Oct. 13, 1969, p. 44] was developed by Don Calhoun of the company's Data Systems division in Culver City, Calif. It is similar to but apparently lacks the drawbacks of the earlier discretionary-wired LSI, which Texas Instruments promoted and then dropped.

**Conventional start.** The Codem equipment incorporates 17 full 2.2-inch wafers in each system. The TTL circuits start out like conventional ICs, with processing to produce individual cells of moderate, MSI complexity—16 dual gates, or an arithmetic logic unit (54181 equivalent) are examples. The cells have standardized connection-pad locations (as if they were to be diced for individual packaging), then are covered with glass insulation, leaving only the pads accessible for checking, and finally are tested. A map of good cells is stored in a computer.

At this stage, instead of making a completely unique interconnection pattern to fit the good cells, the good units on the wafer are made to fit into a predetermined logic interconnection format. This predetermined format, instead of using the existing cell pads, uses separate pads deposited on the glass near but not connected to the optimum cell pads. Short metal vias complete the connection if the cell closest to an optimum cell is good. But if it is bad, another nearby backup cell is used instead and its terminals are connected to the isolated pads. The pad-relocation interconnections are then coated with glass, leaving only the "good" cells ready for inter-

connection on following metalization layers. Thus, only one metal layer, the pad relocation one, needs to be customized for variations in the wafer yield.

While design of the logic and the interconnections are left to Hughes Data Systems division and GAC, actual part fabrication is done at Hughes' Microelectronic Products division, Newport Beach, Calif. Hughes reports that typically 60% to 70% of the operative circuits in the wafer are used, and that only rare local yield patterns prohibit satisfactory use of a wafer. The company also says that only about 10% of the connections require other than the closest preferred cell.

Previous work has been with TTL small-scale integration, but the new contract will incorporate MSI. Ion-implanted p-MOS wafers have also been used experimentally. For SSI and MSI TTL, typical cell size is 80 by 160 mils, with 200 cells used in a wafer, or the equivalent of 1,400 to 2,800 gates. For MOS, the gate equivalents can be as high as 10,000 if regular devices such as memories and shift registers are included. Schottky TTL and ECL are also usable, and work in these as well as C-MOS-on-sapphire wafers is in progress at Hughes.

The major aim of the use of LSI is higher reliability, and Hughes reports a five to one improvement over conventional MSI in packages and 10 to one over SSI in conventional construction. Much of this effect is attributed to the great reduction in number of wire and terminal interconnections, well known as unreliable parts of a system. □

Solid state

Chips for Polaroid camera exposed

Although all-electronic camera controls, such as the one in Polaroid's SX-70, are only a year or so old, second-generation chip designs could greatly reduce the number of chips required to do the job. All the cam-

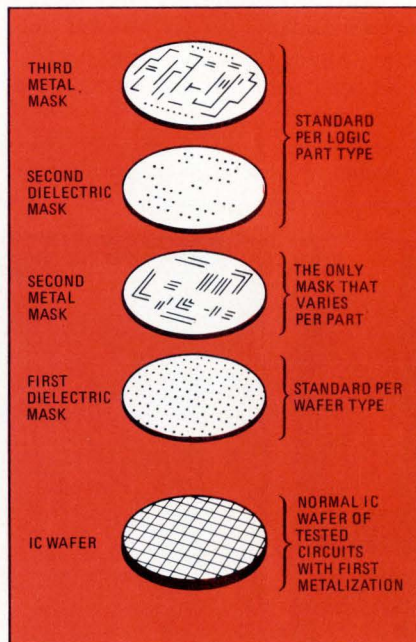

**Pad process.** Hughes has revived pad relocation and claims reliability is high.

## 'Compatible' electronic calculators start a new era at Victor

Victor Comptometer Corp. sees itself as a figuring equipment firm and only incidentally as an electronics manufacturer. But the line of small programable calculators it unwrapped at Wescon gives a sample of the versatility that electronics has brought the old, respected mechanical-calculator giant.

Besides the programables, to be formally introduced next month, Victor will next year begin delivering a stand-alone cash register and will introduce a small billing and accounting system. The company is also currently considering a system directed at a specialized segment of the point-of-sale market. Victor is carefully tailoring its products to markets it serves best through a massive direct sales and service organization and is relying on compatible designs to rapidly shape a diversified product line.

**Compatibility sought.** "When we decided to go to electronics," says J.E. Smith, president of the Chicago-based firm's Business Products group, "we decided to develop a family of products with compatibility of appearance, design, manufacture, marketability, and components." It's an easy transition into more systems-oriented products.

"We make our own wire-matrix

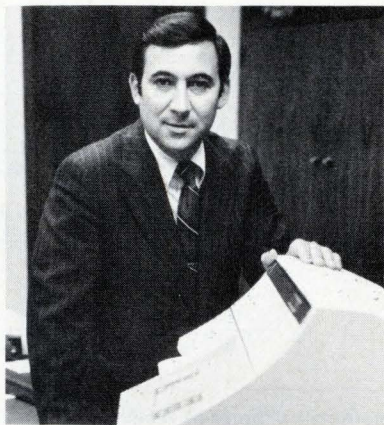

**Compatible.** Victor's J. Smith with friend.

printer, almost all plastic parts and printed-circuit boards, and tactile keyboards, and use a set of chips of our own custom design," he adds. Chip sets are manufactured by Rockwell Microelectronics, and Victor purchases Burroughs' Panaplex displays for its calculators and cash registers.

For the programables, Victor uses the same keyboard and printer as in its earlier electronic printing calculators. The company increased the complexity of the same basic logic and added a magnetic card reader/recorder of its own design and manufacture. It is billed as the "smallest,

fastest, simplest, lowest-priced programable printing calculator on the market," and, importantly, is aimed directly at the business and commercial market, and not at the scientific and engineering markets served by Wang and H-P, and more recently, Olivetti and Monroe.

**From many, one.** "The next logical design step is to take the programable calculator, add a typewriter keyboard, carriage and forms-handling equipment, and we'll have a small billing and accounting system," Smith explains. Victor has already extended its serial-impact dot-matrix printer to complete alphanumeric capability and will be building its own typewriter keyboards, which contact the pc board through a conductive substance.

"Many of the same chips in the programable calculator are also in the cash register as well as the same keyboard and printer," he says. And Victor hopes to build this into a point-of-sale system. "Our stand-alone cash register was designed with the flexibility to adapt to P-O-S," he continues. "It can be modified to take peripherals such as wands, scanners, and data cassettes. So we're looking at the market and its various segments." □

era functions of the SX-70 are controlled by a hybrid assembly composed of three modules. These modules contain a total of seven ICs, including a complex three-chip exposure-control module.

Donald Pezzola, design engineering supervisor for camera products at Fairchild Semiconductor Components, Mountain View, Calif., one of the principal suppliers of the assembly, predicts that the entire exposure-control circuit in future cameras could be put on a single chip. He made his prediction this week in a paper delivered at Wescon.

Pezzola points out that the SX-70 exposure-timing chip, even though it is supported by two other chips in

the present hybrid design, by itself represents all the silicon processing needed for a single-chip control circuit. That chip, which contains a photodiode sensor, is equivalent to a conventional camera's range and exposure control.

Two other modules give the SX-70 its special automatic features. One is an automatic flashlamp-selector circuit, and the other drives the motor. The flash circuit sequentially tests each lamp in a General Electric Flashbar. When it finds an unfired lamp, the circuit triggers it. The motor circuit also monitors the battery, which is part of the film pack.

Pezzola's paper provides the first

detailed look at the SX-70 system. Fairchild engineers had been ordered to keep mum about the inner workings of the custom design until Polaroid Corp. got into volume production and lifted the information embargo. The timing circuit is part of a three-chip exposure-control subsystem. A second chip carries a 12-kilohertz resistor-capacitor oscillator and divider chain that determine shutter-timing intervals. The third chip contains most of the camera-control logic and the shutter-solenoid drivers; it has the job of generating control signals for the other two subsystems.

**Knottier.** One of the knottier problems in developing the timing

control Pezzolo says, was ensuring that noise from the electro-mechanical components would not upset the delicate photo-integration operation on the timer-control chip. The integration circuit processes photo currents as low as 1.5 picoamperes, while the motor, shutter solenoids, and flash lamps generate high-frequency transients at relatively high currents—up to 2 amperes peak—from the motor which actuates the SX-70's reflex and film-handling mechanisms. The solenoids generate 1.5-A peaks.

Much of the problem was solved by a "time-partitioning" concept of system organization. While the integrator operates, the noisy parts of the system are shut down. Also, the system is physically partitioned to minimize sharing of common grounds by low-current and high-current functions. Noise-sensitivity was further reduced by performing the integration with a low-pass filter and by designing voltage clamps and current-regulators into the power controls. □

### Government electronics

## FBI to automate fingerprint system

After spending eight years and several million dollars on development, the Federal Bureau of Investigation is putting the finishing touches on its prototype automated fingerprint reader system called Finder [*Electronics*, June 4, 1970, p. 42] and is planning to go out and buy some. Just when the bureau will request proposals hasn't been decided, but it could be fiscal '74.

An FBI buy of Finder systems would not only give the winning contractor a challenging project but also would help the bureau ease the accessing and cataloging of its monumental fingerprint file. Now a 3,300-person staff searches and compares the 20,000 to 30,000 inquiries a day from a growing file of 20 million records. The bureau figures that Finder offers a faster and

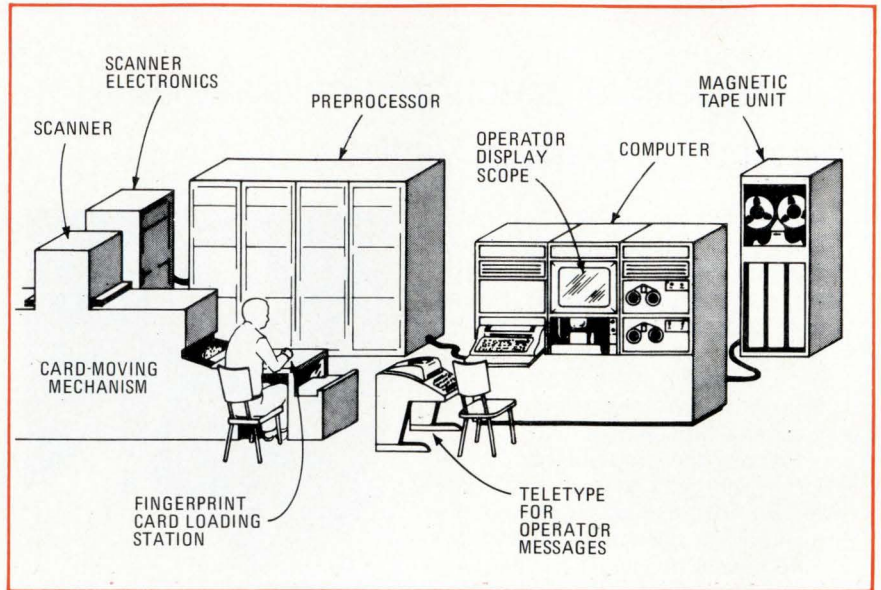

**Automated fingerprint reader.** The FBI's Finder uses computers and scanners to make sweeps over fingerprint lines and compare them with prints on file.

more economical approach than hiring a larger staff.

When it buys, the bureau probably will phase in the units slowly, automating sections of the fingerprint file at a time. As the system uses pattern recognition and processing techniques, a host of companies would be potentially eligible to bid, including Calspan Corp. (formerly Cornell Aeronautical Laboratories), Buffalo, N.Y., which developed the prototype equipment with support from the National Bureau of Standards.

As envisioned, the complete system would consist of several Finder systems, a special high-speed matching processor, a mass data storage and retrieval system, one or more medium- to large-scale general-purpose computers, and related control and interface units. In-house evaluation of the Finder system eats up almost all of the FBI's \$1.4 million research funds for fiscal 1974.

**How much faster?** Basically, Finder reads a 10-print fingerprint card into the computer via a flying-spot scanner, registers it into standard position, classifies it, and matches it against already recorded prints at an average speed of half a second per individual print. The computer for the system is a DEC PDP-15. But the key to the system is the special preprocessor that uses

image-enhancement techniques to clarify smudged fingerprints and identify the complex classification data. Robert M. Stock, Finder technical group head, says that the preprocessor performs in less than a second what it would take an IBM 360/65 more than an hour to do.

The computer from the preprocessor transfers the data onto magnetic tape which is sent to the general-purpose computer. That computer registers, classifies and matches the data. Another important element is the card-moving mechanism that places the trays containing the fingerprint cards before the scanner.

Downstream, Finder technology could be used to match fingerprints found at the scenes of crimes with those on file, and to transfer fingerprint data over voice-grade phone lines among computer data banks. □

### Aerospace electronics

## FAA drops option, seeks ARTS 2 rebids

Lockheed Electronic Co.'s dream of a hefty foreign market for medium-sized air-traffic-control systems, based on its domestic sales to the

# Quick Permanent Repairs with Confidence.

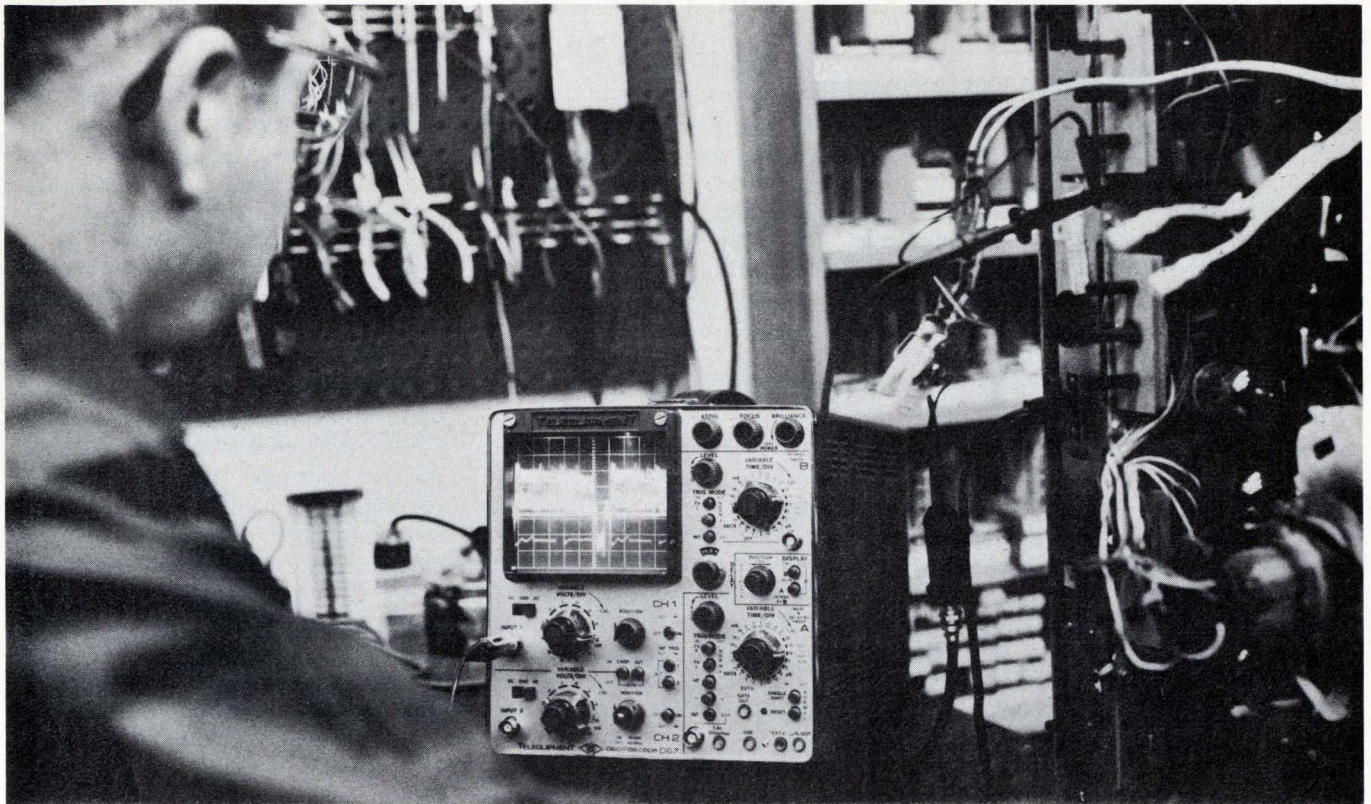

## The D67 ends troubleshooting guesswork in complex TV and audio circuits—at a low price.

TV and audio equipment servicing is outdistancing the capabilities of older test instruments. Also, greater use of electronics in consumer products (pocket calculators, microwave ovens, digital clocks, home intruder alarms, etc.) is opening up new service opportunities. Telequipment offers you the high performance you need in a low-cost scope for this new service business.

The D67 combines dual-trace, delayed sweep, and 25 MHz bandwidth, at a very low price. Non-delayed sweep scopes just can't compete with the D67's delayed sweep measurement flexibility. It allows quick, accurate troubleshooting of IF tuning and color bandpass problems. You can also see fast circuit conditions after relatively long time delays.



If you don't require delayed sweep but need dual trace at 25 MHz, here's another economical, quality scope—the D66. Troubleshooting consumer digital products such as mini-calculators is made easier by using dual trace. Also a "SUM" mode with normal-invert capability makes it possible to look at small signals in the presence of common mode noise—such as power supply hum.

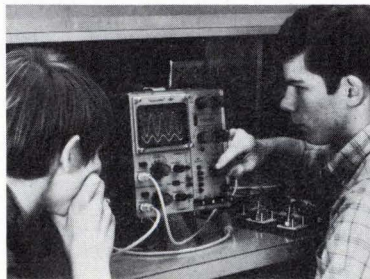

This simple to use, dual trace, 10 MHz D54 gives you low-cost, dependable performance in a wide variety of applications. Like all Telequipment scopes, it is light weight, easy to carry and is backed by Tektronix' warranty and reputation for quality. Students shown are testing amplifier circuit by measuring the gain between input and output signals.

Dual-trace waveforms displayed on a bright CRT are essential for servicing TV and high quality audio systems, where time and phase relationships between signals are critical. Whatever the consumer's electronic service problem, 25 MHz is probably all the bandwidth you will need.

Telequipment products are marketed and supported in the U.S. through the Tektronix network of 52 Field Offices and 35 Service Centers. Telequipment prices range from \$245 to \$1495. For a Telequipment catalog, and a reprint of the ET/D review of the D67, write: Tektronix, Inc., Box 500, Beaverton, Oregon 97005



**TEKTRONIX®**

committed to  
technical excellence

# TELEQUIPMENT



Circle 42 on reader service card

For a demonstration circle 43 on reader service card

Federal Aviation Administration, suffered a blow when that agency dropped its options with the company for 145 production units of the Automated Radar Terminal System (ARTS) 2. Instead, the FAA, after determining qualified companies, plans to issue requests for proposals for only 70 units in October and award a contract early next year.

The FAA's change of mind reopens fierce competition among companies to become the supplier of the ARTS-2-type systems here and abroad. Lockheed's division in Plainfield, N.J., had beaten out Sperry-Univac, Texas Instruments, and Burroughs Corp. for the \$1.5 million contract to develop a prototype system [*Electronics*, July 31, 1972, p. 24]. Production options would have added \$21.7 million for 145 units up to \$29.9 million for 208 units over several years. But not long after Lockheed had delivered the prototype to the Wilkes-Barre-Scranton airport for testing, the FAA began rethinking its numbers [*Electronics*, June 7, p. 53].

Computers

Illiac 4 is about to be unleashed as a giant problem-solver

Will Illiac 4, the huge parallel processor now being brought up to operational status at NASA's Ames Research Center, Moffett Field, Calif., go the way of the dinosaurs? "No," says Mel Pirtle, its chief attendant. He thinks the Illiac concept—the working in parallel of many separate processors on separate data streams under control of one instruction stream—will prove eventually to be economical.

This will happen, he says, as soon as LSI technology allows many identical processors to be duplicated at low cost. And when it does, it may bring about the replacement of conventional large computers, which have relatively inefficient memory organizations.

Meanwhile, Pirtle expects the \$30 million, 64-processor computer and

The estimated value of the 70-unit buy hovers around \$15 million, with perhaps \$8 to \$9 million coming the first year, and if the FAA buys 95 units, the sale would ultimately be worth \$25 million. However, the foreign market, in which the FAA contractor would have a strong selling edge, has been estimated at \$400 million [*Electronics*, Jan. 31, 1972, p. 41].

**Who's right?** "We're not very happy—obviously," says one Lockheed official. "The production quantities put into the contract were selected unilaterally by the FAA, and they were in error. We shouldn't be penalized for their error." He worries that the FAA's decision to rebid delays certifying a system and "will have a negative impact abroad," where Lockheed already has sold one system in Italy and has options for seven more.

The minicomputer-based ARTS 2 provides air-traffic controllers with alphanumeric displays of traffic within their area, including identifications and altitudes. □

Projects Agency (ARPA) scientists to solve previously unsolvable problems in fluid dynamics, aerodynamics, propulsion, weather prediction, oceanics and related research fields. Pirtle is director of the Institute for Advanced Computation, the organization formed by NASA and ARPA to administer Ames's two prime systems—the Illiac 4 and its trillion-bit Unicon laser memory.

**To predict and simulate.** The system is now in limited use. The Rand Corp. employs it to predict weather for short periods—from several days to weeks—by feeding weather data into a mathematical model of the earth's atmosphere. Rand hopes to refine the model to make long-term predictions. The computer will also assess what would happen following a phenomenon such as melting of the polar icecap. For Ames, Illiac 4 will simulate reentry conditions for a 150-foot-long model of the space shuttle vehicle.

Hans Mark, director of Ames Research Center, says Illiac 4's computational power will enable the aerodynamic variables to be defined with far greater precision than in the past. Had Illiac 4 been available when the Cheyenne helicopter and the F-111 aircraft were developed, the errors that caused the Cheyenne's failure and the F-111's costly problems probably could have been avoided, Mark says.

Both weather prediction and air-foil simulation require matrix processing of many data streams. Illiac

its \$10 million support facility to more than earn their keep by allowing NASA and Advanced Research

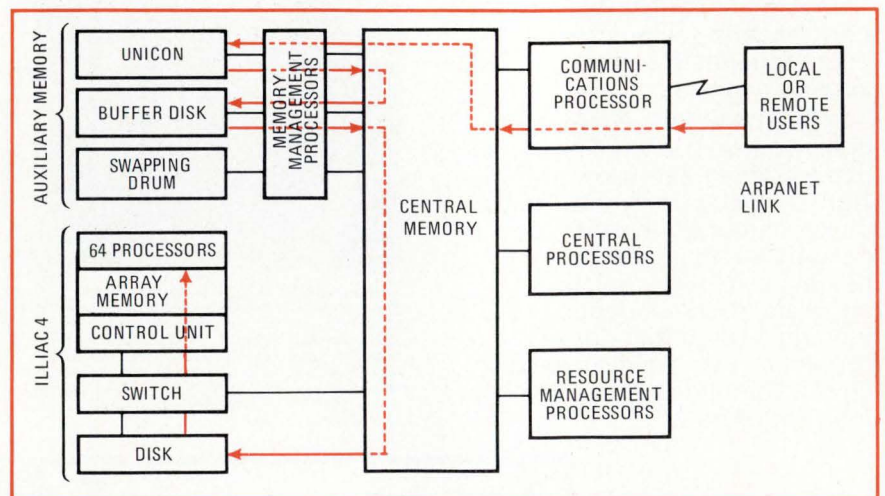

No kluge here. Illiac 4 is expected to reach operational status by early 1974.



# stores anywhere...

**With the Tektronix dual-trace 214 you make storage measurements anywhere, anytime, and with a minimum of effort.**

If you operate a scope around heavy equipment, on catwalks or under other adverse conditions, you'll appreciate the 3½ pounds that the 214 weighs. And its small size of 3 x 5½ x 9½ inches lets you conveniently store it when not in use.

The 214 is the third miniscope from Tektronix. Like the non-storage 211 and dual trace 212, it has a bandwidth of 500 kHz and vertical deflection from 1 mV/div to 50 V/div. Sweep speeds range from 5 µs/div to 500 ms/div. All three are con-

structed of high-impact plastic to withstand rough treatment, and they are double-insulated for greater protection while making high-voltage measurements. Rechargeable internal batteries allow up to 5 hours continuous operation with non-storage and up to 3½ hours in the storage mode.

Costly equipment breakdown in the field requires that you get there with the right tools, find the problem and solve it. And you need to do it fast. In those times, oscilloscope storage is proving itself more and more valuable.

Many times, low or random repetition rate signals are difficult to view. The 214 combines storage with triggered single

sweep to automatically wait for and capture an elusive event. It writes in the storage mode at up to 500 div/ms, and holds the display for up to an hour.

214 Dual-Trace Storage Oscilloscope ..... \$985

Tektronix has field offices in or near all major cities. Call yours for a look at the miniscopes. Or write Tektronix, Inc., P.O. Box 500, Beaverton, Oregon 97005. In Europe, write Tektronix Ltd., P.O. Box 36, St. Peter Port, Guernsey, C.I., U.K.



**TEKTRONIX®**  
committed to  
technical excellence



Circle 44 on reader service card

For a demonstration circle 45 on reader service card

4 can process 64 full-word or 128 half-word data streams simultaneously, or a total of up to 150 million operations a second. The data is fed from the Unicon memory through high-speed disks into solid-state scratchpad memories in each processor.

Such throughput cannot be attained with the present central system—the group of Digital Equipment Corp. PDP-10s and other conventional computers that operate Illiac 4 and the laser memory as number-crunching and mass-storage peripherals. The central system will be improved this year to make Illiac 4 operational and equip it with superfast core, buffer-disk and drum memories. Pirtle expects operational status to be reached early in 1974 and the speed improvements to be completed by mid-1974. Operating and maintenance software is also being upgraded.

**A heart.** A contract for the new central core memory has been placed with Systems Concepts Inc., of San Francisco. The memory, the heart of the complex, will be used by all computers and storage subsystems as an inter-communications subsystem, as well as for storage of programs and data. The present off-the-shelf memory transfers only 1 million words a second. The new \$700,000 memory will transfer 42 million words a second by accessing 28 words every 650 nanoseconds. The design's capacity is a half-million 37-bit words, expandable to a million words.

The upgrading will complete almost 10 years of development, begun in 1965 by Daniel Slotnick, of the University of Illinois, who had worked on the idea for 10 years before that at IBM and Westinghouse. Burroughs Corp. built the Illiac 4 at a cost of \$30 million and shipped it to Ames in 1971. Pirtle indicates it will not be used for secret military work—he says the Institute for Advanced Computation has no plans to make it secure and that the ARPA computing network, of which it is a part, is not secure.

Nor are there plans at present to build the remainder of the original Illiac design. As it stands, Illiac 4 is

one fourth of a four-quadrant system of 256 processors. Pirtle says that 128- and 256-processor systems are under consideration elsewhere and that they will become more practical in computer architecture as LSI costs drop. □

## Companies

### Ballantine's success keyed to marketing

Three years ago, under Singer Co. ownership, Ballantine Laboratories Inc. wasn't breaking much new ground. But things changed when, in 1971, Fred Katzmann, now Ballantine's president, along with partners Milton Lichtenstein and Louis Foundos [*Electronics*, May 8, 1972, p. 147] bought the company from Singer and raised earnings from less than \$750,000 a year to \$1.5 million this year. Nor is Katzmann stopping there—he expects to continue doubling the company's growth every two years.

Bucking instrumentation giants Hewlett-Packard Co. and Tektronix Inc., the tiny Boonton, N.J., firm in July landed a \$1.4 million Air Force contract for 1,198 oscilloscopes and then quickly followed up last month with two more Government contracts, one a \$221,750 award from the Army Missile Command's Redstone Arsenal in Huntsville, Ala., for 43 automatic ac-dc thermal transfer standards, and the other contract was a \$91,062 award from the Federal Aviation Administration for 155 general-purpose oscilloscopes.

While Ballantine underbid both Tektronix and H-P in the Air Force competition, the company's success stems from many other elements, including a strong emphasis on marketing. According to Katzmann, test and measurement is a mature industry and no longer primarily responsive to technological development. Katzmann is also a proponent of decisive, aggressive action.

One of the first things he did was expand the product lines beyond

voltage-measurement equipment, and he has also strengthened distributor networks, stressed mail orders (half of all sales are through the catalog), and pared down the engineering department in favor of maintaining a string of consultants for technological development. Another development was to establish a number of manufacturing and technological agreements with overseas firms such as England's Advance Electronics and Israel's Tabor Electronics.

Katzmann is also keen on watching the development of other companies and believes that owner-management is an important key to success, noting that this is the case with both H-P and Tektronix. His goal is to achieve an equilibrium—to combine the advantages of a big and a small company—and to this

**Ballantine chief.** Fred Katzmann's formula for success includes aggressive marketing.



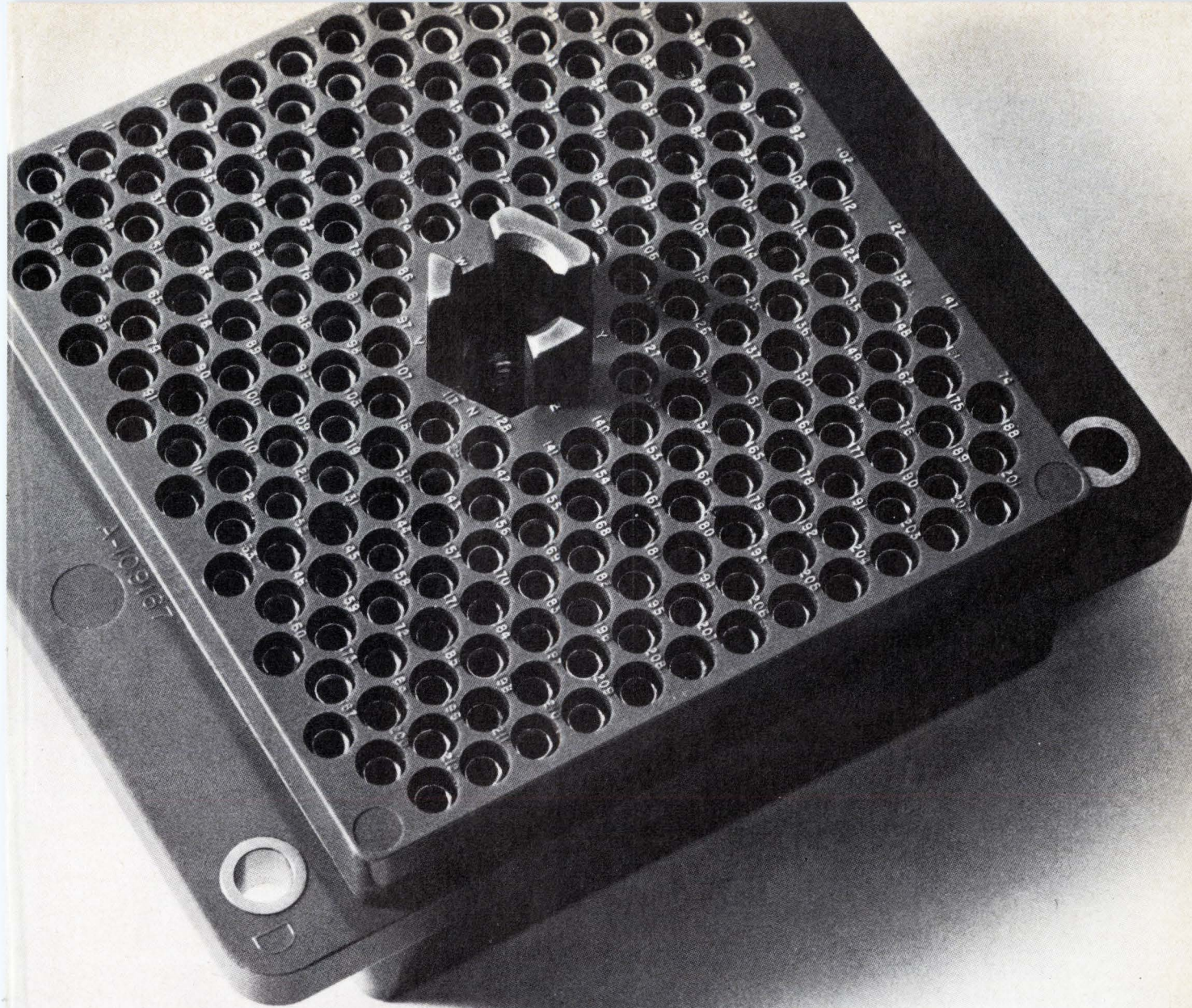

# LOOK MA, MORE CAVITIES!

More than any other connector its size.

Hughes rectangular connectors have the highest contact density in the business.

One of our 212-contact models, like the one shown here, does the job of four 55-pin circular mil-spec connectors.

And does it in one-fourth the space!

Plus greater reliability (thanks to 16-gage contacts) and better contact retention.

And besides standard sizes, miniature and subminiature sizes are available, too.

Hughes high-density connectors. One of the few times more cavities is something to smile about.

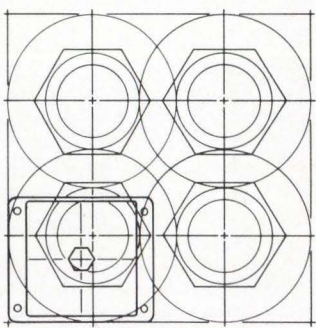

Call or write for our new catalogs:  
500 Superior Avenue,  
Newport Beach,  
California 92663.  
(714) 548-0671.



**CONNECTORS, CABLES, CIRCUITS... ONLY HUGHES PUTS IT ALL TOGETHER.**

Circle 47 on reader service card

## Electronics review

end he has devised a five-year plan. The plan includes diversifying instrument applications into CATV, communications, medical, assemblies, and custom manufacturing, as well as generating maintenance and rental programs, placing still greater emphasis on mail-order sales, and combining financial forces with other small companies to share mailing and sales office expenses.

"Obviously we can't achieve this fast growth from the profits alone," says Katzmann. "A company has to borrow funds, and for us, going public will be inevitable."

The key to Ballantine's success, however, is Katzmann himself. Those who know him tell of the respect he commands in the electronics industries. Another of his observations gives the reason: "You have to have a clear recognition of why and how you can succeed." □

## Military Electronics

### Poseidon failures identified by Navy

The reasons for the Navy's 58% failure rate in operational tests of its first-line Poseidon missiles have been identified as apparent guidance system and motor malfunctions. Navy officials laid the blame on failure of engines to ignite or separate after burnout as well as guidance system problems that led to loss of control in flight or impact outside of target areas.

Although the shortcomings of the system, made by the Lockheed Missile & Space Co., have been publicized widely since their disclosure in recently released testimony before the Senate Armed Services Committee, the reasons have not been identified previously.

The Poseidon program troubles, which have led to a recall of some of the missiles for disassembly and component testing, is intensifying the efforts of congressional advocates of reduced defense spending to cut back \$1.5 billion sought by the Navy to meet its proposed \$1.74

billion fiscal 1974 outlay for the Trident submarine and missile follow-on program to Poseidon (Electronics, Aug. 16, p. 42).

**Secrecy.** Navy sources cited security considerations in refusals to discuss the missile-motor and apparent guidance-system failures, although the details were spelled out in questioning naval operations chief Adm. Elmo Zumwalt in closed hearings May 16 before the House defense appropriations subcommittee.

Navy sources do not deny that the complicated Poseidon guidance system required for the 10 nuclear war-

heads—multiple independently targetable reentry vehicles (MIRV) system—is a likely source of the problem. However, they caution that the exact cause is still unknown to the Navy and note that the probability of problems with MIRV guidance is no more than "reasonable speculation."

Prime guidance system development contractor is the Charles Stark Draper Laboratory Inc., Cambridge, Mass., which fulfilled the contracts when it was a part of the Massachusetts Institute of Technology. Honeywell Inc., St. Peters-

## Electronics Index of Activity

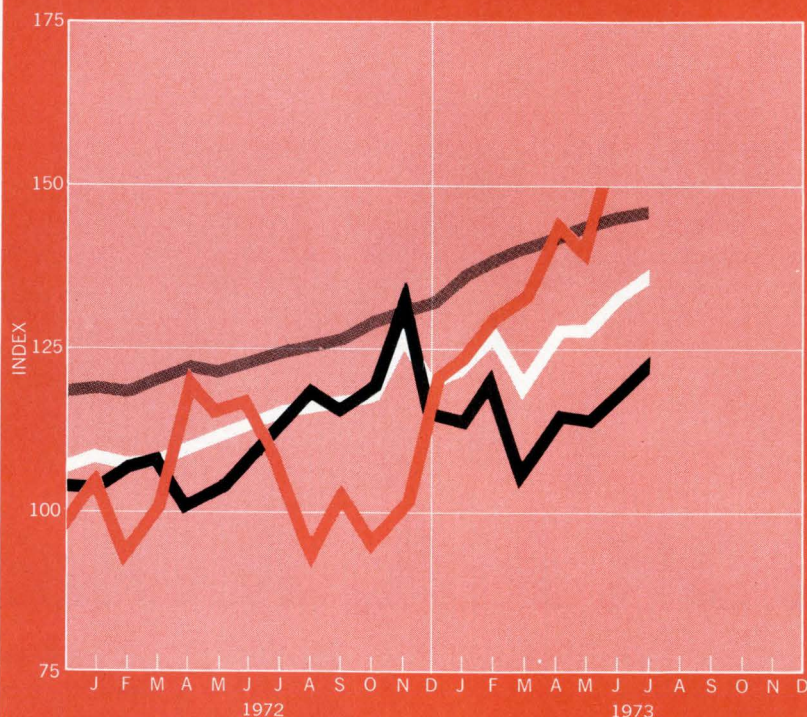

Segment of Industry	July 1973	June 1973*	July 1972
Consumer electronics	163.8	162.8	109.0
Defense electronics	123.8	118.2	116.3
Industrial-commercial electronics	146.3	145.7	124.4
Total industry	137.4	134.0	117.6

In July, the electronics index reached its highest point since October 1969, as it climbed 2.5% (or 18% on an annual rate basis) from June. The consumer sector was up an incredible 50.3% from a year ago, a year-to-year increase which is an all-time record for any sector in any month. The largest gainer of the month was defense, which rose 4.7% in July, leaving it 6.4% higher than July 1972.

Indexes chart pace of production volume for total industry and each segment. The base period, equal to 100, is the average of 1965 monthly output for each of the three parts of the industry. Index numbers are expressed as a percentage of the base period. Data is seasonally adjusted.  
\*Revised.

# Believe it or not, this is a complete data acquisition system

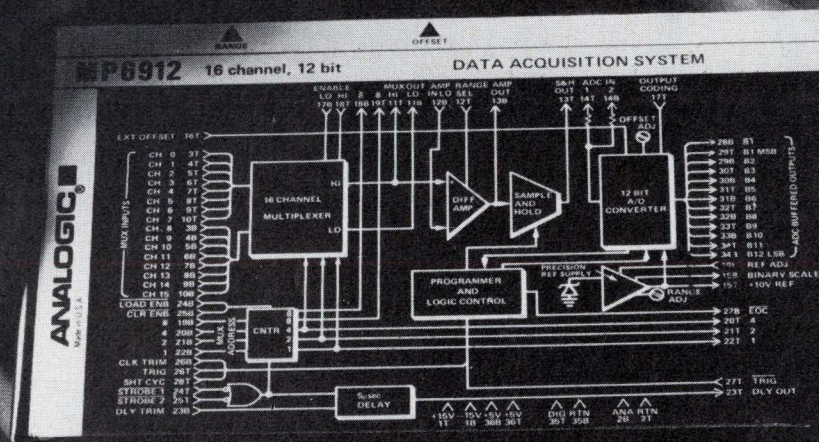

Not a module, a system. All of the circuits for a 16-channel multiplexer with buffer amplifier, fast sample and hold, 12-bit A-D converter, and programming/control/timing logic are in there. Yet the package is only 0.375 inches thin for mounting on standard minicomputer big boards with 0.5-inch spacing.

Look how the MP6912 solves the old problems: First, being an integrated, shielded package, it is relatively immune to wiring parasitics, thermally generated voltage changes, noise pickup (as from a core memory), and other dangers inherent in interconnected modules. Second, it is less expensive, \$695, than the modules it replaces, even before the cost of interconnecting them. Third, it provides significantly better accuracy, stability, linearity, and dynamic response than modules. Fourth, it does all of these things with a throughput of 100KHz, as fast as any system on the market today.

Best of all, the MP6912 takes the problems of designing, building, and testing a data acquisition system out of your plant and into ours — the most experienced data conversion company in the industry. Send for our very complete 16-page system designer's guide on the MP6912, which includes applications, timing diagrams, set-up and calibration procedures, and a lot of other helpful information. Analogic Corporation, Wakefield, Mass. 01880.

Northeast, 617-235-2330, 203-966-2580, 315-446-0220, 201-652-7055, 212-947-0379  
 Mid Atlantic, 215-272-1444, 703-790-5666  
 Midwest, 412-892-2953, 216-267-0445, 513-434-7500, 313-892-2500, 913-362-0919, 314-895-4100, 312-283-0713, 414-476-1500  
 South, 713-785-0581, 214-620-1551, 305-894-4401, 919-227-3639, 205-534-9771, 305-773-3411, 813-867-7820  
 West, 303-744-3301, 505-523-0601, 602-946-4215, 505-296-8303, 714-540-7160, 408-374-5220, 206-762-7664, 503-646-6064  
 Canada, 613-836-4411, 604-688-2619, 416-444-9111, 514-861-1375

**ANALOGIC** ■

Circle 49 on reader service card

# TO-5's WE CAN COOL 'em

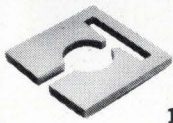

**1.7¢\***

1129-U Press on  
May be stacked  
Typical  $R_{\theta}$ , 56° C/W



**5.1¢\***

2226-U Press-on  
Clears adjacent compo-  
nents  
Typical  $R_{\theta}$ , 59° C/W

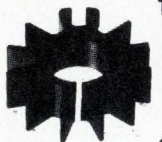

**8.2¢\***

2230-B5, 3/4" Press-on  
gear type, screw mount  
Typical  $R_{\theta}$ , 51° C/W



**8.5¢\***

2257-R 1/2" Press-on  
gear type  
Typical  $R_{\theta}$ , 68° C/W

Popular, easy-to-use economy coolers for PC board components. Thermalloy offers the most complete line of heat sinks in the industry: over 100 designs for cooling all types of packages including DIP's, plastics, TO-3's, TO-66's, and power transistors.

\*Prices for 5000 quantity  
 $R_{\theta}$  values for natural convection @ 1 W

Free Samples  
and Catalog  
Write Today

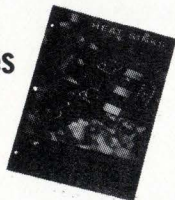

**Thermalloy Inc.**

P.O. BOX 34829  
2021 W. VALLEY VIEW LANE, DALLAS, TEXAS 75234  
PHONE 214-243-4321/TWX 910-860-5542

## Electronics review

burg, Fla., and Hughes Aircraft Co., El Segundo, Calif., have been key hardware contractors for inertial-guidance components and guidance-system electronics.

Before the Navy stopped Posei-

don tests earlier this year, 28 missiles had been fired, during operations of submarines in which contractor personnel participated, while another 24 were fired from operational boats with only Navy

## News briefs

### Bisplinghoff to head B-1 panel

Raymond L. Bisplinghoff, National Science Foundation deputy director, has been named chairman of a special Government-industry study group by Air Force Secretary John L. McLucas to review rising costs and schedule slippages of the Air Force B-1 bomber development contract at Rockwell International. The panel is scheduled to complete its review by the end of October and is empowered to recommend "cost and schedule trades," designed to improve the program's effectiveness. The B-1, still in development, could be the subject of more sweeping recommendations, since its unit cost forecasts have climbed to more than \$54 million from earlier estimates of about \$30 million.

### Bowmar introduces \$59 calculator

As prices of hand-held calculators continue to drop, Bowmar, Acton, Mass., which claims more than half the market, has introduced a slim, lightweight, \$59 eight-digit model that it hopes will prove popular for simple mathematical problems. The Bowmar Brainchild, as it's called, in addition to the 8 digits has all four functions. It weighs 6 oz, is only 3/4-in. thick, and is powered by three AA penlite batteries.

### Three firms to join Comsat/Marsat

ITT World Communications Inc., RCA Global Communications Inc., and Western Union International Corp. were given preliminary approval by the Federal Communications Commission to join the Communication Satellite Corp.'s proposed \$72 million communications satellite project for the Navy and maritime interests [*Electronics*, May 24, p. 42]. Leaving aside some questions on how the companies would jointly manage the venture, the Commission okayed shares of 80.2% for Comsat, 12.5% for RCA, 3.3% for ITT, and 4% for Western Union.

### Allen-Bradley enters precision-resistor business

Allen-Bradley, Milwaukee, is entering the precision-resistor business with a line of 1/4-watt cermet film resistors, available with 1% tolerances in preferred-number values by decades from 10 ohms to 1 megohm. The firm claims the design eliminates end cap-construction problems, a major cause of film-resistor failures.

### DOT demonstrates electronic license plate

An "electronic license plate" that confirms vehicle identity by remote ground or airborne radio interrogation will soon be tested in the New York City area by the Transportation Department. DOT is trying to develop an inexpensive method to stop truck and cargo hijacking. Hoffman Electronics Corp., El Monte, Calif., and Information Identification Inc., Fort Worth, Texas, made units of the system, which recently passed tests at the Department's Transportation Systems Center, Cambridge, Mass.

### Rockwell studies "bubble" flight recorders

Systems integration methods for magnetic-bubble-domain flight recorders on board satellites will be studied by Rockwell International Corp. under a \$139,000, award from NASA's Langley Research Center. According to NASA, the 14-month contract to the company's Electronics Research division, Anaheim, Calif., is an important step in developing reliable solid-state magnetic recorders to replace mechanically driven tape units.

# Interchangeable CPUs. That's modularity.



SUE's basic CPU gives you a minicomputer that's high in flexibility yet low in cost. Other CPU models provide additional arithmetic or math capability to satisfy specific application needs.

These all slide easily in and out of the chassis. Without any wiring. In fact, you can change CPUs at your plant (or even in the field if need be) in about 60 seconds. So a SUE system can change and grow as fast as your customer's needs change and grow.

**The component computer.** And you're not limited to one CPU at a time. SUE's multiprocessor capability lets you hook up as many as four on a single Infibus. Just choose the combination of processors that suits the system best.

That's because SUE (the System User Engineered mini-computer) is the first of its kind: a component computer for systems. Its modular processors, memories and controllers all plug together in almost any combination to solve your application problems.

That includes I/O controllers, but you'll never

# That's SUE.

need more than two basic types with SUE: one bit serial, one word parallel. These will adapt to any I/O device.

#### **Wider choice of peripherals.**

We offer a full line of peripherals to go with SUE: IBM compatible 5440 disk drives, printers from 100 cps to 600 lpm, magnetic tapes, cassettes, punched card devices and paper tapes. Anything your system needs.



**Complete software tools.** To make your programming burden lighter, we offer a full set of software tools: sort/merge, DOS, assemblers, utilities and other programming aids.

And we're the only company we know of that unconditionally warrants all our software for a full year.

**Built for systems builders.** SUE's built-in flexibility makes it fit your systems now, makes it easily changeable later on.

You can be sure we'll be here later on, too. Which is one more advantage of dealing with an established, reputable company like Lockheed Electronics.

Let's talk. Call (213) 722-6810, collect, or write us at 6201 E. Randolph St., Los Angeles, California 90040.



## **Lockheed Electronics** Data Products Division

Boston 861-1880 • New York metro (215) 542-7740 • Philadelphia 542-7740  
Washington (703) 525-3600 • Atlanta 266-0730 • Detroit 557-5037 • Chicago 833-4600  
Dallas 231-6163 • Houston 682-2617 • San Francisco (408) 257-3357

# How one electronics company saves \$157,200 a year with an Applicon Graphic System.

Applicon Graphic Systems help designers and draftsmen improve their output while saving hundreds of manhours and thousands of dollars.

For example: one electronics manufacturer uses his AGS 700 to design twenty new PC boards per month. Two sizes are involved: one with twenty-five ICs, one with fifty. With the AGS 700, he saves 52 manhours

on each board of the first type and 79 manhours on the second. Combined savings add up to \$157,200 a year — far more than the cost of his AGS.

Savings like these are being realized in diversified applications: electronics, architectural, mechanical, diagramming, and others.

For more information, send the reader service card. Or mail the coupon below.



EL-2

APPLICON, INCORPORATED  
 154 Middlesex Turnpike  
 Burlington, Mass. 01803

Please send more data about Applicon Graphic Systems directly to:

NAME \_\_\_\_\_

TITLE \_\_\_\_\_

COMPANY \_\_\_\_\_

STREET \_\_\_\_\_

CITY \_\_\_\_\_

STATE \_\_\_\_\_ ZIP \_\_\_\_\_

**APPLICON**  
 INCORPORATED

---

## Electronics review

---

personnel on board. In the operational tests—the kind of conditions under which the U.S. would have to fire the missiles in wartime—there were 14 failures, equivalent to 58%. In the 28 shakedown firings, however, there were only five Poseidon failures. □

---

## Standards

---

### U.S., EEC sharpen conflict on standards

American hopes that the European Economic Community will subordinate its regional quality assurance and standards for electronic components in favor of a broader international program have been shaken—but not yet shattered—by a renewed challenge from the EEC. The issue erupted again in Washington at a meeting of the International Organization for Standardization (ISO) with a strong EEC defense of its program.

The two-week ISO conference, scheduled to conclude on Sept. 14, drew 1,000 delegates from 56 nations who heard the EEC position sharply challenged by the United States. The regional product standards issue has long been viewed by the U.S. as a major non-tariff trade barrier [*Electronics*, March 30, 1970, p. 69]. Electronic components will be the first category affected by EEC rules.

The trade controversy between the Europeans and the Americans at the ISO on Sept. 11 reopened old wounds and was widely regarded as signalling a period of hard and possibly bitter bargaining at the Nixon round of negotiations under the General Agreement of Tariffs and Trade (GATT) that opened Sept. 10 in Tokyo and will soon settle down at Geneva.

**Heavyweight.** The EEC defense of its regional standards philosophy came in remarks prepared for delivery by one of the EEC's heavyweights, Pierre P. J. Schlosser, who directs the internal market organization of the Commission of European



# What this country needs is a good \$1,000 full-scale computer.



Introducing the computer  
for everybody. NAKED MINI™/LSI.

It's the computer for people who  
never thought they could afford a computer for  
their product.

It's also for people who have always been  
able to afford more, but have always gotten less  
computer than this.

NAKED MINI/LSI is the first OEM mini-  
computer designed for widespread, multi-level  
use. The first computer able to do more jobs  
than any computer could ever do before.

To do this, we had to give it an unheard of  
combination: extensive 16-bit computing power,  
large memory, and a small price tag. Specifically,  
NAKED MINI/LSI is the first computer powered  
to satisfy 90% of all potential minicomputer  
applications—and yet be priced as low as \$990  
in OEM quantities of 200. And that price includes  
4K words of memory.

Imagine it. For a price less than most  
hardwired circuitry or even a microcomputer,

your product can benefit from a  
general purpose computer having  
powerful arithmetic capabilities,  
up to 256K 16-bit words of memory,  
both byte and word processing, and  
uniquely flexible input/output.

Without going into all the jazzy widget  
features, let's just say that the NAKED MINI/LSI  
gives your product all the performance it  
could need to monitor, sequence, and control ef-  
fectively. Which means your product will be more  
competitive, more flexible, and more immune to  
obsolescence.

And because we used LSI technology to  
make our new computer, you can add all this clout  
simply by plugging in a single card that measures  
1" x 15" x 17" and weighs only 4 pounds.

For full details on the NAKED MINI/LSI  
(or its stand-alone counterpart, ALPHA/LSI),  
write Computer Automation, Inc., 18651 Von  
Karman, Irvine, Calif. 92664. Or call: (714)  
833-8830. TWX 910-595-1767.

## The NAKED MINI™/LSI from Computer Automation.

Circle 53 on reader service card

# super 8 channel recorder

O.E.M. CONFIGURATION — No frills, no fancy case, a complete eight channel recorder at a low O.E.M. price.  COMPACT — LIGHT — PORTABLE — 23" wide, 17" high and 6" deep. Weighs just 59 lbs.  FULL 50 MM CHANNEL WIDTH — Permits greater resolution and ease of reading.  AUTOMATIC CHART THREADING — Five second chart loading.  CONTINUOUSLY VARIABLE CHART SPEEDS — ASTRO-DRIVE provides infinite chart speeds with Tachometer read-out.  ASTRO-TIP STYLUS — Rugged, long-lasting tubular construction.

AND LOTS MORE!  
 PHONE OR WRITE FOR BROCHURE.

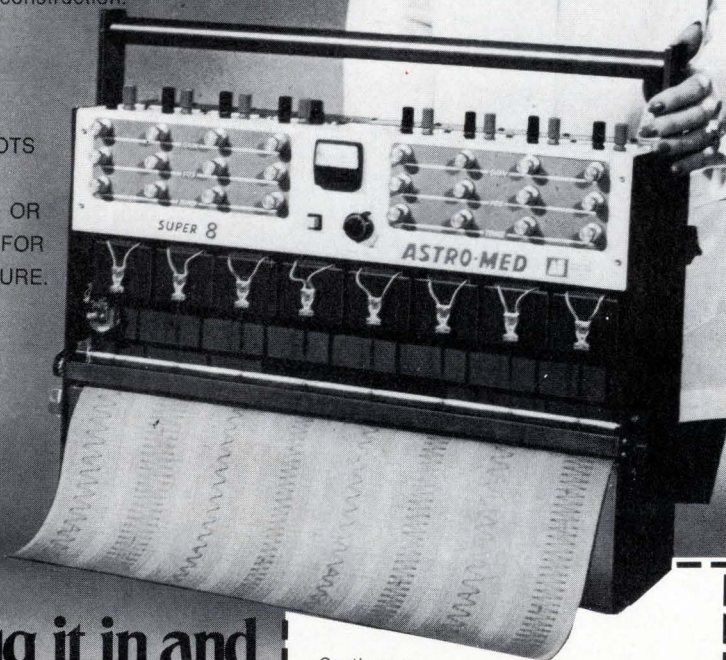

**Plug it in and  
 put it to work  
 for only  
 \$3388**



A DIVISION OF ATLAN-TOL INDUSTRIES, INC.  
 ATLAN-TOL INDUSTRIAL PARK  
 WEST WARWICK, RHODE ISLAND 02893  
 (401) 828-7010

Gentlemen:  
 Please send complete literature.

Our application is \_\_\_\_\_  
 \_\_\_\_\_  
 \_\_\_\_\_

Telephone \_\_\_\_\_

Name \_\_\_\_\_

Title \_\_\_\_\_

Organization \_\_\_\_\_

Street \_\_\_\_\_

City \_\_\_\_\_

State \_\_\_\_\_ Zip \_\_\_\_\_

## Electronics review

Communities at Brussels. His remarks were in sharp contrast to those prepared by the U.S. representative to the ISO meeting, Edson W. Kempe, State Department chief of special trade activities and commercial treaties. Among other criticisms, Schlosser diminished the importance of the International Electrotechnical Commission (IEC) recommendations last year, under which the U.S. and 42 other signatory nations hope to counter EEC's 13-country Multipartite Accord for Electronic Components.

Schlosser, who argued that regional standards need not conflict with international rules, professed that the EEC found it "astonishing" that there is "evidence of growing concern [in other countries] at the establishment of harmonized standards at the regional level." As the EEC sees it, "the existence of ISO or IEC recommendations does not seem to have prevented some countries holding a very important place in international trade from adopting national standards of their own, which sometimes differ appreciably from the specifications" of international organizations.

Edson Kempe countered the Schlosser position with the official U.S. view that EEC's "strong movement toward harmonized product standards, quality assessment arrangements, and certification systems" are seen as possible "new barriers to products originating outside the system." The State Department executive reminded his audience that the earlier GATT Kennedy Round negotiations reduced U.S. tariffs on many products prior to EEC's move toward regional product standards. Kempe dubbed the standards "a significant trade problem" and "an important subject" in the upcoming Nixon round.

**Status.** Although the U.S. has not succeeded in its effort to participate as anything more than an observer at the European Electrical Standards Coordinating Committee, known as Cenel, the group has fallen a year or more behind in its effort to implement EEC components standards—the first of 23 product categories it is developing.

# HOW TO SELECT THE PROPER DRIVER FOR YOUR DISPLAY.

**Our line of Driver Circuits includes the best ICs for most display applications. Our new Data Kit helps you design in the optimum driver for your system.**

**Display/Driver Selection Guide**

Check the Guide. It shows our entire family of IC driver circuits, which includes the best for most display types. Available now in production quantities. Many have features (the result of our experience in both systems and displays) you won't find anywhere else: On-chip fixed or programmable current control. Data storage. Both current sourcing and current sinking. Both multiplex and direct drive. Wide variety of output formats. All of which means easier design and significant savings in board space over discrete systems.

**New Data Kit**

Send for our new Numeric Display Systems Data Kit. It includes data sheets and a comprehensive application note that contains detailed systems design techniques.

Look at the Table of Contents:

- Displays
- Decoder/driver truth tables
- Decoder and display selection guide
- 7 segment decoder/driver format
- Ripple blanking capabilities
- 7 segment incandescent displays
- 7 segment fluorescent displays
- 7 segment cold cathode or neon displays
- Light emitting diode displays
- Basic multiplexing systems
- Multiplexing systems

Precise information to make it easy for you to select the most cost-effective driver for your display system.

**DIRECT DRIVE DISPLAYS**

Display	Driver	Output Drive		Input Compat.	Remarks
		mA	Volts		
<b>LED Common Cathode</b>					
FND 500*, 70 DL 704	7-Segment Decoder/Driver				
	9660 ** Constant Current Source Outputs	5 to 50		MOS	Output Current programmable with a single resistor
DL 4, 402 MAN 3, 4	7-Segment Decoder/Driver/Latch				
	9368 Constant Current Source Outputs	19 @ 1.7 Constant Current		TTL	Direct Drive. No resistors or transistors
DL 4, 402 MAN 3, 4	7-Segment Decoder/Driver/Latch				
	9368 Constant Current Source Outputs	19 @ 1.7 Constant Current		TTL	Requires either resistor current limiting or pulse width modulation to reduce current output
<b>LED Common Anode</b>					
FND 507*, DL 1A, 6, 8, 10, 707 MAN 1, 6, 10, H.P. 5082-7730 SLA 1, 3, 7, T.I.L. 302	7-Segment Decoder/Driver				
	9317B 9317C 9357A (7446A) 9357B (7447A)	40 20 40 40	20 30 30 15	TTL TTL TTL TTL	Requires 7 current limiting resistors per display
7-Segment Decoder/Driver/Latch					
9370	25	7	TTL		
<b>Incandescent</b>					
"Alco Inc." "Appollo" Diametrics Inc. Dialight Corp. EDP Corp. Pinlights Mesa "Minitron" Readouts Inc. "Minitron" Luminetics Inc. "Numitron" RCA Corp.	7-Segment Decoder/Drivers				
	9317B 9317C 9357A (7446A) 9357B (7447A)	40 20 40 40	20 30 30 15	TTL TTL TTL TTL	No additional components required
7-Segment Decoder/Driver/Latch					
9370	25	7	TTL		
<b>Gas Discharge</b>					
1-of-10 Type Nixie® Most Types	1-of-10 Decoder/ Drivers				
	9315 (7441) 93141 (74141)	7 7	65 55	TTL TTL	No additional components required
7-Segment Type Panaplex® Sperry SP Series Alco Elfin	7-Segment Decoders				
	9307 9358 (7448)	2mA @ 0.85V To Drive NPN Transistors		TTL TTL	Requires 7-NPN Transistor interface devices

## MULTIPLEXED LED DISPLAYS

Display	Segment Drivers	Output Drive		Input Compat.	Remarks	Strobe Drivers	Output Drive mA	Input Compat.	Remarks	
		mA	Volts							
<b>Common Cathode</b>										
FNA 30, 35, 37 FND, 500*, 70 MAN 3, 4, DL 4, 33, 34, 704 H.P. 5082-7400 Series	(Current Source)				(Current Sink)					
	7-Segment Decoders					Decoder Drivers				
	9307				TTL	9345 1-of-10 Decoder		80	TTL	
						93145 1-of-10 Decoder		80	TTL	
	7-Segment Decoder/Drivers					Strobe Drivers				
	9660 **		50 @ 3.0		MOS	75492 Hex LED/Lamp Driver		250	MOS	Inverting (sink only)
	7-Segment Decoder/Driver/Latch					75491 Quad Segment Driver		50	MOS	Inverting (sink only)
	9368		16mA @ 2.1V		TTL	9662 ** Quad LED Digit/Lamp Driver		600	MOS	Inverting or non-inverting selection pin
	Segment Drivers					9663 ** Hex LED Digit/Lamp Driver		600	MOS	Inverting or non-inverting selection pin
	9661** Quad Segment Driver		5-75 @ 3.0 Constant Current		MOS					
75491 Quad Segment Driver		50		MOS						
<b>Common Anode</b>										
FND 507* MAN 1, 6A, 10, DL, 6, 10, 707 H.P. 5082-7730 Series T.I.L. 302 SLA 1, 3, 7,	(Current Sink)				(Current Source)					
	7-Segment Decoder/Drivers					Strobe Drivers				
	9317B		40		TTL	9661** Quad Segment Driver		75	MOS	Non-inverting
	9357B (7447) or (7446)		40		TTL	75491 Quad Segment Driver Transistors		50	MOS	Non-inverting
7-Segment Decoder/Driver/Latch					Require current limiting resistors					
9370		25		TTL						

\*Available 4th Quarter '73

\*\*Available 1st Quarter '74



*Before you get any deeper into your system design, write for our Numeric Display Systems Data Kit. It's free. It's good for you.*

MADE IN  
FAIRCHILD

# The Rise and Fall\*

of the 30MHz function generator.

It's variable.  
This is the first function generator that puts out a trapezoidal waveform with adjustable rise and fall time. Which makes our Model 162 very useful for such things as comparator evaluation, measuring core memory drive circuit response, measuring amplifier response time and minimizing switching transients.

But while the trapezoidal waveform was catching your eye, maybe you missed the frequency.

30MHz!

About ten million more Hertz than you ever got from a function generator before.

And the 162 will go as low as  $3\mu\text{Hz}$ , with continuous, triggered or gated modes and a choice of 9 output waveforms.

All this, and more (which we'll gladly tell you about) for just \$845.

You **will** buy it.

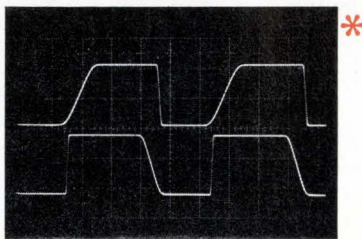

**WAVETEK**®

P.O. Box 651, San Diego, California 92112  
Telephone (714) 279-2200, TWX 910-335-2007

## **Design-to-cost keyed by DDR&E to two studies . . .**

The Defense Department expects to have in hand by the end of October **the results of two major studies with which to begin large-scale implementation of its design-to-cost program for electronics hardware** [*Electronics*, Aug. 28, 1972, p. 25]. First is the study known as Electronics-X, now nearing completion at the Institute for Defense Analyses, Arlington, Va., and the second will consist of the conclusions and recommendations of the Defense Science Board's two-week summer study by DOD and industry leaders at Woods Hole, Mass.

Both studies, scheduled for delivery to the Directorate of Defense Research and Engineering's Jacques S. Gansler, assistant director for planning, **will strongly recommend that DOD employ more off-the-shelf commercial electronics for non-weapons applications.** And, though study members are less certain about the application and extent of warranties in future contracts, both reports will also look favorably on the procurement methodology developed for the commercial airlines by Aeronautical Radio Inc. [*Electronics*, March 1, p. 49].

## **. . . as cost-cutting experiment affects 11 new projects**

Nine military electronics prototype programs out of the 11 selected to participate in design-to-cost experiments are expected to produce useful data for the Electronics-X project. **Of three Navy price-limited efforts**, the largest program is expected to be the low-cost electronic warfare suite for ships; it is now entering negotiations for selection of two prototype developers from competitors Hughes Aircraft, Raytheon, and RCA. The two other Navy projects are an airborne tactical radar evolved from an unsolicited proposal and the all-application digital computer in the Naval Air Systems Command, formerly known as the advanced airborne digital computer [*Electronics*, Aug. 3, 1970, p. 89].

**The Air Force design-to-cost experiments are an airborne tactical air navigation system**, for which competing prototype contractors are now being evaluated, and a tactical uhf command radio now in test and engineering. **The Army projects are a doppler radar**, for which an RFP is in draft, a low-cost forward-looking infrared system still in the conceptual stages, a helicopter Loran system, and a low-cost altimeter for which the RFP is now being revised.

## **Protests pondered against FAA simulator buy**

At least four of 10 possible competitors for a Federal Aviation Administration contract are building toward protesting against a sole-source award for air-traffic-control training simulators now being negotiated with tiny Space Research Corp., North Troy, Vt. **The companies contend the FAA's July 26 disclosure that it planned to sole-source SRC violated its April advertisement for competitive rebids** following the termination of a \$5.3 million award to GTE Sylvania. The FAA, which confirms the negotiations with SRC, denies the charges alleging political influence in the choice. SRC maintains it is "the only American firm that has simulators in operation."

Competitors in the first bidding round included Austin Electronics, E-Systems, Logicon, Singer-Link, Sperry-Univac, and Goodyear. Others reportedly interested in the award, which has an estimated \$8 million value, include Conductron, Litton Systems, Raytheon, Saab, TRW and Varian.

## New numbers game at Commerce

The odds on the Commerce Department's coming up with meaningful statistics on electronics trade for a six-months period after only eight have passed have always seemed long—almost as long as those on President Nixon's voluntary surrender of the Watergate tapes. Nevertheless, the department's Bureau of Resources and Trade Assistance has done it.

Just after Labor Day the bureau's Office of Import Programs made available to an astonished Washington electronics community a comprehensive breakdown of audio and video consumer product imports for the six months ended June 30. Not only are the figures broken down by country of origin and by type, with both unit and dollar values compared with those for 1971 and 1972, but the report forecasts that home entertainment imports for all of 1973 could peak at nearly \$2 billion if they follow the pattern of prior years, in which roughly 55% of the shipments enter during the last half. That estimate is to be compared with totals of \$1.7 billion and \$1.3 billion for 1972 and 1971, respectively.

To manufacturers accustomed to waiting 12 to 18 months for detailed breakdowns on imports, as they have in years past, the performance by the Commerce Department is refreshing. And the fact that the report draws on the same Census Bureau data that has been used for prior statistical analyses demonstrates that meaningful Federal reports to industry are possible before the figures turn cold. At a time when the U.S. electronics industries are continually assessing their future in the world's markets—including the one at home—"we desperately need up-to-date information like this," says one marketing official. "Before we can figure out what we ought to be doing, we have to know where we stand."

### The standings

Where does the U.S. stand in relation to audio-visual imports? Less solidly than it did a year ago, based on first-half figures. Home entertainment imports not only jumped 16.2% to \$874.2 million, reports Commerce, but "substantial value and unit gains occurred in all product categories with the exception of monochrome TVs." And the agency makes clear that the principal competition still comes from Japanese interests, despite protestations from its lobbyists to the contrary. For example, the U.S.-Japan Trade Council, a registered lobby, contends that first-quarter U.S. imports of TV sets from Japan declined by one third in terms

of units. However, the new U.S. figures for the first half provide a different and better perspective on those assertions.

Monochrome TV imports from Japan did decline in the first half to roughly 600,000 sets from a 1.2 million high in 1971. Now U.S. off-shore operations on Taiwan have become the leading supplier. They shipped 1.5 million sets in the first six months compared to 475,000 two years earlier. Color set imports from Taiwan also jumped 18% in quantity and 23% in value, but Japan remained the top seller. It shipped about 75% of the 683,000 sets imported in the first half. Although this percentage is down from Japan's 93% share in 1971, the Commerce Department's analysis makes clear that "a considerable part of Japan's declining percentage is attributable to the commencement of Sony's color TV assembly operations in San Diego and the expanded output of Matsushita's (Panasonic) operations in Puerto Rico."

### New perspectives

The study contains other new and useful perspectives as well, of which the boom in auto radio imports—up 55% in quantity and 73% in value—is only one. Not only are there new numbers but also such informative observations as that Canada—which shares the auto radio lead with Japan—shipped almost all of its 898,000 car radios in the first half "as part of original motor vehicle equipment under the duty-free provisions of the Automotive Products Trade Act of 1965."

For these and other elaborations on the reasons behind the numbers, the Commerce Department deserves a measure of praise. The measure may be as small and grudging as the one offered by one Washington executive, who ventured that "this is no more than the Government should have been doing for years." Or it may take the form of one communications equipment maker's plea that "it may be good information, but it doesn't help me. I could use something like this in our business."

Both of those comments are true, of course. Yet there is no indication from the Commerce Department on whether it plans to continue these analyses of current audio-visual trade information—much less develop them for other areas of electronics. The need for such information is well established. But Commerce, the agency that has the numbers, is the only one that can supply it. It has demonstrated that it can do the job. It should not stop now.

—Ray Connolly





# CMOS DUAL SCHMITT TRIGGER

IGNORES  
TRANSMISSION  
LINE NOISE

## DIFFERENTIAL LINE RECEIVER FOR NOISY ENVIRONMENTS

$R_1$  sets positive threshold  
 $R_2$  sets negative threshold

Try any other Schmitt Trigger in this type of application, and short pulses of common mode noise cause false triggering.

**Motorola's unique MC14583 CMOS\*** Dual Schmitt Trigger avoids this problem by internally connecting an exclusive OR output and its three-state enable.

With the two inputs at different levels, the exclusive OR output is "hi," enabling the three-state output. When sufficient noise occurs on either or both lines to put the two inputs in the same state, the exclusive OR goes "lo," temporarily disabling the three-state output. The three-state load capacitance holds the existing level to generate correct outputs despite the noise seen at the inputs.

Each of the triggers on this monolithic chip is functionally independent of the other, except for the common three-state input and the internally connected exclusive OR provided for line receiver applications. External resistors determine input trigger levels. Other readily recognizable applications include pulse shaper, level detector, level comparator and speed-up of a slow waveform edge in interface receivers.

Schmitt trigger input noise immunity for the MC14583 is typically 60% of  $V_{DD}$ , and quiescent power dissipation is 25 nW/package typical. Otherwise, general CMOS family characteristics describe each of the three versions of this device. Single supply operation is standard.

The CL suffix version is ceramic and costs (100-999) \$3.34. Supply voltage range is +3 to +16 V, and operating temperature range is -40 to +85°C. The MC14583CP has the same supply voltage and operating temperature range as the CP, but it costs only \$3.00. It's plastic, of course. The ceramic AL version is distinguished by a wide +3 to +18 V supply voltage range and -55 to +125°C operating temperature range. Price is naturally the highest of the three at \$6.50.

### New Priority Encoder Unique In CMOS

Another of Motorola's recent CMOS introductions of note is the MC14532 8-bit Priority Encoder, unique in CMOS, yet a versatile addition to any complex logic family. Applications include A/D and D/A converters, 1 of n operation code checkers, code converters, and priority encoders. Same three versions, same two packages. CP is \$4.05, CL is \$4.50, and AL is \$8.75.

Get data from Motorola Semiconductor Products Inc., P.O. Box 20912, Phoenix, Arizona, 85036. And while the supply lasts, we also will send the up-to-date 1973 CMOS Product Directory in response to your data requests. Your franchised Motorola distributor and local Motorola sales office have parts to sell. Try them.

\*Trademark of Motorola Inc.



**MOTOROLA MOS**  
*Expanding dimensions in digital design*

# McMOS

LOGIC OF THE 70's

# Electronics international

Significant developments in technology and business

## Color TV camera from Toshiba to cost \$770

**Bona fide breakthroughs** in engineering are rarities, but Tokyo Shibaura Electric Co. Ltd. appears to have one in a portable single-tube color television camera unveiled late last month. Sales will begin in February at the eye-popping low price of 200,000 yen, or about \$770 at the present rate of exchange.

The unit could open the door to a new consumer market if, as Toshiba expects, such cameras follow magnetic tape recorders into the home and spur a demand for home video recorders. Until now video recorders haven't been able to nudge into that market because camera prices were much too high.

Before the Toshiba announcement, the lowest-priced portable TV camera was a two-tube unit from Akai that cost 450,000 yen—more than twice the Toshiba model. An earlier Toshiba camera sells for 630,000 yen.

The new tube is a classical vidicon type with an integral dichroic color stripe filter added. This makes the basic tube less expensive than some improved camera tubes with higher-performance semiconductor targets, including the Philips Plumbicon, Toshiba Chalnicon, and Hitachi Saticon.

The camera's output is a standard NTSC signal, enabling direct connection to a Japanese or U.S. video recorder or monitor. A simple rf modulator adapter puts the signal of the radio frequency carrier for reception on an unused channel of a TV receiver.

The standard camera with fixed-focal-length lens and optical viewfinder is 320 mm long, 105 mm high and 90 mm wide and weighs 2.5 kilograms. A power supply is included in the price but physically separate because it is heavy, and, in many applications, will be replaced by a battery pack.

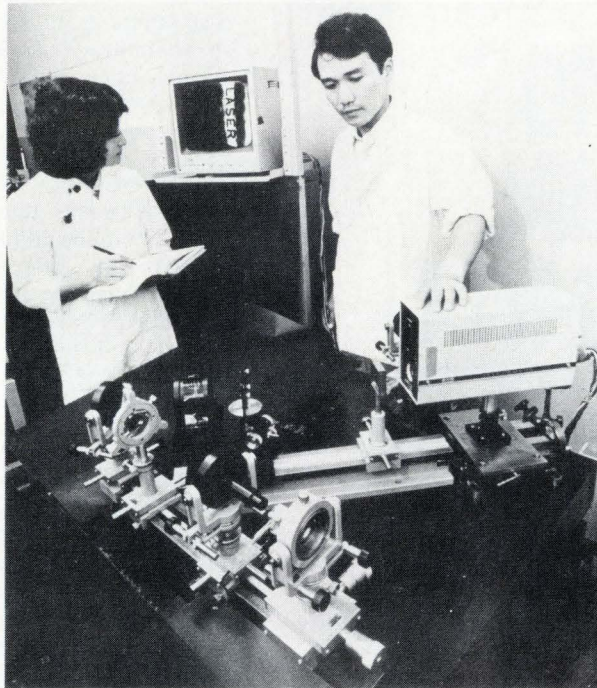

**Pioneer.** Toshiba camera could be first to crack the lucrative consumer market.

The key to Toshiba's low price—and the element of breakthrough in design—is the ability to obtain good performance from a vidicon with a standard antimony trisulphide photoconductor rather than one with a more expensive photoconductor. This is made possible by a new scheme for separating colors that incorporates elements of systems developed earlier by Nippon Columbia Co. [*Electronics*, Jan. 23, 1967, p. 236] and NHK [*Electronics*, Oct. 23, 1972, p. 85].

All these schemes use two sets of dichroic color stripes. One set is cyan and gives a signal that is alternately white between stripes and white minus red under stripes. The other stripes are yellow to give a signal that is white and white minus blue.

But the Nippon Columbia and NHK approaches both have drawbacks that degrade picture quality. Columbia's problems include a requirement for a large bandwidth,

too much bandwidth for a small vidicon to handle with good resolution, degrading the signal-to-noise ratio of the color channels. Further, differences in outputs of the higher and lower-frequency carriers results in color shading.

The NHK method can leave an unattractive horizontal pattern over the picture. The overlap of the two sets of stripes that are slanted with respect to each other alternately increases and decreases as successive horizontal lines are scanned. This can cause a zero frequency beat in color and luminance channels, casting an unattractive horizontal pattern over the picture. The price of eliminating the cause of the pattern is use of a photoconductor whose output is a linear function of illumination, such as the Hitachi Saticon used by NHK.

**The Toshiba way.** An inexpensive system can't afford to use the expensive Saticon, though. Toshiba got around this by staggering the two

carrier frequencies, without completely separating them as Columbia does, and by using a correlation method for carrier separation like NHK does.

If the two carrier frequencies are staggered by about half a megahertz, the beat frequency is raised above the bandwidth of perhaps 0.4 MHz used after the demodulator in the color channels and is eliminated by the low-pass filters in these channels. Staggering the frequencies shows up on the camera tube color stripe pattern as diagonal displacement of the lozenge, or diamond-shaped, overlaps of the stripes that were previously neatly arranged on horizontal lines. A small amount of beat remains in the luminance channel but does not cause serious degradation of signal. □

---

## France

---

### Schneider sets up on its own in the U.S.

General Radio's affair with its French partner, Schneider Electronique, is over. The agreement to set up a joint company to handle sales of each other's products [*Electronics*, Jan. 4, p. 29] and to custom-design systems should have gone into operation in April. Now Schneider has taken the bit between its teeth and set up its own marketing arm in the U.S.

Schneider's decision to go it alone in the American market comes after three attempts to develop a permanent partnership with a U.S. firm. A successful distribution arrangement with Honeywell in the U.S. ended in 1970.

A further distribution deal with Dixon collapsed soon thereafter, and the General Radio venture finally fell apart in June when Schneider's lawyers said there had been "a breach of agreement" by the U.S. company. Schneider says that none of its products was on the American market by June.

With its total 1972 sales at just \$4 million, it seemed an unlikely task

### Around the world

**Bank computer access by telephone**  
Communicating data between a central computer and distant terminals is old hat, but early next year a savings bank in southern Germany will have a system that provides computer access through ordinary push-button telephones over public telephone lines. What's more, the system can be modified to make the computer reply over the telephone in synthetic speech. The first installation phase calls for setting up 40 telephone/printer output/output terminals. The new setup, called Modacom, comes from Siemens AG and is, as the name suggests, a modular data-communications system.  
The phone is part of a desk-top unit, the Comset 1012, which houses an identity-card reader and a printer. Although no bigger than the telephone itself, the printer can produce the computer output on a paper strip up to 8½ inches wide. For data reproduction, the printer uses metalized paper. The printing speed is 20 characters per second, and the data transmission rate over the telephone lines is 200 baud.

**Teletypewriter uses magnetic principle**  
A challenger to the 10-character-per-second teletypewriters is being developed by Cambridge Consultants Ltd., Bar Hill, near Cambridge. Its inventor, Graeme Minto, says the magnetic-based machine will perform better for the same money than a conventional teletypewriter plus paper-tape punch and reader.  
The machine's appeal, Minto says, is that it will cost no more to make in volume than present electromechanical machines but will run many times faster, chopping the time-based connection charges. Since the magnetic unit has only two significant mechanical functions—horizontal printhead-carriage motion and vertical paper motion—it should be totally reliable at 30 characters per second. It's not silent, but it's quiet. Further, Minto says, expenditure on the only consumable item—a magnetic coated paper—should work out about 20% less than the cost of paper, ribbon, and paper tape on present teletypewriters.

for Schneider to pick up the pieces and start from scratch on its own. But in five weeks and 10,000 miles of state-to-state campaigning in July and August, Schneider marketing director Francis Barroux and two other French colleagues set up a network that Barroux claims "covers 90% of the U.S. market." To get a share of that market, Schneider started by taking a booth at Wescon.

Schneider introduced its Digitest 610, a multimeter with built-in temperature probe for \$440. There is no equivalent on the U.S. market, Schneider says. Rival U.S. multimeters are priced at \$295, but, Barroux points out, they do not have the temperature-probe capability, which purchased separately from U.S. suppliers costs an additional \$200 to \$300. The company also showed its \$995 function synthesizer. □

Now that it has taken the plunge, Schneider is happy. "General Radio may have accidentally done us the biggest favor we could ask for," smiles Barroux.

"Those four years with Honeywell," Barroux acknowledges, "were frustrating in that we did not know what was going on in the market. After this trip to set up the outlets, we know it very well."

From a borrowed headquarters in Phoenix, Ariz., Schneider hopes to move up fast. Next year, Barroux figures, he will reach a minimum of \$1 million sales on the American market.

To help the marketing effort along and to coordinate the sales network, Schneider plans to set up its own subsidiary in the U.S. by the end of this year. The new company, Schneider Electronic Corp., will also help to provide after-sales services and technical support. □

# LOW NOISE LOW DRIFT OP AMPS... *made easy!*

0.5  $\mu\text{V}/^\circ\text{C}$

0.6  $\mu\text{V}$  pk-to-pk

8.0  $\mu\text{V}/\text{Month}$

**Max!**

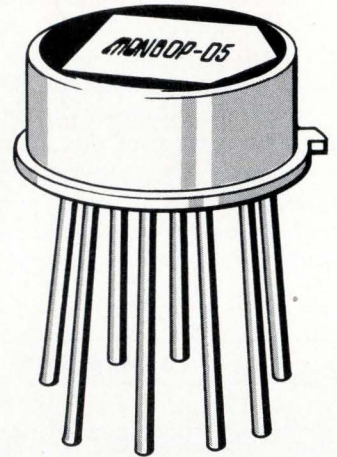

## ***YOUR TOUGHEST OP AMP SOCKET JUST GOT FILLED!***

The new monoOP-05 series guarantees the most accurate input specs in the industry . . . and no additional components are required for frequency compensation or protection! Best of all . . . the parameters are rock-stable, month after month! With offset voltages as low as 150  $\mu\text{V}$  (Max), bias currents as low as 2.0 nA (Max), and CMRR as high as 114dB (Min), the monoOP-05 is the "ideal" op amp for all precision aerospace and industrial transducer and computation circuitry!

Try one! Discover just how easy low noise, low drift op amp designs can be! (The monoOP-05 is a direct replacement in 725, 108 and unnullled 741 sockets . . . upgrade your system now!)

*Units processed to MIL-STD-38510 and/or with long-term stabilities 100% tested and guaranteed to better than 5.0  $\mu\text{V}/\text{Month}$  are available . . . contact the factory or your local PMI representative. Matched dual versions in 14-pin DIP packages are also available . . . inquire about the amazing monoOP-10 series!*

## **GUARANTEED MIN/MAX SPECIFICATIONS**

	monoOP-05A	monoOP-05	monoOP-05E	monoOP-05C	
Operating Temp. Range	-55/+125	-55/+125	0/+70	0/+70	$^\circ\text{C}$
Vos @ 25 $^\circ\text{C}$	0.15	0.5	0.5	1.3	mV
Vos vs. Temp.	0.5	1.0	0.6	1.5	$\mu\text{V}/^\circ\text{C}$
Vos vs. Time	8.0	9.0	9.0	—	$\mu\text{V}/\text{Month}$
Noise (0.1 Hz to 10 Hz)	0.6	0.6	0.6	0.65	$\mu\text{V}$ , pk-to-pk
Input Bias Current	2.0	3.0	4.0	7.0	nA
CMRR	114	114	110	100	dB
Open Loop Gain	300	200	200	120	V/mV
Price @ 100 pcs. (TO-99)	\$44.95	\$19.95	\$14.95	\$7.95	

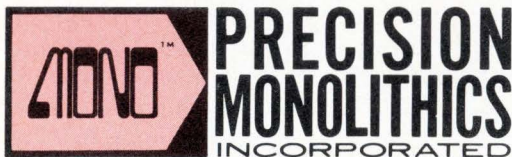

1500 SPACE PARK DRIVE, SANTA CLARA, CALIFORNIA 95050  
TEL. (408) 246-9225 • TWX 910-338-0528 • CABLE MONO

### **AUTHORIZED DISTRIBUTORS**

**NEW YORK METROPOLITAN AREA** Harvey Radio, Woodbury, N.Y.: (516) 921-8700 • **NEW ENGLAND AREA** Gerber Electronics, Dedham, Mass.: (617) 329-2400 • **UPSTATE NEW YORK** Harvey/Federal Electronics, Binghamton, N.Y.: (607) 748-8211 • **NORTHEAST** Newark Electronics, Malden, Mass.: (617) 321-3930 • **BALTIMORE-WASHINGTON** Whitney Distributors, Baltimore, Md.: (301) 944-8080 • **MICHIGAN** RS Electronics, Detroit, Mich.: (313) 491-1000 • **SOUTHEAST** Kirkman Electronics, Winston-Salem, N.C.: (919) 724-0541 • **CENTRAL** Hallmark Electronics, Elk Grove Village, Ill.: (312) 437-8800 • **MINNEAPOLIS**, Minn.: (612) 925-2944 • **ST. LOUIS**, Mo.: (314) 521-3800 • **TEXAS-OKLAHOMA** Sterling Electronics, Houston, Texas: (713) 623-6600 • **DALLAS**, Texas: (214) 357-9131 • **SOUTHWEST** Sterling Electronics, Albuquerque, N.M.: (505) 247-2496 • **PHOENIX**, Ariz.: (602) 258-4531 • **WEST** Westates Electronics Corp., Chatsworth, Calif.: (213) 341-4411 • **Sterling Electronics**, San Carlos, Calif.: (415) 592-2353 • **Intermark Electronics**, San Carlos, Calif.: (415) 592-1641 • **Denver**, Colo.: (303) 936-8284 • **Seattle**, Wash.: (206) 767-3160 • **Salt Lake City**, Utah: (801) 359-0531 • **San Diego**, Calif.: (714) 279-5200 • **Santa Ana**, Calif.: (714) 540-1322 • **WESTERN CANADA** Intek Electronics Ltd., Vancouver, B.C.: (604) 873-2477.

### **Honeywell Bull stalled on Unidata entry**

Honeywell Bull, the Franco-American computer partnership, has been rebuffed in its attempt to create links with Unidata, the new European computer alliance. **The French have told Honeywell Bull that it is "out of the question" for Unidata to take them in as long as the U.S. company Honeywell Information Systems holds on to its 66% control of Honeywell Bull.** The decision, revealed last week by Maurice Allegre of the French government's computer aid agency, is a blow for the Paris-based company. Honeywell Bull president Jean Pierre Brule has been on record since last April as willing and eager to arrange some kind of tie-up with Unidata members—Siemens, Philips, and La Compagnie Internationale pour l'Informatique. Brule is refusing comment on the rebuff, but shows no indication he will meet Allegre's terms. To qualify for entry, in effect, Honeywell Information Systems, would have to sell off 17% of its control to its French partner, Compagnie des Machines Bull, to bring down American ownership to 49%.

### **Licensing battle heats up on video disk . . .**

The Telefunken/Teldec video disk system, which will hit the German market next January, has become the subject of intensive licensing negotiations with domestic and foreign firms, including U.S. and Japanese companies. **An agreement has already been made with Saba-Werke, a German consumer electronics producer and a subsidiary of General Telephone and Electronics.** Other licensing deals are expected to be signed shortly with Japanese firms, but Telefunken officials are not saying who they are. The license fees will be in accordance with the number of systems produced.

The so-called TED—for television disk—system, which had its public debut at the International Radio and Television Show in West Berlin, provides for up to 10 minutes of color playback. It will initially sell for about \$460 dollars or roughly half the price of a 26-inch color-TV set on the German market. **A disk-changer version capable of playing back a stack of 12 disks, with only 5 seconds of dead time between each disk, will follow in 1975.**

Telefunken officials predict that by 1980 every eighth TV set owner in West Germany will have a TED playback unit, a forecast which works out to 2.5 million units. As for the TED disk market, the company predicts that **each system owner will initially have from six to eight disks. They will be priced between \$4 and \$10** depending on the program they contain. The upper price limit for the disk corresponds to the cost of regular long-playing record on the German market.

### **. . . as another, a magnetic disk, is unveiled**

Add another name to the list of companies engaged in video disk system development. Wolfgang Bogen GmbH, a West Berlin electronics company, has demonstrated a video disk that has recording capability. Systems now under development or soon to go to market are for playback only. **The system Bogen demonstrated uses a 12-inch disk, which holds information in a magnetic layer on both sides.** It spins on a turntable at 156 revolutions per minute and feeds its information to the antenna terminals of a regular TV set. A special magnetic head is used for recording and playback. The technique is being developed by an independent German engineer working in cooperation with Bogen.

### IPL readies solid-state video camera

The British solid-state imaging specialists, Integrated Photomatrix Ltd., will show a new solid-state camera with all-electronic scanning on its stand at the New York Electro-Optics Systems Exhibition next week. **It's built around a 64-by-64-element integrated silicon photodiode matrix.** Diodes are at 3 mils centers on a chip about 1/4 inch square, which also includes aluminum-gate MOS scanning circuitry, consisting mainly of two 64-bit shift registers.

The camera consists of the chip, front optics, and head electronics for integration and amplification of the chip output. It will cost about \$5,000. IPL says that its advantages compared to CCD image-scan systems are that it's available here and now and that it will go faster, judging by printed data available on CCD arrays. **It supplements, and doesn't replace, IPL's systems that use a linear photodiode array and scan mechanically in one axis.**

### French company to try hand at PAL TV sets

Thomson-Brandt, best known outside France for the professional equipment produced by Thomson-CSF, hopes to get a foothold in the fast-growing West European PAL color-TV market. **Thomson's consumer-goods group has in development a 110° PAL set with digital touch tuning and ultrasonic remote control.** The company expects to have it on the West German market before late 1974. Thomson officials at the International Radio and Television Show in Berlin this month said they figured they could sell the set at competitive prices on the German market. **Thomson is based in Secam territory and thus has had slight experience so far with PAL circuits, touch tuning, and remote control.**

Thomson-Brandt won't set up its own distributing network for the PAL set. Instead, it expects to team up with a major West German consumer goods wholesaler group. The most likely partner is Weltfunk, an association that sells some \$320 million worth of appliances and consumer electronics products yearly. **Thomson and Weltfunk are thinking in terms of some 30,000 black-and-white sets and between 15,000 and 20,000 color sets at the outset.**

### BPO gives go-ahead for packet-switching trial

The British Post Office has awarded Ferranti Ltd. a contract to build three digital data-switching exchanges organized to operate on real-time packet-switching principles instead of forging dedicated through-links, as is more usual. The exchanges will be in London, Manchester, and Glasgow, linked in a triangle. **The system should be working by 1975, as a trial to investigate the potential of packet-switching techniques.** So far 18 user companies have agreed to co-operate in the trial.

The network will use three Ferranti 700-E control processors in London, splitting the work three ways, and two 700-Es in each other center, sharing the load. There will be another 700-E for system monitoring in each center. In addition, in London alone, each switching processor will have a back-up duplicate. Ferranti will also build hardware to interface modems to the computer system. Initially, there will be a single 48-kilobit multiplex link between cities.

**At the transmission exchange, a message will be broken into packets not longer than 256 eight-bit bytes, plus header,** and any packet may go by either of the two possible routes to the destination exchange according to convenience when the packet is formed. This exchange rebuilds the message and has special fast-responding hardware to send acknowledgement packets back to the origin.

# New from Cinch: compact, easy interconnection

for  
switching and  
test panels,  
programming  
boards,  
and other  
patch cord  
systems

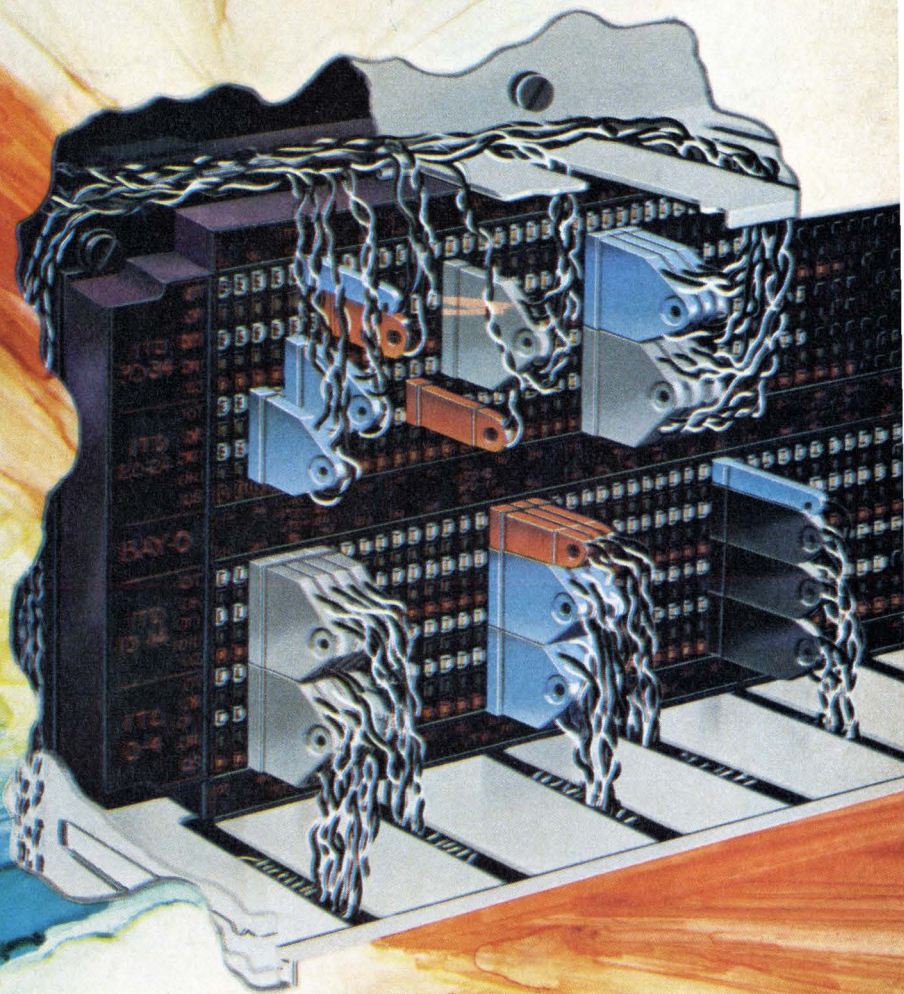

Originally developed and successfully used for telecommunications applications, this Cinch CCB circuit concentration system may now be the answer to *your* complex interconnection problems.

One side of the panel assembly is wirewappable, for automatic, semi-automatic or hand wiring. The other side accepts polarized, positive detent, single through six-pin, color-coded patch cord plugs for rapid circuit changes.

Color coded panels have raised, high-visibility, replaceable marker strips. Contacts are on 0.200" centers and individual contact modules can be replaced in seconds. The compact CCB system is remarkably easy to install, modify and maintain.

For detailed information call TRW/Cinch Connectors at (312) 439-8800 or write TRW/Cinch Connectors, an Electronic Components Division of TRW Inc., 1501 Morse Ave., Elk Grove Village, Ill. 60007.

CM-7310

**TRW** CINCH CONNECTORS

Circle 67 on reader service card



## Check These Six Short Cuts To The Answers You Need.

Whatever your discipline—whatever your needs—HP has a calculator to help you turn problems into solutions... faster, easier. Check the wide array—from hand-held scientific models and special desk-top machines all the way up to computing calculator systems with a complete line of peripherals. All built to HP's high-quality standards. Take a good look at these features—and prices—and you will probably find the answer to your problems in an HP calculator.

**HP-45.** This 9-ounce scientific wizard comes close to being a hand-held computer—complete with 9 addressable memory registers and enough power to solve more than 40 high-level functions. The price? Only \$395\*. (Or you can now buy an HP-35 for just \$295\*.)

**HP-46.** A desk-top version of the HP-45 with a big plus feature—an alphanumeric printer for permanent records. The printer lists the contents of the operational stack and registers, gives error indications, and prints in red or black—or both—on standard paper tape. The powerful, printing HP-46 is just \$695\*.

**HP 9805.** This is the machine that takes the work out of statistics—means, variances, correlations, histograms, curve fits—and gives you printed or plotted answers at the press of a single key. It does hours of laborious calculations in seconds—and it's just \$1295\*.

**HP 9810.** Here is the powerful, programmable calculator you tailor to your specific needs. You





can redesign the keyboard for statistics, mathematics, or your own special functions – by just changing plug-in blocks. It's just as easy to expand the memory or add peripherals. Simple to learn, simple to operate, easy to own – just \$2475\*.

**HP 9820.** If you need an algebraic calculator that handles your input and output in the same straightforward way you'd jot them down on paper, then you'll appreciate the 9820. It's programmable, expandable – with additional memory or peripheral – and economical. \$4975\*.

**HP 9830.** Here is a complete desk-top data processing system that fills the gap between calculators and computers. It can take on just about any business function you can name – from inventory control to

accounts receivable. Then it can turn around and handle such sophisticated scientific tasks as matrix math and statistical analysis. And it speaks BASIC. Best of all it starts at just \$5975\*.

Solutions. Answers. Results. In the shortest possible time. At easy-to-justify costs. That's what HP calculators can do for you. But see for yourself; for more information or a demonstration, write or call.

\*Domestic U.S. prices only.

093/5



Sales, service and support in 172 centers in 65 countries.  
Loveland, Colorado 80537. Offices in principal cities throughout the U.S.

For a demonstration, circle reader service no. 68

For information, circle reader service no. 69



## If you've been designing components good reasons to switch

**1. Excellent soldering:** CA 725 was developed for electronic application where soldering is important. After laboratory exposure at 150 F and 100% Relative Humidity for two years, CA 725 was still solderable.

**2. Overall gold plating has been eliminated:** CA 725 requires no special finishing. The need for gold plating in most applications can be reduced by 90%. Lets you put more gold where it is needed...at the contact point.

**3. Easier to fabricate:** CA 725 may be formed by conventional methods. For example, it is stamped and

formed on dies used for other copper alloys. Bend properties are excellent across the strip width. Even at harder tempers. That gives you additional freedom in die and part design.

**4. Excellent corrosion resistance:** CA 725 needs no protective coating. It resists tarnishing. Wire-wrap connectors can be made without any protective coating. CA 725 has excellent resistance to stress-corrosion cracking to boot.

**5. Greater fatigue strength:** Cold worked CA 725 has higher fatigue strength than similarly cold worked phosphor bronze.

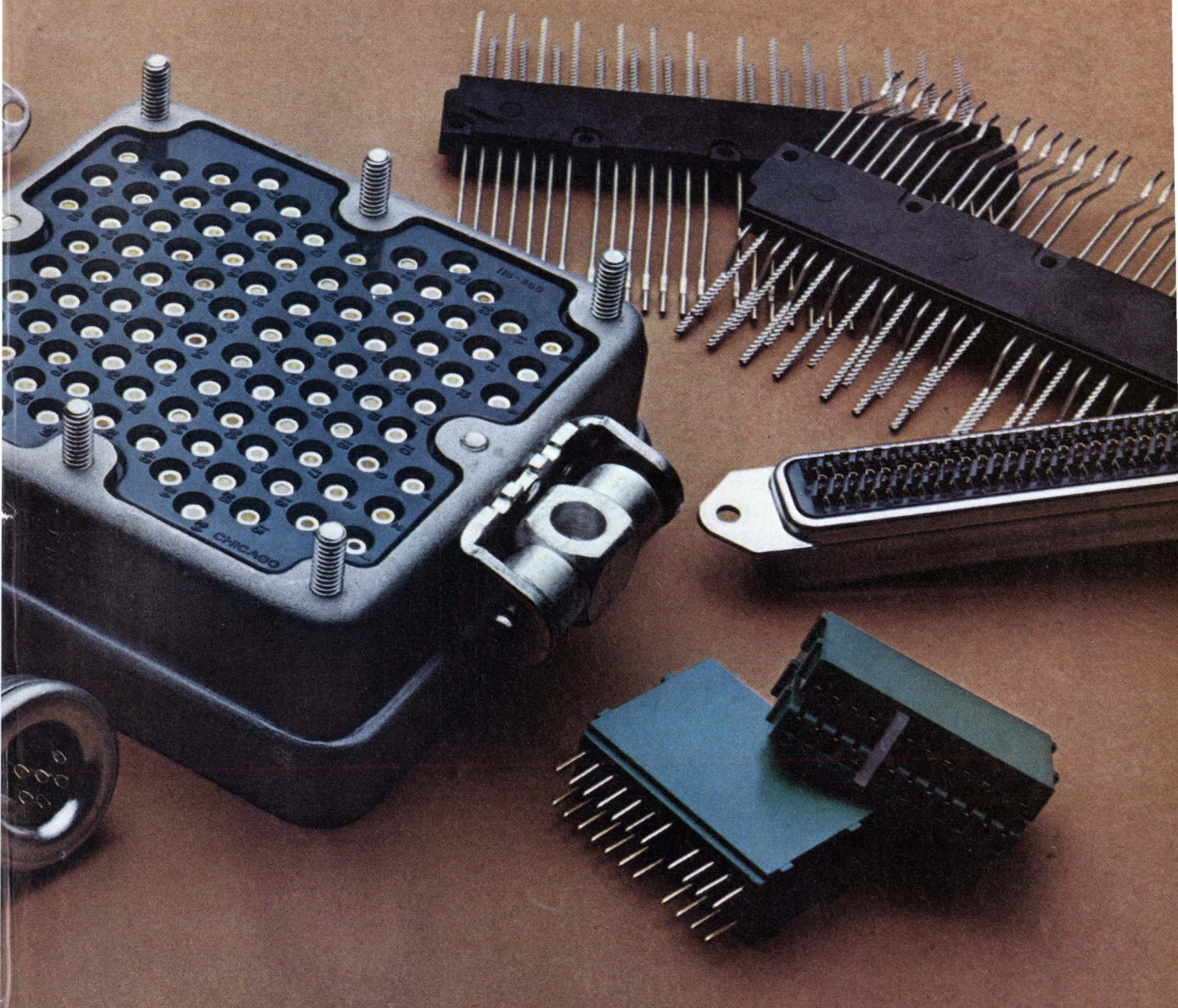

# with phosphor bronze, here are 8 to Copper Alloy 725.

- 6. Better stress relaxation performance:** CA 725 keeps its good spring properties at higher operating temperatures. This is especially important with today's increased packaging densities.
- 7. Readily available:** CA 725 is not an exotic alloy in spite of its extraordinary properties. It is **an industry standard**. You can get it at most copper and brass wire and strip suppliers. If you can't, let us know.

**8. All this and economy too.** Because of CA 725's combination of properties, total material and finishing cost can be dramatically reduced. The

result for one component manufacturer was a superior product. And a 25% reduction in the cost of the part.

They switched from phosphor bronze. We have given you eight reasons why you should switch. Think about it. For more information on CA 725 call your local supplier, or write Department 3473, The International Nickel Company, One New York Plaza, New York, N.Y. 10004.



THE INTERNATIONAL NICKEL COMPANY, INC., NEW YORK  
Circle 71 on reader service card

# Miniature lamps specially packaged for your application

Traditionally, the application of miniature lamps has involved use of the familiar mated metal base and receptacle. The base, usually threaded or bayonet type, is cemented to the bulb. A receptacle of corresponding type is separately wired into the equipment.

Now, other and more convenient techniques for applying both miniature and subminiature

lamps have evolved. Some consist of variations of the base and receptacle method. Others dispense entirely with the wired-in receptacle. All offer certain advantages—economy, faster assembly—in some cases, by automatic machinery.

Wagner is a major supplier of the special types of Tung-Sol lamps shown here. Some of them may suggest methods by which

you might reduce your costs, speed your production, or increase the sales appeal of your product. Inquiry concerning your lamp application is welcomed.

Miniature Lamp Section  
WAGNER ELECTRIC CORPORATION  
630 West Mt. Pleasant Avenue  
Livingston, N.J. 07039  
TWX: 710-994-4865  
Phone: (201) 992-1100;  
(212) 732-5426

© TRADEMARKS WAGNER AND TUNG-SOL REG. U.S. PAT. OFF. AND MARCAS REGISTRADAS

# WAGNER

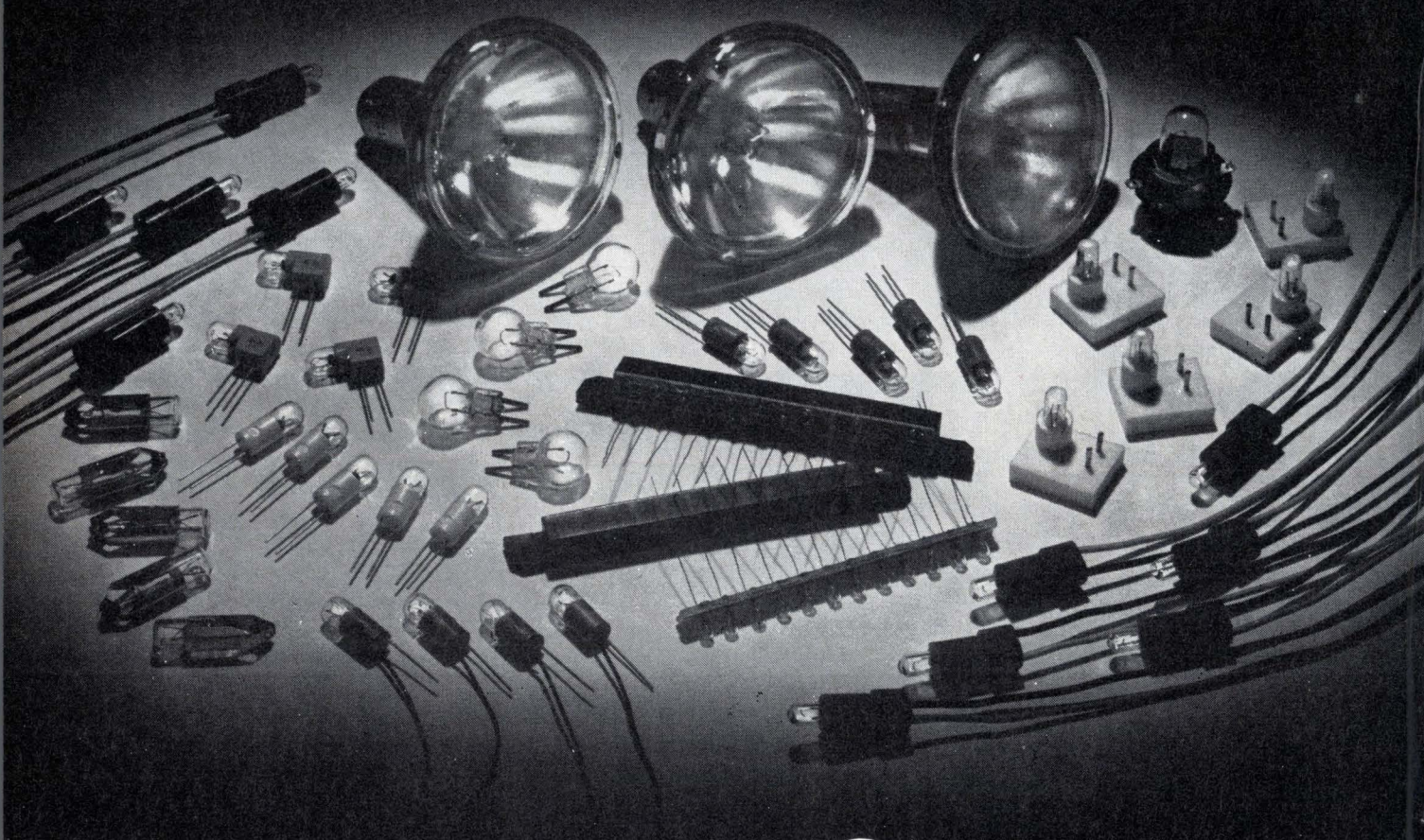

**Standard miniature and subminiature lamps.** Globe, straight side, lens end, tubular, flat end, blister, wedge or cartridge—there is a Tung-Sol lamp in every style. Let us quote on your requirements.

Circle 72 on reader service card

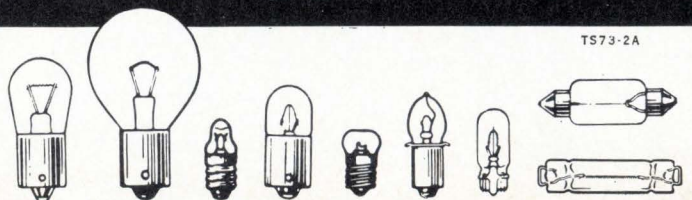

TS73-2A

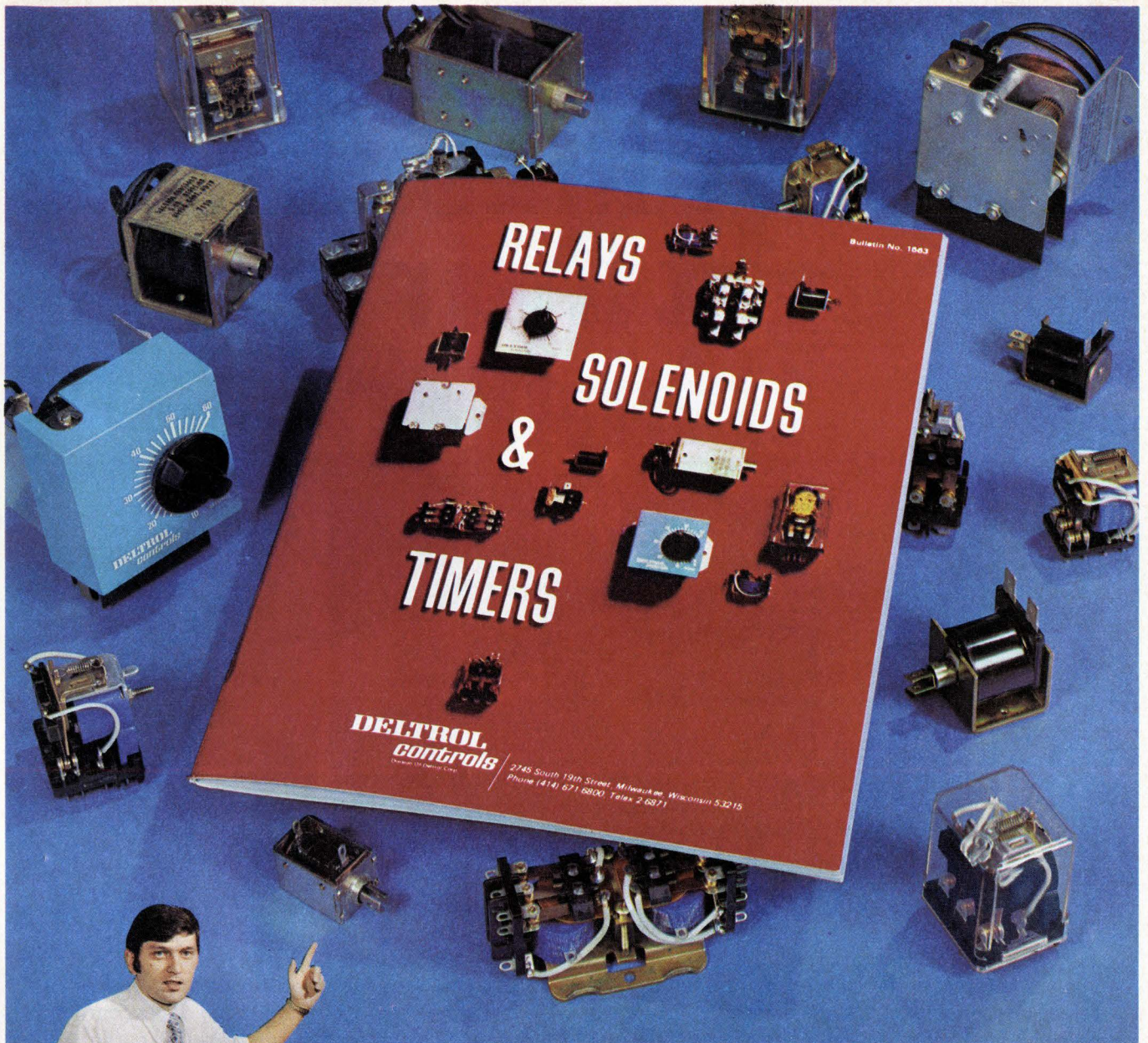

## Deltrol's New catalog lists 1570 relays, 232 solenoids and 218 timers ... and it's yours, free!

One of Deltrol's relays, solenoids or timers may be just what you're looking for. You'll find engineering specs and prices for 5, 10, 15 amp AC and DC general purpose relays, including the popular new 160/165 series...25 amp heavy duty power relays with or without auxiliary switch...magnetic latching relays up to 6PDT...low, medium and highpower intermittent and continuous duty solenoids with optional buzz trimmer that eliminates AC hum...medium and heavy duty clappers with adjustable stops...and interval, pushbutton, repeat cycle, fixed or adjustable automatic reset timers. We'll send you this catalog free if you circle the number below or write to...

**DELTRON**  
*controls*  
 Division Of Deltrol Corp.

2745 S. 19th St., Milwaukee, Wis. 53215  
 Phone (414) 671-6800 Telex 2-6871

# “They’re reliability freaks. That’s why we bought their laser trimmer.”

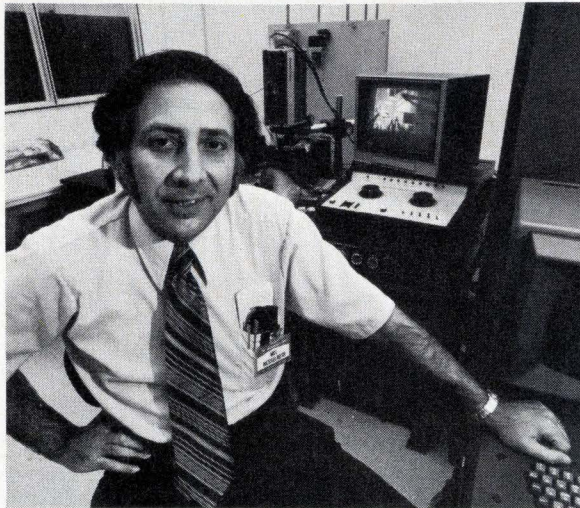

Mel Nesselroth  
Manager, Hybrid Product Engineering  
Motorola Communications Division  
Ft. Lauderdale, Florida

Motorola's Mel Nesselroth is a tough customer. He has to be. His engineering group is responsible for turning out all the hybrid circuits used in the company's portable communications products.

With Mel Nesselroth, reliability is the big thing.

“We picked Teradyne's W311 Laser Trimming System to trim thick-film circuits. Why? Because Teradyne people are such demons for reliability. We're now punishing that system 24 hours a day. Sometimes we throw in Saturdays and Sundays.”

Is it down much?

“Maybe an hour or so a week, for maintenance of mechanical parts.”

The W311's uncommon reliability is matched by its speed, which derives from a

unique galvanometer-controlled beam positioner. Its speed is matched by its accuracy. Motorola has checked its bridge again and again against external standards and has yet to find a discrepancy.

High throughput, total control of trim size, and clear TV monitoring are other features of the W311 that turn Motorola on. But a practical man, Mel Nesselroth keeps coming back to bread-and-butter issues: “I like to think of the savings in support costs we're going to realize because of Teradyne's 10-year warranty. That's a real plus.”

Find out more about Teradyne's W311, the workhorse that has proved itself at Motorola and at companies large and small all over the world. Write Teradyne, 183 Essex Street, Boston, Massachusetts 02111. In Europe: Teradyne Europe S.A., 11 bis, rue Roquépine, 75 Paris 8<sup>e</sup>, France.

## TERADYNE

CHICAGO (312) 298-8610 / DALLAS (214) 231-5384 / NEW ENGLAND (617) 458-1256 / NEW YORK (516) 364-9797 / SUNNYVALE (408) 732-8770  
LONDON (093-28) 61111 / PARIS 265 72 62 / ROME 59 47 62 / MUNICH (0811) 33 50 61 / TOKYO (03) 406-4021

# Probing the news

Analysis of technology and business developments

## Picturephone to change its image

Finding that few people simply want to see their callers, AT&T proposes to add many options to its next generation of video telephones

by Lyman J. Hardeman, *Communications & Microwave Editor*

The Picturephone is going back to the drawing board. AT&T has decided that the instrument itself, for which it once predicted a million installations by 1980, has been hurt by its emphasis on face-to-face communications and its lack of options.

To be sure, the Bell System will maintain a marketing effort in the Chicago area (see "Look at Chicago"). Service also is offered in Pittsburgh and Washington, D.C. At the same time, company officials will make use of the market experience gained since 1970 to come up with a more versatile next-generation unit that they hope will result in a more salable service.

To coordinate both engineering and marketing aspects of the new Picturephone, Edward Goldstein has been named assistant vice president—an appointment that for the first time formally brings such decision-making responsibility for video telephones into the higher levels of AT&T management.

Goldstein is open about the present lack of market acceptance and the possible future directions that Picturephone might take. "Our objectives have changed considerably," he admits. "We originally considered that the Chicago experiment, if it succeeded, would be quickly expanded to similar services elsewhere. . . . It's fair to say that success has been less than expected. . . . We are therefore regrouping to see what changes need to be made to make it more attractive from the marketing point of view."

The basic marketing problem with Picturephone, he contends, is that its design has been optimized for face-to-face communications. "But until you have a fairly large



### Look at Chicago

Picturephone service is almost nonexistent outside of Illinois, where Chicago has been a system testbed. Pittsburgh and Washington, D.C., both offer the service, yet Pittsburgh has but three customers; Washington, none. Illinois Bell currently lists 109 Chicago customers using 473 Picturephone sets—it's garnered this mini-universe by charging an admittedly promotional \$86.50 per month, about half the \$170 charged in Washington and \$160 in Pittsburgh. Installation, extension, and per-minute tariffs are similarly sliced.

About half the Chicago customers, including banks, law firms, architects, several advertising and printing firms, and almost a dozen hospitals, subscribe to internal intercom service only. One such application, at the massive Cook County hospital, links emergency, operating, and recovery rooms to several urology clinics and wards for physician consultation and transmission of X-ray films. "The results were surprisingly successful," says Dr. Irving Bush, chairman of the department of urology. "In some instances, the X rays presented could be seen better over the video system because we were able to brighten and darken poor-quality films."

Picturephones have also found their way into the Cook County sheriff's department, and one pair links a North Chicago prisoner lockup with the downtown night bond court, speeding bonding procedures by eliminating the need for prisoner transportation. Fingerprint and arrest records, though, are still sent by facsimile.

The nation's second largest city also sports five Picturephone booths so that the public, as well as 117 private Picturephone users, can shop by picturephone at several local stores, including retailer Bonwit Teller, a local florist, (picture above) and the Avis and Dollar A Day car-rental firms. That same network also links the public to medical-equipment-leasing companies, management-recruitment firms, the Chicago Convention and Tourism Bureau, and Illinois Bell news and weather programs.

universe of people connected to the system, the service doesn't strike most people as being worth the money that has to be charged."

The giant communications company is, of course, looking for ways to reduce costs. But more importantly, says Goldstein, "We are seeking to increase the utility of the service so that what is charged will be more in line with what customers want to pay."

**Options.** Increased utility for Goldstein means a wide variety of standard options with the basic terminal design. Among those being seriously considered for the next generation of video terminal are:

- A separable camera to allow the customer to move the camera off the executive desk and into other than face-to-face situations. From this comes a need to increase the resolution of the Picturephone camera to that of the 525-line television standard, thus allowing conventional closed-circuit TV cameras and commercial television receivers to be used in a Picturephone terminal.

- A facsimile receiver, so that an operator can make hard copies of images and drawings.

- Video tape recorders that make it easy to record a video session for later replay.

- Keyboard devices for data entry and to give the operator access to banks of data filed in a computer.

- Picture-processing electronics, so that the operator can choose between the high frame rates needed for moving images and the higher resolution often required for transmitting still graphic information. The buffer storage required for this processing capability could at the same time make possible slow-scan techniques for receiving graphics transmitted over the normal telephone lines.

The number of adjuncts that can be added to the basic terminal is limitless. And it's difficult to predict very far into the future what technologies may make what options commercially attractive. However, Bell has now learned from market experience that the key to market penetration is flexibility.

As for those widely discussed



**Well-groomed shopper.** Chicago woman shops for dresses while having her hair done.

technical problems—for example, white spots in the picture, traced to faulty diodes, difficulties with the voice suppressor, visibility loss in bright light—Goldstein says they've either been licked or will offer no resistance and that he's satisfied with the instrument as it now stands. But one of the major marketing drawbacks to Picturephone service, lack of intercity switched service, still exists.

For the customer, this new video telephone will have many parallels with a home stereo component system. In stereo systems, once he has the basic amplifier, he can add a tuner, record changer, or now quadrasonic gear, depending on desire and budget. So could the user mold his terminal to fit his unique needs and budget.

A major difference, however, is that the stereo system stands alone. But the Picturephone must conform to standards that allow it to interface with other terminals in a nationwide, if not worldwide, system. And this is perhaps the most press-

ing problem still facing Goldstein. The decision to adopt the 525-line television-resolution standard, for example, would require a quadrupling of transmission bandwidth. This would substantially increase transmission costs that have already been estimated at 10 times that of voice-grade lines, at the very least.

All the options available to Bell are still being tested, Goldstein emphasizes, and no decisions have yet been made on which will be included. But one thing is certain—the next-generation Picturephone will have a strikingly different image. □



**Whole picture.** AT&T's Edward Goldstein is coordinating Picturephone marketing.



## Another FIRST from DDC

DDC, the company that developed the first synchro converter module back in 1969, has now introduced the first line of microminiature hybrid synchro converters.

Included are a hybrid multiplexed S/D (Model HMSDC) and hybrid tracking S/D and D/S (H-Series) converters . . . specifically designed for applications requiring microminiature size, low power (cmos), high accuracy, and single or multispeed operation. In addition to avionics applications, their extreme low power and high reliability make them ideal for remote data gathering stations and man-portable equipment. They are available as modules for you to package, on cards to your specifications or as NAFI SHP circuit cards.

Both the HMSDC and H-Series feature high reliability (MIL-883 processing) and stability—with no trims, adjustments or calibrations.

Hybrid synchro converters. Latest in a whole line of "firsts" from DDC.

For product or technical applications information, write or call Jim Sheahan or Hans Schloss. They're engineers, so they talk your language.

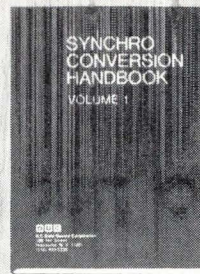

**If you work with Shaft Encoders you will want this REFERENCE BOOK . . .** Written for circuit and systems designers, "Synchro Conversion Handbook" is the first, most complete, and only authoritative text on synchro conversion. Prepared and published by DDC, this 96-page book helps you understand and meet your specific synchro problems. Ample references, tables and supporting illustrations. Covers tracking vs sampling converters, error analysis, converter selection criteria, applications ideas, test circuits, etc. Send \$2.00. Or, if you work in synchro conversion, you may qualify for a free copy.

ILC Data Device Corporation  
100 Tec Street, Hicksville, N. Y. 11801

My synchro application merits a free copy of your new book. Please qualify me.

Enclosed is \$2.00 in check or money order. Please rush my copy of "Synchro Conversion Handbook."

Name \_\_\_\_\_ Title \_\_\_\_\_

Company \_\_\_\_\_

Address \_\_\_\_\_

City \_\_\_\_\_ State \_\_\_\_\_ Zip \_\_\_\_\_

# DDC

A subsidiary of ILC Industries, Inc.

## ILC DATA DEVICE CORPORATION

100 TEC STREET, HICKSVILLE, N. Y. 11801 • PHONE: (516) 433-5330

Shaping the future of data conversion.

APPLICATION CENTERS

Long Beach, Calif.  
(213) 597-5744

Washington, D. C.  
(703) 536-2212

Bruxelles, Belgium  
Tel. 62.01.59

# Shaping the future of synchro conversion.

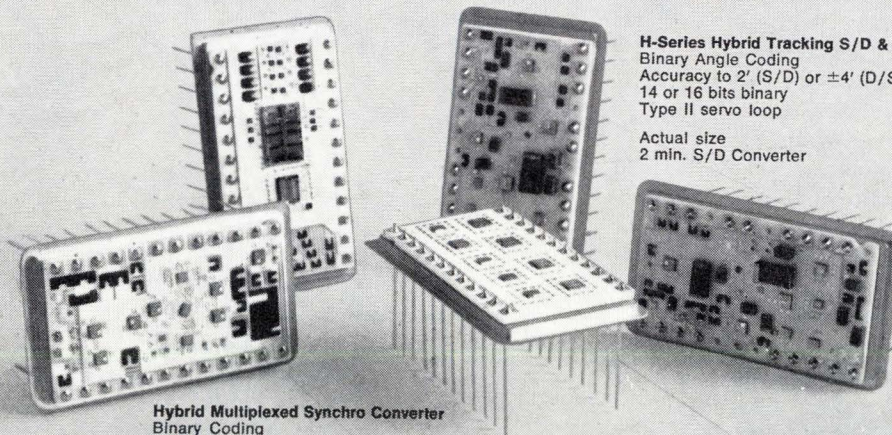

**H-Series Hybrid Tracking S/D & D/S**  
Binary Angle Coding  
Accuracy to 2' (S/D) or  $\pm 4'$  (D/S)  
14 or 16 bits binary  
Type II servo loop

Actual size  
2 min. S/D Converter

**Hybrid Multiplexed Synchro Converter**  
Binary Coding  
Accuracy to 5.3'  
Resolution 1.3'  
150  $\mu$ s conversion time  
(not shown)

Instrumentation

# Computers to monitor waterways

Belgians seek to conserve surface water supplies with network of monitoring equipment, transmission lines, and data processors

by John Gosch, Frankfurt bureau

**Belgian Government** officials have embarked on a long-range project aimed at controlling thousands of miles of rivers and canals traversing the country. And helping them in this effort will be millions of dollars worth of electronics monitoring equipment, transmission lines, and data processing gear.

In what is Europe's—and possibly the world's—first computer-monitored network of waterways, a data processing center at Brussels, Belgium's capital, is already keeping tabs on the water level of major Belgian rivers. Using the inputs from water-level measuring stations, the computer supplies information on how locks and sluice gates should be positioned for optimum water flow.

Later, the computer, operating on a complex mathematical model, will automatically control water locks and sluice gates along rivers and canals. It will also play a vital role in Belgium's fight against water pollution. The project's main purpose, though, is to help the Belgian government make better use of the country's surface water reservoirs.

Main contractor for the project is West Germany's Siemens AG. The company has just completed the first portion of the job—putting the computer and a number of measuring stations to work.

As presently conceived, the Belgian system will eventually comprise some 240 main measuring stations, spotted along 12 water routes. In addition, there will be a number of so-called substations installed along a few tributary streams. When completed in about 10 years, the Belgian network will have from \$10 million to \$12 million dollars worth of electronics hardware alone.

In the network, remote control lines interconnect all stations and also tie them to the computer, a Siemens model 305 process control machine already operating at the Brussels control center. Used for data transmission is the Siemens Z701 remote control equipment based on time-division-multiplexed, pulse-code-modulation techniques. The substations will be fitted with Siemens Z20 transmission equipment for sending data to main stations either over cables or by radio.

**How it works.** A main station can transmit up to 10 different water measurements and 15 messages to the Brussels control center. Measurements are, for example, on the

water level at either side of a lock or a sluice gate or, as is the case with automatic gates, the momentary gate position. The messages can be alarms signaling to the computer that, say, a pump, a gate motor, or any other device is inoperative. The messages sent from the computer to a station include information on how a gate should be positioned for a desired water level.

The process computer works online. In this mode, the computer successively addresses all main stations along a water route and calls in their information. Data transmission is at 200 baud. All information in the control center's store is updated every 45 seconds. □

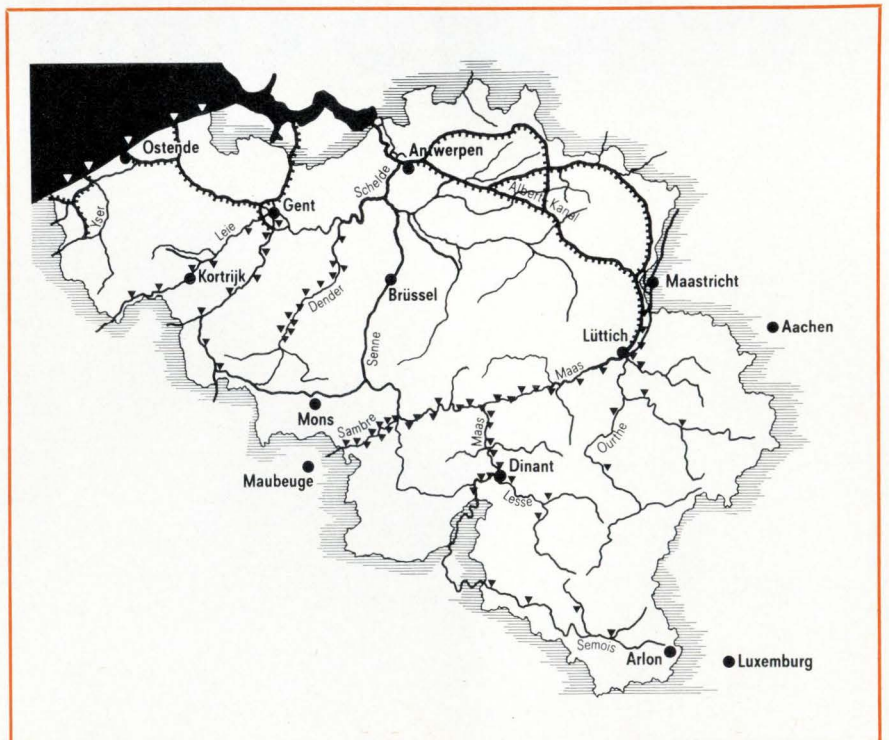

**Water control.** Map of Belgium's computer-monitored network of rivers and canals shows control points as triangles. The system will be complete in 10 years.

# World's biggest MOS ROM

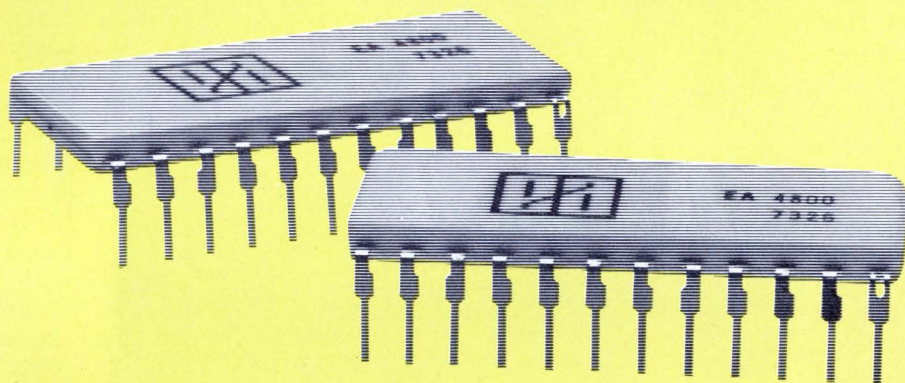

**Stores 16,384 bits at lowest cost per bit ever**

The EA4800 P-channel read-only memory has twice the storage capacity of any other ROM on the market. Using it, you can program calculators, minicomputers, data terminals and similar equipment at the lowest cost per bit ever achieved.

And you will find it very simple to use.

No clocks are required—operation is static.

No address decoding is

required—it's on the chip.

No input pull-up resistors are required for connection to TTL—they're on the chip.

You have your choice of 2048 x 8 or 4096 x 4 organization. You can OR-wire the outputs to expand the memory, and you need only two supplies: +5v and -12v.

The ROM has a maximum access time of 1.2  $\mu$ sec and a low power dissipation of .032 mW per bit. It comes in a

24-pin metal ceramic or silicone-molded DIP.

Price is \$28 in 100-piece quantities in a silicone package.

We can make a mask and deliver the first good ROMs to you in 6 to 8 weeks.

Contact Electronic Arrays, Inc., 501 Ellis Street, Mountain View, California 94040. Phone (415) 964-4321.

**electronic arrays** 

Instrumentation

# The calculator connection

Minicomputer users believe that in many instrument systems, programmable machines can do as well, cost less, and are easier to program

by George Sideris, San Francisco bureau manager

A few years ago, engineers who couldn't afford to buy minicomputers to run their instruments began putting together homemade interfaces so that they could use their desk calculators. At about the same time, several small firms started making calculator-instrument interfaces, an activity that started a quiet movement for programmable calculators to replace minicomputers in small, slow, data-acquisition, process-control, and test systems.

Now that movement has broken into the open via a Wescon session on calculator-based systems. Speakers from Hewlett-Packard Co. and Tektronix Inc. were scheduled to deliver papers showing that, in many cases, calculators do as good a job as minicomputers, cost less, and are far easier for the average engineer to program.

Hewlett-Packard breached the electronic bench-instrument market last year with a high-frequency network analyzer built around an H-P 9820 calculator. This summer, H-P brought out its first data-acquisition system, to be shown at Wescon along with a new low-frequency network analyzer [*Electronics*, Aug. 30, p. 125]. And now that Tektronix has a suitable programmable calculator, it plans to enter the market [*Electronics*, Aug. 2, p. 40, and Aug. 30, p. 108].

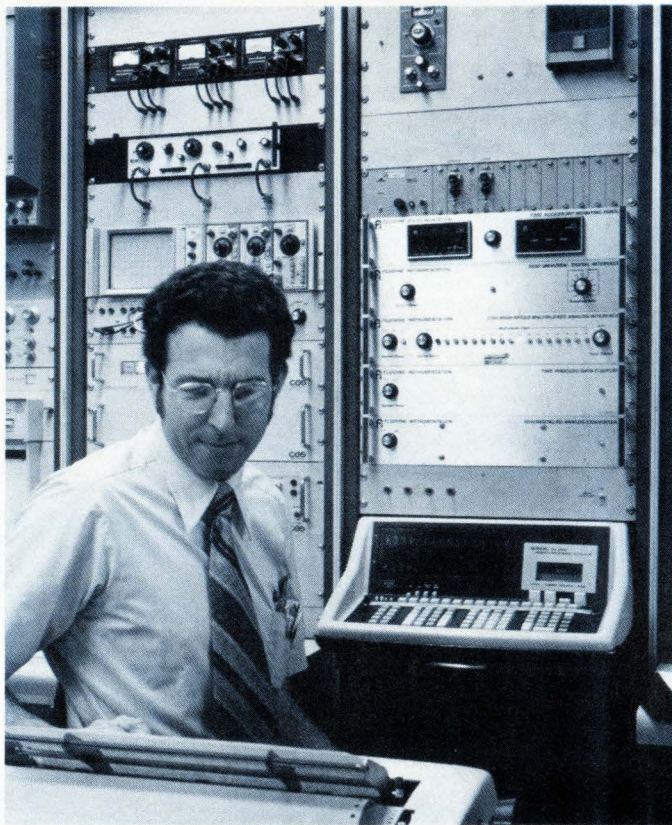

**Doing its job.** Fluidyne installation at the Aerospace Corp. features a Wang 700 programmable calculator in place of a mini.

Peter S. Stone of Hewlett-Packard's Loveland, Colo., division, is to describe at Wescon several calculator-based bench instrument setups used in-house to plot performance characteristics of new instruments, battery modules, and components. He'll also outline the two systems H-P has on exhibit. In his bench instrument setup, Stone uses model 9820 and 9830 calculators.

Tektronix has not yet introduced any calculator-based systems, but a paper by Jack D. Grimes and-

Ronald V. Hill will show how one setup uses the Tek 31 calculator to analyze components and noisy signals. The system includes a digital-processing oscilloscope and other instruments and peripherals. When the scope came out, the recommended processor was a Digital Equipment Corp. PDP-11 minicomputer [*Electronics*, March 15, p. 98].

Stone recommends calculators for bench-test systems, remarking that "some calculators actually rival in computing power a minicomputer with a sophisticated compiler," although the calculators are slower. Adds Grimes, "A very large class of instrumentation applications are slower than a speeding bullet."

At Loveland, Roger Youngberg, H-P's systems product manager, finds it "a little surprising that more companies aren't selling calculator-based systems. While calculators are outclassed by minicomputers in multi-instrument systems, they are a good speed match to instruments like digital voltmeters."

Because a minicomputer operates in microseconds, it must often wait around to receive data from instruments, Youngberg explains. "And the calculator is more friendly, more human-oriented than a computer. You don't need expert programmers."

Another speaker at Wescon, Roger Jennings of Fluidyne Instru-

**This panel  
is worth  
\$380,**

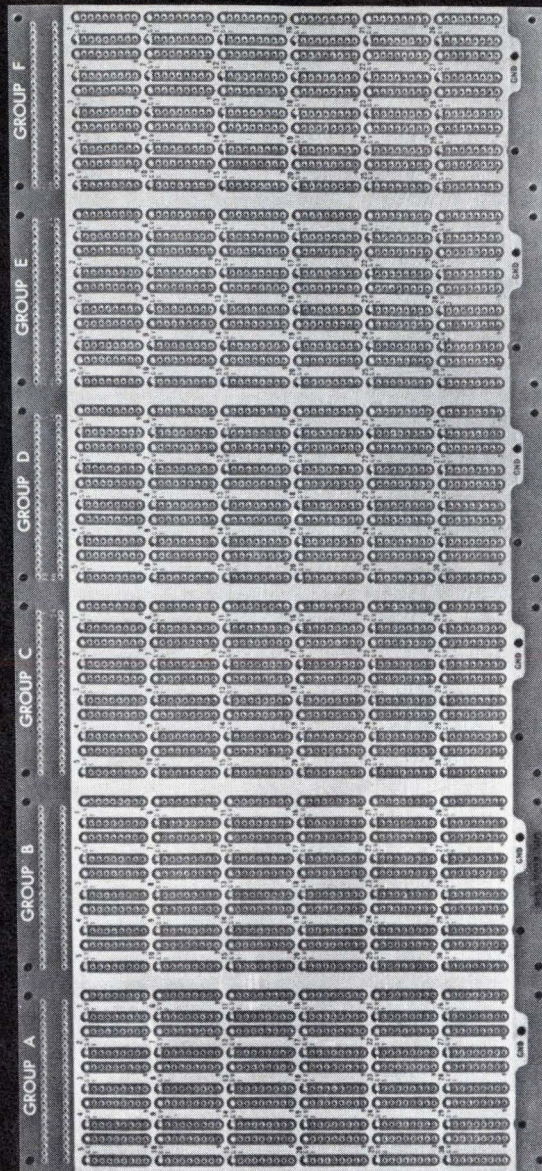

**it costs  
\$380.**

**This panel  
is worth  
\$380,**

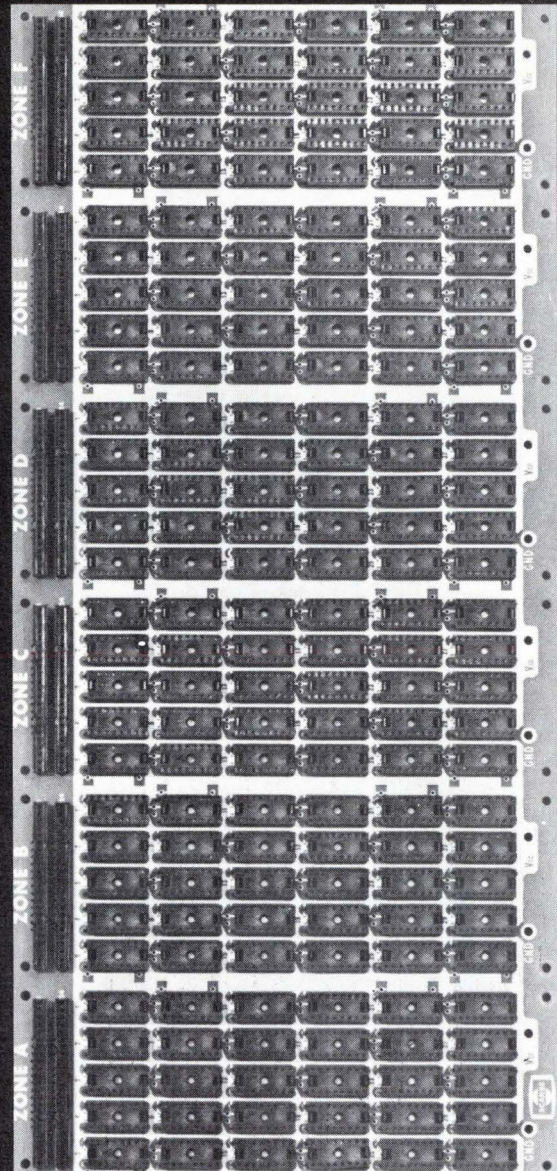

**it costs  
\$273.**

The Scanbe socket panel gives you all the features and benefits of the pin-in-the-board panel for 28% less. In fact, you get two additional very unique features—built-in standard decoupling capacitor provisions and —contacts that accept a much wider range of lead sizes. The socket panel is designed around Scanbe's ME-2 Socket, the most reliable in the industry—not one has ever been rejected. **Write or call. We'll show you how to get four for the price of three.**

Scanbe Manufacturing Corporation  
3445 Fletcher Avenue  
El Monte, California 91731  
Tel: (213) 579-2300 / 686-1202 • TWX: 910-587-3437



## Probing the news

mentation, Oakland, Calif., in the past 18 months has sold 90 systems built around programable calculators supplied by Wang Laboratories Inc. Jennings estimates these sales represent 70% of all the calculator-based data-acquisition and control systems installed to date. Second place apparently goes to Midwest Scientific Instruments, of Kansas City, Kans., which Douglas East, the firm's vice president and sales manager, says has sold nearly 25 systems.

**Industrial market.** Jennings isn't worried about the new competition. He expects the industrial market to zoom rapidly from its present level of about \$1 million a year into the tens of millions of dollars annually. "Right now, we are looking at just the tip of the iceberg," he says.

Giving the movement impetus, he says, are the newer desktop calculators that are programed in a high-level language, Basic, and an input-output structure compatible with minicomputer peripherals, which enable the calculators to be used in conversational mode. And since the Basic compiler is hard-wired into the calculators, they can actually execute their programs faster in that mode than some minicomputers having compilers stored in core memories, he adds.

Jennings hopes to do a land-office business selling calculator-instrument-interface boxes, already a profitable sideline. And Midwest expects its calculator peripherals to outshine its systems sales. East says the firm recently developed a floppy-desk memory that extends Wang calculators' memories to 131,000 programs and has also developed a high-speed printer for Wang machines.

**Minis' place.** It's agreed that minicomputers should be relegated to large data-acquisition systems, complex multi-instrument systems, component testers, and other systems that require a data processor with high throughput.

And General Radio Inc. of Concord, Mass., a maker of large, sophisticated test systems incorporating minicomputers, says it has been investigating the use of calculators.

But, as pointed out by Richard G. Rogers, general manager of component and network testing, "For controlling many instruments, a mini-computer can handle more complicated programs capable of analyzing and diagnosing problems on complex boards. Take a digital logic board containing 100 digital ICs. If you want a test system that can tell an operator which IC is faulty, then you must have a mini-computer."

A calculator could acquire data from more than 1,000 channels, Jennings says. However, given the limitations of analog-to-digital converters and processing delays, 100 channels and about 10 input-output operations per channel-second are practical. That is 10 to 100 times slower than minicomputers run. Much depends, though, on the data rate of each channel.

The vast majority of industrial processes, however, have such inertia that speed is seldom an overriding factor, particularly in supervisory controls, Jennings contends. While data acquisition and reduction has been the mainstay of Fluidyne's calculator-system business (the firm's other major product line is plastics processors), it is moving rapidly into closed-loop industrial controllers.

**Watery job.** Last month, Fluidyne installed an irrigation-control system at the Wu-Shan-Tou reservoir in Taiwan. Fed inputs from weather sensors and also from level sensors in canals, the calculator regulates flows in accordance with climatic conditions. Another system controls electrolytic-reduction pots (tanks full of chemicals) at Taiwan Aluminum Ltd. Others control material feeders at a cement plant, regulate a motor-generator-test system, run automatic gaging equipment in an auto plant, and the like. Jennings is most proud of a system that controls two metal-fatigue testers at Aerospace Corp., El Segundo, Calif. With its help, the wing-failure problems that plagued the F-111 aircraft were solved.

Most of Midwest Scientific's systems process data from blood analyzers, cell counters, scintillation counters, and spectrophotometers in medical labs. A maximum of 17 instruments can time-share a calcu-

# TRUE OR FALSE





1. You can get immediate delivery on bridges from these stocking General Instrument distributors.

True  False

<b>EAST</b>	
ALABAMA, Huntsville	
Cramer Electronics	(205) 539-5722
CONNECTICUT, Stratford	
Greene/Shaw	(203) 378-0485
<b>FLORIDA</b>	
Hollywood	
Cramer Electronics	(305) 923-8181
Orlando	
Cramer Electronics	(305) 894-1511
<b>MARYLAND</b>	
Gaithersburg	
Cramer Electronics	(301) 948-0110
Baltimore	
Radio Electric Service Co.	(301) 823-0070
<b>MASSACHUSETTS, Newton</b>	
Greene/Shaw	(617) 969-8900
<b>NEW YORK</b>	
Buffalo	
Summit	(716) 884-3450
Elmsford	
Zeus Components	(914) 592-4120
Freeport	
Milgray Electronics	(516) 546-6000
Hempstead	
Semiconductor Concepts	(516) 273-1234
Johnson City	
Wilshire Electronics	(607) 797-1236
Plainville	
Fairmont Electronic Sales Co.	(516) 694-8200
<b>NORTH CAROLINA, Winston-Salem</b>	
Cramer Electronics	(919) 725-8711
<b>PENNSYLVANIA</b>	
Philadelphia	
Herbach & Rademan	(215) 426-1700
Philadelphia Electronics	(215) 568-8288
Pittsburgh	
Semiconductor Specialists	(412) 781-8120
<b>MIDWEST</b>	
ILLINOIS, Elmhurst	
Semiconductor Specialists	(312) 279-1000
INDIANA, Indianapolis	
Semiconductor Specialists	(317) 243-8271
IOWA, Cedar Rapids	
Deeco, Inc.	(319) 365-7551
KANSAS, Lenexa	
Hallmark Electronics	(913) 888-4747
<b>MICHIGAN</b>	
Detroit	
Semiconductor Specialists	(313) 255-0300
Grand Rapids	
Stotts Friedman Co.	(616) 241-6731
<b>MINNESOTA</b>	
Minneapolis	
Hallmark Electronics	(612) 925-2944
The Berquist Co., Inc.	(612) 925-2322
Semiconductor Specialists	(612) 854-8841
MISSOURI, St. Louis	
Semiconductor Specialists	(314) 428-6100
<b>OHIO</b>	
Cincinnati	
Newark Electronics	(513) 421-5282
Dayton	
Semiconductor Specialists	(513) 278-9455
Solon	
Reppo	(216) 248-8900
<b>WEST</b>	
<b>ARIZONA</b>	
Phoenix	
Cramer Electronics	(602) 263-1112
Mirco Electronic Dist.	(602) 944-2261
<b>CALIFORNIA</b>	
Culver City	
Avnet Electronics	(213) 836-7200
Newport Beach	
Semiconp Sales	(714) 833-3070
Santa Ana	
Intermark Electronics	(714) 540-1322
San Diego	
Intermark Electronics	(714) 279-5200
Sunnyvale	
Intermark Electronics	(408) 738-1111
Woodland Hills	
Semiconductor Concepts	(213) 884-4560
COLORADO, Denver	
Intermark Electronics	(303) 936-8284
<b>NEW MEXICO</b>	
Albuquerque	
Century Electronics	(505) 265-7839
Cramer Electronics	(505) 265-5767
<b>TEXAS</b>	
Addison	
Computer Components	(214) 239-0271
Dallas	
Semiconductor Specialists	(214) 358-5211
Houston	
Component Specialties, Inc.	(713) 771-7237
Lenert Co.	(713) 225-1465
<b>UTAH, Salt Lake City</b>	
Alta Electronics	(801) 486-7227
<b>WASHINGTON-OREGON, Seattle</b>	
Intermark Electronics	(206) 767-3160

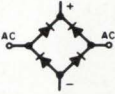

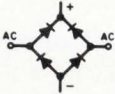
# TRUE OR FALSE

- |  |                                  |                                   |
|--|----------------------------------|-----------------------------------|
| 1. The AQL is lower using a bridge than four discrete rectifiers.  | True<br><input type="checkbox"/> | False<br><input type="checkbox"/> |
| 2. You can get 30-day delivery on 1.5A bridges.  | True<br><input type="checkbox"/> | False<br><input type="checkbox"/> |
| 3. The lowest-priced 1.5A, 400V bridge rectifier you can buy is 40¢ (in quantities of 10,000).   | True<br><input type="checkbox"/> | False<br><input type="checkbox"/> |
| 4. If  =  and  =  , then  =  | True<br><input type="checkbox"/> | False<br><input type="checkbox"/> |

**ANSWERS:**

- True. Rectifiers and bridges are shipped to 1% AQL. Since there are four discrete rectifiers in a bridge, the effective AQL is reduced to 0.25%.
- True. Because General Instrument maintains a minimum domestic inventory of 250,000 bridges at all times.
- False. The lowest-priced is 25¢ and is only available from General Instrument (the 40¢ price is that of our nearest-priced competitor).
- False. Because it will cost you more to buy and assemble the rectifiers into a bridge than to buy an assembled bridge from General Instrument.

(If you scored high, you probably know us. If you didn't, you should.)

For your choice of bridge rectifiers at the lowest prices (and fastest delivery) anywhere, call toll-free 800-645-1247. In New York State call 516-733-3357.

For complete information write: General Instrument Corporation, Dept. M, 600 West John Street, Hicksville, N.Y. 11802, or call, in New York: 516-733-3333; in Chicago: 312-338-9200; in Van Nuys: 213-781-0489. In Canada, call or write: General Instrument Canada, Ltd., 61 Industry Street, Toronto 337, Ontario, Canada, Tel: 416-763-4133. In Europe, write: General Instrument Europe S.P.A., Piazza Amendola 9, 20149 Milano, Italy. In the U.K., write General Instrument (U.K.) Ltd., Cock Lane, Highwycombe, Buckinghamshire, England. In the Far East, write General Instrument of Taiwan Ltd., P.O. Box 22226, Taipei, Taiwan.



GENERAL INSTRUMENT CORPORATION • 600 WEST JOHN STREET, HICKSVILLE, L. I., NEW YORK 11802

## Probing the news

lator. Some systems merge test data with a file of patients' names and print out individual laboratory reports.

Midwest, which is also moving into process control, recently installed a system in a cement plant. The calculator prints out instructions to the operator now, but addi-

tion of servo loops to control the plant is planned.

Cost comparisons are confused by tradeoffs between hard-wiring and software expenses. Calculators easily undercut minicomputer prices when both are bought as packaged subsystems. But when calculators are compared with bare minis, which must be built into systems, the advantage see-saws with memory requirements.

Midwest Scientific's systems range from \$8,000 to \$50,000, depending on the number of instruments interfaced with the calculator and the types of peripherals, East says. Comparable systems with packaged minicomputers range from \$15,000 to \$125,000. A minicomputer system's cost climbs rapidly with system complexity because of software costs. Midwest Scientific supplies software.

Fluidyne's systems prices average around \$12,500, and the top price has been \$40,000, reports Jennings. He breaks the average cost down to \$5,000 for a calculator and typewriter, \$5,000 for the data-acquisition subsystem, and \$2,500 for instrument interfaces and cabling. Software is generally provided as a library of routines that the user puts together through the keyboard.

Hewlett-Packard sells the high-frequency network analyzer for \$22,300 and the new low-frequency model for \$16,250 and adds a software package for \$50. Both include the electronic test instruments. The data-acquisition system ranges from \$14,200 to \$19,600, depending on the number of channels.

**Altogether.** Jennings says Fluidyne plans to shave costs by using bare minis in systems produced in quantity. He has a quote from Computer Automation Inc. of Irvine, Calif., for 50 Alpha LSI Naked Minis with 8,192-word memories for \$2,000 each. That's not as cheap as the less than \$1,000 price offered by Computer Automation to purchasers of large quantities with 4,096-word memories [*Electronics*, June 7, p. 109], but it is less than a packaged calculator costs.

Calculators will retain their edge over bare minis, Jennings thinks, in one-of-a-kind systems and when the purchaser wants to use the calculator for other chores. He expects the two types of processors to complement each other. Jennings explains that if a customer buys several systems, he can use a calculator to modify programs quickly.

"All you do is program a calculator in Basic, give it a list-program command, and dump the program into the minicomputer's core memory via a teletypewriter terminal." The mini's compiler will do the rest. □

# A portable recorder so good we might have to add a warning.

There isn't another portable wideband instrumentation recorder like the Mincom Series 110.

It records up to 28 data channels at speeds from 15/16 to 120 ips, with an analog bandwidth from 400 Hz to 2.0 MHz. Handles all IRIG FM plus the extended Mincom 1 MHz system. And packs in digital data at 20,000 bits per inch.

It's built with a servo-controlled capstan for post-data analysis in the field. With plug-in ferrite heads warranted for 3000 hours. With UNICAL, our own system for internally calibrating all important performance parameters with no additional test equipment.

It's a portable, but with better performance, reliability and convenience than most lab recorders. And that's the problem: once the guys in your lab get their hands on the 110, you might not get it back.

But don't say we didn't warn you.

For details on the 110 and our other recording, test and calibration equipment, contact the Mincom Division, 3M Company, 300 S. Lewis Rd., Camarillo, Calif. 93010. Telephone (805) 482-1911. TWX 910-336-1676.



**We've been there.  
And brought the answers back.**

**3M**  
COMPANY



# 33 skinny ways to check your compact packaging problems:

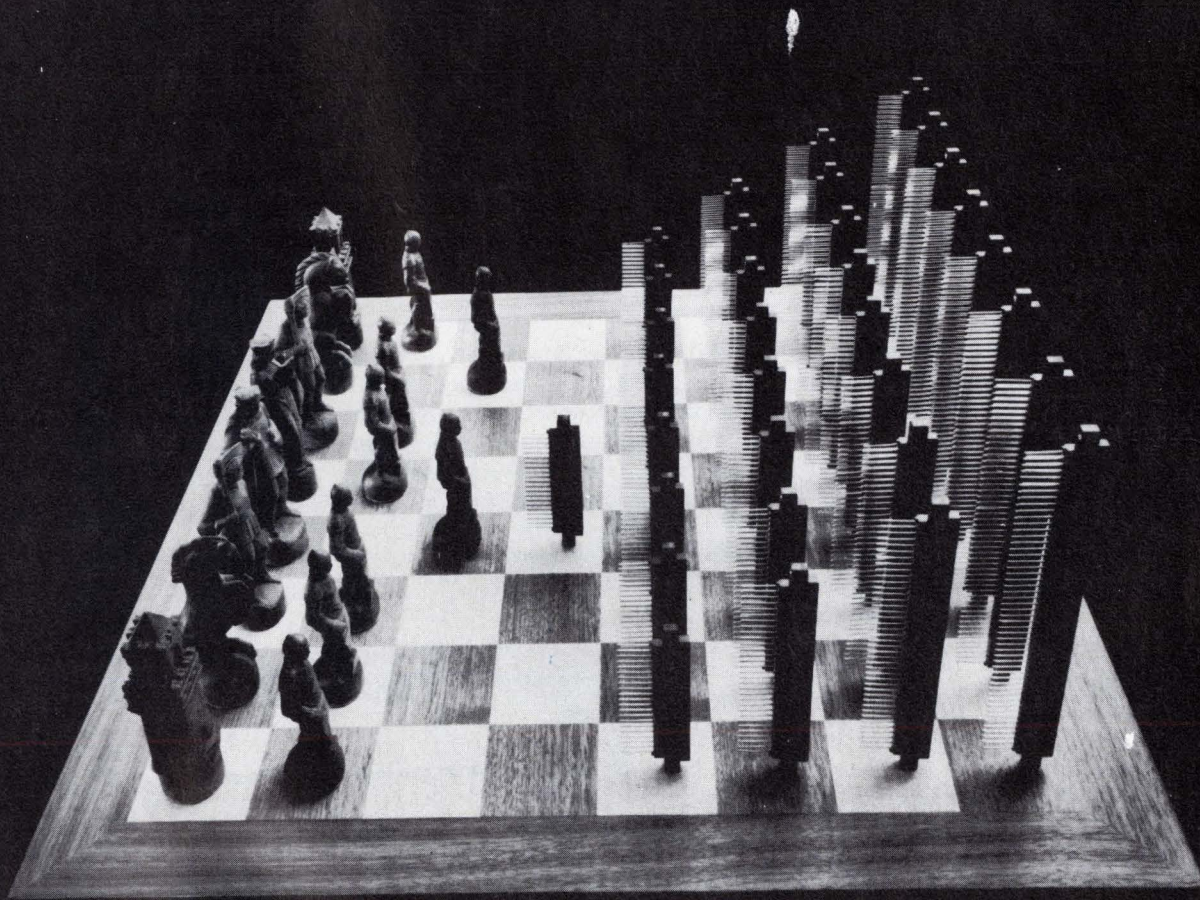

## new DW Series Edgeboard Connectors

Set 'em in close, row upon row. Design for high density wrap post interconnections. And for high volumetric efficiency . . . the kind of compact electronic package design that lets your system perform better, cost less, give less grief — and take up less space, too! If you're aiming for all this, then you'll want to know about new DW Series Edgeboard Connectors from Winchester Electronics and our authorized distributors. The DW Series is designed for 1/16" PC boards. Featuring low insertion/withdrawal forces (3/4 lb. and 1 oz. per contact respectively), these skinny, narrow-molded connectors feature mounting holes between connectors as close as 1/4" (center to center) for installation on your back panel.

Designed especially for today's automatic wrapping techniques, DW connectors are available off the shelf in over 30 standard sizes.



With grid spacing of .125" x .125" and with from 18 to 50 paired contacts to handle double-sided edgeboards.

The DW Series. It can put your design ideas giant steps ahead in today's battle for inner space. With **more** high performance functions in an electronic package made smaller and less costly. And with the profitable benefits of high efficiency, fast automatic wiring production to put your design ahead in the marketplace, too.

Check into Winchester Electronics DW Series Edgeboard Connectors, now. Write for complete details, today, to: Winchester Electronics Division, Main Street & Hillside Avenue, Oakville, Connecticut 06779 (203) 274-8891, or contact our nearest authorized distributor location.



**WINCHESTER ELECTRONICS**

Circle 85 on reader service card

Instrumentation

# Weathermen look to Finland

That's where Vaisala makes radiosondes and rain gages that are used by meteorologists in every latitude and longitude

by Arthur Erikson, Managing Editor, *International*, and Martin Schultz, *McGraw-Hill World News*

**Arctic winters** and bizarre midnight-sun summers make Finns particularly sensitive to the weather. And this sensitivity has been put to good use at Vaisala Oy, based in a Helsinki suburb. The company's radiosondes and rain gages have made Vaisala practically a household word among meteorologists all over the world. The company expects to sell 10 million Finnmarks (roughly \$2.77 million) worth of weather instruments this year, twice the sales figure that was turned in by Vaisala for 1970.

Vaisala's greatest success so far has been its RS-21 transistorized radiosonde. Lofted by a balloon, the sonde broadcasts pressure, temperature, and humidity readings from altitudes between 7,500 and 8,000 feet back to a ground station. The basic ground equipment—essentially a receiver and a recorder—runs from \$10,000 to \$20,000. The sondes themselves sell for \$20 and up. All told, Vaisala figures it will deliver 40 radiosonde ground systems, along with 80,000 sondes, this year.

For Rauno Sirola, marketing consultant for the company, there's no question as to why meteorologists from Greenland to Indonesia have opted for Finnish hardware. "We honestly believe we are years ahead technologically," Sirola boasts. He maintains that Vaisala was first to loft production transistorized radiosondes, back in 1961. The competition has since caught up on that facet of weather-instrument technology, to be sure. But Sirola maintains that Vaisala has bounded ahead again with a new wind-speed option for its radiosondes that the company introduced at the early-August Meteorex show in Helsinki.

With the new hardware, the basic balloon-position inputs needed to compute wind speed and direction at upper altitudes are picked up from the Omega very-low-frequency navigation network by a re-

ceiver on the radiosonde. Back at the ground receiving station, the radiosonde signals are picked up and processed automatically by a Data General Corp. Nova 1220 mini-computer. In a conventional wind-

**Tuned in.** Finland's Vaisala is watchword among weather men. One reason is this recorder.

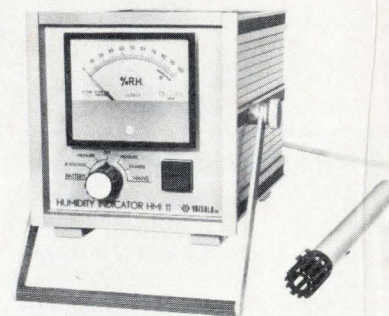
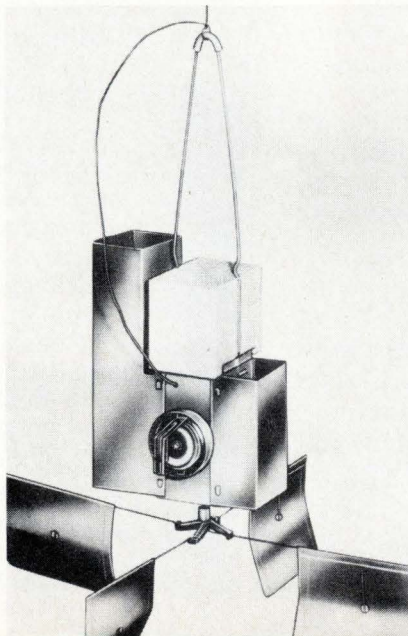

**It's not the heat.** The humidity indicator above is accurate to within 1%.

**Up, up.** Radiosonde balloon attachment at left carries sensors for pressure, humidity, and temperature readings aloft.

# POWER



## MODEL 473 POWER SIGNAL GENERATOR

### 50 watts of solid-state swept RF power!

From AILTECH comes a truly versatile and powerful Power Signal Generator — Model 473.

Capable of being swept over its entire frequency range of 225 to 400 MHz, Model 473 can be used as a cw signal source, linear sweeper, FM or AM generator — functions ideally suited for the development and testing of transistors, amplifiers, filters, matching networks, and all communications instrumentation.

Features include reflected power protection, all solid-state design, single control direct reading frequency dial accurate to 1%, power stability of 0.2 db, low harmonic content and low AM and FM distortion. And more.

AILTECH has always built the world's finest R F power sources. With the Model 473, we're simply maintaining a tradition.

Want to test Model 473? Write or call today.

PART OF THE GOLD LINE SERIES FROM

**AILTECH**   
A CUTLER-HAMMER COMPANY

EAST COAST OPERATION • 815 BROADHOLLOW ROAD • FARMINGDALE, NEW YORK 11735 • TELEPHONE: (516) 595-6471 • TWX: 510-224-6558

WEST COAST OPERATION • 19535 EAST WALNUT DRIVE • CITY OF INDUSTRY, CA. 91748 • TELEPHONE: (213) 965-4911 • TWX: 910-584-1811

Crowthorne, Berks, England (Crowthorne 5777) • 92 Gennevilliers, Paris, France (733.72.20) • Munich, West Germany (0811) 5233023

OTHER SOLID GOLD PRODUCTS FROM AILTECH INCLUDE SPECTRUM ANALYZERS, NOISE MEASUREMENT EQUIPMENT, FUNCTION GENERATORS, OSCILLATORS AND TRANSDUCERS.

Circle 87 on reader service card

# TRIACS & SCR's

## ELECTRICALLY ISOLATED STUD-MOUNT

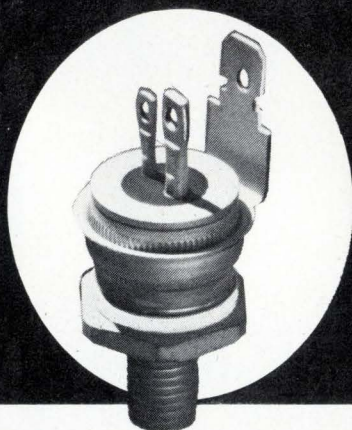

### TRIACS

6 A to 40 A ( $I_{T(RMS)}$ )  
50 V to 600 V ( $V_{DROM}$ )

### SCR's

8 A to 35 A ( $I_{T(RMS)}$ )  
50 V to 600 V ( $V_{DROM}$ )

BeO insulator provides superior thermal characteristics in dual hermetic packaging with a glass-passivated chip in an  $\frac{1}{2}$ " isolated stud-mount package. Center gate design for low switching loss — improved  $dv/dt$  ratings and  $di/dt$  characteristics.



Call or write for  
complete information

## HUTSON INDUSTRIES

BOX 34235 • 2019 W. VALLEY VIEW, DALLAS,  
TEX. 75234 (214) 241-3511 TWX 910-860-5537

### Distributed by:

In Canada: WEBER-SEMAE ELECTRONICS, Downs-  
view, Ont. 416/635-9880

### Vice-President, European Operations:

30 Rue Pierre Semard, Yerres, 91 France Tel:  
Paris 925-8258 • TELEX 21-311

### Distributed in Europe by:

Belgium: C. N. ROOD S.A. Brussels 02-352135  
■ Denmark: E. V. JOHANSEN A/S, Copenhagen  
(01)\* 295622 ■ Norway: INTELCO, Box 158,  
47 2 207451, Sentrum, Oslo ■ Spain: BELPORT,  
Madrid 234.62.62 ■ Sweden: ELEKTROFLEX, Sun-  
dyberg 08-28-9290 ■ Switzerland: D. LEITGEB,  
Dubendorf 051 85 9666 ■ UK, CLAUDE LYONS,  
LTD, Hoddeston, Hertfordshire (09924) 67161

## Probing the news

finding system, by contrast, the balloon has to be tracked by theodolite and the readings plotted manually to determine wind speed and direction.

The Omega-based system, which Vaisala calls CORA (an acronym for correlated radio wind system), sells for roughly \$50,000, including a regular ground system. For the extra money, weathermen get considerably more than the convenience of automatic windfinding. The CORA gear is accurate to within 1 meter per second; 2 meters per second is usual with theodolite systems. In both cases, accuracy for the direction is within  $\pm 2^\circ$ , depending on wind speed.

To pick up the Omega signals, a vlf receiver is tacked onto the radiosonde. Like all Omega receivers, Vaisala's compares phase differences of signals from different base stations to spot changes in position. However, instead of using conventional filters to recover the Omega signals, the Finnish hardware uses a digital correlator. This makes possible detection of signals that are up to 20 decibels below the noise levels, close to the theoretical limit.

The Omega signal modulates the radiosonde's transmitter (403 megahertz for vhf systems, 1,680 MHz for uhf) along with the sonde's usual pressure, temperature, and humidity signals. These signals are picked off sensors that vary the capacitance of three condensers. These and two reference capacitors are switched sequentially into a 25-MHz oscillator that frequency-modulates the transmitter. Frequency swing of the oscillator is from 23.6 to 26 MHz; the pressure, temperature, and humidity signal, plus the two reference signals, are transmitted in 0.1-millisecond bursts (each signal is transmitted twice during the 1-second interval allotted it) every 400 ms.

Vaisala calibrates the pressure and temperature capacitors at the factory, using a computer to match output frequency and simulated pressure temperature conditions. Humidity sensors have to be calibrated at the observing station because they aren't time-resistant;

they are recalibrated constantly as the time for liftoff approaches.

**Down to earth.** Although the bulk of Vaisala's business is radiosondes, the company has some noteworthy down-to-earth weather instruments in its catalog. "Our automatic rain gage is already five years old, but it's still the most advanced for its type and its price range," maintains marketing consultant Sirola. True or not, Vaisala has sold more than 20 of the \$4,000 gages and predicts that sales will hit the 100 mark by 1975.

The gage measures precipitation as it falls, rather than at intervals; that eliminates error caused by evaporation. The water is collected in a large bowl and transferred into a measuring chamber 10 millimeters in diameter and 120 mm long, where, in essence, its capacity is measured by a probe. The readout is digital, and it's transmitted to a remote display unit over telephone lines.

Crucial to the automatic rain

**Latest model.** Vaisala's RS-24 radiosonde causes stir among meteorologists.



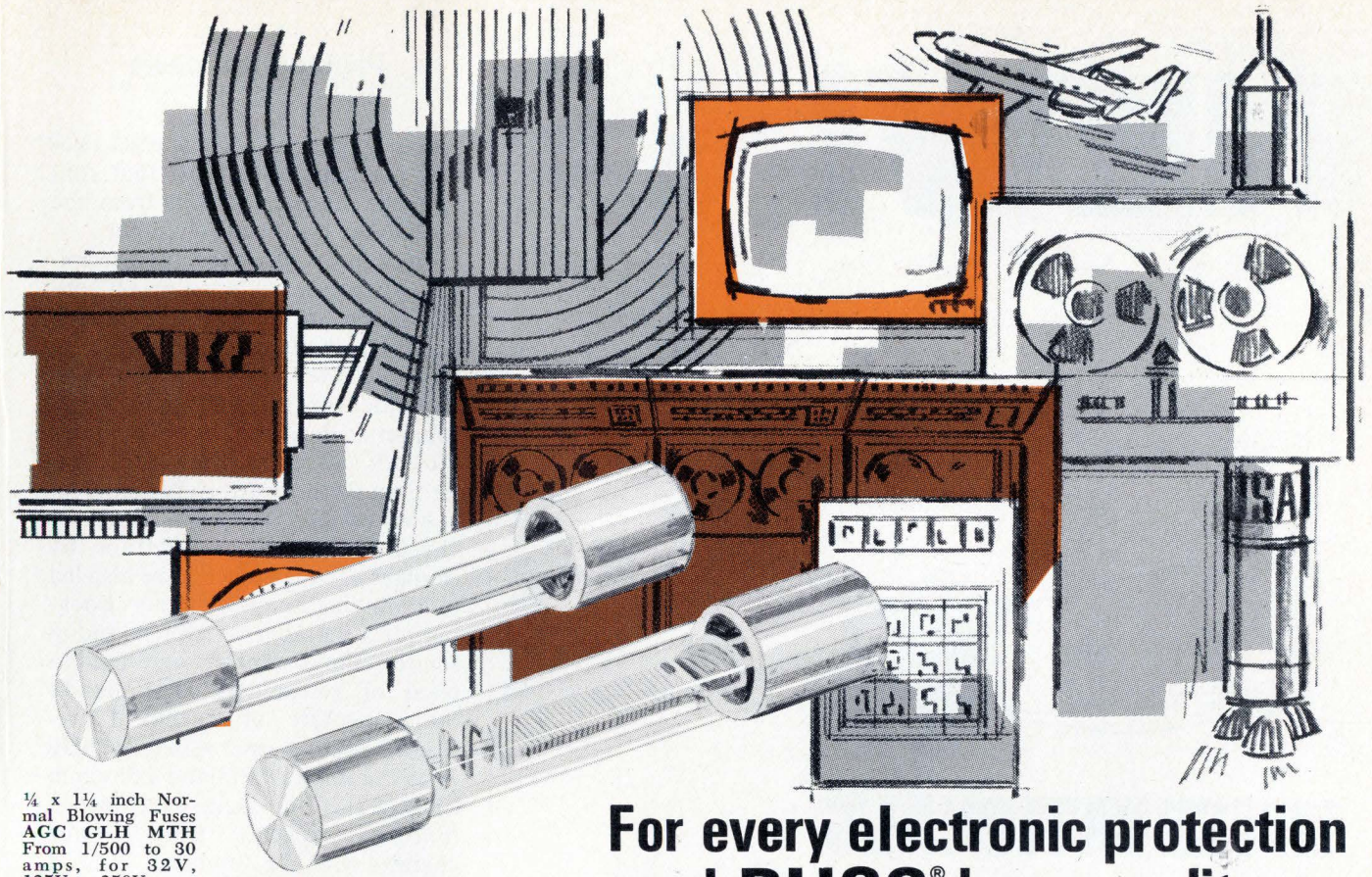

¼ x 1¼ inch Normal Blowing Fuses  
 AGC GLH MTH  
 From 1/500 to 30  
 amps, for 32V,  
 125V, or 250V

¼ x 1¼ inch Time  
 Delay Fuses — From  
 1/100 to 30 amps,  
 MDL MDX for 32V,  
 125V, or 250V

## For every electronic protection need **BUSS**® has a quality Fuse and Fuseholder

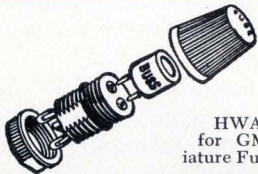

HWA Fuseholder  
 for GMW Subminiature Fuses

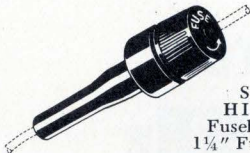

Series HH and  
 HI In-the-Line  
 Fuseholder for ¼ x  
 1¼ Fuses



HTA Space-Saver Panel-Mounted Fuseholder for ¼ x 1¼ Fuses (solder terminals) also HTA-DD, ⅜ Quick-Connect Terminals and HTA-HH, ¼ Quick-Connect Terminals

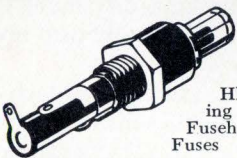

HKL Lamp Indicating - Panel - mounted Fuseholder for ¼ x 1¼ Fuses

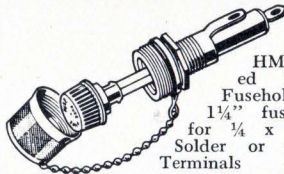

HMR RF-Shielded Panel-Mounted Fuseholder for ¼ x 1¼ fuses and HMS for ¼ x 1 fuses — Solder or Quick-Connect Terminals



HLD Visual-Indicating Panel-Mounted Fuseholder — for ¼ x 1¼ Fuses — Solder or Quick-Connect Terminals

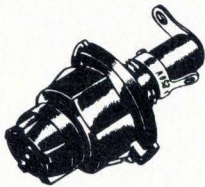

NEW: BUSS SNAP-LOCK rear panel mounted fuseholder for ¼ x 1¼ fuses — a "snap" to install  
 Ask for BUSS Bulletin SFH-14

The BUSS line of fuseholders is as complete as the BUSS line of fuses, covering all applications.

If you've got a circuit to protect, BUSS has the fuseholder as well as the fuse to protect it.

For more information on the complete line of BUSS fuses, fuseholders, fuseblocks, and fuse clips, write for a free copy of BUSS Bulletin SFB.



BUSSMANN MANUFACTURING  
 a McGraw-Edison Company Division  
 St. Louis, Missouri 63107



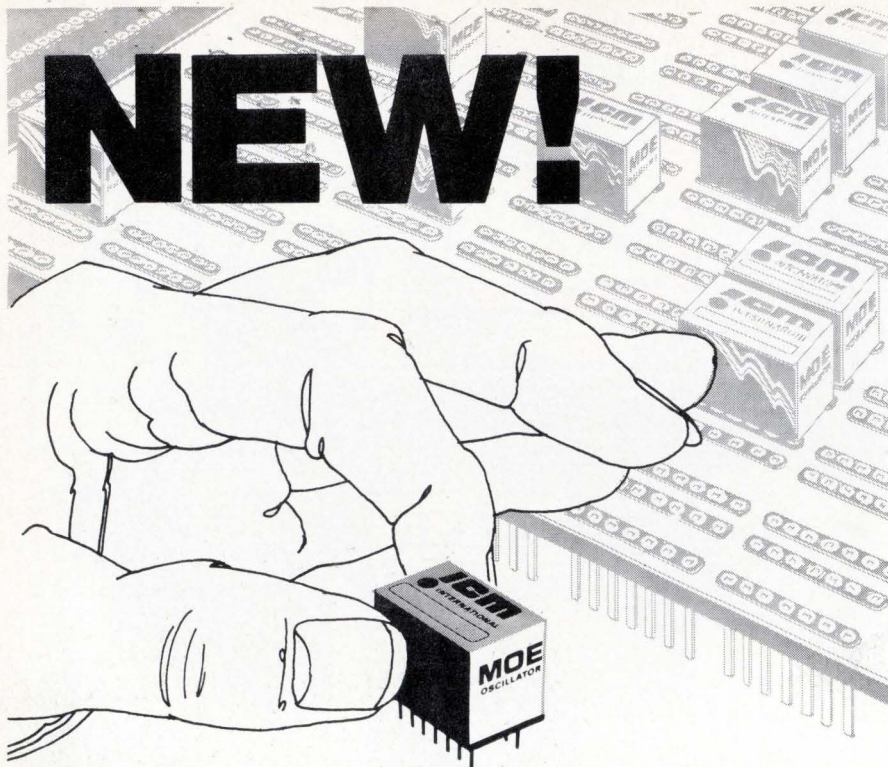

# NEW!

## INTERNATIONAL'S MOE Crystal Oscillator Elements provide a complete controlled signal source from 6000 KHz to 60 MHz

The MOE series is designed for direct plug-in to a standard dip socket. The miniature oscillator element is a complete source, crystal controlled, in an integrated circuit 14 pin dual-in-line package with a height of 1/2 inch.

Oscillators are grouped by frequency and temperature stability thus giving the user a selection of the overall accuracy desired. Operating voltage 3 vdc to 9 vdc.



TYPE	CRYSTAL RANGE	OVERALL ACCURACY	25°C TOLERANCE	PRICE
MOE-5	6000KHz to 60MHz	+ .002% -10° to +60°C	Zero Trimmer	\$35.00
MOE-10	6000KHz to 60MHz	+ .0005% -10° to +60°C	Zero Trimmer	\$50.00

gage's operation is the special two-way magnetic cock valve that controls the transfer of rain from the bowl to the measuring chamber.

Once in the chamber, the precipitation is measured by an on-off contact probe, which is triggered each time the chamber fills, and it, in turn, activates a pulse driver. The driver delivers the drain pulse to the counter at the same time it operates the cock valve, which drains the water from the measuring chamber.

**Fast reading.** Vaisala's knack for checking weather conditions by changes in capacitance have also led to a low-cost humidity meter. Looking for a better sensor for its radiosondes, the company consulted a team of researchers at Finland's State Institute of Technical Research. With some financial help from the Bank of Finland's research fund (Sitra), the team developed a thin-film capacitor whose value changes with the humidity. With a capacitance bridge and a digital readout, it makes a \$700 direct-reading relative-humidity meter that covers the full 0% to 100% range. The response time is particularly faster—at 20°C, for example, the meter reaches 90% of the final reading within 1 second.

Vaisala's humidity sensor, the Humicap, is fabricated by straight-forward thin-film technology. The finished Humicap measures 4 mm<sup>2</sup> in surface area and it's 1 micrometer thick. As have the humidity meters, the Humicap will eventually turn up in Vaisala's radiosondes.

Vaisala's other major high-technology weather instrument is an antenna system that tracks weather satellites automatically over a whole hemisphere. Vaisala calls the system ELSA, for electronic lobe-switching antenna. Twenty of these \$18,000 systems are operating in Asia, Africa, Europe, and the U.S.

Antennas are fixed, and there are eight of them. Two, 4.5 meters high, point to the zenith; the other six are high-gain cross antennas with overlapping lobes. The signal from each antenna is compared with those from the others, and a logic system switches the strongest signal onto the receiver. □

# The 5 fastest ways to make better inverters.

**1 The new 81RM — fastest 125 Amp inverter SCR around.**

It has 20 $\mu$ S turn-off, through 1000V, with efficiency that cuts filtering, commutating and snubbing costs up to 30% in new designs. Plugged into existing circuits, it can increase overload capability or power rating by 50%. Its 30% lower switching losses let you operate efficiently at 10KHz. And for today's circuits, a guaranteed turn-off time of 25 $\mu$ S with an antiparallel diode gives unequalled speed. The best "soft recovery" in the business assures the lowest RFI generation, minimizes false triggering and improves reliability. Voltage ratings from 100-1000V.  $dv/dt$  is 200V/ $\mu$ S, and  $di/dt$  is 800A/ $\mu$ S.

**2 New 35 Amp IR140/141's. None faster. Lowest switching losses.**

At 15 $\mu$ S and 10 $\mu$ S turn-off, there are no faster SCRs in their range. But what really sets them apart is the 30% lower switching loss for unequalled efficiency at high frequencies. No derating to 4KHz, and 50% of the rated current at 20KHz. Excellent as commutating SCRs. Conforms to JEDEC 2N3649-58. Reapplied  $dv/dt$  is 200V/ $\mu$ S, and  $di/dt$  is 400A/ $\mu$ S. Voltage ratings: 50-400V.

To get our Inverter SCR "Data pack" fast, write Dept. E

International Rectifier  
233 Kansas Street  
El Segundo, CA 90245

**New — The fastest Turn-Off (10 $\mu$ S) high-current inverter SCRs available!**

These low-frequency inverter SCRs turn off four times faster than others at their power level. You can reduce commutating component size and cost 1/3 and still increase inverter ratings with greater reliability. Higher surge ratings give you bigger safety margins, easier fuse selection. To top it off, you can choose from three package types in 50-600V ratings to optimize your design.

**3 New 430 Amp (RMS), 275RF Series.** The only stud-mounted 430 Amp (RMS) inverter SCR available. 7000 Amp surge rating. 200,000A<sup>2</sup>Sec. I<sup>2</sup>t rating.

**4 New 710 Amp (RMS), 450PF Series.** Rated 710 Amp (RMS), this ceramic "Hockey Puk" has a surge rating of 9000 Amps and I<sup>2</sup>t of 340,000A<sup>2</sup>Sec.

**5 New 710 Amp (RMS), 451PF Series.** For maximum economy, the first and only plastic encapsulated 710 Amp (RMS) "Hockey Puk" SCR. Surge rating: 9000 Amps. I<sup>2</sup>t is 340,000A<sup>2</sup>Sec.



# International Rectifier

...the innovative power people 

# WE CALL THE 840 THE LOADED NOVA.

## IT'S TOO BIG AND HAIRY TO BE A MINICOMPUTER.

By minicomputer standards, our new Nova 840 is big and hairy and costs a lot of money.

But, in terms of combined hardware/software performance, minicomputer standards just don't apply to the 840.

### BIG HARDWARE

We loaded the 840 with a brand new Memory Management and Protection Unit that turns it into something far more than a minicomputer. MMPU lets the 840 grow to 128K 16-bit words (256K bytes) of main memory, and, most important, lets it take advantage of all the hairy software we've developed.

The 840 also comes with a whole list of peripherals and high-performance options, including a superfast new Floating Point Unit that handles single and double precision arithmetic at speeds that match most big computers.

### HAIRY SOFTWARE

But hardware is only the vehicle. What makes the 840 a different kind of machine is software: the most powerful software available with any

computer at anywhere near its price. Proven software we can deliver today.

It has a Real-time Disc Operating System that supervises the whole system; our new Fortran 5, that produces globally optimized, fast-executing code that's as efficient as machine language; Batch; remote job entry software; timesharing BASIC; and Extended Algol.

Dual Operations on the 840 lets you run any two major software streams concurrently and with complete security: multi-terminal timesharing BASIC along with remote job entry, or a real-time control application while you're doing prototype development in Algol.

### THE PROOF

With all that hardware/software muscle, the 840 has embarrassed a lot of far bigger computers in price/performance benchmark comparisons.

For instance, there was the XDS Sigma 7 that was 40% faster running an independently conducted Fortran

benchmark. And then got wiped out by the 840's more-than 10-to-1 price advantage.

Or the DECsystem-1050 that cost eight times more than the 840. And was actually 7% slower running the benchmark.

If you think those benchmarks are too good to be true, just call us. We'd love the chance to give you a lot more details on the benchmarks and how Data General software makes that kind of price/performance possible.

### THE PAYOFF

We know that Data General isn't the only minicomputer company with a big hairy machine.

We also know that the 840 is, capability-for-capability, feature-for-feature, consistently less expensive than the competition.

And we know we can deliver the 840 faster than the competition can deliver their machines: 90 days after you call us with an order. (617) 485-9100.





# The Case Of The

One of our customers kept losing his digits.

When digits were punched into their CRT terminal, frequently they never showed up on the display terminal.

They got lost.

Or, sometimes, the wrong digits showed up.



A little detective work seemed in order, so our customer called the local Field Applications

Engineer from National Semiconductor, Bruce Mattern.

Bruce figured the problem was to prevent illegal over-voltage spikes that were "nailing" the shift registers and stealing the digits. He added other components to the circuit, thereby controlling the voltage.

It worked.

Problem solved.

Happy customer.

## **The Scotland Yard of the electronics business.**

Our Field Applications Engineers (FAE's) are a field force of 40 top-notch experienced engineers.

Consultants. Free-wheeling types who love to design and create and solve problems that our customers throw at them.

They're also profit-making oriented. With the idea of solving technical aspects in ways that are economically feasible.

They can be a lot of help to our customers.

They might be of some help to you.

## **The Digit Finder.**

Take our FAE Bruce Mattern, for example.

# Disappearing Digits.

He's been with us for about a year or so now. His previous experience was three years with Hazeltine Corporation in R&D, and a year as a systems engineer for Bell Telephone.

He got his BSEE from Penn State.

And, as an example of his creativity, he not only found that customer's missing digits, he wrote the headline for the ad you're reading now.

## Our nifty shift registers.

Since it was our shift registers that found the missing digits, maybe we should say a word or two about them.

Our MM4055/MM5055 family of 512-bit silicon gate static shift registers feature TTL compatibility, on-chip clock, recirculate logic, 2.2 MHz maximum guaranteed operating frequency.

Our speedy dynamic shift registers, like the MM4025/MM5025, family are 2048 bits dense and feature 6 MHz maximum guaranteed data rate, on-chip recirculate logic, and 8-pin mini-dip (not to be

confused with skinny-dip).

## Which brings us to our new MOS devices.

You'll be tickled to hear that we have a couple of new digital clocks available now.

One with the catchy name, "MM5311-14." It'll do nicely for all the digital clock applications.

And another, our MM5316 alarm clock for all industrial and consumer control applications such as "snooze controls," alarm, countdown circuits, etc.

Also hot off the press, one-chip calculator

(MM5725). And a

TV camera sync generator for television camera and VTR applications MM5320.

For further information on any of these new products, or our shift registers, or how to reach one of our FAE's, write National Semiconductor Corporation, 2900 Semiconductor Drive, Santa Clara, California 95051.

Or, to heck with the expense, call (408) 732-5000.



# National/MOS



# NOW THERE'S A BELL & HOWELL TAPE RECORDER FOR ALL ENVIRONMENTS.

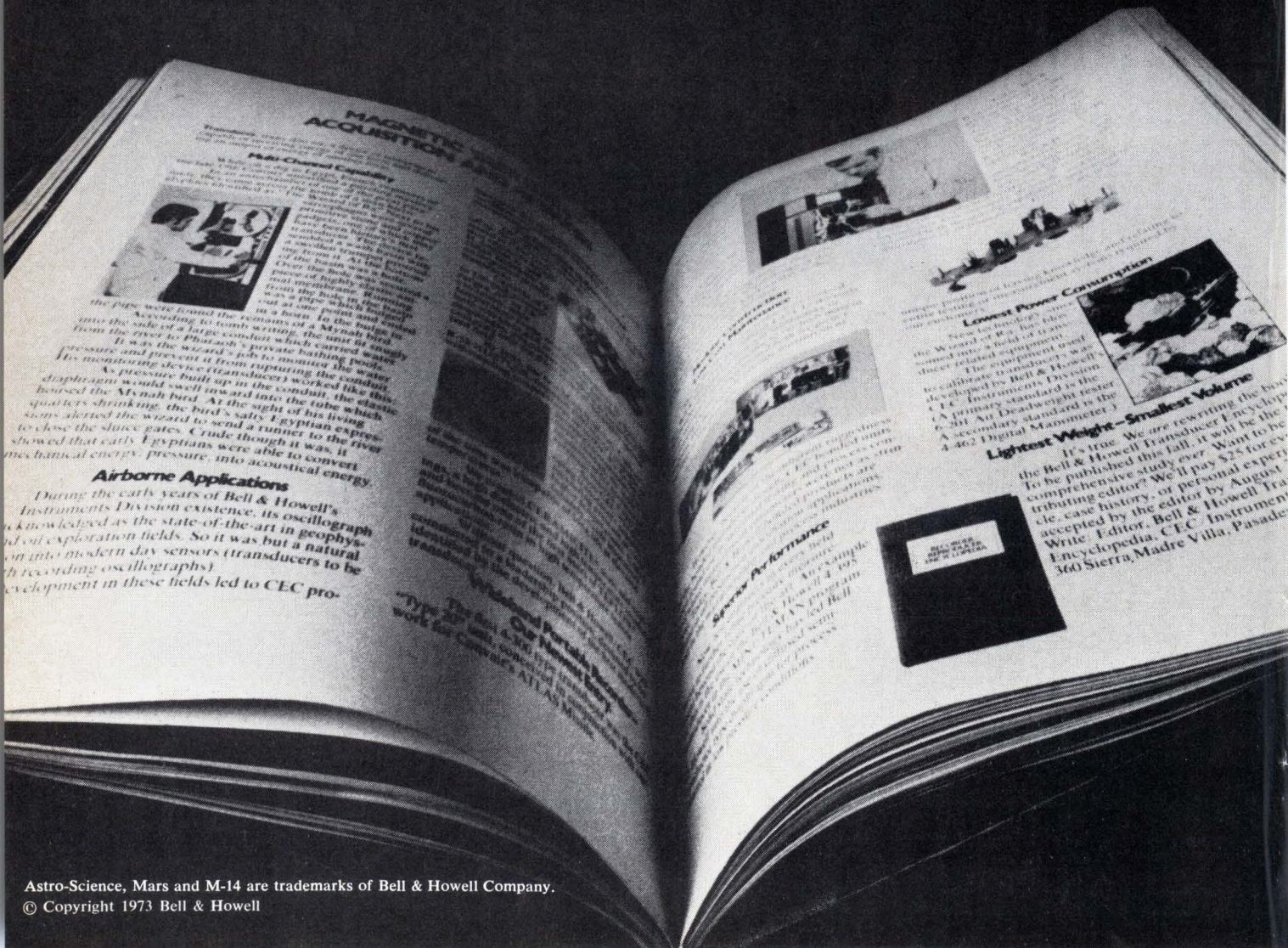

## MAGNETIC ACQUISITION

### Multi-Channel Capabilities



Multi-channel capabilities are essential for the acquisition of data from multiple sensors or channels. This system allows for the simultaneous recording of multiple channels of data, providing a comprehensive view of the data being collected.

According to tomb writing, the unit is buried in the river to Pharaoh's private bathing quarters. His monitoring device (transducer) worked like this: As pressure built up in the conduit, the elastic diaphragm would swell toward into the tube, which alerted the wizard. At the sight of his living quarters alerted the wizard to send a runner to the river to close the sluice gates. Crude though it was, it showed that early Egyptians were able to convert mechanical energy (pressure) into acoustical energy.

### Airborne Applications

During the early years of Bell & Howell's Instruments Division existence, its oscillographs were known as the state-of-the-art in geophysical and oil exploration fields. So it was but a natural step into modern day sensors (transducers to be used in recording oscillographs).

The development in these fields led to CEC products. The instruments were designed to be rugged and reliable, capable of operating in harsh environments. They provided accurate and detailed recordings of data, which were essential for the success of these operations.

The system is designed to be used in a variety of applications, including industrial, scientific, and military. It is capable of recording data at high speeds and with high accuracy, making it a valuable tool for many different types of work.

The system is also designed to be easy to use and maintain. It has a simple and intuitive interface, and it is capable of operating for long periods of time without the need for frequent maintenance. This makes it a very practical and reliable choice for many different types of applications.



This device is designed to provide accurate and reliable recordings of data. It is capable of operating in a wide range of environments, and it is easy to use and maintain. It is a valuable tool for many different types of applications.

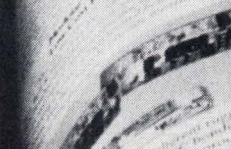

This device is designed to provide accurate and reliable recordings of data. It is capable of operating in a wide range of environments, and it is easy to use and maintain. It is a valuable tool for many different types of applications.



This device is designed to provide accurate and reliable recordings of data. It is capable of operating in a wide range of environments, and it is easy to use and maintain. It is a valuable tool for many different types of applications.

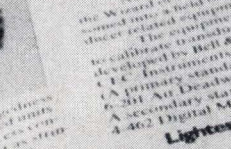

This device is designed to provide accurate and reliable recordings of data. It is capable of operating in a wide range of environments, and it is easy to use and maintain. It is a valuable tool for many different types of applications.



This device is designed to provide accurate and reliable recordings of data. It is capable of operating in a wide range of environments, and it is easy to use and maintain. It is a valuable tool for many different types of applications.



This device is designed to provide accurate and reliable recordings of data. It is capable of operating in a wide range of environments, and it is easy to use and maintain. It is a valuable tool for many different types of applications.

## More "mores" More "biggests" More capabilities. Now.

Now that Astro-Science has joined Bell & Howell, you can call on a single source to meet your data acquisition and analysis system needs. Now, Bell & Howell has the *most advanced* line of recorders and reproducers. With the *biggest range* of capabilities. And with the *largest* staff of service representatives in the industry.

As leaders in laboratory grade magnetic tape recorders/reproducers, we've been keeping an eye out for a colleague with a track record of success in "hostile environments." We've found the perfect organization: Astro-Science, No. 1 in lightweight, small-volume, low-power consumption, high-performance tape recorders.

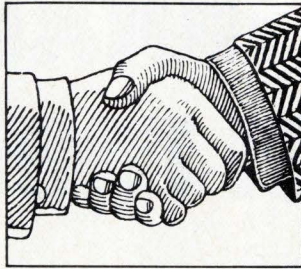

## Our new "high" performance recorders.

Astro-Science has brought under the Bell & Howell banner the remarkable MARS family. There's nothing like 'em. Take the MARS 1400. This precocious little baby is the smallest and lightest multi-speed, lowest power consumption, 14-inch reel airborne recorder going. Hostile environment? It can really take it. All the time. Providing six speeds of operation in 14-28 and 42-channel configurations.

Sharing honors with the dazzling 1400 is the even slimmer and trimmer MARS 1000. It's also state-of-the-art in ruggedness and reliability. Six speeds of wideband data. 14-28 or 42 channels.

Cousin MARS 2000 bears a family resemblance. Developed in an Intermediate and Wideband configuration, this small fry has six speeds and records 14 channels of intermixed direct, FM, and digital data.

Another high flyer, our M-14E, is ideal for airborne tasks. But you're *also* likely to find it in shipboard and mobile applications. It has no competition as a 2MHz direct, FM, and digital wideband unit using 1-inch tape on 14-inch reels and operating at 7 tape speeds.

## Taking notes at 50 fathoms plus.

Many recorder characteristics that are appreciated in the wild blue yonder are equally admired in the deepest briny deep. Lightweight, for one thing. Compactness. Reliability. Our Model M-14G has them all. Designed for sub-surface, land or mobile environments, this wonder "gets it on" where

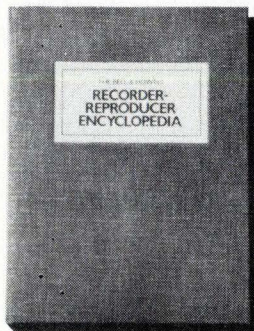

portability and ease of maintenance are important. With 14 or 28 tracks of analog, FM, or digital electronics, the unit has 7 electrically selectable tape speeds.

**Meanwhile back on terra firma.** Need laboratory-caliber performance in rugged and remote field applications? Call on our CPR-4010. This portable has up to seven channels on half-inch and up to 14 channels on 1-inch tape. Seven speeds are standard. Easy maintenance and repair are among its sterling qualities.

The CPR-4010's brother, the wideband CPR-4040, is known in certain select circles as the No. 1 in price-to-performance ratio. Co-planar, portable, this versatile unit features seven bi-directional speeds providing up to 1MHz frequency response at 60 ips.

## We made it big in laboratory grade.

Solving customers' problems is our job. The industry leader, our VR-3700B, is a superb laboratory problem solver. This workhorse recorder/reproducer operates in a wide range of speeds and frequencies. It's available in 7, 14, 28, and 42-channel configurations. It's easy to maintain. With proven reliability. Low cost. All electronics are modular, electrically switchable, and capable of operating at any 8 speeds in Direct or FM modes. High-density PCM/HDDR signal electronics available on order.

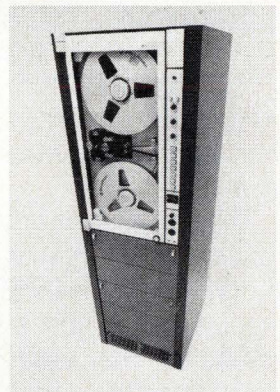

**Single-source capability.** In acquisition and analysis, in hostile environment or laboratory, plainly put, Bell & Howell has more than anybody else: The most advanced line. The widest range. The best service.

**We're rewriting the book.** It's true, we are rewriting the book. The Bell & Howell Recorder/Reproducer Encyclopedia Handbook. It will contain general information and practical aids to help you select the best recorder/reproducer for your project. If you have a point of view, or comment, or a personal story you'd like to contribute to our book, we'll pay \$25.00 for each item selected by our staff. Write Editor, Encyclopedia, Bell & Howell/CEC/Instruments Division, 360 Sierra Madre Villa, Pasadena, California 91109.



**BELL & HOWELL**

WE'RE REWRITING THE BOOK.

# These digital panel meters are changing your thinking about digital panel meters.

They all operate on 5 volts DC. A new class of DPM's.

Most of your electronic systems have lots of digital logic all over the place along with 5 volts of DC to power it. We pioneered a way to use the same 5 volts to power the DPM as well.

The first thing this means is that you don't need a separate power supply just for the DPM. That saves money. It saves space. Less heat is generated. The design becomes simpler and the reliability is improved.

Then, because line-power voltage is kept away from the DPM and its inputs, internally generated noise is virtually eliminated. You get more reliable readings.

Now you can think of a DPM as a component just like any other logic component in your system.

We offer DPM's optimized for economy display applications. Like the AD2001, 3½ digits — \$89\*. The AD2002, a \$59\* 2½ digit replacement for analog meters.

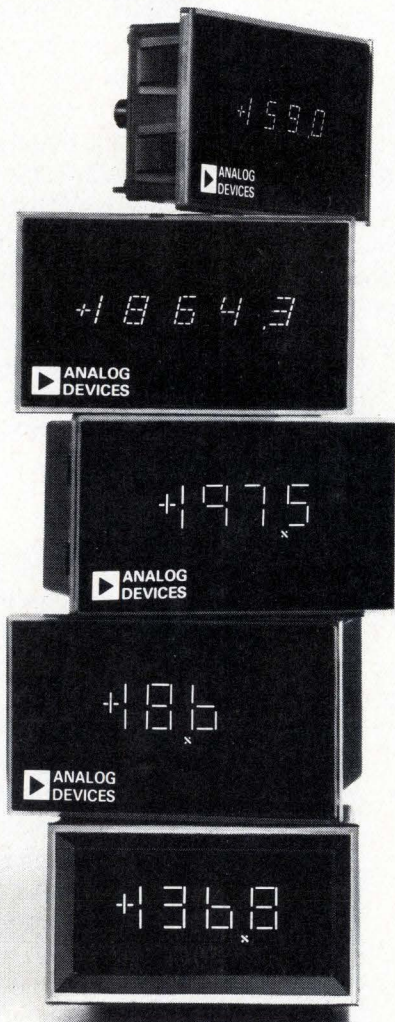

And the smallest, the AD2010, a 3½ digit LED display DPM with fully latched BCD outputs at only \$89\*.

Then, for system interfacing requiring exceptionally clean digital outputs, good isolation and high noise immunity, we offer the AD2003, a 3½ digit DPM with differential input, CMR of 80dB and normal mode rejection of 40dB at 60Hz. All for \$99\*.

If you need 4½ digits, there's the AD2004 LED display DPM with an optically isolated analog section, and fully floating differential input providing CMR of 120dB at ±300 volts and normal mode rejection of 60dB at 60Hz or 50Hz. This one's \$199\*.

BCD outputs on all.

All small.

All given a seven-day burn-in for added reliability.

Our thinking hasn't stopped because yours hasn't either.

And our DPM's give you a lot more to think about.

Analog Devices, Inc., Norwood, Mass. 02062.

\*All prices are the 100-piece price.

**ANALOG DEVICES**

**Call 617-329-4700**

for everything you need to know about 5 volt DC powered DPM's.

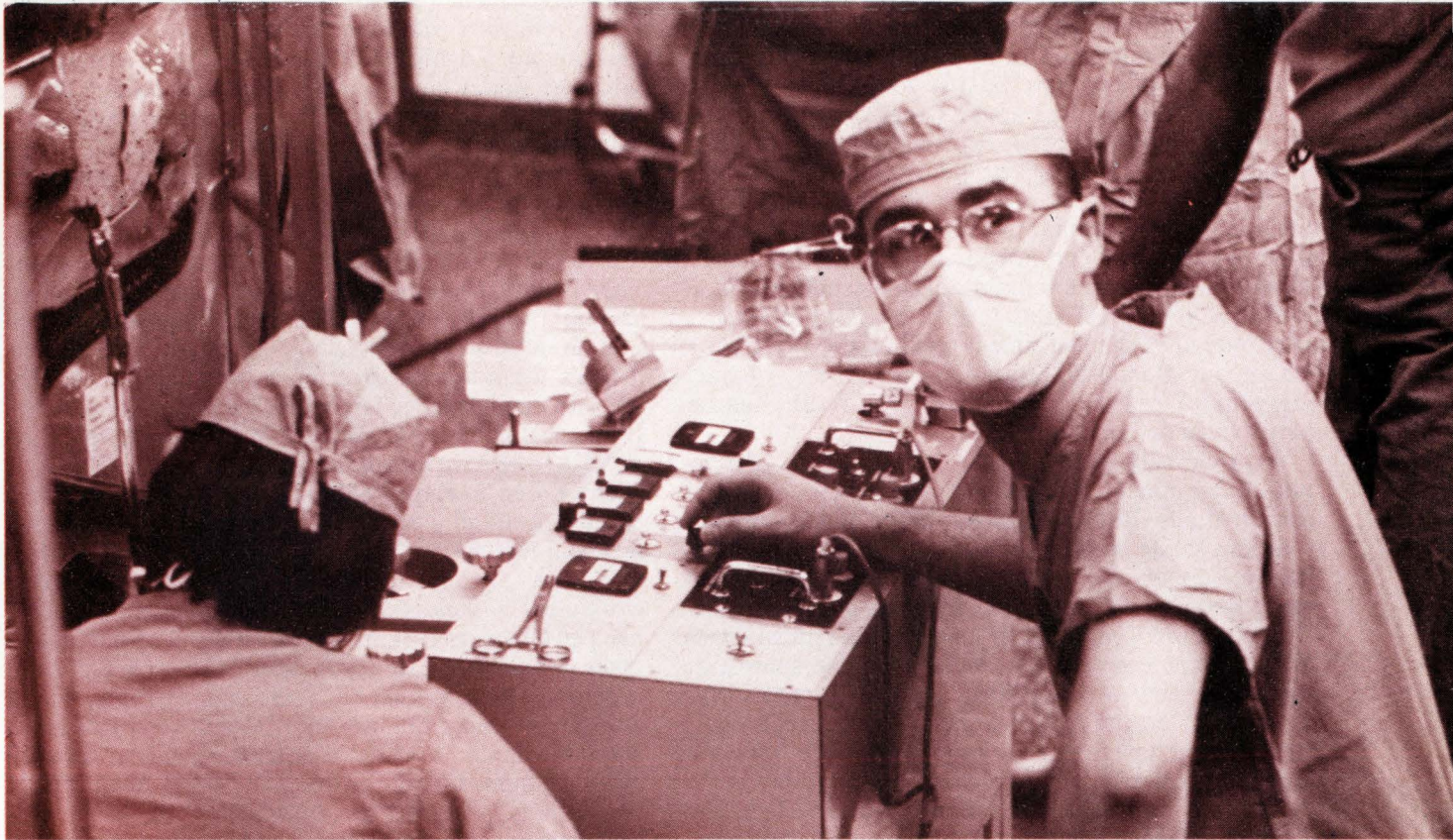

# Doctors call for emphasis shift in designing electronics for hospitals

Hospital officials suggest that manufacturers stifle their tendencies to build exotic equipment and place more emphasis on simpler instruments that are easy to operate and can tolerate the hospital environment

by Michael J. Riezenman, *Instrumentation Editor*

□ Despite the widespread acceptance and success of such medical electronic devices as X-ray machines, electrocardiographs, and cardiac pacemakers, further expansion of electronics into the health-care field depends on overcoming some objections, criticisms, and even resistance on the part of many doctors.

Although substantial progress is being made in such areas as patient monitoring, advanced X-ray technology, infrared thermography, ultrasound and isotope imaging, most of the 12 doctors interviewed for this report say that the electronics industry has a tendency to place too much emphasis on exotic devices with little or no legitimate applicability, while insufficient stress is placed on a variety of urgent problems, some of which appear to be mundane. Four criticisms predominate:

- Electronic equipment is often poorly suited to the rigors of the hospital environment.
- It is often poorly user-engineered.
- Standards don't exist.
- Much existing equipment cannot tolerate the power-line fluctuations that are so prevalent in this age of brownouts.

It may come as a surprise to electrical engineers, who tend to think of hospitals as quiet places where sick people are treated in comfortable surroundings, to learn that the hospital environment is extremely hostile to electronic equipment. For one thing, much electronic equipment—particularly monitoring equipment—is used

# SPECIAL REPORT

on extremely sick people whose conditions are highly unstable. This means that the patients to whom the equipment is connected, or near whom the equipment is likely to be situated, have a fairly good chance of developing such problems as apnea (stoppage of breathing) or asystole (stoppage of the heartbeat).

Needless to say, the key element in treating these conditions is speed. And when doctors and nurses are literally running around in a room, they don't have the time to make sure that nobody bumps into the delicate electronic equipment standing near the patient. Poorly balanced equipment is more than likely to be knocked base over apex the first time it gets in the way during an emergency. Similarly, projections have a way of catching people's sleeves or pant cuffs with results that are better imagined than described.

Another factor that contributes to the rigors of a hospital environment is the fact that hospitals practically run on fluids. Bottles of blood, blood plasma, glucose solution, saline solution, various drugs, samples of urine, etc., are all over the place. As a result, says Dr. Seymour Ben-Zvi, director of the Scientific and Medical Instrumentation Center at the Downstate Medical Center in Brooklyn, every time a doctor or nurse spots a flat surface, he puts a bottle down on it. If the flat surface happens to be the top of a piece of electronic equipment, and if an instrument happens to have some vent holes in the top, it's only a matter of time before the fluid winds up inside it. To combat this problem, Ben-Zvi has arranged for his staff to mount all flat-topped instruments with vent holes in such a way that the tops are tilted and cannot be used as temporary storage places for bottles.

## User engineering

Fluid spillage and normal banging around are perhaps the mildest environmental factors with which electronic equipment must cope. The situation gets brutal when large beds are wheeled around and rammed into shelves on which instruments may be standing. Perhaps the ultimate in harsh treatment, as described by Dr. Ben-Zvi, is the autoclaving of an entire instrument. This kind of mistake is less surprising than it may sound at first. Ben-Zvi explains that much equipment is autoclaved as a matter of routine, and to a nurse who knows nothing of electronics, it seems perfectly natural to stick a whole monitoring scope into an autoclave.

When a heart-attack victim goes into ventricular fibrillation—a condition in which the ventricles of the heart contract in a convulsive, non-synchronized fashion—the pumping effectiveness of the heart is reduced to zero, and emergency action must be taken immediately, or the patient will die. The standard treatment for ventricular fibrillation is the application of a short-duration high-current pulse through the patient's heart by means of large paddle-shaped electrodes placed across the chest. Naturally, to be effective, a defibrillator must be brought to a patient's bedside, turned on, and put into action with a minimum of knob-twirling and other fuss and bother.

Most defibrillators meet these requirements. However, Dr. Erich E. Brueschke, a physician-engineer who heads the medical-engineering research effort at the Illinois Institute of Technology Research Institute in Chicago, recalls a situation in which a manufacturer brought him a defibrillator that looked good and had an adequate power output, but had its fuse inside. Therefore, "by the time you get the case off to replace the fuse," Brueschke explains, "the patient is dead."

Besides this presumably obvious idea that emergency equipment must be able to be put into action in a hurry, user engineering for medical equipment must take into account the fact that doctors and nurses are extremely busy people. Dr. Ben-Zvi regards the idea of a manufacturer coming to a hospital to give a course on the operation of his latest machine as totally impractical. There's too much turnover on hospital staffs, he says, and not enough time. Therefore, he says, the operation of medical equipment must be made simple and fool-proof, and require little or no pre-training.

Dr. Karen S. Kagey, chairman of the subcommittee on electrical and electronic requirements at Peter Bent Brigham Hospital in Boston, recalls that a study at Massachusetts General showed that people distrusted equipment because they didn't understand it. One of her pet bugbears is that "Much equipment has inadequate or inappropriate instructions." There is a push to have instructions put on units, she says, but they are not always written for the user. For instance, electrocardiograph machines look at two or more signals to form an algebraic sum—but the instructions don't tell the user why certain protocols are followed. Thus, if an ECG limb-lead is supposed to be placed on the patient's left wrist, for example, but the left arm has been amputated, the uninformed nurse will have no idea of how to handle the situation. Kagey came up with a set of instructions for this case, and the staff knows how to use them. But she notes, "There are no hospital-wide rules of the road [for electronic equipment] and I think this compromises the use of the systems."

A more insidious user-engineering error, described by Dr. Ben-Zvi, concerned a special surgical drill designed for drilling through the stapes—a tiny bone in the middle ear. The drill was controlled by a footswitch. Both the drill and the footswitch plugged into a control box. Both used the same kind of connector, but the jacks on the control box were unlabeled. If the plugs were interchanged, Ben-Zvi found out, the drill still worked, but it put 37 v dc across the patient's brain.

## Standards are lacking

"A core affliction of today's . . . clinical monitoring is lack of standardization. We have a hodgepodge of incompatible connectors and devices along with non-uniform operations techniques. Incompatibility of components (that are ostensibly designed to serve similar tasks) requires a larger inventory of spare parts, interferes with teaching, introduces safety hazards, and frequently leads to ineffective monitoring. Moreover, since it is difficult to build up a system out of components provided by more than one manufacturer, the consumer tends to be restricted in choice of suppliers. Competition is stifled. Forced dependence on a manu-



facturer-oriented system leads to added expense, poor service, inflexibility, and early obsolescence." So wrote Dr. John M. R. Bruner, an anesthesiologist at the Massachusetts General Hospital, in 1971, and so might he well have written today.

Lack of standardization—particularly with regard to connectors—has become such a problem that the Association for the Advancement of Medical Instrumentation is attempting to come up with a series of basic connector types for use in the medical field. Efforts are also underway to come up with basic parameters for standard module sizes, Dr. Kagey says. "Ideally," she adds, "It would be nice if pieces of equipment A, B, and C could use modules interchangeably." However, she points out, outputs of monitors "vary all over the lot," and many don't have a paper output. So for paper output from an ECG machine, one must ask what the output is, what kind of connector is needed, find out if it fits the recorder, and so on.

"At the Brigham," Kagey says, "we are marrying equipment, which raises eyebrows." In one of their marriages, the people at the Brigham are teaming an ECG machine with another monitor just to add the ECG's chart recorder capability to the other monitor. "There's no reason an ECG can't be used as a slave monitor for other equipment," Kagey opines; "I made up some universal adaptors that we can plug into an ECG. It would be helpful if manufacturers made this type of thing more often."

Lack of standardized connectors in monitoring equipment causes more than mere inconvenience, says Dr. Jerome M. Silver, chief of surgery at the Louis A. Weiss Memorial Hospital in Chicago. Because of the lack of standards, he fumes, adapters must be used, "so noise and hazards are introduced. The problem almost ne-

gates the purpose of having the equipment."

Silver built his operating room, recovery room, and cardiac-care unit around his medical-electronic equipment, a situation that most engineers and physicians would consider to be as close to ideal as anyone can get. But Silver, an electrical-engineer-turned-physician, disagrees:

"I had to settle on the equipment two years before the hospital was built," he says, "and since medical-electronic equipment is obsolete when you buy it, you know what that means."

### Brownout

One advantage of researching a medical-electronics report during the summer is that one can practice taking notes in the dark, or at least by natural light. But cutbacks of unnecessary lighting and other electrical loads is standard procedure whenever the power companies announce a voltage reduction. Dr. Ben-Zvi monitors the line voltages in his hospital's operating rooms and coronary-care units so that he can warn the doctors of impending trouble. During a brownout, he explains, an erratic electrocardiogram probably means that there's something wrong with the ECG machine, not with the patient.

Dr. Kagey says that her hospital's normal voltage of 115 v can drop to 108 v on occasion during a brownout. As a result, the ability to tolerate this voltage drop is one question her committee considers in making pre-purchase evaluations. Most equipment will operate well, she reports, but in a few cases, manufacturers have recommended voltage stabilizers.

Important as their specific complaints are, most clinicians are more concerned about the tendency for electronics companies and young medical students to re-

**X-ray replacement?** Transducer on patient's chest bounces sound waves off heart's interior walls to monitor heart action. Unlike X rays, sonar presents no known biological hazard. Dr. Donald C. Harrison of Stanford University holds transducer on chest of medical student.

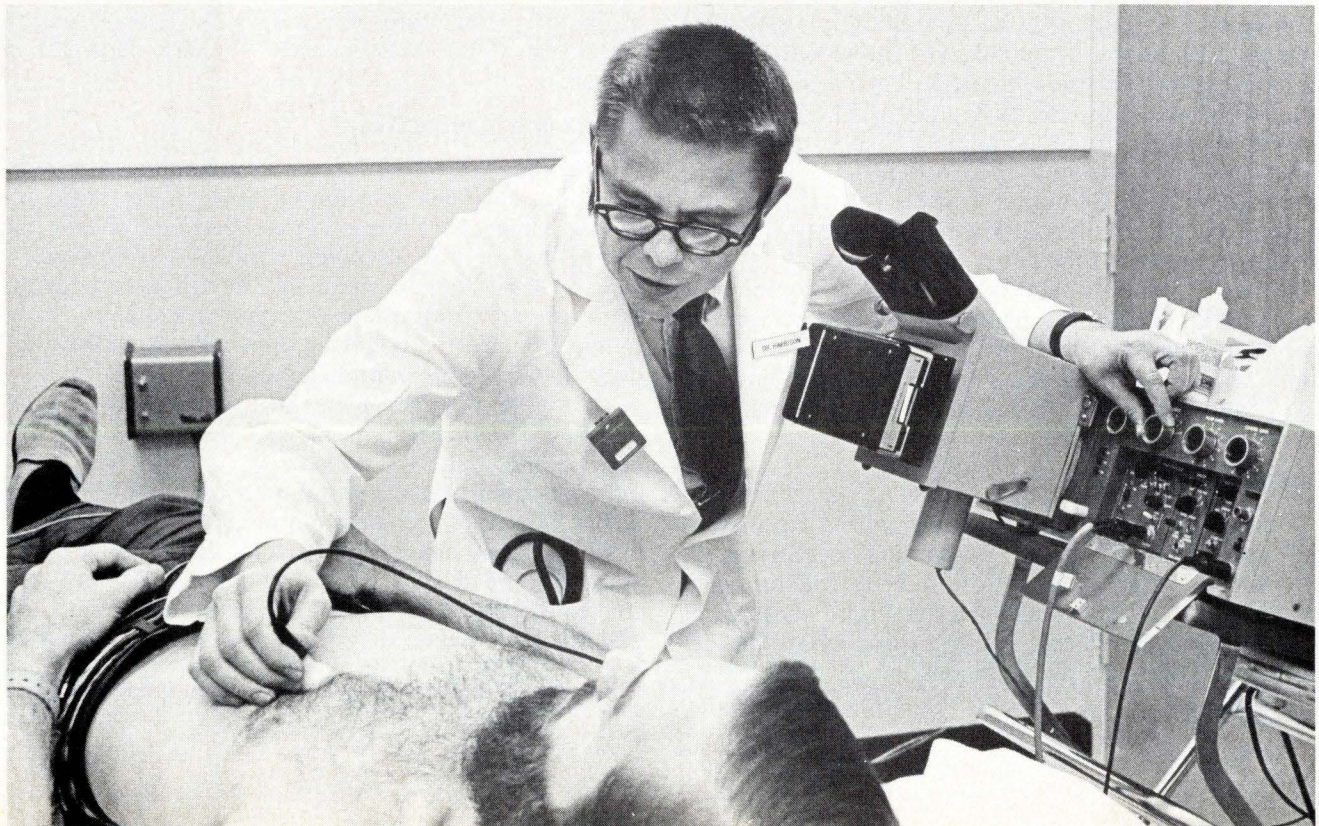

# SPECIAL REPORT

gard instrumentation output more highly than first-hand observation of patients. Dr. Bruner, for example, feels that many specialized pieces of electronic equipment have legitimate, but limited, functions, but that there is a tendency to try to use them where they serve no useful purpose. Computers have established their worth in cardiac catheterization laboratories, where they provide real-time analysis of cardiac output data. Bruner doubts, however, that computers have any legitimate place in routine patient care.

## Instruments aren't doctors

Often, he points out, it is the mundane, unglamorous things that are most important. In an intensive-care ward, he asserts, it is much more important to keep track of the patient's fluid intake and output than it is to use a fancy electronic instrument to automatically count the number of abnormal beats that his heart is producing. Similarly, he cites a case where a patient went into cardiac arrest in the operating room and continued to produce an almost-normal ECG. His point is not that ECGs are worthless, but that they are not always pertinent. The fact that the heart produces a strong electrical signal that can be measured without invading the body or using any troublesome transducers makes ECG monitoring so easy and convenient, Bruner feels, that the heart is routinely monitored even when it produces no useful information.

Dr. Silver, it would seem, couldn't agree more. "I'm not fascinated by this hardware costing millions and millions of dollars," he says. "We do what we can do for technological reasons, and not because it's important to the patient. And I accuse the medical profession and the medical-electronics industry of loading the hospitals with this stuff.

"We in medicine have not sat down to determine which data is important to be sure all the physiological systems are normal. Manufacturers are standing by to make anything we want," he adds, "but without direction, most have done the easiest thing they can do; so most medical electronics equipment is very primitive. It looks sophisticated—with nice cabinets," Silver says, "but it really isn't. Computers, for example, can be used in certain applications, but I don't think they're fundamental to the care of the patient."

Perhaps most important of all, in Silver's opinion, is the negative effect some electronic instrumentation has had on the personal involvement of patient and physician: "We must not forget to look at the patient," he says, "and instrumentation has gotten us away from looking at the patient."

## Getting the picture

Medical diagnostic imaging began with X rays and is still dominated by them. From such commonplace procedures as the examination of bone fractures and the routine screening of patients for certain chest disorders to the measurement (in conjunction with other devices and drugs) of the effectiveness of the pumping action of the heart, X rays have come to be indispensable

in the practice of modern medicine.

Although the dangers to the patient of diagnostic X rays are believed to be very slight, they are not zero, and steps are therefore constantly being taken to reduce dosages. Film speeds are constantly going up, image intensifiers are used in fluoroscopy, and new machines are designed to avoid spilling radiation onto parts of the body that are not being studied. (As of August 1974, the Bureau of Radiological Health will require that all new or reinstalled X-ray equipment have some automatic means for assuring that the X-ray beam be collimated to cover an area no bigger than that of the film being used.) Because of steps like this, Dr. Joshua Becker, chairman of the department of radiology at the Downstate Medical Center of the State University of New York in Brooklyn, estimates that a chest X ray taken with modern equipment probably exposes the patient to no more total-body radiation than 40 to 50 minutes in the sun at a mountain-top resort.

New imaging techniques have come along to either augment or supplant X-ray studies in certain applications to obtain better results, to avoid the use of ionizing radiation, or both. The use of ultrasound is, say most radiologists, the most promising area in imaging today. Unlike X rays, pulsed ultrasound beams, at the power levels used in diagnostic work, present no known biological hazard to the patient, points out Dr. Becker. Further, ultrasound imaging can differentiate between different types of tissue that look the same to X rays.

An X ray can detect a mass in a person's kidney, for example, but cannot tell whether the mass is cystic (fluid-filled) and thus probably benign, or whether it is solid and thus probably a cancer that must be removed by surgery. Actually, this determination can be made by X rays if a dye is introduced into the kidney and a film called an angiogram is made. The technique requires a lot of expensive equipment, a lot of radiation, and a lot of dye; it is best avoided, say the experts. Detecting this differentiation between fluid and tissue is where ultrasound is most useful today, says Dr. Hubert Sear, a radiologist at the Massachusetts General Hospital in Boston.

## Ultrasound is reflective

Unlike X rays, which form images on film from radiation that has been transmitted through the body, ultrasound images are formed by a reflective technique. A typical system uses a piezoelectric crystal transducer (usually lead titanate zirconate) mounted in a probe that is pressed firmly against the patient's skin. A liberal coating of mineral oil on the patient assures good acoustic coupling between probe and skin.

The crystal is driven by a short voltage pulse, which causes it to vibrate at its natural frequency—typically about 2 MHz—and send a narrow conical sound beam into the patient. Like a sonar transducer, the probe is then switched from its transmit mode to a receive mode in which it picks up echo returns for display on a scope. Since fluid-filled areas of the body are transonic—they create no echos—and solid tissue causes some return, the differentiation between cystic and solid tumors is easily made.

But ultrasound is not limited to studying tumors, Dr.

Sear points out: in pregnancy, the uterus is full of fluid and the fetus is suspended within this fluid. Thus ultrasound is an ideal tool for the prenatal detection of multiple fetuses, for the determination of certain congenital anomalies, and even to make sure that an intra-uterine device is really in the uterus. Further, Dr. Sear explains, it's a good idea to avoid the use of X rays in obstetrics because ionizing radiation is believed to present some small but finite risk of genetic mutation when applied to the gonads. And an obstetric X ray would present this threat to two sets of gonads: the mother's ovaries and the ovaries or testes of the unborn child.

### Creating an image from ultrasound

Current techniques for processing ultrasound echo returns into images should appear familiar to engineers with experience in radar or sonar imaging. The simplest type of display is the A-mode (amplitude) display, which simply plots the amplitude of the echo as a function of depth. In the B-mode (brightness), presentation, the strength of the echo is reflected in the brightness of the trace at the various depth positions. By itself, this isn't too good a way to display a sonogram, but it lends itself to a technique called compound B-mode scanning in which the probe is moved across the patient, thus examining a slice of his anatomy. A series of potentiometers on the linkage to which the probe is attached (an arrangement very much like a dentist's drilling apparatus) plots the position of the probe on a storage oscilloscope. The echos are then displayed in the B mode in the correct geometrical relationship to the probe position.

Finally, in the M-mode (motion) display, a standard A or B presentation is plotted on a piece of moving film or chart paper. The result is a time study of the motion of the object at which the probe is pointed. In Fig. 1, for example, the action of the left ventricle of a normal heart is displayed.

The trouble with all of these ultrasound display techniques is that they show at best only a thin slice through the body. To study an entire kidney, for example, it is necessary to make a whole series of sonograms through the abdomen, moving the locus of motion of the probe perhaps a half centimeter for each picture. Not only is this time-consuming, but it is difficult to duplicate precisely the position and orientation of the probe with respect to the patient to obtain subsequent pictures.

A novel acoustic image sensor that promises to overcome these problems and that can provide three-dimensional images of anatomical structures is a monolithic piezoelectric array of transmit/receive transducers being developed at Stanford University Electronics Laboratory for the Stanford University Medical Center. The sensor, which is being developed by J. D. Meindl, J. D. Plummer, and M. G. Maginness of the Stanford Electrical Engineering department, has six major components: an acoustic lens, an array of transducers on a single monolithic piece of piezoelectric ceramic material, a monolithic array of silicon integrated circuits bonded to the transducer array, signal-generating and processing circuitry, digital control circuitry, and a display (Fig. 2). The array of silicon ICs contains a group of

matched high-voltage, low-resistance field-effect transistors that perform the transmit/receive multiplexing for corresponding elements of the piezoelectric transducer array. In the receive mode, each element in the transducer array is thus connected directly, and through a very short path, to a sensitive receiver. This sensitivity is necessary because the alternative method for achieving a high signal-to-noise ratio—increasing the transmitted power—is not permissible when working on human beings.

The image sensor's digital control circuitry permits several modes of operation: any single array element or any row or column of array elements can operate in the A mode; any row or column of elements can operate in the B-scan mode; the full array of elements can operate in a C-scan mode producing the equivalent of many B-scan images at the same time; and, by using range-gating techniques to break the body up into a stack of image planes, the sensor can construct a three-dimensional image from a stack of C-scan returns.

The developmental model of the sensor, which was constructed to prove the feasibility of the idea, uses a 10-by-10 array of transducers, and it operates at a frequency of 3.5 MHz. Its maximum range is approximately 20 centimeters, its field of view is about 1.5 inch square, and it has a resolution of approximately 0.15 in. This prototype array does not contain the monolithic silicon circuitry that is planned for the final version. However, since it demonstrated the feasibility of the concept, Dr. Meindl expects to proceed with the construction of the final package which should be completed by the end of this year.

Another developmental ultrasonic device, this one of potentially great value in surgery, is the pulsed doppler ultrasonic flowmeter. Several different methods for measuring the actual flow rate in blood vessels have been developed and are in actual use. But surgeons are

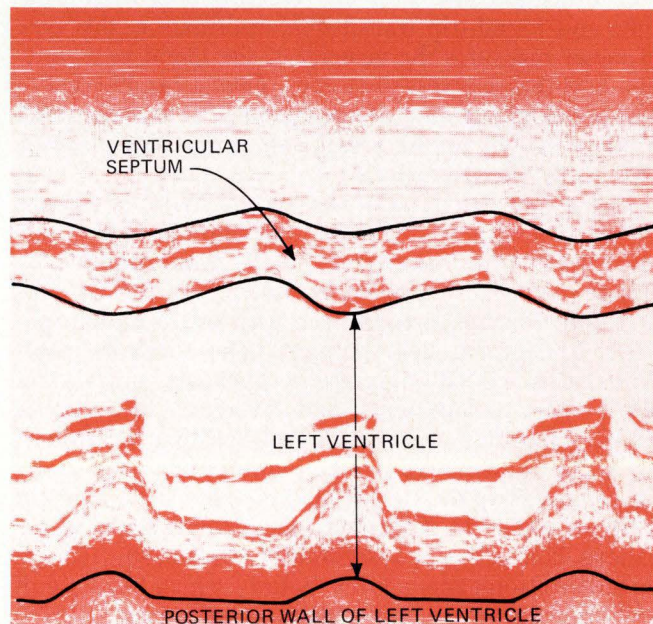

1. Echoes from the heart. M-mode sonogram shows pumping action of heart. Note that ventricular septum (wall separating left and right ventricles) and posterior wall of left ventricle flex so as to maximize change in ventricle volume. [Photo from J.M. Griffith at NIH].

# SPECIAL REPORT

still waiting for one that really works.

One of the kinds of meters in use today is the electromagnetic unit. To operate this instrument, a dc magnetic field is placed across a blood vessel, and the voltage induced across the vessel by the flow of the conducting fluid within it is measured. The induced voltage, unfortunately, is proportional, not only to the magnetic field intensity and the average blood velocity, but also to the inside diameter of the vessel (assuming a circular cross-section). Since this diameter is not generally known, electromagnetic meters must be calibrated by such crude methods as excising the vessel and measuring the volume of blood that flows out of it in a fixed time interval.

## Ultrasound measures blood velocity

Existing ultrasonic doppler flowmeters are of the continuous-wave type. These instruments measure blood velocity by bouncing ultrasonic energy off the red blood cells in the blood stream and measuring the frequency shift caused by the velocity of the cells.

Since blood velocity is not uniform across a cross-section of a blood vessel, the doppler-shifted frequency has a broad spectrum—not a single-line spectrum. And since a knowledge of the vessel diameter and the velocity distribution across it is needed for a true flow measurement, the cw doppler flowmeter leaves something to be desired in this respect. The cw flowmeter is useful for measuring flow velocity at the center of a vessel by carefully positioning the send and receive transducers so that their patterns intersect only at the center of the vessel.

An instrument that holds considerable promise for the measurement of actual blood flow is the pulsed doppler ultrasonic flowmeter. By retaining both frequency-shift and round-trip transit-time information, this type of meter measures the velocity of the blood as a function of distance across the artery. Thus it can be used to plot a velocity profile of the blood in the vessel, and, from reflections off the vessel wall, it measures the vessel's inside diameter (Fig. 3).

In a paper delivered at the Second World Congress on Ultrasonics in Medicine at Rotterdam in June of this year, R. W. Gill, J. D. Meindl, W. R. Brody, and W. W. Angell of Stanford University described a pulsed doppler unit that has already been used on 25 human patients undergoing heart surgery. The surgical procedures included coronary-artery bypasses, mitral and aortic-valve replacements, and the repair of an atrial septic defect. The researchers reported that the ease of use of the new device, which employs only one transducer instead of the two needed by other flowmeters, is a major factor in its attractiveness for surgical applications. Unlike the two-transducer cw ultrasonic devices or the electromagnetic units, both of which need a cuff to completely encircle the blood vessel under test, the pulsed unit's single transducer can either be hand-held on the vessel or sutured in place for the duration of the operation.

As one example of the usefulness of the flowmeter,

Dr. Meindl cited the measurement of pre- and post-operation flow rates. In one case, he recalls, an implanted valve was found to be leaking, and it was replaced by a back-up valve during the same operative procedure. The operation was a success, and the patient left the hospital four days later.

## Pacemaker sets the pace

The implantable cardiac pacemaker, of course, is an unqualified success. Originally developed specifically to treat Stokes-Adams syndrome—a condition in which unconsciousness is caused when the heart rate drops to dangerously low levels—pacemakers are now used to treat a variety of cardiac arrhythmias.

In the 15 years since the world's first permanent cardiac pacemaker was implanted into a Swedish engineer (he's still alive and well) more than 150,000 pacemakers have been put into use around the world. At first, pacemakers were used to treat only one specific condition, the Stokes-Adams syndrome. In this condition, the heart's natural pacemaker, the sinoatrial node, fails to pace the heart at an adequate rate. People with this condition are subject to unpredictable attacks of fainting, and, without a pacemaker, have a 50% chance of dying within one year of the onset of the symptoms.

The earliest artificial pacemakers overcame the problem by pacing the heart at a constant rate of approximately 60 to 70 beats per minute. More modern units are available with two speeds that can be selected externally by means of an induction coil or permanent magnet. The two-speed units have typical rates of 60 to 70 beats per minute in the slow mode, and about 80 to 90 in the fast mode.

Pacemakers are usually implanted into a convenient cavity in the chest or abdomen of the patient and then connected to the heart by means of a catheter inserted into a vein leading to the heart (Fig. 4). The surgery required, which is relatively minor, bears little resemblance to the major procedures undertaken when the heart itself must actually be exposed. Nevertheless, in the parlance of the medical profession, any surgery, however minor, is an "insult" to the body and should be avoided whenever possible.

For this reason, there is great interest in developing power sources that make frequent battery-changing operations unnecessary. At present, carefully selected mercury batteries give pacemakers a useful life of two to three years, and industry authorities estimate that chemical cells capable of five-year operation are possible.

Beyond five years, other approaches are needed. Nuclear-powered pacemakers have been developed, and, at present, on the order of 500 people around the world are using them. They have a minimum estimated life of 10 years and a cost (exclusive of installation) of about \$5,000.

## Batteries can be recharged

Rechargeable pacemakers are also under development. These units use nickel-cadmium batteries and are recharged inductively by means of a coil implanted beneath the skin. Recharging is normally done once a week, although the units can actually run for six weeks

without recharging. Estimated life of the rechargeable units is about 20 years, and cost is projected at about \$1,800. Conventional units, by comparison, cost between \$500 and \$1,000.

A substantial number of patients who use pacemakers are capable of self-pacing most of the time, and only need a pacemaker's help intermittently. For these patients, the demand pacemaker has been developed. Demand units continuously monitor the heart's rhythm, and, as long as the heart beats sufficiently fast, they do nothing else. When the natural heart rate drops below a preset threshold, these units then commence acting as conventional pacemakers.

The market outlook for artificial pacemakers is astounding. In the United States alone, it is estimated that half the people who should have pacemakers don't have them. And the less developed parts of the world presumably have an even greater need. Also, pacemakers are being used more and more for conditions other than the heartblock condition for which they were originally developed. Various cardiac arrhythmias, especially a precursor of ventricular fibrillation—are being found to respond favorably to treatment by means of modified pacemakers.

### Checking the heart

Progress in electrocardiography has been slower than in the pacemaker field, but the contrast between the earliest units, developed before the turn of the century, and modern devices is therefore all the more dramatic.

Although the first electrocardiogram is reported to have been recorded as early as 1887, it was not until Einthoven introduced the use of the string galvanometer in 1903 that the frequency response of the instruments became good enough to permit the faithful recording of the heart's electrical activity.

Even so, many of Einthoven's contemporaries laughed at his crude, impractical apparatus. To measure an ECG, Einthoven had to place a patient in a large Faraday cage (to avoid interference from stray fields) and use immersion electrodes to get satisfactory contact with the patient's skin. These immersion electrodes were nothing more than buckets of saline solution, and one can imagine that Einthoven's detractors had good reason to condemn his machine as impractical.

By contrast, modern ECG machines are available as portable battery-operated devices using throwaway electrodes. Other larger units offer such convenience features as multichannel recording—the simultaneous measurement of voltages from several locations on the chest—as well as protection from overvoltage damage even if a 5,000-v defibrillation pulse is applied to the patient while the ECG is connected to him, and solid-state circuitry that assures almost instant warmup in emergencies.

Some advanced ECG systems can measure vector-cardiograms—three-dimensional measurements of the rotation of the heart's composite electric-field vector. These instruments can display a two-dimensional representation of the motion of the vector in each of three orthogonal planes, or they can display and record the three orthogonal components of the vector as functions of time.

Finally, minicomputers have been coupled to electrocardiographs to provide machine aid in the interpretation of the test results. Various programs are already available for at least routine screening of electrocardiograms.

### Reducing heart-attack deaths

Although electrocardiographs were originally developed as diagnostic tools to help physicians in the detection and analysis of heart disease, they can also be of great value in the treatment of heart-attack patients. About half of the deaths of patients who have suffered a myocardial infarction are caused by electrical malfunctions of the heart. Typically, these fatal electrical abnormalities are preceded by arrhythmias that, if they had been detected in time, would have allowed attending medical personnel to take appropriate corrective action. Further, the actual fatal electrical malfunction—usually ventricular fibrillation—is also treatable by an electrical countershock if it is detected in time. Hence there is a sound medical reason to use ECGs, not only for diagnostic work, but also as monitors of critically ill cardiac patients.

Patient-monitoring has proved to be a lucrative field—in equipment for ambulatory patients, as well as for those recovering in hospitals and nursing homes. In the past 10 years, patient-monitoring equipment sales

**2. Transducer array.** Acoustic image sensor employs a monolithic array of silicon ICs bonded directly to a monolithic array of piezoelectric transducers. System's high sensitivity results in acceptably high signal-to-noise ratio, even at low power densities considered safe.

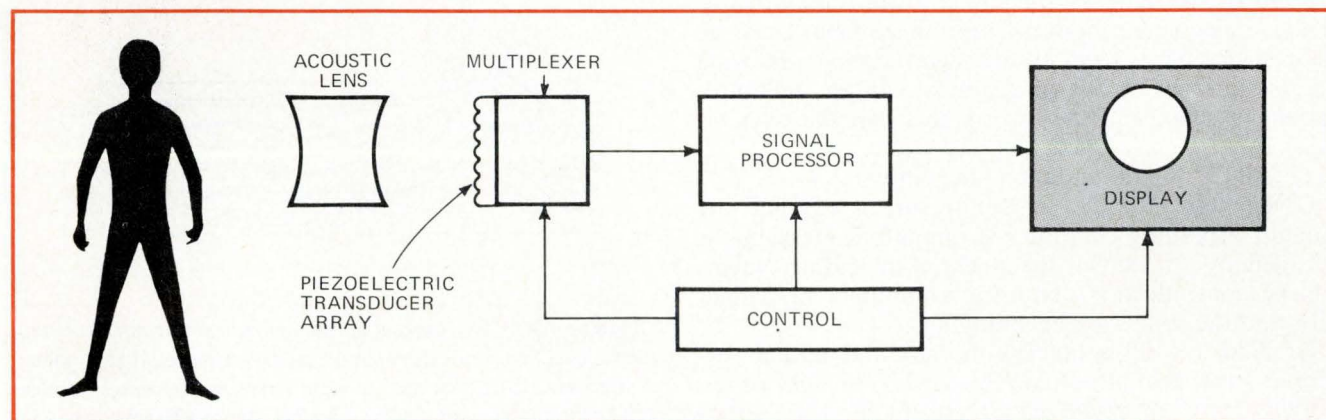

# SPECIAL REPORT

have grown from essentially zero to about \$60 million a year today. From simple ECG monitoring in the beginning, coronary-care monitoring systems have been developed to the point that they now monitor heart rate, temperature, blood pressure in various vessels, respiration rate, respiratory volume, and the concentrations of various chemicals in the blood. In addition, special arrhythmia detectors are available for early detection of abnormal heart rhythms, and apnea alarms warn of breathing stoppage.

Because they only require the placement of simple electrodes on the surface of the body, monitors for ECG, heart rate, and apnea are widely used in intensive-care units, even in situations in which some physicians feel they serve no useful function. The measurement of other parameters—arterial blood pressure, for example—is much more difficult and dangerous, and, as a consequence, it is likely to be done only when it is really necessary.

The measurement of the blood pressure within a vessel requires invasion of that vessel. Either a pressure transducer must be implanted into the vessel, or a catheter must be inserted to provide an hydraulic pathway to an external transducer. If the pressure must be monitored over a long period, there is a real risk of injecting foreign material, inducing a spasm or clotting inside the vessel.

Once the pressure waves have been transduced into electrical signals, they can be amplified and treated in the same manner as such other standard electrical signals as ECGs. Having these various electrical signals displayed on a scope or recorded on a chart recorder at the bedside of a patient is all well and good. But it is not the strong point of patient-monitoring systems. What gives modern patient-monitoring systems their real value is:

- Their ability to bring information from many sickbeds to one convenient monitoring center so that a single nurse can keep a close watch on several patients simultaneously.

- The inclusion of special detectors and alarms that make it unnecessary for a nurse to stare constantly at an ECG—for example, in order to detect life-threatening arrhythmias.

## Machines intervene

These very strengths are also the causes of doctors' greatest misgivings about monitoring systems. They see colorful brochures from electronics companies showing a nurse in front of a large electrical console without a patient in sight, and they worry that concern over instrumentation may cause loss of concern about the object of all this instrumentation—the patient.

Given this attitude, it is not surprising that the thought of adding computers to monitoring systems is not usually greeted with much enthusiasm. Nevertheless, some doctors are using computers in patient care, and the results are encouraging.

Dr. John J. Collins, chief of thoracic and cardiac surgery at Peter Bent Brigham Hospital in Boston, began working on a computerized system for the care of pa-

tients recovering from open-heart surgery about three years ago. "We became convinced that we knew enough about post-heart surgery intervention reactions [to drugs, transfusion, etc.]," he says, "to predict the patients' responses. But the responses are sufficiently changeable that you have to have someone watch them all the time."

For example, if a patient's heart rate is 40 and the doctor wants to raise it to 70, a certain medication is injected continuously into a vein. The more medication fed in, the faster the heart beats. Unfortunately, there is no fixed relationship between the rate at which the drug is administered and the actual heart rate. Other biological factors will affect the patient's response to the medication.

As the patient warms up after surgery and his metabolism rises, the biologic half-time of the drug may decrease, necessitating an increased dosage. Wakefulness and the effects of other drugs can also change the required dosage. The result is that a more-or-less continuous monitoring and adjustment of the dosage is required.

Traditionally, a nurse has controlled the drip rate of the drug, based on heart rate data she had gathered from an ECG machine. Since the nurse has a lot of other things to do at the same time, she may not have a chance to adjust the drip rate very often, or she may adjust it at irregular intervals, resulting in unnecessarily wide variations in the patient's pulse.

To overcome this problem, Collins had the idea of letting a computer take over the task of controlling the rate of infusion of the drug. The computer-controlled system, being developed in conjunction with the Hewlett-Packard Co. Medical Electronics division in Waltham, Mass., monitors body temperature, heart rate, blood-transfusion rate, and pressure in all four chambers of the heart, and this information controls a rotary

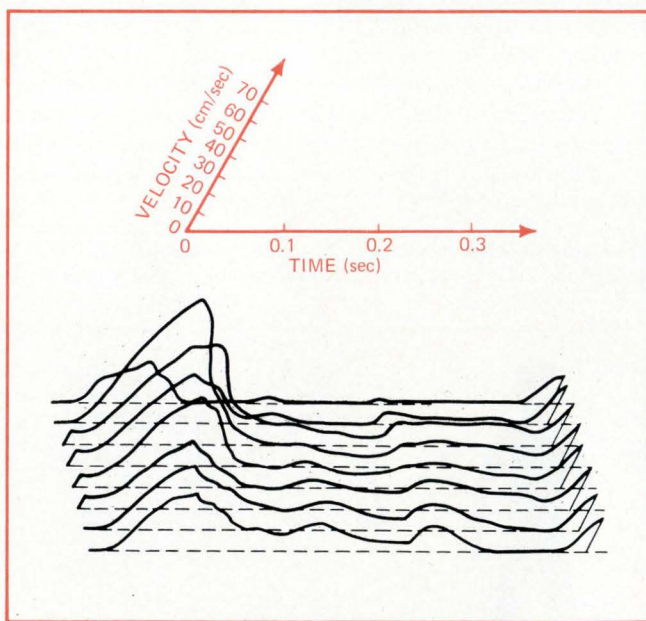

**3. Flow profile.** Pulsed doppler ultrasonic flowmeter measures blood velocity as a function of distance across blood vessel. Range gating provides velocity-vs-time data at eight points in the vessel. Echoes off far and near walls also measure vessel diameter directly.

infusion pump. The hardware for the system is ready, Collins says, and the software is being completed.

Although he is obviously willing to accept electronic equipment and even computers in the hospital, Collins thinks that it is not often that they are really needed. When asked what he would like electronics to do for medicine, he said, "We want simple pieces of equipment. Everyone comes in here and wants to talk computers, but the number of people who need the quick response of a computer is limited." The two things he would like most to see are a simple, cheap, reliable ECG monitor for bedside use, and a simple, cheap, reliable arterial blood-pressure-monitoring system. ECG machines now cost \$1,000, he says. "You pay one quarter the price for industrial gear, but it skyrockets when it's stamped, 'medical'—I'm not sure why."

### Electrosurgery advances

Electrosurgical tools may not be familiar to most people, but surgeons regard them as indispensable in certain operations, particularly those involving the brain and the urinary tract. In fact, the contribution of electronics to surgery goes back much further than ultrasonics or solid-state technology.

"The classic useful electronic device in surgery," says Dr. Philip N. Sawyer, head of Vascular Surgical Services, State University of New York, Downstate Medical Center, Brooklyn, "is the Bovie coagulator, which can also be used for cutting." The instrument to which Dr. Sawyer refers is a powerful spark-gap oscillator developed by Dr. W. T. Bovie in the 1920s and still used today in many surgical procedures.

Operation of the electrocoagulator is based on the observation that the passage of an electrical current through bleeding tissue can stop the bleeding. Most authorities today agree that the mechanism behind this effect is simply the generation of heat in the vicinity of

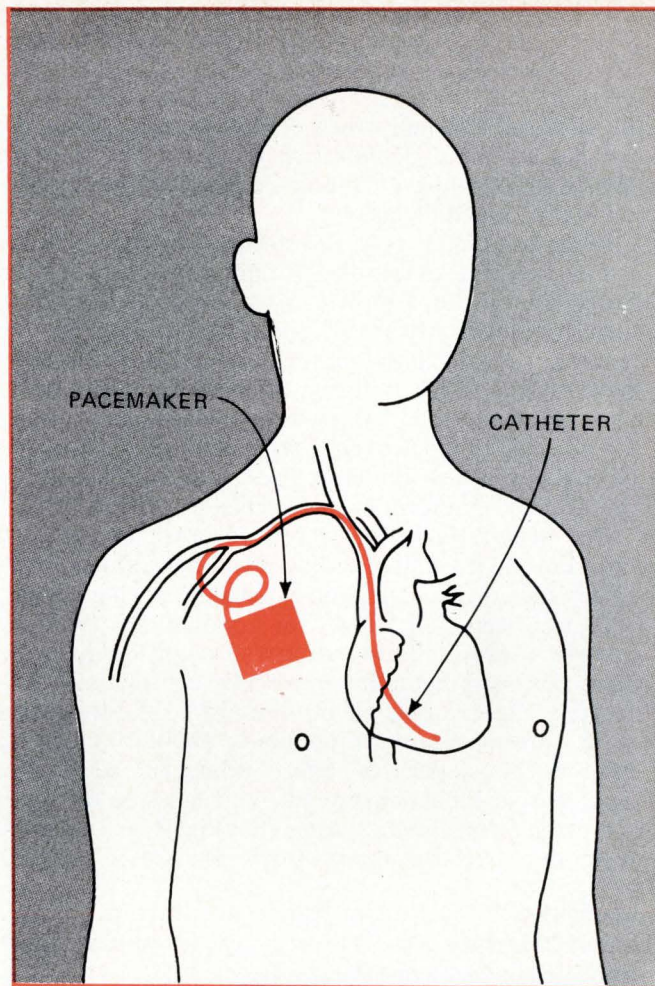

**4. Implanting the pacemaker.** Major surgery is unnecessary to install pacemaker, even though catheter tip must be inserted into the heart. Unit is implanted in a convenient body cavity, and catheter is inserted into heart through a vein (here the right cephalic vein).

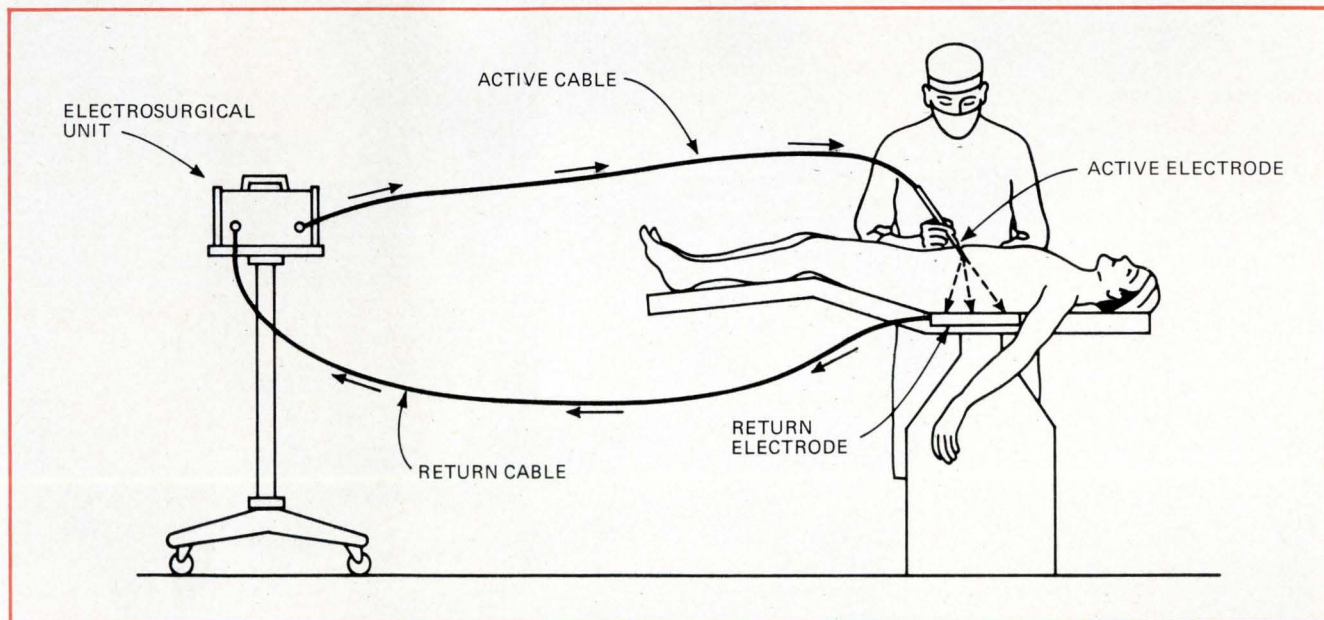

**5. Electrosurgery.** Because of their ability to cut and coagulate tissue simultaneously, electrosurgical tools have proven their superiority over conventional scalpels for operations involving tissues with oozing capillary beds, particularly such organs as the liver, spleen, thyroid, and lung. High current density at tip of active electrode heats tissue for cutting and coagulating. Low current density at large return electrode prevents undesired heating when current leaves body. [Drawing reproduced with permission of "Health Devices," June-July 1973].

# SPECIAL REPORT

the electrode through which the current is applied. The heat causes rapid dehydration of the cells and blood vessels surrounding the electrode, thus stopping bleeding in the immediate area.

When used in surgery, the electrocoagulator must, of course, be connected to the patient at two points in order to establish a complete circuit. Coagulation, however, is desired only at one point. To achieve this, one electrode is made in the form of a large metal plate or a sheet of foil, which is then placed under the patient's back or buttocks or wrapped around his thigh. Since this return electrode covers a large area—typically about 100 square inches—the current density in its vicinity is low, and no significant tissue heating occurs (Fig. 5).

The active electrode, whose exact shape depends upon the use for which it is intended, has a rather small tip at which the current density reaches very high levels.

As has been well known for hundreds of years, the passage of even modest currents through the body can cause powerful involuntary muscular contractions. Fortunately, these muscle effects diminish as the frequency of the current increases, and, above about 10 kilohertz, there is no noticeable effect whatever. And since electro-surgical tools operate at frequencies on the order of a megahertz, muscle spasms should not be a problem in modern electrosurgery. However, according to a

study conducted by the Emergency Care Research Institute, and published in its journal, "Health Devices," some modern instruments do produce enough low-frequency current to cause significant amounts of muscle stimulation, which proves hazardous under some medical conditions.

The original Bovie coagulator used a spark-gap oscillator to produce a waveform that consists of an rf current of approximately 500 kHz modulated by the 60-Hz line frequency. More modern vacuum-tube and transistor units generate a train of highly damped sine waves for coagulation.

For cutting tissue, all units use vacuum-tube or transistor oscillators to generate undamped sinusoids. The heating effect is much greater than with the lower-energy waveform, and the cells immediately adjacent to the active electrode literally explode as the fluid within them is vaporized. For cutting with coagulation, electro-surgical instruments provide various means for mixing the cut and coagulate waveforms.

It is interesting to note that, despite the advent of transistorized electro-surgical instruments, the spark-gap type of unit still has an important place in surgery. According to "Health Devices," contemporary units cannot match the spark-gap instrument's performance in rapidly coagulating broad areas of tissue. For certain surgical procedures, particularly those in which anti-coagulant drugs are used, the modern instruments are simply not good enough. □

**Keeping watch.** Four monitors display ECGs of patients in cardiac care unit at Downstate Medical Center. CCU head nurse Paula Bilton examines ECG made on chart recorder that can be switched to any of the monitors. Bedside alarms warn if heart rate is too fast or too slow.

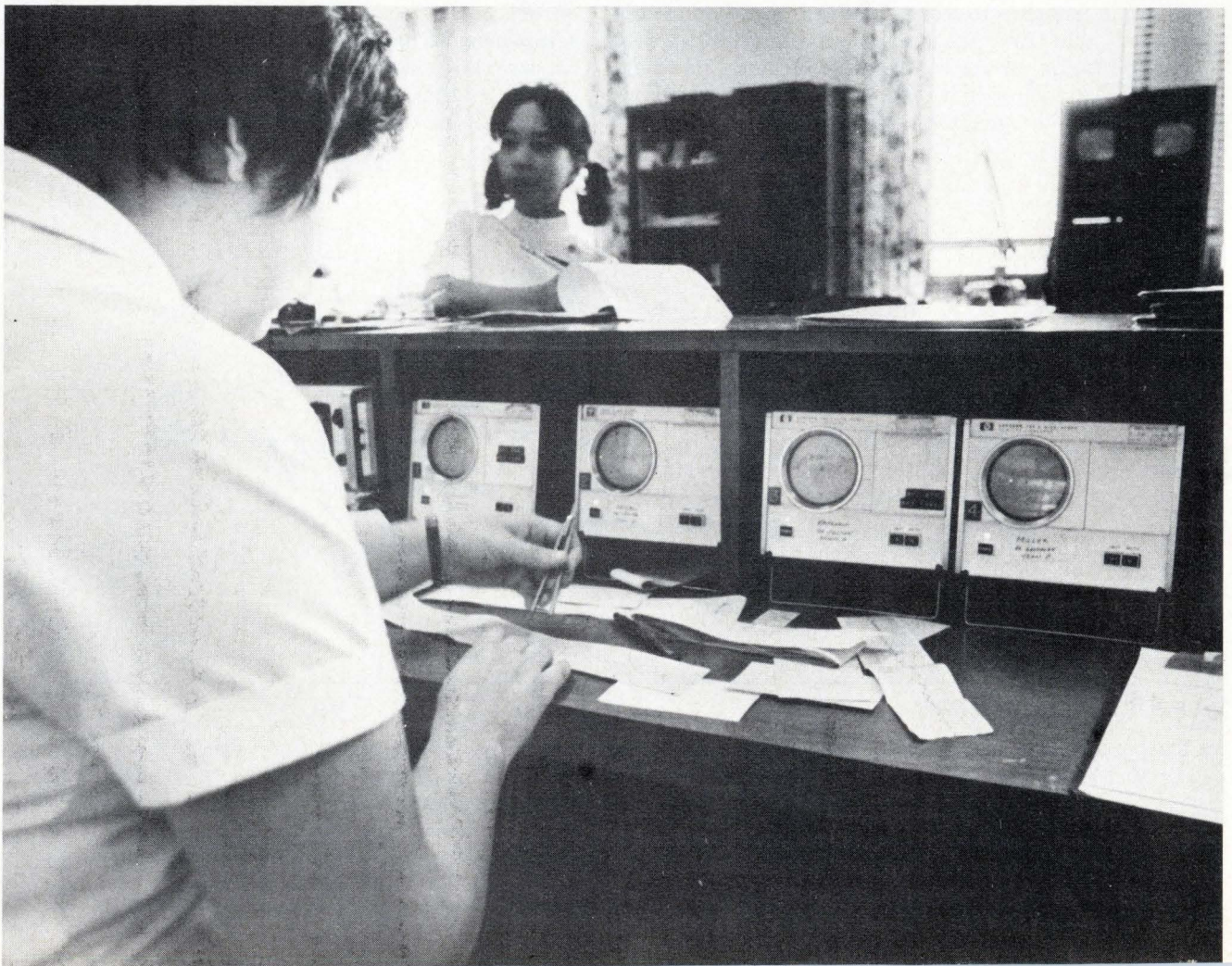



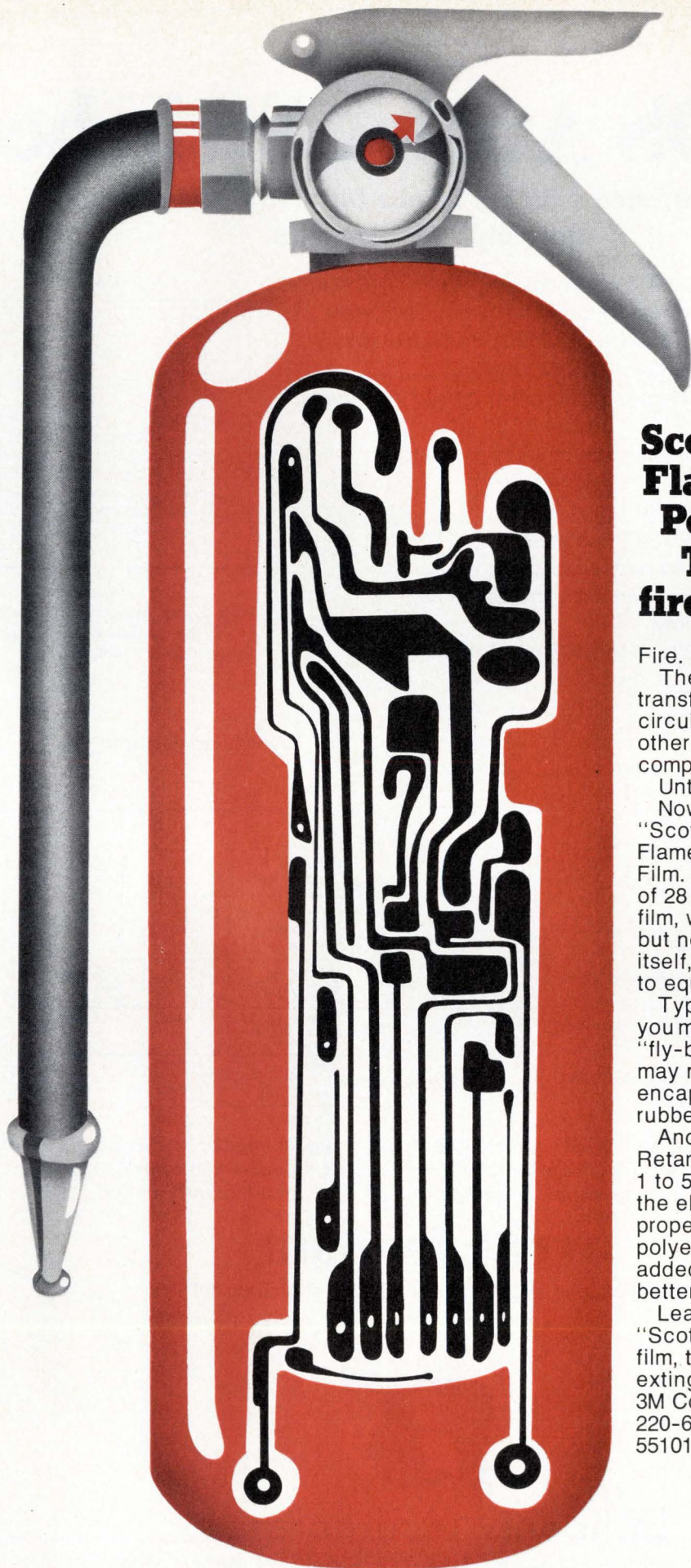

**Scotchpar® Brand  
Flame Retardant  
Polyester Film.  
The built-in  
fire extinguisher.**

Fire.

The common enemy of transformers, flexible circuits, flat cables and other electrical/electronic components.

Until now.

Now 3M introduces "Scotchpar" Type 7300 Flame Retardant Polyester Film. With an Oxygen Index of 28 minimum, Type 7300 film, when ignited, will melt but not burn. It extinguishes itself, easing further danger to equipment and lives.

Type 7300 film can save you money, too. For example, "fly-back" transformers may no longer need encapsulation in silicone rubber.

And, "Scotchpar" Flame Retardant Film, available in 1 to 5 mil thicknesses, has the electrical and physical properties of standard polyester films, with the added benefit of a much better winding surface.

Learn more about "Scotchpar" Type 7300 film, the built-in fire extinguisher by, writing 3M Company, 3M Center, 220-6E, St. Paul, Minnesota 55101.

**3M**  
COMPANY

# CMOS Analog Switches

TTL-controlled switches handle full  $\pm 15V$  signal swing  
with only  $\pm 15V$  supplies.

New **DG200** and **DG201** devices provide channel and gain selection for analog signals up to  $\pm 15V$  power supply levels without exceeding switch signal handling levels (see typical applications circuit below). Devices feature:

- Monolithic CMOS construction; drivers and gates on a single chip.
- Low  $r_{DS}$  over full temperature and signal range.
  - <100  $\Omega$  for **DG200** (dual SPST)
  - <250  $\Omega$  for **DG201** (quad SPST)
- Static protection on all terminals.
- Break-before-make switching action.
- Independent pairs of sources and drains for maximum flexibility.
- Direct TTL, DTL and CMOS compatibility.

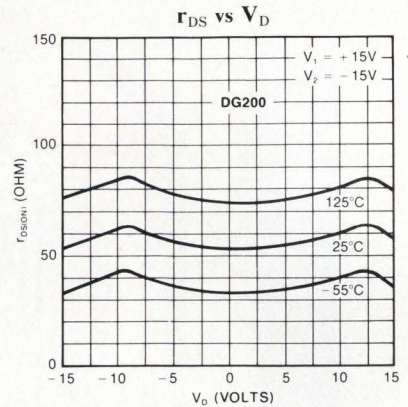

With supply voltage levels less than  $\pm 15V$ , the maximum analog signal always equals supply voltage.

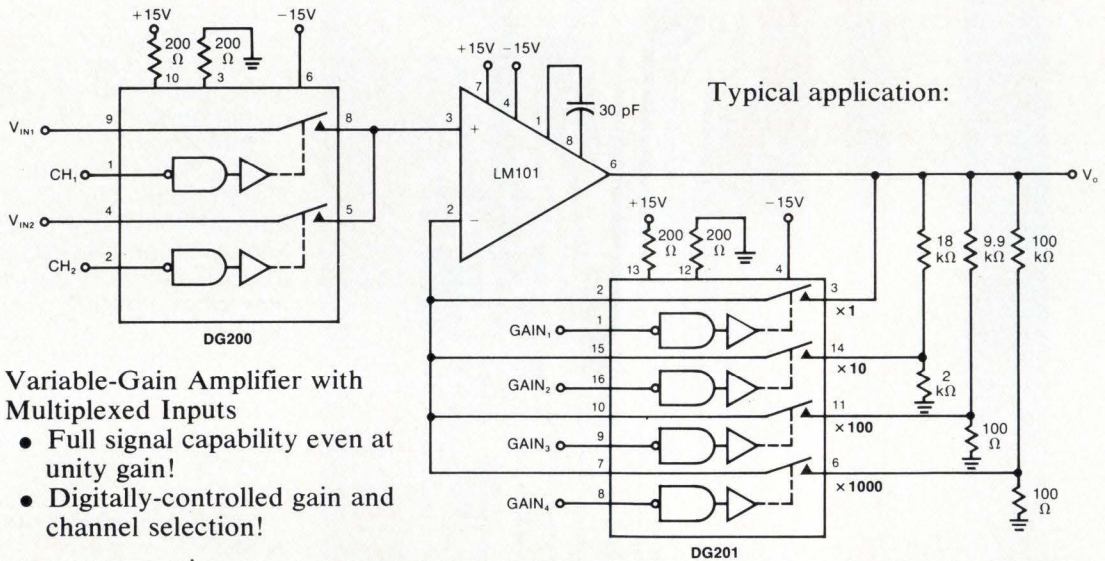

- Variable-Gain Amplifier with Multiplexed Inputs**
- Full signal capability even at unity gain!
  - Digitally-controlled gain and channel selection!

The **DG200** and **DG201** are ideal devices for digital computer interface with this analog world. If your switching problems are unique—and whose aren't—our applications people are eager to help. For complete information

## write for data

Applications Engineering: (408) 246-8000 Ext. 802



**Siliconix incorporated**

2201 Laurelwood Road, Santa Clara, California 95054

## Adding automatic zeroing to analog-to-digital converter

by Tom Birchell  
Advanced Electronic Controls, Fremont, Calif.

Automatic zeroing can easily be added to a counting-type analog-to-digital converter by using up/down decade counters and a digital-to-analog converter to generate an error-correction signal. The automatic zero function can be especially useful in a-d applications involving strain gages or other sensors where mechanical considerations can cause minute-to-minute changes in the effective zero point.

Normally, a zero-setting potentiometer must be adjusted constantly, but with the closed logic servo loop shown, it is only necessary to depress a pushbutton switch to produce the activating logic signal. Essentially, the circuit employs the pulse train occurring at the serial output of the counting-type a-d converter to generate

an error voltage. This error voltage is then fed back to the offset-adjustment input of the a-d converter to correct this device's zero setting.

Switch  $S_1$  (which is optional) loads the four-bit synchronous decade counters with a starting number for calibration purposes. Here, the half-scale point of the d-a converter's output is chosen as the calibration number to obtain a symmetrical correction range. If the expected offset variations will occur predominately in one direction, the calibration number should be selected to optimize the correction range.

Once the decade counters are preloaded, switch  $S_2$  initiates the correction cycle. When switch  $S_2$  is depressed, the pulses from the serial output of the a-d converter drive the decade counters either up or down, depending on the error polarity, which is determined by the sign bit. The output voltage of the d-a converter changes accordingly, adjusting the offset input of the a-d converter until no more pulses are produced at this device's serial output. The circuit is now adjusted to the true digital zero point.

For this circuit, the nominal adjustment range is  $\pm 7\%$  of the full range of the a-d converter.  $\square$

**Eliminating offset error.** Closed servo loop containing decade counters and digital-to-analog converter automatically zeroes the offset voltage of analog-to-digital converter. Pulse train from the a-d converter's serial output is used to generate the error voltage. Depending on the sign bit, the counters are driven up or down, adjusting the d-a converter's output and, therefore, the offset input of the a-d converter.

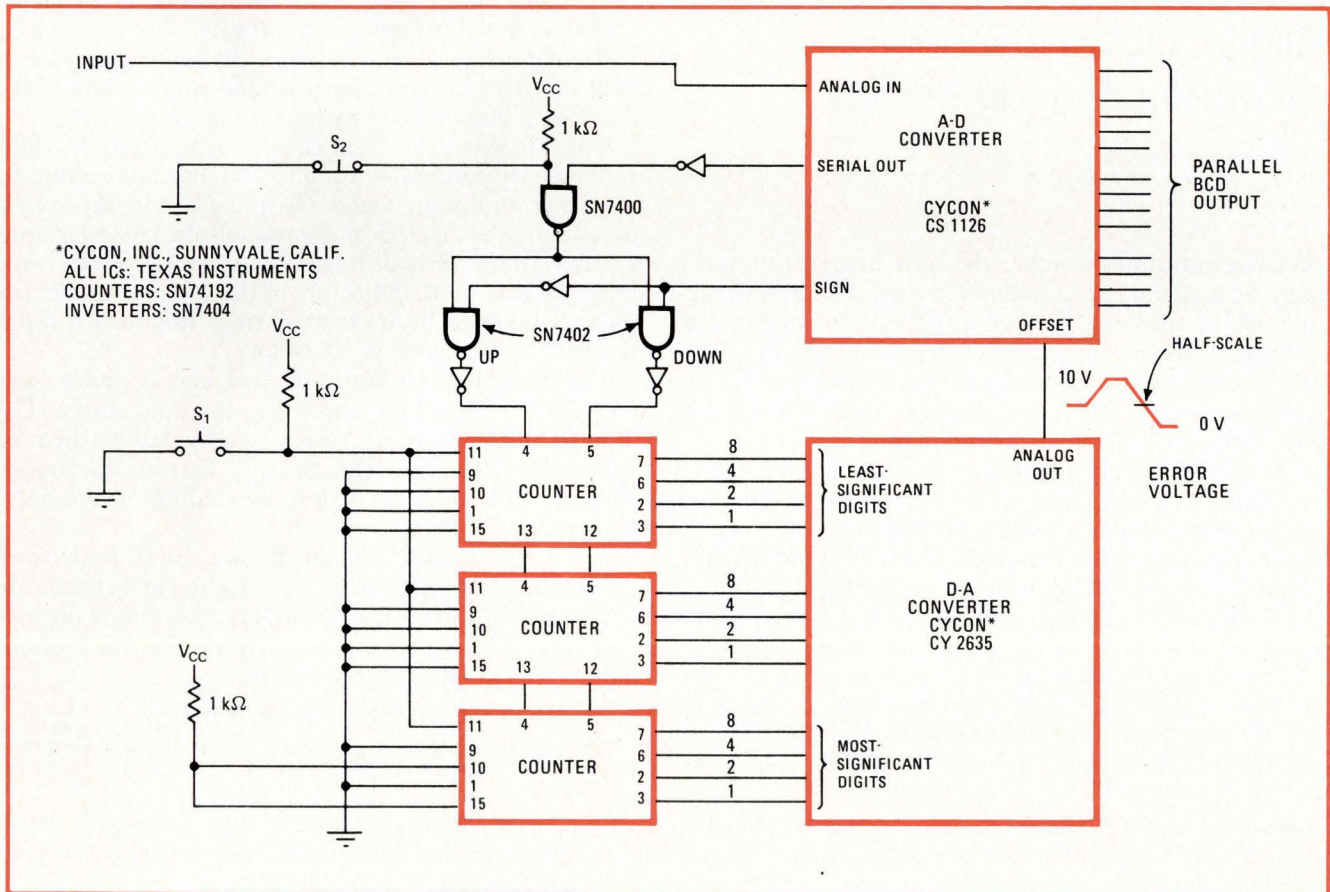

## Boosting IC regulator current with almost no power loss

by Don Kesner

Motorola Inc., Semiconductor Products Div., Phoenix, Ariz.

When the output current of a monolithic voltage regulator is boosted by the addition of a series-pass transistor, the regulator's efficiency is usually lowered because of the base-emitter voltage drop of the outboarded transistor. This added transistor voltage loss raises the input/output voltage differential of the over-all circuit, thereby causing a power loss.

The circuit shown, however, increases regulator current capability without this power loss. The output pin (pin 6 here) of the regulator is grounded so that the device's internal series-pass transistor does not contribute to the over-all input/output saturation characteristics. With this bypass technique, the low voltage differential of the IC alone can be maintained (typically at 1.5 volts here).

For the regulator indicated in the diagram, the absolute minimum differential is based on internal current-source saturation and cannot be lowered, but it is usu-

ally large enough to prevent the external transistor from saturating. Even with a type 2N3055 transistor as the booster, there is no significant difference in the minimum voltage differential with or without current boosting, and with or without a current-limiting resistor. □

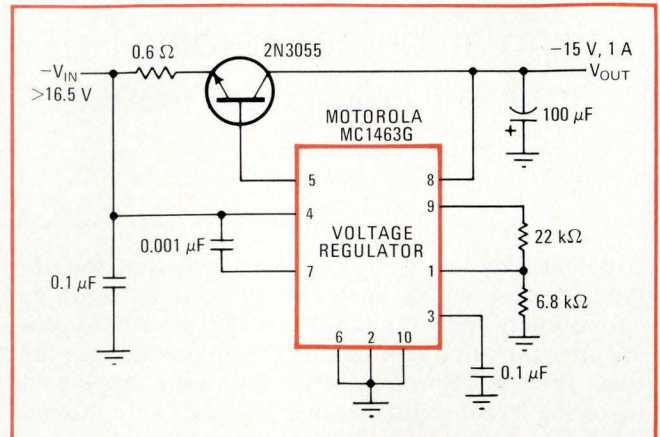

**Current boosting with minimal power loss.** External series-pass transistor increases current capability of monolithic voltage regulator, but decreases power efficiency of over-all circuit. Grounding regulator's normal output terminal (pin 6) bypasses internal series-pass transistor, maintaining over-all circuit's voltage differential ( $V_{IN} - V_{OUT}$ ) at that of the IC alone and making power loss negligible.

## Digital clock/calendar offers dual-mode display

by Gregory A. Baxes

BaKad Electronics, Mill Valley, Calif.

Besides indicating whether the time being displayed is a.m. or p.m., an easily assembled digital clock/calendar features a choice of a 12-hour or 24-hour mode. Furthermore, the calendar section has a switch for conveniently setting the number of days in the month. The clock section, of course, also has a switch for selecting either the 12- or 24-hour operating mode.

The entire circuit is built with TTL ICs, and the display is made up of the seven-segment type of readout. MSI devices—presettable decade counters—are used for the units display of both the clock and the calendar. These counters are preset by switch  $S_1$  to reset to 1 in the 12-hour mode and to 0 in the 24-hour mode. Conventional decade counters are used for the tens display for both the clock and the calendar.

Gates  $G_1$  and  $G_2$  and inverters  $I_1$  and  $I_2$  sense the binary outputs of the clock counters, resetting both the tens and units counters upon a "13 o'clock" pulse or a

"24 o'clock" pulse, depending on the operating mode. Likewise, in the calendar section, gates  $G_3$ ,  $G_4$ , and  $G_5$  and inverters  $I_3$ ,  $I_4$ , and  $I_5$  sense the binary outputs of both counters and reset the calendar upon receipt of the "monthly" pulse chosen by the setting of switch  $S_2$ .

Gate  $G_6$  senses the "12 o'clock" output from the clock counters, triggering the flip-flop and also advancing the a.m./p.m. indicator. Gates  $G_7$  and  $G_8$  and inverter  $I_6$  determine when a clock pulse reaches the calendar units counter. In the 12-hour mode, the clock pulse will come from the a.m./p.m. indicator; in the 24-hour mode, the pulse is initiated by inverter  $I_2$  since this device resets the clock tens counter at "24 o'clock."

The reset pulse for both the clock and calendar units counters is a logic high applied to the data strobe ( $D_S$ ) input of these counters. A reset pulse causes them to strobe their data ( $D_A$ ,  $D_B$ ,  $D_C$ , and  $D_D$ ) inputs and, in effect, to reset to either 1 or 0, depending on the operating mode.

Transistors  $Q_1$  and  $Q_2$  can be any small-signal pnp transistor that can drive the light-emitting-diode a.m./p.m. indicators. The 68-ohm resistor limits the current to the LED that is currently lit. In the 24-hour mode, the a.m./p.m. indicator is off. □

Designer's casebook is a regular feature in Electronics. We invite readers to submit original and unpublished circuit ideas and solutions to design problems. Explain briefly but thoroughly the circuit's operating principle and purpose. We'll pay \$50 for each item published.

**Convenient timer.** Uncomplicated design for digital clock/calendar keeps the user in mind. The clock section can display time as either a 12-hour or a 24-hour period, depending on the setting of switch  $S_1$ . In the 12-hour mode, the clock lights an LED lamp to indicate whether the time is a.m. or p.m. The calendar section can be set, with switch  $S_2$ , for the number of days in the present month.

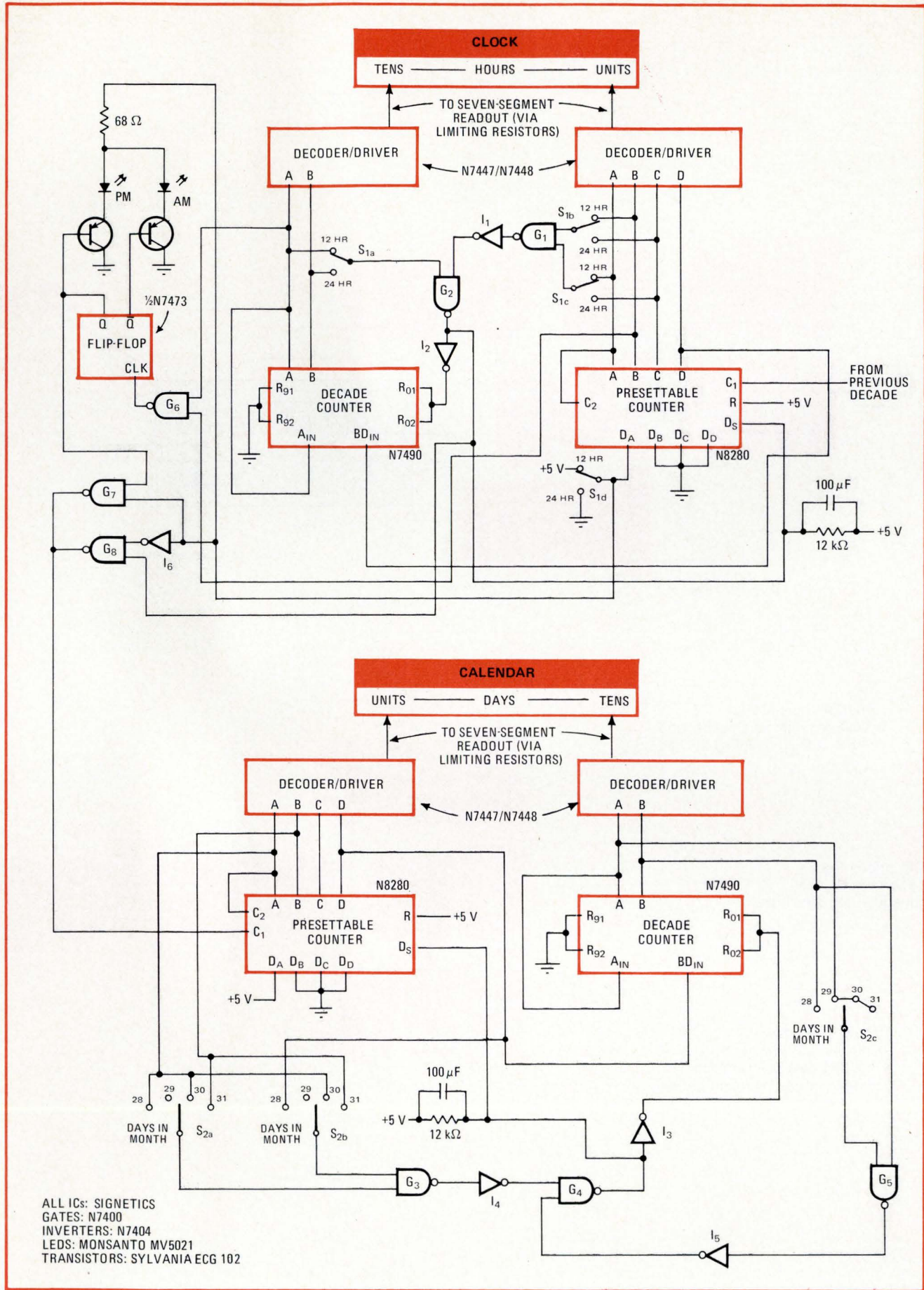

ALL ICs: SIGNETICS  
 GATES: N7400  
 INVERTERS: N7404  
 LEDs: MONSANTO MV5021  
 TRANSISTORS: SYLVANIA ECG 102

# We broke the log jam.

\$12.50

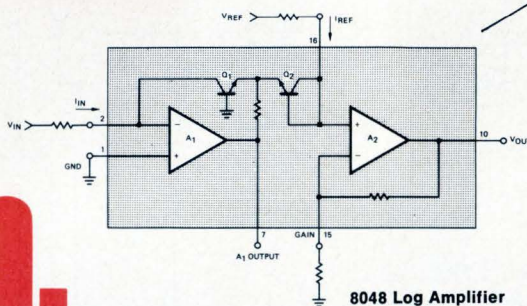

8048 Log Amplifier

**1.**

With the monolithic 8048 logarithmic amplifier and 8049 antilogarithmic amplifier.

**2.**

Both priced from 1/3 to 1/10 the cost of modular log amplifiers.

**3.**

For use in the most cost-sensitive analog data compression and computational applications.

# Also the antilog jam.

## The first monolithic log and antilog amplifiers.

Up to now you've had to pay \$50 to \$150 for big epoxy-filled modules when you wanted a logarithmic amplifier.

No more. Now the Intersil 8048 log amp and 8049 antilog amp cost \$12.50 each in 100+ lots, available immediately.

Meaning that now it's practical to use these monolithic devices, in their 16-pin DIP packages, for signal conditioning with reliable integrity, as well as for a wide range of arithmetic computations.

### Check the specs.

Both amplifiers combine two high performance FET input op amps and a special thin film temperature-compensating resistor network. The 8048 accepts 6 decades of current input (1nA to 1mA) or 3 decades ( $\pm 10$ mV to  $\pm 10$ V) of voltage. The 8049 accepts input voltages up to  $\pm 6$ V. In all respects, performance of these monolithic devices compares beautifully with that of the modules.

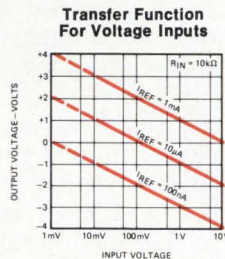
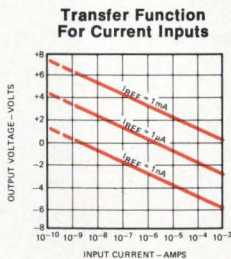

	Order Number	Full Scale Accuracy (Max.)		Dynamic Range		Nominal* Output	Package	100 Pc Price
		@ 25°C	0°-70°C	Current Input	Voltage Input			
<b>8048 Log Amp</b>	ICL8048CCPE	$\pm 1.0\%$	$\pm 2.5\%$	120dB	60dB	1V/dec.	16p pla. DIP	<b>\$12.50</b>
	ICL8048CCDE	$\pm 1.0\%$	$\pm 2.5\%$	120dB	60dB	1V/dec.	16p cer. DIP	<b>15.00</b>
	ICL8048BCPE	$\pm 0.5\%$	$\pm 1.25\%$	120dB	60dB	1V/dec.	16p pla. DIP	<b>25.00</b>
	ICL8048BCDE	$\pm 0.5\%$	$\pm 1.25\%$	120dB	60dB	1V/dec.	16p cer. DIP	<b>27.50</b>
<b>8049 Antilog Amp</b>	ICL8049CCPE	$\pm 1\%$	$\pm 2\%$	—	60dB	1 dec./V	16p pla. DIP	<b>12.50</b>
	ICL8049CCDE	$\pm 1\%$	$\pm 2\%$	—	60dB	1 dec./V	16p cer. DIP	<b>15.00</b>

\*Both 8048 and 8049 adjustable from approx. 1/2 to 2 volts.

# Intersil

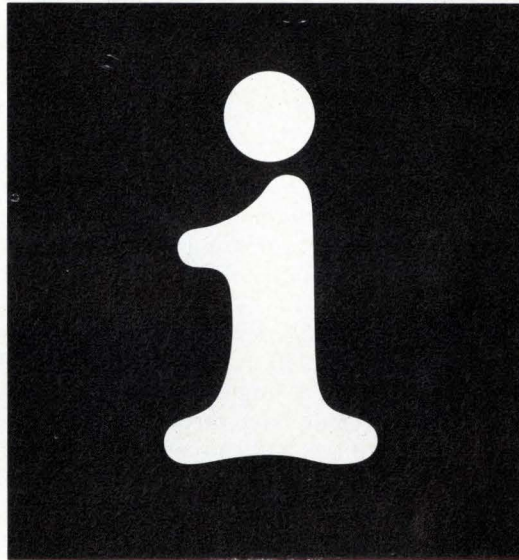

### Get 'em here.

Intersil stocking distributors. Elmar/Liberty Electronics. Schweber Electronics. Semiconductor Specialists. Weatherford.

Intersil area sales offices. Boston (617) 861-7380. Chicago (312) 371-1440. Los Angeles (213) 370-5766. Minneapolis (612) 925-1844. New York (201) 567-5585. San Diego (714) 278-6053. San Francisco Bay Area (home office) (408) 257-5450.

Representatives in all major cities.

# Sense amplifier design is key to 1-transistor cell in 4,096-bit RAM

Cell configuration of n-channel random-access memory increases yield, provides speedy access, and gives bipolar compatibility at low cost; markets are expected to range from microcomputers to large mainframes

by Clinton Kuo, Nori Kitagawa, Ed Ward, and Phil Drayer, *Texas Instruments, Dallas.*

□ A new class of 4,096-bit n-channel random-access memories promises to become the storage medium that will eventually replace traditional core memories in mainframes, as well as to become the big seller in markets for add-on, minicomputer, and even micro computer memories.

One 4,096-bit RAM recently developed by Texas Instruments, [*Electronics*, Aug. 30, p. 143], the TMS4030, has a unique design using a single-transistor memory cell (all others now available have three transistors per cell) that offers small cell size and chip area, high speed, and high yield at low cost. Key to implementing this simpler structure is a new on-chip sense amplifier that is capable of detecting the lower (200 millivolt) logic signals associated with one-transistor designs, thus overcoming a major hurdle in this approach to high-density, low-cost RAM development.

The TMS4030 chip provides access to a single bit of memory in 200 to 300 nanoseconds, which enables mainframes built around the component to operate at

rates many times faster than equivalent core designs. Single memory boards, containing upwards of 100,000 bits, can be accessed at a system speed of less than 400 ns and at power consumption of only 0.1 milliwatt per bit. Most important, the RAM will bring big savings in system costs, not only because of the low cost per bit at the component level, but also because the high packing density of a memory chip means reduced package count, more memory per board, lower wire and assembly costs, and smaller and cheaper memory modules that are fully compatible with bipolar logic.

## Two ways to design a RAM

The problem for the memory-system designer, however, is choosing from among the many RAMs now available or soon to become available. There are now two 4,096-bit RAM designs: a conventional three-transistor cell and a single-transistor cell that stores logic as charge in a capacitor. The selection of the basic cell structure is the most critical step in the development of the device because the type of memory cell selected will have a direct impact on the process used, the resulting chip size, the performance, the reliability, and the cost of the device.

Figure 1 shows schematics of the single-transistor cell structure (a) and two types of three-transistor cell designs. One design has two row-select lines (b), and one has a single row-select line (c). There are important design tradeoffs between the single-transistor and three-transistor-cell approaches. The one-transistor cell has the advantage of a minimum number of active circuit elements, which makes possible small cell size. On the other hand, the three-transistor cell yields larger, more easily detected signals. However, from strictly a process-yield standpoint, a one-transistor cell has an advantage over a three-transistor cell of the same size because the topographical structure of a one-transistor cell is less susceptible to process defects.

Unlike the three-transistor cell, which has a relatively fixed minimum size for a given technology, the size of the single-transistor cell is determined by the performance of a given sense-amplifier design because the magnitude of the signal that must be detected is proportional to the size of the cell capacitor. The more sensitive a sense amplifier is, the smaller the capacitor that is required.

Figure 2 plots the relationship of capacitor size to cell

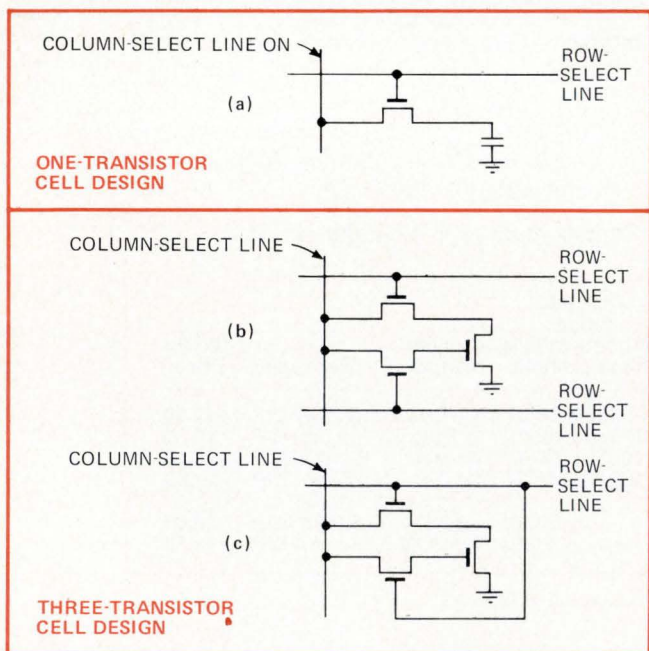

**1. Two roads to RAMs.** In the single-transistor cell (a), a storage capacitor is switched by a single transistor, while a three-transistor cell has traditional flip-flop structure. Here, either a two-select line cell (b) or single-select line cell (c) is possible.



size of the 4,096-bit RAM. It follows that the potential density and yield of the one-transistor cell can be fully realized only if a sensitive sense amplifier can be designed. Many one-transistor-per-cell RAM designs have failed because of inability to design an adequate sense amplifier, and that is why many semiconductor manufacturers are still using the three-transistor cell in their 4,096-bit RAMs.

Again, the single-transistor design was made possible by a sense amplifier that can reliably detect a very small-voltage signal (200 mV). Because the new sense amplifier requires a cell storage capacitance of only 0.1 pF, it is possible, by using well-established process and layout rules, to achieve a cell size of only 2 square mils.

In a one-transistor-cell circuit, the voltage swing available at a digit line for sensing during an interrogation period depends on both capacitance and voltage at the storage node and the digit line. This relationship is expressed:

$$\Delta V_D = (V_{SO} - V_{DO}) / (1 + C_D / C_S)$$

Where  $\Delta V_D$  is the voltage swing at the digit line from the interrogation of a storage cell;  $C_S$  and  $C_D$  are, respectively, the capacitance at the storage node and at the digit line; and  $V_{SO}$  and  $V_{DO}$  are, respectively, the voltage across the capacitors  $C_S$  and  $C_D$  before the cell is selected for interrogation. Capacitance  $C_D$  is parasitic and includes the pn-junction capacitance of the digit line, the sense-amplifier input capacitance, and overlap capacitances between the digit line and gate electrodes of cell-gating transistors.

The equation indicates that to increase the amount of voltage for detection,  $\Delta V_D$ , it is necessary either to increase the storage voltage,  $V_{SO}$ , or to reduce the ratio of digit-line capacitance,  $C_D$ , to storage capacitance,  $C_S$ . Conversely, for a given sense amplifier with a fixed sensitivity, the reduction of the storage capacitance,  $C_S$ , and with it the cell size, can be accomplished by either increasing the storage voltage,  $V_{SO}$ , or reducing the ratio of digit-line capacitance  $C_D$ . In practice, the storage voltage,  $V_{SO}$  is near the maximum value achievable for a given power-supply voltage; therefore, the reduction of  $C_D/C_S$  is the most critical factor to be considered in defining a process and optimizing a cell layout.

Most manufacturers developing 4,096-bit RAMs have

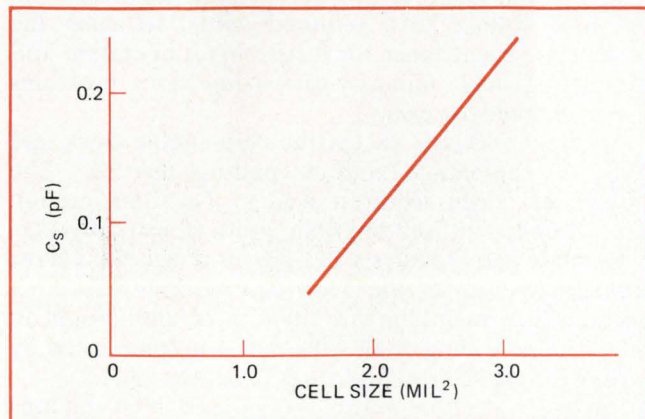

**2. Sizing it right.** Size of a single-transistor cell depends largely on capacitor size. In the 4,096-bit RAM, a 0.2-picofarad capacitor makes possible a cell size of about 2.0 mil<sup>2</sup>—considerably smaller than most existing RAMs, which have three-transistor cells.

selected the n-channel process because of its high speed—it has twice the carrier mobility of p-channel. Since for one-transistor-cell circuits, it is essential to have a low  $C_D/C_S$  ratio, silicon-gate, which is a space-saving, self-aligned-gate process, was adapted to the n-channel process for the TMS4030.

From circuit-design aspects, two parameters of the n-channel process are significantly different from those of the p-channel process: the transfer-conduction factor,  $K'$ , and the threshold voltage,  $V_T$ . Both parameters lean in n-channel's favor. The  $K'$  for the n-channel, silicon-gate process is about 2.5 times higher than that for p-channel silicon-gate. The higher  $K'$  means higher-speed operation, especially for dynamic-type RAM circuits. The lower  $V_T$  for the n-channel, silicon-gate process allows design of memories that are TTL-compatible at both inputs and outputs. This means that lower voltages can be used at no sacrifice of speed and, con-

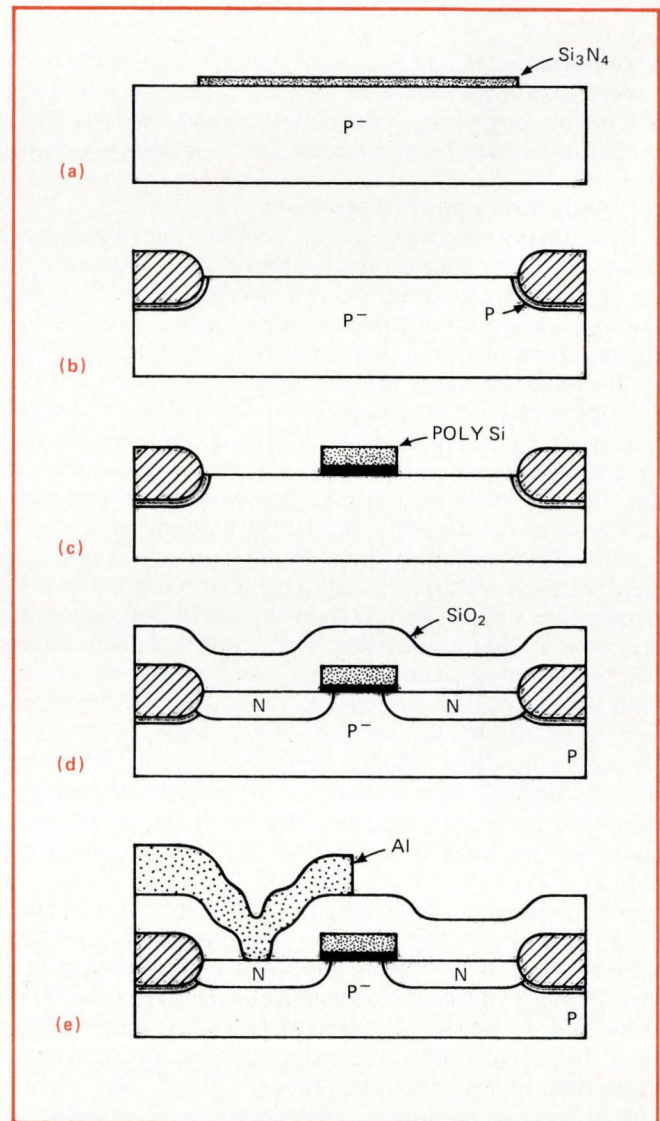

**3. Building it.** Field doping and oxidation are done on a p-type substrate (a) after oxide/nitride depositions; b shows the boron doping and oxidizing growth step; in c, the gate oxide has been grown and the polysilicon processed; d shows the structure after the n- and p-type source, sink, and gate diffusions have been made and the dioxide deposited. After metalization, the device is completed (e).

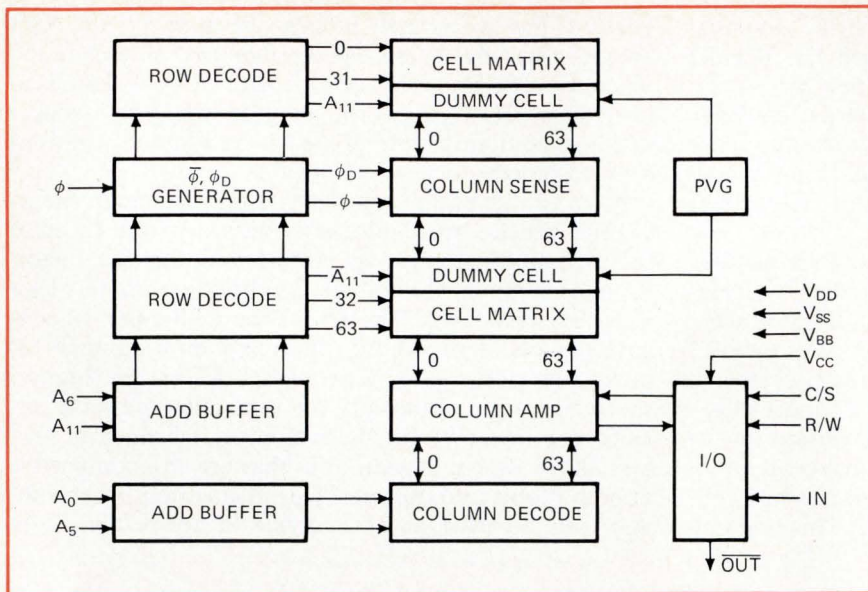

**4. Organization.** The 4,096-bit RAM matrix is organized in 64 columns by 64 rows. A dummy cell serves as a sensitivity reference for the sense amp. A precharging voltage generator sets the logic voltage of the dummy cell as a reference. Only one external clock 0 is needed; all clocks for the dynamic operation of the memory are generated internally.

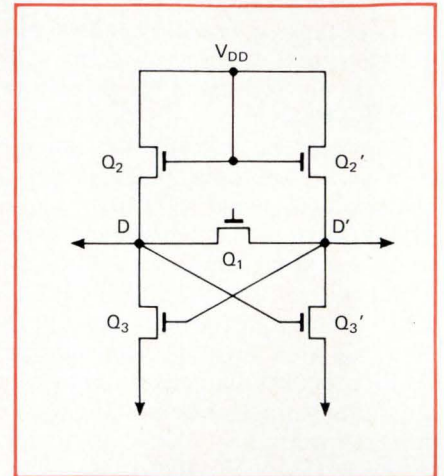

**5. It makes sense.** In a very sensitive amplifier, the introduction of an infinitesimal signal at node D or D' will tip the balance of the flip-flop and switch it in a known direction.

sequently, lower power dissipation.

The silicon area occupied in a cell by the storage capacitor,  $C_s$ , depends on the composition of that capacitor. It is possible to reduce cell size for a given  $C_s$  by making some modifications to the process, such as reducing the thickness of the capacitor's insulator or using an insulator having a higher dielectric constant, but no such modification was needed for the TMS4030 design because a sense amplifier with adequate sensitivity was designed. Indeed, the 4030 has a structure essentially the same as that of a standard p-channel silicon-gate device, thus maintaining simplicity and high yield.

One disadvantage of the n-channel process is that the field turn-on voltage is relatively low without special preventive steps. The low field-threshold voltage tends to cause a leaking junction, which will adversely affect the operation of dynamic circuits and reduce the retention time of charges stored in a capacitor. This problem has been eliminated for the new TI RAM by using a channel-stop diffusion that increases the density of the surface doping and with it the field turn-on voltage. With this preventive measure, the time between refreshings for the RAM is 2 ms over the full temperature range.

The process is shown in Fig. 3. It starts with depositions of a nitride film on top of a p-type substrate. This step is followed by selective removal of film for limited field doping and field oxidation. The field area, which is now free of nitride, is subjected to a light boron diffusion to increase the surface-doping concentration and, consequently, the field-threshold voltage; this is followed by field oxidation. The remaining nitride film is removed, the gate oxide is grown, and the polycrystalline silicon film is deposited and selectively etched. Phosphorous is diffused, and a multilevel insulator is deposited. Finally, contacts between the polysilicon regions and the metal interconnections, as well as between metal and diffusion regions are opened, and then

the metal is deposited and selectively etched.

Externally, the new memory is organized 4,096 words by 1 bit. Only one chip-enable clock is required for operation, which is the simplest possible timing for a dynamic RAM. The chip-enable clock serves as a control to activate the chip operation and as a strobing pulse for the built-in address registers.

#### It's easy to use

By merely turning off the clock, the chip can be operated in a low-power-standby mode. A chip-select-control terminal is also provided for the circuit. The control, when activated, can block the data from being written into or read out of the chip and therefore provides another means for organizational expansion. Like all dynamic RAMs, the TMS4030 needs three power supplies:  $V_{BB}$  ( $-3V$ ), a substrate biasing voltage;  $V_{DD}$  ( $+12V$ ), the power source to all circuits except the output buffer; and  $V_{CC}$  ( $+5V$ ), the supply voltage for the output buffer. The substrate bias voltage,  $V_{BB}$ , shifts the threshold voltage to a required value, reducing the pn-junction capacitance for faster circuit operation and eliminating any minority-carrier-injection problems that may otherwise exist.

All input voltages, except the chip-enable clock, are fully TTL-compatible without pull-up resistors. The chip-enable clock requires  $+12V$ . The data output, which is inverted from the data input, is also fully TTL-compatible and provides a TTL fanout of two. Like most MOS dynamic RAMs, the TMS4030 requires refreshing operations to maintain the integrity of data stored in cells. The refreshing of all 4,096 bits is accomplished by cycling through 64 row addresses from  $A_6$  to  $A_{11}$ .

Internally, the RAM matrix is organized in 64 columns by 64 rows (Fig. 4). A column is selected through a decoder by addressing  $A_0$  through  $A_5$ , and a row is selected by addressing  $A_6$  through  $A_{11}$ . At the center of each column is a differential-type sense amplifier with

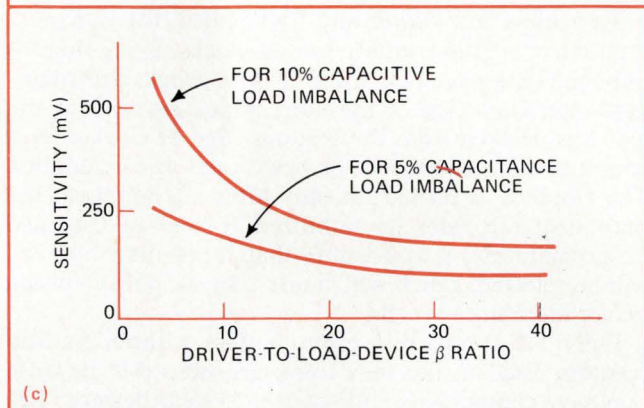
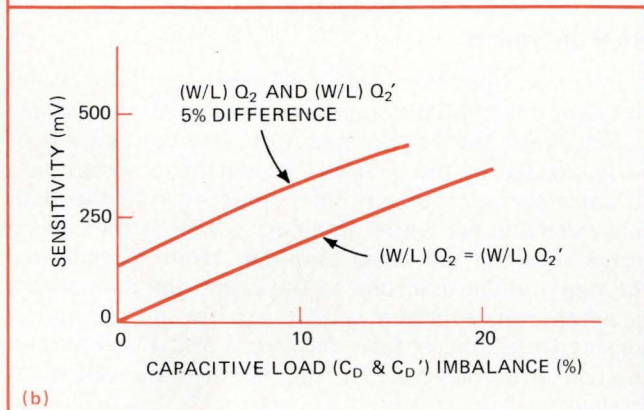
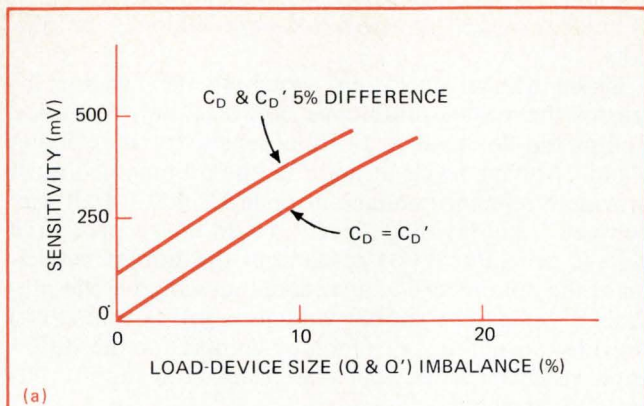

**6. Balancing act.** The curve in a illustrates the degradation of almost 50% in sensitivity when there is an imbalance in the load capacitance of only 5%, while the curve in b indicates an equally degrading effect from size imbalances. In c, as the beta ratio goes from 1% to 10%, the sensitivity increases by a factor of 2.

one-half of a column, or 32 cells, connected to each of its two input terminals. As shown, all the required clocks for dynamic, ratioless-type circuits and sense amplifiers are generated internally.

### The sense amp

Integrating a differential sense amplifier capable of 200-mV detection on a complex memory chip is not only vital for RAM product development, but it may well serve as a design element for other circuit applications as well. The basic operation of the sense amplifier can best be understood by first considering a perfectly balanced flip-flop (Fig. 5), with the inverter formed by  $Q_2$  and  $Q_3$  identical to the one  $Q_2'$  and  $Q_3'$ . In a steady state without any constraints, the flip-flop will

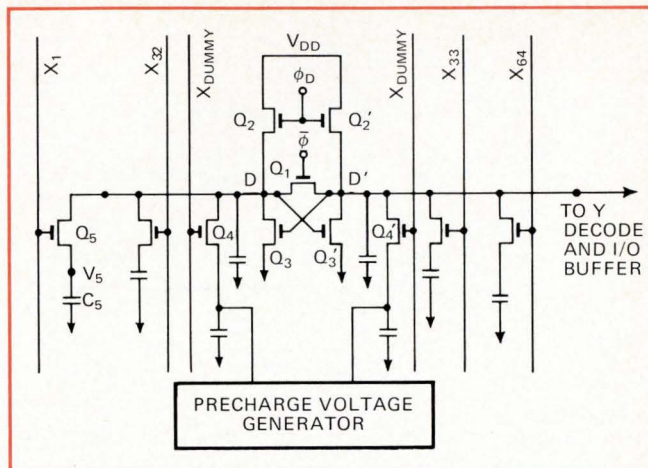

**7. A dummy.** The sense amplifier is connected at both sides with 32 cells and a dummy cell whose function is to minimize the imbalances from coupling noises and provide a voltage reference.

have high and low levels at nodes D and D'. By exerting an external force, such as short-circuiting between nodes D and D', it is possible to have an equal potential on both nodes. At the moment the external force is removed, the flip-flop, which is in an unstable state, will tend to settle down into a steady state. In an ideal condition, the introduction of an infinitesimal amount of charge to a node at that moment will tip the balance of the flip-flop and switch it in a predictable direction.

But since no two devices can be exactly identical in a practical circuit, no such ideal condition exists. The amount of charge that must be introduced to switch the flip-flop will be determined by the amount of imbalance between two halves of the flip-flop. And the greater the imbalance is, the greater the amount of charge required to switch it in the proper direction and the less sensitive is the circuit. In a practical circuit, the imbalance of the flip-flop can be caused by variations in either the physical dimensions or the electrical parameters, such as mobility or threshold voltage, of the two supposedly identical devices.

The sensitivity as a function of imbalance for particular circuit parameters can be obtained through circuit analysis. Figure 6a shows the amplifier sensitivity as a function of the imbalance between load devices,  $Q_2$ , and  $Q_2'$ , in terms of a device width over device length, (W/L). Figure 6b shows the sensitivity as a function of degree of imbalance between total capacitance at nodes D and D'. For a given degree of imbalance in the sense amplifier, the sensitivity is also affected by the device-size ratio of the driver and load devices, as shown in Fig. 6c. The curves shown are for an imbalance of 5% and 10% difference in capacitance between nodes D and D'.

For a 4,096-bit RAM sense amplifier, the imbalance between both halves of the flip-flop is compounded by a multiple connection of cells to each side of it, together with noises generated from capacitive couplings when a cell is selected. To enhance the sensitivity of the sense amplifier, the amount of imbalance contributed by each source must be minimized.

Figure 7 shows the sense amplifier in a 4,096-bit RAM connected at both sides to 32 cells and a "dummy cell,"

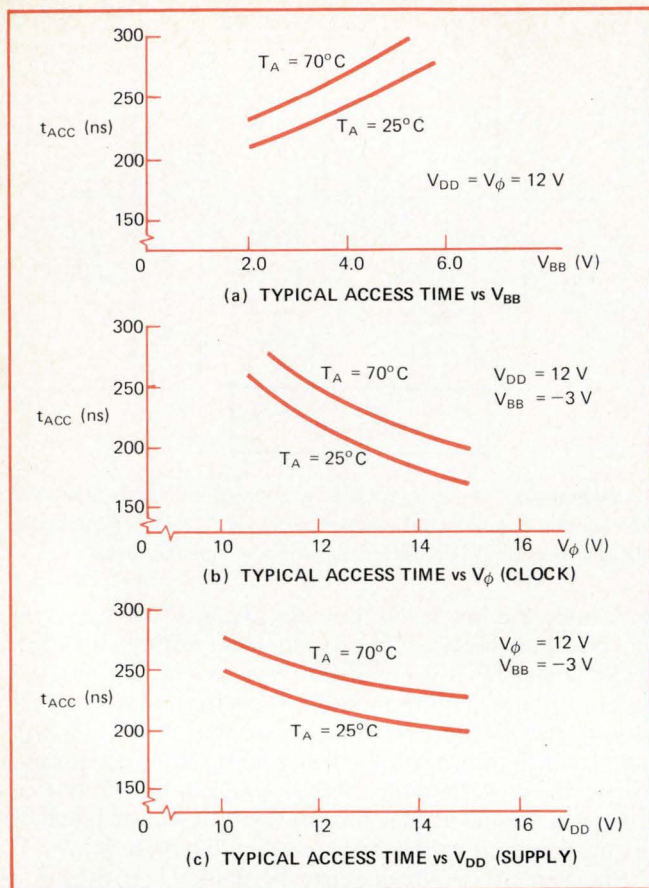

**8. Speeding.** To maximize the access time of a RAM requires optimizing the relationships of several parameters. The slower speed for higher substrate voltages (a) results from the increase of the transistor threshold at higher voltages. And as in all dynamic memory designs, the faster operation of the memory with increased clock and supply voltages are shown in b and c, respectively.

an extra cell identical to the data cells. Dummy cells have two purposes: to minimize the imbalance caused by coupling noises and to provide a reference voltage to the sense amplifier for maximum discrimination between data 1 and 0 signals. Transistor  $Q_1$  is for precharging both D and  $D'$  nodes around one threshold voltage,  $V_T$ . Load devices,  $Q_2$  and  $Q_2'$  are switched off during the precharging time to obtain the desired precharge voltage and to reduce the power dissipation.

As the clock goes to a high level, addressing signals are going through input buffers and the decoder, and one row is selected out of a possible 64. The dummy cell, which is at the opposite side of the sense amplifier from the selected cell, is also selected by the most significant bit of the row address. The memory-cell and dummy-cell-selection voltages are both gated by clock  $\phi_D$ , which is delayed from clock  $\phi$  and is generated by an internal timing circuit.

It is assumed that the memory cell with  $Q_5$  at the left side of the sense amplifier is selected during a read cycle, the dummy cell with  $Q_4$  at the right side will also be selected. When the delayed clock  $\phi_D$  goes to a high voltage, both  $Q_5$  and  $Q_4$  will be turned on, and new voltage levels will appear at D and  $D'$  nodes, according to the equation on p. 117. The switching direction of the flip-flop is determined by the new voltage levels at both

D and  $D'$ , as well as associated parameters of the flip-flop.

Under normal operation, switching the flip-flop increases the voltage difference between the two nodes. For the flip-flop to have an equal sensitivity in detecting 1 and 0 voltage levels at node D, the dummy cell must provide a reference voltage at node  $D'$  that is half-way between 1 and 0 voltage levels. To do this, a precharge voltage generator (PVG) precharges the storage capacitor of the dummy cell to a voltage that will give the prescribed value. The supply voltage is set so that (PVG) provides an optimized reference voltage for the differential sense amplifier, which can track both supply voltage and threshold voltage.

### RAM operation

In a read operation, one of 64 sense amplifiers is selected by a column decoder to interface with the output-buffer circuit. In a write operation, one column out of 64 is selected by the column decoder for external data to enter the selected amplifier and override the data that existed in the sense amplifier, as well as the cell selected. Because the sense amplifier tends to reinforce the signal under detection at the input, the data stored in a cell, which is temporarily lost during the initial sensing operation, is fully recovered and reinforced at the end of a read cycle. In this manner, the cell is refreshed.

To achieve low power and high speed, the dynamic-RAM circuit requires many timing clocks. Since there is only one external clock, most of these clocks are generated internally. One of the most important is clock  $\phi_D$ , which is delayed from the leading edge of clock  $\phi$  by a length of time optimized for best speed and reliability. The clock  $\phi_D$  is turned on only after all signals at the outputs of a decoder are stabilized. If clock  $\phi_D$  is turned on prematurely, it is possible that more than one cell will be selected, which will create a sneak path between two or more storage cells.

Fully TTL-compatible input buffers without pull-up resistors, used in the new RAM, are desirable because they save components and space in system designs. The design of an MOS high-speed, fully TTL-compatible input buffer is almost impossible for a high-threshold voltage process, and it is difficult, even for the low-threshold n-channel silicon-gate process. This is because the conductance of the input-driver device is essentially proportional to the difference between the input voltage and the threshold voltage, and the TTL-level voltage of only 2.4 V makes it a necessity to have a large input-driver device to attain sufficient conductance. The size of the device introduces a large parasitic capacitance that slows down the circuit.

A novel input circuit developed for the RAM has greatly minimized this difficulty, and it has achieved truly TTL-compatible inputs. By connecting the source terminal of the driver device, the maximum allowable 0-level voltage at the output of the first inverter stage is increased by the amount equal to the 1-level input voltage. The allowance of a higher 0-level voltage at the output of the inverter means a lower conductance, and therefore a smaller input driver.

In terms of performance, probably the most impor-

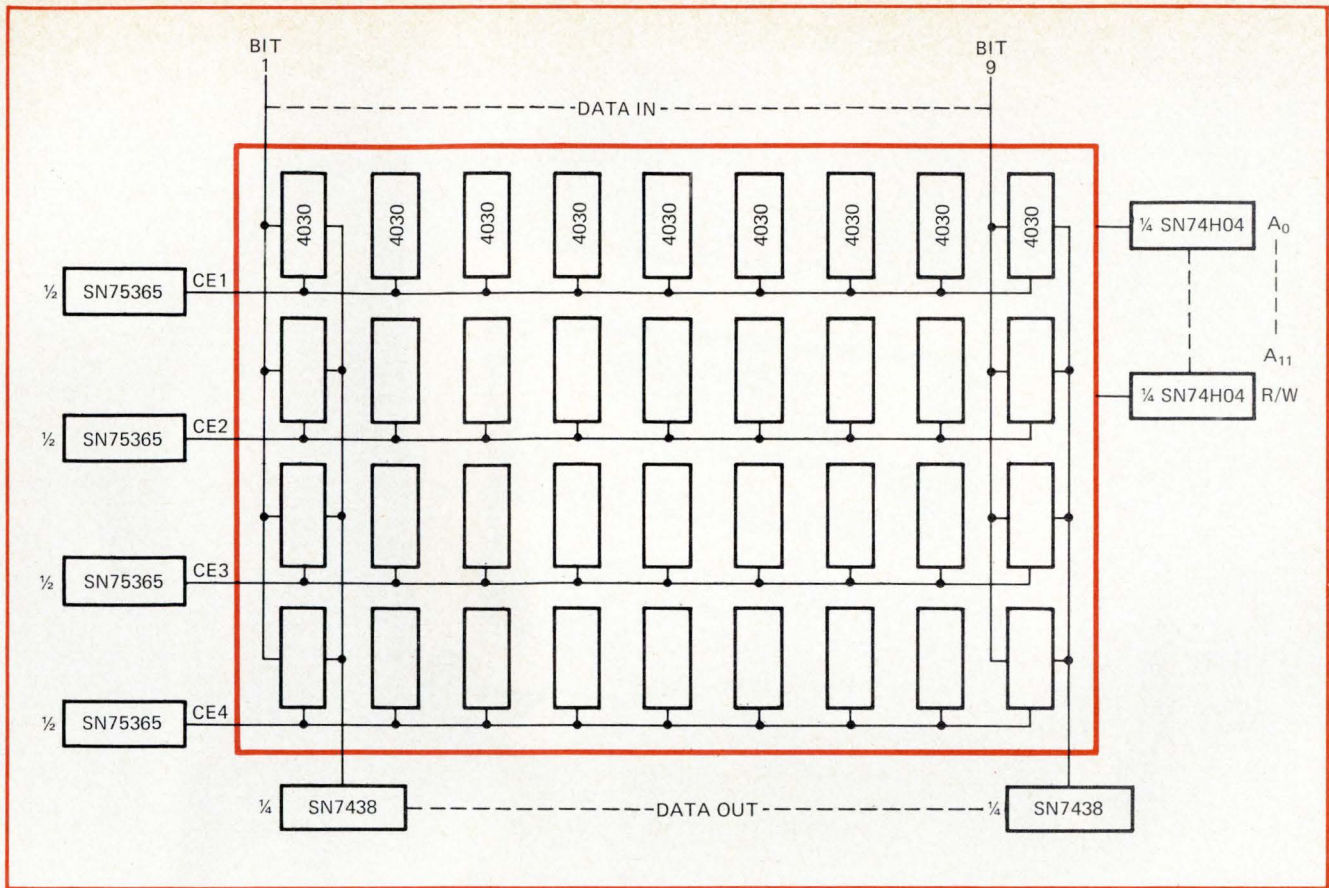

**9. Little systems, big memories.** Designing a 16,384-byte memory board requires only 36 4,096-bit RAMs organized in an array of four rows by nine columns. All data inputs and outputs in a column are connected together to form a memory of 16,384 words of 1 byte each.

tant RAM parameter is speed, and from a sampling of devices produced in various lots, it has been confirmed that the new 4,096-bit RAM is well within the specified access time of 300 ns. As shown in Fig. 8, the speed of the device is a function of various supply voltages. The slower speed at high  $V_{BB}$ , (Fig. 9a) results from the increase of a MOSFET's threshold voltage at a higher  $V_{BB}$ . The minimum  $V_{BB}$  voltage that can be used is determined by the minimum threshold voltage at which the circuit can operate reliably. Figures 8b and 8c, respectively, show the RAM's speed as a function of  $V_{\Theta}$  and  $V_{DD}$ .

### System applications

The high degree of self-sufficiency and simple timing requirements of TMS4030 will substantially reduce complexity in dynamic-MOS memory-system design. Little support circuitry is required for operation or organizational expansion in a system. For example, in a small memory of 4,096 words by 17 bits that may be used in a minicomputer, only one TTL-to-MOS converter/driver is required to directly support the operation of a memory array of 17 4,096-bit RAMs. The same memory design, using 68 1103-type 1,024-bit RAMs requires 39 TTL-to-MOS converter/drivers (17 for data inputs, 10 for addresses, four for chip-enable clocks, four for precharge clocks and four for R/W select) and 17 sense amplifiers to support a memory array of the same size.

Probably the most efficient application for the 4,096-bit RAM will be in such large memory systems as a basic-storage module (BSM), which contains at least one

control board and a number of memory boards, depending on the size of the system. The control board not only provides a method of communicating between the BSM and the central processing unit (by accepting read or write requests and providing data-ready and busy status signals), but it also generates all necessary control signals for read, write, and refresh operations. The memory board contains a storage array, as well as input buffer/drivers and output buffers.

Assembled in a standard 22-pin dual in-line package, the TMS4030 provides very high packing density for a memory system. A memory with a capacity of 65,536 bytes can be designed on a 13-by-13-inch board. Figure 9 illustrates the design of a 16,384-byte memory, using a total of 36 4,096-bit RAMs, organized in an array of four rows by nine columns. All data inputs and data outputs in a column are connected together to realize a capacity of 16,384 words of one byte each.

All chip-enable (CE) clocks in a row are tied together and driven by a clock driver that is gated by the board-select, as well as row-select signals. The clock driver for a CE line can be either an integrated circuit or a discrete driver. However, since all existing IC clock drivers are designed for p-channel circuits, they all have a low-power state when the output voltage is high.

This is contrary to the requirements for low-power operation of an n-channel device, and therefore, a push-pull type discrete driver must now be used if low system standby power is to be achieved. As more n-channel devices are introduced, the demand for an n-channel-type clock driver undoubtedly will result in such a product within a short period of time. □



## Best buy power module for op amps.

**$\pm 15V$  (tracking)  
400 ma... \$85.**

Regulation,  $\pm 0.1\%$ ;  
ripple, 1.5 mv. Size, 3.4"H x  
5.1" W x 5.1"D. Input voltage,  
105-125 VAC, 50-400 Hz.  
Order Model TD15-40. For 1.0  
amp outputs, Model TD15-100  
... price, \$125. Other high  
quality models are available to  
power balanced loads drawing  
from 25 ma to 8.5 amps.

Five year warranty. Three day  
shipment guaranteed. Acopian  
Corp., Easton, Pa. 18042.  
Telephone: (215) 258-5441.



# Standard interfaces promote new minicomputer networks

Recent availability of off-the-shelf interfaces is stimulating rapid growth of multiprocessor systems that have fast data throughput rates at minimum cost, high reliability, and remote-processing capabilities

by Brian Fitzgerald, *Digital Equipment Corp., Maynard, Mass.*

□ Among the tens of thousands of minicomputers now installed, a relatively small percentage are part of processing systems in which more than one computer is involved. This situation, however, is rapidly changing.

Key to the recent upsurge in the use of multi-computer processing systems is the new series of interconnecting hardware and software that minicomputer manufacturers are offering, off-the-shelf, to their customers. Previously, the custom-built interface designs that were needed to implement these multiprocessor systems made such systems, in the main, economically unfeasible.

Because of these new standard interfaces, more and more multiprocessor systems are being used in a variety of applications. In some systems, for example, minicomputers are combined simply to add redundancy when high reliability is needed. In other applications, multicomputer networks allow the kind of distributed processing that is desirable in widely dispersed data-communications systems. And in still other applications, arrays of minis have been teamed up to provide raw processing power surpassing that of a medium-scale computer—at significantly lower cost.

## Minicomputer architecture

To better understand what types of applications lend themselves to multiprocessor systems, it is necessary first to consider the basic minicomputer structure, then to analyze the three standard classes of interfaces that have been developed to combine these computers.

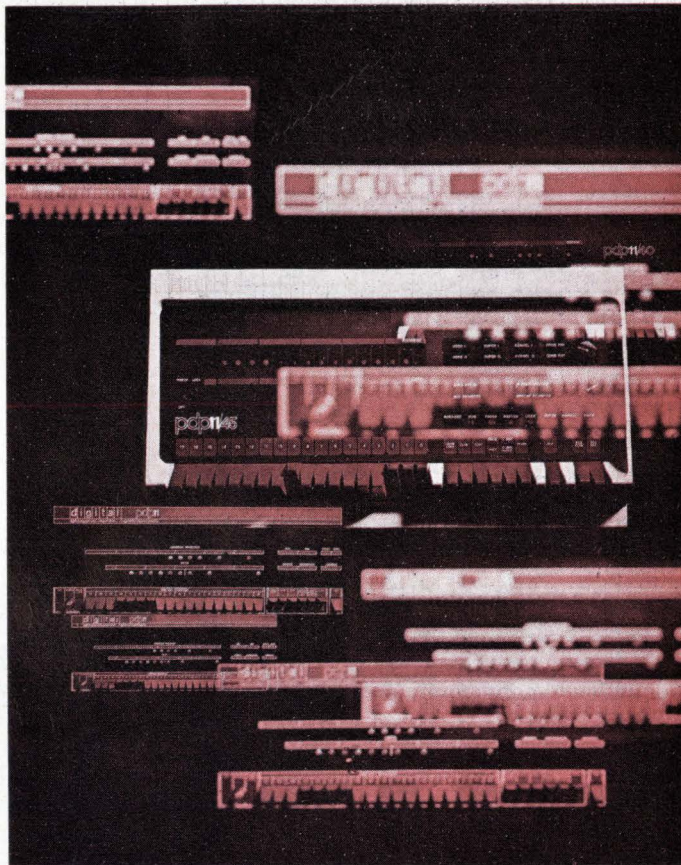

A minicomputer's internal architecture—the arrangement of such major components as the central processor and memory—affects the types of interconnections that can be made between computers. Newer minicomputer designs have a flexible architecture that nearly approximates the degree of freedom available in large computers.

Internally, minicomputer architectures are organized around their bus structure and fall into two broad classes—the separate bus and the unified bus. The most common arrangement is the first, which has separate memory and input/output buses as shown in Fig. 1a.

In the separate bus structure, most operations take place between

the central processing unit and memory, or the CPU and the peripheral devices. Such fast I/O peripherals as disks and tape transports, however, use direct-memory access (DMA) channels to bypass the processor when large blocks of data are being moved into or out of memory.

In separate-bus architecture, because the I/O bus is usually synchronized with processor operation, it is limited to a length of about 50 feet.

A more recent minicomputer architecture is the unified-bus structure shown in Fig. 1b. In this system, both memory and peripherals are connected to a single bus. Each input/output device is defined in terms of a set of registers that appear as locations in bus-address space. As far as the central processing unit is concerned, all address-register locations are equivalent, and therefore any instruction that operates on a memory register can

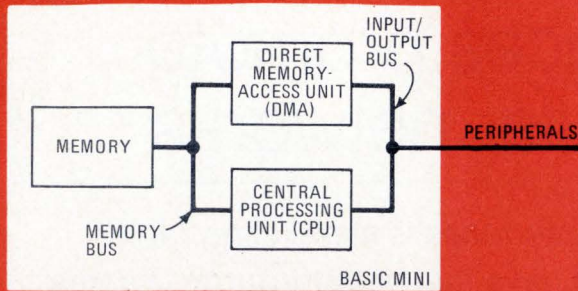

(a) SEPARATE-BUS STRUCTURE

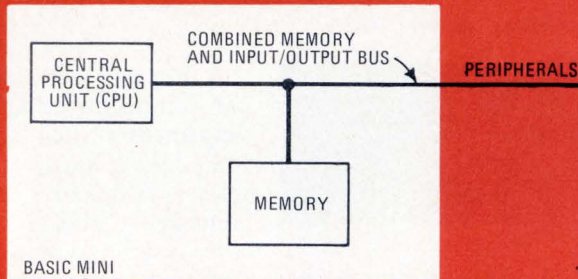

(b) UNIFIED-BUS STRUCTURE

**1. Architecture.** Minicomputer's internal architecture, or arrangement of such major components as central processor and memory, falls into two fundamental configurations—those with a separate memory and input/output bus, and those with a single unified bus.

also operate on an I/O-device register.

Minicomputers using unified-bus architecture generally operate in the asynchronous mode. The combination of the generalized address register and the asynchronous relationship between devices results in a system that is free of inherent constraints on equipment location or bus length. Thus, memory and peripherals can be attached to the bus at whatever point most conveniently suits the system's requirements.

### Interconnecting devices

What is needed to interconnect several computers into a network? It is possible, of course, to interconnect two or more of any kind of central processor and call them a multiprocessing system, just as it is possible to put together any set of engineers and call them a design team. But success in both instances depends as much on the ability to function together as on individual capabilities.

In organizing minicomputer networks, three fundamental interconnecting techniques, each allowing different levels of coupling between processors, have been successfully used in multiple-processor system designs. These techniques, which in varying degrees have been implemented in standard hardware by several manufacturers, are the bus switch, the bus link, and the bus window.

A bus switch, the simplest and most easily implemented of the three interfaces, connects a memory or a peripheral device on its output port to one of two computers attached to its input ports (Fig. 2). Since the ob-

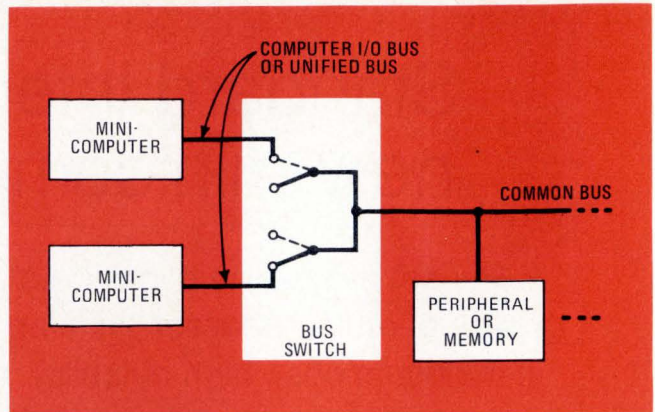

**2. Bus switch.** Simplest and most easily implemented computer interconnecting device is the bus switch, which connects either of two computers to a common memory or peripheral.

jective is to make the switch transparent to the operating program, the switch passes the bus signals through to the output device.

Although the bus switch can be designed to connect two computers of different internal architecture to a common peripheral, circuit complexity and cost factors generally dictate that the two computers have the same internal bus structure. Switching can be either manually or automatically controlled when the failure of an on-line computer is detected.

The bus link, on the other hand, transfers information directly between computers (Fig. 3). One of the common requirements for a link is that it connects machines that are separated by some distance. The input port of the link receives information from the transmitting computer and converts it into a format and signal level suitable for transmission to an output unit at the signal's destination. The transmission link itself can be a high-speed hard-wired cable, or a relatively slower voice-grade telephone line.

The output unit at the signal's destination converts the message back into a format matching that of the receiving computer's bus. Since the bus link handles all the problems of adapting to the signal formats of the computers on each end, this kind of connection can usually be made between any two computers, irrespective of each computer's internal architecture.

As implemented today, bus links can handle data rates from a few characters per second up to several hundred thousand characters per second when parallel data channels are used. In most bus links, processors communicate over serial lines, although data characters are sometimes transmitted in parallel when computers in a network are close together. In both parallel and serial links, the bit stream may be either asynchronous or synchronous.

The maximum data rate through a serial link is a few thousand characters per second, and it is useful in situations where the processors in the network are relatively independent of each other, requiring only a modest amount of interaction.

### Extending the link

The serial link can be conditioned by using modems to operate over long distances. While hard-wired lines



can be extended up to about 1,500 feet, a connection through the telephone network can, of course, be virtually unlimited in distance.

Bus links can be extended to a network of three or more processors, where a common interprocessor bus connects all the computer interfaces. In such a multipoint network, the common bus can be allocated by a simple round-robin polling sequence or by some more complex priority-arbitration pattern. In some large multiprocessor systems, it may even become necessary to add an additional computer to the network to manage the interprocessor traffic through the common bus.

Both bus links and bus switches have been connected in multiprocessor systems with either separate or unified-bus structures. For the sake of optimizing cost and performance tradeoffs in multiprocessor systems using existing minicomputers, the interconnecting devices are usually designed to operate within the confines of the minicomputer's basic architecture. The resulting devices sometimes have less than optimum efficiency. On the other hand, they have the important advantage of allowing the network to be constructed from standard, readily available components, thus keeping system costs down.

### Bus window

The quickest and most efficient way to share data between two processors is the bus window, developed for use with computers having unified-bus architecture. The window extends the concept of dual-port memory at much lower cost by allowing memories to be made shareable or non-shareable dynamically and on line.

The bus-window (Fig. 4) allows each of two processors to share access to part of the other processor's memory on either a read-write or a read-only basis. Connections are established between buses so that subsequent addressing of segments of another computer's memory are allowed. Furthermore, the control of peripherals can be shared between two processors by using a bus-window approach.

The functions of the bus window are better understood by considering the operation of the Digital Equipment Corp. model DA11-F window for use between two PDP-11 minicomputers. First consider the "opening of a window" in one direction between computer A in Fig.

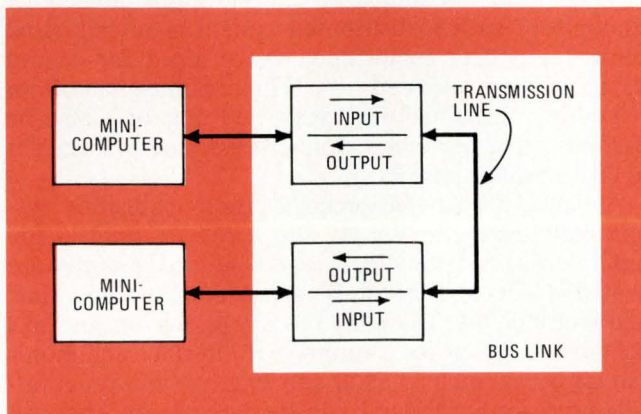

**3. Bus link.** Direct computer-to-computer dialog is permitted by the bus link, which also provides a means for converting between the architectures and signal formats of two unlike computers.

4 and a block of 8,000 words in computer B's memory.

Computer A sends a request to computer B that the channel be opened, identifying the code of the block requested, and indicating whether it is to be on a read-write or read-only basis. Computer B acknowledges the request, and then allows computer A to gain control of part of computer B's memory. Once a channel has been opened, the originating computer can make random accesses through the window without further control operations.

Each processor is given complete control over accesses to locations on its own bus. Therefore, the processor on the target bus can disable transfers through the window, restrict them to read only, or decide which addresses on its bus the window may access. Since each processor ultimately controls window operations directed at its own bus, the two computers must cooperate to establish the access.

The DA11-F window contains two of the window channels described above—one in each direction. Transactions may, therefore, originate on either bus, and data may flow in either direction. Also, since an individual processor is not limited to a single bus window, multiple windows can be arranged to allow intercommunications between several processors.

### Switches add reliability

The choice of which type of interconnecting device to use—switch, link, or window—is determined largely by what system goals the user is trying to achieve. To date, most installations have been in real-time industrial-control systems where multiple processors use the bus switch to improve reliability.

Any desired degree of reliability is possible by properly configuring networks of bus switches. In the elementary bus-switch configuration in Fig. 2, one proces-

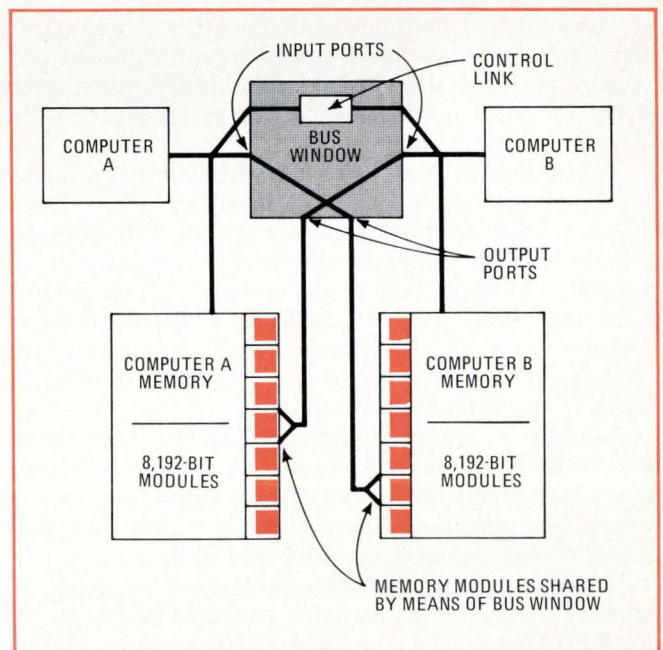

**4. Bus window.** Via a bus window, each of two processors shares access to part of the other processor's memory. Such an arrangement, developed for computers using unified-bus architecture, allows the quickest transfer of data between multiple computers.

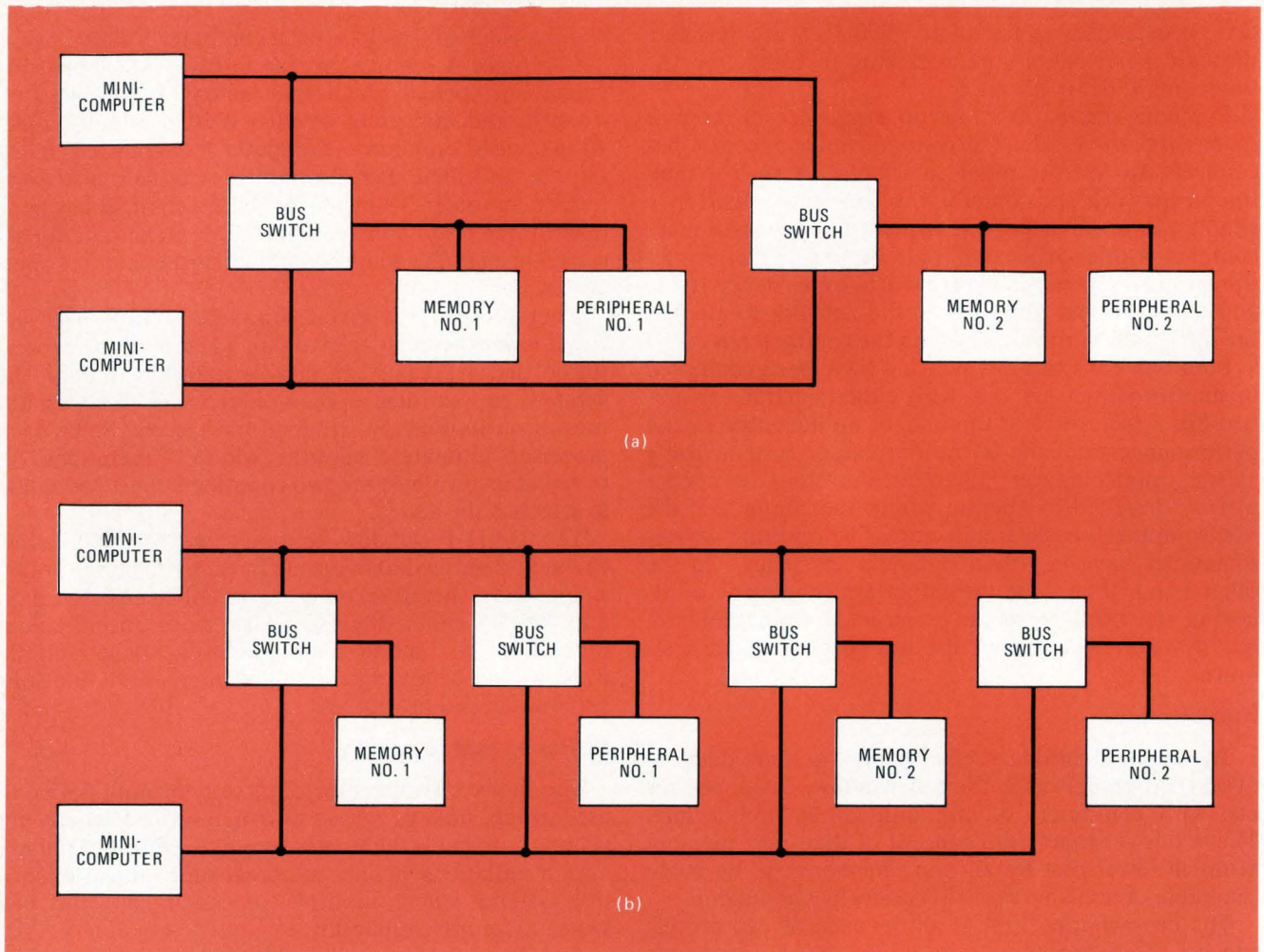

**5. Reliability levels.** A system with the configuration shown in (a) will always work in the event of a single component failure. For even higher reliability, the system shown in (b) can be configured to protect against the occurrence of simultaneous multiple failures.

processor runs on-line programs while the other simply stands by. The redundancy protects against software and processor failures. Systems using such a configuration, however, are still susceptible to device failures on the switched common bus.

The system shown in Fig. 5a affords a much higher level of protection against both hardware and software failures. With two bus switches, together with duplicate memory and peripherals, the user is assured that his system will always work in the event of a single component failure. Not only is there backup for the processor, but the peripheral equipment can be switched to the off-line computer for repair or periodic maintenance without interrupting the on-line task.

For systems requiring highest reliability, a configuration such as the one shown in Fig. 5b can be used. Here, every peripheral device is not only duplicated, but is also isolated by its own bus switch. Such a system is protected against simultaneous multiple failures.

In addition to applications for systems requiring increased reliability, bus switches can save money by allowing peripherals to be shared between two on-line processors. In such systems, each processor is operated as an independent machine running unrelated jobs. Peripherals heavily used by each system, such as disks and tape drives, would normally be connected directly to the

processors. However, such expensive I/O equipment as line printers or card readers can be time-shared via the bus switch, among the multiple processors, thus eliminating the need for two complete systems.

#### Bus links allow distributed processing

While bus-switch interfaces are applied mainly to systems requiring high reliability, bus links have been used extensively in distributed-processing applications. One example of such a distributed system is in industrial control and data acquisition, where input for central data analysis is acquired from remote points. Data from remote terminals may be transmitted raw, or it may be partially processed in a remote processor before transfer to the central processor.

A typical distributed-processor data-acquisition system is illustrated in Fig. 6. The hardware used in the link interfaces varies widely, and standard modules are available for asynchronous, synchronous, single-line, and multiline use. The more recent options for bus links include provisions for a number of interface communications codes (such as ASCII and Baudot) and programmable units so that the link can be dynamically changed between codes, data rates, and either half- or full-duplex operation.

Perhaps the strongest future application for the bus-

link interface, or for any type of multiprocessor interface, for that matter, is in data-communications processors (see "Communications processors pace growth in data-network traffic" [*Electronics*, May 24, p. 89]). In this rapidly expanding service, raw data is reduced and formatted for transfer to a central location via the bus-link interface. Such an interface is used at each point in the distributed system to help handle the communications job.

Bus links that have become available more recently allow the parallel transfer of data between two computers located in the same vicinity. One such interface unit is the DA11-B, a 16-bit parallel bus link for use between two PDP-11 computers. This unit is capable of transferring bulk data at the rate of several hundred thousand bits per second.

**Bus windows add power**

Bus windows, to date, have been applied to relatively few systems, but they have enormous potential for use in systems in which throughput, or the speed that a job is handled, is a primary requirement, as shown in Fig. 7. High-throughput systems can be organized in one of two fundamental ways, and both depend on rapid communications between processors. In the dedicated-task approach (Fig. 7a), each primary system task is pre-assigned to a separate processor. In the example, one processor is dedicated to interaction with real-time interfaces. Data reduction and analyses are split between the next two processors, and a fourth processor is dedicated to the handling of memory files and other peripherals.

Using the dedicated-task-multiprocessor organization, each processor can be optimized to perform its unique task. Thus, in Fig. 7a, the first processor might have solid-state memory for speed of response, the second and third might include floating-point hardware, and the fourth might be a minimum-capability processor needed only to interface with peripherals.

Although the dedicated-task system is extremely useful for well-defined applications, this design is less appropriate in general-purpose applications. The assigned-task structure shown in Fig. 7b, however, is a good alternative for general-purpose applications. Here, it is convenient to designate one processor as the master controller to schedule the work loads of the remaining processors. The master processor loads programs and data into a job processor's memory, then starts up its execution. At the completion of the task, the master processor can pick up the results for storage or printout.

Since the objective of both multiprocessor designs is to increase system throughput, it is of paramount importance that the interface between processors operate at the highest possible data rates. In a dedicated-processor system, data prepared by one processor must be passed quickly to the processor that will work on it next. In an assigned-task system, both programs and data must be passed quickly from master processor to job processor for execution.

This goal of high speed has been achieved in past systems primarily through the use of multiport memories. With these memories, inter-processor communications are handled by making the same memory accessible,

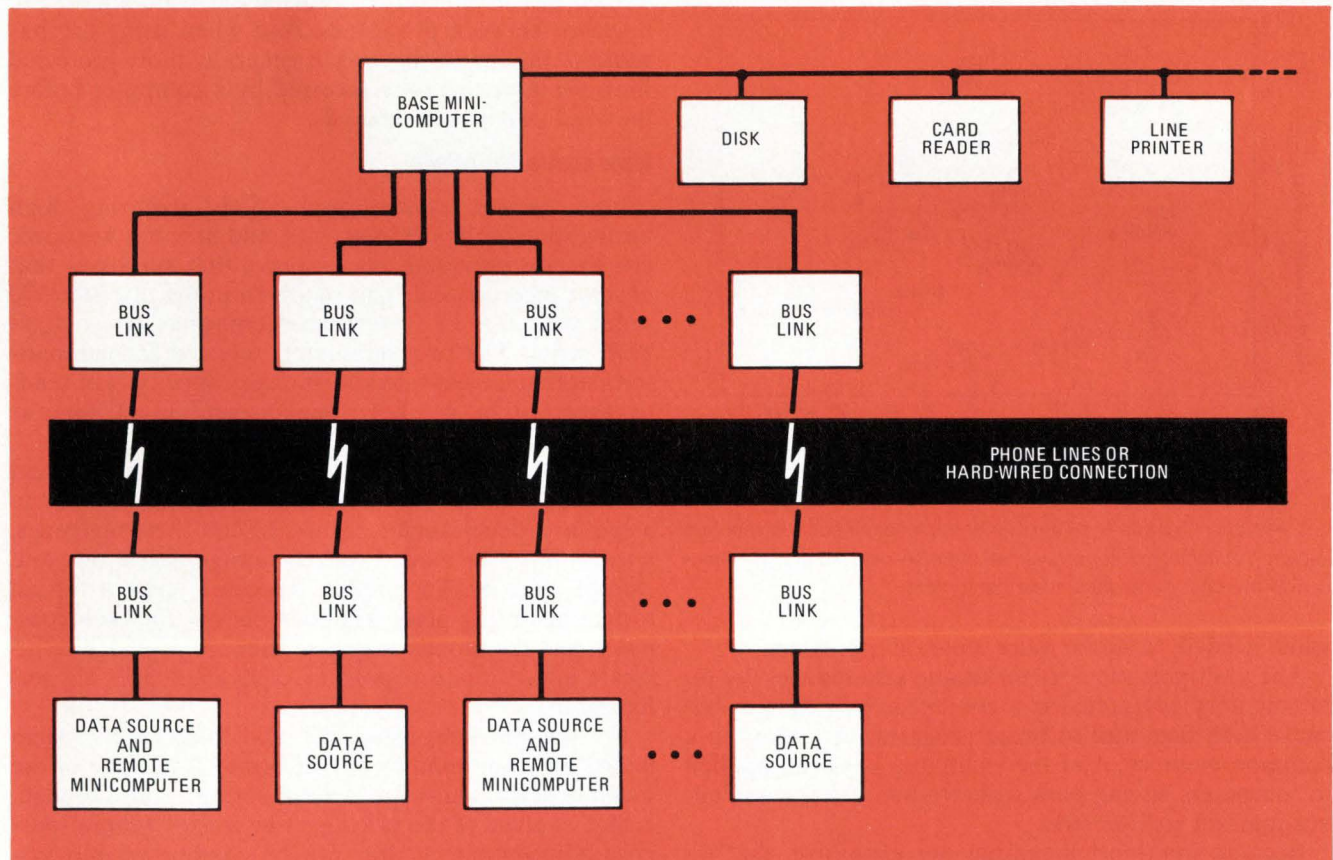

**6. Distributed.** Bus links are extensively used in distributed-processing applications from industrial-process control to nationwide data networks. Bus-link hardware includes options for such system variables as data codes, data rates, and synchronous or asynchronous operation.

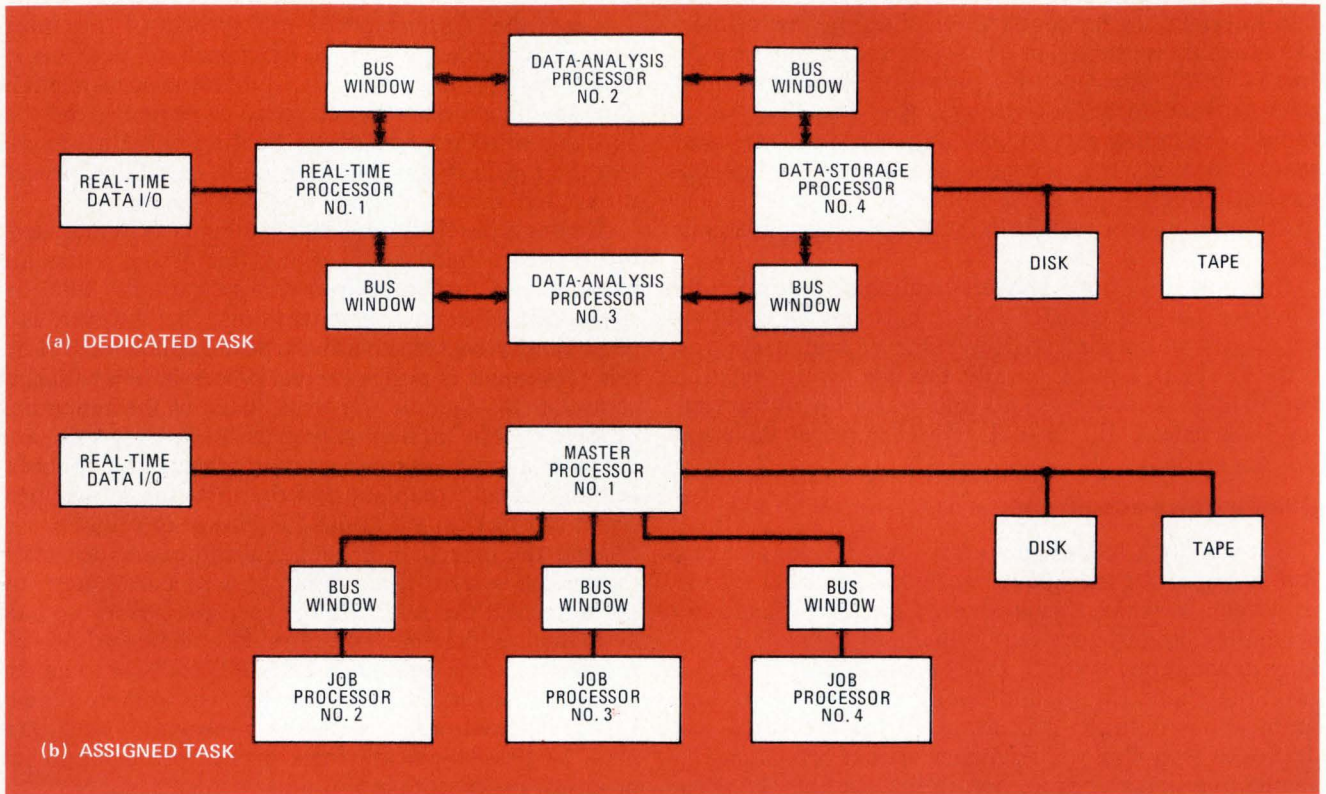

**7. High throughput.** Multiple minicomputers can be arrayed, using bus windows, to substantially increase processing power and system throughput. By following the dedicated-task system structure shown in (a), each processor can be optimized to perform its unique task. For general-purpose applications, however, the assigned-task structure shown in (b) gives best results.

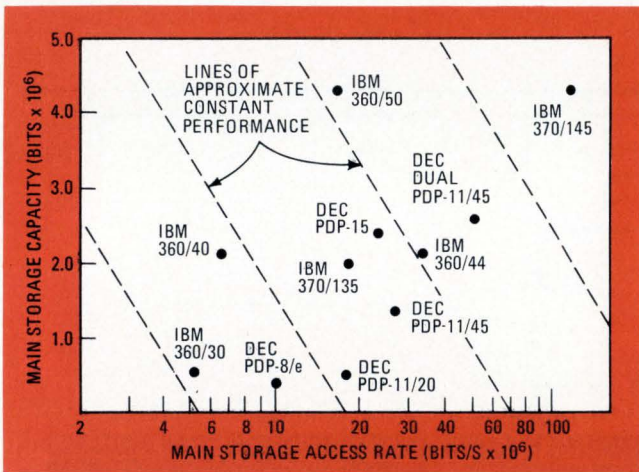

**8. The challenge from minis.** Dual PDP-11/45 system joined by a bus window outperforms all but one of the medium-scale computers shown. Yet minicomputer arrays can often be installed at only a fraction of the cost of medium-scale computers.

when needed, to two or more separate processors.

The multiport-memory technique also reduces the total memory required for a multiprocessor system because both data and software programs are stored in a common memory. And the technique has been applied to computers having both separate-bus and the unified-bus internal architecture.

Because multiport memories are expensive, the bus window, which is often more economical, has been used in several recent installations in minicomputers with

unified-bus architecture to provide the same high-speed interface between processors. And when using the bus window, the shared memory is generally more protected from being accidentally accessed by a computer before the window has been opened.

### New place for minis

For complex system applications requiring high throughput, multiport memories, and now bus windows, are already providing performance that surpasses that of some medium-scale computers from the IBM 360/370 series with that of several minicomputers from DEC's PDP series. The two parameters selected for comparison—storage-access rate and storage capacity—are readily accepted by computer makers and users alike as being of primary importance.

Since the various machines shown have different word lengths, both parameters have been normalized to a common denominator of bits. Within most machines, a tradeoff can be made between storage-access rate and storage capacity. To simplify the chart, then, a typical system operating point has been chosen for each computer, and the broken diagonal lines are provided to indicate approximate regions of equivalent over-all performance.

For the machines listed, the dual PDP-11/45 system joined by a bus window outperforms all but one of the medium-scale computers. The important point, though, is that because of the pricing structures of general-purpose minicomputers, they can be configured into systems comparable to medium-scale machines—often at a price about an order of magnitude lower. □

# Digitest 610. The digital multimeter that measures temperatures, too.

The Digitest 610 is a portable DMM that measures volts, amps, and ohms *plus* component surface temperature. When trouble shooting, this *plus* feature allows the user to quickly identify defective components by surface temperature measurement.

This light-weight, compact, 11,000 count unit goes where needed. When regular power sources are not available the built-in nickel cadmium power pack provides many hours of reliable portable measurement. Bold bright Sperry planar gas discharge displays provide easy viewing, even at angles up to 130° and in direct sunlight. Data can be clearly read at distances up to 40 feet.

Easy to operate push button switches enable rapid selection of all 16 ranges from zero to full scale without further adjustment. Non-skilled personnel can use the Digitest 610 with no training, yet the unit's precision design gives the trained technician and engineer the high degree of accuracy that he needs.

In addition to AC and DC volts, AC and DC currents, the Digitest 610 can measure resistances from 0.1 to 5 megohms, and temperatures from -50°C to +200°C. Accuracy is 0.1% and CMR is 100dB.

Sold and serviced throughout the United States and Canada. U.S. distributorships available.

LOOK FOR US AT  
WESCON  
BOOTH NOS.  
1023-1024-1032-1033



## **SCHNEIDER ELECTRONICS**

c/o PERMAL INTERNATIONAL, 919 3RD AVE., NEW YORK, N.Y. 10022

# OUR ANGLE: Low Cost D/S and S/D Modules



## TYPICAL S/D MODULE SETS

FUNCTION	LINE-LINE	FREQUENCY
S/D or R/D	11.8V	400Hz
R/D	26V	400Hz
S/D or R/D	90V	400Hz
S/D	90V	60Hz

## TYPICAL D/S MODULE SETS

FUNCTION	LINE-LINE	FREQUENCY
D/S or D/R	11.8V	400Hz
D/R	26V	400Hz
D/S or D/R	90V	400Hz
D/S	90V	60Hz

How does a choice of 14-bit resolution, 60 or 400 Hz data frequency, high accuracy, 11.8V to 90V line-line voltages and all kinds of self-protection circuitry look from your angle?

North Atlantic's Series 780 is available now. Only 5 modules make up a complete S/D or D/S converter, and any set nests in an area less than 21 square inches.

S/D specifications include 3 minutes  $\pm$  0.9LSB accuracy, and continuous tracking with low velocity errors. D/S specifications include 4 minute accuracy, 1.25 VA output and 25  $\mu$ sec settling time.

Key performance specifications for both converters include 14-bit (.022°) resolution over 360°, 0-70°C operation and 4000°/sec data rates. Both units are DTL and TTL compatible.

To shrink your prototype schedule, we offer an interconnecting PC board. Or, if you plan to integrate a converter directly onto your own PC cards, we can supply proven mylar artwork.

Any set of modules — \$650. Order a set today. North Atlantic sales engineering representatives are located throughout the free world.



**NORTH ATLANTIC** industries, inc.

200 Terminal Drive, Plainview, New York 11803 Phone (516) 681-8600  
California District Office: 13418 Wyandotte Street, N. Hollywood, CA 91605; Phone (213) 982-0442

## Choosing the right detector for rf power measurements

by Wallace F. White  
Boonton Electronics Corp., Parsippany, N.J.

Thermal detectors are often thought to be the best means of making accurate power measurements at high frequencies. But this is not necessarily true—diode detectors also have their place in rf power measurement.

Actually, the user of an rf power meter is not concerned with what mechanism of conversion lies between his source of high-frequency energy and the instrument readout. What he does care about is the range of measurements possible, their accuracy, and their stability.

In a matched system, the power transmitted by a purely sinusoidal rf signal to a purely resistive load is the product of the equivalent dc voltage and current— $V_{rms}I_{rms}$ . This power can be determined thermally by measuring the heat generated in the load with a calorimeter, a bolometer, or a thermoelectric power meter. The power can also be found by sensing the voltage across the load with a diode detector followed by a properly calibrated voltmeter.

Both methods will result in the same answer. However, it is often mistakenly believed that a diode detector will give a false reading if there is any harmonic distortion present or if the rf signal is modulated. This belief arises because a diode detector is thought to respond only to voltage peaks, while the instantaneous power is varying continuously with the modulation waveform. On the other hand, a thermal detector can always respond correctly since it averages out these variations, providing a true mean power indication.

This explanation tends to oversimplify the actual situation. First of all, only amplitude modulation is really being considered, and, secondly, a diode detector will be inaccurate only if the diode is driven out of its square-law region of operation. For power levels below approximately 20 microwatts, most diodes always perform as square-law devices, and a diode detector will give the same readings for amplitude-modulated or distorted signals as a thermal detector.

Moreover, for the broad range of applications involving frequency-modulated signals, a diode detector will always produce the same readings as a thermal detector. This is because the response of the meter used with a diode detector is shaped to indicate true average sine-wave power, regardless of the level of that power.

The so-called major limitation of diode detectors, then, really only applies for amplitude-modulated signals having a power level of above 20  $\mu$ w. There are, of course, ways around this problem: for example, attenuators could be inserted ahead of the diode detector,

or the power could be sampled with a directional coupler. Naturally, the convenience of either one of these techniques depends on the particular application.

Another common misconception is that thermal power meters are more accurate than diode power meters. Power-meter accuracy is a function of both instrumentation error and detector error. Instrumentation error, which is the dc error or the low-frequency-ac error of the measuring system following the detector head, is typically 0.5% for either thermal or diode power meters. This error is often the only advertised accuracy specification for an rf power meter.

Detector error is a measure of how efficiently the detector converts rf power to a dc signal or a low-fre-

**A good combination.** Rf power meter with diode detector head provides high sensitivity, low zero drift, fast response, and good stability.

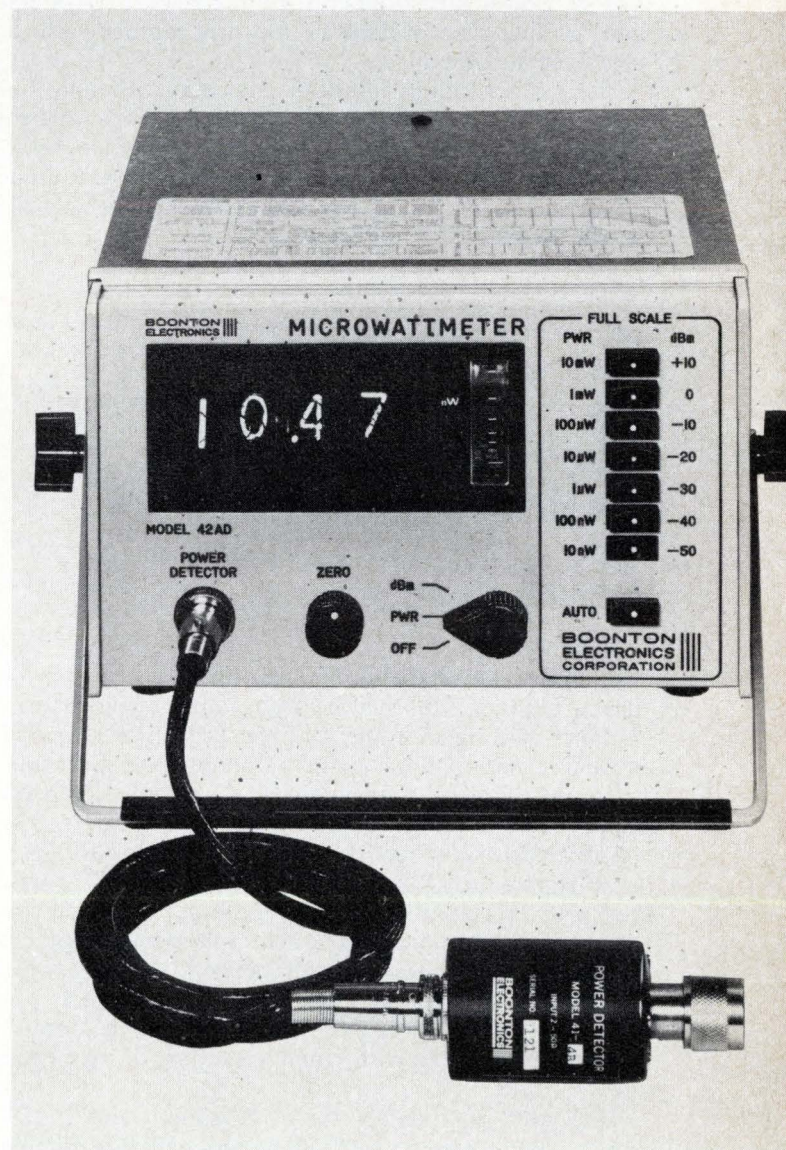

quency ac signal. It is frequency dependent, and may be specified as an over-all uncertainty, a calibration factor, or an effective efficiency. For both thermal and diode detectors, this error is typically 10% or less.

One other detector specification can lead to additional measurement inaccuracy—the detector's input VSWR. For many power measurements, detector VSWR, together with the source VSWR, creates an uncertainty that cannot be resolved without knowing the complex reflection coefficients of both the detector and the source. When the VSWR of both equals 1.3, this uncertainty, which is the same for thermal and diode detectors, is approximately  $\pm 3.5\%$ .

There may be one possible justification for the generalization that thermal detectors are more accurate than diode detectors. The error of a thermal power meter can be checked by applying a known dc power to the detector input. This conveniently links both detector and instrumentation errors for a thermal power meter to an accurate dc measurement.

However, diode power meters can be similarly calibrated with low-rf standardized sources. Therefore, when all the possible major sources of error in high-frequency power measurements are taken into consideration, no one type of detector has any inherent advantage over the other.

Some other things should be considered, though. For instance, diode detectors are inherently more efficient transducers than thermal detectors. Full-scale sensitivity is typically on the order of nanowatts for a diode power meter, as compared to microwatts for thermal power meters.

Additionally, diode power meters offer better zero drift, typically 0.01% for a full-scale range of 10  $\mu\text{W}$ . For the same full-scale range, thermoelectric power detectors have typical zero drifts of approximately 1%, while bolometer detectors may have zero drifts as high as 15%. What's more, the temperature stability of diode detectors can be as high as 0.007 decibel/ $^{\circ}\text{C}$ .

Because of their fast response, diode detectors can be used to measure the average power of pulsed sources. Unlike thermal detectors, they are not restricted to minimum pulse widths of 250 to 350 nanoseconds, and are even useful for measuring low-duty-cycle pulsed signals. For example, a diode power meter can detect 10- $\mu\text{W}$  power bursts of 100-ns duration and with duty cycles down to 0.01%.

Furthermore, diode detectors offer a better low-frequency response. Both bolometer and thermoelectric power detectors usually can be employed only down to 10 megahertz because their VSWR becomes too large at lower frequencies. But diode detectors can be used (with one head) over the range of 200 kilohertz to 12.4 gigahertz. (Additional heads make it possible to operate up to 18 GHz.)

There is one last, but important, consideration—detector burnout. All detectors are susceptible to permanent damage or failure with overloads. Diode detectors generally can be exposed continuously to as much as 300 milliwatts, whereas many thermal detectors will fail at a continuous power level of only 30 mW.

The selection of a diode or thermal power detector should be based on over-all application requirements and not on misleading generalizations.  $\square$

## Handy audio amplifier minimizes power drain

by Fred Riffle  
Raytheon Semiconductor Div., Mountain View, Calif.

Primarily intended for use in hearing aids, a low-power-drain, high-gain monolithic audio amplifier includes a number of design features that make it suitable for a variety of other applications, like tape-recorder preamplifiers and wireless microphones. The device even has a controlled operating-power range, enabling it to be used for moderate-level acoustical power gain applications.

As shown by the basic circuit hookup of Fig. 1, amplifier gain can be adjusted with a standard volume control, while maximum gain is determined by a single external resistor. Automatic gain control, which typically covers a 30-decibel gain range, can be added by outboarding just one capacitor. And the amplifier's input is directly compatible with either a ceramic or an electret microphone.

The unit, Raytheon's model RM8341, runs from a single silver-oxide or mercury battery cell at a nominal

power drain of 100 milliwatts. It can operate over a supply-voltage range of 1.1 to 1.7 volts. In single-unit quantities, the amplifier sells for less than \$8.

Additionally, the space needed by the amplifier and

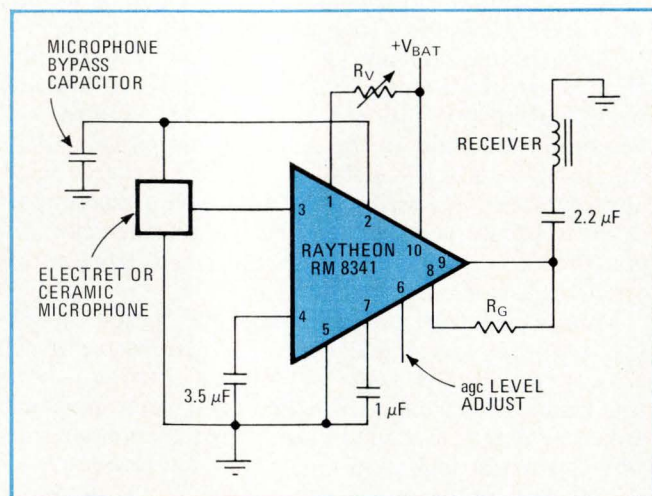

**1. Complete amplifier.** IC audio amplifier can operate from a single battery over a wide voltage range. Automatic gain control is implemented by the capacitor at pin 7; maximum gain is determined by resistor  $R_G$ . A standard volume control,  $R_V$ , can be used.



its supporting network is kept to a minimum, because the RM8341 requires low-value capacitors for frequency compensation. Output distortion is held to 1% nominal, and output linearity is also quite good. The unit provides a single-ended class AB output and can deliver 150 microwatts to a 1-kilohm load.

Figure 2 shows the circuitry of the IC amplifier. Essentially, there are four stages: three in the signal path, and a fourth in the internal dc feedback path.

Stage  $A_1$  (transistors  $Q_1$  and  $Q_2$ ) and stage  $A_2$  (transistors  $Q_3$  and  $Q_4$ ) are differential gain networks, which have a composite gain that is proportional to the product of currents  $I_1$  and  $I_2$ . The first stage,  $A_1$ , is designed to allow the dc level of the input to vary from 0.2 to 0.8 V without affecting output voltage amplitude. Transistors  $Q_5$  and  $Q_6$  are level shifters that provide the proper bias currents for transistors  $Q_3$  and  $Q_4$  of stage  $A_2$ .

The two current sources,  $I_1$  and  $I_2$ , vary simultaneously with the value of volume control  $R_V$  but change only slightly with variations in supply voltage. In this way, the gain loss can be held to less than 2 dB when battery voltage drops from 1.6 to 1.2 V.

The power output stage,  $A_3$ , consists of transistors  $Q_7$ ,  $Q_8$ ,  $Q_9$ , and  $Q_{10}$ . This stage provides the current demanded at the output of stage  $A_2$  by external gain resistor  $R_G$ . Stage  $A_3$ , therefore, is a current-to-voltage

converter whose gain is proportional to the value of resistor  $R_G$ ; this resistor, of course, determines what the amplifier gain is at full volume.

The last stage,  $A_4$ , is made up of transistors  $Q_{11}$  and  $Q_{12}$ . Stage  $A_4$  establishes a dc level at the base of transistor  $Q_2$  that fixes the dc level at the output of stage  $A_3$  at half the battery voltage. This arrangement allows the amplifier to handle large ac signals without clipping them. Stage  $A_4$  also determines the amplifier's low-frequency rolloff response.

When the automatic gain control is activated, transistor  $Q_{13}$  turns off and transistor  $Q_{14}$  turns on, so that the external capacitor from pin 7 to ground begins to charge. This turns on transistor  $Q_{15}$  and its rising collector current decreases the magnitude of current sources  $I_1$  and  $I_2$  and, therefore, the over-all gain.

Both gain stages,  $A_1$  and  $A_2$ , are employed in the agc loop to obtain more gain compression without distortion. The level to which the agc limits the output can be varied by an external resistor from pin 6 to ground. Internal resistors  $R_1$  and  $R_2$  set the agc level to some nominal value. If agc is not wanted, pin 7 is grounded. Resistor  $R_3$  is for microphone supply-line rejection. □

Engineer's Notebook is a regular feature in Electronics. We invite readers to submit original design shortcuts, calculation aids, measurement and test techniques, and other ideas for saving engineering time or cost. We'll pay \$50 for each item published.

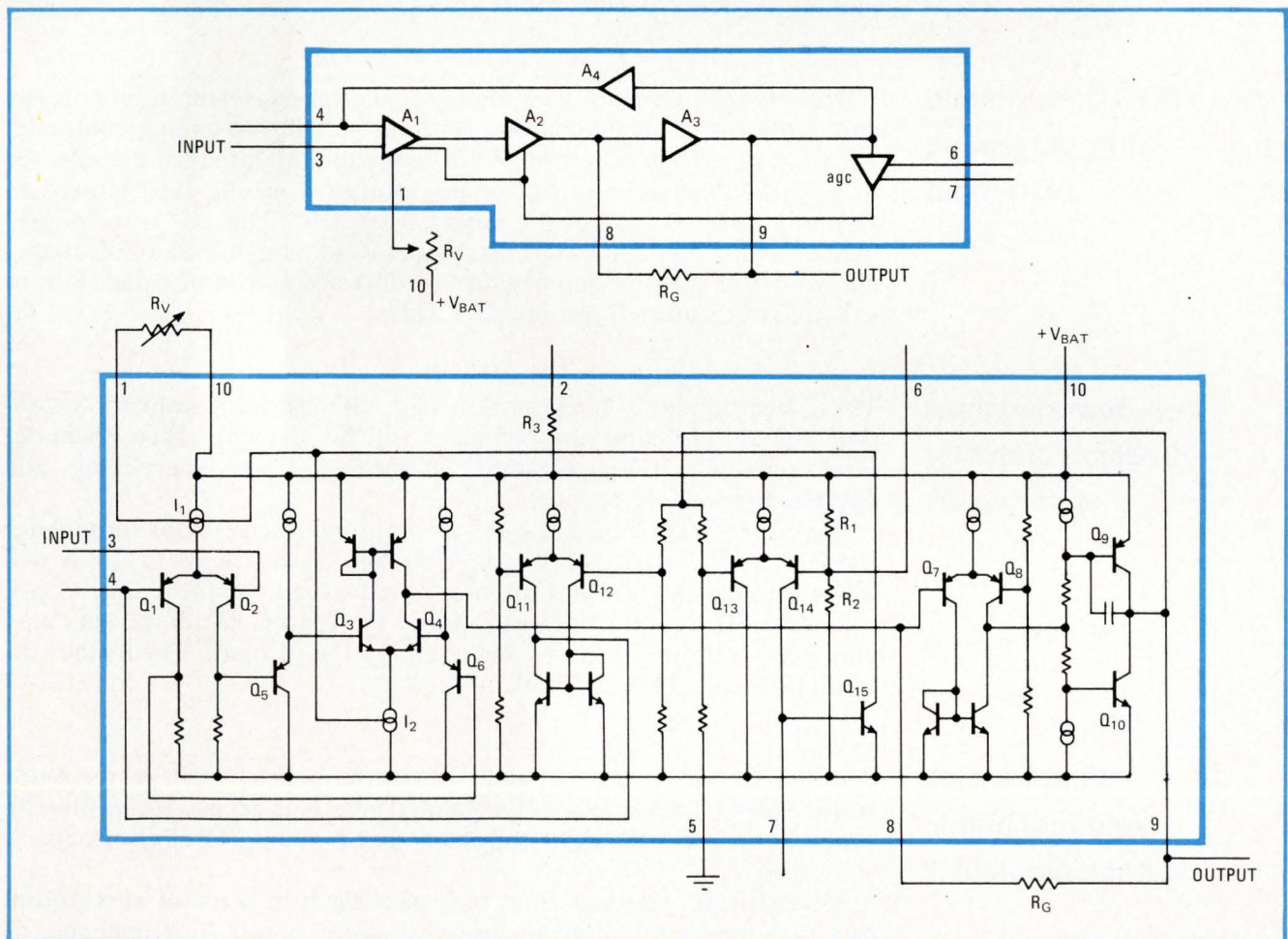

**2. Chip layout.** The amplifier consists of four stages, plus a loop for automatic gain control. The gain of stage  $A_1$  (transistors  $Q_1$  and  $Q_2$ ) and stage  $A_2$  (transistors  $Q_3$  and  $Q_4$ ) is determined by volume control  $R_V$ . Stage  $A_3$  (transistors  $Q_7$  through  $Q_{10}$ ) is the power output network, while stage  $A_4$  (transistors  $Q_{11}$  and  $Q_{12}$ ) adjusts  $A_3$ 's dc output level and prevents the ac signal from being clipped.

## Don't forget the static RAM— it's getting faster

Although dynamic random-access memories have been getting all the glory, static RAMs are becoming steadily more appealing for those medium-speed applications—computer display peripherals, buffers for CRT terminals, printers, and so on. **Some of the new 1,024-bit static n-channel memories sport access times of better than 500 nanoseconds** (as against 300 ns for most 1103 types). Static RAMs are easier to use than the dynamic variety, because they operate off only one +5-volt power supply, they interface directly with bipolar logic, and they also consume less power.

## Need to know? Call Commerce

The U.S. Department of Commerce has instituted a **customized information service that will search the department's files for reports on Government-sponsored research** in different areas. A custom search costs \$50. Or, for \$20, you can select from the large number of searches already completed on the subjects of remote sensing, computer usage and planning, methods of extracting or converting energy from thermonuclear fusion reactors, and the like. Call the National Technical Information Service, (703) 451-0560.

## DAC does double duty correcting ADC input

**Correct the zero drift of your analog-to-digital converter automatically and easily with a servo loop that contains a digital-to-analog converter.** An error signal can be developed from the digital output of the ADC for driving the DAC. In turn, the analog output from the DAC is used to zero any offset voltage at the input of the ADC. The DAC can be preloaded with a digital number that places its analog output at midrange, allowing both positive and negative errors to be accommodated. For an example of this technique, see page 111.

## A new roadshow on semiconductor applications

Texas Instruments is back on the road with its semiconductor videotape shows. This time the company will be showing **three graduate-level courses on the applications of linear and interface circuits and optoelectronic devices.**

As with its MOS course, the TI video unit will make stops **throughout the U.S. and Canada.** Starting in Houston, Texas, Sept. 17-20, it will move through the Midwest up into Canada, then down the East Coast, across the South and Southwest, and up the West Coast. Engineers may enroll in all three courses or any combination of them. For further information, call (214) 238-3894.

## What's inside your monolithic voltage regulator?

Be sure to look at the schematic of the monolithic voltage regulator you're using. These devices frequently give you **access to an on-chip comparator, zener diode, or transistor** that may be useful elsewhere in your design.

**Alternatively, you may want to bypass them in favor of an external part** that may offer more precision or more power. For instance, as shown on page 112, an internal output series-pass transistor may be grounded out so that a bigger external current-boosting transistor can be used without the usual loss in power efficiency.

# Pease Talks.

## Wonderful World of V/F's.

Voltage to frequency converters are not new. You could always buy a good V/F converter in a big, rack-sized module. In fact, H-P and others made huge, monstrous things that cost a thousand dollars each. And they featured pretty good performance, considering.

Nowadays, we're talking about modern, small, reliable hybrid modules that don't cost you an arm and a leg. And don't need half-a-house worth of power to run. Say  $\pm 15$  volts at a dozen or so mA. With the kind of linearity, 0.01%, and ultra-low TC you used to have to buy racks-worth for.

### Why build it if you can't fly it?

Sure you could construct your own V/F converter. But the garden variety are usually pretty crummy. It's hard to get better than 1% linearity. And you just can't make a good V/F easily using the circuits you find in magazines today.

On the other hand, by putting together non-state-of-the-art components in a tricky circuit, we regularly succeed in producing a state-of-the-art V/F converter.

So I guess the big reason for buying and not doing it yourself is that you get more experience, more development, more of everything that makes it work. And less of the guesswork.

### The one and only.

Our competitors in the V/F and F/V area are few and far between. A couple of guys offer one, maybe two versions of V/F converters. But linearity is not one of their strongest features. And that's being charitable.

We have a standard line and we've been making a lot of specials, too. And some of the specials we're trying to trade up to standards. Like micropower ones and ultra-low TC ones and all the way up to 10MHz and weird stuff like that.

We've got the 4701—a 0 to 10kHz V/F, the 4703—a 100kHz V/F, and the big gun—the 4705—a 1MHz V/F. Once we mastered the V/F, the other side of the coin—the F/V—was easy. So we've got the 4702 10kHz and the 4704 100kHz F/V.



We use a precision charge dispensing technique. Which means if you dump a certain value of charge from a capacitor,  $Q = CV$ , the frequency at which you do this determines the current and the amplifier sort of integrates this value and circles around the loop until you get the correct frequency. It's easy in theory, tricky in execution. Another standard approach is  $Q = IT$  which is a little more difficult and not nearly as good.

### After you've got it what are you going to do with it?

We've got loads of standard applications literature on V/F and F/V use. In such areas as telemetry, tachometry, A/D converters, common-mode isolation, integration and how you can offset them or shift the full scale value or filter things. And how to work with different frequencies.

We discovered that several of our customers are using them in pollution monitoring where essentially you have to integrate for a long time without drift. There are some people in photospectrometry who integrate the area under a curve.

Voltage to frequency conversion and vice versa has been in use a long time. Our Teledyne Philbrick V/F Converters make it easier and less tricky to use V/F conversion in a lot of new ways.

### Don't be afraid, ask us.

If V/F or F/V sounds like it may answer your problem. Or if you don't know you have a problem, you really ought to get our Application Notes and spec sheets anyway. Just give us a call toll-free at (800) 225-7883, in Massachusetts (617) 329-1600 or write us. Dedham, Massachusetts 02026 We make your problems disappear.

 **TELEDYNE  
PHILBRICK**

**FASTER  
PROMS  
LOWER  
PRICES**

# 1K

A faster 1K P.ROM from the inventors of the 1K and 2K P.ROM: 60ns access *guaranteed* no matter how many bits you program. Our 6300 has an open collector and the 6301 is the three state version. Not only did we improve access specs, we also improved the programming speed and yield. Typically you can program all bits in less than 10 seconds.

**The lower price: Only \$22 in 100-999 quantity.**

A better mil version, too—5300/01 (open collector/three state).

**Its lower price: \$44 (100-999).**

# 2K

You can count on MMI. We've delivered more P.ROMs than any company in the world. But we did not stop at improving our 1K P.ROM.

Now a faster 2K P.ROM—our 6305/06 (OC/TS): 70ns access guaranteed over all pattern variations.

**The lower price: \$45 (100-999).**

And a better mil version—our 5305/06 (open collector/three state).

**Its new lower price: \$80 (100-999).**

Monolithic Memories, Inc. is the largest P.ROM/ROM producer in the world; we make a habit of delivering what other people only promise. We have just doubled our production capabilities to serve you even better. And that's why you can have off-the-shelf delivery on MMI's 1K and 2K P.ROMs.

If you need parts, see our field sales offices or distributors. Or, if you're in a hurry, call or TWX Dale Williams at (408) 739-3535/TWX 910-339-9229, 1165 East Arques Avenue, Sunnyvale, CA 94086.

## Monolithic Memories, Inc.



EASTERN AREA SALES OFFICE: (617) 653-3158 • NEW ENGLAND REGION: (603) 883-1520 • NEW YORK REGION: (607) 748-3211 • CENTRAL AREA SALES OFFICE: (317) 844-3241 • WESTERN AREA SALES OFFICE: (213) 595-5651

Representing your best buy in memories: ALABAMA, Huntsville (205) 539-1771; ARIZONA, Phoenix (602) 264-7971; CALIFORNIA, San Diego (714) 747-3015; Palo Alto (415) 369-4671; COLORADO, Denver (303) 623-8713; CONNECTICUT, North Haven (203) 239-9762; FLORIDA, Orlando (305) 423-7615; ILLINOIS, Chicago (312) 593-0200; INDIANA, Ft. Wayne (219) 744-4331; KENTUCKY, Louisville (502) 893-7303; MARYLAND, Baltimore (301) 825-3330; MASSACHUSETTS, Boston (617) 444-2484; MICHIGAN, Detroit (313) 358-2020; Grand Rapids (616) 451-8901; MINNESOTA, Minneapolis (612) 929-6721; NEW JERSEY, Teaneck (201) 692-0200; NEW MEXICO, Albuquerque (505) 265-6794; NEW YORK, N.Y./L.I. (201) 692-0200; NORTH CAROLINA, Raleigh (919) 834-6591; OHIO, Cincinnati (513) 521-2290; Dayton (513) 298-9546; Cleveland (216) 228-7525; OKLAHOMA, Tulsa (918) 627-4159; OREGON, Portland (503) 292-5656; PENNSYLVANIA, Willow Grove (215) 674-3850; Pittsburgh (412) 242-0100; TEXAS, Dallas (214) 239-9148; Houston (713) 721-1054; WASHINGTON, Seattle (206) 455-2778.

## Tough-minded advanced linear technology delivers the first true Quad 741 Op Amp!

Several so-called quad op amps have been introduced lately to "replace" the standard 741's. The truth of the matter is this: Only Raytheon Semiconductor makes a true quad op amp that literally replaces four 741 types — the new 4136. For unlike the other quad op amps, no electrical redesign is necessary to substitute the 4136 for 741's.

The 4136 meets or exceeds all specifications for the 741. With low noise PNP front-end transistor, the 4136 is ideally suited for low-noise signal processing applications.

Its 14-pin dual in-line package

can be used with standard pc-board layout techniques and automatic insertion equipment.

Simplicity of design and circuit layout was the objective achieved with the 4136. It consists of two stages of voltage gain and a class AB complementary emitter follower output stage.

The input stage is biased by a constant current source. This stabilizes DC and AC parameters with wide variations in supply voltage.

Instead of the usual resistive load, a current source was used. This provides a means for obtain-

ing single-ended differential voltage gain. The high output impedance of the input stage provides a convenient node for internal frequency compensation with a relatively small capacitor.

The input bias current is a maximum of 500nA. The PNP input configuration performs level shifting with a minimum of noise-producing junctions.

The second stage is a Darlington configuration to provide a high-gain common emitter stage.

The complementary emitter follower output stage is short-circuit protected.

In summary, there are at least four good reasons why Raytheon Semiconductor's new 4136 Quad Op Amp should replace 741's.

(1) The 4136 outperforms 741's. Just look at the comparison table.

(2) The 4136 is about half the cost of four 741's in lots of 1000.

(3) The 4136 has a true 741 input stage, so there's no need to change your design rules.

(4) The 4136 comes in a standard 14-pin dual in-line package for commercial and military applica-

4136 vs. 741

Parameter	RC4136	741
Large Signal Voltage Gain	110dB	106dB
Input Resistance	5M $\Omega$	1M $\Omega$
Slew Rate (Unity Gain)	1.2V/ $\mu$ s	0.5V/ $\mu$ s
Input Bias Current	40nA	100nA
Unity Gain Bandwidth	3MHz	1MHz
Channel Separation	125dB	—

tions — so you need only one mechanical assembly step instead of four.

Raytheon Semiconductor delivers the first *true* Quad 741 Op Amp — so you can get twice your money's worth with the new 4136.

Reader Service No. 241



Raytheon Semiconductor now offers a reliable second source for the 54/74 MSI line. We have more than 24 types, including these hard-to-get ones:

54/74123 54/74163 54/74181  
54/74150 54/74174 54/74194  
54/74160 54/74175 54/74195  
54/74161

In addition, we have our own 54R/74R products — which give you higher performance with no change in price or operating requirements. If you're an engineer who wants more out of the commonplace 54/74, just place an "R" on your order.

Reader Service No. 245

### A Look at Our New Hi-Rel JAN TXV Transistors

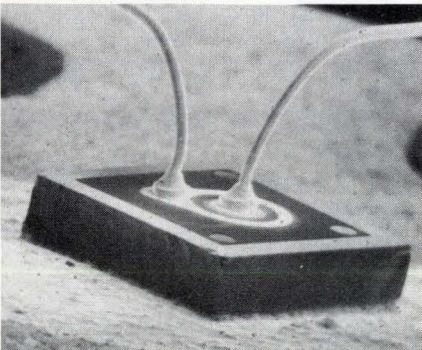

Microscopic inspection assures defect-free hi-rel JAN TXV transistors.

Raytheon Semiconductor now offers you 29 types of hi-rel transistors

with "precap" inspection at lower costs and with faster delivery. Designated JAN TXV, each transistor is 100% inspected with 30- and 100-power microscopes before it's hermetically sealed. This precap visual inspection prevents visible contamination or defects which could affect long-term reliability.

In addition, for those transistors not listed in the military JAN TXV listing, Raytheon Semiconductor offers R TXV transistors tested to the same standards as JAN TXV.

For hi-rel as well as standard small-signal silicon transistors, take a look at Raytheon Semiconductor.

### JAN TXV Devices

JAN TXV 2N718A	JAN TXV 2N2904A
JAN TXV 2N918	JAN TXV 2N2905
JAN TXV 2N1613	JAN TXV 2N2905A
JAN TXV 2N2060	JAN TXV 2N2906
JAN TXV 2N2218	JAN TXV 2N2906A
JAN TXV 2N2218A	JAN TXV 2N2907
JAN TXV 2N2219	JAN TXV 2N2907A
JAN TXV 2N2219A	JAN TXV 2N2920
JAN TXV 2N2221	JAN TXV 2N3019
JAN TXV 2N2221A	JAN TXV 2N3057A
JAN TXV 2N2222	JAN TXV 2N3250A
JAN TXV 2N2222A	JAN TXV 2N3251A
JAN TXV 2N2369A	JAN TXV 2N3553
JAN TXV 2N2484	JAN TXV 2N3700
JAN TXV 2N2904	

Reader Service No. 243

### How Hi-Rel Beam Leads Can Lower Hybrid Costs

In the majority of applications Raytheon Semiconductor hi-rel beam lead devices can reduce the costs of your hybrid modules.

One big factor is bonding. Beam lead bonding is far less complicated than the bonding operation for conventional chips or dice, so your operator needs less training. You'll get higher yields when bonding beam leads, too. That's because Raytheon Semiconductor's beam lead devices are hermetically sealed by nitride passivation. This minimizes the chance of damaging the chip during the bonding operation.

With Raytheon Semiconductor beam lead devices, the hybrid designer can obtain greater packaging densities. And more parts per

module mean greater manufacturing economies.

If you have a hybrid circuit that requires high reliability but you

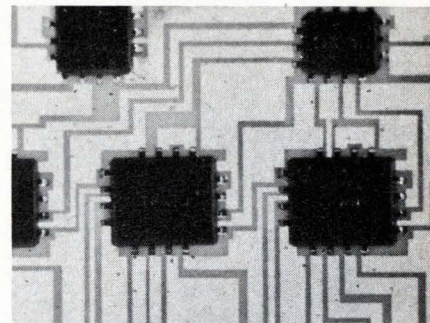

Beam lead bonding techniques are simpler and permit closer spacing of chips.

thought you couldn't afford beam lead devices, contact us. Raytheon Semiconductor may be able to offer you the best of two worlds with our beam lead know-how.

Reader Service No. 242

### Attention! Now a Military 256-Bit Bi-Polar RAM

Raytheon Semiconductor introduces a full MIL 256-bit TTL random access memory. The device is not only guaranteed to operate at specified DC parameters but also AC parameters over the entire temperature range of  $-55^{\circ}\text{C}$  to  $+125^{\circ}\text{C}$ .

Designated RR5300, it is a fully decoded bi-polar read/write RAM organized as 256-words by 1-bit. Readout is non-destructive, and data is maintained in the array without regeneration.

The access time from address to output is 85ns over the full MIL temperature range. Power consumption is a low 475mW. At present the RR5300 is available in a ceramic 16-pin dual in-line package; a flat package version will be offered in the future.

For more information, contact your nearest Raytheon Semiconductor sales outpost.

Reader Service No. 244

Raytheon Semiconductor, 350 Ellis Street, Mountain View, California 94040. Phone (415) 968-9211.

**RAYTHEON**

# MEET THE MONEY SAVERS

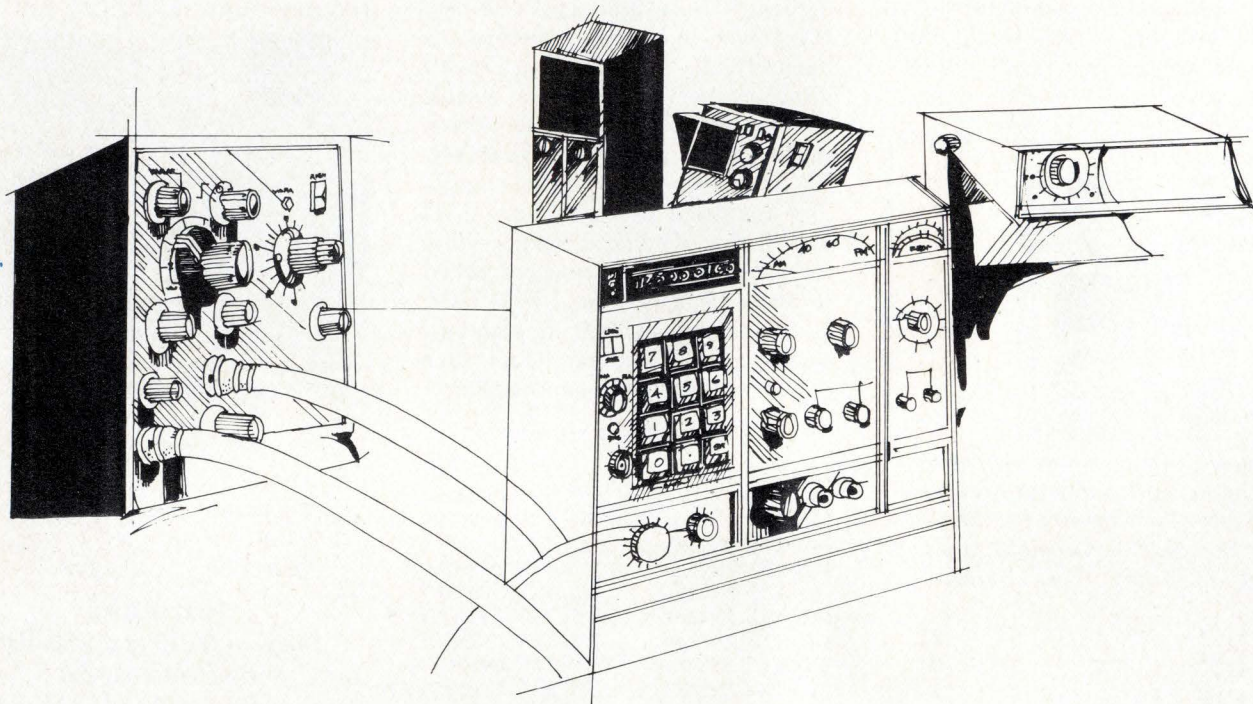

Money Savers like oscilloscopes, and power supplies, and oscillators, and meters, plus many many more—all recognized and respected brand-name merchandise, and all part of our rental and lease inventory.

Some pieces never used, still in manufacturer's original shipping cases. Many more pieces only slightly used, having been replaced in our rental and lease inventory by a newer or more popular model. And all available now, to help equip your laboratory or test department at noteworthy savings!

We are The REI Sales Company, an all-new division of Rental Electronics, Inc., organized especially to provide you direct access to some of the best money saving deals ever on highest-quality, scientific/elec-

tronic test equipment.

We sell REI-owned test equipment only—tested to manufacturer's specifications; some completely refurbished and all are available with a fresh calibration at a slight additional cost. And best of all—every piece of REI Sales Company equipment comes with our iron-clad, Money-Back Guarantee: if the equipment you purchase from us is not all we say it is, just return it to us within ten days... and all you'll pay is the shipping.

The coupon below will bring our new Sales Catalog to you by return mail. We invite you to discover how you can do yourself and your organization a big favor—when you *Meet the REI Money Savers!*

## REI SALES COMPANY

Attn: Mr. Tom Fitzgerald,  
General Manager

99 Hartwell Avenue,  
P.O. Box 223

Lexington, Massachusetts 02173

a division of  
Rental Electronics, Inc.

A **PEPSICO** LEASING COMPANY

(617) 861-7370



Please rush me your REI Sales Catalog. I understand there is no obligation and that no salesman will call.

Name \_\_\_\_\_ Title \_\_\_\_\_

Organization \_\_\_\_\_

Address \_\_\_\_\_

City \_\_\_\_\_ State \_\_\_\_\_ Zip \_\_\_\_\_

I'd like immediate information on the following equipment \_\_\_\_\_

\_\_\_\_\_

E 91373



# Staying power

Everybody knows that a chain is only as strong as its weakest link. So when we came to design and build the P 800 mini-computer we packed it full of the finest components you can buy, our own. And since actions are supposed to speak louder than words you'll appreciate the fact that we use these same mini-computers in our own systems. Which means we know a little of an OEM's problems from your side.

For example, the software had to be right, simply to make our own systems work properly!

On top of that you get the backing of a worldwide organisation that's there wherever your system goes. On price, too, we've something to interest you. There's a lot to be said for a mini-computer company that isn't just a mini-computer company. Full details are at the end of your phone.



Sextant by  
Dollond of London,  
late 19th. century.

Mini-computer by Philips, 1973.

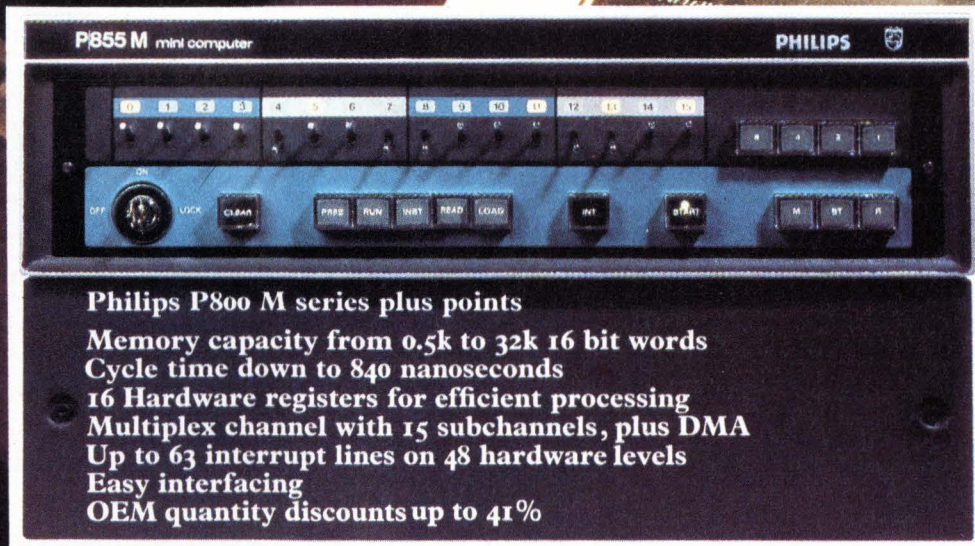

- Apeldoorn 05760 30123 • Brussels 02193900 • Copenhagen 0127 2222 • Essen 02141 236001
- Helsinki 9017271 • London 01 730 3416 • Milan 02 643 6541 • New York 212 697 3600 • Oslo 02679380
- Paris 01 702 2991/ 01 734 7759 • Stockholm 08635000 • Tokyo 034355211 • Toronto 4167521980 • Zurich 01442211

Philips considers your reputation



Data  
Systems

# PHILIPS

Circle 141 on reader service card

# What looks like data here could be garbage there. And vice-versa.

If you've ever tried to combine data interchangeability and low cost digital recording you know the problem: data in, but sometimes only garbage out.

So we've come up with a system for cutting costs without cutting corners:

The "Scotch" Brand Data Cartridge and 3M Data Cartridge Drive.

Fully compatible with proposed ANSI Standards for 1/4" cartridge devices, our system records — and retrieves — up to 5.5 million bits of data on each of 1 to 4 tracks. Shuttles bidirectionally at 90 ips. Reads, writes and backspaces at 30 ips. And provides a data transfer rate of 48,000 bps.

You get reel-to-reel performance for about the price of a 0.150" cassette system.

The medium is our own 1/4" "Scotch" Brand Data Cartridge, with its unique endless drive band. A new concept in tape handling, it requires no external tape guidance and external power at only a single point. Tape handling is so gentle, so precise tape can't cinch, spill, stretch or break and cartridge life expectancy is in excess of 5000 passes.

And to ensure data interchangeability, we've developed a drive with the same simplicity and reliability. A single dc motor with a tachometer feedback speed control. Servo control of the start/stop ramps for accurate inter-



record gap lengths. A die cast top plate for exact cartridge positioning. And foolproof, drop-in loading that auto-

matically positions the cartridge in precisely the same position even after thousands of load/unload operations.

In OEM quantities, the basic DCD-3 Data Cartridge Drive — with a single-channel, read-while-write head and servo electronics — is less than \$350. Full-blown evaluation units with data and control electronics in a 4 track, read-while-write configuration are just \$961 and available now.

It's your chance to clean up your data interchange problems. And your costs.

Contact Data Products, 3M Company, 300 S. Lewis Rd., Camarillo, Calif.

93010. Telephone (805) 482-1911. TWX: 910 336-1676.



**We've been there.  
And brought the answers back.**

**3M**  
COMPANY

# World's Best Bipolar RAMs

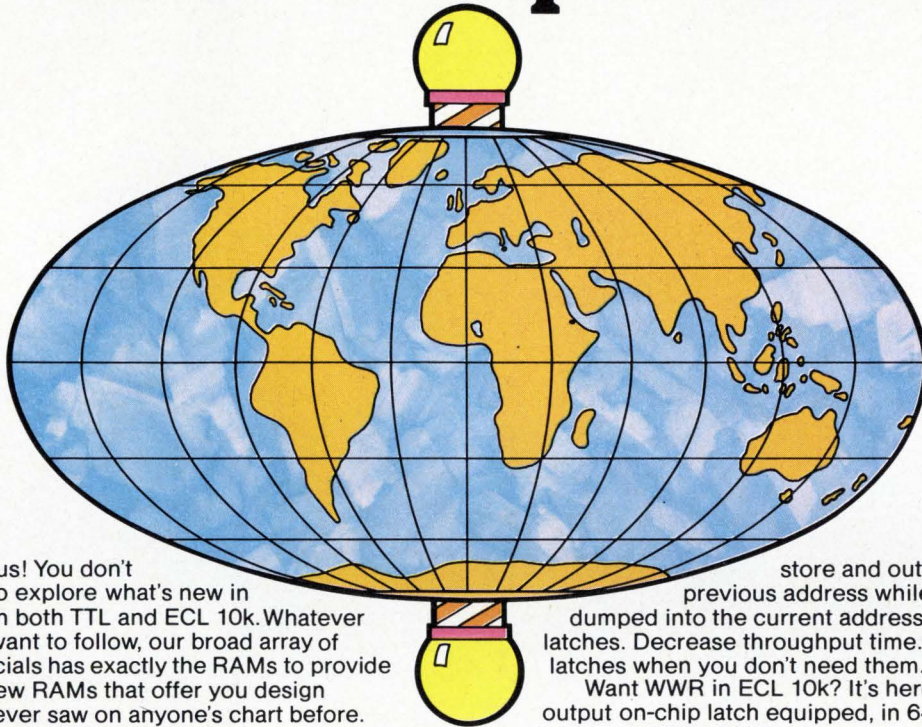

Goodbye, Columbus! You don't need a navigator to explore what's new in RAMs. Here it is, in both TTL and ECL 10k. Whatever design route you want to follow, our broad array of standards and specials has exactly the RAMs to provide it. Plus, we have new RAMs that offer you design possibilities you never saw on anyone's chart before.

Get up on high speed industrial standards. The 256-bit RAM comes MIL and commercial, ceramic and plastic, open collector and tri-state, fast and faster. You'll find all the permutations of the 256-bit RAM on the chart opposite 82S06/07/16/17.

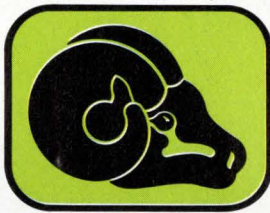

How about a write-while-read memory? That's the 82S21, a 32 x 2 example of schizophrenia, with two on-chip latches. They

store and output data from a previous address while data are being dumped into the current address. Forget separate latches. Decrease throughput time. And bypass these latches when you don't need them.

Want WWR in ECL 10k? It's here. Specify the 10151, output on-chip latch equipped, in 64 x 1. Just the first of a long list of ECL RAMs to come.

Now think of a device that acts like 8 independent 4-bit registers, any two of which can be accessed simultaneously. We call it the 82S12, a multi-port register that replaces 8 separate registers in smart designers' systems.

And think of other benefits, such as a 16 x 4 RAM with output blanking, Content Addressable Memory (CAM) for eliminating a lot of logic circuits, high speed ECL for 10k compatibility — these and many more user-oriented benefits are spelled out in the data sheets for the charted devices. Get some and bone up.

SIGNETICS "MAKE-IT-EASY-FOR-YOURSELF" TABLE:

TYPE	BITS	PRODUCT	FEATURES	Access Time* (ns)	ADVANTAGES	BENEFITS
Std TTL	64	8225	Industry standard w/ output blanking	50	Simplified pcb layout	Lower system cost
	256	82S06/07	Industry standard	65	Lowest cost per bit	Lower system cost
	256	82S16/17	High speed Industry standard	50	TTL compatible	High performance
Spi TTL	8	8220	Content Addressable Memory	45	Associative capability	Simplifies design
	64	82S21	On-chip latches	50	Eliminates external latches	Simplifies design
	32	82S12/112	Simultaneous access	30	Replaces registers	Simplifies design
Std ECL	64	10140/148	High speed ECL	15	10k compatible	Design flexibility (64 x 1)
	64	10145	Super speed ECL	15	10k compatible	High speed ECL. Scratch pad. (16 x 4)
Spi ECL coming soon	64	10151	On-chip latch Read-while-write	15	Eliminates external latch	Simplifies design, lower cost (64 x 1)

\* maximum

CLIP THIS COUPON TO YOUR LETTERHEAD FOR IMMEDIATE ATTENTION

Signetics — RAMs  
811 E. Arques Avenue  
Sunnyvale, Calif. 94086

Okay fellows, produce some data. Specifically, I'd like the data sheets on the following RAMs:

\_\_\_\_\_

\_\_\_\_\_

Name \_\_\_\_\_ Title \_\_\_\_\_

Firm \_\_\_\_\_

Address \_\_\_\_\_

City \_\_\_\_\_ State \_\_\_\_\_ Zip \_\_\_\_\_

Telephone \_\_\_\_\_

Signetics Corporation, a subsidiary of Corning Glass Works.

## signetics



## Over 15,000 delivered in less than a year

*Get your edition of the most popular digital multimeter ever made now. Get low cost of ownership, immediate delivery and super reliability.*

Value and reliability are two important reasons why the Fluke 8000A has become the most popular digital multimeter ever and the standard of excellence in the low cost field.

For the money, \$299, you can't buy a better multimeter. No one gives you higher accuracy (basic dc accuracy is 0.1%), greater sensitivity or more protection. Here's an instrument with 26 ranges to measure ac/dc volts from 100 microvolts to 1200 volts, currents from 100 nanoamperes to 2 amperes and resistance from 100 milliohms to 20 megohms.

### **Reliability**

You can expect your 8000A to work day-in, day-out, year after year. We guarantee 20,000 hours mean-time-before-failure, but with 15,000 units delivered, our own studies indicate a MTBF

of 56,000 hours—the equivalent of 15 years. Only Fluke uses both analog and digital LSI circuitry in one instrument. And to top everything off, we put everything in a high impact case with securely mounted internal electronics.

### **Expanded capability**

Wide choice of low cost options including rechargeable battery pack, digital printer output, deluxe test leads, high voltage probe, RF probe, 600 ampere ac current probe, carrying case, dust cover, and rack mount to make your 8000A the most powerful and versatile low-cost multimeter available anywhere.

### **Stock delivery and local service**

You can get your Fluke 8000A from local sources today. Fluke backs the 8000A with service centers conveniently located throughout the United States, Canada, Europe and the Far East for fast 48-hour turnaround repair service.

Order yours today on a 15 day no obligation trial basis. Use your American Express, BankAmericard, Mastercharge, company purchase order or even money.

In the continental U.S., dial our toll free number 800-426-0361 for the name and address of your nearest local source. Or contact us directly by addressing, John Fluke Mfg. Co., Inc., P.O. Box 7428, Seattle, Washington 98133. Phone (206) 774-2211. TWX: 910-449-2850. In Europe, address Fluke Nederland (B.V.), P.O. Box 5053, Tilburg, The Netherlands. Phone 013-67-3973. Telex: 844-52237. In the U.K., address Fluke International Corp., Garnett Close, Watford, WD2 4TT. Phone, Watford, 33066. Telex: 934583. In Canada, address ACA, Ltd., 6427 Northam Drive, Mississauga, Ontario. Phone 416-678-1500. TWX: 610-492-2119.



# Solid-state rf amplifier puts out 20 watts

By combining outputs of 64 transistors, linear instrument spans 150 kHz to 250 MHz at high power with constant gain of about 45 dB

by Michael J. Riezenman, Instrumentation Editor

**What do laser modulators, ultrasound transducers, CATV distribution systems, and the antennas used in rfi testing all have in common?** They all need a broadband power amplifier that can operate into badly mismatched loads without damaging itself or reducing the forward power delivered to the load.

ENI's model 420L solid-state rf power amplifier can do just that. With a power output of 20 watts over the frequency range from 150 kilohertz to 250 megahertz, the 420L overcomes the problems of inefficiency, large size, and unreliability that plagued the vacuum-tube units formerly required for this kind of performance.

Although recent advances in fine-geometry transistors have permitted increased junction areas, transistors with high gain-bandwidth products are inherently low-power devices. A well-designed Class A transistor amplifier stage can produce a maximum of 0.5 w over the frequency range under consideration. Therefore, the power outputs of a large number of devices must be summed to achieve the 20 w produced by the 420L.

The design of the new ENI unit uses hybrid combining techniques to sum the power outputs of 64 individual transistors. All the transistors are isolated from each other so that the failure of any individual device will merely decrease the total power output of the amplifier, not totally shut it down. The mean time between failures—both calculated and measured—for a 5% reduction in power output is in excess of 10,000 hours, or 30 times better than the figures for vacuum-tube units.

The 420L makes use of an ultra-

linear transistor chip designed primarily for CATV frequencies. The use of negative feedback around each stage further reduces both cross-modulation and harmonic distortion. The output of the amplifier is equivalent to an ideal voltage source in series with a 50-ohm resistance. As a consequence, the unit can be connected to any load impedance whatever (including both open and short circuits) and will still produce a constant forward power into the load. Any power reflected from the load can be safely absorbed at the amplifier's output.

The 420L can be driven to full output power by any signal generator, frequency synthesizer, or sweep generator. Gain is nominally 45 decibels, and is constant to within  $\pm 1.5$  dB over the full 150 kHz to 250 MHz range. Input VSWR of

the amplifier is less than 1.5, and the output VSWR is less than 2.0. A typical third-order intermodulation intercept point for the linear amplifier is +51 dBm. Noise figure is less than 9 dB.

Servicing the amplifier is facilitated by the exclusive use of plug-in amplifier modules. The eight modules that make up the unit are mounted on two aluminum "wash plates" that have very low thermal resistances. Two retaining screws hold the entire rf assembly to the amplifier's base plate. A retractable extender cable from the power supply permits servicing the amplifier out of the chassis.

Price of the 420L is \$2,890, and delivery time is 60 days.

Electronic Navigation Industries Inc., 3000 Winton Road South, Rochester, N. Y. 14623 [338]

**TV distributor.** Solid-state 20-watt rf power amplifier (on top of rack) is shown in one of its applications: distributor of a TV studio signal to remote monitoring locations.

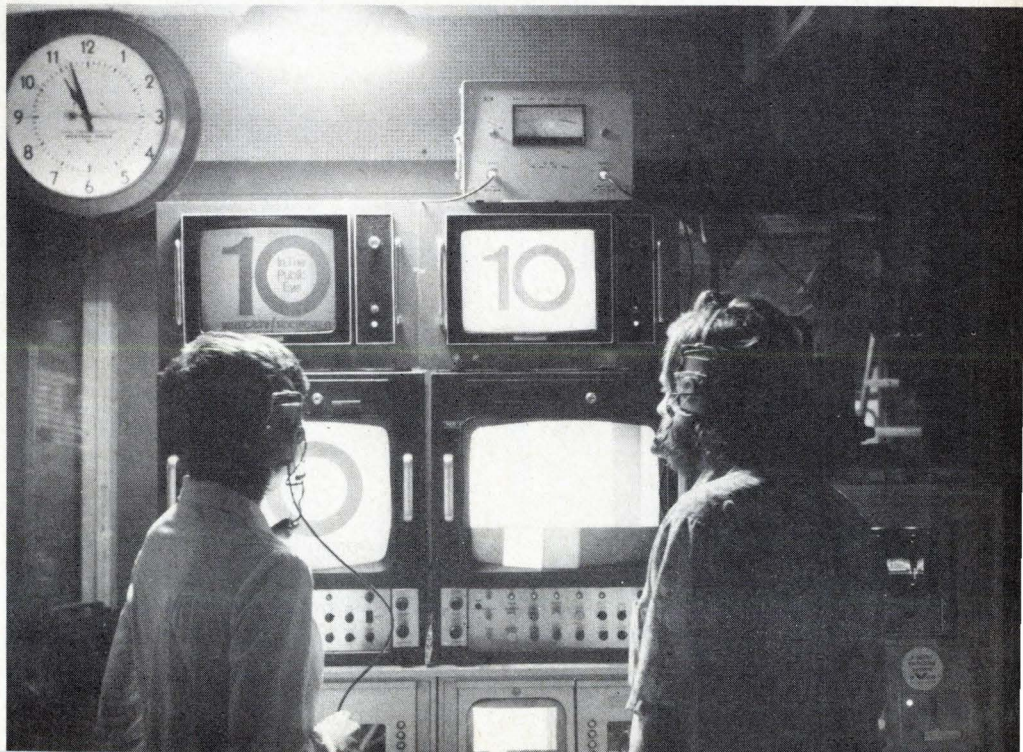

## New products

Instruments

# Multimeter is low-priced

3-digit instrument provides full overload protection on all ranges

Advances in technology can benefit the user by lowering prices or by adding capability. Most digital multimeters take the second route: they offer improved sensitivity, autoranging, extremely small size, and other special features. Ballantine Laboratories, on the other hand, has decided that what the world needs is a rugged, reliable, bare-bones multimeter at the lowest possible price. Its model 3/24, a 3-digit multimeter, is a result of this approach. The only

special feature on the 3/24 not found on most analog multimeters is full overload protection.

Of course, the new instrument also provides all of the intrinsic advantages of digital instrumentation over analog meters: the physical ruggedness of all-solid-state circuitry and a LED display, 3-digit resolution, and the lack of ambiguity of a digital readout.

Accuracy of the meter is within  $\pm(0.2\%$  of reading + 1 digit) on the 1-volt dc and 10-v dc ranges, and  $\pm(0.5\%$  + 1 digit) on the 100-v dc and 1,000-v dc ranges. Accuracy on the four ac voltage ranges is within  $\pm(1\%$  + 2 digits). For its five dc current ranges (from 100 microamperes to 1 ampere) the instrument has a maximum error of  $\pm(0.5\%$  of reading + 1 digit). For ac current measurements over the same five ranges, and for a frequency span of 40 hertz to 20 kilohertz, the meter's maximum error is  $\pm(1.5\%$  of reading + 2

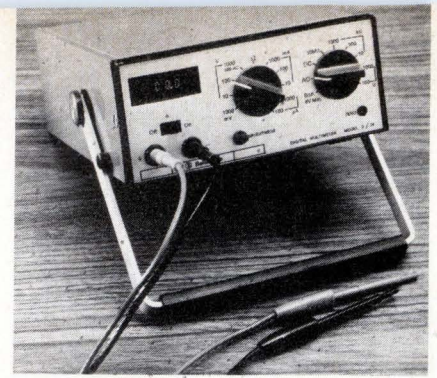

digits). The three lower resistance ranges (100 ohms to 10,000 ohms) have a maximum error of  $\pm(1\%$  of reading + 1 digit), and the three higher ones (100 kilohms through 10 megohms) have a maximum error of  $\pm(2\%$  of reading + 1 digit).

The temperature coefficient of all dc measurements is  $0.02\%/^{\circ}\text{C}$ , based on a reference temperature of  $23^{\circ}\text{C}$ . Similarly, ac measurements have a temperature coefficient of  $0.05\%/^{\circ}\text{C}$ ; and resistance ranges,  $0.05\%/^{\circ}\text{C}$ , except for the 10-megohm range, which has  $0.15\%/^{\circ}\text{C}$ .

Price of the 3/24 is \$195, and it is expected to use no more than three or four \$1.45 batteries per year. The active circuits in the meter use only

**CM4-20**  
GaAsP, clear transparent lens, intense point source indicator.

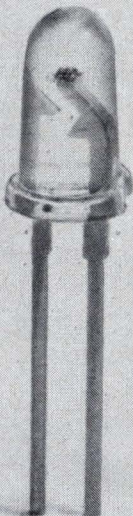

**CM4-23**  
GaAsP, red translucent lens, diffused light source.



**CM4-31**  
GaAsP, high illumination, ideal for back lighting applications.

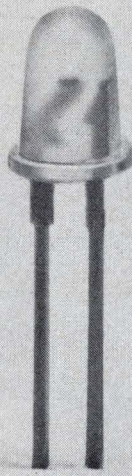

**CM4-43**  
GaAsP, package similar to T-1, plug in leads for close mounting.



**CM4-52**  
GaAsP, small, low cost, versatile, red lens for diffused light.

**CM4-50**  
GaAsP, small, low cost, clear lens.

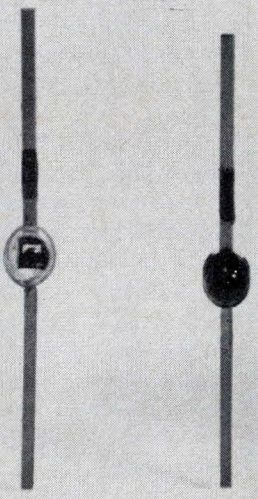

a GENERAL INSTRUMENT company

# Try to find

20 milliwatts altogether, so battery life can be greatly extended by taking advantage of the display-brightness control.

Ballantine Laboratories Inc., P. O. Box 97, Boonton, N. J. 07005 [351]

### Sound-level measurement systems come in kits

A series of sound-level measurement kits each contains a sound-level meter, acoustical type calibrator, carrying case, windscreen, neck strap, batteries, and instruction manual. Aimed at a wide range of applications, each model in the series has either a Type 2 or Type 3 meter combined with either a single- or multi-frequency calibrator. The basic version of the kit is designated the model 370 and features selection of either 100- or 114-decibel sound-pressure level. Price

of the 370 is \$397. Other models range from \$472 to \$587.

Triplett Corp., Bluffton, Ohio 45817 [353]

### Multimeter offers 10- $\mu$ V ac and dc resolution



A fully automatic 3½-digit multimeter provides 10 microvolts ac and dc resolution, ac and dc amperes, ohms, high-level overload protection without fuses, and a direct-reading display. The model 165 offers 31 ranges in all; connections are made to one pair of input terminals

for all functions and ranges. Reading time for all functions is typically 3 seconds. Price is \$495, and an option available for \$18 gives a 2-to-50-ampere ac/dc four-terminal current shunt with a 10-millivolt drop.

Keithley Instruments Inc., 28775 Aurora Rd., Cleveland, Ohio 44139 [357]

### Translator-generator works with any time-code format

A time-code translator and generator—actually two instruments in one chassis—provides simultaneous and independent generation and translation of any time-code format.



**CM4-62**  
GaP, low current indicator in a high millicandela package.

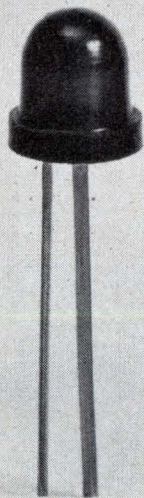

**CM4-73**  
GaAsP, intense compact indicator with wide viewing angle.



**CM4-83**  
GaAsP, lowest cost T-1 ¾ LED available.



**CM4-48**  
GaAsP, small package similar to T-1, heavy duty leads for wire wrapped terminals.



**CM4-100**  
Alpha-Numeric readout, 14 pin DIP.

**CM4-110**  
Alpha-Numeric readout, red encapsulation 14 pin DIP.

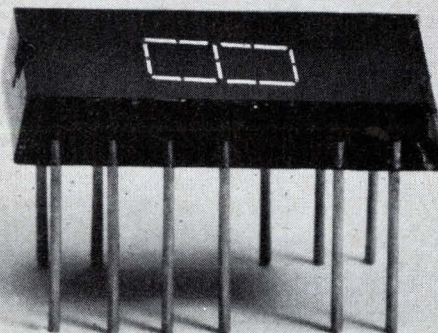

# an LED we don't have...

Circle 147 on reader service card

## New products

For use in, for example, data acquisition systems, data logging systems, and laboratories, the unit is designated the model 540. It has the ability to generate all time codes for output to related equipment, as well as simultaneously translating these outputs into parallel and/or serial form for input to recorders or magnetic tape. Price of the model 540 starts at \$2,300.

Moxon Inc., SCR Division, 2222 Michelson Dr., Irvine, Calif. 92664 [356]

### Hand-held multimeter offers solid-state autoranging

The model 970 A digital multimeter is a compact, hand-held instrument with 3½-digit LED readout. It operates on rechargeable batteries and measures dc volts, ac volts, and ohms. The solid-state numeric display, which is legible from any posi-

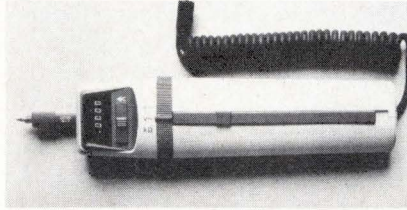

tion, is read at the measuring point. Range-setting through five ranges is fully automatic, and so is decimal-point placement. Dc voltage from 0.1000 v full scale to 500 v is obtainable to an accuracy of within  $\pm(0.7$  of reading + 0.2% of range). Full-scale ranges are 0.1, 1, 10, 100, and 1,000 v (500 v maximum input). Ac voltages from 1 v through the highest range (500 v rms maximum), from 45 hertz to 1 kHz, are read to an accuracy within  $\pm(2\%$  of reading + 0.5% of range). In resistance measurements, the instrument is accurate to within  $\pm(1.5\%$  of reading + 0.2% of range). Ohms ranges are 1 kilohm full scale (1 ohm resolu-

tion) through 10 megohms. Maximum test current will not exceed 10 milliamperes. U.S. price of the multimeter is \$275.

Inquiries Manager, Hewlett-Packard Co., 1501 Page Mill Rd., Palo Alto, Calif. 94304 [355]

### Impedance bridge provides five built-in circuits

Providing four built-in alternating-current bridge circuits and a direct-current Wheatstone circuit, the

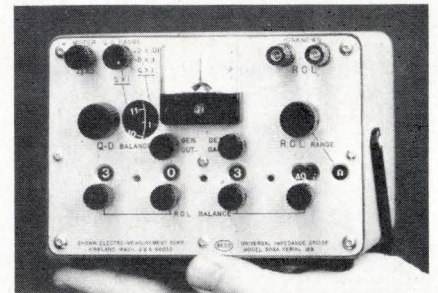

**CM4-101**  
Polarity and overflow readout, 14 pin DIP.

**CM4-111**  
Polarity and overflow readout, red encapsulation 14 pin DIP.

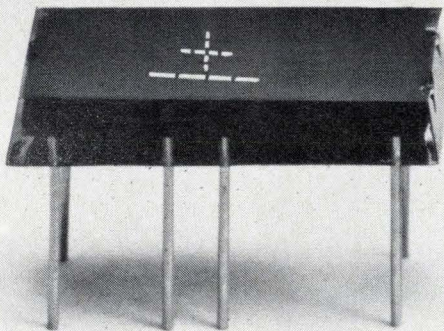

**CM4-301**  
GaP, light pipe display, 1/8" and 1/3" character size.

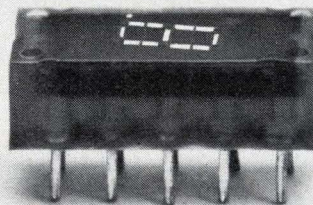

**CM4-9030**  
T-2 LED for slide base applications through 48 volts, plugs into existing T-2 sockets.

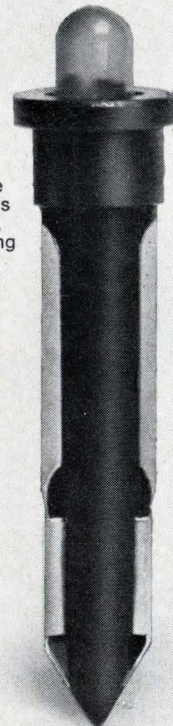

**CM4-5010**  
Opto-Isolator Coupler, standard mini-DIP for easy plug-in.

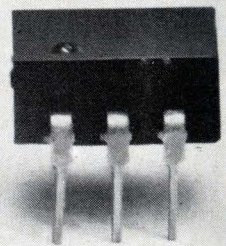

# if we don't have the LED you



model 303A impedance bridge is capable of measuring the series and parallel capacitance and the series and parallel inductance, plus also the storage and dissipation factors of the circuit or device under test. The Wheatstone bridge is one that measures resistance over a wide range. Price is \$355.

Brown Electro-Measurement Corp., 11060 118th Place N.E., Kirkland, Wash. 98033 [358]

Uses for three-channel recorder vary widely

A three-channel recorder designated the model 302 has a variety of applications which include: analog computer readout, temperature-monitoring, and ground-station monitoring of satellite data. In the medical field, the 302 allows simultaneous comparison of three leads

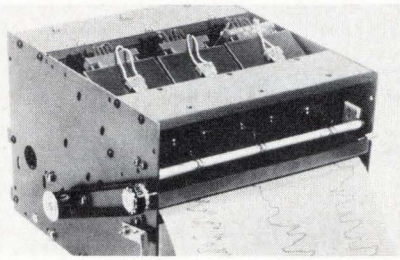

for functions such as electrocardiography. The recording is made without ink by a heated stylus on heat-sensitive paper.

Astro-Med Division, Atlan-Tol Industries Inc., Atlan-Tol Industrial Park, West Warwick, R.I. 02893 [359]

Miniature recorder charts analog and event data

The Rustrak 392 miniature recorder has the ability to handle both analog and event data on a single

chart. One or two channels of analog data, such as ac or dc voltage and current, temperature, pressure or other parameters, may be recorded simultaneously with four or eight channels of event information. A variety of sensitivities, writing speeds, and chart speeds are available. Inkless writing is provided on pressure-sensitive paper.

Gulton Industries Inc., Recorder Systems Division, E. Greenwich, R.I. 02818 [360]

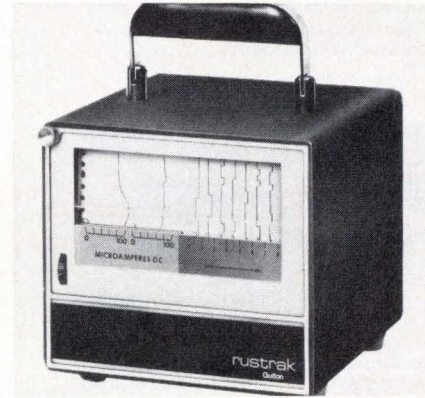

**CM4-8000**  
T-1 3/4 Type LED indicators, interchange with midget flange-base incandescent.

**CM4-7000**  
T-1 3/4 Type LED indicators, interchange with BI-Pin based subminiature incandescent.

**CM44**  
Cartridge Type indicator, short cylindrical cap, interchanges with MIL-L-3361 lamps.

**CM44**  
Cartridge Type indicator, Macrodome cap, interchanges with MIL-L-3361 lamps.

LED's are relatively simple. Some chips, some wire, some plastic. But making LED devices that work—that work exactly right for you—calls for a thorough appreciation of lighting technology, human engineering, even aesthetics.

Chicago Miniature is expert in miniature lighting of all kinds. We specialize in doing tiny things in a big way. And we've learned enough to know how varied your particular needs can be. That's why we provide more kinds of LED devices and packages than any other single source. Right off the shelf. And that's why we provide full support in application engineering.

Whether you're designing new panels, or modifying incandescent lighted panels for LED's, see if Chicago Miniature can help.



**Chicago Miniature Lamp Works**  
4433 N. Ravenswood Ave.,  
Chicago, Illinois 60640

a GENERAL INSTRUMENT company

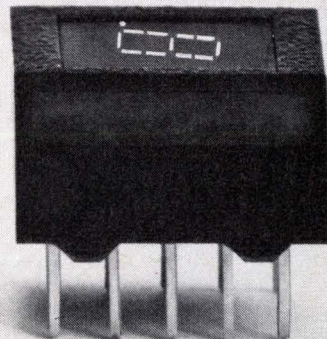

**CM4-170**  
Extremely visible 1/4" character, extremely low power, small size.

**need, we'll make it for you.**

# BERKELEY IS BACK

## PROGRAMMABLE FREQUENCY METER



**Direct  
Counting  
to 500 MHz**

Model 6421 B 500 MHz \$1,340.00  
Model 6420 200 MHz \$ 990.00

Other measurements include ratio and periods. Measurements are instantaneous! In one second, read frequency to one Hertz.

## PROGRAMMABLE UNIVERSAL COUNTER- TIMER



**Two Counters in One!**

Model 6401 200 MHz \$1,290.00  
136 MHz \$1,190.00

Each input channel is equipped with a separate attenuator to allow frequency ratio and time interval measurements between two signal sources.

## UNIVERSAL 21-COLUMN DIGITAL PRINTER



**Reliability,  
flexibility,  
portability,  
low cost.**

Model 1454 \$1,055.00

Offers IC or transistor compatibility, flexible input format and BCD column expansion capability. Accepts data in many codes.

## LINE NOISE GENERATOR

**Controlled  
Line  
Noise!**



Model 3020 \$695.00

Perfect for testing instruments and systems for line noise immunity. Also measures noise up to 1kW peak power.

Berkeley Instruments, Inc., has acquired their high-quality line of digital instruments from Beckman Instruments, Inc. and will maintain the same high standards of excellence established over the years.

For more information, call

TOLL-FREE  
**800-854-3253**  
(outside California)



**BERKELEY INSTRUMENTS INC.**

1701 Reynolds, Santa Ana, Calif. 92705  
(714) 556-0623

## New products

Semiconductors

## IC log amp uses FET input

Log and anti-log units  
in 16-pin DIPs replace  
complex hybrid modules

Perhaps the biggest thrust in the design of linear integrated circuits is the concept of the functional block—a single package that provides an entire linear-circuit function and replaces conventional component assemblies. Examples of the functional-block approach are quad comparators, quad operational amplifiers, and several types of linear circuits for TV.

Now Intersil has carried this approach further with its logarithmic and anti-log amplifiers, each on a single chip. Using FET-input structures and thin-film resistor networks, trimmed on the chip, Intersil's model 8048 and 8049 amplifiers fill the place in the linear-IC family that previously had been occupied by the harder-to-use log-amp modules (see below, left).

More importantly, the 8048 and 8049 reap the benefits of low cost associated with IC construction. Both are housed in 16-pin plastic or hermetic dual in-line packages, and the 100-piece price for either device in plastic is \$12.50 each.

According to Jack Gifford, manager of linear products at Intersil, the low price, well under the \$50 to \$150 for epoxy-filled modules, makes these devices suitable for a wide range of signal-conditioning functions and arithmetic computa-

tions in electronic equipment.

The 8048 log amplifier provides 1 volt of output for each six decades of current input or for each three decades of voltage input. The 8049 is its anti-log counterpart, nominally generating one decade of output voltage for each 1-v change at the input.

Both devices are fully temperature-compensated from 0° to +70°C. Maximum full-scale accuracy is within ±0.5% (8048B) and ±1% (8048C and 8049). Power consumption is 150 milliwatts.

The scale factor on the 8048 is adjustable to 1 v per decade (voltage input) or 2 v per decade (current input). Reference current and offset voltage are also adjustable on both amplifiers.

Intersil Inc., 10900 North Tantau Ave., Cupertino, Calif. 95014 [411]

## LED-displays for calculators plunging below \$1 per digit

The price of small light-emitting-diode displays for pocket calculators has plunged through \$1 per digit and is heading toward 50 cents.

Two displays with nine digits and nine decimal points have been introduced by Fairchild at prices close to \$1 per digit in 1,000-unit quantities. One can be sold in 1974 for about 50 cents per digit and the other for less in larger quantities, estimates Clay Marr, product marketing manager of Fairchild's Optoelectronics division. One display, the FNA 35, costs \$9.45 as a printed-circuit-board assembly, including a bubble magnifier that gives the 0.050-inch-high monolithic chips an apparent height of 0.092 in. A bar magnifier and lens can be added to increase that to 0.130 in. The other display, the FNA 37, is made with 0.070-in. chips and a bar magnifier and red lens that provide an apparent height of 0.130 in. MOS logic will drive both directly. The FNA 35 requires a peak current of 4.5 milliamperes; average drive current is 0.5 mA per segment at 1/9th duty cycle. The FNA 37 is specified at 1 mA per segment, but typically operates at

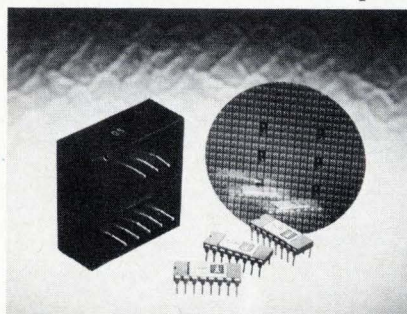

The Mark Ten B Capacitive Discharge Ignition System keeps your car in tune ... and everyone knows that a well-tuned car gets better mileage, requires less maintenance, runs longer and better, and helps in the quest for cleaner air.



... Just ask Detroit and the E.P.A.

Order your Mark Ten B today! Please send me free literature.

Enclosed is \$ \_\_\_\_\_  Ship ppd.  Ship C.O.D.

Please Send: \_\_\_\_\_ Mark Ten B @ \$59.95 ppd. \_\_\_\_\_ Mark Ten B Kit @ \$44.95 ppd.

Car Year \_\_\_\_\_ Make \_\_\_\_\_

Name \_\_\_\_\_

Address \_\_\_\_\_

City \_\_\_\_\_

State \_\_\_\_\_ Zip \_\_\_\_\_

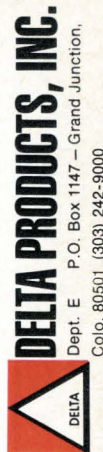

Circle 151 on reader service card

# Delay Lines You name it. We've got it.

Catalog Number	Impedance $Z_0$ (ohms $\pm 10\%$ )	Total Delay (ns $\pm 5\%$ )	No. of Taps	Delay Per Tap	Rise Time (ns max)
9822	50	100	10	10	17
9823	50	125	10	12.5	21
9825	100	100	10	10	17
9826	100	125	10	12.5	21
9827	100	150	10	15	25
9828	100	200	10	20	34
9829	100	250	10	25	42
20410	100	10	4	2.5	4
20411	100	20	4	5.0	7
20412	100	30	4	7.5	10

Now you can choose from the broadest selection of DIP Delay Lines ever.

Available today from quantity stock at any PULSE ENGINEERING regional office in the United States and Europe.

Featuring:

- Fast rise time and low distortion
- Total delay 10 ns to 250 ns
- Delay per tap 2.5 ns to 25 ns

Order today and send for our free product line catalog.

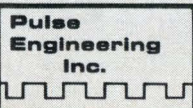

A Varian Subsidiary

**Pulse Engineering, Inc.**

P.O. Box 12235 • San Diego, Calif. 92112  
Phone 714-279-5900 • TWX 910-335-1527

Circle 208 on reader service card

# Send us your photos.



## We'll send you ours.

### Video Image Processing from CVI

Colorado Video offers a complete high quality line of video image processing instruments. Capabilities of these precision instruments span the video field:

- synthetic color
- image subtraction
- contrast expansion
- computer input
- differentiation
- outlining
- computer-processed image display
- shading correction
- edge enhancement

To obtain your free CVI synthetic color photo and a video image processing brochure, simply mail us a black and white photo with your letterhead.

# cv*i*

Colorado Video, Incorporated  
P.O. Box 928  
Boulder, Colorado 80302  
(303) 444-3972

## New products

0.6 mA per segment. Peak current is 6 mA at 1/10th duty cycle. Light outputs are 8 and 9 microcandela.

Discrete Products Group, Fairchild Camera and Instrument Corp., 464 Ellis St., Mountain View, Calif. 94040 [412]

RAMs use no refresh,  
clocks, sensing circuits

Two static random-access memories that have a capacity of 1,024 bits each and use no clocks or sensing circuits are designed for operation from a single +5-volt source in computer peripherals, buffer memories, and minicomputers. Model 2602 offers an access and read cycle time of less than 1 microsecond, while the 2602-1 accesses and reads in less than 500 nanoseconds. Applications include: small buffer memories of either eight words of 1,024 bits each or 16 words of 4,096 bits each; CRTs; terminals; printers; instruments; and point-of-sale terminals. Housed in plastic package, price in 100-lots is \$16 for the 2602 and \$20.48 for the 2602-1. Signetics, 811 East Arques Ave., Sunnyvale, Calif. 94086

Calculator circuit provides  
five functions with memory

A 10-digit calculator circuit, designated the model ML 1007, provides five functions with memory on a p-channel MOS LSI chip. The functions include percentage with mark-up and mark-down.

Other capabilities include a recall memory key, an exchange key for reversing dividend and divisor, round-off and round-up, constant operation for multiplication and division, and fixed and floating decimal. Small quantities are in stock.

Antex Industries Inc., 1059 E. Meadow Circle, Palo Alto, Calif. 94303 [414]

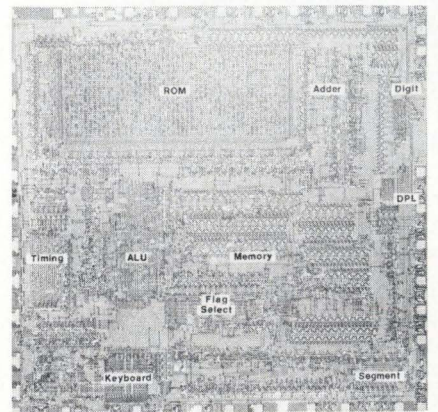

Dual FET-input op amp  
holds drift to 25  $\mu\text{V}/^\circ\text{C}$

The model 8043 monolithic dual FET-input operational amplifier combines two 8007s and is available in two versions, both with a temperature drift of 25 micro-

# PRICED TO FIT YOUR WALLET



## BOURNS LOW COST FAMILY

### IF INDUSTRIAL TRIMPOT® POTENTIOMETERS

POWER: ½ WATT (OR BETTER) AT 70°C

TEMPCO: CERMET— AS LOW AS 100 PPM/°C  
WIREWOUND — AS LOW AS 70 PPM/°C

TEMPERATURE RANGE: -55° UP TO +150°C

Join the growing population of industrial equipment designers who have discovered that *Bourns quality has ever cost so little.*

Bourns LOW-COST FAMILY of industrial TRIMPOT® potentiometers was designed specifically to give cost-conscious industrial electronics equipment manufacturers superior product quality and performance . . . AT LOWER PRICES.

We invite you to compare price and specs on Bourns LOW COST FAMILY models with those of our prime competitors.

#### AVAILABILITY

The Cermet and Wirewound models shown are stocked in depth . . . RIGHT NOW, so delivery is off-the-shelf from your local Bourns distributor or factory-direct.

Complete data, price and delivery details on all LOW-COST FAMILY models is available upon request. Just write, or call, your local Bourns Sales Office, representative, or distributor.

FOR INSTANT  
INFORMATION  
DIAL EEM  
800-645-9200



AVAILABLE FOR IMMEDIATE DELIVERY  
FROM YOUR LOCAL BOURNS DISTRIBUTOR



BOURNS, INC., TRIMPOT PRODUCTS DIVISION • 1200 COLUMBIA AVENUE, RIVERSIDE, CALIFORNIA 92507

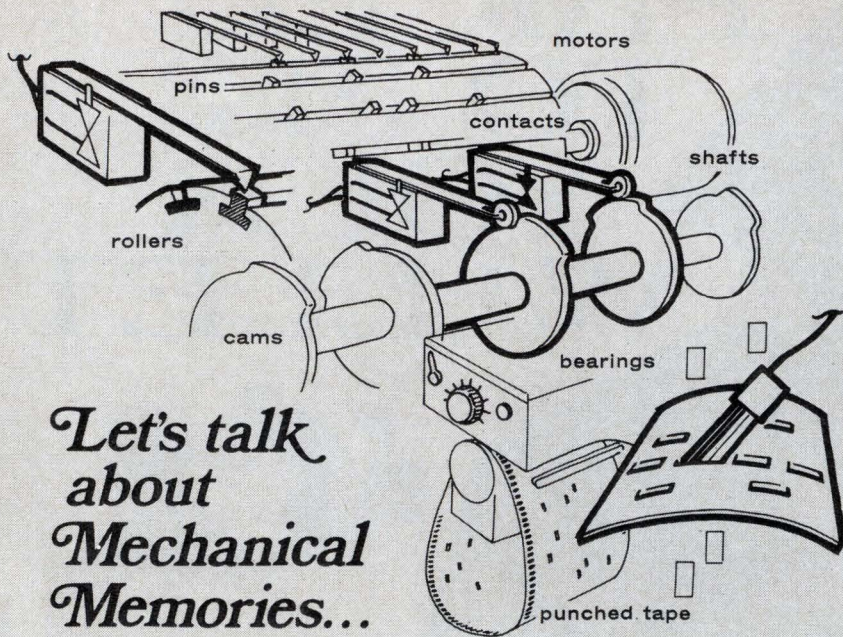

## Let's talk about Mechanical Memories...

Ever wondered why so many control systems still rely on mechanical and electromechanical components to perform "memory" functions? Why they haven't switched over to reliable solid-state electronics—yet?

It's because performing such functions electronically would require two essential characteristics in a single solid-state memory system: (1) It *must* be quickly, easily and selectively reprogrammable to accommodate a variety of functions and function changes. And (2) it *must not* "forget" what it's supposed to do every time power is removed. Then, of course, there's the matter of cost.

Now—how many semiconductor memories are there on the market today that offer true non-volatility—plus selective, repetitive electrical alterability—plus non-destructive readout—all combined in a single, low-cost, integrated array?

*Just one!* And it's available now in standard units ranging from 8-bit up to 2048-bit arrays that can readily be configured to meet your particular requirements.

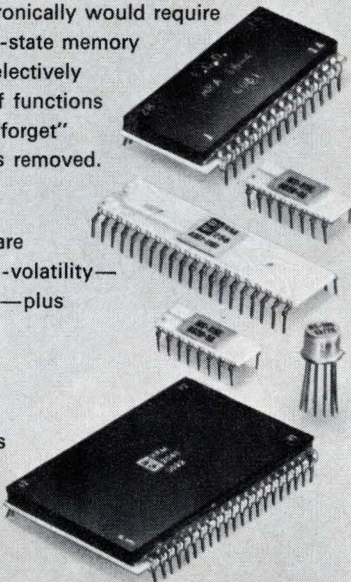

### AMORPHOUS

# RMM

## Non-Volatile/Repetitively Alterable Semiconductor Memory Arrays

If you'd like to know first-hand how RMMs can be used to improve your product's reliability, versatility and cost, our Systems Engineering Group will gladly evaluate your application and submit detailed recommendations. Just call or write Howard Klausmeier at:



RMM DIVISION

**Energy Conversion Devices, Inc.**

1675 WEST MAPLE ROAD • TROY, MICHIGAN 48064  
TELEPHONE: 313/549-7300

### New products

volts/°C, and slew rate of 6V/μs. The 8043M operates from -55° to +125°C with input current of 2 picoamperes typical, 20 pA maximum, and typical offset voltage of 10 millivolts. The 8043C operates from 0° to +70°C, and has an input current of typically 3 pA, 50 pA maximum, and typical offset voltage of 20 mV. The 8043 is useful in such applications as instrumentation amplifiers and active filters.

Intersil, 10900 N. Tantau Ave., Cupertino, Calif. 95014 [415]

### Infrared LED delivers 5-mW output power

Designated the model OP 131, a gallium-arsenide infrared-light-emitting diode delivers a typical output power of 5 milliwatts from an input current of 100 milliamperes. The device is hermetically sealed in a TO-46 package. Its out-

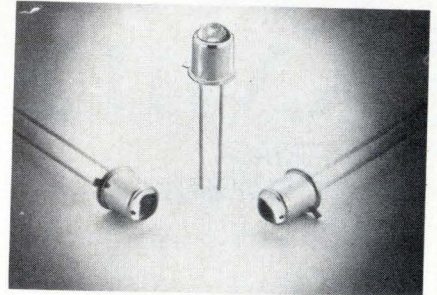

put is spectrally compatible with silicon light sensors, making the device suitable for applications such as shaft encoders, card or tape readers, optical counters and sorters, and alarm systems.

Optron Inc., 1201 Tappan Circle, Carrollton, Texas 75006 [417]

### JFETs designed for high-voltage operation

Eight junction-field-effect transistors, divided into two separate families, are intended for high-voltage operation. In the first group, minimum breakdown voltages of 300 V are provided by the models 2N6449 and A5T6449; the 2N6450 and A5T6450 are rated at 200 V. The

# The UN-new... GUARDIAN 1220 RELAY

This versatile standard of the industry . . . mount-any-way-you-please enclosed relay has NOT been changed or "improved to death." It's a promise from your Guardian Angel. The Guardian 1220 relay still mounts 4 different ways: *Through* the chassis for easy front-side assembly or disassembly. Or, through the chassis *permanently* with a one-piece socket mounting clip. Number three: "Snap-bracket" mount it above the chassis using the socket housing and one-piece mounting clip as a cable connector. Four? Snap-bracket mount it above the chassis for quick connects or soldering. Also available in PC termination. *Any* way you mount it, it's still the good-old-reliable 1220 DPDT, 10 amp relay in a choice of AC or DC.

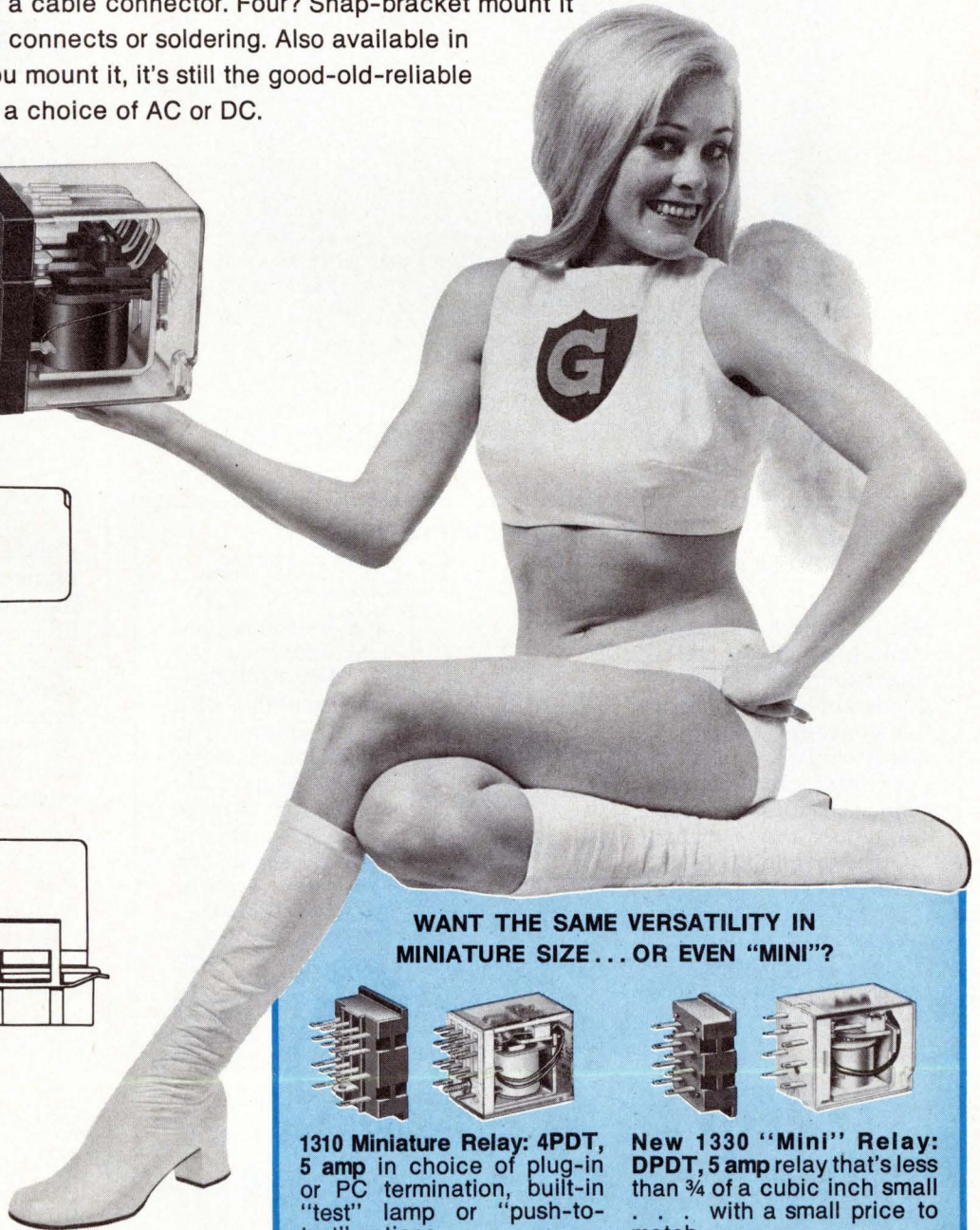
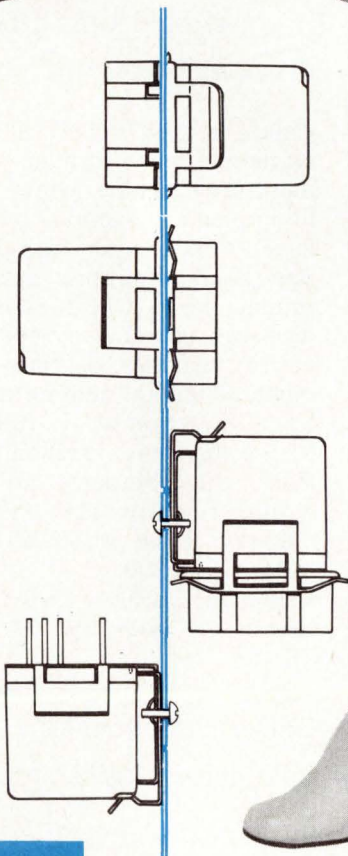
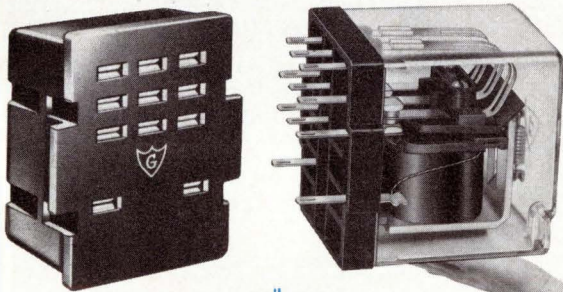

WANT THE SAME VERSATILITY IN  
MINIATURE SIZE . . . OR EVEN "MINI"?

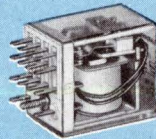
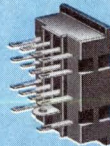

**1310 Miniature Relay: 4PDT, 5 amp** in choice of plug-in or PC termination, built-in "test" lamp or "push-to-test" options.

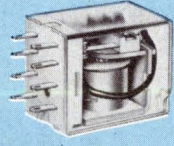

**New 1330 "Mini" Relay: DPDT, 5 amp** relay that's less than  $\frac{3}{4}$  of a cubic inch small . . . with a small price to match.



**GUARDIAN**® *In a hurry? Call your Guardian Distributor.*

GUARDIAN ELECTRIC MANUFACTURING CO. 1566 West Carroll Ave., Chicago, Illinois 60607

# Versatility



## In Digital Temperature Measurement...

With 5 thermocouple ranges . . . 2 millivolt ranges . . . a linearized D.C. output for recording. And, versatility is only the beginning of the YEW 2809 Digital Thermometer Story. It continues with 0.3% accuracy . . . built-in thermocouple linearization . . . built-in cold junction compensation . . . a full floating input . . . and many, many more revolutionary features. The new YEW Model 2809 provides all of the answers to digital temperature measurement in one compact instrument. Why not see how the 2809 can fit into your application. Write for complete technical specifications today.



For Sales and Service in the U.S.A. contact:  
Yewtec Corporation  
1995 Palmer Ave., Larchmont, N. Y. 10538  
Telephone: 914 834-3550

55 Years of Measuring and Recording Instrumentation.

Circle 156 on reader service card

## New products

second family offers low noise-voltage ratings. For the models 2N6451 and 2N6453, noise voltage is 5 nanovolts maximum at 10 hertz, and it is 10 nanovolts maximum at 10 Hz for the 2N6452 and 2N6454.

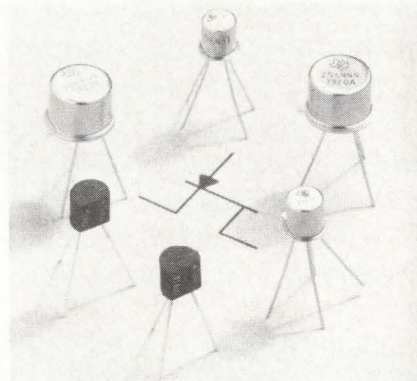

Price ranges from \$1.05 to \$12.70 each, depending on type, for 100 to 999.

Texas Instruments Incorporated, Box 5012, M/S 308, Dallas, Texas 75222 [416]

Programmable logic array provides 96 product terms

Called the DM7575/DM8575, bipolar monolithic integrated circuits are mask-programable arrays intended to implement random logic. They have 14 data inputs and eight outputs. Each output provides a sum of product terms where each product term can contain any combination of 14 variables or their complements. The total number of product terms that can be provided is 96. The equivalent function using a ROM, the company points out, would require 128,000 bits of memory. Price is \$39.60 each in quantities of 100.

National Semiconductor Corp, 2900 Semiconductor Dr., Santa Clara, Calif. 95051

LED drivers built for calculators, logic circuits

Two interface devices are designed for driving light-emitting-diode displays directly from MOS calculator chips and other MOS logic. The first is a quad-segment driver with both

### Our single-chip concept:

Copper grid distributes current most efficiently for lowest  $V_{CE(sat)}$ .

Integral solid copper leads and heat sink make pre-bond chip test and inventory possible.

Meet stringent MIL requirements best with the NPN silicon transistor that's single-minded about performance. The concept: a unique single-chip design that packs the highest current rating in its class . . . keeps saturation voltage low and eliminates second breakdown problems.  $V_{CE(sat)}$  is .75V max. @ 70 Amps, and guaranteed at 120 Amps.  $E_{S/b}$  is 6 joules. And because its very simplicity allows pre-rating

One bigger, beefier chip.

Void-free bonding techniques eliminates hot spots.

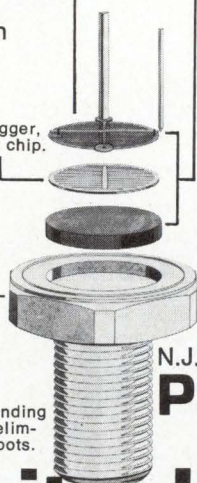

and pre-testing, you can order our JAN & JAN-TX-2N5927 device off-the-shelf for switching regulators, motor controls and other hi-rel power circuits. For tech. data and application assistance, write or call, PowerTech, Inc., 9 Baker Ct., Clifton, N.J. 07011; (201) 478-6205

**PowerTech**  
BIG IDEAS IN  
BIG POWER

# Top of its class.

## 120v @ 120A transistor

# JAN & JAN-TX

156 Circle 236 on reader service card

Electronics/September 13, 1973



# Looking for maximum circuit density and lower cost?

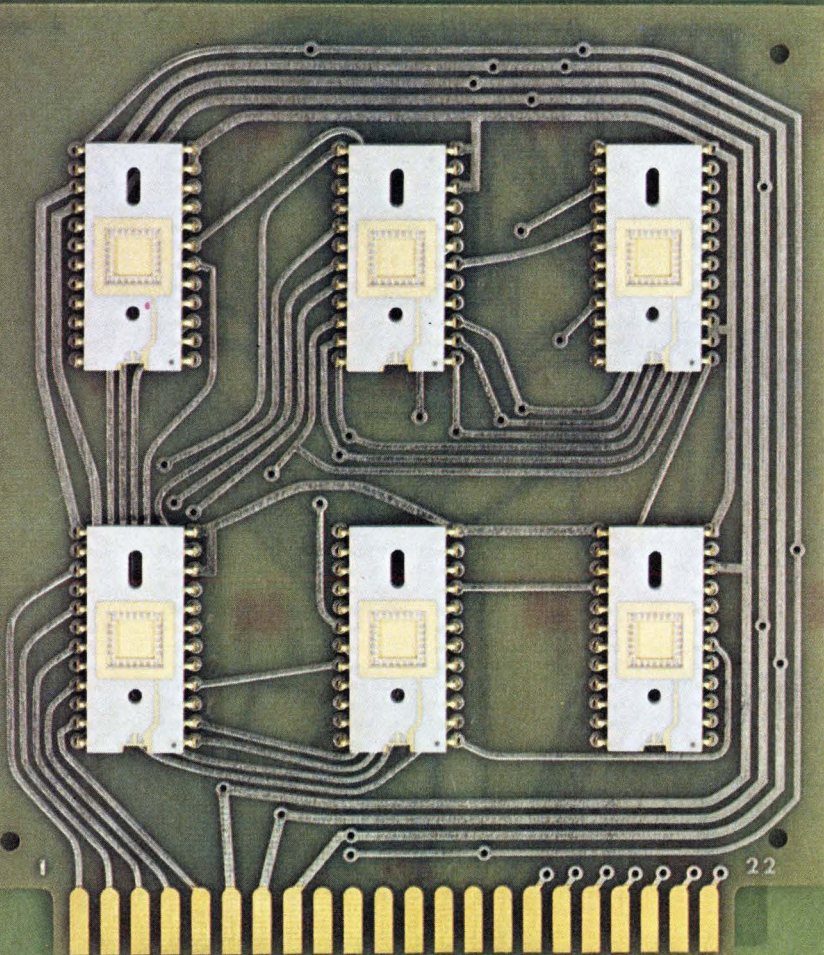

A typical printed circuit board with six standard 24 lead packages with .200" device area.

Let American Lava help solve your space and cost problems with our Hi-Density Leadless Packages. This packaging concept lends itself to automation and permits convenient repair or replacement. Electrical testing after hermetic sealing allows storage of good devices in a less expensive package BEFORE committing to the circuit. The design permits conventional die attach, wire bonding and lid sealing operations . . . and re-flow solder attachment to a multilayer ceramic substrate, hybrid substrate or phenolic circuit board.

**AMERICAN LAVA CORPORATION**  
CHATTANOOGA, TENN. 37405, U.S.A. • PHONE 615/265-3411

## NEW



This single AISiPak® 24-lead hermetic chip carrier has .235" device area.

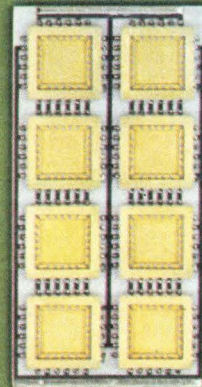

These eight AISiPak® 24-lead hermetic chip carriers on AISiBase® multilayer ceramic substrate give far greater circuit density.

Illustrations approximately actual size.

# AISI-Mag<sup>®</sup>

BRAND

# CERAMICS

SUBSIDIARY OF  
**3M**  
COMPANY

**JAPAN makes  
8,000,000 color TV sets  
a year.**

**SANKEN supplies  
100,000,000  
color-TV diodes  
a year.**

## SANKEN COLOR-TV DIODES

### Fast Recovery Diodes

	HF-1 Series	UF-1 Series	SB-2 Series	TD-13	TD-15	S-34	SF-1
PRV	400~1000V	400~1000V	500~1000V	1300V	1500V	500V	1500V
DC Output Current	0.6A	0.25A	1.0~1.5A	1.0A	1.0A	0.8A	0.03A
Reverse* Recovery Time	0.8 $\mu$ sec.	0.3 $\mu$ sec.	1.0 $\mu$ sec.	1.0 $\mu$ sec.	1.0 $\mu$ sec.	0.3 $\mu$ sec.	0.3 $\mu$ sec.

\* @  $I_F = 2\text{mA}$

### Silicon High Voltage Diodes for Multiplier Assembly

	HVT-18	HVT-30S
PRV	12,000V	18,000V
DC Output Current	15mA	15mA
Reverse Current	1.0 $\mu$ A	1.0 $\mu$ A
Reverse* Recovery Time	0.5 $\mu$ sec.	0.5 $\mu$ sec.

\* @  $I_F = 10\text{mA}$

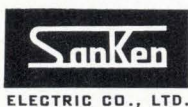

ELECTRIC CO., LTD.

## SANKEN ELECTRIC COMPANY, LTD.

1-22-8 Nishi-Ikebukuro, Toshima-ku, Tokyo, 171 Japan  
Tel: 986-6151 Telex: 0272-2323

## New products

collector and emitter outputs. Designated the MC75491, it can sink or source up to 50 milliamperes. The second, the MC75492, is a hex driver with collector outputs only, to sink up to 250 mA. Both linear de-

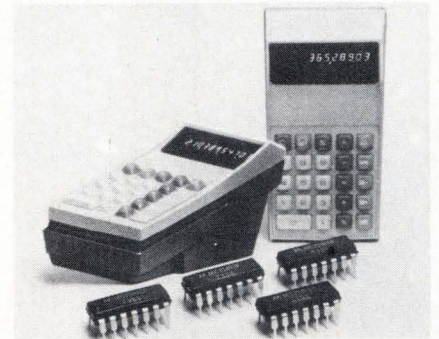

vices link MOS logic to common-cathode LEDs in serially addressed multidigit displays. Price is from \$1.60 to \$2.75, depending upon type and quantity. Both devices are available from stock.

Motorola Inc., Semiconductor Products Division, Box 2024, Phoenix, Ariz. 85036 [419]

FET op amp has slew rate up to 500 volts/ $\mu$ s

The model HX0032 FET-input operational amplifier is designed with a bandwidth to 70 megahertz and a

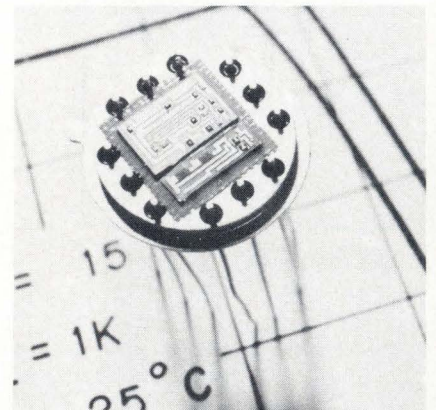

slew rate to 500 volts per microsecond. JFET impedance is  $10^{12}$  ohms. Applications of the device include digital-to-analog summing amplifiers, sample-and-hold circuits, integrators, and video amplifiers. Price is \$40 each in 100-piece lots.

Halex Inc., 3500 West Torrance Blvd., Torrance, Calif. 90509 [420]

# The Big Sweep 100 kHz-18 GHz.



It's a whole new generation of solid state sweep oscillators from Singer.

The 6600 Sweep Oscillator with its wide selection of plug-ins covers the 100 kHz to 18 GHz range. Below 1000 MHz, you have as many as three units

from which to choose the one best suited to your application. One model includes a power-set meter

adjustable over a 140 dB range for applications requiring sweeper *and* signal-generator-like performance. Microwave plug-ins are pin-leveled, internally or externally, all the way up to 18 GHz. And with a 20 dB power control range. But there is much more than exceptional performance to the 6600.

The uncluttered front panel with its lighted, push-button controls, makes operation self-evident and confusion-free. With four sweep modes, full band, marker,  $\Delta F$ , and manual — each with frequency markers — the 6600 sets a new standard for ease and flexibility of operation.

Take a little time to find out more about the big sweep. Write for complete data bulletin now.

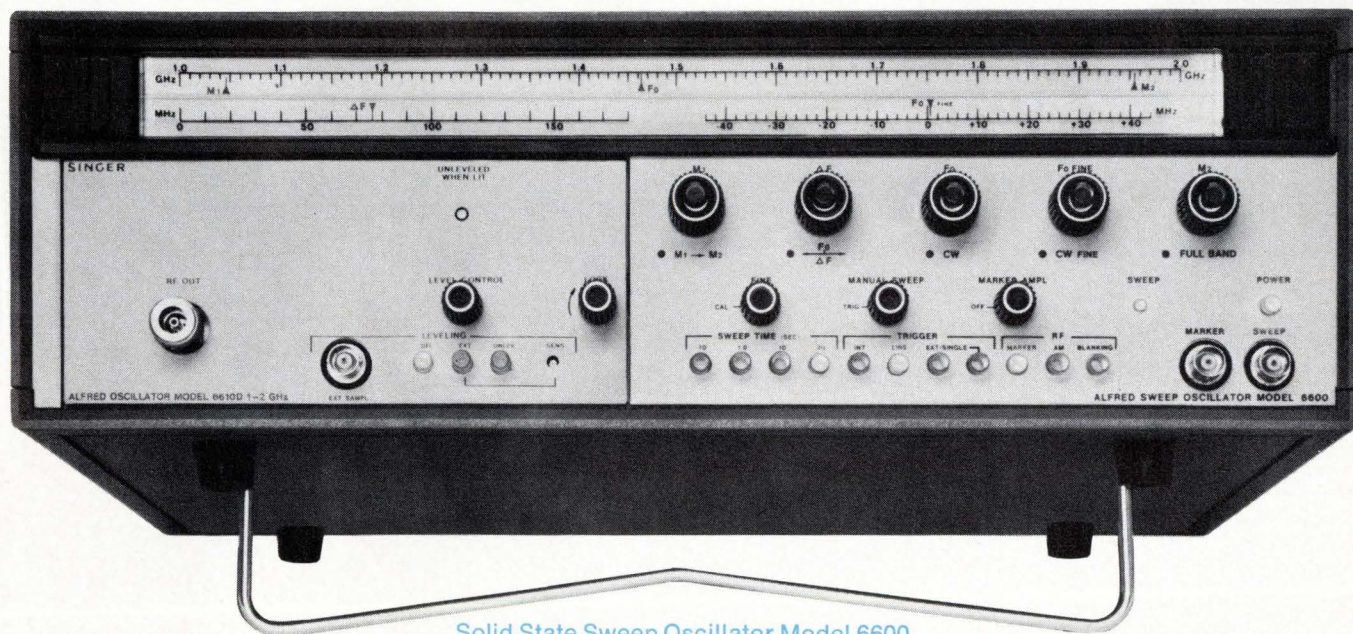

Solid State Sweep Oscillator Model 6600

## SINGER

INSTRUMENTATION

The Singer Company, Palo Alto Operation • 3176 Porter Drive, Palo Alto, Calif. 94304 • Telephone (415) 493-3231

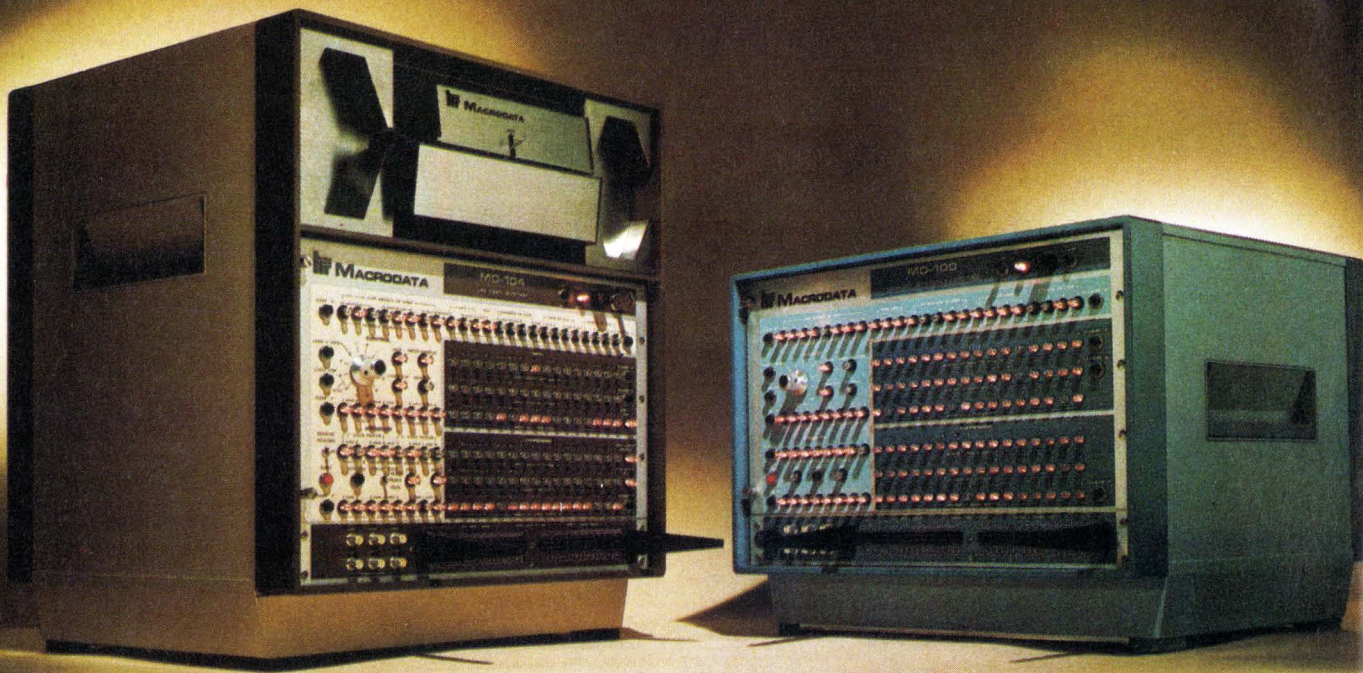

## LSI users! Now you can have full confidence in your devices with the Macrodata MD-104 and MD-100 LSI testers!

**The MD-104** A 10-MHz LSI test system capable of functional testing of both MOS and bipolar devices, including shift registers and random logics as well as high-speed memories like the ECL's.

Look at the big capabilities of these small, easy-to-operate LSI testers. They test RAM's, ROM's, shift registers, random logic devices . . . bipolar or MOS . . . LSI, MSI, or SSI. They test the special new circuits for the electronic watches and clocks, for automotive applications, the single or multiple chips for the new calculators — and they can handle board testing as well.

**The MD-100** A 5-MHz memory exerciser that is now the standard bearer of the industry for functional testing of both bipolar and MOS devices, including shift registers and random logics as well as memories. Prices start at under \$10,000.

They do it all — at your plant, in your lab, on your production line . . . for incoming inspection, for quality control, for engineering evaluation. If you want to fully exercise an MOS memory with such famous Macrodata test programs such as WAKPAT, GALPAT, GALWREC, MASEST, etc., look no further than this twin pair. Or if you want to put your bipolar's — even ECL's — through a true 10-MHz workout, take the measure of the MD-104. Ask also about its random logic capability.

Nowhere else will you find such enormous testing capability in such small easy-to-operate test systems with such low price tags. Take comfort too in the fact that there are more MD-100's in the field testing LSI circuits than all competitive instruments combined. For more information or to place an order just call us directly.

## Macrodata



*Tired of promises from the also-rans? Then remember — when you're in a jam, call your Macrodata man!*

**Macrodata Corporation**, 6203 Variel Avenue, Woodland Hills, California 91364, Phone: (213) 887-5550, Telex: 65-1345  
**Sales Offices:** Northern California Area Tel. (408) 735-9560 • Southwestern Area Tel. (213) 644-3611 • West/Central Area — Denver Tel. (303) 934-5505 • Scottsdale Tel. (602) 947-7841 • Albuquerque Tel. (505) 299-7658 • Dallas Tel. (214) 231-2573 • Houston Tel. (713) 621-0040 • Minneapolis Area Tel. (615) 636-1770 • Chicago Area Tel. (312) 455-5100 • Cleveland Area Tel. (216) 461-8333 • New York and New England Area Tel. (914) 962-7797 • Southeast Area Tel. (205) 883-0140 • International: West Germany — Munich Tel. (0811) 34 56 00 Telex: (841) 521-5969 • Milan, Italy Tel. 871-988/899-248 Telex: (843) 34314 • Sweden and Norway — Stockholm Tel. (08) 87 03 45 • Switzerland and Austria — Bern Tel. (031) 22 44 81 Telex: (845) 33172 • Tel Aviv, Israel Tel. 25 55 69 • Tokyo, Japan Tel. (03) 985-5266 Telex: (781) 272-2171 • Buckinghamshire, England Tel. High Wycombe (0494) 36 3 81 Telex: (851)837236

## New products

Packaging & production

# Mask aligner boosts IC yield

All-reflective system avoids chromatic aberrations, can handle 3-inch wafer

In integrated-circuit processing, the masking step accounts for a significant percentage of production losses. But now a mask aligner designed by Perkin-Elmer Corp. promises increased yields and therefore over-all reductions in IC production costs.

The new Micralign model 100 can align the mask, which contains the circuit pattern to be etched, on wafers as large as 3 inches. But unlike most other mask-alignment systems, this one employs an all-reflecting projection system. Being all-reflective, there is no refractive lens system to cause chromatic aberrations, and it is possible to achieve a line resolution as narrow as 2 micrometers (as against the 5  $\mu\text{m}$  characteristic of the better contact-type mask aligners). Over a 3-inch field, depth of focus for this 2- $\mu\text{m}$  resolution is  $\pm 5.5 \mu\text{m}$ .

Since the Perkin-Elmer system

projects the image, the mask does not touch the wafer, and the mask is not degraded by repeated contact. For that matter, neither does a wafer break, nor is it damaged, by contact with the mask. As a result, yield is increased.

The lens system employs two spherical reflectors that are arranged so that the larger primary lens is used twice and the smaller secondary lens is used once. The mask and wafer are aligned on a common carriage structure on opposite sides of the prism assembly, as shown. A mercury light source shines through the mask, generating the 1-mil image on the wafer. This image reaches the wafer via three flat mirror surfaces, and two spherical reflectors form the 1-mil-wide image on the wafer.

During exposure of the photoresist, the carriage moves so that the entire circuit mask is scanned and the full image is projected on wafer.

Since there is no chromatic aberration, which often restricts refractive systems to a narrow spectral region, usually 50 angstroms wide, the Micralign spectral bandpass is wide, and interference fringing on the photoresist is eliminated. Exposure time is also reduced. What's more, the broad spectrum provides the operator a full-color view, which aids accurate alignment.

Refractive systems are often

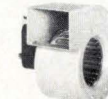
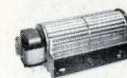
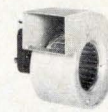
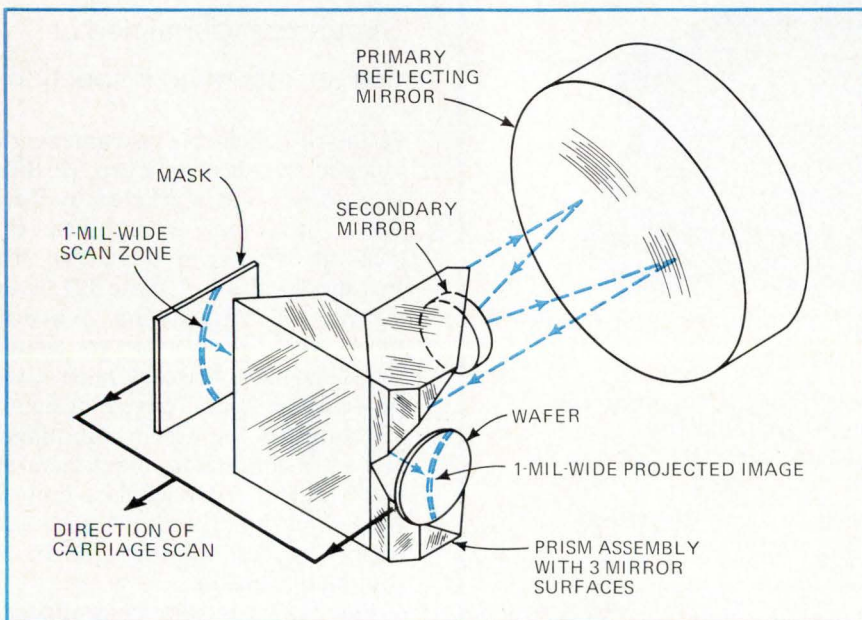

**Ready-to-go  
for  
immediate  
sampling . . .**

**28 standard  
axial,  
centrifugal  
and  
transverse-  
flow  
blowers.**

**(And the  
price  
is light.)**

No test-sample delays if one of our standard blowers meets your spec demands. We have 28 models on the shelf, ready to be sent to you at once. (Your production orders will go out speedily, too.)

**Save time. Write or  
call now for our  
catalog with com-  
plete performance  
and spec data.  
Everything you  
need to know.**

Torin Corporation,  
Kennedy Drive,  
Torrington, Con-  
necticut 06790.  
(203) 482-4422; or  
16300 Roscoe  
Blvd., Van Nuys,  
California 91401.  
(213) 892-0741

**Torin**

Torin Corporation  
United States: Torrington, Ct.  
Van Nuys, Calif.  
Rochester, Ind., Elgin, Ill.  
Canada: Oakville, Ont.  
England: Swindon, Wilts.  
Belgium: Nivelles  
Australia: Sydney



When you see this  
**THOMCAT**  
 symbol it means the  
 company has its catalog in  
**Thomas Register**

When a manufacturer uses the THOMCAT symbol in his ads and literature, it means his catalog is in the THOMCAT volumes of Thomas Register. And THOMCAT contains detailed catalogs from hundreds of manufacturers of all types of products.

Look for the THOMCAT symbol — it will save you countless hours in product searches — eliminate writing away for data and waiting weeks. Next time you need catalog data, let THOMCAT be your guide.

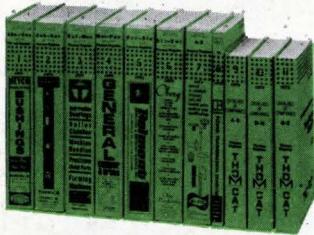

Thomas Register  
 Thomas Register Catalog File  
**THOMCAT**

461 Eighth Avenue, New York, New York 10001

Circle 162 on reader service card

**Perfect mate for integrateds—  
 Micro-Vectorbord® Tenth-Tenth Pattern "P"**

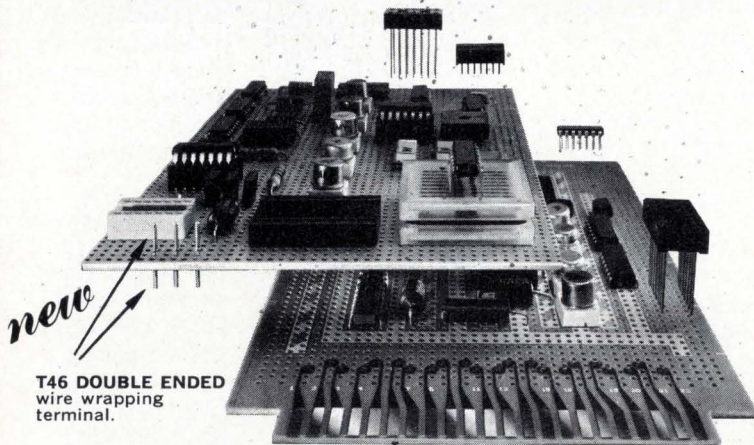

**T46 DOUBLE ENDED**  
 wire wrapping  
 terminal.

Precision punched .042" holes spaced .1" x .1" available in sheets of various sizes up to 8½" wide by 35" long, ¼" thick Epoxy Glass, Epoxy Paper, Phenolic.

Copper Clad and Non-Clad. Also available in Plugboards with etched or Elco Varicon contacts, buses, ground planes.

MINIATURE PUSH IN TERMINALS FOR .042" HOLES.



**T44 MINIWRAP** .025" Square, for wire-wrapping.



**K27** .042" Diameter



**T42-1 Micro-Klip**

**Vector**

Send for complete literature

**ELECTRONIC CO., INC.**

12460 Gladstone Ave., Sylmar, California 91342  
 Phone (213) 365-9661 • TWX (910) 496-1539



"SEE US AT WESCON BOOTH 1708"

Circle 219 on reader service card

162

**New products**

plagued with another problem, called veiling glare. This phenomenon reduces contrast to the point where the use of negative resists should be avoided. But such glare is not a problem with the Micralign projection system, which has only six surfaces between the mask and the wafer.

The aligner, which can handle masks as large as 4 by 5 by 0.25 inches, is priced at \$95,000. Deliveries are expected to begin in early 1974.

Perkin-Elmer Corp., Electro-Optical Division, Wilton, Conn. 06897 [391]

**Flip-chip bonder has  
 optical beam splitter**

A machine, the FC240, developed especially for flip-chip solder bonding of microelectronic chips to substrates, provides semiautomatic operation and will accommodate substrates as large as 2 by 2 inches. An optical beam splitter enables the operator to simultaneously view both the chip and the substrate. This makes possible precise alignment of the die to the substrate. Price of the bonder is \$5,100 plus \$440 for optics.

Laurier Associates Inc., 550 Newtown Rd., Littleton, Mass. 01460 [398]

**Circuit analyzer aimed at  
 design, incoming inspection**

A line of bench-top instruments developed by Accutest Corp. of Billerica, Mass., and marketed by Teradyne Inc., was introduced this week at Wescon by Teradyne. The first model, the Teradyne J27, is designed for engineering functions rather than for go/no go testing, Teradyne says. Primary market will be equipment and device designers selecting ICs for use in equipment, and semiconductor manufacturers who want to test packaged units in the laboratory. Teradyne sees a secondary market for the J127 in incoming inspection.

The J127 has four constant-volt-

Solitron can deliver your specific hybrid product requirements regardless of what they may be. After all, we are the only power hybrid manufacturer to qualify and meet NASA's exacting standards.

Our engineering expertise in power hybrid technology has been successfully proven time and again for military, industrial, and commercial applications. Our capability extends into the designs of custom built hybrid circuitry, providing optimum performance. If your design requires power amplifiers, power control circuits, voltage regulators, or power supplies — from 1 Amps to 200 Amps — Solitron gives you more for your money.

Whatever your power hybrid needs, whatever type of hybrid production and packaging technique required, Solitron's engineering team can do the job. Call us toll free at 1-800-327-3241 and we'll give you the "inside story"!

#### SOLITRON 10 LEAD HYBRID PACKAGE (1.5" X 1.25")

- 10 Lead Flat Pack With Mounting Flanges
- Multiple Power Chip Capability
- Thermal Resistance Less Than 1.0°C/W per device
- High Reliability
- Hermetic Seal
- 10 A dc Leads
- Silicon Gold Eutetic Alloy Die Attachment
- Aluminum Ultrasonic Lead Attachment

For complete information, write:

**Solitron**  
**DEVICES, INC.**

1177 BLUE HERON BLVD. / RIVIERA BEACH, FLORIDA 33404  
(305) 848-4311 / TWX: (510) 952-7610

# Take an inside look at our power hybrid capability.

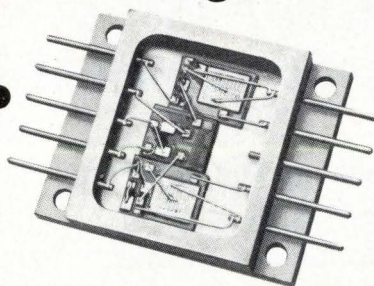

**10 Lead Flat Pack**  
*[Just one of the many  
hybrid packages available  
from Solitron]*

PLANTS IN: CALIFORNIA • FLORIDA • NEW YORK • ENGLAND • HONG KONG • MEXICO

# High Voltage Diffused Silicon Rectifiers

Six series in a wide range of minimum size packages with low leakage currents for commercial and industrial applications requiring high reliability at economical cost.

These devices feature 1kV to 40kV PRV with 5mA to 2A, I<sub>o</sub>. All series available in fast recovery versions.

Typical applications: CRT power supplies, RF transmitters, microwave ovens, electrostatic copiers and precipitators.

Series VG; 20kV PRV. \$1.49 (1000).

Rectifiers for medical and industrial X-Ray equipment and high voltage multipliers also available from Varo.

Write for free catalog.



Design us in —  
We'll stay there



**VARO SEMICONDUCTOR, INC.**

P.O. BOX 676, 1000 N. SHILOH, GARLAND, TEX. 75040, 214/272-4551, TWX 910-860-5178

**ALLIED ELECTRONICS**, Chicago, Ill. 312/421-2400. **THE ALTAIR CO.**, Houston, Tex. 713/781-5300; Richardson, Tex. 214/231-5166. **BELL INDUSTRIES**, Menlo Park, Cal. 415/323-9431; Skokie, Ill. 312/965-7500; Bellevue, Wash. 206/747-1515. **BLUFF CITY DIST. CO.**, Memphis, Tenn. 901/725-9500. **BRIDGEFIELD SUPPLY**, Chesterland, Ohio 216/729-9451. **CRAMER ELECTRONICS**, Nationwide; Newton, Mass. 617/969-7700; **ELECTRONIC PARTS CO.**, Denver, Colo. 303/744-1992. **MILGRAY ELECTRONICS**, Freeport, N. Y. 516/546-6000; Hyattsville, Md., 301/864-1111; Cherry Hill, N. J., 609/424-1300. **WESTATES ELECTRONICS**, Chatsworth, Calif. 213/341-4411.

In Canada:

**ELECTRO SONIC**, Toronto, Ont. 416/924-9301. **R.A.E. IND. ELECTRONICS**, Vancouver, B. C. 604/687-2621. **FRELCO ELECTRONICS, LTD.**, Montreal, Quebec 514/389-8051. **WESTERN RADIO SUPPLY**, Hamilton, Ont. 416/528-0151.

Circle 164 on reader service card

## New NDP 1255-8

from **NATIONAL ELECTRONICS**  
featuring

**Gas Discharge Display Panel**

- Large Character (.3")
- Edge Connector Plug In
- Multiplexed • Low Cost



**NATIONAL ELECTRONICS**

a varian division  
geneva, illinois 60134 (312) 232-4300

164 Circle 220 on reader service card

## New products

age supplies, three with ranges of  $\pm 50$  volts. The fourth has an output range of  $-10$  to  $+100$  v at 40 microamperes up to 75 v and  $20 \mu\text{A}$  at 100 v. Teradyne says this is useful when testing open-collector, high-voltage output devices. This supply can also be swept from an external function generator for ac testing of linear ICs. The constant current supply has ranges of  $\pm 1$ ,  $\pm 10$  and  $\pm 100 \mu\text{A}$ ; voltage limiting is to  $\pm 12$  v.

Resolution of 10 mv between  $-10$  and  $+15$  v is provided by four dual-limit comparators. A 24-by-11 cross-point matrix allows manual connection of tester functions for most devices with up to 24 leads. Dual in-line packages with bent pins or non-standard pin-spacing can be handled by the standard zero-insertion-

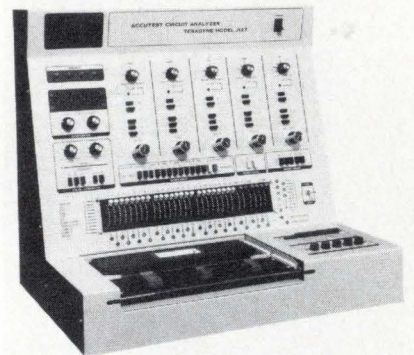

force test decks.

The J127 includes a  $3\frac{1}{2}$ -digit panel meter to indicate measured parametric values, set the forcing functions on tests, and provide comparator information.

Teradyne says the J127 can perform both functional and dc parametric tests on a wide variety of digital ICs, as well as on certain discrete, linear, and optoelectronic devices.

Price of the J127 is \$3,500; delivery time is four weeks.

Teradyne Inc., 183 Essex Street, Boston, Mass. [392]

Positioning system has  
taped program controls

The NC 322 positioning system with a 22-by-22-inch table offers full tape-programed controls. The sys-





# WE'LL SELL YOU A KEYBOARD SWITCH FOR 30¢



...and give you  
**A PENNY CHANGE**



**How to save silver when buying gold:** Spec Cherry Gold "Crosspoint" Contact keyboard switches. With a momentary Form A (SPST/NO) price tag of just 29¢ in 250,000 quantity . . . lower prices in higher quantities.

What do you get besides low price? Unique, proven Cherry Gold "Crosspoint" contact configuration that enhances reliability. Tested beyond 50,000,000 operations. (Test Report No. TK 10071 available on request.) You get Cherry's low profile Keyboard switch featuring rugged construction, 2½ ounce operating force and stable contact resistance (typically 25 milliohms over life). Made by the people who pioneered the Gold "Crosspoint" Contact in snap-action switches.

The result? Cherry keyboard switches are your ideal choice for computer terminals, electronic calculators and credit card validators.

**TEST A FREE SAMPLE.** Choose the 29¢ Form A switch . . . or any of Cherry's complete line of keyboard switch modules. Just TWX 910-235-1572 . . . or PHONE 312/689-7704 and ask Frank to give you facts on Keyboard Switches . . . or circle appropriate reader service number.



**FORM A, MOMENTARY  
(SPST/NO)**  
Circle No. 201 for Free Sample

**ALTERNATE ACTION (SPST)**  
Circle No. 202 for Free Sample

**DUAL FORM A, MOMENTARY  
(DPST/NO)**  
Circle No. 203 for Free Sample

# CHERRY



**CHERRY ELECTRICAL PRODUCTS CORP.**  
3608 Sunset Avenue, Waukegan, Illinois 60085



Cherry affiliates worldwide • Hirose Cherry Precision Co., Ltd., Tokyo • G. W. Engineering Pty. Ltd., Sydney  
Cherry Electrical Products (U.K.) Ltd., St. Albans, Herts • Cherry Mikroschalter GmbH, Bayreuth, Germany

# HORATIO ALGER WAS RIGHT.

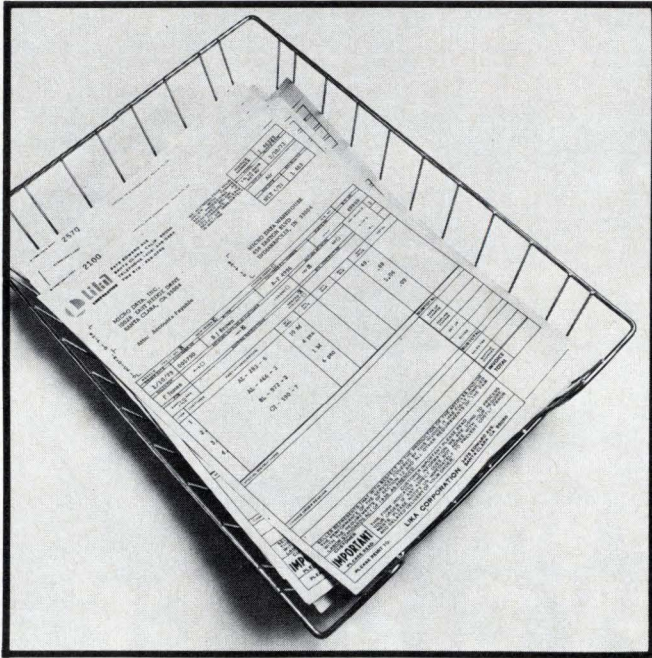

If you work hard, pay attention to detail and make sure that your customers get good value for their money, you're bound to succeed. At least that's how it works for us. Three years ago, we were the little printed circuit board company that nobody ever heard of. Today, we're the largest proprietary manufacturer of P.C. boards in the nation. But even though we're big, we don't forget how we got that way. We still work hard, pay attention to detail and see that our customers get good value for their money. Whether it's a single prototype or a production run of copper, solder, reflowed solder, nickel, gold, solder mask over bare copper circuits. In plated through two-sided, or multi-layer boards. Horatio would have liked that.



3475 Edward Avenue, Santa Clara, California 95052 • (408) 249-0464  
Manufacturing facilities located in Santa Clara, Stockton and Santa Ana.

Circle 166 on reader service card

Why mess around when you can have the **ELECTRONICS BOXER** clean up your copies—keep them in top condition.

And, it's easy and

inexpensive to keep the **ELECTRONICS BOXER** in your corner. Just complete the coupon and mail. Your order will be processed immediately, postpaid.

## ELECTRONICS BOXER

**Jesse Jones Box Corporation**

2250 E. Butler St., Philadelphia, Pa. 19137

Please send me:  boxes @ \$4.25 each;  
 3 boxes @ \$12.00;  6 boxes @ \$22.00

My check or money order is enclosed.

Name \_\_\_\_\_

Address \_\_\_\_\_

City \_\_\_\_\_ State \_\_\_\_\_ Zip \_\_\_\_\_

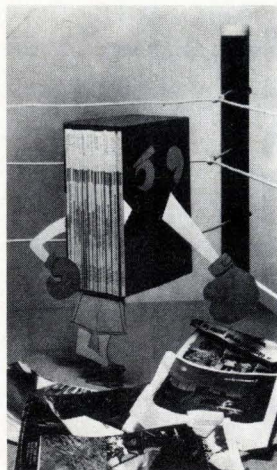

## New products

tem will handle loads of up to two tons. Error is about 0.00005 inch per in. and repeatability is 0.00005 in. The system can run at speeds of 5 in. per second with 0.0005-in. resolution. The 322 is controlled by a

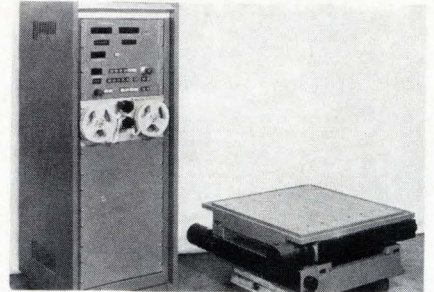

closed-loop encoder feedback dc servo drive.

Aerotech Inc., 4055 William Flynn Highway, Allison Park, Pa. 15101 [393]

Pin and socket connector includes built-in lock

Rated up to 25 amperes per contact, a family of connectors includes sizes with 2, 3, 4, 8, and 9 positions. The units, called Mate-n-Lok, have polarized nylon housings and a built-in locking device to prevent accidental unmating. The crimp-on pre-tinned

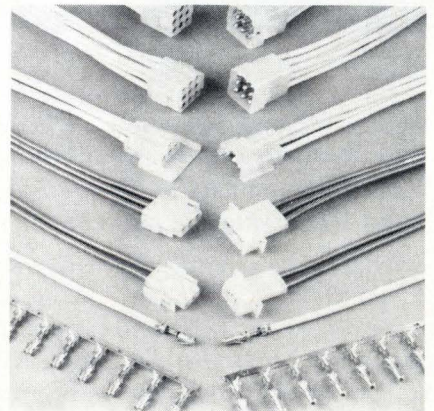

brass contacts accept solid or stranded wire from AWG #20 to #10, with insulation diameters from 0.100 to 0.180 inch. Both pins and sockets have dual locking lances and can be hand-loaded into the housings. The panel-mount versions can be installed without mounting hardware in a 0.040- to 0.070-in.-thick panel simply by being snapped into the panel cutout. The connector

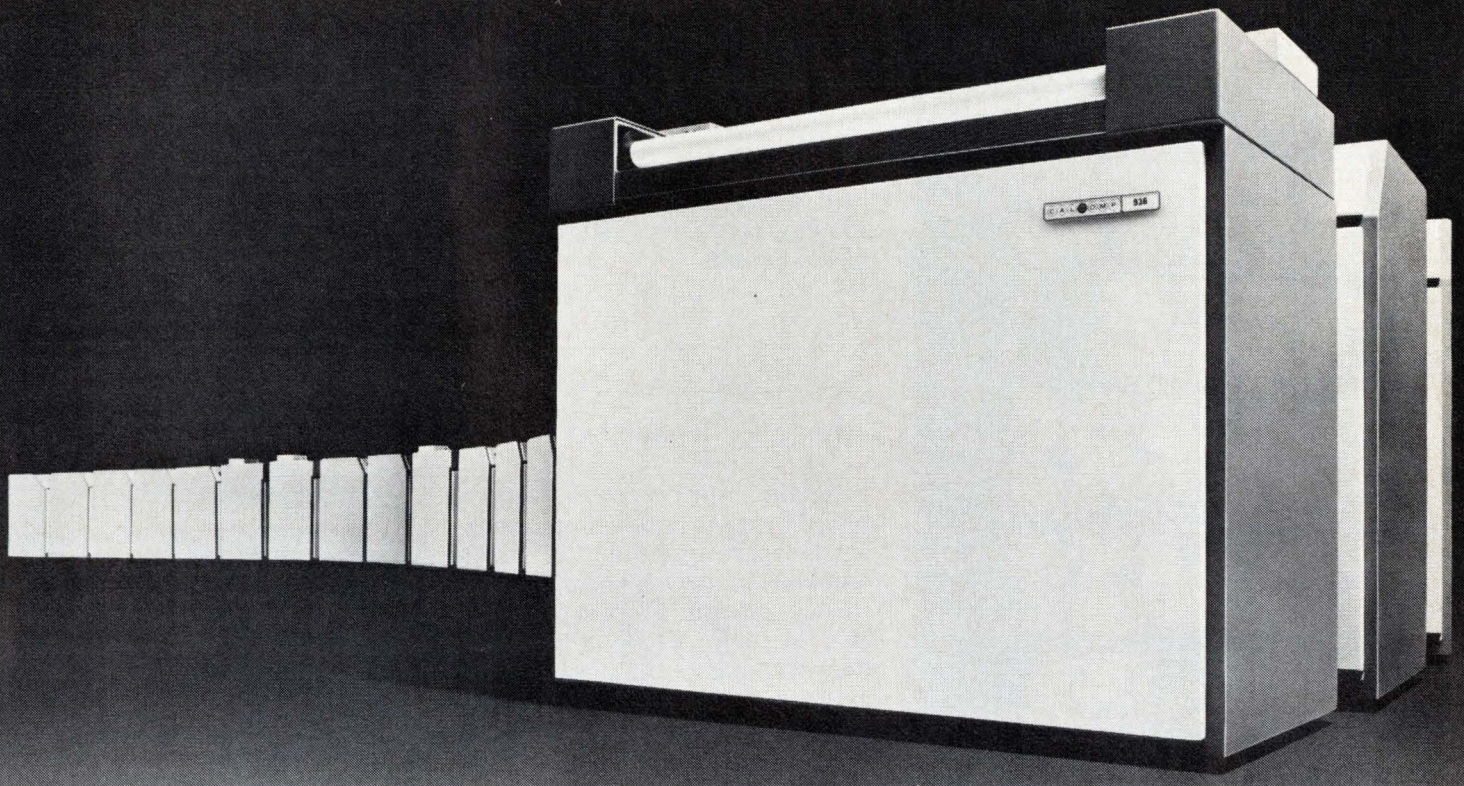

# When you're the leader, how do you follow the leader?

We introduced digital plotting.

For the last ten years, our drum plotters have set the standards of their industry.

Our 565, and the models we've built around it, have made us the largest manufacturer of drum plotters in the world.

But we've known for a long time that someone would come along with something new one day. What we've been working on, is making certain that the new leader would still be us.

Starting now, you'll measure drum plotters by our two new models.

First, the 936. It's faster and it has greater plotting quality than the unit it replaces.

And, it costs less.

Next, our top of the line 1036. It's almost twice as fast as the 936. And again, its plotting quality is higher and its price is lower than the unit it replaces.

We've increased performance and decreased the price of the drum plotter. And that's going to be a hard act to follow.

Call or write California Computer Products, Inc., EM-M9-73, 2411 West La Palma Avenue, Anaheim, California 92801. (714) 821-2011.

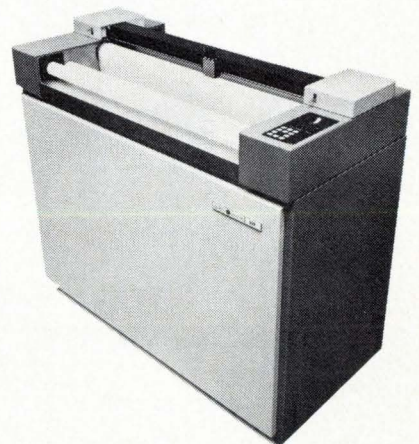

**CALCOMP**

# LEAVE THE DRIVERS TO US!



...If we can't make stepper motor drivers better than you can, faster than you can, and for less than you can...PLEASE call US immediately. We'd like to know how you do it.

Model D100 is a 4-phase, unipolar, 8 amp-per-phase driver for 200 step/rev, 5-10,000 step/sec motors. For details about this and other drivers available, write or call collect. Today!

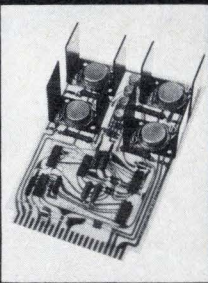

**DBE**  
**DAHMEN BURNETT**  
**ELECTRONICS**  
Grenier Industrial Village  
Londonderry, N.H. 03053  
Tel: 603-668-2777

Circle 168 on reader service card

## New products

family is designed for use in household appliances, office equipment, vending machines, and computer power supplies.

AMP Inc., Harrisburg, Pa. 17105 [394]

Wire-wrapping panels offered in 19 varieties

Providing the engineer with a breadboard-to-production packaging capability, a family of modular planar wire-wrapping panels and frames comes in 19 types of 8-, 14-, 16-, 24-, and 40-pin IC combinations. The panels either may use 72- or 108-pin wire wrap to attach connectors on their input-output or may be mated with up to 108-pin stranded-wire cable assemblies for interfacing to other digital and analog components. The input/output connectors eliminate the need for gold-plated copper fingers

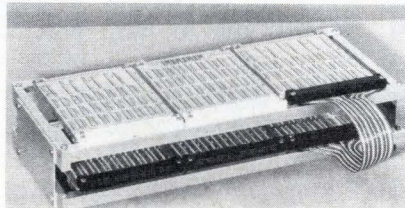

and the associated solder-joint connections of the fingers to the wire-wrap pins. The panels may be mounted in predrilled, tapped holes on a variety of frame sizes and may be automatically or semiautomatically machine-wrapped. Panels are priced in the \$50-\$60 range, and frames are \$12 to \$13.

Mupac Corp., 646 Summer St., Brockton, Mass. 02402 [395]

Adaptor plug accepts LSI devices in DIPs

Built specifically to accept large-scale integrated circuits in dual in-line packages, a glass-epoxy adaptor plug provides flexibility in IC interconnections. The plug accepts 24-, 28-, 36-, and 40-pin LSI devices and adapts them to 14- and 16-pin IC patterns for any of the P, W, and R packaging panels made by Augat

## SOLID STATE IF FILTERS FOR SOLID STATE RELIABILITY

### muRata CERAMIC IF FILTERS

Whether your application includes AM and FM entertainment receivers or communications and TV receivers, Murata has a solid state ceramic IF filter that can replace those tired, wound IF cans for increased performance and reliability with reduced size and cost. 455 KHz filters, 10.7 MHz filters, 4.5 MHz filters including bandwidths for the sharpest communications receiver specifications and bandwidths to meet the "flat-top" requirements of good FM and TV are all included in this, the industry's largest, line of ceramic IF filters.

Why not add solid state reliability to your entire IF strip? Write for complete technical information today, it's yours for the asking.

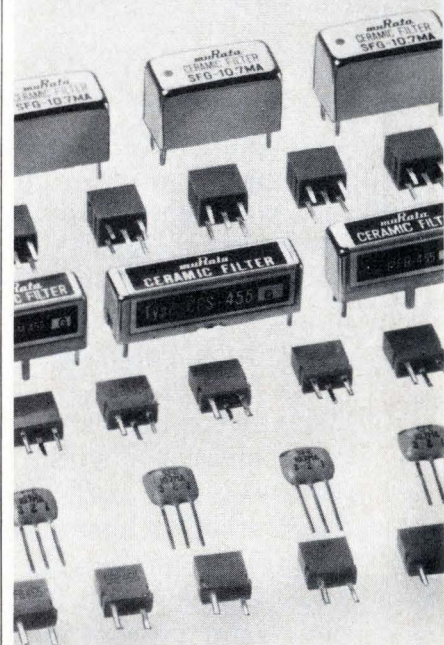

**muRata**

MURATA CORPORATION OF AMERICA

2 Westchester Plaza, Elmsford, New York 10523

Telex: MURATA EMFD 137332

Phone: 914/592-9180

A Subsidiary of  
Murata Mfg. Co., Ltd., Japan

Circle 221 on reader service card

## New products

Inc. The LSI DIPs are soldered into the adaptor, which plugs into the panel. Prices range from \$2.75 to \$6 each, depending on style and quan-

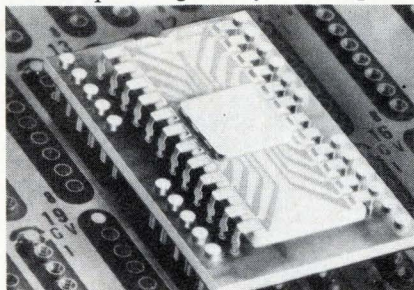

tity. Delivery time is stock to six weeks.

Augat Inc., 33 Perry Ave., Attleboro, Mass. 02703 [396]

## Infrared system fuses tin-lead plate to pc boards

Automating the fusion of tin-lead plate to printed-circuit boards, a conveyORIZED infrared system is said to achieve uniform plating thickness, distribution and composition on the boards. Single-sided, double-sided, and multilayer boards are processed in a single pass. Flux is automatically applied after the operator feeds the board into the conveyor entrance. The board is preheated to minimize warpage and then carried into the high-intensity infrared section where the tin-lead is fused to the copper. The board then passes through preliminary and final cooling stages. A spray-wash section is available as an option to clean and dry boards before delivery. Called the model F-1500, the system has digital displays, plus controls for conveyor speed and temperature.

Radiant Technology Corp., 13906 Bettencourt St., Cerritos, Calif. 90701 [397]

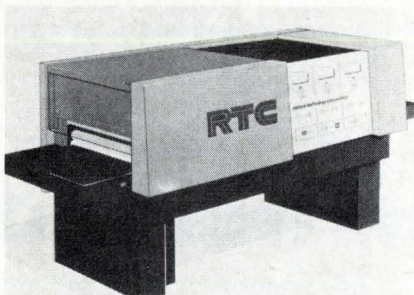

# YOU CAN CREATE ALMOST ANYTHING WITH QT SOCKETS™

No matter what kind of circuits you're designing, it's easy testing them with QT (quick-test) SOCKETS™. ICs, transistors, resistors, capacitors, etc., are simply plugged in and interconnected with solid No.22 AWG hookup wire. There is no soldering required. And components and sockets can be re-used thousands of times. What's more, QT SOCKETS – featuring an exclusive snap/lock construction – can be assembled in any size combination of sockets and bussing strips. Prices start at \$2.00. QT SOCKETS – just the thing for bringing new ideas to life.

## FREE SELECTION GUIDE

Check and return the reader service card for additional information, including application and product photos, drawings, specifications, socket sizes and ordering information.

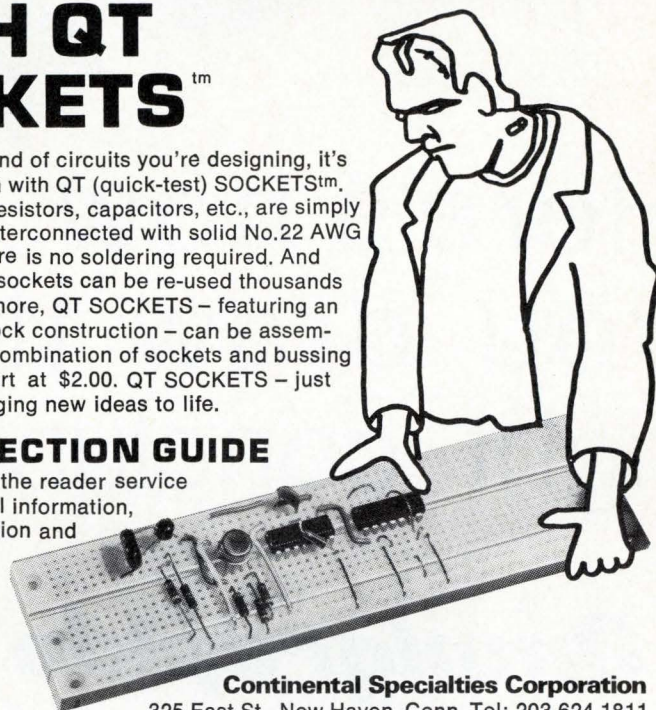

**Continental Specialties Corporation**  
325 East St., New Haven, Conn. Tel: 203 624 1811

Circle 169 on reader service card

## PC PUSH BUTTON MODULES

# Matchless circuit flexibility for coded inputs

You can arrange these modules to suit your needs exactly. Available in 6-button, 3-button, 2-button and one-button styles. You can group them in arrays of any number of buttons, while maintaining the same center to center spacing.

Circuitry available as SPST through 4 PST, normally open. The poles also can be internally shorted so that several terminals become connected when button is actuated.

Unmatched diversity of input coding can be achieved with the proper array, appropriate circuitry selection for each push button and compatible PC board layout.

What application do you have in mind? We've got the low profile push button module and circuitry combination to meet it.

For more information on all Grayhill products, write today for our newest Engineering Catalog. Grayhill Inc., 523 Hillgrove Avenue, La Grange, Illinois 60525 (312) 354-1040



\$395

Model 5112-1 single pen recorder with 1, 2, 5, 10 in./min. chart speeds and 10 mv fixed input spans.

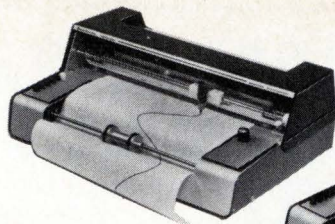

\$445

Model 5110-2 single pen recorder with 2.2, 5, 10, 20 cm/min. chart speeds and 5 input spans of 10 mv up.

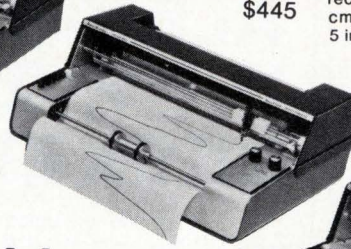

\$595

Model 5212-1 two pen recorder with 1, 2, 5, 10 in./min. chart speeds and 10 mv fixed input spans.



\$690

Model 5212-2 two pen recorder with 1, 2, 5, 10 in./min. chart speeds and 5 input spans of 10 mv up.

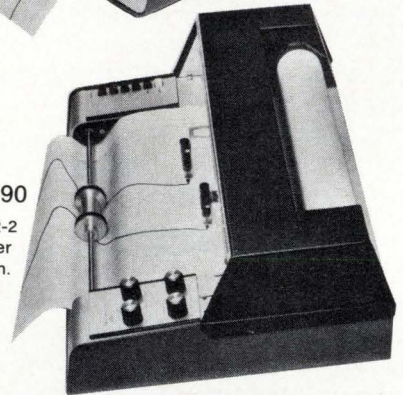

\$990

Model 5220-5 two pen recorder with electric pen lift, 2.5, 5, 10, 20 cm/min. chart speeds and 5 input spans of 1 mv up.



Circle 199 on reader service card

## **OmniScribe™** strip chart recorders

Here's the newest low cost strip chart recorder from The Recorder Company. And when you compare the costs with the performance you'll understand why it pays to buy from a company whose entire resources are devoted to building and servicing the finest laboratory recorders in the world. Mail for your copy of the OmniScribe brochure today.

# Here's how you draw the right conclusions:

## **Omniographic®** x-y and strip chart recorders

If you want one pen or two . . . for GC or spectrometry . . . for thermo-couple or strain gauge . . . the Omniographic recorder with options will give you a full range of inputs combined with operational conveniences. Consider switching to Omniographic recorders . . . built by The Recorder Company.

### 27-plug-in modules for virtually every laboratory function make this the most versatile recorder

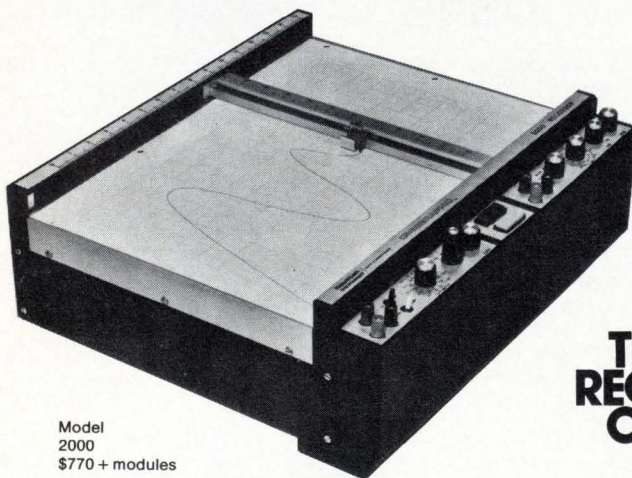

Model 2000  
\$770 + modules

**THE RECORDER COMPANY**

**houston instrument**

4950 TERMINAL AVENUE, BELLAIRE, TEXAS 77401  
(713) 667-7403 CABLE HOINCO TWX: 910-881-5782

OEM DISCOUNTS Circle 170 on reader service card

houston instrument

European Office Rochesterlaan 6 8240 Gistel Belgium  
Telephone 059-27445 Telex BAUSCH 19399B

## New products

Subassemblies

### Isolation amp's gain is variable

Device for medical and industrial applications offers 10-volt output swing

Designed for instrumentation in hospital environments—to isolate patients from ground fault currents—and for interruption of ground loops in industrial applications, an isolation amplifier devel-

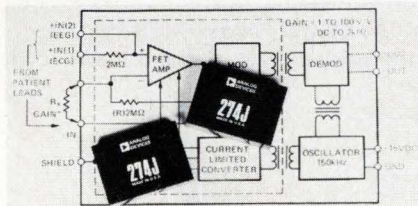

oped by the modular instrumentation division of Analog Devices Inc. provides an adjustable gain and a full  $\pm 10$ -volt output swing. In industrial uses, the recently developed amplifier also provides isolation between transducers and output conditioning circuits.

The model 274J offers a voltage gain that may be varied from 1 to 100 by changing the value of a single external resistor between infinity and 20 kilohms. The gain is sufficient to provide the 10-v output swing. Transformer isolation of the power source is provided from the output as well as from the input.

The unit's 5-kilovolt common-mode voltage with a common-mode rejection ratio enables it to operate in the presence of cauterizers, medical devices that generate high-voltage radio-frequency pulses which can destroy medical instrumentation or saturate them, necessitating long recovery time.

The 274J offers 5-kilovolt differential input and input-to-output defibrillator protection with maximum fault current limiting of 1.2 microamperes rms. With a 2-megohm input resistance for the defibrillator's protection, noise varies

from approximately 16 microvolts peak-to-peak, at a voltage gain of 1, to 12  $\mu\text{V}$  pk-pk at a gain of 20 in a 100-hertz bandwidth. A second input, for use when defibrillator protection is not required, offers maximum allowable gain and lower noise performance. Noise varies from 12  $\mu\text{V}$  pk-pk at a voltage gain of 1 to 5  $\mu\text{V}$  pk-pk at a gain of 100 in a 100-Hz bandwidth. This input is designed for blood-pressure monitoring and other circuits that do not require 5-kilovolt isolation.

The 274J operates from a single 15-v dc supply at 65 mA and is specified for a range of 0° to 70°C. The isolation amplifier is packaged in a module that measures 3.5 by 2.5 by 1.25 inches and sells for \$125 for 1 to 9 units.

Analog Devices Inc., Route 1 Industrial Park, P.O. Box 280, Norwood, Mass. 02062 [381]

Displays present pictures, text, or alphanumeric

A family of multi-message displays has been developed by Shelly/Datatron for a variety of commercial and industrial applications that include teaching and traffic-control machines, computer readouts, and point-of-sale terminals. The displays convey alphanumeric, textual, or pictorial messages with high visual efficiency. Design of the rear-projected units includes 3- to 28-volt miniature T-1 lamps that are replaceable from the front panel, binary-coded-decimal-to-decimal plug-in electronic modules, rf-shielded snap-on or screw-on bezels, and compact housings that are modular.

A major feature of both the model SRO-90 and SRO-600 is the ability of each module to individually project up to 12 five-line messages on a single plane. Graphs, symbols, numerals, phrases, and pictures—anything that is photographically reproducible—can be projected by simultaneous illumination of up to two of the 12 miniature optical projectors. Housings permit readouts to be mounted individually in vertical or horizontal groups or in

intel delivers  
n-channel.

**4K RAM**  
**AT...**

THE NEWEST DESIGNS  
THE WIDEST SELECTION

# Linear & Logarithmic IF Amplifiers

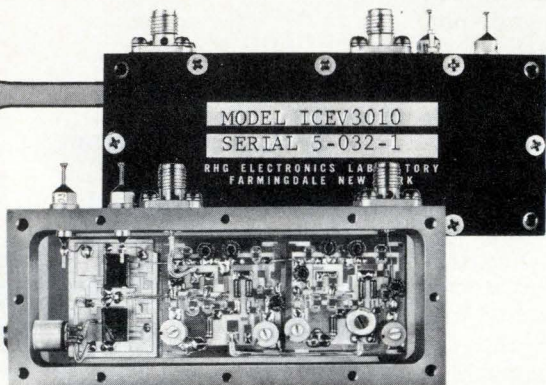

**New!**

## HYBRID IC MODELS

3 1/2" X 1 7/16" X 5/8"

### RANGE OF SPECIFICATIONS

	LINEAR	LOGARITHMIC
Center Frequency	30 to 76 MHz	30 to 76 MHz
Bandwidth	to 20 MHz	to 20 MHz
Risetime	to .05 $\mu$ sec	to .05 $\mu$ sec
Output	IF and Video	DC Coupled Video
Noise Figure	<4 db	<10 db
Dynamic Range	40 db	80 db

Over the years the industry has come to depend upon RHG for a steady stream of innovations and improvements in its various product lines.

This year is no exception, and in the IF Amplifier line alone RHG is offering

- A new line with "IF output only" at \$295.00
- A new line of Hybrid IC Lin & Log IF Amps
- A new line of constant phase shift limiters
- A new line of IC preamps in <1 cubic inch
- A new line of highly accurate & super stable log amps
- 33 new features/improvements/reduced prices

**RHG** RHG ELECTRONICS  
LABORATORY · INC

161 EAST INDUSTRY COURT ■ DEER PARK  
NEW YORK 11729 ■ (516) 242-1100 ■ TWX 510-227-6083

for Reliability, Innovation and Service

## New products

matrixes as large as 12 across and five high. Maximum message height available is 0.438 inch for the SRO-90 and 0.7 in. for the SRO-600.

Shelly/Datatron, 1562 Reynolds Ave., Santa Ana, Calif. 92707 [382]

Power source is  
uninterruptible

An uninterruptible power source features circuitry that automatically turns the unit off in case of overload, short, or battery discharge. Designed for computerized test systems, data generating systems, or timing equipment requiring up to 160 VA with power factors of 0.7, the device, model 583, accepts input from 105 to 225 V ac, 50 to 400 Hz at 250 VA. This is converted to 24 V dc,

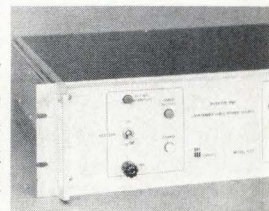

which charges the unit's nickel-cadmium battery. Operating temperature of the model 583 is 0 to 50°C.

Moxon Incorporated, SRC Division, 2222 Michelson Drive, Irvine, Calif. 92664 [383]

FET amplifier settles  
in less than 1  $\mu$ s

A family of amplifiers aimed at uses in high-speed data conversion systems is designated the A956. Each unit plugs into a single 16-pin IC socket. It settles to 0.01% in less than 1.0 micro-second. Over-all slew rate is 40 V/ $\mu$ s, and small signal bandwidth is 5 megahertz. In addition, the device offers a 20-mA output current. Price is either \$24 or \$29 in small quantities, depending on the input bias that is ordered.

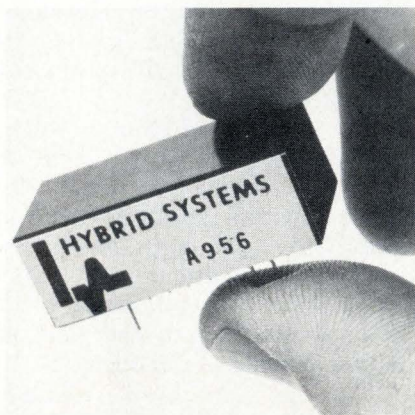

Hybrid Systems Corp., 87 Second Avenue, Burlington, Mass. [385]

FET operational amplifier  
offers high voltage, speed

The AM-300 series of FET-input operational amplifiers offers the following features: a  $\pm$ 140-volt output swing, 100-V/ $\mu$ s slew rate, a 5-megahertz gain-bandwidth product, 2- $\mu$ s output settling time,  $\pm$ 135-volt common-mode voltage, 100-decibel common-mode rejection ratio, and



# LOWEST COST

The 2107 n-channel 4K RAM is the lowest cost production RAM available today. Its low cost and ease of use insure the 2107's position as the next industry standard RAM.

The 2107 is easy to use. It is organized 4096 words by 1-bit, with all decoding on the chip, uses only 1 clock, and is TTL compatible. The 2107 has an access time of 600 nsec maximum, with faster versions coming this fall. Systems using the 2107 consume one-fourth the power of today's semiconductor 1K RAMs while providing comparable system performance.

With Intel's commitment to reach 0.1 cent/bit, the 2107 is going to be the lowest cost/bit semiconductor memory available. This low cost potential is best illustrated by the small chip size, 150 mils on a side, only slightly larger than Intel's 1103 chip. The combination of small chip size and Intel's n-channel technology will make the 2107 the optimum cost/performance RAM for high density/volume memory applications.

To simplify interfacing and minimize package count, we will be introducing this fall the 3210 Address and Clock Driver circuit designed specifically for Intel's n-channel RAMs. The 2107 is available now at all Intel stocking distributors. Intel Corporation, 3065 Bowers Avenue, Santa Clara, California 95051, (408) 246-7501.



intel delivers  
n-channel.

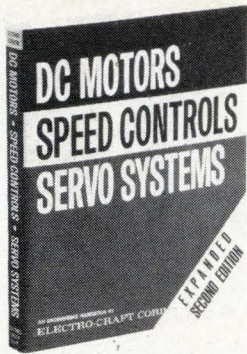

almost  
**FREE  
BOOK  
OFFER**

First printing sold out! New, expanded second edition of this engineering handbook now has 400 pages containing more theory, more applications. The book offers basic background in dc motors, speed controls and servo systems, and covers new developments in this fast changing field. It is aimed at the designer and user in industry, with emphasis on the many practical problems from specifying and testing to applications engineering. The book is priced at \$5, but is available at no charge to qualified engineers sending \$1 to cover postage and handling. To get your copy, just mail \$1 along with your card or company letterhead to:

**ELECTRO-CRAFT CORPORATION**  
BOX 664 HOPKINS, MINN. 55343

Circle 174 on readerservice card

## SUB-MINIATURE TWO-CIRCUIT PCB SWITCHES

... IDEAL FOR SUB-CHASSIS  
CHECKOUT, INTERLOCK  
CIRCUITS AND FIELD SERVICE

- **NO MOUNTING HARDWARE**  
Specifically designed for solder pin insertion into  $\frac{1}{16}$ ,  $\frac{3}{32}$  and  $\frac{1}{8}$ " PC Boards
- **IMPACT AND FLAME-RESISTANT CASE**  
Available in a variety of colors
- **GOLD PLATED CONTACTS**  
Ideal for low level operation—500,000 cycles minimum

2 & 3 Position  
Toggle  
(Actual Size)

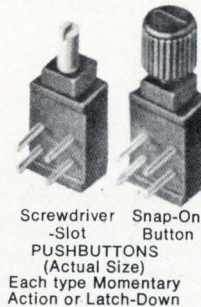

Screwdriver-Slot  
Snap-On  
Button  
PUSHBUTTONS  
(Actual Size)  
Each type Momentary  
Action or Latch-Down

WRITE FOR PORTFOLIO OF TOGGLE  
AND PB APPLICATIONS BULLETINS

## CONTROL SWITCH INC.

A SUBSIDIARY OF CUTLER-HAMMER INC.  
1420 Delmar Drive • Folcroft, Pa. 19032 • (215) LU-6-7500  
Representatives and Stocking Distributors Throughout the  
United States, Canada, and Europe

174 Circle 223 on reader service card

## New products

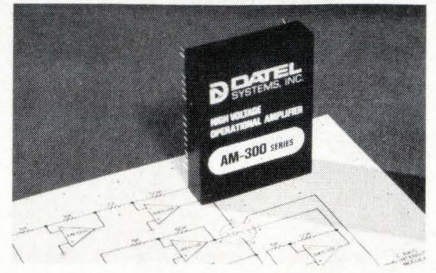

20- $\mu\text{V}/^\circ\text{C}$  drift. Several versions are available, ranging in price from \$75 to \$120.

Dadel Systems Inc., 1020 Turnpike St., Canton, Mass. 02021 [384]

D-a converter has linearity  
of  $\pm\frac{1}{2}$  least significant bit

The MN 360 series hermetic DIP 12-bit d-a converter operates over the temperature range from  $-55$  to

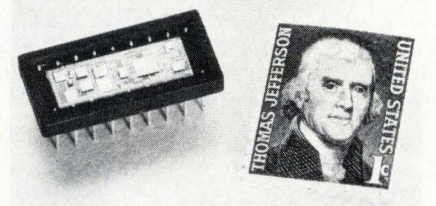

+125 $^\circ\text{C}$  and guarantees, without adjustment of initial zeroing, a linearity of  $\pm\frac{1}{2}$  least significant bit. The unit is available in four models, providing varying voltage outputs in bipolar or unipolar configurations. Settling time is specified at 5 microseconds  $\pm 0.012\%$ .

Micro Networks Corp., 5 Barbara Lane, Worcester, Mass. 01604 [386]

Converter provides

1,000,000-to-1 range

A guaranteed 1,000,000-to-1 dynamic range is a feature of the model 4705 voltage-to-frequency converter that provides TTL-compatible pulses at a 1-megahertz rate for a +10-volt input. The unit maintains typical nonlinearity to  $\pm 0.0002\%$  of full scale,  $\pm 0.012\%$  of signal down to a 1-Hz output for a 10-microvolt input. This means a nonlinearity better than 0.1% of signal over a 1,000-to-1 range of input

Electronics/September 13, 1973

# Introducing

\*\*\*\*\*

## THERMO-465

A totally new magnetic tape.  
It operates at

# 400°F

Or at

# 65°F

below  
zero

Thermo-465, the only product of its kind, was developed by Graham Magnetics, makers of the world's first and only permanent computer tape.

If you have a need for a magnetic tape that functions perfectly in extremely high and/or extremely low temperatures, Thermo-465 is the answer.

Tests results show Thermo-465 both meets and exceeds the stringent environmental requirements for use in systems for aircraft crash recorders.

After exposure to temperature extremes of +400°F and

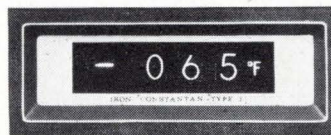
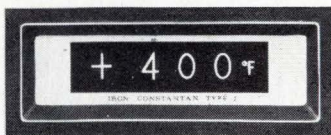

-65°F, it shows no change in its operating characteristics nor in its signal strength. Recording and playback is error-free in every instance. Data has even been recovered after exposure to temperatures up to 800°F.

Thermo-465 is available in 1000' lengths and 1/4" or 1/2" widths. Other configurations available on request.

If you'd like to place an order or would like more information concerning possible applications for this new product, write Graham Magnetics Incorporated, Dept. 465, Graham, Texas 76046, on your letterhead.



## GRAHAM MAGNETICS

Graham, Texas 76046

Another new product from the Research Center of Graham Magnetics, Inc.

Circle 175 on reader service card

**Flameless Compressed-Air Heat Torches** — Lightweight and portable for pinpoint intense heat performance.

**Heat Blowers** — Built for continuous 24-hour duty.

**New! Mite Heat Gun** — Lightweight versatility with three interchangeable nozzles and heat ranges.

**Standard Heat Gun** — Compact and economical, die-cast aluminum housing.



250° to 1,000° F.

**Chrome Heat Gun** — Designed for labs, R & D, and professional use.

# A flameless heat tool for every need. Master makes them all

Master offers you the world's most complete line of flameless heat tools. Each one is precision built for rugged dependability and versatile performance. And every Master heat tool features a complete line of attachments for every production need.

Heat Guns and Blowers are available in U.L. and L.A. approved models. CSA approved in Canada. In Canada, contact Martin Industrial Sales, P.O. Box 576, 4445 Harvest Road, Burlington, Ontario.

Send for your free 12-page catalog and price list on the world's most complete line of flameless heat tools.

**MASTER**  
appliance corporation  
Racine, Wisconsin 53403

## New products

### Philbrick 4705

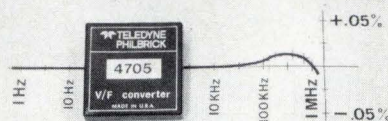

Linearity Error Vs. Frequency (% of F.S.)

signal. Price is \$125.

Teledyne Philbrick, Allied Dr. at Rte. 128, Dedham, Mass. 02026 [388]

### Fiber-optic display modules use incandescent sources

Digital display modules are compact light-emitting devices that read out to four places. Each module measures 0.5 inch by 0.85 inch by 1 inch and gives off 9,000 foot-lamberts typical brightness. They also provide a contrast readout of 15:1. The units incorporate fiber optics and miniature T  $\frac{3}{4}$  incandescent lamps as light sources. The lamp housings also act as heat sinks.

Canadian Marconi Co., 2442 Trenton Ave., Montreal 301, Canada [387]

### DIP oscillator is only 0.35 inch high

The model L14CH is a crystal-controlled IC-compatible oscillator measuring 0.78 by 0.49 by 0.35 inch

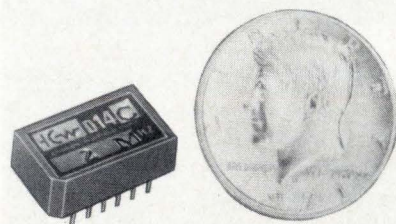

high. It produces a square-wave output at any fixed frequency from 1 megahertz to 30 MHz; total frequency tolerance is  $\pm 0.001\%$  from 0 to 50°C,  $\pm 0.0025\%$  from 0 to 65°C, or  $\pm 0.005\%$  from -25 to 75°C. Duty cycle is 50% with a rise time of less than 50 nanoseconds. Price is \$58.

Connor-Winfield Corp., West Chicago, Ill. 60185 [389]

# The strange case of the disappearing photoplates.

One photoplate where there used to be ten. Were the others victims of foul play? No... just victims of progress.

GAF has solved the mysteries of the disappearing photoplates by producing a diazo Microline photoplate that lasts up to 10 times longer than the old emulsion type. So now there's only one photoplate where there used to be 10. That means reduced costs for photoplate users.

But cost isn't the only reason for using GAF Microline photoplates. Our dry ammonia vapor process eliminates the residue, swelling, and contamination that account for many rejects in finished chips. And GAF Microline photoplates eliminate rejects due to misalignment. So you've got less of a fallout problem than ever before.

GAF® Microline® see-through photoplates give you higher resolution capabilities than you've ever known. (Manufacturers in commercial production have resolved 2000 lines/mm using United States Air Force resolution target in the photo-repeater.) And GAF Microline photoresists are versatile, rugged, acid and alkaline etch resistant, with vanishing pinholes.

But there's more intrigue to come. GAF's positive working, dimensionally stable imaging film permits high resolution reproduction of intricate photomasks using the same dry ammonia vapor process.

Fill out the coupon and send it to us. Whatever the mysteries of your photoimaging problems, GAF has the solution.



**GAF Corporation**  
Photoimaging Products, Dept. 606-093  
140 West 51st Street, New York, New York 10020

Gentlemen:

I'd like  Literature  Sample  Application Assistance on:

Microline High Resolution Photoplates    Microline See-Through Imaging Film     Microline Positive-Working Photoresists

Name \_\_\_\_\_ Title \_\_\_\_\_

Company \_\_\_\_\_ Phone \_\_\_\_\_

Address \_\_\_\_\_

City \_\_\_\_\_ State \_\_\_\_\_ Zip \_\_\_\_\_

Visit the GAF Exhibit at SEMICON/East, Oct. 2-4, Nassau Coliseum, Long Island, N. Y.

435-0750

Circle 177 on reader service card

**For bonding  
metal-  
to-metal-  
to-glass-  
to-glass-to-  
plastics-  
to-plastics-  
to-rubber-to-  
rubber-to-  
metal-to-etc-  
to-etc.**

One drop goes a long way in fastening almost anything to almost anything.

Eastman 910<sup>®</sup> adhesive bonds fast, too. Almost instantaneously. With only contact pressure.

Tensile strength? Up to 5000 psi at room temperature.

New Eastman 910 MHT and THT/Grades hold when the heat's on. Even over 400° F.

For further data and technical literature, write: Eastman Chemical Products, Inc., Kingsport, Tennessee 37662.



**New products/materials**

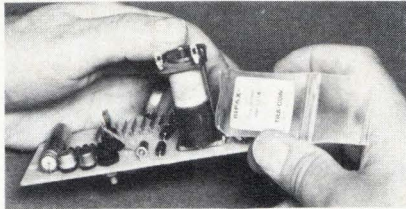

Epoxy "staking" compound called material 2116 is formulated for high-vacuum end use. It is a two-part system that mixes to a smooth thixotropic paste that will not run even on vertical surfaces. It also serves as an electrical insulator with good resistivity, and may be used as an adhesive for securing components to printed-circuit boards. It cures overnight at room temperature, or in a few hours at elevated temperatures.

Tra-con Inc., Resin Systems Division, 55 North St., Medford, Mass. 02155 [476]

**Metacote 1030** is a clear silicone-coating resin system for protecting all types of components, and for use as pyrolytically deposited film. The material may also be used as a cushion coating, or impregnant, for wire-wound resistors or coils to prevent open circuits caused by broken wires during encapsulation. It is chemical- and corrosion-resistant and impermeable to moisture.

Mereco Products, 530 Wellington Ave., Cranston, R.I. 02910 [477]

**For use in semiconductor processing**, Teflon PFA fluorocarbon resin is melt-processible and can be injection-molded to form varying shapes, so that semiconductor carriers can be molded in one piece without secondary machining. Moreover, the material withstands temperatures to 500° F. A nonwetable surface also allows rapid and complete drainage, and the material is compatible with a wide range of acids, bases, and solvents.

DuPont Co., DuPont Bldg., Room 8111, Wilmington, Del. 19898 [478]

**An aluminum conductor alloy** called Stabiloy is intended for use in communications wiring. It affords high strength and ductility, while retaining an electrical conductivity rating of above 61% on the International

**LIVE  
AND  
LEARN**



**In Rochester, N.Y.**

In this fertile, dynamic 9-county area of Western New York, learning is as important as earning. New York State standards of education are high, and the public, private, and parochial schools in our affluent area reflect those standards. With 16 colleges and universities nearby, a student can pursue undergraduate and graduate studies at a variety of institutions specializing in the sciences, humanities, or arts.

Would you like to see if we can really make the grade for your needs? We'll be happy to let you see our report card. Simply call collect, or write to Bob Hall, Director of Area Development, Rochester Gas & Electric, 89 East Ave., Rochester, New York 14649 (Telephone: 716-546-2700).

Nobody has learned more about this area than we have. We're eager to share our knowledge with you.

Rochester Makes the Grade.



# New Process Found for Denser, More Reliable Printed Circuit Boards.

*Hitachi's U.S. Pat. No. 3,681,171 Available for Licensing.*

Hitachi is opening up thousands of its patents. And, where it's needed, backing up the patents with the suitable technology.

We'd like to tell you about a process for laminating multi-layer printed circuit boards that may be of interest to you.

Hitachi has found a new way to laminate multi-layer

printed circuit boards. A way that practically eliminates troublesome blisters. A way that permits greater density and greater reliability.

The principal disadvantage of the conventional method for laminating multi-layer printed circuit boards is that air is often trapped in the adhesive — forming blisters, allowing corrosion, and preventing proper through-hole plating.

Hitachi has developed a better method. By creating a vacuum as the layers of the printed circuit board are brought together, blisters are eliminated.

It's a very simple method, requiring very simple peripheral equipment. It greatly extends the limits of density. It greatly increases reliability. And best of all, since it reduces the number of rejected parts, it saves manufacturers money.

To find out more about this Hitachi patent, please write us at the address below.



**HITACHI**

**Hitachi, Ltd.**

Area section A (Patent Group)  
International Business Operations Division  
6-2, 2-chome, Ohtemachi, Chiyoda-ku,  
Tokyo 100, Japan.

# NEW Data Conversion Catalog

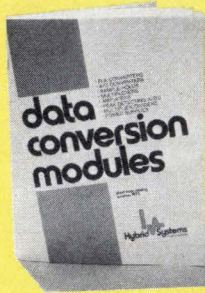

Latest product information on:

- Super Fast Op Amps — \$19
- High Gain Instrument Amps — \$29
- Ultra-Small, 12-Bit DAC's — \$35
- 12-Bit, Dual Slope ADC's — \$85

... and many, many more data conversion modules

Get your free copy of our new 1973 catalog ... and see what's new in DAC's, ADC's, sample-holds, multiplexers, amplifiers, multiplier/dividers, and power supplies.

Call your local representative now. S. CALIF.: 213-921-9791; N. CALIF.: 408-735-9040; N. & S. CAROLINA: 919-722-9671; COLO.: 303-466-6311; D.C.: 703-527-3262; FLA.: 813-446-5006; ILL.: 312-286-6824; IND.: 317-293-9827; MD.: 301-837-6311; MASS.: 617-963-8812; MICH.: 313-643-7203; MINN.: 612-781-1611; N.M.: 505-265-7989; S. N.J.: 609-854-3011; METRO N.Y.: 914-793-1660; UPSTATE N.Y.: 716-482-3000; OHIO: 216-241-4880, 513-296-1010; TEX.: 214-235-3043; MONTREAL: 514-363-5120.

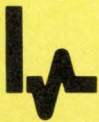

## HYBRID SYSTEMS CORPORATION

87 Second Avenue, Northwest Industrial Park, Burlington, Mass. 01803  
Telephone: 617-272-1522 TWX: 710-332-7584

Visit us at WESCON, Booth #1204.

Circle 180 on reader service card

## THEY MAKE MORE THAN SYRUP IN VERMONT...

Take our custom-fabricated  
U and I cores or recording  
head assemblies for example



We're the Data Materials Corporation of Springfield, Vt., a subsidiary of Ferronics Incorporated. We specialize in the precision manufacturing of electromagnetics components for the computer and communications industries.

In ceramic and electronic engineering circles, we're fast becoming as well known for our intricate fabrications as our state is for its maple syrup.

Our capabilities are extensive. Like the precision grinding of ferrite and white ceramics into a variety of complex configurations ...

like the production of bonded components using epoxy, glass, metal shim, and direct vacuum deposition ... or, like the handcrafting of complete assemblies and wound parts. We do it all.

But, if you're in the market for electromagnetics components, you'll want to know more about our exacting work and attention to detail.

The full Data Materials story is yours for the asking. Simply request Brochure #501 from our parent company:



60 NORTH LINCOLN ROAD, EAST ROCHESTER, NEW YORK 14445 (716) 377-6820

180 Circle 225 on reader service card

## New products/materials

Annealed Copper Standard. Thermal stability is maintained at temperatures above 600°F.

Olin Corp., 460 Park Ave., New York, N.Y. 10022 [479]

**Glass-epoxy unclad laminates** designed for use in additive plated-on circuitry processing are designated G-10A and G-10FRA. They are available in thicknesses ranging from 1/32 to 1/8 inch, with natural color, and with print sheet included in the laminates. The materials are said to maintain good physical and electrical properties.

Norplex Division, Universal Oil Products Co., 1300 Norplex Dr., LaCrosse, Wis. 54601 [480]

**A line of back-contact resistor chips** of tantalum nitride that require only one wire bond offers a resistance range of 100 ohms to 1 megohm on a 20-by-20-mil surface. The other contact is made by eutectically bonding the back of the chip or by using a conductive epoxy. Pad size is 4 by 14 mils. The BCR chips have a power rating of 25 megawatts and a 100-V operating voltage.

Semi-Films Technology Corp., Box 188, W. Hurley, N.Y. 12491 [401]

**CMC-700 aerosol spray** stops the corrosion due to moisture that is said to cause most of the failures of electronic equipment. It then deposits a thin, transparent, non-staining protective film that forms a continuing barrier against moisture. The material may be applied to a variety of nonferrous metals and alloys, including relay points, switches, contacts, and junction boxes.

Control Chemicals Inc., 805 E. Willow Grove Ave., Wyndmoor, Pa. 19118 [402]

**A bright electroless gold** will deposit thin, uniform layers of 24-carat gold by an electroless immersion process on printed-circuit boards, connectors, diode leads, lamps, and other electronic components. It is ready to use as supplied and has good solution stability. Its price, based on the present gold-market situation, is \$70 per gallon.

Transene Co. Inc., Rte. 1, Rowley, Mass. 01969 [403]



# COS/MOS

COMPLEMENTARY MOS PRODUCT GUIDE

## BEST SELLERS

It's Complementary MOS - and SGS-ATES is firmly committed.

It's the SGS-ATES 4000A series, the first true\* second source of this popular COS/MOS family available in plastic dual in-line.

Ask now for a free copy of our "COS/MOS Product Guide".

Available Now		Available Soon		
4001A	4020A	4002A	4019A	4042A
4007A	4025A	4008A	4021A	4045A
4009A	4027A	4012A	4022A	4047A
4010A	4028A	4013A	4023A	4048A
4011A	4029A	4014A	4024A	4051A
4017A		4015A	4030A	4052A
		4016A	4035A	

\*Made with RCA license and know-how



MONOLITHICS:

# THE STATE OF THE ART

## THE X-Y EFFECT

X.

Recently, we received an assignment from customer X to work with him in the development of his new product. Our monolithic crystal filter was to be a key part of his product's system. We started with him on his project at earliest breadboard and carried through over a two year span to final manufacturing. We worked in close collaboration with X, tailoring filter and product to one another. The result is a product unique in its field, which, based on performance and cost, has gained outstanding market acceptance. Our custom monolithics helped.

Y.

Not every new product requires two years to develop. Customer Y saw an immediate market for a new application of radio control. But his existing control receiver would be subject to interference in the new environment. Time was short. We were consulted, and recommended a standard model filter that provided the necessary i-f selectivity. Prototypes were shipped from stock. Later we were able to speed his first production run by supplying several hundred of the same standard model filter in less than four weeks. In addition to saving time, customer Y was able to take advantage of standard model engineering and pricing for his requirement, which eventually totaled a very modest, but highly successful, 1500 units for Y.

And success is the name of the game. Whether it's a brand-new project or a fast retread of an old standby we've got the filters to make your design successful. First there's the industry's largest selection of standard model monolithic and tandem monolithic crystal filters. And when it comes to custom modes, our unmatched experience assures you of the sound engineering advice you need. Last but not least, our unequalled capacity gets you your production units on time. We've proved it for X and Y and we'd like to add you to our alphabet. Drop us a line or call us.



**Piezo Technology Inc.**  
2400 Diversified Way  
Orlando, Florida 32804  
305-425-1574

The Standard in monolithic crystal filters.

## New literature

**Transformers.** Abbott Transistor Laboratories Inc., 5200 W. Jefferson Blvd., Los Angeles, Calif. 90016, has issued a catalog featuring two lines of 60- and 400-hertz MIL SPEC transformers. More than 500 models are described, complete with electrical specifications, operating parameters, dimension charts, and prices. Circle 421 on reader service card.

**Insulation testers.** A brochure on a line of high-voltage dc insulation

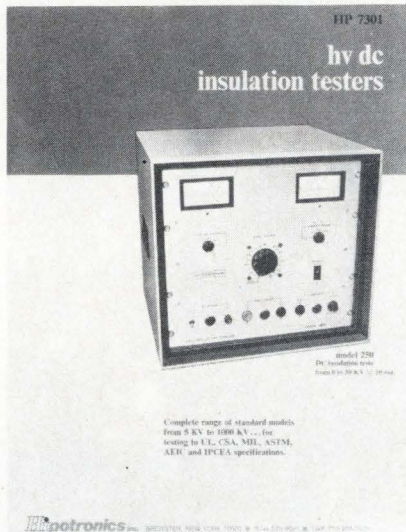

testers is available from Hipotronics Inc., Brewster, N.Y. 10509 [422]

**Component testing.** A six-page brochure from Vanzetti Infrared & Computer Systems Inc., 607 Neponset St., Canton, Mass. 02021, describes an infrared noncontact system for testing printed circuits and electronic components. [423]

**Switches.** Switchcraft Inc., 5555 N. Elston Ave., Chicago, Ill. 60630. A comprehensive catalog outlines the specifications of a line of multi-switch devices. The catalog includes a specification guide. [424]

**Test systems.** Teradyne Inc., 183 Essex St., Boston, Mass. 02111, has issued a 16-page brochure describing the J272 computer-operated system for testing, evaluating and providing data on resistor-capacitor networks for both discrete and hybrid circuits. [425]

**Insertion machines.** A six-page cata-

## CRYSTAL CLEAR EPOXY CASTING RESIN

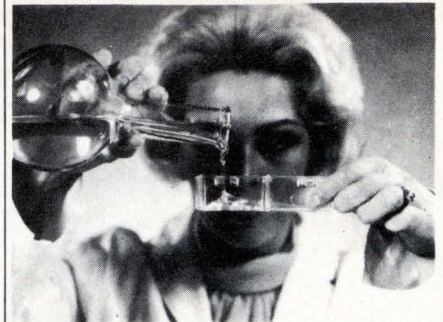

Several transparent Stycast® resins are offered for making display embedments or castings. A convenient chart is available to aid in selection of the most appropriate system. It is yours for the asking.

Circle 226 on reader service card

## NEW BOOKLET DESCRIBES SURFACE COATINGS FOR ELECTRONICS



ECCOCOAT® Surface Coatings include transparents for PC boards and components; dip-coats for transformers and coils; easy-mix and one-part systems for automatic production; and a wide range of special properties such as 500°F capability; resistivities to 10<sup>14</sup> ohms/sq. Several chemical types. Send for copy.

Circle 227 on reader service card

## SPECIFIER'S GUIDE TO INDUSTRIAL ADHESIVES



New ECCOBOND® booklet and fold-out wall chart gives specifications and use criteria for a broad line of industrial/electrical adhesives, epoxies and others. Send for FREE copy.

Circle 228 on reader service card

## Emerson & Cuming, Inc.



CANTON, MASS.  
GARDENA, CALIF.  
NORTHBROOK, ILL.  
Sales Offices  
in Principal Cities

EMERSON & CUMING EUROPE N.V., Oevel, Belgium

# Only one of these synchronous motors

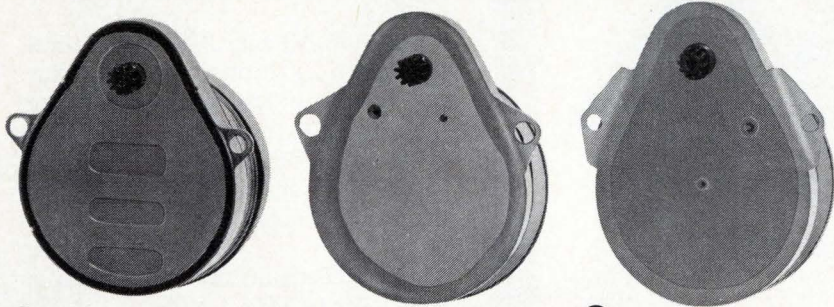

## is a genuine Synchron<sup>®</sup> Motor.

Synchron motors are made in five major styles. Speeds from 900 rpms to one revolution per week. Torque from 8 through 98 oz-in at one rpm. Hundreds of output options.



### Look alike aren't perform-alikes.

Not by a mile. And once a motor is installed in your product, who cares what it looks like? As long as it does its job, is trouble-free and lasts a specified time.

But how do you know which of the three will perform the best? Do you gamble and just pick one, assuming they're all about the same? Hardly. You specify the one that's made by a company that's just as interested in how well the motor performs as you are . . . who will stand by it 100% . . . who will deliver it when you need it . . . at a fair price.

But most of all, from a company dedicated to helping you solve your problems with the best product made. The motor on the left is the one we're talking about. It's the genuine Synchron.

**Call or write for complete Synchron motor specifications and the name of your Hansen representative.**

**MALLORY**



HANSEN MANUFACTURING CO.  
a division of P. R. MALLORY & CO. INC.  
Princeton, Indiana 47670

We make every Synchron motor as if *our* name were on *your* product.

# The Intelligent Printer...

A remote terminal which will perform as many of the functions of a calculator as you choose!  
Add Addmaster's Model 400 to any data output device to record or to record and compute.

Interfaced  
With power supply  
12 characters  
to column  
Numeric or  
limited alpha  
TTL compatible  
115V 60-cycle AC motor  
Uses standard adding machine paper  
Prints 3 lines (36 characters) per second  
Accepts serial by character BCD data  
inputs or 10 discreet lines  
Performs all arithmetic functions  
Hold constants

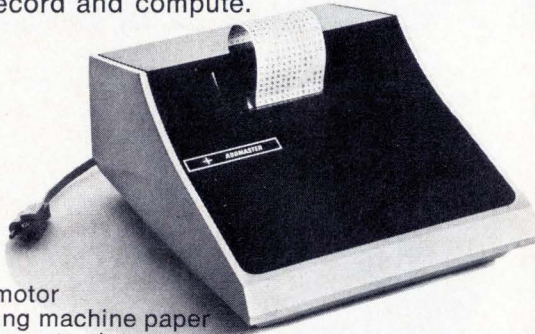

Send your business card for complete information

**ADDMASTER**  
Addmaster Corporation

416 Junipero Serra Drive, San Gabriel, California 91776

Circle 184 on reader service card

## OPEN-LINE REED RELAYS

Quality Engineered at Low Cost  
Broad Line . . . From Distributor Stock

An exceptionally high quality line of Form A and Form C open frame reed relays — with up to 6 contacts (Form A) and 4 contacts (Form C) per relay! Available in standard coil voltages 5 to 48 VDC . . . Capable of switching up to 1/2 amp, 250 VDC (Form A) or 1/4 amp, 28 VDC (Form C). Only .350" high by 1.125" long, with terminals on .1" or .15" grid spacing. Electrostatic and electromagnetic shielding optional. Top performance at low cost . . . Tailored to fit your cost/environmental requirements.

Phone, wire or write.

**ELEC-TROL, INC.**

26477 N. Golden Valley Road  
Saugus, California 91350  
(213) 788-7292  
TWX 910-336-1556

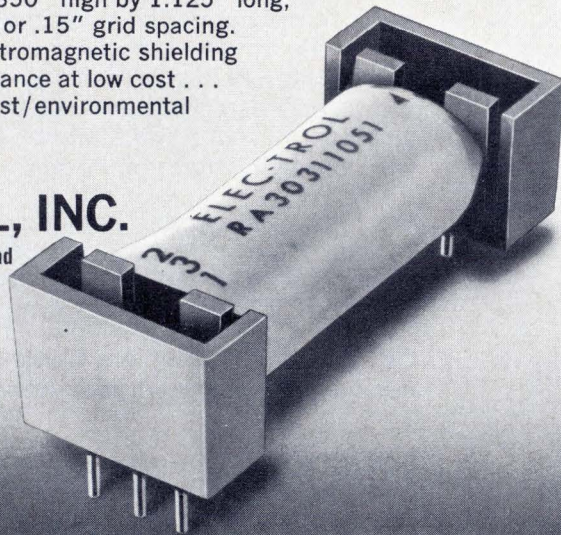

1973-74  
**eem**  
VOL. TWO

184 Circle 229 on reader service card

## New literature

log from Synergistic Products Inc., 1902 McGaw Ave., Irvine, Calif. 92705, describes a line of automated machines for inserting integrated circuits in dual in-line packages. [426]

**Generator.** Ailtech, 19535 E. Walnut Dr., City of Industry, Calif., has published a brochure describing the model M473 swept power signal generator designed for testing equipment in the 225-400 MHz communications band. [427]

**Keyswitches.** Stackpole Components Co., Box 14466, Raleigh, N.C. 27610. Bulletin no. 77-103 provides information on features, specifications, dimensions, and testing conditions for the Lo-Pro 5 keyswitches available for a variety of applications. [428]

**Microwave components.** Teledyne Microwave, 1290 Terra Bella, Mountain View, Calif. 94043. The company's complete line of microwave components is described in a 24-page catalog that provides illus-

trations, diagrams, and descriptions of products, including isolators, filters, coaxial switches, and multiplexers. [429]

**Components.** A 408-page catalog available from Powell Electronics Inc., Box 8765, Philadelphia, Pa. 19101, covers a wide variety of electronics components, including passive devices, semiconductors, and switches. Technical data, appli-

Electronics/September 13, 1973

## High-performance metal-film resistors



### In stock at many TRW distributors

High performance. High precision. This is what the TRW Burlington product is all about. These thin-film resistors *equal or exceed* the performance of high-stability wirewounds—at considerably less cost. Three examples:

**Established Reliability Metal Film (RNR, RNC).** Over 20 style combinations from  $\frac{1}{20}$  to  $\frac{1}{4}$  watt, providing *broad* coverage of MIL-R-55182. Tolerances: 0.1% to 1.0%. TC's to 25 PPM/°C. S-level failure rate.

**High Stability Metal Film (RN).** Premium quality metal-film. Offers TC's and tolerances to  $\pm 25$  PPM/°C and  $\pm 0.1\%$  respectively for precision applications. Resistances to 100 megs. Low noise. Ratings  $\frac{1}{20}$  to 2 watts. Exceeds *all* MIL-R specifications.

**Ultra-precision Series (MAR).** Where speed and precision count, the new MAR Series gives you the optimum in cost/performance ratio. And by "performance," we mean *better* than precision wirewounds. Tolerances: .01% to 1%. TC's: 5 to 25 PPM/°C. TC matching to 1 PPM/°C. Wattage:  $\frac{1}{20}$  to  $\frac{1}{4}$ .

Chances are there's a TRW/IRC stocking distributor near you who has these high-performance metal-films on hand. If you need his name and address, contact us.

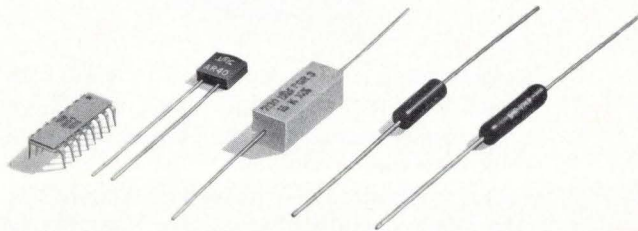

**Complete resistor choice.** TRW offers a total resistor capability—carbon composition, metal-film, Metal Glaze™, wirewound and other types. For information, contact Distributor Operation, TRW/IRC Resistors, an Electronic Components Division of TRW, Inc., 401 N. Broad St., Philadelphia, Pa. 19108. Phone (215) 923-8230.

**TRW<sup>®</sup> IRC RESISTORS**

## encapsulated snap-mount LEDs in red or green!



SoLiCo solid state GAP light emitting diodes are designed for low-voltage applications where panel space and speed of installation are important. Light output is exceptional: 3 milli-candellas at 20 milli-amps. Molded nylon bodies snap-fit into panel front with no tools required. Model D-503 provides a resistor in series, and forward voltages 5-6V, 12-14V, 18V or 28V can apply directly. Color-coded 6" insulated leads save valuable assembly time. Write: SORENSON LIGHTED CONTROLS, INC., Suite 810, 1428 Brickell Ave., Miami, Florida 33131. Tel. (305) 358-6112.

# SoLiCo

Circle 186 on reader service card

## Bug-less X-Y for hassle-free recording

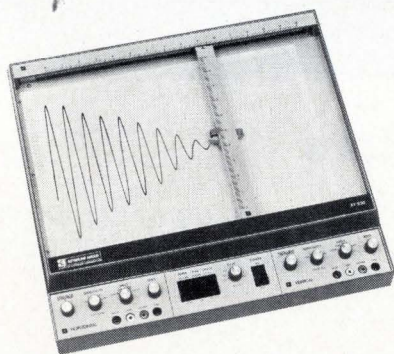

Esterline Angus X-Y recorders do the job reliably—and they are available with the right combinations of features to suit most lab or process applications without tricky modules.

Our hard-wired X-Y recorders accurately, quickly, and simply record one variable against another—or two variables against a third—or one or two variables against time. They're built tough to stand up, and priced to sell. Get a catalog to help you shop. Or a demonstration, Box 24000, Indianapolis, Indiana 46224. Telephone: (317) 244-7611.

 **ESTERLINE ANGUS**  
A UNIT OF ESTERLINE CORPORATION

186 Circle 234 on reader service card

### New literature

cations information, and pricing are given. [430]

**LSI tester.** A four-page brochure from Macrodata Corp., 6203 Variel Ave., Woodland Hills, Calif. 91634, affords information on the company's newest LSI test system, called the model MD-154. [431]

**Optoelectronics.** Monsanto Commercial Products Co., Electronic Special Products, 10131 Budd Rd., Cupertino, Calif. 95014, has issued a short-form catalog on the company's line of solid-state optoelectronic products. [432]

**Comparators.** An updated voltage comparator selection guide is available from National Semiconductor Corp., 2900 Semiconductor Dr., Santa Clara, Calif. 950551

**Load cells.** Sensotec Inc., 1400 Holly Ave., Cols, Ohio 43212, is offering an eight-page catalog of "mini" to "maxi" load cells with capacities to 500,000 pounds. [433]

**Soldering.** A data sheet on a single-station soldering unit has been issued by ITT Industrial and Automation Systems, 41225 Plymouth Rd., Plymouth, Mich. 48170. [434]

**Timers.** Industrial Controls Division, General Time Corp., Thomaston, Conn. 06787. A 10-page catalog provides engineering drawings, specifications, and prices on a line of timers, including solid-state devices, hand-set interval timers, and elapsed-time indicators. [435]

**Capacitors.** A 128-page component selector guide for the company's line of capacitors has been issued by Cornell Dubilier Electronics, 150 Ave. L, Newark, N.J. 07101. [436]

**Oscillators.** Greenray Industries Inc., 840 W. Church Rd., Mechanicsburg, Pa. 17055, has published an 82-page catalog describing the company's oscillators, amplifiers and multipliers. [437]

**Semiconductor chips.** Motorola Inc., Semiconductor Products Division,

Electronics/September 13, 1973

# SPEND A LITTLE LESS, GET A LITTLE MORE.

Spend \$495, get a 9-column digital data printer. With buffered BCD outputs. DTL and T<sup>2</sup>L input compatibility. Externally controlled printing rate up to 3.7 lines/sec. And a single rotating print-drum designed for millions of cycles without readjustment.

Maintenance is easy because the ICs are socket-mounted. Replacement is even easier when you get our optional IC spares kit.

If you need a little more, spend a little more and get 18 columns for \$590.

Either way, the new Newport 810 digital printer offers

a lot of data input for a small dollar outlay. Options include universal breadboard card, input data storage, digital clock and events counter.

Get all the facts. Spend a second and circle the reader service number. Or spend a minute and write Newport Laboratories at 630 East Young Street, Santa Ana, California 92705. For immediate information, call collect. Dial (714) 540-4914. Ask for Lyell Kinney. Or TWX: 910-595-1787.

## NEWPORT

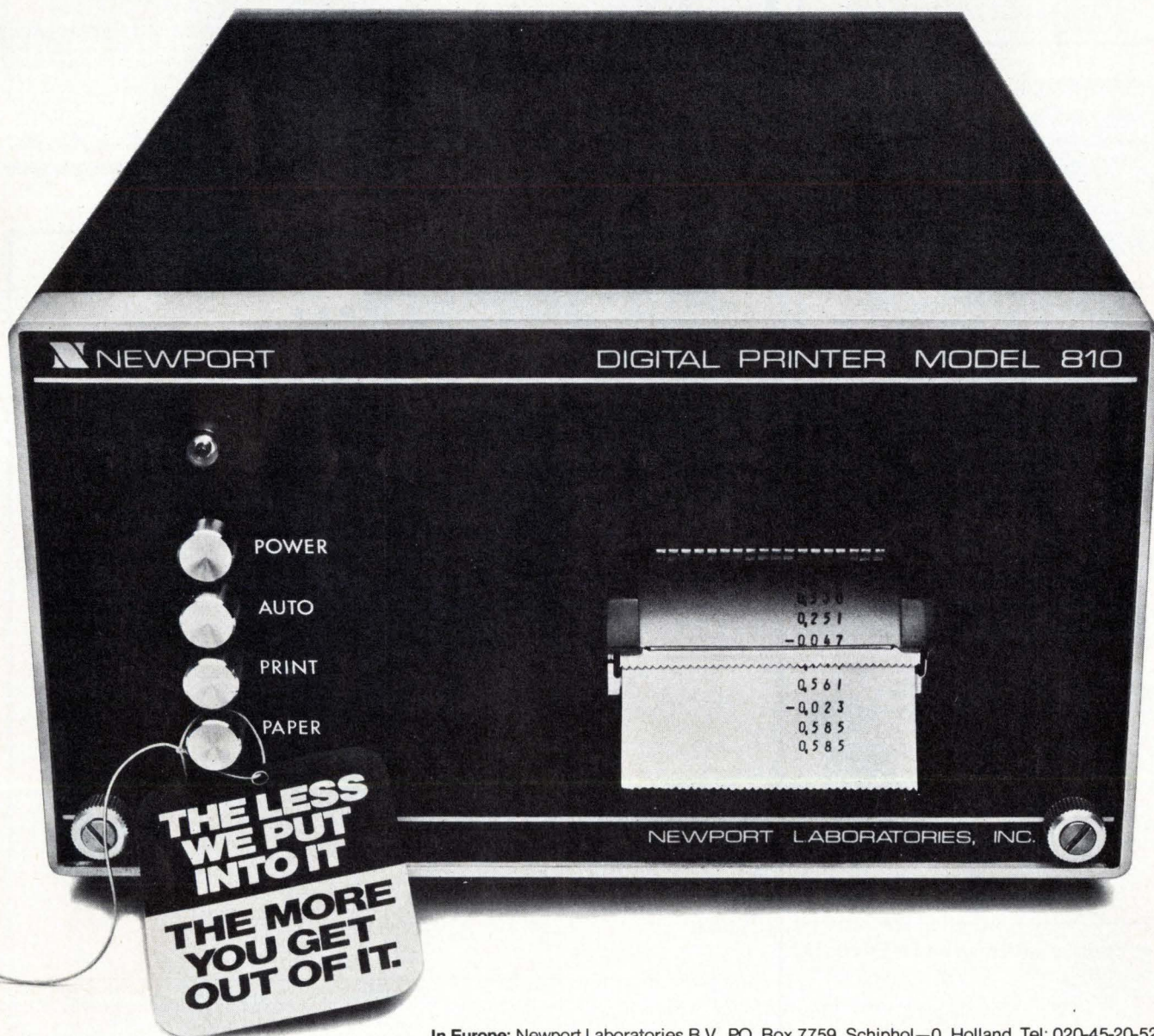

In Europe: Newport Laboratories B.V., P.O. Box 7759, Schiphol-0, Holland, Tel: 020-45-20-52

CLASSIFIED ADVERTISING  
**SEARCHLIGHT SECTION**  
 BUSINESS OPPORTUNITIES  
 USED OR SURPLUS EQUIPMENT

**IMMEDIATE DELIVERY**  
 Minis & Peripherals  
**DEC—HIS**  
**SEL—HP—MOHAWK**

CPU, Card, Printer, Tape, Disk  
**NEW • MOHAWK 4320 PRINTERS**

- DATA PRINTER V132
- CENTRONICS 101A

---

**\$750 Minis**

---

**TELETYPE 35 & 37**

For Sale/Rent  
**617/261-1100**

Send for Free Report "Maintenance of Computers"  
**AMERICAN USED COMPUTER CORP.**  
 P.O. Box 68, Kenmore Sta., Boston, MA 02215

CIRCLE 951 ON READER SERVICE CARD

**free catalog**

**POTTING APPLICATORS**  
 MANUAL OR AIR OPERATED

2 1/2cc 6cc 12cc 30cc  
 FOR POTTING, ENCAPSULATING ETC.

**PHILIP FISHMAN CO., INC.**  
 7 CAMERON ST. WELLESLEY, MASS. 02181

CIRCLE 952 ON READER SERVICE CARD

**SCIENTIFIC PAPERBACKS**

Hundreds of books on electronics, mathematics, physics, computer sciences, chemistry, optics, astronomy, and many other topics. Complete MIT Radlab series. FREE 96 PAGE CATALOGUE

**SHPRENTZ CO., BOX 83-EX, IRVINGTON NY 10533**

CIRCLE 953 ON READER SERVICE CARD

**FREE CATALOG**

**HARD-TO-FIND PRECISION TOOLS**

Lists more than 1700 items—pliers, tweezers, wire strippers, vacuum systems, relay tools, optical equipment, tool kits and cases. Also includes four pages of useful "Tool Tips" to aid in tool selection.

**TENSEN TOOLS**  
 4117 N. 44th Street, Phoenix, Ariz 85018

CIRCLE 954 ON READER SERVICE CARD

**FREE ALARM CATALOG**

Full line of professional burglar and fire alarm systems and supplies. 80 pages, 400 items. Off-the-shelf delivery, quantity prices.

**mountain west alarm**  
 4215 n. 16th st., phoenix, az. 85016

CIRCLE 956 ON READER SERVICE CARD

**RESUME KIT**

**Free Engineer's Resume Kit for Electrical, Mechanical and Industrial Engineers.** Scientific Placement, Inc., Employment Service, 5051 Westheimer, Houston, Texas 77027.

**AUTOTRACK MOUNT**

**AUTOTRACK SCR-584 RADARS**  
 360 degree azimuth, 210 degree elevation sweep with better than 1 mil. accuracy. Missile velocity acceleration and slewing rates. Amplidyne and servo control. Will handle up to 20 ft. dish. Supplied complete with control chassis. **ALSO** in stock 10 cm. van mounted radar system. Conical scan. PPI. 6 ft. dish. Ideal for S band telemetry, weather, balloon trk. missile trk, rocket trk, ECM range. Write for complete data. 600 pg. instr. bk. avail. at \$25 ea.

**1 MEV LINEAR ACCELERATOR**  
 Dual Mode, Ion or Electron. RF Drive, 300 KHZ at 45 KW. Includes control console, RF unit, accelerator, etc.

**MOD IV HIGH RESOLUTION TRACKER**  
 Instrumentation radar; freq. 8.5-9.6 GHz. Pwr: 250 KW. .1 mil tracking accuracy. 6' Fresnel lens antenna with 4 horn monopulse feed. Tracking range 50 or 200 miles. Formerly used as range safety radar at Cape Kennedy.

**PULSE MODULATORS**  
 245 KW LINE PULSER Output 16 KV at 16 amp. .25  $\mu$  at 4000 PPS.  
 405 KW FLOATING DECK PULSER Output 20 KV at 20 amp. 1  $\mu$  to 10 millisecond pulse.  
 500 KW LINE PULSER Output 22 KV at 28 amp. 4/1.75/2.25  $\mu$  at 2500/550/300 PPS.  
 1 MW HARDTUBE MIT MODEL 9 Output 25 KV at 40 amp. 25-2  $\mu$  at .002 D.C.  
 2.0 MW LINE PULSER Output 30 KV at 70 amp. 1/2  $\mu$  at 600/300 PPS.  
 3 MW LINE PULSER Output 39 KV at 75 amp. .25/1  $\mu$  at 500 PPS.  
 10 MW LINE PULSER Output 76 KV at 135 amp. 2.5  $\mu$  at 350 PPS.  
 17 MW LINE PULSER Output 17 KV at 1000 amp. 2-5  $\mu$  at 150-2000 PPS.

**HV POWER SUPPLIES**  
 6.3 KV @ 5 Amp; 20KV @ 1.3 Amps; 35KV @ 1.5 Amps; 28KV, 70MA; 12KV @ 800MA; 18KV @ 2.25 Amps; 17.5KV @ 1.8 Amps.

**RECON DRONE CONTROL RADARS**  
 X Band systems autotrack and search complete with plotting boards. Fully mobile van mounted. Gives PPI, slant range, altitude data. Ground to air control links and beacons also in stock. AN/MPQ-29 & AN/UPW-1

**RADAR DATA MICROWAVE LINK**  
 Freq. 7.1-7.9 GHz. Pwr. 100 MW. 4 channels. Transmits video, pulse, synchro, and voice information. Mfr: Motorola.

**SPARE PARTS IN STOCK**  
 Nike Ajax, Nike Hercules, M-33, MPS-19, TPS-10D, TPS-10D, FPS-6, SPS8, SCR-584, HIPAR.

**RADAR & RF PKGS.**  
 34ghz 40kw Pulse RF pkg  
 24ghz 40kw Pulse bomb toss system  
 16ghz 130 kw Pulse B-58 search radar system  
**X BAND SEARCH 40 KW PULSE WEATHER RADAR**  
**X BAND AUTOTRACK 250KW PULSE M-33**  
 compl w/ plot boards  
**X BAND BEACON 400 W PULSE AN/DPN-62**  
**X BAND AUTOTRACK 50KW PULSE B-47**  
 fire control complete  
**C BAND WEATHER RADAR 250 KW PULSE**  
**C BAND HEIGHT FINDER**  
 AN/FPS-26 5 megawatt output.  
 AN/TPS-37, 1 megawatt output.  
**C BAND 1 MEGAWATT AUTOTRACK**  
 10ft dish mortar locator MPQ-21  
**C BAND 285KW PULSE Search AN / SPS-5**  
**S BAND AUTOTRACK 500 KW PULSE 10' DISH**  
**S BAND 1 MEGAWATT COHERENT AN / FPS-18**  
**S BAND 1 MEGAWATT PULSE NIKEL ACQ.**  
**S BAND 5 MEGAWATT HEIGHT FINDER AN/FPS-6**  
**S BAND 500KW I KW PULSE**  
**L BAND 50KW PULSE AN / TPS-1D / E**  
**L BAND 5 to 20KW PULSE**  
 400mhz 1KW CW AN / FPS-23  
 225mhz 1 MEGAWATT PULSE AN/TPS 28  
 2-30mhz 100K W PULSE  
 CW 950-5ghz 150 WATTS  
 CW 1.5mhz-10.5ghz 5 WATTS  
 CW 7.4 GHZ 2 KW

**HUNDREDS MORE IN STOCK**  
**LARGEST RADAR INVENTORY IN WORLD.**  
 WRITE FOR CATALOG ON YOUR LETTERHEAD

**Radio-Research Instrument Co. INC.**  
 3 Quincy St., Norwalk, Conn. 06850 • 203-853-2600

CIRCLE 955 ON READER SERVICE CARD

**Job-seekers... be the first to know with McGraw-Hill's Advance Job Listings**

By having our new weekly ADVANCE JOB LISTINGS sent First-Class (or by Air Mail, if you prefer) to your home every Monday you can be the first to know about nationwide openings you qualify for both in and out of your field.

This preprint of scheduled employment ads will enable you to contact anxious domestic and overseas recruitment managers BEFORE their advertisements appear in upcoming issues of 22 McGraw-Hill publications.

To receive a free sample copy, plus information about our low subscription rates (from one month to 12), fill out and return the coupon below.

---

**ADVANCE JOB LISTINGS / P.O. BOX 900 / NEW YORK NY 10020**

PLEASE SEND A SAMPLE COPY OF ADVANCE JOB LISTINGS TO:

**McGraw-Hill**

NAME \_\_\_\_\_ ADDRESS \_\_\_\_\_

CITY \_\_\_\_\_ STATE \_\_\_\_\_ ZIP \_\_\_\_\_

E9/13/73



## Time coding can be simpler than you think

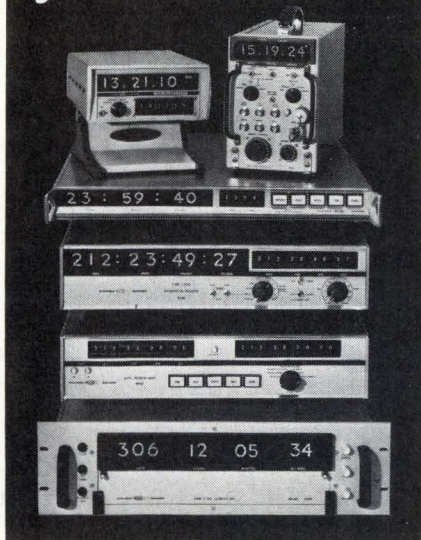

Systron-Donner can help you cut through the profusion of time code formats and equipment—to the selection of the right format and the right equipment for the job.

Our new 90-page handbook will guide you to the best technique for your application, and enable you to select appropriate equipment from the comprehensive line offered by Systron-Donner.

Systron-Donner equipment ranges from compact time code generator/readers costing as little as \$1495, through portable battery-powered generators for field use, to high-precision generator/readers with automatic tape search.

## Send for handbook sample.



Send for free copy of "Selecting time code format," Chapter 3 of our new 90-page, illustrated handbook on time coding techniques. Complete handbook: \$3.00.

**SYSTRON**  **DONNER**

Data Products Division,  
Systron-Donner Corporation,  
10 Systron Dr.,  
Concord, Calif. 94518.  
Phone (415) 682-6161.

Circle 235 on reader service card

### New literature

Box 20924, Phoenix, Ariz. 85036. A semiconductor chips data book describes the line of chips stocked by the company in the most popular product categories. The book covers almost all discrete, linear and digital integrated circuits manufactured in packaged form. Available for \$2, the publication contains eight sections and is 295 pages long. [438]

**Capacitors.** EMI Electronics and Industrial Operations, Blyth Road, Hayes, Middlesex, England, is offering a four-page brochure on the company's line of polyethylene terephthalate capacitors. [439]

**Reed switches.** Thermal reed switches are described in a four-page catalog being offered by National Micronetics Inc., Rte. 28, W. Hurley, N.Y. 12491. Performance curves, tabular information, and configuration drawings are included in the catalog. [440]

**Semiconductor processing.** An eight-page brochure includes photos, performance characteristics, and specifications for semiconductor processing systems manufactured by Corotek Corp., 15515 Minnesota Ave., Paramount, Calif. 90725 [404]

**LEDs.** Eldema Division, Genisco Technology Corp., 18435 Susana Rd., Compton, Calif. 90221. A family of miniature high-intensity wide-angle LED indicator lamps is described in a two-page data sheet. [405]

**Tape readers.** Electronic Engineering Company of California, 1441 East Chestnut Ave., Santa Ana, Calif. 92701. A line of photoelectric punched-tape reader products is described in an eight-page catalog. [406]

**Instrumentation.** A short-form catalog from B&K Instruments Inc., 5111 W. 164th St., Cleveland, Ohio 44142, briefly describes the firm's full line of precision transducers and instrumentation for sensing, measuring, and analyzing sound, noise, and vibration. [407]

# \$125



## it's so easy to take . . .

You can replace your thermopile with a SBN PYROELECTRIC DETECTOR.

- BROADBAND RESPONSE—  
UV to microwaves
- HIGH SENSITIVITY—  
> to 125 V/W
- FAST RESPONSE—  
better than 5ns
- NO CRYOGENICS—  
operates from -40°C to 90°C
- RUGGED AND  
NONHYGROSCOPIC

This package includes a sensing element plus a integral FET and fits a standard 9 pin miniature tube socket. Available from stock for only \$125.00.

Call us at 216/248-7400 with your IR detection and measurement problems.



# HARSHAW

THE HARSHAW CHEMICAL COMPANY  
DIVISION OF KEWANEE OIL COMPANY

Crystal & Electronic Products Department  
6801 Cochran Road • Solon, Ohio 44139  
(216) 248-7400

Circle 189 on reader service card

# LOOK to

THE PEOPLE DOING THINGS THAT MATTER... IMAGINATIVELY

electronic research co. • a harrington div.

# erc

In Hermetically Sealed .200 Inch High Crystal Oscillators

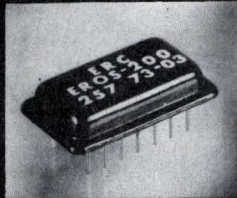

Actual Size

- 30 KHz to 15 MHz
- Ambient Range: up to  $-50^{\circ}\text{C}$  to  $+105^{\circ}\text{C}$
- Ambient Stability: as good as  $\pm .002\%$

Telephone (913) 631-6700  
 7618 Wedd  
 Overland Park, Kansas 66204  
 Mail to: P.O. Box 913, Dept. 7  
 Shawnee Mission • Kansas 66201  
 TWX: (910) 749-6477

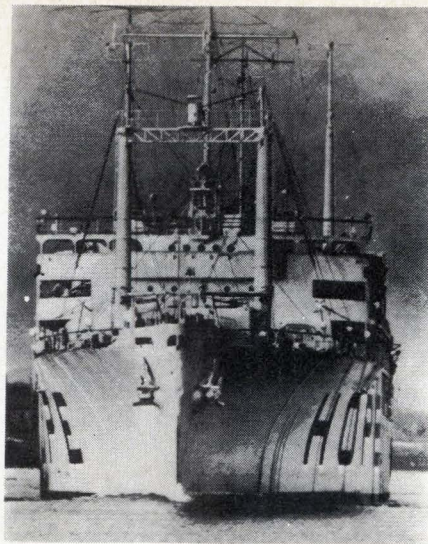

## S.S. HOPE, M.D.

Doctor . . . teacher . . . friend to millions on four continents—this floating hospital is a symbol of America's concern for the world's disadvantaged. Keep HOPE sailing.



Dept. A, Washington, D.C. 20007

### Advertising Sales Staff

**Pierre J. Braudé** [212] 997-3485  
Advertising Sales Manager

**Atlanta, Ga. 30309:** Joseph Lane  
100 Colony Square, 1175 Peachtree St., N.E.  
[404] 892-2868

**Boston, Mass. 02116:** James R. Pierce  
607 Boylston St. [617] 262-1160

**Chicago, Ill. 60611:**  
645 North Michigan Avenue  
Robert W. Bartlett (312) 751-3739  
Paul L. Reiss (312) 751-3738

**Cleveland, Ohio 44113:** William J. Boyle  
[716] 586-5040

**Dallas, Texas 75201:** Charles G. Hubbard  
2001 Bryant Tower, Suite 1070  
[214] 742-1747

**Denver, Colo. 80202:** Harry B. Doyle, Jr.  
Tower Bldg., 1700 Broadway  
[303] 266-3863

**Detroit, Michigan 48202:** Robert W. Bartlett  
1400 Fisher Bldg.  
[313] 873-7410

**Houston, Texas 77002:** Charles G. Hubbard  
2270 Humble Bldg. [713] CA 4-8381

**Los Angeles, Calif. 90010:** Robert J. Rielly  
Bradley K. Jones, 3200 Wilshire Blvd., South Tower  
[213] 487-1160

**New York, N.Y. 10020**  
1221 Avenue of the Americas  
Warren H. Gardner [212] 997-3617  
Michael J. Stoller [212] 997-3616

**Philadelphia, Pa. 19102:** Warren H. Gardner  
Three Parkway,  
[212] 997-3617

**Pittsburgh, Pa. 15222:** Warren H. Gardner  
4 Gateway Center, [212] 997-3617

**Rochester, N.Y. 14534:** William J. Boyle  
9 Greylock Ridge, Pittsford, N.Y.  
[716] 586-5040

**San Francisco, Calif. 94111:** Don Farris  
Robert J. Rielly, 425 Battery Street,  
[415] 362-4600

**Paris:** Alain Offergeld  
17 Rue-Georges Bizet, 75 Paris 16, France  
Tel: 720-73-01

**Geneva:** Alain Offergeld  
1 rue du Temple, Geneva, Switzerland  
Tel: 32-35-63

**United Kingdom:** Keith Mantle  
Tel: 01-493-1451, 34 Dover Street, London W1

**Milan:** Robert Saidel  
1 via Baracchini Phone 86-90-656

**Brussels:** Alain Offergeld  
23 Chaussee de Wavre  
Brussels 1040, Belgium  
Tel: 13-73-95

**Stockholm:** Brian Bowes  
Office 17, Kontor-Center AB, Hagagarten 29,  
113 47 Stockholm. Tel: 24 72 00

**Frankfurt/Main:** Fritz Krusebecker  
Liebigstrasse 27c  
Phone 72 01 81

**Tokyo:** Tatsumi Katagiri, McGraw-Hill  
Publications Overseas Corporation,  
Kasumigaseki Building 2-5, 3-chome,  
Kasumigaseki, Chiyoda-Ku, Tokyo, Japan  
[581] 9811

**Osaka:** Ryji Kobayashi, McGraw-Hill  
Publications Overseas Corporation, Kondo  
Bldg., 163, Umegae-cho Kita-ku [362] 8771

**Australasia:** Warren E. Ball, IPO Box 5106,  
Tokyo, Japan

### Business Department

**Stephen R. Weiss, Manager**  
[212] 997-2044

**Thomas M. Egan,**  
Production Manager [212] 997-3140

**Carol Gallagher**  
Assistant Production Manager [212] 997-2045

**Dorothy Carter,** Contracts and Billings  
[212] 997-2908

**Frances Vallone,** Reader Service Manager  
[212] 997-6057

### Electronics Buyers' Guide

**George F. Werner,** Associate Publisher  
[212] 997-3139

**Regina Hera,** Directory Manager  
[212] 997-2544

## Now Measure Light Directly - in Any Optical Units\*

### The New IL700 Radiometer with easily programmable 20-decade readout

\*even luminous phosage, milliphots, finsens, vitons, etc.

#### Features

- measures UV, visible, infrared—240-1100nm—flash or DC
- sensitive—measures  $10^{-13}$  watts/cm<sup>2</sup> or  $10^{-6}$  footcandles
- integrates—resolves flashes from  $5 \times 10^{-9}$  sec. to 5 min.
- 3½ digit readout—400% overranging
- lightweight, field-portable . . . battery or AC operation

#### Applications

- Radiometry, photometry, spectroradiometry, densitometry
- Ultraviolet radiation hazards • Photolithography (photoresist)
- Environmental studies— atmospheric and oceanographic.

For complete details contact

International Light, Inc.

Dexter Industrial Green, Newburyport,  
Ma. 01950 Tel. (617) 465-5923



international light, inc.

# When your input comes from these new McGraw-Hill books—your output is bigger, better, faster...

## Discover how minicomputers can solve your problems quickly and inexpensively

All the facts, figures, and know-how you need to put minicomputers to work for you are in this new book—the units that are available . . . how to use them . . . how to interpret manufacturers' literature . . . the new minicomputers' architectures.

Even if you already have a minicomputer, this will enable you to realize all of the exceptional possibilities available to you, for it contains a wealth of information and guidance covering every aspect of this new breed of powerful, low-cost little computers, as well as minicomputation, peripherals, and applications.

## MINICOMPUTERS FOR ENGINEERS AND SCIENTISTS

By Granino A. Korn (author, with Theresa M. Korn, of *Electronic Analog Computers, Electronic and Hybrid Computers, Mathematical Handbook for Scientists and Engineers, and Manual of Mathematics*)  
352 pages \$17.75

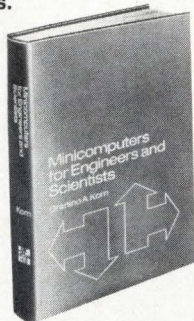

Nowhere else will you find such detailed, interestingly written material on such topics as—the computer's role as live mathematical model . . . the instruction sets, addressing schemes, and common options of single-address computers . . . assembly language and assembler functions, with examples . . . digital-computer interface systems . . . trends in present and future minicomputer architecture . . . essential features and possibilities of the principal minicomputer applications.

There are also many special features that will be of immense value to engineers wishing to use a minicomputer for computation, instrumentation, control, and communication, and the book is equally important to industrial and chemical engineers who want computer control of manufacturing and processes.

The author's discussion of the use of macros for writing simple "home-made" computer languages for special applications, and his comparison of new-generation minicomputers make the book an essential reference and guide for everyone concerned with this remarkable achievement of engineering ingenuity and industrial know-how.

### Special Features

- Gives a basic introduction to minicomputer assembly language—badly needed by those who work only part time with the small computer
- Explains the use of macros for writing simple "home-made" computer language for special applications
- Discusses and compares new-generation in full.

## Handy new reference works

### BASIC ENGINEERING AND MATHEMATICAL TABLES

By **L. S. Srinath**, Editor-in-Chief, and **K. R. Sarma** and **S. V. Patankar**, all of the Indian Institute of Technology, Kanpur, India

Every essential math table you're ever likely to need is in this one compact manual. 42 mathematical tables and 73 engineering tables provide instant mathematical help. Concise, accurate, complete, all in one place!

### SI UNITS: A Source Book

By **G. S. Ramaswamy**, Director, Structural Engineering Research Center, Roorkee and Director, National Building Construction Corp., New Delhi, India and **V. V. L. Rao** (deceased)

This book provides a comprehensive, fully detailed introduction to the use of SI units in science, engineering, and technology. Worked-out numerical examples show exactly how SI is used in calculations in physics, chemistry, and mechanical, civil, and electrical engineering.

New—for all engineers involved in design, development, manufacture and installation of major display and data handling systems associated with radar and communications networks

### ELECTRONIC DISPLAY AND DATA SYSTEMS: CONSTRUCTIONAL PRACTICE

By **C. J. Richards**, Manager Command and Control Systems Engineering, Plessey Radar, England  
432 pages \$22.50

The eleven chapters are arranged in four main subject groups, starting with the generation, transmission and display of electronic data (3 chapters). The second group develops the subject of cathode ray tube displays, the associated equipment, and display usage (2 chapters). The third deals with the design, manufacture and application of the hardware, behind the display-interconnection systems, printed circuit boards and packaged components (3 chapters). The last presents information on the construction of cabinets and consoles, and on systems earthing, previously fragmented but now brought together and related to the rest of the book (3 chapters).

### An engineer's guide to practical digital systems and tools for their design

### FUNDAMENTALS OF DIGITAL SYSTEMS

By **B. R. Bannister**, Lecturer, Department of Electrical and Electronic Engineering, North Staffordshire Polytechnic, and **D. G. Whitehead**, Lecturer, Department of Electronic Engineering, University of Hull, England.  
312 pages \$14.50

This new work presents digital systems as a unified subject with emphasis on engineering rather than mathematical aspects. Wherever possible theoretical concepts are related directly to real life design examples.

There is extensive treatment of the important and relatively new subject of sequential circuit theory and its practical uses, and digital data storage methods are described in depth and current and proposed ideas are examined. Individual chapters cover Combinational Logic, Number Systems and Coding, Minimization, Logic Circuits, Inverting Logic, The Bistable, Sequential Logic, Storage Systems, Digital Computer Structures, Digital Data Transmission, Process Control Elements. And Appendixes cover: Character Codes, Standard Logic Symbols, and Order Code for a Typical Small Computer.

### McGraw-Hill Book Company

1221 AVENUE OF THE AMERICAS, NEW YORK, N.Y. 10020

Please send me the book(s) checked below for 10 days' free examination. At the end of that time I will remit the price of the book(s) plus local tax, postage, and handling or return the book(s) without further obligation. I understand that if I remit in full, plus local tax, with this order McGraw-Hill will pay all postage and handling and that return privileges still apply.

- MINICOMPUTERS FOR ENGINEERS AND SCIENTISTS (353387) \$17.75
- ELECTRONIC DISPLAY AND DATA SYSTEMS (844070) \$22.50
- FUNDAMENTALS OF DIGITAL SYSTEMS (840067) \$14.50
- BASIC ENGINEERING AND MATHEMATICAL TABLES (966087) \$9.95
- SI UNITS (965757) \$8.95

Name \_\_\_\_\_

Address \_\_\_\_\_

City \_\_\_\_\_

State \_\_\_\_\_

Zip \_\_\_\_\_

This offer good only in U.S. and subject to approval by McGraw-Hill.

23-L973

‡ <b>Acopian Corp.</b> Mort Barish Associates, Inc.	122	■ <b>GAF Corporation</b> Michel-Cather, Inc.	177	<b>Raytheon Semiconductor</b> Durel Advertising	138-139
<b>Addmaster Corporation</b> Mich Associates	184	* <b>Ganz Measuring Instruments</b> Hungexpo, Varosliget	24E	<b>RCA Electronic Components</b> Al Paul Lefton Company	194
* <b>Adret Electronic</b> P. Ramain	11E	* <b>General Electric</b> Result Reklame & Marketing NV	122	* <b>RCA Electronic Components</b> Al Paul Lefton Company	38
* <b>Advance Electronics Ltd.</b> Evan Steadman (Services) Ltd.	9E	■ <b>General Instrument Corp. Div.</b> Semiconductor Comp. Div.	82-83	* <b>RCA Ltd.</b> Marsteller Ltd.	16E-17E
<b>Advanced Micro Devices</b> Keye/Donna/Pearlstein	26B&26C	Normal Allen Associates, Inc.		‡ <b>Rental Electronics, Inc.</b> Humphrey Browning MacDougall, Inc.	140
* <b>AEG Telefunken</b> Werbeagentur	18E	* <b>General Instrument Europe S. P. A.</b> Studio Hedy	26E	■ <b>RHG Electronics Laboratory, Inc.</b> Samuel H. Goldstein	172
<b>AILLTECH/Cutler-Hammer</b> R. L. Thompson Advertising	87	* <b>Georg C. K. Withof GmbH</b> Lovell and Rupert Curtis Ltd.	67	<b>Rochester Gas &amp; Electric—</b> <b>Advertising Group</b> Hutchins Advertising Company, Inc.	178
<b>Airpax Electronics</b> Welch, Mirabilis & Co. Inc.	16	■ <b>Gould, Inc./Instrument Systems Div.</b> Carr Liggett Adv., Inc.	10-11	* <b>Rohde &amp; Schwarz</b> Sanken Electric Co., Ltd.	1E 158
<b>Allen-Bradley Company</b> Hoffman, York, Baker & Johnson, Inc.	34	<b>Graham Magnetics</b> Carr Liggett Adv., Inc.	175 169	<b>Scanbe Manufacturing Corp.</b> Warren C. Wilson & Associates	81
■ <b>American Lava Corporation Sub. of</b> <b>Minnesota, Mining &amp; Mfg. Co.</b> Designers Inc.	157	‡ <b>Guardian Electric Mfg. Co.</b> Kolb/Tookee and Associates, Inc.	155	<b>Schauer Manufacturing Corp.</b> Nolan, Keeler & Stites	6
<b>American Power Systems Corp</b> Effenson/Nusbaum/Richard/Advertising	27	■ <b>Hanshaw Chemical Company</b> Industry Advertising Company	189	‡ <b>Schneider Electriciques</b> N. A. Winter Advertising Agency	129
■ <b>Analog Devices Inc.</b> Schneider Parker Guy Inc.	98	■ <b>Hewlett-Packard</b> Richardson, Seigle, Rolfs & McCoy, Inc.	1	* <b>Schneider Electronic</b> Intermedia	27E
<b>Analogic Corporation</b> Grover and Erickson Inc.	49	■ <b>Hewlett-Packard</b> 72 Regis McKenna, Inc.	68-69	* <b>Schoeller</b> Tektronix Inc.	30E 32-33,43,45
<b>Appicon Incorporated</b> Johnson, Raffin & Lingard, Incorporated	52	■ <b>Hewlett-Packard</b> Phillips Ramsey Advertising & Public Relations	2	* <b>Schlumberger Solartron</b> Scott MacTaggart Advertising	14E-15E
<b>Astro-Med</b> Michael London Associates	54	■ <b>Hitachi, Ltd.</b> Dentsu Advertising Ltd.	179	* <b>S. E. Laboratories Ltd.</b> Graphic Publicity Ltd.	28-29
‡ <b>Beckman Instruments, Inc.,</b> <b>Helpot Div.</b> N. W. Ayer/Jorgensen/MacDonald, Inc.	38	<b>Houston Instrument</b> Ray Cooley and Associates, Inc.	170	* <b>Sescomem</b> Perez Publicite	2E-3E
<b>Bell &amp; Howell—Electronics</b> <b>&amp; Instruments Group</b> Boylhart, Lovett & Dean	96-97	■ <b>Hughes Aircraft Company</b> Foote, Cone & Belding	47	<b>SGS-ATES</b> Studio B Communications	181
<b>Berkeley Instruments, Inc.</b> Hallman And Associates	150	<b>Hutson Industries</b> Warren-Guild	88	‡ <b>Siemens Corporation</b> Stiefel/Raymond Advertising, Inc.	28-29
‡ <b>Bourns, Inc.</b> Marlborough Assoc., Inc.	153	■ <b>Hybrid Systems Corp.</b> Susan E. Schur	180	<b>Signetics Corp., Sub. of</b> <b>Corning Glass Works</b> Hall Butler Blatherwick, Inc.	143
■ <b>Bussmann Mfg. Division of</b> <b>McGraw-Hill Co.</b> Henderson Advertising Company	89	■ <b>ILC Data Device Corporation</b> Marchin Weltman Advertising, Inc.	77	* <b>Silec Electronic</b> France M-1	62
<b>California Computer Products</b> Dailey & Associates Advertising	167	<b>Intel Corporation</b> Regis McKenna, Inc.	171,173	<b>Siliconix</b> Robertson West, Inc.	110
<b>Cherry Electrical Products Corp</b> Kolb/Tookee and Assoc., Inc.	165	<b>International Crystal Mfg. Co.</b> Robert V. Freeland & Associates	90	<b>Singer Instrumentation—</b> <b>Alfred Div.</b> N. W. Ayer/Jorgensen/MacDonald, Inc.	85
<b>Chicago Miniature Lamp Works</b> Butt-Roberts Advertising	146-149	<b>International Light, Inc.</b> Marketing, Promotion Services	190	■ <b>Sollitron Devices, Inc.,</b> <b>Transistor Division</b> Hazelmeier Pearson Advertising, Inc.	163
■ ‡ <b>Cinch Connectors, Operation of</b> <b>TRW Electronic Components</b> Stral Advertising Company, Inc.	67	<b>International Nickel Company</b> Ogilvy & Mather, Inc.	70-71	■ <b>Sorenson Lighted Controls, Inc.</b> Selwyn/Conway Advertising, Inc.	186
* <b>CIT Alcatel</b> Promotion Industrielle	32E	‡ <b>International Rectifier Corp.,</b> <b>Semiconductor Division</b> William E. Wilson Company	91	■ <b>Sprague Electric Company</b> Harry P. Bridge Company	8
■ <b>Colorado Video</b> O'Connell Words & Pictures	152	<b>Intersil Inc.</b> Tycer Associates	114-115	■ <b>Systron Donner Concord Instruments</b> Bonfield Associates	7,189
<b>Computer Automation</b> Cochrane Chase & Company, Inc.	53	■ <b>Intronics</b> Impact Advertising Incorporated	6	<b>TEC, Inc.</b> TEC-AD	17-26
<b>Continental Specialties Corp.</b> Bates & Fawcett, Inc.	169	■ <b>ITT CANNON</b> D'Arcy-MacManus & Masius, Inc.	193	<b>Tektronix Inc.</b> McCann Erickson Inc.	32-33,43,45
<b>Control Switch, Inc., Sub.</b> <b>of Cutler-Hammer, Inc.</b> The Larwin Agency	174	■ <b>Krohn-Hite Corporation</b> Impact Advertising, Inc.	5	‡ <b>Teledyne Philbrick</b> Ingalls Associates, Inc. Advertising	135
<b>Counterscan Systems</b> Dahmen Burnett Electronics	194 168	■ <b>Lika Corporation</b> Moorhead Marketing	166	* <b>Teledyne Philbrick</b> Ingalls Associates, Inc. Advertising	28E-29E
■ <b>Dale Electronics, Inc., A Sub.</b> <b>of The Lionel Corporation</b> Swanson, Slinkey, Ellis, Inc. Advertising	4th Cover	<b>Lockheed Electronics Company</b> McCann-Erickson, Inc.	51	<b>Teradyne, Inc.</b> Quinn & Johnson, Inc.	74
<b>Dana Laboratories</b> Dailey & Associates	12-13	* <b>LTT</b> Publibel	31E	<b>Thermalloy</b> Warren-Guild	50
<b>Data General Corporation</b> The Advertising Group	92-93	<b>McGraw-Hill Book Company</b> Macrodata Company	191 160	<b>Thomas Publishing Co.</b> Black-Russell-Morris	162
■ <b>Datel Systems, Inc.</b> John Donlan Advertising	3rd Cover	<b>Master Appliance</b> Klau-Van Pietersom-Dunlap, Inc.	176	<b>Torin Corporation</b> Viscom International, Inc.	161
‡ <b>Delta Products, Inc.</b> The William Loughran Company	151	* <b>Matsushita Electric Trading</b> Hall Advertising Ltd.	129	■ <b>TRW/IRC Resistors</b> Gray & Rogers, Inc.	185
‡ <b>Deltrol Controls</b> Industrial Advertising Services	73	* <b>Microwave &amp; Electronic Systems Ltd.</b> Hall Advertising Ltd.	4E-5E	■ <b>Unitrode Corporation</b> Impact Advertising	37
■ <b>Eastman Chemical Products, Inc.,</b> <b>Industrial Chemicals</b> J. Walter Thompson Company	178	■ <b>3M Company—Film &amp; Allied Products Div.</b> Young & Rubicam International, Inc.	109	■ <b>Varo Semiconductor, Inc.</b> Warren-Guild	164
<b>Eastman Kodak Company,</b> <b>Business Systems Markets Div.</b> J. Walter Thompson Company	9	■ <b>3M Company—Minicom Division</b> D'Arcy-MacManus & Masius, Inc.	84,142	■ <b>Vector Electronic Company, Inc.</b> Communications Management Company	162
<b>Electro-Craft Corporation</b> Inter-Ad Incorporated	174	■ <b>Monolithic Memories, Inc.</b> Paul Pease Advertising, Inc.	136-137	<b>Victoreen Instrument Division</b> Dix & Eaton, Inc.	30
<b>Elec-Trol, Inc.</b> S. Michelson Advertising	184	<b>Mostek Corporation</b> Kaufmann Advertising, Inc.	15	<b>Wagner Electric Corporation</b> Coordinated Communications, Inc.	72
<b>Electronic Arrays</b> Bonfield Associates	79	<b>Motorola Semiconductor Products, Inc.</b> E B Lane & Associates, Inc.	61	* <b>Wandel und Goltermann</b> Werbeagentur	153
<b>Electronic Measurements Inc.</b> Hill Advertising Agency	2nd Cover	<b>Murata Corp. of America</b> Kenmarc Advertising, Inc.	168	<b>Wavetek San Diego</b> Chapman Michetti Advertising	58
■ <b>Electronic Navigation Industries</b> Hart Conway Co., Inc.	14	<b>National Electronics</b> Lea Advertising	164	■ <b>Winchester Electronics</b> Renaccio Advertising & Marketing, Inc.	159
■ <b>Electronic Research Co.</b> Miller Advertising Agency	190	■ <b>National Semiconductor Corp.</b> Chiat/Day, Inc. Advertising	94-95	<b>YEWTEC Corporation</b> Kenmarc Advertising, Inc.	156
<b>Emerson &amp; Cuming, Inc.</b> Edwin F. Hall	182	■ <b>Newport Labs</b> Hall Butler Blatherwick, Inc.	187		
<b>Energy Conversion Devices, Inc.</b> Watkins Rogers, Inc.	154	* <b>Nippon Kogaku K.K.</b> K & L Advertising Agency	135		
* <b>English Electric Valve Co. Ltd.</b> The London Advertising Partnership	20E-21E	<b>North Atlantic Industries</b> Diversified Corporate Services, Inc.	130		
■ <b>Erie Technological Products Co., Inc.</b> Altman Hall Associates Advertising	31	* <b>Oxy-Metal</b> Reinhardt Publicite	13E		
<b>Esterline Angus, A Unit of</b> <b>Esterline Corporation</b> Odiome Industrial Advertising, Inc.	186	* <b>Oscilloquartz SA, Neuchatel</b> M.R. Hofer Werbeagentur BSR/EAAA Bern	6E		
<b>Fairchild Semiconductor, Inc.</b> Carson/Roberts, Inc. Adv., Division of Ogilvy & Mather, Inc.	55-57	* <b>Philips Elcoma</b> Tag Intermarco	22E		
■ <b>Ferronics, Inc.</b> Pierce Brown Associates, Inc.	180	<b>Philips Electrologica</b> TAG Intermarco Delamar	141		
<b>Fluke Manufacturing Co., John</b> Bonfield Associates	144	* <b>Philips N. V. Pit/T &amp; M Division</b> Marsteller International S. A.	64		
<b>Fujitsu Limited</b> Asian Advertisers, Inc.	26D	<b>Piezo Technology, Inc.</b> Shattuck/Roether Advertising, Inc.	182		
		* <b>Plessey, Inc. Materials Div.</b> TCL Advertising	25E		
		■ <b>PowerTech, Inc.</b> The Sommer Agency, Inc.	156		
		‡ <b>Precision Monolithics, Inc.</b> Marlborough Associates, Inc.	64		
		* <b>Pulse Engineering</b> Manning/Bowen and Associates	151		

## Classified & Employment Advertising

F. J. Eberle, Manager 212-971-2557

EQUIPMENT (Used or Surplus New) For Sale	
American Used Computer Corp.	188
Philip Fishman Co., Inc.	188
Jensen Tool	188
Mountain West Alarm	188
Radio Research Instrument Co., Inc.	188
Shprentz Company	188

■ For more information on complete product line see advertisement in the latest Electronics Buyer's Guide  
 \* Advertisers in Electronics International  
 ‡ Advertisers in Electronics domestic edition

# JONES SPECIFIES CANNON® ADAPTA-CON CONNECTORS. POINTS TO FLEXIBILITY, LOW COST. MANAGEMENT RESPONDS.



## “WE’RE NOT SENDING OUR COMPUTER TERMINALS TO THE MOON,” they expostulate.

Jones stayed cool: “Don’t keep connecting Cannon with aerospace costs, connect it with aerospace expertise. Take Adapta-Con. It’s got it all in 0.025” square technology—flexibility, low

insertion force, low cost. Three grid spacings: 0.100”

0.125” 0.150” single or double row.

We can use one connector type for all our equipment. For plugging to feed-through posts, backpanel tails, as I/O connectors and jumpers. They’ll outperform and

outlast any edgecard connector. And their strip-and-crimp machine is the best one made.”

“But isn’t their machine expensive?” someone piped out plaintively.

Jones wasn’t embarrassed: “As far as cost of machine is concerned, you’re thinking of the other guy’s. Cannon’s strip-and-crimp machine is the one that takes twisted pairs, jacketed cable and hard-coated wire, handles up to four gages at a single setting, and is faster and simpler to operate.”

He thought he’d zing it to them about the cost again: “Besides, we can lease Cannon’s machine and more than make up

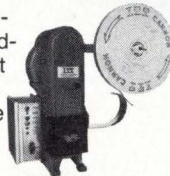

the monthly charge by what we’ll save in just a week’s lower wire preparation costs. Shouldn’t we take a look?!”

Now Jones already had a reputation as a forward thinker. And maybe your management doesn’t convince that easily. Still, if you show them a better, faster way that costs less, they’re bound to look favorably on it. And you. Start by writing for our free catalog.

ITT Cannon Electric, International Telephone and Telegraph Corporation, 666 East Dyer Rd., Santa Ana, Calif. 92702. Telephone (714) 557-4700.



European facilities in: Brussels, Belgium; Basingstoke, Hants, England; Toulouse, France; 7056 Beutelsbach/i.R., Germany; Milano, Italy

# CANNON ITT

# New "one for all" Transistor/FET Tester... for only \$159.\*



RCA introduces the WT-524A, a new "one for all" tester for solid-state devices. With it, you can measure AC beta — up to 5,000 — of any bipolar transistor, and  $G_m$  — up to 100,000  $\mu\text{mhos}$  — of any field-effect transistor (FET). And you'll do it with an accuracy of  $\pm 3\%$ ! It also checks diodes, SCR's and triacs — and can do the job in-circuit or out.

The large, easy-to-read 6½" mirrored scale meter of the new WT-524A features special scales for  $I_C$ ,  $I_{CBO}$ ,  $I_{DSS}$ ,  $I_{CEO}$ , and  $I_D$  currents. Each tester also includes two universal socket adapters and three color-coded test leads.

Try the new WT-524A for yourself. You'll appreciate its quality, accuracy and ruggedness. To buy: order from any one of the more than 1,000 Authorized RCA Distributors worldwide. For more information, write RCA Electronic Instruments, Harrison, N.J. 07029.

**RCA** Electronic Instruments

\*Optional Distributor Resale Price

Circle 194 on reader service card

## COUNTERSCAN SYSTEMS INTRODUCES TWO STATE OF THE ART PRODUCTS

### A Sophisticated Multiple Conductor WIRE ANALYZER

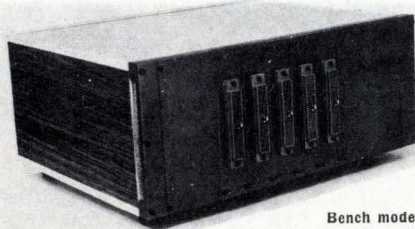

Bench model shown. Larger units are floor consoles.

**Designed Exclusively For:**  
**High Density Backplane Testing**  
**High Density Cable Testing**  
**Multiple Circuit Wire Verification**

Now for the first time, you can get a wire checker that has followed the state of the art. Once programmed, all you need to do to test different cables, harnesses, backplanes, PW boards, etc., is to press a program select button. No mess with putting on reels of tape, cards, or hooking up other peripheral equipment. This machine is completely self contained and even includes a built-in special purpose computer. Programs are stored in electrically reprogrammable MOS LSI ROM's, and the first program is supplied FREE with the machine. The program content can consist of anything of your choosing. Machine capacities available from 240 points to 384,000 points, in 240 point increments.

Super sophisticated electronic circuitry utilizes CMOS technology almost exclusively. The high density switching is accomplished entirely by CMOS LSI bi-directional switches. Advanced packaging techniques reduce the select/deselect switching component volume by 87%. Choice of various test frequencies and test voltages is continuously available and is part of the program. Any pin connection to the device under test may be used as an input or output. An innovative cable attached keyboard/display unit contains all controls for machine operation. Prices for the basic models range from \$3840.00 complete for the 240 point unit and up. Price includes a printer, mating connectors, programming, and a spare parts kit.

### A High Density 480 Channel MULTIPLEXER

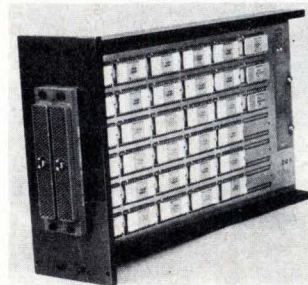

A giant multiplexer/demultiplexer is now introduced to satisfy all high density switching and selecting requirements. This innovative and extremely sophisticated unit utilizes the very latest in switch technology. State of the art solid state LSI-CMOS switches are used throughout. The physically compact unit has a tremendous capacity of 480 channels that may be used both as a Multiplexer and Demultiplexer. Each channel is fully bi-directional and capable of passing plus or minus 12 VDC and 12 V peak AC to greater than one megahertz. The small size of the plug-in-able unit is made possible by one high density wire wrap panel and the utilization of the very new LSI-CMOS switches.

The LSI-CMOS integrated circuits support the Multiplexer design better than any other solid state devices in existence. The CMOS-LSI circuitry permits extremely low power consumption, high reliability, are fully bi-directional, extremely compact unit configuration, and uses electronics that represents the threshold of a new and coming technology. A nine bit parallel straight binary code supplies the address to all channels. Full address decoding with latching selects and maintains switch closures until a reset is desired. Interfacing and supporting components contained on the relatively small size wire wrap panel are a state of the art devices and includes a miniature high density data connector that contains 488 contacts and a miniature edge connector that terminates all 22 wires of a flat cable simultaneously with no preparation.

Prices for the Multiplexers start at \$1800.00 for a quantity of one.

**COUNTERSCAN SYSTEMS P.O. BOX 536 PHONE 402-773-3875 SUTTON, NE 68979**