User's Guide

**HP B1449
8086/186 Assembler, Linker,
Librarian**

Notice

Hewlett-Packard makes no warranty of any kind with regard to this material, including, but not limited to, the implied warranties of merchantability and fitness for a particular purpose. Hewlett-Packard shall not be liable for errors contained herein or for incidental or consequential damages in connection with the furnishing, performance, or use of this material.

Hewlett-Packard assumes no responsibility for the use or reliability of its software on equipment that is not furnished by Hewlett-Packard.

© Copyright 1988, 1990, 1991, 1993, Hewlett-Packard Company.

This document contains proprietary information, which is protected by copyright. All rights are reserved. No part of this document may be photocopied, reproduced or translated to another language without the prior written consent of Hewlett-Packard Company. The information contained in this document is subject to change without notice.

Microtec is a registered trademark of Microtec Research Inc.

SunOS, SPARCsystem, OpenWindows, and SunView are trademarks of Sun Microsystems, Inc.

UNIX is a registered trademark of UNIX System Laboratories Inc. in the U.S.A. and other countries.

Hewlett-Packard Company
P.O. Box 2197
1900 Garden of the Gods Road
Colorado Springs, CO 80901-2197, U.S.A.

RESTRICTED RIGHTS LEGEND Use, duplication, or disclosure by the U.S. Government is subject to restrictions set forth in subparagraph (C) (1) (ii) of the Rights in Technical Data and Computer Software Clause in DFARS 252.227-7013. Hewlett-Packard Company, 3000 Hanover Street, Palo Alto, CA 94304 U.S.A.

Rights for non-DOD U.S. Government Departments and Agencies are set forth in FAR 52.227-19(c)(1,2).

About this edition

Many product updates and fixes do not require manual changes, and manual corrections may be done without accompanying product changes. Therefore, do not expect a one-to-one correspondence between product updates and manual revisions.

Edition dates and the corresponding HP manual part numbers are as follows:

Edition 1	64871-90901, October 1988 E1088
Edition 2	64871-97004, July 1991
Edition 3	B1449-97000, April 1993

B1449-97000 incorporates information which previously appeared in 64871-97004, 64871-97005, 64871-97006, and 64871-92003.

Certification and Warranty

Certification and warranty information can be found at the end of this manual on the pages before the back cover.

Features

The as86 assembler:

- generates code for the complete Intel 8086/8088 and 80186/188 instruction set
- generates code for NEC V20/V30 extensions to 8086/186 instruction set
- supports Intel 8087 floating-point coprocessor instructions
- permits repeated definition of the same or of different code, data, and constants segments within a single source file
- has high-level data structures for structured data types, bit fields, and symbolic memory references
- allows control of the assembly process (conditional assembly, structured control, listing and output control) through a flexible set of assembly control statements
- produces extensive program listings that can include symbol table/cross reference information
- as part of the HP B1449 8086/186 Advanced Cross Assembler/Linker package, is well-integrated with the HP B1493 8086/186 C Advanced Cross Compiler
- comes with a powerful, string-oriented macro preprocessor. The macro preprocessor adds even more flexibility to the assembler with its features (including support for recursive macros).

The ld86 linking loader:

- produces relocatable object modules for later re-linking (incremental linking)
- produces absolute object modules in HP-OMF 86 format absolute, Intel Hexadecimal Object file format absolute, or HP 64000 format absolute
- can include symbols in the absolute object module for symbolic debugging
- allows independent specification of all relocatable segment load addresses
- allows specification of relocatable segment loading order
- supports segment groupings into either GROUP or CLASS
- allows definition of public symbols, or changes to the memory locations of previously-defined public, at load-time (except for incremental links)
- can generate a cross reference table of public symbols and the modules in which they are referenced, and also a memory map

- can load object modules from a user library created by the ar86 librarian
- can make a copy of initialized data values that can be placed in ROM
- gives detailed, well-documented error messages

The ar86 librarian:

- produces libraries that can be loaded by the linking loader
- can add, delete or replace individual modules in a library
- can display library directories
- supports batch command line input and return codes for make-type procedures
- has an optimized structure for fast access during load-time
- can be run in interactive mode as well as batch mode
- can accept Intel library files as input

In This Book

This book is organized into three parts:

Part 1. Quick Start Guide

A short lesson to get you started and summaries of command syntax.

Part 2. Assembler/Macro Preprocessor Reference

Detailed information about the assembler and macro preprocessor.

Part 3. Linker/Librarian Reference

Detailed information about the linker and librarian.

Part 4. Error Messages Reference

Lists of the error messages you might see during the assembly/linking process, and what to do about them.

Contents

Part 1 Quick Start Guide

1 Getting Started

Objectives of the Example Program	2
Description of the Example Program	3
The "mov_msg.s" Program Module	3
The "transfer.s" Program Module	7
The "delay.s" Program Module	8
Assembling the Program Module Source Files	9
Starting the Macro Preprocessor	9
Starting the Assembler	9
Viewing the Assembler Listing Files	9
Creating an Example Library File	15
Linking the Program Module Relocatable Object Files	17
Linking the Object Modules	18

2 Command Syntax

as86(1) 23

ap86(1) 30

ld86(1) 32

ar86(1) 45

Part 2 Assembler/Macro Preprocessor Reference

3 Assembler Introduction

Instruction Set 52

Target Microprocessors 52

Assembler Operation 52

File Formats 53

Input File Characteristics 53

Output File Characteristics 53

4 Assembler Syntax

Assembler Character Set 56

ASCII Codes 58

Symbols 59

Symbol Formation 59

Keywords 60

Instruction Mnemonics 62

Codemacro 62

Label 62

Variable 62
 Structure Name 63
 Structure Field Name 63
 Record Name 63
 Record Field Name 63
 Segment Name 64
 Group Name 64
 EQU Symbols 64

Constants 64
 Integer Constant 65
 Real Constant 66
 Character Constant 67

Delimiters 68

Assembler Statements 68
 General Syntax 68
 Comment 69
 Continuation Lines 70

5 Symbol and Expression Attributes

TYPE 73
 OFFSET 73
 BASE 74
 INDEX 74
 SEGMENT 75
 SEGMENT RELOCATION 75
 RELOCATION TYPE 75
 SEGMENT ADDRESSABILITY 76
 CS ADDRESSABILITY 77

6 Assembler Directives

Segmentation Directives 81
 Program Segmentation 81
 Default Segment - ??SEG 82

Contents

Data Definition Directives	83
Data Objects	83
Linkage Directives	84
Program Linkage	84
ASSUME	86
DB, DW, DD, DQ, DT	88
END	94
EQU	96
EVEN	99
EXTRN	100
GROUP	103
LABEL	105
NAME	107
ORG	108
PROC/ENDP	109
PUBLIC	111
PURGE	112
RECORD	114
SEGMENT/ENDS	118
STRUC/ENDS	123
7 Expressions	
Reference Syntax Conventions	128
Expression Overview	128
Absolute Expression	129
Relocatable Expression	130
External Expression	130
Expression Operands	131
Numeric Values	131
Memory and Register Expressions	133
EQU	136
Expression Operators Introduction	137
Arithmetic Operators	137
Unary Plus, Unary Minus	137

Binary Addition, Subtraction	138
[] Square Brackets	139
. (Dot operator)	140
Multiplication, Division, Modulo	141
SHL, SHR	142
HIGH, LOW	143
 Logical Operators	 144
AND, OR, XOR	144
NOT	145
EQ, NE, LT, LE, GT, GE	145
 Memory Operators	 146
SHORT	146
THIS	146
PTR	147
Segment or Group Override	148
OFFSET	149
SEG	149
TYPE	150
LENGTH	151
SIZE	152
 Record Operators	 154
MASK	154
WIDTH	154
 Segment and Group Operators	 156
SEGOFFSET	156
GRPOFFSET	156
SEGSIZE	157
GRPSIZE	158
 Operator Precedence	 159

8 Instructions and Operands

Operands	162
Accepted Operands	162

Contents

Operand Positioning	164
Immediate Values	164
Registers	165
Memory Expressions and the MODRM Byte	169
Segment Addressability and Overrides	170
Addressability Checking	171
Default Segments	171
Segment Overrides	172
Improper Uses of Segment Overrides	172
Segment Override Byte	172
Overrides and Checking Against ASSUME	173
Segment Override Byte Generation	173
The Instruction Set	174
as86 Assembler Instruction Set	176

9 Assembler Controls

General Syntax for Assembler Controls	195
Primary and General Controls	195
Controls on the Command Line	195
Control Conflicts	196
Controls and File Names	196
Control Abbreviations	196
Controls and the Macro Preprocessor (ap86)	196
Primary Controls	197
[NO]CASE	197
DATE(string)	197
[NO]DEBUG	198
[NO]ERRORPRINT (filename)	198
[NO]EXTERN_CHECK	198
GEN	199
GENONLY	199
[NO]GROUP_INFO	199
[NO]HLASSYM	200
[NO]MACRO(string)	200
MOD086	200

MOD186	201
MODV20	201
[NO]OBJECT (filename)	201
[NO]OPTIMIZE	202
PAGELength(n)	202
PAGEWIDTH(n)	202
[NO]PAGING	203
[NO]PRINT(filename)	203
[NO]SYMBOLS	204
[NO]TYPE	204
[NO]UNREFERENCED_EXTERNALS	204
[NO]WARNING	205
WORKFILES(...)	205
[NO]XREF	205
General Controls	206
EJECT	206
[NO]GEN	206
GENONLY	206
INCLUDE(filename)	207
[NO]LIST	207
RESTORE	207
SAVE	208
TITLE(string)	208
Operational Differences in the Different Modes	209
8086 Mode	209
80186 Mode	209
V20 Mode	209

10 Assembler Listing Description

- Assembly Listing 212
- Cross Reference and Symbol Table Format Description 213

11 Codemacros

- Referencing Codemacros 218
- Codemacro Directives 219
 - CODEMACRO 219
 - ENDM 221
- Codemacro Matching 221
- The Specmod Field 223
- Range Specification 227
- Codemacro Matching Examples 229
- Expressions in Codemacros 231
- Directives within Codemacros 232
 - DB, DD, DW 233
 - MODRM 234
 - NOSEGFIX 235
 - ONLY186 (186 Mode Only) 236
 - Record Name Initialization 237
 - RELB, RELW 238
 - RFIX, RFIXM, RNFIX, RNFIXM, RWFIX 239
 - SEGFIX 241

12 Macro String Preprocessor Introduction

Input Source Characteristics	244
The Metacharacter '%' And The Call Pattern	245
Metacharacter Syntax	246
Literal Character *	247
Input Parsing	248
Output Buffering	248
Include Files	248
Macro Expressions	250
Operators	250
Numbers	251
Symbols	251
Balanced Text String (baltex)	252

13 Pre-Defined Macro Functions

Pre-Defined Macro Functions	254
% ' (Comment Function)	255
% n and % ((Escape and Bracket Functions)	255
% EQS, % NES, % LTS, % LES, % GTS,% GES	256
% EVAL	257
% EXIT	258
% IF (Conditional Assembly Function)	258
% LEN	259
% MATCH	260
% METACHAR	262
% REPEAT	262
% SET	263
% SUBSTR	264
% WHILE	264

Example Problem	265
14 User-Defined Macros	
% DEFINE	269
Macro Reference	271
Referencing Macro-time Symbols	273
15 Assembler versions	
Version 3.10	276
New Product Numbers	276
New Assembler Controls	276
New Linker/Loader Controls	276
New Assembler Defaults	276
New Location for Man Pages	276
Version 3.00	276
Demo Directory Change	276
New Assembler Controls	277
New Assembler Operators	277
New Linker Commands	277
Other Linker Changes	277
16 Converting HP 64853 Assembly Language Programs	
acvt86 Introduction	280
Assembler Differences	281
External Declarations	283
Porting Procedure— Main Files with INCLUDE Files	284
acvt86 Warnings, ap86 Errors, as86 Errors	285
Code Substitution	286
Byte ordering for BIN, DECIMAL, HEX, OCT	287
Manual Macro Translations	287
Macro Calls	288

acvt86(1) Command Syntax	290
Comparison of Keywords	294
ALIGN	294
ASSUME	294
COMN	294
DATA	295
<EOF>	295
EQU	295
EXPAND	296
EXT	296
Label Field	296
LIST	297
MASK	297
NAME	297
NOWARN	297
Operator Field	297
ORG	298
PROC	299
PROG	301
REAL	301
Reserved Words	301
SPC	301
WARN	302
*(Comment)	302
Linking to 64853 Programs	303
L_to_o86(1)	304
nm64(1)	305
17 8086/186 Instructions in Hexadecimal Order	
18 8086/186 Instruction Set Summary	
Footnotes	357

Part 3 Linker/Librarian Reference

19 Linker/Loader Introduction

Linking And Loading From Libraries 362

Linking to the 8087 362

M:_WST, M:_WT, M:_NST, and other Floating Point Externals 363

20 Linker/Loader Operation

Primary Functions 368

Incremental Linking 368

Segments and Load Addresses 369

Logical Segment 369

Base Address 369

Physical Segment 369

Absolute Segment 370

Relocatable Segment 370

Paragraph (Segment) Number 370

Class 370

Group 371

Group Base Address 371

Module 372

Complete Name 372

Segment Attributes 372

Combine-type Attributes 373

Align-type Attribute 374

Segment Alignment 375

Base Address Assignment 378

21 Loader Commands

Loader Commands Introduction 384

Command Symbols 384

Complete Name 385

Order of Commands 385

Command Length 385

Loader Command Descriptions 386

ALIGN 387

Comment (*) 389

END 389

ERROR, WARN, NOERROR 389

EXIT 390

FORMAT 391

GROUP 392

INITDATA 394

LENGTH 395

LIST, NLIST 396

LISTABS 400

LISTMAP 400

LOAD 402

NAME 403

ORDER 403

PUBLIC 405

RESADD, RESNUM 406

SEG 407

SEGSIZE 409

START 410

TYPEMERGE 411

WIDTH 412

22 Linker/Loader Listing Description

Two-Pass Load	414
Object Module Format	414
Loader Command File	415
Starting the Loader	416
Loader Listings	416
Load Map Listing	418
First Assembler Listing	421
Second Assembler Listing	425
Third Assembler Listing	427

23 Librarian Introduction

Librarian Introduction	432
Starting the Librarian	432
Command Line	432
Command File	432
Interactive Operation	433
Librarian Function	433

24 Librarian Commands

Command Syntax	438
Use of Special Characters	438
Command File Comments	439
File Names	439
The SAVE Command	439
Return Codes	440

Commands Summary	441
Shorthand Names	442
ADDLIB	444
ADDMOD	444
CLEAR	445
CREATE	445
DELETE	446
DIRECTORY	446
END	447
EXTRACT	447
FULLDIR	
LIST	448
HELP	449
OPEN	449
REPLACE	450
SAVE	450

25 Librarian Listing Description

Librarian Sample 1	453
Librarian Sample 2	456

Part 4 Error Messages Reference

26 Error Message Formats

Warning	462
Error	462
Fatal Error	462

Contents

Interactive and Non-Interactive Conditions	462
27 Assembler Error Messages	
Syntax Errors	466
28 Macro String Preprocessor Error Messages	
Error Codes and Messages	494
29 Loader Error Messages	
Warning Messages	500
Error Messages	506
Fatal Error Messages	510
30 Librarian Error Messages	
Librarian Error Messages	514

Part 1

Quick Start Guide

Part 1

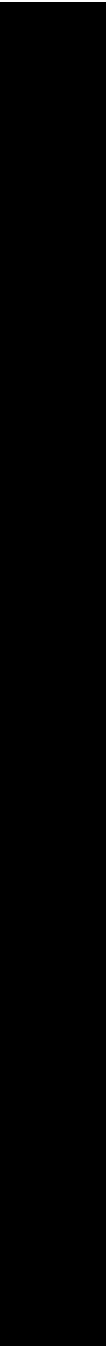

1



Getting Started

A short example of the process of assembling, creating libraries, and linking several program modules.

Objectives of the Example Program

This list of topics covered by the example program is provided here to give you an idea of why the program is written the way it is. The example program is designed to show some of the basic features of the B1449 8086/186 Advanced Cross Assembler/Linker. Consequently, the example programs:

- Contain 8086 assembly language instructions written in a manner that makes use of relocatable program sections.
- Contain a few of the most used assembler directives.
- Contain an example of a simple macro definition.
- Contain an example of structured control statements.
- Show how the relocatable program sections are used with the Linking Loader (**ld86**).
- Show how to link two or more program modules.
- Show how to link object files from a library file.

Note

The example programs in this chapter have been included with your Assembler/Linker/Librarian software and can be found in directory: `/usr/hp64000/demo/languages/as86`



Description of the Example Program

The example program moves data from three different memory locations to a fourth memory location. The program will be written in three modules to show how several program modules are linked together.

The **mov_mesg.s** program module is made up of a data table which contains the messages to be transferred, the main program which will define a macro and call "transfer" and "delay" subroutines, and a RAM location where the messages will be transferred.

The **transfer.s** program module contains the "transfer" subroutine which is called by the main program. The **transfer.s** subroutine will transfer a message from the data table to the destination memory location. The address of the message to be transferred will be passed in register SI, and the length of the message will be passed in register CX.

The **delay.s** program module contains the "delay" subroutine which is called by the main program. The **delay.s** subroutine will delay for the number of seconds which are passed in register CX.

The **delay.o** and the **transfer.o** relocatable object files will be placed into an example library file called **exlib.a**.

The "mov_mesg.s" Program Module

The example program of this chapter will move three messages which are contained in a data table to another memory location. The three messages are labeled MESSAGE_1, MESSAGE_2, and MESSAGE_3. The ends of the messages are also labeled so that the program will know how many words of data to transfer. The destination memory location is labeled VIDEO_RAM.

The example program will (1) move the first message to VIDEO_RAM, where it will be displayed for about 10 seconds, (2) move the second message to

Chapter 1: Getting Started

Description of the Example Program

VIDEO_RAM, where it is displayed for about 7 seconds, and (3) move the third message to VIDEO_RAM, where it is displayed for about 4 seconds. At this point the program will loop back and display the second and third messages, one after the other, repeatedly. The **mov_mesg.s** source file is shown in Figure 1-1.

```
$XREF
NAME MOV_MESG

PUBLIC START, VIDEO_RAM
EXTRN TRANSFER:FAR
EXTRN DELAY:FAR

TABLE SEGMENT
MESSAGE_1 DB 'The example program moves '
DB 'this and two additional '
DB 'messages to a RAM location. '
MESSAGE_1_END LABEL BYTE
MSG_1_LENGTH EQU MESSAGE_1_END - MESSAGE_1

MESSAGE_2 DB 'The first message is'
DB 'displayed for a medium '
DB 'length of time. '
MESSAGE_2_END LABEL BYTE
MSG_2_LENGTH EQU MESSAGE_2_END - MESSAGE_2

MESSAGE_3 DB 'The second message is '
DB 'displayed for a shorter '
DB 'length of time. '
MESSAGE_3_END LABEL BYTE
MSG_3_LENGTH EQU MESSAGE_3_END - MESSAGE_3

TABLE ENDS
```

Figure 1-1. The "mov_mesg.s" Source File

Chapter 1: Getting Started

Description of the Example Program

```
M_CODE SEGMENT
ASSUME CS:M_CODE, SS:STACK, DS:TABLE, ES:DATA

START:MOV AX, STACK; initialize stack
MOV SS, AX
MOV SP, OFFSET STACK_END

MOV AX, TABLE; text source
MOV DS, AX

MOV AX, DATA; text destination
MOV ES, AX

%*DEFINE (SET_UP(ADDRESS,LENGTH,COUNT))(
CALL CLEAR; clear ram area
MOV SI, OFFSET %ADDRESS ; make address source of text
MOV CX, %LENGTH / 2; store length of text in words
CALL TRANSFER; transfer text to ram area
MOV CX, %COUNT; load delay count
CALL DELAY; run delay loop
)

%SET_UP(MESSAGE_1,MESG_1_LENGTH,10)
REPEAT: %SET_UP(MESSAGE_2,MESG_2_LENGTH,7)
%SET_UP(MESSAGE_3,MESG_3_LENGTH,4)
JMP REPEAT; display messages 2 and 3 endlessly @FIGURELISTING =

CLEAR PROC
MOV DI, OFFSET VIDEO_RAM ; point to area to be cleared
MOV CX,30; load number of words to write
AGAIN:MOV ES:[DI], 2020H; write 2 spaces
ADD DI, 2; move pointer 2 bytes
LOOP AGAIN; loop until out of words to clear
RET
CLEAR ENDP

M_CODE ENDS

DATA SEGMENT COMMON
VIDEO_RAM DW 0FFH DUP (?)
DATA ENDS

STACK SEGMENT STACK
DB 0FFH DUP (?)
STACK_END LABEL BYTE
STACK ENDS

END START
```

Figure 1-1. The "mov_mesg.s" Source File (Cont'd)

Chapter 1: Getting Started

Description of the Example Program

PUBLIC Definitions.

The first thing the **mov_msg.s** program module does is define the symbols which can be referenced by other program modules. These definitions are made with the PUBLIC assembler directive. The label VIDEO_RAM is defined as public because the **transfer.s** program module will reference the destination memory locations. The label START is defined as a public for program debugging convenience.

External Definitions.

The EXTRN assembler directive allows you to use labels or variables which are defined in other program modules. In the **mov_msg.s** program module, the CALL TRANSFER and the CALL DELAY instructions use labels which are defined in the **transfer.s** and **delay.s** program modules, respectively. Therefore, TRANSFER and DELAY must be declared as external references.

The TABLE Program Segment.

The TABLE program segment contains the ASCII bytes of the three messages which are written to the destination memory location. The DB assembler directive is used to define the ASCII data. The lengths of the three messages are assigned to labels with the EQU assembler directive.

The M_CODE Program Segment.

The executable code of the **mov_msg.s** program module is found in the M_CODE segment. After the user segment registers and stack pointer are loaded, the SET_UP macro is defined. The three parameters in the macro definition (ADDRESS, LENGTH, and COUNT) are assigned actual values in the macro calls. Each time the macro is called, assembly code is generated which calls the CLEAR, TRANSFER, and DELAY subroutines. (Parameters are moved into registers before the TRANSFER and DELAY calls.) After the macro is defined, it is called three times. The CLEAR subroutine, which moves ASCII spaces to the destination memory locations, appears at the end of the M_CODE program section.

The DATA Program Segment.

Storage locations are defined in the DATA program segment with the DW assembler directive. This storage location is the destination of the three messages and is labeled VIDEO_RAM.

The STACK Program Segment.

Storage locations are defined in the STACK program segment with the DB assembler directive. This storage location is used for data stack.



The "transfer.s" Program Module

The main program branches to the subroutine contained in the **transfer.s** program module. The "transfer" subroutine will move the data from the address passed in SI to the destination memory location VIDEO_RAM. Notice that the executable code in this module appears in a program segment named T_CODE. Also, notice the public definition of the label TRANSFER (which allows the main program to branch to this label) and the external reference of the variable VIDEO_RAM which was defined in the main program module. The **transfer.s** source file is shown in Figure 1-2.

```
$XREF
NAME TRANSFER

PUBLIC TRANSFER

EXTRN VIDEO_RAM: WORD

T_CODE SEGMENT
ASSUME CS:T_CODE

TRANSFER PROC FAR

MOV DI, OFFSET VIDEO_RAM; point to destination
REP MOVSW; move words until CX=0

RET

TRANSFER ENDP

T_CODE ENDS

END
```

Figure 1-2. The "transfer.s" Source File

Chapter 1: Getting Started

Description of the Example Program

The "delay.s" Program Module

The main program branches to the "delay" subroutine contained in the **delay.s** program module. The "delay" subroutine is used to display the various messages for the number of seconds passed in register CX. This program module's executable code is placed in a program segment named D_CODE. Notice the public definition of the DELAY label so that other program modules can refer to this subroutine. The **delay.s** source file is shown in Figure 1-3.

```
$XREF
NAME DELAY

PUBLIC DELAY

D_CODE SEGMENT
ASSUME CS:D_CODE

DELAY PROC FAR

MOV AX, 553; load delay constant
MUL CX; multiply twice by delay count
MUL CX
DLOOP:DEC AX; decrement value until at 0
JNZ DLOOP
RET

DELAY ENDP

D_CODE ENDS

END
```

Figure 1-3. The "delay.s" Source File

Assembling the Program Module Source Files



Assembling program module source files will create object files. The commands to assemble the source files follow.

Starting the Macro Preprocessor

The macro preprocessor must be run for `mov_mesg.s` before it is assembled because it contains macro definitions. The output of the macro processor—the file `mov_mesg.ap`—is then used as input to the assembler. The command to start the macro preprocessor:

```
$ ap86 mov_mesg.s -s > mov_mesg.ap
```

Starting the Assembler

The output of the macro preprocessor and the other two source files are assembled with the following commands:

```
$ as86 -Lh mov_mesg.ap > mov_mesg.lis  
$ as86 -Lh transfer.s > transfer.lis  
$ as86 -Lh delay.s > delay.lis
```

The **-L** in the assembler commands above causes an assembler listing to be sent to the standard output. The **-h** option in the assembler commands above specifies that the assembler create HP 64000 assembler symbol files (with `.A` suffixes). The `>` in the commands above redirects the standard output to a file.

Viewing the Assembler Listing Files

You can view the assembler listings (files with the `.lis` extensions as specified above) with the **more** command. For example, to view the `mov_mesg.lis` file, enter the command below.

```
$ more mov_mesg.lis
```

Assembler listings for each of the program modules are shown in Figures 1-4 through 1-6.

Chapter 1: Getting Started

Assembling the Program Module Source Files

```

Hewlett Packard AS86 HPB1449-19302 A.03.10 24Mar93 Copr. HP 1988 Page 1 Mon
Mar 29 08:36:04 1993
MOV_MESG HPB1449-19302 A.03.10 24Mar93 Copr. HP 1988
Cmdline - as86 -Lh mov_mesg.ap
Line Offset Object-Bytes
1 0000 ; Hewlett-Packard Macro Preprocessor
2 0000 ; HPB1449-19302 A.03.10 24Mar93 Copr. HP
1988
3 0000 ; MKT:@(#) B1449-19302 A.03.10 8086/186
ASSEMBLER/LINKER 24Mar93 Unreleased
4 0000 $XREF
5 0000 NAME MOV_MESG
6 0000
7 0000 PUBLIC START, VIDEO_RAM
8 0000 EXTRN TRANSFER:FAR
9 0000 EXTRN DELAY:FAR
10 0000
11 0000 TABLE SEGMENT
12 0000 54 68 65 20 65 78 MESSAGE_1 DB 'The example program moves '
12 61 6D 70 6C 65 20
12 70 72 6F 67 72 61
12 6D 20 6D 6F 76 65
12 73 20
13 001A 74 68 69 73 20 61 DB 'this and two additional '
13 6E 64 20 74 77 6F
13 20 61 64 64 69 74
13 69 6F 6E 61 6C 20
14 0032 6D 65 73 73 61 67 DB 'messages to a RAM location. '
14 65 73 20 74 6F 20
14 61 20 52 41 4D 20
14 6C 6F 63 61 74 69
14 6F 6E 2E 20
15 004E MESSAGE_1_END LABEL BYTE
16 004E MSG_1_LENGTH EQU MESSAGE_1_END - MESSAGE_1
17 004E
18 004E 54 68 65 20 66 69 MESSAGE_2 DB 'The first message is'
18 72 73 74 20 6D 65
18 73 73 61 67 65 20
18 69 73
19 0062 64 69 73 70 6C 61 DB 'displayed for a medium '
19 79 65 64 20 66 6F
19 72 20 61 20 6D 65
19 64 69 75 6D 20
20 0079 6C 65 6E 67 74 68 DB 'length of time. '
20 20 6F 66 20 74 69
20 6D 65 2E 20
21 0089 MESSAGE_2_END LABEL BYTE
22 0089 MSG_2_LENGTH EQU MESSAGE_2_END - MESSAGE_2
23 0089
24 0089 54 68 65 20 73 65 MESSAGE_3 DB 'The second message is '
24 63 6F 6E 64 20 6D
24 65 73 73 61 67 65
24 20 69 73 20
25 009F 64 69 73 70 6C 61 DB 'displayed for a shorter '
25 79 65 64 20 66 6F
25 72 20 61 20 73 68

```

Figure 1-4. The "mov_mesg.lis" Assembly Listing

Chapter 1: Getting Started

Assembling the Program Module Source Files

```

25      6F 72 74 65 72 20
26      00B7 6C 65 6E 67 74 68          DB 'length of time. '

                Hewlett Packard AS86 HPB1449-19302 A.03.10 24Mar93 Copr. HP 1988 Page 2 Mon
Mar 29 08:36:04 1993
MOV_MESG      HPB1449-19302 A.03.10 24Mar93 Copr. HP 1988
Line Offset Object-Bytes
26      20 6F 66 20 74 69
26      6D 65 2E 20
27      00C7      MESSAGE_3_END LABEL BYTE
28      00C7      MSG_3_LENGTH EQU MESSAGE_3_END - MESSAGE_3
29      00C7
30      00C7      TABLE ENDS
31      0000
32      0000      M_CODE SEGMENT
33      0000      ASSUME CS:M_CODE, SS:STACK, DS:TABLE,
ES:DATA
34      0000
35      0000  B8 00 00          R      START:      MOV AX, STACK          ; initialize
stack
36      0003  8E D0          MOV SS, AX
37      0005  BC FF 00          R      MOV SP, OFFSET STACK_END
38      0008
39      0008  B8 00 00          R      MOV AX, TABLE          ; text source
40      000B  8E D8          MOV DS, AX
41      000D
42      000D  B8 00 00          R      MOV AX, DATA          ; text destination
43      0010  8E C0          MOV ES, AX
44      0012
45      0012
46      0012
47      0012
48      0012  E8 41 00          CALL CLEAR          ; clear ram area
49      0015  BE 00 00          MOV SI, OFFSET MESSAGE_1 ; make
address source of text
50      0018  B9 27 00          MOV CX, MSG_1_LENGTH / 2 ; store
length of text in words
51      001B  9A 00 00 00 00    E      CALL TRANSFER          ; transfer text
to ram area
52      0020  B9 0A 00          MOV CX, 10          ; load delay count
53      0023  9A 00 00 00 00    E      CALL DELAY          ; run delay loop
54      0028
55      0028          REPEAT:
56      0028  E8 2B 00          CALL CLEAR          ; clear ram area

```

Figure 1-4. The "mov_mesg.lis" Assembly List (Cont'd)

Chapter 1: Getting Started

Assembling the Program Module Source Files

```

57  002B  BE 4E 00          MOV SI, OFFSET MESSAGE_2 ; make
address source of text

58  002E  B9 1D 00          MOV CX, MSG_2_LENGTH / 2  ; store
length of text in words

59  0031  9A 00 00 00 00      E    CALL TRANSFER          ; transfer text
to ram area

60  0036  B9 07 00          MOV CX, 7                ; load delay count

61  0039  9A 00 00 00 00      E    CALL DELAY            ; run delay loop

62  003E
63  003E
64  003E  E8 15 00          CALL CLEAR                ; clear ram area

65  0041  BE 89 00          MOV SI, OFFSET MESSAGE_3 ; make
address source of text

66  0044  B9 1F 00          MOV CX, MSG_3_LENGTH / 2  ; store
length of text in words

67  0047  9A 00 00 00 00      E    CALL TRANSFER          ; transfer text
to ram area

68  004C  B9 04 00          MOV CX, 4                ; load delay count

69  004F  9A 00 00 00 00      E    CALL DELAY            ; run delay loop

70  0054
71  0054  EB D2          JMP REPEAT                ; display
messages 2 and 3 endlessly

72  0056
73  0056
74  0056  BF 00 00          R    CLEAR PROC
area to be cleared          MOV DI, OFFSET VIDEO_RAM ; point to

75  0059  B9 1E 00          MOV CX,30                ; load number of words
to write

76  005C  26 C7 05 20 20      AGAIN:  MOV ES:[DI], 2020H  ; write 2
spaces

Hewlett Packard AS86 HPB1449-19302 A.03.10 24Mar93 Copr. HP 1988 Page 3 Mon
Mar 29 08:36:04 1993
MOV_MSG HPB1449-19302 A.03.10 24Mar93 Copr. HP 1988
Line Offset Object-Bytes
77  0061  83 C7 02          ADD DI, 2                ; move pointer 2 bytes

78  0064  E2 F6          LOOP AGAIN                ; loop until out
of words to clear

```

Figure 1-4. The "mov_mesg.lis" Assembly List (Cont'd)

Chapter 1: Getting Started

Assembling the Program Module Source Files

```

Hewlett Packard AS86 HPB1449-19302 A.03.10 24Mar93 Copr. HP 1988 Page 1 Mon
Mar 29 08:36:08 1993
TRANSFER          HPB1449-19302 A.03.10 24Mar93 Copr. HP 1988
Cmdline - as86 -Lh transfer.s
Line Offset Object-Bytes
1      0000                                ; MKT:@(#) B1449-19302 A.03.10 8086/186
ASSEMBLER/LINKER          24Mar93

2      0000                                $XREF
3      0000                                NAME TRANSFER
4      0000
5      0000                                PUBLIC TRANSFER
6      0000                                EXTRN VIDEO_RAM: WORD
7      0000
8      0000                                T_CODE SEGMENT
9      0000                                ASSUME CS:T_CODE
10     0000
11     0000                                TRANSFER PROC FAR
12     0000
13     0000 BF 00 00          E          MOV DI, OFFSET VIDEO_RAM ; point to
destination
14     0003 F3 A5          REP MOVSW          ; move words
until CX=0
15     0005 CB          RET
16     0006
17     0006                                TRANSFER ENDP
18     0006
19     0006                                T_CODE ENDS
20     0000
21     0000                                END

Hewlett Packard AS86 HPB1449-19302 A.03.10 24Mar93 Copr. HP 1988 Page 2 Mon
Mar 29 08:36:08 1993
TRANSFER          HPB1449-19302 A.03.10 24Mar93 Copr. HP 1988
Cross Reference

Label      Type      Value      References
??SEG      SEGM      SIZE=0000 PUBLIC PARA
TRANSFER   PROC      T_CODE:0000 FAR      -5 -11 -17
T_CODE     SEGM      SIZE=0006 PARA      -8 9 19
VIDEO_RAM  EXTERN   WORD      -6 13

NO ASSEMBLY ERRORS
NO ASSEMBLY WARNINGS

```

Figure 1-5. The "transfer.lis" Assembly Listing

Chapter 1: Getting Started

Assembling the Program Module Source Files

```

Hewlett Packard AS86 HPB1449-19302 A.03.10 24Mar93 Copr. HP 1988 Page 1 Mon
Mar 29 08:36:09 1993
DELAY HPB1449-19302 A.03.10 24Mar93 Copr. HP 1988
Cmdline - as86 -Lh delay.s
Line Offset Object-Bytes
1 0000 ; MKT:@(#) B1449-19302 A.03.10 8086/186
ASSEMBLER/LINKER 24Mar93

2 0000 $XREF
3 0000 NAME DELAY
4 0000
5 0000 PUBLIC DELAY
6 0000
7 0000 D_CODE SEGMENT
8 0000 ASSUME CS:D_CODE
9 0000
10 0000 DELAY PROC FAR
11 0000
12 0000 B8 29 02 MOV AX, 553 ; load delay constant
13 0003 F7 E1 MUL CX ; multiply twice by
delay count
14 0005 F7 E1 MUL CX
15 0007 48 DLOOP: DEC AX ; decrement value
until at 0
16 0008 75 FD JNZ DLOOP
17 000A CB RET
18 000B
19 000B DELAY ENDP
20 000B
21 000B D_CODE ENDS
22 0000
23 0000 END

```

```

Hewlett Packard AS86 HPB1449-19302 A.03.10 24Mar93 Copr. HP 1988 Page 2 Mon
Mar 29 08:36:09 1993
DELAY HPB1449-19302 A.03.10 24Mar93 Copr. HP 1988
Cross Reference

Label Type Value References
??SEG SEGM SIZE=0000 PUBLIC PARA
DELAY PROC D_CODE:0000 FAR -5 -10 -19
DLOOP LABEL D_CODE:0007 NEAR -15 16
D_CODE SEGM SIZE=000B PARA -7 8 21

```

```

NO ASSEMBLY ERRORS
NO ASSEMBLY WARNINGS

```

Figure 1-6. The "delay.lis" Assembly Listing

Creating an Example Library File



One of the objectives of this chapter is to show how object modules can be linked from libraries. Before we can link from a library file, a library file must be created. To create an example library file consisting of the "transfer.o" and "delay.o" relocatable object modules, enter the following command:

```
$ ar86 -a delay.o,transfer.o -L exlib > exlib.lis
```

The -a option in the command above specifies that the files which follow are to be added to the library. The -L option in the command above specifies that a library listing file be sent to the standard output (which is redirected to the "exlib.lis" file). The library listing file is shown in Figure 1-7.

Notice the warning message. Warning messages announce something that *might* be a problem. Since you are creating a new library file, you already know that "exlib.a" does not yet exist, so you can ignore the warning. The warning in the first line of the listing appears on the display, not in the listing file.

Chapter 1: Getting Started

Creating an Example Library File

```
< ar86 >
  WARNING: (107) file exlib.a does not exist.
Hewlett-Packard ar86
HPB1449-19302 A.03.10 24Mar93 Copr. HP 1988

OPEN exlib.a
  WARNING: (107) file exlib.a does not exist.
ADDMOD transfer.o
ADDMOD delay.o
LIST exlib.a
Hewlett-Packard ar86          Mon Mar 29 08:36:11 1993
HPB1449-19302 A.03.10 24Mar93 Copr. HP 1988

Library being built exlib.a

Module      Size
TRANSFER ... 290
***** PUBLIC DEFINITIONS *****

TRANSFER
***** EXTERNAL REFERENCES *****

VIDEO_RAM

Public Count = 1
External Count = 1

Module      Size
DELAY ... 280
***** PUBLIC DEFINITIONS *****

DELAY
***** EXTERNAL REFERENCES *****

Public Count = 1
External Count = 0

Module Total = 2

SAVE

END

Warnings = 1
Errors = 0
```

Figure 1-7. The "exlib.lis" Library Listing

Linking the Program Module Relocatable Object Files



Linking is the process in which program modules are joined together to form a single absolute file which can then be executed or debugged. Because you can link several object modules to form an executable file, the Linking Loader is sometimes called the "Linker". Also, because you can specify the load addresses of various program sections, the Linking Loader will sometimes be referred to as the "Loader". Either name is correct; the **ld86** tool does both.

There are two ways that you can specify object files to be linked:

- enter the names of the files on the command line
- specify the names of the object files in a linker command file

The linker command file shown in Figure 1-8 will be used to link the three object modules in the example program.

```
* Demo 8086 loader command file
NAME DEMO
ORDER M_CODE, T_CODE, D_CODE
SEG TABLE=1000H
SEG M_CODE=1400H
SEG DATA=1800H
LOAD mov_mesg.o, exlib.a
END
```

Figure 1-8. The "demo.k" Linker Command File

Chapter 1: Getting Started

Linking the Program Module Relocatable Object Files

Linking the Object Modules

The command to link the example program object modules is shown below. The -c option specifies that a linker command file will be supplying information to the Linking Loader.

```
$ ld86 -c demo.k -Lh > demo.lis
```

The -L option in the command above specifies that an output load map listing file be sent to the standard output (which is redirected to the "demo.lis" file). The -h option specifies that the linker create HP 64000 format output files (demo.X is the absolute file and demo.L is the linker symbol file). The load map listing file is shown in Figure (1-9). The resulting executable (demo.X), along with the linker symbol file (demo.L) and assembler symbol files (mov_mesg.A, transfer.A, and delay.A), may be loaded into an emulator or downloaded into ROM for execution.

```
Hewlett-Packard ld86 Mon Mar 29 08:36:13 1993
HPB1449-19302 A.03.10 24Mar93 Un
released Copr. HP 1988
Command line: ld86 -h -L -c demo.k

* Demo 8086 loader command file

NAME DEMO

ORDER M_CODE, T_CODE, D_CODE

SEG TABLE=1000H
SEG M_CODE=1400H
SEG DATA=1800H

LOAD mov_mesg.o, exlib.a

END

OUTPUT MODULE NAME: DEMO
OUTPUT MODULE FORMAT: HP64000 absolute

START ADDRESS: 00140:00000 -> 01400
```

Figure 1-9. The "demo.lis" Load Map Listing

Chapter 1: Getting Started

Linking the Program Module Relocatable Object Files



```

SEGMENT SUMMARY
-----

SEGMENT/CLASS      GROUP      START      END        LENGTH     ALIGN     COMBINE
??SEG/              00000      00000      00000      00000      Para     Public
STACK/              00000      000FE      000FF      000FF      Para     Stack
??DATA1/??INIT     000FF      00101      00003      00003      Byte     Common
TABLE/              01000      010C6      000C7      000C7      Para     Private
M_CODE/             01400      01466      00067      00067      Para     Private
T_CODE/             01470      01475      00006      00006      Para     Private
D_CODE/             01480      0148A      0000B      0000B      Para     Private
DATA/               01800      019FD      001FE      001FE      Para     Common

MODULE SUMMARY
-----

MODULE      SEGMENT/CLASS      HP SECT  START      END        LENGTH
MOV_MSG /8086/asm/listing/mov_msg.o
  M_CODE/      PROG      01400      01466      00067
  TABLE/     DATA      01000      010C6      000C7
  DATA/      COMMON    01800      019FD      001FE
  STACK/     ABS      00000      000FE      000FF

DELAY /8086/asm/listing/exlib.a
  D_CODE/     PROG      01480      0148A      0000B

TRANSFER /8086/asm/listing/exlib.a
  T_CODE/     PROG      01470      01475      00006

Link completed

Hewlett-Packard ld86  Mon Mar 29 08:36:13 1993
HPB1449-19302 A.03.10 24Mar93 Un
released Copr. HP 1988

```

Figure 1-9. The "demo.lis" Load Map Listing (Cont'd)

This completes the "Getting Started" example. For a complete description of the as86, ap86, ld86, and ar86 commands and their options, refer to the "Assembler/Macro Preprocessor/Linker/Librarian Command Syntax" chapter that follows.

Chapter 1: Getting Started
Linking the Program Module Relocatable Object Files



2

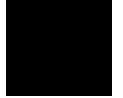

Command Syntax

Syntax for the assembler, macro preprocessor, linker, and librarian.

Chapter 2: Command Syntax

Options may be entered on the command line to control generation of the output listing and object module, and to turn internal assembler flags on and off.

The information on the following syntax pages can be accessed on your workstation via the **man** command. For example, to view the **as86** on-line manual page, just type in the following command:

```
$ man as86
```

If this command doesn't work ("No manual entry"), check that the MANPATH environment variable includes the path \$HP64000/man.

as86(1)

Name as86 - cross assembler for the Intel 8086/186 microprocessors

Synopsis /usr/hp64000/bin/as86 [options] file

Description as86 assembles the named file.

as86 attempts to open the file named on the command line. If this fails and the file does not have a suffix (does not contain a period), as86 appends a .s to the file name and attempts to open that file.

The output is a relocatable file containing Intel 8086/186 instructions and symbolic data. The format of the output file is HP's extension of the INTEL 8086 OMF relocatable file format.

An HP 64000 format assembler symbol file is also produced when the -h option is used. The asmb_sym file name will have a .A suffix added to the source file name.

The name of the object file may be specified with the -o option. If it is omitted, the output file name is created by stripping off the ending suffix from the input file name and appending .o in place of the suffix. Any full path prefix is also stripped from the beginning of the input file name. The output files are placed in the local directory, unless the file named with an -o option specifies a different path.

The -L option may be used to obtain an assembler listing on standard output. Standard output may be redirected into a listing file. This listing contains offsets, instruction codes, symbol table information, symbol table cross reference, and other useful information.

Options The following command line options are recognized by as86:

-f flaglist The flags in flaglist are used to select and change the internal assembler control switches.

Chapter 2: Command Syntax

as86(1)

The flags recognized and their meanings are defined below. Each flag may be set (or unset) either on the command line using the `-f` option as described here or by entering the option in the assembler source program.

Groups of flags following the `-f` option must be separated by commas or separated by white space and quoted. Any option that contains white space must be quoted. For example, the following sets the flags `debug`, `ty`, `title` (my title), and `xref`:

```
-f debug,ty -f "title (my title) xref"
```

A flag may be unset (turned off) by preceding the flag value with `no`. A negated flag may not have a parameter. The following flags may not be negated: `include`, `pagelength`, `pagewidth`, `title`, `date`, `workfile`, and `optimize`. For example, the following turns off the `debug` and `object` flags:

```
-f nodebug,noobject
```

-H asmb_sym_file specifies a file name to override the default file name for the HP 64000 format assembler symbol file. (See the `-h` option below.)

If `asmb_sym_file` has a suffix, then the name is used as is. Otherwise, a `.A` is appended to form `asmb_sym_file.A`.

-h specifies that an HP 64000 format assembler symbol file should be produced. The assembler symbol file name will have a `.A` suffix added to the source file name. The source file name will have all preceding directories and the trailing suffix stripped off before the `.A` is added. If the assembler symbol file is to be used in an HP 64000 station, recall that file names in the HP 64000 are restricted to nine characters in length and must begin with an upper case letter. The default `asmb_sym` file name may be overridden with the `-H` option.

When writing the `asmb_sym` file, all identifiers in the source program are converted to legal HP 64000 identifiers. Illegal characters within identifiers such as `'?'` or `'@'` will be converted to an `'_'`. Identifier names longer than 15 characters will be truncated to 15 characters. No attempt is made to search for duplicate symbols created by the truncation.

-L specifies that an assembler listing file be written to standard output.

-o objfile specifies the name of the output file. This overrides the default file name for the HP-OMF 86 format relocatable file produced.

Flags

The following flags may be specified using the `-f flaglist` option. Flags may be specified as either upper or lower case. All flags have a two-letter abbreviation that may be used. Flags on the command line are set from left to right, so the rightmost setting for a particular flag will be used. Some flags may be used anywhere within a source file, which means the value of a flag might be changed later in the source. These flags are also called general controls. Other flags may only be used on either the command line or the first lines of the source file. These flags are also called primary controls. A primary control used on the command line will override a primary control used in the source file. The last occurrence of a general control will be the one which takes effect. This means that any occurrence of a general control in the source file overrides the general control setting in the command line beginning at the point in the source file where the general control occurs to either the end of the assembly source file or until another duplicate control is found.

<code>case</code> <code>ca</code>	Causes symbols to be case sensitive. That is, upper and lower case characters will be assumed different. The option <code>nocase</code> means that upper and lower case characters in symbols are treated as upper case. Note that INTEL-generated OMF is case insensitive (all upper case). This option, or its negated form, may also be entered on the first assembly source lines. (Default: <code>case</code>)
<code>debug</code> <code>db</code>	Causes debug and type information to be stored in the resulting relocatable file. This option, or its negated form, may also be entered on the first assembly source line. (Default: <code>debug</code>)
<code>eject</code> <code>ej</code>	Causes a page eject to occur and a new page heading to be printed. This option is only useful if a listing is being generated and paging is in effect. This option may be used anywhere within the assembly source.
<code>errorprint</code> <code>['filename']</code> <code>ep ['filename']</code>	Causes error and warning information to be displayed on standard error. If a filename is used with the <code>errorprint</code> control, the filename is ignored. The <code>noerrorprint</code> control suppresses error and warning messages from being displayed on standard error. The <code>nowarning</code> control may be used to suppress warning messages while allowing error messages to be displayed. (Default: <code>errorprint</code>)
<code>extern_check</code> <code>ec</code>	Causes use of external symbols to be checked such that an assume register has been defined that can reference the external symbol. An error is generated if this condition cannot be met. The <code>noextern_check</code> control causes the assembler to allow any use of an external symbol without verifying that the symbol is accessible through an assume register. (Default: <code>extern_check</code>)

Chapter 2: Command Syntax

as86(1)

gen ge	Supplied for Intel compatibility. The assembler does no macro processing. This is done by the macro preprocessor, ap86(1). Therefore, this control has no effect.
genonly go	Supplied for Intel compatibility. The assembler does no macro processing. This is done by the macro preprocessor, ap86(1). Therefore, this control has no effect.
group_info gi	Causes the debug information emitted from the assembler to associate group information to all symbols that belong to segments belonging to a group. Only one group will be assigned, regardless of how many groups a given segment belongs to. The nogroup_info control will only associate group information to labels and procedures; variables will NOT have group information associated with them. (Default: group_info)
hlassym ha	Causes as86 to generate low-level symbol information for static procedures, static data, and embedded code. This option is useful when compiler-generated output is to be debugged in an emulator. If the output is to be debugged in AxDB or AxDE, then the negated form of this option is recommended. (Default: nohlassym)
include('filename') ic ['filename']	Causes the indicated file to be included into the assembly code before any other source is assembled. This option may be used anywhere within the assembly source.
list li ['filename']	Causes assembly source to be displayed in the listing while it is being assembled. The nolist option turns off the listing function until the next list option. This option is only useful if a listing is produced. This option, or its negated form, may be used anywhere in an assembly source file. (Default: list)
mod086 m0	Causes iAPX86 instruction set to be recognized. Errors or warnings will be issued when instructions from conflicting instruction sets are encountered. (Default: mod086)
mod186 m1	Causes iAPX186 instruction set to be recognized. Therefore, BOUND, ENTER, INS, INSB, LEAVE, OUTS, OUTSB, OUTSW, POPA and PUSHA are predefined symbols. The iAPX86 instructions will still be recognized.
modv20 mv	Causes v20/v30 support.

Note	Except for the specific instructions that are V20/V30 extensions, as86 uses Intel mnemonics. as86 uses Intel syntax for all instructions.
object [' <i>filename</i> '] oj	Causes an object (or relocatable) file to be created. The created file will have the same name as the input file, only with a .o extension, unless the -o flag was used. In that case, the object file will have the filename specified with that flag. If a filename is specified with the object control, that filename is ignored. The noobject option causes no relocatable file to be created. This option, or its negated form, may also be entered on the first assembly source lines. (Default: object)
optimize op	Causes extra processing of the input file to remove extraneous NOPs. These NOPs are generated when the assembler encounters certain forward references in instructions. In those cases, the assembler does not know how many bytes the instruction will require, so it allocates the maximum number of bytes needed. If the instruction requires fewer bytes, then the assembler must pad the object code with NOPs, so the addresses of following symbols remains consistent. The optimize option causes the assembler to process the input file to remove these extra NOP bytes, so as to generate the smallest amount of object code possible.
pagelength '(NUMBER)' pl '(NUMBER)'	Sets the maximum number of lines per listing page. This option is only useful if a listing is produced and paging is enabled. This option may be entered on the first assembly source lines. (Default: pagelength(55))
pagewidth '(NUMBER)' pw '(NUMBER)'	Sets the maximum width of each line in the listing. This option is only useful if a listing is produced. This option may be entered on the first assembly source lines. (Default: pagewidth(120))
paging pi	Causes page ejects to occur whenever the maximum number of lines per listing page is generated. The nopaging option causes no page ejects to occur throughout the listing, due to page lengths. This option is only useful if a listing is produced. This option, or its negated form, may be entered on the first assembly source lines. (Default: paging)
print [' <i>filename</i> '] pr [' <i>filename</i> ']	Prints the assembly listing. The noprint control suppresses the generation of the listing file including error messages and symbol table listings. You cannot override noprint with a list control occurring later in the program; however, a list control with no preceding print or noprint implies print. The file name parameter is accepted for Intel compatibility, but it is ignored by

Chapter 2: Command Syntax

as86(1)

the assembler. Any lines that precede the print control will not be output to the listing. (Default: noprint)

restore
rs

Restores a previously saved state for the list/nolist flag. This option is only useful if a listing is being generated. It may appear anywhere within a source file.

save
sa

Saves the current status of the list/nolist flag. These settings may then be restored later by using the restore flag. Up to 64 saves may be made. This option is only useful if a listing is being generated. It may also appear anywhere within a source file.

symbols
sb

Causes an alphabetically-sorted list of symbols to be appended to the listing. This option differs from the xref option in that no cross-reference information is placed in this list. Using the xref option overrides either symbols or nosymbols. This option is only useful if a listing is produced. This option, or its negated form, may also be entered on the first assembly source line. (Default: symbols)

title(TEXT)
tt(TEXT)

Causes the TEXT to become the new title, which is printed at the top of each listing page. This option is only useful if a listing is produced. This option may be used anywhere in an assembly source file. (Default: title (MODULE NAME))

unreferenced_externals
ue

Causes all external symbols, whether they are referenced or not, to appear in the resulting object file. If this option is not used, only those external symbols that have been actually used will be emitted. All unreferenced external symbols would not be generated, since that can cause unnecessary modules to be loaded from library files. (Default: nonreferenced_externals)

warning
wa

Causes warning messages to be displayed on standard error. The negated form suppresses warning messages from being sent to standard error. The errorprint control overrides either use of this control. (Default: warning)

xref
xr

Produces a symbol table in the listing with source line definition and usage cross referencing. This option is only useful if a listing is produced. This option, or its negated form, may be entered on the first assembly source lines. (Default: noxref)

Files

file.s: Assembly language source file.

file.o: HP-OMF 86 format relocatable object file.

file.A: HP 64000 format assembler symbol file.

See Also

HP B1449 8086/186 Assembler/Linker/Librarian User's Guide, ld86(1), ar86(1), ap86(1).

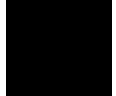

Diagnostics

as86 returns zero if no errors are detected in the assembly source. Otherwise, it returns non-zero.

Diagnostic messages including optional lines containing assembly errors are displayed on standard error.

ap86(1)

Name ap86 - macro preprocessor for the Intel 8086/186 microprocessors

Synopsis /usr/hp64000/bin/ap86 file [-i includepath] [-s] [-e] [-c]

Description ap86 reads the named file and performs macro preprocessor replacements or operations upon this file. The resulting text may be sent to standard output, for redirection to another file for storage. Error messages for macro operations may also be sent to standard error.

ap86 accepts the macro preprocessor language that is described in the Intel 8086 Assembler Reference Manual. This macro language allows the definition and use of macros, evaluation and replacement of expressions, loop control, and including of other text files. Correct use of a macro preprocessor can simplify the task of writing assembly language source when redundant operations are performed or code is shared between files.

Options The following command line options are recognized by ap86:

- i includepath This option causes the macro preprocessor to search that directory for any include files that are referenced in the source file. If this option is not used, the current directory is searched. The search only occurs for file names that use relative paths for the include file. If the path names start with a '/', then no search is required.
- s This option causes the macro preprocessor to send the processed file to standard output. If this option is not used, the input file is processed, but no text output is generated. If this option is used, the output should usually be redirected to a file for use as input to the as86 assembler.
- e This option causes the macro preprocessor to display lines that contain errors and the error message that was generated by processing that line. This text is sent to standard error, so as not to interfere with the -s option. This option is useful since the text generated on standard output does not always display erroneous text in the most identifiable manner.
- c This option causes the macro preprocessor to be case insensitive. The default is case sensitive. For example, if ap86 is started in default mode, then

% SET(var1,-1) and % SET(VAR1,-2) cause substitutions for var1 of -1 and for VAR1 of -2. But if ap86 is started with the -c (case insensitive) option, then the last % SET will cause substitutions for both var1 and VAR1. Note that predefined macro functions written in lower case letters, such as % set and % define, are currently only recognized when the -c option is used. However, predefined macro functions written in upper case letters are always recognized.

Files

file.s Assembly language source file.

See Also

HP B1449 8086/186 Assembler/Linker/Librarian User's Guide, ld86(1), ar86(1), as86(1).

Diagnostics

ap86 returns zero if no errors are detected in the macro source. Otherwise, it returns non-zero.

Diagnostic messages including optional lines containing assembly errors are displayed on standard error.

ld86(1)

Name ld86 - cross linker/loader for Intel 8086/186 microprocessors

Synopsis /usr/hp64000/bin/ld86 [options] [files]

Description ld86 takes one or more relocatable object files as input and combines them to produce a single output file. In doing so, it resolves references to external symbols, assigns final addresses to procedures and variables, revises code and data to reflect new addresses, and updates symbolic debug information (when it is present in a file). ld86 accepts relocatables in Intel 8086 OMF format and HP-OMF 86 format, as well as archive input files in ar86 format. These files may be produced by a cross assembler (as86), or the archive file librarian (ar86). While ar86 libraries are not in strict OMF format, ar86 can read in existing Intel OMF format library files.

By default, the output is HP-OMF 86 absolute. HP-OMF 86 format is HP's implementation of 8086 binary OMF. This file contains Intel 8086/186 instructions and symbolic data. Options to ld86 may be used to create output files in HP 64000 format absolute or the Intel Hexadecimal Object file format absolute.

Typically, the output file contains instructions and data in absolute form. That is, address information has been supplied to locate the program in target memory.

The -i option may be used to specify a relocatable output file in a process called incremental linking. In an incremental link, the input relocatable files are simply combined into an output relocatable file. Incremental linking is only supported for HP-OMF 86 format relocatable. Therefore, the -i option cannot be used with either the -h option or the -H link_symb_file option.
relocatable output file

The operation of ld86 is controlled by LINKER COMMANDS (described below). Linker commands specify the input relocatable and archive files, the location and order of relocatable sections, and the content and format of the output files.

ld86 reads commands from a `command_file` or from standard input if no input filenames were specified on the command line. A `command_file` is specified using either the `-c user_cmd` or `-d` (default `cmd_file`) options. If a `command_file` is not specified (using either the `-c` or `-d` options), then ld86 reads standard input. If standard input is a tty, ld86 enters interactive mode and prompts for commands.

Input files may be specified in "LOAD" commands or on the command line. The order of specification of the input files is significant to the operation of the linker. If input files are specified on the command line, these files are loaded before files specified in "LOAD" commands in the `command_file`.

If the input file names have a suffix, then the name is used as is. Otherwise, ld86 appends `.o` to the name on the command line to form an input file name.

The basic name of the output file is determined in the following way. The default basic file name is the `command_file` stripped of any preceding pathname (up to and including the last '/') and stripped of any suffix (including '.'). The default file name may be overridden by specifying the output file name with the `-o` option. If no `command_file` is used, it is an error not to specify the output file name with the `-o` option.

Depending on the format and type of output file, a suffix is appended to the basic file name to form the output file name.

If the output is HP-OMF 86 format absolute, then the suffix is `.x`.

If the output is HP 64000 format absolute, then the suffixes are `.X` for the absolute file and `.L` for the linker symbol file.

If performing an incremental link, then the output is in HP-OMF 86 format relocatable and the suffix is `.o`.

Options

The following command line options are recognized by ld86:

- `-c command_file` The option specifies the name of the `command_file` to be used to supply information to ld86. The file name part of the command file path, with suffix stripped, is used to form the default names of output files unless the name is specified with the `-o` option.
- `-d` Use the default linker command file. ld86 examines the environment variable `LD86CMD` to find the name of the linker command file. If `LD86CMD`

Chapter 2: Command Syntax

ld86(1)

doesn't exist or is all blank, then the loader attempts to open /usr/hp64000/etc/ld86cmd as the loader command file.

-f flaglist

The flags in flaglist are used to select and change the internal linker control switches.

The flags recognized and their meanings are defined below. A more complete explanation may be found in the HP B1449 8086/186 Assembler/Linker/Librarian User's Guide. Each flag may be set (or reset) in either of two ways. A flag may be set on the command line using the -f option described here. A flag may also be set using the LIST linker command and reset using the NLIST linker command.

Groups of flags following the -f option must either be separated by commas or separated by white space and quoted. For example, the following option sets the flags c, d, s, and x:

```
-f c,d -f "s x"
```

A flag may be reset (turned off) by preceding the flag with no. For example, the following option turns off the o and p flags:

```
-f noo -f nop
```

-H link_sym_file

This option overrides the default file name for the HP 64000 format linker symbol file (.L file) and absolute file (.X file). (See the -h option below.)

-h

The option indicates that the linker should produce HP 64000 format output files. There are two output files, the absolute file and the linker symbol file. The default name for the absolute file is command_file.X and the default name for the linker symbol file is command_file.L. The -f d flag is implied through the use of the -H or -h flags.

It is the user's responsibility to assure that all identifiers (i.e. global symbol definitions and external symbol references) are converted to legal HP 64000 identifiers before being used. For example, Intel assembly language identifiers may contain the characters _ (underscore), ? (question mark), and @ (at sign) and have a maximum of 31 significant characters. To produce legal HP 64000 identifiers, all question marks, and at signs could be converted to _ (underbar). Identifiers will also need to be truncated to 15 characters maximum.

Note Conversion to HP 64000 symbols may have unexpected side effects. Duplicate symbol errors may occur. ld86 DOES perform name translations, but will NOT warn if duplicate symbols have been created. File names must also not exceed 9 characters for the HP 64000 and must begin with an upper case letter.

-i specifies that an incremental link is to be performed. The relocatable input files are combined to produce a relocatable output file. Any linker commands which specify location (e.g. ORDER, GROUP) cause a linker error. The name of the relocatable output file defaults to command_file.o. Incremental linking is only supported for the HP-OMF 86 format. An error will be issued if the -i option is used with either the -h option or the -H option.

-L specifies that an output load map listing be written to standard output.

-o objfile specifies the name of the output file. This overrides the default file name for the HP-OMF 86 format absolute file, the HP-OMF 86 format relocatable file, and the HP 64000 format absolute file.

Linker Commands The linker/loader recognizes the following commands in command files or in interactive mode. Square brackets, [], enclose optional parameters. Ellipsis or '...' indicate the preceding item may be repeated.

*** comment text...** designates a comment.

SEG SEG segment= address
SEG segment= paragraph,offset
SEG /class= address
SEG /class= paragraph,offset

The SEG command specifies the base address of a user's logical segment (LSEG.). The user may also wish to use the ORDER command to control the placement of segments which were not specified in the SEG command.

The 'segment' portion is the name of a relocatable segment which may have a classname attached with a slash, such as 'SEGNAME/CLASSNAME'. If a segment has an associated classname, this classname must be specified or ld86 will not find the correct segment.

Chapter 2: Command Syntax

ld86(1)

The 'class' is the name of a class. A classname preceded by a slash may appear in place of the segment name, whereupon the first segment whose class attribute is 'classname' will be assigned the base address.

The 'address' is the 20 bit address specifying where the segment will begin. The range for 'address' is 0 through 0FFFFFFH. A segment register pointing to the segment should have the value of 'address/16'.

The 'paragraph,offset' base address will be '16*paragraph+ offset' where paragraph or offset may be 0 through 0FFFFH.

Note Addresses are not rounded to conform with an alignment attribute from an ALIGN command.

SEGSIZE SEGSIZE segment= length

SEGSIZE /class= length

The SEGSIZE command specifies the length of a segment in bytes. Although SEGSIZE can be used to set the length of any segment, SEGSIZE is typically used to set the size of a stack segment. A warning message is issued if the segment does not have a combine type of STACK or COMMON.

GROUP GROUP group= address

GROUP group= paragraph,offset

GROUP specifies the absolute base address of a group, which must be a multiple of 16 because it always lies on a paragraph boundary. The GROUP command does not specify the base address of any segments within the group. All such segments should lie within 'group address' through 'group address' plus 0FFFFFFH.

The 'group' is the name of the group.

The 'address' is the 20 bit address specifying where the group will begin. The range for 'address' is 0 through 0FFFFFFH. A segment register pointing to the group should have the value of 'address/16'.

The 'paragraph,offset' base address will be '16*paragraph+ offset' where paragraph or offset may be 0 through 0FFFFH.

ALIGN ALIGN segment= [blank,B,P,I,G,W]

The 'align' command may be used to override the alignment type of an input module without reassembling. A named segment can be specified as Byte, Page, Inpage, Paragraph, or Word relocatable regardless of the type specified by the assembler. This could be used to place all segments on page boundaries while debugging and then to create the final program as byte relocatable without reassembling.

The 'segment' is the name of a relocatable segment. The segment name may have a classname following it, separated by a slash. If a segment has an associated classname, this classname must be specified or ld86 will not find the correct segment.

The 'blank' specifies that the alignment type is to be what the assembler specified.

The 'B' specifies byte alignment.

The 'P' specifies page alignment.

The 'I' specifies inpage alignment.

The 'G' specifies paragraph alignment.

The 'W' specifies word alignment.

Note

Do not put blanks between the '=' and the alignment designator because a blank is a legal alignment designator.

FORMAT

FORMAT [ASCII,HP,OMF86,NOABS]
[INCREMENTAL,LIMITED,LTL]

This command instructs the linker as to what format should be used in the created output file. If the NOABS option is specified, then no object file is generated. If ASCII is specified, then the output file will be in Intel Hexadecimal format. If HP is specified, then the output will be in HP64000 file format. If OMF86 is specified, then the output will be in HP's implementation of Intel OMF file format.

Different forms of OMF can be generated through three modifiers. If no modifier is used, then the output is an absolute file. If the INCREMENTAL modifier is used, then the output is a relocatable object file. If LIMITED is specified, then the output will be an absolute file, but all non-commented records will conform strictly to the Intel absolute file

Chapter 2: Command Syntax

ld86(1)

format document. Finally, the LTL modifier will cause a load-time loadable file to be generated. These options can also be specified through the use of command line options or through the use of the LIST command.

The LIMITED and LTL modifiers are only usable with an output file format type of OMF86.

INITDATA

INITDATA segment [,segment [, ...]] [,address]

Segment is the name of a relocatable segment expressed as either 'segmentname', or 'segmentname/classname', or '/classname'.

Address indicates the beginning address of the ??DATAn/??INIT segment and may be an absolute address from 0 through 0FFFFFFH or the address may be in paragraph, offset from where paragraph and offset are from 0 through 0FFFFFFH. Leading zeros are required on hexadecimal addresses in the initdata command when the hex value begins with A-F.

The INITDATA command is used to specify that the indicated segments and classes will be initialized in memory at run time.

ORDER

ORDER element[, ...]

The first segment specified in the ORDER command will begin at address 0 and subsequent ones immediately after the preceding one. Addresses will not be assigned which conflict with absolute segments, areas specified in RESNUM or RESADD commands, or segments specified in a SEG command. The ORDER command will not override the base address of an absolute segment or one assigned with SEG. However, segments which appear in the ORDER command following one of these segments will be assigned space in memory above it.

The 'element' may be any of the following: a segment name; a classname preceded by a slash; a segment name followed by a slash and a classname; a classname followed by one or more segment names separated by hyphens (as in CLASSNAME-SEG1-SEG2-...-SEGn). A classname preceded by a slash specifies all segment names with that class attribute in the order that the loader finds them. The classname-segmentname-segmentname... element would cause the loader to move the specified segments to the beginning of the class. Any remaining unspecified segments would then immediately follow.

If the first segment in a class has been assigned a base address with the SEG command and an ORDER command has also been used, then the classname should also be placed in the ORDER command so that segments in the class will be assigned adjacent memory.

A segment name may not appear more than once in an ORDER command. This includes both the explicit case of SEGMENT/CLASSNAME and the implicit case of /CLASSNAME. The same classname may not appear more than once following a comma, but it may appear in a SEGMENTNAME/CLASSNAME combination as often as needed.

If an ampersand is encountered while the loader is expecting either a comma or a hyphen, then the next line will be considered a continuation line. Only the last ORDER command is effective. A warning noting that only the last ORDER command is effective will be issued if more than one ORDER command is used.

START START CS-value,IP-value
START address

START specifies the starting values for CS and IP, otherwise they will be taken from the END record of the first main program. If no main program is present, they would be zero.

CS-value and IP-value must be between 0 and 0FFFFH. The address value must be between 0 and 0FFFFFFH.

LOAD LOAD (-)module1[,(-)module2,...,(-)moduleN]

LOAD specifies input object modules to be loaded. Multiple LOAD commands are allowed.

The 'module' is a relocatable object file name or a library file name. Any 'library file' preceded by a minus sign will cause all object modules within the library to be read until an EOF is encountered.

Libraries not preceded by a minus sign will load only those modules needed to resolve undefined EXTRNs.

A library should be loaded after all other non-libraries or else EXTRNs to a library from a subsequently loaded file may not be resolved correctly. Backward EXTRNs within a library are resolved correctly.

Chapter 2: Command Syntax

ld86(1)

END	The END command causes the load to be finished and an output module produced. This command should be included as the last command in a command stream.
[NO]ERROR	<p>[NO]ERROR [UNREF,UNRES,OVERLAP,number] [, ...]</p> <p>The ERROR and NOERROR commands specify that the message or message number indicated is to be treated as an error or a non-error. The undefined external reference message is denoted by the UNREF argument. The unreferenced external message is denoted by the UNRES argument. The memory overlap message is denoted by the OVERLAP argument. If a number is given as an argument then it must corresponds to a particular error or warning number of the linker. These commands have a global effect from the point at which the linker processes the information contained in the command. A subsequent ERROR or NOERROR command overrides any values set by a previous one.</p>
EXIT	The EXIT command causes the linker to exit without finishing the load and without producing an output module. An error message is issued to remind the user that ld86 was terminated early.
PUBLIC	<p>PUBLIC sym1= value1[,sym2= value2]...</p> <p>The PUBLIC command may be used to define and/or change the value of a public definition.</p> <p>The 'symN' specifies a user defined public symbol definition which is considered absolute instead of relative to a segment or a group.</p> <p>The 'value' is the 20 bit value to be assigned to the symbol.</p>
LIST	<p>LIST/NLIST {flag [,flag] ...}</p> <p>LIST sets linker flags. NLIST is the opposite of LIST and suppresses the listing of the elements specified. The flags may also be set on the command line and are defined below.</p> <p>"a" creates an Intel Hexadecimal Object format absolute output file.</p> <p>"b" creates an HP-OMF 86 format absolute output file.</p> <p>"c" prints the identifier cross reference table in the load map. (Default: noc)</p> <p>"d" causes public symbols to be put into the output object module. (Default: d)</p>

"e" causes warning messages to be generated for any remaining undefined external symbols during an incremental link. (Default: noe)

"i" causes incremental linking to occur resulting in a relocatable object file. (Default: noi)

"l" causes warning messages to be printed for any unreferenced, unresolved external references. (Default: nol)

"o" specifies that an object module is produced. (Default: o)

"p" specifies that any symbols present in the input modules (local) be placed in the loader symbol table. Its purpose is to exclude symbols from certain input modules from the output module. One does this by surrounding LOAD commands with NLIST P and LIST P commands. (Default: p)

"q" causes ld86 to produce a 'limited' form of Intel binary OMF which is strictly compatible with Intel's binary OMF document. (Default: noq)

"s" specifies that the local symbols be written into the object module and may be used for debugging. (Default: s)

"t" specifies that the local symbol table be listed in the load map. (Default: not)

"u" disables case sensitivity for matching public symbols, external symbols, segment names, group names, and class names. This also causes all symbols (except module names) to be converted to upper case. (Default: nou)

"v" causes an expanded segment summary that lists the modules where the segment parts came from. (Default: nov)

"w" causes ld86 to display all warning messages. (Default: w)

"x" causes symbols defined in PUBLIC commands to appear in the load map. (Default: nox)

LISTABS

LISTABS [[NO]INTERNALS,[NO]PUBLICS] [, ...]

The LISTABS command controls the output of certain items to the output object module. Multiple LISTABS commands can be specified and have an accumulative effect.

"INTERNALS" causes local symbols to be written to the output file. This is equivalent to the LIST S command. (default: INTERNALS)

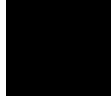

Chapter 2: Command Syntax

ld86(1)

"PUBLICS" causes globally defined symbols to be written to the output file. This is equivalent to the LIST D command. (default: PUBLICS)

The LISTABS command will eventually replace the LIST/NLIST D and LIST/NLIST S commands.

LISTMAP

LISTMAP option [, option] ...

The LISTMAP command controls the output of certain items to the linker's map or listing file. The LISTMAP command options have a global effect. Multiple LISTMAP commands that do not have any inconsistencies with previous LISTMAP commands can be specified and have an accumulative effect.

The valid values for option are as follows:

"[NO]CROSSREF" controls whether or not a cross-reference will appear in the linker listing file. (default: NOCROSSREF)

"[NO]INTERNALS [/BY_NAME,/NAME]" controls the listing of the non-public symbol table to the listing file. If /BY_NAME or /NAME is specified, the symbol table will be sorted by symbol name. (default: NOINTERNALS)

"LENGTH number" controls the page length of the linker listing file. The argument, number, must be between 5 and 255. (default: LENGTH 55)

"[NO]MODULE" controls the output of the module summary to the linker listing file. (default: MODULE)

"[NO]PUBLICS [/BY_ADDR,/ADDR,/BY_NAME,/NAME]" controls the listing of the public symbol table to the listing file. If /BY_NAME, /NAME, or nothing is specified, the symbol table will be sorted by symbol name. If /BY_ADDR, or /ADDR is specified, the symbol table will be sorted by address values. (default: NOPUBLICS)

"[NO]SEGMENT" controls the output of the segment summary to the linker listing file. (default: SEGMENT)

"[NO]VERBOSE" indicates whether or not additional information is to be included in the segment summary portion of the linker listing file. If the LISTMAP NOSEGEMENT option has been selected then the setting for VERBOSE is irrelevant. (default: NOVERBOSE)

"[NO]WARNINGS" controls the output of warning messages to the linker listing file. (default: WARNINGS)

"WIDTH number" controls the page width of the linker listing file. The argument, number, must be between 20 and 255. (default: WIDTH 80)

The LISTMAP command will eventually replace some of the functionality of the LIST command.

NAME name

NAME allows the user to specify the module name in the module header record of the output file.

RESADD

RESADD lowaddress,highaddress
RESNUM lowaddress,number

RESADD and RESNUM allow the user to declare certain areas of memory off limits to the loader.

The 'lowaddress' is a 20 bit address which is the lowest address of the memory that may not be used.

The 'highaddress' is a 20 bit address which is the highest address of the memory that may not be used.

The 'number' is a 20 bit value indicating the number of bytes (including lowaddress) that may not be used.

TYPEMERGE

TYPEMERGE [ALL | SIMPLE]
NOTYPEMERGE

The TYPEMERGE command removes redundant type information from the resulting executable. Normally, no type information is removed by the linker. However, since the HP-OMF 86 file format can only store up to 32k type definitions, it may be necessary to remove some redundant types for larger executables.

The ALL option causes all redundant types to be removed, while the SIMPLE option causes only redundant simple types to be removed.

The NOTYPEMERGE command prevents the linker from removing any redundant types. NOTYPEMERGE is the default operating mode for the linker.

WARN

WARN [UNREF,UNRES,OVERLAP,number] [, ...]

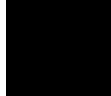

Chapter 2: Command Syntax

ld86(1)

The WARN command specifies that the message or message number indicated is to be treated as a warning. The undefined external reference message is denoted by the UNREF argument. The unreferenced external message is denoted by the UNRES argument. The memory overlap message is denoted by the OVERLAP argument. If a number is given as an argument then it corresponds to a particular error or warning number of the linker.

These commands have a global effect from the point at which the linker processes the information contained in the command. A subsequent WARN command overrides any values set by a previous one.

Files

/usr/hp64000/etc/ld86cmd: Default 8086/80186 linker command file

file.x: HP-OMF 86 format absolute object file

file.X: HP 64000 format absolute file

file.L: HP 64000 format linker symbol file

file.o: HP-OMF 86 format relocatable object file from incremental link

See Also

HP B1449 8086/186 Assembler/Linker/Librarian User's Guide , ar86(1), as86(1), ap86(1).

Diagnostics

ld86 returns zero if no errors are detected while linking, otherwise it returns non-zero. Diagnostic messages are displayed on standard error.

Bugs

Using the -h or -H options will cause global and external identifiers to be converted to legal HP 64000 identifiers. Conversion can cause duplicate symbols to be created.

ar86(1)

Name ar86 - archive/library maintainer for Intel 8086/186 microprocessors

Synopsis /usr/hp64000/bin/ar86
/usr/hp64000/bin/ar86 [options][action] ... archivefile

Description ar86 maintains groups of relocatable files combined into a single archive file. The archive files may then be used by ld86, the 8086/186 linker/loader, to form executable programs for the Intel 8086/186 processors.

Individual relocatable files are inserted without change into the archive file. In addition, there is a library symbol table which is used by the linker/loader, ld86, to effect multiple passes over the library in an efficient manner.

Individual relocatable files define modules which have modulenames. The modulename is usually the same as the name of the assembly source file (with preceding pathname and suffix stripped). However, the assembler, as86, could change the modulename if a NAME directive is used. The modulename is used to identify the various modules that may exist within an archive file.

ar86 operates in either of two modes. The mode is determined by the presence (or absence) of the archivefile name.

In the first mode,

ar86

an archivefile is not specified. ar86 reads librarian commands from standard input. If the standard input is a terminal device, then ar86 operates in interactive mode, prompting the user for librarian commands.

The librarian commands are defined below. The commands completely control the operation of ar86. The commands specify the name of the archive file and the actions to be performed on the modules which constitute the library.

In the second mode,

Chapter 2: Command Syntax

ar86(1)

ar86 [options] [action] ... archivefile

all the control information is contained on the command line.

Archivefile names the archive file to be operated on. If the archivefile does not exist, then an empty archive file is created before the actions are performed.

If the archive file name contains a suffix (i.e. contains a period), then the name is used as is to access the archive file. If the archive file name has no suffix, then .a is appended to the name before accessing the archive file.

[action] is one of the following:

- a filelist The modules contained in the relocatable files in filelist are added to the library contained in the archive file. If a module which already exists in the library is added, it is an error (see -r to replace modules).
- d modulelist The modules in the modulelist are deleted from the library.
- r filelist The modules contained in the relocatable files in filelist replace modules of the same name in the library.
- e modulelist The modules in the modulelist are extracted (i.e. copied) and put into relocatable files. The name of the file is the same as the name of the module but with the suffix .o appended.

These actions are applied in the following order, regardless of their order on the command line: -a, -d, -r, -e.

In filelist (or modulelist), individual file names (or module names) may be separated by commas or separated by white space with the whole list quoted.

If the file names in filelist have a suffix (i.e. contain a period), then the name is used as is to access the relocatable input file. If the name has no suffix, then .o is appended to the name to obtain the name of the input file.

The following option is recognized by ar86:

- L specifies that a library listing file be written to standard output. This output is in the same format as that produced from the LIST command documented below and is for the result of the archive session.

Commands

In the interactive mode, ar86 recognizes the following commands. In the syntax descriptions below, square brackets [] enclose optional items. Ellipsis '...' indicate that the preceding item may be repeated.

ADDLIB archivefile [(module [, ...])]

Add one or more modules from the named library to the present library. If no modules are specified, the entire library is included.

ADDMOD filename [, ...]

Add the module(s) contained in one or more relocatable files to the present library.

CLEAR

Resets the librarian to await the creation or opening of a library. All information about the previous state of the librarian is lost.

CREATE archivefile

Specify the name of a new archive file to be created.

DELETE module [, ...]

Delete one or more modules from the current library.

DIRECTORY archivefile [(module [, ...])] [listfile]

Obtain a brief listing of the modules in a library. If no modules are specified, the entire library is listed. If listfile is not specified, the listing goes to standard output.

**END
QUIT**

Exit the librarian without saving the current library. Use SAVE to save the results of the current session.

EXTRACT module [, ...]

Copy one or more modules to individual relocatable object files. The name of the object file is the module name with .o appended.

FULLDIR archivefile [(module [, ...])] [listfile]

LIST archivefile [(module [, ...])] [listfile]

Obtain a detailed listing of the modules in a library. If no modules are specified, the entire library is listed. If listfile is not specified, the listing goes to standard output.

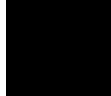

Chapter 2: Command Syntax

ar86(1)

HELP

Displays a list of commands that may be executed at the current time. Only commands that are valid at the current time are displayed.

OPEN archivefile

Specify the name of a existing archive file to be opened. An archive file must be opened before commands like ADDMOD, DELETE, EXTRACT, and REPLACE can be used.

REPLACE filename [, ...]

Replace one or more existing modules in the present library with the modules from the named files.

SAVE

Saves the current library to disk. Use END to exit the librarian. The END command will not save the current library before exiting, so the SAVE command should be used before exiting the librarian if the library is to be saved or updated.

Files

archivefile.a

Relocatable archive file.

file.o

Relocatable file produced by as86(1) or ld86(1).

See Also

HP B1449 8086/186 Assembler/Linker/Librarian Reference Manuals, as86(1), ld86(1), ap86(1).

Diagnostics

ar86 returns zero if no errors are detected. Otherwise it returns non-zero if errors are detected.

Diagnostic messages including optional lines containing assembly errors are displayed on standard error.

Part 2

**Assembler/Macro Preprocessor
Reference**

Part 2

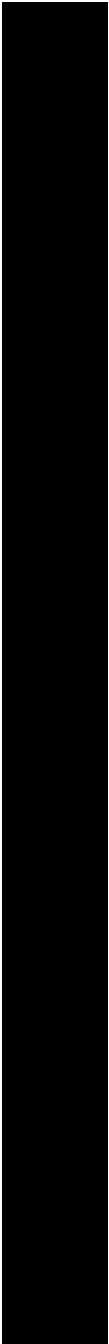

3



Assembler Introduction

Overview of the instruction set, target microprocessors, input and output file formats, and other similar information.

Instruction Set

The as86 assembler supports Intel instruction mnemonics, op codes, and syntax for the target microprocessors and thus is compatible with those used in Intel software and documentation.

The supported instruction set is listed in the chapter titled "Instructions and Operands." For further information about the instruction set, refer to the Intel *iAPX 86/88, 186/188 User's Manual Programmer's Reference*.

Target Microprocessors

The as86 supports the Intel 8086/186 chip family. The 8086/186 family includes the 8086, 8088, 80186, and 80188. In addition to the 8086/186 family, the as86 assembler will accept NEC V20/V30 extensions to the 8086/186. For these instructions, as86 accepts NEC mnemonics, but uses Intel syntax. For overlapping instructions (instructions found in both the 8086/186 and V20/V30), as86 accepts only Intel mnemonics and syntax. Unless an assembler control changes the microprocessor mode, as86 defaults to the 8086 mode.

The as86 assembler also translates instructions specific to the Intel 8087 or 80187 floating-point coprocessor for coprocessor execution.

Assembler Operation

as86 is a two pass assembler. On the first pass, labels, variables, and other user-defined symbols are examined and placed in an internal symbol table. Additionally, structure definitions are stored.

On the second pass, as86 generates the object code, resolves symbolic addresses, and outputs the object module if the assembly was error free. If it was not error free, then as86 displays errors on the output listing device and also a cumulative error count. In addition to the object module, as86 can also output an HP 64000 format assembler symbol file for use in analysis tools.

The assembly listing produced during pass two contains information pertaining to the assembled program, including opcodes, assembled data, and the original source statements. Based on command line options, as86 may also output a symbol table or cross reference table which gives further information not found in the standard assembly listing. Refer to the chapter titled "Assembler Listing Description" for a more complete explanation of the assembly listing and cross reference or symbol table information.

File Formats

Input File Characteristics

The source file input for the as86 assembler is a text file containing 8086/186 instructions, assembler directives, and assembler controls. This file can be produced from an editor or the output file from another component of the HP B1449 package, the ap86 macro preprocessor.

Output File Characteristics

HP-OMF 86

as86 produces a relocatable output object file in HP-OMF 86 format relocatable. HP-OMF 86 format relocatable is a superset of Intel Binary OMF relocatable. HP-OMF 86 format relocatable contains extensions to facilitate code integration and debugging. This format has not been verified to be strictly compatible with Intel Binary OMF relocatable. HP-OMF 86 format relocatable files, therefore, may not work correctly with tools or systems designed to consume Intel Binary OMF relocatable.

HP 64000 Assembler Symbol File

as86 can optionally produce an HP 64000 format assembler symbol file. This file is used by analysis tools. The purpose of the assembler symbol file is to preserve the relationship between symbolic names that appeared in the original source file and the memory locations that they referenced.

Chapter 3: Assembler Introduction
File Formats



4

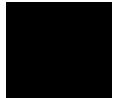

Assembler Syntax

The basic elements of assembler language.

Chapter 4: Assembler Syntax

Assembler Character Set

Assembly language, like other programming languages, has a character set, a vocabulary, rules of grammar, and conventions that allow for definition of new words or elements. The rules that describe the language are referred to as the "syntax" of the language. This chapter describes the basic elements of assembler language:

- the character set
- symbols
- constants
- delimiters

These basic elements, in turn, are put together to form assembler statements. This chapter also gives the general syntax of those statements.

Input source lines over 1024 characters in length will be truncated and an error message will be generated.

Assembler Character Set

The assembler recognizes the characters in the following tables.

The characters are case sensitive by default. If case sensitivity is turned off, then all lower case alphabetic characters are treated as if they were upper case, unless they appear in quoted strings.

Alphabetic Characters

```
A B C D E F G H I J K L M N O P Q R S T U V W X Y Z  
a b c d e f g h i j k l m n o p q r s t u v w x y z
```

Numeric Characters

```
0 1 2 3 4 5 6 7 8 9
```

Special Characters

blank	horizontal tab	>	greater than
\$	dollar sign	<	less than
'	single quote	(left parenthesis
)	right parenthesis	+	plus sign
-	minus sign	.	period
:	colon	!	exclamation point
"	double quote	=	equal sign
?	question mark	%	percent
[left bracket]	right bracket
`	accent grave	{	left brace
	vertical bar	~	tilde
		/	slash
		*	asterisk
		,	comma
		@	commercial at
		&	ampersand
		;	semicolon
		#	sharp
		_	underscore
		\	back slash
		}	right brace
		^	caret (uparrow)

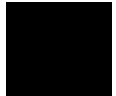

Chapter 4: Assembler Syntax
 Assembler Character Set

ASCII Codes

Char.	ASCII	Char.	ASCII	Char	ASCII
blank	20	@	40	'	60
!	21	A	41	a	61
"	22	B	42	b	62
#	23	C	43	c	63
\$	24	D	44	d	64
%	25	E	45	e	65
&	26	F	46	f	66
,	27	G	47	g	67
(28	H	48	h	68
)	29	I	49	i	69
*	2A	J	4A	j	6A
+	2B	K	4B	k	6B
,	2C	L	4C	l	6C
-	2D	M	4D	m	6D
.	2E	N	4E	n	6E
/	2F	O	4F	o	6F
0	30	P	50	p	70
1	31	Q	51	q	71
2	32	R	52	r	72
3	33	S	53	s	73
4	34	T	54	t	74
5	35	U	55	u	75
6	36	V	56	v	76
7	37	W	57	w	77
8	38	X	58	x	78
9	39	Y	59	y	79
:	3A	Z	5A	z	7A
;	3B	[5B	{	7B
<	3C	\	5C		7C
=	3D]	5D	}	7D
>	3E	^	5E	~	7E
?	3F	_	5F		

Symbols

Symbol Formation

A symbol is a sequence of characters. The first character must be

- A-Z or a-z (alphabetic)
- ? (question mark)
- @ (commercial at sign)
- _ (underscore)

The second and following characters can be any of these characters or the numerals 0-9. Symbols can be up to 255 characters in length, but only the first 31 characters are significant.

Symbols are used to represent arithmetic values, memory addresses, bit arrays (masks), and so on.

Examples of valid symbols:

```
LAB1  
@mask  
LOOP_NUM  
L2345678901234567890123456789012345
```

In the last symbol, the entire symbol is stored, but only 31 characters are used for comparison.

Examples of invalid symbols:

```
ABORT* ;contains special character  
1LAR ;begins with a numeric  
PAN N ;embedded blank, symbol is PAN
```

Different symbols represent different kinds of data objects. In general, only a few kinds of symbols are allowed in any particular syntactic construct. Any of the following elements are considered to be symbols.

Keywords

Keywords (also called Reserved Words) are symbols pre-defined by the assembler which you can reference in certain acceptable constructs. Keyword symbols are not user-definable, nor can you create a user-defined symbol with a name that conflicts with a keyword. Keywords include directives and register names, among others. Keywords are not case-sensitive. The full list of assembler keywords appears in the following table. Although the keywords in the table are in upper case, there is no requirement that they appear in upper case in the source code.

Table 4-1. as86 Assembler Keywords and Instructions

??SEG
AAA
AAD
AAM
AAS
ABS
ADC
ADD
ADD4S
AH
AL
AND
ASSUME
AT
AX
BH
BL
BOUND
BP
BRKEM
BX
BYTE
CALL
CBW
CH
CL

Table 4-2. as86 Assembler Keywords and Instr. (Cont'd)

CLC
CLD
CLI
CLR1
CMC
CMP
CMP4S
CMPS
CMPSB
CMPSW
CODEMACRO
COMMON
CS
CWD
CX
DAA
DAS
DB
DD
DEC
DH
DI
DIV
DL
DQ
DS
DT
DUP
DW
DWORD
DX
END
ENDM
ENDP
ENDS
ENTER
EQ
EQU
ES

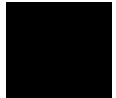

Instruction Mnemonics

A full set of instruction names (mnemonics) is pre-defined by the assembler. Instruction names can be removed from the symbol table with the PURGE directive and re-defined as something else. If you do this, the original meaning of the instruction is lost. There are six instructions (the operators AND, NOT, OR, SHL, SHR and XOR) that cannot be removed. A full list of the pre-defined instruction mnemonics, including the argument combinations acceptable for each, appears at the end of the chapter titled "Instructions and Operands."

Codemacro

A codemacro is a user-defined instruction or prefix to an instruction. The output generated from a codemacro can be a new instruction, a mixture of normal instructions, or just about anything that a customer might want (some assemblers define the normal instructions through the use of codemacros). A codemacro can be defined with the same name as an existing instruction or it can have a completely unique name that describes a new operation. Codemacros can be used anywhere that a predefined instruction can be used.

Label

A label is a user-defined symbol denoting the address of an instruction. Labels can be referenced only in the JMP and CALL instructions and variations thereof. A label can be defined with the PROC directive or with the LABEL directive, but there is another way to define a label that is used most often.

The most common way of defining a label is to place a name (followed by a colon) before an instruction mnemonic, which defines it as a label. Labels have certain attributes, but a discussion of those aspects of labels is left to the chapter titled "Symbol and Expression Attributes." Example:

```
THIS_IS_A_LABEL: MOV AX, 2
```

Variable

A variable is a user-defined symbol denoting the address of a location to be used for data storage. Unlike many other assembly languages, as86 distinguishes between a label and a variable. They are defined according to syntax and cannot be used interchangeably in expressions or instructions.

However, when the LABEL directive is used with the keywords BYTE, WORD, DWORD, QWORD, TBYTE, or with a variable that is a structure name or record name, it defines a variable. When the LABEL directive is used with the type designator NEAR or FAR, it defines a label. Variables have certain attributes, which are discussed in the chapter titled "Symbol and Expression Attributes."

Structure Name

A structure is a user-defined template describing the manner in which a block of storage is to be broken up into elements. A structure template does not have a storage area associated with it which means that a structure name, while it is still a symbol, is not a variable. A structure template name does not have attributes associated with it.

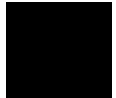

Structure Field Name

The individual elements of the structure template are called structure fields. Structure fields may be optionally assigned names, but again, since the structure template does not occupy storage, the structure field name is not a true variable. A structure field name, when a structure is allocated using the template, can be used with the dot operator to access an element of the structure, but the structure field name cannot be used alone. Structure field names do not have attributes associated with them.

Record Name

A record is a user-defined template describing how a one- or two-byte block of storage is to be broken up into bit fields. A record template does not have a storage area associated with it which means that a record name is not a variable. Record names do not have attributes associated with them.

Record Field Name

Each bit field describes a number of bits and has a name associated with it. Record field names are not variables, however, and do not have any attributes associated with them.

Segment Name

A segment is a user-defined logical division of the assembly source program. A logical segment can contain code, data, or stack information. Logical segments have names associated with them. These names are used to identify the logical segments to the assembler and loader so that they will eventually be placed together in the same physical segment in memory.

Group Name

A group name identifies a collection of logical segments gathered together because of some common factor. At load time, a group will be placed in memory such that any segment that is a member of the group will be within 64 kilobytes of the base of the group. Group names are also significant to the assembler and loader.

EQU Symbols

EQU symbols are names associated with other symbols or expressions through the use of the EQU assembler directive. EQU symbols are simply "replacement names" that can be used anywhere the symbols or expressions they replace could be used. Unlike symbols, however, EQU symbols are not variables and are not allocated storage.

Constants

A constant is an invariant quantity that can be either an arithmetic value or a character constant. Arithmetic values can be represented in either integer or floating-point format.

This section describes integer constants, real constants, and character constants.

Integer Constant

Decimal (base-10) constants can be defined as a sequence of numeric characters optionally preceded by a plus or a minus sign. If unsigned, the value is positive by default.

Internally, the assembler performs arithmetic on 17-bit quantities. A 17-bit value is 16-bit value with the 17th bit (the leftmost bit) as a sign bit. This value may range from -65535 to 65535 (-0FFFFH to 0FFFFH). However, integer constants are only allocated 16 bits when the assembler stores them in the output code. The 17-bit value can be interpreted as a signed or unsigned value and stored in one or two bytes.

A one byte constant can contain an unsigned number with a value from 0 to 255. A two byte unsigned number can range from 0 to 65535. When a constant is negative, its equivalent twos complement representation is generated and placed in the field specified. A 1-byte twos complement number can range from -128 to + 127. A 2-byte twos complement number can range from -32768 to + 32767. Whether or not a number is interpreted as a twos complement or an unsigned number is typically up to you.

Integer constants outside this range (-65535 to + 65535) can appear only in the DD, DQ and DT directives, and on the right side of an EQU directive. The legal range is different for each directive, as discussed in the chapter called "Assembler Directives."

Other Bases

Constants with bases other than decimal are defined by specifying a coded descriptor after the constant. In addition, the base may restrict or expand the accepted digits for the constant. The following list is of the available descriptors and their meanings and the range of acceptable digits for each kind of constant. If no descriptor follows a constant, the number is decimal by default.

- B - a binary constant - digits must be either 0 or 1
- O - an octal constant - digits are 0-7 inclusive
- Q - an octal constant - digits are 0-7 inclusive
- D - a decimal constant (the default if no descriptor appears) - digits are 0-9 inclusive

Chapter 4: Assembler Syntax

Constants

- H - a hexadecimal constant - digits are 0-9 inclusive and the letters A-F (or a-f — either are allowed regardless of case sensitivity)

Note

Hexadecimal constants may not begin with the letters A-F (a-f). In those cases, prefix the constant with a zero.

Examples of acceptable constants:

```
10011B ;binary constant
25      ;defaults to decimal constant
-0FFH   ;hex constant - notice leading 0
1377Q   ;octal constant
2d9fh ;hex constant
```

Real Constant

Real constants can only appear in DD, DQ, DT and EQU directives. There are three syntactically distinct ways of defining real numbers.

Decimal Real Without Exponent

See the following figure for the syntax diagram of decimal reals with exponents.

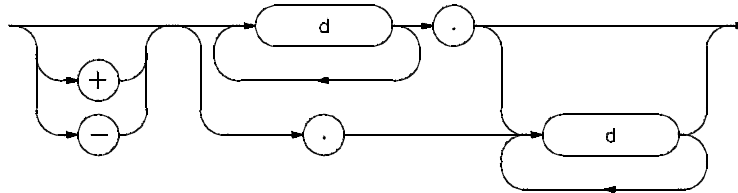

Figure 4-1. Syntax for Decimal Real Without Exponent

Examples:

```
1.234
.1234
1234.
```

Decimal Real With Exponent

See the following figure for the syntax diagram for decimal reals with exponents.

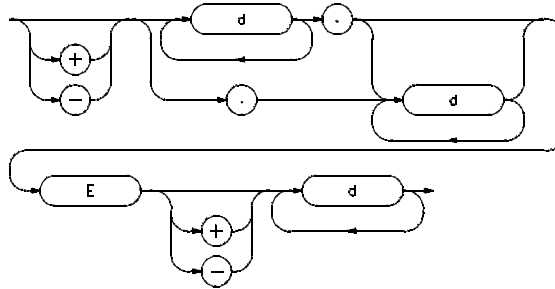

Figure 4-2. Syntax for Decimal Real with Exponent

This format is interpreted to mean that the number to the left of the E is multiplied by 10 raised to the power of the number to the right of the E. Examples:

```
3.14159E-27 ;means 3.14159 * 10-27
-1e4       ;means -10000.
```

Hex Real

The syntax is 8, 16, or 20 hex digits followed by the letter R (or 9, 17, or 21 hex digits if a 0 must be prefixed to constants with leading hex digits of A-F).

Note that no sign is permitted. This format represents the actual bit pattern to be placed in a variable of type DWORD (8 or 9), QWORD (16 or 17), or TBYTE (20 or 21). (Intel's documentation describes the bit patterns used to represent real numbers.) Examples:

```
40490FDBR
0c000000r
```

Character Constant

An ASCII character constant is specified by enclosing one or two characters within single or double quotation marks. The constant is encoded as a 16-bit number stored in different ways depending upon usage.

Chapter 4: Assembler Syntax

Delimiters

A character string of arbitrary length can be specified with the DB assembler directive.

A more complete discussion of character constants is contained in several of the chapters that follow.

Delimiters

The characters "blank" and "tab" are referred to as delimiters.

Note

There must be at least one delimiter between adjacent symbols and/or numeric constants to prevent them from being interpreted as a single item.

Delimiters are significant in character strings. Delimiters are not required between characters that have special meaning to the assembler (such as [, +, =, \$, and so on).

Assembler Statements

General Syntax

The basic elements just described are put together to create statements and instructions that the assembler understands. The rules that govern the ways that statements may be formed are called syntax rules. The general syntax for an as86 assembly language instruction statement is as follows:

```
[ label : ] [ prefix ] keyword [ operand [ , ... ] ] [ ;comment ]
```

Each field in the general syntax has one or more of the delimiters discussed in the previous section between it and adjacent fields. Each field has a different purpose.

Label

The label is optional and, if present, identifies or marks the offset of the instruction. This label may be used as a destination in CALL, JMP or conditional branch instructions. Notice the colon following the label. It must be present if the label is present.

Prefix

The prefix, if present, causes looping with string instructions or forces a bus lock during the instruction's execution. New prefixes can be defined through the use of codemacro definitions.

Keyword

Keywords can be any of the instruction mnemonics (a list of instruction mnemonics appears at the end of the chapter titled "Instructions and Operands"), codemacros defined by the user, or an EQU symbol set to an instruction or codemacro name.

Operand

An operand is an argument to the instruction in the keyword field. Commas separate multiple operands. Operands are discussed more completely in the chapter titled "Instructions and Operands."

Comment

The comment begins with a semicolon and continues until the end of the line. Comments are used to make "notations" about the assembly language code so that you or others may better understand the purpose of the code or how it works.

Comment

Comments can appear after instructions, assembler directives, control statements, macro definitions, or on lines by themselves. In fact, comments can appear anywhere in the assembly source file as long as they are preceded by semicolons. Comments are not processed by the assembler, but are passed through to the assembler listing.

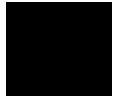

Chapter 4: Assembler Syntax

Assembler Statements

When a comment is on a line by itself, a leading semicolon must be the first non-blank character (tabs are considered blank characters) on the line. Blank lines are treated like comments.

Continuation Lines

Some assembler statements will not fit on a single line. If a statement will not fit on a single line, it may be continued to the next line by beginning the next line with the ampersand (&) character. The ampersand must be in column one of the next line. Symbols, numbers, and strings cannot be broken across lines. It is not acceptable to use the ampersand to continue a comment line. In most cases, an error is likely to occur. Simply begin the new line with a semicolon to make it another comment line.

5



Symbol and Expression Attributes

An introduction to attributes.

Chapter 5: Symbol and Expression Attributes

Symbols and expressions have certain attributes that determine where they may be used with an instruction and what object code will be generated if they are used. Most attributes are only important when a symbol or expression involves a relocatable or external value. Absolute values will not involve most attributes since absolute values are not modified by the loader.

There are nine attributes that a symbol or expression can have. They are

- TYPE
- OFFSET
- BASE
- INDEX
- SEGMENT
- SEGMENT RELOCATION
- RELOCATION TYPE
- SEGMENT ADDRESSABILITY
- CS ADDRESSABILITY

Not all attributes will apply in all cases, however. The following sections discuss the different attributes and how they affect symbols and expressions.

TYPE

The TYPE attribute may belong to either a variable, label, or memory expression. The fixed types are

- BYTE (1 byte)
- WORD (2 bytes)
- DWORD (4 bytes)
- QWORD (8 bytes)
- TBYTE (10 bytes)
- FAR (same or different segment)
- NEAR (same segment)

User-defined types are also possible and are created when a record or structure template is defined. See the chapter titled "Assembler Directives" for more about records and structures.

It is possible for a memory expression to not have a type. Instead, the type is determined by using the expression. These explicitly typeless memory expressions are the so-called anonymous references.

OFFSET

The OFFSET attribute for a variable, label, or memory expression is the offset from the start of a segment or group. It is simply the number of bytes from the start of the segment or group. If the variable or label belongs to a noncombinable segment or if the expression was generated from a numeric value, the offset will be absolute. If the variable or label belongs to a combinable segment or to a group, the offset will be relocatable.

BASE

The BASE register may be set as part of a memory reference. If a base register is used as part of an expression, the expression is known as a register expression, to set it apart from the simpler memory expression.

The base registers are BX and BP. Only one of these registers may be present in a any single register expression, although an index register may be present with the base register. If a base register *is* used in a memory expression, its contents are added to the memory offset at run-time to calculate a final offset for a memory location. If both a base and index register are present in the memory expression, then their values are first added together and then added to the offset to produce the memory reference. If the memory expression does not have a SEGMENT attribute (i.e., no variable, label, or segment override was used as part of the expression), then a default segment register will be used depending upon which base register appears in the register expression. If the BX register is used, DS is the default segment register. If BP is used, the default is SS. The default to SS for BP holds even if an index register is also present in the memory expression.

INDEX

The INDEX register may also be used as part of a memory reference. If an index register is used as part of an expression, either with or without a base register, then the expression is known as a register expression, to set it apart from the simpler memory expression.

The valid index registers are SI and DI. Only one index register can be present in a single register expression. It is also possible, of course, that no index register will be used. If an index register is used in a register expression, its contents are added, at run-time, to a memory offset to calculate a final offset for a memory location. If both an index and base register are used in a register expression, both registers are added to the offset to calculate the final offset. If the memory expression does not have a SEGMENT attribute and no base register is used, then the DS segment register is used as a default.

SEGMENT

The SEGMENT attribute determines which segment a variable, label, or memory expression belongs to. The segment attribute is the base value of that segment. The base value is absolute if the segment has been placed using the AT keyword. Otherwise, it is a relocatable value until load time. (This attribute is also the value that is returned by using the SEG operator.)

SEGMENT RELOCATION

The SEGMENT RELOCATION attribute becomes important when a variable, label, or memory expression belongs to a group. In contrast to the SEGMENT attribute, this attribute determines which *group* the item belongs to. The SEGMENT attribute identifies which segment within the group the item belongs to. These two values must be known to correctly calculate offsets for a memory expression. Normally, this attribute is the same as the SEGMENT attribute unless the expression contains a group override. This attribute can be ignored unless groups are used.

RELOCATION TYPE

The RELOCATION TYPE is determined by a combination of the type of an expression and by operators that are applied to it. This value will be null if the expression can be completely determined at assembly time. This is true of offsets within non-combinable segments and for segment bases of segments that use the AT keyword. This value will be set, however, if the item is an offset from either a combinable segment or a segment base for a non-located segment or group. The possible types of relocation are:

- **OFFSET:** This type of relocation will generate the offset of a variable, label, or memory expression as part of the object code. A 16-bit offset value will be calculated by the loader and inserted into the object code. The offset will be calculated relative to the base of the segment or, if a

Chapter 5: Symbol and Expression Attributes

SEGMENT ADDRESSABILITY

group override is used, relative to the base of the group. It is possible to add a 17-bit value to this offset.

- **BASE:** This type of relocation causes a 16-bit base value to be written directly to the object code. The base will be the base address of the segment that the variable, label, or memory expression belongs to unless a group override is used. In that event, the base will be the base address of the group. It is possible to add a 17-bit value to this base.
- **HIGH:** This type of relocation causes the upper 8-bit portion of an offset to be written to object code. The offset is calculated using the same rules as noted above, but only the high byte will be written out. It is possible to add an 8-bit value to this byte.
- **LOW:** This type of relocation causes the lower 8-bit portion of the offset to be written to object code. The offset is calculated using the same rules as noted above, but only the low byte will be written out. It is possible to add an 8-bit value to this byte.

SEGMENT ADDRESSABILITY

The **SEGMENT ADDRESSABILITY** of a memory location is determined by the segment the memory location belongs to and by any segment or group overrides applied. If a segment override is used to name a specific segment register, that register is used to address the memory location. Otherwise, the values found in the **ASSUME** directives must be tested. If the segment or group is found through the current **ASSUME** values, then that segment register is used to address that memory location. If no match is found, an error is generated, since the memory cannot be accessed.

It is possible to have a memory location that does not belong to a segment or group. This would be true of an anonymous memory reference, which looks like

```
[BX][SI]  
; base and index registers
```

In such a reference, the segment addressability will be determined by using the default segment registers defined for the base and index registers. Recall that

the default segment register will be DS unless the BP base register is used, in which case the default will be the SS segment register.

CS ADDRESSABILITY

The CS ADDRESSABILITY of a label is determined from both the current ASSUME value for the CS register, and any segment or group overrides that are applied to the label.

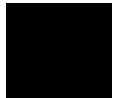

Chapter 5: Symbol and Expression Attributes
CS ADDRESSABILITY



6

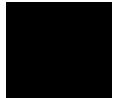

Assembler Directives

Alphabetical description of assembler directives.

Chapter 6: Assembler Directives

This chapter describes the as86 assembler directives. In an assembly language program, assembler directives are written as any other program statement might be, but directives are not translated into equivalent machine language instructions. Instead, assembler directives are interpreted as *instructions to the assembler* to control the program assembly process itself.

In this chapter, directives are organized in alphabetical order for easy reference. (The DB, DW, DD, DQ, and DT directives are described together because of their similarity.) However, assembler directives may also be grouped into three broad categories —Segmentation Directives, Data Definition Directives, and Program Linkage Directives— which identify the parts of the assembly process the different directives are designed to affect. Segmentation Directives inform the assembler about the logical organization of your program. Data Definition Directives control the allocation and initialization of data, variables, and labels. Program Linkage Directives make it possible to create modular assembly language programs. The first sections of this chapter list the directives grouped by these three categories, briefly describe their functions, and more thoroughly discuss some concepts important to understanding how these directives work.

Segmentation Directives

ASSUME informs the assembler of the contents of the segment registers.

GROUP combines several logical segments together.

SEGMENT/ENDS defines a logical segment in the assembly language program code.

These directives control program segmentation (the dividing of the assembly program into logical parts). To better understand program segmentation, read the following discussion.

Program Segmentation

The 8086 can directly address one megabyte of memory. This memory is viewed by the CPU through four segments, known as physical segments, each containing up to 64K bytes. The start of each segment is defined by a value, called a paragraph number, placed in one of the four special registers known as segment registers. A paragraph number, or boundary, is located at a memory address which is divisible by 16 (that is, the least significant hexadecimal digit of the address is 0H). A physical segment is said to be *active* if one of the segment registers contains the base address of the start of the segment.

The four segments are classified as the code, data, stack, and extra segments. They are each pointed to by a separate segment register:

CS for code

DS for data

SS for stack

ES for extra

Executable instructions will be in a physical segment defined by the value in CS. Any stack operation will occur within the segment defined by SS. Data is generally found in the segment pointed to by DS, but it can also be placed in any of the other segments. The segment accessed through the ES register will usually hold data also.

Chapter 6: Assembler Directives

A logical segment is a segment as defined within a single assembly file. The linking loader can combine this logical segment with other segments of the same name to form a single physical segment. The size of the physical segment is limited to 64K, so the sum of the logical segments cannot exceed this limit. The collection of segments into a group is another form of physical segment.

Default Segment - ??SEG

All code and data within a source file must exist within some segment. Any code or data defined outside of segment directives within a source file will be assigned to a segment automatically created by the assembler. This segment is named ??SEG and exists in all object files. The ??SEG segment is defined to be public, so it is combined with all other ??SEG segments from other modules. It is also defined to be paragraph aligned.

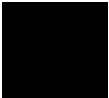

Data Definition Directives

DB defines one byte of storage.

DW defines one word (two bytes) of storage.

DD defines one double word (four bytes) of storage.

DQ defines one quad word of storage (eight bytes - 8087 data types).

DT defines one tbyte (ten bytes - 8087 data types) of storage.

EQU assigns a particular value to a symbol.

EVEN aligns code or data with a word boundary.

ORG adjusts the location counter within the current segment.

PROC/ENDP assigns a label to a sequence of instructions.

PURGE causes a user-defined symbol to become undefined.

RECORD defines a record template.

STRUC/ENDS defines a structure template.

Data Definition Directives control the definition and initialization of data and/or storage as labels, variables, records, or structures.

Data Objects

The two most referenced data objects are variables and labels. With the Data Definition Directives, you may define these and other data objects in your program. Variables are data items, or areas of memory where values are stored. Labels allow you to "mark" locations or sections in your code that may be JMPed to or CALLed. One use of labels is to define "subroutine" locations in order to create structured programs. Unlike high-level language subroutines, however, scoping of names does not occur and you can "fall into" an embedded "subroutine."

Records and structures may also be defined by this category of directives. Records and structures are alike in that they are user-defined templates for storage allocation and initialization, they are not allocated storage at

Chapter 6: Assembler Directives

definition time, the assembler "remembers" what they look like, they can be referenced as often as you like, and each reference generates one or more copies of storage in the format of the template. At the time of the reference, records and structures may optionally have certain of their definition-time default values replaced.

Records and structures are different, however, in their basic makeups. When you define a structure, you specify how many bytes the template covers, how the bytes will be broken up into variables, and what default values will be placed into those bytes at allocation-time. In contrast, a record must be a one or two byte collection of bit fields. When defining a record, you specify how the record is to be broken up into bit fields, and any default values to be placed in the bit fields at allocation-time. The record size depends upon the sum of the number of bits in all the bit fields, which means the total may not exceed 16 bits.

Linkage Directives

END specifies the end of an assembly module.

EXTRN specifies symbols defined in other modules.

NAME assigns a name to an assembly module.

PUBLIC specifies which symbols are public.

Program Linkage Directives make it possible for you to create modular assembly language programs. Refer to the discussion of program linkage that follows to better understand the use of these directives.

Program Linkage

as86 supplies the necessary directives to support multi-module programs. A program may be composed of many individual modules that can be separately assembled or compiled. Each module may define variables or labels that other modules may use. The Program Linkage Directives are the mechanisms in as86 for communicating symbol information from module to module, for identifying those symbols within the current module that may be used by other modules, for stating what symbols (defined elsewhere) can be used within the

Chapter 6: Assembler Directives

current module, and for uniquely naming different object modules that are to be linked together. Using these directives, you may specify a "main module," that is, a module which contains the code that will be initially executed upon loading the program (the address the loader will use to initialize the start address of the program). At the same time, you may also supply initialization values for other segment registers.

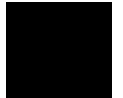

ASSUME

The ASSUME directive is used to inform the assembler of the contents of the segment registers.

Syntax:

```
ASSUME segreg:segpart [,...]
(or)
ASSUME NOTHING
```

Where:

segreg is one of the segment registers CS,DS,ES or SS.

segpart is one of the following:

- **A segment name.** The base address of the segment is assumed to be in the named register. All data (or code) in the segment is addressable through this register.

Example:

```
ASSUME CS:CODE, DS:DATA
```

- **A group name** (must have been previously defined). The base address of the group is assumed to be in the named register. All code or data in all segments in the group are addressable through this register. Example:

```
ASSUME CS:CODEGRP, DS:DATAGRP
```

- **A forward reference.** Forward references with ASSUME are only allowed for symbols which will be defined as segment names later in the program. When the segment name is later defined, then it may be used to address memory within the segment. Failure to define the segment name will cause an error to be reported.
- **The keyword SEG followed by the name of a previously-defined label, variable or external symbol.** The base address of the segment containing the symbol (which may not be known until link-time) is assumed to be in the named register. The specified symbol and any other data known to be

in the segment are addressable through the register. (For an external symbol defined outside a segment, no such data is known.) Example:

```
ASSUME CS:SEG START, DS:SEG COUNT
```

- **The keyword NOTHING.** The register is assumed to contain garbage. The register will not be used to address any memory. The format

```
ASSUME NOTHING
```

is also legal; this is equivalent to

```
ASSUME CS:NOTHING, DS:NOTHING, ES:NOTHING, SS:NOTHING
```

Description: ASSUME is used by the assembler to

- determine if the code or data your program references is addressable
- decide whether a segment override byte should be generated.

Initially, the segment registers contain NOTHING (garbage) by default. The assembler assumes the contents of each segment register has not changed—since initialization or the last ASSUME—unless an ASSUME for that register is encountered. ASSUME itself, however, does not alter the value in the segment register. For example, the statement 'ASSUME DS:DATA' does not alter the contents of DS. You must, at some point, follow the ASSUME with a MOV instruction to DS in order to access data in the DATA segment without error.

CS register initialization, since it is done by the loader, does not require a MOV, but CS still requires an ASSUME before it may be used.

Note

There is an exception to the requirement that the CS register must have an ASSUME before it is used. When a JMP instruction is used without a current CS-ASSUME value, the default is to ASSUME the current segment. The segment registers will not be checked. This only applies to NEAR references, since a JMP to a FAR label requires that the CS register be updated.

DB, DW, DD, DQ, DT

The DB, DW, DD, DQ, and DT directives are used to define variables and/or initialize memory.

Syntax:

1 byte (Byte) initialization:
[name] DB init [,...]

2 byte (word) initialization:
[name] DW init [,...]

4 byte (dword) initialization:
[name] DD init [,...]

8 byte (qword) initialization:
[name] DQ init [,...]

10 byte (tbyte) initialization:
[name] DT init [,...]

(or)

[name] Dx repeatval DUP(init,[,...])
(where x is B, W, D, Q, T)

Where:

name is a unique as86 symbol. Its associated attributes will be:

- **segment** - current segment
- **offset** - current location counter
- **type** - type of data initialization unit

init may take on many possible values depending upon what type of initialization you wish to do. Init may be any of the following:

- **A constant expression.**

- **DB** - 1 byte initialization. An integer constant or an expression which fits into 8 bits (either 0-extended or sign-extended) when stored in twos complement format. The range is -255 to + 255. High and low relocatable numbers (created by the HIGH and LOW operators) are also acceptable scalars. Other relocatable numbers, such as the offset of a variable, are not acceptable. Examples:

```
DB 0
```

```
DB 65535 ;not accepted, out of range
```

```
DB -1 ;these are equivalent
```

```
DB 255 ;both generate hex FF
```

- **DW** - 2 byte initialization. A constant or expression that evaluates to a number (either absolute or relocatable) which must fit into 16 bits (either 0-extended or sign-extended) when stored in twos complement format. The range is -65535 to + 65535. Examples:

```
DW 0
```

```
DW 65536 ;not accepted, out of range
```

```
DW -1 ;these are equivalent
```

```
DW 65535 ;and generate hex FFFFH
```

- **DD** - 4 byte initialization. An integer constant or an expression that evaluates to an absolute number. The value must fit into 16 bits (either 0-extended or sign-extended). The range is -65535 to + 65535. The 16-bit value is stored in the lower 2 bytes in twos complement format (least significant byte first) and the higher 2 bytes are sign-filled. Relocatable numbers are not permitted (it is impossible to determine how to fill the higher 2 bytes at assembly-time).

Use DD for an integer constant in the range -4,294,967,295 to + 4,294,967,295 (from $-(2^{32}+1)$ to $(2^{32}-1)$), but not small enough to qualify for DW. Note that an expression cannot yield a value this large; all expressions evaluate to 17-bit numbers. The value is stored as a 32-bit twos complement integer, low byte first.

Chapter 6: Assembler Directives

DB, DW, DD, DQ, DT

A decimal real. The valid range is roughly -3.4E38 to -1.2E-38, 0, 1.2E-38 to 3.4E38.

A hex real of 8 digits (or 9 digits if its leading digit is 0).

Examples of the possibilities:

```
DD 0           ;yields 00000000
DD 65535      ;yields FFFF0000 (low byte first)
              ;in 16-bit range
DD -1        ;yields FFFFFFFF

DD 65537      ;yields 01000100 (low byte first)
DD -65537     ;yields FFFFFFFF (low byte first)

DD 0.0        ;a decimal real
DD 3.14159    ;another decimal real

DD 0C0000000R ;a hex real
```

- **DQ** - 8 byte initialization. An integer constant, or an expression whose value resolves to a 17-bit absolute number. The range of constants is $-(2^{64}+1)$ to $(2^{64}-1)$. Such integer values are stored in 64-bit twos complement format.

A decimal real number which has an approximate legal range of values is -1.7E308 to -2.3E-308, 0, 2.3E-308 to 1.7E308.

A hex real number consisting of 16 digits (or 17 digits if its leading digit is 0).

- **DT** - 10 byte initialization. An integer constant, or an expression that resolves to a 17-bit absolute number. The range of constants is $-(10^{18}+1)$ to $(10^{18}-1)$. All integer values are stored in 80-bit signed-magnitude packed decimal (BCD) format, least significant byte in the lowest address.

A decimal real number that has an approximate range of -1.1E4932 to -3.4E-4932, 0, 3.4E-4932 to 1.1E4932.

A hex real number consisting of 20 digits (or 21 digits if its leading digit is 0). Examples:

```
DT 65535      ;generates 35550600000000000000H      ;(low byte first)
DT -65535     ;generates 3555060000000000000080H     ;(low byte first)
```

- The character '?' for indeterminate initialization.

- In situations where you wish to reserve storage but do not need to initialize the area to any particular value, use the special character "?" instead of a value. The area will be reserved with an indeterminate value. Examples:

```
ABYTE DB ? ;reserve a byte
AWORD DW ? ;reserve a word (2 bytes)
ADWORD DD ? ;reserve a double word (4 bytes)
AQWORD DQ ? ;reserve a quad word (8 bytes)
ATBYTE DT ? ;reserve a tbyte (10 bytes)
```

- **An address expression.**

Note

Assume registers are not checked when these directives are used with address expressions. Therefore, the only way to get a group-relative reference is to use a group override in the address expression.

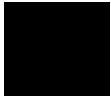

- **DW** - 2 byte initialization. DW may be used with a variable name, a label name, a group name, or a segment name. Using DW with a variable or label name causes the offset of a variable or label (relative to its segment or, if a group override is used, to its group) to be stored. Using DW with a group or segment name causes the paragraph number of that group or segment to be stored.

Examples:

```
DW COUNT ;COUNT is a variable or label
;store offset of COUNT from its segment

DW DATAGRP :COUNT ;store offset of COUNT from its
;group (DATAGRP)

DW CODE ;CODE is a segment or group name
;store the paragraph number
```

- **DD** - 4 byte initialization. DD may be used with a variable name, a label name, a group name, or a segment name. Using DD with a variable or label name causes the offset (relative to its segment or, if a group override is used, to its group) of the variable or label to be stored in the low order word and the segment or group base address for the label or variable to be stored in the high order word. Using DD with a group or segment name causes the paragraph number of that group or segment to be stored in the

Chapter 6: Assembler Directives

DB, DW, DD, DQ, DT

low order word. The high order word will be set to 00H. Using DD with a variable or label name is equivalent to storing a pointer to the variable or label address. Examples:

```
DD COUNT      ;COUNT is a variable or label, a  
              ;pointer to it is stored
```

is equivalent to

```
DW COUNT      ;store offset of COUNT  
DW SEG COUNT  ;store COUNT's segment
```

- **Initialize with a string.**

- **DB** - 1 byte initialization. A string of up to 1024 characters may be specified with the DB directive. Each character in the string, left to right, is assigned one byte of memory, low address to high address. The string must be enclosed within single or double quotes. A single quote may be embedded in the string by using two consecutive quotes. Examples:

```
ALPHABET DB 'ABCDEFGHIJKLMNOPQRSTUVWXYZ'  
WITHQUOTE DB 'THIS AIN''T HARD!'           ;inserting single  
                                              ;quote in string
```

- **DW, DD, DQ**, You may use these directives to code a string of 1 or 2 characters. Such a string is interpreted as a 17-bit number that is stored differently than it would be if DB were used. If two characters are stored, the second character in the string appears in the low byte of the storage and the first character appears in the next higher byte of the storage. If only one character is stored, the low byte of the storage contains the character. With either a 1 or 2 byte string, if any bytes of the storage remain unfilled, they are set to 00H. Using more than 2 characters in a string results in a warning message and only the first 2 characters are used.
- **DT** DT can also code a two character string, but it does it in a way different from the other directives. DT stores the string in BCD packed decimal format. If a single character is stored, its decimal ASCII value is stored in the low byte of storage. The remaining bytes are set to 00H. If two characters are stored, however, it becomes more complicated. It is done as follows:

The 17-bit hexadecimal number representing the string is converted to its decimal equivalent. (The 17-bit hex number is formed by placing the ASCII hex value of the first character of the

2 character string in the leftmost byte of the 17-bit word and placing the ASCII hex value of the second character in the rightmost byte of the 17-bit word. The sign bit is zero.)

Beginning with the rightmost digit of the resulting decimal value, the decimal representation is stored 2 digits per byte, working from right to left in the decimal value, until all digits are stored.

Any remaining bytes of storage are set to 00H.

Examples:

```
DB '01' ;generates 3031H (shown low byte first)
DW '01' ;generates 3130H (shown low byte first)
DW '1'  ;generates 3100H (shown low byte first)
DD '01' ;generates 3130 0000H (shown low byte first)
DQ '01' ;generates 3130 0000 0000 0000H
        ;(shown low byte first)
DT '01' ;generates 3723 0100 0000 0000 0000H
        ;(shown low byte first)
```

Repeating value. The special construct, DUP, can initialize an area of memory with a repeated value or a repeated list of values.

- **repeatval** specifies the number of data initialization units (from 1 to 65535) to be filled (bytes, words, dwords, qwords, or tbytes depending upon whether Dx is DB, DW, DD, DQ, or DT).
- **init** (as an argument to DUP) may be a single occurrence of the possibilities that were acceptable for **init** in the non-repeating-value syntax, including another DUP, or **init** may be a *list* of these same values. DUPs may be nested to eight levels deep. Below are some examples:

```
WORD1 DB 2 DUP (?) ;two consecutive bytes form word
DD 2 DUP ('01') ;generates 3130000031300000H
NESTEDDUP DB 3 DUP (4 DUP (5 DUP (1, 6 DUP (0))))
           ;60 occurrences of 1,6 DUP (0)
```

If an indeterminate initialization is repeated, the memory reserved by that data directive will NOT be initialized to 0. Also, repeating a relocatable value (such as a location in memory) will result in only the first value being assigned correctly. So this practice is discouraged.

Description: The DB, DW, DD, DQ, and DT directives are used to define variables and/or initialize memory. The descriptions of the parts of the syntax adequately describe these directives.

END

The END directive is used to inform the assembler that the last source statement has occurred and optionally to specify initial values for selected registers.

Syntax:

```
END [regint [,...]]
```

Where:

regint This field defines the contents for a segment register (and possibly the IP and SP registers). To initialize the segment registers, the field may take one of the following forms:

```
[CS:] segname[:labelname]  
DS: segname  
SS: segname[:varname]
```

where

- **segname** is either a segment name or a group name. It identifies the paragraph number to be loaded into the segment register.
- **labelname** is the name of a label defined in the module. If it is used alone, its segment will be used to initialize the CS register and its offset will initialize the IP. If it is used with a segname, then just its offset will be used to initialize IP.
- **varname** is the name of a variable defined in the module. Its offset will be used to initialize SP.

Description:

An END directive is required for all assembly language programs. Any statements that follow the END directive will not be processed. Specifying a load address with the END directive also informs the loader that the current module is the main program. The main program defines the start of execution because execution begins at the address specified with the END directive for the main program. If multiple load modules are combined by the loader, only one module can specify a load address and therefore be considered the main program.

The END directive may also be used to define the initial contents of the DS and SS segment registers by specifying values to be placed in these registers by the linker/loader at load-time.

Note

If the code is to be targeted for HP 64000 format absolute, you may only initialize the CS:IP register with END. Initialize the other registers explicitly within the code.

Examples

The following examples show the proper syntax for initializing different segment registers.

CS (code) segment register initialization:

```
END labelname           ;initializes CS and IP
                        ;(the segment part of the
                        ;label is used for CS)
(or)
END CS:labelname        ;same as 'labelname'
(or)
END CS:segname:labelname ;the segment part (paragraph
                        ;number) to be loaded into
                        ;CS is taken from segname
```

SS (stack) segment register initialization:

```
END SS:segname          ;SP will be initialized to be
                        ;equal to the size of the
                        ;segment
```

(or)

```
END SS:segname:varname ;initializes SS and SP
                        ;(SP will be initialized to
                        ;the offset of varname)
```

DS (data) segment register initialization

```
END DS:segname          ;initializes DS
```

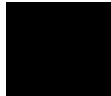

EQU

The EQU directive causes the assembler to assign a particular value to a symbol.

Syntax:

```
equate_symbol EQU expression
```

Where:

equate__symbol is a mandatory symbol defined by this statement.

expression is one of the following items:

- **A numeric constant or numeric expression.** The value of the expression must be determined at assembly time. Any symbols used in the expression must have been previously defined. See the Description section below for more discussion about real constants. Examples:

```
PI EQU 3.14159           ;real constant stored with
                        ;10 byte precision
DD PI                   ;4 byte floating point
DQ PI                   ;8 byte floating point
DT PI                   ;10 byte floating point

E1 EQU 2 + 3            ;numeric expression
E2 EQU E1 AND 4         ;E1 previously defined
E3 EQU (E1 - E2) / 12   ;E1 and E2 previously defined
```

- **A variable or label name** (which may be a forward reference).

```
ALABEL EQU ALAB        ;ALAB not defined yet
ALAB: MOV AX, 0
```

- **A register name**, including ST registers. Example:

```
COUNT EQU CX
POINTER EQU BX
MOV COUNT, 10          ;CX = 10
MOV POINTER, OFFSET ARRAY ;BX = offset of array
FREQ EQU ST(1)
FADD ST, FREQ
```

- **An instruction or codemacro name.**

```
BUMP EQU INC           ;instruction name
BUMP AX                ;same as INC AX
```

- **A register expression.** These may be single register expressions, or they may also include a segment override. This construct is useful when

defining data items to be accessed on the stack. Refer to the Description section for a more information about the use of register expressions.

Examples:

```
STACKWORD EQU WORD PTR SS:[BP + 2]
AVAR EQU [BX + 3]
ANEXTVAR EQU ES:[BX]
```

Description:

The EQU directive in as86 is more powerful than the EQU found in most other assemblers. All the various attributes of address expressions are stored, and any missing attributes may be added later with expression operators at the time the EQUed symbol is referenced.

Decimal real numbers are stored in a full 10-byte format to prevent a loss of precision; they may be used in DD, DQ, or DT directives later in your code. Hex real numbers, however, are stored in as many bytes as the specification indicates; they can be used later only in the single directive that accepts a hex real of that size.

It is possible for a symbol to appear as a forward reference before it is defined in an EQU. When this happens, the assembler assumes that the forward reference will resolve to a number, variable or label. If this turns out not to be the case, an error may occur on pass 2 if the assembler did not leave enough room for an instruction on pass 1.

Symbol chaining (defining a symbol in terms of another symbol which is in turn defined by another symbol) can be accomplished with the EQU directive, but the chain must eventually end as a numeric or address expression. An error occurs if the definition ends in a register or real number expression. Circular EQU definitions are also errors. Example:

```
A EQU B
B EQU A ;ERROR! circular reference
```

A symbol defined by an EQU to an *address expression* consisting of more than one symbol (for example, BYTE PTR VBL) is stored as a variable or label, if possible. The entire EQU expression takes its attributes from the sub-expression on the right-side of the EQU. However, not all attributes will be set if attributes are missing from the right-side sub-expression. If that is the case, missing attributes must be supplied when the symbol on the left-side of the EQU is used elsewhere in an expression.

Examples:



Chapter 6: Assembler Directives

EQU

```
A EQU [BX][SI][5]      ;anonymous reference - type
                        ;information must be supplied
                        ;when A used elsewhere
B EQU WORD PTR 10      ;segment information must be
                        ;supplied later
```

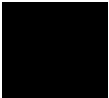

EVEN

The EVEN directive causes the Location Counter to be aligned to an even value (a word boundary).

Syntax:

EVEN

Description:

The assembler brings about alignment by generating a NOP (90H) instruction if the current location counter contains an odd address value. The EVEN directive cannot be used in a byte aligned segment. Doing so will cause an error message to be generated.

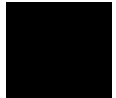

EXTRN

The EXTRN directive is used to declare certain symbols as external references.

Syntax:

```
EXTRN name:type [, ...]
```

Where:

name is a symbol, declared PUBLIC (see PUBLIC directive later in this chapter) in another module, to be defined as an external reference. Its associated attributes are the following:

- **segment** - unknown unless defined within a SEGMENT/ENDS pair
- **offset** - unknown
- **type** - type declared in **type** argument
- **relocation type** - external

type is one of the following:

- The keyword **BYTE**, **WORD**, **DWORD**, **QWORD**, or **TBYTE** for a variable which is one of these types.
- **A structure name.** Names a variable whose type is equal to the number of bytes allocated in a preceding structure definition.
- **A record name.** Names a variable whose type will be either byte or word depending on the preceding record definition.
- **NEAR** or **FAR.** A label of type near or far.
- **ABS.** A constant (17-bit number), always of type word.

Description:

Symbols declared as EXTRN are not expected to be defined in the current module (they cannot be), but are passed to the loader to be matched against symbols declared PUBLIC in other modules. In as86, the EXTRN directive will specify the name of the symbol and its associated type.

Note

The type declaration must agree with the type of the symbol declared PUBLIC, but the loader does not do type-checking. It is your responsibility to maintain type compatibility.

The type ABS is used to declare a constant. Despite the mnemonic ABS, this number can prove to be offset relocatable or absolute when it is resolved depending upon how it was defined as a PUBLIC symbol. In either case, name can be used and treated like a constant value.

You must be careful in the placement of the EXTRN directive in relation to the definition of the program segment. If you know the segment in which the external symbol was defined as PUBLIC, place the EXTRN directive between a SEGMENT/ENDS pair that is *identical* to the SEGMENT/ENDS pair in which the object was defined in the other module. An external symbol defined in this manner will be addressable through the segment register containing the segment in question. In particular, a NEAR label defined EXTRN must be defined in segment identical to the one where it is defined PUBLIC because of the NEAR type restrictions.

Example:

In module "A"

```
DATA SEGMENT WORD PUBLIC
COUNT DB 0           ;declared as byte through DB
PUBLIC COUNT
DATA ENDS
```

In module "B"

```
DATA SEGMENT WORD PUBLIC ;different module, but same
                        ;segment declaration
EXTRN COUNT:BYTE       ;typed as byte
DATA ENDS
```

If you do not know the segment in which the external symbol is defined, or if the segment in which it is defined is non-combinable, place the EXTRN directive outside of all SEGMENT/ENDS pairs in your program. To address the external symbol you must load the segment part (paragraph number) of the symbol into a segment register using the SEG operator and then either use an ASSUME directive to verify addressability or use a segment override for each use of that symbol.

Chapter 6: Assembler Directives

EXTRN

Note

The 8086/186 linker does NOT verify that the definition of an external symbol matches the definition of its resolving public symbol. It is up to the user to make sure that external symbol definitions are placed within the correct segment or they should NOT be placed in a segment at all.

Example:

```
MOV AX, SEG COUNT
MOV ES, AX          ;loads segment
```

(then)

```
ASSUME ES:SEG COUNT ;verify addressability
MOV DL, COUNT       ;use symbol
(or)
MOV DL, ES:COUNT   ;use segment override
```

GROUP

The GROUP directive is used to specify several logical segments that are to be placed in the same physical segment.

Syntax:

```
name GROUP segpart [,...]
```

Where:

name is a mandatory, unique, user-defined name for the group.

segpart is one of the following:

- **A segment name.**
- **The keyword SEG followed by the name of a previously-defined variable, label, or external symbol.** This construct refers to the segment in which the specified symbol lies. For externals, this may not be discovered until link-time.
- **An undefined symbol** that must be defined later in the program as a segment name or the assembler reports an error.

Description:

At assembly-time you may specify that certain logical segments will all go in the same physical segment so the assembler will know that all such segments may be accessed from the same segment register. Such a collection of segments is called a *group*. The ordering of the segments in a GROUP directive will not necessarily control or represent the ordering of the segments in memory nor are the segments in a group necessarily adjacent in memory. GROUPing them only implies that they should lie within the same physical segment.

The total address space covered by all segments in a group must be less than or equal to 64K bytes. The size of the group is equal to the sum of the sizes of all segments in the group. The assembler does not check whether the size of the group is greater than 64K bytes, but the loader does.

A group has a base address. The base address of a group refers to the lowest memory address of any segment in that group. The loader sets the group base

Chapter 6: Assembler Directives

GROUP

address, and all segments in the group are addressable from this same group base address.

Forward references to group names are not allowed.

One of the uses of the group name is with the ASSUME directive. If, for example, you have defined many different data segments that you intend to form into one physical segment when the program is located in memory, you could combine these segments with the GROUP directive. Since the contents of all these data segments will be addressable through DS during the execution of the program, you may use the group name in the ASSUME and to initialize DS. For example,

```
DATAGRP GROUP DATA1, DATA2 ;DATA1 and DATA2 not
                               ;defined yet

DATA1 SEGMENT
ABYTE DB 0
DATA1 ENDS

DATA2 SEGMENT
AWORD DW 0
DATA2 ENDS

ASSUME DS:DATAGRP, CS:CODE ;use group name in ASSUME
CODE SEGMENT
MOV AX, DATAGRP ;AX = base address of group
MOV DS, AX ;initialize DS
MOV AX, AWORD ;addressable through DS
.
.
.
CODE ENDS
```

Use of the OFFSET Operator With Groups

When using the OFFSET operator with a variable or label whose segment is in a group, you must use the group name as a segment override in an expression which references that variable or label, as in

```
MOV BX, OFFSET DATAGRP:COUNT
```

Also, if you wish to store the paragraph number of a variable or label defined with a group, you must use a group override. Otherwise, the paragraph number of the segment that contains the variable is stored instead. Example:

```
DW SEG DATAGRP:COUNT
DD DATAGRP:COUNT
```

LABEL

The LABEL directive is used to create a name for the current location of assembly, whether it is data or code.

Syntax:

name LABEL type

Where:

name is a unique user-defined symbol. Its associated attributes are the following:

- **segment** - current segment
- **CS-assume** - current CS-assume value (labels only)
- **offset** - current location counter
- **type** - as specified below

type is one of the following:

- The keyword **BYTE**, **WORD**, **DWORD**, **QWORD**, or **TBYTE** to create a variable which is one of these types.
- **A structure name** Creates a variable whose type is equal to the number of bytes allocated in a structure definition.
- **A record name** Creates a variable whose type will be either byte or word depending on the record definition.
- **NEAR** or **FAR** To create a label of type near or far.

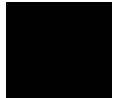

Chapter 6: Assembler Directives

LABEL

Description: The LABEL directive and the idea of a "label" should not be confused. The LABEL directive creates a label or variable at the current location being assembled. A label is a name for a location in the code that can be JMPed to or CALLED.

The LABEL directive is used primarily to address the same data item or same piece of code as different types. As a rule, as86 requires that the type of a data reference match the type of the data definition (known as strong typing), which makes this dual addressing difficult. If you want to access a variable either as a word or as 2 bytes depending upon the context, the following would allow you to do so:

```
WORDNAME LABEL WORD
LOWBYTE DB 0
HIBYTE DB 0
```

The LABEL directive also allows you to define two labels of different types (for instance, both NEAR and FAR) but be careful that the right RET is executed for the type of CALL made. The following (potentially fatal) example illustrates this use:

```
AFARLABEL LABEL FAR
NEARLAB: MOV AX, BX
RET                                ;would be near, so some information
                                   ;would be left on the stack
```

as86 does not, in general, permit data storage at label locations—that makes writing self-modifying code difficult.

NAME

The NAME directive is used to assign a name to an object module.

Syntax:

```
NAME module_name
```

Where:

module_name is a user-defined identifier. The name identifier can be any length, but only the first 40 characters are meaningful.

Description:

Every object module produced by as86 has a name; if you do not provide one, the assembler issues a warning and gives the file a special name. The special name is the source file base name stripped of any path and suffix. A module name is not stored as a symbol. You can therefore duplicate a keyword or a user-defined label without conflict. Module names are not affected by the case control. They are always case-sensitive.

The linker does not require that modules have unique names, but it identifies its input files by module name on its listing map. For this reason, assign each module a unique name for clarity.

The librarian program does identify its modules by name. Every module used as input to the librarian must have a unique name or an error will result.

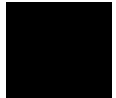

ORG

The ORG directive is used to alter the value of the Location Counter within the current segment.

Syntax:

ORG *expression*

expression evaluates to

- an absolute number (modulo 65536) that does not contain forward references or
- an offset relocatable number (modulo 65536) that is only relocatable from the current segment. Using the offset of '\$' (dollar sign is the special character for the current location counter value) in a PUBLIC segment is an example of this form of ORG.

Description:

The ORG directive is used to locate code or data at a particular location (offset) within a segment. Using ORG with an absolute segment allows you to specify an actual memory location at which the code or data will be located.

Note

Avoid expressions of the form

ORG OFFSET (\$-1000)

since this particular expression will overwrite your last 1000 bytes of assembly (or will re-ORG high in the current segment if the expression evaluates to a negative number). An expression with the syntax "\$+ 1000" will produce an error because this expression evaluates to a label, not to a number. To achieve what is intended, the expression "OFFSET (\$+ 1000)" can be used.

PROC/ENDP

The PROC/ENDP directive pair is used to delimit a section of code which can then be CALLED from elsewhere in the program, much like a procedure in a high-level language.

Syntax:

```
name PROC [type]
.
.
(instructions)
.
.
name ENDP
```

Where:

name is a unique user-defined symbol providing a label for the beginning of the PROC. The name on the ENDP directive must match that on the most recently defined PROC for which an ENDP was not already encountered. The ENDP directive signals the end of a PROC definition to the assembler. The attributes of the PROC name are the following:

- **segment** - current segment
- **CS-assume** - current CS-assume
- **offset** - current location of PROC directive
- **type** - depends on type indicated
- **relocation type** - depends on enclosing segment

type is the type of the label defined at the beginning of the PROC. Type can be NEAR or FAR. NEAR is the default if no type is specified.

Chapter 6: Assembler Directives

PROC/ENDP

Description:

The primary use of the PROC/ENDP pair is to give a type to the RET instruction enclosed by the pair. A RET instruction generates a NEAR return or a FAR return depending on whether the most recently defined PROC is NEAR or FAR. A RET or IRET outside of a PROC/ENDP pair or inside a pair which has no type specified is, by default, of type NEAR. Therefore, any code you wish to CALL FAR and then successfully RET from should be enclosed in a PROC/ENDP pair typed FAR.

Code execution begins at the instruction immediately following the PROC Directive when PROCs are CALLED or JMPed to.

Nested PROCs

When a PROC is defined inside another (nested), it does not necessarily have the same type assigned to its RET or IRET instruction as does the enclosing PROC. For instance, an enclosing PROC may be typed FAR. When the next PROC occurs, it might be a NEAR. For the duration of that PROC until the ENDP, the type of any return instruction will be NEAR and not FAR. When the ENDP is found for the nested PROC, however, the type reverts to the type of the enclosing PROC, in this case FAR. Having a NEAR PROC inside a FAR PROC, then, does not affect the enclosing PROC.

Differences Between PROCs and "Subroutines"

The code in a PROC/ENDP pair is not a procedure in the same sense as it is in high-level languages. A few differences are of note:

- In contrast to the scoping of names in block-structured languages, all labels and variables within the PROC/ENDP pair are not local to the "subroutine", but are global to the entire file.
- It is possible for execution to "fall into" a PROC from the previous instruction; it is not necessary to CALL a PROC to execute it. Executing a RET or a IRET from a "fallen into" PROC can cause unpredictable results.
- The ENDP does not function as a return-from-procedure; it marks the end of the PROC for the assembler. It is possible for execution to "fall out of" a PROC through the ENDP into the next instruction. To return from a CALL, a RET or IRET instruction must be used.

PUBLIC

The PUBLIC directive is used to specify symbols, defined in one module, that are available to other modules at link time.

Syntax:

```
PUBLIC name [, ...]
```

Where:

name is the name of the symbol defined in the current module.

Description:

Symbols designated PUBLIC will be placed in the object file and used by the loader to resolve external references (made with the EXTRN directive) from other modules.

PUBLIC symbols must be variables, labels or 17-bit constants defined by using EQU; any other types will generate an error. A 17-bit constant can be absolute or offset relocatable only; other relocation types are not allowed.

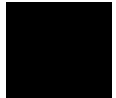

PURGE

The PURGE directive places a flag on the specified user-defined symbol in the symbol table so that the symbol is no longer recognized.

Syntax:

```
PURGE symbol [, ...]
```

symbol can be any keyword or user-defined symbol, *except*

- **register names**
- **segment names** (including ??SEG).
- **group names**
- **hands-off keywords** (see keyword list in chapter titled "Assembler Syntax")
- **any user-defined symbol that appears in a PUBLIC statement**

Description:

A PURGED symbol can be redefined following the PURGE statement. A reference to the symbol following the PURGE statement, but before a re-definition, is treated as a forward reference to the second definition. If a PURGED symbol is never redefined, references to the symbol following the PURGE statement are considered errors (reference to undefined symbol).

Purging symbols does not physically remove them from the symbol table and therefore PURGE cannot be used to deal with symbol table overflow.

If a variable or label that is defined in the current module but does not appear in a PUBLIC or EXTRN statement (that is, a local symbol) is purged, it will not appear in the object module. A PURGE directive, placed just before the END statement can—in combination with the \$DEBUG assembler control statement—be used to pass on only a few selected symbols for debugging purposes.

Any variable, label or absolute number that was defined by an EXTRN statement can be purged, but the symbol will still appear in the object module as an external reference.

If a symbol is defined by an EQU to another symbol (not an expression), a PURGE on one of the symbols can cause unexpected results. The rule is that if a symbol in a EQU chain is PURGED, it and all symbols that precede it to the beginning of the chain are also PURGED.

Given the EQU chain that follows:

```
A EQU B
B EQU C
C DW 0      ;EQU chain resolving at C
```

The following PURGEs, which should not be considered as sequential code but as separate lines somewhere in the assembly source program, would have the described effects.

```
PURGE A      ;purges only A (B and C are still defined)
PURGE B      ;purges A and B (C still defined)
PURGE C      ;purges A, B, and C
```

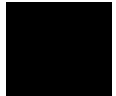

RECORD

The RECORD directive defines a record template.

Syntax:

```
name RECORD recfieldname:nnn[=datum] [, ...]
```

Where:

name is a mandatory user-defined name for the record template.

recfieldname is a mandatory user-defined name for a bit field.

nnn is an integer constant, or an expression containing no forward references, that evaluates to an absolute number. The range of **nnn** is from 1 to 16, inclusive, and denotes how many bits will be in a bit field. Bits are counted from high bit to low bit within the full byte or word. Thus, the first bit field following the RECORD keyword is the most significant field of the record.

datum is an optional integer constant, or an expression containing no forward references which evaluates to an absolute number, specifying a default value for this bit field. This value can be overridden when the record is allocated. If no datum is present, zero is the default. If the datum is present, it must fit into the number of bits specified (**nnn**), zero-filled. For example, the legal default values for a 1-bit field are 0 and 1. Values that are either negative or too large are truncated to fit within a given field. A warning is also generated.

Description:

The RECORD directive always defines a 1-byte or 2-byte template. This definition only describes a record; it does not allocate any memory at definition time. If the total number of bits in a record template is one to eight, the unit used to allocate storage when the record template is used is 1 byte. If the number of bits is 9 to 16, then allocation is 2 bytes.

You might experience some confusion in those cases where the bit field allocation does not fill exactly 8 or 16 bits. Although bit counting begins with the most significant bit in cases where the byte or word is completely filled, partially allocated records (the number of bits in the bit fields do not total exactly 8 or 16 bits) will have their bit fields right-justified in the byte or word

and the remaining most significant bits will be zero-filled. This means that the first bit in the left-most bit field where counting begins will not be the left-most bit of the byte or word. The following definition

```
REC1 RECORD R1:3=7,R2:5 ;generates 11100000B or E0H
```

defines an 8-bit pattern which has all 8 bits filled. Note that R2, because it is not initialized, is set to zero by default. However, the definition

```
REC2 RECORD R3:3=7,R4:3=3 ;generates 00111011B or 3BH
```

leaves two bits remaining in an 8-bit byte. The two three-bit bit fields are right justified, and the remaining two bits, the two most significant bits, are zero-filled. The following figure illustrates how, for the above example of record template REC2, the partial record is defined by the RECORD directive.

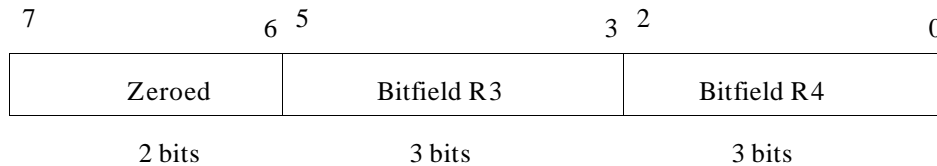

Figure 6-1. "Partial" Record Definition

Similarly, the two 16-bit record definitions below illustrate what happens to 16-bit partial records.

```
REC3 RECORD R5:3=7,R6:13=4095 ;generates 1110111111111111B or 0EFFFH
REC4 RECORD R7:1=1,R8:8=127 ;generates 0000000101111111 or 017FH
```

Remember, the RECORD directive only defines a template, it does not allocate storage. To see how to allocate storage using a record template, read the next section.

Allocating Record Storage

After you have defined a record template, the template definition can be used in the following syntax to allocate storage:

Syntax:

Chapter 6: Assembler Directives

RECORD

```
[name] recname <[[datum],] [...]>
```

(or)

```
[name] recname repeatval DUP (<[[datum],] [...]>)
```

Where:

- **name** is an optional name to be declared as a variable with the following attributes:
 - **segment** - current segment being assembled
 - **offset** - current location counter value
 - **type** - total number of bytes in the record template (either 1 or 2)
- **recname** is the name assigned to a previously-defined record template
- **repeatval** is a 17-bit integer constant, or an expression containing no forward references and evaluating to a 17-bit absolute number, between 1 and 65535 inclusive. Repeatval specifies the number of copies of the record to allocate.
- **datum** is an optional value to be used instead of the default value provided in the template. All such values must be 17-bit integer constants, or expressions that evaluate to 17-bit absolute numbers. Relocatable values are not allowed.
 - The first datum replaces the default value of the first bit field within the record, the second datum replaces the default on the second bit field, etc. Null data items are permitted (separated by commas) to direct the assembler to use the default values; null data values are useful when a default value other than the first needs to be overridden. If a field is mmm bits wide, the least significant mmm bits of the two's complement representation of the datum are used. For example, if a 3-bit field is being overridden, values of 6, -2, and 14 will all generate the 3 bits 110. Examples (using the REC1 definition shown above):

```
FIRSTREC REC1 <>           ;no overrides to defaults,  
                           ;generates 0E0H  
SECNDREC REC1 <4>         ;overrides R1 - generates 080H  
THIRDREC REC1 <,5>       ;overrides R2 - generates 0E5H  
FIVERECs REC1 5 DUP (<>) ;5 copies of default record
```

It is allowable to nest record allocations up to 10 deep.

SEGMENT/ENDS

The SEGMENT/ENDS directive pair is used to define a logical segment.

Syntax:

```
name SEGMENT [align-type][combine-type]['classname']  
.  
.  
name ENDS
```

Where:

name is a mandatory user-defined name that cannot conflict with any other symbol.

align-type specifies what boundary the logical segment must be placed on. If the align-type is not specified, PARA is the default. Align-type may be any of the following keywords:

- **BYTE** - byte alignment. Segment can start anywhere.
- **WORD** - word alignment. The segment must start on an address divisible by 2. (An address which has a least significant bit of 0.)
- **PARA** - an address divisible by 16. (An address which has its least significant hexadecimal digit equal to 0H.)
- **PAGE** - page alignment. The segment must start on an address divisible by 256. (An address which has its two least significant hexadecimal digits equal to 00H.)
- **INPAGE** - inpage alignment. The entire logical segment cannot be more than 256 bytes long; it cannot cross a page boundary (an address divisible by 256). It will be moved to start on an address divisible by 256 only if movement is necessary to prevent the segment from crossing a page boundary.

combine-type specifies the way in which the linking loader combines this segment with other logical segments of the same name to form a physical segment in memory. If combine-type is not specified, the logical segment will not be combined with any other logical segment, not even one with the same name from a different module. Combine-type can be any of the following keywords:

Chapter 6: Assembler Directives

SEGMENT/ENDS

- **PUBLIC** - all segments of the same name defined to be PUBLIC will be concatenated to form a single physical segment. The loader controls the order of concatenation. The length of the resulting physical segment will be equal to the sum of the lengths of the segments that have been combined.
- **COMMON** - all segments of the same name defined to be COMMON will be overlapped, starting at the same physical address, to form a physical segment. The size of the resulting physical segment will be equal to the size of the largest segment of those overlapped.
- **STACK** - all segments of the same name defined to be STACK will be concatenated into a physical segment such that the combined segment will *end* at a certain physical address (overlaid against high memory) and will grow "downward." The length of the resulting segment will be the sum of the lengths of the combined segments. (STACK is not a true keyword. You can define a symbol to be STACK without conflicting with the usage in the SEGMENT directive.)
- **MEMORY** - all segments of the same name defined to be MEMORY will be combined so that the first memory segment encountered by the linker will be treated as the physical "memory" segment. In the list of linked modules, the first module that contains a "memory" segment will be used to define the physical "memory" segment. It will be located at an address above all other segments in the program. Any other segments of the type memory that are encountered by the linker will be treated as common with the first segment. The length of the physical memory segment will be equal to the length of the first memory segment encountered (Memory, like Stack, is not a true keyword. You can define a symbol to be MEMORY without conflicting with the usage in the SEGMENT directive).
- **AT nnn** - this segment will be placed at the paragraph number specified. The expression nnn cannot contain forward references and must evaluate to an absolute number. Absolute segments are not aligned by the linker; the various align-type keywords are syntactically correct when used in combination with AT but are ignored. Note that **nnn** represents a paragraph number, not an actual address; therefore if AT 0444H is specified, the segment will start at address 04440H. A segment created with AT will be non-combinable with segments from other modules.

'**classname**' is a name that may be used to indicate that segments are to be located near each other in memory. When assigning physical addresses to

these logical segments, the linking loader attempts to place logical segments with the same classnames close together. However, the classname cannot be used to combine segments such that they may be addressed through the same segment register.

The classname must be enclosed in single quotes, as shown, or in double quotes.

Classnames are not stored as symbols; they may duplicate symbol names (even keywords) without conflict. If a classname is to be assigned to a segment, assign it at the first occurrence of the segment in the source file.

Description:

The SEGMENT/ENDS directive pair is used to define a logical segment. This segment may be combined with other segments of the same name defined in either the same module or in other modules. These logical segments will form the physical segments, located in memory, that are pointed to by the segment registers. Within a source module, each occurrence of an equivalent SEGMENT/ENDS pair (with the same name) is viewed as being one part of a single program segment.

Multiple Definitions of a Segment

The assembler keeps the value of the offset from the current segment (i.e., the most recent SEGMENT directive) in an internal location called the location counter. The assembler saves the location counter for each segment when it finds an ENDS for that segment, or if it finds a new SEGMENT directive. Later, if the assembler finds another SEGMENT directive which uses the name of that previously defined segment, the earlier location counter is retrieved and used. For this reason, a segment may be broken into pieces within a module, or between modules if it is combinable, and those pieces will still be placed in the same physical segment.

The align-type, combine-type and classname need not be included with the second and later SEGMENT directives for a segment of the same name. If they are absent, the assembler takes the segment's characteristics from the first definition. However, any keywords that are present must match the first definition, or an error is reported. If an absolute segment is broken into pieces and the AT keyword is used on a SEGMENT directive for the second or later piece, the absolute base address must match the first definition, even though the location counter is taken from the stored value. The second part of the segment will not start at the specified base address, but the AT value must match. Examples of breaking a segment:

Chapter 6: Assembler Directives

SEGMENT/ENDS

```
S1 SEGMENT PUBLIC
NOP                ;relocatable location 0
S1 ENDS

S1 SEGMENT        ;assembler uses PUBLIC attribute
ADD AX,2         ;instruction at relocatable location 1
S1 ENDS

S2 SEGMENT AT 0444H
NOP                ;instruction at absolute location 04440H
S2 ENDS

S2 SEGMENT AT 0444H
NOP                ;instruction at absolute location 04441H
DB 14 dup(0)      ;skip 14 bytes
S2 ENDS
S2 SEGMENT AT 0445H ;an error! Must use 0444H
NOP                ;instruction at absolute location 04450H
S2 ENDS
```

Nested or Embedded Segments

It is legal to nest SEGMENT/ENDS pairs. Each ENDS must refer to the most recently-defined SEGMENT whose ENDS was not yet encountered. The fact that a segment is nested inside another does not mean that the code for the nested segment is placed inside the enclosing segment. The code is the same as it would be if no nesting occurred. Nesting helps you to define logical structures to make programming easier. Example:

```
S1 SEGMENT PUBLIC
NOP                ;goes into S1 segment
S2 SEGMENT PUBLIC
ADD AX,2         ;goes into S2 segment
S2 ENDS
SUB AX,3         ;goes into S1, S2 is "closed"
```

Improper Nesting:

```
S1 SEGMENT PUBLIC
NOP
S2 SEGMENT PUBLIC
ADD AX,2
S1 ENDS          ;ENDS does not match most recent SEGMENT
  SUB AX,3
S2 ENDS          ;ENDS does not match remaining SEGMENT
```

Maximum Number of Segments

If you use the default HP-OMF 86 object file format, you may use an unlimited number of segments. The HP 64000 (.X) object file format allows

Chapter 6: Assembler Directives SEGMENT/ENDS

only three named segments. Therefore, if you use the HP 64000 object file format (the **-h** command-line option), use three or fewer relocatable segments per module.

The first relocatable segment with code will be assigned the PROG segment. The first relocatable segment with data will be assigned the DATA segment, if that segment is not used for PROG. The next relocatable segment, whether it contains code or data, will be assigned the COMN segment.

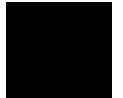

STRUC/ENDS

The STRUC/ENDS directive pair is used to define a structure template.

Syntax:

```
name STRUC
.
.
<data directives>
.
.
name ENDS
```

Where:

name is a unique user-defined symbol that becomes the structure name. The name on the ENDS must match the name on the STRUC. Its `type` attribute is the following:

- **type** - number of bytes defined in structure data directives

Description:

The structure definition only describes a given structure and its contents; it does not allocate any memory at that time. All statements between the STRUC and ENDS directives must be one of the following: DB, DW, DD, DQ, or DT directives, comment lines, blank lines, or assembler controls. Any assembler controls that are included within the STRUC/ENDS pair are not stored as part of the template and therefore are not executed anew each time the structure is referenced. Any symbols referenced in the argument field of any of the included directives must have been previously defined. Forward references are not allowed within a structure definition.

You will notice that the ENDS directive is also used to terminate a SEGMENT definition. This is unambiguous, since an ENDS closing a SEGMENT is not legal within a structure definition.

If a DB or other directive within a structure definition has a name in its name field (which must be unique, and cannot previously have been the object of a forward reference), this name is known as a structure field. It is not the same as a variable, and it is not associated with any particular storage location or segment. Structure names and structure fields can be used in very few syntactic

constructs. Forward references to structure names and structure fields are not allowed.

Structure field names do have associated attributes. They follow:

- **offset** - offset from the beginning of the structure definition
- **type** - type of data definition directive

Allocating Structure Storage

After you have defined a structure template, it can be used in the following syntax to allocate storage:

Syntax:

```
[name] strucname <[[datum],] [...]>  
(or)  
[name] strucname repeatval DUP ( <[[datum],] [...]> )
```

Where:

- **name** is an optional name to be declared as a variable with the following attributes:
 - **segment** - current segment being assembled
 - offset** - current location counter value
 - type** - total number of bytes in the structure template
- **strucname** is the name assigned to a previously defined structure template.
- **repeatval** is a 17-bit integer constant, or an expression containing no forward references and evaluating to a 17-bit absolute number between 1 and 65535 (inclusive); it is the number of copies of the structure to allocate.
- **datum** is an optional scalar to be used in place of the default value provided in the template. The first datum replaces the default value on the first data definition directive within the structure, the second datum replaces the default on the second data definition directive, etc.
 - Null data (separated by commas) is permitted and directs the assembler to use the default value; this is useful when a value other than the first occurring value must to be overridden. The legal values for these scalars are the same as in the data definition directive to which they apply, including the

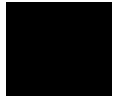

Chapter 6: Assembler Directives
STRUC/ENDS

indeterminate-initialization keyword '?'. Note that repeated data (i.e., DUP expressions) cannot be used as an override.

- Not every default value can be overridden. Default values can be replaced only if the template defined just one unit of data for the data definition directive (structure field) that is to be overridden, or the template defined a character string in a DB directive. These conditions mean that such defaults as DB 1,2 and DW 10 DUP (0) cannot be overridden.

The number of bytes used in a DB string is fixed when the structure is defined. Such a string can be overridden only by another string. If a longer string is used to override, it is truncated, and a warning message is given. If a shorter string is used to override, it is filled out, using the characters at the end of the default string.

The structure definition

```
BLUEPRINT STRUC
  FIRST  DW  0FFFEH
  SECOND DW  BUFFER
  THIRD  DB  7, 5
  FOURTH DB  'A'
  FIFTH  DB  ?
  SIXTH  DW  257
BLUEPRINT ENDS
```

yields a structure template like this:

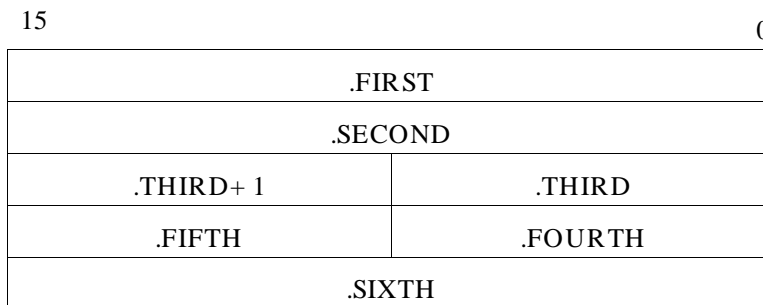

Figure 6-2. Structure Definition and Allocation

The instruction
 B1 BLUEPRINT < >
 allocates storage for B1 that looks like:

15		0
F F F E		
OFFSET (BUFFER)		
0 5		0 7
indeterminate		4 1
0 1 0 1		

The instruction
 B2 BLUEPRINT < ,0,,,255>
 allocates storage for B2 that looks like:

15		0
0 F F F E		
0 0 0 0		
0 5		0 7
F F		4 1
0 1 0 1		



Figure 6-2. Structure Def. and Allocation (Cont'd)

Chapter 6: Assembler Directives
STRUC/ENDS

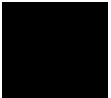

7



Expressions

The syntax and semantics of expressions.

Chapter 7: Expressions

Expression Overview

This chapter describes the syntax and semantics of expressions. The early part of the chapter explains the kinds of expressions and discusses expression operands. The latter part lists the different expression operators and their uses. The end of the chapter has a table showing the precedence ranking of the expression operators.

Reference Syntax Conventions

The sections that include the references about the expression operators follow certain conventions:

- 1 The name of the operator (or a descriptive term for the operator) appears in the lefthand column.
- 2 The proper assembler syntax appears next under a heading of "Syntax."
- 3 A short description follows the syntax. The description explains the syntax and any arguments appearing in the syntax. There may also be other information relating to the operator itself or to using the operator.
- 4 Some expression operators may affect the attributes (see the "Symbol and Expression Attributes" chapter) of its operands. If that is so, a list of attributes and their values follows the description.
- 5 Some short examples that use the operator may follow the description or attributes sections.

Expression Overview

An expression is a simple or complex combination of operands that may be bound by operators. Operands can be numeric values or address expressions. Operators include conventional unary and binary arithmetic operators (+, -, *, /, MOD, etc.), logical operators (AND, OR, XOR, NOT), or special operators such as memory and record operators.

Expressions have certain attributes. Attributes are discussed thoroughly in the chapter named "Symbol and Expression Attributes."

Expressions are in turn used as operands to assembly language instructions and assembler directives. Expressions may be absolute, relocatable, or external.

Absolute Expression

An absolute expression is one whose value is known completely at assembly time. Assembly of absolute expressions results in object code that does not need to be further modified by the loader. An absolute expression will have an operand that is

- a numeric constant
- a constant memory expression (addresses which are known at assembly time)
- record allocation values
- a record bit field offset
- a segment base located during assembly time with the AT keyword (AT is discussed in the SEGMENT/ENDS directive in the "Assembler Directives" chapter)
- an offset for a variable or label from a segment which is non-combinable
- a register name

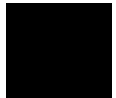

Relocatable Expression

A relocatable expression contains a relocatable operand as part of the expression. The value of a relocatable expression is not known at assembly time and must be assigned later by the loader. Relocatable expression values are 16-bit values unless modified by the HIGH or LOW operators to become 8-bit values. A relocatable expression will have an operand that is

- a segment base where the segment is combinable (including all groups, since their bases are not set until load time)
- a variable or label which belongs to a combinable segment

External Expression

An external expression is a relocatable expression which contains items that are not within the module being assembled. These expressions reference external variables, labels, or numbers. Their values must be assigned by the loader when the module containing the referenced item is available for relocating. External expressions, like relocatables, are assumed to be 16-bits in size, but may be modified with the HIGH or LOW operators to be 8-bit values. More information about external references appears in the chapter titled "Assembler Directives."

During the assembly process, the assembler uses 17-bit numbers to perform arithmetic and other operations involving expressions. A 17-bit number is a 16-bit number with an additional sign bit. The 17-bit number is used within the assembler so that negative numbers with large absolute values (to -65535) may be used in calculations. When the value is coded, the sign bit is discarded and is not output, since only 16-bit values are used in the object code.

Expression Operands

An expression may consist of only an operand, or operand(s) modified by one or more operator(s). Operands are broadly divided into two groups: numeric values and memory or register expressions. A numeric value will be directly represented in the assembled code. A memory or register expression is an indirect value because the assembler is coding a reference—or reserving a space that will be filled later—which points to a location in memory where the actual data resides. Expressions involving the EQU directive can be either a numeric or memory expression.

Numeric Values

Numeric values result from a variety of different operands. Numeric constants, obviously, are numeric values, but other, less clearly numeric operands also produce numeric values. Any of the following operands can generate numeric values:

- **A constant.** There are several ways that an absolute number, or constant, may be represented to the as86 assembler. The easiest and most straightforward way is to make the expression operand a decimal, octal, hexadecimal, or binary number. The various representations are as follows:
 - A decimal number is a series of digits, ranging from 0 to 9, that optionally ends with the character 'D'. Decimal numbers are base-10 and are the numbers people are most familiar with.
 - An octal number is a base-8 number represented by a series of digits, ranging from 0 to 7, and ending with either the character 'O' or 'Q'.
 - A hexadecimal number is a base-16 number represented by a series of digits, ranging from 0 to 9, or by characters, ranging from 'A' to 'F' (or 'a' to 'f'). These numbers must end with the character 'H'. A hexadecimal number may not begin with a character; in those instances, place a leading zero in front of the hex number.
 - A binary number is a base-2 number represented by a series of digits, either 0 or 1, and ending with the character 'B'.

Examples of numeric constants:

Chapter 7: Expressions

Expression Operands

```
MOV AX, 35      ;decimal number
MOV AX, 12D     ;decimal number with optional
                ;following 'D'
MOV AX, 370     ;octal number with the letter 'O'
MOV AX, 12Q     ;octal number with following 'Q'
MOV AX, 12H     ;hexadecimal number
MOV AX, 0A34H   ;hexadecimal number with leading 0
MOV AX, 0110101B ;binary number
```

- **Quoted string.** A one or two character quoted string which is used as an expression operand will be stored as a hexadecimal number in a two byte word. Each byte contains the ASCII value of the character it stores. If two characters are stored in a word, the first character is represented in the high byte of the word and the second character is represented in the low byte. If only a single character is stored, it is represented in the low byte and the high byte is set to 00H. A quoted string always evaluates to a positive 17-bit value. This method of representing numbers is cumbersome and not very useful. It is also much more difficult to verify that the value is correct. Examples:

```
MOV AX, 'A#'    ;generates 04123H
MOV AL, HIGH 'B' ;generates 00H
```

- **Record template.** The chapter titled "Assembler Directives" discusses the record structure. A record is a series of bit fields which may be defined within a one or two byte structure called a template. Template definition does not allocate storage, but specifying an occurrence of a record can allocate memory, much like a DB (define byte) or a DW (define word) directive might allocate memory. A record template may also be used as an expression operand, but in this usage no memory is allocated. Instead, the operand is evaluated to be a positive 17-bit value and used the same as any number.

Examples:

```
R1 RECORD F1:3, F2:5, F3:2 ;the RECORD directive
                           ;defines record template
MOV AX, R1<>               ;value is 0 since
                           ;no defaults specified
                           ;in template definition
MOV AX, R1<2,14,3>        ;value is 0013BH
MOV AX, R1<2,14,3> + 5    ;value is 00140H
```

- **Record field.** You may also use a record field name by itself as an expression operand. If the field name is used without a MASK or WIDTH operator, then the assembler replaces the field name with a number which is the shift value required to move the lower bit of its bit field to the 0th bit position. For example, using the record template definition above, the

value that would be replaced for F1 is 7 since there are 7 bits of data to the right of the field F1. The shift value, combined with the MASK operator described later in this chapter, may be used to extract field values from a record.

- **Segment or group name.** When used as an expression operand, the name becomes an immediate value that is the paragraph number for the segment or group. Since most segments and all groups are not assigned this value by the assembler, it will usually be relocatable. Only segments that use the AT keyword will have a fixed paragraph number known by the assembler. These values may be used as is—to initialize a segment register, for instance—or used wherever a relocatable number may be used (except with HIGH and LOW). Examples:

```
MOV AX, SEG1 ;load paragraph number for segment
MOV DS, AX   ;initialize DS register
MOV AX, GRP1 ;load paragraph number for group
```

Memory and Register Expressions

There are several ways to reference memory in assembly source files. Memory might be referenced with operands which are any of the following:

- **Variables or labels.** Variables are defined through data directives and structure or record allocations. Labels are defined through assembly instructions or PROC directives. Either variables or labels may also be defined through EXTRN statements or LABEL directives. Given the variable and label definitions in the first three lines of the example below, the last two lines use those definitions as memory operands:

```
WMEM DW 2 ;word variable
R1 RECORD F1:3, F2:4 ;record template definition
U1 R1 <> ;byte variable, from
;a record allocation
L1: MOV AX, WMEM ;NEAR label, using a word
;variable

MOV AL, U1 ;uses byte variable as operand
JMP L1 ;uses NEAR label as operand
```

- **Variable with offset.** Variables used as memory operands may have offsets added to them in order to refer to memory locations near the memory location of the variable. The variable with offset operand may be expressed in two ways. Examples of both:

```
MOV AX, WMEM + 5 ;adds 5 to variable address
;accesses memory 5 bytes higher
;than location of variable WMEM
MOV AX, 5 + WMEM ;same result from slightly different
;way of expressing it
```

Chapter 7: Expressions

Expression Operands

```
MOV AX, WMEM[5]           ;same result from very different
                          ;way of expressing it
```

- **Structure field.** Much the same as using an added offset to a variable, using a structure field name as part of a memory operand allows access to memory that is near a variable. Offset is from the variable named when storage using the structure template was allocated. Using a structure field name as a memory operand also changes the type of the memory expression to that of the field. Example:

```
ST1 STRUC
BFIELD DB ?           ;field offset value from ST1 is 0
WFIELD DW ?          ;field offset value from ST1 is 1
ST1 ENDS

MOV AX, BMEM.WFIELD ;adds 1 to offset, word type
```

- **Register indirect reference.** The 8086/186 processors also allow an instruction to indirectly refer to memory by using base and/or index registers. The contents of these registers are added to a variable's offset at runtime, which means a memory address can be created that is not known when the assembly code is written. A register expression operand can contain one base register name, one index register name, or one base and one index register name. Additionally, constants may be part of the operand along with the registers.

The valid base registers are BX and BP and the valid index registers are SI and DI.

Base or index registers used this way must be enclosed in square brackets in a register expression, but there are several different ways to represent expressions given this restriction.

- A base and index register may be added together explicitly by using a '+' sign within the brackets or added implicitly by enclosing each register name in separate, adjacent brackets.
- A base or index register alone may have a constant added to it or subtracted from it in the same manner. (The '-' sign must be used for subtraction, since adjacent brackets are, by default, added.)
- A base and index register added together may also have a constant added using either a '+' sign or adjacent brackets, or a constant may be subtracted by using a '-' sign within the brackets.
- A base and index register cannot be subtracted from one another, however.

Examples:

```
MOV AX, WMEM[BX]           ;one base register,  
                           ;no index register  
  
MOV AX, WMEM[BP][SI]      ;these two slightly different  
MOV AX, WMEM[BP+SI]      ;expressions are equivalent  
                           ;both add one base register  
                           ;and one index register  
  
MOV AX, WMEM[SI]         ;no base register,  
                           ;one index register  
  
MOV AX, WMEM[5][BP]      ;both of these expressions use  
MOV AX, WMEM[5+BP]      ;an index register with a  
                           ;constant added  
  
MOV AX, WMEM[BP-5]       ;one base register with  
                           ;constant subtracted,  
                           ;no index register  
  
MOV AX, WMEM[BX][DI][5]  ;one base and one index  
                           ;register added  
  
MOV AX, WMEM[BX+DI+5]    ;with constant added also  
                           ;both expressions equivalent
```

- **Anonymous reference.** This form of register expression operand contains only constants and registers and does not include a variable or label name. Because there is no variable or label name, no segment or type information is inherent in the expression.

This expression may be given a type and segment, using the PTR and segment override operators. Otherwise, default values are assumed, depending upon the instruction and the registers that are used. If the base register BP is used, the default segment register is SS. Otherwise, the DS segment register is the default segment register.

A default type value may be assumed if other operands to the instruction provide enough information to limit the type of the memory expression. Otherwise, an error is generated. For a constant to be used as a memory reference, it must be typed with the PTR operator so the assembler knows to treat the value as such. Otherwise, the constant is treated as an immediate value.

Examples:

```
MOV AX, [BX]              ;default is DS segment  
MOV AX, [BP][SI]         ;default is SS segment  
MOV AX, ES:[BX]          ;segment is ES  
MOV AX, DS: WORD PTR 5   ;segment is DS  
MOV AX, [BX].WFIELD      ;default is DS segment
```

Chapter 7: Expressions

Expression Operands

EQU

The EQU directive, discussed in the chapter titled "Assembler Directives," allows you to assign a value to a symbol. Some of the possible assignments include register names, variables, memory expressions, or constants. The symbol on the left side of the EQU directive may be used in an expression as an operand. The result is the same as if whatever appears on the right side of the EQU were used as an operand instead. Examples:

```
E1 EQU BX           ;8086 register
MOV AX, E1         ;register to register
MOV AX, BX        ;same as MOV AX, E1

E2 EQU WMEM        ;variable
E3 EQU BMEM[BP][SI] ;register expression
E4 EQU 037B2H      ;constant
MOV AX, WMEM[E1]   ;register from memory
MOV AX, E2[E1]     ;register from memory
MOV AL, E3         ;register from memory
MOV AX, E4         ;immediate value into register
MOV AX, E4 / 5     ;immediate value into register
```

Expression Operators Introduction

Operators are functions that take one or more operands and return a new value. Operators are used to build expressions that cannot be defined strictly as simple operands. Use operators to add numbers, change the type of a memory expression, or to cause segment overrides. You may use a complex expression involving operators anywhere a simple operand may be used if the value returned by the complex expression is equivalent to the value of the simple operand.

Arithmetic Operators

The arithmetic operators conform to the commonly understood notions of these operators. Arithmetic involving these operators is done using the full 17-bit representation of the operands. Negative number results are stored, however, in twos complement form.

Unary Plus, Unary Minus

Syntax:

Unary Plus: + operand
Unary Minus: - operand

Description: The unary operators '+' and '-' each take a single operand and return a single value as the result. The '+' operator may be applied to an absolute or a relocatable value and the result will be an absolute or relocatable value. The '-' operator may only be applied to absolute values. The result will be the 2's complement of the value. These operators may be thought of as being the binary operators '+' and '-' with a lefthand operand of 0. Examples:

```
MOV AX, + 5       ;result is 5 or 00005H  
MOV AX, - 2       ; result is -2 or 0FFFEH  
MOV AX, + WMEM    ;result is memory expression
```

Binary Addition, Subtraction

Syntax:

Addition: operand1 + operand2
Subtraction: operand1 - operand2

Description: The binary operators '+' and '-' each take two operands and return a single value as the result. If memory addresses are used, the offset from the segment base is the value used as an operand. The types of operands that are allowed and the types of the results are shown in the following table.

Table 7-1. Binary Plus and Minus Results

Operand 1	Operator	Operand 2	Result
ABSNUM	+, -	ABSNUM	ABSNUM
RELOCNUM	+, -	ABSNUM	RELOCNUM
ABSNUM	+	RELOCNUM	RELOCNUM
ADDR	+, -	ABSNUM	ADDR
ABSNUM	+	ADDR	ADDR
ADDR	-	ADDR	ABSNUM

The shorthand words in the table mean the following:

ABSNUM = absolute number, constant
RELOCNUM = relocatable number (OFFSET, external ABS, SEG)
ADDR = memory address, possibly relocatable or external

Note that ADDR-ADDR is only valid if both memory addresses are either absolute or relocatable. They must also belong to the same segment so that their offsets are relative to the same base value. This allows the result to be absolute. Neither address may be of an external reference, since its offset is not known at assembly time. Examples:

```
EXTRN EXABS: ABS           ;declared labels - variables
MEMSTART DB ?
WMEM DW 2
MEMEND DW ?

MOV AX, 5 + 15             ;result is 20 or 00014H
MOV AX, 3 - 12             ;result is -9 or 0FFF7H
MOV AX, WMEM + 5           ;result is offset of WMEM + 5
```

```
MOV AX, 4 + EXABS      ;result is external const + 4
MOV AX, MEMEND - MEMSTART ;result is number of bytes
                        ;between MEMSTART and MEMEND
```

[] Square Brackets

Syntax:

```
address [ data_or_reg ]
```

Description: Square brackets give base and/or index attributes to an address expression or create a new address expression. The square brackets must occur in pairs. Such pairs cannot occur within angle brackets. However, more than one pair of square brackets can occur in a single expression.

The contents of the brackets are very limited. The only valid register names that can be used are BX, BP, SI, and DI. The first two, BX and BP, are base registers and only one of the two can be present within an entire expression. The SI and DI registers are index registers and, like base registers, only one of these registers can be present within an entire expression. It is valid to have both a base register and an index register in an expression. It is also possible to place numeric constants within the brackets.

The above items can appear singly within square brackets, as in:

```
mov AX, wmem[BX][SI][5]
```

It is also valid to replace '[']' pairs with a '+' sign, as in:

```
mov AX, wmem[BX+SI+5]
```

The only time a minus sign is valid within square brackets is to subtract a constant, as in:

```
mov AX, wmem[BX+SI-5]
```

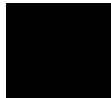

Chapter 7: Expressions

Arithmetic Operators

The constant expression part of the square brackets modifies the offset value of any memory value that is also part of the expression. The base and index registers are used to denote indirect addressing as part of an expression. The contents of the indicated registers are added to any memory expression offset in the expression to create a final memory address.

A memory address is not required to be part of an expression which has square brackets as part of itself. For example, take the following expression:

```
mov AX, [BX][SI][5]
```

This expression represents a memory location that is 5 bytes past the sum of the contents of the BX and SI registers at the moment of execution for that instruction. The segment register used for this instruction would be the DS register. The SS register is used if the BP base register is part of the expression. It is also valid to specify a different segment register through the use of a segment override, such as:

```
mov AX, ES: [BX][SI][5]
mov AX, SEG1: [BX][SI][5]
mov AX, GRP1: [BX][SI][5]
```

. (Dot operator)

Syntax:

```
address '.' struc_field
```

Description: This operand accepts an address expression as its left operand and a structure field as its right operand. The result of the operation is an address expression whose offset is equal to the offset attribute of the left operand plus the offset of the structure field within its structure template (in bytes). The type of the resulting memory expression is the type of the structure field. All other attributes are derived from the left operand. This operator is convenient for addressing fields within memory that contains one or more occurrences of a given structure. For example, suppose a structure was defined like this:

```
STRUCNAME STRUC
BYTEFLD DB 0
WORDFLD DW 5 DUP (3)
          DT 3.14159
STRINGFL DB 'DEFAULT'
STRUCNAME ENDS
```

The offset of BYTEFLD, WORDFLD, and STRINGFL within this structure template are 0,1, and 21, respectively. These structure field names can be used to reference fields within a structure in memory, as in:

```
DATABLOCK STRUCNAME<>
MOV AX, DATABLOCK.WORDFLD      ; WORD type
MOV CL, DATABLOCK.BYTEFLD     ; BYTE type

MOV DI, OFFSET DATABLOCK
MOV AX, [DI].WORDFLD          ; indirectly referencing memory
```

It is not valid to use the dot operator immediately after a digit, due to the possible confusion with a real number. Instead, the operator must be separated from the digit by parenthesis, such as:

```
(DATABLOCK + 2).WORDFLD      ; valid
DATABLOCK + 2.WORDFLD       ; illegal
```

Multiplication, Division, Modulo

Syntax:

```
Multiplication:  absval * absval
Division:        absval / absval
Modulo:         absval MOD absval
```

Description: These three operators each take two absolute values as operands and return a single absolute value. The '*' operator multiplies the two operands and returns the result. The '/' operator divides the first operand by the second operand. The MOD operator returns the value of the first operand modulo the second operand. Modulo division discards the integer quotient and returns a value that is only the remainder. For either straight division (/) or modulo division, the righthand operand cannot have a value of 0. Examples:

```
MOV AX, 5 * 3      ;result is 15 or 0000FH
MOV AX, (-2) * 5   ;result is -10 or 0FFF6H
MOV AX, 5 / 2      ;result is 2
MOV AX, 13 MOD 3   ;result is 1
```

SHL, SHR

Syntax:

```
absval SHL shiftvalue  
absval SHR shiftvalue
```

Description: The SHL and SHR operators shift the first operand bitwise by the value of the second operand. The SHL operator shifts bits to the left and SHR shifts bits to the right. Bits that are shifted to the left beyond the leftmost bit and bits that are shifted to the right beyond the rightmost bit are lost. Bits with a value of 0 are shifted in to fill.

All 17 bits, including the sign bit, are shifted. Thus both operands must be absolute values, and the result is also absolute.

For example, the statement

```
MOV AX, 1FFFFH SHR 3
```

places the value 3FFFH in the AX register. The binary values look like this:

```
1 1111 1111 1111 1111      (1FFFFH, before SHR 3)  
0 0011 1111 1111 1111      (3FFFH, after SHR 3)
```

Notice that the sign bit (the leftmost bit) of the argument in the example was shifted in when the shift right occurred.

It is possible for a shift to produce the invalid 17-bit number -65536 (10000H), which is automatically converted to 0.

If the count is negative, the shift is performed in the opposite direction. If the magnitude of the count is greater than 16, the result is 0.

Some other shifted values:

```
MOV AX, 5 SHL 2      ;result is 20 or 00014H  
MOV AX, 13 SHR 2     ;result is 3  
MOV AX, 44 SHL 11   ;result is 24576 or 06000H  
MOV AX, (-54) SHR 3 ;result is 16377 or 3FF9H
```

HIGH, LOW

Syntax:

HIGH operand
LOW operand

Description: These operators take either an absolute value or relocatable memory expression as an argument and return a BYTE-sized value of the same type. HIGH returns the high byte of the operand, LOW returns the low byte.

If the operand is a memory expression, it cannot contain index or base register names.

Attributes: relocation type - high or low

Examples:

```
MOV AL, HIGH 01234H ;result is 012H
MOV AL, LOW 01234H ;result is 034H
MOV AH, HIGH WMEM ;result is high byte of offset
MOV AL, LOW WMEM ;result is low byte of offset

EXTRN EXTABS:ABS
MOV AL, HIGH EXTABS ;result is high byte of
;external number
```

The following identities apply to HIGH and LOW.

```
High (High X) = 0H
Low (Low X) = Low X
High (Low X) = 0H
Low (High X) = High X
```

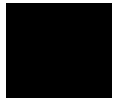

Logical Operators

The logical operators return values that are the result of comparing operands. (NOT can be seen as an exception.) AND, OR, and XOR compare the bits of their operands while EQ, NE, ..., GE all compare the values of their operands.

AND, OR, XOR

Syntax:

```
absval AND absval  
absval OR absval  
absval XOR absval
```

Description: These operators each take two absolute values as operands and return a single absolute value. If n is used to identify any given bit of the result, bit n has its value set differently depending on the operator used. The following rules apply:

- The AND operator will set a bit n of the result to 1 if bit n of both operands is a 1; otherwise bit n is set to 0.
- The OR operator will set bit n of the result to 1 if bit n of either operand is a 1; otherwise bit n is set to 0.
- The XOR operator will set bit n of the result to 1 if bit n of each operand is different; bit n is set to 0 if both bits are the same.

The operations are performed on full 17-bit values. Examples:

```
MOV AX, 035H AND 3145H ;result is 5  
MOV AX, 035H OR 3145H ;result is 3175H  
MOV AX, 035H XOR 3145H ;result is 3170H
```

NOT

Syntax:

```
NOT absval
```

Description: The NOT operator takes an absolute value as its operand and returns an absolute value that is the one's complement of the operand.

The one's complement is derived by toggling the bits of the operand. If bit n of the operand is 1, then bit n of the result will be 0. Similarly, if bit n of the operand is 0, bit n of the result will be 1. The operation is performed on full 17-bit values.

Since the bitwise complement of 0FFFFH is 10000H (-65536) (which is not a valid 17-bit value), NOT 0FFFFH is defined to be 0.

Examples:

```
MOV AX, NOT 1 ;result is 0FFFEH  
MOV AX, NOT 55 ;result is 0FFC8H
```

EQ, NE, LT, LE, GT, GE

Syntax:

```
equal: operand1 EQ operand2  
not equal: operand1 NE operand2  
less than: operand1 LT operand2  
less than or equal: operand1 LE operand2  
greater than: operand1 GT operand2  
greater than or equal: operand1 GE operand2
```

Description: These operators each compare their operands and return a value that depends upon the result of the comparison. The result will be 0 if the comparison is false and the value will be 0FFFFH if the comparison is true. The operands must both be absolute numbers, both be memory expressions, or both be segment base values. Memory expressions may not contain base or index register names, may not refer to externals, and must reside in the same segment. It is the offset portion of the memory addresses that are compared. Offsets and absolute values are compared using 17-bit arithmetic.

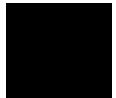

Chapter 7: Expressions

Memory Operators

Examples:

```
MOV AX, 15 GT 3      ;result is 0FFFFH
MOV AX, WMEM EQ BMEM ;result is 00000H
MOV AX, SEG WMEM EQ A ;result depends upon whether
                    ;WMEM lies within segment A
```

Memory Operators

SHORT

Syntax:

SHORT label

Description: The SHORT operator takes a label as its operand. The SHORT operator assures the assembler that the label will be within 127 bytes of the current location counter. SHORT is mainly used with the JMP instruction, where a forward reference to a label can result in either a one-byte or two-byte displacement. The SHORT operator informs the assembler that a one-byte displacement may be used (which only requires one byte of storage) where otherwise a two-byte displacement would result in extra object code size. It is up to you to ensure that the label is within 127 bytes because an error occurs if it is not. Example:

```
JMP SHORT FWDLAB
```

THIS

Syntax:

THIS type

Description: The THIS operator takes a type name as an operator and returns a memory reference of the given type. The memory referenced will be for the current location and segment. The length of the memory will be 1. The valid types for the operand are BYTE, WORD, DWORD, QWORD, TBYTE, NEAR, and FAR. The result of this operator may be used as either the right-hand side of an EQU (in which case it acts the same as a LABEL

directive) or as a memory reference in an instruction (which would be a rare use). Note that THIS NEAR is the same as '\$'. (Dollar sign is the special character used to represent the location counter.)

- Attributes:**
- segment** - current segment
 - offset** - current location counter
 - type** - as defined
 - relocation type** - depends upon current segment
 - segment** - current segment if defining variable
 - CS-assume** - current CS assume value if defining label

Examples:

```
LAB2 EQU THIS FAR      ;create FAR label
LAB1: NOP
DATAW EQU THIS WORD   ;allow word accesses to bytes
DATABL DB 1
DATABH DB 2
```

PTR

Syntax:

type PTR operand

Description: The PTR operator is used to either set or change the type of its operand. The valid types that may be used are BYTE, WORD, DWORD, QWORD, TBYTE, NEAR, and FAR. The resulting expression will behave as a variable, label, memory expression, or register expression of the given type. Valid operands depend upon the type used. For instance, it is not possible to change the type of a register expression to a NEAR or FAR label.

Attributes: **type** - as defined

Examples:

```
MOV AX, WORD PTR BMEM      ;access as word
JMP NEAR PTR LABFAR        ;use far label as NEAR
MOV AL, BYTE PTR [BP]      ;typing an anonymous
                           ;memory reference
MOV DS: WORD PTR 10, AX    ;absolute offset typing
```

Segment or Group Override

Syntax:

operand1 : operand2

Description: The segment override changes the segment attribute of the second operand to that of the first operand for the duration of the instruction statement. The first operand may be

- one of the segment registers (DS, ES, SS, or CS)
- the name of a segment
- the name of a group

The second operand must be a variable, label, memory expression, or register expression. If the first operand is a segment register, then the second operand's segment addressability attribute is changed to that of the segment register and no further testing is done. If the first operand is a segment name or group name, then the ASSUME values are checked to see if a segment register has been assumed to point to the segment or to the group. If one is found, the segment relocation and addressability attributes are changed to that of the matching segment register. If one is not found, it is an error. Remember, segment overrides only affect the current instruction; the ASSUME directive should be used for more global overrides.

The group override is useful when referring to variables or labels that belong to segments in the group. If no override is used, all offsets are relative to the base of the segment that the memory belongs to. The group override must be used to make the offset relative to the base of the group, which is probably a different value.

Attributes:

segment relocation - set to value of group or segment name used

segment addressability - set for variables

CS-assume - set for labels if group or segment name used

Examples:

```
MOV AX, DS: WMEM      ;offset from DS, base of segment
                       ;that WMEM belongs to
MOV AX, SEG1: WMEM    ;offset from base of SEG1, or group
                       ;that SEG1 belongs to, depending upon
```

```
MOV AX, GRP1: WMEM      ;order of ASSUMES  
                        ;offset from base of GRP1  
JMP FARLAB             ;offset from base of segment  
JMP GRP1: FARLAB       ;offset from base of GRP1
```

OFFSET

Syntax:

```
OFFSET variable  
OFFSET label
```

Description: The OFFSET operator takes a variable, label, or memory expression as its operand and returns the offset value from some base as the result. If no segment override appears in the operand, the offset will be from the beginning of the segment. If a group name is used as a segment override, then the offset will be from the group base. Remember that no checking is done against the ASSUME values for the registers. To get the offset from a group, an explicit group override must be used. In either case, the result is an immediate value, not a memory address. The value may be relocatable, depending upon whether the operand resides in a combinable segment or in a group. The result of an OFFSET operator occupies 2 bytes if it is a relocatable value. Otherwise, the number of bytes depends upon the value of the offset. Example:

```
MOV SI, OFFSET WMEM      ;offset from segment base  
MOV SI, OFFSET GRP1:WMEM ;offset from group base
```

SEG

Syntax:

```
SEG variable  
SEG label
```

Description: The SEG operator takes a variable, label, or memory expression as its operand and returns a segment base as its result. The base may be relocatable, depending upon the type of the segment or group that the operand belongs to or on any overrides that have been applied to the operand. The memory expression may not contain index or base register names. Externals are allowed in the operand. The size of a relocatable segment base is always 2 bytes unless the segment definition used the AT keyword. In that

Chapter 7: Expressions

Memory Operators

instance, the number of bytes may be 1 or 2, depending upon the segment location.

The SEG operator should not be used with operands that belong to a group. Instead, a segment register should be initialized to the group base so that all memory addresses will be offset from that base. Otherwise, the group is not being used correctly.

Note that the SEG operator may also be used in the ASSUME directive. See the reference about the ASSUME directive in the chapter titled "Assembler Directives" for more discussion on how SEG may be used with ASSUME.

Note

The SEG operator will also accept a segment name or a group name as an operator. Since segment names and group names do not have segment attributes, SEG with a segment or group name does not perform any function. The assembler ignores the SEG operator and acts as if only the segment or group name were used.



Attributes:

relocation type - base

Example:

```
MOV AX, SEG WMEM; load base value into AX
MOV DS, AX; initialize DS register
```

TYPE

Syntax:

```
TYPE variable
TYPE label
```

Description: The TYPE operator takes a variable, label, structure name, or memory expression as its operand. TYPE returns an absolute value that represents the type of the operand.

For most operands, the result is equal to the number of bytes allocated by a single occurrence of the operand. This value could then be used for incrementing a pointer into a data array, for example. The following are the returned values for variables or labels of a given type:

- BYTE - returns 1
- WORD - returns 2
- DWORD - returns 4
- QWORD - returns 8
- TBYTE - returns 10
- NEAR - returns -1 in two's complement form
- FAR - returns -2 in two's complement form
- record - returns number of bytes described by an occurrence of record
- structure - returns the sum of the sizes of the directives within the structure

Examples:

```
MOV AX, TYPE WMEM           ;result is 2
MOV AX, TYPE LABFAR        ;result is -2 in two's
                           ;complement form (FFFEH)
RECl RECORD F1:3, F2:5     ;record definition with
                           ;RECORD directive
R1 RECl <>                 ;storage allocation
                           ;using record template
MOV AX, TYPE RECl         ;result is 1
MOV AX, TYPE R1           ;result is 1
ST1 STRUC                 ;structure template
                           ;definition
    DB ?
    DW ?
ST1 ENDS
SU1 ST1 <>                 ;storage allocation using
                           ;structure template
MOV AX, TYPE ST1         ;result is 3
MOV AX, TYPE SU1         ;result is 3
```

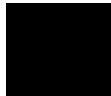

LENGTH

Syntax:

```
LENGTH variable
```

Description: The LENGTH operator takes a variable as its operand. It returns an absolute value equal to the number of units that were defined with the variable. A unit may include several bytes allocated by a single occurrence

Chapter 7: Expressions

Memory Operators

of a type, but it still counts as just one unit. For instance, a single word allocation occupies two bytes, but from the point of view of LENGTH, it is one unit (in this case one word). The length of external symbols is always defined to be 1, regardless of how it is defined in a different file. LENGTH does not operate on structure or record templates. Examples:

```
L1 DB 1
MOV AX, LENGTH L1          ;result in AX is 1

L2 DW 1,2
MOV AX, LENGTH L2        ;result in AX is 2

L3 DB 5 DUP (2)
MOV AX, LENGTH L3        ;result in AX is 5

L4 DW 1, 4 DUP (?)
MOV AX, LENGTH L4        ;result in AX is 5

REC1 RECORD F1:3, F2:5    ;record template definition
R1 REC1 <>                ;variable declared using record
                           ;template
MOV AX, LENGTH R1        ;result in AX is 1

R2 REC1 5 DUP (<>)        ;another variable with record
                           ;template
MOV AX, LENGTH R2        ;result in AX is 5

ST1 STRUC                 ;structure template def.
  DB ?
  DW ?
ST1 ENDS
SU1 ST1 <>                 ;variable declared
                           ;using structure template
MOV AX, LENGTH SU1       ;result in AX is 1
```

SIZE

Syntax:

SIZE variable

Description: The SIZE operator takes a variable, structure name, structure field, or record name as its operand and returns an absolute value equal to the total number of bytes defined by the operand. The size is generally equal to the length of the operand multiplied by the operand's type. Examples:

```
L1 DB 1
MOV AX, SIZE L1          ;result in AX is 1

L2 DW 1,2
MOV AX, SIZE L2        ;result in AX is 4

L3 DB 5 DUP (2)
MOV AX, SIZE L3        ;result in AX is 5
```

Chapter 7: Expressions

Memory Operators

```
L4 DW 1, 4 DUP (?)  
MOV AX, SIZE L4           ;result in AX is 10  
  
REC1 RECORD F1:3, F2:5   ;record template definition  
R1 REC1 <>                ;storage allocation using record  
                           ; template  
MOV AX, SIZE R1          ;result placed in AX is 1  
MOV AX, SIZE REC1       ;result placed in AX is 1  
  
ST1 STRUC                ;structure template def.  
  DB ?  
  STF1 DW ?  
ST1 ENDS  
SU1 ST1 <>                ;variable declared using  
                           ;structure template  
MOV AX, SIZE ST1        ;result placed in AX is 3  
MOV AX, SIZE SU1        ;result placed in AX is 3  
MOV AX, SIZE STF1       ;result in AX is 2
```

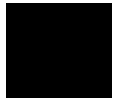

Record Operators

Record operators are used with record structure templates and record allocations to isolate bit fields of records and to find the actual number of bits in a record.

MASK

Syntax:

MASK recfield

Description: The MASK operator takes a record field as its operand. It returns an absolute number that will mask all the bits in a record except for those that belong to the record field operand. A mask is a number that will have 1's for all bits within the record field and have 0's for all other bits. It can be either a byte- or word-sized value, depending upon the size of the record and the positioning of the field within the record.

The MASK operator is useful when combined with the shift value (see "Expression Operands" in this chapter) for a record field. Together, they allow you to extract the value of a field. First, mask the record to isolate the bits that belong to the field. Then, shift the field so that its least significant bit is in the 0th bit position. The value of the result will now be equal to the value in the record field. Example:

```
R1 RECORD F1:5, F2:2
U1 R1 <14,3>
:
:
MOV AL,U1           ;load record into register
AND AL,MASK F1     ;mask out extra bits with MASK
                   ;operator and AND command
MOV CL, F1         ;put field shift value
                   ;in register
SHR AL,CL          ;shift field to lowest bit
                   ;position - AL now contains
                   ;value of record field
```

WIDTH

Syntax:

WIDTH operand

Chapter 7: Expressions

Record Operators

Description: The WIDTH operator takes a record name or record field as its operand. It returns an absolute number that is the number of bits defined in the operand. For a record name, the value will be the sum of the bits in the record fields, and will not include unused bits. For a record field, the value is the number of bits within that particular field. Examples:

```
R1 RECORD F1:5, F2:2
MOV AX, WIDTH R1      ;result in AX is 7
MOV AX, WIDTH F1      ;result in AX is 5
```

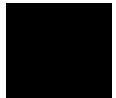

Segment and Group Operators

These operators return values that are only known at link-time. They generally refer to the size or address of segments and groups within a program.

SEGOFFSET

Syntax:

```
SEGOFFSET segmentname
```

Description: The SEGOFFSET operator returns a value that is the offset of the indicated segment from the next-lowest paragraph boundary. This value is the same as the last hex-digit of the base address for the segment. If the segment is paragraph or page aligned or is at an absolute location, then this value will be 0. Otherwise, this value is a relocatable value that will be known at final link time. The value will be range from 0 to 15, but will be word-sized if it is relocatable. Example:

```
A SEGMENT BYTE
; LOAD PARAGRAPH VALUE FOR SEGMENT
MOV AX, A

; LOAD OFFSET OF SEGMENT FROM NEAREST
; PARAGRAPH. TOGETHER, THEY FORM THE
; START LOCATION FOR THE SEGMENT
MOV BX, SEGOFFSET A
```

GRPOFFSET

Syntax:

```
groupname GRPOFFSET segmentname
```

Description: The GRPOFFSET operator returns the offset of a segment's base from the start of a group that it belongs to. The segment must be defined as part of the group or this operator will result in an error. Since the offset within the group is not known until link time, this operator will result in a word-sized relocatable value. The linker will generate a value from 0 to 0FFFFH at link time, which will be the offset of the segment's base from the start of the group. Example:

```
GRGRP GROUP A,B

; POINT DS AT GROUP
MOV AX, GRGRP
MOV DS, AX

; SET UP POINTER TO START
; OF SEGMENT SO LOCATIONS
; WITHIN THE SEGMENT CAN BE
; REFERENCED FROM THE GROUP
; SELECTOR
MOV SI, GRGRP GRPOFFSET B
```

SEGSIZE

Syntax:

```
SEGSIZE segmentname
```

Description: The SEGSIZE operator returns a word-sized value that is the size of the indicated segment. Since this size is not known (usually) at assembly time, this operator generates a word-sized relocatable value. The linker will generate a value from 0 to 0FFFFH at link time. Note that the linker will return the value 0 if the group size is 64K.

Example:

```
A SEGMENT PUBLIC

; LOAD SEGMENT SIZE.
; COULD BE USED TO MAKE
; SURE INDEX VALUES DON'T
; GO OUTSIDE OF A SEGMENT.
MOV AX, SEGSIZE A
```

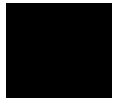

GRPSIZE

Syntax:

```
GRPSIZE groupname
```

Description: The GRPSIZE operator returns a word-sized value that is the size of the indicated group. Since this size is not known at assembly time, this operator generates a word-sized relocatable value. The linker will generate a value from 0 to 0FFFFH at link time, which will be the size of the group. Note that the linker will return the value 0 if the group size is 64K. Examples:

```
GRGRP GROUP A,B
```

```
MOV AX, GRPSIZE GRGRP
```

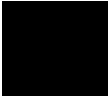

Operator Precedence

Complex expressions, or expressions that contain multiple operators, are evaluated according to operator precedence rules:

- Expressions enclosed within parentheses are evaluated from the innermost set of parenthesis to the outermost set. Within a set of parenthesis, operators conform to the other precedence rules below.
- Excluding parentheses, sub-expressions that have operators of higher precedence will be calculated before sub-expressions with operators of lower precedence. For example, a multiply operation is done before an addition operation.
- Excluding parentheses, sub-expressions which have operators of equal precedence (Operators that appear on the same line in the following table are of equal precedence.) are evaluated left-to-right. Left-to-right evaluation means that if two operators of equal precedence appear in the same expression, the operator which is closer to the leftmost end of the expression will be evaluated before an operator closer to the rightmost end. For instance, in the expression '6 * 5 / 3' the order of evaluation is to multiply 6 by 5 and then divide by 3. The result is 10.

The ranking of operators from higher to lower precedence is given in the following table.

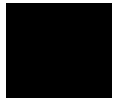

Chapter 7: Expressions
Operator Precedence

Precedence	Operators
<p>Higher</p> <p style="text-align: center;">↑</p> <p style="text-align: center;">↓</p> <p>Lower</p>	<p>() , [] , < > , . , LENGTH, SIZE, WIDTH, MASK , SEGOFFSET, SEGSIZE, GRPOFFSET, GRPSIZE</p> <p>PTR, OFFSET, SEG, TYPE, THIS, Segment Override</p> <p>HIGH, LOW</p> <p>*, /, MOD, SHR, SHL</p> <p>Unary + , -</p> <p>Binary + , -</p> <p>EQ, NE, LT, LE, GT, GE</p> <p>NOT</p> <p>AND</p> <p>OR, XOR</p> <p>SHORT</p>

8



Instructions and Operands

A discussion of operands and a list of recognized instructions.

Operands

You may recall that the general syntax of an assembler statement is as follows:

```
[ label : ] [ prefix ] keyword [ operand [ ,... ] ] [ ;comment ]
```

This section concentrates on the operand field of this syntax.

Accepted Operands

A list of assembly language instructions and the operand combinations acceptable for each instruction is at the end of this chapter. Each allowable combination has a limited range of values. Any other combination results in an error condition.

Compatible Types

In most instances, if an instruction takes more than one operand, the operands must be of the same type. For example, it is only possible to move a WORD-sized value into a WORD destination. A mismatch error occurs if an instruction attempts to move a WORD into a BYTE. It is possible, however, to move a BYTE-sized immediate value into a WORD-sized destination. The immediate is either stored as a WORD or it is sign-extended during execution.

Some instructions allow operands to be of different types. It is best to check the list of instructions at the end of the chapter for allowable operand combinations.

Required Typing

Many instructions do require that the memory operand be typed. Instructions that take a single operand generate different object code depending upon the type of the operand. Or, perhaps the type of one operand does not restrict the valid type of the other operand. The assembler cannot decide what object code to output in these instances. The following instructions demonstrate some unacceptable operand combinations:

```
INC [BX] ;generate byte or word instruction?
```

```
ESC 5,[BX] ;5 doesn't restrict memory  
MOV [BX], 2 ;2 fits in a byte or word storage
```

The INC instruction accepts both BYTE and WORD memory operands. In the above example, the assembler could not decide which instruction to generate.

The ESC instruction also accepts BYTE and WORD memory operands. The immediate value 5, in the example above, does not help limit the type of the memory operand since the value is independent of the memory type.

For the MOV instruction above, the immediate value 2 is small enough to fit in either a BYTE or a WORD. Again, the immediate operand does not restrict the type sufficiently.

When in doubt, type these ambiguous expressions to avoid possible error conditions.

Anonymous References

Most instructions are able to accept operands that do not have type information—references known as anonymous memory references. These references do not have a variable or any type information associated with them, so the assembler must use other knowledge to determine the type. The assembler may type the anonymous operand to be the same as another operand in the instruction, or not require a type at all. The following examples are of typing the same as another operand:

```
MOV AX, [BX] ;WORD since AX is a WORD-sized register  
MOV [BX], AL ;BYTE since AL is a BYTE-sized register  
MOV [BX], 1000 ;WORD since 1000 can't be stored in BYTE
```

Assumed Type With Register

The assembler can easily determine the type of an anonymous reference if the other operand is an 8086 register. Notice in the above example when AX and AL were used. Another example of an instruction not needing a type (since it handles all memory operands the same) is an 8087 floating point instruction. Example:

```
FLDCW [BX]
```

Operand Positioning

If an instruction takes a single operand, the operand position (other than it must be in the proper place) is not critical. Instructions which accept two operands generally treat the first operand as the destination operand and the second operand as the source operand. The movement of data is then from the second operand into the first. The instruction

MOV AX, BX

takes the contents of the BX register and places it in the AX register. There are exceptions. Some string instructions use the first operand as the source operand and the second operand as the destination operand. Check the usage of the operands when in doubt. The instruction list at the end of this chapter—and in the *Intel iAPX 86/88, 186/188 User's Manual*—includes information on data movement between operands.

Immediate Values

Immediate values are operands in many assembly language instructions. In most cases, the immediate value is a source operand. This value is stored directly in the destination operand or used to modify a value already stored elsewhere, say in a register or memory location.

Immediate values are not always numbers. Immediate values are also generated in many non-obvious ways as shown in the "Expressions" chapter.

Range of Immediate Values

Immediate values can be absolute, relocatable, or external numbers. The size of the value is determined by the instruction used, by the value itself, and by what type is assumed for it.

An absolute immediate may range anywhere from -65535 to 65535 depending upon the instruction and the type of the operand. The INT (interrupt) instruction, for instance, can only take a value from 0 to 255 since that is the range of interrupt values for the 8086. A variable of type BYTE may take a value from -255 to 255. A variable of type WORD may take a value from -65535 to 65535.

A relocatable or external immediate is always assumed to be a 16-bit value unless modified with a HIGH or LOW operator.

Registers

A very common operand is a processor register. A processor register is a memory store that is internal to the 8086/186 processors, and the 8087 co-processor. Internal registers can be source operands or destination operands for data. Some registers have special tasks which restrict their uses in programs. Since some instructions may indirectly use or modify these restricted registers, take care their contents are not accidentally modified or misused.

The figure below shows the general purpose and special registers for the 8086/186 processor. Following the figure is a more detailed description of the various processor registers.



Chapter 8: Instructions and Operands
Operands

DATA REGISTERS

7	0 7	0
AH (HIGH BYTE OF AX)	AL (LOW BYTE OF AX)	
BH (HIGH BYTE OF BX)	BL (LOW BYTE OF BX)	
CH (HIGH BYTE OF CX)	CL (LOW BYTE OF CX)	
DH (HIGH BYTE OF DX)	DL (LOW BYTE OF DX)	

POINTER AND INDEX REGISTERS

15	0
SP (STACK POINTER)	
BP (BASE POINTER)	
SI (SOURCE INDEX)	
DI (DESTINATION INDEX)	

SEGMENT REGISTERS

CS (CODE)
DS (DATA)
SS (STACK)
ES (EXTRA)

Figure 8-1. 8086/186 Registers

16-bit Registers AX, BX, CX, DX, DI, SI, SP, BP

There are eight 16-bit (WORD-sized) general purpose registers located on the 8086/186 processors referenced by the unique register names AX, BX, CX, DX, DI, SI, BP and SP. AX, BX, CX, and DX are general purpose data registers. For most instructions that allow a register as an operand, these four registers are used. DI, SI, BX and BP are the index and base registers.

Some instructions explicitly use certain registers. The CX register, for instance, is used to control looping. Many string instructions use the SI as a source pointer and DI as a destination pointer. The SP register points to the top of stack and is modified whenever CALLs, PUSHs, or POPs occur. Data loss can occur through a side effect of these explicit usages. Be careful to protect the contents of these registers so they are not accidentally modified through the use of an instruction.

8-bit Registers AL, AH, BL, BH, CL, CH, DL, DH

There are also eight 8-bit (BYTE-sized) registers. The unique names given to them are AL, AH, BL, BH, CL, CH, DL, and DH. These registers are not separate registers; instead they are the byte-addressable upper and lower halves of the four 16-bit general-purpose data registers (AX, BX, CX, and DX). AX, for instance, is equivalent to AL+ AH. (Not the value, but the register.)

The 'L' in AL means the low byte of AX and the 'H' in AH means the high byte of AX. If you refer to AL, the assembler understands that you mean the low byte of AX. If you refer to AX, the assembler understands that you mean the entire 16 bits of AX.

You may load data into these registers either as a single 16-bit quantity or as two 8-bit quantities. The resulting value in the register is the same.

Segment Registers CS, DS, SS, ES

8086/186 memory addresses are generated by offsetting from segment registers. To be able to address a particular location in memory, that address must be contained in one of the four, currently active physical segments. Each segment has a maximum size of 64K and each has a particular register that contains the base address (lowest memory location) of the segment. Each segment has a different purpose:

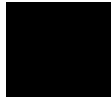

Chapter 8: Instructions and Operands

Operands

- Executable code (program code) is located in the Code segment and is addressable through the CS (Code Segment) register.
- Data is most often located in the Data segment (although it can be in any of the four segments) and is addressed through the DS (Data Segment) register.
- The program stack is located in the Stack segment and is addressed through the SS (Stack Segment) register.
- Data often is located in the Extra segment and is addressed via the ES (Extra Segment) register.

Memory Addressing A memory address is a 20-bit value —allowing the 8086/186 to address 1 megabyte of memory—that is calculated from the segment base address located in one of the segment registers, and an offset supplied either by the IP (instruction pointer), or by operands contained in the instruction itself. To calculate the memory address, the 16-bit value in a given segment register is first shifted to the left 4 bits. Then the offset value (either a 16-bit or 8-bit value) is added to the shifted value to generate the 20-bit address necessary to access memory.

Segment Register Use The four segment registers have restricted use. The only assembly instructions that may reference these registers as operands are the MOV, PUSH, and POP instructions.

Some Assembler Directives also use the register names as part of their syntax, but this use does not cause object code to be generated.

Other instructions indirectly reference the segment registers. LDS and LES, for instance, could change the segment register contents. CALLs and JMPs change the CS register if the branch takes execution out of the current segment. Finally, as noted in the chapter titled "Expressions," segment register names may be used as overrides in memory operands.

8087 Floating Point Registers ST(0)...ST(7)

The 8087 co-processor has eight floating point stack registers. They are referenced by the names ST(0), ST(1), ST(2), ST(3), ST(4), ST(5), ST(6), and ST(7). ST(0) may be referenced as just ST without the appended (0). These registers are only used with some 8087 floating point instructions.

They are not directly accessible to the 8086/186 processors. Instead, 8087 instructions make the contents of these registers available in memory. The 8087 floating point stack registers are 80 bits in size and store their values in IEEE floating point format.

Memory Expressions and the MODRM Byte

Memory expressions may be either simple memory references (using a variable name by itself) or a complex expressions involving register indirection or offsets within structures. A simple memory reference will always take the type of the variable, so that type must either be compatible with an instruction or it must be re-typed with the PTR operator. Examples:

```
MOV AX, WMEM           ;simple variable
MOV AX, [BX][SI]      ;indirect anonymous
                       ;memory reference
MOV AX, [BP].SFWORD   ;indirect anonymous memory
                       ;reference with offset
MOV AX, WMEM[BP][DI]  ;indirect memory reference
MOV AX, STR1.SFWORD   ;structure field reference
MOV AX, WORD PTR DMEM ;typed memory reference
```

Physical Address Calculation

The processor must generate a physical address for each memory reference. The offset part of the address—the value which is added to the shifted segment register address—may be coded into the instruction in one of four ways:

- As a direct 16-bit offset.
- As an indirect offset through a base register, BX or BP, optionally with an added (or subtracted) 8-bit or 16-bit displacement.
- As an indirect offset through an index register, SI or DI, optionally with an added (or subtracted) 8-bit or 16-bit displacement.
- As an indirect offset through the sum of one base register and one index register, optionally with an added (or subtracted) 8-bit or 16-bit displacement.

MODRM Byte

The information describing how the offset is derived is stored in the object code in a special byte called the MODRM byte. This byte has three fields:

Chapter 8: Instructions and Operands

Segment Addressability and Overrides

- 1 The first field describes how many bytes are required to hold the displacement portion of the address. This field can specify that 0, 1, or 2 bytes are required. If the value is a relocatable or external value, two bytes are always required.
- 2 The second field contains a register code or part of the code for the instruction; it is not relevant to this section.
- 3 The third field contains information describing what base and index registers are used, if any, when generating the address.

The MODRM byte, along with any displacement value, determines the offset of the memory address referenced in an instruction. Remember, the value is just the offset of the memory address. The base from which to offset must still be decided.

Single Memory Expression per Instruction

Each memory expression is either a source or destination for the instruction. Most instructions allow only a single memory expression, since the MODRM byte can only describe one. Some string instructions may have two memory expressions as operands, but these instructions are special cases because the operands are only used to check for segment addressability. Their offsets are not emitted as object code. Instead, the SI and DI registers are used for addressing the memory.

Segment Addressability and Overrides

The 8086 or 80186 processor generates a memory address by shifting the value from a segment register four bits to the left and then adding an offset to the shifted value. A segment of memory, up to a maximum of 64K bytes in size, is active only if one of the four segment registers points to that particular piece of memory.

Note that the segment is a physical segment, a physical piece of memory. These physical segments contain the logical segments of your assembly language program that you identified through SEGMENT/ENDS assembler directive pairs and other, similar means.

With the `ASSUME` assembler directive, you tell the assembler what values to assume as the base locations of the currently active segments. The `ASSUME` directive, then, lets you inform the assembler of the relationship between the logical segments you have defined in the program and the physical segments where they will eventually be located.

Addressability Checking

During assembly, if the assembler encounters an instruction that generates a memory reference, the assembler checks that reference against the value in the `ASSUME` for that segment. The assembler generates an error if the location in memory cannot be accessed through that particular segment register. The exception to checking against the `ASSUME` is when a memory reference contains a specific segment override.

`NEAR` and `SHORT` label references are also checked for addressability through the `CS` segment register to assure the assembler that the label can be reached during execution. A segment or group name may be used to override a label if the `CS` segment register value will be different than that currently assumed.

Addressability checking is done so that the correct object code may be generated. Unless a memory reference contains a segment override, the instruction is not preceded by a segment override byte in the generated object code. If no segment override byte is coded with the instruction, then the instruction memory reference defaults to a certain segment, depending upon the nature of the instruction.

Default Segments

If a memory reference does not specifically name a segment register through a segment override, there are default segment registers for memory references. The `CS` register is the default for instruction fetching. The `DS` segment register is the default for most memory data references, unless `BP` (a base register) is specified for register indirection. The `SS` segment register is the default if `BP` is used. Some string instructions default to the `ES` segment register with certain operands.

Although there are default segment registers for references, you must still use the `ASSUME` directive to inform the assembler where the bases of these segments are located; again, to specify the relationship between logical and physical segments and to aid in addressability checking.



Segment Overrides

An instruction may override these default registers by including a segment override in the instruction operand. There are two reasons why a segment override might be included in a memory reference:

- The memory location accessed is not located in the default segment that would be used with a particular instruction.
- The memory location accessed is located within a group in a segment. In this instance, the base of the group must be used for memory access, not the base of the segment.

The override holds for the duration of the instruction only. Segment overrides do not alter the contents of segment registers or the values specified in ASSUME directives.

Improper Uses of Segment Overrides

The section on default segments mentions that some string instructions default to the ES register. For these string instructions, you may not use segment overrides for string operands. You may use segment overrides, however, for the other memory operands in those instructions.

These and other exceptions are noted in the listing of instructions at the end of this chapter.

Segment Override Byte

When the assembler generates code for an instruction containing a segment override, the assembler precedes the instruction code with a segment override byte. (Whether it will appear or not is discussed below.) This override byte, if present, causes a specific segment register to be used to address that memory, regardless of which segment the variable belongs to. In the segment override byte, specific values are associated with specific registers. Examination of these values can tell you which segment the override has been generated for. The values are

CS - 2EH
DS - 3EH
SS - 36H
ES - 26H

Overrides and Checking Against ASSUME

If a segment name is used to override the default segment value for a memory reference, then the ASSUME value for the override segment is checked to see if it has been set to either

- the segment named in the override, or
- to a group that contains the segment named in the override.

If a group name is used, then the group name must match exactly.

Examples of segment overrides:

```
MOV AX, SEG1: WMEM      ;matches segment or group
MOV AX, GRP1: WMEM      ;matches group only
```

Segment Override Byte Generation

A memory reference that includes a segment override generates a segment override byte depending upon the outcome of the following checks:

- 1 If the memory is addressable by the default segment register for that type of instruction and operand, then the instruction needs no override byte.
- 2 If this test fails, then the segment registers are checked in the following order: DS, ES, CS, and SS. If the memory expression is addressable by one of these registers, then an override byte is generated for that register.
- 3 If no register match occurs, an error is generated. The checks are specific. If the variable used in the memory expression was an external defined outside of a segment, it can only match an ASSUME segment that has been set to the SEG value of the external or to a group that includes that segment.



The Instruction Set

This section contains the instruction set accepted by the as86 assembler. All operand combinations are listed for each instruction. Some of these instructions or operand combinations are only valid in certain modes (such as 80186 or V20). These restricted instructions are explained in the notes at the end of the list of instructions.

A special code denotes what operand patterns are allowed for each instruction. If no operands are shown, then none are expected for that instruction. Otherwise, each operand will have a name, indicating what the operand does, followed by a colon and a code indicating what type of operand is to be used. If an operand is restricted to certain values, then these values will be listed in parenthesis after the code. If more than one restricted value is possible, then they will be separated by commas. Numeric ranges will be denoted by their boundary values.



Table 8-1. Operand Codes

AB	AL only
AW	AX only
CB	SHORT label with current segment and within 127 bytes of current location
CD	FAR label, offset and base
CW	NEAR label, within current segment
D	17-bit immediate value
DB	1-byte immediate value, from -255 to 255
DW	2-byte immediate value, from -65535 to 65535
EB	either an 8-bit register or BYTE-type memory expression
ED	DWORD-type memory expression
EW	either a 16-bit register or WORD-type memory expression
F	8087 floating point stack register
M	any type of memory expression
MB	BYTE-type memory expression
MW	WORD-type memory expression
MD	DWORD-type memory expression
MQ	QWORD-type memory expression
MT	TBYTE-type memory expression
RB	8-bit register
RW	16-bit register
S	segment register
T	ST(0); top of 8087 floating point register stack
XB	BYTE-type, simple memory expression; no register indirection
XW	WORD-type, simple memory expression; no register indirection



as86 Assembler Instruction Set

Table 8-2 Assembler Instruction Set.

AAA		
AAD		
AAM		
AAS		
ADC	dst:AB,src:DB	
ADC	dst:AW,src:DB	
ADC	dst:AW,src:DW	
ADC	dst:EB,src:DB	
ADC	dst:EB,src:RB	
ADC	dst:EW,src:DB(-128,127)	
ADC	dst:EW,src:DW	
ADC	dst:EW,src:RW	
ADC	dst:RB,src:EB	
ADC	dst:RW,src:EW	
ADD	dst:AB,src:DB	
ADD	dst:AW,src:DB	
ADD	dst:AW,src:DW	
ADD	dst:EB,src:DB	
ADD	dst:EB,src:RB	
ADD	dst:EW,src:DB(-128,127)	
ADD	dst:EW,src:DW	
ADD	dst:EW,src:RW	
ADD	dst:RB,src:EB	
ADD	dst:RW,src:EW	
ADD4S		(Note 3)
ADD4S	dst:M,src:M	(Note 3)
AND	dst:AB,src:DB	

Table 8-2. Assembler Instruction Set (Cont'd)

AND	dst:AW,src:DB	
AND	dst:AW,src:DW	
AND	dst:EB,src:DB	
AND	dst:EB,src:RB	
AND	dst:EW,src:DB	
AND	dst:EW,src:DW	
AND	dst:EW,src:RW	
AND	dst:RB,src:EB	
AND	dst:RW,src:EW	
BOUND	indx:RW,bptr:MD	(Note 2)
BOUND	indx:RW,bptr:MW	(Note 2)
BRKEM	vector:Db	(Note 3)
CALL	addr:CB	
CALL	addr:CD	
CALL	addr:CW	
CALL	addr:ED	
CALL	addr:EW	
CBW		
CLC		
CLD		
CLI		
CLR 1	dst:Eb,off:D(0,7)	(Note 3)
CLR 1	dst:Eb,off:Rb(CL)	(Note 3)
CLR 1	dst:Ew,off:D(0,15)	(Note 3)
CLR 1	dst:Ew,off:Rb(CL)	(Note 3)
CMC		
CMP	dst:AB,src:DB	
CMP	dst:AW,src:DB	
CMP	dst:AW,src:DW	
CMP	dst:EB,src:DB	
CMP	dst:EB,src:RB	
CMP	dst:EW,src:DB(-128,127)	

Chapter 8: Instructions and Operands
as86 Assembler Instruction Set

Table 8-2. Assembler Instruction Set (Cont'd)

CMP	dst:EW,src:DW	
CMP	dst:EW,src:RW	
CMP	dst:RB,src:EB	
CMP	dst:RW,src:EW	
CMP4S		(Note 3)
CMP4S	dst:M,src:M	(Note 3)
CMPS	SI_ptr:MB,DI_ptr:MB	(Note 1)
CMPS	SI_ptr:MW,DI_ptr:MW	(Note 1)
CMPSB		
CMPSW		
CWD		
DAA		
DAS		
DEC	dst:EB	
DEC	dst:RW	
DIV	divisor:EB	
DIV	divisor:EW	
ENTER	disp:D(0,0FFFFH),level:D(0,255)	(Note 2)
ESC	opcode:DB(0,63),addr:EB	
ESC	opcode:DB(0,63),addr:ED	
ESC	opcode:DB(0,63),addr:EW	
EXT	dst:Rb,count:D(0,15)	(Note 3)
EXT	dst:Rb,src:Rb	(Note 3)
F2XM1		
FABS		
FADD		
FADD	dst:F,src:T	
FADD	dst:T,src:F	
FADD	memop:MD	
FADD	memop:MQ	
FADDP	dst:F,src:T	
FBLD	memop:MT	

Table 8-2. Assembler Instruction Set (Cont'd)

FBSTP	memop:MT	
FCHS		
FCLEX		
FCOM		
FCOM	fpst:F	
FCOM	memop:MD	
FCOM	memop:MQ	
FCOMP		
FCOMP	fpst:F	
FCOMP	memop:MD	
FCOMP	memop:MQ	
FCOMPP		
FDECSTP		
FDISI		
FDIV		
FDIV	dst:F,src:T	
FDIV	dst:T,src:F	
FDIV	memop:MD	
FDIV	memop:MQ	
FDIVP	dst:F,src:T	
FDIVR		
FDIVR	dst:F,src:T	
FDIVR	dst:T,src:F	
FDIVR	memop:MD	
FDIVR	memop:MQ	
FDIVRP	dst:F,src:T	
FENI		
FFREE	fpst:F	
FIADD	memop:MD	
FIADD	memop:MW	
FICOM	memop:MD	
FICOM	memop:MW	



Chapter 8: Instructions and Operands
as86 Assembler Instruction Set

Table 8-2. Assembler Instruction Set (Cont'd)

FICOMP	memop:MD	
FICOMP	memop:MW	
FIDIV	memop:MD	
FIDIV	memop:MW	
FIDIVR	memop:MD	
FIDIVR	memop:MW	
FILD	memop:MD	
FILD	memop:MQ	
FILD	memop:MW	
FIMUL	memop:MD	
FIMUL	memop:MW	
FINCSTP		
FINIT		
FIST	memop:MD	
FIST	memop:MW	
FISTP	memop:MD	
FISTP	memop:MQ	
FISTP	memop:MW	
FISUB	memop:MD	
FISUB	memop:MW	
FISUBR	memop:MD	
FISUBR	memop:MW	
FLD	fpst:F	
FLD	memop:MD	
FLD	memop:MQ	
FLD	memop:MT	
FLD1		
FLDCW	memop:M	
FLDENV	memop:M	
FLDL2E		
FLDL2T		
FLDLG2		

Table 8-2. Assembler Instruction Set (Cont'd)

FLDLN2		
FLDPI		
FLDZ		
FMUL		
FMUL	dst:F,src:T	
FMUL	dst:T,src:F	
FMUL	memop:MD	
FMUL	memop:MQ	
FMULP	dst:F,src:T	
FNCLEX		
FNDISI		
FNENI		
FNINIT		
FNOP		
FNSAVE	memop:M	
FNSTCW	memop:M	
FNSTENV	memop:M	
FNSTSW	memop:M	
FPATAN		
FPO2	opcode:D(0,127)	(Note 3)
FPO2	opcode:D(0,15),addr:Mb	(Note 3)
FPO2	opcode:D(0,15),addr:Md	(Note 3)
FPO2	opcode:D(0,15),addr:Mq	(Note 3)
FPO2	opcode:D(0,15),addr:Mt	(Note 3)
FPO2	opcode:D(0,15),addr:Mw	(Note 3)
FPREM		
FPTAN		
FRNDINT		
FRSTOR	memop:M	
FSAVE	memop:M	
FSCALE		
FSQRT		

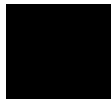

Chapter 8: Instructions and Operands
as86 Assembler Instruction Set

Table 8-2. Assembler Instruction Set (Cont'd)

FST	fpst:F	
FST	memop:MD	
FST	memop:MQ	
FSTCW	memop:M	
FSTENV	memop:M	
FSTP	fpst:F	
FSTP	memop:MD	
FSTP	memop:MQ	
FSTP	memop:MT	
FSTSW	memop:M	
FSUB		
FSUB	dst:T,src:F	
FSUB	dstF,src:T	
FSUB	memop:MD	
FSUB	memop:MQ	
FSUBP	dst:F,src:T	
FSUBR		
FSUBR	dst:F,src:T	
FSUBR	dst:T,src:F	
FSUBR	memop:MD	
FSUBR	memop:MQ	
FSUBRP	dst:F,src:T	
FTST		
FWAIT		
FXAM		
FXCH		
FXCH	fpst:F	
EXTRACT		
FYL2X		
FYL2XP1		
HLT		
IDIV	divisor:EB	

Table 8-2. Assembler Instruction Set (Cont'd)

IDIV	divisor:EW	
IMUL	dst:RW,src1:EW,src2:DB(-128,127)	(Note 2)
IMUL	dst:RW,src1:EW,src2:DW	(Note 2)
IMUL	dst:RW,src2:DB(-128,127)	(Note 2)
IMUL	dst:RW,src2:DW	(Note 2)
IMUL	mplier:EB	
IMUL	mplier:EW	
IN	dst:AB,port:DB	
IN	dst:AB,port:RW(DX)	
IN	dst:AW,port:DB	
IN	dst:AW,port:RW(DX)	
INC	dst:EB	
INC	dst:EW	
INC	dst:RW	
INS	DI_ptr:EB,port:RW(DX)	(Notes 1,2)
INS	DI_ptr:EW,port:RW(DX)	(Notes 1,2)
INS	dst:Rb,count:D(0,15)	(Note 3)
INS	dst:Rb,src:Rb	(Note 3)
INSB		(Note 2)
INSW		(Note 2)
INT	itype:DB(3)	
INT	itype:DB	
INTO		
IRET		
JA	place:CB	
JAE	place:CB	
JB	place:CB	
JBE	place:CB	
JC	place:CB	
JCXZ	place:CB	
JE	place:CB	
JG	place:CB	

Chapter 8: Instructions and Operands
as86 Assembler Instruction Set

Table 8-2. Assembler Instruction Set (Cont'd)

JGE	place:CB	
JL	place:CB	
JLE	place:CB	
JMP	place:CB	
JMP	place:CD	
JMP	place:CW	
JMP	place:EW	
JMP	place:MD	
JNA	place:CB	
JNAE	place:CB	
JNB	place:CB	
JNBE	place:CB	
JNC	place:CB	
JNE	place:CB	
JNG	place:CB	
JNGE	place:CB	
JNL	place:CB	
JNLE	place:CB	
JNO	place:CB	
JNP	place:CB	
JNS	place:CB	
JNZ	place:CB	
JO	place:CB	
JP	place:CB	
JPE	place:CB	
JPO	place:CB	
JS	place:CB	
JZ	place:CB	
LAHF		(Note 2)
LDS	dst:RW,src:ED	
LEA	dst:RW,src:M	
LEAVE		

Table 8-2. Assembler Instruction Set (Cont'd)

LES	dst:RW,src:ED	
LOCK	PREFIX	
LODS	SI_ptr:MB	
LODS	SI_ptr:MW	
LODSB		
LODSW		
LOOP	place:CB	
LOOPE	place:CB	
LOOPNE	place:CB	
LOOPNZ	place:CB	
LOOPZ	place:CB	
MOV	dst:AB,src:XB	
MOV	dst:AW,src:XW	
MOV	dst:EB,src:DB	
MOV	dst:EB,src:RB	
MOV	dst:EW,src:DB	
MOV	dst:EW,src:DW	
MOV	dst:EW,src:RW	
MOV	dst:EW,src:S	
MOV	dst:RB,src:EB	
MOV	dst:RW,src:EW	
MOV	dst:S(ES),src:EW	
MOV	dst:S(SS,DS),src:EW	
MOV	dst:XB,src:AB	
MOV	dst:XW,src:AW	
MOVS	DI_ptr:MB,SI_ptr:MB	(Note 1)
MOVS	DI_ptr:MW,SI_ptr:MW	(Note 1)
MOVSB		
MOVSW		
MUL	mplier:EB	
MUL	mplier:EW	
NEG	dst:EB	

Table 8-2. Assembler Instruction Set (Cont'd)

NEG	dst:EW	
NOP		
NOT	dst:EB	
NOT	dst:EW	
NOT1	dst:Eb,off:D(0,7)	(Note 3)
NOT1	dst:Eb,off:Rb(CL)	(Note 3)
NOT1	dst:Ew,off:D(0,15)	(Note 3)
NOT1	dst:Ew,off:Rb(CL)	(Note 3)
OR	dst:AB,src:DB	
OR	dst:AW,src:DB	
OR	dst:AW,src:DW	
OR	dst:EB,src:DB	
OR	dst:EB,src:RB	
OR	dst:EW,src:DB	
OR	dst:EW,src:DW	
OR	dst:EW,src:RW	
OR	dst:RB,src:EB	
OR	dst:RW,src:EW	
OUT	port:DB,dst:AB	
OUT	port:DB,dst:AW	
OUT	port:RW(DX),dst:AB	
OUT	port:RW(DX),dst:AW	
OUTS	port:RW(DX),SI_ptr:EB	(Note 2)
OUTS	port:RW(DX),SI_ptr:EW	(Note 2)
OUTSB		(Note 2)
OUTSW		(Note 2)
POP	dst:EW	
POP	dst:RW	
POP	dst:S(ES)	
POP	dst:S(SS,DS)	
POPA		(Note 2)
POPF		

Table 8-2. Assembler Instruction Set (Cont'd)

PUSH	src:DB(-128,127)	(Note 2)
PUSH	src:DW	(Note 2)
PUSH	src:EW	
PUSH	src:RW	
PUSH	src:S	
PUSHA		(Note 2)
PUSHF		
RCL	dst:EB,count:DB(0,31)	(Note 2)
RCL	dst:EB,count:DB(1)	
RCL	dst:EB,count:RB(CL)	
RCL	dst:EW,count:DB(0,31)	(Note 2)
RCL	dst:EW,count:DB(1)	
RCL	dst:EW,count:RB(CL)	
RCR	dst:EB,count:DB(0,31)	(Note 2)
RCR	dst:EB,count:DB(1)	
RCR	dst:EB,count:RB(CL)	
RCR	dst:EW,count:DB(0,31)	(Note 2)
RCR	dst:EW,count:DB(1)	
RCR	dst:EW,count:RB(CL)	
REP	PREFIX	
REPC	PREFIX	(Note 3)
REPE	PREFIX	
REPNC	PREFIX	(Note 3)
REPNE	PREFIX	
REPZ	PREFIX	
RET		
RET	src:DB	
RET	src:DW	
ROL	dst:EB,count:DB(0,31)	(Note 2)
ROL	dst:EB,count:DB(1)	
ROL	dst:EB,count:RB(CL)	

Table 8-2. Assembler Instruction Set (Cont'd)

ROL	dst:EW,count:DB(0,31)	(Note 2)
ROL	dst:EW,count:DB(1)	
ROL	dst:EW,count:RB(CL)	
ROL4	dst:Eb	(Note 3)
ROR	dst:EB,count:DB(0,31)	(Note 2)
ROR	dst:EB,count:DB(1)	
ROR	dst:EB,count:RB(CL)	
ROR	dst:EW,count:DB(0,31)	(Note 2)
ROR	dst:EW,count:DB(1)	
ROR	dst:EW,count:RB(CL)	
ROR4	dst:Eb	(Note 3)
SAHF		
SAL	dst:EB,count:DB(0,31)	(Note 2)
SAL	dst:EB,count:DB(1)	
SAL	dst:EB,count:RB(CL)	
SAL	dst:EW,count:DB(0,31)	(Note 2)
SAL	dst:EW,count:DB(1)	
SAL	dst:EW,count:RB(CL)	
SAR	dst:EB,count:DB(0,31)	(Note 2)
SAR	dst:EB,count:DB(1)	
SAR	dst:EB,count:RB(CL)	
SAR	dst:EW,count:DB(0,31)	(Note 2)
SAR	dst:EW,count:DB(1)	
SAR	dst:EW,count:RB(CL)	
SBB	dst:AB,src:DB	
SBB	dst:AW,src:DB	
SBB	dst:AW,src:DW	
SBB	dst:EB,src:DB	
SBB	dst:EB,src:RB	
SBB	dst:EW,src:DB(-128,127)	
SBB	dst:EW,src:DW	
SBB	dst:EW,src:RW	

Table 8-2. Assembler Instruction Set (Cont'd)

SBB	dst:RB,src:EB	
SBB	dst:RW,src:EW	
SCAS	DI_ptr:MB	(Note 1)
SCAS	DI_ptr:MW	(Note 1)
SCASB		
SCASW		
SET1	dst:Eb,off:D(0,7)	(Note 3)
SET1	dst:Eb,off:Rb(CL)	(Note 3)
SET1	dst:Ew,off:D(0,15)	(Note 3)
SET1	dst:Ew,off:Rb(CL)	(Note 3)
SHL	dst:EB,count:DB(0,31)	(Note 2)
SHL	dst:EB,count:DB(1)	
SHL	dst:EB,count:RB(CL)	
SHL	dst:EW,count:DB(0,31)	(Note 2)
SHL	dst:EW,count:DB(1)	
SHL	dst:EW,count:RB(CL)	
SHR	dst:EB,count:DB(0,31)	(Note 2)
SHR	dst:EB,count:DB(1)	
SHR	dst:EB,count:RB(CL)	
SHR	dst:EW,count:DB(0,31)	(Note 2)
SHR	dst:EW,count:DB(1)	
SHR	dst:EW,count:RB(CL)	
STD		
STI		
STOS	DI_ptr:MB	(Note 1)
STOS	DI_ptr:MW	(Note 1)
STOSB		
STOSW		
SUB	dst:AB,src:DB	
SUB	dst:AW,src:DB	
SUB	dst:AW,src:DW	
SUB	dst:EB,src:DB	

Table 8-2. Assembler Instruction Set (Cont'd)

SUB	dst:EB,src:RB	
SUB	dst:EW,src:DB(-128,127)	
SUB	dst:EW,src:DW	
SUB	dst:EW,src:RW	
SUB	dst:RB,src:EB	
SUB	dst:RW,src:EW	
SUB4S		(Note 3)
SUB4S	dst:M,src:M(Note 3)	
TEST	dst:AB,src:DB	
TEST	dst:AW,src:DB	
TEST	dst:AW,src:DW	
TEST	dst:EB,src:DB	
TEST	dst:EB,src:RB	
TEST	dst:EW,src:DB	
TEST	dst:EW,src:DW	
TEST	dst:EW,src:RW	
TEST	dst:RB,src:EB	
TEST	dst:RW,src:EW	
TEST1	dst:Eb,off:D(0,7)	(Note 3)
TEST1	dst:Eb,off:Rb(CL)	(Note 3)
TEST1	dst:Ew,off:D(0,15)	(Note 3)
TEST1	dst:Ew,off:Rb(CL)	(Note 3)
WAIT		
XCHG	dst:AW,src:RW	
XCHG	dst:EB,src:RB	
XCHG	dst:EW,src:RW	
XCHG	dst:RB,src:EB	
XCHG	dst:RW,src:AW	
XCHG	dst:RW,src:EW	
XLAT	table:MB	
XLATB		
XOR	dst:AB,src:DB	

Table 8-2. Assembler Instruction Set (Cont'd)

	XOR	dst:AW,src:DB	
	XOR	dst:AW,src:DW	
	XOR	dst:EB,src:DB	
	XOR	dst:EB,src:RB	
	XOR	dst:EW,src:DB	
	XOR	dst:EW,src:DW	
	XOR	dst:EW,src:RW	
	XOR	dst:RB,src:EB	
	XOR	dst:RW,src:EW	
Note 1:	CMPS INS MOVS SCAS STOS	second operand must be ES addressable. operand must be ES addressable. first operand must be ES addressable. operand must be ES addressable. operand must be ES addressable. The register is always used to address these operands, even if the ASSUMEd contents of ES and DS are the same.	
Note 2:	These instruction/operand combinations will generate code that works correctly on an 80186, or a V20/V30, but not an 8086. A warning is printed whenever one of these combinations is used in 8086 Mode.		
Note 3:	These instruction/operand combinations are accepted only in V20/V30 Mode.		

Chapter 8: Instructions and Operands
as86 Assembler Instruction Set



9



Assembler Controls

Description of assembler controls and control defaults.

Chapter 9: Assembler Controls

Assembler controls are internal assembler switches which let you enable and disable certain aspects of the assembly process. This chapter describes assembler controls and control defaults.

If a [NO] appears in the heading, it indicates that the word NO can be prefixed to a control to make it do the opposite of what the control does normally. For example, LIST turns on the output listing, but NOLIST turns off printing of the listing. (The -L command line option causes a listing to be generated.)



General Syntax for Assembler Controls

The syntax of a control line in the source code is:

```
$control[(parameter)] [...]
```

The dollar sign may be preceded by tabs or blanks. Separators must be included between adjacent controls. Examples:

```
$XREF  
$INCLUDE(filename) DEBUG SYMBOLS  
$PRINT ERRORPRINT(FILENAME)
```

Primary and General Controls

Assembler controls are classified as either primary or general. Primary control statements occur only on the first few lines of the source program before any non-control statements (other than comments and blank lines). Primary controls are not processed when they occur after any statement other than a control line; their presence after any statement other than a control line causes an error. General controls, however, can be specified at any time in the source program. In most instances, an error in either kind of control line causes all remaining controls on the line to be ignored.

Controls on the Command Line

Assembler controls may also be included on the command line when the assembler is invoked. If a primary control is entered on both the command line and in the first lines of the source file being assembled, the control from the command line overrides the control in the file for that particular assembly.

If a general control is entered on both the command line and in the file (since general controls can appear anywhere in the file, the general control might be far, relatively, from the beginning of the file), then the control from the command line is in effect until the control in the source file is found. At that point, the source file control overrides the command line control for the rest of the assembly.

Chapter 9: Assembler Controls

General Syntax for Assembler Controls

Control Conflicts

If a primary control conflicts with another primary control and both are in the source file, then the one that appears last takes effect. If the conflict is between a control on the command line and one in the file, then the control which appears on the command line overrides the one in the file.

If general controls conflict (whether both in the file or one on the command line and one in the file), then the control which appears last will be the one to take effect. Example:

```
$MOD186  
$MOD086 ;this control is last, it will be the one  
;to take effect
```

Controls and File Names

Certain controls accept a file name as a parameter. The file name parameters are optional, except with INCLUDE, and are ignored with all controls except INCLUDE. The [NO] form of these controls does not accept a file name.

Control Abbreviations

Each control can be abbreviated to a two-character equivalent; the abbreviations are listed with each control. Abbreviations may be negated if the full name of the control can be negated. Controls are not case-sensitive; upper-case and lower-case letters are equivalent. Remember that their arguments may be case sensitive, although the controls are not.

Controls and the Macro Preprocessor (ap86)

Most controls are used only by the assembler. The INCLUDE control acts differently, however, if the source file is processed by the macro preprocessor before assembly. If the source file contains INCLUDE controls and does go through the macro preprocessor, then the macro preprocessor will expand the INCLUDEs. The output from the preprocessor will then contain the include files and will no longer contain the INCLUDE controls (not a problem, since they are no longer necessary). The macro preprocessor does not act on any other assembler controls.

Primary Controls

[NO]CASE

shorthand = [NO]CA
default = CASE

Causes symbols to be case sensitive. That is, upper and lower case letters are not equivalent. If this control is negated, then all lower case characters in symbols will be treated as upper case. This control does not affect text within strings (except for class names).

Note

All Intel-generated OMF will contain case insensitive symbols.

DATE(string)

shorthand = DA

(No default necessary.)

The DATE control has no effect. It is supplied for Intel compatibility, and its use will not generate an error. The date printed on the listing and placed in the object file is obtained from the operating system.

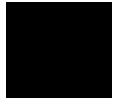

[NO]DEBUG

shorthand = [NO]DB
default = DEBUG

Causes symbolic debug and type information to be placed into the output object module. By default, only non-PURGED variables, labels and numbers are placed into the object module.

[NO]ERRORPRINT (filename)

shorthand = [NO]EP
default= ERRORPRINT

This control causes error and warning information to be displayed on standard error. The filename, if present, is ignored and is only allowed for Intel compatibility. The noerrorprint control suppresses error and warning messages from being displayed on standard error. The nowarning control may be used to suppress only warning messages while allowing error messages to be displayed.

[NO]EXTERN_CHECK

shorthand = [NO]EC
default = EXTERN_CHECK

This control causes the use of external symbols to check that an ASSUME register has been defined such that the external symbol can be referenced from the ASSUME register. The noextern_check control causes the assembler to allow any use of an external symbol without verifying that the symbol is accessible through whatever assume register is used to reference that symbol. This then requires the user to make sure that segment registers are correctly set up to reference the segment that a given external symbol belongs to.

GEN

shorthand = GE
(No default necessary.)

Supplied for Intel compatibility. The assembler does no macro processing. This is done by the macro preprocessor, ap86(1). Therefore, this control has no effect.

GENONLY

shorthand = GO
(No default necessary.)

Supplied for Intel compatibility. The assembler does no macro processing. This is done by the macro preprocessor, ap86(1). Therefore, this control has no effect.

[NO]GROUP_INFO

shorthand = [NO]GI
default = GROUP_INFO

This control causes the debug information emitted from the assembler to associate group information to all symbols that belong to segments that are members of a group. Only one group will be assigned to a given symbol, regardless of how many groups a given segment belongs to. The `nogroup_info` control will only associate group information to labels and procedures; variables will NOT have group information associated.

[NO]HLASSYM

shorthand = [NO]HA
default = NOHLASSYM

Causes as86 to generate low-level symbol information for static procedures, static data, and embedded assembly code. This option is useful when compiler-generated output is to be debugged in an emulator. If the output is to be debugged in AxDB or AxDE, then the negated form of this option is recommended.

[NO]MACRO(string)

shorthand = [NO]MR

(No default necessary.)

Enables or disables macro assembly. Since macro processing is accomplished by a separate program, this control has no effect in either the assembler or the macro preprocessor. It is supplied for Intel compatibility, and its use will not generate an error.

MOD086

shorthand = M0
default = MOD086

Identifies the target microprocessor as 8086. The assembler generates errors for instructions that are not part of the 8086 microprocessor instruction set.

MOD186

shorthand = M1
default = MOD086

Identifies the target microprocessor as 80186. The assembler generates errors for instructions that are not part of 80186 microprocessor instruction set.

MODV20

shorthand = MV
default = MOD086

Identifies the target microprocessor as V20. Causes the V20/V30/V40/V50 instruction set to be recognized. Errors or warnings will be issued when instructions from conflicting instruction sets are encountered. All instructions are accepted without error in this mode.

Note

In V20 mode, the as86 assembler accepts the extensions that are specific to the NEC V20/V30 microprocessor. For these extensions, as86 accepts NEC mnemonics, but uses Intel instruction syntax. Where instructions might overlap (the NEC equivalent of an Intel instruction), as86 accepts only the Intel instruction mnemonic and not the NEC mnemonic or syntax (which might be different for the same function). This assembler is targeted for the 8086/186 family of microprocessors and should not be considered to support the NEC V20/V30 microprocessor instruction mnemonics or syntax.

[NO]OBJECT (filename)

shorthand = [NO]OJ
default = OBJECT

Chapter 9: Assembler Controls

Primary Controls

Generates an output object module, but the optional file name is ignored and only allowed for Intel compatibility. The assembler gives the object file the same root name as the source file, with a '.o' (dot lower case o) default file name extension.

[NO]OPTIMIZE

shorthand = OP
default = NOOPTIMIZE

This control will cause the assembler to spend extra time processing the input file so the resulting object file has as few NOPs as possible. These NOPs are generated when forward references are used in expressions. The assembler does not always know how many bytes of output will be produced for a given instruction, so it reserves extra space. If the instruction turns out to be shorter than that size, then the assembler pads the rest of the length with NOP bytes. This control will allow the assembler to spend time removing these NOPs when they are generated under these conditions. Note that this control will cause the assembler to run for a longer time than it otherwise would.

PAGELength(n)

shorthand = PL
default = 55 lines per page

Specifies the page length of the listing as "n" lines, where n= 20 or more lines.

PAGEWIDTH(n)

shorthand = PW
default= 132 characters per line

Specifies the listing page width in number of characters, where n is a number between 60 and 255, inclusive. Lines exceeding the current page width are wrapped to the next line.

[NO]PAGING

shorthand = [NO]PI
default= PAGING

Formats the output listing so as to have headers at the top of each page. By default, the headers supply the assembler name, title, and the date. If NOPAGING is specified, then the listing does not contain page headers or page ejects (except for an initial header on the first page). This option is only useful if a listing is produced.

[NO]PRINT(filename)

shorthand = [NO]PR
default = NOPRINT

Prints the assembly listing. The noprint control suppresses the generation of the listing file including error messages and symbol table listings. You cannot override noprint with a list control occurring later in the program; however, a list control with no preceding print or noprint implies print. The file name parameter is accepted for Intel compatibility, but it is ignored by the assembler. Any lines that precede the print control will not be output to the listing. (Default: noprint)

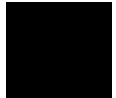

[NO]SYMBOLS

shorthand = [NO]SB
default= SYMBOLS

Prints an alphabetically sorted symbol table with the output listing. The listing will not contain cross-reference information. Cross-reference information is produced with the XREF control. If XREF is used, it will override this control and cross-reference information will be produced. This option is only useful if a listing is output.

[NO]TYPE

shorthand = [NO]TY
default = TYPE

This control is recognized for Intel compatibility only and its use will not have any effect. Whether type information is generated depends upon the DEBUG control being on.

[NO]UNREFERENCED_EXTERNALS

shorthand = [NO]UE
default = NOUNREFERENCED_EXTERNALS

This control will cause all external symbols, including those that are unreferenced, to appear in the generated object file. In certain cases, these externals may be used to cause certain object files to be linked at link time. If this control is not present or if the NOUNREFERENCED_EXTERNALS control is used, any unreferenced externals will be removed from the resulting object file. This form of the control is useful when using inline functions in the Hewlett-Packard C cross compiler. This will prevent unnecessary routines from being linked in that are being processed inline.

[NO]WARNING

shorthand = [NO]WA
default = WARNING

This control causes warning messages to be displayed along with any error messages that may appear on standard error. The nowarning control suppresses the warning messages so only error information is sent to standard error. The errorprint control overrides either form of this control in determining whether any information is sent to standard error or not.

WORKFILES(...)

shorthand = WF

(No default necessary.)

This control has no effect. It is supplied for Intel compatibility, and its use will not generate an error.

[NO]XREF

shorthand = [NO]XR
default = NOXREF

Prints a cross reference table on the output listing. If you use both the XREF and SYMBOLS controls, a cross reference table will be generated.

General Controls

EJECT

shorthand = EJ

(No default necessary.)

Advances the listing form to the beginning of the next page and prints a new header. This is only useful if a listing is being generated and paging is in effect.

[NO]GEN

shorthand = [NO]GE

(No default necessary.)

This control has no effect in either the assembler or macro preprocessor. It is supplied for Intel compatibility, and its use will not generate an error.

GENONLY

shorthand = GO

(No default necessary.)

This control has no effect in either the assembler or macro preprocessor. It is supplied for Intel compatibility, and its use will not generate an error.

INCLUDE(filename)

shorthand = IC

(No default necessary.)

Indicates that the specified file should be included in the source input before the next line of the current source file is processed. Unlike other controls, INCLUDE must appear on a line by itself. No other controls, or other INCLUDEs, can be on the same line.

Note

The default directory for INCLUDE is always the current working directory. To use a file in another directory, specify the complete path name.

[NO]LIST

shorthand = [NO]LI

default = LIST

Turns on assembly listing at any point in the program. If used in combination with NOLIST, you can list a portion of the source file. NOLIST overrides XREF and SYMBOLS. An error summary still goes to stdout and errors still go to stderr regardless of LIST setting.

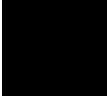

RESTORE

shorthand = RS

(No default necessary.)

Restores, as the current settings, the most recently-saved settings for LIST/NOLIST that are on the stack. This control is used mainly to restore LIST/NOLIST settings after returning from INCLUDE files.

SAVE

shorthand = SA

(No default necessary.)

Saves the current settings of LIST and NOLIST controls on a stack up to 64 entries deep. This control remains in effect until explicitly changed. SAVE is typically used with RESTORE where LIST/NOLIST settings are saved before an INCLUDE control switches the input source to another file. RESTORE can be used to restore the settings at the end of the include file or upon returning from the include file.

TITLE(string)

shorthand = TT

default = module name

Enables you to define a title of up to 41 characters in a page header. Unquoted parentheses in "string" must be balanced. String may be quoted if "unusual" characters are used in the title. The length of the title is bound by PAGESWIDTH. If you want the title to appear on the first page, use the TITLE control on the first source line or the command line.

Operational Differences in the Different Modes

The as86 operates in one of three modes depending upon the choice of control: MOD086, MOD186, or MODV20. The 8086 mode is the default.

8086 Mode

The default 8086 mode is the simplest mode. It is intended for assembling code destined for an 8086 or 8088. The pre-defined instructions which work in the 80186, but not the 8086, are flagged with errors when they appear. The 80186 instructions that will be flagged:

BOUND, ENTER, IMUL with 2 or 3 operands, INS, INSB, INSW, LEAVE, OUTS, OUTSB, OUTSW, POPA, PUSH immediate, PUSHA. The shifts RCL, RCR, ROL, ROR, SAL, SAR, SHL, and SHR with a numeric second operand other than 1.

The extensions for the V20 are also flagged with errors.

80186 Mode

The 80186 mode differs from the 8086 mode in that the pre-defined instructions listed in the 8086 mode discussion above do not generate an error when they are found. The V20 instructions, however, do generate errors.

V20 Mode

The V20 Mode differs from the 80186 mode in that it accepts the additional V20 predefined instructions: EXT, ADD4S, CMP4S, SUB4S, ROL4, ROR4, TEST1, NOT1, CLR1, BRKEM, FPO2, REPC, REPNC, and two additional operand combinations for INS. Remember that for those instructions common to the V20 and 8086 processor families, as86 accepts only Intel mnemonics. In addition, as86 accepts only Intel syntax for all instructions.

If you are assembling programs for NEC V-Series microprocessors, you should consider obtaining the Hewlett-Packard V-Series Cross Assembler.

Chapter 9: Assembler Controls
Operational Differences in the Different Modes

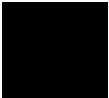

10



Assembler Listing Description

Description of assembler listings, including a description of the optional symbol table and cross reference format.

Assembly Listing

The as86 Assembler uses a two-pass process. During the first pass, labels, variables and other user-defined symbols are examined and placed in the symbol table. Additionally, structures are stored internally.

During the second pass, the object code is generated, symbolic addresses are resolved, and a listing and object module are produced. Errors detected during the assembly process will be displayed on the output listing with a cumulative error count. At the end of the assembly process a symbol table or a cross reference table can be displayed.

The listing contains information pertaining to the assembled program, including op codes, assembled data and the original source statements. The listing can be used as a documentation tool by including comments and remarks that describe the function of the particular program segment.

A sample assembler listing is provided in Chapter 1. Refer to the following points to examine and understand the listing.

- 1** The page headings show the time and date of the program run.
- 2** The column titled "Line" contains decimal numbers associated with the listing source lines. These numbers are referred to in the cross reference table.
- 3** The column titled "Offset" contains a value that represents the first memory address of any object code generated by this statement.
- 4** The columns under "Object-Bytes" show the object code generated by instructions and directives in the file. Bytes are output lowest address first.
- 5** To the right of the data bytes are the assembler relocation flags. The flags are 'R' for relocatable operand, and 'E' for external operand. If one operand is relocatable and the other is external, the 'E' flag will be displayed.
- 6** The original source statements are reproduced to the right of the object-bytes field.
- 7** At the end of the listing the assembler prints the number of assembler errors. The assembler substitutes NOPs when it cannot translate a particular opcode and therefore provides room for patching the program.

Chapter 10: Assembler Listing Description

Cross Reference and Symbol Table Format Description

A symbol table or cross reference table can be generated at the end of the assembly listing if the option specifying its output is used. All user-defined symbols, in alphabetic order, along with the symbol's value type and attributes, are listed in the symbol table.

Cross Reference and Symbol Table Format Description

By default, the assembler produces a symbol table at the end of each listing. If you want the assembler to produce a cross reference table in place of the symbol table, use the XREF option.

If SYMBOLS and XREF are both specified, a cross reference table is produced. The cross reference table includes all the information present in the symbol table, but with line references noted for each symbol. The symbol table listing and cross reference features can be turned on only at the beginning of a program, and once on, cannot be turned off at a later point.

Label In the symbol table or cross reference listing header, the Label field lists the symbol name.

Type The Type field describes the kind of symbol represented by the Label. This field may be any of the following:

SEGM	segment name
GROUP	group name
CLASS	class name
LOCAL	local variable
PUBLIC	public variable
EXTERN	external variable or label
LABEL	local far or near label

Chapter 10: Assembler Listing Description

Cross Reference and Symbol Table Format Description

STRUC	structure definition
STR_FLD	structure field name
REC	record definition
REC_FLD	record field name
EQU	equate symbol
PROC	procedure name
UNDEF	undefined symbol



Chapter 10: Assembler Listing Description

Cross Reference and Symbol Table Format Description

Value	The Value field appears to the right of the Type field and is used to indicate attributes of the symbol. These attributes further describe what the symbol is or where the symbol resides. The specific attributes shown depend upon the Types above.
SEGM	Size of segment (in bytes), followed by combine type (PUBLIC/MEMORY/STACK/COMMON), followed by alignment (BYTE/WORD/PARA/PAGE/INPAGE/AT nnn), followed by classname, if present.
GROUP	List of segments that belong to the group. If a SEG EXTRN was used, then the name of the external will be displayed.
LOCAL, PUBLIC, EXTERN, LABEL, PROC	Segment name (if known), and offset within segment, followed by type (BYTE/WORD/DWORD/QWORD/TBYTE/NEAR/FAR/ABSOLUTE).
STRUC	Size of structure, followed by number of fields.
STR_FLD	Offset within structure, followed by type of field (BYTE/WORD/DWORD/QWORD/TBYTE).
REC	Size of record, followed by number of fields, followed by width of record in bits.
REC_FLD	Bit offset within record, followed by width of field in bits.
EQU	If EQU'd to a register, the name of the register is shown. If EQU'd to a 17-bit value, NNNN. If EQU'd to a real number, REAL. If EQU'd to an instruction, INSTRUCTION.

Chapter 10: Assembler Listing Description

Cross Reference and Symbol Table Format Description

If EQU'd to a memory expression, EXPRESSION.

The UNDEF and CLASS types do not have any attributes.

Cross Reference

If a cross reference is being generated in addition to the symbol listing, then line references will appear to the right of the Value field. Each line reference will be separated from the next by a space.

The line on which the symbol is defined will have a minus sign placed before it. All other line numbers indicate references to the symbol. It is possible for there to be more than one definition of a symbol (for example, a segment). Also, purged symbols may appear more than once in the table.

11

Codemacros

How to use the CODEMACRO directive.

Chapter 11: Codemacros

Referencing Codemacros

Codemacros define 8086, 8087, 8088, 80186, and V20 instructions. A codemacro is a template for generating code, with certain bits fixed and other bits that are supplied when the codemacro is referenced (much as a record or structure). You must define the codemacro using the `CODEMACRO` directive before referencing it.

Referencing Codemacros

Formal arguments can be defined on the call line and then referenced in the body of the codemacro. Forward references to codemacros are illegal.

A codemacro is referenced by using its name in the opcode field of a source statement. You must provide actual parameters at this time, which must match the parameters as to the sort of entity described (number, `WORD` address expression, segment register, etc.). Matching is described in detail below. If matching is successful for all arguments, the codemacro is used to generate code. At this time, the formal arguments in the codemacro body will be replaced with data derived from the corresponding actual parameters.

Multiple codemacros with the same name are legal. When the name is referenced, each of the defined codemacros is checked to determine whether its formal arguments match the actual parameters you provide. The first codemacro whose arguments match is used to generate code. Multiple codemacros are checked in reverse order; the most recently-defined codemacro is checked first. This feature permits a single symbol to generate a variety of different code, depending on the arguments provided. When defined, `as86` compiles the codemacro into a compact internal form and stores it in virtual memory.

Codemacro Directives

CODEMACRO

Enters Codemacro Definition

Syntax

```
CODEMACRO cmac_name [formal:specmod[range]][,formal:specmod[range]]...  
    ...  
ENDM  
  
or  
  
CODEMACRO cmac_name PREFIX  
    ...  
ENDM
```

Description

cmac_name	The name associated with the defined codemacro. It may have been previously defined as a codemacro, but not as anything else. This name is stored as a symbol and should not conflict with reserved words. Note that using an instruction name in this field is legal and results in an additional codemacro to be searched for that name.
formal	An arbitrary symbol defining a formal argument to the codemacro. Formals are not stored as symbols, and can duplicate keywords or even the cmac_name without conflict. Formals have no existence outside their codemacro and do not appear in the symbol table listing, although two formal parameters to the same codemacro cannot have the same name. A codemacro can have at most 255 formal arguments.
specmod	A letter or pair of letters describing the actual parameters that will match this formal parameter.

The legal values for specmod are:

Chapter 11: Codemacros

Codemacro Directives

A	Ab	Aw			
C	Cb	Cd	Cw		
D	Db	Dw			
E	Eb	Ed	Ew		
F					
M	Mb	Md	Mq	Mt	Mw
R	Rb	Rw			
S					
T					
X	Xb	Xd	Xq	Xt	Xw

Upper- and lower-case letters are interchangeable for these values. The convention of one upper-case letter followed by one lower-case letter is used in this chapter for clarity and to avoid confusion with the directives DB and DW. The first letter of the specmod is referred to as the specifier and the second letter as the modifier. The meaning of the various specmods is described in the table on page 223.

range

An optional field that follows a parameter. It describes a range of values that limits the acceptable modules for the parameters matching the formal argument. The first letter of the specmod must be A, D, R, or S. Any other type of specmod is not permitted to have a range field. The syntax and meaning of range fields is further described later in this section.

PREFIX

A keyword that can appear instead of the formal arguments, indicating that the codemacro name cannot take parameters. Instead, it is used to precede another codemacro or instruction name. At the time the codemacro is referenced, an error is detected if another codemacro or instruction does not follow this one.

PREFIX is associated with the codemacro name as a whole rather than separately with each codemacro. If one codemacro uses PREFIX, another codemacro with the same name must also use PREFIX. The last codemacro defined controls in case of conflict. A formal argument cannot be named PREFIX.

The CODEMACRO directive lets you enter the codemacro definition mode and specifies the formal arguments associated with the new codemacro. The ENDM is used to terminate the codemacro definition mode. Each CODEMACRO directive must have a corresponding ENDM directive, and codemacro definitions cannot be nested.

Examples

```
CODEMACRO CMAC1 FORMAL1: Ew, FORMAL2: Db(10, 20)
CODEMACRO CMAC2 FORMAL3: S
CODEMACRO CMAC3
CODEMACRO CMAC4 PREFIX
```

ENDM

Terminates Codemacro Definition

Syntax

ENDM

Description The ENDM directive terminates the codemacro definition mode. Each ENDM must correspond to a CODEMACRO directive. For more information on ENDM, see the description of the CODEMACRO directive in the previous section.

Codemacro Matching

The assembler performs two passes on the input file to match codemacro references to definitions.

- 1 During pass 1, all actual parameters are evaluated. Parameters containing undefined symbols are called “forward references,” and are treated differently from other expressions. as86 is much more liberal concerning what a forward reference can match than what a fully-evaluated expression can match. Forward references are considered to be typeless unless type information is specifically attached with PTR or SHORT.
- 2 The chain of codemacros corresponding to the instruction mnemonic is searched, beginning with the last one defined. as86 looks for a codemacro

Chapter 11: Codemacros

Codemacro Matching

with the same number of formal arguments as there are actual parameters, such that each actual parameter matches the corresponding formal as far as specmod and range goes. Matching is described in the "Range Specification" section. The first codemacro that matches is used as described in # 3 below. If none matches, an error is reported.

- 3** The number of bytes of object code is estimated by executing the codemacro and discarding the generated bytes. This estimate is used to update the location counter. By default, forward references do not require a segment override byte from the SEGFIX, RFIXM, and RNFIXM directives.
- 4** During pass 2, the codemacro chain search starts at the beginning again. Presumably, all forward references have now been resolved. If not, an error is issued and the absolute number 0 is substituted for the undefined symbol, which may in turn cause other errors. This resolution of forward references can cause a different codemacro to be matched than in pass 1. If none matches, an error is reported. If a codemacro matches in pass 1, it does not necessarily have to match in pass 2.
- 5** Code is generated using the matched codemacro. A different number of bytes of code can be generated than was called for in the estimate from pass 1. If more code is generated in pass 1 than in pass 2, the extra room allocated is filled with NOPs (90H). If more code is generated in pass 2 than in pass 1, an error message is issued and the entire space allocated is filled with NOPs.

The Specmod Field

The specmod field determines what actual parameters match each formal argument. In the table which follows, “variable” is an address expression with type BYTE, WORD, DWORD, QWORD, TBYTE, a structure name, or a record name, and “label” is an address expression with type NEAR or FAR. For the purpose of matching, forward references during pass 1 are treated as a special kind of expression that match certain specmods. Specmods match actual parameters as shown in the table.

Table 11-1. Specmods and Parameter Matches

Specmod	Match
A	AX or AL.
Ab	AL.
Aw	AX.
C	Any label, or any forward reference of type NEAR or FAR or no_type.
Cb	Any NEAR label with the same segment definition attribute as the current assumed contents of CS via ASSUME and within the range -128 to + 127 from the beginning of the code macro reference, or any forward reference with SHORT attached.
Cd	Any FAR label, or any forward reference without a type or of type FAR.
CW	Any NEAR label with the same segment definition attribute as the current assumed contents of CS via ASSUME but farther away from the beginning of the codemacro reference than -128 to + 127, or any external NEAR label
D	Any 17-bit number, or any forward reference with no type.
Db	Any absolute number between -256 and 255, inclusive, or any number of relocation type high or low

Table 11-1. Specmods and Parameter Matches (Cont'd)

Specmod	Match
Dw	Any absolute number not between -256 and 255 inclusive, or any number of relocation type offset or base, or any forward reference with no type.
E	Any variable, or any address expression without a type, or any register except segment registers, or any forward reference, except for those typed NEAR
Eb	Any variable with type BYTE
Ed	Any variable with type DWORD, or any forward reference of type DWORD or no type.
Ew	Any variable with type WORD, or any 16-bit register, except segment registers, or any forward reference of type WORD or no type.
F	The floating-point stack or any element thereof: ST
M	Any variable or any address expression without a type, or any forward reference except those of type NEAR
Mb	Any variable with type BYTE, or any forward reference of type BYTE or no type.
Md	Any variable with type DWORD, or any forward reference of type DWORD or no type.
Mq	Any variable with type QWORD, or any forward reference of type QWORD or no type.
Mt	Any variable with type TBYTE, or any forward reference of type TBYTE or no type.
Mw	Any variable with type WORD, or any forward reference of type WORD or no type.
R	Any register except segment registers.
Rb	Any 8-bit register (AH, AL, BH, BL, CH, CL, DH, DL).
Rw	Any 16-bit register except segment registers (AX, BX, CX, DX, SI, DI, BP, SP)

Table 11-1. Specmods and Parameter Matches (Cont'd)

Specmod	Match
S	Segment registers (ES, DS, SS, CS)
T	The floating-point stack top: ST or ST(0) only.
X	Any variable or any address expression without a type, whose base and index attributes are null or any forward reference except those of types NEAR
Xb	Any variable of type BYTE whose base and index attributes are null, or any forward reference of type BYTE or no type.
Xd	Any variable of type DWORD whose base and index attributes are null
Xq	Any variable of type QWORD whose base and index attributes are null, or any forward reference of type QWORD or no type.
Xt	Any variable of type TBYTE whose base and index attributes are null, or any forward reference of type TBYTE or no type.
Xw	Any variable of type WORD whose base and index attributes are null, or any forward reference of type WORD or no type.

In addition, typeless address expressions such as [BX] will sometimes match the specmods Eb, Ew, Mb, and Mw. There must be enough information for as86 to infer the size of the operation. This condition is met if the codemacro has at least two formal arguments, and one or more of the actual parameters corresponding to the other argument(s) is not either another typeless address expression or a number that matches Db.

For example, suppose a codemacro has ARG1:Ew,ARG2:Ew as the formal arguments. The actual parameters [BX],AX match, since AX implies a WORD operation; however, the actual parameters [BX],[BX] do not match since the information to infer the size of the operation is insufficient. This condition means that any codemacro with a single formal parameter of specmod Eb, etc., cannot match a typeless address expression, including several of the built-in instructions (e.g., INC, FISUB, IMUL).

Chapter 11: Codemacros

The Specmod Field

A few built-in instructions (e.g., `FLDENV`) have the specmod `M` on their single formal parameter and, therefore, will accept a typeless address expression.

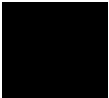

Range Specification

A codemacro range is a parenthesized list of one or two expressions separated by a comma. The syntax of a range specification is:

```
(value1[,value2])
```

Each value must be a register name or an expression evaluating to an absolute number (i.e. not an address). Registers are converted to absolute numbers according to the following table.

Table 11-2. Absolute Number Conversion for Registers

Register	Number
AL, AX, ES	0
CL, CX, CS	1
DL, DX, SS	2
BL, BX, DS	3
AH, SP	4
CH, BP	5
DH, SI	6
BH, DI	7

Some codemacros have specific limits on the range of parameters that can be used. This pertains to formals using specifiers A, D, R, or S.

When codemacros are referenced, the actual parameter is checked against the specified range, converting actual registers according to the table. If the range field contained a single value, the actual parameter must match it. If the range field contained two values, the actual parameter must be greater than or equal to the first and less than or equal to the second. Otherwise, the actual parameter does not match. Relocatable actual parameters and forward references never match a formal with a range field.

Chapter 11: Codemacros

Range Specification

Examples:

S(0,2)	Matches ES, CS, or SS.
S(0)	Matches only ES.
Db(2,-1)	Generates error - invalid range.
Db(-1,2)	Matches -1, 0, 1, or 2. 255 does not match (9-bit comparison).
Db(-1,DL)	Same as previous example.
Rw(DX)	Matches DX.
Rb(CL)	Matches CL.
Db(1)	Matches 1.

Codemacro Matching Examples

This table shows a list of the arguments on some example codemacros for the MOV instruction, in the order they are searched, along with actual parameters that will match each. WORDVAR is a variable of type WORD, and BYTEVAR is a variable of type BYTE.

Table 11-3. Arguments and Actual Parameters

Codemacro Reference	Match
MOV WORDVAR,AX	MOV dst:Xw,src:Aw
MOV BYTEVAR,AL	MOV dst:xb,src:Ab
MOV AX,WORDVAR	MOV dst:Aw,src:Xw
MOV AL,BYTEVAR	MOV dst:Ab,src:Xb
MOV SS,WORDVAR	MOV dst:S(SS,DS),src:Ew
MOV WORDVAR,CS	MOV dst:Ew,src:S
MOV CX,WORDVAR	MOV dst:Rw,src:Ew
MOV CL,BYTEVAR	MOV dst:Rb,src:Eb
MOV DS:[BX],AX	MOV dst:Ew,src:Rw
MOV DS:[BX],AL	MOV dst:Eb,src:Rb
MOV CX,1000	MOV dst:Rw,src:Dw
MOV CX,20	MOV dst:Rw,src:Db
MOV CL,20	MOV dst:Rb,src:Db
MOV WORDVAR,1000	MOV dst:Ew,src:Dw
MOV WORDVAR,20	MOV dst:Ew,src:Db
MOV BYTEVAR,20	MOV dst:Eb,src:Db

Chapter 11: Codemacros

Codemacro Matching Examples

The following is a list of some instructions that do not match the formal argument pairs.

```
MOV CS,WORDVAR      ; CS is not between SS and DS,  
                    ; and not equal to ES.  
MOV ES,BYTEVAR      ; No such 8-bit operation appears.  
MOV WORDVAR,BL      ; In general, 8-bit and 16-bit operands  
                    ; cannot mix.  
MOV BL,WORDVAR      ; Mixed 8- and 16-bit operands.  
MOV BL,1000         ; Mixed 8- and 16-bit operands. 1000 won't fit in BL.  
MOV BYTEVAR,1000    ; Mixed 8- and 16-bit operands. 1000 won't fit in  
                    ; BYTEVAR either.
```

Expressions in Codemacros

Only a small subset of the usual expressions is available within codemacro definitions. The following are allowed:

- Absolute numbers, and expressions which evaluate to absolute numbers. No forward references are allowed within such expressions.
- Segment registers.
- Formal argument names.
- Shifted formal arguments.

Syntax:

`formal_name.recordfield`

where `formal_name` and `recordfield` are symbols. This means to perform a right shift of the actual parameter corresponding to the `formal_name` at the time the codemacro is referenced, by the number of bits given by the shift count of the `recordfield`. The actual parameter must be an expression that evaluates to an absolute number. If the actual parameter is a relocatable number, an error is reported at the time the codemacro is referenced. The predefined ESC instruction uses this construct.

PROCLLEN

PROCLLEN has the value 255 if the most recently defined PROC at the time of codemacro reference was declared FAR. It has the value 0 otherwise. Thus, if the codemacro reference is not in a PROC, PROCLLEN yields 0.

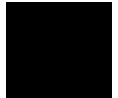

Directives within Codemacros

Only a few directives are legal within a codemacro definition, and these are listed below. Instructions are not allowed within a codemacro definition, but assembler controls and comments are; however, the assembler control is not considered part of the codemacro. None of these directives are allowable outside a codemacro definition unless so described elsewhere in this manual (e.g. DB, DW, DD, and record names).

The following pages describe directives within codemacros.

Table 11-4. Directives within Codemacros

Directive	Function
DB	Generates byte of immediate data.
DD	Generates 4 bytes of immediate data.
DW	Generates 2 bytes of immediate data.
MODRM	Generates ModRM byte.
NOSEGFIX	Checks for addressability through a certain seg register.
ONLY186	(186 Mode only) Identifies 186-only instructions.
recordname	Generates 1 or 2 bytes using the specified record template.
RELB	Generates 1-byte displacement.
RELW	Generates 2-byte displacement.
RFIX	Generates a WAIT (9BH) followed by the first 5 bits of an ESC(0D8H).
RFIXM	Generates a WAIT (9BH) followed by a segment override byte (if needed) followed by the first 5 bits of an ESC (0D8H).
RNFI	Generates an NOP (90H) followed by the first 5 bits of an ESC(0D8H).
RNFI	Generates an NOP (90H) followed by the first 5 bits of an ESC(0D8H).
RNFI	Generates an NOP (90H) followed by a segment override byte (if needed) followed by the first 5 bits of an ESC (0D8H).
RWFI	Generates a WAIT (9BH).
SEGFIX	Generates segment-override byte if needed.

DB, DD, DW

Generates N-Bytes of Immediate Data

Syntax

```
DB absolute_numeric_expression  
DB formal_name  
DB formal_name.recordfield  
DD absolute_numeric_expression  
DD formal_name  
DD formal_name.recordfield  
DW absolute_numeric_expression  
DW formal_name  
DW formal_name.recordfield
```

Description

`absolute_numeric_expression` An absolute numeric expression.

`formal_name` A name that is a formal parameter to the codemacro.

`formal_name.recordfield` A name that is a formal parameter to a codemacro but shifted according to the recordfield.

The DB, DD, and DW directives are similar to their counterparts outside codemacros, but their legal operands are much more restricted.

Each consecutive appearance of a DB, DW, or DD directive within a codemacro generates one, two, or four bytes, respectively.

It is possible for a formal argument with specmod Dw to appear in a DB directive, where it will not fit, which will then cause an error at the time of codemacro reference.

A `formal_name` without a recordfield must be of specifier D for the DB directive and must be of specifier D, C, or X for the DW and DD directives. (A specifier is the first letter of a specmod listed beginning on page 223.)

A `formal_name` appearing with a recordfield must have specifier D.



MODRM

Generates ModRM Byte

Syntax

```
MODRM formal_name2,formal_name1
```

or

```
MODRM number,formal_name1
```

Description

formal_name1	An effective-address parameter. It must have a specifier of E, M, R, X, A, or S. (A specifier is the first letter of a specmod listed beginning on page 223.)
formal_name2	A parameter, usually a register. It must have a specifier of D, R, A, or S.
number	An expression evaluating to an absolute number.

MODRM generates the ModRM byte, which can contain a wide variety of information: a register involved in the instruction, the base and index registers of an operand, the addressing mode (direct address, relative to the current location, immediate, register), a continuation of the opcode, etc.

as86 derives 5 bits of information from formal_name1, and 3 bits from the first parameter. If the first operand of MODRM is a number that is either a constant or a formal matching D, the low 3 bits are used in the generated byte. If the first operand is a register with a matching A, R, or S, the 3 bits to use are taken from the numeric values corresponding to registers as described in the section on Range Specification.

NOSEGFIX

checks for Addressability

Syntax

```
NOSEGFIX segreg , formal_name
```

Description

segreg	One of the segment registers ES, CS, DS, SS.
formal_name	A formal argument name whose specifier is E, M, or X (a memory parameter).

NOSEGFIX ensures that a parameter is addressable through a specific segment register. It is used in the built-in instruction set for the string instructions MOVSB, STOSB, CMPSB, SCASB, INSB[186], for which one operand must be addressable through ES.

NOSEGFIX checks the segment addressability attribute of the actual parameter corresponding to the formal_name to ensure that the parameter is addressable through the specified segment register. If the actual parameter is a register (matching E), it is considered addressable. If the attribute is a segment register, it must match the register on the NOSEGFIX. If the attribute is null, it is not addressable. If the attribute is a segment or group, as86 checks the assumed contents of the specified segment register through ASSUME, as it does for SEGFIX. NOSEGFIX never generates any code. It merely performs an error check. Note that this check is not performed at argument matching time. It is possible for the actual parameters to match the formal arguments of a codemacro that contains a NOSEGFIX directive and then get an error on the NOSEGFIX, even if another codemacro exists farther along in the codemacro chain that would not get this error. No codemacro in the built-in instruction set can do this.



ONLY186 (186 Mode Only)

Identifies 186-Only Instructions

Syntax

ONLY186

Description ONLY186 issues a warning message if the assembler is in 8086 mode. Generation of code proceeds normally. This protects you from accidentally writing a 186-only instruction which will not work when the target machine is an 8086.

Record Name Initialization

Syntax

```
recordname<[expression][,expression]...>
```

Description

recordname The name of a previously-defined record.

expression One of the following:

- An expression evaluating to an absolute number
- A formal argument
- A formal argument plus a `.recordfield`
- Null
- `PROCLLEN`

The record initialization directive lets you control bit fields in codemacro definitions.

Formal arguments in either construct (with or without a `.recordfield`) must be of specifier `D`, and the corresponding actual parameter cannot be relocatable or an error will be reported when codemacros are expanded.

Each expression must evaluate to an absolute number, and only the bits corresponding to the defined size of each `.recordfield` are used. Also, the least significant bits of the expression value are used, and more significant bits are discarded without any check. Null fields, as well as records outside codemacros, result in the use of the default value at the time the record was defined.

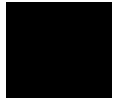

RELB, RELW

Generates N-byte Displacement

Syntax

```
RELB formal_name  
RELW formal_name
```

Description

`formal_name` The name of a formal parameter to the codemacro with specmod type C.

The RELB and RELW directives generate a one- or two-byte displacement, respectively, denoting the distance from the location of the codemacro reference to a target which can only be a label. The displacement is measured from the location after the bytes generated by RELB or RELW. Specifically, if the target is the byte immediately following the generated displacement whether that is 1 or 2 bytes, the generated displacement will be 1. These directives take one operand, a formal argument that must be of specmod Cb or Cw. RELB and RELW do not concern themselves with segment addressability or the contents of CS.

During codemacro matching to Cb and Cw specmods, the assembler assumes that any RELB or RELW in the codemacro will follow exactly one generated byte and, as a result, the restriction of the displacement for Cb to -126 to + 129 occurs. This assumption is correct for all codemacros in the built-in instruction set. You can write codemacros for which this assumption does not hold. For example, you can write one equivalent to several predefined instructions, but if this is done, the wrong match can be made at codemacro reference-time.

RFIX, RFIXM, RNFIX, RNFIXM, RWFIX

Generates WAIT or NOP

Syntax

```
RFIX      formal_or_number
RFIXM    formal_or_number, formal_name
RNFIX    formal_or_number
RNFIXM   formal_or_number, formal_name
RWFIX
```

Description

formal_or_number A codemacro parameter with specifier type D or an absolute expression that evaluates to an absolute number.

formal_name A codemacro parameter with specifier type E, M, or X.

These closely-related directives pertain to floating-point instructions. In all modes, they generate bytes as follows:

RFIX WAIT (9BH) followed by the first word of an ESC (0D8H)

RFIXM WAIT (9BH) followed by a segment override byte (if needed) followed by the first word of an ESC (0D8H)

RNFIX NOP (90H) followed by the first word of an ESC (0D8H)

RNFIXM NOP (90H) followed by a segment override byte (if needed) followed by the first word of an ESC (0D8H)

RWFIX WAIT (9BH)

RFIX and RNFIX have one operand; RFIXM and RNFIXM have two operands; RWFIX has no operands. The first operand of each, except RWFIX, is either a formal parameter with specifier D or an expression evaluating to an absolute number. The least significant 3 bits of this operand are taken as the last 3 bits of the generated ESC. If the corresponding actual parameter is relocatable, an error is reported when codemacros are referenced.

Chapter 11: Codemacros

Directives within Codemacros

The second operand of `RFIXM` and `RNFXM` is a formal argument of specifier `E`, `M`, or `X` representing a memory address. The segment override byte is issued or not, depending on this parameter; the algorithm is exactly the same as that described under `SEGFIX`.

The preceding descriptions assume that the object code will be used on an 8087 chip. These directives are designed for use within floating-point instructions. However, if the linker references the 8087 emulator library instead, the `WAIT` and `NOP` instructions described are changed into instructions to the emulator. The linker performs this function by resolving external references generated by the `R?FIX?` directives. This is why, for instance, a codemacro uses `RWFIX` instead of `DB 9BH`.

Intel provides two libraries, one of which is used as input to its linker for any given absolute object module. One library is used if the code is destined for an 8087, and the other is used if the 8087 is to be emulated.

This use of built-in external references, which typically will not be of concern to you, also means that any codemacro employing one of these directives displays an `E` flag (i.e. external reference) on the output listing when referenced. This includes all the floating-point instructions in the built-in instruction set.

SEGFIX

Generates Segment-Override Byte

Syntax

```
SEGFIX formal_name
```

Description

`formal_name` A codemacro parameter with specifier type E, M, or X.

The SEGFIX directive generates a segment-override byte, if needed (either 26H, 2EH, 36H, or 3EH). This instructs the hardware to use a different segment register for the following instruction.

SEGFIX has one parameter which must be a formal argument name. This argument represents a memory address and, therefore, must have one of the specifiers (1st letter of the specmod) E, M, or X. A register (matching E) never generates a segment override. An address expression has its segment addressability attribute checked as follows:

- If this attribute is null, an error is reported.
- If the attribute is a segment register, that register is used for addressing.
- If the attribute is a group, the assumed contents of the segment registers via ASSUME are checked to see if one of them contains the group.
- If the attribute is a segment, the assumed contents of the segment registers via ASSUME are checked to see if one of them contains the segment or a group containing the segment.

In the last two cases, the segment registers are examined in this order:

- 1 The register implied by the base and index attributes of the actual parameter (DS or SS).
- 2 The other registers are examined in the order ES, CS, SS, DS.

The first register for which the check succeeds is used for addressing. If the actual parameter cannot be addressed through any segment register, an error is issued. Otherwise, once as86 has determined which segment register to use for addressing, it determines whether that register is the default implied by the base and index attributes. If so, no override byte is generated; if not, a segment



Chapter 11: Codemacros

Directives within Codemacros

override byte corresponding to the segment register used for addressing is generated.

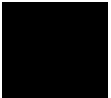

12

Macro String Preprocessor Introduction



Introduction to the Macro String Preprocessor.

Chapter 12: Macro String Preprocessor Introduction

Input Source Characteristics

The Macro String Preprocessor (ap86) is a character string replacement program which performs pre-assembly processing of macros in assembly language source files. It searches the source code for macro calls, and then replaces those calls with the macro return values. The advantage of having the macro string preprocessor is to permit frequently-used segments of code to be used repeatedly by one or several users from a library, without having to re-write the code for each use. You can automatically insert a section of code into the source program by encoding a single line—the macro call.

At definition time, key constructs in the macro may be represented by formal parameters; actual parameters are later substituted for the formal ones. ap86 handles conditional assembly, assembly-time loops, and is also capable of recursion.

Note

The macro preprocessor is case sensitive by default. Upper and lower case characters are not equivalent to the preprocessor. The macro symbol MACSYM would not be the same as macSYM, MaCSYM, or macsym. Case sensitivity can, however, be turned off on the command line.

ap86 is implemented as a program separate from the assembler, thereby saving time for those who do not use macros. It is compatible with the Intel syntax for the 8086/186 macro languages. If you use macros in the source code, you must run the Macro Preprocessor to produce an output file for input to the assembler.

Input Source Characteristics

ap86 views its input file as a stream of characters instead of a sequence of statements. All processing is character-oriented. The ends of lines are treated as if they ended with a < line feed> . This character is called 'end-of-line' or '< EOL>' in text that follows.

The Metacharacter '%' And The Call Pattern

The macro preprocessor searches the input source one character at a time, looking for a special character called the **metacharacter**. By default, this character is the percent sign ('%'), but it can be dynamically changed. Until the metacharacter is found, characters are passed to the output file without change. When the metacharacter is found, the macro preprocessor reads and interprets the characters following it, isolating a **call pattern**. The call pattern is interpreted as instructions to the macro preprocessor and is not passed to the output file. However, the macro preprocessor produces an expansion of the call pattern that is written to the output file in place of the call pattern. The call pattern can contain other metacharacters followed by call patterns; these will also be expanded. Expansions are stacked, analogous to nested subroutines. When the current expansion is complete, the stack is popped, and the next higher expansion resumes where it left off. The expansion of a call pattern is always a string of characters which can be null (zero characters) in some cases, but most often it is one or more characters. When the outermost expansion is completed, the macro preprocessor goes back to copying characters while scanning for the metacharacter.

The source code below has statements that contain macros.

```
NOB
asymb1 EQU 2
DB %LEN( %SUBSTR(5 DUP (0),1,1)) ;note blank before
; %SUBSTR
ADD AX,2
```

The example source code is treated by the macro preprocessor in this way:

- 1 Everything up to the first "%" is passed to the output unchanged. The text has no significance to the macro preprocessor.
- 2 The first "%" invokes the pre-defined macro function LEN, which counts the characters in its argument. (LEN, SUBSTR, and other pre-defined macro functions used in these examples are described in detail in the chapter called "Pre-defined Macro Functions.")

Everything up to but not including the balancing right parenthesis (in this example, the last parenthesis) is the argument to LEN.

- 3 The argument to LEN contains a call to another pre-defined macro function, SUBSTR, which extracts a substring from its first argument according to parameters in the second and third arguments. The

Chapter 12: Macro String Preprocessor Introduction

Metacharacter Syntax

expansion of the outer function LEN therefore pauses while SUBSTR is evaluated.

- 4 In this example, the result of SUBSTR is the single character '5'. After the evaluation, LEN resumes, in effect evaluating "%LEN(5)" (again, notice the space in front of the 5). This produces the string "02H," which is passed to the output.

The space between "%LEN(" and "%SUBSTR" is a significant part of the LEN argument, but is not part of the call to SUBSTR. Following "02H," ap86 puts out the <EOL>, which is the next character following the call pattern of LEN in the source file. Notice that <EOL> is not part of the call pattern. The assembler, therefore, sees the following line of text:

```
DB 02H<EOL>
```

Metacharacter Syntax

The metacharacter can be followed by

- a symbol
- a left parenthesis (
- an apostrophe '
- a decimal digit
- an asterisk * (called the literal character), that in turn must be followed by a symbol.

No other characters are acceptable, particularly spaces and tabs. A symbol following the metacharacter (or the metacharacter-asterisk pair) must be one of three things:

- A pre-defined macro function.
- A call to a previously-defined user macro.
- A reference to a previously-defined macro-expansion-time symbol or, within a macro body, a formal argument or local symbol. The

metacharacter is recognized anywhere in the source text, including within character strings.

Getting a line such as

```
DB '20% inflation'
```

to pass through the macro preprocessor requires special handling. Getting these strings through the macro preprocessor is discussed in the "%n and %((Escape and Bracket Functions) in the chapter titled "Pre-defined Macro Functions."

Literal Character *

The literal character (*) specifies that metacharacters contained in the arguments to a function are not expanded. The literal character is placed between the metacharacter and the function or macro name, and spaces or other separators cannot precede or follow it. The literal character inhibits the expansion of all user macros, symbols, and pre-defined functions. It does not affect formal macro parameters, local symbols within macros, and the escape, comment and bracket functions. If one of the lines of code from the previous example were rewritten to contain the literal character before the LEN macro name,

```
DB %*LEN(%SUBSTR(5 DUP (0),1,1))
```

then the SUBSTR call is not expanded. Instead, LEN counts the length of the string '%SUBSTR(5 DUP (0),1,1)' and returns the string "16H." Output to the assembler would then be

```
DB 16H <EOL>
```

If the literal character preceded SUBSTR instead of LEN, it would have no effect in this example because the argument to SUBSTR does not contain any metacharacters. Misuse of the literal character causes the macro preprocessor to pass strings containing a metacharacter on to the assembler, where they will usually be flagged as errors. The literal character is prohibited all together with some functions; other functions accept it, but ignore it. The literal character should almost always be used when defining a user-macro.

Input Parsing

The macro preprocessor recognizes the operators listed on page 250. The macro preprocessor only understands symbols in specific constructs which are usually preceded by the metacharacter. Assembly-time user-defined symbols (labels, etc.), the location counter, and EQUs are all unknown to the macro preprocessor.

You must be careful that a macro call produces each < EOL> in the right place. Readable input to the macro preprocessor frequently results in a large number of output lines consisting only of blanks and end-of-lines. For user convenience and assembler speed, such lines are always omitted from the output. To create a blank line, deliberately use a blank comment line.

Output Buffering

The macro preprocessor buffers its output in an array that can hold 256 characters. When its buffer is full and another character (other than < EOL>) is received, ap86 breaks the output line into two pieces. The break occurs at the 256 character boundary and the remaining text is placed on the next line of output. This and all other lines created from the long input line will begin with a '&' so the assembler can recognize the line as a continuation. Since the break is made at a fixed location, it is likely that the result will cause a syntax error in the assembler. Thus, it is best if line lengths are restricted to less than 256 characters.

Include Files

INCLUDE is an assembler control command, but the macro preprocessor will act on INCLUDE also. INCLUDE statements cause the macro preprocessor to temporarily stop reading source statements from the current file. It begins reading source statements from the file specified by the INCLUDE. It continues reading from the include file until it finds the end-of-file for the include file or it finds another INCLUDE. When the preprocessor resolves all

INCLUDEs and does find the end-of-file for the include file, it then returns to the file that contained the INCLUDE statement and again begins reading source statements immediately after the INCLUDE statement.

Note

The maximum depth that the macro preprocessor can handle nested INCLUDE controls is to a level of eight. The restriction on the assembler depends only upon the number of open files the operating system allows at one time.

The syntax for the INCLUDE statement:

```
$INCLUDE ( filename )
```

The '\$' must be in column 1 for the preprocessor to recognize it for processing.

The default directory for INCLUDE is always the current working directory.

Any INCLUDE starting in column 1 of a source statement, whether from a source file or an include file, is processed by the macro preprocessor when it is first read. An INCLUDE within a macro definition can be processed at assembly-time or at macro-expansion-time, depending on whether the '\$' starts in column 1 in the definition. If an INCLUDE does have a '\$' in column 1 in the definition, then it is expanded at definition time. Otherwise, INCLUDE is not processed at macro-expansion-time. Example:

```

%*DEFINE (MAC1) ($INCLUDE(filename))      ;assembly-time
%*DEFINE (MAC2) (
$INCLUDE(filename)                        ;macro-definition time
)
%*DEFINE (MAC3 ( PARM1 )) ($INCLUDE(%PARM1)) ;assembly-time
%*DEFINE (MAC4 ( PARM1 )) (
$INCLUDE(%PARM1)                          ;macro-definition time.
)

```

Since % PARM1 is an improper filename, this causes an error.

However, expansions of MAC4 will be the expected:

```
$INCLUDE (value-of-%parml-at-expansion-time)
```

This is the same as MAC3, but MAC3 does not produce an error message.

Any \$INCLUDE processed at macro-expansion-time causes the remainder of its source line to be lost. If an error is detected while processing an INCLUDE, the error message is placed in the output file as usual and the line containing the INCLUDE is handled as ordinary text. If INCLUDE is

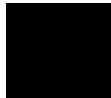

Chapter 12: Macro String Preprocessor Introduction

Macro Expressions

misspelled or if the following left parenthesis is missing, no macro-expansion-time error is reported; the string is passed intact to the assembler.

Macro Expressions

Macro expressions appear in some of the pre-defined instructions and are particularly important to the %SET macro function.

Operators

Expressions consist of one or more operands, and zero or more operators. The recognized operator keywords and their relative precedence are in the following table: (Operators that appear on the same line in the table have the same relative precedence.)

Precedence	Operators
Higher	HIGH, LOW
	*, /, MOD, SHR, SHL
↑	Unary and Binary +, -
	EQ, NE, LT, LE, GT, GE
↓	NOT
	AND
Lower	OR, XOR

Parentheses can be used to override the default precedence of these operators and are recommended for complex expressions.

See Also

Chapter 7, beginning on page 137, for definitions of the operators.

Numbers

Numbers are stored in 17-bit form with a range of -65535 to + 65535. Note that the sign bit is stored, therefore -1 is not the same as + 65535 for purposes of macro-time operations (although they can be the same to the assembler). Integer constants in bases other than decimal are defined by placing a coded descriptor after the integer. The descriptors are as follows:

- B - binary
- O - octal
- Q - octal
- D - decimal (default)
- H - hexadecimal

Symbols

Symbols must begin with a letter or one of two special characters: the question mark ('?'), or the underscore ('_').

Like assembler symbols, the second and following characters can be any letter, digit, question mark, or underscore. Only the first 31 characters of a symbol are used by the macro processor to define that symbol; any additional characters are only for documentation purposes.

By default, the macro preprocessor is case sensitive. That means that upper and lower case letters are not equivalent in macro symbols. "ASYMBOL," according to the default, is not equivalent to "asymbol" or "ASYmBOL." Case sensitivity, however, can be turned off on the command line.

A macro symbol must be preceded by the metacharacter ('% ') or the macro preprocessor will treat it as ordinary text. The exception is a string argument to a specific macro function.

The macro preprocessor does not recognize forward references because it makes only one pass through the source. Any symbol must be defined before it is used. Keywords are stored separately from symbols. Symbol names can therefore duplicate operator keyword names without conflict.

Macro symbols always have a string as a value. If the string happens to represent a valid numeric constant (such as '01Q' or '2'), the symbol can be

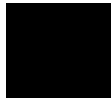

Chapter 12: Macro String Preprocessor Introduction

Macro Expressions

used as the operand of an expression. Only macro-time symbols and 17-bit integer constants are valid macro expression operands. The macro preprocessor does not deal with relocatable numbers of any sort.

See Also

Page 56 for the set of characters supported by the assembler and macro preprocessor.

Balanced Text String (baltex)

A frequently-referenced concept is the balanced-text string ('baltex'), which is a string of characters containing balanced parentheses. Formally, baltex either contains no parentheses, or one or more sets of balanced parenthesis, as in

```
'baltex(baltex)baltex'
```

where each baltex is a balanced-text string (possibly null).

13

Pre-Defined Macro Functions

A description of the pre-defined macro functions found in ap86.

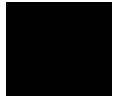

Chapter 13: Pre-Defined Macro Functions

Pre-Defined Macro Functions

Pre-defined macro functions are provided as building blocks so that you may create user-defined macros. It would be nearly impossible to duplicate many useful operations found in the pre-defined functions with equivalent user-defined macros.

Note

A user-defined macro may be re-defined in the source program at some point after the original user definition. Redefinition does not cause errors; it does cause the preceding macro definition to be lost. Pre-defined macro functions, however, may not be re-defined. It is an error to try to do so.

Pre-Defined Macro Functions

The pre-defined macro functions listed below are recognized by the macro preprocessor.

Table 13-1. ap86 Pre-Defined Macro Functions

<code>%'</code> (comment function)	<code>%('</code> (bracket function)
<code>%n</code> (escape function)	<code>%DEFINE</code>
<code>%EQS</code>	<code>%GES</code>
<code>%GTS</code>	<code>%LES</code>
<code>%LTS</code>	<code>%NES</code>
<code>%EVAL</code>	<code>%EXIT</code>
<code>%IF</code>	<code>%LEN</code>
<code>%MATCH</code>	<code>%METACHAR</code>
<code>%REPEAT</code>	<code>%SET</code>
<code>%SUBSTR</code>	<code>%WHILE</code>

Note

The pre-defined macro functions `%IN`, `%OUT`, `%CI` and `%CO` are not supported by the ap86 macro preprocessor. These functions accept user input to macro functions.

The pre-defined macro function `%DEFINE` does not appear in this chapter because it is discussed in detail in the "User-Defined Macros" chapter.

' (Comment Function)

Call Pattern:

' ...any text... ' or end-of-line

Description: The comment function permits insertion of comments without being passed on to the assembler. Everything from the quote up to a matching closing quote or to an end-of-line is considered a comment. Metacharacters within the comment string are not expanded. In the output, the call pattern (including the closing end-of-line, if used) is replaced with the null string.

Example:

```
MOV AX,%ARG1      %' ARG1 is the loop counter'  
MOV SI,0          %' Initialize index register  
JMP $-2  
%SET(symbol,02H) %' Initialize: %SET(symbol,03H)'  
DB %symbol
```

The second line in this example will result in an assembly-time error because the end-of-line terminating the comment is removed along with the comment, so the assembler sees the two instructions

```
MOV SI,0  JMP $-2
```

without an end-of-line between them. The fourth line shows that metacharacters inside a comment are not expanded; the last line expands to 'DB 02H' because the '% SET' was not executed within the comment. The literal character (*) cannot be used with the comment function.

%n and %((Escape and Bracket Functions)

Call Pattern:

escape function: %n[n-characters]
bracket function: %(baltex)

Escape Function

Description: n is a decimal (base-10) digit from 0 to 9 inclusive. The expanded value of the escape function pattern is the n-characters immediately following n itself. These will be passed to the assembler without being

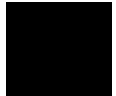

Chapter 13: Pre-Defined Macro Functions

Pre-Defined Macro Functions

examined by the macro preprocessor. For example, '% 1%' passes a '%' to the output. The pattern '% 0' passes no characters.

Bracket Function

Description: The expanded value of the bracket function is the "baltex" that appears between the parenthesis. The bracket function inhibits the expansion of all macros and functions within its argument *except* the escape function, the comment function, and macro parameters. These are always expanded.

Escape and Bracket Functions (Generally)

Description: It is sometimes necessary to hide certain text from the macro preprocessor, such as when a percent sign (%) is desired in the output or when using strings involving unbalanced parentheses or commas as text. The escape and bracket functions serve this need.

The bracket function might be more flexible than the escape function, but it deals only with baltex, and the metacharacter is interpreted (although once a call pattern has been detected it cannot be expanded). Examples:

```
%(1,2,3) ;1,2,3 is passed to the output (this might
;be used as the actual parameter to a
;macro to prevent the commas from being
;interpreted as delimiters)
%330% ;30% is passed to the output
%(30%) ;error - '%' is not legal
%(%330%) ;%330% is evaluated, then used as
;an argument to %()
%(30%1%) ;same
%(%(30)) ;%(30) is passed to the output
DB '30%1%' ;DB '30%' is passed to the output because
;quotes are ignored by preprocessor
```

The literal character (*) is not accepted with the bracket or escape functions.

If the output of the macro is to include the escape character, you must double-escape the output. For example, if macro MAC1 needs to output "DB %'", you could define MAC1 as follows:

```
%DEFINE(MAC1) ( DB '%3%1%' )
```

%EQS, %NES, %LTS, %LES, %GTS,%GES

Call Pattern:

```
%xxS(baltex1,baltex2)
```

Chapter 13: Pre-Defined Macro Functions

Pre-Defined Macro Functions

In the above call pattern, xx represents the first two characters of any of the function names.

Description: The string relational functions all compare two strings, character by character, left to right, and expand to a *logical-valued string*: -1H for TRUE, and 00H for FALSE.

The first string cannot contain a comma unless the comma is protected by parentheses, the escape function, or the bracket function.

Comparison is on the basis of ASCII character values. A blank character has the value 20H, tab has the value 09H, and < EOL> has the value 0AH (< line feed>). The comparison is *true* if the first argument has the relationship to the second indicated by the function. (EQS is true if the two strings are equal. GTS is true if the first string is "greater" than the second string.)

If two strings are of different lengths, but are identical on all characters in the shorter string, the longer string is considered to be greater.

The literal character * is allowed, but it has no effect. Metacharacters in the argument strings are always expanded. Example:

```
%EQS(0,00H) ;yields 00H (false), since comparison is
              ;of strings, not numeric values
%GTS(2,100H) ;yields -1H same reason as above
%GTS(c,CBA)  ;yields -1H (true), since c>C (ASCII
              ;values), which ends comparison
```

%EVAL

Call Pattern:

```
%EVAL(expression)
```

Description: EVAL is used to evaluate an expression and it expands to a string representing the numeric value of the expression. The expanded string represents the value in hexadecimal. The first character of the expanded string is always a digit 0-9, the last character is always 'H', and the characters between are the hexadecimal digits 0-F. The expression is evaluated using 17-bit arithmetic, as always, but the expanded value is at most 16-bits. Negative numbers are shown in two's complement form. The expanded string can be 3, 4, 5 or 6 characters in length. Examples:

```
%EVAL(3+3) ;yields 06H
%EVAL(3-3) ;yields 00H
%EVAL(-2)  ;yields 0FFFEH
```

Chapter 13: Pre-Defined Macro Functions

Pre-Defined Macro Functions

```
%SET(S1,44) ;null (decimal value)
%SET(S2,333Q) ;null (octal value)
%EVAL(%S1+%S2) ;yields 0107H
```

The call pattern `%*EVAL` is legal, but the literal character (`*`) has no effect; metacharacters in the expression are always expanded.

%EXIT

Call Pattern:

```
%EXIT
```

Description: The EXIT function allows immediate exit from the most recently invoked `%REPEAT`, `%WHILE`, or a user-defined macro. The call pattern `%EXIT` has no argument; it ends with the character `T`. Some common uses are to prevent a `WHILE` loop from going on forever and to allow multiple exit points from a user macro.

This macro illustrates the classic example of recursion, the factorial function:

```
.*DEFINE(FACTORIAL(X))
(%IF(%X LE 1) THEN (01H %EXIT) FI %EVAL((%X)*%FACTORIAL(%X-1)) )
```

The same result could also be accomplished by using `%ELSE` instead of `%EXIT`. In this simple case using an `%ELSE` might even be clearer, but in more complex examples the `%IF`s might be nested several levels deep, so `%EXIT` would be much easier.

The call pattern `%*EXIT` is legal, but the literal character (`*`) has no effect.

%IF (Conditional Assembly Function)

Call Pattern:

```
%IF(expression) THEN (baltex1) [ELSE (baltex2)] FI
```

Description: The IF function enables a user to decide at macro-time whether to assemble certain code or not. Doing this at macro-time has the advantage that the assembler (which may require more execution time than the macro preprocessor) sees only that code that is to be assembled.

Chapter 13: Pre-Defined Macro Functions

Pre-Defined Macro Functions

The expanded value of %IF is the expanded value of either baltex1 or baltex2 (if present), but not both. The call pattern %IF first evaluates the *numeric* expression. If the low bit of the 17-bit value is 1, then the expression is considered true. Baltex1 is passed to the output as the expanded value of %IF. If the low bit of the 17-bit value is 0, then the expression is considered false and baltex2 becomes the expanded value of %IF (if baltex2 is present). If it is not present, the expanded value of %IF is null.

Typically, the expression will contain comparison operators (EQ, and so forth) or string comparison macro functions (%EQS, and so forth). These always return -1 for true and 0 for false, so %IF does what you would expect. However, any numeric value is acceptable.

The baltex that is not selected is also not expanded. Any %SETs in it, for instance, will not be executed.

The keywords THEN, ELSE, and FI are not stored as symbols, and user symbols can duplicate these names. Since the arguments are all baltex with parentheses as delimiters, there is no problem with ambiguity.

Call patterns (%IFs) can be nested; each FI (and ELSE, if present) is considered to go with the most recently defined IF. Example:

```

%*DEFINE(MAC(symbol)) (
%IF (%symbol LT 0)
THEN (  %'goes with LT if'
      DB 00H
) ELSE (  %'goes with LT if'
      %IF (%symbol GT 10)
      THEN (
          %set(newsymbol,%symbol-10)
          DB %newsymbol
      ) ELSE (  %'goes with GT if'
              DB %symbol
      ) FI  %'goes with GT if'
) FI  %'goes with LT if'
)

```

The literal character (*) is legal with %IF and has the effect of suppressing metacharacter expansion in whichever baltex is selected to become the output. Metacharacters in the expression are always expanded.

%LEN

Call Pattern:

%LEN(baltex)

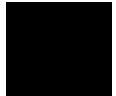

Chapter 13: Pre-Defined Macro Functions

Pre-Defined Macro Functions

Description: The LEN function counts the characters in its argument and expands to a string representing the numeric value of the expression. The expanded string represents the value in hexadecimal. The first character of the expanded string is always a digit 0-9, the last character is always 'H', and the characters between are the hexadecimal digits 0-F. The expression is evaluated using 17-bit arithmetic, as always, but the expanded value is at most 16-bits. Negative numbers are shown in twos complement form. The expanded string can be 3, 4, 5 or 6 characters. The literal character (*) is legal and prevents the expansion of metacharacters in the baltex string. Example:

```
%LEN(countme)           ;yields 07H
%LEN(%EQS(ABC,abc))     ;depends on case sensitivity
%*LEN(%EQS(ABC,abc))    ;counts '%EQS(ABC,abc)'  
                        ;and yields 0DH
%LEN() ;yields 00H
```

An <EOL> counts as one character (the line feed character). %LEN of a SET-symbol will produce a number between 3 and 7 inclusive. It is the number of characters of the internal string representation of the symbol value.

Note

The value is a full 17-bits, with a minus sign if needed (signed magnitude representation). Thus -2 is stored as '-02H' and 65534 is stored as '0FFFEH'. This is the only time (within a %LEN) that the value of a SET-symbol is not really stored as a number.

%MATCH

Call Pattern:

```
%MATCH(name1 delimiter name2) (string)
```

Note

The spaces surrounding the delimiter in the syntax above are not a part of the call pattern; they are shown only for clarity. Spaces between the first and second pair of parentheses are acceptable. Spaces, tabs, or end-of-lines are skipped over if they appear there.

Description: Name1 and name2 are symbols (not necessarily previously defined) and delimiter is a single character separating them. It can be any character that is *not* valid in symbols. It could be a space, tab, comma, end-of-line, parenthesis, or others.

Chapter 13: Pre-Defined Macro Functions

Pre-Defined Macro Functions

MATCH divides a string into two parts at the first occurrence of the delimiter, and assigns each part to a symbol. Its expansion is the null string. MATCH is most commonly used in connection with loops, as described below.

MATCH searches the (expanded) string for the first occurrence of the delimiter. When it is found, all characters in the string preceding the delimiter are assigned as the value of name1. All characters following the delimiter are assigned as the value of name2. Either value can be null. If the delimiter is not present in string, the entire string is assigned to name1 and name2 receives the null string as its value. Examples:

```
%MATCH(NAME1,NAME2) (A,B,C)      ;NAME1='A', NAME2='B,C'
%MATCH(NAME1 NAME2) (A,B,C)     ;NAME1='A,B,C', NAME2=null
%MATCH(NAME1 , NAME2) (A,B,C)   ;Error - illegal spaces
                                ;around comma (delimiter in this example)
```

The literal character (*) is legal in conjunction with %MATCH and inhibits the expansion of any metacharacters in "string." Example:

```
%SET(sym,2)
%MATCH(VAR1,VAR2) (%sym,02H)    ;VAR1=02H, VAR2=02H
%*MATCH(VAR3,VAR4) (%SYM,02H)  ;VAR3=%SYM, VAR4=02H
%SET(SYM,3)
DB %VAR1                        ;yields DB 02H in the output
DB %VAR3                        ;yields DB 03H and %SYM is
                                ;expanded at reference time
DB %*VAR3                       ;yields DB %SYM and causes an
                                ;assembly-time error
```

The last example is case dependent and would not work if case sensitivity was enabled.

The MATCH function is often used to extract similar fields out of a string one at a time. Suppose a string consists of several numbers separated by spaces. Such a string might be the expected value of a formal argument, for instance. To generate a DB for each number:

```
%MATCH(TEMPVAR^JUNK) (%FORMALARG)
%WHILE( %LEN(%TEMPVAR) GT 0 )
(%MATCH(NEXTNUM TEMPVAR) (%TEMPVAR)
DB %NEXTNUM
)
```

The first MATCH copies the formal argument to TEMPVAR, presuming there are no carets (^) in %FORMALARG (this is a trick to evade the fact that SET can assign only numeric values to a symbol; it cannot assign a string). The condition of the WHILE loop states that TEMPVAR must still be non-null. The MATCH inside the loop extracts the next number from TEMPVAR and stores the rest of the string back in TEMPVAR. The DB is then generated and we execute the WHILE test again.

Chapter 13: Pre-Defined Macro Functions

Pre-Defined Macro Functions

%METACHAR

Call Pattern:

`%METACHAR(baltex)`

Description: The METACHAR function changes the metacharacter (%) by default) to a different, user-specified character. These are the acceptable alternative metacharacters:

`@ / + - # . _ = [] < > ! ' " $ & , = % { } ~ ` | \ ^`

The following characters cannot be used as a metacharacter:

the letters (A-Z, a-z)
the digits (0-9)
_ ? * () blank tab <EOL>

The new metacharacter is taken to be the first character of the expanded value of `baltex`, although `baltex` can be any number of characters long. The new metacharacter takes effect immediately at the first character following the right parenthesis delimiting the call pattern of METACHAR. The literal character '*' is accepted on METACHAR, but it has no effect, as the argument of METACHAR is always expanded.

Changing the metacharacter can have unforeseen catastrophic effects. For example, any previously defined macros probably have the default metacharacter (%) in the stored macro body. They will not expand correctly if the metacharacter changes. The expanded value of the METACHAR function is the null string.

%REPEAT

Call Pattern:

`%REPEAT (expression) (baltex)`

Description: The REPEAT function is one way to program a loop. REPEAT evaluates the 17-bit numeric expression and then `baltex` is expanded that many times. Note that the expression is expanded only once. If `baltex` alters macro symbols that are involved in the expression, it does not affect loop control. If the expression evaluates to be less than or equal to zero, `baltex`

Chapter 13: Pre-Defined Macro Functions

Pre-Defined Macro Functions

is expanded zero times (the expanded value of REPEAT is the null string).

Example:

```
%REPEAT(5)      (SHL AX,1  
)
```

Note

The < EOL> within baltex is necessary for correct expansion. Without the < EOL> ; this REPEAT would produce

```
SHL AX,1SHL AX,1SHL AX,1SHL AX,1SHL AX,1
```

% *REPEAT is acceptable. The asterisk inhibits the expansion of metacharacters within baltex. Metacharacters in 'expression' are always expanded.

%SET

Call Pattern:

```
%SET(name,expression)
```

Description: SET defines the string "name" as a symbol, whether or not it was already defined, and gives it the value of "expression." Expression must result in a number, but the value of name is stored as a string (like all macro symbols). Generally, you can ignore this fact and treat name as if it were stored as a number. Multiple SET directives can reference the same name. The expanded value of the % SET call pattern is the null string.

The literal character (*) makes no sense with SET, since its first argument must be a symbol and its second argument must evaluate to a number. Neither argument can contain metacharacters after expansion. If the macro preprocessor attempts to expand % *SET, it will report an error.

It is correct for the symbol-referencing construct to appear inside another SET for the same symbol. Example:

```
%SET(username,%username+1)
```

This increments the value of 'username' by one. However, the next example is incorrect:

Chapter 13: Pre-Defined Macro Functions

Pre-Defined Macro Functions

```
%SET(username,username+1)
```

This example generates a macro-time error because the character string "username" is not a legal expression operand. Symbol-referencing is discussed in the chapter titled "User-Defined Macros."

%SUBSTR

Call Pattern:

```
%SUBSTR(baltex,exp1,exp2)
```

Description: The SUBSTR function extracts a substring from its first argument based on its second and third arguments.

In this pattern, `exp1` and `exp2` are numeric expressions. The expanded value of the pattern is a substring of `baltex`. The substring begins at character number `exp1` and contains `exp2` characters. If `exp1` is less than or equal to 0, or greater than the number of characters in `baltex`, then the expanded value is null. If `exp2` is less than or equal to 0, then the expanded value is null. If `exp1` is of such a size that the expansion value will not be null, but `exp2` implies more characters than remain in `baltex`, then the expanded value is all characters from character `exp1` to the end of `baltex`, inclusive. Examples:

```
%SUBSTR(12345678,4,2)    ;yields  45
%SUBSTR(12345678,-1,2)   ;yields  null
%SUBSTR(12345678,10,2)   ;yields  null
%SUBSTR(12345678,2,-1)   ;yields  null
%SUBSTR(12345678,2,1000) ;yields  2345678
```

The literal character (*) is accepted with SUBSTR, but is ignored. Metacharacters in any of the arguments are always expanded.

%WHILE

Call Pattern:

```
% WHILE (expression) (baltex)
```

Description: The WHILE function programs macro-time loops. It works similarly to the WHILE construct in high level languages.

WHILE evaluates the 17-bit numeric expression each time through the loop. If the least significant bit of the expression is 0, the expanded value of WHILE

is the null string. If the least significant bit of the expression is 1, then `baltex` is expanded and passed on as part of the expanded value of `WHILE`, and the expression is evaluated again. The loop continues until the expression evaluates to false (least significant bit is 0).

For the loop to terminate, `baltex` must modify the value of expression or an `EXIT` function must be used. Otherwise the loop will never exit. `WHILE` is often used in conjunction with either `SET` or `MATCH`, either of which will update a macro symbol on each pass through the loop (see the example under `MATCH`).

The call pattern `%*WHILE` is not accepted, since preventing the expansion of `baltex` would result in an infinite loop. An error will be reported if `%*WHILE` is found.

Example Problem

This example shows the effects of an incorrect factorial macro.

```
%*DEFINE ( FACTORIAL ( X ) )  
( %IF ( %X LE 1 ) THEN ( 01H %EXIT ) FI  
%EVAL ( %X * %FACTORIAL ( %X - 1 ) )  
)
```

The only difference between this example and the one shown with the `%EXIT` function reference is that this one is missing the pair of parentheses around the second `%X`. They are necessary, because the arguments of macros are strings, not numbers. The incorrect version above called with the actual parameter 4 expands successively to the following:

```
4 * FACTORIAL ( 4 - 1 )  
  4 - 1 * FACTORIAL ( 4 - 1 - 1 )  
    4 - 1 - 1 * FACTORIAL ( 4 - 1 - 1 - 1 )  
      01H  
        4 - 1 - 1 * 01H  
          02H  
            4 - 1 * 02H  
              02H
```

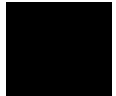

Chapter 13: Pre-Defined Macro Functions

Example Problem

```
4*02H
08H
```

The % FACTORIAL in the next lower calling level is evaluated before the % EVAL in the one that called it is executed. That is as it should be and the recursive property of this function is retained. The problem is that the normal rules of precedence govern *within* the enclosing parentheses of % EVAL. This means that the multiplication is done to just part of the intended value of % X, instead of the full value, at any level. The result is therefore less than it should be.

As a general guide, it is advisable to surround any macro-time symbol with either parentheses or % EVAL() if you expect to produce a numeric value. For this example, one fix is to put % EVAL() around % X-1 in the call to % FACTORIAL. This forces evaluation of the subtraction before the value is passed to the next lower calling level. Another fix is to put parentheses around the second % X—as has been discussed and was done in the example for % EXIT. This causes parentheses to be around the subtractions preceding the multiplication sign that then force the intended order of arithmetic evaluation. The corrected macro definition, using the % EVAL() fix, follows:

```
%*DEFINE ( FACTORIAL ( X )
( %IF ( %X LE 1 ) THEN ( 01H %EXIT ) FI
%EVAL ( %X * %FACTORIAL ( %EVAL ( %X - 1 ) ) )
)
```

The corrected macro definition called with the same parameter of 4 would expand as follows:

```
4*FACTORIAL ( 3 )
  3*FACTORIAL ( 2 )
    2*FACTORIAL ( 1 )
      01H
    2*01H
  02H
  3*02H
06H
4*06H
018H
```

14

User-Defined Macros

Information about defining macros, including the syntax for defining them, and how macros are referenced.

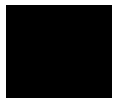

Chapter 14: User-Defined Macros

User-defined macros are created by using the `%DEFINE` macro function.

User-defined macros can be defined in terms of themselves which means they can invoke themselves within their own macro bodies. This ability is called recursion. Any macro that calls itself must include a terminating condition that causes the macro to "bottom out" eventually or the preprocessor can enter into an infinite loop.

%DEFINE

If you want to define a macro, you must use the `DEFINE` function.

Because the syntax for `DEFINE` is somewhat complicated, the following figure contains the syntax diagram for `DEFINE`.

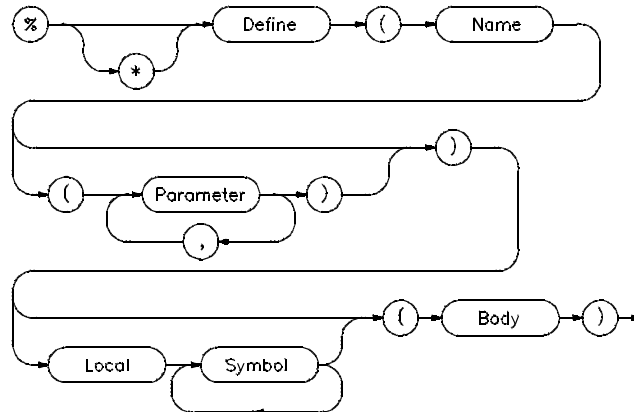

Figure 14-1. Syntax for User-Defined Macros

Where:

% is the current metacharacter (which is usually `%`).

***** is the optional literal character. This character should be used with most definitions. There are two reasons:

- It will inhibit the expansion of macro calls flagged by the current metacharacter (usually `%`) within the macro body at the time of macro definition. Instead, macro calls will be expanded at the time of macro reference.
- You must use the literal character with any macro that has formal parameters. Otherwise, the macro preprocessor will attempt to evaluate any references to the formal arguments within the macro body as symbols or other macro calls, which will result in errors.

Define is the pre-defined macro function for creating user-defined macros.

Chapter 14: User-Defined Macros

Name is the user-defined name to be associated with the macro. It cannot conflict with the predefined macro functions, but it can duplicate an earlier user-defined macro name or symbol. In the latter case, the previous meaning of the symbol is lost. The macro name should not be preceded by the current metacharacter (usually %).

Parameter is a formal parameter name. Formal parameters, if they exist, are replaced by actual parameters when the macro is invoked.

Note

Formal parameter names are not preceded by the metacharacter when they are being declared in the macroname argument list. To reference a formal parameter within the macro body, however, you must precede its name with the metacharacter (as in % ARGUMENT_NAME for the formal parameter ARGUMENT_NAME).

Parameter names must be distinct from one another within a macro, but they can duplicate other formal parameter names in other macros, since they have no existence outside the macro definition. They can also duplicate the names of other user macros or macro functions. If they do duplicate other macro function names, then the other macros or functions cannot be used within the macro body, since the duplicated name will refer instead to the parameter.

Local is the word that must precede the local parameter list.

Symbol is a local symbol name. Such symbols can be used only within the macro body. They are undefined outside of it.

The purpose of local symbols is to avoid multiply-defined symbols in the output of the macro processor. Each time the macro is referenced, each local symbol receives a unique two to five digit suffix. For example, if a local symbol LABEL were defined for use within a macro, then the first macro invocation might substitute LABEL00 and the second invocation might use LABEL01. This way, the assembler would not see a multiply-defined symbol. When locals are initially being declared following the LOCAL keyword, they must not be preceded by the metacharacter. However, when referencing local symbols in the macro body, they must be preceded by the metacharacter. The symbol LOCAL is not reserved; a user symbol or macro can have this name.

Body is a balanced-text string. It can contain references to formal arguments and local symbols, if any, as described above. It can also include references to

user-defined macros (including itself), to macro-expansion-time symbols (preceded by '% '), and to macro functions.

A macro should not redefine itself (% *DEFINE) within its body, however. The expanded value of DEFINE is the null string, but the macro body is stored internally for later use. A re-DEFINE in a macro body, then, is working at cross purposes.

Macro Reference

A macro is referenced by preceding its name with the metacharacter. If the macro was defined with formal arguments, the reference must include the same number of actual parameters, enclosed in parentheses and separated by commas. Actual parameters can be null, but the required delimiters must still be present between them. Each actual parameter is substituted for its corresponding formal parameter, wherever it appears in the macro body, on a string basis.

The literal character ('*') is acceptable in conjunction with references to user-defined macros. Normally, all metacharacters in the actual parameters are evaluated immediately when the macro reference is found and the resulting strings are stored. They are then substituted for the formal parameters as the macro body is copied. The literal character defers evaluation of actual parameters until they are found in the macro body, and they are re-evaluated each time they are found. It is possible, then, that the values of actual parameters might change between evaluations depending on what the macro body does.

Following are some sample macro definitions and references along with short discussions about each. Each new macro and discussion begins with the new % DEFINE, but an implied order of definition from first to last is understood in order that some of the discussions make sense. Some of the macros are intentionally incorrect.

```
%*DEFINE(MAC1) ( DB 2 )
```

MAC1 will have the string value "DB 2" when invoked.

```
%*DEFINE(MAC2(ARG1)) (DB %ARG1)
```

Chapter 14: User-Defined Macros

MAC2 is stored as "DB % ARG1". % ARG1 is to be evaluated at the time of macro reference because of literal character (*) precedes DEFINE.

```
%*DEFINE( ERR1( ARG1 ) ) ( DB ARG1 )
```

ERR1 shows a common error. The '%' is omitted from the formal parameter in the macro body which means it will not be recognized. The assembler will be passed "DB ARG1" when the macro is invoked, which is not likely to be correct.

```
%*DEFINE( MAC3( ARG1 ) ) ( %MAC1  
                           %MAC2( %ARG1 ) )
```

MAC3 references the previously-defined macros MAC1 and MAC2. Since the evaluation of metacharacters in MAC3 is deferred (with *), this example would also work if the definitions of MAC1 or MAC2 followed that of MAC3 (as long as they are defined before MAC3 is invoked).

```
%DEFINE( ERR2( ARG1 ) ) ( %MAC1  
                          %MAC2( %ARG1 ) )
```

ERR2 shows another common error—the literal character was omitted. The metacharacters in the macro body are expanded immediately (at macro-definition time). Since there is a reference to a formal parameter, this cannot be done—there is no actual parameter to substitute for it. The macro preprocessor actually attempts to expand % ARG1 as a macro symbol or user-macro. In some cases this might be possible, although it is not likely to be what is expected.

```
%*DEFINE( ERR3( ARG1 ) ) ( %MAC1 %MAC2( %ARG1 ) )
```

ERR3 shows another frequent user-error, a missing < EOL> . Since the body of neither MAC1 nor MAC2 includes an < EOL> , ERR3 should include one between their invocations (as MAC3 does). The invocation %ERR3(3) will yield "DB 2 DB 3" and cause an assembler error. If MAC1 ended with an < EOL> or MAC2 began with an < EOL> , ERR3 would be correct.

```
%DEFINE( MAC4 ) ( %MAC1  
                 %MAC2( 4 ) )
```

MAC4 shows an acceptable use of DEFINE without **. The stored body of MAC4 is shown in the following example, since the calls to MAC1 and MAC2 are evaluated immediately:

```
'DB 2  
DB 4'
```

With the definitions of MAC1 and MAC2 shown above, %MAC4 is the same as %MAC3(4). But MAC1 and/or MAC2 might be redefined later on. In this case, MAC3 will reference the new values, while MAC4 will not.

```
%*DEFINE (MAC5 (ARG1) ) LOCAL LABEL (
%LABEL:      MOV AX, %ARG1 [DI]
              INC DI
              LOOPNZ %LABEL)
```

MAC5 shows the use of a local symbol. Each invocation of MAC5 will create a unique assembler-time symbol from LABEL.

Note that the macro definitions above produce no output, since each DEFINE expands to the null string. Consider the macros as being defined sequentially without separating blank lines. The end-of-lines between the terminating right parenthesis of each macro body and the following metacharacter (%) of the next macro result in blank lines that are not output. If the macro preprocessor did not remove blank lines, these examples would generate seven blank lines. This behavior is typical of readable macro code. All characters between the delimiting parentheses (including end-of-lines) are considered part of the macro body, which in turn is part of the syntax of DEFINE. Such characters are not considered for output.

Referencing Macro-time Symbols

Symbols are defined by the SET and MATCH functions. A symbol is referenced by preceding its name with the metacharacter, as in

```
%name
```

Without the metacharacter, the macro preprocessor treats "name" like any other character string. The call pattern of the symbol ends where the name

Chapter 14: User-Defined Macros

ends (there is no argument in parentheses). The expanded value of this construct is the character string that had been assigned to it. (For instance: '01H'; or 'STRINGVALUE'; or the null string.)

The literal character (*) is proper with a macro-time symbol. It inhibits the expansion of any metacharacters within the symbol value which otherwise would be expanded. For example, suppose the value of a symbol SYM is "%LEN(01H)." %SYM will expand to '03H', but %*SYM will expand to "%LEN(01H)". Generally, the literal character should be omitted.

The literal character similarly affects formal parameters of macros within the macro body. A formal parameter is not recognized if preceded by the literal character. This permits giving a formal parameter the same name as a macro function while still being able to access the function within the macro body. Example:

```
%*DEFINE (MAC (LEN) ) (DB %LEN  
                        DB %*LEN( %LEN) )
```

The first %LEN is the formal argument LEN, as is the third. The second is not recognized as an argument because of the literal character, so it reverts to its normal meaning as a pre-defined function. The literal character has meaning to this particular function, so the inner %LEN is not expanded.

The literal character cannot be used with local symbols within a macro body.

15



Assembler versions

Information about how this version of the software differs from previous versions.

Version 3.10

New Product Numbers

The old product number for this product was 64871. The new product number is B1449. The product numbers for some associated products, such as the C cross compiler, have also changed from 64xxx to B14xx.

New Assembler Controls

The GEN, GENONLY, OPTIMIZE, EXTERN_CHECK, and UNREFERENCED_EXTERNALS controls are new.

New Linker/Loader Controls

The ERROR, WARN, LISTMAP, and TYPEMERGE controls are new.

New Assembler Defaults

The defaults for the ERRORPRINT, SYMBOLS, and PRINT controls have changed.

New Location for Man Pages

The on-line manual pages have been moved to the \$HP64000/man directory. Set your \$MANPATH environment variable to include this directory.

New Linker Listing Format

The cross-reference table has been combined with the public and local symbol tables.

Version 3.00

Demo Directory Change

The directory that contains the example files, /usr/hp64000/demo/languages/hp64871, has changed to /usr/hp64000/demo/languages/as86. (This change does not apply to the HP 9000 Series 800 version.)

New Assembler Controls

The OPTIMIZE assembler control has been added. Use OPTIMIZE to reduce the number of NOPs generated for forward references.

The [NO]UNREFERENCED_EXTERNALS assembler control has been added. Unreferenced external symbols are removed by default. Use this control to cause all external symbols, including those that are unreferenced, to be placed into the generated object file.

The SYMBOLS assembler control now defaults to SYMBOLS instead of NOSYMBOLS. Thus assembler listings will now normally contain a symbol table.

New Assembler Operators

Four new operators have been added to the assembler. These operators are SEGSIZE, SEGOFFSET, GRPSIZE, and GRPOFFSET. These operators allow a program to access the size of segments or groups, the offset of the start of a segment from a paragraph address, and the offset of a segment from a group address.

New Linker Commands

The linker now supports two new commands: TYPEMERGE and NOTYPEMERGE. These commands are used to control the amount and number of type records within the generated output file. Problems can occur if the number of type records in input files exceeds 32k. If this occurs, an erroneous output file will result. The TYPEMERGE command allows the linker to merge like type records so the number of type records required in the

Chapter 15: Assembler versions

Version 3.00



output file can be kept below this limit. Use of this command, however, will cause the linker to run for a longer amount of time. This is necessary, however, for very large programs.

Other Linker Changes

Modules in Incrementally-linked files will now be reported differently in the listing. Any module within the file will be reported with two dashes (--) before the module name. This is to indicate that the module is part of a larger overall module. Also, incremental linking now works correctly when used to create a final HP64000 absolute file.

One of the duplicate error 812 messages has been changed to become error 825.

16



Converting HP 64853 Assembly Language Programs

Changes that must be made to source files written for the HP 64853 assembler so that they can be assembled with the HP B1449 assembler.

Chapter 16: Converting HP 64853 Assembly Language Programs

acvt86 Introduction

Not everything that appears in the HP 64853 format source files can be translated into something that the HP B1449 assembler will recognize, but most can. Translation is done in two ways. Some translations must be done manually. Most translations, however, can be done by the acvt86 translation program described in this chapter.

Note

The program acvt86 automatically performs most of the transformations described here. acvt86 is an unsupported porting tool. acvt86 is not a part of the B1449 product and is distributed at no cost. Hewlett-Packard makes no warranty on its quality or fitness for a particular purpose.

The first section of this chapter discusses the acvt86 porting tool and issues that are caused by the differences between the two assemblers. The next section describes the manual translations to macros that must be done because the porting tool cannot perform some macro translations. The third section gives the command syntax for acvt86. The final section is an old and new list. This section is arranged alphabetically according to keywords in HP 64853 assembly language. It gives a side-by-side comparison between the old and new syntax and shows you how acvt86 transforms particular HP 64853 constructs.

acvt86 Introduction

This section describes the way that acvt86 approaches the conversion process, what it produces, and its limitations. It also describes the sequence you should follow to translate files that contain include files. This section will give you a better understanding of what you will have to do to complete the translation process.

This section is not a complete description. If you need to find out how acvt86 converts a particular construct, you should write a test program and examine the acvt86 output.

Note

The first line of an HP 64853 program identifies the target processor. HP B1449 assembly language supports only the 8086/186 and 8088/188 processors. The HP B1449 assembler does not support the 70108, 70116, 8089, or 80286 microprocessors. Therefore, the following target processor identifiers are not recognized: "70108", "70116", "8089_86", "8089_88", and "80286".

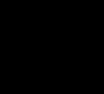

Assembler Differences

The HP B1449 assembler is really two programs: the preprocessor, ap86; and the assembler, as86. The preprocessor implements the following features of the old HP 64853 assembler: SET directives, REPT directives, MACRO definitions and expansions, and IF/ELSE/ENDIF conditional assembly directives. The assembler then completes the process by assembling the file produced by the preprocessor. acvt86 translates these features in the following way.

IF

```
IF <expr>
lines
ELSE
lines
ENDIF
```

translates to

```
%IF( (<expr>)NE 0)
THEN
(lines)
ELSE
(lines)
FI
```

EQU

```
id EQU <expr>
```

translates to

Chapter 16: Converting HP 64853 Assembly Language Programs

acvt86 Introduction

```
id EQU <expr>
```

If <expr> is a constant expression, acvt86 generates %SET(id,<expr>) and acvt86 also stores id in its symbol table. Later, when id is referenced in preprocessor expressions, acvt86 recognizes it and translates it to %id.

MACRO

```
id MACRO &P1,&P2
lines
MEND
```

translates to

```
%*DEFINE(id(P1,P2))
(lines)
```

acvt86 also stores id in its symbol table. Later, when id is referenced, acvt86 recognizes it and translates it to %id.

REPT

```
REPT <expr>
next line
```

translates to

```
%REPEAT(<expr>)
(
next line
)
```

SET

```
id SET <expr>
```

translates to

```
%SET(id, <expr>)
```

acvt86 stores id in its symbol table. Later, when id is referenced, acvt86 recognizes it and translates it to %id.

Note

Sometimes the constant expressions in IFs or REPTs cannot be translated. HP 64853 calculates its constant expressions using 32 bit numbers. acvt86 uses only 17 bit numbers. HP 64853 allows constant expressions to be formed by subtracting two relocatable symbols. acvt86 cannot do this because it has no knowledge of the value of relocatable symbols.

External Declarations

HP 64853 allows an external identifier to be associated with a segment register in the EXT directive. For example:

```
EXT ES:X1 WORD
MOV AX,X1 ;references X1 using ES
```

If you use X1 in certain memory reference operands, the HP 64853 assembler will automatically generate an ES: segment override for the instruction.

The HP B1449 assembler does not have an equivalent capability. Instead, an external identifier can be associated with a segment by placing the EXTRN directive inside a SEGMENT/ENDS pair. The segment may then be associated with a segment register through an ASSUME directive.

Since it would be difficult to automatically perform this kind of rearrangement, acvt86 instead does the following:

- When an external declaration with an associated segment register is found, acvt86 stores the identifier and segment register in its symbol table.
- When the external identifier is referenced, acvt86 will generate (when appropriate) an explicit segment override. For example, the instructions shown above would be translated to the following.

```
EXTRN X1:WORD %'ES:D:X1'
MOV AX,ES:X1 ;references X1 using ES
```

The preprocessor comment %'ES:D:X1' records the information in the original EXT directive. If, in a subsequent translation, acvt86 sees this comment when reading a translated include file, it can update its symbol table just as if it saw the original declaration.

Chapter 16: Converting HP 64853 Assembly Language Programs

acvt86 Introduction

Note

You should not do SET definitions, constant EQU definitions, or "EXT segreg:id" declarations using MACRO parameters. For example:

```
CSWORD MACRO &P1
EXT CS:&P1 WORD
MEND
CSWORD X1
```

While this arrangement works perfectly well in the HP 64853 assembler, acvt86 cannot tell that the variable X1 will have the implied CS: override quality. It may not translate references to X1 correctly.

Porting Procedure— Main Files with INCLUDE Files

Here is a procedure for translating a main file and its INCLUDE files. This sequence gives acvt86 its most complete symbol table and allows it to do the most accurate translation.

- 1 Translate the include files first. Use the `-c` option to specify the main file as the context file. This allows definitions in the main program to be used when translating the include file. Furthermore, as each include file is translated, its definitions are available for translating subsequent include files.
- 2 Make manual corrections to translated include files. Typically, this means rewriting `.IF`, `.GOTO`, etc., directives in MACROS.
- 3 Translate the main file(s). Make corrections to the main file(s).
- 4 Assemble the main file(s) using the HP B1449 preprocessor/assembler. Correct preprocessor and assembly errors.

For example, here are three files: `prog.S`, `inc1`, and `inc2`

Main File `prog.S`

```
" 8086 "  
;prog.S  
EXT ES:X1 WORD  
INCLUDE inc1  
INCLUDE inc2
```

```
M2 ;defined in inc2  
END
```

Include File inc1

```
;incl  
DISP SET 6
```

Include File inc2

```
;inc2  
M2 MACRO  
    MOV AX,X1    ;X1 defined in prog.S  
    ADD AX,DISP ;DISP defined in incl  
MEND
```

First, translate inc1 as follows.

```
$ acvt86 -c prog.S incl > incl.h
```

Second, translate inc2. Because of the "-c prog.S" option and because we have already created incl.h, acvt86 will correctly translate the references to X1 and DISP.

```
$ acvt86 -c prog.S inc2 > inc2.h
```

Finally, translate prog.S. Because inc2.h exists, acvt86 will correctly translate the reference to macro M2.

```
$ acvt86 prog.S > prog.s
```

acvt86 Warnings, ap86 Errors, as86 Errors

To do a successful port, you must pay attention to messages from three sources.

acvt86

acvt86 issues warnings when it detects something that may need your attention. For example, it issues a warning when a MACRO call has more actual parameters than it has formal parameters in the MACRO definition. As previously explained, the two assemblers operate differently in this

Chapter 16: Converting HP 64853 Assembly Language Programs

Code Substitution

situation. Depending on how your MACRO is written, you may or may not need to change this statement.

ap86

After translating your files, you must understand and correct preprocessor errors. For example, errors may result from using constant expressions whose value is too large for the 17 bit preprocessor expression limit.

as86

Finally, you must understand and correct as86 errors. Assembler errors have numerous causes. For example, HP 64853 allowed user labels to duplicate instruction mnemonics (e.g. TEST). HP B1449 does not allow this and produces a syntax error. In this case, you should change the name of the offending label.

Code Substitution

acvt86 has a feature that allows HP B1449 code to coexist with HP64853 code in an untranslated assembly source file. This feature is useful when, instead of doing a one-time port, you want to maintain a single, untranslated source file and then use acvt86 as necessary to obtain translated source.

acvt86 treats the comment ";sub64871;" in a special way. When acvt86 sees that comment, it does the following:

- Discards all the text before the ;sub64871; comment. Any warnings generated by this text are also discarded. Note that acvt86's symbol table is still updated normally if the discarded text contains certain directives.
- Writes any text following the ;sub64871; comment to standard output without any changes.

In the example below, we want to substitute legal HP B1449 code for the .IF and .NOP directives that acvt86 does not translate

```
.IF &P1.GE.0 LAB ;sub64871;%IF(%P1 LT 0) THEN (  
    DW &P1  
LAB .NOP ;sub64871;) FI
```

Chapter 16: Converting HP 64853 Assembly Language Programs

Byte ordering for BIN, DECIMAL, HEX, OCT

acvt86 will produce the following output for the preceding text

```
%IF(%P1 LT 0) THEN (  
    DW %P1  
) FI
```

Note

acvt86 only recognizes the substitution string ;sub64871; at the beginning of the comment field. In the example below, acvt86 will not make a substitution because comment text precedes the ;sub64871; string.

```
DW &&P1 ;indexed parameter;sub64871; DW %P1
```

Byte ordering for BIN, DECIMAL, HEX, OCT

These four HP 64853 directives generate data with bytes that are reversed from the normal 8086 convention. When translating, you must adjust the value of operands to these directives to compensate for this. This applies to any numeric format: binary, decimal, hex, or octal. Example:

HEX

HP 64853	HP B1449
HEX ABCD	DW 0CDABH

Manual Macro Translations

acvt86 automatically translates simple MACRO definitions (i.e. those without .IF, .SET, .GOTO, or .NOP directives and without indexed "&&PNO" parameters).

More complicated structures must be translated manually. Generally, this can always be done except when .IF or .SET expressions use symbol values which cannot be calculated at preprocessor time.

Chapter 16: Converting HP 64853 Assembly Language Programs

Manual Macro Translations

The HP 64853 .IF, .GOTO, and .NOP conditional assembly directives must be manually translated into the HP B1449 % IF preprocessor directives. If the branches in your MACRO do not define a block structure, you must rearrange the MACRO to conform to the IF/THEN/ELSE structure of ap86.

Macros branches which do loops can be translated into % REPEAT or % WHILE structures.)

The HP 64853 .IF directive performs either numeric or string comparisons depending on the operands being compared. Numeric comparisons must translate into ap86 numeric expressions; string comparisons must use the ap86 preprocessor string comparison functions.

HP 64853 allowed a null parameter either to be the null string ("") or to be omitted entirely (except for a comma placeholder). Here is how to test for an omitted or null macro parameter. Check for both of these possibilities in your translated .IF directive.

HP 64853 allows MACRO parameters to be referenced by number. HP B1449 has no equal facility. Two translation techniques can be used.

- 1 Use % *DEFINE to make a new identifier which has the value of the indexed parameter.
- 2 Sometimes a MACRO indexes an indefinite number of parameters. This can be handled with the % MATCH function. For example, the following MACRO defines one word for each actual parameter. It stops on the first null parameter or at the end of the list.

Macro Calls

Sometimes, a MACRO call specifies a different number of actual parameters than formal parameters in the MACRO definition. acvt86 records the number of formal parameters in a MACRO definition. It automatically handles the first two of three situations described below. The third situation usually requires a manual change.

- 3 If you specify fewer actual parameters than there are formal parameters, ap86 will error and not expand the macro. To prevent this, acvt86 automatically generates additional null parameters on the macro call.
- 4 If you specify actual parameters and no formal parameters were declared, ap86 does not consume the actual parameter list and they eventually cause a syntax error. To prevent this, acvt86 suppresses the actual parameter list.

Chapter 16: Converting HP 64853 Assembly Language Programs Manual Macro Translations

- 5 If you specify more actual parameters than formal parameters, ap86 acts as follows: the value of the last formal parameter is equal to the value of its corresponding actual parameter concatenated with all the additional actual parameters and comma delimiters. Any reference to the last formal parameter will generate a different value than it did in the HP 64853 assembler. acvt86 issues a warning in this case. You should either eliminate the extra actual parameters or rewrite the macro to preserve its original function.



acvt86(1) Command Syntax

Note

The program acvt86 automatically performs most of the transformations described here. acvt86 is an unsupported porting tool. acvt86 is not a part of the B1449 product and is distributed at no cost. Hewlett-Packard makes no warranty on its quality or fitness for a particular purpose.

Name

acvt86 - converts 8086 assembly programs from HP 64853 format to HP B1449 format

Synopsis

```
/usr/contrib/bin/acvt86 [-dsw][-a align]
                        [-c context] [-h suffix][file]
```

Description

acvt86 translates assembly source programs from one dialect to another. It assumes the input file is a legal 8086, 8088, 80186, or 80188 assembly program for the HP 64853 assembler. The output may be assembled with the HP B1449 assembler.

acvt86 does not translate "70108", "70116", "8089_86", "8089_88", or "80286" programs that were accepted by the HP 64853 assembler. Programs for these microprocessors are also not accepted by the HP B1449 assembler.

acvt86 reads from standard input or the named file. It writes the translated assembly to standard output. It writes warnings about functional differences between the input and output to standard error.

acvt86 supports a one-time porting of assembly programs from one product to another. The objective is to obtain the same (or functionally equal) bits from the HP B1449 assembler as from the HP 64853 assembler. acvt86 changes directives, delimiters, operators, and so on to achieve this goal. However, because of differences between the two assemblers, this porting process cannot be entirely automatic or trivial.

acvt86 makes two passes over its input file. The first pass builds a symbol table of certain identifiers (MACROS, externals, etc.) that will effect the translation; the second pass performs the translation.

Chapter 16: Converting HP 64853 Assembly Language Programs

acvt86(1) Command Syntax

acvt86 may look at other files to supplement its symbol table. The **-c contextfile** option incorporates the definitions from **contextfile** in the present translation. Typically, a **contextfile** is a main, untranslated assembly module while the present file is an INCLUDE file of **contextfile**. Whenever acvt86 encounters an INCLUDE directive (either in **contextfile** or the present input), it attempts to open the already translated include file and read its definitions. (See the -h suffix option for include file naming conventions.)

acvt86 has a code substitution feature. It allows HP B1449 code to coexist with HP 64853 code in the same untranslated file. Refer to the section "Code Substitution" for more information.

acvt86 was implemented with lex(1) and yacc(1). The source code is available in /usr/contrib/src/acvt86/.

Options

- | | |
|------------|--|
| -c context | Scan the context file (and translated INCLUDE files mentioned in it) for definitions to use when translating file. This option is useful when translating INCLUDE files. Specifying a context allows acvt86 to accurately translate references to certain identifiers (MACROS, externals, etc.) that were defined in the main "context" file or its (translated) INCLUDE files. |
| -a align | Align is one of the HP B1449 align-types of BYTE, WORD, PARA, PAGE, INPAGE. Specify the align-type used in segment directives for relocatable segments. The default align-type of BYTE duplicates the alignment behavior of the HP 64853 assembler. However, the HP B1449 assembler errors when an EVEN directive occurs within a BYTE aligned segment. If EVEN directives will be used, use the -a WORD option. |
| -d | (differences) acvt86 writes pairs of input/output lines only when they are different. This output is not suitable for subsequent assembly. |
| -h suffix | Specifies the suffix (default .h) which is added to file names in INCLUDE directives to form the name of the "translated" include file. If the file name in the |

Chapter 16: Converting HP 64853 Assembly Language Programs

acvt86(1) Command Syntax

INCLUDE directive has a suffix (i.e. contains a period) then suffix replaces the original suffix. Otherwise, suffix is appended to the original file name.

For example, suppose an HP 64853 program contained the following directive.

```
INCLUDE file.H
```

acvt86 would translate this to the following HP B1449 control.

```
$INCLUDE( file.h)
```

It would also assume that file.H had already been translated into file.h and attempt to read file.h before continuing with the present translation.

- s (silent) Suppress warnings to standard error.
- w (warn) Include warning messages (as comment lines) in the standard output following the appropriate translated line.

Chapter 16: Converting HP 64853 Assembly Language Programs acvt86(1) Command Syntax

Files /usr/contrib/bin/acvt86

Executable file for assembly language porting tool.

/usr/contrib/src/acvt86/*

Source code files and make file for assembly language porting tool.

See Also ap86(1), as86(1), asm(1).

Diagnostics acvt86 returns non-zero if errors occur while performing I/O operations or while parsing the command line. Otherwise it returns zero.

Warning messages and the source lines which caused them are written to standard error.

Bugs acvt86 performs a limited set of transformations. Errors may occur when assembling the output. The object code from the 64853 assembly may not be the same as from the B1449 assembly.

acvt86 may detect a syntax error reading a legal HP 64853 program. The syntax of the HP 64853 assembly language is irregular. Occasionally, a legal assembler statement will be unacceptable to the translator. acvt86 will issue a warning when it detects a syntax error. The offending statement must be translated manually.

Comparison of Keywords

This section provides a side-by-side comparison of some of the HP 64853 constructs with the HP B1449 constructs. acvt86 performs most of the conversions shown in this section.

ALIGN

HP 64853	HP B1449
label ALIGN	EVEN label:

In HP B1449 assembly language, EVEN directives cause errors if they appear in segments with align-types of BYTE. Use an align-type of WORD if you want to use the EVEN directive. Any label may appear on the following line.

ASSUME

HP 64853	HP B1449
ASSUME segreg:ORG	ASSUME segreg:abs_segname

Most ASSUME directives need not be changed when moving to the HP B1449 assembler. However, when referring to absolute (for instance, ORGed) segment, you must do things differently. Briefly, when translating the ORG directive, you must create a named absolute segment using the SEGMENT directive. The ASSUME directive should then refer to this segment name. (See ORG for more information.)

COMN

HP 64853	HP B1449
label COMN	<prevproc> END <prevseg> ENDS COMN SEGMENT BYTE COMMON label:

Chapter 16: Converting HP 64853 Assembly Language Programs

Comparison of Keywords

Issue an ENDP to end the previous PROC, if necessary. Issue an ENDS directive to end the previous segment, if necessary. Any label must appear on the line following the directive.

DATA

HP 64853	HP B1449
label DATA	<prevproc> ENDP
	<prevseg> ENDS
	DATA SEGMENT BYTE PUBLIC
	label:

Issue an ENDP to end the previous PROC, if necessary. Issue an ENDS directive to end the previous segment, if necessary. Any label must appear on the line following the directive.

< EOF >

HP 64853	HP B1449
<EOF>	<prevproc> ENDP
	<prevseg> ENDS
	END
	<EOF>

Add an END directive to the module if not already present. Also, issue ENDP and ENDS directives if necessary.

EQU

HP 64853	HP B1449
id EQU <expr>	id EQU <expr>
	%SET(id, <expr>)

Chapter 16: Converting HP 64853 Assembly Language Programs

Comparison of Keywords

If an EQU label is ever referenced in a *preprocessor expression* (IF, REPT, or SET), then you must define that label for the preprocessor using the %SET directive. References to id in preprocessor expressions must be changed to %id.

EXPAND

The EXPAND function cannot be translated.

EXT

HP 64853	HP B1449
EXT id	EXTRN id:NEAR
EXT id type	EXTRN id:type
EXT segreg:id type	EXTRN id:type

The HP 64853 declaration "EXT segreg:id" causes an automatic segment override when id is used in a memory reference operand. The HP B1449 assembler does not have an equal feature. Two approaches can be used to obtain the same code. You can either find all the references to id and add an explicit segment override to the operand when appropriate, or, place all the EXTRN directives with a particular associated segment register inside a segment. In the second case, you then must make sure an ASSUME directive is in effect for the proper segment register when the external identifiers are used.

Label Field

HP 64853	HP B1449
label: directive	label directive
label instruction	label: instruction
label macroname operands	label: %macroname(operands)

Colons following labels are now significant. With the HP 64853 assembler, a colon following a label was optional. HP B1449 assembler prohibits a colon on a label for an assembler directive. HPB1449 assembler requires a colon on a label for a blank line, an instruction, and a macro definition.

LIST

HP 64853	HP B1449
LIST	\$LIST
LIST n	\$PAGELENGTH(n) LIST

Note

PAGELENGTH is a primary control. It, and other HP B1449 primary controls, must be placed at the beginning of the file before any executable statements.

MASK

The MASK function cannot be translated. You must find any ASC directives which are affected and change the operands.

NAME

The NAME function, which puts a comment in the relocatable object module, cannot be translated.

NOWARN

The NOWARN function cannot be translated.

Operator Field

HP 64853	HP B1449
.AN.	AND
.EQ.	EQ
.GE.	GE
.GT.	GT

Chapter 16: Converting HP 64853 Assembly Language Programs Comparison of Keywords

.LE.	LE
.LT	LT
.NE.	NE
.NT.	NOT
.OR.	OR
.SL.	SHL
.SR.	SHR
#1234	1234

Remove the pound sign before literal operands.

Within a string, make the following translations.

- A quote (') becomes two quotes in series (").
- To the macro preprocessor, the percent sign, left parenthesis, and right parenthesis are special characters. You should add a preprocessor escape sequence to percent and to unbalanced parentheses to avoid processor errors.
- HP B1449 string delimiters are different.

HP 64853	HP B1449
"string"	'string'
^string^	'string'
'string'	'string'

ORG

HP 64853	HP B1449
label ORG	<prevproc> ENDP <prevseg> ENDS

Chapter 16: Converting HP 64853 Assembly Language Programs Comparison of Keywords

```
abs_seg SEGMENT AT PARA_VAL
        ORG      OFFSET_VAL
label:
```

The HP 64853 ORG directive begins an absolute segment. Translate as follows.

- Issue an ENDP to end the previous PROC, if necessary.
- Issue an ENDS to end the previous segment, if necessary.
- The upper 16 bits of the ORG expression represents the segment value and the lower 16 bits represent the offset. You must extract the paragraph value and the offset manually because the HP B1449 does not do 32 bit arithmetic.
- Start an absolute segment, using the AT keyword, at the paragraph value.
- Set the offset using the ORG directive.
- Any label must follow the ORG to retain its original value. It is not necessary to create a new absolute segment for every ORG directive. Several ORGed sections (with the same segment values) may be combined. The HP B1449 ORG directive may be used to set the offset with the absolute segment.

PROC

HP 64853	HP B1449
label PROC type	<prevproc> ENDP
	label PROC type
PROC FAR	<prevproc> ENDP
	dummy PROC FAR

Issue an ENDP to end the previous procedure if necessary.

An unlabeled PROC directive is only useful for its effect on subsequent RET instructions. If the unlabeled PROC has type FAR, create a dummy PROC to

Chapter 16: Converting HP 64853 Assembly Language Programs

Comparison of Keywords

retain the same behavior. This dummy procedure is unnecessary if the type of the unlabeled PROC is NEAR because HP B1449, by default, creates NEAR return instructions when RETs appear outside of any procedure.



Chapter 16: Converting HP 64853 Assembly Language Programs Comparison of Keywords

PROG

HP 64853	HP B1449
label PROG	<prevseg> ENDS
	PROG SEGMENT BYTE PUBLIC
	label:

Issue an ENDS directive to end the previous segment if necessary. Any label must appear on the line following the directive.

REAL

The REAL directive cannot be translated. REAL is not useful because the byte order of its numbers is opposite the 8086/186 convention. Use DD, DQ, or DT to create useful real numbers.

Reserved Words

HP 64853	HP B1449
TEST EQU 0	TESTx EQU 0

HP B1449 assembler recognizes more reserved identifiers. HP 64853 assembly language allowed you to define labels that were spelled the same as either instruction mnemonics or assembler directives. HP B1449 assembler does not allow reserved word duplication. Change the spelling of identifiers that duplicate reserved words.

SPC

HP 64853	HP B1449
SPC	

The SPC function can only be translated into an equal number of empty source lines.

Chapter 16: Converting HP 64853 Assembly Language Programs

Comparison of Keywords

WARN

The WARN function cannot be translated.

* (Comment)

HP 64853

HP B1449

* comment

; comment

instr operand comment

instr operand ;comment

HP 64853 sometimes allows comments to begin with an asterisk and sometimes does not require any delimiter. HP B1449 requires all comments to begin with semicolon.

Linking to 64853 Programs

The HP B1449 linker does not accept either HP 64000 relocatable files or HP 64000 link_sym files. ld86 accepts only binary OMF relocatable files.

The utility L_to_o86 will transfer global symbol definitions from an HP 64000 link_sym file to an HP B1449 relocatable file. Thus, one can reference symbols produced by the HP 64853 linker (or produced by ld86) from binary OMF modules. Using this method, only the symbol definitions are linked. The code from the HP 64853 program is contained in an HP 64000 absolute file and must be loaded separately.

You may reference HP B1449 symbols from HP 64853 modules. Simply link the link_sym file produced by ld86 with the HP 64853 linker.

L_to_o86 uses another utility called nm64. Both are described on the following pages.



L_to_o86(1)

Name L_to_o86 - Transfer global symbol definitions from HP 64000 link_sym file(s) to HP B1449 relocatable file(s)

Synopsis /usr/contrib/bin/L_to_o86 file ...

Note This utility program is unsupported. It is not a part of any HP product and is provided at no cost. Hewlett-Packard makes no warranty on its quality or fitness for a particular purpose.

L_to_o86 takes the global symbol definitions from an HP 64000 link_sym file and puts them into a relocatable file. These absolute symbol values may then be used in a linking operation by the HP B1449 8086/186 linker, ld86.

L_to_o86 produces one relocatable file for each link_sym file. The output file name is formed from the input name by stripping any preceding path name or .L suffix and appending .o.

The conversion is done in three steps. First, nm64 converts the link_sym file to a printable listing. Second, awk rearranges the listing into a 8086 assembly source file. Third, as86 assembles the source into a relocatable.

See Also nm64(1), as86(1), ld86(1).

Diagnostics L_to_o86 returns 1 if there is a command line error or if any input file cannot be opened. Otherwise, it returns zero. If the input file is not an HP 64000 link_sym file, then as86 will generate an assembly error message on standard error. The relocatable file will be valid but will contain no symbol definitions.

nm64(1)

Name nm64 - print symbolic information from HP 64000 asmb_sym and link_sym files

Synopsis /usr/contrib/bin/nm64 [-t] [file] ...

HP-UX Compatibility

Level:

Contributed Software

Origin:

Hewlett Packard - Logic Systems Division

Note

This utility program is unsupported. It is not a part of any HP product and is provided at no cost. Hewlett-Packard makes no warranty on its quality or fitness for a particular purpose.

Description

Nm64 is similar to the HP-UX utility, nm(1). It prints (on standard output) the symbol names, values, and relocation counter names for symbols contained in HP 64000 asmb_sym (assembly symbol) and link_sym (linker symbol) files. For the latter, it also prints the other types of records present: processor configuration, name, and memory space.

Usually, asmb_sym files have a .A suffix and link_sym files have a .L suffix.

If no files are specified, nm64 attempts to read standard input.

If the -t option is specified, it will print lines prior to each section of the file telling what disk address the section starts at.

See Also

File Format Reference for the HP 64000-UX Microprocessor Development Environment.

Chapter 16: Converting HP 64853 Assembly Language Programs nm64(1)

Diagnostics

Nm64 returns 1 if it cannot open the input file. Otherwise, it returns zero.

Bugs

Addresses for different target processors may be stored in either one-word or two-word quantities. Assembly symbol files have no indication of which is used so applies a simple heuristic test to figure it out. The test could possibly fail.

Nm64 may also attempt to interpret other types of files with unpredictable results.

17



8086/186 Instructions in Hexadecimal Order

Chapter 17: 8086/186 Instructions in Hexadecimal Order

Hex Binary	MODRM Byte	Instruction	Parameters	Function
00 00000000	MOD REG R/M	ADD	EA,REG	BYTE ADD (REG) TO EA
01 00000001	MOD REG R/M	ADD	EA,REG	WORD ADD (REG) TO EA
02 00000010	MOD REG R/M	ADD	REG,EA	BYTE ADD (EA) TO REG
03 00000011	MOD REG R/M	ADD	REG,EA	WORD ADD (EA) TO REG
04 00000100		ADD	AL,DATA8	BYTE ADD DATA TO REG AL
05 00000101		ADD	AX,DATA16	WORD ADD DATA TO REG AX
06 00000110		PUSH	ES	PUSH (ES) ON STACK
07 00000111		POP	ES	POP STACK TO REG ES
08 00001000	MOD REG R/M	OR	EA,REG	BYTE OR (REG) TO EA
09 00001001	MOD REG R/M	OR	EA,REG	WORD OR (REG) TO EA
0A 00001010	MOD REG R/M	OR	REG,EA	BYTE OR (EA) TO REG
0B 00001011	MOD REG R/M	OR	REG,EA	WORD OR (EA) TO REG
0C 00001100		OR	AL,DATA8	BYTE OR DATA TO REG AL
0D 00001101		OR	AX,DATA16	WORD OR DATA TO REG AX
0E 00001110		PUSH	CS	PUSH (CS) ON STACK
0F 00001111		(not used)		
10 00010000	MOD REG R/M	ADC	EA,REG	BYTE ADD (REG) W/ CARRY TO EA
11 00010001	MOD REG R/M	ADC	EA,REG	WORD ADD (REG) W/ CARRY TO EA
12 00010010	MOD REG R/M	ADC	REG,EA	BYTE ADD (EA) W/ CARRY TO REG
13 00010011	MOD REG R/M	ADC	REG,EA	WORD ADD (EA) W/ CARRY TO REG
14 00010100		ADC	AL,DATA8	BYTE ADD DATA W/CARRY TO REG AL
15 00010101		ADC	AX,DATA16	WORD ADD DATA W/ CARRY TO REG AX
16 00010110		PUSH	SS	PUSH (SS) ON STACK
17 00010111		POP	SS	POP STACK TO REG SS

Chapter 17: 8086/186 Instructions in Hexadecimal Order

Hex Binary	MODRM Byte	Instruction	Parameters	Function
18 00011000	MOD REG R/M	SBB	EA,REG	BYTE SUB (REG) W/ BORROW FROM EA
19 00011001	MOD REG R/M	SBB	EA,REG	WORD SUB (REG) W/ BORROW FROM EA
1A 00011010	MOD REG R/M	SBB	REG,EA	BYTE SUB (EA) W/ BORROW FROM REG
1B 00011011	MOD REG R/M	SBB	REG,EA	WORD SUB (EA) W/ BORROW FROM REG
1C 00011100		SBB	AL,DATA8	BYTE SUB DATA W/ BORROW FROM REG AL
1D 00011101		SBB	AX,DATA16	WORD SUB DATA W/ BORROW FROM REG AX
1E 00011110		PUSH	DS	PUSH (DS) ON STACK
1F 00011111		POP	DS	POP STACK TO REG DS
20 00100000	MOD REG R/M	AND	EA,REG	BYTE AND (REG) TO EA
21 00100001	MOD REG R/M	AND	EA,REG	WORD AND (REG) TO EA
22 00100010	MOD REG R/M	AND	REG,EA	BYTE AND (EA) TO REG
23 00100011	MOD REG R/M	AND	REG,EA	WORD AND (EA) TO REG
24 00100100		AND	AL,DATA8	BYTE AND DATA TO REG AL
25 00100101		AND	AX,DATA16	WORD AND DATA TO REG AX
26 00100110		ES:		SEGMENT OVERRIDE W/ SEGMENT REG ES
27 00100111		DAA		DECIMAL ADJUST FOR ADD
28 00101000	MOD REG R/M	SUB	EA,REG	BYTE SUBTRACT (REG) FROM EA
29 00101001	MOD REG R/M	SUB	EA,REG	WORD SUBTRACT (REG) FROM EA
2A 00101010	MOD REG R/M	SUB	REG,EA	BYTE SUBTRACT (EA) FROM REG
2B 00101011	MOD REG R/M	SUB	REG,EA	WORD SUBTRACT (EA) FROM REG

Chapter 17: 8086/186 Instructions in Hexadecimal Order

Hex Binary	MODRM Byte	Instruction	Parameters	Function
2C 00101100		SUB	AL,DATA8	BYTE SUBTRACT DATA FROM REG AL
2D 00101101		SUB	AX,DATA16	WORD SUBTRACT DATA FROM REG AX
2E 00101110		CS:		SEGMENT OVERRIDE W/ SEGMENT REG CS
2F 00101111		DAS		DECIMAL ADJUST FOR SUBTRACT
30 00110000	MOD REG R/M	XOR	EA,REG	BYTE XOR (REG) TO EA
31 00110001	MOD REG R/M	XOR	EA,REG	WORD XOR (REG) TO EA
32 00110010	MOD REG R/M	XOR	REG,EA	BYTE XOR (EA) TO REG
33 00110011	MOD REG R/M	XOR	REG,EA	WORD XOR (EA) TO REG
34 00110100		XOR	AL,DATA8	BYTE XOR DATA TO REG AL
35 00110101		XOR	AX,DATA16	WORD XOR DATA TO REG AX
36 00110110		SS:		SEGMENT OVERRIDE W/ SEGMENT REG SS
37 00110111		AAA		ASCII ADJUST FOR ADD
38 00111000	MOD REG R/M	CMP	EA,REG	BYTE COMPARE (EA) WITH (REG)
39 00111001	MOD REG R/M	CMP	EA,REG	WORD COMPARE (EA) WITH (REG)
3A 00111010	MOD REG R/M	CMP	REG,EA	BYTE COMPARE (REG) WITH (EA)
3B 00111011	MOD REG R/M	CMP	REG,EA	WORD COMPARE (REG) WITH (EA)
3C 00111100		CMP	AL,DATA8	BYTE COMPARE DATA WITH (AL)
3D 00111101		CMP	AX,DATA16	WORD COMPARE DATA WITH (AX)
3E 00111110		DS:		SEGMENT OVERRIDE W/ SEGMENT REG DS
3F 00111111		AAS		ASCII ADJUST FOR SUBTRACT

Chapter 17: 8086/186 Instructions in Hexadecimal Order

Hex Binary	MODRM Byte	Instruction	Parameters	Function
40	01000000	INC	AX	INCREMENT (AX)
41	01000001	INC	CX	INCREMENT (CX)
42	01000010	INC	DX	INCREMENT (DX)
43	01000011	INC	BX	INCREMENT (BX)
44	01000100	INC	SP	INCREMENT (SP)
45	01000101	INC	BP	INCREMENT (BP)
46	01000110	INC	SI	INCREMENT (SI)
47	01000111	INC	DI	INCREMENT (DI)
48	01001000	DEC	AX	DECREMENT (AX)
49	01001001	DEC	CX	DECREMENT (CX)
4A	01001010	DEC	DX	DECREMENT (DX)
4B	01001011	DEC	BX	DECREMENT (BX)
4C	01001100	DEC	SP	DECREMENT (SP)
4D	01001101	DEC	BP	DECREMENT (BP)
4E	01001110	DEC	SI	DECREMENT (SI)
4F	01001111	DEC	DI	DECREMENT (DI)
50	01010000	PUSH	AX	PUSH (AX) ON STACK
51	01010001	PUSH	CX	PUSH (CX) ON STACK
52	01010010	PUSH	DX	PUSH (DX) ON STACK
53	01010011	PUSH	BX	PUSH (BX) ON STACK
54	01010100	PUSH	SP	PUSH (SP) ON STACK
55	01010101	PUSH	BP	PUSH (BP) ON STACK
56	01010110	PUSH	SI	PUSH (SI) ON STACK
57	01010111	PUSH	DI	PUSH (DI) ON STACK
58	01011000	POP	AX	POP STACK TO REG AX
59	01011001	POP	CX	POP STACK TO REG CX
5A	01011010	POP	DX	POP STACK TO REG DX
5B	01011011	POP	BX	POP STACK TO REG BX
5C	01011100	POP	SP	POP STACK TO REG SP
5D	01011101	POP	BP	POP STACK TO REG BP
5E	01011110	POP	SI	POP STACK TO REG SI
5F	01011111	POP	DI	POP STACK TO REG DI

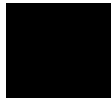

Chapter 17: 8086/186 Instructions in Hexadecimal Order

Hex Binary	MODRM Byte	Instruction	Parameters	Function
60 01100000		PUSHA		PUSH ALL DATA
61 01100001		POPA		POP ALL DATA
62 01100010	MOD REG R/M	BOUND	REG,EA	CHECK INDEX IN REG AGAINST BOUNDS AT EA
63 01100011		(not used)		
64 01100100		(not used)		
65 01100101		(not used)		
66 01100110		(not used)		
67 01100111		(not used)		
68 01101000		PUSH	DATA16	PUSH WORD DATA ON STACK
69 01101001	MOD REG R/M	IMUL	REG,EA, DATA16	MULTIPLY (EA) BY WORD DATA; SIGNED
6A 01101010		PUSH	DATA8	PUSH BYTE DATA ON STACK; SIGN-EXTEND
6B 01101011	MOD REG R/M	IMUL	REG,EA, DATA8	MULTIPLY (EA) BY BYTE DATA; SIGNED
6C 01101100		INS	DST8	BYTE INPUT
6D 01101101		INS	DST16	WORD INPUT
6E 01101110		OUTS	DST8	BYTE OUTPUT
6F 01101111		OUTS	DST16	WORD OUTPUT
70 01110000		JO	DISP8	JUMP ON OVERFLOW
71 01110001		JNO	DISP8	JUMP ON NOT OVERFLOW
72 01110010		JC/JB/JNAE	DISP8	JUMP ON BELOW/NOT ABOVE OR EQUAL
73 01110011		JNC/JNB/JAE	DISP8	JUMP ON NOT BELOW/ABOVE OR EQUAL
74 01110100		JE/JZ	DISP8	JUMP ON EQUAL/ZERO
75 01110101		JNE/JNZ	DISP8	JUMP ON NOT EQUAL/NOT ZERO
76 01110110		JBE/JNA	DISP8	JUMP ON BELOW OR EQUAL/NOT ABOVE
77 01110111		JNBE/JA	DISP8	JUMP ON NOT BELOW OR EQUAL/ABOVE

Chapter 17: 8086/186 Instructions in Hexadecimal Order

Hex Binary	MODRM Byte	Instruction	Parameters	Function
78 01111000		JS	DISP8	JUMP ON SIGN
79 01111001		JNS	DISP8	JUMP ON NOT SIGN
7A 01111010		JP/JPE	DISP8	JUMP ON PARITY/PARITY EVEN
7B 01111011		JNP/JPO	DISP8	JUMP ON NOT PARITY/PARITY ODD
7C 01111100		JL/JNGE	DISP8	JUMP ON LESS/NOT GREATER OR EQUAL
7D 01111101		JNL/JGE	DISP8	JUMP ON NOT LESS/GREATER OR EQUAL
7E 01111110		JLE/JNG	DISP8	JUMP ON LESS OR EQUAL/NOT GREATER
7F 01111111		JNLE/JG	DISP8	JUMP ON NOT LESS OR EQUAL/GREATER
80 10000000	MOD 000 R/M	ADD	EA,DATA8	BYTE ADD DATA TO EA
80 10000000	MOD 001 R/M	OR	EA,DATA8	BYTE OR DATA TO EA
80 10000000	MOD 010 R/M	ADC	EA,DATA8	BYTE ADD DATA W/CARRY TO EA
80 10000000	MOD 011 R/M	SBB	EA,DATA8	BYTE SUB DATA W/BORROW FROM EA
80 10000000	MOD 100 R/M	AND	EA,DATA8	BYTE AND DATA TO EA
80 10000000	MOD 101 R/M	SUB	EA,DATA8	BYTE SUBTRACT DATA FROM EA
80 10000000	MOD 110 R/M	XOR	EA,DATA8	BYTE XOR DATA TO EA
80 10000000	MOD 111 R/M	CMP	EA,DATA8	BYTE COMPARE DATA WITH (EA)
81 10000001	MOD 000 R/M	ADD	EA,DATA16	WORD ADD DATA TO EA
81 10000001	MOD 001 R/M	OR	EA,DATA16	WORD OR DATA TO EA
81 10000001	MOD 010 R/M	ADC	EA,DATA16	WORD ADD DATA W/CARRY TO EA
81 10000001	MOD 011 R/M	SBB	EA,DATA16	WORD SUB DATA W/BORROW FROM EA
81 10000001	MOD 100 R/M	AND	EA,DATA16	WORD AND DATA TO EA
81 10000001	MOD 101 R/M	SUB	EA,DATA16	WORD SUBTRACT DATA FROM EA

Chapter 17: 8086/186 Instructions in Hexadecimal Order

Hex Binary	MODRM Byte	Instruction	Parameters	Function
81 1000001	MOD 110 R/M	XOR	EA,DATA16	WORD XOR DATA TO EA
81 1000001	MOD 111 R/M	CMP	EA,DATA16	WORD COMPARE DATA WITH (EA)
82 1000010	MOD 000 R/M	ADD	EA,DATA8	BYTE ADD DATA TO EA
82 1000010	MOD 001 R/M	(not used)		
82 1000010	MOD 010 R/M	ADC	EA,DATA8	BYTE ADD DATA W/ CARRY TO EA
82 1000010	MOD 011 R/M	SBB	EA,DATA8	BYTE SUB DATA W/ BORROW FROM EA
82 1000010	MOD 100 R/M	(not used)		
82 1000010	MOD 101 R/M	SUB	EA,DATA8	BYTE SUBTRACT DATA FROM EA
82 1000010	MOD 110 R/M	(not used)		
82 1000010	MOD 111 R/M	CMP	EA,DATA8	BYTE COMPARE DATA WITH (EA)
83 1000011	MOD 000 R/M	ADD	EA,DATA8	WORD ADD DATA TO EA
83 1000011	MOD 001 R/M	(not used)		
83 1000011	MOD 010 R/M	ADC	EA,DATA8	WORD ADD DATA W/ CARRY TO EA
83 1000011	MOD 011 R/M	SBB	EA,DATA8	WORD SUB DATA W/ BORROW FROM EA
83 1000011	MOD 100 R/M	(not used)		
83 1000011	MOD 101 R/M	SUB	EA,DATA8	WORD SUBTRACT DATA FROM EA
83 1000011	MOD 110 R/M	(not used)		
83 1000011	MOD 111 R/M	CMP	EA,DATA8	WORD COMPARE DATA WITH (EA)
84 1000100	MOD REG R/M	TEST	EA,REG	BYTE TEST (EA) WITH (REG)
85 1000101	MOD REG R/M	TEST	EA,REG	WORD TEST (EA) WITH (REG)
86 1000110	MOD REG R/M	XCHG	REG,EA	BYTE EXCHANGE (REG) WITH (EA)

Chapter 17: 8086/186 Instructions in Hexadecimal Order

Hex Binary	MODRM Byte	Instruction	Parameters	Function
87 1000111	MOD REG R/M	XCHG	REG,EA	WORD EXCHANGE (REG) WITH (EA)
88 10001000	MOD REG R/M	MOV	EA,REG	BYTE MOVE (REG) TO EA
89 10001001	MOD REG R/M	MOV	EA,REG	WORD MOVE (REG) TO EA
8A 10001010	MOD REG R/M	MOV	REG,EA	BYTE MOVE (EA) TO REG
8B 10001011	MOD REG R/M	MOV	REG,EA	WORD MOVE (EA) TO REG
8C 10001100	MOD 0SR R/M	MOV	EA,SR	WORD MOVE (SEGMENT REG SR) TO EA
8C 10001100	MOD 1-- R/M	(not used)		
8D 10001101	MOD REG R/M	LEA	REG,EA	LOAD EFFECTIVE ADDRESS OF EA TO REG
8E 10001110	MOD 0SR R/M	MOV	SR,EA	WORD MOVE (EA) TO SEGMENT REG SR
8E 10001110	MOD -- R/M	(not used)		
8F 10001111	MOD 000 R/M	POP	EA	POP STACK TO EA
8F 10001111	MOD 001 R/M	(not used)		
8F 10001111	MOD 010 R/M	(not used)		
8F 10001111	MOD 011 R/M	(not used)		
8F 10001111	MOD 100 R/M	(not used)		
8F 10001111	MOD 101 R/M	(not used)		
8F 10001111	MOD 110 R/M	(not used)		
8F 10001111	MOD 111 R/M	(not used)		
90 10010000		XCHG	AX,AX	EXCHANGE (AX) WITH (AX)
91 10010001		XCHG	AX,CX	EXCHANGE (AX) WITH (CX)
92 10010010		XCHG	AX,DX	EXCHANGE (AX) WITH (DX)
93 10010011		XCHG	AX,BX	EXCHANGE (AX) WITH (BX)
94 10010100		XCHG	AX,SP	EXCHANGE (AX) WITH (SP)
95 10010101		XCHG	AX,BP	EXCHANGE (AX) WITH (BP)
96 10010110		XCHG	AX,SI	EXCHANGE (AX) WITH (SI)
97 10010111		XCHG	AX,DI	EXCHANGE (AX) WITH (DI)

Chapter 17: 8086/186 Instructions in Hexadecimal Order

Hex Binary	MODRM Byte	Instruction	Parameters	Function
98	10011000	CBW		BYTE CONVERT (AL) TO WORD (AX)
99	10011001	CWD		WORD CONVERT (AX) TO DOUBLE WORD
9A	10011010	CALL	DISP16,SEG16	DIRECT INTER SEGMENT CALL
9B	10011011	WAIT		WAIT FOR TEST SIGNAL
9C	10011100	PUSHF		PUSH FLAGS ON STACK
9D	10011101	POPF		POP STACK TO FLAGS
9E	10011110	SAHF		STORE (AH) INTO FLAGS
9F	10011111	LAHF		LOAD REG AH WITH FLAGS
A0	10100000	MOV	AL,ADDR16	BYTE MOVE (ADDR) TO REG AL
A1	10100001	MOV	AX,ADDR16	WORD MOVE (ADDR) TO REG AX
A2	10100010	MOV	ADDR16,AL	BYTE MOVE (AL) TO ADDR
A3	10100011	MOV	ADDR16,AX	WORD MOVE (AX) TO ADDR
A4	10100100	MOVS	DST8,SRC8	BYTE MOVE, STRING OP
A5	10100101	MOVS	DST16,SRC16	WORD MOVE, STRING OP
A6	10100110	CMPS	SIPTR,DIPTR	COMPARE BYTE, STRING OP
A7	10100111	CMPS	SIPTR,DIPTR	COMPARE WORD, STRING OP
A8	10101000	TEST	AL,DATA8	BYTE TEST (AL) WITH DATA
A9	10101001	TEST	AX,DATA16	WORD TEST (AX) WITH DATA
AA	10101010	STOS	DST8	BYTE STORE, STRING OP
AB	10101011	STOS	DST16	WORD STORE, STRING OP
AC	10101100	LODS	SRC8	BYTE LOAD, STRING OP
AD	10101101	LODS	SRC16	WORD LOAD, STRING OP
AE	10101110	SCAS	DIPTR8	BYTE SCAN, STRING OP

Chapter 17: 8086/186 Instructions in Hexadecimal Order

Hex Binary	MODRM Byte	Instruction	Parameters	Function
AF 10101111		SCAS	DIPTR16	WORD SCAN, STRING OP
B0 10110000		MOV	AL,DATA8	BYTE MOVE DATA TO REG AL
B1 10110001		MOV	CL,DATA8	BYTE MOVE DATA TO REG CL
B2 10110010		MOV	DL,DATA8	BYTE MOVE DATA TO REG DL
B3 10110011		MOV	BL,DATA8	BYTE MOVE DATA TO REG BL
B4 10110100		MOV	AH,DATA8	BYTE MOVE DATA TO REG AH
B5 10110101		MOV	CH,DATA8	BYTE MOVE DATA TO REG CH
B6 10110110		MOV	DH,DATA8	BYTE MOVE DATA TO REG DH
B7 10110111		MOV	BH,DATA8	BYTE MOVE DATA TO REG BH
B8 10111000		MOV	AX,DATA16	WORD MOVE DATA TO REG AX
B9 10111001		MOV	CX,DATA16	WORD MOVE DATA TO REG CX
BA 10111010		MOV	DX,DATA16	WORD MOVE DATA TO REG DX
BB 10111011		MOV	BX,DATA16	WORD MOVE DATA TO REG BX
BC 10111100		MOV	SP,DATA16	WORD MOVE DATA TO REG SP
BD 10111101		MOV	BP,DATA16	WORD MOVE DATA TO REG BP
BE 10111110		MOV	SI,DATA16	WORD MOVE DATA TO REG SI
BF 10111111		MOV	DI,DATA16	WORD MOVE DATA TO REG DI
C0 11000000	MOD 000 R/M	ROL	EA,DATA8	BYTE ROTATE EA LEFT DATA8 BITS

Chapter 17: 8086/186 Instructions in Hexadecimal Order

Hex Binary	MODRM Byte	Instruction	Parameters	Function
C0 11000000	MOD 001 R/M	ROR	EA,DATA8	BYTE ROTATE EA RIGHT DATA8 BITS
C0 11000000	MOD 010 R/M	RCL	EA,DATA8	BYTE ROTATE EA LEFT THRU CARRY DATA8 BITS
C0 11000000	MOD 011 R/M	RCR	EA,DATA8	BYTE ROTATE EA RIGHT THRU CARRY DATA8 BITS
C0 11000000	MOD 100 R/M	SHL/SAL	EA,DATA8	BYTE SHIFT EA LEFT DATA8 BITS
C0 11000000	MOD 101 R/M	SHR	EA,DATA8	BYTE SHIFT EA RIGHT DATA8 BITS
C0 11000000	MOD 110 R/M	(not used)		
C0 11000000	MOD 111 R/M	SAR	EA,DATA8	BYTE SHIFT SIGNED EA RIGHT DATA8 BITS
C1 11000001	MOD 000 R/M	ROL	EA,DATA8	WORD ROTATE EA LEFT DATA8 BITS
C1 11000001	MOD 001 R/M	ROR	EA,DATA8	WORD ROTATE EA RIGHT DATA8 BITS
C1 11000001	MOD 010 R/M	RCL	EA,DATA8	WORD ROTATE EA LEFT THRU CARRY DATA8 BITSCARRY DATA8 BITS
C1 11000001	MOD 011 R/M	RCR	EA,DATA8	WORD ROTATE EA RIGHT THRU CARRY DATA8 BITS
C1 11000001	MOD 100 R/M	SHL/SAL	EA,DATA8	WORD SHIFT EA LEFT DATA8 BITS
C1 11000001	MOD 101 R/M	SHR	EA,DATA8	WORD SHIFT EA RIGHT DATA8 BITS
C1 11000001	MOD 110 R/M	(not used)		
C1 11000001	MOD 111 R/M	SAR	EA,DATA8	WORD SHIFT SIGNED EA RIGHT DATA8 BITS
C2 11000010		RET	DATA16	INTRA SEGMENT RETURN
C3 11000011		RET		INTRA SEGMENT RETURN
C4 11000100	MOD REG R/M	LES	ES,REG, EA	WORD LOAD REG AND SEGMENT REG ES
C5 11000101	MOD REG R/M	LDS	DS,REG,EA	WORD LOAD REG AND SEGMENT REG DS

Chapter 17: 8086/186 Instructions in Hexadecimal Order

Hex Binary	MODRM Byte	Instruction	Parameters	Function
C6 1100110	MOD 000 R/M	MOV	EA,DATA8	BYTE MOVE DATA TO EA
C6 1100110	MOD 001 R/M	(not used)		
C6 1100110	MOD 010 R/M	(not used)		
C6 1100110	MOD 011 R/M	(not used)		
C6 1100110	MOD 100 R/M	(not used)		
C6 1100110	MOD 101 R/M	(not used)		
C6 1100110	MOD 110 R/M	(not used)		
C6 1100110	MOD 111 R/M	(not used)		
C7 1100111	MOD 000 R/M	MOV	EA,DATA16	WORD MOVE DATA TO EA
C7 1100111	MOD 001 R/M	(not used)		
C7 1100111	MOD 010 R/M	(not used)		
C7 1100111	MOD 011 R/M	(not used)		
C7 1100111	MOD 100 R/M	(not used)		
C7 1100111	MOD 101 R/M	(not used)		
C7 1100111	MOD 110 R/M	(not used)		
C7 1100111	MOD 111 R/M	(not used)		
C8 11001000		ENTER	DATA16, DATA8	PERFORM ENTER SEQUENCE
C9 11001001		LEAVE		PERFORM LEAVE SEQUENCE
CA 11001010		RET	DATA16	INTER SEGMENT RETURN
CB 11001011		RET		INTER SEGMENT RETURN
CC 11001100		INT	3	TYPE 3 INTERRUPT
CD 11001101		INT	TYPE	TYPED INTERRUPT
CE 11001110		INTO		INTERRUPT ON OVERFLOW
CF 11001111		IRET		RETURN FROM INTERRUPT
D0 11010000	MOD 000 R/M	ROL	EA,1	BYTE ROTATE EA LEFT 1 BIT
D0 11010000	MOD 001 R/M	ROR	EA,1	BYTE ROTATE EA RIGHT 1 BIT

Chapter 17: 8086/186 Instructions in Hexadecimal Order

Hex Binary	MODRM Byte	Instruction	Parameters	Function
D0 11010000	MOD 010 R/M	RCL	EA,1	BYTE ROTATE EA LEFT THRU CARRY 1 BIT
D0 11010000	MOD 011 R/M	RCR	EA,1	BYTE ROTATE EA RIGHT THRU CARRY 1 BIT
D0 11010000	MOD 100 R/M	SHL	EA,1	BYTE SHIFT EA LEFT 1 BIT
D0 11010000	MOD 101 R/M	SHR	EA,1	BYTE SHIFT EA RIGHT 1 BIT
D0 11010000	MOD 110 R/M	(not used)		
D0 11010000	MOD 111 R/M	SAR	EA,1	BYTE SHIFT SIGNED EA RIGHT 1 BIT
D1 11010001	MOD 000 R/M	ROL	EA,1	WORD ROTATE EA LEFT 1 BIT
D1 11010001	MOD 001 R/M	ROR	EA,1	WORD ROTATE EA RIGHT 1 BIT
D1 11010001	MOD 010 R/M	RCL	EA,1	WORD ROTATE EA LEFT THRU CARRY 1 BIT
D1 11010001	MOD 011 R/M	RCR	EA,1	WORD ROTATE EA RIGHT THRU CARRY 1 BIT
D1 11010001	MOD 100 R/M	SHL	EA,1	WORD SHIFT EA LEFT 1 BIT
D1 11010001	MOD 101 R/M	SHR	EA,1	WORD SHIFT EA RIGHT 1 BIT
D1 11010001	MOD 110 R/M	(not used)		
D1 11010001	MOD 111 R/M	SAR	EA,1	WORD SHIFT SIGNED EA RIGHT 1 BIT
D2 11010010	MOD 000 R/M	ROL	EA,CL	BYTE ROTATE EA LEFT (CL) BITS
D2 11010010	MOD 001 R/M	ROR	EA,CL	BYTE ROTATE EA RIGHT (CL) BITS
D2 11010010	MOD 010 R/M	RCL	EA,CL	BYTE ROTATE EA LEFT THRU CARRY (CL) BITS
D2 11010010	MOD 011 R/M	RCR	EA,CL	BYTE ROTATE EA RIGHT THRU CARRY (CL) BITS
D2 11010010	MOD 100 R/M	SHL	EA,CL	BYTE SHIFT EA LEFT (CL) BITS

Chapter 17: 8086/186 Instructions in Hexadecimal Order

Hex Binary	MODRM Byte	Instruction	Parameters	Function
D2 11010010	MOD 101 R/M	SHR	EA,CL	BYTE SHIFT EA RIGHT (CL) BITS
D2 11010010	MOD 110 R/M	(not used)		
D2 11010010	MOD 111 R/M	SAR	EA,CL	BYTE SHIFT SIGNED EA RIGHT (CL) BITS
D3 11010011	MOD 000 R/M	ROL	EA,CL	WORD ROTATE EA LEFT (CL) BITS
D3 11010011	MOD 001 R/M	ROR	EA,CL	WORD ROTATE EA RIGHT (CL) BITS
D3 11010011	MOD 010 R/M	RCL	EA,CL	WORD ROTATE EA LEFT THRU CARRY (CL) BITS
D3 11010011	MOD 011 R/M	RCR	EA,CL	WORD ROTATE EA RIGHT THRU CARRY (CL) BITS
D3 11010011	MOD 100 R/M	SHL	EA,CL	WORD SHIFT EA LEFT (CL) BITS
D3 11010011	MOD 101 R/M	SHR	EA,CL	WORD SHIFT EA RIGHT (CL) BITS
D3 11010011	MOD 110 R/M	(not used)		
D3 11010011	MOD 111 R/M	SAR	EA,CL	WORD SHIFT SIGNED EA RIGHT (CL) BITS
D4 11010100	00001010	AAM		ASCII ADJUST FOR MULTIPLY
D5 11010101	00001010	AAD		ASCII ADJUST FOR DIVIDE
D6 11010110		(not used)		
D7 11010111		XLAT	TABLE	TRANSLATE USING (BX)
D8 11011---	MOD --- R/M	ESC	EA	ESCAPE TO EXTERNAL DEVICE
D8 11011000	MOD 000 R/M	FADD	Short-real	ADD 4-BYTE EA TO ST
D8 11011000	MOD 001 R/M	FMUL	Short-real	MULTIPLY ST BY 4-BYTE EA
D8 11011000	MOD 010 R/M	FCOM	Short-real	COMPARE 4-BYTE EA WITH ST
D8 11011000	MOD 011 R/M	FCOMP	Short-real	COMPARE 4-BYTE EA WITH ST AND POP

Chapter 17: 8086/186 Instructions in Hexadecimal Order

Hex Binary	MODRM Byte	Instruction	Parameters	Function
D8 11011000	MOD 100 R/M	FSUB	Short-real	SUBTRACT 4-BYTE EA FROM ST
D8 11011000	MOD 101 R/M	FSUBR	Short-real	SUBTRACT ST FROM 4-BYTE EA
D8 11011000	MOD 110 R/M	FDIV	Short-real	DIVIDE ST BY 4-BYTE EA
D8 11011000	MOD 111 R/M	FDIVR	Short-real	DIVIDE 4-BYTE EA BY ST
D8 11011000	1 1 000 (i)	FADD	ST,ST(i)	ADD ELEMENT TO ST
D8 11011000	1 1 001 (i)	FMUL	ST,ST(i)	MULTIPLY ST BY ELEMENT
D8 11011000	1 1 010 (i)	FCOM	ST(i)	COMPARE ST(i) WITH ST
D8 11011000	1 1 011 (i)	FCOMP	ST(i)	COMPARE ST(i) WITH ST AND POP
D8 11011000	1 1 100 (i)	FSUB	ST,ST(i)	SUBTRACT ELEMENT FROM ST
D8 11011000	1 1 101 (i)	FSUBR	ST,ST(i)	SUBTRACT ST FROM STACK ELEMENT
D8 11011000	1 1 110 (i)	FDIV	ST,ST(i)	DIVIDE ST BY ELEMENT
D8 11011000	1 1 111 (i)	FDIVR	ST,ST(i)	DIVIDE ST(i) BY ST
D9 11011001	MOD 000 R/M	FLD	Short-real	PUSH 4-BYTE EA TO ST
D9 11011001	MOD 001 R/M	(not used)		
D9 11011001	MOD 010 R/M	FST	Short-real	STORE 4-BYTE REAL TO EA
D9 11011001	MOD 011 R/M	FSTP	Short-real	STORE 4-BYTE REAL TO EA AND POP
D9 11011001	MOD 100 R/M	FLDENV	14 BYTES	LOAD 8087 ENVIRONMENT FROM EA
D9 11011001	MOD 101 R/M	FLDCW	2-BYTES	LOAD CONTROL WORD FROM EA
D9 11011001	MOD 110 R/M	FSTENV	14-BYTES	STORE 8087 ENVIRONMENT INTO EA
D9 11011001	MOD 111 R/M	FSTCW	2-BYTES	STORE CONTROL WORD INTO EA
D9 11011001	1 1 000 (i)	FLD	ST(i)	PUSH ST(i) ONTO ST
D9 11011001	1 1 001 (i)	FXCH	ST(i)	EXCHANGE ST AND ST(i)
D9 11011001	1 1 010 000	FNOP		STORE ST IN ST
D9 11011001	1 1 010 001	(not used)		

Chapter 17: 8086/186 Instructions in Hexadecimal Order

Hex Binary	MODRM Byte	Instruction	Parameters	Function
D9 11011001	1 1 010 01-	(not used)		
D9 11011001	1 1 010 1--	(not used)		
D9 11011001	1 1 011 (i)	*(1)		
D9 11011001	1 1 100 000	FCHS		CHANGE SIGN OF ST
D9 11011001	1 1 100 001	FABS		TAKE ABSOLUTE VALUE OF ST
D9 11011001	1 1 100 01-	(not used)		
D9 11011001	1 1 100 100	FTST		TEST ST AGAINST 0.0
D9 11011001	1 1 100 101	FXAM		EXAMINE ST AND REPORT CONDITION CODE
D9 11011001	1 1 100 11-	(not used)		
D9 11011001	1 1 101 000	FLD1		PUSH + 1.0 TO ST
D9 11011001	1 1 101 001	FLDL2T		PUSH $\log_2 10$ TO ST
D9 11011001	1 1 101 010	FLDL2E		PUSH $\log_2 e$ TO ST
D9 11011001	1 1 101 011	FLDPI		PUSH π TO ST
D9 11011001	1 1 101 100	FLDLG2		PUSH $\log_2 10$ TO ST
D9 11011001	1 1 101 101	FLDLN2		PUSH $\log_2 e$ TO ST
D9 11011001	1 1 101 110	FLDZ		PUSH ZERO TO ST
D9 11011001	1 1 101 111	(not used)		
D9 11011001	1 1 110 000	F2XM1		CALCULATE $2^x - 1$
D9 11011001	1 1 110 001	FYL2X		CALCULATE FUNCTION $Y * \log_2 X$
D9 11011001	1 1 110 010	FPTAN		CALCULATE TAN OF θ AS A RATIO
D9 11011001	1 1 110 011	FPATAN		CALCULATE ARCTAN OF θ
D9 11011001	1 1 110 100	FXTRACT		EXTRACT EXPONENT AND SIGNIFICAND FROM ST VALUE
D9 11011001	1 1 110 101	(not used)		
D9 11011001	1 1 110 110	FDECSTP		DECREMENT STACK POINTER IN STATUS WORD
D9 11011001	1 1 110 111	FINCSTP		INCREMENT STACK POINTER IN STATUS WORD

Chapter 17: 8086/186 Instructions in Hexadecimal Order

Hex Binary	MODRM Byte	Instruction	Parameters	Function
D9 11011001	1 1 111 000	FPREM		MODULO DIVISION OF ST BY ST(1)
D9 11011001	1 1 110 001	FYL2XP1		CALCULATE VALUE OF $Y * \log_2 (X + 1)$
D9 11011001	1 1 111 010	FSQRT		CALCULATE SQUARE ROOT OF ST
D9 11011001	1 1 111 011	(not used)		
D9 11011001	1 1 111 100	FRNDINT		ROUND ST TO INTEGER
D9 11011001	1 1 111 101	FSCALE		ADD ST(1) TO EXPONENT OF ST
D9 11011001	1 1 111 11-	(not used)		
DA 11011010	MOD 000 R/M	RIADD	Short-integer	ADD 4-BYTE INTEGER EA TO ST
DA 11011010	MOD 001 R/M	FIMUL	Short-integer	MULTIPLY ST BY 4-BYTE INTEGER EA
DA 11011010	MOD 010 R/M	FICOM	Short-integer	CONVERT 4-BYTE INTEGER EA, AND COMPARE WITH ST
DA 11011010	MOD 011 R/M	FICOMP	Short-integer	CONVERT 4-BYTE INTEGER EA, COMPARE WITH ST, POP
DA 11011010	MOD 100 R/M	FISUB	Short-integer	SUBTRACT 4-BYTE INTEGER EA FROM ST
DA 11011010	MOD 101 R/M	FISUBR	Short-integer	SUBTRACT ST FROM 4-BYTE INTEGER EA
DA 11011010	MOD 110 R/M	FIDIV	Short-integer	DIVIDE ST BY 4-BYTE INTEGER EA
DA 11011010	MOD 111 R/M	FIDIVR	Short-integer	DIVIDE 4-BYTE INTEGER EA BY ST
DA 11011010	1 1 -- ---	(not used)		
DB 11011011	MOD 000 R/M	FILD	Short-integer	
DB 11011011	MOD 001 R/M	(not used)		
DB 11011011	MOD 010 R/M	FIST	Short-integer	STORE ROUNDED ST IN 4-BYTE INTEGER EA

Chapter 17: 8086/186 Instructions in Hexadecimal Order

Hex Binary	MODRM Byte	Instruction	Parameters	Function
DB 11011011	MOD 011 R/M	FISTP	Short-integer	STORE ROUNDED ST IN 4-BYTE INTEGER EA, POP
DB 11011011	MOD 100 R/M	(not used)		
DB 11011011	MOD 101 R/M	FLD	Temp-real	PUSH 10-BYTE EA ONTO ST
DB 11011011	MOD 110 R/M	Reserved		
DB 11011011	MOD 111 R/M	FSTP	Temp-real	STORE ST INTO 10-BYTE EA, POP
DB 11011011	1 1 0-- ---	Reserved		
DB 11011011	1 1 100 000	FENI		ENABLE INTERRUPT
DB 11011011	1 1 100 001	FDISI		DISABLE INTERRUPTS
DB 11011011	1 1 100 010	FCLEX		CLEAR EXCEPTIONS
DB 11011011	1 1 100 011	FINIT		INITIALIZE PROCESSOR
DB 11011011	1 1 100 1--	Reserved		
DB 11011011	1 1 101 ---	Reserved		
DB 11011011	1 1 11- ---	Reserved		
DC 11011100	MOD 000 R/M	FADD	Long-real	ADD 8-BYTE EA TO ST
DC 11011100	MOD 001 R/M	FMUL	Long-real	MULTIPLY ST BY 8-BYTE EA
DC 11011100	MOD 010 R/M	FCOM	Long-real	COMPARE ST WITH 8-BYTE EA
DC 11011100	MOD 011 R/M	FCOMP	Long-real	COMPARE ST WITH 8-BYTE EA
DC 11011100	MOD 100 R/M	FSUB	Long-real	SUBTRACT 8-BYTE EA FROM ST
DC 11011100	MOD 101 R/M	FSUBR	Long-real	SUBTRACT ST FROM 8-BYTE EA
DC 11011100	MOD 110 R/M	FDIV	Long-real	DIVIDE ST BY 8-BYTE EA
DC 11011100	MOD 111 R/M	FDIVR	Long-real	DIVIDE 8-BYTE EA BY ST
DC 11011100	1 1 000 (i)	FADD	ST(i), ST	ADD ST TO ELEMENT
DC 11011100	1 1 001 (i)	FMUL	ST(i), ST	MULTIPLY ELEMENT BY ST
DC 11011100	1 1 010 (i)	*(2)		
DC 11011100	1 1 011 (i)	*(3)		
DC 11011100	1 1 100 (i)	FSUBR	ST(i), ST	SUBTRACT ST FROM ELEMENT

Chapter 17: 8086/186 Instructions in Hexadecimal Order

Hex Binary	MODRM Byte	Instruction	Parameters	Function
DC 11011100	1 1 101 (i)	FSUB	ST(i), ST	SUBTRACT ELEMENT FROM ST
DC 11011100	1 1 110 (i)	FDIVR	ST(i), ST	DIVIDE ST(i) BY ST
DC 11011100	1 1 111 (i)	FDIV	ST(i), ST	DIVIDE ST BY ST(i)
DD 11011101	MOD 000 R/M	FLD	Long-real	PUSH 8-BYTE EA ONTO ST
DD 11011101	MOD 001 R/M	Reserved		
DD 11011101	MOD 010 R/M	FST	Long-real	STORE ST INTO 8-BYTE EA
DD 11011101	MOD 011 R/M	FSTP	Long-real	STORE ST INTO 8-BYTE EA
DD 11011101	MOD 100 R/M	FRSTOR	94-BYTES	RESTORE 8087 STATE FROM EA
DD 11011101	MOD 101 R/M	Reserved		
DD 11011101	MOD 110 R/M	FSAVE	94-BYTES	SAVE 8087 STATE TO EA
DD 11011101	MOD 111 R/M	FSTSW	2-BYTES	STORE 8087 STATUS WORD TO 2-BYTE EA
DD 11011101	1 1 000 (i)	FFREE	ST(i)	SET STACK TAG TO "EMPTY"
DD 11011101	1 1 001 (i)	*(4)		
DD 11011101	1 1 010 (i)	FST	ST(i)	STORE ST INTO ST(i)
DD 11011101	1 1 011 (i)	FSTP	ST(i)	STORE ST INTO ST(i), POP
DD 11011101	1 1 1-- ---	Reserved		
DE 11011110	MOD 000 R/M	FIADD	Word-integer	ADD 2-BYTE INTEGER EA TO ST
DE 11011110	MOD 001 R/M	FIMUL	Word-integer	MULTIPLY ST BY 2-BYTE INTEGER EA
DE 11011110	MOD 010 R/M	FICOM	Word-integer	COMPARE 2-BYTE EA INTEGER WITH ST
DE 11011110	MOD 011 R/M	FICOMP	Word-integer	COMPARE 2-BYTE INTEGER EA WITH ST, POP
DE 11011110	MOD 100 R/M	FISUB	Word-integer	SUBTRACT 2-BYTE INTEGER EA FROM ST
DE 11011110	MOD 101 R/M	FISUBR	Word-integer	SUBTRACT ST FROM 2-BYTE INTEGER EA
DE 11011110	MOD 110 R/M	FIDIV	Word-integer	DIVIDE ST BY 2-BYTE INTEGER EA

Chapter 17: 8086/186 Instructions in Hexadecimal Order

Hex Binary	MODRM Byte	Instruction	Parameters	Function
DE 11011110	MOD 111 R/M	FIDIVR	Word-integer	DIVIDE 2-BYTE INTEGER EA BY ST
DE 11011110	1 1 000 (i)	FADDP	ST(i), ST	ADD ST TO ELEMENT
DE 11011110	1 1 001 (i)	FMULP	ST(i), ST	MULTIPLY ST BY ELEMENT, POP
DE 11011110	1 1 010 ---	*(5)		
DE 11011110	1 1 011 000	Reserved		
DE 11011110	1 1 011 001	FCOMP		COMPARE ST WITH ST(1), POP TWICE
DE 11011110	1 1 011 01-	Reserved		
DE 11011110	1 1 011 1--	Reserved		
DE 11011110	1 1 100 (i)	FSUBRP	ST(i), ST	SUBTRACT ST FROM ELEMENT, POP
DE 11011110	1 1 101 (i)	FSUBP	ST(i), ST	SUBTRACT ST(i) FROM ST, POP
DE 11011110	1 1 110 (i)	FDIVRP	ST(i), ST	DIVIDE STACK ELEMENT BY ST, POP
DE 11011110	1 1 111 (i)	FDIVP	ST(i), ST	DIVIDE ST BY STACK ELEMENT, POP
DF 11011111	MOD 000 R/M	FILD	Word-integer	CONVERT 2-BYTE EA AND PUSH ONTO STACK
DF 11011111	MOD 001 R/M	Reserved		
DF 11011111	MOD 010 R/M	FIST	Word-integer	ROUND ST AND STORE IN 2-BYTE INTEGER EA
DF 11011111	MOD 011 R/M	FISTP	Word-integer	ROUND ST, STORE IN 2-BYTE INTEGER EA, POP
DF 11011111	MOD 100 R/M	FBLD	Packed decimal	LOAD BCD TO ST
DF 11011111	MOD 101 R/M	FILD	Long-integer	CONVERT 8-BYTE INTEGER EA AND PUSH ONTO STACK
DF 11011111	MOD 110 R/M	FBSTP	Packed decimal	CONVERT ST, STORE IN 10-BYTE BCD EA, POP
DF 11011111	MOD 111 R/M	FISTP	Long-integer	ROUND ST, STORE IN 8-BYTE INTEGER EA, POP
DF 11011111	1 1 000 (i)	*(6)		

Chapter 17: 8086/186 Instructions in Hexadecimal Order

Hex Binary	MODRM Byte	Instruction	Parameters	Function
DF 11011111	1 1 001 (i)	*(7)		
DF 11011111	1 1 010 (i)	*(8)		
DF 11011111	1 1 011 (i)	*(9)		
DF 11011111	1 1 --- ---	Reserved		
E0 11100000		LOOPNZ/ LOOPNE	DISP8	LOOP (CX) TIMES WHILE NOT ZERO/NOT EQUAL
E1 11100001		LOOPZ/ LOOPE	DISP8	LOOP (CX) TIMES WHILE ZERO/EQUAL
E2 11100010		LOOP	DISP8	LOOP (CX) TIMES
E3 11100011		JCXZ	DISP8	JUMP ON (CX)= 0
E4 11100100		IN	AL,PORT	BYTE INPUT FROM PORT TO REG AL
E5 11100101		IN	AX,PORT	WORD INPUT FROM PORT TO REG AX
E6 11100110		OUT	PORT,AL	BYTE OUTPUT (AL) TO PORT
E7 11100111		OUT	PORT,AX	WORD OUTPUT (AX) TO PORT
E8 11101000		CALL	DISP16	DIRECT INTRA SEGMENT CALL
E9 11101001		JMP	DISP16	DIRECT INTRA SEGMENT JUMP
EA 11101010		JMP	DISP16,SEG 16	DIRECT INTER SEGMENT JUMP
EB 11101010		JMP	DISP8	DIRECT INTRA SEGMENT JUMP
EC 11101010		IN	AL,DX	BYTE INPUT FROM PORT (DX) TO REG AL
ED 11101010		IN	AX,DX	WORD INPUT FROM PORT (DX) TO REG AX
EE 11101010		OUT	DX,AL	BYTE OUTPUT (AL) TO PORT (DX)
EF 11101010		OUT	DX,AX	WORD OUTPUT (AX) TO PORT (DX)
F0 11110000		LOCK		BUS LOCK PREFIX

Chapter 17: 8086/186 Instructions in Hexadecimal Order

Hex Binary	MODRM Byte	Instruction	Parameters	Function
F1 11110001		(not used)		
F2 11110010		REPZ/REPNE		REPEAT WHILE (CX) not equal to 0 AND (ZF) = 0
F3 11110011		REPZ/REPE/REP		REPEAT WHILE (CX) not equal to 0 AND (ZF) = 1
F4 11110100		HLT		HALT
F5 11110101		CMC		COMPLEMENT CARRY FLAG
F6 11110110	MOD 000 R/M	TEST	EA,DATA8	BYTE TEST (EA) WITH DATA
F6 11110110	MOD 001 R/M	(not used)		
F6 11110110	MOD 010 R/M	NOT	EA	BYTE INVERT EA
F6 11110110	MOD 011 R/M	NEG	EA	BYTE NEGATE EA
F6 11110110	MOD 100 R/M	MUL	EA	BYTE MULTIPLY BY (EA), UNSIGNED
F6 11110110	MOD 101 R/M	IMUL	EA	BYTE MULTIPLY BY (EA), SIGNED
F6 11110110	MOD 110 R/M	DIV	EA	BYTE DIVIDE BY (EA), UNSIGNED
F6 11110110	MOD 111 R/M	IDIV	EA	BYTE DIVIDE BY (EA), SIGNED
F7 11110111	MOD 000 R/M	TEST	EA,DATA16	WORD TEST (EA) WITH DATA
F7 11110111	MOD 001 R/M	(not used)		
F7 11110111	MOD 010 R/M	NOT	EA	WORD INVERT EA
F7 11110111	MOD 011 R/M	NEG	EA	WORD NEGATE EA
F7 11110111	MOD 100 R/M	MUL	EA	WORD MULTIPLY BY (EA), UNSIGNED
F7 11110111	MOD 101 R/M	IMUL	EA	WORD MULTIPLY BY (EA), SIGNED
F7 11110111	MOD 110 R/M	DIV	EA	WORD DIVIDE BY (EA), UNSIGNED
F7 11110111	MOD 111 R/M	IDIV	EA	WORD DIVIDE BY (EA), SIGNED

Chapter 17: 8086/186 Instructions in Hexadecimal Order

Hex Binary	MODRM Byte	Instruction	Parameters	Function
F8 1111000		CLC		CLEAR CARRY FLAG
F9 1111001		STC		SET CARRY FLAG
FA 1111010		CLI		CLEAR INTERRUPT FLAG
FB 1111011		STI		SET INTERRUPT FLAG
FC 1111100		CLD		CLEAR DIRECTION FLAG
FD 1111101		STD		SET DIRECTION FLAG
FE 1111110	MOD 000 R/M	INC	EA	BYTE INCREMENT EA
FE 1111110	MOD 001 R/M	DEC	EA	BYTE DECREMENT EA
FE 1111110	MOD 010 R/M	(not used)		
FE 1111110	MOD 011 R/M	(not used)		
FE 1111110	MOD 100 R/M	(not used)		
FE 1111110	MOD 101 R/M	(not used)		
FE 1111110	MOD 110 R/M	(not used)		
FE 1111110	MOD 111 R/M	(not used)		
FF 1111111	MOD 000 R/M	INC	EA	WORD INCREMENT EA
FF 1111111	MOD 001 R/M	DEC	EA	WORD DECREMENT EA
FF 1111111	MOD 001 R/M	CALL	EA	INDIRECT INTRA SEGMENT CALL
FF 1111111	MOD 011 R/M	CALL	EA	INDIRECT INTER SEGMENT CALL
FF 1111111	MOD 100 R/M	JMP	EA	INDIRECT INTRA SEGMENT JUMP
FF 1111111	MOD 101 R/M	JMP	EA	INDIRECT INTER SEGMENT JUMP
FF 1111111	MOD 110 R/M	PUSH	EA	PUSH (EA) ON STACK
FF 1111111	MOD 111 R/M	(not used)		

Chapter 17: 8086/186 Instructions in Hexadecimal Order

FLAGS REGISTER CONTAINS:

X:X:X:X: (OF) : (DF) : (IF) : (TF) : (SF) : (ZF) : X : (AF) : X : (PF) : X : (CF)

*The marked encodings are *not* generated by the language translators. If however, the 8087 encounters one of these encodings in the instruction stream, it will execute it as follows:

- 1 FSTP ST(i)
- 2 FCOM ST(i)
- 3 FCOMP ST(i)
- 4 FXCH ST(i)
- 5 FCOMP ST(i)
- 6 FFREE ST(i) and pop stack
- 7 FXCH ST(i)
- 8 FSTP ST(i)
- 9 FSTP ST(i)

IAPX 86/88/186 Instruction Set Matrix

b	= byte operation
d	= direct
f	= from CPU reg
i	= immediate
ia	= immed.to accum.
ib	= immediate byte
id	= indirect
is	= immed. byte sign ext.
iw	= immediate word
l	= long ie. intersegment
m	= memory
r	= register
r/m	= EA is second byte
SI	= short intrasegment
sr	= segment register
t	= to CPU reg
v	= variable
w	= word operation
z	= zero

Chapter 17: 8086/186 Instructions in Hexadecimal Order

REG IS ASSIGNED ACCORDING TO THE FOLLOWING TABLE.		
16-BIT (W= 1)	8-BIT (W= 0)	SEGMENT REG
000 AX	000 AL	00 ES
001 CX	001 CL	01 CS
010 DX	010 DL	10 SS
011 BX	011 BL	11 DS
100 SP	100 AH	
101 BP	101 CH	
110 SI	110 DH	
111 DI	111 BH	

EA IS COMPUTED AS FOLLOWS: (DISP8 SIGN EXTENDED TO 16 BITS)	
00 000 (BX) + (SI)	DS
00 001 (BX) + (DI)	DS
00 010 (BP) + (SI)	SS
00 011 (BP) + (DI)	SS
00 100 (SI)	DS
00 101 (DI)	DS
00 110 DISP16 (DIRECT ADDRESS)	DS
00 111 (BX)	DS
01 000 (BX) + (SI) + DISP8	DS
01 001 (BX) + (DI) + DISP8	DS
01 010 (BP) + (SI) + DISP8	SS
01 011 (BP) + (DI) + DISP8	SS
01 100 (SI) + DISP8	DS
01 101 (DI) + DISP8	DS
01 110 (BP) + DISP8	SS
01 111 (BX) + DISP8	DS
10 000 (BX) + (SI) + DISP16	DS

Chapter 17: 8086/186 Instructions in Hexadecimal Order

EA IS COMPUTED AS FOLLOWS: (DISP8 SIGN EXTENDED TO 16 BITS) (Cont'd)	
10 001 (BX) + (DI) + DISP16	DS
10 010 (BP) + (SI) + DISP16	SS
10 011 (BP) + (DI) + DISP16	SS
10 100 (SI) + DISP16	DS
10 101 (DI) + DISP16	DS
10 110 (BP) + DISP16	SS
10 111 (BX) + DISP16	DS
11 000 REG AX / AL	
11 001 REG CX / CL	
11 010 REG DX / DL	
11 011 REG BX / BL	
11 100 REG SP / AH	
11 101 REG BP / CH	
11 110 REG SI / DH	
11 111 REG DI / BH	



Chapter 17: 8086/186 Instructions in Hexadecimal Order

IAPX 86/186 Instruction Set Matrix								
	LO							
Hi	0	1	2	3	4	5	6	7
0	ADD b.f.r/m	ADD w.f.r/m	ADD b.t.r/m	ADD w.t.r/m	ADD b.ia	ADD w.ia	PUSH ES	POP ES
1	ADC b.f.r/m	ADC w.f.r/m	ADC b.t.r/m	ADC w.t.r/m	ADC b.ia	ADC w.ia	PUSH SS	POP SS
2	AND b.f.r/m	AND w.f.r/m	AND b.t.r/m	AND w.t.r/m	AND b.ia	AND w.ia	SEG ES	DAA
3	XOR b.f.r/m	XOR w.f.r/m	XOR b.t.r/m	XOR w.t.r/m	XOR b.ia	XOR w.ia	SEG SS	AAA
4	INC AX	INC CX	INC DX	INC BX	INC SP	INC BP	INC SI	INC DI
5	PUSH AX	PUSH CX	PUSH DX	PUSH BX	PUSH SP	PUSH BP	PUSH SI	PUSH DI
6	PUSHA	POPA	BOUND R.R/M					
7	JO	JNO	JB/ JNAE	JNB/ JAE	JE/ JZ	JNE/ JNZ	JBE/ JNA	JNBE/ JA
8	Immed b.r/m	Immed w.r/m	Immed b.r/m	Immed is.r/m	TEST b.r/m	TEST w.r/m	XCHG b.r/m	XCHG w.r/m
9	NOP	XCHG CX	XCHG DX	XCHG BX	XCHG SP	XCHG BP	XCHG SI	XCHG DI
A	MOV m →AL	MOV m →AX	MOV AL →m	MOV AX →m	MOVS b	MOVS w	CMPS b	CMPS w
B	MOV i →AL	MOV i →CL	MOV i →DL	MOV i →BL	MOV i →AH	MOV i →C	MOV i →DH	MOV i →BH

Chapter 17: 8086/186 Instructions in Hexadecimal Order

IAPX 86/186 Instruction Set Matrix								
	LO							
Hi	0	1	2	3	4	5	6	7
C	Shift b.r/m.i	Shift w.r/mi	IRET (i - SP)	IRET	LES	LDS	MOV b.i.r/m	MOV w.i.r/m
D	Shift b	Shift w	Shift b.v	Shift w.v	AAM	AAD		XLAT
E	LOOPNZ/ LOOPNE	LOOPZ/ LOOPE	LOOP	JCXZ	IN b	IN w	OUT b	OUT w
F	LOCK		REP	REPZ	HLT	CMC	Grp 1 b.r/m	Grp 1 w.r/m

IAPX 86/186 Instruction Set Matrix								
	LO							
Hi	8	9	A	B	C	D	E	F
0	OR b.f.r/m	OR w.f.r/m	OR b.t.r/m	OR w.t.r/m	OR b.ia	OR w.ia	PUSH CS	
1	SBB b.f.r/m	SBB w.f.r/m	SBB b.t.r/m	SBB w.t.r/m	SBB b.ia	SBB w.ia	PUSH DS	POP DS
2	SUB b.f.r/m	SUB w.f.r/m	SUB b.t.r/m	SUB w.t.r/m	SUB b.ia	SUB w.ia	SEG CS	DAS
3	CMP b.f.r/m	CMP w.f.r/m	CMP b.t.r/m	CMP w.t.r/m	CMP b.ia	CMP w.ia	SEG DS	AAS
4	DEC AX	DEC CX	DEC DX	DEC BX	DEC SP	DEC BP	DEC SI	DEC DI

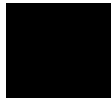

Chapter 17: 8086/186 Instructions in Hexadecimal Order

IAPX 86/186 Instruction Set Matrix								
	LO							
Hi	8	9	A	B	C	D	E	F
5	POP AX	POP CX	POP DX	POP BX	POP SP	POP BP	POP SI	POP DI
6	PUSH iw	IMUL r.iw.r/m	PUSH is	IMUL r.is.r/m	INS b	INS w	OUTS b	OUTS w
7	JS	JNS	JP/ JPE	JNP/ JPO	JL/ JNGE	JNL/ JGE	JLE/ JNG	JNLE/ JG
8	MOV b.f.r/m	MOV w.f.r/m	MOV b.t.r/m	MOV w.t.r/m	MOV sr.f.r/m	LEA	MOV sr.t.r/m	POP r/m
9	CBW	CWD	CALL i.d	WAIT	PUSHF	POPF	SAHF	LAHF
A	TEST b.i	TEST w.i	STOS b	STOS w	LODS b	LODS w	SCAS b	SCAS w
B	MOV i → AX	MOV i → CX	MOV i → DX	MOV i → BX	MOV i → SP	MOV i → BP	MOV i → SI	MOV i → DI
C	ENTER iw.ib	LEAVE	IRET I. (i - SP)	IRET I	INT Type 3	INT (Any)	INTO	IRET
D	ESC 0	ESC 1	ESC 2	ESC 3	ESC 4	ESC 5	ESC 6	ESC 7
E	CALL d	JMP d	JMP i.d	JMP si.d	IN v.b	IN v.w	OUT v.d	OUT v.w
F	CLC	STC	CLI	STI	CLD	STD	Grp 2 b.r/m	Grp 2 w.r/m

Chapter 17: 8086/186 Instructions in Hexadecimal Order

Where								
mod r/m	000	001	010	011	100	101	110	111
Immed	ADD	OR	ADC	SBB	AND	SUB	XOR	CMP
Shift	ROL	ROR	RCL	RCR	SHL/SAL	SHR	SHL/SAL	SAR
Grp 1	TEST		NOT	NEG	MUL	IMUL	DIV	IDIV
Grp 2	INC	DEC	CALL id	CALL I id	JMP id	JMP I id	PUSH	

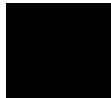

Chapter 17: 8086/186 Instructions in Hexadecimal Order



18

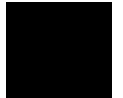

8086/186 Instruction Set Summary

Chapter 18: 8086/186 Instruction Set Summary

Function	Formal	186 Clock Cycles	Comments
DATA TRANSFER			
MOVE = Move:			
Register to Register/Memory	1000100w mod reg r/m	2/12	
Register/Memory to register	1000101w mod reg r/m	2/9	
Immediate to register/memory	1100011w mod 000 r/m data data if w= 1	12-13	8/16-bit
Immediate to register	1011w reg data data if w= 1	3-4	8/16-bit
Memory to accumulator	1010000w addr-low addr-high	9	
Accumulator to memory	1010001w addr-low addr-high	8	
Register/memory to segment register	10001110 mod 0 reg r/m	2/9	
Segment/register to register/memory	10001100 mod 0 reg r/m	2/11	

Chapter 18: 8086/186 Instruction Set Summary

Function	Formal	186 Clock Cycles	Comments
PUSH = Push: Memory	11111111 mod 110 r/m	16	
Register	01010 reg	10	
Segment register	000 reg 110	9	
*Immediate	011010s0 data data if s = 010		
*PUSHA = Push All	01100000	36	
POP = Pop: Memory	10001111 mod 000 r/m	20	
Register	01011 reg	10	
Segment register	000 reg 111 (reg ≠ 01)	8	
*POPA = Pop All	01100001	51	
XCHG = Exchange:			
Register/memory with register	1000011w mod reg r/m	4/17	
Register with accumulator	10010 reg	3	
IN = Input from: Fixed port	1110010w port	10	

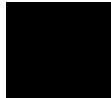

Chapter 18: 8086/186 Instruction Set Summary

Function	Formal	186 Clock Cycles	Comments
Variable port	1110110w	8	
OUT = Output to:			
Fixed port	1110011w port	9	
Variable port	1110111w	7	
XLAT = translate byte to AL	11010111	11	
LEA = Load EA to register	10001101 mod reg r/m	6	
LDS = Load pointer to DS	11000101 mod reg r/m (mod ≠ 11)	18	
LES = Load pointer to ES	11000100 mod reg r/m (mod ≠ 11)	18	
LAHF = Load AH with flags	10011111	2	
SAHF = Store AH into flags	10011110	3	
PUSHF = Push flags	10011100	9	
POPF = Pop flags	10011101	8	

Chapter 18: 8086/186 Instruction Set Summary

Function	Formal	186 Clock Cycles	Comments
ARITHMETIC ADD			
= Add:			
Reg/memory with register to either	00000dw mod reg r/m	3/10	
Immediate to register/memory	10000sw mod 000 data r/m data if s w - 01	4/16	
Immediate to accumulator	0000010w data data if w - 1	3/4	8/16-bit
ADC = ADD with carry:			
Reg/memory with register to either	000100dw mod reg r/m	3/10	
Immediate to register/memory	10000sw mod 010 data r/m data is s w - 01	4/16	
Immediate to accumulator	0001010w data data if w - 1	3/4	8/16-bit
INC = Increment:			
Register/memory	111111w mod 000 r/m	3/15	
Register	01000 reg	3	



Chapter 18: 8086/186 Instruction Set Summary

Function	Formal	186 Clock Cycles	Comments
SUB = Subtract:			
Reg/memory and register to either	001010dw mod reg r/m	3/10	
Immediate from register/memory	100000sw mod 101 r/m data data if s w 01	4/16	
Immediate from accumulator	0010110w data data if w - 1	3/4	8/16-bit
SBB = Subtract with borrow:			
Reg/memory and register to either	000110dw mod reg r/m	3/10	
Immediate from register/memory	100000sw mod 011 r/m data data if s w - 01	4/16	
Immediate from accumulator	0001110w data data if w - 1	3/4	8/16-bit
DEC = Decrement:			
Register/memory	1111111w mod 001 r/m	3/15	
Register	01001 reg	3	

Chapter 18: 8086/186 Instruction Set Summary

Function	Formal	186 Clock Cycles	Comments
CMP = Compare:			
Register/memory with register	0011101w mod reg r/m	3/10	
Register with register/memory	0011100w mod reg r/m	3/10	
Immediate with register/memory	100000sw mod 111 data r/m data if s w - 01	3/10	
Immediate with accumulator	0011110w data data if w - 1	3/4	8/16-bit
NEG = Change sign	1111011w mod 011 r/m	3	
AAA = ASCII adjust for add	00110111	8	
DAA = Decimal adjust for add	00100111	4	
AAS = ASCII adjust for subtract	00111111	7	
DAS = Decimal adjust for subtract	00101111	4	
MUL = Multiply (unsigned):	1111011w mod 100 r/m		
Register-Byte		26-28	
Register-Word		35-37	

Chapter 18: 8086/186 Instruction Set Summary

Function	Formal	186 Clock Cycles	Comments
Memory-Byte		32-34	
Memory-Word		41-43	
IMUL = Integer multiply (signed):	1111011w mod 101 r/m		
Register-Byte		25-28	
Register-Word		34-37	
Memory-Byte		31-34	
Memory-Word		40-43	
*IMUL = Integer immediate multiply (signed)	011010s1 mod reg r/m data data if s= 0	22-25/29-32	
DIV = Divide (unsigned):	1111011w mod 110 r/m		
Register-Byte		29	
Register-Word		38	
Memory-Byte		35	
Memory-Word		44	
IDIV = Integer divide (signed):	1111011w mod 111 r/m		

Chapter 18: 8086/186 Instruction Set Summary

Function	Formal	186 Clock Cycles	Comments
Register-Byte		44-52	
Register-Word		53-61	
Memory-Byte		50-58	
Memory-Word		59-67	
AAM = ASCII adjust for multiply	11010100 00001010	19	
AAD = ASCII adjust for divide	11010101 00001010	15	
CBW = Convert byte to word	10011000	2	
CWD = Convert word to double word	10011001	4	
LOGIC			
Shift/Rotate			
Instructions:			
Register/Memory by 1	1101000w mod TTT r/m	2/15	
Register/Memory by CL	1101001w mod TTT r/m	5+ m/17+ n	
*Register/Memory by Count	1100000w mod TTT count r/m	5+ n/17+ n	

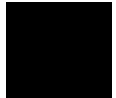

Chapter 18: 8086/186 Instruction Set Summary

Function	Formal	186 Clock Cycles	Comments
	TTT Instruction 000 ROL 001 ROR 010 RCL 011 RCR 100 SHL/SAL 101 SHR 111 SAR		
AND = And:			
Reg/memory and register to either	001000dw mod reg r/m	3/10	
Immediate to register/memory	1000000w mod 100 r/m data data if w= 1	4/16	
Immediate to accumulator	0010010w data data if w= 1	3/4	8/16-bit
TEST = And function to flags, no result:			
Register/memory and register	1000010w mod reg r/m	3/10	
Immediate data and register/memory	1111011w mod 000 r/m data data if w= 1	4/10	
Immediate data and accumulator	1010100w data data if w= 1	3/4	8/16-bit

Chapter 18: 8086/186 Instruction Set Summary

Function	Formal	186 Clock Cycles	Comments
OR = Or:			
Reg/memory and register to either	000010dw mod reg r/m	3/10	
Immediate to register/memory	1000000w mod 001 r/m data data if w= 1	4/16	
Immediate to accumulator	0000110w data data if w= 1	3/4	8/16-bit
XOR = Exclusive or:			
Reg/memory and register to either	001100dw mod reg r/m	3/10	
Immediate to register/memory	1000000w mod 110 r/m data data if w= 1	4/16	
Immediate to accumulator	0011010w data data if w= 1	3/4	8/16-bit
NOT = Invert register/memory	1111011w mod 010 r/m	3	
STRING MANIPULATION			
MOVS = Move byte/word	1010010w	14	
CMPS = Compare byte/word	1010011w	22	

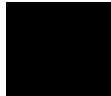

Chapter 18: 8086/186 Instruction Set Summary

Function	Formal	186 Clock Cycles	Comments
SCAS = Scan byte/word	1010111w	15	
LODS = Load byte/wd to AL/AX	1010110w	12	
STOS = Store byte/wd from AL/A	1010101w	10	
*INS = Input byte/wd from DX port	0110110w	14	
*OUTS = Output byte/wd to DX port	0110111w	14	
Repeated by count in CX			
MOVS - Move string	11110010 1010010w	8 + 8n	
CMPS - Compare string	1111001z 11010011w	5 + 22n	
SCAS - Scan string	1111001z 11010111w	5 + 15n	
LODS - Load string	11110010 1010110w	6 + 11n	
STOS - Store string	11110010 1010101w	6 + 9n	
*INS = Input string	11110010 0110110w	8 + 8n	
*OUTS = Output string	11110010 0110111w	8 + 8n	

Chapter 18: 8086/186 Instruction Set Summary

Function	Formal	186 Clock Cycles	Comments
CONTROL TRANSFER			
CALL = Call: Direct within segment	11101000 disp-low disp--high	14	
Register memory indirect within sement	11111111 mod 010 r/m	13/19	
Direct intersegment	10011010 segment offset segment selector	23	
Indirect intersegment	11111111 mod 011 (mod ≠ 11) r/m	38	
JMP = Unconditional jump:			
Short long	11101011 disp-low	13	
Direct within segment	11101001 disp-low disp-high	13	
Register/memory indirect within segment	11111111 mod 100 r/m	11/17	
Direct intersegment	11101010 segment offset segment selector	13	



Chapter 18: 8086/186 Instruction Set Summary

Function	Format	186 Clock Cycles	Comments
Indirect intersegment	11111111 mod 101 (mod ≠ 11) r/m	26	
RET = Return from CALL:			
Within segment	11000011	16	
Within seg adding immed to SP	11000010 data-low data-high		
Intersegment	11001011	28	
Intersegment adding immediate to SP	11001010 data-low data-high	25	
JE/JZ = Jump on equal zero	01110100 disp	4/13	13 if JMP
JL/JNGE = Jump on less not greater or equal	01111100 disp	4/13	taken
JLE/JNG = Jump on less or equal not greater	01111110 disp	4/13	4 if JMP
JB/JNAE = Jump on below not above or equal	01110010 disp	4/13	not taken
JBE/JNA = Jump on below or equal not above	01110110 disp	4/13	

Chapter 18: 8086/186 Instruction Set Summary

Function	Formal	186 Clock Cycles	Comments
JP/JPE = Jump on parity even	01111010 disp	4/13	
JO = Jump on overflow	01110000 disp	4/13	
JS = Jump on sign	01111000 disp	4/13	
JNE/JNZ = Jump on not equal not zero	01110101 disp	4/13	
JNL/JGE = Jump on not less greater or equal	01111101 disp	4/13	
JNLE/JG = Jump on not less or equal greater	01111111 disp	4/13	
JNB/JAE = Jump on not below above or equal	01110011 disp	4/13	
JNBE/JA = Jump on not below or equal above	01110111 disp	4/13	
JNP/JPO = Jump on not parity odd	01111011 disp	4/13	
JNO = Jump on not overflow	01110001 disp	4/13	
JNS = Jump on not sign	01111001 disp	4/13	

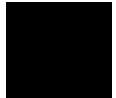

Chapter 18: 8086/186 Instruction Set Summary

Function	Formal	186 Clock Cycles	Comments
LOOP = Loop CX times	11100010 disp	5/15	
LOOPZ/LOOPE = Loop while zero equal	11100001 disp	6/16	
LOOPNZ/LOOPNE = Loop while not zero equal	11100000 disp	16	JMP taken/
JCXZ = Jump on CX zero	11100011 disp	5	JMP not taken
*ENTER = Enter Procedure L = 0 L = 1 L > 1	11001000 data-low data-high L	15 25 22= 16 (n-1)	
LEAVE = Leave Procedure	11001001	8	
INT = Interrupt:			
Type specified	11001101 type	47	
Type 3	11001100	45	if INT.taken/

Chapter 18: 8086/186 Instruction Set Summary

Function	Formal	186 Clock Cycles	Comments
INTO = Interrupt on overflow	11001110	48/4	if INT.not taken
IRET = Interrupt return	11001111	28	
*BOUND = Detect value out of range	01100010 mod reg r/m	33-35	
PROCESSOR CONTROL			
CLC = Clear carry	11111000	2	
CMC = Complement carry	11110101	2	
STC = Set carry	11111001	2	
CLD = Clear direction	11111100	2	
STD = Set direction	11111101	2	
CLI = Clear interrupt	11111010	2	
STI = Set interrupt	11111011	2	
HLT = Halt	11110100	2	
WAIT = Wait	10011011	6	if test = 0
LOCK = Bus lock prefix	11110000	2	



Chapter 18: 8086/186 Instruction Set Summary

Function	Formal	186 Clock Cycles	Comments
ESC = Processor Extension Escape	10011TTT mod LLL r/m (TTT LLL are opcode to processor extension)	6	

Footnotes

The effective Address (EA) of the memory operand is computed according to the mod and r/m fields:

if mod = 11 then r/m is treated as a REG field

if mod = 00 then DISP = 0*, disp-low and disp-high are absent

if mod = 01 then DISP = disp-low sign-extended to 16-bits, disp-high is absent

if mod = 10 then DISP = disp-high: disp-low

if r/m = 000 then EA = (BX) + (SI) + DISP

if r/m = 001 then EA = (BX) + (DI) + DISP

if r/m = 010 then EA = (BP) + (SI) + DISP

if r/m = 011 then EA = (BP) + (DI) + DISP

if r/m = 100 then EA = (SI) + DISP

if r/m = 101 then EA = (DI) + DISP

if r/m = 110 then EA = (BP) + DISP*

if r/m = 111 then EA = (BX) + DISP

DISP follows 2nd byte of instruction (before data if required)

*except if mod = 00 and r/m = 110 then EA = disp-high: disp-low.

SEGMENT OVERRIDE PREFIX

001 reg 110

reg is assigned according to the following:

reg	Segment Register
00	ES

Chapter 18: 8086/186 Instruction Set Summary

01	CS
10	SS
11	DS

REG is assigned according to the following table:

16-Bit (w = 1)	8-Bit (w = 0)
000 AX	000 AL
001 CX	001 CL
010 DX	010 DL
011 BX	011 BL
100 SP	100 AH
101 BP	101 CH
110 SI	110 DH
111 DI	111 BH

The physical addresses of all operands addressed by the BP register are computed using the SS segment register. The physical addresses of the destination operands of the string primitive operations (those addressed by the DI register) are computed using the ES segment, which may not be overridden.

Part 3

Linker/Librarian Reference

Part 3



19

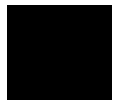

Linker/Loader Introduction

Introduction to the linking loader.

Chapter 19: Linker/Loader Introduction

Linking And Loading From Libraries

The linking loader can be used to combine several independently assembled relocatable object modules into a single absolute object module.

When an absolute load is performed, relocatable addresses are transformed into absolute addresses, external references between modules are resolved, and the final absolute address value is substituted for each external symbol reference. The loader allows you to specify the program segment addresses, external definitions, and assign the final load address and segment loading order. Absolute output can be produced in either HP-OMF 86 format absolute (default), Intel Hexadecimal Object file format absolute, or HP 64000 format absolute.

Note

HP-OMF 86 format is the HP implementation of Intel Binary OMF. It contains certain extensions to facilitate analysis and emulation. HP-OMF 86 has not been verified to be strictly compatible with Intel Binary OMF and may not work correctly in tools or systems designed to consume Intel Binary OMF.

The linking loader can also be used to combine relocatable object modules into a single relocatable object module suitable for later re-linking with other modules. This option is known as incremental linking. Output is produced in HP-OMF 86 format relocatable. Certain loader commands cannot be used with this option: RESADD, RESNUM, GROUP, INITDATA, START and ORDER.

Linking And Loading From Libraries

The linking loader provides the ability to load object modules from a library. The ar86 Librarian is used to create such a library. The loader will include only those modules from a library that are necessary to resolve external references.

Linking to the 8087

This section applies to the code generated in 8086 and 80186 modes that is intended to run on the 8087 coprocessor.

Many target systems use an 8087 coprocessor to execute floating point instructions. However, it is also possible to use software emulation for these same floating point instructions. In fact, Intel has an emulator package that includes an emulation library for the 8087 (named `en87.lib`). Most floating point instructions must be modified at link time if the emulation library code is to be accessed instead of the 8087. To do this, the `as86` assembler generates certain external references to invoke the correct emulation function in the software library.

If you are using an 8087, you must still resolve the external references so that the code is not changed. Unfortunately, the external names that are used contain a colon (':'). Because the assembler does not accept this character in user-defined symbols, the public symbols needed to resolve these externals cannot be created in the assembler. The loader, however, does accept the colon in loader symbols. You must define these publics in the loader command file with the `PUBLIC` command. This command should look like this:

```
PUBLIC M:_WST=0,M:_WT=0,M:_NST=0
PUBLIC M:_WCS=0,M:_WDS=0,M:_WES=0,M:_WSS=0
PUBLIC M:_NCS=0,M:_NDS=0,M:_NES=0,M:_NSS=0
```

This command will cause the created floating point code to work as is with the 8087 coprocessor.

M:_WST, M:_WT, M:_NST, and other Floating Point Externals

A brief explanation of these externals will help you to understand why they exist. As can be seen from the above linker command, there are eleven externals that can be generated.

- The "M:_WST" external is generated whenever a floating point instruction is used that has a 9BH byte at the start of its object code.
- The "M:_NST" external is generated for those floating point instructions that start with a 90H byte.
- The "M:_WT" instruction is used for the `FWAIT` floating point instruction. (The `WAIT` instruction does NOT get modified through the mechanism described here, so it should not be used if software emulation is desired).

Chapter 19: Linker/Loader Introduction

Linking to the 8087

- The "M:_WCS" external is generated whenever a floating point instruction is used that has a 9BH byte at the start of the instruction and a CS segment override byte is required for the memory operand.
- The "M:_NCS" external is generated whenever a floating point instruction is used that has a 90H byte at the start of the instruction and a CS segment override byte is required for the memory operand.
- The "M:_WDS" external is generated whenever a floating point instruction is used that has a 9BH byte at the start of the instruction and a DS segment override byte is required for the memory operand.
- The "M:_NDS" external is generated whenever a floating point instruction is used that has a 90H byte at the start of the instruction and a DS segment override byte is required for the memory operand.
- The "M:_WES" external is generated whenever a floating point instruction is used that has a 9BH byte at the start of the instruction and a ES segment override byte is required for the memory operand.
- The "M:_NES" external is generated whenever a floating point instruction is used that has a 90H byte at the start of the instruction and a ES segment override byte is required for the memory operand.
- The "M:_WSS" external is generated whenever a floating point instruction is used that has a 9BH byte at the start of the instruction and a SS segment override byte is required for the memory operand.
- The "M:_NSS" external is generated whenever a floating point instruction is used that has a 90H byte at the start of the instruction and a SS segment override byte is required for the memory operand.

When a floating point instruction is used that meets one of the above criteria, a fixup is placed in the relocatable file so the floating point instruction can be converted into an equivalent instruction for the 8087 emulation libraries. The fixups convert the floating point instructions to become interrupt instructions that interpret floating point code. If the libraries are not being used, then the public must have a value of 0 so the fixup does not modify the code.

If you are linking with the Intel emulation library, there is no need to define these publics. Instead, the publics will be defined within the library such that the floating point instructions are modified to work with the library. Modify all programs that use the emulation libraries to call the INIT87 Intel library

Chapter 19: Linker/Loader Introduction

Linking to the 8087

routine. It is equally valid to use the FINIT instruction if the emulation libraries are not being used.

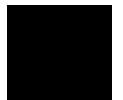

Chapter 19: Linker/Loader Introduction
Linking to the 8087



20

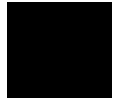

Linker/Loader Operation

Description of loader operation.

Chapter 20: Linker/Loader Operation

Primary Functions

This chapter briefly describes the function of the loader, reviews some concepts necessary to understanding how the loader functions, and explains some aspects of the loader operation—for instance, how the loader goes about locating object modules in memory when a load occurs. A later section of this chapter explains the load procedure and touches on issues the loader must consider when loading modules that are very different in makeup. This information will help you to better control and optimize the load process.

Primary Functions

Many programs are too long to be conveniently assembled as a single module. To avoid long assembly times or to reduce the size of the assembler symbol table, long programs can be subdivided into smaller modules, assembled separately, and then linked together by the linking loader. After the separate program modules are linked and loaded, the output module functions as if it had been generated by a single assembly.

The primary functions of the linking loader are:

- Resolve external references between modules and check for undefined references (link).
- Adjust all relocatable addresses to the proper absolute addresses (load).
- Place debug information in proper format for analysis tools.
- Produce as output the final absolute object module.

Incremental Linking

A powerful and useful feature of the ld86 is the incremental linking ability. Incremental linking means that the loader can produce a single relocatable object module from assembled relocatable object modules, and resolve all external references between the modules loaded. Undefined external references to other modules can still exist in the output object module. These are reported on the load map.

Incremental linking is useful for two reasons:

- First, it enables groups of users to easily share relocatable object modules for joint development of code.
- Long lists of previously-debugged object modules do not have to be linked with those modules currently under development. Instead, one incrementally-linked module can be created and linked with the new modules; it is therefore unnecessary to know all the original module names that are in the incrementally-linked module.

The ORDER, GROUP, INITDATA, START, RESADD, and RESNUM loader commands cannot be used when incremental linking.

Segments and Load Addresses



To effectively use the as86 Assembler and ld86 Linking Loader, you must understand the various program segments and segment load addresses. The terms summarized below are described more completely elsewhere in this manual.

Logical Segment

A logical segment is a programmer-defined division of the assembly program that will assemble into a contiguous segment of related code that is no larger than 64K bytes. Logical divisions would be code, data, and stack segments. The word segment, when used alone, means logical segment or program segment.

Base Address

The base address is the lowest address of a physical segment. All offsets within a segment are counted from the base address.

Physical Segment

A physical segment is a contiguous block of 64K bytes of memory. Physical segments contain the code and/or data when the program is loaded into

Chapter 20: Linker/Loader Operation

Segments and Load Addresses

memory. Physical segments are paragraph-aligned which means that their base addresses are divisible by 16 (least significant hex digit equal to 0H). The base address of a physical segment is the number you ASSUME (the reference is made through a segment name) for a segment register in order to be able to access memory within the segment. The loader does not check against ASSUME values. It is your responsibility to make sure they are correct.

Absolute Segment

An absolute segment is a segment whose base address is completely known at assembly-time. In the assembly source code, the AT keyword followed by an address produces an absolute segment. (The loader command SEG can also assign an absolute address to a relocatable segment.)

Relocatable Segment

A relocatable segment is one whose base address is not known at assembly-time. The base address is calculated by the loader during the load process.

Paragraph (Segment) Number

A paragraph is 16 bytes in length. A paragraph-aligned address starts at a 20-bit address that is divisible by 16 (lowest significant digit is 0H). The upper 16 bits of the 20-bit address is the paragraph number. A paragraph number lies between 0 and 0FFFFH, inclusive. The base address of a segment may be defined in terms of a paragraph number and offset. First, multiply the paragraph number by 16. Then, add an offset from 0 to 15 to that number. The result is a 20-bit address which can be a base address. A paragraph number may also be the start of a physical segment.

Class

A class is a collection of segments that have had the same symbol (class name) associated with them at assembly-time. The segments in a class are placed adjacent to each other in memory by the loader, unless you specify otherwise through loader commands. Note that adjacent does not necessarily mean contiguous. It only means that other segments will not be placed between them.

Group

A group is a collection of segments that are to be placed within the same physical segment. They can therefore be addressed from a single segment register. The segment register must contain the group base address, not the segment base address. Unlike segments in a class, the segments in a group are not necessarily adjacent in memory, but must lie within 64K of the base address of the group.

Note

If a group of a given name exists in more than one file and the lists of segments named as part of the group is not the same in each file, the loader will create a group of that name that has a segment list that is the union of the segment lists from the files. For instance, if file A had the following GROUP directive

```
datagrup GROUP data1, data2, data4
```

and file B has the same group, but the segment list is different, such as

```
datagrup GROUP data1, data3, data5
```

then the loader will merge this group. The result would be a group "datagrup" that contains data1, data2, data3, data4, and data5. Although data1 appears twice, it will not be duplicated in the group.

This is, in effect, a merging of the two group lists. The resulting group must still be contained within the 64K boundary. The loader does not report that it has merged groups.

This feature may be used to create groups when all member segments or externals are not known, or when it is inconvenient to create empty segments just to include them in a group list.

Group Base Address

If set by the loader, the base address of group is the base address of the "lowest" segment in the group (the segment base address that is less than or equal to all the other segment base addresses in the group.) It is a 20-bit address divisible by 16. It is either set at load time by the loader or specified explicitly with the GROUP loader command.

Chapter 20: Linker/Loader Operation

Complete Name

Module

A module is the relocatable object code resulting from a single assembly. It can contain pieces of one or more segments. (Each module contains at least the default segment `??SEG`.)

Provided that the segment parts are not private (non-combinable), the loader can combine parts of a segment from different modules. When combined, these parts make up a contiguous block of memory as if they were from a contiguous piece of object code.

Note

The default combine-type is private (non-combinable).

In order for segment parts to be other than private, they must be explicitly declared as public, or some other combine-type, in the assembly source code.

Complete Name

The loader identifies a segment by its *segment name and its class name together*. The term **complete name** refers to the segment name/class name pair. If two segments from different assemblies have the same segment name but different class names (or if one has a class name and the other does not), these segments are considered to be different, unrelated entities. The loader may not recognize a segment as being valid if it must have a class name appended to it and the class name does not appear. This treatment is different from that of the assembler. Each segment has a unique complete name, but more than one segment can use the same segment name.

Segment Attributes

Each segment (or piece of a segment) has two attributes associated with it at assembly-time: a combine-type attribute and an align-type attribute. All segments have these attributes because if you do not specify explicit attributes,

the assembler defaults to a non-combinable combine-type and a paragraph-aligned align-type.

Parts of the same segment (as specified by a complete name) from different modules must have the same combine-type, or the loader issues an error. The align-types, however, do not have to be the same.

The align-type of an absolute segment is always paragraph because of the manner that it is defined in the assembly code.

Combine-type Attributes

The combine-type attribute specifies how different pieces of a segment will be united by the loader. A segment piece may have a combine-type attribute of non-combinable, public, common, stack, or memory. These attributes are described in the next sections.

Non-combinable

The assembler defaults to non-combinable if you do not specify a combine-type attribute. The term private is sometimes used to mean non-combinable. If different modules contain non-combinable segments of the same name, they are treated as separate segments and are not combined by the loader.

Public

Public means combinable. The loader concatenates pieces of a public segment from different modules to form a contiguous segment. The length of the resulting segment is the sum of lengths of the combined pieces.

Common

Pieces of the common segment from different modules are overlapped. The base address is the same for all such pieces. The length of the combined segment is the length of the largest of the pieces. Such segments are useful as a shared data area.

Stack

Pieces of the stack segment from different modules are concatenated such that they end at the same address (in high memory). The length of the combined

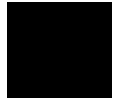

Chapter 20: Linker/Loader Operation

Segment Attributes

segment is the sum of the lengths of all the pieces. Such segments are generally used to hold the system stack.

Memory

Memory combines different segment pieces in the same manner as a common segment, but the memory segment is placed above all other segments in memory (unless specified otherwise by loader commands). The length of the combined memory segment is the length of the largest of those combined. If two segments with different complete names both have the memory combine-type attribute, only the first one encountered is treated as memory; any others are treated as common segments and an error is generated indicating the segment that has not been treated as memory.

Align-type Attribute

The align-type attribute specifies how segment base addresses will be aligned in memory, and, in some cases, how the parts of a segment are aligned within the segment.

A segment can have one of five align-type attributes.

Page

The base address of a page-aligned segment must be divisible by 256 (two least significant hexadecimal digits equal to 00H). Uninitialized bytes may be left between the pieces of a public segment to maintain align-type.

Paragraph

The base address of a paragraph-aligned segment must be divisible by 16 (least significant hexadecimal digit equal to 0H). Uninitialized bytes may be left between the pieces of a public segment to maintain align-type.

Word

The base address of a word-aligned segment must be even (divisible by two). Uninitialized bytes may be left between the pieces of a public segment to maintain alignment.

Byte

The pieces of a segment from different object modules will be placed immediately after each other, regardless of the base address, and there will be no memory wasted.

Inpage

The inpage segment must fit within a page (256 bytes). If the loader determines that such a program segment cannot fit within the current page, it begins the segment on the next page boundary. If the segment is greater than 256 bytes and will not fit within a page at all, a warning is issued. Within a page, segment pieces are byte-aligned.

Segment Alignment

The align-types for different segment parts from different modules do not have to be the same. For this reason, two questions must be addressed.

- 1 How is the segment base address affected by conflicting alignments among parts?
- 2 How is the alignment of the segment parts within the segment affected by conflicting alignments among parts?

The next two sections answer these questions. They will refer to the following example source code pieces.

Assembly source code for Module A:

```
DATASEG SEGMENT WORD PUBLIC ;word-aligned  
.  
.  
DATASEG ENDS
```

Assembly source code for Module B:

```
DATASEG SEGMENT PARA PUBLIC ;paragraph-aligned  
.  
.  
DATASEG ENDS
```

Alignment of Base Address

If align-types do conflict (and there is not an ALIGN command in the command stream), the loader will assign a base address with the most

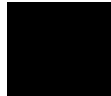

Chapter 20: Linker/Loader Operation

Segment Attributes

restrictive alignment from any part of the segment. In Module A, DATASEG has a word alignment. In Module B, the same segment has a paragraph alignment. The loader will combine these two parts into a single segment at load time. If there is no ALIGN command to assign a different alignment, the loader will use the most restrictive alignment carried by any of the segment parts. The base address of the combined segment will be aligned according to that most restrictive alignment. Of the combine-types, page alignment is the most restrictive. The ranking, from higher to lower, is

PAGE
PARAGraph
WORD
BYTE
INPAGE

In this example, the loader would align DATASEG on a paragraph boundary.

The alignment assignment is the same regardless of the order that the modules were loaded or the combine-types (PUBLIC, STACK, and so on) of the segment parts.

However, if an ALIGN command appeared in the command stream, the alignment it specified would override any alignment carried by the segment parts. (ALIGN is, obviously, a loader command with which you may change the alignment of a segment.) This would occur even if the alignment set by the ALIGN command was less restrictive than the alignments carried by the segments. To continue the example, if the loader command

```
* byte-alignment specified  
ALIGN DATASEG=B
```

appeared in the command stream either before or after the modules containing the segments were loaded, the align-type for the DATASEG segment would be byte despite the fact that both parts carry alignments that are more restrictive (word and paragraph).

Another loader command that affects alignment is the SEG command. SEG is used to assign absolute addresses to relocatable segments. A SEG command will override both the alignment carried by a segment and the alignment specified by the ALIGN command.

Note

Changing the alignment of a non-combinable segment can create problems. Incorrect code might be produced because the loader cannot correctly modify the offsets within non-combinable segments.

Alignment Within a Combined Segment

The combine-type of the segment parts *does* affect how the parts of the combined segment will be aligned within the segment.

PUBLIC Combine-type. Each part of a public segment retains the alignment it carried with it from the assembler. Within the combined segment, the loader aligns each segment part according to the alignment it carries, with the exception of the first segment part. The first segment might not retain its alignment because the loader might adjust it either to conform to the most restrictive alignment or in response to an ALIGN loader command. In the example given earlier, the loader would combine the segment and align the base address and parts in the following way (assume no ALIGN command will be used and the load order is Module A and then Module B):

The most restrictive alignment is paragraph. The entire combined segment will be aligned on a paragraph boundary. Note that since Module A is loaded first, it will be aligned not on a word boundary, but on a paragraph boundary.

Module B is the next segment part to be placed. Its alignment, within the segment, will be on a paragraph boundary. Suppose that the segment part from Module A is just 3 bytes in length. The loader will still move the segment part from Module B to the next paragraph boundary. That leaves 13 bytes unused between the first and second parts. Suppose the segment part from Module B is 10 bytes in length. The entire combined segment will be 26 bytes in length although 13 bytes are unused.

STACK Combine-type. For a stack segment, the align-type attribute applies to the base (low) address of the combined segment. The align-type of the pieces of the segment are ignored by the loader. They are concatenated contiguously in memory just as a stack should be. Again referring back to the example, if the combine-type was STACK instead of PUBLIC, the combined segment would begin on a paragraph boundary and its combined length would be the sum of the lengths of the parts.

Chapter 20: Linker/Loader Operation

Base Address Assignment

COMMON Combine-type. Since pieces of a COMMON segment are overlaid, the align type of any part is only used to determine the most restrictive alignment in the absence of an ALIGN command.

MEMORY Combine-type. Since pieces of a MEMORY segment are overlaid, the align type of any part is only used to determine the most restrictive alignment in the absence of an ALIGN command.

NON-COMBINABLE Combine-type. Private segments are not combined. The alignment a private segment carries from assembly is used to align the base address unless it is changed with an ALIGN command.

Base Address Assignment

Segments are assigned space in memory in a user-controlled order. The order can be both implicit and explicit.

- Implicit order depends upon where the segments appeared in the original source code to the assembler. The order they appeared in the source code controls the order they appear in the object module. The order that they appear in the object module can control the order they appear in the output from the loader, if no other restrictions apply.

The exception is the default segment `??SEG`. It appears first in the object module unless the `-h` or `-H` command line options are used with the assembler. Then the order of the first three segments will depend upon the first code, data, and mixed segments. This ordering is used in the generation of HP64000 absolute files.

Implicit order also depends on the order that the modules are given to the loader. Modules are given to the loader from the command line and from LOAD commands in the command file. The modules specified on the command line "precede" modules in files named in the command file. Among modules in the files named in the command files, the modules that the loader finds nearer to the beginning of the command file "precede" the modules found in files later in the command file.

- Explicit order comes from the loader command `ORDER`, from the ordering caused by the presence of segments made absolute either at

assembly time or load time, and from any classes that might appear in the load files.

If libraries are included in the load, library relocatable object modules that are not selected for inclusion in the absolute object module do not have their segment names examined by the loader. A description of the algorithm used to assign base addresses follows:

- 1** The loader reads all its commands and all files specified in LOAD commands, and determines what segments are present, the align-type, and the size of each. These are placed in an internal structure in the order in which the loader finds their names.
- 2** The loader blocks reserved memory areas and assigns base addresses for absolute segments. Memory reserving is done through the two loader commands RESADD and RESNUM. Absolute segments have their addresses specified either at assembly time with the AT keyword or at load time with the SEG command. The absolute segments are marked in the structure as having had their base addresses assigned.

A segment name can appear in a SEG command, but a SEG command may also refer to a class name. If a class name appears in a SEG command, the first segment in that class that does not yet have a base address (the first such segment whose name was encountered by the loader and was not an absolute segment or was not named in a SEG command) is assigned the specified base address and marked in the structure. Other segments in such a class are not assigned base addresses at this time, however.

- 3** All segments named in ORDER commands, and segments within a class named in ORDER commands, are assigned base addresses in the order in which they were named in the commands. The loader attempts to begin loading these segments at physical address 00000H, if possible.

There are several issues to consider in this step.

The areas of memory reserved with RESADD and RESNUM cannot be used.

If a class is named in an ORDER command, it may contain segments which have already been assigned base addresses because they were either absolute segments or they appeared first in the list following the order command. If, for instance, an ORDER command contains a segment name in the middle of the order specification and that segment was an absolute segment, the

Chapter 20: Linker/Loader Operation

Base Address Assignment

loader must work around that absolute segment when placing the class in memory. Some segments will go before the absolute segment, some will follow it.

Since classes must be adjacent, they cannot be fitted around reserved memory areas.

Alignment must be maintained which means the loader must adjust base addresses so that they conform to the align-type for a segment and/or the alignment restrictions imposed by other segments in the same physical segment.

- 4 The first segment with a combine-type of MEMORY that does not yet have a base address is marked and saved, but is not assigned a base address at this time. (This segment would already have a base address only if it appeared in an ORDER command or SEG command or it was an absolute segment.)
- 5 Any segments remaining in the segment structure are assigned base addresses beginning just above the last segment assigned in step 3. The loader attempts to fill memory contiguously while taking into consideration the reserved memory, absolute segments, and alignment maintenance. The order that segments are assigned addresses is the order that they appear in the internal structure (the order in which the loader first found them.) Of course, if the loader finds a segment with a class name, then it loads all the segments in the class regardless of the order that they appear in the structure.
- 6 The memory segment marked and saved in step 4 is assigned a base address above all addresses used so far. If this cannot be done within a 20-bit address space (the base address needed does not exist in the address space, or the base address plus the size exceeds the address space), an error is reported.
- 7 The base addresses of any groups are assigned, unless they were user-specified in a GROUP loader command. If the loader sets the group base address, it is the 20-bit address of the segment in the group that is "lowest" in memory. (It is an address divisible by 16 and is less than or equal to the lowest base address of any segment in the group.) If the base address has been specified by the GROUP loader command, then the loader error-checks against the value in the GROUP command. Note that this algorithm does nothing to ensure that the segments in a group lie within 64K of the group base; that is your responsibility. However, the loader will report an error if this is not the case. One way to ensure

Chapter 20: Linker/Loader Operation

Base Address Assignment

segments in a group will lie within the 64K limit is to assign all segments in a group the same class name; then they will be adjacent in memory unless you override with SEG commands.

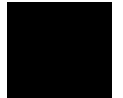

Chapter 20: Linker/Loader Operation
Base Address Assignment

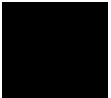

21

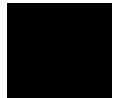

Loader Commands

Description of the various loader commands.

Chapter 21: Loader Commands

Loader commands give you the ability to control the linking/loading process to a very high degree. These commands may be given to the loader in the interactive mode or they may appear in a load command file.

The descriptions include the syntax for the command, a short description of the purpose of the command, and possibly an example of the command in use.

Loader Commands Introduction

The ld86 Linking Loader reads a sequence of commands in batch mode from a command file or reads commands in the interactive mode from some other input device such as a terminal. One of the loader commands, the LOAD command, specifies the object modules to be loaded from files or other logical devices along with the loader commands. The loader generates an absolute load module suitable for loading into an actual microprocessor. The output module is written to the output device in HP-OMF 86 format absolute, unless the optional Intel Hexadecimal Object file format absolute or the HP 64000 format absolute is specified. The loader is also capable of producing HP-OMF 86 format relocatable from an option known as incremental linking. Incrementally-linked object modules can later be re-linked into absolute formats.

All commands must begin in column 1. Command arguments can begin in any column, but the arguments must be separated from the command by at least one separator. Generally, separators (blanks or tabs) are allowed anywhere, except within a symbol or a number. Exceptions are described under the individual commands. The loader command file may have comments placed in it. Comments are denoted by a preceding asterisk.

Command Symbols

Symbols that are command arguments follow the same rules as assembler symbols with the exception that a colon is an accepted character in loader symbols, although not as the first character. Command arguments that are numeric can be either decimal or hexadecimal. Hexadecimal constants are terminated by an upper or lower case H (for instance, 1FH). Like the assembler, hex numbers that begin with the hex digits A-F must have a leading zero to avoid confusing them with symbols in certain commands.

Complete Name

Some of the loader commands take segment names as arguments. If a segment belongs to a class, you must use the segment name and class name together to refer to the segment. The proper form is segment name followed by a slash followed by the class name. The segment name/class name pair is known as the complete name. The loader will not recognize a segment as valid if its class name is missing. Any segment name without a specified class name is assumed to have a null class name. A null class name cannot be explicitly referenced, therefore SEGNAME/ without a following class name is not acceptable.

Note

The loader does not read all loader commands before it begins some processing. Therefore, it cannot always tell whether it has received a valid segment name with a command that accepts one. It is possible to enter a segment name that is invalid at the time it is entered, but that will be made valid by later actions. If the loader completes the load and the invalid segment name has not been resolved, it issues an error stating that it cannot find the segment in question. Unfortunately, a segment name that must have a class name, and does not, will cause this error. A segment name with a group name in the place of a class name will also cause this error. Both cases are not obvious as to why they caused errors so check that the complete name for the segment has been properly specified when this error appears.

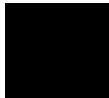

Order of Commands

Commands may be entered in any order. The same command, with the exception of EXIT and END, may be used more than once. (EXIT and END both terminate the reading from the command file). If ORDER, START, NAME, LIST and NLIST appear more than once, only the last one will be in effect. Other commands may appear as often as required, and they will be executed each time.

Command Length

The maximum line length, for a command entered interactively or placed in a command file, is 254 characters.

Loader Command Descriptions

In the command descriptions in this section, square brackets ("[" "]") are used to indicate optional arguments. Square brackets containing an ellipsis indicate that the preceding argument can be repeated zero or more times. The following summary lists the commands in the order of their occurrence in the remainder of this section.

COMMAND	FUNCTION
ALIGN	Set Alignment for a Segment
Comment (*)	Specify Comment
END	End Command Stream and Finish Load
ERROR	Change Message Severity to ERROR
EXIT	Exit Loader
FORMAT	Specifies Output Format
GROUP	Set Group Base Address
INITDATA	Specify Initialized Data in ROM
LENGTH	Set Page Length
LIST	List Specified Elements
LISTABS	List Specified Elements
LISTMAP	Specifies Layout and Content of the Map
LOAD	Load Specified Object Modules
NAME	Specify Output Module Name
NLIST	Do not List Specified Elements
NOERROR	Change Message Severity to NOERROR
NOTYPEMERGE	Do not Merge Type Information
ORDER	Specify Segment Order
PUBLIC	Specify Symbol Definitions
RESADD	Mark Memory as Reserved
RESNUM	Mark Memory as Reserved
SEG	Set Segment Base Address
SEGSIZE	Specify Segment Size
START	Specify Starting Output Module Address
TYPIMERGE	Merge Like Type Definitions
WARN	Change Message Severity to WARNING
WIDTH	Set Page Width

ALIGN

Syntax:

```
ALIGN segment=blank | B | P | I | G | W
```

The vertical bar between arguments means "or" and implies that only one of the six arguments may appear.

Where:

segment is the name of a relocatable segment. Segment can be a segment name or a complete name (segment name/class name pair). An absolute segment is accepted syntactically, but ALIGN on an absolute segment has no effect. The equal sign must be included, even if a blank follows.

blank keeps the align-type the same as specified in the assembler. This is the default. Because blank is a significant character in this location, separating blanks are not permitted between the equal sign and the alignment mnemonic.

B specifies BYTE alignment.

P specifies PAGE alignment.

I specifies INPAGE alignment.

G specifies PARAGraph alignment.

W specifies WORD alignment.

Description:

Each segment from an assembler-generated module carries its align-type information. It is either the align-type specified in the assembly source code or the default align-type of PARA (paragraph alignment). Other possible align-types are BYTE, WORD, PAGE, and INPAGE.

At load time, you may accept the align-type the segment already has or you may override it without re-assembling the module. The ALIGN command allows you to do either.

Chapter 21: Loader Commands

ALIGN

Typically, you would use ALIGN to make all segments page-aligned to assist you with debugging and then, before the final load, use ALIGN to change the segments to byte-aligned to save memory space.

The ALIGN command can appear in the command stream either before or after the modules containing the segment or segment pieces are loaded and it will override the original alignment.

If an absolute segment (set at assembly-time with the AT keyword) appears in an ALIGN directive, ALIGN is ignored and the loader issues a warning. If a relocatable segment that has its base address set with a SEG command appears in an ALIGN directive, the SEG command overrides the ALIGN command and the alignment specified is ignored.

Note

If a non-combinable segment appears in an ALIGN command, incorrect code may be produced because the loader cannot modify the offsets within non-combinable segments.

Examples:

```
ALIGN SEG1=B
ALIGN SEG2/CLASS1=G
ALIGN SEG3=
*blank is argument-align-type is that
*which the segment carries from assembly
```

Comment (*)

Syntax:

```
* loader comment line
```

The asterisk is used to indicate a comment in the command stream. The asterisk must be entered in column 1. The loader ignores any text on the line until the end-of-line character is reached.

END

Syntax:

```
END
```

Description:

This command initiates the final steps in the load process. After an END command is found in the command file, the loader completes the load, produces an output object module, and returns to the host computer operating system. If the command file does not contain an END command, the loader stops reading commands when it detects an end-of-file and initiates the final steps at that point. However, using the END command promotes command file clarity and readability.

ERROR, WARN, NOERROR

Syntax:

```
ERROR condition{condition} ...  
WARN condition{condition} ...  
NOERROR condition{condition} ...
```

Chapter 21: Loader Commands

EXIT

Where:

condition One of UNREF, UNRES, OVERLAP, or a number corresponding to the message number of the error or warning.

UNREF refers to the undefined external reference error. UNRES refers to the unreferenced external warning. OVERLAP refers to the memory overlap warning.

These commands change the way a message or group of messages is treated. ERROR causes the message to be treated as an error; WARN causes the message to be treated as a warning; NOERROR causes the message to be treated as a non-error (that is, the error condition is ignored).

The ERROR, WARN, and NOERROR commands affect all messages which are generated after the linker encounters the command. The change in message severity remains in effect until the linker has finished processing. The effect of these commands cannot be changed by subsequent ERROR, WARN, or NOERROR commands.

Fatal errors and messages generated by the ERROR, WARN, or NOERROR command cannot be overridden or modified.

EXIT

Syntax:

EXIT

Description:

EXIT terminates the loader execution without generation of a load map or output object module.

The EXIT command can be used in the interactive mode to exit the loader when an error occurs that requires leaving the loader to fix. In the interactive mode, most command errors are recoverable; however, errors in the LOAD command are generally not recoverable.

This command can also be used in a command file. In this case, the final load will not take place, but the commands up to and including the EXIT command will be read and checked for errors. The loader ignores any commands following the EXIT command in a command file.

FORMAT

Syntax:

```
FORMAT type  
FORMAT modifier  
FORMAT type modifier  
FORMAT NOABS
```

Where:

type One of the following:

ASCII
HP
OMF86

modifier One of the following:

INCREMENTAL
LIMITED
LTL

Description:

The FORMAT command lets you specify the output object module format.

The type option indicates which output format is to be generated by the linker. A list of acceptable formats follows:

- ASCII refers to the Intel Hexadecimal Object File Format
- HP refers to the HP 64000 Object Module Format (HP-OMF)
- OMF86 refers to Intel Binary OMF86 as extended by HP (HP-OMF86)

Chapter 21: Loader Commands

GROUP

- NOABS prevents an absolute file from being produced

If an unsupported type specifier is encountered, an error or warning will be generated and the default output format will be produced.

If NOABS is specified, no object file will be produced; however, internal processing will be carried out and a map file will be produced if requested. Only one format type may be specified. In addition, NOABS cannot be used with any of the modifier options. If either of these conditions occurs, an error or warning will be issued and the FORMAT command will be ignored.

The following modifiers may be used only with the OMF86 file type. If no type is specified, OMF86 will be assumed.

- The INCREMENTAL modifier to the FORMAT command indicates that incremental linking is to be performed.
- The LIMITED modifier to the FORMAT command limits the amount of usable segment base information contained in the OMF86 data records.
- The LTL modifier to the FORMAT command produces a Load-Time Locatable object module in OMF86 format.

FORMAT cannot be specified without any options. If such a situation is encountered, an error or warning will be issued and the command will be ignored.

The FORMAT command has a global effect. If multiple FORMAT commands are encountered, a warning message will be generated and the first FORMAT command will be used.

All FORMAT commands must appear before the first LOAD command in a command file. Any FORMAT commands appearing after the first LOAD command will be flagged with an error or warning and ignored.

GROUP

Syntax:

```
GROUP group=address  
GROUP group=paragraph,offset
```

Where:

group is the name of a group.

address specifies an address where the group begins. The address must be divisible by 16, or an error is reported. The acceptable range, given the paragraph restriction, is from 0 to 0FFFF0H.

paragraph specifies an actual value to be loaded into a segment register. The range for this value must be within 0 to 0FFFFH, inclusive, or an error is reported.

offset specifies the offset from the given paragraph. The offset must be 0 or the loader reports an error.

Description:

This command specifies the absolute base address of a group. Such an address always lies on a paragraph boundary (a multiple of 16). The default group base, if there is no GROUP command, is calculated by the loader in the manner explained in the "Base Address Assignment" section beginning on page 378.

You can enter multiple GROUP commands specifying the same group name, but only the last one applies.

Note that the GROUP command does *not* assign a base address to any of the segments in the group. If you specify the location of a group with the GROUP command, you must ensure that all such segments lie entirely within the 64K limit imposed on physical segments. This is accomplished with the ORDER and SEG commands. The loader reports an error if this condition does not hold for any segment in the group. Examples:

```
GROUP DGROUP=100H
* DGroup starts at 100H
GROUP CGROUP=7,0
* CGroup starts at 70H
```



INITDATA

Syntax:

```
INITDATA segment [,segment [...]] [,address]
```

Where:

segment could be one of the following:

- **segmentname**
- **segmentname/classname**
- **/classname**

address could be one of the following:

- An address value from 0 to 1048576 (0FFFFFH), inclusive, or
- A paragraph,offset pair. The paragraph and offset may range from 0 to 65535 (0FFFFFH), inclusive. With either form, leading zeros are required for hexadecimal values that start with the hex digits A-F.

Description:

The INITDATA command specifies those data segments or classes that will be initialized in memory at run time. The INITDATA command optionally can be used to specify the base address of the created logical segment(s).

Initialized data in the specified segments is placed in new segments at the specified address. These new segments are named `??DATA n ??INIT`, where n is the number of required segments depending upon the amount of data needed.

If an address is not specified, an address determined by the SEG command or the base address assignment algorithm is used. If you have compiler libraries from the Hewlett-Packard CC8086 C cross compiler, a routine in the compiler startup code copies all initialize data from the created segments into the original segments. Likewise, there is an assembly file, `/usr/hp64000/lib/8086/src/initdata.s`, which may be used to copy the initialize data.

Example:

```
INITDATA /data, 0fff0h
```

The example illustrates the use of the INITDATA command.

LENGTH

Syntax:

```
LENGTH n
```

Description:

Specifies the page length of the output listing as "n" lines, where n is a number greater than 3. The default is 60 lines per page. Example:

```
LENGTH 55
```

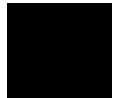

LIST, NLIST

Syntax:

```
LIST [A,B,C,D,E,I,L,O,P,Q,S,T,U,V,W,X]
```

```
NLIST [A,B,C,D,E,I,L,O,P,Q,S,T,U,V,W,X] @NCW = Note
```

The LIST and NLIST commands are being replaced by the FORMAT, LISTABS, and LISTMAP commands.

Note

LIST A, LIST B, and LIST I are mutually exclusive. If more than one appears in a command stream, the first one is used to specify the output format and the others generate warnings and are ignored. Similarly, LIST Q can only be used with LIST B, since LIST Q makes the Intel Binary OMF produced more compatible with older Intel tools that accept the binary format.

Where:

- | | |
|---|---|
| A | LIST - Creates an Intel Hexadecimal Object file format absolute output file.

NLIST - Accepted syntactically, but has no effect. Will not toggle LIST option for this flag. |
| B | LIST - Creates an absolute file in the HP-OMF 86 format absolute. (default)

NLIST - Accepted syntactically, but has no effect. Will not toggle LIST option for this flag. |
| C | LIST - Creates a cross reference listing. Use of this option could slow program execution.

NLIST - Inhibits production of a cross reference listing. (default) |

- D LIST - Places public definition symbols in the output object module. This option causes the Intel Hexadecimal Object format absolute to be unusable in Intel tools. (default)
- NLIST - Inhibits placement of public definition symbols in the output object module.
- E LIST - Causes warning messages to be generated for any remaining undefined external symbols during an incremental link.
- NLIST - Inhibits warning messages for any remaining undefined external symbols during an incremental link. (default)
- I LIST - Produces relocatable output object modules in the HP-OMF 86 format relocatable that can then be incrementally linked. (default is HP-OMF 86 absolute output)
- NLIST - Accepted syntactically, but has no effect. Will not toggle LIST option for this flag.
- L LIST - Causes warning messages to be printed for any unreferenced, unresolved, external references.
- NLIST - Inhibits warning messages for any unreferenced, unresolved, external references. (default)
- O LIST - Specifies that an output object module is to be produced. (default)
- NLIST - Inhibits production of an output module. This is useful when checking for errors.
- P LIST - Places local symbols present in the input modules in the loader symbol table. (default)



Chapter 21: Loader Commands

LIST, NLIST

NLIST - Inhibits placement of local symbols from the input object modules into the loader symbol table. Useful when many modules are being loaded and the loader is executing more slowly due to the large number of symbols.

Q LIST - Causes the loader to produce a "limited" form of Intel binary OMF that is strictly compatible with the Intel Binary OMF document.

NLIST - Causes the loader to produce HP-OMF 86 absolute, the HP extension of the Intel Binary OMF used in high level analysis. (default)

S LIST - Writes local symbol information to the object module. This feature is useful for debugging. Local symbols are those placed into the object module by the assembler that are not external definitions. This option causes the Intel Hexadecimal Object format absolute to be unusable in Intel tools. (default)

NLIST - Inhibits writing of the local symbol table to the object module.

Note

In the relocatable and absolute HP-OMF 86 output modes, line numbers and procedure definitions present in the input files are preserved and stored in the output file. In the Intel Hexadecimal Object file format absolute output mode, external definitions and debug symbols are written to the output file. Since the set of external definition symbols cannot be distinct from the debug symbols, duplicate symbol definitions can occur in the ASCII hexadecimal output file.

T LIST - Prints the local symbol table on the output listing.

NLIST - Inhibits printing the local symbol table on the list output device. (default)

- U LIST - Disables case-sensitivity for matching public and external symbols. Converts all symbols in the file to upper case (which may affect debugging).
- NLIST - Enables case-sensitivity for matching public and external symbols. (default)
- V LIST - Produces an expanded segment summary in the load map that lists the modules where the segment parts were found.
- NLIST - Inhibits production of an expanded segment summary in the load map that lists the modules where the segment parts were found. (default)
- W LIST - Enables display of warning messages to the output listing and to the terminal. (default)
- NLIST - Inhibits display of warning messages to the output listing and to the terminal.
- X LIST - Prints the public definition symbol table on the output listing.
- NLIST - Inhibits listing the public definition symbol table on the list output device. (default)

Description: The LIST and NLIST commands are used to generate or suppress listings of the elements specified.

```
LIST T,X
*prints local and external definition
*symbol tables in the output listing
NLIST O
*suppresses production of
*an output object module
```

LISTABS

Syntax:

The LISTABS command controls the output of the LISTABS command. The output is written to the output file. Multiple LISTABS commands can be specified and have an accumulative effect.

- INTERNALS causes local symbols to be written to the output file. This is equivalent to the LIST S command. (default: INTERNALS)
- PUBLICS causes globally defined symbols to be written to the output file. This is equivalent to the LIST D command. (default: PUBLICS)

The LISTABS command will eventually replace the LIST/NLIST D and LIST/NLIST S commands.

LISTMAP

Syntax:

```
LISTMAP option[,option]...
```

Where:

option	One of the following: [NO]CROSSREF [NO]INTERNALS[/BY_NAME /NAME] LENGTH number [NO]MODULE [NO]PUBLICS[/BY_ADDR /ADDR /BY_NAME /NAME] [NO]SEGMENT [NO]VERBOSE [NO]WARNINGS WIDTH number
--------	---

The LISTMAP command controls the output of certain items to the linker's map file.

Each of the functions of the LISTMAP command are described below:

- **CROSSREF** causes a cross-reference listing to be output to the map file. **NOCROSSREF** suppresses the generation of this cross-reference listing. (default = **NOCROSSREF**)
- **INTERNALS** causes a listing of the non-public (local) symbol table to be output to the map file. **NOINTERNALS** suppresses the output of the non-public symbol table. If **/BY_NAME** or **/NAME** is specified, the symbol table is listed in ASCII order. (default = **NOINTERNALS**)
- **LENGTH** specifies the map file page length to a number between 5 and 255. (default = 255)
- **MODULE** controls the output of the module summary to the map file. (default = **MODULE**)
- **PUBLICS** causes a listing of the public symbol table to be output to the map file. **NOPUBLICS** suppresses the output of the public symbol table. If **/BY_NAME**, **/NAME**, or nothing is specified, the public symbol table is listed in ASCII order. If **/BY_ADDR** or **/ADDR** is specified, the table is listed in address order. (default = **NOPUBLICS**)
- **SEGMENT** controls the output of the segment summary to the map file. (default = **SEGMENT**)
- **VERBOSE** controls the output of additional information to the segment summary in the map file. This option has no effect if **LISTMAP NOSEGMENT** is specified.
- **WARNINGS** controls the output of warnings to the map file. (default = **WARNINGS**)
- **WIDTH** specifies the page width as a number between 20 and 255. (default = **WIDTH 80**)

Note

LISTMAP **CROSSREF** was formerly known as **LIST C**. LISTMAP **INTERNALS** was formerly known as **LIST T**, and LISTMAP **PUBLICS** was formerly known as **LIST X**.

LOAD

Syntax:

```
LOAD [-]module[ , ... ]
```

Where:

module names a file in which the object module or library resides. Any module *or library* preceded by a minus sign will have its object modules read until an EOF is detected. Without the minus sign present, the loader would load only those modules from the library that were necessary to resolve external references. The minus sign preceding a library forces all modules in the library to be loaded.

Description:

The LOAD command is used to specify one or more input object modules to be loaded. The command operand is the name of the file containing the object module. Input object modules can consist of relocatable modules from the assembly process, relocatable modules from incremental linking, or libraries.

If any file name is preceded by a minus sign, it indicates that all object modules should be read from the file. In order that external references are handled correctly, the following order for loading libraries, along with other kinds of object modules, should be observed.

- Libraries should be loaded after all non-libraries. From libraries, the loader will load only those modules that are necessary to resolve undefined external references (EXTRNs), unless the library file name is preceded by a minus sign.
- Backward external references within a library are resolved correctly. However, external references to a library from a file loaded after the library has been loaded are generally not resolved correctly. Therefore, libraries should be loaded last.
- When two libraries makes external references to each other, it is generally necessary to LOAD one of them twice (for example, LOAD LIBA,LIBB,LIBA) in order to pick up all the necessary modules.

Object modules may or may not be read until the EOF. The object modules are loaded in the order specified, with each piece of each segment being

loaded into memory at a higher address than all preceding pieces of the same segment. Any number of LOAD commands can be used. Example:

```
LOAD ONE, -EACH.o
```

In the example, suppose that EACH.o contains two modules. This load command will cause three modules to be loaded: the first from the file named ONE.o, and the next two from the file EACH.o.

NAME

Syntax:

```
NAME name
```

Where:

name is a symbol that specifies the new name for the object module.

Description:

The name command is used to give a new name to the output object module. In the load map listing, the new name (or current name) is found next to the heading "OUTPUT MODULE NAME:".

ORDER

Syntax:

```
ORDER element[,...]
```

Where:

element could be one of the following:

Chapter 21: Loader Commands

ORDER

- **segmentname**
- **segmentname/classname**
- **/classname** Equivalent to specifying all segment names with that class attribute in the order their names were encountered by the loader. All such segments are placed as adjacent as possible in memory (allowing for SEG commands, absolute segments, and reserved areas).
- **classname—segment1—segment2—...—segmentN** (Notice the hyphen separating each name.) The specifically named segments are moved to the beginning of the class and ordered the way they appear in the command. Any segments remaining in the class are assigned memory immediately after the specified ones.

Description:

The ORDER command is used to override the loader's default order of assigning base addresses to segments. It is useful in forcing collections of segments addressed from the same segment register (for instance, a group) to lie close to each other in memory.

All segments specified in the ORDER command are assigned base addresses as follows: the first one specified begins at the lowest address possible, and subsequent segments begin immediately after the preceding one. The loader does not assign addresses that conflict with absolute segments, areas specified in the RESADD/RESNUM commands, or segments specified in a SEG command. The ORDER command does not override the base address of an absolute segment or one assigned with SEG. If any such segment appears in the ORDER command, any segment following it in the ORDER command is assigned space in memory above the absolute segment.

Continuation Line. If more than one line of ordering information is needed, use an ampersand ('&') where the linker is expecting a comma or a hyphen. If breaking at a comma, leave the comma on the first line. If breaking at a hyphen, place the hyphen on the second line.

Examples:

```
ORDER SEG1,SEG2,SEG3
*orders segments
```

```
ORDER SEG1/CLASS1,/CLASS2-SEG2-SEG3
*(the remaining segments in CLASS2 follow, if they exist)
```

```
ORDER SEG1,CLASS1-SEG2-SEG3,&  
SEG4,CLASS2&  
-SEG5  
*note continuation line
```

See Also The "Base Address Assignment" section beginning on page 378.

PUBLIC

Syntax:

```
PUBLIC symbol=address [,...]  
PUBLIC symbol=paragraph,offset [,...]
```

Where:

symbol is a user-defined public symbol

address is the new 20-bit address of the symbol. The address has a range of 0 to 1048575 (0FFFFFFH), inclusive. The symbol's paragraph value is equal to the address shifted right by 4. The offset of the symbol is the address modulo 16.

paragraph is a paragraph boundary number. Paragraph is multiplied by 16 and then the offset is added to it. Paragraph may range from 0 to 65535 (0FFFFH).

offset is a number in the range of 0 to 65535 (0FFFFH). It is added to the multiplied paragraph number to form a 20-bit address.

Description:

This command is used to define and/or change the address of a public definition. If a symbol specified by this command is already a public definition (from an input object module where the symbol was an argument to the assembler PUBLIC directive), the address of the symbol is changed to the user-specified value. If the symbol is not already defined, it is entered into the loader symbol table along with the specified address. It will then be available to satisfy external references from object modules. This command

Chapter 21: Loader Commands

RESADD, RESNUM

allows you to specify the address of some public symbols at load-time and possibly to avoid a reassembly. All symbols used with this command are considered absolute rather than relative to either a segment or a group.

Example:

```
PUBLIC INPUT=2FH, OUTPUT=200H
```

RESADD, RESNUM

Syntax:

```
RESADD lowaddress,highaddress  
RESNUM lowaddress,number
```

Where:

lowaddress is the lowest address of the reserved memory space.

highaddress is the highest address of the reserved memory space. Highaddress must be greater than or equal to lowaddress.

number is the number of bytes, beginning at and including the low address, to reserve. If the number is 0, no area is reserved.

Description:

The RESADD and RESNUM commands allow you to declare certain areas of memory as off limits to the loader; no relocatable code is placed in these areas. You might wish to use these commands to avoid overwriting an operating system in low memory, for example.

If a reserved area conflicts with a previously reserved area, an absolute segment, or a segment name in a SEG directive, the loader issues a warning message and loading continues. If the warning is caused by the RESNUM or RESADD command, any non-overlapping space is reserved.

If the highaddress of the reserved area (either specified directly or computed as lowaddress+ number-1) is greater than 1048575 (0FFFFFFH), all memory from lowaddress to this limit is marked reserved. Examples:

```
RESADD 0,1FFH  
*this and the following are equivalent  
RESNUM 0,200H
```

SEG

Syntax:

```
SEG segment=address  
SEG segment=paragraph,offset  
SEG /class=address  
SEG /class=paragraph,offset
```

Where:

segment is the name of a relocatable segment. It can have a classname attached with a slash as in `segment/classname`.

class is the name of a class

address specifies that the segment will begin at the given address. The range of the address must be from 0 to 1048575 (0FFFFFFH), inclusive, or an error occurs.

paragraph will be a paragraph number ranging from 0 to 65535 (0FFFFFFH), inclusive, or an error occurs.

offset is a number ranging from 0 to 65535 (0FFFFFFH), inclusive, or an error occurs. Base address of the segment will be 16 times the paragraph number plus the offset.

Description:

The SEG command specifies the base address of a logical segment.

In most cases, when you use a SEG command, you should also specify an ORDER command to control the placement of other segments that did not appear in the SEG command.

A class name, preceded by slash, can appear in place of a segment name. In this case, the first segment whose class attribute matches the class name is

Chapter 21: Loader Commands

SEG

assigned the base address. Exceptions apply to absolute segments and segments that appear explicitly in a SEG command. They are not then eligible to be assigned a base address with this classname construct. Other segments with the same class attribute are not assigned base addresses at this time. However, the loader algorithm for assigning base addresses eventually causes these segments to lie immediately above the first segment in the class, unless you have entered an ORDER command.

If you enter a classname and no segments with that class attribute are ever found, a warning is issued following the END command, and loading continues.

The address specification in this command has two variations: it can use either one numeric argument or two numeric arguments separated by a comma. The first form indicates a 20-bit address, which becomes the base address of the segment. The second form indicates a 16-bit paragraph number followed by a 16-bit offset; the base address of the segment is $16 * (\text{paragraph number}) + \text{offset}$. For example, SEG name= 4440H and SEG name= 444H,0 specify the same address. So does SEG name= 440H,40H and other combinations.

A base address specified by the SEG command is never rounded up or down to conform with the alignment attribute carried from the assembly or reset by an ALIGN command. Instead, the loader uses the base address that you specified with SEG and issues a warning if an alignment conflict occurs.

If an absolute segment appears as an argument to SEG, an error is reported, though it might not be reported until the absolute segment is read from an object module. In this conflicting address case, the loader uses the address first found.

Note

Do not use SEG to place a non-combinable segment on anything other than a paragraph boundary. Doing so can cause incorrect output code to be created because the loader cannot properly modify the offsets within a non-combinable segment.

Multiple SEG commands specifying the same segment name or classname can occur, and the loader does not issue an error. The last command, for a given segment, applies.

See Also The "Base Address Assignment" section beginning on page 378 describes the algorithm used to calculate load addresses when they are not explicitly provided.

SEGSIZE

Syntax:

```
SEGSIZE segment=length  
SEGSIZE /class=length
```

Where:

segment is the name of a relocatable segment. It can have a classname attached with a slash as in `segname/classname`.

class is the name of a class.

length specifies the segment length in bytes.

Description:

The SEGSIZE command is used to specify the length of a segment in bytes. If you do not use the SEGSIZE command, the length of each of the segments in the output object module defaults to the length appropriate for the combine-type of the segment.

Use SEGSIZE only for STACK and COMMON segments. SEGSIZE is typically used to set the size of a stack segment.

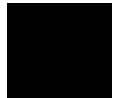

START

Syntax:

```
START CS-value,IP-value  
START address
```

Where:

CS-value used to initialize the CS (code) segment register. The value must be in the range 0 through 65535 (0FFFFH).

IP-value used to initialize IP (instruction pointer). The value must be in the range 0 through 65535 (0FFFFH).

Address Used to initialize CS and IP. CS will be assigned the value of address divided by 16 and IP will be assigned address modulo 16. The address must be in the range 0 through 1048575 (0FFFFFFH).

Description:

This command is used to provide the starting values for CS and IP in the terminator record of the object module. If START is not used, then the CS:IP value comes from the END directive initialization in the main program module. If the END directive has a value and START is also used, then the value specified with START overrides the value from the END directive. If no START is used and no main module is present, then the start value defaults to zero. Example:

```
START 0,100H
```

Note

If the output is to be HP 64000 format absolute, the loader only allows CS:IP pair to be loaded by using an initialization value with the END directive for the main module. The DS and SS registers values may also have had initialization values specified with the END directive, but the loader ignores these values if the output is to be HP 64000 format absolute. You must have assembly code in the program that explicitly loads DS and SS when the target format is to be HP absolute. Do not expect the START command to allow you to get around this restriction.

TYPEMERGE

Syntax: TYPEMERGE [ALL | SIMPLE]
NOTYPEMERGE

Description: The HP-OMF 86 file format is only able to store up to 32k type definitions. If many modules are being linked, many type definitions might exist within each of the modules. In a large executable, the 32k type limit may be exceeded, even though the code size is small. If this limit is exceeded, the loader will stop processing the type information from that point on. Since this information is useful for debugging the executable, it would be best if this information were not lost.

To get around this problem, it is possible to have the loader merge some of the redundant type information so that the total number of types stored in the resulting executable is minimal.

If the SIMPLE form of the TYPEMERGE is used, only the basic type definitions used in assembly code will be merged. While this, by itself, may greatly reduce the number of types in the resulting executable, it may not be enough.

The ALL form of the TYPEMERGE command will cause all redundant type information to be removed. This form will create the smallest amount of type information possible for the resulting executable and will create less than 32k types in all but the most exotic cases. This is the default form of the command, when there are no modifiers to the basic command.

Either form of the TYPEMERGE command will cause extra processing time during the loader's execution. This is due to the extra overhead caused by the checking for redundant types. This overhead may be necessary, however, if the 32k limit is being exceeded during normal linking.

If you do not want to spend the extra processing time for removing redundant types, the NOTYPEMERGE command may be used. Since this is also the default operating mode of the loader, you do not need to specify NOTYPEMERGE to get this behavior. An explicit command is necessary only if you want to remove some or all redundant type information.

Chapter 21: Loader Commands

WIDTH

Either command must be used before any input executables are loaded by the loader. If input has already been read in, a warning is generated and the command is ignored.

Examples:

```
typemerge simple      ; remove only redundant simple types
typemerge all         ; remove all redundant types
notypemerge           ; don't merge any type information
```

WIDTH

Syntax:

WIDTH n

Description:

The WIDTH command specifies the listing page width in number of characters, where n is a number less than 254. Characters outside this page width range are not printed. The default is 80 characters. Note that WIDTH can only appear in a load command file. It does not take effect until the loader finds it. Any output that may have occurred before the WIDTH command will be the default width. Since the WIDTH command cannot appear on the command line, the echo of the command line and the HP header line will always appear at their full width.

Example:

```
WIDTH 60
```

22



Linker/Loader Listing Description

Examples of loader operation.

Chapter 22: Linker/Loader Listing Description

Two-Pass Load

This chapter demonstrates the operation of the loader. It contains a load command file and a load map listing produced by a load using a command file. For reference, this chapter also includes the assembly source listings for the modules that are loaded.

Two-Pass Load

The loader uses a two-pass process. During the first pass, the loader commands and object modules are checked for errors. After the loader finds an END command, a symbol table is formed.

Errors detected during the first pass of processing will be displayed on the listing. If the loader is executed in batch mode, fatal errors cause the loader to terminate with the message "LOAD NOT COMPLETED."

If the loader is executed in the interactive mode, many errors are not fatal and the loader command processing will continue. The loader will report the errors it encounters with a message immediately following the line in error, and the load will end with the message "LOAD COMPLETED."

During pass two of processing, the final absolute object module is produced, along with a module summary and a segment summary. If there are any groups present, they will also appear in the segment summary. A local symbol table, public symbol table, and cross reference table are listed in the load map if you use the options specifying their output. The load map also indicates the starting address of the load, as well as the output module name and format.

Object Module Format

The output object module can be produced in HP-OMF 86 format absolute, Intel Hexadecimal Object file format absolute, or HP 64000 format absolute. Optionally, an incremental format, HP-OMF 86 format relocatable, can be produced instead of the absolute formats. These relocatable format output modules can then be re-linked to form absolute output modules.

Loader Command File

The following figure shows the loader command file "load.k." It contains several of the loader commands described in earlier chapters.

```
* TEST PROGRAM FOR 8086/8087/80186 LINKING LOADER
*
* Note that object modules are read from the files ld86a.o,
* ld86b.o and ld86c.o.
*
list t,s,x,d,c,u
seg /code=500h
seg /data=80000h
order /code,comseg,/stack,/data
resadd 5A0h,5A2h
nlist p
public extraneous= 1000
load ld86a.o
list p
load ld86b.o
load ld86c.o
end
```

Figure 22-1. The "load.k" Loader Command File

Starting the Loader

The following command is used to start the ld86 linking loader with the command file "load.k."

```
$ ld86 -c load.k -o load.x -L > load.lis
```

- The dash c option tells ld86 to use the command file "load.k."
- The dash o option tells ld86 to output the object file as "load.x."
- The dash L option tells ld86 to output a load map listing to standard output.
- The greater than sign redirects standard output to the listing file "load.lis."

The load map file later in this chapter is produced by this command line entry.

Loader Listings

The following pages show a sample loader listing. Note the following points when examining the sample loader listing.

- The first page of the sample listing shows the loader command file, the output module name and format, and warnings or errors that occur.
 - For this example, the absolute object module is produced in the default HP-OMF 86 format absolute. Object modules can also be produced in Intel Hexadecimal Object file format absolute, HP-OMF 86 format relocatable (incremental links), or HP 64000 format absolute.
- The load map file also begins on the first page. Within each summary, the width of each field expands to fit the largest number of characters needed. The line wraps if it is longer than the WIDTH setting.
- The MODULE SUMMARY information contains a listing of all modules, the name of each segment in the modules, the class of each

segment, the segment start address and end address, and a complete filename (including search path if appropriate).

- The SEGMENT SUMMARY shows the segments, the class and/or group of each segment, the segment start and end address, segment length, segment align-type, and segment combine-type. An extra three bytes is generated by the loader for processing the INITDATA command, because you have no initialized data. This is shown in the segment summary as **??DATA1/??INIT**.
- The LOCAL SYMBOL TABLE lists the local symbols and the modules (and function if applicable) where they reside. The table also shows the segment where the symbol is found, the class of that segment, the absolute address of the symbol, and modules where the symbol is referenced.
- The PUBLIC SYMBOL TABLE lists the public symbols and the modules where they reside. The table also shows the segment where the symbol is found, the class of that segment, the absolute address of the symbol, and modules where the symbol is referenced.

The loader listing file follows in the next figure. Following that are the three sample assembler listing files.



Chapter 22: Linker/Loader Listing Description

Load Map Listing

Load Map Listing

```
Hewlett-Packard ld86 Thu Apr 1 14:51:02 1993

HPB1449-19302 A.03.10 24Mar93 Un
released Copr. HP 1988
Command line: ld86 -c load.k -o load.x -L

* TEST PROGRAM FOR 8086/8087/80188 LINKING LOADER
*
* Note that object modules are read from the files ld86a.o,
* ld86b.o and ld86c.o.
*
list t,s,x,d,c,u
seg /code=500h
seg /data=80000h
order /code,comseg,/stack,/data
resadd 5A0h,5A2h
nlist p
public extraneous= 1000
load ld86a.o
list p
load ld86b.o
load ld86c.o
end

OUTPUT MODULE NAME: load
OUTPUT MODULE FORMAT: OMF-86

START ADDRESS: 00050:00000 -> 00500

** ERROR (308): Undefined external(s):

SYMBOL REFERENCES
SCAN MAIN

SEGMENT SUMMARY
-----
SEGMENT/CLASS GROUP START END LENGTH ALIGN COMBINE
ASEG1/ 00000 00025 00026 Abs seg Private
??DATA1/??INIT 00026 00028 00003 Byte Common
??SEG/ 00030 00030 00000 Para Public
CSEG1/CODE CODEGRP 00500 00547 00048 Byte Public
CSEG2/CODE CODEGRP 00548 00591 0004A Byte Public
COMSEG/ 00592 00594 00003 Byte Common
(Reserved Area) 005A0 005A2 00003
```

Figure 22-2. The "load.lis" Load Map File

Chapter 22: Linker/Loader Listing Description Load Map Listing

```

SSEG1/STACK          005A3   005B6   00014   Byte   Stack
DSEG1/DATA           80000   8004F   00050   Byte   Public
DSEG2/DATA           80100   8010D   0000E   Page   Private
ASEG2/               FFFF0   FFFF4   00005   Abs seg Private

```

Hewlett-Packard ld86 Thu Apr 1 14:51:02 1993

HPB1449-19302 A.03.10 24Mar93 Un
released Copr. HP 1988
MODULE SUMMARY

MODULE	SEGMENT/CLASS	START	END	LENGTH
MAIN	/8086/asm/lkref-list/ld86a.o			
	CSEG1/CODE	00500	00547	00048
	SSEG1/STACK	005A3	005B6	00014
	COMSEG/	00592	00592	00001
	DSEG1/DATA	80000	8004F	00050
ABSCODE	/8086/asm/lkref-list/ld86b.o			
	DSEG2/DATA	80100	8010D	0000E
	COMSEG/	00592	00594	00003
	ASEG2/	FFFF0	FFFF4	00005
	ASEG1/	00000	00025	00026
READMOD	/8086/asm/lkref-list/ld86c.o			
	CSEG2/CODE	00548	00591	0004A
	COMSEG/	00592	00592	00001

PUBLIC SYMBOL TABLE

SYMBOL	SEGMENT/CLASS	ADDRESS/VALUE	MODULE	REFERENCES
CRLF	CSEG1/CODE	0050:003D	MAIN	READMOD
ECHO	COMSEG/	0059:0002	MAIN	
EXTRANEIOUS		003E:0008		
IBUFEND	DSEG1/DATA	8000:0050	MAIN	READMOD
IN8	CSEG1/CODE	0050:0025	MAIN	READMOD
INBUF	DSEG1/DATA	8000:0000	MAIN	READMOD
MAINF	CSEG1/CODE	0050:0000	MAIN	ABSCODE
OUT8	CSEG1/CODE	0050:0032	MAIN	READMOD
READ	CSEG2/CODE	0054:0008	READMOD	MAIN
TABLE1	DSEG2/DATA	8010:0000	ABSCODE	

LOCAL SYMBOL TABLE

SYMBOL	FUNCTION	SEGMENT/CLASS	ADDRESS/VALUE	ATTRIBUTE
MODULE	ABSCODE			
ABSCODE			0000:0000	ABS ADDRESS
TABLE1	ABSCODE	DSEG2/DATA	8010:0000	ABS ADDRESS
TABLE2	ABSCODE	DSEG2/DATA	8010:0004	ABS ADDRESS
FIN	ABSCODE	ASEG1/	0000:0025	ABS ADDRESS
DT1	ABSCODE	COMSEG/	0059:0002	ABS ADDRESS

Figure 22-2. The "load.lis" Load Map File (Cont'd)

Chapter 22: Linker/Loader Listing Description

Load Map Listing

```

DT2          ABSCODE          COMSEG/          0059:0003      ABS ADDRESS

MODULE READMOD
READMOD          0000:0000      ABS ADDRESS
READ            CSEG2/CODE      0054:0008      ABS ADDRESS
READ10          READ            CSEG2/CODE      0054:000E      ABS ADDRESS
READ20          READ            CSEG2/CODE      0054:001A      ABS ADDRESS
READ30          READ            CSEG2/CODE      0054:0024      ABS ADDRESS

Hewlett-Packard ld86 Thu Apr 1 14:51:02 1993

HPB1449-19302 A.03.10 24Mar93 Un
released Copr. HP 1988
SYMBOL          FUNCTION          SEGMENT/CLASS  ADDRESS/VALUE  ATTRIBUTE

READ40          READ            CSEG2/CODE      0054:002A      ABS ADDRESS
READ50          READ            CSEG2/CODE      0054:0033      ABS ADDRESS
READ60          READ            CSEG2/CODE      0054:003B      ABS ADDRESS
READ70          READ            CSEG2/CODE      0054:003F      ABS ADDRESS
READ80          READ            CSEG2/CODE      0054:0045      ABS ADDRESS
ECHO            READ            COMSEG/          0059:0002      ABS ADDRESS
ASCR            READ            0000:000D      ABS ADDRESS
BSPA            READ            0000:0008      ABS ADDRESS
BLNK            READ            0000:0020      ABS ADDRESS
TAB             READ            0000:0009      ABS ADDRESS

Link completed

```

Figure 22-2. The "load.lis" Load Map File (Cont'd)

First Assembler Listing

```
Hewlett Packard AS86 HPB1449-19302 A.03.10 24Mar93 Copr. HP 1988 Page 1 Thu
Apr 1 14:50:59 1993
MAIN HPB1449-19302 A.03.10 24Mar93 Copr. HP 1988
Cmdline - as86 -o ld86a.o -L ld86a.s
Line Offset Object-Bytes
1 0000 $XREF DEBUG
2 0000 NAME MAIN
3 0000 PUBLIC INBUF,IBUFEND,IN8,OUT8,CRLF,ECHO
4 0000 PUBLIC MAINF
5 0000 EXTRN READ:NEAR,SCAN:NEAR
6 0000 CODEGRP GROUP CSEG1
7 0000 ASSUME
CS:CODEGRP,DS:DSEG1,SS:SSEG1,ES:COMSEG
8 0000 ;
9 0000 ; DEFINE DATA AREAS AND EQU'S
10 0000 ; ALTHOUGH NOT STRICTLY NECESSARY, PUTTING
THESE AREAS AFTER THE CODE
11 0000 ; SEGMENT RESULTS IN 15 EXTRA BYTES OF NOP'S
DUE TO FORWARD REFERENCES
12 0000 ;
13 0000 SSEG1 SEGMENT BYTE STACK 'STACK'
14 0000 20( DB 20 DUP(?)
14 0000 ?? )
15 0014
16 0014 STAKTOP LABEL BYTE
17 0014 SSEG1 ENDS
18 0000 ;
19 0000 COMSEG SEGMENT BYTE COMMON
20 0000 1( ECHO DB 1 DUP(?)
20 0000 ?? )
21 0001 COMSEG ENDS
22 0000
23 0000 DSEG1 SEGMENT BYTE PUBLIC 'DATA'
24 0000 80( INBUF DB 80 DUP(?)
24 0000 ?? )
25 0050
26 0050 IBUFEND LABEL BYTE
27 0000 DSEG1 ENDS
28 0000 USTAT EQU 0
29 0000 UDATOUT EQU 0
30 0000 UDATIN EQU 0
31 0000 TRDY EQU 1
32 0000 RRDY EQU 2
33 0000 ASLF EQU 10
34 0000 ASCR EQU 13
35 0000 BLNK EQU 20H
```

Figure 22-3. The "ld86a.lis" Assembly Listing

Chapter 22: Linker/Loader Listing Description

First Assembler Listing

```

36 0000 ;
37 0000 ; CODE STARTS HERE
38 0000 ;
39 0000 CSEG1 SEGMENT BYTE PUBLIC 'CODE'
40 0000 MAINF LABEL FAR
41 0000 B8 00 00 R MAIN: MOV AX,DSEG1 ; SET DS, ES and SS
SEGMENT REGISTERS
42 0003 8E D8 MOV DS,AX ; AND BX AND SP AS
POINTERS WITHIN SEGMENT
43 0005 BB 00 00 R MOV BX,OFFSET INBUF
44 0008 B8 00 00 R MOV AX,SSEG1
45 000B 8E D0 MOV SS,AX
46 000D BC 14 00 R MOV SP,OFFSET STAKTOP
47 0010 B8 00 00 R MOV AX,COMSEG
48 0013 8E C0 MOV ES,AX

Hewlett Packard AS86 HPB1449-19302 A.03.10 24Mar93 Copr. HP 1988 Page 2 Thu
Apr 1 14:50:59 1993
MAIN HPB1449-19302 A.03.10 24Mar93 Copr. HP 1988
Line Offset Object-Bytes
49 0015 E8 00 00 E CALL READ
50 0018 8A 07 MAIN10: MOV AL,[BX]
51 001A 3C 20 CMP AL,BLNK
52 001C 43 INC BX
53 001D 74 F9 JZ MAIN10
54 001F E8 00 00 E CALL SCAN
55 0022 43 INC BX
56 0023 EB DB JMP MAIN
57 0025 ;
58 0025 ; NAME - IN8
59 0025 ;
60 0025 ; THIS ROUTINE WILL INPUT A CHARACTER FROM
THE TERMINAL
61 0025 ;
62 0025 ; ENTRY PARAMETERS
63 0025 ; NONE
64 0025 ;
65 0025 ; EXIT PARAMETERS
66 0025 ; AL - INPUT CHARACTER
67 0025 ; DL - DITTO
68 0025 ;
69 0025 ; REGISTERS USED
70 0025 ; AL,BL,DL
71 0025 ;
72 0025 IN8 PROC
73 0025 E4 00 IN AL,USTAT
74 0027 24 02 AND AL,RRDY
75 0029 74 FA JZ IN8
76 002B E4 00 IN AL,UDATIN
77 002D 24 7F AND AL,127
78 002F 8A D0 MOV DL,AL
79 0031 C3 RET
80 0032 IN8 ENDP

```

Figure 22-3. The "ld86a.lis" Assembly Listing (Cont'd)

Chapter 22: Linker/Loader Listing Description First Assembler Listing

```

81 0032 ;
82 0032 ; NAME - OUT8
83 0032 ;
84 0032 ; THIS ROUTINE IS USED TO OUTPUT A CHARACTER
TO THE TERMINAL
85 0032 ;
86 0032 ; ENTRY PARAMETERS
87 0032 ; DL - CHARACTER TO OUTPUT
88 0032 ;
89 0032 ; EXIT PARAMETERS
90 0032 ; NONE
91 0032 ;
92 0032 ; REGISTERS USED
93 0032 ; AL,BL,DL
94 0032 ;
95 0032 OUT8 PROC
96 0032 E4 00 IN AL,USTAT
97 0034 24 01 AND AL,TRDY
98 0036 74 FA JZ OUT8
99 0038 8A C2 MOV AL,DL
100 003A E6 00 OUT UDATOUT,AL

```

Hewlett Packard AS86 HPB1449-19302 A.03.10 24Mar93 Copr. HP 1988 Page 3 Thu
Apr 1 14:50:59 1993

MAIN HPB1449-19302 A.03.10 24Mar93 Copr. HP 1988

```

Line Offset Object-Bytes
101 003C C3 RET
102 003D OUT8 ENDP
103 003D ;
104 003D ; NAME - CRLF
105 003D ;
106 003D ; THIS ROUTINE OUTPUTS A CARRIAGE RETURN AND
LINE FEED
107 003D ;
108 003D ;
109 003D CRLF PROC
110 003D B2 0D MOV DL,ASCR
111 003F E8 F0 FF CALL OUT8
112 0042 B2 0A MOV DL,ASLF
113 0044 E8 EB FF CALL OUT8
114 0047 C3 RET
115 0048 CRLF ENDP
116 0048 CSEG1 ENDS
117 0000
118 0000 END MAINF

```

Hewlett Packard AS86 HPB1449-19302 A.03.10 24Mar93 Copr. HP 1988 Page 4 Thu
Apr 1 14:50:59 1993

MAIN HPB1449-19302 A.03.10 24Mar93 Copr. HP 1988

Cross Reference

Label	Type	Value	References
??SEG	SEGM	SIZE=0000 PUBLIC PARA	
ASCR	EQU	000D	-34 110
ASLF	EQU	000A	-33 112

Figure 22-3. The "ld86a.lis" Assembly Listing (Cont'd)

Chapter 22: Linker/Loader Listing Description

First Assembler Listing

```

BLNK      EQU      0020              -35 51
CODE      CLASS
CODEGRP   GROUP   CSEG1              -6 7
COMSEG    SEGM    SIZE=0001 COMMON BYTE 7 -19 21 47
CRLF      PROC    CSEG1:003D NEAR     -3 -109 -115
CSEG1     SEGM    SIZE=0048 PUBLIC BYTE CLASS 'CODE' 6 -39 116
DATA      CLASS
DSEG1     SEGM    SIZE=0050 PUBLIC BYTE CLASS 'DATA' 7 -23 26 41
ECHO      PUBLIC  COMSEG:0000 BYTE    -3 -20
IBUFEND   PUBLIC  DSEG1:0050 BYTE     -3 -25
IN8       PROC    CSEG1:0025 NEAR     -3 -72 75 -80
INBUF     PUBLIC  DSEG1:0000 BYTE     -3 -24 43
MAIN      LABEL   CSEG1:0000 NEAR     -41 56
MAIN10    LABEL   CSEG1:0018 NEAR     -50 53
MAINF     LABEL   CSEG1:0000 FAR      -4 -40 118
OUT8      PROC    CSEG1:0032 NEAR     -3 -95 98 -102 111 113
READ      EXTERN  NEAR                -5 49
RRDY      EQU     0002                -32 74
SCAN      EXTERN  NEAR                -5 54
SSEG1     SEGM    SIZE=0014 STACK BYTE CLASS 'STACK' 7 -13 17 44
STACK     CLASS
STAKTOP   LOCAL  SSEG1:0014 BYTE      -16 46
TRDY      EQU     0001                -31 97
UDATIN    EQU     0000                -30 76
UDATOUT   EQU     0000                -29 100
USTAT     EQU     0000                -28 73 96

```

```

NO ASSEMBLY ERRORS
NO ASSEMBLY WARNINGS

```

Figure 22-3. The "ld86a.lis" Assembly Listing (Cont'd)

Second Assembler Listing

```

Hewlett Packard AS86 HPB1449-19302 A.03.10 24Mar93 Copr. HP 1988 Page 1 Thu
Apr 1 14:51:00 1993
ABSCODE HPB1449-19302 A.03.10 24Mar93 Copr. HP 1988
Cmdline - as86 -o ld86b.o -L ld86b.s
Line Offset Object-Bytes
1 0000 $SYMBOLS
2 0000 NAME ABSCODE
3 0000 PUBLIC TABLE1
4 0000 EXTRN MAINF:FAR
5 0000 ASSUME CS:ASEG1,ES:COMSEG
6 0000
7 0000 ; FORM RESET START ADDRESS
8 0000 ASEG2 SEGMENT AT 0FFFFH
9 0000 EA 00 00 00 00 E JMP MAINF ; START OF PROGRAM

10 0005 ASEG2 ENDS
11 0000
12 0000 DSEG2 SEGMENT PAGE 'DATA'
13 0000 0A 14 1E 00 TABLE1 DB 10,20,30,0
14 0004 5( TABLE2 DW 5 DUP(?)
14 0004 ?? ?? )
15 000E DSEG2 ENDS
16 0000
17 0000 ASEG1 SEGMENT AT 0
18 0000 14 00 DW 20
19 0002 00 00 DW 0
20 0004 1E 00 DW 30
21 0006 00 00 DW 0
22 0014 ORG 20
23 0014 ;
24 0014 ; PROCESS INTERRUPTS (IF WE GOT THERE CS/IP
WERE STACKED ALONG THE WAY)
25 0014 ;
26 0014 26 80 3E 00 00 00 R CMP ES:DT1,0 ; ES: NECESSARY
TO AVOID ERROR 3

27 001A 74 09 JZ FIN
28 001C F3 A5 REP MOVSW
29 001E 26 C7 06 01 00 01 00 R MOV ES:DT2,1 ; SAME HERE

30 0025 CF FIN: IRET
31 0026 ASEG1 ENDS
32 0000
33 0000 COMSEG SEGMENT BYTE COMMON
34 0000 1( DT1 DB 1 DUP(?)
    
```

Figure 22-4. The "ld86b.lis" Assembly Listing

Chapter 22: Linker/Loader Listing Description

Second Assembler Listing

```
34 0000 ?? )
35 0001 1( DT2 DW 1 DUP(?)
35 0001 ?? ?? )
36 0003 COMSEG ENDS
37 0000 END
```

```
Hewlett Packard AS86 HPB1449-19302 A.03.10 24Mar93 Copr. HP 1988 Page 2 Thu
Apr 1 14:51:00 1993
ABSCODE HPB1449-19302 A.03.10 24Mar93 Copr. HP 1988
Symbol Table
```

Label	Type	Value
??SEG	SEGM	SIZE=0000 PUBLIC PARA
ASEG1	SEGM	SIZE=0026 ABSOLUTE AT 0000
ASEG2	SEGM	SIZE=0005 ABSOLUTE AT FFFF
COMSEG	SEGM	SIZE=0003 COMMON BYTE
DATA	CLASS	
DSEG2	SEGM	SIZE=000E PAGE CLASS 'DATA'
DT1	LOCAL	COMSEG:0000 BYTE
DT2	LOCAL	COMSEG:0001 WORD
FIN	LABEL	ASEG1:0025 NEAR
MAINF	EXTERN	FAR
TABLE1	PUBLIC	DSEG2:0000 BYTE
TABLE2	LOCAL	DSEG2:0004 WORD

```
NO ASSEMBLY ERRORS
NO ASSEMBLY WARNINGS
```



Figure 22-4. The "ld86b.lis" Assembly Listing (Cont'd)

Third Assembler Listing

```

Hewlett Packard AS86 HPB1449-19302 A.03.10 24Mar93 Copr. HP 1988 Page 1 Thu
Apr 1 14:51:01 1993
  READMOD          HPB1449-19302 A.03.10 24Mar93 Copr. HP 1988
Cmdline - as86 -o ld86c.o -L ld86c.s
Line Offset Object-Bytes
1      0000          $XREF DEBUG
2      0000          NAME      READMOD
3      0000          PUBLIC   READ
4      0000          EXTRN   CRLF:NEAR
5      0000          EXTRN   IN8:NEAR,OUT8:NEAR
6      0000          CODEGRP GROUP   CSEG2
7      0000          DSEG1  SEGMENT BYTE PUBLIC 'DATA'      ; PLACE
INBUF, IBUFEND WITHIN

8      0000          EXTRN   INBUF:BYTE,IBUFEND:BYTE ; DSEG1
SO THEY CAN BE ADDRESSED

9      0000          DSEG1  ENDS

10     0000
11     0000          ASSUME  CS:CODEGRP,DS:DSEG1,ES:COMSEG
12     0000          ;
13     0000          ; DEFINE DATA AREA AND EQU'S
14     0000          ;
15     0000          COMSEG  SEGMENT BYTE COMMON
16     0000          ECHO   DB      1 DUP(?)
16     0000          1(
17     0001          ?? )
18     0000          COMSEG  ENDS
19     0000          ;
20     0000          ASCR   EQU    13
21     0000          BSPA   EQU    8
22     0000          BLNK   EQU   20H
23     0000          TAB    EQU   09H
24     0000          ;
25     0000          ; NAME - READ
26     0000          ;
27     0000          ; THIS ROUTINE READS IN A LINE FROM THE
TERMINAL AND
28     0000          ; PLACES IT INTO THE INPUT BUFFER. THE
FOLLOWING ARE
29     0000          ; SPECIAL CHARACTERS.
30     0000          ; CR      - END OF CURRENT LINE
31     0000          ; CONTROL-X - DELETE CURRENT LINE
32     0000          ; DEL     - DELETE CHARACTER
          ; ALL DISPLAYABLE CHARACTERS BETWEEN BLANK

```

Figure 22-5. The "ld86c.lis" Assembly Listing

Chapter 22: Linker/Loader Listing Description

Third Assembler Listing

```

AND Z AND THE
33 0000 ; ABOVE SPECIAL CHARACTERS ARE RECOGNIZED BY
THIS ROUTINE AS
34 0000 ; WELL AS THE TAB. ALL OTHER CHARACTERS ARE
IGNORED. AN
35 0000 ; ATTEMPT TO INPUT MORE CHARACTERS THAN IS
ALLOWED IN THE
36 0000 ; INPUT BUFFER WILL BE INDICATED BY A
BACKSPACE.
37 0000 ;
38 0000 ; ENTRY PARAMETERS
39 0000 ; ECHO - ECHO FLAG, 0=NO ECHO
40 0000 ;
41 0000 ; EXIT PARAMETERS
42 0000 ; INBUF - CONTAINS INPUT LINE
43 0000 ;
44 0000 ; REGISTERS USED
45 0000 ; AL,BX,CL
46 0000 ;
47 0000 CSEG2 SEGMENT BYTE PUBLIC 'CODE'
48 0000 READ PROC
49 0000 BB 00 00 E MOV BX,OFFSET INBUF
50 0003 B9 00 00 MOV CX,0

```

Hewlett Packard AS86 HPB1449-19302 A.03.10 24Mar93 Copr. HP 1988 Page 2 Thu
 Apr 1 14:51:01 1993

READMOD HPB1449-19302 A.03.10 24Mar93 Copr. HP 1988

Line	Offset	Object-Bytes			
51	0006	E8 00 00	E	READ10:	CALL IN8
52	0009	3C 18			CMP AL,24
53	000B	75 05			JNZ READ20
54	000D	E8 00 00	E		CALL CRLF
55	0010	EB EE			JMP READ
56	0012	3C 0D		READ20:	CMP AL,ASCR
57	0014	75 06			JNZ READ30
58	0016	E3 EE			JCXZ READ10
59	0018	C6 07 0D			MOV BYTE PTR [BX],ASCR
60	001B	C3			RET
61	001C	3C 7F		READ30:	CMP AL,127
62	001E	75 0B			JNZ READ50
63	0020	E3 E4			JCXZ READ10
64	0022	4B		READ40:	DEC BX
65	0023	49			DEC CX
66	0024	B2 08			MOV DL,BSPA
67	0026	E8 00 00	E		CALL OUT8
68	0029	EB 0C			JMP SHORT READ70
69	002B	3C 09		READ50:	CMP AL,TAB
70	002D	74 04			JZ READ60
71	002F	3C 20			CMP AL,BLNK
72	0031	72 04			JB READ70
73	0033	88 07		READ60:	MOV [BX],AL
74	0035	43			INC BX
75	0036	41			INC CX
76	0037	81 FB 00 00	E	READ70:	CMP BX,OFFSET IBUFEND
77	003B	74 E5			JZ READ40

Figure 22-5. The "ld86c.lis" Assembly Listing (Cont'd)

Chapter 22: Linker/Loader Listing Description Third Assembler Listing

```

78 003D 26 80 3E 00 00 00 R      READ80: CMP    ECHO,0
79 0043 74 C1                    JZ     READ10
80 0045 E8 00 00                E      CALL    OUT8
81 0048 EB BC                    JMP    READ10
82 004A                    READ  ENDP
83 004A                    CSEG2 ENDS
84 0000                    ;
85 0000                    END

```

```

Hewlett Packard AS86 HPB1449-19302 A.03.10 24Mar93 Copr. HP 1988 Page 3 Thu
Apr 1 14:51:01 1993
READMOD HPB1449-19302 A.03.10 24Mar93 Copr. HP 1988
Cross Reference

```

Label	Type	Value	References
??SEG	SEGM	SIZE=0000 PUBLIC PARA	
ASCR	EQU	000D	-19 56 59
BLNK	EQU	0020	-21 71
BSPA	EQU	0008	-20 66
CODE	CLASS		
CODEGRP	GROUP	CSEG2	-6 11
COMSEG	SEGM	SIZE=0001 COMMON BYTE	11 -15 17
CRLF	EXTERN	NEAR	-4 54
CSEG2	SEGM	SIZE=004A PUBLIC BYTE CLASS 'CODE'	6 -47 83
DATA	CLASS		
DSEG1	SEGM	SIZE=0000 PUBLIC BYTE CLASS 'DATA'	-7 9 11
ECHO	LOCAL	COMSEG:0000 BYTE	-16 78
IBUFEND	EXTERN	DSEG1: BYTE	-8 76
IN8	EXTERN	NEAR	-5 51
INBUF	EXTERN	DSEG1: BYTE	-8 49
OUT8	EXTERN	NEAR	-5 67 80
READ	PROC	CSEG2:0000 NEAR	-3 -48 55 -82
READ10	LABEL	CSEG2:0006 NEAR	-51 58 63 79 81
READ20	LABEL	CSEG2:0012 NEAR	53 -56
READ30	LABEL	CSEG2:001C NEAR	57 -61
READ40	LABEL	CSEG2:0022 NEAR	-64 77
READ50	LABEL	CSEG2:002B NEAR	62 -69
READ60	LABEL	CSEG2:0033 NEAR	70 -73
READ70	LABEL	CSEG2:0037 NEAR	68 72 -76
READ80	LABEL	CSEG2:003D NEAR	-78
TAB	EQU	0009	-22 69

```

NO ASSEMBLY ERRORS
NO ASSEMBLY WARNINGS

```

Figure 22-5. The "ld86c.lis" Assembly Listing (Cont'd)

Chapter 22: Linker/Loader Listing Description
Third Assembler Listing



23



Librarian Introduction

General operation of the librarian.

Librarian Introduction

The ar86 Librarian is used to build program libraries, or collections of relocatable object modules, that reside in a single file. These libraries are the best place to store frequently-used object modules that the linking loader can then efficiently access and combine with newly developed assembly programs. Efficiency is realized through reducing the number of files that must be opened by the loader.

The word "module," when used in discussing the librarian, refers to a relocatable object module that results from assembling a source program with the as86 cross assembler.

Starting the Librarian

There are three ways to start the ar86 Librarian.

Command Line

You may enter librarian commands on the command line. Only certain library commands can be used on the command line. They are `-a`, `-d`, `-r`, `-e`, and `-L`. (They are equivalent to `ADDMOD`, `DELETE`, `REPLACE`, `EXTRACT` and `LIST`, respectively.) All command line commands require a list as an argument and a library file name argument. These librarian commands can be entered in any order on the command line, but the librarian processes the commands in a fixed order of `-a`, `-d`, `-r`, `-e`, and `-L`.

Command File

You may place librarian commands in a command file to be read in batch mode. Any error that occurs during command file processing is considered fatal. The command that generated the error is skipped and processing of any remaining commands continues. These remaining commands are checked for errors—and executed, if possible—but a library file, if specified, is not generated if an error was found. The librarian processes commands in the command file in the exact order in which they are specified.

Interactive Operation

The third method enables you to enter librarian commands interactively from the terminal. In interactive mode, most librarian command errors are not fatal. When an illegal command is entered, the librarian displays an error message and provides an opportunity to re-enter the command.

Librarian Function

When writing modular programs, communication among the various modules is established through use of PUBLIC and EXTERNAL symbols. Public and external symbols can be seen as a way to pass information to the functions and receive information from the functions contained in the library modules. In addition, the functions contain entry points in the form of PUBLIC labels that can be used in CALL and JMP instructions. While it is necessary to know the entry points and parameter passing mechanisms, it is not necessary to know the name of the object module that contains the function. For instance, a library file could contain a dozen or more functions in a single module or a dozen or so functions in a dozen or so modules. As long as you know the function entry points, it does not matter to you how the modules are organized in the library.

The following example is a more practical illustration of using the library.

Suppose a programmer writes a series of program modules consisting of a number of mathematical routines including a few modules that calculate transcendental functions. These modules are then gathered into a library file through use of the ar86 Librarian.

Sometime later, a programmer, either the one who wrote the mathematical routines or someone else, has a requirement to calculate an arc-tangent function within a program being written. The programmer is aware of the fact that there is an arc-tangent function in a library file, knows the name of the entry point of the routine, knows how to pass parameters to the arc-tangent function, and knows how to accept the result of the calculation.

The programmer must do only two things:

Chapter 23: Librarian Introduction

Librarian Function

- CALL the arc-tangent function from the program being developed, placing the public name of the entry point into the argument field of the CALL or JMP instruction, and
- Place the public entry point name of the arc-tangent function in the argument field of an external reference pseudo-op in the program being written.

Even though the programmer does not know the name of the relocatable object module that contains the arc-tangent function, the linking loader includes the relocatable module containing the correct module by informing the loader to use the required library file(s).

You do not have to specify which module contains the arc-tangent function. The loader automatically searches the named library, looking for the entry point name coded as the argument of the CALL statement. When the entry point name has been found, the loader identifies the module in which it resides, and then includes the module containing the entry point name in the current load.

The loader determines which of the library modules to load by examining the internal list of unresolved external references accumulated during the load process. It then accesses the library file to determine if there is a match between unresolved external references, and a label or name that has been declared public in the library file modules. The loader then identifies which modules contain the matching public symbols, and loads those modules just as if the programmer had explicitly directed the loader to load the proper modules.

When the inclusion of a module in the library adds an undefined reference to the list of undefined references, the loader will access the library again until all external references have been satisfied or until no more matches are possible. All public symbols within a library must have unique names.

Note

The librarian is always case sensitive with respect to symbol names. Two symbols with the same characters are only identical if the cases of the characters match as well. This means that "SYMBOL" is not equivalent to "symbol" or "SYMbol." The librarian will treat these three symbols as unique. Trouble might arise if the loader is started with case sensitivity turned off and then asked to load a library containing, for instance, these three symbols. The first occurrence of that symbol, regardless of case, will satisfy the external reference the loader is trying to resolve. However, the resolution may be to the wrong symbol because the loader, unlike the librarian, did not consider case. The result may not be what you intended.

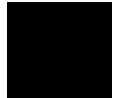

Chapter 23: Librarian Introduction
Librarian Function



24



Librarian Commands

Descriptions of the librarian commands.

Chapter 24: Librarian Commands

The librarian reads a sequence of commands from the command input device in interactive or batch mode. The command sequence must be terminated by the END command. Relocatable object modules are read as input and collected in organized libraries as specified in the command input file.

Command Syntax

The librarian recognizes six special characters:

*	-	asterisk
;	-	semicolon
,	-	comma
(-	left parenthesis
)	-	right parenthesis
+	-	plus

Use of Special Characters

The use of special characters in the command syntax is described in this section.

The asterisk (*) and the semicolon (;), when used on a command line, cause the librarian to ignore the rest of the line. These characters can be used to place comments in a command sequence. The librarian does not process comments; they are passed to the output file.

The comma (,) separates members of a list of similar elements. The list can contain module names or module filenames.

The left and right parentheses (), used in pairs, denote a list of similar elements in a command. Parentheses can be used to group module names that are members of a library only.

The plus sign (+) followed by a carriage return allows you to continue a list on subsequent line(s). Care should be exercised when using line continuation. Do not break up or interrupt a complete syntactical unit (for instance, do not

try to continue a filename, a module name, or a command). If the continuation character is used immediately after a command, it must be separated from the command by at least one blank or the librarian cannot recognize the command. Except as noted above, the line continuation character can appear anywhere in a command line.

Also, blanks can be used freely within commands (between syntactically-identifiable units). Example:

```
DELETE MOD1 , MOD2 ;is the same as
DELETE MOD1,MOD2
```

Command File Comments

Comments can be included in a command file to document the processing. These are included by use of the semicolon (;) or asterisk (*). Example:

```
;this is a complete line of comment
addmod modulea.o
;this is a command line comment
addmod moduleb
* this is another comment
```

File Names

File names appear in commands as arguments. A file name might be the name of an existing library file, a library file being created, or an object file containing one or more modules to be archived. If an open fails on a file name that does not have a suffix, the librarian will append a ".a" for a library file—or a ".o" for an object file—and again try to open the file. Similarly, if the librarian is writing a library to a file name that does not have a suffix, it will append a ".a" to the file before writing it.

The SAVE Command

The SAVE command causes the librarian to save a library with any changes you may have made. At the same time, the SAVE command does the equivalent of the CLEAR command and clears the librarian. You may then open or create another file without affecting or corrupting the previous work.

Chapter 24: Librarian Commands

Return Codes

The librarian provides operating-system specific return codes. The librarian either completes without encountering an error, displays a message or warning, or terminates with an error.



Commands Summary

The following commands are described in this chapter in the order shown:

COMMAND	FUNCTION
ADDLIB	Add Module(s) from Another Library
ADDMOD	Add Object Module(s) to Current Library
CLEAR	Clear Library Session Since Last SAVE
CREATE	Define New Library
DELETE	Delete Module(s) from Current Library
DIRECTORY	List Library Modules
END	Terminate Librarian Execution
EXTRACT	Copy Library Module to a File
FULLDIR	Display Library or Library Module Contents
HELP	Display Context-sensitive Command Syntax
LIST	Display Library or Library Module Contents (Same as FULLDIR)
OPEN	Open an Existing Library
QUIT	Terminate Librarian Executions (Same as END)
REPLACE	Replace Library Module
SAVE	Save Contents of Current Library



Shorthand Names

The librarian allows shortened forms of the above commands. The following list is the minimum characters that may be entered for the command to be recognizable. However, the librarian will accept anything from the minimum number of characters to the full command name as correct. That means that CR, CRE, CREA, CREAT, and CREATE are all acceptable for the create command. (The command is in uppercase here for clarity. Commands can be in either uppercase or lowercase.) The shorthand forms of the commands are as follows:

COMMAND	SHORTHAND
ADDLIB	ADDL
ADDMOD	ADDM
CLEAR	CL
CREATE	CR
DELETE	DE
DIRECTORY	DI
END	EN
EXTRACT	EX
FULLDIR	FUL
HELP	H
LIST	L
OPEN	OP
QUIT	Q
REPLACE	R
SAVE	S

Note

The ar86 librarian archives modules into library files. The librarian references modules by module names. Modules are contained in object files created by the as86 assembler, but a module name may not be the same as the object file name because a module may be explicitly named within the assembly code using the NAME assembler directive. It may be entirely different than the file name. If a module is not explicitly named, *then* the module name defaults to the assembly source file name stripped of its leading path name and trailing suffix (including the period) if the suffix exists.

Module names are of no concern once the library has been built, but each module name must be unique. Therefore, when trying to add modules to a library, it is possible to have module name conflicts. Since the librarian will not allow duplicate module names within a library, it may be necessary to re-assemble the module to change its name. Merely changing the object file name will *not* change the module name because that information is coded into the object file.

To the librarian, module names are always case sensitive, regardless of how the assembler was started.

In the references for the library commands, square brackets ([]) indicate optional arguments. Square brackets containing an ellipsis denote that the preceding argument can be repeated zero or more times.



ADDLIB

Syntax:

```
ADDLIB library_filename[(module_name[,...])]
```

Where:

library_filename is the name of the library where the modules reside.

module_name is the name(s) of the relocatable object module(s) to be added to the library currently being created or modified.

Description:

The ADDLIB command is used to add one or more object modules from one library to the library currently being created or modified.

The OPEN or CREATE command must precede the ADDLIB command, and name the library to which the object modules will be added. Example:

```
OPEN library1.a
ADDLIB math.a (square,sqroot) ;math.a contains modules
                               ;to be added to library1.a
```

ADDMOD

Syntax:

```
ADDMOD filename [,...]
```

Where:

filename is the file to be added to the library currently being created or modified.

Description:

The ADDMOD command adds a non-library file containing one or more relocatable object modules to the library named in the OPEN or CREATE command. The OPEN or CREATE command must precede the ADDMOD command. Example:

```
OPEN    library2.a  
ADDMOD  math.mbr
```

CLEAR

Syntax:

```
CLEAR
```

Description:

Use the CLEAR command to clear the current library session since the last SAVE (or since entering the librarian if no SAVE has been entered since librarian startup). Using CLEAR is equivalent to re-starting the librarian.

CREATE

Syntax:

```
CREATE  library_name
```

Where:

library_name is the name of the library file being created. If the file name already exists, an error occurs.

Description:

Use the CREATE command to define a new library. You can create only one library at a time. A newly-created library must be saved before a second one is created.

In the interactive mode, if the library file name already exists, a warning is displayed. In the command line mode, if the library file already exists, the librarian issues an error message. No library is created. Example:

```
CREATE  math.a
```

DELETE

Syntax:

```
DELETE module_name [,...]
```

Where:

module_name is the name of the module to be removed from the library currently being created or modified.

Description:

The DELETE command removes one or more relocatable object modules from the library named in the OPEN or CREATE command. Object module names are case-sensitive. An OPEN or CREATE command must precede DELETE.

DIRECTORY

Syntax:

```
DIRECTORY library_name  
  [(module_name [,...])] [list_filename]
```

Where:

library_name is the name of the library whose module names and sizes are to be listed.

module_name is the name of a specific module in the library file whose size is to be listed.

list_filename is the file where the directory information should be written. If the listing output file is not specified, the output defaults the standard list device (usually the terminal).

Description: The DIRECTORY command lists module names and sizes of the modules in the specified library. The sizes listed are the number of bytes required to store the modules on the host computer system. If you enter just the library_name, all modules are listed; if you enter specific module_names, directory information is displayed for the named modules only. You can include full file specification (including pathname) for the desired library directory. Object module names are case-sensitive. The directory displays on the standard output device, or it can be directed to a file.

END

Syntax:

```
END  
QUIT
```

Description: The END and QUIT commands terminate librarian command processing. No library file is implicitly saved.

Note

Because END and QUIT do not implicitly save the library file, you must issue a SAVE command before issuing an END command or the library you are working on will be lost. END will not issue a warning that will tell you to save your library before ending.

EXTRACT

Syntax:

```
EXTRACT module_name [, ...]
```

Chapter 24: Librarian Commands

FULLDIR

LIST

Where:

module_name is the module to be copied from the library currently being created or modified.

Description:

The EXTRACT command copies a library module to a file outside the library. The file name will be the module name with a ".o" (dot o) appended. The file can then be added to another library. An OPEN or CREATE command must precede the EXTRACT command.

FULLDIR LIST

Syntax:

```
FULLDIR library_name  
    [(module_name[,...])] [list_filename]
```

```
LIST library_name  
    [(module_name[,...])] [list_filename]
```

Where:

library_name is the library file whose contents are to be listed.

module_name is the name of a specific module whose contents will be listed.

list_filename is the output listing filename. If you do not enter the filename, the output defaults to the standard list device (usually the terminal).

Description:

The FULLDIR and LIST commands are used to request a full directory display of a library's contents including module names, their sizes, and all public symbol definitions and external references. The sizes listed are the number of bytes required to store the modules on the host computer system.

If you enter just the library_name, the contents of all modules are listed; if you enter specific module_names, information is displayed for the named modules only. Both commands perform the same operation.

HELP

Syntax:

HELP

Description:

The HELP command is used to obtain a list of commands with the correct invocation syntax. HELP is context-sensitive. The commands displayed are only those that can be legally entered at the time you type HELP.

OPEN

Syntax:

OPEN library_name

Where:

library_name is the name of the library file to be opened.

Description:

The OPEN command enables an existing library to be referenced in conjunction with succeeding commands that add modules, delete modules, or replace modules. Only one library can be opened at a time.

If the librarian commands require creation of a new version of the library, the old version will be overwritten when the SAVE command is issued.

If the library cannot be located or opened for input, an error is reported. In batch mode or command-line entry, execution is terminated.

REPLACE

Syntax:

```
REPLACE file_name [,...]
```

Where:

file_name the file containing one or more modules that will replace the module of the same name in the library currently being created or modified.

Description:

The REPLACE command is used to replace one or more library modules with one or more non-library object modules with the same name. The replacement object modules (there may be more than one in the object file) must have the same names as the library modules they replace. REPLACE must be preceded by an OPEN or CREATE command.

SAVE

Syntax:

```
SAVE
```

Description:

The SAVE command saves the contents of the library being created or modified. When a SAVE command is issued, all the librarian commands issued since the library was CREATED or OPENed are executed, the library is modified accordingly, and it is written to the library file. If an old version of the library already exists, it will be overwritten by the new version at this time. No backup of the old library file is made. Until a SAVE command is issued, librarian commands are only checked for form, content, and syntax.

Note

You must use the SAVE command to explicitly save the library file. If you END the command session without a SAVE, the library file is not modified and all the changes that you specified will be lost.

25

Librarian Listing Description

Example librarian command files.

Chapter 25: Librarian Listing Description

This chapter shows example librarian command files and librarian listings to illustrate the input command file invocation and the information that can be produced about the library being created or modified. The assembly listings for the object modules that are being archived do not appear in this chapter.

Unless a LIST command or the -L appears in the command stream, only error messages and commands are echoed to standard output. If a LIST command is used in command file batch mode or in interactive mode, a listing that gives more information about the library can be produced. The -L option in command line mode also produces such a listing.

The listing shows each module name, the public and external definitions for each module, the size of each module in bytes, and a count of the public and external definitions for each module. After all modules are listed, the listing gives the number of modules in the library and may report any errors that might have occurred. The listing may also show any loader commands from interactive or command file batch mode execution.

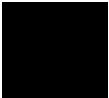

Librarian Sample 1

In librarian sample 1, a new library, **libcmd1.a**, is created. Three modules (modu1.o, modu2.o, and modu3.o) are added to it. The contents of the library are then listed. The librarian command file **libcmd1** is shown in the following figure.

```
cr libcmd1.a
addmod modu1.o
addmod modu2.o
addmod modu3.o
list libcmd1.a
```

Figure 25-1. The "libcmd1" Librarian Command File

The librarian is started in batch mode with a command file in the following way:

```
$ ar86 < libcmd1 > libcmd1.lis
```

ar86 is started interactively, receives input redirected from the command file, and produces a listing in **libcmd1.lis** by redirecting standard output. The **libcmd1.lis** listing file appears in the next figure.

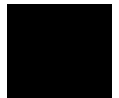

Chapter 25: Librarian Listing Description

Librarian Sample 1

Hewlett-Packard AR86 Wed Nov 2 11:05:44 1988

```
cr libcmd1.a
addmod modul.o
addmod modu2.o
addmod modu3.o
list libcmd1.a
```

Hewlett-Packard AR86 Wed Nov 2 11:05:45 1988

Library being built libcmd1.a

```
Module          Size
MODULE1 ...     424
***** PUBLIC DEFINITIONS *****

MODU1TEN        MODU1SIX
MODU1NINE       MODU1FIVE
***** EXTERNAL REFERENCES *****

MODU1ONE        MODU1TWO
MODU1THREE     MODU1FOUR
MODU1SEVEN     MODU1EIGHT

Public Count = 4
External Count = 6

Module          Size
MODULE2 ...     428
***** PUBLIC DEFINITIONS *****

MODU2SIX        MODU2NINE
MODU2FIVE       MODU2TEN
***** EXTERNAL REFERENCES *****

MODU2ONE        MODU2TWO
MODU2THREE     MODU2FOUR
MODU2SEVEN     MODU2EIGHT
```

Figure 25-2. The "libcmd1.lis" Librarian Listing

Chapter 25: Librarian Listing Description
Librarian Sample 1

```
Public Count = 4
External Count = 6

Module      Size
MODULE3 ... 436
***** PUBLIC DEFINITIONS *****

MODU3NINE   MODU3FIVE
MODU3TEN    MODU3SIX
***** EXTERNAL REFERENCES *****

MODU3ONE    MODU3TWO
MODU3THREE  MODU3FOUR
MODU3SEVEN  MODU3EIGHT

Public Count = 4
External Count = 6

Module Total = 3

save
end
```

Figure 25-2. The "libcmd1.lis" Library Listing (Cont'd)

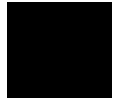

Librarian Sample 2

In librarian sample 2, a new library, **libcmd2.a**, is created. Four modules (modu1.o, modu2.o, modu3.o, and modu4.o) are added to it. However, one of the modules, modu4.o, does not exist. Two things occur because it does not. It causes an error to be generated that says it does not exist and the library is not created because the error occurred in batch mode. A listing is still produced. It lists the modules that did exist and the information about them just as it appears in the first sample, but it also contains a message that informs you the library was not created.

For this sample, the librarian is started in command line batch mode in the following way:

```
ar86 -L -a modu1.o,modu2.o,modu3.o,modu4.o libcmd2.a > libcmd2.lis
```

- The dash L option specifies a listing.
- The dash a option directs the loader to add the file list that follows the -a.
- **libcmd2.a** is the library to be created.
- The greater than sign redirects the listing to the file **libcmd2.lis**.

In addition to the errors reported in the file, a duplicate set of errors are reported to the terminal. The listing appears in the next figure.

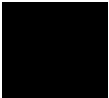

Chapter 25: Librarian Listing Description

Librarian Sample 2

```
WARNING: (107) file libcmd2.a does not exist
          (101) unable to open file modu4.o.
ERROR:   (104) file modu4.o not included.
list libcmd2.a
```

Hewlett-Packard AR86 Wed Nov 2 11:02:57 1988

Library being built libcmd2.a

```
Module      Size
MODULE1 ...  424
***** PUBLIC DEFINITIONS *****

MODU1TEN    MODU1SIX
MODU1NINE   MODU1FIVE
***** EXTERNAL REFERENCES *****

MODU1ONE    MODU1TWO
MODU1THREE  MODU1FOUR
MODU1SEVEN  MODU1EIGHT

Public Count = 4
External Count = 6

Module      Size
MODULE2 ...  428
***** PUBLIC DEFINITIONS *****

MODU2SIX    MODU2NINE
MODU2FIVE   MODU2TEN
***** EXTERNAL REFERENCES *****

MODU2ONE    MODU2TWO
MODU2THREE  MODU2FOUR
MODU2SEVEN  MODU2EIGHT

Public Count = 4
External Count = 6
```

Figure 25-3. The "libcmd2.lis" Library Listing

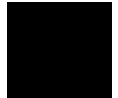

Chapter 25: Librarian Listing Description

Librarian Sample 2

```
Module          Size
MODULE3 ...    436
***** PUBLIC DEFINITIONS *****

MODU3NINE      MODU3FIVE
MODU3TEN       MODU3SIX
***** EXTERNAL REFERENCES *****

MODU3ONE       MODU3TWO
MODU3THREE     MODU3FOUR
MODU3SEVEN     MODU3EIGHT

Public Count = 4
External Count = 6

Module Total = 3

(253) Library libcmd2.a not written.

Warnings = 1
Errors = 1
```

Figure 25-3. The "libcmd2.lis" Library Listing (Cont'd)

Part 4

Error Messages Reference

Part 4

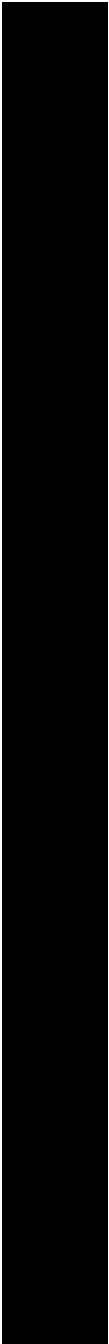

26

Error Message Formats

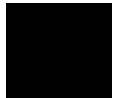

Chapter 26: Error Message Formats

Interactive and Non-Interactive Conditions

There are three classes of errors that may occur during assembler, macro preprocessor, linker, or librarian execution:

Warning

Warnings announce something that *might* be a problem in the output file. This may or may not indicate a problem with the program.

After a warning, the output files are written normally.

After a warning, as86, ap86, ld86, and ar86 return a code indicating "success" so that command files and "make" operations continue normally.

Error

Errors announce something that *is* wrong in the output file. For example, a reference to an unresolved symbol will cause problems at run-time.

After an error, the output files are written normally. The output files are complete and may be useful in subsequent operations.

After an error, an "error" code is returned so that command files and "make" operations stop.

Fatal Error

A fatal error announces a condition that causes processing to be discontinued. After a fatal error, the output files are incomplete and corrupt. They are not useful for subsequent operations.

After a fatal error, an "error" code is returned so that command files and "make" operations stop.

Interactive and Non-Interactive Conditions

Some conditions produce either warnings or errors, depending on whether the tool is run in interactive or batch mode. In interactive mode, a particular condition causes a warning because the user has a chance to reissue the command correctly. In batch mode, the same condition causes an error.

Chapter 26: Error Message Formats

Interactive and Non-Interactive Conditions

For example, suppose the file **tt2.o** does not exist and that **lib.a** does exist. If we invoked the librarian in batch mode as follows:

```
$ ar86 -a "tt2.o" lib.a
```

We would see an error.

```
< ar86 >
          (101) unable to open file tt2.o.
      ERROR: (104) file tt2.o not included.
          (253) Library lib.a not written.
```

ar86 would terminate and return you to the system prompt.

However, in the interactive mode, if you type the following command:

```
ar86> addmod tt2.o
```

You would see a warning.

```
(101) unable to open file tt2.o.
      WARNING: (104) file tt2.o not included.
```

ar86 would then again display its command prompt and allow you to continue.

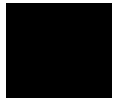

Chapter 26: Error Message Formats
Interactive and Non-Interactive Conditions

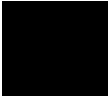

27

Assembler Error Messages

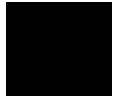

Chapter 27: Assembler Error Messages

Syntax Errors

When the assembler encounters a syntax error, it does not generate code for the instruction or directive on the line and any of its continuation lines where the error occurs. The error message is printed on the line below the error, with a caret (^) pointing to the offending syntax.

In some cases, the assembler issues a general syntax error that indicates there is something wrong at the place the caret points, but the specific nature of the error is not determined.

In the event of a syntax error, the assembler does not generate code, but continues processing with the next statement.

Syntax Errors

500 **Expecting an expression.**

The assembler expected an expression, but found something different at the location pointed to by the caret.

501 **Expecting an OR-level expression.**

The assembler expected an OR-level expression, but found something different at the location pointed to by the caret.

OR-level expressions include all the AND-level expressions plus the OR and XOR operators.

502 **OR or XOR expected.**

The assembler expected an OR or XOR operator, but found something different at the location pointed to by the caret.

503 **Expecting an AND-level expression.**

The assembler expected an AND-level expression, but found something different at the location pointed to by the caret.

AND-level expressions include all the NOT-level expressions, and the AND operator.

504 **AND expected.**

The assembler expected an AND operator, but found something different at the location pointed to by the caret.

505 **Expecting a NOT-level expression.**

The assembler expected a NOT-level expression, but found something different at the location pointed to by the caret.

506 **Expecting a relational operator-level expression.**

The assembler expected a relational-level expression, but found something different at the location pointed to by the caret.

Relational-level expressions include all binary addition-level expressions plus the EQ, NE, LT, LE, GT, and GE operators.

507 **Expecting a relational operator.**

The assembler expected a relational operator, but found something different at the location pointed to by the caret.

The relational operators are: EQ, NE, LT, LE, GT, and GE.

508 **ENDS or constant definition directive expected.**

The assembler expected to find an ENDS directive but found something different at the location pointed to by the caret.

509 **Expecting an addition operator.**

The assembler expected an addition operator, but found something different at the location pointed to by the caret.

The addition operators are plus (+) and minus (—).

510 **Expecting a multiplication-level expression.**

The assembler expected a multiplication-level expression, but found something different at the location pointed to by the caret.

Multiplication-level expressions include all

- byte-level expressions
- MOD, SHR, SHL
- multiplication and division operators

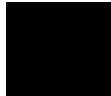

Chapter 27: Assembler Error Messages

Syntax Errors

- base registers (BX, BP) and index registers (SI, DI)

511

Expecting a multiplication operator.

The assembler expected a multiplication operator, but found something different at the location pointed to by the caret.

The multiplication operators are MOD, SHR, SHL, and multiplication (*) and division (/).

512

Expecting a valid argument to NAME.

The assembler expected a valid module name argument to the NAME directive, but found something different at the location pointed to by the caret.

Byte-level expressions include all secondary-level expressions plus the HIGH and LOW operators.

513

Expecting a secondary-level expression.

The assembler expected to find a secondary-level instruction but found something different at the location pointed to by the caret. Secondary-level expressions include all primary-level expressions, the segment override (colon), the PTR, OFFSET, SEG, and TYPE operators.

514

Expecting a primary-level expression.

The assembler expected a primary-level expression, but found something different at the location pointed to by the caret.

Primary-level expressions include all expression primitives as well as the MASK, WIDTH, SIZE, and LENGTH operators, and the dot operator for structures.

516

Expecting a symbolic name.

The assembler expected a symbolic name, but found something different at the location pointed to by the caret.

517

Expecting an integer constant.

The assembler expected an integer constant, but found something different at the location pointed to by the caret.

520

Expecting a register.

The assembler expected a register (such as AX, BX, BP, SI, and others) but found something different at the location pointed to by the caret.

521 **Segment register expected.**

The assembler expected a segment register (CS, DS, ES, or SS) but found something different at the location pointed to by the caret.

522 **NOTHING or segment register expected.**

The assembler expected the keyword NOTHING or a segment register (CS, DS, ES, or SS) but found something different at the location pointed to by the caret.

523 **Expecting an identifier or integer constant.**

The assembler expected an identifier or integer constant, but found something different at the location pointed to by the caret.

524 **Expecting identifier, directive, or colon.**

The assembler expected an identifier, directive, or colon, but found something different at the location pointed to by the caret.

525 **Expecting an identifier or constant definition directive.**

The assembler expected an identifier or constant definition directive (such as DB, DW, DD, and others) but found something different at the location pointed to by the caret.

526 **Expecting an identifier or type.**

The assembler expected an identifier or type, but found something different at the location pointed to by the caret.

527 **SEGMENT expected.**

The assembler expected a segment, but found something different at the location pointed to by the caret.

528 **PTR expected.**

The assembler expected a PTR operator, but found something different at the location pointed to by the caret.

529 **DUP expected.**

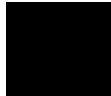

Chapter 27: Assembler Error Messages

Syntax Errors

The assembler expected DUP, but found something different at the location pointed to by the caret.

530 **Expecting a comma.**

The assembler expected a comma, but found something different at the location pointed to by the caret.

531 **Expecting a colon.**

The assembler expected a colon, but found something different at the location pointed to by the caret.

532 **Expecting a period, left bracket, or left angle bracket.**

The assembler expected a period (.), left bracket ([), or left angle bracket (<), but found something different at the location pointed to by the caret.

533 **Expecting right bracket.**

The assembler expected a right bracket, but found something different at the location pointed to by the caret.

534 **Expecting a left parenthesis.**

The assembler expected a left parenthesis, but found something different at the location pointed to by the caret.

535 **Dollar sign expected.**

The assembler expected a dollar sign '\$', but found something different at the location pointed to by the caret.

536 **Expecting comma or right angle bracket.**

The assembler expected a comma or right angle bracket, but found something different at the location pointed to by the caret.

537 **Expecting comma or right parenthesis.**

The assembler expected a comma or right parenthesis, but found something different at the location pointed to by the caret.

538 **Expecting a left bracket.**

The assembler expected a left bracket, but found something different at the location pointed to by the caret.

- 539 **Expecting a right parenthesis.**
The assembler expected a right parenthesis, but found something different at the location pointed to by the caret.
- 540 **Expecting a label or a statement.**
The assembler expected a label or a statement, but found something different at the location pointed to by the caret.
- 541 **Expecting an instruction mnemonic.**
The assembler expected an instruction mnemonic, but found something different at the location pointed to by the caret.
- 543 **Assembler general control expected.**
The assembler expected a general control, but found something different at the location pointed to by the caret.
- 544 **Expecting an assembler control.**
The assembler expected an assembler control, but found something different at the location pointed to by the caret.
- 545 **Constant definition directive expected.**
The assembler expected a constant definition directive such as DB, DW, DD, and others, but found something different at the location pointed to by the caret.
- 546 **Unexpected control or directive name, or missing END directive.**
An illegal primary control or directive was found at the location pointed to by the caret or an END directive was not found before the end of the source file.
- 547 **Expecting a string.**
The assembler expected a string, but found something different at the location pointed to by the caret.
- 548 **Expecting parenthesized text.**
The assembler expected a valid attribute to the SEGMENT directive, but found something different at the location pointed to by the caret.
- 549 **Expecting valid attribute to the SEGMENT directive.**

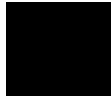

Chapter 27: Assembler Error Messages

Syntax Errors

The assembler expected to find an alignment type such as BYTE, PARA, INPAGE, and others, but found something different at the location pointed to by the caret.

550 **Expecting a combine type.**

The assembler expected a combine type (PUBLIC, STACK, COMMON, and others) but found something different at the location pointed to by the caret.

551 **Continuation line found where initial line was expected.**

The assembler found the continuation character (ampersand ['&']) as the first character on a line that it was expecting to *begin* rather than to *continue* with an assembly statement.

552 **Logical end of program already encountered.**

Assembler statements, directives, or controls were found in a source file AFTER an END directive was encountered. The *only* legal input after an END directive are comment lines or blank lines.

554 **Structure or record initialization expected.**

The assembler expected to encounter a left angle bracket, but found something different at the location pointed to by the caret.

555 **Record field initialization expected.**

The assembler expected to encounter an equal sign, but found something different at the location pointed to by the caret.

556 **Expecting a valid member of a GROUP.**

The assembler expected a valid member of a GROUP (such as a segment name), but found something different at the location pointed to by the caret.

557 **Expecting an item which can be purged.**

The assembler expected an item that can be purged (such as symbolic names, instructions, and others), but found something different at the location pointed to by the caret.

558 **Expecting a valid END initialization element.**

The assembler expected a valid END initialization element, but found something different at the location pointed to by the caret.

- 559 **Expecting a valid ASSUME element.**
The assembler expected a valid ASSUME element, but found something different at the location pointed to by the caret.
- 561 **Expecting valid CODEMACRO parameter information.**
The assembler expected to find valid CODEMACRO parameter information but found something different at the location pointed to by the caret.
- 562 **Expecting a codemacro parameter specifier.**
The assembler expected to find a codemacro parameter specifier but found something different at the location pointed to by the caret.
- 563 **This statement is not valid in a codemacro definition.**
The caret points to a statement that is not legal in the body of a codemacro definition.
- 564 **Expecting a type.**
The assembler expected a Type (such as BYTE, WORD, DWORD, and others) but found something different at the location pointed to by the caret.
- 565 **Unbalanced string delimiters.**
A string that was opened with an apostrophe or quotation mark does not have a closing apostrophe or quotation mark. Usually this is caused by failing to double occurrences of apostrophes or quotation marks that are contained in the text of the string.
- 566 **Syntax error.**
In some cases, the assembler can determine that there is a syntax error, but can't determine exactly what the error is. In these cases, this general message is generated, with the caret indicating the point of the error.
- 567 **Syntax error in command line options.**
Control options on the command line may only be delimited with spaces, tabs, or commas. Also, any arguments to controls must be delimited with parentheses.
- 568 **Unbalanced parentheses.**

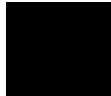

Chapter 27: Assembler Error Messages

Syntax Errors

The number of right parentheses in the line does not match the number of left parentheses. In complicated continued expressions, this could be due to the following line not having its continuation character in the first column.

569 **Illegal operand for unary MINUS or NOT.**

Neither the unary minus nor the NOT operator can have a relocatable operand. The operand pointed to by the caret is relocatable.

570 **Expecting a unary addition-level expression.**

The assembler expected to find a unary addition-level expression, but found something different at the location pointed to by the caret. Unary addition-level expressions include all of the multiplication level expressions as well as unary plus and minus.

571 **Additional information encountered beyond end of statement.**

After reaching what it thought was the logical end of a statement, the assembler found additional text at the location pointed to by the caret.

572 **Expecting decimal or hexadecimal floating-point constant.**

The assembler expected to find a decimal or hexadecimal floating-point constant at the location pointed to by the caret.

573 **Expecting a signed integer constant.**

The assembler expected to find an integer constant with or without a leading unary plus or minus, but found something different at the location pointed to by the caret.

574 **Expecting a SHORT-level expression.**

The assembler expected to find a SHORT-level expression but found something different at the location pointed to by the caret. SHORT-level expressions include all of the OR-level expressions as well as the SHORT operator.

575 **Expecting an argument to an instruction or codemacro.**

The assembler expected to find an argument to an instruction or codemacro, but found something different at the location pointed to by the caret.

600 **Illegal or mismatched argument.**

The caret points to the place where the operand type is incorrect for the instruction, or where the type doesn't match up correctly with another of the operands in the instruction.

601 **Anonymous memory type.**

The size of the operand pointed to by the caret cannot be determined from the operand's expression, or from the content of other operands in the instruction.

602 **Illegal type of expression.**

The expression pointed to by the caret is either not allowed in the directive or in the instruction in which it is specified, or the expression is not a valid expression.

603 **Illegal type of argument in expression.**

The operator that precedes or follows the sub-expression being pointed to by the caret does not allow this type of sub-expression or one of its operands. Certain operators (such as * or /) allow only sub-expressions that resolve to an absolute number as an operand. Other operators only allow non-absolute expressions when certain conditions exist (see the description of '-' and relational operators).

604 **Illegal or duplicate memory argument.**

Only one argument that references a memory location is allowed in any given instruction.

605 **This instruction requires at least one operand.**

More than one operand had been supplied to this instruction, when only one operand is allowed.

606 **This instruction requires at least two operands.**

Less than two operands (or more than two) have been supplied to this instruction; two are required.

607 **This instruction requires three operands.**

Less than three operands have been supplied to this instruction; three are required.

608 **Duplicate declaration of symbolic name.**

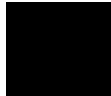

Chapter 27: Assembler Error Messages

Syntax Errors

The symbolic name, pointed to by the caret, has already been declared in a previous statement.

609 **Duplicate specification of module name.**

This message occurs when more than one NAME directive appears in the source program.

610 **Duplicate occurrence of base register in register expression.**

Only one base register (BX or BP) may be used in any given register expression.

611 **Duplicate occurrence of index register in register expression.**

Only one index register (SI or DI) may be used in any given register expression.

612 **This symbol is not defined as a label.**

The caret points to a symbol, in a directive or expression, that must be a label. The symbol pointed to by the caret is not a label.

613 **This symbol is not defined as a segment or group.**

The caret points to a symbol, in a directive or expression, that must be a segment name or group name. The symbol pointed to by the caret is not a segment or group name.

614 **This symbol is not defined as a variable.**

The caret points to a symbol, in a directive or expression, that must be a variable. The symbol pointed to by the caret is not a variable.

615 **This symbol is not defined as a structure.**

The caret points to a symbol, in a directive or expression, that must be a structure. The symbol pointed to by the caret is not a structure.

616 **This symbol is not defined as a structure field.**

The caret points to a symbol, in a directive or expression, that must be a structure field. The symbol pointed to by the caret is not a structure field.

617 **This symbol is not defined as a structure or record.**

The caret points to a symbol, in a directive or expression, that must be a structure or record. The symbol pointed to by the caret is not a structure or record.

618 **This symbol is not defined as a record field.**

The caret points to a symbol in a directive or expression that is required to be a record field in order to be valid. The symbol pointed to by the caret is not of this kind.

619 **This symbol is not defined as a segment.**

The caret points to a symbol, in a directive or expression, that must be a segment. The symbol pointed to by the caret is not a segment.

620 **Alignment type inconsistent.**

The alignment type specified in this SEGMENT directive is not the same as one specified in a previous segment directive for the same segment.

621 **Combine type inconsistent.**

The combine type specified in this SEGMENT directive is not the same as one specified in a previous segment directive for the same segment.

623 **Illegal or premature termination of segment.**

This error indicates improper nesting of segments or a misspelling of the segment name in either the SEGMENT or ENDS directives.

624 **Segment nesting level exceeded.**

Segments can be nested to a level of 16 only.

625 **Missing SEGMENT directive or previous segment nesting error.**

This ENDS directive has no associated SEGMENT directive, either due to omission or to a nesting error on its associated SEGMENT directive.

626 **Expecting alignment type, combine type, or classname.**

The assembler expected an alignment type, combine type, or classname, but found something different at the location pointed to by the caret.

627 **Classname inconsistent.**

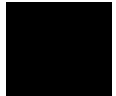

Chapter 27: Assembler Error Messages

Syntax Errors

The classname specified in this SEGMENT directive is not the same as one specified in a previous segment directive for the same segment.

628 **Illegal type of symbol in this ASSUME.**

This error occurs when a symbol other than a segment or group is used in an ASSUME directive without being preceded by the SEG operator.

629 **Initialization nest level exceeded.**

When using the DUP construct in conjunction with a data directive (DB, DW, DD, DQ, or DT), the maximum nesting level for DUPs is eight.

630 **This symbol does not have a defined segment value, or segment not addressable.**

The symbolic name pointed to by the caret does not have a segment attribute in the list of legal attributes.

631 **This argument does not have a defined offset value.**

The symbolic name pointed to by the caret does not have a offset attribute in the list of accepted attributes.

632 **This argument does not have a defined type value.**

The symbolic name pointed to by the caret does not have a type attribute in the list of accepted attributes.

633 **This argument does not have a defined length value.**

The symbolic name pointed to by the caret does not have a length attribute in the list of accepted attributes.

634 **This argument does not have a defined size value.**

The symbolic name pointed to by the caret does not have a size attribute in the list of accepted attributes.

635 **This argument does not have a defined field width value.**

The symbolic name pointed to by the caret does not have a field width attribute in the list of accepted attributes.

636 **This argument does not have a defined mask value.**

The symbolic name pointed to by the caret does not have a mask attribute in the list of accepted attributes.

637 **Immediate value overflow.**

The immediate value is not within the proper range for its context. Specifically, it is not within the range 0 to 0FFH for DB, 0 to 0FFFFH for DW or an instruction, and 0 to 0FFFFFFFFH for all others.

638 **This expression must be absolute.**

The expression must resolve to an absolute number to be permissible in this context.

639 **Item cannot be addressed by segment registers.**

The segment associated with the variable pointed to by the caret is not currently ASSUMEd into any of the segment registers, nor has an explicit segment override been used.

641 **Invalid floating point constant**

The floating point constant pointed to by the caret is not a valid floating point constant. No valid floating-point value can be stored for this constant.

642 **Illegal operand in this register expression.**

Register expressions may contain a base register (BX or BP), an index register (SI or DI), and any expression that evaluates to an absolute value. Expressions or symbols with relocatable results are not permitted.

643 **Division by zero attempted.**

The divisor portion of this expression involving the division operator is itself an expression that evaluates to an absolute number with a value of 0.

645 **This relational operator has an invalid operand or operands.**

See the description of relational operators for what operands are valid.

648 **Hexadecimal real constants are invalid in this context.**

Hexadecimal real constants are allowed only in data definition statements or EQU definitions.

649 **Illegal floating-point stack register (0-7 allowed).**

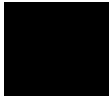

Chapter 27: Assembler Error Messages

Syntax Errors

A mnemonic representing an 8087 floating-point stack register was not in the legal list of mnemonics (ST,ST(0),ST(1),...,ST(7)).

650 **Value too large for one-byte displacement.**

The number (or expression that evaluates to an absolute number) is pointed to by the caret is either less than -128 or greater than 255, and thus cannot be represented in just one byte.

651 **Hex real constant size does not match with data directive.**

Hex real constants must be eight significant hex digits for the DD directive, sixteen significant digits for the DQ directive, and twenty significant digits for the DT directive.

653 **This symbol cannot be purged.**

The following kinds of symbols cannot be purged:

- keywords
- segment names (including ??SEG)
- group names
- any user-defined symbol that has appeared in a PUBLIC statement

654 **Symbol cannot be declared PUBLIC.**

PUBLIC symbols must be variables, labels or 17-bit constants; any other types will generate an error.

655 **This symbol cannot be a member of a group.**

Only segments, externals, or variables may be used in a GROUP directive. Only a segment may be forward referenced.

656 **Illegal statement in this context.**

This error is generated if a PROCLEN directive appears outside of a CODEMACRO definition, a STRUC statement appears within a structure definition, or if a structure initialization occurs within another structure initialization.

658 **Illegal or premature termination of procedure.**

This error indicates improper nesting of procedure or a misspelling of the procedure name in either the PROC or ENDP directives.

659 **Procedure nesting level exceeded.**

Procedures can be nested to a level of 16 only.

660 **Illegal type in this context.**

This error is generated if a type other than NEAR or FAR appears in a PROC directive, or if a type other than a standard type (e.g. a structure or record name) appears as the argument to the THIS operator.

661 **Illegal termination of structure.**

This error indicates a misspelling of the structure name in either the STRUC or ENDS directives.

662 **Null initialization is not allowed in this context.**

Null (or default) initialization is permitted only in structure or record initialization, not in structure or record definition or data definition directives.

663 **Invalid record field size.**

A given field within a record can be no larger than 16 bits, or no smaller than 1 bit.

664 **Maximum record size exceeded.**

The size of a record is limited to 16 bits.

666 **This variable is not defined as a record.**

The caret points to a symbol, in a directive or expression, that must be a record. The symbol pointed to by the caret is not a record.

667 **Include file nesting limit exceeded.**

The limit for nested include files has been exceeded. This limit is operating system specific.

668 **Cannot open include file.**

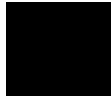

Chapter 27: Assembler Error Messages

Syntax Errors

The filename specified in the preceding include control is misspelled, the associated file is not in the current directory, or the associated file cannot be opened.

669 **Illegal type of EQU in this context.**

An example of this error is an EQU to an 8086 instruction mnemonic as the expression portion of a data definition directive, such as DB. Many other similar conditions exist that will generate this error.

670 **Too many arguments specified for this instruction.**

The particular instruction pointed to by the caret does not allow as many arguments as are specified. INC AX,BX, for example, has one too many arguments.

671 **This type of segment override is illegal in this context.**

Certain types of expressions are not permitted to have a segment override operator (colon operator) as part of the expression. The expression pointed to by the caret is one such expression.

672 **Illegal value for PAGELENGTH control.**

The minimum value in the PAGELENGTH control is 20 lines.

673 **Illegal value for PAGEWIDTH control.**

The legal values for the PAGEWIDTH control fall in the range of 41 to 255 columns, inclusive.

674 **Illegal value for TITLE control.**

The string for a TITLE control is limited to a length of 40 characters.

675 **More than 64 levels of control saves.**

The \$SAVE control cannot be nested to a depth greater than 64.

676 **More than 64 levels of control restores.**

The \$RESTORE control cannot be nested to a depth greater than 64.

677 **This symbol is not a parameter to this codemacro.**

The symbol pointed to by the caret, which is contained within a codemacro definition, is not present in the CODEMACRO statement for the current

codemacro. Therefore, the symbol cannot be a parameter to the current codemacro.

678 **This symbol is not defined as a codemacro parameter.**

The caret points to a symbol in a directive or expression that is required to be a codemacro parameter in order for it to be valid. The symbol pointed to by the caret is not a codemacro parameter.

679 **This codemacro parameter's specifier is invalid in this context.**

Certain directives within a codemacro definition allow only parameters that have specific types of codemacro specifiers. The codemacro parameter pointed to by the caret is not of the specific type needed for the directive in which it is used.

680 **Illegal range expression in codemacro parameter definition.**

Either the range expression pointed to by the caret does not evaluate to an absolute number, or it is out of range according to the codemacro specifier with which it is associated.

681 **This symbol is not a valid codemacro specifier.**

The symbol pointed to by the caret is not one of the valid codemacro specmod fields listed on page 223.

682 **Duplicate definition of codemacro parameter.**

The symbol pointed to by the caret has appeared more than once in the same codemacro directive and is a duplicate definition.

683 **This expression is illegal within a codemacro definition.**

Null initialization expressions, DUP expressions, and dot operator expressions that don't use a record field as their right operand are illegal within a codemacro definition.

684 **This statement is not allowed in a codemacro definition.**

Only a limited number of types of statements is allowed in a codemacro definition. For a complete list, see the chapter titled Codemacros.

685 **This instruction or codemacro has too many operands.**

as86 limits the number of operands to 3 in an instruction and to 255 in a codemacro.

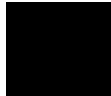

Chapter 27: Assembler Error Messages

Syntax Errors

- 686 **Duplicate use of NOSEGFIX directive in codemacro definition.**
- Only one NOSEGFIX directive can be used in any given codemacro definition.
- 687 **Duplicate use of SEGFIX directive in codemacro definition.**
- Only one SEGFIX directive can be used in any given codemacro definition.
- 688 **PREFIX and non-PREFIX codemacros cannot have the same name.**
- The codemacro symbol being pointed to by the caret has been defined in codemacro directives both with and without the PREFIX keyword. The last definition of the codemacro is the one that will be in effect.
- 689 **Missing PROC directive or previous procedure nesting error.**
- This ENDP directive has no matching PROC directive due to an omission or a nesting error involving its associated PROC directive.
- 690 **This symbol has not been defined.**
- During Pass 1, the assembler assumes that an undefined symbol is a forward reference. This message occurs when the symbol is still not defined in Pass 2. The assembler generates NOPs and continues assembly. You should modify the code to define the symbol, or the symbol will have no value.
- 691 **CS cannot be destination register.**
- CS can only be changed by using an ASSUME directive, a JMP or CALL instruction to a FAR location, and a MOV or POP has been used to load the CS register.
- 692 **Pass 1 estimate of instruction bytes insufficient.**
- The number of bytes reserved for an instruction as a result of a forward reference in Pass 1 did not leave enough code space for the instruction in Pass 2. There are two possible remedies:
- Specify the sizes of forward-referenced variables using the PTR operator.
- Use the \$OPTIMIZE control.
- 693 **This symbol is not defined as a group.**
- The symbol before the GRPOFFSET operator or following the GRPSIZE operator must be a group name. If it is not, then this error is generated.

- 694 **Shift values greater than 31.**
A value for one of the shift or rotate instructions evaluated to a value that was greater than 31. Adjust the shift value and reassemble.
- 695 **ES cannot be overridden in this string instruction.**
Certain types of string instructions (e.g. MOVS) require that their second operand use the ES:DI combination for their reference. In such instances, the ES register cannot be overridden. Modify the program to do such operations through the ES register, and reassemble.
- 697 **Illegal character in numeric constant.**
An illegal character for a numeric constant was found in the constant pointed to by the caret. Remove the illegal character and reassemble.
- 698 **Illegal DUP value.**
A negative or zero repeat count value for a DUP initialization was found at the location pointed to by the caret. Only positive repeat values are allowed. Correct and reassemble.
- 699 **No forward references allowed in EQU expressions.**
The expression pointed to by the caret contains an as-yet undefined symbol. Since this expression is being defined as an EQU symbol, such forward references are not allowed. Eliminate the forward reference by moving the definition of the as-yet undefined symbol in front of this EQU definition, and reassemble.
- 701 **This construct is invalid in the current assembly mode.**
Certain constructs that are accepted only by a given assembly mode (MOD086, MOD186, MODV20) that aren't accepted in the current assembly mode will cause this error to be generated.
- 702 **No module name specified.**
No NAME directive was found in the source program. The default name, which is the basename of the source file, will be used.
- 703 **This symbol was previously declared public.**
The symbol pointed to by the caret previously appeared in this or another PUBLIC directive.

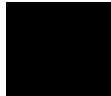

Chapter 27: Assembler Error Messages

Syntax Errors

- 704 **Too many initializations specified: remainder ignored.**
- When re-initializing a structure or record at allocation time, this message is generated if more initialization values were specified than there were fields in the structure or record.
- 705 **This field cannot be re-initialized: value not changed.**
- Structure fields with many values or a DUP expression cannot be re-initialized at allocation time.
- 706 **Illegal initialization value: not re-initialized.**
- An attempt was made to initialize a structure or record field with an invalid value.
- 707 **Location counter overflow.**
- Addition of the current instruction or data definition directive causes the current segment's location counter to exceed the value 0FFFFH, i.e. the 64K limit of a segment. The location counter is set to the value MOD 65536.
-
- Note** This may cause previous code or data to be overwritten if this is ignored.
-
- 708 **This EQU cannot be made public.**
- Certain types of EQU symbols, such as those representing instructions or address expressions, are not permitted to be declared PUBLIC.
- 709 **Floating point overflow: set to infinity.**
- The number of bytes in a floating point value exceeds the limit of a DD (32 bytes), DT (80 bytes) or DQ (64 bytes) directive. Assembly continues; adjust the value to fit within the limit of the Data Directive used.
- 710 **Floating point underflow: set to zero.**
- The number of bytes in a floating point value is under the limit of a DD (32 bytes), DT (80 bytes) or DQ (64 bytes) directive. Assembly continues; adjust the value to fit within the limit of the Data Directive used.
- 711 **BCD value exceeds 18 decimal digits.**
- A packed decimal value (DT) can take 18 digits only; anything over 18 is truncated. Assembly continues; adjust the value to fit within the 18 digit limit.

- 712 **Integer value exceeds 64-bit limit.**
- This warning occurs when an integer constant used in a DQ directive has a value outside the range 0 to FFFFFFFFFFFFFFFFH. Correct the value and reassemble.
- 716 **This and future preprocessor statements will be ignored.**
- Meta characters have not been preprocessed; assembly continues. The assembler does not process any lines with meta characters. Execute the macro string preprocessor before assembling.
- 717 **Segment limit exceeded for this segment.**
- The specified segment contains instructions and/or data that take up more than the maximum allowable 64K bytes of space. Break the segment into multiple segments or shrink the size of the segment, and reassemble.
- 718 **Procedure not closed within this segment.**
- A procedure (or procedures) whose PROC directive was defined in the segment having an ENDS directive which is currently being processed has not yet been closed. The procedure should be closed by inserting an ENDP directive at some point before the ENDS directive.
- 719 **Segment not closed by end of module.**
- One or more segments were open at the point where the assembler found the END directive. The segments should be closed at the appropriate point within the source file.
- 720 **Procedure closed in segment other than the one it was defined in.**
- The ENDP directive, which closes a procedure, appears in a different segment than the one in which the matching PROC directive appears. Make sure that the PROC and ENDP directives reside within the same segment.
- 722 **String truncated to 2 characters before integer conversion.**
- A string that appears anywhere other than in a DB directive must be either 1 or 2 characters long. If such a string is longer than 2 characters, it will be truncated to 2 characters and converted to an integer.
- 724 **Record field overflow: 'value' modulo 'field width' used.**

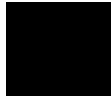

Chapter 27: Assembler Error Messages

Syntax Errors

If a record field initialization or reinitialization expression evaluates to a value that won't fit the specified record field, the appropriate modulo operation is performed in order to force the value to fit.

726

Illegal assembly mode.

The instruction pointed to by the caret is not valid in this assembler.

727

Overriding string too large for field.

If a string field in a structure is reinitialized and the string is too long for the specified field, the string is truncated and this warning message is displayed.

728

Source path names for debug have been truncated to 255 characters.

If the assembly module was produced by the AxLS C compiler and the full path name for the source file or any include file is longer than 255 characters, the assembler will truncate the path name from the left, adding an ellipsis to the name to create a total length of 255 characters, and emit this message.

729

High-level block nesting limit exceeded: some variable scoping lost.

Nesting of high-level procedure or code blocks is allowed up to a depth of 15. Any nesting beyond this depth will result in the loss of information about which block symbols belong to.

800

EVEN directive cannot be in a BYTE aligned segment.

You cannot use the EVEN directive within a segment whose alignment attribute is BYTE. In such a segment, there is no need to force the alignment to be on a word boundary as it will not be any more effective by doing so. Comment out or remove the unnecessary EVEN directive and reassemble.

801

CS-IP initialization required for main module.

Some register initializations were provided on the END directive; however, this error message indicates that no initialization for the CS:IP registers was provided. If any register initializations are provided, an initialization for CS:IP must be provided as well. Add the appropriate initialization and reassemble.

802

Illegal initialization of SS register.

It is illegal to initialize the SS register to anything other than a segment base. In particular, group bases are not allowed. Correct the initialization on the END directive and reassemble.

- 803 **Circular chain of equates.**
EQU symbols in a list with a length of at least one were defined as other EQU symbols in such a way that the last symbol in the list was defined as the first symbol in the list. Usually, such a construct results from symbol spelling errors, or in larger programs, widely scattered EQU definitions. Correct the erroneous EQU definition and reassemble.
- 804 **Illegal to use relocatables in DB, DQ, or DT.**
If a relocatable value appears in an expression for a DB, DQ, or DT directive, this error is generated. Remove the relocatable value and reassemble.
- 805 **Variables or Labels cannot be in DB, DQ, or DT.**
An expression that contains a variable or label is not allowed in a DB, DQ, or DT directive.
- 806 **Illegal to use multiple INCLUDE controls on line.**
Only one INCLUDE control is allowed on any given line containing assembler controls. Split the control line into as many lines as necessary to obtain control lines with only one INCLUDE control per line, and reassemble.
- 807 **Inconsistent AT value given for segment.**
A segment was specified in a previous SEGMENT directive with a different absolute paragraph number than is specified in the current SEGMENT directive. The paragraph values should be the same.
- 808 **This codemacro specifier cannot have a range.**
The codemacro specmod field being pointed to by the caret is not permitted to have an associated range. Only codemacro parameters with specifiers A, D, R, or S can have range values.
- 809 **Duplicate specification of alignment type.**
A segment directive can only have a single alignment type as an option. This error is generated if more than one alignment type is detected in the segment directive.
- 810 **Duplicate specification of combine type.**

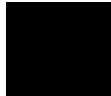

Chapter 27: Assembler Error Messages

Syntax Errors

A segment directive can only have a single combine type as an option. This error is generated if more than one combine type is detected in the segment directive.

811 **Duplicate specification of class name.**

A segment was specified in a previous SEGMENT directive with a different class name than is specified in the current SEGMENT directive. Both SEGMENT directives should use the same class name.

812 **Maximum source line length exceeded.**

An input source line exceeded 1024 characters in length. The assembler will not accept lines longer than this length.

813 **Maximum string length exceeded.**

A string was defined that exceeded 1024 characters in length. The assembler will not accept strings longer than this length.

820 **Relocatable numbers not allowed in DD.**

A relocatable value was used in a DD directive, which is not allowed. Only relocatable full addresses, segment, or group names may be used in a DD directive.

825 **Codemacro argument cannot be addressed by the required segment register.**

The codemacro requires that one of its arguments be addressable through a specific segment register. The current ASSUME contents for that register does not allow that argument to be reached, so this error is generated.

826 **Iterated Data record offset is too large for a fixup.**

Fixups to object code can only occur within the first 1024 bytes of a record. In this instance, an iterated data record is being created that is larger than 1024 bytes and requires a fixup beyond that point. This cannot be represented in HP-OMF86 so this error is generated.

827 **OMF record length exceeds maximum value.**

An HP-OMF86 record can only be 64K in size. Any attempt to generate more than 64K of text in a single HP-OMF86 record will result in this error message.

828 **Codemacro instruction length exceeds 247 bytes.**

Chapter 27: Assembler Error Messages

Syntax Errors

A single codemacro instruction can only generate up to 247 bytes of object code. Any instruction that generates more than that number of bytes will result in this error message.

- 996 **Internal error.**
- 997 **Fatal Error.**
- 998 ***** Fatal Internal Error: Unimplemented Semantics ***.**
- 999 ******* FATAL INTERNAL ERROR *****.**

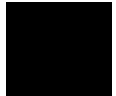

Chapter 27: Assembler Error Messages
Syntax Errors

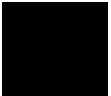

28

Macro String Preprocessor Error Messages

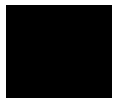

Chapter 28: Macro String Preprocessor Error Messages

Error Codes and Messages

The Macro Preprocessor produces numbered error messages. This chapter explains the meaning of the numeric codes. More than one message may appear for a given source line. Each message is printed immediately upon detection of the error (because the macro processor is character-oriented, not line-oriented). The usual effect is for a message to appear *before* any output from the source line that caused the error. Macro error messages appear as assembler comments in the output source file, like this:

```
; ***** ERROR 301
```

Error Codes and Messages

- 301 **Undefined macro name.**
- The text following a metacharacter (%) is not a recognized user function name or built-in macro function. The reference is ignored, not passed to the output file, and processing continues with the character following the name.
- 302 **Illegal call to %EXIT.**
- %EXIT is outside any user macros, WHILEs, or REPEATs. The call is ignored, %EXIT is not passed to the output file, and processing continues.
- 303 **Illegal expression.**
- A numeric expression was expected. There could be a missing % from a macro-time symbol or a syntax error, among others. This message is produced when ap86 is trying to evaluate an expression within EVAL, IF, WHILE, SUBSTR or REPEAT. The function call is aborted (any output from it is lost) and processing continues following the call pattern of the function. This message is also reported when an illegal character is detected in a string being compared with %EQS (or other string comparison functions).
- 304 **Logical Expression Error**
- 305 **Missing 'FI'.**
- Self-explanatory. This has no effect except to produce the message. However, the search for FI is character-by-character, so that if FE was present when FI

Chapter 28: Macro String Preprocessor Error Messages

Error Codes and Messages

was expected, the F would be removed from the output file. The E and subsequent characters would be passed on normally.

306 **Missing 'THEN'.**

Self-explanatory. The call to IF is aborted and processing continues following the first character which failed to match. Thus the THEN and ELSE clauses, and the ELSE and FI keywords, will be treated as normal text and expanded normally. As with FI, the search for THEN is character- by-character.

307 **Illegal attempt to redefine macro.**

A built-in function cannot be re-defined at any time. It is not possible to re-define a macro formal parameter within the macro body or a macro name within its own body.

309 **Missing balanced string.**

In a call to a built-in function, a required balanced-text string delimited by parentheses is not present. This error can also be generated when the leading left parenthesis is not found where expected. The function call is aborted and scanning continues from the point at which the error was detected.

310 **Missing list item.**

A list item (delimited by commas) is missing. The function or macro call is aborted and scanning continues from the point where the error was detected.

311 **Missing delimiter.**

A delimiter required when scanning of a user-defined macro or built-in function (a comma, usually) is not present. The macro function call is aborted and scanning continues from the point at which the error was detected.

312 **Premature EOF.**

The end of the input file occurred while the call to the macro was being scanned. This usually occurs when a right parenthesis is omitted, causing the Macro Preprocessor to scan to the end of the file searching for it. Note that even if the closing parenthesis of a macro call is given, this error may occur if any preceding commas are missing, since the Macro Preprocessor searches for delimiters one by one.

313 **Macro stack overflow.**

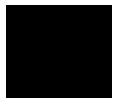

Chapter 28: Macro String Preprocessor Error Messages

Error Codes and Messages

The macro context stack MSTAK has overflowed. This stack is 64 deep and contains an entry for each symbol preceded by the metacharacter. The cause of this error is excessive recursion in macro calls or expansions; a likely source is a user-programmed infinite loop. When this error is encountered, the stack is emptied and all pending output destroyed; scanning continues at the next character in the input file. This message can also be produced to indicate that INCLUDEs were nested too deeply.

314 **Nested macro error.**

315 **String buffer overflow.**

The string buffer used in conjunction with the macro stack to save intermediate results from nested macro calls has overflowed.

318 **Illegal metacharacter.**

Self-explanatory. The current metacharacter remains unchanged.

319 **Unbalanced right parenthesis.**

During the scan of a call to a user-defined macro, an unmatched right parenthesis was encountered. This is frequently because of a missing argument (the right parenthesis terminating the macro call was found when a comma was expected). The call is aborted and scanning continues from the point at which the error was detected.

338 **Invalid symbol.**

A symbol (not preceded by the metacharacter) is required in certain contexts, such as the MATCH, DEFINE and SET functions. This symbol was not valid.

340 **Literal character on SET or WHILE.**

The constructs % *SET and % *WHILE make no sense and produce this message. The * is ignored, and the Macro Preprocessor attempts to expand SET or WHILE normally.

401 **Bad or missing parameter.**

The parameter to a control is not correctly formed, or a control that requires a parameter does not have one. Typographical errors often lead to this message.

414 **Unable to open include file.**

Chapter 28: Macro String Preprocessor Error Messages

Error Codes and Messages

Self-explanatory.

901

Scan stack overflow.

This error indicates that the stack used for evaluating complex expressions has overflowed. This will not occur for any expression likely to be useful in practice. Break the expression into smaller ones.

906

Macro symbol table exhausted.

The macro-time symbol table is full. This table contains symbol names plus the string values of SET and MATCH symbols.

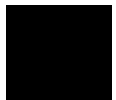

Chapter 28: Macro String Preprocessor Error Messages
Error Codes and Messages

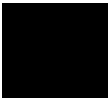

29



Loader Error Messages

List of the loader error messages.

Warning Messages

- 400 **Repeated segment name in ORDER command: [SEGMENT__NAME].**
- The loader displays this message when there is an implicit or explicit reference to the same segment name. If the reference is implicit, the duplicate segment name is embedded in a class specified by a classname in the ORDER command. If the reference is explicit, the duplicate segment name occurs at least twice in the current ORDER command. The duplicate occurrences of the segment name are ignored and loading continues.
- 401 **SEG , ALIGN, or SEGSIZE command used on absolute segment.**
- The loader encountered a user-specified base address for an absolute segment. The user-specified base address is ignored and loading continues.
- 402 **ORDER command cannot be obeyed.**
- The loader generates this message because the placement of absolute segments, SEG commands, and/or reserved areas prohibits placement of the segments in memory in the order specified. This message applies only to segments explicitly named in the ORDER command. Segments implicitly named (such as by specifying a classname with an ORDER command) do not have an implied order. The order of segments will not be as specified in the ORDER command and loading continues.
- 403 **This external symbol is undefined: [SYMBOL__NAME].**
- The loader displays this message when it finds an external symbol in the symbol section of a module that is undefined by the user or undefined in any module. The undefined external symbol may or may not actually be referenced. Loading continues.
- 404 **Group is larger than 65536 bytes: [GROUP__NAME].**
- According to the base address assignment, all members of the group specified by GROUP__NAME do not fit within 64K bytes of one another; thus the segments as currently loaded cannot be addressed by a single segment register (which is the purpose of having groups). By judicious use of classnames in the assembler, or SEG and ORDER commands in the loader, it may be possible to get all group elements within 64K bytes of each other. Relocation errors may result from any references to the group parts outside the 65536 byte group base. Loading continues.

- 405 **Group contains undefined or absolute external.**
- One of the input modules contains a GROUP element defined by means of an external name. The external name is either undefined or defined as absolute; therefore its segment base cannot be determined. Relocation errors will result from references to the external name, whether or not an error is reported. Loading continues.
- 406 **Memory segment is not at the top of memory: [SEGMENT__NAME].**
- The loader displays this message whenever more than one segment has the memory attribute, or whenever a SEG or ORDER command causes the single memory segment to be misplaced. Everything is loaded where assigned and loading continues.
- 407 **Memory overlap by segment [SEGMENT__NAME].**
- The loader generates this warning when an area reserved by a RESNUM or RESADD command, an absolute segment, or a segment specified in a SEG directive conflicts with a previously-reserved area. The previously-reserved area could have been reserved by the RESNUM, RESADD, or SEG directive or by an absolute segment. Any additionally relocatable segments will not overlap. Any additional previously-unreserved space is reserved and loading continues.
- 408 **No segments with classname [CLASS__NAME].**
- The classname displayed in the message appears in a SEG or ORDER command, but no segments with that classname exist. The classname is ignored and loading continues.
- 409 **SEGSIZE used with public or private segment: [SEGMENT__NAME].**
- The SEGMENT__NAME displayed in the message is the name of the segment altered by the SEGSIZE command. The loader issues this message if the segment does not have a combine type of STACK or COMMON.
- SEGSIZE is typically used to set the size of a stack segment but you can use it to set the length of any segment. The user-specified length is used in the segment. There is a possibility of overlapped data. No further warning will be given and loading continues.
- 410 **User-specified base address does not match alignment type for segment [SEGMENT__NAME].**



Chapter 29: Loader Error Messages

- The loader displays this message when the base address specified in the SEG command does not match either the alignment carried by the segment or with the alignment specified by an ALIGN command. The loader ignores the alignment attribute and loads the segment at the user-specified base address. Loading continues.
- 411 **Inpage alignment cannot be performed for segment [SEGMENT__NAME].**
- The named segment is too large to fit in a page (256 bytes). The segment is loaded at the next page boundary. Loading continues.
- 412 **Respecification of output object module format.**
- In any given invocation of the linking loader, you can specify only one output format among the following three: HP-OMF 86 format absolute, Intel Hexadecimal Object file format absolute, or HP 64000 format absolute. You can override the default format; however, if you explicitly request either HP 64000 absolute output or Intel Hexadecimal output on the command line or in a LIST command, or any combination of these, the above warning message is generated. Loading continues; the output format is left as it was first set.
- 413 **The following command/option is not allowed after a LOAD command: [OPTION__NAME].**
- The output format options in the LIST and NLIST commands (B, I, or H) cannot be specified after a LOAD command is issued. This is because the loader's internal data structures have been set to accommodate only the output format in force at the time of the first LOAD command. The option specified in the OPTION__NAME field of the error message is ignored and loading continues.
- 414 **SEGSIZE value too small for stack or common segment: [SEGMENT__NAME].**
- The length chosen for the stack or common segment named in the error message was too small to accommodate the length requested by a portion of the segment. Depending upon the actual amount of stack or common space used by the program, the length may be adequate. To alleviate this condition, eliminate the offending SEGSIZE directive, or increase its length parameter. The user-specified length for the segment is used. The possibility of data overlap exists and no further warning will be given. Loading continues.
- 415 **OMF buffer flushed: NAME command ignored; output module name is: [MODULE__NAME].**

This message occurs if an internal table containing class and segment group names is about to overflow the buffer. It has to be flushed to the output object module before any NAME command is encountered. At that time, the module__name will default to the name of the loader command file, or if there is no command file, to the first file loaded. Module_name becomes the default module name. Loading continues.

416 **Undefined external referenced in module.**

This message is generated only when the LIST E option is selected during an incremental link. This option specifies this warning message be generated during an incremental link for any undefined external symbols that are referenced. The module name displayed in the message makes a reference to an external symbol that was neither defined by you nor defined in another module. The name of the referenced external is listed along with the module name. Linking continues. Note that this warning usually does not indicate a problem as undefined external symbols are permitted in relocatable object modules. However, this warning alerts you to any unresolved external symbols that you may have thought were already resolved.

417 **Duplicate ORDER command: previous order commands ignored.**

The linker found a second or subsequent ORDER command. Any information contained in the previous ORDER command(s) is now lost, even if the newly-found ORDER command contains errors. If the newly-found ORDER command contains errors, no ORDER command information is saved unless another valid ORDER command is found later in the command file. Linking continues.

418 **Null GRPDEF record referenced during relocation.**

A group containing no member segments or externals was used as the base of a relocation operation. The base of the item being relocated rather than the non-existent base of the group was used to perform the relocation. Linking continues.

419 **No object file entries for user-defined segment.**

A segment name or class name has been specified in an ALIGN, INITDATA, ORDER, SEG, or SEGSIZE command that was not found anywhere in the object modules that were loaded by the linker. This error message either means that your command file has an unnecessary segment or class name reference or you are not loading one or more of your object modules. Both of these situations can be remedied in the command file by deleting references

Chapter 29: Loader Error Messages

- to the displayed segment or class or by including LOAD commands for the object modules containing the displayed segment or class. Linking continues.
- 420 **No object file entries for user-defined group.**
- A group name has been specified in a GROUP command that was not found anywhere in the object modules that were loaded by the linker. This either means that your command file has an unnecessary group name reference or you are not loading one or more of your object modules. Both of these situations can be remedied in the command file by deleting references to the displayed group or by including LOAD commands for the object modules containing the displayed group. Linking continues.
- 421 **Nonstandard debug information encountered and removed.**
- Debug information that is not part of the standard HP-OMF86 or Intel file format was stripped from the file.
- 422 **External defined in different segment than specified in reference: [SYMBOL]**
- An external symbol was defined to exist within a specific segment but, after resolving the external with a public symbol, the base segment for the external is different. In this case, the linker gives a warning so the user is aware of this incompatibility. The best solution is to place the definition of the external symbol within the correct segment. If this segment is not known, the external symbol should not be defined within any segments.
- 423 **TYPDEF record limit exceeded - types set to NULL**
- The HP-OMF86 file format is only able to represent 32k types. If this limit is exceeded in the linker, this warning is generated. All type information after the first 32k types will be lost. All of the type information can probably be saved through the appropriate use of the 'TYPEMERGE' command in the linker command file.
- 424 **The following pathname was truncated in the OMF output: [FILENAME]**
- The maximum length for pathnames in OMF is 255 characters. If the length of the absolute path to the object file is greater than this limit, then the pathname must be truncated.
- 425 **Multiple Register Initialization for: [REGISTER]**
- Three registers in the 8086/186 processor may be initialized at runtime. These registers are CS:IP, DS, and SS. Normally, only a single input module contains

Chapter 29: Loader Error Messages

the register initialization information. If more than one input module contains this information, then this error is generated and the last initialization value is used.



Error Messages

- 300 **Invalid name [INVALID__TEXT].**
- The loader displays this message when it encounters illegal characters or too many characters in a command. The maximum length of PUBLICs is 255 characters; the maximum length of SEGs, CLASSES, and GROUPs is 40 characters. The command that uses the name is not processed. Loading continues.
- 301 **Invalid hexadecimal value: [HEX_VAL]**
- The linker expected to find a valid hexadecimal constant; instead, the text displayed in the HEX_VAL field of the message was found. The text should be corrected to conform to the syntax for hexadecimal constants: digits 0 to 9, letters a through f or A through F, preceded by a leading zero if a letter is used as the most significant digit, and followed by a trailing h or H.
- 302 **Invalid command operand.**
- An operand specified for a command contains invalid characters, does not exist, or is too large. Loading continues; the command in which the error occurs is ignored.
- 303 **Error occurred when closing a file.**
- Loading continues; however, the file in question may become corrupt.
- 304 **Undefined external encountered as a member of group.**
- In the assembler, it is possible to define a group in terms of segments, segments of variables, or segments of external symbols. Since external symbols may be defined outside of any segments, the assembler does not have enough information to decide what segment the external belongs to, so it must wait until link time before this is decided. And if the external symbol is not defined in any input modules, the linker is also unable to decide which segment belongs in the group. Under these circumstances, this error message is generated and no segment is placed in the group.
- 305 **Invalid loader command: [INVALID__COMMAND].**
- The command displayed in this message is not a valid loader command. Loading continues; the erroneous command is ignored.

- 306 **Invalid command syntax at or before: [COMMAND__TEXT].**
- Loading continues; the command in which the error occurs is ignored.
- 307 **Duplicate public symbol: [DUPLICATE SYMBOL__NAME].**
- The symbol name displayed in this message was defined previously in another module. Loading continues; the first definition of this public symbol is the one the loader uses for symbol recognition.
- 308 **Undefined external referenced in module [MODULE__NAME:EXTERNAL__NAME].**
- The module name displayed in this message makes reference to an external symbol that was neither defined by the user nor defined in another module. The name of the referenced external is listed along with the module name. Loading continues; zeros are substituted for the value of the external.
- 309 **Relocation error at [ERROR__ADDRESS].**
- A relocated value is too large to fit in the number of bytes allocated for it. For example, this message occurs if a self-relative jump to a NEAR label is outside the boundary of a 16-bit displacement. Loading continues; however, the specific relocation is not performed and the absolute object module is not likely to be useful.
- 310 **Segment mismatch on combine type for segment [SEGMENT__NAME].**
- The loader displays this message when different modules that contain parts of the same segment have different combine type attributes. Loading continues; the specified segment is NOT COMBINED.
- 311 **Combined segment is larger than 65536 bytes.**
- During initial loading, a (combined) segment length exceeds the 64K segment size. Loading continues; however, the absolute file produced is most likely useless.
- 312 **Unexpected character in symbol [SYMBOL__NAME].**
- The loader displays the name of the symbol in which an invalid character occurs. Loading continues; the symbol containing the invalid character is not processed.
- 313 **Segment(s) located beyond 0FFFFFFH boundary.**

Chapter 29: Loader Error Messages

- 314 **Procedure/block nesting limit exceeded.**
The loader displays this message if the source program contains procedures and functions nested to a level deeper than 15. Loading continues; however, the loader cannot produce the proper procedure and scoping information.
- 315 **Continuation line error.**
The loader displays this message when it encounters incorrect syntax for specifying a continuation line. Loading continues; however, the loader ignores continued information until it encounters a line of code beginning with the correct syntax.
- 316 **Specified group base is not divisible by 16 [GROUP__NAME].**
A group base value specified in a GROUP command for the GROUP__NAME displayed in the message is not divisible by 16, and hence is not on a paragraph boundary. In order to fix this problem, a value divisible by 16 should be substituted in the GROUP command. Loading continues; no group addresses are assigned.
- 317 **RESNUM or RESADD command overlaps previously-reserved memory.**
The loader generates this warning when the first part of an area previously reserved by a RESNUM or RESADD directive, an absolute segment, or a segment specified in a SEG directive conflicts with a reserved area. Relocatable segments will not overlap. Loading continues; any additional non-overlapping space is reserved.
- 318 **This command not allowed with relocatable output: ignored.**
The INITDATA command should only be used when you are performing a final (not incremental) link. Loading continues; the INITDATA command is ignored.
- 319 **Numeric value out of range: [BAD_VALUE]**
A numeric value found in the command file was outside the range (0 <= value <= 0FFFFH) for 16-bit values or outside the range (0 <= value <= 0FFFFFFH) for 20-bit values. This can be fixed by correcting the erroneous value in the command file. Linking continues. The command containing the incorrect value is ignored.

329

Invalid BLKDEF record for block: [BLOCK_NAME]

Invalid unnamed BLKDEF record

An illegal BLKDEF record was seen by the linker. This record either has no name or has an illegal attribute. This error probably indicates that the file is either corrupt or was generated by a nonsupported tool.



Fatal Error Messages

- 330 **Bad Intel object record.**
- The byte that was read in as the first byte of an Intel OMF record was not a valid record marker as indicated in the Intel 8086 Relocatable Object Module Format Specification. The input file has probably been corrupted.
- 331 **Invalid checksum in object record.**
- The object record has a checksum error; the input object file has probably been corrupted.
- 332 **Load terminated by user.**
- This error is generated when the EXIT command is encountered.
- 333 **Unable to open file [FILENAME].**
- The file named in this message could not be opened. Check for correct spelling and verify the file's existence.
- 334 **Linker Internal error # [ERROR__NUMBER].**
- Should this error display, contact Hewlett-Packard Customer Support.
- 335 **First record is not a valid relocatable header record.**
- A header record is not the first record in the object module.
- 336 **Unexpected end of file encountered.**
- The loader encountered a physical end-of-file before it read records to indicate end-of-module.
- 337 **Illegal object record length [LENGTH].**
- The object record exceeds 64K bytes. LENGTH is the length of the object record in bytes.
- 338 **Segment, group, or external index out of range.**
- An external reference is made to an external symbol that does not exist in the object module.

- 339 **Unable to open temporary file.**
- 340 **Disk file output error -- program aborted.**
While the linker was attempting to write to a disk file, an error occurred. Usually, this is caused by a lack of disk space. Freeing up some disk space may help.
- 341 **Disk file input error -- program aborted.**
While the linker was attempting to read from a disk file, an error occurred.
- 342 **Disk file seek error -- program aborted.**
While the linker was attempting to seek a position in a disk file, an error occurred.
- 343 **The command line exceeds the command line length limit:**
The maximum command line length is 1024 characters. If this limit is exceeded, then the command line cannot be processed.
- 344 **File Overwrite condition: [TEXT].**
It is possible for the creation of an output file to destroy one of the input files or another output file. For this reason, the linker checks to see if the creation of the output file will overwrite one of these other files. If this is the case, then this error is generated and the linker does not proceed any further.
- 345 **BLKEND record has no matching BLKDEF, or nesting limit previously exceeded.**
If the end of a procedure block (in the debug information within a module) does not have a matching beginning, then this error is generated. The input object file must be recreated by the assembler without any detected errors.

Chapter 29: Loader Error Messages

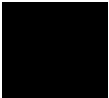

30



Librarian Error Messages

List of the librarian error messages.

Librarian Error Messages

- 100 **Could not close file [FILENAME] to open another file.**
- In order to reduce processing overhead, the librarian keeps OPENed files open. This message is displayed if too many files are open and the librarian unsuccessfully attempts to close a file in order to open a new one. To remedy this situation, reduce the number of files you are working with during a given session.
- 101 **Unable to open file [FILENAME].**
- The librarian could not open the named file when executing an ADDMOD, REPLACE, or OPEN command. This error could be caused by either an invalid filename specification or when the specified file does not exist. The librarian ignores the command that generates this error.
- 102 **Unable to close file [FILENAME].**
- The librarian generates this error when it encounters an operating system error, and cannot close the named file. This message typically is accompanied by another error message that provides a more specific reason for not closing the named file.
- 104 **File [FILENAME] not included.**
- The librarian issues this message when it cannot execute the ADDMOD command because the named file is corrupted or does not exist. This message has a companion message that specifically states why the named file is not included in the library.
- 106 **File [LIBRARY__NAME] exists already.**
- The librarian generates this message when you have used the CREATE command, and the named library currently exists. The librarian displays a warning in batch and interactive modes.
- 107 **File [FILENAME] does not exist.**
- The librarian generates this message when you have issued an OPEN command, and the named file does not exist. If you are creating a new library file, you may ignore this message.
- 108 **Library file [LIBRARY__NAME] not opened.**

201 **Module [MODULE__NAME] not found.**

The librarian could not locate the named module in the library to execute a DELETE, REPLACE, or EXTRACT command.

203 **Module [MODULE__NAME] already exists in current library**

The librarian cannot execute an ADDMOD or ADDLIB command because the module named in the message exists in the current library. If you wish to replace a module in the library, use the REPLACE command. The librarian ignores the ADDMOD or ADDLIB command that contains a duplicate module name.

204 **[FILENAME] is a library file.**

The librarian generates this error message when it attempts to execute an ADDMOD or OPEN command, and the associated filename is not an object module. The command containing the erroneous file is ignored.

205 **[FILENAME] is not a library file.**

The librarian issues this error message when it attempts to execute an ADDLIB or OPEN command, and the associated filename is an object module. The librarian ignores the command containing the erroneous file.

206 **Module [MODULE__NAME] is not included in the library.**

The librarian issues this message with a companion message that gives the specific reason for not including the named module in the library. This message describes the result: the named module is not included in the library.

207 **Bad object record.**

Either the object module has been corrupted or it is not a legal relocatable object file. The librarian issues this message with a companion message that names the file with the bad object record. The command associated with the bad object record file will be ignored.

208 **Bad library header record.**

The library has a bad header record. The librarian issues this message with a companion message that names the file with the bad header record. The command associated with the bad library header record will be ignored.

209 **Duplicate symbol [SYMBOL__NAME].**

Chapter 30: Librarian Error Messages

A module named in an ADDLIB, ADDMOD, or REPLACE command has the same public definition symbol that occurs in another module. The librarian issues this message with a companion message that provides information about what action it takes. The librarian considers symbols to be case-sensitive.

210

Bad object record in file [FILENAME].

The named library or module file may have been corrupted.

250

Out of memory.

The librarian issues this message when there is not enough system memory to execute commands issued since the last CREATE or OPEN command.

251

Failed writing library [REASON].

The librarian generates this message when it attempts to execute a SAVE command and cannot. The message provides the reason for inability to create a library. The librarian abandons the current session affected by the SAVE command that caused the error.

253

Library [LIBRARY_NAME] not written.

The librarian issues this message when an error occurs earlier in the session that prevents the library from being saved. This message is typically accompanied by another message that contains the reason the named library was not created.

254

Failed writing module [MODULE_NAME] to file [FILENAME].

When attempting to execute an EXTRACT command, the librarian cannot write the named module from an existing library to the (new) file, which is external to the library. A companion error message describes the reason that the module cannot be extracted. If an error is encountered in batch mode, all commands following the EXTRACT command will not be executed; however, they will still be checked for syntactic validity.

255

Replacement not done.

The librarian issues this message when it cannot execute the REPLACE command for the reason specified in the companion message.

256

Extraction failed.

The module named in the EXTRACT command is not extracted.

257

Illegal command.

The librarian generates this message when it encounters either an incorrect command sequence or an incorrect command syntax.

259

Quote Not terminated.

A string is missing a closing quote.

262

There is no library to be saved.

The SAVE command does not have a library to save.

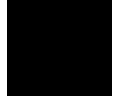

Chapter 30: Librarian Error Messages



Index

- % escape character, **256**
- _ (underscore character), **24**
- A**
 - .A suffix, **23–24**
 - absolute expression, **129**
 - absolute segment
 - loader, **370**
 - acvt86 translation tool, **290–293**
 - adding base and index register
 - in expression, **134**
 - addition operator
 - binary, **138**
 - unary, **137**
 - ADDLIB librarian command, **444**
 - ADDMOD librarian command, **444**
 - ALIGN loader command, **387–388**
 - align-type attribute
 - loader, **374**
 - alignment, **37**
 - allocating record storage, **115**
 - allocating structure storage, **124**
 - AND operator, **144**
 - anonymous reference, **163**
 - with expression, **135**
 - ap86, **30–31**
 - ar86, **45–48**
 - archiver, **45–48**
 - arithmetic operator, **137**
 - as86, **23–29**
 - ASCII codes, **58**
 - asmb_sym file, **23**
 - assembler, **23–29**
 - control general syntax, **195**
 - cross reference format, **213–216**
 - directive, **79–126**
 - error messages, **465–492**



- assembler (continued)
 - general controls, **195**
 - listing, **211–216**
 - operation, **52**
 - primary controls, **195**
 - statement syntax, **68**
 - symbol table format, **213–216**
- assembler controls
 - CASE, **197**
 - DATE, **197**
 - DEBUG, **198**
 - EJECT, **206**
 - ERRORPRINT, **198**
 - GEN, **206**
 - general, **206–208**
 - GENONLY, **206**
 - INCLUDE, **207**
 - INCLUDE with macro preprocessor, **248**
 - LIST, **207**
 - MACRO, **200**
 - MOD086, **200**
 - MOD186, **201**
 - MODV20, **201**
 - OBJECT, **202**
 - OPTIMIZE, **202**
 - PAGELength, **202**
 - PAGEWIDTH, **203**
 - primary, **197**
 - PRINT, **203**
 - RESTORE, **207**
 - SAVE, **208**
 - SYMBOLS, **204**
 - TITLE, **208**
 - TYPE, **204**
 - UNREFERENCED_EXTERNALS, **204**
 - WORKFILES, **205**
 - XREF, **205**
- assembler syntax
 - blank line, **70**
 - comment, **69**
 - continuation line, **70**

- assembler syntax (continued)
 - keyword, **69**
 - label, **69**
 - operand, **69**
 - prefix, **69**
 - symbol, **59**
- assembling program modules, **9–14**
- assembly source translation
 - acvt86 tool, **290–293**
- assembly source translation
 - HP 64853 to HP B1449, **279–306**
- ASSUME directive, **86–87**
- assumed, **163**
- * operator, **141, 389**
- attribute
 - BASE, **74**
 - CS ADDRESSABILITY, **77**
 - INDEX, **74**
 - OFFSET, **73**
 - RELOCATION TYPE, **75**
 - SEGMENT, **75**
 - SEGMENT ADDRESSABILITY, **76**
 - SEGMENT RELOCATION, **75**
 - TYPE, **73**
- B**
 - balanced text string, **252**
 - baltex, **252**
 - base address
 - loader, **369**
 - base address assignment
 - loader, **378–382**
 - BASE attribute, **74**
 - base register
 - in expression, **134**
 - binary minus, **138**
 - binary plus, **138**
 - blank line in syntax, **70**
 - bracket macro function, **255**
 - byte align-type
 - loader, **375**

- C**
 - caret, **466**
 - CASE assembler control, **197**
 - case sensitivity, **399**
 - assembler controls, **197**
 - macro preprocessor, **244, 251**
 - case-sensitivity, **25, 31, 35, 41, 56**
 - changes to the assembler, **275–278**
 - character constant, **67**
 - character set, **56–58**
 - characters, **24**
 - class
 - loader, **370**
 - class name
 - loader, **372**
 - CLEAR librarian command, **445**
 - clearing flags, **24**
 - code translation
 - acvt86 tool, **290–293**
 - HP 64853 to HP B1449, **279–306**
 - colon
 - with label, **62**
 - combine-type attribute
 - loader, **373**
 - command file
 - loader listing, **416**
 - command files, **18, 33**
 - command line length, **511**
 - command syntax, **21–48**
 - commands
 - arguments to loader commands, **384**
 - length of with loader, **385**
 - librarian, **441**
 - order in loader, **385**
 - comment in syntax, **69**
 - comment macro function, **255**
 - comments
 - librarian, **439**
 - loader, **389**
 - comments, linker, **35**
 - common segment
 - loader, **373**

complete name, **385**
 loader, **372**
constant, **64**
 character, **67**
 integer, **65**
 real, **66**
continuation line in syntax, **70**
controls, **25**
controls, assembler
 CASE, 197
 DATE, 197
 DEBUG, 198
 EJECT, 206
 ERRORPRINT, 198
 GEN, 206
 general, **195, 206–208**
 GENONLY, 206
 INCLUDE, 207
 LIST, 207
 MACRO, 200
 MOD086, 200
 MOD186, 201
 MODV20, 201
 OBJECT, 202
 OPTIMIZE, 202
 PAGELength, 202
 PAGEWIDTH, 203
 primary, **195, 197**
 PRINT, 203
 RESTORE, 207
 SAVE, 208
 SYMBOLS, 204
 TITLE, 208
 TYPE, 204
 UNREFERENCED_EXTERNALS, 204
 WORKFILES, 205
 XREF, 205
CREATE librarian command, **445**
creating macros, **269**
cross reference format, **213–216**

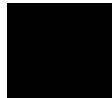

cross reference table, **28**
CS ADDRESSABILITY attribute, **77**

- D** data definition directive, **83**
- data object, **83**
- DATE assembler control, **197**
- DB directive, **88–93**
 - with string, **92**
- DD directive, **88–93**
- DEBUG assembler control, **198**
- debug information, **25**
- default
 - PROC directive, **109**
 - segment, **82**
 - segment register, **87**
 - segments for memory addressing, **171**
- DEFINE macro function, **269**
- defining macros, **269**
- definitions
 - external, **6**
 - PUBLIC, **6–7**
 - storage locations, **6**
- DELETE librarian command, **446**
- differences between processor modes, **209–210**
- directive
 - assembler, **79–126**
 - ASSUME, **86–87**
 - data definition, **83**
 - DB, **88–93**
 - DB with string, **92**
 - DD, **88–93**
 - DQ, **88–93**
 - DT, **88–93**
 - DW, **88–93**
 - DW, DD, DQ, DT with string, **92**
 - END, **94**
 - ENDP, **109–110**
 - ENDS (segments), **118–122**
 - ENDS (structures), **123–126**
 - EQU, **96–98**
 - EXTRN, **100–102**
 - GROUP, **103–104**

- directive (continued)
 - LABEL, 105–106**
 - NAME, 107**
 - ORG, 108**
 - PROC, 109–110**
 - program linkage, **84**
 - PUBLIC, 111**
 - PURGE, 112–113**
 - RECORD, 114–117**
 - SEGMENT, 118–122**
 - segmentation, **81**
 - STRUC, 123–126**
- DIRECTORY** librarian command, **446**
- division operator, **141**
- DQ** directive, **88–93**
- DT** directive, **88–93**
- DW** directive, **88–93**
- DW, DD, DQ, DT** directive
 - with string, **92**
- E**
 - 8086** processor mode, **209**
 - EBCDIC** codes, **58**
 - EJECT** assembler control, **206**
 - eject page, **25**
 - END** directive, **94**
 - END** librarian command, **447**
 - END** loader command, **389**
 - ENDP** directive, **109–110**
 - ENDS** directive, **118–122**
 - ENDS** directive (structures), **123–126**
 - EQ** operator, **145**
 - EQS** macro function, **257**
 - EQU** directive, **96–98**
 - EQU** symbols defined, **64**
 - error messages, assembler, **465–492**
 - ERROR** loader command, **389**
 - error messages
 - formats, **461–464**
 - interactive vs. non-interactive, **462–464**
 - librarian, **513–518**
 - loader, **499–512**
 - macro preprocessor, **493–498**

error messages, suppressing, **25**
ERRORPRINT assembler control, **198**
escape macro function, **255**
EVAL macro function, **257**
example program
 assembling program modules, **9–14**
 description of, **3–8**
 linking relocatable object files, **17–20**
 objectives of, **2**
EXIT loader command, **390**
EXIT macro function, **258**
expression
 absolute, **129**
 anonymous, **135**
 base register in, **134**
 with EQU directive, **136**
 external, **130**
 generally, **128**
 group name operand, **133**
 index register in, **134**
 label name operand, **133**
 in macro preprocessor, **250–252**
 numeric operand, **131**
 operand, **131**
 operands, **162–169**
 operator, **137**
 operator, arithmetic, **137**
 operator, logical, **144**
 operator, record, **154**
 record field operand, **132**
 record operand, **132**
 register indirect, **134**
 relocatable, **130**
 segment name operand, **133**
 string operand, **132**
 structure field operand, **134**
 variable name operand, **133**
external definitions, **6**
external expression, **130**
external references, **6**
 checking, **25**

- EXTRACT librarian command, **447**
- EXTRN directive, **100–102**
- F** file format, **18, 23–24, 29, 32–35, 40, 44**
 - file names
 - assembler output, **24**
 - object, **17, 23**
 - output, **33**
 - source, **23**
 - symbol file, **24**
 - flags
 - assembler, **24–25**
 - unsetting, **24**
 - FORMAT loader command, **391**
 - formats for error messages, **461–464**
 - FULLDIR librarian command, **448**
 - function
 - % ((bracket) macro, **255**
 - bracket macro, **255**
 - % ' (comment) macro, **255**
 - comment macro, **255**
 - DEFINE macro, **269**
 - EQS macro, **257**
 - % n (escape) macro, **255**
 - escape macro, **255**
 - EVAL macro, **257**
 - EXIT macro, **258**
 - GES macro, **257**
 - GTS macro, **257**
 - IF macro, **258**
 - LEN, **245**
 - LEN macro, **260**
 - LES macro, **257**
 - LTS macro, **257**
 - MATCH macro, **260**
 - METACHAR macro, **262**
 - NES macro, **257**
 - REPEAT macro, **262**
 - SET macro, **263**
 - SUBSTR, **245**
 - SUBSTR macro, **264**
 - WHILE macro, **264**



- G** GE operator, **145**
GEN assembler control, **206**
general assembler controls, **195, 206–208**
general controls, **25**
general syntax, **68**
GENONLY assembler control, **206**
GES macro function, **257**
group, **103–104**
 loader, **371**
 mismatched groups merged, **371**
 OFFSET operator with, **104**
 override operator, **148**
group base address
 loader, **371**
GROUP directive, **103–104**
GROUP loader command, **392–393**
group name
 defined, **64**
 as expression operand, **133**
groups, **26, 35–36**
GT operator, **145**
GTS macro function, **257**
- H** HELP librarian command, **449**
HIGH operator, **143**
HP 64000 format
 See file format
HP 64853 programs, linking to, **303–304**
HP 64853 to HP B1449 translation, **279–306**
- I** identifiers, **24**
IF macro function, **258**
immediate, **164**
immediate value
 See also numeric value
INCLUDE assembler control, **207**
 with macro preprocessor, **248**
include file, **26**
incorrect macro example, **265**
incremental linking, **32, 368**
INDEX attribute, **74**

- index register
 - in expression, **134**
- INITDATA loader command, **394**
- initialization
 - record, **115**
 - segment register, **95**
 - structure, **124**
- initialize data, **394**
- initialized memory, **38**
- inpage align-type
 - loader, **375**
- instruction mnemonic defined, **62**
- instruction set, **52**
 - 8086/186, **339**
 - 8086/186 in hexadecimal order, **307–338**
 - assembler, **174**
- instruction sets, **26**
- integer constant, **65**
- K** keyword defined, **60**
 - keyword in syntax, **69**
- L** L_to_o86 porting tool, **304**
 - label, **83**
 - in syntax, **69**
 - LABEL directive, **105–106**
 - label name
 - defined, **62**
 - as expression operand, **133**
 - ld86, **32–44**
 - LE operator, **145**
 - LEN function, **245**
 - LEN macro function, **260**
 - LENGTH loader command, **395**
 - LENGTH operator, **151**
 - LES macro function, **257**
 - library maintainer (ar86), **45–48**
 - librarian
 - command syntax, **438**
 - commands, **441**
 - comments, **439**
 - error messages, **513–518**

librarian (continued)
 features, **v**
 introduction, **432**
 sample program, **453, 456**
 special characters, **438**
 use of, **433**

librarian command
 ADDLIB, **444**
 ADDMOD, **444**
 CLEAR, **445**
 CREATE, **445**
 DELETE, **446**
 DIRECTORY, **446**
 END, **447**
 EXTRACT, **447**
 FULDIR, **448**
 HELP, **449**
 OPEN, **449**
 REPLACE, **450**
 SAVE, **450**

library files, creating, **15–16**

linker, **17**

linker/loader, **32–44**

linking loader
 introduction, **361–366**

linking to 64853 programs, **303–304**

linking, definition of, **17–20**

LIST assembler control, **207**

LIST loader command, **396–399**

LISTABS loader commands, **400**

listing, assembler, **212**

listings, **9, 15, 18, 23**

LISTMAP loader commands, **400–401**

literal (*) character, **247**

literal character, **256**

LOAD loader command, **402**

load map, **18**

loader, **17, 361–366**

- absolute segment, **370**
- align-type attribute, **374**
- base address, **369**
- base address assignment, **378–382**
- byte align-type, **375**
- class, **370**
- class name, **372**
- combine-type attribute, **373**
- command file listing, **416**
- common segment, **373**
- complete name, **372**
- error messages, **499–512**
- fatal error messages, **510**
- features, **iv**
- group, **371**
- group base address, **371**
- incremental linking, **368**
- inpage align-type, **375**
- introduction, **361–366**
- linking/loading from libraries, **362**
- logical segment, **369**
- memory segment, **374**
- merging mismatched groups, **371**
- module, **372**
- non-combinable segment, **373**
- non-fatal error messages, **506**
- page align-type, **374**
- paragraph number, **370**
- physical segment, **369**
- primary functions, **368**
- public segment, **373**
- relocatable segment, **370**
- segment number, **370**
- segments and load addresses, **369**
- stack segment, **373**
- symbol with, **384**
- warning messages, **500**
- word align-type, **374**

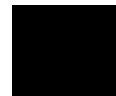

loader command
ALIGN, **387–388**
command argument, **384**
command length, **385**
command order, **385**
* (comment), **389**
descriptions, **386**
END, **389**
EXIT, **390**
FORMAT, **391**
GROUP, **392–393**
INITDATA, **394**
LENGTH, **395**
LIST, **396–399**
LOAD, **402**
NAME, **403**
NLIST, **396–399**
NOTYPEMERGE, **411**
ORDER, **403–404**
PUBLIC, **405**
RESADD, **406**
RESNUM, **406**
SEG, **407–408**
SEGSIZE, **409**
START, **410**
TYPEMERGE, **411**
WIDTH, **412**
loader commands
ERROR, **389**
LISTABS, **400**
LISTMAP, **400–401**
NOERROR, **389**
WARN, **389**
logical operator, **144**
logical segment, **82**
 loader, **369**
LOW operator, **143**
LT operator, **145**
LTS macro function, **257**

- M** **MACRO assembler control, 200**
- macro example (incorrect), **265**
- macro function
 - bracket, **255**
 - comment, **255**
 - DEFINE, **269**
 - EQS, **257**
 - escape, **255**
 - EVAL, **257**
 - EXIT, **258**
 - GES, **257**
 - GTS, **257**
 - IF, **258**
 - LEN, **245, 260**
 - LES, **257**
 - LTS, **257**
 - MATCH, **260**
 - METACHAR, **262**
 - NES, **257**
 - REPEAT, **262**
 - SET, **263**
 - string relational, **257**
 - SUBSTR, **245, 264**
 - WHILE, **264**
- macro preprocessor, **30–31, 243–252**
 - balanced text string (baltex), **252**
 - error messages, **493–498**
 - INCLUDE file, **248**
 - input parsing, **248**
 - input source characteristics, **244**
 - literal character, **247**
 - metacharacter (%), **245**
 - output buffering, **248**
 - starting, **9**
 - symbol in, **251**
 - with expressions, **250–252**
 - with operators, **250–252**
- man pages, **22**
- MASK operator, 154**
- MATCH macro function, 260**
- memory addressing, **168–169**

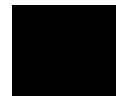

memory segment
 loader, **374**

message severity, **389**

METACHAR macro function, **262**

microprocessors, **52**

—

 binary, **138**

 unary, **137**

 with base and index register, **134**

mismatched groups, merging, **371**

MOD operator, **141**

MOD086 assembler control, **200**

MOD186 assembler control, **201**

modifier (codemacro specmod), **220**

MODRM

 codemacro directive, **234**

 description of MODRM byte, **169**

 values for MODRM byte, **358**

MODRM byte, **169**

module

 loader, **372**

 size, **411**

MODV20 assembler control, **201**

multiple register initialization, **505**

multiple segment definition, **120**

N

 NAME directive, **107**

 NAME loader command, **403**

 NE operator, **145**

 NES macro function, **257**

 nesting segments, **121**

 NLIST loader command, **396–399**

 nm64 porting tool, **305**

 NOERROR loader command, **389**

 non-combinable segment

 loader, **373**

 NOPs, removing, **27**

 NOT operator, **145**

 NOTYPEMERGE loader command, **411**

 number

 17-bit, **130**

- numeric constant
 - other bases, **65**
- numeric value
 - character constant, **67**
 - constant, **64**
 - as expression operand, **131**
 - immediate value, **164**
 - integer constant, **65**
 - real constant, **66**
- O**
 - .o suffix, **23, 27**
 - OBJECT assembler control, **202**
 - OFFSET attribute, **73**
 - OFFSET operator, **149**
 - with group, **104**
 - OMF format
 - See* file format
 - OPEN librarian command, **449**
 - operand
 - in syntax, **69**
 - positioning, **164**
 - required typing, **162**
 - operating notices, **275–278**
 - operation differences, processor modes, **209–210**
 - operation of assembler, **52**
 - operator
 - AND, **144**
 - /, **141**
 - EQ, **145**
 - GE, **145**
 - GT, **145**
 - HIGH, **143**
 - LE, **145**
 - LENGTH, **151**
 - logical, **144**
 - LOW, **143**
 - LT, **145**
 - macro preprocessor, **250–252**
 - MASK, **154**
 - , unary, **137–138**
 - MOD, **141**
 - *, **141**

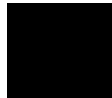

- operator (continued)
 - NE, **145**
 - NOT, **145**
 - OFFSET, **149**
 - OR, **144**
 - + , unary, **137–138, 145**
 - PTR, **147**
 - record, **154**
 - SEG, **149**
 - SHL, **142**
 - SHORT, **146**
 - SHR, **142**
 - SIZE, **152**
 - THIS, **146**
 - TYPE, **150**
 - WIDTH, **155**
 - XOR, **144**
- operator precedence, **159**
- operators, **137**
- OPTIMIZE assembler control, **202**
- optimizing, **27**
- OR operator, **144**
- ORDER loader command, **403–404**
- order of input files, **33**
- ORG directive, **108**
- override
 - group, **148**
 - segment, **148, 172**
 - segment override checked against ASSUME, **173**
- P**
 - % (metacharacter), **245, 255**
 - page align-type
 - loader, **374**
 - page eject, **25**
 - page length, **27**
 - page width, **27**
 - PAGELength assembler control, **202**
 - PAGEWIDTH assembler control, **203**
 - paragraph number
 - loader, **370**
 - physical segment, **81**
 - loader, **369**

- +**, **145**
 - binary, **138**
 - unary, **137**
 - with base & index register, **134**
- porting tool
 - L_to_o86, **304**
 - nm64, **305**
- position of operand, **164**
- pre-defined macro function, **253–266**
- precedence
 - of operators, **159**
- prefix in syntax, **69**
- preprocessor, **30–31**
- primary assembler controls, **195, 197**
- primary controls, **25**
- primary functions
 - loader, **368**
- PRINT assembler control, **203**
- PROC directive, **109–110**
 - default, **109**
- processor mode
 - 80186, **209**
 - 8086, **209**
 - differences, **209–210**
 - V20, **209**
- program linkage, **84**
- program linkage directive, **84**
- program segmentation, **81**
- PTR operator, **147**
- PUBLIC directive, **111**
- PUBLIC loader command, **405**
- public segment
 - loader, **373**
- PURGE directive, **112–113**
- Q** quoted string
 - as expression operand, **132**
- R** real constant, **66**
- record
 - differences from structure, **84**
 - as expression operand, **132**

- record (continued)
 - initialization, **115**
 - name defined, **63**
 - similarities to structure, **83**
- RECORD directive, **114–117**
- record field
 - as expression operand, **132**
 - name defined, **63**
- record operator, **154**
- register
 - 16-bit, **167**
 - 8-bit, **167**
 - 8087, **168**
 - assumed type, **163**
 - base, **167**
 - floating point, **168**
 - index, **167**
 - segment, **81, 167–168**
- register indirect expression, **134**
- relocatable expression, **130**
- relocatable segment
 - loader, **370**
- RELOCATION TYPE attribute, **75**
- REPEAT macro function, **262**
- REPLACE librarian command, **450**
- RESADD loader command, **406**
- RESNUM loader command, **406**
- RESTORE assembler control, **207**
- ROM, **18**
- S**
 - 17-bit number, **130**
 - SAVE assembler control, **208**
 - SAVE librarian command, **450**
 - saving and restoring settings, **28**
 - SEG loader command, **407–408**
 - SEG operator, **149**
 - segment
 - addressability, **170**
 - default, **82**
 - logical, **82**
 - maximum number, **121**
 - nesting, **121**

segment (continued)
 override operator, **148**
 register, **81**
SEGMENT ADDRESSABILITY attribute, **76**
SEGMENT attribute, **75**
SEGMENT directive, **118–122**
segment name
 defined, **64**
 as expression operand, **133**
segment number, loader, **370**
segment override, **172**
 checked against ASSUME, **173**
segment register
 default value, **87**
 initialization, **95**
SEGMENT RELOCATION attribute, **75**
segmentation
 directive, **81**
 multiple segment definition, **120**
 of program, **81**
segments and load addresses
 loader, **369**
SEGSIZE loader command, **409**
SET macro function, **263**
severity, message, **389**
sharing code between files, **30**
SHL operator, **142**
SHORT operator, **146**
SHR operator, **142**
SIZE operator, **152**
/ operator, **141**
specifier (codemacro specmod), **220**
specmod, **219**
stack segment
 loader, **373**
* (comment) loader command, **389**
START loader command, **410**
string
 as expression operand, **132**
 with DB directive, **92**
 with DW, DD, DQ, DT directive, **92**

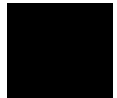

string relational macro function, **257**
STRUC directive, **123–126**
structure
 differences from record, **84**
 initialization, **124**
 name defined, **63**
 similarities to record, **83**
structure field
 as expression operand, **134**
 name defined, **63**
SUBSTR macro function, **245, 264**
subtraction operator
 binary, **138**
 unary, **137**
suffixes, **23–24, 29, 33, 45–46**
supported instruction set, **52**
supported microprocessors, **52**
symbol
 EQU symbols, **64**
 group name, **64**
 instruction mnemonic, **62**
 keyword, **60**
 label, **62**
 label with colon, **62**
 macro preprocessor, **251**
 record field name, **63**
 record name, **63**
 segment name, **64**
 structure field name, **63**
 structure name, **63**
 variable, **62**
symbol in syntax, **59**
symbol information, **26**
symbol table format, **213–216**
symbol with loader, **384**
SYMBOLS assembler control, **204**
syntax
 blank line, **70**
 comment, **69**
 continuation line, **70**
 keyword, **69**

- syntax (continued)
 - label, **69**
 - operand, **69**
 - prefix, **69**
 - symbol, **59**
- T** **THIS** operator, **146**
- TITLE** assembler control, **208**
- translation
 - acvt86 tool, **290–293**
 - HP 64853 to HP B1449, **279–306**
- TYPE** assembler control, **204**
- TYPE** attribute, **73**
- type limit, **411**
- TYPE** operator, **150**
- TYPEMERGE** loader command, **411**
- U** unary minus, **137**
- unary plus, **137**
- unreferenced externals, **28**
- UNREFERENCED_EXTERNALS** assembler control, **204**
- unsettling flags, **24**
- upper case
 - See* case-sensitivity
- user-defined macro, **269**
- user-defined macros, **267–274**
- V** **V20** processor mode, **209**
- V20/V30** mnemonics, **27**
- variable, **83**
- variable name
 - defined, **62**
 - as expression operand, **133**
- version number, **275–278**
- W** **WARN** loader command, **389**
- warnings, suppressing, **28**
- WHILE** macro function, **264**
- WIDTH** loader command, **412**
- WIDTH** operator, **155**
- word align-type
 - loader, **374**
- WORKFILES** assembler control, **205**

Index

- X** XOR operator, **144**
XREF assembler control, **205**



Certification and Warranty

Certification

Hewlett-Packard Company certifies that this product met its published specifications at the time of shipment from the factory. Hewlett-Packard further certifies that its calibration measurements are traceable to the United States National Bureau of Standards, to the extent allowed by the Bureau's calibration facility, and to the calibration facilities of other International Standards Organization members.

Warranty

This Hewlett-Packard system product is warranted against defects in materials and workmanship for a period of 90 days from date of installation. During the warranty period, HP will, at its option, either repair or replace products which prove to be defective.

Warranty service of this product will be performed at Buyer's facility at no charge within HP service travel areas. Outside HP service travel areas, warranty service will be performed at Buyer's facility only upon HP's prior agreement and Buyer shall pay HP's round trip travel expenses. In all other cases, products must be returned to a service facility designated by HP.

For products returned to HP for warranty service, Buyer shall prepay shipping charges to HP and HP shall pay shipping charges to return the product to Buyer. However, Buyer shall pay all shipping charges, duties, and taxes for products returned to HP from another country. HP warrants that its software and firmware designated by HP for use with an instrument will execute its programming instructions when properly installed on that instrument. HP does not warrant that the operation of the instrument, or software, or firmware will be uninterrupted or error free.

Limitation of Warranty

The foregoing warranty shall not apply to defects resulting from improper or inadequate maintenance by Buyer, Buyer-supplied software or interfacing, unauthorized modification or misuse, operation outside of the environment specifications for the product, or improper site preparation or maintenance.

No other warranty is expressed or implied. HP specifically disclaims the implied warranties of merchantability and fitness for a particular purpose.

Exclusive Remedies

The remedies provided herein are buyer's sole and exclusive remedies. HP shall not be liable for any direct, indirect, special, incidental, or consequential damages, whether based on contract, tort, or any other legal theory.

Product maintenance agreements and other customer assistance agreements are available for Hewlett-Packard products.

For any assistance, contact your nearest Hewlett-Packard Sales and Service Office.