

# Agilent Infiniium Oscilloscopes Performance Guide Using 89600 Vector Signal Analyzer Software

Application Note

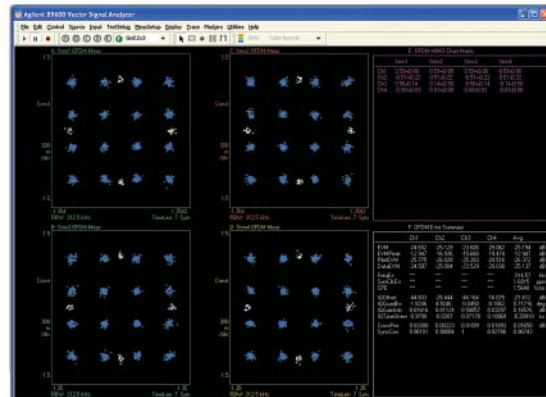

Ultra-broadband vector  
signal analyzer measurements  
using Agilent Infiniium oscilloscopes.

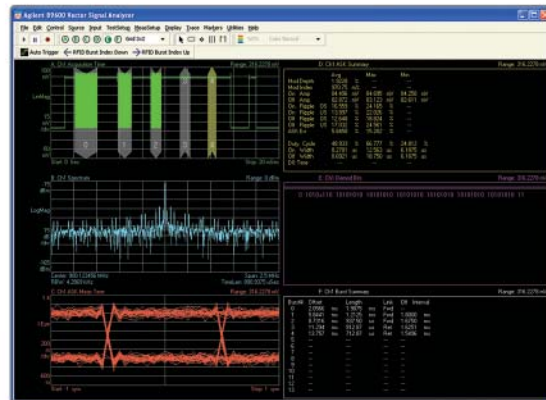
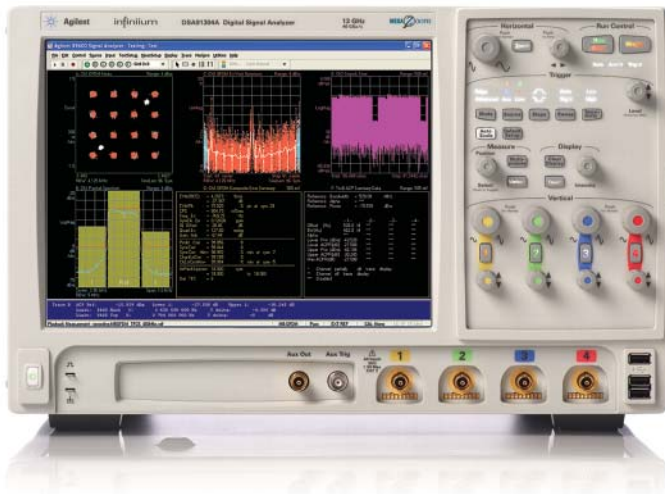
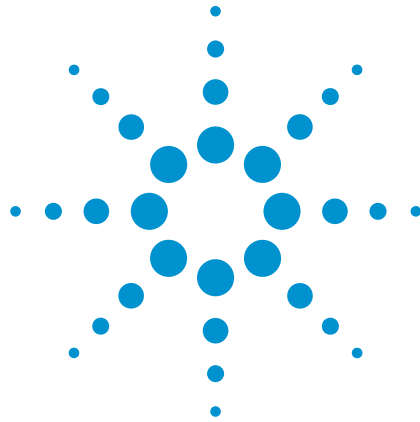

**Agilent Technologies**

# Table of contents

<b>1 Overview</b> .....	3
1.1 89600 VSA software .....	4
1.2 Required software revisions .....	5
<b>2 Install 89600 VSA software</b> .....	6
<b>3 Hardware configuration</b> .....	7
3.1 I/O between computer and oscilloscope .....	7
3.2 Anti-alias filters and alias exposure-free mode .....	8
<b>4 Operation</b> .....	8
4.1 Basic operation .....	8
4.2 Sampling modes: full rate, maximize, minimize, and user rate .....	9
4.3 Resample location parameter .....	12
4.4 Special trigger modes: Traditional low duty cycle hold-off .....	12
4.5 Special trigger modes: Custom trigger commands .....	13
4.6 Changing the preset conditions .....	13
4.7 Differences from 89600 VSA operation .....	14
<b>5 Time and frequency span operating region</b> .....	14
5.1 The relationship of Main Time Length, Span, and Sample Rate .....	14
5.2 Operating region curves for Infiniium oscilloscopes .....	15
5.3 Recording limits for Infiniium oscilloscopes .....	20
<b>6 Out-of-band alias exposure zones</b> .....	21
6.1 Setting up the alias exposure zone checker .....	21
6.2 Using the alias exposure zone checker .....	21
<b>Appendix A: Downconverting RF and microwave signals into the range of the infiniium oscilloscopes</b> .....	25
<b>Appendix B: Cables and I/O cards for connecting a PC to an infiniium oscilloscope</b> .....	26
<b>Appendix C: PC requirements to run 89600 software</b> .....	26
<b>Appendix D: Operating region curves</b> .....	27
<b>For More Information</b> .....	34
<b>Related Literature List</b> .....	34

# 1 Overview

This product note describes the characteristics, setup, and operation of an ultra-broadband vector signal analyzer (VSA) comprised of an infinium 8000, 9000, 80000, or 90000 Series oscilloscope and the 89600 vector signal analyzer software. By taking advantage of the layered architecture and extensive digital signal processing (DSP) routines of the 89600 VSA software, the oscilloscope becomes a new “front end” data acquisition subsystem for the VSA. This hardware-software combination provides up to 13 GHz of analysis bandwidth depending on the oscilloscope used. See Table 1 for the supported oscilloscope models and the corresponding analysis bandwidths. Appendix A contains suggestions for ultra-wideband downconverters.

The 8-bit, high sample rate analog-to-digital converter (ADC) in the Infiniium oscilloscopes produces the large analysis bandwidths shown in Table 1. These bandwidths are capable of providing a spurious-free dynamic range greater than or equal to 40 dB. This is sufficient for 1.5 to 2% error vector magnitude measurements in most cases. For spectrum measurements with higher dynamic range, a traditional spectrum analyzer should be used.

**Table 1. Infiniium oscilloscopes supported by 89600 VSA software**

Model	Analysis bandwidth	Max. sample rate	Main time memory options supported
8064	0 to 600 MHz	2 Gsa/s	2 M (4/8/16/32/64 M options)
8104 <sup>1</sup>	0 to 1.0 GHz	4 Gsa/s	2 M (4/8/16/32/64 M options)
9104	0 to 1.0 GHz	5 Gsa/s	10 M (20/50/100/200/500 M options)
9254	0 to 2.5 GHz	10 Gsa/s	10 M (20/50/100/200/500 M options)
9404 <sup>3</sup>	0 to 4.0 GHz	20 Gsa/s	10 M (20/50/100/200/500 M options)
80204	0 to 2 GHz	10 Gsa/s	512 K (64 M option)
80304	0 to 3 GHz	10 Gsa/s	512 K (64 M option)
80404	0 to 4 GHz	20 Gsa/s	512 K (64 M option)
80604	0 to 6 GHz	20 Gsa/s	512 K (64 M option)
80804 <sup>2</sup>	0 to 8 GHz	40 Gsa/s	512 K (64 M option)
81004 <sup>2</sup>	0 to 10 GHz	40 Gsa/s	512 K (64 M option)
81204 <sup>2</sup>	0 to 12 GHz	40 Gsa/s	512 K (64 M option)
81304 <sup>2</sup>	0 to 13 GHz	40 Gsa/s	512 K (64 M option)
90254	0 to 2.5 GHz	10 Gsa/s	10 M (20/50/100/200/500 M/1 G options)
90404	0 to 4 GHz	20 Gsa/s	10 M (20/50/100/200/500 M/ 1 G options)
90604	0 to 6 GHz	20 Gsa/s	10 M (20/50/100/200/500 M/ 1 G options)
90804	0 to 8 GHz	40 Gsa/s	10 M (20/50/100/200/500 M/ 1 G options)
91204	0 to 12 GHz	40 Gsa/s	10 M (20/50/100/200/500 M/ 1 G options)
91304	0 to 13 GHz	40 Gsa/s	10 M (20/50/100/200/500 M/ 1 G options)

1. When using 3 or 4 VSA channels, analysis bandwidth is limited to 781.25 MHz, and max sample rate is limited to 2 Gsa/s.
2. When using 3 or 4 VSA channels, analysis bandwidth is limited to 7.8125 GHz, and max sample rate is limited to 20 Gsa/s.
3. When using 3 or 4 VSA channels, analysis bandwidth is limited to 3.90625 GHz, and max sample rate is limited to 10 Gsa/s.

## 1.1 89600 VSA software

The 89600 vector signal analyzer (VSA) software is the heart of the ultra-broad-band VSA. This software provides flexible tools for analyzing and demodulating even the most advanced digital modulations, including those not defined by an established standard.

The VSA makes measurements on signals in the time and frequency domains using either the BB (baseband) or IF zoom mode. In BB mode, the analysis frequency range is from 0 Hz to the stop frequency. In IF zoom mode, the analysis frequency range is defined by center frequency and span. There is also an I+jQ mode for analyzing two baseband quadrature channels. For supported 4-channel Infiniium oscilloscope models, the 89600 software provides up to four channels of vector signal analysis, or dual I+jQ capability. Results for any mode can be displayed as magnitude or phase, in I/Q and several other formats.

In addition, the 89600 software provides a signal record feature for later playback and analysis.

With the optional digital demodulator, option AYA, modulation quality measurements in the form of error vector magnitude (EVM) can be made on digital wireless communications signals with bandwidths of hundreds of MHz. In addition, powerful diagnosis capabilities allow you to determine the exact impairments that cause a digitally modulated signal to fail quality standards.

The features of the digital demodulator include variable-block-size signal acquisition, pulse burst edge search, synch word search and a user-controllable adaptive equalizer.

User-selectable filter types include cosine (raised and square-root raised), gaussian, lowpass, and user-defined. You can vary the filter alpha/BT shape factor. Supported modulation formats for both burst and continuous carriers include FSK, BPSK, QPSK, OQPSK, DQPSK,  $\pi/4$ DQPSK, 8PSK, QAM (16 to 1024), MSK and more.

For IEEE 802.11n WLAN applications, option B7Z provides 2-, 3-, or 4-channel MIMO analysis which can be used with supported 2- or 4-channel Infiniium models.

Mobile WiMAX™ 2x2 MIMO analysis is available in Option B7Y IEEE 802.16e OFDMA modulation analysis.

LTE 4x4 MIMO modulation analysis is also available. Option BHD supports LTE FDD, while Option BHE supports LTE TDD.

For information on additional modulation analysis options, see the 89600 VSA software data sheet, 5989-1786EN.

## 1.2 Required software revisions

The following table lists the software revisions, by model number, for an oscilloscope to work with the 89600 software. GPIB and LAN refer to the choice of connections between the oscilloscope and the PC running the software. Firmware version numbers greater than these will also work.

**Table 2. Software revision numbers**

<b>Model #</b>	<b>Infiniium GPIB</b>	<b>Infiniium LAN</b>	<b>89600<sup>1</sup></b>
8064	A.04.90	A.04.90	6.20
8104	A.04.90	A.04.90	6.20
9104	02.00	02.00	11.00
9254	02.00	02.00	11.00
9404	02.00	02.00	11.00
80204	A.05.00	A.05.00	6.20
80304	A.05.00	A.05.00	6.20
80404	A.05.00	A.05.00	6.20
80604	A.05.00	A.05.00	6.20
80804	A.04.00	A.04.00	6.00
81004	A.04.00	A.04.00	6.00
81204	A.04.00	A.04.00	6.00
81304	A.04.00	A.04.00	6.00
90254	01.00	01.00	8.00
90404	01.00	01.00	8.00
90604	01.00	01.00	8.00
90804	01.00	01.00	8.00
91204	01.00	01.00	8.00
91304	01.00	01.00	8.00

---

1. Version 10.00 or later required for 3- or 4-VSA channel analysis.

## 2 Install 89600 VSA software

There are two operating modes for running the software: embedded in the Infiniium scope, or with the software running remotely in a PC connected to the oscilloscope.

### **Remote PC connection**

Insert the Agilent 89600 Series software installation CD-ROM and follow the instructions in the installation manager window. Click **Install 89600 Series Software**. Continue through the Installation Manager to complete the installation. Exit the installation manager window.

### **Embedded operation**

Infiniium Series oscilloscopes come with 89600 VSA software. To install, double click the VSA executable file. The most recent version of the software can also be downloaded from [www.agilent.com/find/89600](http://www.agilent.com/find/89600). Scroll down to "TRY THE 89600 VSA SOFTWARE..." and follow the links to download the software or order a CD. For more information, follow the instructions in the installing 89600 software in Agilent Infiniium Scopes section of the installation and VXI service guide. This guide can be found on the Agilent Technologies 89600 Series software CD at \manuals\InstallationGuide.pdf.

**Note: For embedded operation, be sure to use the *software-only installation (no hardware support)* selection as directed by the installation guide.**

**Note: Not all Infiniium Series scopes have built-in CD drives. For those units, you need the appropriate option for an internal drive, an optional external DVD-RW drive (such as the Agilent N5473A), or access to an external DVD or LAN to download the software.**

# 3 Hardware Configuration

Connect the oscilloscope and the computer as shown in Figures 1a through 1c. There are two options for the connection, GPIB and LAN. Refer to Appendix B for more information on the LAN cable, the GPIB cable, and the GPIB interface cards.

For improved measurement speed, use of a LAN is recommended with deep memory oscilloscopes (8000, 9000, 80000, or 90000 Series).

## 3.1 I/O between computer and oscilloscope

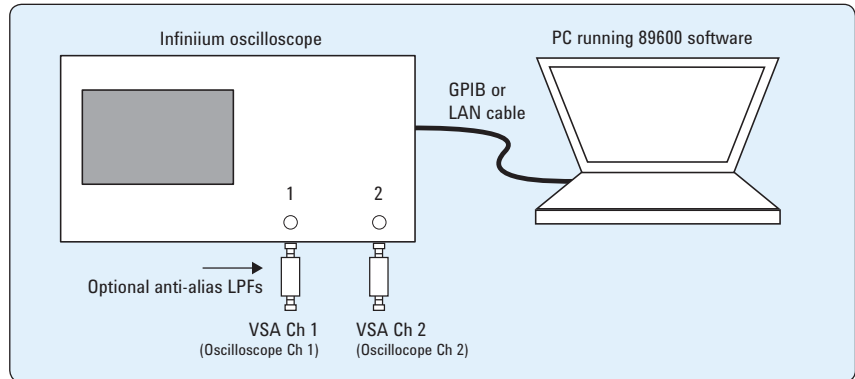

Figure 1a. Equipment connections for 2-channel oscilloscopes

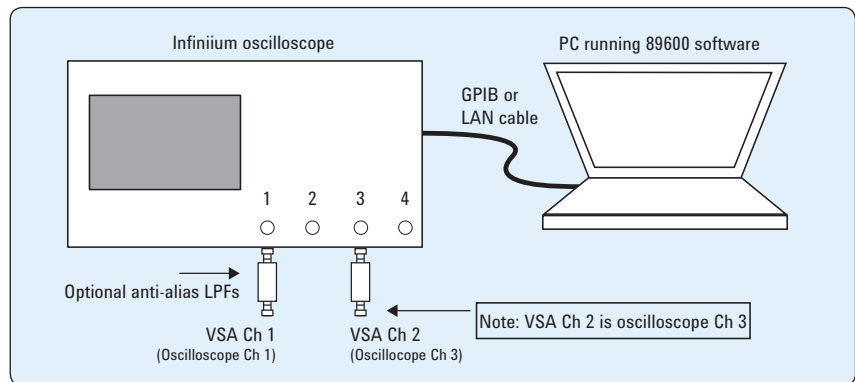

Figure 1b. Equipment connections for 4-channel oscilloscopes used to provide 2-channel input to 89600 VSA software

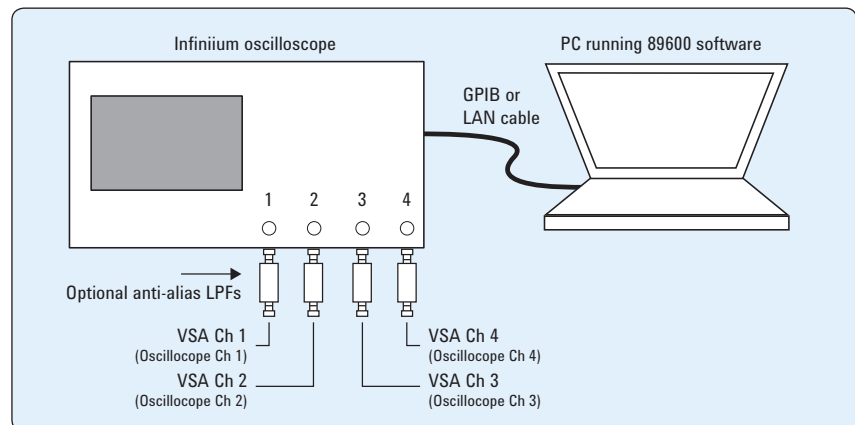

Figure 1c. Equipment connections for 4-channel oscilloscopes used to provide 3- or 4-channel VSA measurements using the 89600 VSA software

To complete the configuration of the PC, follow the instructions in the “Configuring Infiniium Windows XP Scopes” chapter in the installation and VXI service guide. This guide can be found on the VSA software CD at \manuals\InstallationGuide.pdf.

## 3.2 Anti-alias filters and alias exposure-free mode

The ultra-broadband VSA can be configured to be essentially alias-free by using the **Full Rate Sampling Mode** and installing an external lowpass filter on the oscilloscope input. The need for a lowpass filter depends on the scope model number being used, the number of channels on the scope being used, and the analysis frequency. Table 3 provides information on the lowpass filter characteristics needed when making measurements for the given scope listed, and the number of channels being used.

**Table 3. Minimum lowpass filter characteristics**

Oscilloscope model <sup>1</sup>	Number of scope channels used	Cutoff frequency	Stopband frequency <sup>2</sup>
80804/81004/81204/81304	3 or 4	7.8125 GHz	12.2 GHz
8104	1 or 2	1.0 GHz	3.0 GHz
8104	3 or 4	781.25 MHz	1.22 GHz
8064	1, 2, 3, 4	600 MHz	1.4 GHz

# 4 Operation

## 4.1 Basic operation

Operation of the ultra-broadband VSA is substantially the same as that of the 89600 VSA. See the following sections for some differences or special configurations. There is an online tutorial and getting started guide under the help/roadmap toolbar in the 89600 software.

**NOTE: DO NOT adjust any controls on the oscilloscope's front panel. All oscilloscope operation is controlled by the software. The oscilloscope controls cannot be locked, and adjusting them may cause the software to give errors.**

**NOTE: Calibrate the oscilloscope periodically by following its calibration instructions. With a mouse connected to the oscilloscope at power on, select Utilities>Calibration and follow the displayed instructions.**

- 
1. Models with channel configurations not listed do not require a low-pass filter. The scope's input circuitry provides sufficient alias protection.
  2. Frequency at which the loss must be > 40 dB.



## 4.2 Sampling modes: full rate, maximize, minimize, and user rate

### Full rate mode

When the **Sample Mode** is set to **Full Rate** using the **Utilities>Hardware>ADC1 >Infiniium series oscilloscope>Configure>Sample mode>Edit** menu path, the oscilloscope sample rate is fixed at the maximum for each oscilloscope model according to Table 4.

**Table 4. Sample rates of Infiniium oscilloscopes in Full Rate mode**

Infiniium model	Full sample rate
8104	4 Gsa/s <sup>1</sup>
8064	2 Gsa/s
9104	5 Gsa/s
9254	10 Gsa/s
9404	20 Gsa/s <sup>3</sup>
80204/80304	10 Gsa/s
80404/80604	20 Gsa/s
80804	40 Gsa/s <sup>2</sup>
81004	40 Gsa/s <sup>2</sup>
81204	40 Gsa/s <sup>2</sup>
81304	40 Gsa/s <sup>2</sup>
90254	10 Gsa/s
90404/90604	20 Gsa/s
90804/91204/91304	40 Gsa/s

With the addition of the anti-alias lowpass filter described earlier, this mode is free of alias exposure zones. This means that no signal anywhere in the range of the VSA's center frequency will alias upon the desired signal and corrupt the measurement.

There is a trade-off when using this mode. The 8000, 9000, 80000, and 90000 Series oscilloscopes have deep memories allowing long record lengths. If a longer **Main Time** (or **Result Length** for digital demodulation) is needed for more resolution in the frequency domain, go to the **Configure** menu, click on **Sample mode>Edit** and select either **Maximize** or **Minimize** from the drop-down menu. The **Main Time** limit for any sample rate is shown in the operating region curves that appear later in this application note.

**NOTE: Any limitation to Main Time (or Result Length) will be indicated by the inability of the software to increase the Main Time or decrease RBW when Number Of Frequency Points is increased.**

### Maximize mode

When the **Sample Mode** is set to **Maximize**, the sample rate is set by the software to the largest value possible for proper sampling with the selected center frequency/span combination. In this mode, sometimes called IF subsampling, the sample rate is selected to ensure no alias fold over in the desired center frequency/span region.

Depending on the center frequency/span combination, the IF subsample rate can be less than the full sample rate available in the oscilloscope. When it is much less than the full rate, significant increases in **Main Time** are possible. As with the **Full Rate** mode, any limitation of the **Main Time** for proper sampling will be indicated by the inability of the software to increase the **Main Time** when **Number Of Frequency Points** is increased.

This mode allows operation in the middle values of **Main Time** (as shown

- 
1. 2 Gsa/s when using 3 or 4 VSA input channels.
  2. 20 Gsa/s when using 3 or 4 VSA input channels.
  3. 10 Gsa/s when using 3 or 4 VSA input channels.

by the operating region curves in Appendix D) with the penalty of some alias exposure zones.

Alias exposure zones are those bands of frequencies that, if occupied by an unwanted signal, will alias down into the frequency span of interest and corrupt the measurement. However, **Maximize** mode will spread the out-of-band alias exposure zones away from the desired signal to the greatest degree. Exposure zones will not be a problem with the majority of measurements of clean, single-signal devices. However, devices with multiple signals or spurious signals could cause problems. See Section 6.1 to find out how to determine if there are any unwanted signals at frequencies that can alias down into the frequency span of the measurement.

While operating in **Maximize** mode, caution must be exercised under measurement conditions that change the record length. Changes to record length generally result in changes to the oscilloscope's sample rate that, in turn, cause changes in the alias exposure regions, which can adversely affect measurement results.

In addition to changing **Main Time Length** (or **Result Length** in digital modulation analysis operation), here are some other measurement situations that may change record length:

- When taking a recording the 89600 software will generally change the acquisition length to match the desired record length. This may be significantly different from the acquisition length used to set up the recording.
- When entering digital modulation analysis from **Demod Off** the acquisition length is generally changed significantly.
- When changing search length during a digital modulation analysis measurement.
- When changing **RBW** in non-demod operation. **RBW** changes have a direct impact on **Main Time Length**.

As stated earlier, the primary way to avoid alias problems in these measurement situations is to ensure that the measured signal is band-limited to the frequencies of interest. If this is not possible, then the alias checker macro should be utilized to ensure that any alias components do not negatively affect your measurement results.

### **Minimize Mode**

When the **Sample Mode** is set to **Minimize**, the oscilloscope's sample rate is set to the smallest value possible for proper IF subsampling with the current center frequency/span combination. Depending on the center frequency/span combination, the IF subsample rate can be less than the full sample rate available in the oscilloscope. When it is much less than the full rate, significant increases in **Main Time** are possible.

Minimize mode gives the largest values of **Main Time** on the operating region curves. However, it produces less spreading of the out-of-band alias exposure zones. Use **Minimize** if there are no out-of-band signals and the longest **Main Time** values are desired.

### **User Rate Mode**

The **User Rate** setting allows you to directly control the oscilloscope's sample rate. In this mode you select the oscilloscope sample rate to be used. The actual sample rate selected will be the highest rate that is less than or equal to the **User Sample Rate** setting. By controlling the oscilloscope's sample rate you can directly influence the update rate of the VSA. This is because sample rate directly affects the number of points the oscilloscope must transfer to the PC. Certain measurements can be made significantly faster by limiting the oscilloscope sample rate due to reduced data transfer requirements.

There are two types of signal aliasing to be concerned with when using the 89600 VSA application with the infiniium oscilloscope. The first is aliasing of unwanted out-of-band signals into the measurement span. This will not be a problem with the majority of clean, single-signal devices. However, devices with multiple or spurious signals could have this type of aliasing. Section 6 describes how to perform a check to determine if there are any unwanted signals present that can alias down into the measurement span. A second type of aliasing happens when the sample rate causes the in-band signal to fold over on itself. This in-band (or self-) aliasing is avoided in **Full Rate**, **Maximize** and **Minimize** mode by automatically selecting a suitable sample rate. However, in **User Rate** in-band aliasing may be a problem. To avoid in-band aliasing you must select a suitable sample rate based on your measurement center frequency and span.

To avoid in-band aliasing the oscilloscope sample rate ( $F_s$ ) must be selected so that the analysis span falls within confined regions. Staying within these regions prevents the analysis span from being positioned too close to  $F_s/2$ . When  $F_s$  is selected so that the span is confined to be within a single gray box (see diagrams below), in-band aliasing is avoided. See the following table for the equations that describe these in-band alias-free regions.

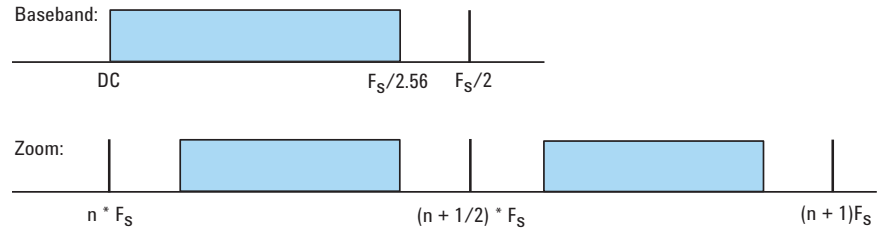

**Figure 2. Avoiding in-band aliasing by selecting  $F_s$  within a confined span**

The primary use of **User Rate** mode is to increase the update rate for measurements that have been carefully engineered to avoid unwanted alias signals.

**NOTE: The VSA does not attempt to avoid alias exposure regions when in User Rate mode.**

This table summarizes the difference in approach to alias protection between the various sample modes:

**Table 5. Varying approaches for alias protection**

<b>Full rate</b>	Both in-band and out-of-band aliasing are prevented through use of an appropriate low-pass filter.
<b>Maximize and minimize</b>	<p>In-band aliasing is avoided by VSA software making appropriate sample rate selection based on the center frequency and span settings.</p> <p>Out-of-band aliasing is minimized through use of appropriate low-pass filter. Use of alias checker macro (Section 6) is required to detect other unwanted out-of-band signal aliasing. (Note: aliasing of unwanted signals can be eliminated through use of appropriate band-pass filter.)</p>
<b>User rate</b>	<p>You are responsible to avoid in-band aliasing through appropriate selection of sample rate based on center frequency and span. To ensure no in-band aliasing is present the oscilloscope sample rate (FS) must be selected to meet this criteria:</p> <p>Baseband: <math>F_{STOP} \leq F_s/2.56</math></p> <p>Zoom: <math>(n \cdot F_s)/2 \leq F_{CENTER} - (1.28 \cdot F_{SPAN})/2</math>  AND  <math>((n+1) \cdot F_s)/2 \geq F_{CENTER} + (1.28 \cdot F_{SPAN})/2</math>  where n = 1,2,3,4...</p> <p>Out-of-band aliasing is minimized through use of appropriate low-pass filter. Use of alias checker macro (Section 6) is required to detect other unwanted out-of-band signal aliasing. (Note: aliasing of unwanted signals can be eliminated through use of appropriate band-pass filter.)</p>

Another concern in **User Rate** mode is that you may see unwanted amplitude variability in two channel measurements. This can occur if any part of the measurement frequency span falls within the regions defined by:

$$(2 \cdot n + 1) \times F_s / 2 \pm 0.1 \times F_s$$

where n = 1,2,3,4...

where  $F_s$  is the actual oscilloscope sample rate. Make sure you choose a sample rate where such overlap does not occur.

### 4.3 Resample location

The 8000, 9000, 80000, and 90000 Series oscilloscopes have deep memories allowing long record lengths. The 89600 VSA software automatically resamples the data taken to the span required, which minimizes the amount of data actually required for the measurement. However, the large number of data points possible with the Infiniium scopes configured with large memory options can exceed the software's internal limit. Many hardware platforms will resample the data before sending it to the VSA software, but this is not the case for the Infiniium scopes. To deal with this, resampling is available in the VSA's Infiniium driver, or in the main body of the VSA software.

The advantage of choosing resampling in the driver is that longer time lengths are available, since only needed measurement points are sent to the VSA software. The tradeoff is that the raw scope data is not available for viewing, which may mean that some events may not be seen in the VSA's traces. For instance, a trigger may occur on oscilloscope data that is outside of the measurement span and therefore not visible in the VSA's traces. Resampling in the driver is on by default, but may be turned off by changing the **Resample Location** parameter to **Measurement** instead of **Driver** in the **Hardware Configuration** menu. There is an exception to this: When the **Sample Mode** is set to **Maximize**, the resample location will be **Driver**

regardless of the state of the **Resample Location** parameter (in order for the **Maximize** mode behavior to be backward compatible).

You will see that when the **Resample Location** is set to **Driver**, the **Raw Main Time** trace title will be changed to **Resampled Raw Main Time**. This helps avoid confusion and makes it easily apparent when the resampling is occurring in the VSA's infiniium driver and not in the main VSA software.

There will be some additional changes that may affect backward compatibility when the **Resample Location** hardware parameter is set to **Driver**.

- The **Raw Main Time** trace will no longer display the scope's baseband data when the **Resample Location** hardware parameter is set to **Driver** (except when using baseband mode and the measurement sample rate is at the same sample rate as the oscilloscope). Instead, it will display the data from the output of the driver's resampler.
- Recordings will normally capture complex data at the measurement sample rate/span/center frequency instead of the raw scope data (i.e., real baseband data at the scope sample rate).
- Channel triggering may be harder to set up since the triggering is being done by the scope hardware before the resampler, but **Raw Main Time** will be displaying the data from the output of the resampler.

#### 4.4 Special trigger modes: traditional low duty cycle hold-off

The trigger parameter hold-off has two modes in the VSA software: **Burst** and **Low Duty Cycle**. In the **Burst** mode, hold-off is defined as an amount of time that a pulsed carrier must be off before a trigger event can occur (see the interactive help tool). The **Burst** mode is selected under **Utilities>Hardware>ADC1>Infiniium>Configure>Hold-off type>Edit>Burst hi duty cycle**. The **Burst** mode definition is optimized for high duty cycle communications bursts and is different from the traditional definition of hold-off for low duty cycle pulses. For low duty cycle pulses, hold-off is defined as a dead time after the trigger event during which no additional trigger events can occur.

To activate the traditional **Low Duty Cycle** pulse hold-off mode, click **Utilities>Hardware>ADC1>Infiniium>Configure>Hold-off type>Edit>Low duty cycle**. Enter a time that is longer than the expected duration of the input pulse.

See the interactive help tool for a complete description of the high duty cycle hold-off. See the oscilloscope's help tool for a description of the traditional low duty cycle hold-off.

#### 4.5 Special trigger modes: custom trigger commands

The infiniium oscilloscopes have extensive trigger conditioning and pattern capability. To take advantage of any mode not covered in the ultra-broadband VSA personality, a custom trigger mode is available. Click **Utilities>Hardware>ADC1>Infiniium>Configure>Custom trigger type>Edit** and click the check box. You can then enter the SCPI commands for specific triggering modes using the custom trigger command entry box. Click **Utilities>Hardware>ADC1>Infiniium>Configure>Custom trigger commands>Edit**. Enter the sequence of SCPI trigger commands in the dialog box. Use a semicolon to separate the commands. The commands will be transmitted to the oscilloscope upon clicking the last **OK** box when closing the configure windows and whenever standard trigger commands are sent.

#### 4.6 Changing the preset conditions

The preset conditions can be changed for the oscilloscope by entering SCPI commands in the **Hardware>ADC1>Infiniium>Configure>User SCPI preset** menu path. Separate commands with a semicolon. Verify that any commands do not conflict with the normal operation of the software.

## 4.7 Differences from 89600 VSA operation

- No **Magnitude Trigger** (however, **Channel Trigger** is available).
- Possible limitation of movement on the operating region curve to avoid alias corruption of the measured signal. This depends on the settings of **Center Frequency**, **Span**, **Sample Mode**, and **Number Of Frequency Points**. There is also potential interference due to the alias products of out-of-band signals. (See Section 6.)
- No built-in wideband calibrator. The frequency response corrections are determined from factory data.

## 5 Time and frequency span operating region

The operating region curves for the ultra-broadband VSAs are different from those of standard VSAs because the **Main Time Length** may be limited for some sample rate, center frequency, and span combinations. The differences are due to three hardware characteristics of the ultra-wideband ADCs in the Infiniium oscilloscopes:

- A much higher sampling rate
- The lack of a hardware decimator, which means the decimation must be performed by the software from same-length records taken at much higher sampling rates
- Limited memory capacity

### 5.1 The relationship of main time length, span, and sample rate

The record length, or **Main Time Length** of a measurement is shown in the lower right corner of a spectrum or time display window. This is the length of time the oscilloscope sampled the input waveform for the measurement. These samples are transferred to the DSP and measurement algorithms running on the software.

Maximum **Main Time Length** is normally adjusted by setting **Number Of Frequency Points** in the **MeasSetup>ResBW** menu. **ResBW Coupling** is set to **Auto**, and **ResBW Mode** is set to **Arbitrary** or **1-3-10**. The **Time** tab can then be used to set **Main Time Length** up to this maximum limit. This setup keeps **Main Time Length** maximized and within the DSP requirements.

Although **Main Time Length** can be adjusted directly by the **MeasSetup>Time** menu, it cannot be greater than the limit imposed by the **Number Of Frequency Points** line on the operating region chart. See the online help tool for a complete discussion.

**Note: The maximum Main Time Length can be found as follows:**

The relationship between the parameters is shown below:

$$\text{Max Main Time Length} = \frac{\text{Number of frequency points}}{\text{Span}}$$

$$\text{where Span} = \frac{\text{Sample rate}}{1.28} \quad (\text{for IF Zoom mode})$$

$$\text{Max Main Time Length} = \frac{1.28 \times \text{Number frequency points}}{\text{Sample rate}}$$

where **Sample rate** = current sample rate computed by the software for alias-free measurements

Maximum **Main Time Length** may be further limited by oscilloscope memory depth.

## 5.2 Operating region curves for Infiniium oscilloscopes

Several interrelated characteristics of both the Infiniium oscilloscopes and the 89600 VSA software combine to form a region within which the VSA is constrained to operate. The 89600 VSA software characteristics that affect this operating region include maximum number of time points, the minimum number of time points (not user settable), a maximum acquisition record size (not user settable) and a maximum decimation factor (not user settable). The Infiniium characteristics that affect the operating region are sample rate and memory depth. This section describes the effects each of these parameters have on the VSA operating region.

The operating region is described in terms of span and time record length. For a given window type it could just as easily be described in terms of span and RBW. Figure 3 shows the effects of the number of time points the 89600 VSA software is allowed to collect. Because sample spacing is inversely proportional to span, the record length decreases as span increases. Although a family of lines is shown, only two define the operating region at any one time. The lowest line gives the smallest time record length allowed for any given span. The position of this line is determined by minimum number of time points (16) the VSA requires in a time record. The line that defines the upper time record length boundary is positioned by the maximum number of time points the VSA allows in a time record. The maximum number of time points is determined by the **Frequency Points** setting (**MeasSetup>ResBW>Frequency Points**). The 89600 VSA is constrained to operate in the region between these two lines. Note that the operating lines of Figure 3 are the same for all Infiniium models.

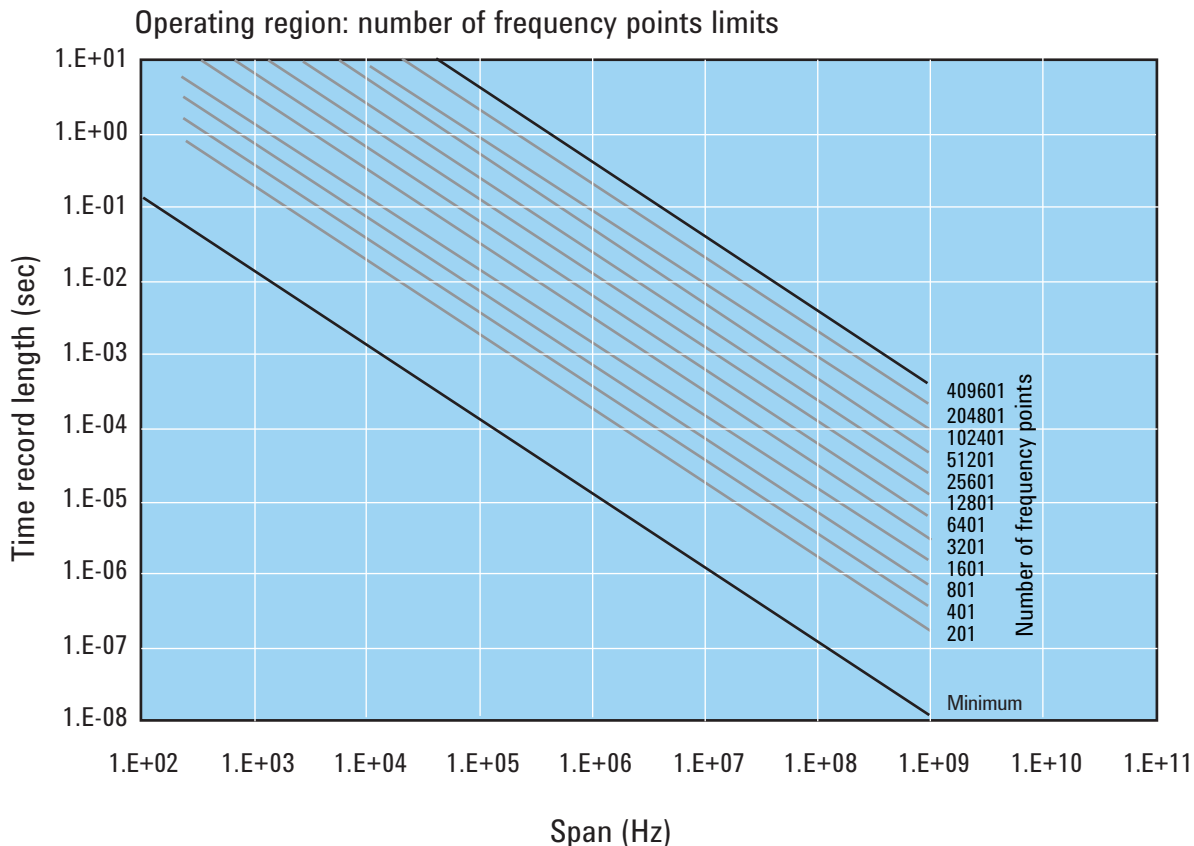

Figure 3. The user-settable parameter, frequency points, begins to determine the boundaries of the time record length and frequency span operating region.

In addition to the time record length limits, there are limits to the allowable range of spans. These are represented as vertical lines on the operating region in Figure 4. The upper span limit is set by the scope's sample rate. For the highest sample rate supported by the scope this boundary may be further limited by the analog performance of the scope's front-end. To zoom in on a signal of interest by reducing the span, traditional VSA instrumentation reduces the effective sample rate through the use of decimating filters while keeping the ADC at full rate. This technique allows for maximum alias protection. Unlike traditional VSA instruments, the infiniium scopes have no decimating filters. To compensate for this shortcoming, decimating filters have been built into the 89600 VSA software. The maximum amount of decimation allowed by the 89600 VSA software sets the minimum span for any given scope sample rate.

The operating region depicted in Figure 4 is determined by constraints imposed by both time record length and span. The infiniium scopes support many sample rates. For each sample rate, the operating region shifts slightly on the operating region graph. As the sample rate decreases, the operating region shifts slightly up and to the left. So, for any given scope, there will be a family of overlapping operating regions, one for each supported sample rate.

In general, these regions would be the same for every scope that supports a given sample rate. The only difference is when the maximum span at the maximum sample rate is limited by analog performance of the scope's front-end rather than just by the sample rate.

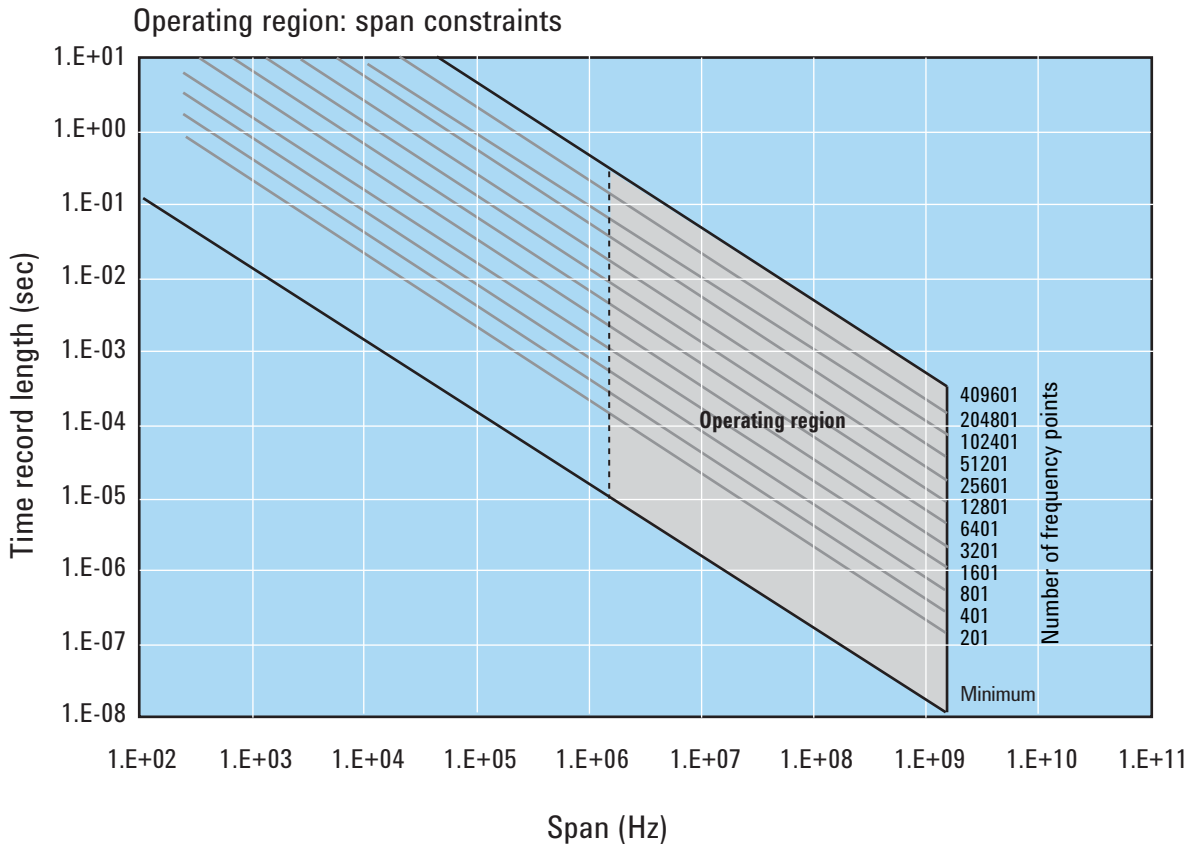

Figure 4. The allowable range of spans, which may differ by model, further bound the operating region of the oscilloscope.



In addition to time record and sample rate limits, the operating region can be further limited by memory constraints. Both the scope and the 89600 VSA software impose different, but similar, constraints due to maximum memory usage. Figure 5 shows how memory limits can actually affect both maximum time length and minimum span (mostly the horizontal curve that drops at the left). For a given scope sample rate the scope memory imposes an upper bound on the time record length. This is shown as the upper portion of the operating region that is effectively cut off by the horizontal memory line. This limit is fairly constant until the span narrows significantly. The sharp drop at the left end of the memory curve is due to the effects of decimation and extra points acquired for 89600 VSA software filter settling. As the amount of decimation increases, the portion of the available sample memory that is required for settling becomes a much higher percentage of the available overall sample memory. When this happens, the portion of the sample memory that is available for displayed time record length is quickly reduced.

The memory curve moves up, exposing more of the available operating region, as the scope's optional memory is increased. However, the 89600 VSA software imposes its own record size limit. Increasing the scope's memory beyond the 89600 VSA software limit has no further impact on the available operating region.

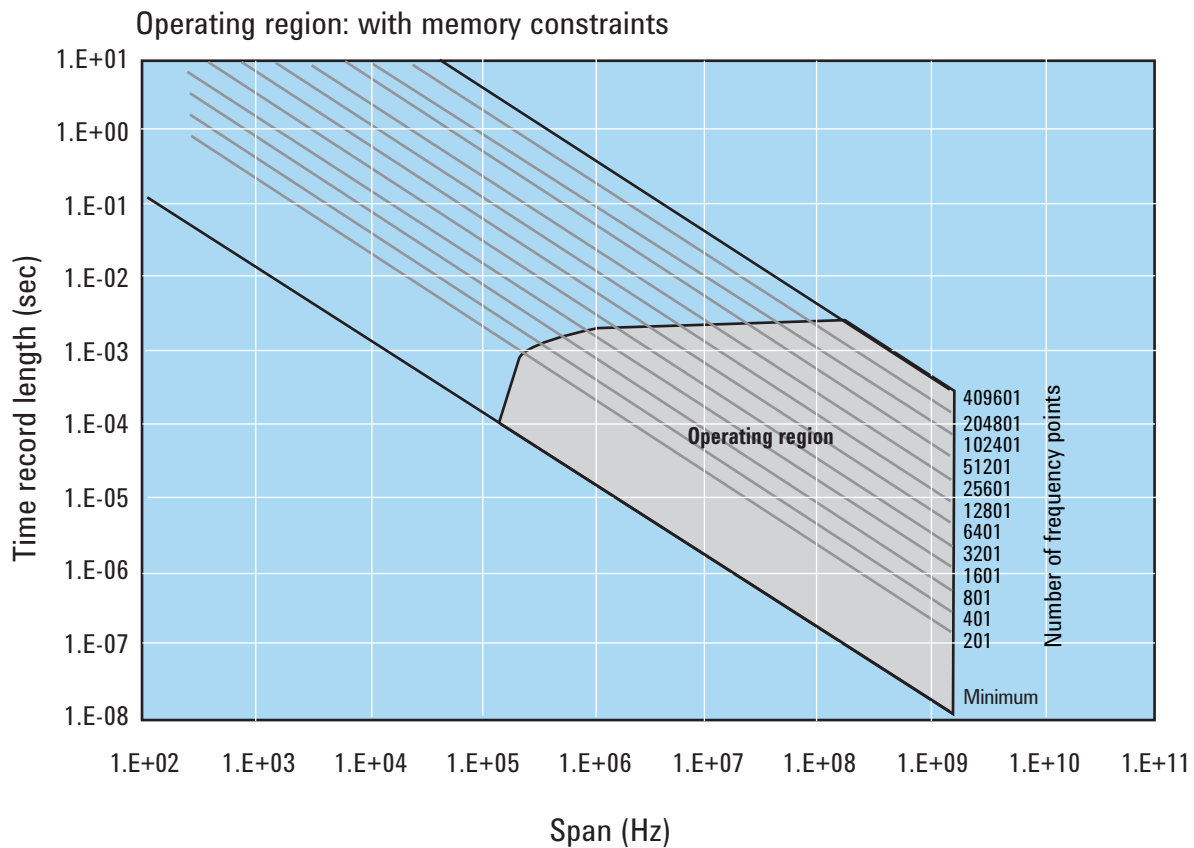

Figure 5. The oscilloscope's available memory also constrains the operating region.

Taken together, these constraints form an operating region that the 89600 VSA software must remain within (Figure 6). To complete our understanding there are a couple of additional points regarding sampling mode and alias exposure that must be presented.

The graphs presented in this section describe discrete operating regions that are a function of sample rate. In **Full Rate** or **User Rate** sample modes a single operating region curve fully describes the constraints imposed on the measurement. However, when in **Maximize** or **Minimize Sample** modes the 89600 VSA software freely transitions from region to region based on the optimum sample rate it chooses. Choosing **Maximize** or **Minimize** allows **Main Time** to increase beyond the alias exposure-free zone limit. The family of operating region curves should be taken as an approximation of how the 89600 VSA software operates when in **Maximize** and **Minimize** modes.

Keep in mind that in **Maximize** and **Minimize** sampling modes, while the time record limit is increased, alias-free operation is not guaranteed. This means that signals outside the measurement span may appear in the analysis span.

In **Full Rate** sample mode with the use of appropriate low pass filtering (Table 3) signal aliasing is completely avoided. In this case the **Operating Region** is renamed **Alias Exposure Free Zone** to indicate this special condition.

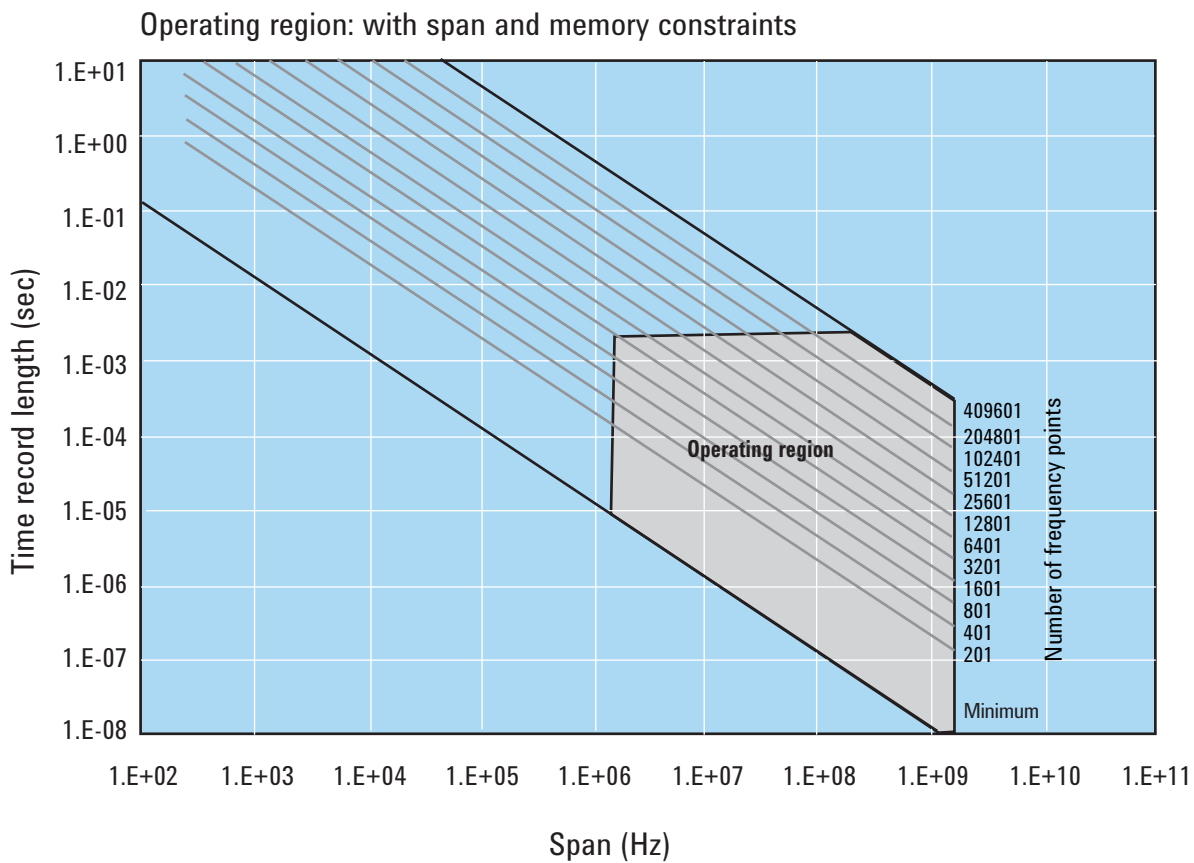

Figure 6. The true operating region is fully described when constrained by all the previous parameters: number of frequency points, span, and oscilloscope memory. See Appendix D for operating region charts for the various supported oscilloscopes.

Although the operating regions for all scope models are similar, each model or model family may have important differences in their operating region curves due to differences in maximum sample rate, front-end analog performance, and memory option. Appendix D provides the operating curves for all supported scopes and most memory options.

Here are some additional details to keep in mind when viewing the curves:

#### **8000 and 9000 Series**

These models have deep memory, which allows greater movement on the operating region curves for the full rate and user rate sampling modes.

Memory utilization has these additional effects on the operating curves:

- For optional memory greater than 2 M-samples the operating region for the 4 Gsa/s and 2 Gsa/s are very similar, differing only in the minimum span (8000 Series only).
- When using 3 or 4 VSA channels, the time record limit is half of the 2-channel limit.

#### **80000 and 90000 Series models**

These models have deep memory, which allows greater movement on the operating region curves for the full rate and user rate sampling modes.

Memory utilization has these additional effects on the operating curves:

- Optional memory is not utilized for sample rates of 5 Gsa/s and above (80000 Series only).
- When using 3 or 4 channels, the time record limit is half of the 1- or 2-channel limit for sample rates of 5 Gsa/s and above (80000 Series only).

### 5.3 Recording limits for infinium oscilloscopes

The 89600 VSA software allows the acquisition of long records to be captured. Analysis is done as a post-processing operation. This feature is called recording. Recordings can be much longer than time records in live measurements.

Prior to taking a recording, live test measurements of **Main Time Length** are usually made at the desired span. Then, when the recording is made, the analyzer no longer uses **Main Time Length** but, instead, uses **Recording Length** to determine length of the acquired record. When in **Maximize** mode the change in acquisition length can affect sample rate as well as aliasing. Therefore, it is recommended that recordings be made only in **Full Rate**, **User Rate**, or **Minimize** sampling modes.

When making an 89600 VSA recording, the scope sample rate and memory depth determines the maximum recording length. When in **User Rate** mode the maximum recording lengths will increase as the sample rate decreases. In some cases the recording length increase is directly proportional to the sample rate decrease or the memory depth increase. However, this is not always the case, as some scopes do not support optional memory the same for all sample rates. The following table indicates the maximum recording length at full rate for each supported scope.

**Table 6. Maximum recording lengths at maximum span using Full Rate sampling mode for each oscilloscope model with memory as shown**

Model	Max span	Recording length for possible memory option configurations							
		256 K	512 K	2 M	4 M	8 M	16 M	32 M	64 M
8064	600 MHz	–	250 $\mu$ s	–	2 ms	4 ms	8 ms	16 ms	32 ms
8104	781.25 MHz	–	250 $\mu$ s	–	2 ms	4 ms	8 ms	16 ms	32 ms (3-, 4- chans)
8104	1 GHz	–	125 $\mu$ s	–	2 ms	4 ms	8 ms	16 ms	32 ms (1-, 2- chans)
80204	2 GHz	–	48 $\mu$ s	–	–	–	–	–	200 $\mu$ s <sup>1</sup>
80304	3 GHz	–	48 $\mu$ s	–	–	–	–	–	200 $\mu$ s <sup>1</sup>
80404	4 GHz	–	24 $\mu$ s	–	–	–	–	–	100 $\mu$ s <sup>1</sup>
80604	6 GHz	–	24 $\mu$ s	–	–	–	–	–	100 $\mu$ s <sup>1</sup>
80804	8 GHz <sup>2</sup>	–	12 $\mu$ s	–	–	–	–	–	50 $\mu$ s <sup>1</sup>
81004	10 GHz <sup>2</sup>	–	12 $\mu$ s	–	–	–	–	–	50 $\mu$ s <sup>1</sup>
81204	12 GHz <sup>2</sup>	–	12 $\mu$ s	–	–	–	–	–	50 $\mu$ s <sup>1</sup>
81304	13 GHz <sup>2</sup>	–	12 $\mu$ s	–	–	–	–	–	50 $\mu$ s <sup>1</sup>

**Table 7. Maximum recording lengths at maximum sample rate for Infinium 9000/90000 Series models with memory as shown**

Model	Max span	Recording length for given memory option configurations					
		10 M	20 M	50 M	100 M	200 M	500 M/1G
9104 <sup>3</sup>	1 GHz	4 ms	8 ms	20 ms	40 ms	80 ms	200 ms
9104 <sup>4</sup>	1 GHz	2 ms	4 ms	10 ms	20 ms	40 ms	100 ms
9254 <sup>3</sup>	2.5 GHz	2 ms	4 ms	10 ms	20 ms	40 ms	100 ms
9254 <sup>4</sup>	2.5 GHz	1 ms	2 ms	5 ms	10 ms	20 ms	50 ms
9404 <sup>3</sup>	4.0 GHz	1 ms	2 ms	5 ms	10 ms	20 ms	50 ms
9404 <sup>4</sup>	3.90625 GHz	1 ms	2 ms	5 ms	10 ms	20 ms	50 ms
90254	2.5 GHz	1 ms	2 ms	5 ms	10 ms	20 ms	50 ms
90404	4 GHz	0.5 ms	1 ms	2.5 ms	5 ms	10 ms	25 ms
90604	6 GHz	0.5 ms	1 ms	2.5 ms	5 ms	10 ms	25 ms
90804	8 GHz	0.25 ms	0.5 ms	1.25 ms	2.5 ms	5 ms	12.5 ms
91204	12 GHz	0.25 ms	0.5 ms	1.25 ms	2.5 ms	5 ms	12.5 ms
91304	13 GHz	0.25 ms	0.5 ms	1.25 ms	2.5 ms	5 ms	12.5 ms

1. Significantly longer when in **User Rate** sample mode for user rates up to 4 Gsa/s.
2. 7.8125 GHz when using 3 or 4 VSA channels.
3. 1 or 2 VSA channels.
4. 3 or 4 VSA channels.

## 6 Out-of-band alias exposure zones

As mentioned above, the **Maximize** and **Minimize** sampling modes increase the maximum **Main Time** length at the expense of possible aliasing of out-of-band signals into the frequency span of the measurement. The spectrum ranges subject to the alias conversion are called alias exposure zones. To determine if any out-of-band signals exist in the exposure zones, run the **Alias Exposure Zone Checker** macro.

### 6.1 Setting up the alias exposure zone checker

Follow this procedure for setting up the **Alias Exposure Zone Checker**:

1. Start the VSA application.
2. Click on **Utilities>Macros>Recall**. Navigate to the examples\macros subdirectory in the directory where you installed the VSA application (for example, C:\Program files\Agilent\89600 VSA\Examples\Macros). Select **RecallSetupAfterAliasCheck** and **AliasChecker** files, and click **OK**.

Right click on the top of the VSA application. You will see a popup showing the various toolbars. Select the **Macros** toolbar. This will make the alias checker icons appear on your VSA application toolbar.

### 6.2 Using the alias exposure zone checker

The **Alias Exposure Zone Checker** calculates the frequencies of the alias exposure zones for any combination of center frequency, span, and oscilloscope sample rate. It then measures the power in each zone and compares it to the power of the desired signal in the span of the measurement setup at the time the checker was started. An unwanted signal in an exposure zone is a source of interference if it is larger than the desired signal's amplitude minus 40 dB. This -40 dBc threshold is approximately the same level as the quantization errors in the oscilloscope's 8-bit digitizer, and represents the limit of the oscilloscope's dynamic range. The -40 dBc level is sufficient for 1 to 2 percent EVM measurements.

Launch the checker macro by using the tool path **Utilities>Macros>Alias checker** or click its icon (shown below) on the bottom of the tool bar.



When the macro stops, a full-span spectrum trace (Figure 7) will appear in Trace A (green). It shows the desired signal plus any unwanted signals. Superimposed is an orange Trace C showing boxes for each exposure zone frequency range. Any unwanted signal falling inside the zone box is a source of alias interference. If the height of any box is higher than the orange reference line, the power in that zone is greater than the  $-40$  dBc threshold of interference.

Click **Yes** in the checker dialog box to return to the original measurement setup. Click **No** for further examination of the out-of-band signals. You can return to the original measurement setup by clicking the **Recall setup after alias check macro icon**.

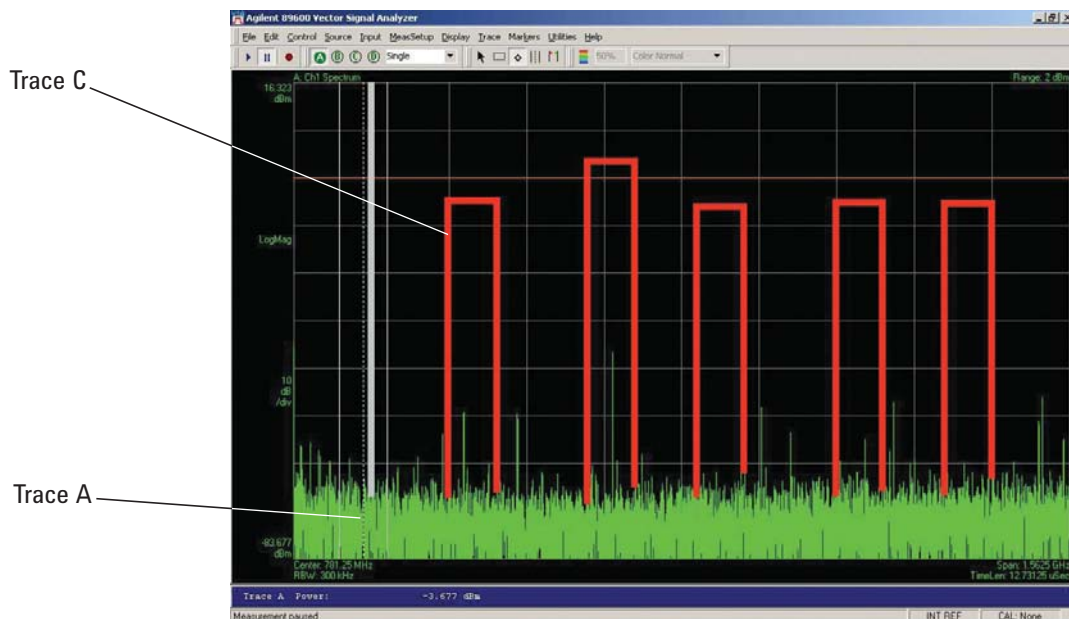

Figure 7. Alias exposure zone checker results. The desired signal is at 150 MHz and an out-of-band signal is at  $-35$  dBc and 642 MHz. The unwanted signal in the second alias zone is 5 dB above the  $-40$  dBc threshold line.

When no alias zones exist because the current sampling mode is alias free, no orange zone boxes will appear. In addition, the message **No alias zones detected! Restore initial settings?** will appear (see Figure 8).

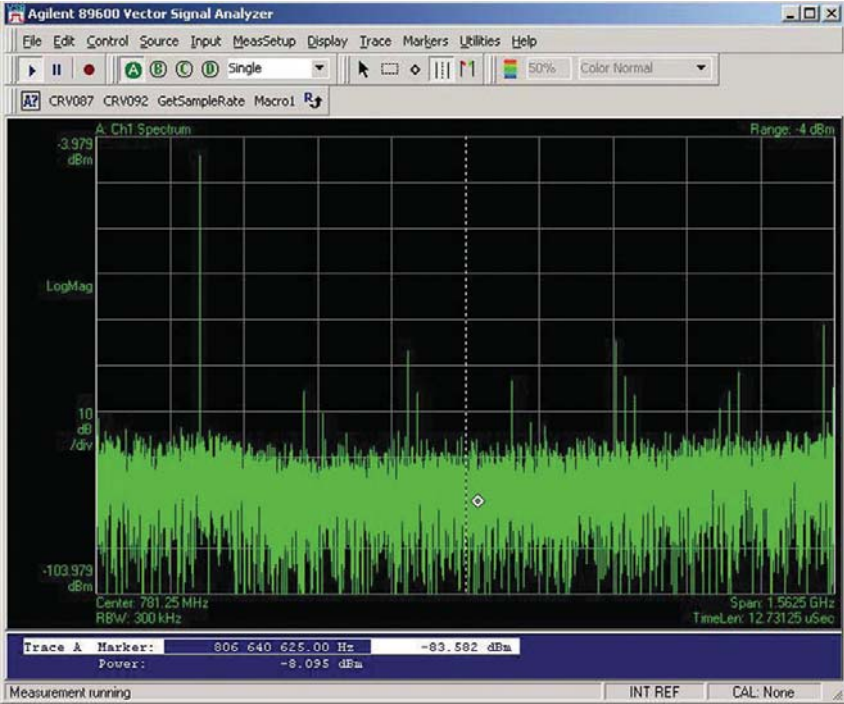
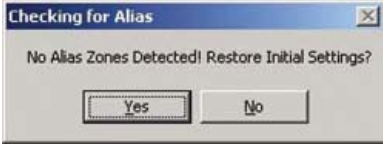

Figure 8. Alias checker results when no zones are detected. No orange alias zone boxes appear.



When the original center frequency/span is inadvertently tuned to an alias response of a signal whose frequency is not the center frequency, the checker will attempt to suggest the signal's frequency. The checker results at the desired center frequency location (box formed by white solid and dashed lines) will show no signal, and a large signal will appear in one of the zones, as shown in Figure 9. Further, all zone boxes will be well above the orange threshold line.

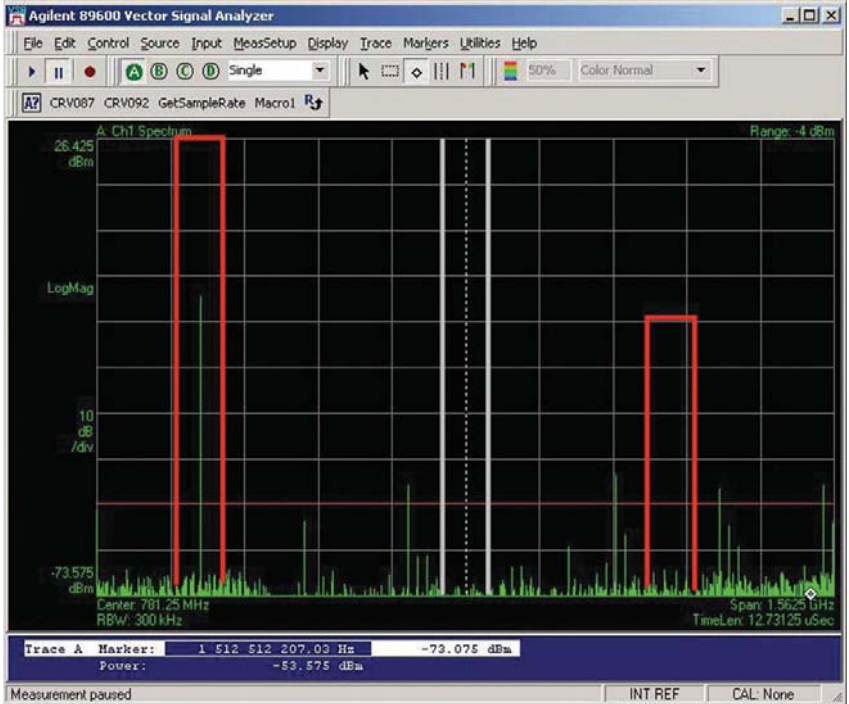

Figure 9. Alias checker results when the center frequency is originally tuned to an alias product. The checker shows no signal at the desired frequency (white solid/dashed box) and large zone boxes at the zones containing the desired signal.





## Appendix A

### Downconverting RF and Microwave signals into the range of the infiniium oscilloscopes

External components with wide bandwidths can be used to downconvert signals into the range of the ultra-broadband VSAs.

The 89600 VSA software can account for the mixing equation of the external downconverter. While the downconverter cannot be controlled by the software, the downconverter's input center frequency, IF bandwidth, external bandwidth, and IF mirroring can be taken into account by using the **Utilities>Calibration>Frequency** menu picks. See the help text for further details on using the external frequency tool.

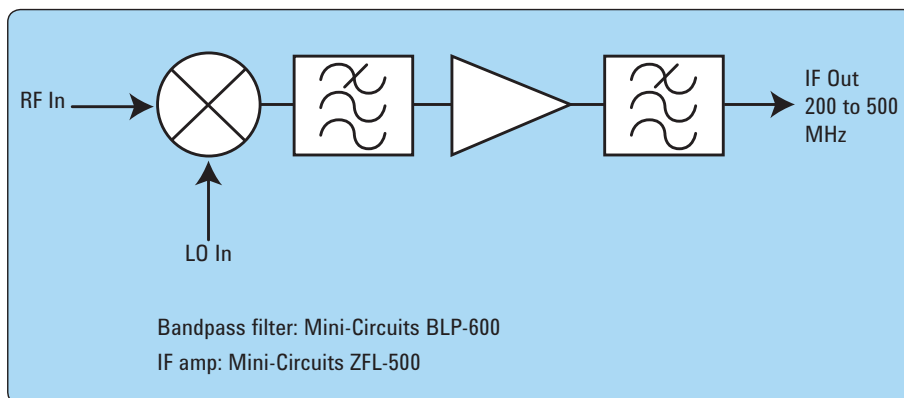

Figure 13. Block diagram of suggested downconverter. See Table 8 for further details.

Table 8. External wideband downconverter details

RF range	Mixer	LO	IF amp	Remarks
0 to 13 GHz (see Table 1)		None	None	Use oscilloscope Ch 1 or Ch 3 (VSA Ch 2)
10 MHz to 26.5 GHz	Agilent N5280A	Agilent N5183A	$F_{IF} = 10 \text{ kHz} - 1.5 \text{ GHz}$	Four coherent channels on common LO
0.2 to 6 GHz	Marki <sup>1</sup> M2-0006MA	16 to 19 dBm $F_{LO} = F_{RF} - F_{IF}$	Mini-Circuits <sup>2</sup> $Z_{FL} = 500$ $F_{IF} = 200 - 500 \text{ MHz}$	Mxr, CL = 8 dB TOI = 18 dBm Amp, gain = 20 dB NF = 5.5 dB TOI = +18 dBm
5 to 40 GHz	Marki <sup>1</sup> M9-0540IN	3 to 17 dBm $F_{LO} = F_{RF} - F_{IF}$	As above	Mxr, CL = 8 dB TOI = 16 dBm
26.5 to 40 GHz	Agilent 11970A	15 dBm $F_{LO} = (F_{RF} - F_{IF}) / 8$ $F = 0 - 1 \text{ GHz}$	As above	8th harmonic waveguide mixer. Mxr, CL = 22 dB TOI = 15 dBm
33 to 50 GHz	Agilent 11970Q	15 dBm $F_{LO} = (F_{RF} - F_{IF}) / 10$ $F_{IF} = 0 - 1 \text{ GHz}$	As above	10th harmonic waveguide mixer. Mxr, CL = 24 dB, TOI = 15 dBm

1. Marki microwave,  
<http://www.markimicrowave.com>  
Telephone: 408-778-4200,  
FAX: 408-778-4300, 215  
Vineyard Court, Morgan Hill, CA 95037
2. Mini-Circuits, Inc.,  
1-800-654-7949,  
44-1252-83600,  
<http://www.minicircuits.com>.

## Appendix B

Cables and I/O cards for connecting a PC to an infiniium oscilloscope

Table 9. PC interfaces and connection cables

Description	Part number	Notes
PCMCIA GPIB card	778034-02	For laptop PCs. Comes with two-meter GPIB cable. Available from National Instruments.
PCI GPIB interface card	82350	For desktop PCs. Requires GPIB cable (10833A). Available from Agilent.
USB/GPIB interface	82357	Requires USB port and Windows 2000 <sup>®</sup> or XP Professional <sup>®</sup> .
One-meter GPIB cable	10833A	Available from Agilent.
LAN cross-over cable	8121-0545	Available from Agilent.
LAN/GPIB gateway	E5810	Available from Agilent.

## Appendix C

PC requirements to run 89600 software

For external PC use, the 89600 VSA requires a PC connected via GPIB or LAN I/O to the infiniium oscilloscope. Either a laptop or desktop PC may be used as long as it meets or exceeds the following minimum requirements: <sup>1</sup>

Table 10. User-supplied PC requirements

Microsoft <sup>®</sup> Operating system	Windows <sup>®</sup> XP Professional, service pack 2	Windows Vista Business <sup>®</sup> Enterprise <sup>®</sup> , or Ultimate <sup>®</sup>
<b>CPU</b>	> 1700 MHZ Pentium <sup>®</sup> or AMD-K6 <sup>®</sup> > 2 GHz recommended	1 GHz 32-bit (x86) > 2 GHz recommended
<b>RAM</b>	512 MB 1 GB recommended for oscilloscopes with optional memory 2 GB recommended when using 3- or 4-channels	1 GB 2 GB recommended for oscilloscopes with optional memory 2 GB recommended when using 3- or 4-channels
<b>Video RAM</b>	4 MB 16 MB recommended	126 MB 512 MB recommended
<b>Additional drives</b>	CDROM to load the software; license transfer requires 3.5 inch floppy drive, network access, or USB memory stick	

1. For best immunity from electrostatic discharge (ESD), use a desktop PC.

# Appendix D

## Operating region curves

Note: All graphs shown for **Resample Location** set to **Driver**. **Maximum Time Record** lengths may be significantly shorter when **Resample Location** is set to **Measurement**.

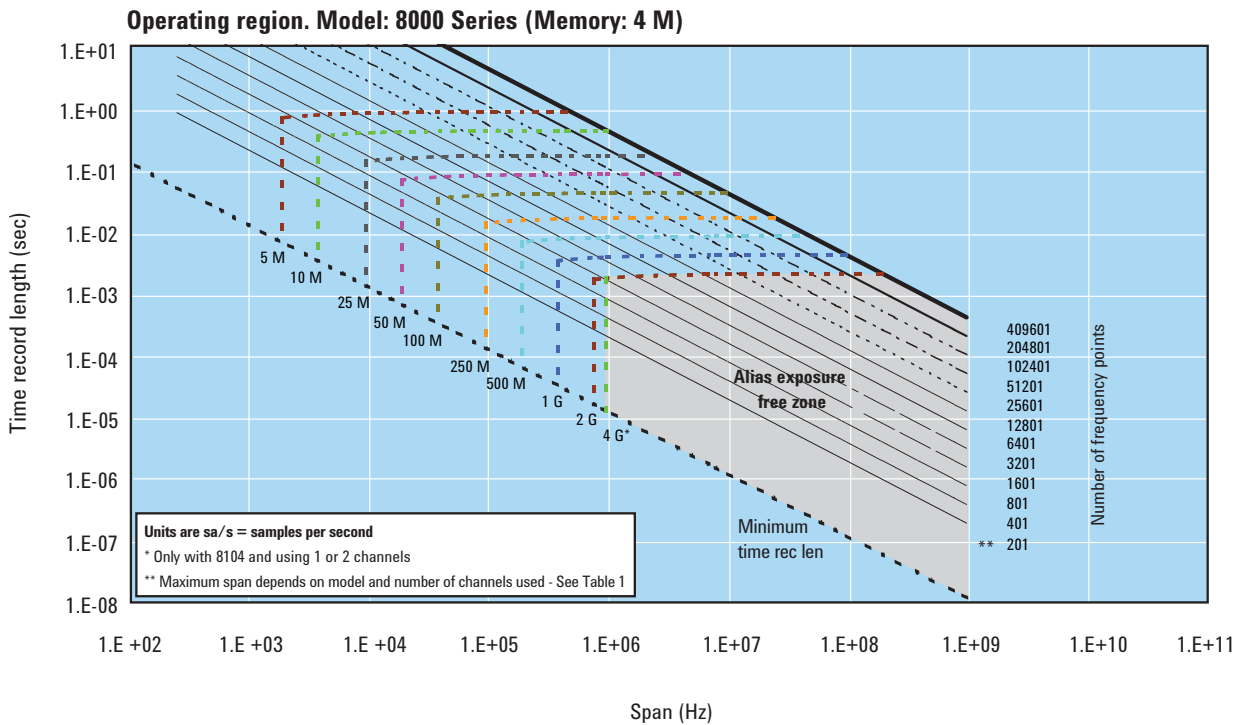
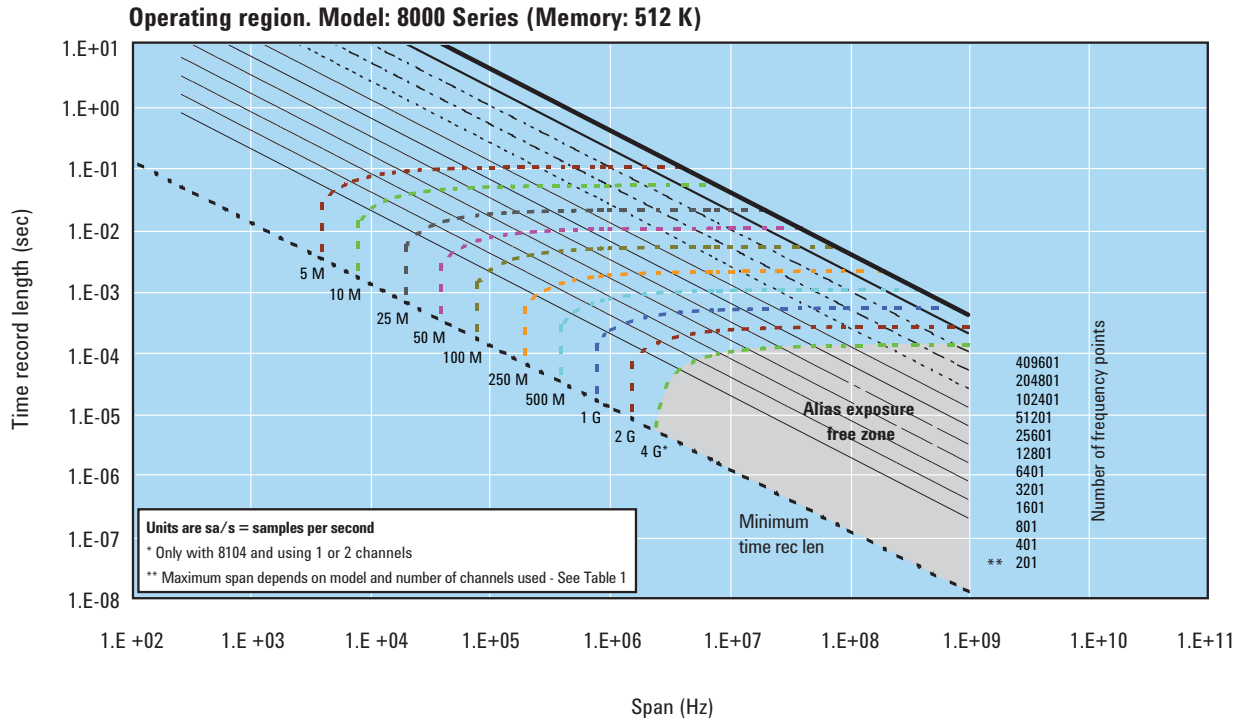

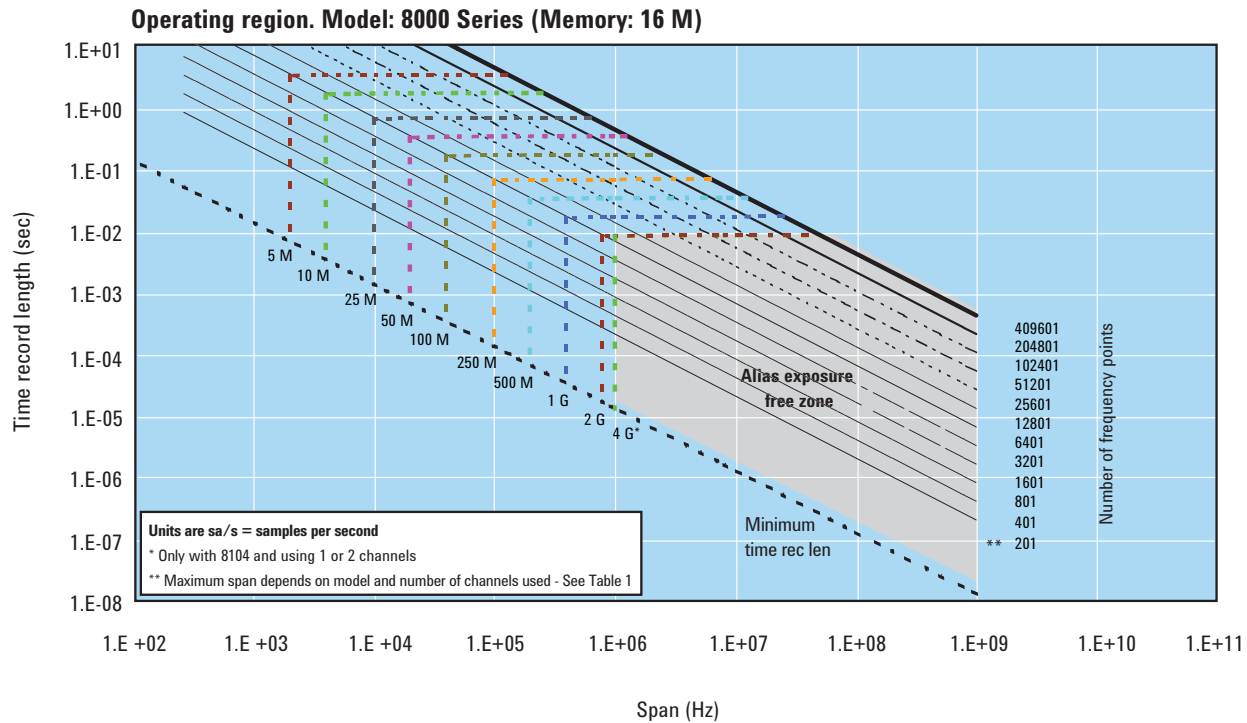
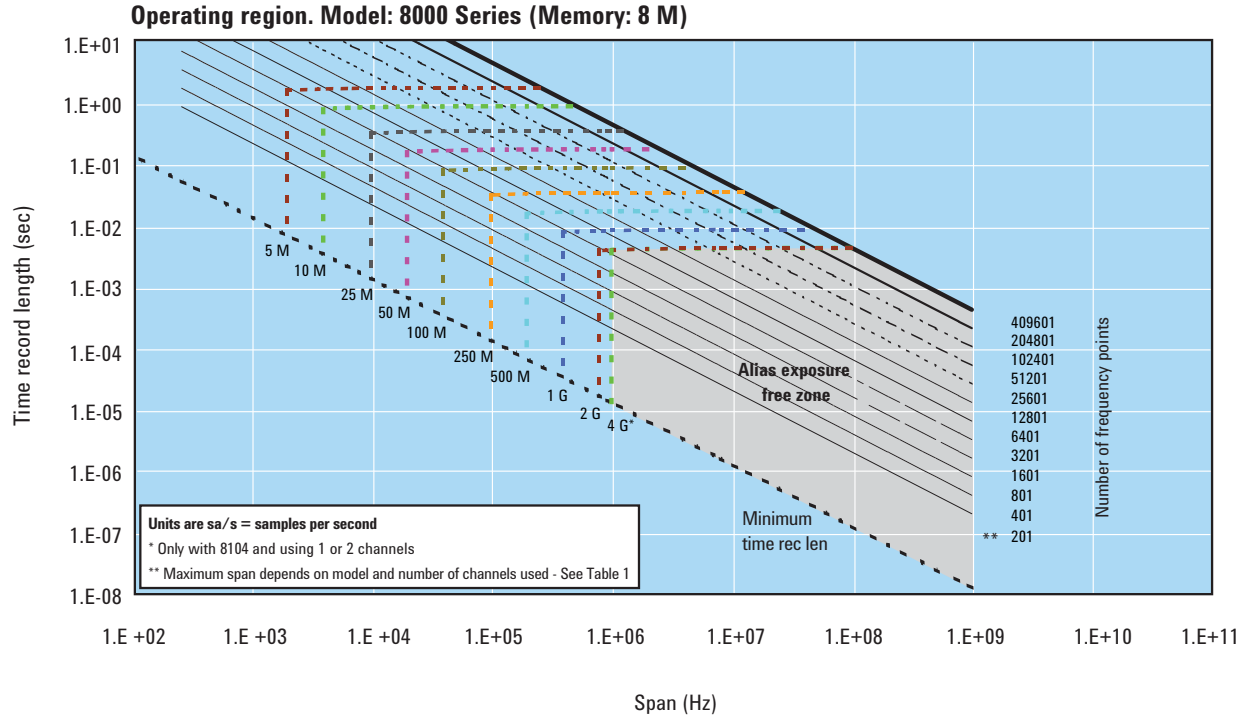

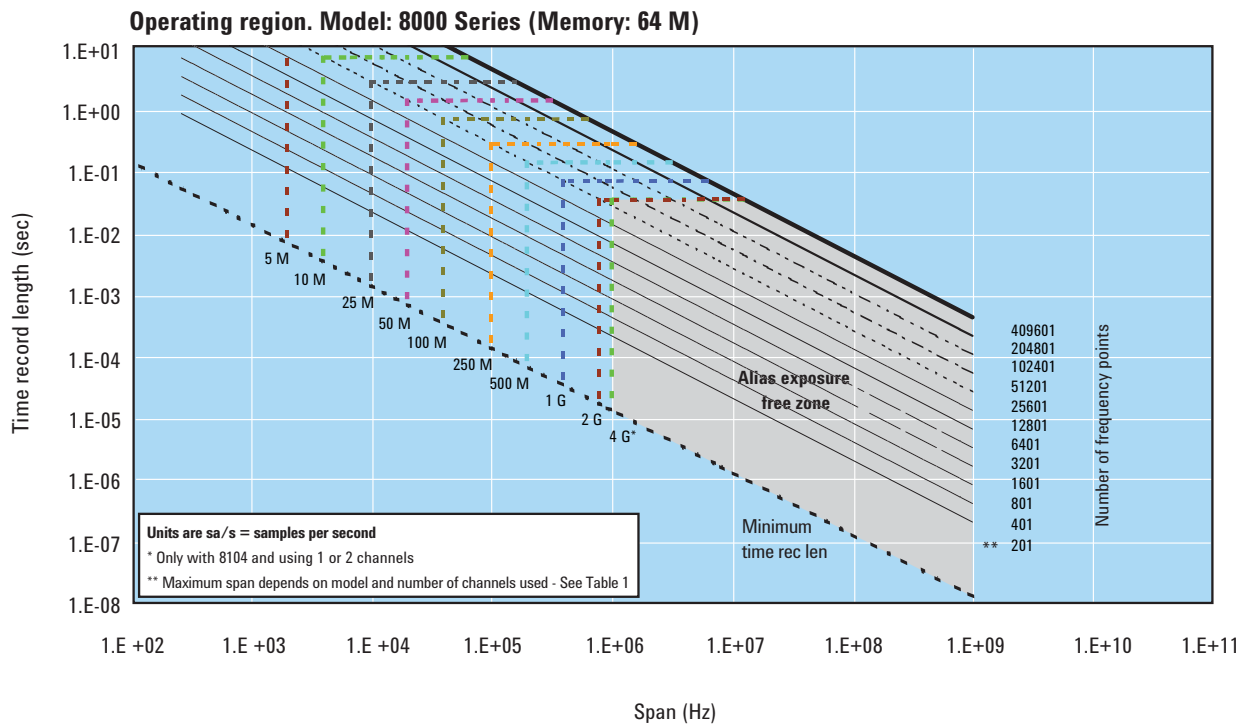
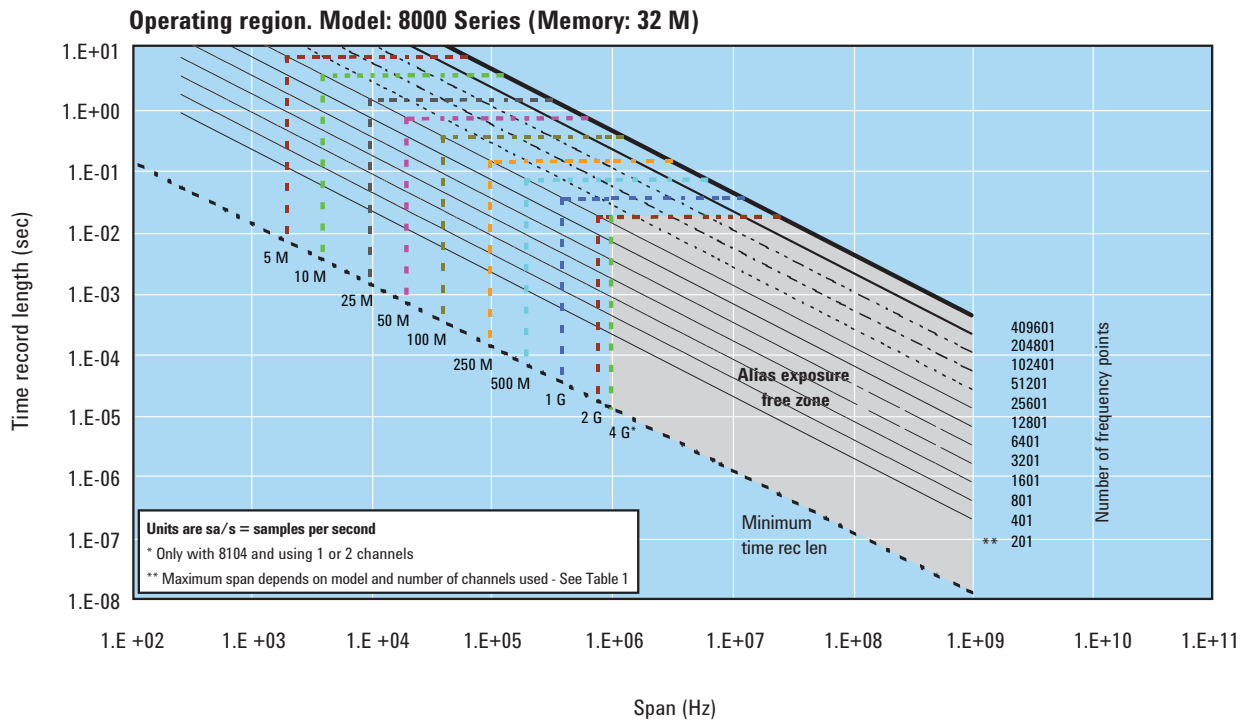

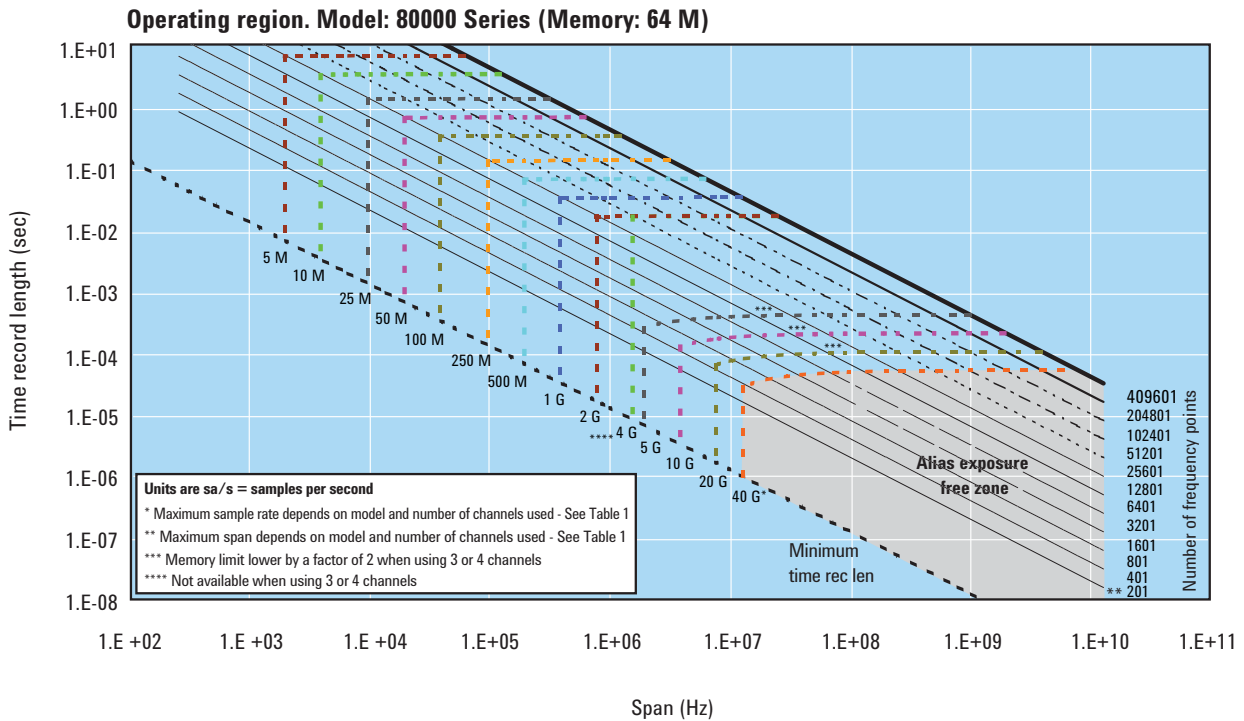
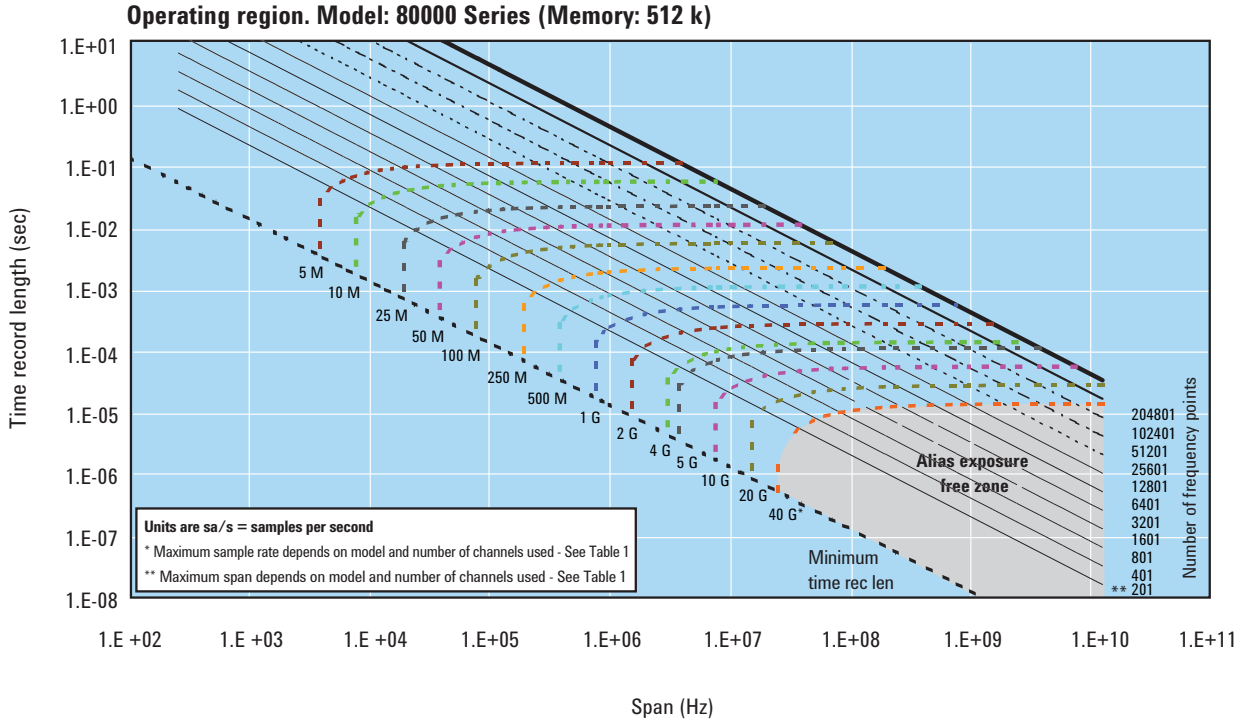

**Operating region. Model: 9000, 90000 Series (Memory: 10 M)**

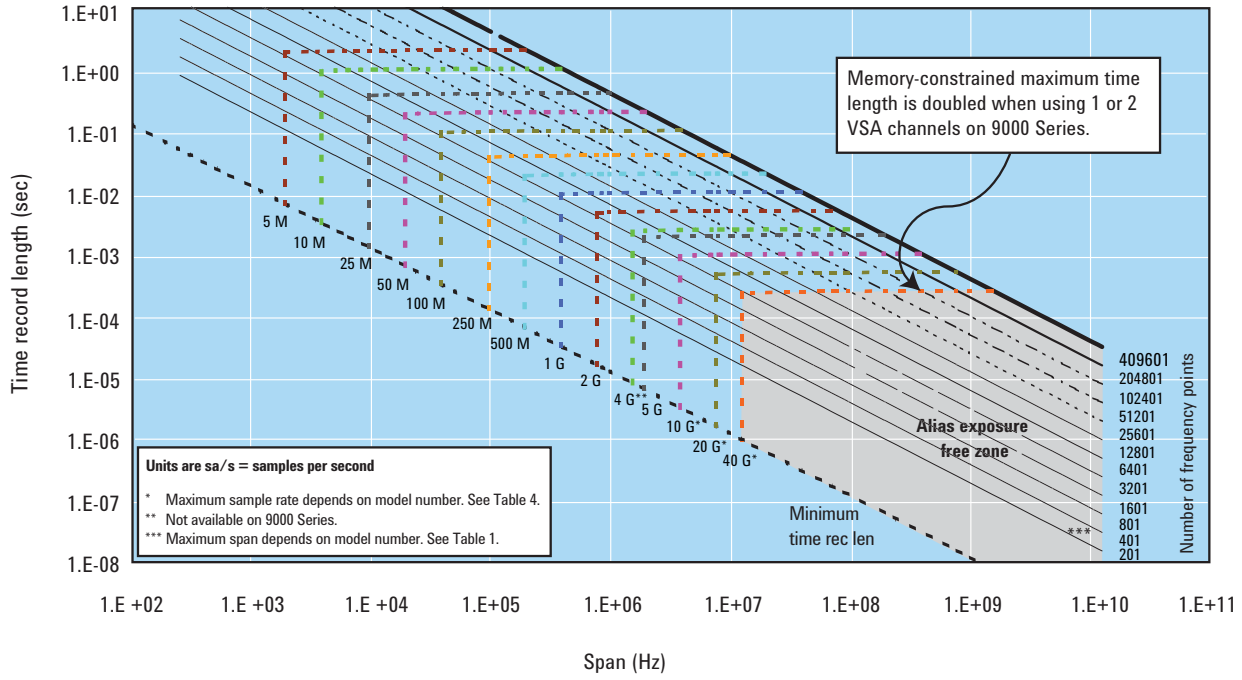

**Operating region. Model: 9000, 90000 Series (Memory: 20 M)**

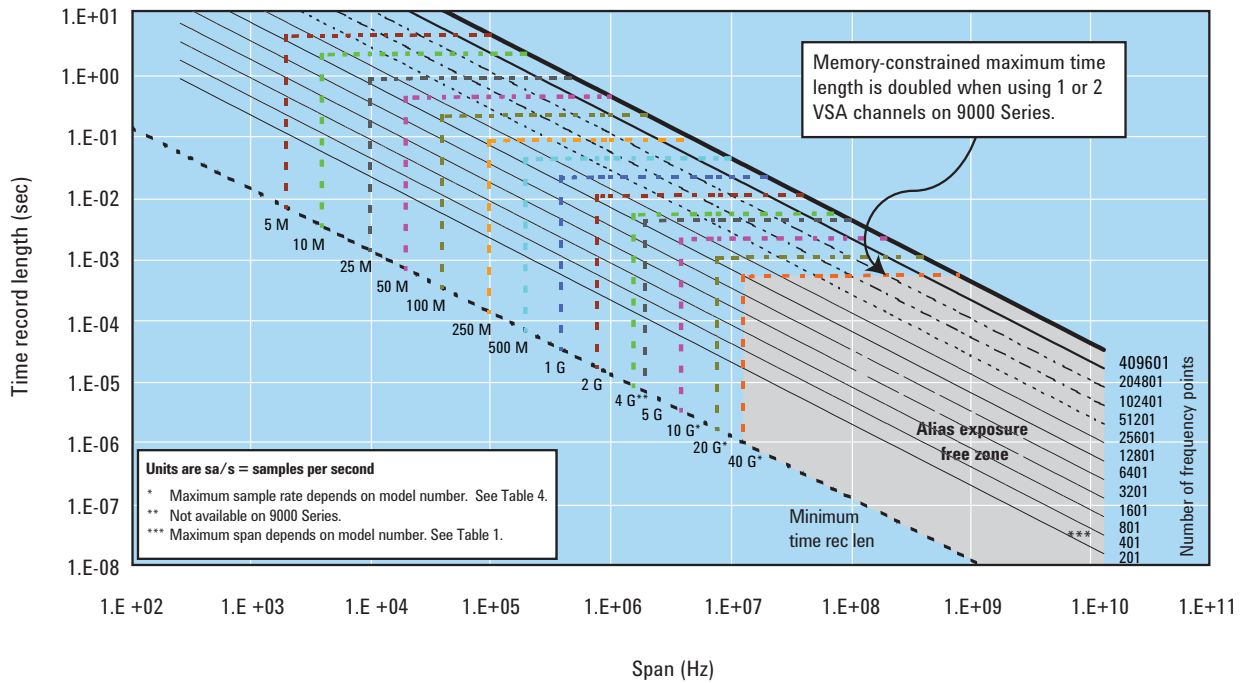

**Operating region. Model: 9000, 90000 Series (Memory: 50 M)**

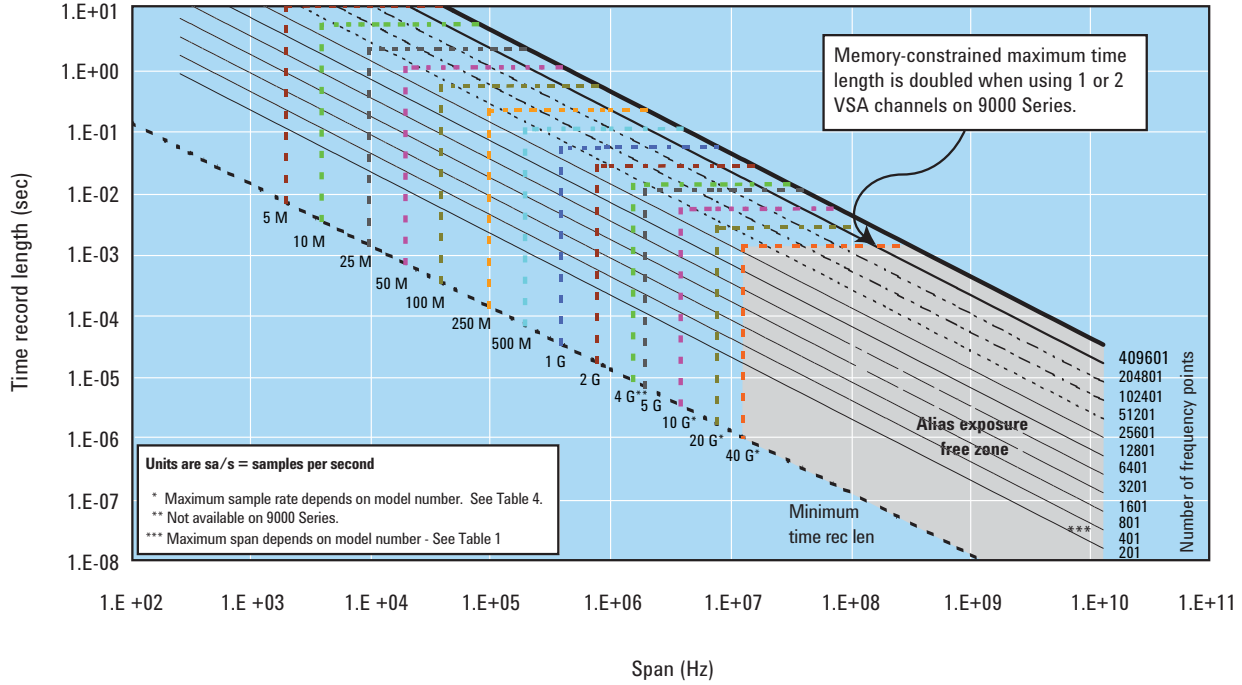

**Operating region. Model: 9000, 90000 Series (Memory: 100 M)**

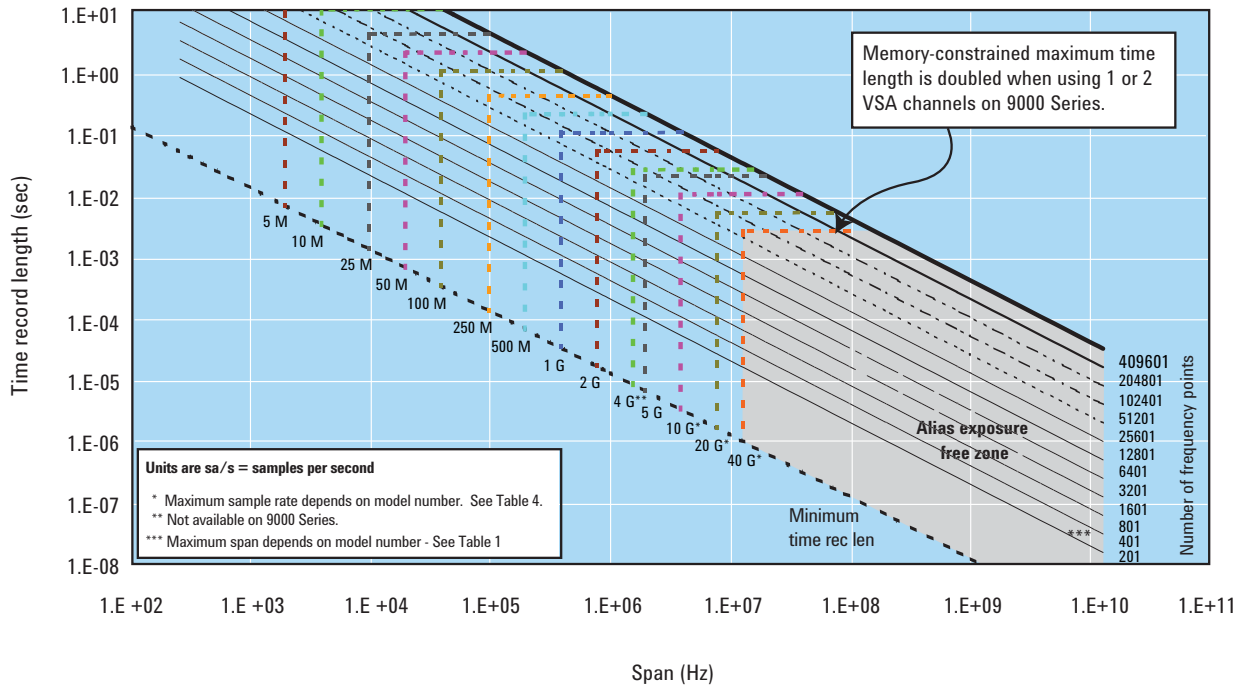



**Operating region. Model: 9000, 90000 Series (Memory: 200 M)**

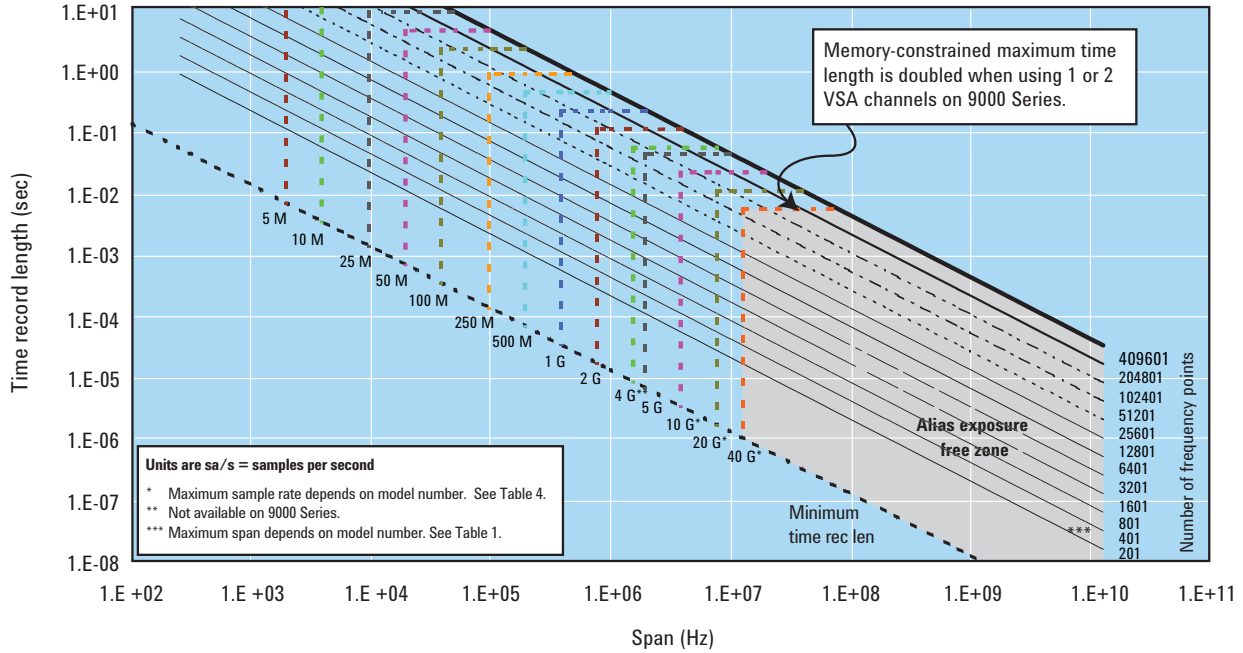

**Operating region. Model: 9000, 90000 Series (Memory: 500 M)**

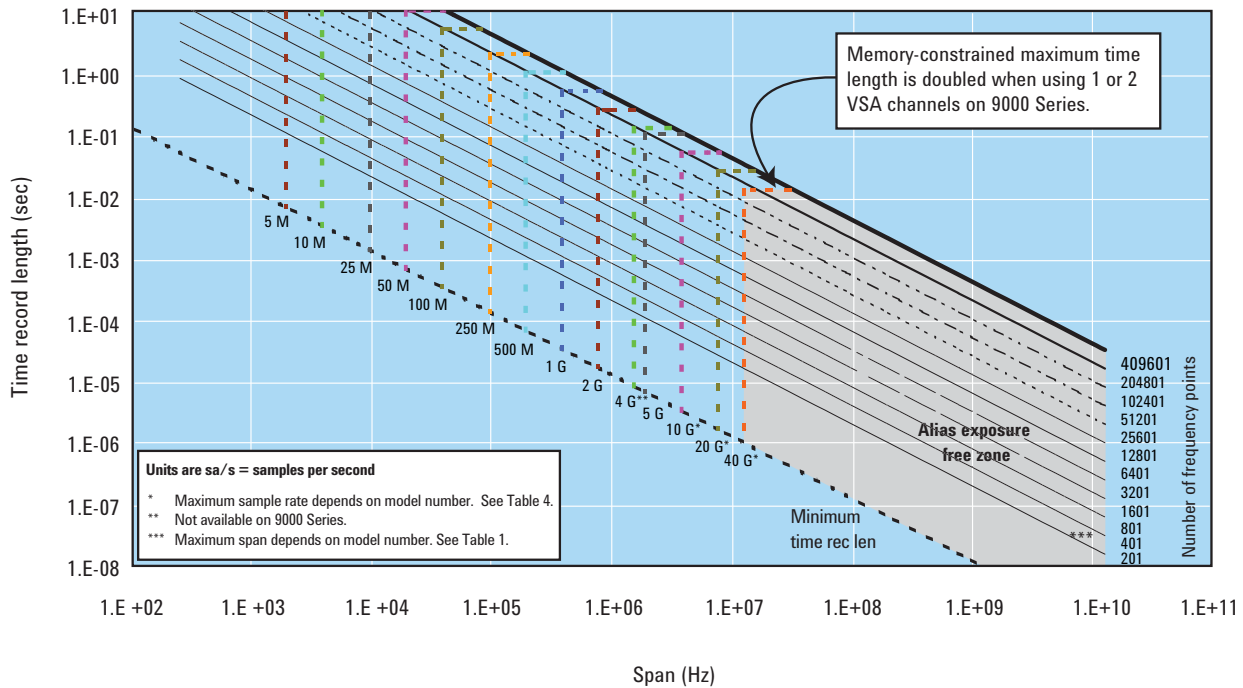

## For more information

For more product literature visit  
[www.agilent.com/find/89600](http://www.agilent.com/find/89600)  
[www.agilent.com/find/vsascope](http://www.agilent.com/find/vsascope)

## Related literature list

*89600 Vector Signal Analyzer CD*, literature number 5980-1989E

*89600 Vector Signal Analysis Software 89601A/89601AN/ 89601N12, Technical Overview*, literature number 5989-1679EN

*89600 Vector Signal Analysis Software 89601A/89601AN/ 89601N12, Data Sheet*, literature number 5989-1786EN

*Agilent InfiniiVision Series Oscilloscopes Performance Guide Using 89600 Vector Signal Analyzer Software*, literature number 5989-4523EN

*Hardware Measurement Platforms for the Agilent 89600 Series Vector Signal Analysis Software, Data Sheet*, literature number 5989-1753EN

*89600S Vector Signal Analyzers, VXI Configuration Guide*, literature number 5968-9350E

*89650S Wideband Vector Signal Analyzer System with High Performance Spectrum Analysis, Technical Overview*, literature number 5989-0871EN

*89650S Wideband Vector Signal Analyzer System with High Performance Spectrum Analysis, Configuration Guide*, literature number 5989-1435EN

*Understanding Time and Frequency Domain Interactions in the Agilent Technologies 89400 Series Vector Signal Analyzers*, literature number 5962-9217EN

*89607A WLAN Test Suite Software, Technical Overview*, literature number 5988-9574EN

*89604A Distortion Test Suite Software, Technical Overview*, literature number 5988-7812EN



### Agilent Email Updates

[www.agilent.com/find/emailupdates](http://www.agilent.com/find/emailupdates)  
Get the latest information on the products and applications you select.



### Agilent Direct

[www.agilent.com/find/agilentdirect](http://www.agilent.com/find/agilentdirect)  
Quickly choose and use your test equipment solutions with confidence.



[www.agilent.com/find/open](http://www.agilent.com/find/open)  
Agilent Open simplifies the process of connecting and programming test systems to help engineers design, validate and manufacture electronic products. Agilent offers open connectivity for a broad range of system-ready instruments, open industry software, PC-standard I/O and global support, which are combined to more easily integrate test system development.

*WiMAX, Mobile WiMAX, and WiMAX Forum are trademarks of the WiMAX Forum.*

*Microsoft is a U.S. registered trademark of Microsoft Corporation.*

*Windows is a U.S. registered trademark of the Microsoft Corporation.*

*Pentium is a U.S. registered trademark of the Intel Corporation.*

## Remove all doubt

Our repair and calibration services will get your equipment back to you, performing like new, when promised. You will get full value out of your Agilent equipment throughout its lifetime. Your equipment will be serviced by Agilent-trained technicians using the latest factory calibration procedures, automated repair diagnostics and genuine parts. You will always have the utmost confidence in your measurements. For information regarding self maintenance of this product, please contact your Agilent office.

Agilent offers a wide range of additional expert test and measurement services for your equipment, including initial start-up assistance, onsite education and training, as well as design, system integration, and project management.

For more information on repair and calibration services, go to:

[www.agilent.com/find/removealldoubt](http://www.agilent.com/find/removealldoubt)

Product specifications and descriptions in this document subject to change without notice.

For more information on Agilent Technologies' products, applications or services, please contact your local Agilent office.

The complete list is available at:

[www.agilent.com/find/contactus](http://www.agilent.com/find/contactus)

### Americas

Canada	(877) 894-4414
Latin America	305 269 7500
United States	(800) 829-4444

### Asia Pacific

Australia	1 800 629 485
China	800 810 0189
Hong Kong	800 938 693
India	1 800 112 929
Japan	0120 (421) 345
Korea	080 769 0800
Malaysia	1 800 888 848
Singapore	1 800 375 8100
Taiwan	0800 047 866
Thailand	1 800 226 008

### Europe & Middle East

Austria	01 36027 71571
Belgium	32 (0) 2 404 93 40
Denmark	45 70 13 15 15
Finland	358 (0) 10 855 2100
France	0825 010 700*
Germany	07031 464 6333
Ireland	1890 924 204
Israel	972-3-9288-504/544
Italy	39 02 92 60 8484
Netherlands	31 (0) 20 547 2111
Spain	34 (91) 631 3300
Sweden	0200-88 22 55
Switzerland	0800 80 53 53
United Kingdom	44 (0) 118 9276201

Other European Countries:

[www.agilent.com/find/contactus](http://www.agilent.com/find/contactus)

Revised: October 6, 2008

© Agilent Technologies, Inc. 2009  
Printed in USA, June 11, 2009  
5988-4096EN

