

DALE

FULL LINE CATALOG

CHIP POTENTIOMETERS	Page 4
OSCILLATORS	6
INDUCTORS	11
TRANSFORMERS & TOROIDS	28
CONNECTORS	48
THERMISTORS	84
RESISTOR NETWORKS	96
FILM RESISTORS	132
WIREWOUND RESISTORS	170
TRIMMERS	199
PLASMA PANEL DISPLAYS	208

	Page
ALPHABETICAL INDEX	2
MILITARY INDEX	3
SURFACE MOUNTED DEVICE INDEX	3
CHIP POTENTIOMETERS (Phone 602-967-7874)	
ST-22, -23, surface mounted, chip	4
OSCILLATORS (Phone 602-967-7874)	
XOSM-51B, surface mounted, hybrid crystal clock	6
XO-43, hybrid crystal clock	7
XO-51B, hybrid crystal clock	8
XO-53B, low cost, hybrid crystal clock	9
XO-54B, hybrid crystal clock	10
INDUCTIVE COMPONENTS (Phone 605-665-9301)	
IMC-1812, molded, surface mounted, chip inductors	11
IMS-5, molded, shielded inductors, (MIL-C-15305, TYPE LT)	12
IMS-2, molded, shielded miniature inductors	14
IM-1, -2, -4, -6, -8, -9, -10, molded inductors, (MIL-C-15305, TYPE LT)	15
IR-2, -4, coated inductors	18
IRF-1, -3, coated inductors	20
IH, high current filter inductors	21
IHA, high current filter inductors	22
IHD-1, -3, high current filter inductors	23
IHB, high current filter inductors	24
IHM-2, high current filter inductors	26
IHV, high current filter inductors	27
Switch Mode Magnetics/ Air Cores/Custom	28
Surface Mounted Magnetic Components (custom)	29
TE & TD, toroid filter inductors	30
TA, telephone coupling audio transformers	34
TC, converter transformers	37
PT-10, -20, trigger type, pulse transformers	38
PT-50, SCR isolation, trigger transformers	40
PLS & PLD, single primary — dual secondary and dual primary — dual secondary, power transformers	42
PL-11, -12, -13, -14, -32, -33, -34, single primary, low power transformers	44
PL-22, -23, -24, -42, -43, -44, dual primary — dual secondary, low power transformers	46
CONNECTORS (Phone 605-665-9301)	
Connectors for Special Applications	48
High Temperature, 200°C Burn-In, Edgeboards	49
EB4, .100" edgeboards	54
EB6, .125" edgeboards	57
EB7, .156" edgeboards	60
EB8, .156" edgeboards	64
EBT156, .156" edgeboards	66
300, dip solder, printed circuit	69
DS, D-Subminiature, right angle, PC mount	72
MM22 & MM24, microminiature, rack and panel	74
SM20, subminiature, rack & panel	80
THERMISTORS (Phone 915-592-3253)	
W, chip, surface mounted	84
G, H & J, hybrid chip, surface mounted	85
X, M, C, F & T, coated (NTC)	86
NTC Thermistor Assemblies	88
Resistance vs. Temperature Conversion	89
How To Select An NTC Thermistor	90
Interchangeable & Point Matched	93
Thermistor Conversion Tables	94

	Page
THICK FILM RESISTOR NETWORKS (Phone 915-592-3253)	
SOMC, small outline molded DIP, surface mounted	96
SOJC, .300" wide J-lead, molded DIP, surface mounted	98
CSC, coated, SIP	100
MSP, molded, SIP	104
MDP, molded, DIP	108
MDP16-45, molded, DIP	112
DFP, flat pack	114
MSM, molded, SIP, (MIL-R-83401, TYPE RZ)	116
MDM, molded, DIP, (MIL-R-83401, TYPE RZ)	120
DFM, flat pack, (MIL-R-83401, TYPE RZ)	123
R/C Networks, SIP & DIP	126
MDRC, molded, DIP, R/C networks	128
CSRC, coated, SIP, R/C networks	130
FILM RESISTORS (Phone 402-371-0080)	
TLCC, commercial, hermetic, surface mounted thin film chip carrier networks	132
TOMC, small outline molded DIP, surface mounted thin film networks	134
TNP, chip resistor, commercial, precision thin film	136
TNPW, chip resistor, commercial, precision thin film	137
CRCW, chip resistor, commercial, thick film	138
RC & RCWP/RCW, chip resistor, commercial, thick film	140
RCM & RCWPM/RCWM, chip resistor, (MIL-R-55342, TYPE RM) E-Rel, thick film	141
CCF-07, commercial, coated, metal film	142
CCF-50, commercial, coated, metal film	143
CCF-55, -60, commercial, coated, metal film	144
FRJ-50, -55, commercial, coated, jumper resistor, metal film	145
CMF, commercial, coated, metal film	146
PTF, coated, low T.C. tight-tolerance precision thin film, (PTF-56-3/MIL-R-122, TYPE RF, E-Rel, also included)	148
CPF, commercial, power, flameproof, metal film	150
ERL, coated, (MIL-R-39017, TYPE RLF), E-Rel, metal film	151
ERC, coated, (MIL-R-55182, TYPE RNC), E-Rel, metal film	152
CMF, coated, (MIL-R-10509, TYPE RN), (MIL-R-22684, TYPE RL), metal film	154
TDP, molded, DIP, thin film networks	156
CMF-55-39, -60-64, fusible, flameproof, metal film	158
SPW, high frequency load, carbon film	159
RNX, high voltage, metal oxide	160
ROX, high voltage, metal oxide	162
FHV, flat, high voltage, metal oxide	164
HACW, HADW, M-51 & HSD, ultra high value, oxide & carbon film	166
HVV, MVW & HVX, high voltage, metal alloy	167
Metal Film Resistors for Special Applications	168
Checklist For Ordering Metal Film Resistors	169
WIREWOUND RESISTORS (Phone 402-564-3131)	
WSM-1, -2, precision power, surface mounted	170
LVSF-3, -5, low value, precision power, surface mounted	171
LVR-2, -5, -10, low value, precision power	172
LVR-3, -5, low value, precision power	173
RH, housed, chassis mount, (MIL-R-18546, TYPE RE), precision power	174
PH, housed, thru-chassis mount, precision power	176
RS, coated & molded, (MIL-R-26, TYPE RW), precision power	178

	Page
G, coated & molded, (MIL-R-26, TYPE RW), precision power	180
Ordering Information, Industrial Power Wirewounds (HL)	182
HL & NHL, tubular, industrial power	183
HL & HLM, flat, industrial power	184
HLW, tubular, axial lead, industrial power	185
HLZ, edgewound, industrial power	185
HLA, adjustable, industrial power	186
HLT, tapped, industrial power	186
HL Terminal Specifications	187
CW, coated, axial lead, industrial power, (MIL-R-26, TYPE RW models included)	188
CA & CR, axial or radial lead, commercial power	189
CP, axial lead, commercial power	190
CPL, axial lead, low resistance, commercial power	191
CPSL, four lead, current sensing, commercial power	192
CPR, radial terminal, commercial power	193
ESS, ESW, EGS, EGW, ESN & EGN, coated & molded, (MIL-R-39007, TYPE RWR) E-Rel	194
ERH & ENH, housed, chassis mount, (MIL-R-39009, TYPE RER) E-Rel	196
Special Purpose Wirewounds	198
TRIMMER POTENTIOMETERS (Phone (49) (89) 80960)	
Quick Reference Index	199
Series 721/921, 723/923 & 724/924, low profile wirewound	200
Series 781/981, 783/983 & 784/984, low profile cermet, industrial grade	202
Series 100, single turn, cermet	204
Series 781P/981P, 783P/983P & 784P/984P, low profile cermet, professional grade	206
CHIP POTENTIOMETERS (Call 602-967-7874)	4
PLASMA DISPLAYS (Phone 402-564-3131)	
Introduction	208
Construction and Operation	209
PD-04A200, 4 characters, 2.00" high	210
PD-16A040, 16 characters, .400" high	212
PD-32A025, 32 characters, .250" high	214
APD-016M040, 16 character module, dot matrix, w/drive electronics and controller	216
APD-32A025, 32 character module, w/drive electronics	218
PDS-200, Standard Bus, Display Interface	220
APD-192G088, -192G088-1, 192 by 88 graphics display, dot matrix, w/drive electronics. Model APD-192G088-1 is w/controller	222
APD-240M026, -240M026A, -240M026A-1, 240 character, dot matrix modules, w/drive electronics. Model APD-240M026A has enhanced brightness. Model APD-240M026A-1 is w/controller	226
APD-256M026, -256M026-1, 256 character, dot matrix modules, w/drive electronics. Model APD-256M026-1 is w/controller	232
PBG-C, linear bar graphs, extra long columns	236
PBG, dual linear bar graphs	238
GENERAL INFORMATION	
DALE QUALITY ASSURANCE	
PROGRAMS & FACILITIES	250
PACKAGING	243
MILITARY PRODUCT IDENTIFICATION	248
DALE DISTRIBUTORS	254
DALE REPRESENTATIVES	256
WHERE TO ORDER	Inside Back Cover
GOVERNMENT SOURCE INSPECTION AND FEDERAL SUPPLIER CODES	Inside Back Cover

TYPE	PRODUCT	PAGE	TYPE	PRODUCT	PAGE	TYPE	PRODUCT	PAGE
300 SERIES	Connectors	69	INDUCTORS	Custom Products	28	Series 7811/9811,		
APD-016M040	Plasma Display Modules	216	IR-2, -4	Inductors	18	7831/9831,		
APD-32A025	Plasma Display Modules	218	IRF-1, -3	Inductors	20	7841/9841	Trimmers	202
APD-192G088	Plasma Display Modules	222	LTMIL-C-15305	Inductors (IM)	15	Series 781P/981P,		
APD-192G088-1	Plasma Display Modules	224	LTMIL-C-15305	Inductors (IMS)	12	783P/983P,		
APD-240M026	Plasma Display Modules	226	LVR-2, -5, -10	Wirewound Resistors	172	784P/984P	Trimmers	206
APD-240M026A	Plasma Display Modules	228	LVR-3, -5	Wirewound Resistors	173	SM20	Connectors, rack & panel	80
APD-240M026A-1	Plasma Display Modules	230	LVS-R-3, -5	Wirewound Resistors (SMD)	171	SOJC	Resistor Networks (SMD)	98
APD-256M026	Plasma Display Modules	232	MAGNETIC COMPONENTS	Magnetic Components, surface mounted, custom	29	SOMC	Resistor Networks (SMD)	96
APD-256M026-1	Plasma Display Modules	234	MAGNETIC COMPONENTS	Magnetic Components, switch mode	28	SPW	Carbon Film Resistors	159
ASSEMBLIES	NTC Thermistor Assemblies	88	MDM	Resistor Networks, (MIL-R-83401, Type RZ)	120	ST-22, -23	Chip Potentiometers	4
CA & CR	Wirewound Resistors	189	MDP	Resistor Networks	108	TA	Transformers	34
CCF-07	Metal Film Resistors	142	MDP16-45	Resistor Networks	112	TC	Transformers	37
CCF-50	Metal Film Resistors	143	MDRC	Resistor/Capacitor Networks	128	TDP	Resistor Networks, Thin Film	156
CCF-55, -60	Metal Film Resistors	144	MM22 & MM24	Connectors, rack & panel	74	TE & TD	Inductors	30
CMF	Metal Film Resistors	146	MSM	Resistor Networks, (MIL-R-83401, Type RZ)	116	TLCC	Resistor Networks (SMD), Thin Film	132
CMF	Metal Film Resistors, (MIL-R-10509, Type RN), (MIL-R-22684, Type RL)	154	MSP	Resistor Networks	104	TNP	Chip Resistors, Thin Film	136
CMF-55-39, -60-64	Metal Film Resistors	158	NETWORKS	Resistor/Capacitor Networks	126	TNPW	Chip Resistors, Thin Film	137
CONNECTORS	Special Application	48	PBG	Bar Graph Displays	238	TOMC	Resistor Networks (SMD), Thin Film	134
CP	Wirewound Resistors	190	PBG-C	Bar Graph Displays	236	W	Thermistors, chip	84
CPF	Metal Film Resistors	150	PD-04A200	Plasma Displays	210	WSM-1, -2	Wirewound Resistors (SMD)	170
CPL	Wirewound Resistors	191	PD-16A040	Plasma Displays	212	X, M, C, F & T	Thermistors, NTC	86
CPR	Wirewound Resistors	193	PD-32A025	Plasma Displays	214	XO-43	Oscillators	7
CPSL	Wirewound Resistors	192	PDS-200	Standard Bus, Plasma Display Interface	220	XO-51B	Oscillators	8
CRCW	Chip Resistors	138	PH	Wirewound Resistors	176	XO-53B	Oscillators	9
CSC	Resistor Networks	100	PL-11, -12, -13, -14, -32, -33, -34	Transformers	44	XO-54B	Oscillators	10
CSRC	Resistor/Capacitor Networks	130	PL-22, -23, -24, -42, -43, -44	Transformers	46	XOSM-51B	Oscillators (SMD)	6
CW	Wirewound Resistors, (MIL-R-26, Type RW)	188	PLS & PLD	Transformers	42	PRODUCT INFORMATION		
DFM	Resistor Networks, (MIL-R-83401, Type RZ)	123	PT-10, -20	Transformers	38	NTC THERMISTORS		
DFP	Resistor Networks	114	PT-50	Transformers	40	Resistance vs. Temperature Conversion	89	
DS	Connectors, D-Subminiature	72	PTF	Metal Film Resistors, (MIL-R-122, Type RF)	148	How To Select An NTC Thermistor	90	
EB4	Connectors, edgeboards	54	RC & RCWP/RCW	Chip Resistors	140	Interchangeable & Point Matched	93	
EB6	Connectors, edgeboards	57	RCM & RCWPM/RCWM	Chip Resistors, (MIL-R-55342, Type RM)	141	Thermistor Conversion Tables	94	
EB7	Connectors, edgeboards	60	REMIL-R-18546	Wirewound Resistors (RH)	174	PLASMA PANEL DISPLAYS		
EB8	Connectors, edgeboards	64	RERMIL-R-39009	Wirewound Resistors (ERH & ENH)	196	Introduction	208	
EBT156	Connectors, edgeboards	66	RESISTORS	Metal Film Resistors, Special Applications	168	Construction and Operation	209	
ERC	Metal Film Resistors, (MIL-R-55182, Type RNC)	152	RESISTORS	Wirewound Resistors, Special Purpose	198	RESISTORS		
ERH & ENH	Wirewound Resistors, (MIL-R-39009, Type RER)	196	RFMIL-R-122	Metal Film Resistors (PTF-56-3)	148	Checklist For Ordering Metal Film Resistors	169	
ERL	Metal Film Resistors, (MIL-R-39017, Type RLR)	151	RH	Wirewound Resistors, (MIL-R-18546, Type RE)	174	Ordering Information,		
ESS, ESW, EGS, EGW, ESN & EGN	Wirewound Resistors, (MIL-R-39007, Type RWR)	194	RLMIL-R-22684	Metal Film Resistors (CMF)	154	Industrial Power Wirewounds (HL)	182	
FHV	Metal Oxide Resistors	164	RLRMIL-R-39017	Metal Film Resistors (ERL)	151	HL Terminal Specifications		
FRJ-50, -55	Metal Film Jumper Resistors	145	RMIL-R-55342	Chip Resistors (RCM/RCWPM/RCWM)	141	(Industrial Power Wirewounds)	187	
G	Wirewound Resistors, (MIL-R-26, Type RW)	180	RNMIL-R-10509	Metal Film Resistors (CMF)	154	TRIMMERS		
G, H & J	Thermistors, chip	85	RNCMIL-R-55182	Metal Film Resistors (ERC)	152	Quick Reference Index	199	
HACW, HADW, M-51 & HSD	Oxide & Carbon Film Resistors	166	RNX	Metal Oxide Resistors	160	GENERAL INFORMATION		
HIGH TEMP	Connectors	49	ROX	Metal Oxide Resistors	162	Contents	1	
HL & HLM	Wirewound Resistors	184	RS	Wirewound Resistors, (MIL-R-26, Type RW)	178	Alphabetical Index	2	
HL & NHL	Wirewound Resistors	183	RWMIL-R-26	Wirewound Resistors (G)	180	Military Index	3	
HLA	Wirewound Resistors	186	RWMIL-R-26	Wirewound Resistors (CW)	188	Surface Mounted Device Index	3	
HLT	Wirewound Resistors	186	RWMIL-R-26	Wirewound Resistors (RS)	178	Packaging	243	
HLW	Wirewound Resistors	185	RWRMIL-R-39007	Wirewound Resistors (ESS, ESW, EGS, EGW, ESN & EGN)	194	Military Product Identification	248	
HLZ	Wirewound Resistors	185	RZMIL-R-83401	Resistor Networks (DFM)	123	Dale Quality Assurance Programs & Facilities	250	
HVW, MVW & HVX	Metal Alloy Resistors	167	RZMIL-R-83401	Resistor Networks (MDM)	120	Dale Distributors	254	
IH	Inductors	21	RZMIL-R-83401	Resistor Networks (MSM)	116	Dale Representatives	256	
IHA	Inductors	22	Series 100	Trimmmers	204	Where To Order	Inside Back Cover	
IHB	Inductors	24	Series 721/921, 723/923 & 724/924	Trimmmers	200	Government Source Inspection And Federal Supplier Codes	Inside Back Cover	
IHD-1, -3	Inductors	23				PRODUCTS/PHONE NUMBERS		
IHM-2	Inductors	26				CHIP POTENTIOMETERS, OSCILLATORS		
IHV	Inductors	27				(Phone 602-967-7874)		
IM-1, -2, -4, -6, -8, -9, -10	Inductors, (MIL-C-15305, Type LT)	15				INDUCTIVE COMPONENTS, TRANSFORMERS, CONNECTORS		
IMC-1812	Chip Inductors	11				(Phone 605-665-9301)		
IMS-2	Inductors, shielded	14				THICK FILM RESISTOR NETWORKS, THERMISTORS		
IMS-5	Inductors, shielded, (MIL-C-15305, Type LT)	12				(Phone 915-592-3253)		
INDUCTORS	Inductors, aircore	28				FILM RESISTORS, THICK & THIN FILM CHIP RESISTORS, THIN FILM RESISTOR NETWORKS		

INDUCTORS (Phone 605-665-9301)

MIL-C-15305	DALE MODEL	PAGE
• MS75087, MS75088, MS75089	IMS-5	12
• MS75083, MS75084, MS75085	IM-2	15
• MS14046, MS18130, MS90538	IM-4	15

CONNECTORS (Phone 605-665-9301)

MIL-C-28748/7,8	DALE MODEL	PAGE
	MM22	74

RESISTOR NETWORKS (Phone 915-592-3253)

MIL-R-83401	DALE MODEL	PAGE
• RZ010, RZ020	MDM	120
• RZ030	DFM	123
• RZ040, RZ050, RZ060, RZ070, RZ080, RZ090	MSM	116

THICK FILM CHIP RESISTORS (Phone 402-371-0080)

MIL-R-55342/2,3,4,5,6	DALE MODEL	PAGE
• RM0505, RM1005, RM1505, RM0705, RM2208	RCM & RCWPM/RCWM	141

METAL FILM RESISTORS (Phone 402-371-0080)

MIL-R-122	DALE MODEL	PAGE
	PTF-56-3	148
MIL-R-10509		
• RN50, RN55, RN60, RN65, RN70	CMF	154
MIL-R-22684		
• RL07, RL20	CMF	154

METAL FILM RESISTORS (Continued)

MIL-R-39017	DALE MODEL	PAGE
• RLR05, RLR07, RLR20	ERL	151
MIL-R-55182		
• RNC50, RNC55, RNC60, RNC65, RNC70	ERC	152

WIREWOUND RESISTORS (Phone 402-564-3131)

MIL-R-26	DALE MODEL	PAGE
• RW67, RW68, RW69	CW	188
• RW70, RW74, RW78, RW79	RS	178
• RW80, RW81	G	180
MIL-R-18546		
• RE60, RE65, RE70, RE75, RE77, RE80	RH	174
MIL-R-39007		
• RWR71, RWR74, RWR78	ESS, ESW, ESN	194
• RWR80, RWR81	EGS, EGW, EGN	194
• RWR82	EGS, EGW	194
• RWR84	EGS, EGW, EGN	194
• RWR89	ESS, ESW, ESN	194
MIL-R-39009		
• RER40, RER45, RER50, RER55	ENH	196
• RER60, RER65, RER70, RER75	ERH	196

NOTE 1: Consult factory for more detail on QPL products.
NOTE 2: DALE ELECTRONICS, INC. manufactures many products to meet Military Specifications—consult catalog.

CHIP POTENTIOMETERS (Phone 602-967-7874)	PAGE
ST22 & ST23, surface mounted	4
OSCILLATORS (Phone 602-967-7874)	
XOSM-51, surface mounted, hybrid crystal clock	6
INDUCTORS & TRANSFORMERS (Phone 605-665-9301)	
IMC-1812, molded, surface mount chip inductors	11
Surface Mounted Magnetic Components	29
THERMISTORS (Phone 915-592-3253)	
W, chip, surface mounted	84
G, H, J, hybrid chip, surface mounted	85
THICK FILM RESISTOR NETWORKS (Phone 915-592-3253)	
SOMC, small outline molded DIP, surface mounted	96
SOJC, dual-in-line, .300 wide J-lead, surface mounted	98
DFP, flat pack	114
DFM, flat pack (MIL-R-83401)	123

FILM RESISTORS (Phone 402-371-0080)	PAGE
TLCC, commercial, hermetic, surface mounted thin film chip carrier networks	132
TOMC, small outline molded DIP, surface mounted thin film networks	134
TNP, chip resistor, commercial, precision thin film	136
TNPW, chip resistor, commercial, precision thin film	137
CRCW, chip resistor, commercial, thick film	138
RC & RCWP/RCW, chip resistor, commercial, thick film	140
RCM & RCWPM/RCWM, chip resistor, (MIL-R-55342) E-Rel, thick film	141
WIREWOUND RESISTORS (Phone 402-564-3131)	
WSM-1 & WSM-2, precision power, surface mounted	170
LVSF 3 & LVSF 5, low value, precision power, surface mounted	171



SURFACE MOUNTED CHIP POTENTIOMETERS

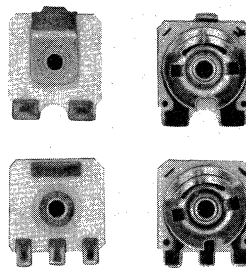

MODELS ST-22, ST-23

FEATURES

- Designed for efficient, accurate miniaturization
- Can be wave or dip soldered without rotor problems
- Coded marking for easy identification of resistance value
- Models for standard, automatic or reverse adjustment
- 12mm tape and reel packaging

STANDARD RESISTANCE VALUES

Ohms	Ohms	Ohms
100	2K	50K
200	5K	100K
500	10K	200K
1K	20K	500K
		1 Meg.

SPECIFICATIONS

Resistance Values	100Ω-1MΩ
Resistance Tolerance	±30%
Rated Power	0.2W (70°C)
Rated Voltage	100 VDC
Rotation Life	20 Rotations
Torque	20 to 200 g/cm
Rotation Angle	270 ± 20° Total
Operating Temp. Range	-40°C to +100°C
TCR	±250 PPM
CRV	5% Max.

SPECIFICATIONS AND TEST METHODS

PARAMETER	SPECIFICATION	TEST METHODS
Rotation Life (Resistance)	$\Delta R < \pm 15\%$ of initial value	Rotate 20 times through 90° of effective rotation angle at a rate of 10 rotations per minute.
Vibration	$\Delta R < \pm 1\%$ of initial value	Set rotor to nominal value frequency 10-55 Hz, amplitude 1.5mm duration 2 hours in X, Y, and Z axis.
Temperature Cycle	$\Delta R < \pm 2\%$ of initial value	Set rotor to full value 5 cycles from -40°C to 25°C, to +100°C to 25°C. Dwell for 30 minutes at -40°C and +100°C. Dwell 15 minutes at 25°C. Stabilization time is 1 hour each.
Heat Resistance	$\Delta R < \pm 3\%$ of initial value	Set rotor to full value, bake at +100°C ± 3°C for 250 hours, stabilize at 25°C for 1 hour prior to taking final measurements.
Load Life in Moisture	$\Delta R < \pm 3\%$ of initial value	Set rotor to full value, test temperature +40°C ± 2°C at 90-95% RH. Cycle voltage on for 90 minutes, off for 30 minutes for 500 hours. Stabilize at 25°C for 1 hour. Measure resistance value.
Rotation Life (Torque)	Torque to be 20 g/cm-200 g/cm	Rotate rotor 10 times through 270° arc. Measure torque after 5 and 10 rotations.
Solvent Resistance	$\Delta R < \pm 1\%$ of initial value	Set rotor to full value, immerse in Trichloroethylene or equivalent for 15 minutes. Air dry at 25°C for 5 hours. Measure resistance value.
Load Life	$\Delta R < \pm 3\%$ of initial value	Set rotor to full value, test temperature +70°C ± 2°C, cycle voltage on for 90 minutes, off for 30 minutes for 1000 hours. Stabilize at 25°C for 1 hour. Measure resistance value.
Resistance to Soldering Heat	$\Delta R < \pm 1\%$ of initial value	Set rotor to full value, immerse in SN62 solder bath at 250°C for 5 ± 1 seconds. Stabilize at 25°C for 5 hours. Measure resistance value.

DIMENSIONAL & TERMINAL CONFIGURATIONS [Numbers in brackets indicate millimeters]

NOTE: Numbers without specified tolerance are for reference only.

ST-22 Standard Adjustment

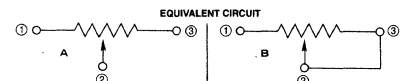
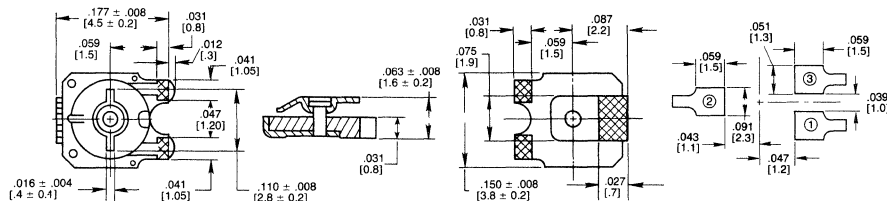

ST-23 Standard Adjustment

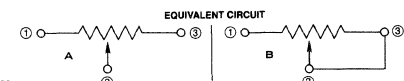
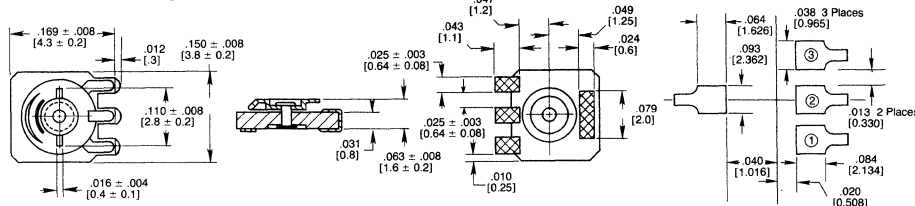

DALE ELECTRONICS, INC., 1155 West 23rd St., Tempe, AZ 85282 • Phone 602-967-7874
 Canada: Dale Electronics Ltd., 18 Howden Rd., Scarborough, Ontario M1R 3E6
 Europe: Dale Electronics GmbH, Benzstrasse 28, 8039 Puchheim, West Germany

ST-22 and ST-23 SERIES
ST-23 Automatic Adjustment

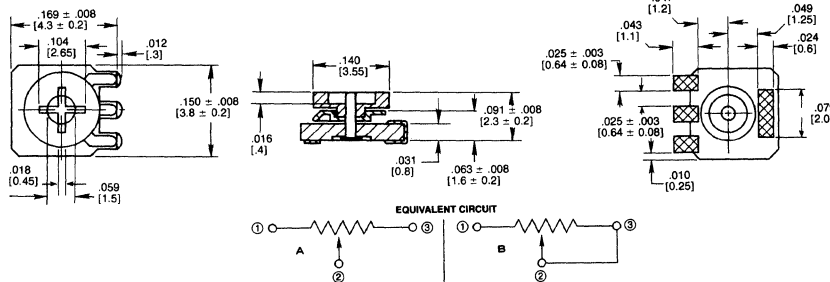

Standard PC Board Pattern

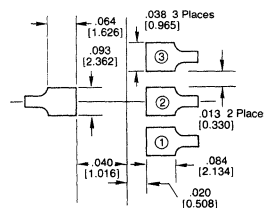

ST-23 Reverse Adjustment

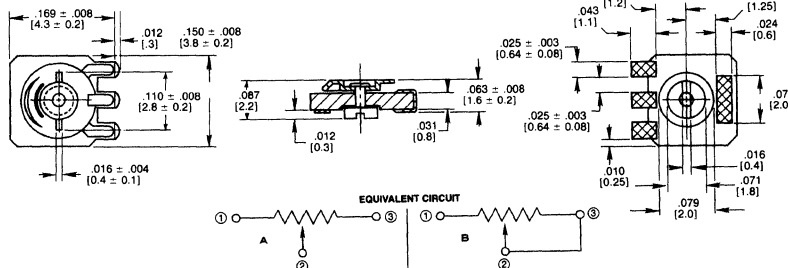

ST-23 Reverse Standard Mounting Pad-Pattern

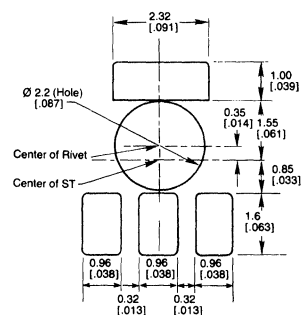

TAPE AND REEL PACKAGING

1. Material: Styrene-System-Plastic Sheet
2. Dimension

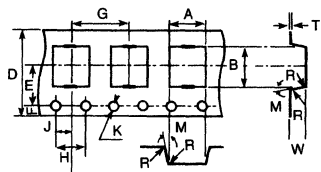

MARKING

RESISTANCE CODE

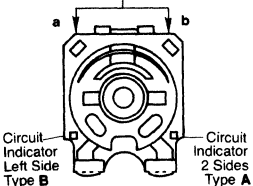

MARKING CODES

Resistance value	a	b	Resistance value	a	b
100 ohms	1	1	200K	X	4
1K	1	2	500 ohms	Y	1
10K	1	3	5K	Y	2
100K	1	4	50K	Y	3
200 ohms	X	1	500K	Y	4
2K	X	2	1 meg.	1	5
20K	X	3			

CODE	A	B	D	E	F	G	H	J	K	M	R	W	T
DIM.	.177 ± .008 [4.5 ± 0.2]	.189 ± .008 [4.8 ± 0.2]	.472 ± .012 [12.0 ± 0.3]	.217 ± .004 [5.5 ± 0.1]	.059 ± .008 [1.5 ± 0.2]	.315 ± .004 [8.0 ± 0.1]	.157 ± .004 [4.0 ± 0.1]	.079 ± .004 [2.0 ± 0.1]	.059 ± .004 [1.5 ± 0.1]	15° ± 0	0.3° ± 0	.106 ± .004 [2.7 ± 0.1]	.012 ± .004 [0.3 ± 0.1]

CODE	DIMENSIONS	
	1000 PER REEL	5000 PER REEL
A	7.01 ± .080 [178 ± 2.0]	16.5 ± .079 [420 ± 2.0]
B	1.97 [50]	3.15 ± .079 [80.0 ± 2.0]
C	.709 ± .020 [18.0 ± 0.5]	.709 ± .020 [18.0 ± 0.5]
D	.827 ± .031 [21.0 ± 0.8]	.827 ± .031 [21.0 ± 0.8]
E	.079 ± .020 [2.0 ± 0.5]	.079 ± .020 [2.0 ± 0.5]
W	.551 ± .059 [14.0 ± 1.5]	.551 ± .059 [14.0 ± 1.5]
T	.039 ± .020 [1.0 ± 0.5]	.079 ± .020 [2.0 ± 0.5]
R	.039 [1.0]	.197 [5.0]

REEL

1. Material: Cardboard
2. Dimension

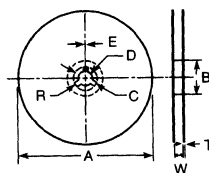

TAPE LOADING

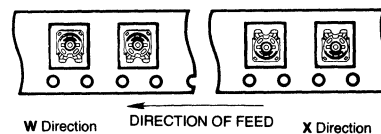

HOW TO ORDER



A=3 terminal
(Voltage Divider Circuit)
B=2 terminal
(Rheostat Circuit)

The first two digits are significant.
 The third digit is the number of zeros following to express resistance in ohms.

A = standard
B = automatic adjustment
C = reverse adjustment



SURFACE MOUNT, HYBRID CRYSTAL CLOCK OSCILLATOR

MODEL XOSM-51B, 240 Hz to 1.5 MHz; 4.0 MHz to 60.0 MHz

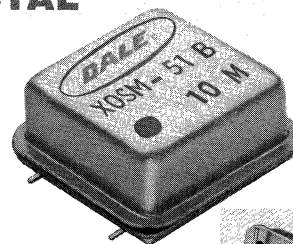

ACTUAL
SIZE

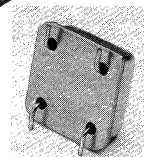

FEATURES

- HCMOS, CMOS, NMOS, TTL, LS-TTL, S-TTL Compatible
- Miniature size (.50" square) for greater packaging density
- Hermetically sealed package

SPECIFICATIONS

ELECTRICAL

Operating Temperature Range: 0°C to +70°C

Storage Temperature Range: -55°C to +125°C

Frequency Stability: (Inclusive of Calibration Tolerance at 25°C, Temperature Change, Input Voltage Change, Load Change, Aging, Shock and Vibration): ±.01% (±100 PPM)

Input Voltage: (Vdd) +5.0 ± 0.5 VDC

Input Current: 5 to 40 mA Typ. (see graph)

Rise Time: 10nS Max. (CMOS Levels), 6nS Max. (TTL Levels)

Fall Time: 10nS Max. (CMOS Levels), 6nS Max. (TTL Levels)

Logic '0' Level: 0.1 Vdd Max. CMOS, 0.4V Max. TTL

Logic '1' Level: 0.9 Vdd Min. CMOS, 2.4V Min. TTL

Logic '0' Sink Current: 16 mA Min.

Logic '1' Source Current: 0.4 mA Min.

Output Waveform: Squarewave, HCMOS, CMOS, NMOS, TTL, LS-TTL, S-TTL Compatible, Waveform Symmetry (0.5 Vdd CMOS or 1.4V TTL Levels): 50 ± 10%

Output Load: 50 pF HCMOS or 1-10 TTL Loads (3 TTL Max. below 4 MHz)

Environmental:

Temperature Cycle: -55°C to + 85°C, 3 cycles

Shock: 1000 G's 0.35 millisecond, ½ sine wave, 3 shocks each plane

Vibration: .06 D.A., 10-55 Hz, 35 G, 55-2000 Hz

Humidity: 85% relative humidity @ 85°C, 240 Hours

Mechanical:

Hermetically Sealed Package: Leak rate less than 2 x 10⁻⁸ atmosphere cc/sec. of helium

Marking Ink: Epoxy, solvent resistant

Solvent Resistance: Isopropyl alcohol, Trichloroethane, Freon TMC

Terminal Solderability: Per MIL-STD-202, Method 208C

PIN	CONNECTION
1	N/C
4	Circuit/Case Ground
5	OUTPUT
8	INPUT (Vcc)

TTL TEST CIRCUIT

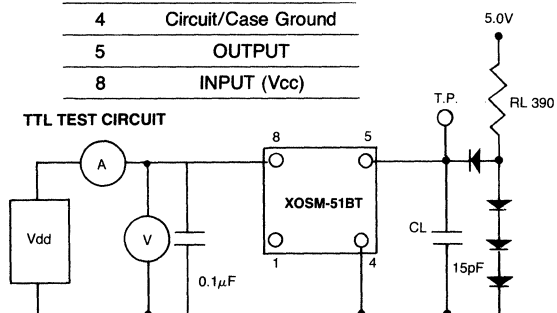

CMOS TEST CIRCUIT

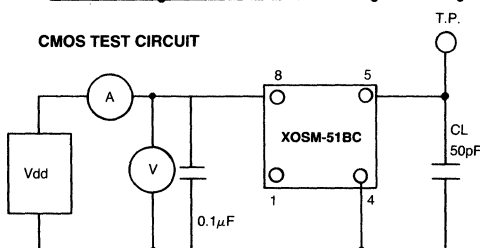

CL — To include probe and fixture capacitance

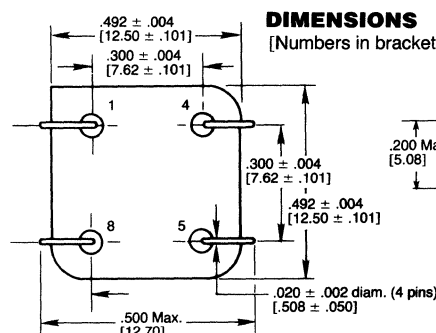

DIMENSIONS

[Numbers in brackets indicate millimeters]

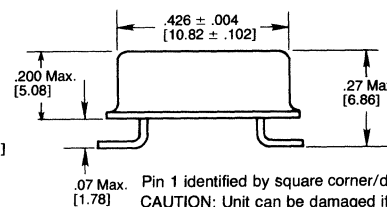

FREQ — IDD CHARACTERISTICS

(TYPICAL @ VDD = 5.0 VDC)

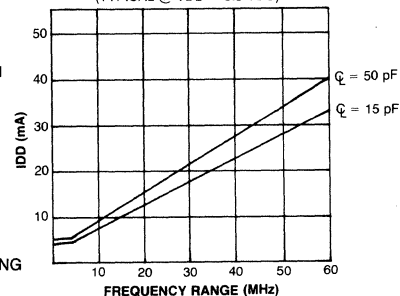

PACKAGING METHODS

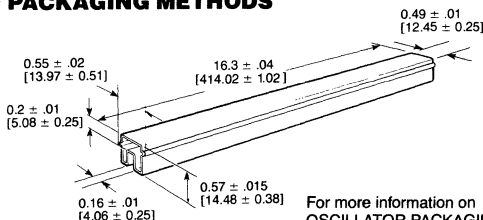

For more information on OSCILLATOR PACKAGING write or phone.

HOW TO ORDER

XOSM-51

PART NO. CODE

B

FREQ. ACCURACY

- A = .005%
- B = .01% (Std. Tol.)
- C = .05%

10

MEASUREMENT METHOD

- C: C-MOS Level
- T: TTL Level

FREQ./MHZ

Contact factory for other models, logic families, stabilities and temperature ranges.

DALE ELECTRONICS, INC., 1155 West 23rd St., Tempe, AZ 85282 • Phone 602-967-7874

Canada: Dale Electronics Ltd., 18 Howden Rd., Scarborough, Ontario M1R 3E6

Europe: Dale Electronics GmbH, Benzstrasse 28, 8039 Puchheim, West Germany



HYBRID CRYSTAL CLOCK OSCILLATOR

MODEL XO-43, 250 KHz to 60 MHz Low Profile, Resistance Welded Metal Package

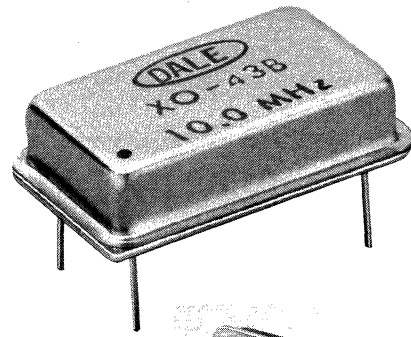

ACTUAL
SIZE

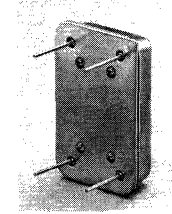

FEATURES

- Able to withstand flow soldering
- Wide range of standard frequencies available from stock (listed below)
- Hermetically sealed package
- Low profile .225 inches [5.72] max. seating height
- Metal Case - corrosion resistant and grounded for EMI shielding
- Glass standoffs for spacing from mounting surface

SPECIFICATIONS

Input Voltage: +5 VDC $\pm 0.5V$

Frequency Range: 250 KHz to 60 MHz

Operating Temperature Range: 0°C to 70°C

TTL Compatible: Will drive 1-10 TTL Gates

Environmental:

Temperature Cycle: -55°C to +85°C, 3 cycles

Shock: 1000 G's 0.35 millisecond, 1/2 sine wave, 3 shocks each plane

Vibration: .06" D.A., 10-55 Hz, 35 G, 55-2000 Hz

Humidity: 85% relative humidity @ 85°C, 240 Hours

Mechanical:

Hermetically Sealed Package: Leak rate less than 2×10^{-8} atmosphere cc/sec. of helium

Marking Ink: Epoxy, solvent resistant

Solvent Resistance: Isopropyl alcohol, Trichloroethane, Freon TMC

Terminal Solderability: Per MIL-STD-202, Method 208C

Package: Cold Rolled Steel (CRS), Nickel-Plated Base with Resistance Welded Stainless Steel Cover

STOCKING FREQUENCIES (MHz) "B" accuracy only

1.0	5.0	16.0	25.0
1.2288	5.0688	16.384	30.0
2.0	6.0	18.432	32.0
2.4576	8.0	19.6608	40.0
4.0	10.0	20.0	50.0
4.9152	12.0	24.0	

PIN	CONNECTION
1	N.C.
7	GND
8	OUTPUT
14	+5 VDC

SCHEMATIC

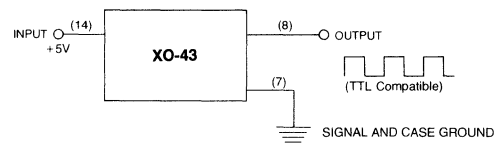

MODEL XO-43 DIMENSIONS

[Numbers in brackets indicate millimeters]

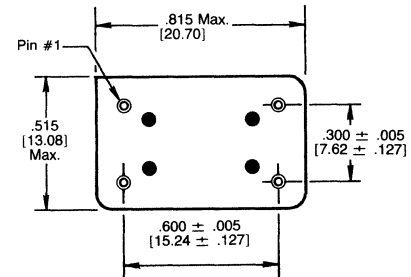
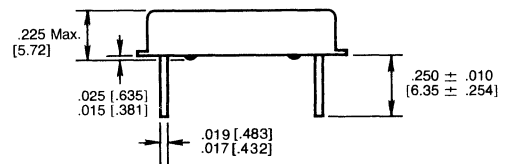

Pin #1 is identified by square corner

FREQUENCY RANGE	INPUT CURRENT (mA)	WAVEFORM SYMMETRY @ 1.4 VDC	TTL OUTPUT RISE & FALL TIME (From Zero to One Level)	"ZERO" LEVEL SINKING 16 mA	"ONE" LEVEL SOURCING 0.4 mA
250 KHz to 3.99 MHz	65 max.	55/45	15 nS max.	0.4 volts max.	2.4 volts min.
4.0 MHz to 24.99 MHz	40 max.	60/40	10 nS max.	0.4 volts max.	2.4 volts min.
25.0 MHz to 60.0 MHz	50 max.	60/40	6 nS max.	0.4 volts max.	2.4 volts min.

HOW TO ORDER

XO-43	B	25
PART NO. CODE	FREQ. ACCURACY (All Conditions)	FREQ./MHz
	A = $\pm 0.005\%$ (± 50 PPM)	
	B = $\pm 0.01\%$ (± 100 PPM)	
	C = $\pm 0.05\%$ (± 500 PPM)	
	D = $\pm 0.1\%$ (± 1000 PPM)	
	H = $\pm 1\%$	

Contact factory for other models, logic families, stabilities and temperature ranges.



HYBRID CRYSTAL CLOCK OSCILLATOR

MODEL XO-51B, 240 Hz to 1.5 MHz; 4.0 MHz to 60.0 MHz

FEATURES

- HCMOS, CMOS, NMOS, TTL, LS-TTL, S-TTL Compatible
- Miniature size (.50" square) for greater packaging density
- Hermetically sealed package

SPECIFICATIONS

ELECTRICAL

Operating Temperature Range: 0°C to +70°C

Storage Temperature Range: -55°C to +125°C

Frequency Stability (Inclusive of Calibration Tolerance at 25°C, Temperature Change, Input Voltage Change, Load Change, Aging, Shock and Vibration): ±.01% (±100 PPM)

Input Voltage: (V_{dd}) +5.0 ± 0.5 VDC

Input Current: 5 to 40 mA Typ. (see graph)

Rise Time: 10nS Max. (CMOS Levels), 6nS Max. (TTL Levels)

Fall Time: 10nS Max. (CMOS Levels), 6nS Max. (TTL Levels)

Logic '0' Level: 0.1 V_{dd} Max. CMOS, 0.4V Max. TTL

Logic '1' Level: 0.9 V_{dd} Min. CMOS, 2.4V Min. TTL

Logic '0' Sink Current: 16 mA Min.

Logic '1' Source Current: 0.4 mA Min.

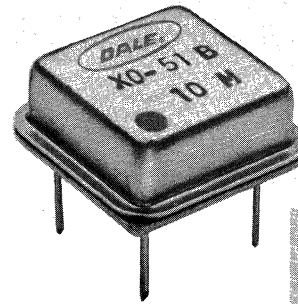

ACTUAL
SIZE

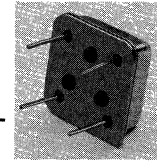

Output Waveform: Squarewave, HCMOS, CMOS, NMOS, TTL, LS-TTL, S-TTL Compatible, Waveform Symmetry (0.5 V_{dd} CMOS or 1.4V TTL Levels): 50 ± 10%

Output Load: 50 pF HCMOS or 1-10 TTL Loads
(3 TTL Max. below 4 MHz)

Environmental:

Temperature Cycle: -55°C to + 85°C, 3 cycles

Shock: 1000 G's 0.35 millisecond, ½ sine wave,
3 shocks each plane

Vibration: .06 D.A., 10-55 Hz, 35 G, 55-2000 Hz

Humidity: 85% relative humidity @ 85°C, 240 Hours

Mechanical:

Hermetically Sealed Package: Leak rate less than 2 x 10⁻⁸
atmosphere cc/sec. of helium

Marking Ink: Epoxy, solvent resistant

Solvent Resistance: Isopropyl alcohol, Trichloroethane,
Freon TMC

Terminal Solderability: Per MIL-STD-202, Method 208C

PIN	CONNECTION
1	N/C
4	Circuit/Case Ground
5	OUTPUT
8	INPUT (V _{cc})

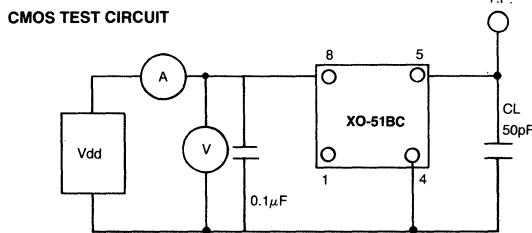
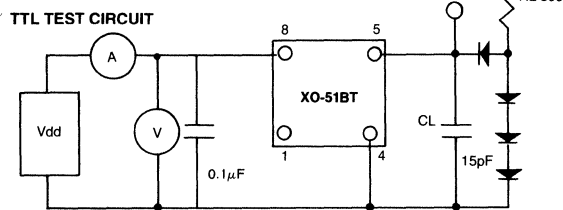

CL — To include probe and fixture capacitance

DIMENSIONS [Numbers in brackets indicate millimeters]

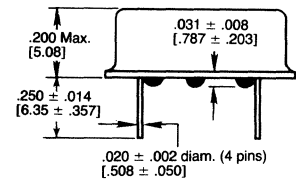
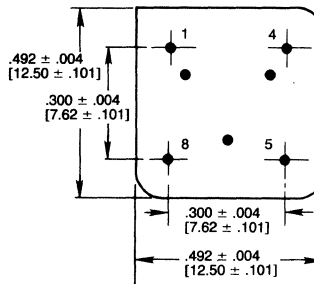

Pin 1 identified by square corner/dot
CAUTION: Unit can be damaged if
plugged in backwards

FREQ — I_{DD} CHARACTERISTICS (TYPICAL @ V_{DD} = 5.0 VDC)

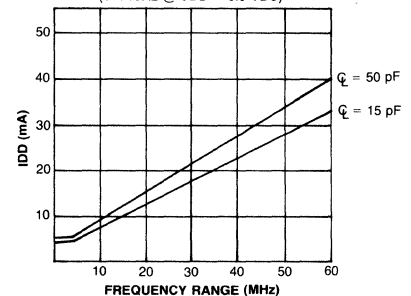

HOW TO ORDER

XO-51	B	T	10
PART NO. CODE	FREQ. ACCURACY	MEASUREMENT METHOD	FREQ./MHZ
A	.005%	C: C-MOS Level	
B	.01% (Std. Tol.)	T: TTL Level	
C	.05%		

Contact factory for other models, logic families, stabilities and temperature ranges.

DALE ELECTRONICS, INC., 1155 West 23rd St., Tempe, AZ 85282 • Phone 602-967-7874

Canada: Dale Electronics Ltd., 18 Howden Rd., Scarborough, Ontario M1R 3E6
Europe: Dale Electronics GmbH, Benzstrasse 28, 8039 Puchheim, West Germany



HYBRID CRYSTAL CLOCK OSCILLATOR

MODEL XO-53B, 1.0 MHz to 50 MHz Low Profile, Resistance Welded Metal Package

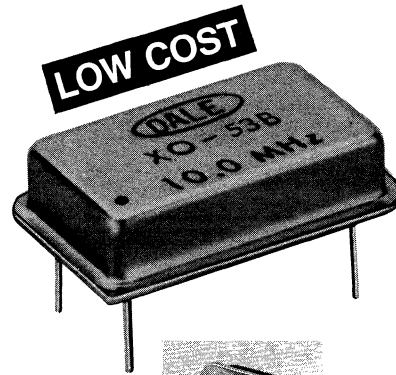

ACTUAL
SIZE

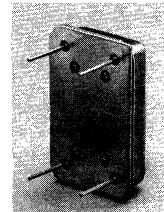

FEATURES

- Able to withstand flow soldering
- Wide range of standard frequencies available from stock (listed below)
- Hermetically sealed package
- Low profile .225 inches [5.72] max. seating height
- Metal Case - corrosion resistant and grounded for EMI shielding
- Glass standoffs for spacing from mounting surface

SPECIFICATIONS

Input Voltage: +5 VDC $\pm 0.5V$

Frequency Range: 1.0 MHz to 50 MHz

Frequency Stability: $\pm .01\%$ (± 100 PPM)

Operating Temperature Range: 0°C to 70°C

TTL Compatible: Will drive 1-10 TTL Gates

Environmental:

Temperature Cycle: -55°C to +85°C, 3 cycles

Shock: 1000 G's 0.35 millisecond, 1/2 sine wave, 3 shocks each plane

Vibration: .06" D.A., 10-55 Hz, 35 G, 55-2000 Hz

Humidity: 85% relative humidity @ 85°C, 240 Hours

Mechanical:

Hermetically Sealed Package: Leak rate less than 2×10^{-8} atmosphere cc/sec. of helium

Marking Ink: Epoxy, solvent resistant

Solvent Resistance: Isopropyl alcohol, Trichloroethane, Freon TMC

Terminal Solderability: Per MIL-STD-202, Method 208C

STOCKING FREQUENCIES (MHz)

1.0	4.9152	12.0	20.0
1.2288	5.0	14.31818	24.0
1.8432	5.0688	16.0	25.0
2.0	6.0	16.257	30.0
2.4576	8.0	16.384	32.0
3.6864	9.8304	18.432	40.0
4.0	10.0	19.6608	50.0

PIN	CONNECTION
1	N.C.
7	GND
8	OUTPUT
14	+5 VDC

DESIGN SUBJECT TO CHANGE WITHOUT NOTICE.

SCHEMATIC

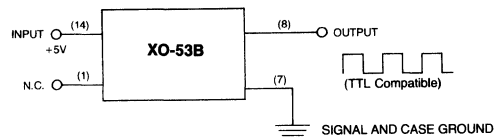

MODEL XO-53B DIMENSIONS

[Numbers in brackets indicate millimeters]

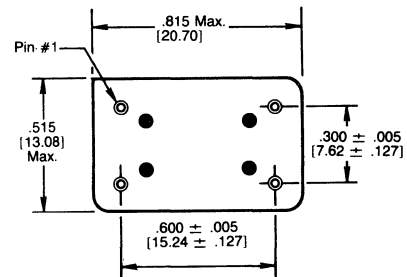
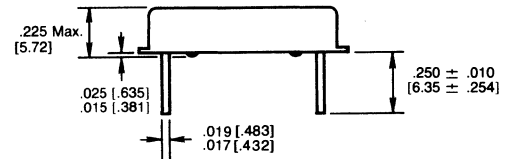

Pin #1 is identified by square corner

FREQUENCY RANGE	INPUT CURRENT (mA)	WAVE FORM SYMMETRY @ 1.4 VDC	TTL OUTPUT RISE & FALL TIME (From Zero to One Level)	"ZERO" LEVEL SINKING 16 mA	"ONE" LEVEL SOURCING 0.4 mA
250 KHz to 3.999 MHz	90 max.	60/40	15 nS max.	0.4 volts max.	2.4 volts min.
4.0 MHz to 8.999 MHz	40 max.	60/40	15 nS max.	0.4 volts max.	2.4 volts min.
9.0 MHz to 24.999 MHz	40 max.	60/40	10 nS max.	0.4 volts max.	2.4 volts min.
25.0 MHz to 31.999 MHz	70 max.	60/40	10 nS max.	0.5 volts max.	2.4 volts min.
32.0 MHz to 60.0 MHz	70 max.	60/40	6 nS max.	0.5 volts max.	2.4 volts min.

HOW TO ORDER

XO-53	B	25
PART NO. CODE	FREQ. ACCURACY (All Conditions)	FREQ./MHz
B = $\pm .01\%$ (± 100 PPM)		

Contact factory for other models, logic families, stabilities and temperature ranges.

DALE ELECTRONICS, INC., 1155 West 23rd St., Tempe, AZ 85282 • Phone 602-967-7874

Canada: Dale Electronics Ltd., 18 Howden Rd., Scarborough, Ontario M1R 3E6
Europe: Dale Electronics GmbH, Benzstrasse 28, 8039 Puchheim, West Germany



HYBRID CRYSTAL CLOCK OSCILLATOR

MODEL XO-54B, 250 KHz to 60 MHz Low Profile, Resistance Welded Metal Package

FEATURES

- HCMOS, CMOS, NMOS, TTL, LS-TTL, S-TTL compatible
- Enabled tri-state output optional
- Hermetically sealed package

SPECIFICATIONS

ELECTRICAL

Operating Temperature Range: 0°C to 70°C

Frequency Stability: (Inclusive of Calibration Tolerance at 25°C Temperature Change, Input Voltage Change, Load Change, Aging, Shock and Vibration): ±.01% (±100 PPM)

Input Voltage (Vdd): +5.0 ± 0.5 VDC

Input Current: 5 to 40 mA Typ. (see graph)

Rise Time: 10nS Max. (CMOS Levels), 6nS Max. (TTL Levels)

Fall Time: 10nS Max. (CMOS Levels), 6nS Max. (TTL Levels)

Logic '0' Level: 0.1 Vdd Max. CMOS, 0.4V Max. TTL

Logic '1' Level: 0.9 Vdd Min. CMOS, 2.4V Min. TTL

Logic '0' Sink Current: 16 mA Min.

Logic '1' Source Current: 0.4 mA Min.

Output Waveform: Squarewave, HCMOS, CMOS, NMOS, TTL, LS-TTL, S-TTL Compatible, Waveform Symmetry (0.5 Vdd CMOS or 1.4V TTL Levels): 50 ± 10%

Output Load: 50 pF HCMOS or 1-10 TTL Loads

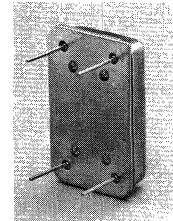
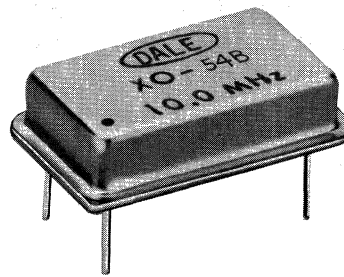

ACTUAL
SIZE

Enable/Disable Option: Output on Pin 8 is normal when Pin 1 is open or above 2.2V level. Output is disabled (high impedance) when Pin 1 is below 0.8V.

Enable Input: 2.2V Min. @ 10µA Max.

Disable Input: 0.8V Max. @ 150µA Max.

Enable/Disable Delay Time: 100nS Max.

Environmental:

Temperature Cycle: -55°C to +85°C, 3 cycles

Shock: 1000 G's 0.35 millisecond, 1/2 sine wave, 3 shocks each plane

Vibration: .06 D.A., 10-55 Hz, 35 G, 55-2000 Hz

Humidity: 85% relative humidity @ 85°C, 240 Hours

Mechanical:

Hermetically Sealed Package: Leak rate less than 2 x 10⁻⁸ atmosphere cc/sec. of helium

Marking Ink: Epoxy, solvent resistant

Solvent Resistance: Isopropyl alcohol, Trichloroethane, Freon TMC

Terminal Solderability: Per MIL-STD-202, Method 208C

PIN	CONNECTION
1	N.C. or E/D
7	GND
8	OUTPUT
14	+5 VDC

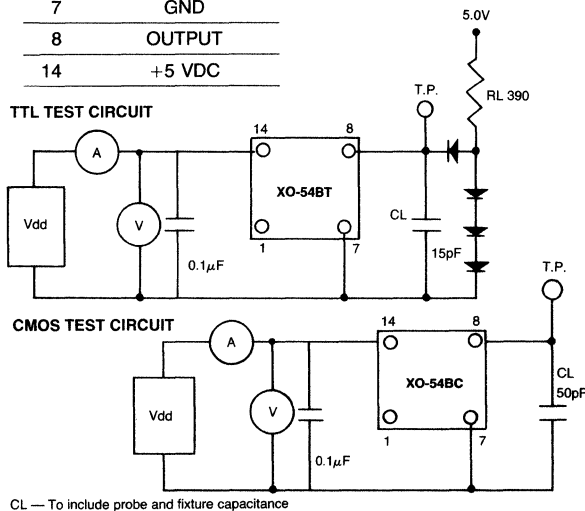

CL — To include probe and fixture capacitance

STANDARD FREQUENCIES (MHz)

14.31818	32.0
20.0	40.0

DIMENSIONS [Numbers in brackets indicate millimeters]

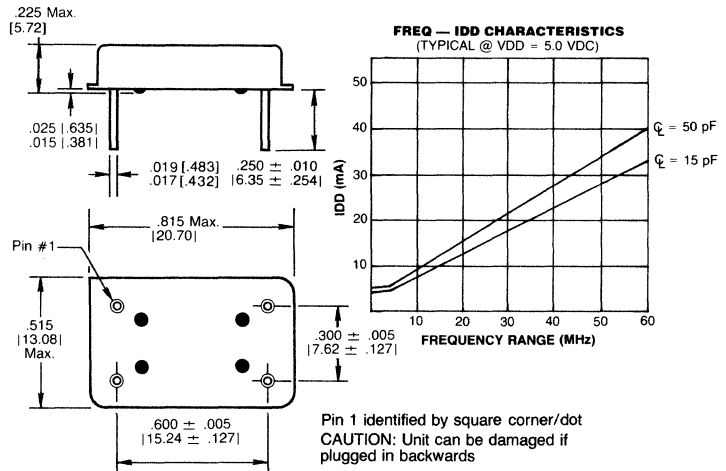

HOW TO ORDER

XO-54	B			10
PART NO. CODE	FREQ. ACCURACY	MEASURING METHOD	ENABLE/DISABLE FUNCTION	FREQ./MHz
A = .005%	C: C-MOS Level	E: With Function		
B = .01% (Std. Tol.)	T: TTL Level	BLANK: #1 Pin Open		
C = .05%				

Contact factory for other models, logic families, stabilities and temperature ranges.

DALE ELECTRONICS, INC., 1155 West 23rd St., Tempe, AZ 85282 • Phone 602-967-7874

Canada: Dale Electronics Ltd., 18 Howden Rd., Scarborough, Ontario M1R 3E6
Europe: Dale Electronics GmbH, Benzstrasse 28, 8039 Puchheim, West Germany



**MOLDED
CHIP INDUCTOR**

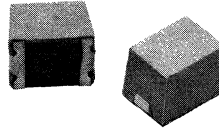

DALE IMC-1812 SERIES

FEATURES

- Molded construction provides superior strength and moisture resistance
- Precision performance, excellent reliability, sturdy construction
- Compatible with vapor phase and infra-red reflow soldering
- Solid phosphor bronze, tin plated terminals. No leaching!
- Special inductance tolerances available ($\pm 10\%$, $\pm 5\%$ and $\pm 3\%$) upon request
- Printed marking
- Wide inductance range in small package
- Tape and reel packaging for automatic handling
- Component shape designed to accommodate automatic machine placement

ELECTRICAL SPECIFICATIONS

Inductance Range: $.01\mu\text{H}$ to $1000\mu\text{H}$

Standard Tolerances: $\pm 20\%$ for $.01\mu\text{H}$ to $.39\mu\text{H}$
 $\pm 10\%$ for $.47\mu\text{H}$ to $1000\mu\text{H}$

Temperature Range: -20°C to 105°C

Coilform Material: Ceramic for $.01\mu\text{H}$ to $.82\mu\text{H}$
Ferrite for $1.0\mu\text{H}$ to $1000\mu\text{H}$

TEST EQUIPMENT

- H/P 4342A Q meter with Dale test fixture or equivalent
- H/P 4191A RF Impedance Analyzer (for SRF measurements)
- Wheatstone Bridge

DIMENSIONAL SPECIFICATIONS

[Numbers in brackets indicate millimeters]

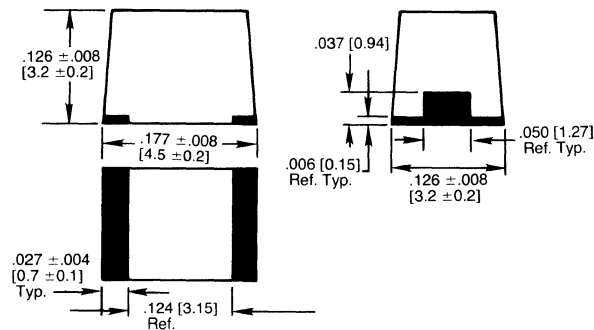

ORDERING INFORMATION

IMC-1812 **10 μh** **$\pm 10\%$**
 1. 2. 3.

1. Basic model
2. Inductance value (μh)
3. Inductance tolerance

IMC-1812 ELECTRICAL SPECIFICATIONS

INDUCT (μH) & TOL.	Q MIN.	TEST FREQ. L & Q (Mhz)	SELF-RESONANT FREQ. MIN. (Mhz)	DC RESISTANCE MAX. (Ω)	COILFORM MATERIAL	
.010 $\pm 20\%$	50	50.0	1000.	.20	Ceramic	
.012 $\pm 20\%$	50	50.0	1000.	.20		
.018 $\pm 20\%$	50	50.0	1000.	.20		
.022 $\pm 20\%$	50	50.0	1000.	.20		
.027 $\pm 20\%$	50	50.0	1000.	.20		
.033 $\pm 20\%$	50	50.0	1000.	.30		
.039 $\pm 20\%$	50	50.0	1000.	.30		
.047 $\pm 20\%$	50	50.0	1000.	.30		
.056 $\pm 20\%$	40	50.0	900.	.35		
.068 $\pm 20\%$	40	50.0	800.	.35		
.082 $\pm 20\%$	40	50.0	700.	.40		
.10 $\pm 20\%$	30	25.2	650.	.32		
.12 $\pm 20\%$	30	25.2	600.	.30		
.15 $\pm 20\%$	30	25.2	500.	.30		
.18 $\pm 20\%$	30	25.2	400.	.35		
.22 $\pm 20\%$	30	25.2	350.	.40		
.27 $\pm 20\%$	30	25.2	300.	.45		
.33 $\pm 20\%$	30	25.2	250.	.55		
.39 $\pm 20\%$	30	25.2	220.	.70		
.47 $\pm 10\%$	30	25.2	190.	.80		
.56 $\pm 10\%$	30	25.2	170.	1.20		
.68 $\pm 10\%$	30	25.2	150.	1.40		
.82 $\pm 10\%$	30	25.2	140.	1.60		
1.0 $\pm 10\%$	50	7.96	100.	.50		Ferrite
1.2 $\pm 10\%$	50	7.96	80.	.55		
1.5 $\pm 10\%$	50	7.96	70.	.60		
1.8 $\pm 10\%$	50	7.96	60.	.65		
2.2 $\pm 10\%$	50	7.96	55.	.70		
2.7 $\pm 10\%$	50	7.96	50.	.75		
3.3 $\pm 10\%$	50	7.96	45.	.80		
3.9 $\pm 10\%$	50	7.96	40.	.90		
4.7 $\pm 10\%$	50	7.96	35.	1.00		
5.6 $\pm 10\%$	50	7.96	33.	1.10		
6.8 $\pm 10\%$	50	7.96	27.	1.20		
8.2 $\pm 10\%$	50	7.96	25.	1.40		
10. $\pm 10\%$	50	7.96	20.	1.60		
12. $\pm 10\%$	50	2.52	18.	2.00		
15. $\pm 10\%$	50	2.52	17.	2.50		
18. $\pm 10\%$	50	2.52	15.	2.80		
22. $\pm 10\%$	50	2.52	13.	3.20		
27. $\pm 10\%$	50	2.52	12.	3.60		
33. $\pm 10\%$	50	2.52	11.	4.00		
39. $\pm 10\%$	50	2.52	11.	4.50		
47. $\pm 10\%$	50	2.52	10.	5.00		
56. $\pm 10\%$	50	2.52	9.0	5.50		
68. $\pm 10\%$	50	2.52	9.0	6.00		
82. $\pm 10\%$	50	2.52	8.0	7.00		
100. $\pm 10\%$	50	2.52	8.0	8.00		
120. $\pm 10\%$	40	.79	6.0	8.00		
150. $\pm 10\%$	40	.79	5.0	9.00		
180. $\pm 10\%$	40	.79	5.0	9.50		
220. $\pm 10\%$	40	.79	4.0	10.0		
270. $\pm 10\%$	40	.79	4.0	12.0		
330. $\pm 10\%$	40	.79	3.5	14.0		
390. $\pm 10\%$	40	.79	3.0	16.0		
470. $\pm 10\%$	40	.79	3.0	26.0		
560. $\pm 10\%$	30	.79	3.0	30.0		
680. $\pm 10\%$	30	.79	3.0	30.0		
820. $\pm 10\%$	30	.79	2.5	35.0		
1000. $\pm 10\%$	30	.79	2.5	40.0		



MOLDED SHIELDED INDUCTORS

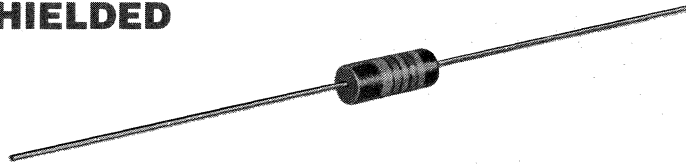

MODEL IMS-5

FEATURES

- Epoxy molded construction provides superior moisture protection
- Meets requirements of MIL-C-15305
- Precision performance, excellent reliability, sturdy construction
- Wide inductance range in small package
- Flame retardant coating
- Electromagnetic shield — finest shield available
- Standard inductance tolerance $\pm 10\%$
(Special inductance tolerances available on request.)

SPECIFICATIONS

ELECTRICAL

- Inductance Tolerance:** $\pm 5\%$, $\pm 10\%$
- Insulation Resistance:** 1000 Megohms minimum per MIL-STD-202, Method 302, Test Condition B
- Dielectric Withstanding Voltage:** 1000 VAC per MIL-STD-202, Method 301 (sea level)
- Percent Coupling:** 3% max. per MIL-C-15305

MECHANICAL

- Terminal Strength:** 5 lb. Pull and Twist per MIL-STD-207, Method 211, Test Condition A and D
- Vibration:** Per MIL-STD-202, Method 204, Test Condition D
- Shock:** Per MIL-STD-202, Method 213, Test Condition I
- Solderability:** Per MIL-STD-202, Method 208
- Weight:** IMS-5 = .85 grams maximum

MATERIAL

- Encapsulant:** Epoxy
- Standard Terminal:** #22 AWG tinned copper

ENVIRONMENTAL

- Barometric Pressure:** Per MIL-STD-202, Method 105, Test Condition C
- Moisture Resistance:** Per MIL-STD-202, Method 106
- Immersion:** Per MIL-STD-202, Method 104, Test Condition B
- Thermal Shock:** Per MIL-STD-202, Method 107, Test Condition A-1
- Flammability:** Per MIL-STD-202, Method 111
- Resistance to Soldering Heat:** Per MIL-STD-202, Method 210, Test Condition A
- Resistance to Solvents:** Per MIL-STD-202, Method 215
- Low Temperature Storage:** Per MIL-C-15305
- Overload:** Per MIL-C-15305

NOTE: Listing of Military Standard does not imply qualification. Contact factory for latest government QPL information.

INDUCTANCE RANGE & MIL STANDARD

INDUCTANCE RANGE		CLASSIFICATION		MATERIAL		MILITARY STANDARD
From	To	Grade	Class	Core	Shield	
.10 μ H	.82 μ H	1	A	Phenolic	Powd. Iron	MS75087
1.0 μ H	12.0 μ H	1	A	Powd. Iron	Powd. Iron	MS75088
15.0 μ H	100,000 μ H	1	A	Ferrite	Ferrite	MS75089

DIMENSIONS

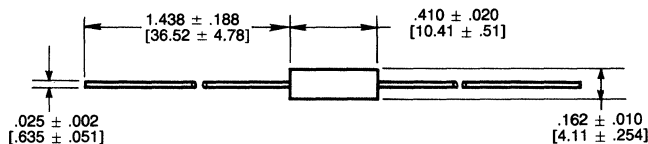

**ELECTRICAL CHARACTERISTICS (Initial)
MODEL IMS-5**

Inductance ±10% (μH)	Mil. Std.	Type Desig.	Q Min.	Test Freq. (MHz)	Self- Resonant Freq. Min. (MHz)*	DC Resistance at 25°C Max. (Ohms)	Rated DC Current (ma)**	Incre- mental Current (ma)†	Inductance ±10% (μH)	Mil. Std.	Type Desig.	Q Min.	Test Freq. (MHz)	Self- Resonant Freq. Min. (MHz)*	DC Resistance at 25°C Max. (Ohms)	Rated DC Current (ma)**	Incre- mental Current (ma)†
MS-75087 LT10K								MS-75089 LT10K									
.10	-1	191	50	25	250	.025	1790	—	120.0	-12	228	55	.79	9.7	3.60	150	95
.12	-2	192	51	25	250	.034	1530	—	150.0	-13	229	55	.79	8.5	4.10	140	90
.15	-3	193	51	25	250	.037	1470	—	180.0	-14	230	55	.79	8.0	4.40	135	85
.18	-4	194	50	25	250	.047	1300	—	220.0	-15	231	55	.79	7.5	5.00	125	80
.22	-5	195	49	25	250	.067	1100	—	270.0	-16	232	55	.79	7.0	5.80	115	70
.27	-6	196	47	25	250	.11	855	—	330.0	-17	233	55	.79	6.5	6.40	110	65
.33	-7	197	46	25	250	.13	780	—	390.0	-18	234	60	.79	6.2	7.40	105	60
.39	-8	198	44	25	250	.18	670	—	470.0	-19	235	60	.79	5.7	9.50	92	58
.47	-9	199	44	25	235	.25	565	—	560.0	-20	236	60	.79	4.7	10.5	90	55
.56	-10	200	43	25	210	.33	490	—	680.0	-21	237	60	.79	4.5	11.8	80	50
.68	-11	201	42	25	190	.45	420	—	820.0	-22	238	60	.79	4.2	13.0	80	45
.82	-12	202	40	25	180	.59	370	—	1,000.0	-23	239	60	.79	3.8	17.5	70	40
MS-75088 LT10K								MS-75089 LT10K									
1.00	-1	203	44	25	140	.07	1070	—	1,200.0	-24	240	45	.25	1.5	22.1	60	35
1.20	-2	204	44	7.9	130	.10	895	—	1,500.0	-25	241	45	.25	1.2	26.5	55	33
1.50	-3	205	44	7.9	115	.12	815	—	1,800.0	-26	242	45	.25	1.0	29.9	50	30
1.80	-4	206	44	7.9	105	.14	775	—	2,200.0	-27	243	45	.25	.97	33.8	50	27
2.20	-5	207	44	7.9	100	.19	650	—	2,700.0	-28	244	45	.25	.92	47.3	40	25
2.70	-6	208	44	7.9	92	.28	535	—	3,300.0	-29	245	45	.25	.84	53.0	40	22
3.30	-7	209	44	7.9	85	.35	480	—	3,900.0	-30	246	45	.25	.80	73.8	35	20
3.90	-8	210	44	7.9	75	.40	450	—	4,700.0	-31	247	45	.25	.74	81.6	31	19
4.70	-9	211	44	7.9	70	.55	380	—	5,600.0	-32	248	44	.25	.73	98.9	28	17
5.60	-10	212	44	7.9	65	.72	335	—	6,800.0	-33	249	40	.25	.66	111.0	27	16
6.80	-11	213	50	7.9	55	1.02	280	—	8,200.0	-34	250	40	.25	.54	119.0	26	15
8.20	-12	214	50	7.9	50	1.32	250	—	10,000.0	-35	251	40	.25	.47	137.0	24	14
10.0	-13	215	50	7.9	46	1.62	220	—	12,000.0	-36	252	30	.079	.33	143.0	23	13
12.0	-14	216	55	2.5	44	2.00	200	—	15,000.0	-37	253	30	.079	.29	157.0	22	12
MS-75089 LT10K								MS-75089 LT10K									
15.0	-1	217	45	2.5	49	.80	315	250	18,000.0	-38	254	30	.079	.28	175.0	21	10
18.0	-2	218	45	2.5	45	.89	300	235	22,000.0	-39	255	27	.079	.25	274.0	17	9
22.0	-3	219	45	2.5	41	.96	290	220	27,000.0	-40	256	27	.079	.21	308.0	16	8
27.0	-4	220	45	2.5	38	1.19	260	200	33,000.0	-41	257	27	.079	.19	343.0	15	7.5
33.0	-5	221	45	2.5	34	1.37	240	190	39,000.0	-42	258	27	.079	.17	376.0	15	6.0
39.0	-6	222	50	2.5	29	1.93	205	180	47,000.0	-43	259	23	.079	.16	473.0	13	5.5
47.0	-7	223	50	2.5	27	2.11	195	175	56,000.0	-44	260	23	.079	.14	512.0	13	5.0
56.0	-8	224	50	2.5	25	2.23	190	160	68,000.0	-45	261	23	.079	.13	580.0	12	4.0
68.0	-9	225	50	2.5	21	2.70	170	150	82,000.0	-46	262	21	.079	.12	618.0	11	3.5
82.0	-10	226	50	2.5	10.5	2.44	180	140	100,000.0	-47	263	18	.079	.11	678.0	11	3.0
100.0	-11	227	50	2.5	10.0	3.12	160	120									

*Measured with full length lead.

**Rated DC current based on temperature rise not to exceed 15°C at 90°C ambient.

†Incremental Current: The DC current required to cause a 5% reduction in the nominal inductance value.

ORDERING INFORMATION

IMS-5 10 μH ±10%
1. 2. 3.

1. Basic model
2. Inductance value
3. Inductance tolerance

MILITARY PART ORDERING INFORMATION

MS75088 -13 LT 10 K 215
1A. 2A. OR 1B. 2B. 3B. 4B.

- | | |
|---|---------------------|
| 1A. Basic Military Standard | 2B. Grade and class |
| 2A. Dash number indicating inductance value | 3B. Family |
| 1B. Style | 4B. ID Number |



MOLDED SHIELDED MINIATURE INDUCTORS

MODEL IMS-2

FEATURES

- Epoxy molded construction provides superior moisture protection
- Designed to meet requirements of MIL-C-15305 and applicable military standards listed below
- Precision performance, excellent reliability, sturdy construction
- Small package for a shielded inductor
- Flame retardant coating
- Electromagnetic shield
- Standard inductance tolerance $\pm 10\%$ (Special inductance tolerances available on request)

SPECIFICATIONS

ELECTRICAL

Inductance Tolerance: $\pm 10\%$ standard, $\pm 5\%$ available

Insulation Resistance: 1000 Megohms minimum per MIL-STD-202, Method 302, Test Condition B

Dielectric Withstanding Voltage: 200 VAC per MIL-STD-202, Method 301 (sea level)

Percent Coupling: 3% max. per MIL-C-15305

MECHANICAL

Terminal Strength: 3 lb. Pull and Twist per MIL-STD-202, Method 211, Test Condition A and D, except 180° rotation for a total of 540°

Vibration: Per MIL-STD-202, Method 204, Test Condition D

Shock: Per MIL-STD-202, Method 213, Test Condition I

Solderability: Per MIL-STD-202, Method 208

Weight: IMS-2 = .25 grams maximum

MATERIAL

Encapsulant: Epoxy

Standard Terminal: #24 AWG tinned copper

ENVIRONMENTAL

Barometric Pressure: Per MIL-STD-202, Method 105, Test Condition C

Moisture Resistance: Per MIL-STD-202, Method 106

Immersion: Per MIL-STD-202, Method 104, Test Condition B

Thermal Shock: Per MIL-STD-202, Method 107, Test Condition A-1

Flammability: Per MIL-STD-202, Method 111

Resistance to Soldering Heat: Per MIL-STD-202, Method 210, Test Condition A

Resistance to Solvents: Per MIL-STD-202, Method 215

Low Temperature Storage: Per MIL-C-15305

Overload: Per MIL-C-15305

ORDERING INFORMATION

IMS-2 **10 μ h** **$\pm 10\%$**
 1. 2. 3.

- Basic model
- Inductance value (μ h)
- Inductance tolerance

IMS-2 ELECTRICAL SPECIFICATIONS

INDUCTANCE $\pm 10\%$ (μ H)	MIL STD	TYPE DESIG.	Q MIN.	TEST FREQ. (Mhz)	*SELF RESONANT FREQ. MIN. (Mhz)	DC RESISTANCE (Ω)	RATED DC CURRENT** (ma)	INCREMENTAL CURRENT*** (ma)
MS-21426 LT10K								
.10	-1	518	54	25.	490.	.10	670	—
.12	-2	519	52	25.	430.	.11	635	—
.15	-3	520	50	25.	415.	.12	610	—
.18	-4	521	49	25.	375.	.13	585	—
.22	-5	522	47	25.	330.	.15	545	—
.27	-6	523	46	25.	300.	.16	530	—
.33	-7	524	44	25.	260.	.18	495	—
.39	-8	525	42	25.	230.	.19	485	—
.47	-9	526	41	25.	220.	.21	460	—
.56	-10	527	41	25.	210.	.23	440	—
.68	-11	528	39	25.	180.	.24	430	—
.82	-12	529	38	25.	165.	.27	405	—
1.0	-13	530	37	25.	150.	.30	385	—
1.2	-14	531	40	7.9	130.	.73	247	—
1.5	-15	532	41	7.9	115.	.86	228	—
1.8	-16	533	43	7.9	105.	.95	217	—
2.2	-17	534	45	7.9	95.	1.1	202	—
2.7	-18	535	48	7.9	90.	1.2	193	—
3.3	-19	536	49	7.9	80.	1.3	185	—
3.9	-20	537	50	7.9	75.	1.5	173	—
4.7	-21	538	53	7.9	70.	2.4	136	—
5.6	-22	539	54	7.9	60.	2.9	124	—
6.8	-23	540	55	7.9	55.	3.2	118	—
8.2	-24	541	55	7.9	53.	3.6	111	—
10.	-25	542	57	7.9	50.	4.0	106	—
12.	-26	543	36	2.5	35.	3.0	122	—
15.	-27	544	38	2.5	30.	3.4	115	—
18.	-28	545	40	2.5	26.	3.8	108	—
22.	-29	546	40	2.5	24.	4.9	96	—
27.	-30	547	40	2.5	21.	5.8	88	—
33.	-31	548	41	2.5	20.	6.5	83	—
39.	-32	549	42	2.5	19.	7.9	75	—
47.	-33	550	44	2.5	16.	9.3	69	—
56.	-34	551	44	2.5	15.	11.0	64	—
68.	-35	552	45	2.5	13.	12.0	61	—
82.	-36	553	45	2.5	11.	13.0	59	—
100.	-37	554	40	2.5	10.5	16.8	51	—
MS-21427								
120.	-1	555	31	.79	13.	5.8	88	27
150.	-2	556	33	.79	12.	7.9	75	24
180.	-3	557	33	.79	11.	9.4	69	22
220.	-4	558	35	.79	10.	11.	64	20
270.	-5	559	37	.79	9.	12.	61	18
330.	-6	560	40	.79	8.	16.	53	16
390.	-7	561	38	.79	7.8	21.	46	14
470.	-8	562	36	.79	7.5	24.	43	13
560.	-9	563	36	.79	7.0	28.	40	12

*Measured with full length lead.

**Rated DC based on the following maximum temperature rise not to exceed 15°C at 90°C ambient.

***Incremental Current: The DC current required to cause a 5% reduction in the nominal inductance value.

TEST EQUIPMENT

- H/P 4342A Q-Meter
 - Measurements Corporation Megacycle Meter, Model 59
 - Wheatstone Bridge
- (Test procedures per MIL-C-15305)**

NOTE: Refer to back of catalog for Reel Pack and Color Banding Specifications

INDUCTANCE RANGE & MIL STANDARD

INDUCTANCE RANGE		CLASSIFICATION		MATERIAL		MILITARY STANDARD
FROM	TO	GRADE	CLASS	CORE	SHIELD	
.10 μ H	100 μ H	1	A	Powd. Iron	Powd. Iron	MS-21426
120 μ H	560 μ H	1	A	Ferrite	Ferrite	MS-21427

DIMENSIONS [Numbers in brackets indicate millimeters]

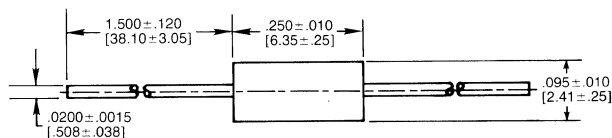

NOTE: Listing of Military Standard does not imply qualification. Contact factory for latest government QPL information.

DALE ELECTRONICS, INC., East Highway 50, Yankton, SD 57078 • Phone 605-665-9301

Canada: Dale Electronics Ltd., 18 Howden Rd., Scarborough, Ontario M1R 3E6
 Europe: Dale Electronics GmbH, Benzstrasse 28, 8039 Puchheim, West Germany



MOLDED INDUCTORS

MIL-C-15305 MODELS IM-1, IM-2, IM-4, IM-6, IM-8, IM-9 and IM-10

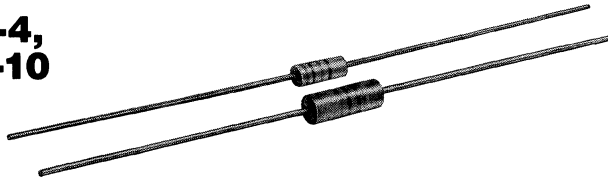

FEATURES

- Epoxy molded construction provides superior moisture protection
- Designed to meet requirements of MIL-C-15305 and applicable military standards listed below
- Precision performance, excellent reliability, sturdy construction
- Wide inductance range in small package
- Flame retardant coating
- Wide range of tolerances: $\pm 1\%$, $\pm 3\%$, $\pm 5\%$, $\pm 10\%$, $\pm 20\%$

SPECIFICATIONS

ELECTRICAL

Tolerance: $\pm 1\%$, $\pm 3\%$, $\pm 5\%$, $\pm 10\%$, $\pm 20\%$ and other special tolerances available on request

Insulation Resistance: 1000 Megohms minimum per MIL-STD-202, Method 302, Test Condition B

Dielectric Strength: Per MIL-STD-202, Method 301: 1000 VAC for IM-2, -4, -6, -8, -9 and -10. 200 VAC for IM-1.

MATERIAL

Encapsulant: Epoxy

Standard Terminals: IM-1 & IM-2, 24 AWG; IM-4, IM-6 & IM-9, 22 AWG; IM-8, 21 AWG; and IM-10, 20 AWG, Tinned Copper

MECHANICAL

Terminal Strength: Per MIL-STD-202, Method 211, Test Condition A and D: for IM-1, 3 lb. Pull and Twist, except 180° rotation for a total of 540°. For IM-2, -4, -6, -8, -9 and -10, 5 lb. Pull and Twist.

Vibration: Per MIL-STD-202, Method 204, Test Condition D

Shock: Per MIL-STD-202, Method 213, Test Condition I

Solderability: Per MIL-STD-202, Method 208

Weight:
IM-1 = .25 gram max. IM-8 = 1.5 gram max.
IM-2 = .30 gram max. IM-9 = 2.0 gram max.
IM-4 = .65 gram max. IM-10 = 2.5 gram max.
IM-6 = .95 gram max.

ENVIRONMENTAL

Barometric Pressure: Per MIL-STD-202, Method 105, Test Condition C

Moisture Resistance: Per MIL-STD-202, Method 106

Immersion: Per MIL-STD-202, Method 104, Test Condition B

Thermal Shock: Per MIL-STD-202, Method 107, Test Condition A-1

Flammability: Per MIL-STD-202, Method 111

Resistance to Soldering Heat: Per MIL-STD-202, Method 210, Test Condition A

Resistance to Solvents: Per MIL-STD-202, Method 215

Low Temperature Storage: Per MIL-C-15305

Overload: Per MIL-C-15305

INDUCTANCE RANGE & MIL STANDARD

MODEL NO.	INDUCTANCE RANGE Mil. Range shown in bold face		CLASSIFICATION		MILITARY STANDARD
	FROM	TO	GRADE	CLASS	
IM-1	.10 μ H	1000 μ H	—	—	—
	.10 μH	1.00 μH	1	B	MS75083
IM-2	1.2 μH	27 μH	1	A	MS75084
	33 μH	1000 μH	1	A	MS75085
IM-4	.15 μ H	4.7 μ H	1	B	MS18130
	5.6 μH	33 μH	1	A	MS14046
	36 μH	240 μH	1	A	MS90538
IM-6	270 μ H	1800 μ H	—	—	—
	.10 μ H	2.7 μ H	1	B	MS75008
	3.3 μH	27 μH	1	A	MS75101
IM-8	33 μ H	220 μ H	—	—	—
	270 μH	1000 μH	1	A	MS90539
IM-8	1100 μH	3600 μH	1	A	MS90540
IM-9	68 μH	150 μH	1	A	MS14047
IM-10	3900 μH	10,000 μH	1	A	MS90541

NOTE: Listing of Military Standard does not imply qualification. Contact factory for latest government QPL information.

DIMENSIONS

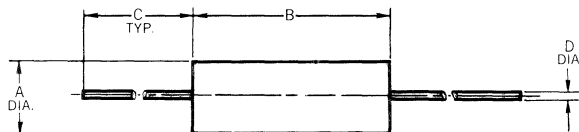

NOTE: Refer to back of catalog for Reel Pack and Color Banding Specifications.

TEST EQUIPMENT

1. H/P 4342A Q-Meter
 2. Measurements Corporation Megacycle Meter, Model 59
 3. Wheatstone Bridge (Test procedures per MIL-C-15305)
- [Numbers in brackets indicate millimeters]

MODEL NO.		A	B	C	D
IM-1	MAX.	.086 [2.18]	.210 [5.33]	1.62 [41.15]	.0215 [0.546]
	MIN.	.070 [1.78]	.190 [4.83]	1.38 [35.05]	.0185 [0.470]
IM-2	MAX.	.105 [2.67]	.260 [6.60]	1.626 [41.30]	.0215 [0.546]
	MIN.	.085 [2.16]	.240 [6.10]	1.250 [31.75]	.0185 [0.470]
IM-4	MAX.	.165 [4.19]	.385 [9.78]	1.625 [41.28]	.027 [0.686]
	MIN.	.145 [3.68]	.365 [9.27]	1.250 [31.75]	.023 [0.584]
IM-6	MAX.	.200 [5.08]	.450 [11.4]	1.625 [41.28]	.027 [0.686]
	MIN.	.180 [4.57]	.430 [10.9]	1.250 [31.75]	.023 [0.584]
IM-8	MAX.	.225 [5.72]	.570 [14.5]	1.625 [41.28]	.030 [0.762]
	MIN.	.205 [5.21]	.550 [14.0]	1.250 [31.75]	.026 [0.660]
IM-9	MAX.	.260 [6.60]	.570 [14.48]	1.625 [41.28]	.027 [0.69]
	MIN.	.240 [6.10]	.550 [13.97]	1.250 [31.75]	.023 [0.58]
IM-10	MAX.	.250 [6.35]	.750 [19.0]	1.625 [41.28]	.034 [0.864]
	MIN.	.230 [5.84]	.730 [18.5]	1.250 [31.75]	.030 [0.762]

MODEL NO. IM-1

ELECTRICAL SPECIFICATIONS

MODEL NO. IM-1								MODEL NO. IM-2 (Cont'd.)																							
Ind. & Tol. (μH)	Mil. Std.	Type Desig.	Q Min.	Test Freq. L&Q (Mhz)	Self-Resonant Freq. Min. (Mhz)	DC Resistance Max. (Ω)	Rated** DC Current (ma)	Ind. & Tol. (μH)	Mil. Std.	Type Desig.	Q Min.	Test Freq. L&Q (Mhz)	Self-Resonant Freq. Min. (Mhz)	DC Resistance Max. (Ω)	Rated** DC Current (ma)																
PHENOLIC CORE								MS75085 LT10K																							
																.10	—	—	35	25.0	680.	.13	895.	33.0 ±10%	-01	078	45	2.5	24	3.4	130
																.12	—	—	35	25.0	650.	.15	835.	39.0 ±10%	-02	079	45	2.5	22	3.6	125
																.15	—	—	35	25.0	560.	.18	760.	47.0 ±10%	-03	080	45	2.5	20	4.5	110
																.18	—	—	35	25.0	540.	.21	705.	56.0 ±10%	-04	081	45	2.5	18	5.7	100
																.22	—	—	30	25.0	500.	.25	645.	68.0 ±10%	-05	082	50	2.5	15	6.7	92
																.27	—	—	30	25.0	440.	.38	525.	82.0 ±10%	-06	083	50	2.5	14	7.3	88
																.33	—	—	25	25.0	410.	.49	460.	100. ±10%	-07	084	50	2.5	13	8.	84
																.39	—	—	25	25.0	380.	.59	420.	120. ±10%	-08	085	30	.79	12	13.	66
																.47	—	—	25	25.0	340.	.82	410.	150. ±10%	-09	086	30	.79	11	15.	61
IRON CORE								MODEL NO. IM-4																							
																.56	—	—	40	25.0	250.	.18	510.	MS18130 LT4K							
																.68	—	—	40	25.0	215.	.20	485.								
																.82	—	—	40	25.0	200.	.22	465.								
																1.0	—	—	40	25.0	190.	.25	435.								
																1.2	—	—	35	7.9	170.	.28	410.								
																1.5	—	—	40	7.9	150.	.49	310.								
																1.8	—	—	40	7.9	135.	.56	290.								
																2.2	—	—	45	7.9	130.	.72	257.								
																2.7	—	—	45	7.9	110.	.85	236.								
3.3	—	—	45	7.9	100.	1.2	198.																								
3.9	—	—	50	7.9	95.	1.5	178.																								
4.7	—	—	55	7.9	88.	2.1	150.																								
5.6	—	—	55	7.9	78.	2.8	130.																								
6.8	—	—	55	7.9	69.	3.2	122.																								
8.2	—	—	45	7.9	52.	4.4	104.																								
10.	—	—	45	7.9	47.	5.2	95.																								
12.	—	—	40	2.5	31.	3.0	126.																								
15.	—	—	40	2.5	26.	3.4	118.																								
18.	—	—	40	2.5	23.	3.8	112.																								
22.	—	—	45	2.5	20.	4.3	105.																								
27.	—	—	45	2.5	17.	4.7	100.																								
33.	—	—	45	2.5	15.	5.2	95.																								
39.	—	—	45	2.5	13.5	6.8	83.5																								
47.	—	—	45	2.5	12.5	8.2	76.																								
56.	—	—	45	2.5	11.5	10.0	69.																								
68.	—	—	45	2.5	10.5	11.5	64.																								
82.	—	—	45	2.5	10.0	16.0	54.5																								
100.	—	—	45	2.5	9.5	17.5	52.																								
FERRITE CORE								MS14046 LT10K																							
																120.	—	—	35	.79	8.9	16.0	54.5								
																150.	—	—	35	.79	7.9	18.0	51.								
																180.	—	—	35	.79	7.5	20.0	49.								
																220.	—	—	35	.79	7.1	26.5	42.5								
																270.	—	—	35	.79	6.6	30.5	39.								
																330.	—	—	35	.79	6.2	40.5	34.								
																390.	—	—	35	.79	5.9	43.0	33.								
																470.	—	—	35	.79	5.4	48.0	31.5								
																560.	—	—	35	.79	5.0	60.0	28.								
680.	—	—	35	.79	4.5	66.0	27.																								
820.	—	—	35	.79	3.9	72.0	25.5																								
1000.	—	—	35	.79	3.3	79.0	24.5																								
MODEL NO. IM-2								MS90538 LT10K																							
PHENOLIC CORE								MS75083 LT4K																							
																.10±10%	-01	339	40	25.0	680.	.08	1350								
																.12±10%	-02	340	40	25.0	640	.09	1270								
																.15±10%	-03	341	38	25.0	600	.10	1200								
																.18±10%	-04	342	35	25.0	550	.12	1105								
																.22±10%	-05	343	33	25.0	510	.14	1025								
																.27±10%	-06	344	33	25.0	430	.16	960								
																.33±10%	-07	345	30	25.0	410	.22	815								
																.39±10%	-08	346	30	25.0	365	.30	700								
																.47±10%	-09	347	30	25.0	330	.35	650								
IRON CORE								MS75084 LT10K																							
																1.20±10%	-01	061	25	7.9	150	.18	590								
																1.50±10%	-02	062	28	7.9	140	.22	535								
																1.80±10%	-03	063	30	7.9	125	.30	455								
																2.20±10%	-04	064	30	7.9	115	.40	395								
																2.70±10%	-05	065	37	7.9	100	.55	355								
																3.30±10%	-06	066	45	7.9	90	.85	270								
																3.90±10%	-07	067	45	7.9	80	1.00	250								
																4.70±10%	-08	068	45	7.9	75	1.20	230								
																5.60±10%	-09	069	50	7.9	65	1.80	185								
6.80±10%	-10	070	50	7.9	60	2.00	175																								
8.20±10%	-11	071	55	7.9	55	2.70	155																								
10.0 ±10%	-12	072	55	7.9	50	3.70	130																								
12.0 ±10%	-13	073	45	2.5	40	2.70	155																								
15.0 ±10%	-14	074	40	2.5	35	2.80	150																								
18.0 ±10%	-15	075	50	2.5	30	3.10	145																								
22.0 ±10%	-16	076	50	2.5	25	3.30	140																								
27.0 ±10%	-17	077	50	2.5	20	3.50	135																								
IRON CORE								MS75085 LT10K																							
																36. ± 5%	-01	001	60	2.5	15.5	2.50	180								
																39. ± 5%	-02	002	60	2.5	14.5	2.60	176								
																43. ± 5%	-03	003	60	2.5	13.7	2.70	172								
																47. ± 5%	-04	004	55	2.5	13.0	2.75	170								
																51. ± 5%	-05	005	55	2.5	12.7	2.85	167								
																56. ± 5%	-06	006	55	2.5	12.0	3.00	164								
																62. ± 5%	-07	007	55	2.5	11.5	3.15	160								
																68. ± 5%	-08	008	55	2.5	11.0	3.30	156								
																75. ± 5%	-09	009	55	2.5	10.5	3.70	147								
82. ± 5%	-10	010	50	2.5	10.3	3.90	143																								
91. ± 5%	-11	011	50	2.5	10.0	4.30	136																								
100. ± 5%	-12	012	50	2.5	9.5	4.50	133																								
110. ± 5%	-13	013	60	.79	8.9	4.90	128																								
120. ± 5%	-14	014	65	.79	8.7	5.20	124																								
130. ± 5%	-15	015	65	.79	8.5	5.45	121																								
150. ± 5%	-16	016	65	.79	8.0	6.05	114																								
160. ± 5%	-17	017	65	.79	7.5	6.40	111																								
180. ± 5%	-18	018	65	.79	7.0	6.75	108																								
200. ± 5%	-19	019	65	.79	6.5	7.10	106																								
220. ± 5%	-20	020	65	.79	6.2	7.45	103																								
240. ± 5%	-21	021	65	.79	5.9	7.80	101																								
270. ± 5%	—	—	65	.79	5.7	11.0	129																								
300. ± 5%	—	—	65	.79	5.4	11.5	125																								
330. ± 5%	—	—	65	.79	5.1	12.0	123																								
360. ± 5%	—	—	65	.79	4.8	15.5	108																								
390. ± 5%	—	—	65	.79	4.5	16.3	105																								
430. ± 5%	—	—	65	.79	4.2	17.1	102																								
470. ± 5%	—	—	65	.79	3.9	17.9	100																								
510. ± 5%	—	—	65	.79	3.7	18.8	98																								
560. ± 5%	—	—	65	.79	3.5	24.7	85																								
620. ± 5%	—	—	65	.79	3.3	25.9	83																								
680. ± 5%	—	—	55	.79	3.1	27.2	81																								
750. ± 5%	—	—	55	.79	2.9	28.6	79																								
820. ± 5%	—	—	55	.79	2.7	30.0	77																								
910. ± 5%	—	—	55	.79	2.5	31.5	76																								
1000. ± 5%	—	—	55	.79	2.3	33.1	74																								
1100. ± 5%	—	—	30	.25	2.1	43.5	64																								
1200. ± 5%	—	—	30	.25	2.0	45.7	63																								
1300. ± 5%	—	—	30	.25	1.9	49.0	61																								
1500. ± 5%	—	—	30	.25	1.8	52.5	59																								
1600. ± 5%	—	—	30	.25	1.7	54.0	58																								
1800. ± 5%	—	—	30	.25	1.6	56.7	56																								



EPOXY CONFORMAL COATED INDUCTORS

MODELS IR-2 and IR-4 Uniform Roll Coated

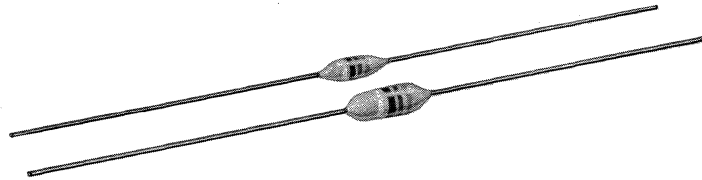

FEATURES

- Equivalent in quality to molded chokes at a lower price
- Epoxy coating is more durable than lacquer coated models, yet is priced comparably
- Uniform coating is excellent for automatic insertion
- Excellent environmental characteristics
- Flame-retardant coating
- Color band identification
- Wide range of tolerances: $\pm 1\%$, $\pm 3\%$, $\pm 5\%$, $\pm 10\%$, $\pm 20\%$
- Wide temperature range (-55°C to $+105^{\circ}\text{C}$)

SPECIFICATIONS

ELECTRICAL

Tolerance: $\pm 1\%$, $\pm 3\%$, $\pm 5\%$, $\pm 10\%$, $\pm 20\%$ and other special tolerances available on request

Insulation Resistance: 1000 Megohms minimum per MIL-STD-202, Method 302, Test Condition B

Dielectric Strength: 1000 VAC per MIL-STD-202, Method 301

MECHANICAL

Terminal Strength: 5 lb. Pull and Twist per MIL-STD-202, Method 211, Test Condition A and D

Vibration: Per MIL-STD-202, Method 204, Test Condition D

Shock: Per MIL-STD-202, Method 213, Test Condition I

Solderability: Per MIL-STD-202, Method 208

Weight: IR-2 = .3 gram maximum
IR-4 = .65 gram maximum

ENVIRONMENTAL

Barometric Pressure: Per MIL-STD-202, Method 105, Test Condition C

Moisture Resistance: Per MIL-STD-202, Method 106

Immersion: Per MIL-STD-202, Method 104, Test Condition B

Thermal Shock: Per MIL-STD-202, Method 107, Test Condition A-1

Flammability: Per MIL-STD-202, Method 111

Resistance to Soldering Heat: Per MIL-STD-202, Method 210, Test Condition A

Resistance to Solvents: Per MIL-STD-202, Method 215

Low Temperature Storage: Per MIL-C-15305

Overload: Per MIL-C-15305

MATERIAL

Coating: Epoxy-uniform roll coated

Lead: Tinned Copper

DIMENSIONS

[Numbers in brackets indicate millimeters]

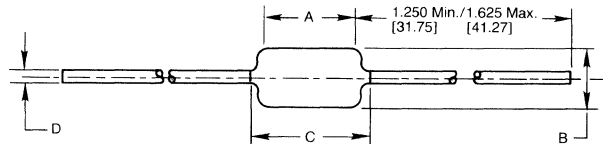

MODEL	A (Max.)	B (Max.)	C (Max.)	D
IR-2	.260 [6.60]	.120 [3.05]	.330 [8.38]	.0200 \pm .0015 [.508 \pm .038]
IR-4	.385 [9.78]	.180 [4.57]	.440 [11.18]	.025 \pm .002 [.635 \pm .051]

ELECTRICAL SPECIFICATIONS

MODEL NO. IR-2

MODEL NO. IR-4

IND. (μH)	TOL.	Q MIN.	TEST FREQ. L & Q (Mhz)	SELF-RESONANT FREQ. MIN. (Mhz)	DC RESISTANCE MAX. (Ω)	RATED** DC CURRENT (ma)	CORE MATERIAL	
.10	±10%	40	25.0	680	.08	1350	Phenolic	
.12	±10%	40	25.0	640	.09	1270		
.15	±10%	38	25.0	600	.10	1200		
.18	±10%	35	25.0	550	.12	1105		
.22	±10%	33	25.0	510	.14	1025		
.27	±10%	33	25.0	430	.16	960		
.33	±10%	30	25.0	410	.22	815		
.39	±10%	30	25.0	365	.30	700		
.47	±10%	30	25.0	330	.35	650		
.56	±10%	30	25.0	300	.50	545		
.68	±10%	28	25.0	275	.60	495		
.82	±10%	28	25.0	250	.85	415		
1.00	±10%	25	25.0	230	1.00	385		
1.2C	±10%	25	7.9	150	.18	590		Iron
1.50	±10%	28	7.9	140	.22	535		
1.80	±10%	30	7.9	125	.30	455		
2.20	±10%	30	7.9	115	.40	395		
2.70	±10%	37	7.9	100	.55	355		
3.30	±10%	45	7.9	90	.85	270		
3.90	±10%	45	7.9	80	1.00	250		
4.70	±10%	45	7.9	75	1.20	230		
5.60	±10%	50	7.9	65	1.80	185		
6.80	±10%	50	7.9	60	2.00	175		
8.20	±10%	55	7.9	55	2.70	155		
10.0	±10%	55	7.9	50	3.70	130		
12.0	±10%	45	2.5	40	2.70	155		
15.0	±10%	40	2.5	35	2.80	150		
18.0	±10%	50	2.5	30	3.10	145		
22.0	±10%	50	2.5	25	3.30	140		
27.0	±10%	50	2.5	20	3.50	135		
33.0	±10%	45	2.5	24	3.4	130	Ferrite	
39.0	±10%	45	2.5	22	3.6	125		
47.0	±10%	45	2.5	20	4.5	110		
56.0	±10%	45	2.5	18	5.7	100		
68.0	±10%	50	2.5	15	6.7	92		
82.0	±10%	50	2.5	14	7.3	88		
100.	±10%	50	2.5	13	8.	84		
120.	±10%	30	.79	12	13.	66		
150.	±10%	30	.79	11	15.	61		
180.	±10%	30	.79	10	17.	57		
220.	±10%	30	.79	9	21.	52		
270.	±10%	30	.79	8	25.	47		
330.	±10%	30	.79	7	28.	45		
390.	±10%	30	.79	6.5	35.	40		
470.	±10%	30	.79	6	42.	36		
560.	±10%	30	.79	5	46.	35		
680.	±10%	30	.79	4	60.	30		
820.	±10%	30	.79	3.8	65.	29		
1000.	±10%	30	.79	3.4	72.	28		

IND. (μH)	TOL.	Q MIN.	TEST FREQ. L & Q (Mhz)	SELF-RESONANT FREQ. MIN. (Mhz)	DC RESISTANCE MAX. (Ω)	RATED** DC CURRENT (ma)	CORE MATERIAL	
.15	±20%	50	25.0	525	.03	2450	Phenolic	
.22	±20%	50	25.0	450	.055	1810		
.33	±20%	45	25.0	360	.09	1400		
.47	±20%	45	25.0	310	.12	1225		
.56	±10%	50	25.0	280	.135	1150		
.68	±10%	50	25.0	250	.15	1100		
.82	±10%	50	25.0	220	.22	900		
1.00	±10%	50	25.0	200	.29	785		
1.20	±10%	33	7.9	180	.42	650		
1.50	±10%	33	7.9	160	.50	600		
1.80	±10%	33	7.9	150	.65	525		
2.20	±10%	33	7.9	135	.95	435		
2.70	±10%	33	7.9	120	1.20	385		
3.30	±10%	33	7.9	110	2.00	300		
3.90	±10%	33	7.9	100	2.30	280		
4.70	±10%	33	7.9	90	2.60	260		
5.60	±10%	45	7.9	60	.32	495		Iron
6.80	±10%	50	7.9	55	.50	395		
8.20	±10%	50	7.9	50	.60	360		
10	±10%	55	7.9	45	.90	290		
12	±10%	65	2.5	42	1.10	265		
15	±10%	65	2.5	40	1.40	240		
18	±10%	75	2.5	34	2.25	185		
22	±10%	75	2.5	30	2.50	175		
27	±10%	60	2.5	25	2.60	170		
33	±10%	65	2.5	19	3.00	165		
36	± 5%	60	2.5	15.5	2.50	180		
39	± 5%	60	2.5	14.5	2.60	176		
43	± 5%	60	2.5	13.7	2.70	172		
47	± 5%	55	2.5	13.0	2.75	170		
51	± 5%	55	2.5	12.7	2.85	167		
56	± 5%	55	2.5	12.0	3.00	164		
62	± 5%	55	2.5	11.5	3.15	160		
68	± 5%	55	2.5	11.0	3.30	156		
75	± 5%	55	2.5	10.5	3.70	147		
82	± 5%	50	2.5	10.3	3.90	143		
91	± 5%	50	2.5	10.0	4.30	136		
100	± 5%	50	2.5	9.5	4.50	133		
110	± 5%	60	.79	8.9	4.90	128		
120	± 5%	65	.79	8.7	5.20	124		
130	± 5%	65	.79	8.5	5.45	121		
150	± 5%	65	.79	8.0	6.05	114		
160	± 5%	65	.79	7.5	6.40	111		
180	± 5%	65	.79	7.0	6.75	108		
200	± 5%	65	.79	6.5	7.10	106		
220	± 5%	65	.79	6.2	7.45	103		
240	± 5%	65	.79	5.9	7.80	101		
270	± 5%	65	.79	5.7	11.0	129		
300	± 5%	65	.79	5.4	11.5	125		
330	± 5%	65	.79	5.1	12.0	123		
360	± 5%	65	.79	4.8	15.5	108		
390	± 5%	65	.79	4.5	16.3	105		
430	± 5%	65	.79	4.2	17.1	102		
470	± 5%	65	.79	3.9	17.9	100		
510	± 5%	65	.79	3.7	18.8	98		
560	± 5%	65	.79	3.5	24.7	85		
620	± 5%	65	.79	3.3	25.9	83		
680	± 5%	55	.79	3.1	27.2	81		
750	± 5%	55	.79	2.9	28.6	79		
820	± 5%	55	.79	2.7	30.0	77		
910	± 5%	55	.79	2.5	31.5	76		
1000	± 5%	55	.79	2.3	33.1	74		
1100	± 5%	30	.25	2.1	43.5	64		
1200	± 5%	30	.25	2.0	45.7	63		
1300	± 5%	30	.25	1.9	49.0	61		
1500	± 5%	30	.25	1.8	52.5	59		
1600	± 5%	30	.25	1.7	54.0	58		
1800	± 5%	30	.25	1.6	56.7	56		

*Measured with full length lead.

**Rated DC based on the following maximum temperature rise:

IR-2

.1 to 1.00 μH = 35°C at 90°C ambient
 1.2 to 27 μH = 15°C at 90°C ambient
 33 to 1000 μH = 15°C at 90°C ambient

IR-4

.15 to 4.7 μH = 35°C at 90°C ambient
 5.6 to 33 μH = 15°C at 90°C ambient
 36 to 240 μH = 15°C at 90°C ambient
 270 to 1800 μH = 35°C at 90°C ambient

TEST EQUIPMENT

1. H/P 4342A Q-Meter
 2. Measurements Corporation Megacycle Meter, Model 59
 3. Wheatstone Bridge
- (Test procedures per MIL-C-15305)

NOTE: Refer to back of catalog for Reel Pack and Color Banding Specifications



EPOXY CONFORMAL COATED INDUCTORS

MODELS IRF-1 and IRF-3 Uniform Roll Coated

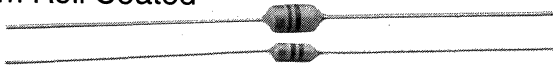

FEATURES

- Superior electrical specifications
High Q & SRF, Low DC resistance, High rated DC current
- Available in bulk, ammo and reel pack per EIA RS-296
- Flame-retardant coating
- Color band identification
- Wide inductance range: .10 μ h to 1000 μ h
- Uniform coating is excellent for automatic insertion

SPECIFICATIONS

ELECTRICAL

Tolerance: $\pm 5\%$, $\pm 10\%$, $\pm 20\%$ and other special tolerances available upon request

Insulation Resistance: 1000 Megohms minimum per MIL-STD-202, Method 302, Test Condition B

Dielectric Strength: 1000 VAC per MIL-STD-202, Method 301

MECHANICAL

Terminal Strength: 5 lb. Pull and Twist per MIL-STD-202, Method 211, Test Condition A and D

Vibration: Per MIL-STD-202, Method 204, Test Condition D

Shock: Per MIL-STD-202, Method 213, Test Condition I

Solderability: Per MIL-STD-202, Method 208

Weight: IRF-1 = .3 gram maximum IRF-3 = .6 gram maximum

ENVIRONMENTAL

Flammability: Per MIL-STD-202, Method 111

Resistance to Soldering Heat: Per MIL-STD-202, Method 210, Test Condition A

Resistance to Solvents: Per MIL-STD-202, Method 215

Overload: Per MIL-C-15305

MATERIAL

Coating: Epoxy-uniform roll coated

Lead: Tinned copper **Core:** Ferrite

PHYSICAL CONFIGURATIONS

[Numbers in brackets indicate millimeters]

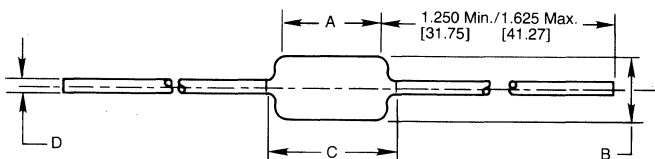

DALE TYPE	DIM. A (Max.)	DIM. B (Max.)	DIM. C (Max.)	DIM. D
IRF-1	.260 [6.60]	.110 [2.79]	.330 [8.38]	.020 \pm .0015 [.508 \pm .038]
IRF-3	.385 [9.78]	.165 [4.19]	.410 [10.41]	.025 \pm .002 [.635 \pm .051]

ORDERING INFORMATION

IRF-1 **10 μ h** **$\pm 10\%$**
1. 2. 3.

1. Basic model
2. Inductance value (μ h)
3. Inductance tolerance

ELECTRICAL SPECIFICATIONS MODEL NO. IRF-1

Ind. (μ H)	Tol.	Q Min.	Test Freq. L & Q (Mhz)	Self-Resonant Freq. Min. (Mhz)	DC Resistance Max. (Ω)	Rated** DC Current (ma)
.10	$\pm 20\%$	40	25.0	400	.06	1350
.12	$\pm 20\%$	40	25.0	400	.06	1270
.15	$\pm 20\%$	40	25.0	400	.07	1200
.18	$\pm 20\%$	40	25.0	380	.075	1155
.22	$\pm 20\%$	40	25.0	360	.08	1110
.27	$\pm 20\%$	40	25.0	350	.08	1110
.33	$\pm 20\%$	40	25.0	320	.09	1000
.39	$\pm 20\%$	40	25.0	300	.10	1000
.47	$\pm 20\%$	40	25.0	280	.11	950
.56	$\pm 20\%$	40	25.0	250	.12	900
.68	$\pm 20\%$	40	25.0	200	.12	900
.82	$\pm 20\%$	40	25.0	180	.15	815
1.0	$\pm 10\%$	50	7.9	165	.18	740
1.2	$\pm 10\%$	50	7.9	150	.20	700
1.5	$\pm 10\%$	50	7.9	125	.23	655
1.8	$\pm 10\%$	50	7.9	115	.25	630
2.2	$\pm 10\%$	50	7.9	100	.28	595
2.7	$\pm 10\%$	50	7.9	90	.30	575
3.3	$\pm 10\%$	50	7.9	80	.32	555
3.9	$\pm 10\%$	50	7.9	75	.35	530
4.7	$\pm 10\%$	50	7.9	65	.40	500
5.6	$\pm 10\%$	50	7.9	60	.45	470
6.8	$\pm 10\%$	50	7.9	55	.55	425
8.2	$\pm 10\%$	50	7.9	50	.72	370
10.	$\pm 10\%$	50	2.5	40	.80	350
12.	$\pm 10\%$	50	2.5	35	.88	335
15.	$\pm 10\%$	50	2.5	30	1.0	315
18.	$\pm 10\%$	50	2.5	25	1.2	285
22.	$\pm 10\%$	50	2.5	20	1.35	270
27.	$\pm 10\%$	50	2.5	24	1.5	255
33.	$\pm 10\%$	50	2.5	22	1.7	240
39.	$\pm 10\%$	50	2.5	20	2.3	205
47.	$\pm 10\%$	60	2.5	18	2.6	195
56.	$\pm 10\%$	60	2.5	15	2.9	185
68.	$\pm 10\%$	60	2.5	14	3.2	175
82.	$\pm 10\%$	60	2.5	13	3.5	165
100.	$\pm 10\%$	60	.79	5.4	3.8	160
120.	$\pm 10\%$	60	.79	4.75	4.4	150
150.	$\pm 10\%$	60	.79	4.35	5.0	140
180.	$\pm 10\%$	60	.79	4.0	5.7	130
220.	$\pm 10\%$	60	.79	3.7	6.5	120
270.	$\pm 10\%$	60	.79	3.4	9.5	100
330.	$\pm 10\%$	60	.79	2.8	10.5	95
390.	$\pm 10\%$	60	.79	2.55	11.6	90
470.	$\pm 10\%$	60	.79	2.35	13.0	85
560.	$\pm 10\%$	60	.79	2.0	18.0	75
680.	$\pm 10\%$	60	.79	1.85	23.0	65
820.	$\pm 10\%$	60	.79	1.4	26.0	60

MODEL NO. IRF-3

.22	$\pm 20\%$	55	25.0	380	.10	1400
.27	$\pm 20\%$	55	25.0	340	.11	1320
.33	$\pm 20\%$	55	25.0	300	.12	1280
.39	$\pm 20\%$	55	25.0	280	.13	1200
.47	$\pm 20\%$	55	25.0	250	.14	1150
.56	$\pm 20\%$	55	25.0	230	.15	1100
.68	$\pm 20\%$	55	25.0	210	.16	1030
.82	$\pm 20\%$	55	25.0	172	.17	980
1.0	$\pm 10\%$	55	25.0	157	.19	920
1.2	$\pm 10\%$	50	7.9	144	.21	880
1.5	$\pm 10\%$	50	7.9	131	.23	830
1.8	$\pm 10\%$	55	7.9	121	.25	790
2.2	$\pm 10\%$	55	7.9	110	.28	750
2.7	$\pm 10\%$	60	7.9	100	.30	720
3.3	$\pm 10\%$	65	7.9	94	.34	670
3.9	$\pm 10\%$	65	7.9	86	.37	640
4.7	$\pm 10\%$	70	7.9	80	.39	620
5.6	$\pm 10\%$	70	7.9	74	.43	590
6.8	$\pm 10\%$	75	7.9	68	.48	550
8.2	$\pm 10\%$	80	7.9	53	.52	530
10.	$\pm 10\%$	85	7.9	45	.58	500
12.	$\pm 10\%$	75	2.5	42	.63	480
15.	$\pm 10\%$	70	2.5	40	.72	460
18.	$\pm 10\%$	65	2.5	34	.77	430
22.	$\pm 10\%$	60	2.5	30	.84	410
27.	$\pm 10\%$	55	2.5	25	.94	390
33.	$\pm 10\%$	55	2.5	19	1.03	370
39.	$\pm 10\%$	50	2.5	14.5	1.12	350
47.	$\pm 10\%$	45	2.5	13.0	1.22	340
56.	$\pm 10\%$	40	2.5	12.0	1.34	320
68.	$\pm 10\%$	40	2.5	11.0	1.47	305
82.	$\pm 10\%$	35	2.5	10.3	1.62	290
100.	$\pm 10\%$	30	2.5	9.5	1.8	275
120.	$\pm 10\%$	70	.79	3.8	3.7	185
150.	$\pm 10\%$	70	.79	3.5	4.2	175
180.	$\pm 10\%$	70	.79	3.3	4.6	165
220.	$\pm 10\%$	70	.79	3.0	5.1	155
270.	$\pm 10\%$	70	.79	2.8	5.8	145
330.	$\pm 10\%$	70	.79	2.6	6.4	137
390.	$\pm 10\%$	65	.79	2.4	7.0	133
470.	$\pm 10\%$	65	.79	2.25	7.7	126
560.	$\pm 10\%$	65	.79	2.1	8.5	120
680.	$\pm 10\%$	65	.79	1.95	9.4	113
820.	$\pm 10\%$	65	.79	1.85	10.5	105
1000.	$\pm 10\%$	65	.79	1.4	14.0	100

*Measured with full length lead

**Rated DC current based on a temperature rise of 15°C at 90°C ambient

TEST EQUIPMENT

1. H/P 4342A Q-Meter
2. Measurements Corporation Megacycle Meter, Model 59
3. Wheatstone Bridge
(Test procedures per MIL-C-15305)

DALE ELECTRONICS, INC., East Highway 50, Yankton, SD 57078 • Phone 605-665-9301

Canada: Dale Electronics Ltd., 18 Howden Rd., Scarborough, Ontario M1R 3E6
Europe: Dale Electronics GmbH, Benzstrasse 28, 8039 Puchheim, West Germany



HIGH CURRENT FILTER INDUCTORS

MODEL IH

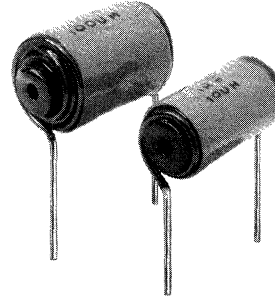

FEATURES

- Printed circuit mounting
- Pre-tinned leads

TYPICAL APPLICATIONS

Noise filtering for switching regulators, power amplifiers, power supplies and SCR or Triac control circuits.

ELECTRICAL SPECIFICATIONS					DIMENSIONS			
MODEL	IND. @ 1 KHz ±10%	RATED CURRENT (Max.)	DC RESISTANCE (Max.)	INCREMENTAL CURRENT**	Dimension in Inches [Dimensions in Millimeters]			
					A (Max.)	B (Max.)	±.062 [1.59] C	±.005 [0.13] D
IH-3	5 μh	10 amps	.015 Ω	16 amps	0.875 [22.23]	0.625 [15.88]	0.500 [12.70]	.042 [1.067]
IH-3	10 μh	9 amps	.018 Ω	13 amps	1.125 [28.58]	0.625 [15.88]	0.687 [17.45]	.042 [1.067]
IH-3	27 μh	7 amps	.035 Ω	10 amps	0.875 [22.23]	0.812 [20.62]	0.437 [11.10]	.042 [1.067]
IH-3	50 μh	5.6 amps	.050 Ω	7 amps	0.875 [22.23]	0.812 [20.62]	0.750 [19.05]	.042 [1.067]
IH-3	100 μh	5.2 amps	.065 Ω	6 amps	1.125 [28.58]	0.812 [20.62]	0.937 [23.80]	.042 [1.067]
IH-3	150 μh	5 amps	.075 Ω	5 amps	1.375 [34.93]	0.812 [20.62]	1.062 [26.97]	.042 [1.067]
IH-3	250 μh	5 amps	.090 Ω	4 amps	1.625 [41.28]	0.812 [20.62]	1.312 [33.32]	.042 [1.067]
IH-5	5 μh	14 amps	.012 Ω	20 amps	0.875 [22.23]	0.640 [16.26]	0.750 [19.05]	.053 [1.35]
IH-5	10 μh	12 amps	.015 Ω	16 amps	1.125 [28.53]	0.640 [16.26]	1.000 [25.40]	.053 [1.35]
IH-5	27 μh	9 amps	.025 Ω	13 amps	0.875 [22.23]	0.875 [22.23]	0.562 [14.27]	.053 [1.35]
IH-5	50 μh	8 amps	.030 Ω	10 amps	1.125 [28.53]	0.875 [22.23]	0.750 [19.05]	.053 [1.35]
IH-5	68 μh	7.5 amps	.035 Ω	9 amps	1.125 [28.53]	0.875 [22.23]	0.875 [22.23]	.053 [1.35]
IH-5	100 μh	7.5 amps	.050 Ω	7 amps	1.375 [34.93]	0.875 [22.23]	1.000 [25.40]	.053 [1.35]
IH-5	150 μh	7 amps	.060 Ω	5 amps	1.625 [41.28]	0.875 [22.23]	1.250 [31.75]	.053 [1.35]
IH-10	5 μh	19 amps	.010 Ω	20 amps	1.125 [28.53]	0.687 [17.45]	0.812 [20.62]	.065 [1.65]
IH-10	10 μh	16 amps	.012 Ω	17 amps	1.375 [34.93]	0.687 [17.45]	1.218 [30.94]	.065 [1.65]
IH-10	27 μh	12.5 amps	.018 Ω	12 amps	1.125 [28.53]	0.937 [23.80]	0.687 [17.45]	.065 [1.65]
IH-10	50 μh	11 amps	.025 Ω	10 amps	1.375 [34.93]	0.937 [23.80]	0.937 [23.80]	.065 [1.65]
IH-10	68 μh	10 amps	.027 Ω	8 amps	1.375 [34.93]	0.937 [23.80]	1.125 [28.53]	.065 [1.65]
IH-10	100 μh	10 amps	.030 Ω	7 amps	1.625 [41.28]	0.937 [23.80]	1.312 [33.32]	.065 [1.65]
IH-15	5 μh	24 amps	.008 Ω	25 amps	1.375 [34.93]	0.725 [18.42]	0.937 [23.80]	.082 [2.08]
IH-15	10 μh	20 amps	.010 Ω	17 amps	1.687 [42.85]	0.725 [18.42]	1.500 [38.10]	.082 [2.08]
IH-15	27 μh	16 amps	.015 Ω	14 amps	1.375 [34.93]	1.000 [25.40]	0.937 [23.80]	.082 [2.08]
IH-15	50 μh	15 amps	.020 Ω	10 amps	1.625 [41.28]	1.000 [25.40]	1.125 [28.53]	.082 [2.08]

*Inductance measured with zero D.C. current.

**Incremental current reduces inductance by 10% or less.
Average current must not exceed specified rated current.

SCHEMATIC

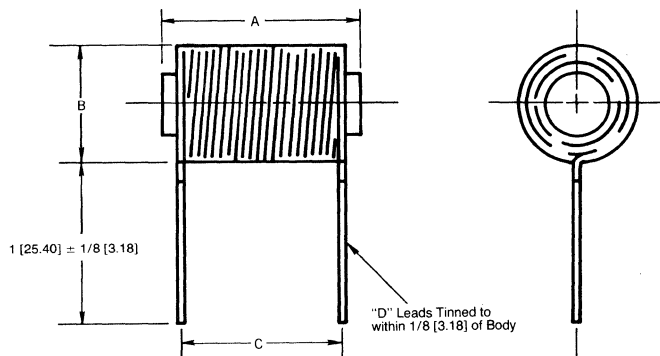

ORDERING INFORMATION

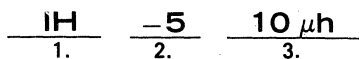

1. & 2. Basic model high current choke
3. Inductance (μh)

DALE ELECTRONICS, INC., East Highway 50, Yankton, SD 57078 • Phone 605-665-9301

Canada: Dale Electronics Ltd., 18 Howden Rd., Scarborough, Ontario M1R 3E6
Europe: Dale Electronics GmbH, Benzstrasse 28, 8039 Puchheim, West Germany



HIGH CURRENT FILTER INDUCTORS

MODEL IHA

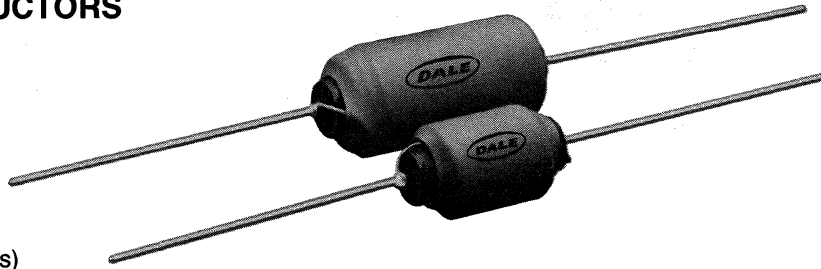

FEATURES

- Printed circuit mounting (axial leads)
- Pre-tinned leads
- Low cost construction
- Designed for use with switching power supplies
- Protected by polyolefin sleeve

SPECIFICATIONS

ELECTRICAL

Inductance: Measured at 1 KHz with no DC current.

Current Rating: Maximum continuous operating current (DC or RMS) based on a 50°C temperature rise.

Dielectric Rating: 2500 VRMS, 60 Hz, applied for one minute between winding and outer circumference to within .25" of the insulation sleeve edge.

Temperature Rating: -55°C to +105°C

MECHANICAL

Winding: Layered solenoid type with magnetic core

Wire: Solid soft copper

Terminals: Tinned copper leads

Coating: Polyolefin tubing

ELECTRICAL SPECIFICATIONS

MODEL	INDUCTANCE @ 1 KHz ±10%	CURRENT (Max.)	DC RESISTANCE (Max.)
IHA-101	50 μh	2.5 amps	.12Ω
IHA-102	100 μh	2.1 amps	.18Ω
IHA-103	250 μh	1.8 amps	.30Ω
IHA-104	500 μh	1.6 amps	.50Ω
IHA-105	1000 μh	1.4 amps	.60Ω
IHA-201	27 μh	3.7 amps	.085Ω
IHA-202	50 μh	3.1 amps	.10Ω
IHA-203	100 μh	2.7 amps	.15Ω
IHA-204	250 μh	2.4 amps	.25Ω
IHA-205	500 μh	2.3 amps	.45Ω
IHA-301	5 μh	6.8 amps	.025Ω
IHA-302	10 μh	6.1 amps	.035Ω
IHA-303	27 μh	4.8 amps	.05Ω
IHA-304	50 μh	4.3 amps	.065Ω
IHA-305	100 μh	4.2 amps	.075Ω
IHA-501	5 μh	9.3 amps	.015Ω
IHA-502	10 μh	8.3 amps	.025Ω
IHA-503	27 μh	6.5 amps	.035Ω
IHA-504	50 μh	6.1 amps	.05Ω
IHA-505	100 μh	5.9 amps	.065Ω

MECHANICAL SPECIFICATIONS

MODEL	A (Max.)	B (Max.)	C ±.002 [0.05]
IHA-101	.475 [12.06]	.800 [20.32]	.032 [0.81]
IHA-102	.475 [12.06]	.800 [20.32]	.032 [0.81]
IHA-103	.475 [12.06]	1.050 [26.67]	.032 [0.81]
IHA-104	.550 [13.97]	1.050 [26.67]	.032 [0.81]
IHA-105	.550 [13.97]	1.175 [29.84]	.032 [0.81]
IHA-201	.500 [12.70]	.800 [20.32]	.032 [0.81]
IHA-202	.500 [12.70]	.800 [20.32]	.032 [0.81]
IHA-203	.500 [12.70]	.920 [23.37]	.032 [0.81]
IHA-204	.600 [15.24]	.920 [23.37]	.032 [0.81]
IHA-205	.750 [19.05]	1.050 [26.67]	.032 [0.81]
IHA-301	.475 [12.06]	.800 [20.32]	.032 [0.81]
IHA-302	.475 [12.06]	.920 [23.37]	.032 [0.81]
IHA-303	.550 [13.97]	.800 [20.32]	.032 [0.81]
IHA-304	.550 [13.97]	.920 [23.37]	.032 [0.81]
IHA-305	.550 [13.97]	1.175 [29.84]	.032 [0.81]
IHA-501	.475 [12.06]	1.050 [26.67]	.040 [1.02]
IHA-502	.475 [12.06]	1.050 [26.67]	.040 [1.02]
IHA-503	.700 [17.78]	1.050 [26.67]	.040 [1.02]
IHA-504	.700 [17.78]	1.050 [26.67]	.040 [1.02]
IHA-505	.700 [17.78]	1.300 [33.02]	.040 [1.02]

SCHEMATIC

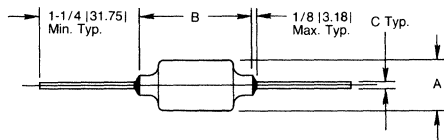

ORDERING INFORMATION

IHA -101
1. 2.

1. Basic model high current choke
2. Dash number for current and inductance value desired.



HIGH CURRENT FILTER INDUCTORS

MODELS IHD-1 and IHD-3

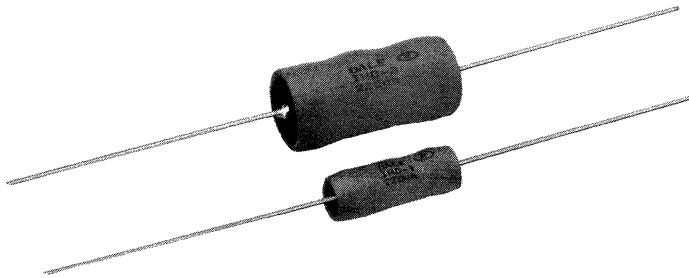

FEATURES

- Printed circuit mounting (axial leads)
- Protected by polyolefin sleeve
- Pre-tinned leads
- High saturation bobbin used allowing high inductance with low DC resistance

SPECIFICATIONS

ELECTRICAL

Inductance: Measured at 1 KHz with no DC current

Current Rating: Maximum continuous operating current based on a 50°C temperature rise

Dielectric Rating: 2500 VRMS between winding and outer circumference to within 0.25" of the insulating sleeve edge

Temperature Rating: -55°C to +105°C

MECHANICAL

Wire: Solid soft copper

Terminals: 20 AWG tinned copper leads

Coating: Polyolefin tubing

DIMENSIONS

[Numbers in brackets indicate millimeters]

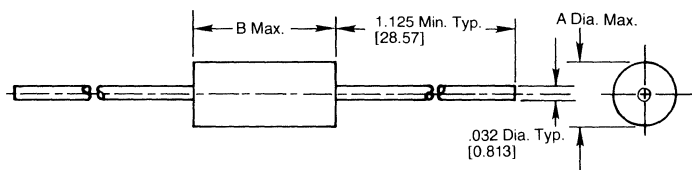

MODEL	A (Max.)	B (Max.)
IHD-1	.250 [6.35]	.650 [16.51]
IHD-3	.453 [11.51]	.900 [22.86]

ELECTRICAL SPECIFICATIONS

MODEL NO. IHD-1			MODEL NO. IHD-3		
INDUCT @ 1KHz (±15%)	DCR (Max.) (Ω)	RATED CURRENT Max. (Amps)	INDUCT @ 1KHz (±15%)	DCR (Max.) (Ω)	RATED CURRENT Max. (Amps)
3.9	0.008	1.280	3.9	0.007	4.000
4.7	0.010	1.280	4.7	0.008	4.000
5.6	0.013	1.280	5.6	0.009	4.000
6.8	0.014	1.280	6.8	0.011	4.000
8.2	0.022	1.280	8.2	0.013	4.000
10.	0.024	1.280	10.	0.017	4.000
12.	0.031	1.280	12.	0.019	4.000
15.	0.033	1.280	15.	0.022	4.000
18.	0.036	1.280	18.	0.023	4.000
22.	0.046	1.280	22.	0.026	4.000
27.	0.054	1.280	27.	0.027	4.000
33.	0.066	1.280	33.	0.032	4.000
39.	0.094	1.280	39.	0.033	4.000
47.	0.109	1.010	47.	0.035	4.000
56.	0.140	0.804	56.	0.037	3.200
68.	0.146	0.804	68.	0.044	2.500
82.	0.152	0.804	82.	0.060	2.000
100.	0.208	0.804	100.	0.080	1.600
120.	0.283	0.804	120.	0.090	1.600
150.	0.340	0.632	150.	0.107	1.600
180.	0.362	0.508	180.	0.123	1.600
220.	0.430	0.508	220.	0.138	1.600
270.	0.557	0.508	270.	0.162	1.600
330.	0.665	0.508	330.	0.183	1.600
390.	0.772	0.400	390.	0.212	1.600
470.	1.150	0.400	470.	0.281	1.200
560.	1.270	0.315	560.	0.360	1.000
680.	1.610	0.315	680.	0.404	1.000
820.	1.960	0.250	820.	0.548	0.800
1000.	2.300	0.200	1000.	0.622	0.800
1200.	2.650	0.200	1200.	0.884	0.600
1500.	3.450	0.200	1500.	1.040	0.600
1800.	4.030	0.158	1800.	1.180	0.600
2200.	4.480	0.158	2200.	1.570	0.500
2700.	5.400	0.125	2700.	2.060	0.400
3300.	6.560	0.125	3300.	2.530	0.400
3900.	8.630	0.100	3900.	2.750	0.400
4700.	9.660	0.100	4700.	3.190	0.400
5600.	13.900	0.082	5600.	3.920	0.315
6800.	16.300	0.082	6800.	5.690	0.250
8200.	20.800	0.065	8200.	6.320	0.250
10000.	26.400	0.050	10000.	7.300	0.250
12000.	29.900	0.050	12000.	9.210	0.200
15000.	42.500	0.039	15000.	10.500	0.200
18000.	46.300	0.039	18000.	14.800	0.158
			22000.	21.800	0.125
			27000.	22.700	0.125
			33000.	25.700	0.125
			39000.	31.800	0.100
			47000.	36.100	0.100
			56000.	40.900	0.100
			68000.	57.300	0.082
			82000.	79.300	0.065
			100000.	89.700	0.065

ORDERING INFORMATION

IHD-1 3.9 μh ±15%
1. 2. 3.

1. Basic model
2. Inductance value (μh)
3. Inductance tolerance



HIGH CURRENT FILTER INDUCTORS

MODEL IHB

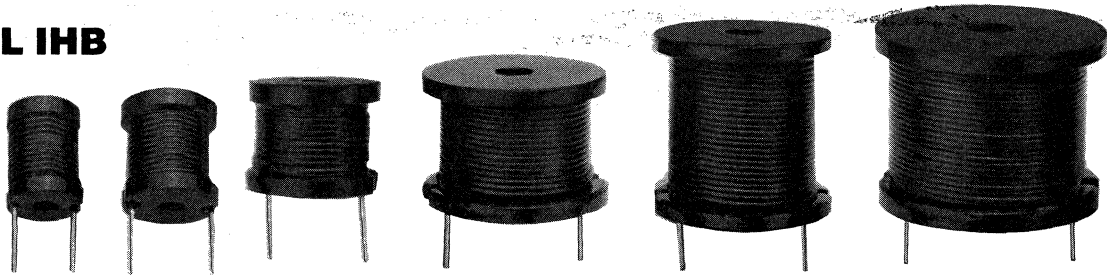

FEATURES

- Printed circuit mounting
- Wide range of inductance and current ratings
- Pre-tinned leads
- Optional insulating covering and printing available at additional cost

SPECIFICATIONS

ELECTRICAL

Inductance: Measured at 1KHz with no DC current

Temperature Range: -55°C to +130°C

Current Rating: Maximum continuous operating current based on a 50°C temperature rise.

Dielectric: 2500 VRMS between winding and .250" of insulating covering edge (with optional insulating covering)

MECHANICAL

Terminals: Extensions of winding wire, solder coated to within 1/16 [1.59] of body

Mounting: Center hole for mechanical mounting

DIMENSIONS

[Numbers in brackets indicate millimeters]

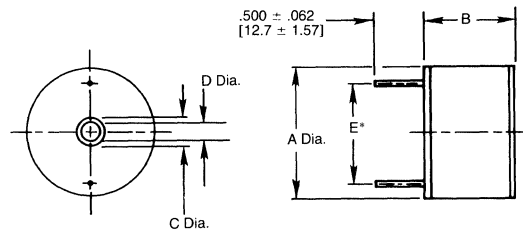

*E varies between components. See individual model spec. for details.

MODEL NO.	A (Max.)	B (Max.)	C (Max.)	D (Max.)
IHB-1	.660 [16.76]	.840 [21.34]	.162 [4.11]	.115 [2.92]
IHB-2	.825 [20.95]	.840 [21.34]	.162 [4.11]	.115 [2.92]
IHB-3	1.100 [27.94]	.840 [21.34]	.162 [4.11]	.115 [2.92]
IHB-4	1.600 [40.64]	1.030 [26.16]	.250 [6.35]	.175 [4.44]
IHB-5	1.600 [40.64]	1.450 [36.83]	.250 [6.35]	.175 [4.44]
IHB-6	2.000 [50.80]	1.500 [38.10]	.330 [8.38]	.160 [4.06]



HIGH CURRENT FILTER INDUCTORS

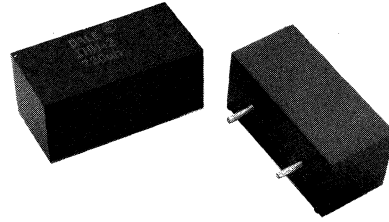

MODEL IHM-2

FEATURES

- Totally encapsulated using a potted flame-resistant shell
- Pre-tinned leads
- Printed circuit mounting
- Designed to meet MIL-T-27 specifications

SPECIFICATIONS

ELECTRICAL

Inductance: Measured at 1 KHz with no DC current

Current Rating: Maximum continuous operating current based on a 50°C temperature rise.

Dielectric Rating: 1500 VRMS between windings and top of component

Insulation Strength: 10 Megohms minimum

Temperature Rating: Continuous operation at temperatures between -55°C and +125°C

MECHANICAL

Terminals: 18 AWG tinned copper

Encapsulant: Flame-resistant shell potted with epoxy

DIMENSIONS

[Numbers in brackets indicate millimeters]

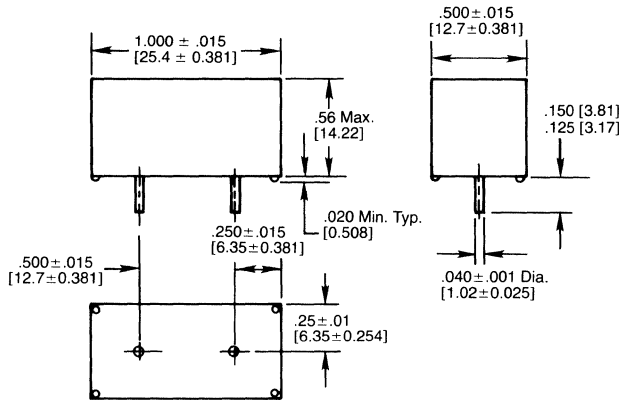

IHM-2 ELECTRICAL SPECIFICATIONS

INDUCT (μ H) ($\pm 10\%$)	DC RESIST (Ω)	CURRENT RATING Max. (Amps)
1.	0.005	17.80
1.2	0.005	17.00
1.5	0.006	16.20
1.8	0.006	15.60
2.2	0.007	15.00
2.7	0.008	14.50
3.3	0.008	14.00
3.9	0.009	13.50
4.7	0.010	13.00
5.6	0.011	12.75
6.8	0.012	12.50
8.2	0.013	11.25
10.	0.014	10.00
12.	0.016	9.25
15.	0.022	8.50
18.	0.024	7.50
22.	0.033	6.50
27.	0.037	6.00
33.	0.051	5.50
39.	0.056	5.00
47.	0.076	4.50
56.	0.084	4.25
68.	0.093	4.00
82.	0.103	3.65
100.	0.140	3.30
120.	0.175	3.00
150.	0.210	2.70
180.	0.241	2.45
220.	0.330	2.20
270.	0.420	1.95
330.	0.510	1.70
390.	0.561	1.65
470.	0.610	1.60
560.	0.687	1.45
680.	0.910	1.30
820.	1.030	1.15
1000.	1.400	1.00
1200.	1.570	0.92
1500.	2.200	0.84
1800.	2.420	0.77
2200.	3.300	0.69
2700.	3.720	0.62
3300.	5.100	0.55
3900.	5.580	0.50
4700.	7.700	0.45
5600.	8.320	0.41
6800.	11.700	0.36
8200.	12.800	0.35
10000.	14.200	0.33
12000.	15.700	0.30
15000.	21.900	0.26

ORDERING INFORMATION

IHM-2 10 μ h $\pm 10\%$
1. 2. 3.

1. Basic model
2. Inductance value (μ h)
3. Inductance tolerance



HIGH CURRENT FILTER INDUCTORS

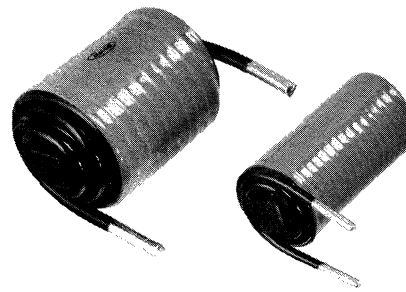

MODEL IHV

FEATURES

- Printed circuit mounting
- Low cost construction
- Designed for use with switching power supplies
- Pre-tinned leads
- Epoxy coated for durability and reliability

SPECIFICATIONS

ELECTRICAL

Inductance: Measured at 1 KHz with no D.C. current

Dielectric: 2500 Volts RMS between winding and outer circumference to within 0.25 inches of the insulation sleeve edge.

Temperature: Operating: -55°C to +105°C
Storage: -55°C to +130°C

Current Rating: Based on continuous operation at room temperature ambient. Derating is required at elevated ambient temperatures in accordance with the derating curve.

MECHANICAL

Terminals: Extensions of winding wire, solder coated

Coating: Epoxy conformal coated

ELECTRICAL SPECIFICATIONS

MODEL	INDUCTANCE* ±10%	CURRENT (Max.)	DC RESISTANCE (Max.)	SELF-RESONANT FREQUENCY (Min.)
IHV-15-500	500 μh	15 amps	.050Ω	0.8 MHz
IHV-20-200	200 μh	20 amps	.021Ω	1.2 MHz
IHV-28-60	60 μh	28 amps	.0085Ω	1.9 MHz
IHV-30-150	150 μh	30 amps	.013Ω	2.1 MHz
IHV-40-39	39 μh	40 amps	.0048Ω	2.5 MHz
IHV-45-92	92 μh	45 amps	.0075Ω	2.9 MHz
IHV-50-50	50 μh	50 amps	.0045Ω	3.1 MHz
IHV-60-24	24 μh	60 amps	.0025Ω	5.7 MHz

*Will not decrease more than 10% at rated current.

DERATING CHART

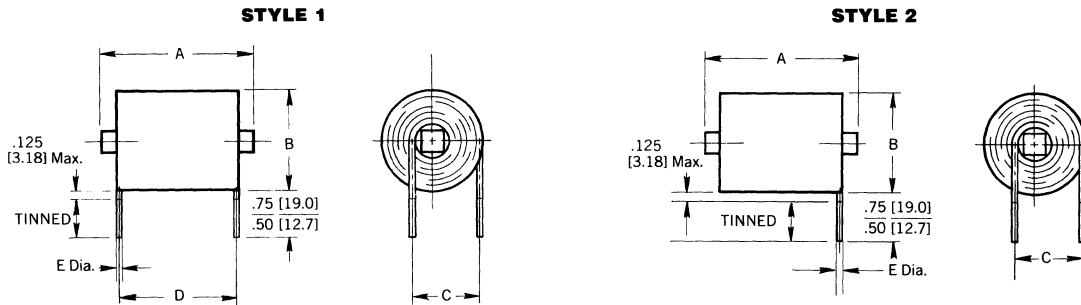
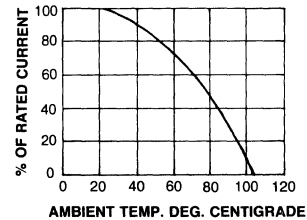

MECHANICAL SPECIFICATIONS

MODEL	STYLE	A (Max.)	B ±.050 [1.27]	C ±.062 [1.57]	D ±.062 [1.57]	E (Dia.)	TYPICAL WEIGHT (Grams)
IHV-15-500	1	2.45 [62.2]	1.45 [36.8]	.98 [24.9]	1.95 [49.6]	.082 [2.08]	305
IHV-20-200	2	2.45 [62.2]	1.45 [36.8]	.98 [24.9]	—	.102 [2.59]	310
IHV-28-60	2	2.45 [62.2]	1.02 [25.9]	.77 [19.6]	—	.102 [2.59]	160
IHV-30-150	2	2.45 [62.2]	1.65 [41.9]	1.08 [27.4]	—	.129 [3.28]	470
IHV-40-39	2	2.45 [62.2]	1.15 [29.2]	.82 [20.8]	—	.129 [3.28]	210
IHV-45-92	2	2.55 [64.8]	1.92 [48.8]	1.21 [30.7]	—	.162 [4.11]	650
IHV-50-50	1	2.55 [64.8]	1.57 [39.9]	1.05 [26.7]	2.10 [53.3]	.162 [4.11]	420
IHV-60-24	2	2.45 [62.2]	1.27 [32.3]	.89 [22.6]	—	.162 [4.11]	270

ORDERING INFORMATION

IHV -15 500 ±10%
1. 2. 3.

1. Basic model high current choke
2. Current rating maximum (amperes)
3. Inductance (μh)

DALE ELECTRONICS, INC., East Highway 50, Yankton, SD 57078 • Phone 605-665-9301

Canada: Dale Electronics Ltd., 18 Howden Rd., Scarborough, Ontario M1R 3E6
Europe: Dale Electronics GmbH, Benzstrasse 28, 8039 Puchheim, West Germany



SWITCH MODE MAGNETICS

CUSTOM DESIGN AND PRODUCTION

Dale has extensive facilities for custom design and production of custom magnetics used in switching power supplies including:

- Switching Converters
- Power Transformers
- Current Sense Transformers
- Inductors

PACKAGE DESIGN AND MATERIALS SELECTION

If you can have your own electrical design we can add value by assisting you with selection of the most economical materials and efficient packaging design.

Designs to meet UL, CSA, IEEE and VDE requirements.

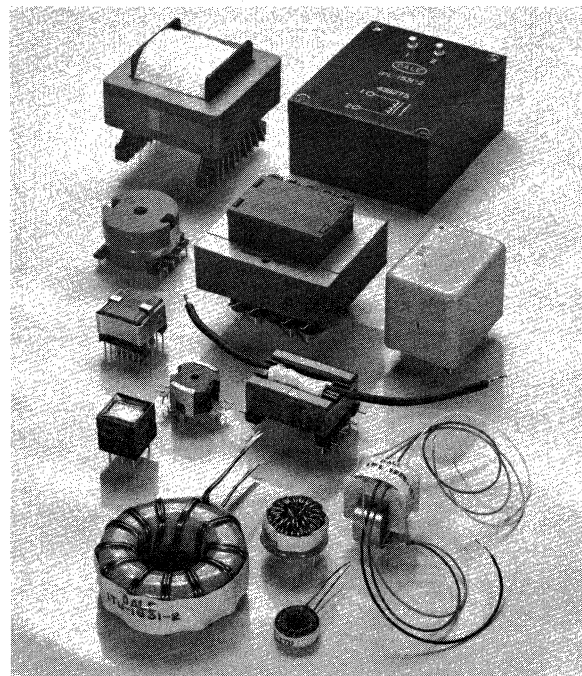

AIR CORE INDUCTORS

Produced to your specifications for a wide range of high frequency applications including:

- Television
- Radio (2-way, scanners, AM/FM)
- Cable TV Systems
- Satellite Communication
- Microwave
- Test Equipment

SPECIFICATIONS

ELECTRICAL

Frequency: To 500 MHz

Current: 10 amp max.

Temperature: To 130°C

MECHANICAL

Winding: 1 to 32 turns, clockwise or counter-clockwise with variable pitch.

Wire Gauge: #18 to #32

Leads: Automatically tinned. Various configurations available.

Coil Inside Diameter: .079" to .354"

Coil Length: Up to 1.26"

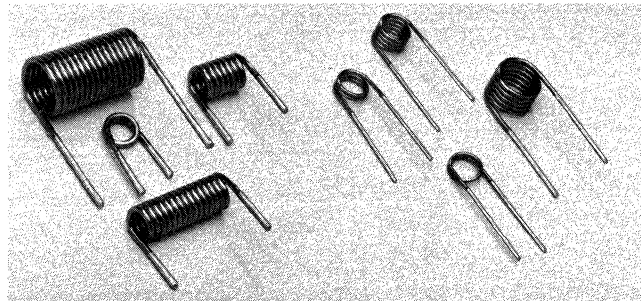

Representative models shown actual size.

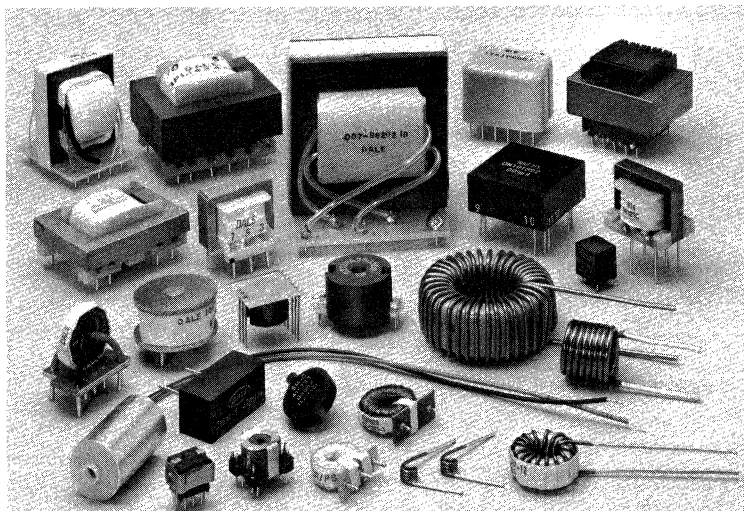

CUSTOM INDUCTIVE PRODUCTS

Can't find it in the catalog? Dale has the custom capability to design and produce a wide range of magnetic components to your requirements.

POWER TRANSFORMERS:

50 to 400 Hz, VA ratings to 100 VA. Specialty models in Low Profile and PC Mount

INDUCTORS:

Inductance values to 20 H, current ratings to 60 amps. Capability of many styles, including: Toroidal, Laminated, E Core, Pot Core, Slug Core, Air Core

AUDIO TRANSFORMERS:

Coupling Transformers and Hybrid Transformers available in PC Mount, Leadset and Low Profile

TRANSFORMERS:

Switching Magnetics, Converter Transformers, Pulse Transformers, High Voltage Transformer

- UL, CSA & VDE Capabilities
- Designs to Military Specifications

SURFACE MOUNT MAGNETIC COMPONENTS

- Offer the designer the convenience of holeless PC boards
- Capabilities include power transformers, inductors, audio transformers, switching magnetics, pulse transformers, etc.
- Configurations to meet your board space requirements
- No compromises in electrical performance
- Compatible with wave, vapor phase reflow and infrared reflow soldering
- Terminations include Gull Wing, J Hook, Butt Joint, etc.
- Encapsulated or open construction
- Packaging available for automatic handling

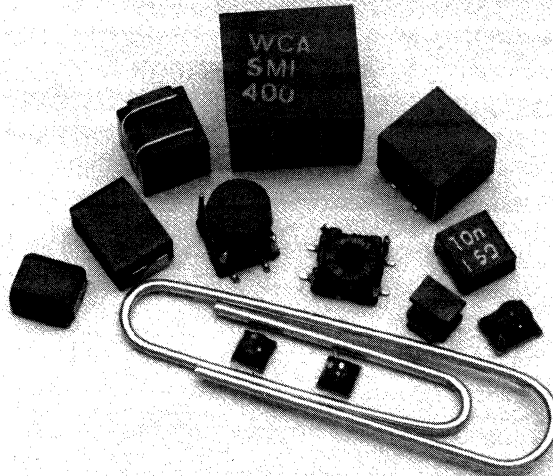

EXAMPLES

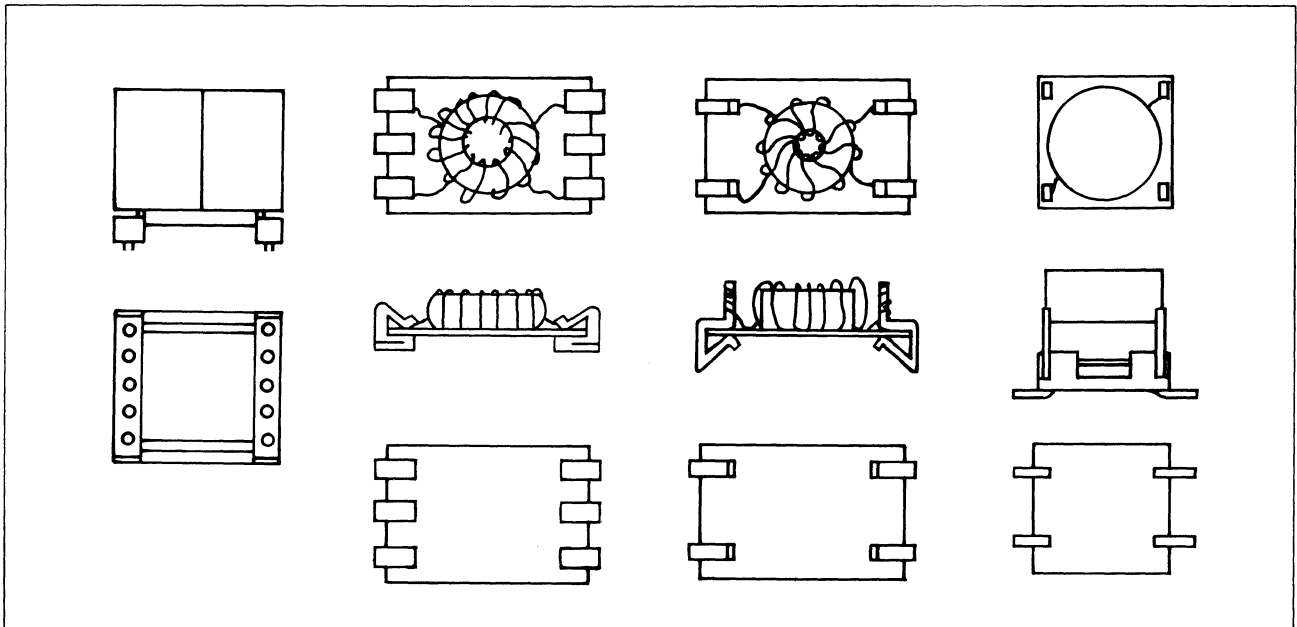

CUSTOM DESIGN AND PRODUCTION

Dale's custom engineering staff is ready to assist you in designing all types of magnetic components for surface mounting. Our experience in selecting materials and developing functional packaging can save you time and development costs. For more information, please contact us at the address below.



TOROID FILTER INDUCTORS

MODELS TE and TD

FEATURES

- Choice of encapsulated (TE) or dipped (TD) styles
- TE style designed to meet the requirements of MIL-T-27, Type TF5S20ZZ. TD style combines low cost with excellent performance in commercial applications
- High Q and wide selection of Q vs frequency ranges in one small package. Large number of standard inductance values

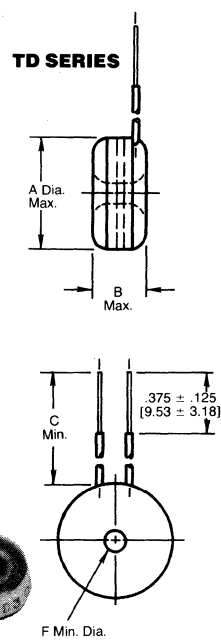
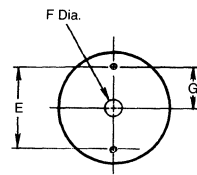
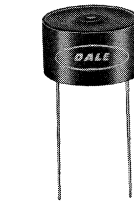
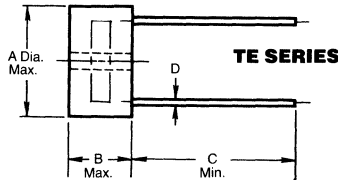

SPECIFICATIONS

ELECTRICAL

Tolerance:

- TE-2, TD-2 = ±1% > 2mH, ±2% = 0.05mH to 2.0mH
- TE-3, TD-3 = ±1% > 2mH, ±2% 154μH to 2.0mH, ±5% < 150μH
- TE-4, TD-4 = ±1% > 2mH, ±2% < 2mH
- TE-5, TD-5 = ±1% > 2mH, ±2% < 2mH

Insulation Resistance: 1000 Megohms minimum

Dielectric Strength: 1000 Volts minimum (TE)
500 Volts minimum (TD)

MECHANICAL

Terminal Strength: 2 lb. pull test (TE)

Vibration: Per MIL-T-27 (TE)

Shock: Per MIL-T-27 (TE)

Weight: TE-2 = 2 grams TD-2 = 1.6 grams typ.
TE-3 = 5.1 grams TD-3 = 4.9 grams typ.
TE-4 = 20 grams TD-4 = 17 grams typ.
TE-5 = 53 grams TD-5 = 52 grams typ.

MATERIAL

Encapsulant: Epoxy (TE)

Coating: Vinyl (TD), non-flammable, abrasion and moisture resistant. Resists most cleaning agents. (Consult factory for chemicals which may be used.)

Standard Terminals: Tinned copper (TE); Stranded, tinned copper, Teflon insulated (TD)

Gauge: TE-2 = 24AWG TD-2 = 30AWG
TE-3 = 22AWG TD-3 = 26AWG
TE-4 = 20AWG TD-4 = 24AWG
TE-5 = 20AWG TD-5 = 24AWG

DIMENSIONS [Numbers in brackets indicate millimeters]

TYPE	A	B	C	D	E	F	G
TE-2	.437 [11.10]	.270 [6.86]	1.00 [25.40]	.020 [0.51]	.300 [7.62]	—	—
TD-2	.437 [11.10]	.250 [6.35]	2.00 [50.80]	—	—	—	—
TE-3	.685 [14.86]	.385 [9.78]	1.00 [25.40]	.025 [0.64]	.500 [12.70]	.093 [2.36]	.250 [6.35]
TD-3	.685 [14.86]	.320 [8.13]	3.0 [76.20]	—	—	.125 [3.18]	—
TE-4	1.062 [26.97]	.500 [12.70]	1.00 [25.40]	.032 [0.81]	.900 [22.86]	.120 [3.05]	.450 [11.43]
TD-4	1.062 [26.97]	.437 [11.10]	4.0 [101.6]	—	—	.220 [5.59]	—
TE-5	1.32 [33.53]	.725 [18.42]	1.00 [25.40]	.032 [0.81]	1.00 [25.40]	.144 [3.66]	.50 [12.70]
TD-5	1.32 [33.53]	.688 [17.48]	6.00 [142.4]	—	—	.220 [5.59]	—

INDUCTANCE RANGES

T.C. AVAIL.	TE-2 TD-2	TE-3 TD-3	TE-4 TD-4	TE-5 TD-5
Q0	50μH to 10mH	50μH to 15mH	150μH to 20mH	1mH to 100mH
Q3	470μH to 120mH	500μH to 1H	1mH to 2H	5mH to 2H
Q4	1mH to 250mH	1mH to 4H	2mH to 7.5H	10mH to 20H

TEMPERATURE COEFFICIENT CODE (APPLIES TO CORE ONLY)

DALE TYPES				T.C. CODE	TEMPERATURE COEFFICIENT	TEMPERATURE RANGE	T.C. AVAILABILITY		
TE-2 TD-2	TE-3 TD-3	TE-4 TD-4	TE-5 TD-5				Q0	Q3	Q4
X	X	X	X	TA	0 ± 1%	-55°C to +125°C	X	X	
		X	X	TB	0 ± 0.1%	+13°C to +35°C	X	X	
X	X	X	X	TD	0 ± 0.1%	0°C to +55°C	X	X	
		X	X	TE	0 ± 0.15%	0°C to +55°C		X	
	X	X	X	TL*	+40 to +110 PPM/°C +85 to +185 PPM/°C	-55°C to +25°C +25°C to +85°C		X	
X	X	X	X	TM	0 ± 0.25%	-65°C to +125°C	X	X	
X	X	X	X	TR	50 PPM/°C (Typical)	-65°C to +125°C	X		
X	X	X	X	TW	0 ± 0.25%	-55°C to +85°C		X	

*Inverse of typical Temperature Coefficient of polystyrene capacitor.

DALE ELECTRONICS, INC., East Highway 50, Yankton, SD 57078 • Phone 605-665-9301

Canada: Dale Electronics Ltd., 18 Howden Rd., Scarborough, Ontario M1R 3E6
Europe: Dale Electronics GmbH, Benzstrasse 28, 8039 Puchheim, West Germany

MODELS TE and TD

DC RESISTANCE AND SELF-RESONANT FREQUENCIES
(Typical Values)

TE-2, TD-2

INDUCTANCE (mH)	DC RESISTANCE (Ohms)			SELF-RESONANT FREQUENCIES (MHz)		
	Q0	Q3	Q4	Q0	Q3	Q4
0.050	1.9	—	—	10	—	—
0.100	2.7	—	—	7	—	—
0.330	7.7	—	—	3.1	—	—
0.470	9.3	2.3	—	2.5	2.4	—
1.00	26	4.2	2.3	1.4	1.2	2.0
3.30	79	9.7	5.4	.70	.79	.95
10.0	251	31	18	.34	.40	.43
33.0	—	118	54	—	.18	.21
100	—	408	227	—	.06	.10
250	—	—	450	—	—	.05

TE-3, TD-3

INDUCTANCE	DC RESISTANCE (Ohms)			SELF-RESONANT FREQUENCIES (MHz)		
	Q0	Q3	Q4	Q0	Q3	Q4
50.0 μ H	.68	—	—	7.6	—	—
100. μ H	1.0	—	—	5.1	—	—
330. μ H	3.3	—	—	2.9	—	—
1.00 mH	6.9	1.5	.82	1.4	1.1	1.0
3.30 mH	24	4.1	2.3	.79	.57	.55
10.0 mH	84	14	5.9	.40	.29	.25
15.0 mH	106	17	9.1	.34	.24	.21
33.0 mH	—	40	18	—	.14	.12
100. mH	—	138	58	—	.080	.077
330. mH	—	555	220	—	.040	.038
1.0 H	—	1500	670	—	.021	.019
4.00 H	—	—	2700	—	—	.009

TE-4, TD-4

INDUCTANCE	DC RESISTANCE (Ohms)			SELF-RESONANT FREQUENCIES (MHz)		
	Q0	Q3	Q4	Q0	Q3	Q4
150. μ H	.54	—	—	2.6	—	—
1.00 mH	2.8	.70	—	1.0	.75	—
2.00 mH	5.5	1.4	.78	.64	.54	.45
10.0 mH	27	4.9	2.5	.24	.21	.18
20.0 mH	54	9.6	5.0	.18	.15	.13
100. mH	—	56	23	—	.059	.051
1.00 H	—	570	260	—	.016	.014
2.00 H	—	1200	520	—	.013	.011
7.5 H	—	—	2000	—	—	.004

TE-5, TD-5

INDUCTANCE	DC RESISTANCE (Ohms)			SELF-RESONANT FREQUENCIES (MHz)		
	Q0	Q3	Q4	Q0	Q3	Q4
1.00 mH	1.8	—	—	.80	—	—
3.30 mH	5.2	—	—	.44	—	—
5.00 mH	6.5	1.8	—	.33	.32	—
10.00 mH	13	2.4	1.7	.21	.20	.15
33.00 mH	49	8.8	3.9	.12	.11	.086
100.00 mH	133	27	11	.061	.057	.044
330.00 mH	—	80	44	—	.032	.024
1.00 H	—	222	121	—	.016	.012
2.00 H	—	475	217	—	.012	.008
10.00 H	—	—	1300	—	—	.003
20.00 H	—	—	2400	—	—	.002

INDUCTANCE VS D.C. BIAS
INDUCTANCE VS A.C. EXCITATION

TE-2, TD-2

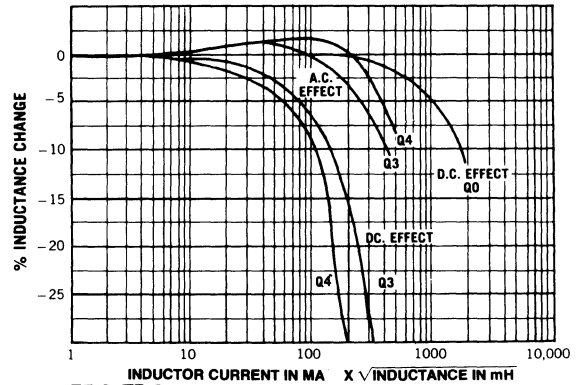

TE-3, TD-3

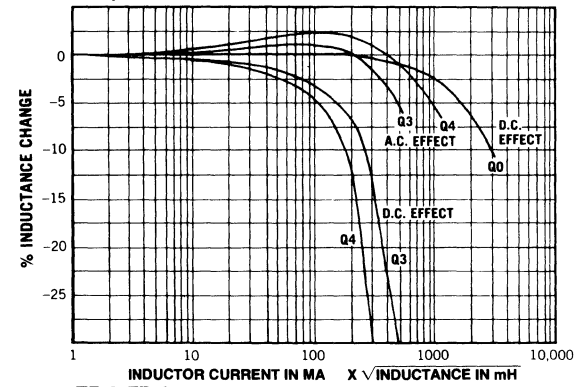

TE-4, TD-4

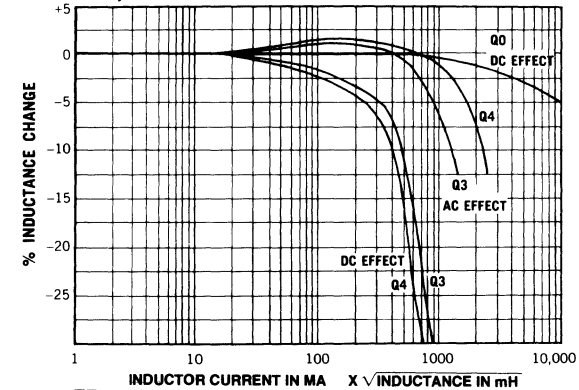

TE-5, TD-5

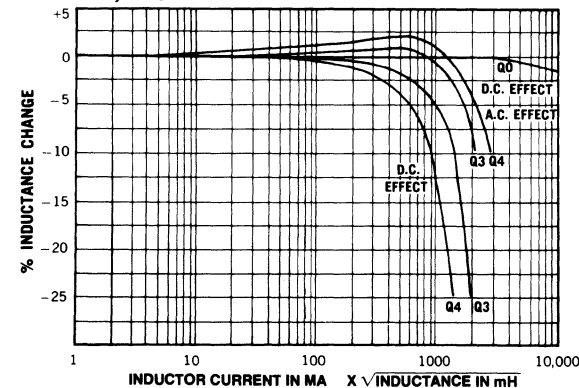

TE and TD PERFORMANCE GRAPHS — TYPICAL Q VS. FREQUENCY

TE-2 and TD-2

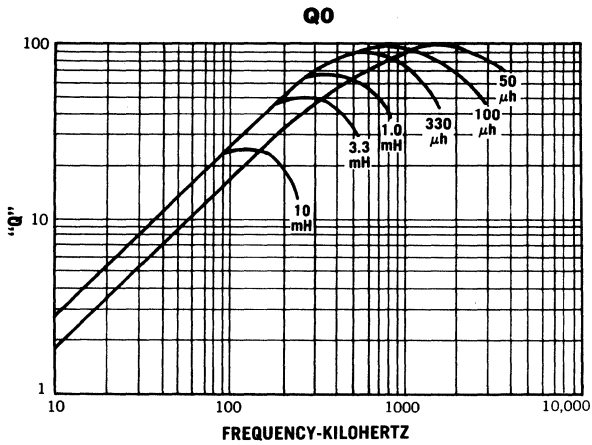

Q3

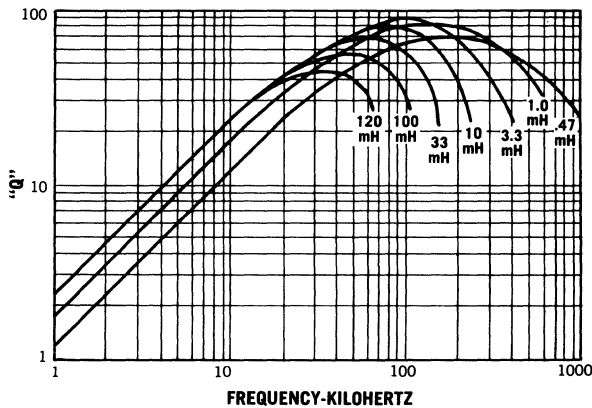

Q4

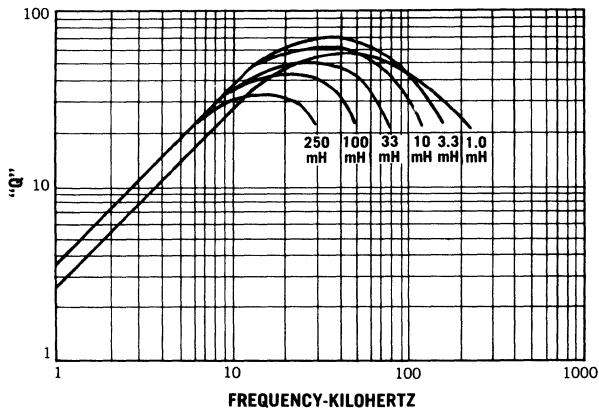

TE-3 and TD-3

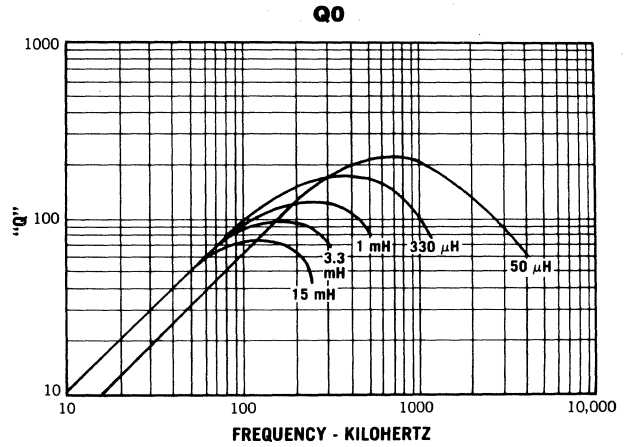

Q3

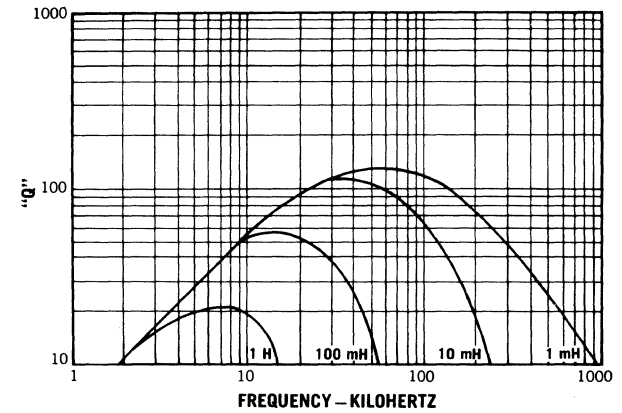

Q4

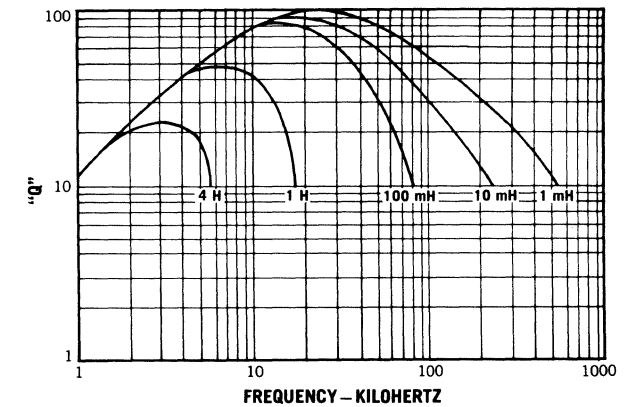

STANDARD INDUCTANCE VALUES

The following standardization chart is offered for your design and ordering convenience. Each value listed is within one percent of the preceding and succeeding values shown. All decade multiples of these values, within the range shown for each model in the chart, are Dale standard values. (Example: For a TE-2 200μH, 20mH and 200mH are all decade multiples of 2.00 and are all standard values.)

1.00	1.21	1.47	1.78	2.15	2.61	3.09	3.74	4.42	5.23	6.19	7.32	8.66
1.02	1.24	1.50	1.82	2.21	2.67	3.16	3.83	4.53	5.36	6.34	7.50	8.87
1.05	1.27	1.54	1.87	2.26	2.74	3.24	3.92	4.64	5.49	6.49	7.68	9.00
1.07	1.30	1.58	1.91	2.32	2.80	3.32	4.00	4.75	5.62	6.65	7.87	9.09
1.10	1.33	1.62	1.96	2.37	2.87	3.40	4.02	4.87	5.76	6.81	8.00	9.31
1.13	1.37	1.65	2.00	2.43	2.94	3.48	4.12	4.99	5.90	6.98	8.06	9.53
1.15	1.40	1.69	2.05	2.49	3.00	3.57	4.22	5.00	6.00	7.00	8.25	9.76
1.18	1.43	1.74	2.10	2.55	3.01	3.65	4.32	5.11	6.04	7.15	8.45	

TE and TD PERFORMANCE GRAPHS — TYPICAL Q VS. FREQUENCY

TE-4 and TD-4

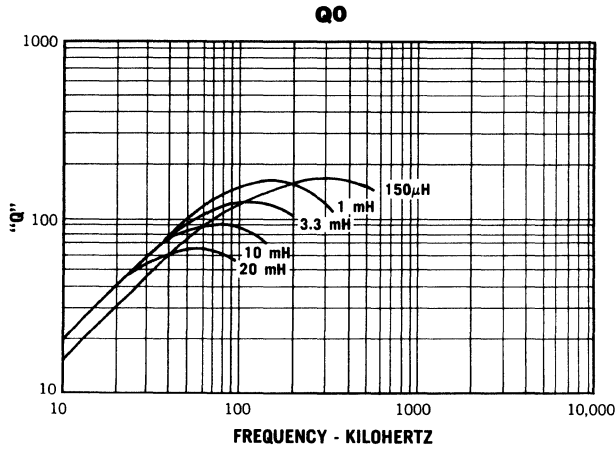

TE-5 and TD-5

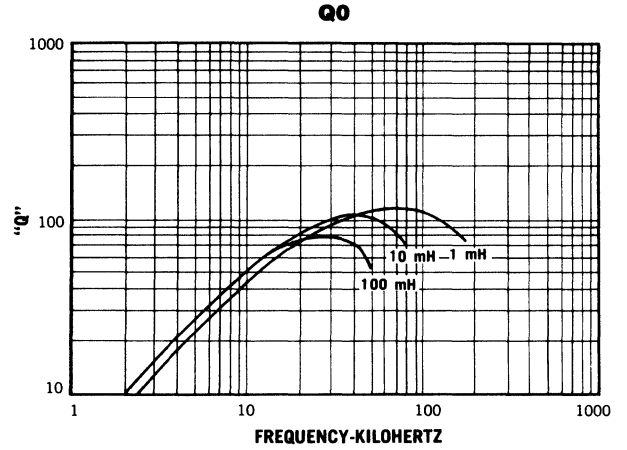

SAMPLE PART NUMBER

TE-2, TD-2
 TE-3, TD-3
 TE-4, TD-4
 TE-5, TD-5

DALE SIZE

Q0

Q TYPE

TR

T.C. CODE

5mH

INDUCTANCE

2.0

% TOLERANCE

DALE ELECTRONICS, INC., East Highway 50, Yankton, SD 57078 • Phone 605-665-9301

Canada: Dale Electronics Ltd., 18 Howden Rd., Scarborough, Ontario M1R 3E6
 Europe: Dale Electronics GmbH, Benzstrasse 28, 8039 Puchheim, West Germany



TELEPHONE COUPLING AUDIO TRANSFORMERS

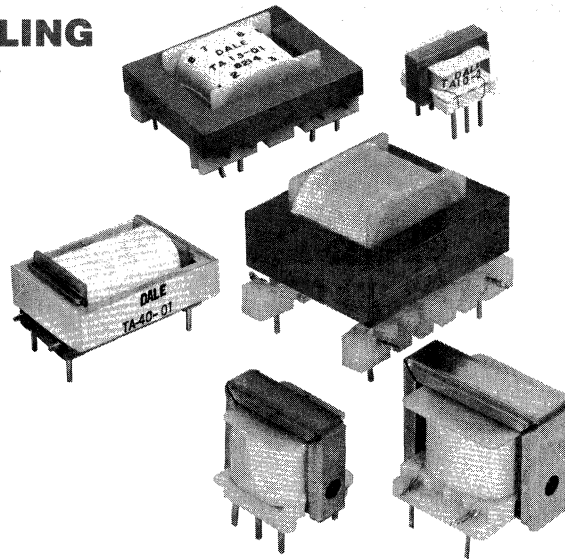

MODEL TA

Designed to meet FCC Part 68

FEATURES

- Designed and built to meet telephone company requirements for data and voice access on leased private telephone lines or through dial-up switched telephone networks
- Provide line isolation, impedance matching and line balance

SPECIFICATIONS

ELECTRICAL

Power Level: -45 dBm to +7 dBm except TA-40-01 (-45 dBm to +10 dBm)

Longitudinal Balance: Per FCC 68.310 60 dB min. = 200-1000 Hz
45 dB min. = 1000-4000 Hz

Dielectric Strength: Per FCC 68.304 1500 V peak

Frequency Range: Data/Voice = 300 to 3500 Hz
Data = 800 to 3500 Hz

MECHANICAL

Coating: Impregnated with polyester varnish.

Terminals: Precision spaced PC type plug-in terminals.

APPLICATION TABLE*

IMPEDANCE		COUPLING APPLICATION	UNBALANCED DC CURRENT (MA)	RETURN LOSS MIN. (dB)	INSERTION LOSSES @ 1 KHz (dB)	FREQUENCY RESPONSE REF. at 1 KHz (dB)	IMPEDANCE MATCHING (%)	DISTORTION (%)	STYLE	SCHEMATIC NO.	MODEL NO.
PRI	SEC										
600Ω	600Ω	DATA/VOICE	0	26	1.0	±0.5	±10	0.5	C	5	TA-10-08
600Ω	600Ω	DATA/VOICE	0	26	1.0	±0.5	±10	0.5	J	5	TA-10-07
600Ω	600Ω	DATA/VOICE	0-5	14	1.5	±1.5	±25	5.0	J	5	TA-30-06
600Ω	600Ω	DATA/VOICE	0	26	0.6	±0.5	±10	0.5	B	5	TA-10-05
600Ω	600Ω	DATA/VOICE	0-5	15	1.4	±1.5	±25	5.0	B	5	TA-30-02
600Ω	600Ω	DATA	0-90	8	2.4	±1.0	±25	5.0	G	5	TA-30-03
600Ω	600Ω	DATA/VOICE	0-80	11	1.2	±1.5	±25	5.0	M	13	TA-32-02
600Ω	600Ω	DATA/VOICE	0-90	14**	1.7**	±0.2**	±20	0.5	N	13	TA-40-01
600Ω	600Ω	DATA/VOICE	0-100	8	1.6	±1.5	±25	5.0	E	15	TA-33-02
600Ω	600Ω CT	DATA	0-90	8	2.4	±1.0	±25	5.0	H	9	TA-30-04
600Ω CT	600Ω CT	DATA/VOICE	0	26	0.6	±0.5	±10	0.5	A	4	TA-10-04
600Ω CT	600Ω CT	DATA/VOICE	0-5	15	1.4	±1.5	±25	5.0	A	4	TA-30-01
600Ω SPLIT	600Ω	DATA/VOICE	0-50	8	1.4	±1.5	±25	5.0	K	11	TA-31-01
600Ω SPLIT	600Ω	DATA/VOICE	0-80	11	1.2	±1.5	±25	5.0	L	14	TA-32-03
600Ω	600Ω SPLIT	DATA/VOICE	0-75	13	1.2	±0.5	±10	0.5	E	7	TA-13-01
600Ω	600Ω SPLIT	DATA/VOICE	0-100	8	1.6	±1.5	±25	5.0	E	7	TA-33-01
600Ω	600Ω/600Ω	DATA/VOICE HYBRID	0	26	0.8	±0.5	±10	0.5	A	1	TA-10-01
600Ω	600Ω/600Ω	DATA/VOICE HYBRID	0-5	14	1.4	±1.5	±25	5.0	A	10	TA-30-05
600Ω	600Ω/600Ω	DATA/VOICE HYBRID	0	26	0.8	±0.5	±10	0.5	D	1	TA-11-01
600Ω	900Ω	DATA/VOICE	0-5	14	1.5	±1.5	±25	5.0	J	2	TA-30-07
600Ω	900Ω	DATA/VOICE	0	26	0.7	±0.5	±10	0.5	B	2	TA-10-02
600Ω/900Ω	600Ω	DATA/VOICE	0-100/0-120	8	1.4	±1.5	±25	5.0	L	12	TA-32-01
600Ω	600Ω/900Ω	DATA/VOICE	0-100/0-120	14	0.5	±0.5	±10	0.5	F	8	TA-14-01
900Ω	900Ω	DATA/VOICE	0	26	0.7	±0.5	±10	0.5	A	6	TA-10-06
4KΩ	600Ω	DATA/VOICE	0	22	0.7	±0.5	±10	0.5	B	3	TA-10-03

Model TA-3 is the low-cost alternative to Model TA-1.

*For HOLDING COIL information, refer to MODEL TE/TD. **Reference for TA-40-01 is 1.8 KHz.

DALE ELECTRONICS, INC., East Highway 50, Yankton, SD 57078 • Phone 605-665-9301

Canada: Dale Electronics Ltd., 18 Howden Rd., Scarborough, Ontario M1R 3E6
Europe: Dale Electronics GmbH, Benzstrasse 28, 8039 Puchheim, West Germany

SCHEMATICS

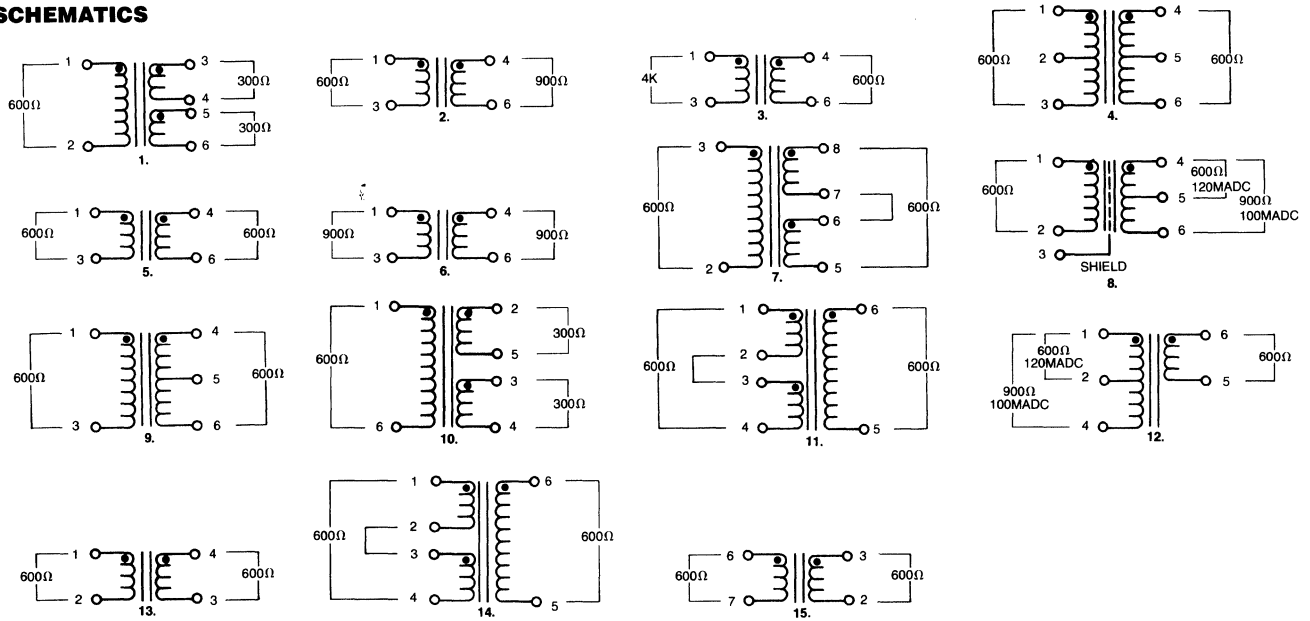

DIMENSIONS (Styles G, H, J, K, L, M shown on next page)

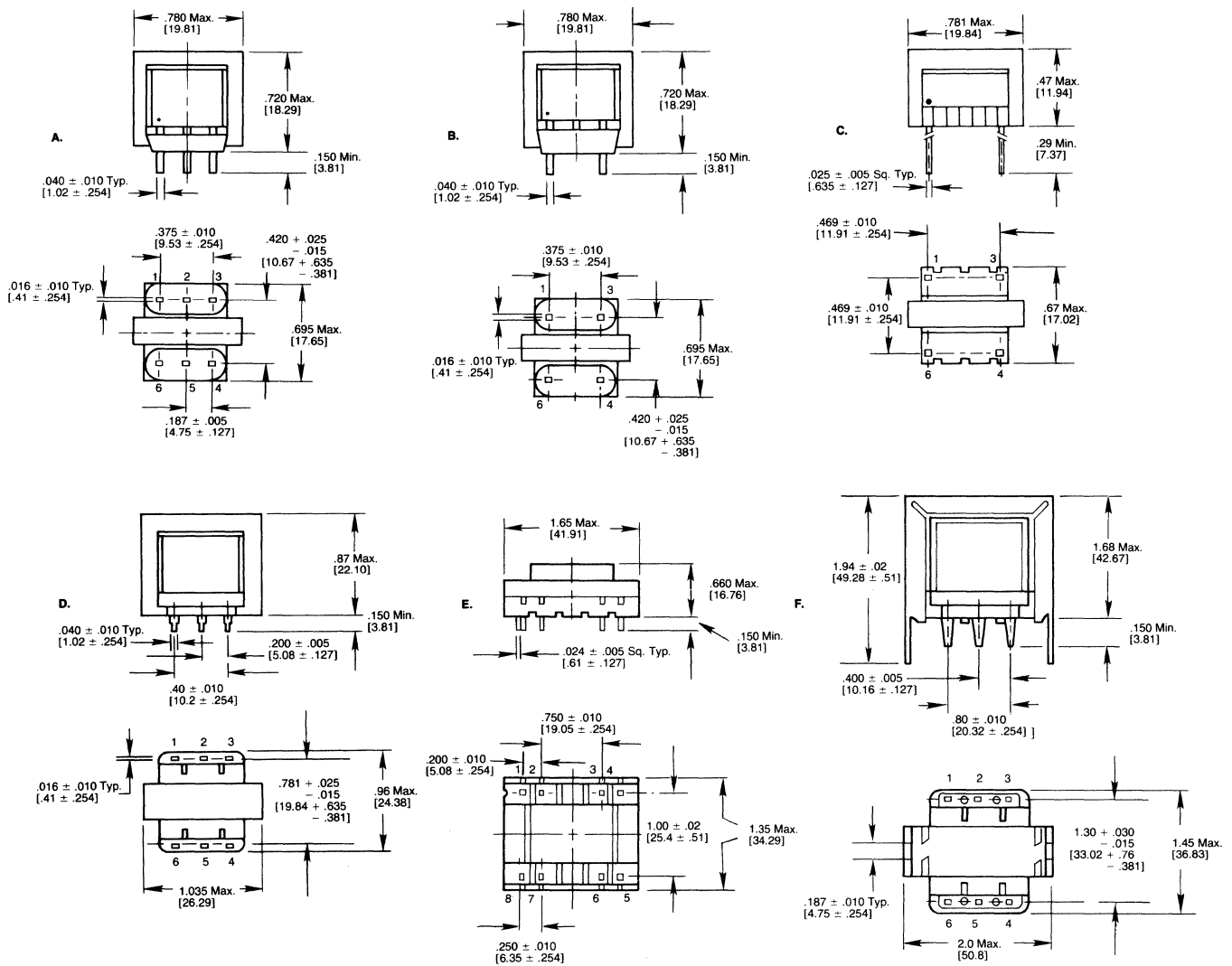

DIMENSIONS (Continued)

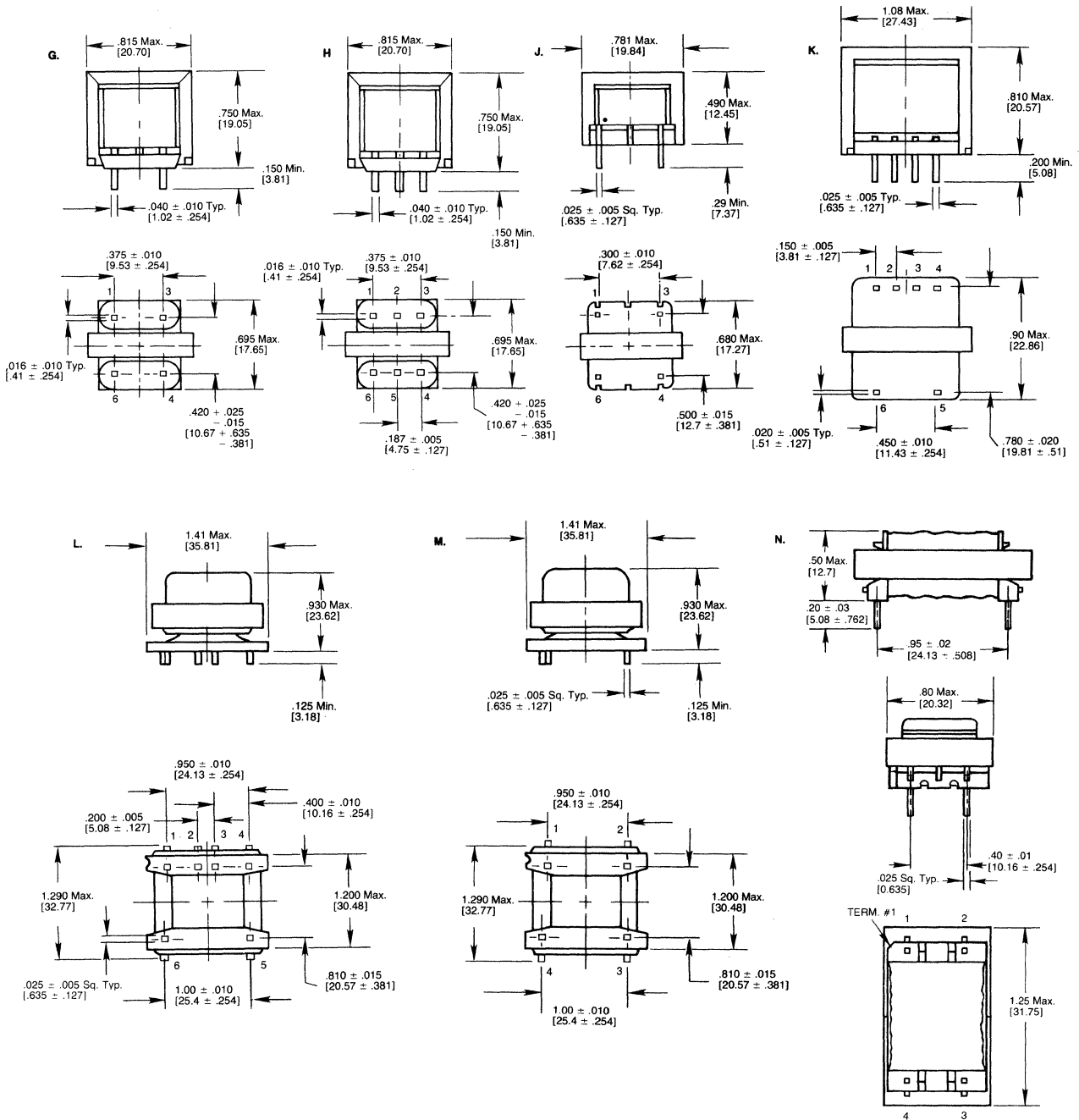

ORDERING INFORMATION

The following model number information must be supplied when ordering transformers.

TA	—	10, 11, 13, 14, 30, 31, 32, 33, 40	—	01 thru 08
STYLE		SIGNIFIES SIZE OF UNIT		DASH NUMBER SIGNIFIES VALUE

Special designs not listed are available on request.

DALE ELECTRONICS, INC., East Highway 50, Yankton, SD 57078 • Phone 605-665-9301
 Canada: Dale Electronics Ltd., 18 Howden Rd., Scarborough, Ontario M1R 3E6
 Europe: Dale Electronics GmbH, Benzstrasse 28, 8039 Puchheim, West Germany



CONVERTER TRANSFORMERS

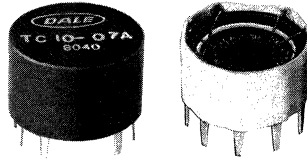

MODEL TC

FEATURES

- High conversion efficiency from DC input to filtered DC output
- Designed especially for low-power solid state circuits
- Designed for mounting on printed circuit boards
- Miniature size for minimum space
- Choice of encapsulated or open (impregnated) styles

SPECIFICATIONS

ELECTRICAL

Transformer Power Rating: 3 watts

Isolation, Primary-Secondary: 500 volts 60 Hz

Operating characteristics may be varied to suit specific applications by appropriate selection of circuit components.

ENVIRONMENTAL

Operating Temp. Range: -20°C to +80°C

Intended for use in enclosed commercial and industrial applications

MECHANICAL

Coating: Varnish dip coat or epoxy encapsulated

Terminals: .015" thick, solder plated, varnish-free. Intended for P.C. board mounting.

OPERATING CHARACTERISTICS*

Model	Input	Output	Frequency ±20%	Efficiency Min.	Test Circuit	Schematic No.
TC 10-01	3.6 VDC	+7.2 ± .2 VDC at 150 MW -7.2 ± .2 VDC at 150 MW	7.5 KHz	50%	1	1
TC 10-02	5 VDC	200 ± 10 VDC at 250 MW	11 KHz	64%	2*	4
TC 10-03	5 VDC	200 ± 10 VDC at 250 MW +15 ± .4 VDC at 125 MW -15 ± .4 VDC at 125 MW	11 KHz	60%	2	2
TC 10-04	5 VDC	+15 ± .4 VDC at 500 MW -15 ± .4 VDC at 500 MW	8 KHz	75%	3	1
TC 10-05	5 VDC	+170 ± 5.1 VDC at 850 MW +32 ± 1.0 VDC at 510 MW	11 KHz	75%	4	5
TC 10-06	5 VDC	+35 ± 1.0 VDC at 610 MW	11 KHz	70%	4*	5*
TC 10-07	7.5 VDC	16.3 ± .4 VDC at 330 MW	7 KHz	65%	5	1
TC 10-08	12 VDC	±15 ± .4 VDC at 1 watt	7.5 KHz	72%	3	1
TC 10-09	12 VDC	160 ± 5 VDC at 1.5 watts	10 KHz	75%	6	3
TC 10-10	12 VDC	14.2 ± .7 VDC at 3 watts	10 KHz	70%	5	1
TC 10-11	12 VDC	+24 ± .5 VDC at 2.0 watts	10 KHz	80%	5	1
TC 10-12	24 VDC	170 ± 5.1 VDC at 850 MW 32 ± 1.0 VDC at 510 MW	11 KHz	70%	4	5

*Characteristics relate to transformer when operated in applicable test circuit and at specified load power.

TYPICAL APPLICATIONS

Power supply for gas discharge display, battery-operated portable instruments, operational amplifier power supplies.

SCHEMATICS

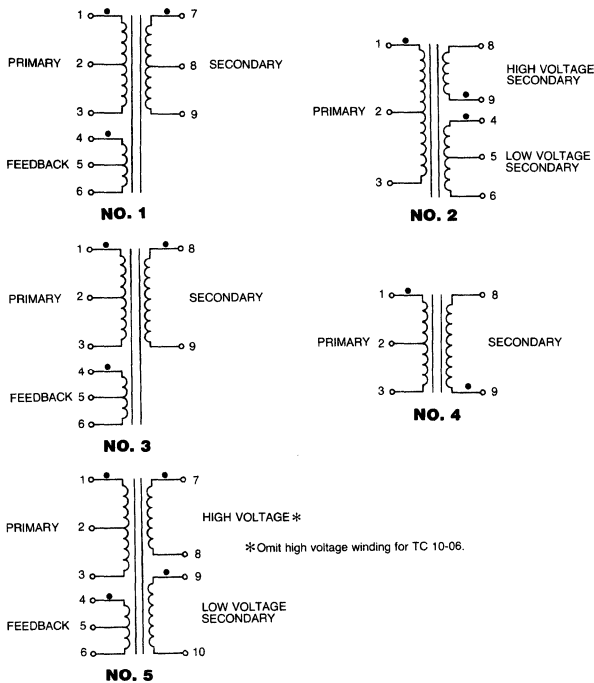

DIMENSIONS (All Models)

[Numbers in brackets indicate millimeters.]

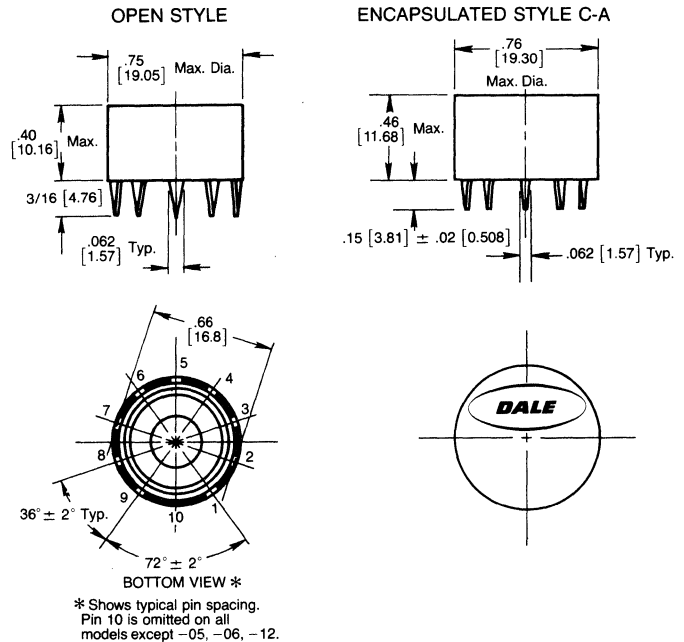

ORDERING INFORMATION

TC-10

-01

A

DASH NUMBER

ENCAPSULATED STYLE.

Leave blank for open style.

DALE ELECTRONICS, INC., East Highway 50, Yankton, SD 57078 • Phone 605-665-9301

Canada: Dale Electronics Ltd., 18 Howden Rd., Scarborough, Ontario M1R 3E6
Europe: Dale Electronics GmbH, Benzstrasse 28, 8039 Puchheim, West Germany



TRIGGER TYPE PULSE TRANSFORMERS

MODELS PT10 and PT20

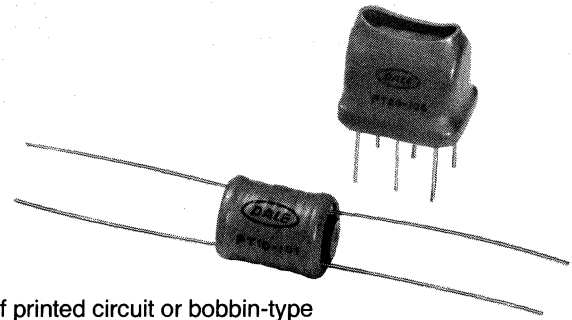

FEATURES

- Designed for low-cost trigger source isolation in half and full wave SCR power control circuits, including motor speed controls, heater controls and incandescent lighting controls.
- Choice of printed circuit or bobbin-type configurations.
- Designed to transfer high amplitude or long duration pulses without saturation.

SPECIFICATIONS

ELECTRICAL

Primary Inductance Values: From 200 μ H to 5000 μ H

Turns Ratio: 1:1, 1:1:1, 2:1, 2:1:1 and 5:1

Temperature Range: -10°C to +70°C

Dielectric Test @ 60 Hz: 1600 Volts RMS (Windings to case)

AC Line Voltage @ 60 Hz: 240 Volts RMS Max. in test circuits shown

MATERIAL

Bobbin: Nylon

Leads: Tinned, solderable.

PT10 = Polyurethane insulated magnet wire for clip or bracket mounting. PT20 = Tinned copper #20 AWG for printed circuit mounting.

Header: Thermoset plastic

Covering: Thermoplastic

DIMENSIONS

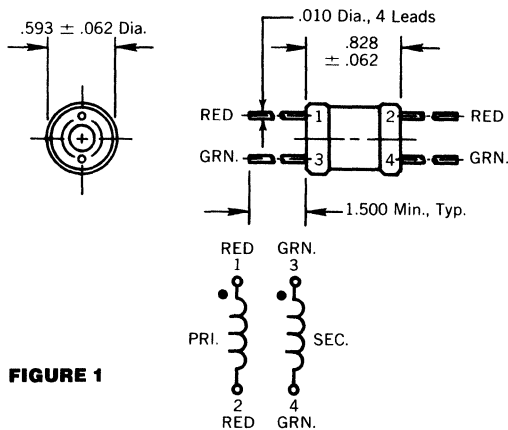

FIGURE 1

PT10

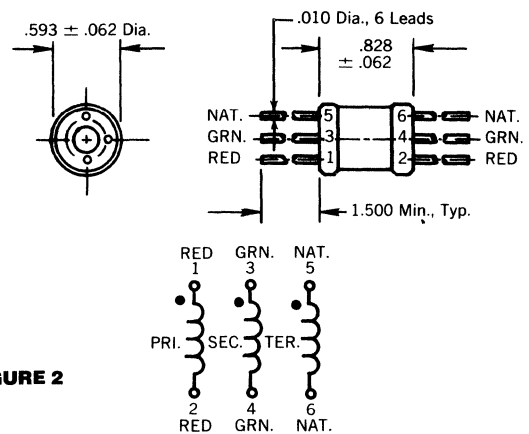

FIGURE 2

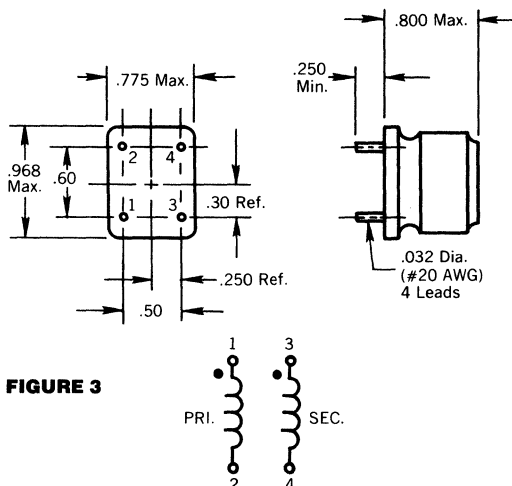

FIGURE 3

PT20

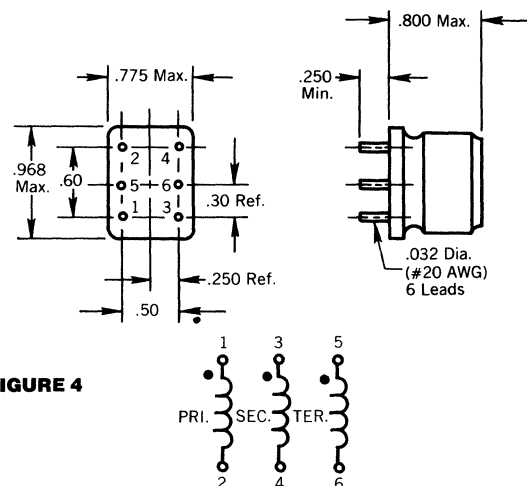

FIGURE 4

ELECTRICAL SPECIFICATIONS

DASH NO.	TURNS RATIO ±10%	FIGURE	PRIMARY INDUCTANCE (μH Min.)	LEAKAGE INDUCTANCE (μH Max.)	INTERWINDING CAPACITY (pf Max.)	DCR (Ohms Max.)
*101	1:1	1/3	200	3.0	800	1.5-1.5
*102	1:1	1/3	500	6.0	1500	4.5-4.5
*103	1:1	1/3	1000	12.0	2000	8-8
104	1:1	1/3	2000	13.0	2800	12-12
105	1:1	1/3	5000	15.0	3500	18-18
*106	1:1:1	2/4	200	3.0	800	2-2-2
107	1:1:1	2/4	500	6.0	1500	6-6-6
108	1:1:1	2/4	1000	12.0	2000	10-10-10
109	1:1:1	2/4	*2000	13.0	2800	15-15-15
110	1:1:1	2/4	5000	15.0	3500	27-27-27
*111	2:1	1/3	500	6.0	1000	4-2
*112	2:1	1/3	1000	10.0	1300	10-2
113	2:1	1/3	2000	12.0	1800	10-5
114	2:1	1/3	5000	15.0	2400	18-10
*115	2:1:1	2/4	200	8.0	700	4-2-2
*116	2:1:1	2/4	500	11.0	1000	6-2-2
*117	2:1:1	2/4	1000	15.0	1300	10-2-2
118	2:1:1	2/4	2000	60	2000	10-5-5
119	2:1:1	2/4	5000	75	2100	20-10-10
*120	5:1	1/3	5000	1500	400	19-3
121	5:1:1	2/4	5000	1500	400	20-4-4

*Standard items in PT10 Style. Other dash numbers available on request. All dash numbers standard in PT20 Style.

TYPICAL CIRCUIT DIAGRAMS

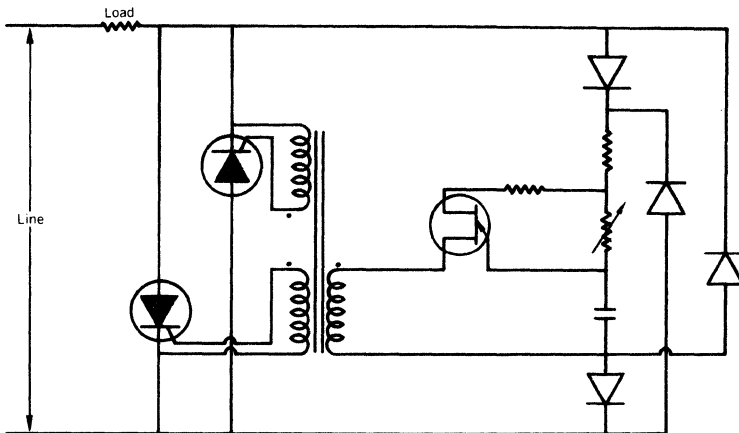

Transformer Coupled Unijunction Transistor Triggering Circuit

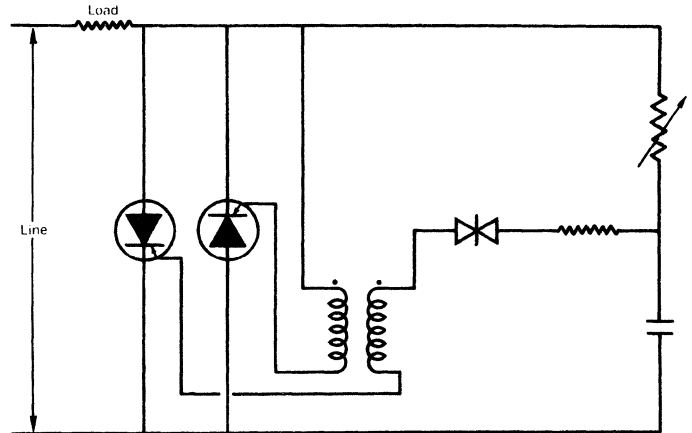

Transformer Coupled Breakdown Diode Triggering Circuit

ORDERING INFORMATION

PT
- 10-
101
DALE TYPE
STYLE
DASH NUMBER



SCR ISOLATION TRIGGER TRANSFORMER

MODEL PT50

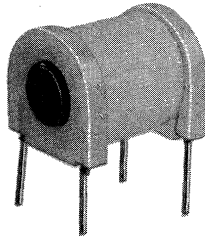

FEATURES

- Designed for low-cost trigger source isolation in SCR Power Control Circuits
- Small physical size and low profile provide packaging advantages
- Interchangeable. Designed for circuit board mounting using same mounting dimensions as 11Z and PT20 models
- Designed to transfer high amplitude or long duration pulses without saturation.
- Industrial and commercial applications include motor speed controls, lighting controls and heater controls.

SPECIFICATIONS

ELECTRICAL

Primary Inductance Values: From 200 μ H to 5000 μ H
Turns Ratio: 1:1, 2:1 and 5:1
Temperature Range: -55°C to +105°C
Dielectric Test @ 60 Hz: 1600 Volts RMS (Windings to core)
AC Line Voltage @ 60 Hz: 240 Volts RMS Max. in test circuits shown

MATERIAL

Bobbin: Glass-filled nylon
Terminals: .025 Sq. tinned copper
Material Rating: 105°C Class A

DIMENSIONS

[Numbers in brackets indicate millimeters]

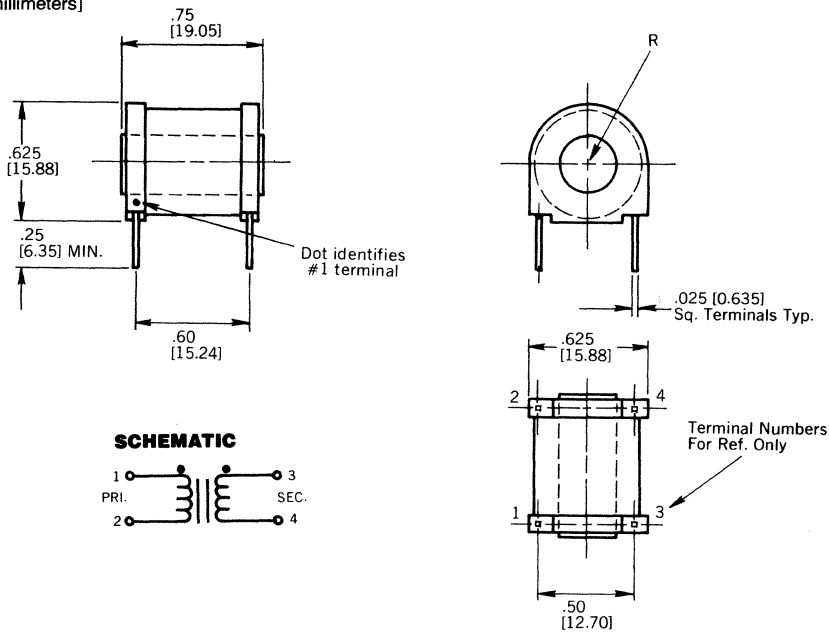

ELECTRICAL SPECIFICATIONS

DASH NO.	TURNS RATIO ±10%	PRIMARY INDUCTANCE (μ H Min.)	LEAKAGE INDUCTANCE (μ H Max.)	INTERWINDING CAPACITY (pf Max.)	DCR (Ohms Max.)
101	1:1	200	3.0	800	1.5-1.5
102	1:1	500	6.0	1500	4.5-4.5
103	1:1	1000	12	2000	8.0-8.0
104	1:1	2000	13	2800	12-12
105	1:1	5000	15	3500	18-18
106	2:1	500	6.0	1000	4-2
107	2:1	1000	10	1300	10-2
108	2:1	2000	12	1800	10-5
109	2:1	5000	15	2400	18-10
110	5:1	5000	1500	400	19-3

TYPICAL CIRCUIT DIAGRAMS

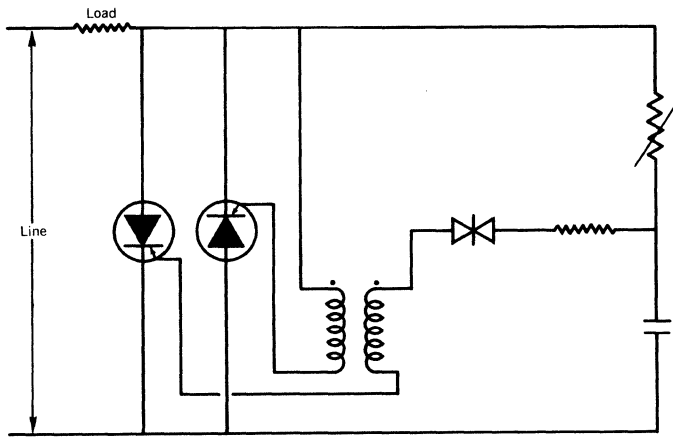

Transformer Coupled Breakdown Diode Triggering Circuit

ORDERING INFORMATION

PT 50 -101
DALE TYPE STYLE DASH NO.

Contact factory for special designs not listed.



SINGLE PRIMARY – DUAL SECONDARY DUAL PRIMARY – DUAL SECONDARY POWER TRANSFORMERS

PLS and PLD SERIES

Single: PLS-52, PLS-53, PLS-54, PLS-55, PLS-56, PLS-57; 6 Pin, 115 Volts

Dual: PLD-52, PLD-53, PLD-54, PLD-55, PLD-56, PLD-57; 8 Pin, 115/230 Volts

COMMON FEATURES

- P.C. pin mounting
- Designed to meet UL and CSA requirements
- Dual Secondary for **series connection** obtains twice winding voltage with center tap, or for **parallel connection** obtains twice winding current rating
- Split-section winding for increased dielectric strength between primary and secondary windings, plus reduced interwinding capacitance
- PLD: Dual Primary for operation at 115 V or 230 V, 50/60 Hz
- Provides isolation from power line
- Laminated construction for low-cost industrial applications, including power supplies, controls and instrumentation
- Modification to these standard items are available as specialty products

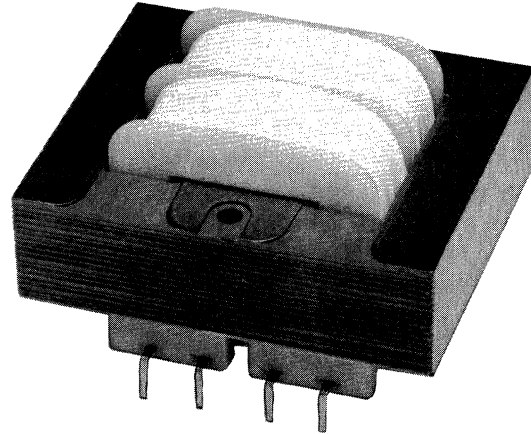

SPECIFICATIONS

Output Power Rating:

PLS-52, PLD-52 = 1.1 VA	PLS-55, PLD-55 = 12.0 VA
PLS-53, PLD-53 = 2.4 VA	PLS-56, PLD-56 = 20.0 VA
PLS-54, PLD-54 = 6.0 VA	PLS-57, PLD-57 = 36.0 VA

Output Voltage: (See table)

Excitation Current at 115 V, 60 Hz:

PLS-52, PLD-52 = 20 MA max.	PLS-55, PLD-55 = 45 MA max.
PLS-53, PLD-53 = 25 MA max.	PLS-56, PLD-56 = 65 MA max.
PLS-54, PLD-54 = 35 MA max.	PLS-57, PLD-57 = 110 MA max.

Dielectric Strength:

Primary to secondary windings and all windings to core: All Units = 2500 V
Between secondary Windings: All Units = 1000 V
Between primary windings: PLD = 500 V

Temperature Class:

Insulation Class B, 130°C

MECHANICAL

Rated: 130°C

Bobbin: Split type, nylon

Terminals: Brass, solder coated

Weight:

PLS-52, PLD-52 = 73 grams	PLS-55, PLD-55 = 295 grams
PLS-53, PLD-53 = 114 grams	PLS-56, PLD-56 = 386 grams
PLS-54, PLD-54 = 182 grams	PLS-57, PLD-57 = 500 grams

SCHEMATIC BASIC STYLES

PLS

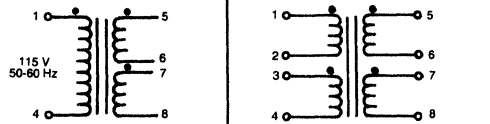

PLD

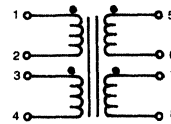

SCHEMATIC OPTIONS

PLS

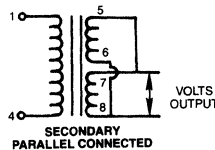
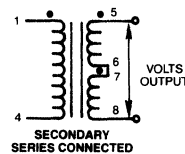

PLD

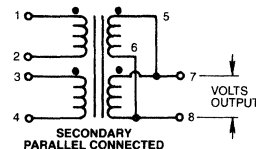
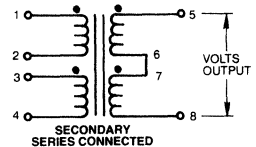
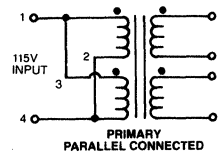
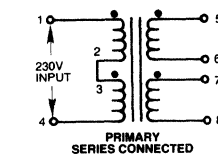

DALE ELECTRONICS, INC., East Highway 50, Yankton, South Dakota 57078 • Phone 605-665-9301

Canada: Dale Electronics Ltd., 18 Howden Rd., Scarborough, Ontario M1R 3E6
Europe: Dale Electronics GmbH, Benzstrasse 28, 8039 Puchheim, West Germany



SINGLE PRIMARY, INPUT 115 VOLTS LOW POWER TRANSFORMERS



PL SERIES

Dual Secondary: PL-11, PL-12, PL-13, PL-14

Single Secondary: PL-32, PL-33, PL-34

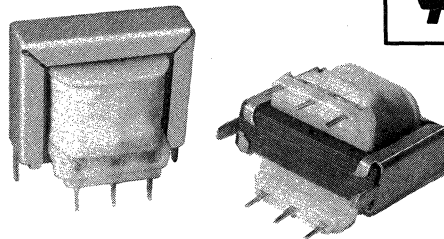

COMMON FEATURES

- P.C. pin mounting
- Recognized under the Component Program of Underwriters Laboratories, Inc. (U.L. File E71961). For general purpose transformers (U.L. Standard 506)
- Provides isolation from power line
- Laminated construction for low-cost industrial applications, including power supplies, controls, and instrumentation
- Mounting frames and bobbin standoff are available
- Modification to these standard items are available as specialty products

UNIQUE FEATURES

PL-11, PL-12, PL-13, PL-14

- Dual secondaries for **series connection** to obtain twice voltage with center tap or, **parallel connection** for twice current rating

PL-32, PL-33, PL-34

- Single secondary
- Lower cost construction

SPECIFICATIONS

Output Power Rating:

PL-11 = 0.75VA
 PL-12, PL-32 = 1.50VA
 PL-13, PL-33 = 4.50VA
 PL-14, PL-34 = 10.0VA

Output Voltage: (See table)

Excitation Current at 120V 60Hz:

PL-12, PL-32 = 25 MA max.
 PL-13, PL-33 = 35 MA max.
 PL-14, PL-34 = 45 MA max.

Dielectric Strength: All models are 1500V 60Hz from primary to secondary windings and all windings to core

Temperature Class:
 Insulation Class A, +105°C

MECHANICAL

Terminals: Brass, solder coated

Weight: PL-11 = 35 grams
 PL-12, PL-32 = 100 grams
 PL-13, PL-33 = 160 grams
 PL-14, PL-34 = 240 grams

SCHEMATIC For PL-11, PL-12, PL-13, PL-14

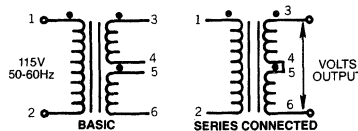

SCHEMATIC For PL-32, PL-33, PL-34

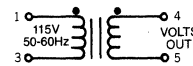

DIMENSIONS

BASIC STYLE

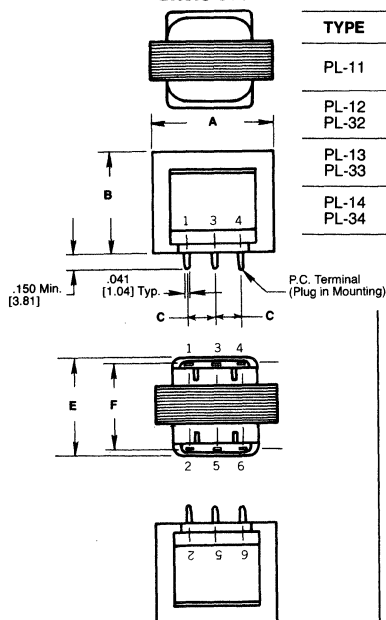

BASIC SCHEMATICS [Numbers in brackets indicate millimeters]

TYPE	A	B	C	E	F	G	I	J	K	L	M
PL-11	1.04 [26.4]	.860 [21.8]	.250 [6.35]	.920 [23.4]	.720 [18.3]	1.07 [27.2]	1.38 [34.9]	1.69 [42.9]	.018 [.46]	.125 [3.20]	.125 [3.18]
PL-12 PL-32	1.43 [36.3]	1.20 [30.5]	.312 [7.92]	1.19 [30.2]	1.00 [25.4]	1.50 [38.1]	1.75 [44.4]	2.12 [53.8]	.031 [.79]	.125 [3.20]	.188 [4.78]
PL-13 PL-33	1.68 [42.7]	1.38 [35.1]	.400 [10.2]	1.30 [33.0]	1.10 [27.9]	1.75 [44.5]	2.00 [50.8]	2.44 [62.0]	.031 [.79]	.125 [3.20]	.188 [4.78]
PL-14 PL-34	1.93 [48.0]	1.64 [41.7]	.400 [10.2]	1.48 [37.6]	1.30 [33.0]	2.00 [50.8]	2.38 [60.3]	2.88 [73.2]	.031 [.79]	.188 [4.78]	.188 [4.78]

"A" TYPE OF MOUNTING FRAME

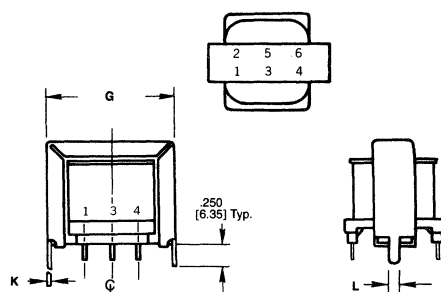

"B" TYPE OF MOUNTING FRAME

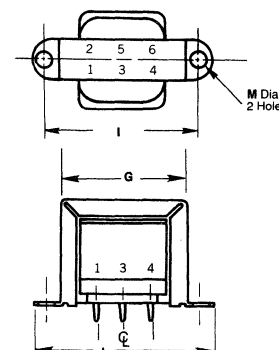

ELECTRICAL CHARACTERISTICS
INPUT VOLTAGE = 115V @ 60Hz
OUTPUT VOLTAGE TABLE

DUAL SECONDARY					SINGLE SECONDARY		
OUTPUT VOLTAGE		OUTPUT CURRENT (MA)		MODEL NO.	OUTPUT VOLTAGE	OUTPUT CURRENT (MA)	MODEL NO.
Series	Parallel	Series	Parallel				
					6.4 V	200 700 1300	PL-32-01 PL-33-01 PL-34-01
8 V CT	4 V	94 188 562 940	188 376 1124 1880	PL-11-01 PL-12-01 PL-13-01 PL-14-01			
10 V CT	5 V	75 120 440 1000	150 240 880 2000	PL-11-02 PL-12-02 PL-13-02 PL-14-02	10 V	120 450 800	PL-32-02 PL-33-02 PL-34-02
12.6 V CT	6.3 V	60 100 350 800	120 200 700 1600	PL-11-03 PL-12-03 PL-13-03 PL-14-03	12.6 V	100 350 650	PL-32-03 PL-33-03 PL-34-03
15 V CT	7.5 V	50 100 300 500	100 200 600 1000	PL-11-04 PL-12-04 PL-13-04 PL-14-04	15 V	80 300 550	PL-32-04 PL-33-04 PL-34-04
16 V CT	8 V	47 75 260 640	94 150 520 1280	PL-11-05 PL-12-05 PL-13-05 PL-14-05			
20 V CT	10 V	38 60 220 500	76 120 440 1000	PL-11-06 PL-12-06 PL-13-06 PL-14-06	20 V	60 225 400	PL-32-05 PL-33-05 PL-34-05
24 V CT	12 V	31 50 180 450	62 100 360 900	PL-11-07 PL-12-07 PL-13-07 PL-14-07	24 V	50 185 330	PL-32-06 PL-33-06 PL-34-06
30 V CT	15 V	25 50 150 250	50 100 300 500	PL-11-08 PL-12-08 PL-13-08 PL-14-08	30 V	40 150 270	PL-32-07 PL-33-07 PL-34-07
34 V CT	17 V	22 35 125 300	44 70 250 600	PL-11-09 PL-12-09 PL-13-09 PL-14-09			
40 V CT	20 V	19 30 110 250	38 60 220 500	PL-11-10 PL-12-10 PL-13-10 PL-14-10			
54 V CT	27 V	28 84 140	56 168 280	PL-12-11 PL-13-11 PL-14-11	54 V	22 80 150	PL-32-08 PL-33-08 PL-34-08
56 V CT	28 V	20 80 180	40 160 360	PL-12-12 PL-13-12 PL-14-12			
76 V CT	38 V	20 60 100	40 120 200	PL-12-13 PL-13-13 PL-14-13	76 V	16 60 110	PL-32-09 PL-33-09 PL-34-09
88 V CT	44 V	15 50 120	30 100 240	PL-12-14 PL-13-14 PL-14-14	88 V	14 50 90	PL-32-10 PL-33-10 PL-34-10
					115 V	10 40 70	PL-32-11 PL-33-11 PL-34-11
120 V CT	60 V	10 35 85	20 70 170	PL-12-15 PL-13-15 PL-14-15			
180 V CT	90 V	6 24 55	12 48 110	PL-12-16 PL-13-16 PL-14-16	180 V	7 25 45	PL-32-12 PL-33-12 PL-34-12
230 V CT	115 V	5 20 40	10 40 80	PL-12-17 PL-13-17 PL-14-17	230 V	5 20 35	PL-32-13 PL-33-13 PL-34-13

ORDERING INFORMATION

The following model number information must be supplied when ordering transformers.

PL-11	-01	A	S
POWER TRANSFORMER, Miniature P.C. Mount	DASH NUMBER for Output Voltage and Current	TYPE OF MOUNTING FRAME, if required (If none, leave blank.)	FOR BOBBIN STANDOFF (If not required, leave blank.)
	<i>Special designs not listed, available upon request.</i>		.063 [1.6] Bobbin Standoff



DUAL PRIMARY – DUAL SECONDARY LOW POWER TRANSFORMERS



PL SERIES – 115/230 Volts PL-22, PL-23, PL-24, PL-42, PL-43, PL-44

COMMON FEATURES

- P.C. pin mounting
- Dual Primary for operation at 115V or 230V, 50/60Hz
- Dual Secondary for **series connection** obtains twice winding voltage with center tap, or for **parallel connection** obtains twice winding current rating
- Provides isolation from power line
- Mounting brackets and bobbin standoff are available
- Laminated construction for low-cost industrial applications, including power supplies, controls and instrumentation

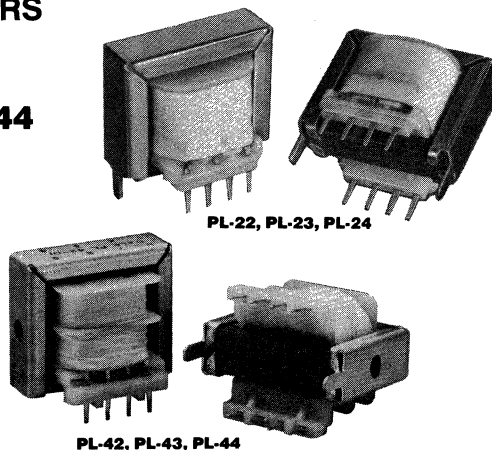

- Modification to these standard items are available as specialty products

UNIQUE FEATURES

PL-22, PL-23, PL-24

- Concentric windings for increased coupling, decreased leakage reactance and improved regulation
- Recognized under the Component Program of Underwriters Laboratories, Inc. (U.L. File E71961)

PL-42, PL-43, PL-44

- Split-section winding for increased dielectric strength between primary and secondary windings plus reduced interwinding capacitance
- Designed to meet U.L. requirements

SPECIFICATIONS

Output Power Rating: PL-22, PL-42 = 1.50VA
 PL-23, PL-43 = 4.50VA
 PL-24, PL-44 = 10.0VA

Output Voltage: (See table)

Excitation Current at 120V 60Hz:

PL-22, PL-42 = 25 MA max.
 PL-23, PL-43 = 35 MA max.
 PL-24, PL-44 = 45 MA max.

Dielectric Strength:

Between primary windings and secondary windings and core:

PL-22, PL-23, PL-24 = 1500V
 PL-42, PL-43, PL-44 = 2500V

Between secondary windings to core: All Units = 1000V

Between primary to primary windings: All Units = 500V

Between secondary to secondary windings: All Units = 500V

Temperature Class:

PL-22, PL-23, PL-24
 Insulation Class A, 105°C
 PL-42, PL-43, PL-44
 Insulation Class B, 130°C

MECHANICAL

Terminals: Brass, solder coated

Weight: PL-22, PL-42 = 100 grams
 PL-23, PL-43 = 160 grams
 PL-24, PL-44 = 240 grams

SCHEMATIC BASIC STYLE

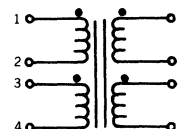



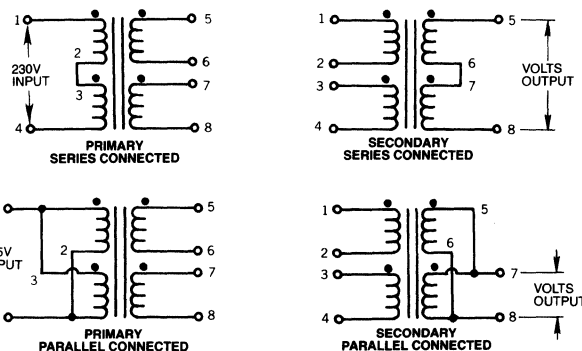



SCHEMATIC OPTIONS



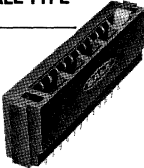

SPECIAL APPLICATIONS CONNECTORS

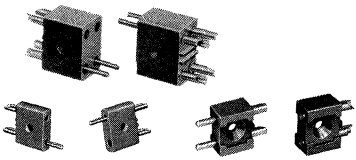
Dale can provide engineering assistance in meeting your special connector requirements. Here are some of the special models which can be provided.

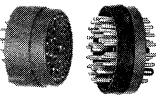
DALE TYPE	DESCRIPTION
ES1 & ES5 DIGITAL DISPLAY CONNECTOR	 <p>Single readout digital display connectors. Permit custom variations in substrate length, width and number of contacts without tooling charge. Substrate lengths from 1.000 [25.4] to 6.000 [152.40] in .050 [1.27] increments. These accept 3/64 [1.19], 1/16 [1.59], 1/8 [3.18] substrates. From 10 through 60 contacts can be provided on .100 [2.54] centers.</p>
ED1 & ED5 EDGEBOARD	 <p>Dual readout edgeboard connectors. Permit custom variations in substrate length, width and number of contacts without tooling charge. Substrate lengths from 1.200 [30.48] to 4.500 [114.30] in .050 [1.27] increments. These accept 1/32 [0.79] and 1/16 [1.59] substrates. From 20 through 87 contacts can be provided on .050 [1.27] centers.</p>
303 DIP SOLDER	 <p>Right angle or straight-through terminals. Series 303 has 45 staggered contacts in compact 3-row design. (.050 x .200 grid pattern). Meet paragraphs of MIL-C-55302.</p>
315 DIP SOLDER	 <p>50 contacts with .200 spacing. Staggered rows provide a .100 grid. Right angle or straight-through terminations. Interchangeable polarization guides can be oriented to provide 144 keying variations.</p>
PJ & 500SR5 TEST POINT	 <p>Right angle or straight-through dip solder pins for permanent mounting. Models with 1 and 5 contacts (.150" spacing) accept .080" diameter probes.</p>
A20 & WA20 SIDE MOUNT	 <p>Body components available with any desired pin and socket combination. Floating contacts. Hole through body permits flat or building block type mounting. Meets applicable paragraphs of MIL-C-28748.</p>
G20 & G16 SIDE MOUNT	
S20 HOUSED	 <p>Lightweight. Protective housing and hood. For RF and power interconnect applications. Floating contacts withstand vibration and aid in alignment. Shell design provides polarization.</p>
QX32	 <p>Umbilical types. QX styles designed for use in missile firing systems.</p>

For complete information, write or phone

DALE ELECTRONICS, INC., East Highway 50, Yankton, SD 57078 • Phone 605-665-9301
Canada: Dale Electronics Ltd., 18 Howden Rd., Scarborough, Ontario M1R 3E6
Europe: Dale Electronics GmbH, Benzstrasse 28, 8039 Puchheim, West Germany



DUAL READOUT EDGEBOARD CONNECTORS

200°C BURN-IN CONNECTORS

A high temperature, long life connector series designed specifically for burn-in oven and automatic temperature testing applications. Priced affordably and available in a wide range of sizes.

SERIES EB4, .100 [2.54] C-C

SERIES EB6, .125 [3.17] C-C

SERIES EB7, EB8, .156 [3.96] C-C

FEATURES

- High temperature, glass reinforced PPS connector bodies
- Right angle models now included
- High reliability spinodal alloy contacts
- Accepts standard .054-.071 thick P.C. boards
- High reliability bifurcated bellows contacts
- Gold-plated contacts
- Card extender style terminals standard
- Variety of mounting styles available
- Competitively priced
- **Recognized under the Component Program of Underwriters Laboratories Inc. Listed under File E65524.**

[Numbers in brackets indicate millimeters]

SPECIFICATIONS

Body Material: Fiberglass reinforced polyphenylene sulfide, 200°C operating temperature, flame-retardant (UL94V-O)

Contacts: Copper-nickel-tin spinodal alloy per ASTM B 740

Plating: Gold plating (.00003 min. thick), over .00005 min. nickel underplate

Current Rating: 5 amps

Test Voltage Between Contacts:

At sea level: 1800 VRMS At 70,000 feet: 450 VRMS

Insulation Resistance: 5,000 megohms min. at 500 VDC potential

Contact Resistance: 30 millivolts max. at rated current

Humidity: 48 hours at 95% relative humidity at 90°C, insulation resistance 5,000 megohms

Shock: 3,50G shocks in each of 3 mutually perpendicular planes with no loss of continuity

SPECIAL APPLICATION NOTE:

When operating units at elevated temperatures, solder having a melting point 50°C above the operating temperature should be used. Contact factory for specific solder information.

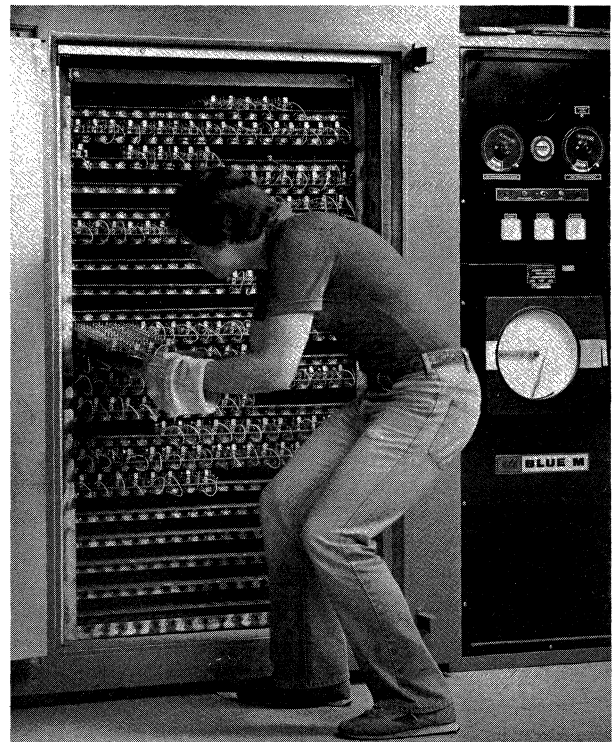
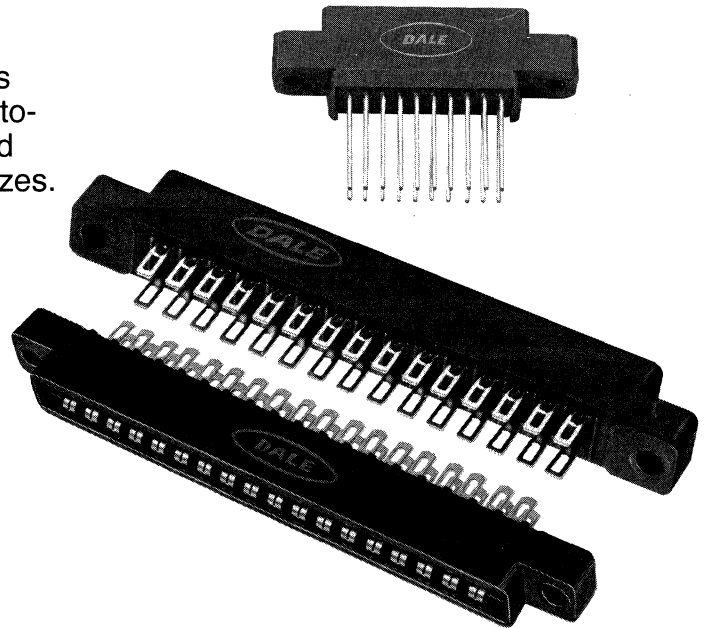



BURN-IN CONNECTORS DIMENSIONAL SPECIFICATIONS: EB7 and EB8 SERIES (.156" C-C)

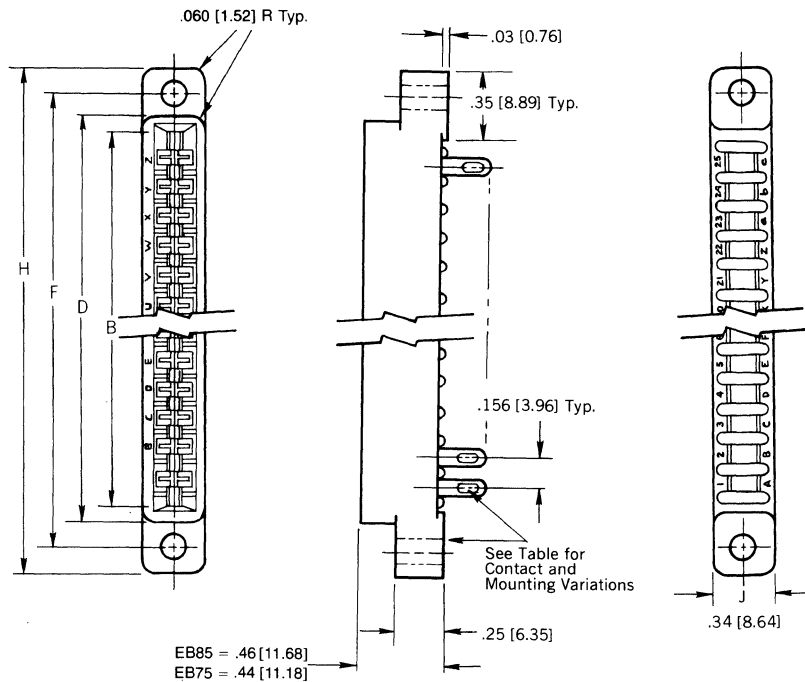

DALE PART	NUMBER OF CONTACT POSITIONS	DIMENSIONS					CARD SLOT DEPTH
		B	D	F	H	J	
EB85-P□6GX	6	1.100 [27.94]	1.248 [31.70]	1.531 [38.89]	1.78 [45.21]	.34 [8.64]	.330 [8.38]
EB85-P□10GX	10	1.724 [43.79]	1.864 [47.35]	2.156 [54.76]	2.41 [61.21]	.34 [8.64]	.330 [8.38]
EB85-P□12GX	12	2.036 [51.71]	2.176 [55.27]	2.469 [62.71]	2.72 [69.08]	.34 [8.64]	.330 [8.38]
EB85-P□15GX	15	2.504 [63.60]	2.644 [67.16]	2.937 [74.60]	3.19 [81.03]	.34 [8.64]	.330 [8.38]
EB85-P□18GX	18	2.972 [75.49]	3.112 [79.05]	3.406 [86.51]	3.66 [92.96]	.34 [8.64]	.330 [8.38]
EB85-P□22GX	22	3.596 [91.34]	3.736 [94.89]	4.031 [102.39]	4.28 [108.71]	.34 [8.64]	.330 [8.38]
EB85-P□24GX	24	3.911 [99.34]	4.051 [102.89]	4.344 [110.33]	4.59 [116.68]	.34 [8.64]	.330 [8.38]
EB85-P□25GX	25	4.067 [103.30]	4.207 [106.86]	4.500 [114.30]	4.75 [120.65]	.34 [8.64]	.330 [8.38]
EB75D-P□36GX	36	5.778 [146.65]	5.906 [149.90]	6.219 [157.84]	6.53 [165.78]	.438 [11.12]	.260 [6.60]
EB75D-P□43GX	43	6.802 [172.64]	7.000 [177.66]	7.302 [185.33]	7.615 [193.27]	.500 [12.70]	.260 [6.60]

ORDERING INFORMATION

□ = Indicate "A" for solder eyelet or "E" for card extender. Note dimensions are same for "A" and "E" styles.

EB4 DUAL READOUT

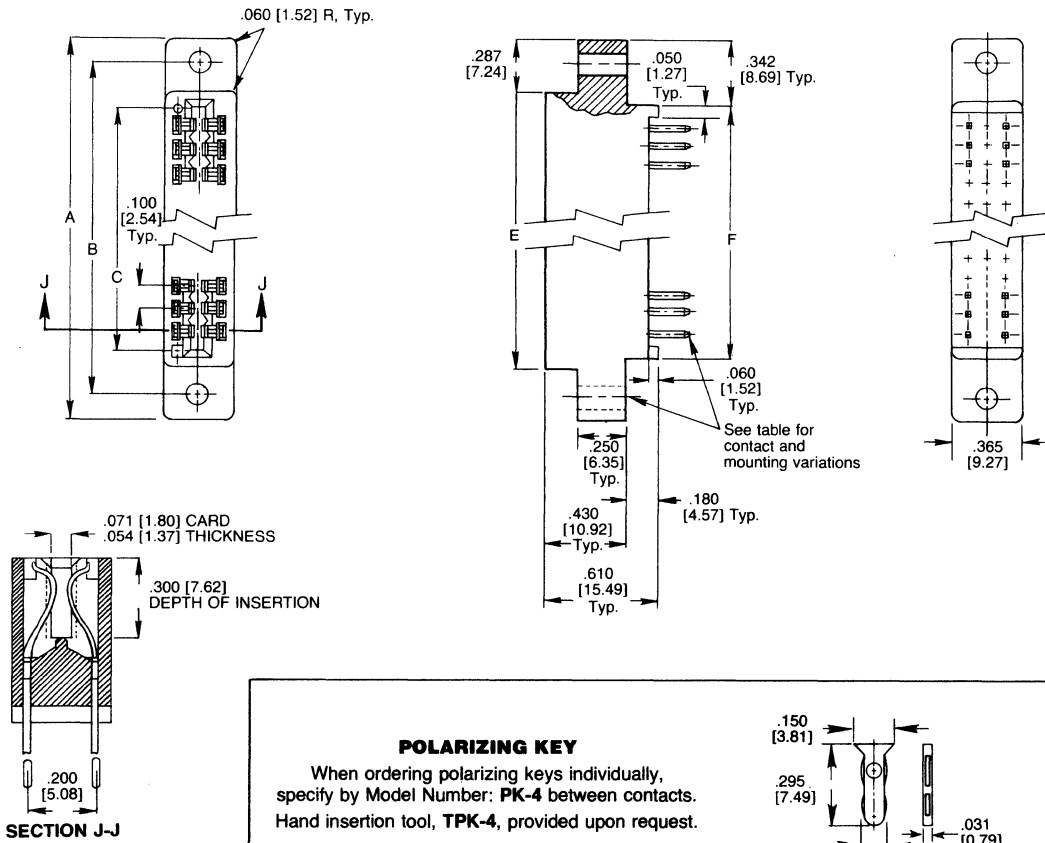

POLARIZING KEY
 When ordering polarizing keys individually, specify by Model Number: **PK-4** between contacts. Hand insertion tool, **TPK-4**, provided upon request.

NO. OF CONTACT POSITIONS PER SIDE	DIMENSIONS				
	A	B	C	E	F
10	1.835 [46.61]	1.575 [40.00]	1.100 [27.94]	1.260 [32.00]	1.150 [29.21]
12	2.035 [51.69]	1.775 [45.08]	1.300 [33.02]	1.460 [37.08]	1.350 [34.29]
15	2.335 [59.31]	2.075 [52.70]	1.600 [40.64]	1.760 [44.70]	1.650 [41.91]
18	2.635 [66.93]	2.375 [60.32]	1.900 [48.26]	2.060 [52.32]	1.950 [49.53]
20	2.835 [72.01]	2.575 [65.40]	2.100 [53.34]	2.260 [57.40]	2.150 [54.61]
22	3.035 [77.09]	2.775 [70.48]	2.300 [58.42]	2.460 [62.48]	2.350 [59.69]
25	3.335 [84.71]	3.075 [78.10]	2.600 [66.04]	2.760 [70.10]	2.650 [67.31]
28	3.635 [92.33]	3.375 [85.72]	2.900 [73.66]	3.060 [77.72]	2.950 [74.93]
30	3.835 [97.41]	3.575 [90.80]	3.100 [78.74]	3.260 [82.80]	3.150 [80.01]
31	3.935 [99.95]	3.675 [93.34]	3.200 [81.28]	3.360 [85.34]	3.250 [82.55]
35	4.335 [110.11]	4.075 [103.50]	3.600 [91.44]	3.760 [95.50]	3.650 [92.71]
36	4.435 [112.65]	4.175 [106.04]	3.700 [93.98]	3.860 [98.04]	3.750 [95.25]
40	4.835 [122.81]	4.575 [116.20]	4.100 [104.14]	4.260 [108.20]	4.150 [105.41]
43	5.135 [130.43]	4.875 [123.82]	4.400 [111.76]	4.560 [115.82]	4.450 [113.03]
44	5.235 [132.97]	4.975 [126.36]	4.500 [114.30]	4.660 [118.36]	4.550 [115.57]
48	5.635 [143.13]	5.375 [136.52]	4.900 [124.46]	5.060 [128.52]	4.950 [125.73]
49	5.735 [145.67]	5.475 [139.06]	5.000 [127.00]	5.160 [131.06]	5.050 [128.27]
50	5.835 [148.21]	5.575 [141.60]	5.100 [129.54]	5.260 [133.60]	5.150 [130.81]
60	6.835 [173.61]	6.575 [167.00]	6.100 [154.94]	6.260 [159.00]	6.150 [156.21]
65	7.335 [186.31]	7.075 [179.71]	6.600 [167.64]	6.760 [171.70]	6.650 [168.91]

ORDERING INFORMATION Description of Part Nomenclature

EB4 **3** — **K** **20** **SG** **X** — **15**

Edgeboard P.C.
Connector Series

BODY MATERIAL
1 = Diallyl Phthalate
2 = Phenolic
3 = Glass-filled Polyester

Polarizing Key Positions: Key(s) are located to right of position(s) designated. Use odd-numbered contact for ordering: -1, -3, -5, etc. Required only when polarizing keys are to be factory installed.
NOTE: To order polarizing keys individually, specify model PK-4.

STANDARD TERMINAL VARIATIONS

TYPE "C" (SOLDER DIP)
TYPE "D" (SOLDER DIP)

TYPE "C": .175 [4.44]
TYPE "D": .115 [2.92]

TYPE "K" (WIRE WRAP)

RIGHT ANGLE TERMINAL VARIATIONS

TYPE	"A"	"B"
1R	.150 [3.81]	.120 [3.05] ± .030 [.762]
2R	.200 [5.08]	.120 [3.05] ± .030 [.762]
3R	.150 [3.81]	.180 [4.57] ± .030 [.762]
4R	.200 [5.08]	.180 [4.57] ± .030 [.762]

Number of Contact Positions: 10, 12, 15, 18, 20, 22, 25, 28, 30, 31, 35, 36, 40, 43, 44, 48, 49, 50, 60 and 65 per side.

MOUNTING VARIATIONS

TYPE "X" CLEARANCE HOLE RAISED MOUNTING FLANGE

TYPE "XF" CLEARANCE HOLE FLUSH MOUNTING FLANGE

TYPE "Y" THREADED INSERT RAISED MOUNTING FLANGE

TYPE "YF" THREADED INSERT FLUSH MOUNTING FLANGE

TYPE "W" NO MOUNTING FLANGE

TYPE "XS" RIGHT ANGLE MOUNTING FLANGE

CONTACT PLATING:
SG—Selective Gold Plating (.00003 min. thick) on contact area with Gold Flash on terminal.
SGF—Selective Gold Plating (.000010 min. thick) on contact area with Gold Flash on terminal.
All Gold Plating over .000050 min. Nickel Underplate.
Contact factory for additional plating options.



DUAL READOUT EDGEBOARD CONNECTOR — .125 [3.17] C-C

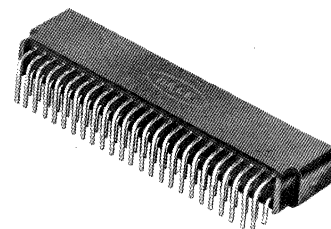

DALE SERIES EB6

Military, Industrial and Commercial Grades
Standard and Right Angle Terminals

Grid Patterns: .125 C-C x .150 [3.17 x 3.81]
.125 C-C x .200 [3.17 x 5.08]
.125 C-C x .250 [3.17 x 6.35]

FEATURES

- Designed to meet the requirements of MIL-C-21097/24
- Greater design latitude
3 body materials: *Diallyl phthalate, phenolic, glass-filled polyester*
3 contact termination styles — Standard
4 contact termination styles — Right Angle
19 body sizes
6 mounting styles
- Selective gold plating

[Numbers in brackets indicate millimeters]

PHYSICAL CHARACTERISTICS

Contact Type: Bifurcated Cantilever Beam

Number of Contacts: 6, 10, 14, 15, 18, 22, 24, 25, 28, 30, 31, 32, 35, 36, 40, 43, 44, 49 and 50 per side

Contact Terminal Variation: STANDARD TERMINALS

Type "C" — Dip Solder, .025 [0.63] square terminals, .175 [4.44] nominal terminal length below standoffs.

Type "D" — Dip Solder, .025 [0.63] square terminals, .115 [2.92] nominal terminal length below standoffs.

Type "K" — Wire Wrap[®], .025 [0.63] square terminals, .570 [14.47] nominal terminal length below standoffs.

Contact Terminal Variation: RIGHT ANGLE TERMINALS

Type "1R" — Dip Solder, .025 [0.63] square terminals, .120 [3.05] nominal terminal length x .150 [3.81] nominal terminal row spacing.

Type "2R" — Dip Solder, .025 [0.63] square terminals, .120 [3.05] nominal terminal length x .200 [5.08] nominal terminal row spacing.

Type "3R" — Dip Solder, .025 [0.63] square terminals, .180 [4.57] nominal terminal length x .150 [3.81] nominal terminal row spacing.

Type "4R" — Dip Solder, .025 [0.63] square terminals, .180 [4.57] nominal terminal length x .200 [5.08] nominal terminal row spacing.

Contact Spacing: .125 [3.17] center to center

Contact Terminal Row Spacing:

Standard = .250 [6.35] nominal.

Right Angle = .200 [5.08] nominal and .150 [3.81] nominal.

Card Thickness: .054 [1.37] to .071 [1.80]

Card Slot Depth: .300 [7.62]

Connector Polarization: Between contact polarization key(s) are located to the right of the contact position(s) designated.

ELECTRICAL CHARACTERISTICS

Current Rating: 3 amps

Test Voltage between Contacts:

At Sea Level: 1500 VRMS

At 70,000 feet [21,336 meters]: 325 VRMS

APPLICATION

For use with .0625 [1.59] printed circuit boards requiring an edgeboard type connector on .125 [3.17] centers.

See page 49 for high temperature, burn-in .125C-C edgeboard connectors.

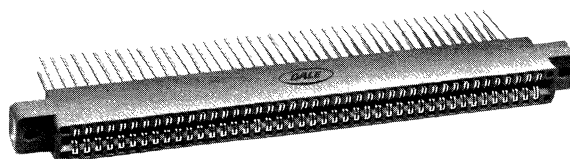

- Will accept printed circuit board thickness from .054 [1.37] to .071 [1.80]
- Polarization between contact positions in all sizes. Between contact polarization permits polarizing without loss of contact position.
- **Recognized under the Component Program of Underwriters Laboratories Inc. Listed under File E65524, Project 77CH3889.**

Insulation Resistance: 5000 megohms minimum at 500 VDC potential.

Contact Resistance: 30 millivolts maximum at rated current (with gold plating).

Operating Temperature: -65°C to +125°C

Humidity: 96 hours at 90% relative humidity at 40°C dried at room temperature for 3 hours minimum, insulation resistance was greater than 5000 megohms.

Durability: After 500 cycles of insertion and withdrawal of a .070 [1.78] thick steel test board, contact resistance less than .030V at 3 amps on gold plated contacts, and individual contact pair separation force when measured with a .054 [1.37] thick steel test blade was greater than 1/2 oz.

Shock: Three 50G shocks in each of 3 mutually perpendicular planes with no loss of continuity.

Vibration: 2 hours in each of 3 mutually perpendicular planes, frequency sweep 10 to 55 cps at .06 double amplitude with no loss of continuity.

COMPONENT MATERIAL

Body: "1" glass-filled diallyl phthalate per MIL-M-14, Type SDG-F green. Flame retardant (UL 94V-0).

"2" glass-filled phenolic per MIL-M-14, Type MFH, dark green. Flame retardant (UL 94V-0).

"3" thermoplastic polyester, glass-filled, black. Flame retardant (UL 94V-0).

Contacts: Phosphor bronze. (See Ordering Information.)

Polarizing Key: Glass reinforced nylon, flame retardant (UL 94H-B).

Contact Plating: Gold. (See Ordering Information.)

EB6 DUAL READOUT

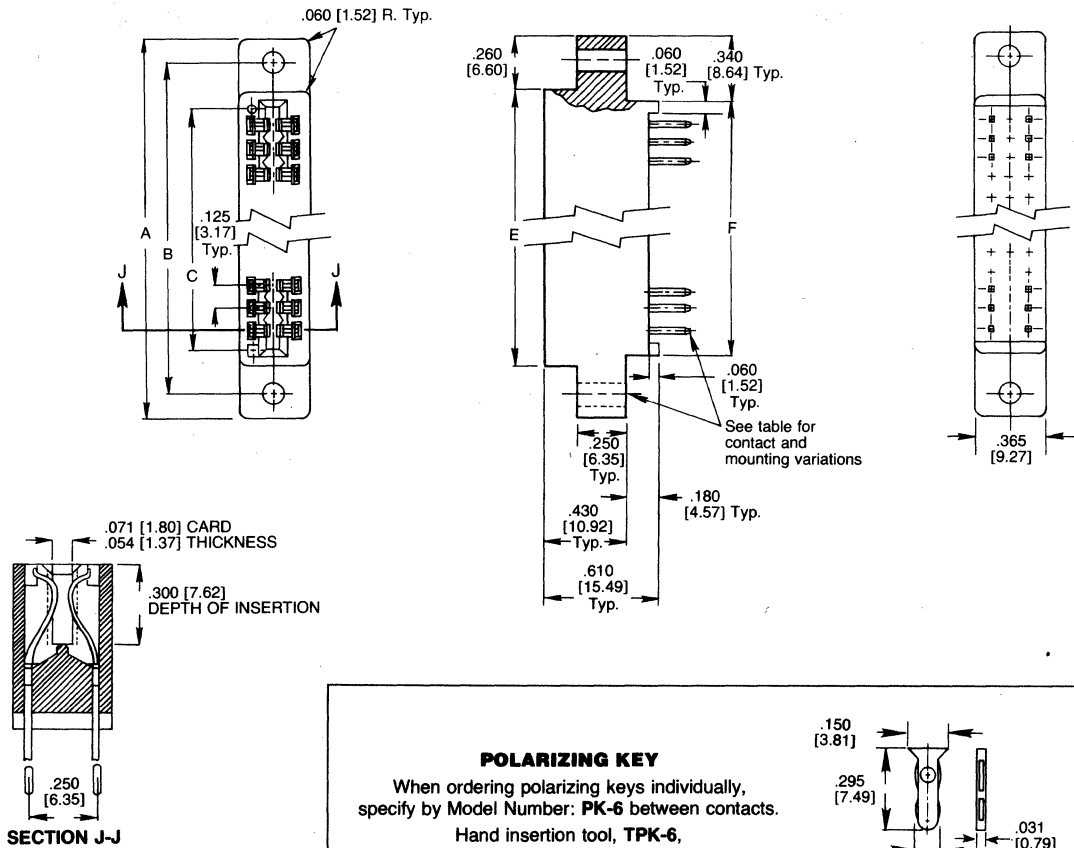

POLARIZING KEY

When ordering polarizing keys individually,
specify by Model Number: **PK-6** between contacts.
Hand insertion tool, **TPK-6**,
provided upon request.

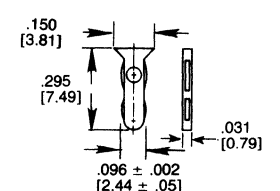

NO. OF CONTACT POSITIONS PER SIDE	DIMENSIONS					
	A	B	C	E	F	
6	1.555 [39.50]	1.295 [32.89]	.875 [22.22]	1.035 [26.29]	.875 [22.22]	
10	2.055 [52.20]	1.795 [45.59]	1.375 [34.92]	1.535 [38.99]	1.375 [34.92]	
14	2.555 [64.90]	2.295 [58.29]	1.875 [47.62]	2.035 [51.69]	1.875 [47.62]	
15	2.680 [68.07]	2.420 [61.47]	2.000 [50.80]	2.160 [54.86]	2.000 [50.80]	
18	3.055 [77.60]	2.795 [70.99]	2.375 [60.32]	2.535 [64.39]	2.375 [60.32]	
22	3.555 [90.30]	3.295 [83.69]	2.875 [73.02]	3.035 [77.09]	2.875 [73.02]	
24	3.805 [96.65]	3.545 [90.04]	3.125 [79.38]	3.285 [83.44]	3.125 [79.38]	
25	3.930 [99.82]	3.670 [93.22]	3.250 [82.55]	3.410 [86.61]	3.250 [82.55]	
28	4.305 [109.35]	4.045 [102.74]	3.625 [92.08]	3.785 [96.14]	3.625 [92.08]	
30	4.555 [115.70]	4.295 [109.09]	3.875 [98.42]	4.035 [102.49]	3.875 [98.42]	
31	4.680 [118.87]	4.420 [112.27]	4.000 [101.60]	4.160 [105.66]	4.000 [101.60]	
32	4.805 [122.05]	4.545 [115.44]	4.125 [104.78]	4.285 [108.84]	4.125 [104.78]	
35	5.180 [131.57]	4.920 [124.97]	4.500 [114.30]	4.660 [118.36]	4.500 [114.30]	
36	5.305 [134.75]	5.045 [128.14]	4.625 [117.48]	4.785 [121.54]	4.625 [117.48]	
40	5.805 [147.45]	5.545 [140.84]	5.125 [130.18]	5.285 [134.24]	5.125 [130.18]	
43	6.180 [156.97]	5.920 [150.37]	5.500 [139.70]	5.660 [143.76]	5.500 [139.70]	
44	6.305 [160.15]	6.045 [153.54]	5.625 [142.88]	5.785 [146.94]	5.625 [142.88]	
49	6.930 [176.02]	6.670 [169.42]	6.250 [158.75]	6.410 [162.81]	6.250 [158.75]	
50	7.055 [179.20]	6.795 [172.59]	6.375 [161.92]	6.535 [165.99]	6.375 [161.92]	

EB6 DUAL READOUT

ORDERING INFORMATION Description of Part Nomenclature

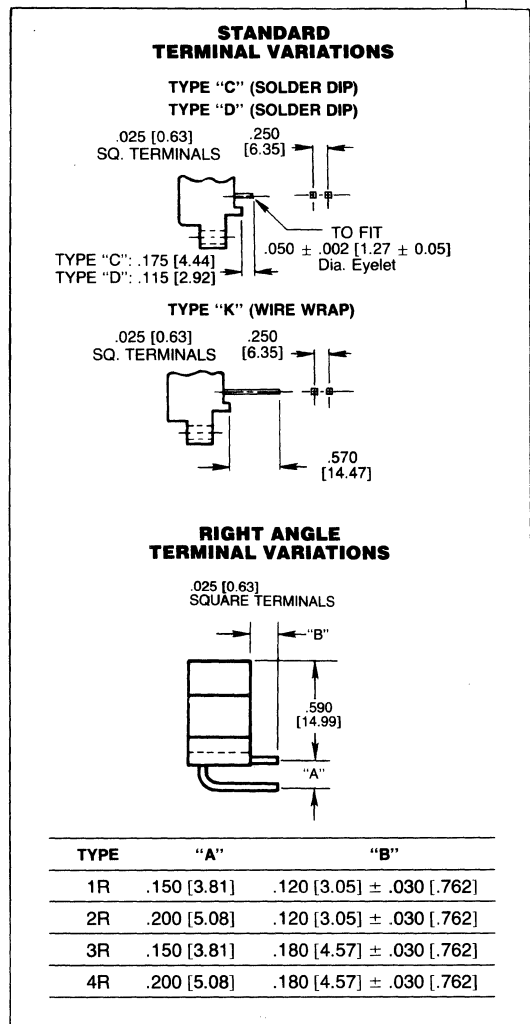
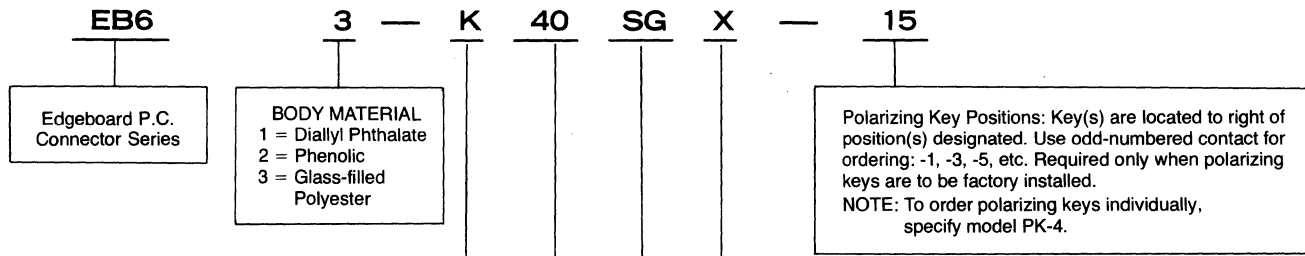

Number of Contact Positions: 6, 10, 14, 15, 18, 22, 24, 25, 28, 30, 31, 32, 35, 36, 40, 43, 44, 49, and 50.

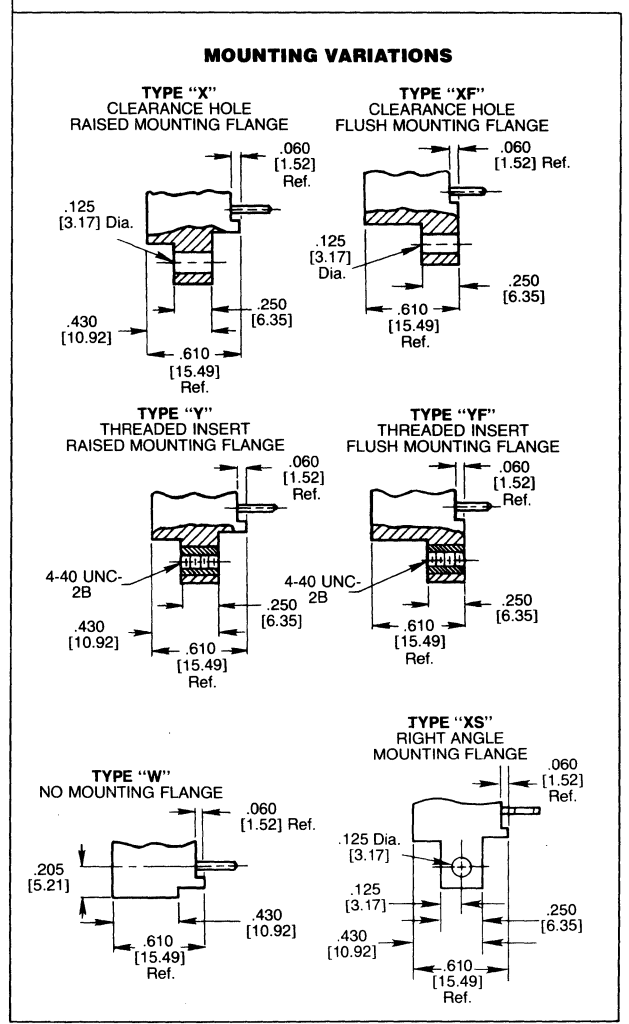

CONTACT PLATING:
SG—Selective Gold Plating (.00003 min. thick) on contact area with Gold Flash on terminal.
SGF—Selective Gold Plating (.000010 min. thick) on contact area with Gold Flash on terminal.
All Gold Plating over .000050 min. Nickel Underplate.
Contact factory for additional plating options.



SINGLE READOUT EDGEBOARD CONNECTOR—.156 [3.96] C-C

DALE SERIES EB 7S

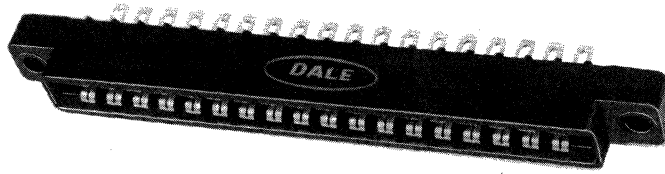

FEATURES

- Bifurcated bellows contacts provide 2 flexing contact surfaces to assure positive contact under adverse conditions such as vibration or P.C. board irregularities.
- Will accept printed circuit board thickness from .054 [1.37] to .071 [1.80]
- Polarization between contact positions in all sizes, between contact polarization permits polarizing without loss of a contact position.
- Selective gold plating.
- Polarizing key is reinforced nylon, may be inserted by hand, requires no adhesive.
- Protected entry, provided by recessed leading edge of contact, permits the card slot to straighten and align the board before electrical contact is made. Prevents damage to contacts which might be caused by warped or out of tolerance boards.

• **Recognized under the Component Program of Underwriters Laboratories Inc. Listed under File E65524, Project 77CH3889.**

[Numbers in brackets indicate millimeters]

PHYSICAL CHARACTERISTICS

Contact Type: Bifurcated bellows
Number of Contacts: 6, 10, 12, 15, 18 and 22 per side
Contact Spacing: .156 [3.96] center to center

Card Thickness: .054 [1.37] to .071 [1.80]
Card Slot Depth: Single Readout = .300 [7.62]

ELECTRICAL CHARACTERISTICS

Current Rating: 5 amps
Test Voltages between Contacts:
 At Sea Level: 1800 VRMS
 At 70,000 feet [21,336 meters]: 450 VRMS
Insulation Resistance: 5000 megohms minimum at 500 VDC potential
Contact Resistance: 30 millivolts maximum at rated current (with gold plating).
Operating Temperature: -55°C to +125°C
Humidity: 96 hours at 90% relative humidity at 40°C, dried at room temperature for 3 hours minimum, insulation resistance 5000 megohms.

Durability: (With gold plating.) After 500 cycles of insertion and withdrawal of a .070 [1.78] thick steel test gauge, contact resistance less than .030 V at 5 amps, and individual contact retention forced when measured with a .054 [1.37] thick steel test slug greater than 1/2 oz.
Shock: Three 50G shocks in each of 3 mutually perpendicular planes with no loss of continuity.
Vibration: 2 hours in each of 3 mutually perpendicular planes, frequency sweep 10 to 55 cps at .06 double amplitude with no loss of continuity.

COMPONENT MATERIAL

Body: (Standard) Glass-filled phenolic per MIL-M-14, dark green. Flame retardant (UL 94V-0).
 (Optional—See Ordering Information)
 "1" glass-filled diallyl phthalate per MIL-M-14, Type SDG-F, green. Flame retardant (UL 94V-0).
 "3" thermoplastic polyester, glass-filled, black. Flame retardant (UL 94V-0).

Contacts: Phosphor bronze
Polarizing Key: Glass reinforced nylon, flame retardant (UL 94H-B).
Contact Plating: Gold.
 (See Ordering Information.)

APPLICATION

For use with .062 [1.57] printed circuit boards requiring an edgeboard type connector on .156 [3.96] centers.
 See page 49 for high temperature, burn-in .156C-C edgeboard connectors.

EB 7 S SINGLE READOUT

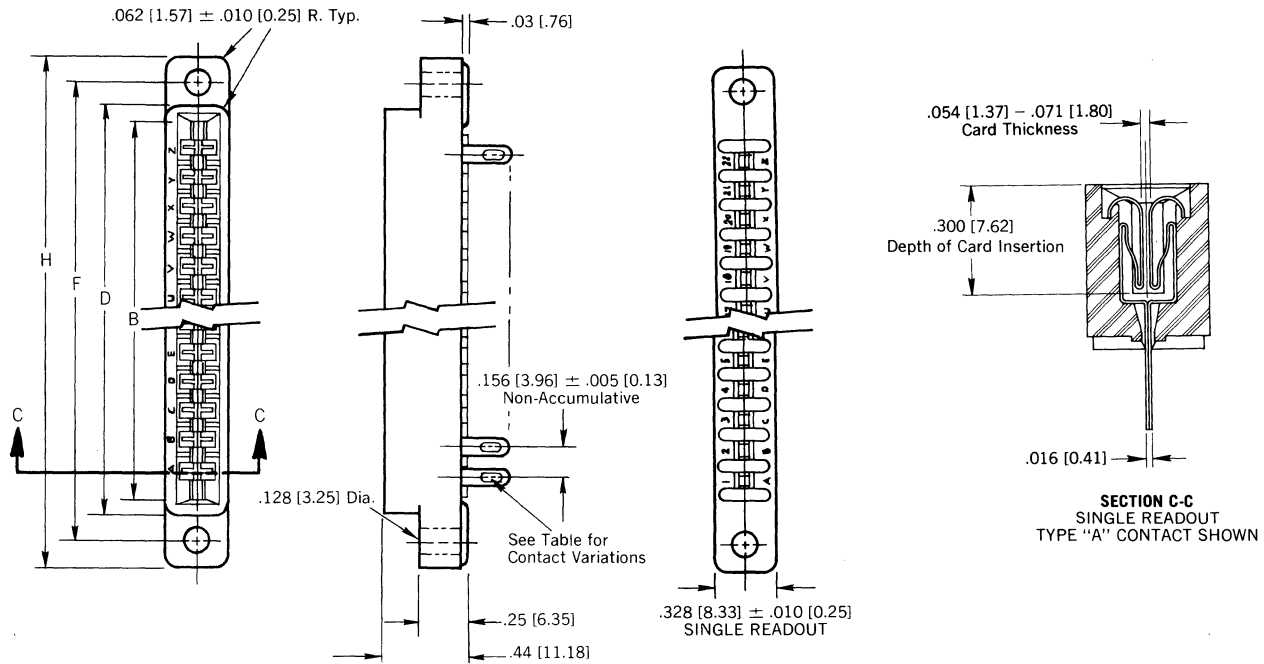

SECTION C-C
SINGLE READOUT
TYPE "A" CONTACT SHOWN

NUMBER OF CONTACT POSITIONS	DIMENSIONS			
	B	D	F	H
6	1.100 [27.94]	1.218 [30.94]	1.531 [38.89]	1.78 [45.21]
10	1.724 [43.79]	1.843 [46.81]	2.156 [54.76]	2.41 [61.21]
12	2.036 [51.71]	2.156 [54.76]	2.468 [62.69]	2.72 [69.09]
15	2.504 [63.60]	2.624 [66.65]	2.937 [74.60]	3.19 [81.03]
18	2.972 [75.49]	3.093 [78.56]	3.406 [86.51]	3.66 [92.96]
22	3.596 [91.34]	3.717 [94.41]	4.031 [102.39]	4.28 [108.71]

POLARIZING KEY

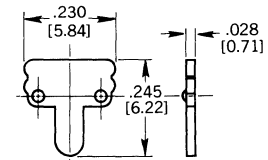

When ordering polarizing keys individually, specify by Model No.: **PK-7** between contacts.

Hand insertion tool, **TPK-7**, provided on request.

ORDERING INFORMATION

EB 7

1

S

-A

22

G

X

-A

Edgeboard P.C. Connector Series

Optional Body Material. Omit for standard phenolic.
-1 = Diallyl Phthalate
-3 = Glass-filled Polyester

Readout:
S = Single

Polarizing Key Positions: Key(s) are located to right of position(s) designated. Required only when polarizing keys are to be factory installed.

STANDARD TERMINAL VARIATIONS

TYPE "A" (PIERCED)

To fit 3, #22 AWG WIRES

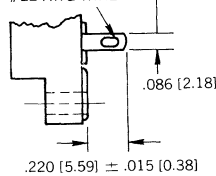

TYPE "B" (SOLDER DIP)

To fit .051 [1.30] Dia. Eyelet

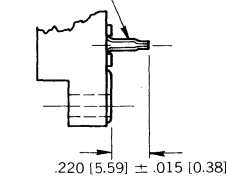

Number of Contact Positions: **6, 10, 12, 15, 18 or 22**

CONTACT PLATING:

SG— Selective Gold Plating (.00003 min. thick) on contact area with Gold Flash on terminal.
SGF— Selective Gold Plating (.000010 min. thick) on contact area with Gold Flash on terminal.
All Gold Plating over .000050 min. Nickel Underplate.

Contact factory for additional plating options.

MOUNTING VARIATIONS

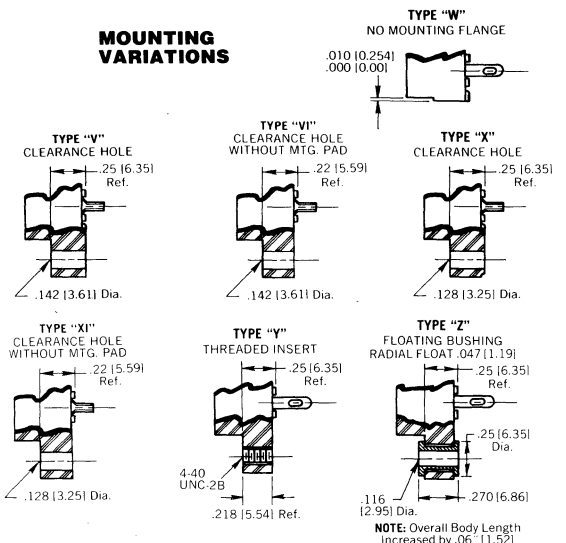

NOTE: Overall Body Length increased by .06 [1.52]



DUAL READOUT EDGEBOARD CONNECTOR — .156 C-C X .140 GRID [3.96 X 3.56]

DALE SERIES EB 7D

6, 10, 12, 15, 18, 22, 36, 43 Contacts per side

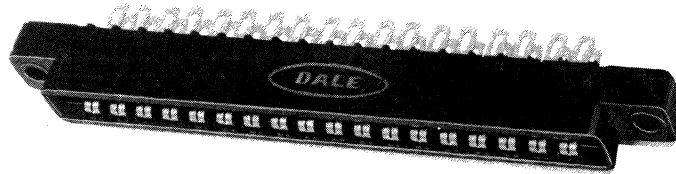

FEATURES

- Bifurcated bellows contacts provide 2 flexing contact surfaces to assure positive contact under adverse conditions such as vibration or P.C. board irregularities.
- Will accept printed circuit board thickness from .054 [1.37] to .071 [1.80]
- Polarization between contact positions in all sizes, between contact polarization permits polarizing without loss of a contact position.
- Selective gold plating.
- Polarizing key is reinforced nylon, may be inserted by hand, requires no adhesive.
- Protected entry, provided by recessed leading edge of contact, permits the card slot to straighten and align the board before electrical contact is made. Prevents damage to contacts which might be caused by warped or out of tolerance boards.

[Numbers in brackets indicate millimeters]

PHYSICAL CHARACTERISTICS

Contact Type: Bifurcated bellows

Number of Contacts: 6, 10, 12, 15, 18, 22, 36 and 43 per side

ELECTRICAL CHARACTERISTICS

Current Rating: 5 amps

Test Voltages between Contacts:

At Sea Level: 1800 VRMS

At 70,000 feet [21,336 meters]: 450 VRMS

Insulation Resistance: 5000 megohms minimum at 500 VDC potential

Contact Resistance: 30 millivolts maximum at rated current (with gold plating).

Operating Temperature: -55°C to +125°C

Humidity: 96 hours at 90% relative humidity at 40°C, dried at room temperature for 3 hours minimum, insulation resistance 5000 megohms.

COMPONENT MATERIAL

Body: (Standard) Glass-filled phenolic per MIL-M-14, dark green. Flame retardant (UL 94V-0).
(Optional—See Ordering Information)
"1" glass-filled diallyl phthalate per MIL-M-14, Type SDG-F, green. Flame retardant (UL 94V-0).
"3" thermoplastic polyester, glass-filled, black. Flame retardant (UL 94V-0).

Contact Spacing: .156 [3.96] center to center

Card Thickness: .054 [1.37] to .071 [1.80]

Card Slot Depth: Dual Readout = .260" [6.60]

Durability: (With gold plating.) After 500 cycles of insertion and withdrawal of a .070 [1.78] thick steel test gauge, contact resistance less than .030 V at 5 amps, and individual contact retention forced when measured with an .054 [1.37] thick steel test slug greater than ½ oz.

Shock: Three 50G shocks in each of 3 mutually perpendicular planes with no loss of continuity.

Vibration: 2 hours in each of 3 mutually perpendicular planes, frequency sweep 10 to 55 cps at .06 double amplitude with no loss of continuity.

Contacts: Phosphor bronze

Polarizing Key: Glass reinforced nylon, flame retardant (UL 94H-B).

Contact Plating: Gold.
(See Ordering Information.)

APPLICATION

For use with .062 [1.57] printed circuit boards requiring an edgeboard type connector on .156 [3.96] centers.

See page 49 for high temperature, burn-in .156C-C edgeboard connectors.

EB 7D DUAL READOUT: 6, 10, 12, 15, 18, 22, 36 and 43 contacts

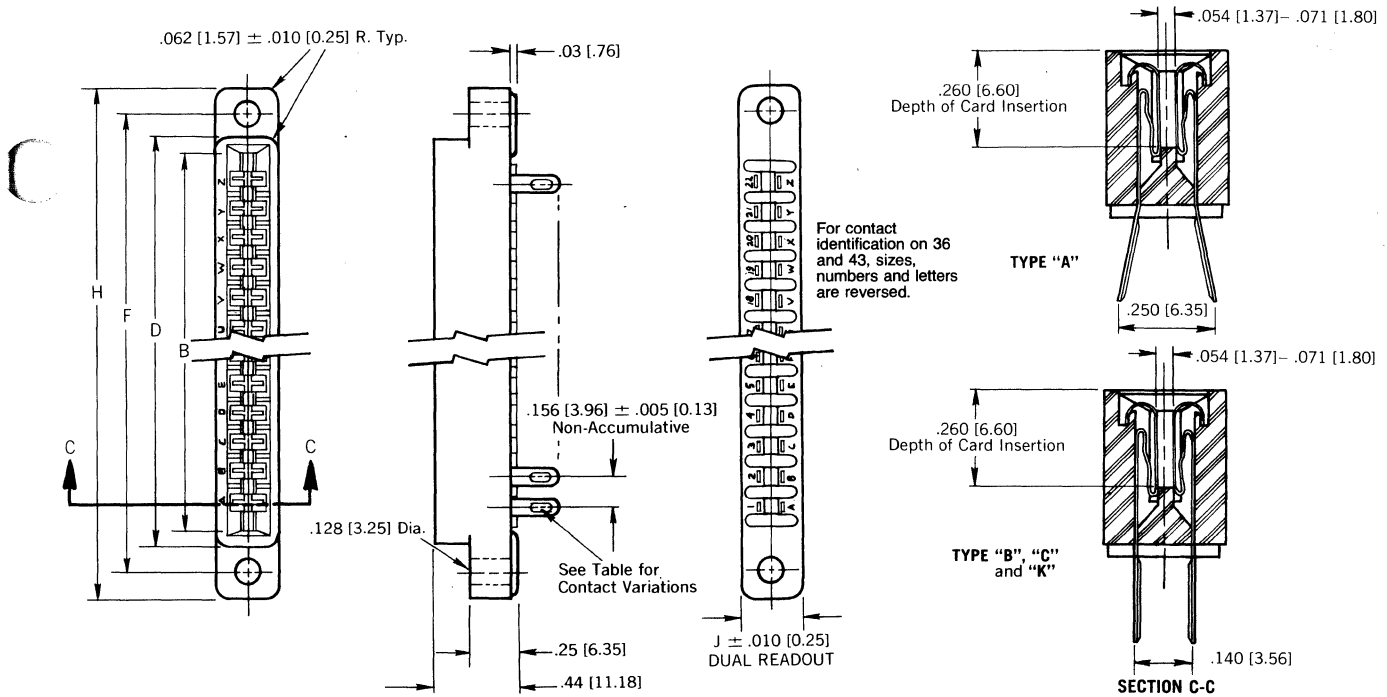

NUMBER OF CONTACT POSITIONS	DIMENSIONS				
	B	D	F	H	J
6	1.100 [27.94]	1.218 [30.94]	1.531 [38.89]	1.78 [45.21]	.328 [8.33]
10	1.724 [43.79]	1.843 [46.81]	2.156 [54.76]	2.41 [61.21]	.328 [8.33]
12	2.036 [51.71]	2.156 [54.76]	2.468 [62.69]	2.72 [69.09]	.328 [8.33]
15	2.504 [63.60]	2.624 [66.65]	2.937 [74.60]	3.19 [81.03]	.328 [8.33]
18	2.972 [75.49]	3.093 [78.56]	3.406 [86.51]	3.66 [92.96]	.328 [8.33]
22	3.596 [91.34]	3.717 [94.41]	4.031 [102.39]	4.28 [108.71]	.328 [8.33]
36	5.778 [146.65]	5.906 [149.90]	6.219 [157.84]	6.53 [165.78]	.438 [11.12]
43	6.802 [172.64]	7.000 [177.66]	7.302 [185.33]	7.615 [193.27]	.500 [12.70]

POLARIZING KEY

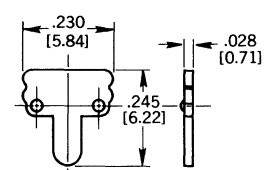

When ordering polarizing keys individually, specify by Model No.: **PK-7** between contacts.
Hand insertion tool, **TPK-7**, provided on request.

ORDERING INFORMATION

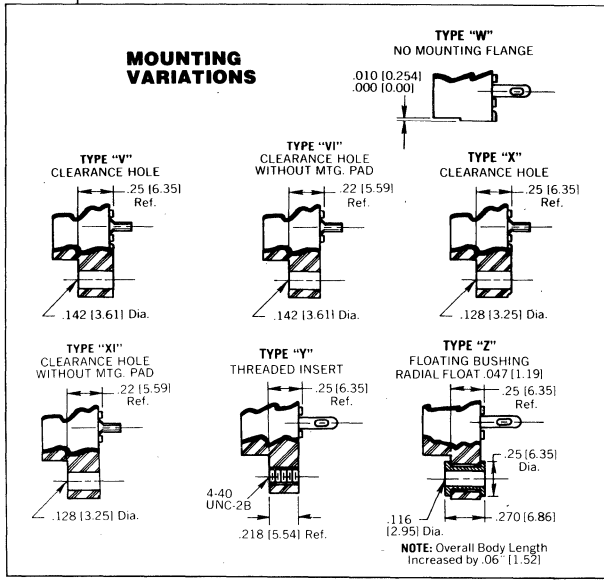
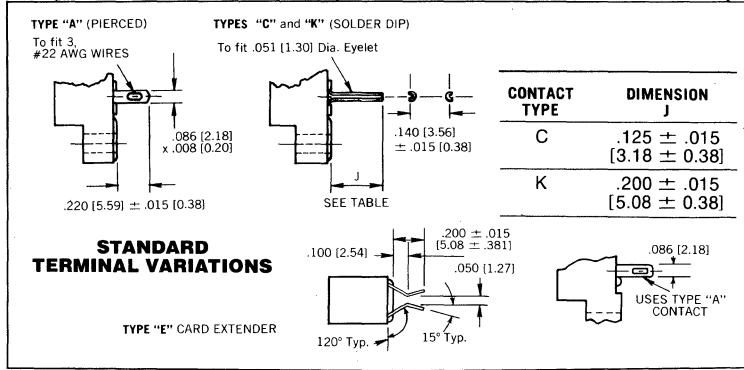
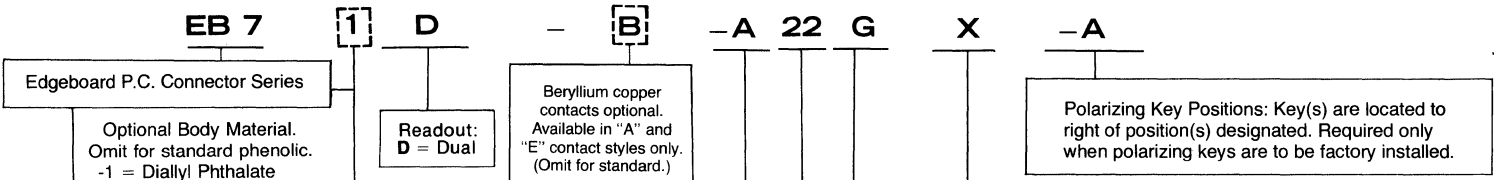

CONTACT PLATING:
SG - Selective Gold Plating (.00003 min. thick) on contact area with Gold Flash on terminal.
SGF - Selective Gold Plating (.00010 min. thick) on contact area with Gold Flash on terminal.
All Gold Plating over .000050 min. Nickel Underplate.
 Contact factory for additional plating options.



DUAL READOUT EDGEBOARD CONNECTOR—.156 C-C X .200 GRID [3.96 X 5.08]

DALE SERIES EB8

Military, Industrial and Commercial Grades

FEATURES

- Designed to meet MIL-C-21097
- Greater design latitude
3 body materials: *Diallyl phthalate, phenolic, glass-filled polyester*
6 contact termination styles
8 body sizes
7 mounting styles
- Selective gold plating
- Bifurcated bellows contacts provide 2 flexing contact surfaces

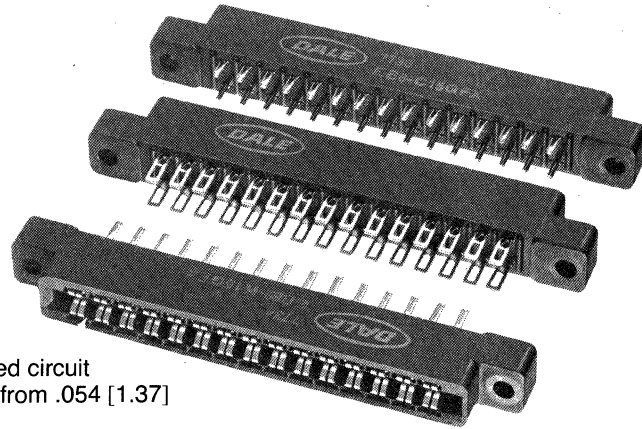

- Will accept printed circuit board thickness from .054 [1.37] to .071 [1.80]
- Polarization between contact positions in all sizes
- **Recognized under the Component Program of Underwriters Laboratories Inc. Listed under File E65524, Project 77CH3889.**

[Numbers in brackets indicate millimeters]

PHYSICAL CHARACTERISTICS

Contact Type: Bifurcated bellows.

Number of Contacts: 6, 10, 12, 15, 18, 22, 24 and 25 per side

Contact Spacing: .156 [3.96] center to center.

Card Thickness: .054 [1.37] to .071 [1.80]

Card Slot Depth: .330 [8.38]

ELECTRICAL CHARACTERISTICS

Current Rating: 5 amps

Test Voltage between Contacts:

At Sea Level: 1800 VRMS

At 70,000 feet [21,336 meters]: 450 VRMS

Insulation Resistance: 5000 megohms minimum at 500 VDC potential.

Contact Resistance: 30 millivolts maximum at rated current (with gold plating).

Operating Temperature: -55°C to +125°C

Humidity: 96 hours at 90% relative humidity at 40°C, dried at room temperature for 3 hours minimum, insulation resistance 5000 megohms.

Durability: (With gold plating.) After 500 cycles of insertion and withdrawal of a .070 [1.78] thick steel test gauge, contact resistance less than .030 V at 5 amps, and individual contact retention force when measured with a .054 [1.37] thick steel test slug greater than ½ oz.

Shock: Three 50G shocks in each of 3 mutually perpendicular planes with no loss of continuity.

Vibration: 2 hours in each of 3 mutually perpendicular planes, frequency sweep 10 to 55 cps at .06 double amplitude with no loss of continuity.

COMPONENT MATERIAL

Body: "1" glass-filled diallyl phthalate per MIL-M-14G, Type SDG-F green. Flame retardant (UL 94V-0).

"2" glass-filled phenolic per MIL-M-14G, dark green.

Flame retardant (UL 94V-0).

"3" thermoplastic polyester, glass-filled, black. Flame retardant (UL 94V-0).

Contacts: Phosphor bronze standard.

Polarizing Key: Glass reinforced nylon, flame retardant (UL 94V-0).

Contact Plating: Gold
(See Ordering Information.)

APPLICATION

For use with .062 [1.57] printed circuit boards requiring an edgeboard type connector on .156 [3.96] centers.

See page 49 for high temperature, burn-in .156C-C edgeboard connectors.

EB8 DUAL READOUT

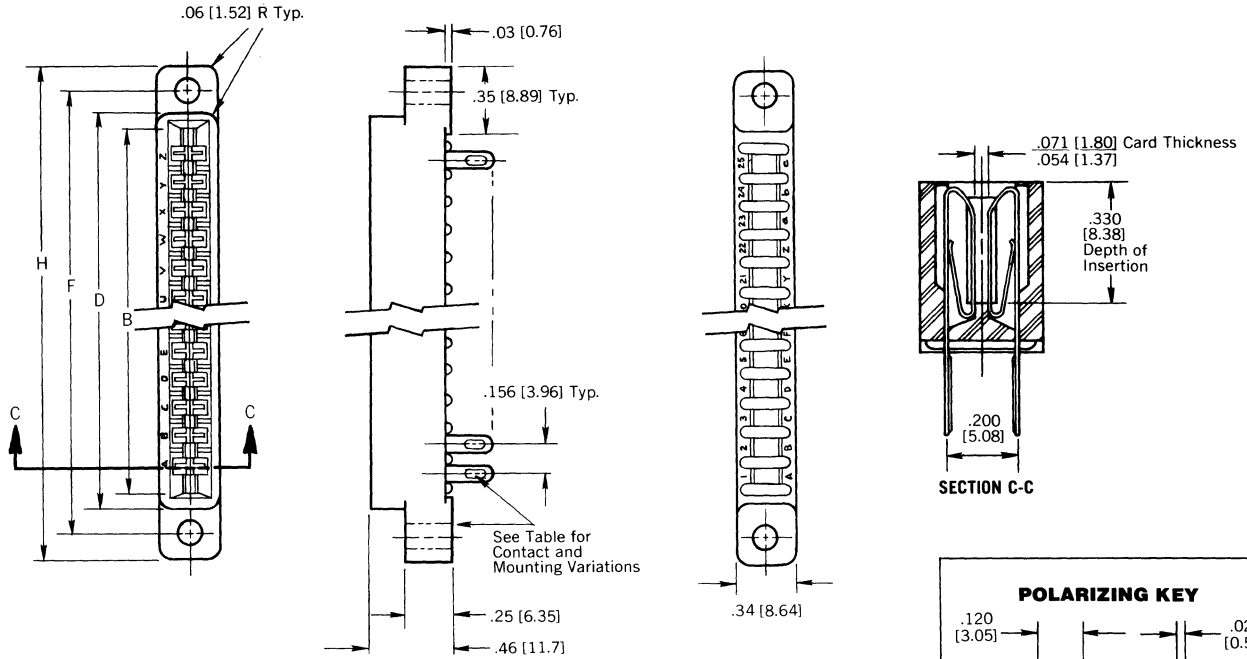

NUMBER OF CONTACT POSITIONS	DIMENSIONS			
	B	D	F	H
6	1.100 [27.94]	1.248 [31.70]	1.531 [38.89]	1.78 [45.21]
10	1.724 [43.79]	1.864 [47.35]	2.156 [54.76]	2.41 [61.21]
12	2.036 [51.71]	2.176 [55.27]	2.469 [62.71]	2.72 [69.08]
15	2.504 [63.60]	2.644 [67.16]	2.937 [74.60]	3.19 [81.03]
18	2.972 [75.49]	3.112 [79.05]	3.406 [86.51]	3.66 [92.96]
22	3.596 [91.34]	3.736 [94.89]	4.031 [102.39]	4.28 [108.71]
24	3.911 [99.34]	4.051 [102.89]	4.344 [110.33]	4.59 [116.68]
25	4.067 [103.30]	4.207 [106.86]	4.500 [114.30]	4.75 [120.65]

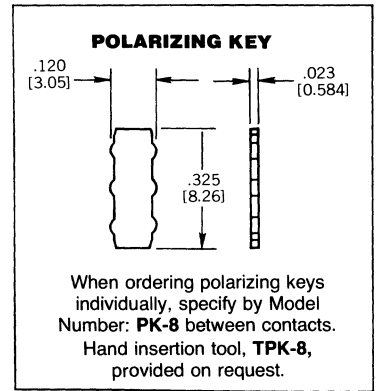

ORDERING INFORMATION Description of Part Nomenclature

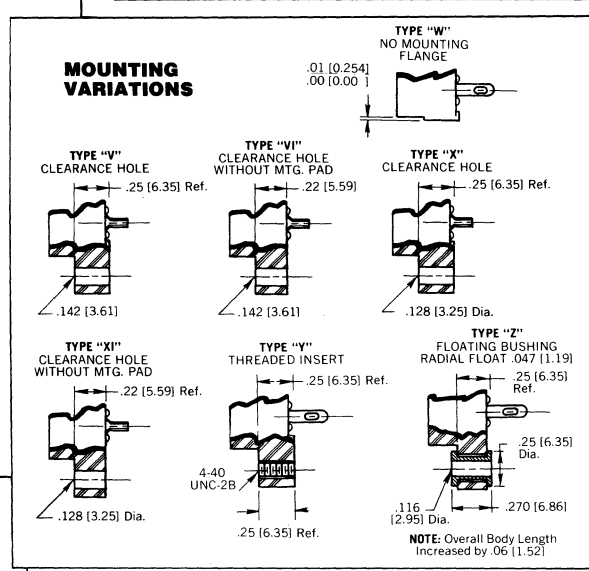
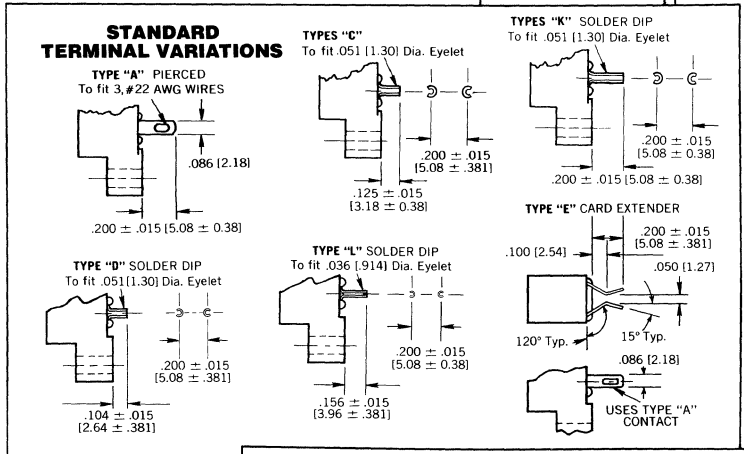
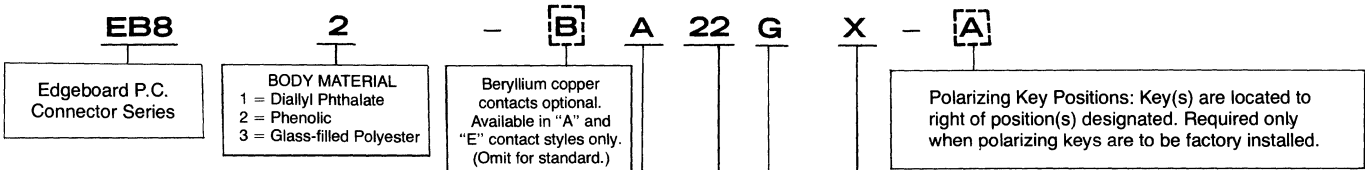

Number of Contact Positions: 6, 10, 12, 15, 18, 22, 24, or 25

CONTACT PLATING:
SG— Selective Gold Plating (.00003 min. thick) on contact area with Gold Flash on terminal.
SGF— Selective Gold Plating (.000010 min. thick) on contact area with Gold Flash on terminal.
All Gold Plating over .000050 min. Nickel Underplate.
 Contact factory for additional plating options.



SINGLE READOUT EDGEBOARD CONNECTOR — .156 [3.96] C-C SPACING

DALE SERIES EBT 156

Dip Solder, Eyelet and
Wire Wrap™ Termination

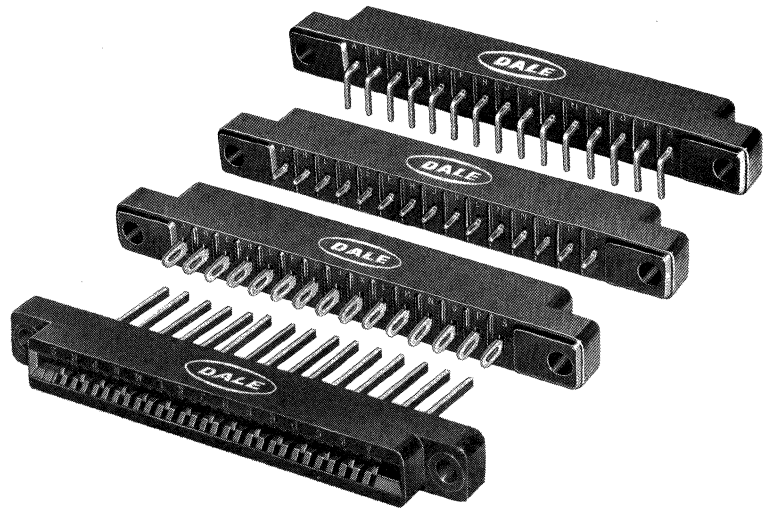

FEATURES

- Modified tuning fork contacts have chamfered lead-in to reduce wear on printed circuit board contacts without sacrificing contact pressure and wiping action.
- Will accept printed circuit board thickness from .054 [1.37] to .070 [1.78]
- Polarization on or between contacts position in all sizes. Between contact polarization permits polarizing without loss of a contact position.
- Polarizing key is reinforced nylon, may be inserted by hand, requires no adhesive.
- Protected entry, provided by recessed leading edge of contact permits the card slot to straighten and align the board before electrical contact is made. Prevents damage to contacts which might be caused by warped or out of tolerance boards.

- Optional terminal configurations, including eyelet (Type A), dip-solder (Type B, C, D and R) Wire Wrap™ (Type E and F).
- Meets or exceeds MIL-C-21097/6
- **Connectors with Type A, B, C, D or R contacts are recognized under the Component Program of Underwriters Laboratories Inc. Listed under File E65524, Project 77CH3889.**

[Numbers in brackets indicate millimeters]

PHYSICAL CHARACTERISTICS

Number of Contacts: 6, 10, 12, 15, 18 or 22
Contact Spacing: .156 [3.96]

Card Thickness: .054 [1.37] to .070 [1.78]
Card Slot Depth: .330 [8.38]

ELECTRICAL CHARACTERISTICS

Current Rating: 5 amps

Insulation Resistance: 5000 megohms minimum

Test Voltage between Contacts:

At Sea Level: 1800 VRMS

At 70,000 feet [21,336 meters]: 450 VRMS

Contact Resistance: (Voltage Drop) 30 millivolts maximum at rated current with gold flash.

COMPONENT MATERIAL

Body: Glass-filled phenolic per MIL-M-14, Type MFH, black, flame retardant (UL 94V-0).

Contacts: Style(s) A, B, C, D, E and F = Alloy 688.
Style "R" (Right Angle) = CA725.

Finish: -1 = Electro Tin Plate
-2 = Gold Flash

(See Ordering Information.)

Polarizing Key: Glass-filled nylon.

Optional Threaded Mounting Insert:
Nickel plated brass. (Type Y)

Optional Floating Mounting Bushing:
Cadmium plated brass. (Type Z)

APPLICATION

For use with .062 [1.57] printed circuit boards requiring an edgeboard type connector on .156 [3.96] centers.

DALE ELECTRONICS, INC., East Highway 50, Yankton, SD 57078 • Phone 605-665-9301

Canada: Dale Electronics Ltd., 18 Howden Rd., Scarborough, Ontario M1R 3E6
Europe: Dale Electronics GmbH, Benzstrasse 28, 8039 Puchheim, West Germany

EBT 156

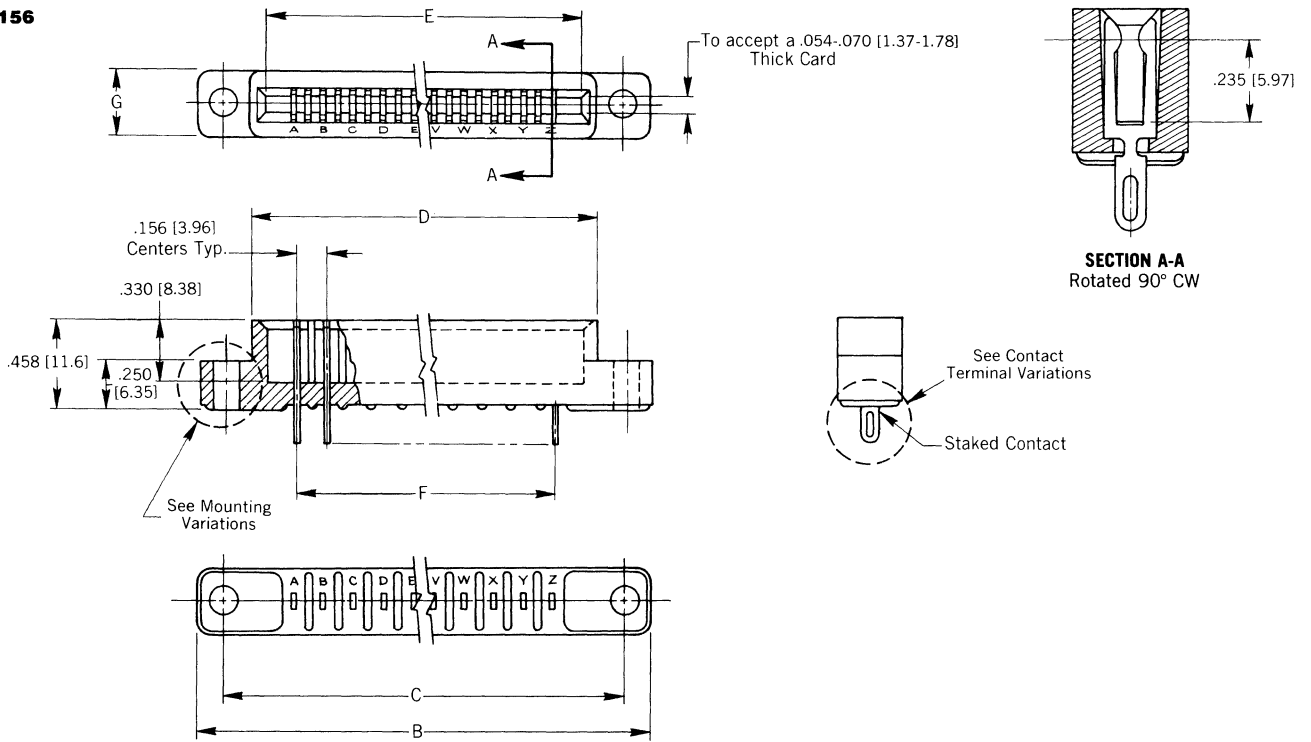

NUMBER OF CONTACTS	DIMENSIONS					
	B	C	D	E	F	G
6	1.798 [45.7]	1.531 [38.9]	1.239 [31.5]	1.098 [27.9]	.781 [19.8]	.340 [8.64]
10	2.425 [61.6]	2.156 [54.8]	1.864 [47.3]	1.723 [43.8]	1.406 [35.7]	.340 [8.64]
12	2.735 [69.5]	2.468 [62.7]	2.176 [55.3]	2.035 [51.7]	1.718 [43.6]	.340 [8.64]
15	3.205 [81.4]	2.937 [74.6]	2.645 [67.2]	2.504 [63.6]	2.187 [55.5]	.340 [8.64]
18	3.675 [93.3]	3.406 [86.5]	3.114 [79.1]	2.972 [75.5]	2.656 [67.5]	.340 [8.64]
22	4.300 [109]	4.031 [102]	3.739 [95.01]	3.597 [91.4]	3.281 [83.3]	.340 [8.64]

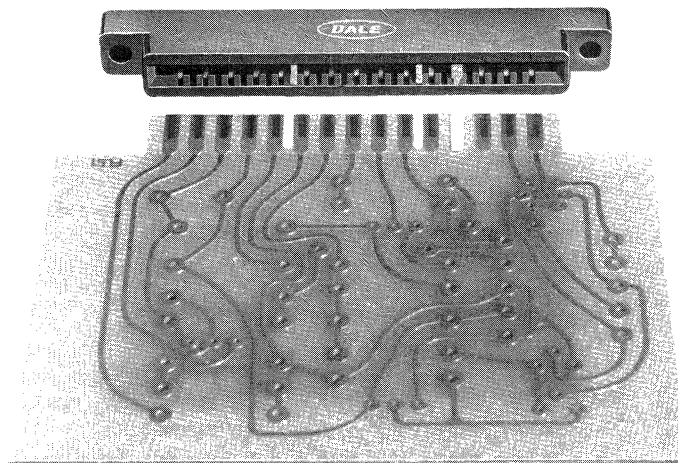

*Between contact
or on contact
polarization
available in all
sizes for factory
or field insertion.*

**ON CONTACT
POLARIZING KEY**
(Field insertable)

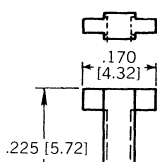

PKC156

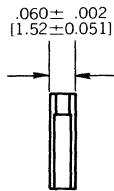

**BETWEEN CONTACT
POLARIZING KEY**
(Can be substituted in
place of a contact.)

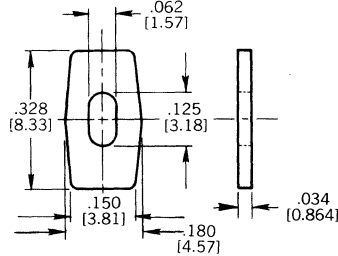

PK156

When ordering
polarizing keys
individually,
specify by Model
No. **PK156** or
PKC156.

ORDERING INFORMATION Description of Part Nomenclature

EBT156 -10

Edgeboard P.C. Connector Series

Number of Contacts: **6, 10, 12, 15, 18, 22**

A

1

X -A, J

A9, J9

ON CONTACT POLARIZATION: Required *only* when polarizing key(s) are to be **factory installed**. Polarization key replaces contact. When polarizing key(s) replaces contact(s) indicate by adding suffix "9" to contact position(s) desired. Example: **A9, J9** means keys replace terminal **A & J**.

BETWEEN CONTACT POLARIZATION: Required *only* when polarizing key(s) are to be **factory installed**. Polarization key positions. Between contact polarization key(s) are located to the right of the contact position(s) desired. Example: **A, J** means keys between **A & B, J & K**.

CONTACT TERMINAL VARIATIONS

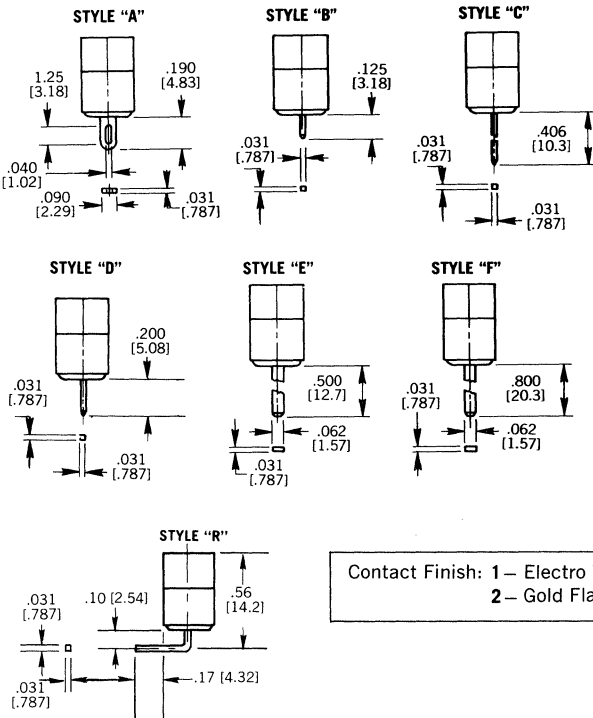

Contact Finish: **1** - Electro Tin Plated
2 - Gold Flash

MOUNTING VARIATIONS

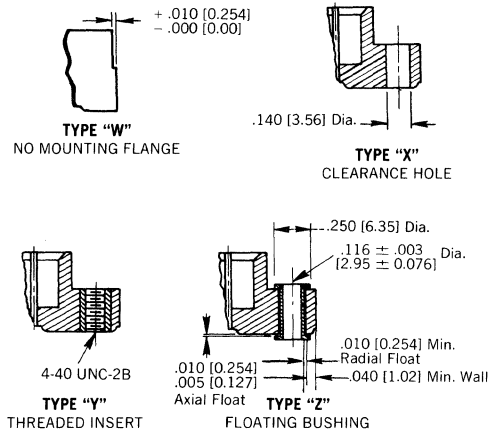



DIP SOLDER PRINTED CIRCUIT CONNECTOR

DALE SERIES 300

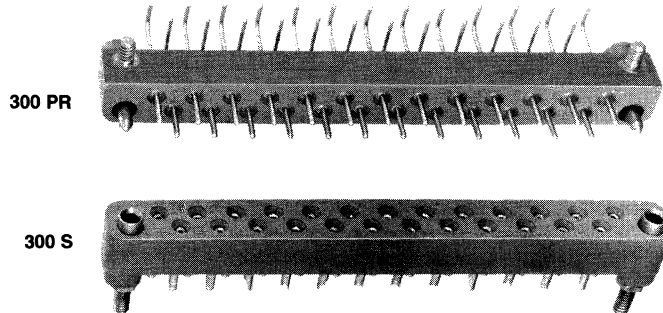

FEATURES

- Right angle or straight through dip solder terminals
- Threaded mounting studs
- Male contacts molded in
- Mating connector has solder cup or dip solder terminals
- Female contacts float to aid in alignment and resist vibration
- Permanent mounting provides greater reliability
- Polarization provided by contact arrangement and guide pin location
- Meets applicable paragraphs of MIL-C-55302

PHYSICAL CHARACTERISTICS

No. of Contacts: 7, 15, 19 and 25

Contact Spacing: 0.250", staggered rows provide a .125" grid.

Contact Gauge: #20 AWG

Minimum Creepage Path between Contacts: .16"

Minimum Air Space between Contacts: .11"

ELECTRICAL CHARACTERISTICS

Current Rating: 7.5 amps

Breakdown Voltage: At Sea Level: 3600 VRMS
At 70,000 feet: 975 VRMS

COMPONENT MATERIAL

Contact Pin: Phosphor Bronze

Contact Socket: Phosphor Bronze

Contact Plating: Gold Plated

Guide Pins: Stainless steel, passivated

Standard Body: Glass-filled diallyl phthalate per MIL-M-14, Type GDI-30F, green.
Other body material supplied upon request.

APPLICATION

Where permanent mounting of male connector to printed circuit board is required with mating female connector available.

300S SERIES

PANEL CUTOUT DIMENSIONS

NO. OF CONTACTS	DIMENSIONS		
	A	B	C
7	1.150	1.000	1.275
15	2.150	2.000	2.275
19	2.650	2.500	2.775
25	3.400	3.250	3.525

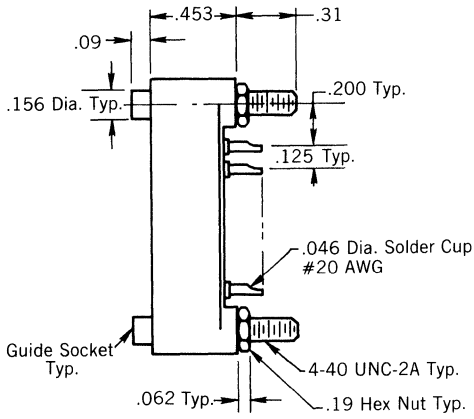

TYPICAL SIDE VIEW

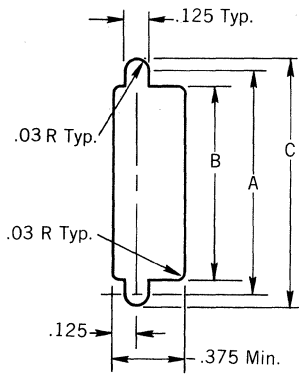

PANEL CUTOUT

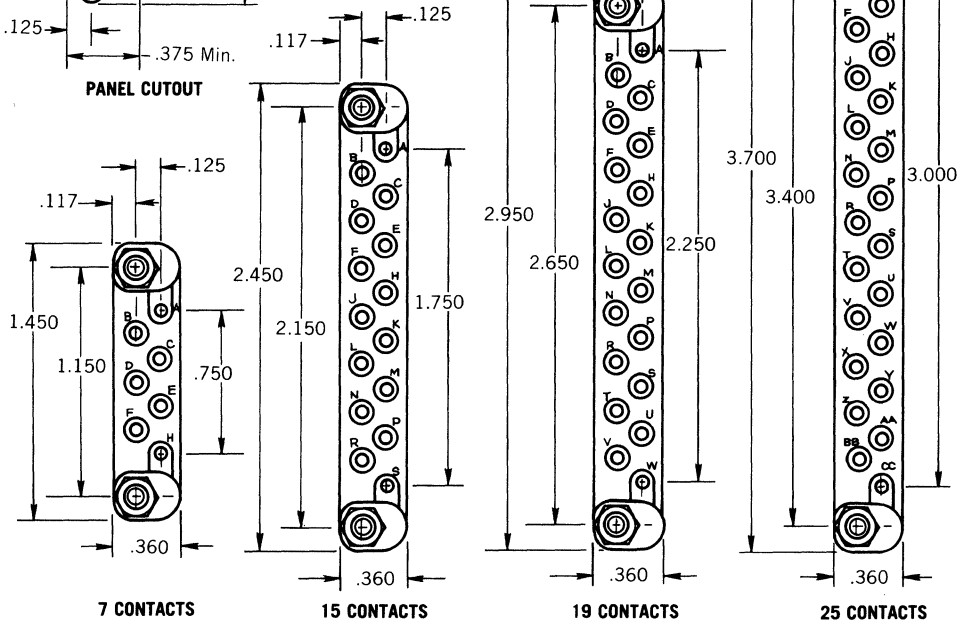

7 CONTACTS

15 CONTACTS

19 CONTACTS

25 CONTACTS

300SE SERIES

PANEL CUTOUT DIMENSIONS

NO. OF CONTACTS	DIMENSIONS		
	A	B	C
7	1.150	1.000	1.275
15	2.150	2.000	2.275
19	2.650	2.500	2.775
25	3.400	3.250	3.525

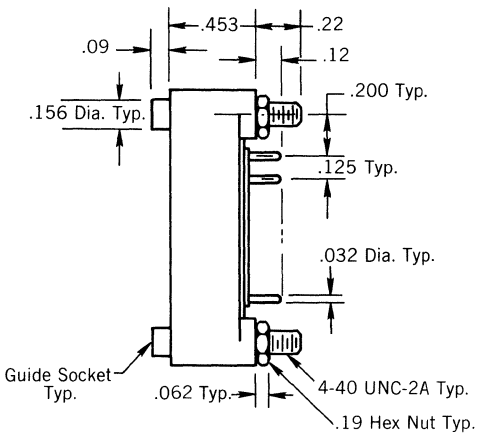

TYPICAL SIDE VIEW

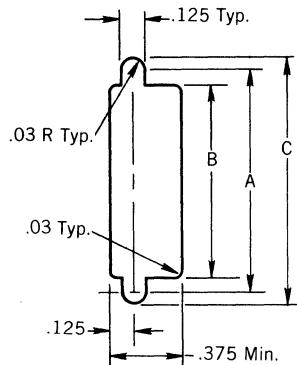

PANEL CUTOUT

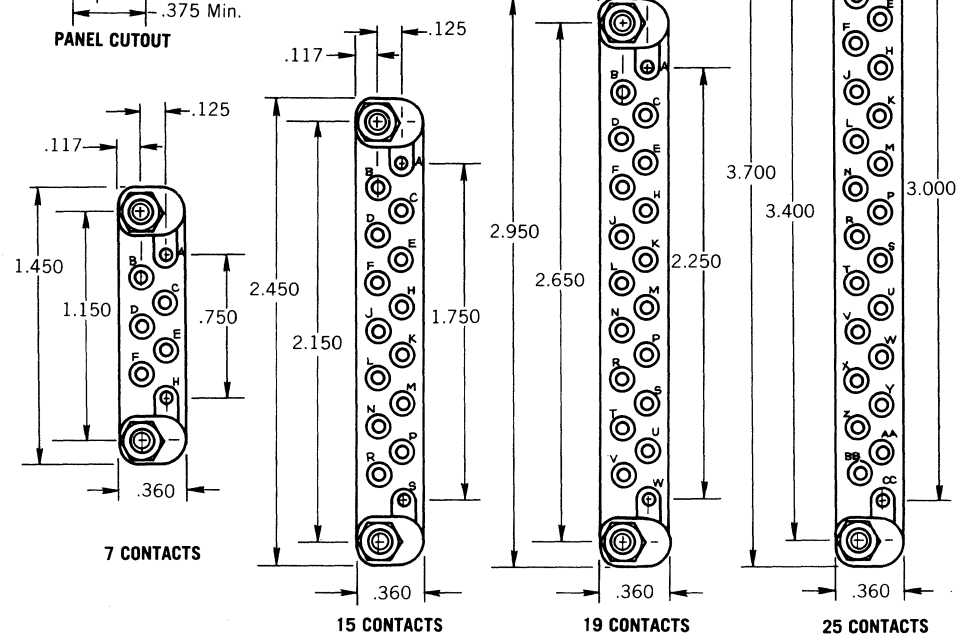

7 CONTACTS

15 CONTACTS

19 CONTACTS

25 CONTACTS

ORDERING INFORMATION

Description of Part Nomenclature

300	S	PE	SE	PR	7	W
1.	2.	3.	4.			

- 300 Series
- Socket or Pin Connector
 S – Socket with solder cup
 PE – Pin with dip solder terminals
 SE – Socket with dip solder terminals
 PR – Pin with right angle dip solder terminals
- Number of Contacts (7, 15, 19 or 25)
- Without Guides (optional on S, PE and SE models only).

300PE SERIES

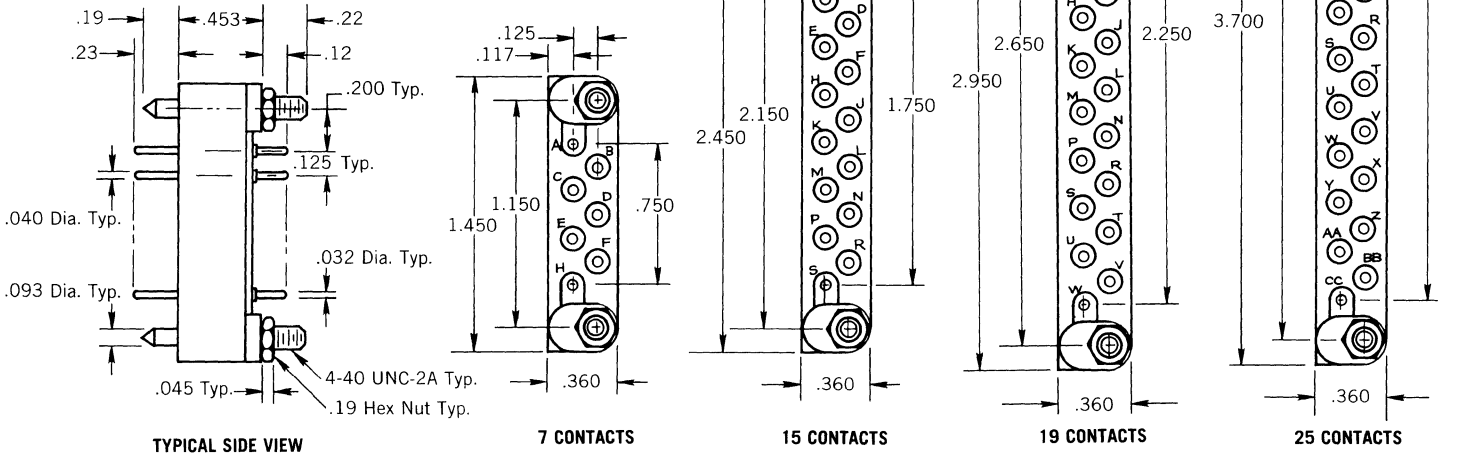

300PR SERIES

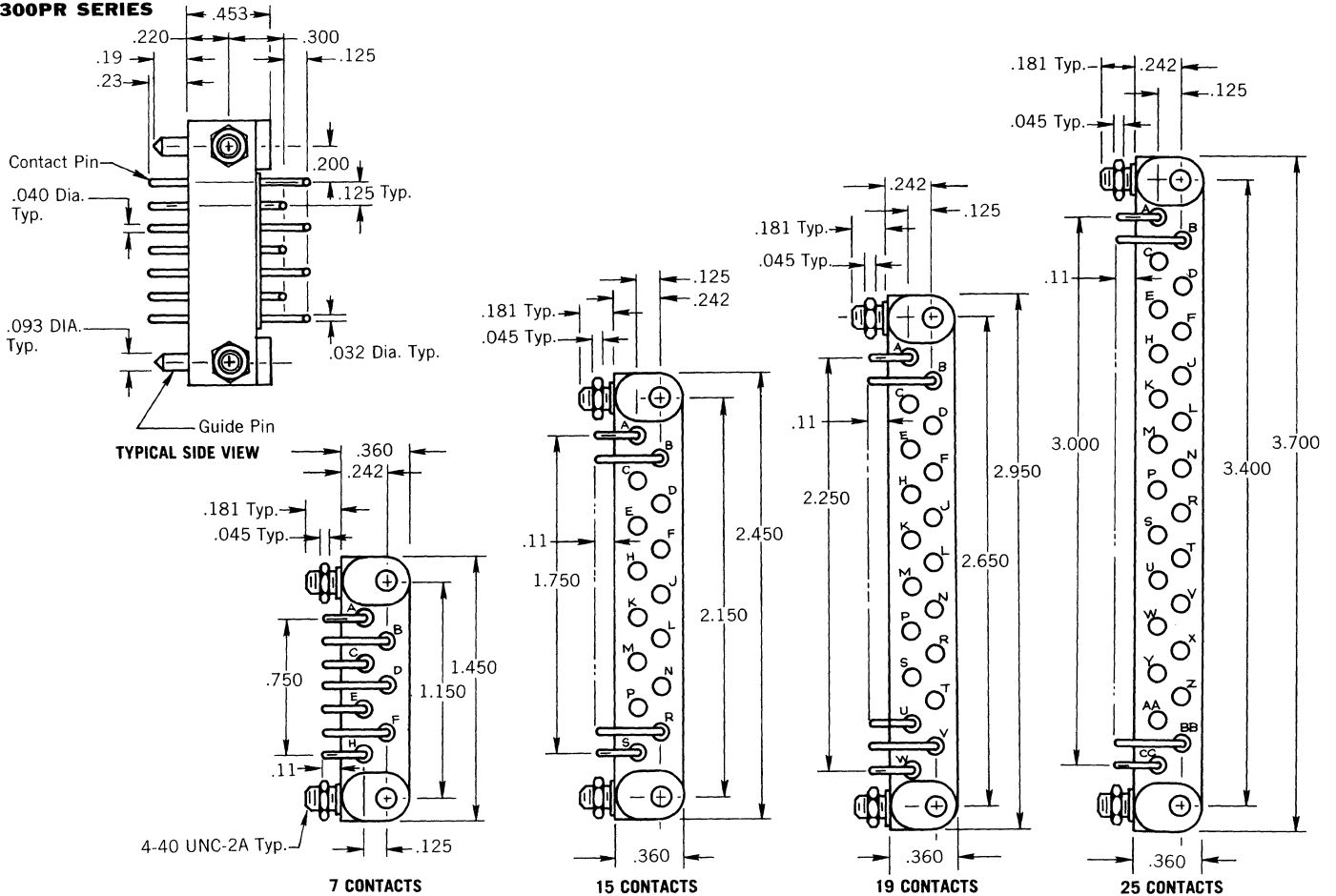



D-SUBMINIATURE RIGHT ANGLE PC MOUNT CONNECTOR

DALE SERIES DS

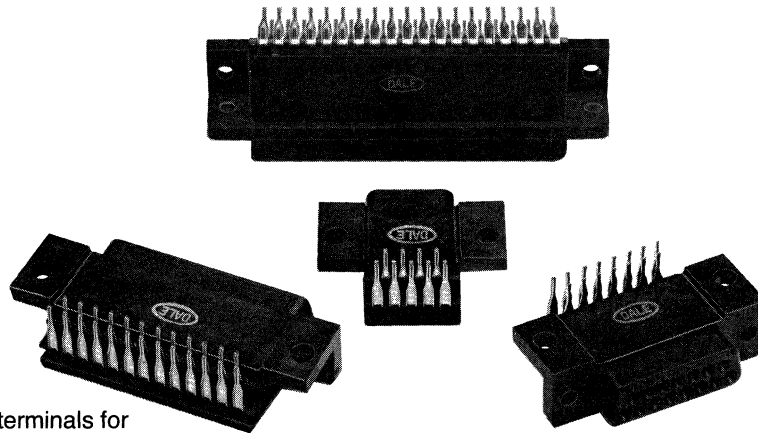

FEATURES

- All plastic design with right angle terminals for economical PC board mount applications.
- Precision rigid terminals with precise spacing for easy board insertion.
- Selective gold plating placed in contact area only to minimize cost.
- 60/40 tin lead solder terminals provide excellent solderability for wave soldering applications.
- Mounting options to fit your particular application.
- Available in 9, 15, 25 and 37 contact positions.

[Numbers in brackets indicate millimeters]

PHYSICAL CHARACTERISTICS

Contact Type: Formed socket contacts, will accept .040" [1.02] dia. pins.

Contact Termination: Right angle dip solder tails, will fit .038" [0.97] dia. hole.

Recommended Board Thickness: .093" [2.36] maximum.

Individual Contact Engagement and Separation Forces:

Engagement: 12 ounces max. using a .041" [1.04] dia. test pin.
Separation: .75 ounce min. using a .039" [0.99] dia. test pin.

Total Connector Engagement and Separation Forces:
8 ounces times the number of contacts maximum.

Individual Contact Retention: 3 pounds minimum.

Durability: After 200 cycles of insertion and withdrawal with a mating connector, there shall be no damage detrimental to the ability of the connector to meet all parameters.

Operating Temperature: -55°C to +125°C

Number of Contacts: 9, 15, 25 and 37.

ELECTRICAL CHARACTERISTICS

Current Rating: 5 amps

Operating Voltage: 600 VDC (sea level)

Insulation Resistance: 5000 megohms minimum at 500 VDC potential.

Dielectric Withstanding Voltage: At sea level: 1000 VRMS

Contact Resistance: 10 milliohms maximum at rated current.

Operating Temperature: -55°C to +125°C

COMPONENT MATERIAL

Body: Glass-filled polyester, black flame-retardant UL 94V-0.

Contacts: Phosphor bronze

Contact Plating: Selective gold/tin lead over nickel. Nickel underplating per QQ-N-290, .000050" [0.0013] thick overall with .0001"-0.0003" [0.0025-0.008] thick tin lead (60/40) on contact terminals.

Contact Plating (continued):

Gold per MIL-G-45204, Type II, .000010" [0.00025] thick on contact sockets model designator "GF."

Gold per MIL-G-45204, Type II, .000030" [0.0008] thick on contact sockets model designator "G."

Threaded Insert: Brass—zinc plated.

APPLICATION

For use on any PC board requiring a D-subminiature connector with .59" [15.00] of mounting space between board edge and first row of contacts.

SERIES DS-SUBMINIATURE

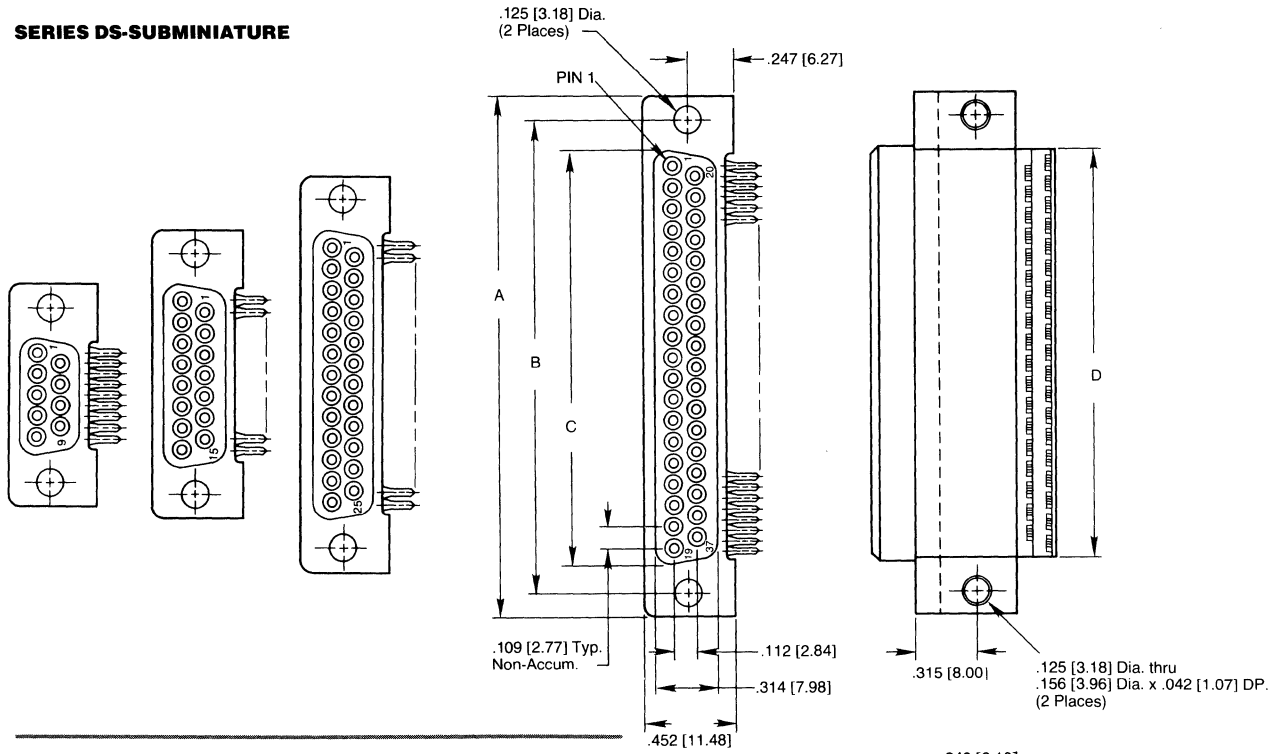

NUMBER OF CONTACTS	DIMENSIONS			
	A	B	C	D
9	1.224 [31.09]	.984 [24.99]	.646 [16.41]	.624 [15.85]
15	1.552 [39.42]	1.312 [33.32]	.974 [24.74]	.952 [24.18]
25	2.092 [53.14]	1.852 [47.04]	1.514 [38.46]	1.492 [37.90]
37	2.740 [69.60]	2.500 [63.50]	2.162 [54.92]	2.140 [54.36]

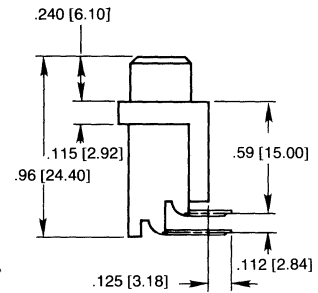

ORDERING INFORMATION (Typical Model Number)

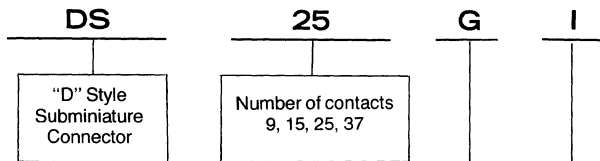

PLATING OPTIONS

G.F. = .000010" gold over .000050 nickel in contact area with .0001" to .0003" 60/40 tin/lead on contact tail.

G = .000030" gold over .000050" nickel in contact area with .0001" to .0003" 60/40 tin/lead on contact tail.

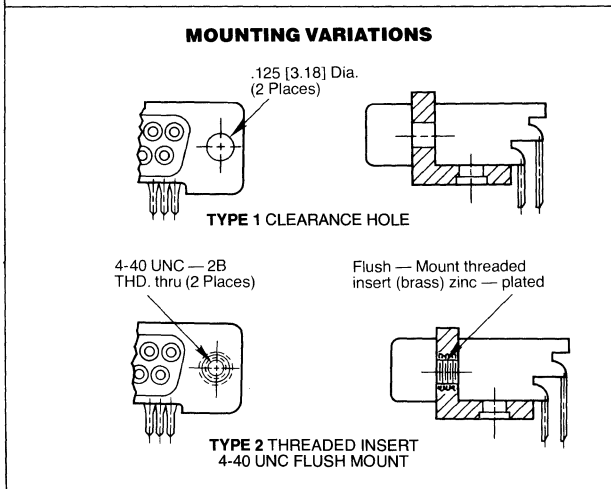
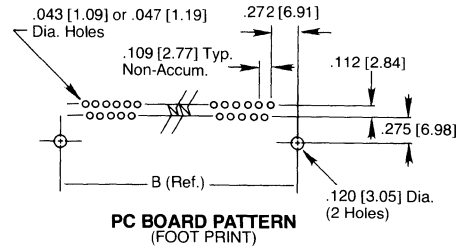



MICROMINIATURE RECTANGULAR RACK AND PANEL CONNECTOR

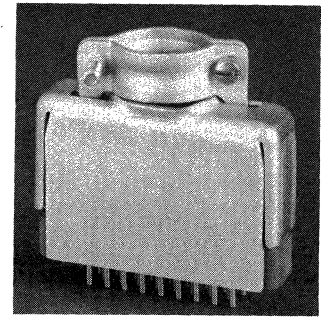

DALES SERIES MM22 and MM24 With Optional Hoods

FEATURES

- Qualified to MIL-C-28748/7 and /8
- Solder cup contacts
- Dip solder contacts
- Fixed and turnable screwlocks
- Optional closed entry socket contacts

PHYSICAL CHARACTERISTICS

No. of Contacts: 5, 7, 9, 11, 14, 18, 20, 26, 29, 34, 44 or 50

Contact Gauge:
MM22 Series = 22 AWG
MM24 Series = 24 AWG

Minimum Creepage Path between Contacts: .08 [2.03]

Minimum Air Space between Contacts: .05 [1.27]

ELECTRICAL CHARACTERISTICS

Current Rating: MM22 Series = 5 amps
MM24 Series = 3 amps

Breakdown Voltage: At Sea Level: 2000 VRMS
At 70,000 feet: 500 VRMS

COMPONENT MATERIAL

Contact Pin: Phosphor Bronze

Contact Socket: Phosphor Bronze
(Beryllium copper available on request.)

Contact Plating: Gold

Screwlocks: Stainless steel, passivated

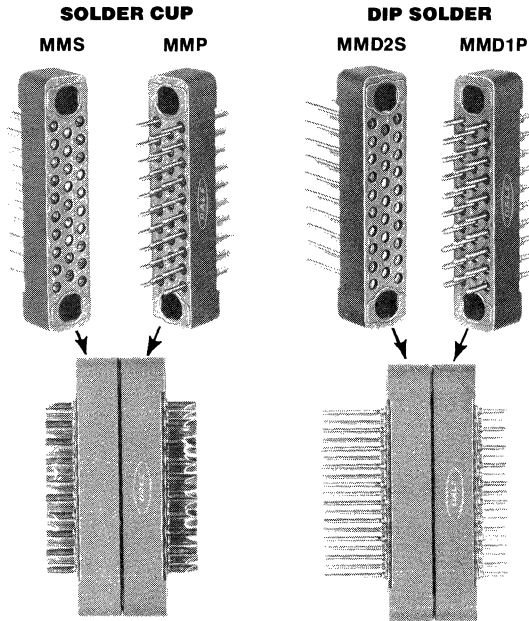

Guides: Brass, gold plated or stainless steel, passivated

Standard Body: Glass-filled diallyl phthalate per MIL-M-14, Type GDI-30F, green.

[Numbers in brackets indicate millimeters]

APPLICATIONS

Especially suited for use in airborne, instrumentation, and portable equipment applications or wherever the following requirements must be met: Minimum space and weight without sacrifice of performance, high quality materials, long service life, high vibration and shock resistance, and positive locking.

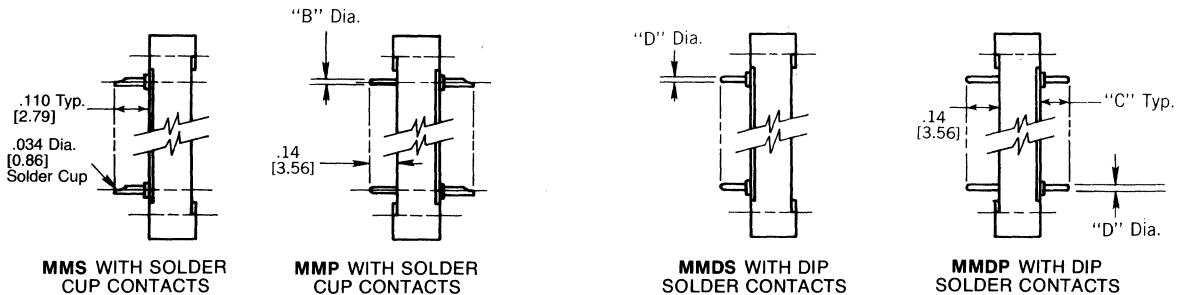

CONTACT GAUGE	"B" DIA.
22 AWG	.030 ± .001 [0.762 ± 0.025]
24 AWG	.025 ± .001 [0.635 ± 0.025]

CONTACT GAUGE	"C" DIP TAIL LENGTH	"D" DIA.
22 AWG	.16 or .35 Nom. [4.06 or 8.89]	.025 ± .002 [0.635 ± 0.05]
24 AWG	.16 or .35 Nom. [4.06 or 8.89]	.025 ± .002 [0.635 ± 0.051]

DALE ELECTRONICS, INC., East Highway 50, Yankton, SD 57078 • Phone 605-665-9301

Canada: Dale Electronics Ltd., 18 Howden Rd., Scarborough, Ontario M1R 3E6
Europe: Dale Electronics GmbH, Benzstrasse 28, 8039 Puchheim, West Germany

**MMS22 and MMP22
MMS24 and MMP24**

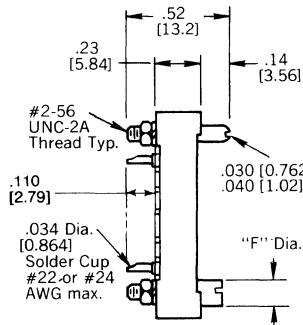

**MMS WITH FIXED
(026, 027) GUIDES**

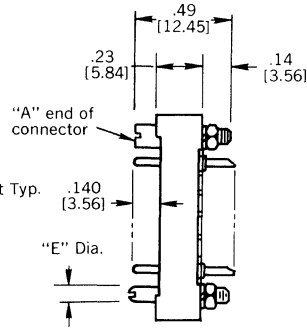

**MMP WITH FIXED
(026, 027) GUIDES**

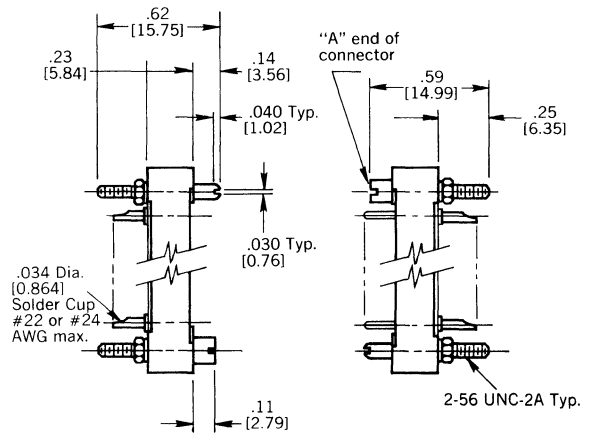

**MMS WITH FIXED
(026L, 027L)
GUIDES**

**MMP WITH FIXED
(026L, 027L)
GUIDES**

HARDWARE TYPE	E DIA.	F DIA.
026	.078 [1.98]	.125 [3.18]
026L	.078 [1.98]	.125 [3.18]
027	.078 [1.98]	.125 [3.18]
027L	.078 [1.98]	.125 [3.18]

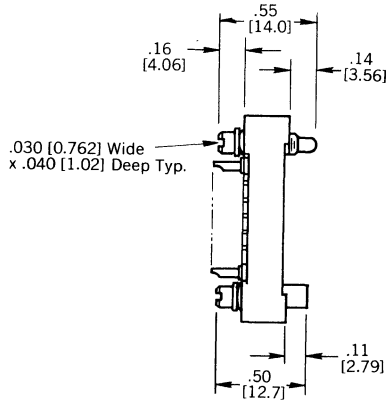

**SHORT TURNABLE
SCREWLOCKS (SK030)**

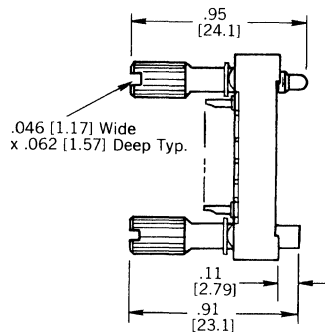

**TURNABLE
SCREWLOCKS (SK)**

NOTE: Either MMP or MMS Connectors may be ordered with any type of hardware shown.

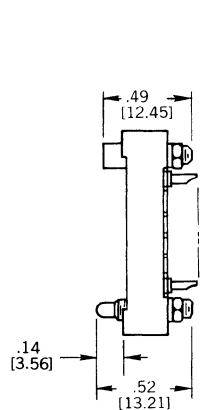

**FIXED
SCREWLOCKS (SL)**

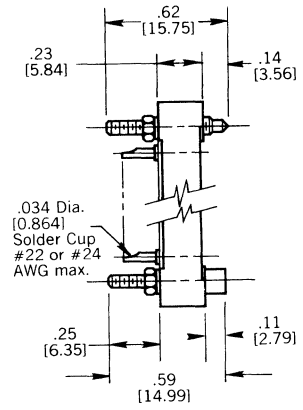

**FIXED
(SLL)
SCREWLOCKS**

HARDWARE MATING CHART

HARDWARE TYPE	MATES WITH HARDWARE TYPE
026	026, 026L
027	027, 027L
SK	SL, NSL or SLL
SK030	SL, NSL or SLL
SK2	SL 2, NSL 2 or SL 2L
SK2030	SL 2, NSL 2 or SL 2L
SK2035	SL 2, NSL 2 or SL 2L

Examples:

1. MMP with 026 Hardware would mate with an MMS with 026 Hardware.
2. MMS with SK Hardware would mate with an MMP with SL or NSL Hardware.
3. MMS with SL-2 Hardware would mate with an MMP with SK2 or SK2030 Hardware.

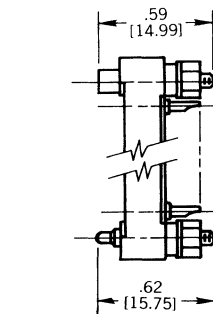

**FIXED SCREWLOCKS
AND NYLON RETAINING NUT
AND FIBER WASHER (NSL)**

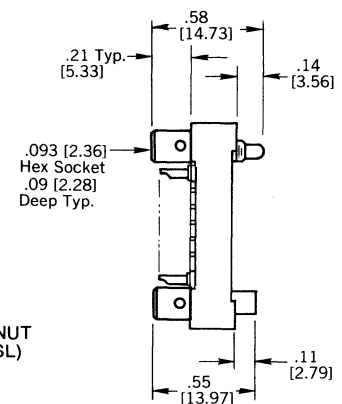

**SHORT TURNABLE
SCREWLOCKS (SK2035)**

MMS22 and MMP22
MMS24 and MMP24

NOTE: The Views below show the wiring side of a pin type connector.
Socket guide is assembled at "A" contact pin end.

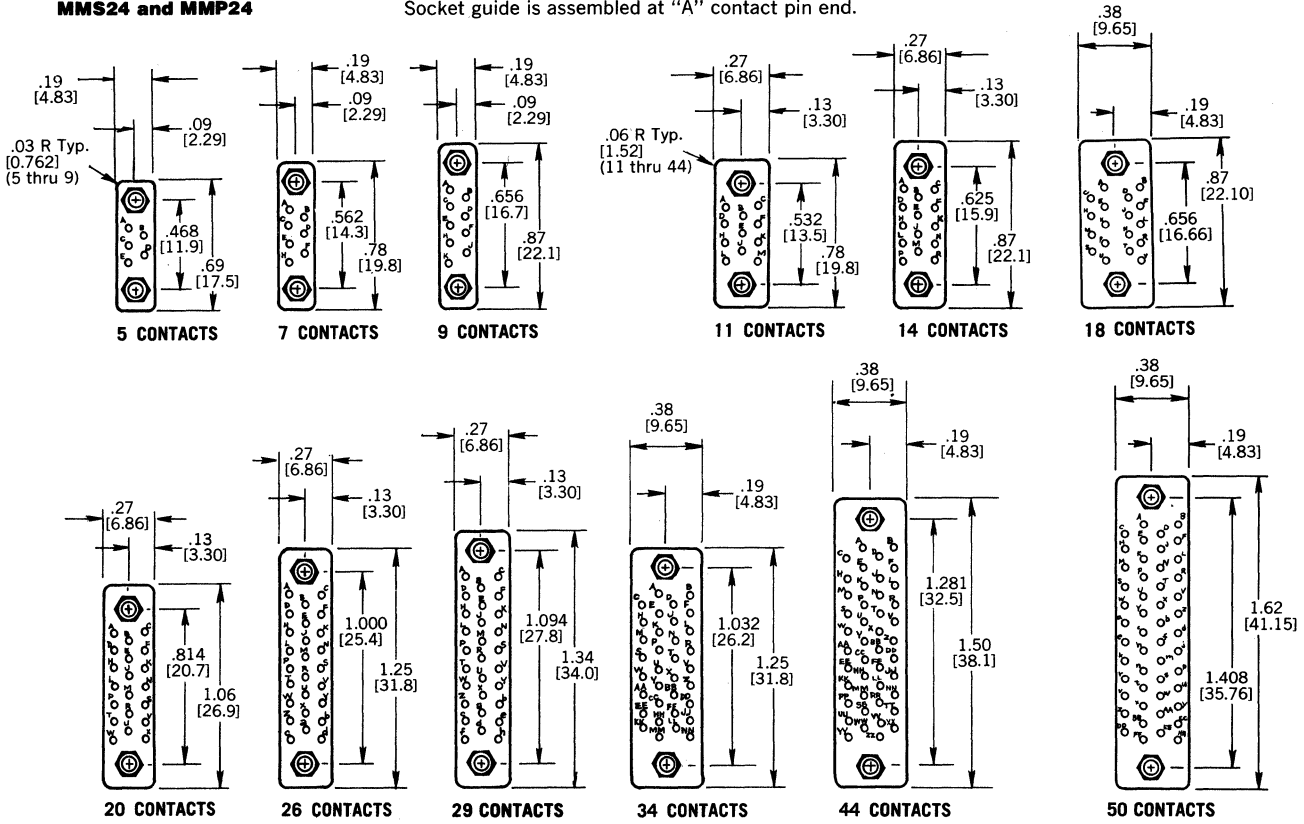

MM SERIES

DIP SOLDER P. C. BOARD MOUNTING PATTERNS
MALE (MMP) CONNECTOR SHOWN—FEMALE IS OPPOSITE

CONTACT, CONTACT ROW AND MATING HOLE \varnothing TO \varnothing DIMENSIONS ALSO APPLIES TO SOLDER CUP STYLE CONNECTORS.

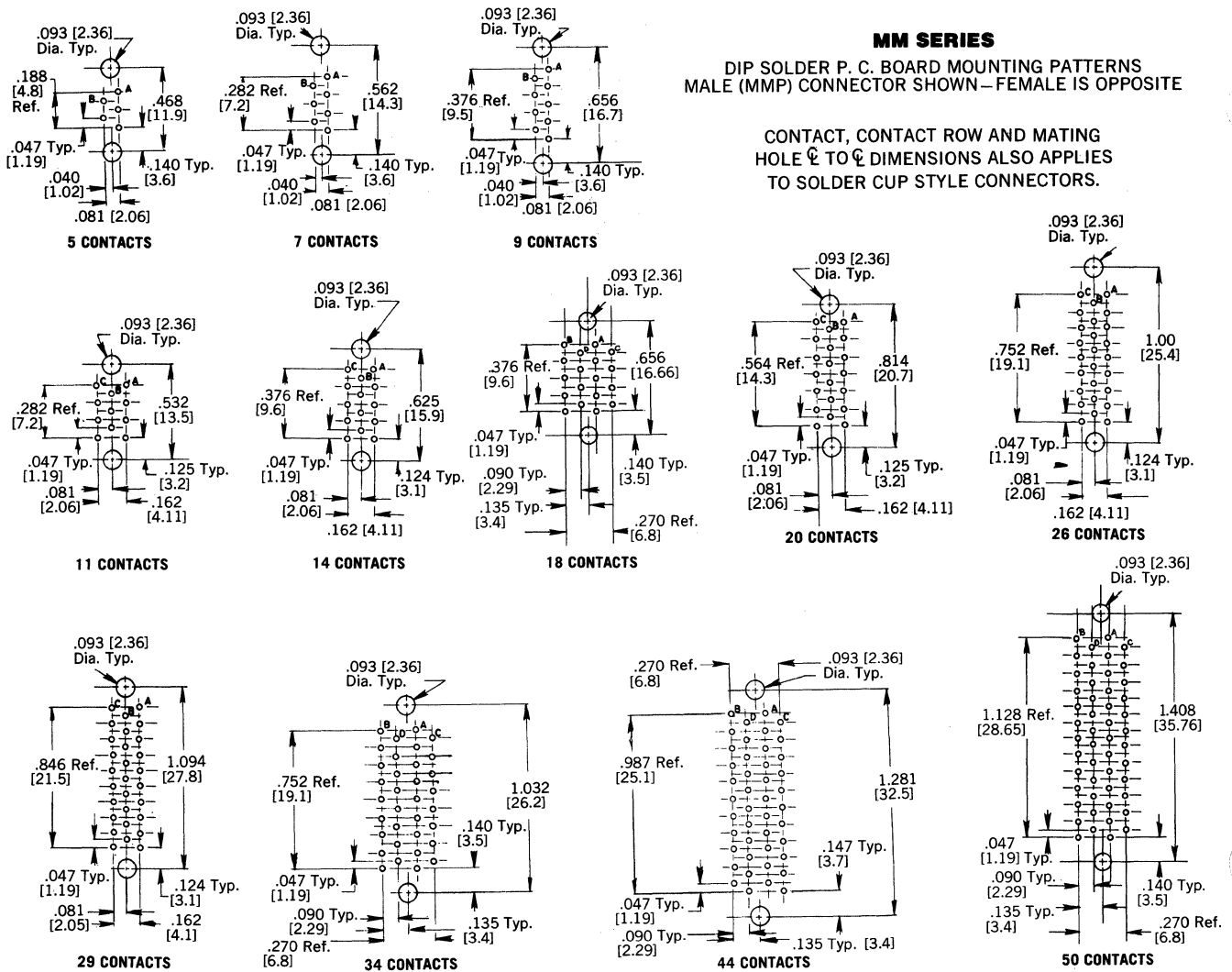

**MMS22 and MMP22
MMS24 and MMP24**

PANEL CUTOUT

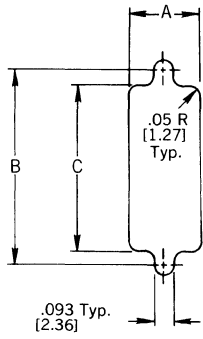

PANEL CUTOUT DIMENSIONS

NO. OF CONTACTS	A	B	C	NO. OF CONTACTS	A	B	C
5	.19 [4.83]	.468 [11.89]	.34 [8.64]	20	.27 [6.86]	.814 [20.68]	.69 [17.53]
7	.19 [4.83]	.562 [14.27]	.44 [11.18]	26	.27 [6.86]	1.000 [25.40]	.87 [22.10]
9	.19 [4.83]	.656 [16.66]	.53 [13.46]	29	.27 [6.86]	1.094 [27.79]	.97 [24.64]
11	.27 [6.86]	.532 [13.51]	.41 [10.41]	34	.38 [9.65]	1.032 [26.21]	.91 [23.11]
14	.27 [6.86]	.625 [15.88]	.50 [12.70]	44	.38 [9.65]	1.281 [32.54]	1.16 [29.46]
18	.38 [9.65]	.656 [16.66]	.53 [13.51]	50	.38 [9.65]	1.408 [35.76]	1.28 [32.51]

NOTE: The views below show the wiring side of a pin type connector.
Socket guide is assembled at "A" contact pin end.

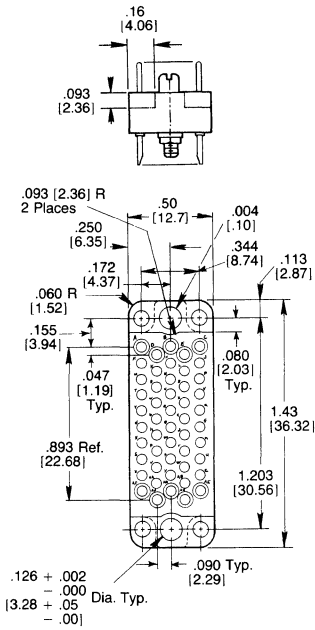

PANEL CUTOUT

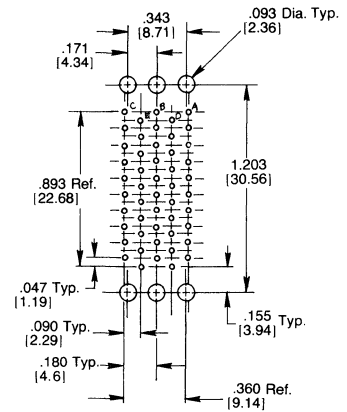
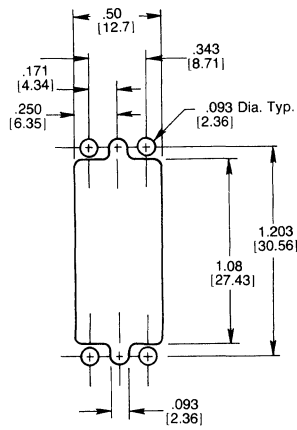

**DIP SOLDER P.C. BOARD MOUNTING PATTERN
MALE (MMP) CONNECTOR SHOWN—FEMALE IS OPPOSITE
CONTACT, CONTACT ROW AND MATING HOLE Q. TO Q. DIMENSIONS
ALSO APPLIES TO SOLDER CUP STYLE CONNECTORS.**

HOOD DIMENSIONS

NO. OF CONTACTS	A	B	C	D	"E" Cable Opening (Sq. In.)
5	.69 [17.53]	.63 [16.00]	.468 [11.89]	.31 [7.87]	.028
7	.78 [19.81]	.63 [16.00]	.562 [14.27]	.44 [11.18]	.037
9	.87 [22.10]	.63 [16.00]	.656 [16.66]	.50 [12.70]	.052
11	.78 [19.81]	.63 [16.00]	.532 [13.51]	.44 [11.18]	.054
14	.87 [22.10]	.63 [16.00]	.625 [15.88]	.50 [12.70]	.076
20	1.06 [26.92]	.63 [16.00]	.814 [20.68]	.62 [15.73]	.105
26	1.25 [31.75]	.63 [16.00]	1.000 [25.40]	.62 [15.73]	.105
29	1.34 [34.04]	.63 [16.00]	1.094 [27.79]	.62 [15.73]	.105
34	1.25 [31.75]	.63 [16.00]	1.032 [26.21]	.50 [12.70]	.160
44	1.50 [38.10]	1.19 [30.23]	1.281 [32.54]	.50 [12.70]	.190
50	1.62 [41.15]	1.19 [30.23]	1.408 [35.76]	.62 [15.73]	.202

HOOD VARIATIONS

027H

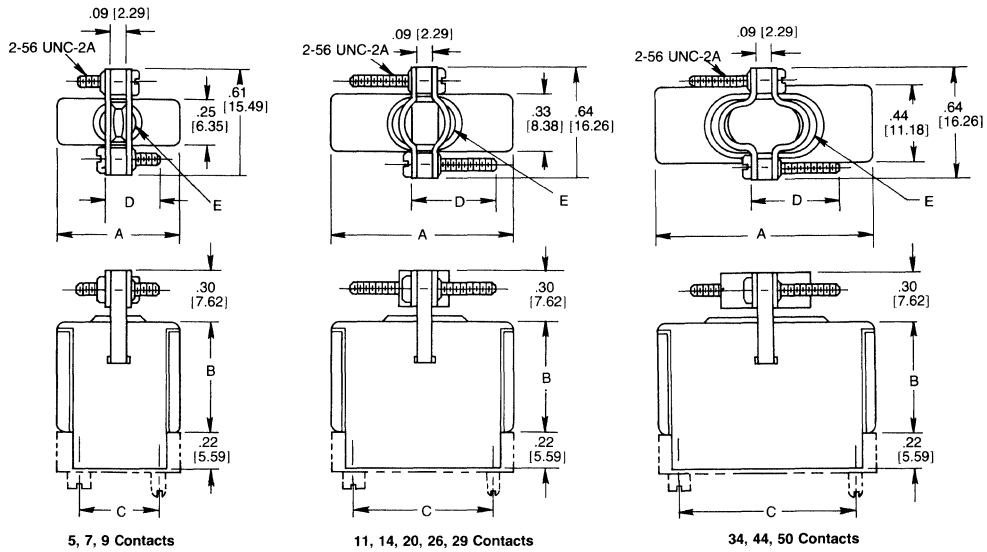

SKH or SK2H

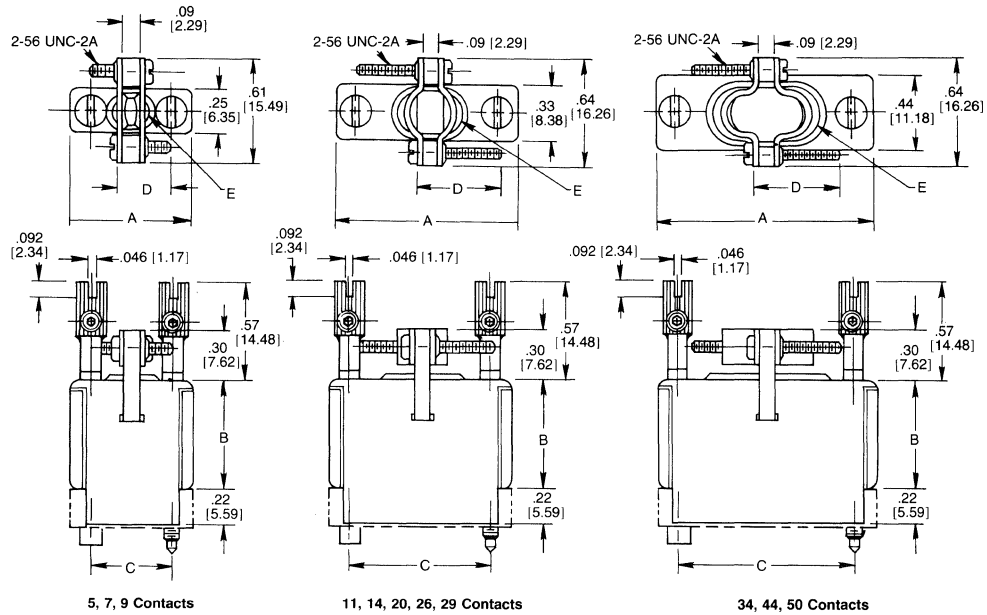

ORDERING INFORMATION Microminiature Series

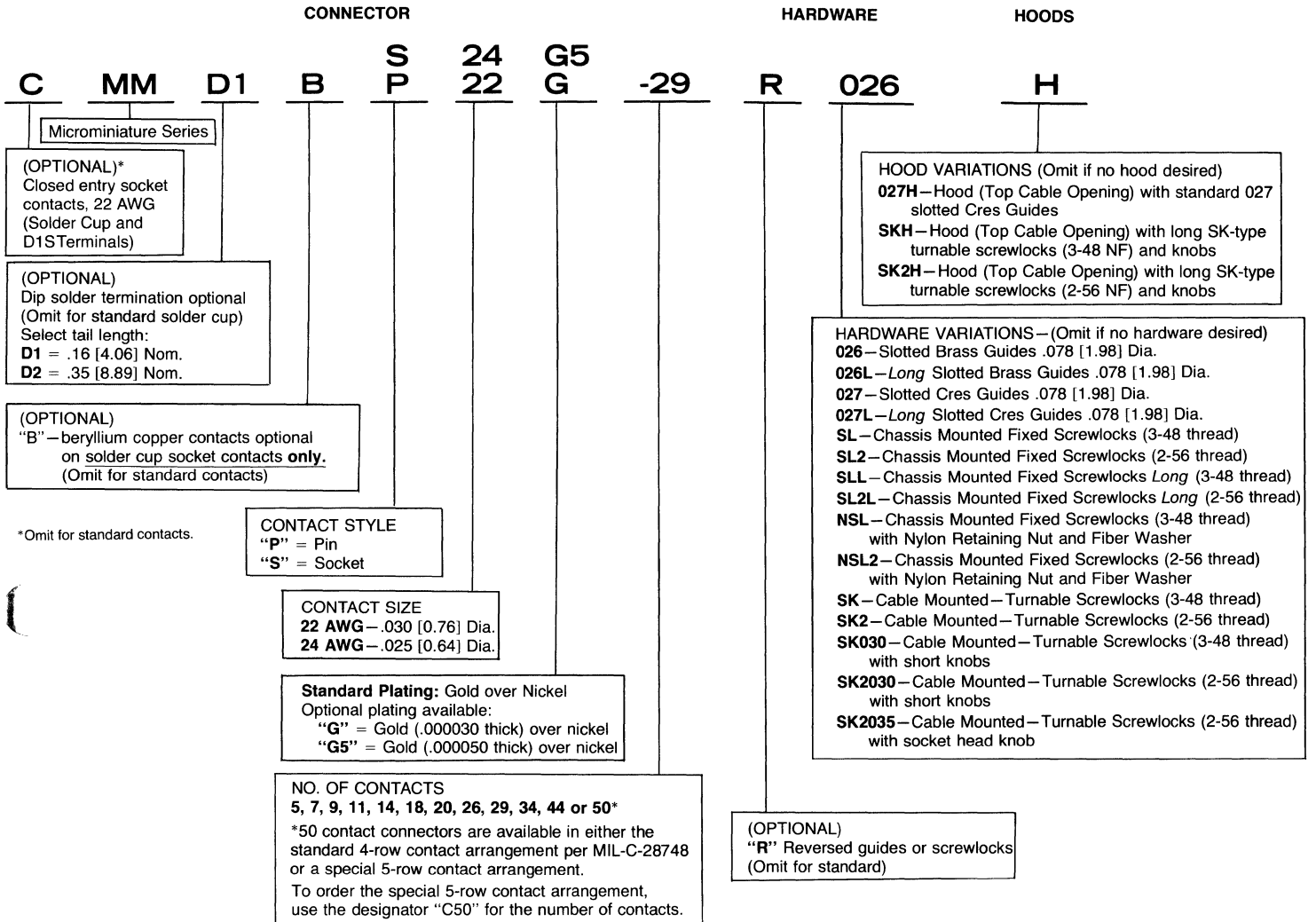

NOTE: To order complete connector with hardware supplied unassembled, add suffix "UA" on end of hardware designation.



SUBMINIATURE RECTANGULAR RACK AND PANEL CONNECTOR

DALE SERIES SM20

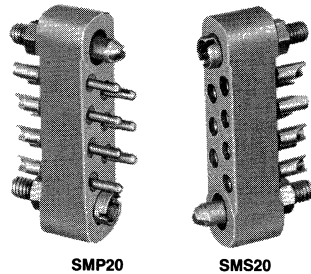

FEATURES

- Lightweight
- Polarized by guides or screwlocks
- Screwlocks lock connectors together to withstand vibration and accidental disconnect
- Overall height kept to a minimum
- Floating contacts aid in alignment and in withstanding vibration
- Contacts, precision machined and individually gauged, provide high reliability
- Insertion and withdrawal forces kept low without increasing contact resistance
- Contact plating provides protection against corrosion, assures low contact resistance and ease of soldering
- Meets or exceeds requirements of MIL-C-28748

PHYSICAL CHARACTERISTICS

No. of Contacts: 5, 7, 11, 14, 20, 26, 34, 42, 50, 75

Contact Spacing: .12" [3.05]

Contact Gauge: #20 AWG

Minimum Creepage Path between Contacts: .08" [2.03]

Minimum Air Space between Contacts: .05" [1.27]

ELECTRICAL CHARACTERISTICS

Current Rating: 7.5 amps.

Breakdown Voltage: At Sea Level: 2000 VRMS

At 70,000 feet [21,336 meters]: 500 VRMS

COMPONENT MATERIAL

Contact Pin: Brass, gold plated.

Contact Socket: Phosphor Bronze, gold plated. (Beryllium Copper available on request.)

Guides: Stainless steel, passivated.

Screwlocks: Stainless steel, passivated.

Standard Body: DG glass-filled diallyl phthalate per MIL-M-14, Type GDI-30F, green.

APPLICATIONS

For use wherever space is at a premium and a high quality connector is required in avionics, automation, communications, controls, instrumentation, missiles, computers and guidance systems.

DALE ELECTRONICS, INC., East Highway 50, Yankton, SD 57078 • Phone 605-665-9301

Canada: Dale Electronics Ltd., 18 Howden Rd., Scarborough, Ontario M1R 3E6
Europe: Dale Electronics GmbH, Benzstrasse 28, 8039 Puchheim, West Germany

SMS & SMP TYPES

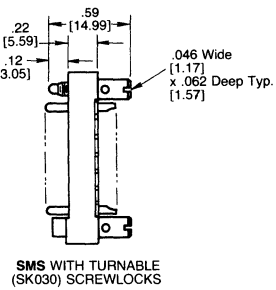
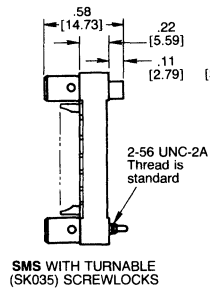
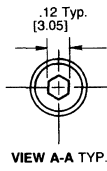
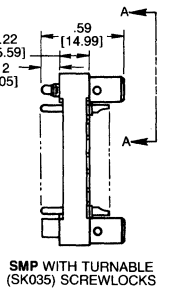
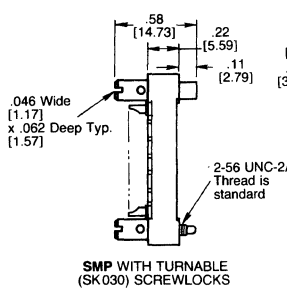
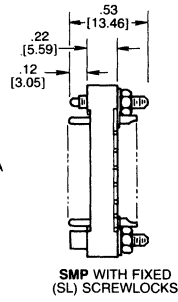
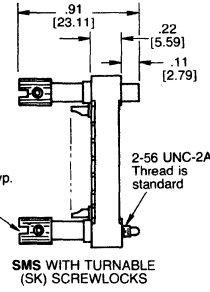
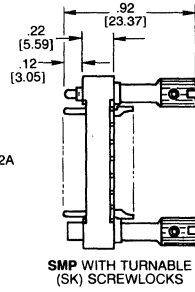
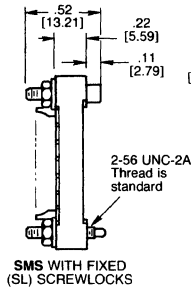
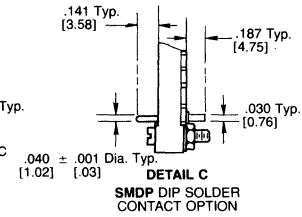
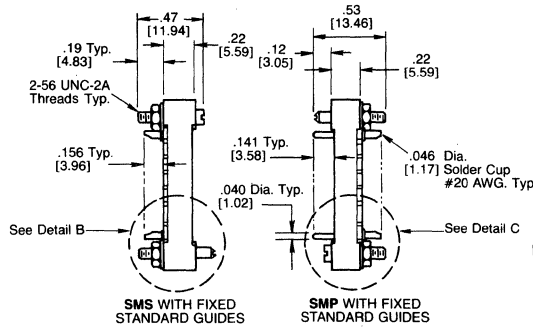
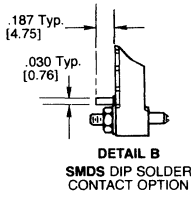

SM SERIES
DIP SOLDER P.C. BOARD MOUNTING PATTERNS
MALE (SMP) CONNECTOR SHOWN - FEMALE IS OPPOSITE

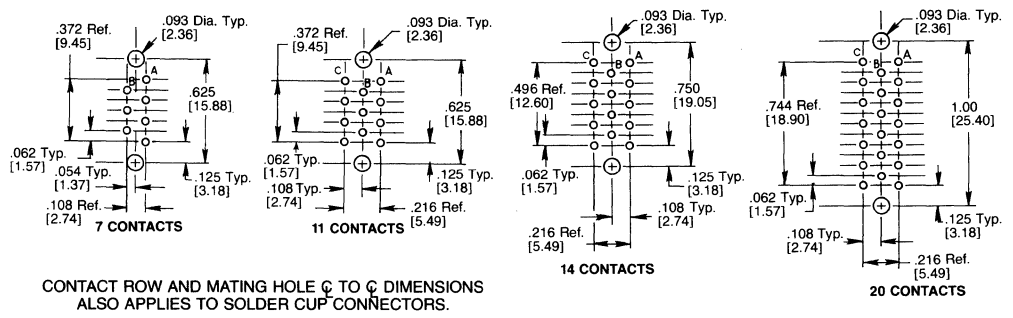
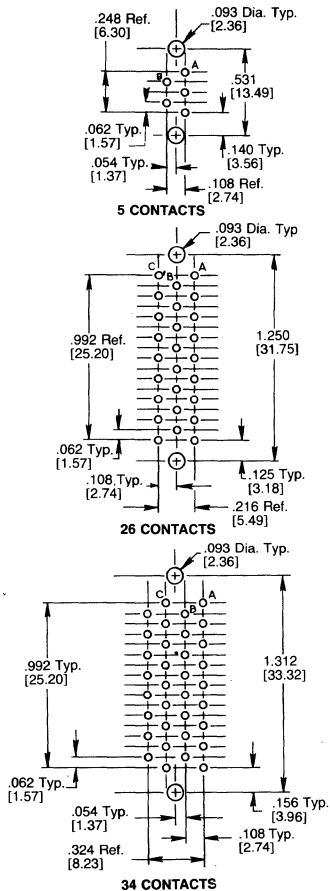

CONTACT ROW AND MATING HOLE ϕ TO ϕ DIMENSIONS ALSO APPLIES TO SOLDER CUP CONNECTORS.

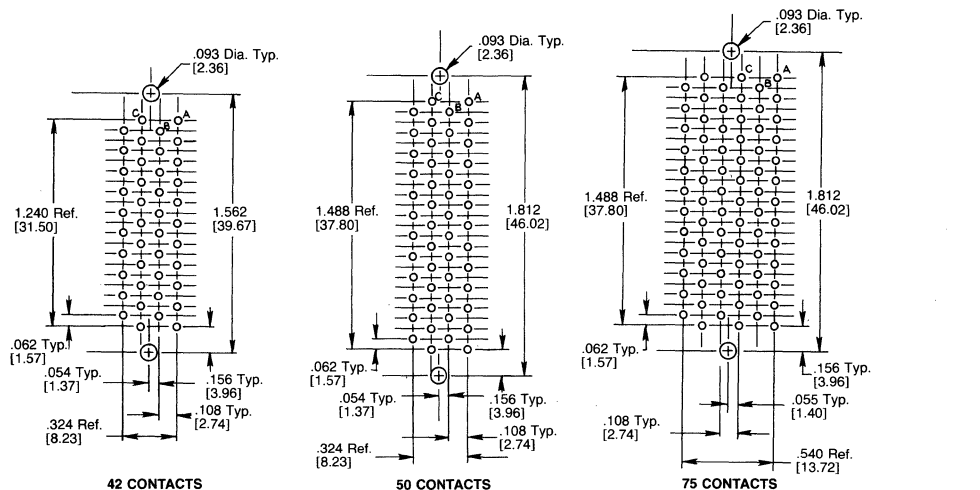

SMS & SMP TYPES

NOTE: The views below show the wiring side of a pin type connector.
Socket guide is assembled at "A" contact pin end.

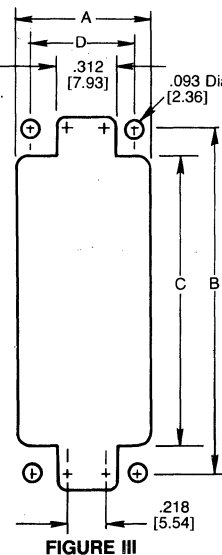
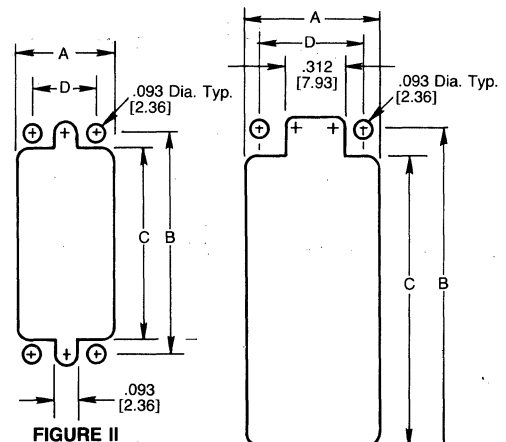
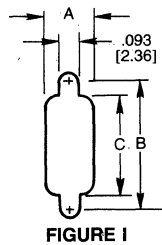
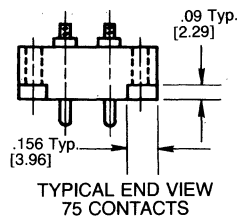
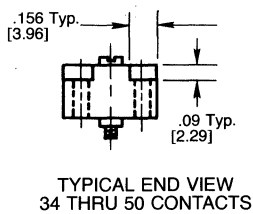
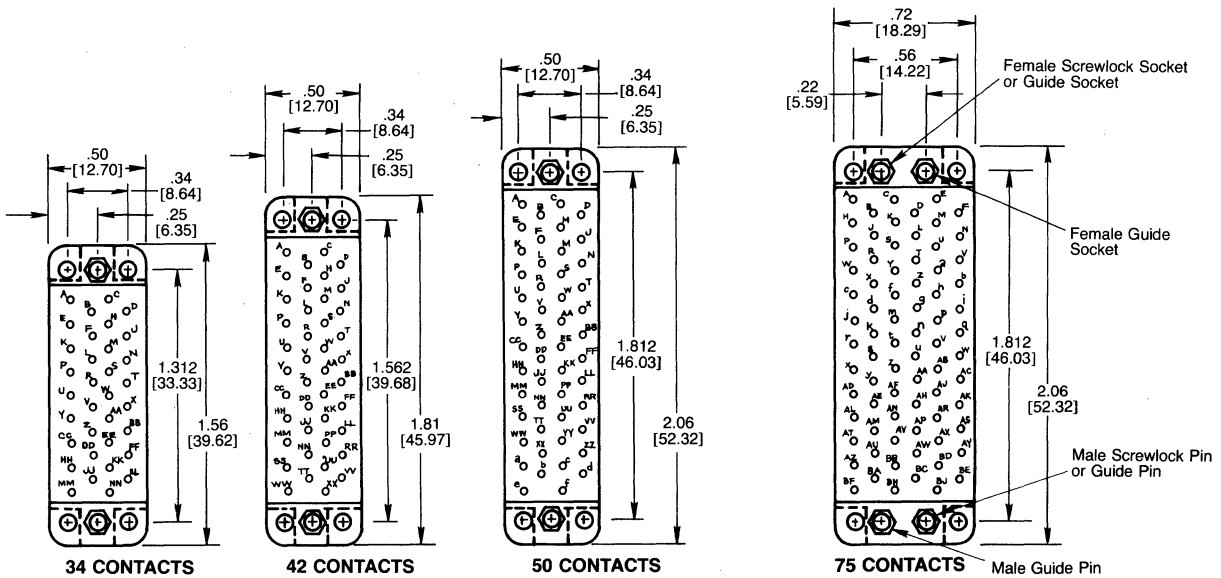
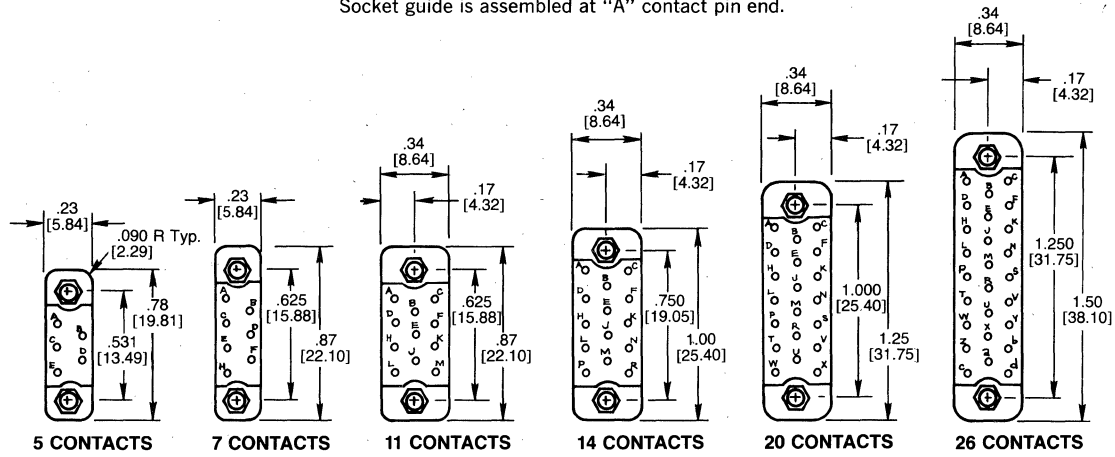

PANEL CUTOUT DIMENSIONS

CONNECTOR	A	B	C	D	FIGURE
5	.23 [5.84]	.531 [13.49]	.41 [10.41]	—	I
7	.23 [5.84]	.625 [15.88]	.50 [12.70]	—	
11	.34 [8.64]	.625 [15.88]	.53 [13.46]	—	
14	.34 [8.64]	.750 [19.05]	.62 [15.75]	—	
20	.34 [8.64]	1.000 [25.40]	.91 [23.11]	—	
26	.34 [8.64]	1.250 [31.75]	1.16 [29.46]	—	
34	.50 [12.70]	1.312 [33.33]	1.16 [29.46]	.343 [8.71]	II
42	.50 [12.70]	1.562 [39.68]	1.41 [35.81]	.343 [8.71]	
50	.50 [12.70]	1.812 [46.03]	1.66 [42.16]	.343 [8.71]	
75	.72 [18.29]	1.812 [46.03]	1.66 [42.16]	.562 [14.28]	

ORDERING INFORMATION Subminiature Series

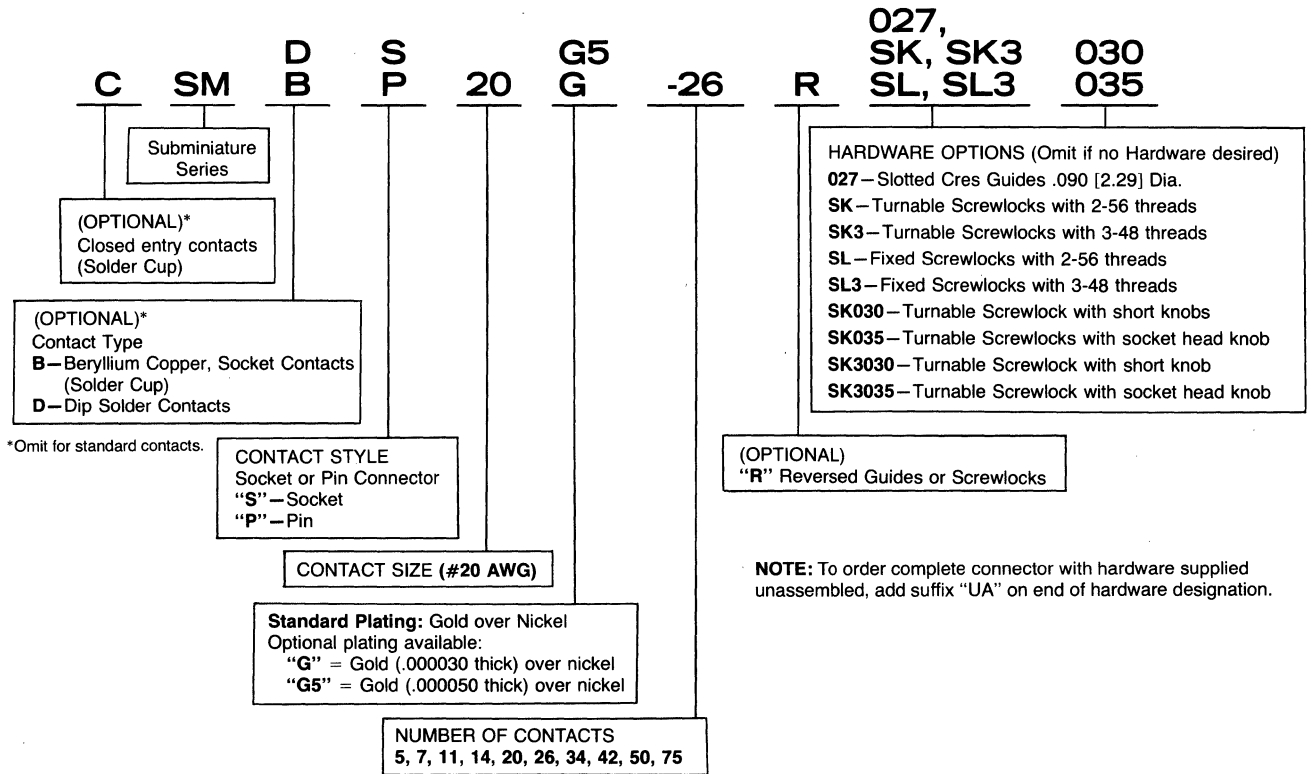

EXAMPLES:

SMBS20-26SK035—Female, 26 Beryllium Copper Socket Contacts with Socket Head Knobs on Turnable Screwlocks for #20 AWG Wiring.

SMP20-14SL3—Male, 14 Contact Pins, Fixed Screwlocks with 3-48 Threads for #20 AWG Wiring.



THERMISTORS

W Style Thermistors – Chip

FEATURES

- Top and bottom surface terminations
- High-density monolithic ceramic construction
- Allows design flexibility for use with hybrid circuitry

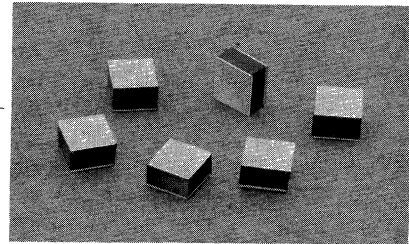
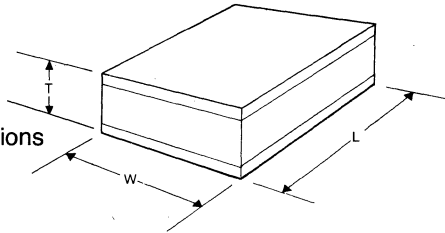

W style is a thermistor die with silver conductors fired on the top and bottom surfaces. The bottom surface can be reflow soldered or conductive epoxied directly to a substrate bonding pad, and the top surface wire bonded to complete the circuit connection.

W Style $\pm 10\%$, $\pm 5\%$ R_{25} tolerance

R_{25} Ω	PART NUMBER	CURVE NUMBER	L	W	T (nom.)
1.0 meg	12W1004	12	.050 \pm .004	.050 \pm .004	.021
500,000	12W5003	12	.062 \pm .004	.062 \pm .004	.017
250,000	12W2503	12	.088 \pm .005	.088 \pm .005	.017
200,000	7W2003	7	.040 \pm .004	.040 \pm .004	.036
100,000	12W1003	12	.139 \pm .008	.139 \pm .008	.017
100,000	8W1003	8	.049 \pm .004	.049 \pm .004	.033
100,000	7W1003	7	.053 \pm .005	.053 \pm .005	.032
80,000	8W8002	8	.050 \pm .004	.050 \pm .004	.028
50,000	8W5002	8	.053 \pm .004	.053 \pm .004	.021
50,000	7W5002	7	.052 \pm .005	.052 \pm .005	.017
30,000	8W3002	8	.073 \pm .005	.054 \pm .004	.018
30,000	7W3002	7	.065 \pm .005	.065 \pm .005	.016
30,000	1W3002	1	.029 \pm .003	.029 \pm .003	.033
20,000	1W2002	1	.035 \pm .004	.035 \pm .004	.033
15,000	1W1502	1	.041 \pm .004	.041 \pm .004	.033
10,000	1W1002	1	.050 \pm .005	.050 \pm .005	.033
3,000	1W3001	1	.066 \pm .005	.054 \pm .004	.016
2,000	1W2001	1	.100 \pm .007	.054 \pm .004	.016
2,000	2W2001	2	.049 \pm .004	.049 \pm .004	.038
1,000	2W1001	2	.052 \pm .004	.052 \pm .004	.023
1,000	1W1001	1	.104 \pm .007	.104 \pm .007	.016
500	2W5000	2	.060 \pm .005	.060 \pm .005	.016
500	1W5000	1	.147 \pm .009	.147 \pm .009	.016
300	2W3000	2	.077 \pm .005	.077 \pm .005	.016
100	2W1000	2	.134 \pm .009	.134 \pm .009	.016
50	2W0500	2	.189 \pm .012	.189 \pm .012	.016



THERMISTORS

G, H and J Style Thermistors—Hybrid Chip

FEATURES

- Wraparound terminations
- Allows design flexibility for use with hybrid circuitry
- High-density monolithic ceramic construction
- Available in 8mm tape and reel

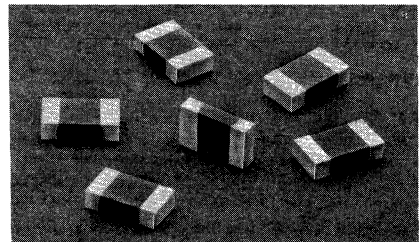
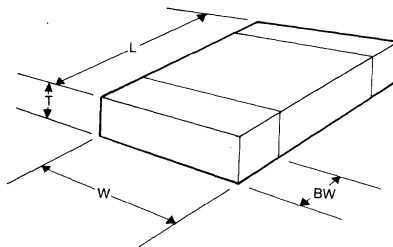

G, H and J Style chips are thermistor dies with wraparound terminations for mounting directly to the bonding pads of a hybrid substrate. The use of low temperature 2% to 5% silver bearing solder paste, or a suitable conductive epoxy is suggested for mounting of G and H Styles. The J Style is suitable to use with standard soldering techniques such as wave or vapor phase.

- Style G** = Palladium Silver
- Style H** = Silver
- Style J** = Platinum Palladium Silver

H Style 10%, 5% R₂₅ tolerance

R ₂₅ Ω	PART NUMBER**	CURVE NUMBER	L (±.010)	W (±.005)	T (±.005)	BW (±.008)
1.0 meg*	7H1004	7	.100	.052	.020	.018
500,000	8H5003	8	.100	.051	.025	.018
100,000	1H1003	1	.105	.041	.018	.018
80,000	1H8002	1	.100	.051	.018	.018
60,000	1H6002	1	.100	.051	.022	.018
50,000	1H5002	1	.100	.049	.027	.018
40,000	1H4002	1	.100	.051	.032	.018
30,000	1H3002	1	.100	.058	.037	.018
15,000	2H1502	2	.100	.041	.016	.018
10,000	2H1002	2	.100	.049	.022	.018
8,000	2H8001	2	.100	.050	.028	.018
7,000	2H7001	2	.100	.054	.027	.018
6,000	2H6001	2	.100	.054	.032	.018
5,000	2H5001	2	.100	.056	.037	.018

*Measured at 70°C. The value will be 144.7K ohms.

**Substitute "G" for "H" in part number if palladium silver termination is desired. Substitute "J" for "H" in part number if platinum palladium silver termination is desired.

HOW TO ORDER (W, G, H and J Styles)

1	G	8002	-5
CURVE NUMBER	STYLE	RESISTANCE VALUE	TOLERANCE @ 25°C
	G = Palladium Silver H = Silver J = Platinum Palladium Silver	First three digits are significant. The last digit is the multiplier. (80,000Ω is illustrated)	±10% = none ±5% = -5

CUSTOM THERMISTOR and SENSOR ASSEMBLIES

The preceding pages list "standard" thermistor resistance values and tolerances. Contact us for additional information and assistance in developing custom thermistors and sensor assemblies to meet your application requirements.



THERMISTORS

TYPE X, M, C, F & T

Coated Thermistors

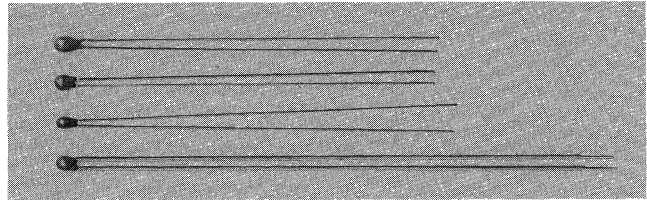
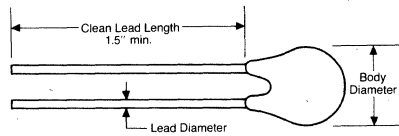

FEATURES

- Small size—conformal coated
- Wide resistance range
- Available in 8 different R-T curves
- Configured for standard P.C. board mounting or assembly in probes.

X, M, C, F and T Styles

are conformally coated, leaded thermistors for standard P.C. board mounting or assembly in probes. The coating is baked-on phenolic for durability and long-term stability. Leads are solid tinned copper, except T styles have solid nickel wires with Teflon® insulation to provide isolation when assembled in metal probes or housings.

X Style

±10%, ±5% R₇₀ tolerance

Leads solid tinned copper
1.8" ± .2" long.

R ₂₅ (Nom) Ω	R ₇₀ Ω	PART NUMBER	CURVE NUMBER	BODY DIAMETER		LEAD DIAMETER
				MAX.	MIN.	
19.68 meg	1.6 meg	*13X1604	13	.095	.075	AWG30 (.010)
9.84 meg	800,000	*13X8003	13	.095	.075	AWG28 (.012)
4.92 meg	400,000	*13X4003	13	.100	.080	AWG28 (.012)
3.08 meg	250,000	*13X2503	13	.125	.100	AWG28 (.012)
1.082 meg	130,000	*12X1303	12	.095	.070	AWG30 (.010)
998,300	120,000	*12X1203	12	.095	.070	AWG30 (.010)

M Style

±10%, ±5%, ±3%, ±2%, ±1% R₂₅ tolerance

Leads solid tinned copper
1.8" ± .2" long, AWG30 (.010")

R ₂₅ Ω	PART NUMBER	CURVE NUMBER	BODY DIAMETER	
			MAX.	MIN.
1.0 meg	*12M1004	12	.095	.070
200,000	7M2003	7	.095	.070
150,000	7M1503	7	.100	.075
100,000	7M1003	7	.095	.070
100,000	8M1003	8	.095	.070
100,000	4M1003	4	.095	.070
80,000	8M8002	8	.095	.070
50,000	8M5002	8	.095	.070
50,000	7M5002	7	.095	.070

R ₂₅ Ω	PART NUMBER	CURVE NUMBER	BODY DIAMETER	
			MAX.	MIN.
50,000	4M5002	4	.085	.060
30,000	8M3002	8	.095	.070
30,000	4M3002	4	.085	.060
30,000	1M3002	1	.095	.070
25,000	1M2502	1	.095	.070
20,000	9M2002	9	.085	.060
20,000	1M2002	1	.095	.070
17,500	1M1752	1	.095	.070
15,000	1M1502	1	.095	.070
10,000	9M1002	9	.095	.075
10,000	1M1002	1	.085	.060
6,000	1M6001	1	.085	.060
5,000	1M5001	1	.085	.060
2,252	1M2251	1	.095	.060
2,000	2M2001	2	.100	.075
1,000	2M1001	2	.085	.060

* Available in ±10% and ±5% R₂₅ tolerance only.

C Style

±10%, ±5%, ±3%, ±2%, ±1% R₂₅ tolerance

Leads solid tinned copper
1.8" ± .2" long, AWG28 (.0125")

R ₂₅ Ω	PART NUMBER	CURVE NUMBER	BODY DIAMETER	
			MAX.	MIN.
500,000	*12C5003	12	.115	.090
250,000	*12C2503	12	.145	.120
150,000	*12C1503	12	.191	.161
100,000	*12C1003	12	.226	.190
100,000	7C1003	7	.095	.070
50,000	7C5002	7	.095	.070
30,000	7C3002	7	.115	.090
30,000	8C3002	8	.095	.070
30,000	4C3002	4	.095	.075
20,000	8C2002	8	.130	.100
20,000	7C2002	7	.130	.105
20,000	4C2002	4	.095	.070
10,000	1C1002	1	.095	.070
9,000	1C9001	1	.095	.070
8,000	1C8001	1	.095	.070
7,000	1C7001	1	.095	.070
6,000	1C6001	1	.095	.070
4,000	1C4001	1	.095	.070
3,000	1C3001	1	.095	.070
2,000	1C2001	1	.095	.070
1,500	1C1501	1	.135	.110
1,250	1C1251	1	.145	.120
1,000	1C1001	1	.160	.130
1,000	2C1001	2	.095	.075
900	2C9000	2	.095	.075
800	2C8000	2	.095	.075
700	2C7000	2	.100	.075
600	2C6000	2	.100	.075
500	2C5000	2	.100	.070
400	2C4000	2	.120	.095
300	2C3000	2	.130	.105
200	2C2000	2	.150	.120
150	2C1500	2	.165	.135
100	2C1000	2	.210	.180
50	2C0500	2	.272	.242

*Available in ±10% and ±5% R₂₅ tolerance only.

F Style

±10%, ±5%, ±3%, ±2%, ±1% R₂₅ tolerance

Leads solid tinned copper
1.8" ± .2" long, AWG32 (.008")

R ₂₅ Ω	PART NUMBER	CURVE NUMBER	BODY DIAMETER	
			MAX.	MIN.
30,000	9F3002	9	.072	.050
15,000	1F1502	1	.072	.050
10,000	1F1002	1	.072	.050
5,000	1F5001	1	.072	.050

T Style

±10%, ±5%, ±3%, ±2%, ±1% R₂₅ tolerance

Leads Teflon® insulated solid nickel
3" ± .25" long, AWG30 (.010")

R ₂₅ Ω	PART NUMBER	CURVE NUMBER	BODY DIAMETER	
			MAX.	MIN.
100,000	8T1003	8	.095	.070
100,000	4T1003	4	.095	.070
50,000	8T5002	8	.095	.070
50,000	4T5002	4	.085	.060
30,000	8T3002	8	.095	.070
30,000	4T3002	4	.095	.075
20,000	9T2002	9	.095	.070
20,000	1T2002	1	.095	.070
10,000	9T1002	9	.095	.075
10,000	1T1002	1	.085	.060
5,000	1T5001	1	.085	.060
3,000	1T3001	1	.095	.070
2,252	1T2251	1	.095	.070

B Style

Leads solid tinned copper
1.8" ± .2" long, AWG 26 (.016")

Contact factory for curves, values and tolerances.

HOW TO ORDER (X, M, C, F and T Styles)

1
CURVE NUMBER

C
STYLE

2001
RESISTANCE VALUE

-5
*TOLERANCE @ 25°C

First three digits are significant. The last digit is the multiplier. (2000Ω is illustrated.)

±10% = (none) ±2% = -2
±5% = -5 ±1% = -1
±3% = -3

*X style is tolerated @ 70°C.

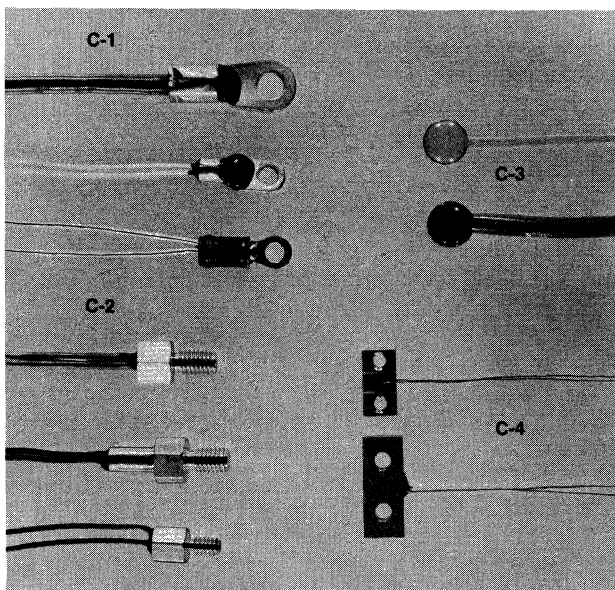
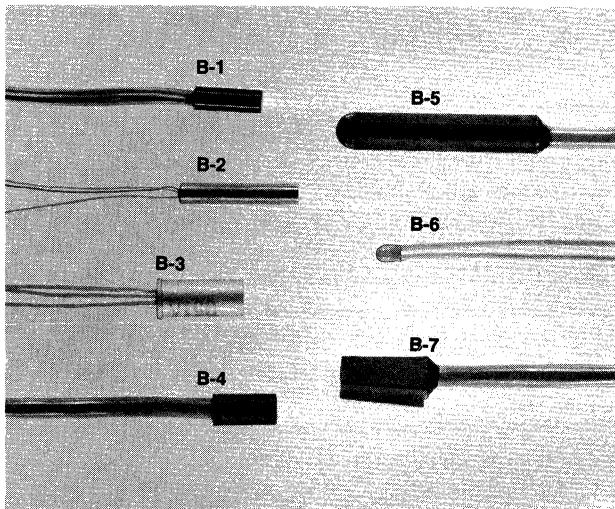
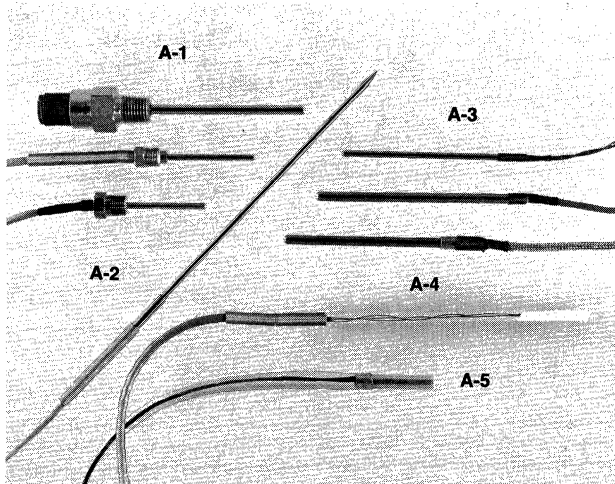

HOW TO ORDER ASSEMBLIES

1. Choose Style — "A" = immersion probe
2. Select Style Type — "1" = thread mount

3. Select Thermistor — 1M1002-C3
4. Indicate style, type and thermistor to factory for part numbers.

Standard and custom assemblies are available in a variety of configurations. The choice of assembly style is dependent on the application.

The primary factors which determine the optimum configuration of a thermistor assembly are the operating environment, mounting, time response and minimum dissipation constant. Refer to, "How to Select an NTC Thermistor" for general design aids in choice of thermistor value, tolerance and R-T curve.

Two factors which do vary considerably with assembly design are time constant and dissipation constant. The time constant will typically be of greater duration in encapsulated thermistors. This is, of course, due to additional mass surrounding the thermistor element; therefore, extending the thermal transfer time. Dissipation constant will also be greater in assemblies. The additional housing mass serves well as a heat sink. Greater power is therefore required to induce self-heating.

Both time constant and dissipation constant will vary with the selected thermistor and housing. Heat transfer properties of the housing, thermistor location, mass and wire type determine these constants. It is recommended to evaluate or consult the factory in applications where T.C. and D.C. are critical.

ASSEMBLY STYLES

A. Immersion Probes

1. **Thread Mounted** — features a stainless steel tube with a hermetically sealed threaded hex fitting. Available in 1/8", 3/16" and 1/4" outer diameter tubes with 1/8" or 1/4" NPT hex fittings. Ideal for pressured, closed systems.
2. **Penetration Probe** — 7" long x 1/8" outer diameter stainless steel tube. Pointed tip easily penetrates soft and semi-frozen materials. Also ideal for soil and ground measurements.
3. **Tubular Stainless Steel** — 1/8", 3/16" and 1/4" outer diameter tubes in variable lengths. Good for universal immersion applications. Adaptable to use with compression thread mounts to give designer variable immersion depths.
4. **Tubular Pyrex®** — 6" long x 3/16" outer diameter glass tube. Excellent for lab use where a chemically inert probe is required.
5. **Flexible Immersion** — 1.5" long x 0.280" outer diameter aluminum housing. Flexible 105°C PVC tubing to protect wire and thermistor element from the liquid medium. Ideal assembly for intermittent immersion in hard to reach areas.

B. General Purpose Sensors

1. **Delrin® Housing** — 1/2" long x 0.170" outer diameter thermoplastic. Excellent for environmental controls and applications below 100°C.
2. **Stainless Steel Rod** — 0.875" long x 0.156" outer diameter. Good for environmental chamber measurement where corrosive gasses exist.
3. **Gold Anodized Flanged Sensor** — 0.630" long x 0.275" outer diameter with a 0.298" flange diameter. An easy to mount press fitting.
4. **Polyester Shell** — 0.476" long x 0.230" outer diameter. Black thermoplastic and configuration suits it well in airflow temperature measurements.
5. **Valox® Housing** — 1.5" long x 0.280" outer diameter. Heavy thermoplastic case makes it ideal for applications requiring delayed time responses. Ideal for process controls in refrigeration and heating.
6. **Epoxy Tip Probe** — durable epoxy encapsulation, small size, fast time response, versatility and low cost make this sensor universally accepted. Assembly size will vary with wire and thermistor choice.
7. **Pipe Sensor** — 0.625" long with a cut-out radius of 0.250" suits this nylon thermoplastic as an ideal pipe sensor. Extensive use is seen in environmental and water heating/cooling systems.

C. Surface Sensors

1. **Ring Tongue Lugs** — surface mount with a #6, #8 or #10 screw. Excellent for measurement and control of surfaces where fast time responses are necessary.
2. **Heat Sink Sensors** — available in brass or aluminum with 6-32 or 10-32 UNC threads. A durable and practical surface sensor, especially where shock and vibration are present.
3. **Skin or Banjo Sensor** — stainless steel sensors for medical temperature measurements or industrial surface measurements. Adaptable for use on any flat surface.
4. **Rectangular Block Sensors** — aluminum blocks for measurement and control of large surface areas. Easily mountable with #6 screws.

NOTE — A variety of wire styles are available from stock. Depending on the probe and application, the wire will vary. Consult the factory for this and other information on assemblies.

TYPICAL THERMISTOR APPLICATIONS

1. TELECOMMUNICATIONS APPLICATIONS

Temperature Compensation of
Crystal Oscillators (TCXO)
Gain Stabilization
Transistor Temperature Compensation
Ambient Temperature Compensation

2. INDUSTRIAL APPLICATIONS

Heat Pump Sensors
Chiller Sensors
Bearing Overtemp Protection
Photographic Processing
Copy Machines
Gas Analyzers
PH Monitors
Compressor Controls
Differential Temperature Control
Industrial Process Controls
Crystal Ovens
Refrigeration
Fan Motor Speed Control
Commercial Vending Machines

3. CONSUMER APPLIANCES

Thermostats
Refrigerators
Air Conditioners
Dishwashers
Microwave Meat Probes
Small Appliances
Coffee Makers
Electronic Thermometers
Energy Efficient Monitors
Solar Collectors
Smoke Detectors
Portable Refrigerators
/Food Warmers

4. INSTRUMENTATION, COMPUTERS AND PERIPHERALS

Oscillator Stabilization
LCD Compensation
Solid State Circuit Overtemp
Protection
Thermal Printer Head Control
Hard Disc Drive Control and
Compensation
Compensation of Solid State Circuit Drift
Laboratory Grade Temperature Probes
Thermocouple Cold-Junction Compensation

5. AUTOMOTIVE AND TRANSPORTATION

Emission Controls
Coolant Sensors
Air Temperature Sensors
Climate Control
Windshield/Mirror Defroster
Altimeter
Automatic Transmission
Temperature Sensor
Oil Temperature Sensor

6. MEDICAL

Ovulation Detector
Oral, Rectal and Esophageal
Temperature Probes
Kidney Dialysis
Blood Oxygenator
Blood Analysis Equipment
Respirators
Blood Gases Monitors
Infant Incubators

HOW TO SELECT AN NTC THERMISTOR

1. Dissipation Constant (DC)

The dissipation constant is the amount of power (expressed in milliwatts) required to self-heat the thermistor suspended by its two inch leads in still air 1°C above its environment. The dissipation constant of NTC thermistor/NTC thermistor sensor assembly is typically defined as the ratio (at a specified ambient temperature) of the power dissipated in the thermistor to the resultant change in the temperature of the thermistor.

This constant (expressed as the power in milliwatts required to self-heat the thermistor 1°C above ambient temperature) increases slightly with increasing temperature. The lead length and type of lead, the type of encapsulating material (epoxy, durez, stainless steel probe, thermoplastic probe, etc.) the mounting of the NTC thermistor/assembly, the medium of the surrounding environment (flowing gas, still air, water, oil, etc.) and other factors generally determine the dissipation constant of an NTC thermistor/NTC thermistor sensor assembly.

Given the variables that affect D.C., it is recommended that a prototype should be tested under actual operating conditions to determine the maximum allowable input current. The current through the thermistor must be small enough to produce negligible self-heating error in the thermistor at the maximum measuring or controlling temperature. At the same time, the current should be as large as possible to maximize system sensitivity.

If the rate of heat loss under actual operating conditions could be fixed, and was constant from system to system, the D.C. would only be a consideration for deter-

mining the maximum power dissipated and an offset allowance could be made. For example, if the D.C. of a thermistor assembly had been determined as 3mW/°C in a stirred oil bath (the medium to be measured) and it was desired to measure the oil bath to an absolute temperature accuracy of ±0.1°C, the maximum power that should be developed in the thermistor by the measuring current is 0.15mW. This is to keep the self-heat factor to 50% or less of the measurement accuracy. The formula for this is:

$$3\text{mW}/^\circ\text{C} \times 0.1^\circ\text{C} \times 50\% = 0.15 \text{ mW}$$

The D.C. of an NTC thermistor/NTC thermistor assembly can be determined by first measuring the zero-power resistance of the NTC thermistor at two temperature points 10°C to 25°C, apart. The thermistor is then placed in series with a variable voltage supply, a current meter and sufficiently large resistor to prevent too much current flowing through the circuit and allowing the thermistor to "run-away." A high-resistance voltmeter is connected across the thermistor. The power supply is then gradually increased until the voltage across the thermistor and the current through it indicate a resistance equal to the measured resistance at the upper temperature. This is determined by using Ohm's Law $E \div I = R$ (E = volts, I = current, R = resistance). The D.C. is then calculated by dividing the power dissipated in the NTC thermistor by the temperature difference between the two measured temperatures. Power is calculated by using Ohm's Law, $P = E \times I$.

2. Time Constant (T.C.)

The time constant is the time in seconds required for the thermistor to change through 63.2% of the difference between its initial and final body temperatures, when subjected to a step change in temperature under zero-power conditions. Since the NTC thermistor's T.C. is determined by the same factors as D.C. (i.e., encapsulation, mounting, lead length, etc.), a prototype should be built if T.C. is important.

The time constant is determined by measuring the resistance of the thermistor at three temperature points, the middle point being 63.2% of the difference between the upper one and the lower one. A precision bridge is set for the middle temperature resistance with the bridge voltage supply set so as not to produce a self-heat error. An auxiliary bridge is set for the higher temperature resistance. The thermistor is placed in the operating medium at the lower temperature, and is connected to the auxiliary bridge. The auxiliary bridge voltage is adjusted to balance the bridge, which, in effect, will self-heat the thermistor to the upper temperature. The thermistor is then immediately switched to the precision bridge. The time required for the precision bridge to balance is the time constant of the NTC thermistor/NTC thermistor sensor assembly in the operating medium.

3. Selection of Resistance Value

Typically, NTC thermistors are specified and/or referenced to 25°C. However, it is equally important to consider the minimum and maximum resistance values at the extremes of the operating temperature range.

The minimum resistance at the maximum temperature point must not be too low to meet the input requirements of the measuring circuit. If the resistance is too low, errors due to contact resistance, line resistance and self-heating increase. It is recommended to have at least 500Ω-1000Ω at the high end of the temperature range.

Conversely, the maximum resistance at the minimum temperature point must not be too high for the measurement circuit input. Range switching with two or more probes should be considered if the minimum/maximum resistance values cannot be met with one thermistor.

Sensitivity also is an important consideration in the selection of the correct resistance value. Usually, the minimum and maximum allowable resistance values typically limit this selection. It then must be determined which resistance value maximizes the output of the measuring system over the entire range, taking into consideration the maximum input current as determined by the dissipation constant and allowable self-heat error.

4. R-T Curve Selection

At present, eight R-T curves are available from Dale Electronics. Each material has a different R-T characteristic. Given the different resistivities of the different R-T materials and the desirability of maintaining uniformity in size, not all resistance values (R25) are available in all R-T curves.

Once the minimum resistance at the maximum temperature is determined, divide this resistance value by a given RT/R25 ratio from one of any of the R-T curves to determine an approximate R25 value. (Note: R-T ratio tables in 1°C increments are included on pages 15 and 16.) If the R25 value is not available in one R-T curve, select another until an appropriate R-T curve is determined. Then select a standard R25 value that is closest to the approximated R25 value. Calculate the maximum resistance at the minimum temperature by multiplying the selected R25 by the given Rt/R25 ratio. If the selected R-T curve and R25 value meet the pre-determined minimum resistance, maximum resistance and sensitivity of the measurement system, then tolerance is the next consideration.

5. Tolerance

Most temperature measurement or control applications express their limitations or accuracy in temperature units (i.e. ± 1.0°C). When designing a system, it is important to consider the overall measurement accuracy of all components. A ± 1.0°C thermistor, coupled with a ± 1.0°C system, will insure measurement accuracy to ± 2.0°C.

Thermistors may be specified with either a temperature tolerance or a resistance tolerance at either a single temperature point or over a temperature range. If the required temperature measurement accuracy is over a temperature range, it is more practical to specify a temperature tolerance in lieu of a resistance tolerance. This is because a resistance tolerance specification over a range will not necessarily guarantee that the required system accuracy will be met unless the non-linear NTC (negative temperature coefficient) is taken into consideration.

NTC is expressed in % resistance change per degree °C. Since one NTC resistance change is approximately equivalent to a 1° temperature change, NTC is useful in specifying temperature tolerances. NTC's are given on the Dale Specification Sheet in ten degree increments; however, the NTC may be calculated at any temperature point using a 1°C R-T table.

$$NTC = \left(\frac{1}{R} \cdot \frac{dR}{dT} \cdot 100 \right)$$

Example: What is the NTC of 10,000Ω (R25) of a Curve 1 thermistor at 44°C?

$$100 \left(\frac{1}{4544\Omega @ 44^\circ C} \times \frac{4368\Omega @ 45^\circ C - 4726\Omega @ 43^\circ C}{2} \right) = 3.9\%$$

To determine the resistance tolerance at any given temperature point, simply multiply the specified temperature tolerance by the NTC at the given temperature.

For example: What are the resistance tolerances at 0°C, 25°C and 70°C for a Curve 1 thermistor with a ± 0.5°C temperature tolerance over the range of 0°C to 70°C?

$$\begin{aligned} R_0 &= \pm 0.5^\circ C \times -5.1\% = \pm 2.55\% \text{ resistance tolerance} \\ R_{25} &= \pm 0.5^\circ C \times -4.4\% = \pm 2.2\% \text{ resistance tolerance} \\ R_{70} &= \pm 0.5^\circ C \times -3.4\% = \pm 1.7\% \text{ resistance tolerance} \end{aligned}$$

It may now be clear why a single resistance tolerance over a temperature range may not be practical for a particular temperature measurement application.

If a single temperature point is the only design specification, NTC and Manufacturing Tolerances are useful in determining temperature tolerances at other temperature points. Manufacturing Tolerance is given on the Dale Specification Sheet in a \pm % resistance tolerance. Point-matched specifications must have the difference in deviation between the specified temperature point and any other temperature point of interest added to the resistance tolerance at the specified temperature.

For example: What are the resistance tolerances at 0°C and 50°C for a standard 1M1002?

R0 = $\pm 10\% + \pm 1.1\% = \pm 11.1\%$ resistance tolerance
R25 = $\pm 10\% + \pm 0.0\% = \pm 10\%$ resistance tolerance
R50 = $\pm 10\% + \pm 1.1\% = \pm 11.1\%$ resistance tolerance

To determine the temperature tolerance at any temperature point, divide the resistance tolerance by the NTC at that point.

For example: What is the temperature tolerance at 0°C for a 1M1002?

$\pm 11.1\% \div -5.1\% = \pm 2.2^\circ\text{C}$ temperature tolerances

It should be noted that the Manufacturing Tolerances listed on the Dale Specification Sheet are all referenced at 25°C. If the thermistor is referenced at a temperature other than 25°C, then the total difference in deviation between the two points, if the 25°C is between them, is the sum of the maximum deviations listed at each point.

For example: What is the maximum resistance tolerance of a Curve 1 thermistor at 0°C if the specified tolerance is $\pm 5\%$ at 70°C?

$(\pm 5\% \text{ resistance tolerance at } 70^\circ\text{C}) + (\text{MT} \pm 1.8\% \text{ at } 70^\circ\text{C}) + (\text{MT} \pm 1.1\% \text{ at } 0^\circ\text{C}) = \pm 7.9\% \text{ resistance tolerance at } 0^\circ\text{C}.$

6. Tolerance Availability vs R-T Curve

Not all temperature/resistance tolerances are available in all R-T Curves. If a temperature tolerance over an extended temperature range is required, then, at present, Curves 1, 2, 4, 8 or 9 may be selected. All other curves may be specified to a resistance or temperature tolerance at a single temperature point. Curves 12 and 13 may only have $\pm 5\%$ or $\pm 10\%$ resistance tolerances specified. Contact the factory for further information.

7. Tolerance Availability vs. Configuration

Not all temperature/resistance tolerances are available in all configurations. Basically, Hybrids, uncoated NTC thermistors without leads and uncoated NTC thermistors with leads are only available in $\pm 5\%$ or $\pm 10\%$ point-matched resistance tolerances.

8. Thermistor resistance measurements must be made at precisely controlled temperature while applying essentially zero-power to assure measurement accuracy.

RESISTANCE-TEMPERATURE RELATIONSHIP

Many empirical equations have been developed over the years in an attempt to accurately describe the non-linear resistance-temperature dependence of NTC thermistors. An early equation called the "Beta" formula proved to be useful over narrow temperature ranges for broad tolerances. The Beta formula may be written using a single material dependent constant B as:

$$R(T) = R(T_0) \exp \left[B \left(\frac{1}{T} - \frac{1}{T_0} \right) \right]$$

where R (T) is the resistance at the temperature T in Kelvin and R (T₀) is a reference point at temperature T₀. The Beta formula requires a two-point calibration, but under the best of conditions is not accurate to $\pm 1^\circ\text{C}$ over the range of 0°C to 100°C and typically not to $\pm 5^\circ\text{C}$ over our published temperature ranges.

The best empirical expression published to date is the Steinhart-Hart equation written explicitly in temperature T as:

$$\frac{1}{T} = A + B (\ln R) + C (\ln R)^3$$

where $\ln R$ is the natural logarithm of the resistance R at temperature T and the A, B and C's are derived coefficients from actual measurement. This form of the Steinhart-Hart equation requires a minimum of three calibration points to determine the derived coefficients. Typical accuracies would be less than $\pm 0.15^\circ\text{C}$ over the range of -50°C to $+150^\circ\text{C}$. If the temperature points selected from the R-T tables to calculate A, B, C lie within a 100°C range, the accuracy is better than $\pm 0.01^\circ\text{C}$, assuming measurement accuracy to at least four significant figures and preferably five.

The Steinhart-Hart equation is an approximation. If tighter tolerance than guaranteed is desired, then each thermistor must be individually calibrated.



INTERCHANGEABLE CURVE TRACKING AND POINT MATCHED THERMISTORS

Interchangeable curve tracking thermistors

are "curve matched" to desired temperature tolerances over selected temperature ranges. They allow component standardization and can reduce cost associated with assembly because they are "interchangeable" to within the tolerance and temperature range specified without re-calibration. They are ideally suited for use in microcomputer measurement and control circuits. The temperature tolerance corresponds to a resistance

tolerance based on the temperature coefficient at each temperature point within the specified range. Standard temperature tolerance and ranges are listed below, along with the available styles and resistances.

To specify, add the appropriate suffix from the following table to the part number.

Example: 1M1002-B3 = Curve 1, 10K @ 25°C, interchangeable to $\pm .5^\circ\text{C}$ from 0° to 70°C.

CURVE NUMBER	TEMP. RANGE		0°C to +70°C			-20°C to +50°C		0°C to +100°C			+20°C to +90°C			0°C to +50°C		
	TEMP. TOLERANCE		$\pm 1^\circ\text{C}$	$\pm .5^\circ\text{C}$	$\pm .2^\circ\text{C}$	$\pm 1^\circ\text{C}$	$\pm .5^\circ\text{C}$	$\pm 1^\circ\text{C}$	$\pm .5^\circ\text{C}$	$\pm .2^\circ\text{C}$	$\pm 1^\circ\text{C}$	$\pm .5^\circ\text{C}$	$\pm .2^\circ\text{C}$	$\pm 1^\circ\text{C}$	$\pm .5^\circ\text{C}$	$\pm .2^\circ\text{C}$
	PART NUMBER SUFFIX		-A3	-B3	-C3	-A2	-B2	-A4	-B4	-C4	-A5	-B5	-C5	-A8	-B8	-C8
	*R 25 Ω	STYLES														
1	2252	M,T	X	X	X	X	X	X	X				X	X	X	
	3000	C,T	X	X	X	X	X	X	X				X	X	X	
	5000	M,F,T	X	X	X			X	X		X	X	X	X	X	
	10,000	M,F,T	X	X	X			X	X	X	X	X	X	X	X	
	20,000	M,T	X	X	X			X	X	X	X	X	X	X	X	
	30,000	M	X	X	X			X	X	X	X	X	X	X	X	
2	1000	M				X	X						X	X		
4	30,000	M,T	X	X	X			X	X		X	X	X	X	X	
	50,000	M,T	X	X	X			X	X		X	X	X	X	X	
	100,000	M,T	X	X	X			X	X		X	X	X	X	X	
8	30,000	M,T	X	X	X			X			X	X	X	X	X	
	50,000	M,T	X	X	X			X			X	X	X	X	X	
	100,000	M,T	X	X	X			X			X	X	X	X	X	
9	10,000	M,T	X	X	X						X	X	X	X	X	
	20,000	M	X	X	X						X	X	X	X	X	
	30,000	F	X	X	X						X	X	X	X	X	

X = Available. Popular Values — contact factory for other values.

* = Standard R₂₅ Values (25° resistance)

Point Matched Thermistors

are available for applications which require a specific resistance value matched to a specific temperature point. (Example: 10,000 Ω $\pm 2\%$ at 80°C). They are useful for applications which require temperature monitoring at

a critical temperature point to control, measure, or shut-down. Consult factory with requirements. Note: All thermistors listed in this catalog are point-matched thermistors at 25°C. (X Styles at 70°C)

Models SOMC-14 and SOMC-16 01, 03, 05 Schematics

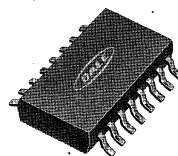

FEATURES

- .090" [2.29] maximum seated height
- Rugged, molded case construction
- Highly stable thick film
- .050" [1.27] lead spacing
- Low temperature coefficient, ± 100 PPM/ $^{\circ}\text{C}$ (-55°C to $+125^{\circ}\text{C}$)
- Reduces total assembly costs
- Compatible with automatic surface mounting equipment
- Wide resistance range
- Uniform performance characteristics
- Thin film version available, see page 134

01 SCHEMATIC

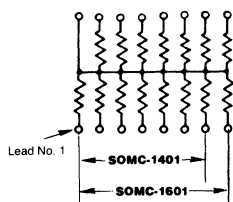

CIRCUIT EXPLANATION

13 or 15 resistors with one lead common

The SOMC-XX01 circuit provides a choice of 13 or 15 nominally equal resistors, each connected between a common lead (14 or 16) and a discrete P.C. board pin. Commonly used in the following applications:

- MOS/ROM Pull-up/Pull-down
- Open Collector Pull-up
- "Wired OR" Pull-up
- Power Driven Pull-up
- TTL Input Pull-down
- Digital Pulse Squaring
- TTL Unused Gate Pull-up
- High Speed Parallels Pull-up

03 SCHEMATIC

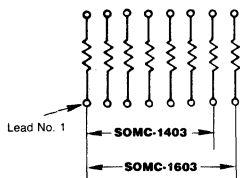

7 or 8 isolated resistors

The SOMC-XX03 circuit provides a choice of 7 or 8 nominally equal resistors with each resistor isolated from all others and wired directly across. Commonly used in the following applications:

- "Wired OR" Pull-up
- Power Driven Pull-up
- Powergate Pull-up
- Line Termination
- Long-line Impedance Balancing
- LED Current Limiting
- ECL Output Pull-down
- TTL Input Pull-down

05 SCHEMATIC

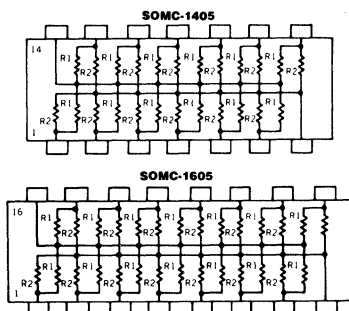

TTL dual-line terminator; pulse squaring, 12 or 14 pairs of resistors

(R_1 Resistors are common to leads 14 or 16)
(R_2 Resistors are common to leads 7 or 8)

The SOMC-XX05 circuit contains 12 or 14 pairs of resistors. Each pair is connected between ground and a common line. The junctions of these resistor pairs are connected to the input leads.

The 05 circuits are designed for TTL dual-line termination and pulse squaring.

SPECIFICATIONS

ELECTRICAL

Resistance Range: 10 ohm to 1 Meg.

Resistance Tolerance:

01 and 03 schematic: $\pm 2\%$ standard, $\pm 1\%$, $\pm 5\%$, $\pm 10\%$ and $\pm 20\%$ available.
05 schematic: $\pm 2\%$ standard, $\pm 5\%$ available.

Resistance Temperature Coefficient: ± 100 PPM/ $^{\circ}\text{C}$ (-55°C to $+125^{\circ}\text{C}$) typical

Resistor Power Rating: 01, 05 schematic = .125 watt maximum at 25°C
03 schematic = .250 watt maximum at 25°C

Package Power Rating: 14 pin 1.625 watts, 16 pin 1.875 watts (maximum at 25°C)

T.C. Tracking: 50 PPM/ $^{\circ}\text{C}$ (-55°C to $+125^{\circ}\text{C}$)

Voltage Coefficient of Resistance: < 50 PPM/V typical

Maximum Operating Voltage: 50 VDC

Operating Temperature Range: -55°C to $+125^{\circ}\text{C}$

Storage Temperature Range: -55°C to $+150^{\circ}\text{C}$

PHYSICAL

Marking: Model Number, Schematic Number, Value Code, Tolerance Code

Marking Resistance to Solvents: Permanency testing per MIL-R-83401

Maximum Solder Reflow Temperature: 255°C

Solderability: Per MIL-R-83401

Terminals: Copper alloy, 60/40 Solder Dipped Terminal

Body: Molded Epoxy

Models SOMC-14 and SOMC-16

ENVIRONMENTAL CHARACTERISTICS (Reference MIL-R-83401, Characteristic "K", typical)

- Thermal Shock: $\pm 0.5\%$ max. ΔR
- Power Conditioning: $\pm 0.5\%$ max. ΔR
- Low Temperature Operation: $\pm 0.25\%$ max. ΔR
- Short Time Overload: $\pm 0.25\%$ max. ΔR
- Terminal Strength: $\pm 0.25\%$ max. ΔR
- Resistance to Soldering Heat: $\pm 0.25\%$ max. ΔR
- Moisture Resistance: $\pm 0.5\%$ max. ΔR
- Shock: $\pm 0.25\%$ max. ΔR
- Vibration: $\pm 0.25\%$ max. ΔR
- Life: $\pm 0.5\%$ max. ΔR
- Insulation Resistance: 10,000 Megohms (minimum)
- Dielectric Withstanding Voltage: No evidence of arcing or damage (200 VRMS for 1 minute)

Type	A	B	C
SOMC-14	.390" [9.906]	.350" [8.89]	.300" [7.62]
SOMC-16	.440" [11.176]	.400" [10.16]	.350" [8.89]

DIMENSIONAL AND TERMINAL CONFIGURATIONS

[Numbers in brackets indicated millimeters]

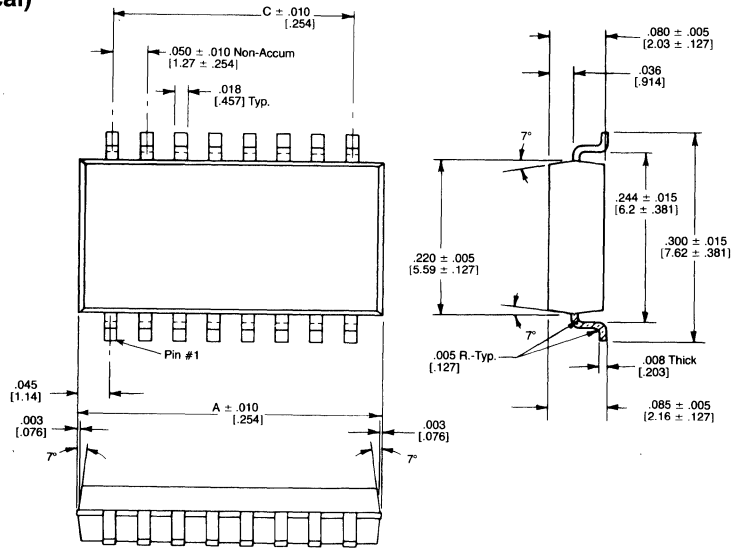

DERATING

01 & 05 SCHEMATIC

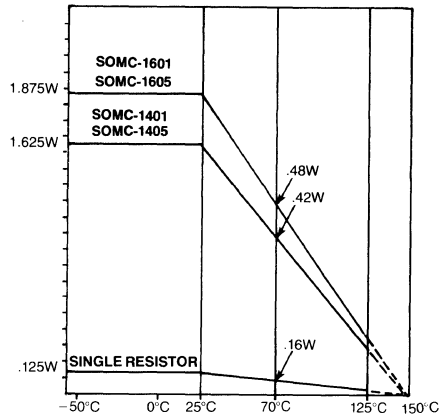

03 SCHEMATIC

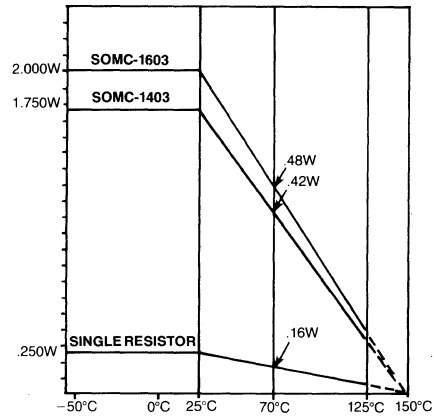

HOW TO ORDER

01, 03 SCHEMATIC

SOMC	—	14 16	03 01	—	XXX or XXXX	G
SERIES		NUMBERS OF LEADS	SCHEMATIC		RESISTANCE VALUE	TOLERANCE
					First 2 digits (3 for "F" tolerance) are significant figures. Last digit specifies number of zeros to follow.	F = $\pm 1\%$ G = $\pm 2\%$ J = $\pm 5\%$ K = $\pm 10\%$ M = $\pm 20\%$

05 SCHEMATIC

SOMC	—	14 16	05	—	XXX or XXXX / XXXX	G
SERIES		NUMBER OF LEADS	SCHEMATIC		R ₁ * VALUE R ₂ ** VALUE	TOLERANCE
					First 2 digits (3 for "F" tolerance) are significant figures. Last digit specifies number of zeros to follow.	F = $\pm 1\%$ G = $\pm 2\%$ J = $\pm 5\%$ K = $\pm 10\%$ M = $\pm 20\%$

*R₁ is the low resistance value
**R₂ is the high resistance value

DALE ELECTRONICS, INC., Box 26728, El Paso, TX 79926 • Phone 915-592-3253

Canada: Dale Electronics Ltd., 18 Howden Rd., Scarborough, Ontario M1R 3E6
Europe: Dale Electronics GmbH, Benzstrasse 28, 8039 Puchheim, West Germany



DUAL-IN-LINE, .300 WIDE J-LEAD SURFACE MOUNT THICK FILM RESISTOR NETWORK

MODEL SOJC-16 and SOJC-20 01, 03, 05 Schematics



FEATURES

- .135" [3.43] maximum seated height
- Rugged, molded case construction
- Highly stable thick film
- .050" [1.27] lead spacing
- Low temperature coefficient, ± 100 PPM/ $^{\circ}$ C (-55° C to $+125^{\circ}$ C)
- Reduces total assembly costs
- Compatible with automatic surface mounting equipment
- Wide resistance range
- Uniform performance characteristics

01 SCHEMATIC

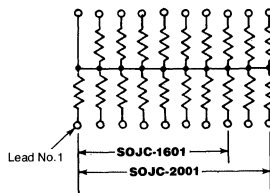

CIRCUIT EXPLANATION

15 or 19 resistors with one lead common

The SOJC-XX01 circuit provides 15 or 19 nominally equal resistors, each connected between a common lead (16 or 20) and a discrete P.C. board pin. Commonly used in the following applications:

- MOS/ROM Pull-up/Pull-down
- Open Collector Pull-up
- "Wired OR" Pull-up
- Power Driven Pull-up
- TTL Input Pull-down
- Digital Pulse Squaring
- TTL Unused Gate Pull-up
- High Speed Parallels Pull-up

03 SCHEMATIC

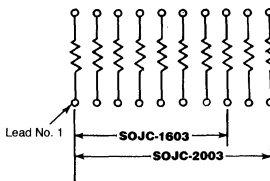

8 or 10 isolated resistors

The SOJC-XX03 circuit provides 8 or 10 nominally equal resistors with each resistor isolated from all others and wired directly across. Commonly used in the following applications:

- "Wired OR" Pull-up
- Power Driven Pull-up
- Powergate Pull-up
- Line Termination
- Long-line Impedance Balancing
- LED Current Limiting
- ECL Output Pull-down
- TTL Input Pull-down

05 SCHEMATIC

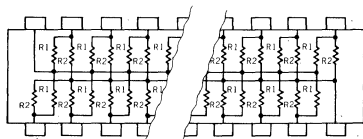

SOJC-1605
SOJC-2005

TTL dual-line terminator:
pulse squaring, 14 or 18 pairs of resistors
(R_1 Resistors are common to lead 16 or 20)
(R_2 Resistors are common to lead 8 or 10)

The SOJC-XX05 circuit contains 14 or 18 pairs of resistors. Each pair is connected between ground and a common line. The junctions of these resistor pairs are connected to the input leads.

The 05 circuits are designed for TTL dual-line termination and pulse squaring.

SPECIFICATIONS

ELECTRICAL

Resistance Range: 10 ohms to 1.0 Megohm

Resistance Tolerance:

- 01 and 03 schematic: $\pm 2\%$ standard.
- $\pm 1\%$, $\pm 5\%$, $\pm 10\%$ and $\pm 20\%$ available.
- 05 schematic: $\pm 2\%$ standard. $\pm 5\%$ available.

Resistance Temperature Coefficient: ± 100 PPM/ $^{\circ}$ C (-55° C to $+125^{\circ}$ C) typical

Resistor Power Rating: 01, 05 schematic = 0.1 watt maximum at 70° C
03 schematic = 0.19 watt maximum at 70° C

Package Power Rating: 1.5 watts, 16 pin; 1.9 watts, 20 pins (at 70° C)

T.C. Tracking: 50 PPM/ $^{\circ}$ C (-55° C to $+125^{\circ}$ C)

Voltage Coefficient of Resistance: < 50 PPM/V typical

Maximum Operating Voltage: 50 VDC

Operating Temperature Range: -55° C to $+125^{\circ}$ C

Storage Temperature Range: -55° C to $+150^{\circ}$ C

PHYSICAL

Marking: Model Number, Schematic Number, Value Code, Tolerance Code

Marking Resistance to Solvents: Permanency testing per MIL-R-83401

Maximum Solder Reflow Temperature: 255° C

Solderability: Per MIL-R-83401

Terminals: Copper alloy, hot-solder dipped

Body: Molded Epoxy

DALE ELECTRONICS, INC., Box 26728, El Paso, TX 79926 • Phone 915-592-3253

Canada: Dale Electronics Ltd., 18 Howden Rd., Scarborough, Ontario M1R 3E6
Europe: Dale Electronics GmbH, Benzstrasse 28, 8039 Puchheim, West Germany

Model SOJC-16 and SOJC-20

ENVIRONMENTAL CHARACTERISTICS (Reference MIL-R-83401, Characteristic "K", typical)

- Thermal Shock: $\pm 0.7\%$ max. ΔR
- Power Conditioning: $\pm 0.7\%$ max. ΔR
- Low Temperature Operation: $\pm 0.25\%$ max. ΔR
- Short Time Overload: $\pm 0.25\%$ max. ΔR
- Terminal Strength: $\pm 0.25\%$ max. ΔR
- Resistance to Soldering Heat: $\pm 0.25\%$ max. ΔR
- Moisture Resistance: $\pm 0.5\%$ max. ΔR
- Shock: $\pm 0.25\%$ max. ΔR
- Vibration: $\pm 0.25\%$ max. ΔR
- Life: $\pm 0.5\%$ max. ΔR
- Insulation Resistance: 10,000 Megohms (minimum)
- Dielectric Withstanding Voltage: No evidence of arcing or damage (200 VRMS for 1 minute)

DIMENSIONAL AND TERMINAL CONFIGURATIONS (Numbers in brackets indicate millimeters)

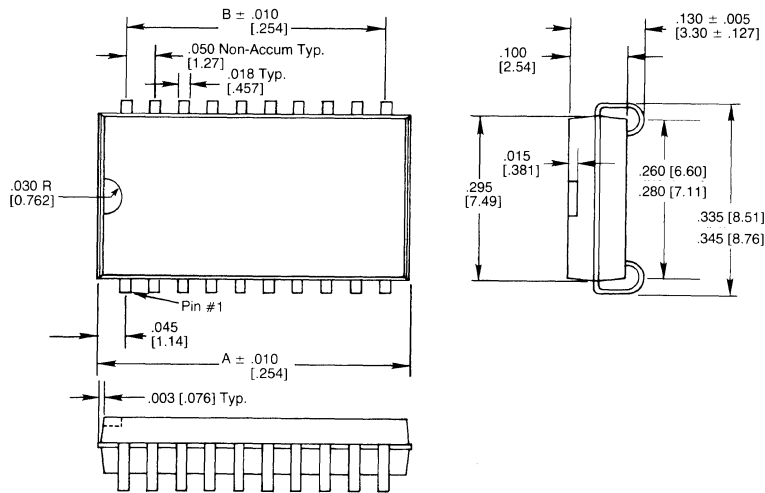

TYPE	A	B
SOJC-16	.440 [11.176]	.350 [8.89]
SOJC-20	.540 [13.716]	.450 [11.43]

DERATING

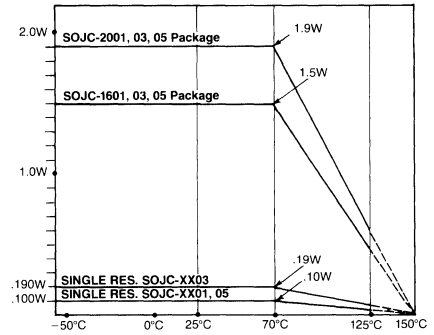

HOW TO ORDER

01, 03 SCHEMATIC

SOJC — 16 or 20 — 03 — XXX or XXXX — G
 SERIES NUMBER OF LEADS SCHEMATIC RESISTANCE VALUE TOLERANCE

First 2 digits (3 for "F" tolerance) are significant figures. Last digit specifies number of zeros to follow.

F = $\pm 1\%$
 G = $\pm 2\%$
 J = $\pm 5\%$
 K = $\pm 10\%$
 M = $\pm 20\%$

05 SCHEMATIC

SOJC — 16 or 20 — 05 — XXX or XXXX / XXX or XXXX — G
 SERIES NUMBER OF LEADS SCHEMATIC R₁* VALUE R₂** VALUE TOLERANCE

*R₁ is the low resistance value
 **R₂ is the high resistance value

First 2 digits (3 for "F" tolerance) are significant figures. Last digit specifies number of zeroes to follow.

F = $\pm 1\%$
 G = $\pm 2\%$
 J = $\pm 5\%$
 K = $\pm 10\%$
 M = $\pm 20\%$



SINGLE-IN-LINE, Coated THICK FILM RESISTOR NETWORKS

Models CSC04A thru CSC10A CSC04B thru CSC12B 01, 03, 05 Schematics

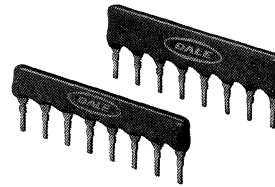

FEATURES

- .195" [4.95] "A" and .250" [6.35] "B" maximum seated heights.
- Highly stable thick film
- Low temperature coefficient ± 100 PPM/ $^{\circ}$ C (-55° C to $+125^{\circ}$ C)
- Reduces total assembly costs
- Resistor elements protected by tough epoxy conformal coating
- Wide resistance range

01 SCHEMATIC

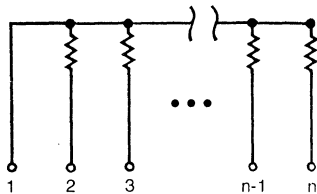

CIRCUIT APPLICATION

"A" Profile = 3 through 9 resistors with one pin common
 "B" Profile = 3 through 11 resistors with one pin common

The Dale Model CSCXXX-01 single-in-line resistor networks provide the user with a choice of 3, 4, 5, 6, 7, 8, 9, 10* or 11* nominally equal resistors, each connected to a common pin (Pin No. 1).

Commonly used in the following applications:

- "Wired OR" Pull-up
 - Power Gate Pull-up
 - MOS/ROM Pull-up/Pull-down
 - Open Collector Pull-up
 - TTL Input Pull-down
 - TTL Unused Gate Pull-up
- *"B" profile only

03 SCHEMATIC

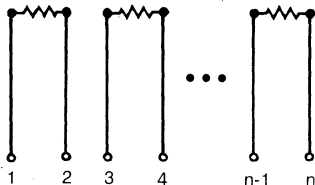

"A" Profile = 2 through 5 isolated resistors
 "B" Profile = 2 through 6 isolated resistors

The Dale Model CSCXXX-03 single-in-line resistor networks provide the user with a choice of 2, 3, 4, 5 or 6* nominally equal resistors. Each resistor is isolated from all others. Commonly used in the following applications:

- "Wired OR" Pull-up
 - Power Driven Pull-up
 - Power Gate Pull-up
 - Line Termination
 - Long-Line Impedance Balancing
 - LED Current Limiting
 - ECL Output Pull-down
 - TTL Input Pull-down
- *"B" profile only

05 SCHEMATIC

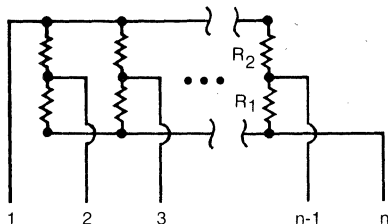

Pulse squaring and TTL dual line terminators

The CSCXXX-05 circuit contains 2, 3, 4, 5, 6, 7, 8, 9 or 10 series pairs of resistors. Each series pair is connected between two common lines. The junction of these resistor pairs is connected to the input terminals. The 05 circuits are designed for TTL dual-line termination and pulse squaring.

Models CSC04A thru CSC10A CSC04B thru CSC12B

DIMENSIONAL AND TERMINAL CONFIGURATIONS

[Numbers in brackets indicate millimeters]

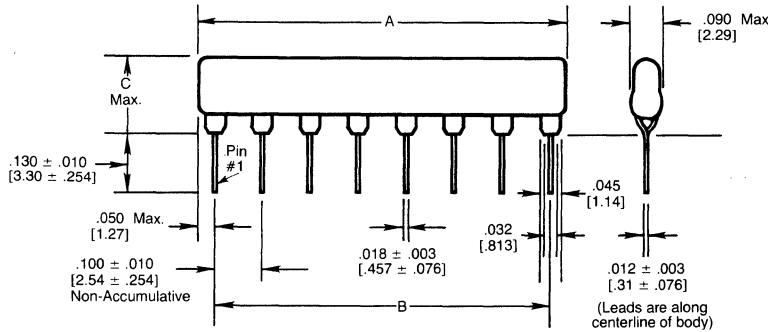

01 SCHEMATIC

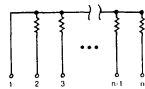

STOCKED RESISTANCE VALUES IN OHMS ("G" Tolerance)

TYPE	NO. OF RESISTORS	A (Max.)	B	C (Max.)
CSC04	3	.390 [9.91]	.300 [7.62]	
CSC05	4	.490 [12.45]	.400 [10.16]	
CSC06	5	.590 [14.99]	.500 [12.70]	
CSC07	6	.690 [17.53]	.600 [15.24]	"A" Profile = .195 [4.95]
CSC08	7	.790 [20.07]	.700 [17.78]	"B" Profile = .250 [6.35]
CSC09	8	.890 [22.61]	.800 [20.32]	
CSC10	9	.990 [25.15]	.900 [22.86]	
CSC11	10	1.090 [27.69]	1.000 [25.40]	
CSC12	11	1.190 [30.23]	1.100 [27.94]	

22	220	1K	5.6K	33K
33	270	1.2K	6.8K	47K
56	330	1.5K	10K	68K
68	390	2K	12K	100K
100	470	2.2K	15K	220K
120	510	2.7K	18K	1 Meg.
150	560	3.3K	22K	
180	680	4.7K	27K	

03 SCHEMATIC



TYPE	NO. OF RESISTORS	A (Max.)	B	C (Max.)
CSC04	2	.390 [9.91]	.300 [7.62]	
CSC06	3	.590 [14.99]	.500 [12.70]	"A" Profile = .195 [4.95]
CSC08	4	.790 [20.07]	.700 [17.78]	"B" Profile = .250 [6.35]
CSC10	5	.990 [25.15]	.900 [22.86]	
CSC12	6	1.190 [30.23]	1.100 [27.94]	

56	470	2.7K	18K
100	510	3.3K	22K
120	560	4.7K	27K
150	1K	6.8K	47K
180	1.5K	10K	100K
220	2K	12K	220K
330	2.2K	15K	1 Meg.

05 SCHEMATIC

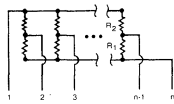

TYPE	NO. OF RESISTORS	A (Max.)	B	C (Max.)
CSC04	4	.390 [9.91]	.300 [7.62]	
CSC05	6	.490 [12.45]	.400 [10.16]	
CSC06	8	.590 [14.99]	.500 [12.70]	
CSC07	10	.690 [17.53]	.600 [15.24]	"A" Profile = .195 [4.95]
CSC08	12	.790 [20.07]	.700 [17.78]	"B" Profile = .250 [6.35]
CSC09	14	.890 [22.61]	.800 [20.32]	
CSC10	16	.990 [25.15]	.900 [22.86]	
CSC11	18	1.090 [27.69]	1.000 [25.40]	
CSC12	20	1.190 [30.32]	1.100 [27.94]	

R ₁ /R ₂	Z ₀
220/270	121
180/390	123
220/330	132
330/390	179
330/470	194
330/680	222
1.5K/3.3K	1031

DALE ELECTRONICS, INC., Box 26728, El Paso, TX 79926 • Phone 915-592-3253

Canada: Dale Electronics Ltd., 18 Howden Rd., Scarborough, Ontario M1R 3E6
Europe: Dale Electronics GmbH, Benzstrasse 28, 8039 Puchheim, West Germany

**Models CSC04A thru CSC10A
CSC04B thru CSC12B**

DERATING 01 and 05 SCHEMATIC

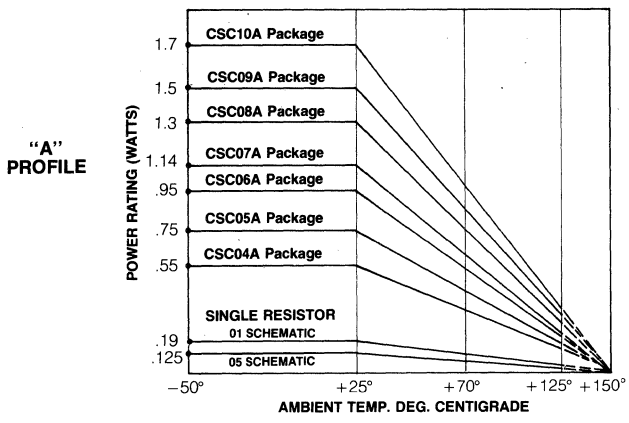

DERATING 03 SCHEMATIC

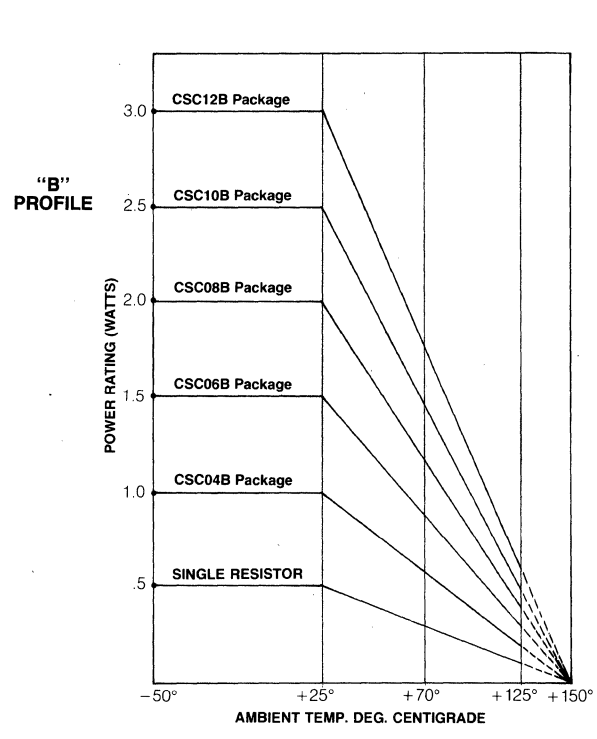
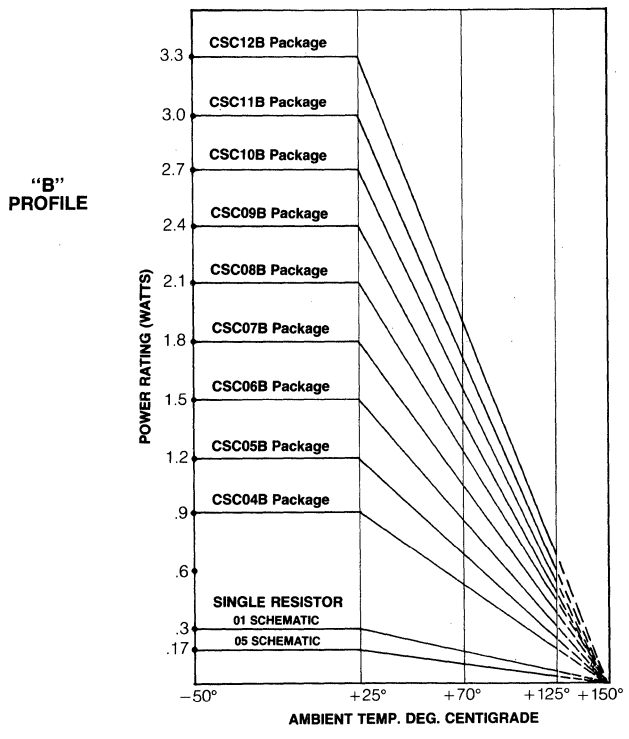
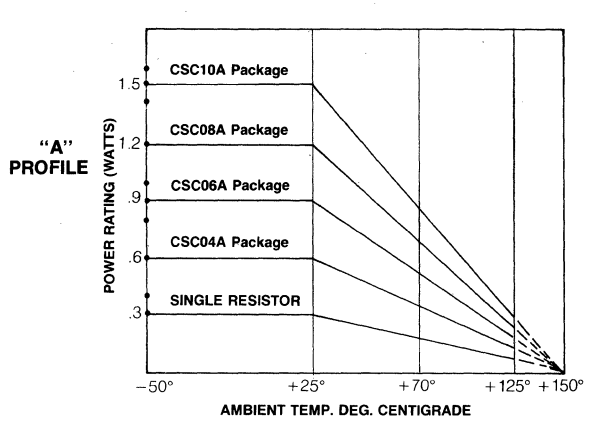

SPECIFICATIONS

ELECTRICAL

Resistance Range: 10Ω to 3.3 Meg.

Resistance Tolerance:

01 and 03 schematic: ±2% standard. ±1%, ±5%, ±10% and ±20% available.
05 schematic: ±2% standard. ±5% available.

Resistance Temperature Coefficient:

±100 PPM/°C (-55°C to +125°C) typical

Isolation Resistance:

03 schematic: >100 Megohms

Resistor Power Rating: (maximum at 25°C)

Schematic	"A" Profile	"B" Profile
01	.19 watt	.30 watt
03	.30 watt	.50 watt
05	.125 watt	.17 watt

Package Power Rating: (See Derating Curve.)

Maximum Operating Voltage: 100 VDC

Voltage Coefficient of Resistance:

< 50 PPM/V typical

T.C. Tracking:

01 and 03 schematic: 50 PPM/°C max. (-55°C to +125°C)
05 schematic: 150 PPM/°C standard (tighter tracking available)

Operating Temperature Range: -55°C to +125°C

PHYSICAL

Marking Resistance to Solvents: Permanency testing per MIL-R-83401

Solderability: Per MIL-STD-202, Method 208E

Terminals: Copper alloy, tin-lead plated

Body: High alumina, epoxy coated.

**Models CSC04A thru CSC10A
CSC04B thru CSC12B**

ENVIRONMENTAL CHARACTERISTICS

(PARTS will meet the following specifications when tested per procedures of MIL-R-83401. Parts are not MIL approved.)

- Thermal Shock:** $\pm 0.5\%$ max. ΔR (5 cycles between -65°C and $+125^{\circ}\text{C}$)
- Low Temperature Operation:** $\pm 0.25\%$ max. ΔR (45 minutes at full rated working voltage at -65°C)
- Short Time Overload:** $\pm 0.25\%$ max. ΔR (2-1/2 x rated working voltage 5 seconds)
- Terminal Strength:** $\pm 0.25\%$ max. ΔR (4-1/2 pound pull for 30 seconds)
- Resistance to Soldering Heat:** $\pm 0.25\%$ max. ΔR (Leads immersed in 350°C solder to within 1/16" of device body for 3 seconds)
- Moisture Resistance:** $\pm 1\%$ max. ΔR (240 hours with humidity ranging from 80% RH to 98% RH)
- Shock:** $\pm 0.25\%$ max. ΔR (Total of 18 shocks at 100 G's)
- Vibration:** $\pm 0.25\%$ max. ΔR (12 hours at maximum of 20 G's between 10 and 2,000 Hz)
- Life:** $\pm 1\%$ max. ΔR (1,000 hours at 70°C , rated power applied 1-1/2 hours on, 1/2 hour off for full 1,000 hour period). See derating curves.
- Insulation Resistance:** 10,000 Megohms (minimum)
- Dielectric Withstanding Voltage:** No evidence of arcing or damage (200 VRMS for 1 minute)

HOW TO ORDER

01 and 03 SCHEMATIC

CSC	08	A	01 03	-101	G
SERIES	NUMBER OF PINS	PACKAGE CODE	SCHEMATIC	RESISTANCE VALUE	TOLERANCE
		A = .195" [4.95] height; .100" [2.54] lead spacing. B = .250" [6.35] height; .100" [2.54] lead spacing.	01 = pin #1 Common to all resistors 03 = Isolated Resistors	First two digits (3 for "F" tolerance) are significant. Last digit specifies the number of zeros.	F = $\pm 1\%$ G = $\pm 2\%$ J = $\pm 5\%$ K = $\pm 10\%$ M = $\pm 20\%$

05 SCHEMATIC

CSC	08	A	05	-221	/	331	G
SERIES	NUMBER OF PINS	PACKAGE CODE	SCHEMATIC	RESISTANCE VALUE R ₁		RESISTANCE VALUE R ₂	TOLERANCE
		A = .195" [4.95] height; .100" [2.54] lead spacing. B = .250" [6.35] height; .100" [2.54] lead spacing		First two digits are significant figures. The third digit specifies the number of zeros to follow.			G = $\pm 2\%$ J = $\pm 5\%$



SINGLE-IN-LINE, Molded THICK FILM RESISTOR NETWORKS

Models MSP06A, MSP08A, MSP10A MSP06C, MSP08C, MSP10C 01, 03, 05 Schematics

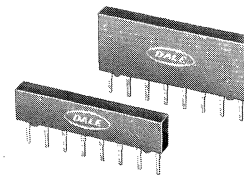

FEATURES

- .195" [4.95] "A" or .350" [8.89] "C" maximum seated height
- Highly stable thick film
- Low temperature coefficient ± 100 PPM/ $^{\circ}$ C (-55° C to $+125^{\circ}$ C)
- Rugged molded case construction
- Reduces total assembly costs
- Compatible with automatic insertion equipment
- Reduces P.C. board space
- Wide resistance range

01 SCHEMATIC

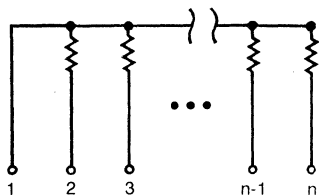

CIRCUIT APPLICATION

5, 7 or 9 resistors with one pin common

The MSPXXX-01 circuit contains 5, 7 or 9 nominally equal resistors, each connected between a common pin (Pin No. 1) and a discrete P.C. board pin. Commonly used in the following applications:

- "Wired OR" Pull-up
- Power Gate Pull-up
- TTL Input Pull-down
- MOS/ROM Pull-up/Pull-down
- Open Collector Pull-up
- TTL Unused Gate Pull-up

03 SCHEMATIC

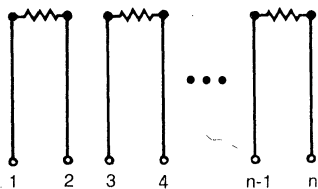

3, 4 or 5 isolated resistors

THE MSPXXX-03 circuit contains 3, 4 or 5 resistors of nominally equal value in a compact package. Each resistor is connected to two discrete P.C. pins.

05 SCHEMATIC

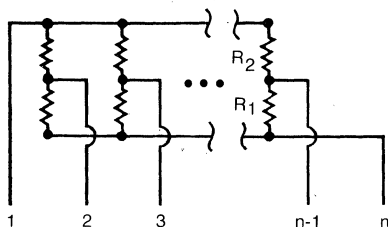

Pulse squaring and TTL dual-line terminators

THE MSPXXX-05 circuits contains 4, 6 or 8 series pairs of resistors. Each series pair is connected between two common lines. The junction of these resistor pairs is connected to the input terminals. The 05 circuits are designed for TTL dual-line termination and pulse squaring.

**Models MSP06A, MSP08A, MSP10A
MSP06C, MSP08C, MSP10C**

DIMENSIONAL AND TERMINAL CONFIGURATIONS

[Numbers in brackets indicate millimeters]

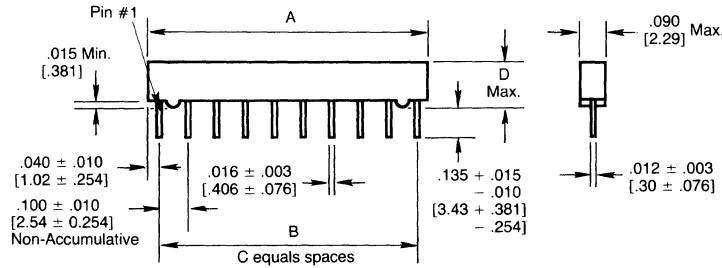

TYPE	A	B	C	D
MSP06	.590 [14.99] Max.	.500 [12.70]	5	MSPXXA = .195 [4.95] MSPXXC = .350 [8.89]
MSP08	.790 [20.07] Max.	.700 [17.78]	7	
MSP10	.990 [25.15] Max.	.900 [22.86]	9	

01 SCHEMATIC

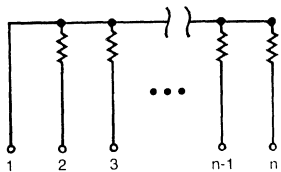

**STOCKED RESISTANCE VALUES IN OHMS
("G" Tolerance)**

*22	82	220	560	1.8K	4.7K	12K	33K	82K	330K
33	100	270	680	2.0K	5.6K	15K	39K	100K	470K
39	*110	330	820	2.2K	*6.0K	18K	47K	*120K	*500K
47	120	390	1K	2.7K	6.8K	*20K	*51K	*150K	1 Meg.
56	150	470	1.2K	3.3K	8.2K	22K	56K	*180K	
68	180	510	1.5K	3.9K	10K	27K	68K	220K	

*MSPXXA only

Additional resistance values are constantly being added. Please contact your local Dale Distributor or Representative to check availability of values not shown.

03 SCHEMATIC

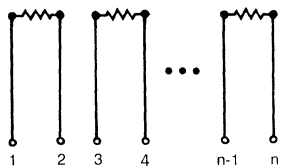

22	*82	270	*820	*2.7K	*8.2K	33K	*120K
*27	100	330	1K	3.3K	10K	*39K	*150K
*29	*110	390	*1.2K	*3.9K	*12K	47K	*180K
33	120	470	1.5K	4.7K	15K	*56K	220K
*39	150	*510	*1.8K	*5.6K	*18K	.68K	*330K
47	180	*560	*2.0K	*6.0K	22K	*82K	470K
56	220	680	2.2K	6.8K	*27K	100K	1 Meg.
68							

*MSPXXA only

Additional resistance values are constantly being added. Please contact your local Dale Distributor or Representative to check availability of values not shown.

05 SCHEMATIC

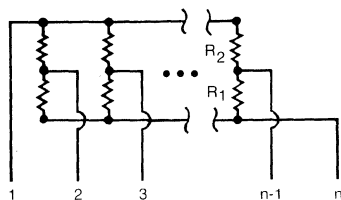

R ₁ /R ₂	Z ₀	R ₁ /R ₂	Z ₀
220/270	121	330/470	194
180/390	123	330/680	222
220/330	132	1.5K/3.3K	1031
330/390	179		

**Models MSP06A, MSP08A, MSP10A
MSP06C, MSP08C, MSP10C**

DERATING

**01
SCHEMATIC**

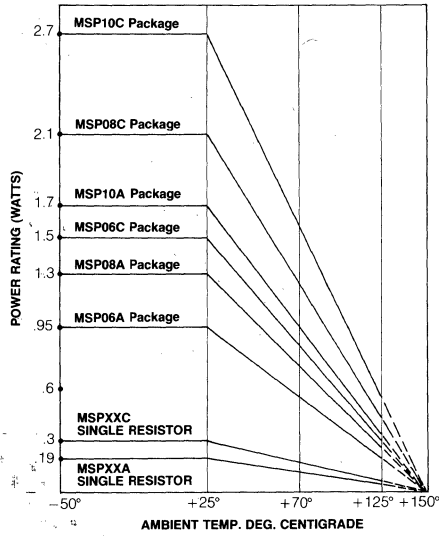

**03
SCHEMATIC**

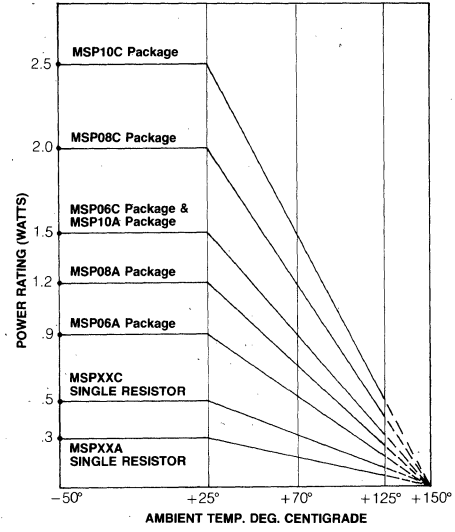

**05
SCHEMATIC**

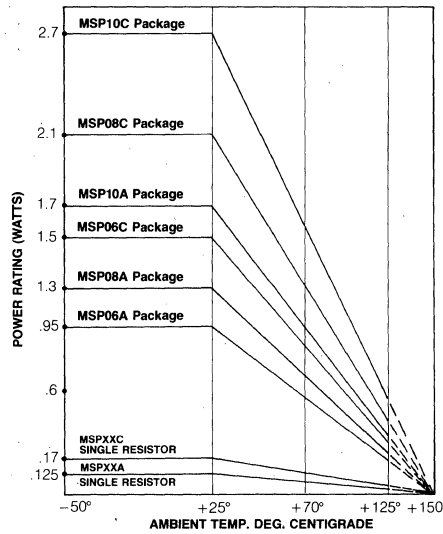

SPECIFICATIONS

ELECTRICAL

Resistance Range: 10Ω to 3.3 Meg.

Resistance Tolerance:

01 and 03 schematic: ±2% standard. ±1%, ±5%, ±10% and ±20% available.
05 schematic: ±2% standard. ±5% available

Resistance Temperature Coefficient:

±100 PPM/°C (-55°C to +125°C) typical

Temperature Coefficient of R Tracking:

01 and 03 schematic: 50 PPM/°C max. (-55°C to +125°C)
05 schematic: 150 PPM/°C standard (tighter tracking available)

Isolation Resistance:

03 schematic: >100 Megohms

Resistor Power Rating: (maximum at 25°C)

Schematic	"A" Profile	"C" Profile
01	.19 watt	.30 watt
03	.30 watt	.50 watt
05	.125 watt	.17 watt

Package Power Rating: (See derating curve.)

Voltage Coefficient of Resistance:

<50 PPM/V typical

Maximum Operating Voltage: 100 VDC

Operating Temperature Range: -55°C to +125°C

Storage Temperature Range: -55°C to +150°C

PHYSICAL

Marking Resistance to Solvents: Permanency testing per MIL-R-83401

Solderability: Per MIL-STD-202, Method 208E

Terminals: Copper alloy, tin-lead plated

Body: Molded epoxy

Weight: MSP06A = .4 gram. MSP06C = .7 gram.
MSP08A = .5 gram. MSP08C = .9 gram.
MSP10A = .6 gram. MSP10C = 1.1 grams.

**Models MSP06A, MSP08A, MSP10A
MSP06C, MSP08C, MSP10C**

ENVIRONMENTAL CHARACTERISTICS

(MIL-R-83401 Ref.)

Thermal Shock: $\pm 0.5\%$ max. ΔR (5 cycles between -65°C and $+125^{\circ}\text{C}$)

Power Conditioning: $\pm 0.5\%$ max. ΔR (At $1\frac{1}{2}$ x rated power, applied $1\frac{1}{2}$ hours on and $\frac{1}{2}$ hour off for 100 hours ± 4 hours at 25°C ambient temperature)

Low Temperature Operation: $\pm 0.25\%$ max. ΔR
(45 minutes at full rated working voltage at -65°C)

Short Time Overload: $\pm 0.25\%$ max. ΔR
($2\frac{1}{2}$ x rated working voltage 5 seconds)

Terminal Strength: $\pm 0.25\%$ max. ΔR ($4\frac{1}{2}$ pound pull for 30 seconds)

Resistance to Soldering Heat: $\pm 0.25\%$ max. ΔR (Leads immersed in 350°C solder to within $1/16''$ of device body for 3 seconds)

Moisture Resistance: $\pm 0.5\%$ max. ΔR (240 hours with humidity ranging from 80% RH to 98% RH)

Shock: $\pm 0.25\%$ max. ΔR (Total of 18 shocks at 100 G's)

Vibration: $\pm 0.25\%$ max. ΔR
(12 hours at maximum of 20 G's between 10 and 2,000 Hz)

Life: $\pm 0.5\%$ max. ΔR (1,000 hours at 70°C , rated power applied $1\frac{1}{2}$ hours on, $\frac{1}{2}$ hour off for full 1,000-hour period). Derated according to the curve.

Insulation Resistance: 10,000 Megohms (minimum)

Dielectric Withstanding Voltage: No evidence of arcing or damage (200 VRMS for 1 minute)

HOW TO ORDER

01 SCHEMATIC

MSP	08	A	—	01	—	101	G
SERIES	NUMBER OF PINS	PACKAGE CODE		SCHEMATIC		RESISTANCE VALUE	TOLERANCE
		A = .195" [4.95] Height .100" [2.54] Lead Spacing C = .350" [8.89] Height .100" [2.54] Lead Spacing				First two digits are significant. (3 for "F" tolerance.) Last digit specifies the number of zeros.	F = $\pm 1\%$ G = $\pm 2\%$ J = $\pm 5\%$ K = $\pm 10\%$ M = $\pm 20\%$

03 SCHEMATIC

MSP	06	A	—	03	—	102	G
SERIES	NUMBER OF PINS	PACKAGE CODE		SCHEMATIC		RESISTANCE VALUE	TOLERANCE
		A = .195" [4.95] Height .100" [2.54] Lead Spacing C = .350" [8.89] Height .100" [2.54] Lead Spacing				First two digits (3 for "F" tolerance) are significant figures; last digit specifies number of zeros to follow.	F = $\pm 1\%$ G = $\pm 2\%$ J = $\pm 5\%$ K = $\pm 10\%$ M = $\pm 20\%$

05 SCHEMATIC

MSP	06	A	—	05	—	221	/	331	G
SERIES	NUMBER OF PINS	PACKAGE CODE		SCHEMATIC		RESISTANCE VALUE R ₁		RESISTANCE VALUE R ₂	TOLERANCE
		A = .195" [4.95] Height .100" [2.54] Lead Spacing C = .350" [8.89] Height .100" [2.54] Lead Spacing				First two digits are significant figures. The third digit specifies the number of zeros to follow.			G = $\pm 2\%$ J = $\pm 5\%$

EXAMPLE:

MSP06A-05-221/331G = A molded single-in-line thick film resistor network with 6 pins on .100" [2.54] centers, .195" [4.95] maximum seated height, 05 schematic with resistances of R₁ = 220Ω and R₂ = 330Ω and a $\pm 2\%$ tolerance.

EXAMPLE:

MSP08A-01-101G = A molded single-in-line thick film resistor network with 8 pins on .100" [2.54] centers, .195" [4.95] maximum seated height, 01 schematic, resistance value of 100Ω and a tolerance of $\pm 2\%$.



DUAL-IN-LINE, Molded THICK FILM RESISTOR NETWORKS

Models MDP14, MDP16, MDP18 01, 03, 05 Schematics

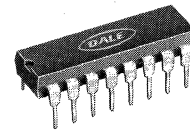

FEATURES

- .160 [4.06] maximum seated height
- Rugged, molded case construction
- Highly stable thick film
- Low temperature coefficient
±100 PPM/°C (-55°C to +125°C)
- Reduces total assembly costs
- Compatible with automatic insertion equipment
- Wide resistance range
- Uniform performance characteristics

01 SCHEMATIC

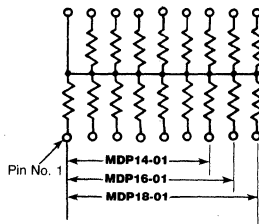

CIRCUIT APPLICATION

13, 15 or 17 resistors with one pin common
The MDPXX-01 circuit provides a choice of 13, 15 or 17 nominally equal resistors, each connected between a common pin (14, 16 or 18) and a discrete P.C. board pin. Commonly used in the following applications:

- MOS/ROM Pull-up/Pull-down
- Open Collector Pull-up
- "Wired OR" Pull-up
- Power Driven Pull-up
- TTL Input Pull-down
- Digital Pulse Squaring
- TTL Unused Gate Pull-up
- High Speed Parallels Pull-up

03 SCHEMATIC

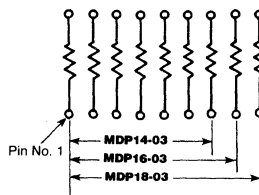

7, 8 or 9 isolated resistors

The MDPXX-03 circuit provides a choice of 7, 8 or 9 nominally equal resistors with each resistor isolated from all others and wired directly across. Commonly used in the following applications:

- "Wired OR" Pull-up
- Power Driven Pull-up
- Powergate Pull-up
- Line Termination
- Long-line Impedance Balancing
- LED Current Limiting
- ECL Output Pull-down
- TTL Input Pull-down

05 SCHEMATIC

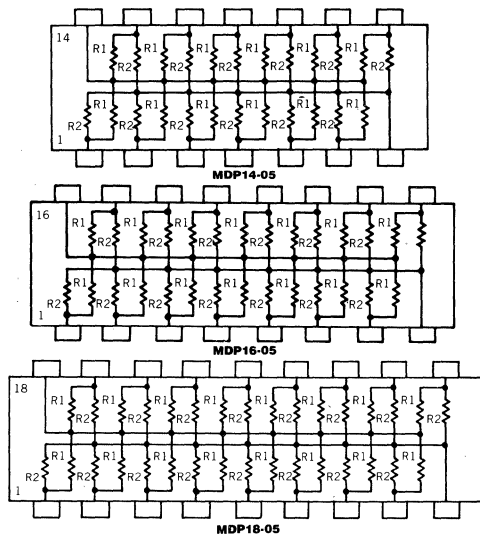

TTL dual-line terminator; pulse squaring

The MDPXX-05 circuit contains 12, 14 or 16 series pairs of resistors. Each series pair is connected between ground and a common line. The junction of these resistor pairs is connected to the input terminals.

The 05 circuits are design for TTL dual-line termination and pulse squaring.

Models MDP14, MDP16, MDP18

DIMENSIONAL AND TERMINAL CONFIGURATIONS

[Numbers in brackets indicate millimeters]

TYPE	A	B	C
MDP14	.750 [19.05]	.600 [15.24]	6
MDP16	.850 [21.59]	.700 [17.78]	7
MDP18	.950 [24.13]	.800 [20.32]	8

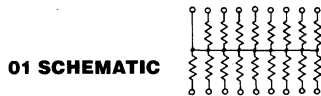
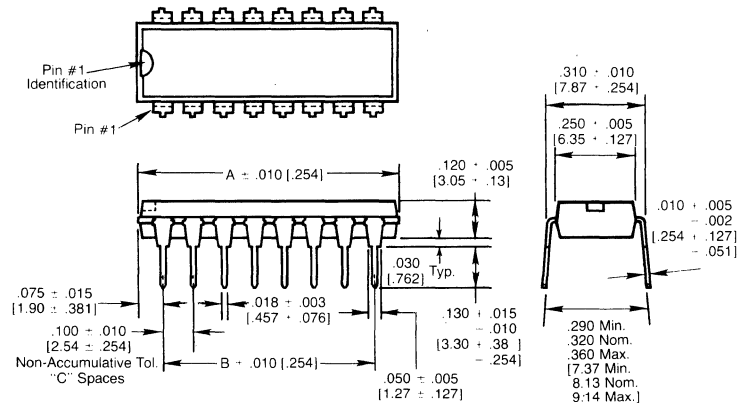

STOCKED RESISTANCE VALUES IN OHMS ("G" Tolerance)

Other values from 10Ω to 3.3 Megohm

MODEL MDP14-01

22	82	220	680	2.2K	6.0K	18K	82K
27	91	240	820	2.4K	6.8K	20K	100K
33	100	270	1K	2.7K	7.5K	22K	120K
39	120	330	1.2K	3.0K	8.2K	27K	150K
47	130	390	1.3K	3.3K	9.1K	33K	180K
51	150	470	1.5K	3.9K	10K	39K	220K
56	160	510	1.6K	4.7K	11K	47K	330K
68	180	560	1.8K	5.1K	12K	56K	470K
75	200	620	2.0K	5.6K	15K	68K	1 Meg.

MODELS MDP16-01 and MDP18-01

22	120	560	2.7K	12K	68K	1 Meg.
33	150	680	3.3K	15K	82K	
39	180	820	3.9K	18K	100K	
47	220	1K	4.7K	22K	120K	
56	270	1.2K	5.6K	27K	150K	
68	330	1.5K	6.0K	33K	180K	
82	390	1.8K	6.8K	39K	220K	
100	470	2.0K	8.2K	47K	330K	
110	510	2.2K	10K	56K	470K	

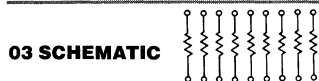

MODEL MDP14-03

22	51	120	300	680	1.6K	3.9K	8.2K	20K	100K
24	56	130	330	750	1.8K	4.3K	9.1K	22K	120K
27	62	150	360	820	2.0K	4.7K	10K	27K	150K
30	68	160	390	910	2.2K	5.1K	11K	33K	180K
33	75	180	430	1K	2.4K	5.6K	12K	39K	220K
36	82	200	470	1.1K	2.7K	6.0K	13K	47K	330K
39	91	220	510	1.2K	3.0K	6.2K	15K	56K	470K
43	100	240	560	1.3K	3.3K	6.8K	16K	68K	1 Meg.
47	110	270	620	1.5K	3.6K	7.5K	18K	82K	

MODELS MDP16-03 and MDP18-03

22	110	560	2.7K	12K	82K
33	120	680	3.3K	15K	100K
39	150	820	3.9K	18K	120K
47	180	1K	4.7K	22K	150K
56	220	1.2K	5.6K	27K	180K
62	270	1.5K	6.0K	33K	220K
68	330	1.8K	6.8K	39K	330K
82	390	2.0K	8.2K	47K	470K
100	470	2.2K	10K	56K	680K
				68K	1 Meg.

05 SCHEMATIC

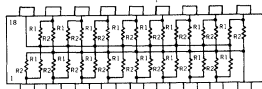

MODELS MDP14-05, MDP16-05 and MDP18-05

VALUE	Zo	VALUE	Zo
180/390	123	330/470	194
220/270	121	330/680	222
220/330	132	1.5K/3.3K	1.03K
330/390	179		

Models MDP14, MDP16, MDP18

DERATING

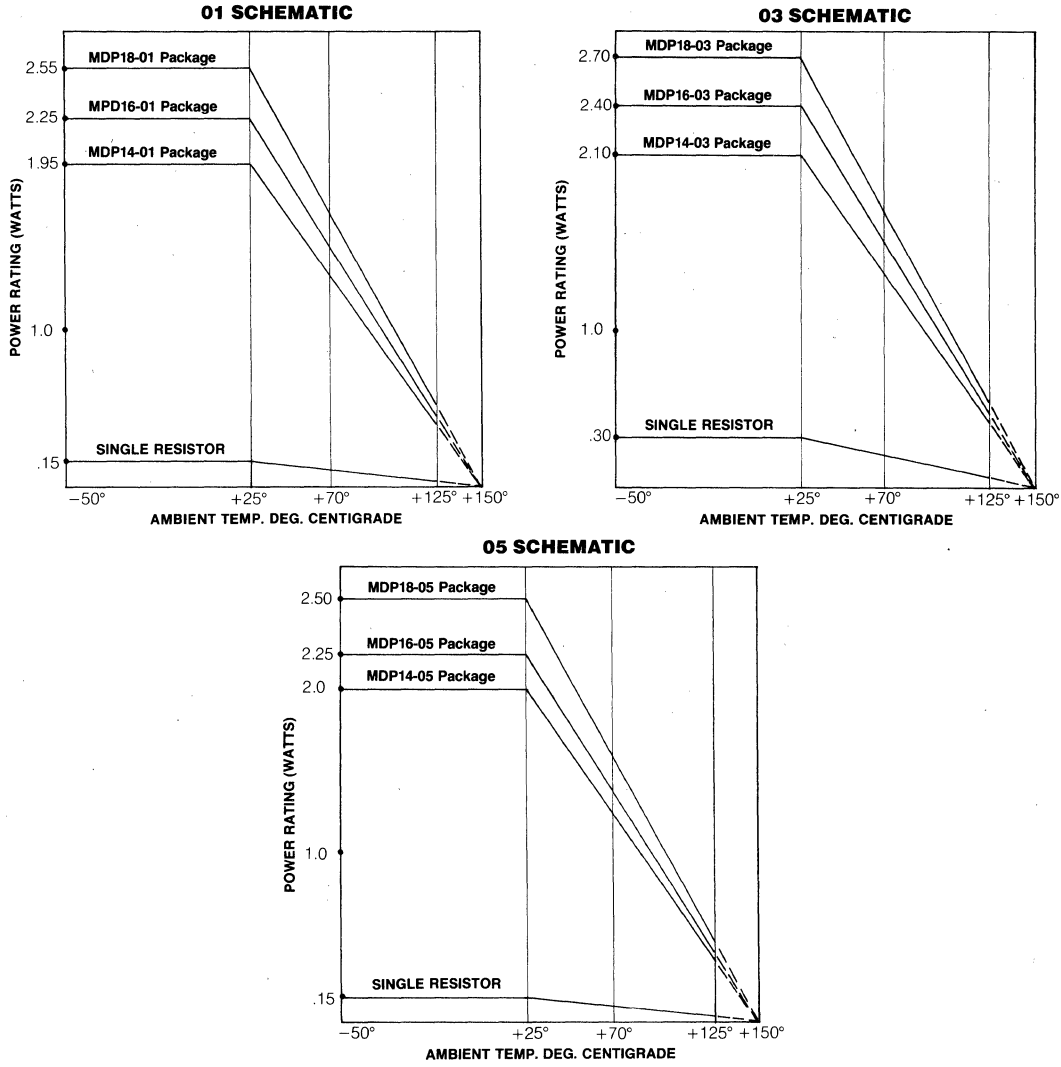

SPECIFICATIONS

ELECTRICAL

Resistance Range: 10Ω to 3.3 Meg.

Resistance Tolerance:

01 and 03 schematic: ±2% standard. ±1%, ±5%, ±10% and ±20% available.
 05 schematic: ±2% standard. ±1% and ±5% available.

Resistance Temperature Coefficient: ±100 PPM/°C (-55°C to +125°C) typical

Resistor Power Rating:

01 and 05 schematic: .15 watt maximum at 25°C
 03 schematic: 0.3 watt maximum at 25°C

Package Power Rating: (maximum at 25°C)

Schematic	14 Pin	16 Pin	18 Pin
01	1.95 watts	2.25 watts	2.55 watts
03	2.1 watts	2.4 watts	2.7 watts
05	2.0 watts	2.25 watts	2.5 watts

T.C. Tracking:

01 and 03 schematic: 50 PPM/°C (-55°C to +125°C)
 05 schematic: ±150 PPM/°C
 standard (tighter tracking available)

Voltage Coefficient of Resistance:

< 50 PPM/V typical

Maximum Operating Voltage: 100 VDC

Operating Temperature Range: -55°C to +125°C

Storage Temperature Range: -55°C to +150°C

PHYSICAL

Marking Resistance to Solvents: Permanency testing per MIL-R-83401

Solderability: Per MIL-STD-202, Method 208E

Terminals: Copper alloy, tin-lead plated

Body: Molded epoxy

Weight: 14 pin = 1.3 grams; 16 pin = 1.5 grams; 18 pin = 1.7 grams

Models MDP14, MDP16, MDP18

ENVIRONMENTAL CHARACTERISTICS
(MIL-R-83401 Ref.)

- Thermal Shock:** $\pm 0.5\%$ max. ΔR (5 cycles between -65°C and $+125^{\circ}\text{C}$)
- Power Conditioning:** $\pm 0.5\%$ max. ΔR (At $1\frac{1}{2}$ x rated power, applied $1\frac{1}{2}$ hours on and $\frac{1}{2}$ hour off for 100 hours ± 4 hours at 25°C ambient temperature)
- Low Temperature Operation:** $\pm 0.25\%$ max. ΔR
(45 minutes at full rated working voltage at -65°C)
- Short Time Overload:** $\pm 0.25\%$ max. ΔR
($2\frac{1}{2}$ x rated working voltage 5 seconds)
- Terminal Strength:** $\pm 0.25\%$ max. ΔR ($4\frac{1}{2}$ pound pull for 30 seconds)
- Resistance to Soldering Heat:** $\pm 0.25\%$ max. ΔR (Leads immersed in 350°C solder to within $1/16''$ of device body for 3 seconds)
- Moisture Resistance:** $\pm 0.5\%$ max. ΔR (240 hours with humidity ranging from 80% RH to 98% RH)
- Shock:** $\pm 0.25\%$ max. ΔR (Total of 18 shocks at 100 G's)
- Vibration:** $\pm 0.25\%$ max. ΔR
(12 hours at maximum of 20 G's between 10 and 2,000 Hz)
- Life:** $\pm 0.5\%$ max. ΔR (1,000 hours at 70°C , rated power applied $1\frac{1}{2}$ hours on, $\frac{1}{2}$ hour off for full 1,000-hour period). Derated according to the curve.
- Insulation Resistance:** 10,000 Megohms (minimum)
- Dielectric Withstanding Voltage:** No evidence of arcing or damage (200 VRMS for 1 minute)

HOW TO ORDER

01 and 03 Schematic

MDP	14	—	01 03	—101	G
SERIES	NUMBER OF PINS		SCHEMATIC	RESISTANCE VALUE	TOLERANCE
				First 2 digits (3 for "F" tolerance) are significant figures, last digit specifies number of zeros to follow.	F = $\pm 1\%$ G = $\pm 2\%$ J = $\pm 5\%$ K = $\pm 10\%$ M = $\pm 20\%$

05 Schematic

MDP	14	—	05	—221	/	271	G
SERIES	NUMBER OF PINS		SCHEMATIC	RESISTANCE VALUE R ₁		RESISTANCE VALUE R ₂	TOLERANCE
				First two digits (3 for "F" tolerance) are significant figures. The last digit specifies the number of zeros to follow.		F = $\pm 1\%$ G = $\pm 2\%$ J = $\pm 5\%$	

EXAMPLE:
MDP14-03-101G = A dual-in-line thick film resistor network with 14 pins on .100 [2.54] centers, 03 schematic, resistance of 100Ω and a tolerance of $\pm 2\%$.

EXAMPLE:
MDP14-05-221/271G = A 14-pin dual-in-line thick film resistor network with 12 series pairs of resistors of 220Ω and 270Ω per pair and a tolerance of $\pm 2\%$.



DUAL-IN-LINE, Molded THICK FILM RESISTOR NETWORKS

Model MDP16-45

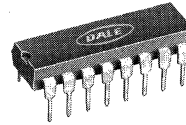

FEATURES

- .190 [4.83] maximum seated height
- Rugged, molded case construction
- Highly stable thick film
- Low temperature coefficient
±100 PPM/°C (-55°C to +125°C)
- Reduces total assembly costs
- Compatible with automatic insertion equipment
- Reduces P.C. board space

SCHEMATIC

MDP16-45

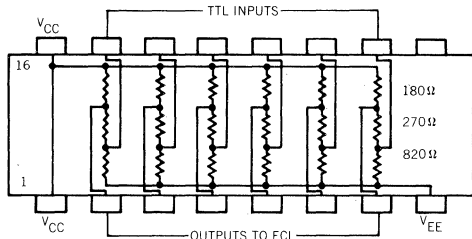

CIRCUIT APPLICATION

TTL to ECL translator

The MDP16-45 network consists of 18 resistors of 3 different values, internally divided into six (6) identical three (3) resistor sections for TTL to ECL translation.

SPECIFICATIONS

ELECTRICAL

Resistance Values: 180Ω, 270Ω and 820Ω
in each of six (6) sections

Resistance Tolerance: ±2%

Resistance Temperature Coefficient: ±100 PPM/°C
(-55°C to +125°C) typical

Temperature Coefficient of R Tracking: ±150 PPM/°C

Resistor Power Rating: .125 watt at 25°C

Package Power Rating: 2.0 watts at 25°C

Voltage Coefficient of Resistance:
< 50 PPM/V typical

Operating Temperature Range: -55°C to +125°C

Storage Temperature Range: -55°C to +150°C

PHYSICAL

Marking Resistance to Solvents: Permanency
testing per MIL-R-83401

Solderability: Per MIL-STD-202, Method 208E

Terminals: Copper alloy, tin-lead plated

Body: Molded epoxy

Weight: 1.5 grams

ENVIRONMENTAL CHARACTERISTICS (MIL-R-83401 Ref.)

Thermal Shock: ±0.5% max. ΔR (5 cycles between -65°C and +125°C)

Low Temperature Operation: ±0.25% max. ΔR
(45 minutes at full rated working voltage at -65°C)

Short Time Overload: ±0.25% max. ΔR
(2½ x rated working voltage 5 seconds)

Terminal Strength: ±0.25% max. ΔR (4½ pound pull for 30 seconds)

Resistance to Soldering Heat: ±0.25% max. ΔR (Leads immersed
in 350°C solder to within 1/16" of device body for 3 seconds)

Moisture Resistance: ±0.5% max. ΔR (240 hours with humidity
ranging from 80% RH to 98% RH)

Shock: ±0.25% max. ΔR (Total of 18 shocks at 100 G's)

Vibration: ±0.25% max. ΔR
(12 hours at maximum of 20 G's between 10 and 2,000 Hz)

Life: ±0.5% max. ΔR (1,000 hours at 70°C, rated power applied 1½
hours on, ½ hour off for full 1,000-hour period). Derated
according to the above curve.

Insulation Resistance: 10,000 Megohms (minimum)

Dielectric Withstanding Voltage: 200 VRMS for 1 minute

Model MDP16-45

DIMENSIONAL AND TERMINAL CONFIGURATIONS

[Numbers in brackets indicate millimeters]

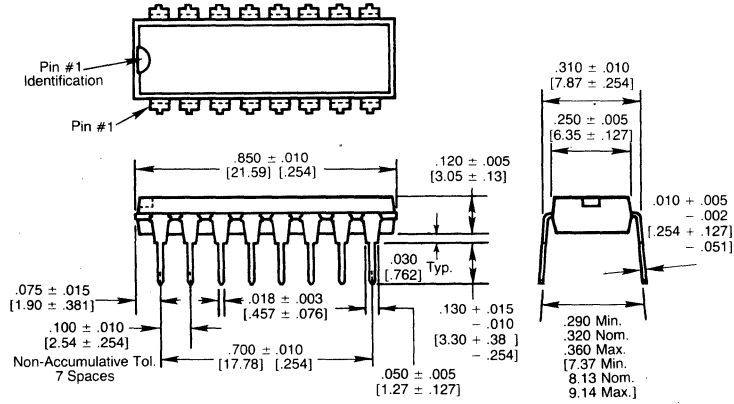

DERATING

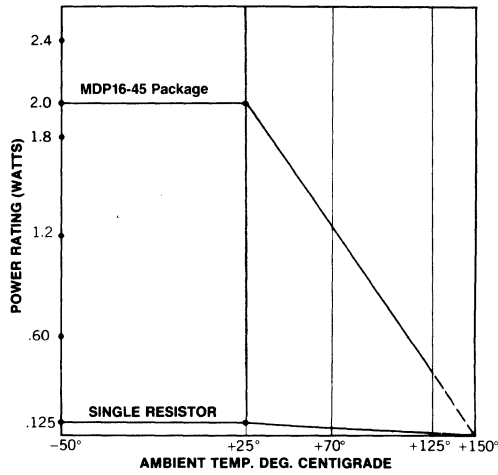

MDP16-45 Schematic

HOW TO ORDER

MDP 16 - 45
 SERIES NUMBER OF PINS SCHEMATIC



FLAT PACK THICK FILM RESISTOR NETWORKS

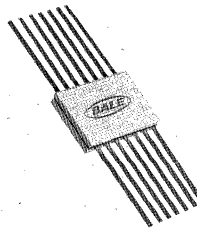

Models DFP14 and DFP16

01, 02 Schematic (Gold Plated Leads)

11, 12 Schematic (Tin-Lead Plated Leads)

FEATURES

- Highly stable thick film
- Hot-solder dipped or gold-plated leads
- .065" [1.65] height for high density packaging
- Low temperature coefficient ± 100 PPM/ $^{\circ}$ C (-55° C to $+125^{\circ}$ C)
- Wide resistance range
- All devices are capable of passing the MIL-STD-202, Method 210, Condition E "Resistance to Soldering Heat" test.

01 and 11 SCHEMATIC

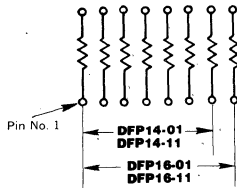

CIRCUIT EXPLANATION

7 or 8 isolated resistors

Dale Models DFPXX-01 and DFPXX-11 provide the user with 7 or 8 nominally equal resistors with each resistor isolated from all others. Commonly used in the following applications:

- "Wired OR" Pull-up
- Power Driven Pull-up
- Power Gate Pull-up
- Line Termination
- Long-line Impedance Balancing
- LED Current Limiting
- ECL Output Pull-down
- TTL Input Pull-down

02 and 12 SCHEMATIC

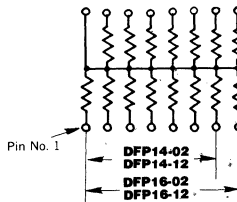

13 or 15 resistors with one pin common

The DFPXX-02 and DFPXX-12 provide the user with a choice of 13 or 15 nominally equal resistors, each connected to a common pin (14 or 16). Commonly used in the following applications:

- MOS/ROM Pull-up/Pull-down
- Open Collector Pull-up
- "Wired OR" Pull-up
- Power Driven Pull-up
- TTL Input Pull-down
- Digital Pulse Squaring
- TTL Unused Gate Pull-up
- High Speed Parallels Pull-up

SPECIFICATIONS

ELECTRICAL

Resistance Range: 10 Ω to 1 Meg.

Resistance Tolerance: $\pm 2\%$ standard. $\pm 1\%$, $\pm 5\%$ available

Resistance Temperature Coefficient: ± 100 PPM/ $^{\circ}$ C (-55° C to $+125^{\circ}$ C) typical

Isolation Resistance:

01 and 11 Schematic: > 100 Megohms

Resistor Power Rating: Maximum at 25° C,

01 and 11 Schematic: 0.25 watt

02 and 12 Schematic: 0.15 watt

Package Power Rating: Maximum at 25° C, 0.65 watt

T.C. Tracking: 50 PPM/ $^{\circ}$ C (-55° C to $+125^{\circ}$ C)

Voltage Coefficient of Resistance: < 50 PPM/V typical

Maximum Operating Voltage: 75 VDC

Operating Temperature Range: -55° C to $+125^{\circ}$ C

Storage Temperature Range: -55° C to $+150^{\circ}$ C

PHYSICAL

Marking Resistance to Solvents: Permanency testing per MIL-R-83401

Solderability: Per MIL-R-83401

Body: Epoxy filled ceramic sandwich

Terminals: Per MIL-STD-1276:

DFPXX-01, DFPXX-02 = Type G (gold plated)

DFPXX-11, DFPXX-12 = Type G (hot-solder dipped)

Hot-solder dipped leads supplied as standard finish unless otherwise specified.

ENVIRONMENTAL CHARACTERISTICS (MIL-R-83401 Ref.)

Thermal Shock: $\pm 0.7\%$ max. ΔR (5 cycles between -65° C and $+125^{\circ}$ C)

Power Conditioning: $\pm 0.7\%$ max. ΔR (At $1\frac{1}{2}$ x rated power, applied $1\frac{1}{2}$ hours on and $\frac{1}{2}$ hour off for 100 hours ± 4 hours at 25° C ambient temperature)

Low Temperature Operation: $\pm 0.25\%$ max. ΔR (45 minutes at full rated working voltage at -65° C)

Short Time Overload: $\pm 0.25\%$ max. ΔR ($2\frac{1}{2}$ x rated working voltage 5 seconds)

Terminal Strength: $\pm 0.25\%$ max. ΔR (24-ounce pull for 30 seconds)

Resistance to Soldering Heat: $\pm 0.25\%$ max. ΔR (Leads immersed in 350° C solder to within $1/16$ " of device body for 3 seconds)

Moisture Resistance: $\pm 0.5\%$ max. ΔR (240 hours with humidity, ranging from 80% RH to 98% RH)

Shock: $\pm 0.25\%$ max. ΔR (Total of 18 shocks at 100 G's)

Vibration: $\pm 0.25\%$ max. ΔR (12 hours at maximum of 20 G's between 10 and 2,000 Hz)

Life: $\pm 0.5\%$ max. ΔR (1,000 hours at 70° C, rated power applied $1\frac{1}{2}$ hours on, $\frac{1}{2}$ hour off for full 1,000-hour period). Derated according to the curve.

Insulation Resistance: 10,000 Megohms (minimum)

Dielectric Withstanding Voltage: No evidence of arcing or damage (200 VRMS for 1 minute)

DALE ELECTRONICS, INC., Box 26728, El Paso, TX 79926 • Phone 915-592-3253

Canada: Dale Electronics Ltd., 18 Howden Rd., Scarborough, Ontario M1R 3E6

Europe: Dale Electronics GmbH, Benzstrasse 28, 8039 Puchheim, West Germany

Models DFP14 and DFP16

DIMENSIONAL AND TERMINAL CONFIGURATIONS

[Numbers in brackets indicate millimeters]

TYPE	A
DFP14	0.037 [0.94]
DFP16	0.012 [0.30]

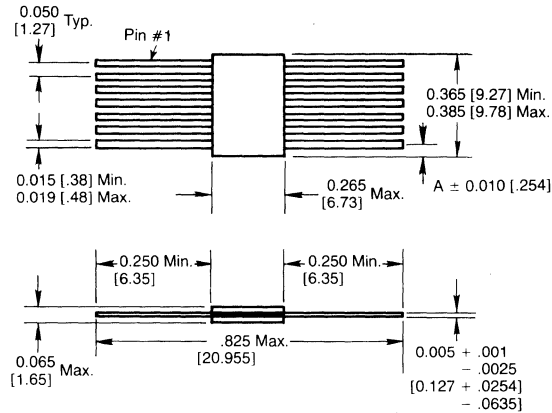

STOCKED RESISTANCE VALUE IN OHMS ("G" Tolerance)

100	470	1.0K	2.2K	4.7K	10K
200	510	1.5K	3.0K	5.1K	22K
330	680	2.0K	3.3K	6.8K	100K

01 and 11 SCHEMATIC

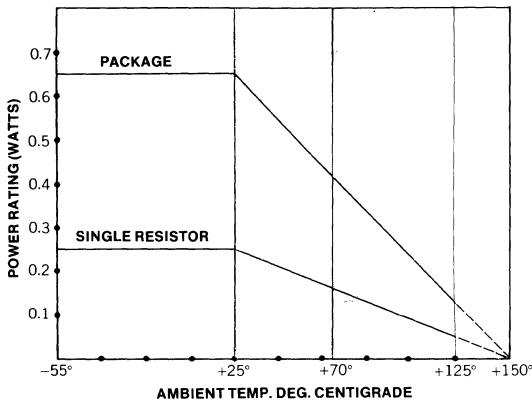

DERATING

02 and 12 SCHEMATIC

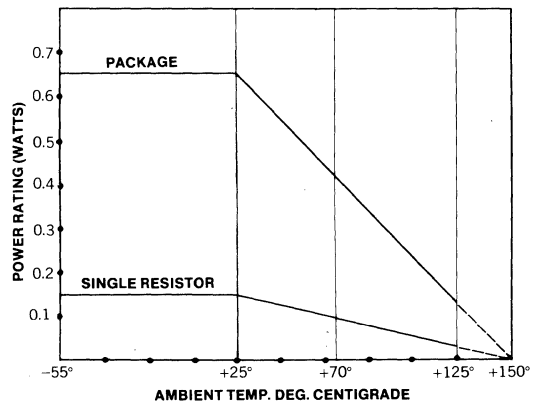

01, 02 SCHEMATIC

HOW TO ORDER

DFP	14	-0	2 1	-102	G
SERIES	NUMBER OF PINS	TERMINAL FINISH	SCHEMATIC	RESISTANCE VALUE	TOLERANCE
		0 = Type G gold, optional 1 = Type G hot-solder dipped, standard	The first two digits (3 for "F" tolerance) are significant figures and the last digit specifies number of zeros to follow.		F = ±1% G = ±2% J = ±5%

EXAMPLE:
DFP14-01-102G = A flat pack thick film network with 14 pins on .050 [1.27] centers, -01 schematic, resistance of 1,000 ohms and tolerance of ±2%, with Type G gold plated terminals.

EXAMPLE:
DFP14-02-102G = A flat pack thick film network with 14 pins on .050 [1.27] centers, -02 schematic, resistance of 1,000 ohms and tolerance of ±2%, with Type G gold plated terminals.



SINGLE-IN-LINE, Molded THICK FILM RESISTOR NETWORKS

MIL-R-83401 Qualified Models MSM06A, MSM08A, MSM10A MSM06C, MSM08C, MSM10C 01, 03, 05 Schematics

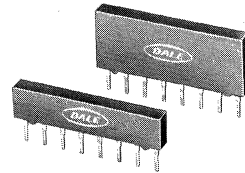

FEATURES

- MIL-R-83401 qualified
- .195" [4.95] "A" and .350" [8.89] "C" maximum seated heights
- Highly stable thick film
- T.C.R. available in "K" (± 100 PPM/ $^{\circ}$ C) or "M" (± 300 PPM/ $^{\circ}$ C) characteristic
- All device leads are hot-solder dipped
- Rugged molded case construction
- Compatible with automatic insertion equipment
- 100% screen tested per Group A, Subgroup 1 of MIL-R-83401
- All devices are capable of passing the MIL-STD-202, Method 210, Condition E "Resistance to Soldering Heat" test.

01 SCHEMATIC

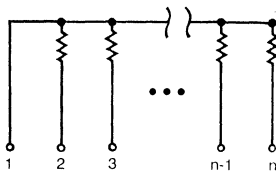

CIRCUIT APPLICATION

5, 7 or 9 resistors with one pin common

"A" Profile	"C" Profile
MSM06A-01 (M8340107XXXXXXC)	MSM06C-01 (M8340104XXXXXXC)
MSM08A-01 (M8340108XXXXXXC)	MSM08C-01 (M8340105XXXXXXC)
MSM10A-01 (M8340109XXXXXXC)	MSM10C-01 (M8340106XXXXXXC)

Dale Model MSM06A-01, MSM08A-01, MSM10A-01, MSM06C-01, MSM08C-01 and MSM10C-01 molded single-in-line resistor networks provide the user with a choice of 5, 7 or 9 nominally equal resistors, each connected to a common pin (Pin No. 1). Commonly used in the following applications:

- "Wired OR" Pull-up
- Power Gate Pull-up
- MOS/ROM Pull-up/Pull-down
- Open Collector Pull-up
- TTL Input Pull-down
- TTL Unused Gate Pull-up

03 SCHEMATIC

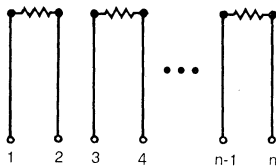

3, 4 or 5 isolated resistors

"A" Profile	"C" Profile
MSM06A-03 (M8340107XXXXXXG)	MSM06C-03 (M8340104XXXXXXG)
MSM08A-03 (M8340108XXXXXXG)	MSM08C-03 (M8340105XXXXXXG)
MSM10A-03 (M8340109XXXXXXG)	MSM10C-03 (M8340106XXXXXXG)

Dale Model MSM06A-03, MSM08A-03, MSM10A-03, MSM06C-03, MSM08C-03 and MSM10C-03 molded single-in-line resistor networks provide the user with a choice of 3, 4 or 5 nominally equal resistors. Each resistor is isolated from all others. Commonly used in the following applications:

- "Wired OR" Pull-up
- Power Driven Pull-up
- Power Gate Pull-up
- Line Termination
- Long-Line Impedance Balance
- LED Current Limiting
- ECL Output Pull-down
- TTL Input Pull-down

05 SCHEMATIC

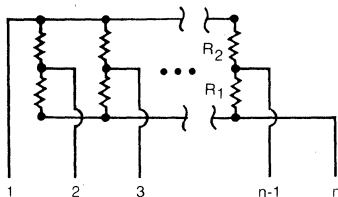

4, 6 or 8 pairs of resistors

"A" Profile	"C" Profile
MSM06A-05 (M8340107XXXXXXH)	MSM06C-05 (M8340104XXXXXXH)
MSM08A-05 (M8340108XXXXXXH)	MSM08C-05 (M8340105XXXXXXH)
MSM10A-05 (M8340109XXXXXXH)	MSM10C-05 (M8340106XXXXXXH)

Dale Model MSM06A-05, MSM08A-05, MSM10A-05, MSM06C-05, MSM08C-05 and MSM10C-05 molded single-in-line resistor networks provide the user with a choice of 4, 6 or 8 pairs of R1/R2 resistor values for pulse squaring and TTL dual-line terminating requirements.

**Models MSM06A, MSM08A, MSM10A
MSM06C, MSM08C, MSM10C**

DIMENSIONAL AND TERMINAL CONFIGURATIONS

[Numbers in brackets indicate millimeters]

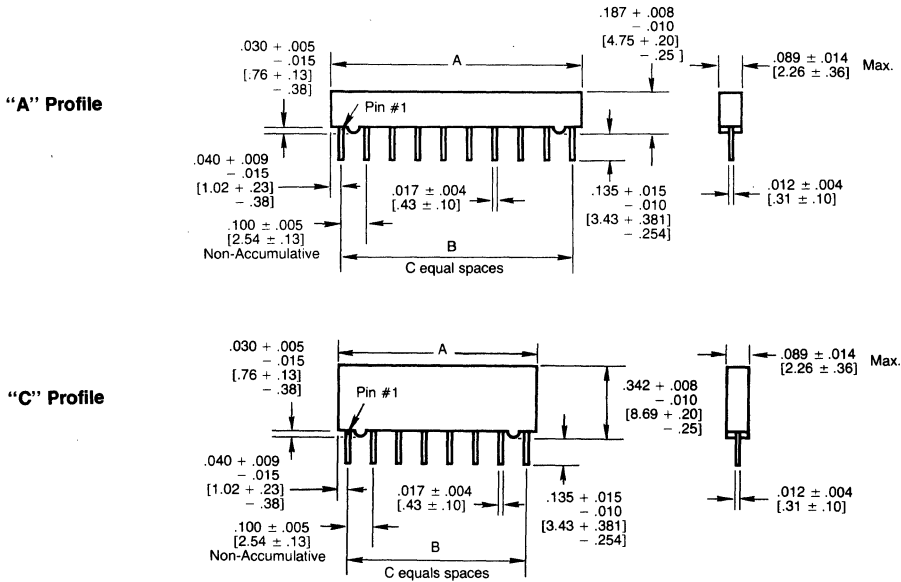

TYPE	A	B	C
MSM06	.583 ± .015 [14.81 ± .38]	.500 [12.70]	5
MSM08	.783 ± .015 [19.89 ± .38]	.700 [17.78]	7
MSM10	.983 ± .015 [24.97 ± .38]	.900 [22.86]	9

01 SCHEMATIC

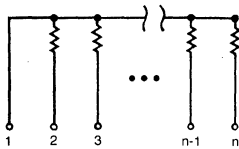

**STOCKED RESISTANCE VALUES IN OHMS
("G" Tolerance)**

MSM06A-01, MSM08A-01, MSM10A-01

100 3.3K 10K 470K
510 4.7K 22K 1 Meg.
1.0K 5.6K 100K

MSM06C-01, MSM08C-01, MSM10C-01

33 82 330 680 1.5K 3.3K 6.8K 22K 82K 1 Meg.
39 100 470 820 2.0K 4.7K 8.2K 27K 100K
47 150 510 1.0K 2.2K 5.1K 10K 47K 220K
68 220 560 1.2K 2.7K 5.6K 15K 56K 470K

03 SCHEMATIC

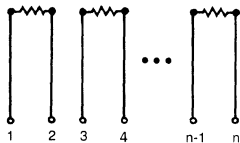

MSM06A-03, MSM08A-03, MSM10A-03

100 1.0K 10K 100K

MSM06C-03, MSM08C-03, MSM10C-03

10 330 3.3K 10K 100K
100 680 4.7K 20K 220K
220 1.0K 6.8K 22K 680K

05 SCHEMATIC

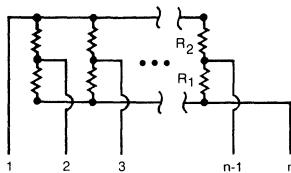

Consult factory for stocked values.

MSM06A-05, MSM08A-05, MSM10A-05
MSM06C-05, MSM08C-05, MSM10C-05

**Models MSM06A, MSM08A, MSM10A
MSM06C, MSM08C, MSM10C**

**DERATING
01 SCHEMATIC
"A" PROFILE**

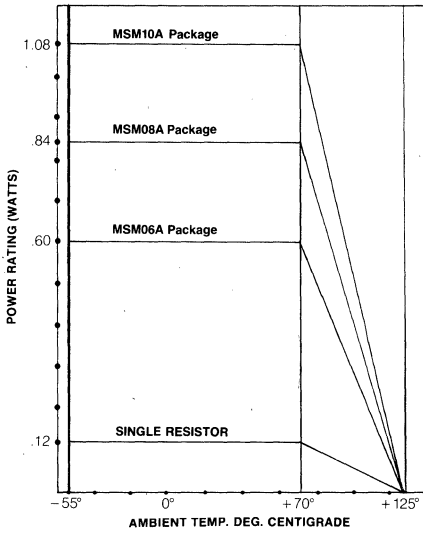

**DERATING
03 SCHEMATIC
"A" PROFILE**

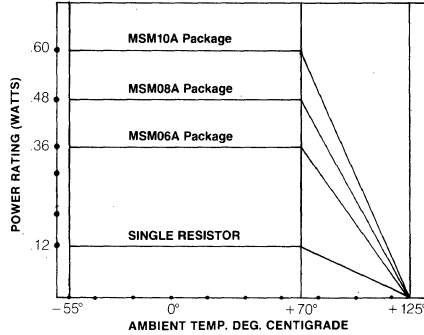

**DERATING
05 SCHEMATIC
"A" PROFILE**

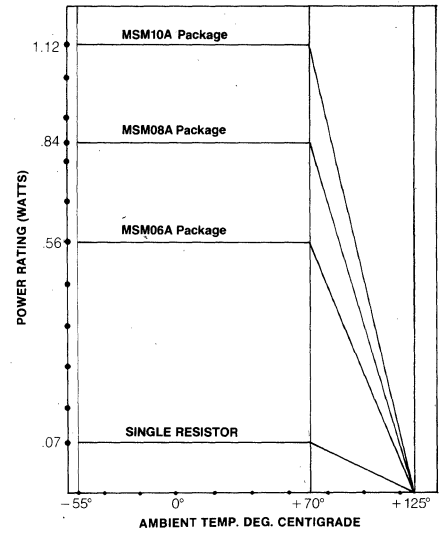

"C" PROFILE

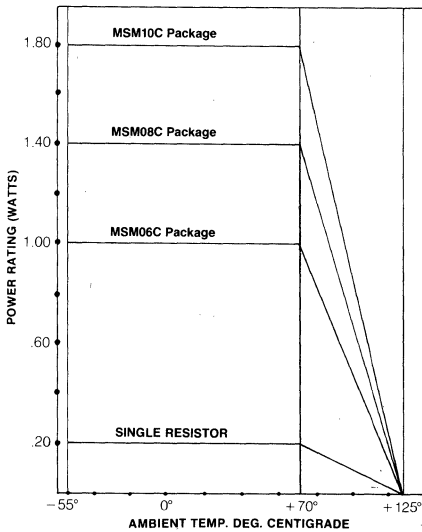

"C" PROFILE

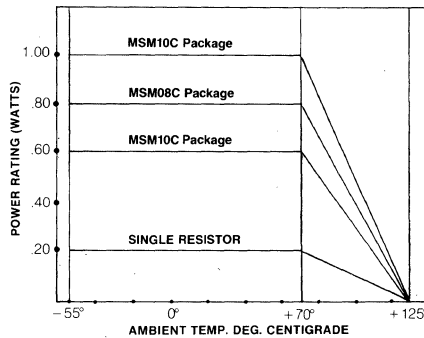

"C" PROFILE

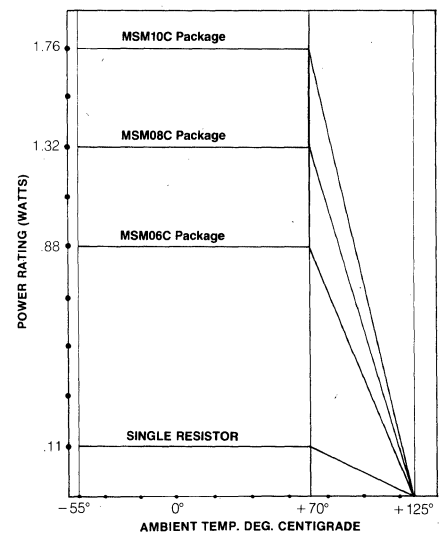

SPECIFICATIONS

ELECTRICAL

Resistance Range: 01 and 03 schematics: 10Ω to 1 Meg.
05 schematic: See values in table.

Resistance Tolerance: ±2% standard. ±1%, ±5% available

Resistance Temperature Coefficient: "K" = ±100 PPM/°C
"M" = ±300 PPM/°C (-55°C to +125°C)

Resistor Power Rating: Maximum at 70°C .2 watt
MSMXXA-01, MSMXXC-01 and MSMXXC-03 = .2 watt
MSMXXA-03 = .12 watt
MSMXXA-05 = .07 watt and MSMXXC-05 = .11 watt

Package Power Rating: Maximum at 70°C

MSM06A-01 = .60 watt	MSM06A-03 = .36 watt	MSM06A-05 = .56 watt
MSM08A-01 = .84 watt	MSM08A-03 = .48 watt	MSM08A-05 = .84 watt
MSM10A-01 = 1.08 watts	MSM10A-03 = .60 watt	MSM10A-05 = 1.12 watts
MSM06C-01 = 1.00 watt	MSM06C-03 = .60 watt	MSM06C-05 = .88 watt
MSM08C-01 = 1.40 watts	MSM08C-03 = .80 watt	MSM08C-05 = 1.32 watts
MSM10C-01 = 1.80 watts	MSM10C-03 = 1.00 watt	MSM10C-05 = 1.76 watts

Maximum Operating Voltage: 50 VDC
Operating Temperature Range: -55°C to +125°C

PHYSICAL

Body: Molded Epoxy
Terminals: Copper alloy, hot-solder dipped
Solderability: Per Mil-R-83401
Weight:

"A" Profile	"C" Profile
6 pin = .4 gram	6 pin = .7 gram
8 pin = .5 gram	8 pin = .9 gram
10 pin = .6 gram	10 pin = 1.1 gram

**Models MSM06A, MSM08A, MSM10A
MSM06C, MSM08C, MSM10C**

**ENVIRONMENTAL CHARACTERISTICS
(MIL-R-83401 Ref.)**

- Thermal Shock:** $\pm 0.7\%$ max. ΔR (5 cycles between -65°C and $+125^{\circ}\text{C}$)
- Power Conditioning:** $\pm 0.7\%$ max. ΔR (At $1\frac{1}{2} \times$ rated power, applied $1\frac{1}{2}$ hours on and $\frac{1}{2}$ hour off for 100 hours ± 4 hours at 25°C ambient temperature)
- Low Temperature Operation:** $\pm 0.25\%$ (Char. K) and $\pm 0.5\%$ (Char. M) max. ΔR (45 minutes at full rated working voltage at -65°C)
- Short Time Overload:** $\pm 0.25\%$ (Char. K) and $\pm 0.5\%$ (Char. M) max. ΔR ($2\frac{1}{2} \times$ rated working voltage 5 seconds)
- Terminal Strength:** $\pm 0.25\%$ max. ΔR ($4\frac{1}{2}$ pound pull for 30 seconds)
- Resistance to Soldering Heat:** $\pm 0.25\%$ max. ΔR (Leads immersed in 350°C solder to within $1/16''$ of body for 3 seconds)
- Moisture Resistance:** $\pm 0.5\%$ max. ΔR (240 hours with humidity ranging from 80% RH to 98% RH)
- Shock:** $\pm 0.25\%$ max. ΔR (Total of 18 shocks at 100 G's)
- Vibration:** $\pm 0.25\%$ max. ΔR (12 hours at maximum of 20 G's between 10 and 2,000 Hz)
- Life:** $\pm 0.5\%$ (Char. K) and $\pm 2.0\%$ (Char. M) max. ΔR (1,000 hours at 70°C , rated power applied $1\frac{1}{2}$ hours on, $\frac{1}{2}$ hour off for full 1,000-hour period)
- Insulation Resistance:** 10,000 Megohms (minimum)
- Dielectric Withstanding Voltage:** No evidence of arcing or damage (200 VRMS for 1 minute)

**HOW TO ORDER—Military Part Number
01, 03 SCHEMATIC**

"A" PROFILE M8340107	K	1003	G	C or G
"C" PROFILE M8340104	K	1003	G	C or G
DETAIL SPEC. NO.	CHARACTERISTIC	RESISTANCE VALUE	TOLERANCE	SCHEMATIC

"A" Profile
M8340107 = 6 pin SIP RZ070
M8340108 = 8 pin SIP RZ080
M8340109 = 10 pin SIP RZ090

"K" = $\pm 100\text{PPM}/^{\circ}\text{C}$
"M" = $\pm 300\text{PPM}/^{\circ}\text{C}$

The first three digits are significant figures and the last digit specifies the number of zeros to follow.

F = $\pm 1\%$
G = $\pm 2\%$
J = $\pm 5\%$

"C" Profile
M8340104 = 6 pin SIP RZ040
M8340105 = 8 pin SIP RZ050
M8340106 = 10 pin SIP RZ060

EXAMPLE:
M8340107K1003GC = A low profile single-in-line resistor network with 6 pins and a T.C.R. of $\pm 100\text{PPM}/^{\circ}\text{C}$, resistance value of 100K ohms, tolerance of 2% and "C" schematic.

EXAMPLE:
M8340104K1003GG = A high profile single-in-line resistor network with 6 pins and a T.C.R. of $\pm 100\text{PPM}/^{\circ}\text{C}$, resistance value of 100K ohms, tolerance of 2% and "G" schematic.

05 SCHEMATIC

"A" PROFILE M8340107	K	A001*	G	H
"C" PROFILE M8340104	K	A001*	G	H
DETAIL SPEC. NO.	CHARACTERISTIC	RESISTANCE VALUE CODE	TOLERANCE	SCHEMATIC

"A" Profile
M8340107 = 6 pin SIP RZ070
M8340108 = 8 pin SIP RZ080
M8340109 = 10 pin SIP RZ090

"K" = $\pm 100\text{PPM}/^{\circ}\text{C}$
"M" = $\pm 300\text{PPM}/^{\circ}\text{C}$

M83401 assigned code for values of R1 and R2.

F = $\pm 1\%$
G = $\pm 2\%$
J = $\pm 5\%$

"C" Profile
M8340104 = 6 pin SIP RZ040
M8340105 = 8 pin SIP RZ050
M8340106 = 10 pin SIP RZ060

EXAMPLE:
M8340107KA001GH = A low profile single-in-line resistor network with 6 pins, a T.C.R. of $\pm 100\text{PPM}/^{\circ}\text{C}$, R1 resistance value of 82 ohms, R2 resistance value of 130 ohms, tolerance of $\pm 2\%$ and "H" schematic.

EXAMPLE:
M8340104KA001GH = A high profile single-in-line resistor network with 6 pins, a T.C.R. of $\pm 100\text{PPM}/^{\circ}\text{C}$, R1 resistance value of 82 ohms, R2 resistance value of 130 ohms, tolerance of $\pm 2\%$ and "H" schematic.

*The H-schematic resistance values are specified by a 4-digit code, which comes from MIL-R-83401. The codes and corresponding resistance values are:

CODE	R1 (ohms)	R2 (ohms)	CODE	R1	R2	CODE	R1	R2
A001	82	130	A006	180	390	A011	330	680
A002	120	200	A007	220	270	A012	1.5K	3.3K
A003	130	210	A008	220	330	A013	3K	6.2K
A004	160	260	A009	330	390			
A005	180	240	A010	330	470			



DUAL-IN-LINE PACKAGE THICK FILM RESISTOR NETWORKS

MIL-R-83401 Qualified Models MDM14 and MDM16 01, 03, 05 Schematics

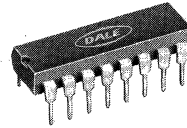

FEATURES

- MIL-R-83401 qualified
- Epoxy molded construction
- T.C.R. available in "K" (± 100 PPM/ $^{\circ}$ C) or "M" (± 300 PPM/ $^{\circ}$ C) depending on style
- All device leads are hot-solder dipped
- 100% screen tested per Group A, Subgroup 1 of MIL-R-83401
- All devices are capable of passing the MIL-STD-202, Method 210, Condition E "Resistance to Soldering Heat" test.

01 SCHEMATIC

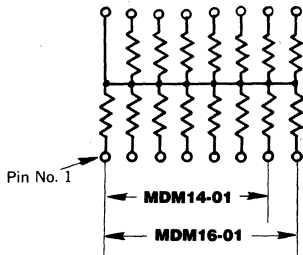

CIRCUIT EXPLANATION

MDM14-01 (M8340101XXXXXXB)
MDM16-01 (M8340102XXXXXXB)

13 or 15 resistors with one pin common

Dale Model MDMXX-01 provides the user with a choice of 13 or 15 nominally equal resistors, each connected to a common pin. Commonly used in the following applications:

- MOS/ROM Pull-up/Pull-down
- Open Collector Pull-up
- "Wired OR" Pull-up
- Power Driven Pull-up
- TTL Input Pull-down
- Digital Pulse Squaring
- TTL Unused Gate Pull-up
- High Speed Parallel Pull-up

03 SCHEMATIC

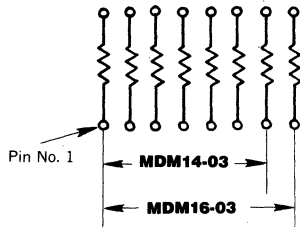

MDM14-03 (M8340101XXXXXXA)
MDM16-03 (M8340102XXXXXXA)

7 or 8 isolated resistors

Dale Model MDMXX-03 provides the user with a choice of 7 or 8 nominally equal resistors with each resistor isolated from all others. Commonly used in the following applications:

- "Wired OR" Pull-up
- Power Driven Pull-up
- Power Gate Pull-up
- Line Termination
- Long-line Impedance Balancing
- LED Current Limiting
- ECL Output Pull-down
- TTL Input Pull-down

05 SCHEMATIC

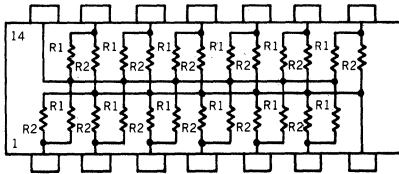

MDM14-05

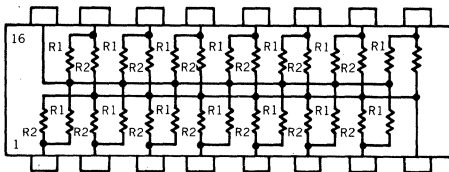

MDM16-05

MDM14-05 (M8340101XXXXXXJ)
MDM16-05 (M8340102XXXXXXJ)

12 or 14 resistor pairs

Dale Model MDMXX-05 provides the user with a choice of 12 or 14 pairs of R1/R2 resistor values for pulse squaring and TTL dual-line terminating requirements.

Models MDM14 and MDM16

DIMENSIONAL AND TERMINAL CONFIGURATIONS

[Numbers in brackets indicate millimeters]

TYPE	A	B	C
MDM14	.750 [19.05]	.600 [15.24]	6
MDM16	.850 [21.59]	.700 [17.78]	7

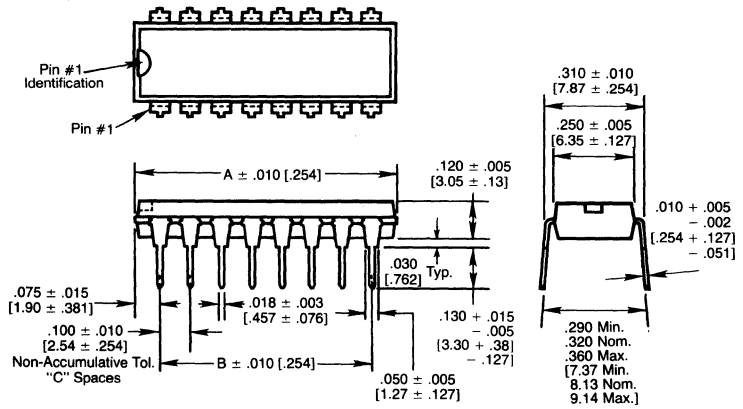

01 SCHEMATIC

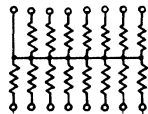

STOCKED RESISTANCE VALUES IN OHMS ("G" Tolerance)

39	75	180	330	680	2.0K	3.3K	5.6K	20K	100K
51	100	200	390	1.0K	2.2K	3.9K	6.8K	22K	470K
56	120	220	470	1.2K	2.7K	4.7K	10K	30K	1 Meg.
68	150	270	510	1.5K	3.0K	5.1K	15K	47K	

03 SCHEMATIC

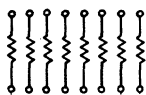

10	68	130	270	680	3.0K	5.6K	22K	470K
22	75	150	330	1.0K	3.3K	6.8K	27K	1 Meg.
39	100	180	390	1.5K	3.9K	10K	30K	
51	110	200	470	2.0K	4.7K	15K	47K	
56	120	220	510	2.2K	5.1K	20K	100K	

05 SCHEMATIC

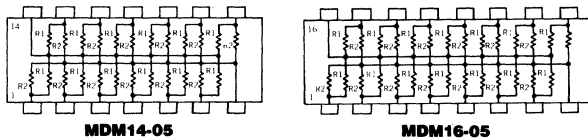

Consult factory for stocked values.

DERATING PER MIL-R-83401

01 SCHEMATIC

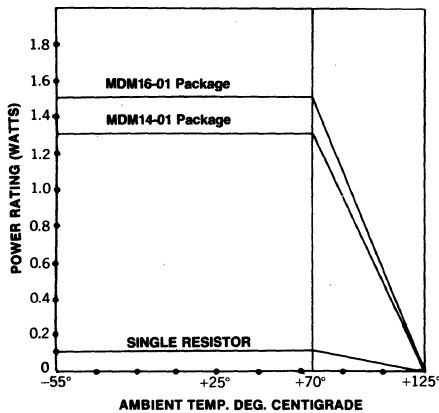

03 SCHEMATIC

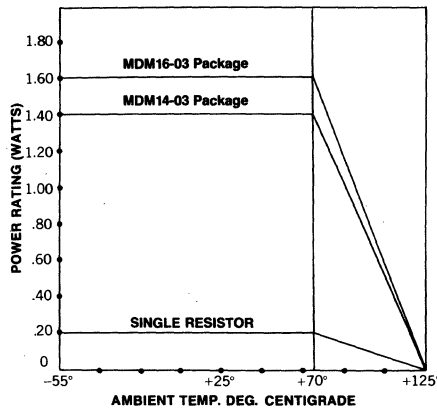

05 SCHEMATIC

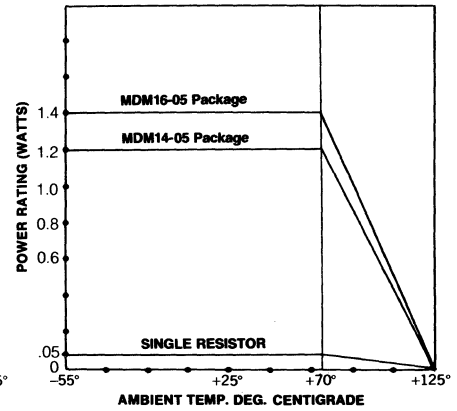

Models MDM14 and MDM16

SPECIFICATIONS

ELECTRICAL

Resistance Range: 01 and 03 schematics: 10Ω to 1 Meg.
05 schematic: See values in table.

Resistance Tolerance: ±1%, ±2% and ±5%

Resistance Temperature Coefficient: (-55°C to +125°C)
"K" = ±100 PPM/°C, "M" = ±300 PPM/°C

Resistor Power Rating: Maximum at 70°C

01 schematic = 0.1 watt
03 schematic = 0.2 watt
05 schematic = 0.05 watt

Package Power Rating: Maximum at 70°C

Schematic	14 Pin	16 Pin
01	1.30 watts	1.50 watts
03	1.40 watts	1.60 watts
05	1.20 watts	1.40 watts

Maximum Operating Voltage: 100 VDC

Operating Temperature Range: -55°C to +125°C

PHYSICAL

Marking-Resistance to Solvents: Permanency testing per MIL-R-83401

Solderability: Per MIL-R-83401

Body: Molded epoxy

Terminals: Copper alloy, hot-solder dipped

ENVIRONMENTAL CHARACTERISTICS (MIL-R-83401 Ref.)

Thermal Shock: ±0.7% max. ΔR (5 cycles between -65°C and +125°C)

Power Conditioning: ±0.7% max. ΔR (At 1½ x rated power, applied 1½ hours on and ½ hour off for 100 hours ±4 hours at 25°C ambient temperature)

Low Temperature Operation: ±0.25% (Char. K) and ±0.5% (Char. M) max. ΔR (45 minutes at full rated working voltage at -65°C)

Short Time Overload: ±0.25% (Char. K) and ±0.5% (Char. M) max. ΔR (2½ x rated working voltage 5 seconds)

Terminal Strength: ±0.25% max. ΔR (4½ pound pull for 30 seconds)

Resistance to Soldering Heat: ±0.25% max. ΔR (Leads immersed in 350°C solder to within 1/16" of body for 3 seconds)

Moisture Resistance: ±0.5% max. ΔR (240 hours with humidity ranging from 80% RH to 98% RH)

Shock: ±0.25% max. ΔR (Total of 18 shocks at 100 G's)

Vibration: ±0.25% max. ΔR (12 hours at maximum of 20 G's between 10 and 2,000 Hz)

Life: ±0.5% (Char. K) and ±2.0% (Char. M) max. ΔR (1,000 hours at 70°C, rated power applied 1½ hours on, ½ hour off for full 1,000-hour period)

Insulation Resistance: 10,000 Megohms (minimum)

Dielectric Withstanding Voltage: No evidence of arcing or damage (200 VRMS for 1 minute)

HOW TO ORDER—Military Part Number

01 SCHEMATIC	M8340101	M	2201	G	B
03 SCHEMATIC	M8340102	M	4701	G	A
05 SCHEMATIC	M8340101	K	A001*	G	J

DETAIL SPEC. NO.	CHARACTERISTIC	RESISTANCE VALUE	TOLERANCE	SCHEMATIC
M8340101 = 14 Pin DIP RZ010 M8340102 = 16 Pin DIP RZ020	"K" = ±100 PPM/°C "M" = ±300 PPM/°C	The first three digits are significant figures and the last digit specifies the number of zeros to follow = 01 and 03 schematics. For 05 schematic see footnote (*).	F = ±1% G = ±2% J = ±5%	

EXAMPLE:

M8340101M2201GB = A dual-in-line resistor network with 14 pins, a T.C.R. of ±300 PPM/°C, resistance value of 2.2K ohms, tolerance of 2% and to schematic "B".

EXAMPLE:

M8340102M4701GA = A dual-in-line resistor network with 16 pins, a T.C.R. of ±300 PPM/°C, resistance value of 4.7K ohms, tolerance of 2% and to schematic "A".

EXAMPLE:

M8340101KA001GJ = A dual-in-line resistor network with 14 pins, a T.C.R. of ±100 PPM/°C, R1 resistance value of 82 ohms, R2 resistance value of 130 ohms, tolerance of ±2% and "J" schematic.

*The J-schematic resistance values are specified by a 4-digit code, which comes from MIL-R-83401. The codes and corresponding resistance values are:

CODE	R1 (ohms)	R2 (ohms)	CODE	R1	R2	CODE	R1	R2
A001	82	130	A006	180	390	A011	330	680
A002	120	200	A007	220	270	A012	1.5K	3.3K
A003	130	210	A008	220	330	A013	3K	6.2K
A004	160	260	A009	330	390			
A005	180	240	A010	330	470			



FLAT PACK THICK FILM RESISTOR NETWORKS

MIL-R-83401 Qualified Models DFM14

01, 02, 05 Schematic (Gold Plated Leads)

11, 12, 15 Schematic (Hot-Solder Dipped)

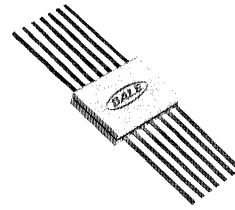

FEATURES

- MIL-R-83401 qualified
- Highly stable thick film
- T.C.R. available in "K" (± 100 PPM/ $^{\circ}$ C) or "M" (± 300 PPM/ $^{\circ}$ C) characteristic
- Hot-solder dipped or gold-plated leads
- 100% screen tested per Group A, Subgroup 1 of MIL-R-83401
- .065" [1.65] height for high density packaging
- All devices are capable of passing the MIL-STD-202, Method 210, Condition E "Resistance to Soldering Heat" test.

01, 11 SCHEMATIC

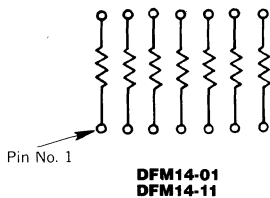

CIRCUIT EXPLANATION

DFM14-01 (M8340103XXXXXXA)
DFM14-11 (M8340103XXXXXXA)

7 isolated resistors

Dale Models DFM14-01 and DFM14-11 provide the user with 7 nominally equal resistors with each resistor isolated from all others. Commonly used in the following applications:

- "Wired OR" Pull-up
- Power Driven Pull-up
- Power Gate Pull-up
- Line Termination
- Long-line Impedance Balancing
- LED Current Limiting
- ECL Output Pull-down
- TTL Input Pull-down

02, 12 SCHEMATIC

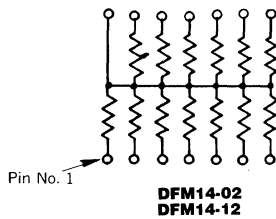

DFM14-02 (M8340103XXXXXXB)
DFM14-12 (M8340103XXXXXXB)

13 resistors with one pin common

Dale Model DFM14-02 and DFM14-12 provides the user with a choice of 13 nominally equal resistors, each connected to a common pin. Commonly used in the following applications:

- MOS/ROM Pull-up/Pull-down
- Open Collector Pull-up
- "Wired OR" Pull-up
- Power Driven Pull-up
- TTL Input Pull-down
- Digital Pulse Squaring
- TTL Unused Gate Pull-up
- High Speed Parallel Pull-up

05, 15 SCHEMATIC

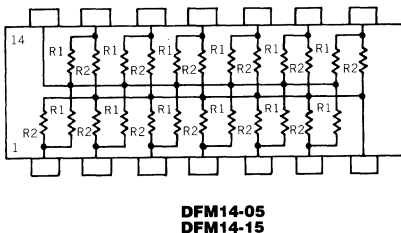

DFM14-05 (M8340103XXXXXXH)
DFM14-15 (M8340103XXXXXXH)

12 pairs of resistors

Dale Models DFM14-05 and DFM14-15 provide the user with 12 pairs of R1/R2 resistor values for pulse squaring and TTL dual-line terminating requirements.

Models DFM14

DIMENSIONAL AND TERMINAL CONFIGURATIONS [Numbers in brackets indicate millimeters]

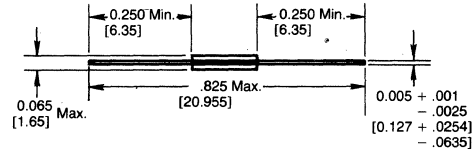
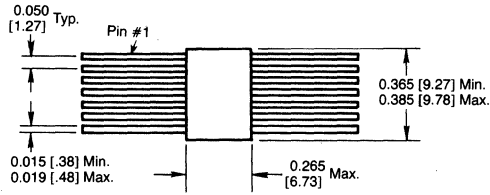

01, 11 SCHEMATIC

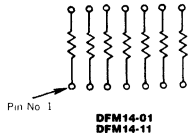

02, 12 SCHEMATIC

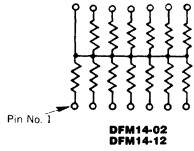

STOCKED RESISTANCE VALUE IN OHMS ("G" Tolerance)

01, 11, 02, 12 SCHEMATIC					
100	470	1.0K	2.2K	4.7K	10K
200	510	1.5K	3.0K	5.1K	22K
330	680	2.0K	3.3K	6.8K	100K

05, 15 SCHEMATIC

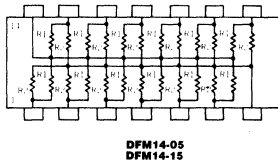

Consult factory for stocked values.

DERATING PER MIL-R-83401

01, 11 SCHEMATIC

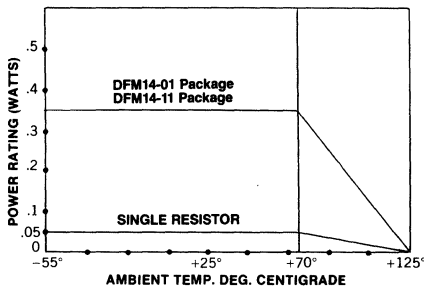

02, 12 SCHEMATIC

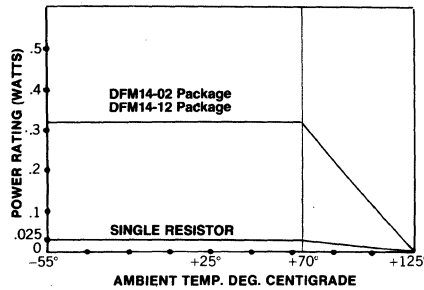

05, 15 SCHEMATIC

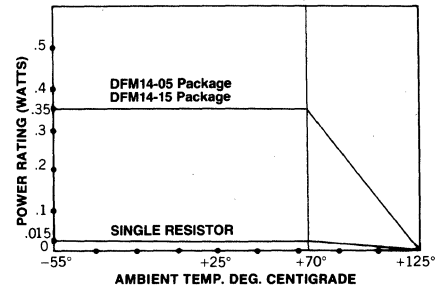

SPECIFICATIONS

ELECTRICAL

Resistance Range: 01 and 02 schematics: 10Ω to 1 Meg.
05 schematic: See values in table.

Resistance Tolerance: ±2% standard,
±1%, ±5% available

Resistance Temperature Coefficient: (-55°C to +125°C) "K" = ±100 PPM/°C, "M" = ±300 PPM/°C

Isolation Resistance: 01, 11 schematic = >100 Megohms

Resistor Power Rating: Maximum at 70°C,

- 01, 11 schematics = 0.050 watt
- 02, 12 schematics = 0.025 watt
- 05, 15 schematics = 0.015 watt

Package Power Rating: Maximum at 70°C,

- 01, 11 schematics = 0.350 watt
- 02, 12 schematics = 0.325 watt
- 05, 15 schematics = 0.350 watt

Maximum Operating Voltage: 50 VDC

Operating Temperature Range: -55°C to +125°C

PHYSICAL

Marking Resistance to Solvents: Permanency testing per MIL-R-83401

Solderability: Per MIL-R-83401

Body: Epoxy filled ceramic sandwich

Terminals: Per MIL-STD-1276:

DFM14-01, 02, 05 = Type G (gold plated)

DFM14-11, 12, 15 = Type G (hot-solder dipped)

Hot-solder dipped leads supplied as standard finish unless otherwise specified.

Models DFM14

ENVIRONMENTAL CHARACTERISTICS
(MIL-R-83401 Ref.)

- Thermal Shock:** $\pm 0.7\%$ max. ΔR (5 cycles between -65°C and $+125^{\circ}\text{C}$)
- Power Conditioning:** $\pm 0.7\%$ max. ΔR (At $1\frac{1}{2}$ x rated power, applied $1\frac{1}{2}$ hours on and $\frac{1}{2}$ hour off for 100 hours ± 4 hours at 25°C ambient temperature)
- Low Temperature Operation:** $\pm 0.25\%$ (Char. K) and $\pm 0.5\%$ (Char. M) max. ΔR (45 minutes at full rated working voltage at -65°C)
- Short Time Overload:** $\pm 0.25\%$ (Char. K) and $\pm 0.5\%$ (Char. M) max. ΔR ($2\frac{1}{2}$ x rated working voltage 5 seconds)
- Terminal Strength:** $\pm 0.25\%$ max. ΔR ($4\frac{1}{2}$ pound pull for 30 seconds)
- Resistance to Soldering Heat:** $\pm 0.25\%$ max. ΔR (Leads immersed in 350°C solder to within $1/16''$ of body for 3 seconds)
- Moisture Resistance:** $\pm 0.5\%$ max. ΔR (240 hours with humidity ranging from 80% RH to 98% RH)
- Shock:** $\pm 0.25\%$ max. ΔR (Total of 18 shocks at 100 G's)
- Vibration:** $\pm 0.25\%$ max. ΔR (12 hours at maximum of 20 G's between 10 and 2,000 Hz)
- Life:** $\pm 0.5\%$ (Char. K) and $\pm 2.0\%$ (Char. M) max. ΔR (1,000 hours at 70°C , rated power applied $1\frac{1}{2}$ hours on, $\frac{1}{2}$ hour off for full 1,000-hour period)
- Insulation Resistance:** 10,000 Megohms (minimum)
- Dielectric Withstanding Voltage:** No evidence of arcing or damage (200 VRMS for 1 minute)

HOW TO ORDER—Military Part Number

01, 11 SCHEMATIC	M8340103	M	6801	G	A
02, 12 SCHEMATIC	M8340103	M	6801	G	B
05, 15 SCHEMATIC	M8340103	K	A001*	G	J
	DETAIL SPEC. NO.	CHARACTERISTIC	RESISTANCE VALUE	TOLERANCE	SCHEMATIC
	M8340103 = 14 Pin DIP RZ030	"K" = ± 100 PPM/ $^{\circ}\text{C}$ "M" = ± 300 PPM/ $^{\circ}\text{C}$	The first three digits are significant figures and the last digit specifies the number of zeros to follow = 01 and 02 schematics. For 05 schematic, see footnote (*).	F = $\pm 1\%$ G = $\pm 2\%$ J = $\pm 5\%$	

DFM14-01, 02, 05 = Type G (gold plated)
DFM14-11, 12, 15 = Type G (hot-solder dipped)

Hot-solder dipped leads supplied as standard
finish, unless otherwise specified.

EXAMPLE:

M8340103M6801GA = A flat pack resistor network with 14 pins, a T.C.R. of ± 300 PPM/ $^{\circ}\text{C}$, resistance value of 6.8K ohms, tolerance of 2% and to schematic "A".

EXAMPLE:

M8340103M6801GB = A flat pack resistor network with 14 pins, a T.C.R. of ± 300 PPM/ $^{\circ}\text{C}$, resistance value of 6.8K ohms, tolerance of 2% and to schematic "B".

EXAMPLE:

M8340103KA001GJ = A flat pack resistor network with 14 pins, a T.C.R. of ± 100 PPM/ $^{\circ}\text{C}$, R1 resistance value of 82 ohms, R2 resistance value of 130 ohms, tolerance of $\pm 2\%$ and schematic "J".

*The J-schematic resistance values are specified by a 4-digit code, which comes from MIL-R-83401. The codes and the corresponding resistance values are:

CODE	R1 (ohms)	R2 (ohms)	CODE	R1	R2	CODE	R1	R2
A001	82	130	A006	180	390	A011	330	680
A002	120	200	A007	220	270	A012	1.5K	3.3K
A003	130	210	A008	220	330	A013	3K	6.2K
A004	160	260	A009	330	390			
A005	180	240	A010	330	470			



DUAL & SINGLE-IN-LINE PACKAGES RESISTOR/CAPACITOR NETWORKS

R/C Networks

FEATURES

- Ideal where repetitive circuits are required.
- Wide range of R/C values for special applications.
- High density packaging for reduced assembly costs, improved performance and simplified board layout.
- Utilize same thick film circuit materials as those qualified to MIL-R-83401.
- Capacitors available to EIA RS 198 or MIL-C-55681.

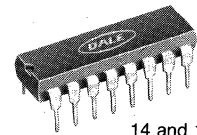

14 and 16 Pin
Molded DIP styles

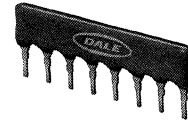

4 thru 12 Pin
Coated SIP styles

GENERAL SPECIFICATIONS

	RESISTORS		*CAPACITORS	
		NPO	BX	X7R
Value Range (SIP)	10Ω-3.3 meg	100pf-4700pf	500pf-0.1μf	500pf-0.1μf
Value Range (DIP)	10Ω-3.3 meg	100pf-2700pf	500pf-0.1μf	500pf-0.1μf
Tolerances	±2% standard, ±1%, ±5%, ±10%, ±20% available	±5% & ±10%	±10% & ±20%	±10% & ±20%
Temperature Characteristics (-55°C to +125°C)	±100ppm/°C Typical	±30ppm/°C	±15% @ OVDC & +15%, -25% @ rated VDC	±15%
Voltage Rating	100VDC	50VDC	50VDC	50VDC
Dissipation Factor (1 VRMS @ 1 KHZ)	N/A	0.1% max	2.5% max	3.0% max
Operating Temperature Range	-55°C to +125°C			

*Capacitors tested at 1 VRMS @ 1 KHZ @ 25°C

STANDARD PACKAGE CONFIGURATIONS DIMENSIONAL AND TERMINAL CONFIGURATIONS: [Numbers in brackets indicate millimeters]

DUAL-IN-LINE

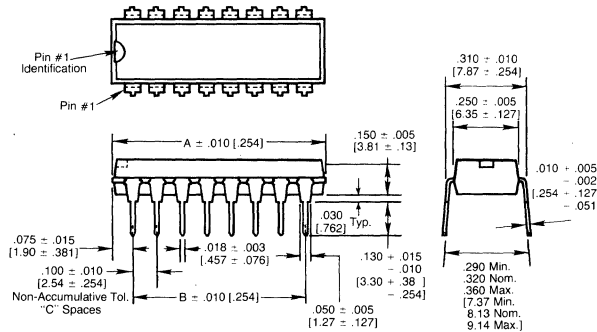

No. of Pins	A	B
14	.750 [19.05]	.600 [15.24]
16	.850 [21.59]	.700 [17.78]

SINGLE-IN-LINE

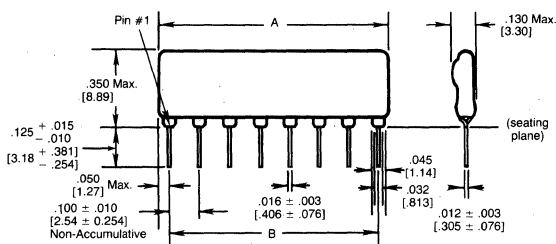

No. of Pins	A (Max.)	B
4	.390 [9.91]	.300 [7.62]
5	.490 [12.45]	.400 [10.16]
6	.590 [14.99]	.500 [12.70]
7	.690 [17.53]	.600 [15.24]
8	.790 [20.07]	.700 [17.78]
9	.890 [22.61]	.800 [20.32]
10	.990 [25.15]	.900 [22.86]
11	1.090 [27.69]	1.000 [25.40]
12	1.190 [30.23]	1.100 [27.94]

DALE ELECTRONICS, INC., Box 26728, El Paso, TX 79926 • Phone 915-592-3253
 Canada: Dale Electronics Ltd., 18 Howden Rd., Scarborough, Ontario M1R 3E6
 Europe: Dale Electronics GmbH, Benzstrasse 28, 8039 Puchheim, West Germany

R/C NETWORKS

DERATING

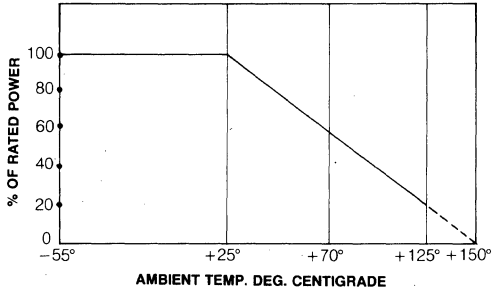

Package Style	Number of Pins	Total Package Power Rating at +25°C	Package Derating (W/°C) ABOVE +25°C
DIP	14	2.1W	.0168
	16	2.4W	.0192
SIP	4	0.9W	.0072
	5	1.2W	.0096
	6	1.5W	.012
SIP	7	1.8W	.0144
	8	2.1W	.0168
	9	2.4W	.0192
	10	2.7W	.0216
	11	3.0W	.024
	12	3.3W	.0264

Dale R/C networks have an operating temperature range of -55°C to +125°C. They must be derated according to the graph and table as indicated.

TYPICAL CIRCUIT APPLICATIONS

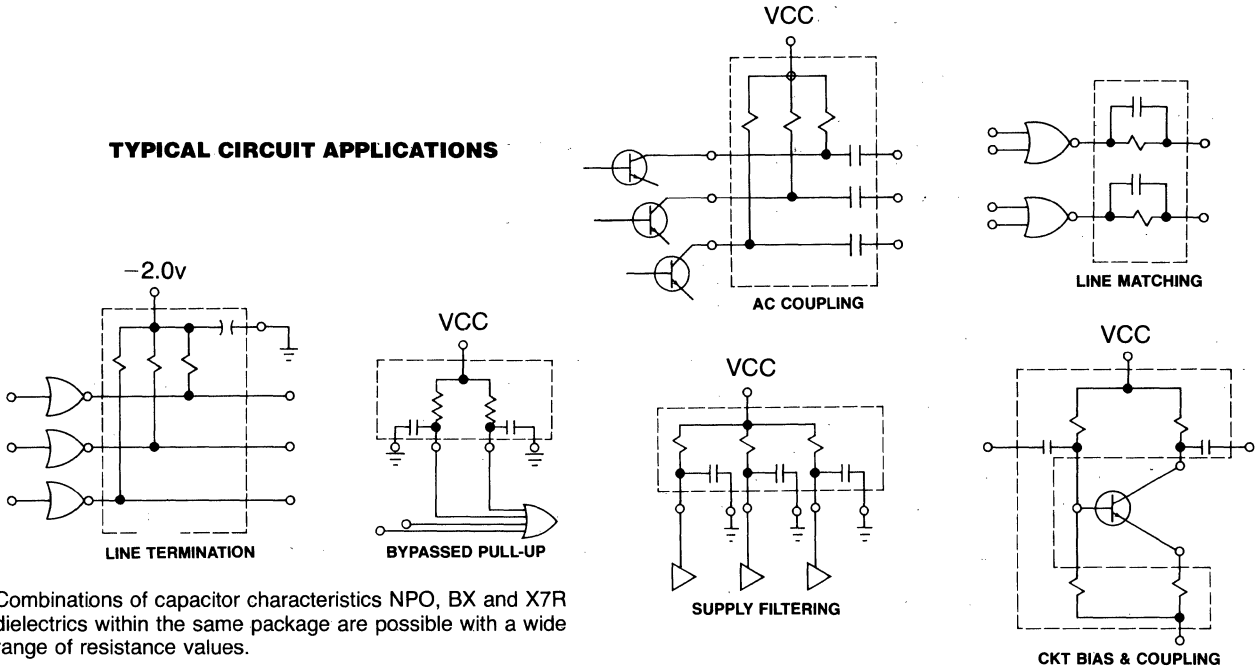

Combinations of capacitor characteristics NPO, BX and X7R dielectrics within the same package are possible with a wide range of resistance values.

DESIGN CONSIDERATIONS

The following guidelines are offered as considerations. They are helpful in minimizing design and production complications.

- Allow room for complex networks. Tight resistor tolerances and large values of capacitance require more space.
- Specify actual power ratings for individual resistors rather than blanket ratings. Keep power dissipation within the total package capability.
- Different resistance values within the same network are accomplished in two ways:
 1. Varying the geometry of resistors
 2. Separate materials used for different value ranges.
 Both methods can be used to provide a wide range of resistance values. The first is most economical.

because a range of resistance can be provided with one screen printing. For a given package style, the practical limitations are:

- DIP- 7:1 resistance range
- SIP-20:1 resistance range

The second method is more costly and reaches practical limits at three printings. However, the greatest range of resistance can be provided with this technique.

- Avoid crossovers if there is a requirement for inter-lead capacitance, unless greater than 20pf can be allowed.
- Provide pin-outs at the junction of buried nodes within a network. This provides access to the circuit so that individual circuit values can be tested.

For answers to your specific network needs, please contact the factory.

DALE ELECTRONICS, INC., Box 26728, El Paso, TX 79926 • Phone 915-592-3253
 Canada: Dale Electronics Ltd., 18 Howden Rd., Scarborough, Ontario M1R 3E6
 Europe: Dale Electronics GmbH, Benzstrasse 28, 8039 Puchheim, West Germany



DUAL-IN-LINE, Molded RESISTOR/CAPACITOR NETWORKS

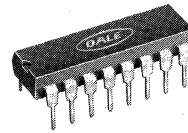

Models MDRC-1641, MDRC-1642 and MDRC-1643

FEATURES

- .190 [4.83] maximum seated height
- Rugged molded case construction
- Highly stable thick film
- Low temperature coefficient ± 100 PPM/ $^{\circ}$ C (-30° C to $+85^{\circ}$ C)
- Reduces total assembly costs
- Compatible with automatic insertion equipment
- Reduces P.C. board space

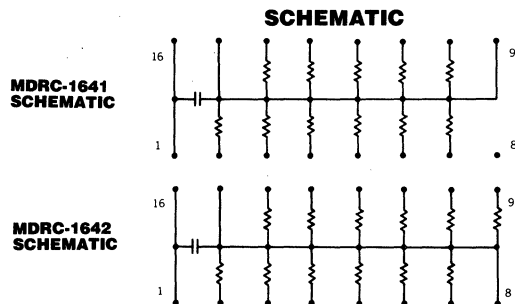

CIRCUIT EXPLANATION

-2.0 and -5.2 Volt ECL Terminator

The MDRC-1641 circuit contains 11 resistors of nominally equal value and a .01 microfarad decoupling capacitor. The MDRC-1641 is designed for ECL Line Termination to a -2.0 volt buss. The .01 microfarad decoupling capacitor is for bypassing transients between supply voltages.

The MDRC-1642 circuit contains 12 resistors of 510Ω each and a .01 microfarad decoupling capacitor. The MDRC-1642 is designed for ECL Pull-down to a -5.2 volt buss. The .01 microfarad decoupling capacitor is for bypassing voltage transients on the voltage buss.

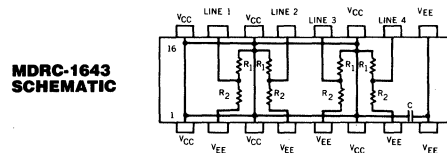

Thevenin equivalent terminator

The MDRC-1643 contains four pairs of series resistors. The circuit is compatible with ECL pin configurations. Each terminator section (series pair) contains a voltage divider between VCC (0 volts) and VEE (-5.2 volt) providing a Thevenin equivalent voltage of -2.0 volts. A .01 microfarad decoupling capacitor bypasses the VEE buss.

SPECIFICATIONS

ELECTRICAL

- Resistance Range:** See values in table.
- Resistance Tolerance:** $\pm 2\%$ or 2Ω , whichever is greater
- Capacitor Tolerance:** .01 microfarad $+40\%$, -20%
- Capacitor Voltage Rating:** 25 volts max.
- Capacitor Dissipation Factor:** $< 3\%$
- Resistance Temperature Coefficient:** ± 100 PPM/ $^{\circ}$ C (-30° C to $+85^{\circ}$ C) typical
- Resistor Power Rating:** Maximum at 25° C
MDRC-1641, MDRC-1642 = .15 watt
MDRC-1643 = .20 watt
- Package Power Rating:** 2.0 watts maximum at 25° C
- Temperature Coefficient of R Tracking:** 50 PPM/ $^{\circ}$ C
- Voltage Coefficient of Resistance:**
 < 50 PPM/V typical
- Operating Temperature Range:** -30° C to $+85^{\circ}$ C
- Storage Temperature Range:** -30° C to $+85^{\circ}$ C

PHYSICAL

- Marking Resistance to Solvents:** Permanency testing per MIL-R-83401
- Solderability:** Per MIL-STD-202, Method 208E
- Terminals:** Copper alloy, tin-lead plated
- Body:** Molded epoxy
- Weight:** 1.5 grams

ENVIRONMENTAL CHARACTERISTICS (MIL-R-83401 Ref.)

- Thermal Shock:** $\pm 0.5\%$ max. ΔR
MDRC-1641 and MDRC-1642 (5 cycles between -30° C and $+85^{\circ}$ C)
MDRC-1643 (5 cycles between -65° C and $+125^{\circ}$ C)
- Low Temperature Operation:** $\pm 0.25\%$ max. ΔR
MDRC-1641 and MDRC-1642
(45 minutes at full rated working voltage -30° C)
MDRC-1643 (45 minutes at full rated working voltage -65° C)
- Short Time Overload:** $\pm 0.25\%$ max. ΔR
($2\frac{1}{2}$ x rated working voltage 5 seconds)
- Terminal Strength:** $\pm 0.25\%$ max. ΔR ($4\frac{1}{2}$ pound pull for 30 seconds)
- Resistance to Soldering Heat:** $\pm 0.25\%$ max. ΔR (Leads immersed in 350° C solder to within $1/16''$ of device body for 3 seconds)
- Moisture Resistance:** $\pm 0.5\%$ max. ΔR (240 hours with humidity ranging from 80% RH to 98% RH)
- Shock:** $\pm 0.25\%$ max. ΔR (Total of 18 shocks at 100 G's)
- Vibration:** $\pm 0.25\%$ max. ΔR
(12 hours at maximum of 20 G's between 10 and 2,000 Hz)
- Life:** $\pm 0.5\%$ max. ΔR (1,000 hours at 70° C, rated power applied $1\frac{1}{2}$ hours on, $\frac{1}{2}$ hour off for full 1,000-hour period). Derated according to the curve.
- Insulation Resistance:** 10,000 Megohms (minimum)
- Dielectric Withstanding Voltage:** 200 VRMS for 1 minute

Models MDRC-1641, MDRC-1642 and MDRC-1643

DIMENSIONAL AND TERMINAL CONFIGURATIONS

[Numbers in brackets indicate millimeters]

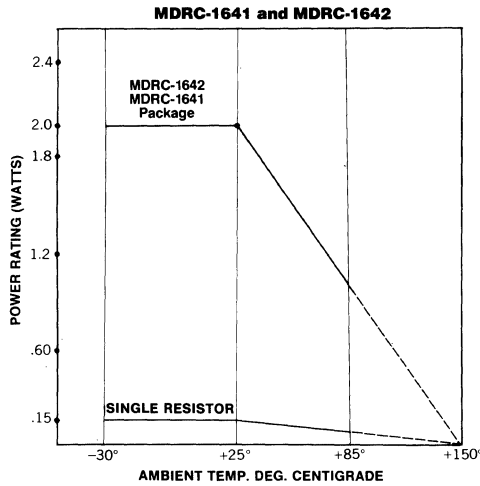
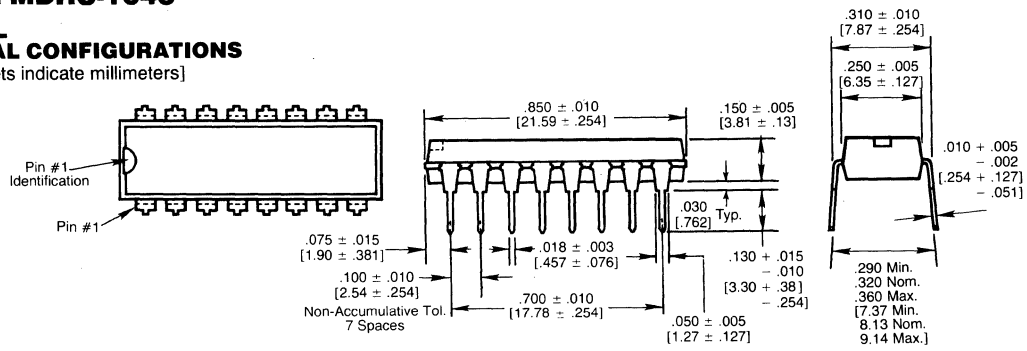

DERATING

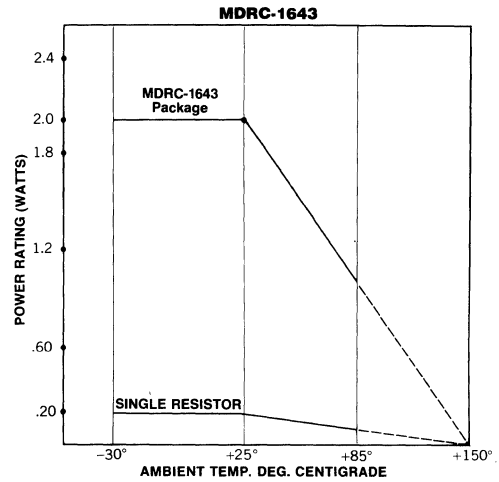

RESISTANCE VALUES IN OHMS ("G" Tolerance)

MDRC-1641
50
68
75
100

MDRC-1642
510

MDRC-1643		
R ₁	R ₂	Z ₀
81	130	50
121	195	75
162	260	100

MDRC-1641 and MDRC-1642

MDRC — **16** — **41** — **500** — **G**
 SERIES NUMBER OF PINS SCHEMATIC RESISTANCE VALUE TOLERANCE

First two digits are significant figures, last digit specifies the number of zeros

G = ±2%

MDRC-1643

MDRC — **16** — **43** — **750** — **G**
 SERIES NUMBER OF PINS SCHEMATIC IMPEDANCE VALUE IN OHMS (Z₀) TOLERANCE

First two digits are significant figures, and the last digit specifies the number of zeros to follow.

G = ±2%
J = ±5%

EXAMPLE:

MDRC-1641-500G = A 16 pin dual-in-line resistor network with eleven 50Ω resistors and a .01 microfarad decoupling capacitor.



SINGLE-IN-LINE, Coated Resistor/Capacitor Network

Models CSRC-08B20, CSRC-10B21 and CSRC-XXC30

ECL and Line Terminator Schematics

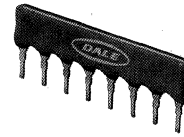

FEATURES

- Highly stable, thick film resistors, ± 150 PPM/ $^{\circ}$ C
- NPO or X7R capacitors for line terminator
- X7R type capacitor for ECL terminator
- Wide operating temperature range, -55° C to $+125^{\circ}$ C

SCHEMATIC

MODEL CSRC-08B20

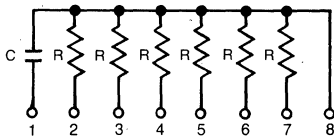

CIRCUIT APPLICATION

Model CSRC-08B20 single-in-line 10K ECL terminator network is used for decoupling and line termination in systems using 10K ECL logic.

MODEL CSRC-10B21

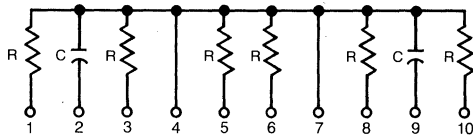

Model CSRC-10B21 single-in-line 100K ECL terminator network is used for decoupling and line termination in systems using 100K ECL logic.

MODEL CSRC-XXC30

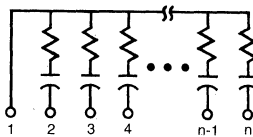

Model CSRC-XXC30 single-in-line terminator network is used for line termination and is available in 6, 7, 8, 9, 10, 11 and 12 pin sizes.

SPECIFICATIONS

RESISTORS

Resistance Range:

CSRC-08B20, CSRC-10B21 =
50 Ω , 68 Ω , 100 Ω , 150 Ω

CSRC-XXC30 = 50 Ω to 1K Ω

(Other values available on request)

Tolerance: $\pm 5\%$ Standard

$\pm 2\%$ Available

Temperature Coefficient: ± 150 PPM/ $^{\circ}$ C

(-55° C to $+125^{\circ}$ C)

Operating Voltage:

CSRC-08B20, CSRC-10B21 = 8 VDC maximum

CSRC-XXC30 = 50 VDC maximum

CAPACITORS

Type: CSRC-08B20, CSRC-10B21 = X7R

CSRC-XXC30 = NPO or X7R

Standard Values:

CSRC-08B20, CSRC-10B21 = .01 μ f.

CSRC-XXC30 NPO type = 56pf, 100pf, 220pf, 470pf

X7R type = 1000pf, .01 μ f.

(Other values available on request)

Tolerance:

CSRC-08B20, CSRC-10B21 = 20% Standard

CSRC-XXC30 NPO type = $\pm 10\%$

X7R type = $\pm 20\%$

Voltage Rating:

CSRC-08B20, CSRC-10B21 = 25 VDC

CSRC-XXC30 = 50 VDC

DALE ELECTRONICS, INC., Box 26728, El Paso, TX 79926 • Phone 915-592-3253

Canada: Dale Electronics Ltd., 18 Howden Rd., Scarborough, Ontario M1R 3E6
Europe: Dale Electronics GmbH, Benzstrasse 28, 8039 Puchheim, West Germany

Models CSRC-08B20, CSRC-10B21, and CSRC-XXC30

DIMENSIONAL AND TERMINAL CONFIGURATIONS

[Numbers in brackets indicate millimeters]

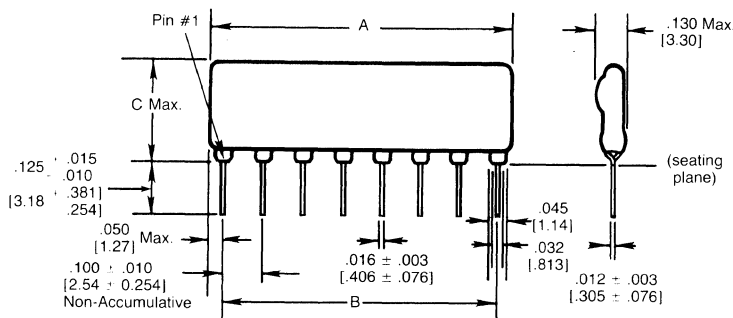

MODEL CSRC-08B20

No. of Pins	A (Max.)	B	C
8	.790 [20.07]	.700 [17.78]	.250 [6.35]

MODEL CSRC-10B21

No. of Pins	A (Max.)	B	C
10	.990 [25.15]	.900 [22.86]	.250 [6.35]

MODEL CSRC-XXC30

No. of Pins	A (Max.)	B	C
6	.590 [14.99]	.500 [12.70]	.350 [8.89]
7	.690 [17.53]	.600 [15.24]	.350 [8.89]
8	.790 [20.07]	.700 [17.78]	.350 [8.89]
9	.890 [22.61]	.800 [20.32]	.350 [8.89]
10	.990 [25.15]	.900 [22.86]	.350 [8.89]
11	1.090 [27.69]	1.000 [25.40]	.350 [8.89]
12	1.190 [30.23]	1.100 [27.94]	.350 [8.89]

CSRC-08B20 and CSRC-10B21

HOW TO ORDER

CSRC	—	08 10	B	20 21	—	101	J
MODEL		NUMBER OF PINS	PACKAGE CODE	SCHEMATIC		RESISTANCE VALUE	TOLERANCE

First two digits are significant figures. Third digit specifies the number of zeros.

G = ±2%
J = ±5%

CSRC-XXC30

CSRC	—	XX	C	30	—	101	J	/	560	K
MODEL		NUMBER OF PINS	PKG. CODE	SCHEMATIC		RESISTANCE VALUE (Ohms)	TOLERANCE		CAPACITANCE VALUE (picofarads)	TOLERANCE

G = ±2%
J = ±5%

First two digits are significant, third digit signifies number of zeros to follow.

K = ±10%
M = ±20%



COMMERCIAL, HERMETIC THIN FILM RESISTOR NETWORK

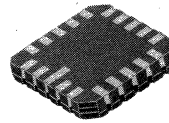

MODEL TLCC-XXA

01 Schematic: 15 to 23 resistors with highest numbered terminal common
03 and 06 Schematics: 8 to 12 isolated resistors

FEATURES

- Highly stable thin film
- Low temperature coefficient Nichrome Film
- Hermetic
- Uniform performance characteristics

DERATING CURVE

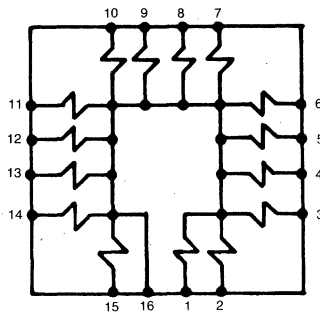
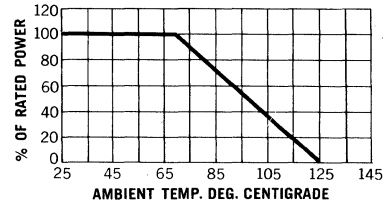

16A01 SCHEMATIC

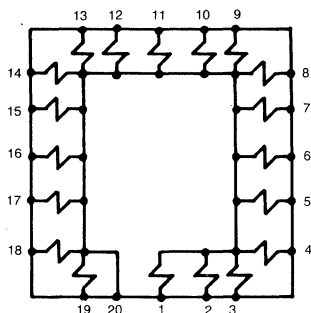

20A01 SCHEMATIC

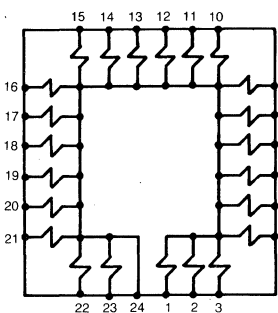

24A01 SCHEMATIC

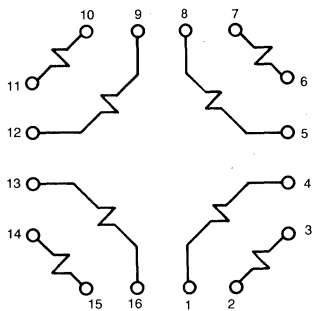

16A03 SCHEMATIC

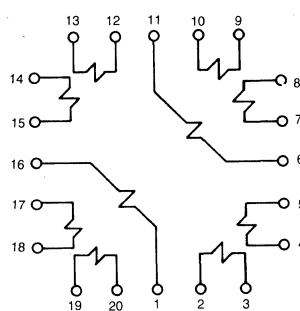

20A03 SCHEMATIC

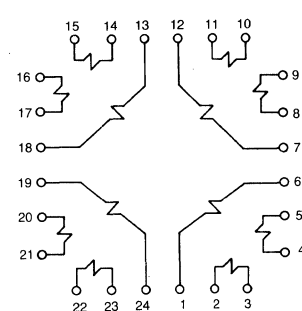

24A03 SCHEMATIC

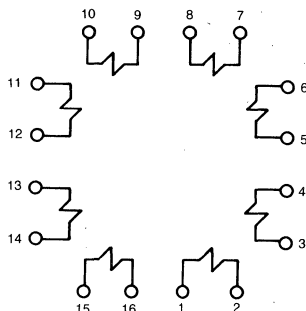

16A06 SCHEMATIC

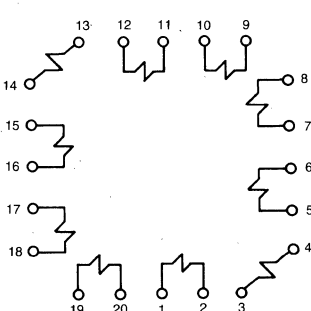

20A06 SCHEMATIC

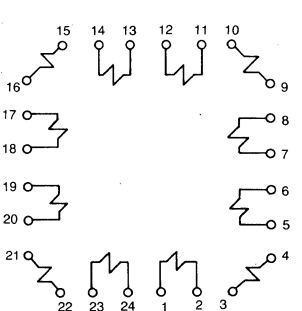

24A06 SCHEMATIC

Model TLCC-XXA

SPECIFICATIONS

ELECTRICAL

- Resistance Range:** 1K ohm to 100K ohm
- Resistance Tolerance:** 2%, 1%, 0.5%
- Resistance Ratio Match:** 1%, 0.5%, 0.1%
- T.C. Tracking:** ±10 PPM/°C (−55°C to +125°C) typical
(±5 PPM/°C, 12.5K and above)
- Power Tracking:** Watts at 70°C (See derating curve)

01 SCHEMATIC	16	20	24
Package	0.8	1.0	1.2
Element	0.05	0.05	0.05
03 and 06 SCHEMATICS	16	20	24
Package	0.8	1.0	1.2
Element	0.100	0.100	0.100

- Resistance Temperature Coefficient:**
±25 PPM/°C (−55°C to +125°C) typical
- Maximum Operating Voltage:** 100 Volts
- Voltage Coefficient of Resistance:** < 5 PPM/V typical
- Operating Temperature Range:** −55°C to +125°C
- Storage Temperature Range:** −55°C to +150°C
- Dielectric Strength:** 200 V minimum
- Insulation Resistance:** 10¹⁰ ohm minimum

PHYSICAL

- Body:** 90% minimum alumina content
- Terminals:** Gold, 60 microinch minimum
- Lid:** Gold plated Kovar
- Seal:** Gold-tin alloy

ENVIRONMENTAL CHARACTERISTICS (Typical MIL-R-83401 Reference)

- Thermal Shock:** ±0.10% max. ΔR
- Low Temperature Operation:** ±0.10% max. ΔR
- Power Conditioning:** ±0.25% max. ΔR
- Short Time Overload:** ±0.10% max. ΔR
- Maximum Solder Reflow Temperature:** 280°C
- Moisture Resistance:** ±0.20% max. ΔR
- Constant Acceleration:** ±0.10% max. ΔR
- Hermeticity:** Fine leak rate less than 5 x 10⁻⁷ cubic centimeters per second
- Vibration:** ±0.25% max. ΔR
- Life:** .3 max. ΔR

DIMENSIONAL CONFIGURATIONS (Reference Dimensions)

[Numbers in brackets indicate millimeters]

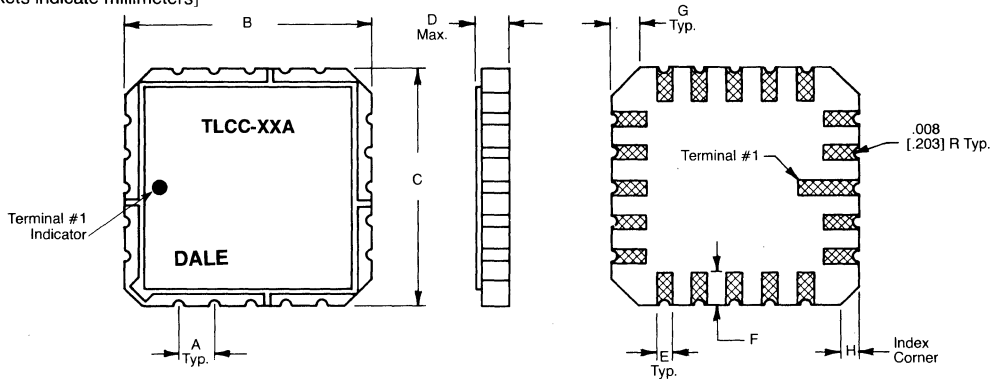

	A	B	C	D	E	F	G	H
16	.050" [1.27]	.300" [7.62]	.300" [7.62]	.077" [1.96]	.025" [.635]	.050" [1.27]	.040" [1.02]	.0200" [.508]
20	.050" [1.27]	.350" [8.89]	.350" [8.89]	.077" [1.96]	.025" [.635]	.050" [1.27]	.040" [1.02]	.0200" [.508]
24	.050" [1.27]	.400" [10.16]	.400" [10.16]	.077" [1.96]	.025" [.635]	.050" [1.27]	.040" [1.02]	.0200" [.508]

HOW TO ORDER

TLCC	—	16 20 24	A	01 03 06	—	XXX or XXXX	F
SERIES		NUMBER OF TERMINALS	SPACING	SCHEMATIC		RESISTANCE VALUE	TOLERANCE
			A = 0.050" [1.27]			First 2 digits (3 for "D" and "F") are significant figures. The last digit specifies the number of zeros to follow.	D = ±0.5%, ±0.1% ratio match F = ±1.0%, ±0.5% ratio match G = ±2.0%, ±1% ratio match



DUAL-IN-LINE, SMALL OUTLINE MOLDED DIP THIN FILM RESISTOR NETWORK

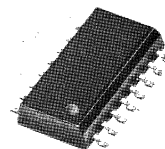

MODELS TOMC-14 and TOMC-16

01 Schematic: 13 or 15 resistors with highest numbered lead common

03 Schematic: 7 or 8 isolated resistors

FEATURES

- .090" [2.29] maximum seated height
- Rugged, molded case construction
- Highly stable thin film
- Low temperature coefficient, ± 25 PPM/ $^{\circ}\text{C}$ (-55°C to $+125^{\circ}\text{C}$)
- Reduces total assembly costs
- Compatible with automatic surface mounting equipment
- Wide resistance range
- Uniform performance characteristics
- Thick film version available. See page 96.

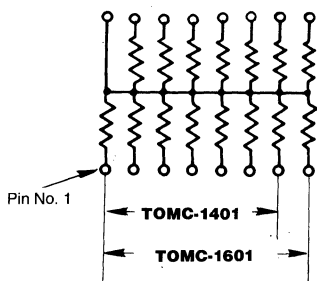

CIRCUIT EXPLANATION

The 01 circuit provides a choice of 13 or 15 nominally equal resistors, each connected between a common lead (14 or 16) and a discrete P.C. board pin. Commonly used in the following applications:

- MOS/ROM Pull-up/Pull-down
- Open Collector Pull-up
- "Wired OR" Pull-up
- Power Driven Pull-up
- TTL Input Pull-down
- Digital Pulse-Squaring
- TTL Unused Gate Pull-up
- High Speed Parallels Pull-up

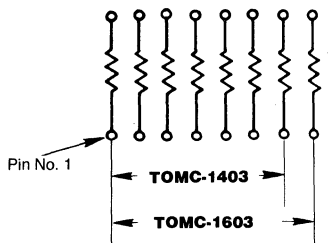

CIRCUIT EXPLANATION

The 03 circuit provides a choice of 7 or 8 nominally equal resistors with each resistor isolated from all others and wired directly across. Commonly used in the following applications:

- "Wired OR" Pull-up
- Powergate Pull-up
- Long-line Impedance Balancing
- ECL Output Pull-down
- Power Driven Pull-up
- Line Termination
- LED Current Limiting
- TTL Input Pull-down

SPECIFICATIONS

ELECTRICAL

- Resistance Range:** 100 ohms to 100K
- Resistance Tolerance:** $\pm 1\%$, 0.5%, .25%, .1%
- Resistance Ratio Match:** 0.5%, 0.1%, 0.05%
- Resistance Temperature Coefficient:** ± 25 PPM/ $^{\circ}\text{C}$
- Resistor Power Rating:** 01 = .05 watt maximum at 25°C
03 = .100 watt maximum at 25°C
- Package Power Rating:** 14 pin or 14 lead = .65 watt
16 pin or 16 lead = .75 watt
(maximum at 25°C)
- T.C. Tracking:** ± 5 PPM/ $^{\circ}\text{C}$ (-55°C to $+125^{\circ}\text{C}$) typical
- Voltage Coefficient of Resistance:** < 5 PPM/V typical

- Maximum Operating Voltage:** 100 VDC
- Operating Temperature Range:** -55°C to $+125^{\circ}\text{C}$
- Storage Temperature Range:** -55°C to $+150^{\circ}\text{C}$

PHYSICAL

- Marking:** Model Number, Schematic Number, Value Code, Tolerance Code and Dale Name
- Marking Resistance to Solvents:** Permanency testing per MIL-R-83401
- Solderability:** Per MIL-R-83401
- Leads:** Copper alloy, solderable
- Body:** Molded epoxy

Models TOMC-14 and TOMC-16

ENVIRONMENTAL CHARACTERISTICS (Typical MIL-R-83401 Reference)

Thermal Shock: $\pm 0.25\%$ max. ΔR

Power Conditioning: $\pm 0.25\%$ max. ΔR

Low Temperature Operation: $\pm 0.10\%$ max. ΔR

Short Time Overload: $\pm 0.10\%$ max. ΔR

Terminal Strength: $\pm 0.10\%$ max. ΔR

Resistance to Soldering Heat: $\pm 0.10\%$ max. ΔR

Moisture Resistance: $\pm 0.20\%$ max. ΔR

Shock: $\pm 0.25\%$ max. ΔR

Vibration: $\pm 0.25\%$ max. ΔR

Life: $\pm 0.10\%$ max. ΔR

Insulation Resistance: 10,000 Megohms (minimum)

Dielectric Withstanding Voltage: No evidence of arcing or damage
(200 VRMS for 1 minute)

DERATING

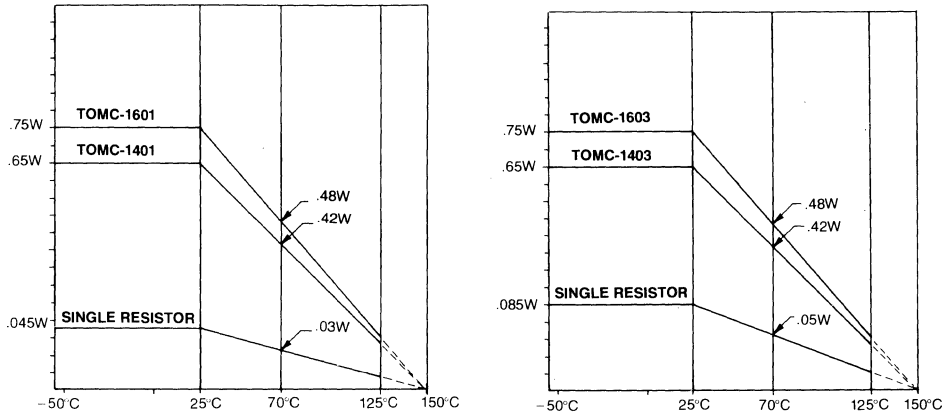

DIMENSIONAL AND TERMINAL CONFIGURATIONS

[Numbers in brackets indicate millimeters]
(Reference Dimensions)

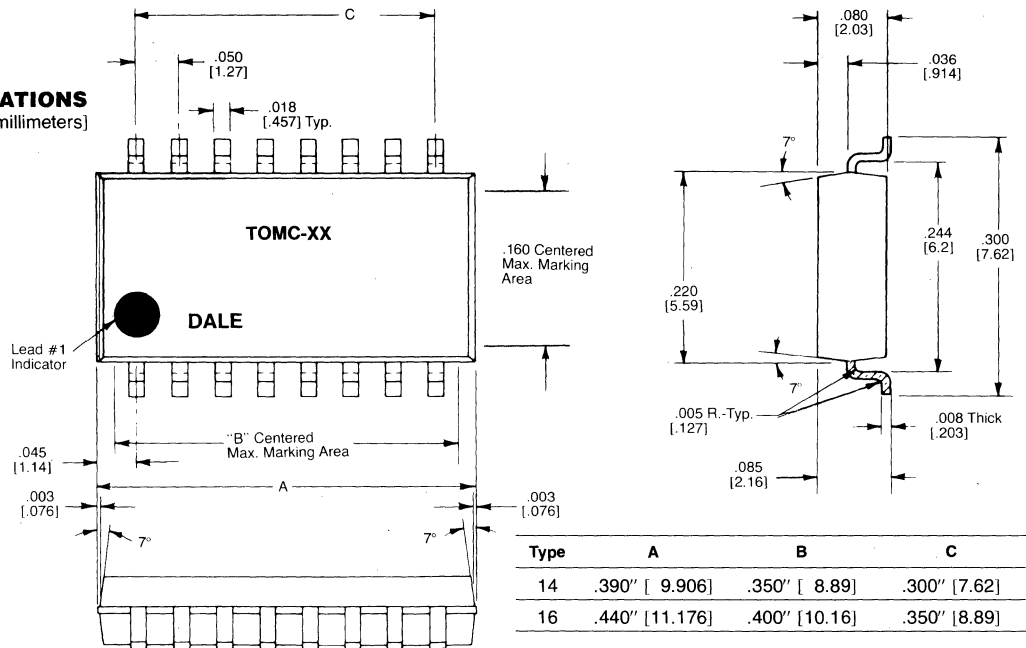

HOW TO ORDER

TOMC- 14 01 03 - XXXX F
 SERIES NUMBER OF LEADS SCHEMATIC RESISTANCE VALUE TOLERANCE AND RATIO TOLERANCE

First 3 digits are significant figures. The last digit specifies the number of zeros to follow.

*Tolerance available on 1K and up only.

*A = $\pm 0.1\%$, $\pm 0.05\%$ ratio match
 *B = $\pm 0.1\%$, $\pm 0.1\%$ ratio match
 C = $\pm 0.25\%$, $\pm 0.1\%$ ratio match
 D = $\pm 0.5\%$, $\pm 0.1\%$ ratio match
 F = $\pm 1.0\%$, $\pm 0.5\%$ ratio match

DALE ELECTRONICS, INC., 2300 Riverside Blvd., Norfolk, NE 68701 • Phone 402-371-0080

Canada: Dale Electronics Ltd., 18 Howden Rd., Scarborough, Ontario M1R 3E6
 Europe: Dale Electronics GmbH, Benzstrasse 28, 8039 Puchheim, West Germany

MODELS TNP-XXXA and TNP-XXXB, Tapped

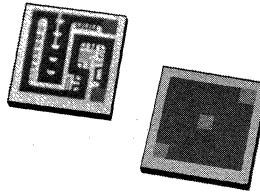

FEATURES

- Highly stable thin film
- Low temperature coefficient, ± 25 PPM/ $^{\circ}$ C (-55° C to $+125^{\circ}$ C)
- Uniform performance characteristics

SPECIFICATIONS

ELECTRICAL

Resistance Range: 250 ohms to 275K ohms total resistance

Resistance Tolerance:

- $\pm 0.1\%$ (1K ohm to 275K) (TNP-330A)
- $\pm 0.1\%$ (500 ohms to 125K) (TNP-330B)
- $\pm 0.5\%$ (250 ohms to 100K) (TNP-550)

Ratio Match: TNP-XXXB: $\pm .1\%$ (500 ohms and above)
 $\pm .5\%$ (250 ohms and above)

Power Rating: .025 watt total at 70° C (TNP-550)
 .015 watt total at 70° C (TNP-330)
 (See derating curve)

Resistance Temperature Coefficient:
 ± 25 PPM/ $^{\circ}$ C (-55° C to $+125^{\circ}$ C) typical

T.C. Tracking: TNP-XXXB: ± 5 PPM/ $^{\circ}$ C
 (-55° C to $+125^{\circ}$ C) typical

Maximum Operating Voltage: TNP-330: 25 Volts
 TNP-550: 40 Volts

Voltage Coefficient of Resistance: < 5 PPM/V typical

Operating Temperature Range: -55° C to $+125^{\circ}$ C

Storage Temperature Range: -55° C to $+150^{\circ}$ C

PHYSICAL

Substrate: Passivated glass

Resistor Material: Nichrome based alloy

Termination: Pt

Passivation: Moisture resistant dielectric

ENVIRONMENTAL CHARACTERISTICS (Typical MIL-R-55342 Reference)

Thermal Shock: $\pm 0.05\%$ max. ΔR

Low Temperature Operation: $\pm 0.05\%$ max. ΔR

Short Time Overload: $\pm 0.05\%$ max. ΔR

High Temperature Exposure: $\pm 0.05\%$ max. ΔR

Bonding Exposure: $\pm 0.05\%$ max. ΔR

Moisture Resistance: $\pm 0.10\%$ max. ΔR

Life: $\pm 1\%$ max. ΔR

DERATING CURVE

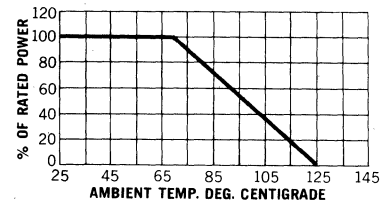

DIMENSIONAL CONFIGURATIONS

[Numbers in brackets indicate millimeters]

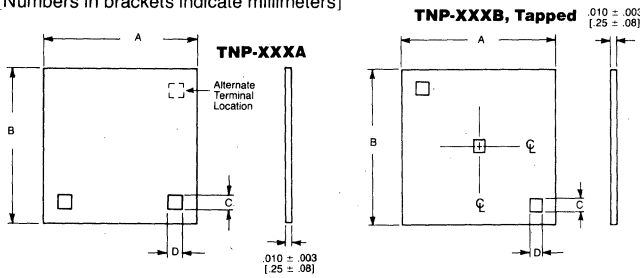

TYPE	A	B	C	D
550	.050 $\begin{smallmatrix} +.010 \\ -.005 \end{smallmatrix}$.050 $\begin{smallmatrix} +.010 \\ -.005 \end{smallmatrix}$.007 $\pm .001$.007 $\pm .001$
	[1.27 $\begin{smallmatrix} +.250 \\ -.130 \end{smallmatrix}$]	[1.27 $\begin{smallmatrix} +.250 \\ -.130 \end{smallmatrix}$]	[.180 $\pm .025$]	[.180 $\pm .025$]
330	.030 $\begin{smallmatrix} +.010 \\ -.005 \end{smallmatrix}$.030 $\begin{smallmatrix} +.010 \\ -.005 \end{smallmatrix}$.0035 $\pm .001$.0035 $\pm .001$
	[.760 $\begin{smallmatrix} +.250 \\ -.130 \end{smallmatrix}$]	[.760 $\begin{smallmatrix} +.250 \\ -.130 \end{smallmatrix}$]	[.090 $\pm .025$]	[.090 $\pm .025$]

HOW TO ORDER

	A	—	XXX or XXXX			
	SCHMATIC		RESISTANCE VALUE			
			XXX	XXX		
			or	or		
			XXXX	XXXX		
			/	/		
			R ₁ *VALUE	R ₂ **VALUE		
			First 2 digits (3 for "B", "D" and "F" tolerance) are significant figures. The last digit specifies the number of zeros to follow.			
			*R ₁ is the low resistance value			
			**R ₂ is the high resistance value			
TNP	550				F	
SERIES	330	B			TERMINATION	A
	SIZE	SCHMATIC				CONSTRUCTION
					B = $\pm 0.1\%$	A = Platinum, Bare Back
					D = $\pm 0.5\%$	A = Glass
					F = $\pm 1.0\%$	
					G = $\pm 2.0\%$	
					J = $\pm 5.0\%$	
					K = $\pm 10.0\%$	



COMMERCIAL PRECISION THIN FILM CHIP RESISTORS

PRELIMINARY

DALE SERIES TNPW

FEATURES

- Internationally standardized size
- Automatic placement compatibility
- Flow solderable
- Thin film resistance element
- Wraparound termination
- Inner electrode protection
- 8MM reel or bulk packaging
- Thick film version available. See page 138.

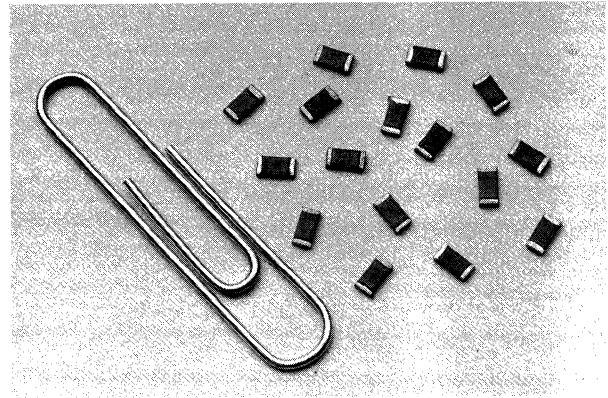
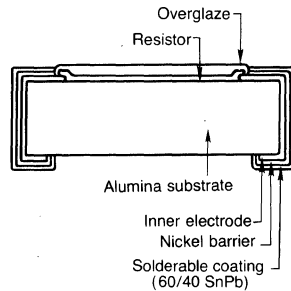

ELECTRICAL SPECIFICATIONS:

Resistance Range: 50 ohms to 100K ohms
Resistance Tolerance: $\pm 0.1\%$ (1K ohm to 100K ohms)
 $\pm 1.0\%$ (50 ohms to 100K ohms)
Resistance Temperature Coefficient: ± 25 PPM/ $^{\circ}$ C (-55° C to $+125^{\circ}$ C)
Power Rating: .125 watts

Maximum Operating Voltage: 100 Volts
Maximum Ambient Temperature: 125° C
 (see derating curve)
Temperature Range: -55° C to $+125^{\circ}$ C

DIMENSIONAL SPECIFICATIONS

[Numbers in brackets indicate millimeters]

DALE TYPE	A (Length)	B (Width)	C (Thickness)	D (Termination)
TNPW1206	.126 [3.20]	.063 [1.60]	.024 [.61]	.018 [.46]

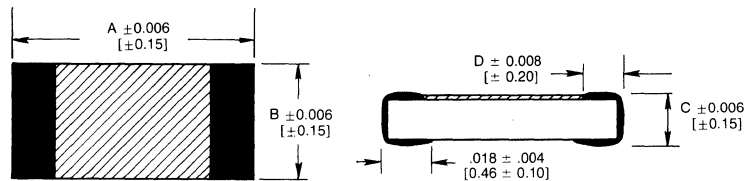

PERFORMANCE CHARACTERISTICS (Test Methods per MIL-R-55342)

TEST	REQUIREMENT	SPECIFICATION
Thermal Shock	$\pm 0.05\%$ Max. $\pm .05\Omega$	MIL-STD-202, Method 107
Low Temperature Operation	$\pm 0.05\%$ Max. $\pm .05\Omega$	MIL-R-55342, Para 4.7.4
Short Time Overload	$\pm 0.05\%$ Max. $\pm .05\Omega$	MIL-R-55342, Para. 4.7.5
High Temp. Exposure	$\pm 0.05\%$ Max. $\pm .05\Omega$	MIL-R-55342, Para. 4.7.6
Resistance to Bonding Exposure	$\pm 0.05\%$ Max. $\pm .05\Omega$	MIL-R-55342, Para. 4.7.7
Moisture Resistance	$\pm 0.05\%$ Max. $\pm .05\Omega$	MIL-STD-202, Method 106
Life	$\pm 0.1\%$ / $\pm .05\Omega$	MIL-STD-202, Method 108
Solderability	230 $^{\circ}$ C, 5 sec., 95% Coverage	MIL-STD-202, Method 208

DERATING

Dale TNPW resistors have an operating temperature range of -55° C to $+125^{\circ}$ C. They must be derated according to the curve.

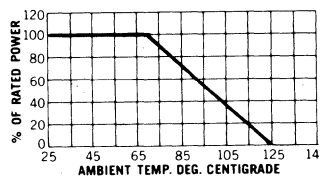



COMMERCIAL THICK FILM CHIP RESISTORS

DALE SERIES CRCW

FEATURES

- Internationally standardized size
- Automatic placement compatibility
- Flow solderable
- Thick film resistance element
- Wraparound termination
- Inner electrode protection
- For thin film chip resistors, see page 137

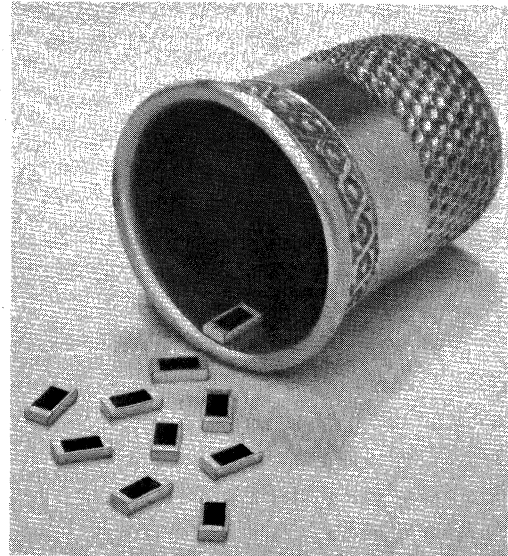
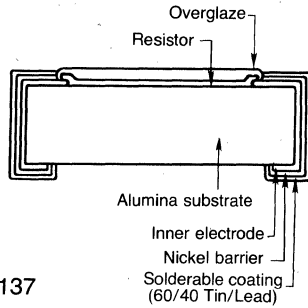

SPECIFICATIONS

Dale Type	T.C.	Resistance, Tolerance & Temperature Coefficient Range					Power Rating and Maximum Operating Voltage (@ 70°C) (See derating curve)	Zero OHM Jumpers	DIMENSIONS [Numbers in brackets indicate millimeters]					
		E-12 Std. Res. Values		E-24 Std. Res. Values		E-96 Std. Res. Values			A (Length)	B (Width)	C	D	E	
		±10% & ±20%	±5%	±2%	±1%	±.5%								
CRCW 0805	±100 PPM/°C				10Ω to 1 Meg.		62.5MW, 100V	0.05Ω Max. 1 AMP Max.	.079 ± .008 [2.00 ± .20]	.049 ± .008 [1.25 ± .20]	.020 ± .008 [.50 ± .20]	.016 ± .010 [.40 ± .25]	.016 ± .010 [.40 ± .25]	
	±200 PPM/°C		10Ω to 1 Meg.											
	±300 PPM/°C		5Ω to 9.9Ω & 1.1 Meg. to 5 Meg.											
CRCW 1206	±100 PPM/°C				10Ω to 1 Meg.	1K to 5K	125MW, 200V	0.05Ω Max. 2 AMP Max.	.126 ± .008 [3.20 ± .20]	.063 + .006 - .008 [1.60 ± .15 - .20]	.022 ± .006 [.56 ± .15]	.020 ± .010 [.50 ± .25]	.020 ± .010 [.50 ± .25]	
	±200 PPM/°C		10Ω to 2.2 Meg.		10Ω to 2.2 Meg.									
	±300 PPM/°C		3Ω to 9.9Ω & 2.4 Meg. to 22 Meg.											
CRCW 1210	±100 PPM/°C				20Ω to 220K		250MW, 200V	0.05Ω Max. 4 AMP Max.	.126 ± .008 [3.20 ± .20]	.098 ± .008 [2.50 ± .20]	.022 ± .006 [.56 ± .15]	.020 ± .010 [.50 ± .25]	.020 ± .010 [.50 ± .25]	
	±200 PPM/°C		10Ω to 1.5 Meg.		10Ω to 1.5 Meg.									
	±300 PPM/°C													

□ = Factory Stocked Resistance Range ◻ = Contact Factory for Delivery ◼ = Contact Factory for Availability

DALE ELECTRONICS, INC., 2300 Riverside Blvd., Norfolk, NE 68701 • Phone 402-371-0080

Canada: Dale Electronics Ltd., 18 Howden Rd., Scarborough, Ontario M1R 3E6
Europe: Dale Electronics GmbH, Benzstrasse 28, 8039 Puchheim, West Germany

**COMMERCIAL
THICK FILM RESISTORS**

PERFORMANCE CHARACTERISTICS

TEST	REQUIREMENT		SPECIFICATION
	1% Tol., 100 PPM	5% Tol., 200 PPM	
Thermal Shock	$\pm(0.5\% + 0.05\Omega)$	$\pm(1.0\% + 0.1\Omega)$	EIA STD IS-30, Para. 3.5
Low Temperature Operation	$\pm(0.5\% + 0.05\Omega)$	$\pm(1.5\% + 0.1\Omega)$	EIA STD IS-30, Para. 3.6
Short Time Overload	$\pm(0.5\% + 0.05\Omega)$	$\pm(2.5\% + 0.1\Omega)$	EIA STD IS-30, Para. 3.7
High Temp. Exposure	$\pm(1\% + 0.05\Omega)$	$\pm(1.5\% + 0.1\Omega)$	EIA STD IS-30, Para. 3.8
Effect of Soldering	$\pm(0.25\% + 0.05\Omega)$	$\pm(3.0\% + 0.1\Omega)$	EIA STD IS-30, Para. 3.9
Moisture Resistance	$\pm(0.5\% + 0.05\Omega)$	$\pm(3.0\% + 0.1\Omega)$	EIA STD IS-30, Para. 3.10
Life	$\pm(2\% + 0.05\Omega)$	$\pm(3.0\% + 0.1\Omega)$	EIA STD IS-30, Para. 3.13
Solderability and Leach Resistance	95% min. coverage of termination	95% min. coverage of termination	EIA STD IS-30, Para. 3.12
Termination Adhesion	0.5 Kg min.	0.5 Kg min.	AXIAL PULL (soldered-on #26 nail-head lead with .037" dia. head)

DERATING

Dale CRCW resistors have an operating temperature range of -55°C to $+125^{\circ}\text{C}$. They must be derated according to the curve.

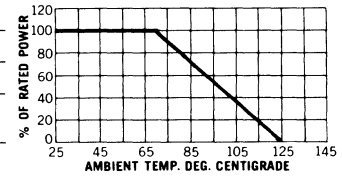

HOW TO ORDER

CRCW
SERIES

XXXX
SIZE

XXX or XXXX
RESISTANCE VALUE CODE

X

TOLERANCE

XXX

PACKAGING

0805
1206
1210

First two digits
(3 for "F" tolerance) are
significant; last digit is
the multiplier

F = $\pm 1\%$
J = $\pm 5\%$

B02 = Bulk — 1,000 pieces per plastic bag.
RT1 = Paper Tape — 5,000 pieces per reel.
RT2 = Punched Plastic Tape — 5,000 pieces per reel.
RT3 = Punched Plastic Tape — 10,000 pieces per reel. (Contact factory)

TAPE AND REEL SPECIFICATIONS

MARKING: All required marking to be on unit package. Individual part marking is available. Stocked, CRCW 1206, 5% units are marked with 3 digit value code.
PACKAGING: Bulk Package — 1000 pieces per plastic bag.
8mm Reel — 5000 pieces per reel per EIA Standard RS-481.

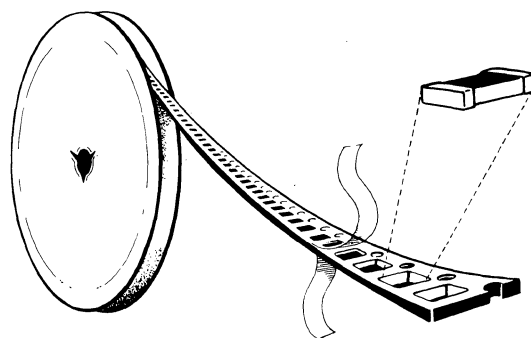

REEL DIMENSIONS

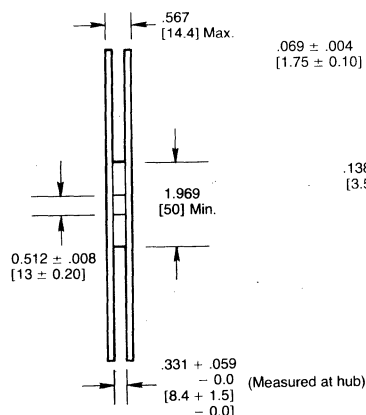
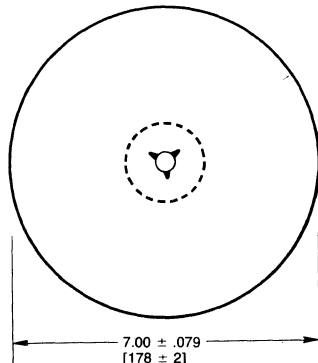

TAPE

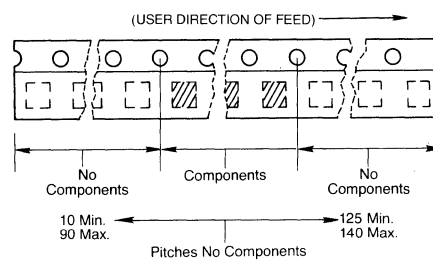

TAPE DIMENSIONS

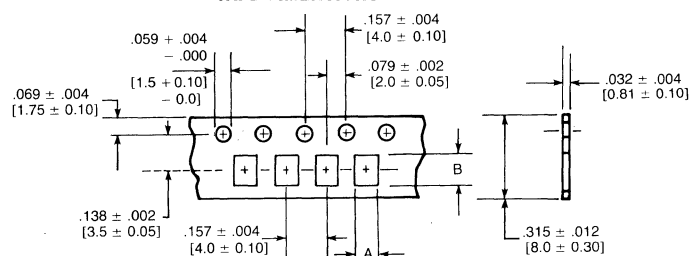

DALE TYPE	A ± .005 [± 0.13]	B ± .005 [± 0.13]
CRCW 0805	.070 [1.78]	.100 [2.54]
CRCW 1206	.080 [2.03]	.142 [3.61]
CRCW 1210	.115 [2.92]	.142 [3.61]



COMMERCIAL THICK FILM CHIP RESISTORS

DALE SERIES RC and RCWP/RCW

FEATURES

- Allows wide design flexibility for use with hybrid circuitry
- One-surface and wrap-around terminations
- Choices of sizes and power ratings
- Dale has complete capability to develop specific reliability programs designed to customer requirements
- Custom sizes can be designed for special applications

SPECIFICATIONS

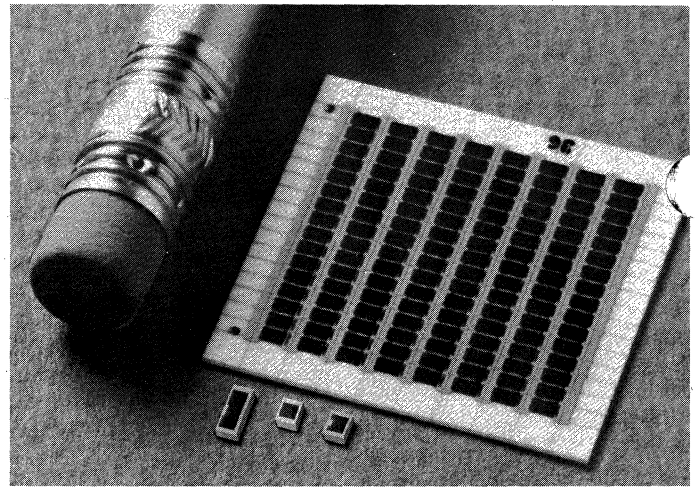

DALE TYPE	A (Length)	B	C (Width)	*RESISTANCE AND T.C. RANGE			MAX. OPER. VOLT.	POWER RATING @ 70°C (See Derating Curve)
				1% to 20%		2% to 20%		
				100 PPM/°C	200 PPM/°C	300 PPM/°C		
RC550	.050 [1.27]	.010 [.25]	.050 [1.27]	10Ω-1 Meg.	5Ω-2 Meg.	5Ω-4.7 Meg.	50 VDC	100MW
RCWP/RCW550	.055 [1.40]	.010 [.25]	.050 [1.27]					
RC575	.075 [1.91]	.015 [.38]	.050 [1.27]	10Ω-1 Meg.	5Ω-5 Meg.	5Ω-10 Meg.	70 VDC	150MW
RCWP/RCW575	.080 [2.03]	.015 [.38]	.050 [1.27]					
RC5100	.100 [2.54]	.015 [.38]	.050 [1.27]	10Ω-1 Meg.	10Ω-5 Meg.	10Ω-15 Meg.	100 VDC	200MW
RCWP/RCW5100	.105 [2.67]	.015 [.38]	.050 [1.27]					
RC5150	.150 [3.81]	.015 [.38]	.050 [1.27]	10Ω-1 Meg.	10Ω-5 Meg.	10Ω-15 Meg.	125 VDC	350MW
RCWP/RCW5150	.155 [3.94]	.015 [.38]	.050 [1.27]					
RC1100	.100 [2.54]	.015 [.38]	.100 [2.54]	10Ω-1 Meg.	5Ω-5 Meg.	5Ω-7.5 Meg.	100 VDC	400MW
RCWP/RCW1100	.105 [2.67]	.015 [.38]	.100 [2.54]					
RC7225	.225 [5.72]	.015 [.38]	.075 [1.91]	10Ω-1 Meg.	10Ω-5 Meg.	10Ω-15 Meg.	200 VDC	600MW
RCWP/RCW7225	.230 [5.84]	.015 [.38]	.075 [1.91]					
RC2010	.200 [5.08]	.015 [.38]	.100 [2.54]	10Ω-1 Meg.	10Ω-5 Meg.	10Ω-15 Meg.	200 VDC	80MW
RCWP/RCW2010	.205 [5.21]	.015 [.38]	.100 [2.54]					
RC2512	.250 [6.35]	.015 [.38]	.125 [3.18]	10Ω-1 Meg.	10Ω-5 Meg.	10Ω-15 Meg.	200 VDC	1000MW
RCWP/RCW2512	.255 [6.48]	.015 [.38]	.125 [3.18]					
RC1206	.120 [3.05]	.015 [.38]	.060 [1.52]	10Ω-1 Meg.	10Ω-5 Meg.	10Ω-10 Meg.	100 VDC	250MW
RCWP/RCW1206	.120 [3.05]	.015 [.38]	.060 [1.52]					
RC540	.050 [1.27]	.010 [.25]	.040 [1.02]	10Ω-1 Meg.	5Ω-2 Meg.	5Ω-4.7 Meg.	40 VDC	80MW
RCWP/RCW540	.055 [1.40]	.010 [.25]	.040 [1.02]					

*Consult factory for extended resistance range.

DIMENSIONAL AND TERMINAL CONFIGURATIONS

[Numbers in brackets indicate millimeters.]

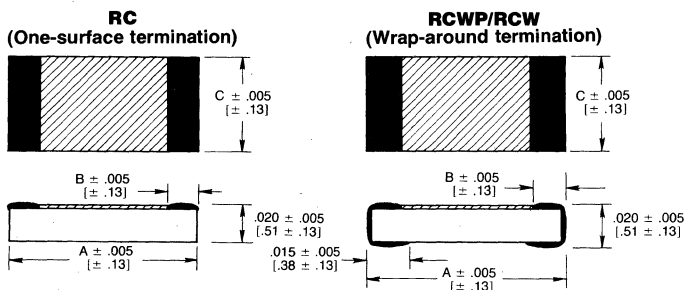

Operating Temperature Range: -55°C to +125°C

PHYSICAL

Body: 95% minimum alumina

Termination: Solder pre-tinned electrodes standard.

Gold, platinum gold or palladium silver available.

DERATING CURVE

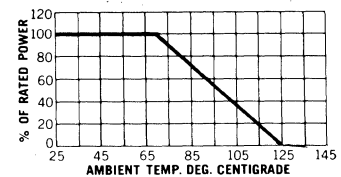

HOW TO ORDER

RC	5100	103	G	40
STYLE	SIZE	RESISTANCE CODE	TOLERANCE	TERMINATION CODE
RC = One-surface termination.	540 1100	The first two digits (three for "F" tolerance) are significant figures and the last digit specifies the number of zeros to follow.	F = ±1%	No Code = Solder
RCW = Wrap-around termination.	550 7225		G = ±2%	Pre-tinned (standard)
RCWP = Wrap-around termination, pre-tinned nickel barrier.	575 2010		J = ±5%	20 = Gold (RC only)
	5100 2512		K = ±10%	40 = Platinum Gold (RC & RCW only)
	5150 1206		M = ±20%	42 = Palladium Silver (RC & RCW only)

DALE ELECTRONICS, INC., 2300 Riverside Blvd., Norfolk, NE 68701 • Phone 402-371-0080

Canada: Dale Electronics Ltd., 18 Howden Rd., Scarborough, Ontario M1R 3E6

Europe: Dale Electronics GmbH, Benzstrasse 28, 8039 Puchheim, West Germany



**ESTABLISHED RELIABILITY
THICK FILM CHIP RESISTORS**

**MIL-R-55342/2, /3, /4, /5, /6
DALE SERIES RCM and RCWPM/RCWM**

FEATURES

- Allows wide design flexibility for use with hybrid circuitry
- Meets requirements of MIL-R-55342
- Established reliability: Verified failure rate (Consult factory for current level.)
- 100% screen tested per Group A, Subgroup 1 of MIL-R-55342
- One-surface and wraparound terminations

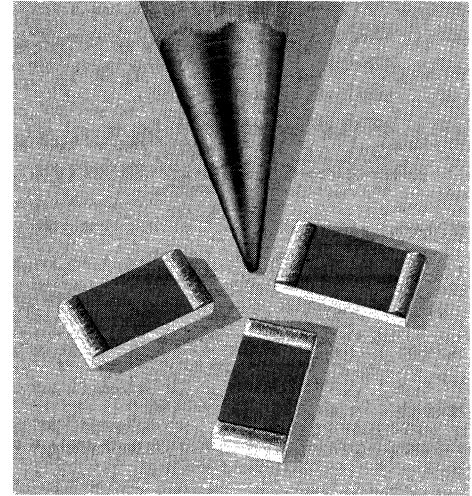

SPECIFICATIONS

MIL SLASH NO.	MIL STYLE	DALE TYPE	DIMENSIONS			TERMINATIONS (See "How To Order")	RESISTANCE RANGE		MAXIMUM OPERATING VOLTAGE	POWER RATING (@ 70°C) (See Derating Curve)
			A (Length)	B	C		(1% & 2%)	(5% & 10%)		
/2	RM0505	RCM550	.050 [1.27]	.010 [.25]	.050 [1.27]	S, R, T, U, B, C	10Ω-294K	10Ω-470K	40VDC	50MW
		RCWPM/RCWM550	.055 [1.40]							
/6	RM0705	RCM575	.075 [1.91]	.015 [.38]	.050 [1.27]	S, R, T, U, B, C	10Ω-499K	10Ω-1 Meg.	50VDC	100MW
		RCWPM/RCWM575	.080 [2.03]							
/3	RM1005	RCM5100	.100 [2.54]	.015 [.38]	.050 [1.27]	S, R, T, U, B, C	10Ω-499K	10Ω-1 Meg.	40VDC	100MW
		RCWPM/RCWM5100	.105 [2.67]							
/4	RM1505	RCM5150	.150 [3.81]	.015 [.38]	.050 [1.27]	S, R, T, U, B, C	10Ω-1 Meg.	10Ω-1 Meg.	40VDC	150MW
		RCWPM/RCWM5150	.155 [3.94]							
/5	RM2208	RCM7225	.225 [5.72]	.015 [.38]	.075 [1.91]	S, R, B, C	10Ω-1 Meg.	10Ω-1 Meg.	40VDC	225MW
		RCWPM/RCWM7225	.230 [5.84]							

DIMENSIONAL AND TERMINAL CONFIGURATIONS

[Numbers in brackets indicate millimeters]

**RCM
(One-surface termination)**

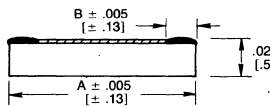
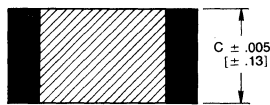

**RCWPM/RCWM
(Wraparound termination)**

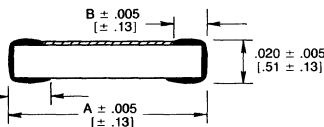
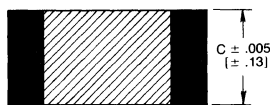

DERATING CURVE

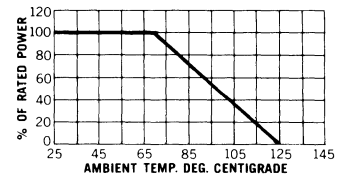

ELECTRICAL

Operating Temperature Range: -55°C to +125°C

PHYSICAL

Body: 95% minimum alumina

Termination: See "HOW TO ORDER" below

Solderability: Per MIL-R-55342

HOW TO ORDER — Military Part Number

M55342/2 —

M

1003

F

S

M

DETAIL SPEC. NO.

M55342/2 = RM0505
M55342/6 = RM0705
M55342/3 = RM1005
M55342/4 = RM1505
M55342/5 = RM2208

CHARACTERISTIC

M = ±300 PPM/°C
K = ±100 PPM/°C

RESISTANCE VALUE

The first two digits (three for "F" tolerance) are significant figures and the last digit specifies the number of zeros to follow.

TOLERANCE

F = ±1%
G = ±2%
J = ±5%
K = ±10%

TERMINATION

S = Pre-tinned Platinum-Gold one-surface (RCM).
R = Pre-tinned Platinum-Gold wraparound (RCWPM).
T = Untinned Platinum-Gold one-surface (RCM).
U = Untinned Platinum-Gold wraparound (RCWM).

FAILURE RATE

M = 1%/1000 hours
P = 0.1%/1000 hours
R = 0.01%/1000 hours

B = Pretinned Nickel Barrier wraparound (RCWPM).
C = Untinned Palladium Silver wraparound (RCWM).



COMMERCIAL METAL FILM RESISTORS

DALE TYPE CCF-07, COATED 2% and 5% tolerance

FEATURES

- 1/4 watt at 70°C power rating
- 2% tolerance, 5% tolerance
- 100 PPM/°C and 200 PPM/°C temperature coefficients
- Meet electrical requirements of MIL-R-22684 (RL07), and MIL-R-11
- Flame retardant epoxy conformal coating
- Standard 4 band color code marking for ease of identification after mounting
- Tape and reel packaging for automatic insertion. Meets EIA RS-296-D, Class I

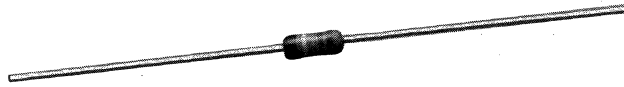

SPECIFICATIONS

ELECTRICAL

Resistance Range: 10Ω to 1 Megohm for ±2% tolerance
10Ω to 2 Megohms for ±5% tolerance

Resistance Tolerance: ±2%, ±5%

Resistance Temperature Coefficient: ±100 PPM/°C for ±2% tolerance
(-65°C to +150°C) ±200 PPM/°C for ±5% tolerance

Resistor Power Rating: 1/4 watt at +70°C

Maximum Working Voltage: 250 VRMS

Insulation Resistance: 10,000 Megohms

Operating Temperature Range: -65°C to +150°C

PHYSICAL CONFIGURATION

[Numbers in brackets indicate millimeters]

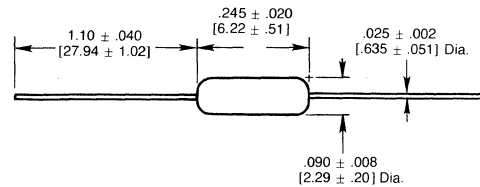

PERFORMANCE CHARACTERISTICS (Test Methods per MIL-R-22684)

ENVIRONMENTAL TEST	Typical ΔR is less than:	
	±2% Tolerance	±5% Tolerance
Thermal Shock	0.1%	0.5%
Low Temperature Operation	0.1%	0.5%
Short Time Overload	0.1%	0.5%
Dielectric Withstanding Voltage	0.05%	0.5%
Resistance To Soldering Heat	0.05%	0.5%
Moisture Resistance	0.2%	1.0%
Life	1.0%	1.0%
Shock	0.1%	0.5%
Vibration	0.05%	0.5%
Terminal Strength	0.1%	0.2%

DERATING

Dale CCF-07 resistors have an operating temperature range of -65°C to +150°C. They must be derated according to the curve.

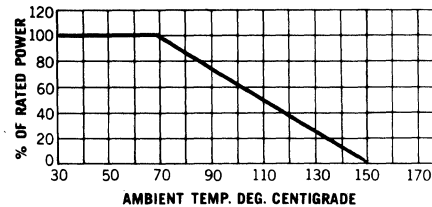

RESISTANCE VALUES

The Dale CCF-07 is available in the standard 24 resistance values per decade. Values are obtained from the following decade table by multiplying by powers of 10. As an example: 24 can represent 24 ohms, 240 ohms, 2.4K, 24K or 240K.

10	12	15	18	22	27	33	39	47	56	68	82
11	13	16	20	24	30	36	43	51	62	75	91

HOW TO ORDER

CCF-07

MODEL NUMBER

241

RESISTANCE VALUE

G

TOLERANCE

First two digits are significant.
Last digit specifies the number of zeros.

G = ±2%
J = ±5%

DALE ELECTRONICS, INC., 2300 Riverside Blvd., Norfolk, NE 68701 • Phone 402-371-0080

Canada: Dale Electronics Ltd., 18 Howden Rd., Scarborough, Ontario M1R 3E6
Europe: Dale Electronics GmbH, Benzstrasse 28, 8039 Puchheim, West Germany



COMMERCIAL METAL FILM RESISTORS

DALE TYPE CCF-50, COATED TAPE AND REEL PACKAGING

FEATURES

- 1/4 watt at 70°C power rating
- 1% tolerance
- 100 PPM/°C temperature coefficient
- Superior electrical performance. Meets or exceeds MIL-R-10509
- Flame retardant epoxy conformal coating
- Color band marking for ease of identification after mounting



SPECIFICATIONS

ELECTRICAL

Resistance Range: 10Ω to 1 Megohm

Resistance Tolerance: ± 1%

Resistance Temperature Coefficient: ± 100 PPM/°C
(-65°C to +165°C)

Resistor Power Rating: 1/4 watt at +70°C

Maximum Working Voltage: 200 VRMS

Insulation Resistance: 10,000 Megohms

Operating Temperature Range: -65°C to +165°C

PHYSICAL CONFIGURATION

[Numbers in brackets indicate millimeters]

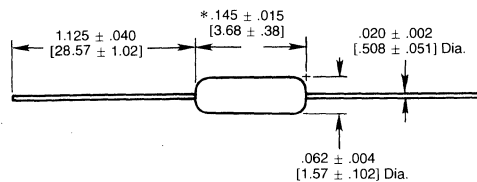

*Leads solderable to within .062 [1.57] of the ends of the body.

PERFORMANCE CHARACTERISTICS

(Test Methods per MIL-R-10509)

ENVIRONMENTAL TEST	Typical ΔR is less than:
Thermal Shock	0.1%
Low Temperature Operation	0.1%
Short Time Overload	0.1%
Dielectric Withstanding Voltage	0.05%
Resistance to Soldering Heat	0.05%
Moisture Resistance	0.2%
Life	0.5%
Shock	0.1%
Vibration	0.05%
Terminal Strength	0.1%

DERATING

Dale CCF-50 resistors have an operating temperature range of -65°C to +165°C. They must be derated according to the curve.

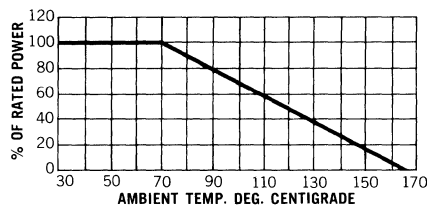

RESISTANCE VALUES

The Dale CCF-50 is available in the standard 96 resistance values per decade. Values are obtained from the following decade table by multiplying by powers of 10. As an example: 30.1 can represent 30.1 ohms, 301 ohms, 3.01K, 30.1K or 301K.

10.0	11.5	13.3	15.4	17.8	20.5	23.7	27.4	31.6	36.5	42.2	48.7	56.2	64.9	75.0	86.6
10.2	11.8	13.7	15.8	18.2	21.0	24.3	28.0	32.4	37.4	43.2	49.9	57.6	66.5	76.8	88.7
10.5	12.1	14.0	16.2	18.7	21.5	24.9	28.7	33.2	38.3	44.2	51.1	59.0	68.1	78.7	90.9
10.7	12.4	14.3	16.5	19.1	22.1	25.5	29.4	34.0	39.2	45.3	52.3	60.4	69.8	80.6	93.1
11.0	12.7	14.7	16.9	19.6	22.6	26.1	30.1	34.8	40.2	46.4	53.6	61.9	71.5	82.5	95.3
11.3	13.0	15.0	17.4	20.0	23.2	26.7	30.9	35.7	41.2	47.5	54.9	63.4	73.2	84.5	97.6

HOW TO ORDER

CCF-50
MODEL NUMBER

3010
RESISTANCE VALUE*

F
TOLERANCE

*Four Digit Figure Examples:

49R9 = 49.9 ohms, 1000 = 100 ohms,
1001 = 1K ohms, 1004 = 1 Megohm

First three digits are significant.
Last digit specifies the number of zeros.

F = ± 1%

EXAMPLE:

CCF-50 3010F = A 1/4 watt metal film resistor with ± 100 PPM/°C T.C., resistance of 301 ohms and tolerance of ± 1%.

DALE ELECTRONICS, INC., 2300 Riverside Blvd., Norfolk, NE 68701 • Phone 402-371-0080

Canada: Dale Electronics Ltd., 18 Howden Rd., Scarborough, Ontario M1R 3E6
Europe: Dale Electronics GmbH, Benzstrasse 28, 8039 Puchheim, West Germany



COMMERCIAL METAL FILM RESISTORS

DALE TYPE CCF-55 and CCF-60, COATED 1% tolerance

FEATURES

- Power Ratings: ¼ and ½ watt at 70°C
- 1% tolerance
- 100 PPM/°C temperature coefficient
- Superior electrical performance. Meets or exceeds MIL-R-22684 (RL07/RL20) and MIL-R-10509 (RN55D/RN60D).
- Flame retardant epoxy conformal coating
- Standard 5 band color code marking for ease of identification after mounting.

- Tape and reel packaging for automatic insertion. Meets EIA RS-296-D, Class 1.



PHYSICAL CONFIGURATION

[Numbers in brackets indicate millimeters]

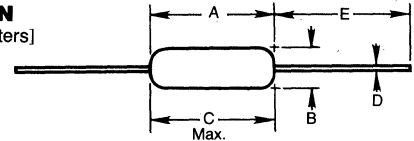

SPECIFICATIONS

ELECTRICAL

Resistance Range: 10Ω to 1 Megohm

Resistance Tolerance: ±1%

Resistance Temperature Coefficient:
±100 PPM/°C (-65°C to +165°C)

Resistor Power Rating @ 70°C: CCF-55 = ¼ watt, ½ watt
CCF-60 = ½ watt, ¾ watt

Maximum Working Voltage: 250 VRMS for CCF-55
350 VRMS for CCF-60

Insulation Resistance: 10,000 Megohms

Operating Temperature Range: -65°C to +165°C

DERATING Dale CCF-55 and CCF-60 resistors have an operating temperature range of -65°C to +165°C. They must be derated according to the curve.

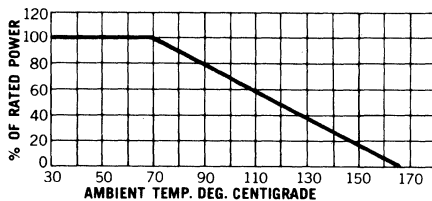

TYPE	DIM. A	DIM. B	DIM. C (Max.)	DIM. D	DIM. E
CCF-55	.245 ± .020 [6.22 ± .51]	.090 ± .008 [2.29 ± .20]	.265 [6.73]	.025 ± .002 [.64 ± .050]	1.10 ± .040 [27.94 ± 1.02]
CCF-60	.344 ± .031 [8.74 ± .79]	.139 ± .009 [3.53 ± .23]	.400 [10.16]	.025 ± .002 [.64 ± .050]	1.00 ± .040 [25.40 ± 1.02]

PERFORMANCE CHARACTERISTICS (Test Methods per MIL-R-10509)

POWER RATING	at 70°C	
CCF-55	¼ Watt	½ Watt
CCF-60	½ Watt	¾ Watt
ENVIRONMENTAL TEST	Typical Δ-R is less than:	
Thermal Shock	0.1%	0.1%
Low Temperature Operation	0.1%	0.1%
Short Time Overload	0.1%	0.2%
Dielectric Withstanding Voltage	0.05%	0.05%
Resistance To Soldering Heat	0.05%	0.05%
Moisture Resistance	0.2%	0.2%
Life	0.5%	1%
Shock	0.1%	0.1%
Vibration	0.05%	0.05%
Terminal Strength	0.1%	0.1%

RESISTANCE VALUES

The Dale CCF-55 and CCF-60 are available in the standard 96 resistance values per decade. Values are obtained from the following decade table by multiplying by powers of 10. As an example: 30.1 can represent 30.1 ohms, 301 ohms, 3.01K, 30.1K or 301K.

10.0	11.5	13.3	15.4	17.8	20.5	23.7	27.4	31.6	36.5	42.2	48.7	56.2	64.9	75.0	86.6
10.2	11.8	13.7	15.8	18.2	21.0	24.3	28.0	32.4	37.4	43.2	49.9	57.6	66.5	76.8	88.7
10.5	12.1	14.0	16.2	18.7	21.5	24.9	28.7	33.2	38.3	44.2	51.1	59.0	68.1	78.7	90.9
10.7	12.4	14.3	16.5	19.1	22.1	25.5	29.4	34.0	39.2	45.3	52.3	60.4	69.8	80.6	93.1
11.0	12.7	14.7	16.9	19.6	22.6	26.1	30.1	34.8	40.2	46.4	53.6	61.9	71.5	82.5	95.3
11.3	13.0	15.0	17.4	20.0	23.2	26.7	30.9	35.7	41.2	47.5	54.9	63.4	73.2	84.5	97.6

HOW TO ORDER

*Four Digit Figure Examples:

49R9 = 49.9 ohms, 1000 = 100 ohms,
1001 = 1K ohms, 1004 = 1 Megohm

CCF-55
MODEL NUMBER

CCF-55
CCF-60

3010
RESISTANCE VALUE*

First three digits
are significant.
Last digit specifies
the number of zeros.

F
TOLERANCE

F = ±1%

EXAMPLE:

CCF-55 3010F = A 1/4 watt metal film resistor with ±100 PPM/°C T.C., resistance of 301 ohms and tolerance of ±1%.



**COMMERCIAL
METAL FILM RESISTORS**

**DALE TYPE FRJ-50 and FRJ-55
JUMPER RESISTOR**

**Coated
TAPE AND REEL PACKAGING**

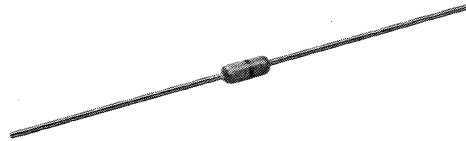

FEATURES

- Provides low resistance circuit interconnections
- Color band marking for ease of identification after mounting
- Flame retardant coating
- Compatible with automatic insertion equipment

PART MARKING

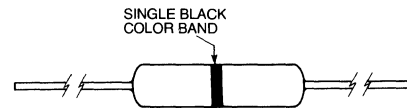

PHYSICAL CONFIGURATION

[Numbers in brackets indicate millimeters]

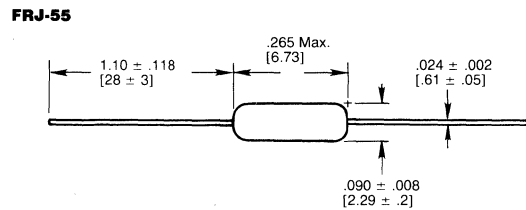
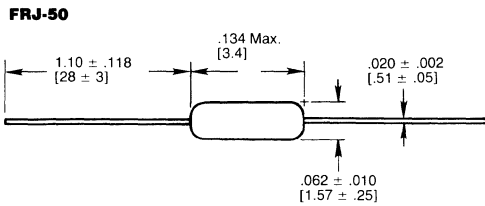

SPECIFICATIONS

ELECTRICAL

Resistance: 0.01Ω max.

Current Rating: 25 amps at 25°C, derating to 0 amps at 150°C

Insulation Resistance: Dry 10,000 Megohms; wet 100 Megohms

Dielectric Strength: Atmospheric — 500V RMS, reduced 325V RMS

Insulation Flammability: Self extinguishing 10 seconds after flame is removed

Lead Material: Tin-plated copper (max. 98% tin)

PACKAGING

Taped Lead and Reel Package Per EIA RS296-D Class I

NOTES:

1. Quantity per reel: 5,000 pieces in 5,000-piece increments.
2. A minimum of 12" 300mm bare tape leader shall be provided at each end of the reel.
3. Paper separator protection between layers of components.
4. Reel arbor hole is 1.25" [31.75].



COMMERCIAL METAL FILM RESISTORS

FOR MILITARY VERSIONS
(Type RN: MIL-R-10509, Type RL: MIL-R-22684)
See page 154

DALE TYPE CMF COATED



FEATURES

- Small size—conformal coated
- Meet electrical requirements of MIL-R-10509 and/or MIL-R-22684
- Flame retardant epoxy coating
- Controlled temperature coefficient
- Excellent high frequency characteristics
- Low noise
- Low voltage coefficient

STANDARD ELECTRICAL SPECIFICATIONS

WATTAGE	COMMERCIAL	
	70°C	125°C
1/20	CMF-50	CMF-50
1/10	CMF-50, 55	CMF-50, 55
1/8	CMF-50, 55, 60	CMF-50, 55, 60
1/4	CMF-55, 60, 65, 70, 07	CMF-55, 60, 65, 70
1/2	CMF-55, 60, 65, 70, 20	CMF-60, 65, 70
3/4	CMF-60*, 65*, 70	CMF-65*, 70
1	CMF-65*, 70	—

*.032 [.813] lead.

TEMPERATURE COEFFICIENT CODE

T.C. CODE	TEMPERATURE COEFFICIENT	TEMPERATURE RANGE
T-00	0 ± 200 PPM/°C	-55°C to +175°C
T-0	0 ± 150 PPM/°C	-55°C to +175°C
T-1	0 ± 100 PPM/°C	-55°C to +175°C
T-2	0 ± 50 PPM/°C	-55°C to +175°C
T-9	0 ± 25 PPM/°C	-55°C to +175°C
T-3	0 + 100 PPM/°C	-55°C to +175°C
T-4	0 - 100 PPM/°C	-55°C to +175°C
T-5	0 ± 25 PPM/°C	+25°C to +145°C
T-6	0 + 50 PPM/°C	-55°C to +175°C
T-7	0 - 50 PPM/°C	-55°C to +175°C
T-8	0 ± 35 PPM/°C 0 ± 25 PPM/°C	-55°C to +25°C +25°C to +175°C

DALE COMMERCIAL VALUE RANGE

DALE TYPE	MAXIMUM WORKING VOLTAGE	T-0	T-1	T-2	T-9
CMF-50	200	10Ω-1 Meg.	10Ω-1 Meg.	10Ω-500K	10Ω-500KΩ
CMF-55	250	1Ω- 5 Meg.	5Ω- 5 Meg.	10Ω-5 Meg.	24.9Ω-2.5 Meg.
CMF-07	250	1Ω- 5 Meg.	5Ω- 5 Meg.	—	—
CMF-60*	350	1Ω- 8 Meg.	5Ω- 8 Meg.	10Ω-8 Meg.	24.9Ω-2.5 Meg.
CMF-20	350	1Ω- 8 Meg.	5Ω- 8 Meg.	—	—
CMF-65*	500	1Ω-15 Meg.	5Ω-15 Meg.	10Ω-10 Meg.	24.9Ω-2.5 Meg.
CMF-70	500	1Ω-15 Meg.	5Ω-15 Meg.	10Ω-10 Meg.	24.9Ω-2.5 Meg.

*CMF-60 and CMF-65 are available in resistances down to 0.1Ω with wider tolerance and/or T.C.

NOTE: Higher resistance values available on all sizes — contact factory.

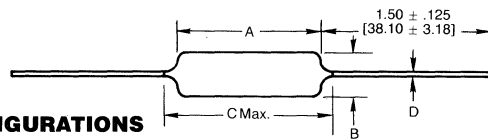

PHYSICAL CONFIGURATIONS

TYPE	DIM. A	DIM. B	DIM. C (Max.)	DIM. D
CMF-50	.150 ± .020 [3.81 ± .508]	.065 ± .015 [1.65 ± .381]	.244 [6.20]	.016 ± .002 [.406 ± .051]
CMF-55	.240 ± .020 [6.10 ± .508]	.090 ± .008 [2.29 ± .203]	** .278 [7.06]	.025 ± .002 [.635 ± .051]
CMF-60	.344 ± .031 [8.74 ± .787]	.145 ± .015 [3.68 ± .381]	.425 [10.80]	*.025 ± .002 [.635 ± .051]
CMF-65	.562 ± .031 [14.27 ± .787]	.180 ± .015 [4.57 ± .381]	.687 [17.45]	*.025 ± .002 [.635 ± .051]
CMF-70	.562 ± .031 [14.27 ± .787]	.180 ± .015 [4.57 ± .381]	.687 [17.45]	.032 ± .002 [.813 ± .051]
CMF-07	.240 ± .020 [6.10 ± .508]	.090 ± .008 [2.29 ± .203]	.278 [7.06]	.025 ± .002 [.635 ± .051]
CMF-20	.375 ± .040 [9.53 ± 1.02]	.145 ± .015 [3.68 ± .381]	.425 [10.80]	.032 ± .002 [.813 ± .051]

*Available with .032 [.813] lead. ** .290 [7.37] for ± .25% and ± .1% resistance tolerances.

TOLERANCE

CMF types are available in the following standard tolerances: Tolerance of ± 1% (F) is available over the entire ohmic range. Tolerances of ± 0.5% (D), ± 0.25% (C) and ± 0.10% (B) are available only in T-2 and T-9 temperature coefficients and over the ohmic range specified in the T-9 column. CMF-07 and CMF-20 are available in 2% (G) or 5% (J) only.

SPECIAL MODIFICATIONS

1. Terminals may be supplied in any commercial material with several type finishes.
2. Special pre-conditioning (power aging, temperature cycling, etc.) to customer specifications.
3. Non-helixed resistors can be supplied for critical high frequency applications.
4. Fusible, flameproof versions available.

DALE ELECTRONICS, INC., 2300 Riverside Blvd., Norfolk, NE 68701 • Phone 402-371-0080

Canada: Dale Electronics Ltd., 18 Howden Rd., Scarborough, Ontario M1R 3E6
Europe: Dale Electronics GmbH, Benzstrasse 28, 8039 Puchheim, West Germany

SPECIFICATIONS

ELECTRICAL

Tolerance: CMF resistors are supplied in $\pm 5\%$, $\pm 2\%$, $\pm 1\%$, $\pm .5\%$, $\pm .25\%$ and $\pm .1\%$ tolerances. Special tolerance and/or T.C. matching is available on request.

Noise: Dale metal film resistors have exceptionally low noise level. Average for standard resistance range is 0.10 micro-volts per volt over a decade of frequency, with low and intermediate resistance values typically below 0.05 micro-volts per volt.

Voltage Coefficient: Maximum voltage coefficient is 5 PPM per volt when measured between 10% and full rated voltage.

Dielectric Strength: 450 VAC for CMF-50, CMF-55, CMF-07; 750 VAC for CMF-60, CMF-20; 900 VAC for all others.

Insulation Resistance: 10,000 megohms minimum dry, 100 megohms minimum after moisture test.

MECHANICAL

Terminal Strength: 2 lb. pull test for CMF-50, CMF-55, CMF-60 and CMF-65; 5 lb. pull test = all others.

Solderability: Continuous satisfactory coverage when tested in accordance with MIL-R-10509.

MATERIAL

Element: Vacuum-deposited nickel-chrome alloy.

Core: Fire-cleaned high purity ceramic.

Coating: Flame retardant epoxy, formulated for superior moisture protection.

Termination: Standard lead material is solder-coated copper. Solderable and weldable.

ENVIRONMENTAL

Temperature Coefficient: CMF resistors are available in 11 standard T.C. codes of which 100 PPM, 50 PPM and 25 PPM are the most commonly required.

General: Environmental performance is shown in the table below. Test methods are those specified in MIL-R-10509 and MIL-R-22684.

Shelf Life: Resistance shifts due to storage at room temperature are negligible.

PERFORMANCE CHARACTERISTICS

(Test methods per MIL-R-22684 for CMF-07 and CMF-20. MIL-R-10509 for all others.)

POWER RATING	at 70°C			at 125°C		
	CMF-50	1/10 watt	1/8 watt	—	1/20 watt	1/10 watt
CMF-55	1/8 watt	1/4 watt	1/2 watt	1/10 watt	1/8 watt	1/4 watt
CMF-60	1/4 watt	1/2 watt	3/4 watt	1/8 watt	1/4 watt	1/2 watt
CMF-65	1/2 watt	3/4 watt	—	1/4 watt	1/2 watt	—
CMF-70	1/2 watt	3/4 watt	1 watt	1/4 watt	1/2 watt	3/4 watt
CMF-07	—	1/4 watt	—	—	—	—
CMF-20	—	1/2 watt	—	—	—	—
Environmental Test	Typical ΔR is Less Than:					
Temperature Cycling	$\pm 0.15\%$	$\pm 0.15\%$	$\pm 0.15\%$	$\pm 0.15\%$	$\pm 0.15\%$	$\pm 0.15\%$
Low Temp. Operation	$\pm 0.05\%$	$\pm 0.05\%$	$\pm 0.05\%$	$\pm 0.05\%$	$\pm 0.05\%$	$\pm 0.05\%$
Short Time Overload	$\pm 0.05\%$	$\pm 0.05\%$	$\pm 0.05\%$	$\pm 0.05\%$	$\pm 0.05\%$	$\pm 0.05\%$
Dielectric With Standing Voltage	$\pm 0.01\%$	$\pm 0.01\%$	$\pm 0.01\%$	$\pm 0.01\%$	$\pm 0.01\%$	$\pm 0.01\%$
Effect of Solder	$\pm 0.03\%$	$\pm 0.03\%$	$\pm 0.03\%$	$\pm 0.03\%$	$\pm 0.03\%$	$\pm 0.03\%$
Moisture Resistance	$\pm 0.05\%$	$\pm 0.05\%$	$\pm 0.05\%$	$\pm 0.05\%$	$\pm 0.05\%$	$\pm 0.05\%$
Load Life	$\pm 0.15\%$	$\pm 0.5\%$	$\pm 1.0\%$	$\pm 0.15\%$	$\pm 0.5\%$	$\pm 1.0\%$
Shock	$\pm 0.01\%$	$\pm 0.01\%$	$\pm 0.01\%$	$\pm 0.01\%$	$\pm 0.01\%$	$\pm 0.01\%$
Vibration	$\pm 0.04\%$	$\pm 0.04\%$	$\pm 0.04\%$	$\pm 0.04\%$	$\pm 0.04\%$	$\pm 0.04\%$

POWER RATINGS

Dale CMF resistor power ratings are based on full power at temperatures and typical ΔR as shown in Performance Characteristics Table in 1,000 hours load life.

HEAT RISE

The increase in resistor surface temperature due to the rated load is shown in the chart at the right. Resistor surface temperature = heat rise + ambient temperature.

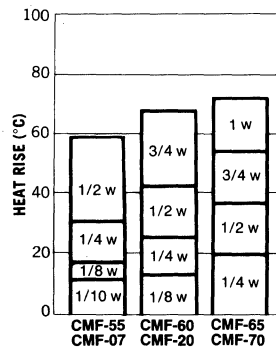

DERATING

Dale CMF resistors have an operating temperature range of -65°C to $+175^{\circ}\text{C}$. They must be derated at high ambient temperatures according to the derating curve.

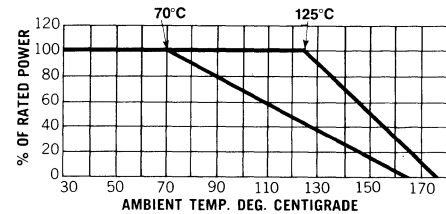

HOW TO ORDER

CMF-55
MODEL NUMBER

3010
RESISTANCE VALUE*

F
TOLERANCE

T-1
TEMPERATURE COEFFICIENT

CMF-50 CMF-07
CMF-55 CMF-20
CMF-60
CMF-65
CMF-70

First three digits are significant. (Two for 2% and 5% tolerance.) Last digit specifies the number of zeros to follow.

F = $\pm 1\%$
D = $\pm 0.5\%$
C = $\pm 0.25\%$
B = $\pm 0.1\%$
G = $\pm 2\%$
J = $\pm 5\%$

T-0 = ± 150 PPM/ $^{\circ}\text{C}$
T-1 = ± 100 PPM/ $^{\circ}\text{C}$
T-2 = ± 50 PPM/ $^{\circ}\text{C}$
T-9 = ± 25 PPM/ $^{\circ}\text{C}$

*(301 Ω illustrated)

(CMF-07 and CMF-20 available only in T-0 and T-1.)
(CMF-07 and CMF-20 available only in 2% and 5% tolerances.)

DALE ELECTRONICS, INC., 2300 Riverside Blvd., Norfolk, NE 68701 • Phone 402-371-0080

Canada: Dale Electronics Ltd., 18 Howden Rd., Scarborough, Ontario M1R 3E6
Europe: Dale Electronics GmbH, Benzstrasse 28, 8039 Puchheim, West Germany



COMMERCIAL, PRECISION THIN FILM RESISTORS

DALE TYPE PTF, COATED Low T.C. — Tight Tolerance

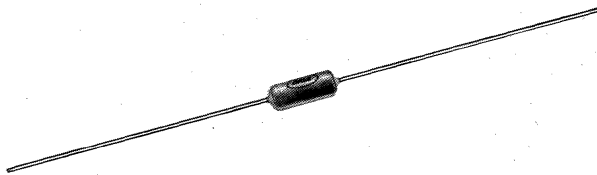

FEATURES

- Performance exceeds MIL-R-55182 requirements
- Models available to meet MIL-R-122, contact factory
- Extremely low temperature coefficients of resistance
- Very low noise and voltage coefficient
- Wide precision resistance range in small package
- 100% laser spiralled
- Very good high frequency characteristics
- Proprietary epoxy coating provides superior moisture protection
- Acceptance testing available
- Can replace wirewound bobbins

STANDARD ELECTRICAL SPECIFICATIONS

DALE TYPE	85°C RATING	MAX. WT. (Grams)	MAX. WORKING VOLTAGE	RESISTANCE RANGE
PTF-51	1/20 W	.11	200	50 Ω to 100K
PTF-56	1/8 W	.35	300	50 Ω to 499K
PTF-65	1/4 W	.75	500	50 Ω to 1 Meg.

Standard tolerances from 1% to .01%.

TEMPERATURE COEFFICIENT CODE -20° to +85°C

T.C. CODE	TEMPERATURE COEFFICIENT
T-10	0 ± 15 PPM/°C
T-13	0 ± 10 PPM/°C
T-16	0 ± 5 PPM/°C

PHYSICAL CONFIGURATIONS

TYPE	DIM. A	DIM. B.	DIM. C (MAX.)	DIM. D
PTF-51	.150 ± .020 [3.81 ± .51]	.070 ± .010 [1.78 ± .25]	.200 [5.08]	.016 [.406]
PTF-56	.250 ± .031 -.046 [6.35 ± .79] -1.17]	.091 ± .009 [2.31 ± .23]	.300 [7.62]	.025 [.635]
PTF-65	.375 ± .062 [9.53 ± 1.57]	.145 ± .016 [3.68 ± .41]	.475 [12.07]	.025 [.635]

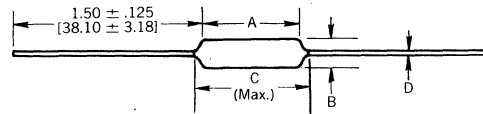

MATERIAL

Element: Precision deposited nickel-chrome alloy with controlled annealing

Core: Fire-cleaned high purity ceramic

Encapsulant: Specially formulated epoxy compounds. Coated construction.

Termination: Standard lead material is solder-coated copper. Solderable and weldable per MIL-STD-1276, Type C.

PERFORMANCE DATA

TEST per MIL-R-55182 (Exceptions Noted)	MAX. ΔR (Typical Test Lots)	SPECIFICATION
Thermal Shock (-55°C to +85°C)	0.02%	MIL-STD-202, Method 107
Moisture	0.08%	MIL-STD-202, Method 106
Resistance to Solder Heat	0.02%	MIL-STD-202-Method 210
Dielectric Withstanding	0.01%	MIL-STD-202, Method 301 & 105
Short Time Overload	0.01%	MIL-R-10509, Para. 4.6.6
Damp Heat	0.08%	IEC Publication #68-2-3 (56 days)
Low Temperature Operation	0.02%	MIL-R-55182, Para. 4.7.9
Life (1000 hours rated power @ 85°C)	0.04%	MIL-R-55182, Para. 4.7.17

DERATING

Dale PTF resistors have an operating temperature range of -55°C to +150°C. They must be derated according to the curve below.

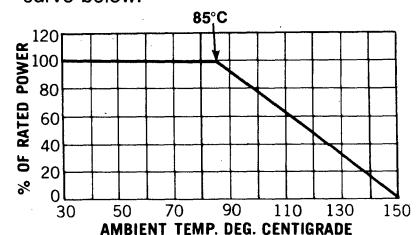

DALE ELECTRONICS, INC., 2300 Riverside Blvd., Norfolk, NE 68701 • Phone 402-371-0080

Canada: Dale Electronics Ltd., 18 Howden Rd., Scarborough, Ontario M1R 3E6
Europe: Dale Electronics GmbH, Benzstrasse 28, 8039 Puchheim, West Germany

HOW TO ORDER

PTF	—	56	20K01	B	T-13
SERIES		SIZE	RESISTANCE VALUE	TOLERANCE	TEMPERATURE COEFFICIENT

EXAMPLE:

PTF-56, 20K01, B, T-13 = A precision thin film resistor. 1/8 watt with resistance of 20,010 ohms, tolerance of $\pm 0.1\%$ and 0 ± 10 PPM/ $^{\circ}$ C TCR.

RESISTANCE VALUE CODE

Decimal Locator/Multiplier
 $R = x 1$ $K = x 1000$ $M = x 1,000,000$

CODE	(Examples)	RESISTANCE
50R	=	50 Ω
62R2	=	62.2 Ω
100R1	=	100.1 Ω
1K001	=	1001 Ω
10K1	=	10,100 Ω
100K1	=	100,100 Ω
1M0	=	1,000,000 Ω

RESISTANCE TOLERANCE CODE

Code	$\pm\%$
F	= 1
D	= 0.5
C	= 0.25
B	= 0.1
A	= 0.05
BC	= 0.02

TEMPERATURE COEFFICIENT CODE

—20 $^{\circ}$ C to +85 $^{\circ}$ C

T.C. CODE	TEMPERATURE COEFFICIENT
T-10	0 \pm 15 PPM/ $^{\circ}$ C
T-13	0 \pm 10 PPM/ $^{\circ}$ C
T-16	0 \pm 5 PPM/ $^{\circ}$ C

TEMPERATURE COEFFICIENT OF RESISTANCE

Temperature coefficient (T.C.) of resistance is normally stated as the maximum amount of resistance change from the original 25 $^{\circ}$ C value as the ambient temperature increases or decreases. This is most commonly expressed in parts per million per degree centigrade (PPM/ $^{\circ}$ C.)

The resistance curve over the operating temperature range is usually a non-linear curve within predictable maximum limits. Dale Electronics' PTF resistors have a very uniform resistance temperature characteristic when measured over the operating range of -20 $^{\circ}$ C to +85 $^{\circ}$ C. The standard temperature coefficients available are T-10 = ± 15 PPM/ $^{\circ}$ C, T-13 = ± 10 PPM/ $^{\circ}$ C and T-16 = ± 5 PPM/ $^{\circ}$ C.

Some applications of the PTF require operation beyond the specifications of -20 $^{\circ}$ C to +85 $^{\circ}$ C. The change in temperature coefficient of resistance is very small (less than 0.05 PPM/ $^{\circ}$ C/ $^{\circ}$ C) over the expanded temperature range of -55 $^{\circ}$ C to +150 $^{\circ}$ C. Therefore, when operating outside the range of -20 $^{\circ}$ C to +85 $^{\circ}$ C, the designer can plan for a worst case addition of 0.05 PPM/ $^{\circ}$ C for each degree C beyond either -20 $^{\circ}$ C or +85 $^{\circ}$ C as indicated in the graph. This applies to all three temperature coefficient codes.

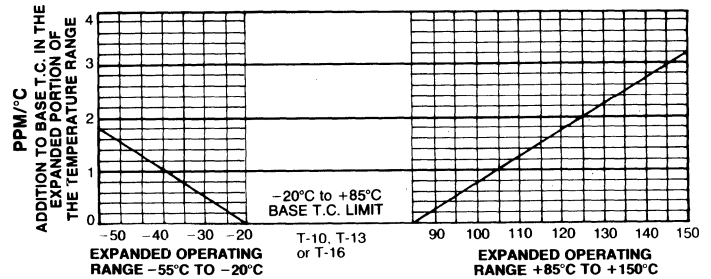

EXAMPLE: Assume the operating characteristics demand a temperature range from -55 $^{\circ}$ C to +125 $^{\circ}$ C. This requires a 35 $^{\circ}$ C Δ below -20 $^{\circ}$ C and a 40 $^{\circ}$ C Δ above +85 $^{\circ}$ C. The extreme Δ being 40 $^{\circ}$ C means that the worst case addition to the specified T.C. will be ± 0.05 PPM/ $^{\circ}$ C/ $^{\circ}$ C times 40 $^{\circ}$ C or 2 PPM/ $^{\circ}$ C. Therefore, a T-16 which is characterized by a base T.C. limit of ± 5 PPM/ $^{\circ}$ C over the temperature range of -20 $^{\circ}$ C to +85 $^{\circ}$ C will exhibit a maximum temperature coefficient of ± 7 PPM/ $^{\circ}$ C over the expanded portion of the temperature range of -55 $^{\circ}$ C to +125 $^{\circ}$ C.

MATCHED SETS — NETWORKS

Dale's many years of experience in matching resistors for sets and networks, combined with the superb performance of the PTF product, provide the best and most economical solution to your precision resistor requirements. Why? Because most applications for precision resistors depend on two or more discretes having an initial tolerance ratio and a resistance tracking capability over temperature rather than each discrete resistor meeting the absolute requirements of the application.

Cost savings approaching 50% can be realized when relatively tight matching requirements are specified while permitting the absolute parameters of the discrete resistors to have more relaxed specifications.

Dale application engineers are available to assist you in specifying your requirements in the most economical way possible.



COMMERCIAL METAL FILM RESISTORS



DALE TYPE CPF Power, Flameproof

FEATURES

- High power rating, small size
- Flameproof, high temperature coating
- Special filming and coating processes
- Excellent high frequency characteristics
- Low noise
- Low voltage coefficient

SPECIFICATIONS

Resistance Tolerance: CPF-1, 2, 4 = .1%, .25%, .5%, 1%, 5%
CPF-5, 75 = .5%, 1%, 5%

Resistor Temperature Coefficient: ±100 PPM/°C;
±50 PPM/°C; ±25 PPM/°C
(measured from -55°C to +125°C, referenced to +25°C)

Insulation Resistance: 10,000 Megohms

Operating Temperature Range: -65°C to +230°C

Dielectric Strength: 900 VAC for CPF-1 through
CPF-5; 1000 VAC for CPF-75

MATERIAL

Element: Proprietary nickel-chrome alloy.

Core: Fire-cleaned high purity ceramic.

Coating: Special high temperature conformal coat.

Termination: Standard lead material is solder-coated copper.
Solderable and weldable per MIL-STD-1276, Type "C".

DALE TYPE	WATTAGE RATING 70°C	VOLTAGE RATING	1% and above RESISTANCE RANGE
CPF-1	1	250	1 ohm-150K
CPF-2	2	350	1 ohm-150K
CPF-4	4	500	1 ohm-150K
CPF-5	5	700	9 ohm-125K
CPF-75	7.5	1000	24 ohm-125K

Contact factory for resistance range in precision tolerance.

MECHANICAL

Terminal Strength: 2 lb. pull test for CPF-1, -2, and -4; 5 lb. pull test for CPF-5 and -75.

Solderability: Continuous satisfactory coverage when tested in accordance with MIL-STD-202, Method 208.

PHYSICAL CONFIGURATION

[Numbers in brackets indicate millimeters]

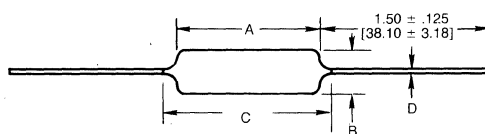

TYPE	DIM. A	DIM. B	DIM. C (Max)	DIM. D
CPF-1	.240±.020 [6.10±.508]	.090±.008 [2.29±.203]	.310 [7.87]	.025±.002 [.635±.051]
CPF-2	.344±.031 [8.74±.787]	.145±.015 [3.68±.381]	.425 [10.80]	.032±.002 [.813±.051]
CPF-4	.555±.041 [14.10±1.04]	.180±.015 [4.57±.381]	.650 [16.51]	.032±.002 [.813±.051]
CPF-5	.937±.062 [23.80±1.58]	.296±.031 [7.52±.787]	1.187 [30.15] Max	.032±.002 [.813±.051]
CPF-75	2.062±.062 [52.38±1.58]	.296±.031 [7.52±.787]	2.312 [58.72] Max	.032±.002 [.813±.051]

SURFACE TEMPERATURE VS. POWER

Surface temperatures were taken with an infra-red pyrometer in +25°C still air. Resistors were supported by their leads in test clips at a point 1/2 inches out from the resistor body ends.

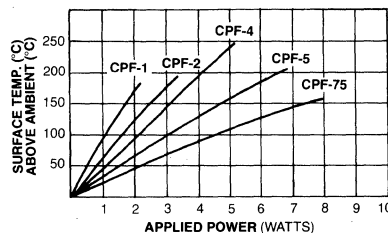

DERATING

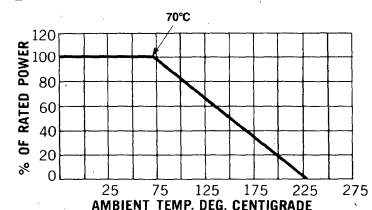

HOW TO ORDER

CPF-1
MODEL NUMBER

CPF-1 CPF-5
CPF-2 CPF-75
CPF-4

XXX or XXXX
RESISTANCE VALUE

First three digits are significant (two for 5% tolerance). Last digit specifies the number of zeros to follow.

F
TOLERANCE

*B = ±0.10%
*C = ±0.25%
D = ±0.5%
F = ±1%
J = ±5%

T-1
TEMPERATURE COEFFICIENT

T-1 = 100 PPM/°C
*T-2 = 50 PPM/°C
*T-9 = 25 PPM/°C

STANDARD PACKAGING: Bulk, Tape & Reel Packaging
per EIA RS-296-D available on request.

*Available only in CPF-1, CPF-2, and CPF-4.

DALE ELECTRONICS, INC., 2300 Riverside Blvd., Norfolk, NE 68701 • Phone 402-371-0080

Canada: Dale Electronics Ltd., 18 Howden Rd., Scarborough, Ontario M1R 3E6
Europe: Dale Electronics GmbH, Benzstrasse 28, 8039 Puchheim, West Germany



**ESTABLISHED RELIABILITY
METAL FILM RESISTORS**

**MIL-R-39017, TYPE RLR, S LEVEL
DALE TYPE ERL, COATED**



FEATURES

- Meets requirements of MIL-R-39017
- Failure Rate: Verified Failure Rate (Contact factory for current level)
- Very low noise
- Excellent high frequency performance
- Epoxy coated construction provides superior moisture protection
- Traceability of materials and processing
- Monthly lot acceptance testing
- Extensive stocking program at distributors and factory in 1% and 2% tolerances
- Dale has complete capability to develop specific reliability programs designed to customer requirements

STANDARD ELECTRICAL SPECIFICATIONS

DALE TYPE	MIL. TYPE	70°C RATING	MAX. WEIGHT (Grams)	MAX. WORKING VOLTAGE	RES. RANGE* T-1 (100 PPM)
ERL-05	RLR05	1/8 W	.11	200	4.7Ω-1 Meg.
ERL-07	RLR07	1/4 W	.35	250	10Ω-3.01 Meg.
ERL-20	RLR20	1/2 W	.75	350	4.3Ω-3.01 Meg.

*Consult factory for values on QPL.

Standard Resistance Tolerances: 1% (F), 2% (G), 5% (J).

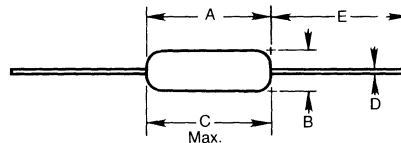

PHYSICAL CONFIGURATIONS

TYPE	DIM. A	DIM. B	DIM. C	DIM. D	DIM. E
ERL-05	.150 ± .020 [3.81 ± .508]	.066 ± .008 [1.68 ± .20]	.175 [4.45] Max.	.016 [.406]	1.25 ± .266 [31.75 ± 6.76]
ERL-07	.250 ± .031 .046 [6.35 ± 1.17]	.090 ± .008 [2.29 ± .20]	.300 [7.62] Max.	.025 [.635]	1.50 ± .125 [38.10 ± 3.18]
ERL-20	.375 ± .041 [9.53 ± 1.04]	.138 ± .023 [3.51 ± .58]	.450 [11.43] Max.	.032 [.813]	1.50 ± .125 [38.10 ± 3.18]

SPECIFICATIONS

APPLICABLE MIL-SPECIFICATION

MIL-R-39017: The above series meet or exceed the electrical, environmental and dimensional requirements of MIL-R-39017.

MIL-R-22684: MIL-R-39017 supersedes MIL-R-22684 on new design. The above series meet or exceed MIL-R-22684 requirements.

ELECTRICAL

Tolerance: Above types are available in the following standard tolerances: 1%, 2% and 5%. (5% tolerance is inactive for new designs.)

Voltage Coefficient: Maximum voltage coefficient is 5 PPM per volt when measured between 10% and full rated voltage.

Dielectric Strength: 300 VAC on RLR-05, 500 VAC on RLR-07 and RLR-20.

Insulation Resistance: 1000 megohms minimum dry. 100 megohms minimum after moisture test.

MECHANICAL

Terminal Strength: 2 lb. pull test on RLR-05, 5 lb. pull test on RLR-07 and RLR-20.

Solderability: Continuous, satisfactory coverage when tested in accordance with MIL-STD-202, Method 208.

MATERIAL

Element: Vacuum-deposited nickel chrome alloy

Core: Fire-cleaned high purity ceramic

Encapsulant: Specially formulated epoxy coating compound

Termination: Standard lead material is solder-coated copper. (Solderable and weldable per MIL-STD-1276, Type C.)

DERATING

The above resistors have an operating temperature range of -65°C to +150°C. They must be derated according to the following curve:

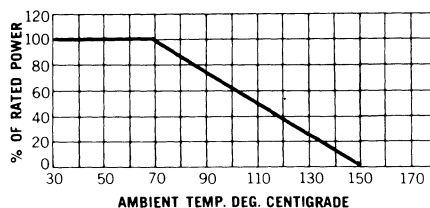

POWER RATING

- Power ratings are based on the following two conditions:
1. 2.0% maximum ΔR in 2000 hours load life.
 2. 150°C maximum operating temperature.

DOCUMENTATION: Qualification and failure rate verification test data is maintained by Dale and is available upon request. Lot traceability and identification data is maintained by Dale for 5 years.



**ESTABLISHED RELIABILITY
METAL FILM RESISTORS**

**MIL-R-55182
DALE TYPE ERC, COATED**

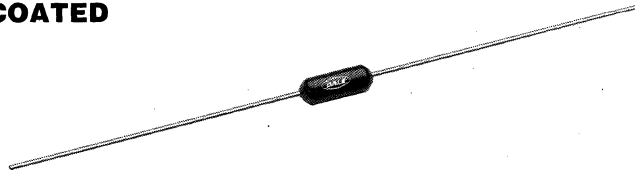

FEATURES

- Meets requirements of MIL-R-55182
- Failure Rate: Verified Failure Rate (Contact factory for current level)
- Very low noise
- Controlled temperature coefficient
- Excellent high frequency performance
- Epoxy coating provides superior moisture protection.
- Standard lead supplied on RNC product is both solderable and weldable
- 100% stabilization and screening tests. Group A Testing, if desired, to customer requirements
- Traceability of materials and processing
- Monthly acceptance testing
- Dale has complete capability to develop specific reliability programs designed to customer requirements
- Extensive stocking program at distributors and factory on RNC50, 55, 60 and 65.

STANDARD ELECTRICAL SPECIFICATIONS

DALE TYPE	MIL. TYPE	70°C RATING	125°C RATING	MAX. WT. (Grams)	MAX. WORKING VOLTAGE	RESISTANCE RANGE (Ohms)*		
						T-1 (K)	T-2 (H)	T-9 (J)
ERC-50	RNC50	1/10 W	1/20 W	.11	200	10Ω-796K	10Ω-796K	10Ω-796K
ERC-55	RNC55	1/8 W	1/10 W	.35	200	10Ω-2 Meg.	10Ω-2 Meg.	10Ω-2 Meg.
ERC-60	RNC60	1/4 W	1/8 W	.75	250	10Ω-3.01 Meg.	10Ω-3.01 Meg.	10Ω-3.01 Meg.
ERC-65	RNC65	1/2 W	1/4 W	.84	300	10Ω-3.01 Meg.	10Ω-3.01 Meg.	10Ω-3.01 Meg.
ERC-70	RNC70	3/4 W	1/2 W	1.6	350	10Ω-3.01 Meg.	10Ω-3.01 Meg.	10Ω-3.01 Meg.

Standard Resistance Tolerances: .1% (B), .5% (D) and 1% (F). .1% not applicable to characteristic K.
*Consult factory for values on QPL.

TEMPERATURE COEFFICIENT CODE

T.C. CODE	MIL. CHAR.	TEMPERATURE COEFFICIENT	TEMPERATURE RANGE
T-1	K	0 ± 100 PPM/°C	-55°C to +175°C
T-2	H	0 ± 50 PPM/°C	-55°C to +175°C
T-9	J	0 ± 25 PPM/°C	-55°C to +175°C

SPECIFICATIONS

APPLICABLE MIL-SPECIFICATIONS

MIL-R-55182: The ERC Series meets or exceeds the electrical, environmental and dimensional requirements of MIL-R-55182.

MIL-R-10509: MIL-R-55182 supersedes MIL-R-10509 on new design. The ERC Series meets or exceeds MIL-R-10509 requirements.

ELECTRICAL

Tolerance: ERC types are available in the following standard tolerances: 1%, .5% and .1%.

Voltage Coefficient: Maximum voltage coefficient is 5 PPM per volt when measured between 10% and full rated voltage.

Dielectric Strength: 450 VAC on ERC-50, -55 and -60.
900 VAC on ERC-65 and ERC-70.

Insulation Resistance: 10,000 megohms minimum dry, 100 megohms minimum after moisture test.
Typical after moisture test is 200,000 megohms.

MECHANICAL

Terminal Strength: 2 lb. pull test on ERC-50, -55, -60 and -65. 4.5 lb. pull test on ERC-70.

Solderability: Continuous, satisfactory coverage when tested in accordance with MIL-STD-202, Method 208.

MATERIAL

Element: Vacuum-deposited nickel-chrome alloy

Core: Fire-cleaned high purity ceramic

Encapsulant: Specially formulated epoxy compound

Termination: Standard lead material is solder-coated copper. Solderable and weldable per MIL-STD-1276, Type "C".

DERATING

Dale ERC resistors have an operating temperature range of -65°C to $+175^{\circ}\text{C}$. They must be derated according to the following curve:

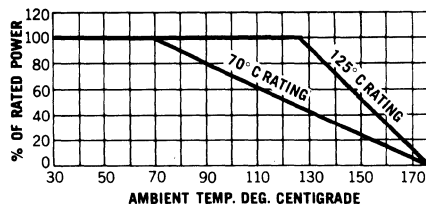

POWER RATING

Dale ERC power ratings are based on the following two conditions:

1. 2% maximum ΔR in 10,000 hours load life.
2. 175°C maximum operating temperature.

DOCUMENTATION

Qualification and failure rate verification test data is maintained by Dale and is available upon request. Lot traceability test data and identification data is maintained by Dale for 5 years.

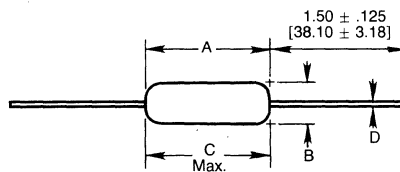

PHYSICAL CONFIGURATIONS

TYPE	DIM. A	DIM. B	DIM. C (Max.)	DIM. D
ERC-50	.150 ± .020 [3.81 ± .51]	.070 ± .010 [1.78 ± .25]	.175 [4.45]	.016 [.406]
ERC-55	.250 ± .031 -.046 [6.35 ± .79] -1.17]	.091 ± .009 [2.31 ± .23]	.300 [7.62]	.025 [.635]
ERC-60	.375 ± .062 [9.53 ± 1.57]	.145 ± .016 [3.68 ± .41]	.450 [11.43]	.025 [.635]
ERC-65	.562 ± .031 [14.27 ± .79]	.175 ± .015 [4.45 ± .38]	.687 [17.45]	.025 [.635]
ERC-70	.562 ± .031 [14.27 ± .79]	.180 ± .015 [4.57 ± .38]	.687 [17.45]	.032 [.813]



**MILITARY
METAL FILM RESISTORS**

**MIL-R-10509, TYPE RN } Higher Commercial
MIL-R-22684, TYPE RL } Ratings**

DALE TYPE CMF, COATED

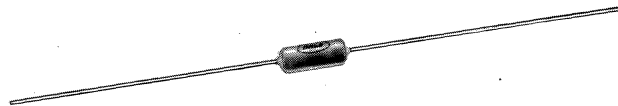

FEATURES

- Very low noise
- Very low voltage coefficient
- Controlled temperature coefficient
- Excellent high frequency characteristics
- Flame retardant epoxy coating

STANDARD ELECTRICAL SPECIFICATIONS

WATTAGE	MILITARY QUALIFIED			COMMERCIAL
	70°C (D)	MIL-R-10509 125°C (C & E)	MIL-R-22684 70°C	
1/20	—	CMF-50 (RN50)	—	Commercial equivalents of military styles are available with higher power ratings. Consult Factory.
1/10	—	CMF-55 (RN55)	—	
1/8	CMF-55 (RN55)	CMF-60 (RN60)	—	
1/4	CMF-60 (RN60)	CMF-65 (RN65)	CMF-07 (RL07)	
1/2	CMF-65 (RN65)	CMF-70 (RN70)	CMF-20 (RL20)	
3/4	CMF-70 (RN70)	—	—	

TEMPERATURE COEFFICIENT CODE

COMMERCIAL T.C. CODE	10509 MIL. CHAR.	TEMPERATURE COEFFICIENT	TEMPERATURE RANGE
T-1	D	0 ± 100 PPM/°C	-55°C to +175°C
T-2	C	0 ± 50 PPM/°C	-55°C to +175°C
T-9	E	0 ± 25 PPM/°C	-55°C to +175°C
T-00	MIL-R-22684	0 ± 200 PPM/°C	-55°C to +150°C

ELECTRICAL SPECIFICATIONS

DALE TYPE	MAXIMUM WORKING VOLTAGE	DALE MILITARY APPROVED VALUE RANGE				DALE COMMERCIAL VALUE RANGE
		CHAR. D	MIL-R-10509 CHAR. C	CHAR. E	MIL-R-22684	
CMF-50	200	—	10Ω-100KΩ	10Ω-100KΩ	—	Extended resistance ranges are available in commercial equivalent types. Consult Factory.
CMF-55	200	10Ω-301K	49.9Ω-100KΩ	49.9Ω-100KΩ	—	
CMF-07	250	—	—	—	51Ω-150KΩ	
CMF-60	300	10Ω-1 Meg.	49.9Ω-499KΩ	49.9Ω-499KΩ	—	
CMF-20	350	—	—	—	4.3Ω-470KΩ	
CMF-65	350	10Ω-2 Meg.	49.9Ω-1 Meg.	49.9Ω-1 Meg.	—	
CMF-70	500	10Ω-2.49 Meg.	24.9Ω-1 Meg.	24.9Ω-1 Meg.	—	

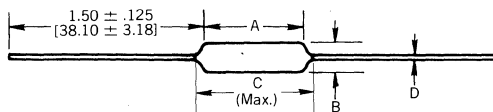

PHYSICAL CONFIGURATIONS

DALE TYPE	DIM. A	DIM. B	Dim. C (Max.)	DIM. D
CMF-50	.150 ± .020 [3.81 ± .508]	.065 ± .015 [1.65 ± .381]	.244 [6.20]	.016 ± .002 [.406 ± .051]
CMF-55	.240 ± .020 [6.10 ± .508]	.090 ± .008 [2.29 ± .203]	.278 [7.06]	.025 ± .002 [.635 ± .051]
CMF-60	.344 ± .031 [8.74 ± .787]	.145 ± .015 [3.68 ± .381]	.425 [10.80]	.025 ± .002 [.635 ± .051]
CMF-65	.562 ± .031 [14.27 ± .787]	.180 ± .015 [4.57 ± .381]	.687 [17.45]	.025 ± .002 [.635 ± .051]
CMF-70	.562 ± .031 [14.27 ± .787]	.180 ± .015 [4.57 ± .381]	.687 [17.45]	.032 ± .002 [.813 ± .051]
CMF-07	.240 ± .020 [6.10 ± .508]	.090 ± .008 [2.29 ± .203]	.278 [7.06]	.025 ± .002 [.635 ± .051]
CMF-20	.375 ± .040 [9.53 ± 1.02]	.145 ± .015 [3.68 ± .381]	.425 [10.80]	.032 ± .002 [.813 ± .051]

DALE ELECTRONICS, INC., 2300 Riverside Blvd., Norfolk, NE 68701 • Phone 402-371-0080

Canada: Dale Electronics Ltd., 18 Howden Rd., Scarborough, Ontario M1R 3E6
Europe: Dale Electronics GmbH, Benzstrasse 28, 8039 Puchheim, West Germany

SPECIFICATIONS

APPLICABLE MIL-SPECIFICATION

MIL-R-10509 and MIL-R-22684: The CMF series meet or exceed the electrical, environmental and dimensional requirements of MIL-R-10509 and MIL-R-22684.

Noise: Dale metal film resistors have exceptionally low noise level. Average for standard resistance range is 0.10 micro-volt per volt over a decade of frequency, with low and intermediate resistance values typically below 0.05 micro-volt per volt.

Voltage Coefficient: Maximum voltage coefficient is 5 PPM per volt when measured between 10% and full rated voltage.

Dielectric Strength: 450 VAC for CMF-50, CMF-55 and CMF-60; 500 VAC for CMF-07; 700 VAC for CMF-20; 900 VAC for CMF-65 and CMF-70.

Insulation Resistance: 10,000 megohms minimum dry; 100 megohms minimum after moisture test.

ENVIRONMENTAL

General: Environmental performance is shown in the table below. Test methods are those specified in MIL-R-10509 and MIL-R-22684.

Shelf Life: Resistance shifts due to storage at room temperature are negligible.

MECHANICAL

Terminal Strength: 5 lb. pull test for CMF-07 and CMF-20; 2 lb. pull test for all others.

Solderability: Continuous satisfactory coverage when tested in accordance with MIL-R-10509 and MIL-R-22684.

MATERIAL

Element: Nickel-chrome alloy.

Core: Fire-cleaned high purity ceramic.

Coating: Flame retardant epoxy, formulated for superior moisture protection.

Termination: Standard lead material is solder-coated copper, solderable and weldable.

ENVIRONMENTAL PERFORMANCE SPECIFICATIONS

REQUIREMENT	CHAR. D	MIL-R-10509			MIL-R-22684			
		CHAR. C	CHAR. E	CHAR. E				
RN50	CMF-50	CMF-50	CMF-50	—				
RN55	CMF-55	CMF-55	CMF-55	—				
RN60	CMF-60	CMF-60	CMF-60	—				
RN65	CMF-65	CMF-65	CMF-65	—				
RN70	CMF-70	CMF-70	CMF-70	—				
RL07	—	—	—	CMF-07				
RL20	—	—	—	CMF-20				
Mil. Temp. Coefficient	+200-500 PPM	±50 PPM	±25 PPM	±200 PPM				
Applicable T.C. Code	T-1 (100 PPM), T-0 (150 PPM)	T-2 (50 PPM)	T-9 (25 PPM)	T-00 (±200 PPM)				
POWER RATING	at 70°C	at 125°C	at 125°C	at 70°C				
RN50	—	1/20 watt	1/20 watt	—				
RN55	1/8 watt	1/10 watt	1/10 watt	—				
RN60	1/4 watt	1/8 watt	1/8 watt	—				
RN65	1/2 watt	1/4 watt	1/4 watt	—				
RN70	3/4 watt	1/2 watt	1/2 watt	—				
RL07	—	—	—	1/4 watt				
RL20	—	—	—	1/2 watt				
ENVIRONMENTAL TEST	MIL. MAX.	DALE TYP.	MIL. MAX.	DALE TYP.	MIL. MAX.	DALE TYP.	MIL. MAX.	DALE TYP.
Thermal Shock	±0.5% ΔR	±0.1%	±0.25% ΔR	±0.1%	±0.25% ΔR	±0.1%	±1.0% ΔR	±0.1%
Low Temp. Operation	±0.5% ΔR	±0.05%	±0.25% ΔR	±0.05%	±0.25% ΔR	±0.05%	±0.5% ΔR	±0.05%
Short Time Overload	±0.5% ΔR	±0.02%	±0.25% ΔR	±0.02%	±0.25% ΔR	±0.02%	±0.5% ΔR	±0.02%
Dielectric Withstanding Voltage	±0.5% ΔR	±0.01%	±0.25% ΔR	±0.01%	±0.25% ΔR	±0.01%	±0.5% ΔR	±0.01%
Effect of Solder	±0.5% ΔR	±0.02%	±0.1% ΔR	±0.02%	±0.1% ΔR	±0.02%	±0.5% ΔR	±0.02%
Moisture Resistance	±1.5% ΔR	±0.05%	±0.5% ΔR	±0.05%	±0.5% ΔR	±0.05%	±1.5% ΔR	±0.05%
Load Life	±1.0% ΔR	±0.15%	±0.5% ΔR	±0.15%	±0.5% ΔR	±0.15%	±2.0% ΔR	±0.15%
Shock	±0.5% ΔR	±0.01%	±0.25% ΔR	±0.01%	±0.25% ΔR	±0.01%	±0.5% ΔR	±0.01%
Vibration	±0.5% ΔR	±0.01%	±0.25% ΔR	±0.01%	±0.25% ΔR	±0.01%	±0.5% ΔR	±0.01%

POWER RATING

Dale CMF resistors have two power ratings depending on operating temperatures of 70°C and 125°C. Both are based on a maximum ΔR of .5% in 1,000 hour load life.

DERATING

Dale CMF resistors have an operating temperature range of -65°C to +175°C. They must be derated according to the following curves:

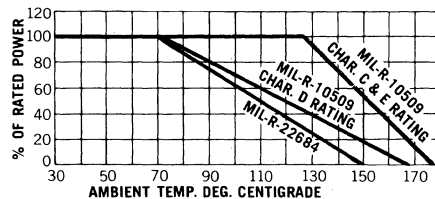

HEAT RISE

The increase in resistor surface temperature due to rated load is shown in the chart at the right. Resistor temperature = heat rise + ambient temperature.

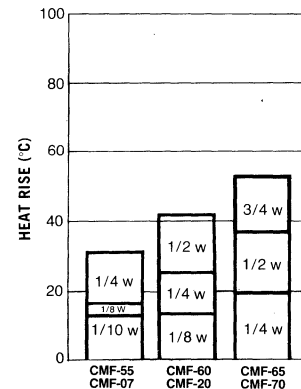



DUAL-IN-LINE NETWORKS THIN FILM, MOLDED

Models TDP1401 and TDP1601 13 or 15 resistors with one pin common
TDP1403 and TDP1603 7 or 8 isolated resistors

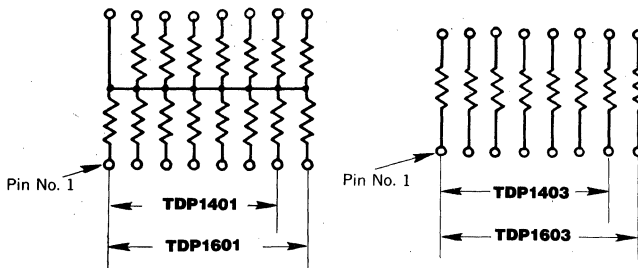
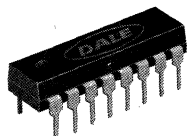

FEATURES:

- Rugged molded case construction
- Highly stable thin film
- Low temperature coefficient Nichrome film
- Compatible with automatic insertion equipment
- Uniform performance characteristics
- Matte finish

CIRCUIT APPLICATION

Dale Model TDP1401 and TDP1601 molded dual-in-line resistor network provides a choice of 13 or 15 nominally equal resistors, each connected between a common pin (14 or 16) and a discrete P.C. board pin. Dale Model TDP1403 and TDP1603 molded dual-in-line resistor network provides a choice of 7 or 8 nominally equal resistors with each resistor isolated from all others and wired directly across. Resistors within a common network body have the performance of matched resistor sets. This performance is retained even when the elements are externally wired in series/parallel combinations to provide different resistance values for applications which include:

- Precision voltage/current dividers
- Differential, instrumentation and summing amplifiers
- Converter ladder, scaling and range setting
- Oscillators and active filters

SPECIFICATIONS

ELECTRICAL

Resistance Range: 100Ω to 100KΩ.

Resistance Tolerance: 1%, .5%, .1%

Ratio Match: .05%, .1%, .5%

Resistance Temperature Coefficient: ±25 PPM/°C

Resistor Power Rating:

01 Circuit = .05 watt/resistor at 25°C

03 Circuit = .1 watt/resistor at 25°C

Package Power Rating: .7 watt/package at 25°C

Maximum Operating Voltage: 100 VDC

Voltage Coefficient of Resistance:
< 5 PPM/V typical

T.C. Tracking: ±5 PPM/°C (-55°C to +125°C)

Operating Temperature Range: -55°C to +125°C

Storage Temperature Range: -55°C to +150°C

PHYSICAL

Marking Resistance to Solvents: Permanency testing per MIL-R-83401

Solderability: Per MIL-R-83401

Terminals: Solder coated copper alloy

Body: Molded epoxy

Weight: 14 pin = .95 gram; 16 pin = .95 gram

ENVIRONMENTAL CHARACTERISTICS

(MIL-R-83401 Ref.)

Thermal Shock: ±0.25% max. ΔR (5 cycles between -65°C and +125°C)

Power Conditioning: ±0.10% max. ΔR (At full rated power for 100 hours ±4 hours at 25°C ambient temperature)

Low Temperature Operation: ±0.10% max. ΔR (45 minutes at full rated working voltage at -65°C)

Short Time Overload: ±0.10% max. ΔR (2-1/2 × rated working voltage for 5 seconds)

Terminal Strength: ±0.10% max. ΔR (4-1/2 pound pull for 30 seconds)

Resistance to Soldering Heat: ±0.10% max. ΔR (Leads immersed in 350°C solder to a depth of 1/8" for 3 seconds)

Moisture Resistance: ±0.20% max. ΔR (240 hours with humidity ranging from 80% RH to 98% RH)

Shock: ±0.25% max. ΔR (Total of 18 shocks at 100 G's)

Vibration: ±0.25% max. ΔR
(12 hours at maximum of 20 G's between 10 and 2000 Hz)

Life: ±0.10 max. ΔR (1,000 hours at 70°C, rated power applied 1-1/2 hours on, 1/2 hour off for full 1,000 hour period). Derated according to derating curve (next page)

Insulation Resistance: 10,000 Megohms (minimum)

Dielectric Withstanding Voltage: No evidence of arcing or damage.
(200 VRMS for 1 minute)

Models TDP1401 and TDP1601 TDP1403 and TDP1603

DERATING

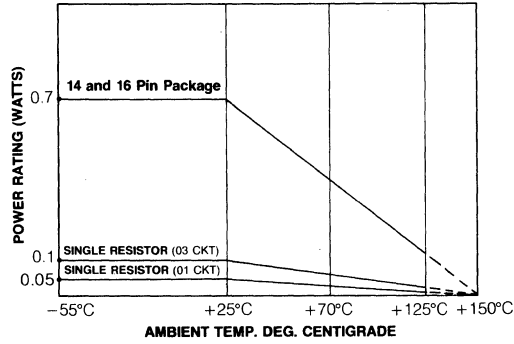

DIMENSIONAL AND TERMINAL CONFIGURATIONS: [Numbers in brackets indicate millimeters]

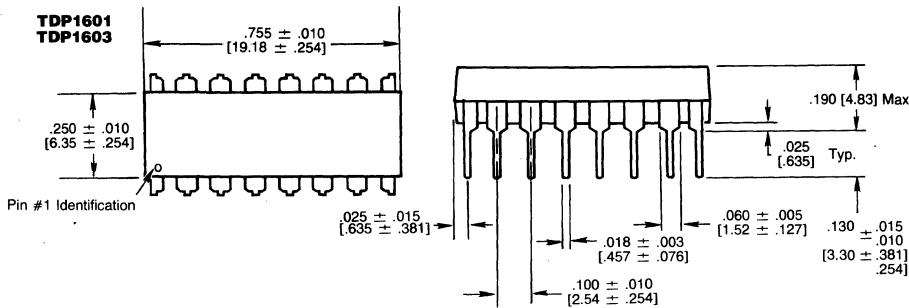
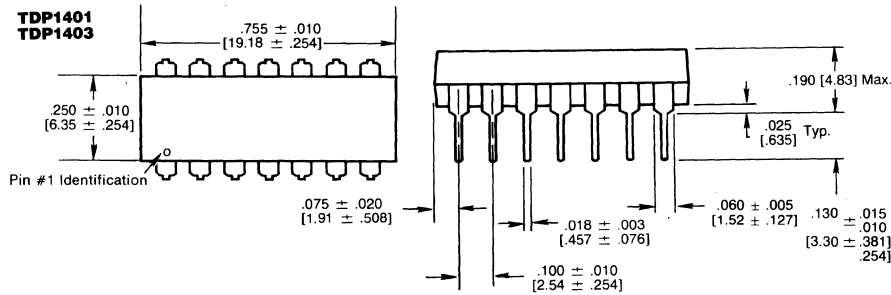

HOW TO ORDER

TDP SERIES	14 NUMBER OF PINS	03 SCHEMATIC	1001 RESISTANCE VALUE	F TOLERANCE AND RATIO TOLERANCE										
		01 = 13 or 15 resistors with one pin common. 03 = 7 or 8 isolated resistors.	First 3 digits are significant figures. Last digit specifies number of zeros to follow.	<table border="1"> <tr> <td>A = ±0.1%</td> <td>A = ±.05%</td> </tr> <tr> <td>B = ±0.1%</td> <td>B = ±.1%</td> </tr> <tr> <td>C = ±.25%</td> <td>C = ±.1%</td> </tr> <tr> <td>D = ±0.5%</td> <td>D = ±.1%</td> </tr> <tr> <td>F = ±1%</td> <td>F = ±.5%</td> </tr> </table>	A = ±0.1%	A = ±.05%	B = ±0.1%	B = ±.1%	C = ±.25%	C = ±.1%	D = ±0.5%	D = ±.1%	F = ±1%	F = ±.5%
A = ±0.1%	A = ±.05%													
B = ±0.1%	B = ±.1%													
C = ±.25%	C = ±.1%													
D = ±0.5%	D = ±.1%													
F = ±1%	F = ±.5%													



SPECIAL PURPOSE METAL FILM RESISTORS

DALE TYPE CMF-55-39 and CMF-60-64 Fusible, Flameproof

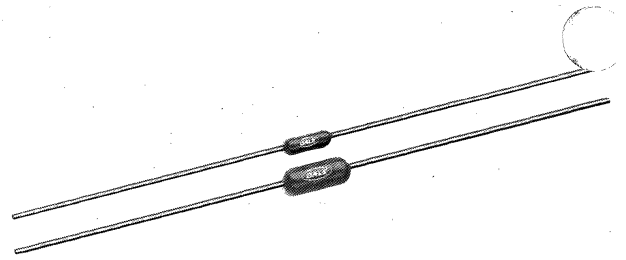

FEATURES

- Fusible—Circuit protection in case of other component failure.
- Flameproof—Meets EIA RS-325, will not flame when overloaded.
- Special filming and coating processes.
- Meets environmental requirements of MIL-R-22684.

SPECIFICATIONS

ELECTRICAL

Resistance Range: 5Ω to 10K

Resistance Tolerance: ±1%

Resistance Temperature Coefficient: ±100 PPM/°C
(-65°C to +165°C)

Resistor Power Rating: CMF-55-39 = 1/4 watt @ +70°C
CMF-60-64 = 1/2 watt @ +70°C
(Derate linearly from rated power at +70°C to zero power at +165°C)

Maximum Flame Test Voltage: CMF-55-39 = 350 VRMS or DC
CMF-60-64 = 500 VRMS or DC

Insulation Resistance: 10,000 Megohms

Operating Temperature Range: -65°C to +165°C

PHYSICAL CONFIGURATION

[Numbers in brackets indicate millimeters]

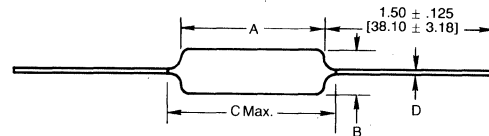

TYPE	DIM. A	DIM. B	DIM. C	DIM. D
CMF-55-39	.240 ± .020 [6.10 ± .51]	.090 ± .008 [2.29 ± .20]	.278 [7.1]	.025 ± .002 [.635 ± .051]
CMF-60-64	.370 ± .035 [9.40 ± .89]	.145 ± .010 [3.68 ± .25]	.425 [10.80]	.032 ± .002 [.813 ± .051]

FUSIBLE, FLAME PROOF (Typical Fusing Times)

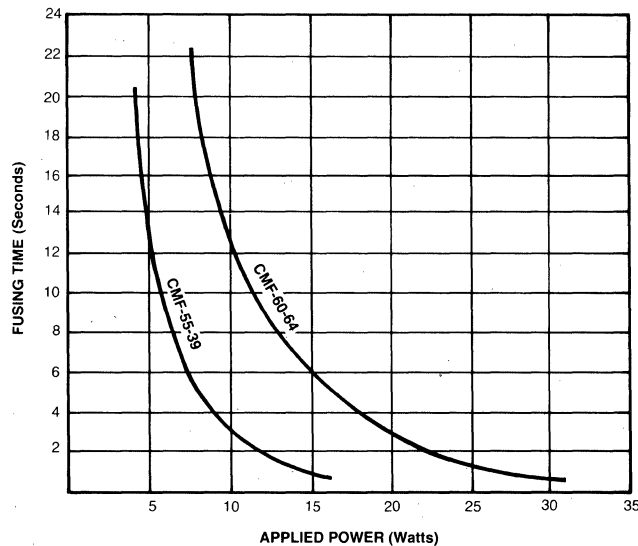



SPECIAL PURPOSE CARBON FILM RESISTORS

MODEL SPW High Frequency Load (Tubes)



FEATURES

- High stability and excellent high frequency characteristics.
- Particularly suited for high frequency applications involving high power, high accuracy RF measurements.
- Carbon film construction.
- Applications include high frequency wattmeters for output measurement in Radio, TV and Radar Transmitters, dielectric heating, and similar RF generating equipment.
- Ideal for use as non-reactive radio frequency terminations.

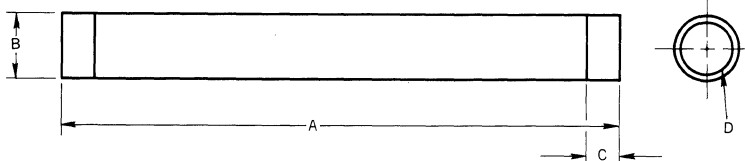

STANDARD ELECTRICAL SPECIFICATIONS

DALE TYPE	DIMENSIONS				WATTAGE FREE AIR (25°C)	RESISTANCE RANGE
	A	B (O.D.)	C	D (I.D.)		
SPW 236	18.0 ± .062 [457.20 ± 1.58]	1.750 ± .025 [44.45 ± .635]	1.0 ± .063 [25.40 ± 1.60]	1.250 ± .025 [31.75 ± .64]	120	50 Ohms Standard. Other values available on special order.
SPW 227	12.0 ± .062 [304.8 ± 1.57]	1.125 ± .025 [28.58 ± .635]	.500 ± .032 [12.70 ± .81]	.875 ± .020 [22.23 ± .508]	55	
SPW 210	12.0 ± .062 [304.8 ± 1.57]	.875 ± .010 [22.23 ± .254]	.625 ± .032 [15.88 ± .81]	.625 ± .020 [15.88 ± .51]	40	
SPW 214	5.0 ± .032 [127.0 ± .81]	.562 ± .006 [14.28 ± .152]	.500 ± .032 [12.70 ± .81]	.375 ± .013 [9.525 ± .33]	10	
*SPW 212	2.0 ± .062 [50.80 ± 1.57]	.250 ± .006 [6.35 ± .152]	.250 ± .032 [6.35 ± .81]	Solid Rod	2	

Note: 1. C dimension may be varied on special order.
2. Wattage ratings do not allow for mounting hardware.

*Representative types only.
Consult factory for special requirements.

ELECTRICAL

Tolerance: ±5% and ±2% standard. Linearity tolerance ±10%.

Temperature Coefficient: 200 PPM/°C average. 250 PPM/°C maximum.

Cooling: Approximate increase in wattage when forced air cooling is employed is 3 times wattages shown, and for liquid cooling (with heat exchanger) is 60 times wattages shown. The limiting factor insofar as the resistor is concerned is the film temperature. This should not exceed 200°C and for maximum stability should not exceed 150°C.

MECHANICAL

Identification: Type designation resistance value, tolerance and code date of manufacture are printed on each unit.

Terminations: All types electroplated copper except SPW 212. The SPW 212 has silver coated termination bands.

LOAD TEMPERATURE RISE OPERATION IN FREE AIR

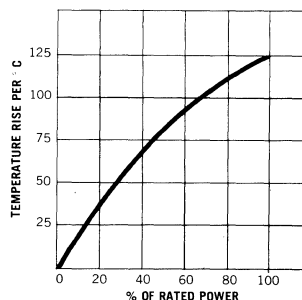



SPECIAL PURPOSE HIGH VOLTAGE METAL OXIDE RESISTORS

MODEL RNX



FEATURES

- Low T.C.: ± 200 PPM standard, ± 100 PPM, ± 50 PPM, ± 25 PPM available
- Tolerance: $\pm 0.1\%$ to $\pm 10\%$
- Values: 100 ohms to 10 gigohms
- Voltages: 750V to 8.0KV
- Coatings: High temperature silicone or epoxy (optional)
- For oil bath or open air operation.

STANDARD ELECTRICAL SPECIFICATIONS

DALE TYPE	POWER (WATTS)*			VOLTAGE RATING	M	RESISTANCE (Ohms) **			N (Non-Inductive)
	25°C	70°C	125°C			K	H	J	
RNX-1/4	.5	.36	.25	750V	1K-100M	1K-100M	1M-22M	1M-22M	100Ω-100K
RNX-3/8	1.0	.72	.5	1.5KV	1K-1G	1K-100M	1M-50M	1M-50M	100Ω-100K
RNX-1/2	1.2	.86	.6	2.0KV	1K-2.0G	1K-250M	1M-100M	1M-100M	100Ω-100K
RNX-3/4	2.0	1.44	1.0	3.0KV	1K-3G	1K-500M	1M-100M	1M-100M	100Ω-100K
RNX-1	2.5	1.8	1.25	4.0KV	1K-5G	1K-500M	1M-100M	1M-100M	100Ω-1M
RNX-1-1/4	3.0	2.16	1.5	5.0KV	2K-10G	1K-500M	—	—	100Ω-1M
RNX-1-1/2	4.0	2.88	2.0	6.0KV	2K-10G	1K-500M	—	—	100Ω-1M
RNX-2	5.0	3.6	2.5	8.0KV	2K-10G	1K-500M	—	—	100Ω-1M

*Increase wattage by 25% for .032 [.813] diameter leads.

**For resistance values above and below those listed, contact factory.

All resistance readings referenced at 100VDC. Other voltages upon request.

SPECIAL MODIFICATIONS

1. Special preconditioning (power aging, temperature cycling, etc.) to customer specifications.
2. Non-helixed resistors can be supplied for critical high frequency applications (Non-inductive).
3. Matched sets available.
4. Flameproof silicone coating available.

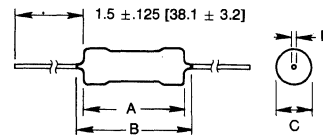

PHYSICAL CONFIGURATIONS [Numbers in brackets indicate millimeters]

DALE TYPE	DIMENSIONS			
	A	B (Max.)	C	D*
RNX-1/4	.290 ± .020 [7.37 ± .51]	.358 [9.09]	.145 ± .010 [3.68 ± .254]	.025 ± .002 [.635 ± .051]
RNX-3/8	.420 ± .020 [10.67 ± .51]	.470 [11.94]	.145 ± .010 [3.68 ± .254]	.025 ± .002 [.635 ± .051]
RNX-1/2	.540 ± .020 [13.72 ± .51]	.595 [15.11]	.145 ± .010 [3.68 ± .254]	.025 ± .002 [.635 ± .051]
RNX-3/4	.790 ± .020 [20.07 ± .51]	.845 [21.46]	.145 ± .010 [3.68 ± .254]	.025 ± .002 [.635 ± .051]
RNX-1	1.040 ± .020 [26.42 ± .51]	1.095 [27.81]	.145 ± .010 [3.68 ± .254]	.025 ± .002 [.635 ± .051]
RNX-1-1/4	1.290 ± .020 [32.77 ± .51]	1.345 [34.16]	.145 ± .010 [3.68 ± .254]	.025 ± .002 [.635 ± .051]
RNX-1-1/2	1.540 ± .020 [39.12 ± .51]	1.595 [40.51]	.145 ± .010 [3.68 ± .254]	.025 ± .002 [.635 ± .051]
RNX-2	2.040 ± .020 [51.82 ± .51]	2.100 [53.34]	.145 ± .010 [3.68 ± .254]	.025 ± .002 [.635 ± .051]

*Available with .032 [.813] leads $\pm .002$ [.051].

SPECIFICATIONS

ELECTRICAL

Tolerance: $\pm 10\%$, $\pm 5\%$, $\pm 2\%$, $\pm 1\%$.
 $\pm 0.5\%$, $\pm 0.25\%$ and $\pm 0.1\%$ available in 50 PPM & 25 PPM.
 NOTE: 1% tolerance not available above 5GΩ. Special tolerances and/or T.C. matching available upon request.

Noise: Exceptionally low noise level. Average for standard resistance range is 0.10 micro-volt per volt over a decade of frequency.

Dielectric Strength: 1000V all styles.

Insulation Resistance: 10,000 Megohms minimum change.
 100 Megohms minimum after moisture.

MECHANICAL

Terminal Strength: 5 lb. pull test for all styles.

Solderability: Continuous satisfactory coverage when tested in accordance with MIL-R-10509.

MATERIAL

Element: High temperature fired cermet film.

Core: High purity 96% alumina.

Coating: Flameproof silicone or flame-retardant epoxy.

Termination: Standard lead material is solder-coated copper.
 Solderable and weldable.

DALE ELECTRONICS, INC., P.O. Box 1179, Robbinsville, NC 28771 • Phone 704-479-6451

Canada: Dale Electronics Ltd., 18 Howden Rd., Scarborough, Ontario M1R 3E6
 Europe: Dale Electronics GmbH, Benzstrasse 28, 8039 Puchheim, West Germany

ENVIRONMENTAL

Environmental Test	Typical Δ R
Temperature Cycling	<±0.5%
Short-Time Overload	<±0.20%
Dielectric Withstanding Voltage	<±0.15%
Effect of Soldering	<±0.10%
Moisture Resistance	<±0.50%
Load Life	<±1.0%
Shock	<±0.20%
Vibration	<±0.20%

DERATING

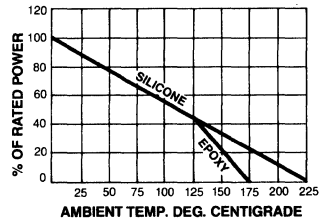

TEMPERATURE COEFFICIENT CODE

CODE	T.C.	RANGE
M	±200 PPM/°C	-55°C to +175°C
K	±100 PPM/°C	-55°C to +175°C
H	± 50 PPM/°C	- 5°C to +125°C
J	± 25 PPM/°C	0°C to +100°C

VOLTAGE COEFFICIENT

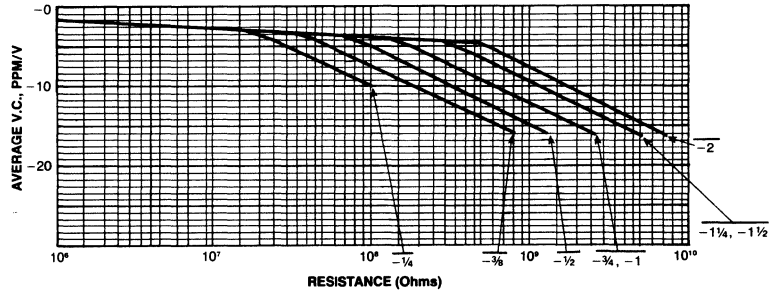

RESISTANCE VALUE CODES

K Kilo 10 ³		M Mega 10 ⁶		G Giga 10 ⁹		T Tera 10 ¹²	
Value	Code	Value	Code	Value	Code	Value	Code
1K	1K0	1M	1M0	1KM	1G0	1MM	1T0
5.5K	5K5	5.5M	5M5	5.5KM	5G5	5.5MM	5T5
9.99K	9K99	9.99M	9M99	9.99KM	9G99	9.99MM	9T99

HOW TO ORDER

RNX-1/2
MODEL NUMBER

E, N, P
OPTIONAL
CONSTRUCTION

E = Epoxy
N = Non-Inductive
P = .032 [.813] Dia. Leads

10K1
RESISTANCE VALUE

K
TOLERANCE

K = ±10%
J = ±5%
G = ±2%
F = ±1%
D = ±.5%
C = ±.25%
B = ±.1%

K
TEMPERATURE
COEFFICIENT

M = ±200 PPM/°C
K = ±100 PPM/°C
H = ± 50 PPM/°C
J = ± 25 PPM/°C



SPECIAL PURPOSE HIGH VOLTAGE METAL OXIDE RESISTORS



MODEL ROX

FEATURES

- Low T.C.: ± 200 PPM/ $^{\circ}$ C standard, ± 100 PPM/ $^{\circ}$ C & ± 50 PPM/ $^{\circ}$ C available
- Tolerances: $\pm 10\%$, $\pm 5\%$, $\pm 2\%$, $\pm 1\%$ and $\pm 0.5\%$
- Values: 100 ohms to 30 gigohms
- Voltages: 1.0KV to 45.0KV
- Wattages: 1.0 watts to 10 watts @ 125° C
- For oil bath or open air operation
- Matched sets available
- Special testing available upon request

STANDARD ELECTRICAL SPECIFICATIONS

DALE TYPE	POWER RATING*			Max. Volt.	Standard TC ± 200 PPM/ $^{\circ}$ C		RESISTANCE RANGE (ohms)				Non-Inductive TC ± 200 PPM/ $^{\circ}$ C	
	@ 25° C	@ 70° C	@ 125° C		Min.	Max.	TC ± 100 PPM/ $^{\circ}$ C Min.	TC ± 100 PPM/ $^{\circ}$ C Max.	TC ± 50 PPM/ $^{\circ}$ C Min.	TC ± 50 PPM/ $^{\circ}$ C Max.	Min.	Max.
ROX-1/2	2.0	1.4	1.0	2.0KV	1K	1G	1K	100M	1M	100M	—	—
ROX-3/4	3.0	2.16	1.5	5.0KV	1K	4G	1K	500M	1M	100M	100 Ω	1M
ROX-1	4.0	2.88	2.0	7.5KV	1K	5G	1K	500M	1M	100M	100 Ω	1M
ROX-1-1/2	5.0	3.6	2.5	11.0KV	1.5K	7.5G	1.5K	500M	1M	100M	100 Ω	1M
ROX-2	6.0	4.32	3.0	15.0KV	2K	10G	2K	1G	1M	500M	100 Ω	1M
ROX-3	10.0	7.2	5.0	22.5KV	3K	15G	3K	1G	1M	500M	400 Ω	10M
ROX-4	12.0	8.64	6.0	30.0KV	4K	20G	4K	1G	1M	500M	500 Ω	10M
ROX-5	16.0	11.52	8.0	37.5KV	5K	25G	5K	1G	1M	500M	500 Ω	10M
ROX-6	20.0	14.4	10.0	45.0KV	6K	30G	6K	1G	1M	500M	500 Ω	10M

*Wattage increases by 25% with .040 lead. All resistance readings referenced at 100VDC. Other voltages available on request.

DIMENSIONAL SPECIFICATIONS [Numbers in brackets indicate millimeters]

DALE TYPE	MODEL E, N, P		MODEL T	MODEL Y	MODEL Z
	A	B	C	C (Max.)	C
ROX-1/2	.600 \pm .032 [15.24 \pm .813]	.700 [17.78]	NA	NA	NA
ROX-3/4	.800 \pm .032 [20.32 \pm .813]	.900 [22.86]	1.168 \pm .022 [29.67 \pm .559]	1.045 [26.54]	.780 \pm .022 [19.81 \pm .559]
ROX-1	.920 \pm .032 [23.37 \pm .813]	1.020 [25.9]	1.288 \pm .022 [32.72 \pm .559]	1.165 [29.59]	.900 \pm .022 [22.86 \pm .559]
ROX-1-1/2	1.55 \pm .032 [38.1 \pm .813]	1.650 [41.91]	1.918 \pm .022 [48.72 \pm .559]	1.795 [45.59]	1.530 \pm .022 [38.86 \pm .559]
ROX-2	2.05 \pm .032 [52.07 \pm .813]	2.150 [54.61]	2.418 \pm .022 [61.42 \pm .559]	2.295 [58.29]	2.030 \pm .022 [51.56 \pm .559]
ROX-3	3.05 \pm .032 [77.47 \pm .813]	3.150 [80.01]	3.418 \pm .022 [86.82 \pm .559]	3.295 [83.69]	3.030 \pm .022 [76.96 \pm .559]
ROX-4	4.05 \pm .032 [102.87 \pm .813]	4.150 [105.41]	4.418 \pm .022 [112.22 \pm .559]	4.295 [109.09]	4.030 \pm .022 [102.36 \pm .559]
ROX-5	5.05 \pm .032 [128.27 \pm .813]	5.150 [130.81]	5.418 \pm .022 [137.62 \pm .559]	5.295 [134.49]	5.030 \pm .022 [127.76 \pm .559]
ROX-6	6.05 \pm .032 [153.67 \pm .813]	6.150 [156.21]	6.418 \pm .022 [163.02 \pm .559]	6.295 [159.89]	6.030 \pm .022 [153.16 \pm .559]

MODEL E, N and P

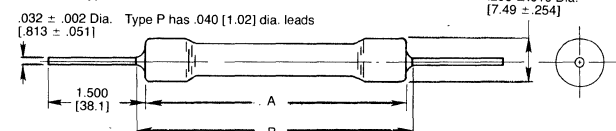

MODEL T

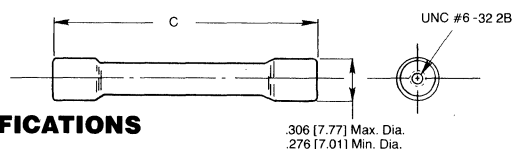

MODEL Y

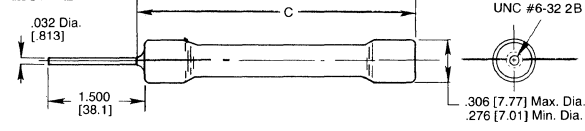

MODEL Z

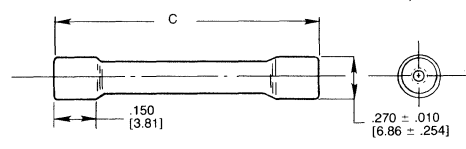

SPECIFICATIONS

ELECTRICAL

Tolerance: ROX's are supplied in $\pm 10\%$, $\pm 5\%$, $\pm 2\%$ and $\pm 1\%$. 0.5% available on resistances up to 500 Meg. Special tolerance and/or TC matching is available upon request.

NOTE: 1% tolerance not available above 10G Ω .

Noise: Dale Metal Oxide resistors have exceptionally low noise level. Average for standard resistance range is 0.10 micro-volt per volt over a decade of frequency.

Insulation Resistance: 10,000 Megohm minimum dry, 100 Megohms minimum after moisture.

Overload: 1.5 times maximum voltage not to exceed 5 times rated power for 5 sec. ΔR 1.0% max.

MECHANICAL

Terminal Strength: 10 lb. pull test

Solderability: Continuous satisfactory coverage when tested in accordance with MIL-R-10509

MATERIAL

Element: High temperature fired cermet film.

Core: High purity 96% alumina.

Coating: Flameproof silicone or flame-retardant epoxy.

Termination: Standard lead material is solder-coated copper over steel core. Solderable and weldable.

DALE ELECTRONICS, INC., P.O. Box 1179, Robbinsville, NC 28771 • Phone 704-479-6451

Canada: Dale Electronics Ltd., 18 Howden Rd., Scarborough, Ontario M1R 3E6
Europe: Dale Electronics GmbH, Benzstrasse 28, 8039 Puchheim, West Germany

ENVIRONMENTAL

Environmental Test	Typical Δ R
Temperature Cycling	< ±0.5%
Short-Time Overload	< ±0.2%
Dielectric Withstanding Voltage	< ±0.15%
Effect of Soldering	< ±0.1%
Moisture Resistance	< ±0.5%
Load Life	< ±1.5%
Shock	< ±0.2%
Vibration	< ±0.2%

TEMPERATURE COEFFICIENT CODE

CODE	T.C.	Range
M	±200 PPM/°C	-55°C to +175°C
K	±100 PPM/°C	-55°C to +175°C
H	± 50 PPM/°C	- 5°C to +125°C

**Silicone Coated
POWER DERATING**

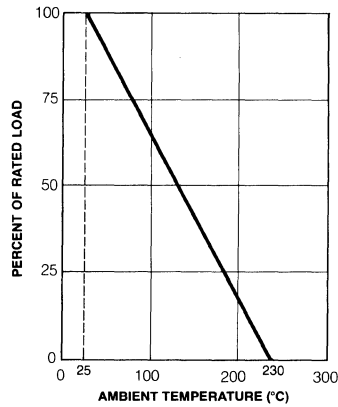

**Epoxy
POWER DERATING**

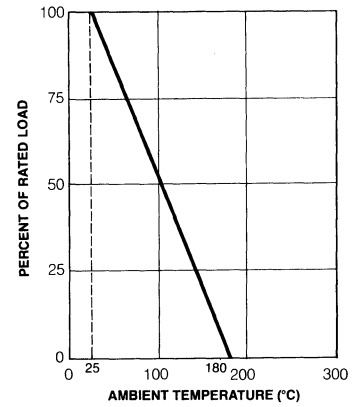

VOLTAGE COEFFICIENT

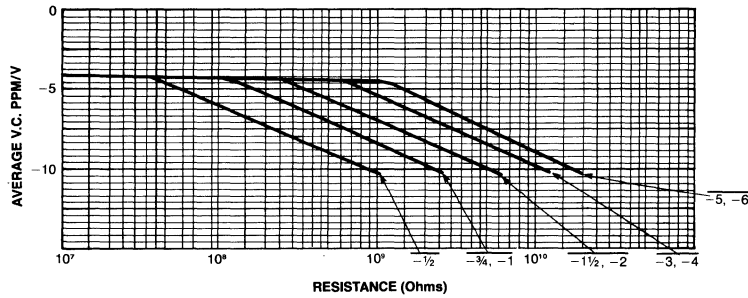

RESISTANCE VALUE CODES

K Kilo		M Mega		G Giga		T Tera	
10 ³		10 ⁶		10 ⁹		10 ¹²	
Value	Code	Value	Code	Value	Code	Value	Code
1K	1K0	1M	1M0	1KM	1G0	1MM	1T0
5.5K	5K5	5.5M	5M5	5.5KM	5G5	5.5MM	5T5
9.99K	9K99	9.99M	9M99	9.99KM	9G99	9.99MM	9T99

HOW TO ORDER

ROX-1/2
MODEL NUMBER

E, N, P
OPTIONAL
CONSTRUCTION

100M5
RESISTANCE
VALUE

F
TOLERANCE

M
TEMPERATURE
COEFFICIENT

- K = ±10%
- J = ±5%
- G = ±2%
- F = ±1%
- D = ±.5%

- M = ±200 PPM/°C
- K = ±100 PPM/°C
- H = ± 50 PPM/°C

CONSTRUCTION OPTION LETTERS:

- None** = Silicone coated, axial leads, tubular body
- E** = Epoxy coated, axial leads, tubular body
- N** = Silicone coated, axial leads, non-inductive
- P** = Silicone coated, .040 [1.02] dia. axial leads, tubular body
(Add 25% to wattage for .040 [1.02] dia. leads)
- S** = Silicone coated, axial terminals, solid body
- T** = Silicone coated, threaded terminals, tubular body
- Y** = Silicone coated, one end axial, one end threaded terminals
- Z** = Silicone coated, plated ferrules, tubular body

NOTE: 1% tolerance not available above 10GΩ.



SPECIAL PURPOSE, HIGH VOLTAGE METAL OXIDE RESISTORS

MODEL FHV, FLAT

FEATURES:

- Low T.C.: ± 200 PPM/ $^{\circ}\text{C}$ standard, ± 100 PPM/ $^{\circ}\text{C}$ available
- Tolerances: 1%, 2%, 5%, 10%
- Values: 100 Ω to 100 gigohms
- Wattages: $\frac{1}{4}$ watt to 4 watts @ 70 $^{\circ}\text{C}$
- Voltages: 400V to 15K volts
- Non-Inductive Design
- Matched Sets Available
- Ratio Dividers Available
- Special Testing Available

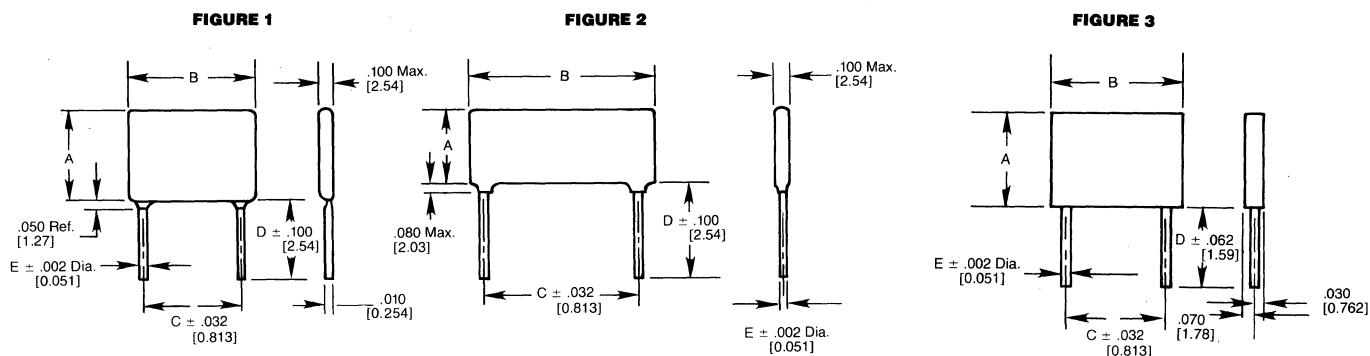
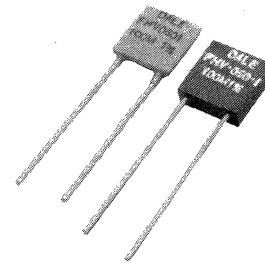

STANDARD ELECTRICAL SPECIFICATIONS [Numbers in brackets indicate millimeters]

DALE TYPE	POWER RATING		MAX. VOLT. (KV)	RESISTANCE RANGE*		DIMENSIONAL SPECIFICATIONS*					FIGURE
	70 $^{\circ}\text{C}$	125 $^{\circ}\text{C}$		± 200 PPM	± 100 PPM	A Max.	B Max.	C	D	E	
FHV-025	.25	.125	.75	10K-100M	10K-100M	.300 [7.62]	.300 [7.62]	.200 [5.08]	.250 [6.35]	.020 [0.51]	1
FHV-050	.50	.25	1.5	10K-500M	10K-100M	.350 [8.89]	.350 [8.89]	.200 [5.08]	.360 [9.14]	.020 [0.51]	1
FHV-050M	—	.75	.40	1M-100M	1M-100M	.300 [7.62]	.300 [7.62]	.200 [5.08]	1.500 [38.1]	.025 [0.635]	3
FHV-075	.25	.125	3.75	100 Ω -1G	500 Ω -500M	.210 [5.33]	.570 [14.48]	.400 [10.16]	1.500 [38.1]	.025 [0.635]	2
FHV-100	1.0	.5	7.5	100 Ω -2G	500 Ω -1G	.280 [7.11]	1.070 [21.18]	.900 [22.86]	1.500 [38.1]	.032 [0.813]	2
FHV-150	1.5	.75	11.25	10K-2G	1M-1G	.330 [8.38]	1.570 [39.88]	1.400 [35.56]	1.500 [38.1]	.032 [0.813]	2
FHV-160	1.0	.5	3.5	100 Ω -2G	500 Ω -1G	.520 [13.21]	.520 [13.21]	.400 [10.16]	1.500 [38.1]	.032 [0.813]	2
FHV-200	2.0	1.0	15.0	200 Ω -8G	500M-1G	.330 [8.38]	2.020 [51.31]	1.900 [48.26]	1.500 [38.1]	.032 [0.813]	2
FHV-400	2.0	1.0	7.5	20K-2G	1M-1G	.520 [13.21]	1.020 [25.91]	.900 [22.86]	1.500 [38.1]	0.32 [0.813]	2
FHV-500	4.0	2.0	15.0	30K-10G	1M-1G	.520 [13.21]	2.070 [52.58]	1.900 [48.26]	1.500 [38.1]	0.32 [0.813]	2

*Resistances are @ 100 VDC. Resistances at other voltages available.

SPECIFICATIONS

ELECTRICAL

Tolerance: $\pm 10\%$, $\pm 5\%$, $\pm 2\%$, $\pm 1\%$. Special tolerance and/or T.C. matching available upon request.

NOTE: 1% tolerance not available above 1G Ω .

Noise: Exceptionally low noise level. Average for standard resistance range is 0.10 micro-volt per volt over a decade of frequency.

Insulation Resistance: 10,000 Megohms minimum dry, 100 Megohms minimum after moisture.

Overload: 1.5 times maximum voltage not to exceed 5 times rated power for 5 sec. ΔR 1.0% max.

MECHANICAL

Terminal Strength: 5 lb. pull test.

Solderability: Continuous satisfactory coverage when tested in accordance with MIL-R-10509.

MATERIAL

Element: High temperature fired cermet film.

Core: High purity 96% alumina.

Coating: Flameproof silicone standard on FHV's.
FHV-050M — Molded epoxy

Termination: Standard lead material is solder-coated copper. Solderable and weldable per MIL-STD-1276 Type C.

ENVIRONMENTAL

ENVIRONMENTAL TEST	TYPICAL ΔR
Temperature Cycling	<±0.5%
Short Time Overload	<±0.2%
Dielectric Withstanding Voltage	<±0.15%
Effects of Soldering	<±0.1%
Moisture Resistance	<±0.5%
Load Life	<±1.0%
Shock	<±0.2%
Vibration	<±0.2%

TEMPERATURE COEFFICIENT CODE

CODE	T.C.	RANGE
M	±200 PPM	-55°C to +175°C
K	±100 PPM	-55°C to +175°C

POWER DERATING

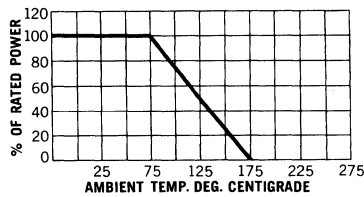

VOLTAGE COEFFICIENT

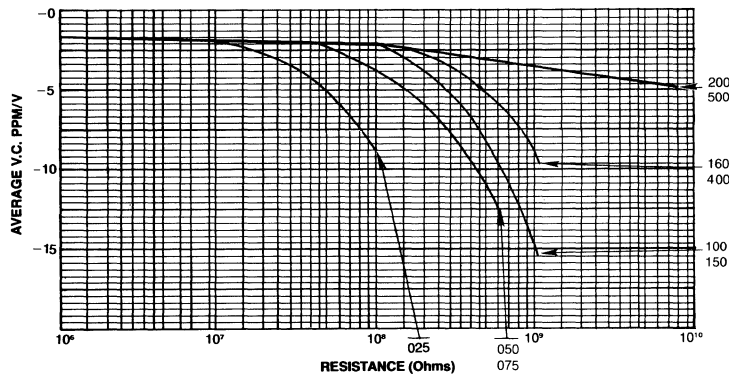

RESISTANCE VALUE CODES

K Kilo		M Mega		G Giga		T Tera	
10 ³		10 ⁶		10 ⁹		10 ¹²	
Value	Code	Value	Code	Value	Code	Value	Code
1K	1K0	1M	1M0	1KM	1G0	1MM	1T0
5.5K	5K5	5.5M	5M5	5.5KM	5G5	5.5MM	5T5
9.99K	9K99	9.99M	9M99	9.99KM	9G99	9.99MM	9T99

HOW TO ORDER

FHV — **XXX** **100M5** **F** **M**
 MODEL — SIZE RESISTANCE TOLERANCE TEMPERATURE
 NUMBER VALUE COEFFICIENT

K = 10%
 J = 5%
 G = 2%
 F = 1%

M = ±200 ppm
 K = ±100 ppm

NOTE: 1% tolerance not available above 1GΩ.



SPECIAL PURPOSE OXIDE & CARBON FILM RESISTORS

MODELS HACW, HADW, M-51, HSD Ultra High Value

FEATURES

- Ultra high values with superior stability and consistent voltage coefficient
- Small size
- M-51 and HSD hermetically-sealed, minimizing effects of moisture or contamination
- HACW-2 and HADW-2 insulation is flame retardant

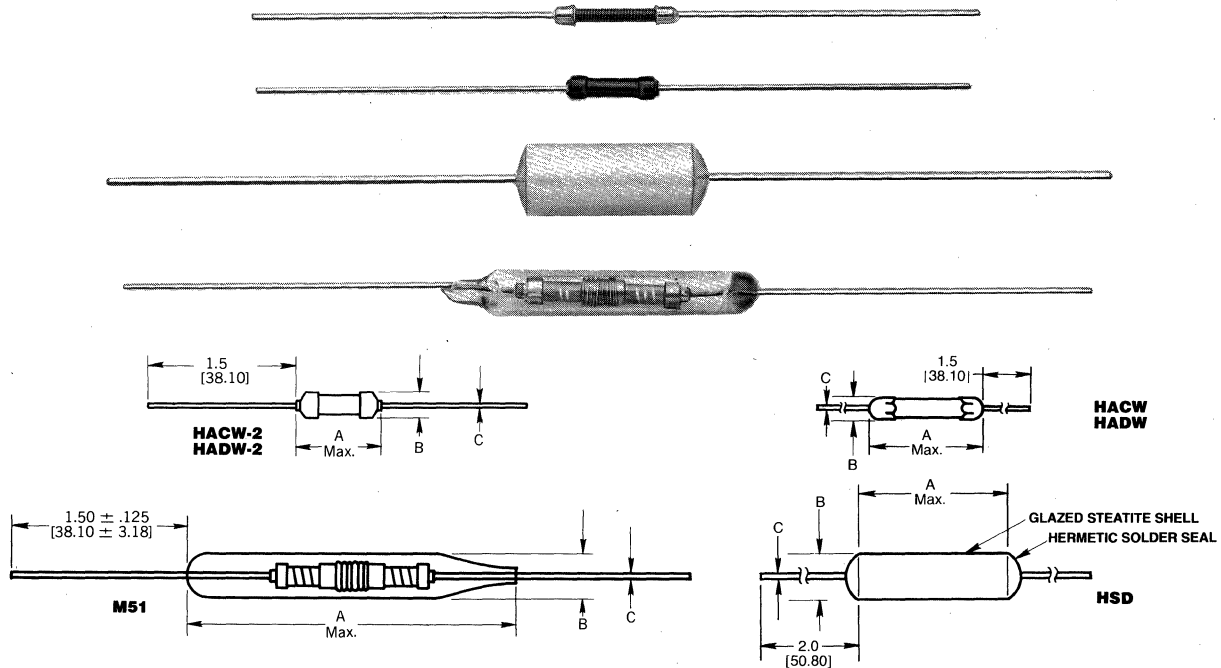

STANDARD ELECTRICAL SPECIFICATIONS

DALE TYPE	WATTS @ 40°C	MAX. VOLTS	DIMENSIONS			RESISTANCE RANGE
			A Max.	B	C	
HACW	0.2	1.0KV	.562 [14.3]	0.100 ± .010 [2.5 ± .254]	.032 [0.81]	10M-10G
HACW-2	0.25	1.5KV	.55 [13.97]	0.140 ± .010 [3.56 ± .254]	.025 [.635]	1G-50G
HADW	0.50	5.0KV	1.00 [25.4]	0.100 ± .010 [2.5 ± .254]	.032 [0.81]	10M-10G
HADW-2	0.50	5.0KV	.95 [24.13]	0.140 ± .010 [3.56 ± .254]	.025 [.635]	1G-50G
HSD	0.50	2.5KV	0.875 [22.2]	0.345 ± .010 [8.8 ± .254]	.032 [0.81]	1M-1T
M-51	0.50	500V	1.88 [47.75]	0.220 ± .010 [5.59 ± .254]	.020 [.508]	60M-10T

SPECIFICATIONS

ELECTRICAL

Tolerance: M-51 = 1%, 2%, 5%, 10%. HACW and HACW-2 = 5%, 10%, 20%. HADW and HADW-2 = 5%, 10%, 20%. HSD = 5%, 10%.

Temperature Coefficient: 10⁷-10⁹ = 1500 PPM/°C; Over 10⁹-10¹¹ = 2000 PPM/°C; Over 10¹¹-10¹² = 2800 PPM/°C. (T.C.'s are typical only and are ALWAYS NEGATIVE.)

Noise: Not normally measurable.

Shelf Life: < 0.5% per year.

Load Life at 85°C: Under DC cyclic load average ΔR < 1%. Maximum 2%.

Maximum Temperature: 125°C.

Temperature Cycling: < 0.5% per MIL-R-14293.

Moisture Cycle: M-51, HSD = hermetically sealed, effects of moisture nil.

MECHANICAL

Identification: Type designation, resistance value, and tolerance are stamped on each unit.

Insulation: HACW-2 and HADW-2 = heat shrunk polyolefin. M-51 = glass sealed. HSD = Hermetic-sealed ceramic. HACW and HADW = insulated with high grade electrical varnish.



SPECIAL PURPOSE HIGH VOLTAGE METAL ALLOY RESISTORS

DALE TYPE HVW, MVW, HVX

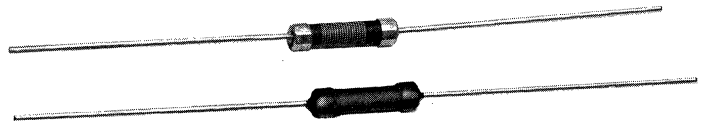

FEATURES

- HVW and MVW = Uncoated, HVX = Silicone coated
- HVW and MVW ratings to 2.6 W, 15 KV, $\pm 5\%$, HVX ratings to 5 W, 15 KV, $\pm 5\%$
- Axial leads—HVW and HVX = Tinned copper. MVW = Copper clad steel.

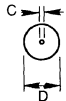
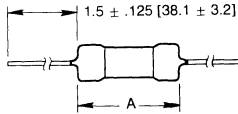

**HVW/MVW
Uncoated**

[Numbers in brackets indicate millimeters]

**HVX
Coated**

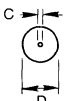
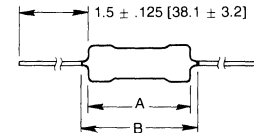

SEMI-PRECISION TYPES* ($\pm 5\%$, $\pm 10\%$, $\pm 20\%$)

HVW/MVW (Uncoated)

DALE TYPE	Power (watts) @ 200°C	Voltage Rating	RESISTANCE (Ohms)		DIMENSIONS		
			Min.	Max.	A Max.	C	D Max.
HVW-1/2	0.5	3.5KV	100	25M	.575 \pm .010 [14.60 \pm 0.25]	.032 [0.81]	0.155 [3.94]
MVW-1/2	0.5	3.5KV	100	25M	.575 \pm .010 [14.60 \pm 0.25]	.032 [0.81]	0.155 [3.94]
HVW-3/4	1.0	7.5KV	100	50M	.895 \pm .010 [22.73 \pm 0.25]	.032 [0.81]	0.155 [3.94]
MVW-3/4	1.0	7.5KV	100	50M	.895 \pm .010 [22.73 \pm 0.25]	.032 [0.81]	0.155 [3.94]
HVW-5/8	0.8	4.0KV	100	50M	.680 \pm .010 [17.27 \pm 0.25]	.032 [0.81]	0.275 [6.99]
HVW-1	1.2	7.5KV	100	100M	.885 \pm .010 [22.48 \pm 0.25]	.032 [0.81]	0.275 [6.99]
HVW-2	2.6	15.0KV	100	200M	2.1 \pm .010 [53.34 \pm 0.25]	.032 [0.81]	0.275 [6.99]

HVX (Silicone Coated)

DALE TYPE	Power (watts) @ 70°C	Voltage Rating	RESISTANCE (Ohms)		DIMENSIONS			
			Min.	Max.	A Max.	B Max.	C	D Max.
HVX-1/2	1.0	3.5KV	100	25M	.651 [16.54]	.680 [17.27]	.032 [0.81]	.180 [4.57]
HVX-3/4	1.5	7.5KV	100	50M	.988 [25.10]	1.062 [26.97]	.032 [0.81]	.180 [4.57]
HVX-5/8	.816	4.0KV	100	50M	.750 [19.05]	.875 [22.22]	.032 [0.81]	.310 [7.87]
HVX-1	2.5	7.5KV	100	100M	.788 [20.02]	1.062 [26.97]	.032 [0.81]	.310 [7.87]
HVX-2	5.0	15.0KV	100	200M	2.150 [54.61]	2.200 [55.88]	.032 [0.81]	.310 [7.87]

*Consult factory for closer tolerance. Leads are OFHC tinned copper.

GENERAL CHARACTERISTICS

TYPES

MVW, HVW	Uncoated, axial lead
HVX	Silicone coated, axial lead

POWER DERATING

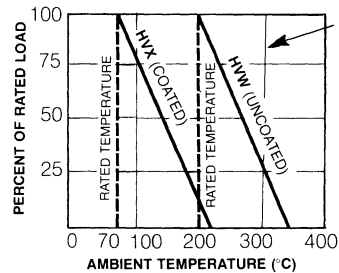

TEMPERATURE COEFFICIENT (-65°C to +125°C)

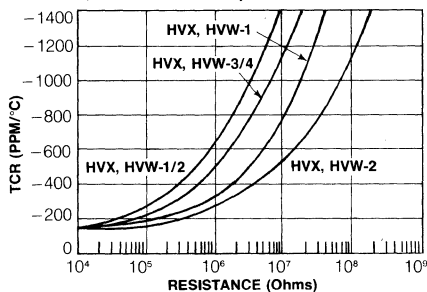

VOLTAGE COEFFICIENT (Average)

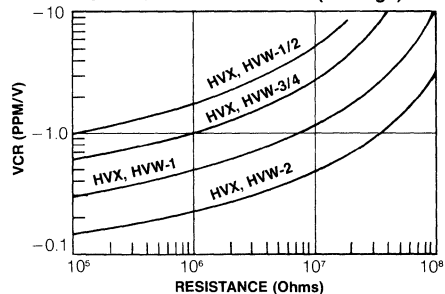

RESISTANCE VALUE CODES

K Kilo		M Mega		G Giga		T Tera	
10 ³		10 ⁶		10 ⁹		10 ¹²	
Value	Code	Value	Code	Value	Code	Value	Code
1K	1K0	1M	1M0	1KM	1G0	1MM	1T0
5.5K	5K5	5.5M	5M5	5.5KM	5G5	5.5MM	5T5
9.99K	9K99	9.99M	9M99	9.99KM	9G99	9.99MM	9T99



DALE ELECTRONICS, INC., P.O. Box 1179, Robbinsville, NC 28771 • Phone 704-479-6451

Canada: Dale Electronics Ltd., 18 Howden Rd., Scarborough, Ontario M1R 3E6
Europe: Dale Electronics GmbH, Benzstrasse 28, 8039 Puchheim, West Germany



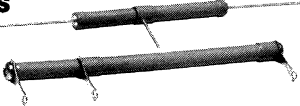
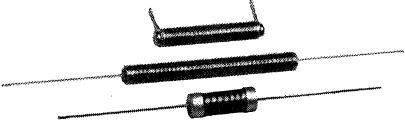
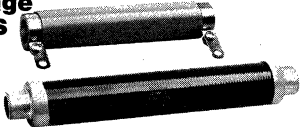

SPECIAL APPLICATIONS FILM RESISTORS

DISCRETE RESISTORS

DALE TYPE	DESCRIPTION
<p>High Power/Ultra High Value RJU SERIES</p> 	<p>Power: 40 to 400 watts at 125°C. Voltage: 25 KV through 125 KV. Resistance Range: 100K to 1 Gigohm. Mounting accessories available. Contact Robbinsville factory at address below.</p>
<p>High Voltage Ratio Dividers RDX SERIES</p> 	<p>Available in ratios up to 10,000:1 with wattage ratings from 2 watts and voltage ratings from 7.5 KV. Mounting accessories available. Contact Robbinsville factory at address below.</p>
<p>High Voltage B, F, H, T SERIES Carbon Film</p> 	<p>Power: .5 to 10 watts. Voltage: 2.5 KV to 40 KV. Models: B = General purpose, 10K to 25 Gigohms F = Noninductive: 20 Ohms to 1 Megohm H = High value: 1 Megohm to 1 Teraohm T = General purpose: 1 Megohm to 1 Gigohm Contact Robbinsville factory at address below.</p>
<p>High Voltage D, G SERIES Carbon Film</p> 	<p>Power: 10 to 100 watts at 25°C. Voltage rating: 25 KV thru 125 KV. Models: D = 50K to 100 Gigohm G = Noninductive: 20 Ohms to 1 Megohm Contact Robbinsville factory at address below.</p>
<p>Commercial MODEL DC Coated Carbon Film</p> 	<p>Power: 1/8, 1/4, 1/2 watt. Tolerances: ±.5%, ±1%, ±2%. Resistance Range: 1 Ohm to 15 Megohms. Note: 1/4 and 1/2 watt sizes conform to RN10, 20, but QPL's are not maintained. Contact Norfolk factory at address below.</p>

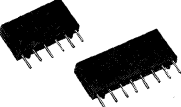
DISCRETE RESISTOR NETWORKS

<p>Single-In-Line MODELS R-4C, R-5C, Molded</p> 	<p>Choice of 6 or 8 pin molded packages. Schematics include 3 or 4 isolated resistors or, 5 or 7 resistors connected to one common pin. Resistance Range: 10 Ohms to 604K. Tolerance: ±.1%, ±.25%, ±.5% and ±1%. TC: ±10 PPM/°C to ±100 PPM/°C. Resistor Power Rating: .1 to .2 watt at 70°C. Package Power Rating: 1 watt at 70°C. Contact Robbinsville factory at address below.</p>
<p>Dual-In-Line MODELS R-1C, R-2C, Molded</p> 	<p>Choice of 14 or 16 pin molded packages. Schematics include 7 or 8 isolated resistors. Resistance Range: 10 Ohms to 604K. Tolerances: ±.1%, ±.25%, ±.5% and ±1%. TC: ±10 PPM/°C to ±100 PPM/°C. Resistor Power Rating: .1 to .2 watt at 70°C. Package Power Rating: 1.3 to 1.6 watts at 70°C. Contact Robbinsville factory at address below.</p>

For information and engineering assistance, contact:

DALE ELECTRONICS, INC., 2300 Riverside Blvd., Norfolk, NE 68701 • Phone 402-371-0080
DALE ELECTRONICS, INC., P.O. Box 1179, Robbinsville, NC 28771 • Phone 704-479-6451



CHECKLIST FOR ORDERING FILM RESISTORS

Orders must have complete information including the following:

1. Resistor type and model number
2. Resistor wattage rating
3. Resistor value
4. Resistor tolerance
5. Temperature Coefficient
6. Special quantity of each item
7. Specify routing
8. If you have a drawing covering the part, specify your part number and drawing number and supply a copy with the order. Including the Dale Electronics specification number on your drawings will assure you of exact duplication on all future orders.
9. Priority rating under DMS regulations and contract number (if applicable)
10. Desired delivery
11. Specify if Letter of Certification is required
12. Prices on specific items and quantities will be quoted on request. Quantity of each item ordered at one time determines unit price for manufacturers' orders.

STANDARD DECADE RESISTANCE VALUES

.1%, .25%, .5%		1%		.1%, .25%, .5%		1%		.1%, .25%, .5%		1%		2%, 5%		10%	
10.0	10.0	17.8	17.8	31.6	31.6	56.2	56.2	10	10						
10.1		18.0		32.0		56.9		11	—						
10.2	10.2	18.2	18.2	32.4	32.4	57.6	57.6	12	12						
10.4		18.4		32.8		58.3		13	—						
10.5	10.5	18.7	18.7	33.2	33.2	59.0	59.0	15	15						
10.6		18.9		33.6		59.7		16	—						
10.7	10.7	19.1	19.1	34.0	34.0	60.4	60.4	18	18						
10.9		19.3		34.4		61.2		20	—						
11.0	11.0	19.6	19.6	34.8	34.8	61.9	61.9	22	22						
11.1		19.8		35.2		62.6		24	—						
11.3	11.3	20.0	20.0	35.7	35.7	63.4	63.4	27	27						
11.4		20.3		36.1		64.2		30	—						
11.5	11.5	20.5	20.5	36.5	36.5	64.9	64.9	33	33						
11.7		20.8		37.0		65.7		36	—						
11.8	11.8	21.0	21.0	37.4	37.4	66.5	66.5	39	39						
12.0		21.3		37.9		67.3		43	—						
12.1	12.1	21.5	21.5	38.3	38.3	68.1	68.1	47	47						
12.3		21.8		38.8		69.0		51	—						
12.4	12.4	22.1	22.1	39.2	39.2	69.8	69.8	56	56						
12.6		22.3		39.7		70.6		62	—						
12.7	12.7	22.6	22.6	40.2	40.2	71.5	71.5	68	68						
12.9		22.9		40.7		72.3		75	—						
13.0	13.0	23.2	23.2	41.2	41.2	73.2	73.2	82	82						
13.2		23.4		41.7		74.1		91	—						
13.3	13.3	23.7	23.7	42.2	42.2	75.0	75.0								
13.5		24.0		42.7		75.9									
13.7	13.7	24.3	24.3	43.2	43.2	76.8	76.8								
13.8		24.6		43.7		77.7									
14.0	14.0	24.9	24.9	44.2	44.2	78.7	78.7								
14.2		25.2		44.8		79.6									
14.3	14.3	25.5	25.5	45.3	45.3	80.6	80.6								
14.5		25.8		45.9		81.6									
14.7	14.7	26.1	26.1	46.4	46.4	82.5	82.5								
14.9		26.4		47.0		83.5									
15.0	15.0	26.7	26.7	47.5	47.5	84.5	84.5								
15.2		27.1		48.1		85.6									
15.4	15.4	27.4	27.4	48.7	48.7	86.6	86.6								
15.6		27.7		49.3		87.6									
15.8	15.8	28.0	28.0	49.9	49.9	88.7	88.7								
16.0		28.4		50.5		89.8									
16.2	16.2	28.7	28.7	51.1	51.1	90.9	90.9								
16.4		29.1		51.7		92.0									
16.5	16.5	29.4	29.4	52.3	52.3	93.1	93.1								
16.7		29.8		53.0		94.2									
16.9	16.9	30.1	30.1	53.6	53.6	95.3	95.3								
17.2		30.5		54.2		96.5									
17.4	17.4	30.9	30.9	54.9	54.9	97.6	97.6								
17.6		31.2		55.6		98.8									



PRECISION POWER WIREWOUND RESISTOR

PRELIMINARY

DALE TYPE WSM-1, -2 Surface Mount Resistors

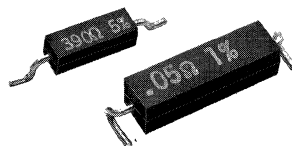

FEATURES

- Complete Welded Construction.
- Molded High Temperature Silicone Encapsulation.
- Available in Non-Inductive Styles with Aryton-Perry Windings for Lowest Reactive Components.

STANDARD ELECTRICAL SPECIFICATIONS

DALE TYPE	POWER RATING	RESISTANCE RANGE (ohms)				MAX. WORKING VOLTAGE*
		.05%	.1%	.25%	.5%, 1%, 3%, 5%	
WSM-1	1W	1.0-1K	.499-1K	.499-3.4K	0.1-3.4K	20V
WSM-2	2W	1.0-2.74K	.499-2.74K	.499-10.4K	0.1-10.4K	54V

*Maximum working voltage determined @ .0008 dia. wire resistance value.

*Max. working voltage determined a .0008 dia. wire res. value.

SPECIFICATIONS

STANDARD TEMPERATURE COEFFICIENTS

- ±90 PPM/°C Below 1.0 Ohm.
- ±50 PPM/°C 1.0 Ohm — 9.9 Ohm.
- ±20 PPM/°C 10 Ohm and beyond.

ELECTRICAL

Tolerance: Available in the following standard tolerances: 5%, 3%, 1%, .5%, .25%, .1%, .05%.

Dielectric Strength: 500VAC.

Insulation Resistance: 1000 Megohms minimum dry, 100 Megohms after moisture test.

Short Time Overload: 5 seconds at 5 times rated power.

Solderability: 60/40 Hot Solder Dipped terminals to facilitate soldering.

MATERIAL

Core: Alumina.

Element: Copper-nickel alloy or nickel-chrome alloy, depending on resistance value.

End Caps: Stainless steel.

Molding: Special high temperature silicone.

Standard Terminals: Tinned copperweld.

ENVIRONMENTAL SPECIFICATIONS

TEST	DALE MAX.
Load Life	±(.5% + .05 ohm) R
Moisture Resistance	±(.2% + .05 ohm) R
Temperature Coefficient	20 to 90 PPM/°C
Thermal Shock	±(.2% + .05 ohm) R
Short Time Overload	±(.2% + .05 ohm) R
Dielectric	±(.1% + .05 ohm) R
Low Temperature Storage	±(.1% + .05 ohm) R
High Temperature Exposure	±(.5% + .05 ohm) R
Shock	±(.1% + .05 ohm) R
Vibration	±(.1% + .05 ohm) R

DERATING

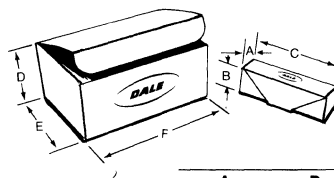
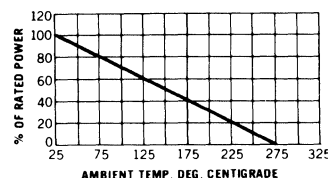

BULK PACK

Units are packaged 100 per box with 10 unit boxes per intermediate container.

A	B	C	D	E	F
1	1	3-5/8	2-1/4	3-3/4	5-3/8
[25.4]	[25.4]	[92.1]	[57.1]	[95.2]	[136.5]

DIMENSION AND TERMINAL CONFIGURATIONS [Numbers in brackets indicate millimeters]

GULL WING LEAD

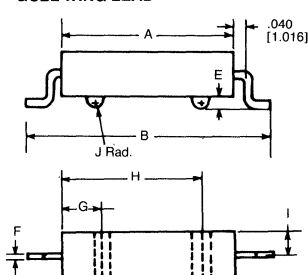

S LEAD

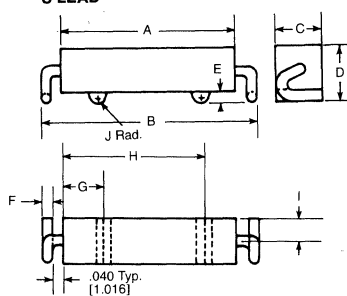

TYPE	B DIM. (Overall Length)	
	LEAD STYLE	
	GULL WING	S
1 WATT	.490 ± .063 [12.45 ± 1.6002]	.370 ± .063 [9.40 ± 1.6002]
2 WATT	.662 ± .063 [16.81 ± 1.6002]	.542 ± .063 [13.77 ± 1.6002]

TYPE	A	C	D	E	F	G	H	I	J Rad.
1 WATT	.250 ± .015 [6.35 ± .381]	.078 ± .015 [1.98 ± .381]	.108 ± .015 [2.74 ± .381]	.028 ± .002 [.711 ± .051]	.020 ± .002 [.508 ± .051]	.060 ± .015 [1.52 ± .381]	.190 ± .015 [4.83 ± .381]	.039 ± .015 [.991 ± .381]	.016 [.406]
2 WATT	.442 ± .015 [11.23 ± .381]	.110 ± .015 [2.79 ± .381]	.140 ± .015 [3.56 ± .381]	.030 ± .002 [.762 ± .051]	.020 ± .002 [.508 ± .051]	.094 ± .015 [2.39 ± .381]	.348 ± .015 [8.84 ± .381]	.055 ± .015 [1.40 ± .381]	.023 [.584]

DALE ELECTRONICS, INC., 2064 12th Avenue, Columbus, NE 68601 • Phone 402-564-3131

Canada: Dale Electronics Ltd., 18 Howden Rd., Scarborough, Ontario M1R 3E6

Europe: Dale Electronics GmbH, Benzstrasse 28, 8039 Puchheim, West Germany



PRECISION POWER WIREWOUND RESISTORS

NEW DESIGN
for all types of
current sensing circuits.

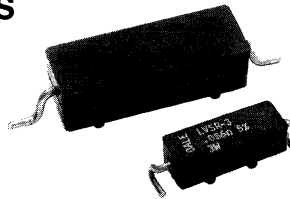

DALE TYPE LVSR-3, -5 Low Value Surface Mount Resistors

FEATURES

- Proprietary processing technique produces extremely low resistance values
- Cooler operation for high power to size ratio
- Excellent load life stability
- Low temperature coefficient
- 275°C maximum operating temperature
- Low inductance
- Ideal for all types of current sensing applications including switching and linear power supplies, test instruments and power amplifiers

SPECIFICATIONS

ELECTRICAL

Tolerance: 1%, 3%, 5%, 10% standard. Lower tolerances available as specials.

Dielectric Strength: 500 VAC

Insulation Resistance: 10,000 Megohms minimum dry

Short Time Overload: 5 seconds at 5 x rated power

Temperature Coefficient: Measured from -55°C to +125°C. Referenced to +25°C.

MECHANICAL

Terminal Strength: 10 lb. pull test

Solderability: 60/40 Electro Tin Plated terminals to facilitate soldering.

RESISTANCE VALUES/TOLERANCES

Value range for this construction is .005 to .2 ohm for the LVSR-3 and .005 to .3 ohm for the LVSR-5, in tolerances from 1%. Values to be stocked at 3% tolerance include: .005, .01, .015, .02, .025, .03, .04, .05, .07 and .08.

TEMPERATURE COEFFICIENT VS. RESISTANCE VALUE

The improved TC characteristics of this type LVSR from -55°C to +125°C (referenced to 25°C) are as follows:

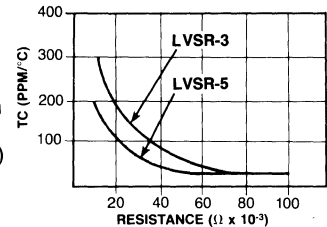

DERATING CURVE 100% Rated Power:

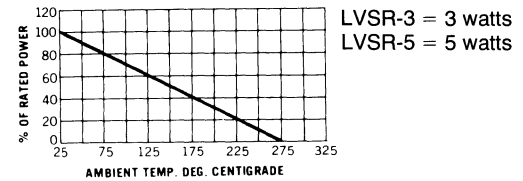

DIMENSION AND TERMINAL CONFIGURATIONS

[Numbers in brackets indicate millimeters]

GULL WING LEAD

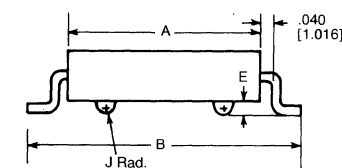

S LEAD

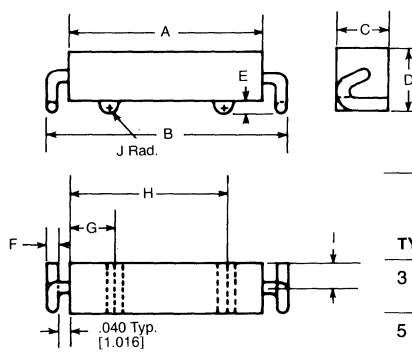

TYPE	B DIM. (Overall Length)	
	GULL WING	S
3 WATT	.896 ± .063 [22.76 ± 1.60]	.704 ± .063 [17.88 ± 1.60]
5 WATT	1.325 ± .063 [33.66 ± 1.60]	1.085 ± .063 [27.56 ± 1.60]

TYPE	A	C	D	E	F	G	H	I	J Rad.
3 WATT	.560 ± .015 [14.22 ± .381]	.205 ± .015 [5.21 ± .381]	.225 ± .015 [5.72 ± .381]	.060 ± .002 [1.52 ± .051]	.032 ± .002 [.813 ± .051]	.135 ± .015 [3.43 ± .381]	.425 ± .015 [10.80 ± .381]	.103 ± .015 [2.62 ± .381]	1/32 [.794]
5 WATT	.925 ± .015 [23.49 ± .381]	.330 ± .015 [8.38 ± .381]	.295 ± .015 [7.49 ± .381]	.070 ± .002 [1.78 ± .051]	.040 ± .002 [1.016 ± .051]	.225 ± .015 [5.72 ± .381]	.700 ± .015 [17.78 ± .381]	.165 ± .015 [4.19 ± .381]	1/32 [.794]

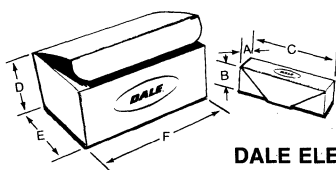

TYPE	A	B	C	D	E	F
LVSR-3	1-1/2 [38.1]	1-1/2 [38.1]	3-5/8 [92.1]	3-1/4 [82.5]	3-3/4 [95.2]	8-1/4 [209.5]
LVSR-5	2-1/2 [63.5]	2-1/2 [63.5]	3-7/8 [98.4]	5 [127.0]	4-3/8 [111.1]	12-1/2 [317.5]

BULK PACK

Units are packaged 100 per box with 10 unit boxes per intermediate container.

DALE ELECTRONICS, INC., 2064 12th Avenue, Columbus, NE 68601 • Phone 402-564-3131

Canada: Dale Electronics Ltd., 18 Howden Rd., Scarborough, Ontario M1R 3E6
Europe: Dale Electronics GmbH, Benzstrasse 28, 8039 Puchheim, West Germany



PRECISION POWER WIREWOUND RESISTORS

DALE TYPE LVR-2, -5, -10 Low Value

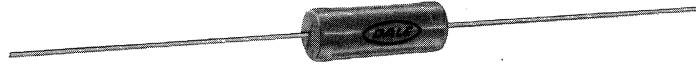

FEATURES

- Extremely low resistance values
- High power rating
- Low temperature coefficient
- 275° C maximum operating temperature

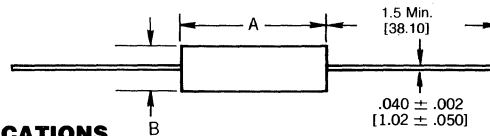

STANDARD SPECIFICATIONS

DALE TYPE	POWER RATING	RESISTANCE RANGE (Ohms)*	"A" Length	"B" Dia.	MAX. WEIGHT (Grams)
LVR-2	2 w	.008 to .332	.675 \pm .010 [17.15 \pm .254]	.250 \pm .010 [6.35 \pm .254]	3.0
LVR-5	5 w	.010 to .659	.927 \pm .010 [23.55 \pm .254]	.343 \pm .010 [8.71 \pm .254]	5.0
LVR-10	10 w	.010 to .800	1.828 \pm .010 [46.43 \pm .254]	.392 \pm .010 [9.96 \pm .254]	11.0

*Resistance must be measured $\frac{1}{2}$ " [9.52] from the body of resistor.

DERATING CURVE

NOTE:

Continuous power rating must be derated at high ambient temperatures per curve at right.

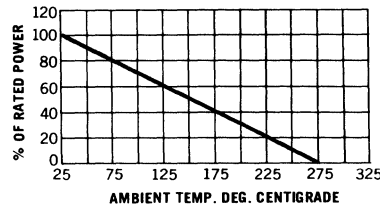

SPECIFICATIONS

ELECTRICAL

Tolerance: 1%, 3%, 5%, 10% standard. Lower tolerances available as specials.

Dielectric Strength: 500 VAC

Insulation Resistance: 10,000 Megohms minimum dry

Short-Time Overload: 5 seconds at 10 times rated power

Temperature Coefficient: Varies with resistance values. Consult factory.

MECHANICAL

Terminal Strength: 10 lb. pull test

Solderability: Satisfactory when tested in accordance with Method 208 of MIL-STD-202



PRECISION POWER WIREWOUND RESISTORS

NEW DESIGN
for all types of
current sensing circuits.

DALE TYPE LVR-3, -5 Low Value

FEATURES

- Proprietary processing technique produces extremely low resistance values.
- Cooler operation for high power to size ratio.
- Excellent load life stability.
- Low temperature coefficient.
- 275°C maximum operating temperature.
- Low inductance.
- Ideal for all types of current sensing applications including switching and linear power supplies, test instruments and power amplifiers.

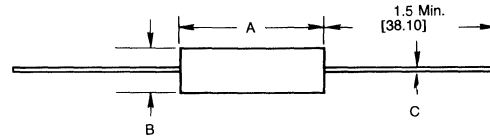
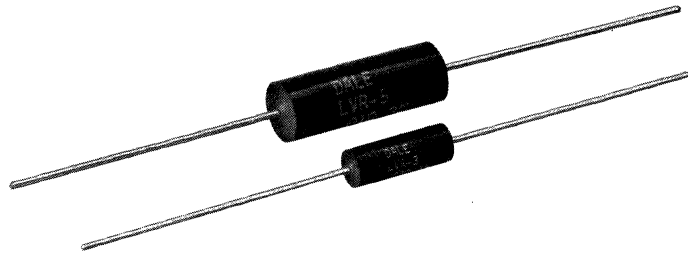

STANDARD SPECIFICATIONS [Numbers in brackets indicate millimeters]

DALE TYPE	POWER RATING	RESISTANCE RANGE (Ohms)*	"A" ±.010 [.254]	"B" ±.010 [.254]	"C" ±.002 [.051]	MAX. WEIGHT (Grams)
LVR-3	3W	.005 to .2	.560 [14.22]	.205 [5.20]	.032 [.813]	2
LVR-5	5W	.005 to .3	.925 [23.50]	.330 [8.38]	.040 [1.02]	5

*Resistance must be measured 3/8" [9.52] from the body of resistor, or at a 1.31" [33.274] or 1.675" [42.545] spacing for the LVR 3 or 5 respectively.

RESISTANCE VALUES/TOLERANCES

Value range for this construction at present is from .005 to .1 ohm in tolerances from 1%. Values to be stocked at 3% tolerance include:

.005 .01 .015 .02 .025 .03 .04 .05 .07 .08 .1

TEMPERATURE COEFFICIENT VS. RESISTANCE VALUE

The improved TC characteristics of this type LVR from -55°C to 125°C (referenced to 25°C) are as follows:

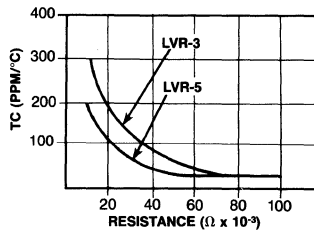

DERATING CURVE

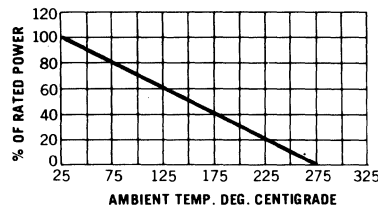

SURFACE TEMPERATURE VS. POWER

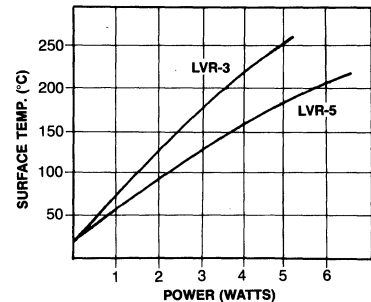

SPECIFICATIONS

ELECTRICAL

Tolerance: 1%, 3%, 5%, 10% standard. Lower tolerances available as specials.

Dielectric Strength: 500 VAC.

Insulation Resistance: 10,000 Megohms minimum dry.

Short-Time Overload: 5 seconds at 5 times rated power.

Temperature Coefficient: Measured from -55°C to +125°C, referenced to +25°C.

MECHANICAL

Terminal Strength: 10 lb. pull test.

Solderability: 60/40 Electro Tin Plated terminals to facilitate soldering.



PRECISION POWER WIREWOUND RESISTORS

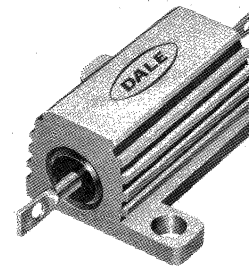

MIL-R-18546, TYPE RE

DALE TYPE RH & NH Aluminum Housed, Chassis Mount

FEATURES

- Standard winding (Type RH). Non-inductive winding (Type NH).
- Molded construction for complete environmental protection.
- Complete welded construction.
- Screw mounts on chassis to utilize heat-sink effect.
- High stability at conventional power ratings.
- Flat marking surface for easy identification.

STANDARD ELECTRICAL SPECIFICATIONS

DALE TYPE	MIL-R-18546 TYPE	Power Rating (Watts)		Resistance Range (Ohms)			Max. Working Voltage	Max. Weight (Grams)	Standard Temperature Coefficient Value Ranges (Ohms)*			
		DALE	MIL.	.05%, .1%	.25%	.5%			1%, 3%, 5%	±50 PPM	±30 PPM	±20 PPM
RH-5	RE60G	7.5 (5)	5	.26-6.75K	.05-24.5K	.02-24.5K	.02-24.5K .1-3.32K	160	3	1 to 9.9	10 to 49	50 to 24.5K
NH-5	RE60N	7.5 (5)	5	.26-3.4K	.05-12.25K	.05-12.25K	.015-12.75K	110	3.3	1 to 9.9	10 to 25	26 to 12.25K
RH-10	RE65G	12.5 (10)	10	.16-12.7K	.05-47.1K	.01-47.1K	.01-47.1K .1-5.62K	265	6	1 to 9.9	10 to 79	80 to 47.1K
NH-10	RE65N	12.5 (10)	10	.16-6.4K	.05-23.5K	.05-23.5K	.02-23.5K	190	8.8	1 to 9.9	10 to 40	41 to 23.65K
RH-25	RE70G	25	20	.16-25.7K	.05-95.2K	.01-95.2K	.01-95.2K .1-12.1K	550	13	1 to 9.9	10 to 169	170 to 95.2K
NH-25	RE70N	25	20	.16-12.8K	.05-47.6K	.05-47.6K	.02-47.6K	390	16.5	1 to 9.9	10 to 85	86 to 47.6K
RH-50	RE75G	50	30	.16-73.4K	.064-273K	.01-273K	.01-273K .1-39.2K	1250	28	1 to 9.9	10 to 469	470 to 273K
NH-50	RE75N	50	30	.16-36.7K	.064-136K	.064-136K	.064-136K	890	35	1 to 9.9	10 to 235	236 to 136K
RH-100	RE77G	100	75	.5-90K	.1-90K	.05-90K	.05-90K	1900	400	1 to 99	100 to 949	950 to 50K
NH-100	RE77N	100	75	.3-25K	.1-25K	.05-25K	.05-25K	1350	440	1 to 49	50 to 475	476 to 25K
RH-250	RE80G	250	120	.5-116K	.1-116K	.1-116K	.05-116K	2300	800	1 to 99	100 to 999	1K to 75K
NH-250	RE80N	250	120	.5-37.5K	.1-37.5K	.1-37.5K	.05-37.5K	1625	880	1 to 49	50 to 499	500 to 37.5K

SPECIAL MODIFICATIONS

1. Threaded mounting holes
2. Special housing configurations
3. Special resistance-temperature characteristics
4. Special terminal configurations and materials
5. Special resistances and tolerances
6. Special pre-conditioning

*.1Ω to .99Ω = ±100 PPM; .01Ω to .099Ω = ±150 PPM.

NOTE: All resistance ranges shown conform to military specifications unless otherwise indicated.

NOTE: Figures in parentheses on RH-5 and RH-10 indicate wattage printed. New construction allows these resistors to be rated at 7.5 and 12.5 watts, but they will be printed with these higher ratings **only** upon customer request.

PHYSICAL CONFIGURATIONS

**RH-100
NH-100**

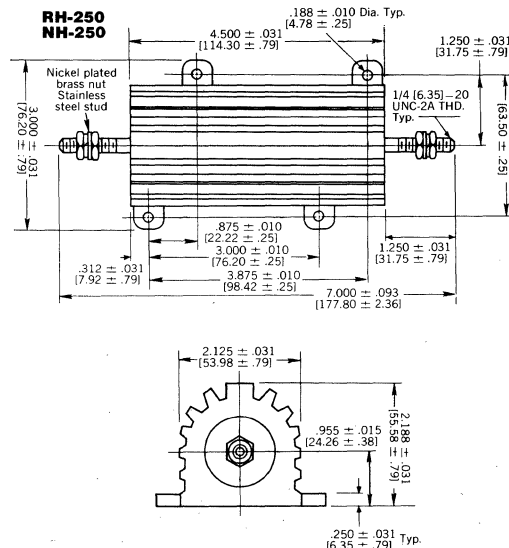
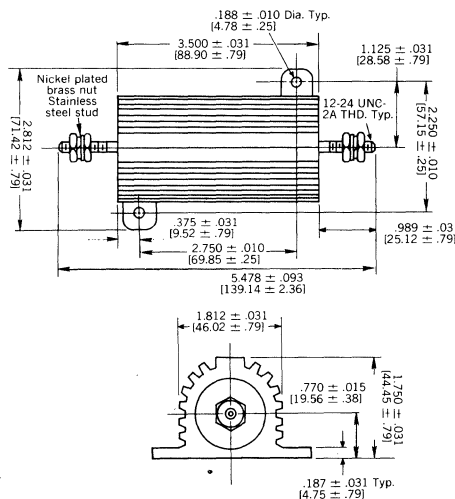

SPECIFICATIONS

APPLICABLE MIL-SPECIFICATIONS

MIL-R-18546: This is the military specification covering housed chassis-mounted power resistors. Dale RH and NH-resistors meet or exceed the electrical, environmental, and dimensional requirements of this specification.

ELECTRICAL

Tolerance: RH and NH types are available in the following tolerances: 3%, 1%, .5%, .25%, .10%, .05%.

Dielectric Strength: 1000 VAC on 5, 10 and 25 watt units, 2000 VAC on 50 watt units and 4500 VAC on 100 and 250 watt units.

Insulation Resistance: 10,000 megohms minimum dry, 1,000 megohms minimum after moisture test.

MATERIAL

Core: Ceramic steatite or alumina, depending on physical size.

Element: Copper-nickel alloy, nickel-chrome alloy or manganese copper, depending on resistance value.

End Caps: Stainless steel.

Sealant: Silicone molded construction.

Housing: Aluminum with hard anodic coating.

Standard Terminals: Tinned Copperweld® on 5 thru 50 watt units. Threaded terminals on 100 and 250 watt units.

MECHANICAL

Terminal Strength:

- 5 lb. pull test=RH-5, NH-5
- 5 lb. pull test=RH-10, NH-10
- 10 lb. pull test=RH-25 thru RH-250 and NH-25 thru NH-250

Solderability: Satisfactory when tested in accordance with Method 208 of MIL-STD-202.

ENVIRONMENTAL

General: RH/NH testing is done according to the procedures and test methods described in MIL-R-18546. The table below shows the military and the Dale performance requirements. All ΔR figures shown are maximums, and all specifications are based on testing of 1% tolerance units.

ENVIRONMENTAL SPECIFICATIONS

TEST	MIL-R-18546	DALE TYPICAL
Load Life	±(1%+.05Ω)ΔR	±(.5%+.05Ω)ΔR
Moisture Resistance	±(1%+.05Ω)ΔR	±(.5%+.05Ω)ΔR
Resistance Temperature Characteristic	±50 PPM to 2000Ω ±30 PPM over 2000Ω	See table
Thermal Shock	±(.5%+.05Ω)ΔR	±(.25%+.05Ω)ΔR
Momentary Overload	±(.5%+.05Ω)ΔR	±(.25%+.05Ω)ΔR
Dielectric	±(.2%+.05Ω)ΔR	±(.1%+.05Ω)ΔR
High Temp. Storage	±(.5%+.05Ω)ΔR	±(.25%+.05Ω)ΔR
Shock	±(.2%+.05Ω)ΔR	±(.1%+.05Ω)ΔR
Vibration	±(.2%+.05Ω)ΔR	±(.1%+.05Ω)ΔR
Terminal Strength	±(.2%+.05Ω)ΔR	±(.1%+.05Ω)ΔR

POWER RATING

RH/NH resistor ratings are based on the following requirements:

- 275° C maximum internal hotspot temperature
- 1% maximum ΔR in 1000 hour load life for RH-5 thru RH-50.
3% maximum ΔR in 1000 hour load life for RH-100 and RH-250.
- Proper heat sink.

- 4x6x2x.040 aluminum chassis=5 and 10 watt units
- 5x7x2x.040 aluminum chassis=25 watt units
- 12x12x.059 aluminum panel=50 watt units
- 12x12x.125 aluminum panel=100 and 250 watt units

DERATING

Dale RH and NH resistors have an operating temperature range of -55° C to +275° C. Derating is required for reduced chassis mounting area and for high ambient temperatures. The following curves apply to operation of unmounted resistors:

- A=5 and 10 watt units
- B=25 watt units
- C=50, 100 and 250 watt units

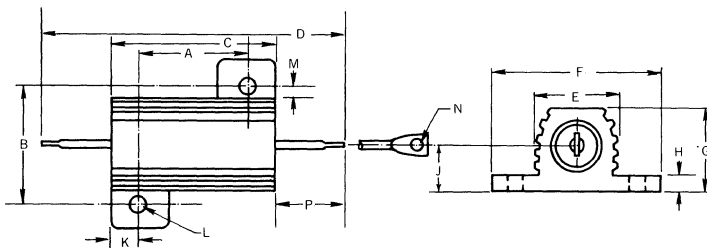
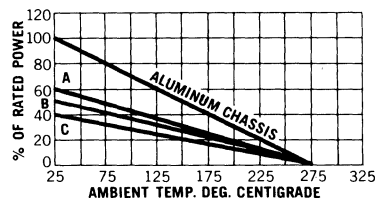

RH-5 thru RH-50
NH-5 thru NH-50

DIMENSIONS [Numbers in brackets indicate millimeters]

TYPE	A	B	C	D	E	F	G	H	J	K	L	M	N	P
RH-5	.444	.490	.600	1.125	.334	.646	.320	.065	.133	.078	.093	.078	.050	.262
NH-5	±.005	±.005	±.031	±.062	±.015	±.015	±.015	±.010	±.010	±.010	±.005	±.015	±.005	±.062
	±.127	±.127	±.787	±.157	±.381	±.381	±.381	±.254	±.254	±.254	±.127	±.381	±.127	±.157
RH-10	.562	.625	.750	1.375	.420	.800	.390	.075	.165	.093	.093	.102	.086	.312
NH-10	±.005	±.005	±.031	±.062	±.015	±.015	±.015	±.010	±.010	±.010	±.005	±.015	±.005	±.062
	±.127	±.127	±.787	±.157	±.381	±.381	±.381	±.254	±.254	±.254	±.127	±.381	±.127	±.157
RH-25	.719	.781	1.062	1.938	.550	1.080	.546	.075	.231	.172	.125	.115	.086	.438
NH-25	±.005	±.005	±.031	±.062	±.015	±.015	±.015	±.010	±.010	±.010	±.005	±.015	±.005	±.062
	±.127	±.127	±.787	±.157	±.381	±.381	±.381	±.254	±.254	±.254	±.127	±.381	±.127	±.157
RH-50	1.563	.844	1.968	2.781	.630	1.140	.610	.088	.260	.196	.125	.107	.086	.406
NH-50	±.005	±.005	±.031	±.062	±.015	±.015	±.015	±.010	±.010	±.010	±.005	±.015	±.005	±.062
	±.127	±.127	±.787	±.157	±.381	±.381	±.381	±.254	±.254	±.254	±.127	±.381	±.127	±.157



PRECISION POWER WIREWOUND RESISTORS

DALE TYPE PH

Aluminum Housed—Thru-Chassis Mount

FEATURES

- Complete welded construction.
- Complete environmental protection.
- Designed to utilize heat-sink effect of chassis.
- PH-10-5 and PH-25A-8 have single termination, chassis ground, and are non-inductively wound
- Plug-in connections available for quick connect/disconnect from circuit.

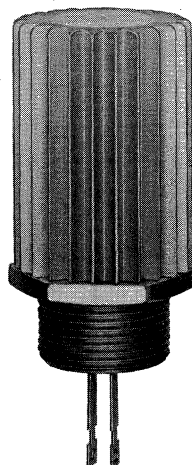

STANDARD ELECTRICAL SPECIFICATIONS

DALE TYPE	DALE RATING (WATTS)	RESISTANCE RANGES (OHMS)*		MAX. WORKING VOLTAGE	MAX. WT. (GRAMS)	STANDARD TEMPERATURE COEFFICIENT VALUE RANGES (OHMS)†		
		.05%, .1%, .25%	.5%, 1%, 3%			±50 PPM	±30 PPM	±20 PPM
PH-10-1	10	1 to 12.7K	.1 to 47.1K	240	6	1 to 9.9	10 to 79	80 to 47.1K
PH-25	25	.5 to 25.7K	.1 to 95.2K	425	22	1 to 9.9	10 to 169	170 to 95.2K
PH-25A	25	.5 to 25.7K	.1 to 95.2K	300	22	1 to 9.9	10 to 169	170 to 47.7K
PH-50	50	3 to 52K	.1 to 75K	1500	80	1 to 99	100 to 999	1K to 75K
PH-100	100	5 to 35K	.1 to 50K	1700	186	1 to 99	100 to 999	1K to 50K

*Consult factory for extended values.

†Consult factory for values below 1Ω and for special T.C. requirements.

SPECIAL MODIFICATIONS

1. Special resistance-temperature characteristics
2. Special terminal configurations and materials
3. Non-inductive type resistor
4. Special pre-conditioning
5. Special resistances and tolerances
6. Special matching available (T.C. and tolerance)
7. Special platings and exterior finishes

PH—NON-INDUCTIVE

Models of equivalent physical and electrical specifications are available with non-inductive (Aryton-Perry) winding.

Two conditions apply:

1. Maximum resistance value must be divided by two.
2. Maximum working voltage must be multiplied by .707.

MOUNTING INFORMATION

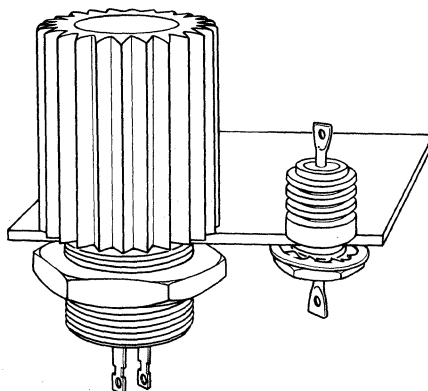

TWO TERMINAL CONFIGURATIONS (PH-10-1, PH-25, PH-50 and PH-100) Thru chassis mounting—two connections required on one or both sides of panel.

DALE ELECTRONICS, INC., 2064 12th Avenue, Columbus, NE 68601 • Phone 402-564-3131

Canada: Dale Electronics Ltd., 18 Howden Rd., Scarborough, Ontario M1R 3E6
Europe: Dale Electronics GmbH, Benzstrasse 28, 8039 Puchheim, West Germany

SPECIFICATIONS

APPLICABLE MIL-SPECIFICATIONS

The Dale PH series meets the electrical and environmental requirements of MIL-R-18546. There are, however, no direct mil equivalents in this configuration.

ELECTRICAL

Tolerance: PH types are available in the following tolerances: 3%, 1%, .5%, .25%, .10%, .05%

Dielectric Strength: 1000 VAC on PH-10; 2500 VAC on PH-25, PH-50 and PH-100

Maximum Working Voltage: Maximum working voltage determined at .001 diameter wire resistance values.

MATERIAL

Core: Ceramic steatite or alumina, depending on physical size.

Element: Copper-nickel alloy or nickel-chrome alloy, depending on resistance value.

End Caps: Stainless steel

Housing: Aluminum with hard anodic coating.

Standard Terminal(s): Tinned Copperweld® on PH-10-1. 180 alloy on PH-25A, PH-25, PH-50 and PH-100.

ENVIRONMENTAL

General: Testing of PH resistors is done according to the procedures and test methods described in MIL-R-18546.

POWER RATING

Dale PH resistor ratings are based on the following requirements:

1. 275° maximum internal hotspot temperature.
2. 1% maximum ΔR in 1000-hours load life for PH-10, PH-25 and PH-50.
3% maximum ΔR in 1000-hours load life for PH-100.
3. Proper heat sink
4x6x2x.040 aluminum chassis=PH-10
5x7x2x.040 aluminum chassis=PH-25
12x12x.125 aluminum panel=PH-50 and PH-100

DERATING

Dale PH resistors have an operating temperature range of -55° C to +275° C. Derating is required for reduced chassis mounting area and for high ambient temperatures. The following curves apply to the operation of unmounted resistors:

A=PH-10, PH-25
B=PH-50, PH-100

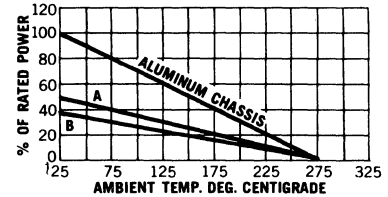

PHYSICAL CONFIGURATIONS

PH-10-1

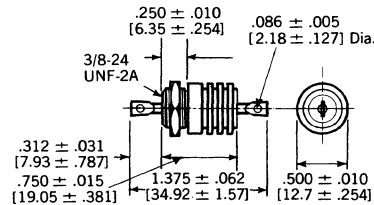

PH-25

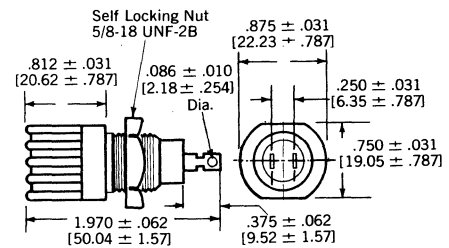

PH-50 & PH-100

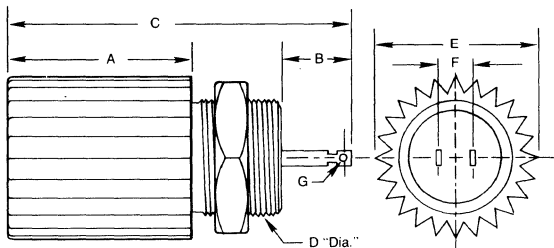

PH-25A
Smaller version
of PH-25

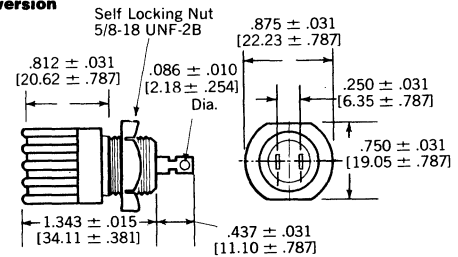

[Numbers in brackets indicate millimeters]

TYPE	A	B	C	D	E	F	G
PH-50	1.675 ± .031 [42.55 ± .787]	.700 ± .031 [17.78 ± .787]	3.000 ± .062 [76.2 ± 1.57]	7/8-20 UNF-2	1.188 ± .031 [30.18 ± .787]	.187 ± .031 [4.75 ± .787]	.093 ± .010 [2.36 ± .254]
PH-100	2.000 ± .031 [50.8 ± .787]	.780 ± .031 [19.81 ± .787]	3.750 ± .062 [95.25 ± 1.57]	1-1/4-18 UNEF-2	1.750 ± .031 [44.45 ± .787]	.375 ± .031 [9.52 ± .787]	.093 ± .010 [2.36 ± .254]



PRECISION POWER WIREWOUND RESISTORS

MIL-R-26, TYPE RW DALE TYPE RS, AXIAL LEAD Silicone Coated and Molded



FEATURES

- Complete welded construction
- High temperature silicone coating and molding
- Meets applicable requirements of MIL-R-26
- Available in non-inductive styles (Type NS) with Aryton-Perry winding for lowest reactive components
- Over 44 million unit-hours of testing with no catastrophic failures have proven a failure rate of less than 0.0066% per 1000 hours (at 60% confidence) with full rated power at 25°C. A failure is defined as $\pm 1\%$ resistance change.
- Coated models: RS-2, 2B, 2C, 5, 7, and 10. Molded models: RS-1/4 thru RS-1A.

STANDARD ELECTRICAL SPECIFICATIONS

DALE TYPE	MIL-R-26 TYPE	DALE RATING		RESISTANCE RANGE (Ohms) MIL. Range shown in bold face				MAX. WORKING VOLTAGE		MAX. WT. GRAMS
		U .05% thru 5%	V 3% & 5%	.05%	.1%	.25%	.5%, 1%, 3%, 5%	U	V	
RS-1/4	—	.4 W	—	1-1K	.499-1K	.499-3.4K	1-3.4K	20	—	.21
RS-1/2	—	.75 W	—	1-1.3K	.499-1.3K	.499-4.9K	1-4.9K	29	—	.23
RS-1A	RW70	1.0 W 1.0 W	—	1-2.74K	.499-2.74K .499-2.74K	.499-10.4K .499-2.74K	1-10.4K 1-2.74K	52	—	.34
RS-1/4-90	—	.4 W	—	1-1K	.499-1K	.499-3.4K	1-3.4K	20	—	.21
RS-1/2-90	—	.75 W	—	1-1.3K	.499-1.3K	.499-4.9K	1-4.9K	29	—	.23
RS-1A-90	—	1.0 W	—	1-2.74K	.499-2.74K	.499-2.74K	1-2.74K	52	—	.34
RS-2	—	4.0 W	5.5 W	.499-12.7K	.499-12.7K	1-47.1K	1-47.1K	210	250	2.1
RS-2B**	RW79	3.0 W 3.0 W	3.75 W	.499-6.5K	.499-6.5K .499-6.49K	1-24.5K 1-6.49K	1-24.5K 1-6.49K	140	157	.70
RS-2C	—	2.5 W	3.25 W	.499-8.6K	.499-8.6K	1-32.3K	1-32.3K	138	157	1.6
RS-2C-17	—	2.5 W	3.25 W	.499-8.6K	.499-8.6K	1-32.3K	1-32.3K	138	157	1.6
RS-5**	—	5.0 W	6.5 W	.499-25.7K	.499-25.7K	1-95.2K	1-95.2K	360	410	4.2
RS-5-69	RW74	5.0 W 5.0 W	6.5 W	.499-24.5K	.499-24.5K .499-24.3K	1-91.0K 1-24.3K	1-91.0K 1-24.3K	350	400	4.2
RS-7	—	7.0 W	9.0 W	.499-41.4K	.499-41.4K	1-154K	1-154K	504	576	4.7
RS-10	—	10 W	13 W	.499-73.4K	.499-73.4K	1-273K	1-273K	858	978	9.0
RS-10-38	RW78	10 W 10 W	13 W	.499-71.5K	.499-71.5K .499-71.5K	1-265K 1-71.5K	1-265K 1-71.5K	846	966	9.0

*Max. working voltage determined at .0008 dia. wire resistance values.

**Values available down to .005 ohm in 1%, 3% and 5% tolerances.

Standard Temperature Coefficients: ± 90 ppm, below 1 Ω ;
 ± 50 ppm, 1 Ω -9.9 Ω ; ± 20 ppm, 10 Ω and beyond.

Consult factory for special T.C. requirements
Molded styles available in coated version. (Example: RS-1A-90)

MIL-R-26C			
DALE TYPE	RS-2C	RS-5	RS-10
MIL. TYPE	RW69	RW67	RW68

MIL-R-23379				
DALE TYPE	RS-1A	RS-2C-23	RS-5	RS-10
MIL. TYPE	RWP18	RWP20	RWP21	RWP23

SPECIAL MODIFICATIONS

1. Terminals can be supplied in any commercial material with several type finishes
2. Terminal lengths and diameters can be varied
3. Various elements available for special T.C.
4. Special configuration available on request
5. Tolerances available to .01% on most types
6. Special matching available (T.C. and tolerance)

NS - NON-INDUCTIVE

Models of equivalent physical and electrical specifications are available with non-inductive (Aryton-Perry) winding. They are identified by substituting the letter N for R in the part number (NS-5), for example). Three conditions apply:

1. For NS Types, divide maximum resistance values by two
2. For NS Types, multiply maximum working voltage by .707
3. For NS Types, maximum weights may slightly exceed those shown on low values.

*Body O.D. may exceed that of the RS-2C by .010".

NS-1/4
NS-1/2
NS-1A
NS-2
NS-2B
*NS-2C
NS-5
NS-7
NS-10

DALE ELECTRONICS, INC., 2064 12th Avenue, Columbus, NE 68601 • Phone 402-564-3131

Canada: Dale Electronics Ltd., 18 Howden Rd., Scarborough, Ontario M1R 3E6
Europe: Dale Electronics GmbH, Benzstrasse 28, 8039 Puchheim, West Germany

SPECIFICATIONS

APPLICABLE MIL SPECIFICATIONS

MIL-R-26E: Designed especially for precision and non-precision power wirewound resistors. The RS series meet the requirements of this specification as well as the older MIL-R-26C and MIL-R-23379 specifications. However, this does not imply qualification. Contact factory for latest Government QPL information.

ELECTRICAL

Tolerance: RS Types are available in the following standard tolerances: 5%, 3%, 1%, .5%, .25%, .10%, .05%.

Dielectric Strength: 500 VAC for RS-1/4 through RS-1A models. 1000 volts for all others.

Insulation Resistance: 1000 megohms minimum dry, 100 megohms minimum after moisture test.

Short Time Overload: 5 seconds at 5 times rated power for 3.25 watt size and smaller; 5 seconds at 10 times rated power for 4 watt size and larger.

MECHANICAL

Terminal Strength:

5 lb. pull test = RS-1/4 thru RS-1A Models
10 lb. pull test = all others

Solderability:

MIL-R-26 Type—Meets requirements of MIL-STD-202, Method 208.

Standard RS (Non-MIL Styles)—60/40 Electro Tin Plated terminals to facilitate soldering.

MATERIAL

Core: Ceramic: Steatite or alumina, depending on physical size.

Element: Copper-nickel alloy or nickel-chrome alloy, depending on resistance value.

End Caps: Stainless steel.

Coating: Special high temperature silicone.

Standard Terminals: Tinned Copperweld®

Weldable Leads: The following weldable lead materials are available from Dale on a standard stocking basis, and can be specified by adding the dash number shown below to the standard part number. Consult factory for charges on special lead materials.
Grade "A" Nickel, untinned -53
(Example: RS-1A-53).
Gold-plated Dumet (50 microinch) -52
(Example: RS-1A-52)

ENVIRONMENTAL SPECIFICATIONS*

TEST	MIL-R-26E REQUIREMENT	DALE MAXIMUM
Load Life	± (.5%+.05Ω) Δ R	± (.5%+.05Ω) Δ R
Moisture Resistance	± (.2%+.05Ω) Δ R	± (.2%+.05Ω) Δ R
Temp. Coefficient	30-90 PPM/°C Max.	See table
Thermal Shock	± (.2%+.05Ω) Δ R	± (.2%+.05Ω) Δ R
Short Time Overload	± (.2%+.05Ω) Δ R	± (.2%+.05Ω) Δ R
Dielectric	± (.1%+.05Ω) Δ R	± (.1%+.05Ω) Δ R
Low. Temp. Storage	± (.2%+.05Ω) Δ R	± (.2%+.05Ω) Δ R
High Temp. Exposure	± (.5%+.05Ω) Δ R	± (.5%+.05Ω) Δ R
Shock	± (.1%+.05Ω) Δ R	± (.1%+.05Ω) Δ R
Vibration	± (.1%+.05Ω) Δ R	± (.1%+.05Ω) Δ R
Terminal Strength	± (.1%+.05Ω) Δ R	± (.1%+.05Ω) Δ R

*All Δ R figures shown are maximum, based on units with an initial tolerance of 1% and maximum operating temperature of 275°C.

PHYSICAL CONFIGURATIONS

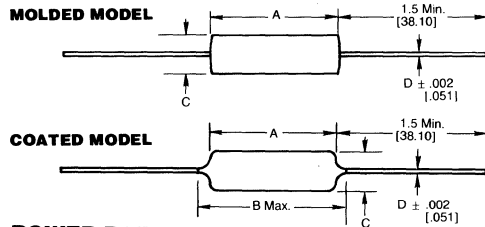

POWER RATING

Dale RS Series have two power ratings, depending on operating temperature and stability requirements.

CHARACTERISTIC U

- 275°C maximum hotspot temperature
- .5% maximum Δ R in 2000 hour load life

CHARACTERISTIC V

- 350°C maximum hotspot temperature
- 3% maximum Δ R in 2000 hour load life

DERATING (Type RS)

Dale RS coated resistors have an operating temperature range of -55°C to +350°C. Dale RS molded resistors have an operating temperature range of -55°C to +275°C. They must be derated at high ambient temperatures according to the curves below.

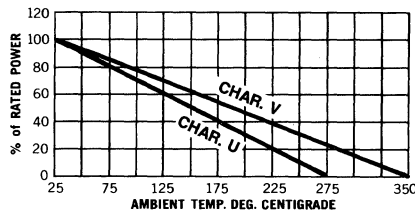

CHARACTERISTIC U:

Coated or molded resistors are available in any tolerance.

CHARACTERISTIC V:

Coated resistors are available in 3% and 5% tolerance.

DIMENSIONAL SPECIFICATIONS

[Numbers in brackets indicate millimeters]

	TYPE	DIM. A	DIM. B	DIM. C	DIM. D
MOLDED MODELS	RS-1/4	.250 ± .015 [6.35 ± .381]	—	.078 ± .015 [1.98 ± .381]	.020 [.508]
	RS-1/2	.312 ± .015 [7.92 ± .381]	—	.078 ± .015 [1.98 ± .381]	.020 [.508]
	RS-1A	.422 ± .015 [10.72 ± .381]	—	.110 ± .015 [2.79 ± .381]	.020 [.508]
	RS-1/4-90	.250 ± .015 [6.35 ± .381]	.265 [6.73]	.078 ± .015 [1.98 ± .381]	.020 [.508]
	RS-1/2-90	.312 ± .015 [7.92 ± .381]	.327 [8.30]	.078 ± .015 [1.98 ± .381]	.020 [.508]
COATED MODELS	RS-1A-90	.422 ± .015 [10.72 ± .381]	.437 [11.10]	.110 ± .015 [2.79 ± .381]	.020 [.508]
	RS-2	.625 ± .062 [15.88 ± 1.57]	.765 [19.43]	.250 ± .031 [6.35 ± .787]	.040 [1.02]
	RS-2B	.560 ± .062 [14.22 ± 1.57]	.622 [15.80]	.187 ± .031 [4.75 ± .787]	.032 [.813]
	RS-2C	.500 ± .062 [12.7 ± 1.57]	.593 [15.06]	.218 ± .031 [5.54 ± .787]	.040 [1.02]
	RS-2C-17	.500 ± .062 [12.7 ± 1.57]	.593 [15.06]	.218 ± .031 [5.54 ± .787]	.032 [.813]
	RS-5	.875 ± .062 [22.23 ± 1.57]	1.000 [25.4]	.312 ± .031 [7.92 ± .787]	.040 [1.02]
	RS-5-69	.875 ± .062 [22.23 ± 1.57]	.937 [23.80]	.312 ± .031 [7.92 ± .787]	.040 [1.02]
	RS-7	1.218 ± .062 [30.94 ± 1.57]	1.281 [32.51]	.312 ± .031 [7.92 ± .787]	.040 [1.02]
	RS-10	1.780 ± .062 [45.21 ± 1.57]	1.875 [47.63]	.375 ± .031 [9.53 ± .787]	.040 [1.02]
	RS-10-38	1.780 ± .062 [45.21 ± 1.57]	1.842 [46.79]	.375 ± .031 [9.53 ± .787]	.040 [1.02]



PRECISION POWER WIREWOUND RESISTORS



MIL-R-26, TYPE RW DALE TYPE G, AXIAL LEAD Silicone Coated and Molded

FEATURES

- From 1.4 to 4 times higher power ratings than conventional resistors of equivalent size.
- Completely welded construction.
- High temperature silicone coated and molded.
- Available in non-inductive styles (Type GN).
- Covered by U.S. Patent 3,295,090.

STANDARD ELECTRICAL SPECIFICATIONS

DALE TYPE	MIL-R-26 TYPE	DALE RATING			RESISTANCE RANGE (Ohms) MIL. Range shown in bold face			MAX. WORKING VOLTAGE		MAX. WT. GRAMS
		U .05% thru 5%	V 3% & 5%	.05%	.1%	.25%	.5%, 1%, 3%, 5%	U	V	
G-1-80		1.0 W	—	1-1K	.499-1K	.499-3.4K	.1-3.4K	33	—	.20
	RW81	1.0 W	—		.499-1K	.499-1K	.1-1K	33	—	.20
G-2	—	1.5 W	—	1-1.3K	.499-1.3K	.499-4.9K	.1-4.9K	42	—	.21
G-3-80		2.0 W	—	1-2.74K	.499-2.74K	.499-10.4K	.1-10.4K	80	—	.34
	RW80	2.0 W	—		.499-2.74K	.499-2.74K	.1-2.74K	80	—	.34
G-5	—	4.0 W	5 W	.499-6.5K	.499-6.5K	.1-24.5K	.1-24.5K	162	184	.80
G-5C	—	5 W	7 W	.499-8.6K	.499-8.6K	.1-32.3K	.1-32.3K	194	230	1.2
G-10	—	7 W	10 W	.499-25.7K	.499-25.7K	.1-95.2K	.1-95.2K	425	508	3.6

*Maximum Working Voltage determined at .0008 dia. wire resistance values.

Standard Temperature Coefficients: ± 90 ppm, below 1Ω ; ± 50 ppm, 1Ω - 9.9Ω ;
 ± 20 ppm, 10Ω and beyond.

Consult factory for special T.C. requirements.

SPECIAL MODIFICATIONS

1. Terminals can be supplied in any commercial material with several type finishes
2. Terminal lengths and diameters can be varied
3. Various elements available for special T.C.
4. Special configuration available on request
5. Tolerances available to .01% on most types
6. Special matching available (T.C. and tolerance)

GN - NON-INDUCTIVE

Models of equivalent physical and electrical specifications are available with non-inductive (Aryton-Perry) winding. They are identified by adding the letter N to the letter G in the part number (GN-5, for example). Three conditions apply:

1. For GN Types, divide maximum resistance values by two.
2. For GN Types, multiply maximum working voltage by .707.
3. For GN Types, maximum weights may slightly exceed those shown on low values.

GN-1-80
GN-2
GN-3-80
GN-5
*GN-5C
GN-10

*Body O.D. may exceed that of the G-5C by .010" [254].

PHYSICAL CONFIGURATIONS

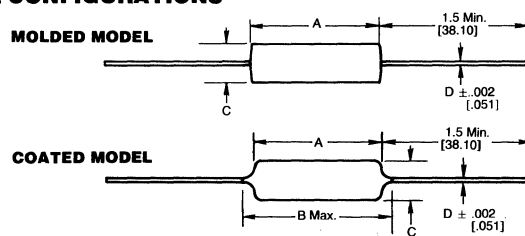

	TYPE	DIM. A	DIM. B	DIM. C	DIM. D
MOLDED MODELS	G-1-80	.250 \pm .015 [6.35 \pm .381]	—	.078 \pm .015 [1.98 \pm .381]	.020 [.508]
	G-2	.312 \pm .015 [7.92 \pm .381]	—	.078 \pm .015 [1.98 \pm .381]	.020 [.508]
	G-3-80	.422 \pm .015 [10.72 \pm .381]	—	.110 \pm .015 [2.79 \pm .381]	.020 [.508]
COATED MODELS	G-5	.562 \pm .062 [14.27 \pm 1.57]	.640 [16.26]	.188 \pm .032 [4.78 \pm .813]	.032 [.813]
	G-5C	.500 \pm .062 [12.7 \pm 1.57]	.593 [15.06]	.218 \pm .032 [5.54 \pm .813]	.040 [1.02]
	G-10	.875 \pm .062 [22.23 \pm 1.57]	1.000 [25.4]	.312 \pm .032 [7.92 \pm .813]	.040 [1.02]

DALE ELECTRONICS, INC., 2064 12th Avenue, Columbus, NE 68601 • Phone 402-564-3131

Canada: Dale Electronics Ltd., 18 Howden Rd., Scarborough, Ontario M1R 3E6
Europe: Dale Electronics GmbH, Benzstrasse 28, 8039 Puchheim, West Germany

SPECIFICATIONS

APPLICABLE MIL-SPECIFICATIONS

MIL-R-26E: This is a military specification designed especially for precision and non-precision power wirewound resistors. The G series meet the requirements of this specification as well as the older MIL-R-26C and MIL-R-23379 specifications.

MATERIAL

Core: Beryllium oxide or alumina depending on power requirements

Element: Copper-nickel alloy or nickel-chrome alloy, depending on resistance value

End Caps: Stainless steel

Coating: Special high temperature silicone

Standard Terminals: Tinned Copperweld®

Weldable Leads: The following weldable lead materials are available from Dale on a standard stocking basis, and can be specified by adding the dash number shown below to the standard part number.

Grade "A" Nickel, untinned -53
Gold-plated Dumet (50 microinch) -52
(Example: G-1-53 or G-1-52)

ELECTRICAL

Tolerance: G Types are available in the following standard tolerances: 5%, 3%, 1%, .5%, .25%, .10%, .05%.

Dielectric Strength: 500 VAC for G-1-80, G-2, G-3-80 models. 1000 VAC for all others.

Insulation Resistance: 1000 megohms minimum dry, 100 megohms minimum after moisture test.

Short Time Overload: 5 seconds at 5 times rated power = G-1-80 thru G-5C (Char. U). 5 seconds at 10 times rated power = all others.

MECHANICAL

Terminal Strength:

5 lb. pull test = G-1-80, G-2 and G-3-80.
10 lb. pull test = all others

Solderability:

MIL-R-26 Type - Meets requirements of MIL-STD-202, Method 208.

Standard G (Non-MIL Styles) - 60/40 Electro Tin Plated terminals to facilitate soldering.

Termination: When G resistors will be operated at full rated power, resistance welding or high temperature solder are the recommended termination methods. Termination should be made within 1/2 inch from end of resistor body.

ENVIRONMENTAL SPECIFICATIONS*

TEST	MIL-R-26E REQUIREMENT	DALE MAXIMUM
Load Life	$\pm (.5\%+.05\Omega) \Delta R$	$\pm (.5\%+.05\Omega) \Delta R$
Moisture Resistance	$\pm (.2\%+.05\Omega) \Delta R$	$\pm (.2\%+.05\Omega) \Delta R$
Temp. Coefficient	30-90 PPM/°C Max.	See table
Thermal Shock	$\pm (.2\%+.05\Omega) \Delta R$	$\pm (.2\%+.05\Omega) \Delta R$
Short Time Overload	$\pm (.2\%+.05\Omega) \Delta R$	$\pm (.2\%+.05\Omega) \Delta R$
Dielectric	$\pm (.1\%+.05\Omega) \Delta R$	$\pm (.1\%+.05\Omega) \Delta R$
Low. Temp. Storage	$\pm (.2\%+.05\Omega) \Delta R$	$\pm (.2\%+.05\Omega) \Delta R$
High Temp. Exposure	$\pm (.5\%+.05\Omega) \Delta R$	$\pm (.5\%+.05\Omega) \Delta R$
Shock	$\pm (.1\%+.05\Omega) \Delta R$	$\pm (.1\%+.05\Omega) \Delta R$
Vibration	$\pm (.1\%+.05\Omega) \Delta R$	$\pm (.1\%+.05\Omega) \Delta R$
Terminal Strength	$\pm (.1\%+.05\Omega) \Delta R$	$\pm (.1\%+.05\Omega) \Delta R$

*All ΔR figures shown are maximum, based on units with an initial tolerance of 1% and maximum operating temperature of 275°C.

POWER RATING

Power ratings of Dale G resistors are 1.4 to 4 times higher than those of conventional wirewound resistors of equivalent size. At the higher ratings, Dale G resistors will meet the same environmental and life stability requirements of the lower rated conventional resistors.

CHARACTERISTIC U

- 275°C maximum hotspot temperature
- .5% maximum ΔR in 2000 hour load life

CHARACTERISTIC V

- 350°C maximum hotspot temperature
- 3% maximum ΔR in 2000 hour load life

DERATING

Ambient Temperature: Dale G coated resistors have an operating temperature range of -55° C to +350° C. Dale G molded resistors have an operating temperature range of -55° C to +275° C. They must be derated at higher temperatures according to the curve at the right.

CHARACTERISTIC U:

Coated or molded resistors are available in any tolerance.

CHARACTERISTIC V:

Coated resistors are available in 3% and 5% tolerance.

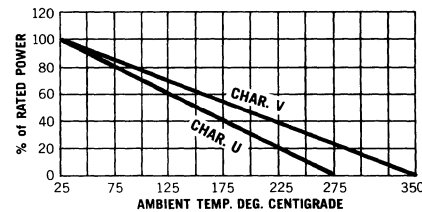

NOTE: All resistance ranges shown conform to military specifications unless otherwise indicated.



INDUSTRIAL POWER WIREWOUND RESISTORS (HL) ORDERING INFORMATION AND SPECIFICATIONS

CHECKLIST FOR ORDERING RESISTORS

INDUSTRIAL WIREWOUND

Orders must have complete information including the following:

1. Resistor type, model and wattage.
2. Resistor value (total and each section if tapped).
3. Resistor tolerance.
4. Terminal style (if lug style).
5. Power rating in amperes, volts or watts for each section (applies to Tapped Resistors only).
6. T.C. (if non-standard).
7. Mounting brackets and other accessories should be listed as separate items by bracket type (if lug style).
8. Include Dale Electronics quotation number, if any.
9. If you have a drawing covering the part, specify your part number and drawing number and supply a copy with the order. Including the Dale Electronics specification number on your drawing will assure you of exact duplication on all future orders.
10. Specify quantity of each item.
11. Prices will be quoted on request on specific items and quantities. Quantity of each item ordered at one time determines unit price for manufacturers' orders.
12. Specify routing.

LUG TYPE PART NUMBER SYSTEM

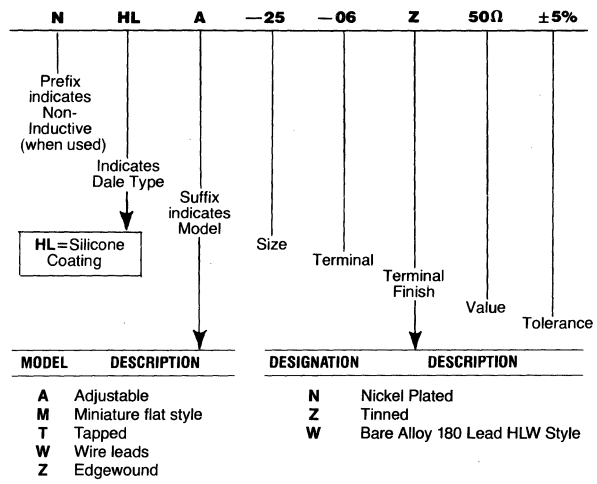

Examples:

- NHL-50-06N, 100Ω ± 5% = Non-inductive 50 watt unit, 06 nickel plated terminals
 HLA-20-20N, 50Ω ± 5% = Adjustable 20 watt unit, 02 nickel plated terminals
 HL-12-05Z, 50Ω ± 5% = Standard 12 watt power resistor, 05 tinned terminals

SPECIFICATIONS FOR POWER WIREWOUND RESISTORS

ELECTRICAL

Tolerance: ±5% is standard on values 1 ohm and above; ±10% is standard below 1 ohm. Lower tolerances are available on HL Series resistors. (Standard tolerance for tapped power wirewound and edgewound resistors is ±10%.)

Dielectric Strength: 1000 VAC minimum for all HL resistors.

Short Time Overload: In intermittent duty the applied power can greatly exceed the wattage rating. However, since each pulse application is somewhat unique, the factory should be contacted for specific requirements.

Temperature Coefficient: ±90 PPM, below 1Ω; ±50 PPM, 1Ω-9.9Ω; ±30 PPM, 10Ω and above.

MATERIAL

Core: Steatite. Chemically inert—will withstand severe thermal shock and is impervious to moisture.

Element: Highest quality copper-nickel alloy or nickel-chrome alloy, depending on resistance value. Special alloys available upon request.

Coating: HL—special high temperature silicone, cured at much lower temperatures than vitreous enamels.

POWER RATING

Power rating is based on:

1. 350°C maximum surface temperature in free air.
2. 3% maximum ΔR in 2000 hour load life test.
3. HLZ resistors have a 375°C heat rise.

DERATING

Dale industrial resistors have an operating temperature range of -55°C to +350°C. They must be derated at high ambient temperatures according to the curve at the right.

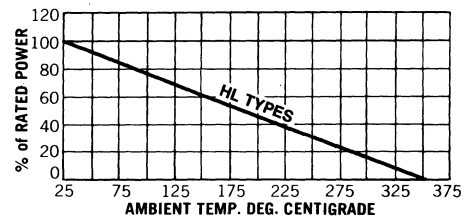

GENERAL DEFINITIONS

TEMPERATURE COEFFICIENT

All resistive materials are temperature sensitive to some extent. Consequently, the resistance value will vary from the original 25°C value as the ambient temperature increases or decreases. The curve of resistance over the whole operating temperature range is usually a non-linear curve that fits within predictable maximum limits. Any individual resistor will trace essentially the same curve on each excursion.

The magnitude of this temperature-dependent resistance change is identified by the temperature coefficient — the maximum amount of resistance change for each degree change in temperature — and is most commonly expressed in parts per million per degree centigrade (PPM/°C). T.C. in PPM/°C is calculated with the following formula:

$$T.C. = \frac{R_2 - R_1}{(T_2 - T_1) R_1} \times 10^6$$

R₁ = resistance at T₁
 R₂ = resistance at T₂
 T₁ = reference temperature (°C)
 T₂ = test temperature

The value of standard T.C. over the full normal operating temperature range varies from ±20 PPM/°C for certain wirewound types to ±500 PPM for carbon film types. Special T.C. from as low as ±5 PPM to as high as +5500 PPM can be produced over more limited temperature ranges.

REACTANCE

All resistors have capacitance and inductance as well as pure resistance, and these factors can become significant at high frequencies.

For wirewound resistors, inductive effects are predominant in low value resistors (below 1000 ohms) and capacitive effects become predominant in higher resistance values. Dale uses specialized winding techniques to produce non-reactive resistors for specific customer requirements. Extensive high frequency data on wirewound resistors has been accumulated by the Dale engineering department and is available upon request.

Dale has the experience and equipment to design special resistors which have specific capacitance, inductance or phase shift requirements. Consult your local Dale representative or write the factory directly for assistance with low reactance resistors.

DALE ELECTRONICS, INC., 2064 12th Avenue, Columbus, NE 68601 • Phone 402-564-3131

Canada: Dale Electronics Ltd., 18 Howden Rd., Scarborough, Ontario M1R 3E6
 Europe: Dale Electronics GmbH, Benzstrasse 28, 8039 Puchheim, West Germany



INDUSTRIAL POWER WIREWOUND RESISTORS



(Includes coating and terminal band.)

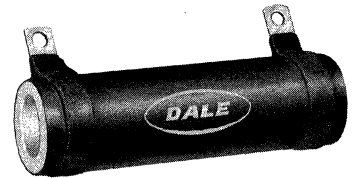

DALE TYPE HL TUBULAR

For inexpensively dissipating larger amounts of power in DC or low frequency AC circuits.

Applications include:

- Grid resistor
- High voltage bleeder resistors in power supplies
- Voltage divider networks
- Load resistor
- Voltage dropping resistor
- Bias supply resistor
- Filament dropping resistor
- Shunt resistor

STANDARD TYPE SPECIFICATIONS

TYPE	WATTAGE RATING	DALE		A MAX.	CORE DIMENSIONS			TERMINAL SETBACK ±1/32 [.79]	STANDARD TERMINAL** DESIGNATION	MOUNTING HARDWARE OPTIONS
		MAX.* RESISTANCE	MAX. WORKING VOLTAGE		LENGTH ±1/16 [1.59]	O.D.	I.D. ±1/32 [.79]			
HL-12	12	70K	500	13/32 [10.32]	1-3/4 [44.45]	5/16 [7.94]	3/16 [4.76]	3/32 [2.38]	05	101, 204, 301
HL-20	20	120K	880	9/16 [14.29]	2 [50.80]	7/16 [11.11]	5/16 [7.94]	3/32 [2.38]	02	101, 203, 301
HL-25	25	155K	1.3K	11/16 [17.46]	2 [50.80]	9/16 [14.29]	5/16 [7.94]	3/32 [2.38]	06	101, 203, 301
HL-50	50	385K	1.9K	11/16 [17.46]	4 [101.60]	9/16 [14.29]	5/16 [7.94]	3/32 [2.38]	06	101, 203, 301
HL-100	100	870K	2.5K	29/32 [23.02]	6-1/2 [165.10]	3/4 [19.05]	1/2 [12.70]	1/8 [3.18]	06	102, 206, 303
HL-175	175	1.7 Meg.	5.2K	1-5/16 [33.34]	8-1/2 [215.90]	1-1/8 [28.58]	3/4 [19.05]	7/32 [5.56]	07	103, 205, 303
HL-225	225	2.1 Meg.	6.1K	1-5/16 [33.34]	10-1/2 [266.70]	1-1/8 [28.58]	3/4 [19.05]	7/32 [5.56]	07	103, 205, 303

*Minimum resistance is .1 ohm for all models. **Contact factory for optional, non-standard terminals, including quick disconnect types. See page 187 for dimensions.
5% tolerance is standard on values 1 ohm and above, 10% on values below 1 ohm. Lower tolerances available.

DALE TYPE NHL NON-INDUCTIVE

Dale NHL resistors utilize Aryton-Perry winding (two single-layer parallel windings in opposite directions) to cancel most of the inductive and capacitive effect.

Applications include:

- Dummy Antennas
- Terminating Resistors
- Any resistance function where low inductive effect and minimum distributed capacity is needed.

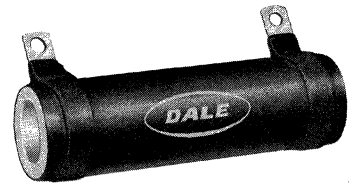

STANDARD TYPE SPECIFICATIONS

TYPE	RATING	MAX. RESISTANCE	MAX. WORKING VOLTAGE	A MAX.	CORE DIMENSIONS			STANDARD TERMINAL** DESIGNATION	MOUNTING HARDWARE
					LENGTH ±1/16 [1.59]	O.D.	I.D. ±1/32 [.79]		
NHL-12	12 W	3.9K	166	13/32 [10.32]	1-3/4 [44.45]	5/16 [7.94]	3/16 [4.76]	05	101, 204, 301
NHL-20	20 W	6.8K	316	9/16 [14.29]	2 [50.8]	7/16 [11.11]	5/16 [7.94]	02	101, 203, 301
NHL-25	25 W	8.8K	432	11/16 [17.46]	2 [50.8]	9/16 [14.29]	5/16 [7.94]	06	101, 203, 301
NHL-50	50 W	21.5K	866	11/16 [17.46]	4 [101.6]	9/16 [14.29]	5/16 [7.94]	06	101, 203, 301
NHL-100	100 W	48.5K	1.9K	29/32 [23.02]	6-1/2 [165.1]	3/4 [19.05]	1/2 [12.70]	06	102, 206, 303
NHL-175	175 W	112K	3.7K	1-5/16 [33.34]	8-1/2 [215.9]	1-1/8 [28.58]	3/4 [19.05]	07	103, 205, 303
NHL-225	225 W	121K	4.5K	1-5/16 [33.34]	10-1/2 [266.7]	1-1/8 [28.58]	3/4 [19.05]	07	103, 205, 303

5% tolerance is standard on values 1 ohm and above. Lower tolerances available.

TYPICAL INDUCTANCE

RESISTANCE	DALE STANDARD WINDING	DALE NON-INDUCTIVE WINDING
90	HL-12 = 9.5 microhenrys	NHL-12 = 0.2 microhenry
300	HL-25 = 50 microhenrys	NHL-25 = 0.25 microhenry
1K	HL-100 = 310 microhenrys	NHL-100 = 0.7 picofarads

Also available as a modification of HLW, HL Flat or HL Miniature styles.

*Minimum resistance is 1 ohm for all models.

**Contact factory for optional, non-standard terminals including quick disconnect types.

See page 187 for dimensions.

NOTE: NHL resistors utilize the same cores, terminals and mounting hardware as the HL models shown above. Resistance values are lower because of spacing allowances which must be made in the Aryton-Perry winding.

DALE ELECTRONICS, INC., 2064 12th Avenue, Columbus, NE 68601 • Phone 402-564-3131

Canada: Dale Electronics Ltd., 18 Howden Rd., Scarborough, Ontario M1R 3E6
Europe: Dale Electronics GmbH, Benzstrasse 28, 8039 Puchheim, West Germany



INDUSTRIAL POWER WIRED WOUND RESISTORS

DALE TYPE HL FLAT

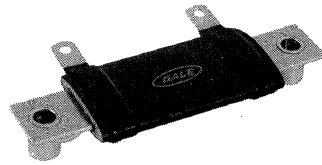

FEATURES

- High power-to-size ratio.
- Mounting accommodations ideally suited to high density packaging.
- Self-stacking hardware for horizontal or vertical placement.
- Withstand high vibration without loosening.
- Mountings function as heat sinks allowing greater heat dissipation and less derating of stacked units.

FLAT TYPE SPECIFICATIONS

TYPE	WATTAGE RATING	MAX.* RESISTANCE	MAX. WORKING VOLTAGE	DIMENSIONS			TERMINAL SETBACK ±1/32 [1.98]	STANDARD TERMINAL** DESIGNATION
				A ±1/16 [1.59]	B ±1/16 [1.59]	C ±1/32 [.79]		
HL-24	30	11K	575	1-1/4 [31.75]	2-1/2 [63.50]	2 [50.80]	5/64 [1.98]	09
HL-35	40	27K	1040	2 [50.80]	3-1/4 [82.55]	2-3/4 [69.85]	5/64 [1.98]	09
HL-55	55	61K	1.8KV	3-1/2 [88.90]	4-3/4 [120.65]	4-1/4 [107.95]	5/64 [1.98]	09
HL-95	95	111K	2.6KV	6 [152.40]	7-1/4 [184.15]	6-3/4 [171.45]	5/64 [1.98]	09

*Minimum resistance is .1 ohm for all models. 5% tolerance is standard on values 1 ohm and above, 10% on values below 1 ohm. Lower tolerances available.
 **Contact factory for optional, non-standard terminals, including quick disconnect types.
 See page 187 for dimensions.

DERATING STACK MOUNTED UNITS

NO. OF RESISTORS IN STACK	MINIATURE		STANDARD
	PERCENT OF SINGLE UNIT RATING WITH 1/4" [6.35] SPACER		
2	72	80	70
3	61	73	60
4	51	64	50

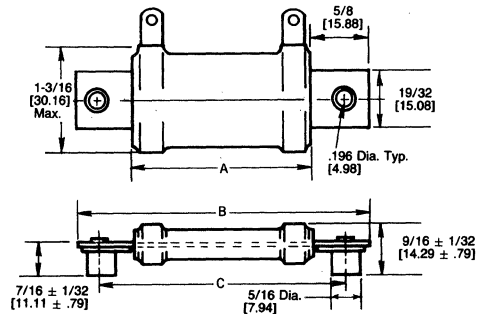

DALE TYPE HLM MINIATURE FLAT

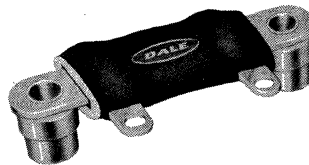

MINIATURE TYPE SPECIFICATIONS

DALE TYPE	WATTAGE RATING†	MAX. RESISTANCE*	MAX. WORKING VOLTAGE	DIMENSIONS			STANDARD TERMINAL** DESIGNATION
				A ±1/16 [1.59]	B ±1/16 [1.59]	C ±1/64 [0.40]	
HLM-10	10	15K	300	.750 [19.05]	1.312 [33.32]	1.000 [25.40]	10
HLM-20	20	65K	1000	2.062 [52.37]	2.625 [66.68]	2.313 [58.75]	10

†Mounted horizontally on 10"x10"x.04" [250.40x250.40x1.02] steel plate. 5% tolerance is standard on values 1 ohm and above, 10% on values below 1 ohm. Lower tolerances available.

*Minimum resistance .1 ohm for all models.
 **Contact factory for optional, non-standard terminals.
 See page 187 for dimensions.

EXCLUSIVE BRACKET DESIGN*

Mounting strap fits snugly through core and is bound tightly against unit by two eccentric spacers. Eliminates expensive cements and improves heat transfer and power handling capabilities.

*Patent 3390367

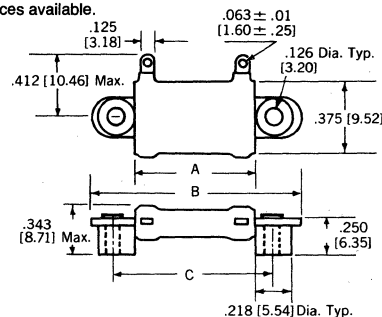



INDUSTRIAL POWER WIREWOUND RESISTORS

DALE TYPE HLW TUBULAR, AXIAL LEAD

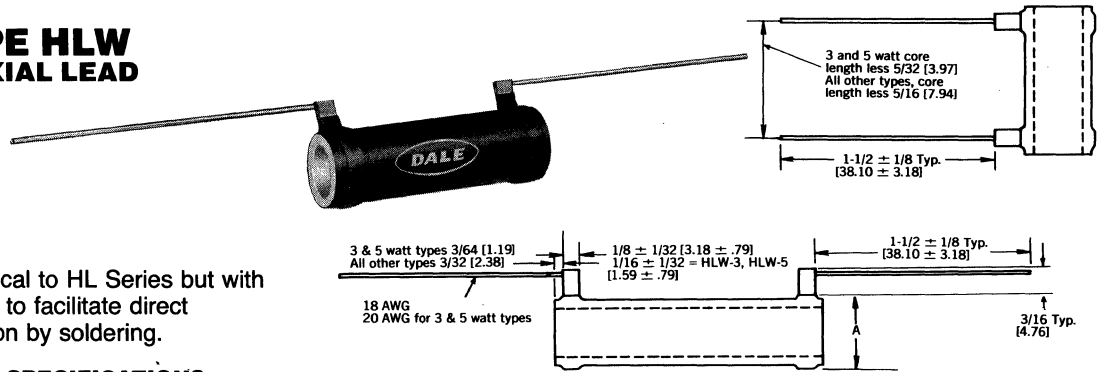

Construction identical to HL Series but with lug-attached leads to facilitate direct electrical connection by soldering.

STANDARD TYPE SPECIFICATIONS

DALE TYPE	WATTAGE RATING	MAX. RESISTANCE*	LENGTH ±1/16 [1.59]	CORE O.D.	CORE I.D. ±1/32 [1.79]	A (Max.)	** AXIAL TERMINAL DESIGNATION	** RADIAL TERMINAL DESIGNATION	MOUNTING HARDWARE
HLW-3	3	6K	7/16 [11.11]	13/64 [5.16]	1/8 [3.18]	19/64 [7.54]	A2	R2	—
HLW-5	5-1/4	15K	5/8 [15.88]	1/4 [6.35]	1/8 [3.18]	11/32 [8.73]	A2	R2	—
HLW-6	8	25K	1 [25.40]	5/16 [7.94]	3/16 [4.76]	13/32 [10.32]	A1	R1	101, 204, 301
HLW-12	12	70K	1-3/4 [44.45]	5/16 [7.94]	3/16 [4.76]	13/32 [10.32]	A1	R1	101, 204, 301
HLW-20	20	120K	2 [50.80]	7/16 [11.11]	5/16 [7.94]	9/16 [14.29]	A1	R1	101, 203, 301

*Minimum resistance is .1 ohm for all models. Consult factory for higher values.

** See page 187 for dimensions.

5% tolerance is standard on values 1 ohm and above, 10% on values below 1 ohm. Lower tolerances available.

DALE TYPE HLZ EDGEWOUND



FEATURES

- Designed to meet heavy-duty requirements where space is at a premium
- High thermal capacity for intermittent or short duration
- Silicone coating allows maximum heat transfer from wire surface

STANDARD TYPE SPECIFICATIONS

TYPE	WATTAGE RATING	RESISTANCE RANGE (Ohms)		LENGTH ±1/16 [1.59]	CORE DIMENSIONS		STANDARD TERMINAL* DESIGNATION	MOUNTING HARDWARE
		Min.	Max.		O.D.	I.D. ±1/32 [1.79]		
HLZ-33	35	.05	1.9	2 [50.8]	9/16 [14.29]	5/16 [7.94]	06	101, 203, 301
HLZ-90	90	.15	5.7	4 [101.6]	9/16 [14.29]	5/16 [7.94]	06	101, 203, 301
HLZ-165	165	.36	13	6-1/2 [165.1]	3/4 [19.05]	1/2 [12.70]	06	102, 206, 303
HLZ-300	300	.23	25	8-1/2 [215.9]	1-1/8 [28.58]	3/4 [19.05]	07	103, 205, 303

*Contact factory for optional non-standard terminals including quick disconnect types. See page 187 for dimensions.

Tolerance: ±10% standard. Also available in ±5%.

Temperature Rise: 375°C at full power. Slightly higher temperatures will occur in maximum resistance units.

Dielectric: 1000 V from terminals to mounting hardware.

Construction: A ribbon element is edgewound onto a ceramic tube and is coated with silicone. Silicone coating holds ribbon wire firmly against core while allowing maximum exposure of wire surface for heat transfer by radiation.



INDUSTRIAL POWER WIREWOUND RESISTORS

DALE TYPE HLA ADJUSTABLE



(Includes coating and terminal band.)

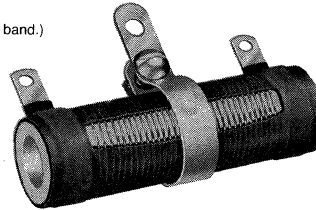

FEATURES

- Adjustable resistor or voltage divider.
- Can be used to quickly obtain odd resistance values.
- Can be used as multi-tap resistor.
- One or more adjustable lugs can be provided for voltage-divider applications.

STANDARD TYPE SPECIFICATIONS

TYPE	WATTAGE RATING	MAX.* RESISTANCE	MAX. WORKING VOLTAGE	CORE DIMENSIONS			I.D. ±1/32 [.79]	TERMINAL SETBACK ±1/32 [.79]	STANDARD TERMINAL** DESIGNATION	ADJ. SLIDER	MOUNTING HARDWARE
				A MAX.	LENGTH ±1/16 [1.59]	O.D.					
HLA-12	12	10K	350	13/32 [10.32]	1-3/4 [44.45]	5/16 [7.94]	3/16 [4.76]	3/32 [2.38]	05	70	101, 204, 301
HLA-20	20	18K	600	9/16 [14.29]	2 [50.80]	7/16 [11.11]	5/16 [7.94]	3/32 [2.38]	02	71	101, 203, 301
HLA-25	25	25K	790	11/16 [17.46]	2 [50.80]	9/16 [14.29]	5/16 [7.94]	3/32 [2.38]	06	72	101, 203, 301
HLA-50	50	100K	1.9K	11/16 [17.46]	4 [101.60]	9/16 [14.29]	5/16 [7.94]	3/32 [2.38]	06	72	101, 203, 301
HLA-100	100	100K	2.5K	29/32 [23.02]	6-1/2 [165.10]	3/4 [19.05]	1/2 [12.70]	1/8 [3.18]	06	73	102, 206, 303
HLA-175	175	100K	4.1K	1-5/16 [33.34]	8-1/2 [215.90]	1-1/8 [28.58]	3/4 [19.05]	7/32 [5.56]	07	74	103, 205, 303
HLA-225	225	100K	4.75K	1-5/16 [33.34]	10-1/2 [266.70]	1-1/8 [28.58]	3/4 [19.05]	7/32 [5.56]	07	74	103, 205, 303

*Minimum resistance is 1 ohm for all models.

**Contact factory for optional, non-standard terminals including quick disconnect types.

See page 187 for dimensions.

Tolerance: The standard tolerance on the total resistance is $\pm 5\%$ and is checked with the adjustable terminal removed from the unit, in accordance with MIL-R-19365C.

ADJUSTABLE RESISTOR INFORMATION

Moving Adjustable Lugs: The Dale coatings protect the resistance wire from shifting and shorting to other turns during adjustment. However, the following three steps should always be taken whenever adjustments are made: (1) Turn off current to avoid possible operator injury and damage to the unit. (2) Loosen adjustable lug until it will slide completely free, without touching the exposed wire. (3) When adjustment point has been selected, retighten lug only enough to assure a firm contact, do not tighten beyond this point. Failure to follow these three steps in order can result in damage to the resistor.

Wattage Rating: To avoid overloading any section of an adjustable resistor, do not exceed the maximum rated current based on total resistance. The wattage ratings shown on the chart apply only when the entire resistance is in the circuit. The adjustable lug divides the wattage rating in proportion to the divided resistance.

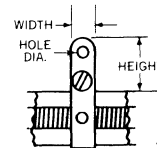

SLIDER MODEL NO.	WIDTH	HEIGHT	HOLE DIA.
70	3/16 [4.76]	33/64 [13.10]	.125 [3.18]
71	1/4 [6.35]	19/32 [15.08]	.156 [3.96]
72	1/4 [6.35]	23/32 [18.26]	.141 [3.58]
73	1/4 [6.35]	25/32 [19.84]	.141 [3.58]
74	5/16 [7.94]	25/32 [19.84]	.170 [4.32]

DALE TYPE HLT TAPPED

FEATURES

- Provides fixed taps for voltage dividers

Tolerance: The standard tolerance is $\pm 10\%$ for the total resistance. Closer tolerance can be supplied upon request.

Power Rating & Maximum Resistance: The winding space is slightly reduced by the additional terminals, resulting in a small reduction of power rating and maximum resistance. Consult the factory for information on specific applications. To INSURE PROPER RESISTOR DESIGN, the power rating for each section must be specified.

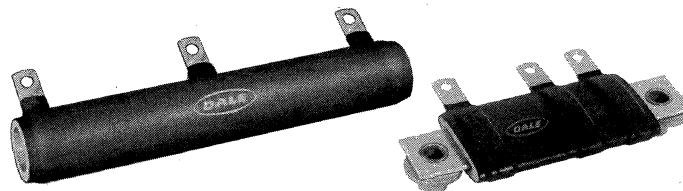

Available as a modification of HL tubular, HL Flat or HL Miniature styles.

DALE ELECTRONICS, INC., 2064 12th Avenue, Columbus, NE 68601 • Phone 402-564-3131

Canada: Dale Electronics Ltd., 18 Howden Rd., Scarborough, Ontario M1R 3E6
Europe: Dale Electronics GmbH, Benzstrasse 28, 8039 Puchheim, West Germany



SPECIFICATIONS INDUSTRIAL POWER WIREWOUND RESISTORS

[Numbers in brackets indicate millimeters]

TERMINAL SPECIFICATIONS

Terminals for HL, HLM and HLW
Power Wirewound Resistors

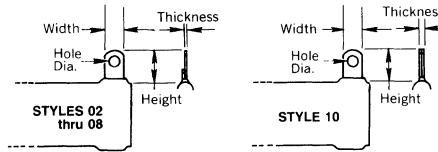

TERMINAL DIMENSIONS

TERMINAL DESIGNATION	02	05	06	07	09	10	A1, R1	A2, R2
WIDTH	3/16 [4.76]	3/16 [4.76]	1/4 [6.35]	3/8 [9.52]	3/16 [4.76]	1/8 [3.18]	1-1/2" [38.10]	1-1/2" [38.10]
HEIGHT	13/32 [10.32]	7/16 [11.11]	9/16 [14.29]	5/8 [15.88]	1/2 [12.70]	3/16 [4.76]	18 AWG Lead	20 AWG Lead
HOLE DIA.	.093 [2.36]	.104 [2.64]	.166 [4.22]	.173 [4.39]	.104 [2.64]	.063 [1.60]		
THICKNESS	.020 [.51]	.020 [.51]	.020 [.51]	.020 [.51]	.020 [.51]	.030 [.76]		

All terminals will be supplied in tinned finish (Z) unless otherwise specified. Optional finishes are nickel plated (N) for HL's, bare alloy 180 (W) for HLW lead styles. Specify proper suffix in part number designation when ordering.

MOUNTING SPECIFICATIONS

HORIZONTAL THRU-BOLT

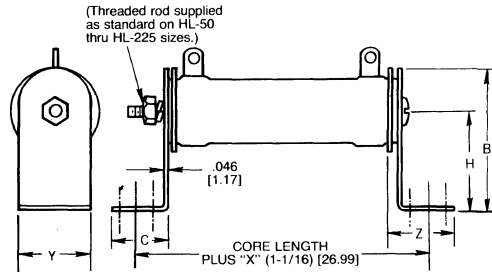

Note: Flat washers are supplied on resistor cores through 9/16 [14.29] diameter.

BRACKET TYPE	X	Y	Z	H	MOUNTING SLOT	C	B
101	1-1/16 [26.99]	1/2 [12.70]	55/64 [21.83]	1 [25.40]	7/32 x 7/16 [5.56 x 11.11]	3/4 [19.05]	1-3/8 [34.92]
102	1-1/16 [26.99]	3/4 [19.05]	55/64 [21.83]	1-1/4 [31.75]	7/32 x 7/16 [5.56 x 11.11]	3/4 [19.05]	1-3/4 [44.45]
103	1-1/16 [26.99]	1-1/4 [31.75]	1 [25.40]	1-1/2 [38.10]	9/32 x 9/16 [7.14 x 14.29]	7/8 [22.22]	2-1/8 [53.98]

PUSH-IN

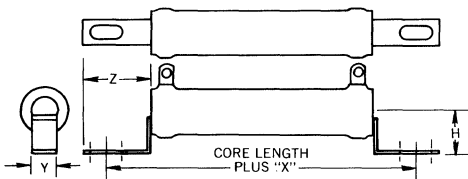

BRACKET TYPE	X	H	Y	Z	HOLE
203	5/8 [15.88]	43/64 [17.06]	1/4 [6.35]	15/32 [11.91]	.161 Dia. [4.09]
204	3/8 [9.52]	9/32 [7.14]	1/4 [6.35]	11/32 [8.73]	.144 Dia. [3.66]
205	13/16 [20.64]	1-25/64 [35.32]	1/2 [12.70]	11/16 [17.46]	.196 x .260 [4.98 x 6.60]
206	23/32 [18.26]	31/32 [24.61]	3/8 [9.52]	5/8 [15.88]	.196 x .375 [4.98 x 9.52]

VERTICAL THRU-BOLT

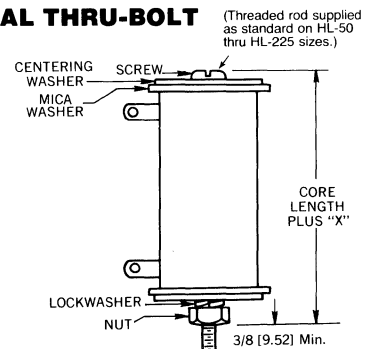

Note: Flat washers are supplied on resistor cores through 9/16 [14.29] diameter.

BRACKET TYPE	X (Approximate)	THREAD
301	7/16 [11-11]	8-32
303	1/2 [12.7]	10-32

DALE ELECTRONICS, INC., 2064 12th Avenue, Columbus, NE 68601 • Phone 402-564-3131

Canada: Dale Electronics Ltd., 18 Howden Rd., Scarborough, Ontario M1R 3E6
Europe: Dale Electronics GmbH, Benzstrasse 28, 8039 Puchheim, West Germany



INDUSTRIAL POWER WIREWOUND RESISTORS



DALE TYPE CW COATED, AXIAL LEAD

FEATURES

- High performance for low cost
- High-temperature silicone coating
- Complete welded construction
- High power/size ratio
- Excellent stability in operation

SPECIFICATIONS

MATERIAL

Core: Ceramic: Steatite or alumina, depending on physical size.

Element: Copper-nickel alloy or nickel-chrome alloy, depending on resistance value.

End Caps: Stainless steel.

Coating: Special high temperature silicone.

Standard Terminals: Tinned Copperweld®

ELECTRICAL

Dielectric Strength: 1000 VAC minimum

Tolerance: Standard tolerance is $\pm 5\%$ 1 ohm and above. $\pm 10\%$ below 1 ohm. 3% available.

Temperature Coefficient: ± 90 PPM/ $^{\circ}$ C below 1 Ω ; ± 50 PPM/ $^{\circ}$ C 1 Ω to 9.9 Ω ; ± 30 PPM/ $^{\circ}$ C 10 Ω and above.

Short Time Overload: 5 seconds at 5 times rated power for 3.75 watt size and smaller; 5 seconds at 10 times rated power for 4 watt size and larger.

MECHANICAL

Terminal Strength: 10 lb. pull test.

Solderability:

MIL-R-26 Types — Meets the requirements of MIL-STD-202, Method 208.

Standard CW (Non-MIL Styles) — 60/40 Electro Tin Plated terminals to facilitate soldering.

ENVIRONMENTAL SPECIFICATIONS*

TEST	DALE MAXIMUM
Load Life	$\pm(3\% + .05\Omega)\Delta R$
Moisture Resistance	$\pm(2\% + .05\Omega)\Delta R$
Temp. Coefficient	± 90 PPM/ $^{\circ}$ C below 1 Ω ; ± 50 PPM/ $^{\circ}$ C 1 Ω to 9.9 Ω ; ± 30 PPM/ $^{\circ}$ C 10 Ω and above
Thermal Shock	$\pm(2\% + .05\Omega)\Delta R$
Short Time Overload	$\pm(2\% + .05\Omega)\Delta R$
Dielectric	$\pm(.1\% + .05\Omega)\Delta R$
Low Temp. Storage	$\pm(2\% + .05\Omega)\Delta R$
High Temp. Exposure	$\pm(2\% + .05\Omega)\Delta R$
Shock	$\pm(.2\% + .05\Omega)\Delta R$
Vibration	$\pm(.2\% + .05\Omega)\Delta R$
Terminal Strength	$\pm(1\% + .05\Omega)\Delta R$

*All Δ figures shown are maximum, based upon testing requirements per MIL-R-26 at a maximum operating temperature of 350 $^{\circ}$ C. ΔR maximum figures are considerably lower when tested at a maximum operating temperature of 275 $^{\circ}$ C.

POWER RATING

Dale CW Series have two power ratings, depending on operating temperature and stability requirements.

CHARACTERISTIC U

1. 275 $^{\circ}$ C maximum hot spot temperature
2. .5% maximum ΔR in 2000 hour load life

CHARACTERISTIC V

1. 350 $^{\circ}$ C maximum hot spot temperature
2. 3% maximum ΔR in 2000 hour load life

STANDARD ELECTRICAL SPECIFICATIONS

DALE TYPE	MIL. TYPE	POWER RATING (Max. Hot Spot)		MIL.	RESISTANCE RANGE (Mil. Range shown in bold face)	MAX. WT. (Grams)	MAX.* WORKING VOLTAGE	
		275 $^{\circ}$ C	350 $^{\circ}$ C				275 $^{\circ}$ C	350 $^{\circ}$ C
CW-2	—	4.0	5.5	—	.1 Ω to 28.7K	2.1	200	235
CW-2B**	—	3.0	3.75	—	.1 Ω to 15K	.70	125	140
CW-2C	—	2.5	3.25	—	.1 Ω to 19.9K	1.6	130	150
CW-2C-1	RW69	2.5	3.25	3.0	.1 Ω to 19.9K .1 Ω to 2K	1.6	130	150
CW-2C-14	—	2.5	3.25	—	.1 Ω to 19.9K	1.6	130	150
CW-5**	—	5.0	6.5	—	.1 Ω to 58.5K	4.2	320	365
CW-5-2	—	4.0	5.0	—	.1 Ω to 40.3K	4.2	240	265
CW-5-3	—	5.0	6.5	—	.1 Ω to 58.5K	4.2	320	365
CW-5-5	RW67	5.0	6.5	6.5	.1 Ω to 58.5K .1 Ω to 8.2K	4.2	320	365
CW-7	—	7.0	9.0	—	.1 Ω to 95.2K	4.7	460	520
CW-10	—	10.0	13.0	—	.1 Ω to 167K	9.0	765	875
CW-10-3	—	10.0	13.0	—	.1 Ω to 167K	9.0	765	875
CW-10-4	RW68	10.0	13.0	11.0	.1 Ω to 167K .1 Ω to 20K	9.0	765	875

*Maximum working voltage determined at .0008" diameter wire resistance values.

**Values available down to .005 Ω in 10% tolerance.

DIMENSIONAL SPECIFICATIONS

[Numbers in brackets indicate millimeters]

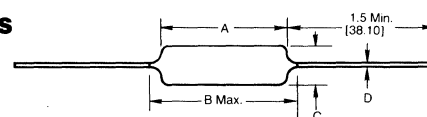

DALE TYPE	A $\pm .062$ [1.57]	B (Max.)	C $\pm .032$ [.81]	D $\pm .002$ [.051]
CW-2	.625 [15.8]	.765 [19.43]	.250 [6.35]	.040 [1.02]
CW-2B	.562 [14.27]	.622 [15.80]	.188 [4.78]	.032 [.81]
CW-2C	.500 [12.70]	.593 [15.06]	.218 [5.54]	.040 [1.02]
CW-2C-1	.500 [12.70]	.593 [15.06]	.218 [5.54]	.032 [.81]
CW-2C-14	.500 [12.70]	.593 [15.06]	.218 [5.54]	.032 [.81]
CW-5	.875 [22.22]	1.000 [25.40]	.312 [7.92]	.040 [1.02]
CW-5-2	.875 [22.22]	1.000 [25.40]	.250 [6.35]	.032 [.81]
CW-5-3	.875 [22.22]	1.000 [25.40]	.312 [7.92]	.032 [.81]
CW-5-5	.875 [22.22]	1.000 [25.40]	.312 [7.92]	.040 [1.02]
CW-7	1.218 [30.94]	1.281 [32.54]	.312 [7.92]	.040 [1.02]
CW-10	1.781 [45.24]	1.875 [47.62]	.375 [9.52]	.040 [1.02]
CW-10-3	1.781 [45.24]	1.875 [47.62]	.375 [9.52]	.032 [.81]
CW-10-4	1.781 [45.24]	1.875 [47.62]	.375 [9.52]	.040 [1.02]

DERATING (Type CW)

Dale CW coated resistors have an operating temperature range of -55° C to $+350^{\circ}$ C. They must be derated at high ambient temperatures according to the curves below.

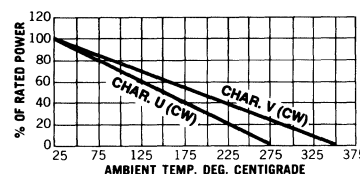

DALE ELECTRONICS, INC., 2064 12th Avenue, Columbus, NE 68601 • Phone 402-564-3131

Canada: Dale Electronics Ltd., 18 Howden Rd., Scarborough, Ontario M1R 3E6
Europe: Dale Electronics GmbH, Benzstrasse 28, 8039 Puchheim, West Germany



COMMERCIAL POWER WIREWOUND RESISTORS

DALE TYPE CA & CR

FEATURES:

- Axial or radial leads
- Available with special silicone coating for corrosion and abrasion protection (CA/CR-5000)

CA-4000 shown (Dimensions also apply to CA-5000)

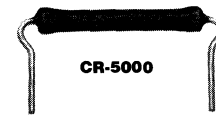
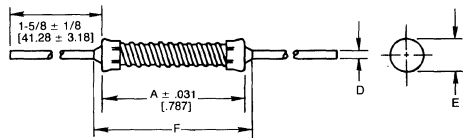

CR-4000 shown (Dimensions also apply to CR-5000)

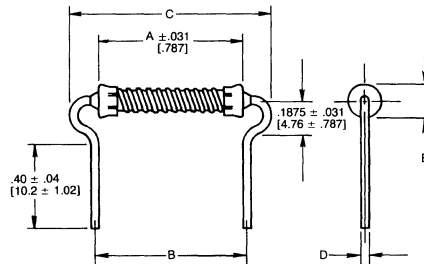

DIMENSIONAL AND POWER SPECIFICATIONS [Numbers in brackets indicate millimeters]

DALE TYPE	DIM. A		DIM. B ± 1/16 [1.59]	DIM. C ± 1/16 [1.59]	DIM. D ± .001 [.03]	DIM. E ± 1/32 [.79]	DIM. F ± 1/32 [.79]
	Min.	Max.					
CA-4000	.5 [12.7]	2.2 [55.9]	N/A	N/A	.032 [.81]	.140 [3.56]	A + .062 [1.57]
CR-4000	.5 [12.7]	2.2 [55.9]	A + 3/32 [2.4]	A + 7/32 [5.6]	.032 [.81]	.140 [3.56]	A + .062 [1.57]
CA-5000	.5 [12.7]	2.2 [55.9]	N/A	N/A	.036 [.91]	.160 [4.06]	—
CR-5000	.5 [12.7]	2.2 [55.9]	A + 3/32 [2.4]	A + 7/32 [5.6]	.036 [.91]	.160 [4.06]	—

CONSTRUCTION

Dale CA and CR Series resistors have a high quality, premium resistance wire wound on woven fiberglass core impregnated and coated with a special grade silicone.

USAGE

Kitchen appliances such as coffee percolators, food blenders or mixers, ranges, toasters and deep fryers; automotive devices such as horns, ignitions, windshield wipers, voltage regulators and instrument gauges. Entertainment devices such as radios and televisions.

Max. Working Voltage = \sqrt{PR}

Tolerance: ± 10% standard, ± 5% also available.

Leads: Standard lead material is tinned copper. Axial lead pull strength on CA Series is 7 lbs.

POWER RATINGS: 4000 Series = 4 watts per inch
5000 Series = 5 watts per inch

Temperature Coefficient:

Below 1 ohm 0 ± 800 PPM
1 ohm and above 0 ± 400 PPM

DERATING

FOR HIGH AMBIENT TEMPERATURE (NEMA)

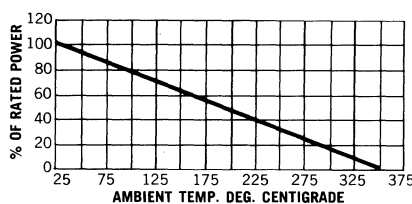

Example: A 1-1/2" [38.10] unit, 4 watts per inch; 350 ohms, ± 10% radial lead unit is designated as shown. Total wattage or unit is 6 watts (4 watts/inch x 1.5").

TABLE 1: 4000 SERIES CA/CR STYLE VS. OHMIC VALUE

CA/CR Type Desig.	Power Rating (Watts)	"A" ± .031 [0.79]	Ohmic Value Min.	Ohmic Value Max.
4050	2.0	.50 [12.70]	.10Ω	270Ω
4055	2.2	.55 [13.97]	.10Ω	300Ω
4060	2.4	.60 [15.24]	.11Ω	350Ω
4070	2.8	.70 [17.78]	.13Ω	430Ω
4080	3.2	.80 [20.32]	.16Ω	510Ω
4090	3.6	.90 [22.86]	.18Ω	590Ω
4100	4.0	1.00 [25.40]	.20Ω	670Ω
4110	4.4	1.10 [27.94]	.23Ω	750Ω
4120	4.8	1.20 [30.48]	.26Ω	830Ω
4130	5.2	1.30 [33.02]	.28Ω	910Ω
4140	5.6	1.40 [35.56]	.30Ω	1000Ω
4150	6.0	1.50 [38.10]	.33Ω	1080Ω
4160	6.4	1.60 [40.64]	.35Ω	1160Ω
4170	6.8	1.70 [43.18]	.38Ω	1240Ω
4180	7.2	1.80 [45.72]	.40Ω	1320Ω
4190	7.6	1.90 [48.26]	.43Ω	1400Ω
4200	8.0	2.00 [50.80]	.45Ω	1480Ω
4210	8.4	2.10 [53.34]	.48Ω	1560Ω
4220	8.8	2.20 [55.88]	.50Ω	1640Ω

TABLE 2: 5000 SERIES SILICONE COATED CA/CR STYLE VS. OHMIC VALUE

CA/CR Type Desig.	Power Rating (Watts)	"A" ± .031 [0.79]	Ohmic Value Min.	Ohmic Value Max.
5050	2.5	.50 [12.70]	.10Ω	2,400Ω
5055	2.75	.55 [13.97]	.10Ω	2,700Ω
5060	3.0	.60 [15.24]	.11Ω	3,100Ω
5070	3.5	.70 [17.78]	.13Ω	3,900Ω
5080	4.0	.80 [20.32]	.16Ω	4,600Ω
5090	4.5	.90 [22.86]	.18Ω	5,300Ω
5100	5.0	1.00 [25.40]	.20Ω	6,000Ω
5110	5.5	1.10 [27.94]	.23Ω	6,800Ω
5120	6.0	1.20 [30.48]	.26Ω	7,500Ω
5130	6.5	1.30 [33.02]	.28Ω	8,200Ω
5140	7.0	1.40 [35.56]	.30Ω	9,000Ω
5150	7.5	1.50 [38.10]	.33Ω	9,700Ω
5160	8.0	1.60 [40.64]	.35Ω	10,400Ω
5170	8.5	1.70 [43.18]	.38Ω	11,200Ω
5180	9.0	1.80 [45.72]	.40Ω	11,900Ω
5190	9.5	1.90 [48.26]	.43Ω	12,600Ω
5200	10.0	2.00 [50.80]	.45Ω	13,300Ω
5210	10.5	2.10 [53.34]	.48Ω	14,100Ω
5220	11.0	2.20 [55.88]	.50Ω	14,800Ω

ORDERING INFORMATION When ordering, please specify: resistor body length, watts/inch, resistance and tolerance.

CR 4 150 350Ω ± 10%

1. Resistor type
2. Watts per inch
3. Overall resistor body length
4. Resistance
5. Tolerance

DALE ELECTRONICS, INC., 2064 12th Avenue, Columbus, NE 68601 • Phone 402-564-3131

Canada: Dale Electronics Ltd., 18 Howden Rd., Scarborough, Ontario M1R 3E6
Europe: Dale Electronics GmbH, Benzstrasse 28, 8039 Puchheim, West Germany



COMMERCIAL POWER WIREWOUND RESISTORS

DALE TYPE CP AXIAL LEAD



FEATURES

- Fireproof inorganic construction
- Special inorganic potting compound provides high thermal conductivity
- Fuse styles (Type RF) available

CP SERIES AXIAL LEAD TYPE [Numbers in brackets indicate millimeters]

DALE TYPE	WATTAGE RATING	EIA STANDARD RS-344 TYPE	RESISTANCE	DIMENSIONS				
				A ± 1/32 [.79]	B ± 1/32 [.79]	C ± 1/32 [.79]	D ± 1/32 [.79]	E ± .001 [.02]
CP-2	2	CRU2A	.1 to 2.4K	11/16 [17.46]	1/4 [6.35]	1/4 [6.35]	—	.032 [.81]
CP-2-3	2	—	.1 to 2.4K	11/16 [17.46]	1/4 [6.35]	1/4 [6.35]	5/16 [7.94]	.032 [.81]
CP-3	3	CRU3	.1 to 7.5K	7/8 [22.22]	5/16 [7.94]	5/16 [7.94]	—	.036 [.91]
CP-3-3	3	—	.1 to 7.5K	7/8 [22.22]	5/16 [7.94]	5/16 [7.94]	3/8 [9.52]	.036 [.91]
CP-5	5	CRU5	.1 to 8.5K	7/8 [22.22]	3/8 [9.52]	11/32 [8.73]	—	.036 [.91]
CP-5-3	5	—	.1 to 8.5K	7/8 [22.22]	3/8 [9.52]	11/32 [8.73]	13/32 [10.32]	.036 [.91]
CP-7	7	CRU7	.1 to 18K	1-25/64 [35.32]	3/8 [9.52]	11/32 [8.73]	—	.036 [.91]
CP-7-3	7	—	.1 to 18K	1-25/64 [35.32]	3/8 [9.52]	11/32 [8.73]	15/32 [11.91]	.036 [.91]
CP-10	10	CRU10	.1 to 30K	1-7/8 [47.62]	3/8 [9.52]	11/32 [8.73]	—	.036 [.91]
CP-10-3	10	—	.1 to 30K	1-7/8 [47.62]	3/8 [9.52]	11/32 [8.73]	15/32 [11.91]	.036 [.91]
CP-15	15	CRU15	.1 to 30K	1-7/8 [47.62]	1/2 [12.70]	1/2 [12.70]	—	.036 [.91]
CP-15-3	15	—	.1 to 30K	1-7/8 [47.62]	1/2 [12.70]	1/2 [12.70]	5/8 [15.88]	.036 [.91]
CP-20	20	—	.1 to 30K	2-1/2 [63.50]	1/2 [12.70]	1/2 [12.70]	—	.036 [.91]
CP-20-3	20	—	.1 to 30K	2-1/2 [63.50]	1/2 [12.70]	1/2 [12.70]	5/8 [15.88]	.036 [.91]
CP-22	22	—	.1 to 30K	2-1/2 [63.50]	1/2 [12.70]	1/2 [12.70]	—	.036 [.91]
CP-22-3	22	—	.1 to 30K	2-1/2 [63.50]	1/2 [12.70]	1/2 [12.70]	5/8 [15.88]	.036 [.91]

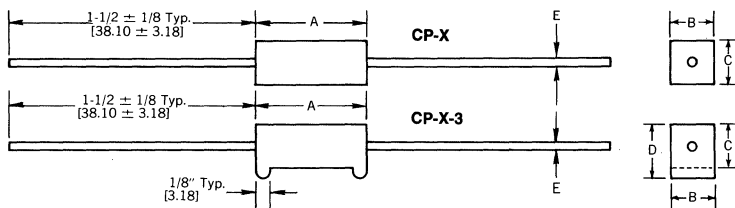

Tolerance: ±10% standard, ±5% also available.

Operating Temperature: -55°C to +275°C.

Temperature Coefficient:

Below 1 ohm 0 ± 800 PPM (Typ.)
1 ohm and above 0 ± 400 PPM (Typ.)

Terminal Strength: 5 lbs. minimum.

Max. Working Voltage = \sqrt{PR}

CONSTRUCTION

Resistance wire is a high quality, premium grade wound onto a woven fiberglass core. Terminals are tinned copper crimped to the wound core with a special brass alloy. The assembly is then potted into a high quality steatite ceramic case using a high temperature, high thermal conducting inorganic potting compound. This results in a completely fireproof inorganic package.

FUSE RESISTOR, TYPE RF

Dale RF resistors can reliably function both as a fuse and as a wirewound resistor. Such components involve compromise between fusing and resistive functions and, therefore, each design should be tailored to the application to insure optimum performance. RF resistors are similar in appearance to Type CA, CP or CR models, but are manufactured with special materials and processes conforming to performance required. Contact factory for design assistance.

DERATING

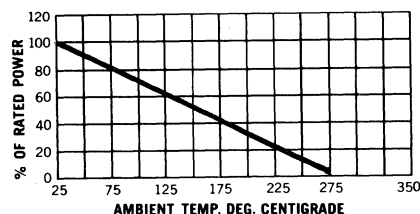

DALE ELECTRONICS, INC., 2064 12th Avenue, Columbus, NE 68601 • Phone 402-564-3131

Canada: Dale Electronics Ltd., 18 Howden Rd., Scarborough, Ontario M1R 3E6
Europe: Dale Electronics GmbH, Benzstrasse 28, 8039 Puchheim, West Germany



COMMERCIAL POWER WIREWOUND RESISTORS

DALE TYPE CPL AXIAL LEAD

FEATURES

- Fireproof inorganic construction
- Special inorganic potting compound provides high thermal conductivity
- Extremely low resistance values
- Complete welded construction

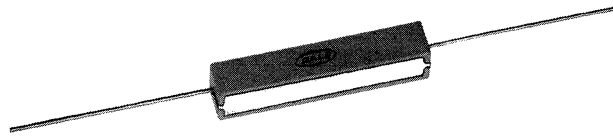

CPL SERIES AXIAL LEAD TYPE [Numbers in brackets indicate millimeters]

DALE TYPE	WATTAGE RATING	DIMENSIONS				
		A ± 1/32 [.79]	B ± 1/32 [.79]	C ± 1/32 [.79]	D ± 1/32 [.79]	E ± .001 [.02]
CPL-3	3	7/8 [22.22]	5/16 [7.94]	5/16 [7.94]	—	.036 [.91]
CPL-3-3	3	7/8 [22.22]	5/16 [7.94]	5/16 [7.94]	3/8 [9.52]	.036 [.91]
CPL-5	5	7/8 [22.22]	3/8 [9.52]	11/32 [8.73]	—	.036 [.91]
CPL-5-3	5	7/8 [22.22]	3/8 [9.52]	11/32 [8.73]	13/32 [10.32]	.036 [.91]
CPL-7	7	1-25/64 [35.32]	3/8 [9.52]	11/32 [8.73]	—	.036 [.91]
CPL-7-3	7	1-25/64 [35.32]	3/8 [9.52]	11/32 [8.73]	15/32 [11.91]	.036 [.91]
CPL-10	10	1-7/8 [47.62]	3/8 [9.52]	11/32 [8.73]	—	.036 [.91]
CPL-10-3	10	1-7/8 [47.62]	3/8 [9.52]	11/32 [8.73]	15/32 [11.91]	.036 [.91]
CPL-15	15	1-7/8 [47.62]	1/2 [12.70]	1/2 [12.70]	—	.036 [.91]
CPL-15-3	15	1-7/8 [47.62]	1/2 [12.70]	1/2 [12.70]	5/8 [15.88]	.036 [.91]

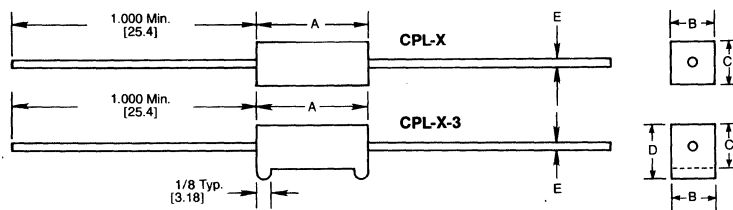

DERATING

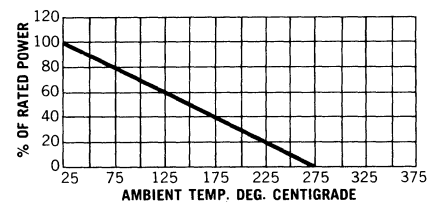

SPECIFICATIONS

ELECTRICAL

Resistance: .01Ω to .10Ω (Resistance is measured 3/8" [9.5] from resistor body.)

Tolerance: ±5% standard, ±3% also available. Lower tolerances available.

Dielectric Strength: 1000 VAC

Temperature Coefficient: Varies with resistance values. 400 PPM Max. Consult factory.

MECHANICAL

Terminal Strength: 5 lbs. minimum

Solderability: Meets requirements of MIL-STD-202, Method 208.



COMMERCIAL POWER WIREWOUND RESISTORS

DALE TYPE CPSL FOUR LEAD

FEATURES

- Fireproof inorganic construction
- Special inorganic potting compound provides high thermal conductivity
- Extremely low resistance values
- Current sensing
- Low temperature coefficients
- Complete welded construction
- High power/size ratio

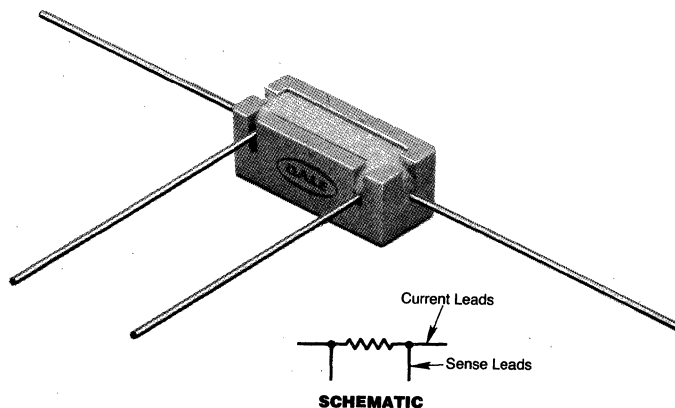

CPSL SERIES FOUR LEAD TYPE [Numbers in brackets indicate millimeters]

DALE TYPE	WATTAGE RATING	DIMENSIONS					
		A ± 1/32 [.79]	B ± 1/32 [.79]	C ± 1/32 [.79]	D ± 1/32 [.79]	E ± .001 [.02]	F ± 1/16 [1.59]
CPSL-3	3	7/8 [22.22]	5/16 [7.94]	5/16 [7.94]	—	.036 [.91]	9/16 [14.30]
CPSL-3-3	3	7/8 [22.22]	5/16 [7.94]	5/16 [7.94]	3/8 [9.52]	.036 [.91]	9/16 [14.30]
CPSL-5	5	7/8 [22.22]	3/8 [9.52]	11/32 [8.73]	—	.036 [.91]	9/16 [14.30]
CPSL-5-3	5	7/8 [22.22]	3/8 [9.52]	11/32 [8.73]	7/16 [11.11]	.036 [.91]	9/16 [14.30]
CPSL-7	7	1-25/64 [35.32]	3/8 [9.52]	11/32 [8.73]	—	.036 [.91]	1 [25.40]
CPSL-10	10	1-7/8 [47.62]	3/8 [9.52]	11/32 [8.73]	—	.036 [.91]	1-3/8 [34.93]
CPSL-15	15	1-7/8 [47.62]	1/2 [12.70]	1/2 [12.70]	—	.036 [.91]	1-3/8 [34.93]

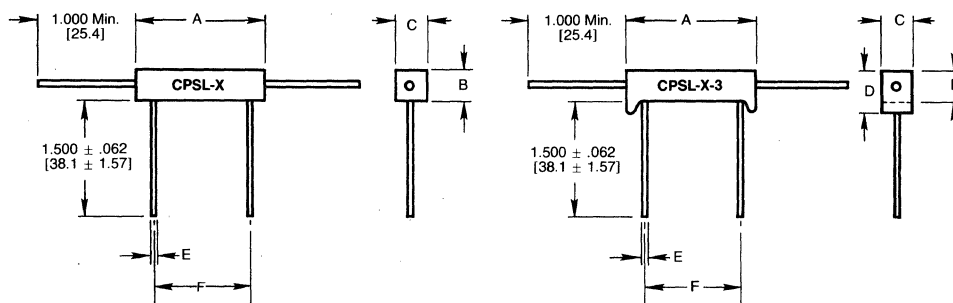

SPECIFICATIONS ELECTRICAL

Resistance: .01Ω to .10Ω
 Tolerance: ±5% standard, ±3% also available
 Dielectric Strength: 1000 VAC
 Temperature Coefficient: ±100 PPM Max.

MECHANICAL

Terminal Strength: 5 lbs. minimum
 Solderability: Meets requirements of MIL-STD-202, Method 208.

DERATING

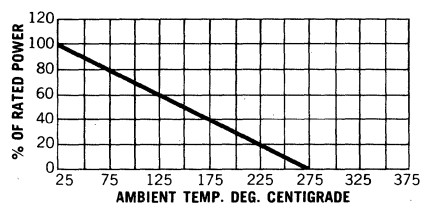

DALE ELECTRONICS, INC., 2064 12th Avenue, Columbus, NE 68601 • Phone 402-564-3131

Canada: Dale Electronics Ltd., 18 Howden Rd., Scarborough, Ontario M1R 3E6
 Europe: Dale Electronics GmbH, Benzstrasse 28, 8039 Puchheim, West Germany



COMMERCIAL POWER WIREWOUND RESISTORS

DALE TYPE CPR RADIAL TERMINAL

FEATURES

- Fireproof inorganic construction
- Special inorganic potting compound provides high thermal conductivity
- Direct mounting on printed circuit board
- Circuit board lock-in mounting tabs
- Fuse styles (Type RF) available

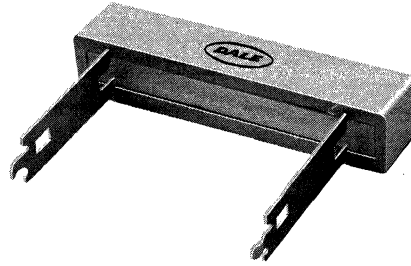

CPR SERIES TERMINAL TYPE [Numbers in brackets indicate millimeters]

DALE TYPE	POWER AT 25°C (Watts)	DIMENSIONS						RESISTANCE RANGE (Ohms)
		A ± .04 [±1.0]	B ± .04 [±1.0]	C ± .06 [±1.5]	D +.08 [+2.0] -.04 [-1.0]	E ± .012 [±0.3]	F ± .008 [±0.2]	
CPR-5	5	1.060 [26.9]	.374 [9.5]	.590 [15.0]	.394 [10.0]	.287 [7.3]	.055 [1.4]	.1 to 700
CPR-7	7	1.398 [35.5]	.374 [9.5]	.886 [22.5]	.984 [25.0]	.287 [7.3]	.055 [1.4]	.1 to 1000
CPR-10	10	1.888 [48.0]	.374 [9.5]	1.38 [35.0]	.984 [25.0]	.287 [7.3]	.055 [1.4]	.1 to 1600
CPR-15	15	1.888 [48.0]	.492 [12.5]	1.28 [32.5]	1.18 [30.0]	.394 [10.0]	.106 [2.7]	.1 to 1600
CPR-20	20	2.498 [63.4]	.492 [12.5]	1.87 [47.5]	1.18 [30.0]	.394 [10.0]	.106 [2.7]	.15 to 2000

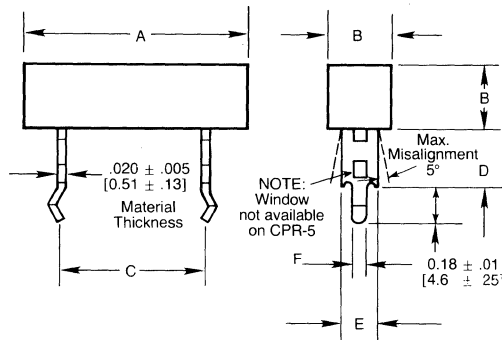

SPECIFICATIONS

ELECTRICAL

Power Rating: 5 watts to 20 watts

Tolerance: ±10%, ±5%

Operating Temperature: -55°C to +275°C

Temperature Coefficient: Below 1 ohm 0 ± 800 PPM
1 ohm and above 0 ± 400 PPM

Max. Working Voltage = \sqrt{PR}

DERATING

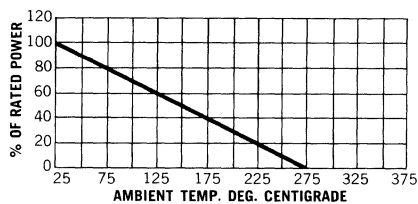

CONSTRUCTION

Resistance wire is a high quality, premium grade wound onto a woven fiberglass core. Tin plated terminals are crimped to wound core. The assembly is then potted into a high quality steatite ceramic case using a high temperature, high thermal conducting inorganic potting compound. This results in a completely fireproof inorganic package.

Fuse Resistor, TYPE RF

Dale RF resistors can reliably function both as a fuse and as a wirewound resistor. Such components involve compromise between fusing and resistive functions and, therefore, each design should be tailored to the application to insure optimum performance. RF resistors are wound with special wire conforming to performance required. Contact factory for design assistance.

DALE ELECTRONICS, INC., 2064 12th Avenue, Columbus, NE 68601 • Phone 402-564-3131

Canada: Dale Electronics Ltd., 18 Howden Rd., Scarborough, Ontario M1R 3E6
Europe: Dale Electronics GmbH, Benzstrasse 28, 8039 Puchheim, West Germany



ESTABLISHED RELIABILITY WIREWOUND RESISTORS

MIL-R-39007, TYPE RWR, R LEVEL DALE TYPE ESS, ESW, EGS, EGW, ESN & EGN

Silicone Coated and Molded
"S" Level Failure Rate Available



FEATURES

- Meets solvent resistance of MIL-STD-202, Method 215.
- 100% power stabilization and screening test.
- Traceability of materials and processing.
- Non-inductive styles – ESN and EGN.
- Covered by U.S. Patent 3,295,090.

STANDARD ELECTRICAL SPECIFICATIONS

DALE TYPE	MIL-R-39007 TYPE	POWER RATING (Watts)	MILITARY RANGE			DALE RANGE (Non-Mil.)			MAX. WEIGHT (Grams)
			.1%	.5 & 1%	.05%	.1%	.25%	.5%, 1%, 3%, 5%	
EGS-1-80*	RWR81S	1	.499-1000	.1-1000	1-1000	.499-1000	.499-3400	.1-3400	.21
EGW-1*	RWR81W	1	.499-1000	.1-1000	1-1000	.499-1000	.499-3400	.1-3400	.21
EGN-1-80*	RWR81N	1	10-499	10-499	1-500	.499-500	.499-1700	.1-1700	.21
EGN-1-10*	RWR81Z	1	10-499	10-499	1-500	.499-500	.499-1700	.1-1700	.21
EGS-2*	RWR82S	1.5	.499-1300	.1-1300	1-1300	.499-1300	.499-4900	.1-4900	.23
EGW-2*	RWR82W	1.5	.499-1300	.1-1300	1-1300	.499-1300	.499-4900	.1-4900	.23
EGS-3-80*	RWR80S	2	.499-3160	.1-3160	1-2700	.499-3160	.499-10,400	.1-10,400	.34
EGW-3*	RWR80W	2	.499-3160	.1-3160	1-2700	.499-3160	.499-10,400	.1-10,400	.34
EGN-3-80*	RWR80N	2	10-1580	10-1580	1-1350	.499-1580	.499-5200	.1-5200	.34
EGN-3-10*	RWR80Z	2	10-1580	10-1580	1-1350	.499-1580	.499-5200	.1-5200	.34
ESS-2A	RWR71S	2	.499-12.1K	.1-12.1K	.499-11.4K	.499-11.4K	.1-42.1K	.1-42.1K	.90
ESW-2A	RWR71W	2	.499-12.1K	.1-12.1K	.499-11.4K	.499-11.4K	.1-42.1K	.1-42.1K	.90
ESN-2A	RWR71N	2	10-6.04K	10-6.04K	.499-5.7K	.499-5.7K	.1-21.05K	.1-21.05K	.90
ESN-2A-10	RWR71Z	2	10-6.04K	10-6.04K	.499-5.7K	.499-5.7K	.1-21.05K	.1-21.05K	.90
ESS-2B	RWR89S	3	.499-4120	.1-4120	.499-6500	.499-6500	.1-24,500	.1-24,500	.70
ESW-2B	RWR89W	3	.499-4120	.1-4120	.499-6500	.499-6500	.1-24,500	.1-24,500	.70
ESN-2B	RWR89N	3	10-2050	10-2050	.499-3250	.499-3250	.1-12,250	.1-12,250	.70
ESN-2B-10	RWR89Z	3	10-2050	10-2050	.499-3250	.499-3250	.1-12,250	.1-12,250	.70
ESS-5	RWR74S	5	.499-12,100	.1-12,100	.499-24,500	.499-24,500	.1-91,000	.1-91,000	4.2
ESW-5	RWR74W	5	.499-12,100	.1-12,100	.499-24,500	.499-24,500	.1-91,000	.1-91,000	4.2
ESN-5	RWR74N	5	10-6040	10-6040	.499-12,200	.499-12,200	.1-45,500	.1-45,500	4.2
ESN-5-10	RWR74Z	5	10-6040	10-6040	.499-12,200	.499-12,200	.1-45,500	.1-45,500	4.2
EGS-10-80	RWR84S	7	.499-12,400	.1-12,400	.499-24,500	.499-24,500	.1-91,000	.1-91,000	3.6
EGW-10	RWR84W	7	.499-12,400	.1-12,400	.499-24,500	.499-24,500	.1-91,000	.1-91,000	3.6
EGN-10-80	RWR84N	7	10-6190	10-6190	.499-12,200	.499-12,200	.1-45,500	.1-45,500	3.6
EGN-10-10	RWR84Z	7	10-6190	10-6190	.499-12,200	.499-12,200	.1-45,500	.1-45,500	3.6
ESS-10	RWR78S	10	.499-39,200	.1-39,200	.499-71,500	.499-71,500	.1-265,000	.1-265,000	9.0
ESW-10	RWR78W	10	.499-39,200	.1-39,200	.499-71,500	.499-71,500	.1-265,000	.1-265,000	9.0
ESN-10	RWR78N	10	10-19,600	10-19,600	.499-35,700	.499-35,700	.1-132,500	.1-132,500	9.0
ESN-10-10	RWR78Z	10	10-19,600	10-19,600	.499-35,700	.499-35,700	.1-132,500	.1-132,500	9.0

*Molded models. All others have conformal coating.

SPECIFICATIONS

APPLICABLE MIL-SPECIFICATION

MIL-R-39007: This is the military specification covering axial lead established reliability power wirewound resistors. Dale ESS, ESW, EGS, EGW, ESN and EGN resistors meet or exceed the electrical, environmental and dimensional requirements of this specification.

MECHANICAL

Terminal Strength: 5 lb. pull for 2-watt size and smaller, 10 lb. pull for 3-watt size and larger.

Solderability: Meets requirements of MIL-STD-202, Method 208.

Solvent Resistance: Meets requirements of MIL-STD-202, Method 215.

ELECTRICAL

Tolerance: These types are available in .1%, .5% and 1% tolerances.

Dielectric Strength: 500 VAC for 2-watt size and smaller. 1000 VAC for 3-watt size and larger.

Insulation Resistance: 1000 megohms minimum.

Short Time Overload: 5 seconds at 5 times rated power for 3-watt size and smaller. 5 seconds at 10 times rated power for 5-watt size and larger.

MATERIAL

Core: Beryllium oxide, alumina and steatite are used, depending on power requirement.

Element: Copper-nickel alloy or nickel-chromium alloy, depending on resistance value.

End Caps: Stainless steel or alloy #46.

Coating: Special high temperature silicone.

Leads: Both solderable and weldable lead materials are available. Solderable – Tinned Copperweld® per MIL-STD-1276, Type W-5. Weldable – Bare Nickel per MIL-STD-1276, Type N-1.

Terminal and Winding: The terminal and the winding are identified by a letter symbol in the military type designation.

Military Symbol	Terminal and Winding
S	SOLDERABLE, INDUCTIVELY WOUND
W	WELDABLE, INDUCTIVELY WOUND
N	SOLDERABLE, NON-INDUCTIVELY WOUND
Z	WELDABLE, NON-INDUCTIVELY WOUND

NOTE: All resistance ranges shown conform to military specifications unless otherwise indicated.

DALE TYPE ESS, ESW, EGS, EGW, ESN, and EGN

POWER RATING

Power ratings are based on a maximum ΔR of .5% + .05 ohm when operated for 2000 hours at rated power and at an ambient of +25° C.

DERATING

These units have an operating temperature range of -55° C to +275° C. For ambient temperatures above +25° C, they must be derated according to the following curve.

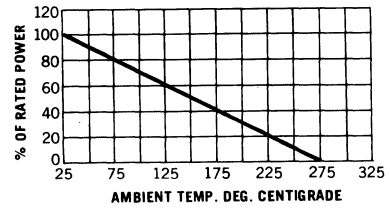

ACCEPTANCE TESTING

TEST	TEST CONDITIONS	LIMITS	SAMPLE SIZE
Power Conditioning	100 hours at rated power and +25°C	.2% + .005Ω	Group A—Sub-Group I, 100%
D.C. Resistance	MIL-STD-202, Method 303	Within tolerance	
Visual & Mechanical	Visual inspection		Group A—Sub-Group II, Level S-4 AQL 1% major • AQL 4% minor AQL 2.5%
Dielectric Strength	500V or 1000V	.1% + .005Ω	
Solderability	Method 208, MIL-STD-202	95% coverage	
Resistance to Solvents	Method 215, MIL-STD-202		
Thermal Shock	Method 107, MIL-STD-202, Condition B	.2% + .005Ω	Group B
Short Time Overload	5 seconds at 10 or 5 times rated power	.2% + .005Ω	AQL 2.5% Level S-4
Insulation Resistance	Method 302, MIL-STD-202, Condition A	1000 megohms	
Load Life	10,000 hours at rated power +25°C	1% + .005Ω	Group C (Monthly)—Sub-Group I
Thermal Shock	Method 107, MIL-STD-202, Condition B	.2% + .005Ω	
T.C.	-55°C to +275°C	0 ± 650 PPM/°C .1Ω-.499Ω 0 ± 400 PPM/°C .499Ω-1Ω 0 ± 50 PPM/°C 1Ω-10Ω 0 ± 20 PPM/°C 10Ω & up	
Low Temperature Storage	-65°C for 24 Hours	.1% + .005Ω	Group C (Monthly)— Sub-Group II, 10 Samples
Dielectric Strength	500V or 1000V	.1% + .005Ω	
Insulation Resistance	Method 302, MIL-STD-202, Condition A	1000 megohms	
Moisture	Method 106, MIL-STD-202	.2% + .005Ω	
Terminal Strength	5 lb. or 10 lb. pull	.1% + .005Ω	
Thermal Shock	Method 107, MIL-STD-202, Condition B	.2% + .005Ω	
Shock	Method 205, MIL-STD-202, Condition C	.1% + .005Ω	Group C (Semiannual)—Sub-Group I, 30 Samples
Vibration	Method 204, MIL-STD-202, Condition D	.1% + .005Ω	
Reactance	Non-Inductive Only		Group C (Semiannual)—Sub-Group II, 30 Samples
High Temp. Exposure	+275°C for 2000 hours	.5% + .05Ω	Group C (Annual)—102 Samples

PHYSICAL CONFIGURATIONS

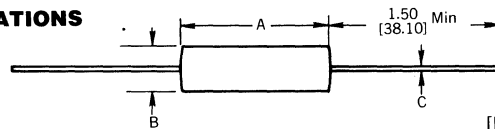

[Numbers in brackets indicate millimeters]

	MIL. TYPE	DIM. A	DIM. B	DIM. C
MOLDED MODELS	RWR81	.250 ± .015 [6.35 ± .381]	.078 ± .015 [1.98 ± .381]	.020 ± .0015 [.508 ± .038]
	RWR82	.312 ± .015 [7.92 ± .381]	.078 ± .015 [1.98 ± .381]	.020 ± .0015 [.508 ± .038]
	RWR80	.422 ± .015 [10.72 ± .381]	.110 ± .015 [2.79 ± .381]	.020 ± .0015 [.508 ± .038]
COATED MODELS	RWR71	.812 ± .062 [20.62 ± 1.58]	.187 ± .031 [4.75 ± .787]	.032 ± .002 [.813 ± .051]
	RWR 89	.560 ± .062 [14.22 ± 1.58]	.187 ± .031 [4.75 ± .787]	.032 ± .002 [.813 ± .051]
	RWR74	.875 ± .062 [22.23 ± 1.58]	.312 ± .031 [7.92 ± .787]	.040 ± .002 [1.02 ± .051]
	RWR84	.875 ± .062 [22.23 ± 1.58]	.312 ± .031 [7.92 ± .787]	.040 ± .002 [1.02 ± .051]
	RWR78	1.780 ± .062 [45.21 ± 1.58]	.375 ± .031 [9.52 ± .787]	.040 ± .002 [1.02 ± .051]



**ESTABLISHED RELIABILITY
WIREWOUND RESISTORS**

**MIL-R-39009, TYPE RER, R LEVEL
DALE TYPE ERH & ENH
Aluminum Housed**

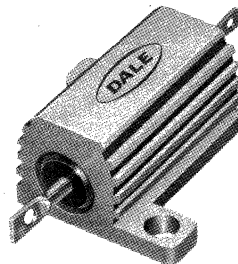

FEATURES

- Standard (ERH) or non-inductive (ENH) winding
- Molded construction gives complete environmental protection
- Complete welded construction
- Screw mounts on chassis to utilize heat sink effect
- High stability at conventional power ratings
- Flat marking surface for easy identification
- Covered by U.S. Patents 201,884, 3,201,855 and 3,206,704
- 100% power stabilization and screening tests

STANDARD ELECTRICAL SPECIFICATIONS

DALE TYPE	MIL-R-39009 TYPE	POWER RATING (Watts)		MILITARY RESISTANCE RANGE (Ohms) 1%	MAX. WORKING VOLTAGE	MAX. WEIGHT (Grams)	MIL-R-39009 STANDARD TEMPERATURE COEFFICIENT VALUE RANGES (Ohms)		
		MOUNTED	FREE AIR				±100 PPM	±50 PPM	±30 PPM
ENH-5	RER40	5	3	1 to 1.65K	128.9	3.3	—	1 to 19.9	20 to 1.65K
ENH-10	RER45	10	6	1 to 2.8K	190	8.8	—	1 to 19.9	20 to 2.8K
ENH-25	RER50	20	8	1 to 6.04K	390	16.5	—	1 to 19.9	20 to 6.04K
ENH-50	RER55	30	10	1 to 19.6K	890	35.0	—	1 to 19.9	20 to 19.6K
ERH-5	RER60	5	3	0.10 to 3.32K	160	3	.1 to .99	1 to 19.9	20 to 3.32K
ERH-10	RER65	10	6	0.10 to 5.62K	265	6	.1 to .99	1 to 19.9	20 to 5.62K
ERH-25	RER70	20	8	0.10 to 12.1K	550	13	.1 to .99	1 to 19.9	20 to 12.1K
ERH-50	RER75	30	10	0.10 to 39.2 K	1250	28	.1 to .99	1 to 19.9	20 to 39.2K

NOTE: All resistance ranges shown conform to military specifications unless otherwise indicated.

SPECIFICATIONS

ELECTRICAL

Tolerance: Only mil. spec. tolerance available is ±1%.

Dielectric Strength: 1000 VAC on 5, 10 and 25 watt units, 2000 VAC on 30 watt unit.

Insulation Resistance: 10,000 megohms minimum dry, 1,000 megohms minimum after moisture test.

MECHANICAL

Terminal Strength: 5 lb. pull test on 5 and 10 watt units. 10 lb. pull test on 20 and 30 watt units.

Solderability: Satisfactory when tested in accordance with Method 208 of MIL-STD-202.

MATERIAL

Core: Ceramic: Steatite or alumina, depending on physical size.

Element: Copper-nickel alloy or nickel-chrome alloy, depending on resistance value.

End Caps: Stainless steel.

Sealant: Molded construction.

Housing: Aluminum with hard anodic coating.

Terminals: Tinned Copperweld®

ENVIRONMENTAL

GENERAL: Testing of ERH and ENH resistors are done according to the procedures and test methods described in MIL-R-39009. The table below shows the military and the Dale performance requirements. All ΔR figures are maximums.

ENVIRONMENTAL SPECIFICATIONS

TEST	MIL-R-39009	DALE TYPICAL
Load Life (2,000 hours)	$\pm(1\% + 0.05\Omega) \Delta R$	$\pm(.5\% + 0.05\Omega) \Delta R$
Moisture Resistance	$\pm(.5\% + 0.05\Omega) \Delta R$	$\pm(.25\% + 0.05\Omega) \Delta R$
Resistance - Temperature Characteristic	± 30 PPM 20Ω and up ± 50 PPM 1Ω to 19.60Ω ± 100 PPM below 1Ω	See Table
Thermal Shock	$\pm(.3\% + .05\Omega) \Delta R$	$\pm(.2\% + 0.05\Omega) \Delta R$
Momentary Overload	$\pm(.3\% + 0.05\Omega) \Delta R$	$\pm(.15\% + 0.05\Omega) \Delta R$
Dielectric	$\pm(.2\% + 0.05\Omega) \Delta R$	$\pm(.2\% + 0.05\Omega) \Delta R$
High Temp. Storage (2 hours)	$\pm(.5\% + 0.05\Omega) \Delta R$	$\pm(.25\% + 0.05\Omega) \Delta R$
Shock	$\pm(.2\% + 0.05\Omega) \Delta R$	$\pm(.1\% + 0.05\Omega) \Delta R$
Vibration	$\pm(.2\% + 0.05\Omega) \Delta R$	$\pm(.1\% + 0.05\Omega) \Delta R$
Terminal Strength	$\pm(.2\% + 0.05\Omega) \Delta R$	$\pm(.1\% + 0.05\Omega) \Delta R$
High Temp. Exposure (2,000 hours)	$\pm(1\% + 0.05\Omega) \Delta R$	$\pm(.75\% + 0.05\Omega) \Delta R$

POWER RATING

Dale ERH and ENH resistor ratings are based on the following requirements:

- 275°C maximum internal hotspot temperature.
- 1% maximum ΔR in 2000 hour load life.
- Proper heat sink:

4x6x2x.040 aluminum chassis for ERH-5, ENH-5, ERH-10 and ENH-10
5x7x2x.040 aluminum chassis for ERH-25, ENH-25, ERH-50 and ENH-50.

DERATING

ERH and ENH resistors have an operating temperature range of -55°C to $+275^{\circ}\text{C}$. Derating is required for reduced chassis mounting area and for high ambient temperatures. The following curves apply to operation of unmounted resistors:

A = ERH-5, ENH-5, ERH-10, ENH-10
B = ERH-25, ENH-25 C = ERH-50, ENH-50

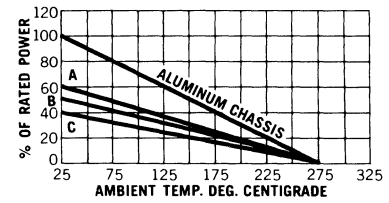

PHYSICAL CONFIGURATIONS

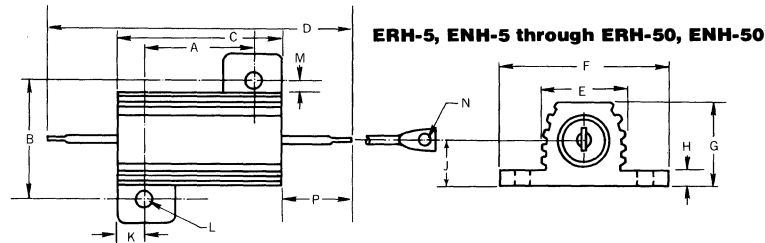

DIMENSIONS [Numbers in brackets indicate millimeters]

TYPE	A	B	C	D	E	F	G	H	J	K	L	M	N	P
ERH-5, ENH-5	.444 [11.28] $\pm .127$.490 [12.45] $\pm .127$.600 [15.24] $\pm .787$	1.125 [28.58] ± 1.58	.334 [8.48] $\pm .381$.646 [16.41] $\pm .381$.320 [8.13] $\pm .381$.065 [1.65] $\pm .254$.133 [3.38] $\pm .254$.078 [1.98] $\pm .254$.093 [2.36] $\pm .127$.078 [1.98] $\pm .381$.050 [1.27] $\pm .127$.262 [6.65] ± 1.58
ERH-10, ENH-10	.562 [14.27] $\pm .127$.625 [15.88] $\pm .127$.750 [19.05] $\pm .787$	1.375 [34.93] ± 1.58	.420 [10.67] $\pm .381$.800 [20.32] $\pm .381$.390 [9.91] $\pm .381$.075 [1.90] $\pm .254$.165 [4.19] $\pm .254$.093 [2.36] $\pm .254$.093 [2.36] $\pm .127$.102 [2.59] $\pm .381$.086 [2.18] $\pm .127$.312 [7.92] ± 1.58
ERH-25, ENH-25	.719 [18.26] $\pm .127$.781 [19.84] $\pm .127$	1.062 [26.97] $\pm .787$	1.938 [49.23] ± 1.58	.550 [13.97] $\pm .381$	1.080 [27.43] $\pm .381$.546 [13.87] $\pm .381$.075 [1.90] $\pm .254$.231 [5.87] $\pm .254$.172 [4.37] $\pm .254$.125 [3.18] $\pm .127$.115 [2.92] $\pm .381$.086 [2.18] $\pm .127$.438 [11.13] ± 1.58
ERH-50, ENH-50	1.563 [39.70] $\pm .127$.844 [21.44] $\pm .127$	1.968 [49.99] $\pm .787$	2.781 [70.64] ± 1.58	.630 [16.00] $\pm .381$	1.140 [28.96] $\pm .381$.610 [15.49] $\pm .381$.088 [2.24] $\pm .254$.260 [6.60] $\pm .254$.196 [4.98] $\pm .254$.125 [3.18] $\pm .127$.107 [2.72] $\pm .381$.086 [2.18] $\pm .127$.406 [10.31] ± 1.58



SPECIAL PURPOSE WIREWOUND RESISTORS

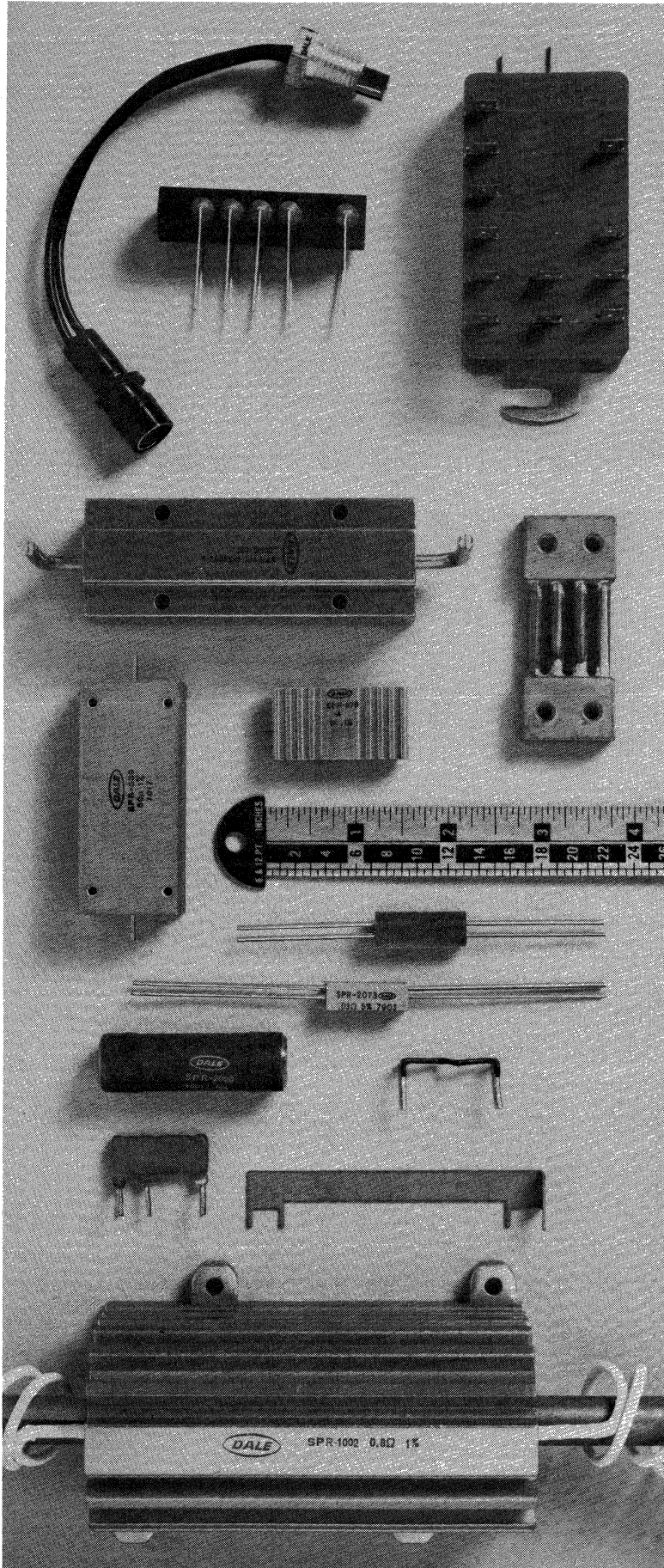

RESISTORS ENGINEERED TO YOUR SPECIAL REQUIREMENTS

The photo at left illustrates only a few of the many special purpose wirewound resistors built in the Dale Special Products Section within the Wirewound Division.

Full-time engineers assigned to this section draw on the industry's largest file of non-standard resistor design and production information. They can often in a matter of minutes determine a fast, practical route to the production of your non-standard part.

The list below shows some of the options and combinations which can be achieved:

WIREWOUND OPTIONS

Packaging: Heat sink, silicone coated, epoxy or silicone molded (single or multi-element), hermetic seal (ceramic tube or metal can encapsulated), clip mounted.

Leads: Radial and axial type, special materials and dimensions, spaded, threaded, insulated, quick-disconnect eyelet, printed circuit, ferrule.

Matching: T.C. by pairs, value and sets, close tolerance, resistance ratio.

Special Types: Extended low or high resistance range, adjustable, low reactance, special wire alloys, very low or high T.C., high stability, special tolerances, tapped, water cooled, temperature sensitive, inductive.

Pre-conditioning: Power aging, temperature cycling, temperature and power, short-time overload, thermal shock, X-ray, temperature aging.

Shunts: Low value, 4-terminal resistors built to customer specifications or designed by our engineers to meet your current sensing requirements.

Fuse Resistors: Are hybrid components designed to act as an ordinary resistor under normal circuit conditions, and as a fuse under fault conditions. Dale offers a variety of standard types, physical sizes and basic styles. Each application should be referred to Dale for an individual design to insure optimum performance in any particular circuit.

FOR FAST ATTENTION TO YOUR SPECIAL
RESISTOR REQUIREMENTS, call or write:
Special Products Section
Wirewound Division
DALE ELECTRONICS, INC.
2064 12th Avenue, Columbus, NE 68601
Phone 402-564-3131





QUICK REFERENCE INDEX TRIMMER and PRECISION POTENTIOMETERS

COMMERCIAL/INDUSTRIAL GRADE POTENTIOMETERS – Wirewound

MODEL	SEAL TYPE	CONFIGURATION	STANDARD RESISTANCE & TOLERANCE	POWER RATING	OPERATING TEMP. RANGE	ADJUSTMENT TURNS	HEIGHT	WIDTH	LENGTH
 721	5	} Printed Circuit Terminals	10 ohms to 20K ohms $\pm 10\%$	1 watt at 70°C, derated to 0 at 150°C	-65°C to 150°C	25 turns nominal	.25	.165	.75
723	5								
724	5								

COMMERCIAL/INDUSTRIAL GRADE POTENTIOMETERS – CERMET

MODEL	SEAL TYPE	CONFIGURATION	STANDARD RESISTANCE & TOLERANCE	POWER RATING	OPERATING TEMP. RANGE	ADJUSTMENT TURNS	HEIGHT	WIDTH	LENGTH
 781 I	5	} Printed Circuit Terminals	10 ohms to 2 Megohms $\pm 10\%$	0.75 watt at 70°C, derated to 0 at 125°C	-55°C to 125°C	25 turns nominal	.25	.165	.75
783 I	5								
784 I	5								
 101T	5	} Printed Circuit Terminals for top and side adjustment	10 ohms to 2 Megohms $\pm 10\%$.5 watt at 85°C derated to 0 at 125°C	-55°C to 125°C	Single turn	.19	.375	.375
102T	5								
150TX	5								
101SR	5								
101SX	5								
150SX	5								
100SX	5								

PROFESSIONAL GRADE POTENTIOMETERS – CERMET

MODEL	SEAL TYPE	CONFIGURATION	STANDARD RESISTANCE & TOLERANCE	POWER RATING	OPERATING TEMP. RANGE	ADJUSTMENT TURNS	HEIGHT	WIDTH	LENGTH
 781 P	5	} Printed Circuit Terminals	10 ohms to 2 Megohms $\pm 10\%$	1 watt at 70°C, derated to 0 at 125°C	-55°C to 125°C	25 turns nominal	.25	.165	.75
783 P	5								
784 P	5								

TRANSLUCENT COVER MODELS

Models 981, 983, and 984 have electrical and mechanical specifications identical to Models 781, 783, and 784 and include a translucent case for determining wiper location.

SEAL TYPE 5

Immersion proof – sealed for board washing – leak tested in 70°C water

ORDERING INFORMATION

When ordering specify model, resistance value and tolerance.

EXAMPLE: 984P, 10K ohm, 10%

(Translucent case professional grade cermet potentiometer)

SURFACE MOUNTED CHIP POTENTIOMETERS



See page 4.



DALE SERIES 721, 723, 724, 921, 923, 924

Low Profile Wirewound Trimmers

FEATURES

- All metal screw and one-piece clutch prevents overtravel damage
- Patented side collector provides excellent setting stability
- A full watt in less space at 70°C
- Translucent case available (920 series)

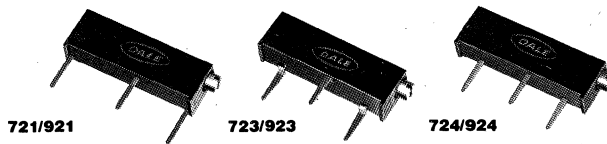

- Sealed for production soldering
- 25-turn screwdriver adjustment for better adjustability
- Panel mount option available

STANDARD RESISTANCE VALUES AND NOMINAL RESOLUTION

Standard tolerance $\pm 10\%$, lower tolerance available.

RESISTANCE (Ohms)	RESOLUTION %	RESISTANCE (Ohms)	RESOLUTION %
10	1.45	1K	.47
20	1.12	2K	.42
50	.89	5K	.30
100	.81	10K	.25
200	.70	20K	.21
500	.68		

PRINTED CIRCUIT PINS

MODEL	LOCATION
721/921	.300 [7.62] x .700 [17.78] x .100 [2.54]
723/923	.200 [5.08] x .500 [12.70] x .200 [5.08]
724/924	.200 [5.08] x .500 [12.70] x .100 [2.54]

HOW TO ORDER: When ordering, specify model, resistance and tolerance. Example: 724, 10K, 10%.

SPECIFICATIONS

ELECTRICAL

Resistance Range: 10 ohms to 20K ohms

Standard Resistance Tolerance: $\pm 10\%$

Absolute Minimum Resistance: 0.5% or 1.0 ohm, whichever is greater

ENR Noise: 100 ohms maximum

Insulation Resistance, 500 VDC: 100 Megohms minimum

Temperature Coefficient: ± 50 PPM/ $^{\circ}$ C maximum

Electrical Adjustment: 22 ± 3 turns

MECHANICAL

Mechanical Adjustment: 25 ± 3 turns

Shaft Torque: 0.1 oz./in. minimum, 5.0 oz./in. maximum

Mechanical Stops: None. Clutch mechanism permits overtravel without damage

Weight: 2.0 grams maximum

Marking: Dale Part No., Terminal Numbers, Resistance Value and Date Code

ENVIRONMENTAL

Power Rating: 1.0 watt at 70°C, derated to 0 at 150°C

Operating Temperature Range: -65° C to $+150^{\circ}$ C

Immersion Proof: Sealed for board washing. Leak tested in 70°C water

Shock: Per MIL-STD-202, Method 213, 100G Contact Bounce: 0.1 millisecond max. Max. Wiper Shift: 1% plus resolution

Vibration: Per MIL-STD-202, Method 204, 20G Contact Bounce: 0.1 millisecond max. Max. Wiper Shift: 1% plus resolution

Sand & Dust: Per MIL-E-5272, Procedure 1

Solvent Resistance: Both the 720 and 920 series are resistant to all common cleaning solvents.

Dielectric Strength: Per MIL-STD-202, Method 301

Room Condition: 1000 VRMS
At 70,000 feet: 250 VRMS

Load Life: 1000 hours, 1 watt at 70°C
Maximum Shift: $\pm 2\%$

Mechanical Life: 200 cycles without discontinuity

DERATING CHART

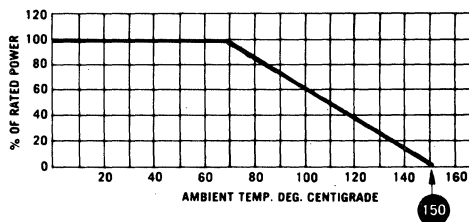

TRANSLUCENT COVER MODELS

Models 921, 923 and 924 have electrical and mechanical specifications identical to Models 721, 723 and 724 and include a translucent case for determining wiper location.

DIMENSIONS AND TERMINAL CONFIGURATIONS

[Numbers in brackets indicate millimeters]

TOLERANCE INCHES .XXX ± .005
 XX ± .010
 [TOLERANCE MM] .XXX ± .127
 XX ± .254

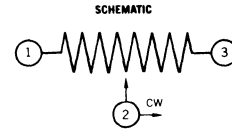

721/921

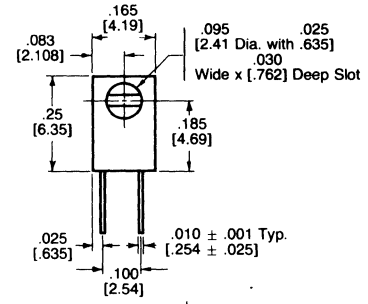
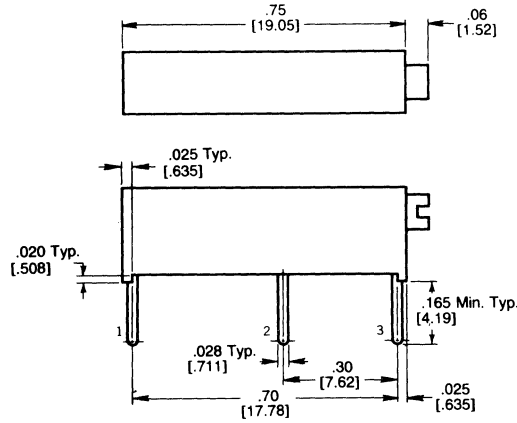

723/923

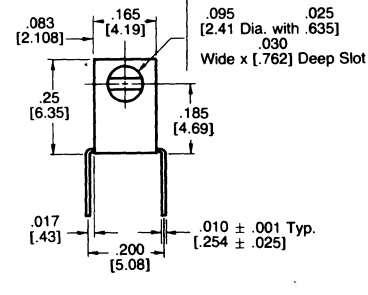
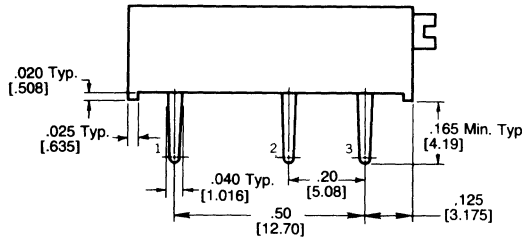

724/924

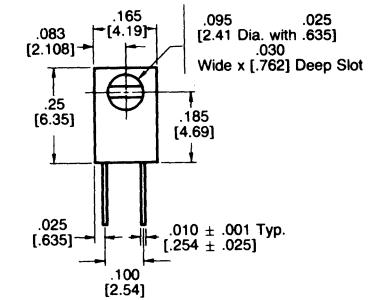
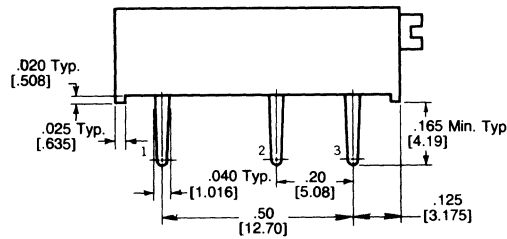

LOW PROFILE STANDOFFS

Standoffs available for above models increasing height of adjustment screw center to mounting surface from .185" [4.70 mm] to .244" [6.20 mm].

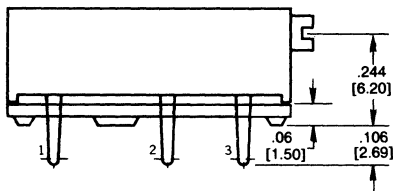

STANDOFF MODEL 700 A

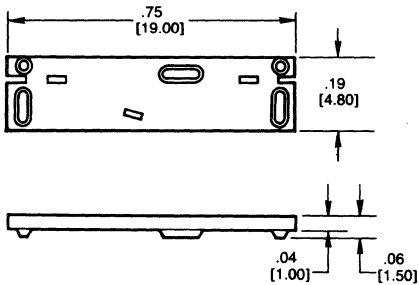

PANEL MOUNT ADAPTER MODEL 700 P

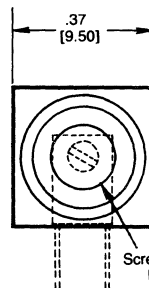
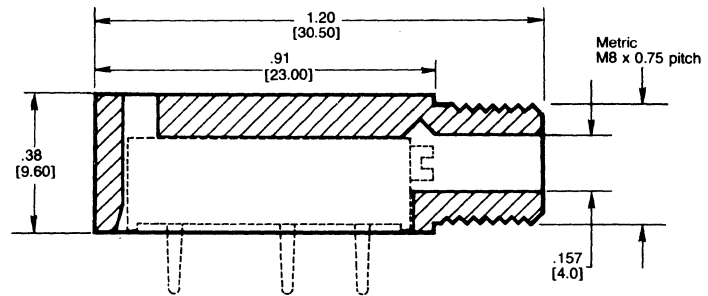

ORDERING INFORMATION

STANDOFFS
 Assembled—Use trimmer model no. with suffix "A" (Ex. 724 A).
 Unassembled—Order part no. 700 A.

PANEL MOUNT ADAPTERS
 Assembled—Use trimmer model no. with suffix "P" (Ex. 724 P).
 Unassembled—Order part no. 700 P.

Model 700 P is supplied with lock washer and hex nut for panel mounting.



DALE SERIES 781 I, 783 I, 784 I 981 I, 983 I, 984 I

Industrial Grade Low Profile Cermet Trimmers

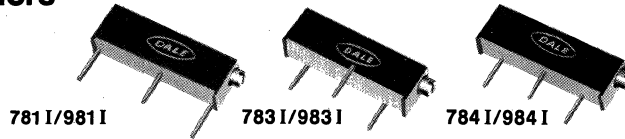
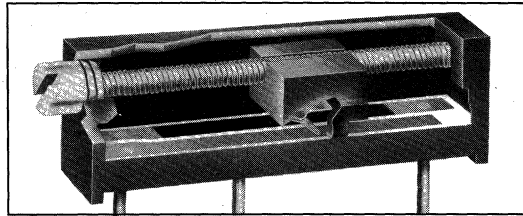

FEATURES

- All-metal screw and one-piece clutch prevents overtravel damage
- Low cost
- 1.25 Watt at 25 °C
- Multiwire wiper for excellent CRV of less than 1%
- Sealed for production soldering
- 25-turn screwdriver adjustment for better adjustability
- Translucent case available (980 I series)
- Panel mount option available

STANDARD RESISTANCE VALUES

Ohms	Ohms	Ohms	Ohms
10	500	20K	250K
20	1K	25K	500K
50	2K	50K	1 Meg.
100	5K	100K	2 Meg.
200	10K	200K	

PRINTED CIRCUIT PINS

MODEL	LOCATION
781I/981I	.300 [7.62] x .700 [17.78] x .100 [2.54]
783I/983I	.200 [5.08] x .500 [12.70] x .200 [5.08]
784I/984I	.200 [5.08] x .500 [12.70] x .100 [2.54]

HOW TO ORDER: When ordering, specify model, resistance and tolerance. Example: 784 I, 10K, 10%.

SPECIFICATIONS

ELECTRICAL

- Resistance Range:** 10 ohms to 2 Megohms
- Standard Resistance Tolerance:** $\pm 10\%$
- Absolute Minimum Resistance:** 2 ohms max.
- Temperature Coefficient:** ± 100 PPM/°C
- Contact Resistance Variation:** 1 ohm or 1%, whichever is greater.
- Insulation Resistance, 500 VDC:** 100 Megohms minimum
- Resolution:** Essentially infinite
- Adjustability:** Output Resistance = $\pm 0.10\%$
Output Voltage Ratio = $\pm 0.05\%$
- Input Voltage:** 300 VDC (RMS) or within power rating, whichever is less
- Electrical Adjustment:** 22 ± 3 turns

MECHANICAL

- Mechanical Adjustment:** 25 ± 3 turns
- Shaft Torque:** 5.0 oz./in. maximum
- Mechanical Stops:** None. Clutch mechanism permits overtravel without damage
- Weight:** 2.0 grams maximum
- Marking:** Dale Part Number, Terminal Numbers, Resistance Value and Date Code

ENVIRONMENTAL

- Power Rating:** 0.75 watt at 70 °C, 1.25 watt at 25 °C, derated to 0 at +125 °
- Operating Temperature Range:** -55 °C to +125 °C
- Immersion Proof:** Sealed for board washing. Leak tested in 70 °C water.
- Shock:** Per MIL-STD-202, Method 213, 100G Contact Bounce: 0.1 millisecond max.
- Solvent Resistance:** Both the 780 and 980 series are resistant to all common cleaning solvents.
- Vibration:** Per MIL-STD-202, Method 204, 20G Contact Bounce: 0.1 millisecond max.
- Sand & Dust:** Per MIL-E-5272C, Procedure 1
- Dielectric Strength:** Per MIL-STD-202, Method 301 Room Condition: 1000 VAC At 70,000 feet: 250 VAC
- Mechanical Life:** 200 cycles without discontinuity

DERATING CHART

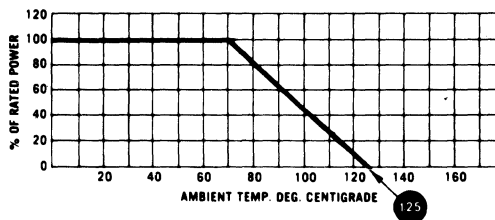

TRANSLUCENT COVER MODELS

Models 981 I, 983 I and 984 I have electrical and mechanical specifications identical to Models 781 I, 783 I and 784 I and include a translucent case for determining wiper location.

DIMENSIONS AND TERMINAL CONFIGURATIONS
 [Numbers in brackets indicate millimeters]

TOLERANCE INCHES .XXX ± .005
 .XX ± .010
 [TOLERANCE MM] .XXX ± .127
 .XX ± .254

SCHMATIC

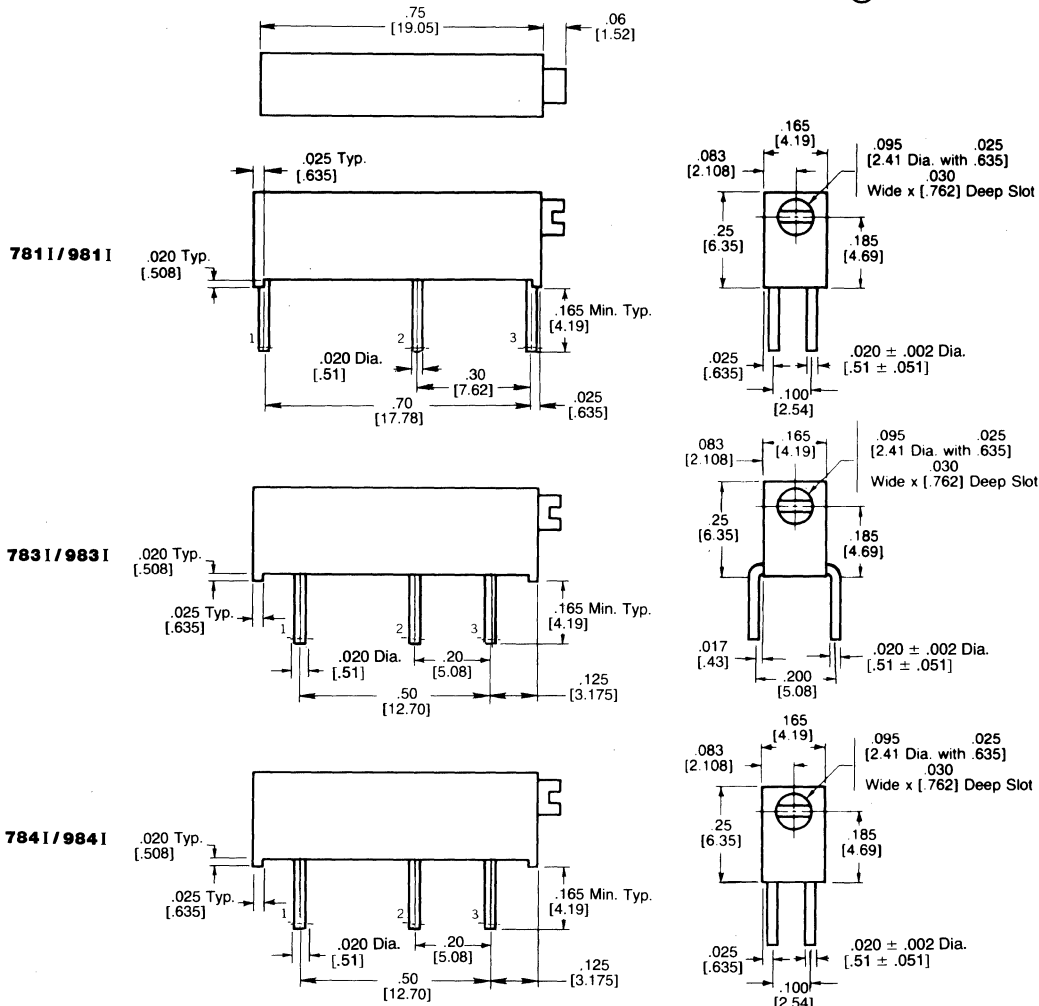
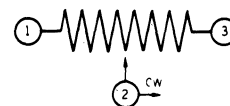

LOW PROFILE STANDOFFS

Standoffs available for above models increasing height of adjustment screw center to mounting surface from .185" [4.70 mm] to .244" [6.20 mm].

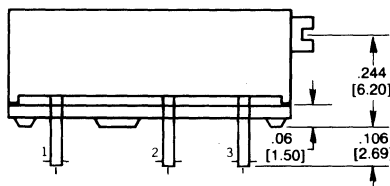

STANDOFF MODEL 700 A

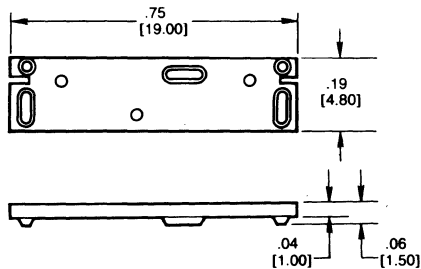

PANEL MOUNT ADAPTER

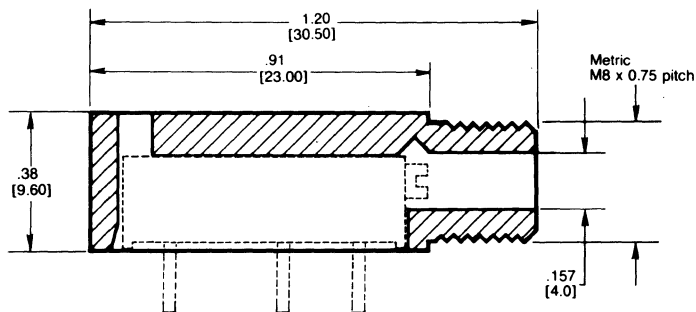

ORDERING INFORMATION STANDOFFS

Assembled — Use trimmer model no. with suffix "A" (Ex. 784 IA)
 Unassembled — Order Part no. 700 A.

PANEL MOUNT ADAPTERS

Assembled — Use trimmer model no. with suffix "P" (Ex. 784 IP)
 Unassembled — Order Part no. 700 P.

Model 700 P is supplied with lock washer and hex nut for panel mounting.

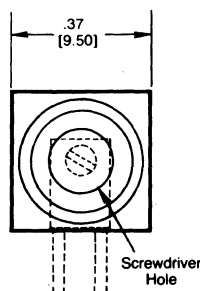



DALE SERIES 100, SINGLE TURN TRIMMERS

Cermet Element, Top and Side Adjustment

FEATURES

- 100 PPM TCR
- Small $\frac{3}{8}$ " [9.53] square package for printed circuit use
- Provides excellent setting stability
- Multiwire wiper for excellent CRV of less than 1%
- Dissipates $\frac{1}{2}$ watt at 85 °C
- Suitable for production soldering
- Single-turn screwdriver adjustment
- Solid stops
- Fully sealed to permit cleaning in common solvents

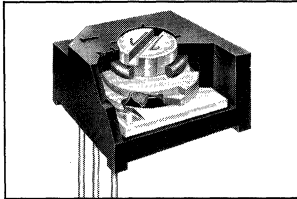

TOP ADJUSTMENT STYLES

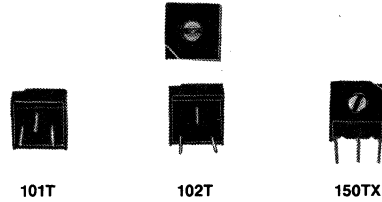

SIDE ADJUSTMENT STYLES

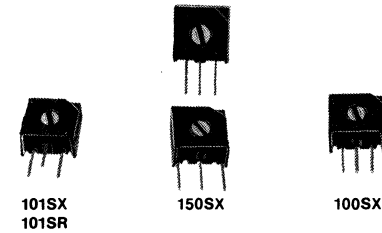

STANDARD RESISTANCE VALUES

Ohms	Ohms	Ohms	Ohms
10	500	20K	250K
20	1K	25K	500K
50	2K	50K	1 Meg.
100	5K	100K	2 Meg.
200	10K	200K	

PRINTED CIRCUIT PINS

MODEL	LOCATION	
101T	.100 x .100 [2.54 x 2.54] Offset	
102T	.100 x .200 [2.54 x 5.08] Offset	Top Adjust
150TX	.150 [3.81] In-Line	
101SR	.100 x .100 [2.54 x 2.54] Offset	
101SX	.100 x .100 [2.54 x 2.54] Offset	Side Adjust
150SX	.150 [3.81] In-Line	
100SX	.100 [2.54] In-Line	

HOW TO ORDER: When ordering, specify model, resistance and tolerance. Example: 101T, 10K, 10%.

SPECIFICATIONS

ELECTRICAL

Resistance Range: 10 ohms to 2 Meg.
Standard Resistance Tolerance: $\pm 10\%$
Absolute Minimum Resistance: 2 ohms max.
Continuity: Maintained for full mechanical range
Insulation Resistance, 500 VDC: 100 Megohms minimum
Resolution: Essentially infinite
Input Voltage: 300 VDC (RMS) or within power rating, whichever is less
Temperature Coefficient:
 ± 100 PPM/ $^{\circ}$ C STD
 -55° C to $+125^{\circ}$ C
Contact Resistance Variation: 1 ohm or 1%, whichever is greater
Effective Electrical Travel: 280° nominal
Adjustability: (Per VRCI-T-215A)
 Voltage ratio $\pm .05\%$
 Resistance $\pm .10\%$

MECHANICAL

Mechanical Travel: 290° nominal
Shaft Torque: 5.0 oz./in. maximum
Mechanical Stops: Solid. 15 oz./in. minimum strength.
Weight: 2 grams nominal
Marking: Dale Part Number, Resistance Value, and Date Code

ENVIRONMENTAL

Power Rating: $\frac{1}{2}$ watt at 85° C derated to 0 at $+125^{\circ}$ C.
Operating Temperature Range: -55° C to $+125^{\circ}$ C
Seal: Sealed to permit cleaning in common solvents
Shock: Exceeds MIL-R-22097, 100G
 Contact Bounce: 0.1 millisecond max.
Vibration: Exceeds MIL-R-22097, 30G
 Contact Bounce: 0.1 millisecond max.
Dielectric Strength: Per MIL-STD-202B
 Method 301 Room Condition: 1000 VAC
 At 70,000 feet: 250 VAC
Rotational Life: 200 cycles without discontinuity
Load Life: 1,000 hours per MIL-R-22097
 Max. Res. Shift: 3%

DERATING CHART

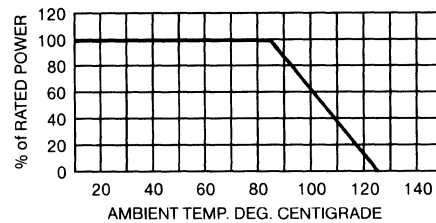

DIMENSIONS & TERMINAL CONFIGURATIONS FOR 100 SERIES

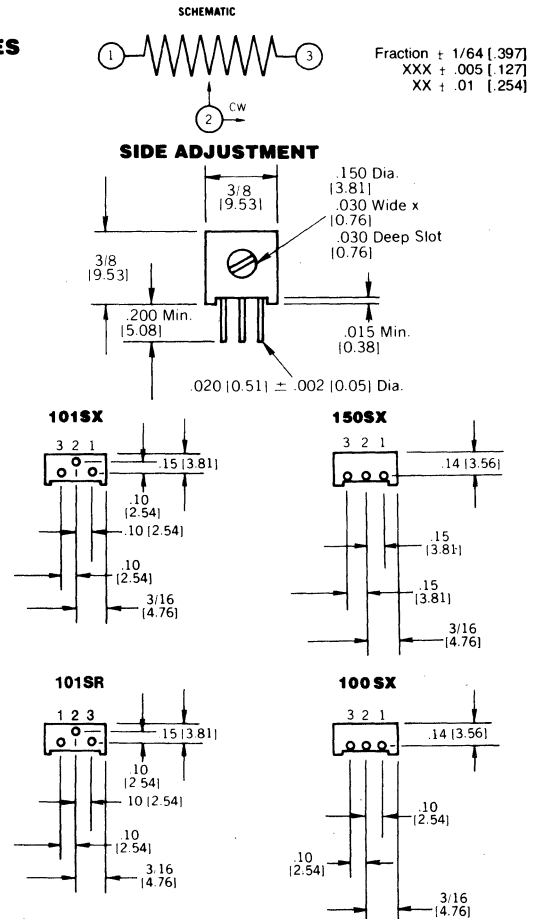
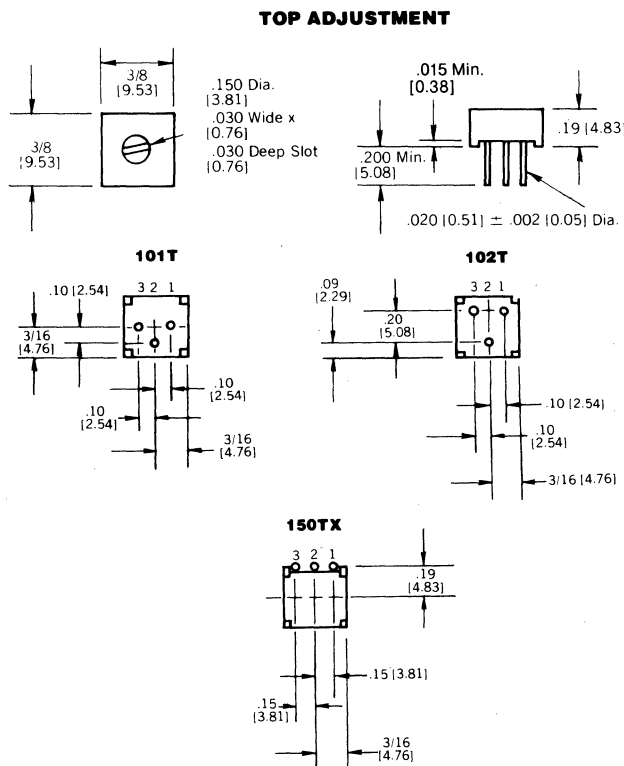



DALE SERIES 781P, 783P, 784P 981P, 983P, 984P

Professional Grade
Low Profile
Cermet Trimmers

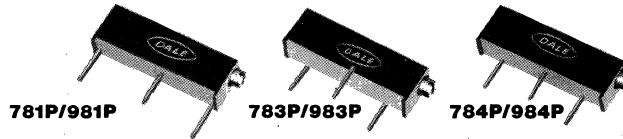
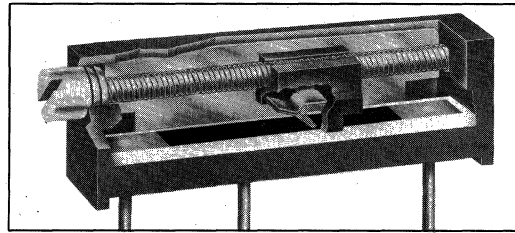

FEATURES

- All-metal screw and one-piece clutch prevents overtravel damage
- Patented side collector provides excellent setting stability by allowing use of larger element
- High power rating – 1.5 Watts at 25°C.
- Multiwire wiper for excellent CRV of less than 1%
- Sealed for production soldering
- 25-turn screwdriver adjustment for better adjustability
- Translucent case available (980P series)
- Panel mount option available

STANDARD RESISTANCE VALUES

Ohms	Ohms	Ohms	Ohms
10	500	20K	250K
20	1K	25K	500K
50	2K	50K	1 Meg.
100	5K	100K	2 Meg.
200	10K	200K	

PRINTED CIRCUIT PINS

MODEL	LOCATION
781P/981P	.300 [7.62] x .700 [17.78] x .100 [2.54]
783P/983P	.200 [5.08] x .500 [12.70] x .200 [5.08]
784P/984P	.200 [5.08] x .500 [12.70] x .100 [2.54]

HOW TO ORDER: When ordering, specify model, resistance and tolerance. Example: 784 P, 10 K, 10 %.

SPECIFICATIONS

ELECTRICAL

- Resistance Range:** 10 ohms to 2 Megohms
- Standard Resistance Tolerance:** $\pm 10\%$
- Absolute Minimum Resistance:** 2 ohms max.
- Temperature Coefficient:** ± 100 PPM/ $^{\circ}$ C
- Contact Resistance Variation:** 1 ohm or 1%, whichever is greater.
- Insulation Resistance, 500 VDC:** 100 Megohms minimum
- Resolution:** Essentially infinite
- Adjustability:** Output Resistance = $\pm 0.10\%$
Output Voltage Ratio = $\pm 0.05\%$
- Input Voltage:** 300 VDC (RMS) or within power rating, whichever is less
- Electrical Adjustment:** 22 ± 3 turns

MECHANICAL

- Mechanical Adjustment:** 25 ± 3 turns
- Shaft Torque:** 5.0 oz./in. maximum
- Mechanical Stops:** None. Clutch mechanism permits overtravel without damage
- Weight:** 2.0 grams maximum
- Marking:** Dale Part Number, Terminal Numbers, Resistance Value and Date Code

ENVIRONMENTAL

- Power Rating:** 1.0 Watt at 70°C, 1.5 Watt at 25°C, derated to 0 + 125°C
- Operating Temperature Range:** -55°C to +125°C
- Immersion Proof:** Sealed for board washing. Leak tested in 70°C water.
- Shock:** Per MIL-STD-202, Method 213, 100G Contact Bounce: 0.1 millisecond max.
- Solvent Resistance:** Both the 780 and 980 series are resistant to all common cleaning solvents.

- Vibration:** Per MIL-STD-202, Method 204, 20G Contact Bounce: 0.1 millisecond max.
- Sand & Dust:** Per MIL-E-5272C, Procedure 1
- Dielectric Strength:** Per MIL-STD-202, Method 301 Room Condition: 1000 VAC At 70,000 feet: 250 VAC
- Mechanical Life:** 200 cycles without discontinuity

DERATING CHART

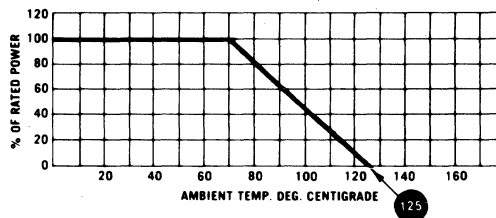

TRANSLUCENT COVER MODELS

Models 981P, 983P and 984P have electrical and mechanical specifications identical to Models 781P, 783P and 784P and include a translucent case for determining wiper location.

DIMENSIONS AND TERMINAL CONFIGURATIONS
 [Numbers in brackets indicate millimeters]

TOLERANCE INCHES .XXX ± .005
 .XX ± .010
 [TOLERANCE MM] .XXX ± .127
 .XX ± .254

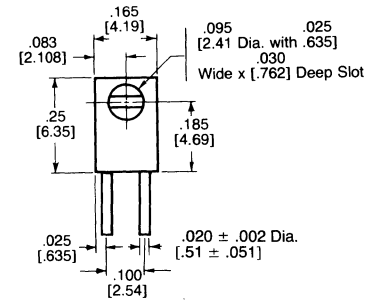
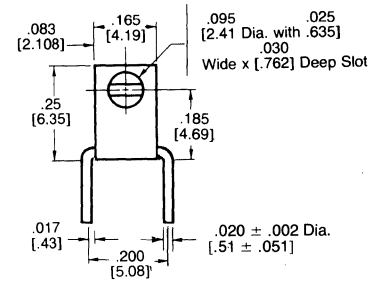
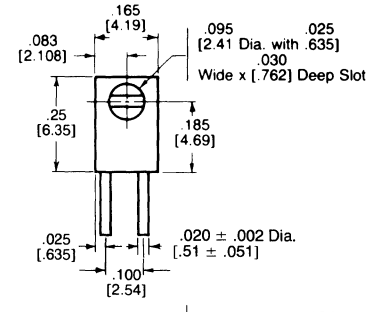
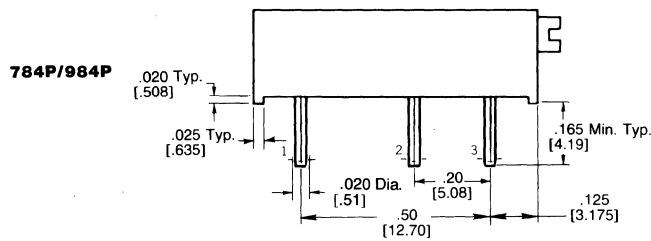
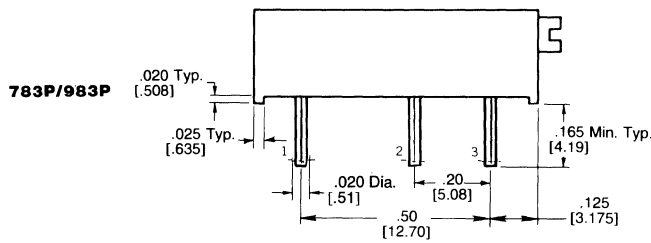
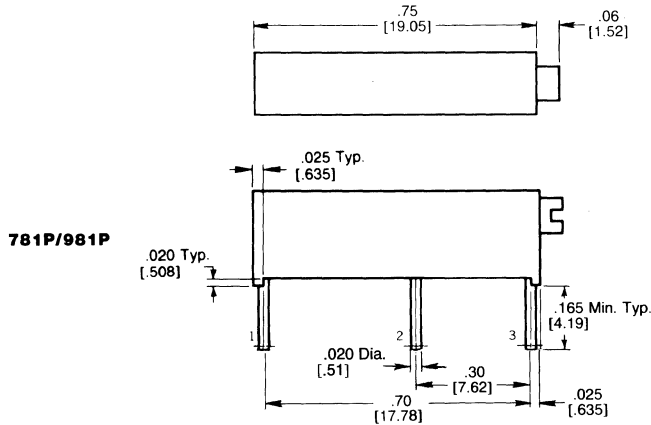
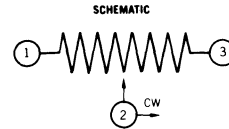

LOW PROFILE STANDOFFS

Standoffs available for above models increasing height of adjustment screw center to mounting surface from .185" [4.70 mm] to .244" [6.20 mm].

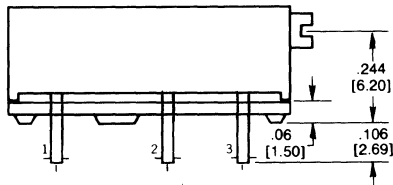

STANDOFF MODEL 700 A

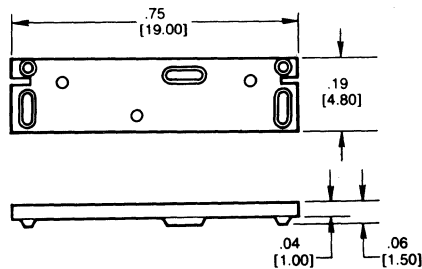

PANEL MOUNT ADAPTER MODEL 700 P

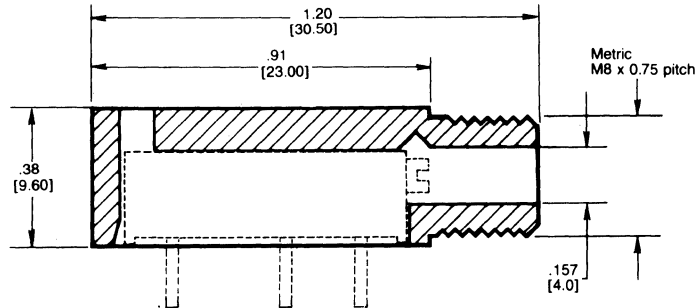

ORDERING INFORMATION STANDOFFS

Assembled - Use trimmer model no. with suffix "A" (Ex. 784PA)
 Unassembled - Order Part no. 700 A.

PANEL MOUNT ADAPTERS

Assembled - Use trimmer model no. with suffix "P" (Ex. 784PP)
 Unassembled - Order part no. 700 P.

Model 700 P is supplied with lock washer and hex nut for panel mounting.

INTRODUCTION

Dale displays are screened image DC plasma (gas discharge) displays. The neon-orange color and screened image construction combine to produce a man-machine interface that has superior ergonomics, with wide viewing angles, and high contrast over a broad range of lighting conditions.

Dale displays have a versatile range of applications including point-of-sale devices, avionics, gasoline pumps, industrial controls and measurement systems, audio equipment, medical instrumentation and programmable controllers.

To meet these needs, Dale provides a variety of models including numeric and alphanumeric segmented displays, linear bar graphs, and segmented and dot matrix modules.

We continue to add new products and enhancements to existing models, so please contact us if your needs are not met by any of the products in this brochure.

Engineering Assistance:

If you would like to discuss the various design parameters and display technologies in order to choose the right display for your application, call our engineering department. They will give you an objective analysis of your options. Consideration will be given to the amount and type of information to be displayed, viewing distance, ambient lighting conditions, operating environment, power, mounting dimensions and cost. Our goal is to help you select the best display — the first time.

CUSTOM DISPLAYS

We "cut our teeth" on custom displays and continue to design and build displays that enable our customers to personalize their products. Our screened image technology al-

lows maximum freedom to display symbols, messages and characters unique to your application — at a price you can afford. Just send us a sketch of your idea, and we'll prepare a counter drawing and a budgetary quotation.

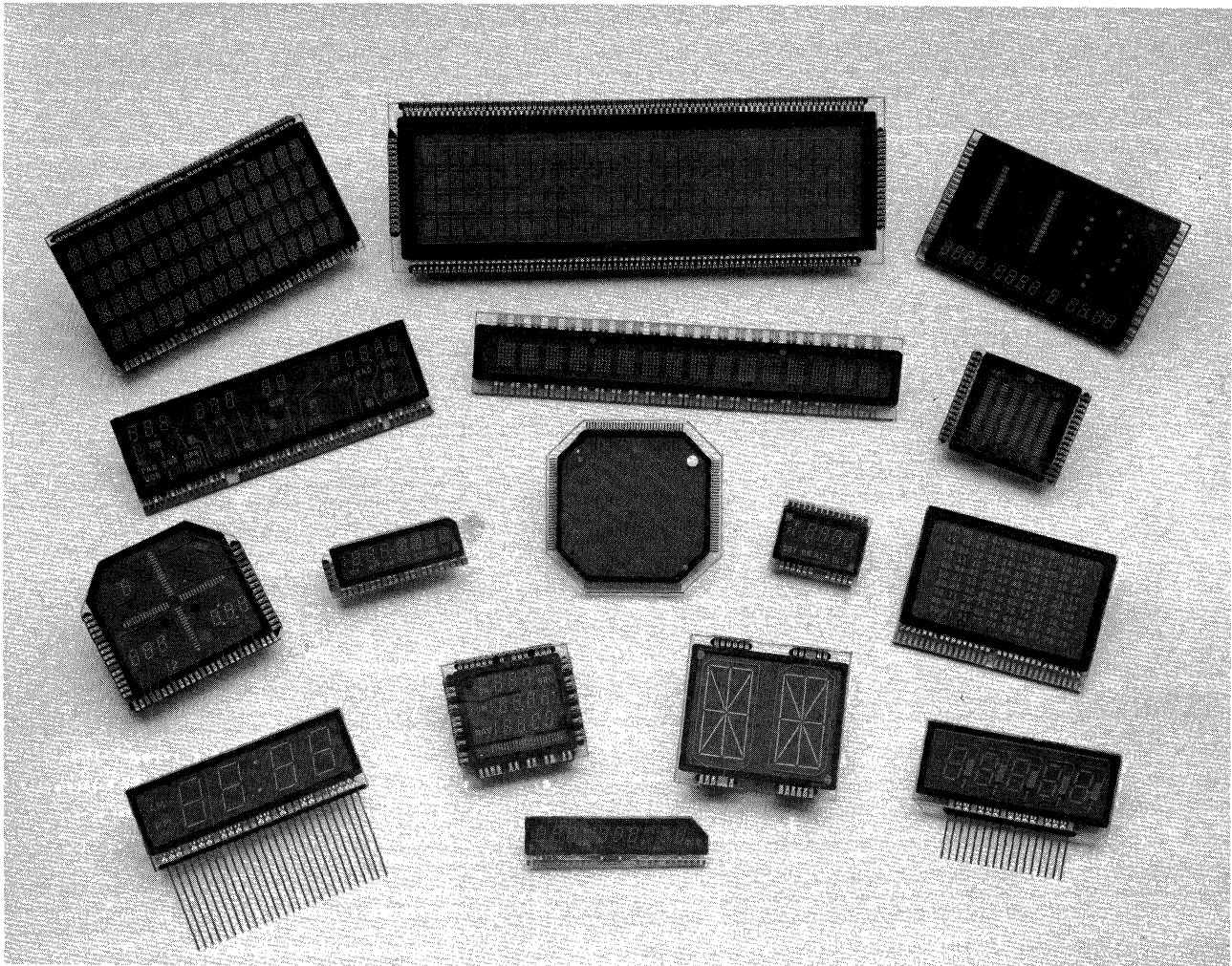

DALE ELECTRONICS, INC., 2064 12th Avenue, Columbus, NE 68601 • Phone 402-564-3131

Canada: Dale Electronics Ltd., 18 Howden Rd., Scarborough, Ontario M1R 3E6

Europe: Dale Electronics GmbH, Benzstrasse 28, 8039 Puchheim, West Germany



FLAT PANEL PLASMA DISPLAYS

CONSTRUCTION AND OPERATION

Dale plasma displays share a common construction method. Cathodes are screen printed and fired on a glass substrate and then outlined with a dielectric to precisely determine the geometry of the display element. Some models have an additional circuit underneath the cathodes to allow for crossovers. The transparent tin oxide anodes on the front substrate are defined by a screen printing and etching process. The two glass substrates are placed together, but separated by a small gap, sealed and filled with a neon-based gas mixture. When an appropriate voltage and current is applied between the anode and cathode electrodes, the gas will ionize, creating an image of the cathode. All Dale displays are designed to be multiplexed to reduce the number of display connections and drivers. Several "keep-alives" are used to supply a low level ion source to ensure rapid ionization and to provide stable operation under a variety of operating conditions. Integrated circuit drivers and DC-DC high voltage converter modules are readily available to facilitate your circuit design.

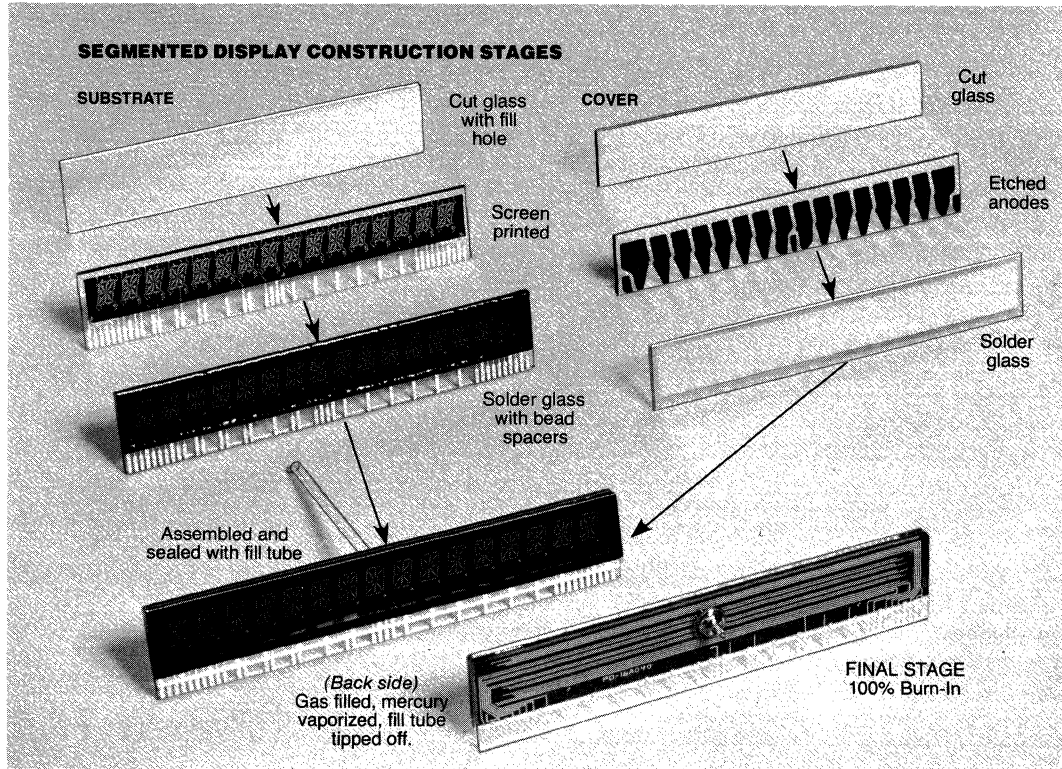
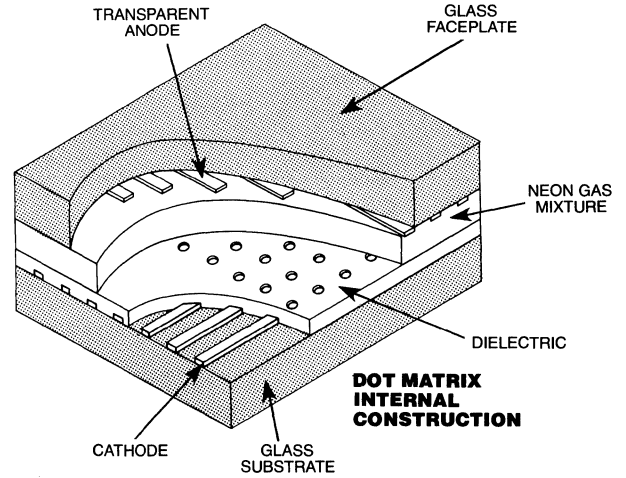

TYPICAL ANODE AND CATHODE WAVE FORMS

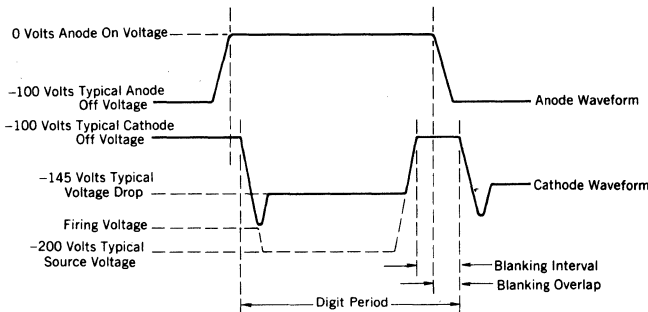



**FLAT PANEL
PLASMA DISPLAY**

MODEL PD-04A200

4 character, 16 segment alphanumeric display with 2.00" [50.80] high characters

FEATURES

- 200 foot lamberts brightness
- Designed for multiplexed operation
- Edgeboard connection (terminals available as PD-04A200-2)
- End stackable

MAXIMUM RATINGS*

Peak Applied Voltage: 250 Volts

Operating Temperature: 0°C to +55°C

Storage Temperature: -55°C to +85°C

Altitude: 70,000 feet

*Values beyond which the life of the device may be reduced.

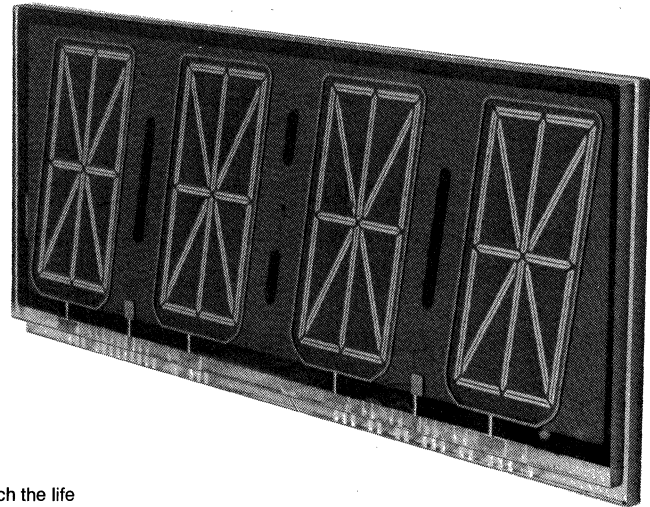

ELECTRICAL CHARACTERISTICS AT 25°C

CHARACTERISTIC	MINIMUM	TYPICAL	MAXIMUM	NOTES
Panel Voltage Drop (at typical cathode current)	130 VDC	145 VDC	170 VDC	
Initial Ionization Time (peak cathode voltage -180)			5 sec.	
Cathode Segment Current (see drawing for cathode designation)				NOTE: At the specified current, a segment shall glow uniformly over its entire surface with no glow visible on any other part of the panel.
Segments a, b, p, l, f and e	2.5 mA	4.3 mA	8.7 mA	†Recommended D.C. keep alive circuit: Use a 1 Meg. resistor in series with cathode and a 1 Meg. resistor in series with anode connected to a 200 VDC source.
Segments c, d, g, h, i, j, k, m, n and o	5.0 mA	8.6 mA	17.5 mA	
Keep alive†	25 μA	50 μA	75 μA	
Source Voltage*	-180 VDC	-200 VDC	-220 VDC	
Anode Off Voltage*	- 35 VDC	-100 VDC	-120 VDC	*Voltage referenced to anode on voltage.
Cathode Off Voltage*	- 35 VDC	-100 VDC	-120 VDC	
Digit period	80 μsec.	1250 μsec.	2500 μsec.	
Cathode blanking interval	20 μsec.	100 μsec.	—	NOTE: Operating limits do not apply simultaneously, e.g., operation at maximum current may require a longer blanking interval than the minimum specified.
Cathode blanking overlap	10 μsec.	50 μsec.	—	
Display scan period	.32 msec.	5 msec.	10 msec.	
Number of anodes per scan	—	4	—	

OPTICAL CHARACTERISTICS:

Color: Neon Orange
(Filterable from red, orange to yellow)

Viewing Angle: 130°

LIGHT OUTPUT

Typical light output is 200 foot lamberts, when measured by using an 820A Gamma Scientific Photometer and 820-18A Photo Multiplier Tube and Control, corrected for the I.C.I. Photopic response curve, using a .006" [0.15] diameter optical probe, calibrated with a standard light source.

PD-04A200 Plasma Panel Display

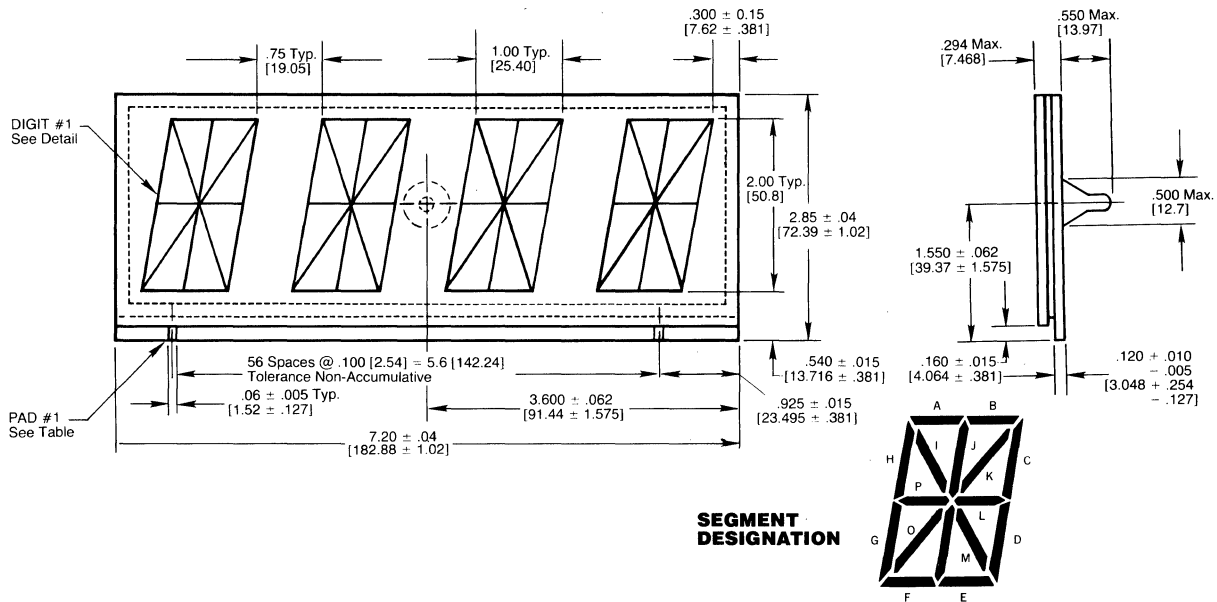

**TERMINAL DESIGNATION
TERMINAL PAD CONNECTIONS**

- | | | | | |
|---------------------|--------------------|--------------------|----------------------|--------------------|
| 1. Anode #1 Digit | 13. Segment "G" | 25. N/C | 37. Anode #3 Digit | 49. N/C |
| 2. Anode #1 Digit | 14. N/C | 26. N/C | 38. Anode #3 Digit | 50. Segment "D" |
| 3. Anode #1 Digit | 15. N/C | 27. N/C | 39. N/C | 51. Segment "C" |
| 4. N/C | 16. Segment "I" | 28. N/C | 40. Segment "O" | 52. N/C |
| 5. Segment "B" | 17. N/C | 29. N/C | 41. Segment "N" | 53. Anode #4 Digit |
| 6. Segment "A" | 18. Anode #2 Digit | 30. N/C | 42. N/C | 54. Anode #4 Digit |
| 7. Segment "J" | 19. Anode #2 Digit | 31. N/C | 43. Segment "P" | 55. Anode #4 Digit |
| 8. Segment "M" | 20. Anode #2 Digit | 32. N/C | 44. Segment "F" | 56. N/C |
| 9. Segment "L" | 21. N/C | 33. N/C | 45. N/C | 57. Segment "K" |
| 10. Left K.A. | 22. N/C | 34. N/C | 46. Anode Right K.A. | |
| 11. Anode Left K.A. | 23. N/C | 35. N/C | 47. Right K.A. | |
| 12. Segment "H" | 24. N/C | 36. Anode #3 Digit | 48. Segment "E" | |

**DALE CONNECTOR for PD-04A200 DISPLAY
Part No. ES14-57T-A-R19-720-C**

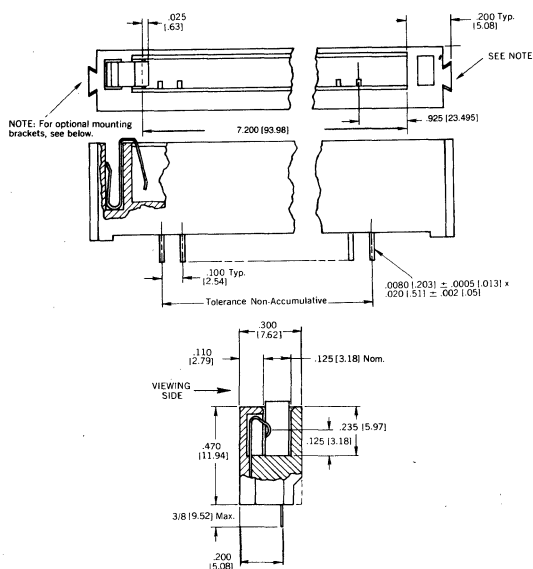

OPTIONAL MOUNTING BRACKETS

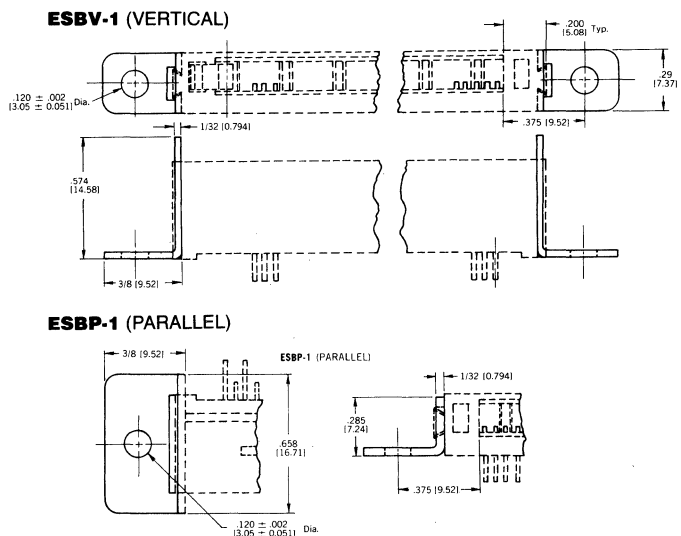



FLAT PANEL PLASMA DISPLAY

MODEL PD-16A040

16 character, 16 segment alphanumeric display with .400" [10.16] high characters

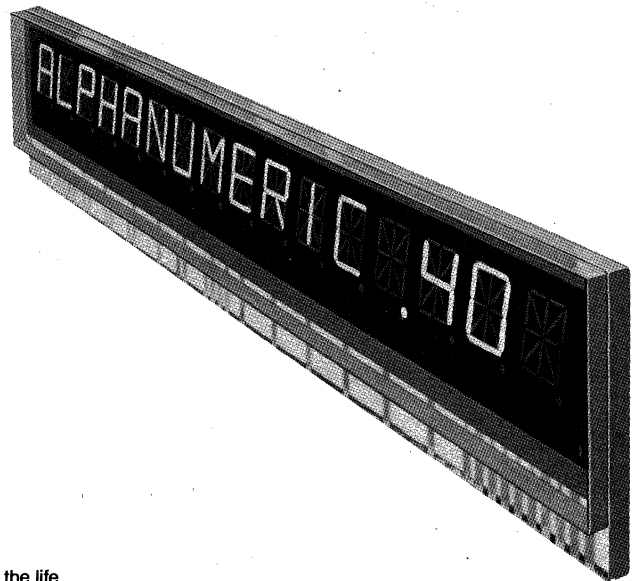

FEATURES

- 50 foot lamberts brightness
- Designed for multiplexed operation
- Edgeboard connection
- Low power consumption

MAXIMUM RATINGS*

Peak Applied Voltage: 250 Volts

Operating Temperature: 0 to +55°C

Storage Temperature: -55 to +85°C

Altitude: 70,000 feet

*Values beyond which the life of the device may be reduced.

ELECTRICAL CHARACTERISTICS AT 25°C

CHARACTERISTIC	MINIMUM	TYPICAL	MAXIMUM	NOTES
Panel Voltage Drop (at typical cathode current)	130 VDC	145 VDC	170 VDC	
Initial Ionization Time (peak cathode voltage -180)			5 sec.	
Cathode Segment Current (see drawing for cathode designation)				NOTE: At the specified current, a segment shall glow uniformly over its entire surface with no glow visible on any other part of the panel.
Segments a, b, p, l, f and e	320 μ A	400 μ A	480 μ A	
Segments m and i	480 μ A	540 μ A	630 μ A	
Segments c, d, g, h, j, k, n and o	560 μ A	630 μ A	680 μ A	†Recommended D.C. keep alive circuit: Use a 1 Meg. resistor in series with cathode and a 1 Meg. resistor in series with anode connected to a 200 VDC source.
Decimal point	320 μ A	400 μ A	480 μ A	
Keep alive†	25 μ A	50 μ A	75 μ A	
Source Voltage*	-180 VDC	-200 VDC	-220 VDC	
Anode Off Voltage*	- 35 VDC	-100 VDC	-120 VDC	*Voltage referenced to anode on voltage.
Cathode Off Voltage*	- 35 VDC	-100 VDC	-120 VDC	
Digit period	80 μ sec.	480 μ sec.	600 μ sec.	
Cathode blanking interval	40 μ sec.	100 μ sec.	—	NOTE: Operating limits do not apply simultaneously, e.g., operation at maximum current may require a longer blanking interval than the minimum specified.
Cathode blanking overlap	20 μ sec.	50 μ sec.	—	
Display scan period	1.3 msec.	7.7 msec.	9.6 msec.	
Number of anodes per scan	—	16	—	

OPTICAL CHARACTERISTICS:

Color: Neon Orange
(Filterable from red, orange to yellow)

Viewing Angle: 130°

LIGHT OUTPUT

Typical light output is 50 foot lamberts, when measured by using an 820A Gamma Scientific Photometer and 820-18A Photo Multiplier Tube and Control, corrected for the I.C.I. Photopic response curve, using a .006" [0.15] diameter optical probe, calibrated with a standard light source.

PD-16A040 Plasma Panel Display

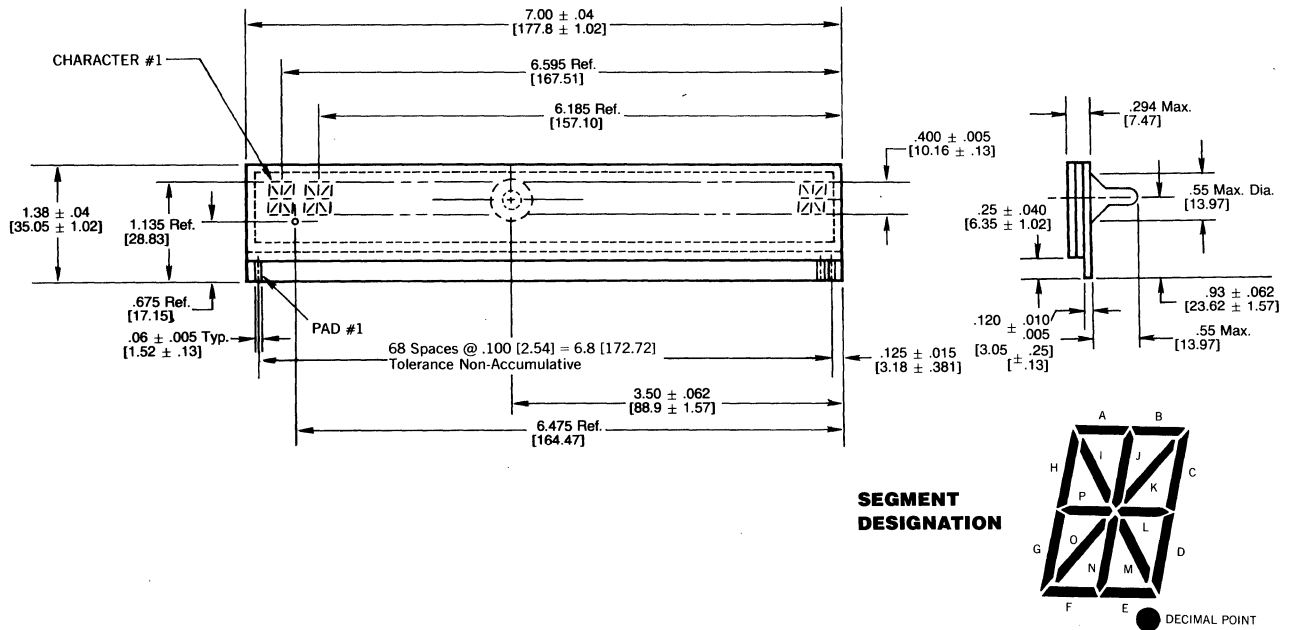

TERMINAL DESIGNATION
TERMINAL PAD CONNECTIONS

- | | | | | |
|--------------------|--------------------|---------------------|---------------------|---------------------|
| 1. Anode, K.A. | 15. N/C | 29. Anode #7 Digit | 43. N/C | 57. Anode #14 Digit |
| 2. Segment "C" | 16. Anode #4 Digit | 30. N/C | 44. N/C | 58. N/C |
| 3. K.A. | 17. Segment "E" | 31. N/C | 45. Anode #11 Digit | 59. N/C |
| 4. Anode #1 Digit | 18. N/C | 32. Segment "M" | 46. N/C | 60. Segment "O" |
| 5. Segment "H" | 19. N/C | 33. Anode #8 Digit | 47. N/C | 61. Anode #15 Digit |
| 6. Segment "B" | 20. Decimal | 34. K.A. | 48. N/C | 62. Segment "L" |
| 7. Segment "A" | 21. Anode #5 Digit | 35. Anode K.A. | 49. Anode #12 Digit | 63. Segment "P" |
| 8. Anode #2 Digit | 22. N/C | 36. N/C | 50. N/C | 64. Segment "K" |
| 9. Segment "G" | 23. N/C | 37. Anode #9 Digit | 51. N/C | 65. Segment "I" |
| 10. Segment "D" | 24. N/C | 38. N/C | 52. N/C | 66. Anode #16 Digit |
| 11. N/C | 25. Anode #6 Digit | 39. N/C | 54. Anode #13 Digit | 67. K.A. |
| 12. Anode #3 Digit | 26. N/C | 40. N/C | 54. N/C | 68. Anode K.A. |
| 13. Segment "F" | 27. N/C | 41. Anode #10 Digit | 55. N/C | 69. Segment "J" |
| 14. N/C | 28. Segment "N" | 42. N/C | 56. N/C | |

DALE CONNECTOR for PD-16A040 DISPLAY
Part No. ES14-69T-A-R3-700-C

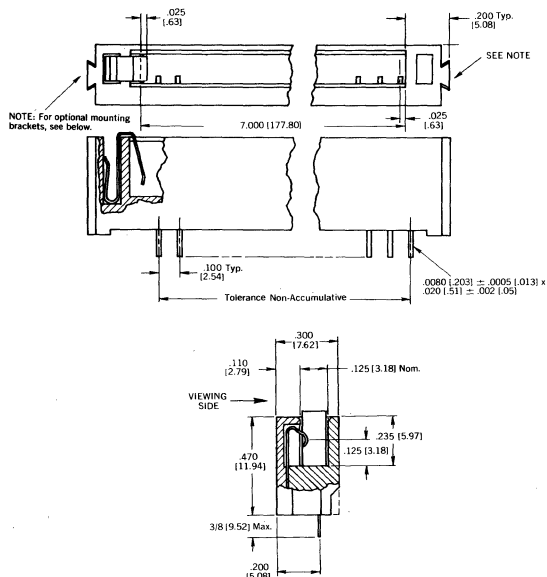

OPTIONAL MOUNTING BRACKETS

ESBV-1 (VERTICAL)

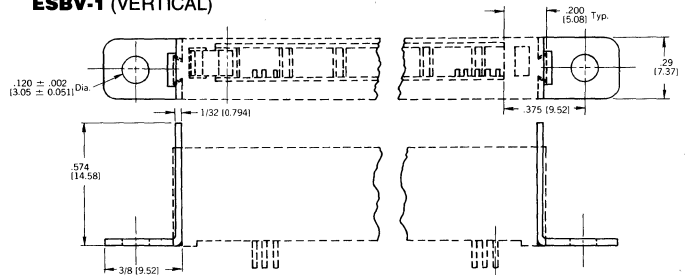

ESBP-1 (PARALLEL)

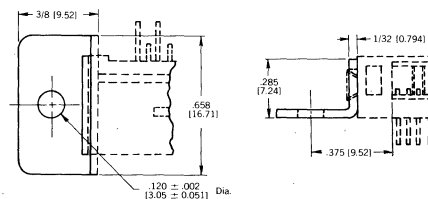



**FLAT PANEL
PLASMA DISPLAY**

MODEL PD-32A025

32 character, 16 segment alphanumeric display with .250 [6.35] high characters

FEATURES

- 80 foot lamberts brightness
- Multiplexed operation
- Integral terminals
- Low power consumption

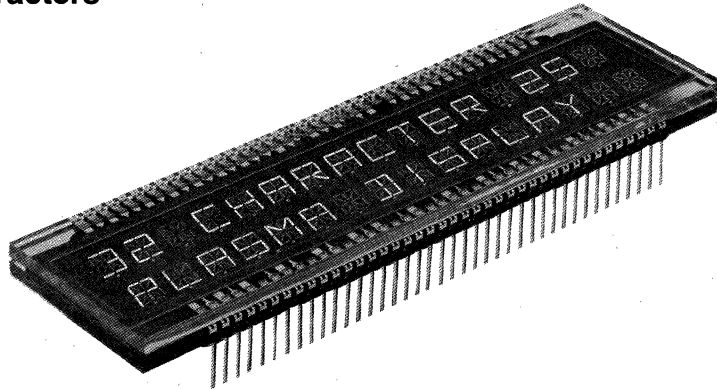

MAXIMUM RATINGS*

Peak Applied Voltage: 250 Volts

Operating Temperature: 0 to +55°C

Storage Temperature: -55 to +85°C

Altitude: 70,000 feet

*Values beyond which the life of the device may be reduced.

ELECTRICAL CHARACTERISTICS AT 25°C

CHARACTERISTIC	MINIMUM	TYPICAL	MAXIMUM	NOTES
Panel Voltage Drop (at typical cathode current)	130 VDC	145 VDC	170 VDC	
Initial Ionization Time (peak cathode voltage -180)			5 sec.	
Cathode Segment Current (see drawing for cathode designation)				NOTE: At the specified current, a segment shall glow uniformly over its entire surface with no glow visible on any other part of the panel.
Segment a, d, f, j, n and t	180 μ A	230 μ A	280 μ A	
Segments b, c, g, h, l and r	270 μ A	350 μ A	430 μ A	
Segments k and p	210 μ A	280 μ A	350 μ A	
Segments m and s	225 μ A	300 μ A	375 μ A	†Recommended D.C. keep alive circuit: Use a 1 Meg. resistor in series with cathode and a 1 Meg. resistor in series with anode connected to a 200 VDC source.
Decimal point e	135 μ A	180 μ A	225 μ A	
Keep alive †	25 μ A	50 μ A	75 μ A	
Source Voltage*	-180 VDC	-200 VDC	-220 VDC	
Anode Off Voltage*	- 35 VDC	-100 VDC	-120 VDC	*Voltage referenced to anode on voltage.
Cathode Off Voltage*	- 35 VDC	-100 VDC	-120 VDC	
Digit period	80 μ sec.	480 μ sec.	600 μ sec.	
Cathode blanking interval	20 μ sec.	100 μ sec.	—	NOTE: Operating limits do not apply simultaneously, e.g., operation at maximum current may require a longer blanking interval than the minimum specified.
Cathode blanking overlap	10 μ sec.	50 μ sec.	—	
Display scan period	1.3 μ sec.	7.7 msec.	9.6 msec.	
Number of anodes per scan	—	16	—	

OPTICAL CHARACTERISTICS:

Color: Neon Orange
(Filterable from red, orange to yellow)

Viewing Angle: 130°

LIGHT OUTPUT

Typical light output is 80 foot lamberts, when measured by using an 820A Gamma Scientific Photometer and 820-18A Photo Multiplier Tube and Control, corrected for the I.C.I. Photopic response curve, using a .006" [0.15] diameter optical probe, calibrated with a standard light source.

DALE ELECTRONICS, INC., 2064 12th Avenue, Columbus, NE 68601 • Phone 402-564-3131

Canada: Dale Electronics Ltd., 18 Howden Rd., Scarborough, Ontario M1R 3E6
Europe: Dale Electronics GmbH, Benzstrasse 28, 8039 Puchheim, West Germany

PD-32A025 Plasma Panel Display

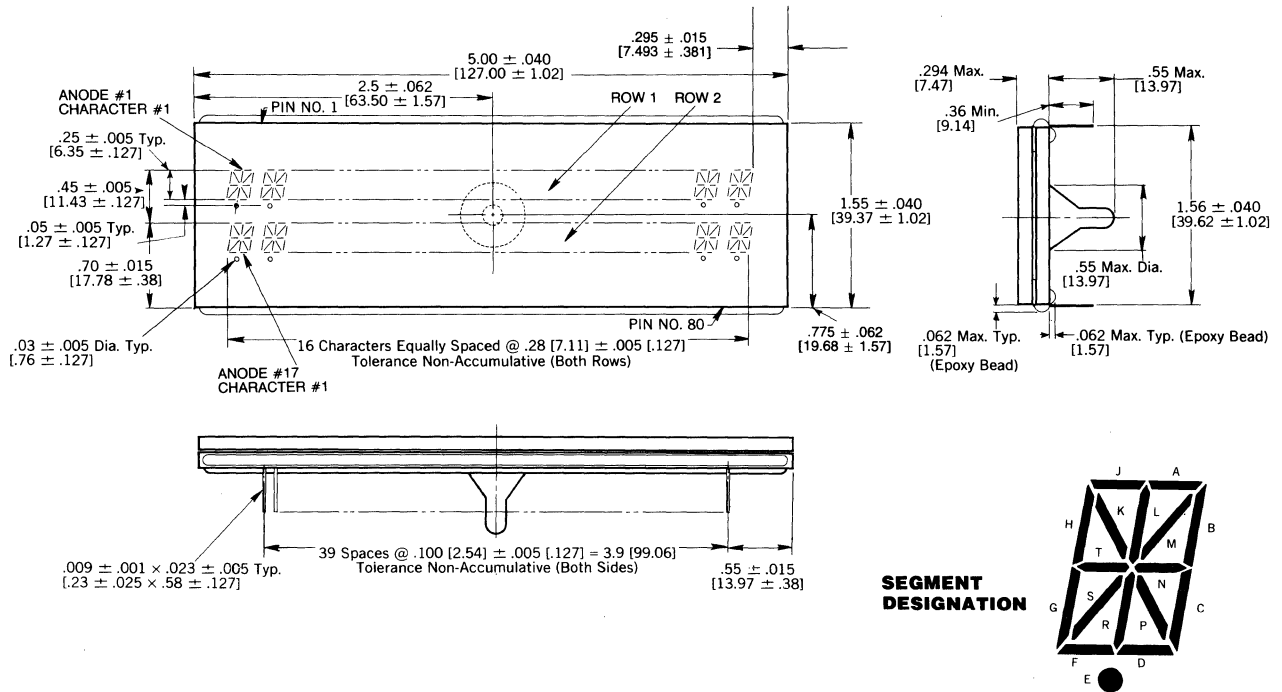

TERMINAL DESIGNATION

TERMINATING PAD NO.	ROW NO.	SEGMENT	ANODE POSITION
1	1	—	1
2	1	D	—
3	1	—	2
4	1	E	—
5	1	—	3
6	1	F	—
7	1	J	—
8	1	—	4
9	1	N/C	—
10	1	H	—
11	1	—	5
12	1	L	—
13	1	—	6
14	1	A	—
15	1	M	—
16	1	—	7
17	1	N/C	—
18	1	K	—
19	1	—	8
20	1	N	—
21	1	N/C	—
22	1	—	9
23	1	T	—
24	1	N/C	—
25	1	—	10
26	1	P	—
27	1	—	11
28	1	N/C	—
29	1	R	—
30	1	—	12
31	1	N/C	—
32	1	B	—
33	1	—	13
34	1	S	—
35	1	N/C	—
36	1	—	14
37	1	C	—
38	1	—	15
39	1	G	—
40	1	—	16

TERMINATING PAD NO.	ROW NO.	SEGMENT	ANODE POSITION
41	2	—	17
42	2	H	—
43	2	—	18
44	2	B	—
45	2	—	19
46	2	A	—
47	2	—	20
48	2	J	—
49	2	—	Left K.A.
50	2	L	—
51	2	—	21
52	2	Left K.A.	—
53	2	—	22
54	2	E	—
55	2	N/C	—
56	2	—	23
57	2	R	—
58	2	N/C	—
59	2	—	24
60	2	S	—
61	2	—	25
62	2	N/C	—
63	2	C	—
64	2	—	26
65	2	D	—
66	2	G	—
67	2	—	27
68	2	F	—
69	2	—	28
70	2	Right K.A.	—
71	2	—	Right K.A.
72	2	P	—
73	2	—	29
74	2	T	—
75	2	—	30
76	2	N	—
77	2	K	—
78	2	—	31
79	2	M	—
80	2	—	32



FLAT PANEL PLASMA DISPLAY MODULE

MODEL APD-016M040

16 character display with drive electronics and controller

The APD-016M040 display module is a 1 line by 16 character 5 x 7 dot matrix display. It includes drive electronics, a microprocessor based controller consisting of a character generator, control logic and a 32 character refresh memory. The controller can be programmed for either parallel or serial interface. An on board DC-DC converter develops the necessary panel voltages from a single 5V input.

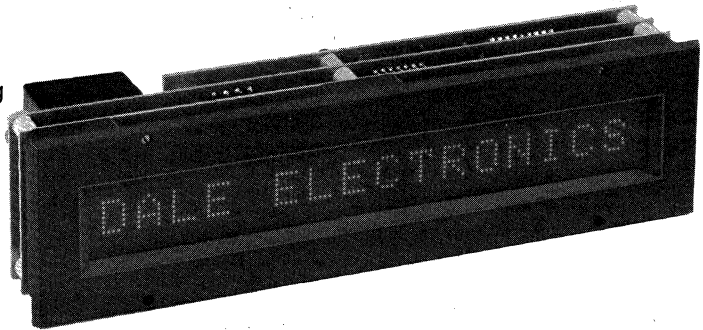

FEATURES

- 16 (1 x 16) alphanumeric characters (5 x 7 dot matrix)
- Bezel and filter included
- Parallel and serial interfaces
- High brightness
- Wide viewing angle (150°)
- Low input voltage
- Compact size
- Enhanced replacement for Burroughs SSD1000-0061 (optionally-0041)

SPECIFICATIONS

OPTICAL

Viewing Area: .40" [10.2] W x 6.69" [169.1] L

Number of Characters: 16

Character Size: .28" [7.1] W x .40" [10.2] H

Dot Size: .036" [.91] dia.

Dot Pitch: .061" [1.55]

Character Spacing: 2 blank columns between successive characters — .147" [3.73]

Brightness: 80 foot lamberts

Color: neon orange

Viewing Angle: 150° cone

ENVIRONMENTAL

Operating Temperature: 0°C to +55°C

Storage Temperature: -55°C to +85°C

Relative Humidity: 10-90% non-condensing

Mechanical Shock: 50G ½ Sine Wave, 11 ms duration, 5 shocks in each of 6 directions

Vibration: .018" displacement amplitude from 10 to 50 Hz, 2G acceleration from 50 to 2000 Hz logarithmic sweep rate. 30 min. duration along each side of the 3 major axes.

DIMENSIONS

[Numbers in brackets indicate millimeters.]

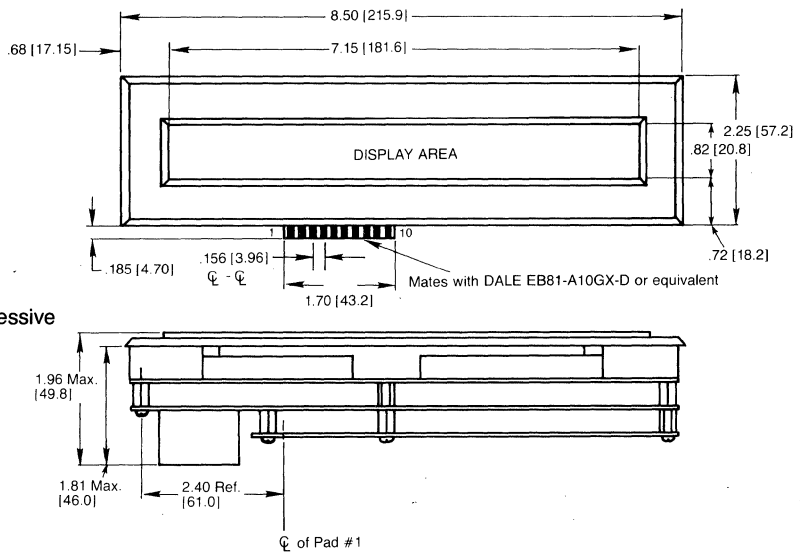

ELECTRICAL

	SYMBOL	MIN.	TYP.	MAX.	UNITS
Supply Voltage	V _{cc}	4.75	5.0	5.25	V
Supply Current (1)	I _{cc}	—	1.25	1.75	A
Logic One Voltage	V _{IH}	2.0	—	—	V
Logic 0 Voltage	V _{IL}	—	—	.8	V

(1) V_{cc} is the input to a DC-DC Converter. There may be peak in rush currents higher than shown.

APD-016M040 Plasma Panel Display Module

GENERAL DESCRIPTION

The APD-016M040 has two modes of operation, parallel or serial input. The parallel interface consists of a 6 bit data bus plus 3 hand-shaking and 3 control lines. New characters are entered from right to left by presenting the appropriate 6 bit code to the data bus and latching it into memory with a DATA PRESENT pulse. A WRITE CYCLE output signal is provided during the time in which data can be written to the display, and a DATA TAKEN pulse occurs after data has been accepted, or when BACK SPACE occurs. BACK SPACE allows the displayed message to be shifted to the right, recalling the last character shifted off the left end of the display. Up to 16 characters may be recalled, after which blanks are entered in the left position of the display. The display may be cleared at any time by bringing the CLEAR line low. A BLANK DISABLE line is provided to blank the display without altering the refresh memory contents.

The serial interface is RS-232-C compatible and has 3 selectable baud rates (300, 1200, 9600). This mode assumes 1 start bit, 7 data bits, 2 stop bits, no parity and half duplex. No hand-shaking is provided. Mode settings and baud rates are selected as follows. (Both lines are internally pulled to Vcc with 6.8K pull-up resistors.)

SS0	SS1	BAUD RATE
0	0	300
0	1	1200
1	0	9600
1	1	Parallel

PIN CONNECTIONS

PIN DESCRIPTION	PIN DESCRIPTION
1 DATA BIT 5	A DATA BIT 4
2 DATA BIT 3	B DATA BIT 2
3 DATA BIT 1	C DATA BIT 0
4 N/C	D DATA PRESENT
5 CLEAR	E BACK SPACE
6 SPEED SELECT 1	F DATA TAKEN
7 WRITE CYCLE	H RECEIVED DATA
8 BLANK DISABLE	J +5V
9 SPEED SELECT 0	K N/C
10 N/C	L GND

Keyway between pins 4(D) and 5(E)

MODIFIED USASCII CHARACTER SET (SERIAL MODE)

Bits					Col										
b7	b6	b5	b4	b3	b2	b1	Row	0	1	2	3	4	5	6	7
0	0	0	0	0	0	0	0								
0	0	0	0	0	1	0	1								
0	0	0	1	0	1	0	0								
0	0	1	0	0	2										
0	0	1	1	3				BON	#	3	C	S	c	s	
0	1	0	0	4				BOFF	\$	4	D	T	d	t	
0	1	0	1	5				RST	%	5	E	U	e	u	
0	1	1	0	6					&	6	F	V	f	v	
0	1	1	1	7					/	7	G	W	g	w	
1	0	0	0	8				BS	(8	H	X	h	x	
1	0	0	1	9)	9	I	Y	i	y	
1	0	1	0	10					*	:	J	Z	j	z	
1	0	1	1	11					+	;	K	[k	{	
1	1	0	0	12				CLR	,	<	L	\	l	;	
1	1	0	1	13					-	=	M]	m	}	
1	1	1	0	14					.	>	N	^	n	~	
1	1	1	1	15					/	?	O	_	o	DEL	

MODIFIED USASCII CHARACTER SET (PARALLEL MODE)

Bits					Col					
b6	b5	b4	b3	b2	b1	Row	0	1	2	3
0	0	0	0	0	0	0	@	P	SP	0
0	0	0	1	1			A	Q	!	1
0	0	1	0	2			B	R	"	2
0	0	1	1	3			C	S	#	3
0	1	0	0	4			D	T	\$	4
0	1	0	1	5			E	U	%	5
0	1	1	0	6			F	V	&	6
0	1	1	1	7			G	W	/	7
1	0	0	0	8			H	X	(8
1	0	0	1	9			I	Y)	9
1	0	1	0	10			J	Z	*	:
1	0	1	1	11			K	[+	;
1	1	0	0	12			L	~	,	<
1	1	0	1	13			M]	-	=
1	1	1	0	14			N	{	.	>
1	1	1	1	15			O	}	/	?

SYSTEM BLOCK DIAGRAM

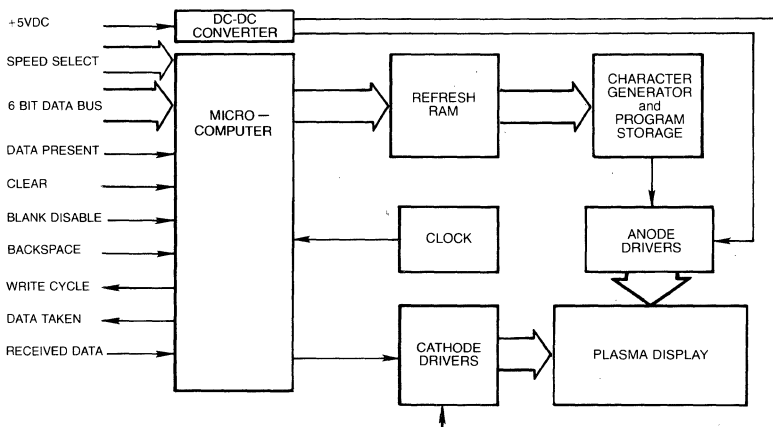

ORDERING INFORMATION

DESCRIPTION	PART NO.
Display and electronics (includes Bezel)	APD-016M040
Display and electronics (includes Bezel). Data entry is left to right	APD-016M040-1
Mating connector	280498-01



FLAT PANEL PLASMA DISPLAY MODULES

MODEL APD-32A025

The Dale APD-32A025 microprocessor based display system gives the superior aesthetics of a plasma display without the need to design the drive electronics, interface circuitry and voltage converter, and in a package that conserves valuable front panel area.

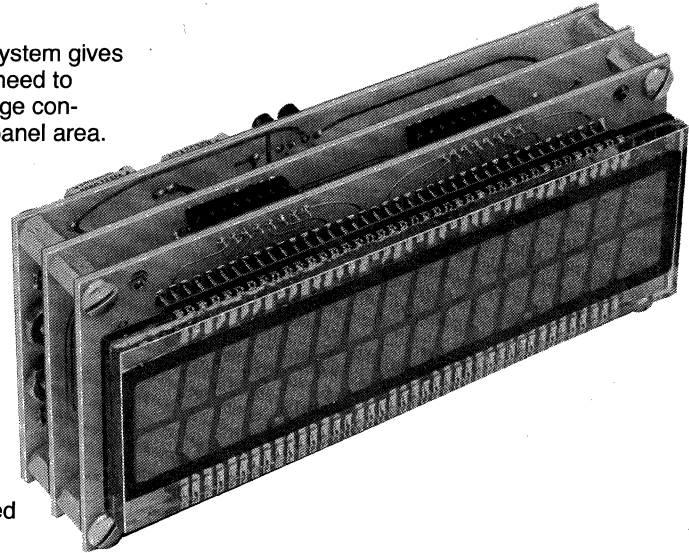

FEATURES

- 32 alphanumeric characters
- 64 ASCII character set
- Refresh memory
- 8 bit, three state, bi-directional data bus
- Decodes and debounces up to 64 key keyboards
- Operates from single 5V power supply
- User enabled blinking, cursor/display
- Cursor addressable or auto incremented/decremented
- Scroll (left or right)
- Compact size
- Neon orange (filterable to red or yellow)
- 60 ft. lamberts light output (typical)
- Standby (low power) mode

MAXIMUM RATINGS

Operating Temperature: 0°C to +55°C
Storage Temperature: -55°C to +85°C
Voltage on any Pin vs. Ground: -0.5V to +7V
Power Dissipation: 5W

SPECIFICATIONS

Character Design: 14 segment starburst
Character Set: ASCII (upper case)
Character Height: .25" [6.35]
Viewing Area: 4.45" [113.03] W x .7" [17.78] L
Viewing Angle: 130°
Dimensions: 5.25" [133.35] L x 2.35" [59.69] H x 2.25" [57.15] D
Supply Voltage: +5V ±5%
Supply Current: 750mA (typical)

MATING CONNECTORS

Power: Dale 280108-01 or Molex® P/N08-50-0106 (terminals) 09-50-3031 (housing) or equivalent
Data: Dale 280105-01 or 3M® P/N3399 (series) or equivalent

ORDERING INFORMATION

DESCRIPTION	PART NO.
DISPLAY AND ELECTRONICS	APD-32A025
DATA CONNECTOR KIT	280105-01
POWER CONNECTOR KIT	280108-01
NON-GLARE FILTER (Amber Circularly Polarized)	280109-01
STANDOFF KIT	280107-01
STD BUS INTERFACE	PDS-200

DIMENSIONS

[Numbers in brackets indicate millimeters]

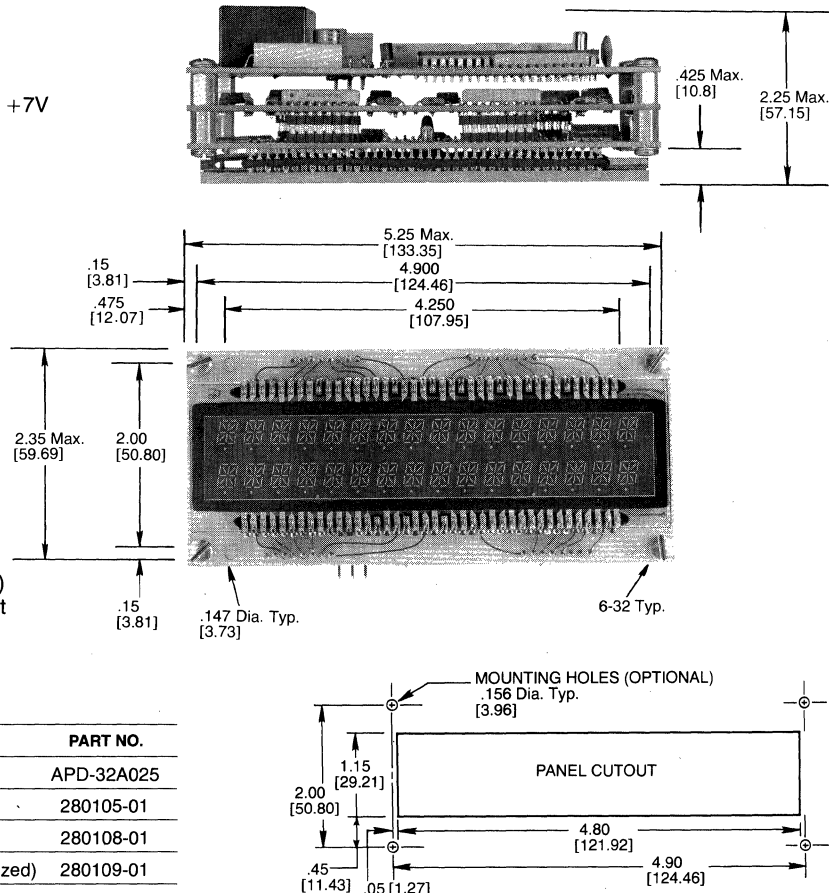

DALE ELECTRONICS, INC., 2064 12th Avenue, Columbus, NE 68601 • Phone 402-564-3131

Canada: Dale Electronics Ltd., 18 Howden Rd., Scarborough, Ontario M1R 3E6
 Europe: Dale Electronics GmbH, Benzstrasse 28, 8039 Puchheim, West Germany

APD-32A025 Plasma Panel Display

CONTROL INFORMATION

- \overline{CS}** **Chip Select**—Enables reading and writing between master CPU and APD-32A025.
- AO** **Address Input**—Used by master CPU to command APD-32A025 to output data or to test APD-32A025 busy flag.
- \overline{WR}** **Write Strobe**—Used by master CPU to write data and commands into the APD-32A025.
- \overline{RD}** **Read Strobe**—Used by master CPU to read data and status from the APD-32A025.
- \overline{EOC}** **End of Command**—Can be used to set a flag or interrupt the master CPU to indicate that the APD-32A025 has completed command execution.
- KB IRQ** **Keyboard flag from APD-32A025.**
Indicates that a key has been depressed and that a key address is ready to be read by CPU.

ABRIDGED COMMAND SET

- MNEMONIC DESCRIPTION**
- RTR** Rotate Display Right
 - RTL** Rotate Display Left
 - SHL** Shift Display Left
 - SHR** Shift Display Right
 - INC** Increment Cursor
 - DEC** Decrement Cursor
 - GKA** Get Key Address
 - GKS** Get Keyboard Status
 - GDS** Get Display Status
 - GCA** Get Cursor Address
 - LCR** Load Cursor and Read Display
 - LKS** Load Keyboard/Character Status
 - LDS** Load Display Status (display on/off, display blink on/off, cursor on/off, etc.)
 - LDM** Load Display Memory
 - LTR** Load Timer Register (can be used to vary brightness)

TYPICAL MICROPROCESSOR INTERFACING

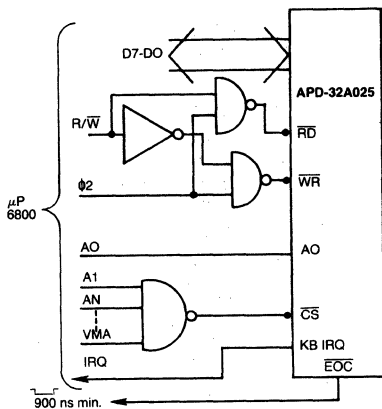
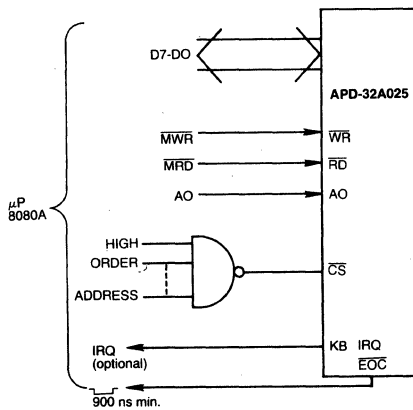

ASCII CHARACTER SET

	000	001	010	011	100	101	110	111
000	G	A	B	C	D	E	F	G
001	H	I	J	K	L	M	N	O
010	P	Q	R	S	T	U	V	W
011	X	Y	Z	[\]	^	_
100		'	"	#	\$	%	&	'
101	z	z	*	+	,	-	.	/
110	0	1	2	3	4	5	6	7
111	8	9	=	/	<	=	>	?

D₇D₆D₅

D₅D₄D₃

NOTE: When cursor is on, the cursor alternates between the character and an underline.



STD BUS PLASMA PANEL DISPLAY INTERFACE

MODEL PDS-200 STD Bus to APD-32A025 Interface Card

The PDS-200 is an STD Bus interface board that enables a Dale APD-32A025 display module to plug directly into the STD Bus without additional hardware.

FEATURES

- Keyboard interface
- Programmable memory map location
- Breadboard area for personalized circuitry
- Access provided for all STD Bus signals

SPECIFICATIONS

- Operating Temperature:** 0°C to +55°C
- Storage Temperature:** -55°C to +85°C
- Supply Voltage:** +5V ±5%
- Supply Current:** 200 mA max
- Logic Signals:** per STD Bus conventions

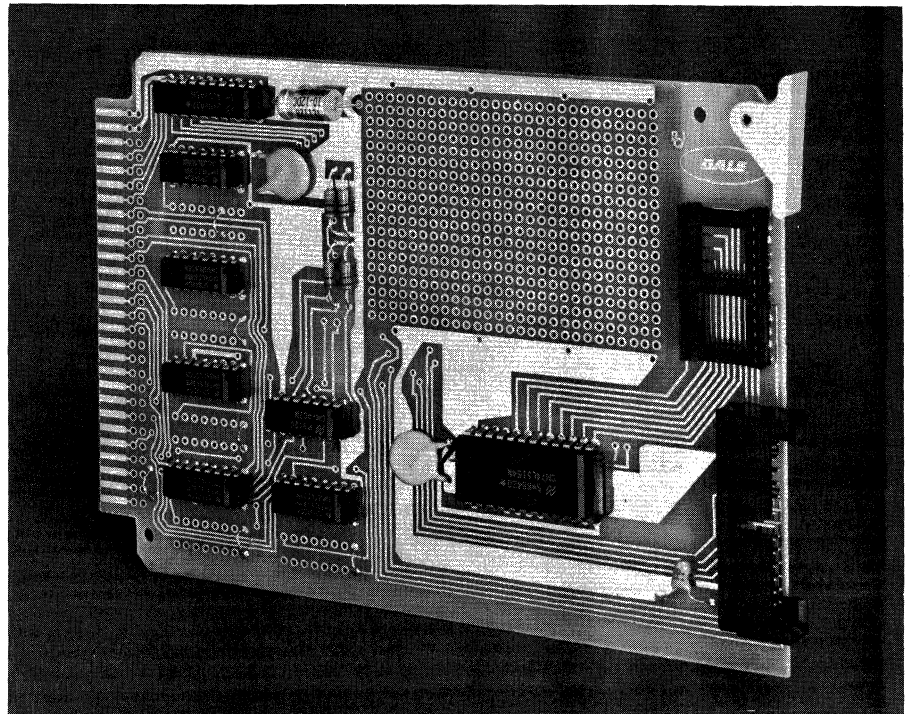

FUNCTIONAL DESCRIPTION

The PDS-200 allows the APD-32A025 to be placed in any two consecutive memory locations, anywhere in the memory map. A 2.6" x 1.8" breadboard area also allows the designer to build personalized circuitry.

The APD-32A025 generated keyboard Interrupt Request (KBIRQ) and End of Command (EOC) signals may be optionally jumpered to STD Bus NMIRQ and INTRQ respectively. Access to all of the STD Bus signals is possible from the plated-through holes near the edge connector. The system reset has been buffered and brought to a plated-through hole near the breadboard area.

Programming the memory map location that the APD-32A025 will reside at, is accomplished by soldering jumper wires across 5 parallel sets of programming pads near each decoder IC as noted on the card layout as P1 through P5. Table 1 provides a decoding chart to place the APD-32A025 anywhere in the memory. (The seven unused pads on P5 can be used as additional I/O select signals.)

EXAMPLE: To place the APD-32A025 at memory locations A4C4-A4C5, jumpers are required at pad locations:

- P1 — pad #6
- P2 — pad #2
- P3 — pad #2
- P4 — pad #0
- P5 — pad #3

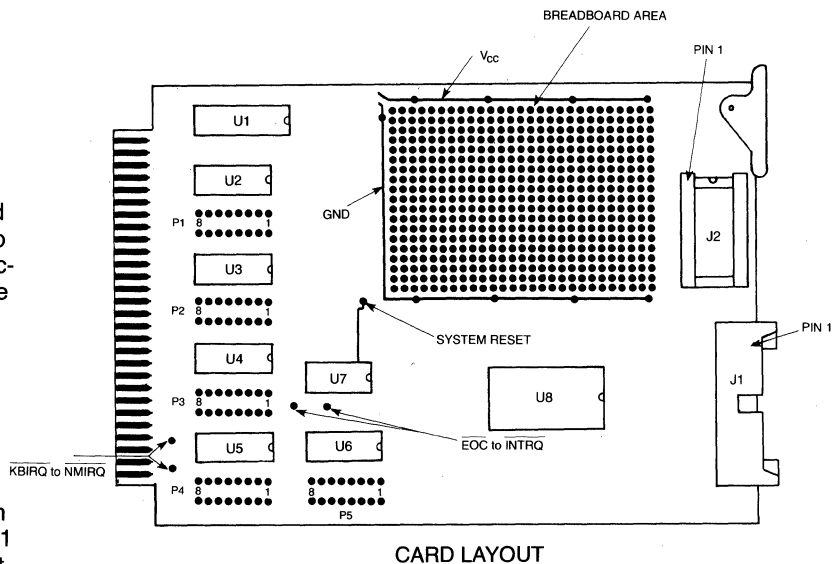

EDGE PIN ASSIGNMENT

Organization and Functional Specifications (with pin definitions):

The STD Bus pinout is organized into four functional groups:

- Dual Power Busses: Pins 1-6 and 53-56
- Data Bus: Pins 7-14
- Address Bus: Pins 15-30
- Control Bus: Pins 31-52

The organization and pinouts are shown in Table 2. This table lists the mnemonic function and signal flow direction (referenced to the interface adaptor card) for each pin of the STD Bus. The STD Bus is further defined as requiring a 56-pin (dual 28) card edge connector, with 0.125" pin centers. Connectors are on a spacing interval of 0.5" centers minimum, and they accept the standard 4.5" x 6.5" x .062" card.

J1 ASSIGNMENT
(26 Pin Header)

PIN #	FUNCTION
1	KI
2	KI
3	KI
4	KI
5	KO
6	KO
7	KO
8	KO
9	D7
10	D6
11	D5
12	D4
13	D3
14	D2
15	D1
16	D0
17	WR
18	A0
19	RD
20	CS
21	GND
22	EOC
23	GND
24	KBIRQ
25	GND
26	RESET

Diagram annotations for J1:

- Pins 1, 2, 3, 4: Timed input signals from keyboard.
- Pins 5, 6, 7, 8: Output timing signals to keyboard.
- Pins 9-16: 8 bit data bus.

J2 ASSIGNMENT
(24 Pin Header)

PIN #	FUNCTION
1	KK0
2	KK1
3	KK2
4	KK3
5	KK4
6	KK5
7	KK6
8	KK7
9	KK8
10	KK9
11	KK10
12	KK11
13	KO
14	KO
15	KO
16	KO
17	KI
18	KI
19	KI
20	KI
21	KK15
22	KK14
23	KK13
24	KK12

Diagram annotations for J2:

- Pins 13, 14, 15, 16: Output timing signals to 16 key keyboard. Subscripted KK0, etc. are demultiplexed keyboard output timing signals for 64 keys.
- Pins 17, 18, 19, 20: Timed input signals from keyboard.

ORDERING INFORMATION

DESCRIPTION	PART NO.
STD Bus to APD-32A025 Intelligent Display Interface	PDS-200
APD-32A025 32 Character Intelligent Display System	APD-32A025



FLAT PANEL PLASMA DISPLAY MODULE

MODEL APD-192G088

192 by 88 graphics display with drive electronics

The APD-192G088 display module is a full field dot matrix display with 192 columns and 88 rows. It includes drive electronics designed to interface easily with CRT controllers. Chip on glass construction eliminates over 900 connections for increased reliability and reduced cost.

FEATURES

- 192 x 88 full field dot matrix
- Chip on glass drivers
- Easily interfaced to CRT controller chips
- High brightness
- Wide viewing angle
- 1:1 aspect ratio
- Thin profile

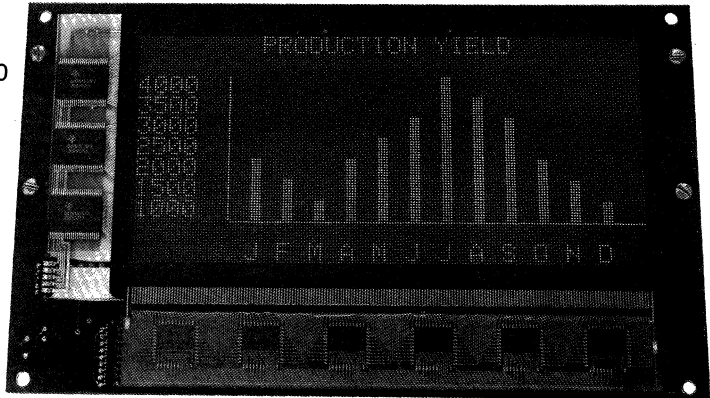

SPECIFICATIONS

OPTICAL

Viewing Area: 7.66" [194.6] x 3.50" [88.9]

Pixel Size: .020" [.51]

Pixel Pitch: .040" [1.02]

Brightness: 80 foot lamberts

Color: Neon orange

Viewing Angle: 120° cone

ENVIRONMENTAL

Operating Temperature: 0°C to +55°C

Storage Temperature: -55°C to +85°C

Relative Humidity: 10-90% non-condensing

Mechanical Shock: 50G 1/2 Sine Wave, 11 ms duration, 5 shocks in each of 6 directions

Vibration: .018" displacement amplitude from 10 to 50 Hz, 2 G acceleration from 50 to 2000 Hz logarithmic sweep rate. 30 min. duration along each side of the 3 major axes.

DIMENSIONS

[Numbers in brackets indicate millimeters.]

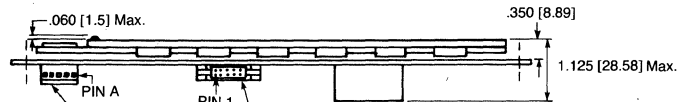
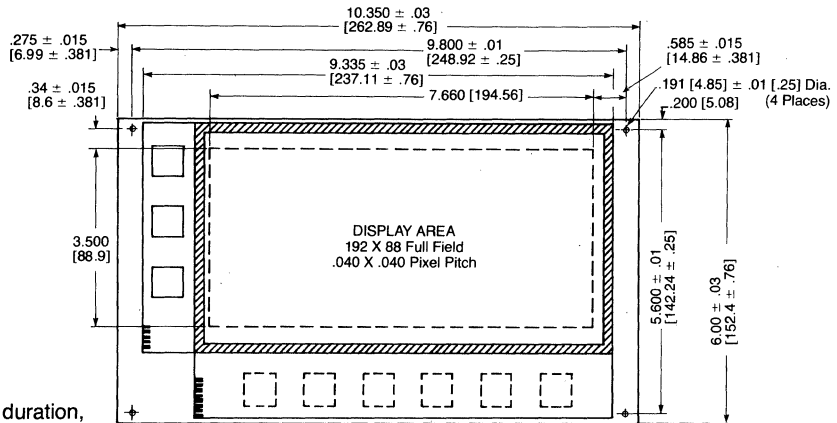

J2 POWER CONNECTOR
 Mates with MOLEX® 09-50-3051 housing
 MOLEX® 08-50-0106 contacts
 (Dale 280500-01) or equivalent

J1 DATA CONNECTOR
 Mates with 3M® 3473 0000
 (Dale 280253-01) or equivalent

ELECTRICAL

	SYMBOL	MIN.	TYP.	MAX.	UNITS
Anode Voltage	HVcc	66.5	70.0	73.5	V
Anode Current	HIcc		50	120	mA
Cathode Voltage	KVcc	-110.0	-115.0	-120.0	V
Cathode Current	KIcc		50	120	mA
Logic Supply 1 Voltage	Vcc1	4.75	5.0	5.25	V
Logic Supply 1 Current(1)	Icc1		125	250	mA
Logic Supply 2 Voltage	Vcc2	11.5	12.0	12.5	V
Logic Supply 2 Current	Icc2		50	80	mA

(1)Vcc1 is the input to a DC-DC converter, there may be peak in rush currents higher than shown.

APD-192G088 Plasma Panel Display Module

GENERAL DESCRIPTION

The APD-192G088 consists of a DC plasma panel display with 88 (horizontal) cathode lines and 192 (vertical) anode lines, and drive electronics. Each cathode line is scanned in sequence from top to bottom, while the anodes are turned on or off to display the intended information. Pixel data are entered in serial (SERIAL DATA) until 192 bits have been received at which time a horizontal sync pulse is used to latch the pixel data to the column driver outputs, and enable the column drivers to display the information. The column drivers are also set up to receive the 192 bits for the next row. When all 88 lines have been scanned, a vertical sync pulse resets the row drivers to begin a new scan. (The display brightness can be varied by delaying the start of the next scan.)

An interface board is standard which includes level shifting and timing circuits making it easy to use standard CRT controllers to supply the 4 key interface signals. Contact the factory for further information on available power supplies and text or graphics controller boards.

PIN CONNECTIONS

J1 Data Connector

PIN	DESCRIPTION
1	DOT CLOCK
2	GND
3	NC
4	+12 VDC
5	V SYNC
6	H SYNC
7	+5 VDC
8	NC
9	GND
10	SERIAL DATA

J2 Power Connector

PIN	DESCRIPTION
A	+12 VDC
B	+5 VDC
C	+70 VDC
D	GND
E	-115 VDC

TIMING DIAGRAM

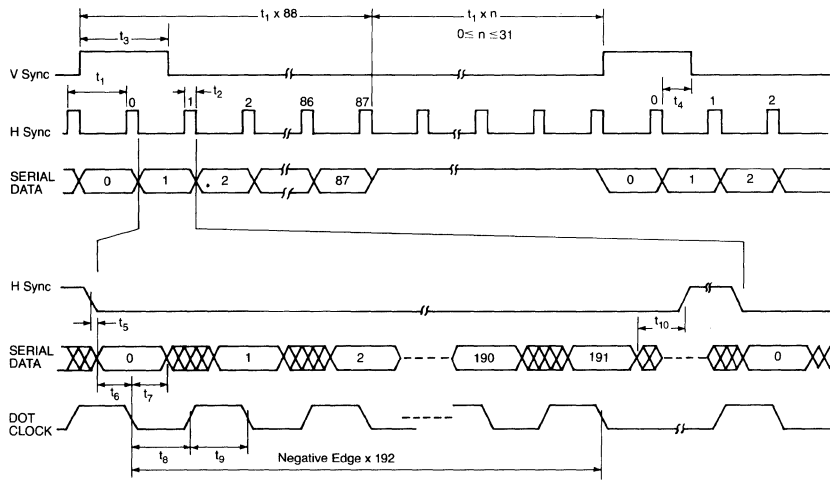

	MIN.	TYP.	MAX.	UNITS
t_1	140	160	190	μ S
t_2	2	10		μ S
t_3	50	150	180	μ S
t_4	1.2			μ S
t_5	0			
t_6	80			ns
t_7	80			ns
t_8	100	200		ns
t_9	100	200		ns
t_{10}	200			ns

SYSTEM BLOCK DIAGRAM

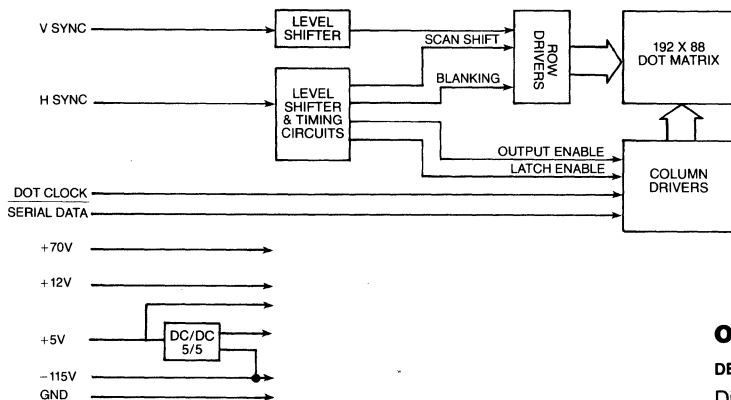

ORDERING INFORMATION

DESCRIPTION	PART NO.
Display drive electronics	APD-192G088
Data connector kit	280253-01
Power connector kit	280500-01
Contrast enhancement filter	280109-06



FLAT PANEL PLASMA DISPLAY MODULE

MODEL APD-192G088-1

192 by 88 graphics display with drive electronics and controller

The APD-192G088-1 is a full field dot matrix display with 192 columns and 88 rows. It includes drive electronics and a microprocessor based controller. The controller maintains all the refresh memory, character generation and control logic with parallel or serial interface and a DC to DC converter to generate the necessary panel voltage. Chip-on-glass construction eliminates hundreds of connections for increased reliability and reduced cost.

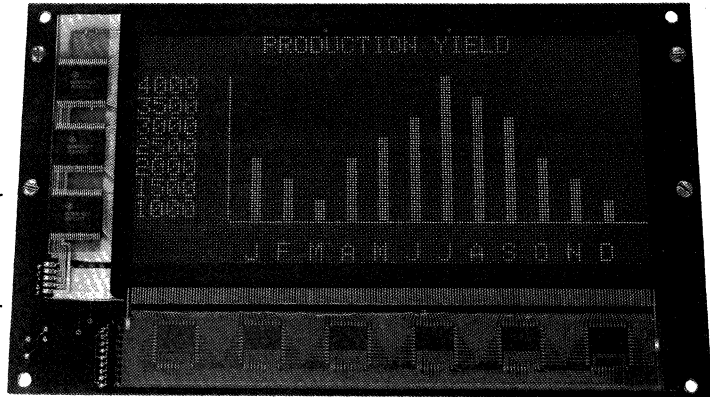

FEATURES

- 192 x 88 full field dot matrix
- Chip-on-glass drivers
- Parallel and serial interfaces
- High brightness
- Wide viewing angle
- Low input voltage
- Compact size
- Software dimming
- All functions software accessible
- Character graphics available

SPECIFICATIONS

OPTICAL

Viewing Area: 7.66" [194.6] x 3.50" [88.9]

Pixel Size: .020" [.51]

Pixel Pitch: .040" [1.02]

Brightness: 80 ft. lamberts

Color: neon orange

Viewing Angle: 120° cone

ENVIRONMENTAL

Operating Temperature: 0°C to +55°C

Storage Temperature: -55°C to +85°C

Relative Humidity: 10-90% R.H. non-condensing

Mechanical Shock: 50 G 1/2 Sine Wave, 11 msec duration, 5 shocks in each of 6 directions

Vibration: .018" [.46] displacement amplitude from 10 to 50 Hz, 2G acceleration from 50 to 2000 Hz logarithmic sweep rate, along each side of the 3 major axes.

DIMENSIONS

[Numbers in brackets indicate millimeters]

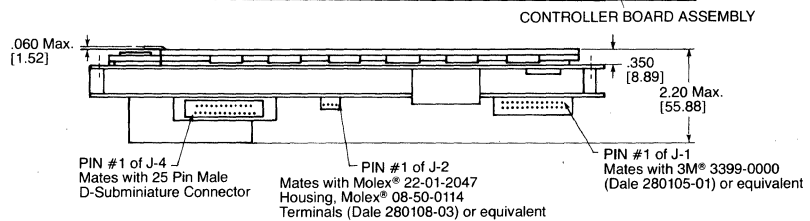
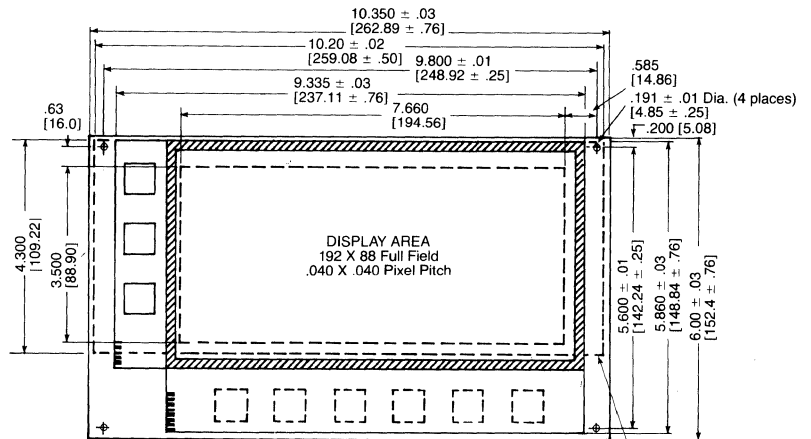

ELECTRICAL

	MIN.	TYP.	MAX.	UNITS
Logic Supply Voltage	+ 4.75	+ 5.0	+ 5.25	V
Logic Supply Current	—	700	—	mA
Panel Supply Voltage	+11.4	+12.0	+12.6	V
Panel Supply Current (1)	—	1.0	2.2	A
Negative Supply Voltage (2)	-11.4	-12.0	-12.6	V
Negative Supply Current	—	60	—	mA
Logic One Voltage	2.0	—	—	V
Logic Zero Voltage	—	—	0.8	V
Logic Zero Input Current	—	—	- 0.4	mA

(1) This is the input to a DC/DC converter. There may be peak in-rush currents higher than shown.

(2) Required only if RS-232-C serial interface is used.

DALE ELECTRONICS, INC., 2064 12th Avenue, Columbus, NE 68601 • Phone 402-564-3131

Canada: Dale Electronics Ltd., 18 Howden Rd., Scarborough, Ontario M1R 3E6
 Europe: Dale Electronics GmbH, Benzstrasse 28, 8039 Puchheim, West Germany

APD-192G088-1 Plasma Panel Display Module

GENERAL DESCRIPTION

The APD-192G088-1 consists of a DC plasma graphics display panel, drive circuitry and controller. Chip-on-glass construction eliminates hundreds of connections for increased reliability and reduced cost.

The controller maintains all the refresh memory, character generation, and control logic to enable the module to serve as a direct readout device for communications terminals, computer readouts, microprocessor instruments, or any other system requiring a self-contained readout. It is programmable to operate in a parallel or serial mode.

The parallel interface is a basic 8 bit parallel interface with hand-shaking and some dedicated control lines. The serial interface is RS-232-C compatible with 8 selectable baud rates (from 75 to 9600) and 2 bit formats.

Single byte and two byte commands allow simplified code generation, yet accomplish complex display tasking such as scrolling, or inserting lines and characters. The character generator is a 4K x 8 bit EPROM and has 256 characters consisting of 128 US ASCII characters (including control codes) and 128 block graphics characters. Alternate character sets can be factory or user programmed.

A DC/DC converter generates the required display voltage from +12 VDC and all input lines are LSTTL compatible with 6.8K pull-up resistors to V_{CC}.

INTERFACING

PARALLEL INTERFACE

The parallel interface offers two forms of hand-shaking called **Ready** and **Data Taken**. Each 8 bit word appearing on the data bus is latched with the falling edge of the **Data Strobe** pulse.

This same negative transition notifies the on-board processor that data has been entered. The **Ready** signal then goes low and the **Data Taken** signal goes low momentarily. The **Ready** signal remains low until the command is completed or the data has been entered. The **Data Taken** pulse is normally 800 nanoseconds long, and indicates when the on-board processor has read the input latch. Data may be entered into the input latch after the rising edge of **Data Taken**.

SERIAL RS-232-C INTERFACE

(See J-4 pin descriptions) The controller is considered to be a DTE type device and will operate with a host that is either a DTE or DCE type device. The serial input and output lines meet RS-232-C specifications. Serial data is entered asynchronously with selectable baud rates. The user can select either 1 start bit, 7 data bits and 2 stop bits, or 1 start bit, 8 data bits and 1 stop bit. In the 7 data bits mode, the graphics characters cannot be displayed.

COMMAND EXECUTION TIMING

DATA	MAX TIME
Displayable Character	190 usec
Cursor Movement (up, down, left, right)	210 usec
Random Cursor Position (each byte of two-byte command)	150 usec
Character Insert/Delete	2.0 msec
Line Insert/Delete	1.3 msec
Clear	6.5 msec
Carriage Return	178 usec
Cursor Home	172 usec
Cursor On	140 usec
Cursor Off	130 usec
Erase to End of Line	2.0 msec
Erase to End of Screen	6.4 msec
Erase Line	1.2 msec
Scroll Control	210 usec
Confidence Test Control	8.0 msec
Blank Control	210 usec
Scan Disable Control	210 usec
Display Control Characters Code	210 usec

NOTES:

Time given for character insert/delete command is for the cursor in the left-most position of a line. Times are reduced in proportion to the number of positions the cursor is moved to the right.

Time given for line insert/delete is for the top line. Times are reduced for inserting/deleting lower lines.

ORDERING INFORMATION

DESCRIPTION	PART NO.
Display, Drive Electronics, plus Controller Board. (Includes DC/DC converter)	APD-192G088-1
Display and Drive Electronics only	APD-192G088
Parallel Data Connector Kit	280105-01
Power Connector Kit	280108-03
Non-Glare Filter (amber circular polarized)— other filters available—contact factory	280109-06

PIN DESCRIPTION

CONNECTOR	PIN	SIGNAL	DESCRIPTION
J1	1, 2, 4, 5, 7, 6, 3, 9	D7-D0	Data bus lines used to transfer data and commands to display.
	13	READY	Used to monitor the display's activity. A logic 0 indicates that the display is busy and cannot respond to new data.
	15	DATA STROBE	Used to notify the display that valid data is present on the data bus. The data byte is loaded with the falling edge of DATA STROBE.
	17	DATA TAKEN	This output goes to logic 0 for approximately 800 nsec when the display has accepted the input data byte after DATA STROBE goes low. New data may be presented coincident with the leading edge of this signal.
	22	SYSTEM SELECT	Used as a unique unit select input. A logic 0 on this line disables the DATA STROBE input.
	10	CURSOR DISABLE	A logic 1 will disable the visual cursor. (This can also be accomplished with a data bus command.)
	16	INITIALIZE	Serves as a display reset. A logic 0 will initialize the controller to its power up state.
	12	RESERVED	This pin is to be left unconnected.
	25, 26	+5 VDC	Logic supply voltage.
	24	-12 VDC	Negative supply voltage (required only for RS-232-C.)
21	+12 VDC	Output available for user (low power only.)	
19, 20	GND	Ground	
J2	1	+12 VDC	Panel supply voltage
	2	+5 VDC	Logic supply voltage
	3	GND	Ground
	4	-12 V	(RS-232-C only)
J4	3	RECEIVE DATA	The display receives data on this pin. (The signal originates at the DCE device transmit pin 2.)
	2	TRANSMIT DATA	The display transmits received data on this pin. (The signal terminates at the DCE device receive pin 3.)
	4	READY TO SEND	This pin will be low when the display is busy and cannot accept new data. (This pin is connected to pin 5 of the DCE device.)
	5	CLEAR TO SEND	Used by the DCE device to cue the display. If the display is not in the serial communications mode, it will not respond with a DATA TERMINAL READY signal.
	20	DATA TERMINAL READY	The display will respond with a high level signal if it is in the serial mode when the DCE cues the display with a high level signal on the CLEAR TO SEND pin.
	7	GND	Signal ground (required)

NOTE: Unidentified pins are not connected

WARNING: Wrong connections or reversing J1 may cause permanent damage to the display and host interface.

FUNCTION SUMMARY

CONTROL CODES	HEX	ASCII
Cursor Home	0E	CNTRL-N
Carriage Return	0D	CNTRL-M
Line Feed	0A	CNTRL-J
Cursor Up	0B	CNTRL-K
Cursor Down	0A	CNTRL-J
Cursor Right	09*	CNTRL-I
Cursor Left	08	CNTRL-H
Alter Cursor Character Position	11	CNTRL-Q
Cursor Character Address (0-1F)	##	
Alter Cursor Row Position	13	CNTRL-S
Cursor Row Address (0-A)	##	
Cursor On	12	CNTRL-R
Cursor Off	14	CNTRL-T
Alter Cursor Format	15	CNTRL-U
Cursor Format Code:	##	
Full block, no blink = 00		
Blinking underbar = 01		
Underbar, no blink = 03		
No Operation	00	CNTRL-@
Clear Screen	0C	CNTRL-L
Character Insert	0F	CNTRL-O
Character Delete	10	CNTRL-P
Line Insert	16	CNTRL-V
Line Delete	17	CNTRL-W
ESCAPE CONTROL CODES		
Erase to End of Line	1B, 0D	ESC, CNTRL-M
Erase to End of Screen	1B, 18	ESC, CNTRL-X
Erase Line	1B, 13	ESC, CNTRL-S
Erase Line and Carriage Return	1B, 25	ESC, SHIFT-%
Alter Brightness	1B, 0C	ESC, CNTRL-L
Brightness Code: 0 = brightest	##	
7 = dimmest	##	
Scroll	1B, 1A	ESC, CNTRL-Z
*End Scroll	1B, 20	ESC, SPACE BAR
Blank Display (on/off alternately)	1B, 11	ESC, CNTRL-Q
Scan Disable (on/off alternately)	1B, 12	ESC, CNTRL-R
Enable Scan Disable Timer	1B, 23	ESC, SHIFT-#
*Disable Scan Disable Timer	1B, 24	ESC, SHIFT-\$
Display Control Characters	1B, 1E	ESC, CNTRL-^
*Disable Control Characters Display	1B, 26	ESC, SHIFT-&
Start Confidence Test	1B, 1F	ESC, CNTRL-__
*Disable Confidence Test (any code)	##	
Reset Controller (to initial state)	1B, 19	ESC, CNTRL-Y

*Indicates power up condition



FLAT PANEL PLASMA DISPLAY MODULE

MODEL APD-240M026 240 character display with drive electronics

The APD-240M026 display module displays up to 240 alphanumeric 5 x 7 dot matrix characters arranged in 6 lines of 40 characters each. The module includes drive electronics and a DC to DC converter to develop the necessary panel voltage. Data interface is equivalent to the Burroughs SII-0640-PD2 as are character dimensions, viewing area and mounting holes.

FEATURES

- 240 (6x40) alphanumeric characters (5x7 dot matrix)
- .14W x .26H character size
- Data interface compatible with Burroughs SII-0640-PD2
- Wide viewing angle (150°)
- Low input voltage (+5 and +12)
- Compact size
- Dimmable with external potentiometer

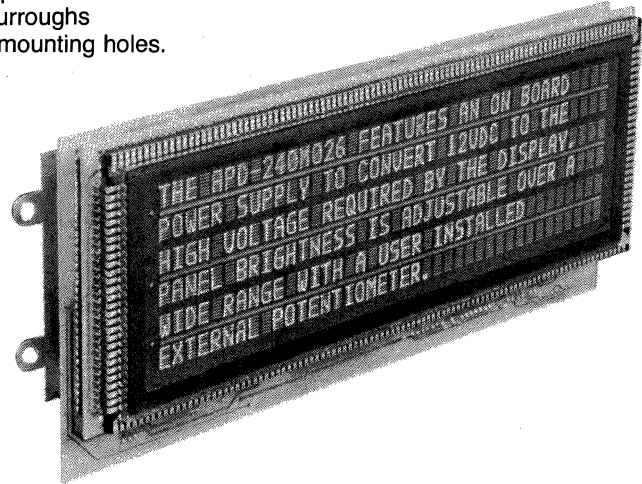

SPECIFICATIONS

OPTICAL

Viewing area: 2.26" [57.40] W x 8.33" [211.66] L

Number of Characters: 240

Character Size: .14" [3.56] W x .26" [6.60] H

Dot Size: .020" [.51] Dia.

Dot Pitch, Vertical: .040" [1.016]

Dot Pitch, Horizontal: .030" [.762]

Character Spacing: 2 blank columns of dots between successive characters

Scanning Rate: 75 Hz

Brightness: 30 foot lamberts

Color: neon orange

Viewing Angle: 150° cone

Panel Dimming: fixed or variable from nominal to less than 50% of nominal

ENVIRONMENTAL

Operating Temperature: 0°C to +55°C

Storage Temperature: -55°C to +85°C

Relative Humidity: 10-90% non-condensing

Mechanical Shock: 50G ½ Sine Wave, 11 ms duration, 5 shocks in each of 6 directions

Vibration: .018" displacement amplitude from 10 to 50 Hz, 2G acceleration from 50 to 2000 Hz logarithmic sweep rate. 30 min. duration along each side of the 3 major axes.

[Numbers in brackets indicate millimeters.]

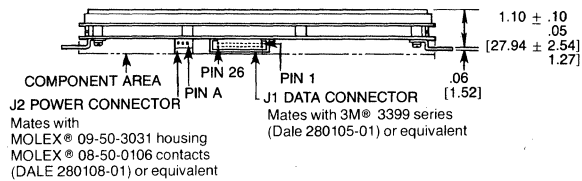
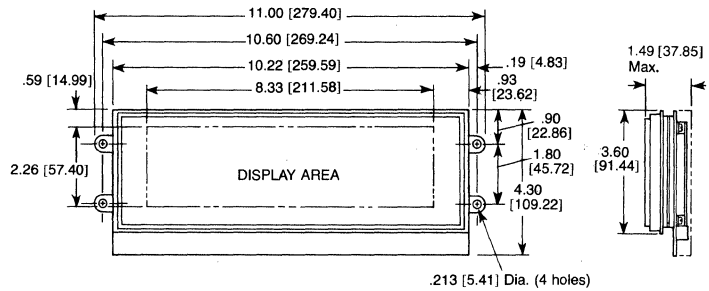

ELECTRICAL

	MIN.	TYP.	MAX.	UNITS
Logic Supply Voltage	+4.75	5.0	+5.25	V
Logic Supply Current	200	210	230	mA
Panel Supply Voltage	11.4	12.0	12.6	V
Panel Supply Current (1)	.85	1.0	1.2	A

(1) This is the input to a DC-DC converter. There may be peak in rush currents higher than shown.

NOTE: SII-0640-PD2 and SII-0640-200 are registered trademarks of the Burroughs Corp.

FUNCTIONAL DESCRIPTION

The APD-240M026 consists of a DC plasma panel display and drive circuitry to accept serially entered column data and generate the required cathode and anode signals to display the desired information. The module displays information in a column scanning mode; that is, column-by-column beginning at the left side, with each character being 7 dots high, and with 6 character rows, 42 bits of dot information per column is supplied to the module as serial data.

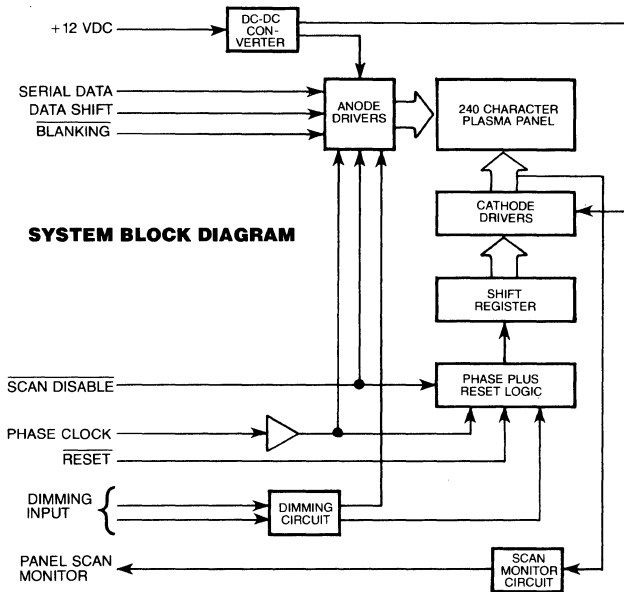

INTERFACE

All input lines are TTL compatible. The Key Interface lines (**Phase Clock, Reset, Data Input, and Data Shift**) are terminated by a low impedance (220Ω to Vcc, 330Ω to ground). These signal interface lines should be driven by open collector buffer gates such as 7407's. The interconnection cable may be up to 84 inches long.

KEY INTERFACE INPUT SIGNALS

Serial Data—The 42 bits of data that represent one column of character data is entered serially on this input. The information is entered at the lowest row position and advanced up one row at a time with each **Data Shift** pulse.

Data Shift—A positive rising edge on this input enters the column data bit present at the **Serial Data** input. This input requires 42 pulses to enter the 42 bits of column data.

Phase Clock—This input increments the cathode column select shift register and transfers data to the latches in the anode drivers. The new anode data is displayed and the clock increments on the positive transition of this signal. This input must be continuously pulsed whenever the display is on to prevent damage to the panel.

Reset—One reset pulse must be applied by the host system after each complete scan to begin a new scan at the left-hand column of the panel. The **Reset** input must be negative for one positive rising edge of the **Phase** clock, but not more than one phase cycle.

J 1 DATA CONNECTOR

PIN	FUNCTION
1	N.C.
2	N.C.
3	N.C.
4	N.C.
5	RESET
6	BLANKING
7	GROUND—PIN 5 RETURN
8	N.C.
9	GROUND—PIN 25 RETURN
10	+ 5 VDC
11	+ 5 VDC
12	+ 5 VDC
13	+ 5 VDC
14	PHASE CLOCK
15	+ 5 VDC
16	SCAN DISABLE
17	GROUND—PIN 14 RETURN
18	DATA SHIFT
19	GROUND—PIN 18 RETURN
20	PANEL SCAN MONITOR
21	N.C.
22	GROUND
23	GROUND
24	GROUND
25	SERIAL DATA
26	N.C.

J 2 POWER CONNECTOR

PIN	FUNCTION
A	GROUND
B	+ 12 VDC
C	GROUND

NOTE:

The APD-240M026 is designed to replace Burroughs SII-0640-PD2 displays. For new designs, Dale recommends the APD-240M026A and APD-240M026A-1. (The APD-240M026A-1 is compatible with Burroughs SII-0640-200.)

ORDERING INFORMATION

DESCRIPTION	PART NO.
Display and Drive Electronics	APD-240M026
Display and Drive Electronics plus Controller Board Mounting Hardware (Does not include Controller Board).....	APD-240M026-2
Data Connector Kit.....	280105-01
Power Connector Kit	280108-01
Non-Glare Filter (Amber Circularly Polarized) — Other filters available	
— Contact factory	280109-03



FLAT PANEL PLASMA DISPLAY MODULE

MODEL APD-240M026A

240 character display with drive electronics

The APD-240M026A display module displays up to 240 alphanumeric 5 x 7 dot matrix characters arranged in 6 lines of 40 characters each. The module includes drive electronics and is easily interfaced to CRT controllers.

FEATURES

- 240 (6x40) alphanumeric characters (5x7 dot matrix)
- .14W x .26H character size
- High brightness (100 ft./lamberts typical)
- Controller Board available with parallel and RS232 inputs
- Wide viewing angle (150°)
- Easily interfaced
- Compact size

SPECIFICATIONS

OPTICAL

Viewing Area: 2.26" [57.40] W x 8.33" [211.66] L

Number of Characters: 240

Character Size: .14" [3.56] W x .26" [6.60] H

Dot Size: .020" [.51] dia.

Dot Pitch, Vertical: .040" [1.016]

Dot Pitch, Horizontal: .030" [.762]

Character Spacing: 2 blank columns of dots between successive characters

Brightness: 100 foot lamberts

Color: neon orange

Viewing Angle: 150° cone

ENVIRONMENTAL

Operating Temperature: 0°C to +55°C

Storage Temperature: -55°C to +85°C

Relative Humidity: 10-90% non-condensing

Mechanical Shock: 50G 1/2 Sine Wave, 11 ms duration, 5 shocks in each of 6 directions

Vibration: .018" displacement amplitude from 10 to 50 Hz, 2G acceleration from 50 to 2000 Hz logarithmic sweep rate. 30 min. duration along each side of the 3 major axes.

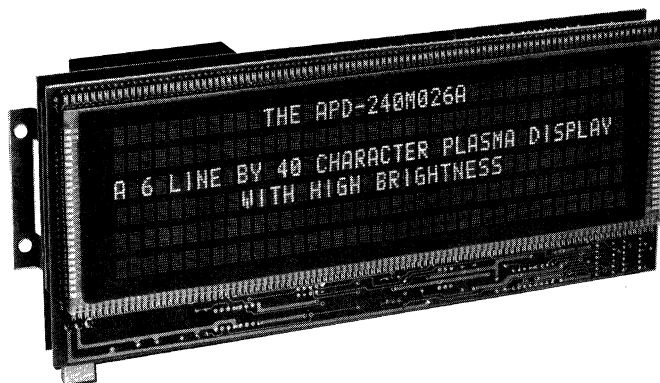

DIMENSIONS

[Numbers in brackets indicate millimeters]

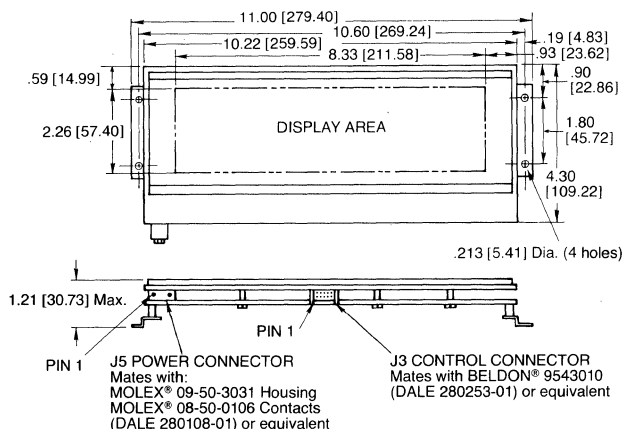

ELECTRICAL

	MIN.	TYP.	MAX.	UNITS
Logic Supply 1 Voltage	4.75	5.0	5.25	V
Logic Supply 2 Voltage	11.40	12.0	12.60	V
Logic Supply 1 Current	—	50	60	mA
Logic Supply 2 Current	—	60	75	mA
Panel Supply 1 Voltage	60.0	65.0	70.0	V
Panel Supply 2 Voltage	-110.0	-115.0	-120.0	V
Panel Supply 1 Current	—	60	128	mA
Panel Supply 2 Current	—	80	135	mA

DALE ELECTRONICS, INC., 2064 12th Avenue, Columbus, NE 68601 • Phone 402-564-3131

Canada: Dale Electronics Ltd., 18 Howden Rd., Scarborough, Ontario M1R 3E6
Europe: Dale Electronics GmbH, Benzstrasse 28, 8039 Puchheim, West Germany

FUNCTIONAL DESCRIPTION

The APD-240M026A consists of a DC plasma panel display and drive circuitry to accept serially entered row data and generate the required cathode and anode signals to display the desired information. The module displays information in a row scanning mode; that is, row by row beginning at the top, with each character being 5 dots wide, and with 40 characters per row, 200 bits of dot information per row is supplied to the module as serial data. When all 200 bits of row information have been loaded, the data will be displayed. This process is repeated until all 42 rows have been scanned in succession. All inputs are TTL compatible.

PIN DESCRIPTION

J-3 DATA CONNECTOR		J-5 POWER CONNECTOR	
PIN	FUNCTION	PIN	FUNCTION
1	DATA SHIFT	A	-115 VDC
2	GROUND	B	GROUND
3	N/C	C	+65 VDC
4	+12 VDC		
5	SCAN SYNC		
6	SCAN CLOCK		
7	+5 VDC		
8	SCAN MONITOR		
9	GROUND		
10	SERIAL DATA		

SYSTEM BLOCK DIAGRAM

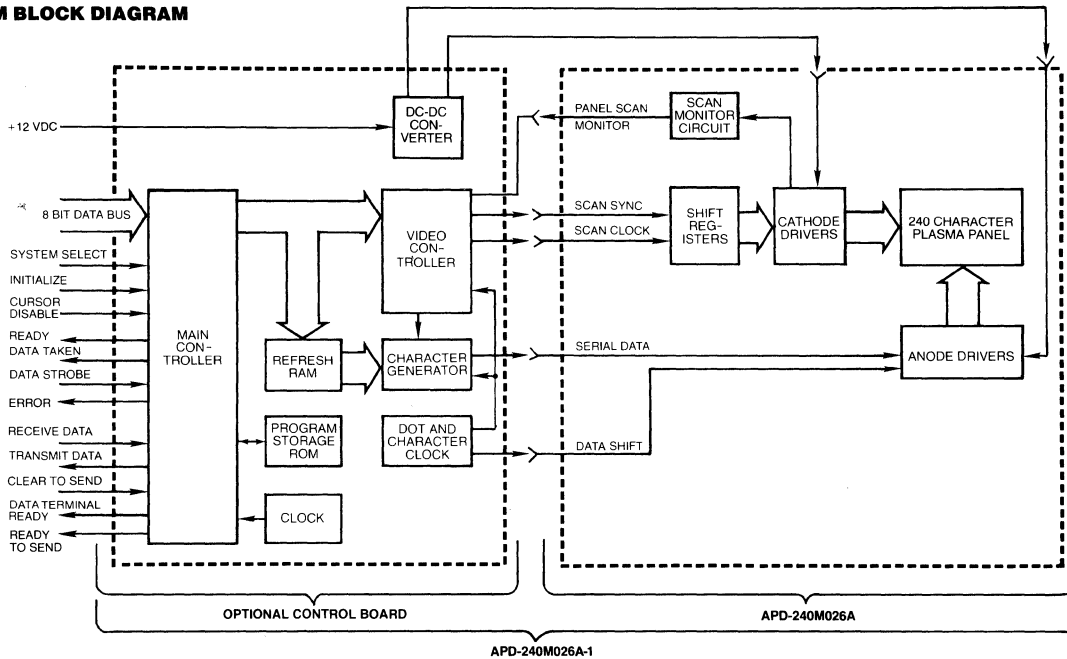

KEY INTERFACE SIGNALS

Serial Data—The 200 bits of data that represent one row of character data is serially entered on this input. The information is entered at the 200th dot position (right side of display) and is advanced one column with each **Data Shift** pulse.

Data Shift—A negative going edge on this input enters the row data bit present at the **Serial Data** input. This input requires 200 pulses to enter the 200 bits of row data.

Scan Clock—Much like horizontal sync on a CRT, this signal is used to advance the row pointer vertically down the display, one row at a time. This input must be continually pulsed whenever the display is on to prevent damage to the panel.

Scan Sync—This pulse is applied after each complete scan to begin a new scan at the top row of the panel, similar to vertical sync on a CRT.

ORDERING INFORMATION

DESCRIPTION	PART NO.
Display and Drive Electronics	APD-240M026A
Display and Drive Electronics plus Controller Board (includes DC-DC high voltage converter)	APD-240M026A-1
DC-DC High Voltage Converter	PDS-400
Data Connector Kit	280253-01
Power Connector Kit	280108-01
Non-Glare Filter (Amber Circularly Polarized)—Other filters available—Contact factory	280109-03



FLAT PANEL PLASMA DISPLAY MODULE

MODEL APD-240M026A-1 240 character display with drive electronics and controller

The APD-240M026A-1 display module displays up to 240 alphanumeric 5 x 7 dot matrix characters arranged in 6 lines of 40 characters each. The module includes drive electronics, a microprocessor-based controller consisting of refresh memory, character generator and control logic with parallel or serial interface and a DC to DC converter to develop the necessary panel voltage.

FEATURES

- 240 (6x40) alphanumeric characters (5x7 dot matrix)
- 128 USASCII character set + 128 user programmable character set
- Parallel and serial interfaces
- High brightness
- Wide viewing angle (150°)
- Low input voltage
- Compact size
- Software dimming

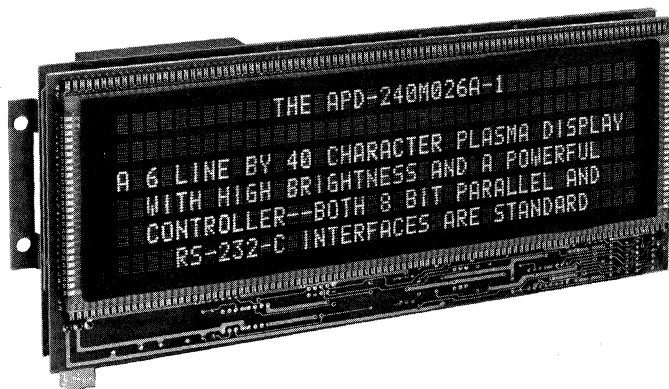

SPECIFICATIONS

OPTICAL

Viewing Area: 2.26" [57.40] W x 8.33" [211.66] L

Number of Characters: 240

Character Size: .14" [3.56] W x .26" [6.60] H

Dot Size: .020" [.51] dia.

Dot Pitch, Vertical: .040" [1.016]

Dot Pitch, Horizontal: .030" [.762]

Character Spacing: 2 blank columns of dots between successive characters

Brightness: 100 foot lamberts

Color: neon orange

Viewing Angle: 150° cone

ENVIRONMENTAL

Operating Temperature: 0°C to +55°C

Storage Temperature: -55°C to +85°C

Relative Humidity: 10-90% non-condensing

Mechanical Shock: 50G 1/2 Sine Wave, 11 ms duration, 5 shocks in each of 6 directions

Vibration: .018" displacement amplitude from 10 to 50 Hz, 2G acceleration from 50 to 2000 Hz logarithmic sweep rate. 30 min. duration along each side of the 3 major axes.

DIMENSIONS

[Numbers in brackets indicate millimeters]

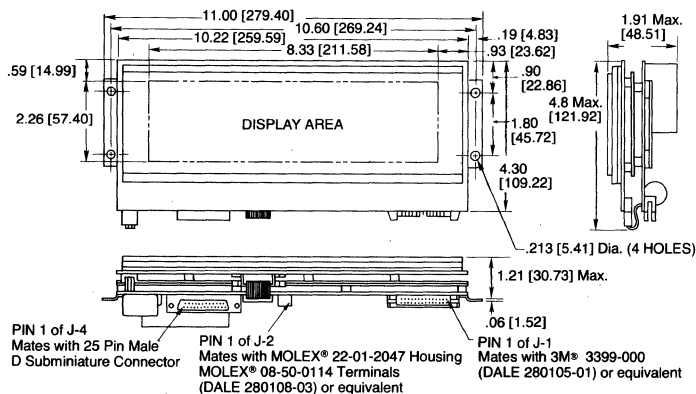

ELECTRICAL

	MIN.	TYP.	MAX.	UNITS
Logic Supply Voltage	+4.75	5.0	+5.25	V
Logic Supply Current	—	700	—	mA
Panel Supply Voltage	11.4	12.0	12.6	V
Panel Supply Current (1)	—	1.0	2.2	A
Negative Supply Voltage (2)	-11.4	-12.0	-12.6	V
Negative Supply Current	—	60	—	mA

(1) This is the input to a DC-DC converter. There may be peak in rush currents higher than shown.

(2) Required only if RS-232-C serial interface is used.

APD-240M026A-1 Plasma Panel Display Module

GENERAL DESCRIPTION

The APD-240M026A-1 consists of a DC plasma panel display, drive circuitry and controller. The controller is programmable to operate in a parallel or serial mode. The parallel interface is a basic 8 bit parallel interface with hand-shaking and some dedicated control lines. The serial interface is RS-232-C compatible with 8 selectable baud rates and 2 bit formats. Single byte and two byte commands allow simplified code generation, yet accomplish complex display tasking such as scrolling, or inserting lines and characters.

The character generator is a 4K x 8 bit EPROM and is capable of storing two 128 character sets. The standard set consists of 128 USASCII characters (including control codes). An alternate set of 128 characters can be user programmed.

A DC-DC converter generates the required display voltage from +12 VDC, and all input lines are LSTTL compatible with 6.8K ohm pull-up resistors to V_{CC}.

FUNCTION SUMMARY

HEX	ASCII
0E	CNTRL-N
0D	CNTRL-M
0A	CNTRL-J
0B	CNTRL-K
0A	CNTRL-J
09	CNTRL-I
08	CNTRL-H
11	CNTRL-Q
##	
13	CNTRL-S
##	
12	CNTRL-R
14	CNTRL-T
15	CNTRL-U
##	
00	CNTRL-@
00	CNTRL-L
0C	CNTRL-L
0F	CNTRL-O
10	CNTRL-P
16	CNTRL-V
17	CNTRL-W
1B,0D	ESC,CNTRL-M
1B,18	ESC,CNTRL-X
1B,13	ESC,CNTRL-S
1B,25	ESC,CNTRL-%
1B,0C	ESC,CNTRL-L
##	
1B,1A	ESC,CNTRL-Z
1B,20	ESC,SPACE BAR
1B,11	ESC,CNTRL-Q
1B,12	ESC,CNTRL-R
1B,0F	ESC,CNTRL-O
1B,0E	ESC,CNTRL-N
1B,23	ESC,SHIFT-#
1B,24	ESC,SHIFT-\$
1B,1E	ESC,CNTRL-^
1B,26	ESC,SHIFT-&
1B,21	ESC,SHIFT-!
1B,22	ESC,SHIFT-"
1B,1F	ESC,SHIFT-.
##	
1B,19	ESC,CNTRL-Y

*Power up condition

PIN CONNECTIONS

J1 DESCRIPTION	J1 DESCRIPTION
9 DATA BIT 1 (LSB)	24 -12 V (RS-232-C ONLY)
3 DATA BIT 2	21 +12 V
6 DATA BIT 3	19 GND
7 DATA BIT 4	20 GND
5 DATA BIT 5	
4 DATA BIT 6	
2 DATA BIT 7	
1 DATA BIT 8 (MSB)	
10 CURSOR DISABLE	
12 ERROR	
13 READY	
15 DATA STROBE	
16 INITIALIZE	
17 DATA TAKEN	
22 SYSTEM SELECT	
25 +5 V	
26 +5 V	

NOTE: UNIDENTIFIED PINS ARE NOT CONNECTED.
WARNING: WRONG CONNECTIONS IN ANY CONNECTORS OR REVERSING J1 MAY CAUSE PERMANENT DAMAGE TO THE DISPLAY AND HOST INTERFACE.

SYSTEM BLOCK DIAGRAM

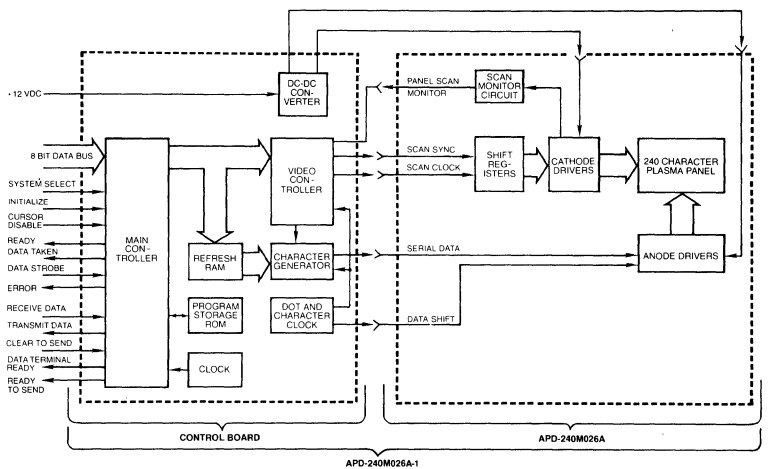

MODIFIED USASCII CHARACTER SET

Bits	b7	b6	b5	b4	b3	b2	b1	Col	0	1	2	3	4	5	6	7
0 0 0 0 0	0	0	0	0	0	0	0	0	NUL	DLE	SP	0	@	P	'	p
0 0 0 0 1	0	0	0	0	1	0	1	1	SOH	DC1	!	1	A	Q	a	q
0 0 0 1 0	0	0	1	0	0	1	0	2	STX	DC2	"	2	B	R	b	r
0 0 1 0 1	0	0	1	0	1	0	1	3	ETX	DC3	#	3	C	S	c	s
0 1 0 0 1	0	1	0	0	0	1	0	4	EOT	DC4	\$	4	D	T	d	t
0 1 0 1 0	0	1	0	1	0	0	1	5	ENQ	NAK	%	5	E	U	e	u
0 1 1 0 0	0	1	1	0	0	0	1	6	ACK	SYN	&	6	F	V	f	v
0 1 1 1 0	0	1	1	1	0	0	1	7	BEL	ETB	'	7	G	W	g	w
1 0 0 0 0	1	0	0	0	0	0	0	8	BS	CAN	(8	H	X	h	x
1 0 0 0 1	1	0	0	0	1	0	0	9	HT	EM)	9	I	Y	i	y
1 0 0 1 0	1	0	0	1	0	0	0	10	LF	SUB	*	:	J	Z	j	z
1 0 1 0 0	1	0	1	0	0	0	0	11	VT	ESC	+	;	K	[k	{
1 1 0 0 0	1	1	0	0	0	0	0	12	FF	FS	,	<	L	\	l	
1 1 0 0 1	1	1	0	0	1	0	0	13	CR	GS	-	=	M]	m	}
1 1 1 0 0	1	1	1	0	0	0	0	14	SO	RS	.	>	N	^	n	~
1 1 1 1 0	1	1	1	1	0	0	0	15	SI	US	/	?	O	_	o	DEL

ORDERING INFORMATION

DESCRIPTION	PART NO.
Display, drive electronics, plus controller board. (includes DC-DC converter).....	APD-240M026A-1
Display and drive electronics only	APD-240M026A
Parallel data connector kit	280105-01
Power connector kit	280108-03
Non glare filter (amber circular polarized) — other filters available — contact factory	280109-03



FLAT PANEL PLASMA DISPLAY MODULE

MODEL APD-256M026

256 character display with drive electronics

The APD-256M026 display module displays up to 256 alphanumeric 5 x 7 dot matrix characters arranged in 8 lines of 32 characters each. The module includes drive electronics and is easily interfaced to CRT controllers.

FEATURES

- 256 (8x32) alphanumeric characters (5x7 dot matrix plus underbar)
- .18W x .26H character size
- High brightness (100 ft./lamberts typical)
- Controller Board available with parallel and RS232 inputs
- Wide viewing angle (150°)
- Easily interfaced
- Compact size

SPECIFICATIONS

OPTICAL

Viewing area: 3.30" [83.82] W x 7.62" [193.55] L

Number of Characters: 256

Character Size: .18" [4.57] W x .26" [6.60] H

Dot Size: .020" [.51] Dia.

Dot Pitch: .040" [1.016]

Character Spacing: .060" [1.52]

Scanning Rate: 70-80 Hz

Brightness: 100 ft. lamberts

Color: neon orange

Viewing Angle: 150° cone

ENVIRONMENTAL

Operating Temperature: 0°C to +55°C

Storage Temperature: -55°C to +85°C

Relative Humidity: 10-90% non-condensing

Mechanical Shock: 50G½ Sine Wave, 11 ms duration, 5 shocks in each of 6 directions

Vibration: .018" displacement amplitude from 10 to 50 Hz, 2G acceleration from 50 to 2000 Hz logarithmic sweep rate. 30 min. duration along each side of the 3 major axes.

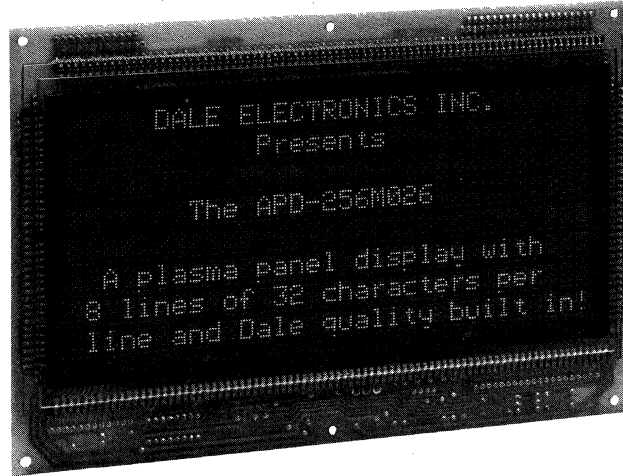

DIMENSIONS

[Numbers in brackets indicate millimeters]

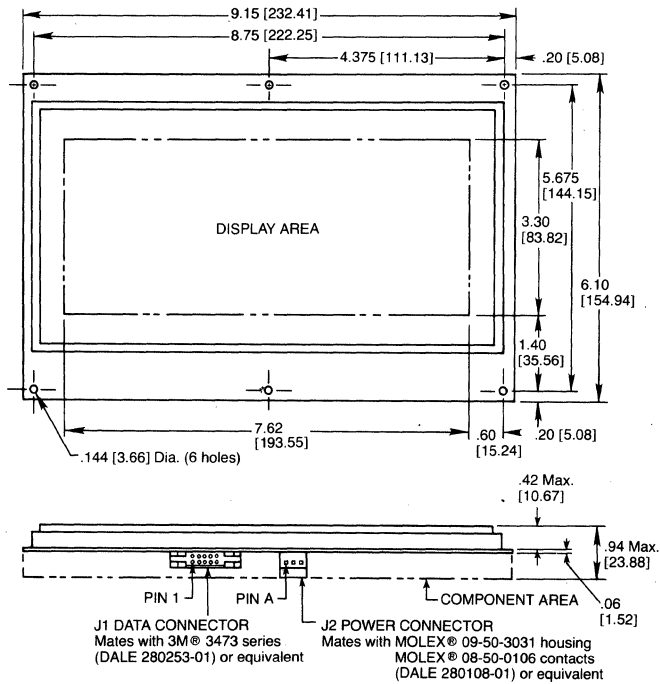

ELECTRICAL

	MIN.	TYP.	MAX.	UNITS
Logic Supply 1 Voltage	4.75	5.0	5.25	V
Logic Supply 2 Voltage	11.40	12.0	12.60	V
Logic Supply 1 Current	—	50	60	mA
Logic Supply 2 Current	—	60	75	mA
Panel Supply 1 Voltage	91.25	95	99.75	V
Panel Supply 2 Voltage	-85.50	-90	-94.50	V
Panel Supply 1 Current	—	60	128	mA
Panel Supply 2 Current	—	80	135	mA

DALE ELECTRONICS, INC., 2064 12th Avenue, Columbus, NE 68601 • Phone 402-564-3131

Canada: Dale Electronics Ltd., 18 Howden Rd., Scarborough, Ontario M1R 3E6
Europe: Dale Electronics GmbH, Benzstrasse 28, 8039 Puchheim, West Germany

PBG-C7005 Plasma Panel Display

PBG-C7008 Plasma Panel Display

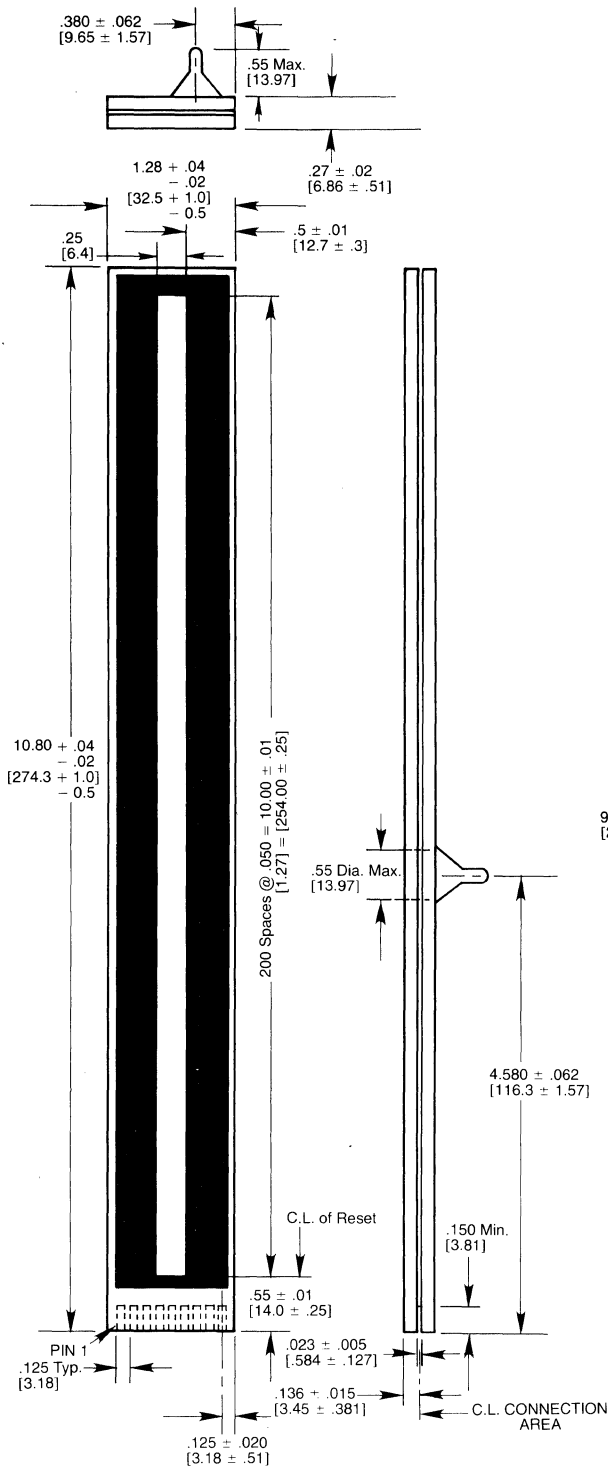

PIN CONNECTIONS

PIN	CONNECTION	PIN	CONNECTION
1	Phase 1 Cathode	6	Phase 2 Cathode
2	Phase 5 Cathode	7	Phase 4 Cathode
3	Reset Cathode	8	Phase 3 Cathode
4	Keep Alive Cathode	9	Display Anode
5	Keep Alive Anode		

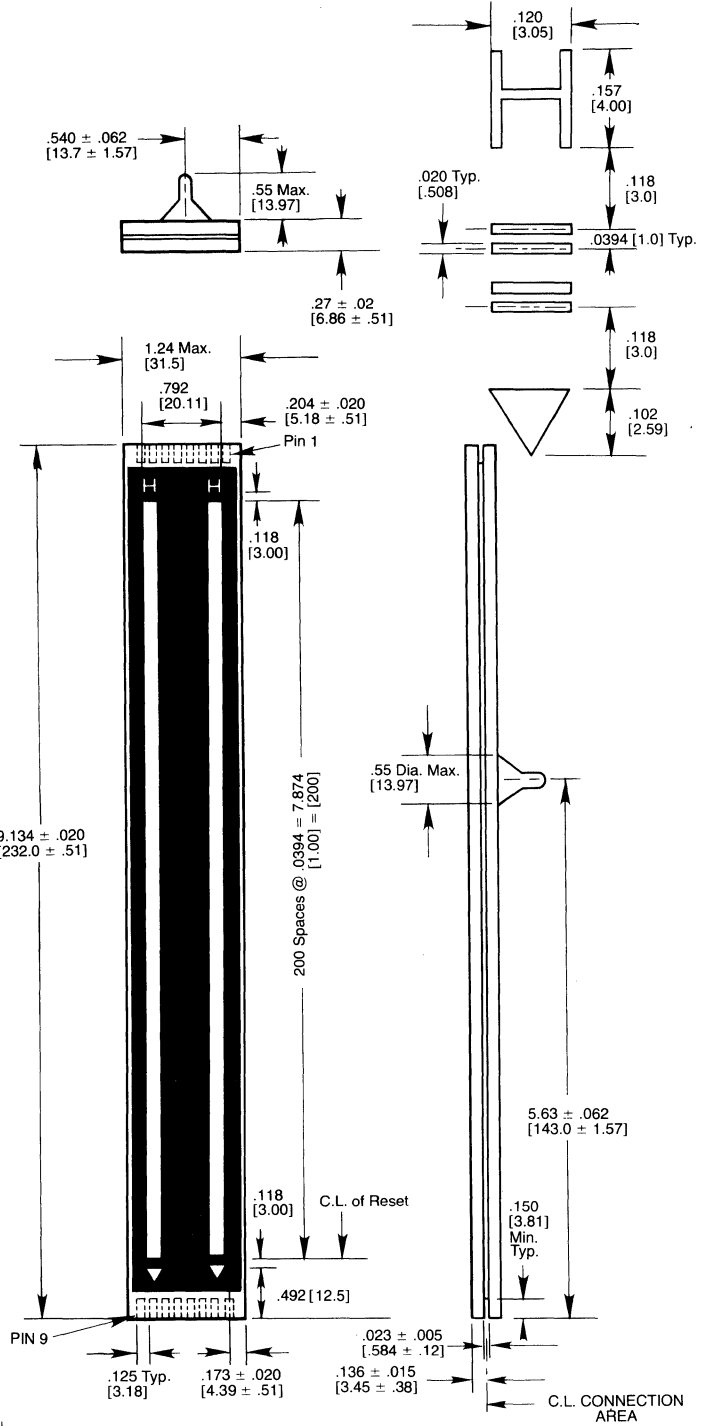

PIN CONNECTIONS

PIN	CONNECTION	PIN	CONNECTION
1	Phase 4 Cathode	9	Left ∇ Anode
2	Right H Anode	10	Phase 1 and H Cathode
3	Phase 5 and ∇ Cathode	11	Left Bar Anode
4	Top Keep Alive Cathode	12	Bottom Keep Alive Anode
5	Top Keep Alive Anode	13	Bottom Keep Alive Cathode
6	Phase 3 Cathode	14	Right Bar Anode
7	Left H Anode	15	Reset Cathode
8	Phase 2 Cathode	16	Right ∇ Anode



DUAL LINEAR BAR GRAPH PLASMA PANEL DISPLAYS

MODEL PBG

FEATURES

- Two separate bar graphs, each including reset for 1/2% or 1% resolution (see chart).
- At normal viewing distances glow blends into continuous, but precisely controlled bar length.
- Unique scanning technique minimizes the number of drivers required.
- PBG-12203 bars may be scanned from either direction or both directions simultaneously.
- PBG-12203 can display four separate columns of information, providing combined total of information does not exceed 201 clock counts per bar.

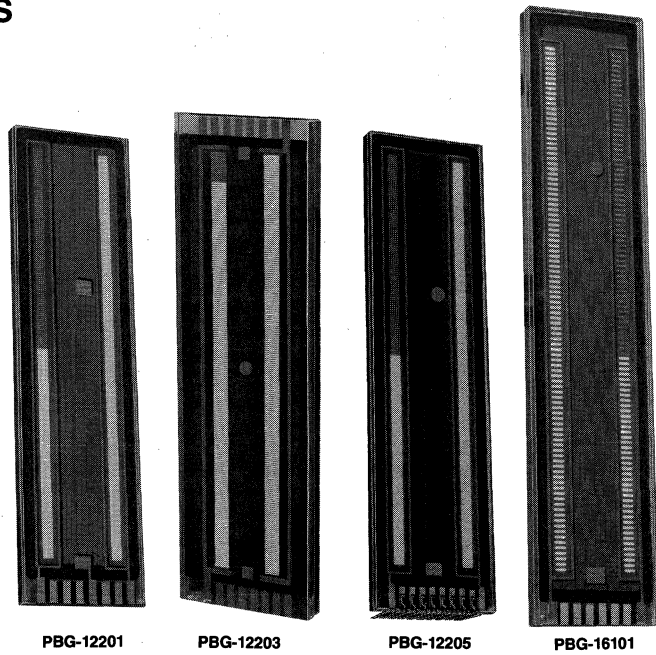

PBG-12201

PBG-12203

PBG-12205

PBG-16101

ENVIRONMENTAL CONDITIONS

Altitude: 0 to 70,000 ft.

Operating Temperature: 0° to +55°C

Storage Temperature: -55°C to +85°C

Relative Humidity (No Condensation): 85% Max.

Vibration: .018 inches DA, 10 to 50 Hz, 2G, 50 to 2000 Hz

Shock: 50G, 1/2 Sinewave, 11 mS Duration

	PBG-12201	PBG-12203	PBG-12205	PBG-16101
Elements	201	203	201	101
Resolution	1/2%	1/2%	1/2%	1%
Segment Length	.100"	.150"	.100"	.100"
Segment Width	.011"	.010"	.011"	.020"
Segment Spacing	.020"	.020"	.020"	.050"
Drivers Required	6	12	8	6
Light Output	35 fl	30 fl	70 fl	60 fl
Viewing Angle	120°	120°	120°	120°
Color	Neon Orange	Neon Orange	Neon Orange	Neon Orange

OPERATING PARAMETERS

Parameter	PBG-12201				PBG-12203				PBG-12205				PBG-16101			
	Min.	Max.	Rec.	Units	Min.	Max.	Rec.	Units	Min.	Max.	Rec.	Units	Min.	Max.	Rec.	Units
Anode Supply Voltage	235	265	250	V	235	265	250	V	235	265	250	V	235	265	250	V
Cathode off Bias Voltage	68	76	72	V	68	76	72	V	68	76	72	V	68	76	72	V
Anode off Bias Voltage	80	120	100	V	80	120	100	V	80	120	100	V	80	120	100	V
Anode Sustaining Voltage (Typical)	—	—	150	V	—	—	150	V	—	—	150	V	—	—	150	V
Refresh Rate	—	—	70	Hz	—	—	70	Hz	—	—	70	Hz	—	—	70	Hz
Keep Alive Anode Resistor	—	—	1M	Ω	—	—	1M	Ω	—	—	1M	Ω	—	—	1M	Ω
Keep Alive Cathode Resistor	—	—	—	—	—	—	1M	Ω	—	—	—	—	—	—	—	—
Keep Alive Current (Typical)	—	—	100	μA	—	—	50	μA	—	—	100	μA	—	—	100	μA
Display Anode Resistor	—	—	36K	Ω	—	—	24K	Ω	—	—	24K	Ω	—	—	20K	Ω
Display Peak Anode Current	2.5	3.0	2.8	mA	3.7	4.5	4.2	mA	3.5	5.0	4.0	mA	4.0	6.0	5.0	mA
Scan Time Per Cathode	70	90	70	μS	70	90	70	μS	60	90	70	μS	120	180	140	μS
Applied Reset Pulse Width	140	180	140	μS	140	180	140	μS	70	180	140	μS	120	180	140	μS

PBG-12201 Plasma Panel Display

DIMENSIONS

[Numbers in brackets indicate millimeters]

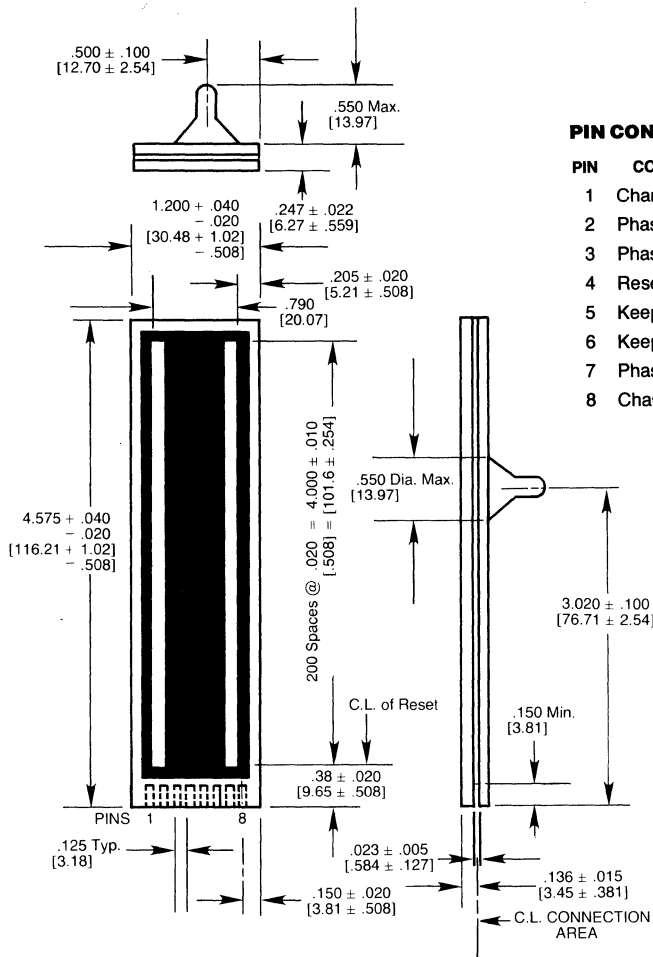

PIN CONNECTIONS

PIN	CONNECTION
1	Channel No. 1 Anode
2	Phase 1 Cathode
3	Phase 3 Cathode
4	Reset Cathode
5	Keep-Alive Anode
6	Keep-Alive Cathode
7	Phase 2 Cathode
8	Channel No. 2 Anode

BLOCK DIAGRAM OF TYPICAL DRIVE CIRCUIT

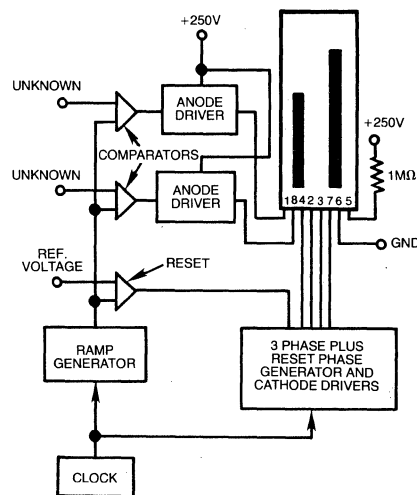

PBG-12203 Plasma Panel Display $.700 \pm .100$ [17.78 ± 2.54] $.550$ Max. [13.97]

DIMENSIONS

[Numbers in brackets indicate millimeters]

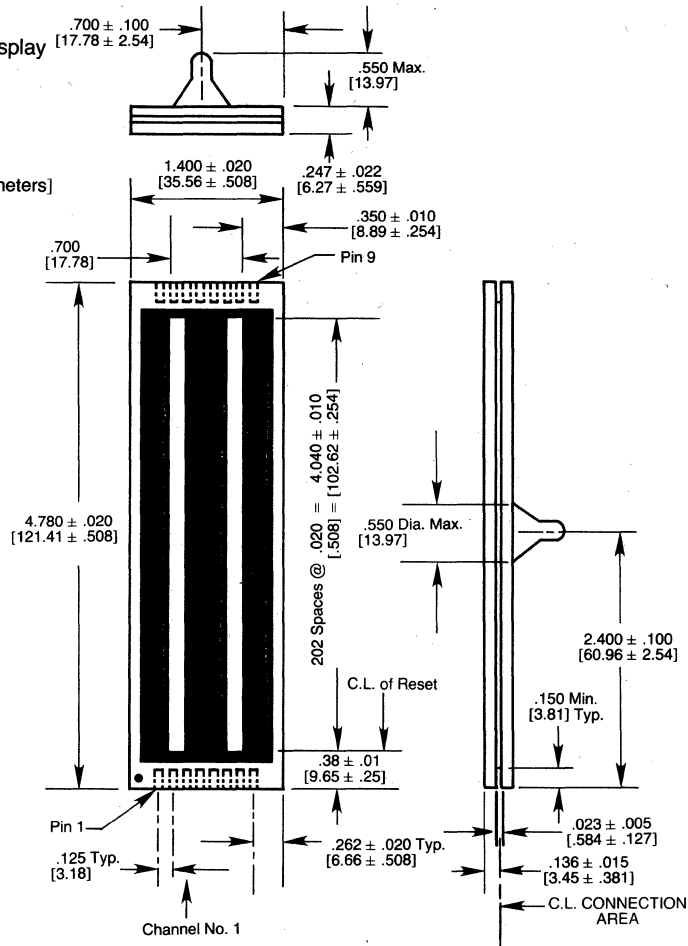

PIN CONNECTIONS

Channel No. 1

PIN	CONNECTION
1	Anode
2	Top Reset Cathode
3	Phase 1 Cathode
4	Bottom Reset Cathode
5	Phase 2 Cathode
6	Keep-Alive Cathode
7	Keep-Alive Anode
8	Phase 3 Cathode

Channel No. 2

PIN	CONNECTION
9	Anode
10	Top Reset Cathode
11	Phase 1 Cathode
12	Bottom Reset Cathode
13	Phase 2 Cathode
14	Keep-Alive Cathode
15	Keep-Alive Anode
16	Phase 3 Cathode

**BLOCK DIAGRAM
MODE 1 OF OPERATION**

Each bar graph scanned from both directions (bottom and top)

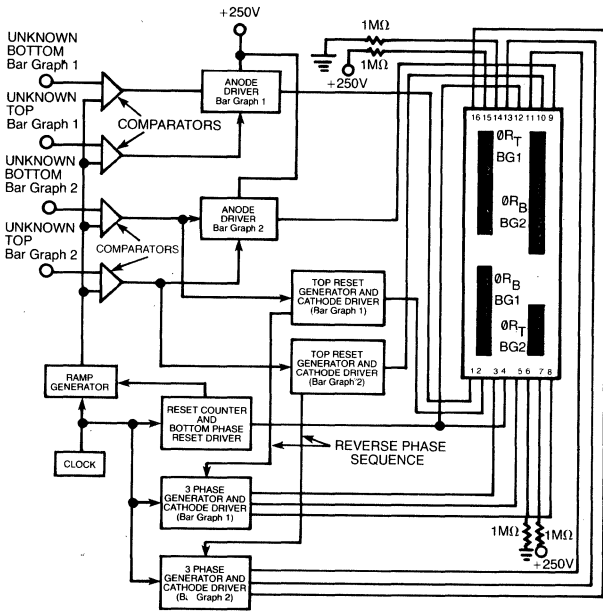

**BLOCK DIAGRAM
MODE 2 OF OPERATION**

Each bar graph scanned from one direction only

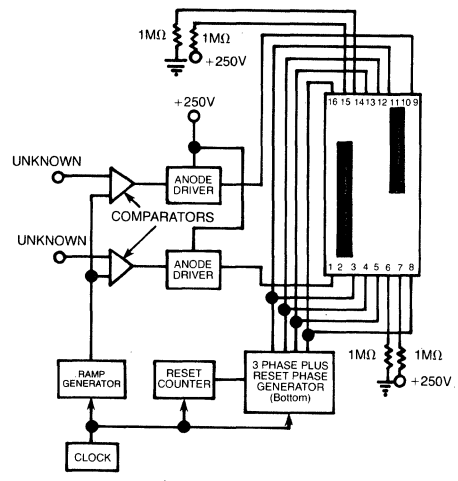

DIMENSIONS

[Numbers in brackets indicate millimeters]

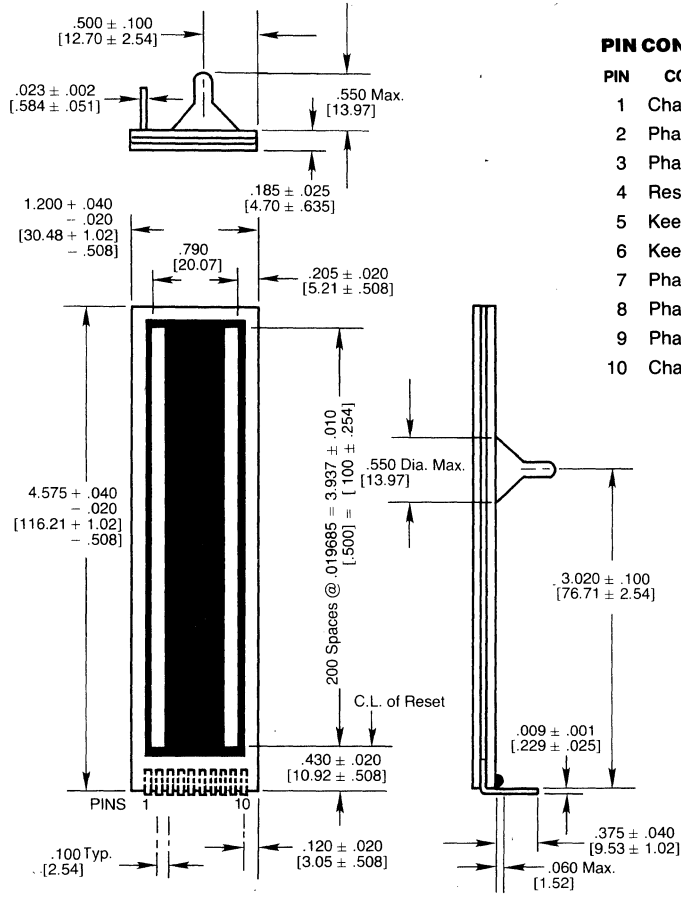

PIN CONNECTIONS

PIN	CONNECTION
1	Channel No. 1 Anode
2	Phase 2 Cathode
3	Phase 1 Cathode
4	Reset Cathode
5	Keep-Alive Anode
6	Keep-Alive Cathode
7	Phase 4 Cathode
8	Phase 3 Cathode
9	Phase 5 Cathode
10	Channel No. 2 Anode

BLOCK DIAGRAM OF TYPICAL DRIVE CIRCUIT

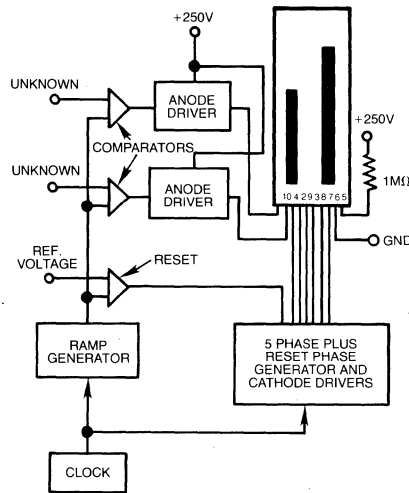

PBG-16101 Plasma Panel Display

DIMENSIONS

[Numbers in brackets indicate millimeters]

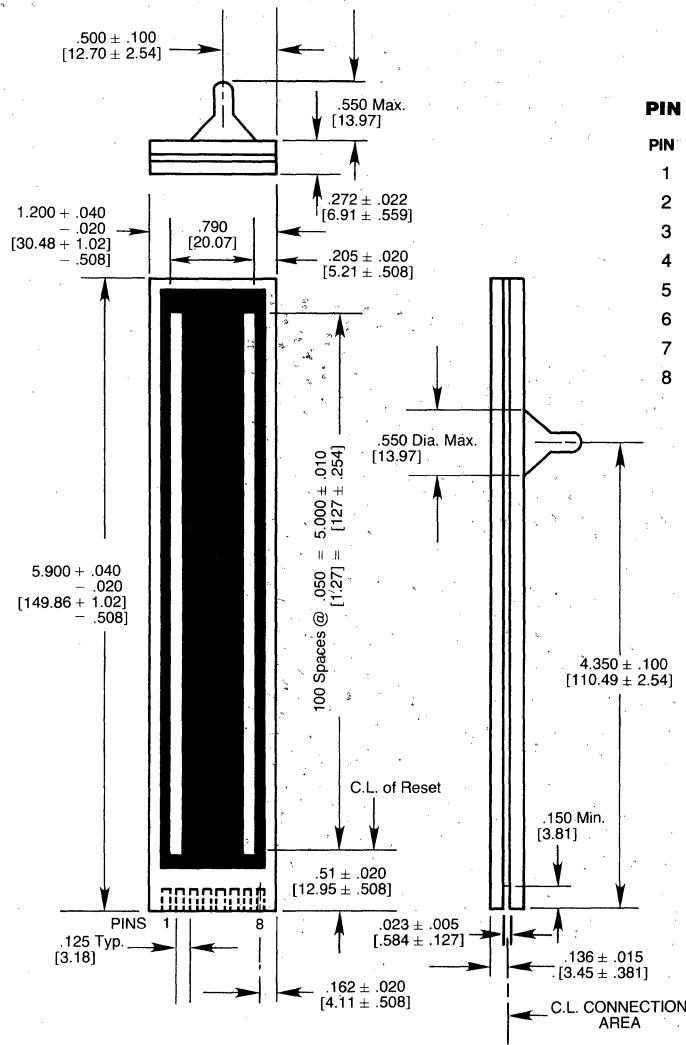

PIN CONNECTIONS

PIN	CONNECTION
1	Channel No. 1 Anode
2	Phase 1 Cathode
3	Phase 3 Cathode
4	Reset Cathode
5	Keep-Alive Anode
6	Keep-Alive Cathode
7	Phase 2 Cathode
8	Channel No. 2 Anode

BLOCK DIAGRAM OF TYPICAL DRIVE CIRCUIT

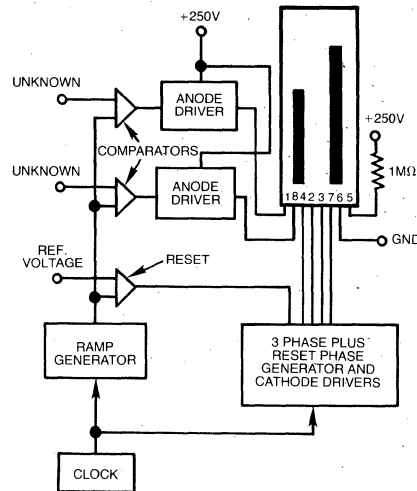



PACKAGING METHODS

These pages show standard packaging methods now in use by Dale Electronics. If you have a question or a special requirement, consult the factory.

CONNECTORS

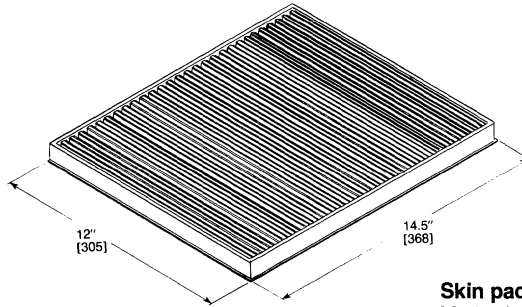

INSERT TRAY

High impact styrene, vacuum formed to protect individual units and for easy disbursement from tray.

TYPICAL TYPES	APPROX. UNITS PER LAYER	APPROX. UNITS PER BOX
EB 7	100	500-900
EB 8	100	500-900
EBT 156	100	500-900

Skin packaging, heat seal per MIL-P-116. Level A Method 1A-8, special boxing and other methods available.

RF CHOKES

REEL PACK

Lead tape reel packaging of axial lead components meets EIA RS 296 standard.

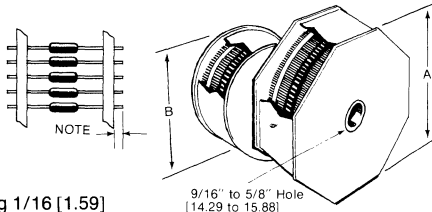

NOTE: Lead trimming 1/16 [1.59] from tape edge available on request as a standard option.

TYPICAL TYPES	Small Flange "B" 7-1/2 [190.50]	Large Flange "A" 11-3/32 [281.78]	PITCH	TAPE SPACING
IM/IR-2	1500	4000	.200 [5.08]	2-1/16 [52.39]
IM/IR-4/IMS-5	1000	2500	.200 [5.08]	2-1/16 [52.39]
IM-6	500	1250	.400 [10.16]	2-1/16 [52.39]
IM-8	—	1000	.400 [10.16]	2-1/16 [52.39]
IM-10	—	800	.400 [10.16]	2-1/16 [52.39]

BULK PACK

Axial units are uniformly packaged 200 per box, with 10 unit boxes per intermediate container.

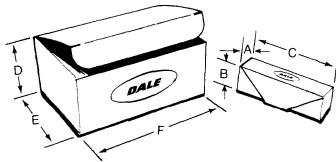

TYPICAL TYPES	UNIT BOX			INTERMEDIATE BOX		
	A	B	C	D	E	F
IM/IR-2	1 [25.4]	1-3/8 [34.9]	3-5/8 [92.1]	3 [76.2]	3-3/4 [95.2]	5-3/8 [136.5]
IM/IR-4	1-1/2 [38.1]	2 [50.8]	3-7/8 [98.4]	4-3/16 [106.4]	4 [101.6]	7-13/16 [198.4]
IMS-5	2 [50.8]	2 [50.8]	3-7/8 [98.4]	4-1/4 [108.0]	4 [101.6]	10-1/4 [260.4]
IM-6	2-1/4 [57.2]	2-1/4 [57.2]	3-7/8 [98.4]	4-3/4 [120.7]	4 [101.6]	11-1/2 [292.1]

AMMO PACK

RF Chokes are lead taped the same as in reel pack, then placed in a continuous "S" pattern (without paper inner leaf) in an appropriate box.

TRANSFORMERS

INSERT LAYER PACK

Die cut corrugated cardboard to fit each of 5 basic sizes.

Cushion wrapping, styrofoam and other methods are available for special sizes and configurations.

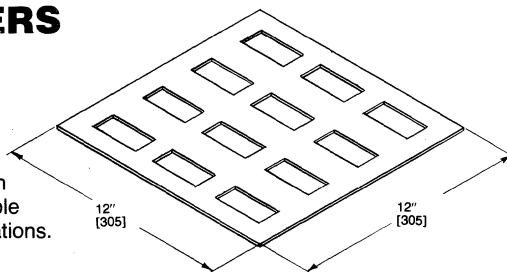

TYPICAL TYPES (SIZES)	UNITS PER LAYER	APPROX. UNITS PER BOX
PL-11 (3/4 watt)	60	300
PL-12 (1-1/2 watts)	48	144
PL-13 (4-1/2 watts)	35	105
PL-14 (10 watts)	24	72

SKIN PACKAGING

A versatile packaging method. Units are placed on double-faced corrugated board, then skin packed to board with polyfilm. Most component types are in multiples of five. For small parts, an "egg crate" partition is placed on board. Quantity per board depends on component size. Typical parts skin packaged include toroids, special transformers and some connectors can also be skin packaged. Consult factory.

For more information on CONNECTOR, CHOKE and TRANSFORMER PACKAGING write or phone:
DALE ELECTRONICS, INC., East Highway 50, Yankton, SD 57078 • Phone 605-665-9301
 Canada: Dale Electronics Ltd., 18 Howden Rd., Scarborough, Ontario M1R 3E6
 Europe: Dale Electronics GmbH, Benzstrasse 28, 8039 Puchheim, West Germany

OSCILLATORS

HYBRID CRYSTAL CLOCK
STYLES (XO-43, XO-51B,
XOSM-51B, XO-53B and XO-54B)

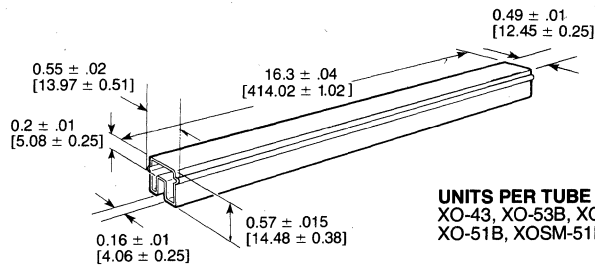

UNITS PER TUBE
XO-43, XO-53B, XO-54B: 20 Pieces
XO-51B, XOSM-51B: 33 Pieces

For more information on OSCILLATOR PACKAGING write or phone:

DALE ELECTRONICS, INC., 1155 West 23rd St., Tempe, AZ 85282 • Phone 602-967-7874
Canada: Dale Electronics Ltd., 18 Howden Rd., Scarborough, Ontario M1R 3E6
Europe: Dale Electronics GmbH, Benzstrasse 28, 8039 Puchheim, West Germany

RESISTOR NETWORKS

STANDARD (●) AND OPTIONAL (X) PACKAGING

PACKAGING STYLES	DUAL-IN-LINE			FLAT PACKS		SINGLE-IN-LINE				SMD'S			
	MDM	MDP	RC Molded	DFM	DFP	CSC	MSM	MSP	RC Coated	RC Molded	LCCC	SOMC	LCMC
End-to-end Magazine (Tube)	●	●	●	●	●	X	●	●		●	●	●	
Poly Bag				X	X	●			●				
Side-by-side SIP							X	X					
Tape and Reel													X

● END-TO-END MAGAZINE (Tube) PACK DIP/SIP.

A magazine pack for single-in-line and dual-in-line resistor networks. Quantity per pack dependent on size of units. Maximum tube length is 23-1/2 [596.9]. Width and depth of tube dependent on size of individual resistor network.

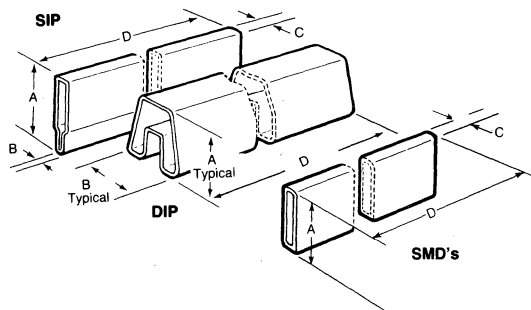

END-TO-END TUBE PACK DIMENSIONS

	A	B	C	D
DIP	1/2 [12.70]	.600 [15.24]	—	23-1/2 [596.90]
SIP Low Profile	.43 [10.92]	.04 [1.02]	.12 [3.05]	23-1/2 [596.90]
SIP High Profile	.605 [15.37]	.04 [1.02]	.12 [3.05]	23-1/2 [596.90]

● MAGAZINE (Tube) PACK FLAT PACK.

All flat packs are packaged in individual protective carriers that are considered as part of all flat pack units. Flat pack units are then packed in magazines (tubes).

SMD's	A	C	D
LCCC	.40 [10.16]	.10 [2.54]	23-1/2 [596.9]
LCMC	.40 [10.16]	.20 [5.08]	23-1/2 [596.9]
SOMC	.40 [10.16]	.15 [3.81]	23-1/2 [596.9]

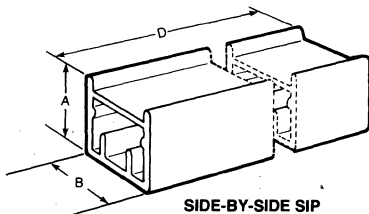
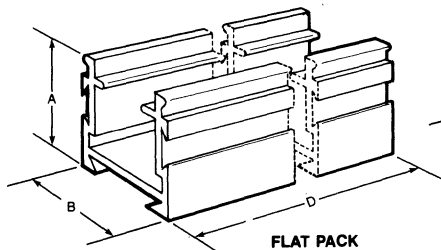

	A	B	D
FLAT PACK	1.38 [35.05]	1.10 [27.94]	23-1/2 [596.9]
SIDE-BY-SIDE SIP			
10 PIN	.65 [16.51]	1.10 [27.94]	23-1/2 [596.9]
8 PIN	.65 [16.51]	.86 [21.84]	23-1/2 [596.9]
6 PIN	.65 [16.51]	.70 [17.78]	23-1/2 [596.9]
4 PIN	.65 [16.51]	.50 [12.70]	23-1/2 [596.9]

● POLY BAG

Units are packaged in poly bags and then packed in boxes.

X SPECIAL PACKAGING

Blister, vial, military, antistatic, and customer special packaging can be provided. Consult factory for information.

NOTE: ALL magazine (tube) packs are antistatic.

For more information on RESISTOR NETWORK PACKAGING write or phone:

DALE ELECTRONICS, INC., Box 26728, El Paso, TX 79926 • Phone 915-592-3253
Canada: Dale Electronics Ltd., 18 Howden Rd., Scarborough, Ontario M1R 3E6
Europe: Dale Electronics GmbH, Benzstrasse 28, 8039 Puchheim, West Germany



PACKAGING METHODS

Consult factory for standard package available for the resistor you have selected.

FILM RESISTORS

TAPED LEAD AND REEL PACKAGE

TYPICAL TYPES	MAX. UNITS PER REEL
CMF-50, ERL-05, ERC-50, CCF-05	5000
CCF-07, CCF-55, CMF-55, CMF-07, ERL-07, ERC-55	5000
CCF-60, CMF-60, CMF-20, ERL-20, ERC-60	3000
CMF-65	2000

BULK PACK

Resistors are uniformly packaged 100 per box with 10 unit boxes per intermediate container.

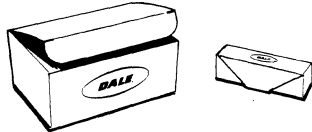

LACER PACK

Resistor body placed in slot, held in place with tongue insert. Terminals protected within folder. 20 units per folder.

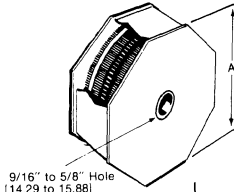
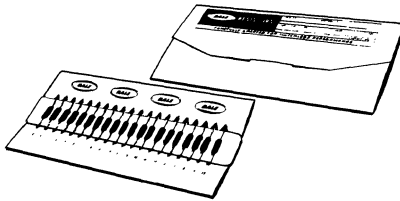

LEAD TAPING DIMENSIONS

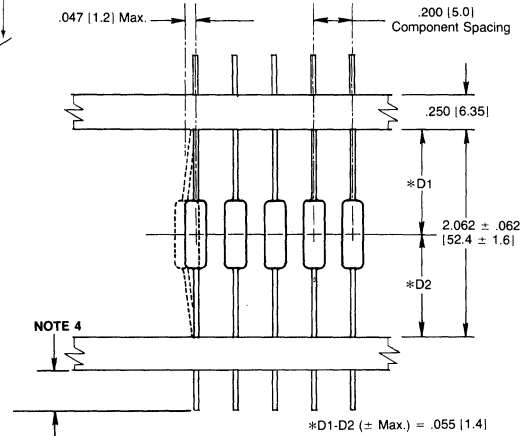

NOTES:

- Quantity per reel: (see table).
- A minimum of 18 inches [457] bare tape leader shall be provided at each end of the reel.
- Protection between layers of components provided by Kraft paper separator.
- Lead trimming 1/16 [1.59] from tape edge available on request. (Standard on CCF-05, CCF-07, CCF-55 and CCF-60.)
- Marking of reeled components in 100-piece intervals available on request. Consult factory.

TAPE AND REEL SPECIFICATIONS

MARKING: All required marking to be on unit package. Individual part marking is available. Stocked, CRCW 1206, 5% units are marked with 3 digit value code.
PACKAGING: Bulk Package — 1000 pieces per plastic bag.
 8mm Reel — 5000 pieces per reel per EIA Standard RS-481.

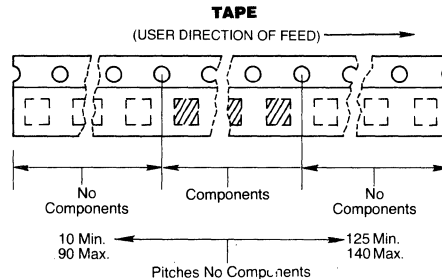
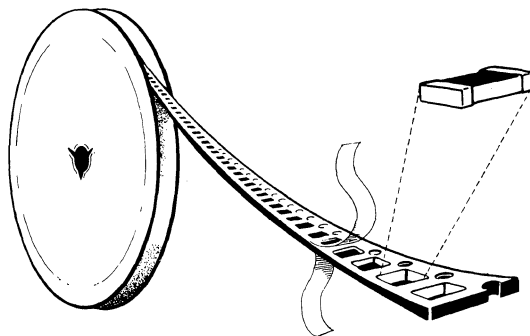

REEL DIMENSIONS

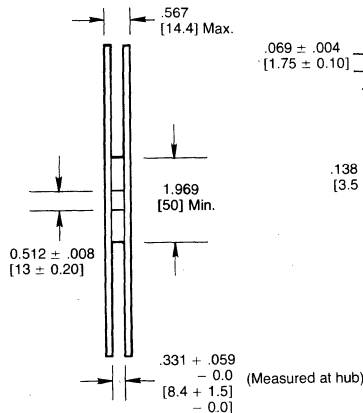
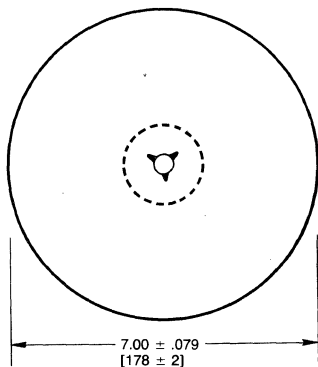

TAPE DIMENSIONS

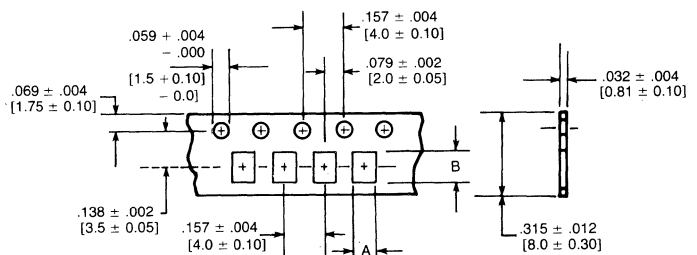

DALE TYPE	A ± .005 [± 0.13]	B ± .005 [± 0.13]
CRCW 0805	.070 [1.78]	.100 [2.54]
CRCW 1206	.080 [2.03]	.142 [3.61]
CRCW 1210	.115 [2.92]	.142 [3.61]

For more information on METAL FILM RESISTOR PACKAGING write or phone:

DALE ELECTRONICS, INC., 2300 Riverside Blvd., Norfolk, NE 68701 • Phone 402-371-0080

Canada: Dale Electronics Ltd., 18 Howden Rd., Scarborough, Ontario M1R 3E6
 Europe: Dale Electronics GmbH, Benzstrasse 28, 8039 Puchheim, West Germany



PACKAGING METHODS

WIREWOUND RESISTORS

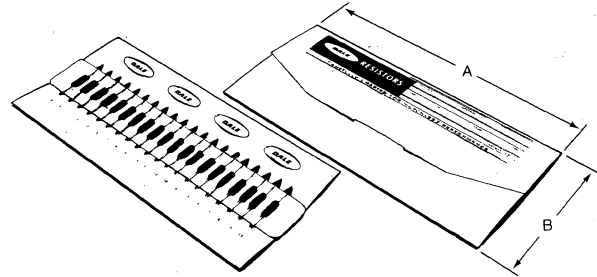

LACER PACK

Resistor body placed in slot, held in place with tongue insert. Terminals protected within folder. 20 units per folder.

TYPICAL TYPES	A	B
G-1, G-2, G-3	8-1/2 [215.90]	3-3/4 [95.25]
RS-1/8, RS-1/4, RS-1/2, RS-1A, RS-1B, RS-2A, RS-2B, RS-2C, G-5, G-5A, G-5C	8-1/2 [215.90]	4 [101.60]
RS-2, WWA-12 to WWA-26, G-6	11 [279.40]	5 [127.00]
RS-5, WWA-36, WWA-38, G-10	12-1/8 [307.98]	5-3/16 [131.76]
RS-7, RS-10, G-12, G-15, DC-2	14-3/16 [376.24]	6-1/10 [154.94]
CW Series (Same as RS Series)		

BULK PACK

Axial units are uniformly packaged 100 per box with 10 unit boxes per immediate container.

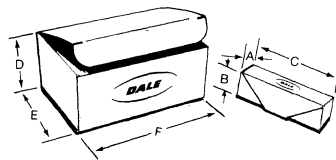

TYPICAL TYPES	A	B	C	D	E	F
RS-1/8, RS-1/4, RS-1/2, G-1, G-2, EGS-1, EGN-1, EGW-1, MWA-8, EGS-2, EGW-2, MWA-10, WSM-1, WSM-2	1 [25.4]	1 [25.4]	3-5/8 [92.1]	2-1/4 [57.1]	3-3/4 [95.2]	5-3/8 [136.5]
RS-1A, G-3, EGS-3, EGN-3, EGW-3, LVSR-3	1-1/2 [38.1]	1-1/2 [38.1]	3-5/8 [92.1]	3-1/4 [82.5]	3-3/4 [95.2]	8-1/4 [209.5]
RS-1B, WWA-13	1-1/2 [38.1]	1-1/2 [38.1]	3-7/8 [98.4]	3-1/4 [82.5]	3-3/4 [95.2]	8-1/4 [209.5]
RS-2, CW-2	3 [76.2]	2-1/4 [57.1]	4-1/8 [104.7]	5 [127.0]	4-1/2 [114.3]	15 [381.0]
RS-2A, CW-2A, G-5A, ESN-2A, ESS-2A, ESW-2A	2 [50.8]	2 [50.8]	4-1/4 [107.9]	5 [127.0]	4-3/8 [111.1]	12-1/2 [317.5]
RS-2B, CW-2B, G-5, ESN-2B, ESS-2B, ESW-2B	2 [50.8]	2 [50.8]	3-7/8 [98.4]	5 [127.0]	4-3/8 [111.1]	12-1/2 [317.5]
RS-2C, CW-2C, G-5C, LVSR-5	2-1/2 [63.5]	2-1/2 [63.5]	3-7/8 [98.4]	5 [127.0]	4-3/8 [111.1]	12-1/2 [317.5]
RS-5, RS-5-69, CW-5, CW-5-5, G-10, ESN-5, ESS-5, ESW-5, EGN-10, EGS-10, EGW-10	3 [76.2]	3 [76.2]	4-1/4 [108.0]	5 [127.0]	4-1/2 [114.3]	15 [381.0]
RS-7, CW-7, G-12	3-7/8 [98.4]	2-1/2 [63.5]	4-5/8 [117.4]	8-1/4 [209.5]	5-3/8 [136.5]	20 [508.0]
RS-10, CW-10, G-15, LVR-10	4 [101.6]	4 [101.6]	5-1/4 [133.3]	8-1/4 [209.5]	5-3/8 [136.5]	20 [508.0]

WIREWOUND RESISTOR PACKAGING continued on next page.



PACKAGING METHODS

WIREWOUND RESISTORS (continued)

REEL PACK

Lead tape reel packaging of axial lead components available per EIA RS 296 standard upon request.

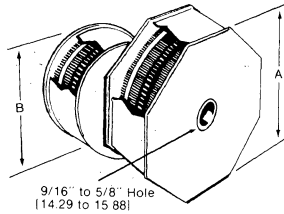

NOTE 1: COMPONENT SPACING STANDARD OPTIONS

Max. Body Dia.	Spacing
0-.200 [5.08]	.200 [5.08]
.201-.375 [5.11-9.52]	.375 [9.52]
.376-.400 [9.55-10.16]	.400 [10.16]

DALE STANDARD PACKAGING TECHNIQUE

TYPICAL TYPES	MAX. UNITS PER REEL		PITCH Note 1	DALE TAPE SPACING Note 2
	Small Flange "B" 7-1/2 [190.50]	Large Flange "A" 11-3/32 [281.78]		
RS-1/4, RS-1/2, G-1, G-2	2000	4500	.200 [5.08]	2-7/8 [73.02]
RS-1A, RS-1B	1500	4000	.200 [5.08]	2-7/8 [73.02]
WWA-13	1350	3000	.200 [5.08]	2-7/8 [73.02]
RS-2A, RS-2B, CW-2A, CW-2B, G-5, G-5A	650	1500	.375 [9.52]	2-7/8 [73.02]
RS-2, WWA-20 Series, CW-2, CW-2C, G-6	450	1000	.375 [9.52]	2-7/8 [73.02]
RS-5, RS-7, CW-5, CW-7, G-10, G-12	—	800	.375 [9.52]	2-7/8 [73.02]
RS-10, CW-10, G-15, MF-1, WWA-30 Series	—	600	.400 [101.6]	3-3/8 [85.72]

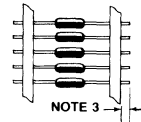

NOTE 2: Tape Spacings Standard Options of 2-1/16 [52.39], 2-1/2 [63.5] available on request.

NOTE 3: Lead Trimming 1/16 [1.59] from tape edge available on request as a standard option.

AMMO PACK Resistors are lead taped the same as in Reel Pack, then placed in a continuous "S" pattern (without paper inner leaf) in an appropriate box.

CARD PACK

Housing placed in slot. Held in place with foldover protective paper. Each pack perforated to tear off into four smaller packs.

TYPICAL TYPES	QTY./PACK	TEAR OFF QTY.
RH-5, NH-5, ERH-5, ENH-5, HG-5	40	10
RH-10, NH-10, ERH-10, ENH-10, HG-10	40	10
RH-25, NH-25, ERH-25, ENH-25, HG-25	20	5
RH-50, NH-50, ERH-50, ENH-50, HG-50	20	5

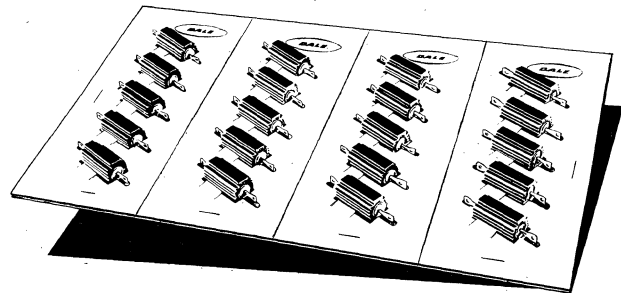

SKIN PACK

A versatile packaging method. Units are placed on double-faced corrugated board, then skin packed to board with polyfilm. Most resistor types are in multiples of five, with insert strips

for easy removal. For small parts, an "egg crate" partition is placed on board. Quantity per board depends on resistor size. Typical parts skin packaged include PH, HL and RLS.

MILITARY AND SPECIAL PACKAGING

Military packaging per MIL-P-116, Method 1A8. Blister pack, Foam pack and Vial pack also available for special requirements.



MILITARY PRODUCT IDENTIFICATION

Specification Cross Reference from the Basic Specification to the Established Reliability Specification.

Title	Basic	Established Reliability
Resistors, Fixed, Wirewound (Power Type)	MIL-R-26 (RW)	MIL-R-39007 (RWR)
Resistors, Fixed, Wirewound (Accurate)	MIL-R-93 (RB)	MIL-R-39005 (RBR)
Resistors, Fixed, Wirewound (Power Type Chassis Mounted)	MIL-R-18546 (RE)	MIL-R-39009 (RER)
Resistors, Fixed, Film & High Stability	MIL-R-10509 (RN)	MIL-R-55182 (RNR)
Resistors, Fixed, Film, Insulated	MIL-R-22684 (RL)	MIL-R-39017 (RLR)
Resistors, Fixed, Film, Chip	None	MIL-R-55342 (RM)
Resistors, Networks, Fixed, Film	MIL-R-83401 (RZ)	None
Coils, Radiofrequency & Transformers, Intermediate (RF)	MIL-C-15305 (LT)	MIL-C-39010
Connectors, Electrical, Rectangular, Rack and Panel	MIL-C-28748	None

GOVERNMENT SOURCE INSPECTION AND FEDERAL SUPPLIERS CODES: See Inside Back Cover.

MILITARY PART ORDERING EXAMPLES

To aid you in ordering, the following are representative samples of military part numbers cross-referenced to Dale part numbers. For additional information, consult QPL list or write for Dale's Military Product Identification Manual.

RESISTORS: Fixed and variable

MIL-R-26E

RW80 U 49R9 F = Dale Type G-3 49.9 ohms 1%
 1 2 3 4
RW69 V 101 = Dale Type CW-2C-1 100 ohms 5%
 1 2 3 1 3

1. Style
2. Characteristic
3. Resistance value
4. Tolerance
1. Style
2. Characteristic
3. Value (tolerance below 1 ohm 10%, 1 ohm and up 5%)

MIL-R-93D

RB55 C E 12701 D = Dale Type WWA-24 12.7K .5%
 1 2 3 4 5 1 4 5

1. Style
2. Terminal
3. Temperature coefficient
4. Value
5. Tolerance

MIL-R-10509F

RN60 D 1003 F = Dale CMF-60 T-1 100K 1%
 1 2 3 4 1 2 3 4

1. Style
2. Temperature coefficient
3. Resistance value
4. Tolerance

MIL-R-18546D

RE65 G 1001 = Dale Type RH-10 1K
 1 2 3 1 3

1. Style
2. Characteristics-maximum continuous operating temperature
3. Resistance value

MIL-R-22684C

RL07 S 103 J = Dale CMF-07 10K 5% **Note: Parts will be color banded.**
 1 2 3 4 1 3 4

1. Style
2. Terminal
3. Resistance value
4. Tolerance

MIL-R-39007F

RWR74 S 10R1 F R = Dale ESS-5 10.1 ohms 1% R
 1 2 3 4 5 1 3 4 5

1. Style
2. Terminal
3. Resistance value
4. Tolerance
5. Failure rate level

MIL-R-39009B

RER65 F 1001 R = Dale Type ERH-10 1% 1K R
 1 2 3 4 1 2 3 4

1. Style
2. Tolerance
3. Resistance value
4. Failure rate level

MIL-R-39017C

RLR07 C 1002 G R = Dale Type ERL-07 10K 2% R
 1 2 3 4 5 1 2 3 4 5

1. Style
2. Terminal type
3. Resistance value
4. Tolerance
5. Failure rate level

MIL-R-55182E

RNC55 H 49R9 F S = Dale ERC 55 T-2 49.9 ohms 1% S
 1 2 3 4 5 1 2 3 4 5

1. Style
2. Characteristic
3. Resistance value
4. Tolerance
5. Failure rate level

MIL-R-55342C

M55342/2 M 1003 F S R = Dale Type RCM550 100K 1% R
 1 2 3 4 5 6 1, 2, 5 3 4 6

1. Style
2. Characteristic
3. Resistance value
4. Tolerance
5. Terminal type
6. Failure rate level

MILITARY PRODUCT IDENTIFICATION

RESISTOR NETWORKS

MIL-R-83401E

M83401-01 M 1003 G A = Date SDM14-01 100K 2% A
 1 2 3 4 5 1 3 4 5

1. Style
2. Characteristic
3. Resistance Value
4. Tolerance
5. Schematic

Resistance Value Examples

Three Digit Figure

100 = 10 ohms, 101 = 100 ohms,
 102 = 1K ohms, 203 = 20K ohms

Four Digit Figure

49R9 = 49.9 ohms, 1000 = 100 ohms,
 1001 = 1K ohms, 1004 = 1 Megohm

Five Digit Figure

10R60 = 10.6 ohms, 10000 = 1K ohms,
 12701 = 12.7K ohms, 10202 = 102K ohms

TOLERANCE EXAMPLES

A = ±0.05% D = ±0.50% G = ±2.0%
 B = ±0.10% F = ±1.0% J = ±5.0%

TRANSFORMERS AND INDUCTORS

MIL-T-27E

TF 5 S 20 ZZ 203 = Dale Type TE-2-1 1.0 mH 2%
 1 2 3 4 5 6

(See Dale Military Identification Manual)

1. Component
2. Grade
3. Class
4. Family
5. Envelope and mounting dimensions
6. I.D. number

MIL-C-15305E

LT 4 K 001 = Dale Type IM-2 (.10 μH to 1.00 μH) 10%
 1 2 3 4

(See Dale Military Identification Manual)

NOTE: Parts will be color banded.

1. Style
2. Grade and class
3. Family CK = coil, radio frequency, fixed
4. I.D. number

MILITARY COLOR CODES FILM RESISTORS

BAND A & B		BAND C		BAND D		BAND E	
COLOR	1st and 2nd SIGNIFICANT FIGURE	COLOR	VALUE MULTIPLIER	COLOR	RESISTANCE TOLERANCE (PERCENT)	COLOR	TERMINAL
Black	0	Black	1	Gold	±5	White	Solderable
Brown	1	Brown	10	Red	±2		
Red	2	Red	100				
Orange	3	Orange	1,000				
Yellow	4	Yellow	10,000				
Green	5	Green	100,000				
Blue	6	Blue	1,000,000				
Purple (Violet)	7	Silver	0.01				
Gray	8	Gold	0.1				
White	9						

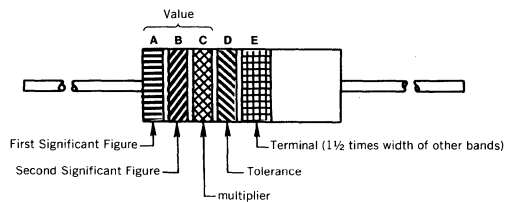

COILS, RF

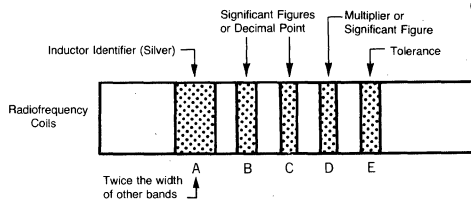

Band "A" is twice the width of the other bands and is silver in color to identify part as an inductor.

FOR INDUCTANCE VALUES LESS THAN 10 either Band "B" or Band "C" will be gold and will represent the decimal point. The other two bands ("B" and "D" or "C" and "D") will represent significant figures. FOR INDUCTANCE VALUES OF 10 OR MORE Band "B" and Band "C" represent significant figures and Band "D" is the Multiplier.

For small units, dots may be used in place of bands.

*The multiplier is the factor by which two significant figures are multiplied to yield the nominal inductance value
 **Indicates body color.

COLOR	BANDS "B" & "C" SIGNIFICANT FIGURES OR DECIMAL POINT	BAND "D" MULTIPLIER OR SIGNIFICANT FIGURE	BAND "E" INDUCTANCE TOLERANCE
Black	0	1	—
Brown	1	10	± 1%
Red	2	100	± 2%
Orange	3	1,000	± 3%
Yellow	4	10,000	± 4%
Green	5	—	—
Blue	6	—	—
Violet	7	—	—
Gray	8	—	—
White	9	—	—
None**	—	—	±20%
Silver	—	—	±10%
Gold	Decimal Point	—	±5%

Wall Chart and Pocket-Size Cards for Color Code Identification

For a wall chart or a supply of pocket-size cards showing actual colors used in marking film resistors and RF chokes, write DALE ELECTRONICS, INC., Dept. 860, 2064 12th Ave., Columbus, NE 68601.

Indicate type of chart and product desired.



QUALITY ASSURANCE PROGRAMS AND FACILITIES

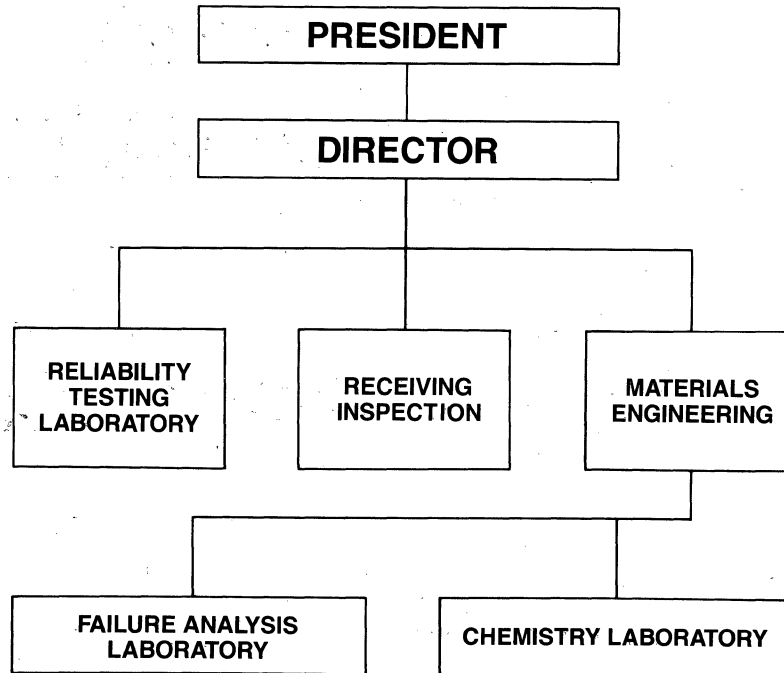

At Dale Electronics, Inc., quality assurance is an independent organization which reports directly to the president. The infrastructure represented above has been in operation for more than 20 years. It symbolizes a commitment to excellence which has been steadily growing in terms of people, equipment and integrated systems such as statistical process control.

Today's "Zero Defects" and "Partnership" concepts put ever increasing demands on the ability to control, document and improve the consistency of manufacturing processes. Dale Electronics, Inc., is both committed and equipped to continue its long-term leadership in these areas.

These pages describe — from receiving inspection to statistical process control — the elements involved in Dale's quality system. They detail a continually evolving system and a constant commitment to meet the needs of a wide variety of customers with stringent performance requirements. From the beginning, these requirements have challenged Dale to take a leadership role in establishing quality and performance levels for the electronic components industry.

This leadership began in 1951 with the development of a "High Performance" Navy specification to describe Dale's first product, a power wirewound resistor. Since then, Dale has remained in the forefront of activities centered on documenting electronic part performance standards and quality assurance requirements. This includes major contributions toward developing "High Reliability" and "Established Reliability" specifications. As part of this effort, Dale engineering personnel are active in both the Electronic Industry Association (EIA) and International Electrotechnical Commission (IEC) and have chaired numerous committees for developing industry standards both in the United States and internationally.

The end product of these ongoing efforts provides specific benefits to Dale customers, including a wide range of Dale products available with U.S. military and international Qualified Parts List (QPL) status and the ability to provide specialized testing, including "Ultra-MIL" requirements.

We welcome your interest in Dale's quality system. Please let us know if we can provide additional information on how it can be used in improving the performance of your products.

Receiving Inspection

Receiving inspection has been an important part of Dale's quality control procedures for more than 30 years. In addition to its in-plant work, this department has also been an innovator in developing vendor programs to improve raw material quality. These programs, which today would be called "ship-to-stock," provided vendors with feedback from inspection results. This data was used to improve process control in the manufacture of wire used for established reliability resistors. Since then, Dale's commitment to the importance of receiving inspection in quality control has steadily increased. This can be easily seen in the type of equipment employed, including optical comparators, laser micrometers, X-ray fluorescent plating measurement instruments, solderability testing stations, clean booth optical inspection, tension and compression testers, and many other instruments. Most of the equipment used provides statistical data outputs and quality histograms which are used in a vendor rating program. Key vendors are identified and assisted in developing internal inspection plans and statistical process control programs leading to a reduction in receiving inspection sampling. These programs, backed by more than three decades of experience, give Dale enhanced ability to ensure the reliability of its raw materials.

Dale's Reliability Testing Laboratory was established in 1957 in connection with the Minuteman High Reliability Program. Since then, it has been a pacesetter in responding to the industry's ever increasing needs for product evaluation and performance documentation. Today, it offers the most advanced and comprehensive testing facilities available from a component manufacturer.

Beginning with a resistance bridge, a moisture jar, power supplies and a few load life ovens, the laboratory now has over 750 pieces of equipment representing a capital commitment of more than one million dollars. In space which has grown from 1,000 to 17,000 square feet, it can perform virtually any test to any specification covering the components manufactured by Dale. In addition, it can fabricate special equipment when nonstandard testing is required.

By definition, the laboratory's charter is to perform electrical, physical and environmental testing for product evaluation, qualification and production line quality monitoring. Each year the laboratory's 32 employees complete approximately 7,000 reports for customer, military and internal use...with over 4,000 units completing a test each day. It should be noted that this volume includes only sample testing, with all production testing being done in the manufacturing process.

Dale matches the broad scope of its testing program with a commitment to constant updating of processes, equipment and staff training. The result is extra efficiency in implementing and coordinating reliability testing programs.

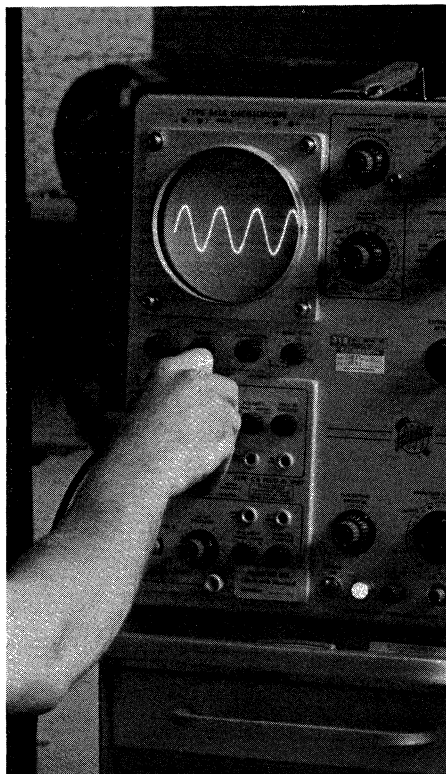

Reliability Testing

Material Engineering Department

Material engineering has always been an integral part of Dale's quality assurance function. Today, this department includes both a failure analysis laboratory and a chemistry laboratory.

Failure Analysis

Dale's first production facility included equipment and personnel for material and failure analysis. Since then, this function has kept pace with the growth of the company. The concept of a "closed loop of reliability" (i.e. origin of failure, analysis of cause and corrective action) was started in the failure analysis laboratory and is still in use today. In the early 1960s, the laboratory played an important role in helping achieve the goals of the Minuteman Reliability Improvement Program. And, as Dale's leadership in established reliability increased, so has its commitment to maintaining state-of-the-art failure analysis procedures and equipment. In the early 1970s, the laboratory was equipped with a Scanning Electron Microscope (SEM) and X-ray Energy Spectrometer (XES). Included among the recent equipment additions are instruments for quantitative X-ray analysis for bulk elemental analysis, and a quantitative micro X-ray analysis system with image analysis capability for use with the SEM. These instruments, plus a wide range of other equipment, give the laboratory exceptional capability to quickly locate the source of performance problems and initiate corrective action.

Chemistry Laboratory

For more than 25 years, the chemical laboratory has been an effective component in Dale's quality assurance organization. During this time, the

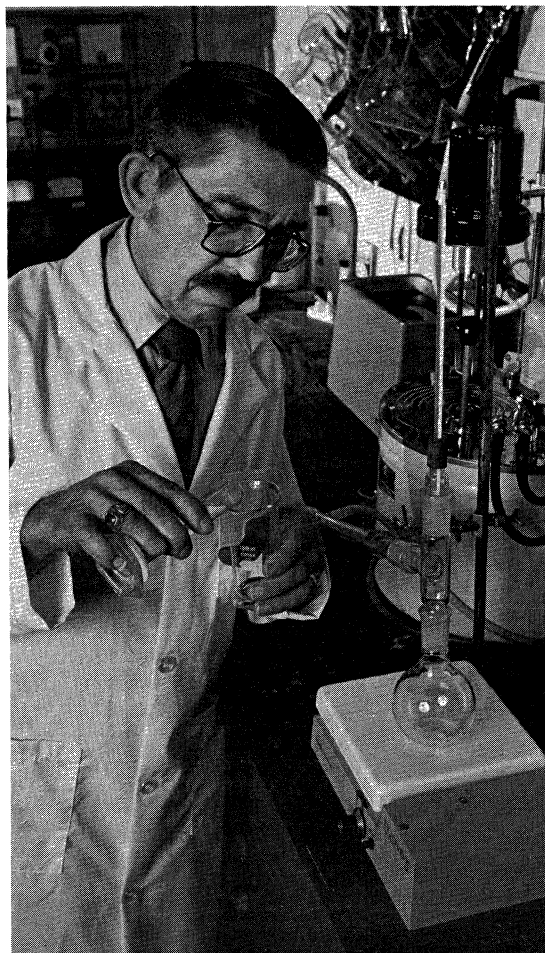

laboratory has developed innovative analysis procedures which, through sharing with other component manufacturers, have become standard in the industry. The laboratory can perform all standard methods of chemical analysis using ASTM methods. In addition, it is equipped to utilize advanced procedures such as atomic absorption, infrared and visible spectrophotometry and gas chromatography. In 1981, the operation became part of the Materials Engineering Department. As such, it works closely with failure analysis and receiving inspection, giving Dale exceptional in-house capability to determine what is needed to improve the uniformity of raw materials and increase the reliability of finished products.

Statistical Process Control

Dale's ultimate quality goal is to meet or exceed 100% of the performance requirements for **all** of its products. Statistical Process Control (SPC) will be a major factor in achieving that goal. Dale's use of SPC began in 1981. Shortly thereafter, a total corporate commitment was made to implement SPC procedures at all manufacturing levels. Since then, guidelines on SPC documentation, training, process design and outgoing quality measurement have become thoroughly integrated into standard company procedures.

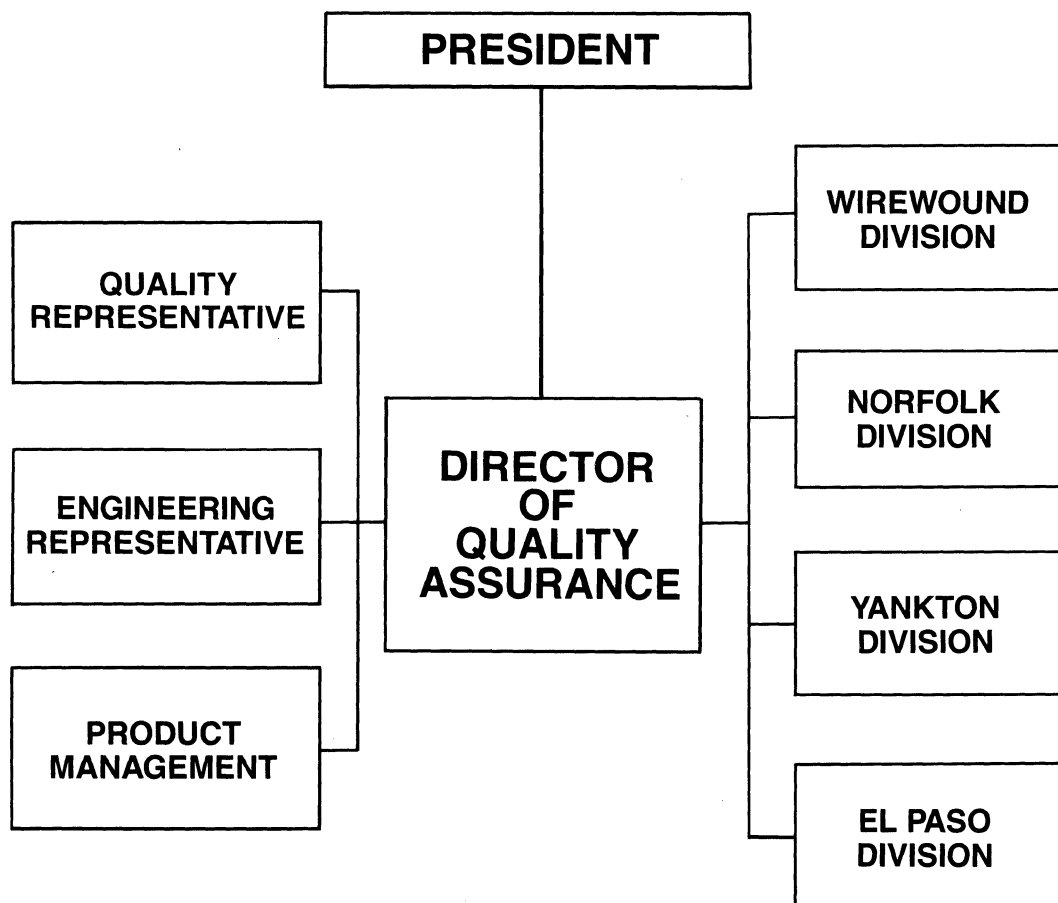

Today, Dale's director of quality assurance heads a corporate SPC steering committee which includes engineering, quality and product management representatives, plus an SPC coordinator from each product division. This committee continually evaluates the progress of SPC and determines areas where special emphasis is required.



DISTRIBUTORS

AUTHORIZED U.S. DISTRIBUTORS

ALABAMA

Huntsville 35805
Hamilton/Avnet
4940 Research Drive
Tel: 205-837-7210

Huntsville 35805
Pioneer-Technologies
4825 University Square
Tel: 205-837-9300

ARIZONA

Chandler 85226
Hamilton/Avnet
30 South McKerny Avenue
Tel: 602-961-6400

Phoenix 85036
Sterling Electronics
P.O. Drawer 20867
Tel: 602-268-2121

Tempe 85282
Acacia/VWR Electronics
2105 S. Hardy Drive
Tel: 602-894-2874

Tempe 85281
Shelley-Ragon, Inc.
549 So. 48th Street
Suite 104
Tel: 602-894-2058

Tempe 85282
T.T.I., Inc.
4625 S. Wendler Drive
Suite 108
Tel: 602-431-1191

CALIFORNIA

Chatsworth 91311
Hamilton/Avnet
9650 Desoto Avenue
Tel: 818-700-6578

Chatsworth 91311
Shelley-Ragon, Inc.
9314 Eton Avenue
Tel: 818-998-3333

Chatsworth 91311
T.T.I., Inc.
21540 Prairie Avenue
Unit E
Tel: 818-709-1010

Costa Mesa 92626
Avnet Electronics
350 McCormick Avenue
Tel: 714-754-6021

Costa Mesa 92626
Hamilton Electro Sales
3170 Pullman Street
Tel: 714-641-4110

Culver City 90230
Hamilton/Avnet
10950 Washington Blvd.
P.O. Box 2647
Tel: 213-558-2111

Gardena 90248
Hamilton/Avnet
1361 "B" West 190th St.
Tel: 213-217-6700

Gardena 90248
Hamilton Electro Sales
1361 "B" West 190th St.
Tel: 213-217-6750

Inglewood 90304
Newark Electronics
4747 W. Century Blvd.
Tel: 213-671-7370

Inglewood 90304
Newark/Trexon
4747 W. Century Blvd.
Tel: 213-671-7377

Irvine 92714
Acacia/VWR Electronics
16592 Milliken Avenue
Tel: 213-971-2428

Milpitas 95035
T.T.I., Inc.
1535 McCandless Drive
Tel: 408-946-5577

Ontario 91764
Hamilton/Avnet
3002 East G Street
Tel: 714-989-8816

Sacramento 95838
Hamilton/Avnet
4103 Northgate Blvd.
Tel: 916-920-5531

San Diego 92111
Acacia/VWR Electronics
7292 Opportunity Road
Suite E & F
Tel: 619-565-4365

San Diego 92123
Hamilton/Avnet
4545 Viewridge Avenue
Tel: 619-571-7536

San Diego 92121
Shelley-Ragon, Inc.
4040 Sorrento Valley Blvd.
Tel: 619-453-7133

San Diego 92121
T.T.I., Inc.
6150 Lusk Blvd.
Suite B100
Tel: 619-587-4888

San Jose 95131
Shelley-Ragon, Inc.
1466 Seareel Lane
Tel: 408-432-0600

Sunnyvale 94088
Acacia/VWR Electronics
1288 Hammerwood Avenue
P.O. Box 3448
Tel: 408-745-7200

Sunnyvale 94086
Hamilton/Avnet
1175 Bordeaux
Tel: 408-743-3358

COLORADO

Commerce City 80022
Waco Electronics
4900 Monaco Parkway
Tel: 303-289-4743

Denver 80222
Newark Electronics
2170 So. Grape Street
Tel: 303-757-3351

Denver 80221
T.T.I., Inc.
6800 N. Broadway
Suite 107
Tel: 303-429-6806

Englewood 80111
Hamilton/Avnet
8765 East Orchard Road
Suite 708
Tel: 303-740-1020

Englewood 80110
Shelley-Ragon, Inc.
Hampden Park West, Bldg. 4
1500 West Hampden
Tel: 303-762-0670

Lakewood 80215
Acacia/VWR Electronics
938 Quail Street
Tel: 303-232-2882

CONNECTICUT
Danbury 06810
Hamilton/Avnet
Commerce Drive
Commerce Park
Tel: 203-797-2854

Norwalk 06851
Pioneer-Standard
112 Main Street
Tel: 203-853-1515

Stratford 06497
Electro/Comp, Inc.
2415 Main Street
Tel: 203-375-5811

Stratford 06497
T.T.I., Inc.
2874 Main Street
Suite 2 D & F
Tel: 203-375-1400

FLORIDA

Altamonte Springs 32701
Pioneer-Technologies
221 N. Lake Blvd.
Tel: 305-834-9090

Deerfield Beach 33442
Pioneer-Technologies
674 South Military Trail
Tel: 305-428-8877

Fort Lauderdale 33309
Hamilton/Avnet
6801 N.W. 15th Way
Tel: 305-979-5211

Largo 33541
Lodan Electronics
1901 Ulmerton Road
Suite L
Tel: 813-586-2851

Orlando 32809
T.T.I., Inc.
6220 S. Orange Blossom Trail
Suite 516
Tel: 305-859-1000

St. Petersburg 33702
Hamilton/Avnet
3197 Tech Drive, N.
Tel: 813-576-3930

Tampa 33625
Reptron Electronics
14501 McCormick Drive
Tel: 313-525-2700

Tampa 33619
Shelley-Ragon, Inc.
1202 Tech Blvd., Suite 100
Tel: 813-623-6560

Winter Park 32792
Hamilton/Avnet
6947 University Blvd.
Tel: 305-628-3888

GEORGIA

Norcross 30092
Hamilton/Avnet
5825-D Peachtree Corners E.
Tel: 404-447-7523

Norcross 30071
Pioneer-Technologies
3100 F. Northwoods Place
Tel: 404-448-1711

Norcross 30071
T.T.I., Inc.
2979 Pacific Drive
Suite A
Tel: 404-662-0911

ILLINOIS

Bensenville 60106
Hamilton/Avnet
1130 Thorndale Avenue
Tel: 312-860-8501

Chicago 60640
Newark Electronics
4801 N. Ravenswood
Tel: 312-784-5100

Chicago 60624
Newark/Trexon
500 N. Pulaski Road
Tel: 312-785-5100

Elk Grove Village 60007
Bell Industries
Elect. Distributor Div.
515 Busse Road
Tel: 312-640-1910

Elk Grove Village 60007
Pioneer-Standard
1551 Carmen Drive
Tel: 312-437-9680

Lombard 60148
Shelley-Ragon, Inc.
1100 S. Main Street
Tel: 312-629-8833

Palatine 60076
Ohm Electronics
746 Vermont Avenue
P.O. Box 368
Tel: 312-359-5500

INDIANA

Carmel 46032
Hamilton/Avnet
485 Gradle Drive
Tel: 317-844-9333

Fort Wayne 46801
Bell Industries
(Graham Division)
3443 E. Washington Blvd.
P.O. Box 776
Tel: 219-423-3422

Indianapolis 46268
Bell Industries
5230 West 79 Street
P.O. Box 68885
Tel: 317-875-8200

Indianapolis 46250
Pioneer-Standard
6408 Castleplace Drive
Tel: 317-849-7300

IOWA

Cedar Rapids 52406
Dee Electronics, Inc.
2500 16th Avenue S.W.
Tel: 319-365-7551

Cedar Rapids 52404
Hamilton/Avnet
915 33rd Avenue, S.W.
Tel: 319-362-4757

KANSAS

Overland Park 66215
Hamilton/Avnet
9219 Quivira Road
Tel: 913-541-7924

KENTUCKY

Lexington 40511
Hamilton/Avnet
805 A Newtown Pike
Tel: 606-259-1475

MARYLAND

Baltimore 21236
RESCO/Baltimore, Inc.
4961 Mercantile Road
Tel: 301-529-0500

Beltsville 20705
RESCO/Washington
10523 Ewing Road
Tel: 301-937-9100

Columbia 21045
Hamilton/Avnet
6822 Oak Hall Lane
Tel: 301-995-3526

Columbia 21045
T.T.I., Inc.
6420 Dobbin Road
Tel: 301-995-1331

Gaithersburg 20877
Pioneer-Technologies
9100 Gaither Road
Tel: 301-921-0660

MASSACHUSETTS

Billerica 01821
A. W. Mayer Company
34 Linnell Circle
Tel: 617-229-2255

Lexington 02173
Pioneer-Standard
44 Hartwell Avenue
Tel: 617-861-9200

Peabody 01960
Hamilton/Avnet
10D Centennial Drive
Tel: 617-596-7668

Wilmington 01887
T.T.I., Inc.
100 Research Drive
Tel: 617-658-4700

Woburn 01801
Sterling Electronics
15D Constitution Way
Tel: 617-938-6200

MICHIGAN

Grand Rapids 49508
Hamilton/Avnet
2215 29th Street
Tel: 616-243-8805

Grand Rapids 49508
Pioneer-Standard
4505 Broadmoor S.E.
Tel: 616-698-1800

Grand Rapids 49505
S-F Electronic Supply, Inc.
1200 Monroe Avenue, N.W.
Tel: 616-459-0216

Livonia 48150
Hamilton/Avnet
32487 Schoolcraft Road
Tel: 313-522-4700

Livonia 48150
Pioneer-Standard
13485 Stamford
Tel: 313-525-1800

Livonia 48150
R-S Electronics
34443 Schoolcraft
Tel: 313-525-1155

Livonia 48150
Reptron Electronics
34403 Glendale
Tel: 313-525-2700

Oak Park 48237
Newark Electronics
20700 Hubbell Avenue
Tel: 313-967-0600

MINNESOTA

Eden Prairie 55344
T.T.I., Inc.
11457 Valley View Road
Tel: 612-944-5080

Minneapolis 55413
Newark Electronics
336 Hoover Street, NE
Tel: 612-331-6350

Minneapolis 55405
Stark Electronics
401 Royalston Avenue, N.
Tel: 612-332-1325

Minnetonka 55343
Hamilton/Avnet
12400 Whitewater Drive
Tel: 612-932-0670

Minnetonka 55343
Pioneer-Standard
10203 Bren Road East
Tel: 612-935-5444



DISTRIBUTORS

AUTHORIZED U.S. DISTRIBUTORS (continued)

St. Paul 55114
Shelley-Ragon, Inc.
2515 Wabash Avenue
Tel: 612-642-2828

MISSOURI
Earth City 63045
Hamilton/Avnet
13743 Shoreline Court
Tel: 314-344-1254

Independence 64055
Shelley-Ragon, Inc.
3121B S. Dodgion
Tel: 816-254-3410

NEW HAMPSHIRE
Manchester 03104
Hamilton/Avnet
444 East Industrial Drive
Tel: 603-624-9400

NEW JERSEY
Cherry Hill 08003
Hamilton/Avnet
One Keystone Avenue
Tel: 609-424-0117

Cranford 07016
GSI Electronics
Garden State Ind. Elect., Inc.
70 Jackson Drive
Tel: 201-272-6400

Fairfield 07006
Hamilton/Avnet
10 Industrial Road
Tel: 201-575-3490

Kenilworth 07033
Federated Purchaser, Inc.
50 Lafayette Place
Tel: 201-272-0505

Pine Brook 07058
Pioneer-Standard
45 Route 46
Tel: 201-575-3510

NEW MEXICO
Albuquerque 87106
Hamilton/Avnet
2524 Baylor, SE
Tel: 505-765-1500

NEW YORK
Binghamton 13904
Pioneer-Standard
68 Corporate Drive
Tel: 607-722-9300

Bohemia 11716
March Electronics
25 Feldland Street
Tel: 516-563-6000

Bohemia 11716
Shelley-Ragon, Inc.
1450 Church Street
Tel: 516-567-7751

Buffalo 14202
Summit Distributors
916 Main Street
Tel: 716-887-2800

Endwell 13760
ASI Electronics
3000 Wayne Street
P.O. Box 91
Tel: 607-754-3823

Fairport 14450
Pioneer-Standard
840 Fairport Park
Tel: 716-381-7070

Farmingdale 11735
Command Electronics
42 Central Drive
Tel: 516-293-1212

Hauppauge 11788
Fairmont Electronic Sales
295 Oser Avenue
Tel: 516-231-3313

Hauppauge 11788
Hamilton/Avnet
933 Motor Parkway
Tel: 516-231-9800

Rochester 14623
Hamilton/Avnet
333 Metro Park
Tel: 716-272-2704

Rome 13440
Rome Electronics
216 Erie Blvd., East
Tel: 315-337-5400,

Ronkonkoma 11779
T.T.I., Inc.
921 S. 2nd Street
Tel: 516-737-2000

Syracuse 13206
Hamilton/Avnet
103 Twin Oaks Drive
Tel: 315-437-2641

Valley Stream, LI 11580
L & S Electronics
139 N. Central Avenue
Tel: 516-561-2474

Woodbury 11797
Pioneer-Standard
60 Crossways Park West
Tel: 516-921-8700

NORTH CAROLINA
Charlotte 28210
Pioneer-Technologies
9801 A. Southern Pine Blvd.
Tel: 704-527-8188

Raleigh 27604
Hamilton/Avnet
3510 Spring Forest Road
Tel: 919-878-0819

Raleigh 27612
RESCO/Raleigh
6005 Resco Court
Highway 70 West
Tel: 919-781-5700

Winston-Salem 27108
Kirkman Electronics
901 West Second Street
Drawer K, Salem Station
Tel: 919-722-9131

OHIO
Cleveland 44128
Hamilton/Avnet
4588 Emery Industrial Pkwy.
Tel: 216-831-3500

Cleveland 44105
Pioneer-Standard
4800 E. 131st Street
Tel: 216-587-3600

Columbus 43085
T.T.I., Inc.
670A Lakeview Plaza Blvd.
Tel: 614-848-5770

Dayton 45459
Bell Industries
Elect. Distributor Group
444 Windsor Park Drive
Tel: 513-435-8660

Dayton 45459
Bell Industries
Military Division
118 West Park Road
Tel: 513-434-8231

Dayton 45459
Hamilton/Avnet
954 Senate Drive
Tel: 513-439-6700

Dayton 45459
Hamilton/Avnet
954 Senate Drive
Tel: 513-439-6730

Dayton 45404
Pioneer-Standard
P.O. Box 291
Tel: 513-236-9900

Dayton 45439
Stotts-Friedman Co., Inc.
2600 East River Road
Tel: 513-298-5555

Valley View 44125
Trexon Electronics
5543 Canal Road
Tel: 216-447-8860

Westerville 43081
Hamilton/Avnet
777 Brooksedge Blvd.
Tel: 614-882-7004

OKLAHOMA
Tulsa 74146
Hamilton/Avnet
12121 E. 51st Street
Suite 102A
Tel: 918-252-7297

Tulsa 74119
Radio, Inc.
1000 South Main
Tel: 918-587-9123

OREGON
Beaverton 97005
Acacia/VWR Electronics
7763 S.W. Cirrus Drive
Building #26
Tel: 503-646-3377

Lake Oswego 97034
Hamilton/Avnet
6024 S.W. Jean Road
Bldg. "C", Suite 10
Tel: 503-635-8831

Portland 97214
Radar Electric Company
704 S.E. Washington
Tel: 503-232-3404

PENNSYLVANIA
Horsham 19044
Pioneer-Technologies
261 Gibraltar Road
Tel: 215-674-4000

McKean 16426
Advacom
5620 W. Road
P.O. Box 296
Tel: 814-476-7774

Pittsburgh 15222
Hamilton/Avnet
2800 Liberty Avenue
Building E
Tel: 412-281-4150

Pittsburgh 15238
Pioneer-Standard
259 Kappa Drive
Tel: 412-782-2300

York 17404
E.C.I. Inc.
1569 West King Street
Tel: 717-846-5334

TEXAS
Austin 78758
Hamilton/Avnet
1807A W. Braker Lane
Tel: 512-837-8911

Austin 78758
Pioneer-Standard
1826-D Kramer Lane
Tel: 512-835-4000

Dallas 75244
Pioneer-Standard
13710 Omega Road
Tel: 214-386-7300

Dallas 75243
Shelley-Ragon, Inc.
9722 Skillman Avenue
Building 9
Tel: 214-349-2424

Dallas 75229
Sterling Electronics
11090 Stemmons Freeway
P.O. Box 29317
Tel: 214-243-1600

Fort Worth 76111
T.T.I., Inc.
4033 East Belknap
Tel: 817-831-8300

Garland 75042
Newark Electronics
707 Easy Street
Tel: 214-494-5911

Garland 75042
Newark/Trexon
707 Easy Street
Tel: 214-256-6585

Houston 77001
Lenert Company
1420 Hutchins
P.O. Box 2184
Tel: 713-225-1465

Houston 77036
Pioneer-Standard
5853 Point West Drive
Tel: 713-988-5555

Houston 77001
Sterling Electronics
P.O. Box 1229
Tel: 713-627-9800

Irving 75062
Hamilton/Avnet
2111 West Walnut Hill
Tel: 214-550-6155

Stafford 77477
Hamilton/Avnet
4850 Wright Road
Suite 190
Tel: 713-274-9336

UTAH
Salt Lake City 84119
Hamilton/Avnet
1585 W. 2100 South
Tel: 801-974-9649

WASHINGTON
Bellevue 98005
Hamilton/Avnet
14212 NE 21 Street
Tel: 206-453-5842

Redmond 98052
Shelley-Ragon, Inc.
15209 N.E. 95th
Tel: 206-883-2220

Redmond 98052
T.T.I., Inc.
9577 N.E. 153rd
Tel: 206-882-0291

Seattle 98119
Radar Electric Company
168 Western Avenue, West
Tel: 206-282-2511

WISCONSIN
Milwaukee 53214
Marsh Electronics, Inc.
1563 So. 101st Street
P.O. Box 14608
Tel: 414-475-6000

New Berlin 53151
Hamilton/Avnet
2975 Moorland Road
Tel: 414-784-4510

AUTHORIZED CANADIAN DISTRIBUTORS

ALBERTA
Calgary T2E 6Z2
Hamilton/Avnet Int'l
2816 21st Street, N.E.
Tel: 403-250-9380

BRITISH COLUMBIA
Burnaby V5M 3Z3
Hamilton/Avnet Int'l
2550 Boundary Road
Suite 115
Tel: 604-437-6667

ONTARIO
Mississauga L4V 1R2
Hamilton/Avnet Int'l
6845 Rexwood Drive
Tel: 416-677-7432

Mississauga L4T 1G5
Prelco Electronics
2767 Thames Gate Drive
Tel: 416-678-0401

Nepean K2H 9C1
Carsten Electronics, Ltd.
215 Stafford Road
Unit 106
Tel: 613-726-9250

Nepean K2E 7J5
Hamilton/Avnet Int'l
190 Colonnade Road South
Tel: 613-226-1700

Nepean K2H 9C1
Prelco Electronics
195 Stafford Road, West
Tel: 613-726-1800

Scarborough M1W 3K6
Carsten Electronics, Ltd.
3791 Victoria Park Avenue
Tel: 416-495-9999

Willowdale M2H 3B3
Electro Sonic, Inc.
1100 Gordon Baker Road
Tel: 416-494-1666

QUEBEC
Montreal H3L 2B9
Prelco Electronics
480 Port-Royal Street, West
Tel: 514-389-8051

Pointe-Claire H9R 5C7
Future Electronics, Inc.
237 Hymus Blvd.
Tel: 514-694-7710

St. Laurent H4S 1R7
Carsten Electronics, Ltd.
9480 Trans-Canada Highway
Tel: 514-334-8321

St. Laurent H4S 1P8
Hamilton/Avnet Int'l
2795 Halpern
Tel: 514-335-2477



CUSTOMER REPRESENTATIVES

will help you solve your component problems

AUTHORIZED U.S. CUSTOMER REPRESENTATIVES

ALABAMA

Huntsville 35803
JWL Associates, Inc.
Suite M
12021 South Memorial Parkway
Tel: 205-883-1712

ARIZONA

Tempe 85282
Dale Sales Office
1155 West 23rd Street
Tel: 602-966-0291

CALIFORNIA

Los Alamitos 90720
Reed Electronic Marketing
P.O. Box 206
Tel: 213-598-6676
TWX: 910-341-7295

Redwood City 94063

James S. Heaton Co.
3696 Haven Avenue
P.O. Box 5826
Tel: 415-367-9000
TWX: 910-378-5415

San Diego 92154

Vishay San Diego
District Office
3137 Beyer Boulevard,
Suite B
Tel: 619-690-5112
FAX: 619-690-0132

COLORADO

Colorado Springs 80918
Dale Sales Office
6755 Earl Drive
Suite 110
Tel: 303-593-7529

Loveland 80537

Dale Sales Office
Suite 2
4221 West Eisenhower
Tel: 303-667-7500
FAX: 303-669-3253

CONNECTICUT

(See New York)

DELAWARE

(See Pennsylvania)

DISTRICT OF COLUMBIA

(See Maryland)

FLORIDA

Coral Springs 33065
Graham Associates, Inc.
8286 N.W. Second Manor
Tel: 305-755-6733

Lake Park 33403

Graham Associates, Inc.
P.O. Box 12221
Tel: 305-622-4049

Melbourne 32902

Graham Associates, Inc.
P.O. Box 397
Tel: 305-773-6631

Winter Garden 32787

Graham Associates, Inc.
P.O. Box 1628
Tel: 305-656-9369

GEORGIA

Marietta 30067
JWL Associates, Inc.
Suite 110
177 Frey's Gin Road
Tel: 404-429-8010

IDAHO (See Colorado)

ILLINOIS

Skokie 60077
Industrial Rep., Inc.
8430 Gross Point Rd.
Tel: 312-967-8430
TWX: 910-221-0308

INDIANA

Fort Wayne 46818
Scott Electronics, Inc.
Lima Valley Office Village
8109 Lima Road
Tel: 199-489-5690

Indianapolis 46256

Scott Electronics, Inc.
7321 Shadeland Station
Suite 256
Tel: 317-841-0010
FAX: 317-841-0107

IOWA (See Illinois)

KANSAS

Shawnee Mission 66202
Dale Sales Office
Suite 212
6901 West 63rd Street
Tel: 913-432-9140

MARYLAND

Glen Burnie 21061
Tri-Mark, Inc.
1410 Crain Highway NW
Suite 4-B
Tel: 301-761-6000
TWX: 710-867-0508

MASSACHUSETTS

Wakefield 01800
Howard C. Jappe Company
427 Water Street
Tel: 617-245-9359

MICHIGAN

Plymouth 48170
Jay Marketing Assoc.
P.O. Box 521
Tel: 313-459-1200
TWX: 810-242-1431
FAX: 313-459-1697

MINNESOTA

Bloomington 55420
MFI, Inc.
1120 East 80th Street
Suite 103
Tel: 612-854-8020
FAX: 612-854-8269

MISSOURI

(Western — See Kansas)
(Eastern — See Illinois)

NEW JERSEY

(Southern — See Pennsylvania)
(Northern)
Fairlawn 07410
Kaelber & Mack
(See Commack, NY)

NEW MEXICO (See Arizona)

NEW YORK

Commack 11725
Kaelber & Mack
P.O. Box 441
Tel: 516-499-2924

Liverpool 13088

Dale Sales Office
300 Tulip Street, Suite 3E
Tel: 315-457-1401

NORTH CAROLINA

Charlotte 28211
JWL Associates, Inc.
P.O. Box 2468
Tel: 704-541-5750
FAX: 704-541-5749

Raleigh 27609

JWL Associates, Inc.
P.O. Box 17353
Tel: 919-787-4826

OHIO

Cincinnati 45242
Scott Electronics, Inc.
10901 Reed Hartman Hwy.
Suite 301
Tel: 513-791-2513

Cleveland 44143

Scott Electronics, Inc.
360 Alpha Park
Tel: 216-473-5050
TWX: 810-427-5050

Dayton 45439

Scott Electronics, Inc.
3131 S. Dixie
Suite 200
Tel: 513-294-0539

Reynoldsburg 43068

Scott Electronics, Inc.
Suite 9
6515 E. Livingston Avenue
Tel: 614-863-1281

OKLAHOMA (See Texas)

OREGON

Beaverton 97075
LD Electronics
P.O. Box 626
Tel: 503-684-8221
TWX: 910-467-8713
FAX: 503-684-5571

PENNSYLVANIA

Horsham 19044
TMI
415 Horsham Road
Tel: 215-441-4300
TWX: 215-441-4302

QUEBEC

Montreal H4T 1S2
Bach-Simpson, Ltd.
7033 Trans Canada Highway, Suite 207
St. Laurent
Tel: 514-331-6817, Telex: 05-824563

SOUTH CAROLINA

(See North Carolina)

TENNESSEE

(See North Carolina)

TEXAS

Dallas 75206

Edward F. Aymond Co.
Suite 214
4300 N. Central Expressway
Tel: 214-826-7620
TWX: 910-861-4231

Houston

Edward F. Aymond Co.
Tel: 713-880-8229

San Antonio 78227

Edward F. Aymond Co.
7907 Stagecoach
Tel: 512-675-8339

UTAH

(See Colorado)

VIRGINIA (See Maryland)

WASHINGTON

Snohomish 98290
LD Electronics
7410 77th Avenue, S.E.
Tel: 206-568-0511

Spokane 99214

LD Electronics
P.O. Box 14586
Tel: 509-922-4883

WISCONSIN

Milwaukee 53226
Industrial Rep., Inc.
631 N. Mayfair Road
Tel: 414-259-0965

AUTHORIZED CANADIAN CUSTOMER REPRESENTATIVES

ONTARIO

Scarborough M1R 3E6
Dale Electronics, Ltd.
18 Howden Road
Tel: 416-759-5631
Telex: 514-331-6312

London N5W 2C2

Bach-Simpson, Ltd.
P.O. Box 5484
Tel: 519-452-3300
Telex: 064-5843 WILBAC LDN

Ottawa

Bach-Simpson, Ltd.
Tel: 613-829-3828

Toronto

Bach-Simpson, Ltd.
Tel: 416-288-9932

AUTHORIZED OVERSEAS CUSTOMER REPRESENTATIVES

ARGENTINA

Reycom Electronica SRL
Arcos 3631
1429 Buenos Aires
Tel: (54) (1) 701-4462
Telex: 25133 REYCOM AR
FAX: (54) (1) 111 721

AUSTRIA

Dale Electronics GmbH
Benzstrasse 28
Postfach 1251
D-8039 Puchheim
West Germany
Tel: (089) 80960
Telex: 05-212950
FAX: (089) 801398

AUSTRALIA

Rifa Pty., Ltd.
202 Bell Street
Preston, Victoria 3072
Tel: (61) (3) 480 1211
Telex: AA31001
FAX: (61) (3) 4843645

BELGIUM

Klees Electronics, B.V.B.A.
Electriciteitstraat 35, 001
2800 Mechelen
Tel: 015/20.16.55
Telex: 20441 KLEES B
FAX: 015/20.46.26

BRAZIL

Hitech Commercial E.
Industria, Ltd.
801-CONJ. III
04571 Brooklin, Sao Paulo
Tel: (55) (11) 531-9355
Telex: (55) (11) 53288 HTHB

CHILE (See South America)

COLOMBIA

(See South America)

COMECON & YUGOSLAVIA

ELRA

Muhlfeldgasse 1
A-1020 Wien, Austria
Tel: (0222) 24 4277
Telex: 135 507 elra a
FAX: (0222) 263-834

DENMARK

A. Fredslund Pedersen
Finsensvej 39
DK 2000 Copenhagen F
Tel: (01) 194500
Telex: 15052 AFPSA DK
FAX: (01) 862589

FINLAND

Tahinik Oy
PB 117
00381 Heisinki
Tel: (080) 565-3233
Telex: 12-2749 TINIK SF
FAX: (080) 565-3571

FRANCE

Vishay Micromasures
98, Boulevard Gabriel
Peri-PB 51
92242 Malakoff Cedex
Tel: (014) 655-9800
Telex: 270140 F
FAX: (014) 253-6794

GERMANY

Dale Electronics GmbH
Benzstrasse 28
Postfach 1251
D-8039 Puchheim
West Germany
Tel: (089) 80960
Telex: 05-212950
FAX: (089) 801398

PLZ 1, 2, 30, 31

Wilfried Dunger
Brunschentwiete 68a
2000 Hamburg 56
Tel: 040/81 76 35
Telex: 2 16 46 39

PLZ 35, 54, 55, 6

Dieter Ley
Radeberger Str. 4
6800 Mannheim 31
Tel: 0621/70 65 67
Telex: 4 63 655

PLZ 3, 4, 5

Dirk Sachau
Am Rottchen 116
4000 Dusseldorf 30
Tel: 0211/42 44 97

PLZ 7

Rudolf Perthold
Ulrichstr. 10
7152 Aspach
Tel: 0719/1 2 24 60

PLZ 8, Osterreich

Wolfgang Stingl
Sandgrubenweg 42
8000 Munchen 83
Tel: 089/6 80 16 17

PLZ 85, 86, 87, 88, 89

Osterreich PLZ 67, 68, 69
Martin Jeschke
Benediktenwandstr. 10b
8910 Landsberg/Lech
Tel: 08191/17 55

HOLLAND

(See Netherlands)

HONG KONG

Desner Far East, Ltd.
RM 1002, Park Tower
15 Austin Road
Tsimshatsui, Kowloon
Tel: (852) (3) 7231736
Telex: 57815 LUXBO HK
FAX: (852) (3) 695260

INDIA

RDS World Services
4 Candy House
Mandlik Road
Bombay 400 039
Tel: 202-8888
Telex: 011-71481

(U.S.A. Office)

101 Frostwood Court
Crombush, SC 29212
Tel: 803-749-1267
Telex: 0493-0151 RIS

IRELAND

Neltronic, Ltd.
John F. Kennedy Road
Naas Road
Dublin 12
Tel: (01) 501845
Telex: 24837 NELIT EI

ISRAEL

Alexander Schneider Co., Ltd.
44 Petach Tikva Road
P.O. Box 18055
Tel-Aviv 61180
Tel: (03) 372089
Telex: 033-613 DYGal IL
FAX: (03) 370-337

ITALY

Sisram SPA (Sales Office)
Piazzale Lavater 5
20129 Milan
Tel: (02) 29405070/81
Sisram S.A.S. (Mail Address)
Casella Postale Ferrovia 1168
Torino
Tel: (011) 441782/3/4
Telex: 221142 SISRAM I
FAX: (011) 446521

JAPAN

Nippon-Vishay Co., Ltd.
Morino 2-26-16
Machida-Shi, Tokyo 194
Tel: (81) (4) 27-26-7131
Telex: 02872-538 VISHAY J
FAX: (81) (4) 27-29-3400

KOREA

Dongwoo Corporation
P.O. Box 46, Young Dong
Dae Ho Building — 3rd Floor
1462-7, Seocho-Dong,
Kangnam-Ku Seoul
Tel: (82) (2) 586-6111/5
Telex: DWCORP K27575
FAX: (82) (2) 586-3564

LUXEMBURG (See Belgium)

MEXICO

Panamtek (Mexico City)
Cienfuegos No. 651
Col. Lindavista
07300 Mexico, D.F.
Tel: 011-52-(5) 586.8443
Telex: 1773470

Panamtek (Guadalajara)

Av. Union 163-402
Sector Juarez
44100 Guadalajara, Jalisco
Tel: 011-52-(36) 30.30.29
FAX: 011-52-(36) 30.31.15

NETHERLANDS

Klees Electronics, B.V.
Bouwerij 70
1185 XX Amstelveen
Tel: (020) 434351
Telex: 17199 KLEES NL
FAX: (020) 473167

SOUTH ZEALAND

Professional Electronics, Ltd.
P.O. Box 31143
Milford 22A Milford Road
Milford Auckland
Tel: (64) (9) 493-029/493-048

NORWAY

Tahonic A/S
Postboks 140
Kaldbakken
0902 Oslo 9
Tel: (02) 161610-161611
Telex: 77397 TONIC N
FAX: (02) 257317

PERU (See South America)

PUERTO RICO

DK Marketing
215 Duran Building
San Jose Shopping Center
Rio Piedras 00926
Tel: (809) 765-5380/5306
Telex: 324-162014 DK MARK

SINGAPORE

Dale Electronics
Asia PTE, Ltd.
8 Jalan Kilang Timor
04-01 Kewalram House
Singapore 0315
Tel: 274-1687
Telex: RS 55523 DALEFE
FAX: 278 1149

Desner Electronics (Far East) PTE, Ltd.

190 Middle Road
#16-07 Fortune Centre
Singapore 0718
Tel: (65) 3373188/3373189
Telex: DTD RS39191
FAX: (65) 3373180

REPUBLIC OF SOUTH AFRICA

Electronic Building Elements
(PTY), Ltd. (Street Address)
Corner of Pinaster & 18th Street
Hazelwood, Pretoria
Tel: (27) (12) 46-9221/9
Telex: 3-22786 SA/3-20723 SA
FAX: (27) (12) 463761

Electronic Building Elements (PTY), Ltd. (Mail Address)

P.O. Box 4609
Pretoria 0001

NORTH AMERICA

(Peru, Colombia, Chile, Venezuela)

Etek Electronics Corp.

1490 NW 79



DALE ELECTRONICS, INC.

2064 12th Avenue
Columbus, Nebraska 68601

Phone 402-564-3131