

XDS51x Emulator Installation Guide

SPNU070C
February 2002



Printed on Recycled Paper

IMPORTANT NOTICE

Texas Instruments Incorporated and its subsidiaries (TI) reserve the right to make corrections, modifications, enhancements, improvements, and other changes to its products and services at any time and to discontinue any product or service without notice. Customers should obtain the latest relevant information before placing orders and should verify that such information is current and complete. All products are sold subject to TI's terms and conditions of sale supplied at the time of order acknowledgment.

TI warrants performance of its hardware products to the specifications applicable at the time of sale in accordance with TI's standard warranty. Testing and other quality control techniques are used to the extent TI deems necessary to support this warranty. Except where mandated by government requirements, testing of all parameters of each product is not necessarily performed.

TI assumes no liability for applications assistance or customer product design. Customers are responsible for their products and applications using TI components. To minimize the risks associated with customer products and applications, customers should provide adequate design and operating safeguards.

TI does not warrant or represent that any license, either express or implied, is granted under any TI patent right, copyright, mask work right, or other TI intellectual property right relating to any combination, machine, or process in which TI products or services are used. Information published by TI regarding third party products or services does not constitute a license from TI to use such products or services or a warranty or endorsement thereof. Use of such information may require a license from a third party under the patents or other intellectual property of that third party, or a license from TI under the patents or other intellectual property of TI.

Reproduction of information in TI data books or data sheets is permissible only if reproduction is without alteration and is accompanied by all associated warranties, conditions, limitations, and notices. Reproduction of this information with alteration is an unfair and deceptive business practice. TI is not responsible or liable for such altered documentation.

Resale of TI products or services with statements different from or beyond the parameters stated by TI for that product or service voids all express and any implied warranties for the associated TI product or service and is an unfair and deceptive business practice. TI is not responsible or liable for any such statements.

Mailing Address:

Texas Instruments
Post Office Box 655303
Dallas, Texas 75265

Read This First

About This Manual

This manual describes how to install an XDS510™ emulator controller and the XDS511™ emulator board.

There are several XDS510 emulator controllers for use with different computers. These emulator controllers are the XDS510 and XDS510PP for use with PCs, and the XDS510WS™ for use with a SPARCstation or an HP workstation.

This manual includes a chapter for each of the controllers and one chapter for the XDS511.

Notational Conventions

In this manual, program listings, program examples, and interactive displays are shown in a special typeface similar to a typewriter's. Examples use a **bold version** of the special typeface for emphasis; interactive displays use a **bold version** of the special typeface to distinguish commands that you enter from items that the system displays (such as prompts, command output, error messages, etc.).

Here is a sample program listing:

```
0011 0005 0001      .field    1, 2
0012 0005 0003      .field    3, 4
0013 0005 0006      .field    6, 3
0014 0006           .even
```

Here is an example of a system prompt and a command that you might enter:

```
C:  csr -a /user/ti/simuboard/utilities
```

Information About Cautions and Warnings

This manual contains cautions and warnings.

This is an example of a caution statement.

A caution statement describes a situation that could potentially damage your software or equipment.

This is an example of a warning statement.

A warning statement describes a situation that could potentially cause harm to you.

The information in a caution or a warning is provided for your protection. Please read each caution and warning carefully.

Related Documentation From Texas Instruments

The following books describe the C source debugger for the TMS370C8, TMS370C16, or TMS320C2xx devices and the JTAG cable. To obtain a copy of any of these TI documents, call the Texas Instruments Literature Response Center at (800) 477–8924. When ordering, please identify the book by its title and literature number.

JTAG/MPSD Emulation Technical Reference (literature number SPDU079) provides the design requirements of the XDS510™ emulator controller, discusses JTAG designs (based on the IEEE 1149.1 standard), and modular port scan device (MPSD) designs.

TMS370C8 C Source Debugger User's Guide (literature number SPNU063) tells you how to invoke the TMS370C8 XDS™ emulator, and simulator versions of the C source debugger interface. This book discusses various aspects of the debugger interface, including window management, command entry, code execution, data management, and breakpoints. It also includes a tutorial that introduces basic debugger functionality.

TMS370C16 C Source Debugger User's Guide (literature number SPNU065) tells you how to invoke the TMS370C16 XDS™ emulator, and simulator versions of the C source debugger interface. This book discusses various aspects of the debugger interface, including window management, command entry, code execution, data management, and breakpoints. It also includes a tutorial that introduces basic debugger functionality.

TMS320C2xx C Source Debugger User's Guide (literature number SPRU151) tells you how to invoke the TMS320C2xx™ emulator and simulator versions of the C source debugger interface. This book discusses various aspects of the debugger interface, including window management, command entry, code execution, data management, and breakpoints. It also includes a tutorial that introduces basic debugger functionality.

FCC Warning

This equipment is intended for use in a laboratory test environment only. It generates, uses, and can radiate radio frequency energy and has not been tested for compliance with the limits of computing devices pursuant to subpart J of part 15 of FCC rules, which are designed to provide reasonable protection against radio frequency interference. Operation of this equipment in other environments may cause interference with radio communications, in which case the user at his own expense will be required to take whatever measures may be required to correct this interference.

Trademarks

320 Hotline On-line, TI&ME, XDS510, XDS510PP, XDS510WS, XDS511, and XDS522 are trademarks of Texas Instruments Incorporated.

HP-UX, HP 9000 Series 700, and PA-RISC are trademarks of Hewlett-Packard Company.

IBM and PC are registered trademarks of International Business Machines Corp.

OpenWindows, SunOS, and SPARCstation are trademarks of Sun Microsystems, Inc.

UNIX is a registered trademark of Unix System Laboratories, Inc.

Contents

1	Introduction	1-1
	<i>Describes the systems and provides information for you to decide which system to use. Provides definitions and directs you to the next step after completing the installation.</i>	
1.1	Some Definitions	1-2
1.2	Information About the Hardware	1-3
1.2.1	Selecting an XDS510	1-3
1.3	Where to Go From Here	1-4
2	Installing the XDS510 in a PC	2-1
	<i>Explains how to install the XDS510 emulator controller in your PC.</i>	
2.1	What You'll Need	2-2
2.2	Step 1: Preparing the XDS510 for Installation	2-3
2.3	Step 2: Placing the XDS510 Into Your PC	2-4
2.4	Step 3: Connecting the XDS510 to Your Target System	2-5
2.5	Where to Go From Here	2-6
3	Installing the XDS510PP on a PC	3-1
	<i>Explains how to install the XDS510PP emulator controller on your PC.</i>	
3.1	What You'll Need	3-2
3.1.1	Required Hardware	3-2
3.1.2	Optional Hardware	3-2
3.2	Step 1: Connecting the XDS510PP to Your PC	3-3
3.3	Step 2: Connecting the XDS510PP to Your Target System	3-4
3.4	Step 3: Supplying Power to the XDS510PP	3-5
3.5	Where to Go From Here	3-7

4	Installing the XDS510WS on a SPARCstation	4-1
	<i>Explains how to install the XDS510WS emulator controller on your SPARCstation.</i>	
4.1	What You'll Need	4-2
4.2	Step 1: Preparing for the Installation	4-3
4.2.1	Access Required	4-3
4.2.2	Ensuring That the XDS510WS Is Working Correctly	4-3
4.3	Step 2: Connecting the XDS510WS to Your Workstation	4-5
4.3.1	Locating a SCSI Bus With an Unused Identifier	4-5
4.3.2	Setting the SCSI ID on the XDS510WS	4-7
4.3.3	Adding the XDS510WS Onto the SCSI Bus	4-8
4.3.4	Terminating the SCSI Bus	4-9
4.4	Step 3: Configuring Your Workstation to Recognize the XDS510WS	4-10
4.4.1	Using SunOS 5.5	4-10
4.4.2	Using SunOS 5.6, 5.7 or 5.8	4-11
4.5	Step 4: Allowing the Debugger to Access the XDS510WS	4-12
4.5.1	Using SunOS 5.5	4-12
4.5.2	Using SunOS 5.6, 5.7 or 5.8	4-12
4.6	Step 5: Connecting the XDS510WS to Your Target System	4-14
4.7	Where to Go From Here	4-16
4.8	Uninstalling the XDS510WS	4-17
4.9	Troubleshooting the XDS510WS	4-18
4.9.1	Unable to Load Device Driver	4-18
4.9.2	Code Composer Errors on Initial Use	4-19
4.9.3	Intermittent Errors Occur With Code Composer Studio for Solaris	4-20
5	Installing the XDS510WS on an HP Workstation	5-1
	<i>Explains how to install the XDS510WS emulator controller on your HP workstation.</i>	
5.1	What You'll Need	5-2
5.2	Step 1: Preparing for the Installation	5-3
5.2.1	Access Required	5-3
5.2.2	Ensuring That the XDS510WS Is Working Correctly	5-3
5.3	Step 2: Connecting the XDS510WS to Your Workstation	5-5
5.3.1	Locating a SCSI Bus With an Unused Identifier	5-5
5.3.2	Setting the SCSI ID on the XDS510WS	5-6
5.3.3	Adding the XDS510WS Onto the SCSI Bus	5-7
5.3.4	Terminating the SCSI Bus	5-8
5.4	Step 3: Setting Up Your Workstation to Recognize the XDS510WS	5-9
5.5	Step 4: Allowing the Debugger to Access the XDS510WS	5-10
5.6	Step 5: Connecting the XDS510WS to Your Target System	5-11
5.7	Where to Go From Here	5-12

6	Installing the XDS511	6-1
	<i>Explains how to install the XDS511 emulator board.</i>	
6.1	What You'll Need	6-2
6.1.1	Required Hardware	6-2
6.1.2	Optional Hardware	6-2
6.2	The XDS511	6-3
6.3	Step 1: Setting the Jumpers on the XDS511	6-4
6.3.1	Jumper Settings When Using a 'C8 or 'C16 SE Device	6-4
6.3.2	Jumper Settings When Using a 'C2xx SE Device	6-5
6.4	Step 2: Connecting the SE Device to the XDS511	6-7
6.4.1	Inserting an SE Device Into a Lever-Type Socket	6-7
6.4.2	Inserting an SE Device Into a Screwdriver-Type Socket	6-8
6.5	Step 3: Connecting the JTAG Cable, Power Supply, and Adapter Board	6-9
6.6	Step 4: Connecting a Target System to the XDS511 (Optional)	6-11
6.6.1	Direct Method	6-11
6.6.2	Target Cable Method	6-12
6.7	Where to Go From Here	6-14
A	Interpreting the XDS510WS LEDs	A-1
	<i>Explains how the LEDs (light-emitting diodes) on the XDS510WS relate to emulator operation.</i>	
A.1	XDS510WS LEDs	A-2
A.2	Power Indicator: LED 1	A-2
A.3	Power-Loss Indicator: LED 2	A-3
A.4	Emulation-Instruction Indicator: LED 3	A-3
A.5	Error/Status Indicators: LEDs 4, 5, and 6	A-4
A.6	SCSI-Transfer Indicators: LEDs 7 and 8	A-4
A.7	XDS510WS LED Interpretation	A-5
B	Glossary	B-1
	<i>Defines acronyms and key terms used in this manual.</i>	

Figures

2-1	XDS510 I/O Switches	2-3
2-2	Placing the XDS510 Into Your PC	2-4
2-3	Connecting the XDS510 and Your Target System	2-5
3-1	Connecting the XDS510PP to Your PC	3-3
3-2	Connecting the XDS510PP to Your Target System	3-4
3-3	Connecting the Power Supply Adapter Cable	3-6
4-1	Rear View of the XDS510WS	4-4
4-2	Front View of the XDS510WS	4-4
4-3	SCSI ID Switch on the XDS510WS	4-7
4-4	Connecting the XDS510WS to Your Workstation	4-9
4-5	Connecting Your Target System	4-14
5-1	Rear View of the XDS510WS	5-4
5-2	Front View of the XDS510WS	5-4
5-3	Front View of the XDS510WS	5-6
5-4	Connecting the XDS510WS to Your Workstation	5-7
5-5	Connecting Your Target System	5-11
6-1	XDS511 Emulator Top View	6-3
6-2	XDS511 Bottom View	6-3
6-3	Jumper Settings That Remain the Same for All Modes	6-5
6-4	Inserting an SE Device Into a Lever-Type Socket	6-7
6-5	Inserting an SE Device Into a Screwdriver-Type Socket	6-8
6-6	Connecting the JTAG Cable, Power Supply, and Adapter Board to the XDS511	6-10
6-7	Attaching the Target Cable to the XDS511	6-13
A-1	XDS510WS LEDs	A-2
A-2	Standard LED Sequences	A-5

Notes

Minimizing Electrical Shock and Fire Hazard	2-2
Minimizing Static Shock	2-2
Minimizing Personal Injury	2-4
Minimizing Equipment Damage	2-5
If You Are Using the XDS511	2-5
Minimizing Electrical Shock and Fire Hazard	3-2
Minimizing Personal Injury	3-3
Minimizing Equipment Damage	3-3
If You Are Using the XDS511	3-4
Minimizing Equipment Damage	3-4
Minimizing Electrical Shock and Fire Hazard	4-2
Minimizing Electrical Shock and Equipment Damage	4-5
Minimizing Personal Injury	4-8
Reduction in Maximum Transfer Rate	4-8
Terminator for SCSI-2 Only	4-9
False Warning Message	4-13
Minimizing Equipment Damage	4-14
If You Are Using the XDS511	4-14
Minimizing Electrical Shock and Fire Hazard	5-2
Minimizing Electrical Shock and Equipment Damage	5-5
Minimizing Personal Injury	5-7
Minimizing Equipment Damage	5-11
If Using the XDS511	5-11
Minimizing Electrical Shock and Fire Hazard	6-2
Minimizing Static Shock	6-2
Minimizing Equipment Damage	6-7
Minimizing Equipment Damage	6-9
Equipment Damage	6-12

Introduction

This chapter provides background information to help you determine what information in this manual you need to use. The systems discussed in this manual are described so that you can decide which ones you want to use.

Additionally, this chapter contains definitions you will need to understand to install the XDS51x emulator.

Topic	Page
1.1 Some Definitions	1-2
1.2 Information About the Hardware	1-3
1.3 Where to Go From Here	1-4

1.1 Some Definitions

Certain terms are used throughout this book. A list of some of the most frequently used terms are defined here to eliminate confusion.

- | | |
|-----------------------|--|
| target system | The system you want to debug. This can be your actual system, a test system you have created, or an XDS511 with an SE device attached to it. |
| JTAG cable | The cable that attaches the XDS510, XDS510WS, or XDS510PP to your target system. |
| JTAG connector | A 14-pin connector on the target system that is used to connect the JTAG cable. |

1.2 Information About the Hardware

The installation of the hardware shown in Table 1–1 is described in this manual.

Table 1–1. Hardware Descriptions

System	Description
XDS510	Emulator controller board for use in an IBM™-type PC™. The XDS510 is a board installed in your PC. After installing the XDS510, you connect it to your target system. The XDS510 enables your debugger to communicate with the target system.
XDS510PP	Emulator controller for use with an IBM-type PC. The XDS510PP is an external piece of hardware that is connected to your PC using the parallel printer port. This configuration is ideal for portable PCs. After installing the XDS510PP, you connect it to your target system. The XDS510PP enables your debugger to communicate with the target system.
XDS510WS	Emulator controller for use with a UNIX™-type workstation. The XDS510WS is an external piece of hardware that is connected to your workstation using a SCSI connection. After installing the XDS510WS, you connect it to your target system. The XDS510WS enables your debugger to communicate with the target system.
XDS511	Emulator used to emulate a target system. The XDS511 is connected to an XDS510, XDS510PP, or XDS510WS. In turn, you can connect the XDS511 to a target system.
SE device	Device that connects to the XDS511. An SE device is a specialized device that performs the same functions as your target device but includes features for gathering debugging information. There is an SE device for each of the TMS370C8, TMS370C16, and TMS320C2xx devices.

1.2.1 Selecting an XDS510

The XDS510 that you select depends on the computer you are using. Use the following table to select the device you want to use:

If you are using . . .	Then use the . . .
An IBM-type PC	XDS510, which you install in your PC; or XDS510PP, which you attach to your PC's parallel printer port
A UNIX workstation	XDS510WS, which you attach to a SCSI port

1.3 Where to Go From Here

After reading this chapter, turn to the chapter that describes how to install the XDS510 that you have selected and follow the instructions in that chapter.

If you are going to install the . . .	Turn to chapter . . .
XDS510	<i>2, Installing the XDS510 in a PC</i>
XDS510PP	<i>3, Installing the XDS510PP on a PC</i>
XDS510WS on a SPARCstation	<i>4, Installing the XDS510WS on a SPARCstation</i>
XDS510WS on an HP workstation	<i>5, Installing the XDS510WS on an HP Workstation</i>

Installing the XDS510 in a PC

This chapter explains how to install the XDS510 emulator controller in your PC. It also describes how to use the JTAG cable to connect the XDS510 to a target system.

Topic	Page
2.1 What You'll Need	2-2
2.2 Step 1: Preparing the XDS510 for Installation	2-3
2.3 Step 2: Placing the XDS510 Into Your PC	2-4
2.4 Step 3: Connecting the XDS510 to Your Target System	2-5
2.5 Where to Go From Here	2-6

2.1 What You'll Need

To install the XDS510, you will need the following hardware:

- | | | |
|--------------------------|----------------------------|---|
| <input type="checkbox"/> | host | An IBM PC/AT or 100% compatible ISA/EISA-based PC |
| <input type="checkbox"/> | slot | One 16-bit slot |
| <input type="checkbox"/> | emulator controller | XDS510 emulator controller board |
| <input type="checkbox"/> | JTAG cable | Cable that connects the XDS510 to your target system |
| <input type="checkbox"/> | target system | A system of your own design or an XDS511 emulator |
| <input type="checkbox"/> | JTAG connector | A 14-pin connector (two rows of seven pins) on your target system |

Minimizing Electrical Shock and Fire Hazard

To minimize the risk of electric shock and fire hazard, be sure that all major components that you interface with Texas Instruments devices are limited in energy and certified by one or more of the following agencies: UL, CSA, VDE, or TUV.

Minimizing Static Shock

Special handling methods and materials should be used to prevent equipment damage. You should be familiar with identification and handling of ESD sensitive devices before attempting to perform the procedures described in this manual.

2.2 Step 1: Preparing the XDS510 for Installation

The XDS510 uses 32 bytes of the PC I/O space. Before you install the XDS510, set its switches to correctly identify the I/O space that the XDS510 can use. Figure 2–1 shows the location of the switches.

Figure 2–1. XDS510 I/O Switches

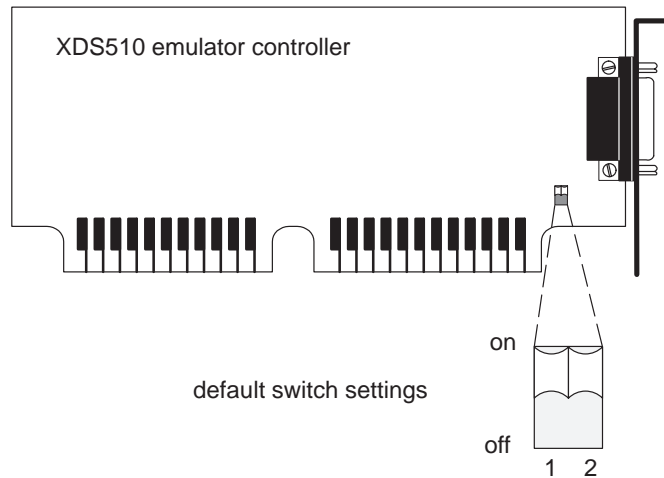

The switches on the XDS510 are shipped in the default settings. All possible switch settings are listed in Table 2–1.

In most cases, you can leave the switch settings in the default position. However, you must ensure that the XDS510 emulator controller I/O space does not conflict with other bus settings. For example, if you've installed a sound card in your system, you might not be able to use the default switch settings for the I/O space—the sound card might use this space.

Refer to your PC technical reference manual and your other hardware-board manuals to see if there are any I/O space conflicts. If you find a conflict, change the switch settings to one of the alternative settings listed in Table 2–1.

Table 2–1. XDS510 Switch Settings

	Address Range	switch #	
		1	2
default	0x0240–0x025F	on	on
	0x0280–0x029F	on	off
	0x0320–0x033F	off	on
	0x0340–0x035F	off	off

2.3 Step 2: Placing the XDS510 Into Your PC

After you've prepared the XDS510 for installation, follow these steps to place it into your PC.

Minimizing Personal Injury

To minimize the risk of personal injury, *always* turn off the power to your PC and unplug the power cord before installing the XDS510.

- 1) Turn off your PC's power and unplug the power cord.
- 2) Remove the cover of your PC.
- 3) Remove the mounting bracket from an unused 16-bit slot.
- 4) Carefully but firmly push the XDS510 into a 16-bit slot (see Figure 2–2).
- 5) Return the mounting screw to the mounting bracket and tighten the screw (see Figure 2–2). Note which slot contains the XDS510 for later use.
- 6) Replace the PC cover.

Figure 2–2. Placing the XDS510 Into Your PC

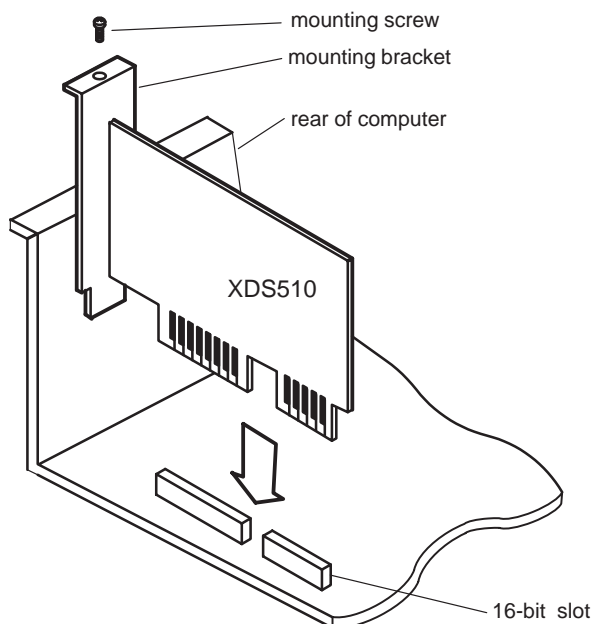

2.4 Step 3: Connecting the XDS510 to Your Target System

Follow these steps to connect your XDS510 to your target system.

Minimizing Equipment Damage

To minimize the risk of damage, be careful with the JTAG cable connectors. Connect them gently; forcing the connectors into position can damage them.

- 1) Turn off your target system and unplug the power cord.
- 2) Plug the 25-pin connector side of the JTAG cable into the XDS510 (see Figure 2–3).

Note: If You Are Using the XDS511

If you are using the XDS511 emulator with or instead of a target system of your own design, stop here and turn to Chapter 6, *Installing the XDS511*.

- 3) Plug the 14-pin connector side of the JTAG cable into the JTAG connector on your target system. For information about creating the connector on your target system, see the *JTAG/MPSD Emulation Technical Reference*.
- 4) Plug in the power cord for your PC and target system.
- 5) Turn on your PC and target system.

Figure 2–3. Connecting the XDS510 and Your Target System

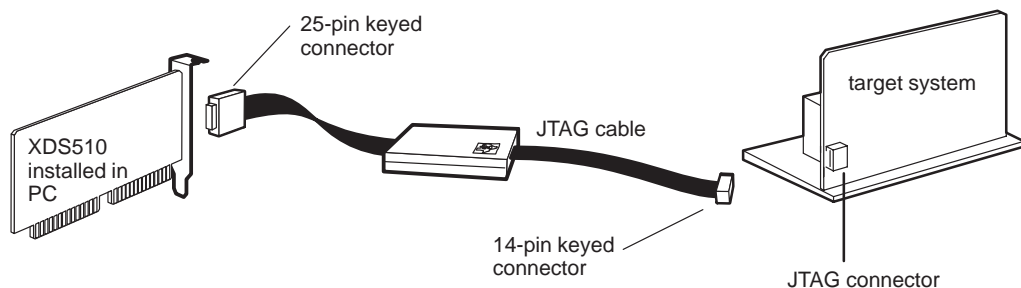

2.5 Where to Go From Here

Your XDS510 is now installed. At this point, do one of the following:

- If you plan to install the XDS511, turn to Chapter 6, *Installing the XDS511*.
- If you are not planning to install the XDS511, install the C source debugger for your device. The installation instructions are in the getting started guide for your device's C source debugger.

Only after installing and running the C source debugger for your device can you determine if the XDS510 is installed properly.

Installing the XDS510PP on a PC

This chapter explains how to install the XDS510PP emulator controller on your PC.

Topic	Page
3.1 What You'll Need	3-2
3.2 Step 1: Connecting the XDS510PP to Your PC	3-3
3.3 Step 2: Connecting the XDS510PP to Your Target System	3-4
3.4 Step 3: Supplying Power to the XDS510PP	3-5
3.5 Where to Go From Here	3-7

3.1 What You'll Need

This section describes the required and optional hardware you need to install the XDS510PP.

3.1.1 Required Hardware

To install the XDS510PP, you will need the following hardware:

- | | | |
|--------------------------|----------------------------|---|
| <input type="checkbox"/> | host | An IBM PC/AT or 100% compatible |
| <input type="checkbox"/> | parallel port | One parallel printer port (LPT1 or LPT2) |
| <input type="checkbox"/> | emulator controller | XDS510PP emulator controller |
| <input type="checkbox"/> | target system | A system of your own design or an XDS511 emulator |
| <input type="checkbox"/> | JTAG connector | A 14-pin connector (two rows of seven pins) on your target system |
| <input type="checkbox"/> | printer cable | 25-pin D-connector printer cable |

3.1.2 Optional Hardware

To install the XDS510PP, you might need the following hardware (see Section 3.4 on page 3-5):

- | | | |
|--------------------------|---|-----------------------------------|
| <input type="checkbox"/> | emulator-controller power supply | 5 volts @ 1 ampere |
| <input type="checkbox"/> | power supply adapter cable | 6-inch power supply adapter cable |

Minimizing Electrical Shock and Fire Hazard

To minimize the risk of electric shock and fire hazard, be sure that all major components that you interface with Texas Instruments devices are limited in energy and certified by one or more of the following agencies: UL, CSA, VDE, or TUV.

3.2 Step 1: Connecting the XDS510PP to Your PC

Follow these steps to connect the XDS510PP to your PC.

Minimizing Personal Injury

To minimize the risk of personal injury, *always* turn off the power to your PC and unplug the power cord before installing the XDS510PP.

Minimizing Equipment Damage

To minimize the risk of damage, be careful with the printer cable connectors. Connect them gently; forcing the connectors into position can damage them.

- 1) Turn off your PC's power and unplug the power cord.
- 2) The printer port connections on the back of your PC are 25-pin female D connectors. Connect one end of the printer cable to the printer port that you intend to use—LPT1 or LPT2 (see Figure 3–1).
- 3) Connect the other end of the printer cable to the 25-pin connector on the XDS510PP (see Figure 3–1).

Figure 3–1. Connecting the XDS510PP to Your PC

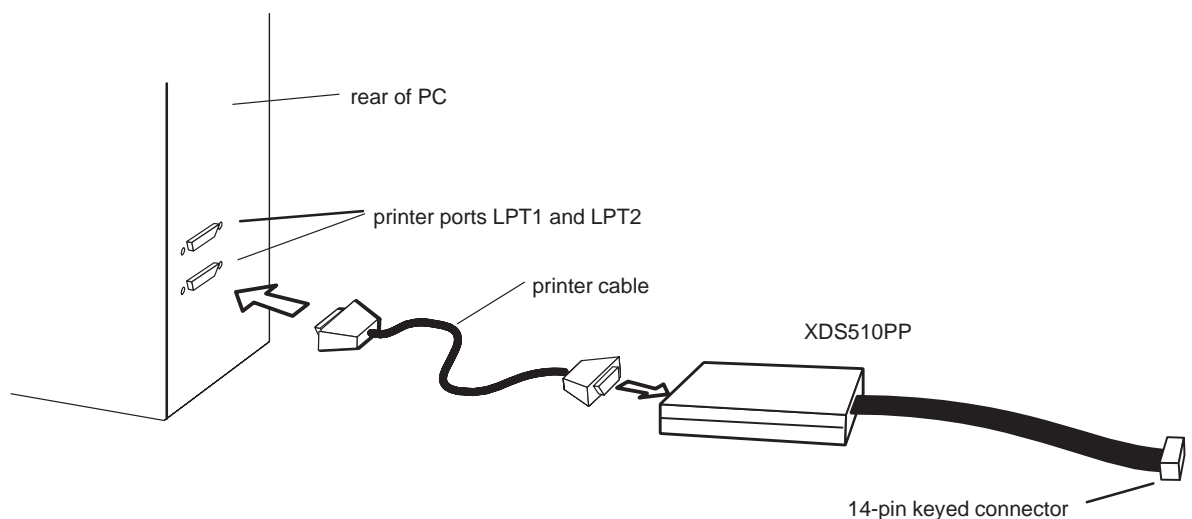

3.3 Step 2: Connecting the XDS510PP to Your Target System

Note: If You Are Using the XDS511

If you are using the XDS511 emulator with or instead of a target system of your own design, stop here (that is, do not perform Step 2 or Step 3) and turn to Chapter 6, *Installing the XDS511*.

- 1) Turn off your target system and unplug the power cord.
- 2) To connect the XDS510PP to your target system, plug the 14-pin connector on the XDS510PP cable into your target system (see Figure 3–2).

For information about creating the connector on your target system, see the *JTAG/MPSD Emulation Technical Reference*.

Minimizing Equipment Damage

To minimize the risk of damage, be careful with the XDS510PP cable connectors. Connect them gently; forcing the connectors into position can damage them.

Figure 3–2. Connecting the XDS510PP to Your Target System

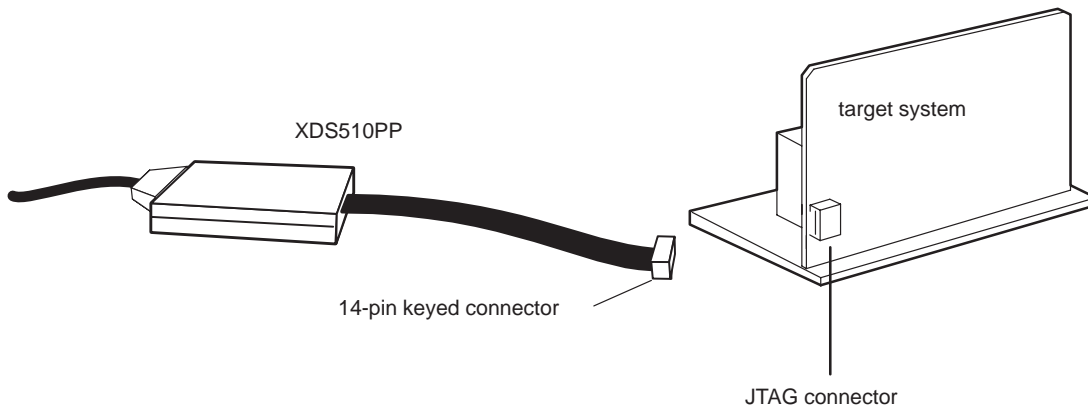

3.4 Step 3: Supplying Power to the XDS510PP

The XDS510PP requires a power supply of 5 volts. How you supply power depends upon what the XDS510PP connects to. The following table describes the possibilities:

Connection Scenario	Power Supply Option
The XDS510PP is connected to an XDS511.	Power is supplied by the XDS511. This is true whether or not the XDS511 is connected to a target system. You do not have to connect power directly to the XDS510PP. Connecting power directly to the XDS510PP when using the XDS511, however, will not harm the XDS510PP or the XDS511.
The XDS510PP is connected directly to a 3-volt target system.	You must connect the provided power supply (5 volts @ 1 ampere) to the XDS510PP.
The XDS510PP is connected directly to a 5-volt target system.	While you do not have to connect the provided power supply to the XDS510PP, it is highly recommended. Connecting the power supply ensures that the XDS510PP receives enough power.

If you need to connect the power supply to the XDS510PP, follow these steps:

- 1) Connect the 2.1 mm barrel jack end of the power supply adapter cable to the power jack on the XDS510PP (see Figure 3–3).
- 2) Connect the 5-pin circular connector end of the power supply adapter cable to the power supply (at the circular connector of the DC power cord).
- 3) Plug in the power cord for your PC, XDS510PP, and target system. Turn on your PC and target system.

Figure 3–3. Connecting the Power Supply Adapter Cable

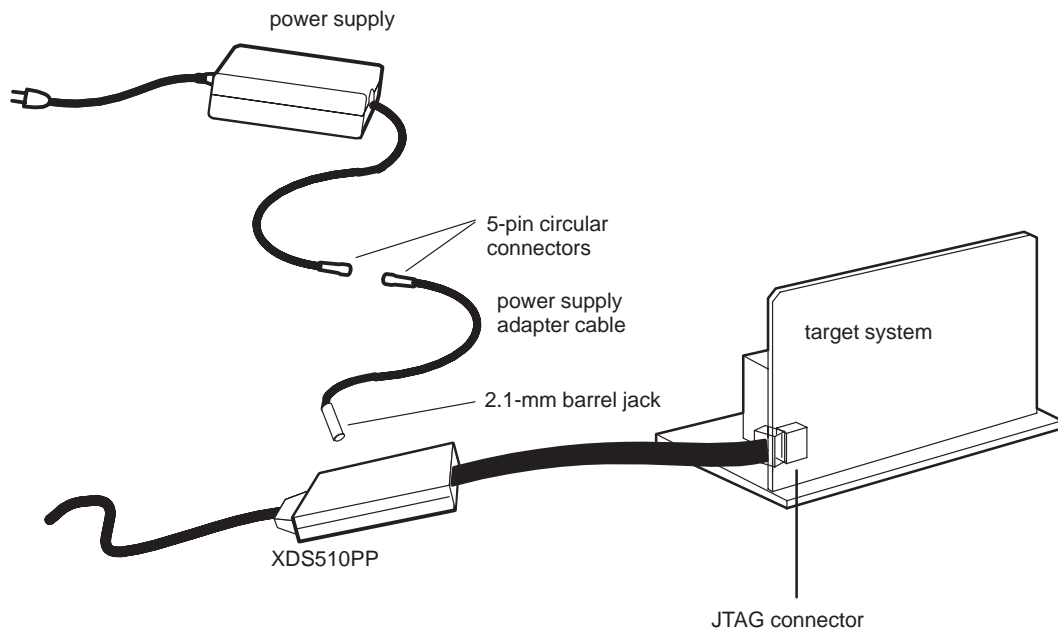

3.5 Where to Go From Here

Your XDS510PP is now installed. At this point, do one of the following:

- If you plan to install the XDS511, turn to Chapter 6, *Installing the XDS511*.
- If you are not planning to install the XDS511, install the C source debugger for your device. The installation instructions are in the getting started guide for your device's C source debugger.

Only after installing and running the C source debugger for your device can you determine if the XDS510PP is installed properly.

Installing the XDS510WS on a SPARCstation

This chapter explains how to install the XDS510WS emulator controller on a SPARCstation running OpenWindows™ under SunOS™ version 5.5 (or higher).

Topic	Page
4.1 What You'll Need	4-2
4.2 Step 1: Preparing for the Installation	4-3
4.3 Step 2: Connecting the XDS510WS to Your Workstation	4-5
4.4 Step 3: Configuring Your Workstation to Recognize the XDS510WS	4-10
4.5 Step 4: Allowing the Debugger to Access the XDS510WS	4-12
4.6 Step 5: Connecting the XDS510WS to Your Target System	4-14
4.7 Where to Go From Here	4-16
4.8 Uninstalling the XDS510WS	4-17
4.9 Troubleshooting the XDS510WS	4-18

4.1 What You'll Need

To install the XDS510WS, you will need the following hardware:

- | | | |
|--------------------------|---|--|
| <input type="checkbox"/> | host | A SPARCstation or 100% compatible system |
| <input type="checkbox"/> | interface to host | A SCSI bus controller with at least one free SCSI identifier between 0 and 6 |
| <input type="checkbox"/> | emulator controller | An XDS510WS emulator controller |
| <input type="checkbox"/> | emulator-controller power supply | The provided external power supply for the XDS510WS (approximately 5 volts @ 3 ampere) |
| <input type="checkbox"/> | SCSI cable | A SCSI cable used for connecting the XDS510WS to your SPARCstation. The SCSI cable packaged with your system is a SCSI-2 to SCSI-2 cable. If your workstation has a SCSI-3 interface only, please obtain a SCSI-3 to SCSI-2 cable, or use a converter. |
| <input type="checkbox"/> | SCSI terminator | A SCSI bus terminator if the XDS510WS is at the end of the SCSI chain |
| <input type="checkbox"/> | JTAG cable | Cable that connects the XDS510 to your target system. The JTAG cable voltage should match your target system. |
| <input type="checkbox"/> | target system | A system of your own design or an XDS511 emulator |
| <input type="checkbox"/> | JTAG connector | A 14-pin connector (two rows of seven pins) on your target system |

Minimizing Electrical Shock and Fire Hazard

- 1) To minimize the risk of electric shock and fire hazard, be sure that all major components that you interface with Texas Instruments devices are limited in energy and certified by one or more of the following agencies: UL, CSA, VDE, or TUV.
- 2) Turn the power off before you connect components and cables.
- 3) Never disconnect or reconnect any cables or other hardware devices while the XDS510WS is turned on.

4.2 Step 1: Preparing for the Installation

To prepare for the installation, you must have the correct access to the host machine, and you must determine if the XDS510WS is working correctly. This section explains these requirements.

4.2.1 Access Required

You *must* have root access to the host machine you intend to connect to the XDS510WS. If you do not, contact your system administrator.

4.2.2 Ensuring That the XDS510WS Is Working Correctly

Before you attach the XDS510WS to your workstation, be sure it is working correctly. To do this, follow these steps. See Figure 4–1 and Figure 4–2 for illustrations of the XDS510WS.

- 1) Connect the power supply to the XDS510WS and plug in the power supply.
- 2) Turn on the XDS510WS.
 - LED 1 lights to indicate that the power is on. If LED 1 does not come on, turn off the XDS510WS, check your power connections, and restart the XDS510WS.
 - LED 6 lights to indicate that the XDS510WS is running through a self test. Within a minute, the self-test should be done and LED 6 goes out.

The XDS510WS is ready and running correctly when LEDs 1, 2, and 5 are on, and all other LEDs are off. If these LEDs do not come on, something is wrong with the XDS510WS. Recheck your connections and turn the XDS510WS off and on a second time. If LED 1, 2, or 5 is still off, shut off the XDS510WS and contact the TI DSP or Microcontroller Hotline (see the Preface). For detailed information about the LEDs, see Appendix A, *Interpreting the XDS510WS LEDs*.

Figure 4–1. Rear View of the XDS510WS

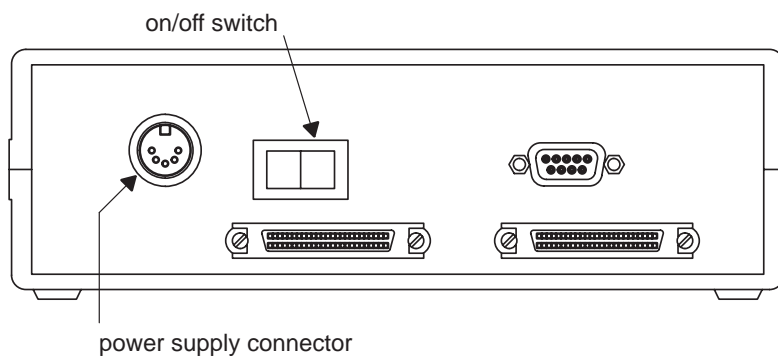
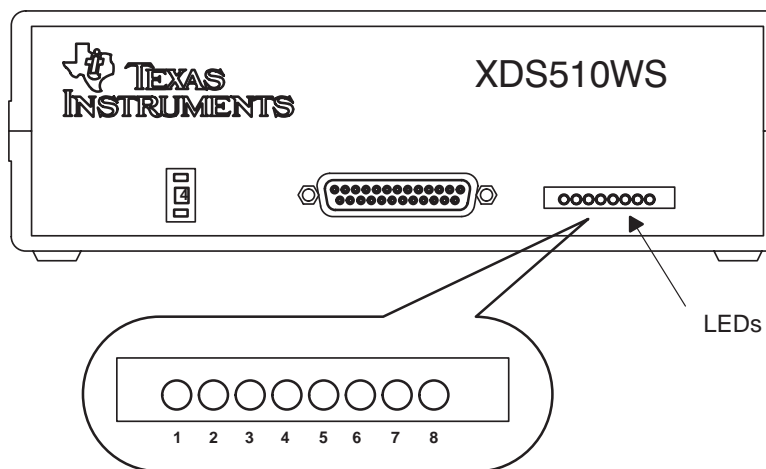

Figure 4–2. Front View of the XDS510WS



4.3 Step 2: Connecting the XDS510WS to Your Workstation

The XDS510WS is connected to your workstation using a SCSI bus. This section describes how to locate a SCSI bus to use and how to connect the XDS510WS to the SCSI bus.

Minimizing Electrical Shock and Equipment Damage

- 1) **Never disconnect or reconnect any cables or other hardware devices while the XDS510WS is turned on.**
- 2) **Be sure that all devices on the SCSI bus, your workstation, and the XDS510WS are turned off before you connect the XDS510WS to your workstation.**

4.3.1 Locating a SCSI Bus With an Unused Identifier

Each SCSI controller in your workstation has its own SCSI bus. A workstation usually has only one SCSI controller (unless you have added additional controller cards). The SCSI bus, on a card with only SCSI-2 connectors, can support up to eight devices (including the workstation), each uniquely numbered 0 through 7. The SCSI bus, on a card with at least one SCSI-3 connector, can support up to 16 devices (including the workstation), each uniquely numbered 0 through 15.

Priority for the IDs is 7 to 0, 15 to 8, highest to lowest. Your workstation is SCSI ID 7 by default; it is recommended that this ID not be changed. The XDS510WS uses SCSI ID 4 by default. If, however, SCSI ID 4 is already in use, you must change the ID of the XDS510WS to one that is not used.

To get a list of the SCSI IDs used on your workstation, follow these steps:

- 1) As the root user, type the following command to get the PROM prompt:

```
halt 
```

- 2) If you receive the following message:

```
Program terminated
Type b(boot), c(continue), or n(new command mode)
>
```

Type:

```
n 
```

If you do not receive this message, skip to the next step.

- 3) For SunOS 5.5 skip to step 5. For SunOS 5.6, 5.7, and 5.8 type:

```
setenv auto-boot? false
```

- 4) After you receive the following message:

```
auto-boot? = false
```

Reset the workstation by typing the following for SunOS 5.6 or 5.7:

```
reset
```

Reset the workstation by typing the following for SunOS 5.8:

```
reset-all
```

If reset doesn't work for 5.6 or 5.7, try reset-all. Similarly, if reset-all doesn't work for 5.8, try reset.

- 5) To probe the SCSI devices attached to the workstation enter the following for SunOS 5.6 or 5.7:

```
probe-scsi
```

For SunOS 5.8, enter:

```
probe-scsi-all
```

The probe-scsi-all command can be used for all SunOS operating systems, but it is primarily used for probing workstations with multiple SCSI cards. If probe-scsi does not work, try probe-scsi-all.

You should see a list of used SCSI IDs scroll on your screen similar to the following:

```
Target 3
  Unit 0 disk SEAGATE ST1480 SUN Copyright (c) 1992
  Seagate all rights reserved 0000
ok
```

The number following the word *Target* represents the currently used SCSI IDs. In the above message, SCSI ID number 3 is taken. The workstation's SCSI ID is not in this list. Rather, it is stored in the PROM environment variable *scsi_initiator_id* and can be viewed at this point when you type **printenv**.

- 6) To revert the auto-boot? variable to the default value, type:

```
setenv auto-boot? true
```

The following message will appear:

```
auto-boot? = true
```

To continue with the regular SunOS boot for your workstation, type:

```
boot
```

4.3.2 Setting the SCSI ID on the XDS510WS

If your workstation is already using SCSI ID 4 (see subsection 4.3.1), you must change the SCSI ID on the XDS510WS. Follow these steps to change the SCSI ID:

- 1) Turn off the XDS510WS.
- 2) Set the switch to a number of an unused SCSI ID.

The SCSI ID of the XDS510WS is controlled by a switch on its front panel (see Figure 4–3). The switch has positions 0 to 9. Do not use settings 8 and 9. (The XDS510WS uses only the three LSBs of the switch number; therefore, a setting of 8 would set the SCSI ID to 0, and a setting of 9 would set the SCSI ID to 1.)

Figure 4–3. SCSI ID Switch on the XDS510WS

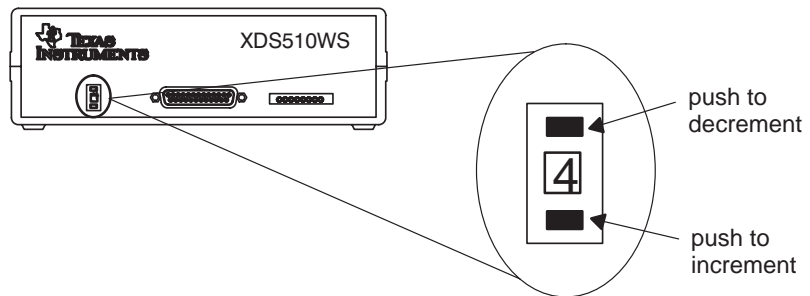

4.3.3 Adding the XDS510WS Onto the SCSI Bus

The SCSI bus is a chain with two distinct ends; it is not a loop. Although there may be SCSI devices within your host, the visible chain begins at the host and ends at one of the external SCSI devices.

You can connect the XDS510WS into the SCSI bus anywhere along this chain. Place the XDS510WS where you can easily connect it to your target system, read the LEDs, and reach the power switch.

Minimizing Personal Injury

To minimize the risk of personal injury, *always* turn off the power to your workstation and unplug the power cord before installing the XDS510WS.

To connect the XDS510WS to your workstation, follow these steps:

- 1) Power down your workstation and SCSI devices, then unplug the power cords.
- 2) For configurations using an external, 50-pin SCSI-2 interface:
 - a) Connect one end of a SCSI-2 to SCSI-2 cable to the back of the XDS510WS. You can use either of the SCSI connectors that are on the XDS510WS. See Figure 4-4.
 - b) Connect the other end of the SCSI-2 cable to the back of your workstation or to another SCSI device.
- 3) For configurations using an external, 68-pin SCSI-3 interface:
 - a) Connect the 50-pin SCSI-2 connector of the SCSI-3 to SCSI-2 cable to the back of the XDS510WS. You can use either of the SCSI connectors that are on the XDS510WS. See Figure 4-4.
 - b) Connect the 68-pin connector of the SCSI-3 to SCSI-2 cable to the back of your workstation or another compatible SCSI-3 device.

Note: Reduction in Maximum Transfer Rate

Due to restrictions in the SCSI interface, connection of a SCSI-2 device to a SCSI-3 device chain reduces the maximum transfer rate along the bus. The maximum SCSI-2 connection speed is 20MB/s, as compared to the potential 80MB/s or 160MB/s over SCSI-3. In most cases the external bus is separated from the internal bus(es) of the SCSI card, and thus the XDS510WS only affects transfer rates over external devices.

Figure 4-4. Connecting the XDS510WS to Your Workstation

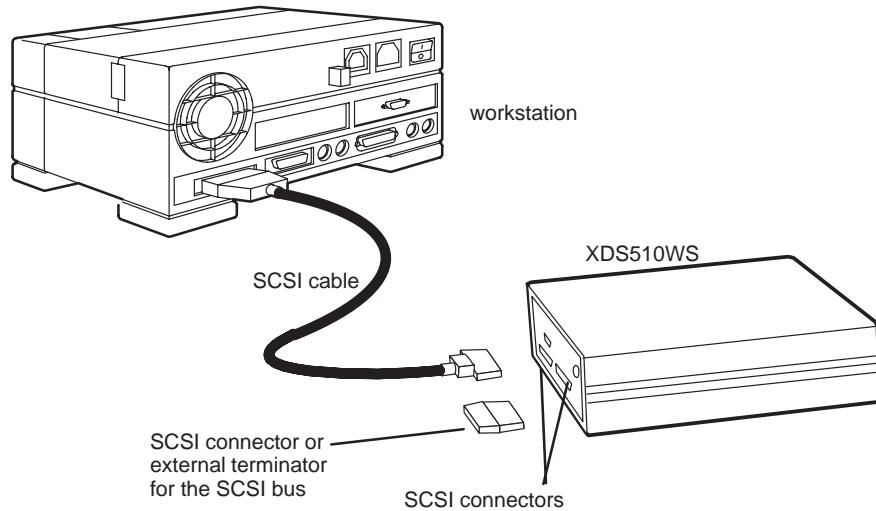

4.3.4 Terminating the SCSI Bus

You *must* terminate the SCSI bus at each end of its chain to reduce signal noise. The device farthest from your workstation on the chain should be terminated. Terminating intervening devices can cause intermittent errors in the SCSI bus.

If the XDS510WS is at the end of the SCSI bus, terminate the bus by connecting an external terminator (see Figure 4-4) to the unused SCSI connector on the back of the XDS510WS.

Turn on all external SCSI devices (including the XDS510WS) from the farthest/terminated device inward, then turn on your workstation.

Note: Terminator for SCSI-2 Only

The terminator packaged with the system is for use with a SCSI-2 device. It will not work on a SCSI-3 device.

4.4 Step 3: Configuring Your Workstation to Recognize the XDS510WS

This step varies, depending on which version of the operating system you are using. The following table directs you to the proper section:

Operating System	See Subsection
SunOS 5.5	4.4.1
SunOS 5.6	4.4.2
SunOS 5.7	4.4.2
SunOS 5.8	4.4.2

4.4.1 Using SunOS 5.5

If you are using SunOS 5.5, follow these steps to have your workstation recognize the XDS510WS:

- 1) As the root user, enter:

```
halt 
```

- 2) With the XDS510WS properly connected and powered up, reboot your workstation with the following PROM command:

```
boot -r 
```

- 3) Once the system comes back up, as the root user, execute the following command:

```
/usr/sbin/disks 
```

- 4) Go on to section 4.5 on page 4-12.

4.4.2 Using SunOS 5.6, 5.7 or 5.8

If you are using SunOS 5.6, 5.7 or 5.8, follow these steps to have your workstation recognize the XDS510WS:

- 1) Make sure that the XDS510WS is properly connected and powered up.
- 2) Login as root, or login as a regular user and use the su command to change to root.
- 3) Determine if the XDS510 driver has been previously installed on the workstation with the following command:

```
ls /dev |grep xds 
```

If the driver is installed, rxds510# will be returned where # is the SCSI ID of the XDS510WS box. If the driver is installed, uninstall it using the instructions in section 4.8 on page 4-17 before installing the new driver.

- 4) Insert the CD and go to the soldrv directory on the CD.
- 5) Run the script by entering the following. Then follow the script directions.
`solaris-driv-install.sh` 
- 6) When prompted, enter the lun number of the SCSI card. This applies to workstations where there is more than one card present, if your workstation has only one card you should enter 0.
- 7) When prompted, enter the SCSI port number for the XDS510WS chosen in section 4.3 on page 4-5 (default setting for the XDS510WS is 4).
- 8) Answer Yes when prompted to reboot the machine.
- 9) Go to section 4.5 on page 4-12.

4.5 Step 4: Allowing the Debugger to Access the XDS510WS

The debugger accesses the XDS510WS by reading from and writing to the device driver you defined in the EMULATOR configuration file. As a result, to execute the debugger, you must have read/write privileges on the driver file.

This step varies, depending on which version of the operating system you are using. The following table directs you to the proper section:

Operating System	See Subsection
SunOS 5.5	4.5.1
SunOS 5.6	4.5.2
SunOS 5.7	4.5.2
SunOS 5.8	4.5.2

4.5.1 Using SunOS 5.5

If you are using SunOS 5.5, nothing further is required. To confirm proper operation, enter:

```
ls -l /dev/rsd*a
```

If rsd#a is not listed (where # is a device driver number), repeat the steps in section 4.4.1 on page 4-10.

If rsd#a is listed with permissions other than lrwxrwxrwx, enter the following command:

```
chmod 777 /dev/rsd#d
```

4.5.2 Using SunOS 5.6, 5.7 or 5.8

To confirm proper operation if you are using SunOS 5.6, 5.7, or 5.8, enter:

```
ls -l /dev/rxds510#
```

If rxds510# is not listed (where # is the SCSI ID of the device), repeat the steps in section 4.4.2 on page 4-11.

At the end of the line you should also see something similar to:

```
/xds510@4,0:character
```

Where, in this example, the 4 following the @ is the SCSI ID chosen in section 4.3 on page 4-5, and 0 represents the lun number of the SCSI card. The lun number should be 0 unless the XDS510WS is connected to a secondary SCSI card on the workstation.

If `rxds510#` is listed with permissions other than `lrwxrwxrwx`, enter the following command:

```
chmod 777 /dev/rxds510#
```

To ensure that correct permissions are set on the actual device, enter the following command:

```
ls -lL /dev/rxds510#
```

If `rxds510#` is listed with permissions other than `crwxrwxrwx`, enter the following command:

```
chmod 777 /dev/rxds510#
```

Note: False Warning Message

When booting your workstation you may notice an error displayed as follows:

```
WARNING: {device location}/sd@4,0 (sd4):  
        corrupt label - wrong magic number
```

{device location} refers to the directory as displayed after executing the following command, starting from after `../devices/`:

```
ls -l /dev/rxds510#
```

This error has not proven to be of any significant problem with operation of the XDS510WS, and can be ignored.

4.6 Step 5: Connecting the XDS510WS to Your Target System

Follow these steps to connect the JTAG cable to your XDS510WS and your target system. Figure 4–5 illustrates the connection.

Minimizing Equipment Damage

To minimize the risk of damage, be careful with the JTAG cable connectors. Connect them gently; forcing the connectors into position can damage them.

Remember, the connectors are keyed. Be sure to connect the cable so that the keys fit in the correct slots.

- 1) Power down your SCSI devices, workstation, XDS510WS, and target system. Unplug all of the power cords.
- 2) Plug the 25-pin connector side of the JTAG cable into the XDS510WS. The connector is keyed to ensure proper connection.

Note: If You Are Using the XDS511

If you are using the XDS511 emulator with or instead of a target system of your own design, stop here (that is, complete only steps 1 and 2 of this section) and turn to Chapter 6, *Installing the XDS511*.

- 3) Plug the 14-pin connector side of the JTAG cable into the JTAG connector on your target system. The connector is keyed to ensure a proper connection. For information about creating the connector on your target system, see the *JTAG/MPSD Emulation Technical Reference*.
- 4) Plug in the power cords for your workstation, SCSI devices, XDS510WS, and target system.
- 5) Turn on your SCSI devices, workstation, XDS510WS, and target system.

Figure 4–5. Connecting Your Target System

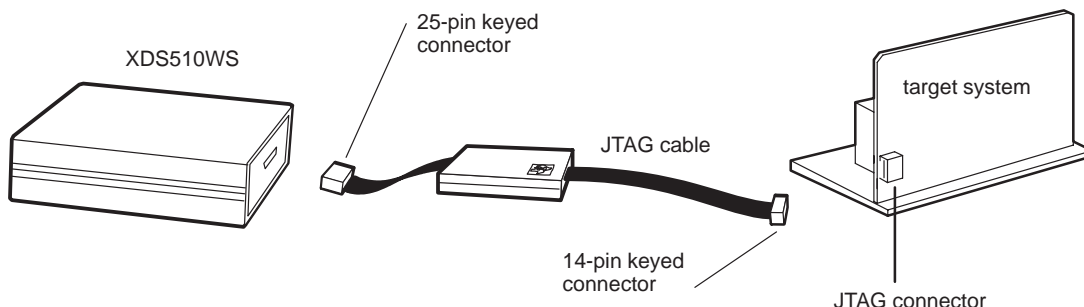

If you want to change the target system connected to the JTAG cable, then follow these steps:

- 1) Power off the XDS510WS and the target systems.
- 2) Disconnect the 14-pin connector side of the JTAG cable from the old target system, and connect it to the new target system.
- 3) Power on the XDS510WS.
- 4) Power on the new target system.

The workstation can be left running, provided that the SCSI cable(s) connecting the workstation to the XDS510WS and any other SCSI devices are left connected, and that the XDS510WS is only powered off for a short period of time.

4.7 Where to Go From Here

Your XDS510WS is now installed. At this point, do one of the following:

- If you plan to install the XDS511, turn to Chapter 6, *Installing the XDS511*.
- If you are not planning to install the XDS511, install the C source debugger for your device. The installation instructions are in the getting started guide for your device's C source debugger.

Only after installing and running the C source debugger for your device can you determine if the XDS510WS is installed properly.

4.8 Uninstalling the XDS510WS

To uninstall the XDS510WS from your system, follow these steps:

- 1) Login as root, or login as a regular user and use the su command to change to root.

- 2) Enter this command:

```
/usr/sbin/rem_drv xds510
```

- 3) Remove the dangling symbolic link rxds510# in /dev. The # sign represents the SCSI ID of the XDS510WS device.

- 4) Remove the following line from the /etc/devlink.tab file:

```
type=sample_driver;name=xds510;minor=character rxds510\A1
```

- 5) If the following files are present, remove them:

```
/usr/kernel/drv/xds510  
/usr/kernel/drv/xds510.conf  
/usr/kernel/drv/sparcv9/xds510
```

- 6) Reboot the system.

4.9 Troubleshooting the XDS510WS

Before looking for troubleshooting help in this section, please make sure that the XDS510WS is in proper working order. Make sure that the device is properly powered and all cable connections are securely attached to the XDS510WS, target, and workstation. If you have reason to believe that the XDS510WS is broken or damaged, refer to section 4.2.2 on page 4-3, or contact the TI DSP or Microcontroller Hotline.

4.9.1 Unable to Load Device Driver

If you are unable to load the device driver, follow these steps:

- 1) Make sure that the correct driver file is being used:
 - a) Determine the correct device driver for your current target.
 - b) Load driver, if different than the previously loaded one.
- 2) Ensure that the correct SCSI ID is being referenced by the driver. Check the currently used SCSI IDs by using the probe command in Unix (see section 4.3 on page 4-5 for details).
- 3) If steps 1 and 2 are not helpful, the XDS510WS may need to be reset. It is not necessary to power down the workstation so long as the XDS510WS is being powered off for a short period of time.
 - a) Using a board **with** a working reset switch:
 - i) Make sure that no programs are running for your debugger.
 - ii) Power off the XDS510WS.
 - iii) Power on the XDS510WS.
 - iv) Reset the target board.
 - v) Reload the target device driver.
 - b) Using a board **without** a reset switch:
 - i) Make sure that no programs are running for your debugger.
 - ii) Power off the target board then the XDS510WS.
 - iii) Power on XDS510WS then the target board.
 - iv) Reload the target device driver.

4.9.2 Code Composer Errors on Initial Use

If the attempt to execute Code Composer Studio for the first time results in one of the following error messages:

```
Can't Initialize Target DSP. Trouble with JTAG controller,  
check your Cabling and your Multiprocessing Configuration
```

```
Can't Initialize Target DSP. I/O port - <address>
```

There are several troubleshooting areas to consider when encountering this error. These are listed below from most likely to least likely to have invoked this error message.

- 1) Make sure that the device driver loaded onto the XDS510WS matches the actual target.
- 2) Check the Code Composer Studio Setup Configuration. To do that, launch Code Composer Studio Setup, right-click on the board name in the left pane, and select Properties from the context menu.
 - a) Select the Board Name tab of the Board Properties dialog, and check that the board data match the actual target.
 - b) Select the Board Properties tab of the Board Properties dialog, and make sure that the I/O port address set for the target board matches the actual SCSI address of the XDS510WS.
 - c) If you are using a multi-processor board or multiple boards, select the Processor Configuration tab of the Board Properties dialog, and check that the type and order of processors matches that on the actual target.

Please refer to the Code Composer Studio Setup online help for details on correctly configuring your Code Composer Studio Multiprocessing System.

- 3) Check the DSP Target Setup.
 - a) Make sure your DSP is not in a Hold or a Reset state and is correctly powered up.
 - b) Check that the target processor pin is not active. The target processor must be ready for the debugger to execute. If there is a hardware problem on the ready line, if possible, put the processor into Microcomputer mode, reset the system, and try bringing up the debugger again. In Microcomputer mode, all memory accesses should be on-chip and the ready signal should have no effect. Check your device user's guide for details.
 - c) Check that the processor hold pin is not active. Same issue as the target process pin being active.

- d) The JTAG signal may not be clear enough. In order to provide high-quality signals between the emulator and the target processor, check that the unbuffered distance between the emulator header and the processor is less than 6 inches. If this distance is in excess of 6 inches, the emulation signals should be buffered.
- e) The processor may not have a clock out. Processor must be receiving and generating the proper clocks. Check your clock in circuit and clock mode.
- f) Check that the EMU0/1 pins are high. The value of the EMU0/1 pins and reset can be used to turn off device pins and/or invoke device test modes. You should have these pins pulled high through a resistor in your target system.

4.9.3 Intermittent Errors Occur With Code Composer Studio for Solaris

Three types of intermittent errors might be occasionally observed when debugging a program in Code Composer Studio for Solaris using the XDS510WS:

- Code Composer Studio is launched after all hardware is properly connected and all settings correctly set, but it produces an error message like:
`Can't initialize target CPU: Target initialization failed`
- Code Composer Studio is launched without errors or warnings, but an attempt to load a program onto the target results in an error message like:
`Data verification failed at address address`
- Code Composer Studio is successfully launched and a program is successfully loaded onto the target, but an attempt to run or step through the program results in an error message such as the following:
`Data verification failed at address address`
or
`Can't run target CPU`

To recover after any of the above listed errors, follow these steps:

- 1) Exit Code Composer Studio for Solaris.
- 2) Reset the system as described in step 3 of section 4.9.1 on page 4-18.
- 3) Start Code Composer Studio for Solaris.

In case occurrence of the above listed errors significantly hinders debugging, consider using a shorter SCSI cable to connect your workstation to the XDS510WS.

Installing the XDS510WS on an HP Workstation

This chapter explains how to install the XDS510WS emulator controller on an HP 9000 Series 700™ PA-RISC™ computer running HP-UX™ 9.0x.

Topic	Page
5.1 What You'll Need	5-2
5.2 Step 1: Preparing for the Installation	5-3
5.3 Step 2: Connecting the XDS510WS to Your Workstation	5-5
5.4 Step 3: Setting Up Your Workstation to Recognize the XDS510WS	5-9
5.5 Step 4: Allowing the Debugger to Access the XDS510WS	5-10
5.6 Step 5: Connecting the XDS510WS to Your Target System	5-11
5.7 Where to Go From Here	5-12

5.1 What You'll Need

To install the XDS510WS, you will need the following hardware:

<input type="checkbox"/>	host	An HP 9000 Series 700 PA-RISC computer
<input type="checkbox"/>	interface to host	A SCSI bus controller with at least one free SCSI identifier
<input type="checkbox"/>	emulator controller	An XDS510WS emulator controller
<input type="checkbox"/>	emulator-controller power supply	The provided external power supply for the XDS510WS (approximately 5 volts @ 3 ampere)
<input type="checkbox"/>	SCSI cable	A SCSI cable used for connecting the XDS510WS to your HP workstation
<input type="checkbox"/>	SCSI terminator	A SCSI bus terminator if the XDS510WS is at the end of the SCSI chain
<input type="checkbox"/>	JTAG cable	Cable that connects the XDS510 to your target system
<input type="checkbox"/>	target system	A system of your own design or an XDS511 emulator
<input type="checkbox"/>	JTAG connector	A 14-pin connector (two rows of seven pins) on your target system

Minimizing Electrical Shock and Fire Hazard

- 1) To minimize the risk of electric shock and fire hazard, be sure that all major components that you interface with Texas Instruments devices are limited in energy and certified by one or more of the following agencies: UL, CSA, VDE, or TUV.
- 2) Turn the power off before you connect components and cables.
- 3) Never disconnect or reconnect any cables or other hardware devices while the XDS510WS is turned on.

5.2 Step 1: Preparing for the Installation

To prepare for the installation, you must have the correct access to the host machine, and you must determine if the XDS510WS is working correctly. This section explains these requirements.

5.2.1 Access Required

You *must* have root access to the host machine you intend to connect to the XDS510WS. If you do not, contact your system administrator.

5.2.2 Ensuring That the XDS510WS Is Working Correctly

Before you attach the XDS510WS to your workstation, be sure it is working correctly. To do this, follow these steps. See Figure 5–1 and Figure 5–2 for illustrations of the XDS510WS.

- 1) Connect the power supply to the XDS510WS and plug in the power supply.
- 2) Turn on the XDS510WS.
 - LED 1 lights to indicate that the power is on. If LED 1 does not come on, turn off the XDS510WS, check your power connections, and restart the XDS510WS.
 - LED 6 lights to indicate that the XDS510WS is running through a self test. Within a minute, the self-test should be done and LED 6 goes out.

The XDS510WS is ready and running correctly when LEDs 1, 2, and 5 are on, and all other LEDs are off. If these LEDs do not come on, something is wrong with the XDS510WS. Recheck your connections and turn the XDS510WS off and on a second time. If LED 1, 2, or 5 is still off, shut off the XDS510WS and contact the TI DSP or Microcontroller Hotline (see the Preface). For detailed information about the LEDs, see Appendix A, *Interpreting the XDS510WS LEDs*.

Figure 5–1. Rear View of the XDS510WS

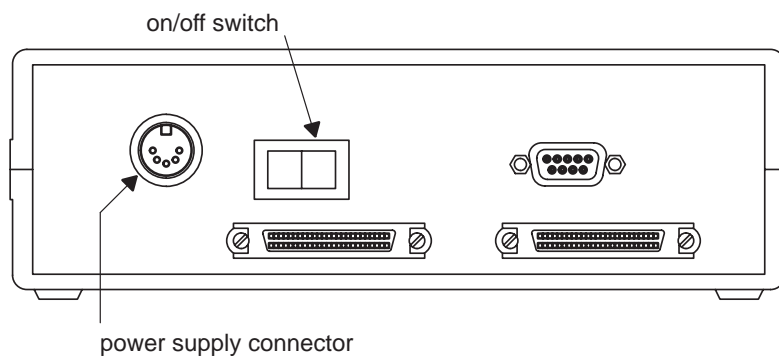
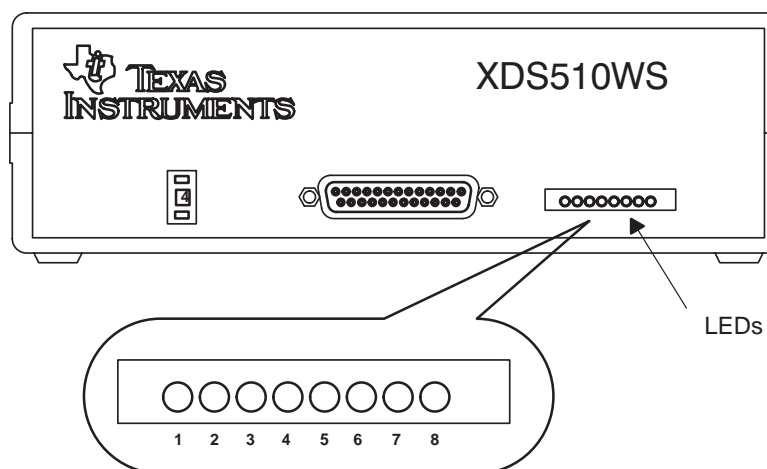

Figure 5–2. Front View of the XDS510WS



5.3 Step 2: Connecting the XDS510WS to Your Workstation

The XDS510WS is connected to your workstation using a SCSI bus. This section describes how to locate a SCSI bus to use and how to connect the XDS510WS to the SCSI bus.

Minimizing Electrical Shock and Equipment Damage

- 1) **Never disconnect or reconnect any cables or other hardware devices while the XDS510WS is turned on.**
- 2) **Be sure that all devices on the SCSI bus, your workstation, and the XDS510WS are turned off before you connect the XDS510WS to your workstation.**

5.3.1 Locating a SCSI Bus With an Unused Identifier

Each SCSI controller in your workstation has its own SCSI bus, and a workstation usually has only one SCSI controller (unless you have added additional controller cards). A single bus can support up to eight different devices (including the workstation), each uniquely numbered 0 through 7, with the higher priority devices assigned to the larger SCSI ID numbers. Your workstation is SCSI ID 7 by default. CD-ROM drives are ID 6 by default. The XDS510WS uses SCSI ID 4 by default. If, however, SCSI ID 4 is already in use, you must change the ID of the XDS510WS to one that is not used.

To get a list of the used SCSI IDs on your workstation, follow these steps.

- 1) As the root user, enter the following command:

```
/usr/bin/sam 
```

- 2) Once SAM (System Administration Manager) is running, select View All from the Peripheral Devices menu.

You should see a list of used SCSI IDs scroll on your screen; it should look similar to the following:

Path	Driver	Description	Status
====	=====	=====	=====
1.0.0	graph3	Graphics Subsystem	ok
2.0.1	c700	SCSI Interface	ok
2.0.1.4.0	scsi	SCSI CD-ROM drive	ok
2.0.1.5.0	scsi	SCSI Disk Drive	ok
2.0.1.6.0	scsi	SCSI Seagate ST31200N Disk Drive	ok
2.0.2	lan01	LAN Interface	ok
2.0.4	asio0	RS-232 Interface	ok
2.0.6	parallel	Parallel Interface	ok
2.0.8	audio	Audio Interface	ok
2.0.11	ps2	Keyboard/Mouse Port	ok
2.0.12	ps2	Keyboard/Mouse Port	ok

The currently active SCSI devices have SCSI as their driver type and the name x.x.x.Y.0, where Y is the SCSI ID on the x.x.x controller. In this example, the XDS510WS is described as the *SCSI Disk Drive*, the controller (x.x.x) is 2.0.1, and the SCSI ID (Y) is 5.

5.3.2 Setting the SCSI ID on the XDS510WS

If your workstation is already using SCSI ID 4 (see subsection 5.3.1), you must change the SCSI ID on the XDS510WS. Follow these steps to change the SCSI ID:

- 1) Turn off the XDS510WS.
- 2) Set the switch to a number of an unused SCSI ID.

The SCSI ID of the XDS510WS is controlled by a switch on its front panel (see Figure 5–3). This switch has ten positions, 0 through 9. Do not use settings 8 and 9. (The XDS510WS uses only the three LSBs of the switch number; therefore, a setting of 8 would set the SCSI ID to 0, and a setting of 9 would set the SCSI ID to 1.)

Figure 5–3. Front View of the XDS510WS

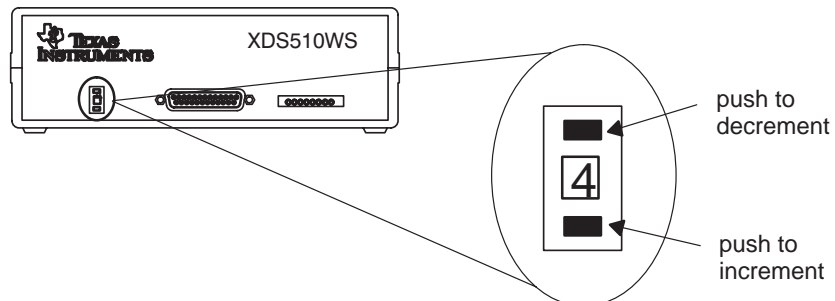

5.3.3 Adding the XDS510WS Onto the SCSI Bus

The SCSI bus is a chain with two distinct ends; it is not a loop. Although there may be SCSI devices within your host, the visible chain begins at the host and ends at one of the external SCSI devices.

You can connect the XDS510WS into the SCSI bus anywhere along this chain. It is best, however, to place the XDS510WS where you can easily connect it to your target system. The LEDs on the XDS510WS should be visible and its power switch readily accessible.

Minimizing Personal Injury

To minimize the risk of personal injury, *always* turn off the power to your workstation and unplug the power cord before installing the XDS510WS.

To connect the XDS510WS to your workstation, follow these steps:

- 1) Turn off the power to your workstation and SCSI devices, and unplug the power cords.
- 2) Connect one end of a SCSI cable to the back of the XDS510WS. You can use either of the SCSI connectors that are on the XDS510WS. See Figure 5–4.
- 3) Connect the other end of the SCSI cable to the back of your workstation or to another SCSI device.

Figure 5–4. Connecting the XDS510WS to Your Workstation

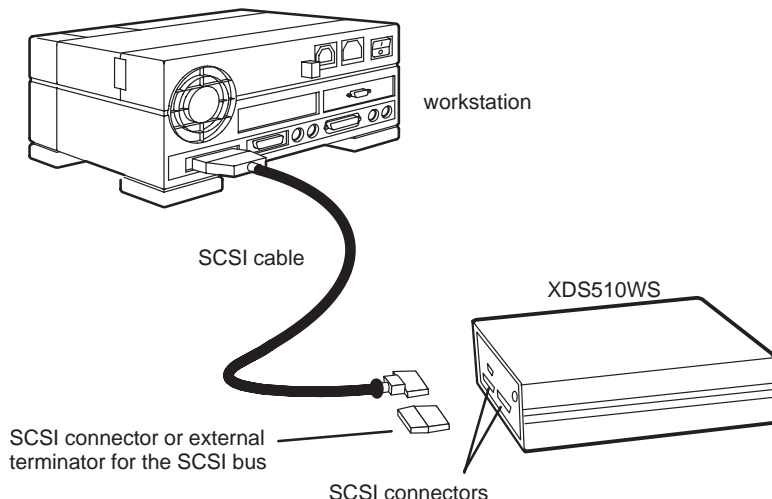

5.3.4 Terminating the SCSI Bus

You *must* terminate the SCSI bus at each end of its chain to reduce signal noise. The device farthest from your workstation on the chain should be terminated. Terminating intervening devices can cause intermittent errors in the SCSI bus.

If the XDS510WS is at the end of the SCSI bus, terminate the bus by connecting the external terminator (see Figure 5-4) to the unused SCSI connector on the back of the XDS510WS.

Turn on all external SCSI devices (including the XDS510WS) then turn on your workstation.

5.4 Step 3: Setting Up Your Workstation to Recognize the XDS510WS

Ensure that the device driver exists. Look for file `/dev/rdisk/cXdYs0`, where X is the ID of the SCSI controller that the emulator is attached to and Y is the SCSI ID of the emulator. Usually X is 201.

If this file does not exist, get your system administrator to help you create one with the HP `mkdev` utility.

5.5 Step 4: Allowing the Debugger to Access the XDS510WS

The debugger accesses the XDS510WS by reading from and writing to the device driver you looked for in Section 5.4.

To execute the debugger, you must ensure that any user who uses the XDS510WS has read/write privileges for the `/dev/rdsb/cXdYs0` file. To determine the read/write privileges, enter the following command:

```
ls -l /dev/rdsb/cXdYs0
```

If the file does not have the appropriate read/write privileges, as the root user, enter the following command:

```
chmod a+rw /dev/rdsb/cXdYs0
```

5.6 Step 5: Connecting the XDS510WS to Your Target System

Follow these steps to connect the JTAG cable to your XDS510WS and your target system. Figure 5–5 on page 5-11 illustrates the connection.

Minimizing Equipment Damage

To minimize the risk of damage, be careful with the JTAG cable connectors. Connect them gently; forcing the connectors into position can damage them.

Remember, the connectors are keyed. Be sure to connect the cable so that the keys fit in the correct slots.

- 1) Turn off the power to your SCSI devices, workstation, XDS510WS, and target system. Unplug all of the power cords.
- 2) Plug the 25-pin connector side of the JTAG cable into the XDS510WS. The connector is keyed to ensure proper connection.

Note: If Using the XDS511

If you are using the XDS511 emulator with or instead of a target system of your own design, stop here (that is, complete only Step 1 of this section) and turn to Chapter 6, *Installing the XDS511*.

- 3) Plug the 14-pin connector side of the JTAG cable into the JTAG connector on your target system. The connector is keyed to ensure a proper connection. For information about creating the connector on your target system, see the *JTAG/MPSD Emulation Technical Reference*.
- 4) Plug in the power cords for your workstation, SCSI devices, XDS510WS, and target system.
- 5) Turn on your SCSI devices, workstation, XDS510WS, and target system.

Figure 5–5. Connecting Your Target System

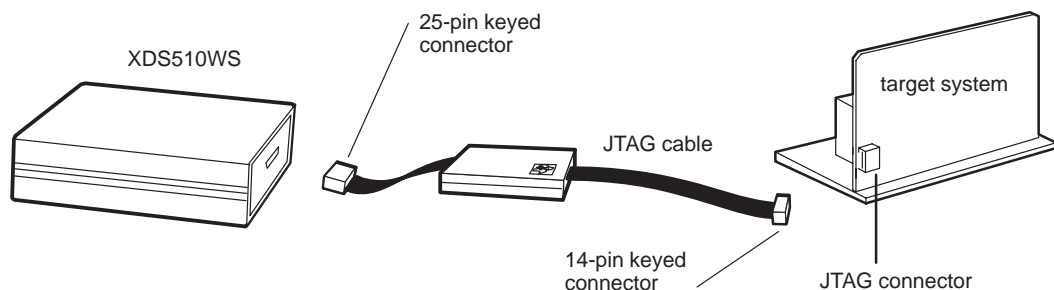

5.7 Where to Go From Here

Your XDS510WS is now installed. At this point, do one of the following:

- If you plan to install the XDS511, turn to Chapter 6, *Installing the XDS511*.
- If you are not planning to install the XDS511, install the C source debugger for your device. The installation instructions are in the getting started guide for your device's C source debugger.

Only after installing and running the C source debugger for your device can you determine if the XDS510WS is installed properly.

Installing the XDS511

This chapter describes how to set up and install the XDS511 emulator board. If you plan to use the XDS511 as your target system, follow the instructions in this chapter.

Topic	Page
6.1 What You'll Need	6-2
6.2 The XDS511	6-3
6.3 Step 1: Setting the Jumpers on the XDS511	6-4
6.4 Step 2: Connecting the SE Device to the XDS511	6-7
6.5 Step 3: Connecting the JTAG Cable, Power Supply, and Adapter Board	6-9
6.6 Step 4: Connecting a Target System to the XDS511 (Optional) ...	6-11
6.7 Where to Go From Here	6-14

6.1 What You'll Need

This section describes the required and optional hardware you need to install the XDS511.

6.1.1 Required Hardware

To install the XDS511, you will need the following hardware:

- | | | |
|--------------------------|-----------------------------------|--|
| <input type="checkbox"/> | emulator controller | An XDS510, XDS510PP, or XDS510WS installed as described in Chapters 2–5 |
| <input type="checkbox"/> | emulator | XDS511 emulator board |
| <input type="checkbox"/> | emulator power supply | The provided external power supply for the XDS510WS (approximately 5 volts @ 3 ampere) |
| <input type="checkbox"/> | power supply adapter cable | 6-inch power supply adapter cable |
| <input type="checkbox"/> | target cable adapter board | Adapter board |
| <input type="checkbox"/> | SE device | SE device for the C8, C16, or C2xx |

6.1.2 Optional Hardware

To install the XDS511, you might want the following hardware:

- | | | |
|--------------------------|----------------------|---|
| <input type="checkbox"/> | target system | A system of your own design |
| <input type="checkbox"/> | target cable | A cable that you purchase from TI to connect the XDS511 to your target system |

Minimizing Electrical Shock and Fire Hazard

To minimize the risk of electric shock and fire hazard, be sure that all major components that you interface with Texas Instruments devices are limited in energy and certified by one or more of the following agencies: UL, CSA, VDE, or TUV.

Minimizing Static Shock

Special handling methods and materials should be used to prevent equipment damage. You should be familiar with identification and handling of ESD sensitive devices before attempting to perform the procedures described in this manual.

6.2 The XDS511

Figure 6–1 and Figure 6–2 show the top and bottom views of the XDS511 emulator and call out components that are referred to in this chapter.

Figure 6–1. XDS511 Emulator Top View

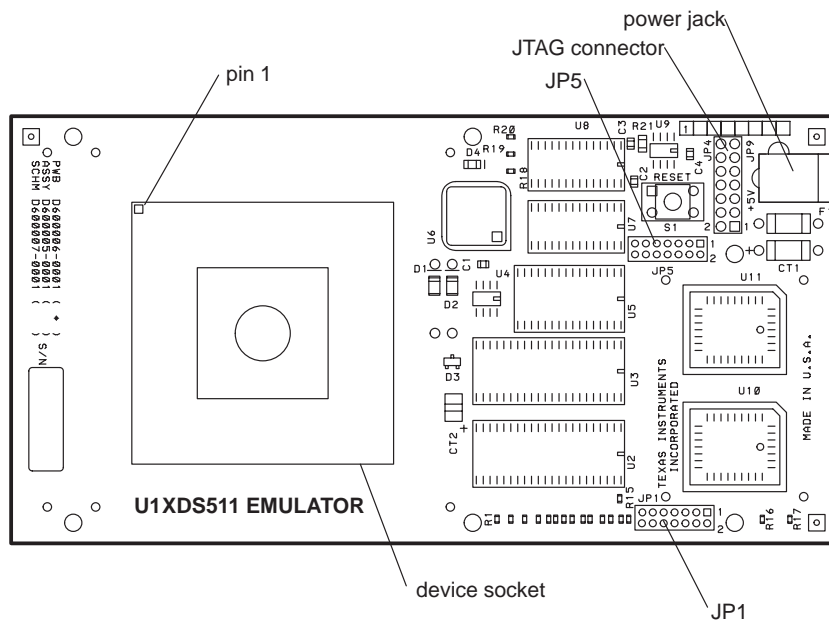
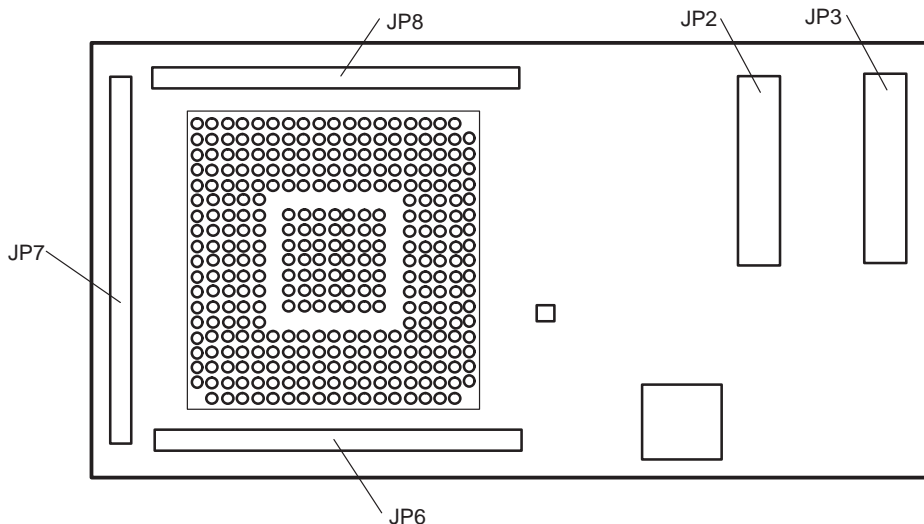

Figure 6–2. XDS511 Bottom View



6.3 Step 1: Setting the Jumpers on the XDS511

The XDS511 has two blocks of jumpers that must be set. The locations of the jumper blocks are shown in Figure 6–1 on page 6-3.

To set a pair of jumpers, place a jumper on the pins that correspond to the jumper numbers. To disable a setting, remove the jumper from the pins that correspond to the jumper numbers.

The jumpers are set to correspond to the SE device that you are using.

SE Device Used	See Subsection
C8	6.3.1
C16	6.3.1
C2xx	6.3.2

6.3.1 Jumper Settings When Using a C8 or C16 SE Device

The following table shows the jumper settings for jumper blocks 1 and 5 (JP1 and JP5) when using the C8 or C16 SE device.

Jumper block	TMS370C8	TMS370C16
Jumper block 1 (JP1)	<p>Diagram of Jumper block 1 (JP1) for TMS370C8. The diagram shows a vertical column of 14 pins. Pins 14, 12, 10, 8, 6, and 4 are numbered on the left. Pins 13, 11, 9, 7, 5, and 3 are numbered on the right. Jumper settings are indicated by black bars: pins 10, 8, 6, and 4 have black bars between them, while pins 14, 12, 13, 11, 9, 7, 5, and 3 do not.</p>	<p>Diagram of Jumper block 1 (JP1) for TMS370C16. The diagram shows a vertical column of 14 pins. Pins 14, 12, 10, 8, 6, and 4 are numbered on the left. Pins 13, 11, 9, 7, 5, and 3 are numbered on the right. Jumper settings are indicated by black bars: pins 10, 8, 6, and 4 have black bars between them, while pins 14, 12, 13, 11, 9, 7, 5, and 3 do not.</p>
Jumper block 5 (JP5)	<p>Diagram of Jumper block 5 (JP5) for TMS370C8. The diagram shows a vertical column of 14 pins. Pins 14, 12, 10, 8, 6, and 4 are numbered on the left. Pins 13, 11, 9, 7, 5, and 3 are numbered on the right. Jumper settings are indicated by black bars: pins 10, 8, 6, and 4 have black bars between them, while pins 14, 12, 13, 11, 9, 7, 5, and 3 do not.</p>	<p>Diagram of Jumper block 5 (JP5) for TMS370C16. The diagram shows a vertical column of 14 pins. Pins 14, 12, 10, 8, 6, and 4 are numbered on the left. Pins 13, 11, 9, 7, 5, and 3 are numbered on the right. Jumper settings are indicated by black bars: pins 10, 8, 6, and 4 have black bars between them, while pins 14, 12, 13, 11, 9, 7, 5, and 3 do not.</p>

6.3.2 Jumper Settings When Using a C2xx SE Device

When using the C2xx SE device, the jumper settings for the XDS511 vary depending upon which operating mode you use. These modes are:

native	The XDS511 replacement memory is disabled. Memory access is on-chip or on the C2xx logic interface.
EPROM	The C2xx on-chip ROM is replaced by the XDS511 EPROM. The XDS511 is limited to 50-ns operation when 35-ns EPROMs are used.
RAM	The C2xx on-chip ROM is replaced by the XDS511 RAM bank 1.
fast-RAM	The C2xx on-chip ROM is replaced by the XDS511 RAM bank 1. The memory timing signals are advanced to achieve faster operating speed. The replacement RAMs are continuously enabled, consuming more power than RAM mode.
boot	The contents of the EPROM are copied to RAM bank 2 on reset. The EPROMs are enabled continuously during copying. Writes to RAM bank 2 occur at the end of a cycle, and one complete read/write cycle takes two clock cycles. The EPROM is disabled at the end of the copy operation, and the normal device reset occurs.

Jumper settings for 1–2, 3–4, 5–6, and 7–8 for both JP1 and JP5 are the same for all operating modes. These settings are shown in Figure 6–3. The remaining jumpers vary and are shown in Table 6–1.

Figure 6–3. Jumper Settings That Remain the Same for All Modes



Table 6–1. Jumper Settings That Change for the Various Modes

If you want this mode ...	And you want ...	Then set JP1 like this ...	And set JP5 like this ...
Native	—	(14) <input type="radio"/> <input type="radio"/> (13) (12) <input type="radio"/> <input type="radio"/> (11) (10) <input checked="" type="checkbox"/> (9)	(14) <input checked="" type="checkbox"/> (13) (12) <input checked="" type="checkbox"/> (11) (10) <input type="radio"/> <input type="radio"/> (9)
EPROM	—	(14) <input checked="" type="checkbox"/> (13) (12) <input checked="" type="checkbox"/> (11) (10) <input type="radio"/> <input type="radio"/> (9)	(14) <input checked="" type="checkbox"/> (13) (12) <input checked="" type="checkbox"/> (11) (10) <input type="radio"/> <input type="radio"/> (9)
RAM	The debugger to always write to replacement memory, and the CPU to write to replacement memory when memory mapping overlay functions are enabled	(14) <input type="radio"/> <input type="radio"/> (13) (12) <input type="radio"/> <input type="radio"/> (11) (10) <input checked="" type="checkbox"/> (9)	(14) <input type="radio"/> <input type="radio"/> (13) (12) <input checked="" type="checkbox"/> (11) (10) <input type="radio"/> <input type="radio"/> (9)
RAM	To boot on the power up of the XDS511. You must have programmed EPROMs inserted.	(14) <input checked="" type="checkbox"/> (13) (12) <input type="radio"/> <input type="radio"/> (11) (10) <input checked="" type="checkbox"/> (9)	(14) <input type="radio"/> <input type="radio"/> (13) (12) <input checked="" type="checkbox"/> (11) (10) <input type="radio"/> <input type="radio"/> (9)
RAM	To boot on the power up of the XDS511 and on the power up of the CPU. You must have programmed EPROMs inserted.	(14) <input type="radio"/> <input type="radio"/> (13) (12) <input type="radio"/> <input type="radio"/> (11) (10) <input checked="" type="checkbox"/> (9)	(14) <input checked="" type="checkbox"/> (13) (12) <input type="radio"/> <input type="radio"/> (11) (10) <input type="radio"/> <input type="radio"/> (9)
Fast-RAM	The debugger to always write to replacement memory, and the CPU to write to replacement memory when memory mapping overlay functions are enabled	(14) <input checked="" type="checkbox"/> (13) (12) <input type="radio"/> <input type="radio"/> (11) (10) <input checked="" type="checkbox"/> (9)	(14) <input checked="" type="checkbox"/> (13) (12) <input type="radio"/> <input type="radio"/> (11) (10) <input type="radio"/> <input type="radio"/> (9)
Fast-RAM	To boot on the power up of the XDS511. You must have programmed EPROMs inserted.	(14) <input type="radio"/> <input type="radio"/> (13) (12) <input type="radio"/> <input type="radio"/> (11) (10) <input checked="" type="checkbox"/> (9)	(14) <input type="radio"/> <input type="radio"/> (13) (12) <input type="radio"/> <input type="radio"/> (11) (10) <input type="radio"/> <input type="radio"/> (9)
Fast-RAM	To boot on the power up of the XDS511 and on the power up of the CPU. You must have programmed EPROMs inserted.	(14) <input checked="" type="checkbox"/> (13) (12) <input type="radio"/> <input type="radio"/> (11) (10) <input checked="" type="checkbox"/> (9)	(14) <input type="radio"/> <input type="radio"/> (13) (12) <input type="radio"/> <input type="radio"/> (11) (10) <input type="radio"/> <input type="radio"/> (9)

6.4 Step 2: Connecting the SE Device to the XDS511

An SE device is connected to the XDS511 by inserting the device into a socket. The XDS511 can have a lever-type socket or a screwdriver-type socket.

Minimizing Equipment Damage

To minimize the risk of damage, be very careful with the SE device. Connect it gently; forcing the pins into position can damage them.

Remember, the device is keyed. Be sure to connect the device so that the key fits in the correct slot.

6.4.1 Inserting an SE Device Into a Lever-Type Socket

Follow these steps to insert your SE device into a lever-type socket:

- 1) Pull up the lever on the socket.
- 2) Carefully push the SE device into the socket. The device is keyed, using a pin in one corner (pin 1) to fit in only one way.
- 3) Push the lever down until it locks into place.

Figure 6–4. Inserting an SE Device Into a Lever-Type Socket

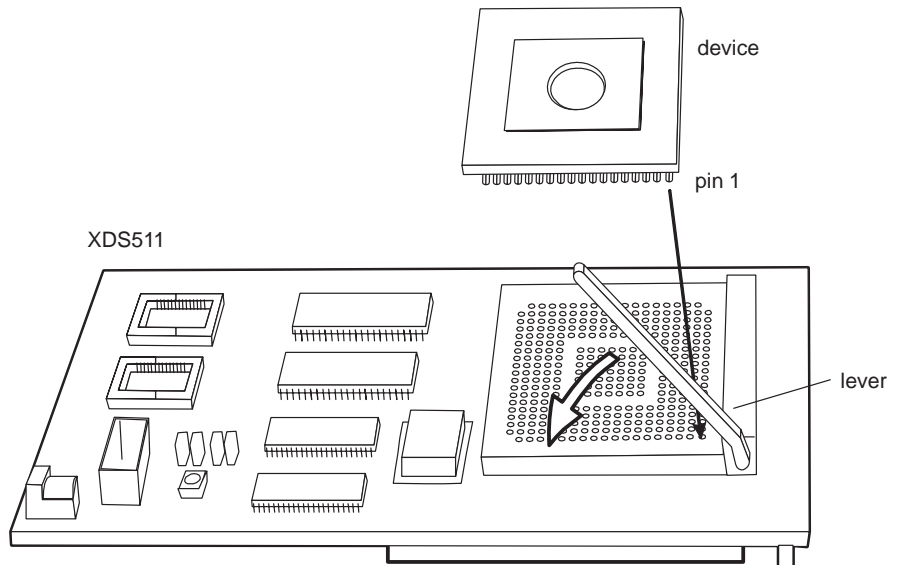

6.4.2 Inserting an SE Device Into a Screwdriver-Type Socket

Follow these steps to insert your SE device into a screwdriver-type socket:

- 1) Insert the head of a flathead screwdriver into the slot marked OPEN on the side of the socket. Using the screwdriver as a lever, slide the top of the socket toward the center of the socket until it clicks open. The socket may already be open.
- 2) Carefully push the SE device into the socket. The device is keyed, using a pin in one corner (pin 1) to fit in only one way.
- 3) Insert the tip of a flathead screwdriver into the slot marked LOCK on the side of the socket. Using the screwdriver as a lever, slide the top of the socket toward the center of the socket until it clicks closed.

The lock is tight, so you must apply force to slide the socket to the side.

Figure 6–5. Inserting an SE Device Into a Screwdriver-Type Socket

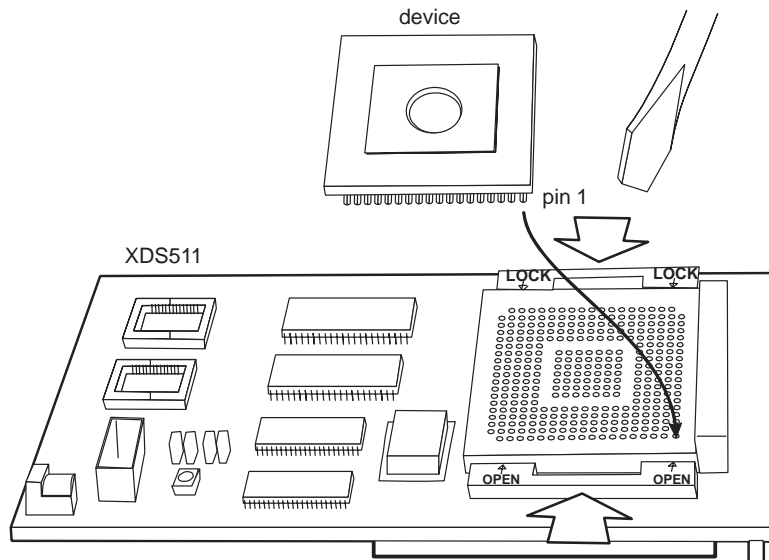

6.5 Step 3: Connecting the JTAG Cable, Power Supply, and Adapter Board

Follow these steps to connect the JTAG cable to the XDS511. You should have already connected the cable to your XDS510 (see the previous chapters).

Minimizing Equipment Damage

To minimize the risk of damage, be very careful with the JTAG cable connectors. Connect them gently; forcing the connectors into position can damage them.

Remember, the connectors are keyed. Be sure to connect the cable so that the keys fit in the correct slots.

- 1) Plug the 14-pin connector side of the JTAG cable into the JTAG connector on the XDS511 (see Figure 6–6). The connector is keyed to ensure a proper connection.
- 2) Connect the adapter board to the bottom of the XDS511 by matching the three 100-pin connectors on each board (see Figure 6–6). On the XDS511, the connectors are labeled JP6, JP7, and JP8. On the adapter board, the connectors are labeled JP3, JP4, and JP5.
- 3) Connect the 2.1-mm barrel jack end of the power supply adapter cable to the power jack on the XDS511 (see Figure 6–6).
- 4) Connect the 5-pin circular connector end of the power supply adapter cable to the power supply at the circular connector of the A/C power cord (see Figure 6–6).
- 5) Plug in the power cords for your workstation, SCSI devices, XDS510WS, and XDS511.
- 6) Turn on your SCSI devices, workstation, XDS510WS, and XDS511.

Figure 6–6. Connecting the JTAG Cable, Power Supply, and Adapter Board to the XDS511

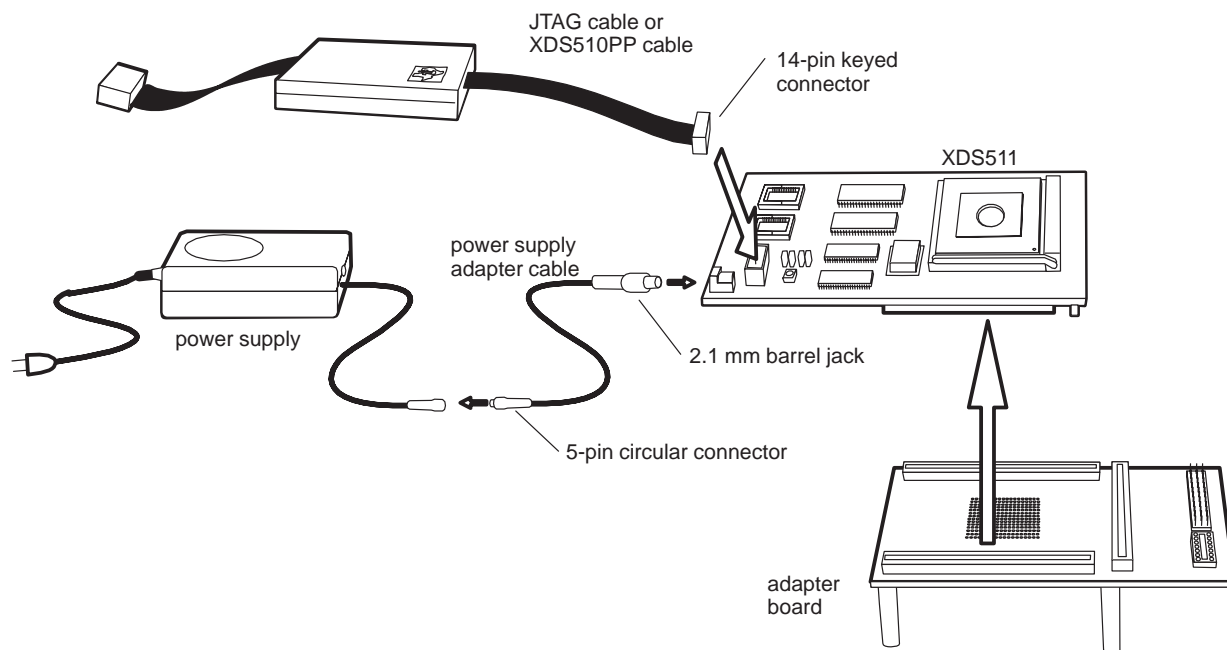

6.6 Step 4: Connecting a Target System to the XDS511 (Optional)

You can use the XDS511 emulator as your target system while doing most of your testing. Then you can replace the XDS511 with your target system (see the previous chapters for information about connecting to your target system). Or you can connect your target system to the XDS511.

Your target system is connected to the XDS511 either directly or with a target cable. The method used depends upon the type of target system. Use the following table to select a method.

Type of System	Method to Use	See Subsection
C2xx	Direct or target cable	6.6.1 or 6.6.2
C8	Direct or target cable	6.6.2 or 6.6.2
C16	Target cable	6.6.2

6.6.1 Direct Method

Follow these steps to connect your target system directly to the XDS511:

- 1) Turn off your SCSI devices, workstation, XDS510WS, XDS511, and target system.
- 2) Unplug the power cords for your workstation, SCSI devices, XDS510WS, XDS511, and target system.
- 3) Remove the adapter board from the bottom of the XDS511.
- 4) Plug your target system into the three 100-pin connectors on the bottom of the XDS511. The connectors on the XDS511 are labeled JP6, JP7, and JP8 (see Figure 6–2 on page 6-3).
- 5) Plug in the power cords for your workstation, SCSI devices, XDS510WS, XDS511, and target system.
- 6) Turn on your SCSI devices, workstation, XDS510WS, XDS511, and target system.

For information about creating the necessary connectors on your target system, see the information on the diskette in your device configuration kit.

6.6.2 Target Cable Method

Follow these steps to use a target cable to connect your target system to the XDS511:

- 1) Turn off your SCSI devices, workstation, XDS510WS, XDS511, and target system.
- 2) Unplug the power cords for your workstation, SCSI devices, XDS510WS, XDS511, and target system.
- 3) Connect the 169-pin connector end of your target cable to the bottom of the adapter board.

Equipment Damage

The 169-pin connector is not keyed. You must position it as shown in Figure 6–7. Failure to properly position the connector causes damage to the equipment.

- 4) Connect the other end of your target cable to your target system (see Figure 6–7).
- 5) Plug in the power cords for your workstation, SCSI devices, XDS510WS, XDS511, and target system.
- 6) Turn on your SCSI devices, workstation, XDS510WS, XDS511, and target system.

Figure 6–7. Attaching the Target Cable to the XDS511

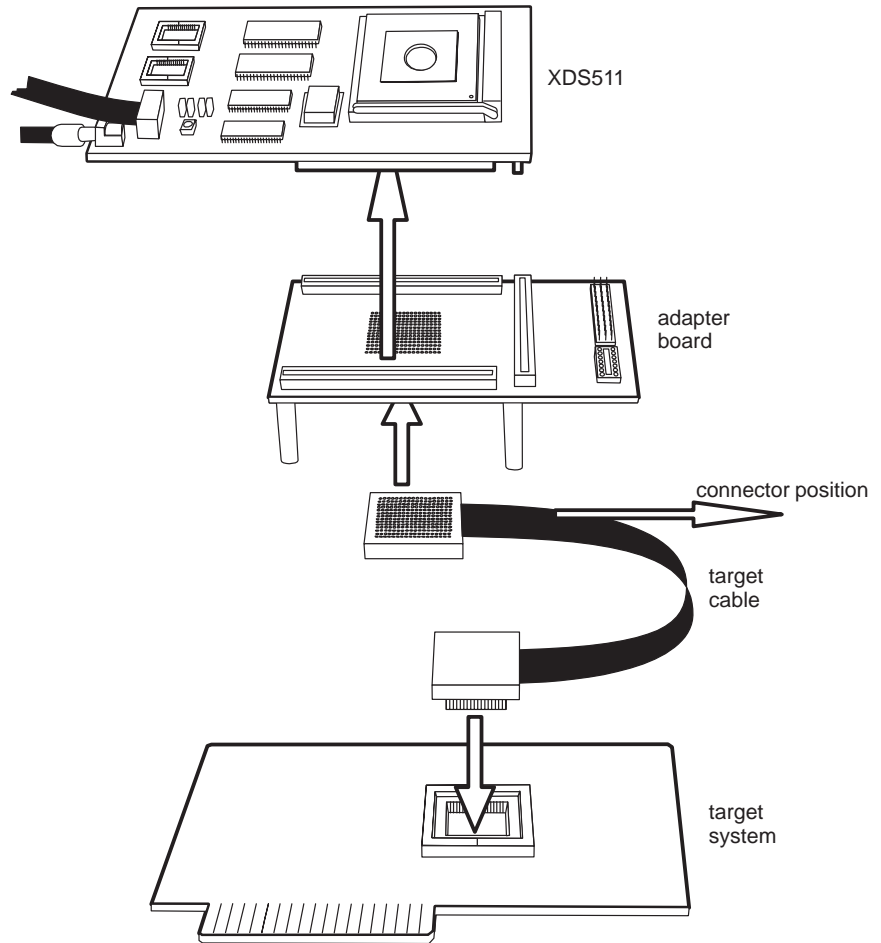

6.7 Where to Go From Here

Your XDS511 is now installed. Perform these additional installation tasks as needed:

Task	Go To
Connect additional hardware to the XDS511 (such as the XDS522™)	The installation instructions that accompany the hardware
Install the C source debugger for your device	The installation instructions are in the getting started guide for your device's C source debugger

Only after installing and running the C source debugger for your device can you determine if the XDS511 and XDS510 emulator controller are installed properly.

Interpreting the XDS510WS LEDs

The XDS510WS emulator controller provides status information about the operation of the emulator through eight LEDs. The LEDs are located on the front panel of the XDS510WS.

Topic	Page
A.1 XDS510WS LEDs	A-2
A.2 Power Indicator: LED 1	A-2
A.3 Power-Loss Indicator: LED 2	A-3
A.4 Emulation-Instruction Indicator: LED 3	A-3
A.5 Error/Status Indicators: LEDs 4, 5, and 6	A-4
A.6 SCSI-Transfer Indicators: LEDs 7 and 8	A-4
A.7 XDS510WS LED Interpretation	A-5

A.1 XDS510WS LEDs

On the front of the XDS510WS is a small panel of LEDs that provide status information during the operation of the emulator (refer to Figure A–1).

Figure A–1. XDS510WS LEDs

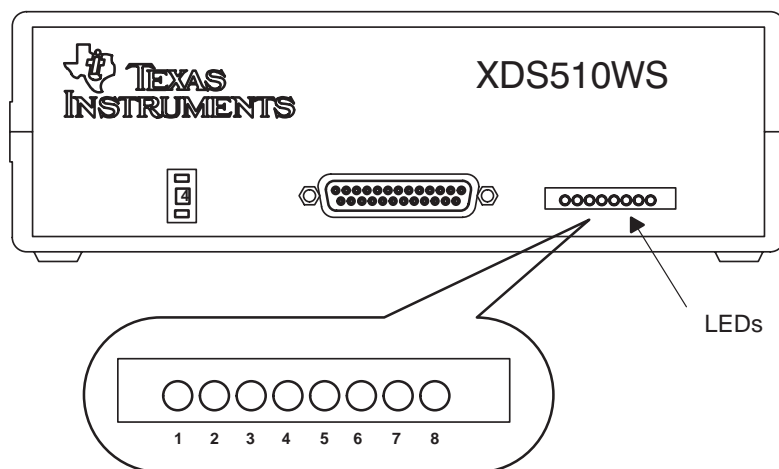

The LEDs are numbered from left to right, starting with LED 1 through LED 8. The three LED conditions are:

LED Symbol	Meaning
○	Off
●	On
◐	Intermittently on and off; no steady state

A.2 Power Indicator: LED 1

LED 1 is on whenever the system is plugged in and switched on. If LED 1 does not come on, you should:

- 1) Ensure that the power supply is firmly plugged into a proper outlet.
- 2) Check to see that the power supply cable is firmly plugged into the XDS510WS.
- 3) Check to see that the XDS510WS is switched on.

A.3 Power-Loss Indicator: LED 2

When LED 2 is on, the XDS510WS has detected a power loss on the target system.

Note

After you apply power to the target, this LED remains on until you invoke the debugger and it communicates with the target system.

When you invoke the debugger, if LED 2 fails to go off and the debugger fails to start, ensure that the emulation cable is firmly and correctly attached to both the XDS510WS and the target. Also, check to see that the target is turned on and powered sufficiently. Also, check to see if the target was designed to provide V_{CC} to the emulation header pin, PD.

Once LED 2 has gone off, if it comes on during your debugging session, the target system has lost power.



A.4 Emulation-Instruction Indicator: LED 3

LED 3 is on whenever the XDS510WS is executing an emulation instruction. Normally, you should not notice the sporadic on state of this LED.

Occasionally, when you're performing a time-consuming emulation command such as filling a large block of memory using the FILL command, LED 3 and LED 1 will be the only LEDs on. If the debugger is not responding to commands and LED 3 stays on for too long (greater than five minutes), there is a problem. To continue working, exit the debugger, cycle the power on the XDS510WS, and begin again.

A.5 Error/Status Indicators: LEDs 4, 5, and 6

LEDs 4, 5, and 6 indicate error messages and signify the state of the emulator.

LEDs	State	Explanation
	Self test	When you first power up the XDS510WS and immediately after you execute an emurst command, the emulator performs a self-test. The self-test should take only a few seconds. If this pattern remains for more than a minute, something is wrong.
	Self test completed	The self test is finished, and it completed successfully.
	Self test completed	The self test is finished, but it did not complete successfully. A communications error occurred. This error generally is not serious, but if you cannot continue without intervention, cycle the power on the XDS510WS, reexecute emurst, and restart the debugger.

A.6 SCSI-Transfer Indicators: LEDs 7 and 8

LEDs 7 and 8 indicate that a SCSI transfer is in progress with the emulator. If the debugger seems to hang and the LEDs become fixed (not flashing) in any pattern other than 7 and 8 off as shown below, there is probably a problem:



You can cycle the power on the XDS510WS, execute emurst again, and restart the debugger.

A.7 XDS510WS LED Interpretation

Figure A–2 shows the standard LED sequences. These patterns allow you to understand quickly the operational status of the emulator and its functions.

Figure A–2. Standard LED Sequences

On ●	Off ○	Intermittent ◐	Key to LED Status
----------------	-----------------	--------------------------	------------------------------

Power-On Sequence



before power-on



steady state



Emurst Sequence



before emurst



steady state



Debugging Sequence



before debugging



steady state



Glossary

B

boot mode: An operating mode of the 'C2xx SE device. In this mode, the contents of the EPROM are copied to RAM bank 2 on reset. The EPROMs are enabled continuously. Writes to RAM bank 2 occur at the end of a cycle, and one complete read/write cycle takes two clock cycles. The EPROM is disabled at the end of the copy operation, and the normal device reset occurs.

C

configuration kit: An SE device, target cable adapter board, and an information diskette.

E

EPROM mode: An operating mode of the 'C2xx SE device. In this mode, the 'C2xx on-chip ROM is replaced by the XDS511 EPROM. The XDS511 is limited to 50-ns operation when 35-ns EPROMS are used.

F

fast-RAM mode: An operating mode of the 'C2xx SE device. In this mode, the 'C2xx on-chip ROM is replaced by the XDS511 RAM bank 1. The memory timing signals are advanced to achieve faster operating speed. The replacement RAMs are continuously enabled, consuming more power than RAM mode.

J

JTAG cable: The cable that attaches the XDS510 or XDS510WS to your target system.

JTAG connector: A 14-pin connector (two rows of seven pins) on the target system that is used to connect the JTAG cable.

N

native mode: An operating mode of the 'C2xx SE device. In this mode, the XDS511 replacement memory is disabled. Memory access is on-chip or on the 'C2xx logic interface.

R

RAM mode: An operating mode of the 'C2xx SE device. In this mode, the 'C2xx on-chip ROM is replaced by the XDS511 RAM bank 1.

S

SE device: A device that connects to the XDS511. An SE (special emulation) device is a specialized device that performs the same functions as your target device but includes features for gathering debugging information. There is an SE device for each of the TMS370C8, TMS370C16, and TMS320C2xx devices.

T

target cable: A cable that you make to connect the XDS511 emulator to your target system.

target system: The system you want to debug. This can be your actual system, a test system you have created, or an XDS511 with an SE device attached to it.

X

- XDS510:** An emulator controller board for use in an IBM-type PC. The XDS510 is a board installed in your PC. The XDS510 enables your debugger to communicate with the target system.
- XDS510PP:** An emulator controller for use with an IBM-type PC. The XDS510PP is an external piece of hardware connected to your PC using the parallel printer port. The XDS510PP enables your debugger to communicate with the target system.
- XDS510WS:** An emulator controller for use with a UNIX-type workstation. The XDS510WS is an external piece of hardware connected to your workstation using a SCSI connection. The XDS510WS enables your debugger to communicate with the target system.
- XDS511:** An emulator used to emulate a target system. The XDS511 is connected to an XDS510, XDS510PP, or XDS510WS. In turn, you can connect the XDS511 to a target system.

A

- access required for XDS510WS
 - HP workstation 5-3
 - SPARCstation 4-3
- adapter board
 - illustration 6-13
 - installation 6-9

B

- boot mode definition 6-5, B-1

C

- C16 SE device
 - jumper settings on the XDS511 6-4
- C2xx SE device
 - boot mode definition 6-5
 - EPROM mode definition 6-5
 - fast-RAM mode definition 6-5
 - jumper settings on the XDS511 6-5 to 6-6
 - native mode definition 6-5
 - RAM mode definition 6-5
- C8 SE device, jumper settings on the XDS511 6-4
- checklist, hardware
 - XDS510 2-2
 - XDS510PP 3-2
 - XDS510WS
 - HP workstation 5-2
 - SPARCstation 4-2
 - XDS511 6-2
 - XDS522 6-2
- configuration kit definition B-1
- conventions
 - notational iii

D

- debugger access to an XDS510WS
 - HP workstation 5-10
 - SPARCstation 4-12
- documentation
 - related v

E

- electrical shock minimizing
 - XDS510 2-2
 - XDS510PP 3-2
 - XDS510WS
 - HP workstation 5-2
 - SPARCstation 4-2
 - XDS511 6-2
- emulator
 - XDS511 6-1
- emulator controller
 - selecting 1-3
 - XDS510 2-1
 - XDS510PP 3-1
 - XDS510WS
 - HP workstation 5-1
 - SPARCstation 4-1
- EPROM mode definition 6-5, B-1

F

- fast-RAM mode definition 6-5, B-1
- FCC warning vi
- fire hazard minimizing
 - XDS510 2-2
 - XDS510PP 3-2
 - XDS510WS
 - HP workstation 5-2
 - SPARCstation 4-2
 - XDS511 6-2

H

hardware checklist
 XDS510 2-2
 XDS510PP 3-2
 XDS510WS
 HP workstation 5-2
 SPARCstation 4-2
 XDS511 6-2
 XDS522 6-2

host for emulator controller

XDS510 2-2
 XDS510PP 3-2
 XDS510WS
 HP workstation 5-2
 SPARCstation 4-2

HP workstation

allowing debugger access to an
 XDS510WS 5-10
 configuring to recognize an XDS510WS 5-9
 connecting to an XDS510WS 5-7
 host system 5-2
 XDS510WS installation 5-1

I

I/O address space

avoiding conflicts for the XDS510 2-3
 for the XDS510 2-3

interface to XDS510WS

HP workstation 5-2
 SPARCstation 4-2

intermittent errors

Code Composer Studio for Solaris 4-20

J

JTAG cable

definition 1-2, B-2
 XDS510 connection 2-5
 XDS510WS connection
 HP workstation 5-11
 SPARCstation 4-14
 XDS511 connection 6-9

JTAG connector definition 1-2, B-2

jumper settings on the XDS511

C16 SE device 6-4
 C2xx SE device 6-5 to 6-7
 C8 SE device 6-4

jumpers

how to set on the XDS511 6-4

N

native mode definition 6-5, B-2

notational conventions iii

P

parallel port

XDS510PP 3-2

PC

host system 2-2, 3-2
 XDS510 installation 2-1
 XDS510PP installation 3-1

power supply

connection
 XDS510PP 3-4, 3-5
 XDS510WS
 HP workstation 5-3
 SPARCstation 4-3
 XDS511 6-9

requirements

XDS510PP 3-2
 XDS510WS
 HP workstation 5-2
 SPARCstation 4-2
 XDS511 6-2

printer cable

XDS510PP 3-2

R

RAM mode definition 6-5, B-2

related documentation v

S

SCSI bus for an XDS510WS

adding

HP workstation 5-7
SPARCstation 4-8

locating

HP workstation 5-5

SCSI bus for an XDS510WS (continued)

SPARCstation 4-5

setting ID

HP workstation 5-6*SPARCstation* 4-7

terminating

HP workstation 5-8*SPARCstation* 4-9

SE device

definition B-2

description 1-3

socket types 6-7

supported devices 1-3

XDS511 connection

lever-type socket 6-7*screwdriver-type socket* 6-8

slot for XDS510 2-2

SPARCstation

allowing debugger access to an
XDS510WS 4-12

configuring to recognize an XDS510WS 4-10

connecting to an XDS510WS 4-8

host system 4-2

XDS510WS installation 4-1

static shock minimizing

XDS510 2-2

XDS511 6-2

switch settings

XDS510 2-3

T

target cable definition B-2

target system

definition 1-2, B-2

XDS510 connection 2-5

XDS510PP connection 3-4

XDS510WS connection

HP workstation 5-11*SPARCstation* 4-14

XDS511 connection 6-11

TMS320C2xx SE device

boot mode definition 6-5

EPROM mode definition 6-5

fast-RAM mode definition 6-5

jumper settings on the XDS511 6-5 to 6-6

native mode definition 6-5

RAM mode definition 6-5

TMS370C16 SE device

jumper settings on the XDS511 6-4

TMS370C8 SE device

jumper settings on the XDS511 6-4

trademarks vi

troubleshooting the XDS510WS 4-18

Code Composer errors on initial use 4-19

unable to load device driver 4-18

U

uninstalling the XDS510WS 4-17

X

XDS510

definition B-3

description 1-3

electrical shock minimizing 2-2

fire hazard minimizing 2-2

hardware checklist 2-2

host for 2-2

I/O address space 2-3

avoiding conflicts with 2-3

illustration 2-3

installing in a PC 2-1

JTAG cable connection 2-5

placing in your PC 2-4

selecting 1-3

slot 2-2

static shock minimizing 2-2

switch settings 2-3

target system connection 2-5

what you'll need 2-2

XDS510PP

definition B-3

description 1-3

electrical shock minimizing 3-2

fire hazard minimizing 3-2

hardware checklist 3-2

host for 3-2

illustration 3-3

installing on a PC 3-1

parallel port 3-2

PC connection 3-3

power supply 3-5

connection 3-4*requirements* 3-2

printer cable 3-2

selecting 1-3

- XDS510PP (continued)
 - target system connection 3-4
 - what you'll need 3-2
- XDS510WS
 - debugger access to
 - HP workstation 5-10
 - SPARCstation 4-12
 - definition B-3
 - description 1-3
 - electrical shock minimizing
 - HP workstation 5-2, 5-5
 - SPARCstation 4-2, 4-5
 - equipment damage minimizing
 - HP workstation 5-5
 - SPARCstation 4-5
 - fire hazard minimizing
 - HP workstation 5-2
 - SPARCstation 4-2
 - hardware checklist
 - HP workstation 5-2
 - SPARCstation 4-2
 - host for
 - HP workstation 5-2
 - SPARCstation 4-2
 - HP workstation connection 5-7
 - illustration
 - HP workstation 5-4
 - SPARCstation 4-4
 - installing
 - HP workstation 5-1
 - SPARCstation 4-1
 - interface to
 - HP workstation 5-2
 - SPARCstation 4-2
 - JTAG cable connection
 - HP workstation 5-11
 - SPARCstation 4-14
 - LED lights
 - explained A-1 to A-6
 - HP workstation 5-3
 - interpreting A-5
 - SPARCstation 4-3
 - states A-2
 - power supply
 - connection
 - HP workstation 5-3
 - SPARCstation 4-3
 - requirements
 - HP workstation 5-2
 - SPARCstation 4-2
- XDS510WS (continued)
 - recognizing
 - HP workstation 5-9
 - SPARCstation 4-10
 - root access
 - HP workstation 5-3
 - SPARCstation 4-3
 - SCSI bus
 - adding
 - HP workstation 5-7
 - SPARCstation 4-8
 - locating
 - HP workstation 5-5
 - SPARCstation 4-5
 - setting ID
 - HP workstation 5-6
 - SPARCstation 4-7
 - terminating
 - HP workstation 5-8
 - SPARCstation 4-9
 - selecting 1-3
 - SPARCstation connection 4-8
 - target system connection
 - HP workstation 5-11
 - SPARCstation 4-14
 - troubleshooting 4-18
 - Code Composer errors on initial use 4-19
 - intermittent errors with Code Composer Studio for Solaris 4-20
 - unable to load device driver 4-18
 - uninstalling 4-17
 - what you'll need
 - HP workstation 5-2
 - SPARCstation 4-2
 - working correctly (ensuring)
 - HP workstation 5-3
 - SPARCstation 4-3
- XDS511
 - adaptor board connection 6-9
 - definition B-3
 - description 1-3
 - electrical shock, minimizing 6-2
 - fire hazard, minimizing 6-2
 - illustrated 6-3
 - installing 6-1
 - JTAG cable connection 6-9
 - jumper settings
 - C16 SE device 6-4
 - C2xx SE device 6-5 to 6-7
 - C8 SE device 6-4

XDS511 (continued)

jumpers

how to set 6-4

power supply

connection 6-9*requirements* 6-2

SE device connection

lever-type socket 6-7*screwdriver-type socket* 6-8

static shock minimizing 6-2

target system connection 6-11

what you'll need 6-2