

# COMPUTER DESIGN

BS/CS  
Computer Science  
Library

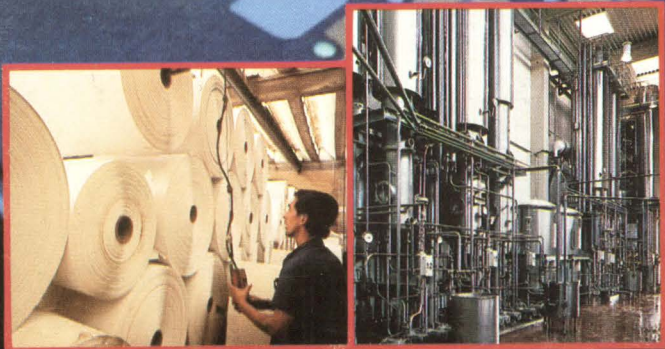
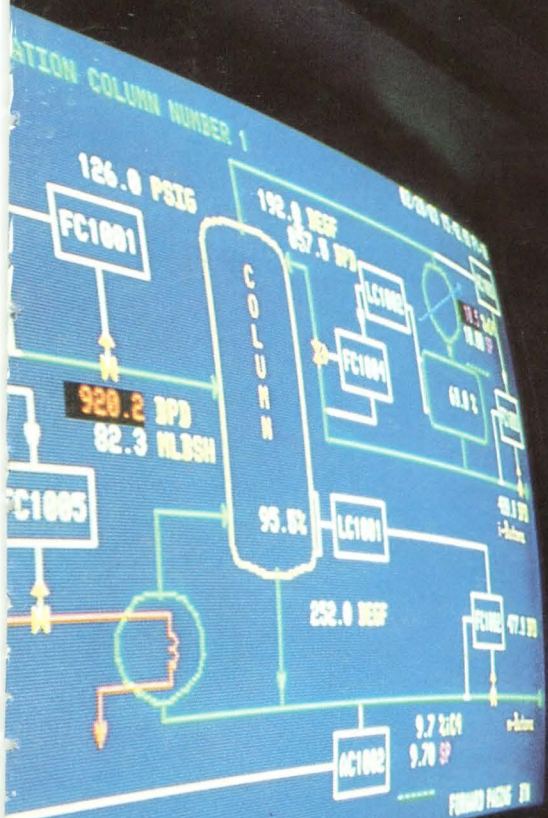

**AUTOMATION & CONTROL**  
**PREMIER EDITION**

# THE BLUE COLLAR COMPUTER IS LOOKING FOR WORK.

Hard work. Economy. Reliability. Those are the working-class virtues of the Rockwell International family of microcomputer modules. Our RM 65, AIM 65 and AIM 65 / 40 form compatible, cost-effective solutions for process control.

**The Blue Collar Computer's roots are in a hard-working chip.** Its 6502 processor remains the world's most popular CPU\*, year after year.

**There's a Blue Collar Computer for every job.** You can start with one of the three computers, each on a single board, then add functions in a Eurocard format. For savings and convenience, there are two pre-packaged AIM microcomputer modules with on-board keyboard, printer and display. Rockwell also offers modular intelligent peripherals, including printers and displays.

**The Blue Collar Computer arrives ready for work.** You can program your systems using BASIC, Instant Pascal, assembly language or FORTH.\*\* All are available on easy-to-install ROMs. BASIC and FORTH compilers are available on disk.

**In any configuration, the Blue Collar Computer is easy to buy and easy to use.** The modular design and pre-packaged AIMs allow you to add or subtract functions quickly and economically. All modules you receive are burned-in, fully tested and ready to use.

**If you're designing an OEM product that could use an economical, hardworking Blue**

**Collar Computer,** contact your local Rockwell Distributor, or call the Electronic Devices Division, Rockwell International, at (800) 854-8099. In California, call (800) 422-4230. Or write us at P.O. Box C, MS/501-300, Newport Beach, CA 92660.

\* Source: Dataquest  
\*\* Trademark FORTH, Inc.  
AIM 65 is a registered Trademark of Rockwell International Corp.



**Rockwell International**

...where science gets down to business

CIRCLE NO. 1

4-5-83

You've concluded that you need the performance and capacity that only an 8 inch Winchester drive can provide. Which one should you buy?

There are 109 different models available.

Of this 109, only 39 are 8 inch floppy form-factor compatible.

28 of these 109 perform an average seek in 30 milliseconds or less.

And of this 109, only 17 offer true SMD compatibility.

Puzzled?

Only one company provides a disk drive with all the features —

## Kennedy and Model 7300

with the right size, the right interfaces and the right price.

Write or give us a call.

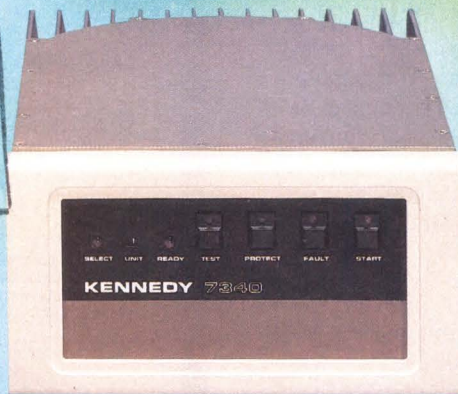

## KENNEDY

An Allegheny International Company

1600 Shamrock Ave., Monrovia, CA. 91016

(213) 357-8831 TELEX 472-0116 KENNEDY

TWX 910-585-3249

### KENNEDY INTERNATIONAL INC.

U.K. and Scandinavia

McGraw-Hill House

Shoppenhangers Road

Maidenhead

Berkshire SL6 2QL England

Tel: (0628) 73939

Telex: (851) 847871 KEN UKS G

### KENNEDY INTERNATIONAL

Koningin Elisabethplein, 8

B-2700 Sint-Niklaas

Belgium

Tel: (03) 777.1962

Telex: 71870 KEN CO

### SPECIFICATIONS:

- 41 and 82 MB Capacities
- Rotary Voice Coil 30 msec average seek
- SMD, ANSI or PICO BUS Interfaces
- 1209 KByte/sec. transfer rate
- Available 30-45 days ARO
- Q100: \$2,560/\$3,195

# KENNEDY • QUALITY • COUNT ON IT

CIRCLE 2

# How You can Cut the Cost of Custom Memory Down to Size.

## First, Compare Making Your Own to Buying From Us.

When you make your own, costs can vary. You gamble on finding and keeping experienced memory design engineers. Internal priorities can delay delivery. And your materials come from several sources.

When you buy from us, the price we quote, upfront, is the price you pay. Plus, you get the benefit of more than 10 billion bytes of experience in building memory products with an average of 250,000 hours MTBF. And you get a single product, on time, with a full warranty.

## Then, Clip this Coupon and Send it to Us.

Need more information? Just clip this coupon and send it to us. Better yet, include your product specs for a free, confidential quote. Or call our Microsystems Division at (408) 743-4442. We're the name to remember in custom memory.



## Impress Me.

I'd like more information on your Custom Memory Program.

## Convince Me.

Enclosed are my immediate Custom Memory Requirements. Please send me a quote.

## Send Me.

Please send me your literature on G. E. Intersil Systems Standard Memory Products.

NAME: \_\_\_\_\_

TITLE: \_\_\_\_\_

COMPANY: \_\_\_\_\_

CITY: \_\_\_\_\_ STATE: \_\_\_\_\_ ZIP: \_\_\_\_\_

PHONE: \_\_\_\_\_

Intersil Custom Memory Boards-  
Used worldwide by Atlantic Research  
in series data communications  
protocol analyzers.

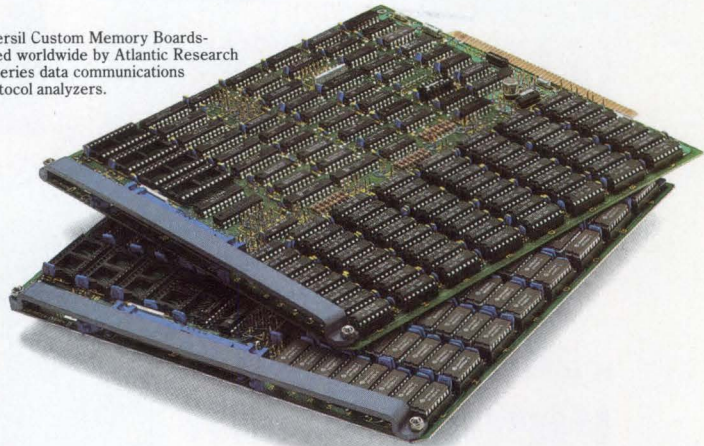

Microsystems Division

1275 Hammerwood Avenue • Sunnyvale, CA 94086 • (408) 743-4442

INSTITUTE OF

MAY 4 1983

TECHNOLOGY

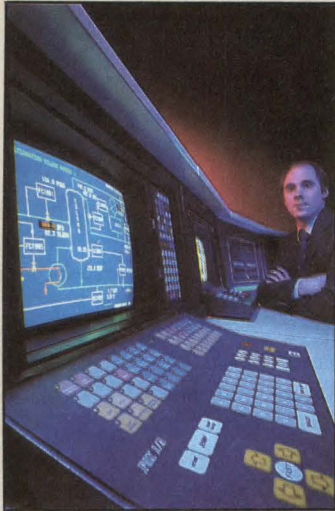

Cover photo shot on location at The Foxboro Co by Jonathan Goell. Pictured is a demonstration unit of the company's process control system.

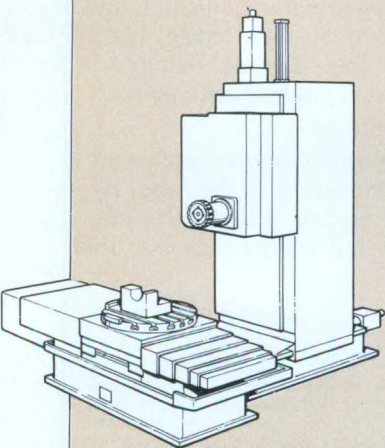

## Features

- 32 Analog I/O boards get smarter**  
*by Richard Parker and Sydney F. Shapiro*—Microprocessor technology has strongly influenced modern data acquisition and control. Now even I/O boards, still mostly analog, are being impacted by digital architecture.
- 48 Single-board computers master industrial applications**  
*by Rick Nelson*—Hardware and software features as well as packaging innovations are combining to adapt single-board computers to the factory environment.
- 65 Prospects for expert systems in CAD**  
*by Mark J. Stefik and Johan de Kleer*—Although widespread use of expert systems in solving complex CAD problems is several years away, artificial intelligence concepts are being applied in experimental systems for tomorrow's knowledge based design assistance.
- 81 Call Forth for realtime control programming**  
*by Al Whitney and Marvin C. Conrad*—Forth is ideal for realtime distributed process control. High on the list of pluses is easy interface to assembly language modules—limiting the execution of time-critical routines only to the intrinsic speed of the processor.
- 89 Machine vision in the real world of manufacturing**  
*by James K. West*—Machine vision, like human vision, has limitations. Yet this important technology can become a cost-effective tool when the mysteries surrounding it are removed.
- 101 Analog I/O board brings personal computer into the plant**  
*by Andrew Davis and John Fierke*—A data conversion board plugs into the IBM Personal Computer to give 12-bit resolution and 13,000-sample/s throughput. Just three BASIC statements unlock all the board's data acquisition functions.
- 111 The impact of microprocessors on process control**  
*by James Andrew Rovnak, Wayne C. Dunlap, Heinz B. Opladen, and James A. Mann*—Although hidden by the massive components it controls, the microprocessor has become the major influence in digital control system development, even in the automated power plant.
- 119 Control software for factory automation**  
*by John Sylvan*—A multitasking operating system architecture provides dynamic CPU access so that individual control loops can be programmed as independent software tasks in high level, extended BASIC.
- 131 Software aspects of factory machine control**  
*by Theodore B. Ruegsegger*—Impact of the computer on the integrated factory floor has resulted in improved product fabrication methods. Smooth interaction between machine tools and people, however, depends upon practical software.
- 145 Microcontrollers maintain the loop for dc drives**  
*by A. Ira Horden*—Variable speed motors, whether used in the smallest tape recorder or the largest steel mill, require controllers. A single-chip microcontroller now replaces older multiple-chip versions.

## Departments

4 Up front	163 Designers' preference survey*	176 System showcase
11 Editorial	172 Literature	178 Advertisers' index
16 Calendar	174 Reader survey	179 Designer's bookcase
27 Technology		181 Reader inquiry card
151 Products		181 Change of address card

\*Appearing in Domestic issues only

### **Walking robot to serve as extension for humans**

A multilegged walking robot that can move on any terrain in any direction, much like a human, has been introduced by Odetics, Inc of Anaheim, Calif. Unlike most other industrial robots, which consist of one or more arms and hands, the Odex I has six legs (articulators) attached to a body (primary structure). The command/control center is on top of the body; the power source is on the bottom.

Unlike most industrial robots, this walking robot, or "functionoid," is not fixed to a platform and not limited to single tasks. It can go anywhere humans can go and operate in similar environments. However, it can also assume different stances (from 3' to 6.5' high and as narrow as 21"), and any one articulator can lift 450 lb when the robot is moving, or 600 lb when stationary. Maximum carry loads are 1800 lb when walking on level ground at higher speeds. Articulators can extend to nearly 5.5' in height. In addition, the robot can climb up and down in 2.5' steps.

Possible sites for Odex I include mining, nuclear power plants, fires, or construction. It also could be used for sentry duty by the military and, since it is controlled by radio links, for long-distance remote operations, such as in a space station. Of course, reaction speed decreases as distance increases.

Both small and mid-size system control requirements can be met by a programmable controller introduced by Gould's Modicon Programmable Control Div of Andover, Mass. Modularity of the 884 system permits the final package to match specific requirements. Major components include a controller with CMOS RAM and up to 256 I/O points, choice of 10 I/O modules, power supply, module racks, and CRT programmer. More than 35 instructions are available.

Each of three microprocessors in the system is dedicated to specific tasks: one executes user logic programs, a second controls communication between controller and modules, while the third handles communication between the system and external devices. All communications are handled through a built-in RS-232-C port using the Modbus protocol.

### **Programmable controller system fits many applications**

## **Pretriggers**

**A military temperature range EEROM**, a version of its model 5213 5-V only 16K device, has been introduced by Seeq Technology of San Jose, Calif. The DM5213 provides 350-ns access times and 10-ms byte write over the full -55 to 125 °C range. It can be written by using either a single 5-V TTL level or 21-V signal and can be erased or written up to 10k times.

**A software tool that allows industrial engineers to implement** plantwide computer based data acquisition and control has been released by Modular Computer Systems of Ft Lauderdale, Fla. Intended for use by engineers with limited knowledge of computer technology, the modular MAXPAC set of standard and optional software enables parameters of control functions to be defined readily.

**Robot voice command capability** has been added by RB Robot Corp of Golden, Colo for its RB5X intelligent robot. Although the voice recognition unit is presently connected to the robot by cable in conjunction with a personal computer, a future version will permit radio communications to transmit commands. Eventually, the unit will be built into the robot for independent functioning.

Computer Design (ISSN-0010-4566) is published monthly, with a thirteenth and fourteenth issue respectively in April and October by PennWell Publishing Company, Advanced Technology Group, 119 Russell Street, Littleton, MA 01460. P. C. Lauinger, Chairman; Philip C. Lauinger, Jr., President; Joseph A. Wolking, Senior Vice President; H. Mason Fackert, Group Vice President. Second-class postage paid at Tulsa, Oklahoma. COMPUTER DESIGN is distributed without charge to U.S. and W. Europe-based engineers and engineering managers responsible for computer-based equipment and systems design. Subscription rate for others is \$50 in U.S.A. and \$75 elsewhere. Single copy price is \$5.00 in U.S.A. and \$7.50 elsewhere. Microfilm copies of COMPUTER DESIGN are available and may be purchased from University Microfilms, a Xerox Company, 300 North Zeeb Road, Ann Arbor, Michigan 48106. POSTMASTER: CHANGE OF ADDRESS-FORM 3579 to be sent to COMPUTER DESIGN, Circulation Department, P.O. Box 593, Littleton, MA 01460 (USPS 127-340).

© Computer Design is a registered trademark of Computer Design, a PennWell Publication, 119 Russell Street, Littleton, MA 01460. All rights reserved. No materials may be reprinted without permission. Phone (617) 486-9501.

▽BPA ✶ABP

# This Lundy has an all-pervasive breath-takingly beautiful 4097th color. It's called high resolution.

**Lundy's T5484 Color Raster Graphics Terminals have the highest color resolution available. Think of that resolution as a Super Hue—a 4097th color—that mixes with all other 4096 colors to make each as sharp as you've ever seen.**

Our 5480 Series of color raster terminals and workstations aren't the only ones with 4096 colors. But the colors have never looked so good. Because resolution has never been higher.

## **New standards.**

The  $1536 \times 1024$  pixels set a new standard for displayable resolution. Raster staircasing is significantly reduced without the complexity of anti-aliasing.

But new standards don't stop with highest resolution. Areas are filled virtually instantaneously so the 5480 Series also sets a new standard for polygon fill.

Vector generation sets a new standard, too. The time lapse between the moment you draw until the picture is generated is as much as 50 percent faster than many others.

## **Enemy of obsolescence.**

You shouldn't be forced to ditch programs in place when you buy a new terminal. For that reason, standard with all 5000 Series models is a Tektronix



*Lundy's 5484 color raster design workstation.*

4010 or 4014 Emulator with mixed-mode software switch for enhancing existing programs with color-native protocol.

Currently, our terminals can be driven by many of the leading software products. And the list is growing rapidly. Because Lundy is committed to an aggressive third-party software develop-

ment program to provide the most comprehensive application packages.

## **Lundy will help you see more in graphics.**

When you look at our 5480 Series, take a close look at Lundy, too. We're a company that's as good as its products.

A company that balances high tech with solid business sense.

A company as proud of its service (one of the largest service organizations in the industry—39 locations nationwide) as its engineering expertise.

A company you can count on to help you see more in graphics—and get more out of graphics—both now and in the long term.

For more information, write Lundy, Glen Head, New York 11545, or call: (516) 671-9000.



# **LUNDY**

*The Lundy 5484 displays 16 high resolution colors at a time. User downloadable character fonts; programmable character sizes.*

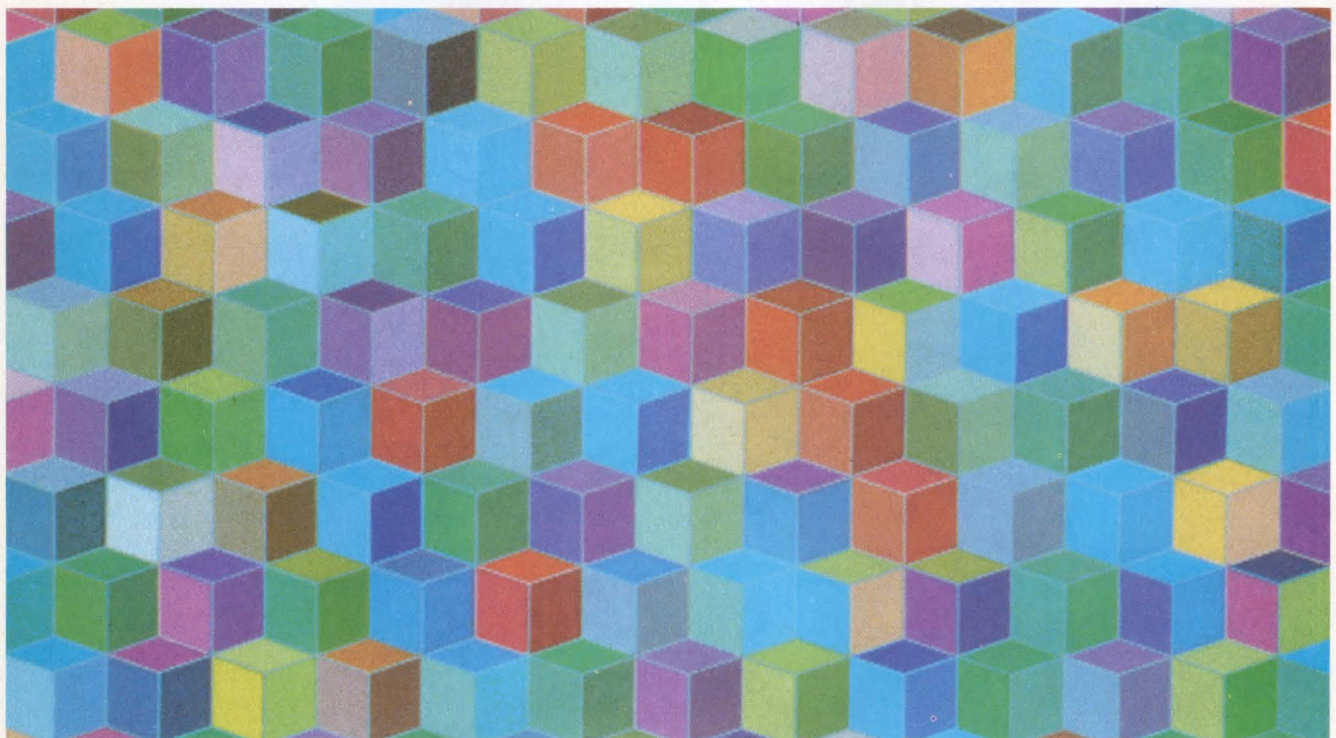





# A fully programmable digital storage plug-in: Tek 7000 Series Scopes pay off again!

**For the price of a single plug-in, you can now convert your Tek 7000 Series scope to powerful digital storage. Or take advantage of this new productive digital dimension to invest in the high-performance 7000 Series scopes for the first time.** The 7D20 is the latest and most rewarding dividend to the 7000 Series plug-in concept—a concept that keeps your scope current not only with each new application, but with new scope technology as well.

**As you expect, Tektronix packed the 7D20 with capabilities well beyond anything comparable, beginning with the power to store, recall, magnify and reposition waveforms at will.** A sampling rate of up to 40 MHz offers single-shot bandwidth performance to 10 MHz and 70 MHz for repetitive signals. Waveform storage and dual channel inputs let you record, display and compare up to three pairs of simultaneous events or six independent signals. You can



store up to 10 divisions (full-screen) of pre-trigger data, or delay up to 1500 divisions, always with sharp, jitter-free displays.

**A convenient self-monitoring envelope mode captures and displays subtle variations among random events, so your time is spent more productively.** Enveloping reveals otherwise difficult to detect amplitude and frequency deviations such as a missing pulse and jitter.

Also included are signal averaging for reducing uncorrelated

noise of a repetitive signal. On-screen cursor read-out. Non-volatile memory storage for up to six front panel settings. And extensive self-diagnostics. All designed to improve measurement accuracy and repeatability, save you time and eliminate guesswork.

**IEEE-488 interface is built-in.** You have the option to delegate repetitive measurements or other long-term monitoring tasks to a controller, facilitating complete and accessible documentation. Tek's Standard Codes and

Formats makes programming and bus control unusually easy.

**Plug into the digital world now. Affordably. Powerfully.** The 7D20 is an exceptional value. It is a dependable investment in more productive time. More creative opportunities. And in greater versatility than ever from the expanding 7000 Series. Talk to your Tektronix Sales Representative soon, or contact:

U.S.A., Asia, Australia,  
Central & South America,  
Japan

Tektronix, Inc.  
P.O. Box 4828  
Portland, OR 97208  
Phone: 800/547-1512  
Oregon only: 800/452-1877

Europe, Africa,  
Middle East  
Tektronix Europe B.V.  
Post Box 827  
1180 AV Amstelveen  
The Netherlands  
Telex: 18312

Canada  
Tektronix Canada Inc.  
P.O. Box 6500  
Barrie, Ontario L4M 4V3  
Phone: 705/737-2700

## The Answer By Any Measure

**Tektronix**  
COMMITTED TO EXCELLENCE



FLOPPYDISK

WP ACTIVE POWER

DATA SYSTEMS DESIGN

TAPE DRIVE

BOT EJECT ACTIVE POWER

DATA SYSTEMS DESIGN

WINCHESTER

WP ACTIVE POWER

DATA SYSTEMS DESIGN

PROCESSOR

LTC RIM POWER

DATA SYSTEMS DESIGN

\* StacPac, HyperDiagnostics, Rapid Module Exchange and HyperService are trademarks of Data Systems Design, Inc.  
\* DEC is a registered trademark of Digital Equipment Corporation. \* Multibus is a registered trademark of Intel Corporation.

# DSD STACKS THE DEC. AND THE MULTIBUS, TOO.

## Presenting StacPac™ systems and modules.

This is a brand new deal for systems integrators.

StacPac systems and modules. Modular storage and backplane units that stand alone or stack together to form the basis of a small but powerful tabletop computer.

They're available in either DEC®- or Multibus®-compatible versions. And there are lots of advantages to both.

On the DEC side, you can put a StacPac system in places a rack-mount just doesn't fit.

On the Multibus side, you can use our StacPac system to deliver serious minicomputer performance with microcomputer economy.

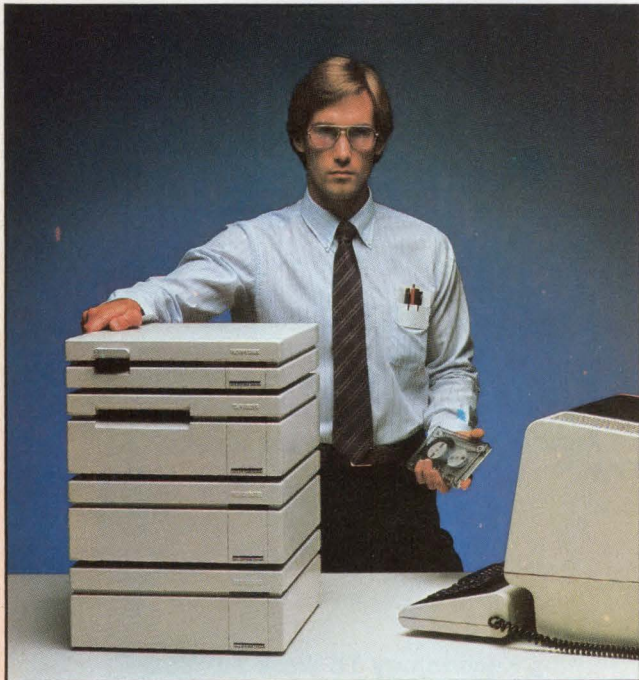

Either way you get greater flexibility to configure just the right system. And the easy upgradability to expand it whenever you like.

But perhaps one of the most important advantages is that you can protect your software investment—and your customers'—because inside, you're still selling the same system. You'd just never know it to look at it.

Which brings up another point.

Underneath that slick, compact exterior is the very latest in storage technology. 8" slimline floppy drives. High capacity, highly reliable 8" Winchester. Compact 1/4" cartridge tape drives. And the best high performance controllers in the business. (Packaged systems are also available without controllers at your option.)

And if you're thinking about 5 1/4" storage, there's our 5 1/4" Winchester/floppy module. (Available in the Spring of 1983.)

Configuring an elegant system solution is a simple matter of picking out the storage option you want and adding your own CPU boards, I/O and memory to our uncommonly accommodating backplane units.

Naturally, we back it all up with HyperDiagnostics™, Rapid Module Exchange™ and HyperService™. Some of the most economical and intelligent service features ever devised.

And you can have more information about StacPac modules just by writing for our brochure.

But you just watch. You start marketing your systems in our StacPac modules and your competition will say you have an unfair advantage.

And you know something? They'll be right.

Corporate Headquarters: 2241 Lundy Avenue, San Jose, CA 95131. Eastern Region Sales and Service: Norwood, MA, (617) 769-7620. Central Region Sales and Service: Dallas, TX, (214) 980-4884. Western Region Sales: Santa Clara, CA, (408) 727-3163.

## DATA SYSTEMS DESIGN

CIRCLE 7

INTERNATIONAL SALES: Australia 03/544 3444; Belgium and Luxembourg 02/7209038; Canada 416/625 1907; Denmark 02/63 22 33; Finland 90/88 50 11; France 03/411 5454; Hong Kong and Peoples Republic of China 03/696231; Israel 52-52444; Italy 02/4047648; Japan, Osaka 06/323 1707, Tokyo 03/345 1411; Netherlands 02977-22456; New Zealand 04/693 008; Norway 02/78 94 60; Singapore, Malaysia, and Indonesia 2241077; Spain 01/433 2412; Sweden 08/38 03 70; Switzerland 01/741 41 11; United Kingdom 7073/34774; West Germany and Austria 089/1204-0; Yugoslavia 61/263 261



See us at NCC, Booth #P-7424

# Add Intelligent Analog & Discrete I/O To Your System: Only \$35 Per Point!

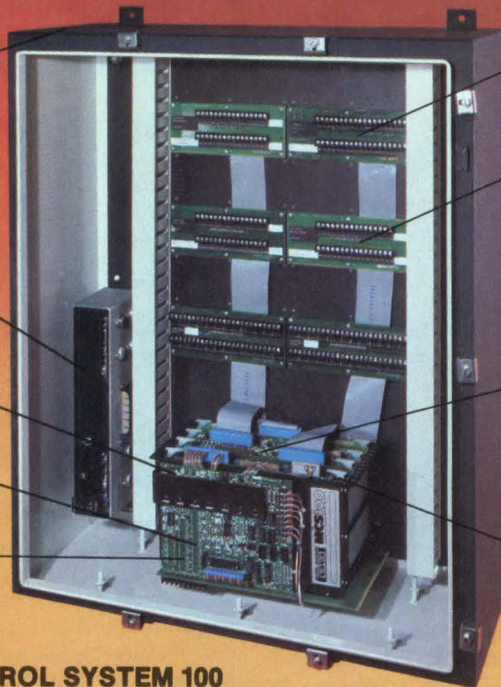

NEMA enclosures,  
explosion proof  
and rack mount available

120VAC Power Supply Std.  
220V, 24V UPS and dual supply optional

LED Status Indicators

RS-232-C, RS-422, 20mA Current Loop  
communications options - dual port inputs.  
Transient protection optional

Watch dog timer

Screw Terminations

IEEE surge-withstand  
protection optional  
on all terminations

4 or 9 I/O slots:

Direct Inputs for  
Thermocouples

RTD's

4-20mA,  $\pm 10V$

Pulse

Discrete (TTL to 220VAC)

Outputs for  
Analog

4-20mA,  $\pm 10V$

Discrete (TTL to 220VAC)

CPU card with 24K PROM,  
4K RAM communications port  
and 24 TTL-I/O points

**MICRO CONTROL SYSTEM 100**

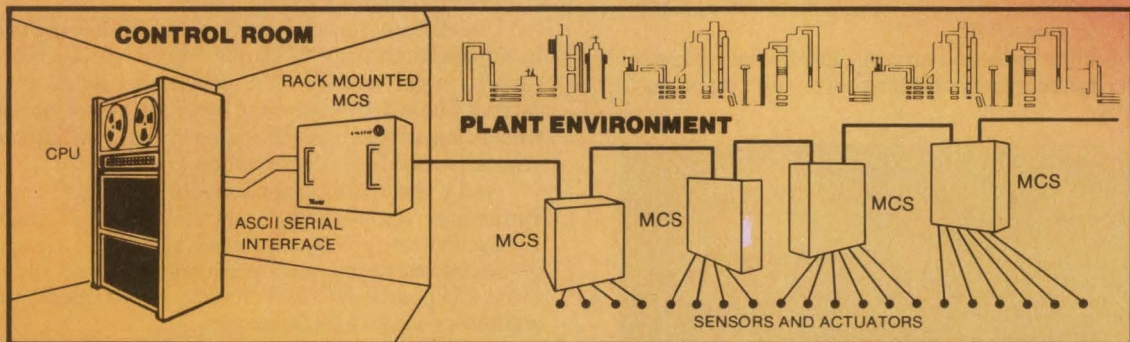

Modular, field expandable MCS Series provide direct sensor interface for RTD's and thermocouples and include cold junction compensation and linearization. Isolated pulse inputs and voltage, current and discrete inputs and outputs are available. Analog inputs are autoranged and autozeroed. Both input and output can be scaled 0 to 100%.

Communications: ASCII serial interface with dual ports. RS-232-C standard; RS-422 and 20mA current loop are interface options. Full control for Bell 202 modems is available. All systems may be

multi-dropped with up to 255 systems on a single line. Proprietary local clustering technique lets several MCS Series systems be controlled by a single modem at a remote site.

Screwdriver compatible barrier terminations for all I/O's offer optional IEEE surge-withstand protection. All systems are offered in NEMA 4, NEMA 12 and rack mount configurations.

Call for detailed descriptive brochure and specifications

**Data Acquisition and Control Systems Division,**  
3631 E. 44th Street, Tucson, AZ 85713. (602) 747-0711



Putting Technology To Work For You

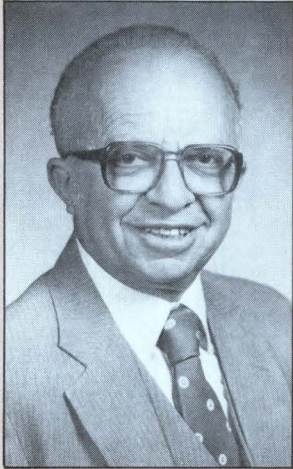

## **COMPUTER DESIGN'S PREMIER EDITION ON AUTOMATION & CONTROL**

Why dedicate an entire issue, this Premier Edition, to automation and control? The answer is quite obvious to us, and hopefully to you as well.

Although several broad areas of technology promise exceptional growth over the next several years, automation and control is probably at the forefront. Yet, the range of subtechnologies involved in automation and control is so broad that it is sometimes

difficult to define all subjects accurately or to enumerate them completely. Factory automation . . . robotics . . . artificial intelligence . . . computer integrated manufacturing . . . numerical control . . . data acquisition . . . . The list is endless, and no one subject can stand by itself; they all interrelate.

For each subject, the technology has advanced dramatically in the near past, even if only on a theoretical level. But all are about to explode with innumerable practical applications. *Computer Design* recognizes this and is bringing you the information you need to prepare—not for the future but for now.

When planning our approach, we realized that we could not thoroughly cover all subtechnologies of automation and control in a single issue. Yet we have involved a very high percentage of the most important ones in this Premier Edition. We have covered smart I/O boards, single-board microcomputers, artificial intelligence (expert systems), realtime control programming, machine vision, personal computers for industrial control, the impact of microprocessors on process control, factory automation software, NC, DNC, CNC, microcontrollers, data acquisition systems, data loggers, terminals, fiber optic cables, CCD cameras, sensors, and much more.

To borrow a buzzword, we have prepared an integrated package—and, we believe, a good package. But the true measurement is how valuable this package is to you, the reader, in your work. Let us know.

A handwritten signature in cursive script that reads "Syd Shapiro".

Sydney F. Shapiro  
Premier Edition Editor

---

# Nice try,

Well, Motorola's still trying to get the 68000 System together.

Unfortunately, it's not only too late. It's too slow.

**THE 68000 WAS FAST.  
BUT THE iAPX286 IS  
A WHOLE LOT FASTER.**

The new 286 is three times faster than the 68000. Even our extremely cost-effective 186, which integrates 20 LSI devices into one chip, outperforms it. (Sorry, Motorola.)

And you can forget what Motorola's been saying about memory. The 286 not only addresses 16 Megabytes of physical memory, it addresses 1 Gigabyte per user of virtual memory.

Unlike the 68000, the 286 even has the memory management, the protection, and the operating system interface functions built on to the chip itself. So you get software protection and software-in-silicon with no external components

to drain the juice out of your CPU.

But there's a lot more to the iAPX86 family than performance.

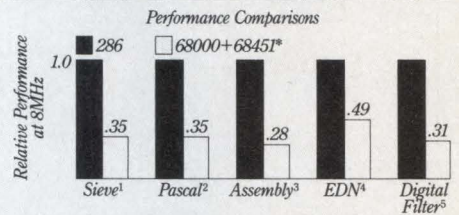

\*Performance adjusted to reflect indicated system configuration. Details available from AMD. <sup>1</sup>A High Level Language Benchmark, Byte, Sept., 1981. <sup>2</sup>A Performance Evaluation of the Intel iAPX 432 Computer Architecture News, June, 1982. <sup>3</sup>16 Bit Microprocessor Benchmarks, EDN, Sept., 1981. <sup>4</sup>Digital Filter Implementation on 16 Bit Microprocessors, IEEE Micro, Feb., 1981.



# Motorola.

## THE WORLD'S FIRST PARTNERCHIP.™

The Partnership gives you two responsible sources for every part in the family:

Intel and Advanced Micro Devices.

(Motorola has their second sources spread out from here to Tokyo. Not one comes close to offering you the entire product line.)

Together, we have more peripherals on the shelf than any other 16-bit family.

And since we've signed

an agreement to exchange parts, masks and R&D, we'll be delivering a lot more than promises over the next 10 years.

So if you want the system that'll keep you way out in front, climb aboard the Partnership.

It's a lot better than what Motorola's peddling.

## The iAPX86 People.

Advanced Micro Devices 

901 Thompson Place, Sunnyvale, CA 94086 • (408) 732-2400



# Looking for a faster processor-to-processor communications link?

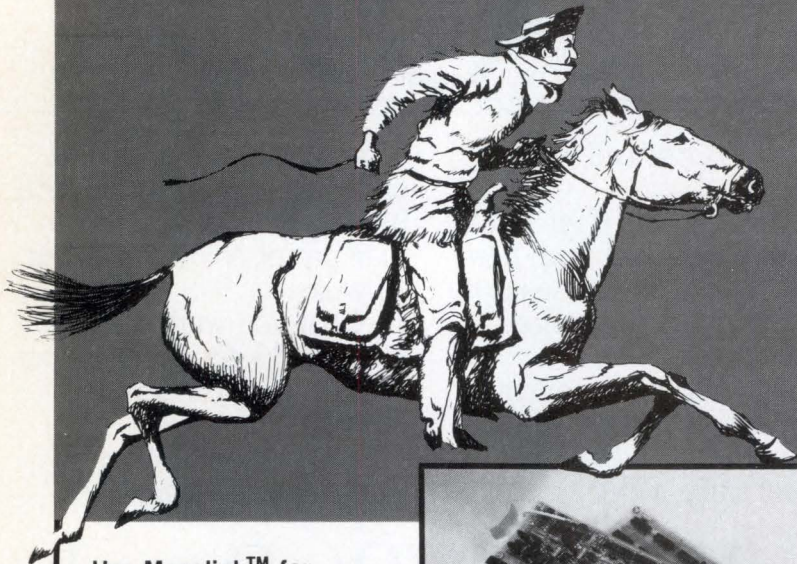

Use Megalink™ for  
1 Megabit/sec DMA transfer  
between multiple DEC and  
Intel processors on local  
networks up to 32,000 feet  
long.

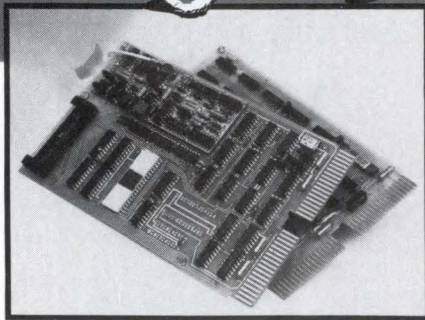

- Q bus, Unibus, and Multibus compatible units plug directly into DEC and Intel backplanes.\*
- Multidrop operation of different processors on single coaxial cable for distributed networks.
- Integral 1 Megabit/sec FSK modem is immune to baseband noise, has better than 1 bit/10<sup>12</sup> error rate.
- Loadable RT-11, RSX-11M, and RSX-11S device drivers available on floppy disk.
- Virtual disk subsystem.
- HDLC protocol implemented in hardware.
- Polled, token pass, or CSMA contention networks possible.

Call Garry Stephens today at (203) 544-9371, or write now for specifications of Megalink DMA Interface Units

## COMPUTROL

Division of Kidde Automated Systems, Inc.

### KIDDE

15 Ethan Allen Highway  
Ridgefield, CT 06877-6297 USA  
203-544-9371  
Telex 643358

\*DEC, Q bus, and Unibus are trademarks of the Digital Equipment Corporation.  
Intel and Multibus are trademarks of the Intel Corporation.

## COMPUTER DESIGN

Pennwell Publishing Company  
Advanced Technology Group  
119 Russell Street, Littleton, MA 01460  
Tel: 617/486-9501

*Editor in Chief*, Saul B. Dinman  
*Executive Editor*, Michael Elphick  
*Premier Edition Editor*  
*Managing Editor*, Sydney F. Shapiro  
*Technical Editor*, Chris Brown  
*Senior Editor*, Peg Killmon  
*Associate Editor*, Deb Highberger  
*Assistant Editor*, Mary Therese Cipar  
*Senior Copy Editor*, Suki Adams  
*Copy Editors*, Colleen Feeny  
Linn Kurkjian  
Jocelyn J. Melanson

### *Western Editorial Staff*

*Managing Editor*, Tom Williams  
*Field Editor*, Sam Bassett  
540 Weddell Dr, Suite 8,  
Sunnyvale, CA 94086, Tel: 408/745-0715  
*Field Editor*, Joseph A. Aseo  
5199 E Pacific Coast Highway, Suite 303A,  
Long Beach, CA 90804, Tel: 213/597-6894

*Production Manager*, Linda M. Wright  
*Asst Production Manager*, Lou Ann Morin  
*Production Assistant*, Philip Korn  
*Design Consultant*, Ken Silvia  
*Technical Art*, Designline

*Publisher*, Ronald W. Evans

*Director of Marketing*, Gene Pritchard  
*Promotion Director*, Steve Fedor  
*Marketing Services/PR Mgr*, Linda G. Clark  
*Advertising Coordinators*, Cherie LaFrance  
Sally H. Bowers  
*Adv/Production Assistant*, Ginger Rhoads  
*Circulation Director*, Robert P. Dromgoole  
*Controller*, David C. Ciommo  
*Computer System Manager*, Ken Spiewak  
*Data Services Manager*, Wanda Holt  
*Data Services Assistant*, Sue Bowker

## PennWell

PUBLISHING COMPANY

*Chairman of the Board*, P.C. Lauinger  
*President*, Philip C. Lauinger, Jr.  
*Senior Vice President*, Joseph A. Wolking  
*Group Vice President*, H. Mason Fackert  
*Group Vice President*, Carl J. Lawrence  
*Vice President/Finance*, V. John Maney  
*Vice President*, L. John Ford



Industry faces an unprecedented challenge. To compete successfully in the world marketplace, we must not only look to new plants and equipment, but must be more productive through automation of existing machinery.

Gould is in a unique position to help you automate through a skillful blend of electronic hardware, software and engineering expertise. Our broad range of products enables you to create the precise system you need today. You can start with a

single process and upgrade to full automation as your requirements dictate.

Complete automation often requires powerful minicomputers, graphics terminals and displays, programmable controllers, servomotors and controls, solid-state switching devices and measurement sensors, all interconnected by a flexible communications and control network.

Gould offers all of the integrated electronics products required to do the job. All standard and all

compatible, right from the start.

Gould expertise in automation and control can improve productivity for you ... now. Call or write:

**Gould Inc., S.E.L.**  
**Computer Systems Division,**  
6901 West Sunrise Boulevard,  
Fort Lauderdale, Florida 33313,  
1-800-327-9716.



**GOULD**

*Electronics & Electrical Products*

# Computerized intelligence for factory automation.

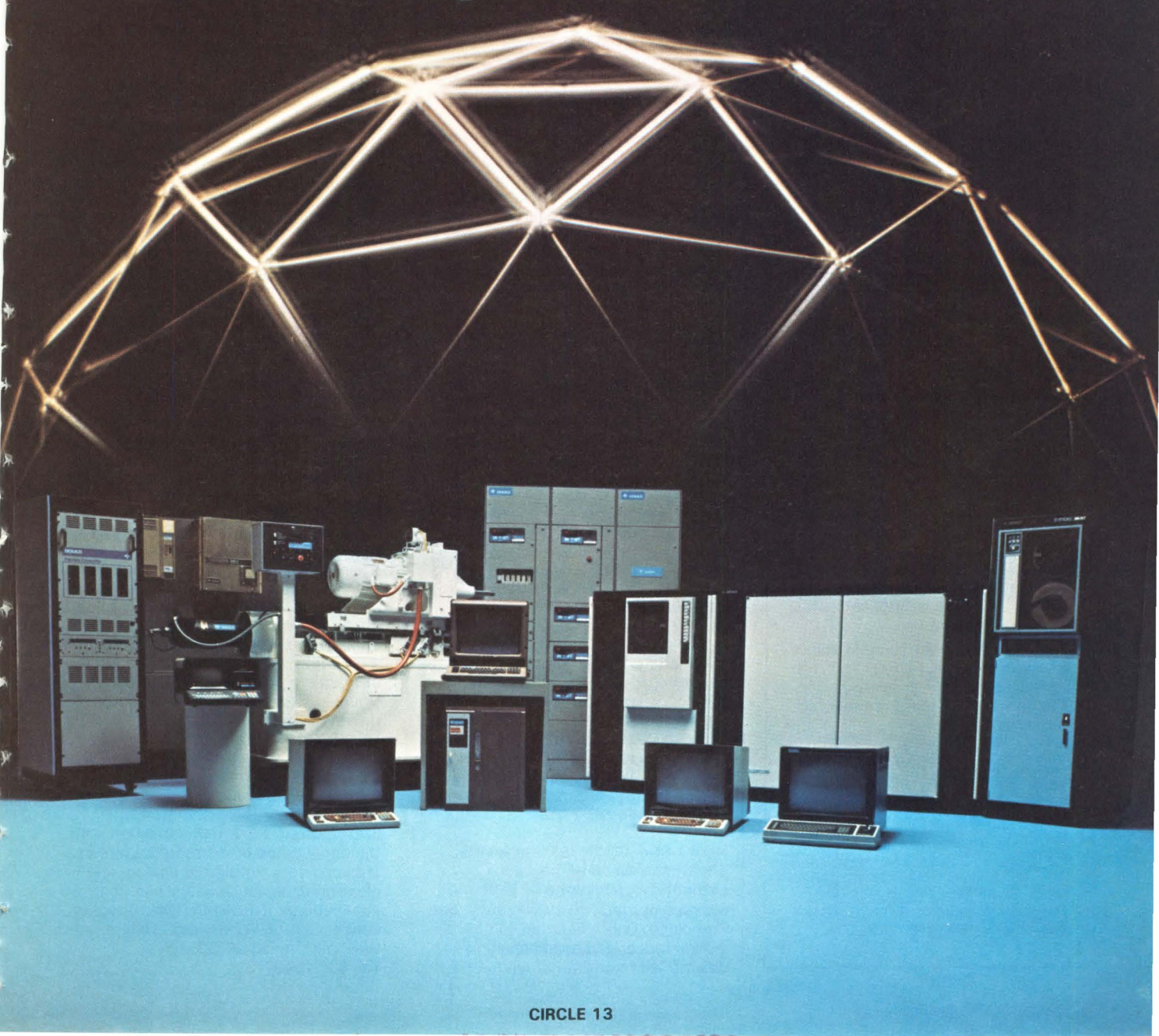

# polyFORTH II

The Operating System and Programming Language designed especially for

## REAL-TIME APPLICATIONS

- Robotics
  - Instrumentation
  - Process Control
  - Graphics
- ... and many more.

polyFORTH II has the high-performance features you need to slash development time by months:

### POWER

All the programming tools you need — multiprogrammed OS, FORTH compiler and assembler, editor, over 400 primitives and debugging aids — resident and ready to use.

### SPEED

3-5 times faster than Pascal, 20 times faster than Basic, with a resident assembler for time-critical functions.

### MULTITASKING/MULTI-USER

Supports any number of tasks. Even the smallest systems may have two or more programmers coding and testing interactively.

### COMPACT CODE

Entire development system resident in under 12K. ROMable applications can run under 1K. Large applications up to 10 times smaller than with other techniques.

### SUPPORT

On-line interactive documentation, over a thousand pages of manuals, FORTH Programming Courses, and the FORTH, Inc. Hot Line plus Contract Programming and Consulting Services.

Available for most popular minis and micros. From FORTH, Inc., the inventors of FORTH, serving professional FORTH programmers for ten years.

## FORTH, Inc.

2309 Pacific Coast Hwy.  
Hermosa Beach  
CA 90254

(213) 372-8493  
TWX 910-344-6408  
(FORTH INC HMBH)

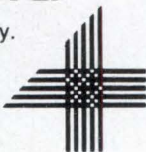

CIRCLE 14

## AUTOMATION & CONTROL CALENDAR

### CONFERENCES

**MAY 25—Trends and Applications Conf, Automating Intelligent Behavior: Applications and Frontiers**, National Bureau of Standards, Gaithersburg, Md. Organized to provide better understanding of artificial intelligence, presentations will include vision and sensing, speech synthesis, knowledge acquisitions, robotics and automated reasoning, situation assessment, and societal impact. INFORMATION: Marvin Denicoff, PO Box 639, Silver Spring, MD 20901. Tel: 202/696-4302

**JULY 25-29—SIGGRAPH, Conf on Computer Graphics and Interactive Techniques**, Detroit, Mich. INFORMATION: SIGGRAPH Conf Office, 111 E Wacker Dr, Chicago, IL 60601. Tel: 312/644-6610

**SEPT 12-14—IEEE Internat'l Conf on Computer Aided Design**, Santa Clara, Calif. Areas of interest will include VLSI designs and methodologies, CAD systems, simulation techniques, design verification, digital test, interactive graphics, design automation, and large scale engineering systems. INFORMATION: John A. Domiter, American Bell Inc, PO Box 3505, New Brunswick, NJ 08903

**SEPT 13-15—Autofact Europe Conf and Exhibition**, Palexpo Exhibition Ctr, Geneva, Switzerland. Focus will be upon CAD/CAM, robotics, flexible manufacturing systems, graphics, NC, DNC, CNC, and human factors of factory automation. INFORMATION: Computer and Automated Systems Assoc of SME, PO Box 930, Dearborn, MI 48128. Tel: 313/271-1500

**SEPT 26-29—ISA Internat'l Conf and Exhibit on Worldwide Progress Through Instrumentation**, Rivergate Exhibition Ctr and Louisiana Superdome, New Orleans, La. Papers will cover automatic control, computer technology, process management and control, scientific instrumentation and research, standards and practices, test and measurement, and industry application areas. INFORMATION: Instrument Society of America, 67 Alexander Dr, PO Box 12277, Research Triangle Park, NC 27709

**NOV 7-11—IECON IEEE Industrial Electronics Society Conf on Industrial Applications of Mini and Microcomputers**, Hyatt Regency, San Francisco, Calif. Included will be workshops and special sessions dealing with current hardware and

software topics related to automation and control, such as automated manufacturing, CIM, NC, robotics, local area networks, distributed systems, machine vision, and instrumentation. INFORMATION: Patrick P. Fasang, Siemens Corp, 105 College Rd E, Princeton, NJ 08540. Tel: 609/452-7070

**NOV 14-17—Autofact 5 Conf and Expo**, Cobo Hall, Detroit, Mich. Discussions and exhibits will include analysis and simulation, CAD/CAM, flexible manufacturing, robotics, group technology, automatic assembly, QC, materials handling, and other computer aspects of the automated factory. INFORMATION: CASA/SME Public Relations, PO Box 930, Dearborn, MI 48121. Tel: 313/271-0777

**NOV 14-17—PCI/MOTORCON Conf and Exhibition**, Cobo Hall, Detroit, Mich. Focus is on electronics, motors, drives, controls, sensors, semiconductors, and other electronic and power devices used in automation systems. INFORMATION: Conference Director, Intertec Communications, 2909 Ocean Dr, Oxnard, CA 93030. Tel: 805/985-2289

### SHORT COURSES

**MAY, JUNE, JULY—Digital Control Systems 4-Day Courses**, Philadelphia, San Diego, Boston, Los Angeles, Washington, DC. Courses combine theory and practice with emphasis on real-world problems. INFORMATION: Ruth Dordick, Integrated Computer Systems, PO Box 5339, Santa Monica, CA 90405. Tel: 213/450-2060

**JULY 7-8—An Applications-Oriented Approach to Artificial Intelligence**, George Washington Univ, Washington, DC. An understanding of the design, application, and implementation of an intelligent system based on artificial intelligence processing techniques that are directly applicable to the solution of practical problems. INFORMATION: Douglas Green, George Washington Univ, Washington, DC 20052. Tel: 800/424-9773

**JULY 18-22—Microcomputers in Control Systems Including Interfacing Methods**, George Washington Univ, Washington, DC. A familiarization with the capabilities of microcomputers as replacements for digital, analog, and electromechanical elements in control applications. INFORMATION: Douglas Green, George Washington Univ, Washington, DC 20052. Tel: 800/424-9773

## Realtime graphics interface controls PC based automation

System level human/machine interface of the D-1200 gives operators direct control over programmable controller based automation through an interactive graphics display. In addition, software tailors the color display to the user's point of view. Three levels of operation—overview, group, and point—are depicted via fixed-format or user configurable options. A series of user transparent subroutines written in a mixture of FORTRAN and assembly language handles process control functions.

Variable area focusing precorrelates displays and display levels to create a standard mechanism for shifting from one display to another without programming. Overview shows the realtime alarm status of up to 144 control/monitoring groups. The next level offers 144 group displays, which can each contain up to 9 points of any type for a total of 1296 field items.

A point is defined as a digital control station, discrete alarm, PID controller, analog input or batch control indicator, or counter/timer/weight indicator with set point and accumulated value. Each device in a group of nine can be from a separate process controller area.



At the group level, 2-state devices can be controlled; measuring devices can have presets changed; and analog controllers can have mode changes, set

point changes, and outputs driven up or down. At the point level, the operator monitors realtime status, changes whatever was allowed in group level, and assigns the point to a group or groups.

Software options include user configurable report generation and multipoint realtime and historical trending, as well as ladder listing with user defined labels and comments. Batch configurations display up to 200 steps/page for the recipe operation, highlighting the active step. Each batch page displays run, stop, pause, and advance controls.

High end model 1230 supports four intelligent terminals up to 4000' (1219 m) from the central controller over a dual-loop network. Each station functions independently, and can maintain a discrete data base or share its data base with another station. The terminals store up to 128K bytes of main memory and run their own operating system. Four individually programmable RS-232-C ports allow communication to multiple intelligent devices and/or networks. **Process Control Industries Inc.**, PO Box 386, Mansfield, MA 02048.

Circle 241

## Adroit light assembly robot integrates vision, tool changes



Targeted for specialized electronics assembly and parts handling, the 6-axis model 605 robot arm carries 5 lb (2 kg) within a 33.4" (84.8 cm) radius at 40 ips. Above-shoulder placement of the proprietary Wrist Twist joint permits the arm to approach work from contorted angles.

Integrated vision system accepts up to 16 CCD or Vidicon cameras. Vision supports 100 object definitions with 256- x 256-pixel resolution. Under software control, the robot will recognize randomly

placed objects, determine which should be manipulated and how, then follow an assembly routine. Reported applications include loading heads into a hard disk drive assembly in a clean room, inserting odd-shaped components into a printed circuit board, and operating printed circuit board testers.

The robot controller is designed around Intel's 8086 microprocessor, which addresses 1M byte of system memory, and the 8087 math processor. Closed-loop performance monitoring adjusts the robot to changes in temperature and payload.

Integrated end effectors are controlled by a dedicated 8088, and feature automatic tool change within one continuous work cycle. A standard set of end effectors accommodates variously sized and shaped electronic parts; custom grippers are also available.

Programmed in Microsoft BASIC, the company's enhanced Robot BASIC contains over 150 robotic commands, including 30 for control of end effector and vision systems. The robot can also be programmed offline on a personal computer.

Up to 256 work routines load into the robot controller for long-term memory storage. Access to the appropriate work routine is through a push button on the controller's front panel. A handheld teach pendant allows an operator to direct the robot through simple work procedures without computer programming.

The system comes with 128K RAM; maximum additional memory is 768K. Maximum program size is 64K, with 4000 defined points. Six peripheral connectors accept memory expansion boards for user designed electronics. Of the five RS-232-C ports, one is dedicated to the host computer link and another to daisy chaining robots to the central controller, leaving three ports for expansion.

A separate safety computer continuously monitors the robot's activities and halts movements if user specified tolerances are exceeded. In that case, the safety controller overrides normal system commands, shuts down the robot, and notifies the operator. **Intellex, Inc.**, 33840 Eastgate Circle, Corvallis, OR 97333.

Circle 242

## CAI: an indispensable tool for expanding factory automation

Jim O'Toole, professor of management at the University of Southern California, retells the story—possibly apocryphal—of Walter Reuther's trip to see the first industrial robot in Detroit. At the factory, Henry Ford marked Reuther's shocked expression and asked what was wrong; didn't Reuther know how to organize robots? To this Reuther replied, "No, Henry, that's not what I'm worried about. I'm worried about how you are going to get them to buy cars."

Control engineers today are working for the Fords and not the Reuthers, but they are feeling ramifications on all sides that stem from the shift to gray-collar production. Typically in America's heavy industry, robots came in one door and blue-collar workers went out the other. According to O'Toole, who served as special assistant to the secretary of Health, Education, and Welfare and as chairman of the secretary's task force on work in America, writing off millions of technologically displaced Americans will be "a prescription for revolution."

O'Toole has studied the decline of innovation in this country and how that

impacts productivity. He suggests that imaginative private/public partnerships will eventually solve the training problems facing industry, but only with the cooperation of labor and management. "The most effective job training," he remarks, "occurs in industry where corporations can train people on the actual machines they are using or on the machines they are installing."

Professionals involved in computer aided design, manufacturing, and engineering know firsthand how powerful a tool the computer can be. While making enormous advances in their work, they have witnessed astronomical jumps in productivity. Changes in these areas, however, are clouding formerly clear-cut distinctions between computer designers and computer operators in the control and automation environment.

O'Toole confirms that within this transitioning workplace the relationship between workers and supervisors is changing, and both need training to deal with this. Blue-collar workers operating computer terminals have access to a lot of managerial information they didn't before. "The supervisor can no longer

be an authoritarian or a policeman," O'Toole comments. "He has to become an expert consultant to the worker."

Individually paced computer aided instruction (CAI) can effectively retrain existing workers to handle the tasks that spin off advancing technologies. In one cooperative venture between the United Auto Workers and General Motors, workers are being retrained on the shop floor with Control Data's Plato, a comprehensive program of computer based training for personnel who maintain and repair computer aided manufacturing equipment.

Reinforcing his opinion that computer instruction is a *sine qua non* for keeping pace with future technological expansion at design and implementation levels, O'Toole stresses the need to anticipate problems corollary to the developing technologies. "We spend hundreds of millions of dollars on new technology," he asserts, "but not nearly enough in preparing the people for this. Very seldom do these technologies fail, but the people fail the technologies."

—Deb Highberger, Associate Editor

## Data logger stands alone for onsite data reduction

A self-contained data logger, MiniDAS doubles as a data acquisition system with a 16-bit 28002 microprocessor supporting an onsite data reduction package. The system acquires, digitizes, and stores data from a full range of transducer types while achieving a 20k-sample/s measurement rate. Interactive menu format stored in EPROM prompts untrained operators.

MiniDAS can function independently or be incorporated into a network of data acquisition systems; a high speed transmission channel links the unit to a larger distributed area acquisition network. Through this channel the system can receive a downloaded setup file and transmit acquired data back to the host processor. At the same time, the system continues operating as an independent data acquisition unit. Optional channels for general purpose communication include RS-232-C and IEEE 488.

Configured with a solid state, alternate-relay multiplexer and extended-resolution ADC, MiniDAS will handle common-mode inputs to 250 V rms. The master chassis contains the complete system, including discrete analog inputs and bus



addressing for up to eight signal conditioner cards (64 additional input channels). Each of 6 supported expansion chassis houses 8 additional signal conditioner cards for a total expansion to 448 channels. Low and high level transducer outputs are handled directly.

An expanded math package handles data reduction onsite. Single-input chan-

nels are converted to engineering units such as strain temperature, volts, and displacement. For instance, the system will apply a fifth-order polynomial to a measurement or calculate horsepower from rpm and torque. **Cyber Systems, Inc.**, 2031 E Cerritos Ave, Anaheim, CA 92806.

Circle 243

## Batch controller oversees independent analog outputs

With onboard intelligence, diagnostics, and power supply for complete local control, Batch PAC can operate independently as a measurement and control system or as the lowest element in a distributed network. It is the most recent addition to the Cinch PAC family of single-board computers for industrial process control, production test, and factory automation in hostile environments.

Introduced last year as a class of primary automation controllers, Cinch PAC represents the first level of control above the primary sensor (*Computer Design*, June 1982, p 76). Further, 2K bytes of RAM, 24K bytes of additional EPROM, a 14-bit ADC, and a 12-bit DAC equip the controller to perform data collection, linearization, compensation, control, actuation, and reporting.

User-settable variables preprogram Batch PAC to directly control six independent analog outputs for batch process control routines. Besides that, the controller can make inquiries on subroutines and current activities, as well as on data acquisition of analog input channels. Powerful intervention/override commands let the user take control over

current or future processes without destroying resident operations.

Each control subroutine loaded into Batch PAC accommodates up to 30 process segments. Beyond that, each segment specifies a target output value and a time to ramp from the last output value to the new target. Ramp or soak/dwell times for any segment in the process operation can be set from 1 s to 350 h.

In addition, Batch PAC can store several subcycles within each operation. For example, start-up cycle, repeat cycle(s), and shutdown cycle can all be contained in a subroutine for any batch output and commanded remotely at any time by a host computer or terminal operator. The controller automatically repeats subcycles stored within subroutines for a specified number of times, counting current number of repeats for reporting.

Advance notification is given of each cycle completion. When the number of process segments remaining in an operation falls below predetermined levels, the controller gives automatic warnings and alarms to request the next operation or signal a new recycle. The latest output values and the number of process



segments remaining are automatically reported at a specified time interval, from 1 s up.

The controller hooks up to the 125-node Cinchnet network, which coordinates 2000 analog input points, 2000 control loops, and 8000 digital data points. Transmission rate is 28.8k baud to 4000' (1219 m) over direct 4-wire via RS-485, with carrier sense multiple access/collision detection. Since any device in the network can initiate a message, polling or token passing is not necessary. **Inconix Corp.**, 10 Tech Circle, Natick, MA 01760.

Circle 244

## Robotic system adjusts to feedback in work area

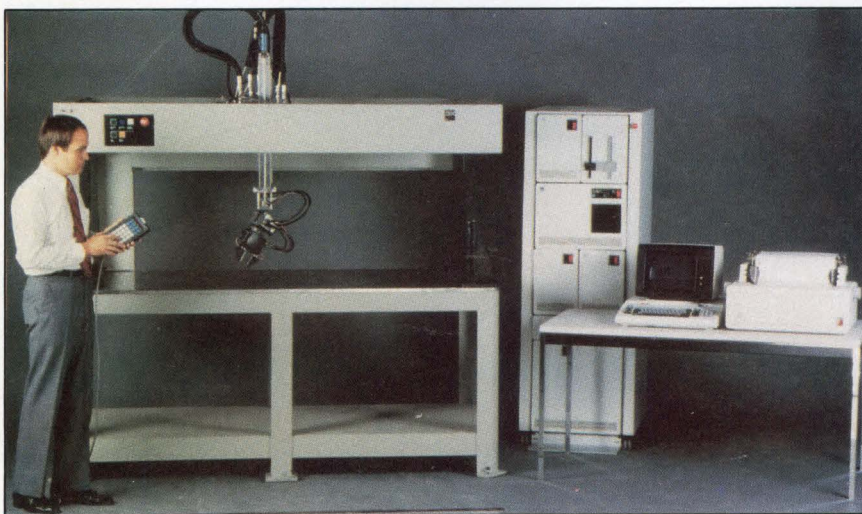

A modified Series/1 computer is the heart of an intelligent robotic system that can respond to changes in its work environment. The model 7565 manufacturing system is intended for light fabrication and materials handling, electronic component insertion, precision mechanical assembly, and testing jobs.

Its controller monitors the robot's arm position and operation 50 times/s.

If arm motion exceeds defined tolerance limits, motion is stopped. Moreover, the control program can be "frozen" from issuing move instructions; in that case, if the arm moves, the hydraulic power will be shut off.

An interactive manufacturing language, AML, accesses system functions through high level subroutines that control motion, monitor sensors, perform complex

calculations, and manage storage, printer display, and communications. Though it includes commands like approach, withdraw, transport, and grasp, AML is only a base interface for programmers. Programmers expand this applications language through the PRBE (program robot by example) package.

The 2-finger servo controlled gripper "feels" parts and tools in its work area. Strain gauges sense force at the tip, side, and pinch surfaces of each finger. Feedback from optical (light) and tactile (force) sensors in the gripper fingers enables the controller to respond to changes in the work environment and adapt the manipulator to an application. Through programming, the force with which objects are grasped can be controlled, corners or edges of objects detected for calibration and angle measurement, and the presence or absence of a part between the grippers sensed. Alternately, a handheld programmable control box, or "teach pendant," can move the arm and gripper during application development. **IBM Corp., System Products Div.**, 1000 NW 51st St, Boca Raton, FL 33432. Circle 245



**THE HIGH DENSITY CONNECTOR SOURCE.**

## **More ways to shrink size, squelch noise and trim application costs.**

AMP subminiature D connector systems are where today's news in high density packaging is happening.

Among the latest additions to this giant family of space-savers are the HDE's, with pre-loaded insulation displacement contacts. They can save you up to 40 percent through mass termination, and come with the proven manual or automatic tooling you expect from AMP.

Worried about EMI/RFI? You need not with our shielded high density connectors. And filter-pin models stop conducted noise at the connector.

Want low profile? The new HDF is only .335" high, provides compact right angle termination of flat cable.

Connecting to pc boards? Our exclusive compliant pin header installs without solder and without damage to plated holes.

When you think high density interconnects, think AMP — for the selection, performance and total economy you need.

---

Get full information by calling the AMPLIMITE Connector Desk at (717) 780-4400. AMP Incorporated, Harrisburg, PA 17105.

---

## **AMP** means productivity.

### **AMP Facts**

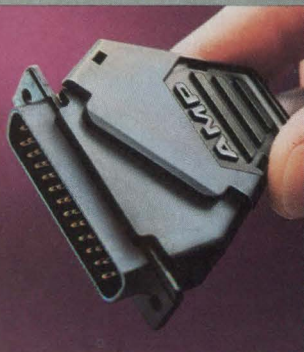

HDE snap-together strain relief is available in 90° or 180° configuration.

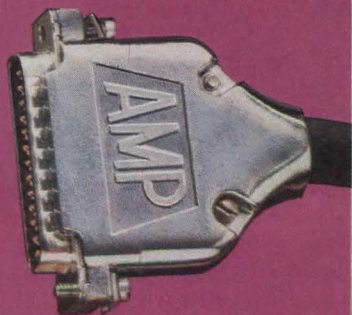

Shielded styles to help you meet EMC requirements.



MIL-C-24308 family for your aerospace needs.



Low-profile right-angle termination of flat ribbon cable saves space.

CIRCLE  
NUMBER  
**10**

# ANALOG I/O BOARDS GET SMARTER

**Microprocessor technology has strongly influenced modern data acquisition and control. Now even I/O boards, still mostly analog, are being impacted by digital architecture.**

**by Richard Parker, Contributing Editor and Sydney F. Shapiro, Managing Editor**

**D**igital computer process control in the industrial factory environment is an accepted fact of life. Yet, communication links between the process and the computer remain largely analog. Even now, analog sensors and transducers produce signals that are typically amplified, signal conditioned, and multiplexed. Those signals are then converted to digital form by an analog to digital converter. In some cases, the analog signals travel a mile or more, from the amplifier to the signal conditioning circuit, over twisted pair wiring. The output of the controlling computer must then be reconverted back to analog form (through a digital to analog converter) to drive the appropriate actuators and valves that regulate the process (Fig 1).

However, the advent of high speed and low cost microprocessors is forcing a change. Microprocessors are heavily impacting realtime industrial process data acquisition and control applications. Board level distributed processing at relatively low cost is increasing the number of possible digital subsystems within the process loop. An excellent example can be seen in the plethora of analog input/output (I/O) boards that are becoming available. Because of this, the digitization process is now moving much closer to the sensor and transducer, providing a higher level of process control reliability, flexibility, and efficiency.

Many modern analog I/O boards are nothing short of complete systems in their own right, lacking only input sensors and output actuators. Such boards can do it all, from amplifying, signal conditioning, multiplexing, and digitizing signals, to processing the signals with sophisticated algorithms and driving high power loads. The trend involves multiple facets:

- Increased data conversion speeds and resolutions of analog I/O boards, as well as the number of input and output channels, to handle the demands of realtime process control. Often, a multitude of sensors and actuators is involved. Upward integration of more functions on the same board is a related trend.
- Improved I/O interface architectures to offload the host central processing unit's (CPU) burden. The use of direct memory access (DMA) techniques is a notable example. Along with this trend is improvement of the intelligence of the analog I/O interface.



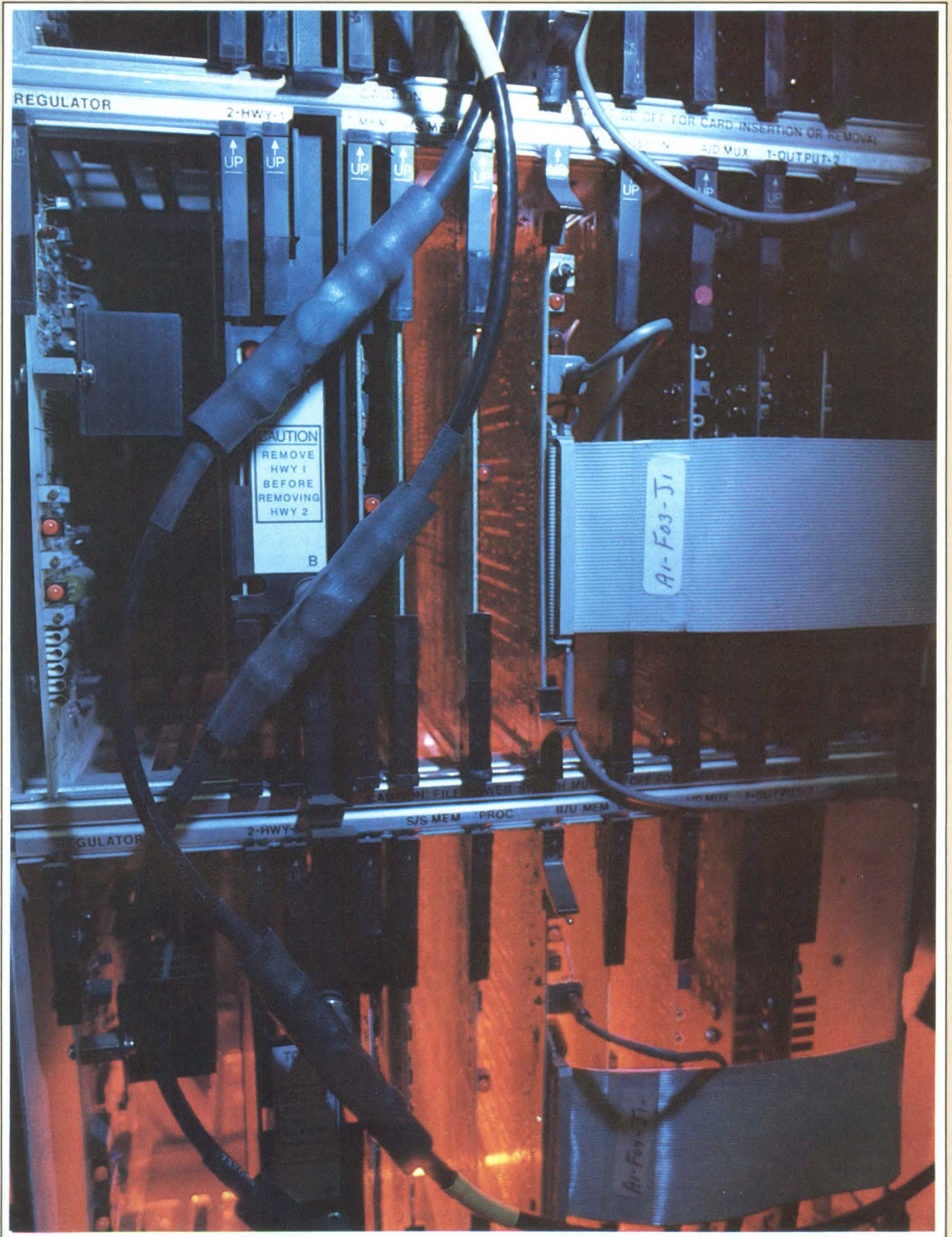

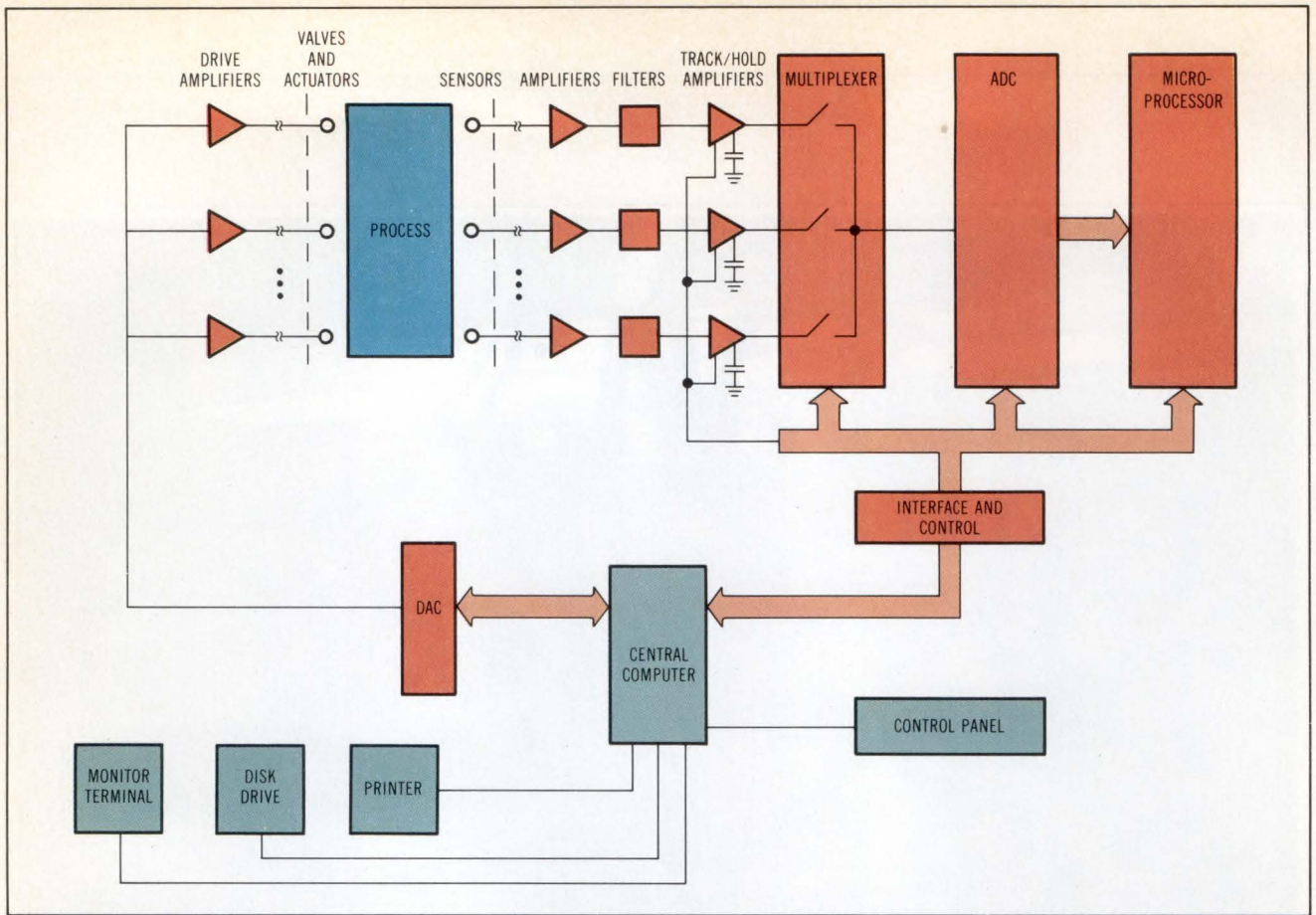

**Fig 1** Although a large part of the modern data acquisition and control system such as this still handles analog signals, the digital takeover is proceeding slowly and surely. The proliferation of low cost microprocessors is one major reason why.

- Distributed intelligence to reduce high wiring costs. Serial data transmissions over twisted pair wiring is one method of reducing wiring costs.
- Improved flexibility of analog I/O boards through modular hardware and software.
- Reduced overall power consumption through the use of complementary metal oxide semiconductor (CMOS) integrated circuits (ICs).

### Higher speeds and better resolutions

Analog I/O boards and cards can now boast of input data conversion speeds of up to 250 kHz, and resolutions spanning 8 to 16 bits. Such boards can handle sensor and transducer signals on anywhere from 4 to 64 input channels. They can produce outputs over 2 to 8 channels at resolutions of 8 to 12 bits and data conversion speeds of up to 800 kHz.

The latest generation boards perform a wide range of functions formerly reserved for separate subsystem cards and modules, from acquiring and conditioning millivolt level signals mired in noise, to digitizing them, performing number crunching operations, and providing hefty analog drive signals to fine tune the process. Still, the use of individual cards and boards as subsystem elements within the data acquisition and control loop (ie, the use of separate signal conditioning circuits, multiplexers, and data converters) is also popular, since it provides the necessary flexibility to optimize

subsystem performance levels. For example, very harsh industrial environments where relay, motor, elevator, machinery, and arc welder noise sources can play havoc with input signals require high voltage isolation. In such cases, the 300 to 400 V of input isolation available on some boards is insufficient, and subsystem components such as the 3B family of I/O units from Analog Devices, Inc (Norwood, Mass) with  $\pm 1500$ -V isolation are called for.

Because microprocessor chips are relatively inexpensive and widely available, they are being used in record numbers on analog I/O boards. The result has been a large increase in board intelligence, allowing many boards to be bus independent since they can operate on virtually any popular microprocessor bus. Yet, a large number of boards are also making use of the STD bus, which is proving popular for industrial applications. Some bus independent analog I/O boards go so far as to provide a dedicated microprocessor to control the board's own local I/O port, leaving all interface and communications tasks to a host computer.

Bus independence offers several advantages, including freedom from noise and error sources due to the shortening of I/O lines, unburdening of the host CPU, and the flexibility of handling a wide variety of far flung sensors and transducers under the control of a single board. One need only look at Analog Devices'  $\mu$ MAC-4000 to see why this is so. That intelligent single-board system family includes a microcomputer, control logic, universal

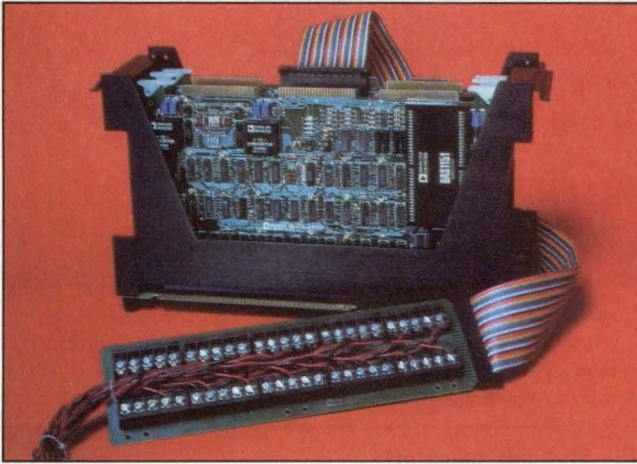

**Analog I/O boards add data acquisition and control capability to Multibus compatible microcomputers. This board contains all necessary hardware circuitry to interface with analog input and output signals. Courtesy Analog Devices, Inc.**

asynchronous receiver/transmitter, common analog bus, 13-bit A-D converter (ADC), isolated 8-bit digital input and output ports, programmable-gain amplifier, power supply, and provisions for analog and digital channel expansion.

The  $\mu$ MAC-4000's 12 input channels can be mixed or matched to accept sensor inputs in groups of four with  $\pm 1000$ -V isolation. In addition to the usual control tasks, the board's microcomputer performs such things as thermocouple-transducer cold junction compensation, linearization, and conversion to engineering units.

Thanks to two modules—one holding eight and the other holding four sample/hold amplifiers as well as a 12-bit ADC, the DT3388 analog I/O board from Data Translation Corp (Marlborough, Mass) can simultaneously sample 12 high level input signals, hold them within an aperture uncertainty time of  $\pm 5$  ns, and then digitize them at a 90-kHz rate. Thereafter, digital data are transferred to memory. The board has a programmable-random access memory (RAM) register that allows the user to specify which of the frozen input channels is to be scanned at any time. Thus, the scanning rate for each input channel is increased, and more efficient use of system memory is made. The board is designed to operate with the Digital Equipment Corp (Maynard, Mass) LSI-11 bus and is available with the computer program library software package that supports Fortran IV programs under DEC's RT-11 realtime operating system, through library subroutines. A 4-channel board version is also available.

Not all manufacturers of I/O boards concentrate their efforts on single boards. Some choose the box level approach, achieved by providing several board subsystems that plug into a common local bus within a card cage. In this manner, the user starts with a basic system, expandable and reconfigurable, through additional plug-in boards, to match changed needs. Furthermore, assigning specific tasks to boards within the card cage maximizes individual circuit performance and minimizes the time wasted by each on unrelated tasks.

Although there are many such box level products, a good example is the intelligent data acquisition and con-

trol (IDAC) chassis from Data General Corp (Westboro, Mass). This powerful system, using a 16-bit microcomputer and handling up to 4800 digital and analog lines, can be configured in both standalone and integrated modes. In the former configuration, it is available with a cathode ray tube terminal, dual-floppy disk drive (or Winchester disk drive), and a medium speed printer. In the latter configuration, several IDAC chassis can be put under the control of a large host computer, with each chassis programmed to handle a certain distributed processing task. Each IDAC chassis has five card slots for memory, processing, and signal input lines.

### Gaining from better ICs

Many of the board level analog I/O products on the market owe much of their power to the proliferation of advanced linear ICs such as multiplexers, converters, programmable-gain and instrumentation amplifiers, sample and hold amplifiers, and filters. Thus, as higher performance versions of a semiconductor device become available, the board manufacturer upgrades the I/O board by incorporating an improved IC. Furthermore, building block system designers are provided with the convenience and flexibility of building their own data acquisition and control systems, particularly as some of the ICs begin to incorporate more than one function on the chip. However, powerful data acquisition systems such as the modular MDAS-940S (16-channel single-ended operation) and the MDAS-940D (8-channel differential operation) from Datal-Intersil (Mansfield, Mass) both with onboard programmable-gain amplifiers, make the buy-instead-of-build decision much easier.

Manufacturers such as National Semiconductor Corp (Santa Clara, Calif) provide linear devices optimized for the industrial process. The firm's hybrid DAC-1242 12-bit digital to analog converter (DAC) is designed specifically to drive one of the most widely used interfaces in the factory, the 4- to 20-mA current loop. It is particularly intended to work with ISA Type 3 standard connections to drive signals long distances over twisted pair wiring.

Monolithic programmable-gain amplifier ICs have made it possible for data acquisition systems to work with a wide range of sensors and transducers that produce

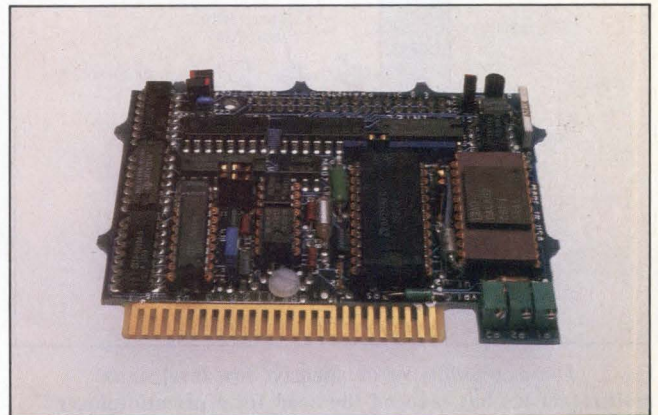

**The ISBX 328 analog output multimodule has eight channels of voltage for current analog output on a single-width multimodule board that plugs into any ISBX compatible ISBC board. Courtesy Intel Corp.**

millivolt outputs, as well as those of several volts, without the need for pushing the resolution of monolithic and hybrid ADCs. Such amplifiers are simply placed ahead of the converter, one for each transducer or sensor, allowing the use of lower resolution converters that can operate close to if not at their full scale ranges.

Normally, the outputs of such amplifiers are fed to a high signal level multiplexer before being digitized by the ADC [Fig 2(a)]. Now, however, the advent of multiplexer ICs that can handle lower input signal levels has made it possible to eliminate many programmable-gain amplifier ICs by having several low level sensors and transducers feed their outputs directly to the multiplexer. A single programmable-gain IC amplifier then amplifies the multiplexer's output before digitization [Fig 2(b)].

Some monolithic ADCs are available with serial output data streams instead of the usual parallel output data formats. This makes them suitable for distributed industrial data collection systems that transmit information serially over long distances. There are even companding type DACs that mate well with logarithmic output transducers. Such converters provide a straight line approximation of a logarithmic input and are thus great linearization partners for many transducers.

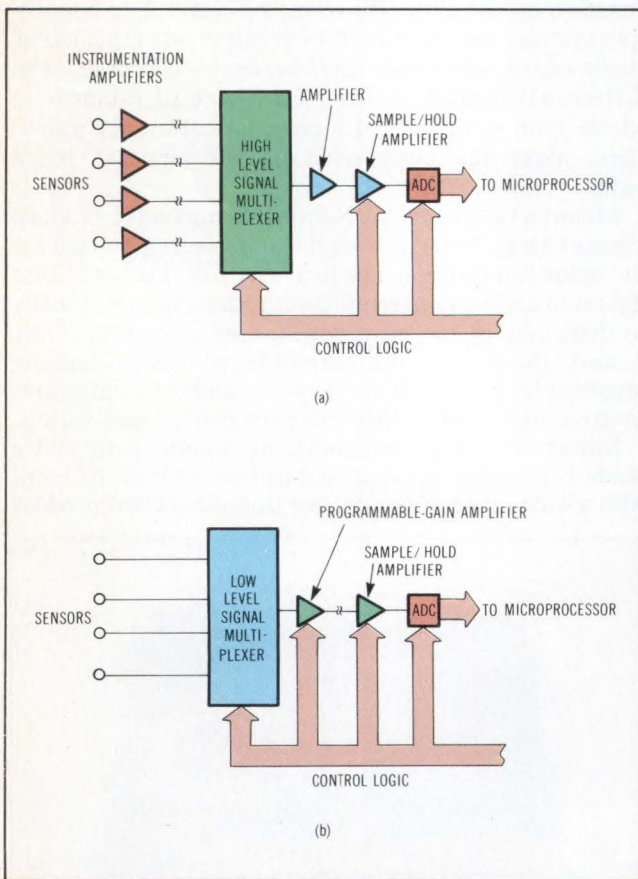

**Fig 2** The availability of inexpensive low level signal multiplexer ICs has reduced the need for a premultiplexer instrumentation amplifier per sensor, the conventional arrangement when using standard high signal level multiplexer ICs (a). Instead, a single programmable-gain amplifier can be placed after the multiplexer to handle several sensors (b).

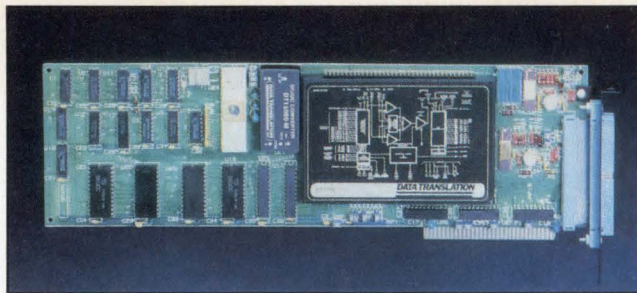

Complete analog and digital I/O functions are available to the IBM Personal Computer via the DT2801 single-board system. This I/O peripheral fits into one of the host computer's expansion slots. Courtesy Data Translation.

### The Multibus takes off

A large number of analog I/O boards and data acquisition components are designed to interface directly to the Multibus, as the latter finds more uses in industrial applications. Increasing popularity of the STD bus and the Multibus has meant an upsurge in the availability of bus dependent I/O boards, as well as optimization for the buses they serve.

Burr-Brown Research Corp (Tucson, Ariz), for example, offers the MP8430 board that can interface with sixteen 3-wire resistance-temperature detectors (RTDs). This board provides all the necessary sensor excitation, signal multiplexing, amplification, and A-D conversion for direct Multibus interfacing.

For the STD bus, Analog Devices offers its RTI-1270 series of intelligent analog input boards. These boards work under the control of a host CPU via the STD bus. Included are preprocessing, signal conditioning, and linearization of input sensor signals, such as those produced by thermocouples, RTDs, strain gauges, and IC temperature sensors. Also included on the boards are ADCs and semiconductor RAMs. The series is made up of the basic RTI-1270 card, which includes the CPU and ADC, and up to four RTI-1271 signal conditioning/multiplexer cards.

Although Intel Corp (Santa Clara, Calif) helped set the *de facto* standard for Multibus analog I/O cards with its iSBC 700 family of Multibus boards, that company is now offering analog I/O capabilities for Multibus systems via the iSBX piggyback connector available on single-board computers. However, many board manufacturers are offering analog I/O boards that not only are plug compatible with the older Intel iSBC 700 family, but also offer higher performance hardware and software features. Analog Devices' RTI-700 family of boards with memory mapped extended addressing over a 24-bit address range is just one of many examples. The boards are direct replacements for the industry standard Intel iSBC 700 Multibus boards, but can also be used in 16-bit computer systems that might require as much as 16M bytes of memory.

### Better I/O architecture

Increases in analog I/O board speed and resolution levels can go only so far before the board's capabilities begin to outstrip the capabilities of the interfaces to the board. As a result, the trend is to diversify board I/O architectures to take advantage of additional hardware and software board advances and to lighten the host CPU's



MAKING THE LEADING EDGE WORK FOR YOU

# Who says SMD Controller design is so r-r-rough? Introducing our new WD1050.

When you make the Wizards of Disk Controllers your design partners, there's no cause to approach any disk interface task with trepidation. Because now, in addition to our industry standard floppy disk controllers and ST500/SA1000 Winchester disk controllers, Western Digital delivers a single chip solution to SMD, CMD, MMD, LMD and FHT interfaces. Oh my!

It's the WD1050, a 64-pin VLSI controller/formatter. That's *one* chip, instead of up to 40MSI devices and a microprocessor. And instead of innumerable nights and weekends of software drudgery.

How powerful is the WD1050? Powerful enough to handle eight high level macro commands, auto format/verify with programmable interleaving, single/multiple record operation, hard sector formatting, CRC checking with external ECC compatibility and a 16-bit direct buffer access interface for disk drive-to-buffer data transfers.

Systems builders already following our Yellow Brick Road of disk controller solutions know that our ongoing LSI innovations soon turn into cost effective board level products for those who prefer "buy" to "build."

Starting today, though, adding the extra capacity and higher performance of SMD compatible drives to your system doesn't take courage. Just the brains to start with our new WD1050.

The next step is yours. Call our Controller Hot Line, (714) 966-7827 for more details. Or write on your letterhead.



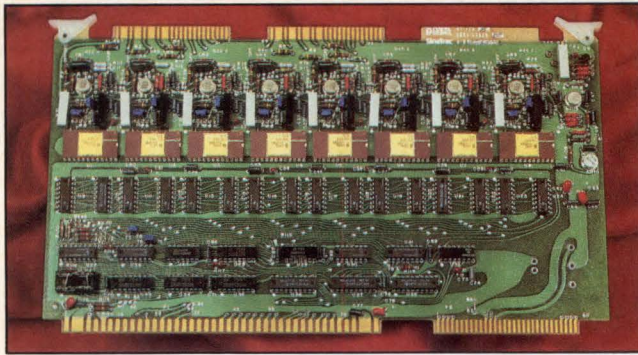

ST-728 industrial Multibus D-A board has eight 4- to 20-mA outputs and mates to 8- or 16-bit CPUs with 12-bit resolution. Courtesy Datal-Intersil.

burden. Many modern analog I/O boards have parallel I/O buses of their own. Many can communicate with one or more host computers over a serial link at high data rates of up to 76k bps.

Instead of simple programmed I/O (PIO) interface architectures that are limited to relatively slow data conversion speeds of 35 kHz or less—requiring a fairly high degree of system hardware and software overhead—the more sophisticated analog I/O boards feature DMA interface architectures and dual-port RAMs. These handle data conversion rates of up to 200 kHz. Such speeds are high enough to minimize the monopolizing of expensive bus and CPU time. Software overhead is less than that of older PIO boards.

Boards with DMA architectures usually have local buffer memories that hold the converted data until they are transferred to a preselected system memory location, thus freeing valuable CPU time. Such boards can be found for a variety of microcomputer buses. However, even DMA architectures are sometimes lacking applications. Thus, more advanced architectures are being examined. This is precisely what Data Translation has done. That company has developed what it calls an Advanced Architecture, offering the control flexibility of PIO architectures and the high speed data capabilities of DMA architectures, but with fewer of either approach's disadvantages. Data Translation is making this architecture available in a family of boards for the LSI-11 bus. The boards can acquire analog inputs and digitize them into semiconductor memory at a 250-kHz rate, and into slower magnetic disk memories at a 100-kHz rate. At such speeds, the LSI-11's host computer, the RT-11 software operating system, and even some Winchester disk drives are being stretched to their performance limits. Thus, it is not surprising that Data Translation also offers pertinent software and Winchester disk drives with its LSI-11 Advanced Architecture boards.

With the Advanced Architecture, only the host computer concentrates on initiating A-D conversion cycles. Individual channel addressing, as input data, is scanned from a list stored onto an onboard RAM. A pair of onboard buffer memories alternately accumulate and transmit converted data in such a way that the data appear to the controlling host computer as a continuous stream.

One problem with the Advanced Architecture boards is that they are less tolerant of delays as the number of

users per board grows. This problem was solved by Data Translation using dual-port architecture. This doubles the effective bandwidth of the host processor bus and eliminates the need for high speed software house-keeping tasks between buffer memories (Fig 3). Available for Data Translation's DT3300 family of LSI-11 analog I/O boards, the architecture allows throughput rates of 250 kHz using the DT3362 dual-port ADC interface and the DT3369 RAM board. Boards with dual-port architectures use a data path external to the host computer bus and a very large buffer memory. This handles multi-user applications and is insensitive to CPU or software latency times.

### Serial communications for low wiring costs

With the increasing capabilities of analog I/O boards and other data acquisition components, the need to keep wiring costs within reasonable bounds is becoming a major issue. In the simplest but also the most expensive case, every remote sensor and transducer would have a dedicated line of wires running to the controlling computer board. This strategy may be acceptable for a few sensors and transducers that are only a few feet apart. When the number of sensors and transducers begins to climb into the dozens, however, and each one may be hundreds if not thousands of feet from the host computer, the wiring costs become astronomical. In addition, there is the difficulty of future expansion to handle additional sensors, and the rat's nest of wiring that can cause mammoth noise problems with low level signals. It is not uncommon to experience costs of \$50,000 to \$60,000 to wire up 20 to 25 sensors, located about 100' apart, directly to a central computer board that may be about 150' from each sensor. Thus, the installation costs of just the wiring and associated conduits can easily exceed one-half the total data acquisition and control system costs.

Fortunately, many analog I/O boards are designed with serial I/O ports. These boards work with remote serial receiver/transmitter modules that dramatically reduce wiring costs (Fig 4). An excellent example is the Remdacs II from Intersil, Inc (Sunnyvale, Calif), which allows hundreds of sensor signals to be transmitted to the host computer on a single piece of twisted pair

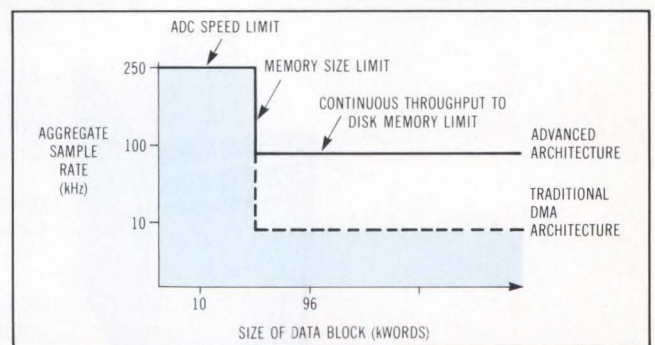
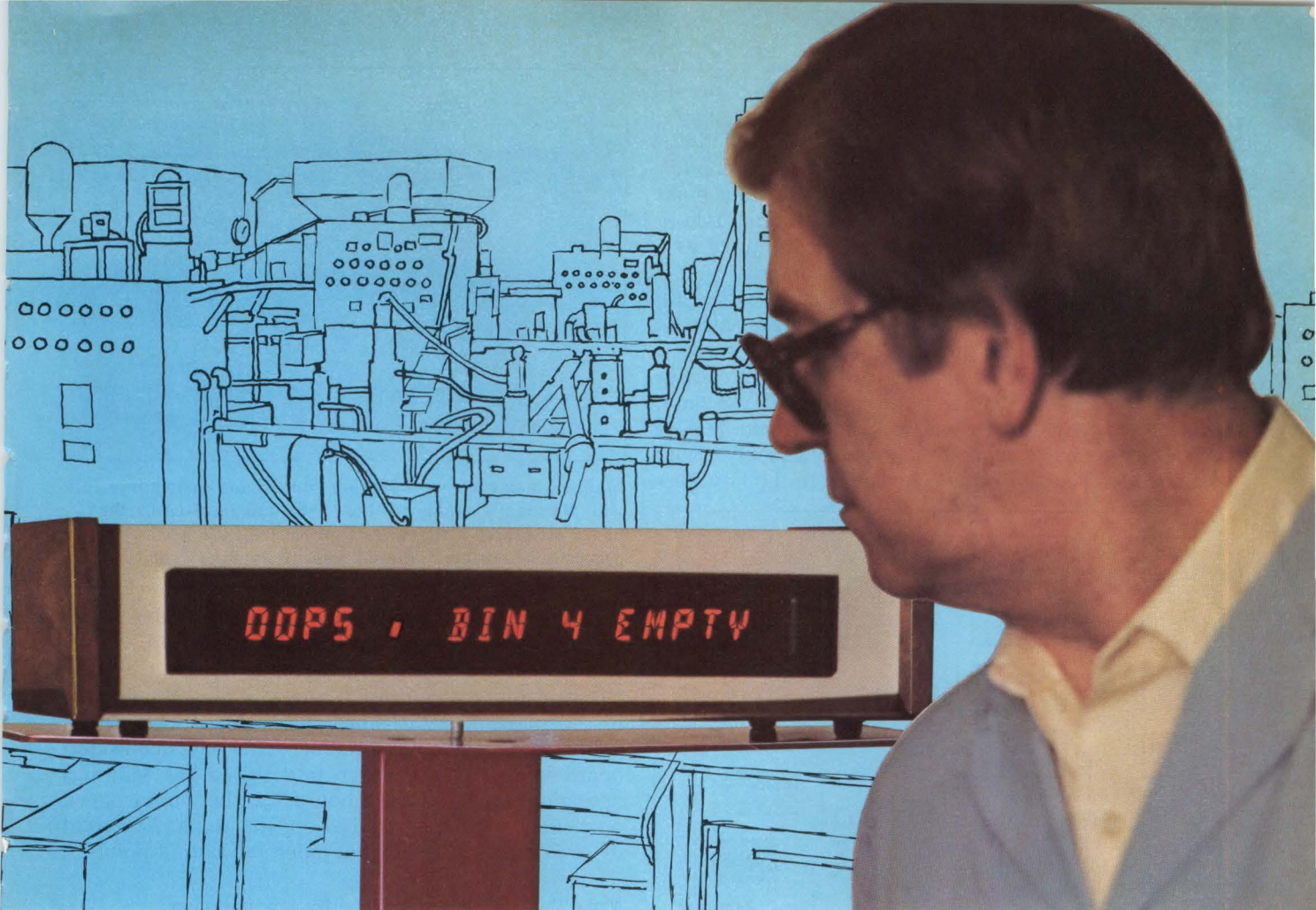

Fig 3 Unlike conventional analog I/O board DMA architectures, which are limited to handling aggregate sampling rates of about 10 kHz, Data Translation's Advanced Architecture and dual-port architecture extend operating limits up to 250 kHz. The result is an unburdening of the host processor, allowing multiple users to share the same processor with no delays.



## Teach your programmable controller to **WRITE**

For less than \$300 you can teach your programmable controller to write. And you don't have to tie up a serial port to display diagnostic or prompting messages. If your PC has TTL output drivers (5VDC) Cherry can teach it to display messages in plain English to instantly inform your equipment operator what has gone wrong or what to do next.

Costs less than \$300 in OEM quantities (vs over \$1,000 for competitive units). Installs in minutes...with just 2 color coded wires: one power and one signal. Display panels 16, 20 or 24 characters. Longer instructions can be

scrolled. Stores up to 64 messages of 32 characters each. Urgent messages can be flashed...bright orange characters get the operator's attention... fast! **Cut down-time to the bone.** No more wasted operator time looking up code numbers or searching for the source of equipment shut-down.

Whichever brand of PC you have, Cherry can economically enhance your productivity. Right now. No waiting. The Cherry Model 1058 is in stock available for immediate delivery.

Give us a call and we'll tell you more ...in plain, simple English.

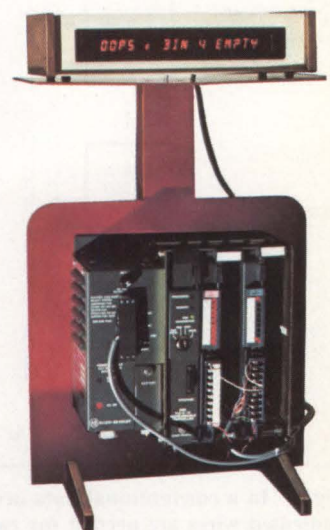

# CHERRY

# DISPLAYS

CHERRY ELECTRICAL PRODUCTS CORP. 3614 Sunset Avenue, Waukegan, IL 60087 • 312/578-3500

wiring. Remdacs provides analog and digital I/O connections for up to 512 separate locations, all multiplexed on the single twisted pair wire. Host computer connection for any sensor can be made at any point along the wire, via a parallel bus, an RS-232 link, or even a modem. Any remote station can be configured as a multichannel analog or digital input or output.

The Remdacs II receiver/transmitter card works with remote station cards under microprocessor control. (The microprocessor is in each remote station card, as well as the receiver/transmitter card). Each processor generates its own command codes, formats the data, and programs its own operation. Each of the remote station cards has a separate address in a highly secure serial code. The address is transmitted to the host pro-

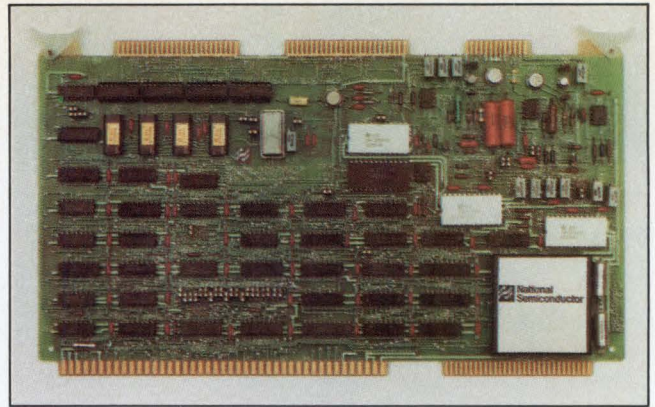

**Mailbox memory eases software control and system interface with National's analog I/O board. Signals received by the board are stored after conversion for later use by the host processor. Courtesy National Semiconductor Corp.**

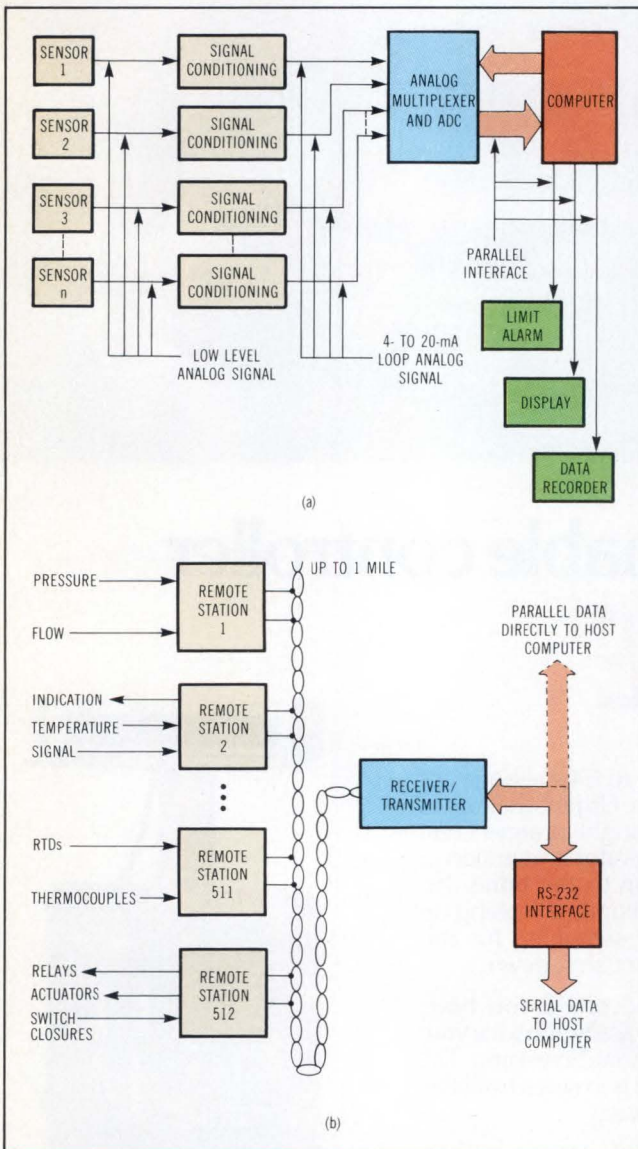

**Fig 4** In a conventional data acquisition system (a), dedicated wires are needed for each analog signal input to a controlling computer, leading to tremendously costly and massive wiring needs, not to mention much rfi/emi influence on system signals. Modular serial receiver/transmitters working with remote station cards (such as those in the Intersil Remdacs system) allow the use of only a single twisted pair wire, greatly reducing wiring costs and complexities and ensuring an rfi/emi-free system (b).

cessor over the twisted pair wire in a half-duplex mode. Because of the party line wiring architecture of the Remdacs II system, the wiring path can be arbitrary, allowing a large degree of flexibility while retaining the low cost advantages of single pair wiring.

Burr-Brown also has a remote serial data acquisition board in its MCS100, which is designed for Multibus operation. Up to 15 such boards can be multiplexed on a single serial communications line to handle a total of 16,320 analog and digital input and output points.

### More flexible and modular software emerging

The move toward fully integrated data acquisition and control systems has brought with it a parallel move to develop simpler and more user oriented software. In fact, demand for good software often exceeds that of hardware for board level data acquisition and control products. Although the use of assembly language programming optimizes a board's performance levels, the user finds it more efficient to program in a high level language like BASIC or FORTRAN. Assembly language programming is cumbersome and not user oriented. Fortunately, modular software packages that allow the user the best of both language worlds are becoming available. Such modules allow the user to employ a high level language to write the applications programs. Languages are then linked, via a linker, to software programs written in assembly language for time critical tasks such as the scanning of input analog channels upon receipt of a command signal from the controlling processor. Thus, the assembly language programs are, in effect, subroutines of the applications programs that are written in a high level language.

Virtually every manufacturer of high performance analog I/O boards offers such flexible and modular software packages in support of its products. Often, it is the software package that defines how flexible and powerful an analog I/O board really is. This is not surprising; many data acquisition and control systems are so complex that far too many parameters need to be controlled. Only the proper software program can make such systems perform optimally under various conditions and applications.

As this trend accelerates, the choice of the right software package, the type of operating system, the kind of



# In the world of emulating terminals... VISUAL is a world apart.



## VISUAL EMULATION CAPABILITY

**VISUAL 50/55 are low cost smart terminals.** The VISUAL 50 emulates DEC VT52®, ADM3A, HAZ Esprit and ADDS Viewpoint. VISUAL 55 emulates the same plus HAZ 1500 and 1510.

**VISUAL 100 is 100% compatible with the DEC VT100®** and also emulates the VT52.

**VISUAL 300/330 are versatile terminals that can be easily customized.** The VISUAL 300 emulates the DEC VT100 and VT52. VISUAL 330 emulates the DEC VT52, ADM3A, HAZ 1500 and Data General D200.

**VISUAL 500/550 are low cost, high resolution graphic terminals with powerful alphanumeric capabilities.** The VISUAL 500 emulates the VT52, ADM3A, HAZ 1500, D200, TEK 4010 and TEK 4014. The VISUAL 550 emulates the VT100, VT52, TEK 4010 and TEK 4014.

All VISUAL terminals feature extended ergonomics including tilt and swivel non-glare 12" or 14" screens, detached keyboard, large character size, menu-style setup, sculptured key caps and more.

VISUAL has earned for itself an exclusive place . . . a solitary niche . . . in the arena of emulating terminals. Four great terminal series offer a combination of advanced features found on no other terminals anywhere in the world. Each series delivers higher performance at lower cost for its particular market segment. And nobody else gives such a wide choice of emulations as VISUAL . . . the pioneer in the field.

So check the chart before you choose your next terminal. See for yourself why VISUAL stands alone as the first choice for emulating terminals.

Service available in principal cities through Sorbus Service, Division of Management Assistance, Inc.

# VISUAL

See for yourself

Visual Technology Incorporated  
540 Main Street, Tewksbury, MA 01876  
Telephone (617) 851-5000. Telex 951-539

language, system memory size, and support peripherals will all become important issues. It will no longer be just what type of microprocessor or multiplexer is on the board. A user attempting to develop software for such complex systems can run very costly debugging problems that can often be nearly impossible to solve.

### Bit and byte protocols contend

Both bit and byte oriented protocols are being used for serial data transmission of sensor and processor information over factory floor local networks. Bit oriented protocols such as the high level data link control (HDLC) protocol are simpler than byte oriented ones. Whereas byte oriented protocols have a control character for each message within a message frame, bit oriented protocols use a single control character at the beginning and end of the message frame (Fig 5). Thus, bit oriented protocols require less complex decoding circuits and are capable of transmitting information faster than byte oriented ones. While there are many analog I/O boards that use bit oriented protocols, fewer are available for byte oriented protocols such as the Samux II system from Opto 22 (Huntington Beach, Calif). That protocol is easier to implement than a bit oriented one (much as a high level language is easier to use than an assembly language, even though the latter is more efficient). In the Samux II system, a host computer interfaces with a processor based board that can address four driver boards. Each driver board, in turn, interfaces with four solid state relay boards, each of which can handle 24 analog or digital points.

Still, bit oriented protocols such as HDLC are gaining momentum in factory networking applications using serial communications links. Other protocols being used include Bisync, synchronous data link control, ASCII, and Packed ASCII. However, HDLC allows an unlimited number of nodes to be networked together due to an accommodating address field that can stretch to any

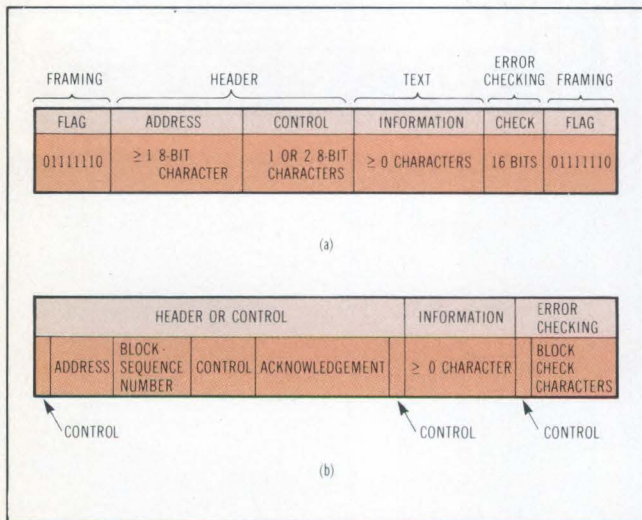
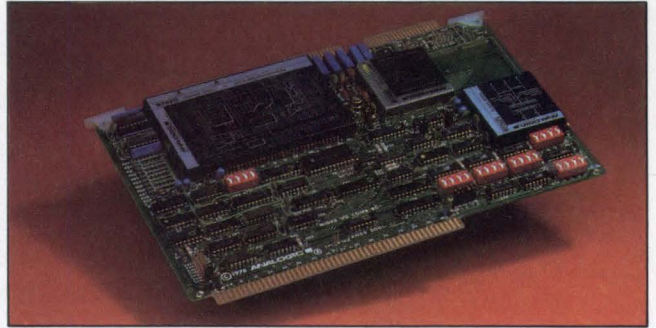

**Fig 5** Bit oriented protocols (a) such as HDLC are rapidly gaining in industrial networking applications in which computers and peripherals communicate with one another. Unlike byte oriented protocols (b), bit oriented protocols are simpler (fewer control characters) and can transmit information faster. Byte oriented ones, on the other hand, are easier to implement.

size. Furthermore, a large number of messages can be sent with HDLC protocols since the HDLC information field can be extended to any length.

### CMOS brings down power consumption

Efficiency in data communication protocols for data acquisition and control systems is being rivaled by efficiency in power consumption. The trend is to use as



**A complete plug-in, 12-bit data acquisition and distribution subsystem for the Texas Instruments TM990 series microcomputer, the ANDS3001 offers up to 32 single-ended or 16 differential input and 2 analog output channels. Courtesy Analogic Corp.**

many CMOS parts as possible. In fact, some analog I/O boards such as those of the Cosmac system from RCA Solid State Div (Somerville, NJ) and the Cimbus family from National Semiconductor Corp are virtually all CMOS boards.

Some firms such as Diversified Technology Inc (Ridgeland, Miss) produce CMOS analog I/O boards with harsh industrial environments (eg, oil rig drilling) in mind. One example is Diversified's CBC8731-2 series of boards for the Multibus. Such boards dissipate a mere 2.5 W and have battery backup operation. The boards have 32 single-ended and 16 differential A-D channels, and 2 D-A output channels. They also include programmable-gain amplifiers, optional programmable offsets, software selectable true rms to dc conversion, user selectable addressing, and provisions for 4- to 20-mA current loop inputs and outputs.

CMOS parts are particularly useful for factory environments since they have high noise immunity, can operate at high temperatures, tolerate wide swings in power supply voltages, and dissipate little power to make them battery operable. In fact, the traditional higher price disadvantage of CMOS ICs compared to conventional N-channel metal oxide semiconductor parts is fast dwindling. Thus, within the next few years, all CMOS data acquisition and control systems may be as common as RS-232 and 4- to 20-mA interface loops are in today's industrial plants.

*Please rate the value of this article to you by circling the appropriate number in the "Editorial Score Box" on the Inquiry Card.*

High 701

Average 702

Low 703

*In photo on p 33, I/O boards are shown in place in a Honeywell TDC 2000 control system. Courtesy Honeywell Process Management Div.*

---

The  
World's Most Elegant  
Microprocessor  
Family is Here. Now.

# NS16000

---

Elegance is everything.

## **No more band-aids to stretch an architecture.**

The NS16000 features a totally new, totally practical architecture—not simply an enhancement of an existing one. With supporting National and third-party software, the NS16000 microprocessor family becomes the first to offer system designers the opportunity to adopt the migration path and performance of a full 32-bit architecture that will endure to the end of the century. That's elegance.

## **No more programming in novel ways for obscure reasons.**

Only the NS16000 microprocessor family's architecture is deliberately based on high level languages, intentionally designed to support their use. The architecture's structure and behavior correspond directly to the objects and operations of HLLs—enabling symmetric use of general-purpose registers, memory locations, expanded addressing modes, data types, and sophisticated instructions. The disadvantages of writing programs in HLLs for microprocessor-based systems have now been elegantly relegated to computer history.

## **No more dead-end segmentation.**

The NS16000 is the first commercial microprocessor to solve the problems of large memory management by using both uniform addressing and Demand Paged Virtual Memory. With this memory strategy—equivalent to that used in the VAX™-11 and all present IBM mainframe computers—each programmer, each program, each task, can simultaneously and independently access a uniform addressing space of 16 megabytes, without reservation or special exception. That's elegance.

Think about it.

## The New Criterion in Software Productivity: The NS16000 Microprocessor Family.

**The pure migration path and the virtuoso performance inherent in the NS16000 microprocessor family are just the beginning.**

The NS16032 CPU, now available, has a 16-bit-wide data path to memory and 32-bit architecture. Other CPUs in the family will feature 8- and 32-bit-wide data paths, but the 32-bit implementation in each ensures that the software you write today will work *without modification* tomorrow, when you upgrade from one CPU to the next.

Evaluating performance: a 32-bit integer multiply on the NS16032 CPU takes only 8.3 $\mu$ s at 10MHz.

**The architecture of the NS16000 family is based on the roots of all the most powerful high level languages—to fully support the use of HLLs.**

Programmers have long asked for a microprocessor designed with the software in mind. The regularity of the architecture for which code is being generated significantly affects its quality: the more regular the architecture, the simpler it is to produce lean, fast code. And, of course, designers and programmers write programs more quickly in high level languages.

The CPUs in the NS16000 family provide a high degree of regularity in the arrangement and use of their 32-bit registers. Data can be read or written 1, 8, 16, or 32 bits at a time, as a sophisticated program requires. Transfers from one register to another are not restricted: no special conditions inhibit a programmer's creativity.

The virtuosity of the NS16000 instruction set is clear. It includes over 100 basic instruction types, chosen on the basis of the use and frequency of specific instructions in various applications. Special-case instructions, which compilers cannot use, have been avoided.

The instruction set is also symmetrical: instructions can be used with any addressing mode, any operand length (byte, word, and double-word), and can use any general-purpose register. Instructions are *genuine* two-operand instructions as well.

These factors, combined with the regularity of the NS16000's architecture, mean that programs require significantly less code—greater code density, in fact, than the VAX-11. The simplicity by which it now becomes possible to implement a compiler, for example, is matched only by the increased speed of its execution.

**The NS16000 family provides the largest number of different addressing modes ever included in a microprocessor.**

Elegant programming demands that instructions be as powerful as possible, and that the range of addresses be as large as possible. So to be effective, a powerful instruction set must be accompanied by a powerful set of modes of referring to data in registers and memory.

The NS16000 architecture supports not only the standard addressing modes common to most processors (*register*, *immediate*, *absolute*, and *register relative*, for example), it also introduces HLL-oriented modes unique to microprocessors:

1. Top-of-stack (a simple, very powerful mode used to evaluate arithmetic expression in HLL);
2. Scaled Indexing (used to access elements in byte, word, double-word, or quad-word arrays);
3. Memory Relative (used for manipulating fields in a record); and,
4. External (used to access data in separately compiled modules.

Moreover, there are no restrictions on the use of these addressing modes—an instruction that operates on data of a particular kind can use any of the addressing modes that refer to that data.

**With an architecture that supports uniform addressing, the NS16000's Demand Paged Virtual Memory strategy makes a gigantic memory possible at a minimum cost.**

The NS16082 Memory Management Unit (MMU), provides dynamic address translation, virtual memory management, memory protection, and both hardware and software debugging support. Customers now sampling this MMU are impressed with its raw power.

The NS16082 breaks the logical address space into 32,768 pages, each with a fixed size of 512 bytes. Which specific 512-byte pages of a program or data are actually in *real* memory is a function of the most recent demands of the program itself.

This Demand Paged Virtual Memory operates automatically, and gives an applications programmer complete freedom from any consideration of memory size or allocation strategy. Since the operating system places part of the user's programs and data in peripheral storage and brings them into real memory only as needed, the user may regard the combination of real and peripheral storage as a single, large memory, and can write large programs without worrying about the physical memory limitations of the system.

The power of Demand Paged Virtual Memory allows any number of separate and independent programs or tasks to execute cooperatively and efficiently in a substantially smaller (real) memory configuration than needed by a microprocessor using a *segmented* memory management scheme.

And, because it does not limit data base growth, Demand Paged Virtual Memory provides for continuing future data expansion.

**Floating point is just one of the nine data types that the NS16000 architecture directly supports.**

The NS16081 Floating Point Unit (FPU) offers very high-speed floating-point operations for both single- and double-precision operands. A 32-bit floating-point multiply, for instance, takes place in 4.8  $\mu$ s at 10MHz.

Designing the NS16081 into a system will allow programmers to treat floating-point numbers as any other data types, and any of the addressing modes may be used to reference them. Customers now sampling this FPU are amazed at its performance.

The optional use of the FPU and MMU Slave processors—integral parts of the NS16000's architecture—gives the systems designer the ability to determine a price/performance trade-off while preserving all the initial software investment.

**Evaluation tools are available now.**

The DB16000 evaluation board is a complete microcomputer system. It carries the NS16032 CPU, the NS16201 Timing Control Unit, sockets for the MMU, FPU, and ICU (Interrupt Control Unit), 32K bytes of on-board RAM, a wide range of both standard and optional I/O interface devices, and a monitor program in PROM. To allow interfacing with a variety of computer systems, a complete pin-out of CPU addresses and functions for data and control are also included. Two BLX connectors enable functional enhancements.

A component evaluation kit (the NS160KIT) is also available, with complete documentation for each part.

**The first products in a line of development tools—the NSX-16,<sup>™</sup> with a PASCAL compiler, and the ISE/16<sup>™</sup>—are available now.**

The NSX-16 software development package allows quick and easy compiling or assembly of NS16000 programs on the VAX-11, using the VMS<sup>™</sup> operating system. The package includes a PASCAL compiler, assembler, linker, librarian, symbolic debugger, and other utilities. Once compiled, programs can be down-loaded through

a serial data link to the DB16000 for execution. (A NSX-16 hosted on RSX<sup>™</sup>-11M, and a C cross-compiler for VAX will be available by mid-year. Before the end of this year, a full NS16032-based development system, with a UNIX<sup>®</sup> operating system and a choice of either a C or PASCAL compiler, will also be available.)

The ISE/16 In-System Emulator—the first in a series—is available to ease integration of user software with NS16000 hardware. It runs with the NSX-16 software development package, and allows real-time emulation of the NS16032 CPU, the NS16201 Timing Control Unit, and the NS16082 Memory Management Unit.

**The availability of third-party software for the NS16000 family is growing day by day.**

Suppliers are now working on operating systems (UNIX, for example), language compilers (such as PASCAL, C, and COBOL), and software for program development (among them, on CP/M<sup>®</sup>).

**Training classes are in progress now.**

Courses lasting from two to five days—held either at the Microprocessor Systems Division Training Center, or on-site—cover “The NS16000 Architecture,” “NSX-16 Software Development Support on Starplex II<sup>™</sup> or VAX,” and “ISE/16.”

**Now you have every reason to explore elegant applications using the NS16000 microprocessor family—from personal computers, to graphics systems, to process control.**

# NS16000

Elegance is everything.

## Talk with us.

Please call the National sales representative nearest you for more information, and the answers to your questions. Or, circle the number below.

## See it.

The NS16000 microprocessor family will be on exhibition at Electro '83 (look for booth number 4312), and NCC (look for booth number D-2022).

## Read about it.

Introduction  
to the NS16000  
Architecture

# SINGLE-BOARD COMPUTERS MASTER INDUSTRIAL APPLICATIONS

---

**Hardware and software  
features as well as  
packaging innovations are  
combining to adapt  
single-board computers to  
the factory environment.**

---

**by Rick Nelson, Contributing Editor**

---

**A**s the automation and control industries catch up with the computer revolution, single-board computers are finding use in a wide range of factory environments. To spur the encroachment of these microcomputers into territory once dominated by analog control circuitry and electromagnetic relays, manufacturers are providing the needed hardware, software, and packaging features to adapt their computers to industrial applications.

Although these features greatly enhance the products' performance, they also can complicate the designer's task if faced with incorporating computer intelligence into industrial original equipment manufacturer equipment. Judging by the many industries that have already benefited from computer technology, the designer will have to select one or more single-board computer and design it into an industrial control system.

A pioneer in furnishing computer control for industrial applications, Xycom (Saline, Mich) has been designing and installing such single-board computers for some time. Its 180+ industrial computer line, which meets such stringent factory environment specifications as a 65 °C operating temperature range, has been used in applications ranging from transportation to lumber processing. For instance, the firm's microcomputer controlled data communications products serve in a train-location monitoring system manufactured by HSQ Technology (South San Francisco, Calif). Operators use the system outputs to control San Francisco's underground mass transit cars. In the lumber industry's Pope and Talbot sawmill in Port Gamble, Wash, Xycom 280 series industrial microcomputers are used in a system that monitors log shape and controls saw operation in a way that minimizes board production waste.

Further illustrating the range of industrial computer applications, Xycom's products are also used in a distribution warehouse order selection system manufactured by Rapistan (Grand Rapids, Mich) and in a programmable filament winder manufactured by McClean Anderson (Milwaukee, Wis). Rapistan's system uses computer storage of order information and computer



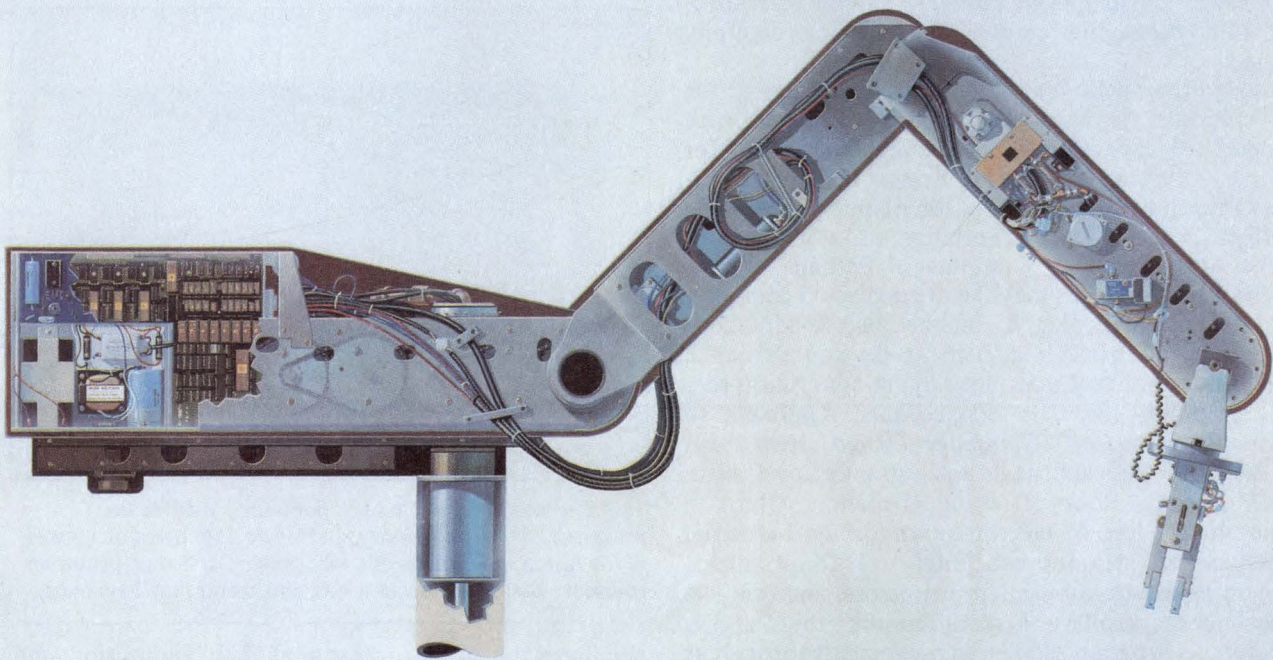

controlled conveyer tracking. It displays desired quantities to an operator working at a specific merchandise storage location when a conveyer-carried container reaches that location, thus minimizing paperwork and operator errors. The filament winder allows an operator to program desired winding parameters; machine setups can be stored on cassette.

Computers are also serving energy-producing industries. Inconix (formerly Control Logic) of Natick, Mass has found its Cinch Pac intelligent automation controllers used on board oil tankers and in coal-gasification control. Based on the Intel 8051 micro-computer, these controllers offer 32 digital and 16 analog input data points with 14-bit analog to digital (A-D) accuracy. Wintek (Lafayette, Ind) reports that its 6800 microprocessor based single-board computers and control systems are used in robot control, engine testing, satellite communication, grain drying, artificial limb control, and brain wave analysis.

Yet another application promises to spread the use of computers throughout virtually all industries. Driven by energy shortages, Pacific Gas and Electric is instituting a group-load-curtailement plan that involves monitoring load conditions and signaling users to disconnect noncritical loads during peak demand situations; the program covers commercial and industrial users in downtown San Francisco. HSQ Technology's group-load-curtailement system, built around two PDP-11/24s from Digital Equipment Corp (Maynard, Mass), uses Xycom Z80A based model 1861A intelligent serial communications modules to scan load data and transmit load-shedding requests.

#### **Selection is difficult**

Unfortunately, the task of finding the optimum product for a particular system is complicated. There are often no right or wrong single-board computer choices for a specific industrial control task. The very flexibility that

makes microprocessor technology attractive in industrial applications implies that almost any microcomputer board can be adapted to almost any application.

Industrial applications, which typically involve real-time environments, are generally best served by computers that excel in input/output (I/O) capability and interrupt handling. Data processing applications, typically memory intensive, require processors that are able to handle memory management chores. Because many processors perform well in all these areas, the selection procedure cannot rule out manufacturers who do not specifically tout in product literature their computers' industrial control suitability. Subtle trade-offs involving cost, power consumption, software support, architecture, and packaging constraints must be carefully weighed.

Moreover, a single-board computer might not be the best solution; perhaps, a desktop computer with extended I/O capability would serve better. (See, for example, "Analog I/O Board Brings Personal Computers into the Plant," pp 101-106 of this issue, which describes the use of Data Translation's DT2801 I/O board in the IBM Personal Computer.) Perhaps, multi-processor requirements may dictate dedicated computer board design, a step taken by International Robomation/Intelligence (Carlsbad, Calif) in its development of a standalone robot that does not require connection to a host computer. (See "A Single-Board Approach to Robotic Intelligence," *Computer Design*, Nov 1982, pp 193 - 201). This approach was also taken by Cincinnati Milacron's Robot Division (Lebanon, Ohio) in developing its line of electric-motor driven industrial robots, which includes two Intel 8086 16-bit microprocessors, six 8085 8-bit microprocessors, and one 8048 8-bit microcontroller, a combination that allows operators to program sequential movements through as many as 3000 points in 3-dimensional space (see *Solutions*, Nov/Dec 1982, Intel Corp, p 2).

For most applications, however, the low cost and compact size compared with desktop units, and the design simplicity compared with developing special boards, make single-board computers the best choice. Although not a comprehensive listing, the single-board

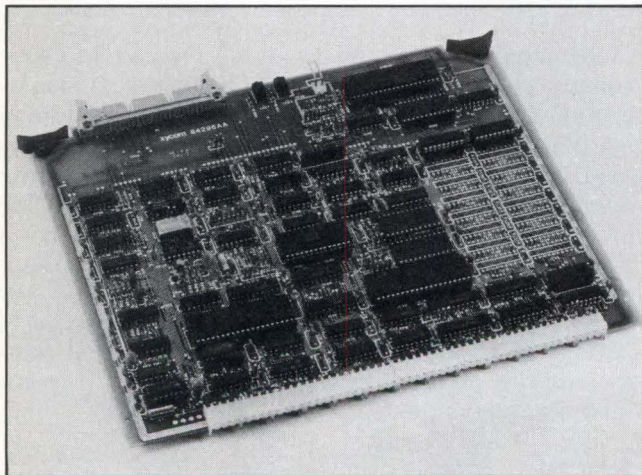

Xycom's model 1860+ contains a Zilog Z80A processor and operates in a 0 to 65 °C ambient temperature range to suit industrial applications.

computers discussed here represent available performance levels and feature combinations. A knowledge of their capabilities provides a solid background for informed evaluation of competitive models.

### Architectural considerations

When selecting a single-board computer, the designer will likely consider architecture first; the right choice in this area can reduce the system's total board count and, thus, its size and cost. For example, selecting a single-board computer with onboard data converters, random access memory (RAM), and programmable read only memory (PROM) for systems requiring such features can

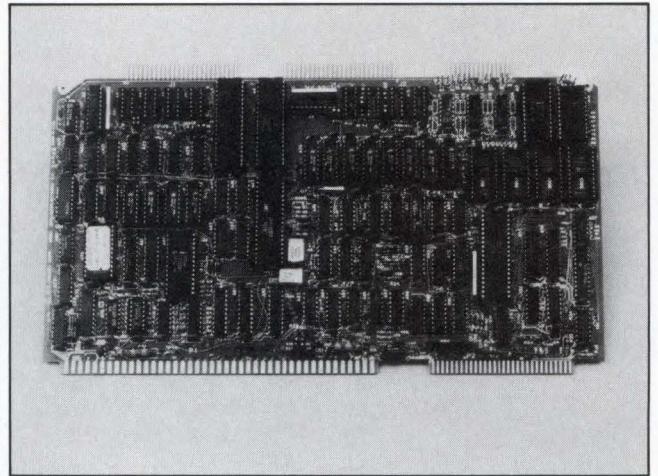

This CPU board from Comark contains a 5-MHz 8085A processor, 4K bytes of RAM, and up to 16K bytes of EPROM. It fits into a manufacturer's oil-, water-, and dust-protected enclosure that also houses a CRT and membrane keyboard.

eliminate the need for external data acquisition and memory boards. But, in addition to finding a board with most of the needed onboard functions, the designer will also want to be sure that the board can mate with a standard bus in order to readily suit system expansion.

An example of a board with these capabilities is the iSBC 88/40 from Intel Corp (Hillsboro, Ore). Aimed at process control and data acquisition applications, this 12" x 6.75" (30- x 17.15-cm) board can monitor 16 differential or 32 single-ended analog input signals and has 24-channel digital I/O capability. Using a proportional, integral, derivative algorithm, it can concurrently process and update 16 control loops in less than 200 ms.

The board is compatible with Intel's Multibus to allow it to work with memory expansion or mass storage controller boards; the Multibus capability allows it to serve as a master, slave, or standalone processor, depending on the application. Moreover, the board has an internal bus that permits communication among the onboard devices. Those devices include an iAPX 88/10 processor, a 12-bit A-D converter, an 8253 programmable interval timer (which contains three independent 16-bit counters), and PROMs that users can plug into the board's four 28-pin sockets. The sockets accept 2732 or 2764 devices, thus permitting up to 32K bytes of onboard firmware; for nonvolatile data storage, they also accept Intel 2816 electrically erasable PROMs (EEPROMs).

An onboard dc/dc converter operating under program control furnishes the necessary 21-V, 10-ms wide

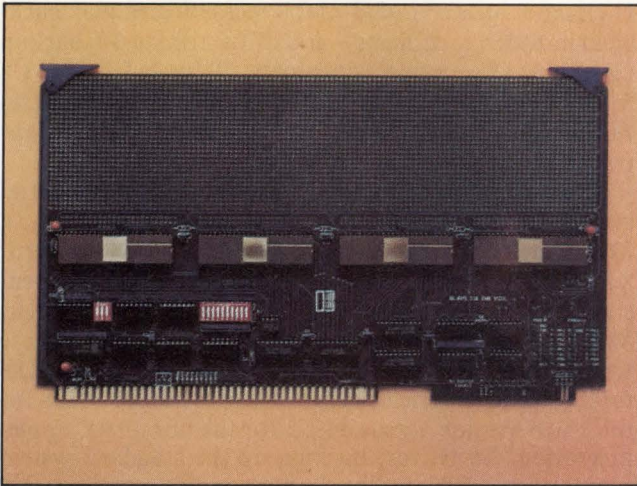

To facilitate the design of systems based on its manufacturer's line of single-board computers, this expander board from Omnibyte includes 35 in<sup>2</sup> of prototyping area and four 24-bit programmable timers.

EEPROM programming pulse, thus allowing dynamic alteration of control loop setpoints. A 1K-byte dual-port RAM is accessible via either the Multibus or the internal bus; an additional 3K bytes of RAM (called private RAM) are accessible only via the internal bus.

In addition to its Multibus expansion capabilities, the iSBC 88/40 can be expanded via three onboard iSBX Multimodule connectors. Multimodule options include a numeric data processor that handles floating point arithmetic, an additional 4K bytes of private RAM, and four more 28-pin PROM sockets.

Since interrupt capability is important in industrial applications, the iSBC 88/40 handles nine vectored interrupt levels. The highest level is nonmaskable; an onboard 8259A programmable interrupt controller provides vectoring for the other levels. Interrupt priorities are software programmable by storing a single byte in the 8259A's interrupt mask register. Interrupts can be furnished over the Multibus or the Multimodule connectors or by the onboard timers. To enable the system to deal with fluctuating power conditions common in some industrial and process control environments, the iSBC 88/40 includes power failure control logic that can accept an ac-low interrupt signal from an Intel iCS 645 power supply.

Many other manufacturers have also chosen the Multibus concept for their single-board computers. Among them are Digital Microsystems Inc (Oakland, Calif) with its Z80 based DSC-4, and Central Data Corp (Mountain View, Calif) with a Z8000 microprocessor based board. (Digital Microsystems' DSC-3, however, uses a proprietary bus.) Also, Zendex Corp (Dublin, Calif) offers the ZX86 microcomputer board, which uses an 8086-2 microprocessor and offers a choice of 5-, 8-, or 10-MHz clock frequencies.

In Canada, Matrox Electronic Systems, Ltd (Montreal, Quebec) has the Z80A based ZBC-80 and the MBC-86/12, both Multibus compatible. The latter uses an 8086 microprocessor and includes 128K bytes of dual-ported RAM and 32K bytes of ROM/EPROM. It is fully

software compatible with, and essentially an enhanced version of, Intel's iSBC-86/12 microcomputer.

Of course, other architectures are used by many manufacturers. For instance, Rockwell International's Electronic Devices Div (Anaheim, Calif) has the AIM 65/40 family of board-level devices. The series 1000 version in this family features system address expansion up to 131K bytes, with up to 65K bytes of onboard memory (up to 48K bytes RAM and up to 32K bytes of ROM or EPROM). I/O capability provides an RS-232-C asynchronous interface with programmable data rates up to 19,200 bps plus a 20-mA current loop interface. Software compatibility to this family is also maintained on the model 6500 from Cubit Inc (Mountain View, Calif). This 4.5" x 6.5" (11.4- x 16.5-cm) board has up to 4K bytes of onboard RAM and 2K to 20K bytes of ROM, with 72 parallel I/O lines.

Still another company, Forward Technology Inc (Santa Clara, Calif), uses a 68000 microprocessor. Its FT-68M has 128K to 256K bytes of RAM and 8K to 32K bytes of ROM. The basic version has a 16-MHz clock, while a second model has a 19.66-MHz clock.

#### Multibus CMOS computers

For the designer who wants the noise immunity and low power consumption advantages of complementary metal oxide semiconductor (CMOS) but also wants to take advantage of the multivendor support enjoyed by Multibus, the single-board computers and peripherals from Diversified Technology Inc (Ridgeland, Miss) are claimed to be the only CMOS boards for the Multibus. These computer boards are based on the NSC800 CMOS microprocessor manufactured by National Semiconductor (Santa Clara, Calif). The device uses the Zilog (Cupertino, Calif) Z80 microprocessor architecture and instruction set but dissipates only 5% of the power required by the Z80. Onboard timers stop the processor during idle periods and restart it when necessary, thus saving additional power when the processor is not in use by eliminating the switching losses inherent in CMOS chips when they are clocked.

Use of the NSC800 allows Diversified Technology's CBC 800 series computers to typically draw only 110 mA at 5 V and 5.6 mA at  $\pm 12$  V. The boards accept 4K, 8K,

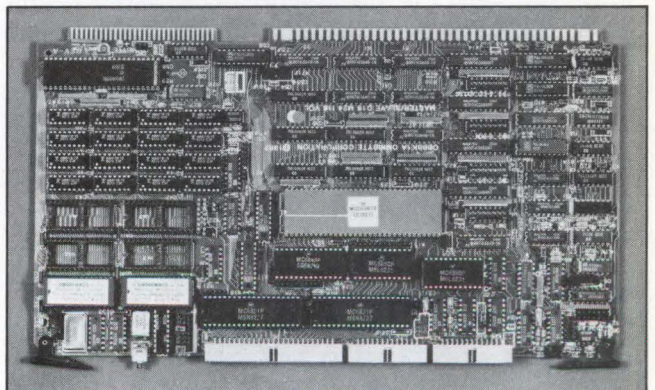

Based on Motorola's 68000 microprocessor, Omnibyte's Multibus compatible model OB68K1A has 32K or 128K bytes of dual-ported RAM and can accept 96K bytes of EPROM.

or 16K bytes of static CMOS RAM and up to 32K bytes of ROM or PROM. Other features include 44 programmable I/O lines with sockets for interchangeable line drivers and terminators, an asynchronous communications interface with RS-232-C drivers and receivers, 12 levels of prioritized vectored interrupts (11 are maskable), 4 general purpose programmable timer/counters, and a program controlled processor sleep/wake-up mode. Multibus interfacing signals are CMOS compatible on standard boards; transistor-transistor logic compatibility is optional.

Diversified Technology peripheral boards, all Multi-bus compatible with the CBC 800 computers, include a

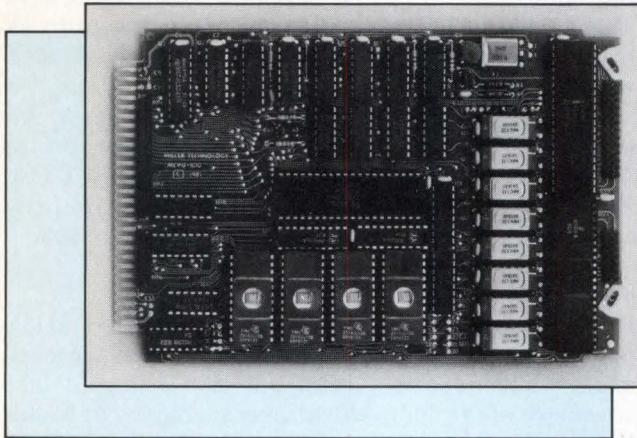

Miller Technology's model MCPU-800 includes a 4-MHz Z80 processor and can interface to the STD bus.

line of analog I/O boards, RAM expansion boards, and a floppy disk controller. The CBC 8730 analog I/O boards use CMOS devices and typically dissipate only 1.2 W. They handle as many as 32 single-ended or 16 differential input channels with 12-bit integrating CMOS A-D converters and can furnish two analog outputs via two 12-bit CMOS digital to analog converters. Optional features include true root mean square to dc conversion. The CBC 256 series memory expansion boards furnish 16K to 256K bytes of RAM; 256K-byte versions dissipate only 250 mW and include onboard NiCd batteries for 3000-h backup. Lithium batteries furnish up to six years of backup. Series CBC 8100 memory I/O expansion boards accept up to 64K bytes of mixed RAM and EPROM and feature 22 programmable I/O lines, 2 asynchronous communications interfaces, 10 interrupt request lines, and 2 general purpose counter/timers. Finally, the CBC 8204 disk controller board handles most Shugart compatible single- and double-density drives and controls as many as four standard (8") or minifloppy (5 1/4") drives.

#### CMOS simplifies packaging

The low power consumption of CMOS computers can significantly simplify system packaging, a major consideration in designing computers into industrial products. Moreover, CMOS can ease system power supply design. To demonstrate CMOS's benefits in both these areas, Diversified Technology conducted a study to determine the cost of packaging systems—implemented in

N-channel MOS TTL and CMOS technologies and packaged in NEMA 12 cabinets—and of furnishing 6-h backup capability. The NEMA 12 cabinets, 20" x 24" x 6" (51 x 61 x 15 cm), are designated by the National Electrical Manufacturers' Association as sealed, dust-tight enclosures.

The system used for the comparison is an industrial remote terminal unit composed of a CPU card, a 32K-byte RAM card, and a 12-bit analog I/O card. Although the CMOS computer hardware is more expensive than the standard implementation (\$3473 versus \$2655, respectively), the latter results in a 38 °C case temperature rise and thus requires a heat pump. The total price of the enclosed systems is therefore \$3528 for the CMOS version versus \$4065 for the non-CMOS implementation. Moreover, backing up the standard system requires use of an ac line uninterruptible power supply (UPS) system; the CMOS system needs only a dc UPS unit, resulting in a \$3836 CMOS system price versus \$5485 for the standard implementation.

Though incorporating CMOS based boards into sealed enclosures might be the most elegant solution to the packaging constraints often imposed by harsh industrial environments, other options are available. For example, Comark (Waltham, Mass) offers its MB 85 I Multibus compatible industrial computer, which incorporates that firm's MC 85 single-board computer, an 8-slot Multibus card cage, 80- x 24-character video display (with reverse video, blink, and underline attributes), and an ASCII coded membrane keyboard or hexadecimal keypad in an oil-, water-, and dust-protected enclosure.

A heat exchanger can dissipate more than 200 W to keep internal temperature at an acceptable level. A temperature signal that can be configured as a processor interrupt indicates when case temperature reaches 115 °F (46 °C); a second thermostat cuts system power if case temperature exceeds 125 °F (51.7 °C). The unit's standard configuration is free standing (on rubber feet); options include provision for 19" (48-cm) rack mounting, wall mounting, and hanging from an overhead structure.

The MC 85 computer includes an 8085A 5-MHz CPU, 48 programmable I/O ports, 4K bytes of RAM, up to 16K bytes of EPROM, 12 vectored interrupts, 3 programmable timers, a ROM based monitor program, and dual-ported memory-mapped display RAM. The MB 85 I system's mean time to repair is 10 min; mean time between failures is 12,500 h. Options include a 5 1/4" floppy disk drive; 64K bytes of dynamic RAM; 16K or 32K bytes of non-CMOS static RAM; 8K, 16K, or 32K bytes of CMOS static RAM; battery backup; a column printer; and communications and data conversion boards.

National Semiconductor uses its CMOS NSC800 8-bit microprocessor in its Series/800 microcomputers. Designed on 3.9" x 6.3" (9.9- x 16.0-cm) Eurocard format boards, the microcomputers use the Z80 instruction set and handle 158 instructions. Onset Computer Corp (formerly Synapse) of North Falmouth, Mass also bases its CMOS CPU-800 on the NSC800 microprocessor. This board executes the Z80 instruction set and has 1K bytes of RAM with 22 I/O lines. The company's CMOS CPU-6805

# MPA-2000 Intelligent I/O Controller Your Key to Multibus\* Modularity

## Serial I/O

- ASYNC/BISYNC
- SDLC/HDLC
- X.25

## Disk I/O

- SASI Interface
- Winchester Disk
- Floppy Disk

## Parallel I/O

- Bus-to-Bus  
Intelligent Link
- Data Acquisition

## Local Area Network

## As Versatile As Your Imagination

Imagine, a single MULTIBUS board that can measure up to your most demanding requirements, now and in the future! The MPA-2000 packs more plug-in versatility in a SINGLE CARDSLOT, for applications as diverse as data communications, disk, inter-bus link or single board computers. In fact, the possibilities offered by the unique modularity of the MPA-2000 are limited only by your imagination. And since it is from METACOMP, the MPA-2000 means high performance . . .

- ON-BOARD 8 MHz. iAPX-186 CPU WITH:
  - Full 16M address, Multimaster capability
  - 64K EPROM
  - 128K RAM with parity (64K can be dual-ported)
  - i80130 OSF (iRMX-86\* kernel)
  - Flexible interrupt structure
  - Serial I/O Monitor/Debug Port
- EIGHT PROGRAMMABLE DMA CHANNELS
- LOW PROFILE PLUG-IN MODULES
  - Field interchangeable
  - Modules for Serial I/O, Disk, Parallel I/O
  - Custom modules easily designed
  - Serviced by DMA channels
  - Can be configured as iSBX\* module sites
- STANDARD MULTIBUS INTERFACE
  - Single unit load
  - Single cardslot height (even with plug-in modules)
- UNIQUE MetaPaket™ ARCHITECTURE
  - High speed hardware/firmware technique allows message transfer between intelligent devices
  - Shared memory not required



METACOMP, INC.  
7290 Engineer Rd., Suite F • San Diego, CA 92111  
(619) 571-1168 • TWX: 910-335-1736 METACOMP SDG

offers eight digital I/O lines and eight analog inputs and is based on the 146805E2 microprocessor.

### Software considerations

The product discussions thus far have concentrated on architecture, packaging, and power consumption. Equally important is available product software support. Many of these products can run both standard software, such as the CP/M 2.2 operating system, and languages such as Forth that are suited to industrial applications.

Diversified Technology's CBC 800 single-board computers, for example, run both CP/M and Forth 79. CP/M permits access to a variety of prepackaged software, and Forth, originally written for realtime process control applications, allows the computers to achieve necessary operating speeds by conveniently including assembly language routines for time critical operations. (See "Call Forth for Realtime Control Programming," pp 81-84 of this issue, for Texas Instruments' discussion of this subject.)

CBC 800 computers also run Diversified Technology's IOS-4 operating system, which supports both Forth and a macro assembler, thereby allowing users to conveniently develop programs optimized for runtime performance. Compile and assembly are completed on a line by line basis to facilitate interactive debugging. Furnishing an alternative to an expensive development system, IOS-4 permits compacted object code to be compiled to a disk in suitable form for transmission to PROM programmers using a ROM compiler.

Although languages such as Forth specifically suit industrial process control tasks, standard languages are often used in industrial applications. Xycom, for example, offers its 1872+ industrial BASIC module, which consists of a CMOS memory module with an industrial BASIC interpreter in EPROM and 14K bytes of user memory.

To support process control applications, Xycom's industrial BASIC, which runs on that firm's Z80 based 180+ series microcomputer boards, includes several enhancements to standard BASIC. For instance, the

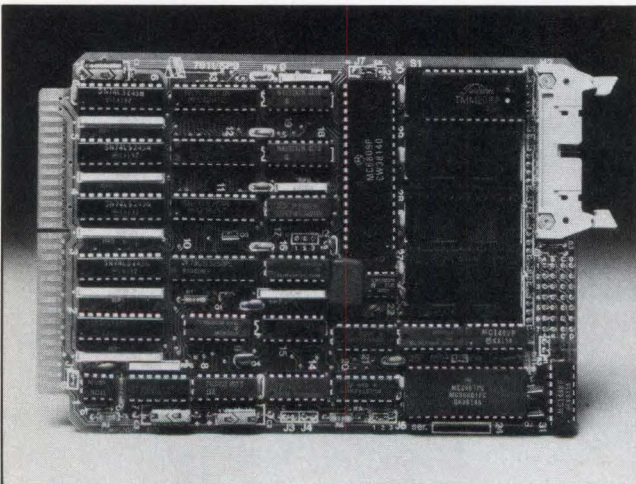

Matrix Corp's model 7911/SP9 single-board computer is based on Motorola's 6809 microprocessor and is STD bus compatible.

industrial BASIC permits data transfer to and from time of day and analog and digital I/O modules. Furthermore, an industrial BASIC program can include as many as 10 assembly language routines to speed program execution. In addition, industrial BASIC permits creation of user defined functions, and subroutine nesting is limited only by available stack space. The language permits four types of maskable interrupts: absolute time of week, backplane, keyboard, and periodic. Interrupt occurrence causes program execution to branch to a specific interrupt service routine; after interrupt servicing, control automatically returns to the main program.

Other single-board computer software support comes from firms such as Monolithic Systems Corp (Englewood, Colo) which offers its MSOS (monolithic systems operating system), a PROM-resident operating system for the company's line of Multibus compatible Z80A based single-board computers. The PROM residence combines with a proprietary file structure to ensure program security. MSOS subroutines are readily accessible to user application programs. The operating system simplifies user access to character oriented and file oriented devices and places no limit on the number of I/O handlers it can contain. In addition to MSOS, the manufacturer offers versions of CP/M and MP/M operating systems. Typical features of the Monolithic Systems single-board computers include 64K bytes of dynamic or 8K bytes of static RAM, provision for 32K bytes of EPROM, as many as 48 programmable parallel I/O lines, and an 8-level vectored priority interrupt structure.

While Xycom, Diversified Technology, and Monolithic Systems furnish their own operating system or high level language versions, some single-board computer manufacturers rely, at least to some extent, on outside software suppliers. Omnibyte (West Chicago, Ill), for example, uses software suppliers such as Forth, Inc (Hermosa Beach, Calif), Industrial Programming, Inc (Jericho, NY), and Hunter & Ready (Palo Alto, Calif) to support its products. These products include the OB6000 and the 16-bit OB68K1A Multibus compatible single-board computers, the first based on the 6808 and the other on the 68000 microprocessors, both from Motorola Semiconductor Products (Austin, Tex). The OB6000 includes 10 interrupt levels (9 maskable), 9K bytes of static RAM (expandable to 15K bytes), up to 16K bytes of EPROM, and three 16-bit counter/timers. Three MC6821 peripheral interface adapters furnish 60 bits of binary I/O. The OB68K1A features 32K or 128K bytes of dual-ported RAM, direct addressing to 16M bytes, up to 96K bytes of EPROM, two RS-232 ports, two 16-bit parallel ports, and one 16-bit triple counter/timer. Software support for Omnibyte products includes Forth's 16-bit polyForth (available in ROM for single-board computer applications), Industrial Programming's MTOS-68KF, and Hunter & Ready's VRTX/68000.

MTOS-68KF, a realtime multi-user/multitasking/multiprocessor operating system on a chip, resides in 16K bytes of EPROM. It accommodates 2048 tasks and includes a priority scheduling algorithm that allows users to assign dynamically modifiable priorities ranging from 0 through 255. Other features include

# THE NEW CHROMATICS CT4200



**WITH OUR 2 YEAR GUARANTEE**

**\$3995**

## **NOBODY ELSE DELIVERS SO MUCH RELIABILITY FOR SO LITTLE MONEY.**

- Best price/performance color terminal on the market.
- 512 x 512 x 4 Bitmap image, 512 x 384 viewable.
- No flicker 60 Hz refresh rate.
- 85 characters by 48 lines alphanumeric display.
- High resolution 13" precision in-line CRT.
- Optional 1024 x 1024 x 4 with 1024 x 768 viewable.
- 2 year limited warranty on all parts and factory service.
- Supported by many popular graphics packages.
- Quantity discounts available.

**Chromatics™**

For full product information on the best price/performance color terminal in the business, contact:  
Chromatics, Inc./2558 Mountain Industrial Blvd./Tucker, Ga. 30084/Telephone: 404/493-7000/TWX: 810/766-8099.  
Offices Worldwide

CIRCLE 20

interrupt controlled I/O, dynamic memory allocation that allows 32 memory pools, an onboard monitor, a dynamic debugger that can be removed from production versions, and high level language interface to Pascal and C. The operating system can handle as many as 16 processors on a common bus.

Hunter & Ready's VRTX is also software on a chip. More compact than MTOS-68KF, it consists of a 4K-byte nucleus supplied in PROM. It supports interrupt driven task scheduling (and handles as many as 256 tasks at 256 priority levels), intertask communication and synchronization, dynamic memory allocation, realtime clock support, and character I/O.

### Bus choices

Many of the products discussed thus far have furnished Multibus compatibility, a popular choice for industrial control environments. But other buses, too, can serve those environments. Digital Equipment Corp, for example, offers its LSI-11 bus configuration and supports it with single-board computers such as its recently introduced model SBC-11/21, which contains a 40-pin PDP-11 microprocessor that executes the PDP-11 base level instruction set. This board has 4K bytes of RAM and four 28-pin PROM sockets. Other features include two asynchronous serial I/O ports that operate at 300 to 38.4k bps, a 24-line parallel I/O port, two 8-bit data ports, one 8-bit control port, and a realtime clock.

Another popular bus for industrial applications is the STD bus from Pro-Log. This firm (located in Monterey, Calif) has just introduced its model 7806 Z80 based STD bus single-board computer. It accepts four 28-pin PROMs and has two RS-232 channels and four counter/timers.

Other Pro-Log offerings include single-board computers not structured around a particular bus. These products, models PLS 858, 868, and 898, are based on 8085, Z80, and 6800 microprocessors, respectively. They can accept 2K bytes of RAM and 8K bytes of EPROM and have three 8-bit output ports and two 8-bit input ports. The firm's ABL-1 development system can help in writing application programs for the boards; Forth and an industrial BASIC for the boards are offered by independent suppliers.

Jib Ray (Santa Barbara, Calif), for example, supplies a Forth monitor, in four 2716 EPROMs, that runs on a Pro-Log 7803 processor card, and Mark Williams Co (Chicago, Ill) offers a ROMable XYBASIC that runs on the Pro-Log STD computer. This language, tailored to measurement and control applications, includes an enable function that permits simultaneous program execution and monitoring of external devices; before executing each program step, this function checks external conditions. XYBASIC also has a delay command that can build realtime delays into programs without requiring a realtime system clock. Other features include PEAK and POKE commands and several assembly language-like bit manipulation commands, including ROTATE, SHIFT, TEST, and SENSE.

Other manufacturers of STD bus compatible single-board computers include Daticon (Lake Oswego, Ore), Matrix Corp (Raleigh, NC), Miller Technology (Los

Gatos, Calif), and Ziatech (San Luis Obispo, Calif). Daticon, for example, offers its model ACS 09 STD bus single-board computer based on the Motorola 6809 microprocessor. The board accepts up to 40K bytes of memory and includes RS-232 and RS-422 signal drivers; it runs its manufacturer's D-Forth language.

Matrix Corp also offers a 6809 based STD bus computer. Its model 7911/SP9 comes with 2K bytes of RAM; four 28-pin sockets accept up to 32K bytes of RAM, ROM, and EPROM. In addition, the firm offers its model 7911/SP80, a Z80A based STD bus computer with a similar

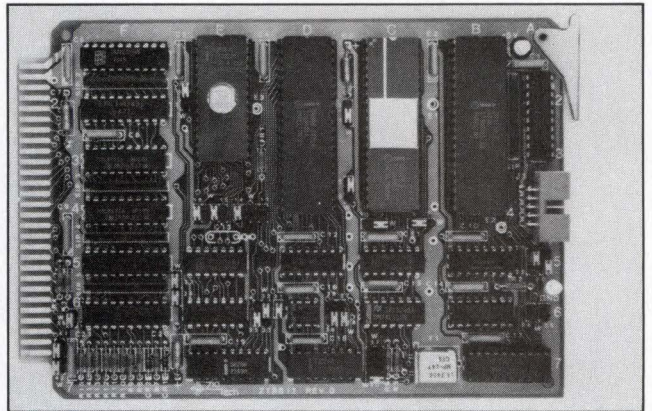

A family of single-board computers from Ziatech uses Intel's 16-bit 8088 microprocessor and plugs into the STD bus originally designed by Pro-Log for 8-bit computers.

memory configuration. Both models include RS-232-C line drivers and receivers, modem control lines, memory mapping, and 128K-byte address space.

Also compatible with the STD bus, Miller Technology's model MCPU-800 single-board computer uses a 4-MHz Z80 microprocessor and comes with 32K bytes of ROM, 64K bytes of RAM, 32 parallel I/O lines, a programmable serial port, and I/O expansion and memory mapping capability. The board can run CP/M and 2K- and 8K-byte BASICs. The 2K BASIC, available in ROM, serves as a compact solution for control applications not requiring floating point arithmetic. It permits 26 variables (A through Z) and operates on integers within a -32767 to 32767 range. The 8K BASIC, available in four 2K-byte ROMs, is a full-function BASIC interpreter.

Ziatech brings 16-bit performance to the STD bus with its 8088 family of single-board computers, which employ Intel's 8088 16-bit microprocessor. That device allows 8800 series boards to operate at 5 or 8 MHz and to directly address 1M byte of memory and to run iRMX 86 and CP/M 86 operating systems. To help in writing application programs for Ziatech's products, Micro/Sys (La Canada, Calif) offers a CP/M 86 development system built around 8800 series boards, and RTCS (Camarillo, Calif) offers software that allows Intel iRMX 86 development packages to run on the IBM Personal Computer.

### Building block approach

Not all manufacturers accept the approach of including a lot of functions on one board. For example, RCA (Somerville, NJ) offers its Microboard series of 4.5" x 7.5"





# SEEING IS BELIEVING

NOW WANGTEK'S 1/4-INCH STREAMER PACKS 20 OR 45 MEGABYTES INTO A HALF-HIGH 5.25-INCH SPACE.

Wangtek now opens up new design and marketing options to the systems integrator and the OEM with its introduction of the Series 5000,\* the only available 20 or 45 Mbyte half-high 1/4-inch streamer; an ideal backup for 5 1/4-inch Winchester.

Check these advanced features:

**Small size:** The Series 5000 can be easily packaged with a half-high 5 1/4-inch floppy or half-high Winchester.

**D.C. voltages:** Uses the same voltages as a minifloppy and 5 1/4-inch Winchester (+5V, +12V).

**QIC-compatibility:** Packaged in an additional half-high module, the two-board intelligent formatter is capable of reading and writing the QIC-24 defined recording format facilitating data interchange and is I/O compatible to the QIC-02 defined intelligent interface standard.

**Easy cartridge loading:** The Series 5000 incorporates a unique single-action cartridge loading mechanism for easy operation.

**Positive tape interchangeability:** With its rigid and stable aluminum deck, stiffer head carriage assembly and track reference burst, the Series 5000 can consistently and precisely position the read-write heads over a desired track on a cartridge written on any 1/4-inch streamer.

**Host adapter:** The half-high intelligent formatter module contains an additional slot for a custom PCB that could be used as an adapter to any host CPU bus.

The Series 5000 is easy to integrate into existing systems and a must for future designs. Call now for delivery, pricing, and facts on Wangtek's new Peripheral Integration Program.

Wangtek, 5845 Uplander Way, Culver City, California 90230, (213) 410-1444, Telex: 664425.

\*Patent to be applied for.

 **wangtek** FORMERLY WANGCO

See Us During NCC at "The Hilton At the Park."

CIRCLE 21

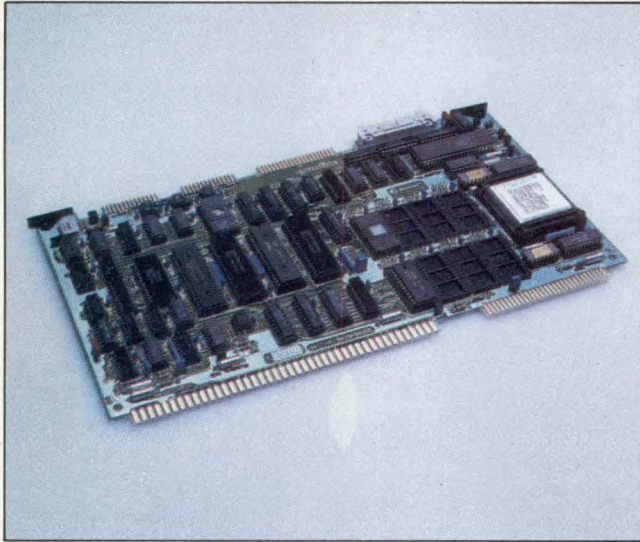

**Bubbl-tec's BBC-128 Multibus compatible computer contains an onboard 128K-byte bubble memory expandable to 8M bytes.**

(11.4- x 19-cm) boards; each board essentially handles one function (such as processing, memory, data conversion, or I/O) and plugs into the firm's 44-pin universal backplane. Each computer board in the series contains an RCA Cosmac CMOS CPU, a crystal controlled clock, 1K to 4K bytes of RAM, and sockets that can hold 1K to 8K bytes of user supplied ROM. Microboard memory boards can accept 4K, 8K, or 16K bytes of CMOS static RAM, 8K bytes of CMOS static RAM with battery backup, and 4K, 8K, 16K, 32K, or 64K bytes of CMOS or standard ROM or EPROM.

Other Microboards handle control and display functions (via onboard switches and light emitting diode status indicators), digital I/O, data conversion (at 8- or 12-bit resolution), and video/audio/keyboard interfacing. (One board includes a universal asynchronous/receiver/transmitter to furnish RS-232-C compatibility; others include general purpose 8-bit I/O ports, some with optical isolation.)

For mass storage, one Microboard with provision for up to 24K bytes of EPROM or ROM includes two tape I/O channels that interface to an audio-cassette drive at 700 bps. In addition, a floppy disk controller Microboard supports as many as four Sony OA-D30V 3½" floppy disk drives. Each drive can store 322k bytes at a 500k-bps data transfer rate; RCA's model MSIM50 consists of two such drives mounted in an industrial chassis. The MSIM50 consumes only 15 W and can derive its power from the universal backplane. Other Microboards include direct connect modems, featuring automatic or manual dialing and answering, that can transfer data over the switched direct distance dialing network at 300 or 1200 bps. Microboard software options include fixed point binary and floating point arithmetic packages and a BASIC interpreter/compiler.

Other examples of major multiple-board systems are offered by Data General Corp (Westboro, Mass) and Hewlett-Packard (Cupertino, Calif). Data General's

16-bit S/20 system places the power of a full Eclipse on two 7" x 9" (18- x 23-cm) boards. The CPU is a micro Eclipse chip. Hewlett-Packard's A600 handles up to 4M bytes of main memory and up to 200M bytes of mass storage. This 2-board system uses four Schottky bipolar bit slice microprocessors and processes more than 1M instruction/s. It is horizontally microprogrammed with a 56-bit microword format and is based on the RTE-A.1 operating system.

Additionally, Bubbl-tec (Dublin, Calif) has concentrated on onboard mass storage rather than on data conversion capabilities such as those on Intel's iSBC 88/40. Bubbl-tec's model BBC-128 single-board computer contains 128K bytes of onboard bubble memory, expandable to 8M bytes. It thus offers high reliability in hostile industrial environments by eliminating the need for electromagnetic storage devices.

An onboard "shadow" ROM implements a bubble interface protocol to facilitate transfer of block organized data to and from bubble memory; reading a specific block simply requires a READ command followed by the block number. There is no need for the system programmer to become involved in the bit level complexities involved in controlling the bubble device. The shadow ROM includes diagnostic and power-up bootstrap routines as well as error detection and correction algorithms used on transfers between main and bubble memory. Operating systems such as CP/M can be used, and Forth is available to handle the multitasking requirements often found in industrial process control applications.

The board's 64K-byte user memory space can be allocated among any combination of 24- or 28-pin 1K-, 2K-, 4K-, or 8K-byte RAM, ROM, or EPROM devices. Other BBC-128 features include two synchronous/asynchronous serial I/O ports with modem control lines, two 8-bit bidirectional parallel I/O ports with handshake lines, four counter/timer channels, Multibus bus arbitration logic, and a maskable, vectored-priority interrupt structure.

#### **A myriad of choices**

The hardware and software products discussed here illustrate the range of available features from which the designer must choose when selecting computers for industrial applications. However, they only scratch the surface of available offerings. Manufacturers offer a seemingly endless number of single-board computer hardware and software products configured around a variety of processors and bus structures.

*Please rate the value of this article to you by circling the appropriate number in the "Editorial Score Box" on the Inquiry Card.*

High 704

Average 705

Low 706

*Illustration on p 49 is an artist's rendition of a robot arm with microcomputer board in place. Courtesy International Robomation/Intelligence.*

---

**FUJITSU**

---

**DOESN'T**

---

**ANNOUNCE**

---

**THE STATE**

---

**OF THE ART.**

---

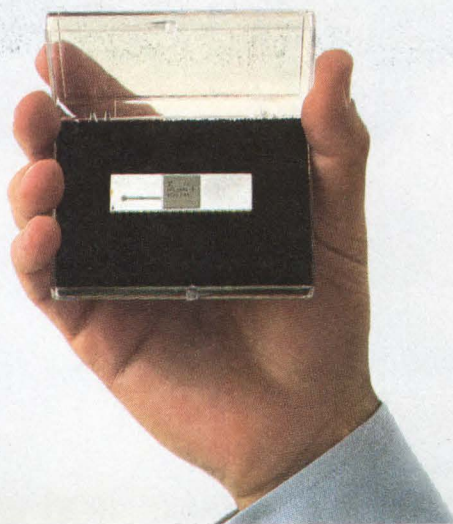

# WE JUST MA

Hearing about new semiconductor devices is always nice. But getting your hands on one usually isn't. So while some companies go on bragging, we go on building.

The result is technology that works. Not just on paper. But in your socket. Because when we formally announce a product, we know we can build it in quantity.

Of course, quantity is nothing without quality. And that's where we've built our reputation. The proof is in our parts.

First you get wide operating margins. The widest in the industry. When we design a new part, we design it for one set of specs. Then we test it only to those specs. If it doesn't meet them, we dump it. There's no "bell curve" for performance. And no binning. That's why all our parts – memories and microprocessors – are so perfectly compatible with competitive devices. The margins are designed in, then built in.

Then there's manufacturing. We do things a little differently here, too. Our production people are dedicated to one product or family, eliminating extra handling. And our plants are the most highly automated in the business.

Finally, there's Quality Assurance. We have more people dedicated to quality assurance than most manufacturers. And we use some of the most exhaustive test and inspection methods – starting at the design stage and continuing through process evaluation, production and final assembly. By the time a new part leaves the line, it's been tested hundreds of times.

What's it mean to you? Plenty. When we say our 10K ECL RAM runs at 7 nsec, it runs at 7 nsec or better. Period. So when you get a device from FMI – even when it's at the very edge of technology – you know it's going to work.

If you'd like to know more about how we make technology work, write for our detailed Quality Brochure. Or call your nearest FMI sales office.

You'll see why some of the world's leading companies are putting our technology to work.



# MAKE IT WORK.

## **FUJITSU MICROELECTRONICS**

Technology that works.

### FMI Sales Offices

- Boston 617/964-7080 • Chicago 312/934-6400;
- Dallas 214/669-1616 • New York 516/273-6660
- Northern California 408/866-5600;
- Southern California 714/475-9525.

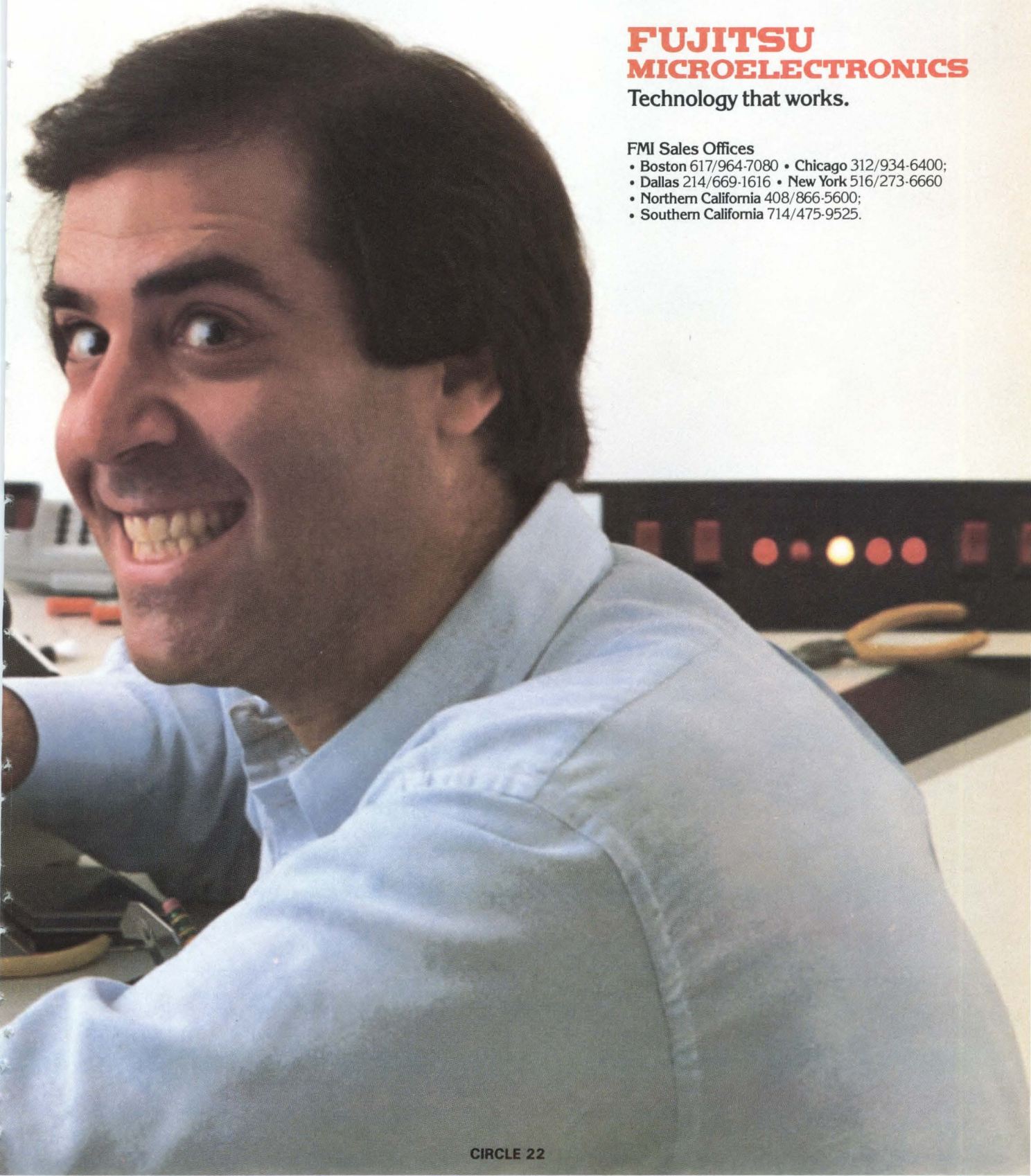



Shown are IBM-PC® compatible programs. The Columbia MPC runs MS-DOS® plus six other operating systems.



# THE COLUMBIA MPC WORKS WITH A WORLD OF SOFTWARE. \$3,000 WORTH COMES FREE WITH THE SYSTEM.

**World Headquarters:**  
8990 Route 108  
Columbia, MD 21045  
(301) 992-3400  
TWX 710-862-1891

**West Coast:**  
3901 MacArthur Blvd.  
Suite 211  
Newport Beach, CA 92663  
(714) 752-5245  
Telex 277778

**Europe:**  
Limitenstr. 94  
4050 Moenchgladbach 2  
West Germany  
Phone 02161-33159  
Telex 852452

**Call our distributor nearest you.**  
Access Systems  
Wellesley, MA  
(617) 237-7743

Advanced Management  
Systems  
Aurora, CO  
(303) 752-2972

Central Microcomputer  
Distributors  
Montreal, Quebec, Canada  
(514) 849-7533

N.I.D.I. (National Instru-  
ment Distribution Inc.)  
Dayton, OH  
(513) 435-4503

RPC Electronics  
Cleveland, OH  
(216) 461-2280

RPC Electronics  
Pittsburgh, PA  
(412) 782-3770

Distributors in Australia, Austria, Belgium, Colombia, Denmark, Hong Kong, Israel, Italy, Malaysia, Netherlands-Antilles, Norway, Portugal, Spain, Sweden, Switzerland, United Kingdom, Venezuela.



Today, the Columbia MPC takes on hundreds of IBM-PC compatible software programs and IBM-PC add-ons or peripherals.

What's more, six other Columbia-supported operating systems are available — CP/M-80\*, CP/M-86\*, Concurrent CP/M-86\*, MP/M-86\* (OASIS-16\* and XENIX\* available soon) — stretching the Columbia MPC's software compatibility beyond any other personal computer.

**Farther, faster, for far less.**

The Columbia MPC is shipped with fully supported software that will save you \$3,000. Included is the entire self-teaching Perfect Software™ family: Perfect Writer™, a word processor; Perfect Speller™, a 50,000 word dictionary; Perfect Filer™, a data

base manager; and Perfect Calc™, a financial calculation system.

In addition you get MS-DOS, CP/M-86, Macro/86 Assembler, BASICA®, Asynchronous Communications Support, Diagnostics and the Columbia Tutor program. This means your Columbia MPC is up and running right out of the box. Space Commanders and Fast Graphs show off the Columbia MPC's full-color graphics.

**Way out front in value and performance.**

With a list price of \$3,995 — including 128K RAM, 640K in dual disk drives, 8 IBM-PC compatible expansion slots, 2 serial and 1 parallel I/O, IBM-PC compatible keyboard, and color graphics monitor controller — the Columbia MPC is

ready to go. And a complete 12MB hard disk system lists for \$5,995 — software included! B/W or color monitors and printers optional.

**Made in U.S.A. — supported worldwide.**

All Columbia hardware and software are backed by the "Call for Columbia" national service program. So, call us or our distributor for the dealer nearest you — and start looking at the Columbia MPC. It'll show you a whole new world of performance and value.

**COLUMBIA**  
DATA PRODUCTS, INC.

Commerical Computer Sales  
Atlanta, GA  
(404) 256-9190

Empire Micro Products  
Rochester, NY  
(716) 626-3660

MP Systems  
Dallas, TX  
(214) 385-8885

Mid Tech Associates  
Desoto, KS  
(913) 441-6565

Mid Tech Associates  
Florissant, MO  
(314) 837-5200

Mytec, Inc.  
Sanford, FL  
(305) 321-2301

Renaissance Technology  
Corp.  
Concord, CA  
(415) 676-5757

Southeastern Data  
Products  
Lynchburg, VA  
(804) 237-6286

Tek-Aids Industries  
Arlington Heights, IL  
(312) 870-7401

Tele-Terminals  
Brooklyn Park, MN  
(612) 328-3072

Waybern Corporation  
Garden Grove, CA  
(714) 554-4520

Perfect Software, Perfect Writer, Perfect Speller, Perfect Filer, and Perfect Calc are trademarks of Perfect Software, Inc. IBM is a trademark of International Business Machines. CP/M and MP/M are registered trademarks of Digital Research, Inc. OASIS is a trademark of Phase One. MS-DOS and XENIX are trademarks of MICROSOFT.

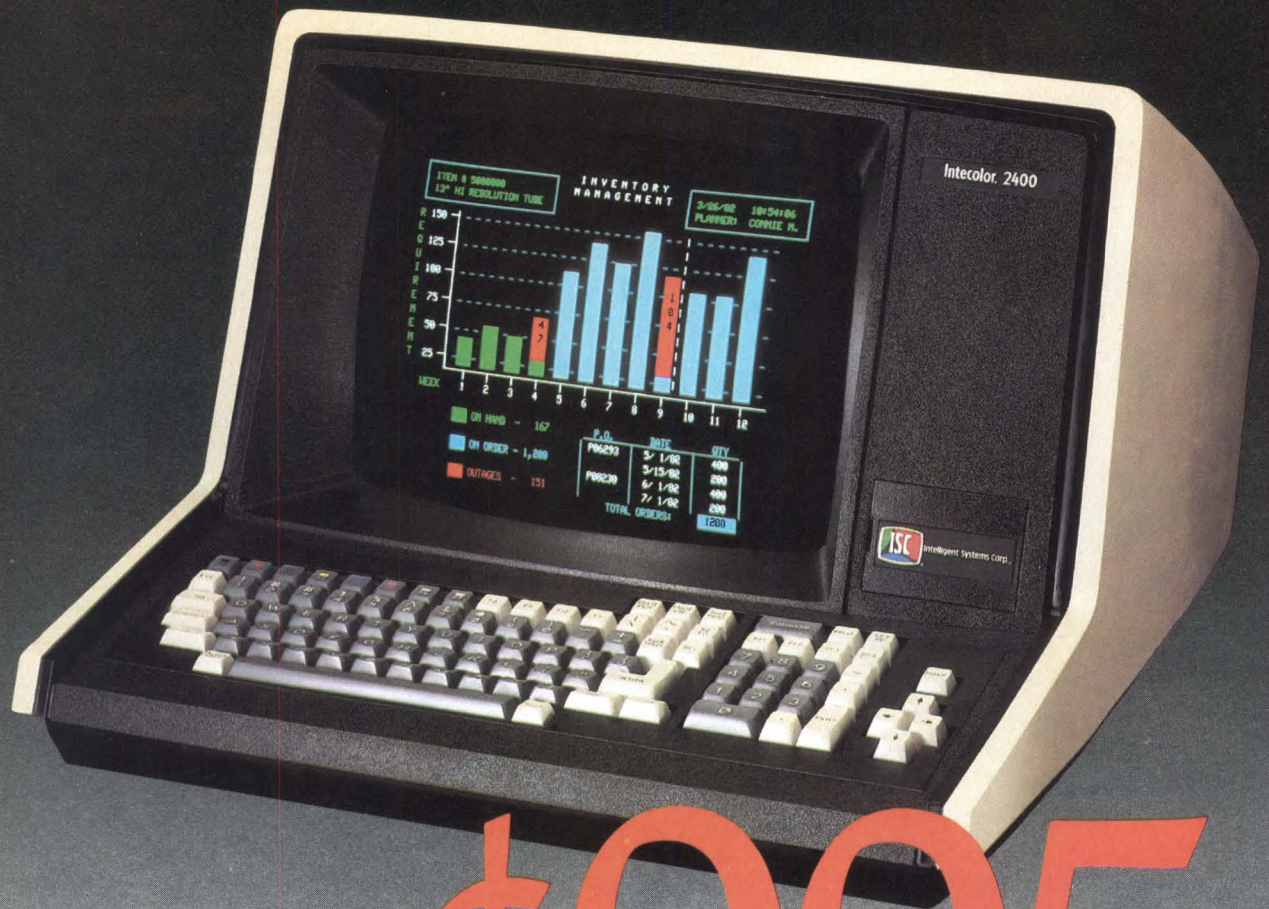

# \$995

### Special offer. Immediate delivery.

The logical switch to color has never cost less. Now you can buy an Intecolor 2405 single evaluation unit at the 100-piece price of \$995 (U.S. domestic only). You get the advantage of vector graphics on an 80 column by 24 line screen, without sacrificing the most important capabilities you want from a VT100 terminal. Plus, the 2405's vibrant color conveys more information, more quickly and with greater comprehension than monochrome.

**ANSI X3.64 system compatibility.** The 2405 is the ideal replacement or add-on terminal. Highly compatible with VT100 and numerous other ANSI X3.64 terminals, the 2405 is easily integrated into any ANSI X3.64 environment. It also includes ASCII codes and a VT52 mode.

**With all the features you need.** Eight foreground and eight background colors. Terminal based

## Our ANSI X3.64 terminal has all the VT100 features you'll ever need in a conversational terminal.

### Plus color and vector graphics.

vector graphics. Data transmission baud rates from 50 to 19,200. English language menu set-up mode. Non-volatile set-up memory. Two full pages of screen RAM. In-line CRT. Auto degaussing. Powerful, 6 MHz 8085 microprocessor with four hardware interrupts. Plus, up to 72 function key definitions, optional.

**Introductory price good through May 31, 1983.** After that, our regular single-piece price of \$1195 goes into effect. So act now. Take full advantage of the color, vector graphics and flexibility of the Intecolor 2405—at the 100-piece price. Once you

do, we're confident that you'll enthusiastically agree with the growing number of OEMs and users who are making it dramatically clear that, "The future belongs to color!"

For the name of the distributor or sales representative in your area, or for complete specs, ask about our \$995 special: **Call 404/449-5961.**

 **Intecolor**<sup>®</sup>  
AN INTELLIGENT SYSTEMS COMPANY

Intecolor Drive, 225 Technology Park,  
Norcross, GA 30092, TWX 810-766-1581



# PROSPECTS FOR EXPERT SYSTEMS IN CAD

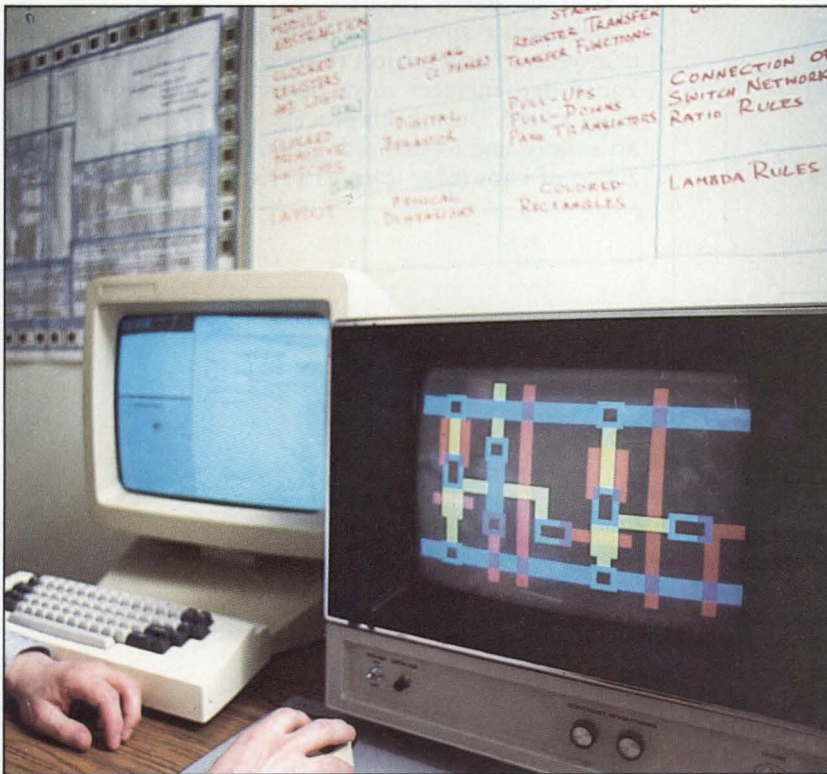

**Although widespread use of expert systems in solving complex CAD problems is several years away, artificial intelligence concepts are being applied in experimental systems for tomorrow's knowledge based design assistance.**

by **Mark J. Stefik and Johan de Kleer**

A new breed of computer systems—*expert systems*—is now emerging from artificial intelligence research and is being used in applications normally thought to require human specialists for their solution. For example, expert systems have been used to solve problems such as equipment diagnosis, medical diagnosis and therapy, experiment planning in genetics, and computer configuration—problems that do not yield to numerical or statistical techniques. Expert systems gain their power by the use of “expert knowledge,” recorded in a knowledge base, which enables programs to mimic the reasoning of human experts.

*Mark J. Stefik is a member of the research staff at Xerox Corp, Palo Alto Research Center, 3333 Coyote Hill Rd, Palo Alto, CA 94304. Dr Stefik works in the Knowledge Systems Area. He has a PhD in computer science from Stanford University.*

*Johan de Kleer is a member of the research staff at the Xerox Palo Alto Research Center's Cognitive and Instructional Sciences Group. Dr de Kleer has a PhD from the Massachusetts Institute of Technology's Artificial Intelligence Laboratory.*

In applying expert systems to design tasks, the idea is to pit knowledge against complexity, using expert knowledge to whittle complexity down to a manageable scale. Expert systems will eventually be applied in many design areas, but an important example is their use in digital system design, particularly in computer aided design (CAD).

Although there are no expert systems commercially available for electronic system design as yet, work is proceeding at several research centers. For instance, computer scientists at Digital Equipment Corp (DEC) are developing expert systems for several applications, including digital design. One example is an experimental expert system for determining transistor size in integrated circuits, given circuit parameters such as load and capacitance. In conjunction with researchers at Carnegie-Mellon University in 1978, DEC began activity on expert systems to develop a knowledge based program called XCON for configuring VAX-11/780s. This program is now used to configure every VAX that is shipped.

For more than a decade, the Heuristic Programming Project at Stanford University has pioneered and developed expert systems. Eurisko is an artificial intelligence (AI) program used to search for mathematical concepts and configure naval fleets in competition games. Recently, Eurisko was used to search for useful

microcircuit structures made possible by multilayer fabrication technology (Fig 1). The program has discovered several novel devices.

Researchers at the Massachusetts Institute of Technology Artificial Intelligence Laboratory have been creating and experimenting with engineering AI pro-

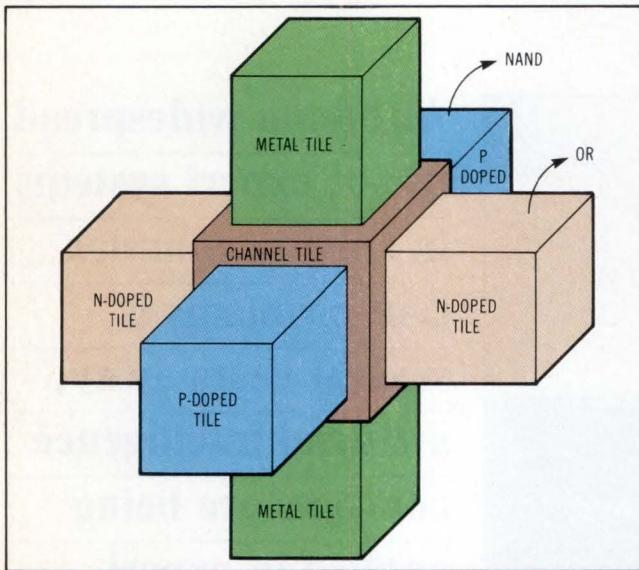

**Fig 1** Illustration of a microcircuit device discovered by Eurisko. This device can be used to simultaneously compute NAND and OR. The device handles silicon volume efficiently since it can be packed in the plane and vertically. Eurisko uses a technique called heuristic search to generate plausible devices and find the interesting ones.

grams for many years. Two examples are the EL and SYN programs that help a designer analyze and synthesize analog circuits. Key to these systems is the idea that the possible values for parameters describing circuits are represented and manipulated in terms of constraints. Fig 2 shows an example of the kind of problem that EL can solve.

At Xerox Palo Alto Research Center and Stanford University, researchers are developing a prototype expert system called Palladio. The key idea is that designers should design not only circuits, but also knowledge. Knowledge in Palladio is expressed in a knowledge representation language called Loops (see Fig 3). Using Palladio, a designer will interact with previously designed circuit fragments and rules taken from knowledge bases. While working on an individual design, a designer can discover gaps and errors in the knowledge base by applying it to his own design. The designer can create personal versions and modifications to the knowledge bases, which can later be incorporated. Palladio is intended to foster experimentation with design methodologies.

Related work is proposed or underway at the Japanese 5th Generation Computer Project, the Institute for Information Sciences, Lincoln Labs, and Symbolics.

### The technology

One method for developing an expert system involves a collaboration between a specialist (the *expert*) and a computer scientist (the *knowledge engineer*). The expert provides sample problems and the knowledge engineer

provides a programming framework, including a knowledge representation language. The knowledge engineer interviews the expert as he solves the sample problems and helps him to articulate the knowledge he is using. Together they define the scope of the expert system and enter the expert's knowledge into a knowledge base, often in terms of if-then rules. The resulting program is given hypothetical tasks. Differences between the expert's results and the program are identified, and the knowledge base is updated.

Developing an expert system generally takes several man-years. For a project to succeed, the expert and the knowledge engineer must become familiar with each other's field. During this process, a body of knowledge is articulated and formalized. Often the necessary formalization of knowledge leads to a crisper and deeper under-

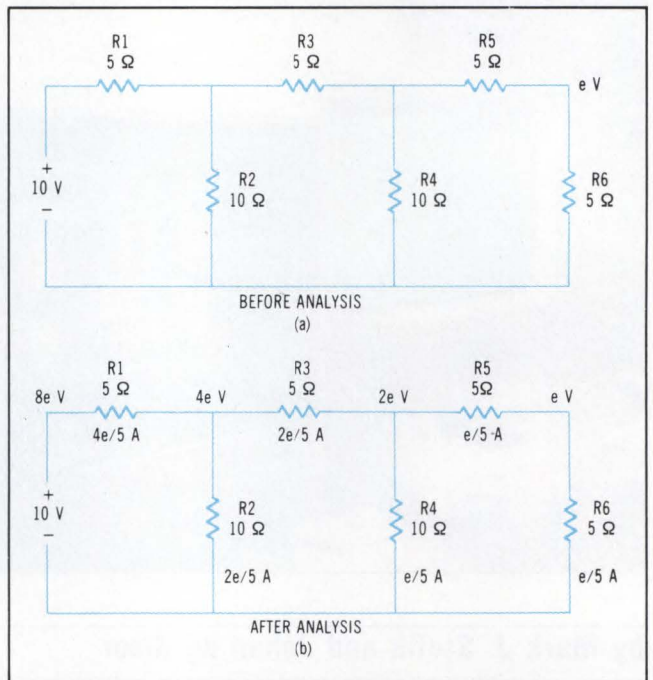
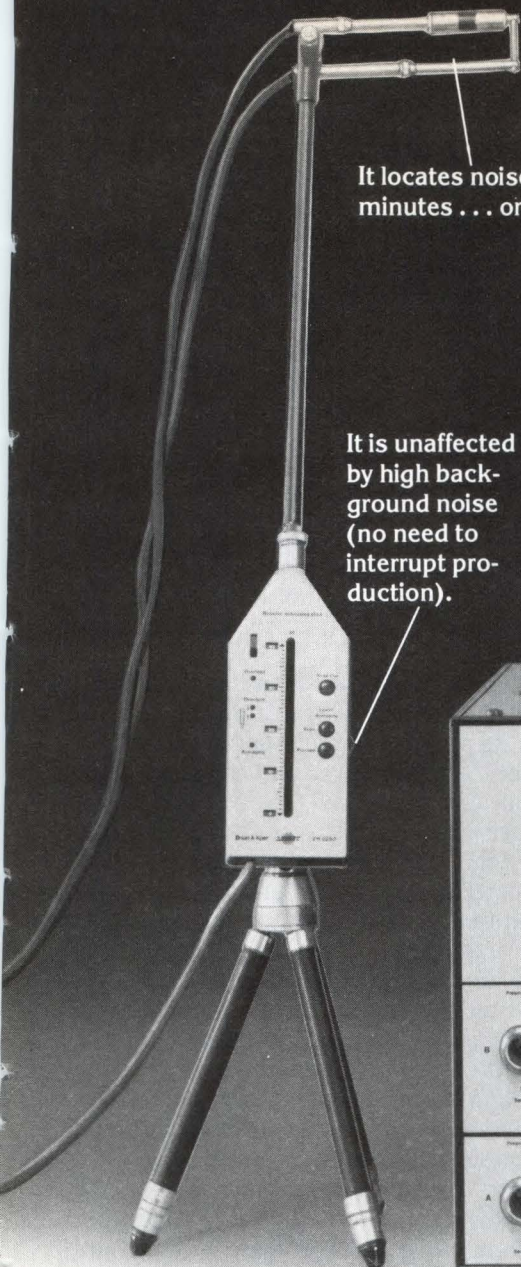

**Fig 2** A simplified example that can be solved by EL. "Before analysis" (a) shows an electrical circuit whose components are known, but whose voltages and currents need to be analyzed. Analysis begins by assigning the symbol *e* to the unknown voltage at the upper right corner of the ladder. Other values are derived by stepwise application of Ohm's and Kirchoff's laws to produce the "after analysis" diagram (b).

standing by the expert of his field. Sometimes the formalization leads to knowledge and methods of reasoning that have not been used previously.

Although this depiction of an expert system's construction and organization is oversimplified, it illustrates the kinds of issues the expert system builder must face and the technology that must be applied. The knowledge engineer's task is to encode the expert's knowledge to be effectively used by a computer. This task is difficult because the expert is rarely articulate about the knowledge. Such difficulties are addressed by expert systems technology.

Debugging a knowledge base provides a vehicle for formalizing an expert's often tacit knowledge. Throughout expert system development, the knowledge at certain



It locates noise sources in minutes . . . or less.

It is unaffected by high background noise (no need to interrupt production).

It's the first real-time 1/3 octave sound intensity measuring system.

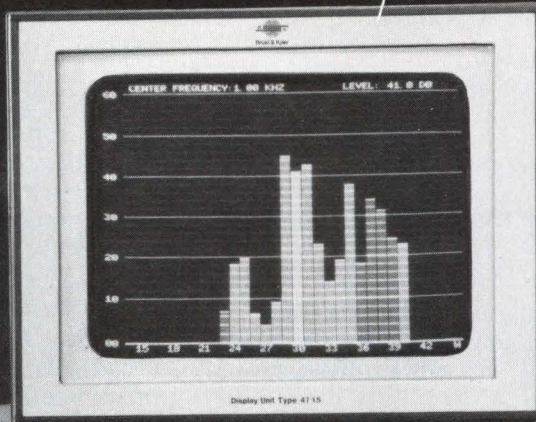

It displays intensity/pressure spectrums.

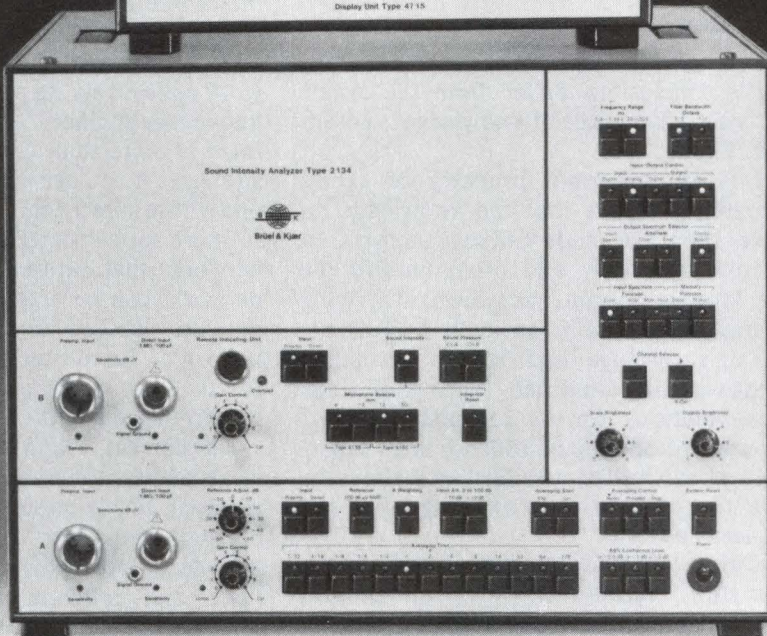

It's portable . . . easy to use . . . needs no external computer.

## It's the new, do it all, 3360 system.

Bruel & Kjaer's new 3360 system opens new horizons for acoustical measurements. It's the first to measure sound intensity over a 3.2 Hz to 10 kHz range in octave and third-octave bands. And, by measuring the vector quantity sound intensity to determine sound power, you eliminate the need for special anechoic chambers. With this

sophisticated portable system, in situ measurements are as practical as they are precise. Even high levels of background noise can be tolerated.

The complete system includes a sound intensity probe of advanced design, large-screen display unit, remote indicating unit, and digital frequency sound intensity analyzer. No external computer needed.

Whatever your requirements — location and identification of sources, mode studies, noise control, tracing of energy flow lines in vehicles or other closed spaces, or measurement of sound absorption — investigate the new 3360 system. It does it all.

Write for product data and application note.

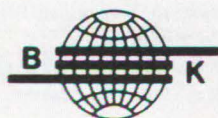

# Bruel & Kjaer Instruments, Inc.

185 Forest Street, Marlborough, Massachusetts 01752 • (617) 481-7000 • TWX 710-347-1187

World Headquarters: Nærum, Denmark. Offices in 55 countries

```

        {Priority←'High'}
IF wire:type='GND' Known(VDD:direction)
THEN wire:direction←VDD:direction;

        {Priority←'Moderate'}
IF wire:length > longSize
THEN wire:level←'Metal';

IF wire:type='VDD'
THEN wire:level←'Metal';

IF wire:length < longSize wire:type='Control'
THEN wire:level←'Poly';

```

**Fig 3 Example of a set of rules expressed in the Loops language. Rules like these can provide heuristics for assigning directions and levels to "wires" in a switch representation of a circuit.**

places is incomplete and incorrect. This is apparent when a human expert's conclusions differ from the expert system's. Identifying which piece of knowledge is absent or incorrect is difficult.

*Transparency* is an important property of expert systems. Transparency means that the knowledge an expert system uses should be made visible to its users. In particular, the user can view and often modify the knowledge base. More important, the system, in arriving at a recommendation, maintains an audit trail of the steps and pieces of knowledge used. Hence, the culprit piece of knowledge is easily identified. (Such audit trails also provide explanations for its recommendations, thereby helping users to develop confidence in an expert system.) These mechanisms for user feedback allow the knowledge base to continue to grow long after the knowledge engineer has left.

In an application, knowledge can include facts, theorems, heuristics, equations, rules of thumb, assumptions, strategies, tactics, probabilities, advice, and causal laws. To manage such diverse forms of knowledge, AI has developed a wide variety of *knowledge representation* and *inference* schemes. A knowledge representation scheme is a way to codify knowledge; an inference scheme is a way to use knowledge to arrive at new knowledge. One of the first decisions a knowledge engineer must make is the choice of knowledge representation and inference schemes.

A good starting place is the vocabulary and description of those things that the expert system will reason about. For example, an expert system about chip design would include a vocabulary of transistors used as switches, restoring logic, clocks, and steering logic. One popular approach is to define such things in terms of objects (Fig 4). Most knowledge representation languages come with special facilities for instantiating, combining, and specializing object descriptions.

Often the knowledge that goes into an expert system is decision-making knowledge that can be expressed in terms of if-then rules (Table 1). These rules indicate that certain actions can be taken if certain kinds of situations arise. Most rule based systems contain hundreds of rules, each representing a "chunk" of knowledge about a particular field. Rules can be used to represent both *inferences* and *heuristics*.

Each rule in a knowledge base represents the knowledge behind a single decision. Organizing the rules to work collectively on problems is an important task for a knowledge engineer. As this is an area of active research, there is more than one approach. One of the simplest strategies is to have an interpreter scan the rules to find one whose antecedents match assertions in the data base. In more sophisticated systems, rules are organized into networks that determine when rules get applied. Such networks can be organized to apply rules when certain data are changed, or to try rules when certain goals are indicated. Inferences are statements about what facts follow from given conditions; heuristics are rules of thumb that guide the search for solutions.

The current technology of building expert systems has weak points, some of which require substantially more research. For example, an expert, like a good designer, is distinguished from a mediocre one not only by the knowledge possessed about the field, but by intuition, taste, and common sense. Unfortunately, these are difficult to recognize, let alone formalize. As a consequence, most current expert systems lack breadth and common sense. That is not to say that they cannot solve difficult problems requiring sophisticated expertise. Rather, when posed slightly different problems than they were designed for, they can fail in surprising ways.

AI is only recently facing these issues squarely, and it will be some time before one sees anything even approximating broad human expertise. Nevertheless, a great

Instance Variables

```

pullUp:      "pullup1003" doc(* Pull-up element for the inverter.)
pullDown:    "pullDown1003" doc(* Pull-down element for the inverter.)
ratio:       4 doc(* Pull-up/pull-Down ratio) reason "auditRecord33"
xOrigin:     188
yOrigin:     3876
orientation: Up doc(* One of Up, Down, Right, Left)
perspectiveNode: "InvPerspl003" doc(* Pointer to perspective objects
for displaying the inverter, etc)

```

Methods

```

Simulate Inverter.Simulate doc(* Procedure for simulating an inverter)

```

**Fig 4 An object representation example in Loops. Part of the representation task in an expert system is creating the vocabulary and representations for the things that the system will reason about.**

# How do Unibus\* users spell peak I/O rate relief?

High speed data acquisition can be a real headache. Especially during peak I/O rates when transfer can exceed the CPU's capacity and key bits of information go off in thin air.

So we developed a DR11-W module. First for the Unibus. Now for the Q-Bus. Both feature our exclusive DMA Throttle that efficiently regulates data flow down to average rates to maximize overall CPU performance. But that's not all.

Additional design features make it a cure for many other troublesome Unibus or Q-Bus system ills. For example, it offers:

- Edge mounted LED's to illuminate performance status
- Micro-sequencer driven, self-test diagnostics
- Long lines capability
- Switch selectable 22-bit addressing (Q-Bus)

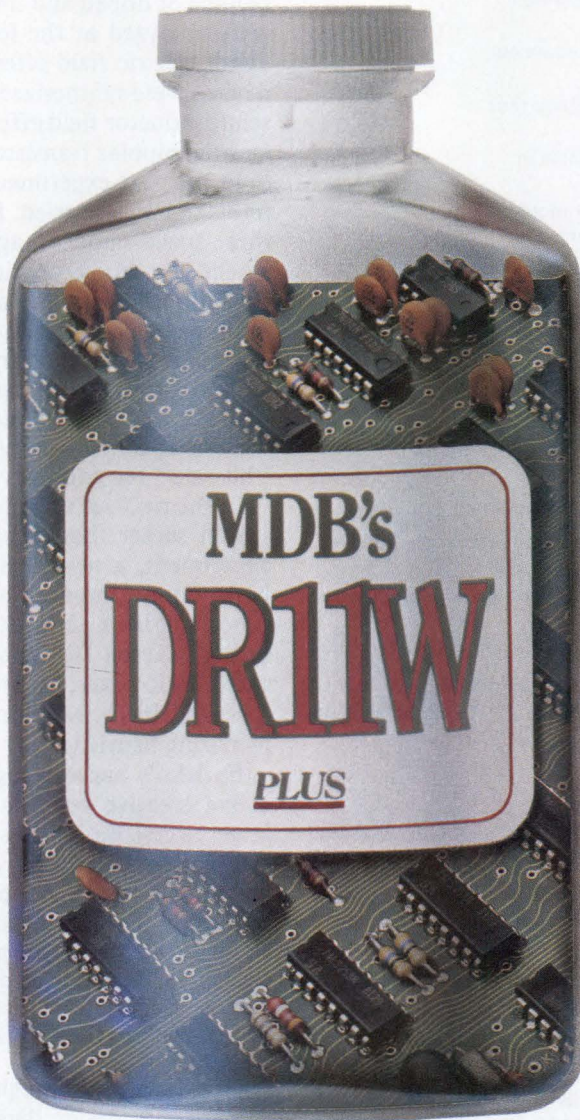

- Bus Address Extension for memory transfer throughout the 4 megabyte range (Q-Bus)
- Switch selectable, 4-level or single level interrupt arbitration (Q-Bus)
- Compatibility with 16, 18 and 22-bit backplanes (Q-Bus)

This high speed, digital input/output device is prescribed for such typical applications as:

- High speed graphics
- Digital data acquisition
- Parallel information processing
- Interprocessor linking between a Unibus and Q-Bus

There's more. And we're anxious to spell out all that the DR11-W and our complete line of computer interfaces can do for you. Call or write today and ask about full year warranty. Available under GSA contract #GS-00C-03330.

## Now for Q-Bus\* users too.

\*TM Digital Equipment Corp.

See us at NCC

**MDB**  
SYSTEMS INC.

1995 N. Batavia Street, Orange, CA 92665  
714-998-6900 TWX: 910-593-1339

**TABLE 1**  
**Sample If-Then Rules**

The XCON System (configuring VAX systems)

IF: The current active context is selecting a box and a module to put in it  
The next module in the optimal sequence is known  
The number of system units of space that the module requires is known  
At least that much space is available in some box  
That box does not contain more modules than some other box on a different unibus

THEN: Try to put that module in that box

The MYCIN System (medical diagnosis and therapy)

IF: The site of the culture is blood  
The portal of entry of the organism is GI  
The patient is a compromised host

THEN: It is definite (1.0) that bacteroides is an organism for which therapy should cover

The PROSPECTOR System (mineral exploration)

IF: Volcanic rocks in the region are contemporaneous with the intrusive system (coeval volcanic rocks)

THEN: (800, 1) The level of erosion is favorable for a porphyry copper deposit

deal of technology can be of immediate practical use in expert systems to solve problems that require a significant amount of expertise or creativity.

**Design as search**

In artificial intelligence, many problem solving systems are based on the formulation of problem solving as search. In this formulation, a description of a desired solution is called a goal, and the set of possible steps leading from initial conditions to possible solutions is the space to be searched. Problem solving is carried out by searching for sequences that lead to solutions that satisfy a goal.

Often, rules in expert systems can be viewed as heuristics for generating and pruning candidate solutions. Search is at the heart of a reasoning system, and failure to organize it properly can result in problem solvers that are inefficient, naive, or unreliable. The simplest approach is to search a solution space exhaustively (ie, to search it in a way that will find all possible solutions). This is appropriate only if the space of possible solutions is quite small, or if powerful pruning heuristics are available for quickly eliminating most of the space from consideration. Another approach is to use heuristics for plausible generation (ie, to guide the search to the most promising avenues).

Stanford University's Eurisko is an example of an AI program that uses heuristic search. It has been applied to the task of inventing new 3-dimensional microelectronic devices that can be fabricated using laser recrystallization techniques. Eurisko's exploration is carried out by generating a device configuration, computing its

input/output behavior, parsing this into a functionality that it recognizes, and then evaluating the device against known comparable devices.

Two different solution space characterizations have been tried in Eurisko. In the first experiments, the solution space was characterized in terms of abutted regions of doped and undoped semiconductors. Devices were analyzed at the level of charged carriers moving under electric field effects. Many well-known primitive devices were synthesized quickly, such as the metal oxide semiconductor field effect transistor, the junction diode, and the bipolar transistor.

In the next experiments, a level describing circuits in terms of *tiles* was tried. In the tile model, each region is a three-space cube of approximately the same size. A device is a lattice of tiles in a particular 3-dimensional configuration. Fig 1 is an example of a device described in terms of tiles. Initial tile level experiments were done using exhaustive search. Basic elements supplied included the logical operations, flipflops, stack cells, and a few others. Thousands of hours of runs with this version of Eurisko convinced the experimenters that the "hit rate" for good devices was below one in a billion.

In the next set of experiments, Eurisko used heuristic search rather than exhaustive search. In the previous experiment, a new device was synthesized every 0.9 s. Now, with a hundred heuristics guiding the generation process, it took about 30 s to produce each device design (using a Xerox 1100 personal scientific information processor). However, the frequency of valuable new devices rose to 1 in 10. Much of the power came from a symmetrizing heuristic.

Eurisko's success suggests that computers can play active creative roles in the design process. Although large circuit design is still a distant possibility, a new symbiotic relationship is emerging between designer and machine. The designer can be free from concern about a particular device's structure, and instead concern himself with heuristics for guiding the computer program's search for interesting designs. The computer can thus explore the possibilities based on the heuristics and present alternatives to the designer for evaluation.

**Gaining leverage through abstraction**

Coping with design details is a challenge. While failure to attend to them leads to disaster, focusing on them in a project's early stages can blind a designer to the overall picture. For example, a digital systems designer can become bogged down in his approach to system architecture if he initially tries to contend with the details of every transistor. Instead, the approach should make big design steps to get the whole picture, then tend to the details systematically.

In software practice, programming languages provide an abstract level of description for programs that allow bigger steps than machine instructions. The same idea of using formal languages has been proposed for hardware.

Fig 5 illustrates three architectural approaches to designing a hardware stack. In a high level architectural language like Linked Module Abstraction (LMA), which emphasizes storage and communication features,

# MULTIBUS\* PLUS

## PERFORMANCE

## DEPENDABILITY

## FLEXIBILITY

Monolithic Systems Corporation has always been synonymous with Multibus technology. In fact, MSC has the distinction of having designed the first patented single board computer. Other firsts include: the first use of 64K RAM elements, on-board EPROMS, floppy disk controllers, APU's, user selectable addressing and multimaster CPU configurations. These board level accomplishments have benefited OEM's for over 12 years and have culminated into a powerful line of systems, the MSC 8800 series.

As the leading innovator in Multibus products, Monolithic Systems offers a family of systems intended to do things never done before. Systems to assist and create test programs for the scientific and industrial markets, to be multi-user and multi-tasking, to be expandable, rugged and reliable beyond anyone's expectations. Available with operating systems by Digital Research, the MSC 8800 series and board level products will be prominent factors in Multibus applications now and in the future.

For more information about Monolithic Systems Corporation and its Multibus product line call Toll Free 1-800-525-7661.

 **Monolithic Systems Corp.** ... means technically advanced solutions.

#### USA

84 INVERNESS CIRCLE EAST  
ENGLEWOOD  
COLORADO 80112  
303-770-7400  
TELEX: 45-4498

#### EUROPE

JUSTINIANSTRASSE 22  
6000 FRANKFURT aM MAIN 1  
WEST GERMANY  
611590061  
TELEX: 41-4561

#### CANADA

6503 NORTHAM DRIVE  
MISSISSAUGA  
ONTARIO, CANADA L4V 1J2  
416-678-1500  
TELEX: 96-8769

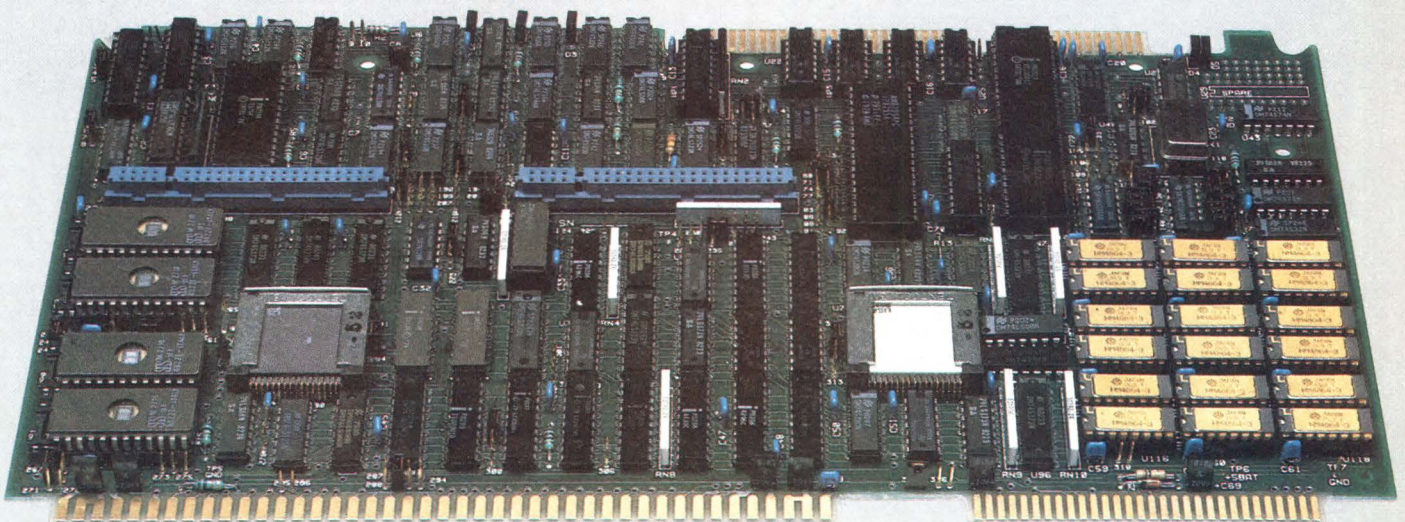

### 16 BIT PROCESSING

- iAPX 186 8 Mhz. CPU
- 128 OR 256 KBYTE PARITY RAM
- UP TO 64 KBYTES EPROM
- FOUR 16 BIT COUNTER TIMERS
- TWO iSBX CONNECTORS
- ONE RS232C PORT
- 24 LINES PARALLEL I/O
- 1 YEAR WARRANTY

\*Multibus is a registered trademark of Intel Corporation.

descriptions are concise. Furthermore, minor architectural variations often correspond to minor changes in the descriptions. The pointer stack (a) corresponds to the usual software implementation. Information is stored in a register array. An index register (the pointer) contains the top of the stack's address. Push and pop instructions increment and decrement the pointer. The roving marker stack (b) uses a mark bit associated with each storage cell to indicate the top of the stack. In a push or pop instruction all cells receive the command, but only the one with the mark bit set performs the operation. It combines a register array for data storage with a shift register for marker storage. In the buffered stages stack (c), the top of the stack is always the leftmost cell and all

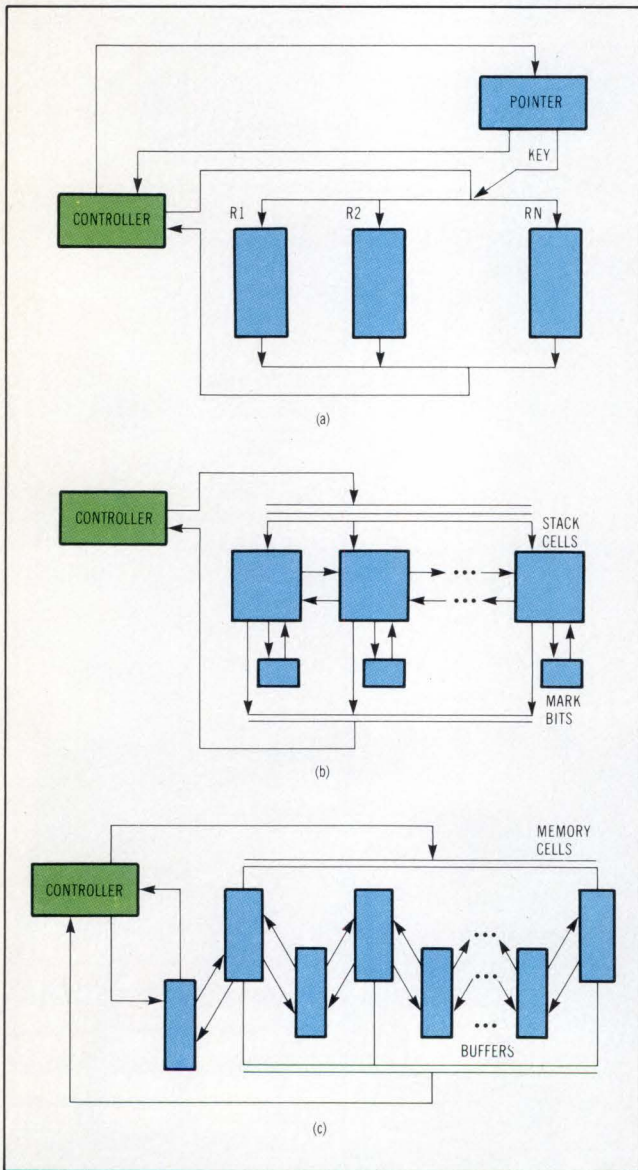

**Fig 5** Some alternative designs for a stack: pointer stack (a), roving marker stack (b), and buffered stages stack (c). When specifications for these different stacks are written in a language that emphasizes storage and communications features, the description is much shorter than one written in terms of device layouts. Furthermore, minor architectural variations often correspond to minor changes in the descriptions.

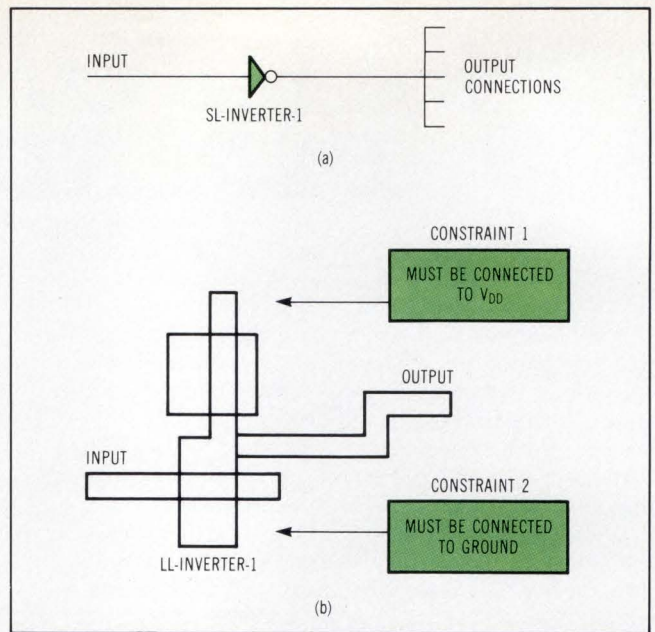

**Fig 6** Introducing constraints in a design. In this figure, the layout level description (b) is an implementation of the switch-level description (a). Implementation is only partially specified since the designer chooses only to introduce constraints about connections to power and ground, rather than deciding exactly how to route the wires to make the connections.

data in the stack move simultaneously. Intermediate stages buffer the data as they move between cells.

Ideas of languages and big steps can be iterated to yield an ordered set of languages providing intermediate abstractions. (See Table 2.) Languages serve to partition design concerns, and each successive description of a system surfaces a new level of details to consider. Using the languages in design can be helpful to a designer if decisions that are made at a more abstract level do not need to be revised in a more detailed language. A designer who systematically carries a design through several implementations in different languages is guided by an "invisible hand" that determines the kinds of decisions made at each step.

Invention and language experimentation for describing abstractions is not unique to expert systems. For example, using multiple languages to describe hardware has been tried many times. The main point is that such languages can enable big steps in roughing out a design. Since the languages divide up a design process, they also provide a framework in an expert system for organizing knowledge according to sets of concerns.

### Representing constraints and dependencies

Exploratory design often requires making significant changes late in the design cycle. This is inconvenient with current design tools, which do not capture the dependencies among decisions. To make a change, designers often must alter large portions of a design that are disturbed by a seemingly minor change.

In AI research, it is useful in such problems to represent explicit *dependencies* and *constraints*. A dependency is a situation where one quantity depends on others. This is analogous to the algebraic distinction



# Now you can build in seconds what used to take forever.

If you have been waiting to view your solid models, your waiting days (or even minutes) are over. Now there's SOLIDVIEW.™ A revolutionary, new display technology for viewing solid models that significantly increases system speed. And significantly decreases host overhead, software development time, and total system cost.

By processing tasks like hidden surface removal, visible surface shading, sectional views, contouring, and even piercing objects, SOLIDVIEW slashes image construction time from minutes to seconds. The host is then free to handle viewing transformations and clipping concurrently; system throughput is greatly improved.

What's more, SOLIDVIEW constructs images using polygons instead of pixels. These images are built piece by piece, instead of line by line. So you not only get more speed, but more information.

You can also do more with

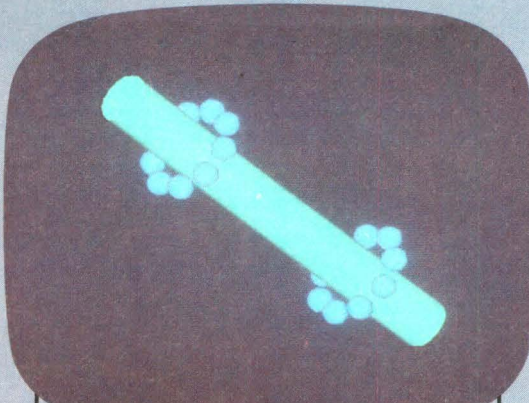

Construct images in less than four seconds.

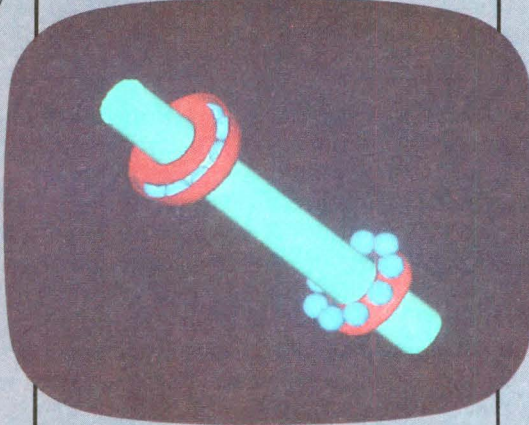

Then build incrementally. In seconds.



Create complex solids just as fast.



SOLIDVIEW. You can add new parts without redrawing the entire screen. You can manipulate objects with a minimum of recalculating. You can make exploded or sectional views in seconds. You can even use translucent shading to see behind surfaces.

SOLIDVIEW is available in two models, with a wide array of features. Both offer you 12 x 24 color lookup table, 19" monitor, and the power required to view your images interactively for the first time. Options include pan/zoom, four overlays, hardware cursor, serial interface, and a selection of peripherals.

SOLIDVIEW from Lexidata. It's so fast, it will completely change the way you view your solid images. For fast and interactive response to all your questions, just call us at (617) 663-8550. Or write to us at 755 Middlesex Turnpike, Billerica, MA 01865. TWX 710-347-1574.

**LEXIDATA**

The clear choice in  
raster graphics.

**TABLE 2**  
**Synthesis Languages for Palladio**

Description Level	Concerns	Terms	Composition Rules	Bugs Avoided
Linked module abstraction (LMA)	Event sequencing	Modules Forks Joins Buffers	Token conservation Fork/join rules	Deadlock Data not ready
Clocked registers and logic (CRL)	Clocking 2-Phase	Stages: Register transfer Transfer functions	Connection of stages	Mixed clock bugs Unclocked feedback
Clocked primitive switches (CPS)	Digital behavior	Pull-ups Pull-downs Pass transistors	Connection of switch networks Ratio rules	Charge sharing Switching levels
Layout	Physical dimensions	Colored rectangles	Lambda rules	Spacing errors

between dependent and independent variables. Dependencies can be used in a design to represent situations where the system could automatically make changes in one part of a design to reflect changes made in another part. A constraint is a situation where several quantities are interrelated. Unlike dependencies, a constraint does not distinguish between dependent and independent quantities. In AI programs, constraints are coupled with knowledge for propagating and satisfying sets of constraints.

EL is an example of an AI system that represents and manipulates constraints. As an aid to designers analyzing analog circuits, EL computes electrical parameters of a circuit using circuit behavior laws, such as Ohm's law and Kirchoff's current law. EL's knowledge about the values of voltages and currents at different parts of a circuit is represented as symbolic constraints.

Much of EL's power derives from the ability to reason with constraints by propagating them algebraically through a circuit description. For example, using Ohm's law constraints can be propagated in three ways. First, if the voltage across the resistor is known, and the resistance is known, the current through it can be assigned. Second, if the voltage across the resistor is known, and the current through it is known, the resistance can be assigned. And third, if the current through the resistor is known, and the resistance is known, the voltage across the resistor can be assigned.

Constraints are an important vehicle for representing partial specifications (Fig 6). For example, constraints can describe requirements for parts of a structure whose implementation is yet to be worked out. The SYN program provides an example of this in an AI system. SYN was applied to the task of circuit synthesis (ie, determining the parameters of the parts of a network). Like EL, SYN uses constraints for representing assertions about a circuit. Much of a constraint's power is that it allows a designer to specify only part of a circuit; eg, imposing a constraint that the bias current be 10% of the transistor current does not completely determine what the bias cur-

rent is. From the point of view of bias stability, the exact value is irrelevant. Other constraints can be imposed to determine its value.

Using constraints to characterize partial specifications can be especially useful for representing interface contracts between parts of a design, especially when different people design the parts. A design system that includes the means for communication between designers could provide support for negotiating changes to interfaces. Such a system would help mediate the tension between defining interfaces early to divide the labor, versus revising interfaces later as a design is fleshed out. It would make it easier for designers and managers to see when interface contracts were violated, and also to weigh the effect of proposed changes.

### Reasoning with heuristics

An important but sometimes unrecognized characteristic of designing is the necessity of making guesses along the way. This follows from the absence of a complete synthetic design theory in most applications. To cope with the lack of a theory, designers resort to heuristic search. They begin projects without knowing exactly what is possible or what they want. In the beginning, a designer typically sets approximate goals. As he works top down, he explores the entailments of the design decisions; as he works bottom up, he gains information about what is possible and can adjust the goals. This amounts to a dialectic between what is desired and what is possible (ie, between goals and possibilities).

Heuristic reasoning is needed to compensate for the lack of a complete theory. Designers guess, but only when they have to. Some bad guesses are inevitable. This creates an incentive to find ways to revise decisions efficiently when guesses do not work out. In AI systems, dependency and constraint records are valuable in systems that reason heuristically, then revise decisions. This can be illustrated by examples from the EL system. In analyzing circuits, EL follows a heuristic approach from electrical engineering called the *method of assumed*

# Introducing the World's Most Versatile Vector-to-Raster Converter



## The KMW VP-30 Vector Processor

It really doesn't matter if your electrostatic is Calcomp, Benson, or Versatec. With a storage capacity of a million vectors, the VP-30 is capable of driving even the largest electrostatic printer/plotter at full speed . . . a feat no other vector-to-raster converter or electrostatic plotter controller can match. The VP-30 features switch selectable support for the full range of electrostatic plotters.

### Connect Your Electrostatic Plotter to IBM

A variety of host input configurations are available including IBM, CDC, and Univac channel interfaces, mag tape, high-speed communications including IBM Bisync and SNA/SDLC, as well as a Dataproducts front-end for attachment to mini-systems. In all, there are nine host input options available and KMW is constantly developing new options to serve the electrostatic user.

### Eliminate the Software Overhead Associated with Electrostatics

The VP-30 eliminates the need to burden the host computer with the time consuming and expensive vector-to-raster data conversion task. The VP-30 accepts random vectors, symbols, and other graphic data from the host mainframe, reduces it to raster form and outputs it to the electrostatic plotter.

### Operate the VP-30 in Either Dedicated Mode or as a Fully Interactive Remote Graphics Workstation

By simply attaching any CRT/keyboard console, the VP-30 can be used as a fully programmable workstation utilizing the popular CP/M\* operating system.

### Other Important VP-30 Features Include:

- Multiplot overlay capability
- High speed, high capacity (up to 1 million vectors)
- Variable line thicknesses
- Erase mode (reverse polarity)
- Variable area pattern fill, with a variety of patterns and shades
- Trace sequential (seismic) data input capability

For the complete story on the industry recognized leader in vector-to-raster conversion and electrostatic plotter control, contact:

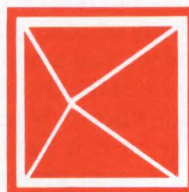

**KMW  
SYSTEMS  
CORPORATION**

8307 Highway 71 West Austin, Texas 78735 512/288-1453  
TWX: 910-874-2005/CABLE: KMWSYS

\*CP/M is a trademark of Digital Research, Inc.

states. This method uses a piecewise linear approximation for complicated devices. It also requires making an assumption specifying a linear region for device operation. For example, EL has two possible states for diodes (on and off) and three states for transistors (active, cutoff, and saturated). Once a state is assumed, EL can use tractable linear expressions for the propagation analysis as before.

After making an assumption, EL must check whether the assumed states are consistent with the voltages and currents predicted for the devices. Incorrect assumptions are detected by means of a contradiction. When this happens, some assumptions need to be changed.

---

*An infrastructure for groups of designers to create an articulated and permanent body of knowledge is a key idea in expert systems.*

---

Intelligent contradiction processing involves determining which assumptions to revise. This is where the dependency records come in. EL uses these records to save justifications for each of its 1-step deductions. These justifications enable EL to identify the assumptions behind a contradiction. Knowing what information in the analysis is dependent on contradictory assumptions enables EL to focus its attention in revising the analysis. First it decides which assumptions to withdraw, then it can gracefully withdraw those additional decisions that are dependent on the original bad assumptions. Contradictions are remembered so that choice combinations found to be inconsistent are not tried again.

#### **Accumulating design experience**

Currently, much of the design knowledge is informal and not written down. Expert designers carry in their heads the knowledge gained from experience, such as special rules of thumb and particular elegant solutions to special problems. This knowledge builds up as designers search for solutions to particular design problems. However, when a designer leaves or forgets, this knowledge can be lost.

A key idea for expert systems for design is to provide an infrastructure for groups of designers to create not only designs, but also an articulated and permanent body of knowledge. For example, a designer of bit-serial signal processors could create a collection of parameterized components (at some level of abstraction) that carry out part of a signal processing task, a body of composition rules for combining these components, and a body of implementation rules that capture some of the critical tradeoffs in mapping these devices into silicon. When such knowledge is saved in a knowledge base, it would enable other designers, less expert in bit-serial processors, to use the library of parts and rules. Community use of such knowledge would also provide the expert with feedback about the correctness and completeness of his knowledge base. In effect, the designer makes his

knowledge available (through a computer surrogate) to consult with other designers.

For example, much of the success of university VLSI design courses can be attributed to the development of a network infrastructure for implementing chips quickly and economically. Extensions of this work to include packaging and boards may help accelerate the growing participation of computer scientists and others interested in experimenting with the silicon medium for building computer systems.

#### **Future prospects**

Assessing the potential impact of expert systems in CAD, it is interesting to look for limiting factors. One critical factor is the number of people with experience building expert systems. There are fewer than 200 people in the United States with experience in expert systems, and only a fraction of these have a substantial interest in design or electronics. As a field, artificial intelligence in general and expert systems in particular seem to be long on ideas and short on manpower. To maximize its impact, it is essential for AI to simplify its methods and to export its ideas.

It is reasonable to ask whether expert systems for design will emerge gradually from the more traditional work outside the expert system community. Certainly, work on silicon compilers is a step in the right direction. However, several fundamental principles for building expert systems are missing in both the silicon compiler work and the traditional CAD systems and methods. These include the use of explicit representations for knowledge (eg, as rules), explicit representations for goals and constraints, and infrastructure for adding knowledge to a knowledge base and debugging a knowledge base.

There are several encouraging signs, however. For instance, several large companies with an interest in electronics and design, including Fairchild, Hewlett-Packard, Schlumberger, and Texas Instruments, have recently organized artificial intelligence laboratories. Also powerful personal workstations supporting appropriate AI languages (eg, LISP), programming environments, and graphics are now available from Lisp Machine Inc (LMI), Symbolics, and Xerox. Finally, knowledge representation languages tailored for expert systems are emerging: Loops (Xerox), MRS (Stanford University), and OPS5 (Carnegie-Mellon University).

Research in these laboratories is likely to lead to new insights. On balance, more examples of prototypical expert systems for assisting designers in the next two or three years are expected, but the widespread use of expert systems in design is several years away.

*Please rate the value of this article to you by circling the appropriate number in the "Editorial Score Box" on the Inquiry Card.*

High 707

Average 708

Low 709

*Photo on p 65 is of the inter LISP-D/Loops programming environment used at Xerox PARC to create expert systems for VLSI system design.*

**INTEL  
INTRODUCES  
TURBO-CHARGED  
MICRO-  
PROCESSING.**

**THE FASTEST,  
EASIEST,  
MOST EFFICIENT  
WAY TO BOOST  
SYSTEM  
PERFORMANCE.**

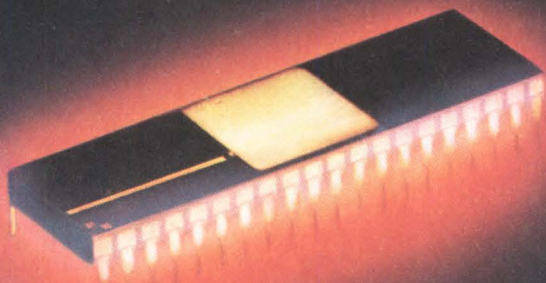

Introducing a revolutionary advancement in microprocessor system design.

Intel Coprocessors.

They work much like a turbocharger in an automobile. Dramatically increasing the power of your CPU, by "kicking-in" whenever specific functions are required.

Intel Coprocessors are an architectural triumph. Processor extensions. Beyond peripherals. They're designed for complete compatibility with Intel microprocessors, boards and systems.

Everything that's needed to boost your power is on one chip. Not a bag of parts.

And no "kludge" of parts can equal the performance, the ease of use, or the cost effectiveness.

There's the 8087 and the 80287 Numeric Coprocessor. Made to work with the Intel iAPX 86 family of 8 and 16-bit processors. Both Coprocessors have the power to accelerate your floating point math calculations an incredible 50 to 100 times. Eliminating the need for a mini-computer in the process.

And there's the 8089 I/O Channel Coprocessor. Capable of tripling your performance in the I/O-intensive parts of your application. Such as in hard disk control and communications.

Intel is the only company with a family of Coprocessors. For the component, board and system level. All being delivered in production quantities, now. With new types of Coprocessors on the way.

Like the 82730 Text Coprocessor.

The first VLSI solution for fast manipulation and display of high-quality text.

And the 82586 LAN Coprocessor. Replacing 100 IC's for Ethernet,\* or other Local Area Network designs.

The competition has yet to produce their first Coprocessor.

---

Typical Performance Improvements with Math Coprocessor  
(All Clock Speeds 8 MHz.)

	8086	8086 + 8087
Double Precision (64 bit) Floating Point Multiply	1,313 $\mu$ S	17 $\mu$ S
Interest Rate Calculation	628 mS	.66 mS
3-D Graphics Image Generation	90.5 seconds	1.78 seconds
FORTRAN Whetstone Calculations	3K Whetstones per second	169K Whetstones per second
Real Matrix Multiply	134 seconds	4.08 seconds

---

Discover just how powerful and cost-effective Coprocessors can be.

For complete documentation, including application notes, call us toll-free. (800) 538-1876. In California, (800) 672-1833. Your information will be on its way in less than 24 hours.

Or write us. Dept. F3, 3065 Bowers Avenue, Santa Clara, CA 95051.

Or contact your Intel Sales Representative.

And don't be alarmed by our enthusiasm when you ask about Coprocessors.

We're just charged-up.

**intel** delivers  
solutions

United States and Canadian Distributors: Alliance, Almac Electronics Corporation, Arrow Electronics, Avnet Electronics, Hamilton/Avnet, Hamilton Electro Sales, Harvey, Kierulff Electronics, Inc., L.A. Varah, MTI Systems Sales, Mesa Technology Corporation, Pioneer, Wyle Distribution Group, Zentronics. In Europe and Japan, contact your local Intel Sales Office.

\*Ethernet is a trademark of Xerox Corporation.

See us at NCC Booth #3910

CIRCLE 31

# THE BUS STOCKS HERE:

PSM-512A: 512 kbyte Multibus™ memory with ECC, 275 nsec access time. Fixes single-bit errors, flags multi-bit errors.

**CIRCLE 32**

PSM-512P: 512 kbyte Multibus parity memory, 240 nsec access time. Very economical.

**CIRCLE 33**

PSM6463: 64 kbyte non-volatile CMOS Multibus memory, 200 nsec access time. 350 hour standby with on-board rechargeable NiCd's, 8 years with lithium. For process control, telecommunications, other critical applications.

**CIRCLE 34**

NEW PSM1VA: 1 megabyte VERSAbus™ memory with ECC, 300 nsec access time. Lots faster and much less expensive than Motorola and IBM equivalents. Full 32-bit VERSAbus compatibility.

**CIRCLE 35**

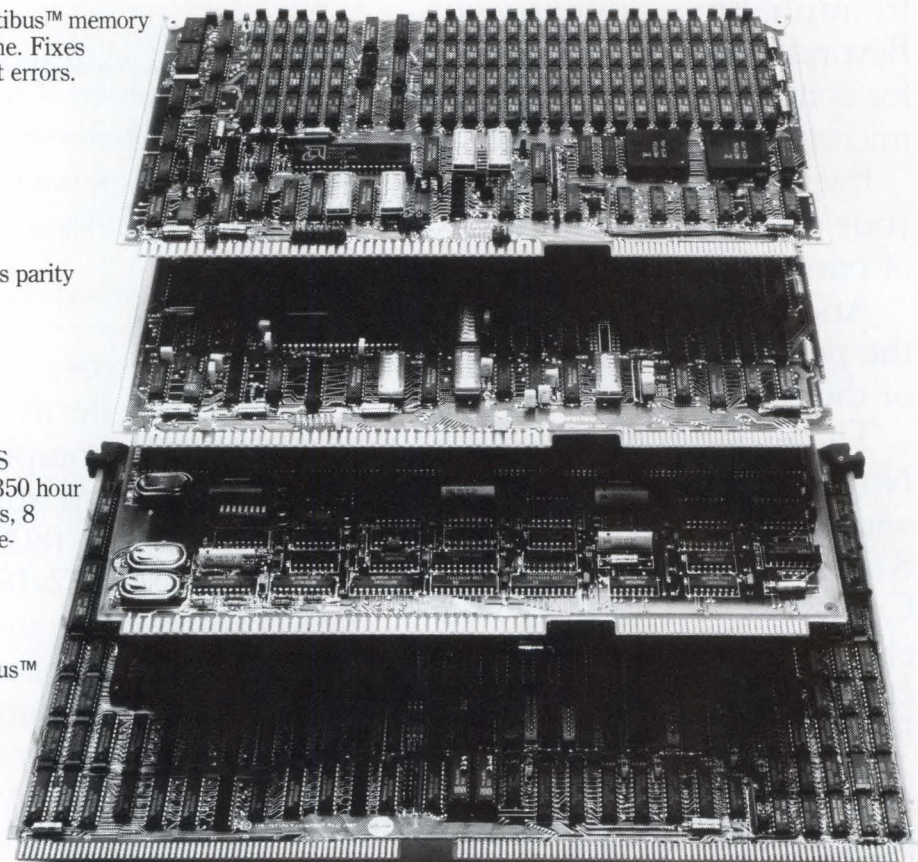

If you're on board the Multibus or VERSAbus, we've got the memories you need to get where you're going faster, for less. ECC, parity and non-volatile CMOS. All in stock now, all with one thing in common. Their first name is Plessey.

And since Plessey makes them all, they all have high reliability, a one year warranty and Plessey support worldwide.

For more information, just contact Plessey

Microsystems, 451 Hungerford Drive, Rockville, MD 20850. (301) 279-2892, TWX 710-828-9815. Irvine, CA: (714) 540-9931.

In Europe, contact: Towcester, UK: (0327)50312, Telex 31628. Paris: 776 41 06. Noordwijk: (01719) 19207. Munich: (089)2362226. Rome: (06) 350189.

Or get on board fast by calling (800) 368-2738 today. Your bus ought to be going our way.

 **PLESSEY**

Multibus is a trademark of Intel  
VERSAbus is a trademark of Motorola



# CALL FORTH FOR REALTIME CONTROL PROGRAMMING

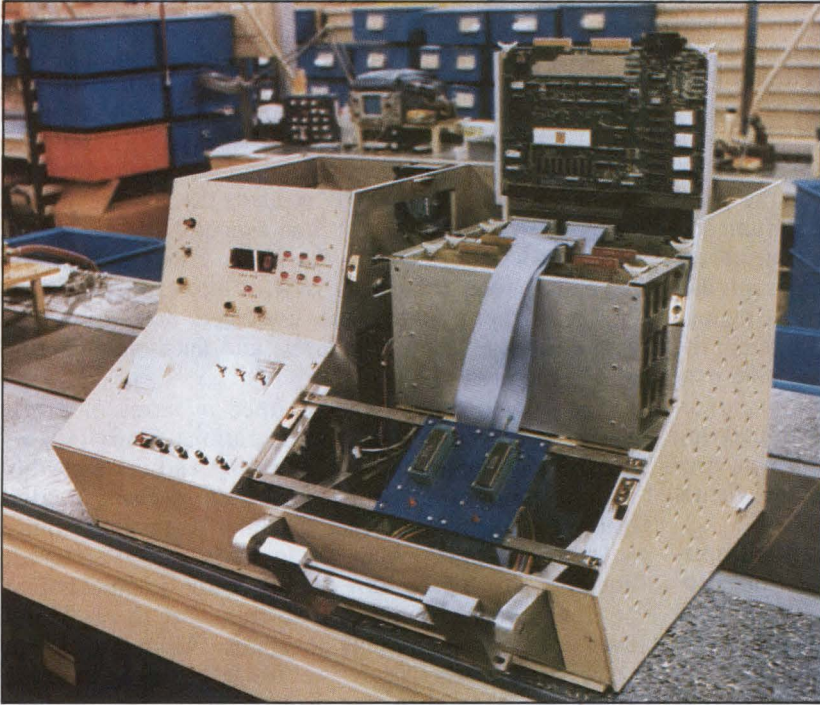

**Forth is ideal for realtime distributed process control. High on the list of pluses is easy interface to assembly language modules—limiting the execution of time-critical routines only to the intrinsic speed of the processor.**

by **Al Whitney and Marvin C. Conrad**

**F**orth is different from other languages—enough so that many computer experts do not understand its value. In fact, there is some question as to whether it is best described as an assembler, a compiler, or an interpreter. Forth is more than a high level, machine independent language. It is a problem-solving method that dovetails with the requirements of a particular situation. Forth is ideally suited to distributed process control applications because it eases the task of custom software design for each major process.

Now that hardware costs for microcomputer chips are lower, designers are turning away from centralized,

*Al Whitney is development support marketing manager at Texas Instruments' Semiconductor Group, Programmable Products Div, PO Box 1443, Houston, TX 77001. He is responsible for market introduction of development tools. Mr Whitney holds a BSEE from Franklin University, Columbus, Ohio.*

*Marvin C. Conrad is a senior member of the technical staff of TI's Semiconductor Group, Programmable Products Div. He is manager of software support product development. Mr Conrad holds a BS from Northeast Louisiana State University.*

general purpose computers with multitasking software to equip realtime process control systems. Controller based system strategies are easier to develop, maintain, and upgrade than central processing unit schemes. Placing the processing power directly at the execution site, rather than multiplexing all operations through a mammoth central processor, leads to more efficient designs that provide fast-acting reliable control. Development methods and support tools are evolving to facilitate this transition to distributed, onsite process control.

Whereas today's software design trend is toward readability, Forth encourages maximum program efficiency instead of easy to read code. With Forth, programmers can shortcut Pascal's enforced structures and write time-critical programming sections in assembly language. This feature unblocks the local processor's throughput to the microcomputer's intrinsic speed limit—with no penalty for the convenience of programming in a high level language.

In some cases, the Forth application can be based on a separate, low cost hardware implementation of Forth. In other cases, as with polyForth, it can be based on a task spawned by the main program. Thus, Forth can support both multiprogramming and multitasking. In multitasking mode, Forth allows usable tasks as small as 22 to 25 bytes. Hundreds of tasks can be handled very

efficiently. Moreover, this approach to multitasking allows the execution time predictability that is so critical to effective process control.

What Forth lacks in universal intelligibility, due to the absence of standardized data structures, it makes up for in fast execution time, compact size, and ease of use. According to Forth's inventor, Charles Moore, the simplest solution to a problem is the correct one. This is achieved in Forth by combining a top-down definition of the total solution with a bottom-up implementation. Compact modular execution and testing somewhat offset the lack of readability in large code sections. Programmers are less likely to read large sections of code in Forth than in other structured languages.

Forth gives the programmer complete access to machine language as well as total control of the stack through which most Forth operations communicate. Conventional languages render these details transparent to programmers. The payoff is that Forth programs can execute almost as fast as their assembly language counterparts. Forth programs can even be written in the host's assembly language. Meanwhile, a 64K-byte memory has plenty of room for a large program, plus an interactive Forth compiler running as its own operating system, a Forth assembler to optimize time-critical programs, and a Forth interpreter, text editor, and virtual memory management system.

Moreover, execution is fast because Forth is implemented as a threaded code interpreter. The final program is actually a string of addresses, each pointing to subroutines at lower levels. As few as two instructions are needed to go from one subroutine to another. The string of addresses can be likened to a thread that weaves through the subroutines and controls overall program execution.

Verification and debugging are simplified because both Forth and assembly language routines are ready for execution as soon as they are written. The assembler does its job in only one pass, with no link passes or file handlers. Each routine can be executed and checked out separately just by typing in test data and the name of the routine.

### Extending Forth to meet the application

A principal feature of Forth is its limitless extensibility. Programmers can easily add new operations, data types, or definitions to the basic language, and can customize it for a specific application. This extensibility is greatly enhanced through the defining meta words `<BUILDS . . . DOES>`. For instance, Forth does not have a `CASE` statement as part of its standard definition. However, using the meta defining `<BUILDS . . . DOES>` allows quick extension of Forth to include a `:CASE` word. The general form of the `<BUILDS . . . DOES>` is

```
: XXX<BUILDS (compile-time words) DOES>
(execution-time words) ;
```

giving a definition of `:CASE` as follows

```
: :CASE<BUILDS ] DOES>SWAP 2 * + @
EXECUTE;
```

`:CASE` is now a defining word. Given the following definitions

```
: LEFT . "turn left" ;
: RIGHT . "turn right" ;
: STRAIGHT . "go straight" ;
```

Now to create the `CASE` direction becomes

```
: CASE direction LEFT RIGHT STRAIGHT ;
0 DIRECTION will print "turn left"
2 DIRECTION will print "go straight"
```

In this example the codes break down as follows: `[']` enters the compile mode, `"SWAP"` reverses the top two stack entries, `"2"` goes onto the stack, `"*"` multiplies two times the second stack entry, `"+"` adds the result to the next stack item, `"@"` replaces the address with its content, and `"EXECUTE"` then executes the dictionary entry whose address is on the stack. This example only partially shows the power of `<BUILDS . . . DOES>`. It can be further used to create intelligent data structures, range checking data structures, and auto-incrementing data structures.

Each Forth operation is defined in terms of previously defined, more primitive operations. Since it is syntactically impossible to mix assembly and nonassembly within a definition, dependency upon a given instruction set is restricted to each module. If transportability is an issue for a given design, it is easily achieved; however, Forth programs can be written so quickly that programmers may not wish to transport them. Moreover, transportability may go against the grain of Forth programmers who prefer to use every programming advantage that they can gain from a specific host environment.

Postfix notation, which is also used in the Hewlett-Packard calculator, places the operation code after the arguments instead of between them as in conventional languages. This reflects the natural order of events in stack protocol: the last items put in are the first ones taken out.

For example, the expression  $(A + B) * C$  would be written in postfix notation as `A B + C *`. This notation is also more efficient for linking subroutines together without using `CALL` statements, argument lists, or passing parameters.

### Programming dictionary and vocabulary tree

Forth differs most from conventional languages in that it is basically a dictionary housing about 100 operation routine definitions (eg, arithmetic and stack manipulations) and 40 "primitives" (operations defined in machine language). The programmer combines these routines and primitives as needed to form new commands and the overall application. All Forth programs are a series of dictionary entries, whether they are applications or the compiler, assembler, or editor, for instance. All programs are executed by the same technique.

Among other items, each dictionary entry contains either a machine language statement, a list of addresses of previously defined operations, or an address of, for

example, a variable or array. The programmer codes an application by defining a sequence of ever-newer routines based on previously defined routines; hence, the resulting program may be likened to an outward-growing spiral of routines. The set of 40 primitive functions and assembly routines is at the center of this spiral. At runtime, the compiler replaces all operation names with their dictionary entry addresses. The Forth interpreter then executes each statement by working only with those addresses.

When the interpreter finishes executing the operation in a given dictionary entry, a pointer in the interpreter indicates the next definition address to be executed. Separate linked lists of dictionary entries, called vocabularies, control the sequence of dictionary search at compile time and in applications.

---

*Forth statements can be mixed with assembly language to perform such time-critical tasks as input/output control.*

---

Thus, the richness of a Forth programming environment—its expressiveness, for instance—is a function of its current library. Operation names not found in a special vocabulary (eg, the text editor) are sought in the natural Forth vocabulary, which is the root of the whole vocabulary tree. A link address in each dictionary entry points to the previous dictionary entry. Each routine is based on a previously defined routine.

Each dictionary entry begins with an 8-byte header. The first 4 bytes identify the entry and include a "precedence bit," which indicates whether the operation is to be performed immediately or later. Immediate operations—usually macros or compiler directives—are performed instantly even with the system in compile mode.

The next 2 bytes in the header comprise the link address, and the 2 bytes following them give the address of the code that implements the operation. The rest of the dictionary entry, as previously noted, is a machine language statement or a list of addresses.

Primitive or user defined code routines end with a machine language branch to the NEXT location in the interpreter. The NEXT code increments the address pointer to indicate the dictionary entry of the next operation in the program. The interpreter then uses the incremented address to find the next routine.

If the next routine is not code but a basic Forth definition, a code routine is invoked to establish the current nesting level. The header's code address points to code that first pushes the value of the interpreter pointer onto the return stack; then, it sets the pointer to indicate the address just prior to the body of the Forth definition. Now, the code branches to NEXT, and the statements in the basic definition are executed as just described.

An entry is created in the dictionary by typing in a "colon" definition. The colon operation (:) initiates

two events: it prepares a dictionary entry for the word (name) following the colon, and it triggers compilation of subsequent operations stated in the definition. A semicolon ends the definition. Since the system remains in the compile mode until the semicolon is entered, special operations can be entered within a definition and executed at compile time. After the semicolon is typed, the new definition is available from the keyboard then or in a later definition.

For example, the following definition, called quadratic, may be written to evaluate the polynomial  $52x^2 - 15x - 10$ .

```
: QUADRATIC DUP DUP * 52 * SWAP 15 * - 10;
```

DUP DUP makes two copies of the top of the stack (which contains the argument) and pushes the copies onto the top three stack registers. If the argument is 10, the stack now reads 10 10 10. Multiplication (\*) leaves the stack with two entries, 100 10. The expression 52 \* pushes 52 and multiplies 52 by 100; the stack now reads 5200 10. SWAP reverses the top two entries of the stack. SWAP 15 \* executes the calculation of 5200 - 52(10). Finally, 10 - completes the polynomial evaluation and the semicolon closes the definition.

The user can test the definition, for instance, with  $x = 5$  by typing "5 QUADRATIC." The operation "." prints the top of the stack's contents. The system will respond 1215 OK, where OK indicates execution is complete and the system is awaiting the next input.

#### Mixing Forth with assembly

Forth statements can be mixed with assembly language to perform such time-critical tasks as input/output control. The assembler is invoked by a definition beginning with CODE instead of a colon. The machine language code is generated as the definition is entered. No special calling sequence is needed, since the completed definition is executed like any other Forth statement.

The assembly language instruction for the host processor must be entered in a postfix notation. The operand and addressing modes are written first, followed by the mnemonic operation code. An output statement for the TMS9900, for example, can be written as the definition of a dictionary entry named Terminal-Out

```
CODE Terminal-Out XOP 14 NEXT JMP;
```

XOP 14 causes a string of characters to be written to the terminal, until an all-zero byte is found. NEXT JMP transfers control to the dictionary entry for the next operation in the program. Assembler conditional branch instructions, such as IF...ELSE...THEN and BEGIN...END are Forth operations that are handled like macros. They are patched into the dictionary entry following the initial CODE in a definition. The single-pass assembler implements forward branching (IF) by leaving an empty space for the forward address on the stack. The forward address is patched into the empty space, where it is found by the interpreter.

#### Creating data types

One of the most advanced concepts in Forth is the <BUILDS...DOES> structure for creating new data types. In defining a data table, for example, the BUILDS

portion is executed when the table is defined; the DOES portion specifies the procedure for executing the table definition.

This approach can also be used to define other arrays, including record structures, classes of user defined operations, or byte or bit arrays. Once the array has been defined, that definition can be used to define any number of arrays of different dimensions.

The following dictionary entry, for example, creates a table with N elements and provides for a table lookup procedure

```
: Table (...N -   BUILDS O DO, LOOP DOES> SWAP ;  
   BUILDS O DO, LOOP compiles N elements (supplied  
   with the program, of course), while DOES> SWAP exe-  
   cutes table lookup.
```

### Virtual memory files

The traditional Forth file system is a simple but practical feature implemented with virtual memory. The entire disk (or disks) is a single virtual array of blocks, where each block is 1024 bytes long regardless of each disk sector's physical length. Each block is called a screen because it can be displayed as 16 lines of 64 characters on a display terminal or printer. Forth stores its source code in these screens. A screen, therefore, can have high level or assembly language definitions or operations for immediate execution.

Further, the file system can read or write any part of the disk with a single access. The BLOCK operation reads from disk as necessary; it takes a disk block number from the stack and automatically buffers the returned block and places the buffer address on the stack. A microprocessor buffer usually holds 128 bytes whereas a minicomputer buffer typically holds 1024 bytes.

A LOAD command takes a screen number off the stack and processes the information in the screen as if it had been typed at the terminal. Source code is compiled or commands are executed. A single LOAD instruction within a screen can initiate the compilation of a large source program.

Thus, Forth is more than a language—it is a problem-solving method. Its execution speed and bottom-up implementation make it perfect for solving complex problems in distributed systems using more than one microsystem. The Forth language's commonality allows the selection of process control microprocessors and microcomputers whose performance is optimized for particular solutions.

*Please rate the value of this article to you by circling the appropriate number in the "Editorial Score Box" on the Inquiry Card.*

High 710

Average 711

Low 712

*Photo on p 81 is of a production test machine designed by Texas Instruments and programmed in Forth.*

# Information at a touch.



Carroll adds touch advantages to the graphic capabilities of high resolution displays. Quick response for control of steel mills, power plants and pipelines. User friendly in consumer environments. Eliminates keyboarding. Removes language barriers. For information, contact the leader in touch technology.

© 1983 Carroll Touch Technology, Inc.

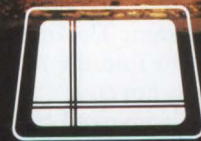

## Carroll Touch Technology

2902 Farber Drive, Champaign, IL 61821  
217/351-1700 TWX 910 245-0149

Keeping computers in touch with people

# Name one microsystem with

- multi-user capability
- a real-time operating system
  - 1 MIPS performance
  - integrated disc storage
- 3-D interactive graphics software
- 4.27 Mbytes/second I/O bandwidth
  - 12 interfaces
- memory expandable in 128kb, 512kb or 1Mb increments
  - data base management software
- powerful networking capabilities
  - a starting price of just \$8,021.

# This is the one.

## The HP 1000 Model 6.

You'll be amazed at how much you can do with such a little computer. Because the HP 1000 Model 6 is only small in size and cost. When it comes to performance, it's another story.

By using our range of plug-in cards, you can easily put together a wide variety of configurations. You could, for example, plug in 8 terminals, 12 instruments, a plotter, printer, hard discs, machine tools and communications links with other computers—and have them all running at the same time. Mostly because of the way our multi-tasking operating system—RTE—takes advantage of the hardware, and delivers big system power. As a result, we can give you virtual memory capability. Dynamic memory positioning. And multiple real-time ways to schedule programs—by event, time, or operator. Not bad for a system that starts at only \$8,021.

And because it's a complete system, you don't have to hassle over compliance with the increasingly tight RFI regulations. Or go through all the paperwork it takes to get UL® approval. Or lie awake nights worrying whether the hardware and software will work together. When you use the HP Model 6, all those problems are behind you.

Even better, the architecture and operating system give you so much flexibility that you can fine-tune our micro to your application as if you'd built it yourself.

### It's so fast it makes you faster.

To get 1 MIPS performance, you'd expect to have to pay for a much more expensive minicomputer. But that's the kind of speed we're talking about in the

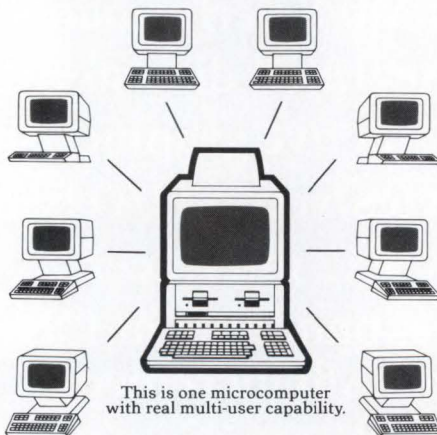

HP Model 6 microsystem. So you don't have to spend time optimizing your application. And with all the system integration, government testing, and government approvals already taken care of, you can get your system to market a lot faster.

With high-speed Direct Memory Access (total I/O bandwidth up to 4.27 Mbytes/second) and a powerful mem-

ory system, you're really flying. And our wide range of interfaces gives you 12 ways to communicate with the outside world. There's even an I/O processor built into every single interface. This takes a big load off the CPU, freeing it for more important tasks. By distributing intelligence in this way, our micro turns in macro performance.

### A growth path that's easy to follow.

HP offers the widest range of instruments and peripherals to fit into your system. They were all made to interface easily, and stand up to a lot of hard work.

And since the Model 6 is based on our A600 processor, it's easy to upgrade. Just move up to our A700 with optional floating point hardware and microprogramming. Both processors are 100% software compatible. That's another powerful argument in favor of HP microcomputers. And our competitive pricing discounts are another example of our commitment to OEMs.

For more information about the HP 1000 Model 6, call your local HP sales office listed in the white pages of your telephone directory. Ask for a technical computer representative. Or write for our OEM Information Kit to: Hewlett-Packard, Attn: Joe Schoendorf, Dept. 12152, 11000 Wolfe Road, Cupertino, CA 95014.



**HEWLETT  
PACKARD**

Choice of integrated terminals with graphics, forms, scientific character sets, large characters, protected fields

8-channel multiplexer allows connection of 8 additional terminals, all managed by RTE

Optional hard-copy graphics

Integrated graphics display, driven by CORE-compatible software

HP-IB card for connection to hundreds of instruments, 14 at a time

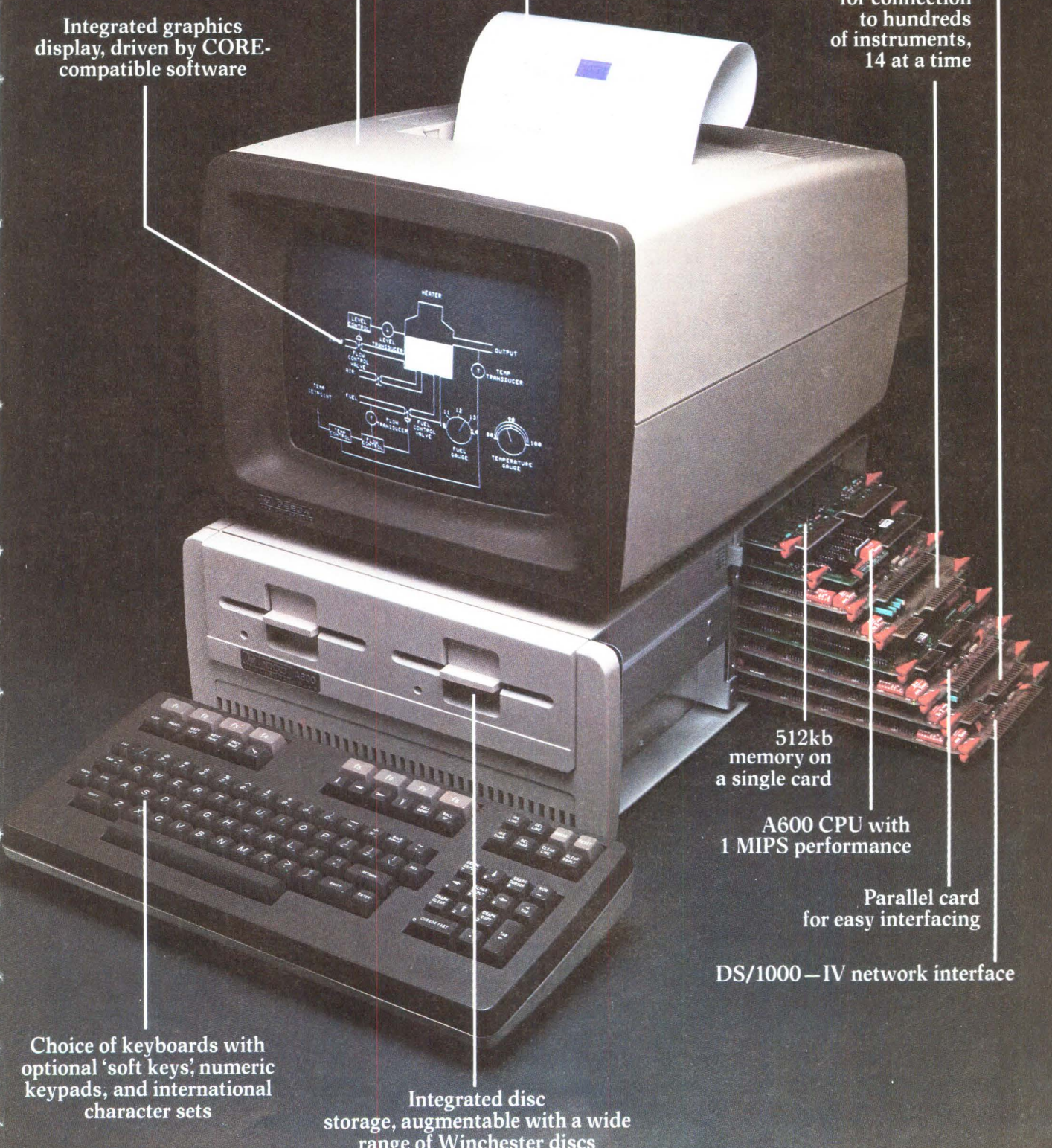

512kb memory on a single card

A600 CPU with 1 MIPS performance

Parallel card for easy interfacing

DS/1000-IV network interface

Choice of keyboards with optional 'soft keys', numeric keypads, and international character sets

Integrated disc storage, augmentable with a wide range of Winchester discs

# How to dress up your IBM.

Fred Molinari, President

## Low cost data acquisition and control for the IBM Personal Computer.™

Data Translation is fashioning a new look in the personal computer market.

Our new single board plug-ins bring complete analog and digital I/O capability to your IBM Personal Computer.

The complete DT2801 I/O system fits on just one board. It includes A/D with programmable gain, D/A, digital I/O, and a programmable clock and has direct memory access capabilities. The DT2805 features the same functionality, with provision for low level analog input.

With power and performance to match that of the IBM PC, either board provides 12-bits of resolution with over 14kHz throughput rates under BASIC.

And whether your application is in laboratory data acquisition or in industrial process control, you will find both boards highly reliable at a very low cost.

The DT2801 and DT2805 are easy to use. Just plug either one into an IBM Personal Computer expansion slot. No need for separate housing or cables. A screw terminal panel with optional thermocouple cold junction compensation is available for connecting analog and digital input signals.

And they're easy to program. More than 30 I/O functions are accessed with just 3 commands from BASIC. Programming instructions and sample routines are detailed in the comprehensive User Manual.

Plus, as with all Data Translation products, the DT2801 and

DT2805 are fully backed by our service and support team.

No other analog I/O system for the IBM Personal Computer offers such quality, power, and performance for such a reasonable price.

But, by now you probably expect that from Data Translation.

We don't just follow the latest trends. We set the style.

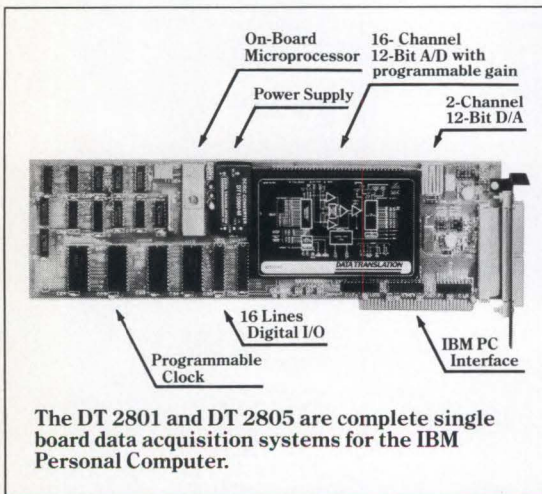
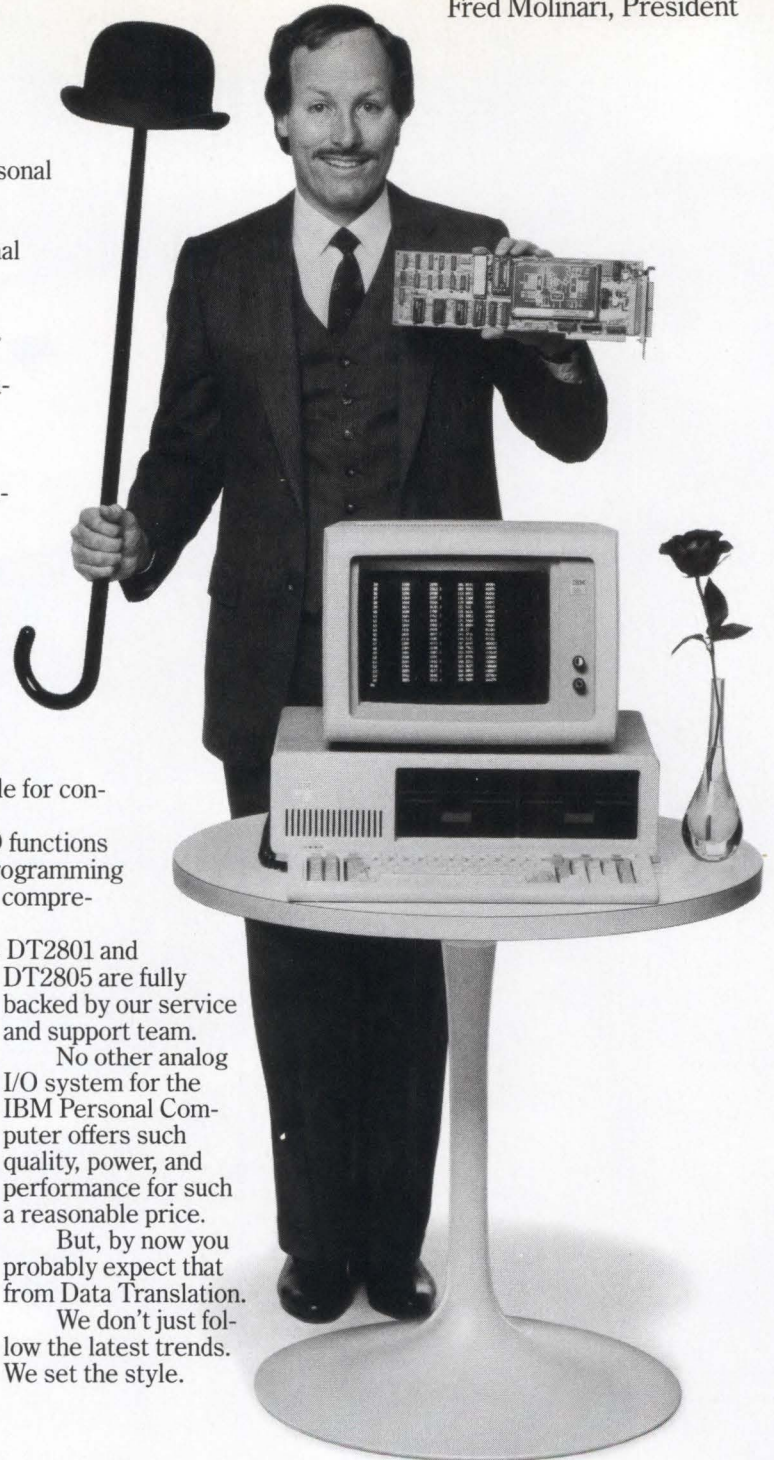

# DATA TRANSLATION

World Headquarters: Data Translation, Inc., 100 Locke Dr., Marlboro, MA 01752 (617) 481-3700 Tlx 951-646.

European Headquarters: Data Translation, Ltd., 430 Bath Rd., Slough, Berkshire SL1 6BB England (06286) 3412 Tlx 849-862.

IBM Personal Computer is a registered trademark of IBM.



# MACHINE VISION IN THE REAL WORLD OF MANUFACTURING

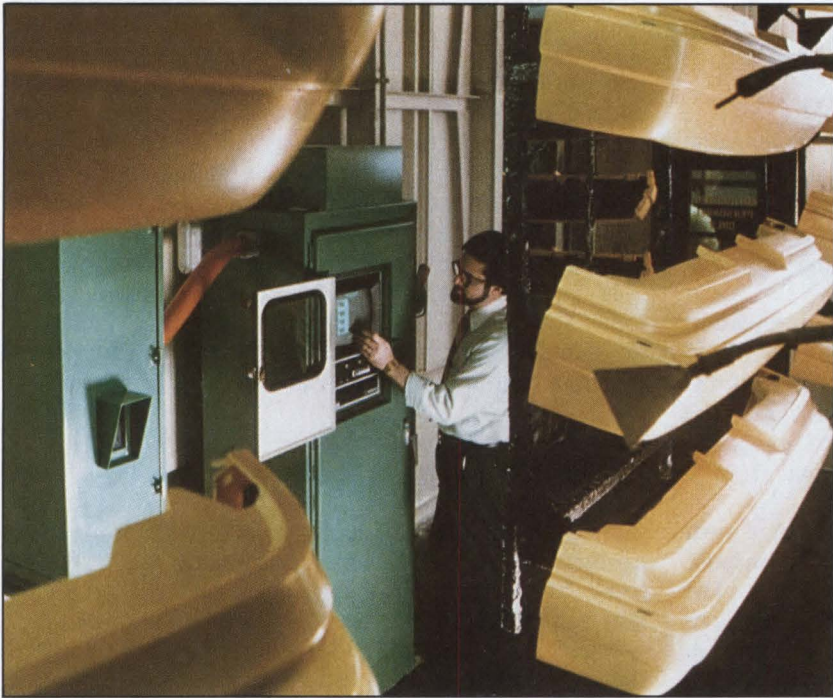

**Machine vision,  
like human vision,  
has limitations.  
Yet this important  
technology can  
become a  
cost-effective tool  
when the mysteries  
surrounding it  
are removed.**

by James K. West

**A**pplication of machine vision capability is frequently made difficult, excessively costly, or downright impossible because of the very human habit of thinking about industrial vision in terms of human vision. When we think about vision machines, we imagine systems that will closely emulate human vision. Yet no current machine can even approach the capabilities of human vision.

Human vision is highly general and exquisitely adaptable, but the depth of knowledge about this physiological phenomenon is extremely shallow. Studies at the University of Iowa have shown that no human inspector has ever achieved more than 87% effectiveness on a shift basis. Those in industrial quality control circles

*James K. West is cofounder and vice president of software development at Perceptron, Inc, 23920 Freeway Park Dr, Farmington Hills, MI 48024. Formerly, he was senior project engineer at the General Motors Technical Center. Mr West has a BSEE from General Motors Institute, Flint, Mich, and an MSEE from the University of Illinois, Champaign.*

who claim to manually inspect 100% of their parts are kidding themselves. Human vision is incapable of reliably performing most of the measurement, gauging, and counting tasks so important to the industrial environment.

No one would ever doubt the value of a machine that could demonstrate the robustness, generality, and adaptability of the human system. However, as Perry West, a consultant for Automated Vision Systems, has stated, "There is no reason to impose human-like limitations on (machine vision) technology."<sup>1</sup>

Research documents on vision often stress the importance of building general purpose machines. Yet this way of thinking can be a trap. The Swiss Army knife, for example, is a wonderful general purpose tool but a horrible knife.

The power of human vision lies in its generality and judgment. For the immediate future, humans can best solve tasks requiring these qualities. The power of automation is specialization, and the power of machine vision lies in the ability of specialized vision machines to perform their tasks more effectively and reliably than human operators.

One cannot argue against the economic inadvisability of producing one-of-a-kind vision solutions, but the

answer does not lie in building general purpose machines, either. The answer lies in the creation of flexible machines that serve the needs of substantial and well-defined market segments.

Technical staffs of most manufacturing facilities are not sophisticated in vision technology and will seek solution-oriented systems. Vendors must work to identify significant markets, study the needs, and design systems that solve problems specific to those markets in a flexible, user friendly way. Customers should be wary of buying machines that are labeled "user programmable" and instead, work with vendors sensitive to their broader automation requirements.

### The challenge of industrial applications

Processing and understanding visual images by machine has been of interest ever since the digital computer emerged as a practical device. Over the past three decades, technology made great promises and had lofty expectations, but the realization of results has been disappointing at best.

Many authorities attribute this lack of application generally to the difficulty of the task, but particularly to the lack of fast computers and robust algorithms. Though these problems are real and challenging, the true problem is the psychological one of expecting human levels of adaptability and judgment from a machine.

Users and vendors must stop complaining that most industrial vision applications have been single-purpose machines instead of general purpose automata. The secret to practical application of vision technology is to understand and accept the need to achieve a balance in real-world tradeoffs.

To succeed, it is essential that the application engineer choose a problem that management feels is important

enough to solve, and that labor feels is desirable to automate. Both the problem and the environment in which the solution must live also need to be well-defined by the user and understood by the vendor. The feasibility of the application must be studied thoroughly, and the solution must then be applied to a large set of sample parts during development.

The field of vision already has failures on its record because the technology has been misapplied. For too long, vendors have claimed to possess equipment that could solve almost every problem. In addition, the researchers in the field have been forced, either by the academic environment or their own biases, to ignore real-world problems because those problems supposedly undermine "good" research. Lastly, although the user desperately needs this technology, there is a reluctance to design a product or modify the manufacturing processes to accommodate automation. Also, the user is often unrealistic with the research and vendor communities when relating the true scope of his needs.

Is it possible to apply machine vision technology in today's industries? No, if we are trying to create a mechanical man; Yes, if we are just trying to find cost-effective solutions to realistically defined problems.

### Classifying vision problems

Prior to evaluating the capabilities of today's commercially available machine vision systems, it is important to classify the difficulty level of the production problem to be solved. Vision tasks tend to fall into three levels of difficulty, categorizing aspects of problems that can be controlled versus those that cannot.

Problems at the simplest level (level 1) are those where the object under scrutiny can be controlled both in position and appearance [Fig 1(a)]. Position control implies that the environment in which the object exists allows it

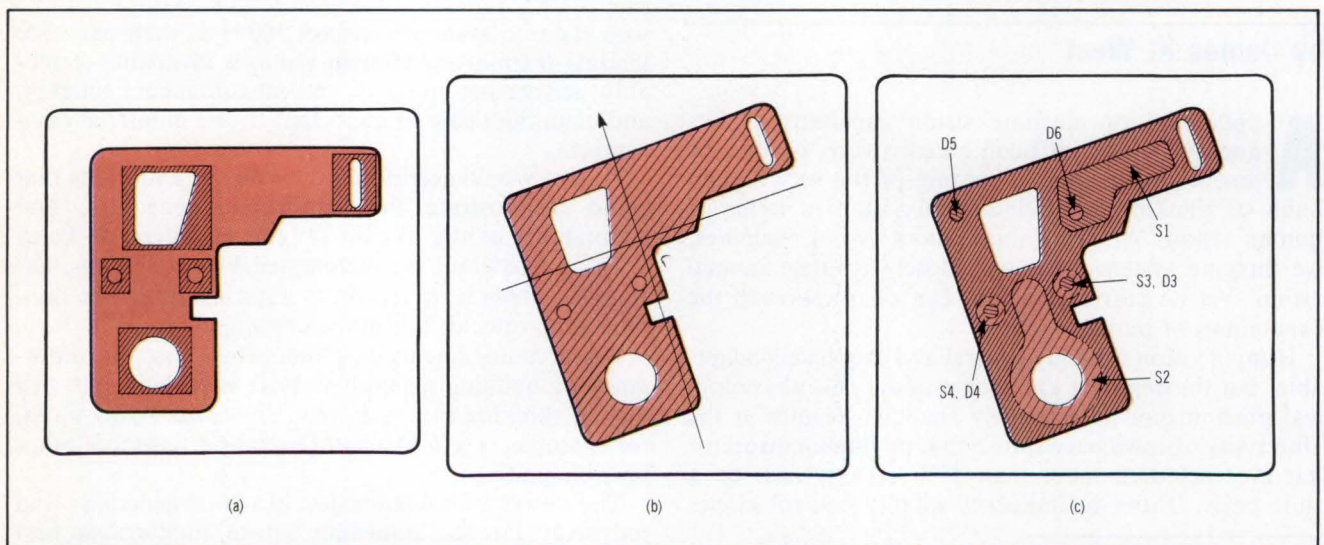

**Fig 1 Available machine vision capabilities fall into three levels of difficulty. In level 1 (a), the simplest level, problems are structured such that both the object's appearance and position are controlled. Level 2 problems (b) are structured such that either the object's appearance or position is allowed to vary, but not both simultaneously. Level 3 problems (c) lack sufficient structure to allow control over either appearance or position and require advanced vision capabilities. In this representation, an S represents a surface feature while a D represents a blind hole diameter.**

# AYCON 16/SERIES

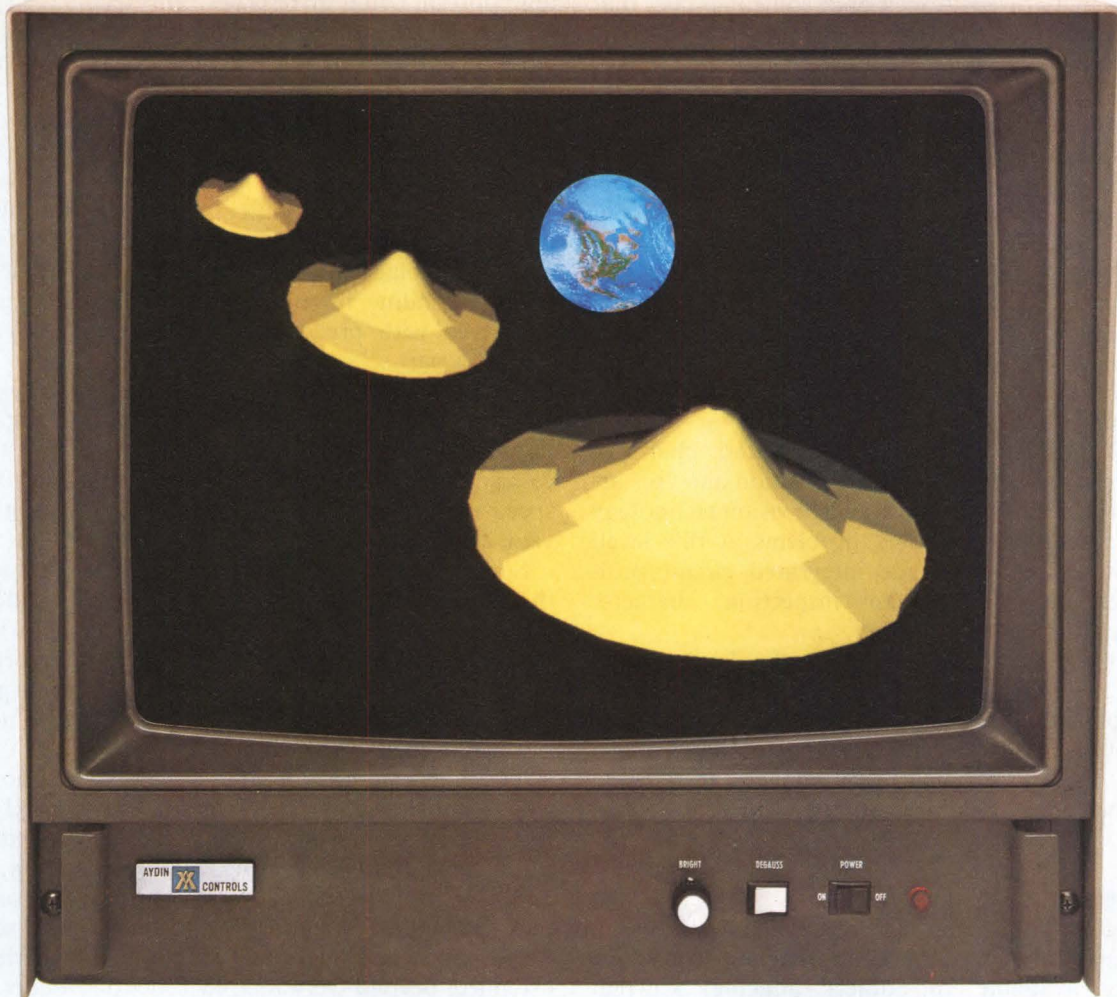

## brings high performance color graphics down to earth.

Only AYDIN CONTROLS' 15 years of experience in raster scan color graphics could bring you a display computer with the total capability of the AYCON 16/SERIES...and now at such an affordable price!

The overwhelming acceptance of the AYDIN original Model 5216 allows us to offer an enhanced version of this field-proven unit. Check this unmatched combination of **systems/hardware features available with the AYCON 16/SERIES:**

- Up to 1024 x 1024 pixel x 16 bit (Z-axis) color display.
- Refresh at up to 60Hz.
- A variety of video modules.
- Characters in three sizes.
- Vectors at 800 ns per pixel.
- 80 x 48 character A/N overlay.
- Multiple 16-bit micro's. AYDIN software or you program them... even up to 14!

- Single or multiple WORK-STATIONS...up to four!
- High-resolution RGB monitors - delta or in-line gun.

### And when it comes to Software/Firmware:

- Graphics Firmware with fill and zoom standard!
- AYGRAF/CORE 2-dimensional Firmware/Software with World-to-Screen translation, rotation, and scaling...world coordinates of 64K x 64K!
- Plus AYGRAF/3D, AYGRAF/LIST, and support Software.

But if all this is not enough to excite you, how about more economy with standard PACKAGED

SYSTEMS, single or multiple WORKSTATION pre-engineered for the most common color display applications?

If you're ready to fly with your color graphics display application, we can help you "get off the ground" with a system to meet your industrial, business, scientific or commercial requirements.



**Aydin  Controls**  
**Command Performance in Color Graphics**

414 Commerce Drive, Fort Washington, PA 19034 (215) 542-7800, TWX: 510-661-0518 Telex: 6851057

to be precisely fixtured. Appearance control implies that the object itself has a precisely predictable surface coloration and texture, or that the environment allows a predictable appearance to be created via structured lighting. A few examples of level 1 problems include material thickness gauging, shaft diameter measurement, feature presence checking, foreign object detection, and label verification.

Level 2 problems are somewhat more difficult because the object under scrutiny is uncontrollable in either position or appearance, but not both simultaneously [Fig 1(b)]. Production problems illustrating controllable appearance and variable position include object location for robot guidance, part recognition and sorting, and code reading.

Level 3 problems present the greatest challenge because they involve simultaneous position and appearance uncertainties [Fig 1(c)]. Machine vision technology has only recently approached problems at this level. Production examples include integrated circuit positioning, engine valve retainer inspection, character reading, and limited bin picking.

Successful application of existing technology requires balancing the cost of process changes necessary to constrain problem complexity with the cost of system sophistication needed to overcome the existing problem condition. Failure to achieve this balance can result in systems that are unreliable or that fail to achieve cost payback.

### Available vision capabilities

Depending on the process to be controlled in the manufacturing environment, several approaches to machine vision are available for object imaging. Current approaches include binary image subtraction, window and pixel counting, gray scale signature correlation, and binary segmentation. Each approach has unique advantages, as well as limitations, that must be collectively weighed to effect a true solution to a manufacturing problem. It may be that vision is not the correct solution at all.

*Binary image subtraction* is perhaps the simplest image recognition process today. It involves fundamental comparisons of light and dark images. An image intensity value is selected from the brightness range of the image to define a black/white threshold level. Pixels (picture elements) darker than this level are set to black; lighter pixels are set to white. The result is a silhouetted binary image of the object.

A precisely positioned sample part is first viewed by the vision system and its binary image is stored in computer memory. Subsequent parts viewed by the system are converted to binary images and subtracted from the sample part image. The remaining pixels are counted and the difference between the two images represents the degree of error. This difference count is compared with preset limits to produce an accept/reject decision.

Reliable results are possible only if the objects exhibit random appearance and position variations that cause count differences much less than those characteristic of the defects or other differences to be detected. Lighting must be carefully arranged and controlled to minimize

unimportant count differences. This technique is useful in high speed processes requiring a simple Yes-No or Go-No Go decision. For instance, does the object have one, two, or more holes?

*Window and pixel counting* is similar to the binary image subtraction method and requires image thresholding. A user-designated window is defined to enclose the object or feature of interest. This window also simplifies the scene by eliminating unimportant detail. The number of black and white pixels included within the interest window is counted, and the resulting count compared with predetermined limits to recognize or inspect a part.

Window and pixel counting does not require extensive software design to be effective in factory situations. A microcomputer is frequently used to implement the process and tailor it to the specific application. Processing speed is excellent. Some systems can be configured to view 2000 windows in one frame time (1/30 s).

Simplicity of the binary process imposes limitations in the factory environment. As mentioned, window and pixel counting requires object representation with simple black/white count values. Objects, therefore, must be presented to the camera in precisely the same position and orientation so that features of interest do not shift out of the predefined windows.

The same cautions for binary image subtraction apply when implementing the window and pixel count method. Environment must be strictly controlled to produce repeatability. Lighting, part orientation, color, and random variations all affect accuracy. More complex recognition functions require considerable software development and operator programming experience. If extended beyond very simple functions under highly controlled conditions with objects of unvarying appearance, window and pixel counting becomes decidedly "unfriendly" to the user.

*Gray scale signature correlation* is a compression technique that takes a generalized view of a scene based on some universal factor (eg, size, shape, orientation) and reduces the information to one numerical representation. Unlike thresholded systems and methods, the digitized intensity of each pixel is retained as 1 of 16 or more shades of gray.

Signature correlation has some attractive, if limited, uses. It is a high speed process that is not data dependent. Computation for each scene is fixed and decision time is minimal. In fact, a frame takes the same time to process whether or not it contains an object. This approach has been applied to tasks such as label inspection where it can quickly check label registry or print quality. It is also an economical way to recognize groups of parts or objects by class, size, shape, or position, as long as the scene is highly controlled. The hardware is relatively inexpensive and simple. Since scene signatures require minimal storage, a large memory is not required.

*Binary image segmentation* development represented a breakthrough in 1974 and is attributed to Gleason and Agin of SRI International.<sup>3</sup> This popular technique reduces a thresholded image to a group of region descriptions. The image pixel rows are sequentially scanned and transition points (where levels change from

# INDUSTRIAL TOUGH AND AFFORDABLE

## THREE MULTIBUS™ CHASSIS FROM ETI MICRO

The ETI Multibus Chassis is not just another pretty face. Behind the attractive, removeable front bezel you'll find a rugged, sophisticated package.

The ETI chassis family includes a 9-slot and 15-slot multibus chassis, as well as a dual 8" diskette chassis.

Welded steel construction provides an efficient EMI shield for the electronics. The use of welded seams, instead of screw mounting, assures a rugged, stress-resistant enclosure.

The multibus chassis comes completely integrated with card cage, power supplies, fans, EMI line filter, reset button and on/off circuit breaker.

For multibus systems designed to function in even the toughest environments, you can't afford to put it in a flimsy bolted or aluminum chassis. Choose the model that fits your needs.

Rugged and affordable...order yours now!

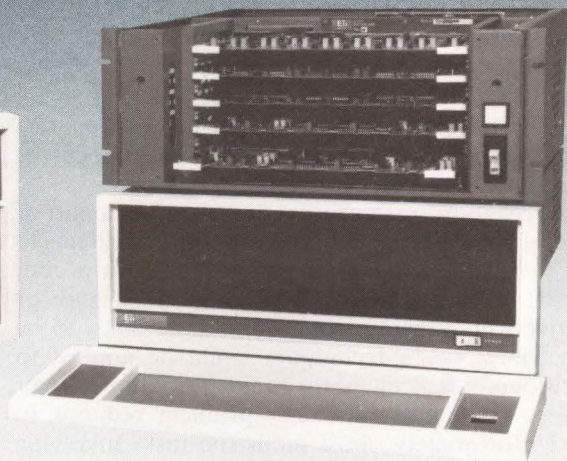
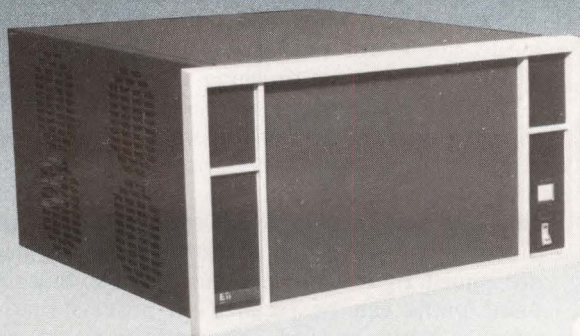

		Quantity: 1
8100	9-slot multi-bus chassis	\$1250
8215	15-slot multi-bus chassis (supports parallel or serial bus priority)	\$1700
8300	Dual 8" diskette chassis (includes two disk drives)	\$2510

MULTIBUS is a trademark of Intel Corporation

**ETI**  
MICRO

ETI MICRO, 6918 SIERRA COURT, DUBLIN, CA 94568, (415) 829-6600

0 to 1 and from 1 to 0) are marked. From these transitions, regions are developed through connectivity analysis. As the regions are pulled out of the image, they are reduced to a list of descriptors such as area, perimeter, major and minor axis angles, hole count and area, and several shape-defining measures. These rotationally invariant descriptors represent an object regardless of its position and orientation in the original scene.

A system using this technique can learn to recognize a part by viewing a series of samples that represent the range of normal part appearance and position variations. By converting the part descriptors to ranges based on the sample set, a model of the part can be constructed. During recognition, the image of the part of interest is reduced to a list of descriptors that are matched to the stored models using either a binary decision tree or a normalized nearest neighbor comparison.<sup>3</sup>

While this technique is powerful, it has significant limitations. As with most other commercially available techniques, it also assumes that the scene can be reduced to a binary image. More important, though, it is still only a 2-dimensional technique. It is quite capable of recognizing silhouetted objects that vary widely in both position and orientation within the image plane (X, Y, roll), but variations in part presentation out of the image plane (Z, pitch, yaw) destroy this approach's effectiveness.

### Applying the technology

Overall, the library of available techniques provides a comprehensive set of solutions to a wide range of industrial problems. It is important to remember that not all machine vision companies can provide all of these techniques. The user must find the vendor with a solution to match the problem rather than letting any vendor twist a problem to fit an existing solution.

The majority of vision related problems primarily fall in two production areas: object recognition and inspection. Challenges encountered in successfully applying available techniques to problems in the recognition area especially strengthen the case for the development of flexible solutions to market specific problems.

Object recognition is a process that classifies a part or feature as different from the others in a set. The items to be classified might be castings traveling down a conveyor belt, holes in a stamped sheet metal shroud, or automotive trim hanging from a hook and ready to be painted. Many vision techniques could be applied to object recognition if all parts could be fixtured, their appearance controlled, and any problem reduced to level 1. Unfortunately, most industrial tasks involving recognition present parts in an unfixtured state. It is fortunate, though, that the industrial environment often allows the appearance of objects or features to be highly controlled through structured lighting. Binary image segmentation is the most useful technique for level 2 object recognition.

In the production environment, the finishing (painting) industry is attempting to accelerate the cost-effective application of spraying robots and programmable reciprocators. To make full use of the flexibility of these devices and eliminate the need to batch process, a general part recognition capability is required. Some past

attempts to automate this task have failed due to the complexity and inflexibility of limit switch or photocell systems that can recognize large part mixes. Machine vision via segmentation is a capable solution to the problem (Fig 2).

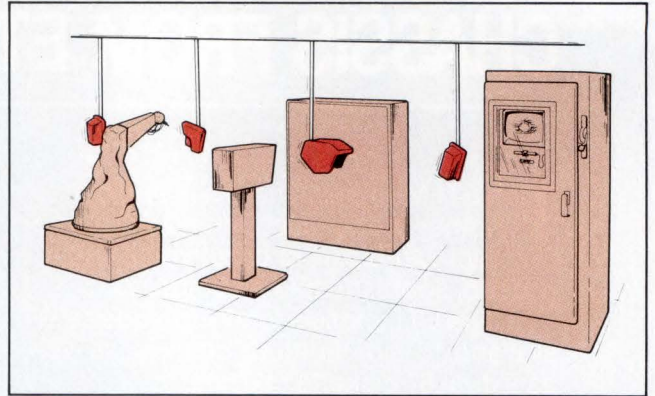

**Fig 2 Binary image segmentation applies well to the part identification problem for paint robot control in level 2. Visual automation allows the user to randomly mix part types and colors, thus avoiding batch production inefficiency. The challenge of this application was to make the vision system as flexible and as "user friendly" as the robot.**

For many reasons, the segmentation process works. First, finishing conveyor systems typically carry parts hanging from hooks, thus allowing backlighting techniques to create the necessary high part contrast. Second, the segmentation process's immunity to absolute part position and orientation accommodates the swinging so common with hanging parts. Key statistics about an object necessary for recognition are accumulated by the computer through a simple teach-by-showing operation. This makes training for new parts easy for the unskilled operator. Last, the compact size of the generated part model allows for the large part mixes that sometimes approach 200 in the finishing world.

The real challenge of successful application concerns aspects somewhat removed from the type of vision technique used. Finishing systems must recognize special color flags that instruct the finishing equipment to change colors. The effect of the hook must be filtered out of the process by a special function. Systems must distinguish right- from left-hand parts so that the proper paint paths can be recalled—a process that requires advancements beyond the traditional SRI-developed algorithm. Finally, the nature of the finishing environment precludes collecting parts in batches even for teaching purposes. This requires a more sophisticated teach-by-showing approach that accepts part samples in a random mix while continuing to control the finishing equipment.

A segmentation-based machine can also control sorter mechanisms in belt-conveyorized operations. General Motors developed such a system for sorting castings in a foundry finishing room. In the finishing process, many of the small castings become randomly mixed in bins. Traditionally, a worker had to sort this mixture by hand and successfully identify hundreds of

# You won't find this kind of software versatility anywhere else

When it's time to buy an Instrument Controller/Computer for your next automated test system, software is one of the most important considerations. And that's the reason you should look to Fluke for PASCAL, FORTRAN, two kinds of BASIC and Assembly software. Languages designed to make your system building task easier. Here's how:

## Our BASIC is anything but

The 1720A comes standard with an interpretive BASIC. It, along with the optional Compiled BASIC, features 28 extensions specifically written to control IEEE-488 programmable instruments. For instance, Fluke BASIC has 7 types of interrupts to signal a variety of external events. We've written the code and embedded it in the language so you don't have to.

Plus, to take full advantage of our mass storage peripherals, this BASIC utilizes Virtual Arrays, a software feature usually found only on larger, more expensive systems.

## For more complex tasks—try our new PASCAL

Many programmers favor PASCAL because of its ability to easily support complex data structures. Fluke's PASCAL combines this feature with three extensions

which tailor the language to the programmable instrument environment. These extensions are:

- Real-time run mode that allows the 1720A to react to any external asynchronous event.
- Seventeen IEEE-488 pre-declared bus procedures embedded in the language for simplified programming.
- Powerful file handling capabilities that allow the user to take full advantage of Fluke's Virtual Arrays memory system.

## Special Edition FORTRAN and Assembly Languages

Our FORTRAN and Assembly have all the features of these standard programming languages, but with a little extra. Built-in routines allow use of the IEEE-488 bus and other convenience features. And with our BASIC's linking feature, you can combine a FORTRAN or Assembly routine with any BASIC program. You'll save time in programming and running your systems.

## Find out more

For more information on these languages or the Fluke Instrument Controller family, contact your local Fluke Sales Engineer, write to us at the address below, or phone us direct at 1-800-426-0361.

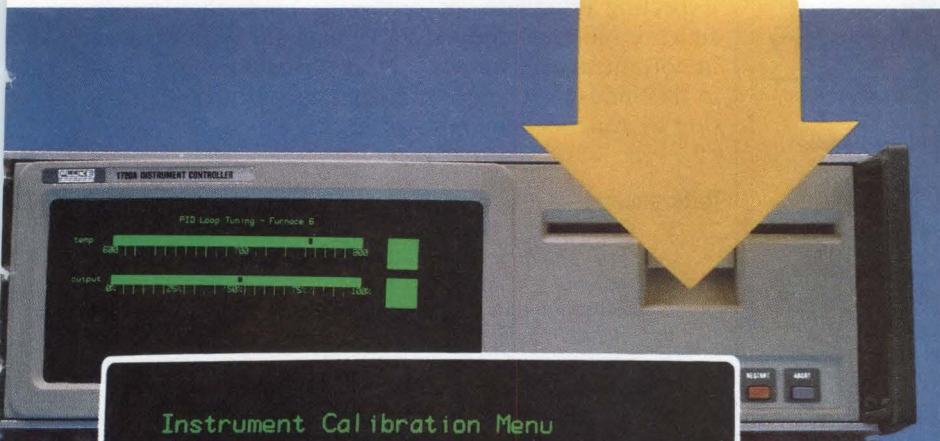

### Instrument Calibration Menu

- > [ ] Calibrate an Instrument
- > [ ] Review Calibration Data
- > [ ] Modify Calibration Procedure

Touch Block

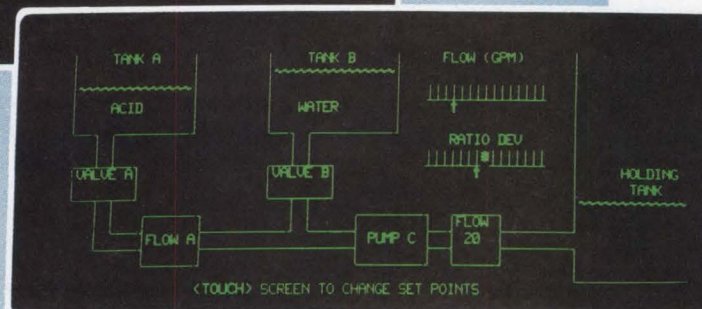

IN THE U.S. AND NON-EUROPEAN COUNTRIES:

John Fluke Mfg. Co., Inc.  
P.O. Box C9090, M/S 250C  
Everett, WA 98206  
(206) 356-5400 Tlx: 152662

IN EUROPE:

Fluke (Holland) B.V.  
P.O. Box 5053, 5004 EB  
Tilburg, The Netherlands  
(013) 673973, Tlx: 52237

**FLUKE**®

1720A Instrument Controller.  
Now with Compiled BASIC,  
FORTRAN and PASCAL

different part types. The manual operation was not only slow and tiring, but very prone to errors. Vision via segmentation, in conjunction with the GM-patented Consight lighting system, allowed a machine to be created that one operator could control to automate the entire plant's sorting needs.

Randomly positioned and oriented parts are carried on a high speed conveyor belt past a line camera augmented with the special lighting system (Fig 3). This

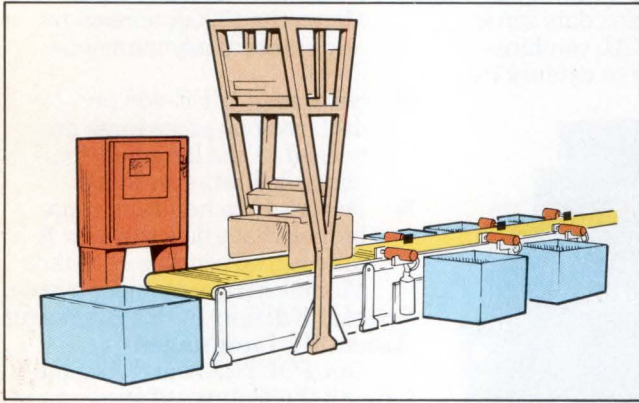

**Fig 3** Sorting castings from a conveyor belt with binary image segmentation was only possible after General Motors developed the patented Consight lighting principle to provide high part/belt contrast. The challenge of this application was to marry the vision algorithms with sophisticated operator graphics for sorter control and inventory tracking.

structured light concept creates the high part/belt contrast required by the segmentation process. As parts are recognized, their positions are recorded and passed to a sorting mechanism that kicks the parts into appropriate bins.

The visual recognition process required for sorting is a rather straightforward application of the segmentation algorithm. However, additions required to create the sorting machine are another story. In addition to controlling the recognition of up to 200 different parts that could appear on the belt in a variety of poses, the operator needs to control 16 pneumatic kickers flanking the conveyor belt and the quantity of parts accumulating in the bins.

To provide the information transfer level necessary for efficient control, the system is equipped with a high resolution color monitor with lightpen input. With this flexible interactive tool and menu-driven graphics, the operator can create and analyze part models, direct the parts to target bins, gain information about bin contents, and monitor the machine's operating condition. The system is also equipped with an audio alarm to warn the operator of part rejects and can stop the conveyor automatically when operator intervention is required.

#### In conclusion

To make machine vision a cost-effective tool, considerable hardware and software tailoring is required beyond supplying general recognition capability. Providing true solutions to specific manufacturing problems requires cooperation and honesty from both the user and the vendor. Machine vision cannot do all things—but what it can do, it does very well when properly applied. Expecting otherwise, or promising more than is possible, is counterproductive to machine vision as an important new technology. It also works against those in this industry who are contributing to the modernization of America's manufacturing base.

#### References

1. P. C. West, "Overview of Machine Vision—1982," *Applied Machine Vision Conference Technical Papers*, RI/SME MS82-184, Apr 1982, p 1.
2. G. J. Gleason and G. J. Agin, "A Modular Vision System for Sensor-Controlled Manipulation and Inspection," *Proceedings of Ninth International Symposium on Industrial Robots*, Mar 1979, pp 57-70.
3. W. B. Gevarter, *An Overview of Computer Vision*, National Bureau of Standards NBSIR82-2582, Sept 1982, p 43.
4. R. Baumann and D. Wilmshurst, "Consight Vision System Streamlines Robotic Part Handling," *Robotics Today*, Aug 1982, p 44.

Please rate the value of this article to you by circling the appropriate number in the "Editorial Score Box" on the Inquiry Card.

High 713

Average 714

Low 715

Photo on p 89 illustrates machine vision in use at Ford Motor Co to identify parts and detect missing ones.

## DCS High Reliability Multibus Microcomputer Systems for Industry



**DCS/86L**  
16-bit (8086) microcomputer system with CDC Lark 16 megabyte (Winchester) removable cartridge disk.  
(DCS/86 system prices start at \$6900.00).

**DCS**  
Distributed Computer Systems is a manufacturer of high reliability, rugged Multibus systems for industrial control, factory and laboratory automation, data communications and software development. Since 1979 DCS has been praised by hundreds of customers for its systems reliability and rugged design. DCS offers the *best industrial microcomputer system value in the industry* and we welcome your comparison.

**Distributed Computer Systems**

#### Software

The DCS/86 utilizes standard operating systems such as CPM/86, MPM/86 (multi-user, multi-tasking), Concurrent CPM/86 (single user, multi-tasking), MS-DOS (original operating system selected for IBM PC), Xenix (UNIX) and iRMX86 (Intel multi-tasking DOS). High level languages include Fortran, Basic, Pascal, PL/1 (subset G), PLMX, Cobol, "C" and ADA. DCS offers the *largest selection of software available for 16-bit microcomputer systems and a staff to provide customer support.*

#### Field Proven

Hundreds of DCS systems are in use throughout the United States and Western Europe in demanding industrial applications. Whether it is a complete system or OEM components, please be assured that DCS is first in quality, support and price/performance.

223 Crescent Street, Waltham, Ma. 02154  
617 899-6619 Toll Free 1-800-225-4589  
TWX 710-324-6476



# OMNIBYTE

## OB68K1A

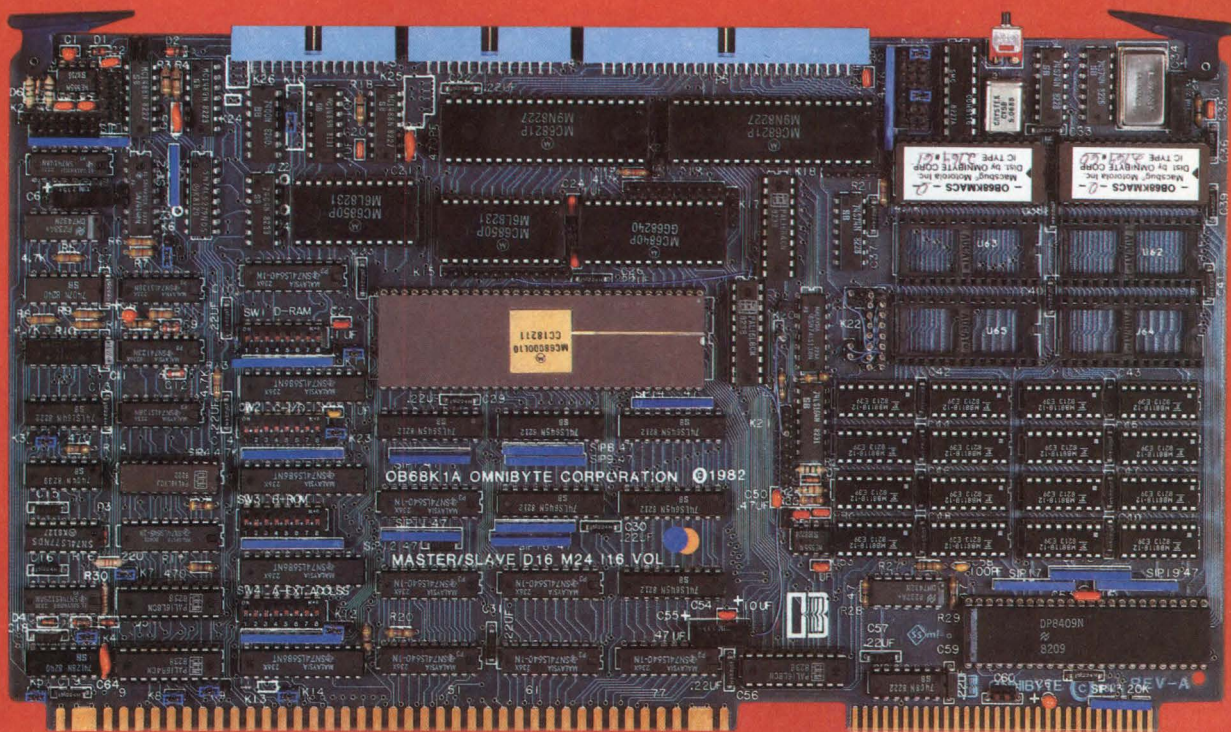

### MC 68000 SINGLE BOARD COMPUTER (MULTIBUS / IEEE 796BUS)

#### THE BEST JUST GOT BETTER

The OB68K1A is an extremely powerful stand-alone microcomputer board designed to serve as a high performance upgrade for OMNIBYTE's popular K1 single board computer. It features:

- ★ 10MHz MC68000 16-BIT CPU
- ★ 32K/128K/512K-bytes of dual ported RAM
- ★ Up to 192K-bytes of EPROM
- ★ (2) RS232C serial ports
- ★ (2) 16-BIT parallel ports
- ★ A triple 16-BIT timer/counter
- ★ (7) prioritized-vectored interrupts
- ★ Switch selectable memory mapping

- ★ Software/hardware selectable baud rate generator
- ★ Directly addresses 16M-bytes
- ★ Multibus/IEEE 796 BUS compatible

The OB68K1A is a high performance single board computer designed as a direct replacement for our OB68K1. Enhancements include a 10MHz MC68000 CPU, hardware ram refresh circuit with zero-wait-state operation, 32K or 128K-bytes of ram (512K-bytes in fourth qtr., 83), up to 192K-bytes of EPROM, and a low noise multi-layered design. Other features include (2) RS232C serial ports, crystal controlled baud rate generator (50-19.2K), (2) 16-bit parallel ports, a triple 16-bit timer/counter, and 24 address lines for directly addressing up to 16M-bytes.

#### SOFTWARE SUPPORT

A variety of software packages are available for the OB68K1A. They range from the optional MACSBUG monitor/ debugger to Realtime Executives and Target Operating Systems in silicon. Four commercial software manufacturers have complete operating systems, including development tools and high level languages.

*FOR MORE INFORMATION ABOUT THE OB68K1A, ASK FOR OUR FREE SUMMARY SHEET OR SEND \$10 FOR A DETAILED TECHNICAL MANUAL.*

Contact Sue Cochran, Sales Manager

**Quality, Reliability,  
Performance**



#### OMNIBYTE CORPORATION

245 W. Roosevelt Rd.  
West Chicago, IL 60185  
(312) 231-6880

OB68K1® is a trademark of Omnibyte Corporation  
MULTIBUS® is a trademark of Intel Corporation  
MACSBUG® and MEX68K DM are trademarks of Motorola, Inc.



# CalComp's \$11,000 vs. their \$16,000

Why settle for a plodding plotter when you can double your throughput with an all-new Model 945 or Model 965 beltbed plotter from CalComp for approximately the same price?

Productivity gains can range from 25% to more than 500%. It's like having up to two plotters for the price of one.

*CalComp Model 945 beltbed plotter (left) for sheets up to ANSI size D (or ISO size A1), and Model 965 plotter for drawings up to sheet size E (or size A0).*



What's the difference? The basic philosophy behind each plotter design. Their plotters trade off speed for one-time economies of smaller size, lighter weight, less powerful components. *You* pay the price in plotting time with each pen and paper movement (their 24-ips maximum vs. CalComp's 42-ips) and each excursion of the single-pen carriage to a side-mounted carousel.

CalComp's Model 945 and Model 965 plotters, by comparison, allow you to map up to 16 logical pens to four physical pens continuously poised over the plot surface—ready to be activated



# 6,000 plotter 00 plodder.



in a fraction of a second. If more than four pens are needed, the plotter performs an automatic stop and prompts the operator to change pens.

Plus the user-friendly control panel provides local control and plot manipulation with easily understood English language messages.

The same interactive firmware gives the operator complete control

over plot parameters. Training time is all but eliminated.

Your CalComp Model 945 or Model 965 plotter starts delivering high-speed plots the day it is installed, without changing a line of industry-standard software. Industry-standard because it was developed by CalComp—world leader in computer graphics and CAD/CAM.

So write or phone today for your illustrated copy of "The Plotter and the



Plodder." Compare the performance specifications. Then make your own move into the fast track of plotter technology—with CalComp. California

Computer Products, Inc., 2411 West La Palma Avenue, Anaheim, CA 92801. 714-821-2011 TWX: 910-951-1154

**CALCOMP**

A Sanders Graphics Company



**SANDERS**

# ACHIEVE THE STANDARD IN WINCHESTER, FLOPPY AND TAPE DEVICE TEST!

Come up to the standard in rotating memory device test in **HARDWARE**: with complete correlation of test results from system to system.

in **SOFTWARE**: with fully configured menu driven test programs including inside and outside window margins, long term read errors and random read/write error testing as well as flaw mapping.

in **SYSTEMS**: with complete compatibility throughout the entire product line of final production and receiving test systems.

in **PRODUCTIVITY**: with the ability to test up to 100 devices in simultaneous operation.

ACT systems today test more than 2,000 5 1/4" drives daily. But ACT's experience does not stop there. Since its inception in 1976, Applied Circuit Technology has gained valuable experience in designing and manufacturing the electronics for servo track writers, single and multi-disk analyzers, drive controllers, data separators and floppy media certifiers as well as its own line of highly-advanced, unique test systems and disk certifiers.



**ITS (Intelligent Test System)** tests up to 100 units in simultaneous operation.

All this has made ACT systems the standard in final production and receiving test.

You can achieve the standard by contacting Hank Pselos at Applied Circuit Technology, 2931 La Jolla Street, Anaheim, CA 92806. (714) 632-9230.



**Applied  
Circuit  
Technology**

MORE THAN A QUESTION OF PASS/FAIL

## SEE US AT NCC

# ANALOG I/O BOARD BRINGS PERSONAL COMPUTER INTO THE PLANT



**A data conversion board plugs into the IBM Personal Computer to give 12-bit resolution and 13,000-sample/s throughput. Just three BASIC statements unlock all the board's data acquisition functions.**

by **Andrew Davis and John Fierke**

**P**eripherals that readily adapt microcomputers to process control environments are spearheading the entry of desktop systems into an area once fielded entirely by minicomputers and mainframes. Microcomputers can bring closed loop control to processes that

*Andrew Davis is marketing director at Data Translation, Inc, 100 Locke Dr, Marlboro, MA 01752, where he is responsible for all marketing functions. Prior to joining Data Translation, he served as a product manager with Data General Corp. Mr Davis holds both a BS and an MS from Cornell University, and an MBA from Harvard University.*

*John Fierke is a project engineer at Data Translation, Inc, where he is responsible for development of analog I/O boards and associated onboard firmware. Prior to joining Data Translation, he earned a BSEE at the Massachusetts Institute of Technology.*

used to run open loop, even though they could have benefited from a process controller. Moreover, the desktop models open the door to inexpensive computer control over applications that have traditionally used analog and/or electromechanical relay based schemes.

Modification is perhaps the most compelling issue favoring computer control over analog and relay based process control systems. A computer based system can perform statistical operations on data and generate reports, storing the results on disk for future evaluation. Onsite software modifications are far easier to make than time-consuming and costly hardware modifications of analog printed circuit boards or relay panels, for instance. In many cases, debugged subroutines are already available, further reducing the chance of onsite wiring errors.

Mainframes and minicomputers remain the best solutions for single-process applications that monitor hundreds of inputs. However, one mainframe often controls a series of identical processes. Several microcomputers

can readily handle this kind of task, provided that the input/output (I/O) requirements of each process can be matched by a microcomputer based system.

Distributed microcomputer control offers several advantages over centralized mainframe or minicomputer control. For example, if one mainframe controls many identical processes, all processes stop when the mainframe goes down. Distributing the processes among a series of microcomputers eliminates this problem. In addition, centralized control is often remote from the data acquisition equipment. This causes difficulty because low level analog signals degrade over long transmission distances.

To illustrate, thermocouples often furnish less than a 50-mV full-scale voltage change over their operating temperature range. Thermistors typically exhibit resistance changes of only 0.4%/°C. The received analog signals are susceptible to noise contamination even when the sensors are connected in bridge configurations with instrumentation amplifiers.

Overcoming these problems for digital transmission to a remote computer usually requires costly measures such as voltage to frequency conversion of analog signals or conversion of analog levels at the sensor site to serial data streams following RS-232-C protocols. Locating a desktop computer at the sensor site eliminates these complexities.

Another solution to industrial control requirements is to use a custom designed microcomputer based controller. For some high speed applications, this solution may be adequate. But it incurs costs in the design time necessary to engineer specialized hardware and software. In addition, custom hardware and software generally demand that the original engineers make field modifications.

### Teaming up for control

One innovation in microcomputer based distributed process control is Data Translation's DT2801 analog to digital I/O board, which plugs into an expansion slot in IBM's Personal Computer. A typical configuration has 64K bytes of random access memory, two 5¼" floppy disk drives, a display monitor, and a dot-matrix printer. Programmability in BASIC via either a BASIC interpreter or compiler lets engineers quickly adapt the peripheral board to specific applications while taking advantage of its performance features.

The board/microcomputer combination achieves 12-bit resolution and 13,000-sample/s throughput while managing 16 single-ended or 8 differential analog input channels, 2 analog output channels, and 16-channel digital-I/O lines arranged in 2 bytes (each line can serve input and output functions). An onboard microprocessor and firmware handle housekeeping and interfacing tasks, which allows the computer to control all board functions via only three BASIC commands.

Consider the hypothetical application in Fig 1. The controller for such a system must monitor the analog outputs of pressure or level sensors. Based on these values, it will determine the number of pumps that should operate at full speed and furnish the digital outputs to connect them to the ac line. Also based on the sensors' analog outputs, the controller must determine

the exact speed at which the variable-speed pump should operate as well as furnish an analog output proportional to that speed. In addition, the controller will periodically interchange lead and lag pumps to provide equal wear on all pumps. It will monitor motor overtemperature switches, shutting down any overheated motor and shifting it to the lowest priority in the lead/lag sequence.

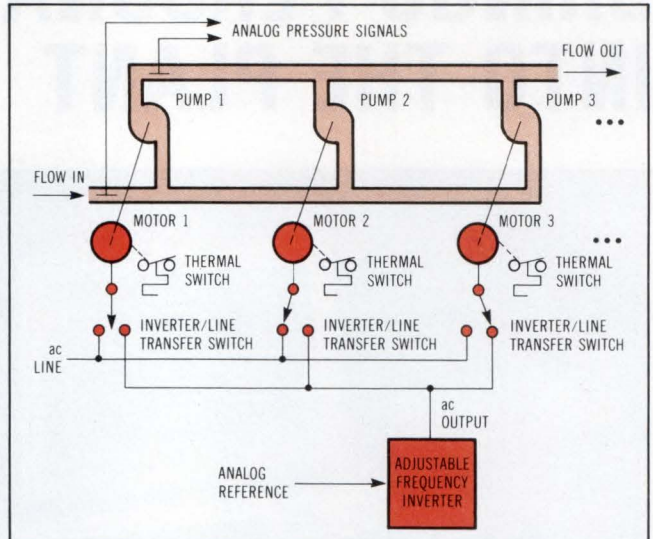

**Fig 1** Water pumping system illustrates the range of I/O functions common in microcomputer-run process control systems. Several variable-speed pumps operate in a lead/lag sequence in response to outputs of water pressure or level sensors that indicate demand. Inverter frequency proportional to the inverter's analog input determines motor speed.

In traditional industrial control settings, analog regulating circuitry handles motor speed calculation, and electromechanical relays perform the lead/lag sequencing. Whether the microcomputer/board combination could handle the water pumping system depends on the hydraulic time constants involved. Those determine whether the computer will have enough time to execute the necessary motor speed calculations after handling I/O functions.

### Unlocking process control functions

The computer accesses all of the peripheral board's features through three BASIC commands: INP (read), OUT (write), and WAIT. Fig 2 illustrates the use of these statements. Communication between the computer and the board takes place through the board's command/status and data registers. The program accesses the peripheral board via two addresses within the computer's I/O address space. Located at the base address, selectable by the peripheral's onboard jumpers, a data register allows transfer of data into and out of the I/O board. In the Fig 2 example, the base address is 748, as shown in source line 106. Located at the base address +1 (source lines 105 and 107), the command/status register allows the computer to write commands to the board.

The commands are 4-bit operational codes (op codes) summarized in decimal form (source lines 170 to 185), and range from a reset operation (line 170) to a signal to

# Hard Facts About The ROLM Military Hard Disk

## Fact: The ROLM® Disk Is Tough

The ROLM Disk Subsystem operates with military computers deployed in severe environments. At high altitudes. In sand and dust. Even in salt fog. Wherever and whenever you need to add dependable memory to your computer system.

## Fact: The ROLM Disk Is Reliable

The system has few moving parts. Its recording heads and media are sealed in an enclosure to keep out humidity and contaminants. The resulting MTBF rating is a high 3900 hours per MIL-HDBK-217C. Modular design plus a subsystem self-test capability simplify maintenance and contribute to maximum computer availability.

## Fact: The ROLM Disk Is 35.6 MB Plus

It gives you 35.6 megabytes of formatted data base capability in a compact, light-weight package. And subsystem capacity can be expanded to 142.4 megabytes on a single controller. The removable data module is front accessible, allowing loading and unloading of mission data files in less than 2.5 minutes.

## Fact: The ROLM Disk Has The Best Price And Delivery

Compare the cost and availability of military memory storage products. You'll find ROLM offers the lowest price per megabyte of any military disk available today. And ROLM can deliver in 90 to 120 days!

## Fact: The ROLM Disk Is On Active Duty

You'll find it on a variety of military and industrial systems. Recent applications include the Army Trailblazer (AN/TSQ-114B) Program, and the Air Force Advanced Airborne Command Post. ROLM Disks provide the same reliable performance as the 5,000 plus ROLM processors deployed worldwide. Whatever computer you use, the ROLM Disk is the solution for your memory expansion requirements. It's hard to beat.

**ROLM**

MIL-SPEC  
Computers

For more information, contact:  
ROLM Corporation,  
4900 Old Ironsides Drive, Santa Clara, CA 95050.  
(408) 988-2900 Ext. 2060.

```

001A 0002 10 REM $TITLE: 'SAMPLE PROGRAMMING OF THE DT2801'
001A 0002 50 '
001A 0002 51 ' set up constant values
001A 0002 100 '
001A 0002 105 COMMAND.REGISTER = 749 ' command register address
0033 0006 106 DATA.REGISTER = 748 ' data register address
003B 000A 107 STATUS.REGISTER = 749 ' status register address
0043 000E 110 '
0043 000E 120 '
0043 000E 121 DATA.O.A = 2 ' WAIT and parameter for data output
004B 0012 125 DATA.O.X = 2 ' WAIT xor parameter for data output
0053 0016 130 DATA.I.A = 1 ' WAIT and parameter for data input
005B 001A 131 DATA.I.X = 0 ' WAIT xor parameter for data input
0063 001E 135 COMMAND.A = 4 ' WAIT and parameter for command output
006B 0022 150 COMMAND.X = 0 ' WAIT xor parameter for command output
0073 0026 160 '
0073 0026 161 ' DT2801 COMMANDS
0073 0026 162 '
0073 0026 170 CRESET = 0 ' RESET command
007B 002A 171 CCLEAR = 1 ' CLEAR command
0083 002E 172 CERROR = 2 ' READ ERROR command
008B 0032 173 CLOCK = 3 ' SET CLOCK RATE command
0093 0036 174 CSIN = 4 ' SET DIO FOR INPUT command
009B 003A 175 CSOUT = 5 ' SET DIO FOR OUTPUT command
00A3 003E 176 CDIOIN = 6 ' READ DIO command
00AB 0042 177 CDIOOUT = 7 ' WRITE DIO command
00B3 0046 178 CDAOUT = 8 ' WRITE D/A IMMEDIATE command
00BB 004A 179 CSDA = 9 ' SET D/A PARAMETERS command
00C3 004E 180 CWDA = 10 ' WRITE D/A (BLOCK) command
00CB 0052 181 CTEST = 11 ' TEST command
00D3 0056 182 CADIN = 12 ' READ A/D IMMEDIATE command
00DB 005A 183 CSCA = 13 ' SET A/D PARAMETERS command
00E3 005E 184 CRAD = 14 ' READ A/D (BLOCK) command
00EB 0062 185 CSTOP = 15 ' STOP COMMAND
00F3 0066 186 '
00F3 0066 190 MDMA = 16 ' DMA mode bit value
00FB 006A 191 MCONT = 32 ' CONTINUOUS mode bit value
0103 006E 192 MLOCK = 64 ' EXTERNAL CLOCK mode bit value
010B 0072 193 MTRIG = 128 ' EXTERNAL TRIGGER mode bit value
0113 0076 194 '
0113 0076 199 REM $PAGE
0188 007A 300 '
0188 007A 301 ' ***** EXAMPLE: to read dio word *****
0188 007A 302 '
0188 007A 307 PRINT : PRINT ' space
0193 007A 310 INPUT: "DIO CHANNEL"; DIOCHAN ' get dio channel
01A2 007E 312 PRINT : PRINT ' space
01AD 007E 315 WAIT STATUS.REGISTER,COMMAND.A,COMMAND.X ' wait
01CA 007E 320 OUT COMMAND.REGISTER,CDIOIN ' start dio command
01DE 007E 325 WAIT STATUS.REGISTER,DATA.O.A,DATA.O.X ' wait
01FB 007E 330 OUT DATA.REGISTER,DIOCHAN ' set dio channel
020F 007E 335 WAIT STATUS.REGISTER,DATA.I.A,DATA.I.X ' wait
022C 007E 340 DIOVALUE = INP(DATA.REGISTER) ' get dio value
023F 0082 345 PRINT "DIO BYTE IS ".HEX$(DIOVALUE) ' print it
024E 0082 350 '
024E 0082 351 ' continue for channel 2 only
024E 0082 352 '
024E 0082 355 IF NOT(DIOCHAN = 2) THEN GOTO 390 ' channel 0 or 1 done
025B 0082 360 WAIT STATUS.REGISTER,DATA.I.A,DATA.I.X ' wait
0278 0082 365 DIOVALUE = INP(DATA.REGISTER) ' get dio value
028B 0082 370 PRINT "SECOND DIO BYTE IS ".HEX$(DIOVALUE) ' print it
029A 0082 390 ' dio done
029A 0082 490 REM $PAGE

```

**Fig 2** A BASIC compiler accesses process control functions through INP, OUT, and WAIT commands. All communication between the computer and the peripheral board takes place via the board's command/status and data registers—in this case at locations 749 and 748, respectively (source lines 105 to 107). Here, source lines 170 to 185 represent the board's op codes; a digital-I/O read routine begins at line 300.



# MODEM ECONOMY GETS DOWN TO EARTH WITH THE UDS 212 LP

UDS has combined smart design with large-quantity, high-quality manufacturing to bring 212 modem prices down to earth.

Our 212LP is a low-priced, line-powered modem that's fully 212A-compatible for full-duplex, 1200 bps asynchronous communication only.

No AC connection is required, since operating power comes directly from the telco line. The unit is FCC certified for direct connection to the DDD network and it fits

**\$495**  
(quantity one)

under your telephone handset.

For down-to-earth modem buyers, the message is simple: if 1200bps capability is all you need, that's all you should pay for! Add that saving to the economies of scale in UDS' high-volume delivery capability and you'll find *real* modem economy. Get details from your UDS distributor, or contact Universal Data Systems, 5000 Bradford Drive, Huntsville, AL 35805-1953. Phone 205/837-8100; TWX 810-726-2100.

 Universal Data Systems

 **MOTOROLA INC.**  
Information Systems Group

**DISTRICT OFFICES:**

Old Bridge, NJ, 201/251-9090 • Blue Bell, PA, 215/643-2336 • Atlanta, 404/998-2715 • Chicago, 312/441-7450 • Columbus, OH, 614/895-3025 • Boston, 617/875-8868  
Richardson, TX, 214/680-0002 • Englewood, CO, 303/694-6043 • Houston, 713/988-5506 • Tustin, CA 714/669-8001 • Sunnyvale, 408/738-0433



 Universal Data Systems

collect a block of analog to digital conversions (line 184). These op codes occupy the least significant bits of the command register. Appending bits in the high-order nibble selects direct memory access, an external clock mode, or an external trigger mode, depending on the bits' position.

Direct memory access is a continuous mode of operation in which functions such as data conversion occur until a STOP command is received. In external clock mode, an external signal, rather than the peripheral's onboard clock, controls operations. In external trigger mode, an operation is deferred until an external signal is triggered (source lines 190 to 193).

When read from rather than written to, the command/status register provides operating status and error messages from the board. These status indications can tell the host computer when data are ready, thus off-loading both host computer and programmer from the task of ensuring that sufficient time has been allowed for data acquisition and conversion.

An example routine in Fig 2 illustrates the use of the command/status register. Lines 300 to 490 demonstrate reading a digital-I/O word. Program input (line 310) consists of the I/O word's channel—the high byte, the low byte, or both bytes of the 16 digital-I/O lines. Writing CDIOIN (op code 6 from source line 176) to the command register in line 320 initiates the digital-I/O read operation.

The computer writes the digital-I/O channel acquired in line 310 to the I/O board's data register in line 330. After waiting for the operation to complete (line 335), the computer reads the resulting digital-I/O word in line 340. Line 355 causes the computer to acquire a second digital-I/O byte if the line 310 channel input signals a 2-byte digital-I/O word request.

Both designers and users of process control equipment stand to benefit significantly from the proliferation of low cost desktop computers. Distributing microcomputer based systems will handle a variety of control problems that, less than a decade ago, could only be solved with minicomputers. Easily programmable peripherals that equip today's powerful microcomputers for industrial process control will help to bring this about, reducing system cost while improving performance.

Please rate the value of this article to you by circling the appropriate number in the "Editorial Score Box" on the Inquiry Card.

High 716

Average 717

Low 718

Photo on p 101 shows an IBM Personal Computer with Data Translation's A-D I/O board.

# High Resolution RGB Color Monitor Designed for the IBM Personal Computer

## FEATURES

- 80 characters x 25 lines
- 690 dots horizontal resolution
- 16 colors
- .31 mm dot pitch tube
- non-glare, black matrix
- plugs directly to IBM PC, cable supplied
- FCC Class B Approved

Princeton Graphic Systems' new HX-12 high resolution color monitor is designed with an NEC.31 mm dot pitch CRT to give you up to 690 dots horizontal resolution. You need not compromise the display quality of your system with monitors rated at less than the 640 horizontal dots generated by your IBM PC. The PGS HX-12 delivers 16 super colors, 80 characters x 25 lines. It is the best price/performance PC direct drive monitor in the market today. Get the PGS HX-12 and discover for yourself how well it complements your IBM Personal Computer.

**PGS**

**Princeton  
Graphic Systems**



phic Systems High Resolution 80 ch  
 phic Systems High Resolution 80 ch  
 phic Systems High Resolution 80 ch  
 phic Systems High Resolution 80 ch  
 phic Systems High Resolution 80 ch

80 character display

# THE ORCATECH KID

# DOES IT AGAIN



# THE ORCA FAMILY OF



## The ORCA family

Orcatech has built its reputation on high speed, programmable, graphics computer systems for the serious CAD professional. Now, for the first time, we announce the Orcatech family of graphic computers. They bring you more *choice*, *power* and *cost-effectiveness* than ever previously offered.

All members of the Orcatech family offer a high-speed multi-processor architecture, with 1024 × 1024 viewable and 64K × 64K virtual graphics resolutions, monochrome or color. All are highly user programmable, at both the graphics and application level, offering sophisticated software development environments providing full support for secondary storage and peripheral devices. All support an implementation of SIGGRAPH CORE locally.

These are some of the Orca family traits, now read on for the specifics.

## ORCA1000

The Orca1000 is the most cost-effective, programmable workstation on the market. It incorporates all of the above family characteristics, plus 4014, 4114™ emulation capabilities. The Orca1000 offers up to 1.5Mb of user program memory and up to 512Kb of display file memory with unlimited virtual display file size. Monochrome or color. At a price that will, frankly, amaze you.

# GRAPHIC COMPUTERS



## ORCA2000

This is the big brother of the Orca1000. With even greater modularity and color capabilities, the Orca2000 is aimed at the user who wants to tailor a machine precisely to current requirements, and which can grow as demands increase. As an emulator, front end processor, network node or stand alone computer, the Orca2000 has all the bases covered.

## ORCA3000

The most powerful combination of graphics and application processing power available. From anyone! This machine has the works. An application program address range of 16Mb for the really large applications, together with a physical memory capacity of up to 8Mb. A full UNIX® software environment with C, Pascal and Fortran compilers. Megabytes of local display file memory. Full color look-up table facilities. And a wide choice of high speed disk capacities. Together with full DMA support for high speed host computer communications.

Orcas for all reasons. We have an Orcatech graphic computer system that is exactly what you have been looking for. Backed up by a worldwide service and sales network. Let's discuss your particular application and specific design requirements. Call today for complete technical details or a hands-on demonstration with the Orca of your choice.

**ORCATECH**  
Graphic Computer Systems

# ORCAS FOR ALL REASONS



Features	ORCA1000	ORCA2000	ORCA3000
Display Size	19 inches	19 inches	19 inches
Viewable Resolution	1024 × 1024	1024 × 1024	1024 × 1024
Virtual Resolution	64K × 64K	64K × 64K	64K × 64K
Color Palette/Displayable	8/8	16.7M/256	16.7M/256
Internal Processors	Intel 8086/87 AMD 2900	Intel 8086/87 AMD 2900	MC 68000/68010 AMD 2900
Software	Orca OS, File System Command Interpreter Text Editor, CORE Emulators, Fortran IV Assemblers	Orca OS, File System Command Interpreter Text Editor, CORE Emulators, Fortran IV Assemblers	Unix®, C, Pascal CORE, Emulators Fortran 77, Fortran IV Assemblers
Program Memory	128Kb-1.5Mb	256Kb-2Mb	512Kb-8Mb
Display File Memory	128Kb-512Kb	128Kb-512Kb	512Kb-5Mb
Communications	RS232 to 19.2Kbaud Parallel to 1Mbyte/sec	RS232 to 19.2Kbaud Parallel to 1Mbyte/sec Ethernet to 10Mbaud	RS232 to 19.2Kbaud Parallel to 1Mbyte/sec Ethernet to 10Mbaud
Hard Disk Capacities	10/20Mb	10/20/30/40/80Mb	10/20/30/40/80Mb
Diskette Capacity	1Mb	1Mb	1Mb
Peripheral Support	Tablet, Text Screen Printers, Plotters	Tablet, Text Screen Printers, Plotters	Tablet, Text Screen Printers, Plotters
Price Range	\$8,500*-\$25,000	\$12,000*-\$40,000	\$15,000*-\$80,000

**ORCATECH**  
Graphic Computer Systems

Orcatech Inc.  
2680 Queensview Drive  
Ottawa, Ontario, Canada  
K2B 8H6

Telephone (613) 820-9602  
Telex 053-3868

Offices in Chicago, Los Angeles,  
San Jose, Boston, Washington,  
St. Louis, England, France, West  
Germany, Switzerland, Italy.

Representatives in Minneapolis,  
Houston, Dallas, Austin, Phoenix,  
Dayton, Detroit, Chicago.

\*OEM quantity 100 price  
®Unix is a registered trademark of  
Bell Laboratories  
™4014, 4114 are registered trademarks of  
TEKTRONIX, Inc.  
Product innovations may cause our  
specifications to change without notice.  
Printed in Canada  
Orcatech © 1983

# THE IMPACT OF MICROPROCESSORS ON PROCESS CONTROL

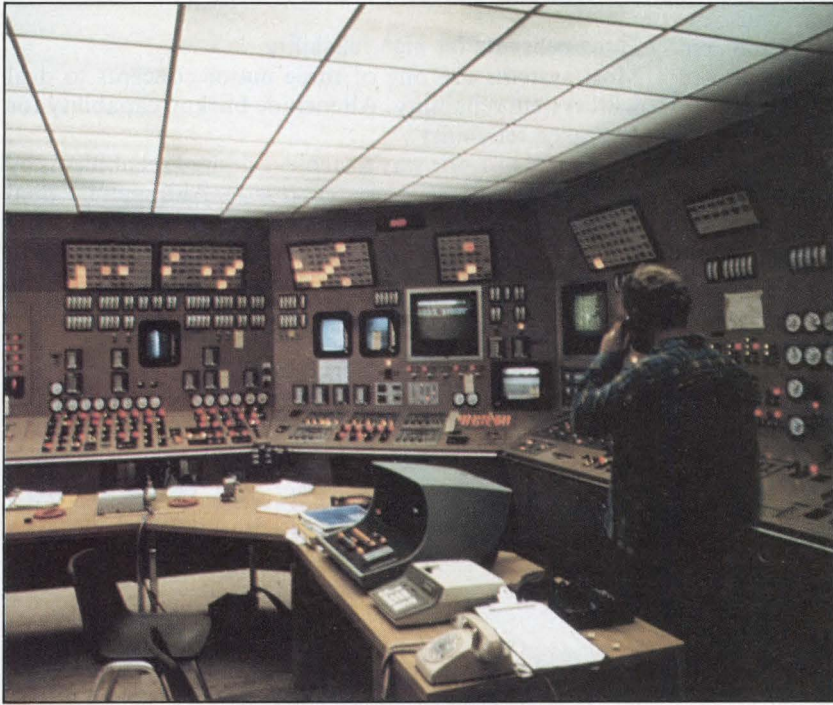

Although hidden by the massive components it controls, the microprocessor has become the major influence in digital control system development, even in the automated power plant.

by James Andrew Rovnak, Wayne C. Dunlap, Heniz B. Opladen, and James A. Mann

**T**raditional control concepts based on a centralized computer system are steadily being replaced by the distributed system concept. The major stimulus for this shift is the availability of inexpensive but capable large scale integrated circuits—microprocessors in particular.

Yet, there has been a degree of lethargy in implementing system changes. Early computer controlled utility plants used fully analog systems or hybrid systems: digital for data acquisition and analog for control. As the

*James Andrew Rovnak is supervisor of the Computer Systems and Studies Group at Stone & Webster Engineering Corp, 245 Summer St, Boston, MA 02107. He is responsible for procurement of plant computer systems and transient simulation studies. Mr Rovnak has a BSME and an MS in nuclear engineering from Pennsylvania State University.*

*Wayne C. Dunlap is control systems engineer at Stone & Webster, where he is responsible for power plant computer systems. Mr Dunlap holds a BS in chemical engineering from New Mexico State University.*

reliability of digital computers became evident, plant designers eventually accepted such computers for their total control systems.

Early power plant control systems were monolithic. Because a computer failure in such centralized control could disrupt an entire plant, first analog then digital computer backup was required. Of course, such redundant systems are expensive.

The advent of microprocessors has brought about the biggest change: the ability to distribute digital control both functionally and geographically throughout the plant—and at a relatively low cost, even for redundant circuitry. Although there are lingering problems in locating equipment in harsh environments, which limit geographical distribution, solutions are surfacing. In

*Heinz B. Opladen is a consultant at Stone & Webster and is involved in digital computer systems. Mr Opladen holds engineering degrees from Fachhochschule Cologne and Hochschule Aachen in West Germany.*

*James A. Mann is a technical writer and editor at Stone & Webster. Previously, he was a technical writer for Goodyear Atomic Corp. Mr Mann has a BA in physics and English from Carnegie-Mellon University.*

addition, microprocessors have enabled digital control devices to replace analog devices with analog control algorithms emulated in digital software.

Though it is preferable from a system security standpoint for a microprocessor to control a single loop, it is often more economical and functional to allow a microprocessor to handle from 2 to 30 control loops per module. The latter method simplifies control function integration, reduces required control room space and maintenance costs, and simplifies repairs. In addition, microprocessor based intelligent remotes allow distribution of the data acquisition function. Thus, the microprocessor's influence has helped replace the centralized computer system concept with the distributed system concept.

### Basic system concepts

All the elements of a distributed system—printers, processing units, intelligent remote input/output (I/O) cabinets, operators' consoles—are connected by a data highway. Modern data highways have a communication range of 250k to 2M bps, although an increase to 10M bps is expected in the near future.

The data highway can be arranged in either a bus or a ring configuration. (Tree and star configurations also exist, but they are not generally used by the utility industry.) Microprocessor based intelligent remotes offload the host central processing unit (CPU) and reduce data highway traffic. One way to accomplish this is to transmit a variable's engineering value over the data highway only when the variable changes by a specified amount (report by exception).

Two dominant but widely varying network access control schemes have proved successful: carrier sense multiple access/collision detection (CSMA/CD) and token passing. In CSMA/CD, the highway is randomly accessed by remotes, and provisions must be made to prevent collision or loss of information. These provisions are extremely critical, especially for process control. In a token passing access method, most information is broadcast in a time-division slot for each remote, while less critical information is passed along in a democratic mode, filling the remaining time slice once time-division information is passed along. This is the preferred communication method because of the inherent high security for control functions.

In addition, the use of intelligent cathode ray tubes (CRTs) permits more flexibility in the CRT's self-diagnostic operations, vector graph generation, and multiple display background storage in local memory. New raster scan based CRT terminals also use dot (pixel) addressable display color graphics, rather than conventional fixed-character display color graphics, which improves display resolution and appearance. Color display alone improves operator responsiveness and reduces operational errors.

Areas of the plant in harsh environments used to be primarily controlled by relay devices. Now, these areas are controlled by programmable controllers (PCs). These PCs are connected in local area networks (LANs) and can communicate with the plant computer through the data highway. For long distance transmission, modems are used. More sophisticated control units handle other

areas, although PCs have taken over many motor control functions. Moreover, with the incorporation of proportional, integral, and differentiation control functions, PCs can emulate local analog control.

Taking these attributes into account, there are many possible configurations for the plant computer system. The simplest concept is a single computer with a front-end system for data acquisition, which may or may not be connected to a control system. However, due to the high reliability that power plants require, a single computer system is undesirable.

### Three concepts for high reliability

Most systems use one of three major concepts to deal with system reliability. All include backup capability for increased reliability.

In concept 1, the way to achieve desired reliability is by using two identical computers (Fig 1). Although the dual CPUs in concept 1 use the same software programs, only one CPU, known as the running CPU, controls the data acquisition system and the shared peripherals. If the

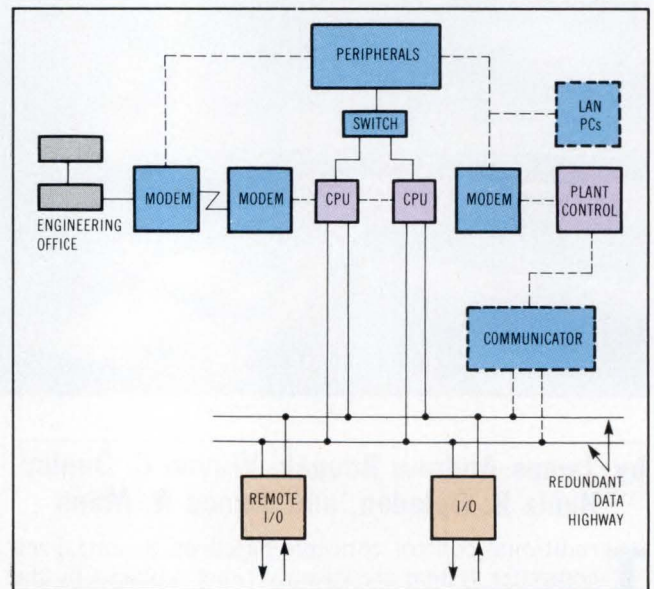

**Fig 1 Dual CPUs in a concept 1 system provide the necessary reliability for control of the data acquisition system only. If the online CPU fails, the backup computer takes over. This system connects to a separate plant control computer.**

running CPU fails, hardware switches the peripherals and the data acquisition system to the backup computer. This system is connected to a separate digital control system.

Using modems, the plant control system can be connected to the data acquisition system either through a computer interface from the data highway or directly through the CPUs. Changes in the control system configuration and setpoint can be made from the control computer system operator's console. In addition, control loop parameters can be displayed on the operator's console CRT.

In concept 2, dual-CPU systems are connected to others by high speed computer to computer communication links. One dual-CPU system updates the data base by



# FROM PETROCHEMICAL PROCESSING TO UTILITY SYSTEMS



## FLIC PUTS YOUR SYSTEM IN CONTROL

FLIC software links your system with the world of process monitoring and control.

A highly interactive, distributed software system, FLIC combines real-time monitoring and control with exceptional user friendliness. And FLIC's modularity and configurability allow you to target your control system to a broad spectrum of vertical markets, from petrochemical processing to utility systems.

FLIC's preprogrammed, "fill-in-the-blanks" functions allow a user to define control strategies and configure the system to a plant's exact process control needs, without programming. A complete real-time FORTRAN facility is included, should special programs be required.

FLIC features a unique facility for user-creation of graphic CRT display

formats tailored to a specific plant and process. FLIC's friendly man-machine interface utilizes simple commands and color graphics for maximum ease of use. FLIC supports a variety of operator interface aids, including touch screens, function buttons, track balls and joysticks.

Designed for use with DEC and MODCOMP operating systems, FLIC supports input/output equipment of most major manufacturers. FLIC can be implemented in hardware environments ranging from single, standalone computers to highly available, hierarchical computer networks.

Since 1972 FLIC has provided process control technology to industry, with over 80 systems installed worldwide. Now merged with Quadrex and its expertise in the exacting field of nuclear power generation, Quadrex FLIC Com-

puter Systems, Inc. offers you the advantage of a complete software system for every process control requirement.

For a demonstration of the FLIC system, and more information about OEM agreements, please call Tim Pellegrino at (609) 924-3900.

### AVAILABLE ON DEC

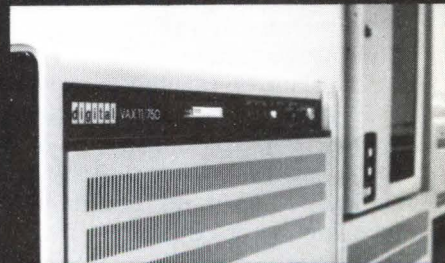

**QUADREX FLIC  
COMPUTER  
SYSTEMS, INC.**

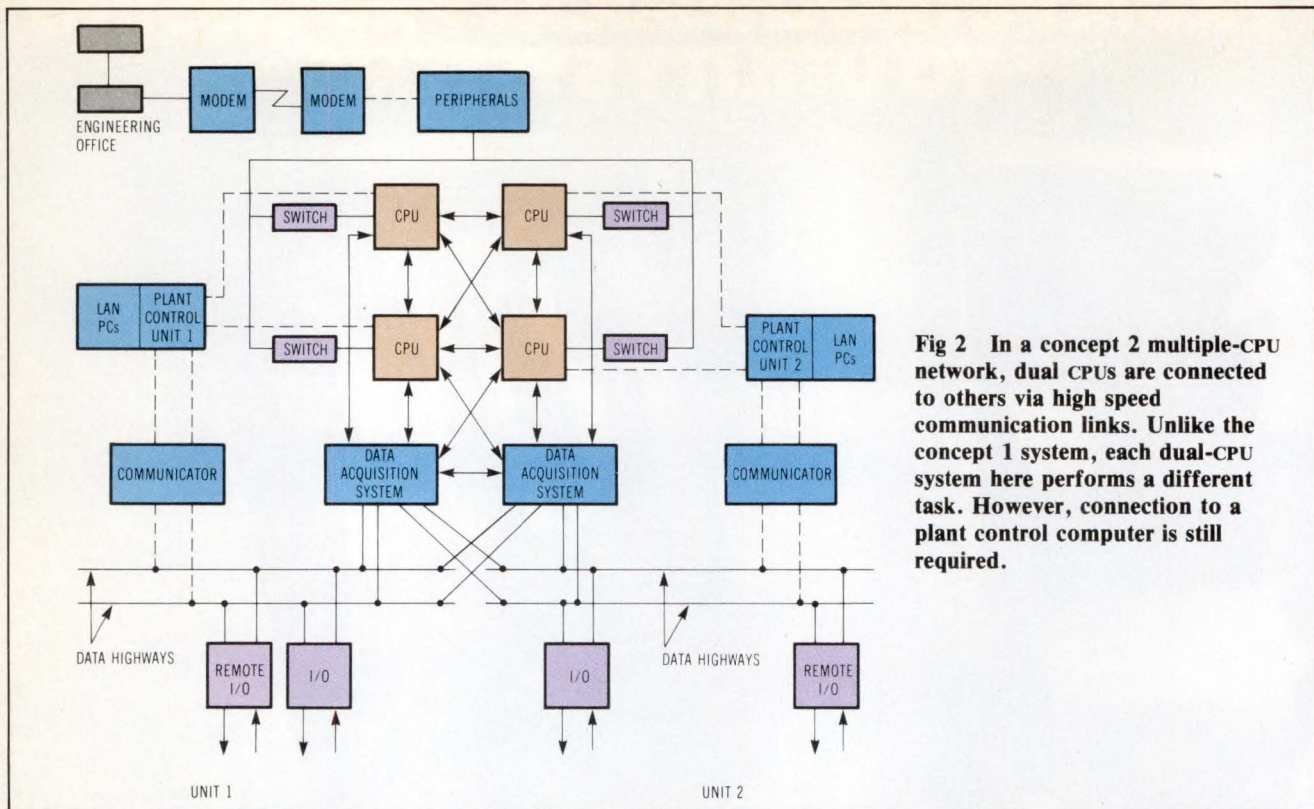

**Fig 2** In a concept 2 multiple-CPU network, dual CPUs are connected to others via high speed communication links. Unlike the concept 1 system, each dual-CPU system here performs a different task. However, connection to a plant control computer is still required.

obtaining current process information from a remote or local data acquisition system via a single or redundant data highway. All dual-computer systems have access to the data base.

In contrast to concept 1, each dual-CPU system performs a different task. For each CPU, an operating system performs realtime computer system control and provides an environment to create and execute process application programs. Extending the operating system and including high speed data links allow all CPUs in a distributed network to be connected. Furthermore, when CPUs are networked, their use is transparent to the user and they are field expandable without changing the user's program. Fig 2 illustrates the networking of more than two CPUs. Not all CPU to CPU links shown are necessarily used.

Concept 3, a distributed data acquisition and control system, eliminates the use of a central computer (Fig 3). Microprocessor based units provide a functionally and physically distributed data base. A masterless high speed data highway links the various parts of the system. Individual processing units are drops on this data highway. Each microcomputer performs its tasks independent of other system microcomputers.

The control function nearly merges with the data acquisition function. No distinction is made between control and data acquisition boards, thus minimizing spare parts inventory. Both functions are handled similarly as drops on the data highway and can even be combined at one drop.

### Power plant distributed control

Power plant control differs from control in other plants in its complexity of system interactions. A change in one part of the system results in changes throughout. Feed-forward and lead/lag compensations are used extensively

to obtain the best responsiveness, a complicated matter since power plants must operate together on a grid. This forces all power plants to respond to changes on the grid according to their capabilities.

Currently, analog control functions are implemented in digital subroutines. Inroads are being made with model based adaptive control algorithms that encompass

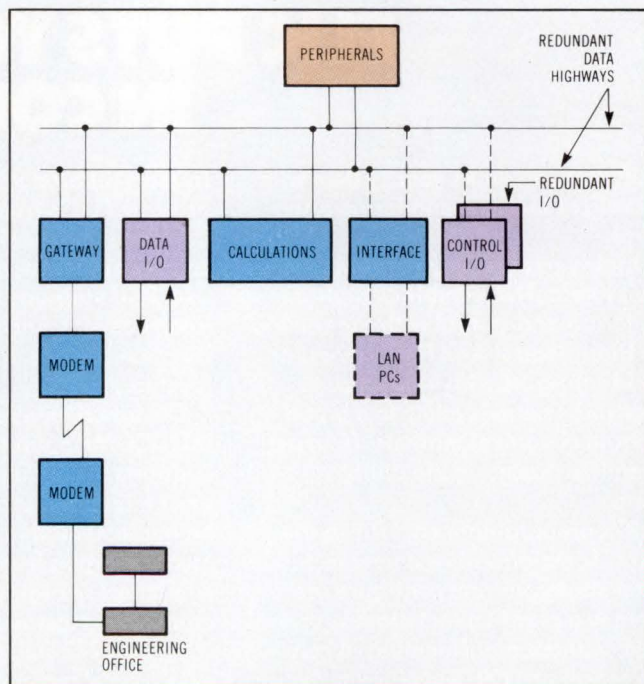

**Fig 3** A concept 3 distributed data acquisition and control system eliminates reliance on a central control computer. Control and data acquisition functions nearly merge; both are handled as drops on the high speed data highway.

# THE TERMINAL SOLUTION! from \$192\*



**MICROTERMINAL™ Control Panels:** Easy to install, simple to interface and to operate ... the practical answer for data entry/display applications everywhere. Priced for OEM designs; tough, water resistant for plant environment; uncomplicated keyboards for factory data collection; pretty enough to enhance control consoles; so versatile they can often replace fragile CRT's and printers. If your man/machine communications are complex - or simple - one of these solid state, compact (8.5" x 4.5" x 0.6") terminals may be ready to talk to you ... but talk to us first!

Model	Alpha Display Characters	Baud Rate	Data Buffers: Characters	Keyboard	Function Keys (3)	Features	Supply Voltage
TM71	16	110-19200	320 <sup>(1)</sup>	Alpha	14	Full feature	+5VDC
TM77	16	110-19200	320 <sup>(1)</sup>	Numeric	14	Larger keys	+5VDC
TM71-I/O	16	110-19200	320 <sup>(1)</sup>	Alpha	14	TTL I/O	+5VDC
TM77-I/O	16	110-19200	320 <sup>(1)</sup>	Numeric	14	Larger keys	+5VDC
TM71B	16	110-19200	320 <sup>(1)</sup>	Alpha	16	Bar Code Wand	+24VAC/DC
TM71MS	16	110-19200	5 x 50 <sup>(2)</sup>	Alpha	16	Mag Stripe Reader	+24VAC/DC
TM77B	16	110-19200	320 <sup>(1)</sup>	Numeric	16		+24VAC/DC
TM77MS	16	110-19200	5 x 50 <sup>(2)</sup>	Numeric	16		+24VAC/DC
TM71M	16	110-9600	320	Alpha	14	Military	+5VDC
TM70	12	300 & 1200	36	Alpha	8	Low cost	+5VDC
TM76	12	300 & 1200	36	Numeric	8	Larger keys	+5VDC
TM25	8	300	8	Numeric/Hex	7	Low Cost	+15VDC
TM27	8	300-4800	8	Numeric/Hex	6	Low Cost, polled	+8 to +12VDC

1) Two 80-character input buffers - two 80-character output buffers. 2) 5 x 50-character buffers also included for bar code and magnetic stripe reader data. 3) User programmed.



Putting Technology To Work For You

(206) 455-2611 - (213) 991-8544 - (214) 681-5781 - (303) 663-4440 - (312) 832-6520 - (313) 474-6533 - (408) 559-8600  
 (602) 746-1111 - (614) 764-9764 - (617) 444-9020 - (713) 988-6546 - (714) 835-0712 - (805) 496-7581 - (914) 253-9333

larger portions of the integrated process. Stone & Webster Engineering Corp has recently simulated an entire fossil power plant system in order to influence coordinated, complete system architecture from a model point of view. Parts of this model can be incorporated in the engineering calculation drops on the data highways to perform supervisory, control, equipment protection, and optimization functions in future power plants, or to act as retrofits on existing power plants.

By distributing the data base, this system minimizes the potential loss in the event of failure. The failure of

---

*The computer will not only do a better job of performing its current tasks, it will also perform more tasks.*

---

one element does not disrupt the rest of the system. In addition, repairs are simplified because of the modularity and similarity of the equipment and because only a part of the system has to be removed for repair.

#### **A look toward the future**

Two trends are evident in power plant computer systems. Data acquisition is becoming more distributed to the point that, in some systems, the CPU is just another drop on the data highway. Also, as control with microprocessors becomes more economical, data acquisition and control are merging. This results in an integrated power plant system employing distributed CPUs, PCs, special function microprocessors, and intelligent front-end systems.

Previously, if distant parts of the plant were to be included in the plant computer system, extensive cable was needed to connect each controller or I/O element into the system. PCs with remote I/O are replacing these cable runs, thus reducing costs and enabling this information to be included in the computer data base. Furthermore, by grouping areas of the plant into LANS, data from distant parts of the plant are more readily available, and cable runs and costs are further reduced.

The integrated plant system can more quickly supply operators with more information. Operators are better able to monitor and control plant functions, making the power plant more efficient. In addition, the distribution of functions enhances reliability, which also contributes to overall plant efficiency. More automation of plant control and information management will follow.

The integrated plant system, with advances in network communication, also makes more information available to plant management. Because network communication and protocols are becoming established and readily available, plant system information can be transmitted directly to utility managers, though they are often far from the power plant and employ a different type of computer.

Power plant computer systems have undergone a number of changes in the last decade and will undergo even more in the future. The computer will not only do a better job of performing its current tasks, it will also perform more tasks.

As the system becomes distributed, the plant computer has less information to process. This leftover computer power will be used for developing management information and optimizing and automating the power plant. Database programs will be developed for spare parts inventories, preventive maintenance schedules, economic optimization, modern control concepts, and many other applications.

Systems will also be improved by incorporating new technology. Remote I/O units are currently tied into the system by baseband networks. Broadband highways can either replace the baseband highways or run parallel to them. These broadband systems will allow transmission of color pictures as well as data. With pattern recognition algorithms being developed, vision based control and equipment protection become possible. The first implementation may be to monitor and protect control loops and equipment.

Hardware and software developments will result in a number of other changes. For one, 3-dimensional bar charts will replace 2-dimensional displays. The third dimension could be used to show trends or immediate history, or to project future status. More and better information will thus be available to the plant operator, and plant processes will be better automated and optimized. Another improvement is that 32-bit microprocessors will replace 8- and 16-bit microprocessors—providing faster, more accurate data. Also, automatic tuning algorithms will constantly upgrade the control parameters, keeping the plant at maximum responsiveness. Modern control techniques will make inroads as their functional flexibility outperforms present digital emulations of analog controllers.

Furthermore, report generation will become less procedure based and more flexible as the distributed database software improves. Moreover, electronic office elements such as word processing and electronic mail will be more widely used at power plants. In addition, future control boards will be based on electronic and CRT advancement. Dials and gauges will be replaced by CRTs, and switches will be replaced by touch panels. Finally, fault-tolerant microcomputers, which perform calculations in triplicate to ensure reliability through 2-out-of-3 selection logic, will be used at all data highway drops.

Present power plant computer systems *monitor* entire plants. In the future, analytical math models will be used in engineering-calculation drops to predict, monitor, and eventually *control* the entire plant. Serious consideration is already being given to automating nuclear plant control in France. The automated power plant, once a dream, is fast becoming a reality. Future control rooms may feature operators whose sole function is to monitor the plants and take an active role only in the event of failure.

*Please rate the value of this article to you by circling the appropriate number in the "Editorial Score Box" on the Inquiry Card.*

*High 719*

*Average 720*

*Low 721*

*Photo on p 111 shows a typical power plant control console.*

This announcement is neither an offer to sell nor a solicitation of an offer to buy these securities.  
The offer is made only by the Prospectus.

March 16, 1983

# TeleVideo Systems, Inc.

6,250,000 Shares

Common Stock

Price \$18 Per Share

Copies of the Prospectus may be obtained from the undersigned only in States where the undersigned may legally offer these securities in compliance with the securities laws thereof.

L. F. ROTHSCHILD, UNTERBERG, TOWBIN

ROBERTSON, COLMAN & STEPHENS

SHEARSON/AMERICAN EXPRESS INC.

BEAR, STEARNS & CO.

THE FIRST BOSTON CORPORATION

BLYTH EASTMAN PAINE WEBBER  
Incorporated

DILLON, READ & CO. INC.

DONALDSON, LUFKIN & JENRETTE  
Securities Corporation

DREXEL BURNHAM LAMBERT  
Incorporated

GOLDMAN, SACHS & CO.

E. F. HUTTON & COMPANY INC.

KIDDER, PEABODY & CO.  
Incorporated

LAZARD FRERES & CO.

LEHMAN BROTHERS KUHN LOEB  
Incorporated

MERRILL LYNCH WHITE WELD CAPITAL MARKETS GROUP  
Merrill Lynch, Pierce, Fenner & Smith Incorporated

PRUDENTIAL-BACHE  
Securities

SALOMON BROTHERS INC

SMITH BARNEY, HARRIS UPHAM & CO.  
Incorporated

WARBURG PARIBAS BECKER  
A. G. Becker

WERTHEIM & CO., INC.

DEAN WITTER REYNOLDS INC.

ALEX. BROWN & SONS

HAMBRECHT & QUIST  
Incorporated

TUCKER, ANTHONY & R. L. DAY, INC.

ALLEN & COMPANY  
Incorporated

F. EBERSTADT & CO., INC.

A. G. EDWARDS & SONS, INC.

MONTGOMERY SECURITIES

MOSELEY, HALLGARTEN, ESTABROOK & WEEDEN INC.

OPPENHEIMER & CO., INC.

PIPER, JAFFRAY & HOPWOOD  
Incorporated

ROTHSCHILD INC.

THOMSON MCKINNON SECURITIES INC.

# FREE VAX

---

## OR DATA GENERAL MV

---

If you're trying to support more than 4 programmers doing 8086 software with stand-alone microprocessor development systems, here's an offer you'd be crazy to refuse:

Buy our MicroSET-86™ software cross-development tools and a DEC VAX or DG MV/Family system to run them on. You'll save enough on your first major project to pay for the computer system.

Of course, if you already have access to a VAX (or MV or any IBM-compatible mainframe), you're that much further ahead.

People with experience in cross-development know it's the only sane way to tackle big software projects. As for which cross-development tools to use — just remember this astonishing fact:

*Of the first 20 companies to try MicroSET-86, not one has bought a competing system.*

---

### THE ONLY COMPLETE PASCAL DEVELOPMENT SYSTEM

---

Our Pascal cross-compiler for the 8086 family is a full systems implementation language; you'll have little need for assembly language programming. And it's efficient, too: independent benchmarks (available on request) show a savings of 15% in code size and 31% in execution time compared with Intel Pascal-86.

MicroSET-86 also includes an Intel compatible linker, locator, and assembler.

Just as important as MicroSET's efficiency is the shortening of the development cycle. Using our high-level Cross-Debugger to control execution on the target system, you can locate, fix, and re-test an erroneous line of code in a fraction of the normal time.

Multiply by a few hundred, and you'll understand how MicroSET-86 users routinely shave months off typical development schedules — while producing more reliable, more maintainable systems.

---

### TRY MICROSET-86 AT NO RISK

---

MicroSET-86 supports the entire 8086 family: 8086/8088/186/286 and 8087. It works perfectly with any Intel in-circuit emulators you already own, and has a complete set of host-target communication programs and other valuable utilities that you can't get anywhere else.

If you're interested in a dramatic productivity boost for your microprocessor development efforts, call us now to arrange a free, no-obligation evaluation of MicroSET-86 on your own computer.

If you're like the others who have accepted this offer, you'll be convinced too: nothing beats MicroSET-86 for software productivity.

Intel is a trademark of Intel Corporation.  
VAX is a trademark of Digital Equipment Corporation.  
© 1983 First Systems Corp.



## First Systems Corporation™

---

Products for productivity.

---

865 Manhattan Beach Blvd.,  
Manhattan Beach, CA 90266

**(213) 546-5581**

TELEX: 4992635

# CONTROL SOFTWARE FOR FACTORY AUTOMATION



**A multitasking  
operating system  
architecture provides  
dynamic CPU access  
so that individual  
control loops  
can be programmed  
as independent  
software tasks in  
high level, extended  
BASIC.**

by **John Sylvan**

**T**he shift from centralized process control means placing an ever-increasing amount of computing power on the factory floor. One thing is certain: converting the electronic, mechanical, and pneumatic systems to computerized control systems will be the responsibility of the control engineer, not the system designer. What is more, control engineers can expect to do their own programming.

Just how easy the transition to automated control will be, therefore, depends on how easy it will be to program the computer equipment. An extended BASIC and an MP/M-86 operating system in a measurement and control system such as the Macsym 350 can simplify programming by dividing an overall control task into independent software processes.

Real-world input/output (I/O) performance suffers from the inherent conflict between the asynchronous nature of data processing and the synchronous nature of the real world. A barrage of analog information competes

simultaneously for limited access to central processing unit (CPU) time. One alternative, improving processing speed through hardware design, minimizes delays between a real-world event and when the system responds to it. Another is to coordinate the operating system with the nature of real-world signals. Multitasking software architecture permits control engineers to assign different levels of priority, execution schedules, and execution rates to individual parts of the control program.

While measuring and controlling real-world events, the system must also interface with human operators for data display and operator intervention. Such demands make data acquisition and control computers I/O intensive. Consequently, the I/O scheme is of great importance in the overall system design: a good one can result in significant hardware and software savings.

The two most common I/O structures are program controlled and interrupt I/O. With programmed I/O, the I/O instructions initiate and control data transfer. In a simple program, the system repeats a status check until the device or input channel is ready. The checking procedure, which occurs whether or not any channel is ready for data transfer, requires halting program execution for status checks and may waste processing time. This becomes important in a system with several I/O channels, since a periodic status check must be made on each one. The channel polling operation may also

*John Sylvan is currently a systems application engineer for Analog Devices Inc, Rte 1 Industrial Park, Norwood, MA 02062. Prior to joining the company in 1980, he received a BS from Colby College in Waterville, Maine.*

introduce a considerable time delay between an interrupt and when the system responds to it— unacceptable for many monitoring and control applications.

Interrupt I/O is the second type of I/O structure. An interrupt system allows I/O channels to halt main program execution when, and only when, they are ready for data transfer. Since these interrupts are hardware dependent, flexibility is lost in changing priority or sequence of interrupts. A more acceptable I/O structure for data acquisition combines the speed of interrupt I/O with the flexibility of program controlled I/O. This third type of I/O operating system, popular in measurement and control systems, is multitasking.

### Multitasking data acquisition

Multitasking refers to the operating system's support of several independent operations on a synchronized basis. The programmer divides the overall control program into separate, easier to manage software tasks. A system executive manages the tasks by keeping track of the status, priority, and requirements of each. Independent tasks can also communicate on a task to task basis. In the multitasking system, all variables and data are global—that is, available to all tasks. Thus, data acquired in one task can be used by another task without additional programming.

An MP/M-86 multitasking operating system, designed for a multi-user environment, can support industrial control applications. Preprogrammed software tasks, instead of multiple users, compete for limited access to CPU time. These tasks might be independent process variables, control loops, or test stands. The multitasking system considers each task as a process rather than a program.

By definition, a program is simply software instructions residing in memory or on a disk; it is essentially static. A process in MP/M-86 is dynamic and can be thought of as a "logical machine" that not only executes the program's code, but also executes code in the operating system. Subsequently, the process, not the program, controls all access to the system's resources. With resident system processes, users write custom processes and include them in the system along with those supplied by MP/M-86.

A realtime multitasking nucleus called the realtime monitor acts as the system executive. The realtime monitor coordinates running process execution and arbitrates conflicts for the system's resources. This includes process dispatching, queue management, flag management, device polling, and system timing tasks. Also, the realtime monitor arbitrates among tasks and causes the execution of one line of tasks with equal priority on a round-robin basis. The system clock generates interrupts once every clock tick (approximately 16 ms), thereby generating time slices for CPU-bound processes.

With tasks of different priorities, the system executes the highest priority task until the system halts, suspends, or encounters an inherent dead-time statement—a wait statement, file I/O, or an analog to digital conversion and other activities that needlessly tie up the processor. When this occurs, the system switches to another task and returns when the dead-time statement is complete.

Tasks can also remain dormant until some external condition starts their execution, for example, the procedure associated with tripping of a safety limit. Since high priority computer-bound processes tend to monopolize the CPU resource, it is advisable to lower their priority to avoid degrading overall system performance. Fig 1 shows the execution of two tasks of equal priority. The system gives equal access to both tasks until it encounters an inherent dead-time statement. Task 2 is executed by the system until task 1 is taken off the suspended list.

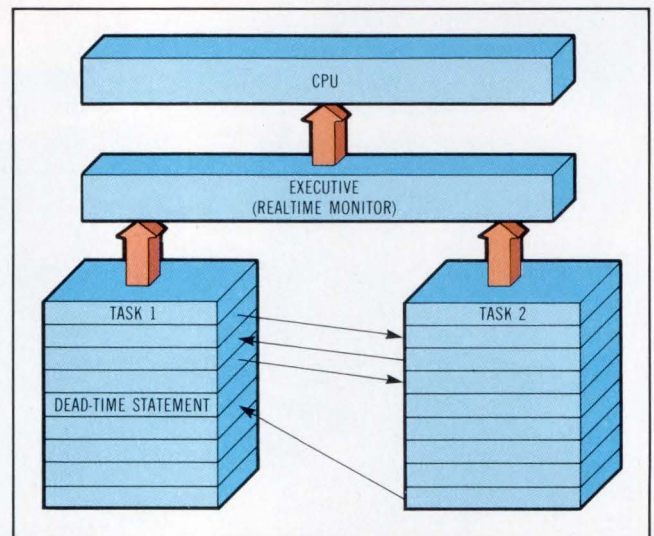

**Fig 1** The MP/M-86 operating system coordinates the execution of up to 18 independent software tasks. When the realtime monitor encounters an inherent dead-time statement, it transfers system resources until the statement is complete.

To manage process scheduling and priority requires a method for transferring CPU resources from one event to another. Unless it is specifically written to communicate or synchronize execution with other processes, a process runs unaware that other processes may be competing for the system's resources. Eventually, with the round-robin scheduling of equal tasks, the system will suspend the process from execution and start another.

The realtime monitor transfers the CPU resource from one process to another by means of a dispatcher. Each process running under MP/M-86 is associated with two data structures: the process dispatcher and user data area. These save and restore the current state of the running process. Each process in the system resides in one of three states: ready, running, and suspended. A ready process is one waiting for the CPU resource, a running process is one the CPU is currently executing, and a suspended process is one waiting for some other system resource or a defined event.

In the sequence of operations, the dispatcher suspends the process from execution and stores the current state in the process descriptor and user data area. The dispatcher then scans all the suspended processes on the ready list and selects the one with the highest priority. At this point, the dispatcher restores the state of the selected process from the process descriptor and the user data area gives it the CPU resource. The process executes



# Ran·yan Com·put·er En·hance·ment Sys·tems

formed with the sole aim of  
subsystems to enhance DEC\*

1. A company that was becoming the specialist in providing systems and  
2. A company that is currently manufacturing a family of unique products proven to enhance DEC computer performance. *e.g.* **Peripheral Processor Link Series** including (a) PPL-1 that provides a comprehensive interface between two DEC computer systems with a "memory window" technique newly developed by Ranyan. (b) PPL-2. Same as above but

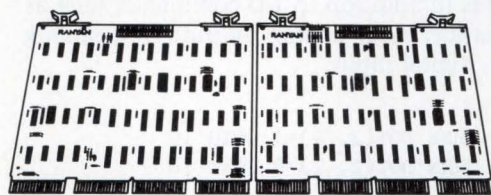

Peripheral Processor Link PPL-1

links Q-Bus or Unibus systems with VAX machines. *e.g.* **Bus Manipulator Series** including (a) BMA-2 Q-Bus To Unibus Adapter which permits DEC users to update older PDP-11 systems to Q-Bus processor performance. (b) BMA-1Q Q-Bus Repeater which doubles the Q-Bus processor load capacity by providing a physical and electrical extension of the standard Q-Bus. (c) BMA-1U Unibus Repeater which provides the same benefits listed above to the Unibus. *e.g.* **Intelligent Multi-Shared Memory**, a fully integrated subsystem specifically designed

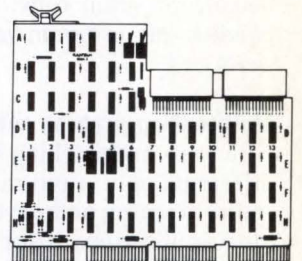

Q-Bus to Unibus Adapter BMA-2

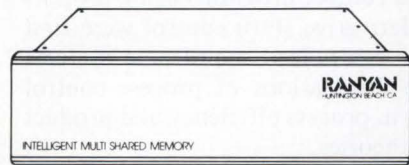

Intelligent Multi-Shared Memory MSM-1/5

to enable memory sharing by up to four DEC computers, thus providing higher throughputs and expanded computing power while eliminating the need to invest in an entirely new system. 3. A company that will continue developing and marketing unique products, such as those listed above, to further enhance the performance of DEC computer systems.

\*DEC, Q-Bus, Unibus, and VAX are trademarks of Digital Equipment Corp.

# RANYAN

GIVING NEW MEANING TO DEC SYSTEM PERFORMANCE.

RANYAN COMPUTER ENHANCEMENT SYSTEMS · 15239 SPRINGDALE ST. · HUNTINGTON BEACH, CA 92649 · 714-895-5504

## Cou·pon

*n.* 1. A device at the end of an ad which allows you easy access to further information on the products mentioned in the ad.

PLEASE SEND ME MORE INFORMATION ON THE FOLLOWING:  Peripheral Processor Link Series  Bus Manipulator Series

Intelligent Multi-Shared Memory

Name \_\_\_\_\_ Title \_\_\_\_\_

Company \_\_\_\_\_ Phone \_\_\_\_\_

Address \_\_\_\_\_ City \_\_\_\_\_ State \_\_\_\_\_ Zip \_\_\_\_\_

Mail coupon to: Ranyan Computer Enhancement Systems, 15239 Springdale St., Huntington Beach, CA 92649

CD/AC

until a resource is needed, a resource is freed, or an interrupt occurs. Now, a dispatch occurs, allowing another process to run. Only processes that are placed on the ready list are eligible for selection during dispatch. By definition, a process is on the ready list if it is waiting for other system resources and cannot execute until these requirements are satisfied. The operating system uses system queues to change the status of processes.

Queues perform several critical functions for processes running under MP/M-86. They communicate messages between processes and synchronize process execution. Each system queue is composed of two parts: the queue descriptor and the queue buffer. These are special memory files with a specified number of fixed length messages. Like files, queues are made, opened, related, read from, and written to.

Typical queue operations in a process control environment using MP/M-86 would include a specified number of system clock ticks before removing a process from the suspended state, such as in a wait statement; a system flag to be set to remove a dormant or suspended task and put it on the ready list, as in the case of an alarm condition; and an I/O event to complete, such as in an analog to digital conversion. In addition, the dispatcher and queue architecture permits operator access to program variables and system flags while a multitasking program runs. Tasks can be activated or suspended, and program variables altered, from a terminal keyboard.

### Multitasking process control

Although multitasking is appropriate for a number of different applications ranging from product test to laboratory research and development, one of the most common applications is for batch process control. Process control applications consist of a number of individual but interrelated control loops. The system monitors a controlled variable such as temperature and provides the necessary feedback through a manipulated variable such as steam flow. This controlled variable is input into the system and compared with an external preprogrammed setpoint. An error signal (difference between the setpoint and controlled variable) generates the manipulated variable. The system's job is to drive the error signal to zero in the shortest possible time. A control loop is necessary because processes are dynamic and subject to fluctuation from many influences—changes that translate into regulatory operations.

In a multitasking control system, the task or process takes the place of the individual controller. The first assignment, however, is to divide the overall control program into individual control tasks and program the required control strategy for each task. Each task, at minimum, consists of an analog or digital input statement, a setpoint variable, a control statement, and an analog or digital output statement. Once tasks are programmed individually, they can be combined in a coherent control strategy using multitasking.

On-off action, the simplest process control, can be performed by basic mechanical, analog, and programmable controllers. Such a controller measures a variable like temperature, compares it to the external setpoint,

and switches a relay on or off according to the conditions. On-off control, however, can be rather coarse when the measured variable fluctuates around the setpoint. Use of a deadband increases this coarseness but improves the lifespan of system elements.

For instance, a furnace can be programmed to turn on if the temperature drops below a predetermined point. This point is called the minimum deadband value. If the temperature exceeds a predetermined maximum value (maximum deadband value), the heater will turn off. When the temperature falls between these two values, no change will occur. This type of control results in a process that oscillates around the setpoint between the high and low limit.

A program to generate this control can be written in MACBASIC, a version of BASIC that is extended for measurement and control applications. It uses standard BASIC commands in addition to I/O commands such as DOT, digital output; AOT, analog output; AIN, analog input; and DIN, digital input.

```
10 X=AIN (1,2)
20 IF X < M THEN DOT(2, 1)=1 GOTO 10
30 IF X > M1 THEN DOT(2, 1)=0 GOTO 10
40 GOTO 10
```

In the preceding program, the analog input statement assigns that analog input from slot 1, channel 2 to variable X. The digital output at slot 2, channel 1 outputs a high or a low logic signal to switch a relay if the voltage exceeds either the high (M1) or the low (M) limit.

### PID control loop

Any potential for a computerized measurement and control system is wasted in on-off action. The digital technology used in process control for over two decades has evolved to where more complex control strategies are possible. Advanced control programs using proportional, integral, and derivative (PID) control were first implemented on large centralized mainframe systems and have become the foundations of process control theory. Improvements in process efficiency and product quality validate these theories.

The basic characteristic in defining process loop is quality, which translates into the stability of the controlled variable (Fig 2). This dynamic variable is

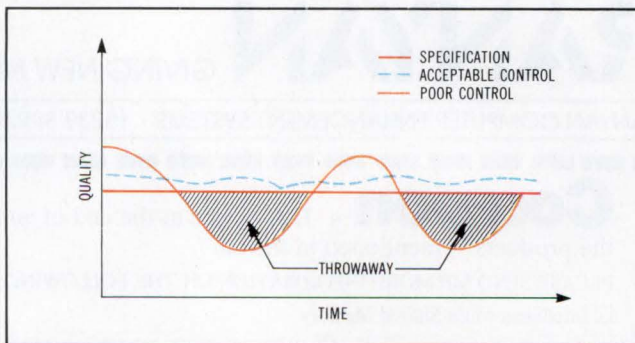

**Fig 2** The goal of process loop control is to minimize deviation of the dynamic variable from the setpoint. One gauge of quality control is how long it takes the dynamic variable to regain or settle within certain limits of the setpoint after a disturbance.

# Tiny BASIC MICROCOMPUTERS TRANSWAVE'S K-8073 SERIES



The "ENGINEER'S" computer is available in three powerful versions offering real-time Tiny BASIC.

**\$684<sup>00</sup>**

\*24K BYTE SINGLE UNIT



## K-8073B XCALIBUR

**Low Cost—Powerful/Versatile  
Rapid Implementation of Control Programs**

In its price range, the NEW Transwave K-8073B, "XCALIBUR," is the computer for the engineer or technician. Rapidly implemented, the "XCALIBUR" can be up and running sophisticated applications of measurement and control in hours instead of weeks or months. Transwave has added many important features to its original Tiny BASIC K-8073. Memory has been expanded to 24K byte of RAM with 16K battery backup. An additional 8K byte is available for HI RES color video and is contiguous to the first 16K RAM. EPROM is increased to 16K with an on-board programmer. The "XCALIBUR" comes in a heavy-duty extruded aluminum housing with a 16-key data input keyboard and 8-digit, real-time display. A constantly expanding EPROM software library allows fast implementation of many industrial control applications.

\*Supplied with 16K EPROM, 6K RAM, 2.5K ROM.  
With full memory—\$992—16K EPROM, 24K RAM.

### Expanded Features:

- INS-8073 XMOS\* 8MHZ or 4 MHZ Tiny BASIC microinterpreter.
- Extended memory—24K RAM battery backup, 16K EPROM w/on-board programmer.
- Color video generator for full HI RES graphics/text.
- RS-232 w/printer handshake.
- Real-time clock—yr., mo., wk., day, hr., sec. w/interrupt.
- Socketed RAM: 2K or the new 8K 6264LP.
- Buffered ADD/DATA/CONTROL LINES.
- ART/RC Master, for single wire data I/O of 128 "Slaves."
- 8-digit status display w/16-key data input keyboard.
- New interlocking extruded aluminum metal housing for industrial use.

\*When available from NSC.

## K-8073A

**The Satellite Tiny BASIC Computer  
Features:**

- INS 8073 microinterpreter MPU
- On-board, real-time clock
- RS-232 communications
- Color video generator w/graphics
- Up to 40K RAM/EPROM memory
- Battery backup for RTC & RAM
- ART/RC communications link
- Extruded aluminum module

For stand-alone control applications, the K-8073A provides a low-cost alternative. After software has been developed, the small K-8073 module can be installed just about anywhere. As a satellite, the K-8073A can report or receive instructions from a host computer.

24K BYTE SINGLE UNIT **\$478<sup>00</sup>**



K-8073A

## K-8073

**The Original Board Level Tiny BASIC  
Computer  
Features:**

- INS 8073 MPU w/Tiny BASIC language
- STD (modified) bus
- On-board, real-time clock
- On-board EPROM (2716) programmer
- 1K byte local RAM
- 8K byte EPROM
- PPI—three 8-bit programmable I/O
- RS-232 communications
- ART/RC for single wire I/O to 128 "Slaves"
- Auto start capability
- Accessories:
  - Dual voltage power supply
  - 8K RAM board
  - 16K memory board (RAM or EPROM)
  - A/D module
  - TRIAC output
  - Assembler/disassembler

SINGLE UNIT **\$388<sup>00</sup>**

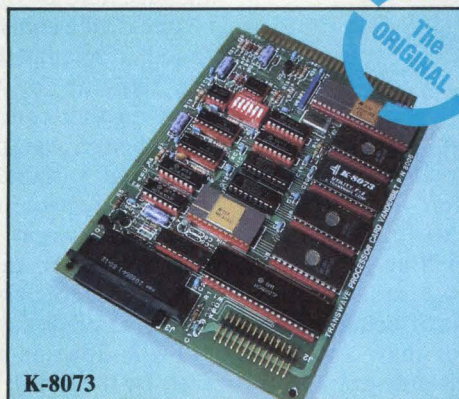

K-8073

For orders and information only:  
(800) 245-6843/Telex 902992



**TRANSWAVE CORPORATION**

Cedar Valley - Box 489  
Vanderbilt, PA 15486  
(412) 628-6370

considered stable when it stays within an acceptable error limit. Instabilities arise from outside disturbances, interactions with related control loops, and setpoint changes. Major excursions from the specification limit result in throwaway and process inefficiencies. Computers tighten process control and improve product quality.

Since analog outputs offer significantly higher resolution than digital, analog control generally provides tighter control. It falls into the category of proportional control, where the controlled variable is adjusted according to the measured variables. For example, in the temperature application discussed earlier, the on-off valve for heat can be replaced by a proportional valve that varies the flow of gas into the furnace. The system regulates the position of the valve by altering the analog voltage supplied to the valve. If the furnace is too cold, more gas is supplied; the colder it is, the more gas supplied. Conversely, if the furnace is too hot, gas flow slows down; the hotter it is, the less gas supplied.

```
10 S=5
20 C=5
30 E=S-AIN(1,0)
40 AOT(2,0)=E+C
50 WAIT 1
60 GOTO 30
```

In this proportional control program, the system generates an error signal, E, by calculating the difference between the setpoint, S, and the input voltage from a temperature sensor, AIN(1,0). Channel 0, the proportional output on slot 2, controls the gas flow in this example. Offset C provides an analog output even when the error signal is zero. The system will scan the channel once every second and change the position of the valve as the temperature changes.

One limitation of proportional control is its inability to respond to changes in operational characteristics. That is, if incorrect values for S and C are chosen, or if other factors change, the program does not accomplish the necessary control. For example, if offset C is too low, the controller cannot force the output high enough to achieve the setpoint. One technique that allows the program to adapt to the application (by learning) involves the use of integral action. The integral factor accumulates the errors of past performance by adding the current error value to the integral. Output response not only adjusts itself according to how far off the input value is compared with the setpoint, but also to how long and how far it has been away from the setpoint.

```
10 S=5      50 E=S-AIN(1,0)
20 C=5      60 I=I + P*E
30 I=0      70 AOT (2,0)= E + I + C
40 P=.1     80 WAIT 1
           90 GOTO 50
```

In this proportional-integral program, the integral is used to generate the analog output for slot 1, channel 0. Two new variables are added, however: I, which accumulates error, and P, which factors the integral to an appropriate output. The value of P will be determined by taking into account the update rate caused by the wait command and the relative weight of being off setpoint. Choice of the incorrect values may cause too much weight being attributed to this integral factor.

Also, due to the speed of digital computers, the integral factor may accumulate too quickly, resulting in saturation. Because the integral factor may overwhelm the output long after the setpoint, an integral limiter is usually required.

The proportional factor relates to the present and the integral to the past. Derivative control attempts to anticipate the future by taking into account the rate at which the input changes. The system compares the previous input value, F, with F's previous value. As the measured variable nears the setpoint, the derivative factor decreases and slows down the rate of change, R. The following program combines the factors of PID control. The analog output [AOT(2,0)] is a factor of the proportional, E; integral, I; and derivative, R. The last factor, C, is the offset.

```
10 S=5      70 E=S-AIN(1,0)
20 C=5      80 I= I + P*E
30 I=0      90 R=(F-E) * D
40 P=1     100 AOT (2,0)= E + I + R + C
50 D=1     110 F=E
60 F=S     120 WAIT 1
           130 GOTO 70
```

Proportional, integral, and derivative control combine in a PID control loop. A combination of the three control modes provides loop damping according to the values chosen in the control program. The loop is overdamped when the deviation approaches the setpoint value smoothly with no oscillations. In a critically damped loop, the duration for a noncycling response is minimal although the deviation may be larger. An underdamped loop is where the deviation executes a number of oscillations about the setpoint.

### Multivariable cascade control

Control programs discussed so far have been concerned with just one control loop. Most process control situations involve a number of interrelated control loops managing a single process. The principal challenge in designing a control system for industrial processes is to minimize disturbances from interactions among control loops. The most effective control system is not a simple arrangement of single loops, but a coordinated structure whose interactions mirror the relationships of the controlled process. However, there is usually a "best" pairing for any given process, and determining this pairing is essential to achieving steady-state process stability. Strategies such as cascade control permit better management of these multivariable processes.

In cascade control, two or more control loops are tied together so that the output of one controller provides the setpoint for the other. The inherent interaction between two control loops in many applications provides better overall control. Each controller has its own measured variable. The two measurements are taken from the system and each used in its own control loop. In the outer loop, however, the controller output is the setpoint of the inner loop. For example, if the outer loop's dynamic variable changes, the error signal input to the controller effects a change in the setpoint.

Fig 3 shows an application of dual-loop, cascade control. By the time a change in fuel flow influences the hot

# 60+ Ways To Get I/O Data From Sensors to $\mu$ C Bus... Easily

More than 60 different analog/digital I/O boards provide a variety of off-the-shelf, plug-in quick solutions for sensor-to-microcomputer bus compatibility. Designed - proven in Intel Multibus™, Motorola Micromodule, DEC LSI-11 and Zilog MCB/MCS (and others), these boards offer the important features that save you time and money in designs, hardware and testing. Consider:

- Simple software requirements - many of our I/O boards need only one instruction per conversion
- Versatile, memory-mapped designs
- 10mV to 10V analog input operation
- I/O's powered from the microcomputer's supply
- Up to 64 input channels per board
- Analog inputs and outputs on the same board
- 8- or 12-bit resolution
- Software programmable gains from 1 to 1024V/V (on-board RAM sets gain for each channel addressed)
- Relay outputs for power switching
- Isolated digital input and output
- Input overvoltage protection

You'll find this combination of features, options, availability - and our low prices - described in a new Microcomputer I/O Board brochure now available. Ask for it!

**Data Acquisition and Control Systems Division**  
3631 E. 44th Street, Tucson, AZ 85713  
(602) 747-0711

**BURR-BROWN®**  
**BB**

Putting Technology To Work For You

water temperature, a considerable amount of energy will be absorbed by the water in the tank. This will continue to drive the hot water away from the setpoint, long after the fuel flow valve makes a correction. Cycling of the measured variable and unacceptable delays in the return to the setpoint result.

Addition of a secondary controller, whose measured variable is fuel flow, allows flow variations to be corrected before they can affect the hot water temperature. By connecting the output of the primary (temperature) controller to provide the setpoint to the secondary (fuel) controller, gradual excursions of the hot water temperature from the setpoint are also corrected.

With multitasking programming, primary and secondary controllers are represented by independent tasks. Since MP/M-86 permits intertask communication, the pressure data from the secondary loop can be used to change the setpoint of the primary loop. The following multitasking program is divided into four sections: the process dispatcher (lines 10 to 60), which sets up the location, priority, and execution schedule of the three independent tasks; task 1 (lines 70 to 100), the primary controller; task 2 (lines 110 to 150), the secondary controller; and task 3 (lines 160 to 200), a dormant alarm.

```

10 Task 1, 70, 2
20 Activate 1, Period 2
30 Task 2, 110, 2
40 Activate 2, Period .5
50 Task 3, 160, 1
60 STOP

70 C=1, S=10, S2=5, X=5
80 E=S-AIN(1,0)
90 DISMISS
100 GOTO 70

110 P=S2-AIN(1,1)
120 AOT(2,0)= E + P + C
130 IF X < AIN(1,1) THEN ACTIVATE 3
140 DISMISS
150 GOTO 110

160 SUSPEND 1
170 SUSPEND 2
180 DOT(4,1)=1
190 PRINT "ALARM CONDITION"
200 END

```

The process dispatcher defines the starting point, execution schedule, and priority of the independent tasks. For example, the first instruction sets up task 1 starting at line 70 with a priority of two. Line 20 activates the task and tells the system to execute it once every 2 s. The third task is given a higher priority of 1; when activated, it monopolizes the available CPU time.

Task 1 serves as the primary temperature controller. Input from a temperature sensor generates an external input (E) to the secondary controller, task 2. The dismiss statement is the programmed suspension of a task, which places it in a waiting state. After 2 s, the system will resume task execution at the next line.

Task 2 is the secondary controller. It measures the fuel flow with an analog input statement and generates an error signal for any variation from the flow setpoint.

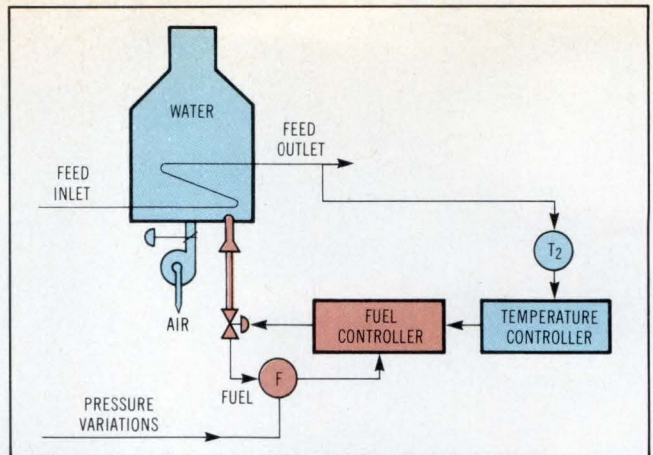

**Fig 3 Cascade control ties at least two process loops together. The slower, outer loop consists of the primary (temperature) controller, its process variable, the control valve, and the process. The secondary, inner loop will control deviations in fuel flow before they show up in temperature variations.**

The analog output controls the fuel valve and is a function of the error signal from task 1, the temperature deviation, and the error in task 2, the flow deviation. This task is executed every half second, since variations in fuel flow occur faster than temperature deviations. Another part of the task is to activate task 3 when the fuel flow exceeds a programmed limit.

Task 3 suspends the execution of the first two tasks and outputs an alarm signal. A digital output sounds an alarm and a print statement generates an alarm message. Until the alarm limit is exceeded in task 1, this task remains in a suspended state to the process dispatcher.

When a cascade system is placed in operation, both controllers are initially set in manual during startup. After the process stabilizes, the secondary controller is placed in automatic and the correct control action settings are determined. Since the keyboard remains live while the program executes, process variables can be changed while the task is run. When the secondary controller operation in automatic is satisfactory, the primary controller is placed in automatic and its optimum control action settings are determined.

### Bibliography

- J. Biber, *Microprocessors in Instruments and Control*, John Wiley & Sons, New York, NY, 1977.
- D. P. Burton and A. L. Dexter, *Microprocessor Systems Handbook*, Analog Devices Inc, Norwood, Mass, 1977.
- C. D. Johnson, *Process Control Instrumentation Technology*, John Wiley & Sons, New York, NY, 1977.
- F. G. Shinsky, *Controlling Multivariable Processes*, The Foxboro Co, Foxboro, Mass, 1981.

Please rate the value of this article to you by circling the appropriate number in the "Editorial Score Box" on the Inquiry Card.

High 722

Average 723

Low 724

Photo on p 119 is of an Analog Devices Macsym 350 running MP/M-86.



## Texas Instruments and Racal-Vadic team up to slim modems down.

- TI's new TMS99532 modem chip enables Racal-Vadic to slim modems down from large subsystems to small-scale components (Page 2).
- Packing more functionality on chip, TI universal microprocessor peripherals cut system size, boost overall performance (Page 3).
- New CMOS A/D peripherals reduce component count and power requirements in microprocessor-based systems (Page 4).

# By using cuts size

That's only the beginning of what's happening to modems at Racal-Vadic, world's largest supplier of low- and medium-speed modems. Couple those space savings with 3-to-1 reductions in power requirements. And in costs.

Racal-Vadic's key to shrinking the modem is the new TMS99532 FSK modem chip from Texas Instruments.

Result: Modems no longer need be large PC boards, or expensive, space-consuming, stand-alone subsystems. They are simply becoming small-size components in such equipment as the new professional computer shown here, in interactive terminals, in point-of-sale and in credit-verification systems.

## Performance-packed package

Racal-Vadic calls TI's TMS99532 "the only complete Bell 103-compatible modem chip on the market." In a space-saving 18-pin DIP, the '99532 provides all the modulation, demodulation, and filtering functions needed for a serial, asynchronous-communications link.

Parts count in Racal-Vadic full-duplex modems has been cut by around 40 ICs and board size reduced from approximately 75 square inches to 25. But with room left for Racal-Vadic to add needed intelligence — for auto dialing, pulse and tone dialing, as well as number storage.

TI's '99532 modem chip has a maximum continuous power dissipation of 550 mW and a TTL-compatible digital interface. It can be direct-connected electronically through FCC registered interface circuits, or acoustically via a microphone and speaker. Interface to a handset requires only a few operational amplifiers. Racal-Vadic finds the TMS99532 extremely reliable and uses the device in other products.

**For more information** on the TMS99532, as well as the TMS99534 designed to meet European requirements, return the coupon at the end of this ad. Or call your nearest TI distributor or TI field sales office.

◀ **Slim size, trim cost** characterize Racal-Vadic innovative modems. Full utilization of the functionality packed into TI's new TMS99532 modem chip results in substantially fewer components.

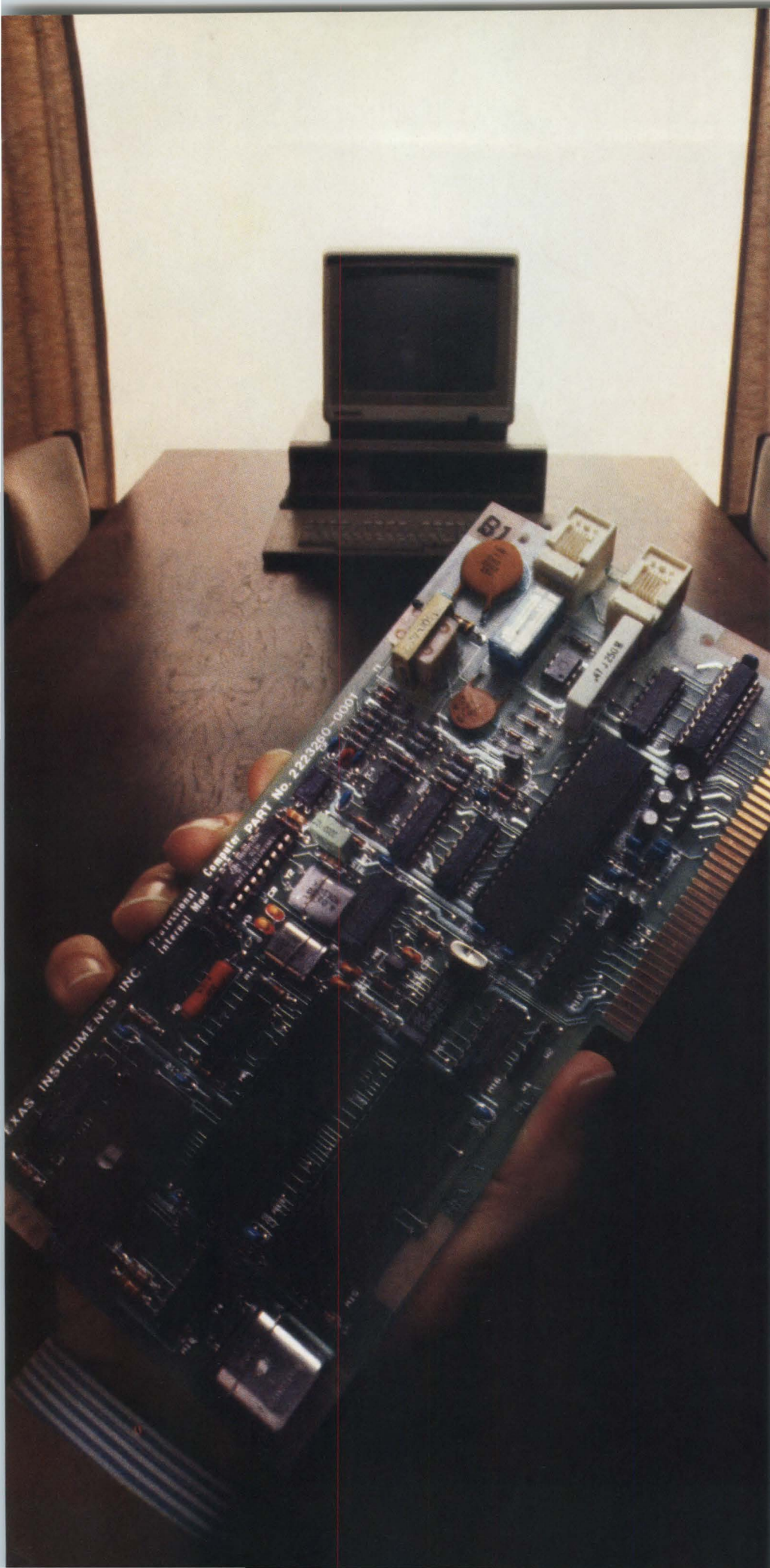



# TI's '99532 chip, Racal-Vadic of modems by two-thirds.

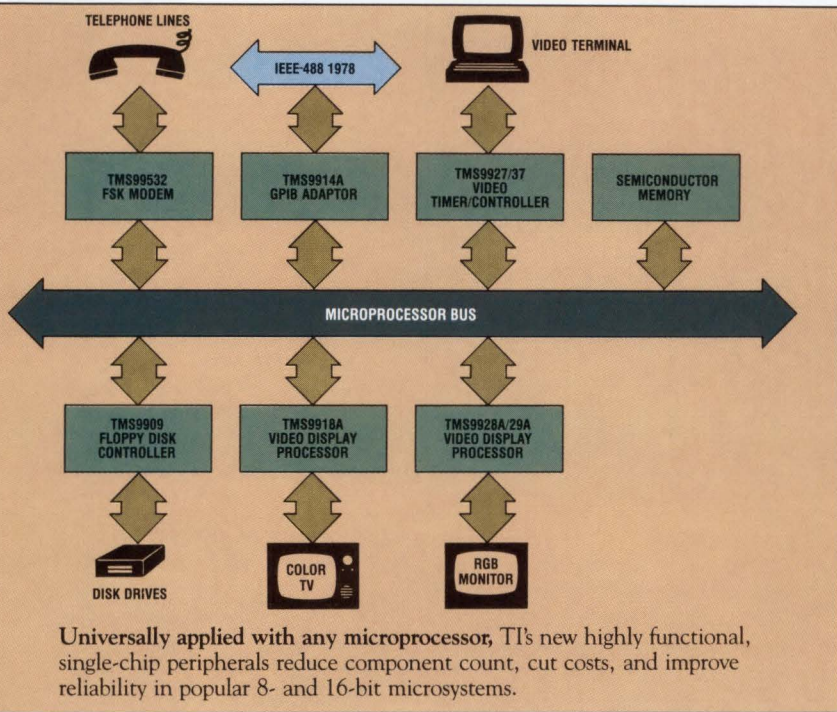

## Simpler color video display processor

Video and arcade games. Home computers. Graphics terminals. Learning aids. Industrial process monitoring. Drafting and animation systems. You create an entire color system for any of these using only TI's TMS9918A display processor and picture storage dynamic random access memories (DRAMs). The composite video is generated directly on the chip, and refresh of the DRAMs is automatic and transparent.

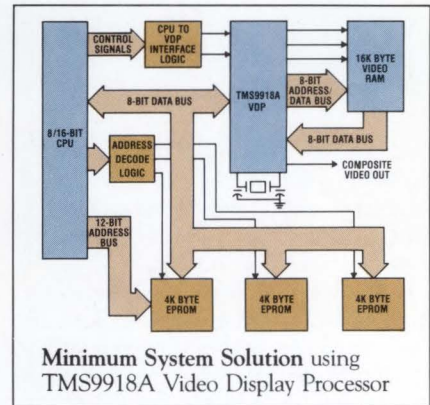

The '9918A produces 15 colors plus transparent, with 256 x 192 pixel on-screen resolution. The similar TMS9928A (525 lines) and TMS9929A (625 lines) offer separate luminance and chromance outputs for better resolution with R-G-B monitors.

## Industry-standard video/timer controllers

Pin-compatible with industry-standard 5027s and 5037s, the TI single-chip TMS9937 generates video display timing signals for EIA Standard RS-170, as well as for non-standard CRT monitors. In non-interlaced operation, with an even or odd number of scan lines per data row. Or in interlaced operation, with an even number of scan lines per data row. And the '9937 can be programmed for interlaced operation for an odd number of scans per data row. This eliminates character distortion caused by the uneven beam current associated with odd/even field interlacing of alphanumeric displays.

All TI universal microprocessor peripherals are at your TI distributor. For more details, return the coupon.

# TI's advanced microprocessor peripherals: Fewer parts, lower costs, better reliability.

The TMS99532 modem chip that helped Racal-Vadic pare modem size is just one of TI's advanced microprocessor peripherals. Each new single-chip component performs functions that usually require multiple devices. Or entire boards.

Best of all, they are *universal* — compatible with all popular 8- and 16-bit microprocessors. So you can upgrade your design now, yet save your software investment.

## Flexible, versatile floppy disk controller

TI's TMS9909 controls the floppy disk drives used in today's word processing, business, and industrial systems, as well as personal computers.

The TMS9909 reads from or writes into partial, single, or multiple sectors of hard or soft disks. It simultaneously controls two different disks and can support any combination of up to four different single/double-sided standard 8" or 5 1/4" mini disk drives. It can be used with all data-recording formats and frequency-modulation data-encoding formats.

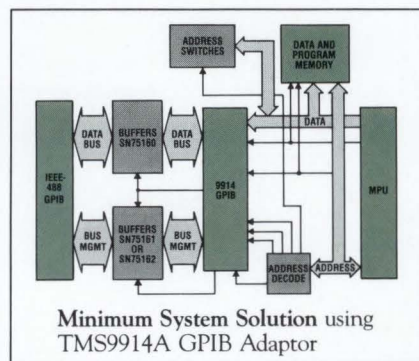

## Single-chip GPIB adaptor

The Texas Instruments TMS9914A combines talker, listener, and controller in one General Purpose Interface Bus Adaptor. And meets IEEE Standard 488-1975, 1978, and 1980 revisions.

TI's TMS9914A provides a flexible, unambiguous interrupt structure which separately latches all interrupts. No lost interrupts. No spurious interrupts.

And the '9914A is fast on the bus: Data rates as high as 500K bytes per second are possible.

# Six new TI CMOS A/D converters slash microprocessor parts count.

# Authorized TI Distributors

## TI's New 8-Bit A/D Converters

	TL520	TL522	TL530	TL531	TL532	TL533
Analog Inputs (To Multiplex)	—	8	8	9 to 15*	9 to 15*	5 to 11*
Digital Inputs (To Register)	—	0	0	6 to 12*	6 to 12*	0 to 6*
Resolution	Bits	8	8	8	8	8
Unadjusted Error	LSB	± 0.75	± 0.5	± 0.5	± 1.0	± 0.5
Analog Access + Conversion Time	µsec	70	200	300	300	300
Supply Range	Volts	4.5 to 6	3 to 6	4.5 to 6.5	4.5 to 6.5	4.5 to 6.5
Operating Power (Typ)						
At 5 Volts	mW	2.5	2.5	15.0	15.0	15.0
At 3 Volts	mW	N/A	0.3	- Not Available -	- Not Available -	- Not Available -
Operating Power (max)	mW	5.0	0.6	88	88	88

\* Includes 6 multipurpose (analog or digital) inputs.

Designed as peripherals for 8- and 16-bit microprocessor-based systems, TI's new family of CMOS A/D converters offers the designer six alternatives to cut space and power requirements.

You can now build a microprocessor-based system that can read and respond to a set of analog inputs with a low IC part count and low (CMOS) power. The new Texas Instruments family of six CMOS ICs, designed as peripherals for both 8- and 16-bit microprocessors, all make available an 8-bit digital conversion to the processor's data bus of any one of 8 to 15 analog inputs. They replace A/D converter, multiplexer, sample-and-hold, and control ICs.

The TL520 Series is a modern "switched-capacitor" 8-input A/D peripheral that replaces the "standard"

ADC0808 and ADC0809 with lower power and a wider power supply range.

The new TL530 Series offers the greatest flexibility to the system designer. These ICs can handle either digital inputs and/or analog signals from up to 21 different sources — making this data available to the 8-bit or 16-bit processor on the 8-line data bus via an 8-pin I/O port. Furthermore, the TL530 Series can be controlled and its inputs selected (from the data bus) through this same I/O port.

All the new CMOS A/D peripherals are available from your TI distributor.

© 1983 TI

27-5063

**Texas Instruments** P. O. Box 401560  
Dallas, Texas 75240

Please send me more information on:

PP04  TI's Advanced Peripheral Family  
LA01  TI's new CMOS A/D Peripherals  
SPP013OS300C

NAME \_\_\_\_\_

TITLE \_\_\_\_\_

COMPANY \_\_\_\_\_

ADDRESS \_\_\_\_\_

CITY \_\_\_\_\_ STATE \_\_\_\_\_ ZIP \_\_\_\_\_

AREA CODE \_\_\_\_\_ TELEPHONE \_\_\_\_\_ EXT. \_\_\_\_\_

ALABAMA: Hall-Mark (205) 837-8700.

ARIZONA: Phoenix, Kierulff (602) 243-4101, Marshall (602) 968-6181; Wyle (602) 249-2232; Tucson, Kierulff (602) 624-9986.

CALIFORNIA: Los Angeles/Orange County, Arrow (213) 701-7500, (714) 851-8961; IEC/JACO (714) 540-5600, (213) 998-2200; Kierulff (213) 725-0325 (714) 731-5711; Marshall (213) 999-5001, (213) 442-7204, (714) 556-6400; F Weatherford (714) 634-9600, (213) 849-3451, (714) 623-1261; Wyle (213) 322-8100, (714) 641-1600; San Diego, Arrow (619) 565-4800; Kierulff (619) 278-2112; Marshall (619) 578-9600; R. V. Weatherford (619) 695-1700; Wyle (619) 565-9171; San Francisco Bay Area, Arrow (408) 745-5600; Kierulff (415) 968-6292; Marshall (408) 732-1100; Wyle (408) 727-2500; Santa Barbara, R. Weatherford (805) 965-8551.

COLORADO: Arrow (303) 758-2100; Kierulff (303) 790-4444; Wyle (303) 457-9953.

CONNECTICUT: Arrow (203) 265-7741; Diplomat (203) 797-9674; Kierulff (203) 265-1115; Marshall (203) 265-3822; Milgray (203) 795-0714.

FLORIDA: Ft. Lauderdale, Arrow (305) 776-7790; Diplomat (305) 971-7160; Hall-Mark (305) 971-9280; Kierulff (305) 652-6950; Orlando, Arrow (305) 725-1480; Diplomat (305) 725-4520; Hall-Mark (305) 855-4020; Milgray (305) 647-5747; Tampa, Diplomat (813) 443-4514; Hall-Mark (813) 576-8691; Kierulff (813) 576-1966.

GEORGIA: Arrow (404) 449-8252; Hall-Mark (404) 447-8000; Kierulff (404) 447-5252; Marshall (404) 923-5750.

ILLINOIS: Arrow (312) 397-3440; Diplomat (312) 595-1000; Hall-Mark (312) 860-3800; Kierulff (312) 640-0200; Newark (312) 638-4411.

INDIANA: Indianapolis, Arrow (317) 243-9353; Graham (317) 634-8202; Ft. Wayne, Graham (219) 423-3422.

IOWA: Arrow (319) 395-7230.

KANSAS: Kansas City, Component Specialties (913) 492-3555; Hall-Mark (913) 888-4747; Wichita, LCOMP (316) 265-9507.

MARYLAND: Arrow (301) 247-5200; Diplomat (301) 995-1226; Hall-Mark (301) 796-9300; Kierulff (301) 247-5020; Milgray (301) 468-6400.

MASSACHUSETTS: Arrow (617) 933-8130; Diplomat (617) 429-4120; Kierulff (617) 667-8331; Marshall (617) 272-8200; Time (617) 935-8080.

MICHIGAN: Detroit, Arrow (313) 971-8200; Newark (313) 967-0600; Grand Rapids, Newark (616) 243-0912; Arrow (616) 243-0912.

MINNESOTA: Arrow (612) 830-1800; Hall-Mark (612) 854-3223; Kierulff (612) 941-7500.

MISSOURI: Kansas City, LCOMP (816) 221-2400; St. Louis, Arrow (314) 567-8888; Hall-Mark (314) 291-5350; Kierulff (314) 739-0855.

NEW HAMPSHIRE: Arrow (603) 668-6968.

NEW JERSEY: Arrow (201) 575-5300, (609) 235-1900; Diplomat (201) 785-1818; General Radio (609) 964-8560; Hall-Mark (201) 575-4415, (609) 424-7300, JAI (201) 778-4722; Kierulff (201) 575-6750; Marshall (201) 882-0320; Milgray (609) 983-5010.

NEW MEXICO: Arrow (505) 243-4566; International Electronics (505) 345-8127.

NEW YORK: Long Island, Arrow (516) 231-1000; Diplomat (516) 454-6334; Hall-Mark (516) 737-0600; JACO (516) 273-5500; Marshall (516) 273-2424; Milgray (516) 546-5600, (800) 645-3986; Hall-Mark (516) 737-0600; Rochester, Arrow (716) 275-0300; Marshall (716) 235-7620; Rochester Radio Supply (716) 454-7800; Syracuse, Arrow (315) 652-1000; Diplomat (315) 652-5000; Marshall (607) 754-1570.

NORTH CAROLINA: Arrow (919) 876-3132, (919) 725-8711; Hall-Mark (919) 870-0712; Kierulff (919) 852-9440.

OHIO: Cincinnati, Graham (513) 772-1661; Hall-Mark (513) 563-5980; Cleveland, Arrow (216) 248-3990; Hall-Mark (216) 473-2907; Kierulff (216) 587-6558; Columbus, Hall-Mark (614) 891-4555; Dayton, Arrow (513) 435-5558; ESCO (513) 226-1133; Marshall (513) 236-8088.

OKLAHOMA: Arrow (918) 665-7700; Component Specialties (918) 664-2820; Hall-Mark (918) 665-3200; Kierulff (918) 252-7537.

OREGON: Kierulff (503) 641-9150; Wyle (503) 640-6000.

PENNSYLVANIA: Arrow (412) 856-7000, (215) 928-1800; General Radio (215) 922-7037; Hall-Mark (215) 355-7300.

TEXAS: Austin, Arrow (512) 835-4180; Component Specialties (512) 837-8922; Hall-Mark (512) 258-8848; Kierulff (512) 835-2090; Dallas, Arrow (214) 386-7500; Component Specialties (214) 357-6511; Hall-Mark (214) 341-1147; International Electronics (214) 233-9323; Kierulff (214) 343-2400; El Paso, International Electronics (915) 778-9761; Houston, Arrow (713) 491-4100; Component Specialties (713) 771-7237; Hall-Mark (713) 781-6100; Harrison Equipment (713) 879-2600; Kierulff (713) 530-7030.

UTAH: Diplomat (801) 486-4134; Kierulff (801) 973-6913; Wyle (801) 974-9953.

VIRGINIA: Arrow (804) 282-0413.

WASHINGTON: Arrow (206) 643-4800; Kierulff (206) 575-4420; Wyle (206) 453-8300.

WISCONSIN: Arrow (414) 764-6600; Hall-Mark (414) 761-3000; Kierulff (414) 784-8160.

CANADA: Calgary, Future (403) 259-6408; Varah (403) 230-1235; Hamilton, Varah (416) 561-9311; Montreal, CESCO (514) 735-5511; Future (514) 694-7777; Ottawa, CESCO (613) 226-6905; Future (613) 820-8313; Quebec City, CESCO (418) 687-4231; Toronto, CESCO (416) 661-0220; Future (416) 663-5563; Vancouver, Future (604) 438-5545; Varah (604) 873-3211; Winnipeg, Varah (204) 633-6190.



# SOFTWARE ASPECTS OF FACTORY MACHINE CONTROL



**Impact of the computer on the integrated factory floor has resulted in improved product fabrication methods. Smooth interaction between machine tools and people, however, depends upon practical software.**

by Theodore B. Ruegsegger

**T**oday's automated factory has a bewildering array of machines which, while they obviously and spectacularly cut metal, only vaguely resemble their manually operated ancestors. There are also some novel items: driverless vehicles moving materials about, apparently knowing where they are going; robots—not the clanking mechanical men of science fiction, or even Artoo Detoo of *Star Wars*, but disembodied arms on pedestals performing mysterious tasks with patience and precision; and data display terminals attended by people who belie the old stereotypes of machinists. Those machinists are now applying their still indispensable experience and knowledge of production processes to programming the machines or supervising the systems at several levels.

Despite the many buzzwords related to factory automation—computer aided design (CAD), computer aided

manufacturing (CAM), computer integrated manufacturing (CIM), integrated computer aided manufacturing (ICAM), and flexible manufacturing systems (FMS)—the desired result is fabrication of a product. A study of product fabrication, on the factory floor level, reveals that dramatic strides have taken place there, also. Probably one of the most dramatic involves various software issues.

## Elements of the automated factory floor

A typical automated machine, or workstation, has a work table on which the workpiece can be securely mounted and a spindle to hold a tool. On a basic 3-axis machine, the spindle can be moved (relative to the part) in the three orthogonal directions (X, Y, and Z axes). If the part is mounted on an index table, the table can be rotated as well (the B axis), making this a 4-axis machine. A modern 5-axis machine can also rotate the spindle head about a horizontal axis (the A, or H, axis), so that the tool can approach the part from the top, from the side, or at an angle. Addition of B- and A-axis movement greatly reduces the need to refixture the part, since all sides but the bottom are now completely accessible.

A numerically controlled (NC) machine has special hardware added to effect these motions, control coolant

*Theodore B. Ruegsegger is currently a senior system engineer at SofTech, Inc, 460 Totten Pond Rd, Waltham, MA 02154, where he is responsible for diverse projects in manufacturing technology. He has an SB and an SM from the Massachusetts Institute of Technology.*

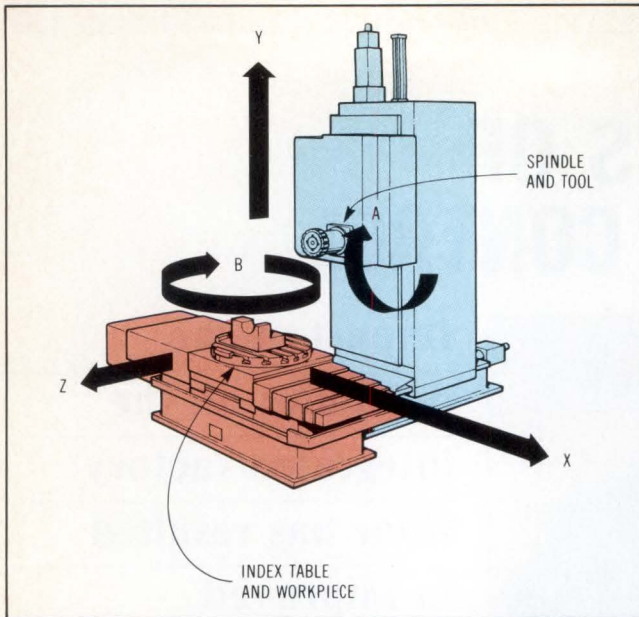

On a typical 5-axis workstation, the spindle and tool move in three orthogonal directions (X, Y, and Z) relative to the part. In addition, the table rotates in the B axis and the spindle head rotates about the A or horizontal axis. The tool, therefore, can contact the workpiece from the top or side or from an angle; the workpiece need not be refixed except to approach the bottom.

flow, and change cutting speeds. Stepping motors for each axis, solenoid actuators, solenoid valves, pumps, limit switches, and position sensors all must be interfaced to the controller via relays. Adding tool carousel and automatic tool changing equipment relieves the operator of still another time-consuming task. An NC controller turns all these devices on or off according to a sequence specified by a part program on punched paper tape.

The tape run by the NC reader is akin to a simple machine language computer program, consisting of a series of binary codes to accomplish the desired actions. This program is normally developed using high level language (eg, APT, SPLIT, or COMPAC II) on a computer located away from the workstation. Thus, the NC programmer can directly specify the tool's path, without worrying about the details of driving the stepping motors. In a manner analogous to that of a compiler, a program called a postprocessor translates the task oriented instructions of the universal language to the machine language of the chosen NC machine. Naturally, there are separate postprocessors for different NC machines.

Performance of this workstation can be greatly improved by installing a "black box" called a behind tape reader (BTR) between the tape reader and the controller. This BTR has its own memory for part programs, an interface and drivers for a data display terminal, limited editing features, and some enhancements to the controller's basic instruction set. To the controller, it looks like the tape reader passing on a stream of operation codes.

For the NC programmer, however, the BTR provides more convenience in that the tape needs to be read only once and numerous programs can be stored in the

memory. The programmer selects programs via the terminal and can edit them without returning to the source program at the main computer. Editing is confined to the machine language level, however, and is therefore only practical for minor changes and debugging because a new tape cannot be punched easily. (Moving a punch to the workstation and connecting it is generally more bothersome than correcting the source at the main computer, especially since the source must eventually be updated anyway.)

Addition of the BTR makes this a computer numerically controlled (CNC) workstation; newer models combine the controller and the BTR using a minicomputer or, now more commonly, a microcomputer. Such workstations still use tapes and the programmer needs to go back and forth between the main computer and the workstation to get a part program working.

The greatest advantage of CNC systems is that they can be connected directly to the main computer to build a direct numerical control (DNC) configuration. Under DNC, a central library of part programs is maintained, and machine language programs are downloaded to workstations as required. (This is the origin of the term "direct numerical control"; it does not imply that the central computer directly controls the machines.)

With appropriate data communication facilities and software support, DNC can result in enormous increases in productivity. Although the original development is probably still done on the main computer (or a dedicated design system connected to it), the part programmer can edit the source program via the terminal in the high level language without leaving the workstation. Not only has punched tape disappeared, but, at least for the programmer, so has the cumbersome machine language.

To complete factory integration, as far as the production process is concerned, an automated material handling system is added. Because of a central storage facility for work in process, only a small backlog (typically one shift's worth) need be maintained at each workstation. There is also a material movement system, which may use conveyors, overhead trolleys, or even self-propelled,

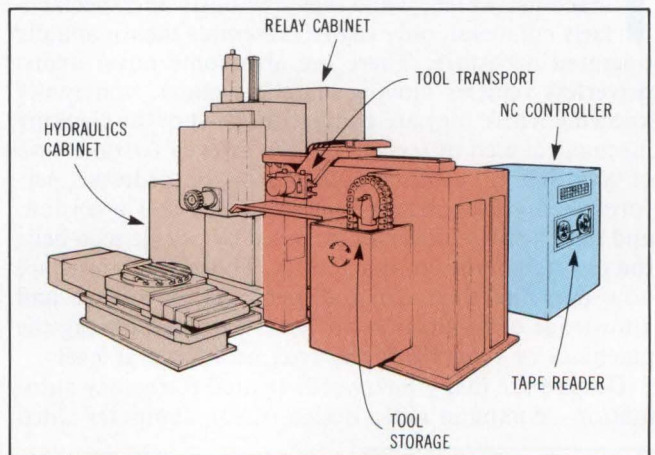

**Adding numerical control, tape reader, and automatic tool changer to the 5-axis workstation relieves the operator of many time-consuming tasks. The NC controller provides automated axis control as well as tool changing in a sequence set up by a punch paper tape.**

# THE IC

IN CIRCUIT DEBUGGER



**NOW WE  
HAVE ...  
8086  
8087  
8088  
8085  
Z80B**



Our new 8086-88 Stand Alone Emulator offers you things that you can't get with any stand alone emulator or for that matter, most  $\mu$ P developments systems. With our ICD-178/8086-88 Emulator you get real time 8086 emulation to 10 MHz and 8088 emulation to 8 MHz, PLUS 8086-8087 and 8088-8077 co-processor emulation. Just a few of our standard features include 128K of static memory (expandable to a full 1 Megabyte), 13 breakpoints, and in-line assembler for code patching, full upload/download to host computers with no special software, displays in hex/ASCII or disassembled code, and a 2K X 64 real-time trace buffer. We also run in either the MIN or MAX modes. There are 20 different debugger commands to make your job of software debug and system integration much easier. Call us on our toll free number 800-421-0982 for literature or if you would like a demonstration by one of our representatives.

**IN THE  
FUTURE ...  
68000  
8048  
8051  
6809  
6502**

**Zax**  
Zax Corporation

8311 Westminster Ave.,  
Westminster, California 92683  
Toll Free 1-800-421-0982  
CA, HA, AK 714-898-2373

computer guided robot carts to move work between stations and the central storage facility. Finally, robots, pallet changers, or other mechanisms transfer materials between the storage facility, the material movement system, and the workstations.

Hierarchical control is an issue that deserves mention. Although the factory described here has two levels, many factories have more: machines are grouped into clusters made up of work cells; these clusters form work centers, and so on. The tradeoffs between added complexity and capital cost versus more efficient control and more logical task distribution differ widely, depending on the nature of the products and the scale of the operation.

### The NC part programmer's view

The part programmer's job is to translate the part design into an efficient part program and verify that program by overseeing the first part's production. It is nice to have features, implemented in the CNC controller's software, firmware, or hardware, that allow separation of data from the program. This reduces the need to edit and recompile the program merely because some operational parameters, such as tool lengths and cutter diameters, have changed. "Canned cycles" (eg, drill and tap) make for a more powerful instruction set at the machine language level.

Another key advantage is the availability of powerful high level languages that are, as far as possible, independent of any particular machine's idiosyncracies, but have the flexibility to make use of special features that a particular machine may have. With such a language, the programmer worries about the operations on the part, and the compiler worries about the details of getting the machine to perform them. Other benefits include the ability to define locations and machining sequences referred to in subsequent operations; automatic geometric (eg, laying out bolt circles), speed, and feed calculations; simplified program modification; and reduced errors.

In order to generate, update, and keep track of programs comfortably, the part programmer wants powerful program development utilities for editing and file management. Since part families have similar operation sequences, it should be easy to take an existing part program and, with a few changes, create a new program for

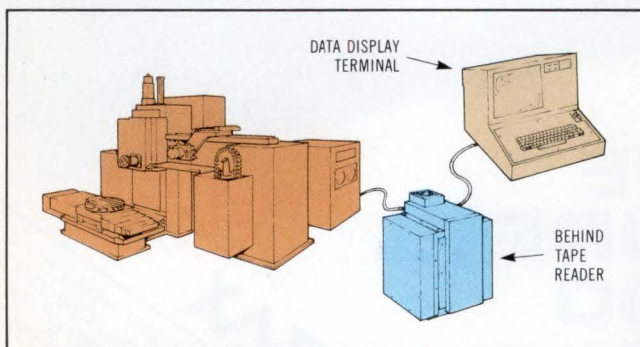

**Including a behind tape reader (BTR) and a data display terminal converts the NC workstation to a computer numerically controlled (CNC) system. The BTR retains part programs from several tapes; the operator chooses one of those programs through the terminal for instruction to the controller.**

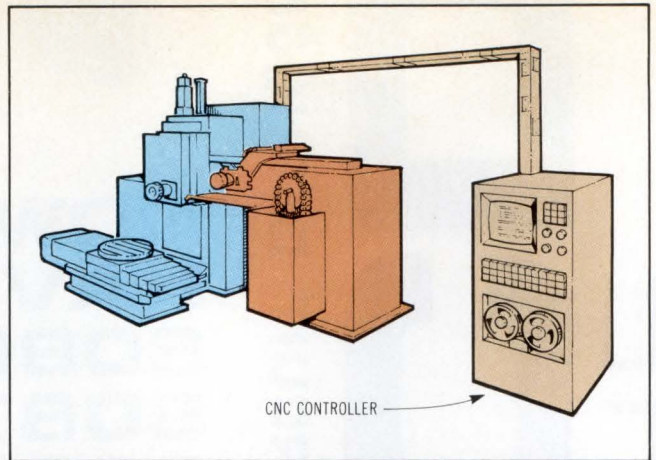

**Functions of the NC controller and BTR are combined in more recent CNC systems. Either a minicomputer or, now, a microcomputer provides the control.**

a similar part. Software for editing and postprocessing should be very interactive, and downloading of the compiled machine language program should be fast, since much of the debugging and testing of part programs is done from the shop floor in a DNC configuration.

Farther upstream from all of this, the programmer is faced with a part design and must create a part program from scratch. Today, this process is supported by interactive graphic CAM facilities. The programmer sits at a graphic display terminal and calls forth the part design from the data base (it was presumably developed on a CAD system by the designer). Examining the part on the screen, the programmer inputs size and shape parameters and queries the system for similar parts that have been made in the past. Often, this family grouping approach locates a part whose program needs only minor modifications to produce the new part.

If this is not the case, the programmer selects a class of CNC machines and decides on a sequence of operations to make the part. This includes a list of tools needed (checking to see that they are all available) and a description of fixturing, eg, clamps, locating pins, and manufacturing aids (holes, flanges, or "ears" added to a part to facilitate machining). As operations are input to the CAM system, it prompts the user for the desired tools, speeds, and feeds. All of this information is resolved by the system into a high level language part program.

Now, the programmer can simulate the machining operations on the screen; watch the cutter path to be sure that there is no interference among part, tool, and fixtures; and ensure that the correct shape is produced. This simulation is normally done in real time. For some operations, this can be painfully time consuming for the programmer and can tie up expensive CAM system resources. A precise milling operation on a very large part, for example, may take a long time but yield no useful information in the simulation, since the programmer cannot check the surface finish until an actual part has been made. To avoid this, some programmers change the part program to work at ridiculously high feed rates and restore the correct parameters after simulation. A highly desirable innovation would be a software capability of speeding up simulation (when

# THE DAWN OF A NEW HORIZON

## A State-of-the-Art Breakthrough Magnetic Amplifier Switcher Series

Rugged magnetic amplifier regulated switch-mode power supplies provide state-of-the-art efficiency plus power fail circuitry.

Elpac's 23 years of proven experience provides the **MASS-300** (300 Watts) - the first in a new family of multiple output, switch-mode power supplies.

### Check these features:

- Typically 80% efficiency.
- State-of-the-art design employing high frequency, magnetic amplifier regulators for auxiliary outputs.
- High efficiency regulated auxiliary outputs result in saving storage energy in the input filter capacitors, therefore providing longer hold-up time.
- Power fail circuit monitors stored energy in the input filter.
- Power limited and thermally pro-

tected against excessive power conditions.

### Now, check these specifications:

- **MASS-300** - The "Ultimate" of switching regulators at an affordable price of under \$1.00 per watt in OEM quantities.
- Packaged in a convenient 1.6 watts per cubic inch (15.00" x 4.95" x 2.50") open or enclosed chassis.
- AC Input of 90-132/180-264 VAC at 47-440 Hz.
- DC Outputs: 5v, 25A (30A Peak); 12v, 4A (6A Peak); 12v, 4A (6A Peak); 24v, 4A (6A Peak).
- All outputs regulated.
- Full rated to 55°C with air flow.

### Complies with Safety Specifications:

UL 478/1012\*  
CSA 22.2-154\*

VDE804/5.72 (Class I)  
\*Recognition pending.

Elpac has a reputation where reliability comes first. We've done it again with **MASS-300**. Plus, a worldwide network of over 200 distributors providing fast, responsive delivery at an affordable price.

For detailed specifications on our new **MASS-300** or for a free catalog or applications assistance on our full line of power supplies and low power DC-DC converters, call or write today!



### Elpac Power Systems

3131 S. Standard Ave.,  
Santa Ana, CA 92705  
(714) 979-4440 • TWX 910-595-1513

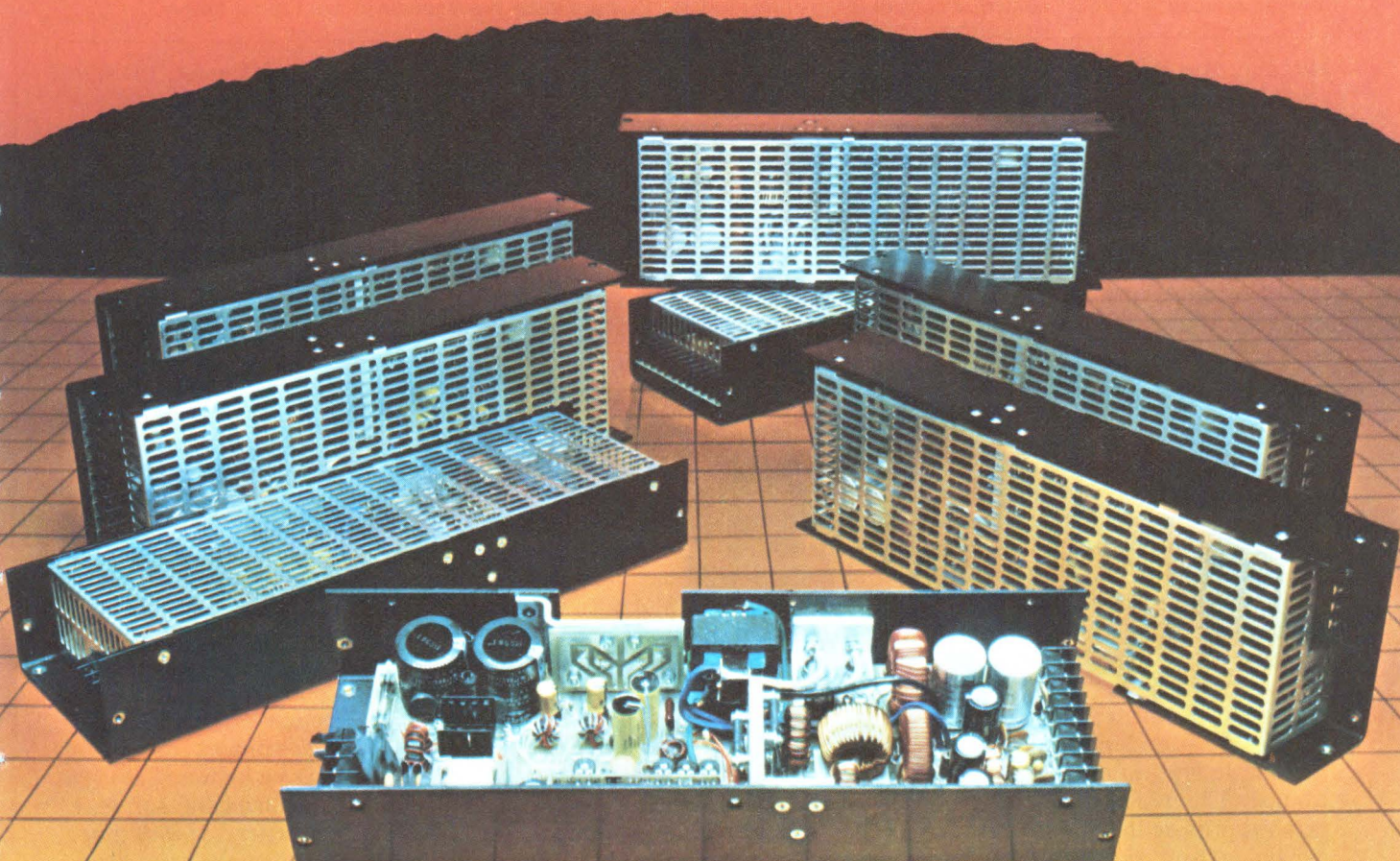

## MASS-300 SERIES

ANOTHER UGLY® Where Beauty is in the Performance

CIRCLE 57

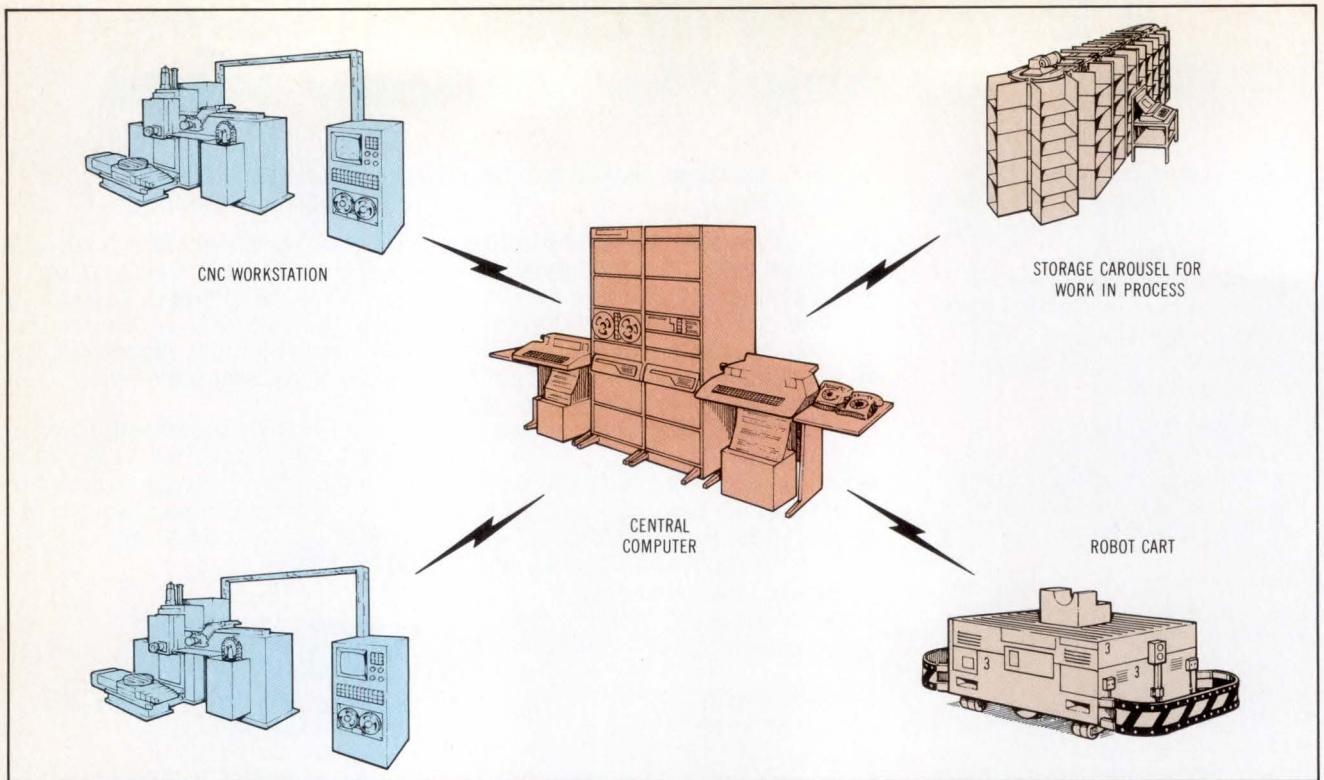

**A central computer can manage several CNC workstations as well as other components such as a robot cart or storage carousel in a direct numerical control (DNC) configuration. Part programs are maintained in a central library.**

checking for interference) and slowing it down again (eg, for careful inspection of an interpolated cutter path) at will, without changing the actual part program.

For certain part classes, part program generators can automatically produce the operation sequence from the design geometry. However, at the current state of the art, the programmer can usually do as well or better, because for such part classes there probably will exist programs on file that need very little editing to make the new part. Once the part program has been simulated, further testing and editing are done at the workstation.

#### **The CNC controller software designer's view**

Many of the features that make life easier for the NC part programmer are the responsibility of the CNC controller software, which interprets part programs, drives the machine, and communicates with the central computer. State of the art optimal or adaptive control features can compensate for tool wear, tool deflection, backlash, fixture positioning errors, temperature changes, variations in materials, slide calibrations, irregular ways, and a host of other gremlins that plague machine tools.

Controller functions are not necessarily implemented in software—the Japanese have even developed a single large scale integration chip for interpolation and servo control. The designer must evaluate such features and perhaps provide the option (to the part programmer) of bypassing them. For example, the user may wish to program a special interpolation scheme rather than use those available.

In a DNC environment, communication is not limited to downloading programs from the central computer to the CNC station. The controller must provide the

necessary links so that the part programmer, through the data display terminal, can operate the CNC station, edit sources on the main computer, and request transfers of machine language programs between the two. During normal production, the workstation operator will need to pass other information to the central computer such as requests for material, tools, or maintenance; the operational status of the workstation; the status of work in process; and requests to move completed work elsewhere.

#### **The DNC system designer's view**

To achieve the highest overall productivity, the system designer defines the architecture of the total computerized manufacturing system. This means high utilization of all this expensive machinery; low in-process inventory; accountability for parts, tools, and data; reliability and responsive maintenance; product quality assurance; and timely and accurate information for management. Within the scope of control software, some issues stand out.

First of all, in the DNC factory there obviously is going to be a great deal of data communication between the workstations, the central computer, the material movement system, and the various support systems in the network. Loads on all links must be known. Capacity of the hardware and the network managing software must be ample since such loads always grow with time.

Consideration must be given to software task distribution. Since the CAD and CAM systems would clearly place too great a burden on the general purpose central computer, they have separate processors and share a data base of part designs. There are also enormous files of part programs, robot programs, tool tracking



# The new boss of the control room just came on board.

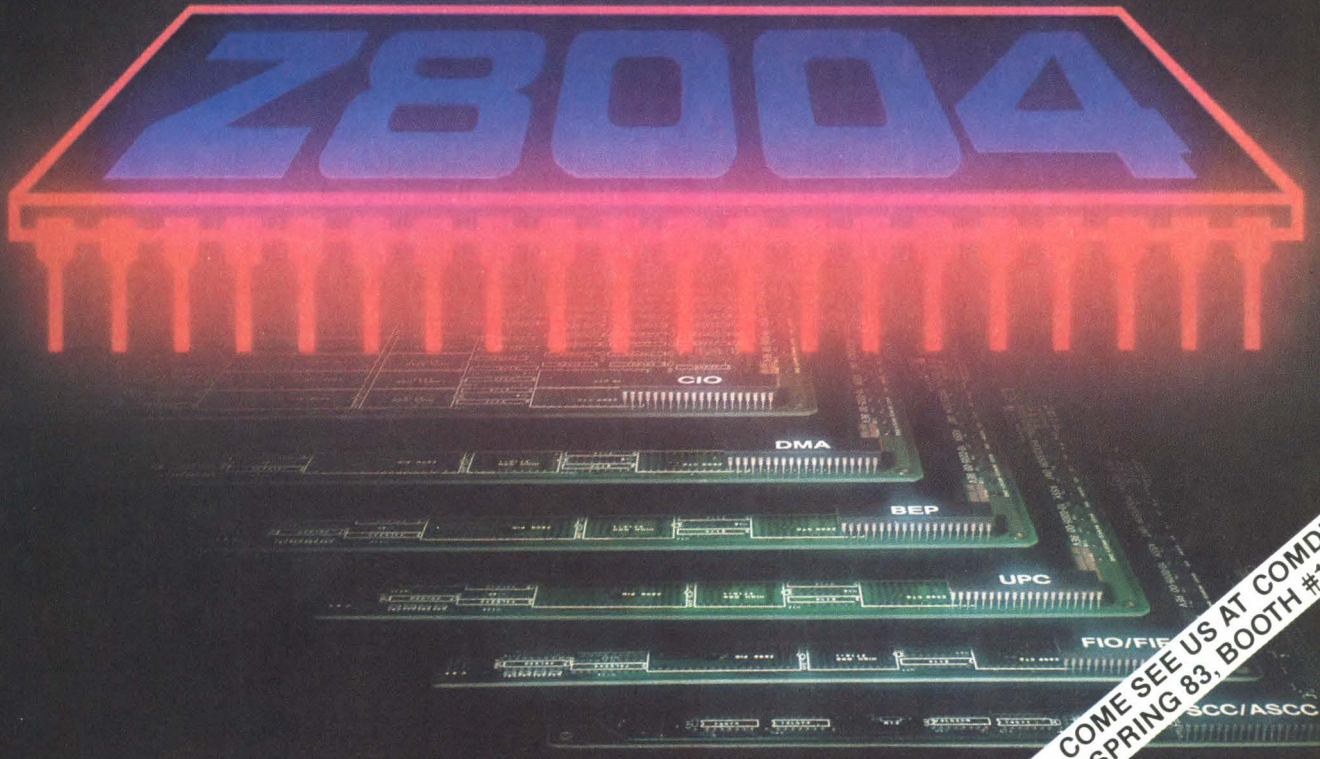

COME SEE US AT COMDEX/  
SPRING 83, BOOTH #1356.

Zilog's new Z8004 is the fast working 16-bit CPU built to perform in tough controller environments where timing is of the essence. With or without a DMA, the chip gives you fast 16-bit throughput. Its bit manipulation capabilities, 16 general-purpose registers and 32-bit arithmetic (including multiply and divide) further its controller performance. But that's not all.

The Z8004 features Zilog's atomic Test and Set instruction for multiprocessor applications. Its tightly encoded instruction set permits smaller programs, faster controller response time and helps cut systems cost. The chip now runs up to at least 10 MHz with even higher speeds just around the corner. And it makes block moves faster than any other 16-bit

microprocessor on the market.

The Z8004 is tough enough to handle the controller job single-handedly. But you can always enhance its performance by giving it the right crew. Here's how.

Take the powerful Z8004 CPU, add Zilog second generation peripherals, and you've got an unbeatable team for a total controller package.

So, for your controller designs, bring the boss on board. The Z8004 is the new microprocessor that really takes charge!

Find out what the boss can do for you. Mail the coupon to: Zilog, Inc., Components Tech. Publishing, 1315 Dell Avenue, Campbell, CA 95008. Or call TOLL-FREE (800) 272-6560.

- I'd like more information at this time.  
 Please have a salesman contact me.

Name \_\_\_\_\_

Title \_\_\_\_\_

Company \_\_\_\_\_

Address \_\_\_\_\_

City \_\_\_\_\_

State \_\_\_\_\_ Zip \_\_\_\_\_

Phone \_\_\_\_\_ / \_\_\_\_\_

Z8004

CD 4/21/83

## Zilog

*Pioneering the Microworld.*

An affiliate of EXON Corporation

information, material movement status, and all other data to support a now very complex system.

It may well be more efficient to maintain a central data base. This would involve high capacity mass storage ideally managed by dedicated database management software on a separate processor. Perhaps it is extreme to have all data on the central system, but it seems reasonable for anything used by more than one processor. A central data base not only conserves storage resources; it also tends to increase data integrity by discouraging duplication of data.

Current practice is to perform postprocessing of part programs on the central computer, then download the machine language programs to the CNC workstation. There is normally a separate postprocessor for each CNC machine, so the "post" is not a shared resource. Should the postprocessor be part of the CNC station's software? While it would hardly be cost effective to retrofit present systems, costs of memory and processor power continue to decline.

It seems reasonable that, in the future, new CNC systems will "speak APT" or some other high level language, just as every home computer "speaks BASIC." This would be more or less transparent to the part programmer, who, for the sake of data integrity, would continue to edit and maintain source files on the central computer. Postprocessing would not be a separate stage that the programmer need be concerned about or even notice, especially if the postprocessor were implemented as an interpreter. There would be no need to keep track of a separate machine language program. For the DNC

system designer, this would represent a significantly reduced load on the central computer and the communications network. Another benefit of such an innovation would be increased industry-wide demand for standardization of high level languages.

#### In conclusion

Software requirements of the integrated factory are those that have come to be recognized as common to all computerized systems, as well as those springing from the historical development of manufacturing. Because of the capital outlays involved, the process of evolution is somewhat slow and guarded. CNC systems are generally added to existing facilities, or installed for new production operations, on a piecemeal basis.

Thus, when the factory eventually evolves to a DNC configuration, it includes many dissimilar elements at various levels of technology. Even so, experience has shown that although the risks are high, they are amply justified by reduced costs, greater throughput, and higher quality.

Please rate the value of this article to you by circling the appropriate number in the "Editorial Score Box" on the Inquiry Card.

High 725

Average 726

Low 727

Photo on p 131 is of a sophisticated NC operation at the General Dynamics Convair Plant. Courtesy of White Sundstrand Machine Tool Co.

## For all your perforating needs...

# DIAMOND TALKS ELECTRONICS

When designing for the electronics industry, *think perforated materials*. They can be engineered to the exact open area to fulfill your airflow and cooling requirements - in **computers, input terminals, copiers, electronic enclosures, circuit board housings** and many more custom applications. Perforated metals also provide inherent structural strength, plus full forming capabilities to meet your specific design needs.

And when you think perforated, *think Diamond*.

Our efficient computerized presses perforate ferrous and non-ferrous metals and a variety of other materials. Special services include:

- Shearing • Notching • Blanking • Degreasing
- Custom fabricating • Custom finishing

Diamond offers trained technicians to serve you through our two production facilities and national sales office network.

**For 24-hour quotations, call toll-free 1-800-233-9601. In PA call collect 717-693-0300.**



**DIAMOND MANUFACTURING COMPANY**

and **LONE STAR PERFORATING COMPANY**

subsidiaries of DIAMOND CONSOLIDATED INDUSTRIES, INC.

P.O. Box 174, Wyoming, Pennsylvania 18644

# Put a little tape backup in your DEC microcomputer.

SMS' DSX-11 is a complete DEC microcomputer with 80Mb Winchester and 1/4" cartridge tape backup. With over 20Mb per tape cartridge, Winchester backup has never been so easy. Emulating DEC's latest TS11 tape device, standard RT-11 and RSX-11M software makes disk backup, system boot, media interchange, archiving and software distribution a snap!



256Kb main memory (expandable 4Mb)

Expansion space for 15 dual height modules.

LSI-11/23 16 bit CPU with memory management.

4 Serial ports.

Advanced disk controller with ECC, flaw management, bootstrap, error retry and non-interleaved data transfer.

PDP-11\* architecture compatible with RT-11, RSX-11M and UNIX\*\* software.

17.8Mb, 35.6Mb or 71.2Mb Winchester disk.

Self test with LED display of system faults.

Start/stop tape supports file operations.

Compact 3M Cartridge.



**Scientific Micro  
Systems, Inc.**

777 E. Middlefield Road  
Mountain View, California 94043  
(415) 964-5700

AUTHORIZED SMS DISTRIBUTOR FOR DEC  
Q-BUS PRODUCTS: FIRST COMPUTER  
CORPORATION (312) 920-1050

SMS SALES OFFICES:

**Phoenix, Arizona** (602) 978-6621;

**Boston, MA** (617) 246-2540; **Atlanta, Georgia**

(404) 296-2029; **Morton Grove, Illinois** (312)

966-2711; **Yorba Linda, California** (714) 993-3768.

TAPE CONTROLLER ONLY AVAILABLE FOR VOLUME REQUIREMENTS.

\* Trademark of Digital Equipment Corporation. \*\* Trademark of Western Electric.

# SPRING

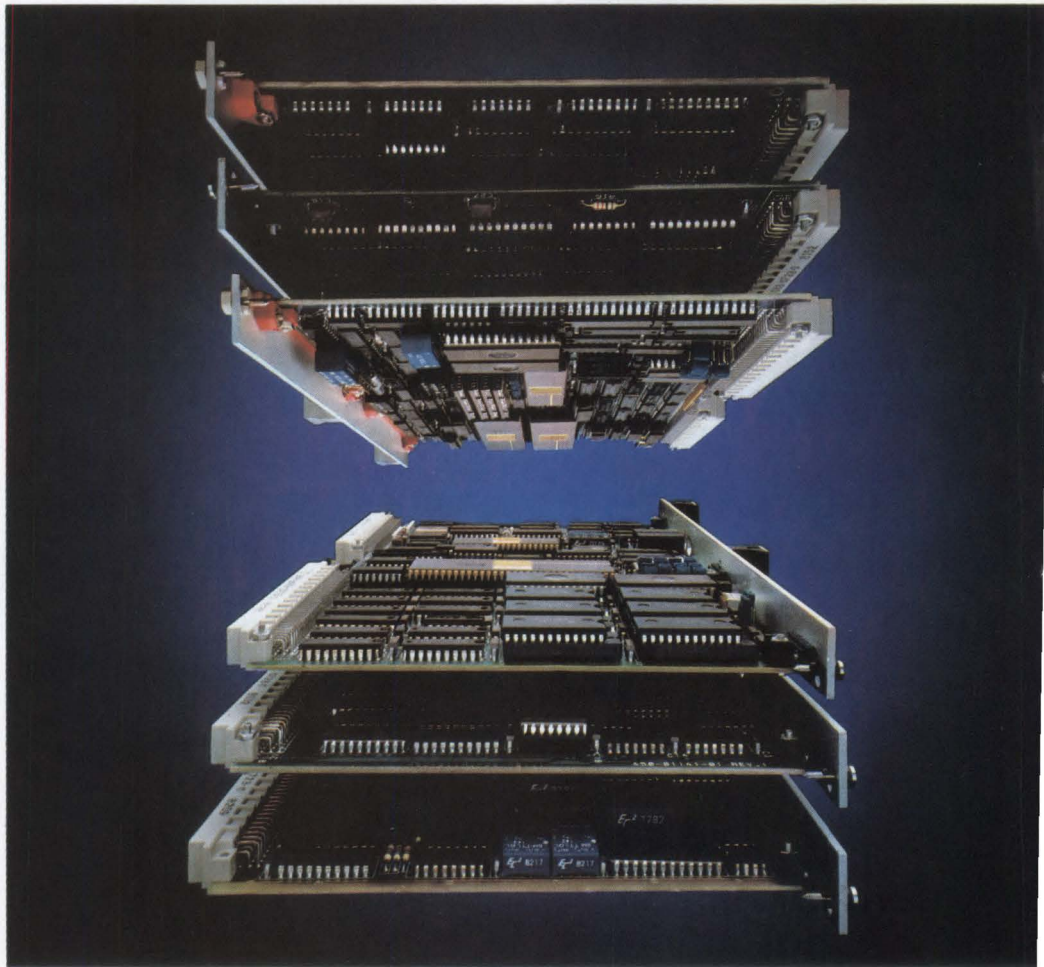

# BOARDS

Get ready to make a quantum leap past your competition. Because with our six new 68000 VMEbus boards and UNIX™ operating system, that's exactly what you'll be able to do. What's more, our new board-level solutions are just the first wave of the multi-user system solutions you'll be able to get from Mostek. So now, there's no reason not to be launching into the future with the Mostek MK68000.

What makes us so confident? First of all, consider the VMEbus, a very compact board structure with truly high-performance timing parameters. And inherent expansion to 32-bit address and data.

Second, look at the boards: VME-SBC: At the heart of it, an 8 MHz MK68000 with upgradeability to 10 or 12 MHz, SIO, BYTEWYDE™ memory and a firmware monitor. VME-SASI: A SASI™ controller with DMA. VME-FLOPPY: A double-sided, double-density floppy disk controller with DMA and sector buffer. VME-SIO: Four-channel (RS-422/RS-232). VME-DRAM: ¼ MB DRAM with byte parity, plus full 32-bit VME interface. VME-MMCPU: Memory-managed CPU with on-board 128K bytes DRAM and full multiprocessor capability.

Third, there's our VME BASELINE System to get you started. It includes three boards (SBC, DRAM, SIO) and a power supply in a 10-slot card cage.

Finally, coming later this year will be UNIX, the high-performance, program-development operating system that opens the door to Pascal and C, as well as our Assembler/Linker software and RADIUS™ development station.

Together, it all adds up to the most powerful and versatile way yet to hit the ground running with a 68000 system solution. To find out more, contact Mostek Corp., 1215 W. Crosby Rd., MS2205, Carrollton, Texas 75006. (214) 466-6000. In Europe, Mostek International (32) 2.762.18.80. In Japan, Mostek Japan KK (81) 3.404.7261. In the Far East, Mostek Asia Ltd. (852) 5.296.866.

UNIX is a trademark of Bell Laboratories.  
SASI is a trademark of Shugart Associates, Inc.

\*BYTEWYDE is a trademark of United Technologies' Mostek Corp.  
\*RADIUS is a trademark of United Technologies' Mostek Corp.



```

      XXXX Stopped @ breakpoint @ XXXX
D0 32FFFFFF  D4 FFFF7FFF  A0 FFFFFFFF  A4 FFFFFFFF  PC 00000000
D1 00000000  D5 FE7B0E7C  A1 FFFFFFFF  A5 FFFFFFFF  USP 00000510
D2 FFFF7FFF  D6 FFFF7FFF  A2 FFFFFFFF  A6 FFFF7FFF  SR 00000430
D3 FFFF7FFF  D7 FFFFFFFF  A3 FFFFFFFF  XMS
User stack +0 2700      +2 3057      +4 0009      +6 0040      +8 0209
System stack +0 2935      +2 FFFF      +4 2922      +6 10C0      +8 0202
Supervisor Program
040501050104  SUBI.L #01050104,05
00200C 0004010500C4  ORI.L #010500C4,04
002012 000500050105  ORI.L #00050105,(A5)
002018 0104  BCLR D0,04
00201A 040501010005  SUBI.L #01010005,05
002020 020004000004  ANDI.L #04000004,D0
002026 0104  BCLR D0,04
      -42 -38 -32 -28 -24 -18 -12 -04 -02
A1 _____|_____
A2 _____|_____
A3 _____|_____
A4 _____|_____
A5 _____|_____

```

KRONTRON ELECTRONICS

KRONTRON

F1 F2  
F3 F4  
F5 F6

# Kontron KDS

## The Ultra-productive Multifunction Development System

Producing the next wave of smart products isn't enough. You've got to be first! To be first and stay there you need a development system that makes your designers more efficient, a system that speeds up the time-consuming task of developing and integrating hardware and software.

The ultra-productive environment you need is available now in the KDS. Kontron's field-proven CPU, mass storage, slave in-circuit emulation and logic analysis capabilities are perfectly blended in this user-configurable, ergonomically designed workstation. The KDS solution starts with stackable, card-configurable modules that may be located wherever convenient. Add the detached keyboard and adjustable CRT, and a truly productive working environment emerges. You can tilt, swivel, raise or lower the CRT to suit your viewing angle. The detached keyboard gives you control over all systems and the ability to display all functions on the extra-large (15-inch), easy-to-read screen. Two 5 $\frac{1}{4}$ " floppy disk drives are incorporated in the CPU; an optional 10 Mbyte hard disk plugs in if you need it. Software, emulation and logic analysis are fully integrated.

You have complete control over up to four KSE slave emulators and one KSA logic analyzer. Emulation support is available for most popular 8- and 16-bit chips. You can select the 32-, 48- and 64-channel logic analyzer (to 100 MHz) that suits your needs for timing and state analysis.

KDS comes complete with all the applications software you need. Editors, linkers and assemblers are provided for assembly language programming and for use with Pascal compilers. Software developed on other Kontron systems can be ported to the KDS via an RS-232 link. Industry-standard operating systems\* make KDS even more versatile, opening the door to third party software and many new applications. Find out how much more the KDS Multifunction Development System can do for you. Write for a demonstration, or call 1-800-EMULATE.

ADVANCED  
ELECTRONIC  
INSTRUMENTATION



**KONTRON  
ELECTRONICS**

**In the United States:**  
KONTRON ELECTRONICS  
630 Price Avenue  
Redwood City, CA 94063  
TWX: (910) 328-7202; (910) 378-5207  
(800) EMULATE; (800) 227-8834

**In California:**  
(213) 641-7200; (415) 361-1012

**In Europe:**  
Kontron Messtechnik GmbH  
Breslauer Straue 2  
8057 Eching West Germany  
(0 89) 31901-1  
Telex: 05 22 122

\*CP/M® available now; 68000/UNIX™ available in June 1983.

\*CP/M is a registered trademark of Digital Research, Inc.

\*UNIX is a trademarked product of Bell Laboratories.

Circle 62 for Literature  
Circle 92 for Demonstration



# Our Gate Arrays Will Save You Money

**#3**  
IN A SERIES

## **GATE ARRAYS FROM INTERNATIONAL MICROCIRCUITS USE LESS SILICON.**

1. Integrated circuit production costs depend on chip size. Small chips are necessary for credible low prices.
  2. It is easy to design large, inefficient chips. The challenge is to design tight gate arrays that use very little area and are developed very quickly. It is not true that gate arrays are inherently inefficient.
  3. At International Microcircuits we have been making efficient gate arrays since 1974. Our corporate commitment is to provide small, efficient chips for your logic, smaller than with other approaches. This means that we focus our development resources in four critical areas:
    - We develop our own processing and interconnect technologies, optimized for our gate arrays;
    - We design our base arrays with small areas per gate and small numbers of wiring channels;
    - We provide a large and growing number of base arrays (currently 38) with a fine resolution of gates-per-chip so that one will be just right for your logic problem;
    - Our wiring techniques provide at least 95% utilization of the gates on each array, using computer-verified interactive design techniques rather than fully automatic layout.
  4. The results: small, competitive chip sizes and viable low production prices. Even if many millions of your circuit will be produced, efficiently-sized gate arrays compete easily with standard cell approaches and with full custom.
- Interested? Send us your logic for a quick, confidential quote. Or ask for more information about our products. Our gate arrays will save you money!

---

**INTERNATIONAL  
MICROCIRCUITS  
INCORPORATED**

---

The Logical Choice for Gate Arrays

TELEPHONE: 408 727 2280 • TWX: 910 338 2032  
3350 SCOTT BLVD • BUILDING 37 • SANTA CLARA • CA 95051

CIRCLE 63



# MICROCONTROLLERS MAINTAIN THE LOOP FOR DC DRIVES

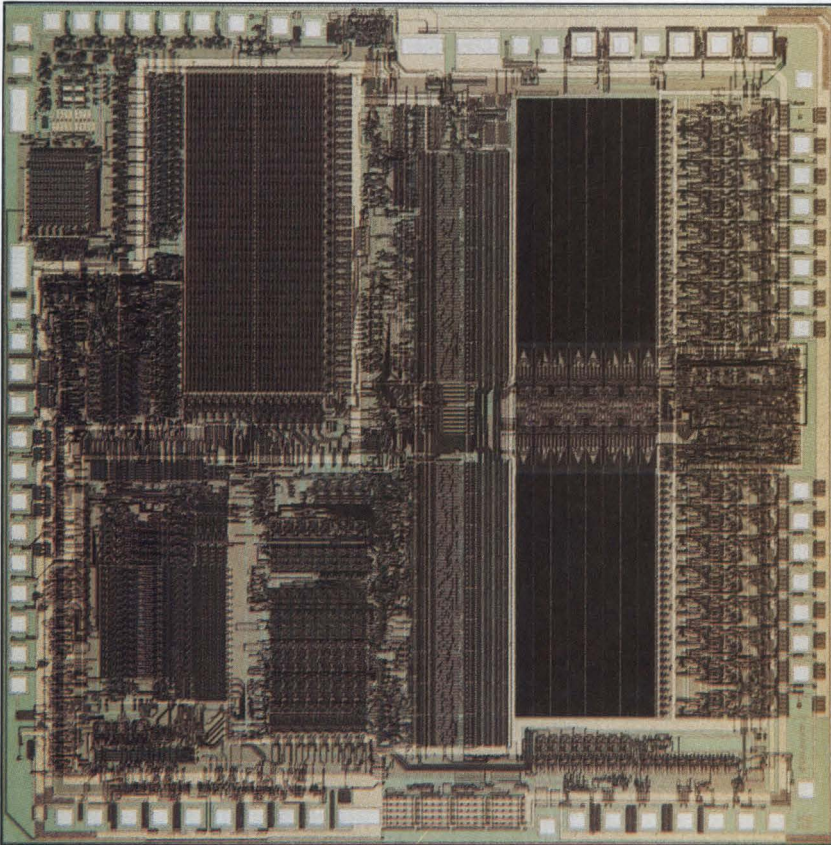

**Variable speed motors, whether used in the smallest tape recorder or the largest steel mill, require controllers.**

**A single-chip microcontroller now replaces older multiple-chip versions.**

by **A. Ira Horden**

**V**ariable speed dc motors serve many purposes. Most common, however, are speed control applications such as conveyor belt systems, chemical measurement pumps, and robot arms. Applications also exist for constant torque control, ranging from steel rolling mills to a robot's fingers. Even motors that do not need to run at controlled speeds may require variable voltage inputs during startup to avoid burning out.

These applications have one thing in common: a variable voltage is applied to a motor, based on that motor's condition (ie, speed, torque, current) and an external control setting. The circuit that provides this voltage is referred to as the driver, of which there are many types.

*A. Ira Horden is an applications engineer for Intel Corp, 5000 W Williams Field Rd, Chandler, AZ 85224, where he is responsible for the iACX-96 product family. Mr Horden holds a BEE from the University of Delaware and a Masters of engineering and an MBA from Widener University in Chester, Pennsylvania.*

Although there are also several types of dc motors, only the most common—those requiring a single power supply—are considered here.

In any case, a controller is necessary to maintain speed required for process variations. Routinely, such controllers have consisted of several integrated circuits (ICs), but now single-chip controllers can do the job. These microcontrollers combine a central processing unit (CPU) with random access memory (RAM), read only memory (ROM), counters, timers, and input/output (I/O). Instruction sets are usually designed for control applications rather than for general data processing.

Information is supplied to the controller by several methods. Temperatures, currents, and voltages can be measured; shaft rotations can be counted; external settings can be read; or master computers can send information to the controller. Some of these signals would need hardware external to a microprocessor to convert them to digital form.

Either a power amplifier or a switching power supply usually provides the variable dc voltage required for running the motors. In the case of the power amplifier, linear devices amplify the control signal to the levels

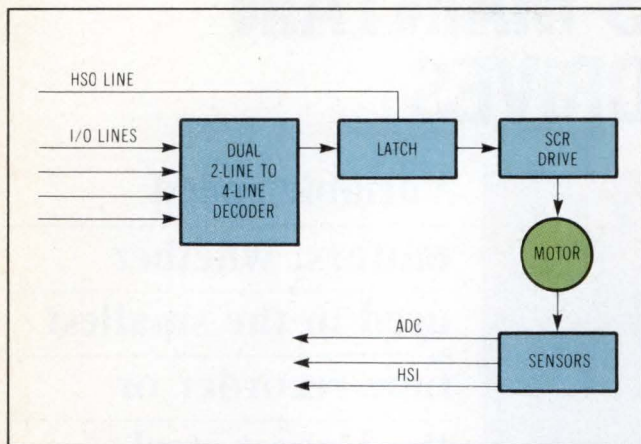

**Typical design for a motor control system.** Four of these systems can be connected to the same microcontroller. Each system can trigger up to eight silicon controlled rectifiers (SCRs), sense two analog signals, and decode one pulse tachometer, using a total of only eight I/O lines.

required to operate the motor. Unfortunately, the power lost in the amplification device can be as much power as the motor uses itself. For this reason, switching-type supplies are used for all but the smallest of motors.

Switching-type supplies operate by rapidly turning on and off the motor's power. The advantage of this method is that the switching devices are either on or off. Most power losses in the devices occur during the period of time a device switches from completely on to completely off. Some power loss does occur while the devices are on because of the internal resistance of a device, but that loss is very small.

Providing a constant dc level to a motor is, in theory, quite simple. It becomes less simple when the motor speed must remain constant or change at a set rate, or when current and voltage to the motor must remain within desired limits. To provide these functions, the controller must be able to sense what is happening in the real world.

There are two sources of information for a motor controller. The first is either a control panel or a master computer. Information from these sources is most easily transmitted over a serial link. The second source of information is the motor itself. Information from the motor can be in either analog or digital form. If in analog form, the information can be input directly to an analog to digital converter (ADC). Typical information includes the voltage across or current through any of the incoming phases or motor windings, and torque or speed measurements. If it is necessary to take a measurement at a specific time, a high speed output (HSO) can be programmed to start an A-D conversion at that time. Because the HSO can be used to trigger the ADC, the CPU is less likely to become bogged down.

Digital information from the motor would probably be from a pulse tachometer. This device outputs a pulse train with a frequency proportional to the motor speed. By using a high speed input (HSI) to record the transition

times, the pulse train frequency can be determined. Like the HSO, the HSI functions almost independent of the CPU. HSO and HSI relate to the 8096 CPU, discussed later in this article.

### Control algorithms

Most controllers use the same types of hardware to interface to the real world. The distinction between controllers is in the hardware's accuracy and the algorithm's complexity. Even the best hardware performs poorly if the algorithm is not well designed.

There are three major categories of control algorithms: proportional, integral, and differential. Most control algorithms are a combination of these types. Proportional control is the simplest type of algorithm. The output is simply the error signal multiplied by a constant, as shown in the following equation. Since a motor does not react immediately to the voltage applied to it, the motor's acceleration may not be approaching zero when the error signal is zero. The result is that the actual speed overshoots the desired speed

$$\text{OUT} = K_p * \text{ERR}$$

where

OUT is the output signal  
 $K_p$  is the proportional constant  
 ERR is the error signal

If the constant is made large, the motor will accelerate quickly to speed, but its high acceleration will cause it to continue accelerating beyond the desired velocity. If the constant is made small, the motor will take a long time to reach the desired velocity, but it will not have much overshoot. To overcome these problems, some differential control is usually added to the proportional control.

Differential control involves using the rate of change (the time derivative) of the error signal to generate the output signal. A control system's response can be sped up by using differential control, since the output will change quickly if the error changes quickly. The difficulty is that slowly changing error signals, such as those that occur when the error is near zero, produce slowly changing outputs. In some cases the output could change so slowly that the error would never be reduced to zero. For this reason, differential control is usually used with proportional control

$$\text{OUT} = K_p * \text{ERR} + K_d * d(\text{ERR})/dt$$

where

$K_d$  is the derivative constant  
 $d(\text{ERR})/dt$  is the derivative of the error signal with respect to time

If high accuracy is desired, an integral control term can be added to the equation. This term compensates for any offset in the system and helps the actual speed to be closer to the desired speed in the steady state condition.

# EMULATION PLUS FROM AMPEX



## New editing terminals that do more and cost less.

They're packed with the features you need: Over a dozen resident emulations of major makes. Detached standard and Selectric-type keyboards.

Seven resident national character sets. Ergonomic design.

Three phosphor choices, including **Amber**. Non-volatile memory. Smooth scrolling. Keyboard setup mode. Also x-on/x-off. FCC compliance.

Nationwide TRW service. And much more. At prices so competitive they'll surprise you.

## AMPEX

Ampex Corporation • One of The Signal Companies



For more information on the D150 and D175 models or our distributor near you:  
CALL TOLL-FREE **800-421-6863** IN CALIFORNIA **213-416-1422**  
Ampex Corporation, Memory Products Division, 200 North Nash Street  
El Segundo, CA 90245 • Dealer and distributor inquiries welcome.

By using this term, the speed fluctuation can be reduced to near zero, once the desired speed is reached. With the integral term added, the previous equation becomes

$$\text{OUT} = K_p * \text{ERR} + K_d * d(\text{ERR})/dt + K_i \int \{ \text{ERR} \}$$

where

$K_i$  is the integral constant

An algorithm using this equation, or a variation of it, is referred to as a proportional, integral, and differential (PID) control algorithm. Through the use of mathematical modeling and empirical testing, the constants  $K_p$ ,  $K_d$ , and  $K_i$  can be selected to provide a system with fast response and little overshoot.

Although the last equation is simple and does not require fast computational power, many control systems use several variables to determine the output value. Frequently, the integrals and differentials of the variables are also used. As the algorithm becomes more complex, the processor must become faster.

State of the art microprocessors and microcontrollers have become so fast that they are usually not the limiting factor. Many processors are capable of controlling more than one motor at a time—making them ideal for use in robot and conveyor belt systems, where several motors must run synchronously.

### The microcontroller

One example of a single-chip microcontroller designed specifically for control applications is Intel's 8096, a 16-bit CPU. Its onchip features include 232 bytes of RAM, 8K bytes of ROM, two hardware and four software timer/counters, programmable timer controlled outputs, ADCs, pulse width modulation (PWM) output, and a full-duplex serial port. Its instruction set is geared toward high speed calculations, I/O manipulations, and interrupt processing.

Onchip RAM serves as sources and destinations for the instruction set. Most instructions use one operand from anywhere in memory and a second operand from the internal RAM. The destination is always in internal RAM. Some instructions allow the destination to be a different location than that of either operand.

The first operand can be accessed by one of five addressing modes, while the second operand and the destination are always directly addressed. There are direct, indirect, and immediate 8-bit modes, in addition to a 16-bit immediate mode. To make table usage easier, an auto-incrementing indirect mode is included. In this mode, the specified register is incremented after every indirect access. Indexed addressing modes with both 8- and 16-bit offsets are supported. This mode is extremely flexible since any 16-bit word in internal RAM can be used as the index register.

Although this microcontroller is primarily a 16-bit machine, byte operations are supported to reduce memory usage when byte quantities need to be manipulated. Multiply and divide instructions provide

the high speed arithmetic capability often needed in a controller environment. The multiply instruction operates on bytes or words with a resulting word or double word, respectively. Division can be done as a double word divided by a word or as a word divided by a byte, with a resulting word or a byte, respectively.

Maximum flexibility is maintained by the configurable I/O system. Although both parts are internally identical, a 68-pin version has 26 bidirectional lines plus 12 input and 2 output lines, whereas a 48-pin version does not have some of these lines bonded out to leads. Many of the I/O lines can be used for alternate functions. All of the I/O configurations can be done in software. This allows the same part to be used in many applications and helps eliminate the need for costly custom ICs.

---

*The HSO can be programmed to switch output lines, generate interrupts, or start the A-D conversion at predetermined times.*

---

A high speed I/O unit (HSIO) controls both the input and the output. This programmable I/O subsystem is referenced to one of two 16-bit timers. The HSI records when transitions take place on any of its inputs and stores this information in an 8-level first in, first out. By using this feature, the CPU can keep track of event times, or time differences between events, without having to be interrupted just to record a time. The HSO can be programmed to switch output lines, generate interrupts, or start the A-D conversion at predetermined times. Using the HSIO allows the CPU more time for calculations since it is not constantly being interrupted for simple I/O tasks.

Analog interface is provided by the PWM output and the 8-channel ADC. The PWM output is driven by an 8-bit timer that switches the output to high when a programmed value is reached and to low when the timer overflows. This output can be integrated and amplified to provide an analog output. The ADC provides 10-bit resolution on any one of its eight channels in 42  $\mu$ s when a 12-MHz crystal is used.

*Please rate the value of this article to you by circling the appropriate number in the "Editorial Score Box" on the Inquiry Card.*

High 728

Average 729

Low 730

*Illustration on p 145 is a microphotograph of the 8086 controller chip.*

**CONCEIVED BY  
INNOVATORS  
DESIGNED  
AND BUILT  
BY EXPERTS  
USED BY  
PROFESSIONALS**

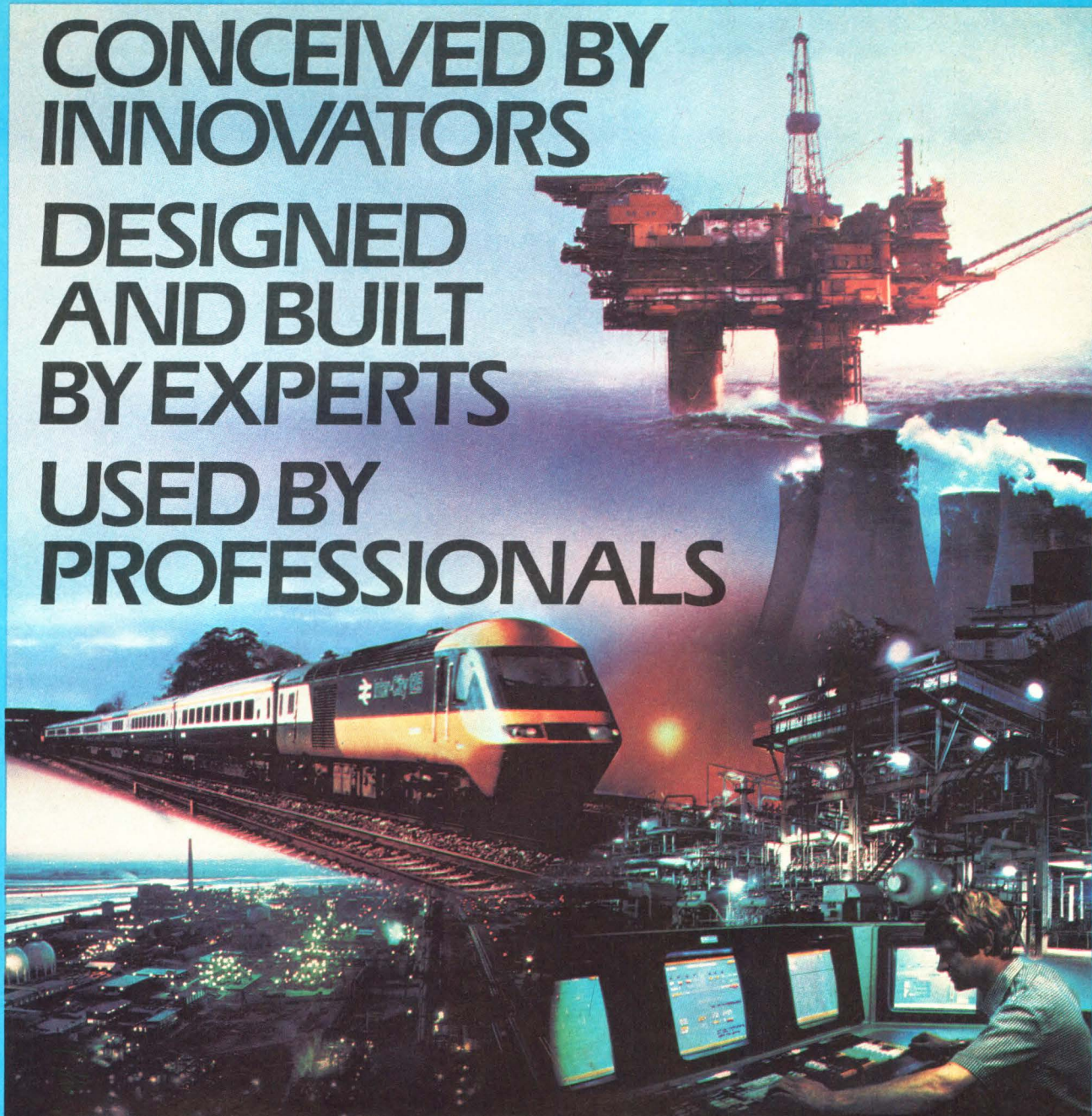

## **THE EASYCOLOUR 4000 SERIES**

In the world of computer graphics, today's impossibility is often tomorrow's reality. The TDS Easycolour 4000 series was conceived and designed to match this phenomenal growth.

The entire 4000 family evolved through extensive co-operation with customers, resulting in a colour display system offering extreme flexibility, low cost and a high level of picture quality.

To engineers, systems designers and end users alike, the TDS Easycolour 4000 series offers a unique combination of advanced technology, proved performance and complete reliability.

Full technical and descriptive literature is yours for the asking. Please write direct to TDS at the address below. Find out for yourself why life's so easy with TDS Easycolour.

**easycolour**



**Our technology... your success**

Terminal Display Systems Inc., 1901 Royal Lane, Suite 100, Dallas, Texas 75234, USA. Tel: 214 8690000.

# NOBODY DELIVERS DEC CONTROLLERS LIKE PLESSEY.



Because nobody has the range of DEC-compatible controllers and mass storage subsystems that Plessey has.

Controllers, floppies, cartridges, disc packs, Winchesters and magnetic tape, including a proven 1/4" streamer. All the storage you need for your LSI-11, PDP-11 or VAX computers. (Complete subsystems with savings of up to 50%, too).

Just check the chart, then check us out at (800) 992-8744.

We can also help your budgets and your systems with communications multiplexers. And with a huge selection of memories, typically 30% less expensive than the DEC equivalents. 32 kbytes to 1 Mbyte. ECC, parity and non-parity. MOS and non-volatile core. They're fully DEC-compatible, but run up to 30% faster, occupy less space and come with an extensive 1-year warranty.

And we'll back you up with our own worldwide network of factory-trained specialists. They can service products from a variety of vendors and answer all your questions about configuration, operation or software. You get the responsiveness of an in-house technician at a

fraction of the cost.

Nobody else even comes close.

For the rest of the story, contact: Plessey Peripheral Systems, Computer Products Division, 1674 McGaw Avenue, Irvine, CA 92714. Telephone (800) 992-8744 or (714) 540-9945.

CONTROLLER	EMULATION	COMPATIBLE DRIVES	FORMATTED CAPACITY
<b>Q-BUS</b> Floppy: PM-XCV21 PM-XCV31 Disc Cartridge/ SMD/MMD: PM-DCV06A PM-DCV02A	RX02 RX03  RK06 RM02 RM05	Shugart/NEC/Quime. Single or double-density Shugart/NEC/Quime. Double-sided/double-density  CDC Phoenix CMD Drive or Ampex DFR9xx Series (32, 64, or 96MB ea.) 80MB CDC 9762 SMD/80 CDC 9730-80 MMD/ 160MB CDC 9730-160 MMD 300MB CDC 9766 SMD/600MB CDC 9775 FMD/ (also any CDC-compatible SMD interface)	512KB per drive (x2) 1024KB per drive (x2)  Min: 28MB (2 logical RK06) Max: 8 logical RK06, up to 2 physical drives Min: 674MB (1 logical RM02) Max: 2 physical drives/4 logical RM02 (268MB total) Min: 256MB (1 logical RM05) Max: 2 physical drives/4 logical RM05 (1024MB total)
<b>Fixed (Winchester):</b> PM-FCV21	RL01/02	Industry-standard, Seagate technology interfaced 5.25" Winchester drives with buffered seek	Min: 10.4MB (1 RL02 or 2 RL01) Max: 41.6MB (4 physical drives/4 logical RL02) or any combination of RL01/02 up to 4 logical drives
<b>Tape:</b> PM-CCV11A	N/A	Cipher 'Quarterback'	20MB per 450-ft. cartridge
<b>UNIBUS</b> Floppy: PM-XC21 PM-XC31 Disc Cartridge: PM-DC06A SMD (Removable)/ MMD (Fixed): PM-DC02A	RX02 RX03  RK06 RM02 RM05	Shugart/NEC/Quime. Single or double density Shugart/NEC/Quime. Double-sided/double-density  CDC Phoenix CMD Drive or Ampex DFR932 Series (32, 64, or 96MB ea.)  80MB CDC 9762 SMD/80MB CDC 9730-80 MMD/ 160MB CDC 9730-160MMD 300MB CDC 9766 SMD/600MB CDC 9775 FMD/ (also any CDC-compatible SMD interface)	512KB per drive (x2) 1024KB per drive (x2)  Min: 28MB (2 logical RK06) Max: 8 logical RK06 with up to 4 physical drives  Min: 67MB (1 logical RM02) Max: 268MB (4 logical RM02) Min: 256MB (1 logical RM05) Max: 1024MB (4 logical RM05)
<b>Tape:</b> PM-TC11B	TM11	Kennedy or Pertec 1/2-inch, 9-track, reel-to-reel, 12.5 to 125ips, 800/1600bpi	4 Tape Transports per controller
<b>VAX</b> SMD (Removable) MMD (Fixed): PM-DCG03	RM03/ RM05/ RM80	80MB CDC 9762 SMD/160MB CDC 9730-160 MMD (2 logical RM03 or 1 logical RM80)/300MB CDC 9766 SMD (1 logical RM05)/474MB Fujitsu M2351 (3 logical RM80)/600MB CDC 9775 FMD (2 logical RM05)/(also any CDC-compatible, SMD interface)	Min: 67MB (1 logical RM03) Max: 2048MB (8 logical RM05) Supports up to 4 physical or 8 logical drives

 **PLESSEY. ASK ANYBODY.**

**Programmable controller systems**

Members of the IPC 620 family of PC systems cover simple to large capacity application ranges. The 620-10 single module device is a ladder diagram processor with capacities for up to 256 I/O and 256 16-bit data registers; the -15 combines ladder logic with data handling functions. Both have 0.5K to 2K bytes of RAM. The -20, with increased speed and power, has from 2K to 8K bytes of memory and 2048 17-bit data registers. For demanding distributed control, the -30 processor contains up to 24K bytes of memory, can support 2048 I/Os, and has 4096 data registers. Scan times for both the -20 and -30 are approximately 3 ms/k instructions. Each of the processors is housed in a 19" (48-cm) wide chassis. **Industrial Solid State Controls, Inc**, 435 W Philadelphia St, York, PA 17405. Circle 391



**Data logging and control system**



With the CR7 data logger, precision measurement and control are combined with distributed data processing in a single battery operated system. The unit is mounted in a 20" x 13" x 10" (51- x 33- x 25-cm) environmentally sealed fiberglass enclosure. Each control module contains an RCA 1802A microprocessor, 24K to 64K bytes of RAM and ROM, and an 8-digit LCD. Serial communication links accommodate up to 4 I/O modules, each of which can be expanded to include up to 448 differential or 896 single-ended input channels, 64 pulse counting channels, and up to 128 analog outputs. The operating range is -25 to 50 °C, 0% to 90% RH (or -40 to 60 °C on special

order). A-D and D-A conversions are 16-bit precision at 0.02% (10 ppm/°C) accuracy. Input resolution is 50 nV at a 20-channel/s scan rate or 350 nV at 500 channels/s. **Campbell Scientific, Inc**, PO Box 551, Logan, UT 84321. Circle 392

**FORTRAN IV programmable DAS**

The Focus 5010 and 5020 feature realtime operation with up to 100k measurements/s, accuracy to 16 bits, and over 1000 channels of field upgradable analog and digital I/O (in the expanded unit). Focus 5010 runs DEC's RT-11 operating system, optimized for single-user access, while the 5020 runs DEC's multi-user, multitasking RSX-11M. Both models provide 128K RAM and 30M bytes of mass storage using a Winchester drive. Central to the Focus measuring capability, the ANDS5400 data acquisition system provides up to 512 addressable channels in the standard unit. **Analogic Corp**, 14 Electronics Ave, Danvers, MA 01923. Circle 393

**Did you "borrow" this copy?**

*If you are reading someone else's copy of this Premier Edition, please circle 742 on the Reader Inquiry Card.*

**Color graphics terminal**

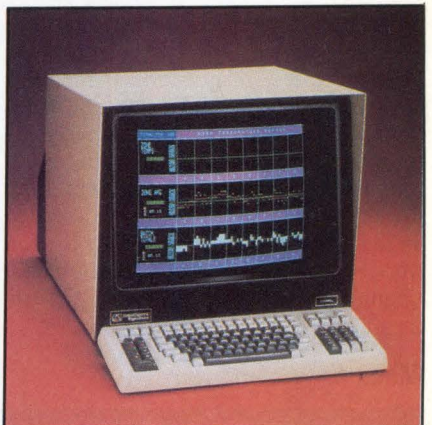

Conformance to UL 478 (electronic data processing) and FCC Class A regulations, plus completely redesigned analog circuitry, are key features of the 8001G/82 19" color terminal. (Digital circuitry is unchanged from the company's 8001G version.) Other features include ±20% line load regulated switching power supply, switch selectable 115- or 220-V input, and 8-slot card cage for configuration flexibility. According to the company, the terminal can withstand the most difficult industrial environment without posing a safety hazard, and can provide an MTBF of 8k to 10k hours. Modular design allows easy access and fast component replacement. **Intelligent Systems Corp**, 225 Technology Park, Norcross, GA 30092. Circle 394

## Small programmable controller

Logic, timing, counting, and sequencing control for small scale applications that require more capability than found in standalone, dedicated PCs can be provided by a mid-range version. The PLC-4 Microcontrol includes 20 input and 12 output points and 640 words of 16-bit EPROM or battery-backed RAM. Processor, power supply, I/O interface, and memory are in a single package. A separate, portable programmer (shown in photo) gives the operator access to control configurations down to the single-element address level. Up to 8 units at remote locations can be linked by an expansion module to provide 256 I/O points and over 4k words of memory for distributed control. A communications interface offers access to a data highway



network. 120-Vac, 24-Vdc, and 220-Vac versions are available. **Allen-Bradley Co, Systems Div, PC Business, 747 Alpha Dr, Highland Heights, OH 44143. Circle 395**

## High speed relay scanner card

A high speed relay scanner for data acquisition in manufacturing and laboratory environments, HP 69754A scans 32 single-ended channels with a 1000-channel/s scanning measurement rate. Up to 32 of these cards can be cascaded in the HP 6942A multiprogrammer to span 1024 single-ended or 512 differential channels in a scanner subsystem. One HP

69750A scan control/pacer card controls one or more scanner cards, featuring random access and sequential scanning operation. With an HP 69751A A-D converter card, bipolar readings can be taken with 12-bit resolution in the 100-mV and 1-, 10-, or 100-V ranges, achieving the 1000-channel/s scan rate. **Hewlett-Packard Co, 1820 Embarcadero Rd, Palo Alto, CA 94303. Circle 396**

## Mass flow computer

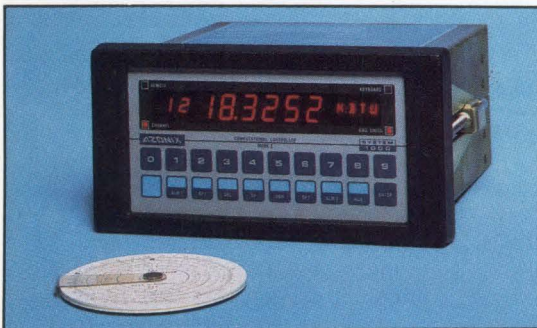

Achievement of 0.1% accuracy in the System 1000 is claimed to be a first in physical measurement for a mass flow computer. A 32-bit binary floating point arithmetic processor performs calculations with 26 decimal place accuracy (triple FORTRAN precision). The system measures flow and simultaneously corrects for temperature, pressure, and

viscosity. It is mounted in a compact case requiring a 92- x 186-mm panel cutout. Output is a 12-bit DAC and/or RS-232-C duplex serial port. Readout is in choice of engineering units. The user performs math equation programming and constant entry in English, with calculator-style entries. The system is accurate enough to be used as a calibrator for existing mass flow systems, or used as a flow computer directly with orifice plates or turbine flow meters. Any transducer can be custom linearized and retained along with all equations in a nonvolatile memory. **Azonix Corp, 25 Adams St, Burlington, MA 01803. Circle 397**

## Acquisition and control system

Packaged with its own extended BASIC software called I/OBASIC, BASYS furnishes a fully integrated data acquisition and control system for inexperienced users. The software includes long variable names as well as specification of I/O values in engineering units. I/O occurs concurrently with program execution to allow running at close to assembly language speeds. The software incorporates DEC runtime RT-11 as the OS, providing powerful utility features such as KED keyboard editor, directory, and expansion capability to other languages. Based on the standard LSI-11 bus, the system contains a choice of LSI-11/2 or /23 micro-computer. Users can select from more than 30 I/O boards and signal conditioning panels to achieve A-D conversions to memory at speeds up to 100k/s. The system supports 64 high level analog inputs, 1024 low level analog inputs, 128 analog outputs, up to 2048 discrete I/Os, a console, and 7 local serial lines. **ADAC Corp, 70 Tower Office Park, Woburn, MA 01801. Circle 398**

## Robotic vision system

Multisensor vision system "i-bot 1" interfaces with a Unimation PUMA 560 industrial assembly-type robot, allowing robots to acquire random workpieces that are jumbled in a bin. The system will be interfaced with a range of other vendors' robots during 1983. A gripper mechanism (equivalent to the robot's hand) is activated electronically rather than by hydraulic or air pressure. Computer controlled parallel jaw gripper has both vision and tactile sensors. System employs a CRT, video monitors, and a 16-bit microprocessor communicating with the PUMA controller. **Object Recognition Systems, Inc, 1101-B State Rd, Princeton, NJ 08540. Circle 399**

### We want to please

*How well did this issue relate to your work? Rate it on the Reader Inquiry Card as Very Much 734, Somewhat 735, or Not At All 736. Then tell us why in the Editorial Comments box.*



**Sealed CRT with color graphics**

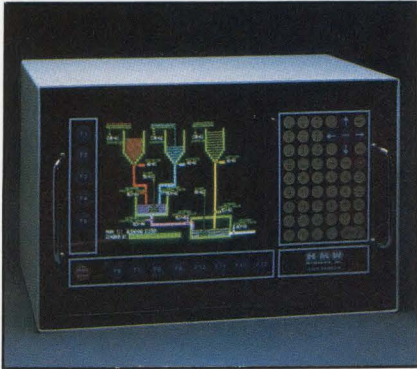

Industrial grade 9203 Rainbow terminal is impervious to high humidity, weak acids and alkalis, and most petroleum based solvents. A dust- and liquid-proof enclosure houses the graphics display; the front panel is a touch-sensitive membrane keyboard with a clear viewport for the CRT. Alphanumeric, character graphics, point, vector, and bar plot graphics can be displayed in 8 foreground and background colors. The ISC 8001G plug compatible 8085 based terminal packs up to 40K of user memory for onboard picture storage or unique data processing routines. Communication is via single RS-232-C or optional dual RS-232-C/20-mA interfaces, or internal modem. **HMW Enterprises, Inc.**, 604 Salem Rd, Eters, PA 17319.  
Circle 400

**Disk-armature dc servos**

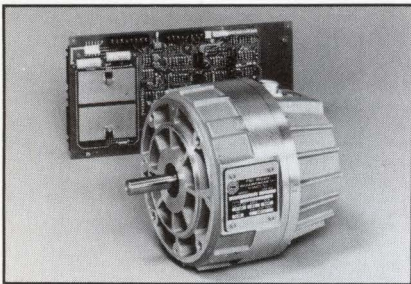

High performance disk-armature dc servomotors for industrial robot and specialty machinery, 1-hp JR16M4C and 1/4-hp JR16M4CH have peak torque ratings of 210 and 332 lb-in, respectively. Torque output is constant up to 4000 rpm. The motors have a high torque-to-weight ratio and low inertia for rapid starts, stops, and reversing. Ironless, flat disk-armature configuration eliminates commutation arcing. **PMI Motors, Inc., ServoDisc Products Group**, 5 Aerial Way, Syosset, NY 11791.

Circle 401

**Microcomputer software**

An Apple II software package for distributed industrial control and monitoring allows the microcomputer to become the master or controlling computer in a network using Wintek's 6801 micro control system (MCS). The MCS is a single-board computer incorporating both analog and power I/O on a 4.5" x 6.5" (11.4- x 16.5-cm) card. Network communications is via single or twisted pair wires. **Wintek Corp.**, 1801 South St, Lafayette, IN 47904.

Circle 402

**Supervisory DAS**

The latest addition to the Microvisory family of control and data acquisition products, MV-160 accommodates 100 to 200 points, 10 remote locations, and 10 CRT pages. Besides application programs, the entire data base can be defined online in English through the keyboard. All system functions are also accessible via the operator keyboard without special development consoles or loaders. Standard MV-160 configuration includes an 8-bit MC6809 microprocessor; 16K bits

of RAM; 36K bits of EPROM; 8K bits of EEROM (data base); monochrome CRT and keyboard; serial line interface; Bell 202 compatible modem; hardcopy system logger; and documentation. **Quantum Systems, Inc.**, 652 Papworth Ave, Metairie, LA 70005.

Circle 403

**Solid state camera**

A 16,384-pixel, 128 x 128 square format image sensing camera is designed for robotics and other factory automation applications. Model MC528 uses the same image sensor design as the 100 x 100 model MC521. Only dc power and X-Y clock inputs are required to operate the camera. Clock frequencies to 5 MHz can be used to generate frame rates up to 300 frames/s. Pixel data outputs from the camera in a serial differential S/H analog bit stream. Digital timing signals allow high speed video images to be digitized with standard A-D hardware and adapted to common computer buses. **EG&G Reticon**, 345 Potrero Ave, Sunnyvale, CA 94086.

Circle 404

**DISK SYSTEMS**

**\$ SPECIAL • LOW PRICES • SPECIAL \$**

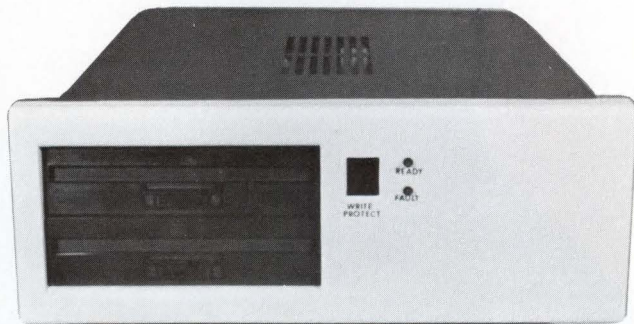

- CI-1240-WF** 42 megabyte Winchester disk system with controller. 42 megabytes fixed and 2 megabytes floppy backup. **\$6995.00**
- CI-1220-TF** Dual drive, double density, double sided, 2MB capacity floppy, plus DMA LSI 11 controller, occupying 3 1/2" of vertical space. **\$2695.00**
- CI-520** 10MB 5 1/4" Winchester with 2MB 5 1/4" floppy, RX02/RL02 or RX50/WD50 emulation. **\$3995.00**

*DON'T ASK WHY WE CHARGE SO LITTLE, ASK WHY THEY CHARGE SO MUCH.*



**Chrislin Industries, Inc.**

31352 Via Colinas • Westlake Village, CA 91362 • 213-991-2254  
TWX 910-494-1253 (CHRISLIN WKVG)

LSI 11 is a trademark of Digital Equipment Corporation.

# “I buy Amphenol’s Spectra-Strip® IDC’s. I get MIL-C-83503 compatibility and more.”

Spectra-Strip 812 Series IDC sockets and 816 Series headers are designed for quick, low-cost interconnection of computers, peripherals and communications equipment. They also have lots of added features to speed up assembly and cut costs.

For example, the lock-and-eject

feature makes for more secure connects and faster disconnects. And it virtually eliminates stress on disconnects. You can install this feature either during assembly or in the field.

Also, you hear an audible “snap” when mating the connectors. You

know for sure they’re mated. And the optional socket strain relief can be snapped on any time.

Find out more about extra-value, extra-easy Spectra-Strip sockets and headers. Call your nearest Amphenol sales office or distributor listed here.

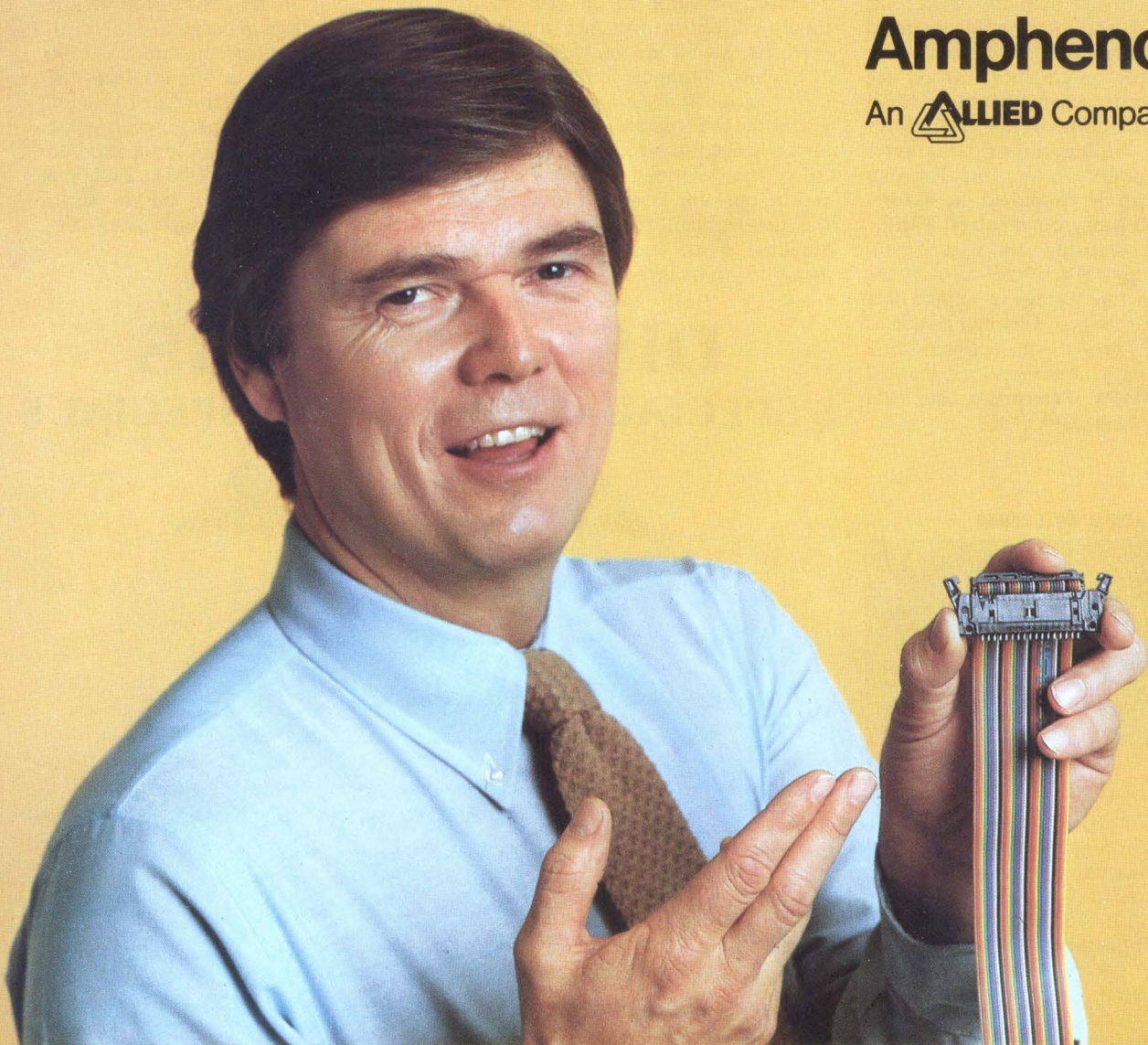

**Amphenol**  
An  **ALLIED** Company

**Amphenol World Headquarters:** 2122 York Road, Oak Brook, Illinois 60521  
**Sales Offices:** Atlanta (404) 394-6298 • Boston (617) 475-7055, (617) 938-8580 • Boulder (303) 443-4780 • Chicago (312) 986-2330 • Dallas (214) 343-8420  
Dayton (513) 294-0461 • Detroit (313) 722-1420 • Greensboro (919) 292-9273 • Houston (713) 444-4096 • Indianapolis (317) 842-3245 • Kansas City, Mo. (816) 737-3937  
Knoxville (615) 690-6765 • Los Angeles (213) 532-3180 • Miami (305) 981-2100 • Milwaukee (414) 542-9566 • Minneapolis (612) 835-4595 • New York (516) 364-2270  
Orlando (305) 678-5504 • Philadelphia (215) 732-1427 • Phoenix (602) 265-3227 • St. Louis (314) 569-2277 • Salt Lake City (801) 364-6481 • San Diego (714) 272-5451  
San Francisco (408) 732-8990 • Seattle (206) 455-2525 • Syracuse (315) 455-5786 • Washington, D.C. (703) 524-8700  
**Canada:** Montreal (514) 482-5520 • Toronto (416) 291-4401 • Vancouver (604) 278-7636  
**International:** Oak Brook, Illinois TELEX 206-054

© 1983 Allied Corp.

CIRCLE 68

## AMPHENOL SPECTRA-STRIP® DISTRIBUTORS

### ARIZONA

Bell, Tempe—(602) 966-7800  
Cetec, Phoenix—(602)272-7951

### CALIFORNIA

Bell, Gardena—(213) 515-1800  
Sunnyvale—(408) 734-8570  
Cetec, San Diego—(714) 278-5020  
San Jose—(408) 263-7373  
South Gate—(213) 773-6521  
El-Com, Cerritos—(213) 926-7887  
San Diego—(714) 578-0906

### COLORADO

Bell, Wheat Ridge—(303) 424-2185  
Storm Products, Broomfield—  
(303) 466-1991

### FLORIDA

KSM Electronics, Ft. Lauderdale—  
(305) 739-5880

### ILLINOIS

GBL/Goold Electronics,  
Elk Grove Village—(312) 593-3220  
Newark, Chicago—(312) 638-4411  
Ohm, Palatine—(312) 359-5500

### INDIANA

Genesis, Indianapolis—(317) 637-5571

### MARYLAND

Vertex Electronics Mid-Atlantic, Inc.,  
Beltsville—(301) 937-0180

### MASSACHUSETTS

Gerber, Norwood—(617) 769-6000  
Pacer, Woburn—(617) 935-8330  
QPL Electronic Distributors, Burlington—  
(617) 229-2424

### MICHIGAN

Ambur Electronics, Walled Lake—  
(313) 669-3710

### MINNESOTA

Custom Connections, Burnsville—  
(612) 894-4090

### MISSOURI

L-Comp, Kansas City—(816) 221-2400  
Maryland Heights—(314) 291-6200  
Olive Industrial Electronics, St. Louis—  
(314) 426-4500

### NEW HAMPSHIRE

Yankee Electronic Supply, Manchester—  
(603) 625-9746

### NEW MEXICO

Connecting Components, Albuquerque—  
(505) 345-8921

### NEW YORK

Arrow Electronics, Farmingdale—  
(516) 231-1030  
Help Electronics, Binghamton—  
(607) 729-3528  
Schweber, Westbury—(516) 334-7474  
Summit Distributors, Buffalo—  
(716) 887-2800  
Vertex, Farmingdale—(516) 293-9880

### NORTH CAROLINA

Hammond Electronics, Greensboro—  
(919) 275-6391

### OHIO

Schuster Electric, Cincinnati—  
(513) 489-1400  
Twinsburg—(216) 425-8134  
Stotts Friedman, Dayton—(513) 298-5555

### PENNSYLVANIA

CAM/RPC Industries, Pittsburgh—  
(412) 782-3770  
Omega Wire & Cable, Harleysville—  
(215) 247-7820  
Pytronic, Montgomeryville—  
(215) 643-2850

### TEXAS

Allied Electronics, Ft. Worth—  
(817) 336-5401  
Altair, Houston—(713) 462-3029  
Richardson—(214) 231-5166  
Harrison Equipment, Dallas—(214) 239-2750  
Stafford—(713) 879-2600  
Solid State Electronics Company, Irving—  
(214) 438-5700  
Houston—(713) 772-8483

### UTAH

Diplomat, Salt Lake City—(801) 486-4134  
Standard Supply, Salt Lake City—  
(801) 486-3371

### WASHINGTON

Carlyle Technical Sales, Seattle—  
(206) 575-8750

### WISCONSIN

Taylor Electric Company, Mequon—  
(414) 241-4321

## PRODUCTS AUTOMATION & CONTROL

### Process control display generator



The Aycon 15 display generator, directly compatible with Digital Equipment Corp's PDP-11/DR-11C programmed I/O controller, interfaces a variety of host computers. This advanced version of the company's model 5215 can alternately interface the DEC DR-11B or DR-11W DMA controller. It also provides downward compatibility for new hardware as well as total compatibility with existing software. While all enhanced features are interchangeable with the earlier system, the 15 is intended to replace previous systems. **Aydin Controls**, 414 Commerce Dr, Fort Washington, PA 19034.

Circle 435

### Fiber optic cable

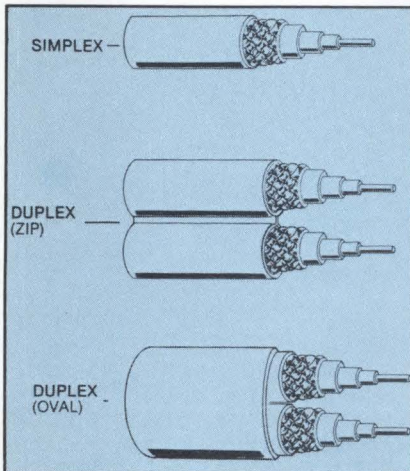

Available in simplex, oval duplex, and zip duplex construction, plastic clad silica (PCS) fiber optic cable meets the requirements for factory automation and process control applications. Features include low loss optical signal transmission, rfi/emf immunity, high radiation resistance, and higher numerical apertures with simpler termination than communications cable with glass optical fiber. Individual lightguides within the cable are silicone clad silica core covered with an opaque black buffer to protect the cladding and

prevent crosstalk between adjacent lightguides. Cabling adds a tight tube, a braid over the tube, and an overall jacket of PVC or other compound depending on application specs. Attenuation is as low as 8 dB/km at 790 nm. The op temp range is -20 to 80 °C. **EOTec Corp**, 200 Frontage Rd, West Haven, CT 06516.  
Circle 405

### iAPX based CPU board

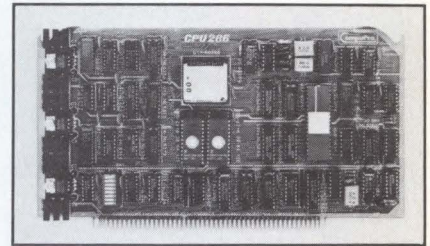

Designated CPU 286, an IEEE 696 standard CPU board based on Intel's iAPX 286/10 microprocessor is code compatible with 8086 and 8088 software. Standard features include sockets for an 80287 math coprocessor for high speed number crunching, and up to 16K bytes of EPROM for system development and multi-user applications. A clock switching circuit permits 8- or 16-bit slave processors to run on the same bus at various rates, without timing conflicts, so that users can execute alternate software libraries. With a 24-bit address and 16-bit data bus, the board accesses 16M bytes of online system memory without segmentation. **CompuPro, div of Godbout Electronics**, Oakland Airport, CA 94614.

Circle 406

### Programmable CAMAC processors

Series CAB 4800 has a 5-MHz, 16-bit bipolar bit-slice processor that provides multi-operation and multi-operand instructions with a 200-ns basic cycle time, including 16- x 16-bit multiplies and 16-bit shifts. The system includes 4K x 24 bits of RAM each for data memory and instruction memory. It can solve data rate problems by participating in trigger decisions and/or compacting the data before readout by an online computer. The unit installs in a CAMAC crate without external supplies or buses; depending on the model, it will completely control the dataway or the branch highway. Software support includes cross assembler, linker, pusher, and debugger. **LeCroy Research Systems Corp**, 700 S Main St, Spring Valley, NY 10977.

Circle 407

# MICROPROCESSOR SOFTWARE DEVELOPERS:

Now you can cross-compile PL/M source code to any of these Micro-processors . . .

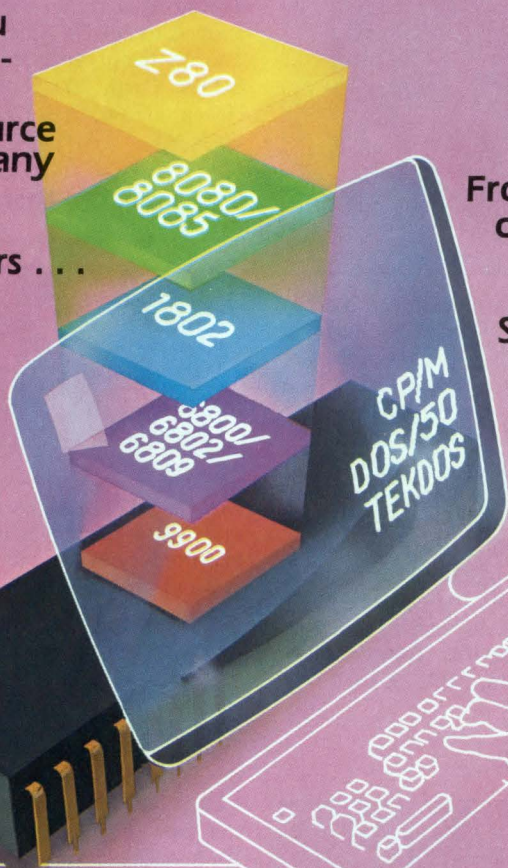

From any of these Operating Systems

If you need to write code for one or more of these microprocessors, then PLMX is the language for you. Compatible with Intel's highly successful PL/M development language, PLMX has the right combination of high-level structure and low-level control of assembly language. It's ideal for process control and other real time system development.

Look at the outstanding features of PLMX:

**Block Structured**—designed to support modular, top-down structured programming.

High level control statements, assembly language target code.

Relocatable and ROMable native code.

Linkable, so several tasks can be linked into one executable module.

Minimal run time overhead—benchmark programs execute faster than those of nearly any comparable compiler.

Floating Point, Memory Management, Assemblers, and Character and String I/O companion packages.

The other fine features have to be used to be appreciated, such as the assembly language source file that is produced as the object code. It makes for easy modification, optimization, and debugging.

Best of all, PLMX is available *now* so you can break out of the assembly language rut right away. Call us today at (619) 292-PLMX, and let us show you the easy way to 8-bit microprocessor software development.

# PLMX



**SYSCON CORPORATION**

4015 HANCOCK ST., SAN DIEGO, CA 92110

(619) 292-PLMX, TWX: 910-335-1660

## PRODUCTS

### Multibus motor controller

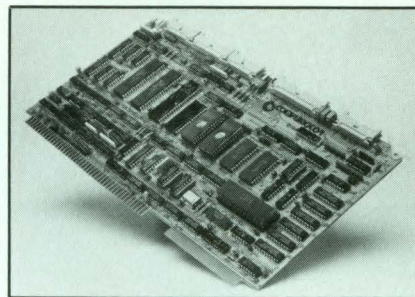

The 8088 microprocessor based model 1810 provides open loop control of microstepping motor/drives, standard stepper translators, and phase-locked dc servo drives. It receives high level commands from the host processor and executes those commands to control a single axis of motion. Multibus compatible, the device provides digital control of acceleration, velocity, and distance. Its structured command language contains 75 commands. A model 1811 closed loop controller will be available in mid year. **Compumotor Corp.**, 1310 Ross St, Petaluma, CA 94952.

Circle 408

### Distributed processing network

CRISP-DRM distributes up to 7 independent remote microprocessors and one high level host. Configurations can range from extremely loose coupling to a closely integrated system with the host performing high level applications software developed in CRISP, FORTRAN, or BASIC-Plus. Communication is over CRISP-Link, a 1M-bps multidrop coaxial data highway spanning up to 32,000' (9754 m). A function library includes software for PID control strategies, recipe management, interlocking, sequencing, message generation, alarm handling, communication with other systems, and high level math operations. The field mounted units are based on PDP-11/03 or PDP-11/23 hardware. **Anaconda Advanced Technology, Inc., Anatec**, 6360 Dublin Industrial Ln, Dublin, OH 43017.

Circle 409

### Want to participate?

*Would you like to write a design article on a phase of automation and control? Circle 743 on the Reader Inquiry Card for a free copy of the Author's Guide.*

**Intelligent monitor/control terminal**



Full-duplex RS-232-C cable for host communications provides an alternative to hardwired systems, point to point wiring, and customized control panel for the MCT 10 microprocessor based terminal. Function modules such as push-button numeric entry/display, ASCII keyboard, speech synthesizer, and plasma display plug into benchboard console or rack enclosures containing power supply and control board. A control unit communicates with the host and provides interface to the modules via ribbon connectors. Standard message formats and programming are built in. The terminal operates in a 0 to 50 °C range at up to 95% RH (noncondensing) from a 115/230-V, 50/60-Hz power supply. It surpasses NEMA's 1800V showering arc test. **Eaton Corp, Cutler-Hammer Products**, 4201 N 27th St, Milwaukee, WI 53216.

Circle 410

**Miniature optical shaft encoder**

Model 268-0739 encoder is as big as a size 11 resolver and comes in servo mount, face, or flange mount configuration. Its low inertia metal code disk is less susceptible to vibration or shock than glass or plastic disks, and operates in ambient temperatures up to 85 °C. Standard units offer various line structures up to 512 lines, plus an optional marker pulse. A larger unit comes with up to 1024 lines and marker pulse. Moire fringe techniques to detect the line structure permit a revolution of 13,000 rpm. **Micron Instrument Corp**, 210 Express St, Plainview, NY 11803.

Circle 411

**Talk to us, please**

*Did this Premier Edition help you in your work? Or did we miss the mark?*

*Write your answer in the Editorial Comments box on the Reader Inquiry Card.*

# Label Your PROMs

## Economically... Professionally...

New Low-Cost **Microlabeller™** prints neat, legible, permanent labels for PROMs, PALS . . . or any other device in a DIP package.

**LOW-COST**—Microprocessor-controlled, yet priced far below the cost of traditional IC marking systems. Choose from various label types with pressure-sensitive adhesive backings for temporary or permanent labeling. **FAST**—The **Microlabeller** prints up to 120 labels per minute. Self-contained memory stores up to 24 different labels. **EASY TO USE**—48-character keyboard is quickly mastered . . . no programming skills necessary. **VERSATILE**—Serves programmers, design engineers as well as high-volume manufacturing environments.

For full details on the **Microlabeller**, call 408/746-0333. **EPC** . . . Everything for the PROM User.

See us at **Electro '83—Booth 4706!**



3681 Enochs St.  
Santa Clara, CA 95050  
408/746-0333; TWX: 910-338-2311

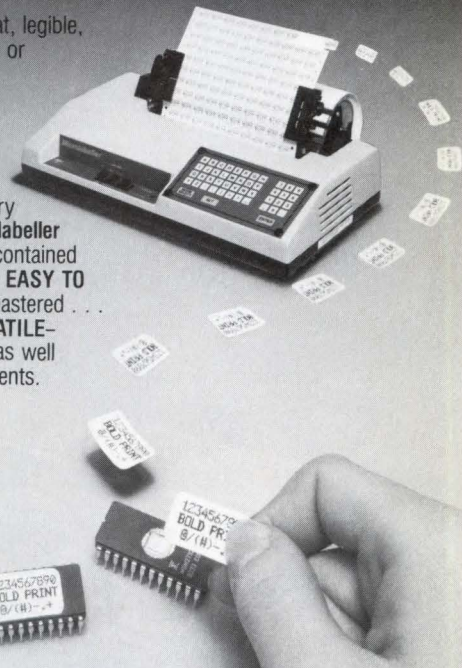

CIRCLE 70

# COMPACT PORTABLE RS232 TAPE LOADER

The low-cost Braemar MTL-II offers fast and accurate loading of ANSI-compatible tapes through any RS232 port.

Ideal for program loading, diagnostics, or transmission of remotely collected data.

Features variable block length and automatic data re-read. Up to 136K bytes capacity on 80-ft. tape at 800bpi. Data rate selectable from 150 to 9600 baud.

Panel LED's show system status. Membrane keyboard controls operation. Optional second port for terminal or modem connection. Fitted with standard RS232C/DE connector. Built-in AC supply. Priced from \$350.00 in quantity. Call or write for free literature.



**BRAEMAR COMPUTER DEVICES** INCORPORATED  
11950 TWELFTH AVENUE SOUTH / BURNSVILLE, MINNESOTA 55337 / 612 890 5135

CIRCLE 71

COMPUTER DESIGN/April 21, 1983

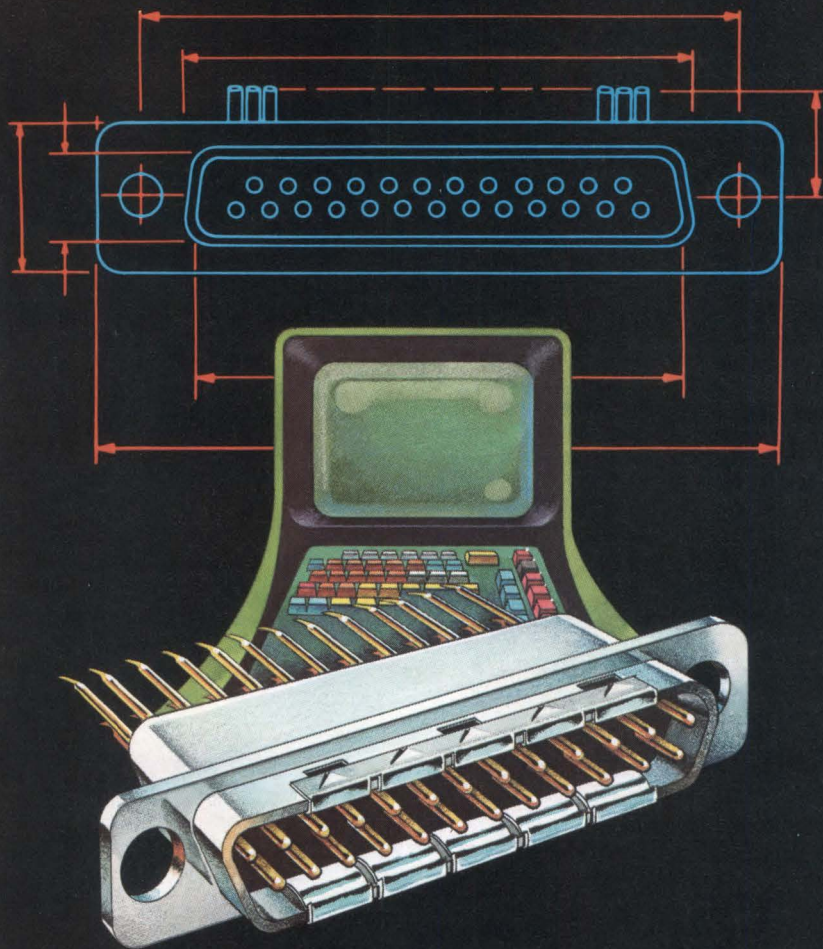

## When the FCC says control your interference

### use Spectrum's shielded-filtered connector\*

Spectrum Control's low cost filtered and shielded D subminiature connectors are effective ways to make your computers comply with the FCC's Electromagnetic Interference (EMI) regulations.\*\*

Spectrum Control's new filtered and shielded D Subminiature connectors provide maximum versatility and compatibility while eliminating any EMI problems. And they're far less expensive than you might think.

Spectrum connectors feature a complete range of performance options, and they're totally adaptable for easy retrofitting. The design is based on proprietary ceramic technology

of proven reliability and performance, and features programmable filter positions for unlimited versatility.

Spectrum Control itself, offers you a full range of electromagnetic compatibility services and products for both custom and standard applications. For more information call, or write for Engineering Bulletin 27-0027-53. Write Spectrum Control, Inc., 2185 W. Eighth Street, Erie, PA 16505. Or call 814/455-0966, TWX 510/699-6871. Spectrum's filtered connectors could be the low cost solution you're looking for.

\*Patent Pending

\*\*FCC Part 15 Sub Part J VDE and Mil STD 461 A/B



**SPECTRUM CONTROL INC.**

Making technology compatible with technology.

## Ruggedized computer systems

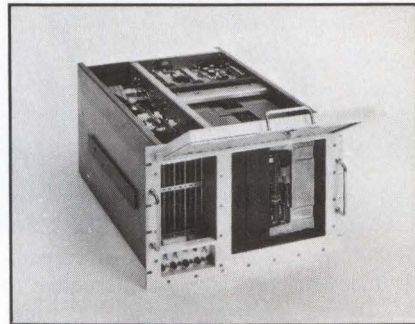

Trilobyte II fills the gap between standard commercial and expensive militarized minicomputer systems. The PDP-11/LSI-11 Winchester based system runs full RT-11, TSX+, RSX-11M/M-Plus, RSTS/E, and Unix systems and standard DEC interface hardware. In addition, Trilobyte II provides cooling and protection from dust, shock, and vibration so that commercial Unibus/Q-bus processors, memories, interfaces, and disks can be used in adverse environments. The 12.25" (31.12-cm) rugged aluminum rackmount chassis accommodates from 2 full-height to 4 half-height 8" Winchester and/or floppy drives. **Trilobyte Computer Corp**, 780 W Grand Ave, Oakland, CA 94612.

Circle 412

## Single-board DAS

Model SBDAS-80 is a z80 based data acquisition and control system that uses a 16K-byte ROM BASIC monitor designed specifically for data acquisition and control. Application programs can be written using onboard BASIC, then transferred for permanent storage to battery backup ROM or to an optional cassette. The board includes up to 64K bytes of memory (RAM and/or ROM), serial and parallel I/O, and APU. It offers 16- or 32-channel A-D multiplexing, as well as up to 48 lines of digital I/O. Onboard STD connector and drivers accommodate system expansion. **Environmental Systems Corp**, 200 Tech Center Dr, Knoxville, TN 37912.

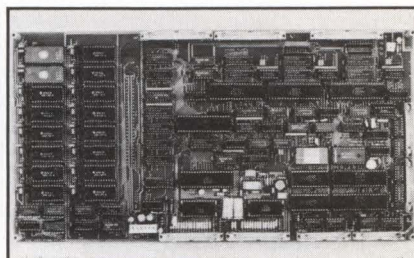

Circle 413

**Robot arm tester interface**

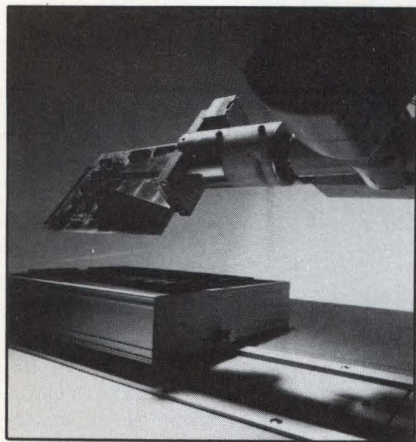

The 600 RBHS robotic board handling system is designed to work with Intellex' 605 6-axis robot arm (see p 27). A modular add-on to Zehntel's 300 and 800 series testers, the RBHS acts as an in-circuit tester/robot interface and standard board-handling program. Guided by an integrated vision system, the robot arm locates a board (up to 5 lb) for testing and picks it up with customized end effectors. When it places

the board on the tester's bed-of-nails fixture, the vacuum seal and test sequence start automatically under program control. Next, the tester signals to the robot arm whether the board has passed or failed, and the arm picks the board up and consigns it to the appropriate holding area. **Zehntel, Inc, a sub of Plantronics, Inc, 2625 Shadelands Dr, Walnut Creek, CA 94598.**

Circle 414

**8-axis stepping motor**

Step-pak model MDU-8, an 8-axis stepping motor drive package, drives eight stepping motors and currents up to 6 A/motor phase. Two-level driver design offers high performance and efficiency. Other features are forced air cooling, internal logic power supply, 8 motor current cutoff switches, and 3 power status LEDs. MDU-8 requires step and direction input signals for each channel, and dual motor power supply of 10 and 36 Vdc. **Advanced Control Systems Corp, 24 Teed Dr, Randolph, MA 02368.**

Circle 415

**Rugged keyboard panel system**

The KPSS lighted keyboard panel system features front relampability with T<sub>1</sub>, bi-pin lamps that come in 5 or 28 Vdc. The low profile keyboard can be custom designed for specific military or commercial requirements. Besides the standard lens arrangements, lighted characters, and lighted backgrounds, the unit offers legends that are readable in bright sunlight. Complete integrated panels, including custom keyboard layout, come prewired and assembled for easy installation. **Master Specialties Co, 1640 Monrovia Ave, Costa Mesa, CA 92627.**

Circle 416

**Good, bad, or so-so?**  
*Did you rate all the articles in this Premier Edition? If not, do so in the Editorial Score Box on the Reader Inquiry Card.*

**ON THE PROWL FOR KNOWLEDGE.**

Ithaco presents **AUTO GAIN® TAC-CAT**; a family of flexible, intelligent, subsystems specifically designed for system integrators, original equipment manufacturers and engineers building distributed process systems to acquire, compute/control and transfer data.

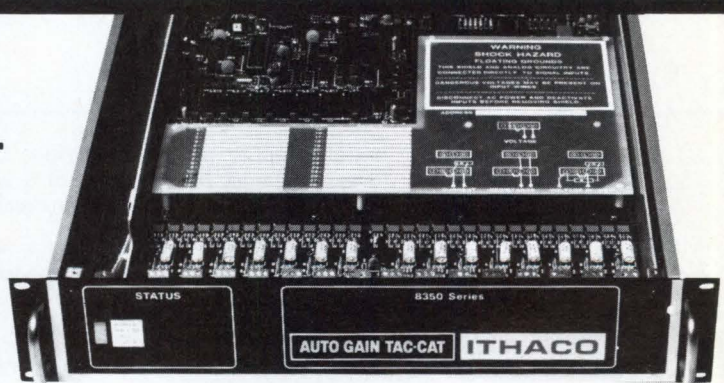

**ACQUIRE**

- Intermix 30 inputs: TC, MA,  $\mu$ VDC, HVAC, Resistance
- Expand to 210 analog & 64 digital I/O (optional)
- Auto-zero & slope, line synchronous integrating ADC
- Built-in filters and cold junction compensation
- AUTO-GAIN® and user programmable gain per channel
- >180dB CMRR, >80dB NMRR, and 250V isolation
- Definable scan sequence and group assignments

**COMPUTE/CONTROL**

- Continuous scanning allows real-time limit checking
- 3 to 6 full digit programmable resolution and integration
- Full Z80 single board computer with bus extension
- Multi-point piecewise-linear scaling functions
- Non-volatile RAM for set-up, acquired and calibration data
- Digital outputs for external DACs and on/off control (optional)
- Linearization tables, mx+b and post scaling transformations

**TRANSFER**

- Host and local operator RS232 communications ports
- Remote-computer, full-duplex, message oriented protocol
- Highly stylized serial link management, easy interfacing
- Asynchronous event reporting, error checking and hand-shaking
- Names identify transducers/sensors, scale functions and groups
- High speed differential current-loop, 6000 ft. daisy chaining

- Additional GPIB interface per IEEE 488 (optional)
- Catch a CAT of your own. Call, write or telex Ithaco today for complete information. ITHACO, Inc., 735 West Clinton Street, P.O. Box 6437, Ithaca, New York 14850-6437, (607) 272-7640 Telex 510-255-9307



... A MEASURABLE DIFFERENCE.

139C-CD-483

**Microprocessor UPS**

Model MUP-0503 provides reliable 5-Vdc power to a microprocessor logic and memory system. The unit replaces a standard power supply; internal nickel-cadmium batteries power the computer memory for over 1 h after line failure; input voltage is 100 to 132 Vac, 47 to

63 Hz, 10 to 25 VA maximum; output voltage is 5 Vdc at 3 A. With enclosure or open printed circuit board, units cost \$50 to \$120 in OEM quantities. **Instrumentation and Control Systems, Inc., Electro-Pac Div., 520 Interstate Rd., Addison, IL 60101.**  
Circle 417

**Analog I/O, TTL boards**

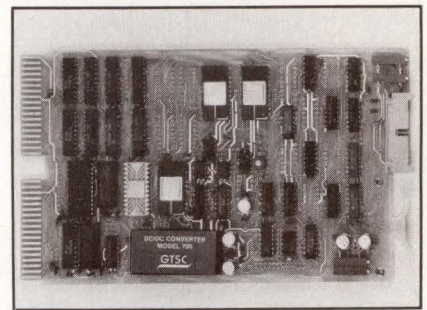

Analog I/O board models 116, 117, 118, and 119 are compatible with DEC's LSI-11, -11/2, -11/23, and Falcon series microcomputers. Basic features on all are 16 single-ended PD or 8 DI high level analog input channels, 12-bit resolution, program control, full 4-level interrupt interface, and dc-dc power converter that allows operation from the computer's 5-V supply. Jumper selection of full-scale ranges, multiplexer configuration, internal or external triggering, random or sequential mode access, and register and vector addressing add to the flexibility. **Grant Technology Systems Corp., 11 Summer St, Chelmsford, MA 01824.**  
Circle 418

**Toko America's Numerical Control Board – LSIs Combine For Improved CPU Efficiency**

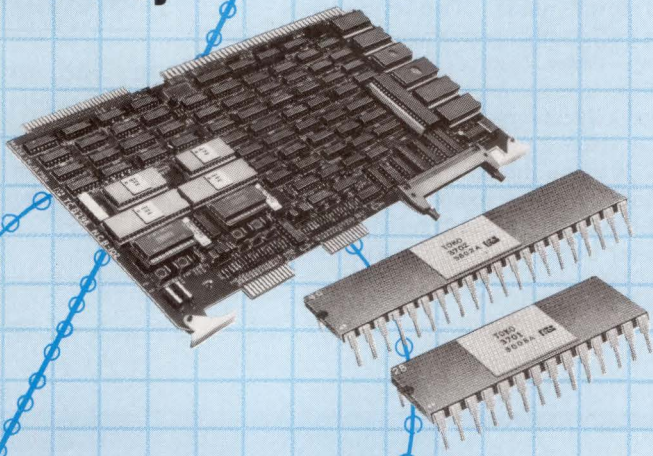

Advanced Numerical Control Module NCB-102 – using LSIs KM3701/KM3702 – offer easy, low-cost development of a wide variety of NC systems . . . for function generation; positioning control.

- Directly pin compatible with IEEE 796; 8 bit microprocessor monitors multibus lines, drives interpolation pulse generator when addressed.
- Linear and circular interpolation
- NCB-102 eliminates interpolation logarithmic development . . . reduces software, debugging time & costs.
- KM3701 LSI efficiently generates interpolation pulses for X and Y axes as instructed by CPU.
- KM3702 precisely monitors input pulse; generates required pulses for D/A converter.
- Simultaneous 2-axis control . . . 3 and 4 axes control possible.
- Built-in microprocessor, automatic acceleration/deceleration control eases overall operation.

Send for complete information on NCB-102 module – Circle

For data on LSIs – Circle 74



**TOKO AMERICA INC.**

5520 W. Touhy Ave. Skokie, IL. 60077 Tel: 312/677-3640 Telex: 23-0724372

**STD bus computer board**

STD bus compatible SCMT-88 computer board has onboard memory capacity to 128K bytes. The 8088 microprocessor board features an address selection technique that lets users choose from a family of byte-wide ROMs, EPROMs, static RAMs, and pseudostatic RAMs. Eight 28-pin sockets give an onboard memory addressing range from 2K to 128K bytes. Compatible with JEDEC 28-pin standard DIP pinout, each socket can be configured to accept from 2K- to 16K-byte wide ROMs/EPROMs or RAMs. Onboard RAM is selectable from 2K to 32K bytes. Memory map and device type (ROM or RAM) is jumper selectable. **Solarcom Technology, Inc., PO Box 4715, Hayward, CA 94544.**  
Circle 419

**We want to please**

*How well did this issue relate to your work? Rate it on the Reader Inquiry Card as Very Much 734, Somewhat 735, or Not At All 736. Then tell us why in the Editorial Comments box.*



# Crack the OEM Market in '83

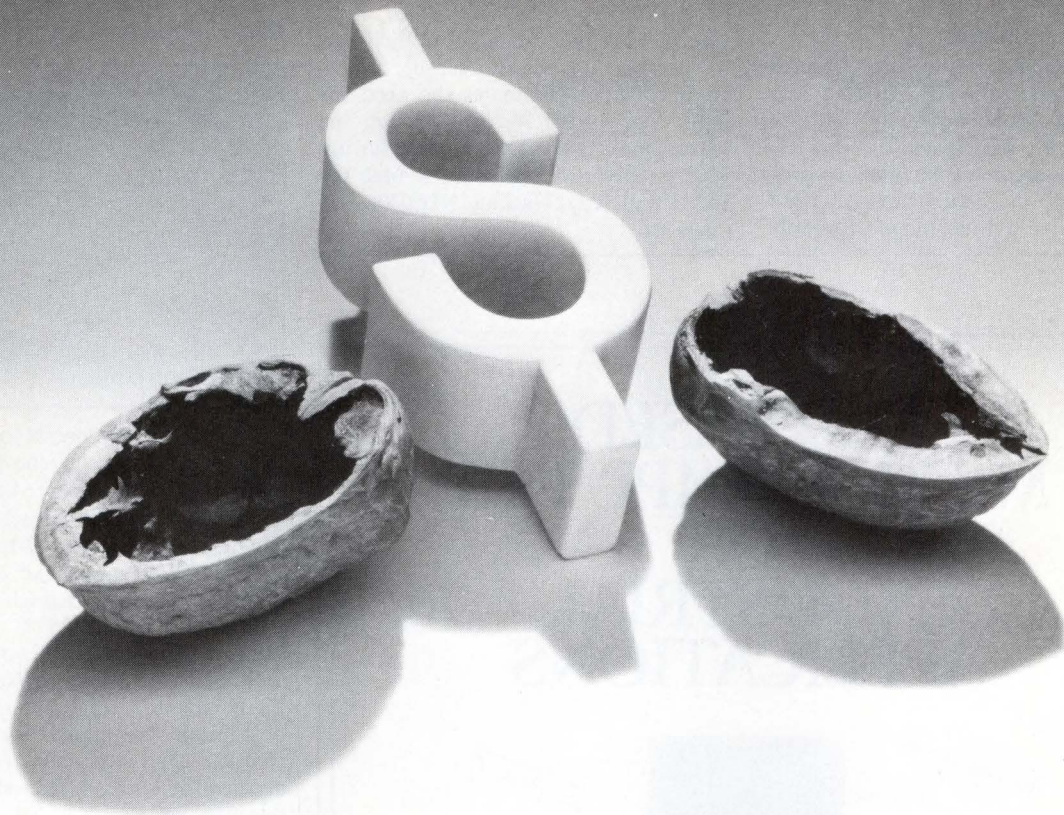

Go one-on-one with the key systems integrators, assemblers, designers, and software specialists in the hard-to-reach high technology OEM.

Make the best use of your marketing dollars in 1983. Exhibit in Mini/Micro.

If you supply or manufacture computers, peripherals, data communications equipment or software services, we offer you four major opportunities to reach one of the nation's largest markets, on a regional basis.

## **Over 50,000 Projected Attendance.**

Marketing in the 80s can be little more than a shell game. Take the chance out of your market planning. Select any (or all) of four key shows, sited at the regional centers of the U.S. market.

## **Reach the Decision Makers.**

Talk to the buyers and specifiers of your products and services, on their own terms, and in their own back yards. They represent the Who's Who of high technology. These are individuals with demonstrated buying power, and a demonstrated need for your kind of product.

## **You'll be in Good Company.**

Exhibit with companies such as Apollo Computer, Atari, Digital Equipment, Hewlett-Packard, Intel, MDB Systems, Micom Systems, Rockwell International, Radio Shack/Tandy and Zilog.

These companies recognize this unique opportunity to reach the OEM in a manner no other exhibition or convention can offer, and the added

benefit of holding these exhibitions in conjunction with, but separate from, the nation's leading regional electronics symposiums.

## **Make Plans to Reserve Space Now.**

Call our sales department today. Ask for complete details on how to crack the OEM, and why it should be important to you. The show prospectus and comprehensive audience profile (detailing the 1982 Mini/Micro audience) are yours for the asking. Act now. And get a clear picture of where your sales are coming from in 1983.

**Call Toll Free:  
800/421-6816.  
In California, dial  
800/262-4208.**



## **Mini/Micro 83**

**Mini/Micro Northeast**  
New York Coliseum, New York, NY

April 19 - 21

**Mini/Micro Midwest**  
O'Hare Exposition Center, Chicago, IL

Sept. 13 - 15

**Mini/Micro Northwest**  
Portland Coliseum, Portland, OR

May 10 - 12

**Mini/Micro West**  
Brooks Hall, San Francisco, CA

Nov. 8 - 11

Produced by Electronic Conventions, Inc., 8110 Airport Blvd., Los Angeles, CA 90045, 213 772-2965.

**Wideband amplifier**

Model 980 wideband amplifier features input impedance over 10 GΩ from 3 to 250 kHz; 50-Ω load capability; and pin programmable, fixed gains of 10, 5, 2, and 1. Other attributes include low profile, 14-lead DIP, low distortion, and operation over a wide range of supply

voltages. The unit can be coupled directly to a high impedance sensor. Bootstrapped input eliminates the need for input bias current return through the sensor, making the unit suitable for use with piezoelectric transducers. **Mel Tec Inc.**, 3 Bud Way, Nashua, NH 03063. **Circle 420**

**Microcomputer input module**

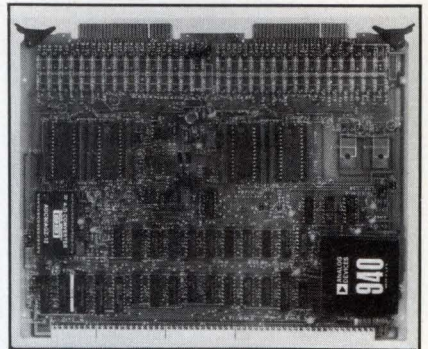

Operating under control of a host or slave model 180+ CPU, the 1856+ analog input module provides 64 single-ended or 32 differential jumper selectable input channels. It provides 12-bit resolution with ±1 LSB accuracy and 20-kHz maximum conversion throughput. System accuracy is 0.01% at 25 °C. The user has a choice of 5 input signal voltage ranges, and choice of binary, offset binary, or 2's complement digital output format, both jumper selectable. Some operating characteristics are software selectable, and sensitivity can be altered by software selection of X1, X2, X4, or X8 gain factor. Software commands are provided to force an interrupt and an A-D conversion, and reset the module. Input circuitry is protected from damage if connected to long signal leads that are left open-circuited, and if there is a power loss while signal sources are still powered. **Xycom**, 750 N Maple Rd, Saline, MI 48176.

**Circle 421**

**6502 BASED  
MICROCOMPUTER  
FOR  
INDUSTRIAL  
APPLICATIONS**

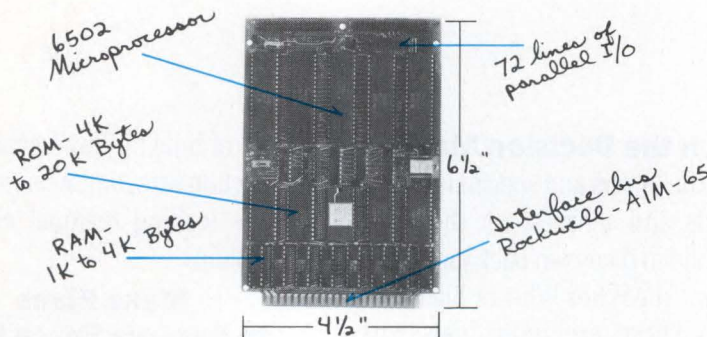

**When you buy a microcomputer from Cubit, we don't forget you need software and peripherals to talk to it.**

Cubit starts with an inexpensive board based on the 6502 microprocessor. We have 72 lines of I/O and plenty of memory, but that is just the beginning.

You can add a 20 character display, or a CRT, a printer and any of several keyboard options. And you can program the board in any of the Rockwell languages: Assembler, FORTH, BASIC, PL/65 or PASCAL. Include our EPROM Programmer, and you have a complete development system for under \$1,000.

Once you have written your program, our computer board can function as a stand-alone controller for under \$200 in your OEM product, or you can add additional boards to increase its power. Give us a call at (415) 962-8237.

**Expansion Modules**

- Display • Printer • 3 Keyboards • Serial I/O
- Parallel I/O • Power Switching Bus • RAM Expansion
- ROM Expansion • CRT Controller • Motherboards • Card Cage

**CuBIT INC.**  
A Proteus Company

240 Polaris Avenue, Mountain View, California 94043, Telephone: (415) 962-8237

**IBM compatible CAD/CAM**

System 8000 combines 4 to 12 of the company's VG 8250 display stations with a 32-bit IBM compatible mainframe computer and a full range of storage and other peripheral devices. The turnkey CAD/CAM system will cost under \$50,000 per workstation for the complete equipment complex, and runs CADAM Inc's CADAM software, Northrup Corp's N-CAD software, or both concurrently. These programs reside in an IBM 370 or compatible computing system and use the IBM graphics access method (GAM) driver designed to support the IBM 2250 and 3250 classes of display system. Remote display stations can be located up to 3 mi (5 km) from the host. The 3M-bps communication line supports 8 terminals at a site without response degradation. **Vector General**, 21300 Oxnard St, Woodland Hills, CA 91367.

**Circle 422**

# More Room... More Multibus® Cages.



ONLY FROM ELECTRONIC SOLUTIONS!

## More Room

You get more room for extra cards without increasing overall size, because our design gives you greater inside dimensions.

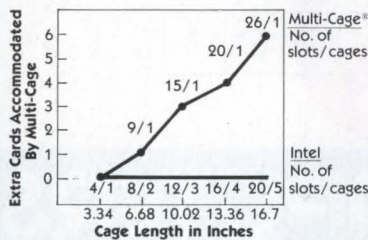

## More Reliability

All cages are constructed of sturdy, durable anodized aluminum with a single mother board backplane... a concept that increases reliability and minimizes interconnections.

## Rack Mounting Too!

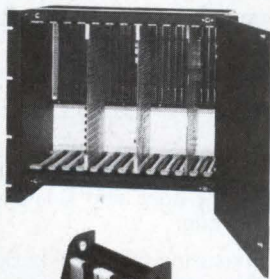

## More Models

We have more models than all our competitors combined. Choose a cage with 3, 4, 5, 6, 7, 8, 9, 12, 14, 15, 16, 20, 24 or 26 slots for the right solution to your problem. We have models with either 0.6" or 0.75" card centers and can even accommodate wirewrap cards.

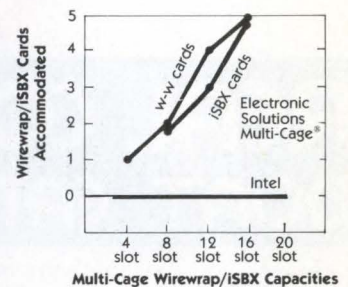

All models are electrically and dimensionally interchangeable with Intel's iSBC-80® Cages.

## More Warranty

A three year warranty is your assurance of quality.

## More Information?

Call our toll free number  
(800) 854-7086  
In Canada Call:  
Transduction Ltd.  
(416) 625-1907



## Electronic Solutions

5780 Chesapeake Ct., San Diego, CA 92123  
(619) 292-0242  
Telex II (TWX): 910-335-1169

Note: Multi-Cage is a registered trademark of Electronic Solutions  
Multibus, Intel and iSBC-80 are trademarks of Intel.

# MULTI-CAGE®

**Rugged processors and disk subsystems**

Based on the company's concept of ruggedizing commercial computer subsystems, R/730 and R/750 processors, along with R/RUA80 and R/RUA81 mass storage devices, offer military and industrial users computer technology for

severe environmental conditions at prices comparable to commercial products. VAX 11/730 electronics are at the heart of the R/730 processor, and VAX 11/750 in the R/750. Both support the VMS operating system. The R/730 supports 5M bytes of ECC MOS RAM and floating point accelerator, while the R/750 supports 8M

bytes of ECC MOS RAM, 4K-byte memory cache, and floating point accelerator. Both storage devices contain DEC's 14" Winchester disk drive and controller. **Rugged Digital Systems, Inc.**, 2895 Northwestern Pkwy, Santa Clara, CA 95051.

Circle 423

**Frequency output pressure transducer**

The EAF high performance pressure transducer's output signal is a frequency modulated square wave with a nominal 5-kHz range, set from 1 to 6 kHz. The primary advantage of this logic level frequency output signal is the ease with which the transducer can interface to most microprocessors. High noise immunity allows the EAF to perform in a variety of harsh environments without shielded cable or special transmission line protection. Since it is a logic level signal at relatively low frequency, long communication lines can be used and simple wave shape reconstruction performed if necessary. Units come in pressure ranges from 0 to 6 psi to 0 to 5000 psi; interchangeability is  $\pm 1\%$  and accuracy is  $\pm 0.5\%$ . **Data Instruments Inc.**, 4 Hartwell Pl, Lexington, MA 02173.

Circle 424

**DAS/MUX system**



A microprocessor based data acquisition and multiplexing system, Series 1874-MUX furnishes a parallel or serial interface between analog field signals and host processors or programmable controllers. The 1874-S serial version interfaces to the host device via RS-232-C, RS-422, or isolated 20-mA current loop. It has baud rates from 110 to 19.2k baud, 300-channel/s throughput (at 19.2k baud), and a preformatted ASCII command/reply set. Multiple units can connect in multi-drop configuration for maximum interface capacity of 16,384 analog channels. The 1874-P parallel version employs a simple handshake protocol and interfaces directly through the host's thumb-wheel switch cards or TTL I/O cards. **Acromag, Inc.**, 30765 Wixom Rd, Wixom, MI 48096.

Circle 425

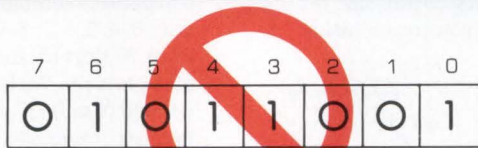

**REAL COMPUTERS DON'T EAT 8-BIT DATA**



Ziatech's new family of **8088 based STD Bus** boards gives you 16 bit processing power and 1 Megabyte of memory addressing capability. Processing power many times that of a Z80 or 6809 for a small increase in cost. One Megabyte memory addressing with no additional overhead.

**Power and memory** capacity to enable your STD Bus system to tackle today's tough real-time and computation-intensive applications.

**Vectored interrupt control** for timely response to important events.

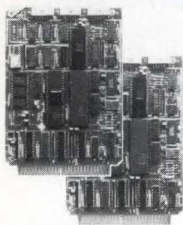

**Two processor boards** are available to meet your needs:

**ZT 8810 CPU** — Featuring the 5 MHz 8088 processor, (1) RS-232 port and 8-line vectored interrupt controller.

**ZT 8811 CPU** — Featuring the 8 MHz 8088 processor and 8-line vectored interrupt controller.

**Coming Soon:** The ZT 8812 CPU — Featuring 8088 processor, 8087 math processor and RMX or CP/M, silicon operating system.

**Coming Soon:** The ZT 8820 byte-wide memory board — Featuring 20 bit addressable RAM, EPROM and EEPROM.

Ziatech also manufactures IEEE 488 controllers and interfaces for STD Bus and MULTIBUS\* systems.



For information, write or phone

**Ziatech Corporation**

3433 Roberto Court  
San Luis Obispo, California 93401  
(805) 541-0488

\*MULTIBUS is a trademark of the Intel Corporation

**WHEN ZENITH PROMISES HI-TECH CRT DISPLAYS, ZENITH DELIVERS...  
ON TIME AND TO YOUR SPECIFICATIONS.**

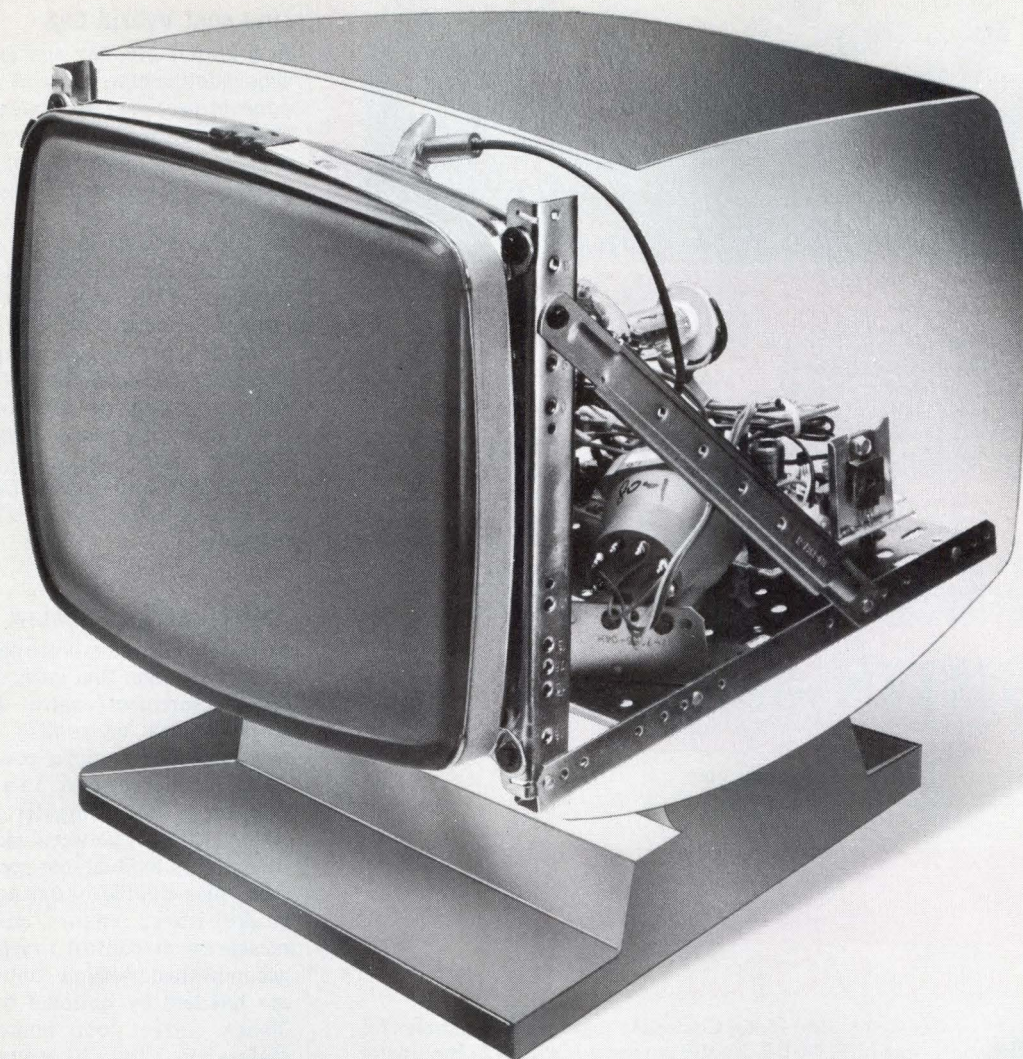

**ZENITH CRT DISPLAY FULL LINE SPECIFICATIONS**

FEATURES	5" CRT DISPLAY	7" CRT DISPLAY	9" CRT DISPLAY	12" CRT DISPLAY	14" CRT DISPLAY	15" CRT DISPLAY
Picture Tube/ Display Area	70° Deflection 4 x 5 Aspect Ratio	85° Deflection 4 x 5 Aspect Ratio	90° Deflection 3 x 4 Aspect Ratio	90° Deflection 3 x 4 or 4 x 5 Aspect Ratio or 110° Deflection 3 x 4 Aspect Ratio	90° Deflection 4 x 5 Aspect Ratio	110° Deflection 3 x 4 Aspect Ratio
Synchronization	Horizontal: 15-24 kHz/Vertical 47-63 Hz			Horizontal: 15-32 kHz/Vertical: 47-63 Hz		
Input Power Requirement	12 VDC	12 VDC or 15 VDC				24 VDC

**OPTIONS AVAILABLE ON ALL MODELS**

Package Design: Kit, Frame or Custom Design Plastic Cabinets  
Landscape or Portrait Modes

All EIA Phosphors and Custom Blends

Face Treatments: Chemical Etch, Light Mechanical Etch, Strain, Polished, PPG, Double Contrast

CHROMAGOLD™ Ergonomic Amber Enhanced Tube

110/220 V Switching Power Supplies (Powers both display and system logic program)

Soft Arc — Improved Arc Suppression

Wide Band Video (To 30 MHz)

Dynamic Focus (Available on 9", 12", 14" and 15" Models)

**For details call or write Zenith Radio Corporation**

**1000 Milwaukee Ave., Glenview, Illinois 60025. Telephone: (312) 391-7733; Telex 25-4396.**



The quality goes in before the name goes on®



See us in NCC Booth P-7052.

## TALK TO THE EXPERTS ABOUT FCC/VDE RFI-EMI EMISSION COMPLIANCE

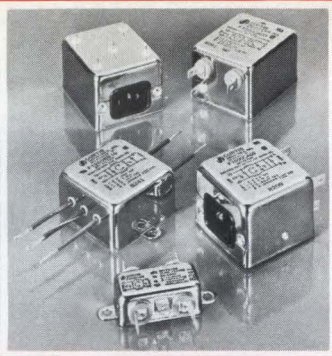
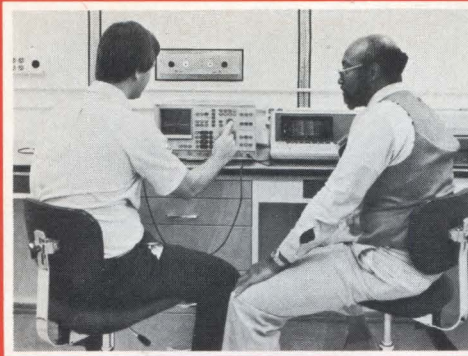

### FULL RFI-EMI CONDUCTED EMISSIONS TESTING OFFERED

Let Curtis test your equipment to FCC Part 15 and/or VDE 0871 RFI-EMI conducted emissions standards in our new laboratory that provides total isolation of equipment and instrumentation. We supply complete documentation and advise you on the filters you need to achieve compliance.

### TEST REPORT & FILTER RECOMMENDATIONS

Computer-generated graphics and test reports ensure fast turnaround on all testing. On-site Curtis filter design/applications engineers as-

sist in evaluating test results and determine cost-effective solutions to conducted emissions problems.

### BROAD LINE OF FILTERS MEET UL, CSA, VDE, SEV SPECIFICATIONS

Curtis offers a broad range of 1, 3, 6, and 10 amp models available for immediate delivery from stock. Choice of wire leads, quick connects, PC mount or IEC connectors.

Properly matched with your equipment, Curtis filters help you meet or surpass FCC/VDE requirements on noise emissions. All models are UL recognized, CSA approved and are designed to meet VDE and SEV specifications.



**CURTIS** INDUSTRIES, INC.  
8000 West Tower Avenue, Milwaukee, WI 53223, 414/354-1500

Send for Filter  
Engineering Manual



CIRCLE 80

4212

## PRECISION POSITIONING

## MULTIBUS MOTOR CONTROL

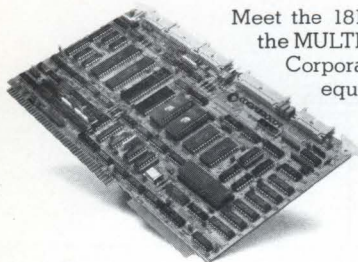

Meet the 1810 Motor Controller—a single axis controller for the MULTIBUS. It's the newest addition to Compumotor Corporation's advanced line of digital positioning equipment. Designed to be used with our 25,000 step per revolution motor/drives or standard stepper translators.

The 1810 is an intelligent peripheral that controls a complex series of open or closed loop positioning tasks. Several 1810's and motor/drives can be easily combined for sophisticated multi-axis control.

The Compumotor System leads the motion control field in performance and ease of use. With the 1810 we're making the job even easier.

- MULTIBUS/IEEE-796 Bus Compatible
- Digital Control of Acceleration, Velocity, and Distance
- Complex Motion Sequences Performed by On-board 8088 Processor
- Communication through Bi-directional Hardware FIFO's
- Continuous Failsafe Monitor and Automatic Self Test

The leader in advanced motion control technology

**COMPUMOTOR**  
CORPORATION™

1310 Ross Street, Petaluma, California 94952  
(707) 778-1244 / (800) 358-9068 / TLXII 510 744 2115

## PRODUCTS

### AUTOMATION & CONTROL

#### Low cost hybrid DAS

In a 28-pin DIP, the HS9410 series data acquisition system contains all the components necessary to convert 8 analog channels into a 12-bit accurate digital output. Throughput sampling rates of 30 kHz are achieved. Three-state outputs are buffered with control lines to directly interface with 8- or 16-bit microprocessors. Designed around the industry standard 2-chip HS574 12-bit ADC, which provides complete conversion accurate to 0.012% in 25  $\mu$ s, the complete system also comprises an 8-channel multiplexer and S/H. HS9410 operates from  $\pm 15$  and 5 V with a total power consumption of 900 mW. In quantity-100, each unit costs \$82. **Hybrid Systems Corp.**, 22 Linnell Cir, Billerica, MA 01821.

Circle 426

#### Serial interface system

Modules 232M and 232S are part of a serial interface system that daisy chains up to 100 measurement/control devices on a single RS-232-C or RS-422-A communication link. The modules couple multiple 16-bit parallel I/O ports to a single serial port on a host computer, with up to 4000' (1219 m) between each dual-port module. Individual bit access at each port, plus double buffering and handshake lines, ensure most digital measurement/control functions can be accomplished. Analog control functions are handled by optional built-in 4- to 20-mA current loop boards with full scaling capability. **JC Systems, Inc.**, PO Box 23445, 4360 Viewridge Ave, San Diego, CA 92123.

Circle 427

#### Very low pressure transmitter

An intrinsically safe, very low pressure transducer/transmitter for industrial and process control installations has been approved by Factory Mutual Research for applications in Class I, Div 1, Groups A, B, C, and D hazardous locations. Model 157S uses a capsule and linear variable differential transformer combination to convert the input pressure to an electrical output. It comes in ranges from 0" to 2" H<sub>2</sub>O up to 25" H<sub>2</sub>O, gauge or differential. Static error band is  $\pm 0.75\%$  full scale. The unit operates from a 12- to 38-Vdc source; output is 2-wire, 4 to 20 mA. A NEMA type 4, GE Valox housing protects the 157S for outdoor use. **Robinson-Halpern**, 1 Apollo Rd, PO Box 248, Plymouth Meeting, PA 19462.

Circle 428

# ESPRIT II <sup>TM</sup>

goes TVI-950 one better.

Our new Esprit III™ is a plug-to-plug replacement for the TeleVideo TVI-950. Same command set. Same keyboard layout. The same features. Even the same user-PROM capability.

But Esprit III goes TVI-950 one better. And that one important difference is price. Esprit III costs \$300 less. In fact, it costs \$100 less than TeleVideo's far less capable TVI-925.

Look at the numbers. TVI-950 performance for less than TVI-925 cost. You'll agree. Esprit III is the best one.

	Esprit III	TVI 925*	TVI 950*
Buffered mode	Yes	Yes	Yes
Programmable function keys	Yes	No	Yes
Line graphics	Yes	No	Yes
Page/line transmit	Yes	Yes	Yes
Smooth scrolling	Yes	No	Yes
Price	<b>\$895</b>	\$995	\$1,195

\*Trademarks of TeleVideo Systems, Inc.

Esprit Systems, Inc., Hazeltine Terminals Division, 500 Commack Road, Commack, NY 11725 (516) 462-5598

*Esprit* Systems, Inc.  
Hazeltine Terminals Division



See us at  
NCC  
Booth W6288

## Monitoring and control system



Digistrip<sup>®</sup> IV and Digi-Link IV provide analog accuracy and 17-bit resolution with extensive logic and control oriented firmware for data logging, machine monitoring, remote sensing, and precise process control. Measurement and computation precision of 0.0015% and analog output resolution of 0.01% allow analog control of critical processes. Onboard capacity is 16 isolated digital and 64 analog inputs, expandable to 128. Up to 48 relay outputs are available. Digistrip IV has a built-in line

printer; Digi-Link IV has no display, but interfaces to any RS-232-C printer. The system is user configurable to a wide range of measurement communication tasks. **Kaye Instruments Inc**, 15 De Angelo Dr, Bedford, MA 01730.

Circle 429

## MIL spec control terminal

TM71M operator panel/terminal is adapted from the RM71 alphanumeric model currently used in industrial control and factory data collection. It conforms with MIL-E-16400, MIL-STD-454, MIL-S-901 (shock), and MIL-STD-167-1 (vibration). It has a -55 to 65 °C operating range and 48-h burn-in at 65 °C. Measuring 8.5" x 4.5" x 0.85" (21.6 x 11.4 x 2.16 cm), the unit has a 42-key keyboard and generates 80 alphanumeric characters. Custom function key definitions can be loaded by the host CPU or by inserting an EPROM module into the terminal. **Burr-Brown, Industrial Systems Products Div**, Box 11400, Tucson, AZ 85734.

Circle 430

## Function processor

SLC 3700 function processor is a configurable digital device dedicated to process manipulations. Operating in engineering units, it performs a variety of tasks on analog and digital signals. In addition to 8 analog inputs, 4 analog outputs, 4 digital inputs, and 4 digital outputs, there are 4 analog and 4 digital internal signals for cascading tasks. A handheld configurator defines tasks, then sets them in sequence for execution. Desired functions, such as mathematical calculations, Boolean algebra, timing and function generation, and totalization, are created from the built-in software library. **Bristol Babcock Inc**, 40 Bristol St, Waterbury, CT 06708.

Circle 431

### Your opinion counts

*Do you like single-subject issues? Yes, circle 737 on the Reader Inquiry Card.*

Miniline has just made a "little" history...

## THE WORLD'S smallest BALL SLIDE

The MINILINE .312 is just that wide, only .200 high and comes in 1 & 2 inch lengths. Loads to 10 ounces.

Miniline's price conscious larger models... .375, .500, .625, .750, 1.000... up to 1.5" wide and 4.5" long, for loads to 25 lbs., all feature:

- Black anodized aluminum bodies
- Stainless balls & hardened ways
- Satin-smooth low friction
- Near-zero backlash & sideplay
- Test-inspected precision preloading for extremely high accuracy.

NO COST custom design assistance is available for production applications of carriage actuator or ball slide assemblies. Please send for our catalog or call us for details at (203) 853-4437. **We can help.**

**MINILINE, INC.**

32 Hemlock Place, P.O. Box 1056  
So. Norwalk, CT 06856

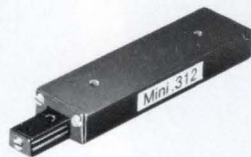

## CY232 NETWORK CONTROLLER AND PARALLEL-SERIAL INTERFACE

will connect any RS232 CRT or computer to any 8-bit parallel TTL I/O port and works with one port or up to 255 parallel ports in several network configurations.

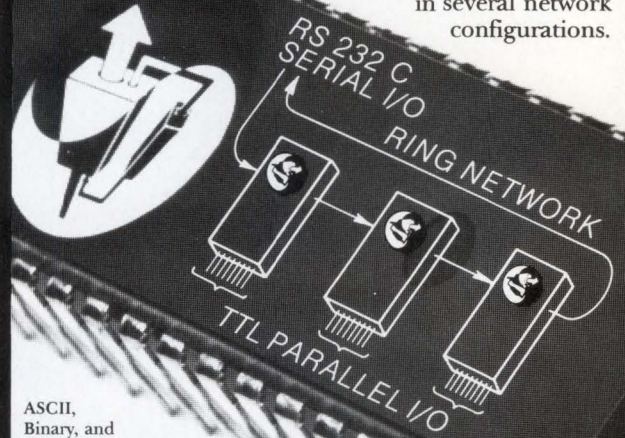

ASCII, Binary, and ASCII-hex modes of operation for maximum flexibility  
\$50 ea. (\$25/100)  
Prototyping board available.



**Cybernetic Micro Systems**

P.O. Box 3000, San Gregorio, CA 94074  
(415) 726-3000 Telex: 171-135 attn: Cybernetic



**Trend recorder/data logger**

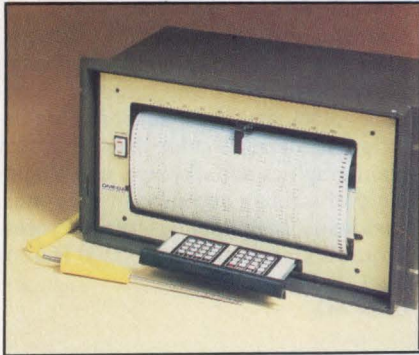

Microprocessor controlled OM270/OM271 has 32 separately programmable channels. It monitors each channel every 2 s, compensating for cold junction, linearizing, and logging all input data. After thermocouple type or voltage range is chosen, the microprocessor takes over to monitor and filter each channel. An ASCII adapter allows transmitting or programming the input from a remote data bank. All channels have high and low alarm set points, with a built-in alarm mode that triggers the recorder to auto-

matically print the date and time. When a set point is exceeded, the chart moves at a preprogrammed speed until the alarm condition ends. **Omega Engineering, Inc, an Omega Group Co, 1 Omega Dr, PO Box 4047, Stamford, CT 06907.**

Circle 432

**2-wire control modules**

The 2-wire remote control system 128 controls or monitors up to 128 channels over a single set of 2 wires, significantly reducing cable and simplifying maintenance. The system can be set up for centralized or decentralized control, and built modularly with 1- or 8-channel system 128 units. Included are transmitting, receiving, and power supply modules to operate with existing sensors, monitors, and control devices. Contact positions can be implanted or located at outside addresses within 10 km. Modules can be added anywhere along the same 2 wires as required. **Electromatic Components Ltd, 1531 Burgundy Pkwy, Streamwood, IL 60103.**

Circle 433

**Plug-in fiber optic module**

A plug-in TTL/ECL fiber optic communications module, T/R-2010 transmits high speed TTL/ECL digital data signals from dc to 50M bps while eliminating emc problems common to metallic cables. At 50M bps, the system has a 1-mi distance; 2 mi at 25M bps. Both T-2010 transmitter and R-2010 receiver modules plug directly into the SL-2000 universal card frame. Modules have dual 50-Ω BNC I/Os—one for TTL, one for ECL. Instant channel response without loss of initial bits eliminates the problem of megabit loss during AGC acquisition time in ordinary ac coupled fiber data links. **Artel Communications Corp, PO Box 100, West Side Station, Worcester, MA 01602.**

Circle 434

**Carry on?**

*Do you want more special editions on automation and control? If so, tell us by circling 740 on the Reader Inquiry Card.*

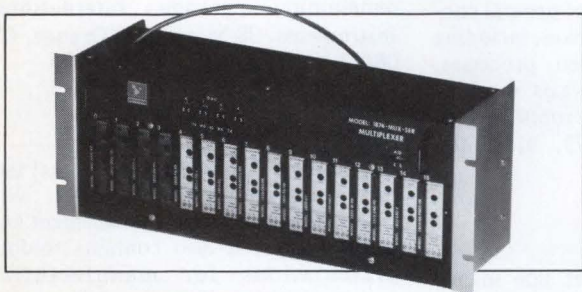

**New Series 1874-MUX—  
an integrated approach to multiplexing  
and signal conditioning**

This is an expansion of the unique Acromag Series 1800 analog signal conditioning system. It provides either a parallel interface (BCD or binary) or serial interface (RS-232-C, 422 or 20 mA loop) to your PC, micro or mini computer. The Series 1874-MUX, can isolate and condition up to 64 analog I/O points.

This new system accepts the same variety of analog input and output signals as the Series 1800, including thermocouple, RTD, strain gauge and frequency inputs, current outputs, etc.

Call your Acromag rep. Or write for complete details. **Acromag, Inc., 30765 Wixom Road, Wixom, MI 48096. (313) 624-1541.**

CIRCLE 84

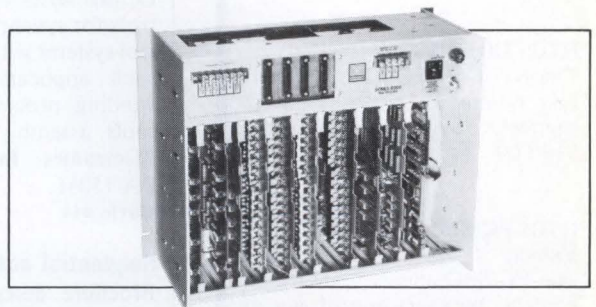

**New Series 6000—  
latest state-of-the-art multiplexing system**

Here's a remote system for 16 to 135,168 I/O points—one that can scan up to 300 analog channels/sec.—faster than any other standard multiplexer.

It's the most convenient multiplexer to start up, calibrate, and maintain: it features local monitoring and calibration while the unit is on line, without disturbing host or field wiring.

Host communication occurs through an RS-232-C, RS-422, or 20 mA current loop, using a simple command/reply format. The Series 6000 accepts a broad variety of sensor-based analog signals and digital inputs.

Call your Acromag rep. Or write for complete details. **Acromag, Inc., 30765 Wixom Road, Wixom, MI 48096. (313) 624-1541.**

CIRCLE 85

## JOIN THE PROFESSIONALS

RTCS Products give your PC/MDOS computer, professional program development capabilities, just like Intel's Series III or System 86/330.

RTCS offers a family of Operating System Development Tools.

- **RTCS UDI**

The UDI allows your PC to execute Intel's Compilers, Assemblers and Utilities.

\$500.00

**Features**

Memory Management  
File Management  
PC/MSDOS File Structures  
8087 Support

- **RTCS PC/RMX**

The RTCS PC/RMX lets your PC run under Intel's Real-Time Operating System, iRMX.

\$2250.00

**Features**

Up to 65536 tasks  
Hierachial Directories  
Multi-User Capability  
Supports IBM Peripherals  
Hard Disk Support  
Ethernet Support

- **RTCS UDEBUG**

The RTCS UDEBUG is a powerful system debugger. 8087 support. Symbolic debugging.

\$195.00

- **RTCS PC/SBC Execution Vehicle**

The PC/SBC allows your PC to control the execution of any of Intel's SBC Computers. Both download and upload capability.

\$195.00

MDOS IS A TRADEMARK OF MICROSOFT CORP.  
SBC & IRMX ARE TRADEMARKS OF INTEL CORP.

**REAL-TIME COMPUTER  
SCIENCE CORPORATION**  
P.O. Box 3000-886 (805) 482-0333  
Camarillo, CA 93011  
TELEX #467897

## AUTOMATION & CONTROL LITERATURE

### DAS plotter graphics

Brochure describes use of HP 9872C/T and HP 7470A plotters in data acquisition systems applications, particularly for production test, process monitoring, incoming inspections, QC, R&D, and performance testing; benefits for presenting large amounts of data are also discussed.

**Hewlett-Packard Co**, 1820 Embarcadero Rd, Palo Alto, CA 94303.

Circle 441

### Nonservo robotics

Booklet originally written for in-plant use by company employees provides specs for nonservo B·A·S·E robots for precision benchtop work, robotic components for support to other robot systems, and LO-PROFILE cylinders for use in automation system jigs and fixtures.

**Mack Corp**, PO Box 1756, Flagstaff, AZ 86002-1756.

Circle 442

### Process controller MUX

Data sheet describes features and benefits of remote (field mounted) IP/C3000 data highway based controller multiplexer. Both signal and control microprocessor based MUXes with photos, schematics, and technical details and specs are described.

**Leeds & Northrup Co**, North Wales, PA 19454.

Circle 443

### Modular motion controls

Brochure gives detailed information on GC-1000 series of industrial motion controls for synchronization of general control systems with up to 16 axes, including such applications as web processes, winding processes, multi-axis machine tools, assembly lines, and robotics.

**BEI Electronics, Inc**, Box 273, Indianola, PA 15051.

Circle 444

### Sequential controller

Brochure describes model 2020 microprocessor based, user friendly programmable controller featuring full branching, counting, and input monitoring capabilities, including 24 general purpose inputs, 16 open collector outputs, switch mode power supply, and English language programmer.

**Control Technology Corp**, 82 Turnpike Rd, Westboro, MA 01581.

Circle 445

### Programmable controllers

Full color brochure explains capabilities of microprocessor based programmable automation controllers that convert specialized machinery and equipment into fully programmable automation systems; units combine power of computer, flexibility of programmable logic

controller, and 8-axis motion control.

**International Cybernetics Corp**, 263 Kappa Dr, Pittsburgh, PA 15238.

Circle 446

### Process control systems

Bulletin covers all aspects of distributed process control systems, including system architecture and controller functions, block diagrams, keyboard use description, detailed color illustrations of plant graphics and displays, and a summary of training and support programs.

**Beckman Instruments, Inc, Process Controls Operations**, L-19, 2500 Harbor Blvd, Fullerton, CA 92634.

Circle 447

### Data acquisition

Booklet contains series of nine recently published articles and papers about company's analog peripheral products, including Am6112 12-bit ADC, Am6108 8-bit ADC, and Am6688 100-MHz 4-bit ADC; as well as cross reference guide to all of company's major linear products.

**Advanced Micro Devices Inc, Advanced Analog Peripherals**, M/S 24, 901 Thompson Pl, Sunnyvale, CA 94086.

Circle 448

### Multipoint alarm/controller

Bulletin gives complete electrical and physical characteristics of universal multipoint alarm/controller that continuously and independently monitors, alarms, or controls up to 18 process signals in a single 19" relay rack- or panelmount package.

**International Instruments**, 88 Marsh Rd, Orange, CT 06477.

Circle 449

### Factory automation

Brochure describes company's total factory automation technology, with emphasis on electronic management and control tools; it also contains foldout presentations for manufacturing systems, entire factory, full manufacturing complex, and global manufacturing network.

**Gould Inc, Electronic Systems Group**, 1280 E Big Beaver Rd, Troy, MI 48084.

Circle 450

### Remote monitor system

Catalog sheet provides description and specification for remote monitor systems, designed for realtime content monitoring of digital communication links from an unnamed remote location that maintains status of 15 EIA leads, with system schematic diagram and specs.

**Dataproducts New England, Inc**, Barnes Park N, Wallingford, CT 06492.

Circle 451

# For the first time...an oscilloscope to match the timing accuracy demands of today's fastest technologies.

## Laboratory quality timing accuracy plus the convenience of a portable oscilloscope.

If the accuracy of your timing measurements must keep pace with the latest technology, the HP 1726A Time Interval Oscilloscope is your best solution. It can handle tough timing problems. Although most general-purpose, laboratory oscilloscopes solve a variety of problems, their timing accuracy is typically design limited to  $\pm 500$  picoseconds. This simply is not adequate for designing and producing many of today's products.

### Introducing the 50 ps scope.

HP's 1726A time-interval oscilloscope solves this timing limitation with a revolutionary approach. Its new method of making timing measurements is based on combining HP counter technology with HP's advanced oscilloscope triggering circuits. The results? New levels of accuracy ( $\pm 50$  ps), resolution ( $\pm 10$  ps), and repeatability ( $\pm 30$  ps). All this in a portable package



TIME-INTERVAL MEASUREMENT

TIME INTERVAL	500 ps	5 ns	1.2 $\mu$ s
1726A Accuracy	$\pm 50$ ps	$\pm 50$ ps	$\pm 50$ ps
1726A Resolution	$\pm 10$ ps	$\pm 10$ ps	$\pm 10$ ps

that won't clutter your bench or test station. Typically, the 1726A's accuracy is a factor of ten improvement over most laboratory scopes, including the one you're probably using or planning to purchase.

Also, it provides accurate first-pulse measurements...and it's easy to use.

### Check the time interval table.

With the 1726A, your time-interval answers are consistently accurate...and oscilloscope timing calibration is preserved even with its Time/Div vernier out of detent. In fact, intervals as long as 1.2  $\mu$ s can be measured with  $\pm 50$  ps accuracy.

For unprecedented convenience and  $\pm 30$  ps repeatability, dial in start/stop trigger levels with 1 mV resolution,

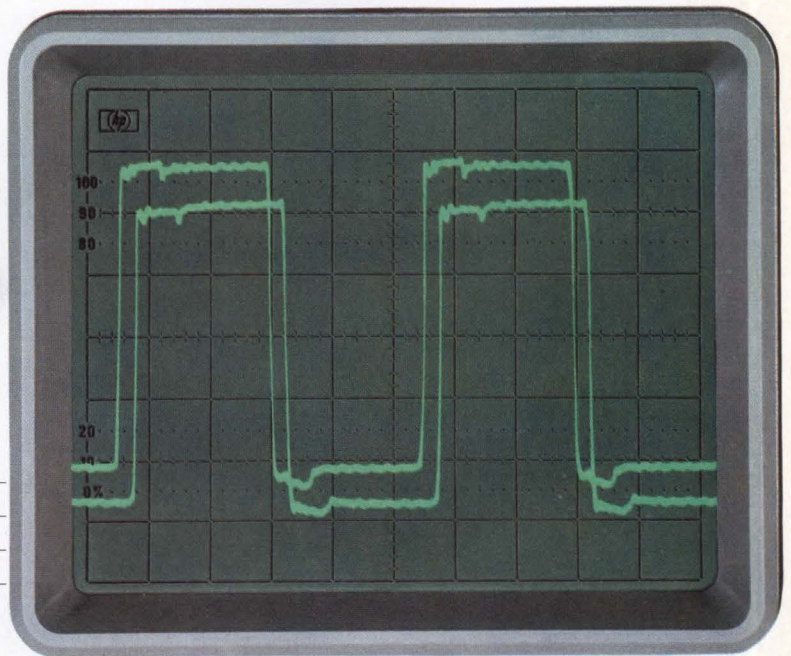
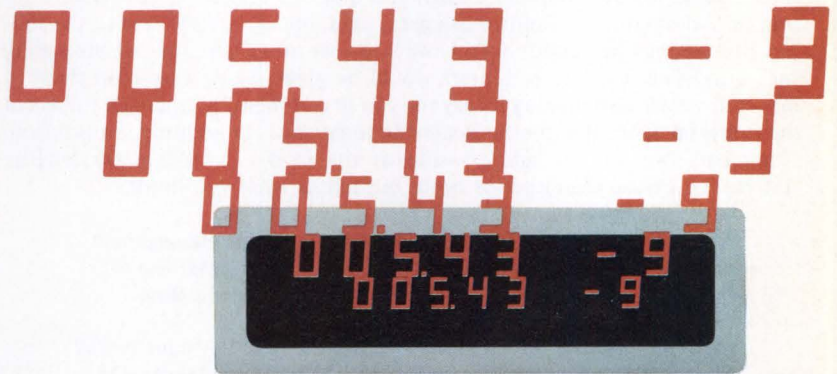

position the on-screen markers, and read the answer on the 1726A's LED display. You get fast, convenient, results you can trust...time after time.

### Meeting the needs of today's technology.

With continuing IC advances, you'll need the capabilities of the 1726A in your lab or production area. Use it to uncover 400 ps clock skew in computer mainframes. Determine 200 ps propagation

delays in IC's or hybrids. With the 1726A's 50 ps accuracy, observe the 20 ns round-trip delay of a test signal within a test system. Or, tie the 1726A to your data-logging system through its HP-IB interface. And with its time-interval module turned off, you'll find the 1726A to be a high-quality, general-purpose, dual-channel 275 MHz oscilloscope.

Get all the details by calling your local HP sales office listed in the telephone directory white pages. Ask for the electronic instruments department.



**HEWLETT  
PACKARD**

HP-IB: Not just IEEE-488, but the hardware, documentation and support that delivers the shortest path to a measurement system.



0801302

We want your opinions—

This Automation & Control issue of *Computer Design* is a Premier Edition in two ways: it inaugurates *Computer Design's* first effort to publish two issues in one month, and it is the first time in *Computer Design's* 21-year history that we have dedicated an entire issue to a single technological subject area.

Of course, we at *Computer Design* feel that this concept of a Premier Edition on Automation & Control is a great idea, but we are so close to the subject that we may be biased; in fact, we know we are. Therefore, we are asking for your frank comments. Letters would be great, and please send them to me—but we are also making it easy for you to comment by circling numbers in the Editorial Score Box on the Reader Inquiry Card. In addition, an Editorial Comments box on the address side of the card is available for lengthy statements. Please use either or both, but tell us what you think.

Are you directly involved in the design or design management of automation and control systems either for internal use or resale? If so, please circle 731 in the Editorial Score Box.

How well did the information in this issue relate to your work? Rate it in the Editorial Score Box as 734 for Very Much, 735 for Somewhat, or 736 for Not At All. Then tell us why in the Editorial Comments box on the flip side of the card.

Do you like single-subject issues? Circle 737 for Yes.

Do you want more special editions on automation and control? If so, tell us by circling 740.

Did you "borrow" this copy? If you are reading someone else's copy or a library copy of this Premier Edition, please circle 742.

Did you remember to rate all of the articles in this Premier Edition? If not, please do so in the Editorial Score Box. (See relevant numbers at end of each article.)

Finally, would you like to write a design article on a phase of automation and control for a future issue? You can get a free copy of *Computer Design's* Author's Guide by circling 743. If you already have a specific idea, note it in the Editorial Comments box.

Thanks for your cooperation and help. Your opinions and comments will be useful in planning future special editions. (By the way, watch for our October Premier Edition on Office Systems Design.)

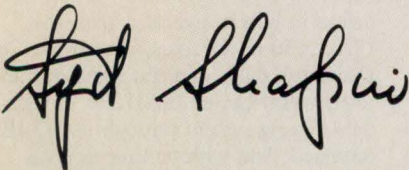

Sydney F. Shapiro  
Premier Edition Editor

What is "The Alps Advantage", and why is it important to you, our customers?

Essentially, The Alps Advantage encompasses a whole series of customer benefits, brought together to help give you a competitive edge in your marketplace.

**Welcome To The Alps Advantage** For design engineers, it means a vast array of electro-mechanical components and system products—particularly noteworthy for their innovative technology, state-of-the-art performance, high degree of miniaturization, built-in quality and long-life reliability. It also means a never-ending flow of new product introductions and helpful application engineering assistance from our Technical Product Managers.

For purchasing and production people, The Alps Advantage takes on other meanings—competitive pricing, automated manufacturing facilities and on-time deliveries. Equally important, it means a special kind of philosophy based on a spirit of teamwork and cooperative customer relations.

The Alps Advantage is everything you need to improve your products and enhance your competitive position—and everything you'd expect from a world-class supplier. Since its founding in 1948, Alps Electric Co., Ltd. has experienced steady, stable growth—to a level of world-wide sales now up to \$1-billion per year!

We look forward to the opportunity of putting The Alps Advantage to work for you—to get started, please contact the Alps Sales Rep nearest you:

AL	Huntsville (Jack Harvey & Assocs.)	(205) 536-4414
AR	Phoenix (Eltron)	(602) 266-2164
CA	Santa Clara (Nova-Tronix, Inc.)	(408) 727-9530
CA	Woodland Hills (Relcom, Inc.)	(213) 340-9143
CA	San Diego (Cercro)	(714) 560-9143
CO	Englewood (Nelligan Co.)	(303) 761-2121
FL	Plantation (Gallagher & Assocs.)	(305) 473-2101
GA	Norcross (Jack Harvey & Assocs.)	(404) 449-4643
IL	Arlington Heights (Micro Sales, Inc.)	(312) 956-1000
IN	Indianapolis (Jack Harvey & Assocs.)	(317) 872-1031
IN	Kokomo (Jack Harvey & Assocs.)	(317) 453-4260
KS	Kansas City (BC Electronic Sales, Inc.)	(913) 342-1211
KS	Wichita (BC Electronic Sales, Inc.)	(316) 942-9840
MD	Timonium (Allen Assocs.)	(301) 252-4133
MA	Waltham (Technology Sales, Inc.)	(617) 647-5700
MI	Oak Park (A. Blumenberg Assocs., Inc.)	(313) 968-3230
MN	Minneapolis (P.S.I.)	(612) 944-8545
MO	St. Louis (BC Electronic Sales, Inc.)	(314) 291-1101
NJ	Boonton (PAF Assocs.)	(201) 335-0680
NY	Smithtown (PAF Assocs.)	(516) 360-0940
NY	Albany (Reagan/Compar)	(518) 489-4777
NY	Endwell (Reagan/Compar)	(607) 723-8743
NY	Fairport (Reagan/Compar)	(716) 271-2230
NY	New Hartford (Reagan/Compar)	(315) 732-3775
NC	Raleigh (Burgin-Kreh Assocs., Inc.)	(919) 781-1100
OH	Rocky River (Norman Case Assocs.)	(216) 333-0400
OK	Tulsa (Norcom, Inc.)	(918) 832-7747
PA	Willow Grove (Harry Nash Assocs.)	(215) 657-2213
TN	Johnson City (Jack Harvey & Assocs.)	(615) 928-7588
TX	Dallas (Norcom, Inc.)	(214) 386-4888
TX	Austin (Norcom, Inc.)	(512) 451-2757
TX	Houston (Norcom, Inc.)	(713) 933-6021
VA	Lynchburg (Bergin-Kreh Assocs., Inc.)	(804) 239-2626
WA	Belleuve (Venture Electronics)	(206) 454-4594
CANADA:	St. Laurent (Vitel Electronics)	(514) 331-7393
CANADA:	Mississauga (Vitel Electronics)	(416) 676-9720
CANADA:	Stitsville (Vitel Electronics)	(613) 836-1776

# The Alps Advantage in micro-printers:

**"Simply amazing, yet amazingly simple!"** That's the usual reaction to our new Series DPG printer-plotters. We think you'll agree they're a good example of the innovative technology that's such an important part of The Alps Advantage. Totally unique and different from any other printer on the market today, they offer an exclusive combination of design and performance features:

**Ball point pen writing, for alpha- numerics and graphics.** Exclusive ink technology developed by Alps makes possible the use of specially engineered, tiny ball point pens that actually *write*, in 1 or 4-colors, with a simultaneous plotter action in the X and Y-axes. Virtually unlimited

capability for character size variations, special symbols, images, even 3-D graphics.

**Battery operated, totally portable.**

Four Ni-Cd rechargeable batteries power the DPG, ideal for portable applications. Or, use an AC-DC line converter for fixed installations.

**2 1/4" or 4 1/2" plain paper.** All DPG mechanisms use standard commercially available plain paper: 2 1/4" for Models DPG 11 or 13 (1 or 4-color); 4 1/2" for Models DPG 21 or 23 (1 or 4-color).

**High performance specifications.**

Printing speed 12 characters per sec. average. Column capacity up to 40 for 2 1/4" models; 80 for 4 1/2" models.

5 VDC operation. A choice of intelligent LSI driver-controllers is available, depending on model and application requirements.

**Get your hands on The Alps Advantage.** There are many ways we can help you—technical data, evaluation samples, application assistance, price-delivery information, etc. Write or call today, and let us put The Alps Advantage to work for you.



**ALPS ELECTRIC (USA), INC.**

100 N. Centre Ave., Rockville Centre, NY 11570  
Phone 516-766-3636 • Telex (WU)14-4508

## Series DPG microminiature printer-plotters.

**Alpha- numerics and graphics in 1 or 4-colors. Battery operated, totally portable.**

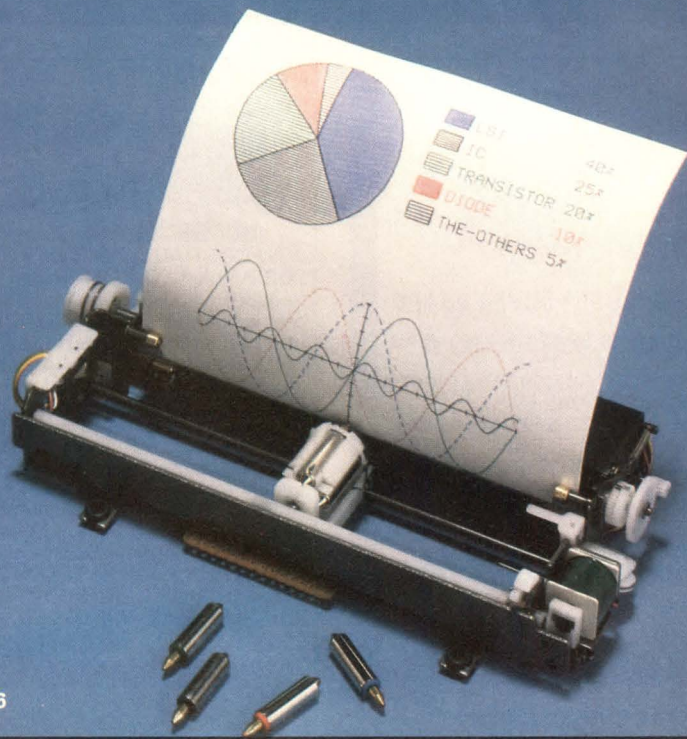
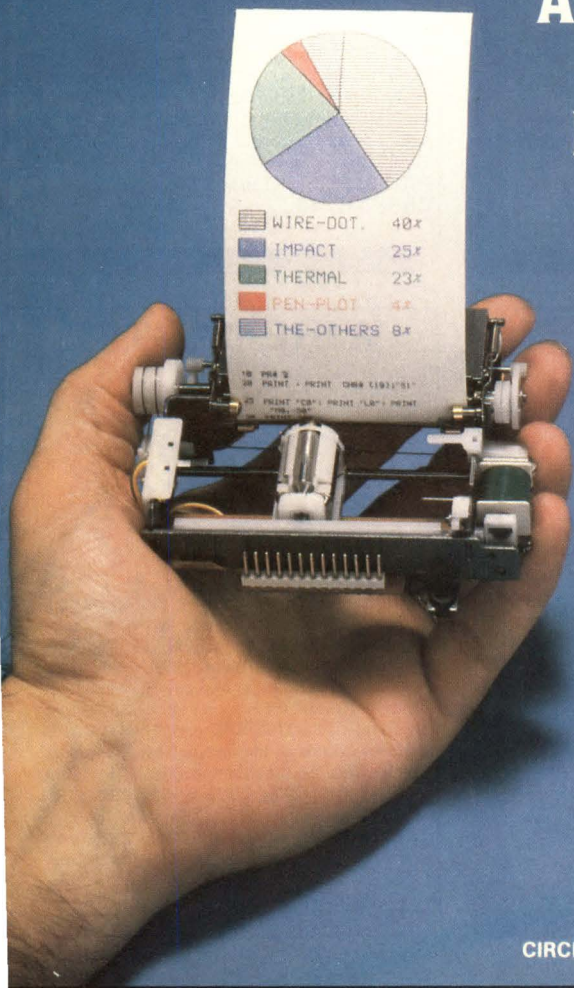

# Presenting: System Showcase

Your product could be represented here next month...

**CALL MAUREEN SEBASTIAN**  
(617)486-9501  
**TOLL FREE**  
(800) 225-0556

CIRCLE 475

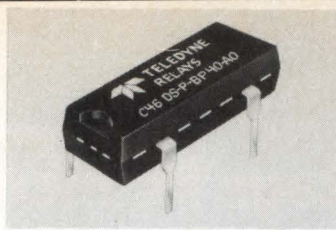

## SOLID STATE POWER FET AC/DC RELAY

Teledyne's C46/C47 series are pin compatible replacements for DIP reed relays where low EMI switching, high reliability and long life are required. Switches AC or DC up to 400V. On-resistance as low as 7 ohms. Control voltage range is 3.8 to 32VDC. Optical coupling provides 1500VDC isolation. Features no offset voltage, low off-state leakage, and high switching speed. \$5.80 ea for 5000 pcs. **TELEDYNE RELAYS**, 12525 Daphne Ave, Hawthorne, CA 90250. Tel: (213) 777-0077. **CIRCLE 491**

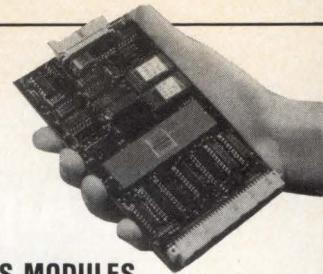

## VME BUS MODULES

Are you looking for 68000 16 bit power in a small size for your automation and control problems? Mizar has the answer with a complete line of single height VME bus modules that include the VME 8100 CPU module shown above with sockets for 16K EPROMs and an RS232 port all for only \$680.00 in single quantities, or the VME8505 GPIB interface for only \$350.00. Ten other modules are in stock, available for immediate shipment. Call for more info. **MIZAR INC.**, 302 Chester Street, St. Paul, MN 55107. Tel: (612) 224-8941, Telex: 469542. **CIRCLE 492**

## UV EPROM ERASER

- Erases over 15 EPROMS - 15 minutes erase time
- Operates for 7700 hours
- Intensity 12961 u/cm<sup>2</sup> at 1"
- Erases all UV EPROMS (2716, 2732, 2516, 2532, etc.)

**\$49.95\***

\*HOBBY MODEL

INDUSTRIAL MODEL

DUV-18 / 2N

\$68.95

WITH TIMER AND SAFETY SWITCH

DUV-18 / 2T

\$97.50

INTELLIGENT PROGRAMMER

STAND ALONE

RS-232

\* RELIABLE

\* EASY COPY

\* USER FRIENDLY

PROGRAMS: 2508, 2516, 2532, 2716, 27C16, 27C32,

2732, 2732A, 2758, 8748, 8748H, 8748H,

OPTIONAL MODULES: 2564, 2764, 8755A, 8741

\* STAND ALONE, CRT, OR COMPUTER CONTROL

\* UP TO 400 PROGRAMS IN MOTOROLA OR INTEL HEX FORMAT

\* MICROPROCESSOR BASED • 4 K INTERNAL RAM

\* 90 DAY PARTS & LABOR WARRANTY ON ALL PRODUCTS

SOON TO BE RELEASED:

PROMPRO-8 128K Version 5689

**MONEY BACK GUARANTEE**

(MCS-48)

PROGRAMMING

PRICE INCLUDES PERSONALITY MODULE

**\$489.00**

**LOGICAL DEVICES INC.**

781 W. OAKLAND PARK BLVD. • FT. LAUDERDALE, FL 33311

Phone Orders (305) 974-0967 • TWX: 510-955-9496

CIRCLE 476

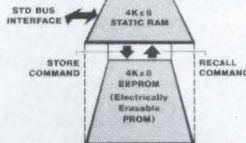

## STORE 4K BYTES IN 10 mSEC?

That's right! The PM2212A STD-BUS Nonvolatile RAM card can safely store ALL of its 4K byte RAM array into EPROM in just 10 milliseconds. Long waits between byte writes are eliminated. No complicated software...two I/O commands control data STORE and RECALL. No batteries to fail or corrode. 10+ years data retention. Available NOW in 1K, 2K & 4K versions. **PENN MICROSYSTEMS, INC.**, 2318 WEST EIGHTH ST, ERIE, PA 16505. Tel: (814) 452-4005. **CIRCLE 477**

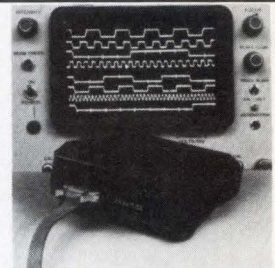

## OUR REAL TIME LOGIC ANALYZER

could become your most valuable accessory. Easily attaches to any oscilloscope to compare 8 ± 15 volt signals simultaneously. Make accurate timing and phase relation measurements from DC to 8 Mhz. Low power design takes power directly from circuit under test. Complete with 30 inch E-Z-Microhook probe set, manual and full 1 year warranty for only \$119.95. Send Check or money order to **HEAVYSIDE INDUSTRIES**, PO Box 2742, Westport, CT 06880-0742. **CIRCLE 478**

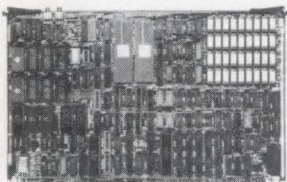

## 68000 'VERSABUS'™ SUPER BOARD

- 8, 10, 12MHz OPERATION—NO WAIT STATES
- 256K DUAL PORT RAM W/BYTE PARITY
- ON-BOARD OPTIONAL MMU
- 64K ROM, 2 FLEXIBLE SERIAL PORTS,
- BUFFERED PARALLEL PORT, TIMERS,
- POWERFUL INTERRUPT STRUCTURE
- 'SASI'™ BUS DISK/TAPE INTERFACE
- FULL VERSABUS IMPLEMENTATION
- RUNS UNIX, ADA, PASCAL, CP/M 68K
- COMPLETE STAND ALONE, OR MULTI-PROCESSOR SYSTEM

**BRI**, 748 Cascadilla St, Ithaca, NY 14850. Tel: (607)273-3300. **CIRCLE 479**

## NEW ENHANCED SL-800E SERIES



LOW COST ANALOG & DIGITAL I/O FOR DATA ACQUISITION AND CONTROL Requires no bus interfacing. Operates with any computer via **RS-232-C/RS-423** at user selectable (300-9600) baud rate; completely transparent to host when in assembly or any high level language. **FEATURES:** 16 Analog inputs (1, 1, 10V Ranges) 12-bit res. • Autorange or Programmable • 2 Analog outputs (12-bit res.) • 8 Digital inputs & 8 Digital Outputs (expandable to 40 lines total) • Local Data Storage (1600 Measurements) • Real Time Clock • AC Power Supply. **PRICES** from \$995. (Qty 1) Board Level. \$1895. (Qty 1) Rackmount or Tabletop Configuration. **SERIAL LAB PRODUCTS INC**, PO Box 766, Marlboro, MA 01750. Tel: (617) 481-1684. **CIRCLE 480**

## WIRESMASTER

Whip your wire wrap and PC layout problems with **WIRESMASTER**



**WIRESMASTER** is a software tool for design, layout, and assembly of hardware. Your schematic is fed to **WIRESMASTER**, which produces network maps, cross-references, wire and parts lists, and debug checklists. **CHANGEMASTER** keeps track of fixes and updates. **PLOTBOARD** and **PRINTBOARD** give pictures of the layout. **Post-processors** for wirewrap machines available. Runs on 8 and 16 bit CP/M, CDOS, and MSDOS. \$195.

**AFTERTHOUGHT ENGINEERING** 7266 Courtney Dr., San Diego, CA 92111, (619) 279-2868. **CIRCLE 481**

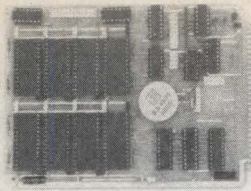

### STD BUS - UNIVERSAL MEMORY CARD

The UMEM-64 universal memory card with battery backup enables the user to mix and match a variety of memory types on the same card: 2k, 4k, 8k x 8, RAM, PROM, EEPROM to 6 MHz. Memory is retained if the board is removed from the system or the power shut off, making this card ideal for data logging and critical process control applications. Prices begin at \$250. DRAM 256k memory cards from \$495. For information on the full line of STD Bus products offered, contact: **COMPUTER DYNAMICS, INC.**, 105 S Main St, Greer, SC 29651. Tel: (803) 877-7471. **CIRCLE 482**

## DISCOVER CHEYENNE!

**NO—Corporate Income Tax**  
**NO—Personal Income Tax**  
**NO—Inventory Tax**  
**NO—Tax on In-transit Goods**  
**NO—Tax on Intangibles**  
**NO—Problems!**

- 2 Industrial Parks • 2 Major Railroads
- 9 Truck Lines • "Right-to-Work" State

*Locate your corporate HQ,  
 master distribution warehouse,  
 or manufacturing plant in  
**CHEYENNE, WYOMING***

HAROLD M. MILLER, Ex. Director  
 Industrial Development Assn. of Cheyenne  
 Municipal Building, 2101 O'Neil Ave.  
 Cheyenne, WY 82001 • 307-637-6385

**CIRCLE 483**

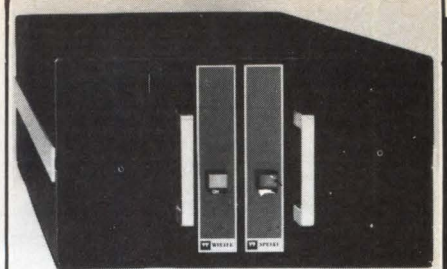

### SPRINT 68 MICROCOMPUTER

CONTROL COMPUTER DEVELOPMENT SYSTEM 6800 MPU, serial I/O, 48K RAM, dual 8" drives, WIZRD multitasking DOS, editor, assembler, 16K BASIC, all for \$3949. Options; C, PL/W, PASCAL, FORTRAN, EROM programmer, analog I/O, parallel I/O, 488 GPIB interface, CMOS RAM/battery, power fail detect/power on reset. **WINTEK CORP.**, 1801 South Street, Lafayette, IN 47904; (317) 742-8428.

**CIRCLE 484**

## ANALOG ↔ DIGITAL DIGITAL ↔ ANALOG

CONVERSION MODULES

SOFTWARE  
 GAIN CONTROL

high accuracy — programmable gain instrumentation amplifier — custom board test — \$100 — 2 to 15 khz conversion time — mixable high and low inputs — gain from 1 to 1024 — 12-bit — sample and hold amplifier 8-channel differential — 16-channel — analog to digital high accuracy — programmable gain instrumentation amplifier — custom board test — \$100 — 2 to 15 khz conversion time — mixable high and low inputs — gain from 1 to 1024 — 12-bit — sample and hold amplifier 8-channel differential — 16-channel — analog to digital high accuracy — programmable gain instrumentation amplifier — custom board test — \$100 — 2 to 15 khz

For additional details about the AD-100-4 and other fine California Data Corporation 100% individually tested, high reliability products, circle the reader service card number below or for faster response write or call us.

### CALIFORNIA DATA CORPORATION

3475 Old Conejo Road, Suite C-10  
 Newbury Park, CA 91320

(805) 498-3651

**CIRCLE 485**



### COLOR GRAPHIC VT 100<sup>®</sup>

A fully interactive, 7 color high resolution 13" or 19" ANSI/ASCII standard display terminal that is available with or without an ISC8001G<sup>®</sup> emulator. The unit is capable of displaying 24 or 48 lines, non-interlace. The 87 key detachable keyboard has 24 programmable function keys. Additional graphic capabilities and light-pen are optional. Volume prices as low as \$2200. **COLORGRAPHIC COMMUNICATIONS CORP.**, PO Box 80448, Atlanta, GA 30366. Tel: (404)455-3921.

**CIRCLE 486**

COMPUTER DESIGN'S  
**HOTLINE**  
**AAA ACTION**  
**CARDS**  
 A NEW AUDIENCE

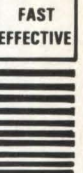

### MORE HOT SALES LEADS...

Computer Design's Hotline Action Cards are mailed to a special list of 65,000 readers including the most recent inquirers to our new product editorial items. Rates start at \$895 per card. If you run 2 or more cards in Computer Design's regular Direct Action Card Mailings your Hotline Card costs only \$795.00—A \$100 saving! Closings: May 21, August 21, October 21. Contact Shirley Lessard, **COMPUTER DESIGN**, 119 Russell St, Littleton, MA 01460. Tel: Toll Free (800)225-0556.

**CIRCLE 487**

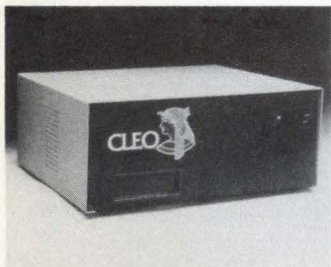

### 3276 PROTOCOL CONVERTER

CLEO allows up to eight asynchronous ASCII terminals to communicate with a BSC port and may be multi-dropped with other cluster controllers from one port. CLEO may be local or remote over leased-line modems. ASCII terminals may be on-site or remote, over dedicated lines or dial-up. **PHONE 1, INC.**, 461 N Mulford Rd, Rockford, Illinois 61107. Tel: (815) 397-8110.

**CIRCLE 488**



### HAND-HELD CONTROL/DISPLAY TERMINALS

Brochure from Termiflex Corp. shows versatile line of standard and custom hand-held terminals used both as control panels and field service tools. Terminals offer displays of 16 to 80 characters. Operating temperature ranges include -18°C to +50°C and -40°C to +50°C. Terminals described interface with host computers in much the same way as a CRT terminal. **TERMIFLEX CORP.**, 18 Airport Rd, Nashua, NH 03063. Tel: (603) 889-3383, TWX: (710)228-7545.

**CIRCLE 489**

ELIMINATE PAPER TAPE  
 ON YOUR  
 NC MACHINES!

VMEbus 68000 NC CONTROLLER  
 WITH  
 NETWORKING SOFTWARE

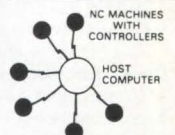

- REPLACES PAPER TAPE INPUT TO YOUR NC MACHINES WITH IRONICS' VMEbus CONTROL COMPUTER
- NETWORKING SOFTWARE ALLOWS DOWN LOADING OF PROGRAMS DIRECTLY FROM HOST and RETURNS PRODUCTION STATUS INFORMATION
- INTERFACES TO ALL TYPES OF NC MACHINES VIA UNIVERSAL INTELLIGENT CONTROLLER.



**IRONICS INCORPORATED**  
 DMS FACTORY AUTOMATION DIVISION  
 117 Eastern Hts. Dr. P.O. Box 356  
 Ithaca, NY 14850 (607) 277-4060

**CIRCLE 490**

# AUTOMATION & CONTROL AD INDEX

Acromag.....	172	Ithaco-Scientific.....	159
<i>Brewer Associates Inc Advertising</i>		<i>Northrup and Teel Inc</i>	
Advanced Micro Devices.....	12, 13	Kennedy Co.....	1
<i>Keye/Donna/Pearlstein</i>		<i>R L Thompson Advertising</i>	
Afterthought Engineering.....	176	KMW Systems Corp.....	75
Alps Electric (USA).....	174, 175	<i>Bonner McLane Advertising Inc</i>	
<i>Industrial Marketing Associates</i>		Kontron Electronic.....	142, 143
AMP.....	30, 31	<i>Galusha &amp; Associates</i>	
<i>The Aitkin-Kynett Co Inc</i>		Lexidata.....	73
Ampex, Memory Products Div.....	147	<i>Humphrey Browning MacDougall</i>	
Amphenol, an Allied Co.....	154, 155	Logical Devices.....	176
<i>Marsteller Inc</i>		Lundy.....	5
Applied Circuit Technology.....	100	<i>Lundy House Advertising Agency</i>	
<i>Cube 4</i>		MDB Systems.....	69
Aydin Controls.....	91	Metacomp.....	53
<i>Gain Advertising</i>		Miniline.....	170
Braemar Computer Devices.....	157	Mini/Micro.....	161
<i>Dewey Advertising Inc</i>		Mizar.....	176
Bio Research.....	176	Monolithic Systems.....	71
Bruel & Kjaer.....	67	<i>Dan Meinerz Graphics</i>	
<i>Advertising Assistance Inc</i>		Mostek.....	140, 141
Burr-Brown Corp.....	10, 115, 125	<i>Crume &amp; Associates Inc</i>	
<i>Corporate Advertising Management</i>		National Semiconductor Corp.....	43-47
Calcomp.....	98, 99	<i>Reiser Williams DeYong</i>	
California Data.....	177	Omnibyte Corp.....	97
Carroll Touch Technology.....	84	<i>Jon R Burton and Associates Inc</i>	
<i>Richard Newman Associates Inc</i>		Orca Tech.....	107-110
Cherry Electrical Products.....	39	Penn Microsystems.....	176
<i>Kolb &amp; Bauman Advertising Inc</i>		<i>D E Wendelboe Associates Inc</i>	
Chrislin Industries.....	153	Phone 1.....	177
Chromatics.....	55	Plessey Microsystems.....	80
<i>Nucifora &amp; Associates</i>		<i>Pawluk Advertising Inc</i>	
Colorgraphic Communications.....	177	Plessey Peripherals.....	150
<i>Design &amp; Visual Effects</i>		<i>Pawluk Advertising Inc</i>	
Columbia Data Products.....	62, 63	Princeton Graphic Systems.....	106
Compumotor.....	168	Quadrex Corp.....	113
Computer Dynamics.....	177	Ramtek.....	Cover IV
<i>Lines Unlimited</i>		<i>Pinné Garvin &amp; Hock Inc</i>	
Computrol Div of Kidde Automated Systems.....	14	Raryan Computer Enhancement Systems.....	121
<i>Technell Inc</i>		<i>DeSpain &amp; Co</i>	
Cubit.....	162	Real-Time Computer Science Corp.....	171
Curtis Industries.....	168	Rockwell International.....	Cover II
<i>Wilson Picciolo &amp; Krymkowski Inc</i>		<i>Ketchum Advertising</i>	
Cybernetic Micro Systems.....	170	ROLM Corp.....	103
Data Systems Design.....	8, 9	<i>McArthur &amp; Associates</i>	
<i>Tycer • Fultz • Bellack</i>		LF Rothschild Unterberg Towbin.....	117
Data Translation.....	88	<i>Albert Frank-Guenther Law</i>	
<i>Quinn &amp; Johnson Inc</i>		Scientific Micro Systems.....	139
Diamond Manufacturing Co.....	138	Serial Lab Products.....	176
Distributed Computer Systems.....	96	Shugart Associates.....	17-26
Electronic Programming Corp.....	157	<i>Chiat/Day Advertising Inc</i>	
Electronic Solutions.....	165	Spectragraphics Corp.....	Cover III
<i>Bowen &amp; Associates Inc</i>		Spectrum Control.....	158
Elpac Power Systems.....	135	<i>Barickman Advertising</i>	
<i>EEL Advertising</i>		Syscon Corp.....	156
Esprit Systems.....	169	<i>GB Administrative Services</i>	
<i>TCl Advertising Inc</i>		TDS.....	149
ETI Micro.....	93	<i>June Whitworth &amp; Associates Inc</i>	
<i>Marken Communications</i>		Tektronix.....	6, 7
First Systems.....	118	<i>Tektronix Advertising</i>	
<i>Nathanson Advertising Inc</i>		Teledyne Relays.....	176
John Fluke Mfg Co.....	95	<i>Michelson Advertising</i>	
Forth.....	16	Termiflex Corp.....	177
Fujitsu FMI.....	59, 60, 61	<i>Spencer Bennett Nowak Inc</i>	
<i>Austin Associates</i>		Toko America.....	160
GE Intersil Systems.....	2	<i>Prophet Associates</i>	
<i>Ebey Utley &amp; McManus Advertising</i>		Transwave.....	123
Gould, SEL Computer Systems Div.....	15	Universal Data Systems.....	105
<i>Group 3hree Advertising Corp</i>		<i>Dayner/Hall Advertising Inc</i>	
Heaviside Industries Ltd.....	176	Visual Technology.....	41
Hewlett Packard.....	85, 86, 87	<i>Blackwood Associates Inc</i>	
<i>Wilton Coombs &amp; Colnett Inc Advertising</i>		Wangtek.....	57
Hewlett Packard.....	173	<i>R L Couch &amp; Co</i>	
<i>Tallant/Yates Advertising Inc</i>		Western Digital.....	37
Hicomp Technology Corp.....	180	<i>Larry Pao Design</i>	
Industrial Development Association of Cheyenne.....	177	Wintek Corp.....	177
<i>Ray Lansing Advertising</i>		ZAX.....	133
Intel.....	77, 78, 79	<i>Sales Management International Inc</i>	
<i>Chiat/Day Inc Advertising</i>		Zenith Radio Corp.....	167
Intelligent Systems Corp.....	64	<i>Footo Cone &amp; Belding</i>	
<i>The Marcus Group Inc</i>		Ziatech Corp.....	166
International Microcircuits.....	144	Zilog.....	137
<i>Ad Design</i>		<i>Pinné Garvin &amp; Hock Inc</i>	
Ironics.....	177		



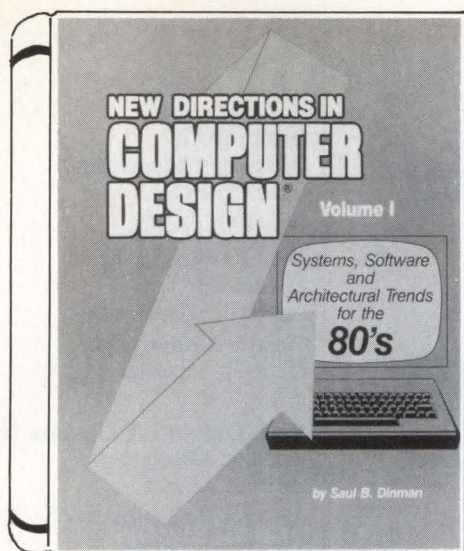

## New Directions in Computer Design: Systems, Software and Architectural Trends for the 80's Volume I, by Saul Dinman

Some 20 years of technological innovation have created dramatic developments and changes in the computer systems industry. The book presents systems, software, and architectural trends for the 80's through a collection of articles covering Minicomputers, Microcomputers, Memory Systems, Software, and Data Communications.

PennWell Books, 1982, 135 pages, ISBN 0-87814-209-6, \$19.95. **Circle 455**

### HOW TO ORDER:

#### 15-DAY FREE EXAMINATION (U.S. AND CANADA ONLY)

Simply circle the appropriate number(s) on the Reader Inquiry Card at the back of this magazine.

Your book will be sent to you for your **15-day free trial**. If you are satisfied, keep the book and an invoice will follow. Otherwise return the book by the end of the 15-day period, and owe nothing.

## Microcomputer Systems by Ivan Flores and Christopher Terry

Until now, microcomputer books simply told how to buy a microcomputer and then summarized what was available, discussed specific computer language and operating systems, or described families of integrated circuits. But this one-of-a-kind guide on microcomputer systems clearly explains both how each part of the system works and how they all fit together.

208 pp, 6 x 9, \$22.50, April **Circle 456**

## Musical Applications of Microprocessors by Hal Chamberlain

Immediately acclaimed as a classic! Covers all current electronic and computer music performance techniques as they apply to microprocessors. Signal-processing techniques are presented in nonmathematical language and applied to newer, more powerful 16-bit microprocessors.

#5753-9; 688 pages; Hayden Book Co, Inc.; \$26.95 **Circle 457**

## The S-100 Bus Handbook by David Bursky

Exclusively discusses S-100 bus computer systems and how they are organized. Covers computer fundamentals, basic electronics and the parts of the computer. Explains all operating details of commonly available S-100 systems. Each major system board detailed as to its operation and how it connects to the rest of the system.

0897-X, 272 pages; Hayden Book Co., Inc. \$15.75 **Circle 458**

## Operating Systems A Pragmatic Approach by Harry Katzan

Computer pro Harry Katzan provides here authoritative coverage of the construction, functions, and terminology of operating systems. He fully explains such areas as dynamic loading and address translation, use of public and private storage, and virtual memory, data sets, and access methods. "A valuable addition to any computing library."

374 pp, 6 x 9, \$10.95, February **Circle 459**

## DATA COMMUNICATIONS a user's guide by Kenneth Sherman

A BRAND NEW quick and effective source for pinpointing and eliminating system malfunctions, discovering new, more efficient data movement, learning effective troubleshooting, ensuring strong, clear signal transmission and achieving maximum performance and value. Put these *all new* ideas and many others to work for you!

348 pages; 95 illustrations; Reston Publishing Company Inc; \$21.95. 1981. **Circle 460**

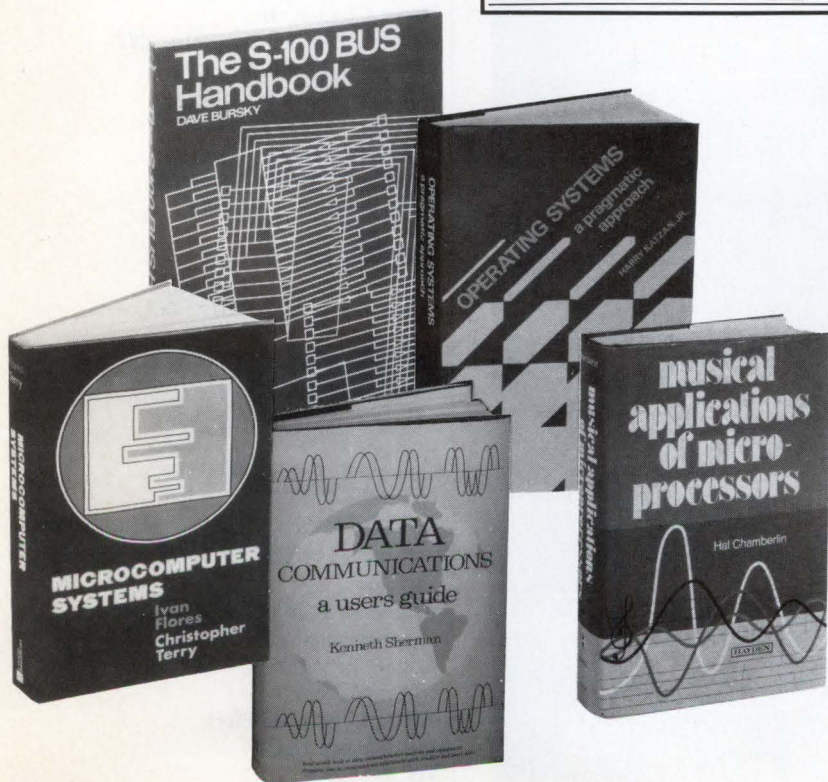

# TOUGH BUBBLE, NO TROUBLE

New! Emulate your floppy disk drive with Hicomp's high reliability one megabyte bubble memory peripheral.

Now you can forget about the problems that plague disk drives. The MBM-1 is compatible with industry standard 5 1/4" and 8" floppy disk controllers and requires no software driver development.

**Reliable - your data is there when you need it.** The MBM-1 has no mechanical parts and fans to wear out or break down. It has a minimum MTBF of 30,000 hours - 2 to 5 times greater than commercial disk drives.

**Survivable - even in the toughest environments.** Bubble memory has high tolerance to extreme temperature, humidity, shock and vibration. This allows you to put your system in environments that would destroy floppy or Winchester disk-based systems.

**Non-volatile bubble memory - the technology that doesn't forget.** When the power goes down, the MBM-1 retains all data, without expensive battery back-up systems.

Add greater reliability and performance to your new or existing computer system. Call Hicomp and ask about our MBM-1 one megabyte bubble memory peripheral.



## HICOMP

Tough technology for hostile environments.

Hicomp Computer Corporation  
3860 148th Ave. N.E.  
Redmond, WA 98052 (206) 881-6030  
Telex: 32-0357

## CD\* SALES OFFICES

**Home Office**  
**Director of Marketing**  
Gene Pritchard  
**Direct Marketing**  
Shirley Lessard  
**List Rental**  
Robert P. Dromgoole  
**Classified Advertising**  
Maureen Sebastian

**New England & Upstate New York**  
**Regional Manager**  
Barbara Arnold  
**Account Representative**  
Maureen Sebastian  
119 Russell St.  
Littleton, MA 01460  
(617) 486-9501

**Middle Atlantic States,**  
**Long Island & Southeastern States**  
**Dick Busch, Inc.**  
Richard V. Busch  
6 Douglass Dr., R.D. #4  
Princeton, N.J. 08540  
(201) 329-2424  
Eleanor Angone  
74 Brookline Ave.  
E. Atlantic Beach, NY 11561  
(516) 432-1955

**Midwestern States & Colorado**  
**Berry Conner Associates**  
Berry Conner, Jr.  
88 West Schiller St., Suite 2208  
Chicago, IL 60610  
(312) 266-0008

**Western States & Texas**  
**Buckley/Boris Assoc., Inc.**  
Tom Boris  
John Sabo  
Terry Buckley  
2082 SE Bristol, Suite 216  
Santa Ana, CA 92707  
(714) 957-2552  
(408) 866-8735  
Terry Buckley  
M. Patricia Shay  
P.O. Box 278  
Campbell, CA 95009  
(408) 866-8735  
(714) 957-2552

\*(TM)

**Europe**  
**American Publishers**  
**Representatives Inc.**  
Robert Broekman  
L'Avant Seine  
4 Rue Robert De Flers  
75015 Paris  
Tel: 609.95.95

# SPECTRAGRAPHS SYSTEM 1250 IBM-COMPATIBLE COLOR GRAPHICS

Good news for people who think in color.

You now have a comparably priced alternative to the IBM black-and-white 3250. System 1250 from Spectragraphics.

With a graphics workstation that replaces black-and-white with 16 vibrant colors.

And gives you complete area fill capability

"Fat" line and large point generation, and overlaying.

A 12 Mhz pixel writing rate and 40 Hz refresh rate.

And the ability to add up to 64 workstations—sixty four—anywhere from the next office to two miles

away, from a single channel connection.

So if your present IBM 3250 system has you bound hand and cable to black-and-white, take heart.

Because now you can afford to think color. And for a lot less than you thought.

||||||| **SPECTRAGRAPHS**

Spectragraphics Corporation / 10260 Sorrento Valley Road / San Diego, CA 92121 / (619) 450-0611



THE BEST HAS JUST  
BECOME THE BEST DEAL.

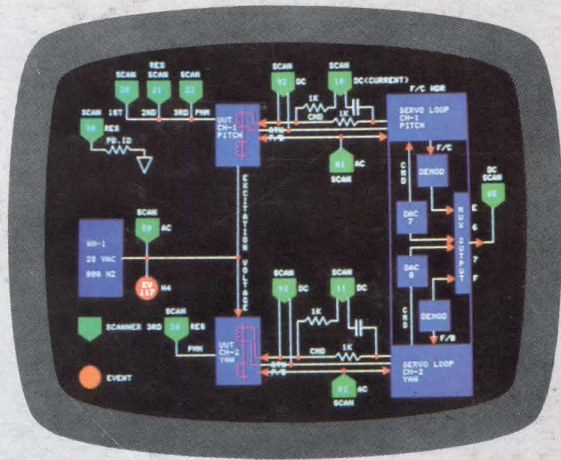

Ramtek's popular 6211 Colorgraphic Terminal is now just \$4995\* This versatile desk-top unit is ideally suited for the majority of color graphic applications in CAD, science, business, and control systems. Rack mounted (without monitor), it's even more of a value at just \$3995.

Need data terminal functions, too? The companion 6221 with full VT 100™ compatibility is priced at just \$5995. Plus, a discount is available on 6211 and 6221 systems when both a color printer and 35 mm slide camera are purchased.

The price of quality has never been lower. Volume discounts are also available. For details, call our office nearest you. Or, contact us at 2211 Lawson Lane, Santa Clara, CA 95050. (408) 988-1044.

**Ramtek**

OUR EXPERIENCE SHOWS.

**World Headquarters**—Santa Clara, CA (408) 988-2211 **European Offices**—Amsterdam (31) 2968-5056; London (8956) 76211; Cologne (2234) 78021 **U.S. Offices**—Dallas, TX (214) 422-2200; Los Angeles, CA (714) 979-5351; Seattle, WA (206) 575-1600; Chicago, IL (312) 397-2279; Houston, TX (713) 774-2233; McLean, VA (703) 893-2020; Denver, CO (303) 694-0758; Cleveland, OH (216) 524-1882; Upper New York/Canada (716) 425-1742; New Jersey (201) 238-2090; Florida (305) 645-0780; Boston, MA (617) 273-4590; Atlanta, GA (404) 252-5066.

\*Light pen sold separately

VT 100 is a registered trademark of Digital Equipment Corporation.