

COMPUTERS AND AUTOMATION

CYBERNETICS • ROBOTS • AUTOMATIC CONTROL

Office Equipment Outlook . . . Oliver J. Gingold

New Products and Ideas

Group Behavior of Robots . . . Manfred Kochen

Robots and Automata: A Short History . . . James T. Culbertson

Automatic Computing Machinery — List of Types

Components of Automatic Computing Machinery — List of Types

The Computer Field: Products and Services for Sale or Rent —
List of Headings

Vol. 6
No. 3

Mar.
1957

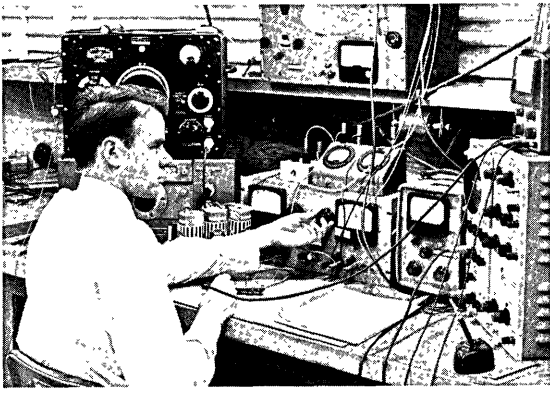

RESEARCH AND DEVELOPMENT

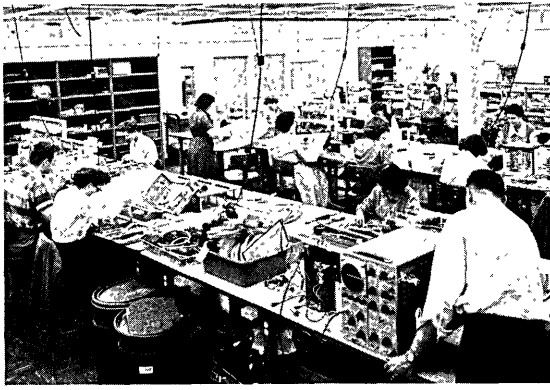

PILOT LINE PRODUCTION



FINAL ASSEMBLY



TESTING IN SCREEN ROOM

COMMUNICATIONS at Ramo-Wooldridge

Communications activities at The Ramo-Wooldridge Corporation include research, development, and manufacture of advanced types of radio communication systems, ground-reference navigation systems, and electronic countermeasure systems. Major programs are in progress in each of these fields.

New and unusual techniques have been employed to provide systems having a high order of security in the transmission of information, broad flexibility in combating unfavorable signal propagation conditions, and substantially greater information capacity per operating channel.

Some of the techniques used have made possible an increased range for given levels of transmitter power and reliability of communications. Others have provided specific advantages in very long distance communications or in operational situations requiring unique signaling capabilities. Developments in navigation systems have resulted in new equipment that is suitable for the guidance of aircraft at long ranges from their bases.

In the work currently under way, some systems are in the laboratory development stage, some in the flight test stage, some are in production. Several types of systems developed and manufactured by Ramo-Wooldridge are in extensive operational use.

*Openings exist
for engineers
and scientists
in these fields of
communications
activities:*

Systems study and analysis
Airborne transmitters
Transistorized video and pulse circuitry
Airborne receivers
Reconnaissance systems
Digital communications systems

The Ramo-Wooldridge Corporation

5730 ARBOR VITAE STREET • LOS ANGELES 45, CALIFORNIA

COMPUTERS AND AUTOMATION

CYBERNETICS • ROBOTS • AUTOMATIC CONTROL

Vol. 6, No. 3

March, 1957

ESTABLISHED SEPTEMBER, 1951

ARTICLES

Office Equipment Outlook	... Oliver J. Gingold	8
Group Behavior of Robots	... Manfred Kochen	16
Robots & Automata: A Short History (Part 1)	... James T. Culbertson	32

NEW PRODUCTS AND IDEAS

10

REFERENCE INFORMATION

New Patents	15
Automatic Computing Machinery - List of Types	22
Components of Automatic Computing Machinery - List of Types	24
The Computer Field: Products and Services for Sale or Rent - List of Headings	28
Survey — Estimate of the Computer Market	39

FORUM

Courses in Automatic Control	25	
Symposium on Systems for Information Retrieval	29	
Education & Computers: Discussion	... A. Lange and others	30
The Service Bureau	31	
International Conference on Operations Research	42	
Education and Computers	... B. Brown	44
Numerical Analysis Course	45	
Instruments and Regulators Conference, Chicago, Apr. 7-10	47	

The Editor's Notes	6
Index of Notices	6
Advertising Index	50

Editor: Edmund C. Berkeley Assistant Editors: Neil D. Macdonald, F.L. Walker
Contributing Editors: Andrew D. Booth, John M. Breen, John W. Carr, III, Alston S. Householder
Advisory Committee: Samuel B. Williams, Herbert F. Mitchell Jr., Howard T. Engstrom,
Alston S. Householder, H. Jefferson Mills, Jr.

Publisher: Berkeley Enterprises, Inc.
815 Washington Street, Newtonville 60, Mass. - Decatur 2-5453 or 2-3928

Advertising Representatives:

New York - Milton L. Kaye, 601 Madison Ave., New York 21, N.Y., Plaza 5-4680
San Francisco - W.A. Babcock, 605 Market St., San Francisco 5, Calif., Yukon 2-3954
Los Angeles - Wentworth F. Green, 439 So. Western Ave., Los Angeles 5, Calif., Dunkirk 7-8135
Elsewhere - the Publisher

COMPUTERS AND AUTOMATION is published monthly. Copyright, 1957, by Berkeley Enterprises, Inc.

Subscription rates: in the United States - one year \$5.50, two years \$10.50; in Canada - one year \$6.00, two years \$11.50;
elsewhere - one year \$6.50, two years \$12.50

Entered as second class matter at the Post Office, New York, N.Y.

*Design engineers indicate widespread
use for*

Sylvania Power Transistor Type 2N242

While the type 2N242 is well known for its original use in the output stage of hybrid auto radio, it is rapidly becoming the standard for general purpose use in a wide range of power applications.

There are good reasons for its growing popularity—10 watts collector dissipation, for instance—welded hermetic seal—and a storage temperature of 85° C to eliminate heat problems under idle conditions.

If you have plans for general purpose transistors you'll be glad to know Sylvania's semiconductor plant in Hillsboro, New Hampshire is just about completely devoted to the production of the Type 2N242. That means Sylvania can meet your volume requirements. And, Sylvania's leadership in the manufacture of semiconductors means you're assured of high product uniformity and dependable performance.

GENERAL FEATURES OF THE 2N242 PNP POWER TRANSISTOR—

- 10 watts max. collector dissipation
- 2 amps max. collector current
- 45 volts max. collector voltage
- New welded hermetic seal
- 30 db minimum power gain (typically 35 db)
- 85° C storage temperature
- 100° C junction temperature
- Thermal drop—3° C per watt (typically 2° per watt)

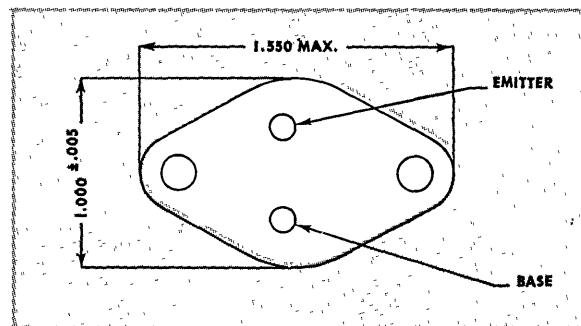

SYLVANIA

SYLVANIA ELECTRIC PRODUCTS INC.
1740 Broadway, New York 19, N. Y.
In Canada: Sylvania Electric (Canada) Ltd.
Shell Tower Building, Montreal



Here are just some of the applications in which designers are effectively using or planning to use the 2N242

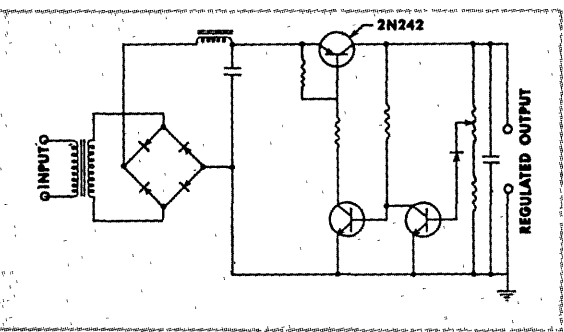

Transistor Voltage Regulation

Transistorization of voltage regulator circuits is one of the most popular general purpose applications indicated for the 2N242. Here is a typical regulator circuit incorporating the Type 2N242. DC to AC converter rates second in popular usage for this power transistor.

How about your general purpose plans for the Type 2N242 power transistor? Call your Sylvania representative or write for technical data.

- * VOLTAGE REGULATION
- DC CONVERTER
- OSCILLATOR, AMPLIFIER
- TRANSISTOR COMPUTER
- MAGNETIC CORE DRIVER
- SERVO AMPLIFIER
- VERTICAL SWEEP OUTPUT
- PULSE POWER OUTPUT
- HIGH CURRENT SWITCH
- RF MODULATOR

	<u>Page</u>
1. The Computer Directory and Buyers' Guide	6
2. Estimate of the Computer Market	6
3. 53 Foreign Subscriptions At Once	38
4. Reference Information	38

**THE COMPUTER DIRECTORY
AND BUYERS' GUIDE, 1957**

The June 1957 issue of "Computers and Automation" will be the third issue of "The Computer Directory". It will be called "The Computer Directory and Buyers' Guide, 1957". The last issue was published in June, 1956.

Part 1 of the Directory in 1957 will be a cumulative "Roster of Organizations in the Computer Field". The last cumulative listings were published in the June and August 1956 issues of "Computers and Automation", and covered over 380 organizations. In the cumulative listing in the Directory, there will be a requested nominal charge of \$10 an entry.

Part 2 of the Directory will be a cumulative "Buyers' Guide to the Computer Field: Products and Services for Sale or Rent". Over 700 entries under 67 headings appeared in the last issue; and it is anticipated that more will appear in the 1957 issue. There will be a requested nominal charge of \$10 an entry; there will also be an opportunity for pictures and associated advertisements. The list of 67 headings appears on page 28 in this issue.

The previous entries and blank forms will be mailed out in February and March to organizations for revisions, changes, and additions. The closing date for receipt of corrected information will be about April 10. The form of entry for organizations and for products appears on page 43 of this issue.

Part 3 of the Directory will be a cumulative edition of "List of Automatic Computers". The last edition appeared in June, 1956 and contained about 220 entries.

It is expected that some other new features will also be included.

One part of the directory in former years, the "Who's Who in the Computer Field", has grown so large that it will be published separately. The next edition is expected to appear in March, and will contain over 190 pages of names, addresses,

and some other information for over 10,000 computer people; it is an extra number of "Computers and Automation", not included in the subscription.

**SURVEYS — ESTIMATE OF THE MARKET
FOR COMPUTERS AND DATA PROCESSORS**

Several of our readers have told us that a magazine that covers a field has an unparalleled opportunity to find out answers to questions about the field by means of surveys — which any single business or organization in the field cannot easily make. We believe this.

The computer field contains many hard-to-answer questions, which can be partly answered through surveys. One of them is the size of the market for computers, data processors, and related equipment. We are devoting our first survey to this problem. (cont'd on page 38)

* ————— *

NEW PRODUCTS AND IDEAS

	<u>Page</u>
1. Simulators for Training Airplane Crews	10
2. Transistor Arithmetic Control Unit	11
3. Miniature Tape Recorder	12
4. Electronic Roulette Demonstrates Computers	13
5. Supermendur — An Improved Magnetic Alloy	14
6. New Air-to-Air Guided Missile	14

* ————— *

INDEX OF NOTICES

<u>For Information on:</u>	<u>See Page:</u>
Advertising Index	50
Advertising Rates and Specifications	40
Back Copies	46
Bulk Subscription Rates	47
Computer Directory and Buyers' Guide	6
Corrections	44
Manuscripts	42
Reader's Inquiry Form	50
Roster Entry Forms	43
Special Issues	44

Address Changes: If your address changes, please send us both your new and your old address (torn off from the wrapper if possible), and allow three weeks for the change.

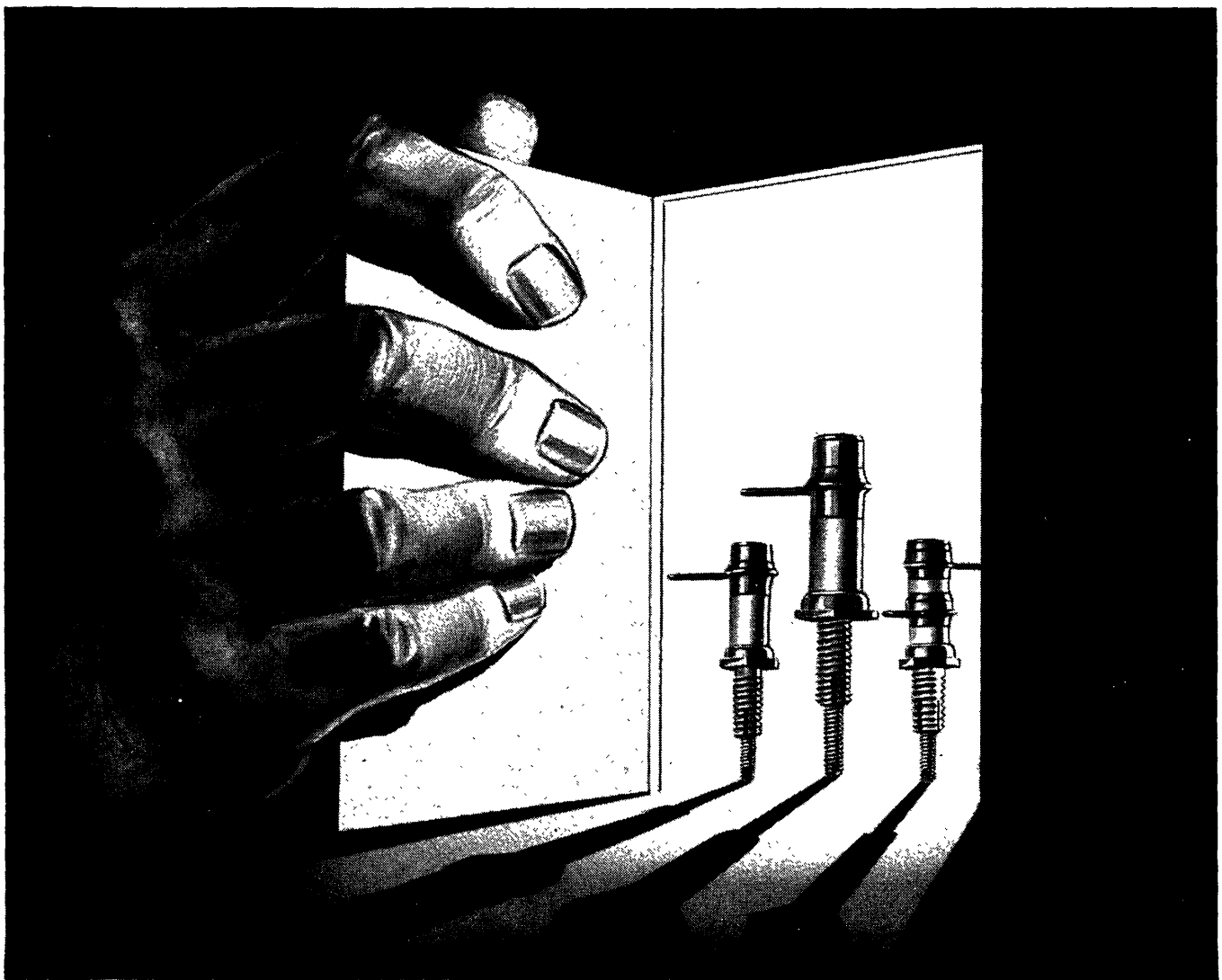

CTC Capacitor Data: Metallized ceramic forms CST-50, in range 1.5 to 12.5 MMFD's; CST-6, in range 0.5 to 4.5 MMFD's; CS6-6, in range 1 to 8 MMFD's; CS6-50, in range 3 to 25 MMFD's; CST-50-D, a differential capacitor, with the top half in range 1.5 to 10 MMFD's and lower half in range 5 to 10 MMFD's.

These Midgets do big jobs well

These capacitors outperform capacitors several times their size. Their tunable elements virtually eliminate losses due to air dielectric, resulting in wide minimum to maximum capacity ranges. The tuning sleeves are at ground potential, and can be locked firmly to eliminate undesirable capacity change.

Every manufacturing detail has to conform to the highest quality control standards. Because of these standards, CTC can guarantee the performance of this family, and of every electronic component CTC makes.

Other precision-made CTC components that benefit from CTC high quality standards include terminals, terminal boards, swagers, hardware, insulated terminals and coil forms. For all specifications and prices, write Cambridge Thermionic Corporation,

456 Concord Ave., Cambridge 38, Mass. On the West Coast contact E. V. Roberts and Associates, Inc., 5068 West Washington Blvd., Los Angeles 16, and 61 Renato Court, Redwood City, California.

New Series X2122 Stand-Off Capacitors with ceramic dielectric are exceptionally rugged. These are general RF by-pass capacitors for use in high quality electronic equipment. The encapsulating resin provides rigidity and durability under extreme conditions of shock, vibration, and humidity. Over-all height mounted is under $\frac{3}{8}$ ". Available in a range of values.

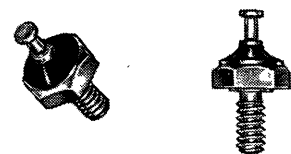

CTC

CAMBRIDGE THERMIONIC CORPORATION

*makers of guaranteed electronic components
custom or standard*



See CTC's Guaranteed Components on Display at Booth 2219, IRE Show, New York Coliseum, March 18-21

OFFICE EQUIPMENT OUTLOOK

Oliver J. Gingold
New York, N. Y.

(Reprinted with permission from The Wall Street Journal, January 17, 1957,
published by Dow Jones & Company, Inc., New York 4, N. Y.)

Business machine manufacturers are riding the crest of the biggest boom in the industry's history and they expect it to pick up added momentum this year. Trade sources calculate that the industry rolled up nearly \$2 billion in sales during 1956 after doing \$1.7 billion in 1955. The forecast for 1957: A jump of approximately 20%, which would push the figure to \$2.4 billion. Earnings generally have kept pace with sales, though some companies insist prices are too low to produce what they consider a reasonable profit. Steps to correct this were taken in 1956: typewriter producers jacked up portable prices in the spring, office models in the fall; and giant International Business Machines Corp. stiffened rental fees for the first time in its history. More of the same seems almost inevitable some time during 1957. Individually, companies assess the outlook this way:

I. B. M. Eyes \$1 Billion Sales —

International Business Machines Corp. which chalked up new sales and earnings records in 1956, is fast on its way to becoming the industry's first billion-dollar company. In fact, IBM now anticipates revenue of \$1,250,000,000 by 1960 — more than double its 1955 volume.

In 1956, it is understood, sales were in the neighborhood of \$700 million, a gain of more than 20% over the \$563,548,792 registered in 1955. Net profits soared, too, reaching more than \$65 million, or about \$12.40 a share, compared with \$55,872,633, or \$10.64 a present share a year earlier.

IBM officials expect continued growth in both sales and earnings during 1957, "assuming a continued healthy economic climate." As they did last year, new products (at least one major computer development is nearing completion) will play a key role in bolstering volume.

Another factor tending to push this year's sales and earnings higher — perhaps at the ex-

pense of profits in later years — is IBM's offer, under the terms of its 1956 consent decree, to sell as well as lease its machines. The company concedes this point, but maintains that "a large majority of customers will continue to rent the equipment."

The concern's expenditures for factories, laboratories, equipment and "rental machine assets" last year topped the record \$134,015,108 spent for these purposes in 1955; and executives figure 1957 capital spending will go even higher. The principal reason is a string of new plants, now under construction at Rochester, Minn., San Jose, Calif., Owego, N. Y., Lexington, Ky., and Sherman, Texas; and a new research laboratory — IBM's ninth — at Yorktown, N. Y. The present state of the money market, says IBM, will have no effect on these projects.

Burroughs Counts on New Products —

Burroughs Corp. in 1956 earned "somewhere between \$2.25 and \$2.40 a share" on the 6,029,000 shares currently outstanding, John S. Coleman, president, disclosed. For 1955 the company reported profits of \$2.19 a share, based on the 5,549,000 shares then outstanding. Last year's sales were up, too, climbing to about \$260 million from \$218,592,481 in 1955.

Mr. Coleman took a rosy view of Burroughs' prospects for 1957, predicting the company's revenues this year will move past the \$290 million mark. New products, involving all the company's major divisions, will be introduced during the last six months of this year. It is understood at least one of these will come from Burroughs' Electro-Data division — acquired last year to give the company an entree into the burgeoning computer business.

The Detroit-based concern, undaunted by the tight money market, is pushing the most extensive construction program in its history, with new

plants abuilding in the United States.

Royal McBee Making Progress —

Sales of Royal McBee Corp., the nation's biggest manufacturer of typewriters, are growing at a somewhat faster pace than earnings. In the four months to November 30, first four of the fiscal year, volume was about 12% ahead of a year earlier, it is understood, while profits were approximately 5% better. It is anticipated that the same percentages generally will carry through the remainder of the first half, which ends January 31.

The company, which initiated last year's round of price increases on manual and office typewriters, concedes that further increases may be in the offing. But, officials add, this time stiffer prices will most likely affect portable rather than office machines. Royal McBee currently is pondering several major expansion programs, despite the tight money situation.

National Cash Register Prospects —

National Cash Register Co. in 1957 expects to better the sales and earnings records set in 1956. Stanley C. Allyn, president, disclosed recently the big Dayton concern earned between \$18 million and \$19 million in 1956, compared with \$15,387,861 in 1955. Sales also jumped ahead last year, reaching \$340 million against \$301 million in 1955. The current 12 months, Mr. Allyn predicts, will produce sales in the neighborhood of \$400 million, and profits greater than those registered in 1956.

Addressograph Records in Sight —

Indications are that Addressograph-Multi-graph Corp. will post new highs in sales and earnings in the fiscal year ending July 31, 1957, with sales expected to cross the \$100 million mark for the first time. The best previous performance was turned in during fiscal 1956, when sales totaled \$86,980,514, and profits amounted to \$7,289,268, or \$8.34 a share.

Despite disruptions of operations resulting from a seven-day strike in November and the usual holiday slow-down, it is anticipated sales and earnings for the second quarter of the fiscal year will be comparable to those in the first quarter. In that period, ended October 31, the company reported volume of \$25,586,825 and profits of \$1,967,289, or \$2.22 a share; both figures were substantially higher than a year earlier.

The company's cheerful outlook on 1957 is reflected in a decision to boost sales quotas 27% over

last year, Mr. Ward said, and its optimism for future years is demonstrated by a \$5,500,000 expansion project now under way at Cleveland. The addition, providing 50% more floor space for a planned increase in research, engineering, and manufacturing, is slated for completion in March.

Sperry's Stake —

Remington Rand division of Sperry Rand Corp. will complete "the biggest year in its history" on March 31, "and it would appear that next year will be even bigger," Marcell N. Rand, executive vice president and general manager, asserted. In the nine months ended December 31, 1956, sales and earnings of the division "ran well ahead" of a year earlier, Mr. Rand added. No figures are available for comparison, however, since Remington Rand operated as an individual company until July 1, 1955, when it merged with Sperry Corp. to form the present concern.

A few months ago, Gen. Douglas MacArthur, Sperry Rand chairman, forecast that the company's 1957 sales would reach \$775 million. It is understood that sales of Remington Rand office equipment continue to account for about one third of Sperry Rand sales.

Mr. Rand voiced the opinion that prices on office equipment should be raised to meet constantly climbing costs. But as to Remington Rand's probable course of action, he would say only that "the company is studying prices on all our products quite carefully."

Remington Rand, which added four new plants in calendar 1956, is presently considering further expansion projects. Tight money, says Mr. Rand, hasn't affected such planning up to this time.

Smith-Corona Acquisition Helpful —

The acquisition of Kleinschmidt Laboratories, Inc., completed last August after a protracted legal battle, is apparently paying off for Smith-Corona, Inc. Elwyn L. Smith, president, believes sales and earnings for the six months ended December 31 were "substantially" ahead of the records set in the first half of fiscal 1956. In the earlier period, the Syracuse concern posted profits of \$866,000 on sales of \$19,300,000.

He anticipates that sales and earnings for fiscal 1957, ending June 30, will also be at new highs. Supporting this forecast, he added, is the fact that new orders outstripped production for several weeks late in 1956. A further boost may come from the introduction of an electric port-

(cont'd on page 31)

NEW PRODUCTS AND IDEAS

SIMULATORS FOR TRAINING AIRPLANE CREWS

American Airlines
Los Angeles, Calif.

The first of four DC-6 and DC-7 airplane procedural trainers developed by American Airlines for training new flight crews and refreshing veteran crews in cockpit operating techniques has been installed by American Airlines at Los Angeles.

These trainers, which are on the ground and not airborne, are full-scale mockups of the DC-6 and DC-7 flight deck, and include pilot's, co-pilot's, and flight engineer's positions. Each will be used by the airline to make crews familiar with the cockpit, the location of instruments, and operational techniques. The new equipment will enable crews to practice engine starting and control, management of fuel, operation of electrical and hydraulic systems, emergency procedures, and coordination of the crew under simulated operating conditions. The trainers are designed primarily to make crews familiar with all parts of normal and emergency procedures, but navigational training is not included. Incorporated in the equipment is

an instructor's station and a control panel. An instructor thus may introduce emergencies and operational problems, for the crew in training to solve.

These trainers have been constructed by Burton Rodgers, Technical Training Aids, Cincinnati, Ohio. They are being installed in American Airlines' major training bases at New York, Chicago, and Fort Worth, as well as at Los Angeles. All units have mechanical-type computers, externally mounted adjacent to the cockpit. They are designed for swift disassembling and easy shipment, and may be separated into sections no larger than 60 inches wide and 80 inches high.

Development of the trainer goes back to 1948 when M. C. Thompson, of American Airlines, designed, constructed, and installed a handmade version at the company's former training base at Ardmore, Okla.

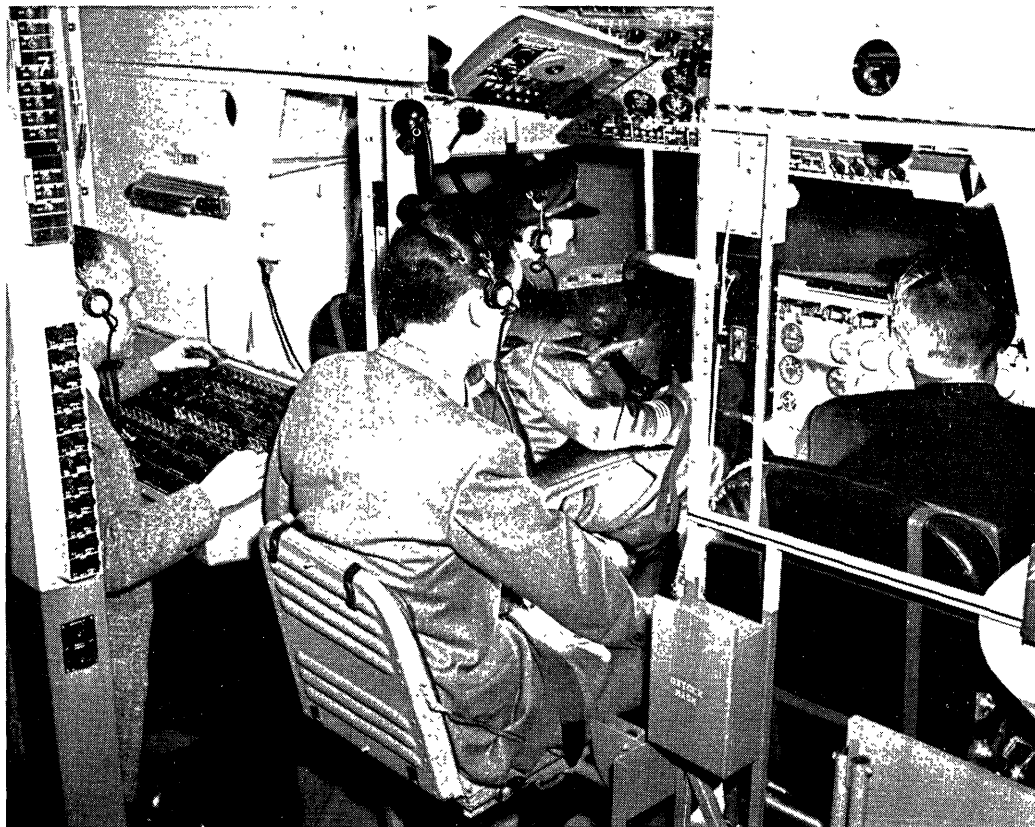

Airplane Procedural Trainer — This trainer was developed by American Airlines to familiarize flight crews for DC-6 and DC-7 planes in cockpit operating techniques. The instructor (left) may use his control panel to introduce operational problems and emergencies for the three-man flight crew to solve. Virtually any problem encountered in flight may be simulated in these procedural trainers, to be installed in New York, Chicago, Fort Worth, and Los Angeles.

TRANSISTOR ARITHMETIC CONTROL UNIT

Philco Corp.,
Philadelphia, Pa.

Figure 1 shows a Transac arithmetic control unit, developed at Philco's Government and Industrial Division. This computing unit occupies only one-third cubic foot and weighs less than 12 pounds. It operates on only 3 volts potential and employs a unique direct-coupled circuitry, and thereby eliminates many components usually found in electronic computers. The unit contains nearly 1,000 tiny transistors, 300 resistors and 12 capacitors permanently dip-soldered into compact, plug-in, printed-circuit cards. Each card provides all the necessary functions for one binary digit including add, subtract, multiply, divide, square root, shift right,

shift left, sign magnitude, and absolute magnitude. Ten "math" cards and seven "control" cards are plugged into the ten inch long unit to provide all arithmetic processing facilities between conventional input and output devices. Input-output connections are made by plugs. This Transac unit adds two numbers in 1.5 microseconds; it multiplies in 15 microseconds. A row of indicator lights provides visual display of results. Transac math-control units with larger digital capacities can be built in "building block" fashion by simply increasing the number of plug-in "cards".

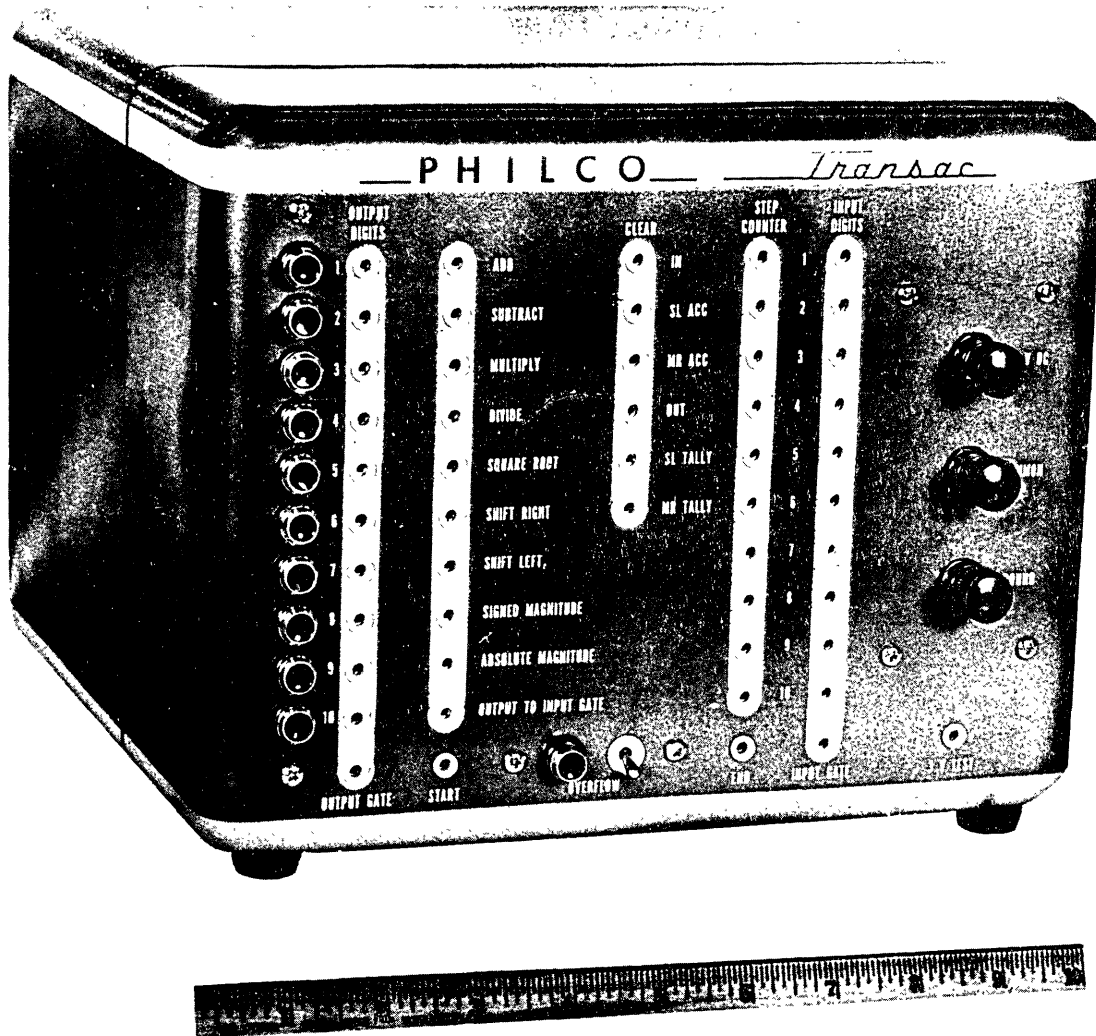

Figure 1 — Transac Arithmetic Control Unit

MINIATURE TAPE RECORDER

North American Instruments, Inc.
Altadena, Calif.

A tiny tape recorder has solved one of the most perplexing problems in missile flight test programs: the collection of aerodynamic data from missiles too small for telemetering equipment.

Developed by North American Instruments, Inc., Altadena, California, the miniature magnetic recorders are being used by a dozen different companies which are conducting rocket and missile tests on government contracts.

To date, the principal use of the instrument has been for obtaining skin temperatures during critical periods in high-speed, high altitude flights of missiles. In particular, it has gathered vital data from test flights of the hypersonic test vehicle (HTV) developed by Aerophysics Development Corp., Santa Barbara. The HTV has reached a speed of 5,000 miles per hour at altitudes in the region of 50,000 feet.

The recorders also are beginning to be used to gather many kinds of data from both test missiles and free-flying models in wind tunnels. Until recently, data from both the real and simulated flights usually has been transmitted by radio signals from heavier, bulkier telemetering equipment.

Use of telemetering equipment has presented problems for midget missiles and models.

The newly-developed miniature recorders are four inches in diameter, five inches high and weigh 2-1/4 pounds and, according to Eugene Bollay, president of North American Instruments, they are extremely reliable and rugged.

One Northam recorder, Bollay says, has been recovered and reused eight times in missile tests at Holloman Air Development Center, New Mexico. In contrast, telemetering equipment shatters upon initial ground impact.

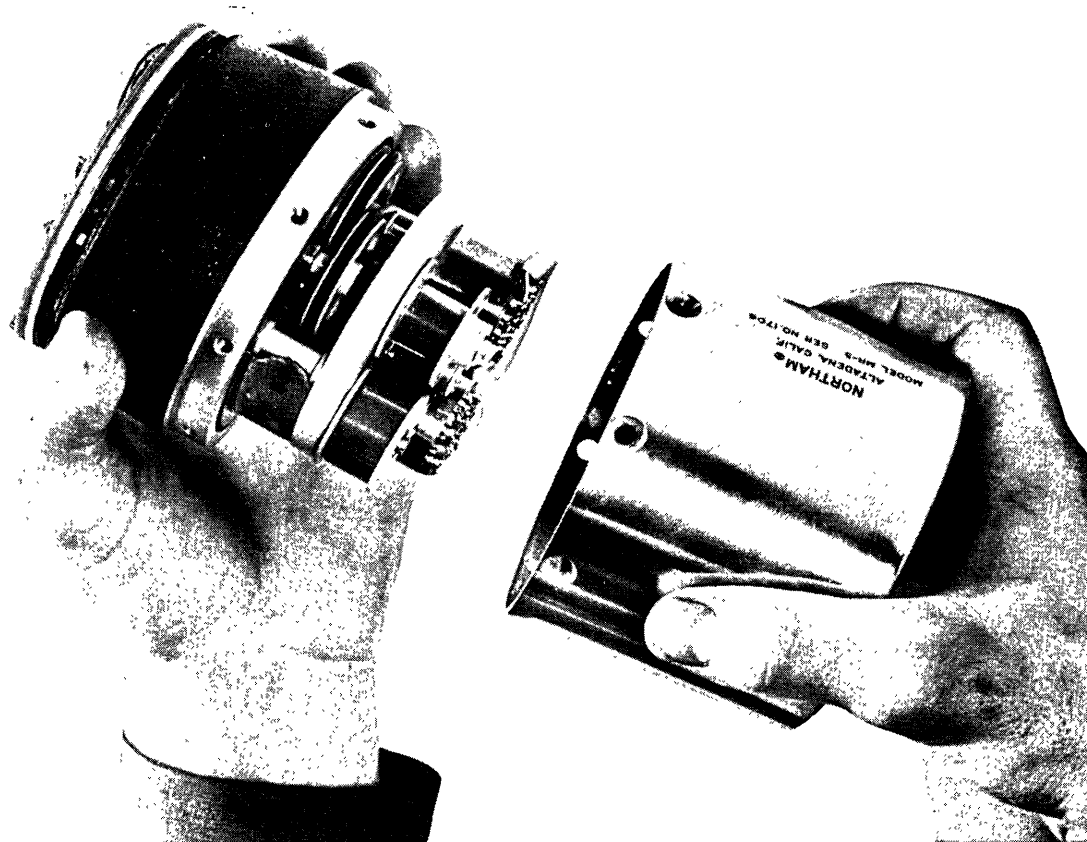

Rugged Miniature Tape Recorder — This miniature (4" wide, 5" high, 2-1/4 pounds) tape recorder made by North American Instruments has demonstrated its durable construction by surviving eight high-altitude missile flights in the HTV (hypersonic test vehicle) program at Holloman Air Development Center.

ELECTRONIC ROULETTE DEMONSTRATES COMPUTERS

Bendix Aviation Corp., Computer Div.
Los Angeles, Calif.

To demonstrate the automatic features of the Bendix G-15 Computer at the recent Automation Exposition held at the beginning of December, 1956, in New York, an electronic roulette game called "GAMBIT" was introduced to visitors at the Bendix Computer Division exhibit. Players placed "chips" on the board and when all chips were down the computer blinked lights, rang bells, figured the odds, typed out the winning numbers. "GAMBIT" derives its name from "Game for Automation-Minded Bigwigs Insensitive to Treachery".

Maurice Horrell, General Manager of Bendix Computer Division, said, "The digital computer has a reputation for drudgery — all work and no play. Year in and year out they help overworked engineer-

ing and research staffs solve complex and repetitive mathematical problems. So we gave one a short vacation and took it to New York to let it live a little, Las Vegas style."

Bendix Computers are being used in a number of applications such as solving problems in the design of cams, gears and optical lenses; in the construction of highways and pipe lines; in strain gauge testing, automatic control of high-precision machine tools, wind tunnel experiments, correlation of hydroelectric power factors, astronomical navigation studies, flight path calculations, crude oil reservoir and gas storage problems, plus an increasing number of general laboratory uses.



ELECTRONIC ROULETTE, "GAMBIT", a game devised by engineers of the Bendix Aviation Corporation's Computer Division to illustrate the company's newest general purpose computer. When all of the jumbo "chips" are down, the attendant flicks a switch, the computer calculates the odds and automatically types out the winning number.

**SUPERMENDUR —
AN IMPROVED MAGNETIC ALLOY**

Bell Telephone Laboratories
New York, N. Y.

Substantial improvements in magnetic amplifiers, switching and memory devices, pulse transformers, and power transformers are now possible as a result of a new magnetic alloy which has been developed at Bell Telephone Laboratories. This material will permit reductions in the size of magnetic components without any sacrifice in performance, and will facilitate the design of new components having greatly improved performance characteristics.

Called Supermendur, the alloy has a number of exceptional properties, including higher permeability and lower hysteresis losses at high flux densities than any material heretofore available.

The composition of Supermendur (nominally 49% iron, 49% cobalt and 2% vanadium) is similar to 2V-Permendur, a magnetic alloy developed at Bell Laboratories many years ago. However, H. L. B. Gould and D. H. Wenny have improved the characteristics of the alloy to a remarkable degree. The hysteresis losses have been reduced by a factor of ten. Maximum permeability is now 66,000 at 20,000 gauss; remanence, 21,500 gauss; coercive force, .26 oersted; and saturation, 24,000 gauss. Core losses are under 6 watts per pound at 400 cycles at a flux density of 100,000 lines per square inch. The hysteresis loop is rectangular with a flux swing of 45,500 gauss from minus remanence to plus saturation.

These outstanding properties have been achieved by using commercial materials of the highest purity, melting in a controlled atmosphere furnace, and subjecting the resulting alloy to a prescribed schedule of rolling and heat treatment in a magnetic field. The material is so malleable that it can be cold-rolled from 0.090" to 0.003" without intermediate anneals and without losing its ductility.

Power transformer cores of .004" or .002" Supermendur tape can provide an output more than 30% greater than comparable grain-oriented silicon steel cores, the best previously available material. Advantages on an ampere turn excitation basis are even greater percentage-wise. This permits a reduction in core size and weight of at least 30% for the same output, a significant factor in many applications. Flux density can ex-

ceed 140,000 lines per square inch without excessive losses.

Characteristics of this material make it ideally suited for power transformers, pulse transformers, and magnetic amplifiers. The precipitous sides of the hysteresis loop indicate that the gain of a magnetic amplifier can be increased as much as 80% over that obtainable with grain-oriented silicon steel. Other possible applications include telephone receiver diaphragms, and switching and memory devices. The material may be especially useful where miniaturization is desired, or where high temperature operation is contemplated.

Western Electric Company, Inc. does not plan to produce Supermendur for commercial consumption. However, a number of companies have expressed an interest in the material and it probably will be manufactured under Western Electric license in the near future.

* ————— *

NEW AIR-TO-AIR GUIDED MISSILE

Hughes Aircraft Co.
Culver City, Calif.

The United States Air Force and Hughes Aircraft Company have announced the existence of a new air-to-air guided missile that can climb at supersonic speed higher than any other existing armament of its kind.

The missile, a new version of the Hughes Falcon designated GAR-ID, was developed in the Culver City, Calif. laboratories of Hughes and is being manufactured by it at Tucson, Ariz.

The GAR-ID is a radar-guided supersonic missile designed to be carried in quantity by all-weather jet interceptors like the Northrop F-89H Scorpion and the supersonic delta-wing Convair F-102A, the joint announcement said. It is slightly longer than six feet, has an air-frame diameter of approximately six inches and weighs less than an average man.

With a range measured in miles, the new Falcon can be launched well below an enemy bomber and the tremendous thrust from its rocket motor will carry it to altitudes well in excess of the capability of the interceptor.

NEW PATENTS

RAYMOND R. SKOLNICK Reg. Patent Agent
Ford Inst. Co. Div. of Sperry Rand Corp.
Long Island City 1, New York

The following is a compilation of patents pertaining to computers and associated equipment from the Official Gazette of the United States Patent Office, dates of issue as indicated. Each entry consists of: Patent number / inventor(s) / assignee / invention.

December 11, 1956 (cont'd from Feb. issue):

2,774,026 / George H. Towner, San Diego, Calif. / Northrop Aircraft Inc., Hawthorne, Calif. / A digital servomotor.

December 18, 1956: 2,774,429 / Edward J. Rabenda, Poughkeepsie, N. Y. / I. B. M. Corp., New York, N. Y. / A magnetic core converter and storage unit.

2,774,534 / Roland H. Dunn, London, Eng. / International Standard Electric Corp., New York, N. Y. / Electrical counting and like devices.

2,774,535 / Lloyd D. Anderson, Tacoma Park, Md. / - / A variable amplitude signal analyzer.

2,774,825 / Solomon Sherr, Tuckahoe, N. Y. / General Precision Lab., Inc., N. Y. / A logarithmic amplifier.

2,774,868 / Byron L. Havens, Closter, N. J. / I. B. M. Corp., New York, N. Y. / A binary-decade counter.

2,774,957 / George H. Towner, San Diego, Calif. / Northrop Aircraft Inc., Hawthorne, Calif. / An analog to digital function converter.

December 25, 1956: 2,775,122 / Robert E. Smith, Downey, and John M. Wuerth, Whittier, Calif. / North American Aviation, Inc., Calif. / A vertical velocity computer.

2,775,124 / Frederick H. Gardner, Long Beach, James C. Elms, Newport Beach, and David Rosenstock, Long Beach, Calif. / North American Aviation, Inc., Calif. / An angle of attack computer.

2,775,402 / Eric Weiss, Los Angeles, Calif. / - / A coded decimal summing circuit.

2,775,404 / Harold R. Lahr, Chicago, Ill. / United Air Lines, Inc., Chicago, Ill. / A computer for the solution of navigation problems.

2,775,694 / Alan D. Blumlein, Ealing, London, Eng. / Electric and Musical Industries, Ltd.,

Eng. / An electrical circuit arrangement for effecting integration and applications thereof.

2,775,726 / Jan Louis de Kroes and Alphonsus Heetman, Hilversum, Netherlands / Hartford National Bank and Trust Co., Hartford, Conn. / An apparatus for registering pulses.

2,775,727 / John J. Kernahan, Livingston, and John C. Lozier, Short Hills, N. J. / Bell Telephone Lab., Inc., New York, N. Y. / A digital to analog converter with digital feedback control.

2,775,754 / Robert L. Sink, Altadena, Calif. / Consolidated Electrodynamics Corp., Pasadena, Calif. / An analog-digital converter.

2,775,755 / Robert L. Sink, Altadena, Calif. / Consolidated Electrodynamics Corp., Pasadena, Calif. / An angular position transducer.

2,775,756 / Sylvanus B. Bracy, Eatontown, N. J. and Paul M. Levy, New York, and Rocco L. Sarlo, Mamaroneck, N. Y. / U. S. A. / A facsimile recorder computer.

January 1, 1957: 2,766,418 / Ralph Townsend, Letchworth, Eng. / The British Tabulating Machine Co., Ltd., Letchworth, Eng. / Apparatus for comparing a first and second binary pulse train using an electronic storage device.

2,776,419 / Jan A. Rajchman, Princeton, and Milton Rosenberg, Trenton, N. J. / Radio Corp. of America, Del. / A magnetic memory system.

2,776,422 / Eugene A. Slusser, Arlington Heights, Mass. / U. S. A. / A range tracking system.

2,776,423 / Frank L. Richardson, Carle Place, N. Y. / Sperry Rand Corp., Del. / A moving range indicator for automatic tracking radar.

2,776,426 / Frederick J. Altman, Ridgewood, N. J. / International Telephone and Telegraph Corp., Maryland / A moving target range tracking unit.

January 8, 1957: 2,776,794 / Frederick C. Williams, Timperley, and Arthur A. Robinson, Scunthorpe, Eng. / National Research Development Corp., London, Eng. / An electronic circuit for multiplying binary numbers.

2,777,098 / Paul Duffing, Berlin-Siemensstadt, and Gerhard Conradi, Berlin-Tegel, Germany / Siemens-Schuckertwerk Aktiengesellschaft, Berlin-Siemensstadt, Germany / A magnetically controlled electric counting apparatus.

2,777,103 / Arthur E. Reed, Schenectady, N. Y. / General Electric Co., N. Y. / A drift stabilized velocity servo.

2,777,109 / Arlon G. Sangster, Leominster, Mass. / - / An electromechanical servo positioning mechanism.

January 15, 1957: 2,777,354 / Michael E. Stickney, Alhambra, Calif., Royal Glen Madsen, Greenwich, Conn., and Lawrence R. Pugh, Monrovia, Calif. / Beckman Instruments, Inc., So. Pasa-

(cont'd on page 27)

GROUP BEHAVIOR OF ROBOTS

Manfred Kochen
International Business Machines Corp.
Poughkeepsie, N.Y.

(The contents of this article were presented as part of a lecture entitled "Networks of Multipole Sequence Transducers", at the meeting of the Association for Computing Machinery in Philadelphia, Sept. 1955.)

Introduction

The behavior of people in social groups is very complex, even if the behavior of each individual could be accurately and consistently described. The construction and analysis of models, mathematical and otherwise, presents difficult conceptual, logical, and empirical problems. The simulation of group behavior with the use of large high-speed digital computers may serve to bring these problems into relief, and it may help the social scientist to formulate his basic concepts and assumptions more precisely. Furthermore, this use of computers may be of help in the solution of the mathematical problems encountered by the model-builder, which have frequently been beyond the scope of presently available analytical knowledge. Most important, however, is the possibility of "testing" models by mirroring an experimental situation within the computer (e.g. Monte Carlo Methods), when actual experimentation or observation is much more costly, or even impossible. The numerical experiments to be reported here illustrate the concrete realization of a highly idealized model of social interaction by means of a computer program.

Conceptual Framework

In order to describe the experiments, as well as to illustrate how computer simulation can guide the scientist in the development of precise, testable concepts, it will be necessary to summarize some of the basic concepts of a model on which the experiments are based. The model is more fully and rigorously developed elsewhere.^{1, 2} The main ideas in this model are discussed below:

1. Each component or individual in a group of such members is specified by the manner in which its "response" and present "internal state"

is codetermined by a "stimulus" and "internal state" at the preceding instant. For instance, if the "internal state" of an organism at a certain time is interpreted as a state of sleep, and a stimulus in the form of a pin prick is applied at that time, there is a high probability that the internal state at the next instant of time will be a waking state, accompanied by a response in the form of a yell or a jerk. In the idealized description, it is assumed that there are only two possible responses, which are abstractly denoted by 0 and 1. This was assumed because of the mathematical simplification which results, because of the binary nature of most digital computers, and also because this is suitable for certain applications, such as switching circuits. The internal state was also supposed to be specified by a finite number of binary digits, for the same reasons as above. The stimulus or input to each component is composed of the outputs or responses of the other components. (Possibly the output of a component may be fed back to be part of its own input one time unit later.) Hence, the input also consists of a finite number of binary variables, or bits. The values of all these binary variables can change only at regular intervals; this assumption is again related to the synchronous character of computers and the simplicity of the mathematics. The joint conditional probability of the response (output) and the state variables at any instant of time, given

¹Kochen, M., "An Information-Theoretic Model of Organizations", Transactions of I.R.E., P.G. I.T. - 4, p. 67, Sept. 1954

²Kochen, M., "Organized Systems with Discrete Information Transfer", Journal of the Association for Computing Machinery, forthcoming.

Group Behavior

the stimulus (input) and state-variables at the instant of time corresponding to the preceding clock pulse, is called the behavior function of the component in question. Thus, in a switching circuit, a response of 1 might denote the presence of a pulse at the output terminal, and 0 the absence of a pulse; a set of 0's and 1's in the input denote the absence or presence of pulses at the input terminals; the set of 0's and 1's in the state variables represent the state of the internal switches or secondary relays (open or closed). The behavior function is determined by the topology of the switching network, the physical laws governing the behavior of the switching elements and their reliabilities. Another simple example is furnished by a type of counter, where an output of 0 means that the number of 1's in both the input and the "old" state together is even, and an output of 1 means that it is odd; the "new" state consists of the "old" state with the variables of the input replacing certain variables which were previously all 0. In human individuals, the stimuli may be interpreted as questions encoded into binary form, and the response as No (0) or Yes (1) answers, with the internal state being interpreted as the accumulated state of knowledge or experience. Note the similarity of the components as described here with the "robots" introduced by Murray³.

2. It is assumed that the outputs and internal states of all the N components in a group are sampled at the same time, at regular intervals. That is, all the components' actions are regarded as synchronized with a system clock, with all the outputs occurring simultaneously. The group behavior is specified by the variation of the set of outputs from all the components with time. Whereas each input bit is the output of some component in this system, the internal variables of a given component are not directly affected by the internal variables of any other component. Thus, an example of a system, or group of components is furnished by several switching circuits, with the output terminal of each connected to the input terminals of one or more of the others; the entire system has no input or output terminals.

3. The organizational structure of the system (network topology) is specified by describing from which other components each component receives the output from one component other than himself, a directed circle network is obtained.

If there is one component who receives information from all others, with the others receiving information only from him, a type of star network is obtained. Another example is the case in which each component is connected to every other one.

4. Each individual is "rewarded" or "punished" for his response to the stimulus (or a time sequence of these extending into the past) according to a specified reward schedule, called the Value functions. In one of the experiments which will be described, the Value functions can be described as follows: Let P_i denote the i th in a group of N individuals. P_i is rewarded at the present instant if he responds with a 1 (pulse, Yet, etc.) to a 0 by P_{i-1} at the previous instant, or if he responds with a 1 at present to a 0 by P_{i-1} previously; P_i is punished at present if he does not so respond. P_i can control whether or not he shall be rewarded only if he can receive information from P_{i-1} (about what P_i 's response was at the preceding instant); this information must be part of P_i 's input. If P_i 's behavior function is such that whenever he can control his reward, he will respond in such a manner as to assure himself of reward rather than punishment, this behavior function is said to be self-oriented with respect to the Value function for P_i . In the following experiments, the Value functions are specified, and the only assumptions about the behavior functions are that they are self-oriented. This may, in some applications, be a more realistic procedure than to make definite assumptions about the behavior functions themselves.

In the early stages of the interaction process under discussion, P_i may be thought of as selecting his response at random, i. e.: tossing a coin and making the response 1 in case of heads, 0 in case of tails. P_i does, however, record the outcome. More precisely, he records what response he chose (at random) together with the associated stimulus and the fact whether this response was rewarded or punished. The internal state, or "memory" of P_i , thus is changed from "blank" (storing no information) to the storage of this one item of experience (consisting of three variables). The next time that a stimulus is presented to P_i , P_i 's memory will be searched for a previous occurrence of this stimulus. If this stimulus has not occurred previously, it will not be found in the memory, and the response is again determined at random, and the outcome is stored again as a new item of experience ready for future reference. If, however, the incoming stimulus has occurred before, it will have been stored; the Value (reward or non-reward)

³Murray, F. J., "Mechanisms and Robots", Jn'l of the Ass'n for Comput. Mach., April 1955

associated with this previous experience is looked up; if it was reward, the present output is the same as the one made in that previous experience; if the Value was punishment, the present output is the opposite of what it was then. This is the scheme which was actually used, but it is only one of several possible behavior functions which are self-oriented. For example, if the Value associated with the previous experience was punishment, the present response might be made at random rather than oppositely to what it was previously, as described above.

Several interesting questions may be raised with regard to the properties of the conceptual framework which was informally sketched above. The most important theoretical properties relate to the existence of self-oriented and other types of behavior functions, and how these, together with the organizational network, determine the group behavior. If the components are interpreted as the memory and computing circuits (adders, Scheffer organs, etc.) organized into a complex information processing system, questions of system reliability, efficiency, and asymptotic behavior, may be precisely formulated and in some cases answered. The converse problem, of how to select and combine robots according to their behavior functions so as to realize a specified group behavior is of great practical and theoretical interest, for instance in complex automata, such as guidance and control systems, etc. It may be expected that direct simulation procedures could be of considerable value in such synthesis and design problems, and some practical problems have already been attacked by this procedure.

Numerical Experiments

The main object of these experiments is to demonstrate a technique of using digital computers as logical tools to help in the construction of models, rather than to obtain specific results. It is, therefore, of some interest to describe the program used in the design of the experiment, and the manner in which it employs the non-arithmetical features of the machine. This use of computers is related to the simulation procedures which are more frequently associated with analogue devices; when a digital computer is used instead, the name "numerical experiment" has been used. Monte Carlo Procedures, as used in the testing of learning models, for instance, are examples of numerical experiments.

Figure 1 gives a verbal flow diagram of the pro-

gram in summary. Initially, responses were selected from a stored table of random binary digits. It was necessary to obtain the random numbers from a table rather than to generate pseudo-random numbers by means of a subroutine (e.g. squaring a 20-bit number, extracting the middle 20 bits from the 40-bit product, and repeating the process), because of the frequency with which they were required; also, it was required that the random choices of P_1, \dots, P_N were statistically independent of each other, and also independent of these choices at all other times. The table was such that the probabilities of 0 and 1 were nearly equal.

Each P_i is essentially specified by a set of storage locations containing the instructions and variables which are associated with the behavior function of P_i . The computer which was used had a capacity of 1024 40-bit words of high-speed memory (Williams tubes), and 2048 words of lower speed memory (Magnet drum). Using the entire capacity of the machine, it is possible to permit each component to "remember" up to 256 items of experience, with a network consisting up to 32 components (robots), each connected to at most 8 others. This means that each component is described by $256 \times (8 + 1 + 1) = 2560$ binary state-variables; by 8 binary input variables, and one binary output variable; in addition, there is 1 binary Value (reward) variable associated with each component.

The problem on which these experiments were focused was as follows: Given a set of N Value functions, with self-oriented behavior functions as described before, what is the effect of various organizational networks on the group behavior? The rewards were assigned by a subroutine which was not associated with any of the components, and the Value functions were the same for each component.

Experiment I: N robots were connected in a circle network, in which each robot received information from only a right and a left neighbor. It was desired to study the effect of N upon the group behavior, i.e. the variation of the combination of all the N outputs with time. In this case it is possible to formulate the problem analytically, but the estimation of numerical results still involves tedious computations. It is easy to show that as N increases, the probability of any particular group output time sequence decreases exponentially. Such conclusions can be tested experimentally by repeating each run a large number of times, each time with a different table of

Group Behavior

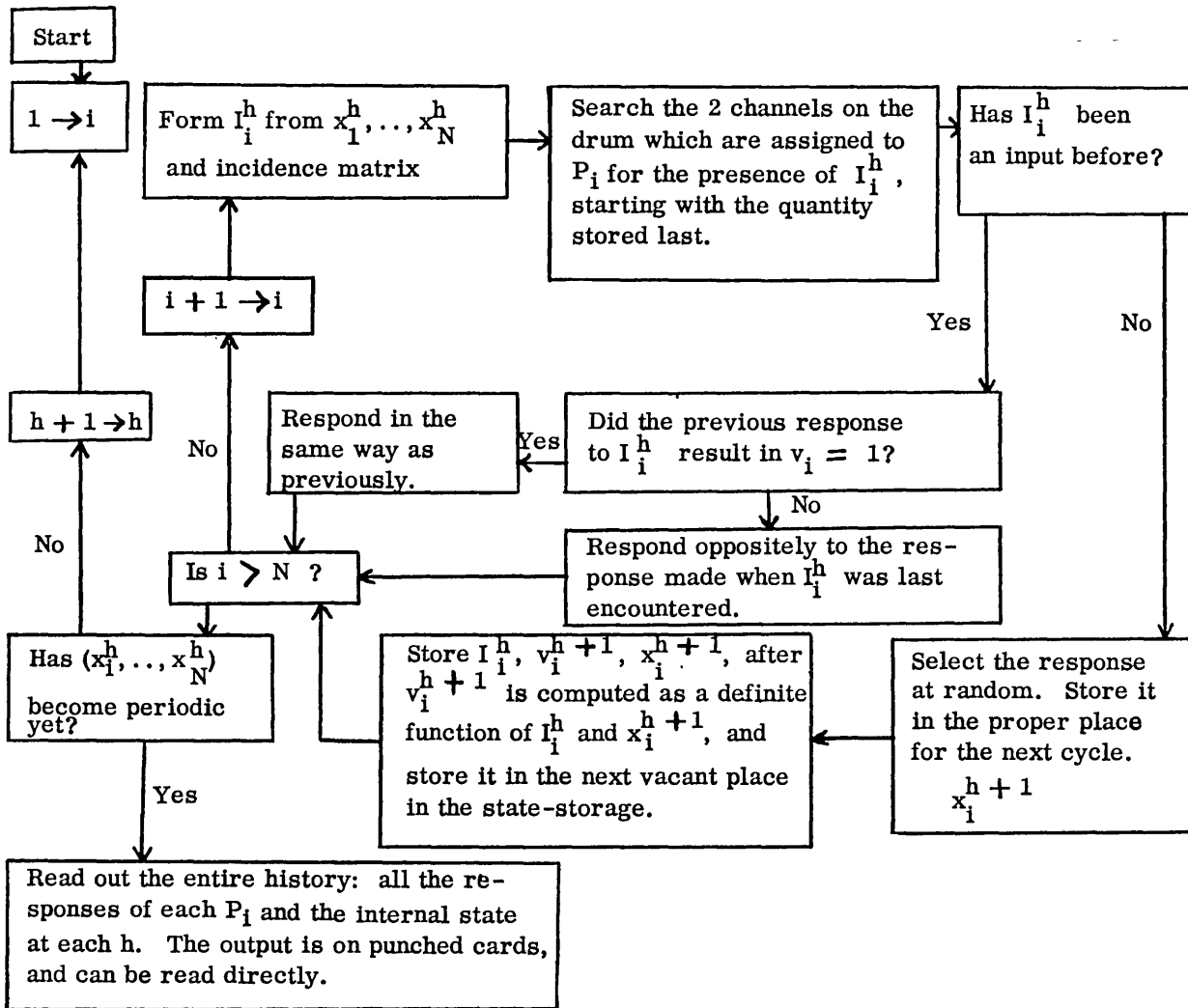

Figure 1 — Flow Diagram for the Program to Simulate the Group Behavior of Robots

x_i^h represents the output, or response, of P_i at time h . (0 or 1)

I_i^h represents the input, or stimulus, to P_i at time h . It consists of the outputs at time $h - 1$ of those P_j from which P_i receives information, as specified by the organizational network (i. e., the incidence matrix)

v_i^h is the Value (1 if reward, 0 if punishment) assigned to P_i at time h , on the basis of response x_i^h to stimulus I_i^{h-1} .

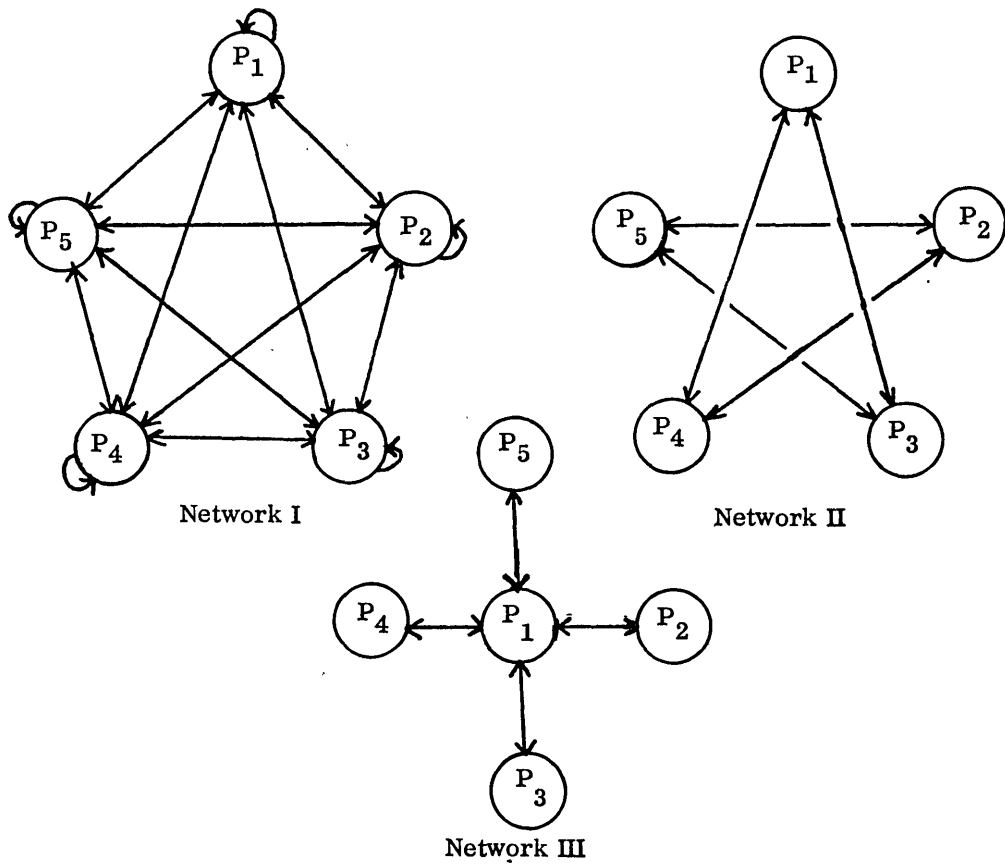

Figure 2

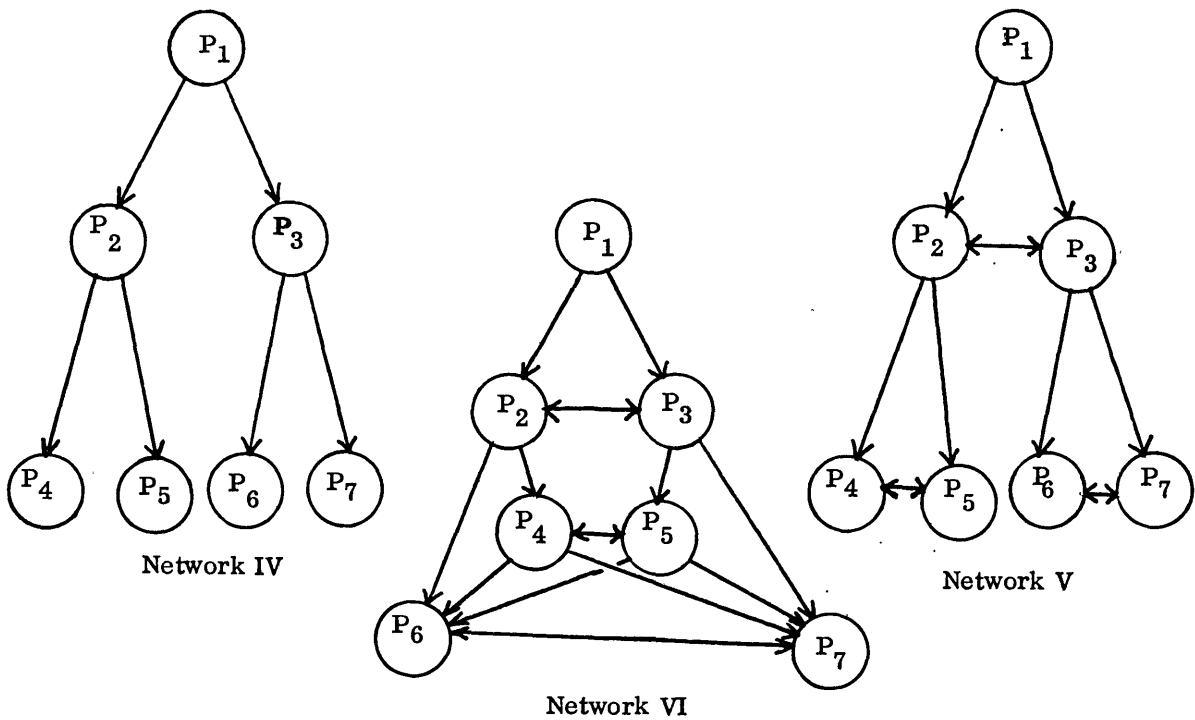

Figure 3

random numbers, in order to obtain a good sample. It was not possible to carry out this procedure satisfactorily, because each run took about 10-20 of machine time. (The time was limited by the access time to the drum via mechanical relays; within the highspeed memory, the speed is of the order of minutes.) The following table shows a sample of a group output sequence for a circle network with $N = 4$.

<u>Time</u>	<u>Output</u>	<u>Time</u>	<u>Output</u>
1	1111	9	1101
2	1001	10	0101
3	0110	11	0100
4	1001	12	1100
5	0111	13	1101
6	0101	14	0101
7	0001	15	0100
8	0110	16	1100

It can be demonstrated rigorously that after a certain time the group behavior will become periodic; the periodic cycle in the above run is: (1101, 0101, 0100, 1100). This cycle is of length 4, and first starts on the 9th trial. The four robots, P_1 , P_2 , P_3 and P_4 stored 3, 3, 3, and 4 items of experience in terms of their internal state variables at the time periodicity began. For example, the first item which was stored by P_1 was the fact that its response of 1 to the previous responses of 1 by both P_4 and P_2 , resulted in punishment, (0). The reward schedule (Value functions) used in the program was such that if P_i responded with a 1 to a previous response by $P_i - 1$ and by $P_i + 1$ of 10 or 01, and with a 0 to 11 or 10, the consequence was reward, and punishment otherwise. Initially, all the state variables were taken equal to 0, with all inputs and outputs 0 also.

The following table shows the results of runs on circle networks with $N = 6, 7, 8$ and 9, with another sample for $N = 4$, and two samples for $N = 6$. Instead of presenting the complete output sequence for each run, the following data are summarized: Column 2 shows the trial number (time) at which periodicity first appeared (a complete cycle begins); Column 3 shows the length of the cycle (the period); Column 4 gives the number of items of experience stored by P_1, \dots, P_N in that order.

<u>N</u>	<u>Time to periodicity</u>	<u>Period</u>	<u>No. items stored</u>
4	8	5	3, 3, 3, 4
6	25	15	3, 2, 2, 3, 3, 1
6	4	1	4, 4, 4, 4, 4, 4
7	5	8	2, 3, 4, 4, 3, 4, 3
8	13	12	4, 4, 4, 4, 4, 4, 4, 4
9	8	4	4, 3, 2, 3, 3, 2, 3, 3, 4

Experiment II: N was kept constant at 5, and the effects of networks I, II, and III of Figure 2, on the group behavior were studied. In these network diagrams (oriented linear graphs), an arrow terminating on a component indicates that this component receives information from that component from which the arrow originates. Four samples were obtained for network I, three for network II, and only one run was made on III. The results, tabulated as above, were:

<u>Network</u>	<u>Sample</u>	<u>Time to period</u>	<u>Period</u>	<u>Number items stored</u>
I	1	18	7	8, 7, 7, 9, 2
	2	23	1	13, 13, 13, 13, 1
	3	20	1	7, 8, 4, 4, 5
	4	10	1	7, 7, 8, 8, 2
II	1	13	1	4, 2, 3, 3, 4
	2	13	2	3, 3, 4, 4, 3
	3	5	2	3, 3, 4, 3, 4
III	1	8	1	5, 1, 2, 1, 1

Experiment III: The three networks, IV, V, and VI of Figure 3, with $N = 7$ were tested for their effect upon group behavior. The results, with a single run on each network, are shown below:

<u>Network</u>	<u>Time to periodicity</u>	<u>Period</u>	<u>No. of items stored</u>
IV	20	1	8, 10, 8, 4, 4, 3, 3
V	12	8	5, 11, 12, 7, 7, 6, 6
VI	43	7	7, 22, 22, 20, 20, 22, 22

Discussion

In these experiments, the capacity of the machine was only partly utilized. In more complex systems, if the number of trials required to reach periodicity exceeds 256, no further items of experience can be stored. An alternate program might erase those items which were stored in the remote past, and the storage locations thus liberated could be used to store the newly experienced items at the most recent end. Ordinarily, the state-variables are scanned, one item of experience at a time, starting with the one which was stored most recently, and proceeding to those which were stored in the more remote past. Another variation of the program which is readily introduced is that of weighting the most recently stored experiences more heavily than the remote ones. This may be accomplished by decreasing the density of the number of items to be consulted with progress towards the remote end of the memory. For example, each of the five most re-

(cont'd on page 48)

Automatic Computing Machinery — List of Types

(Edition 3, cumulative, information as of February 3, 1957)

The purpose of this list is to report types of machinery that may well be considered automatic computing or data processing machinery, that is, automatic machinery for handling information or data, reasonably.

We shall be grateful for any comments, corrections, and proposed additions or deletions which any reader may be able to send us.

Accounting-bookkeeping machines, which take in numbers through a keyboard, and print them on a ledger sheet, but are controlled by "program bars", which, according to the column in which the number belongs, cause the number to enter positively or negatively in any one of several totaling counters, which can be optionally printed or cleared.

Addressing machines, programmable, which take in names and addresses, either on metal plates or punch cards, and print the names and addresses on envelopes, wrappers, etc., and which may be controlled for selection and in other ways, by notches, punched holes, and other signals, on the plates or cards.

Air traffic control equipment (including ground control approach equipment), which takes in information about the location of aircraft in flight and gives out information or control signals for the guidance of the flight of the aircraft.

Analog computers, which take in numerical information in the form of measurements of physical variables, perform arithmetical operations, are controlled by a program, and give out numerical answers.

Analog-to-digital converters, which take in analog measurements and give out digital numbers.

Astronomical telescope aiming equipment, which adjusts the direction of a telescope in an observatory so that it remains pointed at the spot in the heavens which an astronomer intends to study.

Automatic process controllers, pneumatic, electronic, hydraulic, etc., which take in indications of humidity, temperature, pressure, volume, flow, liquid level, etc., and put out signals for changing positions of valves, altering

speeds of motors, turning switches on and off, etc.

Automobile traffic light controllers, that take in indications of the presence of motor cars from the operation of treadles in the pavement or in other ways, and give out signals, according to a program of response to the volume and density of traffic.

Card-to-tape converters, which will take in information on punched cards, and put out corresponding or edited information on punched paper tape or on magnetic tape.

Control systems for handling connected or flowing materials, which will take in indications of flow, temperature, pressure, volume, liquid level, etc., and give out the settings of valves, rollers, tension arms, etc., depending on the program of control.

Control systems for handling separate materials, which will move heavy blocks, long rods, or other pieces of material to or from stations and in or out of machines, while taking in indications furnished by the locations of previous pieces of materials, the availability of the machines, etc., all depending on the program of control.

Data sampling systems, which will take in a continuous voltage or other physical variables and give out samples, perhaps once a second or perhaps a thousand times a second; this machine may be combined with an analog-to-digital converter, so that the report on the sample is digital not analog.

Desk calculating machines, including desk adding machines, which may take in numbers to be added, subtracted, multiplied, and divided, and put out results either shown in dials or printed on paper tape; such machines store one up to several numbers (but not many numbers) at one time, and may store a simple program such as automatic multiplication by controlled repeated addition and shifting.

Digital computers, which take in numerical, alphabetic, or other information in the form of characters or patterns of yes-noes, etc., perform arithmetical and logical operations, are controlled by a program, and put out in-

- formation in any form.
- Digital-to-analog converters, which take in digital numbers and give out analog measurements
- Facsimile copying equipment, which scans a document or picture with a phototube line by line and reproduces it by making little dots with a moving stylus or with an electric current through electrosensitive paper.
- File-searching machines, which will take in an abstract in code, and search for and find the reference or references alluded to.
- Fire control equipment, that takes in indications of targets from optical or radar perception and puts out directions of bearing and elevation for aiming and time of firing for guns, according to a program that calculates motion of target, motion of the firing vehicle, properties of the air, etc.
- Flight simulators, which will take in simulated conditions of flight in airplanes, and the actions of airplane crew members, and show the necessary results, all for purposes of training airplane crews.
- Game-playing machines, in which the machine will play a game with a human being, either a simple game such as tit-tat-toe or nim (which have been built into special machines) or a more complicated game such as checkers, chess, or billiards (which have been programmed on large automatic digital computers).
- Inventory machines, which will store as many as ten thousand totals in an equal number of registers, and will add into, subtract from, clear, and report the contents of any called-for register (these machines apply to stock control, to railroad and airline reservations, etc.).
- Machine tool control equipment, which takes in a program of instructions equivalent to a blueprint, or a small size model, or the pattern of operations of an expert machinist, and controls a machine tool so that a piece of material is shaped exactly in accordance with the program.
- Navigating and piloting systems, which will take in star positions, time, radio beam signals, motion of the air, etc., and deliver steering directions.
- Network analyzers, which take in analog information about the resistances, inductances, and capacitances of an electric power plant's network of electrical lines and loads, and enable the behavior of the system to be calculated, and the system to be appropriately designed and rendered safe and economical.
- Printing devices of high speed, which will take in punched cards or magnetic tape and put out printed information at rates from 600 to 2000 characters per second.
- Punch card machines, which will sort, classify, list, total, copy, print, and do many other kinds of office work.
- Railway signaling equipment, which for example enables a large railroad terminal to schedule trains in and out every 20 seconds during rush hours with no accidents and almost no delays.
- Reading and recognizing machines, which scan a printed digit or letter, observe a pattern of spots, route the pattern through classifying circuits, recognize the digit or letter, and activate output devices accordingly.
- Sale recorders, also called point-of-sale recorders, which take in the amount, the type, and other information about sales of goods, and produce records in machine language, which can later be automatically analyzed and summarized by punch card or computing equipment.
- Spectroscopic analyzers, which will vaporize a small sample of material, analyze its spectrum, and report the presence and the relative quantities of chemical elements and compounds in it.
- Strategy machines, which enable military officers in training to play war games and test strategies, in which electronic devices automatically apply attrition rates to the fighting forces being used in the game, growth rates to the industrial potential of the two sides, etc.
- Tape-to-card converters, which will take in information on punched paper tape or on magnetic tape, and put out corresponding or edited information on punched cards.
- Telemetry transmitting and receiving devices, which enable a weather balloon or a guided missile to transmit information detected by instruments within it as it moves; the information is recorded usually on magnetic tape in such fashion that it can later be used for computing purposes.
- Telephone equipment including switching, which enables a subscriber to dial another subscriber and get connected automatically.
- Telephone message accounting systems, which record local and long distance telephone calls, assign them to the proper subscriber's account, and compute and print the telephone bills.
- Test-scoring machines, which will take in a test paper completed with a pencil making electrically conductive marks, and will give out the score.
- Toll recording equipment, which will record, check, and summarize tolls for bridges, highways and turnpikes.
- Training simulators, which will take in simulated conditions affecting the training of one or more persons in a job, and their responses

(cont'd on page 25)

Components of Automatic Computing Machinery —

List of Types

(Edition 3, cumulative, information as of February 3, 1957)

The purpose of this list is to report types of components of automatic machinery for computing or data processing.

We shall be grateful for any comments, corrections, and proposed additions or deletions, which any reader may send us.

LIST

1. Storage mediums, for both internal and external storage:
 - Punch cards
 - Punched paper tape
 - Magnetic tape
 - Magnetic Wire
 - Metal plates
 - Plugboards, i. e., panels of patch cords

(All these physical forms express machine language; when inserted into a machine, they give the machine information and instruction; when left in a filing cabinet, they hold information and instructions in reserve for later use. Sometimes it is the whole area of the storage medium which is used, as in the ordinary punched card. Sometimes it is only the edge which is used, as in edge-punched cards or edge-slotted metal plates.)
2. Storage mediums, internal only:
 - Magnetic drums
 - Magnetic tape devices
 - Magnetic disc devices
 - Magnetic belt devices
 - Magnetic cores, arranged either one-dimensionally as in a magnetic shift register, or in two or three dimensions as a magnetic core matrix memory; they may be made of special iron alloys, iron oxide ceramics called ferrites, etc.
 - Electrostatic storage tubes, in particular cathode ray storage tubes and glass-metal honeycomb-type storage tubes
 - Delay lines, of mercury, quartz, nickel, electrical elements, etc.
3. Calculating and controlling devices:
 - Mechanical computing elements: latches, gears, levers, ratchets, "program bars", cams, etc.
 - Relay, stepping switch, and other switching circuits
 - Electronic tube circuits
 - Rectifier circuits, using diodes: electronic tube, germanium, selenium, silicon
 - Other solid state device circuits
 - Transistor circuits
 - Cryotron circuits
 - Auxiliary circuit elements: amplifiers, pulse transformers, voltage regulators, etc.
 - Analog computing elements: resolvers, synchros, integrators, adders, etc.
 - Automatic process controllers as such, pneumatic, electronic, hydraulic, etc.
4. Input devices:
 - Buttons
 - Switches
 - Paper tape readers: mechanical, electrical, photoelectric
 - Punch card readers: mechanical, electrical, photoelectric
 - Magnetic tape readers
 - Automatic curve followers: photoelectric
 - Scanners: electric, photoelectric
 - Sensing instruments of all kinds

(The category "sensing instruments" verges

(cont'd on page 25)

under these simulated conditions, and show the results, all for the purpose of teaching them; SEE also flight simulators.

Typing machines, programmable, which will store paragraphs and other information, and combine them according to instructions into correspondence, form letters, orders, etc., stopping and waiting for manual "fill-ins" if so instructed.

Vending machines, which will take in various coins and designations of choices, and then give out appropriate change, coffee, soft drinks, sandwiches, candy, stockings, and a host of other articles, or else allow somebody to play a game for a certain number of plays, etc.

- END -

COMPONENTS
(cont'd from page 24)

into the science of instrumentation, where humidity, temperature, pressure, volume, flow, liquid level, etc., and many other physical variables can be measured and reported to a machine in machine language.)

5. Output devices:

Visual displays, such as lights, dials, oscilloscope screen, etc.

Electric typewriter, or other electrically-operated office machine

Line-at-a-time printer

Matrix printer, that forms each character by a pattern of dots

Automatic plotter, which will trace or plot a curve according to information delivered by the machine

Facsimile printer

Photographic recording

Paper tape punch

Magnetic tape recorder

Punch card punch

Microphones, telephones, loud speakers, alarms, etc.

Article delivery mechanisms as in vending machines

Positioning devices, that may operate a valve, roller, tension arm, etc., resulting in control of a manufacturing operation or process, the aiming of a gun, etc.

News Release

COURSES IN AUTOMATIC CONTROL

Univ. of Michigan
College of Engineering
Ann Arbor, Mich.

The University of Michigan, College of Engineering, has announced two summer Intensive Courses in Automatic Control. The first is scheduled for June 17 to 22 inclusive, and the second for June 24 to 26, 1957, inclusive. The courses are intended for engineers who find it necessary or who wish to obtain a basic understanding of the field, but who cannot spare more than a few days for this purpose. The aim of the courses is to make it easier to learn by a coherent presentation of the fundamentals of modern automatic control and by providing a comprehensive set of notes to serve as a framework for further study.

The courses are built around the principles and application of measurement, communication and control. Course I will consist of the fundamentals in each of these fields and will include some basic work in nonlinear systems. Course II will take up applications of the fundamentals to more advanced problems. There will be four hours of lecture each morning and three hours of laboratory demonstration in the afternoon. Extensive use will be made of computing, instrumentation and servo laboratories on the campus. The role of analog computing methods will be emphasized. These courses have been given previously in the summers of 1953, 1954, and 1955.

April 15 is the closing date for registration. Further information may be obtained by writing to Professor L. L. Rauch, Room 1521, East Engineering Building, University of Michigan, Ann Arbor, Michigan.

- END -

■ Research and development at Lockheed Missile Systems Division laboratories in Palo Alto is of a most advanced nature. Particular areas of interest include microwaves, telemetering, radar, guidance, reliability, data processing, electronic systems, instrumentation, servomechanisms. Inquiries are invited from those qualified by ability and experience for exploratory efforts of utmost importance.

Here members of the Electronics Division discuss systems radar problems related to measurement of missile trajectories. Left to right: K. T. Larkin, radar and command guidance; Dr. S. B. Batdorf, head of the Electronics Division; Dr. H. N. Leifer (standing), solid state; Dr. R. J. Burke, telemetering; S. Janken, product engineering.

Lockheed

MISSILE SYSTEMS DIVISION

research and engineering staff

LOCKHEED AIRCRAFT CORPORATION

PALO ALTO • SUNNYVALE • VAN NUYS

CALIFORNIA



I·R·E

NATIONAL CONVENTION AND RADIO SHOW

Significant developments at Lockheed Missile Systems Division have created new openings for:

- Controls Systems Engineers**—to analyze and synthesize complex automatic control systems.
- Inertial Guidance Engineers**—to perform systems analysis and design of inertial guidance systems.
- Infrared Specialists**—to perform preliminary systems design and parametric optimization of advanced infrared detection systems.
- Data Processing Systems Specialists**—to perform advanced system development and design in new techniques of automatic data processing.
- Weapons Systems Specialists**—to perform basic analysis and systems evaluation of advanced weapons systems.
- Electronic Product Engineers**—to translate laboratory electronic systems into prototype models meeting the rigid requirements of modern weapons systems.
- Radar Systems Engineers**—to develop advanced radar systems associated with guided missiles.
- Theoretical Physicists**—to analyze propagation of electromagnetic waves through the ionosphere and through dielectric materials and study radiation problems pertaining to advanced antennas in the microwave and millimeter domain, including scattering problems related to the reflection of electromagnetic waves from simple and complex boundaries.
- Experimental Physicists**—to investigate microwave circuit components including ferrites and various millimeter wave techniques such as MAZUR.
- Antenna Specialists**—to design and develop airborne antennas and radomes for high speed missiles for telemetering, radar, and guidance systems application.
- Video Specialists**—to develop advanced systems for the transmission of visual data by electronic means.
- Circuit Design Specialists**—to design telemetering and guidance systems utilizing advanced circuit components.

Positions are open at the Palo Alto Research Center and Sunnyvale and Van Nuys Engineering Centers. M. H. Hodge, M. W. Peterson and senior members of the technical staff will be available for consultation at the convention hotel. Phone PLaza 14860 or 14861.

Lockheed

MISSILE SYSTEMS DIVISION

NEW PATENTS
(cont'd from page 15)

- dena, Calif. / An apparatus for recording and reproducing variables.
- 2,777,634 / Frederic C. Williams, Timperley, and Tom Kilburn, Manchester, Eng. / National Research Development Corp., London, Eng. / An electronic digital computing machine.
- 2,777,635 / Geoffrey C. Tootill, Shriveham, near Swindon, Frederic C. Williams, Timperley, and Tom Kilburn, Manchester, Eng. / National Research Development Corp., London, Eng. / An electronic digital computing machine.
- 2,777,637 / Morton P. Matthew, Takoma Park, Md. / The Ahrendt Instrument Co., College Park, Md. / A shaft revolution counter for counting the number of revolutions of an input shaft.
- 2,777,945 / Henri Gerard Feissel, Paris, France / Compagnie des Machines Bull, Paris, France / A pulse producing system with interrelated repetition frequencies..
- 2,777,946 / John C. Owen, Palisades Park, N. J., and Alfred Bennett, Bronx, N. Y. / Bendix Aviation Corp, Teterboro, N. J. / An electronic integrator.
- 2,777,947 / Conrad H. Hoepfner, Washington, D. C., and Carl Harrison Smith, Inc., Arlington, Va. / - / A pulse width discriminator.
- 2,777,959 / John E. Richardson, Los Angeles, Calif. / The Magnavox Co., Los Angeles, Calif. / A control apparatus for producing pulses.
- 2,777,971 / Frederic C. Williams, Timperley, and Tom Kilburn, Davyhulme, Eng. / International Business Machines Corp., New York, N. Y. / A method of writing information into or reading information from a cathode ray tube storage means in which the information is stored on a raster of lines.
- 2,777,981 / John D. Rector, Edgar H. Fritze, and Leo P. Kommerer, Cedar Rapids, Iowa / Collins Radio Co., Cedar Rapids, Iowa / An A. C. to D. C. converter
- 2,778,009 / Jack E. Bridges, Franklin Park, Ill. / Zenith Radio Corp., Ill. / An encoding mechanism for a subscription type of communication system.
- 2,778,011 / Robert E. Frank, New York, N. Y. / Sperry Rand Corp., Del. / An apparatus for time-delay measurement.
- 2,778,012 / Philip W. Crist, Hempstead, N. Y. / Sperry Rand Corp., Del. / A pulse synchronizer
- January 22, 1957: 2,778,472 / James E. Young, Los Angeles, Calif. / The Garrett Corp., Los Angeles, Calif. / A multi-stage actuating mechanism.
- 2,778,623 / Louis D. Statham, Beverly Hills, Calif. / Statham Laboratories, Inc., Los Angeles, Calif. / An angular accelerometer.

- END -

The Computer Field: Products and Services

for Sale or Rent—List of Headings

Following is the preliminary list of headings which we expect to use for products and services in the list of them in "THE COMPUTER DIRECTORY AND BUYERS' GUIDE, 1957", the June 1957 issue of "Computers and Automation".

If you notice headings that you wish your products or services to be included under, please send us entries at once (see details on p.43). Although the closing date for this section is April 10, we expect to be able to squeeze in additional entries up to April 30 or the first few days in May.

If your products and services do not fit under any of the listed headings, we will gladly consider your suggestions for other headings.

- A: Adding Machines
Addressing Machines
Analog Computers
Analog-to-Digital Converters
Arithmetical Circuits (for Digital Computers)
Automatic Control Equipment
- C: Capacitors (computer types)
Card-to-Tape Converters
Computer Components (see also specific types)
Computers (see also: Analog Computers, Digital Computers)
Computers, Test Equipment
Computing Services
Connectors (computer types)
Consulting Services
Courses by Mail (computer field)
- D: Data Processing Machinery (see also Digital Computers)
Delay Lines (computer types)
Desk Calculators
Differential Analyzers (see also Analog Computers)
Digital Computers
Digital-to-Analog Converters
Diodes (computer types)
- E: Electric Typewriters, controlled
Electronic Tubes (computer types)
- F: Fire Control Equipment
- I: Information Retrieval
- K: Keyboards
- L: Line-a-Time Printers
Logical Circuits (for Digital Computers)
- M: Magnetic Cores (computer types)
Magnetic Drums
Magnetic Heads
Magnetic Storage Systems
Magnetic Tape
Magnetic Tape Handlers (see also Magnetic Tape Recorders)
Magnetic Tape Recorders (see also Magnetic Tape Handlers)
- O: Office Machines (computer types) (see also specific types)
- P: Paper Tape Filing Systems
Paper Tape Punches
Paper Tape Readers
Patchcords
Photoelectric Card Readers
Photoelectric Decoding Readers
Photoelectric Tape Readers
Photographic Recorders (computer types)
Plotters
Potentiometers
Printers (see also Line-a-Time Printers, Electric Typewriters, controlled)
Publications
Pulse Transformers
Punch Card Machines
- R: Recording Papers
Rectifiers
Relays (computer types)
Resistors
Resolvers
Robots, Small
- S: Scanners
Signaling Controls

(cont'd on page 29)

SYMPOSIUM ON SYSTEMS
FOR INFORMATION RETRIEVAL

Western Reserve University
Cleveland 6, Ohio

The School of Library Science of Western Reserve University, and its Center for Documentation and Communication Research, will present on April 15, 16, and 17, 1957, a comprehensive demonstration of systems presently in use for the organization, storage, and retrieval of recorded information, together with a symposium on information-handling problems and techniques:

A co-sponsor of these activities is the Council on Documentation Research, a group recently formed by representatives of organizations in government, industry, and education to promote cooperation among those who produce, organize, and use information of all types in all fields.

This symposium is an outgrowth of the Conference on the Practical Utilization of Recorded Knowledge held in Cleveland January, 1956. The April three-day program will bring together 20 or more information systems devised or adapted by their users to meet specific problems. Machines needed to make the presentations most effective will also be demonstrated, but the emphasis is to be on working systems.

Verner Clapp, Director of the Council on Library Resources recently formed by the Ford Foundation, will discuss the role of foundations in documentation research.

For the three days of the symposium a model information center will be set up on the University campus, and answers to questions asked in Cleveland will be sought in the information resources of cooperating organizations across the country and abroad. In this way both high-speed transmission methods and rapid searching techniques will be shown in operation.

Following is a list of organizations already participating in this activity. Further information may be obtained from:

Jesse H. Shera, Dean
School of Library Science
Western Reserve University
Cleveland 6, Ohio

American Bar Foundation
American Documentation Institute
American Library Association
American Society for Metals
Bakelite Corporation
Case Institute of Technology
Center for Documentation and Communication Research, Western Reserve University
Chemical-Biological Coordination Center
Cleveland Public Library
Committee on Technical Aids to the Law, American Bar Association
Eastman Kodak Company
Electro Metallurgical Company
Ethyl Corporation
Filmorex Corporation of France
The John Crerar Library
Lehigh University
Linde Air Products Corporation
Midwest Interlibrary Center
National Bureau of Standards
New Jersey Law Institute
Office of Ordnance Research, U. S. Army
Smith, Kline, and French
Socony-Mobil Corporation
Watertown Arsenal
Wyandotte Chemical Company
U. S. Patent Office

HEADINGS
(cont'd from page 28)

Simulators
Stepping Switches
Storage Systems (see Delay Lines, Magnetic Storage Systems)
Synchros

T: Tape-to-Card Converters
Transistors
Translating Equipment

V: Visual Displays

EDUCATION AND COMPUTERS — DISCUSSION

I. From A. Lange,
Wayland, Mass.

Mr. Truitt's article "Objective Measures of Education" in the January issue of "Computers and Automation" is certainly of interest to us all; most of us are greatly concerned with the general problem of education from several viewpoints; as parents, as engineers or scientists, as educated people concerned with the social and technological requirements of a complex society, and so on. Consequently, the shock we all received from becoming aware of poor Sam's illiteracy would certainly stir us into action, if we only knew how or where to act. Mr. Truitt has made some positive suggestions which should certainly prove beneficial, but I think he begs the issue of how we are to convince our fellow townspeople that such steps are not only desirable but necessary.

While reading Mr. Truitt's article, it seemed to me that it existed on at least two planes of meaning: one concerned with education, the other concerned with Sam's morals. (The thought occurred to me that Sam and the smoking essay were supposed to be considered as an allegory; however, in this event, the illiteracy Sam displayed is an invention of Mr. Truitt's. Regardless of how real are the facts upon which this invention is based, the shock loses its impact if it is founded on a fiction. Hence, I rejected the possibility of the incident being an allegory).

The question that comes to mind is why did Mr. Truitt make this particular agreement with Sam? There seem to be two possibilities: one, that Mr. Truitt was encouraging Sam to accept some sort of self-discipline, or, two, that Mr. Truitt was inducing Sam not to smoke or drink.

If the latter is true, Mr. Truitt attempted to bribe Sam, and such an attempt seems doomed to fail. In fact, one cannot help but feel that Sam was correct in deciding that the gain of \$100 was an insufficient motive for accepting the personal domination of another person.

If Mr. Truitt was encouraging Sam to assume a program of self-discipline, he might have approached the problem from Sam's viewpoint; Sam has evidently demonstrated considerable self-discipline in the fields of automotive mechanics and

cabinet making.

In either of these fields, or some related one, Sam might have over-turned heaven and earth for \$100: I agree that it would be deplorable if a person of Sam's capabilities were to limit himself to the pragmatic (as opposed to the abstract) disciplines, but he is young enough to broaden his interests himself, if suitably encouraged. And it may be noted that it will take more than \$100 bonuses to induce our many Sams to seek more refined goals than they do now.

Lastly, to this reader (and to most professionals concerned with the effects of smoking and drinking), Sam's conclusions seem both valid and logical. In fact, the "statistic" that "4,000,000 people have trouble with drinking" cannot logically lead one to the conclusion that one shouldn't drink. There is no evidence in the statistic or in the research behind it, that drinking is the cause of the "trouble". In fact, the evidence seems to show that drinking is a result of "trouble".

All of these latter points are important only in that they point up how much Mr. Truitt has weakened his central theme, which is important, and demands the immediate concern of all of us.

II. From D. Truitt,
Nelleston, Conn.

In regard to Mr. Lang's letter, first let me say that Sam is a real person, and everything that he wrote in the quoted report is absolutely real. He is a relative of mine, in fact; the original intention of the arrangement between Sam and me was to persuade him to put off drinking and smoking until a wise age to decide for himself what he wanted to do. There was no intention to "bribe" Sam either way — simply to "reward" him for waiting. Personally I believe that every young person, as soon as he is old enough, should make all his own decisions: the important problem often is to persuade a young person to wait to be old enough in order to make his decisions wisely.

I am sorry that the example was so vivid perhaps that it distracted from my main thesis: that all of us need to be intensely concerned with the actual quality of education that our young people are actually receiving.

(cont'd on page 42)

able typewriter — billed by the company as "the world's first" — which will go on public sale in February.

Underwood An Exception —

Underwood Corp., alone among the major companies in the industry, will report a loss for 1956.

A variety of factors have resulted in the concern's sudden reversal, which has carried it from a 1955 profit in excess of \$1,500,000 to a 1956 loss which may reach \$7 million. A big chunk of the red ink is the result of a non-recurring write-off of \$3,624,079 made in September, and inventory adjustments to \$602,389, made at the same time. But these additional elements had their part in the earnings plunge: A strike at Bridgeport, Conn., plant which halted output throughout September; an expanded advertising effort; a substantial stepping up of training programs; large expenditures for the development of new products.

Just when Underwood will be able to climb out of the red isn't certain, but Fred M. Farwell, president, feels confident the concern will show a profit for 1957 as a whole. He's not so sure, however, that the first two quarters will find Underwood in the black. The Elecom 125 computer, introduced last year, is counted on to make the company a factor in the lucrative data processing business; and new models in other lines, it is hoped, will bolster sales, too.

One advantage accruing to Underwood from its bad fortune last year, the company asserts, is a tax carry-forward of roughly \$3,750,000 available for deduction against taxable income in the years 1957-1962.

At the Water Cooler —

Sales of dictating equipment are humming, too. Voicewriter division of the newly-formed McGraw-Edison Co. pegs industry sales at \$55 million in 1956, against \$50 million a year ago. Voicewriter's volume jumped 20% to \$18 million last year, reports Charles H. Goddard, vice president. . . . Dictaphone Corp. (over the counter) also reportedly chalked up sales gains during 1956. . . . Clary Corp. (American) sums up 1956: "Sales up, earnings down." Hugh L. Clary, president, said he expected second half 1956 earnings equaled first half net, which was 9 cents a share; profits in 1955 totaled 34 cents a share. He is optimistic about this year. . . . Marchant Calculators, Inc., is expected to report earnings of about \$1,770,000, or \$3 a share, com-

pared with net of \$1,558,000, or \$2.75 a share, in 1955. The company's future results may be aided by a \$5 million plant at Oakland, Calif., which will be ready for partial occupancy late this year. A 6% to 10% price increase last November is expected to substantially bolster profit margins. . . . Acquisition of Commercial Controls Corp., a data processing concern, in April, 1956, strengthened second half operations of Friden Calculating Machine Co., Inc. (Pacific Coast). The West Coast company's first half earnings were \$1,265,823, and second half profits, it is calculated, will be at roughly the same rate. The company earned \$2,300,000 in 1955.

- END -

News Release

THE SERVICE BUREAU

International Business Machines Corp.
New York, N. Y.

International Business Machines Corporation has announced that control of its nationwide service bureau operations has been transferred, effective January 1, to a wholly-owned subsidiary corporation, to be known as The Service Bureau Corporation.

The company will utilize advanced accounting machine and electronic equipment to handle commercial and scientific data processing for customers on an hourly contract or volume basis. Each branch Service Bureau will be equipped with the complete line of IBM punched card accounting machines. In 16 larger cities, they also will operate an IBM 650 electronic magnetic drum computer. These machines solve with ease such problems as pipeline design, production scheduling, design characteristics for advanced aircraft, earth movement calculations for road builders, production control calculations, and cost accounting. Technical and methods assistance will be provided to customers by a field force of sales representatives and applied science specialists following a comprehensive training program.

Applications, both commercial and scientific, suitable for processing on giant brains will be handled by a scientific computing center in New York City equipped with an IBM 704 electronic data processing machine. Similar centers are planned for other locations to provide a nationwide network of high-speed data processing.

ROBOTS AND AUTOMATA:

A SHORT HISTORY

James T. Culbertson
California State Polytechnic College
San Luis Obispo, Calif.

(Taken from the first chapter of a forthcoming book "The Minds of Robots: Behavior and Sense Data in Hypothetical Automata". Numbers in brackets refer to the bibliography; the whole bibliography of the book is included at the end of this article.)

Even before the dawn of history, men have been interested in trying to explain self-moving self-acting beings, and for over 2000 years, men have experimented in making such devices. The stages of mythology and imagination, simple experiments and ingenious devices, and scientific investigation and extraordinary technical achievement may all be found.

Legends About Man's Creation

In philosophical biology there are mechanists and vitalists. The mechanists say that the laws of physics and chemistry suffice to explain the operation and also the creation of living things; or at least these laws will suffice, they say, when we know more about them.

The vitalists, on the other hand, deny this. They hold that animals and plants are essentially different from non-living things due to some kind of principle or capacity not found in inorganic objects. No combination of component parts, they say, however put together, can result in a living thing, since in addition to the physical parts correctly put together there must be added the non-physical living principle, or entelechy — the "spark of life" so to speak. This is the traditional point of view, especially in regard to human beings. Thus Genesis says that Yahweh-Elohim, or Jehovah, made the earth and heaven and after that "he formed man of dust from the ground and then blew into his nostrils the breath of life and then man became a living being". In other words, not just the right components properly put together can make a man, but only these plus the "breath of life" or vital principle.

Again and again in the various legends of the creation we find this same emphasis on the necessity of a supernatural animating principle. In the Gnostic myth, the first man, so far as his body was concerned, was completely constructed by the angels who created the world. As thus created, however, man was unable even to move until the Supreme Power put into him the "spark of life" and he became alive.

Some accounts tell of several failures before the successful instillation of the human spirit into created bodies. According to the Central American version found in the PopulVuh, or book of national traditions of Guatemala, the creators said "earth" and the earth was formed like a cloud or fog. Then mountains appeared "like lobsters from the water", after which there appeared beasts and birds, but these could not speak the names of the creators. So the creators then tried making men out of clay, but these had no vitality or consciousness and melted into the water. Then the creators tried a race of wooden automata or mannikins which were not much better; so they burned these by pouring pitch down on them. Those that survived became the present day monkeys. Finally the first four men with the spark of human life, and their wives, were properly created and the human race came into being. Why four couples were required is not clear.

Sometimes after the principal creation there were special creations to satisfy local needs. In Greek mythology, for example, Cadmus grew some new military recruits by planting dragon's teeth. Also, the gods animated Pygmalion's statue so that it became his wife, the beautiful

Galatea.

The principle of the robots and automata discussed here is non-vitalistic. All automata discussed are definitely mechanistic.

Robots in Literature and Mythology

As early as 1624 Francis Bacon prophesied various mechanical automata in his description of "Salomon's House" where they "imitate motions of living creatures by images of men, beasts, birds, fishes and serpents". Also, however, he rashly prophesied that they could chemically "make a number of kinds of serpents, worms, flies, fishes, of putrefaction, whereof some are advanced (in effect) to be perfect creatures, like beasts or birds, and have sexes, and do propagate" (4). (Note also the homunculi made by the alchemists; Paracelsus' *De generatione rerum*; and Goethe's *Faust*, Part 2.)

In Mrs. Shelley's novel, "Frankenstein or the Modern Prometheus", the hero, a physiologist, creates a powerful living monster with human desires and in the form of a man, though very ugly. Likewise in Capek's play "R. U. R.", although Rossum's Universal Robots at first merely acted like intelligent humans but lacked feelings, those later constructed were able to experience emotions and for this reason revolted against their enslavement by man. (The word "robot", first used in this play, comes from a Czech word meaning "forced labor" or "work". The Teutonic Christian name "Robert" derives from "brilliant and famous" and has no connection with this, but the Czech names "Robot", "Robath", "Roboth", "Robold", "Robelt", are all derived from "worker".)

In Greek mythology there are a few instances where something like the construction of automata is suggested. Vulcan, who built the bronze houses of the gods, their chariots and winged shoes for flying, Jupiter's thunder-bolts, and whatever modern, or rather divine, conveniences they needed, gave self-motion to some of his devices. He made the tables and chairs (tripods) to move about by themselves as required — in and out of the celestial hall or up to anyone who wished to be seated. Presumably some signal was always given by any expectant sitter.

Prometheus, one of the Titans, a race of giants who inhabited the earth before man, constructed a device of manlike shape and action, but then, being an imperfect robotologist, he had to steal fire from heaven to give it "life" and also

superiority over the other animals. Woman was not yet made. "The gods were assembled in council, and it was determined that woman should be created, and sent to man as a punishment for receiving Prometheus's gift" (15). Vulcan made the first one and she was called Pandora.

Self-moving machines or robots simulating the form and actions of human beings were called androides or androids. The mythical Daedalus made one of these, a bronze man who repelled the Argonauts, and he also made a wooden cow for Pasiphae. (We do not know how this cow compared with the very lifelike mechanical cow at the Century of Progress Exposition in Chicago. This certainly looked just like a cow — walked, moved its head, jaws, eyes, ears, belly and tail, while its sides went through the motions of breathing. Simulated milk was pumped through concealed tubes to the udder. The purpose of this realistic bovine was to demonstrate the use of a milking machine.)

The ancients were very much interested in automata as evidenced by the fantastic stories they made up about them, like the story of the brass fly trained as a watch dog, which was stationed on the gate of the city and kept all the other flies from entering for eight years.

In Hebrew mythology we find reference to an android. There is the old Jewish legend of "Golem", the strong — a man artificially made but having no soul. The Golem, running amuck, is destroyed just in time by its maker. A Seventeenth Century version says that the mysterious Rabbi Loew of Prague constructed the gigantic quasi-human, the Golem, to protect the persecuted Jews if things ever got too bad. The Golem was kept in suspended animation most of the time. He was much too powerful to be let loose on ordinary occasions since he twisted iron beams, pushed over walls and cracked pillars when up and about.

History of Automata

The ancients constructed simple automata in the form of mechanical devices to imitate spontaneously the movements of men and animals. Needless to say these were not believed to be alive or conscious by those who constructed them, no matter how much they looked like or behaved like living beings. The ancients refer to temple statues that moved and were considered divinely animated by the populace.

The first authentic automata, though perhaps quite simple, were the human figures which announced the hours by means of bells and horns on the clepsydra or water clocks of the Egyptians about 1500 B. C.

When we examine the early history of automata, we find that the accounts of some of them seem very surprising. Thus in 400 B. C. Archytas of Tarentum is said to have made a wooden pigeon that could take off, fly around, and then land. Surprising as this may be, it is well authenticated since "Many well-known Greeks and the philosopher Favorinus, a very assiduous antiquarian, have definitely asserted that Archytas constructed a wooden model of a dove according to certain mechanical principles, and that the dove actually flew, so delicately balanced was it with weights and propelled by a current of air enclosed and concealed within it" (20).

Some historical devices were run hydraulically like some of those constructed by Heron of Alexandria about 300 B. C. He was the man who made the jet rotated steam engine or eolipile and wrote treatises on mechanics. He made a figure of Hercules and the dragon, which was powered hydraulically. When activated, Hercules launched an arrow at the dragon which rose with a scream and then fell. (On a larger and more complex scale was the famous hydromechanical theater at the palace of Hellbrun, near Salzburg, built around 1615.)

Heron of Alexandria also made the first penny-in-the-slot machines. By inserting one dinar, the Greek customer could cause such a machine to give some life-like performance (88).

Leon of Thessalonica, who flourished about 829-867 and was the inventor of an optical telegraph, made similar life-like contrivances; while the Persian poet Firdawsi (932-1020) made sundry inventions including various automata (88). Then about 1200 many Eastern Muslims were concerned "with the invention or making of automata and contrivances such as were described by Heron of Alexandria and other Hellenistic mechanics" (88).

During the Middle Ages many instances of automata are recorded, such as the android butler of Albertus Magnus. This robot, which took thirty years to construct, advanced to the door when anyone knocked and then opened it and saluted the visitor. It was broken to pieces by Thomas Aquinas.

A later example is the little iron fly of Reg-

iomontanus which he constructed around 1470 and which would flutter around the room and return to his hand. He also made an eagle which flew before the emperor Maximilian when he entered Nuremberg.

Around 1500 Leonardo da Vinci, unsuccessful with his flying machine, turned to making animated toys. To some of these he gave a surprising artistic twist, like the "lion constructed with marvelous subtlety which walked from its place in a room and then stopped and opened its breast which was full of lilies and other flowers" (69). He also made "figures of animals, formed of a paste made of wax, which flew through the air when inflated" (69).

In the fifteenth and sixteenth centuries, the Swiss and other Europeans made very ingenious mechanical figures which announced the hours — such as those on the famous Nuremberg clock. Likewise the public clock at Strassburg, constructed in 1574, displayed a sequence of scenes including processions of the apostles and other persons and a crowing rooster; and a Venice clock had two bronze giants that struck the hours.

The philosopher Descartes was certainly one of the first to say that one could find out how the parts of the body interact, investigating it as if it were a machine. He compared animals to machines and hence was much impressed by automata such as the above-mentioned hydromechanical ones at Hellbrun. He may have constructed automata himself but some accounts of this seem apocryphal. It is said that he constructed an automaton in the figure of a woman, which he called his daughter Frances. He took Frances on a sea trip, but the captain, suspecting magic in her human-like movements, had her thrown overboard (38). This may not be true, however, since in another account Frances was not his daughter at all but a beautiful salamander he kept in a large chest — one of those female fire spirits that loved the alchemists.

The earliest efforts of mechanical ingenuity in Europe were chiefly directed towards the construction of clocks, watches, and automata. Men did not think of applying this mechanical ingenuity to any other industrial operations. The clocks and watches were, of course, very useful; but the automata were just toys. Yet talented mechanical artisans sometimes devoted a whole lifetime to some ingenious device which, after all, was of value only as an entertaining curiosity.

History

The goal of these early robotologists was merely to make the simulation of living agencies by inanimate clockwork as complex, detailed, and natural as possible. Never did they make any practical applications — it is principally supposed because the steam engine was not yet invented. The power available was weak except for the waterfalls which they could have used.

These automata were self-acting machines contrived so as to simulate the conduct of living creatures. Thus Pierre Droz, the Swiss watchmaker, made a large clock and orrery with many attached automata run by it — a sheep that walked about bleating, a dog which snarled and barked when anyone tried to take some fruit from a basket it was guarding, and some human figures that moved about in a natural manner, one of which used a pencil to draw pictures of the king and queen of Spain.

The wonderful duck made by Jacques de Vaucanson, the famous eighteenth century mechanic, is often mentioned. This duck waddled about and was able to eat, drink, and imitate exactly the natural voice of that fowl. Still more remarkable, the food it swallowed was evacuated in a digested state, or at least it was altered by chemicals in its artificial stomach. The wings, viscera and bones closely resembled those of a living duck, and its behavior in eating and drinking showed the strongest resemblance, even to the muddling of water with its bill. Later, when exhibited in Paris in 1844, it was broken but was successfully repaired by Robert Houdin, the celebrated conjurer and robot maker. Vaucanson also made the mechanical flute player mentioned below, while the renowned Doctor Camus constructed a little chariot which would run around the edge of any suitable table, various personnel getting in and out and bowing or saluting from time to time.

In 1738 Vaucanson finally finished his flute player "... a figure about five feet and a half in height situated on a fragment of a rock, fixed upon a square pedestal. ... Nine pairs of bellows discharged their air into three different tubes, which, ascending through the body of the figure, terminated in three small reservoirs in its trunk; these then united into one, which, ascending to the throat, formed the cavity of the mouth. To each of the three pipes, three pairs of bellows were attached. ... Another piece of clockwork, contained within the pedestal, was for the purpose of communicating the proper motions to his fingers, his lips, and his tongue. ... This mechanism enable M. Vaucanson to produce all the motions requisite for an expert flute player, which it executed in such a manner as to produce music equal in beauty to that de-

rived from the exertions of a well-practiced living performer" (36).

Another Swiss made a female piano player. She was said to perform eighteen tunes and her movements were always elegant and graceful, and "so nearly imitating life that even on a near approach the deception can hardly be discovered. Her bosom heaves and her eyes move to follow the keys." ... (36).

A whole automaton opera in miniature was constructed by Father Truchet to entertain Louis XIV, and likewise a number of tiny mechanical theaters were created.

These automata, however complex, merely execute a planned series of actions and, unlike modern automata, they do not contain "feedback" devices.

Most non-feedback automata act in a prefixed way regardless of circumstances that arise during the course of their behavior. Feedback enables an automaton to adjust its behavior to circumstances that arise either from its own activity or from some other source. Automata having feedback devices are goal seeking in the following sense. They receive input or stimuli from the goal in such a way that their deviation from goal directed behavior is continuously corrected. This input is called negative feedback. A mechanical "dog" embodying negative feedback correction is discussed later on in this section.

In the latter half of the 18th century, Pierre Droz, the Swiss mechanic already mentioned above, and his son, Henry, made some famous androids which are still preserved in the museum at Neuchatel, Switzerland. One of these was their famous writing automaton. This was a figure of a boy sitting at a desk holding a pen. It would dip the pen into an inkwell and then carefully write on a piece of paper. It would write out a whole page and then sign its name at the bottom.

Pierre Droz was one of the most accomplished of the Swiss watchmakers. It must be admitted, though, that he sometimes enhanced the amazing animation of his devices by a little innocent intervention. On his disastrous trip to Spain he took along one of his clocks.

"... This clock was so constructed as to be capable of performing the following movements. There was exhibited on it a negro, a shepherd, and a dog. When the clock struck, the shepherd played six tunes on his flute, and the dog approached and

fawned upon him. This clock was exhibited to the King of Spain, who was greatly delighted with it. 'The gentleness of my dog', said Droz, 'is his least merit. If your majesty touch one of the apples which you see in the shepherd's basket, you will admire the fidelity of this animal'. The king took an apple, and the dog flew at his hand, and barked so loud that the King's dog, which was in the same room during the exhibition, began to bark also; at this the courtiers, not doubting that it was an affair of witchcraft, hastily left the room, crossing themselves as they went out. Having desired the master of marine, who was the only one who ventured to stay behind, to ask the negro what o'clock it was, the minister asked, but he obtained no reply. Droz then observed that the negro had not yet learned Spanish, upon which the minister repeated the question in French and the black immediately answered him. At this new prodigy the firmness of the minister also forsook him, and he retreated precipitately, declaring that it must be the work of a supernatural being. It is probable that, in the performance of these tricks, Droz touched certain springs in the mechanism, although this is not mentioned in any of the accounts of his clock" (18).

With an English manager, Droz showed these robots in Spain where the King was much interested and Droz was very well received at court. But the superstitious populace resented the lifelike androids. Droz was cast into the Dungeon of the Inquisition, over which the King had no jurisdiction. His manager stole his robots and sold them to a French count. Droz was released and made an unhappy return to Switzerland. The French owner died on a trip to America and the androids were left forgotten in his attic for many years. Art experts in 1900 estimated the value of the "Pianist", the "Draughtsman", and the "Musician" at \$60,000. No androids like these, in complex mechanical perfection, have ever been made since.

Many others besides Droz were making devices of this kind. Bontemps made mechanical singing birds and other such mechanical contrivances. Friederich Kaufmann made automatic trumpeters that played marches. Maillardet made a snake which crawled along, hissing while its tongue darted in and out. Also he made a spider of steel which ran around in a spiral toward the center of a table. Miral constructed figures which played various instruments and gave concerts.

In 1782, Miral completed two mechanical heads which were said to speak whole phrases on their own. A long flat wire properly notched just right with extreme care and drawn rapidly along

the edge of a suitable diaphragm could produce the sounds and was supposed by some to have been the means he used. Few nowadays would spend the many years he did to produce such a merely amusing result.

(Over a century later Edison's talking manikin was easily and quickly constructed as a pleasing diversion once he had developed the phonograph. This device was a large doll with a concealed mechanism. The doll would repeat in a clear voice any speech addressed to it.)

The largest exhibit recently given of these historically interesting grownups' toys was in a Manhattan gallery in 1950. The Pretalozza Foundation of America exhibited 165 automata, all still in working condition — some even from the 16th and 17th centuries but most of them from the 18th and 19th. There were 18th century mechanical mice, each a unique individual creation. One of these would become animated if we pulled his tail. He would rise on his feet, hesitate, dart away, stop suddenly, turn about three times, and then take off in a different direction. Also there was a caterpillar that, when wound up, inched along with a remarkable simulation of nature.

One small 18th century mechanical juggler was powered by falling sand. A large container was filled with sand before each performance. From this the sand fell out through a small hopper to move paddle wheels connected to the rest of the mechanism, the whole being constructed entirely of cardboard and wire. The juggler went through a long and complex series of maneuvers with little green and red balls.

As just a single example from the last century consider the celebrated life-size zither player, Isis, constructed by C. E. Nixon, a dentist in San Francisco. Her works were in her body and also in the cabinet on which she sat. She played any one of sixty-three compositions, in response to the human voice or the proper note struck on the piano. If the room got too hot she removed her veil.

Most of the robots before this century involved practically no feed-back, as we have said. Their performance was not corrected or adjusted very much by input during their performance. They were merely automatic machines which functioned in a fixed way throughout their cycle of operation without the intervention of human effort. Thus they were essentially the same as the less spectacular watches, clocks, orreries, and other

clockwork toys of the Renaissance and later times. Many machines used even now in industrial operations such as wrapping up chewing gum or cigarettes are just the same except, of course, that they are useful. Disregarding all information except the throw of the starting switch, their behavior proceeds with pre-fixed inexorable relentlessness, regardless of further stimuli until they are turned off, or run down, or become jammed or broken. The new engineering emphasis, as is well known, is on the use of devices with corrective or "negative" feedback, so that during their performance they can modify their behavior according to the circumstances that arise. Two stock examples are thermostats and engine governors.

A very interesting twentieth century robot with feedback was the mechanical dog invented by J. H. Hammond, Jr., in 1915. This goal-directed automaton was positively phototropic, that is, it would move toward the light like a moth. If it began to deviate too much from the direct route to the light, this deviation caused the steering wheel (by "negative feedback") to turn the moth or "dog", as it was called, back again onto the direct route to the light source. It would pursue the light however the light moved (73).

"This 'Orientation Mechanism' consists of a rectangular box, about 3 feet long, 1-1/2 feet wide, and 1 foot high. This box contains all the instruments and mechanism, and is mounted on three wheels, two of which are geared to a driving motor, and the third, on the rear end, is so mounted that its bearings can be turned by solenoid electro-magnets in a horizontal plane. Two 5-inch condensing lenses on the forward end appear very much like large eyes.

"If a portable electric light, such as a hand flashlight, be turned on in front of the machine it will immediately begin to move toward the light, and moreover, will follow that light all around the room in many complex maneuvers at a speed of about 3 feet per second. ...

"Upon shading or switching off the light the dog can be stopped immediately, but it will resume its course behind the moving light so long as the light reaches the condensing lenses in sufficient intensity. Indeed, it is more faithful in this respect than the proverbial ass behind the bucket of oats. To the uninitiated the performance of the pseudo dog is very uncanny indeed.

"The explanation is very similar to that given by Jacques Loeb, of reasons responsible for the flight of moths into a flame....

"The orientation mechanism ... possesses two selenium cells corresponding to the two eyes of the moth, which when influenced by light effect the control of sensitive relays.... The two relays ... control electro-magnetic switches, which effect the following operations: When one cell or both are illuminated the current is switched on to the driving motor; when one cell alone is illuminated an electro-magnet is energized and effects the turning of the rear steering wheel. The resultant turning of the machine will be such as to bring the shaded cell into the light. As soon and as long as both cells are equally illuminated in sufficient intensity, the machine moves in a straight line toward the light source. By throwing a switch, which reverses the driving motors, the machine can be made to back away from the light in a most surprising manner...."

This automaton, and others like it, exhibited as interesting curiosities, were a little before their time. They did not excite the great military interest that their target-seeking descendants now do. Clearly, however, Hammond's phototropic dog was the Adam of a new species quite different from the previous clockwork automata each executing its planned series of predetermined actions without benefit of feedback correction.

To carry the history of automata further into the present century would be too large a topic to include in this book, though some modern robots such as Grey-Walter's turtles (47), E. C. Berkeley's electromechanical squirrel (140), the RAND automata, and Shannon's maze running rat are referred to later.

The bibliography, to which the numbers for notes refer, will be published in the next issue.

SECOND NATIONAL SIMULATION CONFERENCE,
HOUSTON, TEXAS, APRIL 11-13

The Second National Simulation Conference and the Ninth Southwestern I. R. E. Conference and Electronic Show will take place at the Shamrock-Hilton Hotel, Houston, Texas, April 11, 12, and 13. Topics of the sessions include Instrumentation, Computer Devices, Geophysics, Physical Simulation, Communications, Function Generators, Medical Electronics, and Applications. Approximately 100 exhibitors will take part in the show. For more information write to M. A. Arthur, Humble Oil, P. O. Box 2180, Houston 1, Texas.

The survey form (a copy of it appears on page 39) asks mainly two questions:

1. What kinds of computer products and services does your organization buy or rent?

2. Can you estimate roughly how much your organization is likely to spend on such products and services in the next twelve months? in the next five years?

The third question in the survey is: What perplexing subjects would you like us to inquire about in our surveys? We shall be particularly glad to hear from our readers in regard to this. The purpose of the surveys is to help the computer field.

The survey form is being mailed to our subscribers. But we shall be glad to have a reply from any computer person, whether subscriber or not, and take his reply into account also. The survey form may be copied on any piece of paper, filled in, and sent to us

53 FOREIGN SUBSCRIPTIONS AT ONCE

One day in the middle of February we were surprised and pleased to receive a single order (with check for \$304.00) for 53 foreign subscriptions to "Computers and Automation". The 19 sub-orders were to be sent as follows:

<u>No.</u>	<u>Class</u>	<u>Place</u>
5	New (N)	Moscow 31
1	Renewal (R)	Moscow
1	R	Moscow 34
2	1 N, 1 R	"
1	N	"
1	R	Leningrad 164
1	R	"
1	N	"
2	1 N, 1R	Moscow
1	R	Tbilisi
1	N	Moscow
1	N	"
3	1 N, 2R	Leningrad
4	N	Moscow
8	R	Moscow 71
7	R	Moscow 88
3	N	"
9	2 N, 7 R	Moscow
<u>1</u>	<u>R</u>	<u>Moscow 37</u>
53	21N, 32R	

This suggests a 65 percent increase in circulation of "Computers and Automation" in the U. S. S. R. from 1956 to 1957.

REFERENCE INFORMATION

The reason this magazine exists is "reference information". In September 1951 we issued a "Roster of Organizations in the Computing Machinery Field", a purple ditto list of 12 pages listing some 75 organizations in the field. That turned out to be vol. 1 no. 1 of "Computers and Automation". We now publish 16 kinds of reference information, and we look forward to the day when we shall be publishing 30 kinds of reference information.

What do we mean by "reference information"? Such information consists of answers to questions like "What are all the ?"; it is the kind of information found in directories, almanacs, tables, dictionaries, lists, rosters, and all kinds of enumerations.

Often when one investigates a subject, the crucial knowledge is reference information. For instance, if you are investigating from whom to buy a magnetic drum, the crucial knowledge consists of the names and addresses of suppliers so that a reasonable choice can be made between them. This particular kind of information is provided in a piece of reference information which we publish called "Roster of Products and Services in the Computer Field"; the next cumulative list will be in the June 1957 issue of "Computers and Automation".

In the present issue of the magazine, we bring up to date and publish once more three pieces of reference information that are related to the Roster of Products and Services. One is "Automatic Computing Machinery -- List of Types" (on page 22); this list reminds a reader of some of the many ways automatic machinery for handling information is now being applied. A second list is "Components of Automatic Computing Machinery -- List of Types" (on page 24); this reflects pointedly the progress of the computer art to date. The third list is "Products and Services in the Computer Field - List of Headings" (on page 28); this is a list of headings which we expect to use with minor changes in the next issue of the Roster of Products and Services.

On page 46 of this issue appears a list of the 16 kinds of reference information which we publish.

Any comments, revisions, and suggestions which any one may be kind enough to send us, will be welcome.

- END -

SURVEY — ESTIMATE OF THE COMPUTER MARKET

The computer field contains many hard-to-answer questions, which can be partly answered through surveys. The purpose of this first survey being made by "Computers and Automation" is to form an estimate of the size of the market for computers, data processors, and related equipment. Following is the inquiry form for this survey. The response of any person who considers himself in the computer field is welcome, and will be much appreciated. The form may be torn out of the magazine, or may be copied on any piece of paper. We hope that the results when published will be of use to all our readers.

ESTIMATE OF THE MARKET FOR COMPUTERS AND DATA PROCESSORS

Questions

1. What kinds of computer products and services does your organization buy or rent (or is considering buying or renting)?

<u>Computers</u>	<u>Yes</u>	<u>No</u>
- automatic digital computers?	()	()
- automatic analog computers?	()	()
- simulators?	()	()
- other data processing machines?	()	()
such as: _____		

<u>Components</u>	<u>Yes</u>	<u>No</u>
- delay lines?	()	()
- magnetic tape devices?	()	()
- transistors?	()	()
- other components?	()	()
such as: _____		

<u>Services</u>	<u>Yes</u>	<u>No</u>
- computing services?	()	()
- consulting services?	()	()
- other services?	()	()
such as: _____		

2. Can you estimate (roughly and approximately) about how much your organization is likely to spend on products and services in the computer field

- in the next twelve months?
between \$ _____ and \$ _____

- in the next five years?
between \$ _____ and \$ _____

3. What perplexing questions or subjects would you like us to inquire about in our surveys?

_____ (attach paper if needed)

4. Any remarks? _____

And for statistical purposes: Your department?

Your chief job responsibilities? _____

Do your recommendations affect purchases?

Your organization's main products? _____

No. of employees? _____

Filled in by: Name _____

Title _____ Date _____

Organization _____

Address _____

When completed to the extent you conveniently can, please return this survey form to E. C. Berkeley, Editor, Computers and Automation, 815 Washington St., Newtonville 60, Mass.

ADVERTISING IN "COMPUTERS AND AUTOMATION"

Memorandum from Berkeley Enterprises, Inc.
Publisher of COMPUTERS AND AUTOMATION
815 Washington St., Newtonville 60, Mass.

1. What is "COMPUTERS AND AUTOMATION"?

It is a monthly magazine containing articles, papers, and reference information related to computing machinery, robots, automatic control, cybernetics, automation, etc. One important piece of reference information published is the "Roster of Organizations in the Field of Computers and Automation". The basic subscription rate is \$5.50 a year in the United States. Single copies are \$1.25, except the June issue, "The Computer Directory", (1956, \$6.00; 1955, \$4.00). For the titles of articles and papers in recent issues of the magazine, see the "Back Copies" page in this issue.

2. What is the circulation? The circulation includes 2650 subscribers (as of Feb. 15); over 300 purchasers of individual back copies, and an estimated 4000 nonsubscribing readers. The logical readers of COMPUTERS AND AUTOMATION are people concerned with the field of computers and automation. These include a great number of people who will make recommendations to their organizations about purchasing computing machinery, similar machinery, and components, and whose decisions may involve very substantial figures. The print order for the February issue was 3000 copies. The overrun is largely held for eventual sale as back copies, and in the case of several issues the overrun has been exhausted through such sale.

3. What type of advertising does COMPUTERS AND AUTOMATION take? The purpose of the magazine is to be factual and to the point. For this purpose the kind of advertising wanted is the kind that answers questions factually. We recommend for the audience that we reach, that advertising be factual, useful, interesting, understandable, and new from issue to issue. We reserve the right not to accept advertising that does not meet our standards.

4. What are the specifications and cost of advertising? COMPUTERS AND AUTOMATION is published on pages 8 1/2" x 11" (ad size, 7" x 10") and produced by photooffset, except that printed sheet advertising may be inserted and bound in with the magazine in most cases. The closing date for any issue is approximately the 10th of the month preceding. If possible, the company advertising should produce final copy. For photooffset, the copy

should be exactly as desired, actual size, and assembled, and may include typing, writing, line drawing, printing, screened half tones, and any other copy that may be put under the photooffset camera without further preparation. Unscreened photographic prints and any other copy requiring additional preparation for photooffset should be furnished separately; it will be prepared, finished, and charged to the advertiser at small additional costs. PLEASE DO NOT SEND US METAL PLATES OR ELECTROS; please send reproduction proofs instead. In the case of printed inserts, a sufficient quantity for the issue should be shipped to our printer, address on request.

Display advertising is sold in units of a full page (ad size 7" x 10", basic rate, \$190), two-thirds page (basic rate, \$145), half page (basic rate, \$97), and quarter page (basic rate, \$55); back cover, \$370; inside front or back cover, \$230. Extra for color red (full pages only and only in certain positions), 35%. Two-page printed insert (one sheet), \$320; four-page printed insert (two sheets), \$590. Classified advertising is sold by the word (60 cents a word) with a minimum of 20 words.

5. Who are our advertisers? Our advertisers in recent issues have included the following companies, among others:

A M P, Inc.	Lockheed Aircraft Corp.
American Bosch Corp.	Lockheed Missile Systems
Ampex Corp.	The Glenn L. Martin Co.
Armour Research Found.	Monrobot Corp.
Arnold Engineering Co.	Norden-Ketay Corp.
Automatic Electric Co.	Northrop Aircraft Inc.
Bendix Aviation Corp.	George A. Philbrick Researches, Inc.
Bryant Chucking Grinder Co.	Potter Instrument Co.
Cambridge Thermionic Epsco, Inc.	Ramo-Wooldridge Corp.
Ferranti Electric Co.	R. C. A. Service Co.
Ferroxcube Corp.	Reeves Instrument Co.
General Electric Co.	Remington Rand, Inc.
General Transistor Corp.	Republic Aviation Corp.
International Business Machines Corp.	Sprague Electric Co.
	Sylvania Electric Products, Inc.

ARE YOU LOOKING FOR

COMPUTER PEOPLE?

— mathematicians, engineers, programmers, systems analysts, supervisors, and other trained people in the computer field? If so —

● We can help you in three ways :

1 — Who's Who in the Computer Field 1956-57:

This extra number of "Computers and Automation" will be published probably in March. We estimate that it will be over 190 pages long, and will contain names, addresses, and some information for over 11,000 computer people. Sample full entry (interpreted): Carr, John W, III / Asst Prof Math, Univ of Michigan, Ann Arbor, Mich / ADLMP (i. e. , main interests: Applications, Design, Logic, Mathematics, Programming) / (born:) '23, (last college:) Mass Inst of Techn, (entered computer field:) '48, (occupation:) mathematician / (distinctions:) pres Asscn for Computing Machinery 1956-8. Sample brief entry: Sutherland, Ivan / 152 Bradley Road, Scarsdale, N Y .

● Following is an order form

2 — Advertising in "Computers and Automation".

Many important companies use our pages for their ads to enlist computer people for their organizations. Our advertisers of employment opportunities include General Electric, International Business Machines, Lockheed, North American Aviation, Ramo-Wooldridge, Remington Rand, and many more. We have over 2500 subscribers and an additional (estimated) 5000 readers. Quarter page rate, \$55; full page, \$190.

● Our rate card and details will be sent to you for the asking

3 — Mailings to Computer People. We have on metal address plates over 10,000 names of computer people (entrants in the Who's Who, members of computer societies, expiries to "Computers and Automation", registrations at computer meetings, etc.). They are subdivided geographically. Their number is increasing daily. Cost,

From:
COMPUTERS AND AUTOMATION
Berkeley Enterprises, Inc.
815 Washington St.
Newtonville 60, Mass.

\$19 a thousand envelopes addressed (less for participants in the list, and for non profit organizations). (Note: Send us your proposed mailing piece first for approval, then send the envelopes for addressing NOT TO us in Massachusetts BUT TO Publishers Mailing Service, 38 First St. , New York 3, N. Y. , where the plates are located.)

● Following is an order form

I hope we can be of help to you —

Edmund C. Berkeley

Edmund C. Berkeley
Editor, Computers and Automation

----- MAIL THIS REQUEST or a copy of it -----

To: COMPUTERS AND AUTOMATION
815 Washington St.
Newtonville 60, Mass.

1. () Please send us _____ copy(ies) of "Who's Who in the Computer Field 1956-57" when published, at \$17.50. Returnable within one week after delivery (probably in March), if not satisfactory, for full refund. We enclose \$_____.

2. () Yes, we may be interested in advertising in "Computers and Automation". Please send us rate card and more information.

3. () We are interesting in using your address plates for mailings to computer people. Here is our proposed mailing piece for your approval.

Name _____ Title _____

Organization _____

Address _____

I think Mr. Lange has put his finger on the most important of all the points: "how we are to convince our fellow townspeople that such steps are not only desirable but necessary." In order to convince people, you have to have evidence (or information or data or literature) and you have to have authority (or standing or status or reputation); then you can be convincing. So there are two steps that go hand in hand: publications and publicity on "The Improvement of Education" and an organization "Society for the Improvement of Education". In other words, we need a pressure group; even the best causes need pressure groups!

I believe it is up to Mr. Lange and me and any other people who agree with us to form a society and put out information in a coordinated, organized way, leading towards "The Improvement of Education".

Forum

INTERNATIONAL CONFERENCE ON OPERATIONAL RESEARCH

Operations Research Society of America
The Institute of Management Sciences, U. S. A.
Operational Research Society of Great Britain

An International Conference on Operational Research is being organized by these three Societies, and will be held at Oxford, England, from September 2 to September 6, 1957. The object of the conference will be to unify and extend the science of Operational Research. Papers will be presented in several sessions, including: the "Wholeness" or Underlying Unity of Operational Research; the Methodology; Applications; etc.

Further information regarding this conference will be circulated later this year. In the meantime, proposed papers are invited. Summaries totalling not more than 200 words should be sent to

Dr. Thornton Page
7100 Connecticut Ave.
Chevy Chase, Md.

Opportunities will be made available for people coming from abroad to visit British Operational Research Establishments studying specific problems or using specific techniques. Arrangements are being made to publish the conference proceedings.

MANUSCRIPTS

We are interested in articles, papers, reference information, and discussion relating to computers and automation. To be considered for any particular issue, the manuscript should be in our hands by the fifth of the preceding month. Ordinarily, the length should be 1000 to 4000 words.

Articles. We desire to publish articles that are factual, useful, understandable, and interesting to many kinds of people engaged in one part or another of the field of computers and automation. In this audience are many people who have expert knowledge of some part of the field, but who are laymen in other parts of it. Consequently a writer should seek to explain his subject, and show its context and significance. He should define unfamiliar terms, or use them in a way that makes their meaning unmistakable. He should identify unfamiliar persons with a few words. He should use examples, details, comparisons, analogies, etc., whenever they may help readers to understand a difficult point. He should give data supporting his argument and evidence for his assertions. We look particularly for articles that explore ideas in the field of computers and automation, and their applications and implications. An article may certainly be controversial if the subject is discussed reasonably. A suggestion for an article should be submitted to us before too much work is done.

Technical Papers. Many of the foregoing requirements for articles do not necessarily apply to technical papers. Undefined technical terms, unfamiliar assumptions, mathematics, circuit diagrams, etc., may be entirely appropriate. Topics interesting probably to only a few people are acceptable.

Reference Information. We desire to print or reprint reference information: lists, rosters, abstracts, bibliographies, etc., of use to computer people.

Discussion. We desire to print in "Forum" brief discussions, arguments, announcements, news, letters, descriptions of remarkable new developments, etc., anything likely to be of substantial interest to computer people.

Occasionally, we print or reprint science fiction which explores scientific ideas and possibilities about computers, robots, cybernetics, automation, etc., and their implications, and which is at the same time a good story.

Payments. In many cases, we make small token payments for articles and papers, if the author wishes to be paid. The rate is ordinarily ½¢ a word, with a maximum of \$20, and half that if it has been printed before.

ROSTER ENTRY FORMS

"Computers and Automation" publishes from time to time over a dozen types of reference information. One type is "Roster of Organizations in the Computer Field"; the last instance of this Roster appeared in the August, 1956 issue. Here is a sample entry:

"Potter Instrument Co., 115 Cutter Mill Rd., Great Neck, N. Y. / Great Neck 2-9532 / *C Electronic counters. Magnetic and perforated paper tape handlers; digital printer. Shift registers. Magnetic core memory. Random access memory. High-speed printer ("Flying Typewriter"): 6-1/2 lines of characters printed per second. Analog-to-digital converter. Ms(115) Me(1942) Dc RMSa (MEANING: Medium size, 115 employees. Established 1942. Interested in digital computing machinery. Research, manufacturing, and selling activity.)"

A second type is "The Computer Field: Products and Services for Sale or Rent"; the last instance of this appeared in the June, 1956 issue. Here is a sample entry (together with the heading under which it appeared):

" 21. DIGITAL-TO-ANALOG CONVERTERS

"ACF ELECTRONICS, INC., 800 N. Pitt St., Alexandria, Va. / ACF Model 1002 Decoder / DESCR: All-electronic, rack-mountable converter providing rapid, precise, and dependable conversion of digital data to analog voltages. Unit capable of accepting up to 200,000 ten-bit binary codes per second with a precision one part in 1024. / USE: applications in digital computing systems or data transmission links / \$950 "

The next issue in which these rosters will be published, cumulative and up to date, is the June 1957 issue, "The Computer Directory and Buyers' Guide", which closes about April 10.

If you are interested in sending information to us for these rosters, following is the form of entry. To avoid tearing the magazine, the form may be copied on any piece of paper. The requested nominal charge of \$10 per entry applies to the cumulative listing in the Directory issue, but not to supplements published in the magazine from time to time.

Organization Entry Form

1. Your organization's correct name?

2. Your address? _____
3. Telephone number? _____

4. Types of computing machinery or components or computer field products and services that you are interested in?

5. Types of activity that you engage in:
() research () other (please
() manufacturing explain) _____
() selling _____
() consulting _____

6. Approximate number of your employees? _____

7. Year when your organization was established?

Filled in by _____
Title _____ Date _____

When filled in, please send this form to COMPUTERS AND AUTOMATION, 815 Washington St., Newtonville 60, Mass., with \$10.00 requested nominal charge per entry, on or before APRIL 10, 1957.

Product Entry Form

1. Name or identification of produce (or service)?

2. Brief description (20 to 50 words): _____

3. How is it used? _____

4. What is the price range? _____

5. Under what headings should it be listed?

Organization _____

Address _____

Filled in by _____

Title _____ Date _____

When filled in, please send this form to COMPUTERS AND AUTOMATION, 815 Washington St., Newtonville 60, Mass., with \$10.00 requested nominal charge per entry, on or before APRIL 10, 1957.

EDUCATION AND COMPUTERS

Bo Brown
Jenkintown, Pa.

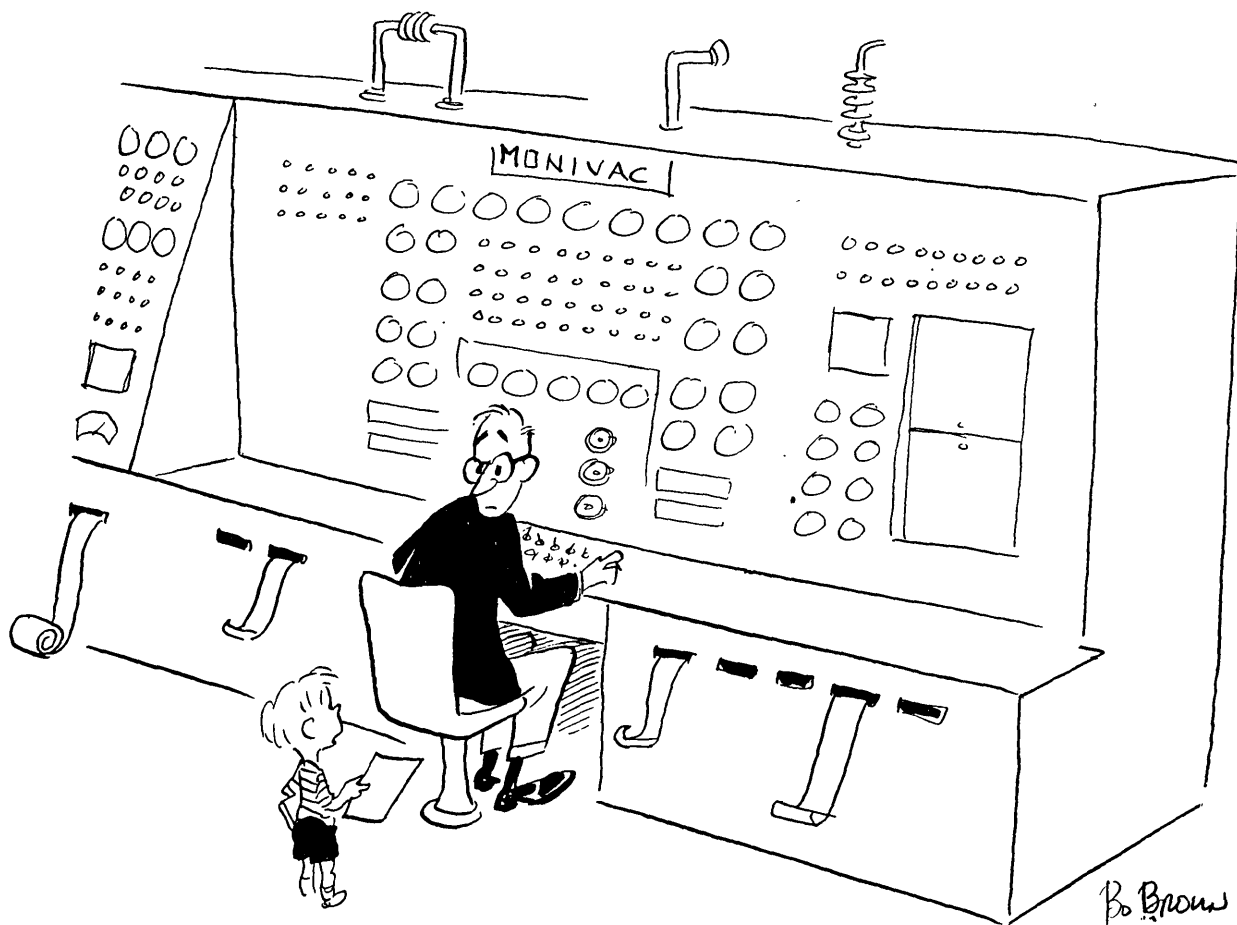

"Daddy, could you run my homework through again?"

**SPECIAL ISSUES OF
"COMPUTERS AND
AUTOMATION"**

The June issue of "Computers and Automation" in each year commencing with 1955 is a special issue, "The Computer Directory", containing a cumulative "Roster of Organizations" and a cumulative "Roster of Products and Services in the Computer Field", and other reference information.

In June 1957 we shall publish the special issue "THE COMPUTER DIRECTORY AND BUYERS' GUIDE, 1957". For more information about this issue see page 6.

In early 1957, we shall publish Edition No. 2 of a cumulative "Who's Who in the Computer Field", as an extra number of "Computers and Automation". For more information, see page 6.

CORRECTIONS

In the February, 1957 issue of "Computers and Automation":

Page 24, 1st column, 6th line, replace "with" by "wish".

Page 25, 2nd column, replace "this about" by "this is about".

Page 41, 1st column, 8th line, replace "Trump" by "Trumpet".

NUMERICAL ANALYSIS COURSE

Clemson College
Mathematics Department
Clemson, South Carolina

Beginning with the second semester, 1957, the Mathematics Department will offer a course in "Numerical Analysis (Math 308)." The course is unique in that it is the first time that a mathematics course will be conducted on a "Theory-Lab" basis, the 3 hour credit being 2 theory hours and a 3-hour lab. Also, Clemson will be one of the few colleges or universities offering Numerical Analysis at the undergraduate level. Any student who has completed Integral Calculus (Math 204) will be eligible for enrollment.

The primary objectives of the course are to present the theory of various methods of obtaining approximate solutions to problems arising in the physical, biological and social sciences, and to provide practice in rapid means of obtaining the approximations through the use of mechanical and electronic computing devices.

The course will have three major aspects:

(1) Approximation Methods — to include "trapping techniques, interpolation and extrapolation methods, successive approximations, series solutions, etc. These will be applied to arithmetic problems, high degree algebraic equations, transcendental equations, differential equations, and certain boundary value problems.

(2) Theory of Approximations — to include elements of error analysis, numerical differentiation and integration, principle of least squares, probability equations, central-difference formulas, etc.

(3) Introduction to High-speed Computer Methods — to include elementary Boolean algebra and Laws of Logic, principles of data reduction and programming. If possible, a small scale digital computer, using relays, will be constructed and used for demonstrations and practice in these areas.

The course, although elementary, should be useful to all Engineering and Science majors, and of particular value to students interested in nuclear work and certain phases of Industrial Management.

- END -

**Physicists and
mathematicians
HOW DO YOUR
SPECIAL SKILLS
FIT INTO THE
AIRCRAFT
NUCLEAR
PROPULSION
PICTURE**

AT GENERAL ELECTRIC

Many physicists and mathematicians who recognize the exceptional promise of a career in General Electric's fast growing Aircraft Nuclear Propulsion Department have asked if their skills can be used in this significant project.

If you are qualified to work on
THERMODYNAMIC and AIR CYCLE ANALYSIS

REACTOR ANALYSIS

SHIELD PHYSICS

NUCLEAR INSTRUMENTATION

APPLIED MATHEMATICS

DIGITAL and ANALOG COMPUTER

THEORETICAL PHYSICS

you can move NOW into major assignments in the development of nuclear propulsion systems for aircraft.

You do not need previous nuclear experience. Through General Electric's full-tuition refund plan for advanced university courses and inplant training conducted by experts, you'll acquire the necessary nucleonics knowledge.

The field itself assures you a rewarding future, but, more than that, the physicist or mathematician who likes to work in a top-level scientific atmosphere will appreciate General Electric's encouragement of creative thinking, its recognition of accomplishment.

Comprehensive benefit program • Periodic merit reviews • Excellent starting salaries • Relocation expenses paid

OPENINGS IN —

Cincinnati, Ohio and Idaho Falls, Idaho

Write in confidence stating salary requirements, to location you prefer:

J. R. ROSSELOT
P. O. Box 132
Cincinnati, Ohio

L. A. MUNTHNER
P. O. Box 535
Idaho Falls, Idaho

GENERAL  ELECTRIC

COMPUTERS AND AUTOMATION — Back Copies

REFERENCE INFORMATION

Sixteen kinds of reference information that computer people can hardly afford to be without (latest issues containing each are indicated):

Organizations:

- Roster of Organizations in the Computer Field (June, Aug. 1956)
- Roster of Computing Services (June 1956)
- Roster of Consulting Services (June 1956)

Computing Machinery and Automation:

- Types of Automatic Computing Machinery (March 1957)
- Roster of Automatic Computers (June 1956)
- Outstanding Examples of Automation (July 1954)
- Commercial Automatic Computers (Dec. 1956)
- Types of Components of Automatic Computing Machinery (March 1957)

Products and Services in the Computer Field:

- Products and Services for Sale (June 1956)
- Classes of Products and Services (March 1957)

Words and Terms: Glossary of Terms and Expressions in the Computer Field (Oct. 1956)

Information and Publications:

- Books and Other Publications (many issues)
- New Patents (nearly every issue)
- Roster of Magazines (Dec. 1955)
- Titles and Abstracts of Papers Given at Meetings (many issues)

People: Who's Who in the Computer Field (various issues)

ARTICLES, PAPERS, ETC.

June: THE COMPUTER DIRECTORY, 1956 (104 pages)

- Part 1: Roster of Organizations in the Computer Field (cumulative)
- Part 2: The Market Place -- The Computer Field: Products and Services for Rent or Sale (cumulative)
- Part 3: Who's Who in the Computer Field (supplement)
- Part 4: Roster of Automatic Computers (cumulative)

August: Two Electronic Computers Share a Single Problem -- National Bureau of Standards

- IBM Electronic Data Processing Operations in the Midwest -- Neil D. Macdonald
- Complaint by Sperry Rand Corp. in Anti-Trust Suit Against Intern. Bus. Mach Corp., & Answer and Counterclaim by IBM

September: The IBM Computer AN/FSQ-7 and the Electronic Air Defense System SAGE -- H.T. Rowe

- Glass and Metal Honeycomb Type of Electrostatic Storage Memory -- General Electric Research Laboratory
- The Computer Age -- Staff of Business Week
- An Ocean-Based Automatic Weather Station -- National Bureau of Standards
- U.S. District Court, U.S.A., Plaintiff, vs. IBM Corp., Defendant. Final Judgment

October: Glossary of Terms in the Field of Computers and Automation (cumulative)

- Systems Engineering in Business Data Processing -- Ned Chapin
- Magnetic Ink Character Recognition in Mechanization of Check Handling

November: Use of Automatic Programming -- Walter F. Bauer

- Data Problems of a Grocery Chain -- Frank A. Calhoun
- The Power of the Computer -- George J. Huebner, Jr.
- An Automatic Micro-Image File -- National Bureau of Standards

December: Indexing for Rapid Random Access Memory Systems -- Arnold I. Dumey

- Self-Repairing and Reproducing Automata -- Richard L. Meier
- The Computer's Challenge to Education -- Clarence B. Hilberry

January, 1957 (vol. 6, no.1): Modern Large-Scale Computer System Design -- Walter F. Bauer

- Logical and Combinatorial Problems in Computer Design -- Robert McNaughton
- Transistorized Magnetic Core Memory -- Bell Telephone Laboratories

Education for Automation -- Alston S. Householder

- Social and Public Relations' Responsibilities of the Computer Industry -- Jay W. Forrester
- High School Science Education -- Richard W. Melville

Objective Measures of Education -- Donald Truitt

February: Computation for an Earth Satellite -- Neil D. Macdonald

- New Computer Developments Around the World -- Everett S. Calhoun

Industry and the Automated Future: Problems Along the Way -- John Diebold

- Electronic Digital Data-Handling -- Howard T. Engstrom

The Solution of Boundary Value Problems on a REAC Analog Computer -- M. Yanowitch

BACK COPY PRICE: If available, \$1.25 each, except June 1955, \$4.00, and June 1956, \$6.00 (the June issue is the Computer Directory issue)

- - - - Mail this coupon (or a copy of it) - - - -

To: Berkeley Enterprises, Inc.
815 Washington St., R191
Newtonville 60, Mass.

Please send me the following back copies:

I enclose \$_____ in full payment. If not satisfactory, returnable within week for full refund (if in good condition).

My name and address are attached.

DATA
PROCESSING

Ramo-Wooldridge has several opportunities available for persons experienced in the application of electronic data processing equipment to complex business systems. Applicants should have a college degree in engineering or physical science, and a knowledge of scientific management techniques as applied to business and industrial operations. They should be analytically inclined and have the ability to work effectively with Managements of client organizations.

Those interested are invited to explore the range of openings at The Ramo-Wooldridge Corporation by submitting a resume of education and experience to: Mr. R. Richerson

The Ramo-Wooldridge Corporation

5730 ARBOR VITAE STREET • LOS ANGELES 45, CALIFORNIA

News Release

**INSTRUMENTS AND REGULATORS CONFERENCE,
CHICAGO, APRIL 7-10, 1957**

The American Society of Mechanical Engineers
New York 18, N. Y.

The Instruments and Regulators Division of the American Society of Mechanical Engineers will hold its Third Annual Conference at Northwestern University, Evanston, Ill. (adjacent to Chicago), on April 8, 9, and 10, 1957. The Conference will be devoted to papers concerned with the application of new techniques as reported in previous conferences to actual control problems.

These techniques include the use of frequency response methods for the analysis of non-linear controls, analog computers, statistical methods, effects of noise on operation, designing to fit the statistical properties of actual disturbances, impulse methods, and the optimizing of industrial processes. A subject of particular interest is the performance of industrial automatic controls in the presence of random disturbances and the application of statis-

tical methods for the solution of this problem.

There will be least one paper on the use of analog computers in various applications.

- END -

BULK SUBSCRIPTION RATES

These rates apply to prepaid subscriptions coming in together direct to the publisher. For example, if 7 subscriptions come in together, the saving on each one-year subscription will be 24 percent, and on each two-year subscription will be 31 percent. The bulk subscription rates, depending on the number of simultaneous subscriptions received, follow:

**Bulk Subscription Rates
(United States)**

Number of Simultaneous Subscriptions	Rate for Each Subscription, and Resulting Saving to Subscriber	
	One Year	Two Years
7 or more	\$ 4.20, 24 %	\$ 7.25, 31 %
4 to 6	4.60, 16	8.00, 24
3	5.00, 9	8.80, 16
2	5.25, 5	9.55, 9

For Canada, add 50 cents for each year; outside of the United States and Canada, add \$1.00 for each year.

cently acquired items is consulted; only every other item which was stored during the ten trials prior to that is consulted; and only every third item on the 15 items stored previous to that, etc. Another variation which is easily effected consists of permitting certain of the robots to skip their turns at specified times. There is a great freedom of choice in selecting the Value functions; relative to each Value function, it is possible to construct behavior functions other than the ones which were discussed above. For instance, they might be such that the majority of the robots will be rewarded, even though individual robots may at times be punished.

There are also some other interesting variations on these experiments, which would involve a slight revision of the program. Thus, outputs consisting of more than a single binary variable could be considered without much difficulty. The form of the behavior function may be made to vary with time, by altering the instructions which specify the behavior function automatically. One of the robots might be outside of the computer (such as a source of random numbers), but this would slow the program down somewhat.

It may be observed that if the storage capacity allotted to each robot (number of state variables) is too small, it may happen that the response will continue to be chosen at random; that is, P_i will not have been able to acquire and store enough information upon which to base "rational" decisions which will insure reward. Periodicity begins when the last robot has ceased to guess his response. It is possible that different strategies for acquiring items of experience may increase the speed of learning, and reduce the minimum required memory capacity.

Conclusions

The experimental results may be roughly summarized as follows: After a certain time, the time variation of the group responses becomes periodic. The length of the period, and the time at which periodicity first appears, are not related to the number of robots involved for the cases which were tested: 4, 6, 7, 8, 9 robots connected in a circle network. The average time to the start of periodicity increases with the complexity of the network, although the period is not affected greatly. When periodicity is reached, the internal state variables of the robots no longer change. These state-variables specify the accumulated and stored experiences acquired by a robot during

the course of its interactions with the others and with the reward schedule. The final complexity of this internal state (number of items of information stored when periodicity is reached) increases with the complexity of the network, particularly with the position of that robot in the network. If the storage capacity allotted to each robot for storing experience is sufficiently small, periodicity will not obtain, and responses will continue to be made at random.

These experiments suggest that digital computers could serve as useful tools in the construction of models in the social sciences. A program of the type discussed can take the place of writing a very complicated set of difference equations, not to mention solving these. It may further serve to help the model-builder in proving the falseness of conjectures, as guides to the revision of basic concepts and assumptions, and in the generation of "data" to be compared with empirical results. Such programs are in no way substitutes or crutches for mathematical thinking; on the contrary, it is intended and expected that they will free the model-builder from chores which are not his chief interest, so that he may devote more effort to that area of thought in which a machine cannot at present be used: in creative mathematical thinking, involving the invention and formulation of fruitful concepts, definitions, assumptions, conjectures, and methods of proof.

Acknowledgement: The use of the computer and facilities at the Electronic Computer Project of the Institute for Advanced Study, at Princeton, N. J., where these experiments were programmed and run in the summer of 1955, is hereby gratefully acknowledged.

- END -

SYMPOSIUM ON THE THEORY OF SWITCHING,
CAMBRIDGE, MASS., APRIL 2-5

An International Symposium on the Theory of Switching will take place at the Computation Laboratory of Harvard University, Cambridge 38, Mass., April 2 to 5, 1957. Topics to be discussed include Abstract Models, Contact Networks, Magnetic and Transistor Logic, Switching Systems, etc. For more information, write to Howard Aiken, Director of the Computation Laboratory.

- Powder to parts: light metal powders form solid finished parts needing little or no machining.
- Connections are important: new IBM developments in printed circuitry solve two contact problems.
- Contact erosion studies: measurements of erosion or bridging by electric arcs on various contact materials.

Powder to parts

Although IBM's modern data processing machines have been streamlined they are still complicated affairs. Even a small machine like the Card Punch is composed of some 3,000 parts. Many of these parts, ranging from simple stampings to complex die castings, are fabricated by conventional methods. Others, because of either their shape or the machine requirements which they must fulfill, are most satisfactorily and economically produced by using the sintered metal technique. This technique involves the pressing of metal powders in a mold and heat-treating the resulting shape to form usable parts requiring little or no machining.

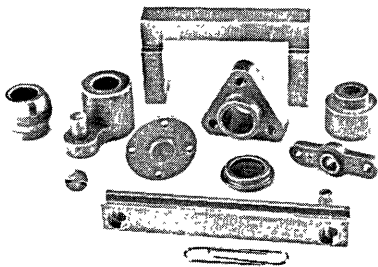

Small parts manufactured by the sintered metal technique.

In his technical paper, "The Use of Sintered Metal Parts in IBM Products," Athan Stosuy of the Poughkeepsie Product Development Laboratory cites the details behind the two major reasons for the company's interest in sintered metals—economics and machine improvement.

In addition to illustrating a number of sintered metal applications, the author details several special functions of sintered metal products—magnetic cores, the "memory" units for electronic computers, for example—and outlines the typical procedures used at IBM to maintain the highest possible standards of quality and usefulness of sintered metal parts.

Mr. Stosuy's paper was presented at the Metal Power Association meeting at Cleveland on April 11, 1956. Write for IBM Bulletin No. 600.

Connections are important

"What won't they think of next?" is a question that can certainly be applied to electronic computers. At the Product Development Laboratory, though, we more often say "What did they think of *this* morning?" We keep up with the newest things this way. Such things, for instance, as a special three-dimensional printed wire back panel for interconnecting circuit packages. This new panel has helped lick two problems in the application of printed wiring techniques to complex computing machines. These problems were the design of individually printed circuit cards for economical mass-production, and the interconnection of these printed wiring packages.

IBM's E. R. Wyma explains how this has been accomplished in his recent paper, "The Three-Dimensional Printed Back-Panel." He begins with a section devoted to "Back Panel Design Requirements," then proceeds to the "Three-Dimensional Array" itself, in which circuit connections are made by terminating the machine's printed wiring cards at a large printed panel—a big step, obviously, in machine simplification, cost reduction, and time saving.

"The purpose of this paper is to show how the three-dimensional printed circuit concept satisfies the requirement for flexible design of the panel and permits mechanized production of the connecting devices." Write for IBM Bulletin No. 601.

Contact erosion studies

To see what could be done to meet the vital need for more reliable electrical components such as circuit breakers and relays, a contact studies team headed by Dr. William B. Ittner, III, was organized in IBM's Product Development Labora-

tory at Endicott, New York. The group studied the electrical and metallurgical phenomena affecting contact life and performance.

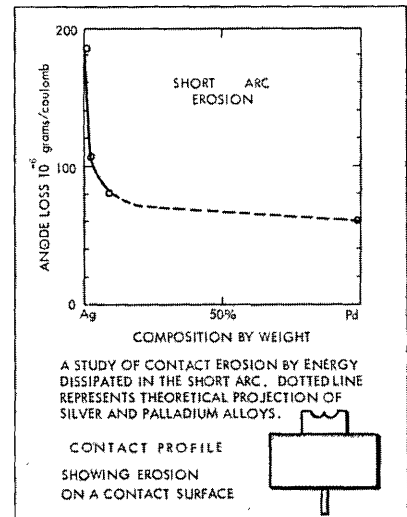

There were three distinct types of arcs where investigations were most needed: the short arc, the normal arc, and the high-powered arc. During the investigation, pure forms and alloys of palladium, copper, platinum, silver, tungsten and other materials were tested. The fundamental behavior characteristics of these arcs were observed to determine bridging and erosion by such arcs on all types of contact materials. Measurements of anode and cathode erosion or bridging were also made.

When all the facts were in, the group made specific recommendations for metals and alloys to be used in IBM relays, circuit breakers, and contact points for particular circuit parameters.

Full details are described in IBM Bulletin No. 602.

●RESEARCH at IBM means IDEAS at work. For bulletins mentioned above, write International Business Machines Corp., Dept. CA-22, 590 Madison Avenue, New York 22, New York.

ADVERTISING INDEX

The purpose of COMPUTERS AND AUTOMATION is to be factual, useful, and understandable. For this purpose, the kind of advertising we desire to publish is the kind that answers questions such as: What are your products? What are your services? And for each product: What is it called? What does it do? How well does it work? What are its main specifications?

Following is the index and a summary of advertisements. Each item contains: Name and address of the advertiser / subject of the advertisement / page number where it appears / CA number in case of inquiry (see note below).

- AMP, Inc., 2100 Paxton St., Harrisburg, Pa / Patch-cords / Page 52 / CA No. 151
- Cambridge Thermionic Corp., 430 Concord Ave., Cambridge 38, Mass. / Components / Page 7 / CA No. 152
- Computers and Automation, 815 Washington St., Newtonville 60, Mass. / Advertising, Computer People, Back Copies / Pages 40, 41, 46 / CA No. 159
- General Electric Co., Aircraft Nuclear Propulsion Dept., Cincinnati, Ohio / Employment Opportunities / Page 45 / CA No. 153

- General Transistor Corp., 1030-11 90th Ave., Richmond Hill, N. Y. / Transistors / Page 51 / CA No. 154
- International Business Machines Corp., 590 Madison Ave., New York 22, N. Y. / Employment Opportunities / Page 49 / CA No. 155
- Lockheed Missile Systems Division, Box 504, Sunnyvale, Calif. / Employment Opportunities / Page 26, 27 / CA No. 156
- The Ramo-Wooldridge Corp., 5730 Arbor Vitae St., Los Angeles 45, Calif. / Data Processing, Employment Opportunities / Pages 2, 47 / CA No. 157
- Sylvania Electric Products, Inc., 1740 Broadway, New York, 19, N. Y. / Diodes / Pages 4, 5 / CA No. 158

READER'S INQUIRY

If you wish more information about any products or services mentioned in one or more of these advertisements, you may circle the appropriate CA Nos. on the Reader's Inquiry Form below and send that form to us (we pay postage; see the instructions). We shall then forward your inquiries, and you will hear from the advertisers direct. If you do not wish to tear the magazine, just drop us a line on a post-card.

Paste label on envelope: ↓

READER'S INQUIRY FORM

Enclose form in envelope: ↓

4¢ Postage Will Be Paid By ---

BERKELEY ENTERPRISES, INC.

38 East 1st Street
New York 3, N. Y.

BUSINESS REPLY LABEL

NO POSTAGE STAMP NECESSARY IF MAILED IN U.S.A.

FIRST CLASS

PERMIT NO 1680

Sec. 349, P. L. & R.
NEW YORK, N. Y.

READER'S INQUIRY FORM

Name (please print).....

Your Address?.....

Your Organization?.....

Its Address?.....

Your Title?.....

Please send me additional information on the following subjects for which I have circled the CA number:

1	2	3	4	5	26	27	28	29	30	51	52	53	54	55	76	77	78	79	80	101	102	103	104	105	126	127	128	129	130
6	7	8	9	10	31	32	33	34	35	56	57	58	59	60	81	82	83	84	85	106	107	108	109	110	131	132	133	134	135
11	12	13	14	15	36	37	38	39	40	61	62	63	64	65	86	87	88	89	90	111	112	113	114	115	136	137	138	139	140
16	17	18	19	20	41	42	43	44	45	66	67	68	69	70	91	92	93	94	95	116	117	118	119	120	141	142	143	144	145
21	22	23	24	25	46	47	48	49	50	71	72	73	74	75	96	97	98	99	100	121	122	123	124	125	146	147	148	149	150

REMARKS:

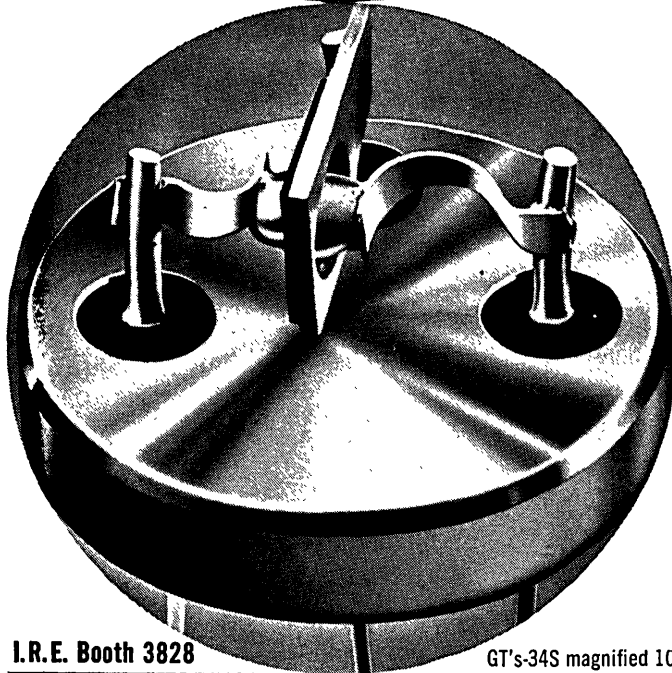
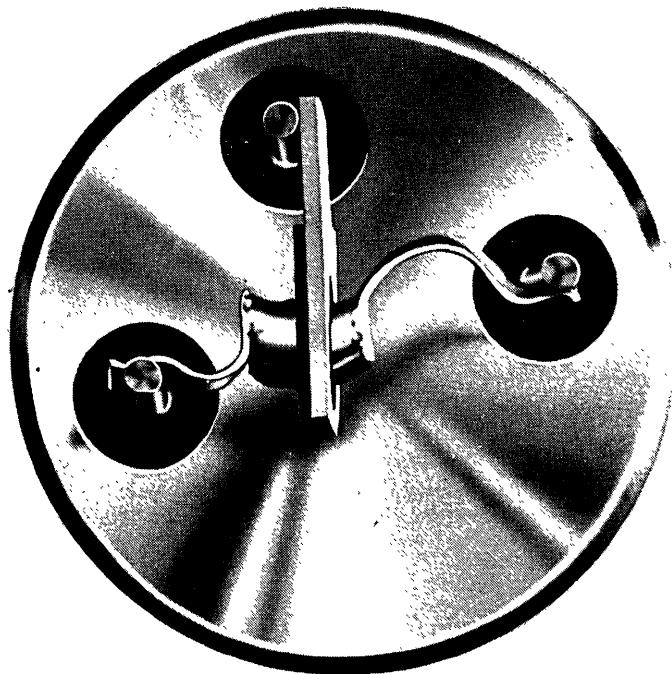

I.R.E. Booth 3828

GT's-34S magnified 10½ times.

WHEN CAN ONE TRANSISTOR REPLACE 2?

In computer or in other applications where current must be amplified in either direction, you can now specify General Transistor's new GT-34S bi-directional transistor.

As developed by GT, this symmetrical transistor can also be used as a bi-directional switch when placed in series with the load. For greater reliability, to save production time, and for compactness you should examine GT's-34S . . . another reason for General's leadership in the manufacture and development of transistors for computers.

Write for Bulletin GT-34S for complete specifications.

Maximum collector to base voltage	40 volts
Maximum emitter to base voltage	40 volts
Peak current	½ amp.

DC current gain is > 10 when $I_b = 20$ ma, $V_{ce} \leq .3$ V.

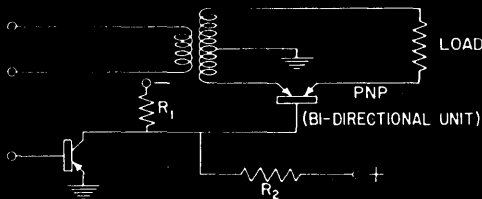

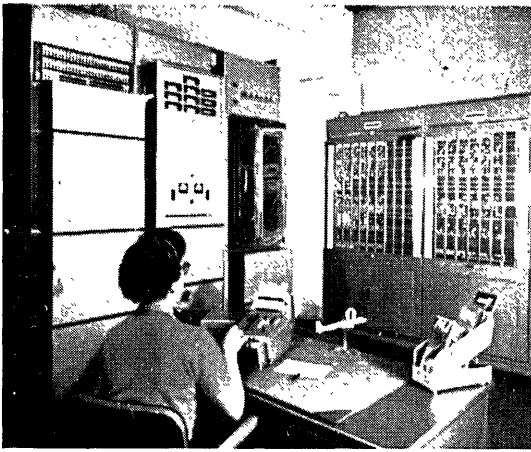

AMP'S PATCHCORD PROGRAMMING SYSTEM

Speeds confirmation of airline reservations

A wide variety of AMP Taper Technique product provides long-life assurance of perfect electrical terminations and is a contributing factor in keeping electronic equipment compact. The AMP Patchcord Programming System offers a multiformity of internal wiring arrangements and connections and permits circuit versatility by use of prepatched, removable front boards.

A number of major airlines, including the Long Island City facilities of Pan American Airlines (shown above), have installed electronic equipment manufactured by Teleregister Corporation, Stamford, Connecticut to eliminate delay and uncertainty in air travel reservations procedure. AMP Taper Technique and AMP Patchcord Programming Systems are prominent in the design of this equipment.

AMP Taper Technique and AMP Patchcord Programming Systems have been utilized for years to solve problems inherent in the design of computers, business machines, and automatic control equipment.

Complete information is available on request.

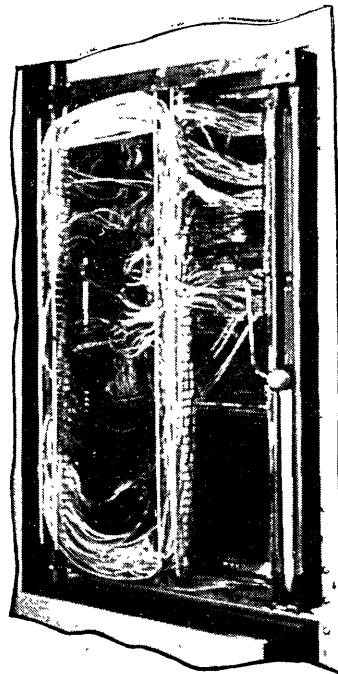

You are cordially invited to visit our display at the IRE show in New York City, March 18th to 21st, 1957.

BOOTHS 2427-2429

AMP INCORPORATED



General Office: Harrisburg, Pa.

Wholly Owned Subsidiaries: Aircraft-Marine Products of Canada Ltd., Toronto, Canada

Aircraft-Marine Products (G.B.) Ltd., London, England

Societe AMP de France, Le Pre St. Gervais, Seine, France

AMP—Holland N.V. 's-Hertogenbosch, Holland

Japanese Distributors: Oriental Terminal Products Co., Ltd., Tokyo, Japan

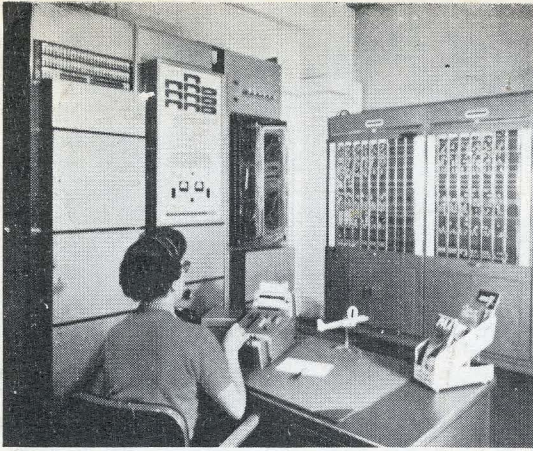

AMP'S PATCHCORD PROGRAMMING SYSTEM

Speeds confirmation of airline reservations

A wide variety of AMP Taper Technique product provides long-life assurance of perfect electrical terminations and is a contributing factor in keeping electronic equipment compact. The AMP Patchcord Programming System offers a multifirmity of internal wiring arrangements and connections and permits circuit versatility by use of prepatched, removable front boards.

A number of major airlines, including the Long Island City facilities of Pan American Airlines (shown above), have installed electronic equipment manufactured by Teleregister Corporation, Stamford, Connecticut to eliminate delay and uncertainty in air travel reservations procedure. AMP Taper Technique and AMP Patchcord Programming Systems are prominent in the design of this equipment.

AMP Taper Technique and AMP Patchcord Programming Systems have been utilized for years to solve problems inherent in the design of computers, business machines, and automatic control equipment.

Complete information is available on request.

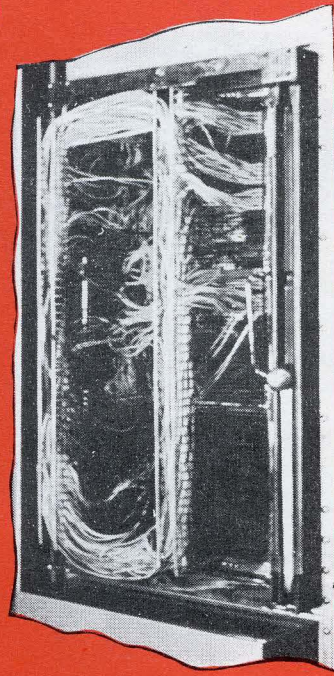

You are cordially invited to visit our display at the IRE show in New York City, March 18th to 21st, 1957.

BOOTHS 2427-2429

AMP INCORPORATED



General Office: Harrisburg, Pa.

Wholly Owned Subsidiaries: Aircraft-Marine Products of Canada Ltd., Toronto, Canada
Aircraft-Marine Products (G.B.) Ltd., London, England
Societe AMP de France, Le Pre St. Gervais, Seine, France
AMP—Holland N.V. 's-Hertogenbosch, Holland
Japanese Distributors: Oriental Terminal Products Co., Ltd., Tokyo, Japan