

~~CONFIDENTIAL~~

or

# computers and automation

COMPUTERS,  
TEACHING  
MACHINES,  
AND  
PROGRAMMED  
LEARNING

Implications of  
Automatic  
Data Processing  
on the  
Engineering  
Profession



FEBRUARY  
1962

•  
Vol. XI — No. 2

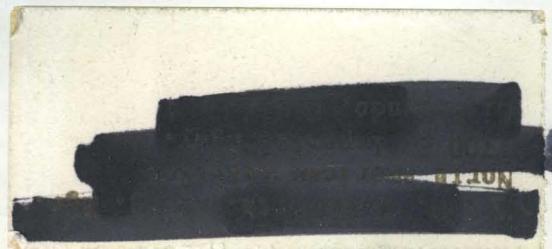

# Say "Good-bye" to Tension

GET RESULTS AND RELAXATION

... DIVIDENDS FROM

**STATISTICAL'S**

DATA-PROCESSING

*Experience*

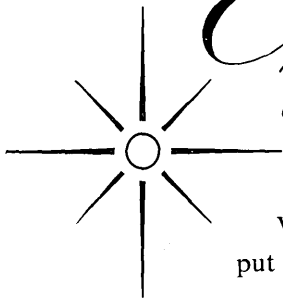

When data-processing problems put the pressure on you, you'll find the "safety valve" you need at STATISTICAL. A wealth of experience is always ready to go to work for you here. Behind every assignment is a searching understanding of management problems and solutions . . . gained in serving America's top companies since 1933.

From this experience comes the consistently-high quality service you would expect from America's oldest and largest independent data-processing and computer service. Sophisticated methods.

Responsible personnel. The latest electronic equipment. Coast-to-coast facilities. Advantages like these add up to "know-how" and "show-how" that can not be acquired overnight.

This experience-in-depth service is available to you day or night. A call to our nearest data-processing and computer center will bring you the results you want . . . and relaxation.

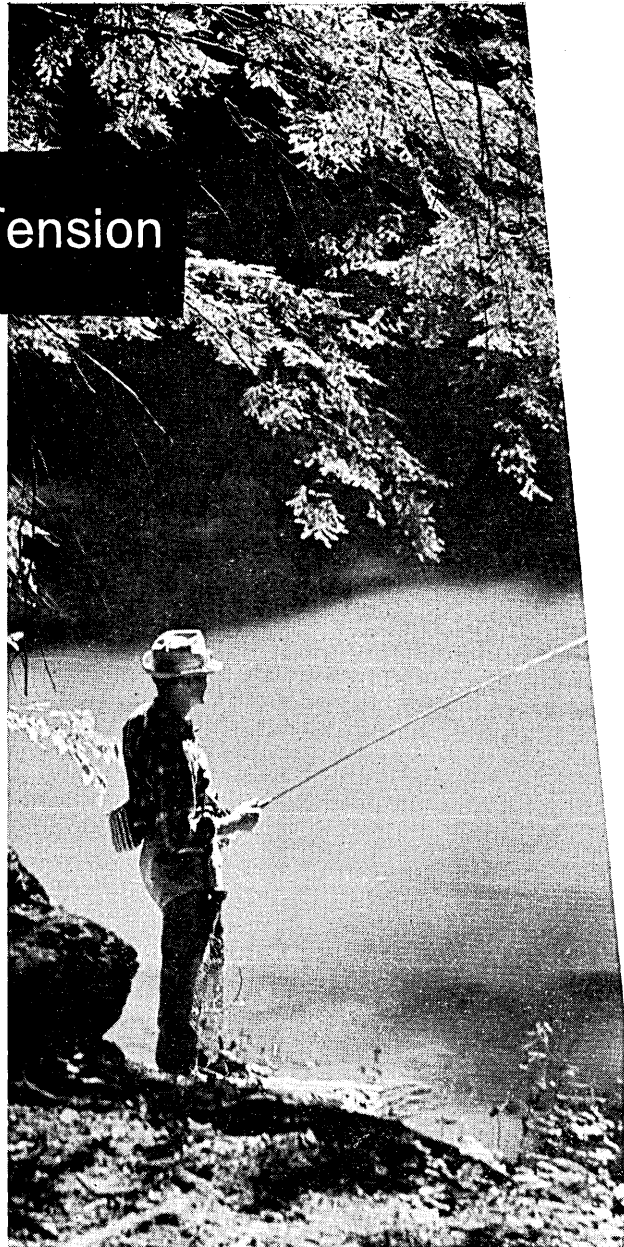

Established 1933

*Statistical*

**TABULATING CORPORATION**

NATIONAL HEADQUARTERS

*104 South Michigan Avenue · Chicago 3, Illinois*

OFFICES IN PRINCIPAL CITIES — COAST TO COAST



THE STATISTICAL MARK OF EXCELLENCE

COMPUTERS and AUTOMATION for February, 1962

of p  
sion  
men  
ext  
  
sol  
nig  
qua  
war  
of p

cou  
inf  
ma  
ava

T

COM

121.30  
 106.00  
 126.00  
 71.68  
 59.40  
 58.00  
 88.33  
 143.43  
 46.16  
 61.64  
 47.84  
 52.56  
 50.07  
 750.07

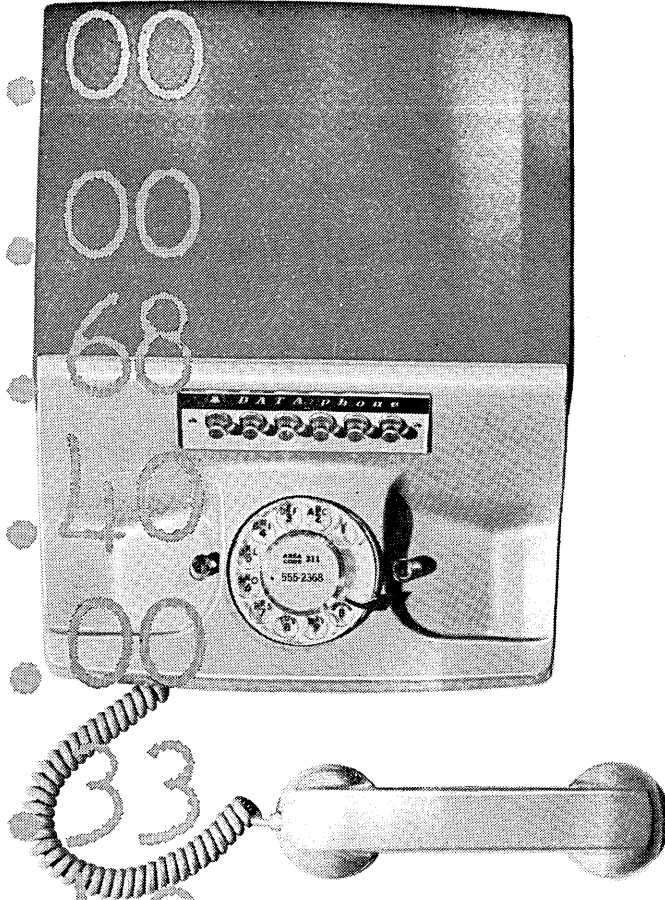

## How to telephone a payroll

You can send an entire company payroll, a day's volume of orders, stacks of waybills, inventories—almost any kind or amount of business data—by telephone today.

You simply use Bell System DATA-PHONE service.

This new service takes machine data from punched cards or tapes and sends it over telephone lines in a special tone language. At the other end, the data is received in exactly its original form.

Transmission is super-fast. For example: payroll data for thousands of employees can be sent in minutes. And the DATA-PHONE call costs no more than a regular telephone call.

Think—how DATA-PHONE service could speed up your data handling, how it could cut your costs and improve your service to customers. Then reach for your phone. Call your Bell Telephone Business Office—and one of our Communications Consultants will bring you the complete DATA-PHONE story.



**BELL TELEPHONE SYSTEM**

# COMPUTERS and AUTOMATION

COMPUTERS AND DATA PROCESSORS, AND THEIR CONSTRUCTION,  
APPLICATIONS, AND IMPLICATIONS, INCLUDING AUTOMATION

Volume XI  
Number 2

FEBRUARY, 1962

Established  
September, 1951

EDMUND C. BERKELEY *Editor*  
PATRICK J. MCGOVERN *Assistant Editor*  
MOSES M. BERLIN *Assistant Editor*  
NEIL D. MACDONALD *Assistant Editor*  
SYDNEY STARR *Art Director*

## CONTRIBUTING EDITORS

ANDREW D. BOOTH  
JOHN W. CARR, III  
PETER KUGEL  
NED CHAPIN  
ALSTON S. HOUSEHOLDER

## ADVISORY COMMITTEE

MORTON M. ASTRAHAN  
GEORGE E. FORSYTHE  
ALSTON S. HOUSEHOLDER  
HOWARD T. ENGSTROM  
RICHARD W. HAMMING  
HERBERT F. MITCHELL, JR.

## SALES AND SERVICE DIRECTOR

PATRICK J. MCGOVERN  
815 Washington St.  
Newtonville 60, Mass.  
DEcatur 2-5453

## ADVERTISING REPRESENTATIVES

*Los Angeles* 5 WENTWORTH F. GREEN  
439 So. Western Ave. DUmkirk 7-8135  
*San Francisco* 5 A. S. BABCOCK  
605 Market St. YUkon 2-3954  
*Elsewhere* PATRICK J. MCGOVERN  
815 Washington St. DEcatur 2-5453  
Newtonville 60, Mass.

COMPUTERS and AUTOMATION is published monthly at 815 Washington St., Newtonville 60, Mass., by Berkeley Enterprises, Inc. Printed in U.S.A.

SUBSCRIPTION RATES: United States, \$15.00 for 1 year, \$29.00 for 2 years, including the June Directory issue; Canada, add 50c a year for postage; foreign, add \$1.50 a year for postage. Address all Editorial and Subscription Mail to Berkeley Enterprises, Inc., 815 Washington St., Newtonville 60, Mass.

ENTERED AS SECOND CLASS MATTER at the Post Office at Boston, Mass.

POSTMASTER: Please send all Forms 3579 to Berkeley Enterprises, Inc., 815 Washington St., Newtonville 60, Mass.

Copyright, 1962, by Berkeley Enterprises, Inc.

CHANGE of ADDRESS: If your address changes, please send us both your new address and your old address (as it appears on the magazine address imprint), and allow three weeks for the change to be made.

## Computers, Teaching Machines, and Programmed Learning:

The Computer-Assisted School System, by DON D. BUSHNELL . . . . .	6
A Decision Structure for Computer-Based Teaching Machines, by RICHARD D. SMALLWOOD . . . . .	9
Computer Teaching Machine Project: PLATO on ILLIAC, by DONALD L. BITZER and PETER G. BRAUNFELD . . . . .	16
Teaching Machines and Programmed Learning— Roster of Organizations and What They Are Doing, by PATRICK J. MCGOVERN . . . . .	33

## FRONT COVER

Working with Computer-Controlled Teaching Machine . . . . .	1, 6, 44
----------------------------------------------------------------	----------

ACROSS THE EDITOR'S DESK . . . . .	21
------------------------------------	----

## ARTICLES

Computer Marketing Trends—Some Comments, by NORMAN STATLAND . . . . .	18
Implications of Automatic Data Processing on the Engineering Profession, by DICK H. BRANDON . . . . .	48

## READERS' AND EDITOR'S FORUM

Reliability Record, by PHYLLIS HUGGINS . . . . .	44
Conference on Self-Organizing Systems, May 1962, by MARSHALL C. YOVITS . . . . .	44
Application No. XXX . . . . .	44
Who's Who in the Computer Field—Cumulative Edition, 1962 . . . . .	44
Calendar of Coming Events . . . . .	45

## REFERENCE INFORMATION

Who's Who in the Computer Field (Supplement) . . . . .	51
Books and Other Publications . . . . .	54
New Patents . . . . .	56

## INDEX OF NOTICES

Advertising Index . . . . .	54
Computer Directory and Buyers' Guide . . . . .	see Oct., page 31
Glossary of Computer Terms . . . . .	see Nov., page 50
Manuscripts . . . . .	see Oct., page 30
Reference and Survey Information . . . . .	see Oct., page 31
Who's Who Entry Form . . . . .	53



### COMMERCIAL INFORMATION HANDLING

Our client, a leader in the Commercial Information Handling Systems field, is seeking several creative minded individuals at the Ph.D. level who are interested in advancing the state of the art in one or more of the following areas:

Reliability Analysis and Prediction  
 Electrophysics Display Techniques  
 Optical Maser Technology  
 Photo-Information Processing  
 Solid-State Memory Development  
 Microwave Data Transmission  
 Polymer Chemistry Synthesis  
 Linear Programming  
 and Queuing Theory

Complex Systems Integration  
 Diagnostic Programming Techniques  
 Control Logic, Buffering & Arithmetic  
 Solid Logic and Thin Films  
 Advanced Circuit Analysis  
 Magnetic Device Analysis  
 Advanced Systems Planning  
 Magnetic Recording Surfaces  
 Piping and Heat Exchange

*Salaries are open to \$25,000*

In addition, we are seeking individuals with interest and experience in Advanced Programming Technology for assignments in N. Y. C. and Boston.

Compiler Writing  
 Language Analysis  
 Artificial Language  
 Construction

Non-Numerical Mathematics  
 on Computers  
 System Design (Both Hardware  
 and Programming)

Game Playing on Computers  
 Symbolic Logic  
 List Processing Techniques  
 Information Retrieval

Symbol Manipulation  
 Artificial Intelligence  
 Operations Research  
 Automatic Programming

If you seek analytical stimulation, creative leeway and an environment which encourages both – write for personal interview, including a complete resume of your background.

MR. DWIGHT L. GREENLAND  
*Executive Vice President*

## HAMILTON WITTMAN ASSOCIATES

*Management Consultants*

551 Main St., East Orange, N. J.

*Our client is an equal opportunity employer*

# The Computer-Assisted School System

Don D. Bushnell

Automated Education Project  
System Development Corporation  
Santa Monica, Calif.

The System Development Corporation has conducted an active program of research in automated education for the past three years. Initial experiments were performed with an instructional system controlled by a Bendix G-15 computer. With this computer-based teaching machine, various branching techniques were studied with some six hundred students acting as experimental subjects.

More recently a new facility, designated CLASS (Computer-Based Laboratory for Automated School Systems), has permitted members of the Automated Education Project staff at SDC to broaden their scope of research. The investigations have included both experimentation with optimum sequences of educational materials for individual student instruction, and development of a computer-assisted school system which makes individualized education feasible. The new laboratory, a part of the general purpose Systems Simulation Research Laboratory at SDC, utilizes a Philco 2000 computer to provide high-speed data-processing assistance to many parts of a simulated educational system.

CLASS permits simultaneous automated instruction to twenty students in either an individual or group mode of study. In the individual mode, CLASS operates in much the same way as the Bendix-based system.

## Adaptive Control over the Individual Student

The first teaching system used by the SDC staff is shown in Fig. 1. The Bendix computer, operating under program control, transmits instructions to a Random-Access slide Projector (RAP) Model 600 for the selection of one of six hundred slides held in storage. The sequence of slides seen by the student is determined on the basis of the student's response to a single question, or to several questions, or on the basis of the time interval between presentation of material and response. The student receives feedback messages through the computer-controlled typewriter keyboard or by means of additional slides.

Prior to an experimental run, the G-15 is programmed for its teaching functions by input of a perforated paper tape. The instructions on this tape represent decisions in regard to type and sequence of educational "items" to be selected for each student on the basis of his overt learning behavior.

The G-15 sends four signals of four bits each to the Projector Adapter; three of these signals set the stepping switches which record the computer's instruction to the RAP 600. The first signal clears the relay register of any previous information. In addition to these signals, there is an interlocking feedback control which prevents changing of instructions while the system is in operation. It takes the G-15 about 6/10 of a second

to transmit to the RAP 600 the full command for a slide selection.

A sample teaching machine lesson used with the Bendix G-15 is given in Appendix 1. Although actual lessons are longer and generally more complex than this one, this sample does illustrate a number of important facets of the lesson design. Some of the instructional items branch the student to remedial paths designed to correct particular errors. At two points in this lesson, decisions are made on the student's cumulative error tallies. At these points, additional instructional items are given to the student if he is experiencing difficulty in learning the material. At the end of the lesson, a self-evaluation item is presented to students who have made at least one error. This gives the student the choice of deciding whether or not he needs more instruction.

## The CLASS Facility

Use of the Philco 2000 computer in the new laboratory enables the researchers to teach twenty students in several modes of automated instruction—an individual mode, a group mode, or a mixed mode in which some students study independently while others work in small groups. Except for classroom space limitations in our laboratory, the Philco 2000 could instruct some three hundred students in the individual mode with each student seeing a different sequence of instructional materials adapted to his particular needs. In the group mode, this number of students instructed could be 900.

For individual instruction, a manually operated film

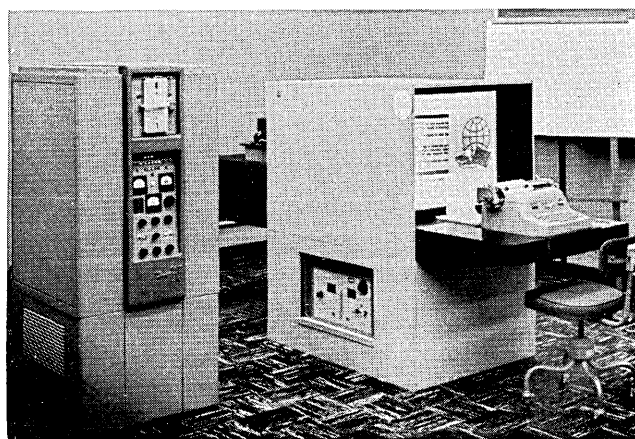

FIGURE 1

The first experimental computer-based teaching machine used by the Automated Education Project at SDC for research in auto-instruction is shown here. On the left is the Bendix G-15 Computer and on the right, the teaching machine unit which houses a random access slide projector, rear-view projection screen, and an alpha-numeric typewriter tied to the computer.

Dubi  
tion  
Re  
Av  
off  
TH  
root  
prox  
using  
the  
which  
Corre  
Ki  
In  
/  
A  
math  
paran  
chem  
STAC  
cedu  
porta  
speed  
tures  
How  
Im  
Ro  
nic  
of  
ice  
set  
Fo  
ture  
descr  
form  
techn  
given  
are o  
sirab  
concl  
Reiff  
L.  
En  
gu  
int  
Pr  
65  
Th  
dame  
ment  
to es  
ching  
comp  
parts  
Anal  
the p  
form  
puter  
card  
of a  
Two  
Codi  
ching  
Opti  
Pract  
lator  
Char  
me  
of  
Wi  
Ne  
pp  
Th  
who  
tions  
the  
over  
the a  
ics i  
of d  
term  
one;  
ineq  
cludi  
tions  
conce  
outli  
symp

viewer serves as the output source. A student, working independently, makes multiple-choice responses on the response unit keyboard (see the front cover of this issue). The computer is programmed to analyze these responses, signal the correct answer on the response keyboard, and instruct the student where to proceed next by way of a four-digit read-out panel on the response unit.

Automated or semiautomated group instruction can be effected by using the RAP 600 or teacher-controlled audio-visual projectors for generating a common stimulus display over the large closed-circuit TV screens in the classrooms. As seen in Fig. 2, students in CLASS are learning in the group mode.

The teacher will have five sources of information available with which to watch and check student learning behavior or call up information on individual or group performance. These components are: (1) a teacher's console with automatic alarm lights, corresponding to each student station, alerting the teacher to students who are not meeting predetermined criteria programmed in the computer; (2) a read-out panel, similar to the student response device, making it possible for the instructor to monitor a specific student; (3) a remote-control panel for sequencing and controlling audio-visual materials; (4) a film viewer for following the educational program; and (5) an educational data display, generating performance or historical data directly from the computer memory drum.

To study the application of data processing methods in other school functions, special areas are available in CLASS for administrative and counseling functions. A teletype unit in the counseling office will aid the counselor in preparing daily scheduling programs and conducting interviews, and will generate displays to aid the teacher in classroom management. Automatic referrals will bring students to the counselor before serious educational problems are encountered.

For administrators, a 900-line-a-minute high-speed printer, operated either on-line or off-line, will supply immediate information on the state of academic knowledge of each student. Less urgent reports necessary for scheduling, curriculum planning, budgeting and logistics can be retrieved when the computer is not selecting and analyzing instructional programs.

A real-time switch and storage transducer, which permits coupling human inputs to and outputs from the computer, has been developed by SDC engineers. This machine is capable of recording in the computer some 4,000 input signals ten times a second. The machine also permits distribution of 4,000 output signals to the simulation area every 1/10 second. A plugboard for rearranging the receptor and effector connections to computer memory locations is also included.

#### Programming for CLASS

Computer programs written for this project fall into two broad categories: the lesson assembler and the instruction control program. The lesson assemblers resemble, in both structure and function, the typical computer compiler-assembler. The instruction control program, called Mentor 2000, has many of the characteristics of the usual process control programs.

Lesson assembly programs for CLASS are designed to generate a magnetic tape that contains a complete

FIGURE 2

Students in CLASS are learning French in a group mode of automated instruction. The teacher, Gerald Newmark, sequences the educational items presented to the students via the closed-circuit TV system and the students respond to questions in French about the pictures shown. The computer records and analyzes student responses and presents displays to the teacher in real time.

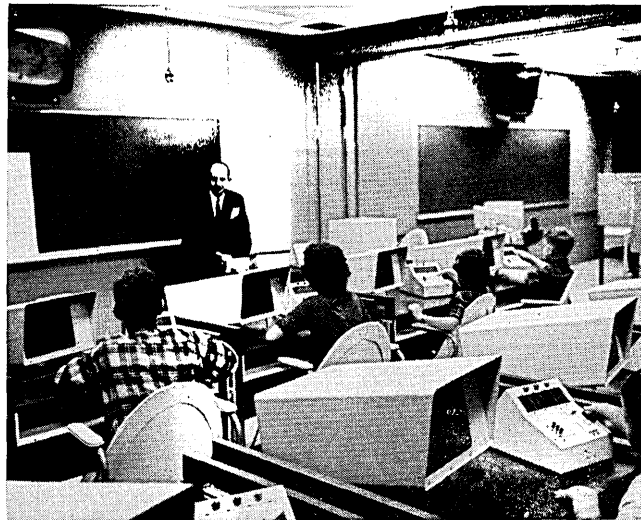

description of the teaching machine's program. The assembled tape, when read into the computer, will store in the memory, the codes of the instructional items, the codes of counters to be used for tallying the number of student errors per teaching concept, and teaching instructions.

The teaching control program will be designed to control the input/output functions, process teaching routines, and record the results of instruction.

The primary language to be used for the CLASS computer program will be JOVIAL, a general-purpose programming language initiated at SDC. It is a readable and concise language, utilizing self-explanatory English words and the familiar notations of algebra and logic. It has been found especially suitable for problems requiring an optimum balance between data storage and program execution time.

Besides, JOVIAL is a machine-independent programming language and can serve as a means of realizing a stated process on a number of different computers.

#### The Future School System and New Technology

CLASS development has recognized that the most practical and immediate need for a computer in our educational systems is probably to automate paperwork, a prosaic function in school, but we foresee the future role of the computer in education to be more than that of bookkeeper. The evidence for this projection lies in some of the recent developments in computer technology:

- (1) The computer-based teaching machine with the potential for handling individual student differences in learning rate, background, and aptitude;
- (2) Information retrieval systems, i.e., automated library services utilizing abstracting and translating machines;
- (3) Computer programs for aiding management

# NCR ...Research

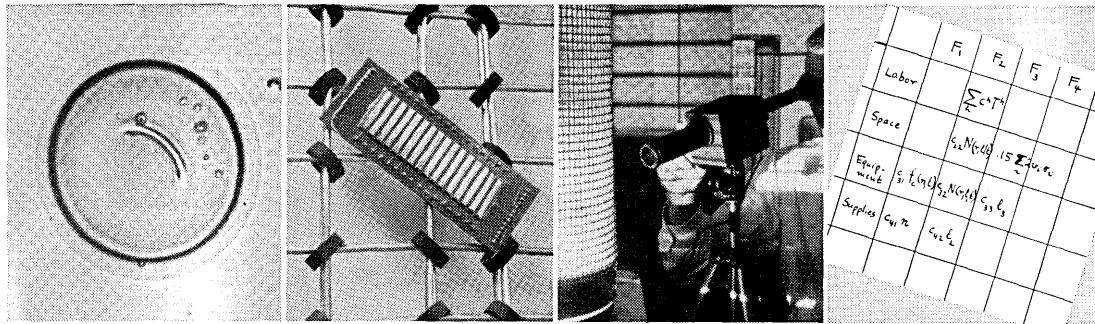

MICRO-ENCAPSULATION

MAGNETICS

THIN FILMS

OPERATIONS

# ...Development



OPTICS

LOGIC & CIRCUITRY

MECHANICS

DIGITAL SYSTEMS

# ...New Products

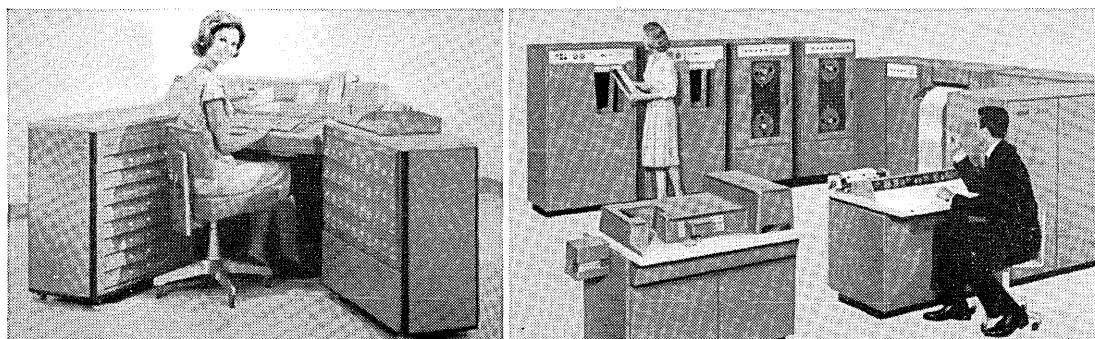

THE NCR 450 CONTROL AND PROOF MACHINE

THE NCR 315 COMPUTER

NCR offers a wide range of opportunities for experienced scientists and engineers interested in commercially oriented projects or advanced military electronic development. Current work encompasses a broad field of activity including semi conductor research, low temperature physics, micro-electronics, photochromics, advanced electronic systems development, high frequency communications, and operations research studies related to

complex business and financial systems. Previous efforts of NCR research and development have resulted in new products such as: NCR (no carbon required) Paper, the highly successful Electronic Data Processing Systems, and other items for the electronic and business machine industries. Rapid growth has caused openings at all levels of experience and education and provide opportunity for technical or administrative growth.

Send letter of application and résumé to: T. F. Wade, Technical Placement, G 5, The National Cash Register Company, Dayton 9, Ohio.

An equal opportunity employer.



®Trademark — Reg. U.S. Pat. Off.

**ELECTRONIC DATA PROCESSING  
ADDING MACHINES • CASH REGISTERS  
ACCOUNTING MACHINES  
NCR PAPER (NO CARBON REQUIRED)**

**THE NATIONAL CASH REGISTER COMPANY, DAYTON 9, OHIO**

**ONE OF THE WORLD'S MOST SUCCESSFUL CORPORATIONS**

**78 YEARS OF HELPING BUSINESS SAVE MONEY**

IN  
W  
Bas  
A  
C  
an  
DIR  
TH  
ers'  
June  
AND  
the  
Roste  
Roste  
to  
Surve  
Surve  
Descr  
Surve  
Surve  
and  
Auton  
List  
Comp  
Ma  
Over  
Appli  
Comp  
Roste  
Con  
Robot  
Teach  
GLOS  
SIG  
Ov  
defini  
BAC  
For  
excep  
1960,  
BE B  
AUG  
SUBS  
U.S.  
add  
elsew  
BUL  
Th  
to  
comi  
Nun  
Simul  
Subsc  
7 or 1  
4 to  
3  
2  
For C  
side  
\$1.50  
C  
815  
If m  
COM



and decision-making activities in schools paralleling those in business which supply periodic economic forecasts, balance budgets, and plan financial strategies;

(4) New techniques for processing educational data such as real-time registration and scheduling programs, counselor and teacher data displays, automated diagnostic interviews, and testing routines.

The application of the digital computer to educational functions holds the potential of an important technological breakthrough in a field that has been remarkably resistant to change. With more students to teach, fewer teachers, and an increasing portion of

the working population to retrain, educators are being pressed in the direction of automation.

The question whether school systems can afford the large general-purpose computers currently being marketed would in many instances have to be answered in the negative. But the development of the special-purpose computer with multiprocessing, time-sharing capabilities is on the horizon. It would be short-sighted to delay the research until the hardware is available. As new uses are explored and computers are designed with educational functions in view, many school systems will join those pioneers who have already made the leap into the modern technological world.

---

# A Decision Structure for Computer-Based Teaching Machines

Richard D. Smallwood

Research Laboratory for Electronics  
Massachusetts Institute of Technology  
Cambridge 39, Mass.

In the teaching machine field, although one hears statements that "the devices problem has been solved," it would appear that the tremendous speed and versatility of modern day computers can nevertheless be used most profitably.

A great deal of the current research in the development of new educational techniques has been in the area of teaching machines. Most of the contributors in this area up to now have been psychologists interested in applying their theories of the psychology of learning to new teaching techniques.

Now, the opportunity for contribution by the designers and programmers of computers is fast approaching.

Basically, present day teaching machines<sup>1, 2, 3</sup> present a subject to a student in short increments—each increment being followed by a question. These increments (hereafter referred to as "information blocks" or just "blocks") may be anywhere from a sentence to a paragraph in length and may contain pictures, diagrams, and even auditory information. They are presented to the student in long sequences called teaching machine programs (not to be confused with computer programs); these sequences are constructed in such a way that the student is led in an easy and straightforward way to eventual mastery of the subject matter.

The advantages of present-day teaching machines,

1. Crowder, N. A., "Automated tutoring by means of intrinsic programming," Chapter X in *Automatic Teaching* by Galanter (ed), John Wiley & Sons, N. Y., 1959.

2. Lumsdaine, A. A., and Glaser, R., *Teaching Machines and Programmed Learning: A Source Book*, Dept. of Audio-Visual Instruction, National Educational Association, 1960.

3. Smallwood, R. D., *Automated Instruction Decision Systems*, Sc.D. Thesis, Electrical Engineering Dept., M.I.T., Cambridge, Mass., 20 October 1961.

include self-paced instruction and immediate evaluation for the student of his answers to the questions, etc.; but the important thing to remember is that we are first and foremost interested in the development of techniques that will "teach better." Since one of the best teaching methods that we know today is the human tutor, a logical approach to automated instruction is to try to simulate as many properties of a human tutor as possible; and indeed, this is the criterion commonly used to describe the advantages and indicate the vast potential of teaching machines. Two very important properties of the human tutor, however, are present in only a very limited degree in the teaching machines currently in vogue; these are adaptability to the student and systematic improvement with experience.

## Student Adaptability

A desirable feature of any tutor or teaching machine is that it be able to react to differences among students and adapt its presentation to the individual learning characteristics of each student. For the tutor or machine to do this implies a decision process that uses some known past history of the student to decide which presentation of the material is likely to be best for him; and this decision process is no less important for a teaching machine than for a tutor.

The process of providing different teaching machine programs for different students is called "branching." One of the most commonly used methods of branching is the "intrinsic programming" of Norman Crowder<sup>1</sup> in which the next block presented to the student is determined by his answer to the last question. A natural extension of this method is to base the decision on the *entire past history* of answers of the student too

the teaching program; a structure for such a decision process is the subject of this paper.

### Systematic Improvement with Experience

When a tutor is good, we expect him to become better at his job as he teaches more and more students. The same property is a desirable one for a teaching machine. At the present time this property is available in teaching machines only through the improvements that the researchers make in their teaching machine programs. Improvements in the teaching machine programs are, of course, desirable, but a method for systematic improvements in the quality of the branching decisions is also needed. A good teaching machine should be capable of improving its decision processes as it "learns" more about the effects that are caused by the decisions. Thus, we should like for the next tutoring decision to depend not only on the present student's past responses, but also on other available information including the responses of all past students; in other words, the teaching decision system should be an adaptive system.

### Structure

The class of teaching machines proposed here is based on a particular structure; the elements of this structure are: (1) an ordered set of concepts; (2) a general branching network; (3) a model for estimating probabilities of responses.

#### 1. An Ordered Set of Concepts

Every educator, no matter whether he is a teacher or a writer of teaching machine programs, must have

a set of goals. This is list of things that he is trying to teach successfully to his students. We shall call these things *concepts*, although a very broad definition of the word concept is intended.

Generally, the educator will also arrange these concepts in some reasonable order so that he can teach the concepts to the students in sequence. Therefore, we shall assume that the subject matter to be taught has been decomposed into an ordered set of concepts.

The question of measurement also arises: How shall we find out whether or not a student understands a concept? For this purpose we shall assume that there exists a set of test questions for each concept being taught. Answering the test questions correctly is considered to be equivalent to understanding the concept. These test questions will be given to each student at the end of his instruction on the concept to determine how well he has absorbed the subject matter and how well he understands the concept.

#### 2. The General Branching Network

In order to provide a high branching capacity in the class of teaching machines discussed here, a large network of *information blocks* (see Fig. 1) is assumed to exist for each concept to be taught. Each block contains information or material that one might want to present to a student during the course of the instruction.

Each block is identified by two numbers  $i$  and  $j$ . The first number  $i$  specifies the level or rank of the block in the sequence of concepts to be taught. The second number  $j$  is a serial number that identifies

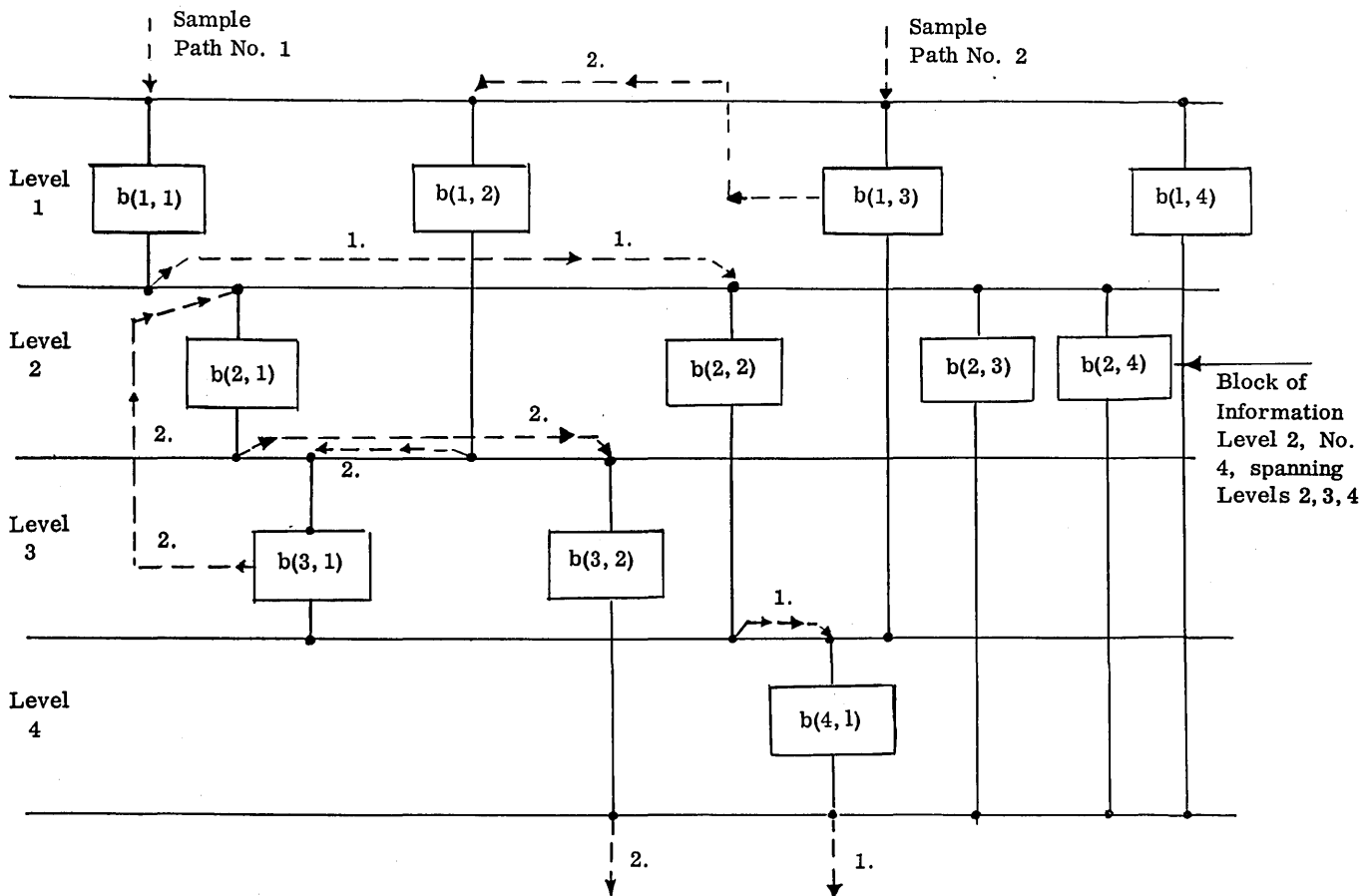

FIGURE 1—A diagram of a sample of a general branching network of blocks of information of various spans. Wrong answers take the learner out to the left. Right answers take him through the entire span.

the block among alternatives explaining that information. Thus block  $b(3,2)$  is block no. 3 in level and no. 2 in manner of explaining. Some blocks may span more than one level; in this case, the level number denotes the first of the levels spanned by the block. In Fig. 1 the branching network shows in Path 1 and Path 2 how two students have progressed through the branching network. In general, students start at the first level and travel downward through the blocks as they learn more and more about the subject material. Generally the same material will be contained in sequences of blocks spanning the same levels; for example in Fig. 1,  $b(1,3)$ ,  $[b(1,1), b(2,1), b(3,1)]$ ,  $[b(1,1), b(2,2)]$ , and  $[b(1,2), b(3,1)]$  will all contain the same information. The presentations, of course, will be different; for example  $b(1,3)$  would present the information in a much more condensed form than  $[b(1,1), b(2,1), b(3,1)]$ . Alternate presentations of the same material are also illustrated as in  $b(2,3)$  and  $b(2,4)$  of Fig. 1.

### Test Questions

At the end of each block there will be a question for the student. These questions can be used either as reinforcing agents for conditioning student behavior or as tests to determine the student's comprehension of the information. The answers to each of these block questions are classified into a finite number of exhaustive alternatives so that every answer can be recognized by the teaching machine. Furthermore, it is desirable that the student be told whether or not he has answered the question correctly. (One can also use this opportunity to explain to the student his likely error if he missed the question.) For this reason each information block will generally have a fine or more detailed structure similar to that shown in Fig. 2.

### Student Procedure

The procedure for a student taking the course will consist of many cycles of the following two steps:

1. If the student is at level  $i$ , the teaching machine will decide which of the several blocks leaving this level to present to the student.

2. After reading the information in the block that is presented to him, the student will answer the question at the end of the block. If his answer is correct, it is assumed that he has absorbed the material in the block satisfactorily; and thus, he will be placed at the terminal level of the block and Step 1 repeated. If he does not answer the question correctly, then the student will be placed at some level less than (or perhaps equal to) the terminal level of the block in order to clear up the misunderstanding that caused him to miss the question.

Thus, we see that a student will wend his way through the network of blocks proceeding from the first level to the last with the teaching machine deciding at each level what block to present to the student. The student's level at the end of each block is determined by his answer to the block; that is, we shall assume that a function  $v(i,j,k)$  is given along with the branching network, and the function is equal to the level of a student if he gives the  $k$ th answer to block  $b(i,j)$ .

In Fig. 1 the dotted lines show two possible paths

FIGURE 2—A diagram of the more detailed structure of an information block.

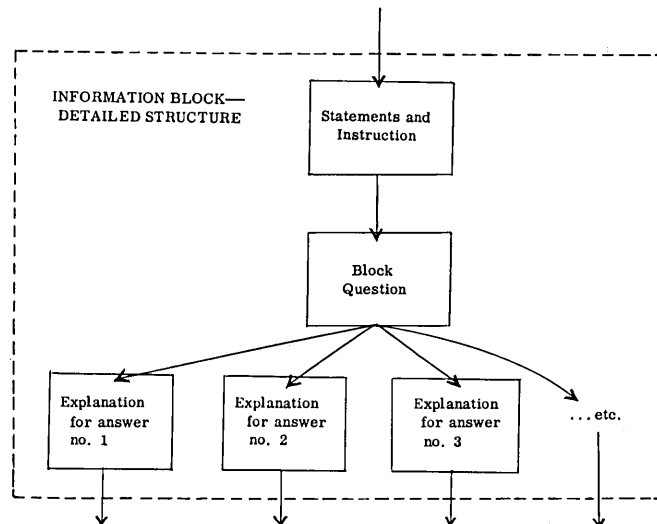

that students might take through the array. Path 1 represents a student who has given all correct answers to the block questions, while the student of Path 2 has missed block questions at  $b(1,3)$  and  $b(3,1)$ .

In any practical application there will be one of these networks of blocks for every concept to be taught.

Although the emphasis in this paper is on the decision-making aspect of teaching machines, the importance of the actual contents of the information blocks can hardly be overstated. On the other hand, the incorporation of a decision mechanism into a teaching machine can make the improvement of the block contents easier through the relative evaluation of alternative presentations of the course material.

### 3. A Response Probability Estimation Model

In order to decide which of the possible blocks the student should receive, it is necessary for the teaching machine to investigate many paths that the student might take. Each of these paths must be weighted with the probability that the student will indeed take that path. This requires a model (see Reference 3) that will estimate the probability,  $p(i,j,k)$ , that the student will respond with the  $k$ th answer to the question at the end of  $b(i,j)$ .

There is a question here of just what is meant by these probabilities. Here the probability  $p(i,j,k)$  that a student with a certain known past history will give the  $k$ th answer to block  $b(i,j)$  will be defined as the fraction of students out of an infinite population of students with the same identical past history who would give the  $k$ th answer to block  $b(i,j)$ .

The problem, then, is to find mathematical models that will use the past history of the student correctly to estimate the true values of  $p(i,j,k)$  as defined above. The particular elements of a student's past history that will be used in this estimation are *part of the model*. These models will formulate an *abstract description* of the process whereby a student's past history determines the value of the abstract probability defined above. As with any mathematical model, the model's description of the process is entirely abstract, and the value of the model is determined by how well this abstract description conforms to the *real world process* being simulated by the model.

In general one would expect the probabilities to be closer to 0 and 1 as the past history of the model includes more and more pertinent details about the student. Unfortunately, as the number of such details increases, it becomes more difficult to use them correctly and the complexity of the computations also increases. Thus, one must face the eventual trade-off between high uncertainty in the true probabilities on one hand, and inaccurate prediction and complex computations on the other.

We see here an example of how the teaching machine will be able to improve its decision process with experience. As the number of students that the device has taught increases, the errors in the probability estimates due to lack of information will generally decrease and the decision process of the machine will become more accurate.

### Decision Criterion

In making the decision, the computer must have some criterion (or utility function) to use for deciding which of several alternate paths through the "blocks" of subject matter is to be selected for teaching to the learner. The particular criterion chosen will depend, in general, on the opinions and goals of the educator using it. Some possible criteria that might be used are:

$$U = \frac{n_n}{N}, \quad L = \frac{1}{N}(n_n - n_i), \quad \text{or} \quad R = \frac{1}{NT}(n_n - n_i)$$

where  $n_i$  and  $n_n$  are the number of test questions for that concept that the student answered correctly before and after taking the presentation of the material represented by the path;  $N$  is the number of test questions for that concept; and  $T$  is the time for the student to read and respond to the material in the path.

### An Actual Demonstration

In order to illustrate the structure presented here and to study its potential advantages, a preliminary teaching system containing an example of each of the preceding elements was developed. When one considers what is potentially attainable within the structure, the system described here will appear rather unsophisticated—and indeed, it is. Nevertheless, the teaching system was applied to instruct 20 students, and indicated that it was capable of distinguishing among students, making different decisions for students with different past histories. Furthermore, the system also changed its decision process with experience.

The physical device was composed of three interconnected pieces of equipment: (1) a microfilm reader; (2) an electric typewriter; and (3) the IBM 709 digital computer at the M.I.T. Computation Center. The array of information blocks was stored on microfilm; and the microfilm reader was connected to the computer so that it could select any particular frame of the microfilm and display it to the student.

The instruction process for the system consisted of the following steps:

1. After giving the student some brief instructions on the operation of the microfilm reader and typewriter, the computer decided what block to present to the student first and then cycled the microfilm forward to the frame that contained the desired block.

Each of these blocks contained a paragraph or so of information about the course, followed by a question that tested the student's comprehension of the information.

2. The student wrote his answer to the block question on an answer pad; then he advanced the microfilm reader forward one frame to where a list of possible answers to the question was displayed. (In each case, of course, one of the alternatives was a catch-all for any answer not listed.) Next to each of these possible answers was a number; the student entered the number next to his answer into the typewriter and then punched the "carriage return" key.

3. Upon sensing the carriage return, the computer advanced the microfilm to a frame that explained to the student whether or not he had answered the question correctly; if he had not, this frame also attempted to explain to him where he had gone wrong. While the student was digesting this explanation, the computer calculated the next block that the student should receive. When finished reading the explanation to his last answer, the student was instructed to punch the "carriage return" on the typewriter.

4. The computer then advanced the microfilm to the next block and the process was repeated until the student finished the instruction on a particular concept and arrived at the test question(s). The test questions were given to the student in the same way as the blocks; the only difference was that *all* students received the same test questions.

5. At the end of the instruction the student's responses were used to update the parameters needed by the system's decision process.

The computer program for this teaching system used approximately 5000 of the 32,000 registers available on the M.I.T. 709.

### Content of the Sample Teaching System

It may be of some interest to report what was the actual content of the material taught. This was a miniature (or finite) geometry expressed in the following statements:

- Postulate 1. There is a point.
- Postulate 2. Every line is a set of exactly two points.
- Postulate 3. Every point lies on exactly two lines.
- Postulate 4. For every line there are exactly three parallel lines.
- Definition 1. If a point  $P$  belongs to a set  $L$ , then  $P$  lies on  $L$ , and  $L$  contains  $P$ .
- Definition 2. Two lines are parallel if and only if there is no point that lies on both.

The outcome of the teaching system was for the student to be able to demonstrate two theorems:

- Theorem 1. There are exactly six points.
- Theorem 2. There are only two models.

(One of the models is a hexagon, with the convention of the points being the vertices and the lines running along the edges of the hexagon, and stopping at the vertices; the other model is two separate triangles, with the same convention.)

This particular subject was chosen because it is short, simple, and relatively unknown.

The best way to test new equipment is to put it into actual use. But how can the performance of advanced airborne guidance systems be evaluated without spending millions of dollars in production and flight test of equipment? How can the effect of possible design changes be determined? How much can systems and equipment be improved before over-all performance becomes subject to diminishing returns?

Scientists have been exploring these questions—and many more—at the Simulation Laboratory of the IBM Space Guidance Center in Owego, N. Y. For example, they constructed mathematical and logical models of every factor in a major B-52 air strike. Into an IBM computer went simulation data on enemy missiles, radar, fighter defenses, as well as detailed weather and terrain data and complete aircraft performance parameters. After more than 1200 simulated battles were “fought” inside the

computer, the scientists had the answers to their questions.

The IBM people doing simulation studies such as this have extremely varied backgrounds, mathematics, physics, engineering. But they have in common—the ability to “see” physical problems in mathematical terms and to solve them by machine computation. For people with this ability IBM offers the advantages of advanced technical facilities and widely experienced associates.

If you are interested in one of the areas in which IBM is making important advances—semiconductors, micro waves, simulation, magnetics, superconductivity, or many others—we’d like to hear from you. IBM is an Equal Opportunity Employer. Write to:  
Manager of Technical Employment  
IBM Corporation, Dept. 5390  
590 Madison Ave., N. Y. 22, N. Y.

**IBM**  
®

## **SIMULATION: 1200 air battles inside a computer**

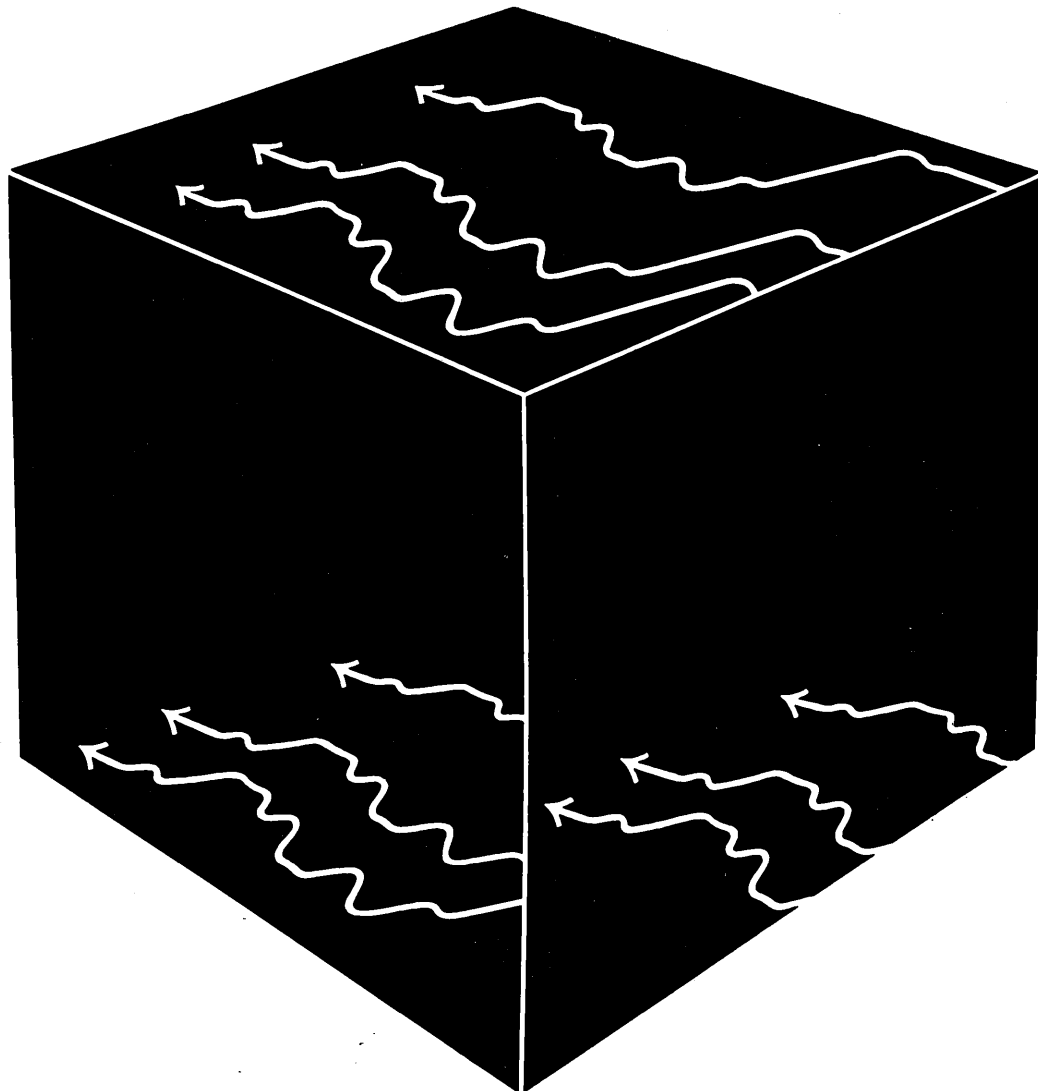

The teaching system usually (but not always) presented a paragraph of information, and offered usually (but not always) three answers, of which only one was the right answer. In other words, it was like the scrambled book of Norman Crowder (see Reference 1).

### Equipment Limitations

Due to equipment limitations, only one student at a time was taught by the teaching system described above. This was a tremendously inefficient use of computer time, since the calculation of each decision required less than one second of computer time. A student took from 1 to 6 minutes to complete a block with 2.5 minutes a typical time. Hence, we see that over 99 per cent of the computer time was spent waiting for the student to answer a question or finish reading an explanation. The answer to this inefficiency is either to allow the computer to teach many students at once, or to allow some one else the use of the computer during the idle time. A time-sharing system is currently under development at M.I.T. that will provide this latter solution to the problem. The former solution is the natural one for the computer-in-a-school situation.

The response probabilities for this teaching system were estimated by a simple intuitive model<sup>3</sup> that estimated  $p(i,j,k)$  as a function of:  $\theta$ , the fraction of correct responses by the student in the past;  $\phi_{ij}(k)$ , the fraction of students taking  $b(i,j)$  in the past who have responded with the  $k$ th answer; and  $a$ , the fraction of correct responses by students to all questions in the past.

The course covered two concepts containing 12 and 13 levels and 25 and 27 information blocks, respectively. The entire course used 224 frames of micro-film.

Twenty students took the course as taught by the teaching system. The average instruction time was 53.0 minutes with a range from 33 to 75 minutes. The total fraction of correct responses was 0.753 with a range from 0.529 to 0.938.

There were many instances in which the computer made different decisions for students with different past histories (for this simple system the entire past history of the student was contained in  $\theta$ , the fraction of correct responses in the past).

### Analysis of Results

These results indicate that the teaching system described in this paper can (1) make quantitative decisions in its presentation of the course material to students so that different students, depending on their past performance, receive different presentations, and (2) change this decision process with experience. We have not proved, of course, that this teaching machine is a better machine than any other; we have not even proved that the changes mentioned above are changes for the better. At this point one must rely on his intuition to convince himself that a system capable of making systematic changes in its presentation of material and in its internal decision process must be a potentially better teaching device than one without these advantages.

On the debit side of the ledger there are some practical disadvantages that should be mentioned

concerning the implementation of an extensive teaching system along the lines of the above comments. First there is the problem of storage space in the computer. While it is true that the teaching of many subjects to many students would indeed tax the core storage requirements of most computers, it should be possible to employ auxiliary storage such as magnetic tapes and drums to solve that problem (at a slight reduction in speed). This compromise plus the technical advances in the future plus the possible advantages to be gained from a mass-produced, special-purpose teaching-decision computer should adequately solve this problem.

### Cost

A more serious problem is the cost of such a teaching system: First of all there is the cost of the computer; but when one considers the reduction (in dollars per instruction hour per student) that should be achievable with special-purpose, mass-produced computers capable of teaching many students at once, the cost restrictions from this source become less severe.

A more significant chunk of the cost dollar will go toward the writing of the information blocks. This is admittedly a tougher job for the system discussed here than for the usual straight-line teaching machine programs, since there are two to three times as many blocks to write. However, the computer may be able to help with this problem—first, by providing relative evaluations of alternate presentations of material (as in  $b(2,3)$  and  $b(2,4)$  of Figure 1), and secondly, by spotting situations in which the addition of blocks to the branching networks may be advantageous.

On the other hand, if, after all is said and done, computers are the only way to do the required job, then the economics of the problem may have to be subordinated to educational necessity.

The structure defined above has two further applications other than general classroom instruction. First, teaching systems using this structure could be used for the evaluation of teaching machine programs. As an example, one could use the teaching system to find a preferred path through the branching network and then use this preferred path in simpler, less expensive teaching machines.

Secondly, this class of teaching machines could find valuable applications in the area of educational research. Through the use of the wide versatility in the controlled situation enforced by the system, it should be possible to conduct research into important educational problems, such as: What are the important measurements that should be made in the educational situation? How can the data for a particular student be used most effectively in teaching decisions? What is the best simple decision mechanism that one can use in an inexpensive teaching machine?

### Acknowledgment

This paper is a short summary of work submitted in partial fulfillment of the requirements for the degree of Doctor of Science in the Electrical Engineering Department of the Massachusetts Institute of Technology. The computer work was done at the M.I.T. Computation Center.

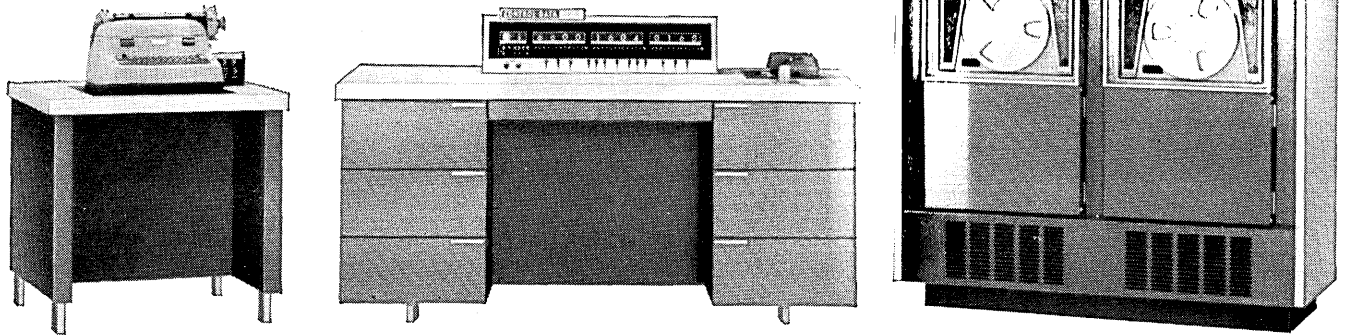

# NEW CONTROL DATA 160-A COMPUTER

## Desk Size Computer with Large Computer Capabilities

In most computer evaluations, the flexibility and capability of the computer to handle input-output operations is of special importance. No other small scale computer on the market today has the input-output features that are standard on the Control Data 160-A Computer.

For example, the 160-A exchanges data with input-output devices at any rate up to 70,000 12-bit words per second. The 160-A also has the capability of buffering data while computing... or while the operator manually enters data (whether the computer program is running or stopped). This input-output flexibility is combined with the following 160-A features:

- Internal and external INTERRUPT
- 8192 words of magnetic core storage (expandable to 16,384; 24,576; or 32,768 words)
  - 6.4 microseconds . . . . memory cycle time
  - 12.8 microseconds . . . . basic add time
  - 15.0 microseconds . . . . average execution time
- Flexible repertoire of 130 instructions
- External multiply-divide unit (optional)
- Completely solid state
- Low power requirements: 16 amps, 110 volt, 60 cycles

There are two input-output channels in the 160-A: a *buffer channel* and a non-buffer channel called the *normal channel*. Both can be used simultaneously for any combination of input-output operations.

During an input-output operation via the *normal channel*, computation is halted temporarily while the operation is carried out. However, once an input-output operation is initiated on the *buffer channel*, the 160-A either continues computation or performs some other I/O operation on the normal channel.

The Control Data 350 Paper Tape Reader and the BRPE-11 Teletype Paper Tape Punch—standard equipment on the 160-A—are connected to the normal channel and are not buffered. Other peripheral devices can be connected either to the normal channel or buffer channel.

When a peripheral device is connected to the normal channel, data is transmitted between the 160-A and the peripheral device via the normal channel only. However, when it is connected to the buffer channel, data can be transmitted between the 160-A and the peripheral device via *either* the buffer or normal channels. In this case, the normal channel is utilized at any time the buffer channel is not engaged.

A desk-size computer, the Control Data 160-A has the speed, capability, and flexibility of many large-scale computers. For more detailed information write for Publication No. B12-61.

**CONTROL DATA**  
CORPORATION

COMPUTER DIVISION  
501 PARK AVENUE, MINNEAPOLIS 15, MINNESOTA

# COMPUTER TEACHING MACHINE PROJECT: PLATO ON ILLIAC

Donald L. Bitzer and  
Peter G. Braunfeld

University of Illinois  
Coordinated Science Laboratory  
Urbana, Ill.

A certain teaching machine developed at this laboratory has been named PLATO, standing for "Programmed Logic for Automatic Teaching Operations."

It is a device for teaching a number of students individually by means of a single, central, high-speed, general-purpose digital computer, in this case the ILLIAC, the University of Illinois automatic computer. The general structure of PLATO is indicated in Fig. 1. For simplicity, only one student is represented in the diagram. The central element of PLATO is the high-speed digital computer.

Each student communicates with the computer by means of his own keyset, which can be provided with up to 64 keys representing a full complement of alphanumeric characters. When asked to answer questions posed to him by the machine, the student's answers may thus take such varied forms as numerals, algebraic expressions, and words or phrases.

Special keys enable the student to control the presentation of material to him by the machine. The machine communicates with each student by means of closed-circuit television. Material is presented in two different ways:

(1) The machine presents static textual material by commanding an electronic switch to connect the video output of the appropriate slide to the appropriate student's display.

(2) Dynamic non-textual material, or material furnished in the course of instruction (such as student answers), is written by the machine on the student's TV display tube by means of an intervening buffer storage device.

For multiple student operations, a keyset, television display, and intermediate output buffer storage device

are provided for each student. The central computer and slide selector, however, need not be duplicated; they serve all students on a time-shared basis.

It appears to be important in multiple-student operations, to require the condition that no student shall be aware of any other student's existence. To meet this condition, we are requiring the computer to respond to any student's request within 200 milliseconds.

The general logic by which instruction takes place is indicated by Fig. 2.

Textual material is presented on a sequence of slides. When the student has finished reading a given slide, he may proceed to the next slide by pushing the "continue" button on his keyset. Similarly, if he desires to review material contained on a previous slide, he may do so by pushing "reverse." On certain slides, questions are posed to the student. He cannot "continue" beyond such a slide until he has successfully answered all the questions thereon. As the student types in his answer, the machine displays it—character by character—in the space provided for the answer on the slide. As soon as the student indicates to the machine that he has completed his answer, the machine responds by indicating "OK" or "NO," depending on the correctness of the answer. The student may continue to punch in revised answers until the machine indicates that the answer is correct.

If the student indicates to the machine that he needs help in answering the question—by pushing the "help" button—the machine jumps to a "HELP" sequence appropriate to that question. In this sequence, further relevant textual material, if necessary, is presented, and the original question is broken up into a series of "easy" subquestions, designed to lead the student stepwise to the solution of the main question. A student need not complete a help sequence. At any point in the help sequence, he may indicate to the machine his desire to be confronted once again with the original troublesome question by pushing the "aha" button. As indicated in Fig. 2, failure to answer this question properly, leads to a return to the help sequence at the point it was broken off. In the case where a student should feel it necessary to ask for help for a question posed in the help sequence, the machine itself will provide him with the appropriate correct answer to that question.

The important features of the machine are:

1. The material is presented to every student in a standard, objective fashion.

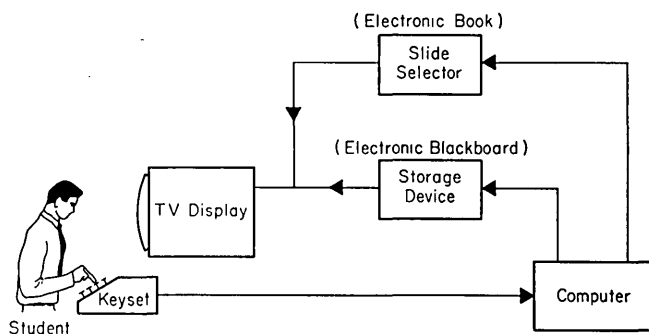

Fig. 1 General organization of PLATO equipment.



# HOW

■ *can multi-processing make all components of your computer system work full time for you?*

■ *can your jobs run simultaneously in any combination even though your programs are written to run by themselves?*

■ *can you feed new jobs into the system any time without interfering with programs in process?*

■ *can you add a second central processor to the system and thus get true parallel processing without reprogramming?*

■ *can you have automatic scheduling, memory allocation, error checking, and routine control functions without the inefficiencies of conventional operating systems?*

A Burroughs B 5000 is your answer to all these questions. Take multiple processing. We define it as "priority processing on a time-sharing basis." This is the way the B 5000 is normally used. When you want to feed in another job, the B 5000 does not need additional instructions for sequencing and scheduling. It has its own master control program that does scheduling automatically. The programmer doesn't even have to specify the components to be used. He just feeds in the new program. Any time. Usually while other jobs are processing. The master control will integrate it into the work load and see that the components operate at maximum efficiency. The human error factor in scheduling is virtually eliminated.

And your work load can't outgrow the B 5000. It's the only computer on the market that can accommodate a second central processor. A new processor can be linked in any time—*without* costly reprogramming. Thus equipped, the B 5000 can solve several problems absolutely simultaneously; this is *true* parallel processing.

You see our master control program wasn't patched up to fit the computer. We designed the computer to fit a carefully thought-out master control. This is the secret of the built-in operating system's unmatched flexibility and efficiency. It does all the things we mentioned in our 5th question and also permits the addition of new equipment and programs.

Another thing: The B 5000 can process programs written in COBOL or ALGOL—but that's a story in itself. If you would like the details on *all* the advantages of this remarkable computer, just write Burroughs and ask for a copy of *The B 5000 Concept*, Burroughs Corporation, Detroit 32, Mich.

Burroughs—TM

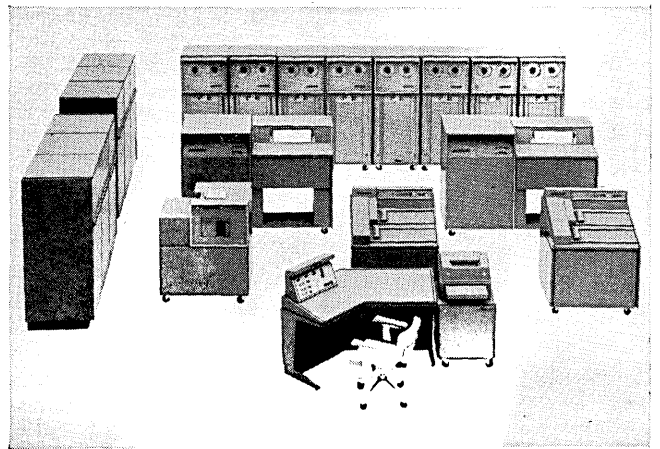

Burroughs Corporation



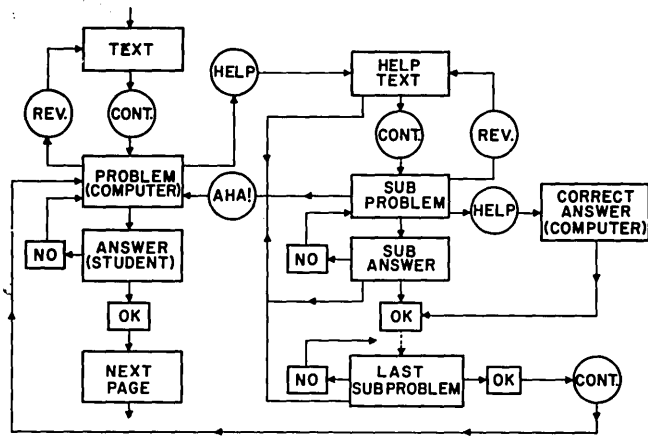

Fig. 2 PLATO programmed logic.

2. Each student may proceed at his own speed, seeking as much or little supplementary material as he wishes, subject to the boundary condition that he must solve successfully a prescribed sequence of problems.

3. The machine keeps an accurate record of each "move" the student makes. Thus at the end of an instruction period, the experimenter has at his disposal a print-out of how long the student spent on each page, what right and wrong answers were given

and in what sequence, how long a problem took for solution, at what points help was requested, etc.

4. The student knows as soon as he has worked the problem, whether his solution is correct or incorrect. In the latter case, the machine can indicate "NO" without in any way revealing the correct solution.

5. To test the versatility of the machine as well as the basic logic of the computer program, a number of instructional sequences have been prepared ranging from topics in mathematics (such as the elementary theory of congruences) to instruction in computer programming. To change machine instruction from one subject-matter to another requires only replacing slides in the slide selector and giving the computer an appropriate set of parameters.

A study using the machine to teach high school students the binary and other non-decimal number representations has been completed. Post-tests given the students participating in this study indicated that they had been able to learn from the machine. It also provided useful information on data-rates—considering the teaching system from the standpoint of an information processing system.

Studies on teaching students computer programming are currently in progress.

## COMPUTER MARKETING TRENDS — SOME COMMENTS

Norman Statland

Vice President

Charles W. Adams Associates, Inc.  
Bedford, Mass.

Historically, the commercial use of computers passed the tenth anniversary mark only in 1961. Those familiar with general-purpose digital computers and their applications have witnessed the progress and increasing speed of central-processor equipment from electrostatic-tube memory devices through delay line storage to the predominance of magnetic core storage. Most recent developments point toward the use of thin-film deposits for faster memories. Similar increases in the speed of photoelectric card readers and paper-tape readers, as well as new techniques for higher density magnetic tape recording, have combined to increase the potential speed of computer systems. With these more powerful systems have come a lowering of unit costs of data processing and a second generation of computer marketing directly concerned with software programs and advanced logical design features for the central processor.

In the production of second-generation solid-state computers, a new breed of equipment manufacturer has appeared on the marketing scene. Being small, these companies cannot hope to compete with the largest concerns. Rather, what they produce has ap-

peal to the more sophisticated users of electronic data processing systems. They sell their equipment at a potentially lower cost for each unit processed, but they leave almost entirely to the customer the organization of the installation, the development of complex software programs, and the provision of on-site assistance. The advent of this group poses the interesting question of what trends the computer market will follow during the decade of the Sixties. To this no firm answer can be given but some conjectures can be made.

It is quite possible that the computer industry may follow the course which developed in the automobile industry about fifty years ago. During those early years there were many manufacturers of "horseless carriages." Some grew large, others remained small, while many withdrew from the fiercely competitive race or were absorbed by bigger companies. In time, the Big Three emerged. But there always were—and still are— independent manufacturers offering a limited number of models to a specialized segment of the market. These companies, all relatively small, are among the first to adopt new design features; they

# EAST VS. WEST DIAGRAMS VS. EQUATIONS

THE COMPUTER'S ANSWER TO A LONG-STANDING COMPUTER ISSUE.

For a decade East Coast and West Coast computer designers have been using different methods of representing computer logic—the Easterners with diagrams, the Westerners with equations.

$$\begin{aligned}
 \text{LBSMI} &= (\text{LXA1})(\text{LXA2}^*)(\text{LFCA}^*) \\
 &+ (\text{LXA1}^*)(\text{LXA2})(\text{LFCA}^*) \\
 &+ (\text{LXA1}^*)(\text{LXA2}^*)(\text{LFCA}) \\
 &+ (\text{LXA1})(\text{LXA2})(\text{LFCA}) \\
 \text{LFCAJ} &= (\text{LXA1})(\text{LXA2}) \\
 \text{LFCAK} &= (\text{LXA1}^*)(\text{LXA2}^*)
 \end{aligned}$$

In the example illustrated here, the diagram and the equation tell us exactly the same thing. Either represents a serial full adder where the sequence of pulses at the output, LBSM, will represent a serial binary number that is the sum of two serial binary input numbers occurring at LXA1 and LXA2. (The asterisks indicate binary complements; for example, whenever LXA1 is energized LXA1\* is not, and vice versa. LFCA is a carry flip-flop.)

There are persuasive arguments on both sides. Eastern proponents of diagrams point out that the logical interconnections can be seen at a glance and followed through any number of stages by eye. The logical structure of an entire system can be understood from a diagram more directly and intuitively, they maintain, than from a set of equations.

The Western argument for equations goes like this. It's not true that diagrams communicate better to the viewer's intuition, except at first exposure. The human mind is highly adaptive. After working analytically with the equations for a while, the mind begins to operate intuitively in that symbology. Then the intrinsic superiority of equations over diagrams begins to make itself evident. One advantage, say the Westerners, is that equations can represent the same information more compactly and efficiently, as our illustration shows. Another is that equations lend themselves better to computer manipulation of logical design information.

As evidence of the latter advantage Westerners point to a recent achievement of some Litton Systems people: a completely mechanized procedure for translating logical designs into wiring lists, including operational simulation of the design to verify its accuracy. A procedure enormously facilitated by the computerizability of logical equations. It's easy to picture the benefits in cost, delivery schedules, reliability, price. Using only a partial development of this method Litton Systems recently brought a major computer system from concept to operation in less than a year.

Now under consideration at Litton: a machine that will accept as inputs a supply of standard computer components and a set of coded specifications defining the logical functions desired, and will crank out completely fabricated systems.

*Maybe you think we've loaded the argument in favor of equations. You're right. But we're ready to listen to arguments on either side. Drop us a card. Or better still, drop in in person. You'll like the*

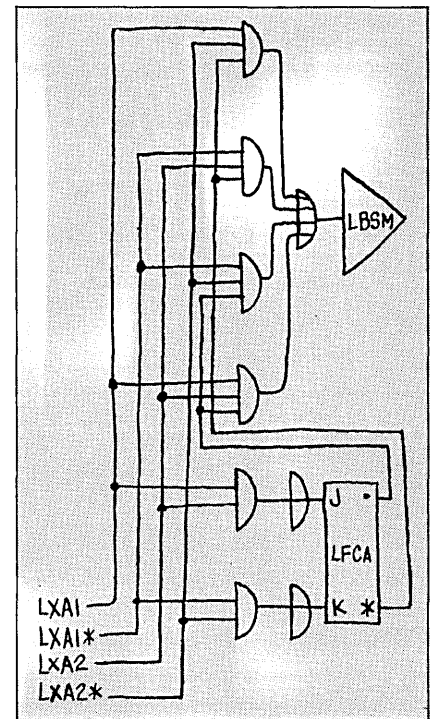

*imagination-stretching atmosphere generated by Litton management's appreciation of the rewards of creative controversy. We have a few excellent opportunities for computer design people. Ask for Harry Laur at Litton Systems, Inc., Data Systems Division, 6700 Eton Ave., Canoga Park, California.*

An equal opportunity employer

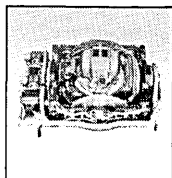

**LITTON  
SYSTEMS, INC.**

A DIVISION OF LITTON INDUSTRIES

DATA HANDLING & DISPLAY SYSTEMS • GUIDANCE & CONTROL SYSTEMS • COMPUTER SYSTEMS • SPACE SCIENCE • BIOELECTRONICS • ADVANCED COMMUNICATIONS TECHNOLOGY

led in the recent introduction of the American compact car.

The trend in the computer industry shows a close correlation. In it there are today large corporations producing a wide range of equipment for the complete market spectrum. There are also at least a half-dozen smaller computer manufacturers who generally offer no more than one or two models aimed at specific installations.

The activity of this segment of the marketing group is evidenced by Digital Equipment Corporation's introduction of high-speed and low-cost computers for primarily scientific applications, and the emulation of this development by Advanced Scientific Instruments, Computer Control Company, General Mills, Packard Bell and Ramo-Wooldridge. While some may argue with this rather arbitrary selection, the fact remains that these organizations have presented machines of small binary word length having fast internal speeds coupled with attractive pricing (under \$4,000 per month average rental), in order to gain a place in the computer marketing race. It is true that the larger companies have entries which may compete directly with the machines of these smaller firms; but one must recognize the quandary of their sales people in first selecting a system for a prospective user and then gathering enough arguments to outweigh either the price or the speed advantage sometimes enjoyed by the competition.

It is perhaps in the area of support, machine backup and software and other intangibles that the public image of a corporation is most important; yet it is probably the most difficult to comment on since each case must be treated independently.

One large manufacturer, International Business Machines Corporation, presently occupies a dominant position in the electronic data processing industry. The other companies appear to be somewhat behind, except a few small ones which are seemingly coming along well and show promise of offering performance figures that are quite admirable for young boys com-

peting against grown men. One cannot help wondering how many others are going to cast themselves in the role of David engaging Goliath in combat with only a small stone in the sling. Yet every time that everyone agrees it takes around ten to fifteen million dollars to get into the commercial marketing and manufacturing of EDP equipment, some new small organization turns up and begins to distribute marketing information and literature.

On paper, each of the newly-designed computers competes very well, especially in price, with its adjacent competition. Most if not all manufacturers have found, however, that price is not the only key to the sale of equipment. Some of these low prices can continue only if the manufacturer considers the development of software and a large sales staff as luxuries not required by its particular type of prospective customer. Following this pattern, such companies as Control Data Corporation and Digital Equipment Corporation have been successful in producing and selling small computers to a limited segment of the market.

On the other hand, there are companies such as Burroughs, National Cash Register, Remington-Rand and Royal McBee, to name only a few, which have long been in the data-processing business and evidently feel that to maintain their competitive position they must stay in the computer race. These manufacturers have extensive sales staffs and in varying degrees have endeavored to compete with IBM in the development of software for their various systems. Likewise, Bendix, General Electric, Minneapolis-Honeywell and Radio Corp. of America, all large corporations, have ventured into the hardware production battle with the hope of reaping profits from what promises to be a multi-billion dollar industry during the next ten years. All have already learned, however, that considerable manpower and money must be invested before even a glimpse of adequate return can be realized.

Because of its many installations in active operation, IBM's library of software programs still exceeds that of any of its competitors. This is not to be construed as an endorsement of IBM software as superior or more applicable to a particular situation than anything produced by others. It is simply a statement intended to suggest that one way to whittle a giant down (assuming this to be desirable) is by flanking rather than frontal attacks, so to speak. To increase their competitive position, it might be well for companies which have entered the EDP field during the past ten years to consider the desirability of concentrating their efforts—design, production, programming and sales—on specialized equipment areas. By so doing, they could eliminate some needless expense in areas where they do not have much hope of competing successfully.

Recognizing that the initial expenditure will cover only a limited amount of research and subsequent program support, there is mounting evidence to strengthen the contention that a more limited approach to the marketing of selected systems rather than an entire range of systems seems the logical course for those organizations to follow if they desire to continue as successful producers of equipment.

### Number of Computer and Data Processing Systems, by Monthly Rental

Monthly Rental	Number
\$50,000 and above .....	7
\$30,000 to 50,000 .....	4
\$20,000 to 30,000 .....	6
\$15,000 to 20,000 .....	4
\$10,000 to 15,000 .....	5
\$5,000 to 10,000 .....	8
\$2,500 to 5,000 .....	10
under \$2,000 .....	7
Total: .....	51

Source: "Computer Characteristics Quarterly," issue of December 1961, published by Charles W. Adams Associates, Inc., Bedford, Mass.

“We  
“ON  
have  
statist  
form  
Since  
tiona  
this  
econ  
“TW  
cessi  
ourse  
390,  
lang  
since  
NCR  
thro  
The N  
COM

# **ACROSS THE EDITOR'S DESK**

## **News of Computers and Data Processors**

---

### **New Firms, Divisions, and Mergers**

#### **IBM WORLD TRADE CORP TO MOVE HEADQUARTERS**

IBM World Trade Corporation has announced that it will move its corporate headquarters to White Plains, N.Y., from its present location at 821 United Nations Plaza, New York City. Its UN Plaza building will be kept for other company purposes.

The new site is located 2½ miles from downtown White Plains. It consists of a 35-acre tract of which 20 acres are zoned for office-campus use. The relocation will take place after January 1964.

#### **NEW COMPANY MAKES OPTICAL CHARACTER RECOGNITION EQUIPMENT**

Recognition Equipment Inc., located on Ross Avenue at Prairie, Texas, specializes in making machines that read. This new company is one of a very small number of manufacturers of optical character recognition equipment in the world. Recognition Equipment will also engage in military and commercial contracts for the development of mechanical, electro-mechanical, electronic, and optical apparatus.

All personnel of Recognition Equipment were associated previously with a Dallas concern which designed and manufactured the first all-electronic optical character reader now in commercial use. Principals of the new concern are: Herman L. Philipson, Jr., President; E. Gordon Perry, Jr., Executive Vice President; Thomas Q. LeBrun and Robert L. Woolfolk, Vice Presidents; G. William Childs, Director of Mechanical Design; and H. Gene Emery, Secretary.

#### **TECHNICAL OPERATIONS, INC. ACQUIRE BECKMAN AND WHITLEY, INC.**

Technical Operations, Inc. of Burlington, Mass. and Beckman and Whitley, Inc. of San Carlos, Calif., have agreed in principle to pooling their interests through the acquisition of Beckman and Whitley by Technical Operations. A probable factor in bringing the two organizations together is the comple-

mentary nature of B&W's and Tech/Ops' product and research activities. Tech/Ops' Directors have approved the issuance of approximately 150,000 shares of stock to Beckman and Whitley, Inc., which will continue to be operated by its present management. Beckman and Whitley, as a wholly-owned subsidiary, will be represented on Tech/Ops' Board of Directors.

#### **PERIPHERAL PRODUCTS DIVISION ESTABLISHED BY CONTROL DATA CORPORATION**

This company has formed a Peripheral Equipment division to help provide a complete line of digital peripheral equipment to be supplied with the firm's electronic digital computers.

The CDC 350 punched paper tape reader is already being marketed. The CDC 606 magnetic tape unit is scheduled for first deliveries in the last half of 1962.

Offices and manufacturing facilities of the new division are now in full operation in the Minneapolis suburb of Bloomington.

#### **BURROUGHS FINANCE CORP**

Burroughs Corp., of Detroit, Mich., has formed a wholly-owned sales affiliate, the Burroughs Finance Corp.

This new affiliate was capitalized at \$3.6 million. It will handle the sale and lease of the corporation's electronic data processing systems. Headquarters for Burroughs Finance will be in the corporation's Detroit offices.

#### **DATA PROCESSING SYSTEMS TO BE PRODUCED BY NEW FIRM**

Albert F. Sperry and Max Palevsky have formed a new firm, Scientific Data Systems, Santa Monica, Calif. Its function will be to design and build all devices necessary for scientific data processing systems and process control systems, including associated analog-oriented electronics. SDS systems will be built on modular subsystems that can be expanded to large, complex systems. The computers themselves will be special purpose digital systems employing silicon transistors.

## NEW PRODUCTS

### DEFT -- DYNAMIC ERROR FREE TRANSMISSION

General Dynamics/Electronics  
Rochester 3, N.Y.

#### MODEL AD-10A ANALOG-TO-DIGITAL CONVERTER

Raytheon Company  
Communications & Data Processing Operation  
1415 Providence Highway  
Norwood, Mass.

This company has developed a new high speed analog-to-digital converter which can give 500,000 complete 10-bit conversions per second. Output is either serial (5 million bits per second) or parallel straight binary (500,000 words per second). Accuracy is about 1/10 of a percent, plus or minus one-half of the least significant bit. The Model AD-10A can be operated internally or externally for sampling command. This converter has 12 plug-in panels with the 10 logic panels directly interchangeable.

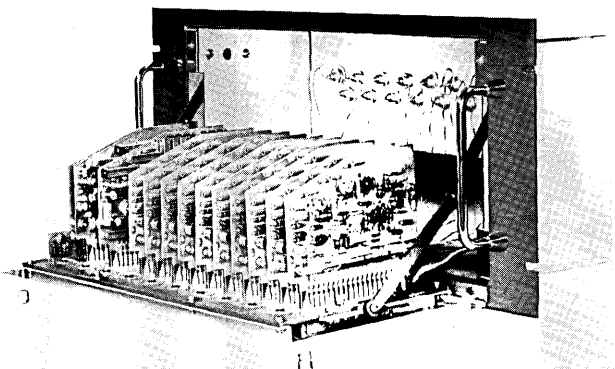

This company has developed a new technique, for high-speed transmission of data over ordinary telephone lines at rates up to 15,000 words per minute. This is equivalent to 150 different teletypewriter messages transmitted all at once.

Alphanumeric characters are coded into phase relationships among simultaneously transmitted tones. It makes use of a new phase modulation technique that makes the possible number of symbols that can be generated astronomical in magnitude. The differences between the very few characters in the English alphabet are great enough so that automatic character recognition is almost error-proof. It also gives DEFT an exceptional resistance to interference, noise, and jammings.

The character-recognition technique does not require either dynamic logic or storage circuitry.

#### SEQUENCE STACKER

The Standard Register Company  
Dayton 1, Ohio

This company has produced a new Sequence Stacker which accumulates burst forms in sequence as they issue from a bursting operation.

The device is designed to carry burst forms by continuous belt action directly from the burster to an accumulator tray where they are stacked evenly and smoothly in the exact sequence in which they were detached from the continuous web. The accumulator tray will hold up to 800 tab card-size forms or 400 long lightweight sheets.

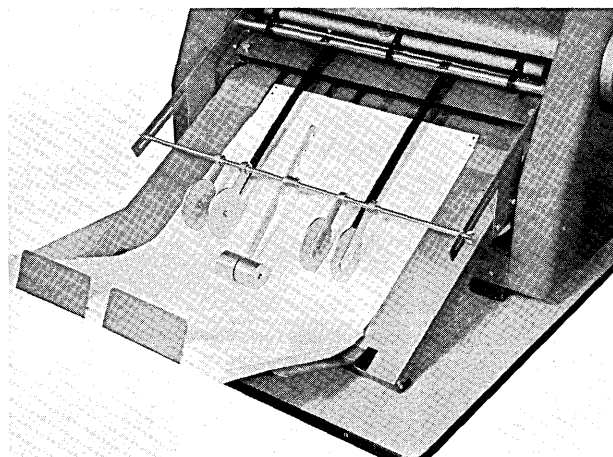

#### MEDICAL COMPUTER FOR BLOOD VOLUME DETERMINATION

Delta Instrument Corporation  
250 Delawanna Ave.  
Clifton, N.J.

A new medical computer for precise determinations of total circulating blood volume or red cell volume in operating and recovery rooms has been produced by this company.

The Delta Volume computer automatically calculates blood volume, and presents data in a lighted, numerical display, indicating in liters directly. An illuminated panel control guides the operator. Radioactive iodine is used to measure total blood volume and radioactive chromium-labeled compounds measure red cell volume.

## MODEL 791-S ANALOG-TO-DIGITAL CONVERTER

Librascope Division  
General Precision, Inc.  
808 Western Ave.  
Glendale 1, Calif.

This miniaturized electromechanical converter for analog-to-digital conversion is designed primarily for low-speed conversion of linear data into digital form.

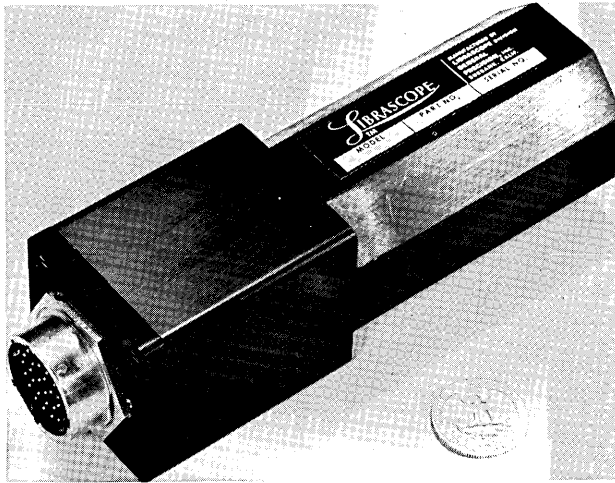

The converter accepts 400-cycle AC voltages, and produces an 11-bit binary output. The converter's parallel and unambiguous output can be increased to as high as 19 bits. Accuracy is one part in 2048.

It is said to be easily adaptable to a wide range of input functions in digital computers, fire control systems, airborne navigation systems, and machine tool control systems.

### MEMORY UNITS FOR TELSTAR SYSTEM

Di/An Controls, Inc.  
944 Dorchester Ave.  
Boston 25, Mass.

Twelve magnetic core memory systems have been delivered by this company to Bell Telephone Laboratories for use in the Telstar Satellite Communication System. The Telstar System is designed to test the feasibility of instantaneous voice relay from an orbiting satellite.

The Di/An memory units are part of the digital servo control system which steers a giant antenna. The six memories in each set are standard, sequential-access, coincident-current buffer-storage units. An unusual feature which has been added to two of the buffers is a programming device which gener-

ates marker pulse train outputs at any predetermined memory addresses on up to 32 separate lines. Selection of marker outputs at any address is easily made in the field, so that as tracking experience is gained, diagnostic testing routines may be modified without difficulty.

### POSEIDON -- FAST DIGITAL UNIT

Ferranti, Ltd.  
Hollinwood, England

A new high-speed real-time digital computer has been developed by this company and the British Admiralty Surface Weapons Establishment. The new computer, called Poseidon, is in the same speed category as Ferranti's big Atlas computer.

The computer is capable of performing one completed operation every 2 microseconds. Poseidon is a parallel machine working in binary notation with a word length of 24 binary digits; a magnetic core storage capable of holding 8192 words; and immediate access to 32 addresses. Program instructions are held permanently in a fixed storage with a capacity of 4096 words.

The speed in the arithmetic section of the computer is made possible by a special adder-subtractor.

### MILE-A-MINUTE MEMORY

International Telephone & Telegraph Corp.  
320 Park Avenue  
New York 22, N.Y.

Creed & Company Ltd., British associate of this company, has introduced a tape storage unit that provides automatic retrieval and read-out of prepunched tape data on reels revolving at speeds of 88 feet per second. The unit, called the Model 2000, has a capacity of 240,000 alphanumeric characters per reel. Maximum access time is 13 seconds.

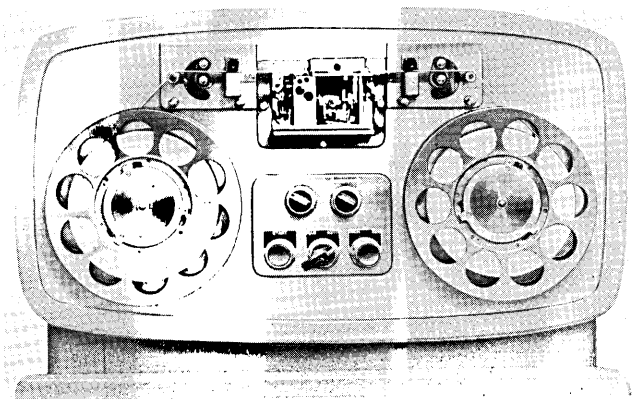

### PLUG-IN MEMORY ARRAY

Sylvania Electric Products Inc.  
730 Third Ave.  
New York 17, N.Y.

This company has developed a plug-in magnetic-core memory array, which can be used individually or in groups to provide information storage capacity in a large-scale digital computer.

Usually when there is a malfunction in a conventional memory array, four to eight hours are needed to remove it, install a new one, and resolder. But this plug-in memory can reduce time for changing from a faulty memory to a properly working one to 15 minutes. Since down time for a computer may cost over \$400 an hour, the saving is considerable.

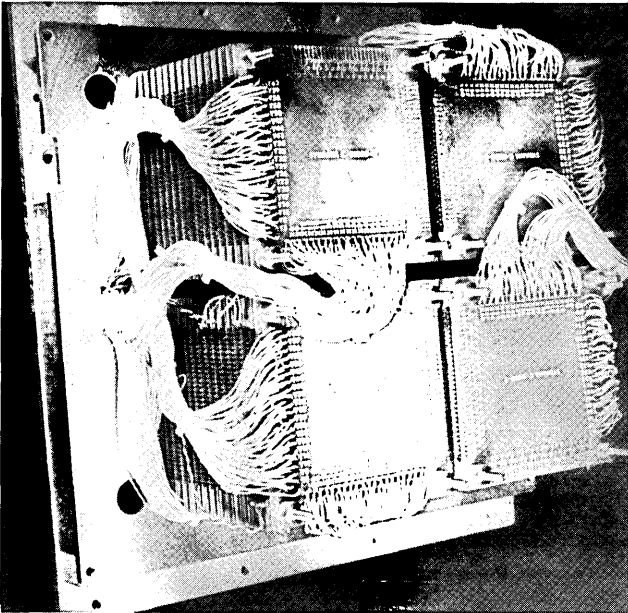

### INSERTION OF COMPONENTS TO BE AUTOMATED

Sperry Gyroscope of Canada, Ltd.  
Montreal, Quebec, Canada

This company has developed and is now building new numerical control systems to automate the insertion of components and the wiring of boards and racks in computers.

One such system is for application to a high-speed punching and drilling machine which will produce printed circuit boards. Another system is for the first station of a 12-station component insertion line for Sperry's Remington Rand Univac division.

### 16,000-WORD MEMORY UNIT

Radio Corp. of America  
Semiconductor & Materials Division  
Needham, Mass.

This company is building a 16,000-word memory unit for a new computer under development at the Univ. of Illinois, Urbana, Ill.

Each memory location will be accessible within 2 microseconds. Each machine word will consist of only 16 bits due to the "unconventional" uses planned for the computer. More than 250,000 ferrite memory cores and associated electronic circuitry will go into the memory.

The computer is sponsored by the three military services and the Advanced Research Projects Agency (ARPA) of the Defense Department. The computer is expected to be in operation early next year. Among the applications of the computer will be studies on how computers can be used in teaching both general subjects and specialized skills, air traffic control, man-machine relationships, and computer programming and design.

### PUNCHED CARD TO PUNCHED TAPE CONVERTER

Electronic Datacouplers, Inc.  
Subsidiary of Dashew Business Machines, Inc.  
Los Angeles, Calif.

This company has developed a punched-card to punched-tape converter, Model DC-3000, and a converter-comparator combination, DC-3500.

The processing rate is 60 characters per second, or 45 cards per minute. Any card format can be converted to any 5, 6, 7 or 8 channel tape code format.

### NEW HIGH-SPEED TAPE PERFORATOR

Anadex Instruments, Inc.  
Van Nuys, Calif.

A tape perforator produced by this company has speeds up to 60 cps. It is designed for recording digital data in punched tape from computer output, and also for systems for data logging machine control, automatic test, simulation, data transmission, etc.

It has a non-synchronous drive. Five to eight code channels are available. It uses paper or mylar tape in widths up to one inch and has a simplified tape loading.



## NEW POWERFUL IBM COMPUTERS

International Business Machines Corp.  
Data Processing Division  
White Plains, N.Y.

Two new modular electronic computers, for scientific data processing, are being produced by this company. The IBM 7040 and 7044 are compatible with each other, with a wide variety of input-output equipment and with the IBM 1401. Data recorded in paper tape or transmitted over wire is accepted by these systems. They also can be linked to such devices as analog-to-digital converters, radar, microwave transmitters, and telemetering equipment.

The new 7044 data processing system has a memory access time of 2.5 microseconds. In one second it can perform 400,000 logical decisions, 200,000 additions or subtractions, 33,333 multiplications or 20,000 divisions.

A typical configuration of the 7040 contains a card read-punch, high-speed printer, and low-cost magnetic tapes. A basic system could be expanded in stages to include high-speed tape drives, magnetic disk files and an on-line IBM 1401 data processing system. A typewriter built into the computer's console will print messages during testing and "debugging" of programs.

Advanced modular design makes available hundreds of computer configurations built around the two new central processing units.

### DISC FILE UNIT EXPANDS MEMORY OF TWO UNIVAC COMPUTERS

Remington Rand Univac  
315 Park Avenue South  
New York 10, N.Y.

The rapid-access storage capacity of the Univac 490 Real-Time Computer and the 1107 Thin-Film Computer will be increased by an additional 700 million bits with a new mass-memory disc file. This memory can include up to 24 identical storage discs per unit. Discs are rotated at a rate of 900 RPM. Data can be stored on both sides of each 39-inch diameter disc. Each disc face accommodates 768 recording tracks which are arranged in six groups or zones. Six data read-write heads (one for each zone) are aligned with each disc face. Fully-transistorized read-, write-, and selection-circuits connect the magnetic heads with appropriate logic circuits in the system.

## NEW ANALOG-DIGITAL CONVERTER

Norden Division  
United Aircraft Corp.  
Norwalk, Conn.

A new size 11 analog-digital encoder with small size, long life, and high conversion accuracy, is now being produced by this company. The conversion accuracy is plus or minus 27 minutes. It has 256 counts per turn, and operates at temperatures ranging from minus 60 degrees to plus 180 degrees Fahrenheit.

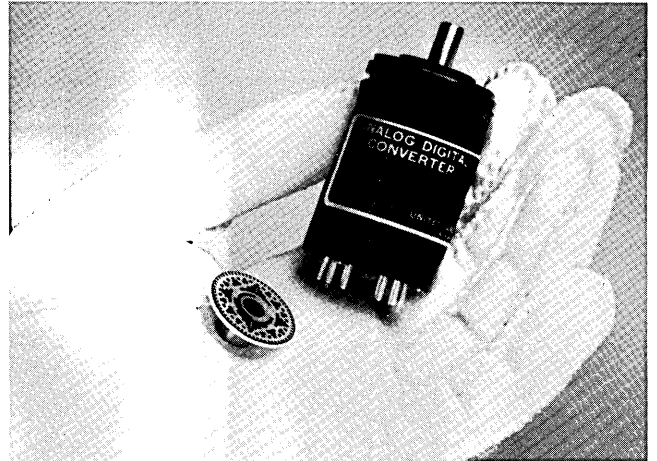

### DISTANCE MEASURING EQUIPMENT "DME"

International Telephone & Telegraph Corp.  
320 Park Ave.  
New York 22, N.Y.

ITT has developed a transistorized, lighter-weight distance-measuring equipment (DME) to meet the "pinpoint en route" guidance needs of super-speed commercial aircraft.

The new model has 10 electron tubes and weighs only 29 pounds. Earlier versions, now in service, have 33 tubes and weigh 34 pounds. The elimination of 23 electron tubes and their associated circuitry enables the transistorized model to operate at cooler temperatures.

DME enables a pilot to read from a dial his exact distance in nautical miles from a selected ground station in the nationwide check-point network operated by the Federal Aviation Agency. The equipment furnishes important in-flight information regarding arrival schedules and holding patterns and is said to be a major advance in aviation safety.

## COINCIDENT CURRENT MEMORY SYSTEM

Daystrom, Inc.  
Military Electronics Division  
Archbald, Pa.

This company's most recent development in memory systems is a coincident-current Memory System, called the CCM Series; it provides cycle times to 3.5 microseconds. It is available in random access, sequential-interlaced and sequential-non-interlaced models, with up

to a 30% reduction in size over presently available commercial units.

All circuitry is solid-state design and power supplies are self-contained and transistor-regulated. A variety of memory capacities are available with word sizes to 4096 and bit lengths to 64.

Shown below is an exposed view of the coincident current memory system.

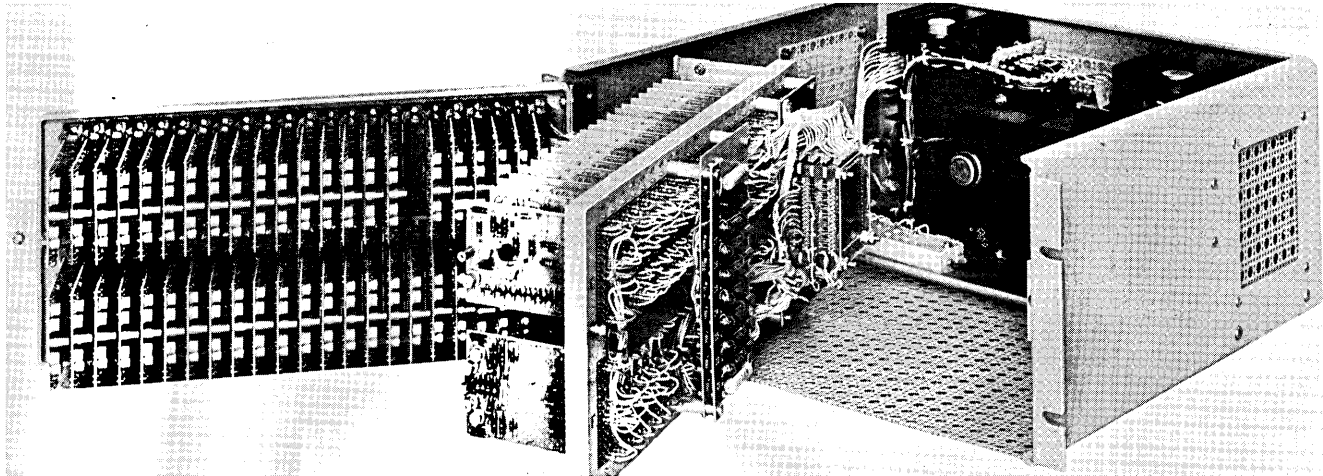

## NEW INSTALLATIONS

### POST OFFICE MAIL-SORTER

An advanced experimental electronic address reader has been delivered to the Post Office Department, Washington, D.C. by Farrington Electronics, Inc., Alexandria, Va.

This new reader is an optical scanning device that reads addresses at a rate of 9300 letters an hour. It will undergo a period of testing on live mail in the Post Office research laboratory in Washington, D.C.

The automatic address reader reads typewritten, printed or imprinted addresses, single or double spaced, staggered or flush, "almost anywhere" on the facing of any letter size envelope. A special reading technique has demonstrated its capabilities with a 50-way state sort and a 61-way city-state sort. The reader can be programmed to read any combination of destinations by use of interchangeable wired panels. The experimental machine will not accept hand-addressed envelopes; however Post Office Department figures show that today nearly 85% of letter mail is printed or machine addressed.

### BURROUGHS VISIBLE RECORD COMPUTER SYSTEM

South Shore National Bank at Quincy, Mass. has completed installation of a computer system handling ledger records. The system consists of an electronic sorter-reader, a fully transistorized central processor, a program card reader, the record processor, and the control console.

Processing of the accounts will be the first step in the bank's transition to complete electronic accounting. Later the bank intends to process electronically all information necessary for savings, installment and mortgage loan accounting as well as management reports.

### UNIVERSITY OF NAPLES INSTALLS BENDIX G-20

A Bendix G-20 is scheduled for installation in January at the University of Naples, Italy.

This high-speed computer will be used to provide teaching and research support to the university's engineering school. It will be used by students and faculty in civil engineering, electronics, hydraulics, naval engineering, chemistry, and aeronautical engineering.

ton.  
Creati  
St.  
Cybur  
brid  
D: D  
St.  
Daystr  
mar  
Devere  
Proc  
50.  
work  
tary  
of a  
comp  
Deve  
Dictap  
/ M  
Digit  
May  
Dorset  
Norm  
the  
thei  
pane  
\* info  
Dougl  
Sant  
deve  
pane  
DuKane  
ible  
the  
gran  
Amer  
Dyna S  
5, 1  
plas  
text  
stud  
Dynate  
Proc  
has  
DT-5  
of c  
nary  
dial  
ber  
E: E  
Thom  
ange  
in a  
reac  
tion  
Proc  
Ed-U-C  
Long  
Educat  
Long  
Educat  
sity  
Educat  
Eure  
teac  
The  
by a  
bord

## TWO UNIVAC 490 SYSTEMS FOR EASTERN AIR LINES

A multi-million dollar set of electronic computer equipment -- two Remington Rand Univac 490 Real Time Computing Systems -- has been shipped to Eastern Air Lines Electronic Data Processing Center at Charlotte, N.C.

The new Univac system is replacing a Remington Rand Univac File Computer which has been controlling reservations in nine metropolitan areas. The new system, when in full operation, will have direct links through 4880 miles of high-speed telephone communication lines. As applied to the Eastern Air Lines reservations system, the real-time principle will permit almost instantaneous receipt and transmission of data on reservations and other flight information between the computer center in Charlotte and any ticket selling point in the Eastern Air Lines System.

## "SPACETRACK" COMPUTER

A Philco 2000 Electronic Data Processing System has been delivered to Hanscom Air Force Base, Mass. It will be used in conjunction with the Philco 2000 in NORAD's Space Detection and Tracking System (SPADATS) in Colorado Springs, Colorado.

The Hanscom computing system, known as Spacetrack, will provide basic programs and operational concepts for SPADATS. It will be available for backup should SPADATS ever be out of commission.

## TOTAL OPERATIONS PROCEDURES SYSTEM -- TOPS

Barber-Colman Company has installed a Philco 2000 Electronic Data Processing System. TOPS will be utilized by Barber-Colman for its business data processing.

The system will be used for three major applications: payroll and labor distribution; material control and production planning; and machine center loading, order scheduling, and work-in-process.

## N.H. INSURANCE COMPANY HAS FIRST HONEYWELL 400

The New Hampshire Insurance Group, Manchester, N.H. has received delivery of the first commercial model of the Honeywell 400 electronic computer.

The Honeywell 400 is a full-scale data processing system including magnetic tapes and input-output equipment.

## COMPUTER-CONTROLLED PAPER MACHINE

Instrumentation is being installed for the automatic control of a miniature paper-making machine at the Thomas J. Watson Research Center of International Business Machines Corp. in Yorktown, N.Y. The ultimate aim of the research program is the production of uniform paper by control of physical properties such as caliper, moisture content and weight.

Fischer & Porter, Warminster, Pa., are supplying the instruments to be used in the two phases of the program. The first phase is measurement of all process variables by means of instruments. Phase two involves integrating these instruments with a digital computer to regulate the settings on the machine and achieve optimum quality and quantity of paper produced. The machine is a scale-model of those used in paper mills.

## FEDERAL RESERVE BANK OF BOSTON TO INSTALL SECOND NCR SYSTEM

Another automatic check-handling computer system will be installed in the Federal Reserve Bank of Boston by April. The bank has successfully completed a six-month trial of National Cash Register Co.'s electronic check-handling equipment. The current installation, including an NCR 304 computer and allied equipment, has helped the reserve bank sort and list an average of 1.3 million checks per day. The ordered equipment consists of two additional electro-mechanical check sorters connected to a NCR 315 computer.

## ELECTRONIC COMPUTER FOR NASSAU COUNTY

Nassau County, N.Y., has installed an electronic computer to handle a growing mountain of paper work which has accompanied its own rapid growth.

The IBM 1401 computer's first task was processing the payroll of nearly 10,000 county employees. The computer is scheduled for additional use in budget preparation and control, appropriation and revenue accounting, inventory, and other functions. Eventually it will be programmed to help in analysis and control of operations in all departments of the county.

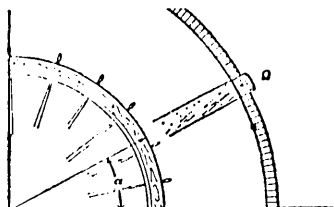

## NEW APPLICATIONS

### CANCER CENTER USES COMPUTER IN TREATMENT OF CANCER

Hospital scientists at the Memorial-Hospital Sloan-Kettering Cancer Center in New York, N.Y., are programming a Bendix G-15 computer system for use in applying data processing techniques to the study of radiation in diagnosing and treating cancer patients. The computer will be used in general for the diagnosis and treatment of cancer, and in particular, at the start, to quickly and accurately determine the amount of radiation from external sources delivered to cancer tissue and surrounding normal tissues, and the distribution of radiation by radioactive needles and seed implants.

The G-15 system, manufactured by The Bendix Corporation's Computer Division in Los Angeles, Calif., includes two magnetic tape units and a PA-3 graph plotter.

### COMPUTER APPLICATION IN AIRFRAME INDUSTRY

A computer has been applied to cut in half the time required to process parts catalog changes for Convair jetliners. This application is by General Dynamics/Convair, San Diego, Calif.

The heart of the system is a master list, which contains detailed information about each of more than 50,000 parts in each Convair jetliner. When a parts change decision is made, writers make the required revisions on a master work sheet. The data processing department, using IBM 1405 and 705 computers, process, analyze, and reassemble the change data.

Detailed parts information formerly was contained on almost one million key-punched cards. They have now been converted to magnetic tape. Instead of 30 days to process parts change transactions, which average about 2500 each day, the computer system will need only 15 days.

### SATELLITE TRACKING STATION

Under direction of the 6594th Aerospace Test Wing, Lockheed Missiles & Space Company is the contractor and manager of the tracking station at Vandenberg AFB (Calif.). This tracking station is composed of VHF and UHF equipment, VERLORT (Very Long Range Radar) and telemetry readout equipment. Its main

functions are: vehicle tracking; data reception and recording; and satellite command and control.

The nerve center of the tracking station is the Data Acquisition and Processing Center. Among the instruments in use there are the PAM/FM telemetry, IBM 1604 computer, and a storage and dissemination device called PICE (Programmable Integrated Control Equipment).

The 1604 computer performs normal computer functions.

PICE, an electronic "storage cabinet", receives all data-tracking, vehicle performance and payload performance at a high speed -- converts it into a common digital language -- and stores it until needed. PICE functions as the central memory of the system with the computer doing its thinking.



Lockheed engineers and Air Force personnel intently watch systems time displays, as the estimated time to acquire Discoverer satellite approaches zero.

### AUTOMATION IN LEGAL RESEARCH

A pilot study, being conducted by Data-control Corp., Silver Spring, Md., and George Washington University Law Center, indicates that electronic computers may be useful in automating legal research. The first field being studied is merger and monopoly cases arising under the Anti-Trust Laws.

A "special electronic legal language" has been developed for the retrieval project. Using this, a researcher may ask the computer to provide a list of citations for all the cases fitting certain descriptive specific terms. Or, the researcher might ask for citations, pleadings, briefs, or motions related to a specific type of merger or monopoly Anti-Trust Law case.

## U.S. ARMY'S SATELLITE COMMUNICATIONS PROGRAM

A 60-foot, 9-ton parabolic reflector antenna is placed on a three-story pedestal at Fort Dix, N.J., completing the installation of the final major component of one of the ground antenna stations for a U.S. Army communications satellite program. This program is called ADVENT. Sylvania Electronic Systems, a division of Sylvania Electric Products Inc., is responsible for the development and installation of the operations facilities, except for communications and telemetry electronics.

The objective of the ADVENT program is to show the possibility of a communication system that would produce almost instantaneous global transmission of both voice and radio-teletype traffic making use of satellites in a synchronous, equatorial orbit, 22,300 miles high.

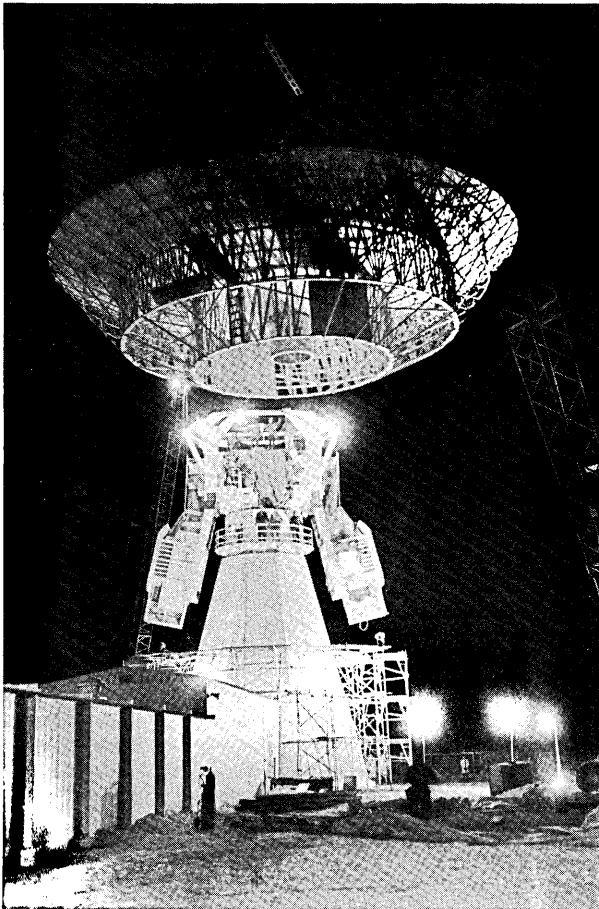

## AUTOMATION FOR U.S. DEPARTMENT OF AGRICULTURE

An administrative improvement program to cut costs and increase efficiency in the Dept. of Agriculture is starting. Electronic com-

puters will be put to work on routine record keeping and paper work. The new system was designed entirely within the Department by USDA employees. It will use existing equipment.

The first step, already underway, will combine payroll, personnel record keeping, and related budget and accounting work into an automatic data processing system. The second step will apply the information gathered to new management techniques.

Among the expected benefits once the new system is in full operation are: savings of as much as \$1.5 million per year; month by month evaluation of the effectiveness of Department programs; greater opportunity for advancement and service in the special fields of professional and technical employees; and elimination of most of over 17,000 individual reports now produced each year.

## CONNECTICUT STUDENTS INTRODUCED TO COMPUTERS

Students in Fairfield County, Conn., are finding that computers really aren't so difficult to understand and operate as they thought they were. Fifteen minutes after being "introduced" to a computer, one 11-year-old girl wrote a workable program of step-by-step instructions to the machine for solving a mathematical problem. Others, from junior high to college level, have become absorbed in writing programs of their own for the computer to process.

The computer is an IBM 1620 data processing system. It has been loaned to the schools for a series of brief introductory courses which give the students training in the art of communicating instructions to computers.

The series was launched early in November at Weston Junior High in conjunction with the "Madison Project," an experimental mathematics program. Since then the IBM 1620 has been made available to students at several schools and universities. At Fairfield University it was used for teaching programming techniques and also for improving methods of teaching logic at all class levels, freshman to senior. At Bridgeport University, the computer was used as an aid to developing a regular college course in computer technology. Staples High used the machine to learn the fundamentals of programming. And at Joel Barlow High School the use of computers in the fields of mathematics and science was demonstrated.

The purpose of loaning the machine is to encourage students to take a serious look at careers in applied mathematics and allied subjects.

## RACE TRACK USES PORTABLE COMPUTER

A Clary DE-60 computer has been introduced as part of the totalisator service at Santa Anita Racetrack.

The new computing system, developed by the Clary Corporation of San Gabriel, Calif., saves time and increases accuracy in the determination of prices paid on winning horses.

This system is a prelude to installations expected to be made in 15 to 20 major race tracks in the country. A second system has been completed; four others are under construction.

The computer performs the necessary computations during the minute or so each race is being run. The system has a decoding device which scans the totalisator board and converts the pooled figures into the numerical system used by the computer. State and track percentages are deducted automatically. As soon as the winners are announced, the numbers of the win, place and show horses are punched into the computer and calculated within a few seconds.

## HIGH SCHOOL GIRLS USE COMPUTER AS PART OF CLASSROOM WORK

At St. Vincent Ferrer Catholic High School in New York City, 400 girls are using, experimentally, a general purpose electronic computer as part of their regular classroom work. The project is being carried out jointly by the school and Royal McBee Corporation, Port Chester, N.Y., which has provided the computer -- a Royal Precision LGP-30.

During the initial period of instruction the high school is putting one hour of introductory electronic data processing into the first semester mathematics courses. In the second semester, the computer will be integrated into the curriculum and, for those who so elect, 80 class hours will be devoted to the programming and operation of electronic computers.

Among the objectives of this experiment are: (1) to determine at what point the electronic computer can be effectively and desirably introduced into the high school curriculum; (2) to study the value of the electronic computer as a tool of teaching and learning in mathematics and science areas at the high school level; and (3) to explore the extent of interest of young women in electronic computer operation and programming as a career.

## FIRM REBUILDS ANALOG COMPUTERS

David R. Miller, President  
Comcor, Inc.  
Denver 22, Colo.

In recent years a number of advances have been made in analog computer technology that greatly increase the utility and applicability of analog computers. Most of these new features are offered on computers currently being sold, but have not been available to computer users whose computing equipment was acquired several years ago.

Therefore, this company has undertaken a program of rebuilding analog computers so as to raise older computers to present technology levels. Computer components are reworked and upgraded, and controls and logic are replaced to permit automatic high speed programming and readout.

Modernization converts an old analog computer into the equivalent of the best new machines, often at a fraction of the cost of a new analog computer. Furthermore, funds for modernization can often be obtained when funds for new equipment are not available. Modernization funds are already established for much government owned equipment, and similar budgets often exist in private industry also.

## AIRBORNE COMPUTER CONTROLS THE MANAGEMENT OF JET ENGINES

A computer-controlled instrumentation system to simplify the "management" of jet engines and improve the efficiency of jet-powered aircraft has been developed by The Bendix Corporation of Teterboro, N.J.

Its basis is this: an advanced digital computer scans all engine functions at a rate of  $2\frac{1}{2}$  times a second. The system "feels the pulse of an engine". The computer automatically decides which engine is in need of corrective action and displays its characteristics on a single set of indicators.

Thus, in the test aircraft, instead of 36 indicators to present 36 conditions of engine performance, there are only 10 indicators to present 80 conditions of engine performance.

The new system eliminates tedious computations by the crew to determine proper engine settings for each part of a flight. If the computer fails to function properly in flight, engine performance will continue to be displayed, but manual pushbutton selection would then replace the automatic selection and detection features.

## PEOPLE OF NOTE

### ALVIN N. LIPPITT JOINS BENDIX

Alvin N. Lippitt, a member of the CODASYL Task Force for COBOL 61, has joined the Systems Programming Section of Bendix Computer Division, Los Angeles, Calif. Mr. Lippitt will head the Bendix COBOL (Common Business Oriented Language), Development Group.

### GENERAL MANAGER OF EASTERN OPERATION

Richard M. Osgood, former General Manager of the Waltham Laboratories, has been appointed as General Manager of the Sylvania Electronic Systems new Eastern Operation. The Eastern Operation includes three facilities in Waltham and two in Needham.

Before joining Sylvania, in 1955, Mr. Osgood was chief of the Air Force's Electronic Defense Systems Division of the Air Material Command.



### DIRECTOR OF MILITARY PROGRAM MANAGEMENT

Vern E. Leas has been appointed director of military program management for the Univac Military department.

Mr. Leas is responsible for the direction and supervision of all major military programs at St. Paul Univac, including computers for the Titan ICBM (Athena computer), Nike-Zeus anti-missile missile (Target Intercept computer), Mobile Atlantic Range Station (1206 computer), and an advanced digital computer for aerospace applications.

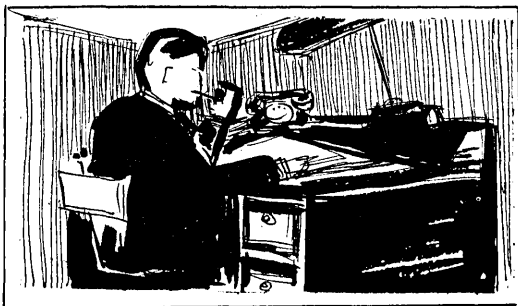

(This section continued on page 40)

## NEW CONTRACTS

### NEW ANALOG COMPUTER FOR TORY II-C REACTOR

Electronic Associates, Inc., Long Branch, N.J., has been awarded a contract to produce a large-scale analog computer for simulation and control of the TORY II-C reactor, which is the nuclear power source for the U.S. Atomic Energy Commission's Project PLUTO ramjet missile. The \$192,000 contract was awarded by the Lawrence Radiation Laboratory of the Univ. of California.

The contract covers a 300-amplifier computer system consisting of a number of special purpose computers. Each of these will serve a particular function. The primary use will be controlling the various functions of the nuclear reactor during test. Other uses will be simulation of the reactor systems for training operators. Each of the computers in the system will be made up of EAI's PC-12 solid-state components.

### DATA DISPLAY EQUIPMENT CONTRACT

A government subcontract from Aircraft Armaments, Cockeysville, Md. has been awarded to Kollsman Instrument Co., Elmhurst 73, N.Y. for the prototype development of electronic visual display equipment.

This equipment consists of eighteen electronic display projectors and a character generator which supplies all eighteen projectors with the proper alpha-numeric symbols.

The total system is being developed by Aircraft Armaments for the U. S. Naval Training Device Center, Port Washington, N.Y., as a submarine training device for the simulation of tactical maneuvers of both friendly and unfriendly surface and subsurface ships. The intelligence information is displayed on two six-by-six-foot and one twenty-by-twenty-foot screen where actual traces show the paths of friendly and hostile ships.

### LANGUAGE DATA PROCESSING

Ramo-Wooldridge Corp., Canoga Park, Calif., will continue its investigation of new techniques for language data processing under a cost-sharing contract from the National Science Foundation. The work will include processing 300,000 words of Russian text as part of a program to partially automate dictionary compilation.

U.S. STATE DEPARTMENT ORDERS  
AUTOMATIC DATA SYSTEM

An ITT 7300 Automatic Data Exchange (ADX) system has been ordered from the ITT Information Systems Division of International Telephone and Telegraph Corporation, New York, N.Y. by the U.S. State Department.

This high-speed message/data communications system is scheduled to be installed in the Paris (France) Embassy early in the year. The system will serve as the nerve center for European operations and will be connected directly to State Department headquarters in Washington. It is expected to handle automatically all of the State Department's message traffic between Washington, the Paris Embassy, and most of the U.S. embassies throughout Europe.

NATIONAL SCIENCE FOUNDATION GRANT  
FOR INDEXING RESEARCH

A National Science Foundation grant has been made to National Biomedical Research Foundation, New York, N.Y., for further development of "Tablex", a coordinate method of indexing a bibliography by tables of numbers corresponding to articles, and associated with descriptive indexing words found in the articles. The grant will permit work on the use of computers to assist in automatic preparation of such indexes.

GUARANTY BANK OF PHOENIX PLACES CONTRACT  
WITH GENERAL ELECTRIC

The Guaranty Bank of Phoenix, Ariz., has placed a contract for handling all demand-deposit activities with General Electric Computer Department's information processing center in Phoenix.

This will be the first time that the GE 225 general-purpose computer at G.E.'s Deer Valley Park Plant will be used for bank account processing.

It is expected that the switch-over to electronic bookkeeping will permit processing up to 30 times the present accounts without expanding office facilities.

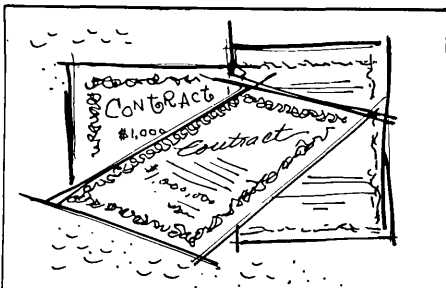

BURROUGHS B5000 FOR STANFORD UNIVERSITY

A large-scale Burroughs B5000 Information Processing System has been ordered by Stanford University. Its installation early in 1963 will climax a multi-million dollar expansion of the Stanford Computation Center. The Stanford machine is valued at approximately \$1,300,000.

Stanford is the first university to purchase a B5000. This electronic system writes its own machine-language programs after receiving instructions prepared in English statements for business data processing and algebraic notation for scientific problems. The B5000 system ordered by the university will consist of one central processor with 16,000 words of magnetic core memory, two input-output channels, six magnetic tape transports as well as a high speed printer, punched card readers, and a card punch.

Stanford University, a pioneer in popularizing electronic computer education, now has 43 courses concerned with or using computers. Principal users of the computer facilities are students, University staff members, the two-mile linear accelerator project, Stanford Research Inst., the Graduate School of Business, etc.

CONTRACT FOR NIAGARA POWER COMPUTER

Leeds & Northrup Co., Philadelphia, Pa., has received a contract of approximately \$300,000 for a transistorized digital computer system to be used in connection with the control of the on-line operation of the Niagara Power Project of the Power Authority of the State of New York. Uhl, Hall & Rich, Boston, Mass., the Authority's consulting engineers, issued the contract. It provides for equipment to be used at the two Stations of the Project; the Robert Moses Niagara Power Plant and the Lewiston Pump Generating Plant.

POTTER INSTRUMENT COMPANY RECEIVES CONTRACT

The award of a contract amounting to over \$800,000 for its model 906II tape transports has been announced by this company.

The ITT Federal Laboratories has selected this equipment for use in a project for the Strategic Air Command. The 906II Tape Transport System will be used in the Electronic Data Transmission Control Center that is part of the overall Strategic Air Command Control System (SACCS).

U.S.  
tenn  
Fort  
of t  
grou  
muni  
is c  
a di  
is r  
stal  
cept  
trom  
  
to s  
syst  
eous  
radi  
ites  
22,3

AUTOM  
cut  
of A  
COM



# TEACHING MACHINES AND PROGRAMMED LEARNING — ROSTER OF ORGANIZATIONS AND WHAT THEY ARE DOING

Patrick J. McGovern  
Assistant Editor  
Computers and Automation

Following is the second cumulative edition of a roster of organizations in the field of teaching machines and/or programmed learning. Additions, corrections, and comments are invited.

### Abbreviations

- \* -- See last-minute addenda at end.
- M -- teaching machines, auto-instructional devices
- P -- programmed learning, programs
- C -- using computers
- B -- books expressing teaching machine philosophy
- R -- research and development in the area
- S -- simulated teaching machines and simulators to teach skills

### Roster

- A: A-Alpha Pattern & Manufacturing Co., 2523 E. 4th St., Los Angeles 33, Calif. / M,S  
Aeronutronic (Div. of Ford Motor Co.) Ford Road, Newport Beach, Calif. / S,C  
American Institute for Research, 410 Amberson Ave., Pittsburgh 32, Pa. / R, particularly in the preparation, use, or refinement of auto-instructional materials and techniques. Has several grants from the U. S. Office of Education on the evaluation of independent thinking and judgment evoked by self-instructional devices, the role of machines in an educational information system, and programs in such areas as chemistry, mountain-climbing, geometry, creative writing, etc. Has cooperated with the DuKane Corporation of St. Charles, Ill., in design and development of a flexible 35mm rear-screen projection device. The program here consists of a short, Skinner-type frame and includes both textual material and drawings.  
American Management Association, Inc., 1515 Broadway, New York 36, N.Y. / This organization is active in two areas: (a) it is holding seminars, workshops and conferences on the general subject of programmed instruction. One was held in Los Angeles in November of 1961. The next is planned for the Hotel Astor, New York, N.Y. in August, 1962, (b) it is holding special evening programs which will incorporate the

orientation and demonstration of programmed learning materials for management. This program is expected to begin in April or May, 1962. It is called PRIME -- "Project -- Programmed Instruction for Management Education."

- American Seating Co., 901 Broadway, Grand Rapids 2, Mich. / An experimental communications system is under development. It includes a desk assembly with a closed circuit television screen, a response device, and a tape recorder for audio materials.  
American Systems, Inc., 1625 E. 126th St., Hawthorne, Calif. / Presently developing an audio-visual type machine without a response mechanism.  
American Teaching Systems, Inc., 12902 So. Broadway, Los Angeles 61, Calif. / M,P  
American Telephone & Telegraph Co., 195 Broadway, New York 7, N.Y. / This organization has been writing and field testing audio-instructional training programs for their telephone operators. See entry for Bell Laboratories.  
Anirama Company, 385 East Green St., Pasadena, Calif. / Developing audio-visual type machine without a response mechanism.  
Applied Communications Research, Culver City Airport, Culver City, Calif. / A training station is available with an audio-visual desk console. The trainee sits in the middle of a semi-circular desk facing a screen on which is shown filmed programs. The device has been successfully applied to training for production assembly line work and testing inspection and quality control among other areas.  
Applied Communications Systems, Div. of Litton Systems, Inc., 8535 Warner Dr., Culver City, Calif. / Developing audio-visual type machine without response mechanism.  
Astra, Inc., 31 Church St., New London, Conn. / Presently marketing a multiple choice teaching device of the Pressey type, called AUTOSCORE. It presents punched cards with ten questions, each question having up to five possible answers. An error counter keeps track of wrong answers and a digital clock keeps track of time expended on each card. Designed expressly to reinforce material already presented rather than to present new material.  
Auerbach Electronics Corp., 1634 Arch St., Phila-

- delphia 3, Pa. / P Program is called the AUERBACH Required COBOL-1961 Self-Teacher. It will consist of 4 volumes. The first is a student manual which contains an introduction to COBOL-1961, a glossary of required COBOL-1961, a glossary of computer and EDP terms, illustrative and summary material, a checklist for writing COBOL-1961 programs, and a final examination. The other three volumes are programmed text material consisting of 2,500 linearly programmed frames. At selective frames the student is advised to consult the diagrams and illustrations to aid in comprehension. The first 500 of these frames is an introduction to EDP and computer fundamentals. The self-teacher is expected to be available in May 1962.
- Auto Instructional Devices, Inc., 12 Manheim Rd., Essex Fells, N. J. / Markets a multiple choice question box with three possible responses selected by a stylus. Correctness of response indicated by colored lights, and a counter keeps student's score. A number of programs available.
- Automated Instructional Materials Corp., Box 181, Ansonia Station, New York 23, N.Y. / P
- \* B: Basic Systems, Inc., 42 E. 52 St., New York, N.Y. / P This group is largely formed from workers at Columbia University. They have entered into an agreement with the Meredith Publishing Co. for production of a variety of programmed industrial and academic teaching textbooks. They offer consulting services concerned with the application of the behavioral sciences to the teaching situation.
- Battelle Memorial Institutions, Columbus, Ohio / R Bell Telephone Laboratories, Inc., 463 West St., New York 14, N. Y. / R,M,C The device has a random access slide projector controlled by a computer and a visual display.
- Billerett Company, 1544 Embassy St., Anaheim, Calif. / M
- Bolt, Beranek and Newman, 15 Moulton St., Cambridge, Mass. / R,P,C A computer-centered teaching device is designed to instruct sonar operators in the distinctive quality of sound. It has a typewriter keyboard input and presents aural stimuli from recording tape for recognition of various characteristics: frequency, amplitude, repetition, time, duty cycle and length. The unit uses the PDP-1 computer as the sound producer and student performance evaluator. Work also being carried on in the programming of foreign languages, and mathematics. A compact portable, relatively inexpensive, automatic framing, teaching machine is expected to be available in April, 1962.
- Britannica Center for Studies in Learning and Motivation, Stanford University, Palo Alto, Calif. / Study being conducted in the applications of learning theory to actual school situations. Consists of programming and then evaluating the results of the use of programmed course material.
- Burgess Cellulose Company, Grade-O-Mat Division, P. O. Box 560, Freeport, Ill. / Developing test scoring device.
- Burroughs Corp., 850 Third Avenue, New York 22, N. Y. / Has conducted experiments on the use of a typewriter as a "teaching machine" in four teachers' colleges in the United States.
- Burtek, Inc., 7041 E. 15th St., Tulsa, Okla. / S,C
- C: Center for Programmed Instruction, Inc., 365 West End Ave., New York 24, N. Y. / P Non-profit educational organization supported by grants from the Carnegie Foundation, the Ford Foundation for the Advancement of Education, has been extending the activities of the New York Collegiate School Teaching Machine Project. It has been translating research findings into classroom application by programs for beginning French, spelling, French via pictures, beginning German, and in elementary and intermediate mathematics. A programmed physics course incorporating the materials created by the Physical Science Study Commission will be tested at schools in 1962.
- Central Scientific Company, Division of Cenco Instruments, 1700 Irving Park Road, Chicago 13, Ill. / M Claim emphasis on the logical and scientific approach, both the inductive and the deductive. A multiple choice device with programs is expected to be available in the summer, 1962.
- Chester Electronic Laboratories, Inc., Chester, Conn. / A mechanical teaching center is being developed in cooperation with the University of Michigan and Yale University. The device will probably have a modified language laboratory set-up employing programmed materials with a dialing system at each student's position to allow him to select different programs.
- Columbia University Teachers' College, New York, N. Y. / An experimental test run using the IBM 650 computer to teach business and marketing procedures employing game playing techniques. The rules of economic theory were programmed into the machine and various teams of students were given hypothetical business assets. They independently developed their businesses and fed the data into the computer for analysis of the final results produced. The experiment ran 20 hours consecutively and demonstrated the versatility of the computer as a self-instruction device. Work also being done in programming mathematics courses. A summer institute course in program instruction and programming technique is planned.
- Comparator, P. O. Box 452, Petaluma, Calif. / M
- Conceptograph Corp., 179 Berkeley St., Rochester 7, N. Y. / M The model COG-7 uses the rolled paper strip technique for a linear program, having two display areas, one for the program material itself, and the other for the constructed response.
- Concord Control, Inc., 1282 Soldiers Field Rd., Boston 35, Mass. / R,M
- Consolidated Lithographing Corp., Carle Place, P.O. Long Island, N. Y. / A modified multiple choice device and other self-instructional devices developed in cooperation with the New York Institute of Technology. The unit uses individual television screens, earphones, and a multiple choice response panel. It works on an intrinsic programming principle. If the student makes too many errors, he is advised to see the instructor.
- Consolidated Systems Corporation, Space Science Department, 1500 South Shamrock Ave., Monrovia, Calif. / R,M
- Robert E. Corrigan and Associates, 8701 Adah St., Garden Grove, Calif. / M Students watch the program on a television display screen and make multiple choice responses on an individual response panel. Colored lights provide feedback. Scoring is automatic.
- Corrigan Communications, Inc., 1111 Ash St., Fuller-

ton, Calif. / P  
Creative Education Resources, Inc., 1544 Embassy  
St., Anaheim, Calif. / P  
Cyburtek Corporation, 102 Mt. Auburn St., Cam-  
bridge, Mass. / P

D: Davis Scientific Instruments, 12137 Cantura  
St., Studio City, Calif. / R  
Daystrom, Inc., Control Systems Div., 4055 Mira-  
mar Rd., La Jolla, Calif. / R  
Devereux Teaching Aids, Box 717, Devon, Penn. /  
Producers of the Devereux Teaching Aid, model  
50. A simple multiple-choice device employing  
workbooks which set on top of each unit. A ro-  
tary switch is used to synchronize the pattern  
of answers on the page with the machine. The  
company is a self-sustaining adjunct to the  
Devereux Foundation, Devon, Penn.  
Dictaphone, Inc., 73 Third Ave., New York, N.Y.  
/ M,P (industrial training)  
Digital Equipment Corporation, 146 Main St.,  
Maynard, Mass. / M,C  
Dorsett Electronics, Inc., 119 West Boyd St.,  
Norman, Okla. / M Telescholar. Students watch  
the program displayed on a screen and indicate  
their answers by pressing 5 buttons on a response  
panel, with colored lights providing feedback  
\* information.  
Douglas Aircraft Corp., 300 Ocean Park Blvd.,  
Santa Monica, Calif. / R Auto-instructional  
devices using a visual display and button-  
panel input.  
Dukane Corp., St. Charles, Ill. / Producing a flex-  
ible 35 mm. rear screen projection device for  
the use of a program with short, linearly pro-  
grammed frames. Working in cooperation with the  
American Institute for Research.  
Dyna Slide Company, 600 So. Michigan Ave., Chicago  
5, Ill. / Produces the Slide-a-Mask, a flexible  
plastic sliding mask which fits over a programmed  
text page showing the correct answer after the  
student has constructed his answer.  
Dynateck Corp., 471 79 St., Miami 38, Fla. /  
Producers of a digital logic demonstrator which  
has uses as an instructional device. Called the  
DT-508 digital computer, it is composed of a set  
of clear lucite flip-flop cards holding two bi-  
nary readout lights each. Employs a telephone  
dial input, and multiplies and sums to the num-  
ber 31.

E: Edex, 809 San Antonio Rd., Palo Alto, Calif. /  
Thomas A. Edison Research Laboratories, West Or-  
ange, N. J. / Presently doing device research  
in areas such as the teaching of typing and  
reading to pre-school children. Has a publica-  
tion called "Program Learning in the Educational  
Process" edited by Annice L. Mills.  
Ed-U-Cards Manufacturing Company, 13-05 44th Ave.,  
Long Island City, N. Y. / M,P  
Educational Aids Publishing Corp., Carle Place,  
Long Island, N. Y. / P  
Educational Design of Alabama, Inc., 1428 Univer-  
sity Ave., Tuscaloosa, Ala. / R,P  
Educational Development Associates, 2302 J St.,  
Eureka, Calif. / P Producers of a sequential  
teaching program to be placed on a punched card.  
The student proceeds from one frame to another  
by a coded sequence of holes punched along the  
border of the programmed card.

Educational Development Corp., 200 California Ave.,  
Palo Alto, Calif. / M Utilizing paper tape and  
offering a flexible programming capacity; expec-  
ted to be available in the late Spring or early  
Summer, 1962.

Educational Development Labs., 75 Prospect St.,  
Huntington, N. Y. / Producers of film strip  
projector using a paced presentation for teach-  
ing, called Tach-X. Also make a simpler circu-  
lar hand masking device called Flash-X.

Educational Engineering Associates, 3810 Pacific  
Coast Hwy., Torrance, Calif. / Producers of a  
slide display device, using multiple choice  
responses and feed back supplied directly by the  
program, i.e., a correct response changes the  
question.

Educational Television Aids, 111 Hampton Rd., West,  
Williamsport, Md. / Presently designing an in-  
structor controlled teaching device. Unit uses  
linearly programmed frames with a constructed  
response elicited from the student.

Electronic Teaching Labs., 5034 Wisconsin Ave., N.W.  
Washington 16, D.C. / Producers of various forms  
of film strip or slide materials coordinated with  
an aural program for teaching purposes. Modifi-  
cations of this arrangement used for speech ther-  
apy training.

Encyclopedia Britannica Films, Inc., 1150 Wilmette  
Ave., Wilmette, Ill. / P Presently field test-  
ing, mainly in mathematics. Emphasis is on film  
strips and books.

Epsco, Inc., 275 Massachusetts Ave., Cambridge 39,  
Mass. / Self-contained logic demonstrator of  
digital circuitry for industrial laboratory and  
training applications.

ERA Research, Inc., 1009 Montana Ave., Santa Mon-  
ica, Calif. / R Science teaching devices.

Execugraf Corporation 113 No. San Vicente, Beverly  
Hills, Calif. /

E-Z Sort Systems, Ltd., 45 Second St., San Fran-  
cisco 5, Calif. / S

F: Fairchild Camera and Instrument Co., Syosset,  
Long Island, N. Y. / R  
Field Enterprises Educational Corporation, Merchan-  
dise Mart Plaza, Chicago 54, Ill. / M,P  
Forbes Product Corp., 6255 Goodwin St., Rochester  
3, N. Y. / M Consists of large display window,  
typewriter roller operation, and detachable an-  
swer unit. Teaching devices are being field  
tested in the Rochester Public School System.  
Foringer and Co., Inc., 312 Maple Drive, Rockville,  
Md. / Produce simple teaching device consisting  
of a projected film strip with one or two levers  
on which the student indicates his response to  
a question. Physical reinforcement includes  
presentation of marble upon a correct answer.  
Other experimental teaching devices concerned  
with the field of applied psychology, i.e., con-  
trolled environment boxes for training animals.  
W. G. Fuller Products Co., 5880 Hollywood Blvd.,  
Hollywood 28, Calif. / M Self-teaching device  
has been indicated to be available.

G: General Atronics Corp., 1 Balla Ave., Bala-  
Cynwyd, Pa. / Producers of the Atronics Tutor,  
Model 580. This machine is a portable, mechani-  
cal, multiple-choice teaching device. It oper-  
ates by allowing pages of programmed material to  
fall by gravity when an operator selects correct

answers by pushing a button at the base of the machine. Also, produces the TAG System which is a modified punch board device used mainly for recording answers in scoring. The company indicates a general interest in industrial training with accent on electronic data processing in programmed form.

General Education, Inc., 96 Mt. Auburn St., Cambridge 38, Mass. / P Currently making the GEM-1, a molded plastic machine using an 8½ x 11 sheet for linear programs. Have recently written a training program to train programmers of educational materials. The personnel have been responsible for the development of a program statistics probability course used at the Harvard Business School.

General Electric Co., Schenectady, N. Y. / R

G. E. Control, Inc., Minneapolis 20, Minn. / R,M

General Precision, Inc., Link Div., Binghamton, N. Y. / Produces an electronic maintenance trainer where punch cards provide the conditions for the student to measure some hypothetical fault on a simulated circuit tester.

General Programmed Teaching Corporation, 1719 Girard, N.E., Albuquerque, N. Mex. / M,P

Ginn and Company, Statler Building, Boston 17, Mass. / B Investigating the publication of programmed materials.

Graflex, Inc., 3750 Monroe Ave., Rochester 3, N.Y. /

Graphics, Inc., 3750 Monroe Ave., Rochester 3, N. Y. / The Graphics Audiographic System is a coordinated slide and audio presentation unit used for training in industrial assembly procedures. The audio record is repeatable at the request of the student.

Gray Manufacturing Company, Special Products Division, 16 Arbor St., Hartford 1, Conn. /

The Grolier Society, Inc., 575 Lexington Ave., New York 22, N.Y. / Currently distributes various models of self-instructional devices for Teaching Machines, Inc. Example is the Min/Max machine. See Teaching Machines, Inc.

H: Hamilton Research Associates, 4 Genesee St., New Hartford, N. Y. / M,P This company has recently withdrawn its Visitator, a 35 mm microfilm program device. It is developing a 3 x 5 card model Visitator and microfilm unit using a film sort card. The unit is expected to be available in July, 1962.

Harcourt, Brace & World, Inc., 750 Third Ave., New York 17, N. Y. / P

D. C. Heath, Inc., Boston, Mass. / R,P

Holt, Reinhart, and Winston, Inc., 383 Madison Ave., New York 17, N. Y. / P Presently publishing program materials for the Center for Programmed Instruction; also looking into the development and writing of other programs.

HRB-Singer, Inc., P. O. Box 60, Science Park, State College, Pa. / P

Hughes Aircraft Co., Videosonic Systems, P. O. Box 9094, Airport Station, Los Angeles 45, Calif. / Developers and producers of the Videosonic System. The equipment consists of desk slide projector and a synchronized tape recorder. It has direct application in industrial assembly line training procedures. The device can be programmed incrementally and the subject matter can be presented visually and orally to a learner using slide displays and coordinated oral

instructions. Either multiple choice or constructed responses are possible. The Videosonic System has the ability to be used in an oral-complement response mode. The student can speak the answer into the machine and then the student's answer, the correct answer, and the appropriate slide display are shown together for direct comparison, and correction.

Hunter Manufacturing Co., Inc., P. O. Box 153, Coralville Branch, Iowa City, Iowa. / Producers of the Model 340 Cardmaster. This is a control circle card display device for paced-practice learning. Other automated instructional devices being developed.

I: Industrial Education Corp., 33 North LaSalle St., Chicago 2, Ill. / P Programs are prepared on a custom basis for clients for use in sales training purposes and are normally linear, constructed response type.

Information Products Corp., 156 Sixth St., Cambridge 39, Mass. / M,C An interrogator and display unit which allows selective correction, deletion, and addition of alphanumeric characters on a cathode ray tube display. Expected to allow a ready means of student constructed response to questions on a computer-based teaching machine. Ready by the summer, 1962.

The Institute for Behavioral Research and Programmed Instruction, P. O. Box 302, Ann Arbor, Mich. / P

Institute of Behavioral Research, College Park, Md. / R, in the field of programmed learning, program writing, evaluation, and field testing.

Institute for Instructional Improvement, Inc., 110 E. 30th St., New York 16, N.Y. / P

Institute of International Research and Development, Inc., P. O. Box 4456, Lubbock, Texas / P

Institute of International Research and Development, Inc., Educational and Training Methods

Div., 4910 13th St., Lubbock, Tex. / This unit does research and development work in educational testing and preparation of self-instructional programs. Evaluation and testing of programs also done. Plans call for the design of materials and training methods for use in underdeveloped countries. The unit is already publishing a newsletter to serve as a clearing house for information on programmed learning: AID.

Instructional Systems, 497 No. Santa Cruz Ave., Los Gatos, Calif. / P

Instrument Research Co., 12031 Euclid Ave., Garden Grove, Calif. / Producing a self-instructional device using 3 x 5 inch cards with a linear program. Provides for multiple choice response, and feedback is by colored slides.

Intellect, Inc., 42 Pleasant St., Newburyport, Mass. / P, ranging from training mail-order house personnel to developing programs in probability and statistics and U.S. Navy store management. A study of the use of graphics in programmed education being conducted under a grant from the U. S. Office of Education.

International Business Machines, Corp., Research Center, P. O. Box 218, Lamb Estate, Yorktown Heights, N. Y. / Has developed program text to teach electronics to their employees. Has been studying a computer base system for teaching purposes for several years. Has been field testing experimental arithmetic teaching mach-

ines in Yorktown, N. Y. public school system. The machine being used has the capacity to recognize and correct constructed answers of up to 9 alphanumeric characters.

International Teaching Systems, 457 Washington, S.E., Albuquerque, N. Mex. / P  
Itek Corp., Information Technology Lab., 10 Maguire Rd., Lexington, Mass. / R,P,M Emphasizes advances in the field of optics. For example, work being conducted on use of a light pen for the construction of student responses on the surface of a cathode ray tube for direct input into a computer.

J: Jensen, Gerald J., 1267 Wensley Ave., El Centro, Calif. / P

K: Konzept-O-Graph Corporation, 179 Berkeley St., Rochester 7, N. Y. / M  
Kunins Engineering Company, 1730 Popham Ave., New York 53, N. Y. / M

L: LaBelle Industries, Oconomowoc, Wis. / Developing audio-visual type machine without response mechanism.  
Learning, Inc., 1317 W. Eighth St., Tempe, Ariz. / P

Learning Resources Institute, 680 Fifth Ave., New York, N. Y. / Presently conducting an evaluation of currently available programs and teaching machines for professional educational organizations.  
Lectron Corporation of America, 9929 W. Silver Springs, Milwaukee, Wis. / M,R  
Link Division, General Precision, Inc., Binghamton, N. Y. / S,C and electronics training.

M: The Macmillan Company, 60 Fifth Ave., New York 11, N. Y. / P

Management Research Associates, Room. 1300, 185 No. Wabash, Chicago 1, Ill. / Currently producing a pull-tab, multiple choice teaching machine.  
The Marquardt Corporation, 2709 No. Garey Ave., Pomona, Calif. / M,S,C

William Barton Marsh Co., Inc., 18 East 48 St., New York 36, N. Y. / P, with emphasis on LP records and programmed textbooks.  
Mast Development Company, Inc., 2212 E. 12th St., Davenport, Iowa / M

McGraw Hill Book Co., Inc., 330 W. 42nd St., New York 36, N. Y. / The company is presently selling the Holland-Skinner book "The Analysis of Behavior" with nearly 2,000 linearly programmed frames. They claim to have under development nearly 40 other kinds of teaching machine type programs, some intended for the program books, others for both books and machines. Also developing machines using fan-folded paper tapes. First unit expected to be available in May 1962.  
Minneapolis Honeywell Regulator Co., Ordnance Division, 1724 So. Mountain Ave., Duarte, Calif. / Presently developing an audio-visual instruction system. Expected to be demonstrated the first time this month and to be generally available the summer of 1962. Instructional programs are specific in this device.

Motorola Corp., 4545 Augusta Blvd., Chicago 51, Ill. / R,M

Multi-Matics Machines, Inc., 6782 La Jolla Blvd., La Jolla, Calif. / M

N: National Blank Book Company, 2829 Water St., Holyoke, Mass. / Developing a masking device.  
National Communication Laboratories, 507 Fifth Ave., New York 17, N. Y. / R,P,M

National Education Assoc., Div. of Audiovisual Instruction, 1201 16th St., N.W., Washington 6, D. C. / This division of NEA, the American Psychological Assoc., and a committee of the American Educational Research Assoc. are cooperating in the evaluation of teaching devices and programmed learning. Criteria are being worked on to determine the effectiveness of programmed learning techniques. The Association also sponsors the publication of books and periodicals concerned with teaching machines and programmed learning. One such is its "AV Communication Review" which appears bi-monthly. An "Occasional Paper No. 3" which has just appeared surveys the current industrial activities in teaching machines and programmed learning. It is written by Dr. James D. Finn and Donald G. Perrin.

National Educational Systems, Inc., 9250 Wilshire Blvd., Beverly Hills, Calif. / R,P,M / Developing programs and teaching machines.

National Teaching Machines, P. O. Box 4016, El Paso, Texas / R,P

Navigation Computer Co., Valley Forge Industrial Park, Norristown, Pa. / Experimenting with computer centered teaching device. Work being done in investigating programming methods for teaching in various disciplines.

North American Aviation Corp., Columbus, Ohio / R,M

Nortronics, Div. of Northrop Corp., 222 N. Prairie Ave., Hawthorne, Calif. / R,M An audio-visual training device with visual student response under development.

P: Paromel Electronics Corporation, 3956 Belmont Ave., Chicago 18, Ill. / Serving as an electronics trainer.

Perceptual Development Laboratory, 6767 Southwest Ave., St. Louis, Mo. / Making a modified movie projector for training purposes. Can be used for a flash projection of individual frames or superimposing two different films upon one another. An adaption allows 10 possible multiple-choice panel for student reaction to the questions and ideas in the film.

Phoenix Associates Teaching Machines, 13012 Willamette St., Westminster, Calif. / P, consulting.

Picture Recording Company, 1392 W. Wisconsin Ave., Oconomowoc, Wisc. / Developing a 35 mm slide projector with synchronized aural presentation. Student unit provides multiple-choice push button response.

Polaroid, Inc., Cambridge 39, Mass. / R,M

Positronics, Inc., Chicago, Ill. / R,M

Prentice Hall, Inc., Englewood Cliffs, N. J. / P  
Programmed Learning Associates, 700 Font Blvd., San Francisco 27, Calif. / P and consulting.

Programmed Teaching Aids, Inc., 3810 S. Four Mile Run Dr., Arlington 6, Va. / R,P,M

Prudential Insurance Co. of America, 763 Broad St., Newark 1, N. J. / R,P

The Psychological Corporation, 304 E. 45th St., New York 17, N. Y. / P

Psychological Research Associates, 507 So. 18 St., Arlington, Va. / Currently working on an audio-

visual training device for research purposes. It is designed as a modified sound film projector which would allow for forward branching review.

Psychotechnics, Inc., 105 West Adams St., Chicago 3, Ill. / P,R,S

Public Service Research, Inc., 91 Prospect St., Stamford, Conn. / R,P Recently completed traffic safety teaching program.

**R:** Radio Corporation of America, Research and Development Div., Camden 8, N. J. / Research on experimental devices employing audio-visual display techniques now being conducted.

Random House, Inc., 501 Madison Ave., New York 22, N. Y. / P,B

Recordak Corp., a Div. of Eastman Kodak, Inc., 415 Madison Ave., New York 17, N. Y. / P,M  
Work based upon their microfilm reader. They anticipate availability of the auto-instructional device in 1963.

Renner, Incorporated, 1530 Lombard St., Philadelphia 46, Pa. / P Developing masking device.

Rheem Califone Corp., 5922 Bowcroft St., Los Angeles 16, Calif. / Producers of the Didak Model 501, a teaching machine using a linear program. The program is manually moved through the device on rollers and the student can record each error by punching a hole in the response strip with a pencil. The strip provides an accounting system for improving the program by indicating the number of times a question is misread or misunderstood. / The company has also established a division to do programming research for writing. Currently testing its programs in the Los Angeles School system. / Also in production is a Didak 101, a pre-verbal device that indicates correct answers by a bell or buzzer. The Didak 601, a multiple choice version of the 501, and the Didak 1001, an industrial training device that depends upon the ability of the person to make the correct physical response to a situation in order to advance the program. / Publishes a monthly magazine, Automated Teaching Bulletin.

Rheem Electronics, 5200 W. 104th St., Los Angeles 54, Calif. / Developing computer-controlled teaching machine.

Richards Manufacturing Co., Melrose Park, Ill. / M.

Roto-Vue, Room 1212 Holland Bldg., 211 No. 7th St., St. Louis, Mo. / R,M

**S:** Sanford Associates, 159 Crescent Dr., Menlo Park, Calif. / P, consultant.

Science Research Associates, 259 East Erie St., Chicago 11, Ill. / R,P (math course available)

Scientific Development Corp., 372 Main St., Watertown 72, Mass. / M, the Minivac 601, a unit suitable for self-instruction in the basic principles of digital computer operation. This device uses relays and switching circuits for binary addition and subtraction. Texts accompany the unit to guide the student.

Scott, Foresman, and Company, 433 E. Erie St., Chicago 11, Ill. / P

Seminar Inc., 480 Lexington Ave., New York 17, N.Y. / Part of an industrial programming group.

Shoe Corporation of America, 35 N. 46th St., Columbus 16, Ohio / Presently using several

semi-automatic devices in program materials and and sales training. / Device research being conducted using a programmed projector as a central display unit. A three-button response panel operated by the student. This device provides for both forward and backward branching in the program.

Shoentgen, Brandt & Associates, 385 E. Green St., Pasadena, Calif. / B,P, distributing an audio-visual device made by the Anirama Company of Japan.

Sigma Press, 2140 K. St., N.W., Washington 7, D.C. / P

H. R. B. Singer, Inc., Science Park, State College, Pa. / Developing a device called Star using a printed circuit board without a dual button response panel. Color device provides feedback.

Smith-Harrison, Inc., Box 717, Devon, Pa. / M, Units rely on a buzzer or light for feedback. A Model 15 uses display cards for an instructor produced program. Models 15 and 80 rely on a paper program placed on top of the machine and the Model 90 has a fixed program of 24 problems which represent the 4, 6, 7, 8, 9, and 12 multiplication tables.

Solartron Electronics Group, c/o Rheem Mfg. Co., 400 Park Avenue, N.Y., N.Y. / C, M, consisting of a display screen for film or paper programs to teach keyboard operation for typing, adding machine, or keypunch work.

Standard Projector and Equipment Co., Inc., 7433 N. Harlem Ave., Chicago 48, Ill. / M

Standard Teaching Machine, 7106 Touhy Ave., Chicago 31, Ill. / M, a converted film strip with a push button response unit.

Stanford Research Institute, Menlo Park, Calif. / R,P

Staples-Hoppmann, Inc., 500 East Monroe Ave., Alexandria Va. / This is a rear-view projecting device for the presentation of film and slides, both individually and simultaneously. The instructor has individual control of the microphone audio for the materials that accompany the film.

Staten, J. B., Box 44, Bay City, Texas / R,M

Synchro-Mat Equipment Corp., 1316 Wildwood Ave., Jackson, Mich. / Presently developing a synchronized audio presentation device for training purposes.

System Development Corporation, 2500 Colorado Ave., Santa Monica, Calif. /R,M A report on the present activities of this group appears elsewhere in this magazine.

Systems Research Ltd., London, England/ R,P Using a "game-playing" technique, an attempt to form a logico-mathematical system as a basis for programming is being conducted.

**T:** Teaching Aids, Inc., 3810 S. Four Mile Run Drive, Arlington, Va. / M

Teaching Machines, Inc., 235 San Pedro, N.E., Albuquerque, N.M. / Producers of the Min/Max teaching machine. It uses a constructed response student-scored program. An improved version, the "1984" machine has a handle to move the program forward. The Wyckoff Film Tutor is a portable device with a keyboard response panel. A microfilmed program is automatically advanced as long as the student continues to choose the correct answer.

Teaching Materials Corp., Sales Organization for Teaching Machines, Inc., 575 Lexington Ave., New York 22, N.Y.

Teaching Materials Corp., A Division of Grolier, Inc., 575 Lexington Ave., New York 22, N.Y. / Distributors of the Min/Max and other teaching devices produced by Teaching Machines, Inc.

Teleprompter Corp., 311 W. 43rd St., New York 36, N.Y. / R,M

Thompson Ramo Wooldridge, Inc., Intellectronics Division, 8344 Fallbrook Ave., Canoga Park, Calif. / R The unit being developed uses a synchronized audio-visual display, a six button multiple choice response panel and is controlled by a small analog computer. Educational Electronics Division includes Dage (educational television), Magnetic Recroding Industries (language laboratories) and the Intellectronics Division.

TOR Education, Inc., 55 Fifth Ave., New York 3, N.Y. / P

Training Systems Inc., 12248 Santa Monica Blvd., Los Angeles 25, Calif. / P Programs in management development, sales training, chapter writing, etc. expected to be available by June, 1962.

Tucker, Dr. J. A., 504 W. 19th St., Wilmington 2, Del. / P, consultant

U: United States Air Force, Aero Medical Laboratory, Wright Air Development Center, Air Research and Development Command, United States Air Force, Wright-Patterson Air Force Base, Ohio / Have been engaged in a project for teaching SAGE (anti-missile) personnel the techniques of trouble-shooting misfunctions in electronic equipment. The Psychological Research Associates, Systems Development Corporation, and Western Design Division of U. S. Industries are cooperating in this project. The device being used is the U. S. Industries' Auto-Tutor. / A Program course has been prepared for pilot training and retention of in-flight information. The machine designed by the U.S. Navy Training Devices Center presents multiple-choice information items to the student. Scoring is based on the time delay and the accuracy of the response. A problem of flight was presented to the student pilots, and they were required to make decisions about the action that should be taken. Final conclusions were that "the self-tutoring approach to pilot training and retention of in-flight information appears profitable." / Other research involves a card device and programing techniques, as well as proper prompting procedures. This is an effort to analyze the meaning of intrinsic motivation and reinforcement in successful programing efforts. / Further research is being carried on at: (a) Air Force Personnel and Training Research Center, Lackland Air Force Base, Texas. (b) Armaments Systems Training Res. Lab., Lowry AFB, Denver, Colo. (c) Operations Laboratory, Air Force Personnel and Training Research Center, Air Research and Development Command, Randolph AFB, Texas. (d) Pilot Training Res. Lab., 6656th Res. and Development Group, Goodfellow Air Force Base, Texas.

United States Army / Teaching device and programing research now being conducted at: (a) U.S. Signal Corps School, Fort Monmouth, N.J. (b) U.S. Southeastern Signal Corps School, Ft.

Gordon, Ga. (c) HUMRRO Human Resources Research Office, U.S. Infantry Human Research Division, Ft. Benning, Ga.

United States Industries, Robodyne Division, 12345 New Columbia Pike, Silver Springs, Md. / Digiflex, a device to train the post office mail sorting machine operators. Uses a simulated keyboard and a slide projector to train the operator in the appropriate response to the addresses presented.

United States Industries, Western Design and Electronics Division, Santa Barbara Airport, Goleta, Calif. / Producers of the Autotutor, Models Mark I and Mark II. Mark I is a 35mm film program with a 40 push button multiple-choice response panel surrounding a display screen. The machine can display motion pictures as well as single frames. The student sees a question, answers it, and is told next to his answers the frame to which he should dial ahead. This is the only machine to automate total branching programs for every question. / The Mark II a simplified version of Mark I does not allow for the extensive branching of the former device. The company has also established a center for programmer training, instruction and field testing. A large amount of work is being done in training personnel for the electronics programs of the United States Air Force. / Under Dr. Norman Crowder computer texts have been developed in the following areas: advanced electronics, football, strategy statistics, introduction to music, chess, etc.

Universal Electronics Laboratories Corp., 510 Hudson St., Hackensack, N.J. / R,M

United States Naval Training Devices Research Center, Port Washington, N.Y. / R,P Main aims are towards training programs in electronics for technical personnel, radio men, computer programers, and guided missile maintenance crews.

U. S. Photo Supply Company, Inc., 6478 Sligo Mill Rd., Washington 12, D.C. / M,P Developing programs and teaching machines.

University of California, Berkeley 4, Calif. / P, Programing work on college engineering courses being done in cooperation with the Systems Development Corp. Also some field-testing various programs and devices in local school systems / Experimentation in one facet of digital computer program using a semi-automatic technique.

University of California, Los Angeles 24, Calif. / The Data Processing Center, Graduate School of Business Administration has produced a book "FORTRAN: An Auto-instructional Introduction to Computer Programming". The book provides no response frames but optional forward skimming. Exercises with immediate feedback and programming coding tasks and diagnosis. To be published by McGraw-Hill Publishing Co. in the spring of 1962.

University of California, Los Angeles, Calif. / A project being planned to compare current human and machine teaching methods. Also a program to develop a model of an automated system under computer control. / Programing of science courses for elementary grades using the Hughes Videoscope device performed. Additional program is being developed in reading and mathematics.

V: Van Valkenburgh, Nooger and Neville, Inc., 15 Maiden Lane, New York 38, N.Y. / P, linear programs in the area of electronic technician training.

Varian Associates, 611 Hudson Way, Palo Alto, Calif. / R,M,P Device research presently in its initial stages for programming and teaching units. Also doing research in programming several disciplines.

Viewflex Inc., 3501 Queens Blvd., Long Island City, N.Y. / M Viewflex, a film strip, or slide device from which the program advances with the correct choice. Additional material can be produced when errors are made.

W: Webster Publishing Company, St. Louis 26, Mo. / P

Westinghouse Corp., 3 Gateway Center, Pittsburgh 3, Pa. / Teaching machine device research in its initial stages.

Westrex Co., Division of Litton Industries, 335 North Maple Drive, Beverly Hills, Calif. / Producing a portable audio-visual unit called the Communicator. It is about the size of a desk typewriter. It contains a 35mm automatic 36 frame slide viewer and a synchronized sound tape playback mechanism. It is especially suitable for military field service where self-contained battery supply is needed. The unit has an optional voice control panel for direct student pacing. / Development is under way in a film strip teaching device expected to be available by the end of 1962. / The company has entered into an arrangement with the Prentice-Hall Publishing Co. to offer a variety of teaching devices for programs in the near future.

John Wiley & Sons, Inc., 440 4th Ave., New York 16, N.Y. / P, publishing

Williams Research Corp., P.O.Box 95, Walled Lake, Mich. / Producing a 16mm film projection unit with a four-button response panel. Immediate automatic scoring is provided on a separate piece of paper and feedback is by light above the question buttons. It is called the Science Desk.

Roger Wurtz Company, Box 524, San Rafael, Calif. / P, consultant

\* ADDENDA

AVTA (Audio-Visual Teaching Aids) Corp., 3450 Wilshire Blvd., Los Angeles 5, Calif. / M Marketing a learner paced, constructed response, paper roll, separate answer strip teaching device called AVTA 440. The device has a variable display area. Programming is being done by the International Research and Development Co., Lovelock, Texas.

Doubleday & Co., Inc., 501 Franklin Ave., Garden City, N.Y. / The publishers of the Tutor Text, a scrambled book using an unsequential arrangement of pages in order to achieve a branched program. Developed in cooperation with Dr. Norman A. Crowder of the Western Design Div. of the United States Industries.

PEOPLE OF NOTE (Cont'd from page 31)

JOHN DIEBOLD RECEIVES AWARD

The U.S. Junior Chamber of Commerce has announced the selection of John Diebold as one of the Ten Outstanding Young Men of the Year. The award, aside from being a personal honor, indicates a growing public awareness of and concern for the whole field of automation, information processing, and electronics communications and control.



Mr. Diebold, who is 35, is president and founder of The Diebold Group, Inc., a multinational corporation providing management services to private as well as public organizations with offices in 13 cities on three continents. Mr. Diebold started his organization in 1954. He is a pioneer in the field of automation; wrote the first book on automation at the age of 26, and originated many of the concepts which are today accepted as basic in the field. He has an MBA degree with distinction from the Harvard Business School; an engineering degree from the United States Merchant Marine Academy; and a degree with high honors in economics from Swarthmore College. Mr. Diebold is a member of Secretary of Labor Goldberg's advisory committee on Automation and Manpower.

I.B.M. AIDE IS PROMOTED

John J. Fitzgerald has been named director of organization for International Business Machines Corporation. Mr. Fitzgerald, formerly director of organization for the company's data-processing division, succeeds Richard H. Bullen, who was recently named treasurer.

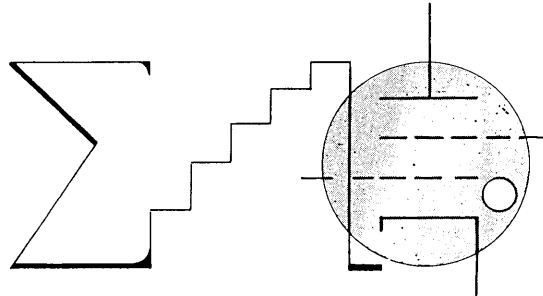

N  
IB  
tha  
to  
tio  
City  
othe  
down  
across  
off  
plac  
Ros  
mak  
is  
of  
the  
eng  
for  
mech  
were  
cern  
all-  
comm  
are  
E. C  
Thom  
Pres  
Mech  
tary  
Mass  
Carl  
pool  
tion  
Oper  
the  
COM





**hycon...**

*"a major contributor  
to the aerospace age."*

## "why we chose the NCR computer"

Hycon Manufacturing Co., Monrovia, California

**"We chose the NCR 390 Computer for three basic reasons:**

**"ONE ...** Dealing primarily with government contracts, we have daily need for the ability to get our accounting and statistical data quickly organized and recorded in a visible form for ourselves and government personnel to utilize. Since the NCR 390 is a computer which employs conventional business-type records, it will permit us to accomplish this first requirement in an extremely fast, efficient, and economical manner.

**"TWO ...** It is absolutely essential that our records be accessible, sometimes for years, for audit and reference by ourselves as well as government personnel. With the NCR 390, our records will be constantly available, in human-language form, to satisfy this second requirement. And, since these same records will store data in the electronic-

language of the computer, they will be constantly available for high speed processing.

**"THREE ...** The NCR 390 will up-grade our reporting abilities. It will contribute greatly to the needs we have for more timely factual data at every level of management, which is so essential in a highly competitive market.

"With these many abilities, we are sure our choice of the NCR 390 Computer was a highly-profitable decision."

Trevor Gardner  
Chairman of the Board and President  
Hycon Manufacturing Company

**NCR PROVIDES TOTAL SYSTEMS—FROM ORIGINAL ENTRY TO FINAL REPORT—**  
through Accounting Machines, Cash Registers or Adding Machines, and Data Processing  
The National Cash Register Company—1039 Offices in 121 Countries—78 Years of Helping Business Save Money





## New Hypertape Drive gives your IBM

*Here's a new input/output device that will let you get more information into your computer to take even greater advantage of the tremendous electronic speed with which it processes information internally.*

*This new Hypertape stores two to four times as much information and delivers the information to your computer two to four times faster than your present tape system.*

*The magnetic tape is kept in a sealed, dust-proof cartridge. All you do is place the cartridge in the tape drive...the rest is automatic. No more manual threading and unthreading. It takes only 20 seconds or about one-quarter the time it takes with conventional reels.*

*Ask your local IBM Representative for details.*

E  
W  
D  
E  
THE C  
STAN  
For a  
Coas  
been  
repr  
East  
West

LBS  
LFC  
LFC

In th  
diag  
exact  
sents  
sequ  
LBS  
num  
binar  
LXA  
indic  
exam  
gize  
LFC



DATA HA

CON

for  
arked  
in-  
icate  
solu-  
ll as  
er of  
ging  
itary  
pro-  
one  
lides  
pro-  
stu-  
epre-  
the  
they  
pro-  
ering  
nfor-  
ning  
CS  
data  
at a  
but  
gani-  
plex  
ssist-  
sting  
will  
s no  
n be

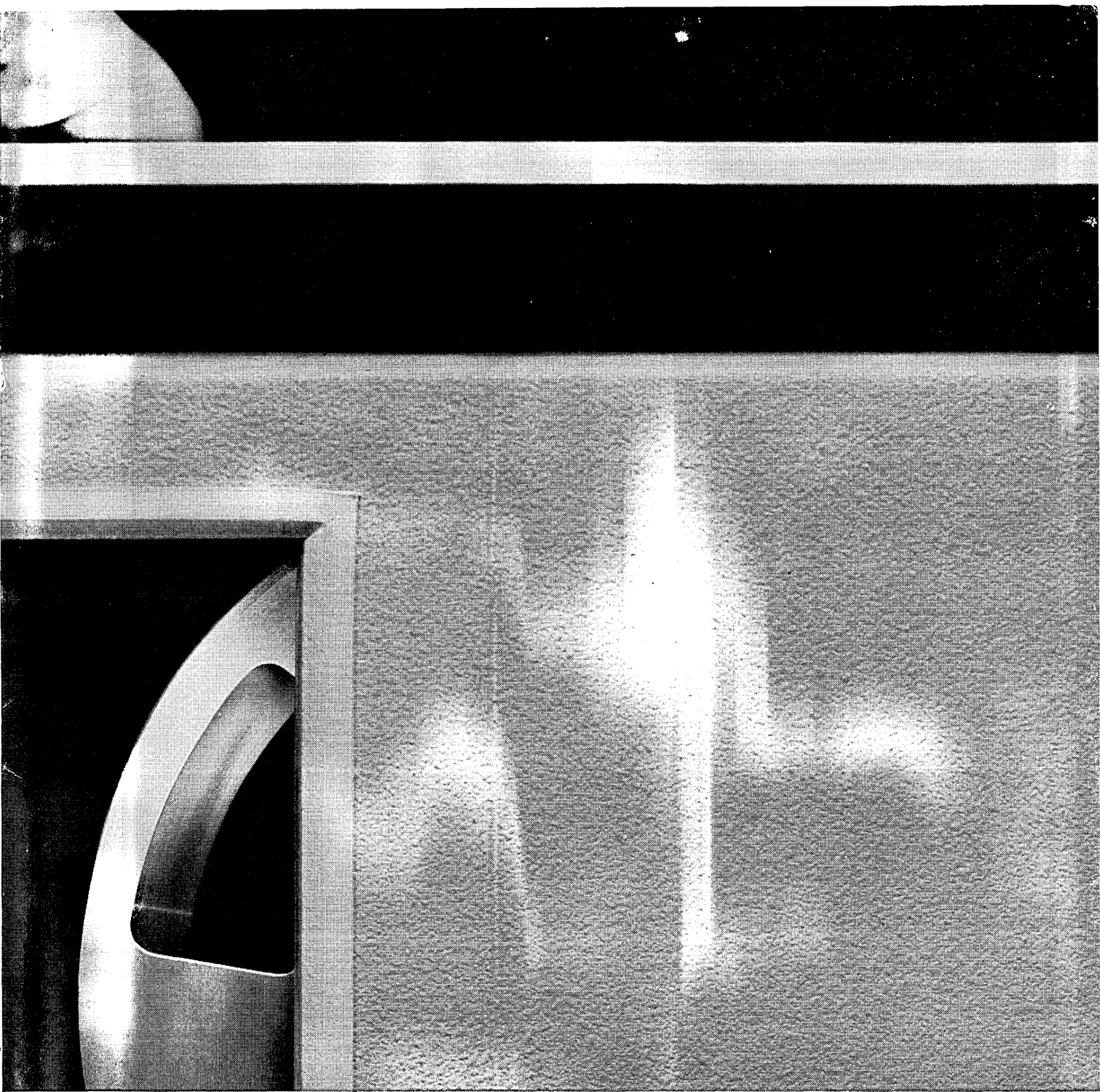

## computer information twice as fast

may  
obile  
early  
eless  
small,  
itive  
ime,  
-and  
lim-  
the  
are  
they

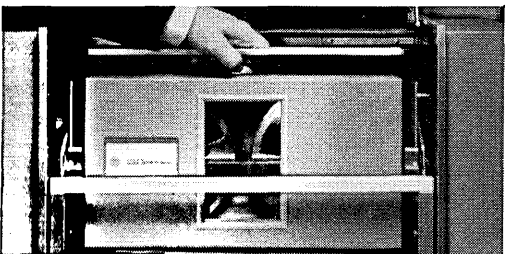

■ The new IBM 7340 Hypertape Drive detects all errors; automatically corrects all one-bit, and most two-bit errors; and, depending on the system with which it is used, processes up to 340,000 numeric or 170,000 alphabetic characters per second.

**IBM**<sup>®</sup>  
DATA PROCESSING

# Readers' and Editor's Forum

## FRONT COVER: STUDENT WORKING WITH COMPUTER-CONTROLLED TEACHING MACHINE

The front cover shows a student, working independently, making his selection of a multiple-choice answer on the response keyboard of a computer-controlled teaching-machine system. The system is the "Computer-based Laboratory for Automated School Systems" or CLASS of System Development Corporation, Santa Monica, Calif., which is exploring a computer-controlled teaching-machine system. For more information, see the article in this issue "The Computer-Assisted School System" by Don D. Bushnell.

## RELIABILITY RECORD

Phyllis Huggins

The Bendix Corporation  
Los Angeles 45, Calif.

Although the reputation of the Bendix G-15 computer for reliability is well known, we thought **Computers and Automation** might be interested in the most recent statistic—this we believe is a record that has not yet been equaled:

The Bendix G-15 computer, machine No. 334, installed at Eastman Kodak Co., Rochester, N. Y., has had an uptime of 100 per cent, for more than a year. The computer is used approximately 50 hours a week.

Incidentally, the average uptime figure for all G-15 customer installations is, according to present records, over 97 per cent. We understand that this record also has not yet been equaled. It is worth remarking that the G-15 is an electronic tube computer.

## CONFERENCE ON SELF-ORGANIZING SYSTEMS—MAY, 1962

Marshall C. Yovits  
Conference Chairman  
Office of Naval Research  
Washington 25, D. C.

A conference on Self-Organizing Systems will be held on May 22, 23, 24, 1962, co-sponsored by the Information Systems Branch, Office of Naval Research and the Armour Research Foundation. This Conference will be held at the Museum of Science and Industry, Chicago, Illinois.

The objective of this Conference is to bring together research workers who are concerned with the evolution of self-organizing information systems. While improved understanding and modeling of cognitive, learning, and growth processes is clearly of interest, this Conference is primarily concerned with these fields only insofar as they interact with the major objective. In the three years intervening since the previous ONR-ARF Conference on this topic there has been greatly increased emphasis placed on Self-Organizing Systems. It appears to be an appropriate

Application No. XXX

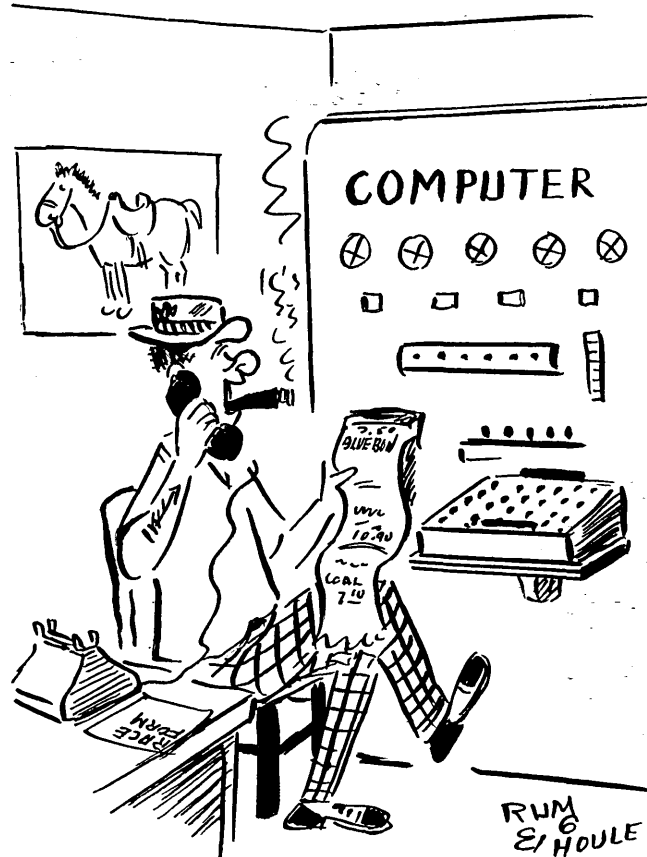

"Blue Bonnet looks good in the fifth race."

time to evaluate recent progress and to consider the future directions of research. It is hoped to examine this topic in depth with particular emphasis upon the more salient research of the past three years.

Attendance is open to all interested technical personnel. Further information and a preliminary conference program, when available, may be obtained by contacting:

MR. GEORGE T. JACOBI  
COSOS Conference Secretary  
Armour Research Foundation  
10 West 35th Street  
Chicago 16, Illinois

## WHO'S WHO IN THE COMPUTER FIELD — CUMULATIVE EDITION, 1962

**Computers and Automation** is publishing this spring a cumulative edition of "Who's Who in the Computer Field." The closing date for receiving entries is February 28, 1962. If you are in the computer field, please fill in the Who's Who entry form (which may be copied on any piece of paper) shown on page 52 of this issue, and send it to us for your free listing in the Who's Who. If you have friends in the computer field, please call their attention to sending us their Who's Who entries. (Even if you find out about this a little late, we still may be able to get your entry in!)

■ ca  
comp  
■ ca  
tion  
them  
■ ca  
with  
■ ca  
tem  
repre  
■ ca  
catio  
with  
syste  
A B  
ques  
as "  
This  
you  
not  
sche  
that  
mer  
to b  
time  
mas  
and  
effie  
virtu

# CALENDAR OF COMING EVENTS

- Feb. 1-3, 1962: Forum on Electronic Computers, Statler-Hilton Hotel, Los Angeles, Calif.; contact John E. Mulder, Director, Joint Comm. on Continuing Legal Education, 133 South 36 St., Phila. 4, Pa.
- Feb. 6-7, 1962: Symposium on Redundancy Techniques for Computing Systems, Dept. of the Interior Auditorium, C St. between 18th & 19th St., N.W., Washington, D. C.; contact Miss Josephine Leno, Code 430A, Office of Naval Research, Washington 25, D. C.
- Feb. 7-9, 1962: 3rd Winter Convention on Military Electronics, Ambassador Hotel, Los Angeles, Calif.; contact IRE Los Angeles Office, 1435 So. La Cienega Blvd., Los Angeles, Calif.
- Feb. 12-16, 1962: 4th Institute on Information Storage and Retrieval, American University, Washington, D. C.; contact Dr. Lowell H. Hattery, Director, Center for Technology and Administration, The American University, 1901 F St., N.W., Washington 6, D. C.
- Feb. 14-16, 1962: International Solid State Circuits Conference, Sheraton Hotel & Univ. of Pa., Philadelphia, Pa.; contact Richard B. Adler, Rm. C-237, MIT Lincoln Lab., Lexington, Mass.
- Feb. 19, 1962: Symposium for Owners and Managers of Service Centers, NCR Data Center, 660 Madison Ave., New York, N. Y.; contact Mr. W. H. Evans, Association of Data Processing Service Organizations, 1000 Highland Ave., Abington, Pa.
- Feb. 26-Mar. 9, 1962: Data Processing Systems Seminar, Wright-Patterson Air Force Base, Ohio; contact Public Information Div. (MCKP), Wright-Patterson Air Force Base, Ohio
- Feb. 27, 28-Mar. 1, 1962: Symposium on the Application of Switching Theory in Space Technology, Lockheed Missiles and Space Co., 1123 No. Mathilda Ave., Sunnyvale, Calif.; contact Kenneth T. Larkin, Lockheed Missiles & Space Co., Sunnyvale, Calif.
- Mar. 8-10, 1962: 10th Annual Scientific Meeting of the Houston Neurological Society, Symposium on Information Storage and Neural Control, Texas Medical Center, Houston, Tex.; contact William S. Fields, M.D., Symposium Chairman, Houston Neurological Society, 1200 M. D. Anderson Blvd., Houston 25, Tex.
- Mar. 13-15, 1962: Symposium on Application of Statistics and Computer to Fuels and Lubricants Research Programs (Unclassified), Granada Hotel, San Antonio, Tex.; contact Roy Quillian, Southwest Research Inst., Box 2296, San Antonio 6, Tex.
- Mar. 24, 1962: 6th Annual Symposium on Recent Advances in Computer Technology, Ohio State University, Columbus, Ohio; contact R. K. Kissinger, Publicity Chairman, c/o Nationwide Insurance Companies, 246 No. High St., Columbus, Ohio
- Mar. 26-29, 1962: IRE International Convention, Coliseum & Waldorf-Astoria Hotel, New York, N. Y.; contact E. K. Gannett, IRE Headquarters, 1 E. 79 St., New York 21, N. Y.
- April 2-5, 1962: Annual Meeting of POOL (LGP-30, RPC-4000, and RPC-9000 Electronic Computer Users Group), Penn-Sheraton Hotel, Philadelphia, Pa.; contact Dr. Henry J. Bowlden, Union Carbide Corp., P. O. Box 6116, Cleveland 1, Ohio
- April 4-6, 1962: Univac Users Association and Univac Scientific Exchange Organization, Leamington Hotel, Minneapolis, Minn.; contact David D. Johnson, Sec'y, Univac Users Association, Ethyl Corp., P. O. Box 341, Baton Rouge, La.
- April 9-13, 1962: Business Equipment Exposition, McCormick Place, Chicago, Ill.; contact G. H. Gutekunst, Jr., Mgr., Press Information, Business Equipment Manufacturers Exhibits, Inc., 235 E. 42 St., New York 17, N. Y.
- April 11-13, 1962: SWIRECO (S. W. IRE Conference and Electronics Show), Rice Hotel, Houston, Tex.; contact Prof. Martin Graham, Rice Univ. Computer Project, Houston 1, Tex.
- April 16-18, 1962: Symposium in Applied Mathematics on "Interactions Between Mathematical Research and High-Speed Computing," at American Mathematical Society and Association for Computing Machinery Symposium, Atlantic City, N. J.; contact Mrs. Robert Drew-Bear, Head Special Projects Dept., American Mathematical Society, 190 Hope St., Providence 8, R. I.
- April 18-20, 1962: Conference on Information Retrieval in Action, Cleveland, Ohio; contact Center for Documentation and Communication Research Conference, Western Reserve Univ., 10831 Magnolia Dr., Cleveland 6, Ohio
- April 24-26, 1962: 12th Annual International Polytechnic Symposium, devoted to "The Mathematical Theory of Automata," United Engineering Center, 345 E. 47 St., New York, N. Y.; contact Symposium Committee, Polytechnic Inst. of Brooklyn, 55 Johnson St., Brooklyn 1, N. Y.
- April 30-June 8, 1962: Seminar in Search Strategy, Graduate School of Library Science, Drexel Institute of Tech., Phila. 4, Pa.; contact Seminar in Search Strategy, Graduate School of Library Science, Drexel Inst. of Tech., Phila. 4, Pa., Att: Mrs. M. H. Davis
- May 1-3, 1962: Spring Joint Computer Conference, Fairmont Hotel, San Francisco, Calif.; contact Richard I. Tanaka, Lockheed Missile & Space Div., Dept. 58-51, Palo Alto, Calif.
- May 8-10, 1962: Electronic Components Conference, Marriott Twin Bridges Hotel, Washington, D. C.; contact Henry A. Stone, Bell Tel. Lab., Murray Hill, N. J.
- May 9-11, 1962: Operations Research Society of America, Tenth Anniversary Meeting, Shoreham Hotel, Washington, D. C.; contact Harold O. Davidson, Operations Research Inc., 8605 Cameron St., Silver Spring, Md.
- May 14-16, 1962: National Aerospace Electronics Conference, Biltmore Hotel, Dayton, Ohio; contact George A. Langston, 4725 Rean Meadow Dr., Dayton, Ohio
- May 21-25, 1962: Institute on Electronic Information Display Systems, The American University, Washington, D. C.; contact Dr. Lowell H. Hattery, Director, Center for Technology and Administration, The American University, 1901 F St., N.W., Washington 6, D. C.
- May 22-24, 1962: Conference on Self-Organizing Systems, Museum of Science and Industry, Chicago, Ill.; contact Mr. George T. Jacobi, COSOS Conference Sec'y, Armour Research Foundation, 10 W. 35 St., Chicago 16, Ill.
- May 28-June 1, 1962: Colloquium on Modern Computation Techniques in Industrial Automatic Control, Paris, France; contact French Association of Automatic Control (AFRA), 19, Rue Blanche, Paris 9, France.
- June 18-Sept. 14, 1962: Engineering Summer Conference Courses, Univ. of Mich., Ann Arbor, Mich.; contact Raymond E. Carroll, Univ. of Mich., 126 West Engineering Bldg., Ann Arbor, Mich.
- June 19-21, 1962: Fourth Joint Automatic Control Conference, Univ. of Texas, Austin, Tex.; contact Prof. Otis L. Updike, Dept. of Chemical Engineering, Univ. of Va., Charlottesville, Va.

*The use of programmed instruction in schools, business, industry, and the armed forces is one of the most exciting and promising innovations ever made in the field of education and training. Now, this new book brings together the many and complex hows and whys:*

# PROGRAMMED INSTRUCTION

## USES IN INDUSTRY AND ARMED FORCES

*Edited by* **STUART MARGULIES,**  
*Research Psychologist, and*

**LEWIS D. EIGEN,** *Executive Vice President,*  
*Center for Programed Instruction, Inc.*

Forty leading figures in the field of programed instruction have combined their experience, and their research findings, to present vital information on applications and implementation of this important new technique. Most of the material has been prepared especially for this book, and it gives intensive coverage of all areas of application (present and projected), estimates of economic feasibility, data on uses of programed instruction, and reactions of students to the material. In short, virtually everything that is known about the subject is covered here.

Drawing upon a wealth of empirical data, the authors make a penetrating analysis of the role of machines in training and education. Equally important, they explore the many practical questions involved in applying programed instruction:

- How much time and money must be spent in preparing training programs using machines?
- Should you use teaching machines or programed books?
- What sort of situations are appropriate for using programed instruction?
- How much training time will programed instruction require, as against programs using conventional methods?

These and a good many other questions are set against such a background that you will be able to answer them precisely and correctly. In effect, you will have a sound basis for making necessary policy decisions with regard to the application of programed instruction to specific training and educational situations.

READY IN MARCH • NOW IN PRESS

*Send now for your on-approval copy*

**JOHN WILEY & SONS, Inc.**

440 PARK AVENUE SOUTH, NEW YORK 16, N. Y.

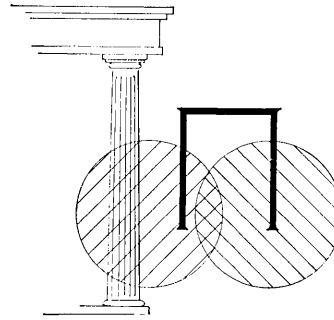

June 19-22, 1962: National Machine Accountants Association International Conference, Hotel Statler, New York, N. Y.; contact R. Calvin Elliott, Exec. Dir., NMAA, 524 Busse Highway, Park Ridge, Ill.

June 27-28, 1962: 9th Annual Symposium on Computers and Data Processing, Elkhorn Lodge, Estes Park, Colo.; contact W. H. Eichelberger, Denver Research Inst., Univ. of Denver, Denver 10, Colo.

June 27-29, 1962: Joint Automatic Control Conference, New York Univ., New York, N. Y.; contact Dr. H. J. Hornfeck, Bailey Meter Co., 1050 Ivanhoe Rd., Cleveland 10, Ohio.

July 18-19, 1962: Data Acquisition & Processing in Medicine & Biology, Whipple Auditorium, Strong Memorial Hospital, Rochester, N. Y.; contact Kurt Enslein, Brooks, Inc., 499 W. Comm. St., P. O. Box 271, E. Rochester, N. Y.

Aug. 21-24, 1962: 1962 Western Electronic Show and Convention, California Memorial Sports Arena and Statler-Hilton Hotel, Los Angeles, Calif.; contact Wescon Business Office, c/o Technical Program Chairman, 1435 S. La Cienega Blvd., Los Angeles 35, Calif.

Aug. 27-Sept. 1, 1962: 2nd International Conference on Information Processing, Munich, Germany; contact Mr. Charles W. Adams, Charles W. Adams Associates, Inc., 142 the Great Road, Bedford, Mass.

Sept. 3-7, 1962: International Symp. on Information Theory, Brussels, Belgium; contact Bruce B. Barrow, Postbus 174, Den Haag, Netherlands

Sept. 3-8, 1962: First International Congress on Chemical Machinery, Chemical Engineering and Automation, Brno, Czechoslovakia; contact Organizing Committee for the First International Congress on Chemical Machinery, Engineering and Automation, Vystaviste 1, Brno, Czechoslovakia.

Sept. 19-20, 1962: 11th Annual Industrial Electronics Symposium, Chicago, Ill.; contact Ed. A. Roberts, Comptometer Corp., 5600 Jarvis Ave., Chicago 48, Ill.

Oct. 2-4, 1962: National Symposium on Space Elec. & Telemetry, Fountainbleu Hotel, Miami Beach, Fla.; contact Dr. Arthur Rudolph, Army Ballistic Missile Agency, R & D Op. Bldg. 4488, Redstone Arsenal, Ala.

Oct. 8-10, 1962: National Electronics Conference, Exposition Hall, Chicago, Ill.; contact National Elec. Conf., 228 N. LaSalle, Chicago, Ill.

Oct. 30-31, 1962: Conference on Eng. Tech. in Missile & Spaceborne Computers, Disneyland Hotel, Anaheim, Calif.; contact William Gunning, EPSCO-West, 240 E. Palais Rd., Anaheim, Calif.

Nov. 5-7, 1962: 15th Annual Conf. on Elec. Tech. in Medicine and Biology, Conrad Hilton Hotel, Chicago, Ill.; contact Dr. J. E. Jacobs, 624 Lincoln Ave., Evanston, Ill.

Nov. 13-15, 1962: NEREM (Northeast Res. & Engineering Meeting), Boston, Mass.; contact NEREM-IRE Boston Office, 313 Washington St., Newton, Mass.

Dec. 4-5, 1962: Eastern Joint Computer Conference, Bellevue-Stratford Hotel, Philadelphia, Pa.

# PLOT YOUR DIGITAL DATA FOR GRAPHIC RESULTS ...

**... WITH ACCURATE, LOW COST EAI SERIES 3100 DATAPLOTTER**

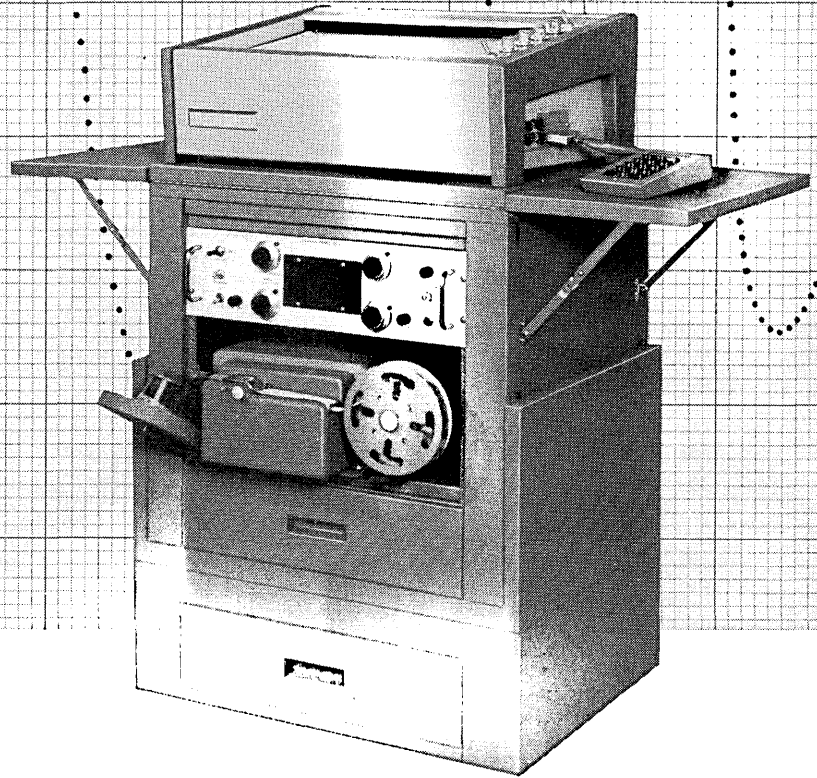

#### Outstanding Features of the EAI Series 3100 DATAPLOTTER include:

- System accuracy up to 0.175% of full scale.
- Punched card, tape or keyboard input.
- Plotting speeds up to 80 points per minute.
- Provisions for "off-board" origin.
- Compact, self-contained single cabinet design. Punched card reader external.
- Adaptable to any computer system.
- Accepts analog as well as digital inputs.
- Automatic off-scale point rejection.

The full potential usefulness of digital computer calculations is seldom fully realized. Because of the excessive cost of hand plotting, the benefits of graphic displays of digital data are usually sacrificed. Now, with the DATAPLOTTER 3100, this lost dividend can be recovered.

The quickest and easiest way to analyze the voluminous output of digital computers is in the form of easy-to-read x-y charts. With graphs plotted on the EAI Series 3100 [11"x 17"] DATAPLOTTER, digital information achieves new accessibility and convenience for computer data users. This new low-cost digital plotter enables project groups to set up independent data interpretation operations utilizing information obtained from central computer services. Experience shows that this equipment will deliver plots more rapidly and accurately and free valuable man-hours for engineering and management.

Some of the applications in which the EAI Series 3100 DATAPLOTTER is extremely valuable include Frequency Response Curves • Fluid Flow Charts • Stress Analysis • Aerodynamic Studies • Chemical Reaction Rates • Missile Trajectories and Orbits • Thrust Studies • Flight Data • Sales and Market Analyses.

EAI Series 3100 DATAPLOTTER® can save you money and improve your engineering and computer services. For information on this new equipment, write to Department CA-22.

# EAI

ELECTRONIC ASSOCIATES, INC. Long Branch, New Jersey

# Implications of Automatic Data Processing in the Engineering Profession

Dick H. Brandon

Director of Programming Services  
John Diebold & Associates, Inc.  
New York, N.Y.

(Based on a talk before the Engineers Club, New York, October 24, 1961)

## Further Technical Progress

I would like to begin this article with a quotation:

"Automation constitutes the chief and decisive means for ensuring further technical progress in the economy, and on this basis a new rise in labor productivity, the lowering of cost prices, and the improvement of quality of products."

That remark was made by Premier Nikita Khrushchev addressing the 21st Congress of the Communist Party of the Soviet Union.

At another time, when he was touring the partially automated Renault plant in Southern France, Mr. Khrushchev was asked what he thought about the new technology. With his usual jagged wit Mr. Khrushchev replied, "Automation? Automation is a good thing. It is through such methods that we will beat you capitalists."

I think these quotations, plus the wholehearted endorsement given automation in the recent Soviet Draft Program, should serve sufficiently to emphasize the importance of automation and the challenge it proposes to all of us. It certainly points up the need for national awareness and national planning in the most effective use of this technology against our devoted competitors.

## Automatic Data Processing

Automatic data processing is one of the forms of automation. I believe it is the most significant and will ultimately be the most important. It is the technology of processing information automatically—i.e., using a computer capable of internally controlling the process. The process is therefore truly independent of human operation, even though the computer requires a great deal of initial human instruction.

Automatic data processing (ADP) is becoming a great deal more important than it was a few years ago, because its scope is expanding so that it now encompasses such areas as: process control; numerical control of machine tools; management information systems; business and environment simulation; social research; medical research; and cybernetics (the science of simulating the human mind).

In addition, ADP is expanding in sheer volume. The first commercial computer was installed in March of 1951. In 1961, we had approximately 6,000 computers installed. During 1962 we hope to have approximately 10,000 machines installed, and in 1963 this number will probably increase to 14,000. The printers associated with these machines will have a capability of printing information at a rate of up to

1500 lines per minute. This means, for example, that if you have 50 lines on a page, this equipment can produce 30 pages in one minute. And furthermore, these machines can read magnetic tape at a rate of 200,000 characters per second. Why are all these speeds significant? Well, if you consider that the Social Security System of the United States each day processes one and one half million transactions, and that a major New York life insurance company intends to pass 40 million policy records two times a day, then you can see that these speeds are necessary.

## New Developments

Of course, this is only a beginning. Computer technology has a tremendous potential which has only begun to emerge. Let's consider for a moment some new developments in this technology.

### Data Communications:

American Telephone & Telegraph Company estimates that by 1970, more time will be spent and more revenue obtained from machines talking to one another along long distance lines than from human conversation.

### Cryogenics:

Current computer speeds are in the microsecond range, i.e., information is processed in a few millionths of a second. Lowering the environmental temperatures of computer systems to close to absolute zero can increase this speed significantly. Today's fastest machines, for example, can perform only about 160,000 additions in one second. Using cryogenics, there is the possibility of increasing this by a factor of five, so that machines within the next few years will be capable of one million additions in one second.

### Thin Film Memory:

Another newly developed storage device permits storage and rapid recall of hundreds of thousands of bits of information, using only a few square inches of thin magnetic film.

### Molecular Electronics:

This idea carries sub-miniaturization to an extreme degree and makes use of the structure and properties of arrays of a few molecules to accomplish electronic circuitry.

### Optical Scanning:

Equipment today is capable of scanning documents "seeing" light and dark areas and translating the printed information into the computer's language.



Voice Communication to and from the Computer: Bell Telephone Laboratories has developed a machine which is capable of recognizing a spoken vocabulary of about 500 words, and translating the words spoken into internal symbols. This translation requires at present a certain monotonous voice and a vocabulary of only about 500 words, but the machine may have tremendous impact on our communication system. Further, another machine can generate the spoken word from computer information, by putting together syllables mechanically.

### Effects on Engineering

What are the specific implications of automatic data processing for the engineering profession? First, and in my opinion least important, the technology of automatic data processing can be used to aid engineering. It can be used to eliminate menial tasks, to expand one's ability to examine many alternatives, to extend knowledge, to eliminate errors, to reduce elapsed time, to increase safety. Here are just a few examples:

#### Mechanical Engineering:

The drawing of simple blueprints. Here, one company managed to save over \$5 million by the elimination of 600 draftsmen, using the computer instead to generate the necessary blueprints. (The draftsmen were relocated not discharged.)

#### Industrial Engineering:

Time and motion studies. The application of automatic time measurement standards. Production control.

#### Chemical Engineering:

The control and design of processes. The expansion of knowledge of the processes. (Here, the problem often is that we do not know enough about the process.)

#### Civil Engineering:

Cut and fill calculations. Bridge design. Highway design.

#### Power Engineering:

The control of the process resulting in the reduction of human error, the elimination of human failure, and the optimization of the output.

#### Electrical Engineering:

Design of optimum motors.

### Effects of Engineering on Automatic Data Processing

The technology of engineering can be used to assist automatic data processing. One aspect of this is design, to create better, faster, more reliable, and more versatile machines. Technology, however, has made fantastic strides in the last decade, occasioned by phenomenal emphasis on design, which has been forced upon the manufacturers by severe competition (which has not yet subsided). The technology however is far ahead of our ability to use the supplied tools effectively; engineering should be able to remedy this, however.

In data processing we are given a tremendously complex, capable tool and yet often we cannot make

effective use of it because of our lack of ability to encompass all of the things which this equipment can do. The design of bigger and better computers has in the past reduced the emphasis on effective use. This has caused a significant increase in the development cost necessary to create programs and systems to use the machine effectively; i.e. to change a general-purpose digital computer into a specific functioning unit. As an illustration, the cost of software (the system necessary to operate the machine), has begun to outstrip the cost of hardware. As an example, one of the major financial users in downtown New York spent over \$3 million on development and programming for a machine which cost only \$2½ million. Similarly, in the process control area, to run a power plant we need only two programs; one to start up and shut down the plant, and another to do the actual operation of the plant. These two programs, however, in one prominent case, have taken over 35 man years to develop, which, translated, would have cost well over a half million dollars.

Hardware costs today range from \$50,000 to \$20 million and software costs range from about \$15,000 to \$25 million. Of course, these two are not directly related, since the cost of software is dependent on the complexity of the operation and not on the cost of the hardware.

### Programmers

Where does this money go? The development of the necessary software is done by systems analysts and programmers, individuals whose particular skills and education are scarce. This scarcity has skyrocketed salaries of programmers and systems analysts to unrealistic heights. One magazine recently reported a range of from \$6,000 to \$23,000 per year for a programmer. This of course has caused phenomenal growth in this vocation; it is well worth considering future requirements as compared with this growth. In 1951, there were a very small group of about 100 to 200 programmers. In 1961, there are more than 20,000 programmers. In 1971, there will probably be needed over 200,000 skilled and experienced people, people who have the capability of keeping up with the technology.

Today I believe we are at a critical point. I believe that this vocation needs recognition, and needs it desperately. I advocate that this recognition should be as part of the engineering profession. Whether you call it computer engineering, or systems engineering matters very little, but I believe that the engineering profession is the profession which can give this recognition to a vocation which will assume a great deal of importance in our economy in the next decade.

### Educational Program

The greatest need in this field, especially in light of our competition with the U.S.S.R., is a formal, established educational program. Today there is no curriculum which leads into the profession of computer engineer. Not even the industrial engineering departments have assumed responsibility for this. I believe that it is absolutely necessary and essential that such a formal educational curriculum be estab-

lished to train these individuals to meet this ever-growing demand. In addition to the standard subjects, the curriculum should include such subjects as: logic; Boolean algebra; matrix algebra; accounting; accounting systems; business management; inventory control; production control; management control; personnel; computer concepts; and programming concepts.

Note that this is not a purely technical course of study, for the essential need is not to teach specifics, but to teach basic concepts and logically ordered thinking. The swift rate of change in this industry is making many specifics obsolete. Probably this is true of the engineering profession in general. We must therefore emphasize concepts and develop an ability to adapt to change, to adapt to very rapid

change. Today's techniques are often becoming obsolete even before they are put into effective use. This, of course, has caused a tremendous increase in the demand for skilled and experienced personnel with the ability to adapt. There is no adequate supply to meet this demand. This has resulted in a lowering of requirements, an increase in cost and salaries, and ineffective use of the equipment. In fact, inadequate programming ability has been largely responsible for some of the more widely publicized failures.

The vocation of programmer needs the educational advantages and status of a profession. The engineering profession, even within its current scope, is the most suitable candidate for the task of making this change for programmers—computer engineers. This is a challenge which faces all of us.

# Who's Who in the Computer Field

## (Supplement)

A full entry in the "Who's Who in the Computer Field" consists of: name / title, organization, address / interests (the capital letters of the abbreviations are the initial letters of Applications, Business, Construction, Design, Electronics, Logic, Mathematics, Programming, Sales) / year of birth, college or last school (background), year of entering the computer field, occupation / other information such as distinctions, publications, etc. An absence of information is indicated by - (hyphen). Other abbreviations are used which may be easily guessed like those in the telephone book.

Every now and then a group of completed Who's Who entry forms come in to us together from a single organization. This is a considerable help to a compiler, and we thank the people who are kind enough to arrange this. In such cases, the organization and the address are represented by . . . (three dots).

Following are several sets of such Who's Who entries.

### Continental Can Company, Inc.

Glomb, J D / Physics Res Engr, . . . 7622 S Racine Ave, Chicago 20, Ill / AM / '31, Polytechnic Inst, Bkln, '54, sys engr / publn on Control System Analysis and Mathematical Procedure

Murphy, Garret T / Sr Systems Analyst, . . . 633 3rd Ave, NYC / ABMP / '31, Harvard, '57, -

### Dela Data Corporation, 3134 Shane Drive, Richmond, Calif

Cooper, William L / Vice Pres, . . . / ABLMP / '35, Univ of Calif, '56, dir of prgmg

Curran, Ronald W / Sls Consltnt, . . . / ABS / '31, Fairleigh Dickenson Univ, '60, sls

Deardoff, Dick / Sls Consltnt, . . . / ABS / '33, UCLA, '60, sls

De La Briandais, Rene / Pres, . . . / ABMP / '33, Calif State Polytechnic Coll, '55, mgmt / Paper WJCC-1959

Verdon, Thomas R / Dir of Sls, . . . / ABS / '34, Univ of Calif, '60, mgmt

### A. T. Kearney, 135 So LaSalle St, Chicago, Ill

Diehl, C S / Consltnt, . . . / A / '23, Harvard Bus Schl, '49, mgmt consltg

Dunne, Raymond F / Sr Staff Consltnt, . . . / ABP / '28, Notre Dame (BS), Northwestern (MBA), -, conslnt

Strom, Kenneth G / Mgmt Consltnt, . . . / ABELPS, mfg, info retrieval / '28, Northwestern Univ (BS, MBA, CPA), '51, mgmt conslnt

### Remington Rand, Div of Sperry Rand Corp.

Etlinger, Louis / Supervisory Atty, . . . Wilson Ave, South Norwalk, Conn / Patents / '22, Rutgers Univ, '55, patent atty

Mayerchak, George A / Prgrmr, . . . St Paul 16, Minn / AP / '30, Newark Coll Engrg, '55, customer engr

### Remington Rand Univac Div of Sperry Rand Corp, 2720 Third Ave, Seattle 1, Wash

Hamilton, Dennis E / Systms Analyst, . . . / ALMP / '39, Univ of Washington, '58, prgrmr/analyst-conslnt / routine publns on utility routines

Kreek, Peter / Systms Analyst, . . . / ABLP / '33, Univ of Washington, '58, prgrmr

### Sperry Gyroscope Company, Great Neck, L I, N Y

Cea, Eugene J / Sr Prgrmr, . . . / MP / '33, Columbia Univ, Iona Coll (BS physics), '56, systems prgmg grp leader

Cristodero, Damian / Sr Prgrmr, . . . / AMP / '31, Adelphi, '56, prgmg grp leader

D'Asaro, Florence / Prgrmr, . . . / AMP / '37, Adelphi, '59, prgrmr

Kelly, Frederick G / Prgrmr, . . . / P / '29, Hofstra Coll, '60, prgrmr

Morgan, Julian, Jr / Cmpr Analyst, . . . / AMP / '33, Columbia Univ, '60, prgrmr

Morris, John / Sr Prgmg Analyst, . . . / AMP, compr educatn / '27, Adelphi (MS), '54, cnsltg and compr educatn grp leader

Phelps, Richard J / Engrg Sect Hd for Dig Analysis, . . . / ACDELMP / '16, NYU, '45, mgr of scientific compg installation

Sanderson, June / Prgrmr, . . . / MP / '35, Adelphi Coll, '58, scientific prgmg

Stuzin, Gerald J / Assoc Engr, . . . / MP / '37, NYU (MS), '59, -

Turiano, Catherine / Prgrmr, . . . / AMP / '28, Adelphi Coll, '57, prgrmr

### System Development Corp, 2400 Colorado Ave, Santa Monica, Calif

Bethe, Donald / Prgrmr Anlyst Sr, . . . / ADP / '25, Tufts Univ, '58, prgrmr

Brooks, Amsdry M / Sector Techl Asst, . . . / B / '25, Univ of Va (BS), '57, ind engr

Gross, Leonard D / Elecnc Sys Engr, . . . / AB / '35, Univ of Washington, '61, elec engr

Keith, Donald J / Sr Prgmg Anlyst, . . . / ABP, EDP systems studies / '27, Boston Univ, '55, -

Levy, Sydney D, Jr / Prgmg Anlyst Sr, . . . / D, proj analysis, info retrieval res, operatns planning for command sys / '21, Pearl River College (BS), '55, -

### Texas Instruments, Central Research Bldg, 13500 North Central Expressway, Dallas, Tex

Blakemore, John W / Sr Engr, . . . / AM / '30, Rice Univ, Univ of Texas, '56, res in computational techniques / "Reaction Rate Equations"

Headley, DueWayne / Prgrmr Anlyst, . . . / ABP / '32, Oklahoma State Univ (BS), Harvard Bus Schl, Univ of Tex (MBA), '59, -

### International Business Machines Corporation

Speckhard, Arthur E / Mbr, Corporate Logical Sys Stds Group, . . . White Plains, N Y / P / '29, Univ of Mich, '50, mathn / occasional contribtn to trade publns

Timberlake, Wm D / Mgr Systems Prgmg, . . . Boardman Rd, Poughkeepsie, N Y / ABP / '30, Univ of Louisville, '56, -

**HOW PRECISE IS EP COMPUTER AUDIOTAPE** Extra precise. An unscientific term but an accurate one. We know EP Computer Audiotape is extra precise (which is what EP stands for) because every step in its production is directed toward that end. From raw material to sealed container, this computer tape is measured, checked, controlled, inspected, tested. Automatic Certifiers record and play back every inch of every reel and if just one test pulse out of 40 million doesn't reproduce properly out goes the entire reel. On high density tapes, it takes 112 million perfect pulses to qualify. Is it unreasonable to call this extra precision? Try EP Computer Audiotape.

**AUDIO DEVICES INC., 444 MADISON AVENUE, NEW YORK 22, NEW YORK**

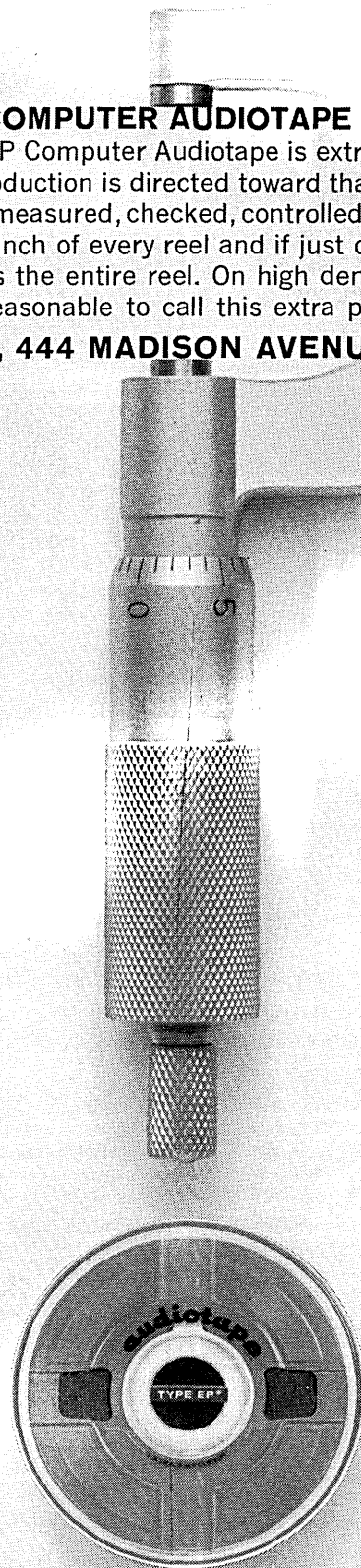

**General Electric Company**

Longo, Leonard F / Specialist, . . . , Flight Propulsion Div, Cincinnati 15, Ohio / P / '26, Ohio State Univ, '57, prgmr  
Mann, Arthur R / Proj Engr, . . . , French Rd, Utica, N Y / E / '31, The Citadel, '57, circuit dsgn

**General Electric Company, Computer Department, Information Processing Center, Tempe, Ariz**

Korff, Renee / Prgmg Analyst, . . . / AB / '28, Wayne State Univ, '56, —  
McCauley, Ed J / Sr Prgmg Analyst, . . . / AB / '20, Univ of Mich, '54, —

Steele, Robert E / Mgr, Product Planning, Philco Corp, Computer Div, Willow Grove, Pa / AD / '24, Temple Univ, '54, Mgr, product planning

Supple, Joseph L / Methods Specialist, RCA, EDP Div, 200 Berkeley St, Boston, Mass / ABPS / '34, Holy Cross Coll, '60, EDP methods

Symmes, W K / Dist Sales Mgr, Farrington Electronics, Inc, Needham Heights 94, Mass / A, input / '23, Yale Univ, '54, Rem Rand Univac

Tandon, Tej B / Senr Mbr of Tech Staff, Auerbach Electronics Corp, 1634 Arch St, Philadelphia 3, Pa / ADMP / '31, Harvard Univ, '56, systems analyst

Tavares, Everett A / Dig Comptr Prgmr, North Island Naval Air Station, San Diego 35, Calif / P, systems development / '28, San Jose State Coll, '58, —

Thörn, Hans / Mgr Data Handling, Elektronikbolaget AB, Barnängsgatan 30 / S / '29, Univ of Stockholm, '55, sales engr / publications in prgmg techniques

Tilley, Merten A / Operations Analyst, Comms, Pan American World Airways, 28-19 Bridge P North, LIC 1, N Y / AE, data and record transmission, input/output / '26, Univ of Vienna, '56, analyst, communications

Tinsley, Charles H, Jr / Supvsr, Comptr Operations, Du Pont Co, Engrg Dept, Wilmington 98, Del / ABCEP, operational philosophies and techniques / '25, The Citadel, '54, engr

Trampel, Kurt M / Proj Mgr, IBM Corp, DSD, Poughkeepsie, N Y / DE / '34, CCNY, '56, electrical engr / "Design and Application of the Transistor NOR Circuit", 6 invention disclosures

Tritter, Alan L / Prgm Analyst, Data Processing, Inc, 1334 Main St, Waltham 54, Mass / ABDLMP / '35, Univ of Chicago, '52, consultant / co-author "The Morse Distribution"

Valeska, Vernon L / Chief Meth Engr, Time Inc, 540 N Michigan, Chicago, Ill / ABEP, mgmt / '17, Iowa Univ, '50, coordinator

Van Brink, Herbert F / Res Engr, Missile Div, North American Aviation, 12214 Lakewood Blvd, Downey, Calif / AMP / '37, Queens Coll, New York Univ, '59, prgmr

Vesley, Allan / Supvsr of Systems and Prgmg, The Sperry and Hutchinson Co, 114 Fifth Ave, New York 11, N Y / ABP / '31, Cornell Univ (BS), New York Univ (MBA), '56, management

Villani, Carmen D / Comptr Section Leader, Vitro Corp of America, 200 Pleasant Valley Way, West Orange, N J / AMP / '30, New York Univ, '52, engr's aide

Vitale, Walter L / Tech Staff-Systems, Belock Instrument Corp, College Point 56, L I, N Y / ABPS, market res / '23, LaSalle, '43, tech staff-systems / various pubens

Watson, Gordon M / Prgmg Instructor, Bendix Computer Div, 291 S La Cienega Blvd, Beverly Hills, Calif / ELP / '36, UCLA, '59, prgmr

Wegstein, Joseph H / Asst Chief, Computation Laboratory, National Bureau of Standards, Washington D C / visiting lecturer for 1961 winter trimester at Computation & Data Processing Center, Univ of Pittsburgh, Pittsburgh 13, Pa

Wells, Joan / App Science Prgmr I, Calif Div of Highways, P O Box 1499, Sacramento 7, Calif / LMP / '29, Vassar Coll, '60, prgmr

West, Charles B / Dev Engr, ITT Laboratories, 492 River Rd, Nutley, N J / A / '24, New York Univ, Columbia Univ, '58, electrical engr

West, Irwin / Sales Engr, Computer Systems Inc, Monmouth Jct, N J / AS / '35, CCNY, '56, sales engr

Westneat, Arthur S, Jr / Tech Dir, Ortholog Div of Gulton Industries, Inc, P O Box 37, Princeton Junction, N J / E, statistical data handling eqpmnt, telemetry, communications, modulation systems / —, Purdue Univ (BSEE, MSEE), '43, —

Wolff, Fred G / Tech Consultant, self, 6 Kent Lane, Paoli, Pa / D / specifcn, system, and logic dsgn of comptr peripheral eqpmt / '23, Frankfurt, Germany, '50, tech consultant

Wolff, S Arnold / Systems Analyst, Daystrom Systems, 4455 Miramar Rd, La Jolla, Calif / AP / '34, Univ of Fla, Univ of Calif, '59, prgmr

Wolzein, Frank J / Tech Serv Supvsr, Electronic Ctrs, Inc, Eileen Way, Syoset, N Y / AELP / '34, CCNY, '56, field serv engr

Woodcock, Gerald E / Adm officer, U S Railroad Retirement Board, Chicago, Ill / mgmt level analysis and studies in evaluation of business data prog with respect to feasibility, coordination and integration of inter-departmental processes, costs and comparisons and machine utilization / '06, Stinson Flight, Manufacturers Computer Schools, '56, managmnt analysis officer

Woodson, William B / Electronics Methods, J P Stevens & Co, Inc, Charlotte, N C / AELMP / '21, Univ of N C, Harvard Business School, '55, electronic methods and prgmg

Zellmer, Neale A / Sr Staff Engr, Lenkurt Electr Co, San Carlos, Calif / data transmission subsets / '21, Iowa State Coll, '58, elec engr / "A Quaternary Frequency-Shift Data Transmission Subset"

Addiscott, Derek H / Mgr, Elcnc Data Proc Dept, Pan American World Airways, Inc, Guided Missile Range Div, P O Box 4187, Patrick AFB, Fla / AB / '10, educated in England, '58, administrator

Anderson, Walter R / Pres, Commercial Computers, Inc, 36 Pleasant St, Watertown 72, Mass / B, industrial and scientific / '28, Clark Univ, Worcester Polytech, '57, engr

Babb, R A / Sysms Apln Engr, Friden, Inc, 2350 Wash Ave, San Leandro, Calif / ABDEPS / '23, Colo State, '48, plng / dir S F Chap NMAA

Blumenthal, S C / Pres, National Computer Analysts, Inc, Route 206 Center, Princeton, N J /

Briney, William F / Pres, William Briney Co, P O Box 1759, La Jolla, Calif / S / '20, Montana State Univ, '59, —

**WHO'S WHO IN THE COMPUTER FIELD — CUMULATIVE EDITION, 1962**

Computers and Automation will publish this spring a cumulative edition of "Who's Who in the Computer Field." The closing date for receiving entries is Feb. 28, 1962. If you are interested in computers, please fill in the following Who's Who entry form (which may be copied on any piece of paper) and send it to us for your free listing. If you have friends in the computer field, please call their attention to sending us their Who's Who entries. The cumulative edition will include only the entries of persons who send us their Who's Who information.

Name? (please print) .....  
Your Address? .....  
Your Organization? .....  
Its Address? .....  
Your Title? .....  
Your Main Computer Interests?  
( ) Applications  
( ) Business  
( ) Construction  
( ) Design  
( ) Electronics  
( ) Logic  
( ) Mathematics  
( ) Programming  
( ) Sales  
( ) Other (specify):

.....  
Year of birth? .....  
College or last school? .....  
Year entered the computer field? ....  
Occupation? .....  
Anything else? (publications, distinctions, etc.) .....

.....  
.....  
.....  
.....  
.....  
.....  
.....  
.....  
.....  
.....

When you have filled in this entry form please send it to: Who's Who Editor, Computers and Automation, 815 Washington Street, Newtonville 60, Mass.

**IN THE COMPUTER FIELD  
Who? What? Where?**

*Answers,  
Basic Source Information,  
Available to You from*

**COMPUTERS  
and AUTOMATION**

**DIRECTORY:**

The Computer Directory and Buyers' Guide, 1961, 156 pages long (the June 1961 issue of COMPUTERS AND AUTOMATION), containing the following reference information: Roster of Organizations in the Computer Field Roster of Products and Services: Buyers' Guide to the Computer Field  
Survey of Computing Services  
Survey of Consulting Services  
Descriptions of Digital Computers  
Survey of Commercial Analog Computers  
Survey of Special Purpose Computers and Data Processors  
Automatic Computing Machinery — List of Types  
Components of Automatic Computing Machinery — List of Types  
Over 500 Areas of Application of Computers  
Application Programs Available  
Computer Users Groups — Roster  
Roster of School, College, and University Computer Centers  
Robots — Roster of Organizations, and Survey Teaching Machines and Programmed Learning — Roster of Organizations  
**Directory . . . . \$15.00**

**GLOSSARY OF TERMS AND EXPRESSIONS IN THE COMPUTER FIELD:**  
Over 860 careful, clear, understandable definitions. 5th cumulative edition . . . **\$3.95**  
(10 or more copies, 20% discount)

**BACK COPIES:**  
For ten years of publication: \$1.50 each, except Directory issues, June 1955 to June 1960, \$4.00 each. ALL BACK COPIES WILL BE BACK IN PRINT BY THE END OF AUGUST.

**SUBSCRIPTIONS:**  
U.S.A. one year, \$15.00; two years, \$29.00; add 50c per year for Canada, \$1.50 per year elsewhere.

**BULK SUBSCRIPTIONS:**  
These rates apply to prepaid subscriptions to **COMPUTERS and AUTOMATION** coming in together direct to the publisher.

**BULK SUBSCRIPTION RATES  
(United States)**

Number of Simultaneous Subscriptions	Rates for Each Subscription, and Resulting Saving:	
	One Year	Two Years
7 or more	\$11.40 — 24%	\$20.00 — 31%
4 to 6	12.60 — 16	22.00 — 24
3	13.65 — 9	24.30 — 16
2	14.25 — 5	26.40 — 9

For Canada, add 50 cents for each year; outside of the United States and Canada, add \$1.50 for each year.

Send prepaid orders or requests for more information to:  
**COMPUTERS and AUTOMATION**  
815 Washington St., Newtonville 60, Mass.  
If not satisfactory, returnable in seven days for full refund.

**DERIVING  
MAJORITY  
LOGIC  
NETWORKS**

**FUND THM:**  $f(X,Y,Z) \equiv (X \# Y \# f_{xy}) \# (\bar{X} \# \bar{Y} \# f_{\bar{x}\bar{y}}) \# f_{xy}$   
**DEFINITIONS:**  $X \# Y \# Z \equiv \text{Maj}(X,Y,Z)$ ;  $f_{xy} \equiv f(X,X,Z)$ ;  $f_{\bar{x}\bar{y}} \equiv f(\bar{X},\bar{X},Z)$   
**DERIVATION:** Let  $f(X,Y,Z)$  be even-parity function  $P$ . Then  $f_{xy} \equiv \bar{Z}$  and  $f_{\bar{x}\bar{y}} \equiv Z$  so

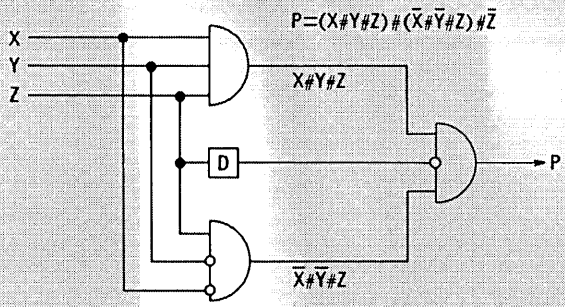

The fundamental theorem of majority-decision logic, a typical product of Univac's Mathematics and Logic Research Department, has practical as well as theoretical interest. The even-parity checker derived above from the fundamental theorem can be freed to determine the parity of  $3^n$  bits in  $n$  logic levels using only  $\sum_{i=0}^{n-1} 3^i$  three-input majority gates.

Qualified applicants will find at Remington Rand Univac a scientific climate tuned to the intellectual curiosity of the professional man. The opportunity and the incentive for advancement are waiting for you in highly significant positions at Univac. You are invited to investigate them immediately.

**ST. PAUL, MINN.**

**LOGICAL SYSTEMS ANALYSTS • COMPUTER PROGRAMMERS  
COMPUTER APPLICATION ANALYSTS • COMPUTER LOGICAL  
DESIGNERS • MILITARY SYSTEMS ANALYSTS • ENGINEER WRITERS**  
For the above positions in our St. Paul, Minnesota, laboratories, send resume of experience and education to:  
**R. K. PATTERSON**  
Remington Rand Univac • Univac Park • St. Paul 16, Minnesota

**SAN DIEGO, CALIF.**

**COMPUTER PROGRAMMERS • MILITARY SYSTEMS ANALYSTS  
• SYSTEMS TEST AND EVALUATION ENGINEERS** for data extraction and reduction, debugging of equipment and systems integration.  
The above positions are now available at Univac in San Diego. Send resume of experience and education to:  
**WILLIAM LOWE**  
Remington Rand Univac • P. O. Box 6068 • San Diego 6, Calif.

**COCOA BEACH, FLORIDA**

A new data processing center is being established in the Cocoa Beach, Florida, area to service the Atlantic Missile Range. Qualified applicants interested in a Florida location can be offered very challenging work on essential range problems. Openings include the following:  
**• PROGRAMMERS • SYSTEMS ANALYSTS** for correlation of radar tracking data and programming techniques for data handling and data reduction.  
Send resume of experience and education to:  
**R. K. PATTERSON**  
Remington Rand Univac • Univac Park • St. Paul 16, Minnesota

RE M I N G T O N R A N D  
**UNIVAC**  
DIVISION OF SPERRY RAND CORPORATION

There are also immediate openings in all areas of digital computer development at our other laboratories. Inquiries should be addressed to:  
**F. E. NAGLE**  
Rom. Rand Univac  
P.O. Box 500  
Blue Bell, Pa.  
**D. CLAVELoux**  
Rom. Rand Univac  
Wilson Avenue  
South Norwalk, Conn.  
(An equal opportunities employer)

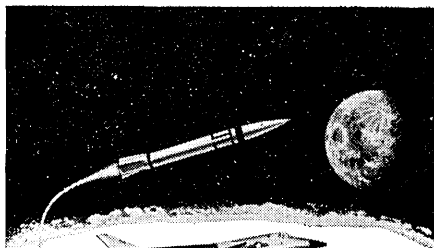

Outstanding opportunities in:

## INTEGRATED DATA PROCESSING

Computing Engineers for research and development of mathematical models. Degree in math or physics with two years of experience.

Applied or Utility Programmers to program integrated data processing systems applied to EDPM 709-7090-1401. Degree in math or accounting or equivalent in directly related experience.

Please write to:

**North American Aviation,  
The Professional  
& Technical  
Employment Office,  
Box CA-439,  
4300 East Fifth Avenue,  
Columbus 16, Ohio**

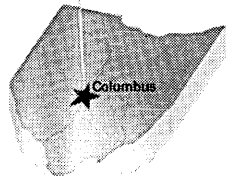

All qualified applicants will receive consideration for employment without regard to race, creed, color, or national origin.

**COLUMBUS DIVISION  
NORTH AMERICAN AVIATION**



## BOOKS AND OTHER PUBLICATIONS

**Moses M. Berlin**  
Allston, Mass.

We publish here citations and brief reviews of books and other publications which have a significant relation to computers, data processing, and automation, and which have come to our attention. We shall be glad to report other information in future lists if a review copy is sent to us. The plan of each entry is: author or editor / title / publisher or issuer / date, publication process, number of pages, price or its equivalent / comments. If you write to a publisher or issuer, we would appreciate your mentioning **Computers and Automation**.

**Indonesian Scientific Periodical Index, 1960 / Pembangunan Publishing House, Gunung Saharo 84, Djakarta, Indonesia / 1961, printed, 91 pp, limited distribution**

This index provides a list of articles published in Indonesian periodicals during 1960. More than 1000 titles are listed. A list of periodicals is then given. The name of the periodical, its translation in English (where necessary), the language and frequency of publication and address of publisher are given. For the articles, the title, author and a classification number are given. In addition, a bibliography is included. The articles are listed under general headings such as: Logic, Religion, Mathematical and Natural Sciences, the Arts, Literature, etc.

**Miller, C. L. / COGO: A Computer Programming System for Civil Engineering Problems / Mass. Inst. of Technology, 77 Massachusetts Ave., Cambridge, Mass. / 1961, offset, 43 pp, limited distribution**

A programming system for solving coordinate geometry problems in civil engineering using a digital computer is described. Applications of the Coordinate Geometry program are given. The author is Director of the Civil Engineering Systems Laboratory at M. I. T. He discusses the commands which the program recognizes and explains their usage. Three appendices include sample problems and discuss design problems and how they were (or why they were not) solved.

**Symposium at the Western Data Processing Center (13 authors) / Contributions to Scientific Research in Management / Western Data Processing Center, University of California, Los Angeles 24, Calif. / 1959, printed, 172 pp, \$2.50**

Twelve papers by 13 authors which were delivered immediately following dedication ceremonies at the center are here published. The headings—which represent sessions—are: The Economics of Management, General Theory of Management and Particular Fields of Management. The papers include the following titles: "Optimization, Decentralization, and Internal Pricing in Business Firms," "Capital Values in a Growing Economy," "Computer Capabilities and Management Models," "Simulation and the Theory of the Firm," and "Forecasting by Generalized Regression Methods."

**Geigenbaum, A. V. / Total Quality Control: Engineering and Management / McGraw-Hill Book Co., Inc., 330 West 42 St., New York 36, N. Y. / 1961, printed, 627 pp, \$11.00**

This book discusses engineering and management methods for achieving maximum quality control. The six parts into which the subject matter is subdivided are: Business Quality Management, Quality-Control Management, Engineering Technology of Quality Control, Applying Total Quality Control in the Company, and Quality-Control Education and Training. The author, Manager of Manufacturing Operations and Quality Control at General Electric, presents an introductory chapter which outlines the principles of quality control. Index.

**Chapin, Ned / Programming Computers for Business Applications / McGraw-Hill Book Co., Inc., 330 West 42 St., New York 36, N. Y. / 1961, offset, 279 pp, \$7.50**

Methods and techniques for efficient programming of "real computers using real programming languages" to control business operations are here discussed on an introductory level and explained. The author, an Assoc. Prof. of Finance at the San Francisco State College and a Systems Analyst at the Stanford Research Inst., presents an introduction to the fundamentals of programming. The chapter, "Programmers and Programming" discusses the role of the programmer and how he fulfills that role. Eight subsequent chapters include: "Automatic Computers," "Translation and Development Programming," "Subroutines and Library Programs," etc. Eight appendices furnish condensed command repertoires for COBOL, IBM 7070 Autocoder and 1401 Systems, Burroughs 220 BLEAP, and other systems. Glossary, selected references and index.

**Bazovsky, Igor / Reliability: Theory and Practice / Prentice-Hall, Inc., Englewood Cliffs, N. J. / 1961, printed, 292 pp, \$10.95**

This interesting and useful book discusses the components which form a reliable system and presents methods for attaining reliability. The first of twenty-six chapters introduces "The Concept of Reliability." The author briefly discusses the meaning of reliability in engineering, failure frequency, probability, and estimates. Other chapters include: "The Exponential Case of Chance Failures," "Wearout and Reliability," "Bayes' Theorem in Reliability," "System Maintenance, Availability, and Dependability," "Design Analysis Examples," "The Implementation of Reliability" and "The State-Of-Art of Reliability." Index.

**Hennie, Frederick C., III / Iterative Arrays of Logical Circuits / John Wiley & Sons, Inc., 440 Park Ave. South, New York 16, N. Y. / 1961, offset, 242 pp, \$4.95**

The properties of one- and two-dimensional iterative networks of logical circuits are examined in this monograph which was presented by the author as his doctoral thesis at M. I. T. in May, 1961. This book may be of interest for people working in the communications sciences. Eleven chapters include: Decidable Systems, Analysis of Transient Behavior, Synthesis of Unilateral Systems, Reduction Techniques, and Conclusions. Two appendices include a proof of a lemma occurring in the text and a list of theorems and corollaries. References and index.

Dubinsky, Alvin C. / Real Root Evaluation with the UNIVAC 120 Computer / Remington Rand UNIVAC, 315 Park Ave. South, New York 10, N. Y. / 1960, offset, 27 pp, free on request

The Newton-Raphson method for real root evaluation can be used to derive approximate solutions to algebraic equations, using the computer. This paper discusses the method and the computer program which gives the approximations.

Correlation and Optimization of Chemical Kinetics Models / Computer Systems, Inc., Culver Rd., Monmouth Jct., N. J. / 1960, offset, 26 pp, free on request

A new procedure for determining the mathematical model and optimum process parameters for economic optimization of chemical processes, is described. The DY-STAC analog computer is used in the procedure. The discussion points out the importance of the dynamic memory and high-speed repetitive operations which are features of the DYSTAC system.

Howe, H. Herbert / ISOPAR—A New and Improved Symbolic Optimizing Assembly Routine for the IBM 650, NBS Technical Note #76, PB 161577 / U. S. Dept. of Commerce, Office of Technical Services, Washington 25, D. C. / 1960, offset, 55 pp plus program listings, \$1.50

Following a brief discussion of the nature of assembly programs, this publication describes ISOPAR. The program's input formats, pseudo-ops, outputs, processing techniques and space requirements are given. Many examples of its application are demonstrated. An analysis of the desirability of the program's unique features concludes the discussion.

Reifler, Erwin, W. Ryland Hill, David L. Johnson and others / Linguistic and Engineering Studies in Automatic Language Translation of Scientific Russian into English / University of Washington Press, Seattle 5, Wash. / 1960, printed, 658 pp, \$10.00

This book presents a summary of the fundamental problems, procedures and achievements of a lexicographical research project to establish an automatic system for machine translation other than the electronic computer systems previously used. In two parts, Linguistic Analysis and Engineering Analysis, the report includes an outline of the project, the selected Russian texts, information on the use of the IBM 650 computer for the study of syntax, dictionary card processing procedures, and a number of appendices containing research papers. Two of the appended articles report on "A Coding and Operational Program for Machine Translation Using a High-Capacity Optical Memory," and "The Design of a Practical Russian-English Mechanical Translator."

Charnes, A., and W. W. Cooper / Management Models and Industrial Applications of Linear Programming, vol. 1 / John Wiley & Sons, Inc., 440 Park Ave. South, New York 16, N. Y. / 1961, printed, 471 pp, \$11.75

This book, designed mainly for persons who are interested in managerial applications of linear programming, is based on the results of actual managerial problems over almost ten years. In twelve chapters the authors discuss: the uses of mathematics in the applications; the interpretation of data; the evaluation of results to determine whether or not a result is the best one; basic theorems in the theory of linear inequalities; and many other topics, including mathematical models and applications. Five appendices include additional concepts and theorems. A suggested topical outline for classroom use, a glossary of symbols, and an index are included.

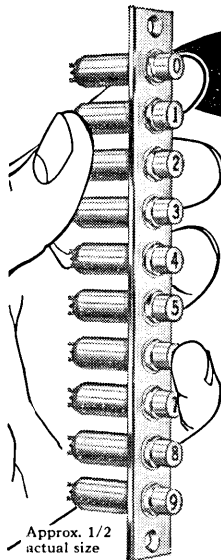

**DATA STRIP** No. DSV-7538-10  
Vertical... complete with ten No. 39-28-1475 Lamp Cartridges. Other configurations to order.

Shown actual size, left to right:  
Lamp Cartridges—Nos. 39-6-1471, 38-1531, 38-931... Lampholder No. 7538... Datalite No. 249-7841-931 with built-in Neon Lamp and resistor.\*

Most Adaptable and Effective  
**For COMPUTERS, DATA PROCESSING, AUTOMATION, INSTRUMENTATION and MINIATURIZATION**

# DATALITES®

FOR USE AS SINGLE INDICATOR LIGHTS, OR GROUPED AS A **DATA STRIP®** OR **DATA MATRIX®**

DATALITES by DIALCO are ultra-miniature Indicator Lights, made in 2 basic styles: *Lampholders* with DIALCO's own *replaceable Lamp Cartridges*; or integrated DATALITES with *Built-in Neon Lamps*\*... Mount in  $\frac{3}{8}$ " clearance hole... **LAMPS USED:** T-1 $\frac{3}{4}$  Incandescent; also Neon NE-2E or NE-2H.

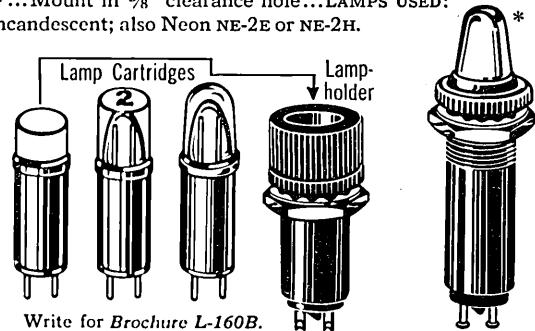

Write for Brochure L-160B.

**DIALCO®**  
**PILOT LIGHTS**

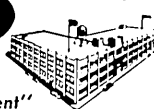

"The Eyes of Your Equipment"

60 STEWART AVE., BROOKLYN 37, N. Y. • Area Code 212, HYacinth 7-7600

Foremost Manufacturer of Pilot Lights

**DIALIGHT CORPORATION**

Interstate Electronics Corp. staff / Digital Application Notes / Interstate Electronics Corp., Marketing Dept., 707 East Vermont Ave., Anaheim, Calif. / 1961, printed, 68 pp, free on request

A basic guide in selecting circuits for various design problems, and some fundamental data on logic theory, are here presented. The first section of the book covers "Basic Logic Design Principles," in which the binary number system, Boolean Algebra and logical implementation of the algebra are discussed. The other sections are: Graphic Symbols for Logic Diagrams, IEC Digital Logic Modules, and "Logic Circuit Configurations."

Shwop, John E., and Harold J. Sullivan, Editors / Semiconductor Reliability / Engineering Publishers, Div., AC Book Co., Inc., P. O. Box 2, Elizabeth, N. J. / 1961, printed, 309 pp, cost ?

Twenty-five of the papers delivered at the Conference on Reliability of Semiconductor Devices, 1961, are here published. They provide a good source of information on the status of semiconductor devices. Among the titles: "Reliability Improvement of Semiconductor Devices—A Status Report," "Failure Modes in Transistors," "Results of 100 Per Cent Screening of Transistors and Diodes for an Airborne Digital Computer," "Reliability Observations Based on Two Billion Unit-Hours," and "Transistor Reliability Estimated with the Poisson Distribution."

Graham, Dunstan, and Duane McRuer / Analysis of Nonlinear Control Systems / John Wiley & Sons, Inc., 440 Park Ave. South, New York 16, N. Y. / 1961, printed, 482 pp, \$9.75

The applications of nonlinear theory in control systems are discussed from an anal-

ysis point of view, with emphasis on actual experiences. The major part of the book concerns a general theory of "quasi-linear" systems and topological phase space techniques. Ten chapters include "General Techniques for Solving Nonlinear Control Problems," "Quasi-Linear Closed Loop Systems with Periodic Outputs," "The Phase Plane Method," and a final chapter "Epilog and Consequence"—a summing up of current developments. Four appendices include charts and additional information. Author and subject indices.

Automatika and Telemekanika, vol. 22, No. 8 / University Nauk, Moscow, U. S. S. R. / 1961, printed, 185 pp, cost ?

This edition of the Russian-language publication contains seventeen articles, including: "On Absolute Stability of Nonlinear Automatic Control Systems," "Automatic Optimization of Space Distribution, part III," "Theory of Switching Circuit Synthesis," "A Problem of Digital Reproduction of an Analog Telemetering System Signal," and "High-Speed Multi-Channel Transistor Distributor."

Linguistic Problems of Cybernetics and Structural Linguistics, 61-21201, Foreign Developments in Machine Translation and Information Processing No. 16 / Office of Technical Services, U. S. Dept. of Commerce, Washington 25, D. C. / 1961, printed, 16 pp, 50 cents

This English translation from the Russian of an article which appeared in *Philosophic Languages*, discusses the objectives of cybernetics, the role of language in the processes of control, structural linguistics as an abstract theory of languages, and the significance of structural linguistics.

# NEW PATENTS

**RAYMOND R. SKOLNICK**

Reg. Patent Agent

Ford Inst. Co., Div. of Sperry Rand Corp., Long Island City 1, New York

The following is a compilation of patents pertaining to computer and associated equipment from the "Official Gazette of the U. S. Patent Office," dates of issue as indicated. Each entry consists of patent number / inventor(s) / assignee / invention. Printed copies of patents may be obtained from the U. S. Commissioner of Patents, Washington 25, D. C., at a cost of 25 cents each.

## October 10, 1961 (Cont'd)

3,004,252 / Edward J. Zola, Jr., Vestal, Kenneth W. Van Mechelen, Endicott, Gene J. Cour, Owego, and William L. McDermid, Vestal, N. Y. / I.B.M. Corp., New York, N. Y. / A binary to digital pulse train converter.

## October 17, 1961

No applicable patents.

## October 24, 1961

3,005,977 / Douglas C. Wendell, Jr., Berwyn, Pa. / Burroughs Corp., Detroit, Mich. / A bi-stable state magnetic element and coupled circuitry.  
3,005,978 / Joseph S. Wapner, Hatboro, Pa. / Fischer and Porter Co., Hatboro, Pa. / An electro-pneumatic data logger.

## ADVANCED SYSTEMS DEVELOPMENT

Emerging now from three years' intensive effort at International Electric is a computer-based communication system that equals the state-of-the-art. Future progress will depend upon our ability to advance the state-of-the-art in our design and development of future systems.

Research Specialists are needed for original contributions in Artificial Intelligence, to result in advanced techniques in man/machine communications. They will perform studies in such fields as linguistics, philology, learning theory, automatic programming, information retrieval, simulation and compilers.

Programming Specialists are needed for advanced program analysis and development for large, real time digital systems.

For consideration, send your resume to Manager of Technical Staffing, Dept. CA.

## INTERNATIONAL ELECTRIC CORPORATION

An Associate of International Telephone and Telegraph Corporation

Rte. 17 & Garden State Pky.  
Paramus, New Jersey

An equal opportunity employer.

## October 31, 1961

3,006,549 / William R. Hughes, Sylmar, Calif. / U. S. A. as represented by the Sec. of the Army / A digital divider.  
3,006,550 / Ewell C. Johnson and Yu Chi Ho, Royal Oak, Mich. / The Bendix Corp., a corp. of Del. / A digital multiplier.  
3,007,056 / Joseph C. Logue, Poughkeepsie, N. Y., and Harold C. Goodman, Rosemont, Pa. / I.B.M. Corp., New York, N. Y. / A transistor gating circuit.  
3,007,137 / John F. Page and Arnold M. Spielberg, Haddonfield, N. J. / R.C.A., a corp. of Del. / An information handling system.  
3,007,138 / Vladimir P. Honeiser, Paramus, and Howard S. Margetts, Lincoln Park, N. J. / International Telephone and Telegraph Corp., Nutley, N. J. / A code recognition circuit.  
3,007,139 / Donald R. Young, Poughkeepsie, N. Y. / I.B.M. Corp., New York, N. Y. / A circuit element for use in logical and memory circuits.  
3,007,140 / Robert C. Minnick, Menlo Park, and Edwin S. Lee, III, San Gabriel, Calif. / Burroughs Corp., Detroit, Mich. / A dynamic storage device for a computer.  
3,007,141 / Hawley K. Rising, Lexington, Mass., and Richard G. Counihan, Poughkeepsie, N. Y. / Research Corp., New York, N. Y. / A magnetic memory device.  
3,007,142 / An Wang, Lincoln, Mass. / I.B.M. Corp., New York, N. Y. / A magnetic flux storage system.  
3,007,143 / Jacob J. Hagopian, San Jose, Calif. / I.B.M. Corp., New York, N. Y. / An apparatus for reading stored information from overlapping recorded pulses.  
3,007,144 / Jacob J. Hagopian, San Jose, Calif. / I.B.M. Corp., New York, N. Y. / A data storage apparatus.  
3,007,145 / Orlando J. Murphy, New York, N. Y. / Bell Telephone Lab., Inc., New York, N. Y. / A synchronizing circuit for a magnetic drum.  
3,007,146 / Arthur J. Fletcher, Torrance, and Edward Dillingham, Los Angeles, Calif. / Thompson Ramo Wooldridge, Inc., Cleveland, Ohio / A magnetic head locking device for a magnetic drum.

## November 7, 1961

3,007,631 / Richard H. Jones, Bridgeport, and Robert S. Bradshaw, Broomall, Pa. / Burroughs Corp., Detroit, Mich. / A data storage and readout unit for accounting machines.  
3,007,642 / Robert M. Lee, Los Angeles, Calif. / The Bendix Corp., a corp. of Delaware / A digit-shifting memory system.  
3,007,643 / John W. Tukey, Princeton, N. J. / Bell Telephone Lab., Inc., New York, N. Y. / A microwave data processing circuit.  
3,008,020 / Warren P. Mason, West Orange, N. J. / Bell Telephone Lab., Inc., New York, N. Y. / A pulse operated reed switch and storage device.  
3,008,055 / Robert L. Crosby, Watertown, Mass., and Gregory J. Prom, St. Paul, and James R. Kelsey, Minneapolis, Minn. / Sperry Rand Corp., a corp. of Delaware / A bistable circuit having unidirectional feedback means.  
3,008,056 / Cravens L. Wanlass, Whittier, Calif. / North American Aviation, Inc. / A general logic gating circuit.  
3,008,057 / Carl M. Campbell, Jr., Bryn Mawr, Pa. / Burroughs Corp., Detroit, Mich. / A bistable circuit.  
3,008,058 / Robert W. Clark, Centerville, Ohio / The National Cash Register Co., Dayton, Ohio / A logical element with

# PAPER : : : TAPE SERVICES

## 5, 6, 7, 8 Channel

Tape to Tab Cards  
Tab Cards to Tape  
Tape Regeneration

Editing and Translations

Machine Tool or Computer

Program Tapes Prepared

Tapes for automatic typesetter or graphotype

USE YOUR OWN TAB CARDS OR  
OUR EXPERIENCED KEY PUNCH DEPT.



## TAPE PROCESSING, Inc.

381 PARK AVENUE SO., NEW YORK 16, N.Y.

YUkon 6-8414

shunt connected impedance changing switching means.

3,008,066 / Sterling P. Newberry, Schenectady, N. Y. / G.E. Co., a corp. of New York / An information storage system.  
3,008,123 / William S. Rohland, Endicott, and Evon C. Greanias, Vestal, N. Y. / I.B.M. Corp., New York, N. Y. / An apparatus for analyzing intelligence manifestations.  
3,008,124 / James T. Warnock, Havertown, Pa. / Philco Corp., Philadelphia, Pa. / A system for transmission and reception of binary digital information.  
3,008,125 / Solomon Zadoff, Flushing, and William Abourezk, Huntington Station, N. Y. / Sperry Rand Corp., a corp. of Del. / A signal identification and alignment system.  
3,008,127 / Richard M. Bloch, West Newton, and Joseph J. Eachus, Cambridge, Mass. / Minneapolis-Honeywell Regulator Co., Minneapolis, Minn. / An information handling apparatus.  
3,008,128 / Ralph R. Powell, Los Angeles, Calif. / The National Cash Register Co., Dayton, Ohio / A switching circuit for a magnetic core memory.  
3,008,129 / Abraham Katz, Haddonfield, N. J. / R.C.A., a corp. of Del. / A memory system.

## November 14, 1961

3,009,068 / Francois H. Raymond, Saint-Germain-en-Laye, Fr. / Societe d'Electronique et d'Automatisme, Courbevoie, Fr. / A binary data processing device.  
3,009,069 / Bock W. Lee, New York, N. Y. / Bell Telephone Lab., Inc., New York, N. Y. / A monostable circuit.  
3,009,134 / Amnon Broshi, Philadelphia, Pa. / American Bosch Arma Corp., Hempstead, N. Y. / A binary signal verification system.



- 3,009,135 / Herbert A. Showell, Chislehurst, and Christopher W. Barrow, Dunton Green, England / Siemens Edison Swan Lim., London, Eng. / A magneto-strictive delay line.
- 3,009,136 / David R. Bennion, Loma Mar, and Douglas C. Engelhart and Edwin K. Van De Riet, Palo Alto, Calif. / Stanford Research Institute, Palo Alto, Calif. / A flux doubling in magnetic core registers.

**November 21, 1961**

- 3,009,636 / Dale H. Rumble, Poughkeepsie, N. Y. / I.B.M. Corp., New York, N. Y. / A data comparing system.
- 3,009,640 / Etienne Honoré and Emile Torcheux, Paris, France / Compagnie Generale de Telegraphie sans Fil, a corp. of France, and Societe Marocaine de Recherches, d'Etudes et de Developpements "Somarede," a corp. of Morocco / Improvements in electric analog computer circuits.
- 3,009,642 / Rolf E. Spencer, London, Eng. / Electric and Musical Industries, Lim., Hayes, Middlesex, Eng. / An apparatus for deriving a differential coefficient of a quadratic function.
- 3,010,035 / John F. Calvert and Tsung W. Sze, Pittsburgh, Pa. / John F. Calvert, Pittsburgh, Pa. / A short-time memory device in a closed loop system.
- 3,010,094 / John L. MacArthur, Silver Spring, Md. / Minneapolis-Honeywell Regulator Co., Minneapolis, Minn. / An electrical data handling apparatus.
- 3,010,101 / Jerry C. Koci, Barrington, Ill., and Stanford M. Heide, Kenosha, Wis. / Chicago Dynamic Industries, Inc., Chicago, Ill. / A device for visually digitally reading to a binary code and its complement.

**November 28, 1961**

- 3,010,653 / Michele Canepa, South Norwalk, Conn. / Ing. C. Olivetti & C., S.p.a., Ivrea, Italy / A digital input mechanism for computing machines.
- 3,010,654 / Raymond W. Ketchledge, Whippany, N. J. / Bell Telephone Lab., Inc., New York, N. Y. / A signal comparison system.
- 3,010,655 / Raymond W. Ketchledge, Whippany, N. J. / Bell Telephone Lab., Inc., New York, N. Y. / A signal comparison system.
- 3,011,023 / Lewis S. Billig, Wayland, and Kenneth C. Perkins, Lynnfield Centre, Mass., and James K. Watson, Concord, Calif. / General Electronics Lab., Inc., Cambridge, Mass. / A frequency shift keyed signal converter.
- 3,011,129 / Kay B. Magleby, San Jose, and Victor E. Van Duzer, Mountain View, Calif. / Hewlett-Packard Co., Palo Alto, Calif. / A plural series gate sampling circuit using positive feedback.
- 3,011,154 / Gerhard Dirks, 44 Marfelder Landstrasse, Frankfurt am Main, Germany / A signal storage device with correction means.
- 3,011,155 / Kermit S. Dunlop, Madison, N. J. / Bell Telephone Lab., Inc., New York, N. Y. / An electrical memory circuit.
- 3,011,156 / Donald H. MacPherson, New Shrewsbury, N. J. / Bell Telephone Lab., Inc., New York, N. Y. / An information storage arrangement.
- 3,011,157 / John R. Anderson, Dayton, Ohio / The National Cash Register Co., Dayton, Ohio / A storage device.
- 3,011,158 / John L. Rogers, Hermosa Beach, Calif. / Bell Telephone Lab., Inc., New York, N. Y. / A magnetic memory circuit.
- 3,011,159 / Peter S. Glaser, Culver City, Walter G. Edwards, Manhattan Beach,

# THINK... High Density

242,000 to  
450,000 BCD Digits/Sec

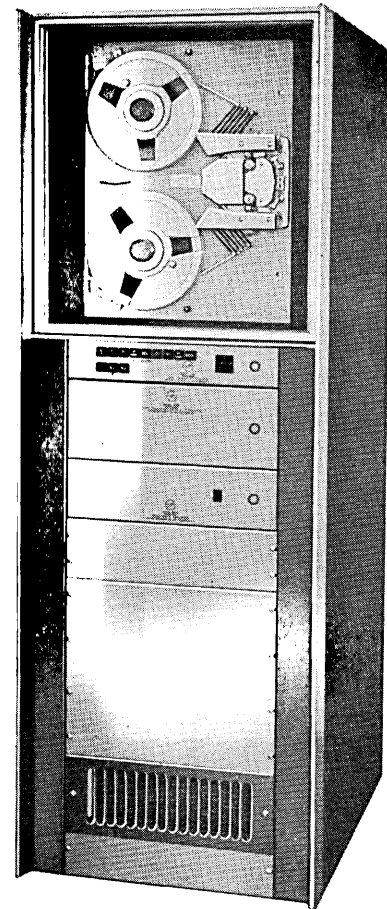

Available from  
**POTTER**  
Today!

Potter High Density Tape Systems provide reliable performance for any computer system...and at bit packing densities higher than any other digital magnetic tape system available now. Each reel of 1-inch tape recorded using the Potter High Density technique holds as much data as eleven reels recorded by the most common systems. This break-through in the art provides data transfer rates of 242,000 to 450,000 BCD digits per second...with a guaranteed recovery of at least 99,999,999 out of 100,000,000 bits recorded at the higher transfer rate.

*There's much more to our story. So much more that we've produced a fact-filled brochure called "The Topic is...HIGH DENSITY." It's designed to answer your questions regarding this advanced recording technique...why not send for your copy today?*



**POTTER INSTRUMENT CO., INC.**  
Sunnyside Boulevard • Plainview, New York

## automation comes to tape-winding

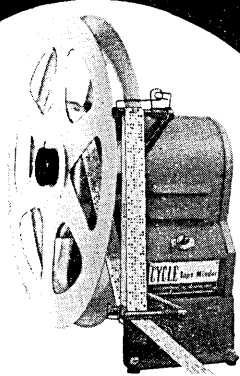

**A better method — a better machine for automatically winding perforated, communications, computing or accounting tape.**

The Cycle Universal Tape Minder is made to satisfy all the demands of modern tape handling techniques. Write for descriptive literature, form # CA-2

**DEALER  
INQUIRIES  
INVITED**

**CYCLE EQUIPMENT COMPANY**  
17480 Shelburne Way • Los Gatos, Calif.



Calif. / The National Cash Register Co., Dayton, Ohio / A shift register device.

### December 5, 1961

- 3,011,703 / Philip S. Rand, Redding Ridge, Conn. / Sperry Rand Corp., New York, N. Y. / A record sensing means.  
3,011,705 / Maurice D. De Mong, Torrance, Calif. / U. S. A. as represented by the Sec. of the Navy / An electronic differential computer.  
3,011,709 / George V. Jacoby, Philadelphia, Pa. / Minneapolis-Honeywell Reg. Co., Minneapolis, Minn. / A computer apparatus for rapidly changing the value of a process variable.  
3,011,710 / Fred E. Sakalay and Delbert E. Elder, Poughkeepsie, N. Y. / I. B. M. Corp., New York, N. Y. / A numeric information storage and translation system.  
3,011,711 / Dudley A. Buck, North Wilmington, Mass. / Research Corp., New York, N. Y. / A cryogenic computing device.  
3,011,712 / Kenneth V. Diprose, Addlington, near Macclesfield, and Geoffrey C. Rowley, Cheam, Eng. / A. V. Roe & Co., Lim., Greengate, Middleton, Manchester, Eng. / A digital computing engine.  
3,012,155 / Edgar J. Jagger, West Covina, Calif. / Hughes Aircraft Co., Culver City, Calif. / A three state memory device.

### December 12, 1961

- 3,012,723 / Gerald Goertzel, White Plains, and John H. Greig, New York, N. Y. / City, Calif. / A three state memory device.  
3,012,724 / Frederic C. Williams, Romiley, Tom Kilburn, Davyhulme, Manchester, Maxwell H. Newman, Altrincham, and Geoffrey C. Tootill, Hawley, Camberley, Eng. / I. B. M. Corp., New York, N. Y. / An electronic digital computing device.

**"By far the most  
comprehensive book  
on the subject"**

SATURDAY REVIEW

## TEACHING MACHINES AND PROGRAMMED LEARNING

*a source book*

edited by  
**A. A. LUMSDAINE &  
ROBERT GLASER**

47 basic papers in full,  
a 28-page bibliography  
and some 200 research  
abstracts

For further information, write . . .

THE DEPARTMENT OF  
AUDIOVISUAL INSTRUCTION  
National Education Association  
1201 Sixteenth Street N.W.  
Washington 6, D. C.

736 pages 1960 \$7.50

## ADVERTISING INDEX

Following is the index of advertisements. Each item contains: Name and address of the advertiser / page number where the advertisement appears / name of agency if any.

American Telephone & Telegraph Co., 195 Broadway, New York 7, N. Y. / Page 3 / N. W. Ayer & Son, Inc.

Audio Devices, Inc., 444 Madison Ave., New York 22, N. Y. / Page 51 / Charles W. Hoyt Co.

Burroughs Corp., Detroit 32, Mich. / Page 17 / Campbell-Ewald Co.

Columbus, A Division of North American Aviation, Inc., 4300 E. Fifth Ave., Columbus 16, Ohio / Page 54 / Batten, Barton, Durstine & Osborn, Inc.

Control Data Corp., 501 Park Ave., Minneapolis 15, Minn. / Page 15.

Cycle Equipment Co., 17480 Shelburne Way, Los Gatos, Calif. / Page 58 / Benet Hanau & Associates, 1011 Park Ave., San Jose, Calif.

Dataman Associates, Inc., 6 Beacon St., Boston, Mass. / Page 60 / Larcom Randall Advertising, Inc.

Dialight Corp., 60 Stewart Ave., Brooklyn 37, N. Y. / Page 55 / H. J. Gold Co.

Electronic Associates, Inc., Long Branch, N. J. / Page 47 / Gaynor & Ducas, Inc.

Hamilton Wittman Associates, 551 Main St., E. Orange, N. J. / Page 5 / Diener & Dorskind, Inc.

International Business Machines Corp., 590 Madison Ave., New York 22, N. Y. / Page 13 / Benton & Bowles, Inc.

International Business Machines Corp., Data Processing Div., 112 E. Post Rd., White Plains, N. Y. / Pages 42 & 43 / Marsteller, Rickard, Gebhardt & Reed, Inc.

International Electric Corp., Rte. 17 & Garden State Pky., Paramus, N. J. / Page 56 / Carpenter, Matthews & Stewart, Inc.

Litton Systems, Inc., Canoga Park, Calif. / Page 19 / Compton Advertising, Inc.

National Cash Register Co., Dayton 9, Ohio / Pages 8, 41 / McCann-Erickson, Inc.

National Education Association, Dept. of Audiovisual Instruction, 1201 Sixteenth St., N.W., Washington 6, D. C. / Page 58.

Potter Instrument Co., Inc., Sunnyside Blvd., Plainview, N. Y. / Page 57 / Gamut, Inc.

Remington Rand Univac, Div. of Sperry Rand Corp., Univac Park, St. Paul 16, Minn. / Page 53 / Mullen & Associates, Inc.

Statistical Tabulating Corp., 104 S. Michigan Ave., Chicago 3, Ill. / Page 2 / Fred H. Ebersold, Inc.

Tape Processing, Inc., 381 Park Ave. So., New York 16, N. Y. / Page 56 / Frederick H. Cassens.

Technical Operations, Inc., 3600 M St., N.W., Washington 7, D. C. / Page 59 / Edwin F. Hall Advertising.

John Wiley & Sons, Inc., 440 Fourth Ave., New York 16, N. Y. / Page 46 / Needham & Grohmann, Inc.

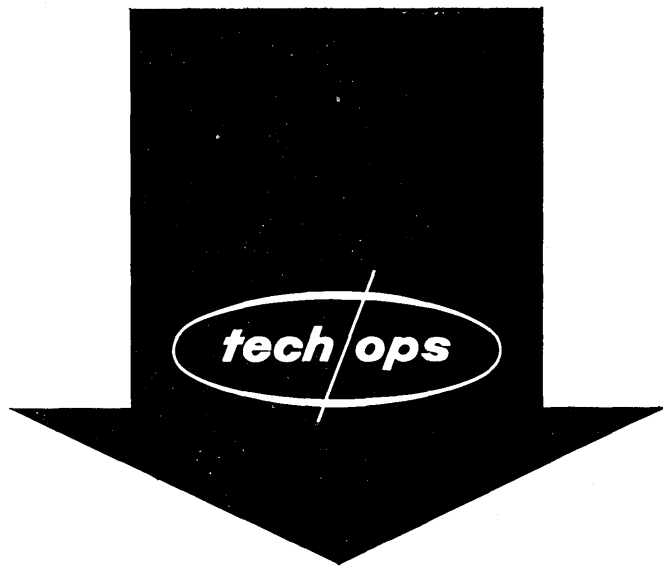

to  
programming  
scientists  
interested  
in solving  
**UNUSUAL**  
problems . . .

We are addressing this to programming scientists who have been in one phase or another of programming work over the past few years and are now seriously assessing their long-range professional development. We are particularly interested in programming scientists who feel that their assignments have not been broad enough to develop their professional and managerial capabilities to the fullest extent. If this strikes a responsive chord with you, we may have a position of more than casual interest.

Tech/Ops' work in Washington, where our staff numbers almost a hundred, consists of solving through the use of rather advanced computer simulation, operations research and related techniques, somewhat complex problems for a variety of different organizations. Sponsors range from Headquarters, U.S. Air Force, for whom we operate Project Omega (a simulation of a large scale strategic air war battle), to the Federal Aviation Agency (analysis of air traffic control systems). Some of the kinds of problems in a little more detail:

- *Development of programming systems (assemblers, compilers, translators, generators, string handling packages, and the like). We have constructed and are using CL-1 and are now ready to build a more powerful computer language.*
- *Simulation techniques: using high-speed computers to determine the impact of new operational procedures, plans or equipment, when direct experimentation is too costly or otherwise impractical.*
- *Analysis and programming for command control systems; status and employment of resources; routing and scheduling; information storage, retrieval and display; report generation.*
- *Evaluation of large, complex weapons and communications systems, studies of logistic systems to increase operational efficiency.*
- *Mathematical analysis and its application to operational problems; e. g., queueing theory, linear programming, inventory control analysis, equations describing combat operations.*

Scientists who fare best in our environment essentially have the problem-solving approach coupled with a specialty in one or more of the following fields: programming; programming systems; information storage, retrieval and display; simulation models; command control systems and man-machine war games. In addition to programming scientists on a senior level, appointments are also available for promising programmers of lesser experience.

Contact Mr. Kingsley Andersson

**TECHNICAL OPERATIONS, INCORPORATED**

3600 M STREET N. W., WASHINGTON 7, D. C.

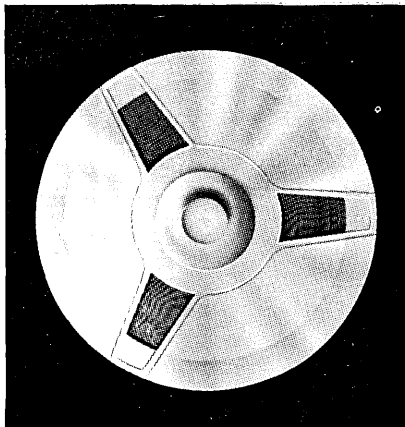

## Careers in COMPUTERS

### **Programmers**

Experience to include programming on large scale equipment with programs and applications of a Business, Scientific or Engineering nature. 7090 experience preferred.

### **Creative Programmers**

Professionals who wish to participate in advancing the state of the art, with experience or training in:

- |                                  |                         |
|----------------------------------|-------------------------|
| Compiler Writing                 | System Design           |
| Automatic Programming            | Language Analysis       |
| Artificial Language Construction | Information Retrieval   |
| Non Numerical Mathematics        | Artificial Intelligence |
| Symbolic Manipulation            | Operations Research     |
| Game Playing                     | Symbolic Logic          |

List Processing Techniques

### **Ph.D.'s in Mathematics, Statistics, Applied Mathematics or E.E.** with experience or interests in any of the following areas:

concepts studies of system availability from the viewpoint of on line data processing systems; knowledge of systems engineering or probability theory necessary.

development of new analysis techniques required in the design of programming large real time computer systems; broad technical background required with specialization in Statistics or Modern Applied Mathematics.

exploration of new techniques in fault location on systems including new logic, diagnostic programming techniques and applied programming techniques.

planning and execution of a full line of computer systems, plan programming systems to accompany the new machines, or the logic design and engineering of one or more of the new systems.

*Our client, a leader in the data processing field, is presently expanding in non-military areas (East Coast location). Professionals whose interests and qualifications are in the above fields, please submit complete resume with salary requirements to:*

**DATAMAN\***  
ASSOCIATES  
PERSONNEL CONSULTANTS

6 Beacon St., Boston, Mass. - Richmond 2-1932

\*DATA MANAGEMENT... Recruiting Specialists for Data Processing and Computer Personnel Exclusively.