



The New York Times and  
Computers and Automation  
have published a practical guide to  
the most elusive components in  
computers and data processing...

# PEOPLE

Who they are...  
What they do...  
Where they do it...

Until now, it has been well-nigh impossible to keep track of the thousands of highly skilled professionals engaged in the world's fastest growing profession.

The painstaking task required to inventory the qualifications and backgrounds of the 15,000 "most necessary" professionals in every branch of the computer field has been accomplished. The oldest magazine in the field, *Computers and Automation*, and the information retrieval services of *The New York Times* have pooled their resources to produce the Fifth Edition of

## WHO'S WHO IN COMPUTERS AND DATA PROCESSING

This is the most extensive register of computer professionals ever published. It is arranged in three volumes:

1. *Systems Analysts and Programmers*
2. *Data Processing Managers and Directors*
3. *Other Computer Professionals* (from professors of computer science to attorneys versed in the computer field)

Each volume has an index to the entire set of entries.

Each computer specialist has a capsule biography detailing: *Birth Date* . . . *Education* . . . *Year Entered Computer Field* . . . *Title* . . . *Honors* . . . *Memberships* . . . *Special Skills* (from applications to logic to sales) . . .

PLUS both home and business addresses. For example:

CHAPIN, Ned / consultant / born: 1927 / educ: PhD, IIT; MBA, Univ of Chicago / entered computer field: 1954 / main interests: applications, business, logic, management, programming, systems, data structures / title: data processing consultant / organization: InfoSci Inc, Box 464, Menlo Park, CA 94025 / publications, honors: 3 books, over 50 papers; member, over 12 associations; CDP; lecturer for ACM / home address: 1190 Bellair Way, Menlo Park, CA 94025

This reference is particularly useful for: personnel managers; employers; recruiting organizations; libraries; conference planners; directors of computer installations; . . . anyone who needs to keep up with the important people in the field.

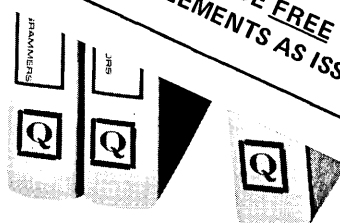
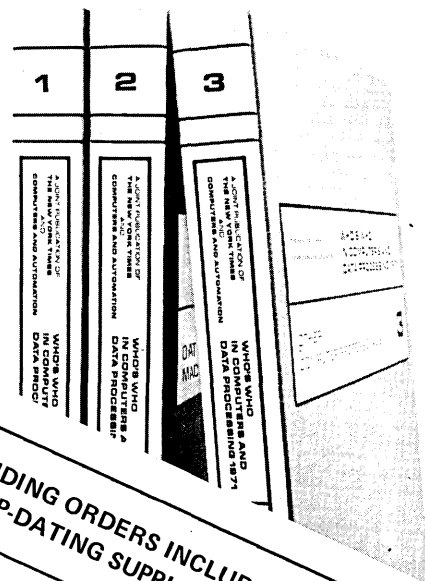

FIFTH EDITION — Over 1000 pages

The coupon below will bring you the 3-volume set at the price of \$75. There is no risk involved. *10-Day Free Examination.*

### WHO'S WHO IN COMPUTERS AND DATA PROCESSING

*Edited by Edmund C. Berkeley*  
3 volumes in durable hard-cover bindings  
Retail price \$75 the set

---(may be copied on any piece of paper)---

#### Who's Who in Computers and Data Processing,

815 Washington St., Newtonville, Mass. 02160

- ( ) Please send the 3-volume set WHO'S WHO IN COMPUTERS AND DATA PROCESSING at \$75. You will bill me *after delivery* and I may return the set within 10 days if not fully satisfied.
- ( ) Please make this order a standing order for the 5th and later editions — so that I will receive all updating supplements free automatically.
- ( ) I have already bought the 5th Edition. Please change my record of purchase to a standing order, and send me Supplement 1 FREE.

NAME \_\_\_\_\_

TITLE \_\_\_\_\_

ORGANIZATION \_\_\_\_\_

ADDRESS \_\_\_\_\_

CITY \_\_\_\_\_

STATE & ZIP \_\_\_\_\_

YOUR SIGNATURE \_\_\_\_\_

P.O. # (IF COMPANY ORDER) \_\_\_\_\_



# computers and automation

The magazine of the design, applications, and implications  
of information processing systems.

---

<i>Editor</i>	<b>Edmund C. Berkeley</b>
<i>Assistant Editors</i>	<b>Linda Ladd Lovett</b> <b>Neil D. Macdonald</b>
<i>Software Editor</i>	<b>Stewart B. Nelson</b>
<i>Advertising Director</i>	<b>Edmund C. Berkeley</b>
<i>Art Directors</i>	<b>Ray W. Hass</b> <b>Daniel T. Langdale</b>
<i>Contributing Editors</i>	<b>John Bennett</b> <b>Moses M. Berlin</b> <b>Andrew D. Booth</b> <b>John W. Carr III</b> <b>Ned Chapin</b> <b>Alston S. Householder</b> <b>Leslie Mezei</b> <b>Ted Schoeters</b> <b>Richard E. Sprague</b>
<i>Advisory Committee</i>	<b>James J. Cryan</b> <b>Alston S. Householder</b> <b>Bernard Quint</b>

---

*Editorial Offices*    **Berkeley Enterprises, Inc.**  
815 Washington St.,  
Newtonville, Mass. 02160  
617-332-5453

---

*Advertising Contact*    **THE PUBLISHER**  
**Berkeley Enterprises, Inc.**  
815 Washington St.,  
Newtonville, Mass. 02160  
617-332-5453

---

Computers and Automation is published monthly (except two issues in June) at 815 Washington St., Newtonville, Mass. 02160, by Berkeley Enterprises, Inc. Printed in U.S.A.  
Subscription rates: United States, 11 monthly issues and two issues in June (one of which is a directory issue) — \$18.50 for 1 year, \$36.00 for 2 years; 12 monthly issues (without directory issue in June) — \$9.50 for 1 year, \$18.00 for 2 years. Canada, add 50¢ a year for postage; foreign, add \$3.50 a year for postage. Address all U.S. subscription mail to: Berkeley Enterprises, Inc., 815 Washington St., Newtonville, Mass. 02160. Second Class Postage paid at Boston, Mass.  
Postmaster: Please send all forms 3579 to Berkeley Enterprises, Inc., 815 Washington St., Newtonville, Mass. 02160. © Copyright 1971, by Berkeley Enterprises, Inc.  
Change of address: If your address changes, please send us both your new address and your old address (as it appears on the magazine address imprint), and allow three weeks for the change to be made.

## Computer Professionals

- 29 WHO'S WHO IN COMPUTERS AND DATA PROCESSING** [R]  
Edition 5, Supplement 1, Part 2, HOM to ZUS  
Updating information for all three volumes of the Fifth Edition, last names beginning HOM to ZUS.

## 2 WHO'S WHO ANNOUNCEMENT

## Computer Systems

- 8 COMMUNICATIONS MESSAGE SWITCHING — AN ANALYSIS** [A]  
by Walter M. Aydelotte, RCA Information Systems  
Division, Camden, N. J.  
How to organize the switching of communications of data between remote business locations, and how to use delay in transmission to great advantage.

- 18 COMPUTERS ENTER THE BUSING CONTROVERSY** [A]  
by Robert L. Glass, University of Washington, Seattle, Wash.  
Designing a school busing plan in Seattle, so as to implement decisions about assigning students to schools.

- 16 PRODUCING COMPUTER LETTERS FROM NAME AND ADDRESS FILES** [A]  
by Byron J. Koch, Claretian Fathers, Chicago, Ill.  
Ways of having the computer produce sense and not nonsense when preparing computer letters.

## Computers and Medicine

- 14 HIPPOCRATES REVERSED BY COMPUTER: BETTER DIAGNOSIS AND TREATMENT WITH REDUCED COSTS** [A]  
by Dr. Albert E. Casey, Memorial Institute of Pathology, Birmingham, Ala.

How the computer can efficiently change the practice of medicine from an effort to cure disease, to an effort to prevent disease.

## Computers and Society

- 24 RESPONSIBILITY** [A]  
by Sir John Wall, International Computers Ltd., London, England  
Industrial selfishness, commercial myopia, national technological independence, "information pollution" from the computer industry, etc. — and what might be done about it.

*Computers and Common Sense*

- 6 **PREVENTING MISTAKES FROM FAILURE TO UNDERSTAND** [E]  
by Edmund C. Berkeley, Editor, Computers and Automation  
Dealing with mistakes which are due to failure to know the correlation or cause; and how computers might be used to keep problems in appropriate focus.
- 3 **THE C&A NOTEBOOK ON COMMON SENSE, ELEMENTARY AND ADVANCED** [R]

*Computers, Science, and Assassinations*

- 51 **THE CENTRAL INTELLIGENCE AGENCY AND THE NEW YORK TIMES** [A]  
by Samuel F. Thurston, President, Responsive Information Systems, Newton, Mass.  
The issue of systematic suppression of questions about the assassination of President John F. Kennedy, and a hypothesis.

*Forum and Golden Trumpet*

- 57 **Mankind's Prospects Over the Next Ten Years**, by Arnold Toynbee [G]
- 58 **The Predicament of the Computer Professional**, by Joanne Schaefer [F]
- 58 **Hitch-Hiker Arrested Via Routine Check With National Crime Information Center** [F]
- 58 **Computers in Literature**, by Leslie Mezei [G]
- 59 **New Computer Started 1½ Years of Woe**, by Lyndon Watkins [F]
- 59 **Data Banks and Criminal Intelligence Systems**, by Robert Kahn [F]
- 60 **Large Market and Fierce Competition is Forecast for the Business of Minicomputers** [F]  
by John R. Musgrave, Auerbach Corp.
- 60 **Size Shrinkage of Computers** [F]  
by E. E. Bolles, The Bunker Ramo Corp.
- 60 **Computer Fair in Japan in October 1970 Nets \$2.5 Million in U. S. Sales — Spurs Second Fair in Munich, November 30, 1971** [F]
- 60 **"Not Understanding a Computer" — Comment**, by John E. Douglas [G]
- 69 **Association of Data Processing Service Organizations vs. Controller of the Currency and American National Bank of St. Paul** [G]
- 69 **Numble Challenges, Given and Returned** [F]  
by Robert R. Weden and the Editor

*Computers and Puzzles*

- 17 **Numbles**, by Neil Macdonald
- 23 **Problem Corner**, by Walter Penney, CDP



*Front Cover Picture*

A computer at Mass. Inst. of Technology takes in a rough sketch drawn by a man on a "data tablet", and instead of reproducing the sketch with its imperfections, the computer interprets the man's "intentions" and displays a more perfect drawing on the screen. For more information, see page 63.

NOTICE

\* D ON YOUR ADDRESS IMPRINT MEANS THAT YOUR SUBSCRIPTION INCLUDES THE COMPUTER DIRECTORY. \* N MEANS THAT YOUR PRESENT SUBSCRIPTION DOES NOT INCLUDE THE COMPUTER DIRECTORY.

*Departments*

- 61 **Across the Editor's Desk**
- 61 **Applications**
- 62 **Education News**
- 63 **Research Frontier**
- 63 **Miscellaneous**
- 69 **Advertising Index**
- 69 **Book Review**
- 70 **Calendar of Coming Events**
- 23 **Correction**
- 66 **Monthly Computer Census**
- 64 **New Contracts**
- 65 **New Installations**

*Key*

- [A] — Article
- [E] — Editorial
- [F] — Readers' Forum
- [G] — The Golden Trumpet
- [R] — Reference Information

## Preventing Mistakes from Failure to Understand

### 1. The Causes of Mistakes

From the point of view of causes, there are many classes of mistakes. Some are caused by forgetting. You leave a pan heating on the stove intending to return in a few minutes; but you forget, and when you do return, the water has boiled away, the pan is almost red hot, and its contents are charred rubbish. Other mistakes are caused by carelessness. A mother leaves a bottle of aspirin too low on a shelf over the washbowl; and she finds her inquisitive and experimental three-year old child ill from having taken several pills "like Mummy does."

### 2. Failure to Understand

But let us consider the class of mistakes that are caused by failure to understand. These are alluded to in statements like these:

- I did not know the gun was loaded;
- The Romans did not know that the lead water pipes they used in their houses would produce lead poisoning;
- Ignorance of the law is no excuse;
- Those who do not learn from the whippings of Nature are condemned to be whipped again and again.

One of the saddest examples of a mistake caused by a failure to understand that I can remember from my life was the case of a young man, Bill Fitzgerald, who worked with me at the time of my first job about forty years ago. One day we heard Bill had indigestion, and could not come to work. A day or so later we heard that his appendix had ruptured, and he was in a high fever. Three days later he was dead. We found out that his mother had not understood the nature of his illness; she had given him a "good dose of castor oil", and that had caused his appendix to rupture.

### 3. Tentativeness vs. Positiveness

One of the most important requirements for preventing mistakes is to remind oneself that human beings do not know very much, and that a great deal of what passes for knowledge in any one year or decade is tentative, and depends on the fashions of the times and the rituals associated with authorities.

If we compare what human beings think they know nowadays with what human beings thought they knew a hundred years ago, we see great changes. Among these are the following:

1. *Why the Sun Gives Light and Heat.* Currently: The sun is a nuclear furnace like a hydrogen bomb converting hydrogen into helium; the supply of hydrogen will be

exhausted about ten billion years from now. Previously: It was easy to calculate that if the sun were all coal, and were burning it, the supply would last three days; but nobody knew how the sun continued year after year.

2. *Flying in Machines Heavier than Air.* Currently: Jet planes on commercial schedules carry people to any place on earth at a speed of about 600 miles per hour. Previously: As late as the end of the nineteenth hundreds, many authorities and learned men asserted that it would always be impossible for a machine heavier than air to carry human beings and fly.

3. *Origin of Life.* Currently: Many learned men consider it possible that life originated on earth from chemicals mixing in warm tidal pools, under an atmosphere that was mainly hydrogen and methane, and full of thunderstorms. Previously: It was maintained that all life originated from prior life — and as to where life began, if it did, undoubtedly God arranged it.

There are many more examples.

Fundamentally, we do not have good ways for knowing which of our current knowledge will still be accepted as true a hundred years from now, and which will be discarded. In addition, there are many tentative theories put forward by scientists which even the authors sprinkle with question marks.

### 4. Observation, Comparison, and Experiment

Another important method for avoiding mistakes from failure to understand is to observe, compare, and experiment. Actually, theoretical understanding, effective remedies, and preliminary guesses may be separated by centuries.

Take the history of malaria as an example.

*Understanding.* No human being knew its cause until in 1880 a young French physician, Charles L. A. Laveran, working in Algeria, found in human red blood corpuscles of malaria sufferers a microscopic organism which he called "Plasmodium". No human being knew how malaria was spread until 1897, when Ronald Ross, a British physician working in India, found Plasmodium in the stomach of a mosquito.

*Effective Treatment.* More than 200 years earlier (in 1630) a message was sent from some Jesuits in Peru to Spain that in the Andes a tree had been found, the bark of which cured malaria. This tree was eventually called Cinchona, and in 1820 the active chemical named "quinine" was isolated from it by two French chemists.

*Guesses.* Even the Romans found out a correlation between marshes, nighttime, and malaria, and they improved public health by draining marshes. This correlation led to the concept and the word "miasma", which accord-

ing to the dictionary is "a vaporous exhalation formerly believed to cause disease"; the word comes from a Greek word "miainein", "to pollute". The word "malaria" came into English in 1740 from the Italian "mala aria", "bad air".

The scientific method is essentially a refinement of the method of observation, comparison, and experiment; the scientific method includes the making of hypotheses, the drawing of deductions, and systematic positive or negative verification. But one can still accomplish a great deal with just the method of observation, comparison, and experiment. For example, I know of no theory yet put forward that explains scientifically how quinine (the key alkaloid from the bark of the Peruvian tree) acts to cure malaria; but the absence of this knowledge has not prevented modern chemists from developing other similar drugs such as atabrine for treating malaria.

### 5. The Application of Computers to the Increase of Understanding

Of course, in one sense, there has been a vast increase of human knowledge in the last 70 years provided we interpret this increase to mean the knowledge recorded in books, scientific journals, laboratory reports, etc., deposited in the storehouses of human culture, the libraries.

But we are rapidly outrunning the powers of any individual human being:

- to keep in mind and even partially understand many important aspects of the world in an unbiased way;
- to maintain the status of our various problems in appropriate focus;
- to have and to maintain perspective.

Perhaps we can apply computers to this urgent task.

We might work out computer programs which would calculate coefficients or weights to represent relative importance, as is done in a chess-playing computer program. The programs might select items of knowledge for us to be reminded of, in accordance with the calculated importance of each item.

Then we might understand better, and make fewer mistakes from failure to understand; we might be wiser and apply more common sense, both elementary and advanced; we might manage to deal better with our ever more numerous problems, produced by an ever more crowded and complicated society, squeezed together in an ever more limited world — a world with more factors, more variables, more "candy" to make us sick with, and more "dynamite" to destroy us with.

As Ed Yourdon said in an article in our May issue:

Maybe the computers can save us after all.  
It would be worth trying.

*Edmund C. Berkeley*

Edmund C. Berkeley  
Editor

*Note:* An expanded discussion of "Preventing Mistakes From Failure to Understand" constitutes Issue No. 15 in *The C&A Notebook on Common Sense, Elementary and Advanced*. See the announcement on page 3.

# computers and automation and people

## A Statement by the Editor

In September 1951, "Computers and Automation" published its first issue, seven purple-ditto pages long. It contained a list of 75 organizations with their names and addresses, and a few notes about each one, entitled "Roster of Organizations in the Computing Machinery Field"; and that was all. (That variant grew into our annual directory issue.)

Now, twenty years later, we are reaching a kind of stock-taking for C&A. What is the present function of C&A? and what is C&A going to do about it?

What is the present mission of C&A?

First, to publish four or five articles a month that are factual, useful, understandable, and significant, dealing with the design, applications, and implications of computerized information systems.

Second, to publish certain news, data, census, and reference information in the field of computers and data processing.

Third, to publish some articles and information (even if computers are not mentioned) which may help computer professionals understand major problems of the United States and the world, especially important problems where (a) understanding is difficult because of bias, deceptions, and lies, and (b) computers may be applied, now or eventually.

Finally, to be interesting, provocative, and disturbing — to help readers think in unaccustomed ways.

We hope our magazine can exert influence in the computer field to help computer professionals become more conscious and more informed about their present and possible role in society. "Computing machinery" (as a problem which is largely solved) is drifting into the background; it is the software, the systems, and the applications to people's problems that are becoming more important. In fact, perhaps we should change the name of our magazine to "Computers and Automation and People".

Why does "Computers and Automation" have almost no advertising?

There seem to be three main reasons.

First, an advertiser likes to reach a lot of "the right people" in regard to his products. So he regularly chooses for his advertising controlled-circulation trade magazines, which are sent free and which cover the audience that he desires to reach.

Second, he does not like to have his advertising money diluted. So he is not very happy about providing copies of the magazine to students, professors, legislators, Ralph Nader, or other persons who logically are unlikely buyers of his products. This is called "waste circulation". A paid-circulation trade magazine which will provide copies of the magazine only to those people who want it enough to pay for it places itself at a competitive disadvantage.

Third, since there is an economic depression in the computer field, many advertising budgets have been drastically cut.

Will C&A continue to publish?

We shall continue to publish as long as the income from our paid subscriptions PLUS negligible income from advertising exceeds the expenses of publishing and mailing the magazine. And we welcome paid subscriptions from everybody who is interested in what we are publishing.

# COMMUNICATIONS MESSAGE SWITCHING— AN ANALYSIS

Walter M. Aydelotte  
RCA  
Information Systems Division  
Camden, NJ 08101

*“Historically, two basic approaches have been utilized to switch data communications traffic. There have been many variations of these two techniques and several hybrid combinations, varying from entirely manual operation to entirely automatic operation.”*

In today's highly competitive business climate, an ever increasing volume of information is required for successful business operation and management. This information frequently must be transferred between widely separated geographical locations within a time frame that is meaningful to the successful operation of the business, whether it be as short as seconds or as long as days.

Unlike telephone voice communications, data communications permits the introduction of delay in transmission. This may be used to great advantage. Availability of the calling person and called person simultaneously is not always required. In addition, delayed transmission is frequently used, even of short duration, to reduce the number of circuits required to handle a given load and also to provide greater flexibility in handling traffic.

The scope and intent of this article is to analyze the transmission and switching of digitized information (data) between remote business locations. Past, present, and future techniques of message switching will be reviewed in detail.

## Data Switching Techniques for Communications

Today, all communications systems can be boiled down into five distinct components. These basic units will frequently be called by different names by different people, but nevertheless, these basic units and their generalized functions can be described as follows:

1. **Encoder** — The encoder typically serializes characters and presents them to the transmitter. Many good examples of this function can be found in today's proliferation of terminal devices.
2. **Transmitter** — The transmitter accepts the serialized character(s), modulates them (optionally) and transmits them over some type of transmission medium. Typical examples are telephone sets and data sets.
3. **Transmission Medium** — The transmission medium is any facility that is capable of carrying the resultant electrical signals.
4. **Receiver** — The receiver receives the modulated (optional) characters, demodulates them, and presents the resultant serialized characters to the

Walter M. Aydelotte is a senior instructor on the communications system education staff at RCA, teaching RCA personnel and customers data communications software concepts. He has spent nine years in data communications and related areas. Mr. Aydelotte received his B.A. in Business Administration from Moravian College, and is presently doing graduate work toward an M.B.A. in Information Science at Temple University.

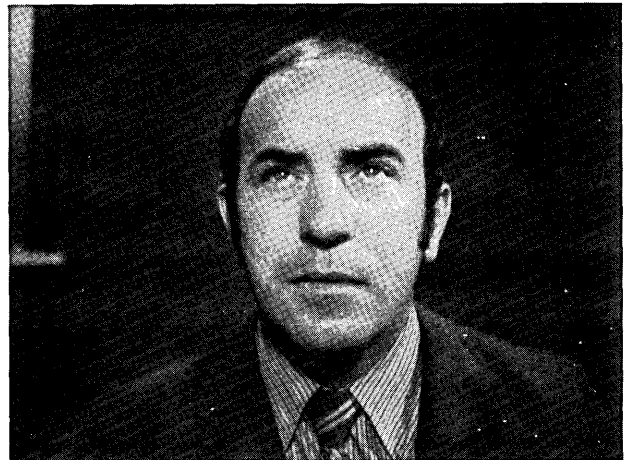



decoder. Telephones and data sets are typical examples of receivers.

5. **Decoder** – The decoder takes each serialized character and translates it to its equivalent printer graphic. The printer graphic, of course, varies depending on the terminal language being utilized. Typical examples of this function are the myriad of on-line data communications terminals available today. In addition, in an environment of switched communications, the switching device itself will be a decoder, being responsible for certain decoding in its own right.

These five basic components in many cases operate in an environment wherein switching techniques are applicable.

### The Reasons for the Switching of Data

Basically though, what is the reason for the “switching” of data? Primarily, it is the need for flexibility while minimizing costs; this has been the goal of most switching systems. Let’s look at the following hypothetical case where there exists a need for telecommunications linkage connecting six cities. One solution to providing telecommunications links between these cities would be to have direct communications between every pair of points as in Figure 1.

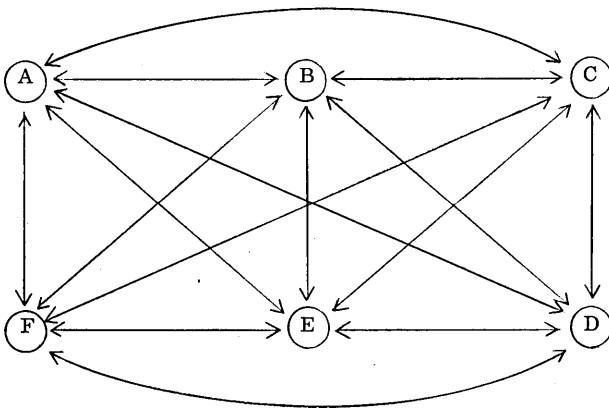

Figure 1. Switching paths, each to every other

An alternative solution, which uses far fewer communication lines, is to connect all the points to a “switching device” as shown in Figure 2.

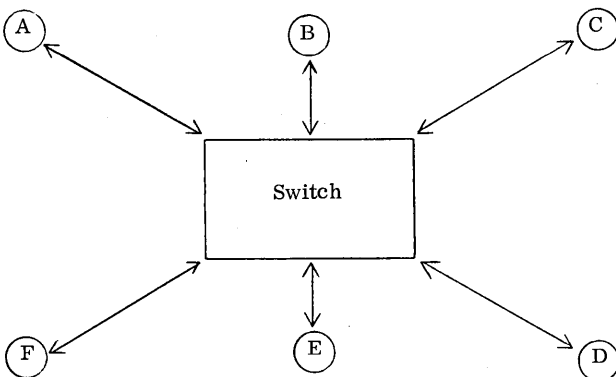

Figure 2. Points connected to a switching device

It can easily be demonstrated that the larger the number of locations, the greater will be the savings in line costs when a switching system of some sort is used. A further reduction in line costs can be achieved by using multi-drop lines, in which one line connects several terminals. Of course this can only be done if the traffic volume is not too high.

An additional justification for switching is that in message switching systems, circuits can frequently be “loaded” with higher traffic volumes. This is accomplished by temporary storage of messages until circuits are clear. It would not be unusual to find a “loading factor” of 85 percent on the trunks of a message switching system, where “loading factor” as used here, means the amount of time that a circuit is actually being used. To handle the same number of messages with the same average time of transit on a circuit switching network serving the same places, as many as four or five times the number of trunks would be needed, and individual loading factors could very well drop to as low as 20 percent. Only in cases where concentrated volumes of data traffic exist between remote locations is switching not required. In these cases, dedicated point-to-point facilities are utilized.

### Line Switching vs. Message Switching

Historically, two basic approaches have been utilized to switch data communications traffic. There have been many variations of these two techniques and several hybrid combinations, varying from entirely manual operation to entirely automatic operation. Basically, these two techniques and their functions are as follows:

1. Circuit or Line Switching.
2. Message Switching.

Circuit or Line Switching is sometimes referred to as space division switching. In this mode of switching the address of the called station is first sent to the switching center. Based on this addressing data, the switching center selects the line of the called terminal and electrically connects (switches) the calling and called lines together. Once the physical switching has been effected, the actual transfer of data can be accomplished. Therefore, during this type of communication, the terminals involved are actually in direct contact.

Today’s modern telephone network is a classic example of a sophisticated Line-Switching system. When you initiate a telephone call, the operation of the dial or touchtone unit effectively sends the address (i.e., telephone number) of the called station to your local telephone central office. This office then logically determines the most expedient method of physically connecting (switching) your telephone line to the called telephone line.

It is important not to think of today’s telecommunications state-of-the-art as being oriented wholly electromechanically. While it is true that the telephone network today is primarily electromechanically switched, Electronic Switching Systems (ESS) are now either already operating or are in the planning stages for many areas of the United States.

In Message Switching systems, the calling terminal transmits its message directly into the switching center, including all necessary addressing (routing) information. As soon as the input transmission is effected, the caller is disconnected. The switching center stores the message, determines from the message header where this message is to be

forwarded, and finally, transmits the message to the proper location(s). Traditionally this is referred to as the "store-and-forward" concept of Message Switching. The essential ingredient of a store-and-forward switching center is operation of the "switcher" independent of the calling and called stations. The center must accept messages from any station when offered regardless of the present unbusy or busy condition of the destination. And likewise, the switching center must store all messages until the destination(s) can accept them, and then, forward the message without regard to the present status of the originator. During the interval between receiving and subsequently sending each message, the switcher must store it, and must accept all responsibility for the integrity and security thereof.

### Evolution of Message Switching

Message Switching has evolved to its present state-of-the-art through definite developmental stages. These stages can be defined as follows:

1. Torn-Paper-Tape Switching Systems
2. Electromechanical Switching Systems
3. Electronic Computer Switching

The development of the paper tape typing reperforator spawned the birth of the "torn-paper-tape" switching systems. The printing reperforator automatically perforates and prints on paper tape as each character is received. The resultant message can then be relayed by passing the new perforated tape through a tape distributor, or reader as it is sometimes referred to. Typically, as messages arrive at the center, they are punched into paper tape for temporary storage. Usually each communication line (half-duplex) has its own reperforator for receiving messages and its own reader for transmitting messages. The messages punched into tape will be preceded by the address or addresses to which they are to be transmitted. Operating personnel in the switching center tear off the received messages, read the addresses to which they are to be sent, and when the proper circuits are available, place them on the corresponding paper-tape reader. Of course, in such a manually controlled system outgoing queues will develop when high volumes of messages are received in short periods of time. The principal advantage of torn-tape switching is its simplicity. An economic trade-off between operator expense and equipment costs is striven for. With expert operators, a very high circuit efficiency can be achieved, and priority messages can get special attention. Today, numerous torn-tape systems are in existence that use various combinations of manual, semiautomatic, or automatic implementation of the "cross-office" function, where, "cross-office" as used here, means the actual process of transferring the message between the reperforator and reader.

As torn-tape systems matured, various electromechanical switching systems enabled message switching systems to become operator-independent. Exemplary among these is the American Telephone and Telegraph Company's 81-A-1 system introduced in 1940. In this system, multi-station lines are used with each station being automatically "polled" in rotation for possible traffic to be transmitted to the center. Each paper tape message is preceded by certain characters (the header) which form a code to control the automatic switching across the office, and the automatic retransmission on the proper output circuit. Although this type of system is completely automatic, paper-tape is still

utilized and the switching logic itself is largely electromechanical and thus, somewhat slow compared to today's solid-state computerized logic.

### Computerized Message Switching

In today's world of ever-increasing complexities, interactions, volumes, and speeds, it is only natural that the digital computer would be called upon to handle the myriad of tasks in Message Switching environments.

In a typical Computerized Message Switching system, data is exchanged between the communications lines and the computer memory via hardware line buffers, a communications controller, and software message buffers. The line buffers convert incoming serial-bit data into characters (deserialization) and outgoing characters into serial-bit data (serialization). The controller samples (scans) all of the line buffers at an appropriate rate and generates "pseudo-interrupts" (cycle stealing) in the digital computer wherever an input line buffer has a character formed, or an output line buffer can accept a character. The computer responds to the "pseudo-interrupt" signal by executing an input/output service request which causes the appropriate character to be exchanged between the line buffer and the software buffer. Not until the software buffer(s) has an entire message, is an entry put on the Message Switching (program) input or output queues. At this point a full "interrupt" is generated to call in the Message Switching program logic.

The software buffers may be dedicated computer memory zones (dedicated buffering) or dynamically allocated memory cells (dynamic buffering). The intermediate message storage devices are typically either random access drums or random access discs. Not unlike the previous examples, Computer Switching itself has evolved through developmental phases.

Initially, pure stand-alone Message Switching Processors were utilized. However, it soon became evident that computers could easily keep up with the relatively slow (due to terminal and line speeds) message switching requirements of the typical installation. Today, due to the development of multiprogramming techniques, advanced supervisory systems and interrupt processing, typical processors can handle Message Switching, communications programs, and batch programs concurrently. Even a stand-alone Message Processor handling 2000 messages per day would be left with much idle time.

We will now analyze, conceptually, the generalized functions that a computerized Message Switcher should perform. In order to more concisely "see" these generalized functions in context, Exhibits A and B concerning Input and Output processing respectively, are included.

### Input for Generalized Message Switching

First, let us examine generalized Message Switching input processing. See Exhibit A.

The model system in this exhibit is an integrated, multi-function processor that is only "interrupted" from its regular data processing when something is "posted" on the Message Switching Input queue. In this system, Message Switching has highest program priority. Once a determination is made that "something" is on queue, the Message Switch determines what it is. Is it a "command language" statement, such as a user asking for certain statistics? If so, the Message Switch enters the subroutine necessary to

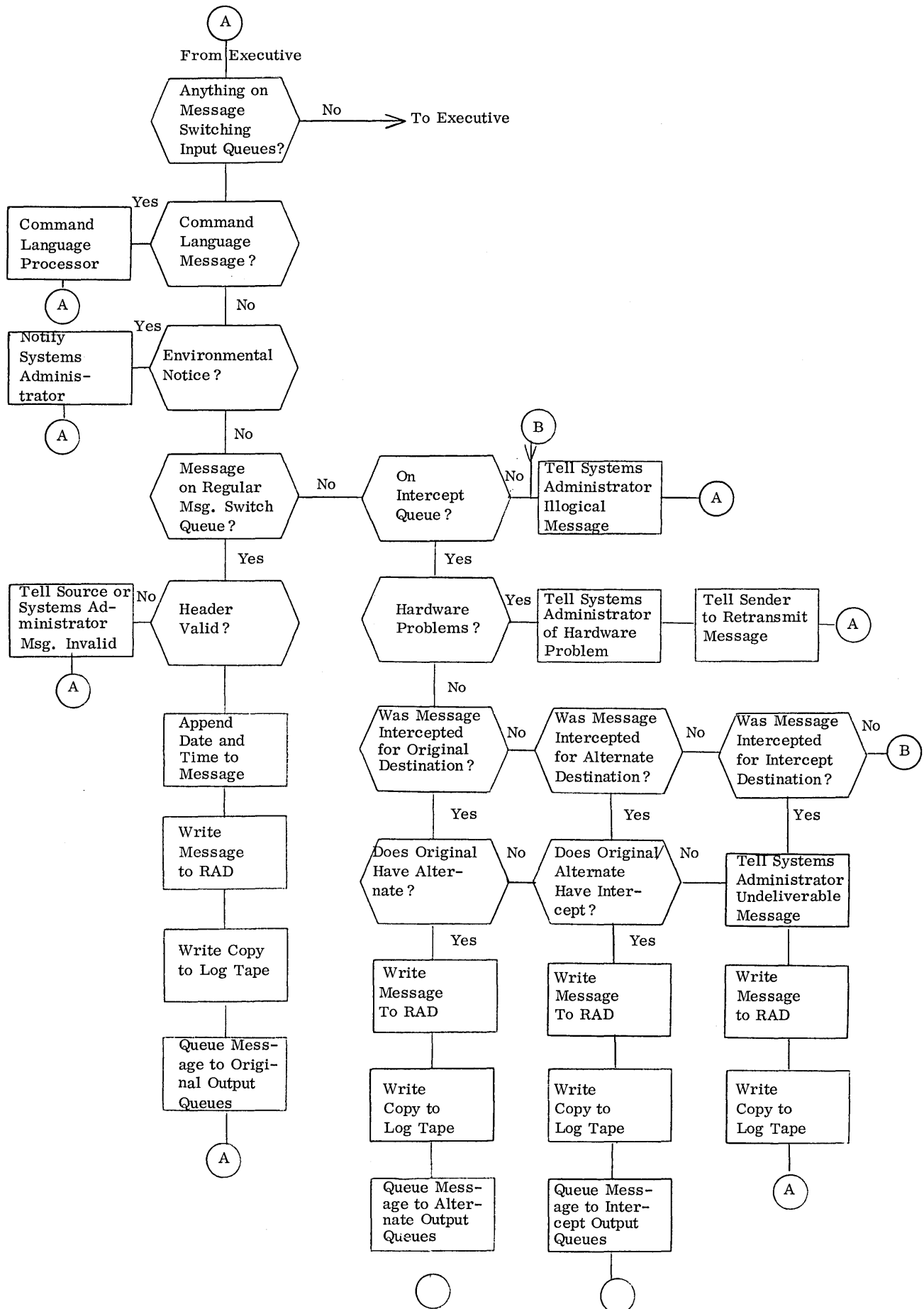

Exhibit A. Message Switch Input Processing

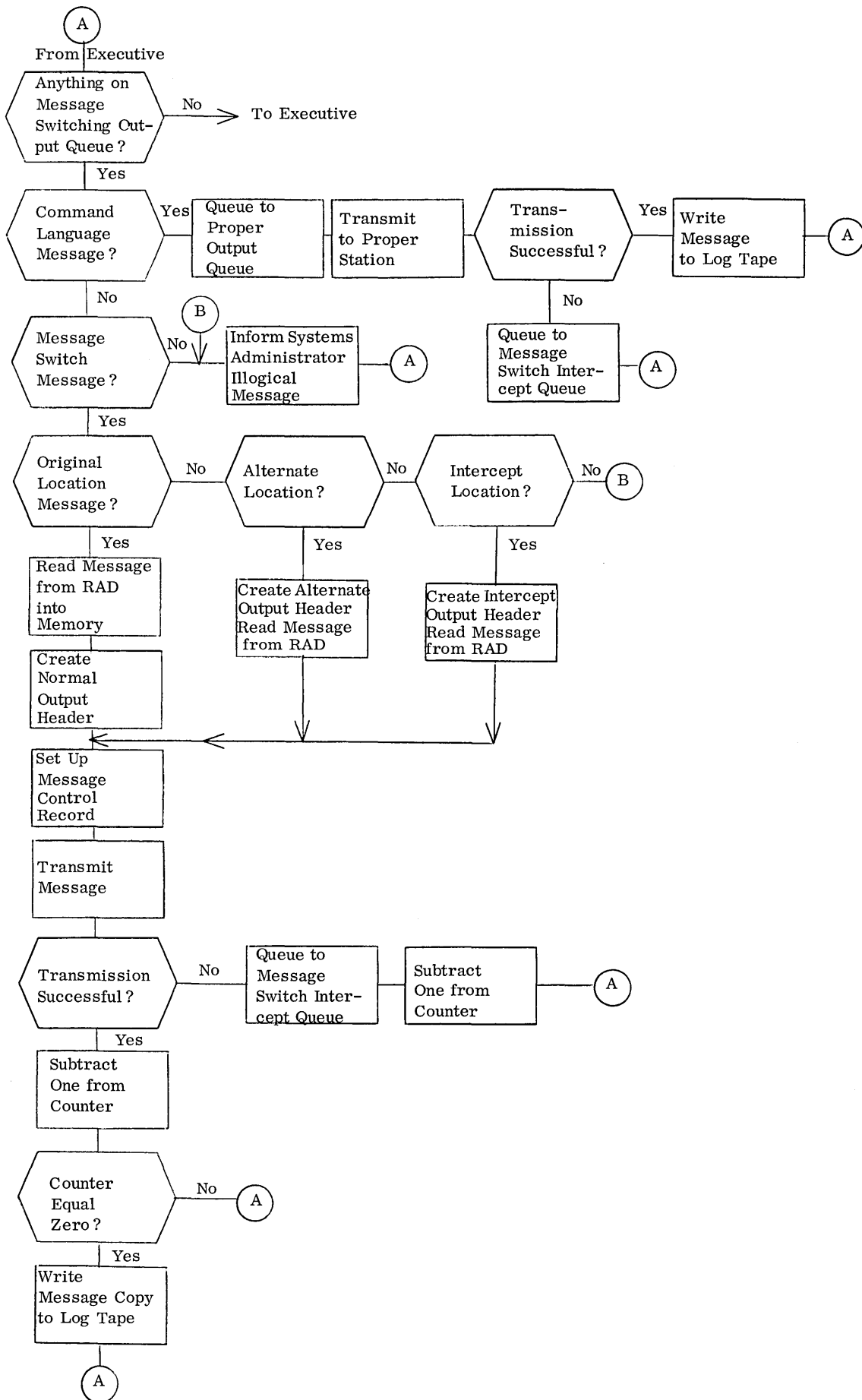

Exhibit B. Message Switch Output Processing

satisfy the request. If it's not a command language statement, is it an "environmental notice" of some sort from the control system? If so, that subroutine is entered. If not, the Message Switch determines if the message is an original message to be switched or a message that was already processed but for some reason was unable to be delivered, i.e., an "intercepted" message. If it is none of these, the Message Switch "knows" that this is an illogical message and so informs the "Systems Administrator," which is commonly a terminal in the computer switching center itself.

If the message is an original message, the Message Switch must determine if the "header" is valid; is its format valid? is its priority valid? is the sender identification valid? are all destinations valid? is the sequence number logical? is the message being switched between terminals of the same language type? If any of these tests are negative, the proper error subroutine is accessed. If the header is valid, the date and time are added to the message, the message is written into the intermediate storage (Random Access Device), copied to the Log tape, and queued to the proper output line queue(s).

If the message is an "intercepted" message, the Message Switch must determine what caused the message to be undeliverable. For example, was there a hardware problem like a disc-read error? Or, was the message intercepted because the original destination could not be reached? If this was the case, did the original have a pre-specified alternate destination? Was this a message to an Alternate that was unable to be reached? Or, was this a message to a station that did not have a prespecified Intercept location? All of these types of situations must be checked for in order to insure that the message is queued to the proper output queue. In addition, "undeliverable messages" must be reported to the System Administrator.

#### **Output from Generalized Message Switching**

Now, let us examine typical output type message processing. See Exhibit B.

Here also, the processor handles typical data processing chores until it is interrupted. Interruption occurs when an item is posted to any Message Switching output queue. Once interrupted, the Message Switch must determine the type of message to be transmitted out. The message logically must either be a command language message or a normal message from Message Switch. Any other type of message will be treated as an error. If the message is a command language message, it is queued to the proper output line and transmitted with a copy going to the Log tape. Command language messages would not require output header construction. If the message is a normal Message Switch message, a determination must be made as to whether the message is an original, alternate, or intercept. The purpose of this action is to append the proper type of output header to the message. Prior to attaching the header, a Message Control Record is set up to keep track of message destinations, priorities, and those messages that are subsequently queued to the intercept input queues. In addition, a transmission counter is set equal to the number of locations that the message is to be sent to. Once these steps are accomplished, the header is appended and the message is sent to the first location as specified in the Message Control Record. If the message is not transmitted properly, the message is queued to the Message Switch intercept

input queue, the transmission counter decremented by one, and the Message Control Record updated. If the transmission was successful, the counter is decremented by one and compared to zero. If the counter is not equal to zero, this message must be sent to additional locations as specified in the Message Control Record. Once the counter equals zero, a copy of the completed message and its Message Control Record is written to the Log tape.

Now that we have seen generally how input and output message processing might be handled in a computerized Message Switching system, let's look at specific functions that might be employed.

Most of today's more sophisticated Message Switching systems are able to perform highly complex analysis of messages. This ability to process messages efficiently in accordance with very complex information is the most noteworthy advantage that the digital-computer switching center has over the older torn-tape systems. For example, common functions include: the interpretation of complex addresses; performance of complex handling instructions, including multiple addresses, group addresses (sometimes called broadcasting or hubbing), and symbolic routing, wherein each location or group of locations is given a symbolic name; queueing and transmission of messages by priority, including pre-emption; translation of different language codes to allow switching between dissimilar language types; speed conversion; data processing based on message content is possible. If original messages are undeliverable, prespecified Alternate or prespecified Intercept locations can receive the message along with a modified header indicating that this is an Alternate or Intercepted message.

In addition to these "analytical" functions, many "service" functions are commonly available. For example, statistics may be accumulated to be used in generating management reports, or statistics may be utilized for the automatic printing of each user's monthly billing statements.

Message Switching might also be continually performing hardware diagnostics — both local and remote. Some form of command language should be available in order to allow "man-machine" interaction. This man-to-machine conversational ability might be used by a station user to query the system for certain statistics, to retrieve certain messages, or to make real-time hardware and software changes. This facility can also be used to pass environmental notices to the Systems Administrator position. An example would be reporting malfunctions or illogical situations, or reporting to a station that a certain message had an invalid header. If the system should fail for some reason, automatic restarting of the system is possible since the total environment can be reconstructed from the message logging tapes which contain all input and output messages with associated Message Control Records.

Historically, Message Switching systems have only been limited by the programmer's imagination and the physical constraints of the particular operating system he was working with. To date, due to the lack of comprehensive manufacturer packages, computerized Message Switching systems have been primarily systems programmed by the customer. However, there now exist "generalized" message-switching systems from several manufacturers that perform all of the functions mentioned in this article without the need for expensive systems programming. □

# Hippocrates Reversed by Computer: Better Diagnosis and Treatment With Reduced Costs

Dr. Albert E. Casey  
Memorial Institute of Pathology  
924 S. Eighteenth St.  
Birmingham, Ala. 35205

*"Medicine is being practised today very much as it was in the time of Hippocrates 2500 years ago. Without the assistance of a large, automated, computerized medical laboratory, the laying on of hands at the annual visit to the physician picks up only such terminal disease as appears above the surface."*

Dr. Albert Casey is the Head Pathologist and Director of Laboratories at the Birmingham Baptist Hospitals in Birmingham, Alabama. He also serves the People's, Longview, Holy Family, Hill Crest, Salvation Army, and Doctor's Center hospitals.

Dr. Casey began doing multi-variate disease-chemistry analysis many years before he was able to computerize his diagnoses. He began his computerized diagnoses in 1964, and has now compiled more than 100,000 medical profiles in a small computer system.

Dr. Casey's many professional memberships include: President of the Medical Staff and Chairman of the Executive Committee of the Medical Staff of the Birmingham Baptist Hospitals, Chairman of the Pathology Section of the Southern Medical Association, Council of the Society of Experimental Biology and Medicine, and the Council of the American Society of Clinical Pathology.

One of Dr. Casey's many interests outside of the field of medicine is history, particularly the history of Ireland and Mississippi. He has written more than a dozen books on history, and is an active member of the American-Irish Historical Society.

## The Diagnosticians

The pathologist is an M.D. or physician who specializes in the study of disease and is a consultant to other physicians in laboratory diagnosis. His training beyond high school is four years of college with a B.S. or A.B. degree, four years of medical school with an M.D. degree, one year of internship, and four years of residency. After this he must pass an examination by the American Board of Pathology to qualify for practice. He usually spends an additional four years in teaching or research in a medical school or hospital — a total of seventeen years of education

and training after graduating from high school before assuming a responsible position.

His associates, without whom he could not function efficiently are Ph.D.'s, medical technologists, and secretaries. The Ph.D.'s in biochemistry, microbiology, physiology, mathematics, and bio-engineering spend some thirteen years in training and the medical technologists some five years after high school.

## Rising Salaries

For the past thirty years Birmingham, Alabama, a steel and coal city, was and is one of the areas of the highest wages in the nation. Thirty years ago the pathologist received \$500 per month, the Ph.D.'s \$250, the medical technologist \$85, and a maid and orderly \$30 a month. The cost of a laboratory test such as blood sugar or blood urea nitrogen at that time was \$10 and very few were done. Seventy percent of the precipitous rise in the cost of medical care during the past thirty years has been due to raising the salaries of medical workers to rates comparable with those in the coal and steel industry. — the maid and orderly from \$30 to \$240 per month, up 800%; the medical technologist from \$85 to \$680, up 800%; the Ph.D. from \$250 to \$2,000, up 800%; and the pathologist from \$500 to \$4,000, up 800%.

## Lower Costs for Laboratory Testing

The cost of a blood sugar or blood urea nitrogen in our laboratory has gone from \$10 in 1940 to 25¢ in 1970, down 97.5%. The cost of the combined series of 75 tests, few of which were even available thirty years ago (including a profile of 28 chemistries, 28 hematology tests and 19 arthritic tests), has gone from a total cost of \$600 down to \$25.00, a reduction of 96%. Thirty years ago no one could get such an abundance of accurate medical information any place in the world at any price. In our hospitals, 80% of the

patients get such profiles on admission, and increasing number of patients get them on annual visits to their physician.

This phenomenal reduction in the cost of laboratory testing is due equally to automated and semi-automated laboratory apparatus and to the use of computers. In our laboratory there are in use twelve separate types of automated machines; for example, a technicon blood grouping machine capable of 1800 separate tests per hour and the SMA 12-60 auto-analyzer capable of 600 different chemistries per hour. The computerization has been accomplished with the Univac 1004 printer and the Univac 418 and 1106 computers, together with programmed diagnoses.

In a recent study presented before the International Cancer Congress in Houston by our group, metabolic profiles on some 18,000 consecutive patients were analyzed for the detection of the cancer prone. In determining the significant relationship of twenty-four different chemistries to the detection of cancer, the computer made over 500,000,000 comparisons in a very short while.

### Medical Practice: What Progress in 2500 Years?

Disease is like an iceberg — only a small portion is visible above the surface. Unfortunately, so often when it appears above the surface, it is too late to cure or prolong the life of the patient. Medicine is being practised today very much as it was in the time of Hippocrates 2500 years ago. A patient consults his physician because of signs or symptoms and he receives medical treatment, just as he did in the time of Hippocrates. If he is a male, he has often delayed the visit to his physician until the disease often claims his life. The female is more likely to run to the physician than the male, and lives about ten years longer. Without the assistance of a large, automated, computerized medical laboratory, the laying on of hands at the annual visit to the physician picks up only such terminal disease as appears above the surface. This kind of medical practice has not progressed much beyond that of ancient Greece.

I believe that the Hippocratic method should be laid to rest and the trend in medicine should be completely reversed. I believe: (1) that the cost of medical care in hospitals will rise to \$100 or \$150 per day; (2) that each physician must see and treat at least three times as many patients as he sees today and do the job infinitely better than he has in the past; (3) that the 40%-50% of hospital admissions for diagnosis must be eliminated and the patient should come to the hospital only after most diagnoses have been made; and (4) that the enormous sums spent on heroic and terminal medicine must be eliminated (about 75% of the medical costs today).

### A Proposed System for Preventive Medicine

The proposed method for conducting annual physical examinations described below is offered as an example of one way the necessary changes in the practice of medicine may come about.

There are 2,000,000 persons living within 100 miles of Birmingham, Alabama. Each one of them should have an annual visit to their physician for advice, examination, and treatment. Physicians would mail to their patients, two weeks before their annual visit, an extensive questionnaire, especially designed for computer use. The patient and his family would fill this out in detail and bring it to a central blood collecting station, which is equipped with computer-

ized apparatus. He should do this some days before the visit to his physician. At the station, (1) the history would be verified by an experienced computer operator and the entire mass of data put into 18 characters by the operator; (2) the patient would then have weight, height, some ten physical measurements, the temperature, pulse, respiration, blood pressure and urinalysis made; (3) next blood would be taken for a 100 test metabolic profile; (4) the patient would then be placed in one of some 36 examining rooms and electrodes applied for brain, eye, heart, lung and neuro-muscular function tests. No physician need be present. With this system about 30 patients an hour or 300 patients per day could have elaborate monitoring for a three-minute period. The electrodes on the patient and the hospital based electrical devices would be connected with several computers located from one to 100 miles away at the central monitoring station. Patients with unusually abnormal physiologic profiles may have repeat monitoring until the physicians in the central laboratory are satisfied. These brain-eye-heart-lung and neuro-muscular tests cost about \$250 by present, non-computerized methods, but could be included as a part of an annual profile of computerized history, measurements, and blood tests for \$26 per patient if there were ten collecting stations in operation. Some 3,000 persons per day would need to be examined in order to serve 2,000,000 persons annually. The entire mass of data would be summarized into some 150 test facts and computerized diagnoses of great finesse should result. In addition the patient's prior examinations by various physicians, hospitals, and clinics, over many years would be available and retrievable by the central computer complex. The central computer library could also furnish the physician with the latest recommended procedure for the particular set of abnormalities with which the patient is afflicted.

### True Preventive Medicine

By such a method, the 84 percent of disease which lies beneath the surface may be detected and treated ten to forty years before it becomes serious trouble. For example, the Pap smear has reduced hospitalization for diagnosis of cancer of the cervix by 80%, and increased the cure to 98%; in the same way such annual examinations may do the same for hidden metabolic disease. This would be preventive medicine in its truest sense. In the nation last year, \$250 per capita was expended for medical care. If \$26 per capita for computerized histories and laboratory data can reduce hospitalization by 80%, medicine will be revolutionized.

The hospitals of the future will treat patients with serious illnesses, and I foresee computers monitoring 500 intensive care patients in distant small hospitals at the same time or in fractions of a second for \$25 instead of the \$100 per day now charged in large hospitals. I foresee that every obstetrical patient during delivery and every surgical patient during an operation will be monitored locally and at a distance for less cost and with more value to the patient than can be done today.

I believe the small computer like the corner drug store and the delicatessen will still be used in hospitals, but will be largely replaced by large computer banks and centralized expertise such as that described above. This, in turn, will at last change the emphasis of medical practice from curing disease to preventing disease. □

# PRODUCING COMPUTER LETTERS FROM NAME AND ADDRESS FILES

*"Preparing computer letters on a modest scale has aided us in developing some rules governing record formats."*

*Byron J. Koch  
Assistant General Manager for Data Processing  
Claretian Fathers  
Chicago, Ill.*

Several articles have been published in recent years concerning the use of computer letters, but they have mostly had to do with copy and the frequency of inserting the recipient's name in the body of the letter. We have been preparing computer letters on a modest scale during the past year and this experience has aided us in developing some mechanical rules governing record formats.

We leave copy and field insertion decisions to our promotion people. They, in turn, rely upon the Data Processing Department to provide a decent heading, a suitable salutation, and the insertion of the fields which they call for. Our experience in these areas may be helpful to others who are planning to produce computer letters in the future.

## **Titles**

At the time we select names with specific characteristics to receive a letter, we also reformat the record to make it easier to prepare the letter. Whenever possible, we have actual titles included in our records — we never use title codes. Title codes or the assumption of titles can be disastrous on computer letters. I have seen many examples of incongruous salutations on such mail. One, that was cited recently by Congressman Gallagher, was addressed to the San Francisco Suicide Prevention Service. The letter commenced with "Dear Mr. Suicide".

## **Salutations**

While reformatting, we build a complete salutation line. If the name field does not start with one of the titles for which we are testing, we do not assume a title. We then scan the field to test for the presence or absence of either "&" or "AND". If one of these elements is found, we greet the recipients with "Dear Friends". If the plural indication is not found, the salutation is "Dear Friend".

We test for longer titles before testing for the short ones. For instance, we look for "MR & MRS" prior to searching for "MR". This eliminates the possibility of having a heading addressed to "Mr. & Mrs. John Smith" coupled with a salutation of "Dear Mr. Smith". Each title we find

must also be followed by a blank. If the blank position is not present, it is not the title we want. Conceivably, we could discover a record starting with the letters "MISS" and assume we were addressing an unmarried lady. That may or may not be true. The entire field might be "MISSIONARIES OF PROVIDENCE" or "MISSOURI CHAMBER OF COMMERCE".

## **Isolation of Last Names**

We have definite rules governing the preparation of input for our files. These rules facilitate the isolation of last names without having a separate field for the last name. When entering a name, the keypunch operators must punch an "at sign" in the column immediately preceding the last name. During the editing portion of our file update we search for this character in order to manufacture an identity code for the record. The "at sign" is used because it is in alpha shift and it is not a character which would otherwise be found in a name field. When we discover the "at sign", we replace it within the program with another valid, but non-printing character. If there is any suffix after the last name, the keypunch operators must leave two blank columns after the name before punching the suffix. This permits them to have a single blank column anywhere within the name and it prevents us from using the suffix as part of the identity code and it prevents us from using it within a salutation.

An example of a keypunched name being entered into the file is: "MR & MRS WILLIAM F@MC MURRAY JR". During the computer letter reformat run, we will find the "MR & MRS" at the beginning of the record and we will start building the salutation line with "Dear Mr. & Mrs.". (Note that we use the ampersand rather than the word "and" as our computer letter program will capitalize the first letter of each word it finds in the salutation.) We then start scanning the name field for our special character. When it is found, we add the last name to the salutation, letter by letter until we either discover two consecutive blanks or we reach the end of the field. Thus we will have a salutation that reads, "Dear Mr. & Mrs. Mc Murray".



### Apostrophe Names

Those proper names which should contain an apostrophe can cause trouble. Our files were originally developed to produce mailing labels in upper case. Our rules for names such as "O'Brien", "D'Souza", etc. had been to run the letters together to avoid having the first letter of the last name mistaken for a middle initial.

The appearance on mailing labels is not bad — they print as "OBRIEN", "DSOUZA", etc. However, on computer letters where the first letter is capitalized when it follows a blank or a special character, these names do not have the proper appearance. "OBRIEN" becomes "Obrien". We now feel it is better to enter such names with a dash where the apostrophe belongs. This preserves the continuity of the name — "O-BRIEN" — on mailing labels. When reformatting for computer letters we test for the dash and replace it with an apostrophe.

### City, State, and Zip

City, State and Zip Code are in three separate fields in our basic record. When reformatting these fields, we left-justify them into a single field for the heading of our letters. In some cases the state abbreviation is replaced by a substitute as here, again, the computer letter program will capitalize the first letter of each word or the first letter that follows a blank or special character. Thus, the separate fields of "ROME-----NY-----13440" will be reformatted to read: "Rome, N.Y. 13440". If the "NY" were not replaced with "N.Y.", they would appear on the computer letter as "Ny". The same is true of suffixes. "MD" will print as "Md". That is O.K. if it is the abbreviation for Maryland, but if it stands for a Doctor of Medicine it might be better if your keypunch operators enter it in the name field as "M.D."

### Inserts

When an insert must be made in the body of the letter from a field within the record, such fields should be left-justified at the time you are reformatting. For instance, a dollar amount field may have six positions assigned to it in the record. When reformatting, you discover there are two high-order zeroes. The zeroes should be eliminated and the four significant digits should be shifted left. This will eliminate blank spaces at the "fill-in" point in the letter.

We are preparing computer letters from several different files, each with its own record format and characteristics. Rather than attempt to write several computer letter programs to work with each of these files, we wrote several reformatting programs. We purchased a letter-writing software package and we have found it to be extremely flexible and adaptable. Although it was originally designed for a system slightly larger than ours, the seller tailored it to fit our IBM 32/K 360/25 tape system.

### The Sharp Human Eye

Finally, if the volume of letters being prepared is not too great, I recommend they be examined by a sharp-eyed clerk before mailing. In spite of the best standards and precautions, some errors will creep into your files. Rather than irritate a customer or potential customer, it would be better to manually re-type inaccurate computer letters or not mail them at all. "Mr. Suicide" might have bought if he had been addressed as "Dear Friend". □

# C.a NUMBLES

## NUMBER PUZZLES FOR NIMBLE MINDS —AND COMPUTERS

Neil Macdonald  
Assistant Editor  
Computers and Automation

A "numble" is an arithmetical problem in which: digits have been replaced by capital letters; and there are two messages, one which can be read right away and a second one in the digit cipher. The problem is to solve for the digits.

Each capital letter in the arithmetical problem stands for just one digit 0 to 9. A digit may be represented by more than one letter. The second message, which is expressed in numerical digits, is to be translated (using the same key) into letters so that it may be read; but the spelling uses puns or is otherwise irregular, to discourage cryptanalytic methods of deciphering.

We invite our readers to send us solutions, together with human programs or computer programs, which will produce the solutions. This month's Numble was contributed by:

Stuart Freudberg  
Newton High School  
Newton, Mass.

### NUMBLE 717

T H O S E				
×     W H O				
I H N R R T				
S B O T I O				
O S H L T W				
= O A S T D W L T				
5300   9481   77367   3014   60396				

### Solution to Numble 716

In Numble 716 in the June issue, the digits 0 through 9 are represented by letters as follows:

N = 0	S = 5
A, U = 1	I = 6
O = 2	B, G, L, P = 7
R = 3	E = 8
T = 4	H = 9

The message is: The earth is a blessing to those upon her.

Our thanks to the following individuals for submitting their solutions — to Numble 715: A. Sanford Brown, Dallas, Texas; Debra Bruno, Cliffside, N.J.; Twite S. Emerick, Harrisburg, Pa.; and T.P. Finn, Indianapolis, Ind. — to Numble 714: Hans G. Ponse, Amsterdam, Holland, and Robert R. Weden, Edina, Minn.

# COMPUTERS ENTER THE BUSING CONTROVERSY

*"If we found a group of students not doing well, and we learned that if they were transferred to another school, they would do better, we would do it. If after deciding that, we learned they were black, would we not do it? After all, it's the kids who count."*

Robert L. Glass  
Computer Center  
University of Washington  
Seattle, WA 98105

The computer, the people, and a dream. It has long been the hope of computer people who care about their world that the computer could work *with* people to achieve a dream. In a small way, in the city of Seattle and on the University of Washington campus, a team of computer and people is beginning to convert a piece of the dream into reality.

Amid tumult.

## The Nature of the Problem

The school bus, long noted for being nothing more significant than the butt of tired jokes, is suddenly the center of a controversy. Busing for practical reasons has long been a suburban necessity. But now that busing is being considered for the cities, it is opposed as being totally impractical.

The reason, of course, is race. Oh, there are a myriad small reasons which say that busing is awkward, and time-consuming, and expensive. But behind them all, loom-

Robert Glass is the winner of the Martin Luther King Memorial Prize contest, Third Year, sponsored by "Computers and Automation". He is a Research Specialist on the staff of the University of Washington Computer Center, and has spent 15 years in the aerospace computing industry, primarily in research and development of advanced software systems. He has published articles on technical subjects and social concerns in various journals; he is chairman of his church's Task Force for Racial Concern, member of the board of Highline Homes (a non-profit housing corporation), and Corresponding Secretary of the Interracial Family Association.

ing like a poised sceptre, is the issue of race. The primary reason for busing is integration. The primary reason for opposing it is to maintain racial status quo.

Into that impasse have moved several forcing functions. The Federal government has pressed for racial balance in the schools. The State of Washington has passed laws saying that no school can be built unless its student body will be integrated (actually, will not be *de facto* segregated). And the Seattle School Council, acting amidst clamor, confusion, and publicly threatened retaliation, decided to proceed with mandatory busing to achieve integration.

The reaction from the urban populace, already vocal, was immediate. A recall petition, designed to remove the School Council from office, was filed (and later ruled illegal in the courts). Citizens' groups on both sides of the issue formed, and gave a series of strong statements to the press. State legislators introduced bills to make mandatory busing illegal. A school levy, innocently caught up in the crossfire, was defeated. Black groups, dissatisfied with the scope of the plan (initially, it only involves busing grades 6-8), threatened a recall petition of their own. The selection of superintendents for the integrated districts exploded into the press when white groups blocked the choice of a black superintendent and black groups called a series of school boycotts in protest.

As time inexorably ticks away toward the fall school opening and the beginning of busing, the tumult, though constantly changing its hue, remains at fever pitch.

## The Role of the Computer

The calm in the computer centers where the groundwork for the busing selection is being laid is in striking contrast to the battle which rages without.

## COMPUTERS ENTER THE BUSING CONTROVERSY

"I say to you today, even though we face the difficulties of today and tomorrow, I still have a dream. It is a dream deeply rooted in the American dream. I have a dream that one day this nation will rise up and live out the true meaning of its creed: 'We hold these truths to be self-evident, that all men are created equal.'"

### BUSING PLAN GAINS SUPPORT

"I have a dream that one day even the State of Mississippi, a state sweltering with the people's injustice, sweltering with the heat of oppression, will be transformed into an oasis of freedom and justice."

### FUNDS SOUGHT TO OPPOSE BUSING PLAN

"I have a dream that one day on the red hills of Georgia the sons of former slave owners and the sons of former slaves will be able to sit down together at the table of brotherhood."

### SCHOOL COUNCIL IN FIGHT FOR ITS LIFE

"I have a dream that one day every valley shall be exalted, every hill and mountain shall be made low. The rough places will be made plain, and the crooked places will be made straight. . . With this faith we will be able to hew out of the mountain of despair a stone of hope."

### BUSING TO BEGIN IN FALL

— from "Dream . . ."  
by Martin Luther King, Jr., and  
headlines by "The Seattle Times"

The plan, after all, is fairly straightforward. The enactment of the plan, complicated in the background implementation details, is conceptually also straightforward.

The plan is this: Of the 58,000-odd students within the Seattle north (white) and central (black) areas, about 1200 students will be selected for mandatory busing this fall. 600 whites will be bused to central area schools. 600 blacks will be bused to north end schools.

The reason for beginning with only 1200 students is this: At the same time the busing program is being implemented, a new grade realignment program, which has come to be known as the "Middle School Plan", is also being implemented. Only these Middle Schools (grades 6-8) are to be integrated initially. The other schools will be integrated in succeeding years.

It is worth noting at this point that the mandatory busing program complements an already-existing voluntary busing program in Seattle. It is also worth noting that the Seattle School Council understands the distinction between simple desegregation and full integration, and intends to take steps to insure that bused students become a part of, do not remain only on the surface of, their new schools.

## The Enactment of the Plan

The enactment of the plan goes like this: Over a ten-year period, the Urban Data Center at the University of Washington, acting under a National Science Foundation grant and with local agency cooperation, has designed and implemented a set of computerized tools to allow two significant things: (1) the formation of an automated geographic base file in which all streets (and their associated address ranges) in Seattle are represented as segments in an X-Y coordinate grid system for the city, and (2) the development of tools which enable the conversion of an automated street address file to the coordinate grid system. This set of techniques they call "geocoding". Street address files with X-Y grid coordinates may then be represented in an organized tabular or graphic form for computer output.

The Seattle School District Data Processing Center, using these tools, has passed its student address file against the street address data base, and the end result is an allocation of students to schools. Then, using manual techniques (the University's Urban Data Center has developed skills for automating this process which will be used in future years when the number of bused students will be larger), a region within each school boundary will be selected and the students in that smaller region will be the ones bused.

### Implementation Details — The SACS Directory

The above description oversimplifies the problems which exist at the implementation level. The geocoding system and Seattle geographic base files, for example, are the culmination of 10 years' work and a half million dollars in



Geocoding allows plotting over pre-defined background material.

Federal grant expenditures. The Urban Data Center, which calls the system the Street Address Conversion System (SACS), has published papers on the subject, and has presented them to such organizations as the Urban and Regional Information Systems Association. (All such research reports are currently available through the National Technical Information Service of the U.S. Department of Commerce.) The SACS system is the basis for many of the techniques used in the U.S. Bureau of the Census 1970 geocoding system; it has been implemented by other agencies in other cities; and the Seattle system has been used for many purposes besides busing selection.

In essence, the construction of such a geographic base file (the Urban Data Center calls it a "Directory") takes place in three phases: (1) manual drafting of the street network and manual coding of the street addresses; (2) translating the coded and drafted data into machine-readable format, through keypunching and digitizing, and (3) machine-merging of the address and street network data, machine graphic editing, and machine integration of the various city-directory segments.

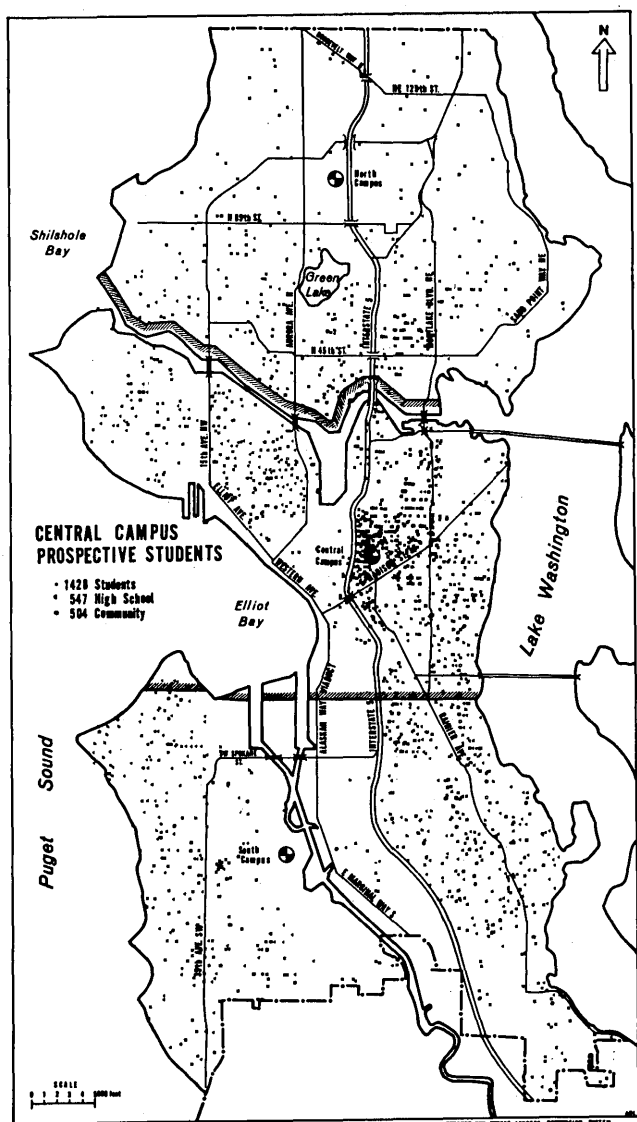

Spatially-oriented data may be readily displayed using geocoding techniques.

The critical basis for geocode accuracy is controlled reference base maps with a coordinate grid reference system overlaid. A state-wide system of plane coordinates was already available for Seattle. This grid was laid over the best street reference maps available.

### A Network of Lines

A street system may be considered as a network of lines. Each line intersection, or the bending of a line, may be considered a node in that network. These nodes are assigned numbers.

Each line segment (between two nodes) is actually a city block face. The address ranges for each block face must be recorded and introduced, along with the nodes and their coordinates, into the Directory. Street address ranges are keypunched into cards; the conversion of street system nodes to X-Y coordinates is done by an automated digitizer, which outputs the set of nodes and their coordinates.

Once the street address ranges and nodes for a particular neighborhood are in computer-compatible form, they are (1) merged into a combined file, (2) extensively edited to correct errors of omission and commission, and (3) integrated with other neighborhoods to form a city-wide directory. The final product is stored on a computer disk for random access and retrieval. At the Urban Data Center, this process takes place on an IBM 1130 computer with 8K of memory and a single disk drive. The SACS Directory for the city of Seattle occupies one disk pack.

The Directory at this point in its evolution is a solution waiting for problems. Enter the busing controversy.

When you have a data base of 58,000 students to deal with (84,000, if the Seattle south area were included), even if you only want to select out 1200 students for a specific purpose, the computer becomes an important consideration.

When you have a nearby University which has pioneered tools which are directly applicable to your problem, and those tools involve the use of a computer, you count your blessings and combine forces with the University.

When you consider the controversial nature of the problem and the aura of impartial omnipotence which a computer exudes, the computer becomes the obvious tool of solution.

### Inter-Agency Cooperation

It would be glib to dismiss the cooperation of the Urban Data Center and the Seattle School District with those comments, however. Inter-agency cooperation is not, unfortunately, a strength of the American way of government (or probably any other, for that matter). The Urban Data Center, especially in the persons of U.W. Professor Edgar M. Horwood and UDC Assistant Director Charles E. Barb, Jr., have worked hard to make the fruits of their research available to the outside world. A consortium, called GEOBASYS (Seattle-King County Geographic Base System), is in the process of being formed, and other local agencies have been invited to participate. Although various governmental bodies have made use of the SACS Directory and participated in an advisory fashion, so far only the Seattle School District has entered the consortium.

Charles Hammond, Manager of Data Processing in the Seattle School District, feels this cooperation may be one of the most important elements in the School District's use

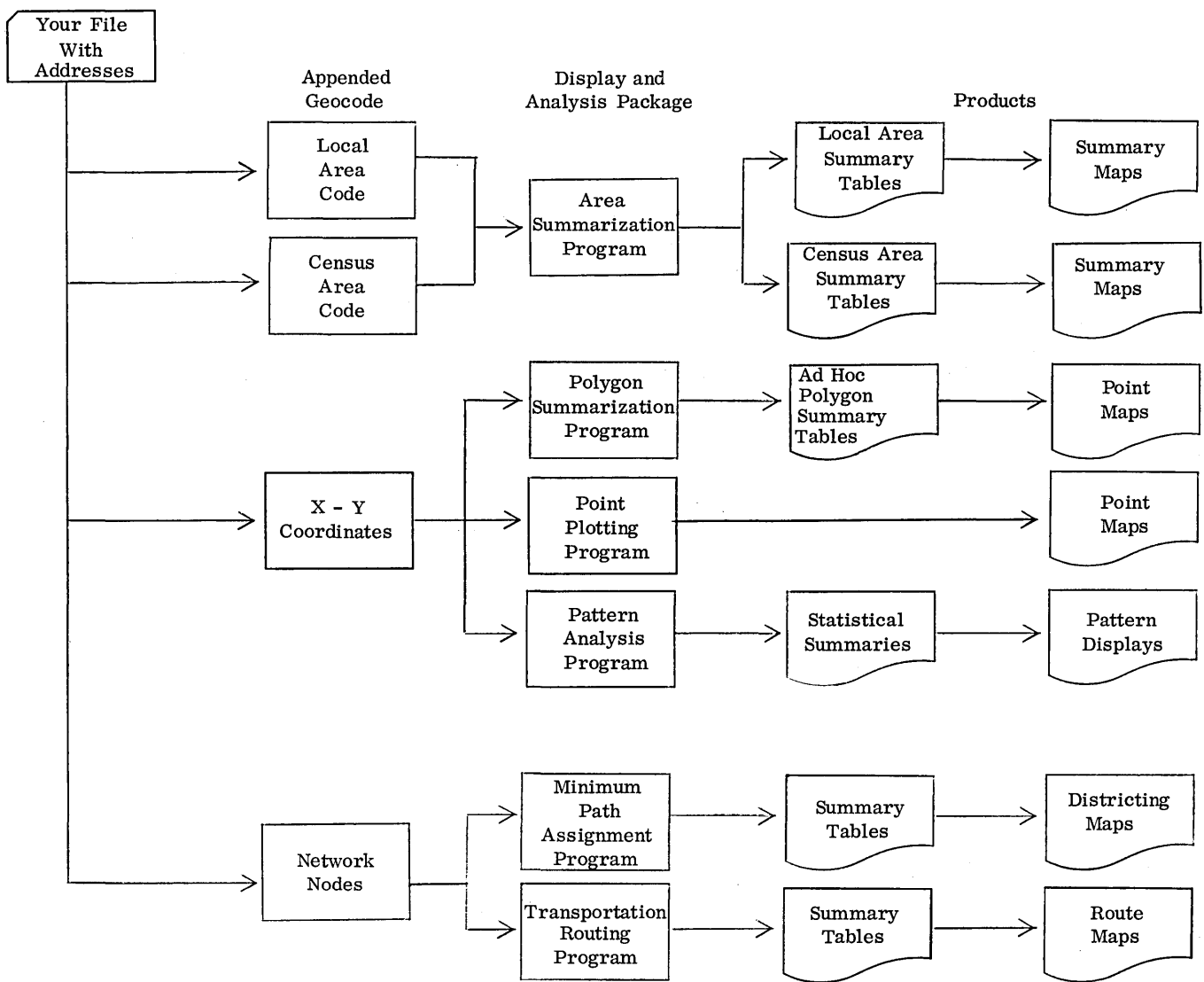

Geocoded data has many applications, from simple summaries to network analysis.

of the SACS Directory. He sees many more uses for geocoding – it “allows the district to make decisions much more quickly” – and the cooperation established for the busing problem may well produce rewards far beyond the initial problem solution.

#### Implementation Details: Polygons and Busing

Actually, even now the Seattle School District’s use of the SACS Directory extends beyond the problem of busing. With the advent of the Middle School Plan came the need to define new school boundaries to match the newly-reorganized schools. Once the school boundaries are established, busing selection is by contrast a fairly simple process, using what is called “polygon retrieval”.

There are 47 schools involved in the redistricting. The process of defining those 47 districts begins with the selection of a set of polygons, one surrounding each school, which are thought to be a logical set of school boundaries. The polygons are then converted into X-Y coordinate form.

The School District’s data processing center is responsible for the computerization of the school boundary definition; its Planning and Evaluation Department is responsible for the final boundary decisions.

At the same time that the first approximation at polygon definition is being made manually, the file of student

addresses must be converted to X-Y coordinates by passing it against the SACS Directory. Tools developed by the Urban Data Center were used for this purpose. The conversion process was not, as might be expected, without incident. For one thing, a fair number of student addresses were rejected (some students find giving a phony address a way of “beating the system”); for another thing, the initial UDC conversion program, adequate for the small research-oriented data bases previously encountered, was too slow for the large data volume of the school district. The solutions to both problems, however, were quick and straightforward. As a side benefit, the school district now has a more adequate address file, and UDC has a more efficient I/O package!

With the student-address file converted and the initial polygons manually defined, the addresses and polygon definitions are now passed against one another. Special programs running on the School District’s IBM 360/40 assign a polygon number to each student address, based on the polygon within which the coordinates of the address fall. A listing is made of the results, ordered by (1) polygon to which assigned, then (2) school presently attended, then (3) grade level, and showing name and race. Summary reports also are available, showing counts by polygon (new school) and grade level.

**STUDENT RESIDENCE LOCATIONS  
3 SEATTLE ELEMENTARY SCHOOLS**

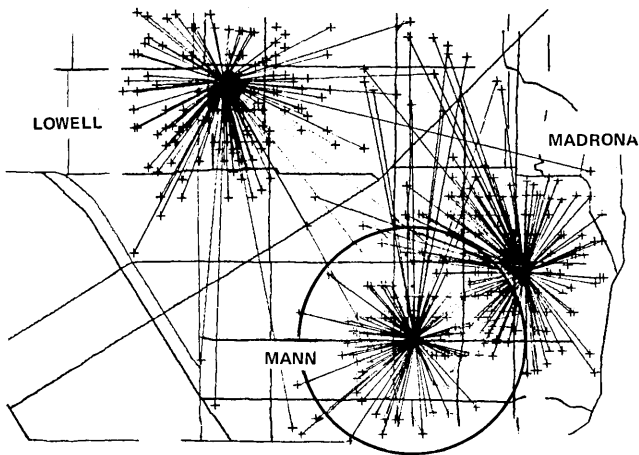

Produced at the Urban Data Center — University of Washington

**Distribution of students assigned to schools may be graphically displayed.**

**A New Set of Polygons**

At this point, Planning and Evaluation examines the grade distribution and the school capacities, and establishes a new set of polygons defining a more equitable distribution of students to grades and schools. The process is repeated until the school loads are balanced.

Only then does the solution to the busing problem enter into the picture. Using such criteria as traffic patterns, population density, and safety considerations, a set of three optimum bus stops is manually selected. One of these is chosen by some random process. Smaller polygons are then manually constructed around this bus stop, and a subset of students within that small polygon are chosen for busing based on their ethnic background and their walking distance to the bus stop.

**The Future**

There are many facets to the future of the component parts of this story.

Politics and public outcry may yet negate the integration plan which technology has been able to produce. There is reason to believe it will not, however. The quiet but constant effect of the forcing functions remain. And Seattle, for all the tumult of this issue, has a better racial climate and potential for racial harmony than most of the rest of the nation. The odds are that, with an assist from the computer, busing will become a reality in Seattle this fall.

The technology itself has a many-faceted future. UDC studies in the assignment of the Seattle population to Civil Defense Shelters using automated network analysis techniques, have implications for the use of the same techniques in fully automated busing selection.

The more powerful techniques for assigning students to schools can result in better selection of school building sites and better decisions on the closing of obsolescent schools.

**Branching Out**

UDC is branching out into new geocoding areas. SACS has already been used for answering such questions as:

- “How are fire bombing incidents geographically distributed in the Seattle area?”
- “Where and how should innovative transportation systems be placed in order to satisfy as many people needs as possible?”
- “Where do the greatest concentrations of (1) crimes against persons and (2) crimes against property take place?”
- “What is the potential student distribution for a three-campus Seattle Community College system?”

But problems occur in the utilization of geocode technology. One, which is solvable by transfusion of money, is the generalization of the software that allows access to the SACS Directory for specific applications. Another, prob-

**SELECTED SOCIAL INCIDENTS**

1-3 February, 1968 — Central Business District, Seattle

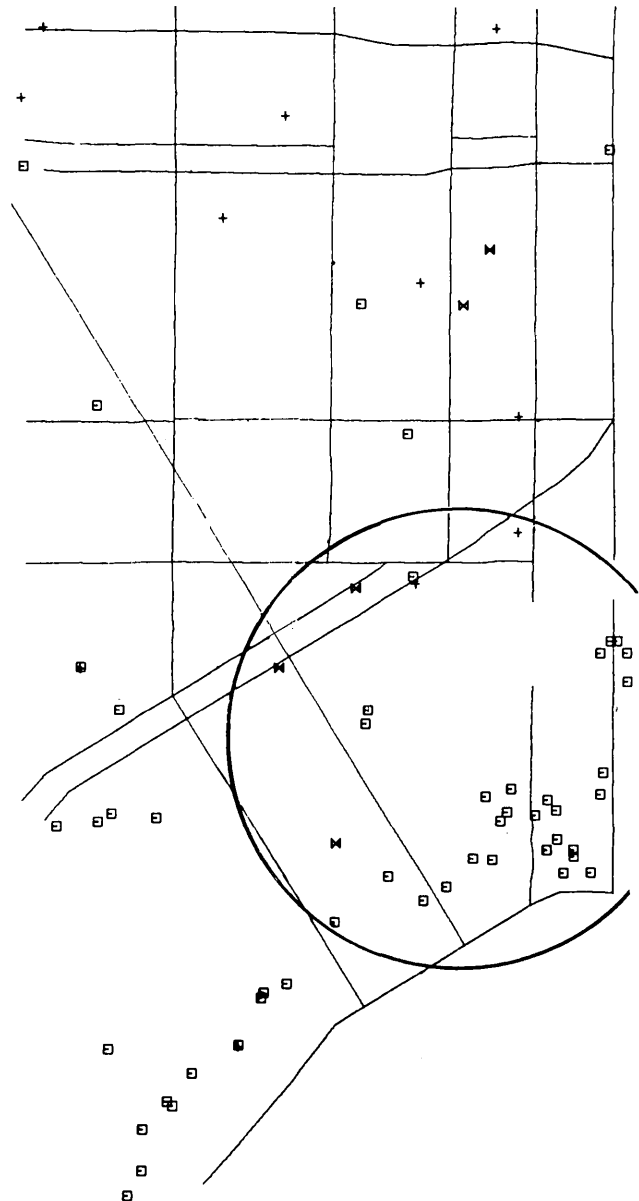

Key:  
 □ Drunkenness  
 + Family Disturbances  
 × Juvenile Delinquency

Produced by the Urban Data Center  
 University of Washington

**Spatially-oriented data.**

Walter Penney, CDP  
 Problem Editor  
 Computers and Automation

ably tougher, although also amenable to a money solution, is SACS Directory maintenance. As the pulse of a city beats, new streets and new homes come into being, and streets close, and redevelopment changes the face of the community. All of these things must be reflected in the Directory, and that turns out to be complicated and expensive. The process of urban change, its monitoring and regulation, is decentralized and uncoordinated. Estimates run to \$100,000/year to operate and maintain an accurate urban geocoding system. (The Directory cost about \$400-\$500 per square mile to build originally.) This is one of the major deterrents to expansion of the previously-mentioned consortium.

**A Personal Note**

The collecting of the information for this article required a goodly number of interviews. There was a feeling, everywhere I went, of acceptance of busing and all it implies. The clamor of the outside world seemed completely remote, when one was standing over the console of the Urban Data Center's 1130 computer, watching University people excitedly consumed by their technology and quietly proud to be agents of positive social change. It seemed even more remote when one was sitting in an office in the gleaming new Seattle Public School Data Processing Center, watching a late season snowfall quietly blot out traces of surrounding urban grime, and talking about the transfer of students for racial reasons as if it were as normal as administering tests, or serving lunches. There was never, in any interview, an underlying current of resentment at being an involuntary participant in a social revolution.

Finally, I asked one educator why.

"Well", he said, "if we found a group of students not doing well, and we learned that if they were transferred to another school they would do better, we would do it. If after deciding *that*, we learned they were black, would we not do it? After all, it's the kids who count."

And there, after all, is the whole point. It's not the technology, or the busing, or the parents who really matter. "It's the kids who count." □

---

"I have a dream that my four little children will one day live in a nation where they will not be judged by the color of their skin, but by the content of their character."

— Martin Luther King, Jr.

**Acknowledgements**

There were many people who contributed time and effort to the preparation of this article. These deserve special mention:

- Urban Data Center — Charles E. Barb, Jr., Prof. Edgar M. Horwood
- Seattle Public Schools — Charles Hammond, William Collison, George Shepherd, William Lagreid
- University of Washington Computer Center — Robert Gillespie

**References**

The University of Washington Urban Data Center has a large file of information pertaining to geocoding and its applications. An appropriate address for inquiries is:  
 Mr. Charles E. Barb, Jr.  
 Assistant Director, Urban Data Center  
 121 More Hall FV-10  
 University of Washington  
 Seattle, Washington 98105

**PROBLEM 717: A STREAM WITH NO PATTERNS**

"Ever hear of a Turing machine?" asked Jim as he sat down to lunch with Helen, a programmer from the Computer Center.

"Is that some sort of camper or trailer?"

"Not quite. It's a kind of Finite Automaton we're studying in Comp. Sci. 101."

"Sounds too science-fictional for me. It must be really far out."

"Not at all, it's very practical," Jim said. "And there are some very interesting concepts in connection with these machines. In fact, I just came up against something I had trouble figuring out."

"What was that?"

"We had to construct a stream using three elements, the only restriction being that there couldn't be any two consecutive patterns the same."

"If two consecutive elements are the same, is this considered a repetition of pattern?" Helen was beginning to get interested.

"Yes, and any longer stretch. For example, there can't be any A B A B or A B C A B C, and so on."

"Well, with three letters to choose from you should be able to form many streams — in fact you ought to be able to keep going indefinitely. What did you have trouble figuring out?"

"Whether one could ever get blocked and not be able to continue without repeating a pattern."

"Does this ever happen?" Does it?

**Solution to Problem 716: A String of Bits**

With an initial vector containing a 1's and b 0's, there will be, after n steps,  $\frac{1}{2} [(a + b)^N + (a - b)^N]$  1's and  $\frac{1}{2} [(a + b)^N - (a - b)^N]$  0's, where  $N = 2^n$ .

---

*Readers are invited to submit problems (and their solutions) for publication in this column to: Problem Editor, Computers and Automation, 815 Washington St., Newtonville, Mass. 02160.*

**CORRECTION**

In the April 1971 issue of Computers and Automation, the following correction should be made:

Page 26, "Numbles":  
 In the last line of "Numble 715",  
 replace "43974" by "43973".

# RESPONSIBILITY

*"The American computer industry carries a very special burden – because if you dominate, you have the greater responsibilities."*

*Sir John Wall, O.B.E., Chairman  
International Computers Limited  
London, England*

(Based on the keynote address given at the Spring Joint Computer Conference, Atlantic City, N.J., May 18, 1971)

## Outline

1. The Responsibility of Computer Manufacturers
2. Problems Facing the Computer Industry
3. Industrial Selfishness and Commercial Myopia
4. "Pollution" from the Computer Industry
5. Privacy of the Individual
6. Losing the Advantages of Voluntary Action
7. Ethically Unacceptable Purposes
8. Professional Protection of Clients
9. Demonstration of Being Worthy of Trust
10. An Ethical Model for the Computer Industry
11. Concrete, Common-Sense Proposals for the Computer Field
12. What the Community Suspects But Does Not Know
13. International Aspects of the Computer Industry
14. Independence Technologically As Well As Politically
15. A Glaring Economic Mistake: Tying the Customers In
16. When Things Look Good, One Makes the Irreversible Mistake
17. The Right to Nationally Independent Technology
18. The Creation of Satellites
19. Partners, a Necessary Nuisance
20. The Substitution of Size and Power, for Wisdom
21. The Use of Technology as an Instrument of Foreign Policy
22. A New Relationship Between Supplier and Customer
23. Responsibility of the Computer Industry for Education and Training of the Community
24. A Better Return from the Investment in the Computer Department
25. Public Fears and Suspicions of Computers
26. Small Technical Groups Holding the Community to Ransom
27. The Customer's Freedom of Choice
28. The Customer's Protection of His Existing Investment
29. World Standards in the Computer Field
30. Plug-To-Plug Peripherals
31. Standard Interfaces
32. Acceptance of the Responsibility that Goes with Power
33. – and With Power, Endless Criticism

It is indeed an honour to be invited to make this keynote address. I am something of a newcomer to the industry, but International Computers Ltd., of which I have the privilege to chairman, certainly is not. As you all know, ICL is a significant international computer force outside America, and has been in data processing for more than 60 years. Along with your industry we have endured all the triumphs and setbacks of the past 20 years – the Great

Euphoria, the Transistor Revolution, the Monolithic Invasion, the Software Famine – right up to the Great Disillusion and the Customers' Revolt. We are united with you in our competition for the same customers over much of the world; we are separated only by the barrier of a common language.

## 1. The Responsibility of Computer Manufacturers

I am delighted that "Responsibility" has been chosen as the topic of this Keynote Address. The responsibility of computer manufacturers badly needs talking about. Responsibility is something which people like to escape from these days; just as we all seem to have rights and nobody seems to have any obligations (giving us that accounting curiosity, a one-sided moral balance sheet), so responsibility is always something that somebody else should take care of. But not this time: it is your responsibilities that are my subject here. The American computer industry does carry a very special burden. You dominate much of the computer industry of the world. And if you dominate, you have the greater responsibilities. In addition, your industry contains a monopoly, if you measure monopoly by the usual British standard of more than 30 to 40 per cent of the market.

In directing my remarks to your responsibilities I am not seeking to minimise in any way the responsibilities which we in ICL also carry. On the contrary I venture to suggest that some of our burdens are greater than yours. We have the task of taking on, virtually singlehanded, the might of your vast industry; of being the only people who can demonstrate to the rest of the world that they too can have – as they must have – successful computer industries of their own, genuinely independent in the sense that their links with your industry are purely commercial and are not enforced or dictated by the absence of a home-grown product. Our success in ICL will, I believe, help to bring about the desirable development of a genuinely international and competitive world industry in information processing.

## 2. Problems Facing the Computer Industry

You are facing many problems. The main problem, I suggest, is the general feeling that the American computer industry is not facing its responsibilities to the community – the international community as well as the American community.

## 3. Industrial Selfishness and Commercial Myopia

What are these responsibilities? They can be summed up in the fashionable word "pollution". It has a multitude of



effects, but only one cause — and that is a failure by industry to foresee, acknowledge, and act upon its responsibilities to the community. It is visible evidence of industrial selfishness and commercial myopia.

#### 4. "Pollution" from the Computer Industry

In recent years more and more industries have been attacked (and rightly) for creating pollution — for pursuing their narrow commercial objectives at the expense of the wider community. While some industries may have a better record than others, it is hard to find any single case where an industry has foreseen that it might create pollution and has taken any action to prevent it — *before* it happened. In every case the pollution has been drawn to the attention of the public and the industry *after* it happened. Industry has then often gone to immense trouble to minimise the harm it has done and to put the wrong right.

For the computer industry, the issue is more difficult still. Hitherto we have been concerned with pollution of the senses or physical welfare — dead rivers and lakes, oil on beaches, smog, plastic bags, insecticides, pesticides, food adulterants, noise.

Now we are facing something different, the fact that the information processing industry can affect the dignity and rights of individuals; the independence of countries; the freedom of choice of consumers.

Our industry has the capacity to increase immensely the wealth and happiness of mankind — to take drudgery out of life by pushing on to new frontiers for greater efficiency. But, at the same time, it has the capacity to damage the true independence of individuals, of organisations, and of countries.

#### 5. Privacy of the Individual

My first point is the privacy of the individual. This important issue is attracting more and more public attention. The response of the industry is shamefully slow. I do not like regulation — but if it is necessary, then let it be self-regulation. But it is hard to detect any effort by the industry to demonstrate its desire or its ability to regulate itself.

I fear, therefore, you are allowing the initiative to pass out of the hands of your industry, where it belongs, into the hands of Government and of other organisations. Your Congress and my Parliament are already considering action to regulate the computer industry. I believe that this kind of restriction and regulation will grow with every year. So the computer industry runs the real risk of having to follow instead of taking the lead on matters of vital importance to its future. In so many spheres of endeavour we are all losing the advantages of voluntary versus enforced action.

#### 6. Losing the Advantages of Voluntary Action

Industries, in general, have failed signally to anticipate their responsibilities to the community. Now you in your industry still have a unique opportunity. Why can't you try and look into the future? assess the dangers and the possible extent of "computer pollution"? make clear to the community at large and to Government, what you, as an industry, think should be done to safeguard the rights of man?

We must all agree that the dangers and risks of the individual's privacy being eroded are not just a newspaper scare. It is true we do have technical solutions, in whole or in part. We can ensure that computer systems which contain confidential information about people will not divulge that information to everybody. Access can be restricted to specific individuals. Even in ICL there are facts to which I as Chairman am not allowed access — and quite rightly.

But, these are only partial solutions: technical solutions often hinge on human operators. Personally, I think any operator who has technical access to this kind of personal data should have to undergo the same rigorous screening as a cypher clerk in the security establishment.

It is a practical, indeed desirable, proposition that there should exist a data base file containing relevant personal facts about every person in the country concerned. The problem arises as to what is, or is not, relevant. If all the details of my life are on file, I am going to be understandably sensitive about the people who have access to the information contained in it — who are going to be in a position to know, for example, whether I have ever served a prison sentence or contacted some unmentionable disease. And yet, at the same time, it may be necessary or desirable that these two pieces of information should be available to certain carefully selected people. But my fears as an individual are, nevertheless, real and totally understandable.

To what degree are we prepared to surrender a small degree of personal privacy — in the knowledge that in doing so we may be assisting in a cure for a disease from which one day we might ourselves be suffering? What steps are you taking as an industry to try and satisfy these conflicting demands, which are likely to become increasingly frequent?

Are you prepared to take the initiative, or will you leave it to others? Will you state openly that because you are responsible for the threat to privacy, you will act responsibly to combat and minimise that threat?

#### 7. Ethically Unacceptable Purposes

The problem is yours — and mine — since we are the ones who have developed the means. The solution cannot be entirely ours because that is up to Governments and to the public. But, certainly the question does arise: what should be my reaction as a Chairman of a national computer company if I were asked by a Government Department or a major customer to install a computer system which I knew was intended for a purpose which I found ethically unacceptable?

This is, I know, a hypothetical question. The obvious answer is that, as the supplier, all I need to do is ask for assurances, and having received them, just sit back. I couldn't, in fact, do more than that because I am, after all, merely a supplier. But, that solution does invite the further question as to whether Pontius Pilate would not have made a marvellous Chairman of a computer company.

One escape from these dilemmas, of course, is to assert "That's all very well, but if my company doesn't provide the service, then another Company will".

This is not an adequate answer though. What positive steps must you take, as an industry acting in concert, to express your sense of responsibility in some practical form? The only adequate answer is, of course, that the industry

must develop some kind of professional ethic. And only the industry can do this.

### 8. Professional Protection of Clients

I can best illustrate my conviction of this need by referring to specific examples. It is very easy for a Government, say, to put pressure on a manufacturer to make nerve gas. It is very hard — almost impossible — for a Government to put pressure on a doctor to disclose details about his patient. Lawyers and Chartered Accountants too have a professional standard of secrecy regarding their clients. The reason is that they both belong to bodies who have a strong hold on the public, in that their professional ethics are generally recognised and accepted as valid.

If it emerged that a Government was trying to force doctors to disclose information about their patients, there would be a national outcry. But the doctors have earned that ethical position and the public support for it — they have not demanded it by right. In my opinion, it is up to the computer industry to demonstrate that it is entitled to the same public support on its ethical stand. Suspicion must be replaced by trust.

### 9. Demonstration of Being Worthy of Trust

But, to do that the computer industry must demonstrate that it deserves this trust and is worthy of it. What we need is a standard of ethics which supports every member of our profession in a stand which he could not sustain on his own; which allows him to say, if necessary, "I will not carry out that instruction unless you publish the fact and your motives in ordering me to undertake it".

And your concern should be to keep your own house in order. For a doctor or a lawyer to be dismissed from his professional organisation by his fellow professionals is a crushing blow. It is not necessarily a loss of livelihood, but it is an enormous loss of professional respect. In that sense, the two go hand-in-hand. The strength of a professional organisation in the eyes of the outside world is, in many ways, the firmness with which it enforces its standards upon its own members.

Your industry must achieve the same sense of status: that to belong is important, and to be dismissed is a disgrace.

### 10. An Ethical Model for the Computer Industry

What the computer industry needs, to use its own jargon, is an *ethical model*. A model for the future. Every other industry, as I said earlier, has committed its mistakes, been attacked for them and only then attempted to set its house in order. Instead of letting Ralph Nader and others attack you as ideal targets, why not anticipate the attack now and forestall it? You are better equipped to do so than anyone else. It is a marvellous prospect: the first industry to protect itself against "clobbering" — the one that builds its own "anti-clobber" model!

I know this sounds easy — and pious and platitudinous. But, I also know that it is, in fact, very difficult. Do you really care (indeed, do you really want to know) how your salesman in the field gets his order? You want him just to get it. You measure him, promote him (or demote him) on this basis and on this basis alone. But, what if you should decide that you will not accept an order for professional

ethical reasons? Do you want good salesmen, or ethical salesmen? Are the two things inconsistent?

Yet I believe that, in spite of many real difficulties, the industry has no alternative but to hasten the establishment of proper ethical professional standards. Without them, however, much you mutter among yourselves and privately wash your hands, you will become willy nilly the instruments of bureaucratic direction and control. With such standards, even if you fail to live up to them, you will have the chance to be at least whiskey priests at the altar of freedom from bureaucracy.

### 11. Concrete, Common-Sense Proposals for the Computer Field

And the ethical standards you establish must be seen to be practical and comprehensive. Not just codes of conduct and good behaviour, but good concrete common-sense proposals. For example: professional certificates which can be revoked, and a Central Council to collect information and to issue judgements in cases of abuse brought to its attention by credit agencies, Governments, Companies, or individuals. It is vital that your actions should appear to be constructive and not defensive or white-washing.

And you will not be the first to move in the right direction. On the 17th February 1971, the British Computer Society adopted a Code of Conduct. The object of the Code is "To promote trust and confidence in integrity and upright dealing; trust and confidence between a professional man and his client; and between the profession as a whole and the public". I quote again from the Code: "Members should have regard to the effect of computer based systems . . . on the basic human rights of individuals whether within the organisation, its customer or supplier, or among the general public." A small start perhaps. But a start.

And it is well worth noting that in the recent debate in our Parliament about the Population Census, all the fears, doubts and prejudices about central information banks became very evident. But our Government gave full approval to discussions about the privacy of the Census data between the British Computer Society and the Census Office. Another step forward.

Can you, with your world domination, refuse to lead? May I quote again — this time from Paul Armer of Stanford:

What can we computer professionals do? We must do something if only for selfish reasons. I suspect that the words: 'if we don't police ourselves the Government will' have been uttered thousands of times in credit bureau circles in recent months . . . We have a duty to help solve the problem of computers and society. If the computer profession does not step up to challenge and help meet it, we will pay for our failure in a frightening variety of ways. Whether or not society holds us accountable in a formal way is probably irrelevant.

### 12. What the Community Suspects But Does Not Know

The community is becoming increasingly aware of the cumulating impact of a fast-growing information industry based on computers. It is increasingly worried by what it sees, and still more by what it suspects but does not know. This must bring with it an increasing demand for regulation.

**WHO'S WHO IN COMPUTERS AND DATA PROCESSING**  
**Edition 5, Published March 1971**  
**Supplement 1, Part 2, HOM to ZUS, Published July 1971**

The Fifth Edition of "Who's Who in Computers and Data Processing", in three volumes, totaling over 1000 pages and containing over 15,000 capsule biographies, was published in March 1971.

The following Part 2 of Supplement 1 consists of updating information (including new entries and corrections of prior entries) for the Fifth Edition, for last names beginning HOM to ZUS.

Three types of information are published here:

- [no asterisk] Entirely new capsule biography entry
- \* Change(s) in, or confirmation of, the entry in the Fifth Edition
- \*\* Entire capsule biography entry which replaces the corresponding entry in the Fifth Edition

The changes reported here are based on information kindly sent to us by entrants: (1) which updates or corrects the information previously published; or (2) which was received by us before publication of the Fifth Edition but too late for inclusion in it; or (3) which was sent to us after publication of the Fifth Edition.

It is hoped that this supplement will be helpful to users of the Fifth Edition. Any purchaser of a complete set (3 volumes) of the Fifth Edition and who has entered (or enters) with us a standing order for the Sixth and later editions will be sent Supplement 1 consisting of Part 1 (published in the prior issue) and Part 2 (published in this issue)

FREE on request. Any other purchaser of one or more volumes of the Fifth Edition may order Supplement 1 at \$1 (please send amount with order to avoid bookkeeping costs).

Part 1 of Supplement 1 was published in the June issue of "Computers and Automation."

Abbreviations include:

- b: born
- ed: education
- ent: entered computer field
- m-i: main interests
- t: title
- org: organization
- pb-h: publications, honors, memberships, other distinctions
- h: home address
- v: volume number

Main Interests:

- |                |                |
|----------------|----------------|
| A Applications | Mg Management  |
| B Business     | Ma Mathematics |
| C Construction | P Programming  |
| D Design       | Sa Sales       |
| L Logic        | Sy Systems     |

\*C 71: Information compiled or checked in 1971 (similarly for other years)

**H (cont.)**

- \*HOMER, Eugene D. / ed: B Ind E, M Ind E, PhD / t: professor and chmn / org: C W Post College of Long Island Univ, Greenvale, NY 11548 / pb-h: Tau Beta Pi, Alpha Pi Mu, Sigma Xi, Amer Assn for the Adv of Science, ASEE (educ), AAUP, ORSA, TIMS, ACM, AIIE, NYAS, SDE, Amer Inst for Decision Sciences; several publications / v: 3 / \*C 71
- \*HOPKINS, Albert L., Jr. / pb-h: IEEE Computer Society Governing Board, chmn technical comm on data acquisition and control, chmn publns comm, various articles / h: 221 Mt Auburn St, Cambridge, MA 02138 / v: 3 / \*C 71
- \*\*HOPPER, Cdr Grace Murray, USNR / mathematician / b: 1906 / ed: BA, Vassar; MA & PhD, Yale / ent: 1944 / m-i: A B P / t: Head, Navy Programming Languages Section / org: Dept of Navy, Information Systems Div, Navy Programming Languages Section, Pentagon 2C319, Washington, DC 20350; on military leave from UNIVAC Div of Sperry Rand Corp, Box 500, Blue Bell, PA 19422 / pb-h: Phi Beta Kappa; Sigma Xi; Upsilon Pi Epsilon; visiting Assoc Prof, Moore School of Electrical Engineering, Univ of Pennsylvania; Fellow IEEE; member, AAAS, ACM, DPMA, SWE; Franklin Inst, US Naval Inst; 5 honorary awards; over 50 published articles on high-level languages, compilers and standards / h: 1400 S Joyce St, Al614, Arlington, VA 22202 / v: 3 / \*C 71
- \*HORN, Reginald L. / org: Vacta Group, Inc, 2605 E Kilgore Rd, Kalamazoo, MI 49002 / h: 10330 Lloy, Portage, MI 49081 / v: 2 / \*C 71
- \*HOROWITZ, Henry F. / h: Marbrook Rd, Owing Mills, MD 21117 / v: 2 / \*C 71
- \*HORTON, Donald W. / org: Computer Guidance Corp, 36 Old Kings Highway S, Darien, CT 06820 / v: 2 / \*C 71
- \*\*HORWICH, Julian / analyst and programmer / b: 1942 / ed: BS, electrical engineering, Northwestern Univ;

- graduate work, Information Science, Illinois Institute of Technology / ent: 1964 / m-i: A Ma P Sy; biomedical applications / t: scientific systems analyst / org: Abbott Labs, 1400 Sheridan Rd, North Chicago, IL 60064 / pb-h: former chmn, Software Comm, GE 400 Users Group; ACM / h: 1239 Glencoe Ave, Highland Pk, IL 60035 / v: 1 3 / \*C 71
- \*HOSICK, Anthony J. / pb-h: ASM, Alpha Tau Gamma / v: 2 / \*C 71
- \*HOUSE, B. Thomas / org: Sparks Regional Medical Center, 1311 S I St, Fort Smith, AR 72901 / pb-h: DPMA, 2 papers / v: 1 2 / \*C 71
- \*HOVLAND, Carl W. / t: director of data processing / v: 2 / \*C 71
- \*HOWERTON, Paul W. / t: assistant dean / v: 2 3 / \*C 71
- HOWLETT, Thomas M. / DP manager / b: 1941 / ed: BA, MA, Coll of St Thomas / ent: 1964 / m-i: Ma P Sy / t: director, DP / org: St Norbert College, West DePere, WI 54178 / pb-h: Phi Alpha Theta, DPMA / h: 1658 Western, Green Bay, WI 54303 / v: 2 / \*C 70
- \*HSU, Charles T. / t: manager computer dept / pb-h: Pi Tau Sigma / v: 3 / \*C 71
- \*HUDDLESTON, Leonard W. / t: asst vice-pres / pb-h: DPMA / v: 1 / \*C 71
- \*HUDSON, Christopher A. / h: 5841 Transit Rd, Depew, NY 14043 / v: 1 2 / \*C 71
- \*HUGHES, R. W. / t: chmn of the board / org: Data Trends, Inc, 50 Intervale Rd, Parsippany, NJ 07054 / pb-h: 16 patents; AMA, IEEE / v: 3 / \*C 71
- HUMPHREYS, J. R. III / research and development / b: 1940 / ed: MBA / ent: - / m-i: P Sy; admn / t: dir computer science / org: Data Technology Inc, 3400 Curtis Dr, Hillcrest Hgts, MD 20027 / pb-h: numerous / h: 6650 Inglewood Ave, Stockton, CA 95207 / v: 1 2 / \*C 70
- \*HUNT, Raymond M. / m-i: A Mg Sy / v: 2 / \*C 71

\*HUNTER, Larry C. / h: 104 NW Seventh, Corvallis, OR 97330 / v: 2 / \*C 71  
\*HUTTO, J. M. / t: senior systems analyst / org: Shell Oil Co, Box 20329, Houston, TX 77025 / h: 1019 Teresa, Houston, TX 77055 / v: 2 / \*C 71  
\*HYNES, Patrick J., III / org: Caltex Petroleum Corp, 380 Madison Ave, New York, NY 10017 / v: 2 / \*C 71

I

\*INGERMAN, Peter Zilahy / computer programming researcher / t: staff programming planner / org: RCA Corp, Bldg 214-2, Camden, NJ 08101 / h: 40 Needlepoint Lane, Willingboro, NJ 08046 / v: 2 / \*C 71  
\*INGLE, Marvin W. / t: director / org: Mid-Iowa Educational Computer Center, 1800 Grand Ave, Des Moines, IA 50309 / v: 3 / \*C 71  
\*INKELES, David J. / pb-h: DPMA, CDP; EDP Assoc of Wall Street / v: 2 / \*C 71  
\*INOUE, Michael Shigeru / pb-h: AIIE, Simulation Symposium, DPMA, CDP, Tau Beta Pi, Alpha Pi Mu; 14 papers, research grants 1968-71 / v: 3 / \*C 71

J

\*JACKSON, Charles / h: 310 S Brookside Ave, Freeport, NY 11520 / v: 2 / \*C 71  
\*JACKSON, Robert F. / pb-h: AMS, MAA, ACM, IEEE / v: 3 / \*C 71  
\*JACOWITZ, Allen / chief of applications programming / m-i: A Mg P Sy / t: higher education associate / v: 1 / \*C 71  
\*JAMES, Charles G. / ed: BS, SF Austin State Univ / v: 2 / \*C 71  
\*JANNEY, Walter C., III / m-i: A B Ma Mg P / t: asst vice-pres / v: 3 / \*C 71  
\*JASPEN, Nathan / h: 100 Bleecker St, New York, NY 10012 / v: 3 / \*C 71  
\*JASPER, Renee B. / h: 6208 Dahlonge Rd, Washington, DC 20016 / v: 1 3 / \*C 71  
JAY, Norbert / executive / b: 1930 / ed: BS, math / ent: 1959 / m-i: P Sy, programming language conversion and compatibility / t: president / org: Systems Programming, Inc, 175 Main St, White Plains, NY 10601 / pb-h: - / h: Box 243 RFD 1, Hunterbrook Rd, Yorktown Hgts, NY 10598 / v: 1 2 3 / \*C 70  
\*JAYNE, Harold M. / pb-h: IEEE, ACM / v: 3 / \*C 71  
\*JEFFRIES, Ronald E. / executive / m-i: A B Mg P Sy; time-sharing, interactive languages / t: vice-pres research & development / h: 2227 Medford, Ann Arbor, MI 48104 / v: 1 2 / \*C 71  
\*JENNEMANN, Vincent F. / ed: St Louis Univ, Columbia Univ, Univ of Tulsa / t: computer analyst, sr grade / org: Amoco Production Co, PO Box 591, Tulsa, OK 74102 / pb-h: ACM and more than 5 other organizations; chmn, Tulsa ACM 1966-67 / v: 1 / \*C 71  
\*JENSEN, E. Douglas / digital applications engineer / m-i: L / t: field applications engineer / org: National Semiconductor Corp, 5925 Forest Lane, Suite 205, Dallas, TX 75229 / pb-h: IEEE, ACM; 7 papers on hardware and software design / h: 14632 Del Prado, Dallas, TX 75240 / v: 1 / \*C 71  
\*JOHANNES, Thomas C. / ent: 1953 / t: vice-pres operation / v: 2 / \*C 71  
\*JOHNS, B. A. / t: senior staff / v: 1 / \*C 71  
\*JOHNSON, Donald D. / org: Amoco Production Co, PO Box 591, Tulsa, OK 74102 / pb-h: SID(display); "Job Accounting for IBM 1800", Common Proceedings, May 1970; "High Performance I/O Devices on IBM 1800", Common Proceedings, Dec 1970 / v: 1 / \*C 71  
\*JOHNSON, Robert L. / t: executive consultant / org: independent / v: 3 / \*C 71

\*JOHNSON, Robert L. / org: IMLAC Corp, 296 Newton St, Waltham, MA 02154 / pb-h: ACM / v: 1 / \*C 71  
\*JOHNSON, Roger V. / t: director of systems / v: 1 2 / \*C 71  
\*\*JOHNSON, Whitney L. / administrator / b: 1927 / ed: BS, Utah State Univ; MS, Univ of Minnesota / ent: 1955 / m-i: Mg / t: ADP administrator / org: State Council of Higher Education for Virginia, Life of Virginia Bldg, 911 E Broad St, Richmond, VA 23219 / pb-h: ASS, Biometric Soc, IMS (math), APHA, AEDS, ACM, Virginia Academy of Science, AOPA; co-author "Moments of a Serial Correlation Coefficient", Jour of the Royal Statistical Society, Series B, Vol 27, No 2, 1965; several papers / h: 7021 Doulton Rd, Richmond, VA 23225 / v: 2 3 / \*C 70  
\*JONES, Charles P. / computer & systems mgr, accounting mgr / t: controller / org: Federal Home Loan Bank of Greensboro, 444 N Elm St, Greensboro, NC 27405 / pb-h: CDP; AAA (acctg), NAA (acctg), DPMA / v: 1 / \*C 71  
\*JONES, John L. / physics & computer science instructor / org: Computer Science Dept, US Naval Academy, Annapolis, MD 21402 / h: 1065 Norman Dr, Annapolis, MD 21403 / v: 1 / \*C 71  
\*JONES, Nolan T. / m-i: A D Sy / h: 22 Squire Rd, Winchester, MA 01890 / v: 1 / \*C 71  
\*JONES, Robert L. / computer center director / t: director / v: 1 2 / \*C 71  
\*JONES, Roland L. — replace by JONES, Ronald L., which see  
\*\*JONES, Ronald L. / asst director of data processing / b: 1936 / ed: coll / ent: 1954 / m-i: A P Sy / t: asst director of data processing / org: Clark County School District, 2832 Flamingo Rd, Las Vegas, NV 89109 / pb-h: CDP; DPMA / h: 2469 Tournament Ct, Las Vegas, NV 89109 / v: 2 / \*C 71  
\*JOSEPH, Jay P. / ed: AB, Columbia; MBA, Pace College Graduate School / t: systems officer / h: 17 Oak Brook La, Merrick, NY 11566 / v: 3 / \*C 71  
\*JUTILA, Sakari T. / t: senior professor of operations analysis & professor of industrial engineering / pb-h: IEE, AEA, Econometric Society, Mid-Continent Regional Science Assoc, NYAS, 11 papers, over 30 consulting reports / v: 3 / \*C 71

K

\*KAERCHER, Jacque E. / t: programming supervisor / v: 1 / \*C 71  
\*KAGANOVE, Jerry J. / assoc mathematician / pb-h: 4 papers for Transactions, American Nuclear Society, paper for APS / v: 3 / \*C 71  
\*KAHN, Louis B. / org: Technical Economics, Inc, 1533 Shattuck, PO 9033, Berkeley, CA 94709 / h: 1533 Shattuck, PO 9033, Berkeley, CA 94709 / v: 2 3 / \*C 71  
\*KALBACH, John F. / org: Burroughs Corp, 14724 E Proctor Ave, City of Industry, CA 91744 / v: 2 / \*C 71  
\*KALBFELL, Dr. D. C. / pb-h: Fellow, IEEE; 13 patents / v: 2 / \*C 71  
\*KALIN, Richard B. / 1694 Main St, Concord, MA 01742 / v: 1 3 / \*C 71  
\*KANARY, Richard L. / h: 39 Forestdale Rd, Kinnelon, NJ 07405 / v: 1 2 / \*C 71  
\*KARPINSKI, Richard H. / t: principal programmer / org: Univ of California, San Francisco, CA 94122 / h: 199 Cañon Dr, Orinda, CA 94563 / v: 1 / \*C 71  
\*KARST, Edgar / pb-h: AMA (math), Sigma Xi, Pi Mu Epsilon; about 30 publns / v: 3 / \*C 71  
\*KATZIVE, Robert H. / org: Varian Data Machines, Graphics & Data Systems Div, 611 Hansen Way, Palo Alto, CA 94303 / v: 2 / \*C 71  
\*KAUFFMAN, Ellwood / executive / t: executive vice pres and director / org: Mainstem, Inc, 1101 State

- Rd (PO Box 2) Princeton, NJ 08540 / v: 3 / \*C 71
- \*KAUFMAN, Robert / executive, controller / t: vice pres - controller / org: Computer Center Inc, 350 Royal Palm Way, Palm Beach, FL 33480 / h: 219 Fairway E, Tequesta, FL 33458 / v: 3 / \*C 71
- \*KEDER, Virko / ed: BSEE, MSEE, Purdue / org: Mitre Corp, 1820 Dolley Madison Blvd, McLean, VA 22101 / pb-h: "Effect of a Nonideal Regeneration Slicing Characteristic on the Error Rate of a Binary Pulse Transmission System"; senior member, IEEE, Computer Society / v: 3 / \*C 71
- \*KEEFER, Roland J. / t: assoc professor of math-director computing center / pb-h: ACM, ASIS, AAAS; coordinator for faculty training seminar in computers, Univ of Wisconsin; "Computers as a Classroom Aid," paper presented at Natl Teachers of Math Spring Session / h: 1717 West 14th, Spokane, WA 99204 / v: 3 / \*C 71
- \*KEENAN, John F. / ed: BA, Robert Morris, Pitt / t: mgr, information systems / v: 2 / \*C 71
- \*KEENAN, Thomas A. / t: program director, software & programming systems / pb-h: 5 assns, board of CBMS, ACM lecturer, 6 books, over 20 papers / v: 2 3 / \*C 71
- \*KEHOE, Thomas J. / systems analyst / v: 1 3 / \*C 71
- \*KEITHLEY, Ray D. / h: 1500 W Scott Pl, Independence, MO 64052 / v: 2 / \*C 71
- \*KELLER, Jeffrey / consultant EDP / t: vice-pres / v: 2 3 / \*C 71
- \*KELLER, Mary K. (Sister) / pb-h: ACM, lecturer for NCTM, Mu Alpha Theta, and DPMA; 4 papers; book Mathematics & Computing, Weber, Prindle & Schmidt, 1971 / v: 1 3 / \*C 71
- KELLEY, Dr. Jay Hilary / engineer / b: 1920 / ed: BS, MS, PhD, Penn State Univ / ent: 1952 / m-i: A / t: president / org: Urbdata Associates, Inc, 3401 Market St, Philadelphia, PA 19104 / pb-h: - / h: 8820 Germantown Ave, Chestnut Hill, Philadelphia, PA 19118 / v: 1 2 / \*C 70
- \*KELLY, Paul H. / sr supervisor programming / ed: BS, business admn, Rutgers / m-i: P Sy; business applications / t: sr supervisor / v: 3 / \*C 71
- \*KELLY, Thomas W. / h: 112 Burley St, Danvers, MA 01923 / v: 3 / \*C 71
- \*KEMENY, John G. / t: pres, Dartmouth College and Albert Bradley Third Century Professor / h: 1 Tuck Dr, Hanover, NH 03755 / v: 3 / \*C 71
- \*KEMPER, Gene Allen / H; 3210 Cherry, Apt 27, Grand Forks, ND 58201 / v: 3 / \*C 71
- \*KEMPTER, John D. / director applications, systems and programming / t: secretary / pb-h: CDP; DPMA, CPCU / h: 578 Oakdale Rd, East Meadow, NY 11554 / v: 2 / \*C 71
- \*KENDALL, Clifford M. / executive / t: president / org: Computer Data Systems Inc, 8121 George Ave, Silver Spring, MD 20910 / v: 2 / \*C 71
- KENNAN, Theodore / manager / b: 1935 / ed: BEE; MBA, Harvard / ent: 1961 / m-i: A B D L Mg Sy; user function architecture / t: systems planner (architecture) / org: IBM Corp, 1000 Westchester Ave, White Plains, NY 10604 / pb-h: IBM Outstanding Contribution Award / h: 670 Barrymore, Mamaroneck, NY 10543 / v: 3 / \*C 70
- \*KENNEY, Harry W. / executive / t: executive vice-pres / pb-h: several papers; FEL; past natl director LOMA; director local AMS; Chamber of Commerce; VFW / h: 6316 W 101 Terrace, OverlandPk, KS 66104 / v: 2 / \*C 71
- \*KENT, Henry K. / t: director mfg operations planning / v: 1 / \*C 71
- KEPPLER, Fred C. / executive / b: 1927 / ed: BS / ent: 1950 / m-i: A B Mg P Sa Sy / t: president / org: Southern Vermont Computer Ctr, 219 Ben-Mont Ave, Bennington, VT 05201 / pb-h: 2 patents, Special National Achievement Award / h: 112 Hillside St, Bennington, VT 05201 / v: 2 3 / \*C 71
- \*KERN, Frederick W. t: operations mgr / v: 2 / \*C 71
- \*KESSLER, Marvin M. / org: IBM Corp, Federal Systems Div, Gaithersburg, MD 20760 / v: 1 / \*C 71
- \*KETCHUM, Sidney J. / asst systems & procedures supvr / t: asst systems & procedures supvr / v: 1 / \*C 71
- \*KIDD, E. M. / ent: 1953 / v: 2 / \*C 71
- \*KIJAC, Peter / h: 44 Kings Cross Dr, Lincolnshire, IL 60015 / v: 2 / \*C 71
- \*KILPATRICK, S. J., Jr. / ed: BSc, pure & applied math; MSc, genetic statistics; PhD, demography / v: 3 / \*C 71
- \*KIMMLE, Manfred S. / ed: DBA, MBA Harvard Graduate School of Bus Admn; lic Univ of Paris; dipl Univ of Berlin; BA Muhlenberg / m-i: A B Ma Mg Sy; mgmt information systems; data processing & general mgmt / pb-h: over 10 publns on mgmt information & data mgmt systems; SMIS, ACM, TIMS / v: 3 / \*C 71
- \*KIRANE, Francis P. / t: DP manager Honeywell Computer Dept / h: 10 Bisson St, N Chelmsford, MA 01863 / v: 3 / \*C 71
- \*\*KIVIAT, Philip J. / executive / b: 1937 / ed: BME, MIE / ent: 1959 / m-i: Mg / t: president / org: Simulation Associates Inc, 1263 Westwood Blvd, Los Angeles, CA 90024 / pb-h: ORSA, ACM, SCI, AAAS, vice-pres TIMS College on simulation & gaming, chmn Fourth Conference on Applications of Simulation, associate editor Simulation, numerous other chairmanships & technical assocs, 3 books, over 20 published papers / h: 2654 Roscomare Rd, Los Angeles CA, 90024 / v: 2 / \*C 71
- \*KLAPPENBERGER, Frederick A. / org: CADCOM, Inc, 2024 West St, Annapolis, MD 21401 / v: 2 / \*C 71
- \*KLASSKIN, Phillip / t: consultant / org: McDonnell Douglas Automation Co, Box 516, St Louis, MO 63166 / h: 7726 Stanford, St Louis, MO 63130 / v: 1 / \*C 71
- \*KLEIN, Melvin S. / m-i: A B Mg P Sa Sy / v: 3 / \*C 71
- \*KLEINECKE, David / h: 1722 Prospect Ave, Santa Barbara, CA 93103 / v: 3 / \*C 71
- \*KLOCK, Harold F. / t: professor / v: 3 / \*C 71
- \*KNEPP, Robert B. / t: assistant manager, corporate systems & programming / v: 2 / \*C 71
- \*KNIAT, Philip J. - replace by KIVIAT, Philip J., which see
- \*KNIGHT, John / m-i: B Mg Sy; information processing / t: director / org: Business Information Division, Dun & Bradstreet Inc, 99 Church St, New York, NY 10007 / v: 1 2 / \*C 71
- \*KOBYLECKY, Peter J. / systems analyst / t: computer systems analyst / org: C P C International, 101 S Wacker Dr, Chicago, IL 60606 / h: 4640 S Homan Ave, Chicago, IL 60632 / v: 1 / \*C 71
- \*KOCKEN, Manfred / t: professor / org: Univ of Michigan, Ann Arbor, MI 48104 / pb-h: distinguished lecturer, ASIS, ACM, AMS (math), APS, RSA, AAAS (science), SIAM; 8 books, numerous articles & reports / h: 2026 Devonshire, Ann Arbor, MI 48104 / v: 3 / \*C 71
- \*KOENIG, Adolph J. / t: chief, administration & organization studies branch / v: 3 / \*C 71
- \*KOFFMAN, Charles R. / m-i: A B Mg P / t: manager, advanced ordinary system div / v: 3 / \*C 71
- \*KOLASA, Susan H. / h: 30 Stonegate Rd, Portola Valley, CA 94025 / v: 2 / \*C 71
- \*KOLKO, Philip / m-i: Mg / t: programming architecture manager, senior programmer / h: 11 Manor Way, Poughkeepsie, NY 12603 / v: 1 / \*C 71
- \*KOLLER, Herbert / ed: ChE; MS, math; graduate work / v: 1 / \*C 71
- \*KOMAR, Joseph A. / h: 2010 Lincoln, St. Paul, MN 55101 / v: 3 / \*C 71
- \*KOPF, John O. / ed: BA and MA, physics, Univ of Conn; PhD, physics, Michigan State Univ / h: 140 Ardmore Rd, Kensington, CA 94707
- \*\*KOPP, Laurence I. / physicist / b: 1935 / ed: BS, MS, physics; PhD, nuclear engineering / ent: 1956 / m-i: Ma P / t: nuclear physicist / org: US Atomic

Energy Commission, Div of Reactor Standards, Washington, DC 20545 / pb-h: ANS, Sigma Xi; several publications in Transactions of the American Nuclear Society / h: 14107 Northwyn Dr, Silver Spring, MD 20904 / v: 3 / \*C 71

\*KOPP, Lawrence I. — replace by KOPP, Laurence I. which see

\*KOPSTEIN, Dr. Felix F. / t: senior staff scientist / org: Human Resources Research Organization, 300 N Washington St, Alexandria, VA 22314 / pb-h: APA, AERA, IAAP, SGRS, ASC / v: 3 / \*C 71

\*KORN, Granino, Arthur / pb-h: editor of Computer Handbook, editor of Digital Computer User's Handbook; author of seven books; AICA Scientific Committee, Sigma Xi, Simulations Councils; lecturer in US and abroad; chmn of editorial board of Simulation / v: 3 / \*C 71

\*KOTELLY, John Christopher / m-i: A B D L Mg Ma P Sy; cybernetics, artificial intelligence, technology transfer, robot vision on mini computer, advanced computer logics / org: Cyberfacts, Inc, 101 Moore Rd, Sudbury, MA 01776 / pb-h: MAA, AMS(math), Charles Sanders Peirce Soc; 4 USAF awards for inventions & patents, reviewer for IEEE Systems & Cybernetics Group, numerous lectures, several publications / v: 1 / \*C 71

\*KOUZMANOFF, James / t: manager of systems & programming / v: 1 / \*C 71

\*KOZURA, Ronald / t: computer systems analyst / org: General Accounting Office, Office of Policy and Special Studies, 441 "G" St, Room 3039, Washington, DC 20548 / v: 1 / \*C 71

\*KRAMER, Eugene H. / org: Wolf & Co, CPA's, 1545 Wilshire Blvd, Los Angeles, CA 90017 / v: 3 / \*C 71

\*KRAUS, Walter F. / t: design manager, design centers coordination / pb-h: Master Design Award, Iron and Steel Institute Design Award, IBM Invention Achievement Awards, Industrial Designers Society of America / h: Guernsey Hill Rd, LaGrangeville, NY 12540 / v: 3 / \*C 71

\*KRAUSS, Leonard I. / president (management and systems consulting) / t: pres / org: Leonard I. Krauss Assoc, 475 Fifth Ave, New York, NY 10017 / pb-h: registered professional industrial engineer, CDP, senior member AIIE, AMA(mgmt), Computer-Based Management Information Systems, Administering and Controlling the Company Data Processing Function / v: 2 / \*C 71

\*KRAUTHEIM, Paul James / t: systems project manager / pb-h: Cum Laude, Rutgers; CDP, DPMA, IMC / v: 1 2 / \*C 71

\*KRAUTKREMER, James J. / t: manager, mgmt information center / v: 2 / \*C 71

\*KRIEBEL, Charles H. / professor, consultant / pb-h: TIMS, ORSA, ACM, AAUP, Amer Statistical Assoc, Amer Assoc for the Adv of Science; over 40 speeches; author 30 articles, 2 books / h: 108 Silent Run Rd, Pittsburgh, PA 15238 / v: 3 / \*C 71

\*\*KUES, Irvin W. / executive / b: 1936 / ed: BES, mechanical engineering; MES, management sciences / ent: 1957 / m-i: A B D L Mg Ma P Sa Sy; time sharing / t: vice-pres / org: Central Information Processing Corp, 300 St Paul Pl, Baltimore, MD 21202 / pb-h: "Computer Cost Comparison of Conventional & Photocomposition Newspaper Manufacturing Methods", American Newspaper Publishers Assoc Research Inst; DPMA; ORSA; TIMS; ASM(mgmt), CDP; Tau Beta Pi; Pi Tau Sigma / h: 1214 Brook Meadow Dr, Baltimore, MD 21204 / v: 2 / \*C 71

\*KUKI, Hirono / h: 5637 S Dorchester, Chicago, IL 60637 / v: 1 / \*C 71

\*KULSRUD, Helene E. / m-i: A / v: 1 / \*C 71

\*KURTZ, Donald R. / ed: BS, Univ of Illinois / v: 2 3 / \*C 71

\*KURTZ, Thomas E. / pb-h: site visitor & reviewer, US Office of Education; Advisory Committee NELINET project & others; Advisory Panel, CIE Section, OCA

of NSF; vice chmn SIGCSE, ACM; vice chmn NERComp, Inc; 2 books co-author & author 9 papers; 18 talks, demonstrations & panel discussions / v: 2 3 / \*C 71

## L

\*LAFLAMME, Robert A. / org: Data Synteks Corp, 41 B St, Burlington, MA 01803 / v: 2 / \*C 71

\*LAFORTY, Arnold E. / h: 317 N Glen Ave, Watkins Glen, NY 14891 / v: 2 / \*C 71

\*LAMBERT, Robert J. / h: 3301 Ross Rd, Ames, IA 50010 / v: 3 / \*C 71

\*LANCASTER, Frederick, Wilfrid / ent: 1963 / pb-h: Library Assn of Great Britain, ASIS; Information Retrieval Systems: Characteristics, Testing & Evaluation, Wiley, 1968; over 25 reports, articles & reviews, numerous speaking & lecturing engagements / h: RR2, Urbana, IL 61801 / v: 3 / \*C 71

\*LANDALL, Steven A. — replace by LANDAU, Steven A., which see

\*LANDAU, Herbert B. / pb-h: officer ASIS & American Soc of Indexers, ACM, SLA, ACM natl lecturer, 10 papers / v: 3 / \*C 71

\*\*LANDAU, Steven A. / mgr EDP planning research & technical support / b: 1933 / ed: AB, Brown Univ / ent: 1960 / m-i: A B Mg Sy / t: assistant secretary / org: Connecticut General Life Ins Co, Hartford, CT 06115 / pb-h: CDP, DPMA, speaker LOMA Automation Forum / h: 89 Rumford St, West Hartford, CT 06107 / v: 3 / \*C 71

\*LANDRETH, Edward B. / product planning-program mgmt / t: program manager / v: 3 / \*C 71

\*LANGSFORD, Guy Lacy / t: director of systems / v: 2 / \*C 71

LARROWE, Vernon, L. / engineer / b: 1921 / ed: BSEE, Univ of Kansas; MSEE, Univ of Illinois; PhD, Univ of Kansas / ent: 1951 / m-i: A L P, analog computing aplns and instr / t: research engineer / org: Univ of Mich, Willow Run Labs, Box 618, Ann Arbor, MI 48107 / pb-h: 48 publications (articles and books) / h: 1219 Share Ave, Ypsilanti, MI 48197 / v: 1 2 / \*C 70

\*LARSEN, Robert W. / org: Lockheed Aircraft Corp, Box 551, Dept 01-62, Burbank, CA 91503 / v: 1 / \*C 71

\*LARSON, Louis I. / information scientist / t: information scientist senior / v: 1 2 / \*C 71

\*LARSON, M. Eric / m-i: A P Ma Sy / v: 3 / \*C 71

\*\*LAUB, Joseph P. / executive / b: 1925 / ed: Univ of Scranton / ent: 1951 / m-i: A Mg Sy / t: vice pres / org: United Penn Bank, 8-18 W Market St, Wilkes Barre, PA 18701 / pb-h: founder of local chapter, pres, natl director, individual achievement award DPMA / h: 31 Gordon Ave, Wilkes Barre, PA 18702

\*LAUCHNER, Julian H. / org: Southern Illinois Univ, School of Engr and Tech, Carbondale, IL 62901 / v: 3 / \*C 71

\*LAURANCE, Neal / h: 876 Heather Way, Ann Arbor, MI 48104 / v: 3 / \*C 71

\*LASO, Erick / ed: 3 yrs college / t: director of all data processing / org: Lawson International, 1001 Avenue of the Americas, New York, NY 10018 / h: 1274 Alicia Ave, Teaneck, NJ 07666 / v: 2 / \*C 71

\*LAVE, Roy E., Jr. / management & educator / t: chairman of the board & assoc professor, Dept of Industrial Engineering, Stanford Univ / org: Systan Inc, 140 Main St, Los Altos, CA 94022 / v: 3 / \*C 71

\*LAVINE, Louis R. / t: assoc dir of analytical studies & services / v: 3 / \*C 71

\*LEAS, J. Wesley / org: Control Data Corp, Card Products Div, 2621 Van Buren Ave, Norristown, PA 19401 / v: 2 / \*C 71

- \*LEDLEY, Robert S. / pb-h: AAAS, APS, ORSA, IEEE, AMS (math), Biophysical Society, editorial board member and reviewer of several publns, editor-in-chief of two journals, 7 books, author & co-author 110 articles / v: 2 / \*C 71
- \*LEE, Chester G. K. / software programmer / t: software programmer / org: Continental Can Co, 36 S Wabash Ave, Chicago, IL 60603 / v: 1 / \*C 71
- LEE, Kaiman / architect / b: 1942 / ed: B, arch; M, arch / ent: 1968 / m-i: A D / t: computer-architecture coordinator / org: Perry, Dean & Stewart, 31 Saint James St, Boston, MA 02116 / pb-h: 3 papers, 2 publns; visiting lecturer / h: 144 Day St, Auburndale, MA 02166 / v: 1 2 3 / \*C 71
- \*LEE, Marvie De / org: Computer Sciences Corp, 6565 Arlington Blvd, Falls Church, VA 22042 / v: 1 / \*C 71
- \*LEE, Stevens T. T. / org: Lutheran Hospital Society of Southern California, 1425 S Grand Ave, Los Angeles, CA 90015 / h: 774 $\frac{1}{2}$ -A-Newlin Ave, Whittier, CA 90602 / v: 2 / \*C 71
- \*\*LEE, Sul H. / systems analyst / b: 1936 / ed: BA, MA / ent: 1967 / m-i: A Mg Sy / t: associate director / org: Eastern Michigan Univ Library, Ypsilanti, MI 48197 / pb-h: ASIS, ALA / h: 2878 Baylis Dr, Ann Arbor, MI 48104 / v: 1 / \*C 71
- \*LEHMAN, Meir M. / research / t: mgr architecture & advanced planning / pb-h: IEEE, IEE, natl lecturer ACM, fellow BCS, over 35 publns, 10 patents & patent aplns / v: 3 / \*C 71
- \*LEISER, Curtis P. / org: Municipality of Metropolitan Seattle, 410 W Harrison St, Seattle, WA 98119 / v: 1 / \*C 71
- \*LESCALLEET, Thomas M. / t: dir, admn, finance; regional mktg mgr / org: Cullinane Corp, One Boston Pl, Boston, MA 02108 / v: 2 / \*C 71
- \*LETELIER, Patricio A. / t: specialist-programming / pb-h: ANS, ACM / h: 1416 Kingman Ave, Apt #3, San Jose, CA 95128 / v: 1 / \*C 71
- \*LEWIS, Jordan D. / t: manager, general operations / pb-h: Sigma Xi, AAAS fellow, IEEE, APS, OSA, SID, many publns / v: 2 / \*C 71
- \*LEVENTHAL, Clifford A. / director, marketing / t: director, marketing staff / h: 3 Brycewood Dr, Dix Hills, NY 11746 / v: 3 / \*C 71
- \*LEVINE, Earle M. / communications mgr / ed: BS, marketing, advertising; MBA intl economics; AE (electronics) / t: communications mgr / org: Honeywell Information Systems, Framingham, MA 01701 / v: 3 / \*C 71
- \*LEVINE, George H. / naval architect / t: dir of engineering / org: ARCTEC, INC, Suite 255, Wilde Lake Village Green, Columbia, MD 21043 / h: 9534 Pamploa Rd, Columbia, MD 21043 / v: 2 / \*C 71
- \*LEVINE, Kenneth H. / org: Grumman Data Systems, GDS Center, Bethpage, NY 11714 / v: 1 / \*C 71
- \*LEVY, Samuel / t: data processing systems engineer / pb-h: Eta Kappa Nu, ACM, registered professional engineer / v: 1 / \*C 71
- \*LIAS, Edward J. / director / t: director Computer Center, Ocean County Information Network / v: 3 / \*C 71
- \*LIGON, Helen H. / pb-h: Beta Gamma Sigma, outstanding teacher of year, Baylor, 1967, outstanding business teacher, 1970 / v: 3 / \*C 71
- \*\*LIGUORI, Robert R. / systems analyst / b: 1932 / ed: BS, nuclear eng, North Carolina State; MS, nuclear eng, North Carolina State / ent: 1957 / m-i: A Mg Ma P / t: professional staff / org: Center for Naval Analyses, 1401 Wilson Blvd, Arlington, VA 22209 / pb-h: ACM, Sigma Pi Pigma, Who's Who in Computer Field, 1963-64 / h: 2208 Hyde Lane, Bowie, MD 20715 / v: 1 / \*C 71
- \*LIITTSCHWAGER, John M. / org: Univ of Iowa, College of Engineering, Iowa City, IA 52240 / pb-h: 15 publns, incl a number on using computers in legislative districting / v: 3 / \*C 71
- \*LILLEY, Robert W. / h: Rte 1, Radford Rd, Athens, OH 45701 / v: 2 / \*C 71
- \*LINDER, William Hines / t: assoc professor computer science / h: 1800 Enoree Ave, Columbia, SC 29205 / v: 3 / \*C 71
- \*LINDSAY, Thomas E., Jr. / professional engineer / pb-h: Tau Beta Pi, Eta Kappa Nu, Sigma Tau, Pi Mu Epsilon, IEEE, DECUS, NJSPE, NSPE; 2 patents / v: 2 / \*C 71
- \*LIPTON, Milton A. / pb-h: AAAS; IEEE; New Jersey Academy of Science; Who's Who in East & others; 3 commendations for outstanding service, prof eng, N.J. / v: 3 / \*C 71
- \*LIQUORI, Robert R. — replace by LIGUORI, Robert R., which see
- \*LIS, Bernard / org: Lawrence Institute of Technology, 21000 W Ten Mile Rd, Southfield, MI 48075 / pb-h: ACM, DPMA, COMMON / v: 2 / \*C 71
- \*LOYD, John M., Jr. / pb-h: past faculty advisor American Univ Chapter ACM / v: 1 3 / \*C 71
- \*LOESER, Rudolf K. / t: sr programmer / org: Smithsonian Astrophysical Observatory, 60 Garden St, Cambridge, MA 02138 / pb-h: ACM, co-author 5 papers on numerical methods for applications in theoretical stellar atmosphere applications / h: 401 Laws Brook Rd, Concord, MA 01742 / v: 1 / \*C 71
- \*LOITERSTEIN, Philip E. / ed: BS, meteorology, City College of New York; MEA, engr admn, School of Engr & Applied Science, George Washington Univ / v: 1 / \*C 71
- \*LONDON, Ralph L. / t: assoc professor / v: 3 / \*C 71
- \*LONG, Raymond J. / t: dir Washington Data Processing Center / org: WDPC, SRS, US Dept of Agriculture, Washington, DC 20250 / v: 2 / \*C 71
- \*LOOMBA, R. P. — replace by LOOMBA, Rajinder P., which see
- \*\*LOOMBA, Rajinder P. / computer design teacher / b: 1936 / ed: PhD / ent: 1960 / m-i: D Mg P Sy; education / t: professor of electrical engineering / org: San Jose State College, San Jose CA 95114 / pb-h: many publns in field of engineering; American Men of Science, Dictionary of Intl Biography, Marquis Whos' Who in the West / h: 1774 Potrero Dr, San Jose, CA 95124 / v: 3 / \*C 71
- \*LOOS, Roger A. / director-systems / t: director-systems / org: Marketdyne, Int'l, 1600 Arch St, Philadelphia, PA 19101 / v: 1 / \*C 71
- \*LOPATKA, Alan / t: systems engineer / h: 354 W Van Buren St, Elmhurst, IL 60126 / v: 1 / \*C 71
- \*LOPES, Harry W. / b: 1921 / pb-h: CDP / v: 2 / \*C 71
- \*LOVIE, Peter M. / pb-h: Fulbright Scholar, Chartered Engineer United Kingdom, Texas PE, 7 technical papers, 1 patent / h: 4515 Briar Hollow Pl, Houston, TX 77027 / v: 1 3 / \*C 71
- \*LOVIN, John W. / h: 2717 Highland Ave, Apt 1006, Birmingham, AL 35205 / v: 2 / \*C 71
- \*LOWERY, Edwin / pb-h: "How To Evaluate Timeshare Services" in Southwest Business; professional engineer registered in California & Texas; CDP (DPMA); life member Phi Kappa Phi, Tau Beta Pi; Soc of Professional Engineers, Houston Soc of Mgmt Consultants; MENSA; Houston Club / v: 2 / \*C 71
- \*LUAR, Joseph P. — replace by LAUB, Joseph P., which see
- \*LUMMIS, Frank M. / h: 6303 N Wayne Ave, Chicago, IL 60626 / v: 1 / \*C 71
- \*LUNIN, Lois F. / pb-h: founder South Texas chapter ADI & Chesapeake Bay chapter, ASIS, ACS, IDCL, AAUP, Council of Biology Educators, Medical Library Assn Eliot Prize Essay Comm, AAAS, ACM, Phi Kappa Phi, Beta Phi Mu, consultant to business and medical institutions, secretary NSIS, Fellow IIS; instructor, Laryngology & Otology, Johns Hopkins Univ School of Medicine; instructor, Public Health Admn (Communicative Sciences), Johns Hopkins Univ School of Public Health; many publns / v: 2 / \*C 71

- \*LUSE, F. Dean / pb-h: URISA, NASW, NCSW / v: 3 / \*C 71
- \*LYKOS, Peter G. / m-i: academic programs in computer science, computer applications in higher education / t: professor of chemistry, director of Information Processing & Information Science Centers / h: 3524 Quebec St, Washington, DC 20016 / v: 3 / \*C 71
- \*LYNCH, Charles H., Jr. / t: supervisor of software, process control / h: 710 Maple St, Meadville, PA 16335 / v: 1 3 / \*C 71
- \*LYNCH, Robert M. / educator / ed: BS, MS, PhD / t: asst professor / org: School of Business, Eastern Illinois Univ, Charleston, IL 61920 / h: 772 42nd St, Brooklyn, NY 11232 / v: 3 / \*C 71
- \*LYNCH, Robert T. / ent: 1955 / t: dir MIS / org: American Standard, Inc, Security-Graphic Arts Div, 40 W 40 St, New York, NY 10018 / v: 1 2 / \*C 71
- \*LYNN, Richard S. / ed: BA, Univ of Cal; MA, California State College; PhD, Univ of Southern Cal / t: project engineer / v: 1 / \*C 71
- M
- \*MA, Anthony / h: 16 W Dennick Ave, Youngstown, OH 44504 / v: 3 / \*C 71
- \*MACDONALD, Donald C. / t: systems programmer / org: RCA Computer Systems, 200 Forest St, Marlboro, MA 01752 / pb-h: editor Twin Cities ACM Newsletter; vice chmn, Twin Cities ACM / h: Gates Rd RFD, Hubbardston, MA 01452 / v: 1 / \*C 71
- \*MACGHAN, Peter H. / org: Naval Research Lab, Code 5474, Washington, DC 20390 / v: 3 / \*C 71
- \*MACKAY, Stanley / org: Scott Graphics, Inc, subsidiary of Scott Paper Co, Holyoke, MA 01040 / v: 1 / \*C 71
- \*MACLAUGHLIN, Dean S. / org: Boston Collaborative Drug Surveillance Program, Boston Univ School of Medicine, 80 E Concord St, Boston, MA 02118 / v: 1 / \*C 71
- \*MADDEN, Joseph J. / org: Kelso-Burnett Electric Co, 5200 Newport Dr, Rolling Meadows, IL 60008 / v: 2 3 / \*C 71
- \*MAGNIER, Eugene A. H., MD / ed: AB, physics, MS, biomedical engineering; MD; PhD, physiology / t: resident / org: Pennsylvania Medical College, Henry Ave, Philadelphia, PA 19129 / v: 2 3 / \*C 71
- \*MAGNUS, Daniel E. / executive / t: president / org: KLD Associates, Inc, 7 High St, Huntington, NY 11743 / pb-h: ASME, AIAA, ACM, NYAS, HRB; Pi Tau Sigma, Tau Beta Pi, Sigma Xi / v: 2 / \*C 71
- \*MAHOOD, Charles E. / ed: BS, math & physics, Muskingum College; MS, systems & information science, Syracuse Univ / v: 1 / \*C 71
- \*MALAKOFF, James L. / h: 30017 Via Rivera, Palos Verdes Peninsula, CA 90274 / v: 2 / \*C 71
- \*MANN, Alan O. / m-i: A D Mg Sy / t: chief planning staff / org: Systems Division, Office of Economic Opportunity, Executive Office of the President, 1200 19th St NW, Washington, DC 20506 / h: 3806 Jocelyn St, Chevy Chase, MD 20015 / v: 2 / \*C 71
- \*MANN, George A. / t: group manager / org: Univac Western Test Center, 212 E Osborn Rd, Phoenix, AZ 85012 / v: 1 2 / \*C 71
- \*MARCHUK, Frank / t: president / org: Computer-General, Inc, 318 W Ball Rd, Anaheim, CA 92805 / pb-h: pres & board chmn, LASER Computer Corp; pres, Microelectronic Evaluation Labs; pres, Inst of Tech Seminars; inventor first all Laser computer; visiting lecturer-universities; 85 publns / v: 2 / \*C 71
- \*MARKS, Morton H. / h: 11208 Country Pl, Oakton, VA 22124 / v: 2 / \*C 71
- \*MARQUARDT, Donald A. / m-i: A B P Sy / org: Reynolds Metals Co, 47 & 1st, Brookfield, IL 60513 / h: 8714 W 44 St, Lyons, IL 60534 / v: 1 / \*C 71
- \*MARSHALL, Irvin / systems integration / t: manager, systems integration / v: 3 / \*C 71
- \*MARSHALL, John J., Jr. / m-i: educational research, programmed instruction, educational materials devt, tech education / t: manager, education devt / org: Honeywell, EDP Div, Marketing Education, 110 Cedar St, Wellesley Hills, MA 02181 / pb-h: COE Fellowship Award, Boston College, '61; DPMA Intl Private EDP School Standards Committee; BEMA, Data Processing Group, Education Committee / v: 2 / \*C 71
- \*MARTIN, David Joseph / t: systems analyst / org: Univ of Tennessee, Chattanooga, TN 37401 / h: 3512 Valley Trail, Chattanooga, TN 37415 / v: 1 / \*C 71
- \*MARTIN, George J. / security analyst / pb-h: IEEE, Simulation Council of America, SSA (NY) / v: 3 / \*C 71
- \*MARTIN, J. Sperling / t: vice pres, systems development / org: Aspen Systems Corp, Pittsburgh, PA 15213 / v: 1 / \*C 71
- \*\*MARTIN, Richard L. / head computer peripheral subsidiary / b: 1924 / ed: BS; PhD, engineering / ent: 1968 / m-i: B Mg / t: pres / org: Telex Computer Products, Inc, subsidiary of The Telex Corp, 6422 E 41 St, Tulsa, OK 74135 / pb-h: Sigma Xi, Tau Beta Pi, Pi Mu Epsilon, Phi Lambda Upsilon / h: 3072 E 38 Pl, Tulsa, OK 74135 / v: 2 / \*C 71
- MARTIN, Ronald K. / programmer-analyst / b: 1942 / ed: Loyola Coll, Univ of Maryland / ent: - / m-i: B P; transportation / t: consultant / org: Peat, Marwick, Mitchell & Co, 1025 Connecticut Ave NW, Washington, DC 20036 / pb-h: ACM / h: 4402 Ridge St, Chevy Chase, MD 20015 / v: 1 / \*C 71
- \*MARVIN, Don / org: Analytical Computer Services, 806 Main, Suite 501, Houston, TX 77002 / h: 12715 Westhorpe, Houston, TX 77077 / v: 2 / \*C 71
- \*MASON, Robert M. / org: Naval Research Lab, Code 5705B, Washington, DC 20390 / pb-h: ACM, MAA, American Musicological Soc, AMS (math), co-author Applied Matrix & Tenor Analysis, Wiley-Interscience, 1970, 6 papers / v: 3 / \*C 71
- \*MASSER, Leon / h: 10503 De Neane Rd, Silver Spring, MD 20903 / v: 2 / \*C 71
- \*MASSIE, John Alan / h: 7335 Dawn Pl, Mentor, OH 44060 / v: 2 / \*C 71
- \*MATHAI, Thomas / b: 1933 / org: ITT, 320 Park Ave, New York, NY 10022 / h: 190 E 72 St, New York, NY 10021 / v: 2 / \*C 71
- \*MATHIS, Robert Fletcher / pb-h: 9 papers, Phi Beta Kappa, Sigma Xi, 7 professional societies / h: 966-A Chatham Lane, Columbus, OH 43221 / v: 2 / \*C 71
- \*MATHUR, Francis Parkash / ed: BEE, Dublin; PhD, UCLA / pb-h: ACM, Sigma Xi, several publns, organizer of First Intl Symposium on Fault-Tolerant Computing; ACM SIGOPS Workshop on Fault-Tolerance, Pacific Palisades 1969; IEEE / h: - / v: 1 / \*C 71
- \*MATTES, Frank J. / ed: BSEE & graduate studies, Univ of Pittsburgh / ent: 1956 / m-i: A P / h: 7 Kletzly Dr, Oakmont, PA 15139 / v: 1 / \*C 71
- \*MATULA, David William / b: 1937 / ed: PhD, engineering science & operations research, Univ of Cal, Berkeley / m-i: L Ma; teaching & research in computational arith, combinatorial math & graph theory / v: 3 / \*C 71
- \*MAYER, A. David / m-i: education systems / org: Montgomery County Community College, 612 Fayette St, Conshohocken, PA 19428 / v: 2 / \*C 71
- \*MAYER, David B. / assistant for total systems evaluation / t: assistant for information systems evaluation / org: IBM, Systems Development Div, Dept D-72, Bldg 705, Poughkeepsie, NY 12602 / v: 2 3 / \*C 71
- \*MAYNARD, John L. / h: 1620 Magnolia Ave, Manhattan Beach, CA 90266 / v: 3 / \*C 71
- \*MCCOY, Noel H. / ed: BS; PhD / m-i: Mg; information systems / t: director operations, junior college div / org: Coordinating Board, Texas College & Univ System, State Finance Bldg, PO Box 12788, Austin, TX 78711 / v: 1 / \*C 71



- \*McDOW, A. E., Jr. / h: 102 Alger Rd, Oak Ridge, TN 37830 / v: 1 / \*C 71
- \*McELWAIN, Merrill Robert, Sr. / staff of the president / pb-h: CDP; DPMA, ASM, SMIS, IACP, NMA / h: Rt #1 Box 245A, Georgetown, IN 47122 / v: 2 \*C 71
- \*McFARLANE, James M. / ent: 1961 / pb-h: ACM, MAA, COMMON / h: PO Box 714, Middletown, CT 06457 / v: 1 2 / \*C 71
- \*McGEACHIE, John S. / t: asst director for system development, dir of data processing / v: 2 / \*C 71
- \*McGREW, Russell G. / t: program mgr, radar systems / org: NOAA Natl Weather Service, 8060 13 St, Silver Spring, MD 20910 / v: 1 3 / \*C 71
- \*McKee, Albert G. / org: Louisiana Tech Univ, Box 6215 Tech Sta, Ruston, LA 71270 / pb-h: ACM, DPMA, No Central Louisiana Data Processing Assoc, ASEE, Louisiana Engineering Society; Louisiana Faculty Senate; Who's Who in the South & Southwest; various publs / v: 2 / \*C 71
- \*McKEE, Robert A. / org: Texas Eastern Transmission Corp, PO Box 1612, Shreveport, LA 71102 / v: 3 / \*C 71
- \*McKEOWN, Thomas W. / t: director, internal data systems / org: Honeywell Information Systems, US Group, Waltham, MA 02154 / v: 3 / \*C 71
- \*McLAUGHLIN, Grant E. / h: 1846 - 153rd SE, Bellevue, WA 98007 / v: 3 / \*C 71
- \*McLEAN, Ephraim R., 3rd / ed: BME, Cornell Univ; SM, PhD, MIT / m-i: mgmt information systems, business aplns of computers / t: asst professor of information systems, director of GBA Computing Services / pb-h: Sigma Xi, NDEA fellow, ACM, TIMS / h: 11313 Rose Ave, Los Angeles, CA 90066 / v: 3 / \*C 71
- \*McMAHON, William M. / h: Hillside Dr, Ellington, CT 06029 / v: 1 / \*C 71
- \*McMATH, C. Wallis, Jr. / pb-h: Upsilon Pi Epsilon; ACM, IEEE; Texas Soc of Registered Professional Engineers; Registered Professional Engineer (Texas) / v: 1 / \*C 71
- \*McMENAMIN, Joseph L. / ed: BS, education; MA / v: 2 / \*C 71
- \*McQUIRNS, Lewis K. / data processing mgr / b: 1933 / ed: 2 yrs college / ent: 1961 / m-i: A Mg Sy / t: data processing mgr / org: Tasty Baking Co, 2801 Hunting Park Ave, Philadelphia, PA 19129 / pb-h: DPMA / h: 2963 Hemlock Dr, Norristown, PA 19403 / v: 2 / \*C 71
- \*McQUIRNS, Lewis K. — replace by McQUIRNS, Lewis K., which see
- \*MEACH, Jerome S. / h: 2372 N Pine Center Dr, Orchard Lake, MI 48033 / v: 2 / \*C 71
- \*MEADS, Jon A. / t: graphics systems designer, consultant / org: Tektronix, Inc, PO Box 500, Beaverton, OR 97005 / pb-h: SID, ACM, DECUS, "Interactive Editing of Radio Astronomy Data", DECUS Symposium, 1969; chmn SIGGRAPH/ACM h: PO Box 1485, Lake Oswego, OR 97034 / v: 1 / \*C 71
- \*MEKKELSON, Leslie / org: State Farm Life Insurance Co, 112 E Washington, Bloomington, IL 61701 / pb-h: CPA, CPCU, FLMI; papers for IASA / v: 2 / \*C 71
- \*MELLINGER, Leo F. / pb-h: DPMA, CDP / h: 3650 Regal Pl, Hollywood, CA 90068 / v: 1 / \*C 71
- \*MELZER, Richard J. / executive; consulting & training / t: president / org: R. J. Melzer Co, 2956 Delaware Ave, Buffalo, NY 14217 / v: 3 / \*C 71
- \*MERKLINGHAUS, Otto E. / t: advisory devt analyst / org: IBM Corp, 1561 California Ave, Palo Alto, CA 94304 / v: 1 / \*C 71
- \*MERRY, Paul M. / ed: BSEE, Univ of Mo; MSEE, Florida Inst of Technology / pb-h: classified documents, IEEE, ACM / v: 1 / \*C 71
- \*METROPOLIS, William / h: 44 Prospect St, Utica, NY 13501 / v: 1 / \*C 71
- \*MEYERSON, Edmund D. / pb-h: ASM, ACM / v: 2 / \*C 71
- \*MILLER, David / h: 2600 W Rascher, Chicago, IL 60625 / v: 2 / \*C 71
- \*MILLER, Edwin W. / ed: B Aero E; MME / pb-h: ACSM (VP '71-'72); ASEE, ASME, NSPE / v: 2 / \*C 71
- \*\*MILLER, J. Philip / director user services / b: 1943 / ed: graduate work, psychology / ent: 1962 / m-i: Mg Sy; natural language processing / t: director user services / org: Washington Univ, Computing Facilities, St Louis, MO 63103 / pb-h: ACM, AERA, Psychometric Soc, various publs / h: 3409D Grand Forest Dr, St Louis, MO 63103 / v: 2 / \*C 71
- \*\*MILLER, Richard I. / org: Harbridge House, Inc, 11 Arlington St, Cambridge, MA 02116 / v: 3 / \*C 71
- \*\*MILLTER, J. Philip — replace by MILLER, J. Philip, which see
- \*MINCIS, Albert Stephen / org: Equity Research Associates, a div of Halle & Stieglitz, Inc, 52 Wall St, New York, NY 10005 / v: 1 / \*C 71
- \*MING, Tao Kuang / ed: PhD, theoretical chemistry, Illinois Inst of Tech / t: computer specialist / h: 23 N Summit Dr, Gaithersburg, MD 20760 / v: 1 / \*C 71
- \*MIRACLE, H. G. / m-i: A Mg P Sy / t: mgr, systems & programming dept / org: Mobil Oil Corp, Los Angeles Accounting & Computer Center, 612 S Flower St, Los Angeles, CA 90051 / v: 2 / \*C 71
- \*MISHELEVICH, David J. / ed: BS, physics, Univ of Pittsburgh; MD, PhD (biomedical engrg), Johns Hopkins Univ School of Medicine / t: vice-pres / org: National Educational Consultants, 711 Saint Paul St, Baltimore, MD 21202 / v: 1 3 / \*C 71
- \*MITCHELL, James Earl / assoc superintendent / t: assoc superintendent, planning & mgmt information / pb-h: PDK, Phi Beta Phi, NEA, AEDS / v: 3 / \*C 71
- \*MOKOTOFF, Gary / m-i: A B Mg P Sy / h: 507 Crest Dr, Northvale, NJ 07647 / v: 1 3 / \*C 71
- \*MONGE, Rolf H. / t: assoc professor / pb-h: ACM, APA, Eastern Psychological Assoc, ASA, Gerontological Soc, Soc for Research in Child Development, 10 papers in geropsychology / v: 3 / \*C 71
- \*MONINGER, David L. / t: mgr, financial systems dept / h: 909 S Owen, Mt Prospect, IL 60056 / v: 1 3 / \*C 71
- \*MONTAGUE, Frank / org: A T Kearney & Co Inc, 437 Madison Ave, New York, NY 10022 / h: 10 Arbor Ridge Lane, Centereach, NY 11720 / v: 3 / \*C 71
- \*MONTESINO, Pablo V. / m-i: A B Mg P Sy / v: 2 / \*C 71
- \*MOORE, D. R. / t: staff engineer / org: Vought Aeronautics Corp, Box 5907, Dallas, TX 75222 / pb-h: AIAA, ACM; Sigma Xi, Sigma Gamma Tau; 4 publications in AIAA journal / h: 2501 Skyline Dr, Irving, TX 75060 / v: 2 / \*C 71
- \*MOORE, Dwight A. / pb-h: pres Detroit Chapter DPMA 1970-1971, DPMA individual performance award; NAA, AMA seminar leader award / v: 2 / \*C 71
- \*MOORE, William S., III / t: engineering systems coordinator / h: 145 Harbor Dr, Key Biscayne, FL 33149 / v: 1 / \*C 71
- \*MORESCHI, John P. / h: 19A Forest St, Cambridge, MA 02140 / v: 2 / \*C 71
- \*MORRIS, Joel / m-i: A Mg Sy / pb-h: publs on computer applications, American Men of Service, Who's Who in Southeast, Who's Who in Space / v: 3 / \*C 71
- \*MORRIS, Joseph C., Jr. / m-i: C D L P Sy / v: 1 / \*C 71
- \*MORRIS, William T., Jr. / t: director, advanced information systems / org: American Institute of Aeronautics & Astronautics, 1290 Ave of the Americas, New York, NY 10019 / v: 2 / \*C 71
- \*MORRISON, Robert L. / programming architecture / pb-h: ACM, Cornell Soc of Engineers / v: 1 2 / \*C 71
- \*MOSER, John L. / org: Computer Machinery Corp, 2231 Barrington Ave, Los Angeles, CA 90064 / h: - / v: 2 / \*C 71
- \*MOSES, Joel / educator / m-i: A Ma P; algebraic manipulation, AI, education / t: associate professor electrical engineering / pb-h: ALM, MAA, NYAS; Phi Beta Kappa, Sigma Xi / h: 50 Gold Star Rd, Cambridge, MA 02140 / v: 3 / \*C 71

\*MOTT, Leo J. / pb-h: AMA, Phi Delta Theta / v: 2 / \*C 71

MOUNTAIN, Clifton Fletcher, M.D. / surgeon, cancer researcher / b: 1924 / ed: AB, MD / ent: 1947 / m-i: A; biomedical research / t: assoc prof of surgery / org: Univ of Texas, M.D. Anderson Hospital and Tumor Institute, 6723 Bertner, Houston, TX 77025 / pb-h: membership in 26 scientific societies, numerous papers / h: 1612 South Blvd, Houston, TX 77006 / v: 3 / \*C 70

\*\*MOURADOGLU, Alkis J. / computer scientist-mathematician / b: 1943 / ed: BS, MA, MS / ent: 1963 / m-i: A Mg Ma P Sy; numerical analysis / t: computer analyst / org: Sun Oil Co, PO Box 2880, Dallas, TX 75221 / pb-h: "Numerical Studies on the Convergence of the Peaceman-Rachford Alternating Direction Implicit Method," TNN-67, June 1967, The Univ of Texas at Austin Computation Center; ACM, AMA, BCS, IEEE, Genl Chmn 2nd ACM South Central Region Conference & Exhibits — Dallas 1970; Who's Who in the South & Southwest / h: PO Box 221, Richardson, TX 75080 / v: 2 / \*C 71

\*MUMM, Robert F. / associate professor of biometry / h: 4640 Orchard St, Lincoln, NE 68503 / v: 2 / \*C 71

\*MUNGUIA, Gustavo / t: director of computer devt / h: 4070 NW 5th St, Coconut Creek, FL 33063 / v: 2 / \*C 71

\*MUROGA, Saburo / m-i: D L Ma; logical design, switching theory / v: 3 / \*C 71

\*MYLER, William J. / h: 101 Sutton Dr, Stamford, CT 06906 / v: 2 / \*C 71

\*MYRICK, John R., Jr. / t: asst manager, computer application studies / org: Western Electric Co Inc, Finance Div, 222 Broadway, New York, NY 10038 / h: 29 Rose Ave, New Providence, NJ 07974 / v: 2 / \*C 71

N

\*NADEL, Robert B. / pb-h: CPA, New York and No Carolina; New York State Bar; New York County Lawyers' Assoc, AICPA; New York State Society of CPA; Computers & Information Systems Comm of AICPA; chmn of systems devt & Exchange Comm of AICPA; ACM, ASM, past member Bd of Education, Hartsdale NY; speaker for various groups / v: 1 / \*C 71

NAGEL, Robert Hoffman / executive / b: 1936 / ed: BS, MS, PhD / ent: 1961 / m-i: A P D; mini-computers / t: president / org: Agrippa-Ord Inc, 155 W 68th St, New York, NY 10023 / pb-h: 4 articles / h: 119 W 71st St, New York, NY 10023 / v: 1 2 3 / \*C 70

\*NAGY, Charles K. / ed: Budapest Univ; Kiel Univ; Leipzig Univ; Boston Univ; MIT / pb-h: DR, RER, POL, cum laude; DR JURIS cum laude; ACM, ECHO, Boston INTERMED, several publications / v: 3 / \*C 71

\*NARIN, Francis / org: Computer Horizons, Inc, 53 W Jackson Blvd, Chicago, IL 60604 / v: 2 / \*C 71

\*NASH, Thomas H., Jr. / ed: AS, computer programming / pb-h: ACM / h: 198 Sampson St, Bridgeport, CT 06606 / v: 1 / \*C 71

\*NAUGLE, Norman W. / org: Applied Scientific Research Inc, 2100 Travis, CNB Rm 500, Houston, TX 77001 / v: 3 / \*C 71

\*NELSON, Donald J. / org: Univ of Nebraska Computing Ctr, 225 Nebraska Hall, 901 N 17, Lincoln, NE 68508 / h: 1620 E Manor Dr, Lincoln, NE 68506 / v: 2 / \*C 71

\*NELSON, Paul, Jr. / pb-h: 8 associations, 11 papers / v: 3 / \*C 71

\*NELSON, Richard W. / t: senior research associate / v: 1 / \*C 71

\*NESS, David / vice-president, assoc professor / t: assoc professor / pb-h: On-Line Computation & Simulation, The PRISM Primer, numerous papers / v: 3 / \*C 71

\*NESTIUK, Askold B. / h: 4217 N Paulina Apt 3E, Chicago, IL 60613 / v: 1 / \*C 71

\*NEUSTADTER, James M. / pb-h: DPMA (vice-pres),

GUIDE, ABA, AIB; advisory comm Florida Jr Coll, Florida Bankers Assoc / v: 2 / \*C 71

\*NEWELL, Richard F. / pb-h: BSNSME, AEDS; Phi Delta Kappa / v: 2 / \*C 71

\*NEWNHAM, Donald O. / asst mgr computer services / t: vice-president / pb-h: DPMA (vice-pres '67-8; pres '68-9; intl director '70-1 — Columbia Chapter), CDP / h: 701 Shadow Brook Drive, Columbia, SC 29210 / v: 1 / \*C 71

\*NICKLES, Lonnie J. / ed: BA, AM, PhD / h: 1410 Chettenham Lane, Columbia, SC 29204 / v: 1 2 / \*C 71

\*NIKOLAI, Paul J. / org: Applied Mathematics Research Lab (ARL/LB), Aerospace Research Labs (AFSC), Wright-Patterson AFB, OH 45433 / v: 3 / \*C 71

\*NOLAN, Jack / ed: BS, math, Univ of Houston / v: 1 / \*C 71

\*NORRIS, Terry O. / t: vice-pres research and development / v: 3 / \*C 71

\*NORTHAM, Michael B. / h: 1608 NE Knott, Portland, OR 97212 / v: 1 / \*C 71

\*NORTON, Peter E. / ed: MBA, Univ of Chicago, Graduate School of Business / t: systems administrator / v: 1 / \*C 71

\*NORWALT, Robert H. / engineer supervisor / m-i: Mg / t: leader engineering staff / h: 18612 Kenya St, Northridge, CA 91324 / v: 3 / \*C 71

\*NOVAK, Gordon S., Jr. / ed: BSEE, MA, computer science; PhD cand, Univ of Texas at Austin / org: Tracor Data Systems, 4201 Ed Bluestein Blvd, Austin, TX 78721 / pb-h: Eta Kappa Nu, Tau Beta Pi, Phi Kappa Phi, Univ of Texas Hamilton Award / h: 600 S First #104, Austin, TX 78704 / v: 1 2 / \*C 71

\*NOVICK, David / h: 1032 Second St, Santa Monica, CA 90403 / v: 2 / \*C 71

\*NUECHTERLEIN, Gerald F. / t: vice-pres & EDP mgr / v: 2 / \*C 71

O

\*OBREGON, Roberto / management education / ed: BA, MBA / t: academic dean / pb-h: Computers: a Management Tool; DPMA, AEA / v: 2 / \*C 71

\*O'BRIEN, William A. / t: principal / v: 3 / \*C 71

\*O'HEIR, Thomas Bryan / t: group director, Technical Computer Center / org: Honeywell Information Systems Inc, 200 Smith St, Waltham, MA 02154 / v: 3 / \*C 71

\*O'HORA, Joseph F. / org: Auerbach Associates, 150 E 58th St, New York, NY 10022 / v: 3 / \*C 71

\*\*OLLE, T. William / independent consultant / b: - / ed: PhD, Univ of Manchester, England / ent: 1953 / m-i: A B Mg Sy; generalized data base management systems, data definition / t: consultant / org: self-employed / pb-h: ASIS, TIMS, BCS, ACM natl lecturer, chmn CODASYL Systems Committee; 14 papers / h: 34 Winston Gardens, Branksome, Poole Dorset, England / v: 2 / \*C 71

\*OLISCHAR, William H. / t: director, computer systems / v: 2 / \*C 71

\*\*OLIVER, Paul / scientist / b: 1940 / ed: BS, MS, PhD / ent: 1962 / m-i: A Mg Ma P; graphics / t: staff scientist / org: UNIVAC Computer Sciences, 2121 Wisconsin Ave, NW, Washington, DC / pb-h: CDP; ACM, IEEE, DPMA, AMA, AAAS, NYAS; Amer Men of Science, faculties of George Washington Univ, American Univ; papers in mathematics and computer science / h: One Don Mills Ct, Rockville, MD 20850 / v: 3 / \*C 71

\*OLMER, Jane / senior staff director of computing center / t: senior mathematician / v: 2 / \*C 71

OLNEY, John Crosby / researcher / b: 1930 / ed: BA, Harvard / ent: 1958 / m-i: computational linguistics / t: consultant / org: System Development Corp, 2500 Colorado Ave, Santa Monica, CA 90404 / pb-h: RESA; 2 publns / h: 2522 Beverly Ave, Santa Monica, CA 90405 / v: 3 / \*C 70

- \*\*OREMAN, Gary / systems programmer / b: 1943 / ed: - / ent: 1962 / m-i: operating systems / t: computer specialist / org: DCA/NMCSSC, Rm BF680A, The Pentagon, Washington, DC 20301 / pb-h: - / h: 6128 Townbrook Dr, Baltimore, MD 21207 / v: 1 / \*C 71
- \*OREMAN, Gery — replace by OREMAN, Gary, which see
- \*ORENSTEIN, Richard H. / executive / t: president / org: National CSS, Inc, 460 Summer St, Stamford, CT 06901 / h: 33 Pinnacle Rock Rd, Stamford, CT 06903 / v: 2 / \*C 71
- \*\*O'REILLY, A. M. / programmer, consultant and manager / b: 1932 / ed: Univ of Illinois, economics; DePaul Law School / ent: 1959 / m-i: A Mg Sy; standards, training / t: vice-pres / org: Brandon Applied Systems Inc, 1611 N Kent St, Arlington, VA 22209 / h: 1826 Susquehannock Dr, McLean, VA 22101 / v: 2 3 / \*C 71
- \*O'RIELLY, A.M. — replace by O'REILLY, A. M., which see
- \*OSBORN, Landon J. / t: manager, time sharing system software (G400/600/6000) / org: Honeywell Information Systems, Inc, 13430 N Black Canyon Hwy, Phoenix, AZ 85029 / v: 1 2 / \*C 71
- \*OSER, Hans J. / t: chief, mathematical analysis section / h: 8810 Quiet Stream Ct, Potomac, MD 20854 / v: 3 / \*C 71
- \*OSTER, Clarence A. / pb-h: CDP, MAA, ACM, SIAM, Sigma Xi; 16 publns / v: 1 3 / \*C 71
- \*OTTO, David L. / h: 760 Great Oaks Blvd, Apt 125, Rochester, MI 48063 / v: 1 / \*C 71
- \*OURSLER, Joseph E. / h: 616 Windrush Dr, St Louis, MO 63122 / v: 2 / \*C 71
- \*OVERTON, Richard K. / org: Overton Associates, Box 2037, Capistrano Beach, CA 92624 / h: 26931 Calle Dolores, Capistrano Beach, CA 92624 / v: 2 / \*C 71
- P
- \*PAINE, William O. / t: systems analyst / org: General Research Corp, PO Box 3587, Santa Barbara, CA 93105 / h: PO Box 6224, Santa Barbara, CA 93105 / v: 1 2 / \*C 71
- \*PALMER, James E. / org: Spectron Corp, 1060 Kings Hwy, N Cherry Hill, NJ 08034 / v: 2 / \*C 71
- \*\*PAN, George S. / senior technical manager / b: 1939 / ed: BSEE, Illinois; MSEE, Syracuse / ent: 1960 / m-i: A Mg Ma P Sy; communications network design, simulation / t: president and technical director / org: Systems Architects Inc, 45 Diauto Dr, Randolph, MA 02368 / pb-h: author, 3 articles / h: 30 Indian Hill Rd, Medfield, MA 02052 / v: 2 3 \*C 71
- \*PAQUETTE, Gerard A. / pb-h: Phi Beta Kappa, Sigma Xi, Tau Beta Pi, Eta Kappa Nu, IEEE, PGEC, ACM (Siggraph); several publns / v: 1 2 / \*C 71
- \*PARKER, Edwin B. / educator / t: professor of communication / pb-h: ASIS, ACM, ASA (sociological), Assoc for Education in Journalism, APA (psych); 2 books, over 30 articles / v: 3 / \*C 71
- \*PARKER, James D., Jr. / t: manager computer dept / pb-h: CDP, ACM; pres DPMA / v: 2 / \*C 71
- \*PARKER, Jonathan E. / marketing analyst, US Navy / org: Louisiana Natl Bank, 451 Florida Blvd, PO Box 1511, Baton Rouge, LA 70821 / pb-h: DPMA, ABA / v: 2 / \*C 71
- \*PARKER, Judith Gayle / t: applications programmer / h: 5254 Atlantic Ave, Apt 305, Long Beach, CA 90805 / v: 1 / \*C 71
- \*PARKER, Michael P. / t: manager of business plans and controls / org: IBM Corp, Systems Development Div, Programming Dept, Poughkeepsie, NY 12602 / v: 2 / \*C 71
- \*PARRISH, C. Peter / org: Home Beneficial Life Insurance Co, Box 27572, Richmond, VA 23261 / h: 343 Albemarle Ave, Richmond, VA 23226 / v: 1 / \*C 71
- \*PARRISH, Thomas D. / org: PRC Information Sciences Co, 7600 Old Springhouse Rd, McLean, VA 22101 / h: 7104 45th St, Chevy Chase, MD 20015 / v: 1 / \*C 71
- \*PATHE, Antone P. / ent: 1957 / v: 2 / \*C 71
- \*PATMORE, James / principle engineer / org: Electronic Associates, Inc, 185 Monmouth Park Hwy, W Long Branch, NJ 07764 / v: 3 / \*C 71
- PAYNE, Benjamin C. / executive / b: 1924 / ed: high school / ent: 1946 / m-i: P Sa Sy; data processing services / t: president / org: Payne Data Processing Service, Inc, 240 W Campbell Ave, Roanoke, VA 24015 / pb-h: DPMA International Director / h: 5444 Warwood Dr, Salem, VA 24153 / v: 1 2 / \*C 70
- \*PAYNE, Robert C. / org: Business Computer Service, 1027 Virginia St, Charleston, WV 25301 / pb-h: CDP; ACM, DPMA, RBP, ASIS AMA; co-author Use of an On-line Digital Computer for Measurement of a Neurological Control System / v: 2 / \*C 71
- \*PEARCE, David R. / manager EDP system / t: manager EDP systems / h: 7918 Hummingbird, San Diego, CA 92123 / v: 2 / \*C 71
- \*PEARSON, Irving M. / t: project engineer / h: 1052 10th St, Hermosa Beach, CA 90254 / v: 3 / \*C 71
- \*PEEPLER, Donald E. / regional director / m-i: Sa Sy; sales of computer services, facilities mgmt, operations and systems / org: GTE Data Services Corp, 6430 Oakbrook Pkwy, Ft Wayne, IN 46805 / v: 2 / \*C 71
- \*PELLMAN, Ed / h: 1520 Sunshine Dr, Glendale, CA 91208 / v: 3 / \*C 71
- \*PELSTER, Raymond L. / m-i: A B P Sy; utilities, teleprocessing / t: asst director, methods & procedures dept / org: Public Service Co of Colorado, 550 15th St, Denver, CO 80202 / pb-h: ACM, CDP / h: 3161 W Bails Pl, Denver, CO 80219 / v: 3 / \*C 71
- \*PENNEY, Leonie (Mrs. Walter) / m-i: Ma P Sy / t: computer specialist / v: 1 / \*C 71
- \*PENNEY, Walter / pb-h: "On the Final Digits of Squares" Amer Math, Dec 60; "A Binary System for Complex Numbers" Journal ACM, Apr '65; co-author "Two-Dimensional Binary Arrays" IEEE Trans on Elec Comp, Feb 66; problem editor Computers & Automation; MAA, CDP / v: 3 / \*C 71
- \*PERRY, John G., Jr. / h: 907 Waddell Rd, Waldorf, MD 20601 / v: 1 / \*C 71
- \*PERRY, M. Keith / manager / t: systems manager / h: 67 Tillotson Rd, Fanwood, NJ 07023 / v: 1 / \*C 71
- \*PETERS, Joseph A. / pb-h: ASM (Mgmt), College & Univ Business Management Inst, Hosp Financial Mgmt Assoc / h: 9310 Tiverton Way, Louisville, KY 40222 / v: 2 3 / \*C 71
- \*PETERSON, David L. / asst director, DP / t: DP asst director / pb-h: 1 article; Data Processing Magazine, ACM / v: 2 / \*C 71
- \*PETERSON, Donald E. / h: 2808 Hickory St No, Fargo, ND 58102 / v: 2 / \*C 71
- \*PETERSON, Duane C. / h: 1544 Milwaukee St, Delafield, WI 53018 / v: 1 2 / \*C 71
- \*PETRUS, Mecys M. / h: 252 Guy Park Ave, Amsterdam, NY 12010 / v: 1 / \*C 71
- \*PETTINE, Anthony V. III / t: eastern regional manager / h: 131 Nantucket Trail, Medford Lakes, NJ 08055 / v: 2 / \*C 71
- \*PHILLIPS, Alexander J. / h: 50 E 96 St, New York, NY 10028 / v: 2 3 / \*C 71
- \*PHILLIPS, Calman P. / org: Phillips Information Technology, 1049 Park Ave, New York, NY 10028 / h: 1049 Park Ave, New York, NY 10028 / v: 2 3 / \*C 71
- \*PHINNEY, Walter Joseph / org: Montag Div Mead Corp, 245 N Highland, Atlanta, GA 30307 / h: 2788 De-fours Ferry Rd, Apt 9G, Atlanta, GA 30318 / v: 2 / \*C 71
- \*PHISTER, Montgomery, Jr. / org: Xerox Data Systems, 555 S Aviation Blvd, El Segundo, CA 90245 / v: 2 3 / \*C 71

- \*PICKEL, Leonard / org: American Cyanamid Co, Berdan Ave, Wayne, NJ 07470 / v: 2 / \*C 71
- \*PIERCE, James L. / pb-h: CDP; pres, local DPMA chapter; member of chapter speaking group / v: 2 / \*C 71
- \*PIERSON, Col. Albert C. — replace by PIERSON, Col. Chad, which see
- \*\*PIERSON, Col. Chad / USAR Corps of Engineers, educator, consultant / b: 1914 / ed: Graduate Schools of Business, Harvard Univ, Columbia Univ / ent: 1956 / m-i: A B P / t: professor of management / org: San Diego State College, San Diego, CA 92115 / pb-h: - / h: 7333 Draper Ave, La Jolla, CA 92037 / v: 3 / \*C 71
- \*PINKERTON, Max / ed: BS, accounting, Indiana Univ; graduate work, business education, Indiana State Univ / t: director support systems / org: Columbia House Div of CBS, 1400 N Fruitridge, Terre Haute, IN 47804 / pb-h: CDP; GUIDE, SHARE, DPMA, ASTD, Delta Pi Epsilon / v: 2 / \*C 71
- \*PISCOPO, Joseph A. / org: Pansophic Systems, Inc, 1211 W 22 St, Suite 720, Oak Brook, IL 60521 / h: - / v: 2 / \*C 71
- \*PLESUMS, Charles A. / pb-h: ACM, Sigma Xi / h: 127 Bennington Rd, Charlottesville, VA 22901 / v: 2 / \*C 71
- \*PODD, George O., Jr. / banker / t: executive vice-pres / org: Old Orchard Bank & Trust Co, Old Orchard Rd, Skokie, IL 60076 / v: 3 / \*C 71
- \*POLISSAR, Jan / org: independent consultant / v: 1 3 / \*C 71
- \*FOLKINGHORN, Frank A., Jr. / h: 9202 Ivanhoe Rd, Oxon Hill, MD 20022 / v: 2 / \*C 71
- \*POPPELBAUM, Wolfgang J. — replace by POPPELBAUM, Wolfgang J., which see
- \*\*POPPELBAUM, Wolfgang J. / principal investigator / b: 1924 / ed: MS, PhD, Lausanne / ent: 1955 / m-i: D / t: professor of electrical engineering and computer science / org: Dept Computer Science, Univ of Illinois, Urbana, IL 61801 / pb-h: Computer Hardware Theory, about 30 papers; IEEE Fellow / h: 2007 S Anderson, Urbana, IL 61801 / v: 2 3 / \*C 71
- \*PORTER, Catherine / ed: BS, Univ of Texas; MA, Univ of Houston; PhD, Univ of Oregon / h: 2367 Emerald, Eugene, OR 97403 / v: 3 / \*C 71
- \*PORZIO, Armand J. / ent: 1958 / t: manager of information systems / v: 2 / \*C 71
- \*POTTS, Alfred W. / t: manager systems devt / org: Aluminum Co of America, 1501 Alcoa Bldg, Pittsburgh, PA 15219 / h: 1715 Partridge Run Rd, Upper St Clair, PA 15241 / v: 2 / \*C 71
- POWELL, William K. / programmer / b: 1948 / ed: BS, math, Mass Institute of Technology / ent: 1968 / m-i: Ma P / t: staff programmer / org: Turn-Key Computer Applications, Inc, 608 Silver Spur Rd, Rolling Hills, CA 90274 / pb-h: project MAC; res Fellow, Cal Institute of Technology / h: 3417 Anchovy Ave, San Pedro, CA 90732 / v: 1 / \*C 70
- \*POWERS, Mary R. / org: Naval Underwater Systems Center, New London Laboratory, New London, CT 06320 / v: 3 / \*C 71
- \*PRERAU, David Stewart / research engineer / ed: BE, CCNY; MS, MIT; PhD, MIT / m-i: A Ma P Sy; pattern recognition, programming languages, research, humanities applications, transportation applications / org: Dept of Transportation, Transportation Systems Center, 55 Broadway, Cambridge, MA 02142 / v: 3 / \*C 71
- \*PRITCHARD, Donald A. / org: Data Systems Engineering, 1620 E Ball Rd, Anaheim, CA 92805 / v: 2 3 / \*C 71
- \*PROS, Anton J. / org: Mid-America Computer Corp, 640 N LaSalle St, Chicago, IL 60610 / v: 2 / \*C 71
- \*PROSENKO, Gary J. / electronic engineer / ed: California Polytechnic State College / t: senior engineer / org: Burroughs Corp, 460 Sierra Madre Villa, Pasadena, CA 91109 / h: 226 San Antonio Rd, Arcadia, CA 91006 / \*C 71
- \*PROSSER, Reese T. / pb-h: AMS, APS, IEEE, ACM, SIAM, AIAA; 30 journal articles / v: 3 / \*C 71
- \*PUNGA, Valdemars / t: chmn information and computer sciences / org: Rensselaer Polytechnic Institute of Connecticut, 275 Windsor St, Hartford, CT 06120 / h: 82 Trout Stream Dr, Vernon, CT 06066 / v: 3 / \*C 71
- \*PURCELL, Francis J. / org: Hoffmann-LaRoche Inc, Nutley, NJ 07110 / h: 613 N Lake Dr, Lakewood, NJ 08701 / v: 3 / \*C 71
- \*PUSL, Joseph A. / t: manager, advanced systems dept / org: LOGICON, INC., 1075 Camino Del Rio S, San Diego, CA 92110 / h: 4380 Osprey St, San Diego, CA 92107 / v: 2 / \*C 71
- \*PYLE, L. Duane / pb-h: ACM, SIAM; 15 publns / v: 3 / \*C 71

## R

- \*RACHLIS, Edwin / ent: 1964 / org: Varatek Computer Systems, Inc, 1 DeAngelo Dr, Bedford, MA 01730 / h: 200 Swanton St, Winchester, MA 01890 / v: 3 / \*C 71
- \*RAGLAND, Joe R. / pb-h: ACM; "The Response-Efficiency Trade-off in a Multiple-University System", Datamation (March 1970) / v: 2 / \*C 71
- \*RAJCHMAN, Jan A. / pb-h: IEEE, ACM, APS, Sigma Xi, Natl Academy of Engineering, AAAS (science); Morris Liebmann Award, 1960; 105 US patents, 43 published papers / v: 2 / \*C 71
- \*RANEY, Don V. / t: manager, computer services / pb-h: DPMA / v: 2 / \*C 71
- \*RASHMIR, Lewis C. / org: Dart Direct Marketing, Division of Dart Industries Inc, 12011 Victory Blvd, N Hollywood, CA 91609 / v: 2 / \*C 71
- \*RAUSCHER, Bernard J. / staff supervisor / ed: BS, MA, Univ of Maryland / t: staff supervisor - internal audits, personnel / pb-h: 2 professional organizations / v: 2 / \*C 71
- \*RAWLS, Barbara Watson / m-i: A B L Mg P Sa Sy; EDP education development and instruction; implementation of medium to large application systems and project selection / pb-h: CDP / v: 1 3 / \*C 71
- \*RAY, Louis C. / m-i: A Mg / pb-h: ACM, PRS, and others; 18 published writings / v: 3 / \*C 71
- \*REICHARD, Robert W. / m-i: A D L Mg Sy / t: manager, engineering planning & admn / org: Honeywell, Framingham Computer Operation, Framingham, MA 01701 / v: 3 / \*C 71
- \*REIGELHAUPT, Norbert H. / org: I/O Systems, Inc, 15 Willow St, Natick, MA 01701 / v: 1 / \*C 71
- \*REINFELDS, Juris / pb-h: ACM, APS; co-editor "Interactive Systems for Experimental Applied Mathematics", Academic Press, 1968; 20 published papers / v: 1 3 / \*C 71
- \*REITMAN, Julian / pb-h: 14 publns / v: 3 / \*C 71
- \*RENIER, James J. / executive / t: vice-pres / org: Honeywell Data Systems Operations, 2701 4th Ave S, Minneapolis, 55408 / pb-h: ACS, Sigma Xi, Scientific Advisory Group of Army Mobility Equipment Research and Development Center; Consultant to Army Scientific Advisory Panel / v: 2 / \*C 71
- \*RENSHAW, Kent S. / m-i: Mg P Sy; CAI, operating systems, languages, interactive graphics, time-sharing / org: Boeing Computer Services, PO Box 24346, Seattle, WA 98124 / v: 1 2 / \*C 71
- \*REUTER, William H. / director of telecommunications / t: director of telecommunications / v: 2 / \*C 71
- \*REYNOLDS, Glen E. / h: Rt 16, Box 220A, Baltimore, MD 21220 / v: 3 / \*C 71
- \*RICCA, Joseph A. / org: Ricca Data Systems, Inc, 1732 Reynolds Ave, Santa Ana, CA 92705 / v: 2 / \*C 71

- \*RICE, William Thomas / t: manager of computer services / pb-h: CDP, ACM, ASM (mgmt), ASIS / h: Bayberry Lane, Belle Mead, NJ 08502 / v: 2 / \*C 71
- \*RICHTER, James C. / t: manager, industry applications / org: Honeywell Information Systems, Inc, PO Box 6000, K-30, Phoenix, AZ 85005 / v: 2 / \*C 71
- \*RICKETTS, Robert E. / h: RR2 Hazelwood West, Geneseo, IL 61254 / v: 2 / \*C 71
- \*RIDLEY, B. Wayne / data processing supervisor / m-i: A B Mg P Sy; pupil personnel services, statistical testing education, business applications / t: supervisor data processing services / pb-h: CDP; DPMA, board of directors, pres Kern Chapter; CASBO, central section data processing chmn / v: 2 / \*C 71
- \*RIDOLFI, Raymond J. / org: Advanced Computer Supplies Inc, 529 Raritan Center, Edison, NJ 08817 / v: 2 / \*C 71
- \*RIFENBERG, Charles J. / technical supervisor / t: supervisor, member technical staff / h: 6 Golf Course Rd, Succasunna, NJ 07876 / v: 1 / \*C 71
- \*RIGSBY, Roy B., Jr. / t: systems specialist (senior) / org: Lockheed-California Co, Dept 8031, Bldg 67, PO Box 555, Burbank, CA 91503 / h: 9364 Crystal View Dr, Tujunga, CA 91042 / v: 1 / \*C 71
- \*RILL, James K. / h: RD #5, Indiana, PA 15701 / v: 2 / \*C 71
- \*RINGEN, E. Richard / h: 60 Glenmere Ter, Ramsey, NJ 07446 / v: 2 / \*C 71
- \*RISSER, Arthur Jerel, II / pb-h: ASM (mgmt) / h: 1857 Edgewood Rd, Baltimore, MD 21234 / v: 1 / \*C 71
- \*RISSLER, Mahlon H. — replace by RISSLER, Mahlon N., which see
- \*RISSLER, Mahlon N. / manager computer center / b: 1936 / ed: ECPI / ent: 1963 / m-i: Mg / t: director, computing center / org: Eastern Mennonite College, Harrisonburg, VA 22801 / pb-h: - / h: 1311 Greystone St, Harrisonburg, VA 22801 / v: 2 / \*C 71
- \*RITCH, Paul A. / pb-h: CDP; DPMA, AVA, TVA, AAUP / v: 3 / \*C 71
- \*ROBB, James A. / t: associate professor / pb-h: CDP, past pres local chapter DPMA, ILLAEDS board member, Omicron Delta Kappa, Alpha Kappa Psi, many speeches & consulting services, review for ACM & Computerworld / v: 3 / \*C 71
- \*ROBINSON, F. Douglas / h: 92 Highland Ave, Orchard Park, NY 14127 / v: 2 / \*C 71
- \*ROBINSON, Robert A. / t: vice-pres, data processing manager / h: 2187 Chevy Chase Lane, Decatur, GA 30032 / v: 2 / \*C 71
- ROCKOFF, Maxine L. / mathematician / b: 1938 / ed: BS, MA, PhD / ent: 1958 / m-i: Ma / t: asst prof / org: Washington Univ, Biomedical Computer Lab, 700 S Euclid, St Louis, MO 63110 / pb-h: Phi Beta Kappa, SIAM, ACM, AMS, MAA, 9 pblns / h: 7420 Cromwell Dr, Clayton, MO 63105 / v: 3 / \*C 70
- \*ROLLINGER, Charles N. / t: director computer science & technology / h: 867 Tucker Dr, St Joseph, MI 49085 / v: 2 / \*C 71
- \*ROMAGNOLI, Adelmo / m-i: A B Mg P Sy / org: E. I. duPont de Nemours & Co, Inc, Wilmington, DE 19898 / pb-h: CDP; DPMA, SPA; editorial review board Journal of Systems Management / v: 1 / \*C 71
- \*ROOD, Robert E. / ent: 1961 / h: 2504 Giuffrias Ave, Apt D, Metairie, LA 70001 / v: 3 / \*C 71
- \*ROOS, Michael / t: senior system design specialist / v: 1 / \*C 71
- \*ROSEN, J. Ben / org: Univ of Minnesota, Computer Science Dept, Inst of Technology, Minneapolis, MN 55455 / h: - / v: 3 / \*C 71
- ROSENBERG, David M. / programming mgr / b: 1942 / ed: - / ent: 1961 / m-i: L P Sy; operating systems, compilers, computer architecture / t: oper assoc / org: New York Univ, Courant Inst, 251 Mercer St, New York, NY 10012 / pb-h: ACM, IEEE / h: 48-20 44 St, Woodside, NY 11377 / v: 1 2 / \*C 70
- \*ROSENTHAL, Lawrence E. / t: director, computer based instructional systems / v: 3 / \*C 71
- \*ROSS, Carolyn / org: Defense Logistics Services Center, Battle Creek, MI 49016 / v: 1 / \*C 71
- \*ROSS, Donald S. / pb-h: National Assoc for State Information Systems, Phi Beta Kappa / v: 2 / \*C 71
- \*ROSSATO, Robert J. / ent: 1959 / h: 637 Cambridge Cir, Richardson, TX 75080 / v: 2 / \*C 71
- \*ROTH, R. Waldo / pb-h: past pres Indiana section ASA; pres CUETUG (College & University 1130 Users Group); ACM Committee on Professional Activities of the Blind; AMS, MAA, NCTM / v: 2 / \*C 71
- \*ROTHENBACK, George J. / pb-h: Beta Epsilon, data processing consultant to area vocational-technical-adult education, EDP training consultant to Bureau of Systems & Data Processing - DOT, State of Wisconsin / v: 3 / \*C 71
- \*ROTHMAN, John / t: director library and information services / h: 101 Highland Rd, Glen Cove, NY 11542 / v: 3 / \*C 71
- \*ROWAN, William H., Jr. / t: chairman dept of systems and information science / pb-h: ACM, ASEE, ASCE, vice-pres Nashville Chapter PE's, Tau Beta Pi, Sigma Xi, Chi Epsilon, Phi Kappa Phi; 20 publications & reports / v: 3 / \*C 71
- \*ROWE, Alan J. / t: associate dean, graduate school of business administration / v: 3 / \*C 71
- \*RUBENFELD, Murray J. / org: E J Korvette, 450 W 33 St, NYC 10001 / v: 2 3 / \*C 71
- \*RUBY, Gordon C. / ed: BSME; MSME / v: 2 / \*C 71
- \*RUDOLPH, Luther D. / t: associate professor / v: 3 / \*C 71
- \*RUDY, John P. / t: operations research supervisor; instructor, Fitchburg State College / m-i: A B Mg; operations research, system design, simulation / pb-h: conference on applications of simulation; TIMS / h: 205 Walden St, Cambridge, MA 02140 / v: 3 / \*C 71
- \*RUSSELL, Charles R. / org: Coastal States Gas Producing Co, PO Drawer 521, Corpus Christi, TX 78403 / v: 2 / \*C 71
- \*RUSSELL, James H. / manager, engineering data processing / t: manager, engineering data processing / v: 2 / \*C 71
- \*RUSSO, Roy L. / pb-h: Penn State Univ writing award, IBM outstanding contribution award, Sigma Xi, Eta Kappa Nu, IEEE, ACM, 1 patent application, 14 publns / v: 2 / \*C 71
- \*RUST, John W. / t: asst director of systems / org: Univ of Cincinnati, 414 Procter Hall, Cincinnati, OH 45221 / pb-h: CDP; DPMA; College and Univ Machine Records Conference, 2 papers: On-Line Admissions 1970, MIS 1971 / v: 1 / \*C 71
- \*RUTENBERG, Yechezkel H. / org: Computax Corp, 601 Nash, El Segundo, CA 90245 / pb-h: ORSA, TIMS, ACM, ASA (statistics), Sigma Xi; lecturer UCLA dept of engineering systems; 3 publns / v: 2 / \*C 71
- \*RYDELL, Mary Ann / h: 444 Saratoga Ave, Apt 40D, Santa Clara CA 95050 / v: 1 / \*C 71
- \*RYMER, John E. / systems analyst / t: systems analyst / pb-h: SPA, ASM / v: 1 / \*C 71

S

- \*\*SABOL, Philip J. / dir of marketing / b: 1932 / ed: BS, BA / ent: 1959 / m-i: A Sa Sy / t: sr staff analyst / org: Union America Computer, 1000 S Hope St, Los Angeles, CA 90015 / pb-h: DPMA, NAA; Introduction to EDP / h: 4045 Exultant, Palos Verdes, CA 90274 / v: 1 / \*C 71
- \*SAGALYN, James M. / org: Western Electric, Bell Telephone Labs, Whippany Rd, Whippany, NJ 07981 / h: 21 Mt Kemble Ave, Morristown, NJ 07960 / v: 3 / \*C 71
- \*SAGE, Redmond T. / t: manager, real time systems development / v: 3 / \*C 71
- \*SAISOL, Philip J. — replace by SABOL, Philip J., which see

- \*SALAPATAS, James N. / pb-h: registered PE, Who's Who in South & Southwest (Marquis), Personalities of the South, 1970, 1971; speaker-author on computer aplns in utility indus; designed and developed MECA, published many articles on industrial engr / h: 9480 SW 97 St, Miami, FL 33156 / v: 3 / C 71
- \*SALEH, Hussein A. / ed: MA, arch; PhD, Univ of Pa / org: Vincent G Kling, Arch & Partners, 1401 Arch St, Philadelphia, PA 19102 / pb-h: "A dynamic model for the construction of low-cost housing", 1970 / v: 3 / \*C 71
- \*SAMMET, Jean F. / m-i: L Mg Ma P Sy; programming languages. formula manipulation, non-numerical math, programmer productivity / pb-h: ACM; MAA; ACL; Northeast Regional Representative ACM Council; organizer & first chmn ACM, SIGSAM; chmn ACM Committee on Special Interest Groups & Committees; ACM national lecturer; chmn, ACM SIGPLAN; book, Programming Languages: History & Fundamentals, 1969; numerous published articles / v: 1 3 / \*C 71
- \*\*SAMUELS, Thomas E. / manager management information services / b: 1924 / ed: Robert Morris College / ent: - / m-i: A B D L Mg Sy / t: manager, management information services / org: Electrical Products Div, Midland-Ross Corp, 1207 Columbus Ave, Pittsburgh, PA 15233 / pb-h: DPMA, AAOONS, pres Steel Federal Credit Union / h: 19 High St, Pittsburgh, PA 15223 / v: 2 / \*C 71
- \*SAMUELS, Thomas E. — replace by SAMUELS, Thomas E., which see
- \*SANDERS, Charles L. / m-i: A B Mg P Sy; financial models / t: manager, systems coordination / pb-h: ASM, DPMA, AMA, ACM / v: 3 / \*C 71
- \*SANFILIPPO, Louis J. / org: Catholic Family Life Ins Society, 1572 E Capitol Dr, Milwaukee, WI 53211 / pb-h: Honeywell Users Group / v: 2 / \*C 71
- \*SAUNDERS, Iverin / ed: Roosevelt Univ, Northwestern Univ, Cornell Univ / v: 2 / \*C 71
- \*SAVAS, E. S. / t: first deputy city administrator / h: 1 Bogardus Pl, New York, NY 10040 / v: 2 / \*C 71
- \*SAVIDGE, David V. / org: Data Transmission Co, PO Box 6228, Dallas, TX 75222 / v: 1 3 / \*C 71
- \*SAVITZKY, Abraham / h: 3 Mail Coach Ct, Wilton, CT 06897 / v: 1 / \*C 71
- \*SCARBROUGH, Wendel A. / instructor data processing / t: instructor data processing / org: Albuquerque Technical-Vocational Institute, PO Box 1927, Albuquerque, NM 87103 / h: 1037 Western Meadows Ct NW, Albuquerque, NM 87114 / v: 2 / \*C 71
- \*SCEARCE, William A., Jr. / h: 3508 Hillsboro Ct, Louisville, KY 40207 / v: 1 2 / \*C 71
- \*SCHAD, Roger P. / h: 4908 Fairheath Rd, Charlotte, NC 28210 / v: 2 / \*C 71
- \*SCHAFER, Emil / org: Univ of Southern Calif, Univ Computer Center, 1020 W Jefferson, Los Angeles, CA 90007 / v: 1 / \*C 71
- \*\*SCHARP, Glenn A. / computer scientist / b: 1925 / ed: BSEE, MS computer science / ent: 1957 / m-i: Sy / t: - / org: Deseret Test Center, Fort Douglas, UT 84113 / pb-h: - / h: Box 8085, Salt Lake City, UT 84108 / v: 3 / \*C 71
- \*SCHEINOK, P. / pb-h: ACM, MAA, SIAM, IMS; Tims; author and co-author of publns / h: 220 Locust St, Philadelphia, PA 19106 / v: 2 3 / \*C 71
- \*SCHEURMAN, Marion L. / operating system analyst / ed: AA Boise College / m-i: A P Sy / t: operating system analyst / v: 1 / \*C 71
- \*SCHILLER, Herman / t: project programmer / org: IBM, Dept D95, Bldg 705, Box 390, Poughkeepsie, NY 12602 / v: 1 / \*C 71
- \*SCHLEA, Robert E. / org: Baldwin-Wallace College, Berea, OH 44017 / v: 3 / \*C 71
- \*SCHMAL, Richard L. / org: Timeplex, Inc, 65 Oak St, Norwood, NJ 07648 / v: 2 / \*C 71
- \*SCHMIDT, Allan H. / pb-h: American Inst of Planners, ACM, URISA; consulting, 7 publns / h: 56 Coburn Hill Rd, Concord, MA 01742 / v: 3 / \*C 71
- \*SCHMIDT, Paul E. / org: RCA Corp, 633 W Wisconsin Ave, Milwaukee, WI 53203 / pb-h: Achievement Club / h: 2525 S Shore Dr, Milwaukee, WI 53207 / v: 3 / \*C 71
- \*SCHMITT, Frederick E., III / management sciences / ed: BEE, Cornell Univ; MBA, Univ of Delaware / m-i: time-sharing, process control, scientific applications, teaching, mgmt sciences / t: operations research analyst / org: Hercules Inc, Wilmington, DE 19899 / h: 2016 Gravers Ln, Wilmington, DE 19810 / v: 3 / \*C 71
- \*SCHMITZ, Lawrence W. / t: manager, data processing and communications / pb-h: CDP; DPMA, pres Wisconsin Honeywell Users Group / v: 2 / \*C 71
- SCHMUTZ, Mathias E. / manager / b: 1930 / ed: BA, MBA / ent: 1954 / m-i: Mg / t: DP manager / org: Hewlett Packard, 1501 Page Mill Rd, Palo Alto, CA 94304 / pb-h: - / h: 715 Casa Bonita Ct, Los Altos, CA 94022 / v: 2 / \*C 70
- \*SCHUSTER, Daniel J. / ent: 1961 / t: supervisor of computer services, RD&E div / pb-h: PLAN project chmn, COMMON, ACM, IEEE; paper, "Engineers and Computers", Montreal COMMON Conference; paper, "Computer Usage Accounting Language Under PLAN", St. Louis COMMON Conference / v: 3 / \*C 71
- \*SCHWARTZ, M. H. / t: director, division of mgmt info and telecommunication / pb-h: pres SMIS, "Computer Project Selection in the Business Enterprise" & more than 25 additional articles / v: 2 / \*C 71
- \*SCHWENKER, J. E. / org: Bell Telephone Labs, Crawford Corner Rd, Holmdel, NJ 07733 / v: 2 / \*C 71
- \*SCHWISTER, Robert / h: 2370 N 82, Wauwatosa, WI 53213 / v: 1 / \*C 71
- \*SCOTT, Dan W. / t: professor and chmn dept computer science / org: North Texas State Univ, PO Box 13866, Denton, TX 76203 / v: 3 / \*C 71
- \*SCOTT, G. E. / m-i: A Sy / h: - / v: 1 / \*C 71
- \*SCOTT, John Scott / pb-h: ACM, IEEE, Phi Kappa Phi, Pi Mu Epsilon, Sigma Pi Sigma; about 12 papers in computer aplns / v: 2 / \*C 71
- \*SCOTT, Leslie H., Jr. / t: asst vice-pres / h: 1700 Blanding Blvd, Jacksonville, FL 32210 / v: 2 / \*C 71
- \*SCOTT, Merlyn J. / org: Georgia-Pacific Corp, 900 SW 5th Ave, Portland, OR 97204 / v: 1 / \*C 71
- \*SEARLES, J. R. / director / t: director of administrative services / org: Honeywell Information Systems, 200 Smith St, Waltham, MA 02154 / v: 3 / \*C 71
- \*SELIGMANN, Paul / h: 1431 South Blvd, Evanston, IL 60202 / v: 1 / \*C 71
- SELL, Victor L. / engineer / b: 1924 / ed: BSE, elec & mech eng, Queens Univ, Belfast, Ireland / ent: 1957 / m-1: development, engr & mfg of memory cores & stack systems / t: product manager / org: Ampex Corp, 9937 W Jefferson, Culver City, CA 90230 / pb-h: IEEE / h: 347 24 St, Santa Monica, CA 90402 / v: 3 / \*C 70
- \*SEYMOUR, Lawrence F. / systems manager / ed: Loyola of Baltimore / t: systems manager / org: Commercial Credit Corp, 300 St Paul Pl, Baltimore, MD 21202 / pb-h: DPMA, ASM / h: 921 Saxon Hill Dr, Cockeysville, MD 21030 / v: 3 / \*C 71
- \*SHACKELFORD, Lois S. / pb-h: Phi Beta Kappa, Alpha Lambda Delta, Phi Kappa Phi, Pi Mu Epsilon, Xi Sigma Pi; 2 published pamphlets / v: 3 / \*C 71
- \*SHAPIRO, Sonya Ruth / t: senior technical staff / org: Telcomp Corp of America, 50 Moulton St, Cambridge, MA 02138 / pb-h: ACM, ACL, IEEE / v: 1 / \*C 71
- \*SHARP, Glenn A. — replace by SCHARP, Glenn A., which see
- \*SHAW, Richard H. / h: Fieldstone Court, Yorktown Heights, NY 10598 / v: 2 3 / \*C 71
- \*SHEPPARD, Louis C. / pb-h: ACM, AICHe, NSPE, NYAS, Alabama Professional Engineer, Alpha Phi Mu, Theta Tau; Leaders in American Science, 12 articles & pa-

- pers / v: 3 / \*C 71
- \*SHEPSKI, Edwin J. / h: 7804 W 46 St, Lyons, IL 60534 / v: 1 / \*C 71
- \*SHERMAN, John E. / m-i: Mg P Sy; data processing, scientific computing, hybrid computing / t: manager data processing / pb-h: assoc editor "IEEE Transactions on EC"; pres SCI; director of publns, Simulation; director AFIPS / v: 2 / \*C 71
- \*SHOSTACK, Kenneth E. / pb-h: ACM, IEEE, USASI X3.43; "Computerized Methods for the Routing of Printed Circuit Boards", Computer Design; "Optimization of Component Layout and Minimization of Wiring", NEPCON Proceedings / v: 1 / \*C 71
- \*SICHLINGER, Karl H. / ed: 2 yr college / h: 3200 Dublin Dr, San Francisco / CA 94080 / v: 2 / \*C 71
- \*SIGADEL, Myron / h: 14 Herbert Ave, Massapequa, NY 11762 / v: 2 / \*C 71
- \*SILVER, Edward / m-i: C Mg; manufacture & use of plated memory discs & drums / v: 2 / \*C 71
- \*SILVERN, Leonard C. / engineering psychologist and systems engineer / org: Education & Training Consultants, Co, 12121 Wilshire Blvd, Suite 217, Los Angeles, CA 90025 (Mail: Box 49899, Los Angeles, CA 90049) / pb-h: listed in: American Men of Science; Leaders in Education; Two Thousand Men of Achievement (Brit.); Who's Who in the West; Contemporary Authors, Writers Directory (Brit.); Who's Who in California; Who's Who in American Education; Directory of International Biography (Brit.); and others / v: 3 / \*C 71
- \*SIMMONS, Warren G. / computer technology assistant / t: computer technology assistant / org: U S Steel Corp, 1509 Muriel St, Pittsburgh, PA 15203 / v: 2 / \*C 71
- \*SINNOTT, Daniel / t: chmn of the board & president / h: 25 Mahoras Dr, Wayside, NJ 07712 / v: 2 / \*C 71
- \*SKELLY, Patrick G. / m-i: D L Ma Sy; standards / org: Honeywell Information Systems, PO Box 600, Phoenix, AZ 85005 / pb-h: IEEE, vice chmn ACM standards comm, Standards Engineering Society & ANSI committees X3, Y32 / v: 3 / \*C 71
- \*SKRAMSTAD, Harold K. / ed: BS, Univ of Puget Sound, PHD, Univ of Washington / t: scientific director, computing center / v: 2 3 / \*C 71
- \*SMITH, Anderson Q. / t: executive director, computing services / pb-h: AEDS, Institutional representative to EDUCOM; treasurer, local chapter DPMA / v: 2 / \*C 71
- \*SMITH, Charles V. / ed: Univ of Virginia / m-i: A P / v: 2 / \*C 71
- \*SMITH, Christopher F. / vice-pres & director of programming services / t: vice pres & director of programming services / h: 25 Wyandemere Dr, Woodcliff Lake, NJ / v: 3 / \*C 71
- \*SMITH, L. Wheaton / org: IBM Corp, 1501 California Ave, Palo Alto, CA 94304 / v: 3 / \*C 71
- \*SMITH, Robert E. / pb-h: ACM, SPA / h: 365 Chewacla Dr, Auburn, AL 36830 / v: 2 / \*C 71
- \*SMITH, Robert W., Jr. / h: 26 Thomaston Dr, Pittsburgh, PA 15235 / v: 3 / \*C 71
- \*SMITH, Roulette William / ed: BS, MS, PhD / m-i: P; computer assisted instruction, computer models of psychological processes & other educational research employing computers / t: asst professor of psychology and education / org: Univ of California, Santa Barbara, CA 93105 / v: 3 / \*C 71
- \*SMITH, William A. / pb-h: ASIS, APHA / h: 257 Congressional La, Rockville, MD 20852 / v: 1 / \*C 71
- \*SNOWDEN, Mark V. / org: Eagle Computing Corp, PO Box 1693, Midland, TX 79701 / pb-h: Registered Business Programmer, DPMA / h: 4311 Cedar Spring, Midland, TX 79701 / v: 1 2 / \*C 71
- \*SNYDER, Clyde R. / org: York Mechanized Systems, Inc, 497 Hill St, York, PA 17403 / v: 2 / \*C 71
- \*SNYDER, Frank Gerald / org: Lockheed Electronics Co, Data Products Div, 6201 E Randolph St, Los Angeles, CA 90040 / v: 3 / \*C 71
- \*SNYDERMAN, Martin / org: Science Information Exchange, 1730 M St, NW, Room 300, Washington, DC 20036 / pb-h: 9 papers on management of data processing / v: 2 / \*C 71
- \*SPACKEY, Melvin C. / t: corp director systems and data processing / org: Kelsey Hayes, Romulus, MI 48174 / pb-h: ASM, DPMA / v: 2 / \*C 71
- \*SPAMAN, William C. / org: Caltec Inc, 3023 Sylvania Ave, Toledo, OH 43613 / v: 2 / \*C 71
- \*SPRENG, T. E. / ed: BBA, MLA, Southern Methodist Univ / t: assistant vice-pres / v: 2 / \*C 71
- \*STAHL, Benjamin R. / m-i: A B Mg P Sy; education / t: manager, training integration / org: Raytheon Co, Equip Div, 40 Second Ave, Waltham, MA 02154 / v: 1 / \*C 71
- \*STAHL, David Edgar / t: regional applications manager / org: Control Data Corp, 5272 River Rd, Washington, DC 20016 / v: 2 / \*C 71
- \*STANLEY, Billy D. / org: Continental Oil Co, PO Box 1267, Ponca City, OK 74601 / h: 116 N 13th, Ponca City, OK 74601 / v: 1 2 / \*C 71
- \*\*STARK, Edward J. / management consultant / b: 1919 / ed: BS, economics / ent: 1953 / m-i: A B L Mg P Sy; EDP audits and reviews / t: pres / org: Edward Stark Associates Ltd, Hazelton Ave, Needham, MA 02192 / pb-h: developed major apln overall FIS and loan-mortgage sys for institutions; many firsts in info mgmt; exec training courses; certified mgmt consultant; founding member Inst Mgmt Consultants / h: 31 Hazelton Ave, Needham, MA 02192 / v: 3 / \*C 71
- \*STARKEY, H. Chris / ed: BSME, Lehigh; MBA, Northeastern / t: marketing management / v: 3 / \*C 71
- \*STEINBERG, Saul P. / org: Leasco Corp, 280 Park Ave, New York, NY 10017 / v: 2 / \*C 71
- \*STEPHENS, James A. / t: manager, negotiations and contracts / org: Westinghouse Tele-Computer Systems Corp, 2040 Ardmore Blvd, Pittsburgh, PA 15221 / pb-h: Sigma Xi, Phi Beta Kappa, SID, ACM; co-author "The Impact of Interactive Visual Display Systems on the Management Planning Process" IFIPS 1968 / v: 2 / \*C 71
- \*STERN, Ludwig / manager, engineer / m-i: A Mg / t: manager / v: 3 / \*C 71
- \*STEVENS, Herbert Howe, Jr. / ed: BSME, Georgia Tech; MA, liberal studies, New School / m-i: A B Mg Ma P Sy / v: 3 / \*C 71
- \*STEWART, Selden L. / h: 18715 Walkers Choice Rd, #5, Gaithersburg, MD 20760 / v: 3 / \*C 71
- \*STIEFEL, Rudy C. / org: Infotran Inc, 860 Fifth Ave, New York, NY 10021 / v: 3 / \*C 71
- \*STONE, Max W. / org: SCI Electronics, Inc, 8620 Memorial Pkwy, SW, Huntsville, AL 35802 / pb-h: articles in the field of solid rocket propellants; member Executive Board, POOL Users' Group, '61-'62, editor of newsletter; MAA; SMIS; former chmn, vice-chmn and secretary AIAA, Alabama section / h: 7301 Statton Dr, SE, Huntsville, AL 35802 / v: 2 / \*C 71
- \*\*STOUDT, William E. / career navy lieutenant / b: 1933 / ed: BSEE, Purdue; Associate in Electrical Technology, Purdue / ent: 1966 / m-i: Ma P Sy; electronic maintenance, electronic research and development work study / t: programming instructor / org: Plans & Programming Dept, FRAWTC, Dam Neck, Virginia Beach, VA 23461 / pb-h: navy enlisted scientific education program, Group 1, "Work Study of Test Equipment on 692/710 Class Destroyers", published, 1966 / h: 1544 Lake View Dr, Virginia Beach, VA 23455 / v: 1 / \*C 71
- \*STOOUT, William E. — replace by STOUDT, William E., which see
- \*STRAETER, Terry Anthony / ed: AB, MA, PhD, NCSU / h: 846 Isham Pl, Newport News, VA 23602 / v: 3 / \*C 71
- \*STUDEBAKER, David A. / t: sr consultant / org: Zettler Software, Inc, 1144 Dublin Rd, Columbus, OH 43215 / pb-h: past pres Central Ohio Chapter ACM / v: 1 / \*C 71

- \*STUNKEL, Robert A. / h: 8100 Leawood, Little Rock, AR 72205 / v: 2 / \*C 71
- \*STURM, Walter Allan / ed: ScB, physics, Brown; SMEE, MIT; PhD, engineering, UCLA / m-i: D Sy; teaching / pb-h: Sigma Xi, Rhodes candidate, ACM, IEEE Computer Society; several professional papers / h: 6625 Green Valley Cir, Culver City, CA 90230 / v: 1 / \*C 71
- \*STUTZMAN, Byron, W. / h: 123 Pembroke St, Boston, MA 02118 / v: 1 3 / \*C 71
- \*SUSZYNSKI, N. J. / computer scientist-mgr / t: asst dir-research / org: Federal Deposit Insurance Corp, Washington, DC 20429 / v: 1 2 / \*C 71
- \*SUTER, Richard Sturgis / h: 222 Weston Rd, Weston, CT 06880 / v: 2 / \*C 71
- \*SUTFIN, John S. / t: vice-pres / h: 4018 N Adams Rd, Oak Brook, IL 60521 / v: 2 / \*C 71
- T
- \*TAFEL, Nancy L. / org: Honeywell Information Systems, Inc, PO Box 6000, Phoenix, AZ 85005 / v: 2 3 / \*C 71
- \*\*TAJEN, Norman / digital expert in hybrid installation / b: 1930 / ed: BS, applied math / ent: 1960 / m-i: A Ma P Sy / t: mathematician / org: Picatinny Arsenal, Hybrid Analysis Section, Dover, NJ 07801 / pb-h: ACM, SIAM, AMS (math) / h: 665 E 181 St, Bronx, NY 10457 / v: 1 3 / \*C 71
- \*TANGNEY, Eugene M. / t: sr vice-pres / pb-h: pres, SPA, chmn-operations Mass Bankers Assoc / h: 34 Chatham Circle, Wellesley Hills, MA 02181 / v: 2 / \*C 71
- TAYLOR, Alan Armstrong / technical admn / b: 1929 / ed: BS, math, physics, Manchester Univ / ent: 1953 / m-i: A D Mg P Sy / t: deputy dir / org: Commonwealth Bureau of Census & Statistics, Newlands St, Parkes, A C T, 2600, Australia / pb-h: Fellow, Australian Computer Soc / h: 2 Wrest St, Lyons, A C T 2606, Australia / v: 2 / \*C 70
- \*TAYLOR, George David / org: Singer-Link Div, 1300 Bay Area Blvd, Houston, TX 77058 / v: 1 / \*C 71
- \*TAYLOR, N. M. / org: Naval Ship R&D Center, Washington, DC 20034 / v: 3 / \*C 71
- \*TAYLOR, Phillip H., Jr. / org: Univ of Arkansas, Fayetteville, AR 72701 / pb-h: ASA (stat'l), Amer Inst for Decision Sciences Southwest Social Science Assn, Beta Gamma Sigma, Delta Sigma Pi & others; several articles, 1 book in process, editor Arkansas Business & Economic Review / v: 3 / \*C 71
- \*TAYLOR, Richard G. / asst to director of field marketing, western operations / t: asst to the director of field marketing, western operations / org: Honeywell Information Systems Inc, 1801 Ave of the Stars, Los Angeles, CA 90067 / h: 3718 Bobstone, Sherman Oaks, CA 91403 / v: 3 / \*C 71
- \*TAYLOR, Robert Edward / pb-h: ACM, SCI, AIIE, ATTM, TIMS, Alpha Pi Mu, 1 book, 10 papers / h: 213 Craig Dr, Blacksburg, VA 24060 / v: 2 3 / \*C 71
- \*TAYLOR, Robert H. / h: 505 Lake Shore Dr, Chicago, IL 60611 / v: 2 / \*C 71
- \*TAYLOR, Robert L. / t: director of computer services / h: 533 Watson St, Ripon, WI 54971 / v: 2 / \*C 71
- \*TAUBER, Judith A. / org: Probe Systems, Inc, 655 N Pastoria, Sunnyvale, CA 94086 / v: 1 / \*C 71
- \*TAUPEKA, Norman J. / h: 32 Surrey Lane, Eatontown, NJ 07724 / v: 3 / \*C 71
- \*TEJAN, Norman — replace by TAJEN, Norman, which see
- \*TELLER, Henry T. / org: Mnemonics Inc, 1 Parkland Dr, Darien, CT 06820 / h: 28 Reichert Circle, Westport, CT 06880 / v: 2 / \*C 71
- \*TERESA, Salvatore R. / director of information systems / t: director of information systems / pb-h: DPMA, ACM, high school lectures on data processing & future impact on students, committee to improve data processing in the school systems / v: 2 / \*C 71
- \*TERRELL, James R. / t: manager, applications programming / org: Pitney Bowes-Alpex, Inc, Commerce Pk, Danbury, CT 06810 / h: 44 Old Farms Lane, New Milford, CT 06776 / v: 1 2 / \*C 71
- \*TERVELT, Ronald L. / t: systems analyst / h: 2734 Summerdale, Chicago, IL 60625 / v: 1 / \*C 71
- \*TESS, Thomas H. / executive / t: manager-chief executive officer / org: CUNADATA Corp, associated with Credit Union Natl Assoc (CUNA), 1716 Sherman Ave, Madison, WI 53701 / h: 1210 Chapel Hill Rd, Madison, WI 53711 / v: 2 / \*C 71
- \*THOMAS, Robert Jay / pb-h: AAAS, ACM, NCTM, MAA consultant, Sigma Xi, Pi Mu Epsilon, Chi Gamma Iota, American Men of Science, Who's Who in America, and others; consultant Argonne National Lab, several publs / v: 3 / \*C 71
- \*THOMPSON, John H. / ed: BS, MS, AE, engineering, MIT / v: 3 / \*C 71
- \*THOMPSON, Vernon L. / system supervisor / m-i: A C D Sy / org: UNIVAC, Univac Park, PO Box 3525, St Paul, MN 55165 / h: 4626 Dupont Ave S, Minneapolis, MN 55409 / v: 3 / \*C 71
- \*THOMPSON, Willie F. / h: 2020 Japonica Lane, Plano, TX 75074 / v: 1 2 / \*C 71
- \*THRAN, Anna Marie — replace by THRON, Anna Marie, which see
- \*\*THRON, Anna Marie / product development / b: - / ed: BA, chemistry, Beaver College / ent: 1963 / m-i: A B L Ma P Sy / t: mgr, product development / org: Cullinane Corp, One Boston Place, Boston, MA 02108 / pb-h: - / h: 244 Brattle St, Cambridge, MA 02138 / v: 1 / \*C 71
- \*THORSEN, Michael J. / t: director of systems development / h: 6759 Hayhurst St, Worthington, OH 43085 / v: 2 / \*C 71
- \*TICHY, James Michael / senior systems analyst / ed: BS, business admn / t: senior systems analyst / org: Rx Systems, Inc, 15 Spinning Wheel Rd, Hinsdale, IL 60521 / pb-h: DPMA / h: 10524 Crown Rd, Franklin Pk, IL 60131 / v: 1 / \*C 71
- \*TOELLNER, John D. / org: J Toellner & Assoc, 1930 Wilshire Blvd, Los Angeles, CA 90057 / v: 3 / \*C 71
- \*TOMLIN, Horace B. / ed: BS, chemistry; BS, business admn / v: 2 / \*C 71
- \*TRACY, John A. / t: professor of accounting, head division of accounting / pb-h: various articles in Journal of Accountancy and Accounting Review; Understanding Accounting (Prentice-Hall, 1971); ATCPA; FEI; AAA / h: 2795 Vassar Dr, Boulder, CO 80303 / v: 3 / \*C 71
- \*TRIMBLE, Joel / org: Office of Naval Research, 437, Arlington, VA 22217 / v: 1 / \*C 71
- \*TRUXALL, Fred W. / t: manager, product development, tobacco division / h: 4190 Winfield Rd, Columbus, OH 43220 / v: 3 / \*C 71
- \*TUNNEY, James L., Jr. / mgr, management information center / t: mgr, management information center / org: Lau Inc, 2027 Home Ave, Dayton, OH 45407 / v: 2 / \*C 71
- \*TURGEON, Paul C. / org: Iowa Beef Processors, Inc, Dakota City, NE 68731 / h: 2826 Sergeant Rd, Sioux City, IA 51106 / v: 2 / \*C 71
- \*TURNER, Bruce E. / m-i: A B Mg P Sy / t: computer center mgr / pb-h: CDP / h: RR2 Box 528 LaPorte, IN 46350 / v: 2 / \*C 71
- U
- \*UNKE, Willis R. / m-i: A D Mg / t: software development mgr / org: UNIVAC Div of Sperry Rand Corp, 2276 Highcrest Dr, Roseville, MN 55113 / pb-h: past pres ACM TC chapter / v: 1 2 / \*C 71
- \*UPDIKE, Bruce M. / m-i: A D / t: planning rep, advanced systems requirements / pb-h: helped plan IBM 7070 & 1410 data processing systems; architecture team for S/360 / h: 708 Valley View Dr, Endwell, NY 13760 / v: 3 / \*C 71
- UPTON, James F. / executive / b: 1934 / ed: BS, physics, Bates; BSEE, Rensselaer Poly Inst / ent: 1962 /



m-i: A D Mg / t: executive vice-pres / org: Inco-  
term Corp, Hayes Memorial Dr, Marlboro, MA 01752 /  
pb-h: - / h: 73 Blackmer RD, Sudbury, MA 01776 /  
v: 2 / \*C 70

\*\*URSINO, A. / service bureau / b: 1938 / ed: BS,  
mgmt / ent: 1960 / m-i: A B D Mg P / t: profes-  
sional service, division mgr western region / org:  
Matrix Corp, 931 S Douglas St, El Segundo, CA  
90245 / pb-h: technical paper / h: 26581 Saddle-  
back Dr, Mission Viejo, CA 92675 / v: 2 / \*C 71

\*URUBURU, Martin J. / t: systems project mgr / org:  
J C Penney Co, 1700 Broadway, New York, NY 10019 /  
h: 23 Beechwood Pl, Massapequa, NY 11758 / v: 3 /  
\*C 71

## V

VAN ARNEM, Harold L. / executive / b: 1940 / ed:  
BA, economics / ent: 1962 / m-i: A B Mg Ma P Sa  
Sy; facilities mgmt, time sharing service bureau /  
t: president / org: Applied Computer Time Share  
Inc (ACTS), 29200 Southfield, Southfield, MI  
48075 / pb-h: Ntl Accountants Manuscript Award  
1967, Engineering Society of Detroit / h: 392  
Lakeside, Brimingham, MI 48009 / v: 1 2 3 / \*C 71

\*VAN NESS, Robert G. / org: Metropolitan Computer  
Center, 1600 S Glendale Ave, Glendale, CA 91205 /  
h: 1519 Western Ave, Glendale, CA 91201 / v: 2 / \*C 71

\*Van WAGNER, Arthur J. / org: Westwood Pharmaceuti-  
cals Inc. 468 Dewitt St, Buffalo, NY 14213 / v: 2 /  
\*C 71

\*VanHEMERT, Gary A. / t: manager / org: Rocket Re-  
search Corp, 11441 Willows Rd, Redmond, WA 98052 /  
pb-h: DPMA, CDP / v: 3 / \*C 71

\*\*VEDECKAS, Al / manager / t: mgr, systems installa-  
tion / org: Singer, 313 Underhill Blvd, Syosset,  
NY / h: 2201 N Atlantic Ave, Spray Beach, NJ / v:  
1 / \*C 71

\*VELDMAN, Donald J. / h: 3007 Savoy, Austin TX  
78731 / v: 3 / \*C 71

\*VENDELAND, Allan J. / t: project manager / pb-h:  
Cleveland Chapter bd of directors ASM, editor  
Forms Control & Design, & Methods for Evaluating  
Capital and/or Expense Projects / v: 1 / \*C 71

\*\*VERCHOT, Louis J. / writer, marketing administra-  
tor / b: 1933 / ed: BA, English / ent: 1961 / m-i:  
Mg Sa; public relations, marketing publns / t:  
mgr, graphic communications / org: Cybermatics,  
Inc, 2460 Lemoine Ave, Ft Lee, NJ 07024 / pb-h: - /  
h: 636 Ridgewood Rd, Westwood PO, NJ 07675 / v: 3 /  
\*C 71

\*VESINO, A. — replace by URSINO, A., which see

\*VEVECHOT, Louis J. — replace by VERCHOT, Louis J.,  
which see

\*VICKROY, William R. / t: dir of marketing / org:  
McDonnell Douglas Automation Co, Box 516, St Louis,  
MO 63166 / h: 5 Ladue Downs, St Louis, MO 63141 /  
v: 3 / \*C 71

\*\*VILLERS, Philippe / director of engineering / b:  
1935 / ed: AB, Harvard; SM, MIT / ent: 1965 / m-i:  
A Mg; computer graphics / t: senior vice-pres /  
org: Computervision Corp, South Ave, Burlington,  
MA 01803 / pb-h: AIAA, ASME, IEEE / h: 872 Massa-  
chusetts Ave, Cambridge, MA 02139 / v: 2 / \*C 71

\*VILLERS, Philippe — replace by VILLERS, Philippe,  
which see

\*VITALE, Robert F. / t: marketing mgr, indep study /  
org: Honeywell Info Systems, Inc, 70 Walnut St,  
Wellesley Hills, MA 02181 / pb-h: ASTD; lecturer  
in electronic data processing, Northeastern Univ;  
"Honeywell Communications Mix", Audio-Visual Com-  
munications / v: 3 / \*C 71

\*VITELLI, John B. / consultant / t: - / org: - /  
v: 2 / \*C 71

\*VOLBACH, Fritz B. / org: Control Data Corp, 4201 N  
Lexington Ave, Arden Hills, MN 55112 / v: 3 / \*C 71

## W

\*WAGNER, F. R. / m-i: A Ma Mg P / t: chief scientific  
programming / org: McDonnell Douglas Automation  
Co, Box 516, St Louis, MO 63166 / h: 913 Madison  
St, Charles, MO 63301 / v: 3 / \*C 71

\*WALKER, Crayton C. / m-i: A Ma / t: associate pro-  
fessor / org: Univ of Connecticut, Storrs, CT  
06268 / pb-h: 15 publns / h: 63 Mansfield Apts,  
Storrs, CT 06268 / v: 3 / \*C 71

WARNER, Harold F. / manufacturer (memories) / b:  
1923 / ed: AB, Allegheny Coll; MBA, Univ of Mich-  
igan / ent: 1958 / m-i: Mg / t: dir of operations /  
org: Electronic Memories & Magnetics Corp, Keasbey,  
NJ 08832 / pb-h: ACM / h: 18 Overlook Dr, Holmdel,  
NJ 07733 / v: 2 3 / \*C 70

\*WASHINGTON, Herman A. / m-i: A B Ma Sy / org: The  
Systems Discipline Inc, 919 Third Ave, New York,  
NY 10022 / pb-h: ACM, IEEE, AMA (mgmt) / v: 2 3 / \*C 71

\*WATKINS, Douglas E. / t: sr research & planning  
specialist / org: GTE Sylvania Inc, 5700 W Genesee,  
Camillus, NY 13031 / h: 22 Ball Rd, Syracuse, NY  
13215 / v: 2 / \*C 71

\*WATTS, Duane E. / consultant / t: principal, Mgmt  
Advisory Services / h: 159 Big Oak Rd, Stamford,  
Ct 06903 / v: 3 / \*C 71

\*WEBER, Neil J. / m-i: D L Mg P Sa Sy / t: mgr of  
software development / org: Badger Meter Inc,  
Electronics Div, 4545 W Brown Deer Rd, Milwaukee,  
WI 53223 / h: Rt 2, Box 245, Hartland, WI 53029 /  
v: 1 / \*C 71

\*WEGSTEIN, Joseph H. / b: 1922 / ed: BS, MS, Univ  
of Illinois / ent: 1949 / m-i: automated finger-  
print identification / org: Center for Computer  
Sciences & Technology, Natl Bureau of Standards,  
Washington, DC 20234 / pb-h: visiting lecturer  
1961 winter trimester, Computation Data Prog  
Center, Univ of Pittsburgh; ALGOL, COBOL, "Ac-  
celerating Iterative Processes", "Fingerprint  
Automation" / v: 2 / \*C 71

\*WEIBEL, Leonard A. / m-i: time shared legal infor-  
mation retrieval / org: Mead Data Control, Sub-  
sid Mead Corp, 1368 Research Pk Dr, Dayton, OH  
45452 / h: 912 E Rahn Rd, Dayton OH 45429 / v:  
3 / \*C 71

\*WEIL, Allen C. / t: asst actuary / org: Security  
Mutual Life Insurance Co of NY, Court House Sq,  
Binghamton, NY 13902 / h: 5 Riverside Dr, Bing-  
hamton, NY 13905 / v: 3 / \*C 71

\*WEIL, John William / director / t: director / org:  
Advanced Systems & Technology, Honeywell Informa-  
tion Systems Inc, 200 Smith St, Waltham, MA 02154 /  
pb-h: ACM, Various publns on nuclear reactor de-  
sign & information systems / h: 63 Sylvan Rd,  
Weston, MA 02193 / v: 3 / \*C 71

\*WEINBERGER, F. Richard / t: manager software de-  
velopment / org: Lockheed Electronics Co, 6201 E  
Randolph St, Los Angeles, CA 90040 / pb-h: ACM,  
IEEE, ISA / h: 13071 Rainbow St, Garden Grove, CA  
92643 / v: 2 / \*C 71

\*WEIZER, Norman / m-i: DP Sy / t: mgr, LES product  
design & evaluation / org: RCA, SPPL, Bldg 214-1,  
Camden NJ 08101 / pb-h: ACM, IEEE; author of several  
papers on virtual memory systems design and eval-  
uation / v: 1 / \*C 71

\*WELLS, Joan A. / EDP trainer manager / ent: 1959 /  
m-i: A Mg P Sy / t: senior data processing sys-  
tems analyst / org: State of Calif, Office of  
Management Services, 1400 10th, Sacramento, CA  
95814 / pb-h: treas Sacramento Stat Assoc / v:  
1 2 / \*C 71

\*WERNER, Oswald / ed: PhD, Indiana Univ / t: profes-  
sor / h: 2609 Ridge Ave, Evanston, IL 60101 / v: 3 /  
\*C 71

\*\*WESCOTT, Frederic M., Jr. / director computer cen-  
ter / b: 1930 / ed: BA, Harpur College; MA, Colum-  
bia / ent: 1967 / m-i: A Mg Sy / t: director

## Y

- computer center / org: Orange County Community College, 115 South St, Middletown, NY 10940 / pb-h: Phi Delta Kappa / h: Greeves Rd, New Hampton, NY 10958 / v: 2 / \*C 71
- \*WESTCOTT, Frederic M., Jr. — replace by WESCOTT, Frederic M., Jr., which see
- \*WHITFIELD, Russell L. / ed: BBA, MBA, CPA / org: National Twist Drill & Tool Co, Rochester Rd, Rochester, MI 48063 / v: 2 3 / \*C 71
- \*WITTENBORN, August F. — replace by WITTENBORN, August F., which see
- \*WICKENDEN, Henry R. / org: Applied Data Research Inc, Rte 206 Center, Princeton, NJ 08540 / h: 3 Penn-Lawr Rd, Pennington, NJ 08534 / v: 1 3 / \*C 71
- \*WICKER, Rosalind B. / analyst / t: lead system analyst / h: 1101 Great Oak Dr, Columbus, OH 43213 / v: 1 / \*C 71
- \*WILLIAMS, H. C. / programmer-analyst / m-i: A B P Sy / t: sr programmer-analyst / org: Cramer Div, Conrac Corp, Old Saybrook, CT 06475 / pb-h: CDP, Eastern Connecticut Chapter DPMA, Connecticut Chapter ASM / v: 2 / \*C 71
- \*WILLMERT, Winston R. / vice-pres / b: 1925 / t: vice-pres / org: Honeywell Information Systems, Peripheral Operations, 8611 Balboa Ave, San Diego, CA 92112 / v: 2 / \*C 71
- \*WILSON, James Bruce / org: National Biomedical Research Foundation, Georgetown Univ School of Medicine, 3900 Reservoir Rd, NW, Washington, DC 20007 / v: 1 / \*C 71
- \*WILSON, Ross B. / h: 1612 Lincoln St, Evanston, IL 60201 / v: 3 / \*C 71
- \*WILSON, Russell M. / vice-pres & comptroller / ed: BS, Brown Univ; MBA, New York Univ / m-i: A B Mg / t: vice-pres & comptroller / org: United States Envelope Co, Box 3300, Springfield, MA 01101 / pb-h: FEI, ACS, AIIE / v: 3 / \*C 71
- \*WINSTON, Arthur H. / org: Icebreaker Inc, 1966 Broadway, New York, NY 10023 / v: 2 / \*C 71
- \*WISE, Fred H. / pb-h: AMA; IMS; AEDS, Innovation Group; developed Center for Mgmt Systems at Univ of Georgia to stimulate the introduction of EDP and advanced mgmt techniques in business / h: 405 Riverhill Dr, Athens, GA 30601 / v: 3 / \*C 71
- \*WITMER, David R. / ed: BS, history; MS, education admn; PhD, higher education / t: director of institutional studies & academic planning / pb-h: AERA; WLA; AAHE; IRA; PDK; "Unit Cost Studies"; "Economic Benefits of College Education" / h: 6245 S Highlands Ave, Madison, WI 53705 / v: 3 / \*C 71
- \*WITTENBORN, August F. / corporate mgmt / b: 1923 / ed: BSc, MA, PhD, physics / ent: 1953 / m-i: A Mg Ma / t: pres / org: Tracor Computing Corp, 1705 Guadalupe St, Austin, TX 78701 / pb-h: over 30 reports on systems simulation & analysis for sonar, radar, war gaming & general math problem solving / h: 3405 Southhill Circle, Austin, TX 78703 / v: 2 / \*C 71
- \*WIXTED, Joseph F. / ed: 6 yrs evening college / t: senior systems designer / org: CEO/BEO Railroads, Civil Plaza Bldg, Baltimore, MD 21201 / pb-h: ASM, TAG / h: 9906 Hoyt Circle, Randallstown, MD 21133 / v: 2 / \*C 71
- \*WOLFE, H. C. / t: vice-pres / org: Management Systems Corp, 7007 Preston Rd, Dallas, TX 75205 / h: 7920 Greenhollow, Dallas, TX 75240 / v: 3 / \*C 71
- \*WOLFE, William R. / ed: B E Mg / t: supervisor systems programmer / org: GTE Sylvana Inc, 5700 W Genessee St, Camillus, NY 13031 / v: 1 / \*C 71
- \*WOO, Way Dong / org: Kybe Corp, 132 Calvary St, Waltham, MA 02154 / h: 1 Todd Pond Rd, Lincoln, MA 01773 / v: 2 / \*C 71
- \*WOODBURY, Max A. / t: prof of biomathematics & professor of computer science / org: Duke Medical Center, Duke Univ, PO Box 3200, Durham, NC 27706 / v: 3 / \*C 71
- \*WORLEY, Jan / t: staff instructor / org: IBM, 1 California St, San Francisco, CA 94111 / pb-h: CDP / v: 1 3 / \*C 71
- \*YAKE, Douglas E. / DP mgr / ed: U of D / m-i: A Mg Sy / t: div DP mgr / org: North American Rockwell Corp, Clifford at Bagley, Detroit, MI 48231 / h: Coventry Gardens, Royal Oak, MI / v: 3 / \*C 71
- \*YANG, David J. / t: director / h: 6819 Park Lane, Palos Heights, IL 60463 / v: 2 / \*C 71
- \*YANOF, Howard M. / m-i: A D Sy / pb-h: Biomedical Electronics; APS, Biophysical Society; Society for Neuroscience; Sigma Xi / h: 5224 Kearsdale, Toledo, OH 43623 / v: 1 3 / \*C 71
- \*YNGUE, Victor H. — replace by YNGVE, Victor H., which see
- \*YNGVE, Victor H. / professor / b: 1920 / ed: BS, MS, PhD / ent: 1949 / m-i: C D P Sy; linguistics / t: professor / org: Univ of Chicago, Chicago, IL 60637 / pb-h: COMIT language manuals and articles / h: - / v: 3 / \*C 71
- \*YOCKUM, J. Karl / manager / m-i: A B Mg P Sy / t: mgr data processing center / org: National Cash Register, 940 Madison Ave, Baltimore, MD 21201 / pb-h: CDP / h: 5073 W Running Brook Rd, Columbia, MD 21043 / v: 1 2 / \*C 71
- YOCUM, John E. / sales rep / b: 1938 / ed: MBA, Univ of Arizona / ent: 1969 / m-i: B Mg Sa / t: sales rep / org: General Electric Co, Information Systems Div, 3810 Wilshire Blvd, Los Angeles, CA 90005 / pb-h: AMA; AFA; DPMA, publins dir, Long Beach Chpt / h: 5947 Armaga Springs Rd, Palos Verdes Peninsula, CA 90005 / v: 3 / \*C 70
- \*YOUDE, Henry S. / b: 1938 / ed: BA, math, Univ of Bridgeport; Northwestern Univ Grad School of Mgmt / m-i: A B Mg P Sy / t: software engineering mgr / pb-h: DPMA, CDP, ACM, AMA / v: 2 / \*C 71

## Z

- \*ZACHAREK, Anthony J. / ed: BS, engineering math, Univ of Arizona / org: Kitt Peak National Observatory, 950 N Cherry, Tucson, AZ 85717 / v: 1 / \*C 71
- ZAIMI, K. / executive / b: 1939 / ed: BS, engrg; MBA / ent: 1966 / m-i: A B C Mg / t: president / org: World Research Corp, 36 State St, Chicago, IL 60603 / pb-h: 4 professional societies / h: PO Box 195, Chicago, IL 60609 / v: 2 / \*C 70
- ZIEGENER, James G. / systems analyst / b: 1943 / ed: BS, MBA / ent: 1967 / m-i: A B Mg Sy; marketing / t: systems analyst / org: Atlantic Richfield Co, 700 Broadway, New York, NY 10020 / pb-h: - / h: 6 Morse Dr, Maplewood, NJ 07040 / v: 1 / \*C 70
- \*ZIEGLER, James Craig / t: director-advanced systems & part owner / org: Data Communications Corp, 2200 Union Ave, Memphis, TN 38104 / pb-h: 71-72 chmn Memphis Chapter ACM / v: 3 / \*C 71
- \*ZIMMERMANN, G. A. / org: Computer Aid Companies, Inc, Preston Forest Tower, Dallas TX 75230 / v: 1 3 / \*C 71
- \*ZIMMERMANN, William A. / t: sr programmer / h: 118 Shiloh Dr, Madison, WI 53705 / v: 1 / \*C 71
- \*ZINN, Karl L. / org: Center for Research on Learning & Teaching, Univ of Michigan, 109 E Madison St, Ann Arbor, MI 48104 / pb-h: AAAS, AERA, APA, standards comm AEDS, IEEE, chmn ACM SIGCUE: consulting editor, 3 journals; invited contributor to intl conferences on computers in education; chapters 9 books, over 30 articles, co-editor of 3 conference proceedings / v: 1 3 / \*C 71
- \*ZINSLI, Peter F. / vice-pres, product devt / org: Computer Machinery Corp, 2231 S Barrington Ave, Los Angeles, CA 90064 / h: 15045 Altata, Pacific Palisades, CA 90272 / v: 2 / \*C 71
- \*ZOLLER, John D. / ent: 1948 / h: 2012 Ocean Front S, Jacksonville Beach, FL 32250 / v: 2 3 / \*C 71
- \*ZUSMAN, Fred S. / t: pres / org: Scientific Management Systems, 7910 Woodmont Ave, Bethesda, MD 20014 / v: 1 2 / \*C 71

This we see already in a number of countries. It will go much further and faster.

Your industry can leave regulation to others, as you are now doing; or it can take the lead in devising and recommending forms of regulation, codes of behaviour, and standards of professional ethics which will reassure the community and demonstrate that you are a responsible industry — that you can be trusted. I do not believe that this will in any way damage the immense contribution which the industry can make to the economic well-being of the community. It will not damage your commercial effectiveness, nor your efficiency. You must decide. We in Britain are already slightly ahead of you. But we hope not for long.

### **13. International Aspects of the Computer Industry**

My second topic concerns the international aspects of your industry. The question I want to ask is whether you are really looking ahead at the impact on overseas countries of the growth of an information industry which is dominated by your computer industry. Have you thought about the trouble you may be building up for yourselves in the future?

### **14. Independence Technologically As Well As Politically**

I believe that any country that considers itself to be independent must have a certain independence technologically as well as politically. And this applies forcibly to computers — more than to any other industry. Of course I know that some of you accept this and offer technology freely. Others do not. It is to the latter that I address these words.

Looking at you from our side of the Atlantic it is impossible not to be struck by the parallel between the American Empire today and the British Empire of a hundred years ago. Nonsense, you will say. The British Empire was political, ours is simply commercial and industrial. But let me remind you that the British Empire began as a commercial and industrial network, and let me ask you if you are sure the American Empire will not end up as a political system?

Let me hasten to say that I am not here to accuse anyone of neo-imperialism. I know perfectly well that America does not have political designs on any other country, that she has no territorial ambitions in Latin America — or indeed South East Asia. But I also know, from Britain's experience with her Empire, that the logic of large-scale international trade and massive overseas investment leads to certain inescapable conclusions, and they are political conclusions.

They are not necessarily harmful conclusions. I am not here to apologise for the British Empire; I suspect that when the final balance sheet is drawn up there will be more on the credit side, and less on the debit side, than the current fashion allows us to suggest.

### **15. A Glaring Economic Mistake: Tying the Customers In**

But, we made one glaring mistake — an economic mistake — which we are still paying for. I suspect you may make it all over again.

We started, as you did, aggressive, enterprising and astoundingly modern and efficient. There was something irresistible about British technology in the early days of the Empire. But, when we had established our markets, we made the mistake of tying them into our system. Instead of letting them develop independently, instead of competing with other nations for their custom in an open market, we used our dominance to make them take our products. Instead of encouraging them to develop their own technology and know-how, we kept them dependent on ours. It was great while it lasted — we did not have to compete, we did not have to sell, we just had to produce. And gradually we became arrogant, uncompetitive, and more dependent on them than they were on us. Some of our older industries have not recovered yet. And so when the Empire wanted more political independence, we were not ready for independence — for commercial independence.

### **16. When Things Look Good, One Makes the Irreversible Mistake**

You are still in the first aggressive stage, and perhaps these warnings may sound remote. Believe me they are not. It's always the same in business — it's when things look good that you make the irreversible mistake. Can those who dominate your computer industry put their hands on their hearts and say "we are encouraging other countries to develop their own technology, their know-how, so that they can learn to be independent of us — even though it will mean our fighting for their custom in the years ahead? We are not tying any country's information system, any national government's information system, to one American corporation? We are encouraging local participation, issuing local equity, and not just putting in national managers to carry out American policies?" Believe me, the tied market is an addictive drug — a narcotic, and sometimes a hallucinogenic. And I speak as representative of a nation that has been through the cold turkey treatment.

Now as far as these overseas countries are concerned, it is *their* information that is being handled — not American information. Its handling is an integral part of *their* autonomy. So what any self-respecting country should expect from the leading country in the world's technological Empire is technological independence. In other words, a complete range of technology and know-how — not just some segments to suit your management rules about overseas operations.

### **17. The Right to Nationally Independent Technology**

In fact every country has the right to enough independent technology to allow it to carry on independently if political factors make it desirable or necessary. But unfortunately, that is not what is happening. The American technology Empire is making the same mistakes as the British Empire. It is trying to control countries by depriving them of technology in just the same way that we did by keeping from them the machines of our industrial revolution.

You may say that if you do this, i.e., pass on your technology, you will encourage nationalisation (or at least make it easier). Nationalisation is, of course, an emotive dirty word. As an audience you resent it and understandably so. But are you offering any better alternative? Or any alternative?

## 18. The Creation of Satellites

Speaking as a representative of that other Empire, I feel I am in an ideal position to advise you as to what you should do. You argue that laying down plant in various countries is enough. That in so doing you are providing employment for the local inhabitants. But that is not enough. It is not enough merely to create employment, and you should not imagine that by setting down plant and employing nationals you have fulfilled your responsibility. You haven't. I agree that it is an excellent step to take, but it is a fallacy to imagine that because you are in a position to say: "Most of our plant is run by French or British or German personnel" then you have created a real international company. You haven't. You have created a satellite. And that is not the same thing — ask any Czech or Hungarian.

So you must do two things, unless you wish to see your Empire go the same way as ours. You must offer the whole wide spectrum of technology so that, if for political reasons a breach occurs, countries are not cut off — left running around like a chicken without a brain or with only one wing.

## 19. Partners, A Necessary Nuisance

Equally importantly, you may well have to offer some ownership of local business. In my Company, ICL, for example, why shouldn't an Australian be able to buy shares in ICL Australia? The immediate answer is, of course, that ICL shares traded in London reflect sales in seventy markets across the world. But all the Australian wishes, quite simply, is to be able to share directly in the efforts of his own company in his own country.

I can hear you all saying that this is all very well and fine, but we must insist upon 100 per cent ownership in order to run our world-wide business efficiently. You must have one sense of purpose. Now I agree that partners are a nuisance because you have to pay some attention to them. Decisions may get slowed up or have to be changed. But the information business more than any other business is a partnership. One of the unique features of the industry is that the usual buyer/seller relationship is being replaced progressively by a partnership between supplier and customer. There is no other way for the industry. Gone are the days when computer suppliers can continue a "take it or leave it" attitude to their customers.

## 20. The Substitution of Size and Power, for Wisdom

If you do not take the initiative it will, I suggest, be taken from you increasingly over the coming years. I believe that we in ICL are ahead of you in our attitudes. I suspect you may be trying to substitute size and power for wisdom. We — the British — tried it and it did not work.

Perhaps I may paraphrase a recent leading article in the London "Times". The harmonisation of the United States with the rest of the world — which is surely the real purpose of foreign policy — will come more surely if you seek to create a common civilisation and not to control technology. To your friends, the United States seems to be making civilisation the by-product creation of wealth through the control of technology; may we suggest that the creation of wealth be regarded more as the by-product of a

worthwhile civilisation.

Whilst we are talking about the international trade in computers, you will no doubt expect me to comment on trade with the USSR; and Eastern Europe. As you know, your Government exercises a virtual veto over the sale of certain computer systems to those markets. You will also know that ICL has built up a substantial business with the USSR and Eastern Europe, and the further extension of this important business is now being inhibited by your Government.

## 21. The Use of Technology as an Instrument of Foreign Policy

It is my personal view that technology should not be used as an instrument of foreign policy. I believe that the purpose of technology is to increase the wealth and happiness of mankind. It should, therefore, be made widely available. I also believe in World Peace through World Trade — that peace will be preserved longer if the standard of living of all people in all countries is progressively improved.

I accept, however, that Governments have decided to regulate the supply of certain strategic materials to certain countries. This is none of my business. But I do not accept that for computers the present system is achieving any useful purpose. On the contrary, it makes us all look stupid in the eyes of people in Russia and in Eastern Europe. They know they have great technical skills and are rapidly acquiring greater skills. Just look at their achievements in Space. But up to now ordinary commercial and scientific computers do not seem to enjoy a high priority. It is now clearly realised that the proper use of information-handling systems will provide substantial support for increased industrial output and efficiency — for increasing their wealth. Let us not delude ourselves; these countries are going to have a powerful computer industry and I believe we should help them and not hinder them. All the necessary end-use undertakings have been given by the customers. What do we achieve by depriving them of new products and systems? I venture to believe that much of your industry shares my views; otherwise why should the dominant supplier and several other American firms carry several times the number of staff for Eastern Europe that ICL has — and we do have a major share of the business?

## 22. A New Relationship Between Supplier and Customer

To sum up, you dominate a rapidly growing vital industry. The industry is becoming more and more international. Your market place cannot satisfy your aspirations. But, the information industry is unique in demanding a new relationship between supplier and customer — it demands a partnership. You have, therefore, to convince your international customers, Governments, public and private organisations, and Universities that you accept this. You must make them feel that they are not being dominated — that they are your partners.

## 23. Responsibility of the Computer Industry for Education and Training of the Community

My third topic is the responsibility of the industry for education and training. Here I am not just thinking of training your own staff or, for that matter, your customers'

staff. I am thinking of a much wider and more important problem. How do you educate and train the community in general to accept and take advantage of the enormous benefits which our industry can provide? How do we bring down our industry from the stratosphere of the elite to the level of the ordinary man in the street, or at least in the office? Much of the widespread criticism of the computer industry stems from the mystique (or mumbo-jumbo) in which the industry envelops itself; the jargon it proliferates, the elitism it encourages. It is not sufficient to communicate with the computer staff of your customers — you must communicate with the entire organisation from the Board of Directors downwards to the office or the shop floor.

I suggest we have all done this badly. We have encouraged the mystique and elitism; we have concentrated on selling computers, but to the computer staff of our customers and not to the whole organisation. And to be fair many of our customers have encouraged this implicitly if not explicitly. Certainly in Britain the gap between the Board room and the computer room is frequently wide and could well be getting wider. The reasons for this gap are not difficult to find out, nor are the solutions. And again if the industry does not find and sell its own solutions they will be found for us and we may not like them.

#### **24. A Better Return from the Investment in the Computer Department**

I could perhaps mention one solution which we are pursuing in ICL. We have invited the Chairman or Managing Directors of important companies in both the public and private sectors, including Permanent Secretaries of major Government Departments, to join us in discussion groups — 6 or 7 people in each of these groups — for just one and a half days. I have myself been a member of each group. These discussion groups have concentrated their attention solely on the gap between top management and computer departments, so that they can make a better return on their investment. We have already, I believe, removed much of the mystique from the computer and concentrated on the real issue, namely how to improve the performance of the customer's business. These discussion groups have certainly proved to be very successful.

We have also to persuade our customers that they have to demonstrate that their computer room is a normal part of their business. There is nothing different or special about it. It is like any other part of the business. It is there only to improve the performance of the entire organisation, to make life easier and profits bigger. It is not a panacea for bad organisation or poor performance: in fact it would probably make bad organisation worse and poor performance poorer.

#### **25. Public Fears and Suspicions of Computers**

More difficult, is to communicate these same thoughts throughout the community as a whole. The man in the street's growing fears and suspicions of computers are a matter for concern to us all. For, sooner or later these fears and suspicions will be translated into some form of regulation. The dangers inherent in the information handling capability of computers are what we read about in the Press. How often do we read of the great contribution that this same capability can make to human well-being? I suggest that the industry has a major responsibility to

reassure the community, and that means, again, getting away from elitism and mystique — getting down to simple facts and simple descriptions. We simply must not allow boffins and pundits to bemuse an already suspicious community about the brave new fully-computerised world in which few of us would wish to live.

#### **26. Small Technical Groups Holding the Community to Ransom**

One other danger is inherent in the present situation. It also calls, in my view, for urgent study. This danger is the power which is being increasingly vested in the hands of a few people. More and more vital public services are already facing this problem. In Britain and elsewhere key personnel in the electricity supply industry have been able virtually to hold the community to ransom. Similar attitudes have been adopted by the work force in transport (rail, road and air), in sewage, refuse collection and so on. It will be a tragedy if the computer industry does not learn from this bitter experience. And to make certain that a small group within industry cannot hold the community to ransom by refusing to operate vital information systems.

The development of a professional ethical attitude by the work force in the industry can no doubt help. But the real solution will surely have to come from making computer systems more comprehensible and more accessible to a broader stratum of people. We must simplify total systems. We have to design them starting from the customer, and making his requirements the specification for the design of hardware and software; and not, as has been the case in the past, making the customer meet the specifications of the hardware designer and his software ally. It must become possible for a large number of people to continue to operate systems if a small technical group decides to stop work. And this is, surely, what training and education is really about.

#### **27. The Customer's Freedom of Choice**

Last, what more can be done to develop real competition in your industry so that the customer in all countries feels that he has a genuine freedom of choice — is not being dominated?

I suppose there can be few industries where widespread dissatisfaction by the customer with what he has bought is accompanied by equally widespread willingness to continue to take more punishment. Few of you will disagree with the general proposition that in the past the computer industry has tended to give the customer what *it* had and not what *he* needed or wanted. Perhaps this didn't matter when computers were dealing with electronic bookkeeping and scientific uses. But now the industry is concerned deeply with information, especially with giving management in every human activity the means of improving performance and competence, the needs of the user must surely be decisive.

#### **28. The Customer's Protection of His Existing Investment**

What the user needs more than anything else is the protection of his existing, often very large, investment in information systems. And, second, real choice so that he can switch from one computer system to another without undue trouble. The protection of the user's investment is

largely a question of making sure the system he has purchased has a sufficiently long life to make it possible for him to get a proper return on the investment. Too often the user is offered 'dramatic' improvements in performance before he has even had an opportunity of getting a fair return on the investment he has already made. You sell him the blossom on the apple tree and then uproot the tree before he gets the fruit!

The industry must, therefore, ask itself, and ask itself urgently, what it can do to make sure the customer does get a good return on money invested. And this means using his system well and extending its useful life. Let us bear in mind also that this brings equal advantage to the computer manufacturer, who also must be concerned at all times to make sure that the life of the products he is offering for sale in the market place is long enough to justify the investment he has made in producing these products.

### 29. World Standards in the Computer Field

Second, the industry needs, and badly needs, standardisation. As a newcomer, it is to me incredible that an industry of its present size can have made such slow progress along the path of international standards. And I am not seeking to belittle the gallant efforts of BEMA and ECMA. I believe that this slowness must be due very largely to the unusual structure of your industry.

### 30. Plug-to-Plug Peripherals

What we surely need are world standards which look ahead and are not de facto standards imposed by the dominant supplier. There seems to be no reason at all why the industry cannot agree on forward-looking standards, and especially upon standard interfaces. I know that you already have had a real growth in plug-to-plug peripherals which has been assisted by the position of the dominant supplier. But, it needs to go far beyond that. Plug-to-plug peripherals are just the beginning of standard interface arrangements so that peripheral controllers, front end processors and, indeed, complete systems, can have a standard interface. Thus the customer is free to buy a complete system from any manufacturer, or any part of that system — hardware or software — from any number of suppliers. Your industry is ripe for such standards and standard interfaces. Probably the user will never be in a stronger position to insist upon this when the growth rate has had its first real set back.

We, from outside, have seen in your country a serious drive for greater compatibility. In addition, the process of unbundling and of fragmentation has made this search for standards both more necessary and easier. The rapid development of common software languages and common carrier communications standards have brought compatibility very much nearer. I repeat, not just to plug-to-plug compatibility, but systems compatibility. Unbundling itself has opened the gates to increasing customer choice, and it has encouraged the already growing trend towards fragmentation of the industry. We have seen the rapid growth of independent supplies of terminals, services and components. The impact of the sudden proliferation of independent suppliers on the major manufacturers of systems and on the market has not been fully felt yet, — but, it certainly marks a milestone along the road of customer independence from system suppliers. We are bound to see a rapid growth of second suppliers to major users.

### 31. Standard Interfaces

All these developments give a remarkable, perhaps unique, opportunity to use standard interfaces to develop formal or informal standards among computer suppliers — not just in America, but overseas. And this will sharpen international competition, especially from non-American firms.

It cannot be good for you and it cannot be good for us if America continues to dominate the world in this vital, growing, industry. And world standards, looking to the future needs of customers, are surely the right way to bring this change about. We in Europe also hope very much that we will see more and more associations along the lines recently developed between Control Data Corporation in your country, ICL in the U.K., and CII in France.

To sum up, the information industry based on computers is unique in many ways, especially in its novel relationship between supplier and customer. The industry has a special task of giving the customer real value for money, of protecting the customers' growing investment in information systems and of offering customers real freedom of choice. Real freedom of choice, which is what competition is about anyway, must come from genuine international standards such as standard interfaces.

These standards must look to the future needs of the customer. Your industry alone can make this possible. We in Britain, and I think the industry in Europe, will willingly join you in demonstrating this point. Indeed, we have already made a start.

### 32. Acceptance of the Responsibility that Goes with Power

With your usual courtesy, you have been taking, quietly and calmly, advice from someone else as to how you should carry out your own responsibilities. We do not like our neighbours to mow our lawns. They usually pull up more grass than they cut. And how the rose beds suffer!

But, if I am allowed a final assault on your hospitality, may I say that looking at your great country from outside, you still do not seem to have accepted fully the responsibility which goes with power, or reconciled yourselves to the endless criticism which goes with responsibility.

### 33. — and With Power, Endless Criticism

Over some centuries, we in Britain have become used to constant criticism, indeed abuse, of the way in which we have tried to carry out the responsibilities which followed on from our world power. You will feel that great decisions like the Marshall Plan, Korea and Vietnam offer adequate evidence of your determination to match your great world power with equal responsibilities. The fact that the rest of the world may seem at times to doubt this is hurtful, and I offer you no comfort: the criticism will go on as long as the power.

So, with your great computer industry, you have the power. You must now take the lead in demonstrating to the entire international community — of Governments, organisations and individuals — that you have accepted fully the responsibilities which go with that power. The longer you delay, the greater will be the risk that others will take decisions for you. But it is still not too late, and I know that your industry has the capability to do this job well. The only question is: do you have the will? □

# THE CENTRAL INTELLIGENCE AGENCY AND THE NEW YORK TIMES

*"Something stinks about this whole affair. . . .The stench is there and clings to each one of us."*

Samuel F. Thurston  
Newton, Mass.

On December 1, 1970, "The New York Times" published a review by John Leonard of two books. The two books were:

AMERICAN GROTESQUE: An Account of the Clay-Shaw-Jim-Garrison-Affair in the City of New Orleans, by James Kirkwood, 669 pages, Simon and Schuster, \$11.95

A HERITAGE OF STONE, by Jim Garrison, 253 pages, Putnam, \$6.95

In the early edition of "The New York Times" the title of the review was:

Books of the Times:  
WHO KILLED JOHN KENNEDY?

In the later edition the title of the review was:

Books of the Times:  
THE SHAW-GARRISON AFFAIR

In the early edition, the last 43 lines of the review read as follows ("he" in the first line below refers to Jim Garrison):

... And he insists that the Warren Commission, the executive branch of the government, some members of the Dallas Police Department, the pathologists at Bethesda who performed the second Kennedy autopsy, and many, many others must have known they were lying to the American public.

### Mysteries Persist

Frankly, I prefer to believe that the Warren Commission did a poor job, rather than a dishonest one. I like to think that Mr. Garrison invents monsters to explain incompetence. But until somebody explains why two autopsies came to two different conclusions about the President's wounds, why the limousine was washed out and rebuilt without investigation, why certain witnesses near the "grassy knoll" were never asked to testify before the Commission, why we were all so eager to buy Oswald's brilliant marksmanship in split seconds, why no one inquired into Jack Ruby's relations with a staggering variety of strange people, why a "loner" like Oswald always had friends and could always get a passport — who can blame the Garrison guerrillas for fantasizing?

Something stinks about this whole affair. "A Heritage of Stone" rehashes the smelliness; the recipe is as unappetizing as our doubts about the official version of what happened. (Would then-Attorney General Robert F. Kennedy have endured his brother's murder in silence? Was John Kennedy quite so liberated from cold war cliches as Mr. Garrison maintains?) But the stench is there, and clings to each of us. Why were Kennedy's neck organs not examined at Bethesda for evidence of a frontal shot? Why was his body whisked away to Washington before the legally required Texas inquest? Why?

In the later edition, these 43 lines are replaced by the following 13 lines:

... And he insists that the Warren Commission, the executive branch of the government, some members of the Dallas Police Department, the pathologists at Bethesda who performed the second Kennedy autopsy, and many many others must have known they were lying to the American public.

Frankly I prefer to believe that the Warren Commission did a poor job rather than a dishonest one. I like to think that Mr. Garrison invents monsters to explain incompetence.

And that is the end of the review. Even the subtitle "Mysteries Persist" has vanished.

Of course, this left a hole in the later edition, and a hole needs to be filled. And the hole was filled, by a section of editorial matter entitled "New Books", which mentions one new fiction book and nine general books.

The evidence of these changes is shown in the accompanying photographic exhibits.

What happened to John Leonard?

In January 1971, John Leonard became editor of "The New York Times Book Review", having previously been one of the paper's daily reviewers. If he had had any qualms about accepting the surgical change that was made in his review, completely altering its character, presumably he felt it was reasonable to accept the change.

Books of The Times

# Who Killed John F. Kennedy?

By JOHN LEONARD

**AMERICAN GROTESQUE.** An Account of the Clay-Shaw-Jim Garrison Affair in the City of New Orleans. By James Kirkwood. 669 pages. Simon & Schuster. \$11.95.

**A HERITAGE OF STONE.** By Jim Garrison. 253 pages. Putnam. \$6.95.

Bad vibrations.

New Orleans District Attorney Jim Garrison arrested New Orleans businessman Clay Shaw, charging that Mr. Shaw conspired to assassinate President John F. Kennedy. Mr. Shaw was acquitted by a jury. Mr. Garrison then had Mr. Shaw re-arrested on two charges of perjury. Mr. Shaw is suing Mr. Garrison, and a host of others. The judge at Mr. Shaw's trial has since been arrested in a motel room where stag movies and loose women are alleged to have exhibited themselves. The principal witness against Mr. Shaw has since been arrested for burglary. Mr. Garrison has since been accused of molesting a 13-year-old boy at the New Orleans Athletic Club, which is interesting because Mr. Shaw allegedly had links with the New Orleans homosexual underground.

No, this is not a fiction by Gore Vidal. It is a serialized novel on the front pages of our daily newspapers. Maybe that explains why novelist James Kirkwood—"Good Times/Bad Times"—got obsessed with the subject. Mr. Kirkwood met Mr. Shaw, and believed his story, and so wrote a sympathetic article before the trial (published by Esquire) and an indignant article after the trial (rejected by Playboy) and this tome-stone of a book (troubling the reviewer): Did Clay Shaw know David Ferrie and Lee Harvey Oswald? Is Jim Garrison paranoid about the Federal government? One wishes the whole business were a fevered invention.

### 'Perjury' Atop 'Conspiracy'

It isn't. Mr. Kirkwood argues in "American Grotesque" that Jim Garrison used Clay Shaw to try the Warren Commission report; that Garrison scraped the bottom of the barrel for variously sick and variously intimidated witnesses to smear Shaw; that Garrison's guerrillas sought a jury of sub-par intelligence to hemose with bloody fantasies; that, having empaneled such a jury, they were so upset by the acquittal that they added the insult of "perjury" charges to the injury of "conspiracy" accusations. Unfortunately, Mr. Kirkwood is so conscientious in his reportage that one wonders why so many people claimed to have seen Mr. Shaw with Oswald and Ferrie. Were they all mistaken or lying?

To be sure, conspiracy wasn't proved, and the state embarrassed itself with surreal incompetence. But "conspiracy" is no longer the charge against Shaw; perjury is. We have only Mr. Kirkwood's emotional word on innocence to go by. Such a word

isn't conclusive, not even in a book reviewer's court. Mr. Kirkwood's loyalty to a friend is admirable; his taped interviews with all the principals in the first Shaw trial are fascinating; his attention to trivia is in the best parajournalistic tradition—the little boy who cried Tom Wolfe. But legitimate questions about John Kennedy's assassination aren't answered according to the buddy system.

Which brings us to Jim Garrison's "A Heritage of Stone." The District Attorney of Orleans Parish argues that Kennedy's assassination can only be explained by a "model" that pins the murder on the Central Intelligence Agency. The C.I.A. could have engineered Dallas in behalf of the military - intelligence - industrial complex that fended the President's disposition toward a detente with the Russians. Mr. Garrison nowhere in his book mentions Clay Shaw, or the botch his office made of Shaw's prosecution; he is, however, heavy on all the other characters who have become familiar to us via late-night talk shows on television. And he insists that the Warren Commission, the executive branch of the government, some members of the Dallas Police Department, the pathologists at Bethesda who performed the second Kennedy autopsy and many, many others must have known they were lying to the American public.

### Mysteries Persist

Frankly, I prefer to believe that the Warren Commission did a poor job, rather than a dishonest one. I like to think that Mr. Garrison invents monsters to explain incompetence. But until somebody explains why two autopsies came to two different conclusions about the President's wounds, why the limousine was washed out and rebuilt without investigation, why certain witnesses near the "grassy knoll" were never asked to testify before the Commission, why we were all so eager to buy Oswald's brilliant marksmanship in split seconds, why no one inquired into Jack Ruby's relations with a staggering variety of strange people, why a "loner" like Oswald always had friends and could always get a passport—who can blame the Garrison guerrillas for fantasizing?

Something stinks about this whole affair. "A Heritage of Stone" rehashes the smelliness; the recipe is as unappetizing as our doubts about the official version of what happened. (Would then-Attorney General Robert F. Kennedy have endured his brother's murder in silence? Was John Kennedy quite so liberated from cold war clichés as Mr. Garrison maintains?) But the stench is there, and clings to each of us. Why were Kennedy's neck organs not examined at Bethesda for evidence of a frontal shot? Why was his body whisked away to Washington before the legally required Texas inquest? Why?

## Endangered species!



The harpy eagle, whose preserves block development of Central American real estate.

He's one of the ugly, lazy, useless, vicious, or otherwise disagreeable creatures on this planet finally exposed in the book that "rips the lid off the Conservation Movement."

## THE CASE FOR EXTINCTION

An Answer to Conservationists by Morton Stilleter, Hon. Ph.D., in close association with Richard Curtis. Illustrated by Robert Powell. \$4.95 at bookstores.

THE DIAL PRESS



A top thriller fresh from the front pages!

## The Inside-Out Heist

By Thomas B. Reagan

Author of Blood Money

Take a small-town embezzler with a big-time scheme for beating the rap, add a gang of bank robbers hired to pull off the perfect "inside" job, and you have a foolproof set-up—until the embezzler's plotting wife arrives on the scene.

Just Out / \$4.95 at bookstores

PUTNAM

## SMASH HIT!



Exhibit 1 — John Leonard's review in the early edition of *The New York Times*, December 1, 1970, showing part of the surrounding page.



Books of The Times

12/1/70

# The Shaw-Garrison Affair

By JOHN LEONARD

**AMERICAN GROTESQUE.** An Account of the Clay Shaw-Jim Garrison Affair in the City of New Orleans. By James Kirkwood. 669 pages. Simon & Schuster. \$11.95.

**A HERITAGE OF STONE.** By Jim Garrison. 253 pages. Putnam. \$6.95.

Bad vibrations.

New Orleans District Attorney Jim Garrison arrested New Orleans businessman Clay Shaw, charging that Mr. Shaw conspired to assassinate President John F. Kennedy. Mr. Shaw was acquitted by a jury. Mr. Garrison then had Mr. Shaw re-arrested on two charges of perjury. Mr. Shaw is suing Mr. Garrison, and a host of others. The judge at Mr. Shaw's trial has since been arrested in a motel room where stag movies and loose women are alleged to have exhibited themselves. The principal witness against Mr. Shaw has since been arrested for burglary. Mr. Garrison has since been accused of molesting a 13-year-old boy at the New Orleans Athletic Club, which is interesting because Mr. Shaw allegedly had links with the New Orleans homosexual underground.

No, this is not a fiction by Gore Vidal. It is a serialized novel on the front pages of our daily newspapers. Maybe that explains why novelist James Kirkwood—"Good Times/Bad Times"—got obsessed with the subject. Mr. Kirkwood met Mr. Shaw, and believed his story, and so wrote a sympathetic article before the trial (published by Esquire) and an indignant article after the trial (rejected by Playboy) and this tome-stone of a book (troubling the reviewer). Did Clay Shaw know David Ferrie and Lee Harvey Oswald? Is Jim Garrison paranoid about the Federal government? One wishes the whole business were a fevered invention.

### 'Perjury' Atop 'Conspiracy'

It isn't. Mr. Kirkwood argues in "American Grotesque" that Jim Garrison used Clay Shaw to try the Warren Commission report; that Garrison scraped the bottom of the barrel for variously sick and variously intimidated witnesses to smear Shaw; that Garrison's guerrillas sought a jury of sub-par intelligence to bemuse with bloody

fantasies; that, having empaneled such a jury, they were so upset by the acquittal that they added the insult of "perjury" charges to the injury of "conspiracy" accusations. Unfortunately, Mr. Kirkwood is so conscientious in his reportage that one wonders why so many people claimed to have seen Mr. Shaw with Oswald and Ferrie. Were they all mistaken or lying?

To be sure, conspiracy wasn't proved, and the state embarrassed itself with surreal incompetence. But "conspiracy" is no longer the charge against Shaw; perjury is. We have only Mr. Kirkwood's emotional word on innocence to go by. Such a word isn't conclusive, not even in a book reviewer's court. Mr. Kirkwood's loyalty to a friend is admirable; his taped interviews with all the principals in the first Shaw trial are fascinating; his attention to trivia is in the best parajournalistic tradition—the little boy who cried Tom Wolfe. But legitimate questions about John Kennedy's assassination aren't answered according to the buddy system.

Which brings us to Jim Garrison's "A Heritage of Stone." The District Attorney of Orleans Parish argues that Kennedy's assassination can only be explained by a "model" that pins the murder on the Central Intelligence Agency. The C.I.A. could have engineered Dallas in behalf of the military - intelligence - industrial complex that feared the President's disposition toward a détente with the Russians. Mr. Garrison nowhere in his book mentions Clay Shaw, or the botch his office made of Shaw's prosecution; he is, however, heavy on all the other characters who have become familiar to us via late-night talk shows on television. And he insists that the Warren Commission, the executive branch of the government, some members of the Dallas Police Department, the pathologists at Bethesda who performed the second Kennedy autopsy and many, many others must have known they were lying to the American public.

Frankly, I prefer to believe that the Warren Commission did a poor job, rather than a dishonest one. I like to think that Mr. Garrison invents monsters to explain incompetence.

## New Books

### FICTION

**Sambation—?** A Documentary Novel, by Neer Simha Ostrowsky. Bloch Publishing Co., \$7.95. A Polish Jewish town is invaded by the Nazis and liquidated.

### GENERAL

**Dictionary of Quinine's Definitions.** Edited by Eugene E. Bruscia. Gretna, Pa., \$10.45.  
**Frome: From the Revolution and Other Aspects of Modern His-**

**tory.** by Alfred Cobban (Dames & Noble, \$7.50).

**Off the Willow: The Rebekah of Jewish Music.** by Abraham Soria. Bloch Publishing Co., \$7.95.

**The Dream King: Ludwig II of Bavaria.** by Wilfred Blunt, with a chapter on Ludwig and the Arts, by Dr. Michael Pezzer. (Studio Book, Viking, \$14.95). An illustrated biography.

**The Fourteeners: Colorado's Great Staircase.** by Ferry Scherzer and Philip S. Munk. (Sage Books, Swallow Press, Chicago, \$10).  
**The Life, Music and History of the Dog.** by Ferdinand Mery (Grasset

& Dunlop, \$9.95). Illustrated presentation.

**The Nineteenth Century: The Conditions of Progress.** edited by Asa Briggs (McGraw-Hill, \$27.50 until May 31, then \$30). A history with 663 illustrations, 211 in color.

**There Are Two Lives: Poems by Children of Japan.** edited by Richard Lewis, translated by Haruna Kimura (Simon & Schuster, \$1.95).

**The Romantic Tradition in Germany: An Anthology.** with critical essays and commentaries by Ronald Taylor (Dames & Noble, \$7, paperback, \$4.50).

Endangered species!



**THE CASE FOR EXTINCTION**  
An eye-opening account by the author of 'The Case for the Duck' and 'The Case for the Pig'.

**Atul Kohli**  
—from the front pages!  
**The Inside-Out Heist**  
By Thomas E. Reagan  
Author of Blood Money  
Take a million-dollar heist and a pair of both sides lead to the perfect crime. It's not just a heist, it's a masterpiece of the art of the heist. It's the story of a heist that's still on the air.

**SMASH IT!**  
Art  
Schwartz's  
The Art of the Heist

ANSWER TO PREVIOUS PUZZLE

1	2	3	4	5	6	7	8	9	10
11	12	13	14	15	16	17	18	19	20
21	22	23	24	25	26	27	28	29	30
31	32	33	34	35	36	37	38	39	40
41	42	43	44	45	46	47	48	49	50

**THE 70S CRASH**  
and How to Survive It

Twenty-five years  
Elie Wiesel  
native town in  
he buried before

And in that Jewish-less Jewish town, Elie Wiesel found more than the watch — smashed and corroded. He unearthed a Pandora's box of memories — memories as deeply buried as the once golden gift—memories that forced him into a direct confrontation with the past and "an attempt to bring life to words and weight to silence."

One Generation After is the author's journey through time and events. It begins with the Second World War and ends with the Six-Day War. And throughout this journey, he not only searches his memory, but seeks out the testimony of the survivors to find out what has been learned—what has changed. He is haunted by the feeling that neither the holocaust nor the writings about it have

One Generation After

Exhibit 2 — John Leonard's review in the later editions of *The New York Times*, December 1, 1970, showing part of the surrounding page (enlarged from microfilm) and the review itself (reproduced from a clipping).

Why should a severe alteration in a review like this take place in "The New York Times"?

The question can be answered. There is some information which sheds light on news handling by "The New York Times" in regard to the softpedaling of questions about the assassination of President John F. Kennedy. (There are many examples besides the present one.)

One important part of this information may be found in "The Congressional Record", April 30, 1969, in remarks entitled "Otto Otepka: Victim of the New Team by Honorable John R. Rarick of Louisiana, House of Representatives, published in the "Extension of Remarks" page E3527. These remarks follow:

**(Beginning of Excerpt)**

Mr. Rarick: Mr. Speaker, a long-suppressed report on the misuse of the CIA to establish an underground government within our Government has been exposed today in the Government Employees Exchange.

Reportedly the plan of the "new team" in controlling the CIA operation was to "reform" the U.S. domestic and foreign relations through the use of an "elite" who looked to the "spirit of the future" instead of the status quo.

Apparently anyone not on the "new team" who uncovered its sinister plans or interfered — knowingly or unknowingly — was considered a threat and a target for compromise or elimination.

The casualty list from the intermeddlers of the "new team" includes President Diem and his brother of South Vietnam, President Johnson, and Otto F. Otepka.

So that our colleagues may have the opportunity to study this unprecedented exposure in power and to ponder the question, "Who is running our country?" I include the Government Employees Exchange article of April 30 and two articles from the April 16 issue:

(From the Government Employees Exchange, Washington, D.C., April 30, 1969)

**CIA's Vietnam Hit L.B.J., Otepka**

A highly secret and unknown American involvement in Yemen is the prelude to major actions by the Central Intelligence Agency's "New Team" in its November, 1963, offensive against President Ngo Dinh Diem of South Vietnam, against Vice President Lyndon B. Johnson, and against Otto F. Otepka, the State Department's former top Security Evaluator, a former Ambassador with close ties to CIA Director Richard Helms, revealed to this newspaper on April 25.

As readers know, the CIA "New Team" was set up by former Attorney General Robert F. Kennedy following the Bay of Pigs "fiasco" by the CIA "Old Team." Mr. Kennedy recruited into the "New Team" many officials not only from the CIA (such as Richard Helms) and the Federal Bureau of Investigation (such as Cartha "Deke" De Loach) but also from the Internal Revenue Service and the National Security Agency. These agencies and their top members were "knowledgeable" in the exploitation of "wire taps" and secret informers, the former Ambassador said.

Allied with the "paragovernment" (see April 16 issue) of the "New Team" were secret "cooperating and liaison" groups in the large foundations, banks and newspapers, the source added. In that issue, readers will recall, this newspaper reported that the "coordinating role" at The New York Times was in the custody of Harding Bancroft, its Executive Vice President.

**New Team Ready**

By August, 1963, the "New Team" was "ready" for action on a wide variety of fronts. These included international affairs, especially the Vietnam War; domestic affairs, especially preparation for the 1964 Presidential election; and the "final infiltration" by "New Team enthusiasts" of the State Department, Agency for International Development, the United States Information Agency and the Pentagon, the source said.

The basic purpose of the "New Team" was to "reform" United States domestic and foreign relations through the use of an "elite of committed, humanistic pragmatists" who looked at the "spirit of the future" instead of the status quo and the "dead letter of formal and literal law," the source continued.

**"New Team" Targets**

In the international field the main target for "reform" action was Ngo Dinh Nhu, the brother of President Diem, of South Vietnam. He had, the source said, the same relationship to President Diem that Robert Kennedy had to President Kennedy.

President Diem had insisted in his dealings with the "New Team" that the war in Vietnam had to be "run by the Vietnamese." Even though he used CIA resources, he would not allow the CIA to become a "paragovernment" in Vietnam. The Diem and Nhu alliance in Vietnam thus stood in the way of "americanizing" the war there and using the war's opportunity to transform South Vietnam along the lines of the "New Team" program, the source said.

**Robert William Komer**

While relations between President Diem and the "New Team" were disintegrating, a final thrust for "americanizing" the Vietnam War was supplied by Robert William Komer, a career CIA intelligence officer who, from 1947 through 1960, had won the confidence of such top CIA officials as William Langer, Sherman Kent, Robert Amory and William Bundy.

In February, 1961, Mr. Komer was "transformed" from an "Intelligence" into an "Operations Officer" when he joined the National Security Council Staff at the request of McGeorge Bundy, the brother of William Bundy.

Following the "Bay of Pigs," the United States engaged in a series of "guerrilla wars" throughout the world, including Vietnam, Laos, Thailand. Most of them have secret CIA operations, especially of the "counter-insurgency" type.

**"Mr. Komer's War"**

The most secret, however, of these CIA wars was "Mr. Komer's war" in Yemen which was a testing ground for the CIA in the use of "paramilitary and paradiplomatic techniques," the former Ambassador revealed.

Mr. Komer resorted to a major transformation of power, especially at the Agency for International Development, in applying "paradiplomatic" techniques, the source said. Because the United States and AID could not intervene directly in Yemen, Mr. Komer set up "dummy companies" in Europe, the Middle East and in India which "bought" AID goods, "repaired" them, and sold them either back to AID or to other governments. The transactions provided not only "revenues", but most of all "cover" for CIA agents, many of whom were foreign nationals.

To conceal these operations and "protect" them from bona fide AID or other U.S. inspectors, the CIA "New Team" infiltrated the AID security offices, as well as its personnel, operations and inspections divisions, the former Ambassador revealed.

Mr. Komer's other great innovation was to develop and deepen the covert collaboration between the CIA "New Team" and Harding Bancroft, the Executive Vice President of The New York Times, the source revealed.

#### The November "Strikes"

The CIA war in counter-insurgency in Yemen had convinced the "New Team" that to carry-out its program before the 1964 Presidential election, it must gain control of the actions of the South Vietnamese government in 1963. Thus, the New Team, largely on the basis of Mr. Komer's views on the reasons for both successes and failures in the Yemen, decided to move against President Diem in Vietnam. The New Team also moved against Vice-President Johnson and Otto F. Otepka.

On November 1, 1963, the New Team destroyed President Diem and his brother who were "assassinated", on November 5, 1963 the "New Team" moved against Otto F. Otepka who was informed that day that he was dismissed as a security officer; and on November 22, 1963, largely on the urging of Robert F. Kennedy, Don B. Reynolds was appearing before a Senate Committee to supply evidence which was expected to cast a "deep shadow" on Vice-President Lyndon B. Johnson, because of his relationships to Robert "Bobby" Baker, and through Baker, to James H. Hoffa, the Teamster President whom Robert Kennedy was prosecuting.

While Don Reynolds was still in the first phase of his testimony, news was flashed to the Senate Committee that President John Kennedy had been assassinated and Vice President Johnson was now President. Mr. Reynolds never finished his testimony.

Although one of the "targets" of the "New Team", Lyndon B. Johnson, thus escaped immediate destruction, his Presidency was eventually "captured" by such "New Team" members as Walt Whitman Rostow, William Bundy and Robert William Komer, the source added.

Thus, the "momentum of the November 1963 strike" of the New Team carried on through the Presidency of Lyndon Johnson, including the "Americanization of the Vietnam War" and the "dismissal" of Otto F. Otepka, the source concluded.

(From the Government Employees Exchange, Apr. 16, 1969)

Otepka Was Major Roadblock in Takeover  
By a "New Team": New York Times  
Linked to CIA Plot on Official

The Central Intelligence Agency's "New Team," including such "outsiders" as Harding A. Bancroft, now the Executive Vice President of The New York Times, played a critical role in the final decision of Attorney General Robert F. Kennedy to press Secretary of State Dean Rusk to proceed with the dismissal of Otto F. Otepka as the State Department's top Security Evaluator, a former Ambassador associated with CIA Director Richard Helms informed this newspaper on April 11.

According to the source, Mr. Bancroft played a role because of his liaison and coordinating work involving the use of the organization and facilities of The New York Times on behalf of the CIA and the "New Team."

Other persons who had a role included William H. Brubeck, who had been the recipient of the 1960 "leak" of Top Secret information from the State Department to the campaign headquarters of John Kennedy which contributed significantly to Mr. Kennedy's narrow victory at the election polls. After Mr. Kennedy's victory, Mr. Brubeck received complete information about Mr. Otepka's role in tracing this "leak", the former Ambassador revealed.

Other members of the "New Team" were McGeorge Bundy and his brother William Bundy, who had moved from the Central Intelligence Agency to become the Assistant Secretary of State for East Asian and Pacific Affairs, including Vietnam.

#### "The New Team"

The "New Team" at the Central Intelligence Agency was being planned by Attorney General Robert Kennedy even before the Bay of Pigs "fiasco" in 1961. In fact, the former Ambassador said, the Attorney General had a special group of his own "monitoring" the Bay of Pigs operation to determine which persons, not yet projected for the "New Team", would "pass the test".

Although the "Bay of Pigs" was a national disaster, the source said, Robert Kennedy exploited it within the Government to accelerate building the "New Team."

#### New-Team Goals

The "New Team" goals were set by the "personality" of Robert Kennedy and the "philosophy" of President John Kennedy and Secretary of Defense Robert McNamara, the source revealed. The main exponent of this "philosophy" was Major General Maxwell Taylor, assisted by McGeorge Bundy and Walt Whitman Rostow, the former Ambassador said.

The mission of the "New Team" was to contest the Soviet penetration of the "Third World," the so-called nonaligned countries, through "paramilitary, parapolitical and paradiplomatic" means. To do this, the "New Team" was to be a "paragovernment", performing for the United States "the same kind of functions" which the Central Committee of the Communist Party of the Soviet Union performed for the Soviet Union, the former Ambassador revealed.

This required the "New Team" to penetrate every department and agency of the Executive Branch dealing with foreign policy by inserting "trusted members" of the "New Team" into key positions. Among these were the Offices of Security of the State Department, the military services departments, the United States Information Agency and the Agency for International Development, the source added.

## "New Team" Members

Besides Robert Kennedy and Maxwell Taylor, other members of the "New Team" were General Marshall S. Carter, who replaced General Charles B. Cabell as Deputy Director of the CIA. Very early "recruits" to the "New Team" were Richard Helms, today the Director of the CIA, and Cartha "Deke" DeLoach, the second man in charge of the Federal Bureau of Investigation. Together with Robert McNamara and Dean Rusk, the "New Team" acting under the control of Robert Kennedy began the "infiltration" of the State Department and the Defense Departments with Central Intelligence Agency personnel. "Counter-insurgency" projects sprang up in every agency dealing with foreign affairs.

## Outside "Insiders"

Besides key persons officially already in the Government, the "New Team" selected persons in leading banks, law firms and foundations for the penetration of the "non-governmental" apparatus of the United States, the former Ambassador revealed. Because of the paramount role of The New York Times in American life and because of the "black" assignments which it might be asked to perform for the CIA, great care was taken to select a person who had full access to every office in The New York Times and yet could conceal his own operations. This was especially important because "gray" operations, involving special background briefings for such top New York Times representatives as James Reston and Tom Wicker were already going on, and top New York Times reporters were in an especially good position to "uncover" the "black" operations.

## Bancroft's Past

Harding Bancroft had been originally introduced into the State Department by Alger Hiss, and, after Mr. Hiss became the head of the Carnegie Endowment for International Peace, Mr. Bancroft served under Dean Rusk as a member of the Department's Office of Special Political Affairs, renamed the Office of United Nations Affairs. Subsequently, he took the post of General Counsel to the International Labor Organization in Geneva and then went to The New York Times, eventually to be named Executive Vice President.

During the Eisenhower administration, Harding Bancroft worked closely with Dean Rusk, President of the Rockefeller Foundation, maintaining close liaison with John Foster Dulles and with Allen Dulles, the Director of the Central Intelligence Agency.

## Bancroft's "Cover"

Because Mr. Bancroft's liaison role at The New York Times required meetings with top CIA and State Department officials, especially on matters of "personnel", it was decided to provide him with "cover" by designating him a "member" of the newly created State Department Advisory Committee on International Organization Affairs, whose task was to recommend the "best qualified Americans" for those international organization positions in which they could make important contributions.

Although the Advisory Committee eventually prepared a "Report", which was itself controversial in its original draft form, the basic role of the Committee was to provide a "cover" for the "New Team," the source revealed.

## "Roadblock" Otepka

One of the major "roadblocks" to the "infiltration" of the State Department by the Central Intelligence Agency New Team was Otto F. Otepka, its top Security Evaluator. Mr. Otepka had already "annoyed" the Central Intelligence Agency by his "uncovering" the activities of the Central Intelligence Agency in using "double agents" in the Warsaw "sex and spy" scandals. Subsequently, Mr. Otepka "annoyed" Robert Kennedy and Dean Rusk by insisting, in December 1960, that Walt Whitman Rostow would need a "full field FBI investigation" before he could be "cleared" for employment in the State Department. Mr. Rostow had just completed in December a "secret" mission in Moscow for President-elect John Kennedy. The mission was "cleared" by CIA Director Allen Dulles. Previously, Mr. Rostow had established the CIA channels at the Massachusetts Institute of Technology, in Cambridge, Massachusetts. Harvard University professors maintained their own CIA "black" ties with Washington through the Institute, the former Ambassador asserted.

## "Naive" Otepka

While these vast and secret re-organizations of the Central Intelligence Agency's "operational" side were evolving, Mr. Otepka "naively" continued to apply the long-standing Federal and Civil Service standards in the issuance of "Security Clearances". He objected especially to the mass issuance by the State Department of "waivers", alleging these violated both the Statutes and the Regulations.

Mr. Otepka's "miscalculation" lay in his loyalty to the law and regulations, the source said, and his failure to comprehend that a "coup d'etat" was about to take place, in which the "paragovernment" of the "New Team" would displace the "formal government" of the United States. He did not fully comprehend the "coup d'etat" even after the "Thanksgiving Day Massacre" in the State Department in 1961 which liquidated the last vestiges of the old order in the State Department and raised George Wildman Ball to Under Secretary of State, the former Ambassador continued. Concurrently, John McCone succeeded Allen Dulles on November 29, 1961, as the Director of the CIA.

## Otepka's "Great Blunder"

Already on bad terms with the "New Team" at the CIA, Mr. Otepka made his "great blunder" when he insisted that members of the newly-designated Advisory Committee on International Organization Affairs could not be "cleared" without a "full field check" by the FBI. With specific reference to Harding Bancroft, Mr. Otepka produced from his security files information that in 1946, during a "very bitter" controversy between the Department's Office of Near Eastern and African Affairs and the Department's Bureau of United Nations Affairs, Ambassador Loy Henderson had accused Mr. Bancroft both of being under the "influence of Mr. Hiss" and of being "pro-Soviet".

In addition, Mr. Otepka then, in 1961, recalled that both Mr. Rusk and Mr. Bancroft had urged the firing of Robert Alexander, an official in the Visa Division of the State Department because Mr. Alexander had told a Congressional Committee that the United Nations headquarters in New York was a haven for alien communists and espionage agents who were entering the United States under "waivers" of the immigration laws. The recommendations for these "waivers" were made by Mr. Rusk and Mr. Bancroft.

The reference to these "waivers" in the past by Mr. Rusk when he was currently issuing a different kind of "waivers" for Federal employees including one for Mr. Bancroft, sealed the fate of Mr. Otepka with the "New Team," the former Ambassador said.

The "paragovernment" of the New Team decided he had to be removed "no matter what the means", the former Ambassador concluded.

(End of Excerpt)

Can the above information quoted by Representative John Rarick be verified?

It is obvious that such information cannot at this time be verified. A person would be out of his mind if he would expect an organization like the Central Intelligence Agency to answer truthfully questions about this subject brought to it.

But it is astonishing how much light Representative John Rarick's extension of remarks sheds as a hypothesis.

It explains why the Bay of Pigs Operation was the last CIA operation to be fully held up to the light by "The New York Times."

It explains why "The New York Times" regularly goes out of its way to softpedal important questions about the assassination of President John F. Kennedy as in John Leonard's review: the CIA has its man at The Times.

It explains why Robert F. Kennedy as Attorney General never took any kind of action to reveal the plot which slew his brother: RFK was involved in other parts of the same operation.

It explains why the office of Senator Edward Kennedy invariably replies that the Senator has "full confidence in the findings of official law enforcement agencies." Senator Kennedy undoubtedly knows much more than he would like to know. In fact it is quite possible he is being blackmailed by the CIA, as for example by the Chappaquiddick operation, a most successful cloak and dagger caper.

And it supports the assertion of a coup d'etat in the United States, put forward in Jim Garrison's book, "Heritage of Stone"; see the review of Garrison's book that appeared in "Computers and Automation" for March, 1971, on page 45, and read Garrison's book if you have not yet read it.

---

## MANKIND'S PROSPECTS OVER THE NEXT TEN YEARS

*Arnold Toynbee, Historian  
England*

(Based on a report published in the Boston Globe, Feb. 21, 1971)

What are mankind's prospects within the next 10 years?

To try to look ahead is imperative. The elaborate and vulnerable way of life to which we have committed ourselves by our triumphant advance in technology depends, for its maintenance, on our being able to forecast the future and to make long-term plans in the light of what we foresee. But prediction is being baffled by acceleration. ...

Can anything be predicted now with any confidence? Two things, at least, do seem probable. Within the next 10 years the population explosion is going to continue, especially in the "developing" countries, and, during these same 10 years, the price of our technological advance is going to rise so steeply that it may become manifestly prohibitive. The price has to be paid in terms of loss of health and happiness.

Air, earth, and water, including the deep sea, are already being polluted to a degree at which we are being poisoned. At the same time, the nature of the mechanized work, which is poisoning us physically, is making us unhappy, discontented, rebellious and violent.

Technology does produce wealth and power beyond our grandparents' dreams, but we, their grandchildren, are now asking ourselves whether the price, in non-material terms, is going to be higher than we can afford. Since the industrial revolution we have been pursuing the increase of productivity as an absolute objective, without counting the costs. ...

The price of technology is not only physical and psychological; it is also social. The increase in the degree and in the scale of mechanization had deprived the individual of the partial self-sufficiency that he possessed in the pre-industrial age.

Society is now at the mercy of numerically small, but technologically powerful minorities, which have it in their power to bring life to a standstill at short notice by sabotaging, striking, or even just "working to rule." Unionization has put society in the power of indispensable minorities of workers — for instance, the producers of electricity and gas or the servicers of railways and airlines; they can ... hold society to ransom.

I forecast with some confidence that the major issue for the next decade is going to be the conflict between the demands of production and the requirements of life.

This issue is a world-wide affair. It breaks through iron curtains and it makes nonsense of ideological antagonisms. ...

What mankind needs is a new way of life with new aims, new ideals, and a new order of priorities. Health and happiness are more valuable than wealth and power. In our heritage from our ancestors we have spiritual treasures on which we can draw for inspiration in trying to shape our future.

When we are trying to put the world right, let us remember our human limitations, and, remembering these, let us resist our human temptation to lose patience and to turn savage.

Let us face the truth that we do not start free from encumbrance; every generation, and every individual, inherits the burden of karma, the consequence of earlier action. We have it in our power either to mitigate our inherited karma or to aggravate it, but we cannot jump clear of it, and we ignore it at our peril.

We cannot transform this polluted and distracted world into Amida's "pure land": but this unattainable ideal can inspire us to exert ourselves to leave our impure world less impure than we have found it when we have taken over the burden of karma from our predecessors. This is a modest objective, but, if the rising generation achieves it, it will have done a great service to itself and to its descendants.

## THE PREDICAMENT OF THE COMPUTER PROFESSIONAL

Joanne Schaefer  
Mount Prospect, Ill. 60056

One of the tragicomedies of modern business is the plight of the computer "professional" and the company which employs him. The employer must deal with high-paid, independent, impatient, and demanding personnel, and the employed must in turn deal with organizations which seem determined to inspire unrest rather than loyalty in those they hire. While the existence of computer people who are non-professional by anyone's standards cannot be denied, this article will attempt to present the company as the employee sees it, and the employee as he considers himself.

The computer person can go to work tomorrow for a bank, a manufacturer, a consulting firm, or a university. Very few of his contemporaries in the company share this position and the independence afforded by it. As a consequence, if he is not satisfied and if he feels that another company will satisfy him, he is much more likely to change jobs than other employees are. Companies are quick to scorn such persons as job-hoppers, takers, and non-professionals, and slow to contemplate why they are unhappy in their jobs.

Employers complain bitterly that they expend great sums of money to train people, only to have them quit and go elsewhere. Consider the employee who has been with the company for a few years, first in training, then in putting his training to practice; he advances within the framework of company reviews and raises. Along comes an "experienced" new-hire, who has exaggerated his background, competence, and salary to his own advantage. The new man has no knowledge of the shop procedures, little of the business, and perhaps none of the total environment; often he has less experience than the "loyal" home-grown variety, and always higher pay. Perhaps the employer can be forgiven for the poor judgment which creates such inequality, but the employer cannot be excused for refusing to admit and rectify his (or its) error. The original employee must continue in the framework which issues raises on the basis of what is already earned, and there is no way for him to catch up with his inferior counterpart. So he realizes that he too can get ahead by going elsewhere. A company which knows nothing about him will provide the advancement which is denied him by the company to which he has already proved himself. Then comes the miraculous metamorphosis in twenty-four hours, from pre- to post-resignation; he changes from a bright young programmer and hard-worker to an opportunist and malcontent; the company attempts to preserve its image by attack and rationalization.

Programmers and analysts, on the average, are just like people in any other job: they like to be busy, but not overworked. Some companies seem able to manage their systems personnel in only two modes: crisis and rigor mortis. In the systems area, projects are dragged out and worn out while managers shuffle status reports and jockey for political position; in programming, supervisors with second generation mentalities act as if two programs should occupy the programmer all day. As the employee waits for decisions from above and for test results, he crosses off deadlines on his calendar and reads the want-ads. Then suddenly the heat is on and the cold bodies are defrosted; the present system is immediately inadequate and the new system will be up on January 1. Overtime, priorities, and frayed nerves

are the order of the day, and in March a hastily-written and half-tested system is implemented. The planting is followed by the harvest, but as always, what is sown is reaped, and those little gray short-cuts grow into big black bugs. So instead of new projects and a feeling of satisfaction, the employees are faced with months of patchwork and memories of a job not well done.

But perhaps the saddest moment of all, for both employer and employee, is that instant when the employee discovers absurdity and hypocrisy in his organization. He sees the latest model XYZ-99 which leases for \$3,000 a month and is used one hour a day; and he attends a briefing where thirty high-paid people wait twenty minutes for an archaic projector to be threaded. He sees a \$15 monthly raise for an eighteen year clerk rejected because her job classification doesn't permit that big a raise; and he watches her boss entertain some constituents over a \$160 expense-account lunch. He hears his employer speak glowingly and longingly of loyalty, and he watches managers build personal empires of useless projects and paperwork and procedures with no regard for company efficiency and profit. Certainly not all companies are guilty of all these faults, nor do the systems areas have a monopoly on problems. But where systems problems do exist, the little man feels as he does in the face of death and taxes: the system is too big to beat. The saving difference is that he can try another employer. So the employee moves on, and if he is lucky, finds a more satisfying place to work. If he is not so fortunate, he may move again, but eventually he learns to accept his situation and make the most of it — or finds a new field.

If companies are going to demand loyalty and professionalism from their computer people, they had better first examine whether they offer the employee anything worth his loyalty.

### HITCH-HIKER ARRESTED VIA ROUTINE CHECK WITH NATIONAL CRIME INFORMATION CENTER

(Based on a report in "Computerworld," March 24, 1971)

A hitch-hiker was arrested in Pineville, Ky., recently when he stopped at a state police post to use the restroom.

The state troopers made a routine check with the National Crime Information Center of the FBI, and the response through the computer was that the individual, who was hitch-hiking through Kentucky, was violating his parole in Lansing, Michigan.

### COMPUTERS IN LITERATURE

Prof. Leslie Mezei  
Computer Systems Research Group  
University of Toronto  
Toronto, Ontario, Canada

I am interested in studying the role computers and computer specialists play in contemporary literature. Some of the novels in which they figure prominently have been: 480, Killing Zone, The Tin Men, Giles Goat-Boy, The Literature Machine, Player Piano.

I would appreciate if your readers could alert me to other works of this type.

## NEW COMPUTER STARTED 1½ YEARS OF WOE

Lyndon Watkins  
The Globe and Mail  
140 King St. West  
Toronto 1, Ont., Canada

(Based on a report in "The Globe and Mail",  
April 3, 1971)

A.R. Harrington, president of Nova Scotia Light and Power Co. Ltd., Halifax, N.S., has a tale of woe to tell about his company's experience in trying to get a new computer to make out customers' bills correctly.

Two years ago, when it was about to move into a new suite of offices at Scotia Square in Halifax, the company took delivery of the computer, a much more sophisticated model than had been used previously.

"We anticipated some initial problems," Mr. Harrington told the annual meeting of the company, "but we couldn't have imagined the terrible experience that lay ahead. That computer upset a great many of our customers and upset us."

Billing was interrupted for one month to enable the necessary programming to be completed, with three programmers being used. The new machine was being put into service successfully when the unexpected happened — the Nova Scotia Government introduced a sales tax on electricity.

It seemed a simple adjustment to make. The company told the Government it would take a couple of months to complete the change and the tax would be collected retroactively.

Then a fatal error occurred — to include the tax in billings someone chose a slot on the computer already programmed for another purpose.

The result was that small household customers began getting bills for as much as \$275,000.

The solution might seem simple: remove the tax material and start again. But then a second error was discovered. Someone had "inadvertently destroyed" the tape with the tax information on it and the information could not be taken out of the computer.

This meant 150,000 customers' accounts had to be processed manually.

The company's rates are "particularly complicated," and it took one and a half years to get the problem sorted out.

The cash flow of the company, which had operating revenue of \$31.5-million last year, was seriously disrupted. Major billings were kept up to date, but some households didn't get a bill for over a year. People began to think they were giving electricity away in Nova Scotia.

At one time 7,000 inquiries were piled up awaiting an answer. "We put them in boxes. By this time we had given up on fancy files and folders. There were just too many," Mr. Harrington said.

Fortunately, other aspects of the computer program were not affected. Stores accounting, shareholder records and dividend payments, payroll accounts and some general accounting were processed normally.

By October last year, the computer problems had been resolved, but staff had to work many hours of overtime to catch up with past-due accounts.

The computer is now performing everything the company expected of it and Mr. Harrington is able to smile about the whole thing. But it is not an experience that will be quickly forgotten by NSL and P.

From the Editor

Although the "computer" is blamed, this is most clearly a case of human error, and furthermore, a failure of common sense — in the form of backup, keeping at least two copies of any computer program in at least two different places.

## DATA BANKS AND CRIMINAL INTELLIGENCE SYSTEMS

Robert Kahn  
Robert Kahn and Associates  
PO Box 343  
Lafayette, CA 94549

I think that the statement by Professor Foster, "Data Banks — a Position Paper", in the March issue of "Computers and Automation" is the best summary of this issue that I have seen and I would like permission to reproduce it and distribute it to my subscribers...

I object very strongly to statements in the article attributed to Burroughs Corporation on "New York State Identification and Intelligence System".

First, there is the statement, "Offenders' rights are likewise better protected for they may, in appropriate cases, receive summons in lieu of arrest, or if arrested, be discharged on their own recognition"; this certainly does not agree with the recent reports that have come out of New York indicating the high percentage of people held in the city jails where they have not even considered the matter of bail or holding people unable to make to small bail on minor offenses. It is easy enough to close one's eyes to facts — but, fortunately for us, less possible to do so in your publication.

Also I very strongly object to the statement, "If the arrestee in the above example had a record, the Nassau County Police Department would receive a rap sheet defining his criminal history." A "rap sheet" is a record of arrests, and arrest does not constitute a crime. That Burroughs should help to continue to foster this great injustice in our criminal record system is most inappropriate. Although the term "rap" does at times refer to a prison sentence, it often refers to just the charge. It is my understanding that the origin of the word in regard to a "rap sheet" comes from the "record of apprehension" which is certainly different from the record of conviction.

And in this same article I just cannot understand the sentence, "During the course of one year, a technical employee assigned to the Classification Section will carefully study and analyze approximately 200,000 fingerprint patterns." As I analyze this, with 2,000 work hours a year (40 hours a week with two weeks' vacation) this would be at the rate of 100 per hour. It just doesn't seem possible to "carefully study and analyze" fingerprints at that rate. If the statement is correct, let me know how to get in touch with these people, as certainly private industry would pay them a considerable fee for their services.

## LARGE MARKET AND FIERCE COMPETITION IS FORECAST FOR THE BUSINESS OF MINICOMPUTERS

*John R. Musgrave  
Auerbach Corp.  
121 North Broad St.  
Philadelphia, PA 19107*

The potential domestic market for minicomputers is well in excess of 500,000 units, according to a new study just completed. With an installed base of only 21,500 machines at the end of 1970, enormous opportunities exist for future growth in the industry.

The extent to which this large market will be penetrated will be largely dependent on the ability of manufacturers and users to identify, implement, and market on a broad scale new applications. While great opportunities exist, factors such as price declines of 18 percent per year, great competition, and changing technology will place demanding requirements on participants in the minicomputer market.

Industrial control applications will continue to be the largest area of growth. Peripheral devices, which now account for 60 percent of the total cost of a minicomputer system, will grow in importance in minicomputer systems.

The study bases its conclusions on information obtained from both manufacturers and users. The study analyzes the underlying financial, technological and marketing factors of the minicomputer industry, and provides information concerning the current status and trends of the industry, analyzes the basic forces controlling the prospects for the industry, and predicts future directions.

### SIZE SHRINKAGE OF COMPUTERS

*E. E. Bolles  
Vice President and General Manager  
Electronic Systems Division  
The Bunker Ramo Corp.  
Westlake Village, CA 91361*

Tomorrow's electronics will be half the size of today's. Electronic systems — ranging from radios to computers — have been halved in size roughly each seven or eight years, in recent years. And the next halving in size could come even faster.

The prediction is based on the results of a recent research program on miniaturization of electronics. The study particularly measures computer miniaturization; Bunker-Ramo's BR-1018 computer has a capability equivalent to many computers the size of file cabinets.

Computers of such capability originally occupied about 14 cubic feet. Ten years later, they were down to about four cubic feet. Six years later, one cubic foot. Today the new Bunker-Ramo computer occupies 1/20 cubic foot.

The reductions in size are resulting from twin lines of progress. In packaging or assembly of electronics, the industry has moved from vacuum tubes mounted on a chassis, to three-dimensional mounting and interconnection systems. In design of electronic components, the industry has advanced from bulky, single function vacuum tubes to miniature integrated circuits less than postage-stamp size which perform hundreds of electronic circuit functions.

The sharp reduction in computer size to one-twentieth of a cubic foot is probably abnormally rapid development. The whole spread of electronic systems is not expected to go down in size so rapidly. But we are able to predict that in a few years, today's electronic package can be produced in half or less the present size, because of the packaging density now possible.

### COMPUTER FAIR IN JAPAN IN OCTOBER 1970 NETS \$2.5 MILLION IN U.S. SALES — SPURS SECOND FAIR IN MUNICH, NOVEMBER 30, 1971

*Andre Williams  
Dept. of Commerce  
Washington, DC 20203*

\$2.5 million in sales has been reported by the U.S. Department of Commerce for the October 1970 Tokyo Computer solo exhibition cosponsored by the Association for Computing Machinery. The Tokyo fair has also generated \$54 million of projected first-year sales.

Encouraged by this event, the U.S. Dept. of Commerce plans major participation in the November 1971 Munich Fair "Systems 71". The Association for Computing Machinery, in cooperation with the Munich Fair authorities, will coordinate the conferences and symposia, and bring together a roster of computer pioneers and other luminaries to commemorate the quarter century of the invention of the modern computer.

The Commerce Department is encouraging small and medium firms in the computer industry to market abroad by providing a range of supporting marketing services. For months prior to an exhibition opening, a professional field team publicizes the exhibition through carefully selected trade media. An intensive, direct mail campaign consisting of three separate mailings is made, identifying clearly the specific products and services foreign companies are seeking. A series of timely conferences with the most important trade and general news media are held. A personal visit campaign to reach key firms and individuals that might purchase exhibitors' products is conducted by the commercial officers of the consulates and embassies concerned. Commerce's "Systems 71" market promotion campaign will embrace 13 countries on the Continent, and promotion material will be printed in 4 languages.

The Department reports a dollar return on investment for commercial exhibitors to be 14 to 1 and the balance of payments for the United States to be 30 to 1.

### "NOT UNDERSTANDING A COMPUTER" — COMMENT

*John E. Douglas  
1559 Summit Drive  
Charleston, WV 25302*

I read your editorial, "Not Understanding a Computer," in "Computers and Automation" for February with great interest.

There is a definite need for a format setting forth all input data on a basis that can be interpreted by the general layman. When I designed our system in 1967 it was programmed on this basis and has received many favorable comments as to the simplicity in reading and interpretation.

This is only the beginning. The field is unlimited due to the outstanding present and future dependence by society on computers.



# ACROSS THE EDITOR'S DESK

## APPLICATIONS

### FORD WILL MEET CALIFORNIA EXHAUST EMISSION STANDARDS WITH HELP OF COMPUTERS

The California Air Resources Board (State of California), which sets emission standards and monitors compliance, requires vehicle exhaust to be tested for various levels of carbon monoxide, hydrocarbons and oxides of nitrogen. Computers will help the Ford Motor Co. ensure that its 1972 model cars and trucks meet the state's standards. Emission-analyzing equipment — including two Honeywell 1603 data acquisition and control computer systems — will perform end-of-line tests on 25% of all Ford vehicles sold in California.

The Los Angeles Assembly plant will serve as the initial installation for emission testing and diagnostics for a representative sample of Ford vehicles delivered to California residents. The required number of vehicles, some taken directly off the assembly line in Los Angeles and others from among those shipped in by railroad from other assembly plants, will be put through hot-start, simulated road tests established by the California Air Resources Board. A complete test will take about 20 minutes per vehicle, according to Ford officials.

Plant expansion (which is now in progress) will increase emission testing capabilities to 154,000 vehicles per year from the present 34,000 per year. Facilities will include seven test cells, controlled by the two Honeywell systems. Each test cell will consist of a dynamometer, driver-aid, teleprinter, punched card reader and a tailpipe probe that sends exhaust to a five-station gas analyzer attached to the Honeywell computer. Automatic switching equipment will permit one Honeywell computer to handle all seven test cells in case of computer equipment malfunctions.

The computer records each detail of the end-of-line tests, flashes green and red lights if the vehicle passes or fails and prepares a written report on the vehicle. Vehicles that fail are adjusted and re-tested before being approved for sale in California. During testing, the computer systems will handle approximately 85 analog and 60 digital inputs and 30 analog and 250 digital outputs. The H-1603s will run unattended for up to two 10-hour shifts per day.

Ford officials said its end-of-line-test facility will be operational at the Los Angeles Assembly Plant in August, in time for the start-up of 1972 model production.

### NSP'S POWER TROUBLES IN STORMS LOCATED WITH AID OF COMPUTER

Northern States Power Company, Minneapolis, Minn., uses a computer to locate electrical outages caused during storms in the Minneapolis metropolitan area. The system enables the company to pinpoint affected areas more accurately and to respond more quickly to restore service. The system, tested during storms and heat wave conditions, has proven reliable. The Minneapolis area records severe storms six or seven times a year which usually cause outages in the city and its suburbs. The initial result is a deluge of customer calls. To manually sort and analyze the calls, and to quickly dispatch repair crews where they are most needed, becomes very difficult.

Should a bad storm hit after regular business hours, it now is possible for Northern States Power (NSP) to man 40 telephones within 30 minutes. As calls come in, information such as customer's address, type of problem — lights out, line down, etc., — is entered on a form. It is typed into a visual display terminal linked to an IBM System/360 Model 65 computer. The computer compiles related calls, separates calls on one feeder from another, narrows down possible trouble spots, indicates the feeder and number of customers affected and provides the actual location of the electrical protective device involved, such as an overhead oil recloser, line fuse or transformer.

This information is printed for the repair crew dispatcher and allows him to direct crews, via radio, to trouble affecting the largest number of customers first. As repairs are made, the dispatcher enters the information into the computer which provides him with a list of customer telephone numbers for call-backs, helping insure that service has been restored.

In this way, NSP can keep better track of areas in or out of service, restore service faster, and issue more reliable reports on the status of the system and when service will be restored. The computer is available 16 hours a day (7 a.m. to 11

p.m.). However, if a storm warning is received during off hours the system can be made ready within minutes.

### AIR TRAFFIC CONTROL SYSTEM FOR SAFETY IN THE SKIES

Chicago's O'Hare International Airport (Illinois), the world's busiest commercial air terminal, is the first of 62 operational terminals in the U.S. to install the ARTS III computer-aided air traffic control System. (ARTS means Automated Radar Terminal System.) The system was developed and installed for the FAA by Sperry Rand's Univac Defense Systems Division.

The FAA system can automatically show the identity, speed, and altitude of aircraft in letters and numbers next to the target "blips" on the controller's display. The air traffic controller's ARTS III console is linked to the computer via a keyboard, allowing him to use the system flexibly as needed. Each

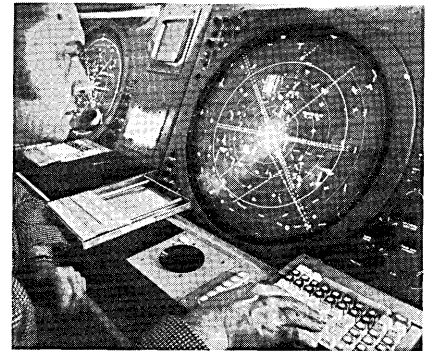

display also is linked, via the computer, to other consoles in the system, allowing control of aircraft to be passed from controller to controller with a minimum of verbal communication. O'Hare's system includes seven horizontal and four vertical displays. The system can track over 100 aircraft simultaneously.

A radio beacon interrogator, attached to antennas of airport surveillance radar, transmits signals to a transponder in the aircraft, triggering a coded identification reply. The transponder, connected to the plane's altimeter, also transmits altitude information. At the terminal, the ARTS III Univac computer processes the information for automatic display next to the proper blip on the controller's console. The controller is, in effect, the interface between the sky, the computer, and his scope.

Horizontal displays in ARTS III allow a "team approach" by FAA con-

trollers. One controller, for instance, might handle all departures east and north, while another handles inbound and outbound flights at satellite airports north of the



terminal. Others may assist in communications, and handoff (to another controller) of aircraft. Overhead panels include frequency-selection switches and other transmitting and receiving equipment.

"As far as we are concerned, ARTS III is the greatest advancement in air traffic control since the invention of radar," said Dan Vucurevich, FAA tower chief at O'Hare. "It reduces the demands on controllers by handling much of their identification and record keeping, and thus, helps them concentrate on the job of directing aircraft." Within the large, windowless, room under a new 200-foot-high concrete control tower, these unseen men who do not see the sky as they work, now know more about it than ever before as they direct over 600,000 flights a year in the terminal area.

#### AETNA AUTOMATES AUTO INSURANCE

Aetna Life & Casualty, Hartford, Conn., has automated its handling of car insurance to a degree believed to be unsurpassed in the auto insurance industry. Seventy-two offices from coast to coast now are able to process auto insurance through a large computer in the company's home office. The network, linked by telephone lines, allows the nation's fourth largest car insurer to slash the time required for many routine insurance operations from days or hours to seconds.

Aetna's SAFARI (System by Aetna for Fast Access to Records and Information) system can calculate rates and issue a policy, change or renew a policy, prepare a bill or provide information needed to settle a claim, within 10 to 15 seconds. SAFARI also delivers up-to-the-minute statistical reports to Aetna's management. The network, will be used to service other kinds of insurance in the near future.

SAFARI was conceived over five years ago to improve service to policyholders while helping Aetna economically manage and process its growing volume of business. Customers benefit, says Aetna, through swifter claims service and the fast, accurate handling of policy transactions. The company's benefits, in addition to greater customer satisfaction, include the capability of processing a growing volume of business with maximum efficiency and immediate access to vital underwriting and rate-making data.

Development of the system, which uses IBM equipment, consumed more than 300 man-years and involved over 100 Aetna employees. At present, SAFARI averages about 15,000 transactions per day over its 20,000 miles of leased telephone lines. Data is fed into the system and requested of it by 160 machine operators stationed at 258 terminals throughout the country.

#### COMPUTER HELPS BREEDER FIND RIGHT "MATE" FOR FARMER'S COW

When an Illinois farmer wants a certain "mate" for his cow, there is a small IBM computer at the Illinois Breeding Cooperative (Hampshire, Illinois) which can help him find it. The System/3 Model 10 stores information on more than 300,000 units of semen in storage at IBC headquarters and 65 field locations. Inventory records are stored on a 2.45 million character disk which provides quick access to answer inquiries and eases the firm's task of updating records every 30 days.

If a farmer wants a certain type of bull, IBM officials check the System/3 Model 10's files to see if the correct unit is available. The ampules, which can be delivered anywhere in the state in 24 hours, are suspended in liquid nitrogen at -320°F until used. The ampules of semen range in value from a few dollars to several thousand dollars.

IBC business manager, Thomas L. Bruening said the computer also helps produce 5,000 statements a month and has helped cut the firm's accounts receivable by \$80,000.

#### EDUCATION NEWS

##### POLYTECHNIC TO GIVE GRADUATE CREDIT FOR IBM SYSTEMS SCIENCE PROGRAM

Polytechnic Institute of Brooklyn (New York) and IBM have signed an agreement that will offer graduate

degree credit to the company's professionals who complete an IBM course in computer science. Since 1960, the IBM Systems Research Institute has offered a full-time, 13-week resident program for senior IBM system professionals. Now, they may receive six credits toward a Master of Science degree at Polytechnic for successful course completion.

Under the reciprocal agreement between Polytechnic and IBM, students who complete the 13-week SRI program will be awarded six credits towards M.S. degrees in Industrial Management — the points to be used as substitutes for credits in Polytechnic's Management Science option. In order to get the credits, students should seek admission at Polytechnic Institute of Brooklyn via the normal admissions procedure. They will then sit for an examination based on the program they took at the Systems Research Institute.

"We feel that this is an innovative and imaginative effort on the part of two great institutions to keep faith with the growing demand in all parts of the country for high-quality off-campus education," said Dr. Edward D. Goldberg, head of Polytechnic's Industrial Management Department, which will offer the graduate credit.

##### BASIC COMPUTER TECHNOLOGY COURSE SPONSORED BY ACPA, POTOMAC VALLEY CHAPTER

Thirty-five Montgomery County High School Seniors and Juniors (Rockville, Md.) will attend a free course on basic computer technology this summer, sponsored by The Potomac Valley Chapter of the Association of Computer Programmers and Analysts (ACPA) in conjunction with the Montgomery County School System. Pupils were nominated by their science instructors and tested to determine eligibility and aptitude. Qualified students begin classes in basic programming and FORTRAN on July 12th. Classes will be held 3 days per week, 3 hours per day through August 20th.

Computer time, classroom facilities, and textbooks are being donated by Control Data Corporation, CDI Division, Rockville, Md. Members of the Potomac Valley Chapter, Mr. Robert L. White of Maryland State Savings and Loan Association, and Mr. Raymond James of CDC have volunteered to be instructors. Mr. White's and Mr. James' companies are donating a portion of their work week in support of this project. Present plans call for this course to be offered again in the Fall. For information on this Pilot Pro-

gram or to help support the Fall program, contact the Potomac Valley Chapter, ACPA, P.O. Box 1752, Rockville, MD 20850.

## RESEARCH FRONTIER

### COMPUTER TERMINAL "TALKS" BRAILLE

A computer terminal that accepts requests in everyday language and prints out answers in Braille could lead to new opportunities for the blind, according to the findings of Norman C. Loeber, an IBM engineer at the company's System Development Division laboratory, San Jose, Calif. Loeber is looking at the feasibility of a terminal system for the blind that could reach from the user's office or home into remote data banks and computing centers. A user would enter his requests at a standard keyboard in everyday language and receive answers at a special terminal printer in the raised-dot language of Braille.

In Loeber's proposed terminal system, reading and interpreting the dot patterns remains a human task, but the tedious job of writing the dots is shifted to machines. To test the concept, he assembled an experimental terminal printer designed around the unique requirements of a blind operator. Results to date are encouraging: the terminal unit, for example, produces high quality dots embossed on the front surface of the paper for easy fingertip reading and checking.



— Dr. Walter Jacobs, a blind colleague at the laboratory, examines the Braille output from an experimental embossing terminal

Input to the system also would be simple since the operator could strike a single alphabetic key to produce all the dots in the corres-

ponding Braille cell. (Present Braille writing devices for the individual either emboss the dots on the reverse side of the paper or require the operator to simultaneously depress separate keys for each dot in the cell.

Some 400 blind computer programmers in the U.S. could be the first to profit from such a Braille terminal. Like their sighted colleagues, they would be able to analyze and debug programs faster through real-time communications with a computer. New career doors for the blind also could open with the increasing emergence of data banks capable of holding huge quantities of information.

Even more important, Loeber feels, is the terminal's potential to take the frustration out of learning for the blind school child. Few parents today can afford the cost or space at home for even an abridged dictionary that, in Braille, fills 36 volumes and several library shelves. For these children, remote access to computerized libraries would mean more time to learn and less time seeking Braille reference works for help on homework assignments.

### GTE SYLVANIA INSTRUMENT HELPS "HUMANIZE" COMPUTER

At Massachusetts Institute of Technology, Cambridge, Mass., experiments designed to give the computer some of the sensory abilities of humans are being conducted using a data tablet manufactured by GTE Sylvania Inc. (a subsidiary of General Telephone & Electronics Corp.), two minicomputers and a display tube. Drawings placed in the computer's memory through the data tablet can be immediately displayed on the tube.

"The processing abilities of today's computers are severely limited because they receive information from the real world through so few media or 'senses'", said Prof. Nicholas Negroponte of M.I.T.'s School of Architecture and Planning. "The GTE Sylvania data tablet transmits material drawn on its face to a computer, and assists in our experiments designed to add touch and sight to the computer's senses.

"It has been possible for years to feed drawings into computers via data tablets," Prof. Negroponte explained, "so long as the sketches were exact. But we are teaching the computer to interpret data not explicitly stated. The machine must handle sketches that include hastily-drawn lines, inaccuracies, crossed-out mistakes, and ambiguities stemming from discrepancies

between the user's intention and his execution."

For instance, if the user hastily sketches a wall with wobbly lines, the computer realizes that he probably meant them to be straight, and corrects the error. If he slowly and deliberately draws a round wall, the computer assumes the roundness is intentional. The computer, according to the professor, will no longer require the user to be any more exact with it than he is with a human being.

## MISCELLANEOUS

### UNINTERRUPTIBLE POWER SERVICE (UPS)

With today's higher operating speeds and improved data storage capabilities, the computer is more vulnerable than ever before to minor fluctuations in the voltage and frequency of its power supply. Such fluctuations — not to mention brownouts or occasional blackouts of today's overtaxed commercial power systems — are becoming a serious problem at computer installations in many parts of the country. In some cases, damage is done to basic operational programming that puts the computer completely out of commission; other times it's just a bothersome error in someone's account that eventually gets straightened out.

C. G. Helmick, manager of the inverter product group for the Westinghouse Industrial Systems Division in Buffalo, N.Y., points out that the electrical industry has had an answer to the problem — just inserting an uninterruptible power system (UPS) between the computer and the commercial power source — but only recently have many computer owners become aware of it.

The UPS uses rectifiers to convert the raw incoming a-c power into direct current. Using the dc as a power source the system then reconstructs a perfect a-c power signal for the computer. The voltage and frequency of this signal are isolated from the effects of any variations in the incoming commercial power. Should the incoming power drop sharply or fail altogether, there is a bank of standby batteries from which the UPS draws power until the commercial power comes back on. When it does, the rectifiers immediately start recharging the batteries to full power. Helmick estimates that 500 to 1000 data processing installations have an UPS in operation today.

# NEW CONTRACTS

TO	FROM	FOR	AMOUNT
International Computers Ltd., London, England	V/O Avtopromimport, Moscow, Russia	Two System 4-62 computers and peripherals to computerize Moskvich, a major Russian car plant; ICL is first Western computer company to get official accredited representation and be allowed to establish an office in Moscow	£1,800,000+
General American Transportation Corp. (GATX), GARD Research Div., Chicago, Ill.	U.S. Postal Service	Fabrication and installation of the ZIP-Code Mail Translator (ZMT) which permits mechanized sorting of up to 36,000 letters per hour, to as many as 277 different ZIP areas	\$5.4 million (approximate)
TRW Inc., Redondo Beach, Calif.	Bonneville Power Administration, Vancouver, Washington	A Real Time Operations, Dispatching and Scheduling (RODS) System for controlling generation and transmission on the Federal Columbia River Power system	\$5.1 million
Control Data Corp., Minneapolis, Minn.	Sulzer Brothers Ltd., Winterthur, Switzerland	A Control Data dual 3500 computer system to expand current business data processing and manufacturing control applications	\$4.5 million
Univac Division of Sperry Rand Corp., Blue Bell, Pa.	Kinki Nippon Railway Co., Ltd., Osaka, Japan	A UNIVAC 1110 to supplement and enhance 3 existing UNIVAC 418-II systems used for real-time, automatic reservation systems (express trains, tourist buses and hotels)	\$4 million
Honeywell Information Systems, Wellesley Hills, Mass.	Abbott Laboratories Inc., North Chicago, Ill.	Placing Model 115 systems at 18 regional sales-distribution centers in U.S. and a Model 115/2 in headquarters for a sales and order-entry network	\$2.5 million
The National Cash Register Co., Dayton, Ohio	First Federal Savings and Loan Assoc., Broward County, Fort Lauderdale, Fla.	An NCR Century 300 system to replace two smaller on-line computers to make a fully integrated data processing system	\$1.6 million
The MEDICUS Corp., Dallas, Texas	Rush-Presbyterian-St. Luke's Medical Center, Chicago, Ill.	A hospital-wide resources utilization program; installing, operating central data processing center and designing elements of a hospital management information system	\$1.5 million
PRC Information Sciences Co., a Planning Research Corp. company, Los Angeles, Calif.	Rome Air Development Center (RADC), New York	Functional expansion of the PACER (Program Assisted Console Evaluation and Review) system which provides support to intelligence analysts	\$1 million (approximate)
Burroughs Corp., Detroit, Mich.	Vulcan Materials Co., Chemicals Div., Wichita, Kans.	A B 2500 computer system to be used for general accounting tasks, payroll, store-room inventory, sales analysis, tank car control system	\$500,000+
Honeywell Ltd., London, England	Rotherham Works of Special Steels Div., British Steel Corp., London, England	Installation and commission of a direct digital control system (an H316 and associated peripherals) for 28 soaking pits	\$500,000+
	Imperial College of London Univ., London, England	A process computer system (H516) for control of a crystallization plant and a carbon dioxide absorber/desorber	\$300,000
Data Products Corp., Woodland Hills, Calif.	Naval Regional Procurement Center, Los Angeles, Calif.	A follow-on order for 15 Model 2910 Military Teleprinters for shipboard use and their associated support hardware	\$250,000+
Computer Technology Inc., a UCC subsidiary, Dallas, Texas	U.S. Social Security Admn., Washington, D.C.	Design, implementation and maintenance of an acceptance test system for control and testing of Bureau of Health Insurance's Medicare Part B Model System	\$170,000 (approximate)
Interdata, Inc., Oceanport, N.J.	London University, London, England	Two Model 5 computers and one 270X front-end processor; the computers (at University College and London Graduate Business School) will communicate with University's IBM 360/65	\$160,000
Varian Data Machines, Irvine, Calif.	Logic Corp., Cherry Hill, N.J.	Additional 23 Varian 620/L computers for use in firm's LC-720 key disc system	—
IBM Corporation, New York, N.Y.	Ovonic Memories, Inc., Los Angeles, Calif.	An IBM System/370 Model 145 for use as one of laboratory instruments for development and testing of OMI memory systems	—
TRW Credit Data, Anaheim, Calif.	Credit Bureau of Phoenix, Arizona	The reporting of consumer credit information to subscribers in Maricopa County; a separate computer file for the Phoenix Credit Bureau will be maintained at Anaheim	—
Honeywell Controls Ltd., Montreal, Quebec, Canada	Bell Telephone Company of Canada	A five-year lease of a Model 6030 computer which will be used for Bell's internal computer service bureau	—
PRC Information Sciences Co., a Planning Research Corp. company, Los Angeles, Calif.	State of Florida	Design and implementation of an automated and consolidated State retirement accounting system	—
Potter Instrument Company, Inc., Melville, N.Y.	Data Products Div. of Lockheed Electronics Co., Inc.	Delivery of 100 LP 3000 Line Printers with option to increase quantity to 500 over a three year period	—
Bunker Ramo Corp., Westlake Village, Calif.	Naval Electronic Systems Command, Washington, D.C.	BR-700 off-line message editing equipment; system will reduce typing and re-typing of teletype messages and reduce errors	—
Raytheon Data Systems Co., Norwood, Mass.	Saint Mary's Health Center, St. Louis, Mo.	A computerized information network, called PULSE, designed especially for hospitals to tie all facilities operations together	—

# NEW INSTALLATIONS

OF	AT	FOR
Burroughs B 6500 system	Department of Defense	Regular operational use; multiprocessing system is oriented toward data communications; achieved effectiveness level of 96.49% in 30-day acceptance test (system valued at \$5.7 million)
Computer Automation, Inc. Model 808 system	Michigan Department of State Highways	Monitoring urban traffic, both surface street and expressway
Control Data 3300 system	United States Coast Guard Washington, D. C.	Personnel accounting, management information services, statistical reporting, communications, scientific analysts (system valued at \$2.1 million)
Control Data 3300 system	Western Electric Co., Inc. Reading, Pa.	Electrical test set control and data analysis
Control Data 6400 system	Dalhousie University, Halifax, Nova Scotia	Administrative, medical research, physics, engineering and computer sciences applications; will also serve other schools in province and plan to offer time to Nova Scotia provincial government as well as other interested users (system valued at \$1.6 million)
Digital Equipment PDP-8/L	Onan Eastern Corp., Long Island City, N. Y.	Automate process of preparing cost proposals for potential customers
Hewlett Packard Model 2000C	Stanford University Graduate School of Business, Stanford, Calif	Use as tool for management problem solving; system is student-oriented and will enable substantial increase of computer use by students
Honeywell Model 2015 system	Equity and Law Life Assurance Society Ltd., Brentford, England	Taking over and further developing workload of Honeywell 400 in use since 1963; includes most of routine work associated with insurance policies (system valued at over \$670,000)
Honeywell Model 3200 system	Prices Tailors Ltd., Leeds, England	Managing credit account system for nearly 640 retail stores; other applications include payroll for over 7,000, sales forecasting system, and a work-in-progress production system in the factories
IBM System/3 Model 10	Wheeler's Remanufactured Engines, Macon, Georgia	Forecasting auto-part needs of car dealers and wholesalers in 13 states
IBM 1130 system	Hydro-Line Manufacturing Company, Rockford, Ill.	Helping produce tapes to guide machine tools
IBM 1130 system	Maryland Datamation, Inc., Cockeysville, Maryland	Turning rough engineering sketches into finished drawings to save time for land developers in twenty states
NCR Century 50 system	First Federal Savings and Loan Association, Savannah, Ga.	Processing savings and mortgage accounts
	High Grade Beverage, New Brunswick, N.J.	Maintaining inventory and doing billing
	Institution Food House, Hickory, No. Car.	Accounts receivable and payable, invoicing, sales analysis and inventory control
	Pepsi-Cola Bottling Company of Central Virginia, Charlottesville	Route settlements and billing
	Southern Woodenware, Nashville, Tenn.	Controlling 6,000-item inventory and processing payroll
	Water Bonnet, Inc., Orlando, Fla.	Forecasting inventory needs, processing accounts payable and receivable and payroll, and general ledger accounting
	William Focke's Sons Company of Dayton, Ohio	Process orders, accounts receivable, payroll and general ledger; also to generate sausage formulas
NCR Century 200 system	Paisley Burgh Council, Glasgow, Scotland	Joint use by Paisley government unit and Renfrew County Council; about 20 major applications planned over next 2 years; now handling general accounting tasks, payroll for 4500, and county's valuation register listing 136,000 properties
UNIVAC 494 system	Yasuda Banking and Trust Company, Tokyo, Japan	An on-line, real-time banking system, covering bank's 36 branches throughout Japan (system valued at about \$2.1 million)
UNIVAC 1106 system	Maricopa County Junior College District, Phoenix, Arizona	Student, faculty and administrative needs of the district which comprises five junior colleges with a total student population of 30,000 (system valued at \$1.5 million)
UNIVAC 1106 system	University of Cape Town, South Africa	Nucleus of computing facility for students, faculty members and the administration; will operate in batch, conversational and real-time modes. (system valued at \$1 million)
UNIVAC 1106 system	University of Copenhagen, Denmark	Student programs and scientific purposes including analysis of bubble chamber films, microwave spectroscopy, linguistic text analysis and datalogy (system valued at about \$2 million)
UNIVAC 9400 system	Nestle Company (Australia) Ltd., Sydney, Australia	Developing completely integrated system involving all aspects of Nestle operation in Australia; this will include linking the head office with factories and branch offices
UNIVAC 9400 system	Suffolk County Federal Savings & Loan Association, Centereach, N. Y.	Communicating with teller windows to increase services to customers at Associations eight offices

# MONTHLY COMPUTER CENSUS

Neil Macdonald  
Survey Editor  
COMPUTERS AND AUTOMATION

The following is a summary made by COMPUTERS AND AUTOMATION of reports and estimates of the number of general purpose electronic digital computers manufactured and installed, or to be manufactured and on order. These figures are mailed to individual computer manufacturers from time to time for their information and review, and for any updating or comments they may care to provide. Please note the variation in dates and reliability of the information. Several important manufacturers refuse to give out, confirm, or comment on any figures.

Our census seeks to include all digital computers manufactured anywhere. We invite all manufacturers located anywhere to submit information for this census. We invite all our readers to submit information that would help make these figures as accurate and complete as possible.

Part I of the Monthly Computer Census contains reports for United States manufacturers. Part II contains reports for manufacturers outside of the United States. The two parts are published in alternate months.

The following abbreviations apply:

- (A) -- authoritative figures, derived essentially from information sent by the manufacturer directly to COMPUTERS AND AUTOMATION
- C -- figure is combined in a total
- (D) -- acknowledgment is given to DP Focus, Marlboro, Mass., for their help in estimating many of these figures
- E -- figure estimated by COMPUTERS AND AUTOMATION
- (N) -- manufacturer refuses to give any figures on number of installations or of orders, and refuses to comment in any way on those numbers stated here
- (R) -- figures derived all or in part from information released indirectly by the manufacturer, or from reports by other sources likely to be informed
- (S) -- sale only, and sale (not rental) price is stated
- X -- no longer in production
- -- information not obtained at press time

SUMMARY AS OF JUNE 15, 1971

NAME OF MANUFACTURER	NAME OF COMPUTER	DATE OF FIRST INSTALLATION	AVERAGE OR RANGE OF MONTHLY RENTAL \$ (000)	NUMBER OF INSTALLATIONS			NUMBER OF UNFILED ORDERS
				In U.S.A.	Outside U.S.A.	In World	
<b>Part I. United States Manufacturers</b>							
Autonetics	RECOMP II	11/58	2.5	30	0	30	X
	RECOMP III	6/61	1.5	6	0	6	X
Bailey Meter Co. Wickliffe, Ohio (A) (6/71)	Bailey 750	6/60	40-250 (S)	32	3	35	0
	Bailey 755	11/61	200-600 (S)	6	0	6	0
	Bailey 756	2/65	60-400 (S)	13	5	18	6
	Bailey 855	4/68	100-1000 (S)	8	0	8	17
Bunker-Ramo Corp. Westlake Village, Calif. (A) (6/71)	BR-130	10/61	2.0	160	-	-	X
	BR-133	5/64	2.4	79	-	-	X
	BR-230	8/63	2.7	15	-	-	X
	BR-300	3/59	3.0	18	-	-	X
	BR-330	12/60	4.0	19	-	-	X
	BR-340	12/63	7.0	19	-	-	X
Burroughs Detroit, Mich. (N) (1/69-5/69)	BR-1018	6/71	23.0 (S)	-	-	-	-
	205	1/54	4.6	25-38	2	27-40	X
	220	10/58	14.0	28-31	2	30-33	X
	B100/B500	7/65	2.8-9.0	-	-	-	-
	B2500	2/67	5.0	52-57	12	64-49	117
	B3500	5/67	14.0	44	18	62	190
	B5500	3/63	23.5	65-74	7	72-81	8
	B6500	2/68	33.0	4	-	4	60
	B7500	4/69	44.0	-	-	-	13
Computer Automation, Inc. Newport Beach, Calif. (A) (6/71)	B8500	8/67	200.0	1	-	1	5
	108/208/808	66/68	5.0 (S)	165	10	175	110
116/216/816	3/69	8.0 (S)	215	20	235	225	
Control Data Corp Minneapolis, Minn. (R) (6/71)	G15	7/55	1.6	-	-	295	X
	G20	4/61	15.5	-	-	20	X
	LGP-21	12/62	0.7	-	-	165	X
	LGP-30	9/56	1.3	-	-	322	X
	RPS4000	1/61	1.9	-	-	75	X
	636/136/046 Series	-	-	-	-	29	-
	160/8090 Series	5/60	2.1-14.0	-	-	610	X
	924/924-A	8/61	11.0	-	-	29	X
	1604/A/B	1/60	45.0	-	-	59	X
	1700/SC	5/66	3.8	-	-	400-450	0
	3100/3150	5/64	10-16	-	-	83-110	C
	3200	5/64	13.0	-	-	55-60	C
	3300	9/65	20-38	-	-	200	C
	3400	11/64	18.0	-	-	20	C
	3500	8/68	25.0	-	-	15	C
3600	6/23	52.0	-	-	40	C	
3800	2/66	53.0	-	-	20	C	
6400/6500	8/64	58.0	-	-	105	C	
6600	8/64	115.0	-	-	85	C	
6700	6/67	130.9	-	-	5	C	
7600	12/68	235.0	-	-	5	C	
							Total: 160 E
Data General Corp. Southboro, Mass. (A) (4/71)	NOVA	2/69	8.0 (S)	-	-	813	-
	SUPERNOVA	5/70	9.6 (S)	-	-	102	-
	NOVA 1200	12/71	5.4 (S)	-	-	100	-
	NOVA 800	3/71	6.9 (S)	-	-	-	-
	SUPERNOVA SC	6/71	11.9 (S)	-	-	-	-
Datacraft Corp. Ft. Lauderdale, Fla. (A) (6/71)	6024/1	5/69	54-300 (S)	12	0	12	3
	6024/3	2/70	33-200 (S)	42	6	48	46
	6024/5	12/71	16-50 (S)	0	0	0	5
Digiatic Corp. Plainview, N.Y. (A) (3/71)	Digiatic 3060	1/70	9.0 (S)	30	-	-	5
	Digiatic 3080	12/64	19.5 (S)	16	-	-	0
	Digiatic 3080C	10/67	25.0 (S)	7	-	-	1
Digital Computer Controls, Inc. Fairfield, N.J. (A) (6/71)	D-112	8/70	10.0 (S)	90	10	100	300
	PDP-1	11/60	3.4	48	2	50	X
Digital Equipment Corp. Maynard, Mass. (A) (2/71)	PDP-4	8/62	1.7	40	5	45	X
	PDP-5	9/63	0.9	90	10	100	X

NAME OF MANUFACTURER	NAME OF COMPUTER	DATE OF FIRST INSTALLATION	AVERAGE OR RANGE OF MONTHLY RENTAL \$ (000)	NUMBER OF INSTALLATIONS			NUMBER OF UNFULFILLED ORDERS
				In U.S.A.	Outside U.S.A.	In World	
Digital Equipment Corp. (cont'd)	PDP-6	10/64	0.5	C	C	23	X
	PDP-7	11/64	0.4	C	C	160	X
	PDP-8	4/65	0.3	C	C	1440	C
	PDP-8/1	3/68	0.4	C	C	3698	C
	PDP-8/S	9/66	0.3	C	C	1024	C
	PDP-8/L	11/68	-	C	C	3902	C
	PDP-9	12/66	1.1	C	C	436	C
	PDP-9L	11/68	-	C	C	48	C
	PDP-10	12/67	8.0	C	C	145	C
	PDP-11	3/70	10.5	(S) C	C	546	C
	PDP-12	9/69	-	C	C	475	C
	PDP-15	-/69	17.0	6	C	15	C
	LINC-8	9/66	-	C	C	142	C
							1350 E
Electronic Associates Inc.	640	4/67	1.2	95	60	155	6
Long Branch, N.J. (A) (6/71)	8400	7/67	12.0	20	6	26	1
EMR Computer	EMR 6020	4/65	5.4	C	-	-	C
Minneapolis, Minn.	EMR 6040	7/65	6.6	C	-	-	C
(A)	EMR 6050	2/66	9.0	C	-	-	C
(2/71)	EMR 6070	10/66	15.0	C	-	-	C
	EMR 6130	8/67	5.0	C	-	-	C
	EMR 6135	-	2.6	-	-	-	-
	EMR 6155	-	-	-	-	-	-
							Total:
							1350 E
General Automation, Inc.	SPC-12	1/68	-	-	-	900	-
Anaheim, Calif.	SPC-16	5/70	-	-	-	70	-
(R) (6/71)	System 18/30	7/69	-	-	-	70	-
General Electric	GE-PAC 3010	5/70	2.0	2	0	2	15
West Lynn, Mass.	GE-PAC 4010	10/70	6.0	5	0	5	23
(Process Control Computers)	GE-PAC 4020	2/67	6.0	181	51	232	50
(A)	GE-PAC 4040	8/64	3.0	45	20	65	X
(6/71)	GE-PAC 4050	12/66	7.0	23	2	25	X
	GE-PAC 4060	6/65	2.0	18	2	20	X
Hewlett Packard	2114A, 2114B	10/68	0.25	-	-	1130	-
Cupertino, Calif.	2115A	11/67	0.41	-	-	326	-
(A) (6/71)	2116A, 2116B, 2116C	11/66	0.6	-	-	705	-
Honeywell Information Systems	G58	5/70	1.0	-	-	-	-
Wellesley Hills, Mass.	G105A	6/69	1.3	-	-	-	-
(A) (2/71)	G105B	6/69	1.4	-	-	-	-
	G105RTS	7/69	1.2	-	-	-	-
	G115	4/66	2.2	200-400	420-680	620-1080	-
	G120	3/69	2.9	-	-	-	-
	G130	12/68	4.5	-	-	-	-
	G205	6/64	2.9	11	0	11	-
	G210	7/60	16.0	35	0	35	-
	G215	9/63	6.0	15	1	16	-
	G225	4/61	8.0	145	15	160	-
	G235	4/64	12.0	40-60	17	57-77	-
	G245	11/68	13.0	3	-	3	-
	G255 T/S	10/67	17.0	15-20	-	15-20	-
	G265 T/S	10/65	20.0	45-60	15-30	60-90	-
	G275 T/S	11/68	23.0	-	-	10	-
	G405	2/68	6.8	10-40	5	15-45	-
	G410 T/S	11/69	11.0	-	-	-	-
	G415	5/64	7.3	170-300	70-100	240-400	-
	G420 T/S	6/67	23.0	-	-	-	-
	G425	6/64	9.6	50-100	20-30	70-130	-
	G430 T/S	6/69	17.0	-	-	-	-
	G435	9/65	14.0	20	6	26	-
	G440 T/S	7/69	25.0	-	-	-	-
	G615	3/68	32.0	-	-	-	-
	G625	4/65	43.0	23	3	26	-
	G635	5/65	47.0	20-40	3	23-43	-
	G655	12/70	80.0	-	-	-	-
	H-110	8/68	2.7	180	75	255	0
	H-115	6/70	3.5	30	-	30	-
	H-120	1/66	4.8	800	160	960	-
	H-125	12/67	7.0	150	220	370	-
	H-200	3/64	7.5	800	275	1075	-
	H-400	12/61	10.5	46	40	86	X
	H-800	12/60	30.0	58	15	73	X
	H-1200	2/66	9.8	230	90	325	-
	H-1250	7/68	12.0	130	55	185	-
	H-1400	1/64	14.0	4	6	10	X
	H-1800	1/64	50.0	15	5	20	X
	H-2200	1/66	18.0	125	60	185	-
	H-3200	2/70	24.0	20	2	22	-
	H-4200	8/68	32.5	18	2	20	-
	H-8200	12/68	50.0	10	3	14	-
	DDP-24	5/63	2.65	-	-	90	X
	DDP-116	4/65	0.9	-	-	250	-
	DDP-124	3/66	2.2	-	-	250	-
	DDP-224	3/65	3.5	-	-	60	-
	DDP-316	6/69	0.6	-	-	450	-
	DDP-416	-	-	-	-	350	-
	DDP-516	9/66	1.2	-	-	900	-
	H112	10/69	-	-	-	75	-
	H632	12/68	3.2	-	-	12	-
	H1602	-	-	-	-	-	-
	H1642	-	-	-	-	-	-
	H1644	-	-	-	-	-	-
	H1646	-	-	-	-	-	-
	H1648	11/68	12.0	-	-	20	-
	H1648A	-	-	-	-	-	-

NAME OF MANUFACTURER	NAME OF COMPUTER	DATE OF FIRST INSTALLATION	AVERAGE OR RANGE OF MONTHLY RENTAL \$(000)	NUMBER OF INSTALLATIONS			NUMBER OF UNFULFILLED ORDERS
				In U.S.A.	Outside U.S.A.	In World	
IBM White Plains, N.Y. (N) (D) (1/69-5/69)	System/3 Model 6	3/71	1.0	-	-	-	-
	System/3 Model 10	1/70	1.1	-	-	-	-
	System/7	11/71	0.35 and up	-	-	-	-
	305	12/57	3.6	40	15	55	-
	650	10/67	4.8	50	18	68	-
	1130	2/66	1.5	2580	1227	3807	-
	1401	9/60	5.4	2210	1836	4046	-
	1401-G	5/64	2.3	420	450	870	-
	1401-H	6/67	1.3	180	140	320	-
	1410	11/61	17.0	156	116	272	-
	1440	4/63	4.1	1690	1174	2864	-
	1460	10/63	10.0	194	63	257	-
	1620 I, II	9/60	4.1	285	186	471	-
	1800	1/66	5.1	415	148	563	-
	7010	10/63	26.0	67	17	81	-
	7030	5/61	160.0	4	1	5	-
	704	12/55	32.0	12	1	13	-
	7040	6/63	25.0	35	27	2	-
	7044	6/63	36.5	28	13	41	-
	705	11/55	38.0	18	3	21	-
	7020, 2	3/60	27.0	10	3	13	-
	7074	3/60	35.0	44	26	70	-
	7080	8/61	60.0	13	2	15	-
	7090	11/59	63.5	4	2	6	-
	7094-I	9/62	75.0	10	4	14	-
	7094-II	4/64	83.0	6	4	10	-
	360/20	12/65	2.7	4690	3276	7966	-
	360/25	1/68	5.1	0	4	4	-
	360/30	5/65	10.3	4075	3144	8219	-
	360/40	4/65	19.3	1260	498	1758	-
	360/44	7/66	11.8	65	13	78	-
	360/50	8/65	29.1	480	109	589	-
	360/65	11/65	57.2	175	31	206	-
	360/67	10/65	133.8	9	4	13	-
	360/75	2/66	66.9	14	3	17	-
360/85	12/69	150.3	-	-	-	-	
360/90	11/67	(S)	5	-	5	-	
370/135	5/72	14.4	-	-	-	-	
370/145	9/71	23.3	-	-	-	-	
370/155	2/71	48.0	-	-	-	-	
370/165	5/71	98.7	-	-	-	-	
360/195	4/71	232.0	-	-	-	-	
Interdata	Model	12/70	3.7	45	10	55	70
Oceanport, N.J. (A) (6/71)	Model 3	5/67	-	N/A	-	200	X
	Model 4	8/68	8.5	200	100	300	90
	Model 5	11/70	10.5	25	15	40	50
	Model 15	1/69	20.0	40	24	64	13
	304	1/60	14.0	15	2	17	X
NCR Dayton, Ohio (A) (6/71)	310	5/61	2.5	8	0	8	X
	315	5/62	7.0	425	300	725	-
	315 RMC	9/65	9.0	125	50	175	-
	390	5/61	0.8	325	500	825	-
	500	10/65	1.0	1000	1700	2700	-
	Century 50	3/71	1.6	10	-	10	-
	Century 100	9/68	2.7	1350	425	1775	-
	Century 200	6/69	7.7	400	125	525	-
	Century 300	2/72	20.0	0	0	0	-
	1000	6/63	7.0	16	-	-	X
Philco Willow Grove, Pa. (N) (1/69)	200-210,211	10/58	40.0	16	-	-	X
	2000-212	1/63	52.0	12	-	-	X
	301	2/63	7.0	140-290	100-130	240-420	-
RCA Cherry Hill, N.J. (N) (5/69)	501	6/59	14.0-18.0	22-50	1	23-51	-
	601	11/62	14.0-35.0	2	0	2	-
	3301	7/64	17.0-35.0	24-60	1-5	25-65	-
	Spectra 70/15	9/65	4.3	90-110	35-60	125-170	-
	Spectra 70/25	9/65	6.6	68-70	18-25	86-95	-
	Spectra 70/35	1/67	9.2	65-100	20-50	85-150	-
	Spectra 70/45	11/65	22.5	84-180	21-55	105-235	-
	Spectra 70/46	-	33.5	1	0	1	-
	Spectra 70/55	11/66	34.0	11	1	12	-
	250	12/60	1.2	115	20	175	X
Raytheon Santa Ana, Calif. (A) (6/71)	440	3/64	3.6	20	-	20	X
	520	10/65	3.2	26	1	27	X
	703	10/67	12.5 (S)	172	31	203	2
	704	3/70	8.0 (S)	64	16	80	32
	706	5/69	19.0 (S)	55	14	69	3
	650	5/66	0.5	23	0	23	X
Scientific Control Corp. Dallas, Texas (A) (6/70)	655	10/66	2.1	137	0	137	0
	660	10/65	2.1	41	0	41	0
	670	5/66	2.7	1	0	1	X
	4700	4/69	1.8	19	0	19	4
	DCT-132	5/69	0.9	45	0	45	23
Standard Computer Corp. Los Angeles, Calif. (A) (6/71)	IC 4000	12/68	9.0	9	0	8	4
	IC 6000	5/67	16.0	9	0	9	-
	IC 7000	8/70	17.0	5	0	4	4
Systems Engineering Laboratories Ft. Lauderdale, Fla. (A) (6/70)	810	9/65	1.1	24	0	24	X
	810A	8/66	0.9	111	5	216	32
	810B	9/68	1.2	75	1	76	26
	840	11/65	1.5	3	0	3	X
	840A	8/66	1.5	36	2	38	X
	840MP	1/68	2.0	31	0	31	2
	Systems 86	-	10.0	0	0	0	2
	I & II	3/51 & 11/57	25.0	23	-	-	X
UNIVAC Div. of Sperry Rand New York, N.Y. (A) (6/71)	III	8/62	21.0	25	6	31	X
	File Computers	8/56	15.0	13	-	-	X



NAME OF MANUFACTURER	NAME OF COMPUTER	DATE OF FIRST INSTALLATION	AVERAGE OR RANGE OF MONTHLY RENTAL \$ (000)	NUMBER OF INSTALLATIONS			NUMBER OF UNFILLED ORDERS	
				In U.S.A.	Outside U.S.A.	In World		
UNIVAC (Cont'd.)	Solid-State 80 I,II, 90, I, II, & Step	8/58	8.0	210	-	-	X	
	418	6/63	11.0	76	36	112	20 E	
	490 Series	12/61	30.0	75	11	86	35 E	
	1004	2/63	1.9	1501	628	2130	20 E	
	1005	4/66	2.4	637	299	936	90 E	
	1050	9/63	8.5	138	62	200	10 E	
	1100 Series (except 1107, 1108)	12/50	35.0	9	0	9	X	
	1107	10/62	57.0	8	3	11	X	
	1108	9/65	68.0	87	114	56	75 E	
	9200	6/67	1.5	1051	822	175	850 E	
	9300	9/67	3.4	387	49	144	550 E	
	9400	5/69	7.0	8	0	3	60 E	
	LARC	5/60	135.0	2	0	2	-	
	Varian Data Machines Newport Beach, Calif. (A) (6/71)	620	11/65	-	-	-	75	X
		620i	6/67	-	-	-	1300	400
		R-260i	4/69	-	-	-	50	30
		520i	10/68	0.4	-	-	150	330
520/DC		12/69	1.6	-	-	25	25	
620/f		11/70	0.5	-	-	7	125	
620/L		4/71	-	3	-	-	200	
Xerox Data Systems El Segundo, Calif. (R) (2/71)	XDS-92	4/65	1.5	10-60	2	12-62	-	
	XDS-910	8/62	2.0	150-170	7-10	157-180	-	
	XDS-920	9/62	2.9	93-120	5-12	98-132	-	
	XDS-925	12/64	3.0	20	1	21	-	
	XDS-930	6/64	3.4	159	14	173	-	
	XDS-940	4/66	14.0	28-35	0	28-35	-	
	XDS-9300	11/64	8.5	21-25	1	22-26	-	
	Sigma 2	12/66	1.8	60-110	10-15	70-125	-	
	Sigma 3	12/69	2.0	10	0	10	-	
	Sigma 5	8/67	6.0	15-40	6-18	21-58	-	
	Sigma 6	6/70	12.0	-	-	-	-	
	Sigma 7	12/66	12.0	24-35	5-9	29-44	-	
	Sigma 9	-	35.0	-	-	-	-	

**ASSOCIATION OF DATA PROCESSING SERVICE ORGANIZATIONS VS. CONTROLLER OF THE CURRENCY AND AMERICAN NATIONAL BANK OF ST. PAUL**

*Bernard Goldstein, President  
Association of Data Processing Service Organizations  
551 Fifth Avenue  
New York, NY 10017*

The start of trial for ADAPSO's case against the U.S. Controller of the Currency and the American National Bank of St. Paul has been fixed for June 21, 1971; the trial is before Judge Neville in the Eighth Circuit District Court in Minneapolis, Minn.

This is the first trial that tests the participation of banks in the data processing industry.

The question is whether the nation's banks may provide EDP services to the public. ADAPSO believes that such activity is contrary to the incidental powers portion of the National Bank Act.

We have sought for four years to have this case tried on its merits. Recent activity has shown the concern of Congress for the economic power of the bank interests, with the passage of restrictive legislation in the area of the one bank holding company.

A similar case in Providence, R.I., brought by Wingate Computing Center, is being withdrawn, without prejudice, in order to concentrate every resource on the Minnesota litigation.

**NUMBLE CHALLENGES, GIVEN AND RETURNED**

*I. Robert R. Weden  
6809 Cresonton Road  
Edina, Minnesota 55435.*

Regarding Numble 714, "Folly does not see":

After substituting the letters in the original problem for consistency, it appears that Y = 6, and after brief experiment that E = 8 and S = 3; then L = 4, ..., and the saying is "Folly does not see its magnitude."

The greatest challenge these recent Numbles have is overcoming the tedious aspect of letter substi-

tution. There is no imagination or intelligence involved in their creation.

**2. From the Editor**

Thank you for your nice, prodding letter.

Stuart Freudberg and I offer two semi-Numbles for you:

1. Find seven solutions to YES x NO = MAYBE,
2. Find one solution to ONE x TWO = EIGHT,

and then make up a message of significance using the letters.

Let us know how you make out.

**BOOK REVIEW**

Weik, Martin H. / Standard Dictionary of Computers and Information Processing / Hayden Book Co., Inc., 116 W. 14 St., New York, NY 10011 / 1969, hardbound, 326 pp., \$10.95.

A useful reference which includes definitions, a number of diagrams, and some essay-type supplementary information, to assure understanding of each of more than 10,000 hardware and software terms in common usage today in the computer field.

**ADVERTISING INDEX**

Following is the index of advertisements. Each item contains: Name and address of the advertiser / page number where the advertisement appears / name of agency, if any.

- ASSOCIATION FOR COMPUTING MACHINERY, 1133 Avenue of the Americas, New York, N.Y. 10036 / page 72 / Corporate Presence, Inc.
- COMMON CAUSE, 2100 M St., N.W., Washington, D.C. 20037 / Page 71
- COMPUTERS AND AUTOMATION, 815 Washington St., Newtonville, Mass. 02160 / Page 3
- NEW YORK TIMES Book & Education Div., 299 West 43 St., New York, N.Y. 10036 / Page 2 / Kingen Feleppa O'Dell

# CALENDAR OF COMING EVENTS

- July 19-21, 1971: 1971 Summer Computer Simulation Conference.** Sheraton-Boston Hotel, Boston, Mass. / contact Donald H. Niese, McDonnell Automation Co., Dept. K676, Box 516, St. Louis, Mo. 63166, or, Peter Stein, McGraw-Hill Publishing Co., 607 Boylston St., Boston, Mass. 02116
- July 19-23, 1971: Conference on Computers in Chemical Education and Research,** Northern Illinois Univ., DeKalb, Ill. / contact: Dr. F. M. Miller, Dept. of Chemistry, Northern Illinois Univ., DeKalb, Ill. 60115
- July 26-29, 1971: First International Computer Exposition for Latin America,** sponsored by the Computer Society of Mexico, Camino Real Hotel, Mexico City, Mexico / contact: Bernard Lane, Computer Exposition, Inc., 254 West 31st St., New York, N.Y. 10001
- Aug. 3-5, 1971: ACM '71 "Decade of Dialogue",** Conrad Hilton Hotel, Chicago, Ill. / contact: Al Hawkes, Computer Horizons, 53 West Jackson Blvd., Chicago, Ill. 60604
- Aug. 3-6, 1971: IFAC Symposium on The Operator, Engineer and Management Interface with the Process Control Computer,** Purdue University, Lafayette, Ind. / contact: Dr. Theodore J. Williams, Purdue Laboratory for Applied Industrial Control, Purdue University, Lafayette, Ind. 47907
- Aug. 11-13, 1971: Joint Automatic Control Conference,** Washington Univ., St. Louis, Mo. / contact: R. W. Brockett, Pierce Hall, Harvard Univ., Cambridge, Mass. 02138
- Aug. 16-19, 1971: International Symposium on the Theory of Machines and Computations,** Technion — Israel Institute of Technology, Haifa, Israel / contact: Sheldon B. Akers, Secretary, IEEE Technical Comm. on Switching and Automata Theory, General Electric Co., Bldg. 3, Room 226, Electronics Park, Syracuse, N.Y. 13201
- Aug. 16-20, 1971: Jerusalem Conference on Information Technology,** Jerusalem, Israel / contact: The Jerusalem Conference on Information Technology, P.O.B. 7170, Jerusalem, Israel
- Aug. 24-27, 1971: Western Electronic Show & Convention (WESCON),** San Francisco Hilton & Cow Palace, San Francisco, Calif. / contact: WESCON Office, 3600 Wilshire Blvd., Los Angeles, Calif. 90005
- Aug. 30-Sept. 10, 1971: International Advanced Summer Institute on Microprogramming,** Saint Raphael, French Riviera / contact: Guy Boulaye and Jean Mermet, Institute de Mathematiques Appliquees, Cedex 53, 38 - Grenoble/Gare, France
- Sept. 1-3, 1971: Second International Joint Conference on Artificial Intelligence,** Imperial College, London, England / contact: The British Computer Society, Conference Department, 29 Portland Place, London, W.1., U.K.
- Sept. 6-10, 1971: DISCOP Symposium (IFAC Symposium on Digital Simulation of Continuous Processes),** Győr, Hungary / contact: The Organizing Committee, Symposium on Simulation, Budapest 112, P.O.B. 63, Hungary
- Sept. 7-9, 1971: IEE 1971 Conference on Computers for Analysis and Control in Medical and Biological Research,** University of Sheffield, Sheffield, England / contact: Manager, Conference Dept., IEE, Savoy Place, London WC2R 0BL, England
- Sept. 9-10, 1971: Third Annual Conference of the Society for Management Information Systems,** Denver, Colo. / contact: Gerald M. Hoffman, Secy., Society for Management Information Systems, One First National Plaza, Chicago, Ill. 60670
- Sept. 14-17, 1971: Canadian Information Processing Society (CIPS) Annual National Conference,** Royal York Hotel, Toronto, Canada / contact: Jack McCaugherty, James Lovick Ltd., Vancouver, British Columbia, Canada
- Sept. 6-10, 1971: IFAC (International Federation of Automatic Control) Symposium on Digital Simulation of Continuous Processes,** Budapest, Hungary / contact: The Organizing Committee, Symposium on Simulation, Budapest 112, POB 63, Hungary
- Sept. 27-29, 1971: Elettronica '71 — 1st International Conference on Applications of Electronics in the Industry,** 21st International Technical Exhibition, Turin, Italy / contact: Dr. Ing. Giovanni Villa, Elettronica 71, Corso Massimo d'Azeglio 15, 10126 Turin, Italy
- Oct. 6-8, 1971: Conference on "Two-Dimensional Digital Processing",** Univ. of Missouri-Columbia, Columbia, Mo. / contact: Prof. Ernest L. Hall, Dept. of Electrical Engineering, Univ. of Missouri-Columbia, Columbia, Mo. 65201
- Oct. 10-12 1971: First Annual ASM Southwest Division Conference** (sponsored by Assoc. for Systems Management, Div. Council 18), Jung Hotel, New Orleans, La. / contact: Albert J. Krail, 636 Baronne St., New Orleans, La. 70113
- Oct. 18-20, 1971: 27th Annual National Electronics Conference and Exhibition (NEC/71),** Pick-Congress Hotel, McCormick Place, Chicago, Ill. / contact: NEC, Oakbrook Executive Plaza #2, 1211 W. 22nd St., Oak Brook, Ill. 60521
- Oct. 18-20, 1971: International Computer Forum & Exposition,** McCormick Place-On-The-Lake, Chicago, Ill. / contact: International Computer Forum & Exposition, Oak Brook Executive Plaza #2, 1211 West 22nd St., Oak Brook, Ill. 60521
- Oct. 25, 1971: Second Annual SIGCOSIM (ACM Special Interest Group on Computer Systems Installation Management) Symposium,** Washington, D.C. / contact: I. Feldman, Wiley Systems, Inc., 6400 Goldsboro Rd., Bethesda, Md. 20034
- Oct. 25-29, 1971: IEEE Joint National Conference on Major Systems,** Disneyland Hotel, Anaheim, Calif. / contact: Institute of Electrical and Electronics Engineers, Inc., 345 East 47th St., New York, N.Y. 10017
- Oct. 25-29, 1971: Systems Science & Cybernetics Conference & 1971 ORSA (Operations Research Society of America) Meeting,** Disneyland Hotel, Anaheim, Calif. / contact: Dr. Michael W. Lodato, Xerox Data Systems, 701 So. Aviation Blvd., El Segundo, Calif. 90245
- Oct. 29, 1971: Sixth Annual ACM Urban Symposium,** New York Hilton Hotel, New York, N.Y. / contact: Gerald M. Sturman, Parsons Brinckerhoff, 111 John St., New York, N.Y. 10038
- Nov. 1-2, 1971: Computer Science and Statistics: Fifth Annual Symposium on the Interface,** Oklahoma State University, Stillwater, Okla. / contact: Dr. Mitchell O. Locks, Oklahoma State Univ., Stillwater, Okla. 74074
- Nov. 4-5, 1971: 1971 American Production & Inventory Control Society (APICS) International Conference,** Chase Park Plaza Hotel, St. Louis, Mo. / contact: Henry F. Sander, American Production & Inventory Control Society, Inc., Suite 504 Watergate Bldg., 2600 Virginia Ave. N.W., Washington, D.C. 20037
- Nov. 16-18, 1971: Fall Joint Computer Conference,** Las Vegas Convention Center, Las Vegas, Nev. / contact T. C. White, AFIPS Headquarters, 210 Summit Ave., Montvale, N. J. 07645
- Dec. 16-18, 1971: IEEE Conference on Decision and Control** (including the 10th Symposium on Adaptive Processes), Americana of Bal Harbour, Miami Beach, Fla. / contact: Prof. J. T. Tou, Univ. of Florida, Gainesville, Fla.
- Mar. 20-23, 1972: IEEE International Convention & Exhibition,** Coliseum & N. Y. Hilton Hotel, New York, N. Y. / contact: IEEE Headquarters, 345 E. 47th St., New York, N. Y. 10017
- April 5-8, 1972: "Teaching Systems '72",** International Congress, Berlin Congress Hall, Berlin, Germany / contact: AMK Berlin, Ausstellungs-Messe-Kongress-GmbH, Abt. Presse und Public Relations, D 1000 Berlin 19, Messedamm 22, Germany
- May 15-18, 1972: Spring Joint Computer Conference,** Convention Ctr., Atlantic City, N.J. / contact: AFIPS Headquarters, 210 Summit Ave., Montvale, N.J. 07645

# Only one person can end the war.

## You.

Yes, you. The average American who has felt so powerless up until now.

As a matter of fact, the more average-American you are, the more power you have to influence events at this crucial moment in American history.

The Gallup poll of January 30 showed that 73% of the people want Congressional action to require the Government to bring home all U.S. troops from Indochina before the end of this year.

73% of the people. You can't get much more average-American than that.

Now all you have to do is ask for it.

If you speak up, it means that other Americans like you will speak up. But if you remain silent, you have no right to expect anyone else to open his mouth.

### Congress can and should act.

The battle of public opinion has been won. Now we must organize for a legislative end to the war.

The Congress of the United States should be the target of your message. It can legislate an end to the war. And members of Congress will do so if they know that is what the people want. Particularly the people from their own states and districts.

That is why it is so essential for your elected representatives to hear from you.

A major—perhaps historic—battle is beginning to shape up in the Senate and House to restore the Constitutional powers of the Congress. The Constitution of the United States asserts that the power to determine when and where we go to war rests with Congress, not the President. But recent Presidents have viewed this assertion lightly.

Many Senators and Representatives—Republicans as well as Democrats, conservatives as well as liberals—are profoundly concerned over the erosion of their historic powers under the Constitution.

As you read this, a bipartisan group of influential Senators and Representatives is working to restore the Constitutional role of Congress, and to exercise the authority they have under the Constitution to withhold war appropriations in order to get all our troops out of Indochina before the end of 1971.

Urge your Congressman and your two Senators to join this movement. Tell them that we want all our armed forces and our prisoners of war withdrawn from Indochina no later than December 31st, 1971. They can do it.

### Appoint yourself a committee of one.

Ask everyone you know to write. Remember: 73% of your fellow citizens are against this war and want us to get out. But they don't know what to do about it.

You can help them make their voices heard.

Write to the newspapers about it. Call up the talk shows and DJs on your local radio stations. Use your imagination!

### Common Cause is bringing fresh forces into the battle.

Common Cause is the new citizen's lobby organized in September by John W. Gardner, former Secretary of Health, Education & Welfare.

We already have a cadre of more than 115,000 active members in every state of the union, and we are growing at the rate of 1,000 new members a day.

We have experience in lobbying. We are organized to tackle tough issues and fight them through.

To give you an idea of the scope of our efforts, Common Cause is running this

*A recent  
Gallup poll showed:*

**73% of the people  
want all our troops  
brought home by the  
end of this year.**

*Can you imagine  
what would happen  
if they all spoke up?*

full page advertisement currently in the following newspapers:

Atlanta Journal/ Constitution	New York Times
Boston Globe	Omaha World Herald
Chicago Sun-Times	Phoenix Republic
Christian Science Monitor	St. Louis Post Dispatch
Denver Post	Salt Lake City Tribune
Los Angeles Times	San Francisco Chronicle/Examiner
Minneapolis Tribune	Seattle Times
National Observer	Washington Post

And this is only the beginning.

This is a powerful, broadly-based, Middle of the Road movement to end the war. Pro-war elements like to claim that only a "fringe" of the American people is anti-war. But 73% isn't a fringe. It's the Middle of the Road. The movement has strong and responsible backing within the halls of Congress.

### We can win this.

On the basis of soundings that we have taken in the Senate and the House, we believe that this fight can be won.

The American people want this end-

less war to end. They want all the soldiers home. They want the prisoners released.

In contrast, the President has not only not set a date for complete termination of our involvement, he has never said flatly and explicitly that he ever intends that all American military forces be withdrawn from Vietnam.

If we can end this disastrous war even one day sooner, it will be worth our best effort.

### If you want to do more...

join us in Common Cause, the new citizen's lobby.

Common Cause is independent and non-partisan, a third force in American life, but not a third party.

It aims to revitalize our institutions of government and make them more responsive to the people.

It defends the public interest against all encroachment, particularly by the special interests that dominate our lives today.

It believes that politics had better become "everybody's business".

Our members played a leading role in the fight to defeat the SST.

We were in the thick of the battle to reform the Congressional seniority system, in which significant changes were made for the first time in 25 years.

We have filed suit against the major political parties for violation of election campaign spending laws.

We invite you to join us in Common Cause.

We cannot and should not depend on big contributors. The money to support our work must come from the members themselves.

Therefore we ask you to enclose a check for \$15 with your application.

With a large and determined membership, we can help end the war and begin to rebuild America.

**Common Cause**  
2100 M St., N.W., Washington, D.C. 20037  
Tel: 202-293-1530

I would like to become an active member of Common Cause. I understand that my annual dues will be \$15, which will help support the work of the organization. (Husband & wife may both join under a single membership.)

Check enclosed.  Bill me.

I want to do more: My check also includes a contribution to Common Cause of \$100 \$50 \$25 \$10. Other \$ \_\_\_\_\_

I would like to pass this ad around to my friends. Please send me \_\_\_\_\_ copies.

Name \_\_\_\_\_  
Address \_\_\_\_\_  
City \_\_\_\_\_ State \_\_\_\_\_ Zip \_\_\_\_\_  
Phone number \_\_\_\_\_

**Common Cause**  
John W. Gardner, Chairman



**Dave Wollin**  
joined ACM for  
more than meet-  
ings, lectures  
and technical  
publications.

## As "Grass Roots" Goals Committee Chairman, he's battling the blame- the-computer syndrome.

David Wollin, B.S. Engineering Science, is a Senior Systems Analyst with a ticket reservations systems service, developing application software. He joined ACM in 1966, fresh out of college. "After four years, I wanted more involvement as a computer professional," says Dave. "More than meetings, lectures and technical publications. ACM seemed sort of clannish. I felt the average member wasn't encouraged to participate.

"Last October I wrote ACM President Walter Carlson with some specific

suggestions. Now I'm heading the newly-formed "Grass Roots" Committee. Our job is to critique ACM's proposed goals on membership development, special interest activities, EDP curricula and public education. And come up with other goals we think are just as important.

"This effort could mean a lot in the next few years. I've wanted to speak up on some things that have been bugging me. Things I see ACM taking a stronger stand on. Like people blaming mistakes on the computer.

The need to cut down on hard copy to avoid waste. The privacy issue. The whole question of the computer's impact on society, I guess."

Dave is only one of 27,000 members of ACM, the oldest and most respected professional association in the computer field. He's enriching his career. Making a contribution to the computer profession. And being heard.

Look into joining ACM. Fill out and mail the coupon today.

Association for Computing Machinery  
1133 Avenue of the Americas  
New York, New York 10036

I would like to consider joining ACM.  
Please send more information.

Name \_\_\_\_\_

Position \_\_\_\_\_

Address \_\_\_\_\_

City \_\_\_\_\_ State \_\_\_\_\_ Zip \_\_\_\_\_

# acm

Association  
for Computing  
Machinery