

コンピュータ

道

COMPUTERS  
THE WAY OF  
THE FUTURE  
FOR THE FAR  
EAST .....

# COMING ON STRONGER!



The professionals who originally specified disk packs bearing the Caelus® trademark have continued to reorder. And reorder. Not because Caelus is lowest

in cost, but because Caelus is highest in value. This same commitment to excellence stands behind the new series of Caelus disk cartridge drives.



**CAELUS® MEMORIES, INC.** P.O. Box 6297, San Jose, California 95133. Telephone (408) 298-7080

CIRCLE 1 ON READER CARD

# Tell a friend about Colorado Instruments.

**Better yet—send us his name.  
We'll send him complete literature  
and tell him ourselves.**

We're the best in source data collection systems, although most of your friends probably don't know we exist. We've been "off in a corner" perfecting!

But we've proven ourselves to a number of the country's leading companies.\* By solving some problems in simple ways that would intrigue you. So we're ready to widen our circle—show a lot more people how we can fill the gap between them and their computers.

Our systems are uniquely designed for speed, accuracy and reliability. They collect data directly from its source—the man on the job—and transmit it to the computer. On-line. Or off-line.

By eliminating the need for keypunching, record keeping and pad-in-hand inventories,

they eliminate man-hours. Increase accuracy. Decrease costs.

They are simply designed. And easily operated. Modularly designed. And easily adapted.

Here, we can only touch upon a few of the advantages of our brand of source data collection. At your convenience we'll demonstrate them all.

So you can tell a friend about Colorado Instruments.

You can tell him how we've helped others solve their problems. With time and attendance recording. With production reporting. With inventory control and materials ordering. With purchasing and receiving.

More important, you can tell him how we can help him!

\*Names available upon request

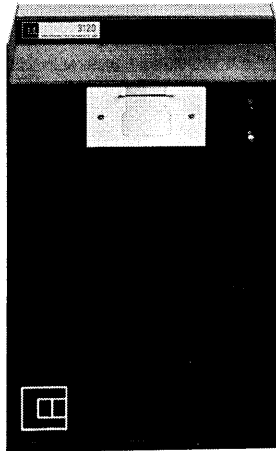

3120 BADGE READING STATION

**Filling the gap between people and computers.**

**COLORADO**  **INSTRUMENTS**

ONE PARK STREET • BROOMFIELD, COLORADO 80020 • (303) 466-1881

CI-342

February 15, 1971

CIRCLE 4 ON READER CARD

Rent or buy our  
extraordinary  
page reader  
and get a \$150,000  
document reader

# FREE

That's what you get when you  
install the new Scan-Optics  
20/20™ page/document reader.  
Because the 20/20 is two  
OCR's in one!

And that's not all. The 20/20  
processes both pages and multi-  
line documents, at extremely high  
throughput rates (like 110 full size  
600-character pages per  
minute) . . . and at a low cost

that'll please your Controller.

Other 20/20 features and advan-  
tages? The best cost/perfor-  
mance ratio (less than 1/2¢ per  
1000 characters processed) in the  
whole industry . . . and that takes  
data to mag tape. Off-line opera-  
tion. Direct conversion of your  
for add-on options. Modular design.  
Comprehensive software.

Even more . . . but see for your-  
self. Call 203 289-6001 for an eye-  
opening demo. Or for starters,  
send for our brochure and specs.  
Scan-Optics Inc  
Prestige Park  
East Hartford  
Connecticut 06108

When was the last time you were  
offered a \$150,000 document  
reader FREE?

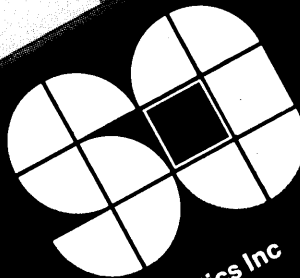
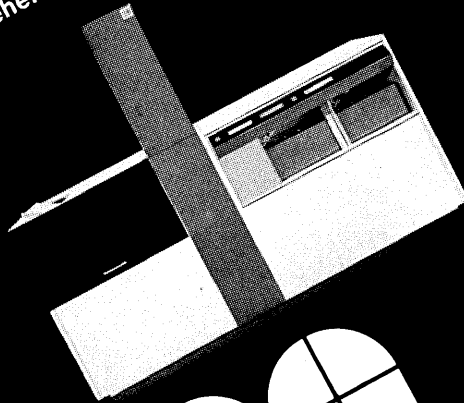

Scan-Optics Inc

# DATA MATION <sup>71</sup>®

FEBRUARY 15, 1971

volume 17 number 4

## GENERAL

### 22 Nippon Computing Nears Take-off Time

Late to enter the edp field, Japan is now showing signs of being ready to move.

### 26 Software in Japan: Supported Growth

Industry takes advantage of a new law as they team with government to expand and develop edp.

### 30 A Mixed Tale of EDP in Taiwan

Their systems analysts and programmers are skilled, but the applications remain low-leveled on Taiwan.

### 41 IFIP in Amsterdam

A Conference Report.

## MANAGEMENT

### 36 Credit Clearance's Slow Change to EDP

A little positive thinking may enable you to re-deploy your old resources when you switch to edp—and speed the conversion in the bargain. A close look at one industry that's in the process.

## COMMENTARY

### 47 Perspective

Possibly the only "computer genius" who is also president of a leading educational institution, Dartmouth's John G. Kemeny talks about the college's time-sharing service, its use by students and faculty, its future in both education and business, and wonders how any executive can get by without a computer.

### About the Cover

With its bold fusion of old and new symbols, Barbara Benson's design reminds us that while the way to the good life for the ancients lay through tranquility and contemplation, the computer is pointing toward a new way for the orient today. The watchword: make way.

### departments

<i>Letters to the Editor</i>	9
<i>Look Ahead</i>	17
<i>Perspective</i>	47
<i>News Scene</i>	52
<i>Hardware</i>	62
<i>Software</i>	73
<i>Literature</i>	81
<i>Washington Report</i>	85
<i>People</i>	89
<i>Index to Advertisers</i>	94

## DATA ENTRY TERMINAL

DOES DATA ENTRY COST YOU LOTS OF \$\$\$? If you don't have a terminal at all points of data origin—data handling and preparation may be costing you more than it should.

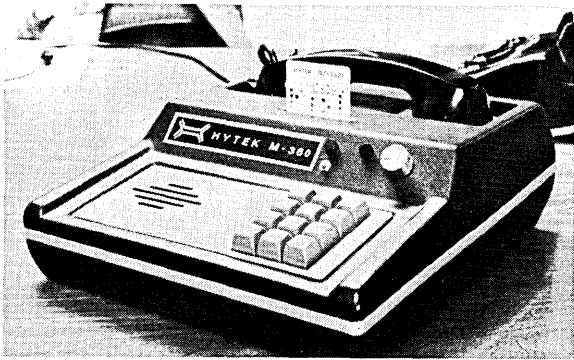

The Model 360 is finding applications in accounting, banking, libraries, schools, hospitals, production shops and many others.

Data entry is with a 12 key keyboard and an electro-optical card reader. Data transmission is through any standard telephone.

The terminal is available now—with or without the card reader. Prices starting from \$236.00 to \$495.00.

### Hytek Technology, Inc.

13239 Northrup Way  
Bellevue, Wash. 98005  
(206) 747-5627

CIRCLE 22 ON READER CARD

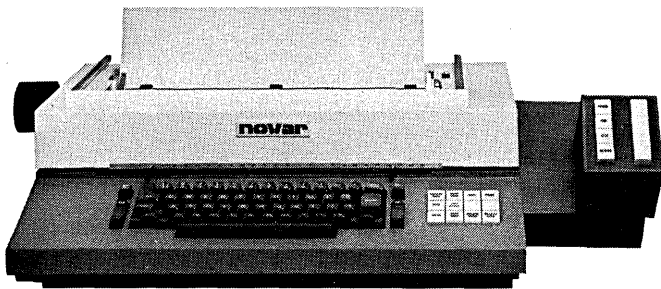

This terminal can be equipped to "carry on" automatically — at any hour and without an operator. It can transmit data, or receive data at high speed from a computer and print at night to be ready for the next day. Ask about Unattended Operation capability.

Novar Corporation • 2370 Charleston Road  
Mountain View, Calif. 94040 • (415) 964-3900  
Nationwide Service In 56 Cities

# NOVAR

A Member of GT&E Information Systems, Inc.

CIRCLE 29 ON READER CARD

# DATAMATION®

FEBRUARY 15, 1971

volume 17 number 4

This issue 110,901 copies

## EDITOR

ROBERT B. FOREST

## EDITORIAL STAFF

### Managing Editor

Senior Associate Editors  
Associate Editors

### Copy Editor

Assistant Editors

### Special Features Editor

Eastern Editors

New England Editor

Washington Editor

Midwestern Editor

European Editor

Australian Editor

Contributing Editors

EDWARD K. YASAKI

WILLIAM J. ROLPH, TOM McCUSKER

AUBREY DAHL, RICHARD A. McLAUGHLIN,  
EDITH D. MYERS, JOHN T. WATERHOUSE

JANET EYLER

MICHAEL WILLIAM CASHMAN

ALMA O'STEEN

ANGELINE PANTAGES

JOHN WESSLER, F. BARRY NELSON

W. DAVID GARDNER

PHIL HIRSCH

LAWRENCE RAGAN

PEARCE WRIGHT

FREDERICK A. BLAND

HOWARD BROMBERG, ROBERT V. HEAD,

PHILIP H. DORN, LOUIS B. MARIENTHAL,

DANIEL D. McCracken, F. G. WITHINGTON,

PAUL ARMER, ROBERT P. BIGELOW

ROBERT L. PATRICK

LOWELL AMDAHL

### Editorial Adviser

Technical Consultant

## EDITORIAL OFFICES

HEADQUARTERS: 94 S. Los Robles Ave., Pasadena, Calif. 91101. Phone: (213) 681-8486; EASTERN: 35 Mason St., Greenwich, Conn. 06830, (203) 661-5400; 19 Marlborough St., Boston, Mass. 02116, (617) 267-9414; 9805 Singleton Dr., Bethesda, Md. 20034, (301) 365-8671; MIDWESTERN: 407 S. Dearborn St., Chicago, Ill. 60605, (312) 922-8245. FOREIGN: 65, Hill Road, Chelmsford, Essex, England; 322, Park Regis, Park St., Sydney, NSW 2000, Australia.

## GRAPHIC DESIGN AND PRODUCTION

Art & Production Director

Production Manager

Production Assistants

CLEVE MARIE BOUTELL

MARILEE PITMAN

GLORIA J. FASANA, LOUISE T. O'CONNOR

## CIRCULATION

35 Mason Street  
Greenwich, Conn. 06830

Circulation Manager

Marketing Research Director

MAE VAN RENNES

DOUGLAS DeCARLO

## PUBLISHER

GARDNER F. LANDON

ASSISTANT PUBLISHER

JAMES M. MORRIS

Circulation audited by  
Business Publications Audit



Member, American  
Business Press, Inc.



DATAMATION is published twice monthly on or about the first and fifteenth day of every month by Technical Publishing Company, 1301 South Grove Ave., Barrington, Illinois 60010; Arthur L. Rice Jr., President; Gardner F. Landon, Executive Vice President. Executive, Circulation and Advertising offices, 35 Mason Street, Greenwich, Conn. 06830 (203) 661-5400. Editorial offices, 94 So. Los Robles Avenue, Pasadena, California 91101. Published at Chicago, Ill.

DATAMATION is circulated without charge by name and title to certain qualified individuals who are employed by companies involved with automatic information handling equipment. Available to others by subscription at the rate of \$25 annually in the U.S. and Canada. Reduced rate for qualified students. Foreign subscriptions are on a paid basis only at a rate of \$38 annually. No subscription agency is authorized by us to solicit or take orders for subscriptions. Controlled circulation paid at Columbus, O. and Form 3579 to be sent to Technical Publishing Company, P.O. Box 2000, Greenwich, Conn. 06830. Copyright 1971, Technical Publishing Company. Microfilm copies of DATAMATION may be obtained from University Microfilms, Inc., 313 No. First St., Ann Arbor, Michigan.

Printed by Beslow Associates, Inc.

DATAMATION

# New

## HARD COPY UNIT



4601 HARD COPY UNIT with T4002 GCT

### *Permanent copies from the Tektronix T4002 Graphic Computer Terminal and . . .*

This New Hard Copy Unit produces copies *directly* from Tektronix Storage CRT's. Operation is easy. At the push of a button or upon programmed command, your computer outputs are permanently recorded on reproducible copies. In just 18 seconds a high resolution copy of even complex displays is ready for use.

Now, information from your computer is quickly copied for distribution to management and office personnel. These copies are ideal for portfolios and permanent records—and serve as a quick, inexpensive method to keep business clients and associates informed with current information.

COPY COST is less than 8 cents per 8.5 x 11-inch copy, depending upon usage.

When people who have a need to know can't come to see the computer display, send them a copy. With the 4601 Hard Copy Unit you'll have a quick, easy, low-cost way to record and send information when and where it's needed.

For additional information, contact your Tektronix Field Engineer or Application Engineer: or write to Tektronix, Inc., P. O. Box 500, Beaverton, Oregon 97005.

4601 Hard Copy Unit . . . . . \$3750  
T4002 Graphic Computer Terminal, less interface . . . . . \$8800

Available in U.S. through the Tektronix lease plan  
U.S. Sales Price FOB Beaverton, Oregon

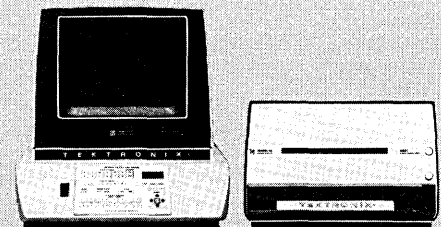

*. . . the T4005 Graphic Display*

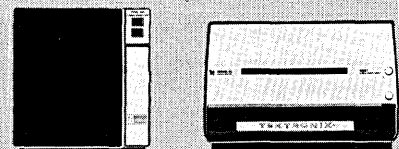

*. . . the 611 Storage Display Unit*



**TEKTRONIX®**

committed to  
technical excellence

# XEROX PRESE

**How you see it.**

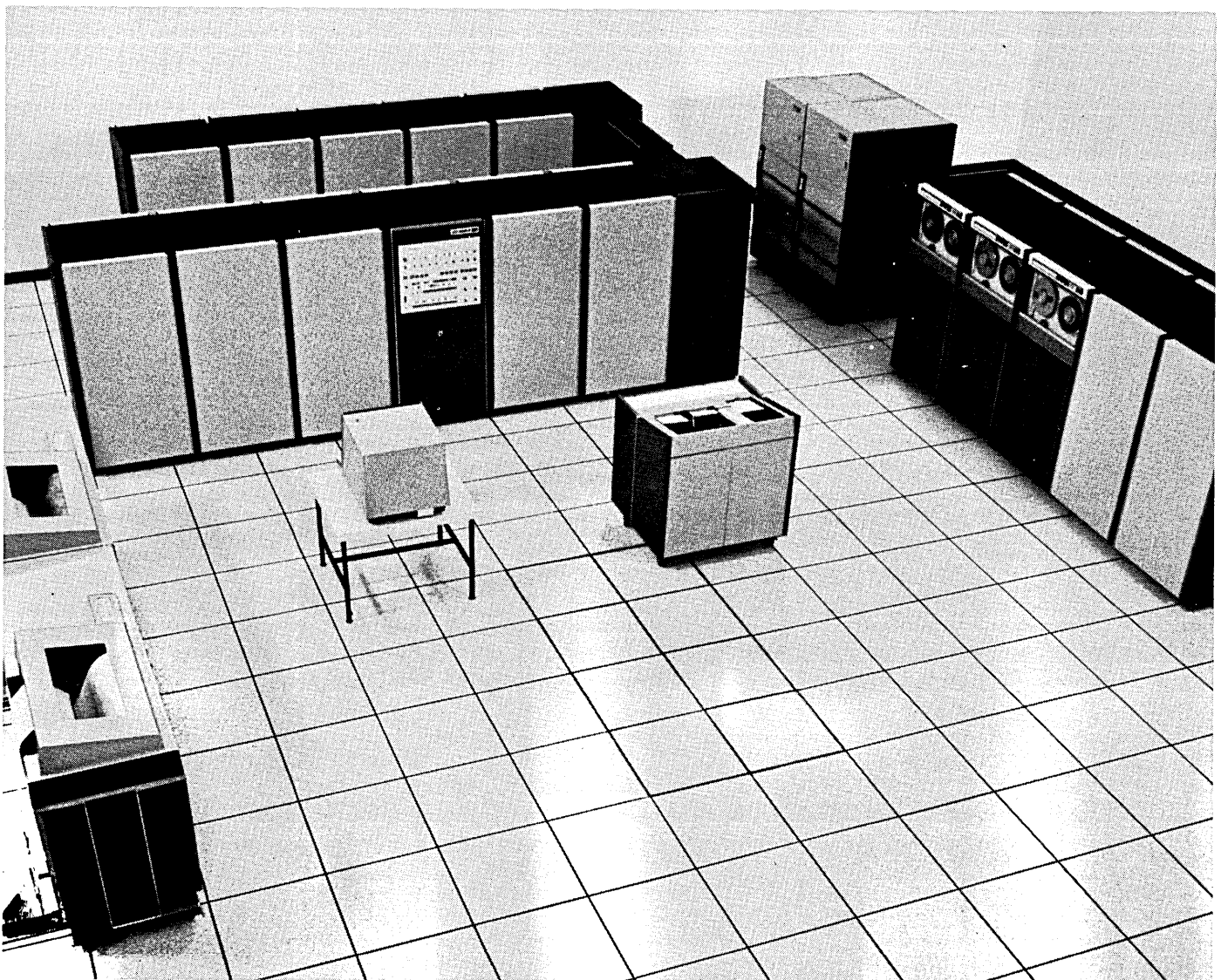



# NTS SIGMA 9.

## How we see it.

Sigma 9 is a powerful computer—up to 2,048,000 bytes of directly addressable memory. It is fast—up to 1,200,000 instructions per second. It performs equally well in transaction-oriented, multiprogramming business environments and in real-time scientific/engineering applications.

Following are some of the features we've put into Sigma 9 to make it a remarkable hardware-software system:

**Two proven operating systems.** A system for the batch-oriented user who needs extensive file-management and communications capability, plus time-sharing, and one for the customer who wants a lot of time-sharing terminals (up to 128) and also has batch and real-time requirements. In addition, all the software systems proven on Sigmas 5, 6 and 7 run on Sigma 9.

**Multi-use.** Sigma 9 is a true multi-purpose system. It can perform commercial data processing, scientific operations, extensive time-sharing, and real-time monitoring and control—all concurrently, with responsiveness, flexibility and efficiency. It can be configured to precisely suit each user's requirements and easily reconfigured as needs change or grow.

**Fail-soft hardware and software.** Sigma 9 is designed for maximum availability. If a failure occurs in an element of the system, the error can be quickly identified and the system reconfigured to continue operating. Parity checking is provided on all bus transmissions. Snapshot registers enable quick diagnoses of error conditions.

**More throughput per dollar.** Sigma 9 is priced in the medium range, but its performance surpasses far more expensive systems. Its architecture is memory-oriented. All input/output is handled by independent, asynchronous I/O processors, leaving the CPU free to compute. Hardware mapping registers provide highly efficient memory management.

**Compatibility and growth.** Sigma 9 is upward-compatible with Sigmas 5, 6 and 7. All user software for the smaller Sigmas runs unmodified on Sigma 9, and the peripherals are also compatible. Thus Sigma 5, 6 or 7 users can move up to Sigma 9 without growth pains, and Sigma 9 users can grow too—adding memory, peripherals—and eventually even CPU's, for Sigma 9 is designed for multi-processing.

Sigma 9 deliveries will begin in mid-1971, but you needn't wait to enjoy the unique Sigma advantages. You can order a Sigma 9 now, and we will install a Sigma 7 immediately. Then when your Sigma 9 is ready you can switch over without missing a byte.

**XDS**  
Xerox Data Systems  
El Segundo, California

Xerox is a registered trademark of Xerox Corporation

**To obtain the real-time system  
you need, you must convert  
from DOS to OS, or BIAM  
to QIAM, or QIAM to TCAM,  
or to CICS, or to IMS.**

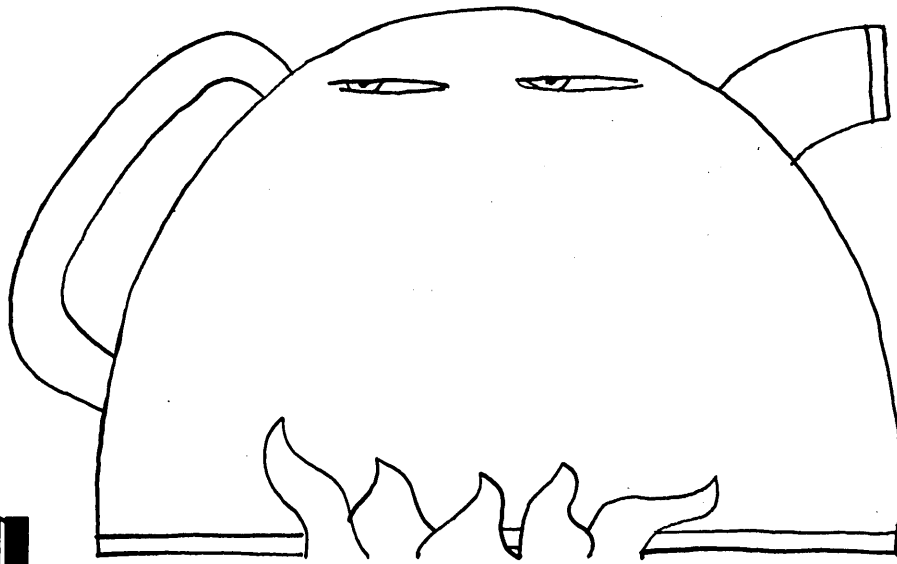

**And a  
watched pot never boils.**

A major liability inherent in most real-time installations is the seemingly endless necessity for conversion. This is because the previously available software has all been stopgap.

There's a better way: an operating system called ENVIRON/1, the first of the 4THWARE products from ISS. It is designed to grow as you grow without reprogramming. ENVIRON/1 can hold your System/360's response time down to three seconds regardless of how often you enlarge the system — or how many terminals you add.

ENVIRON/1 does more than improve your terminal system. In actual use the ENVIRON/1 data management system has shown a 30% increase in job throughput over IBM's ISAM. And our sequential access method shows improvement of 3 to 40 times over IBM's sequential access methods.

If you'd like to get your terminal system out of the dark ages and see the response time you were promised, contact us.

**ISS**

Information Storage Systems, Inc.

SOFTWARE PRODUCTS □ 10435 North Tantau Avenue □ Cupertino, Ca. 95014 □ (408) 257-6220



# LETTERS

## Smutter's day

Sir:

In the Nov. 15 issue, you carried a letter complaining of a dirty article published in the Sept. 15 issue under the title "A New Constrained Art Form: The Hexadecimal Core Dump." This is to inform you that we have reviewed the article in question and find that any pornography contained is purely an octal illusion.

JAMES W. COX

*Vancouver, British Columbia*

## Is Dorn going ape?

Sir:

Mr. Philip A. Dorn says (Jan. 1, p. 22) that "the computer is becoming a standard target for . . . hypersensitive civil libertarians . . ." I wish to take exception to that statement. I think that the thing bothering today's civil libertarians is the *uses* that computers have been put to in certain cases.

Most of us (computer professionals and civil libertarians alike) are well aware of the excesses of some computer users in this area. For every one of the common stories about computer foulups in everyday business (D.D. McCracken, same issue) there could be related a story about the abuse of individual rights and violations of privacy due to such noncaring users.

Examples abound: The various armed forces have been in the news recently for maintaining files on dissenters (not criminals, just those who are outspokenly opposed to whatever policy happens to be). DATAMATION has published an article showing how, by clever application of the theory of sets, one can gain access to information that would otherwise be restricted. It has been reported that people who reject junk mail from a computer list are placed on a crank list, only to be the unwilling targets of advertisements for guard dogs, tear gas pens, alarms, and the like.

As any reasoning being does, I applaud mankind's progress. However, the computer, like any new tool, must be applied with sound judgment in moral areas, as in all other areas. A growing number of persons

associated with computers have these concerns in mind. Hence, the founding of Computer People for Peace (which also concerns itself with social implications and applications of computers that may be against the public interest). The computer is unlike any of mankind's other tools in that it is often an aid to thought, planning, and calculation. I suggest that Mr. Dorn read Aldous Huxley's *Ape and Essence*; perhaps he'll become a little hypersensitive himself.

DAN TANNER  
*Indian Mills, New Jersey*

## Unmasked

Sir:

I am concerned about an inference in the first paragraph of the new product announcement of the Dest Data Corp. model 220 scanner/digitizer (Dec. 15, p. 80). Readers may assume by the use of the word "masquerading" that our firm attempted to "pass the unit off" as an ocr device. Our device is a scanner and digitizer which does not require any special or organized input to function. The DSD-220 will function as an ocr input unit only with appropriate software packages, which we do not currently provide.

MARVIN C. MARKER

*Dest Data Corp.*

*Sunnysvale, California*

## Seven year scratch

Sir:

R. A. McLaughlin ("Fading Species," Nov. 1) erred when he reported that an operational UNIVAC II still exists at the New York Telephone Co. in New York.

It is with deep regret that I must advise you that our "old faithful" has, after almost seven years with us, passed to an ignominious demise; namely, the scrap heap.

At 1600 on July 15, 1970, Mr. John Lowe, General Methods Engineer, cut the main power to our "adopted" friendly giant. This giant was originally saved from an earlier demise when we purchased it from the U.S. Dept. of Agriculture back in

Sept. 1963. In recent times it was kept alive by devoting one out of three shifts entirely to maintenance.

HOWARD E. ROSS

*New York, New York*

## Five the hard way

Sir:

As I peruse your latest (Nov. 1), I notice that on pp. 41-43, "Fading Species," Mr. McLaughlin finds only four remaining U-II's. If you count the fully operational U-II that Univac Federal Systems Div. keeps in its Minnehaha Ave. plant (Plant #2) in St. Paul, the count should be revised upward to five.

CHARLES J. CONNOY

*Morris Plains, New Jersey*

## Now museum, now y'don't

Sir:

The article "Fading Species" in your Nov. 1 issue is a most interesting treatment of the gradual fadeaway of the first generation UNIVAC I's and II's. We would like to point out that Univac contacted science museums throughout the country when we learned early in October that the last UNIVAC I was scheduled to be dismantled. The Smithsonian Institution requested a complete section of vacuum tubes from the walk-in central computer, plus a UNISERVO magnetic tape unit, a UNIPRINTER, which translated the data to printed form, a UNITYPERS, which was the first keyboard to tape unit, and six tape reels.

The requested portions, including a complete thousand-pound vacuum tube bay, were donated by Life and Casualty Insurance Co. of Tennessee, Nashville, Tenn., where the installation was located, and shipped to the Smithsonian's National Museum of History and Technology by Univac. They are expected to be added to the present display of portions from the original Bureau of the Census UNIVAC I.

We have also preserved a Mercury tank from the Mercury delay line memory. In addition, a delay line store, section of circuitry, and tape reel are being supplied to the Science Museum in London.

PETER R. SIGMUND

*Sperry Rand, Univac Division*

*Blue Bell, Pennsylvania*

*(Continued on page 11)*

# MOS.

## You get less, but it does more.

MOS encoding, coupled with proven solid state switch modules, brings new miniaturization and flexibility to MICRO SWITCH keyboards.

What you get less of are the things that can go wrong. Like discrete components. We've eliminated more than a hundred. Reducing behind-panel space.

And we've also reduced the number of solder connections. All of which results in a simpler, more reliable keyboard. At a lower cost to you.

What you get more of is the ability to generate just about any code. Because there's no need for logical pairing. And speaking of codes, up to four levels

can be produced from the same key.

Keyboard interaction with your system is expanded with features such as one-character storage, keyboard output inhibit and system shift. More than was ever possible before from a single keyboard.

You can get more information by calling or writing your MICRO SWITCH Branch Office.

### **MICRO SWITCH**

FREEPORT, ILLINOIS 61032  
A DIVISION OF HONEYWELL



HONEYWELL INTERNATIONAL: Sales and service offices in all principal cities of the world.

### Riding the range

Sir:

In the interest of accurate reporting to your readers I am writing to you about your lead article in the News Scene feature of the Dec. 15 issue. The UNIVAC 1710 does rent for \$155 a month. The UNIVAC 1701 VP does not rent for \$150 . . . it is \$102 a month.

The UNIVAC rental range is therefore \$102 to \$155 compared to the IBM range of \$125-\$150/month.

We have shipped over 20,000 units, and the market is holding very well for the VP and VIP.

A. GEILFUSS

Univac

Blue Bell, Pennsylvania

### The pun is mightier . . .

Sir:

I don't wish to antagonize *anyone*, but in reading your letters (Dec. 15), I need to make this observation.

I believe it is Mr. Doody who is missing the point of the Census. He has stretched his concern to the point of absurdity in wondering what sort of precedent we are setting in ceding "to the government the right to make us criminals . . ."

If Mr. Doody Jr. hasn't yet the decency of mind and character to *cooperate* in a tremendously huge, difficult, and worthwhile endeavor, I still hold hope that he will come to his census.

CAPT. CHARLES T. MILLER  
Sunnyvale, California

### Another for the net

Sir:

An item in the Nov. 15 issue under "Mergers and Acquisitions" refers to three companies that have organized an APL network. There are actually four companies: the three listed and APL Services, Trenton, N.J.

It will be much appreciated if you print this correction.

JOEL A. LAMB

APL Services, Inc.

Trenton, New Jersey

### The Kapur caper

Sir:

Re: "The Instant Programmer" (The

Forum, Nov. 15, p. 220).

Hurrah for Mr. Kapur!

Don't think for a moment that this sort of thing isn't having a very detrimental effect on the service bureau industry, also. "Black eye" might be more appropriate. I recently secured three bids from service organizations to do a relatively simple series of business-oriented reports. The programming bids ranged from \$3000 to \$15,000, and monthly processing charges from \$1100 to \$1900. Need I say more?

PAUL EDMONDS

St. Paul, Minnesota

### Hart attack

Sir:

I would like to correct an error which appeared in Mr. L. E. Hart's "The User's Guide to Evaluation Products" (Dec. 15, p. 32). The monitoring program PROGLOOK was developed by us. However, we do not distribute it. It is distributed by COSMIC at the Univ. of Georgia.

Along another line, I wish Mr. Hart had made the point that it is greatly to an installation's advantage to be able to do its own measurement. After all, a manufacturer like IBM is not likely to recommend less hardware to a customer as the result of measurements done by IBM analysts. Whoever pays the piper calls the tune!

RICHARD H. JOHNSON  
Stanford Linear

Accelerator Center  
Stanford, California

### Big time operators

Sir:

The article by Mr. Edward Yourdon in your Nov. 1 issue is of interest, not least to the many operators of computer bureaus in the USA and Europe. The conclusions he reaches must go a long way towards explaining the failures or withdrawals that are continuing to take place in the bureau field.

May I make the following comments:

On p. 26, Mr. Yourdon suggests a marketing approach designed to attract the larger customer as a possible means of achieving profitability. This suggestion touches on the key issues implicit in the whole paper, namely:

1) How much income can be

generated from the normal customer?

2) How is a customer defined—can he be larger?

*How much income can be generated from the normal customer?*

The relationship between connect time and compute time is one of the key ratios in this field. Time-sharing bureaus generally charge for the computer facilities required by the terminal user for the execution of his work plus a relatively small charge for connect time. The connect time charge is designed to cover the overhead costs involved in the operating system within the computer servicing the terminals which are connected to it.

A relationship of 60:1 between connect time and compute time is by no means unusual; i.e., for every hour that a user is connected by a terminal to a time-sharing bureau he is charged for one minute's worth of the computer facilities.

Such a relationship must mean that the income that can be generated from a terminal customer cannot be but low.

*How is a customer defined—can he be larger?*

The definition of a customer is not straightforward in itself. It is hard to avoid the conclusion that each terminal represents a separate customer since, with the growth of time-sharing services, it is increasingly possible for the terminal user at any particular time to switch from one bureau to another simply by dialing a new number.

This ability to switch around so easily may also explain the attrition rate of 5% per month. I would suspect that Mr. Yourdon's model does not allow for the customer just as easily switching back without any sales effort.

May I suggest that the solution to the problem of making time-sharing bureaus profitable lies in:

1) The ability of the bureau to generate more income per hour of connect time

2) The ability to handle concentrated remote batch or local batch work simultaneously with the time-sharing service and without degradation of either service.

BASIL COUSINS

New Malden, Surrey  
England



## Now, it's safely protected in the Wilson Jones Microform Retention and Retrieval System.

Ever hear the story of the microfiche that was lost? Or scratched? Or mis-filed? Not a chance if it's enclosed in a Wilson Jones transparent Mylar® jacket. Each jacket has a panel for an identifying right-reading title; and is thumb-cut for easy insertion.

In viewers of all kinds you see the micro-images with maximum clarity without removing the fiche from the jacket.

The Wilson Jones system includes 200 jackets, visible-punched for retention in the easel ring binder. Each holds 10 banks of 19 jackets...that's almost 19,000 24X (NMA) micro-images (or more at greater reductions) in one binder! And because titles of all jackets are in full view in seconds, quick reference and retrieval is a certainty. Indispensable for organizing modern microform libraries.

Talk to your office products dealer about the Wilson Jones Microform Retention and Retrieval System best for you. Or fill out the coupon at the right.

TM of E. I. DuPont Co.



### WILSON JONES

A Division of *Sunqline*® Inc.

Dept. D-2  
6150 Touhy Avenue • Chicago, Illinois 60648

Please send me your complete catalog describing 21 products for Microform Retention and Retrieval.

Name \_\_\_\_\_

Address \_\_\_\_\_

Firm \_\_\_\_\_

City \_\_\_\_\_ State \_\_\_\_\_ Zip \_\_\_\_\_

# Put a lock on your print-out problems

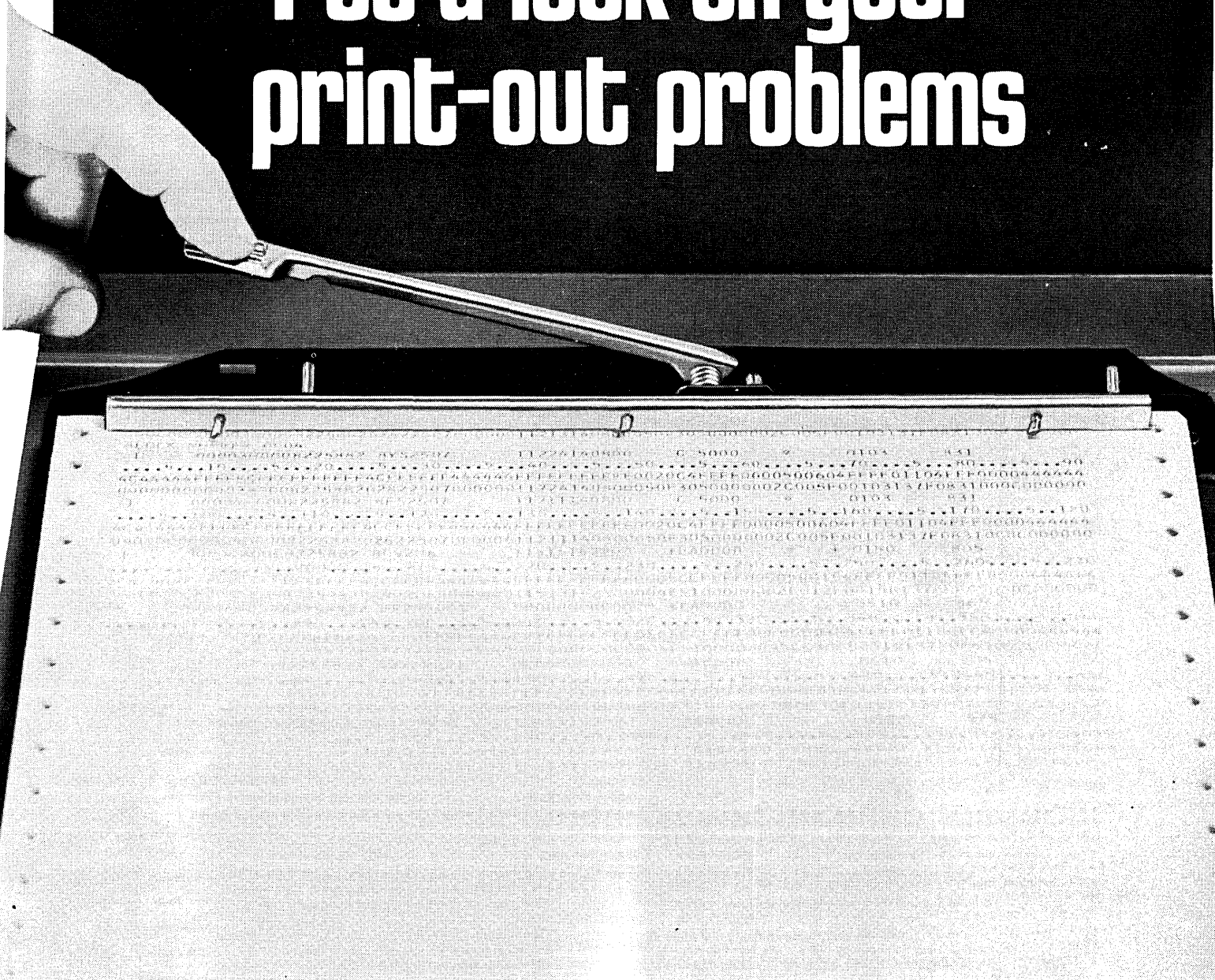

Press the lever in our new heavyweight Accodata binder and it springs open. Insert Forms. Push the lever down and Accogrip bar locks sheets in: burst or unburst. Instantly. No pin feed hole threading. A great time-saver for updating daily reports. Even different size sheets can be combined. In beautifully-textured 90 pt. Accohide\* or genuine pressboard. In 5 popular sizes. In 2 colors: blue and executive red. When you want binding as advanced as your computer, your Acco dealer has the details and so does our new 4/color catalog. You'll like the new Accodata-grip binder. Puts print-out in place. Properly.

**ACCO**



5150 N. Northwest Highway, Chicago, Illinois 60630; New York, Los Angeles, Boston/Canada/England/Holland/Mexico/Venezuela/El Salvador/Jamaica/Japan

\*A chemical resin.

CIRCLE 8 ON READER CARD

# We'll give you our no strings attached.

We'll give you a Cogar System 4™. The data-entry system with a heart. And a heart-shaped cartridge of magnetic tape. That snaps into the Cogar 4 tape deck. And programs the system at the touch of a key. So that the Cogar 4 becomes an advanced replacement for your present data-conversion equipment.

In your keypunch room, the Cogar 4 is the best of both worlds. It has all the automatic features of modern key-to-tape equipment. And all the advanced operator functions of sophisticated key-processor systems. But it comes with no strings. It doesn't have to be tied to a processor because it has its own processor built into each data-entry station. So there's no risk of a single failure shutting down your whole data-entry operation.

No strings means even more. It means, when you're ready, you can move your Cogar 4 out of the keypunch room. Back to remote locations where the source documents originate.

Now, at the touch of a key, you can program Cogar 4 for interactive operator instructions. And for fill-in-the-blanks data-entry. So that it can be used by shipping clerks, purchasing agents, secretaries. People

who don't know computers. But do know what the source document is all about.

And finally, the Cogar 4 can become an on-line communications terminal. So that you can send data from a Cogar 4 in the field to a Cogar 4 at headquarters. That means instant access to data originating at remote locations.

Keypunch replacement. Remote data-collection system. Communications terminal. Plus countless other business functions you can program into the system.

That's quite a lot for one desktop unit.

With no strings attached.

## **Cogar System 4: The data-entry system with a heart.**

Cogar Corp., Information Systems Div.  
Cosby Manor Road, Schuylers, N.Y. 13502  
(315) 797-5750

Please send me additional information on the Cogar 4 data-entry system.

Name \_\_\_\_\_

Title \_\_\_\_\_

Company \_\_\_\_\_

Address \_\_\_\_\_

\_\_\_\_\_ Zip \_\_\_\_\_

Phone \_\_\_\_\_

- I am interested in remote data entry
- I am interested in keypunch replacement
- I am interested in key-to-tape replacement

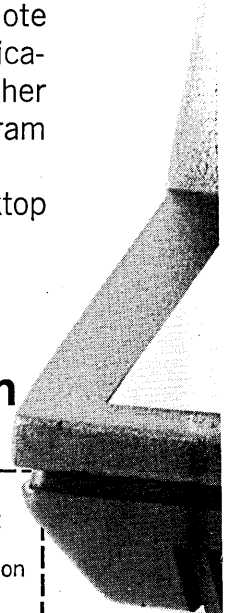



# heart with

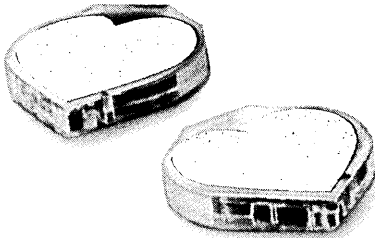

February 15, 1971

CIRCLE 53 ON READER CARD

# Our DTS 1010. The data system problem solver!



Your sophisticated, on-line data communications system can cause complex maintenance problems. But, maintenance responsibility often is divided. Trouble isolation is hard to coordinate. Down time can be a prolonged — and costly — problem.

That's why our DTS 1010 is so important to you. It isolates data communications system hardware problems. DTS 1010 is the advanced data test set now available from Noller — the computer extender people. It's the lightweight, compact field test instrument with laboratory accuracy that sectionalizes the data communications system. To help you find problems. In the terminal, data modem or the transmission circuit. So you can call the **right** people to restore service.

Fast. To save you time and money.

DTS 1010 has some other great features, too. And, it gives you far more for your money. If you don't know about it, you should. Write for our bulletin number 1013. Or call us. We'll be happy to send you the facts.

Contact our Manufacturing Facility and Main Sales Office at 150 East Standard Avenue, Richmond, California 94804, Telephone (415) 233-8220 or our Central Sales Office at 4545 West Brown Deer Road, Milwaukee, Wisconsin 53223, Telephone (414) 355-0400.

**NOLLER**

a division of Badger Meter Manufacturing Company

**DTS 1010** — the field data test instrument with laboratory accuracy.  Lightweight, easily stored under aircraft seat.  Fully interactive: provides bridging, termination or source simulation on 14 EIA-RS232 B and C leads; source simulation to and load simulation for data sets and terminals.  Simultaneously operates all leads independently.  Asynchronous data source is self-contained; bit rates are selectable.  Marginal control voltages and short circuits are positively indicated; marginal test voltages selectable for all leads.  Provides direct reading of bias distortion and peak jitter (characteristic distortion) as recommended in CCITT 3rd Plenary Assembly, volume 8.  Self-contained DB meter provides accurate line level measurements; balanced or unbalanced, bridging or terminating selectable on meter panel.  Furnished with audio speaker monitor plus headset jacks and test jacks for both EIA-RS232 B and C control and data leads and communications circuits.

# LOOK AHEAD

HONEYWELL'S BIG DRIVE  
MAY COME FROM MEMOREX

What's all the commotion between Honeywell and Memorex? At this writing, neither company would comment on reported negotiations over a disc drive similar to IBM's 3330. One report is that Memorex will produce a disc drive for Honeywell with specs similar to those of the 3330, but with a lower price tag. Some expect Honeywell to unveil the machine this month. Even if the Honeywell-Memorex disc drive does get the go-ahead, IBM should have no trouble delivering its 3330 first. IBM is aiming for late 1971, while Honeywell will probably be shooting for a third quarter 1972 delivery--assuming that IBM's suit to restrain Memorex from building a 3330 for 30 months is unsuccessful.

IBM TAKING MAXI TIME  
TO STUDY MINI MARKET

One reason for that lengthy lead time for IBM's minicomputer, the System 7: the computer colossus wants a good deal of time to study the mini market, a new business for IBM. If it likes it IBM will introduce at least one more of the minis it has on the shelf. The 7 has no user-oriented language and can only be used with large host IBM machines. Many believe there could be another IBM mini announced before the company starts deliveries of the 7 in November.

WANT AD PLACED  
FOR SDC CHIEF EXEC

One indication of where System Development Corp. is going was the recent appearance of a blind ad in the "Positions Available" section of the Wall Street Journal asking for applications for the post of chief executive officer of the firm. It isn't known what this portends for board chairman Bill Zisch, who is reported ailing, or president Wes Melahn, but in a recent president's letter to the employees, Melahn indicated that SDC had turned around in the push for profits, reported a net income of \$637K on gross revenues of \$22 million for the last six months of '70, compared to a loss of \$500K on revenues of \$28 million for the previous six months. The firm stated military business is down 19%, space is holding even, commercial is up.

HONEYWELL FACES T-S  
DECISIONS VIS-A-VIS GE

One of the unanswered questions in the formation of Honeywell Information Systems is the future of its overseas time-sharing operation. We hear HIS is now hammering out its plans. With the transfer of the GE computer operations to Honeywell, the ex-GE affiliates abroad kept their licensing agreements to market GE Information Systems Div. (ISD) packages on their own t-s systems. The guess is that HIS will set up a timetable of declining use of that arrangement, lasting until it can establish its own international centers. Of course, if it does, it will face GE overseas, which is certain to fan out abroad.

Latest guesstimated tally on GE's ISD intake for 1970: about \$50 million, up 35-40% over '69. Losses were "much less" than the red \$21 million of a year

## LOOK AHEAD

### DEC PROVIDES BITS OF ITS OWN COMPETITION

ago. An ISD spokesman said that its network plans are right on schedule and a sign of stability is the lack of personnel cutbacks since early '70. Honeywell's time-sharing revenues, by the way, are currently about one-tenth of GE's.

Digital Equipment Corp. is faced with something of a dilemma: the low-cost 16-bit version of the PDP-11 it is readying for announcement may be so cheap that it may impact its 12-bit machine, the PDP-8 line. As a solution, DEC has made a bargain-basement model of the PDP-8 which will help protect that 12-bit machine, if DEC decides to market it. The king of the minicomputer market has good reason to protect its 12-bit line. Unofficial computer census data from DEC is that the company is pumping out 250 PDP-8s and about 90 PDP-11s each month.

### LIBERALIZED DEPRECIATION CAN'T HURT

Liberalized depreciation rules--allowing up to 20% faster writeoffs--probably won't have much impact on the computer industry, though they can't help but do a little good. And they could influence the lease vs. purchase decision, by making purchases--or full payout leases which permit equivalent amortization--more attractive. About the only certainty is that firms which had already planned purchases can get a slight windfall. This assumes that the suit by Ralph Nader's law firm, charging that the Treasury acted illegally in changing the rules without advanced notice and public hearings, doesn't block the liberalization.

### ABOUT FACE FOR LOGIC CORP.

A small keyboard entry system is due for introduction in the next quarter by Logic Corp., Cherry Hill, N.J. This is a switch for the company which up to now has confined its efforts to big systems, one of them a 46-terminal key-to-disc configuration installed at an RCA facility near Cherry Hill. The company also claims it will turn the profitability corner next quarter after surviving five years with three public offerings, the latest gleaning \$1 million last September.

### RUMORS AND RAW RANDOM DATA

Those who were expecting IBM to announce a virtual memory for the 145 may not be disappointed after all. The machine was designed with virtual memory in mind--it's built into the microcode--and IBM can announce it at will. Some think it would make a particularly interesting product in time-sharing installations . . . We hear that announcement of the IBM 370/135 will come Feb. 16 . . . A video cassette terminal user who says the unit's manufacturer recommends its own \$3 cassette, has had no trouble so far with cassettes he bought in a drugstore for 66¢ . . . A note to temper enthusiasm of the key/tape/disc fans: IBM Poughkeepsie was still turning out some 5,000 keypunches per month late last year.

# Remember when people filed their mistakes in wastepaper baskets?



## Cybercom has changed all that.

For eighty-one years, the punched card has been man's solution to the problem of getting man-generated data into the computer.

The bulky punched card. The slow punched card. The ridiculous punched card.

Cybercom has the *now* solution. Key to cassette. Verify electronically. Convert to mag tape. Hand the tape to your computer. Stop and think about it. It makes sense.

Cybercom, 432 Toyama Drive, Sunnyvale, California 94086 (408) 734-3230



CIRCLE 34 ON READER CARD



If your office needs to take or send information up to 1200 words per minute, we have a way.

Our Dataspeed® Magnetic Tape Terminal.

It bridges the gap between low-speed keyboard preparation and high-speed on-line data transmission.

At the same time it reduces the cost of data transmission over regular telephone lines.

The data that is sent and received is recorded on a compact cartridge that has a capacity for 150,000 characters. And the tape is reusable once the information on it is no longer needed.

Besides communicating at high speeds, the terminal has a Forward/Reverse mechanism that can search for specific data on the tape at a rate of 4,000 characters per second.

And time-consuming correction procedures are cut to a minimum since individual lines or characters can be easily located and corrected within a message.

The terminal can be adjusted to answer calls automatically, too. Transmission can be sent and received over regular telephone lines (Data-Phone® service) or private line service.

Often at low-cost after-hour rates.

Call your local Bell Company Communications Consultant for information on how our Magnetic Tape Terminal can be implemented within your existing system without major redesign.

The American Telephone and Telegraph Company and your local Bell Company keep working to improve telephone communications.

This time by helping you communicate at speeds up to 1200 words per minute.



**Tora, tora, tora!**

# Nippon Computing

 In 1959 I rode a Boeing Stratocruiser that whisked me from California to Tokyo at the incredible speed of almost 250 miles per hour. When I boarded the Boeing time machine in California, the period was well into the second-generation computers. When I disembarked in Japan, the period was between the relay computer and the first-generation computer. Japan's first and only large relay computer used for calculations was completed in November 1955.

One's natural reaction to this situation is to wonder if some of the seemingly unnecessary stages that were blindly stumbled through in the original evolution of computers could be eliminated when the ultimate goal was known. My experience has indicated that although they cannot be eliminated, they can be passed through in a fraction of the time when the goal is known. The reasons for this are varied and complicated and perhaps in each geographical location and culture they differ considerably. The situation and conditions in Japan are certainly unique. An understanding of the culture and history will help in understanding this uniqueness and how it has affected the development of the computer industry.

Most foreigners have difficulty understanding the close relationship between the government and industry in Japan. From the outside it is difficult to know if it is the industrialist or the government that charts the path of industrial development. Through apparently unimportant talks, conflicts are settled, a path is chosen, and the full resources and effort of both industry and government are applied to the project. The unfaltering support the government has given

and is giving to the computer industry in the form of high import-duty and import restrictions is an example of this. Another example is the formation of JECC (Japan Electronic Computer Company) by the government to buy computers from the manufacturers and then lease them to the user to relieve the manufacturer of a large capital requirement. This strong government support for industry is unique among the democratic governments of the world.

## Influence and freedom

While the government does have a great influence on industry (by consent), let there be no mistake; industry is free to pursue its best interests in Japan. How else can we explain six companies squeezing into this one profitless, but potentially profitable, field. Each of these six companies has its own reasons for entering the competition, and these reasons have influenced their development and product line.

Three of these companies, Fujitsu, Nippon Electric and Oki, can be classified as manufacturers of communication equipment. They work closely with NTT (Nippon Telephone and Telegraph), a government monopoly. So long as this monopoly is maintained the business of these companies will be controlled by the movements of NTT. They are now, as you might surmise, directing their attentions toward data communications work. These three companies must, in their own manner, make computers effective in communications applications or lose the blessing of their number one customer, NTT.

The other group consists of the manufacturers of



# Nears Take-off Time

by Joseph C. Berston

heavy equipment, which includes Hitachi, Toshiba and Mitsubishi Electric. These companies have come to the realization that most heavy equipment installations now include a computer to control them; i.e., power plants, iron and steel plants. The computer becomes the heart of the system and therefore an important subsystem. To compete each must have the technical know-how to build and use effective control computers. It is difficult to imagine any one of these companies dropping out of the stiff competition for practical and company image reasons.

All six of these companies are competing to gain their share of the information processing industry. Their product line must not only meet special requirements imposed by their position, but must also offer some competitive advantages in information processing. All six at the present time have a tiger by the tail and can't let it go. All have been suffering from unprofitable computer divisions. As Toshiba's president recently said, "This is the transitional period and it is not yet the time to talk about its profitability."

These companies are making long strides and are gaining on the leader. In terms of cpu and memory technology they have just about caught up and may in the near future pass the U.S. in these areas.

Terms used in the computer industry have different meanings to different people, so let me start by defining the terms as I will use them. A "time-sharing" computer is one that is capable of being used by more than one person at the same time in such a way that each user feels he is the only user. Implicit in this definition is the need for an independent terminal for

each user. This terminal may vary from a simple typewriter to another computer. Remote time-sharing means the terminals for the users are not in the proximity of the time-sharing computer. Remote terminals over 4,000 miles and an ocean away from the computer have been successfully used. Terminals at this distance are usually for demonstration only; however, there are installations using remote terminals 3,000 miles away in daily use throughout the United States. The general limit on a practical distance is about 1,000 miles, but special conditions can make any distance economically practical. No city in Japan is over 1,000 miles from Tokyo and therefore distance is no real problem.

Time-sharing service centers have come of age in the United States. In talks with authorities on my last trip, it was said that about 8% of the computers in the U.S. are used part time as time-sharing computers. The time used in the time-sharing mode may vary from a few hours to full time.

There has been an explosion in demand and installation of time-sharing computers. The number of centers has increased at such a rapid rate that ADAPSO has formed a separate group for time-sharing service centers to prevent the formation of a new organization. Some authorities have estimated that by 1973 as high as 80% of all computers will be used as time-sharing computers.

## Time-sharing in Japan

What is the status of time-sharing in Japan? At present there is one commercial time-sharing service

center in Japan. It started limited operation on September 1, 1970. The banks, some of the universities, and a few companies are struggling to do some time-sharing, but it is certainly limited. Japan is presently eight or nine years behind the U.S. in developing time-sharing capability and is six to seven years behind Europe.

The Japanese government has carefully nurtured and encouraged the computer industry. Then why this delay in the introduction of time-sharing computers? What an embarrassing position to be in; on the one hand fostering modernization and on the other hand restricting the development of a service that is forecast to account for up to 80% of future sales.

The strict monopoly practices and attitudes of NTT to reserve this apparently profitable business exclusively for itself is, of course, the reason. The government must share in the responsibility because of its support of the NTT monopoly. Private capital has been ready to develop this field for the past six years. Talks were conducted with NTT and the government as early as 1964, but the results were not favorable. As a result no private capital has been used and the resources of NTT, both financial and personal, have not been sufficient to develop time-sharing.

Utilizing its existing telecommunication network, NTT is now developing a National Datacommunications Service (NDS) on which it plans to spend \$450 million through JFY'72. A simple version was offered to the public in the Tokyo area from September 1. It is scheduled to be expanded in scope and to include the Osaka area by the second half of JFY'70 and extended to Nagoya at a still later date. The system will eventually offer the following services:

1. *Simple computer service.* According to NTT officials, this service is designed primarily to eliminate the electronic desk calculator (and perhaps even the abacus) of the small shopkeeper and business office. The user's only terminal equipment will be a special telephone which can be used both for placing ordinary calls and for making relatively simple arithmetic calculations.

2. *Sales/inventory service.* This service will enable a manufacturer or seller handling a limited number of easily coded items to keep track of sales and inventories on a current basis. The cost of the service will be based on a flat charge for each invoice or transaction processed through the system. The service would not be useful to a supermarket or other organization handling hundreds or thousands of different items not easily coded for individual transactions.

3. *Scientific computations.* This service will provide the use of "canned programs" with standard formats to be charged to subscribers on the basis of actual machine time utilized. Probable examples include linear programming (transportation models, etc.), statistical correlation programs, standard engineering models, etc. Since only standard programs may be run, terminal computers will not be needed. The use of existing telephone circuits will limit the speed of input and output to 1,200 bps (too slow for major scientific problems). According to NTT officials, machine time will be too expensive for using this service for payroll automation or other administrative tasks.

A major concern of computer users and manufacturers along with government planners is that NTT's

financial resources will be insufficient to develop time-sharing and make it available, at reasonable rates, to the large number of potential end users. In part this concern stems from the fact that there are 2.5 million Japanese who have previously applied for installations of ordinary telephones and are still waiting. All these applicants are willing to buy a \$280-420 user bond to obtain a telephone. The concern is if NTT cannot adequately supply the demand for telephones, its basic service, how can it provide adequate time-sharing? Because of this experience, many doubt that NTT will be able to single-handedly provide an adequate data communication system for Japan. NTT officials themselves admit that the \$450 million the company plans to spend during JFY'68-72 on its NDS is "not enough"; as in the case of its telephone services, the corporation plans to finance a significant proportion of development cost by mandatory user bonds.

## Of strength and weakness

Strength can foster weakness. The strong government control and support that have made possible the rapid strides in developing the Japanese computer industry now threaten to stifle development of time-sharing in Japan. Nippon Telephone and Telegraph is able to maintain a monopoly in developing time-sharing because they control the communications circuits throughout Japan and are steadfast in their refusal to allow others to offer time-sharing services to the public over their circuits. A number of companies have requested communication lines linking their computer to customers. All such requests to date have been denied. Although the government is presently allowing NTT to refuse such requests, this support is showing some signs of weakening and a change in attitude seems to be in the process of being made.

My last trip to Japan was again in a Boeing—this time a 747. The improvement in speed and comfort was notable. The Japanese computer industry is no more likely to allow itself to be trapped in an anachronistic second-generation position by the NTT monopoly than were the airlines. Like the airlines, the computer industry knows the big, fast, commodious new machines are there—and they're ready to fly. ■



Mr. Berston, vice president, Far East Region of Com-Stute Inc., is responsible for the activities of the company in Japan. He has been assigned to various computer projects in the Far East since 1959. He is a member of the Association for Computing Machinery and the British Computer Society, as well as the Information Processing Society of Japan. He holds a BS in mathematics from Michigan State Univ. and an MS from Purdue Univ.

These characters illustrate only a few of the elegant, distinctive type faces you can select on the Bright Industries' BI 1215 Bar Printer. Bodoni, Century, Cooper, Futura, Franklin — each imparts its own flavor to a faultless printout.

These characters print crisply, cleanly at 300 lines per minute, with a precision no other line printer can approach. The BI 1215 accommodates fonts of 64, 96 or 128 characters, up to one-quarter inch high; fonts can be changed in the field in minutes.

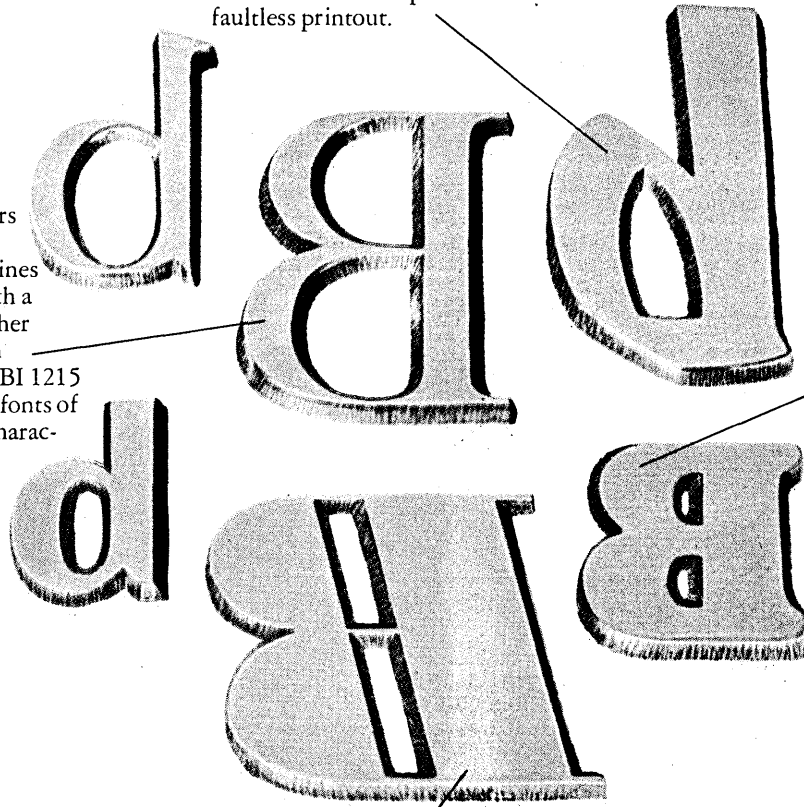

These characters print with such an exact vertical and horizontal alignment that the BI 1215 can go back to overprint, underline or add phonetic symbols. Only an oscillating bar printer with an individual hammer for each column can achieve a printout so exceptional you'd be proud to sign your name to it.

These characters permit you, through your selection of typeface, to express the lifestyle of your company in every communication, in a way never before possible. With the Bright Industries BI 1215 Bar Printer, computer printout comes of age.

These characters were brought to you by the Bright BI 1215 Bar Printer, shown on the right. There's nothing else like it in the world. Please write for full information.

Bright Industries Inc.  
One Maritime Plaza, San Francisco • 94111  
Telephone: (415) 391-9794

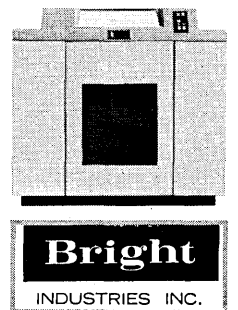

## Unique teaming of industry and government pushes edp development

# Software in Japan:

**G** The Japanese government has encouraged and supported software companies. Although Japan is a private enterprise society like the United States, there is a much greater degree of interdependence between industry and government than you would expect in an advanced industrial country. The government exerts influence over the private sector of the economy through its various agencies. A good example of this influence is the special law that was enacted last spring to promote the information processing industry.

This law has been an impetus for the expansion and accelerated developments of future plans. Many new steps are being considered and taken using this law for support and as the background. One of these steps is the establishment of a new organization which will purchase software packages from companies that develop them and will then lease the software packages to the user. This organization is expected to promote the development of packaged software and those companies that produce the packages. The market for software packages in Japan is ambiguous, but through this organization the government will assume the majority of the risk until the market is better understood.

Another example of the government's influence is the examination for information processing engineers given by them last winter. The test was for computer hardware and design as well as computer software and applications. In the test for programming the examinee could choose FORTRAN, COBOL, or assembly language for his language in solving the problems. Last year more than 30,000 people were tested. As a result of this test about 2,600 engineers were registered as fully qualified engineers. The engineers can be registered in two classes according to their level of competence. More than 30,000 applicants are expected to take the test this year.

The Japanese government has launched an ambi-

tious five-year project to upgrade the technology of the Japanese information processing industry. This project, Large Industrial Engineering Development (LIED), has programs that are being developed by many organizations separately and cooperatively. The participants in the development of these programs are expected to upgrade their staffs' ability and contribute to the overall upgrading of the industry.

One of the important programs in project LIED is centered around the development of a large computer software system using a new approach that distinguishes it from other systems. The fundamental philosophy of this new approach is the idea of common software, which was developed by Electro-Technical Laboratory (now reorganized as General Electronic Research Laboratory). The implementation of the program is being carried on by Fujitsu, Hitachi, Nippon Electric, and Nippon Software. The pilot system is scheduled for completion by the end of 1971.

The philosophical structure of this software system is indicated in Fig. 1. The common software portion is in the outer ring along with the user's programs. The inner circle, or nucleus, contains the core of the operating system. This area is hardware dependent and is developed to fit the hardware specifications. As we move out from the center, to the interface it becomes less dependent on the hardware. The areas beyond the interface ring are independent of the hardware design.

To implement this philosophical idea of an interfacing ring between the dependent and independent portions, special technology in two areas had to be developed. The first involved the selection of macro instructions which transfer control back and forth between the common portion and the nucleus portion. The second was to develop a special language for describing the compilers. A subset of PL/I was decided on as the language for describing the FORTRAN, COBOL, and PL/I compilers. The selection

was made as a compromise between language power and speed of compiling.

The FORTRAN, COBOL and PL/I compilers described in a subset of PL/I will produce an object program in a common intermediate level language. This procedure gives these compilers commonality at the intermediate language level. It is then necessary to compile the object program again to produce the final object program in machine code. A source program thus must be compiled twice by different compilers; however, the first computation can be made completely independent of the hardware specifications. Only the compiler for the intermediate language need be written for changes in hardware or hardware specifications.

that is more powerful and easier to use. A study of the languages is being made with this objective in mind. The study of FORTRAN and ALGOL resulted in five levels of language specifications being established as Japanese Industrial Standards in 1967. A study of COBOL is now under way and will result in the establishment of standard specifications for COBOL.

The working group for ALGOL was sponsored by the Information Processing Society of Japan. The Language Description Group has made an outstanding contribution in this area. They developed the specifications for ALGOL-N as one proposal for ALGOL 68. The language was disclosed to ISO TC9 WG2.1 at Munich, Germany, in 1969. The notable feature of this language is that it allows the user to extend the language to fit his own application.

# Supported Growth

by Atsushi Fujii

Fig. 2 shows this process graphically for a clearer understanding. One disadvantage of this approach is of course the slow speed of compiling, caused by the double compilation. In this project the compiling time is much less than twice because of efficiencies introduced by the intermediate language. The run time efficiency of the object program is believed to be a little higher; this somewhat compensates for the extra compiling time. The efficiency of the control program is a more serious problem. In project LIED the interface is between the nucleus, which includes the control function for the hardware, and the common area, which schedules programs and contains the executive routine for management of data, computation and files for the program.

Software and application programs standardization have been studied by the Japanese industry. There is a strong feeling that good standards are very effective countermeasures against the shortage of qualified software technicians. A concentrated effort has been undertaken to develop practical, useful standards using a large portion of talent available in this critical field. There is a recognition that the investment in developing standards now, even though it means

## Large and sophisticated

The complete library of programs provided with new computers has become larger and more sophisticated. The effort to produce such a library continues to increase at an accelerated speed. This trend can be stopped if the efficiency of producing these programs can be sufficiently increased. One approach to increasing the efficiency is to develop techniques for automatic production of programs and compilers. A project along this line was carried out within project LIED.

The Basic Programming Language was developed to facilitate automatic production of programs. This language was implemented on the NEAC-2200, which is a representative computer of a series of computers manufactured by Nippon Electric Company. BPL is a minimal subset of PL/I that can effectively describe a program system. The software is written in BPL and is then bootstrapped in on a new computer. This has reduced significantly the effort required to produce systems written in BPL on new machines.

A fruitful way of reducing the effort required to program applications by users is to make a language

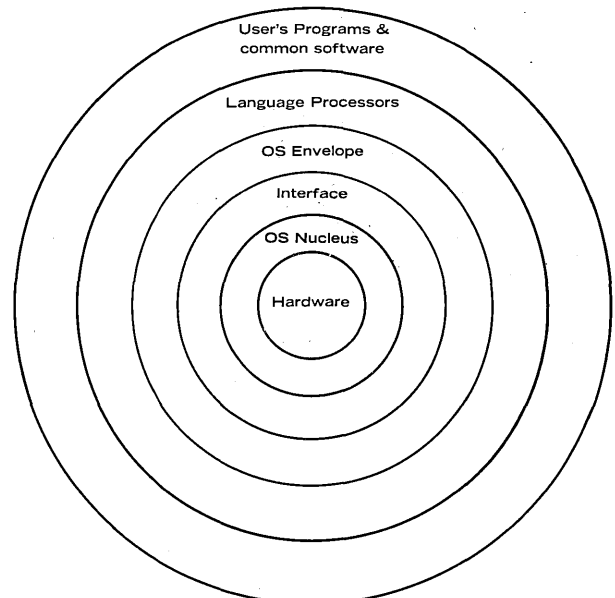
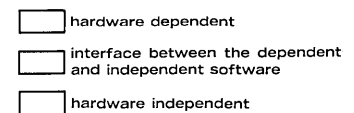
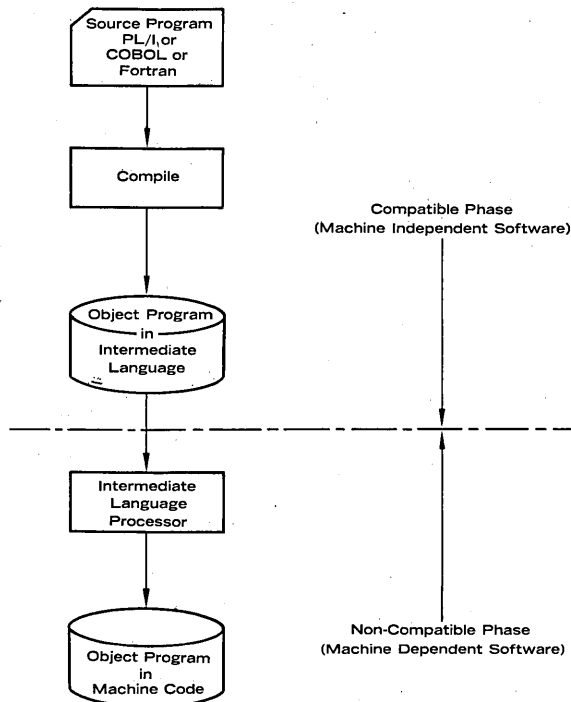

Fig. 1. Operating system configuration for project LIED.

## Software in Japan...

delaying productive work, will in the long run pay big dividends.

One example of this type of investment is the special language developed for programming information retrieval systems. A study group was formed by the government in 1967 to consider the specifications for such a language. This group represented



**Fig. 2. Compilation process of the software system in project LIED.**

various governmental offices and the discussions that followed were conducted internally. Collectively many good techniques then being used were documented. The Electro-Technical Laboratory worked in close cooperation with the study group to finalize the specifications of the new language.

The new language has greatly reduced the work required to program information retrieval programs. The cooperative effort of the study group and the Electro-Technical Laboratory has resulted in a very powerful language to produce programs with large data bases. The Nippon Software Company has implemented a subset of this language on the FACOM 230/60 computer. The implementation was demonstrated this year and evaluated. This has shown how powerful the full language specifications of this language are. A new method for file accessing has been found especially useful for handling system files and macro instructions. The language is useful in programming logical operations, string processing and defining meta-files.

The development of large computer systems in fields such as railway transportation, banking automation, broadcasting operation, and data communications and processing has also given the industry good opportunities to develop sophisticated techniques. Many new methods and advanced concepts have been implemented in these systems. The development of these large systems, including the re-

search, has been paid for by industry.

The large computer systems built in Japan are operated under the control of advanced operating systems. The large NEAC computers built by Nippon Electric Company use the MOD-IV operating system. This system uses a number of new techniques in handling multiprogramming that make it especially powerful and efficient in this area. The Monitor V operating system of the FACOM computers manufactured by Fujitsu Limited incorporates many late features, including time-sharing service capabilities.

The manufacturers are continually updating these operating systems through revisions and the addition of new features. For example, GPSS was made available in both the Monitor V and MOD-IV last year. PL/I was also added to the Monitor V system last year. The ROS operating system for the FACOM 230/25, a small to medium scale computer manufactured by Fujitsu Limited, is outstanding. It offers multiprogramming capability along with many real-time terminals. Background processing can also be performed while operating in the time-sharing mode. These features are normally found only in operating systems for large scale computers.

The Japan Exposition 70 gave the Japanese industry an opportunity to demonstrate their capabilities and their new products. The industry was eager to show their achievements and as a result some applications were presented in a relatively primitive stage of development. All of the computer manufacturers' exhibits placed heavy emphasis on automation. Advanced techniques developed by the computer industry were demonstrated, including among other things a heuristic program for playing Go. The work on this program has suggested some new approaches helpful in development of CAI programs and computer tutorial systems. Applications of the future were also demonstrated such as a cashless society, high speed railway simulation, and newspaper distribution over the telephone lines.

The exposition set new records for both single day and total attendance. It also gave the world and the Japanese public an opportunity to see the progress being made in the computer and automation field. The industry's success in their presentation was outstanding even though it cannot be expressed in numbers. ■



Mr. Fujii is the executive director of Nippon Software Co. He was active in founding this company in 1966. He graduated from the Electrical Engineering Dept. of Tokyo Univ. in 1945. After graduation he took a position with Oki Electric Industries Co. His last assignment at Oki Electric prior to joining Nippon Software was to supervise the development and manufacture of the OKITAC-5090 series of electronic computers.

We're pleased to add a new name to the computer tape field. Media . . . the computer tape with the lifetime guarantee and the promise of 48-hour delivery. Our guarantee means that with proper care and maintenance, Media tape will outlive your present computer installation.

We've been involved in improving the quality of computer tape for almost 12 years now. We've been rehabilitating the other guy's tape for so long that we know everything that can go wrong with it. And Media has made sure that the common errors (and even some un-

common ones) won't happen to us. So sure, in fact, that we've guaranteed our FCI 3200 tape for a lifetime, and backed it in writing.

Media magnetic tape breaks the time barrier in both directions. It gets to you fast, and it lasts a lifetime.

For complete details on our lifetime guarantee write or call today: Media, a division of General Kinetics Incorporated  
11425 Isaac Newton Square  
Reston, Virginia 22070  
(703) 471-7522

# computer tape from

# media

A DIVISION OF GENERAL KINETICS INC.

# GKI



## Introducing the new Media Computer Tape The first to offer you a

## Skilled analysts and programmers and low-level applications is the story in the Other China

# A Mixed Tale of EDP

 In an economy which is expanding at the rate of 10% per year, it is not surprising to find a growing interest in the data processing technology as well as an increasing utilization of data processing applications. This report will present the status of the industry today in terms of the number of installations, the major applications, and the industry's supply conditions. Finally, I shall make a few remarks about the software market and its prospects in Taiwan in the near future.

Computers have been used in military applications by the government since the 1950s. Commercial data processing probably began in 1965 with the establishment of the Taiwan Sugar Corp. with an IBM 1440 computer. Today, there are over 30 computer installations, concentrated primarily in Taipei, the largest city of Taiwan. Included are four service bureaus in Taipei, and one in Kaoshiung.

There are no official figures available on the computer installations in Taiwan. The following tabulation (shown in Fig. 1) is a result of a survey we made recently.

It is evident that IBM and CDC are the leading computer vendors in Taiwan. NEAC (Honeywell),

MODEL	ESTIMATED INSTALLATIONS
IBM 1130	6
IBM 1620	2
IBM 1401	1
IBM S/360	12
Univac	2
Honeywell (NEAC)	1
NCR Century	1
CDC 3300, 3150	4
Fujitsu	1

Fig. 1. Computer installations in Taiwan.

NCR, and Univac are represented to a far smaller extent. Japan's entry in the market comes from Fujitsu Limited. In 1969, IBM installed its first S 360 computer, a Model 40, at its service bureau facility. CDC also has an affiliated service center. Excepting IBM, CDC and NCR, the other manufacturers

are represented in Taiwan through arrangements with local trading companies.

There are no production facilities of computer hardware in Taiwan. IBM, Philips, Ampex, and others have established core memory assembly plants for exports. Recently, the National Chiao Tung University has been experimenting with the development of a small-scale scientific computer. However, there is no intent to produce the computer at this time.

Most computer equipment is on rent. The government levies a 30% to 50% import custom duty on the hardware which is borne by the user with the exception of educational institutions. This has caused high rental charges for the use of computers. To offset the high cost of hardware, computer vendors have been offering application support reminiscent of the early years of the computer industry in the U.S.

### Industry markets

Let us examine the data processing industry in terms of the following market categories: government; government-owned enterprises; educational; and private industries.

*Government.* The utilization of computers within the government has not been extensive. Users of computer services include the Taiwan Highway Bureau, Taiwan Railway Administration, the Tax Bureau of Taipei, the Inspectorate General of Customs, the Bureau of Population Census, Taiwan Tobacco & Wine Monopoly Bureau, etc. Principal applications involve statistical analyses of foreign exchange, import & export, population, and various tax accounting programs. A few general ledger accounting and inventory control programs have been installed.

In the past two years, the Chinese government has begun to place more emphasis on the use of data processing in its various administrative organs. There appears a keen recognition of the need to develop computer-based information services to strengthen management control and to minimize paperwork. A



# in Taiwan

computer center housing a large IBM 360/40 will be opened in the fall of 1970 by the Executive Yuan of the Chinese government. The center will serve the needs of many departments such as taxation, budgets, accounting, and personnel. Other departments have also begun to map out data processing plans and budgets. The list for future projects ranges from weather forecasting and traffic control, to a comprehensive employment placement system.

To promote more sophisticated use of the computer, expertise in system analysis and design is in great demand. The government already has U.S. consultants to assist in the definition and organization of a wide variety of projects. At the same time, it has been encouraging overseas Chinese computer professionals to return for consulting assignments. These steps have shown visible progress. Special edp training programs have been set up for both management personnel and programmers to improve their respective knowledge of new applications. In short, these steps will contribute much to the development of data processing technology in Taiwan.

*Government-owned enterprises.* This is the area where computer applications appear to be most widely accepted. For example, the Taiwan Sugar Corp. started using computer programs as early as 1965. Today, it also has an off-line teleprocessing network between TaiNan and Taipei in the Air Asia Co. Taiwan Power Co. has had a 360/30 since 1967. Another computer user is Asia Cement Corp. Principal applications include payroll, general ledger, inventory control, labor and material accounting, and accounts receivable and payable. Most of these applications are "low-level" as compared with the state of the art in the U.S.

More sophisticated data processing applications are being explored. For example, China Airlines and the Taiwan Railroad Administration have been considering the use of an on-line reservation system to improve customer service and control. The Bank of Taiwan plans to complete a teleprocessing system in

the next three years for its over 33 branches. The system requirements call for on-line processing of time deposits in the first phase and demand deposit accounting in the second phase. These and other situations promise a good market potential for U.S. computer manufacturers and software houses.

*Educational.* Most state universities have small- or medium-scale computers for instructional purposes. National Taiwan Univ., which is the most prestigious institution in Taiwan, has installed a CDC 3150 computer. Typical courses include FORTRAN and assembly programming techniques, machine concepts and system design approaches. One university is offering a course in time-sharing architecture. No university offers a degree in computing science, nor is there graduate work available in the computing studies. Universities enjoy the special privileges of not being levied the substantial import custom duties on computer hardware. A few have taken this price advantage to offer excess machine time to commercial users.

*Private industry.* The private industry group consists of two segments, one that is represented by foreign investment or joint-venture companies, and the other being domestic companies.

The favorable investment climate of Taiwan plus the low cost of skilled labor has caused many manufacturing firms in U.S. and Japan to establish plants there. The bigger ones such as Admiral Overseas and General Instruments, are prime users of data processing service bureaus. Principal applications include inventory control, material analysis, personnel and payroll, and production cost analysis. Because these are production units, the companies lack the incentive to pursue data processing techniques vigorously.

Computer techniques are not generally accepted in the private business sector. A few large companies such as Formosa Plastics Corp. and Far Eastern Textile Co. have installed small- or medium-scale computers for basic accounting applications. In general, progress has been limited by the low labor costs as well as an inherent conservative attitude on the part

by Randolph Kwei

## EDP in Taiwan . . .

of most Chinese businessmen. Only greater exposure to the computer technology and stiffer competition from abroad coupled with a rising wage structure will cause a turn-around of the present situation.

### Personnel

Data processing personnel are trained by three formal sources: the computer vendors, the universities, and private programming schools. The private edp schools generally lack computer facilities. Students pay approximately \$40 (U.S.) for a 10-week program. As is true in the U.S., on-the-job training appears to be the most productive means.

Because the industry has been expanding rapidly, there is a chronic shortage of skilled system analysts and programmers. As a result, there is great mobility of programmers in pursuit of better pay and positions. In some situations, programmers are considered to be at senior level after having had only two-to-three years of career experience.

The highest paying firms are the computer vendors marketing and installing systems. The lowest paying employers are the government and the government-owned companies. However, the latter often offer fringe benefits that are superior. In general, the salaries are fairly high compared with the average pay-scale for professional people in Taiwan. (The average for males in all manufacturing is \$69.30, for high school teachers \$103, for full professors \$206, and for chartered accountants \$200-450 per month.) The different salary ranges are presented in Fig. 2.

POSITION	MONTHLY SALARY
Programmer Manager	\$ 400-700
System Analyst	235-350
Programmer	150-250
Junior Programmer	65-175
Operation Manager	150-300
Computer Operator	75-150
Keypunch Operator	50-150

Fig. 2. Taiwan edp salary structure.

There is no formal professional computer organization in Taiwan. However, the Computer Association was organized in 1967 to act as a general forum for discussions, seminars, and exchange of information. The organization is comprised of representatives from computer vendors, service bureaus, software companies, and large users. Currently, meetings are held on a monthly basis. Plans are being formulated to publish a regular journal for the edp industry. These activities can contribute to the much needed task of stimulating interests in the business sectors of the economy and upgrading the technical skills of the system analysts and programmers.

As was noted before, computer applications are mostly low-leveled. There is little or no scientific application in Taiwan. The edp personnel also lack exposure to system-oriented software. Interestingly enough, in spite of the lack of sophisticated applications, the Chinese system analysts and programmers appear to have a very high aptitude in understanding and absorbing advanced system techniques. This has been demonstrated by the ability of a group of programmers to accomplish a data-based software system for the U.S. market in 1970. During the programming project, it was shown that the average programmer's

productivity in COBOL is equal to or better than that in the U.S. This distinctive asset of the Chinese programmers will play an important part in Taiwan's development of a wider scope of computer applications. This software project also shows that the programmers in Taiwan can play a useful part in meeting the world-wide need for programming talent.

### The software market

The burden of software development has been traditionally shared between the computer vendor and the computer user. Because of manufacturer software support, computer users are not accustomed to go outside for programming requirements. Service bureaus have also traditionally supplied free programming services. To date, there has been no effort by the government to encourage a separate software industry. As a result, it is not surprising that there has been a negligible level of consulting activities. The only users have been the government and government-owned enterprises.

In 1969, International Data Applications established a subsidiary in joint venture with the China Data Processing Center to provide software services in Taiwan and the U.S. This was the first known computer software company in Taiwan. Since then, at least one other software company has been formed. Recently, a company has planned to establish a time-sharing service center in Taipei. The increasing activity from software-oriented firms suggests the recognition of potential demand from a variety of computer users.

The long-range growth of the software industry will be strengthened by two fairly fundamental factors. One is the increasing involvement of the government to promote the computers as a management tool. The other is the rapid growth of industrial activities which will surely necessitate the use of computing equipment for more efficiency in operations. It has been evident that the Chinese programmers have the requisite aptitude to take on more sophisticated and advanced application development projects. What is required are the U.S. system and technological know-how to support the growth of the software industry. ■

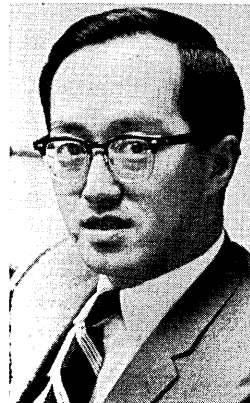

Mr. Kwei is currently the president of International Data Applications, Inc., Montgomeryville, Pa. Before coming to International Data, Mr. Kwei was with IBM. He has had more than ten years' experience in both technical and management aspects of the dp industry, including system design, time-sharing system development, and commercial data processing consulting. His BA is from Yale Univ. and his MBA from Columbia Graduate School of Business.

squeezed for storage display?

# DOUBLE CAPACITY IN TWO MINUTES!

with a  
**BEEHIVE  
TERMINAL**

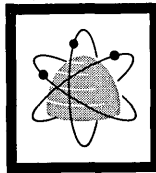

MODEL I  
MODEL II  
MODEL III

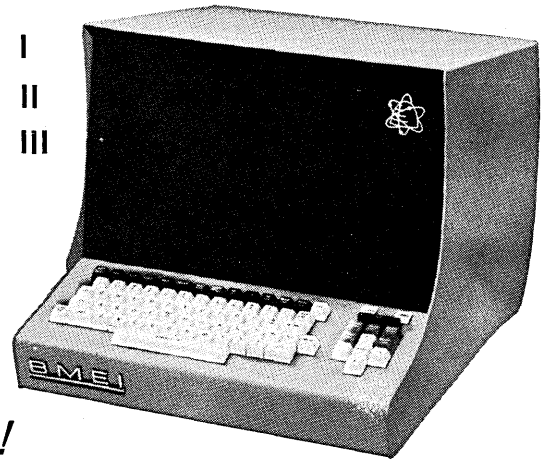

*Now, change functional capabilities in the field. Just add a logic card and presto! 800 character storage and display expands to 1600!*

CRT terminal users are continually finding that the demand for expanding functions has made their terminal obsolete. Beehive, and only Beehive Models I, II, and III, with their unitized construction, enable the user to expand their terminal capabilities, change models, features, or functions

in the field . . . all in less than 2 minutes by just adding logic cards.

If you are just starting, start with Beehive . . . and maintain terminal capability! Avoid a future trade-in loss. Buy the one that can grow with your demands. Buy Beehive!



**FOR BASIC TIME SHARING / BEEHIVE MODEL I**

provides all the minimum functional capabilities required of an alphanumeric CRT display unit with a teleprinter style keyboard. It has 800 character storage and display (20 lines x 40 ch/line), parity detection and generation, composite video, output, four way cursor control, home and clear, switchable baud rate, scroll overflow, RS 232B interface for half and full duplex operation.



**FOR BATCH PROCESSING / BEEHIVE MODEL II**

has all the capabilities of Model I plus the following features: erase screen, erase line, tab, tab set, tab clear, and block transfer.



**FOR SOPHISTICATED BATCH and INQUIRY /**

**MODEL III** incorporates all the features and capabilities of Models I and II and adds: format, edit by line, and edit by page (character and line insert and delete).

**FIELD INSTALLABLE**

**OPTIONS**

Models I, II, III	80 character display
	Parallel I/O adapter
Models II, III	Remote printer adapter
	Cassette adapter and stand alone cassette unit

**MODEL CHANGES**

Model changes as well as options are possible in the field!

**360 USERS ATTENTION!**

Beehive Model IV is our new unit committed to replace the IBM 2260/2265 terminal systems. It has been engineered with the same keen eye for quality, convenience, and LOW COST as our Models I, II, and III. Let us send you complete details.

Nationwide Maintenance Available • National Sales Representation

**BEEHIVE MEDICAL ELECTRONICS, Inc.**

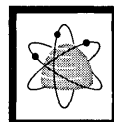

1473 South 6th West • Salt Lake City, Utah 84104  
801 / 487-0741

# THE BEST THING ABOUT DATA GENERAL IS OUR LOW MAIN FRAME PRICES. OR SO PEOPLE THINK.

For too long, people have thought of us as a main frame company.

And justifiably.

After all, we have spent the last couple of years producing the Nova line of fully compatible, 16-bit mini computers.

But we're smart enough to know that main frames and low base prices aren't everything.

Proven performance is important, too. (We've installed over 850 Nova-line computers so far.)

A strong service organization is important.

Software and peripherals are important.

And finally, the ability to put main frames, software and peripherals together in configurations that meet real-world computing requirements at the lowest prices possible is the most important consideration of all.

And that's what we'd like to talk to you about.



## DISC OPERATING SYSTEM ONLY \$27,870

Built around the Nova 800, Data General's DOS provides high-speed data processing capability at a remarkably low price. The system priced here includes the Nova 800, 16K of core memory, a 128K, head-per-track disc, Teletype, high-speed paper tape reader, and device-independent software.

DOS supports system software that includes relocatable assembler, editor, linking loader, and ALGOL 60 and FORTRAN IV compilers.

Substituting a 256 K disc adds only \$1,500, and a 356 lpm, 80-column, 64 character line printer costs \$12,900.



## MAG TAPE SYSTEM ONLY \$29,885

The configuration priced here includes the superfast Supernova, 8K of core memory (interchangeable with 300 nanosecond monolithic memory), Teletype, 8-channel, 10-bit A/D converter, and a 24 ips, IBM-compatible magnetic tape unit.

This is an inexpensive, easily expandable, on-line data acquisition system that can handle its own data processing, or can prepare data for a larger processor.

## TIME SHARING BASIC ONLY \$17,596

This is the least expensive way to provide a sophisticated, easily-used computing capability for as many as 16 users.

The four-user system priced here includes a Nova 1200 with 12K words of core memory, four Teletypes and interfacing. A high-speed paper tape reader adds \$2,650.

The system uses Data General's fully extended time-sharing BASIC with string and matrix manipulation capabilities.

When not time sharing, the system can use all of Data General's extensive list of software and peripherals.

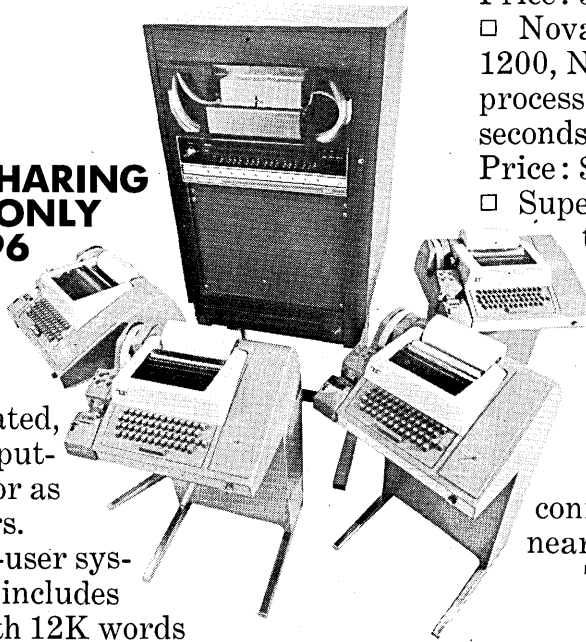

## OUR MAIN FRAMES STARTING AT \$5,450



Everything starts with main frames.

And any one of ours can plug into any one of the systems priced above.

What's more, they are all software compatible, mechanically interchangeable, and all run the same peripherals.

□ Nova 1200: First to take advantage of LSI and MSI. It's fast (1200 nanosecond cycle time), reliable, and less expensive than anything else at its performance level.

Price: \$5,450.\*

□ Nova 800: Faster, more powerful than the 1200, Nova 800 has a fully parallel central processor and a cycle time of 800 nanoseconds.

Price: \$6,950.\*

□ Supernova SC: First to really take advantage of all-monolithic memory, making it the world's fastest mini computer (300 nanosecond add time). Price: \$11,900\* (\$9,600\* with compatible 800 nanosecond core.)

To find out how little *your* configuration will cost, call or write the nearest Data General office.

To know us is to love us.

# DATA GENERAL

Southboro, Mass. (617) 485-9100 / Hamden, Conn. (203) 624-7010 / Commack, L.I., New York (516) 368-3304 / Rochester, New York (716) 235-5959 / Saddlebrook, New Jersey (201) 843-0676 / Bowie, Maryland (301) 262-1198 / Bryn Mawr, Pa. (215) 527-1630 / Orlando, Florida (305) 425-5505 / Chicago, Illinois (312) 539-4838 / Dallas, Texas (214) 233-4496 / Denver, Colo. (303) 758-5080 / Manhattan Beach, Cal. (213) 376-7917 / Palo Alto, Cal. (415) 321-9397 / Clichy, France 270 93 40 / London, England 01 499 7735 / Melbourne, Australia 723-4131 / Munich, West Germany 0811 29 55 13 / Zurich, Switzerland (051) 34 07 77. DATAGEN OF CANADA LTD.: Hull, Quebec (819) 770-2030 / Montreal, Quebec (514) 341-4571 / Toronto, Ontario (416) 447-8000 / Vancouver, British Columbia (604) 731-2711.

\* Main frame prices include 4,096 16-bit words of memory, Teletype interface, and Direct Memory Access data channel.

## Proper use of old assets could cut conversion time of reluctant industries

# Credit Clearance—the



A cartoonist might, within the license of his trade, picture the computer industry as a shiny, chromium-plated, multihorse-powered automobile in imminent danger of being mired to its hubcaps in expanses of mud labelled social environment—the symbol of technological progress immobilized by the resistance to change of human beings and human institutions.

How fair would such a picture be? All normal indicators of industry health are positive. A mid-decade projection in *Business Week* of Feb. 19, 1966, forecast an increase in the installed computers in the United States from 27,000 in 1966 to 45,000 in 1970. These were valued for both years at about a quarter of a million dollars per installation, equivalent to average monthly rentals of \$6,500. Increased per customer usage was presumed to be offset by technological improvements and more computer power per dollar. In actual fact a mid-1968 industry report showed a total of 41,653 installations with the per-installation rental in the range of \$1,000 to \$100,000.

These figures are indicative of a burgeoning industry in which technical obsolescence furnishes rejuvenation (for those who can stand the pace) and for which unbundling has opened new horizons.

In such circumstances why be suspicious of the business indicators? Is there really any reason to suspect that the computer industry, after successfully negotiating the entrance ramp to big industry status, is running on the shoulders rather than on the pavement?

Obviously this is a difficult, judgmental question. Rather than try to answer it this article considers one industry—the credit clearance business—in which computers have not made during the '60s the progress that was safely predicted.

“Credit clearance” is used here to mean the checking of the credit-worthiness of an individual who is not known to the organization initiating the check. As such it is different from “credit validation,” which may be defined to mean the checking of an individual's current account with the organization.

Automation in the credit clearance industry has a number of strikes against it: the need for cooperation among unrelated competing organizations, the tenuous nature of the links established by such organizations. There are also a number of factors working for it: greatly expanded use of credit, greater population mobility. This article suggests that one of the principal impediments to automation has been lack of attention to the alternative deployment of the industry's existing resources. There is a lesson here which

can stand more thorough study before pushing off into the '70s and heading for new records in installed computers.

The essence of the problem is that the application of information technology has two sides: (1) how to get from the present system (“way of doing business”) to a new system, and (2) what to do with the resources rendered redundant in the process. While the first of these has been addressed effectively, the second is seldom considered in a positive way. Why, it may be asked, should it be? Worn-out or outdated resources should have been depreciated before the time came for casting them on the scrap heap. Justification of new computer applications is difficult enough without having to internalize the costs of redeploying the displaced resources.

Possibly so! However, the main contention in this article is that failure to give the old assets equal time has contributed significantly to holding back the application of modern information technology in many industries.

### Insurance vs. process control

There is, for example, an obvious gap between the progress made in the insurance business and that made in process control. Insurance companies, though not necessarily considered among the most innovative of institutions, took to edp early and have progressed steadily from individual applications to well-integrated systems, adequately responsive to the needs of their geographically dispersed field offices. Process control, on the other hand, even in the petroleum industry, has developed only slowly over the same period and even now is not a profitable segment of the data-processing market. Many reasons can be advanced for this gap. Process control implies close integration with physical plants in a way which is not true of insurance; hence, more one-shot effort tends to be needed on each application and on each account.

The “internal service bureau” approach is not so obviously applicable to process control applications. In the insurance business this approach provided a way of centralizing the edp function without initially doing violence to the autonomy of the individual managers involved. An equivalent way of serving individual plant managers has not evolved. A more basic reason is that information in the insurance industry is fairly close to being the end product of the business; in process control the data processed is clearly in a supporting role to the process itself.

But in addition to these there is an obvious dis-

parity in the extent and mobility of the displaced resources. The physical plant of insurance companies consists of buildings which can be remodelled and air-conditioned. The work force of the late '50s consisted of semiskilled and unskilled clerical workers, mostly female, all of them unorganized. Normal turnover rates were high enough to permit reductions in the work force without conflicting with the estab-

agreement—from the accounts of the major banks in the area. Despite the department store orientation of most of the credit bureaus, this approach caused immediate concern among the California bureaus. Encroachment on the business done with the banks was direct. In addition reservation by CDC of the right to sell access to the extracted data posed a threat to the other segments of the bureaus' business.

# Slow Change to EDP

by James C. Hammerton

lished paternalism of the industry. The picture in a petroleum refinery is very different. The work force is skilled, male, and organized. The potential reduction in the work force is dramatic. The value of the physical plant which will be displaced is large. The opportunity to modify it is minimal because it is capable of round-the-clock productivity. Under these circumstances the what-to-do with the displaced resources becomes a problem which is not easily resolved. The rate of progress in automation tends to be limited by the rate at which physical plant becomes uncompetitive and can be replaced by modern facilities, if necessary in a different locality.

## Credit clearance

Where in this picture does the credit clearance industry fit? Information is the end product of the business. First impressions are that it is manned largely by unskilled and semiskilled female labor. Its most obvious physical assets are buildings, if indeed these are owned. All the portents appear favorable, but progress has been slow.

In 1965 the Associated Credit Bureaus of America, which represents the 2,000 or more local credit bureaus across the nation, initiated a joint project with IBM—CB360—in an effort to develop a model, computer-based package which its members could modify and use according to their needs. This, according to *Bankers Monthly Magazine* of Feb. 15, 1967, was launched in 1965, using the Dallas and Houston bureaus to spearhead the development. The eventual goal slated for 1972 was to establish some 27 regional credit bureaus and interconnect them to provide a national network. By the beginning of 1970 there were centers serving Dallas, Houston, Salem (Oregon), and San Francisco/San Jose. All of these owe their existence in some measure to the encouragement and active support of "automaters" at the Associated Credit Bureaus, Inc.

Progress toward the 1972 goal has not, therefore, been negligible. But it has not been as rapid as could reasonably be expected in what seems to be a well-favored industry. The grass roots thrust toward automation that has contributed significantly in other industries, appears to have been spotty at best.

By contrast, the progress of a Detroit-based organization, Credit Data Corporation, has been dynamic. This organization moved into the San Francisco area in 1964. The company's approach was to consolidate installment loan data extracted—under contractual

In fact, as reported in *DATAMATION* of Oct. 1966, CDC started operation in the counties of Los Angeles, Riverside, San Bernardino, and Orange in Sept. 1965. The system required the on-line keypunching of inquiries and the transfer of the resulting punched cards into the computer room by a moving belt where the card was used to interrogate two 2302 files. Subsequently, in Sept. 1968, the system was upgraded. According to *DATAMATION* of March 1969, 200 IBM 2260 video display units are used to interrogate six 2314 random access files through a 360/50 with 512K bytes of core storage. This imposing system processes 100,000 inquiries daily. These include credit validations initiated by sales clerks from points-of-sale in stores.

In the midst of such dynamism as that exemplified by Credit Data Corporation, and with the evident threat of losing their business, why have the retail credit bureaus failed to respond to the urgings of their corporate management? The quoted 1967 article in *Bankers' Monthly* betrayed a lively concern for the future and outlined a plan for swinging with the technology. Why were the rank-and-file bureaus not powering the changeover with their own internal pressures?

## Reasons for foot-dragging

There are a number of reasons, all of them indistinguishable to some degree. The organization of a retail credit bureau leads to a built-in shortage of money and, hence, to an inability to make the major adjustments necessary to stay even with the environment. Most credit bureaus were founded by agreement of the major retailers in their geographical areas and their operations are underwritten by their founders. The bureau is usually a nonprofit venture operated on behalf of its subscribers and, hence, it generates no earnings—the source of independent action. The founders who might reasonably be expected to fund a conversion to a more streamlined system, tend to regard the credit operation as a painful necessity and prefer to concentrate their attention on activities with visible customer value. Possibly, retailers entertain a death-wish with respect to credit clearance. Just as many organizations today are creating independent companies to provide them with data processing, so some retailers may be happy to let others shoulder the burden of providing the credit clearance function.

Another and fundamental reason (to return to the point made at the beginning of this article) lies in the difficulty of using the displaced resources of the credit

## Credit Clearance . . .

bureau. What are these? In general, they fall into two categories: the credit file itself, and the bureau's trained personnel.

Why not convert the file to machine-readable form? First, the typical bureau's files are an assemblage of handwritten notations about trade data and inquiries, plus a sprinkling of newspaper clippings, notices of court proceedings, and copies of any special reports that may have been requested from time to time. The task of converting these to machineable form is beyond the scope of any known pattern recognition equipment. Secondly, a large part of the information in the file is certainly out of date. Weeding the file is arduous, unrewarding, and the criteria to be used difficult to establish on a rational basis; on the other hand, the keypunching of obsolete data is difficult to justify.

There is an obvious alternative, namely, to junk the existing file, throwing out the good data with the bad, and start again. Since most of the large retailers have by this time automated their accounts receivables, the source data for a new, up-to-date file is available. The only potentially difficult task is to provide programs for converting the extracted records from the different retailers into a common format. Regular weekly or monthly updates of these records are as readily available as the original source data. No massive keypunching operation is required. The recording of inquiries as part of these records is a natural by-product of making the inquiry. Given the decision to start from scratch, the switch to automation seems to be attended by a minimum of difficulty compared with most other industries. In fact it is so easy that almost any other group of persons has as good a chance of doing it as the existing credit bureau personnel.

The fundamentals of credit clearance are not difficult to absorb. The difficulties of the new way of doing things are largely technical—selection of the right equipment, development of appropriate file searching strategies, installation of new operating procedures—plus reorientation of the business to marketing and profit-making. The latter is necessary because automation, like jumbo jets, makes the cost of an inquiry very cheap but requires a big enough volume to defray the fixed charges.

Somewhere in this the existing management of credit bureaus has found difficulty in perceiving the "imperatives of technological change" and, hence, in making the required innovative response. In that this response includes the abandonment of a major asset—the credit information file—making it may be too much to expect of management.

### The staff

The credit bureau's other major resource is its trained personnel. These are the managers, the special investigators, and the line supervisors. Typically, they have a number of years of service with the bureau and specialized skills in their lines of work. At first contact the only hopeful solution to the disposition of these resources is early retirement.

This is a brash judgment, however, which exemplifies the overconcern of the technically oriented innovator with how to get to the new system and his lack of concern with what to do with the displaced

resources.

The suggestion offered here is a simple one: that an automated bureau, no matter who operates it, still requires a close association with a group of special investigators. In the Credit Bureau of Greater New York, for example, these persons provide the following range of services:

1. Special Local Report showing age, marital status, dependents, residential and business history, bank references, and trade and litigation information
2. Mortgage Loan Report
3. Residence Check
4. Employment Check
5. Selective Screening Service
6. Private Investigation
7. Real Estate Report on an individual seeking to rent an office, home, or apartment
8. Property Report providing verification of title to real property showing the date title was taken, assessed valuation, mortgages, status of tax payments.

All of these can be classified as "special services" meaning that they require some form of personal investigation and, therefore, are in a different category from the routine information services. In 1963 these special services accounted for 20% of the hours worked and 17% of the operating costs. No information was available at the time on the revenue attributable to them. However, the obvious problem with these services is that they are labor-intensive and, hence, that they are faced by rising costs and, probably, diminishing demand. Even in the mid-sixties this meant that they were being carried by the information services. Automation of the information services under a different management will almost certainly lead to the demise of the special services.

At a time when there is increasing concern about the impersonalization of the credit clearance function the further erosion of the personal, if noisy, touch is presumably undesirable. If the personnel who provide the special services fade away, who will conduct the identity investigation which finally establishes that Mr. X is indeed Mr. X? Who will resolve questions from unhappy and, possibly, morally injured consumers who have been refused credit?

The right to know the basis for refusal of credit is probably constitutionally guaranteed. *Computerworld* of Jan. 7, 1970, reported that a bill had been filed with the New York State legislature which would "require that if an individual is denied credit, wholly or in part, because of a credit bureau report, the person must be told of the fact. . . ." Senator William Proxmire was reported as being particularly concerned about the increasing computerization of credit bureaus. "He warned that in addition to freezing-in errors already in the files, computerization would probably add more errors due to bugs that enter during the conversion period."

Whether or not the senator's caveats are justified, the technocrat does well to heed them. There is an obvious temptation to take over the potentially lucrative functions and to cut out the supporting functions. In this respect the credit clearance industry is a copybook case. The information services are badly in need of an overhaul and the means for doing this are available. The supporting services are important but



unprofitable and, therefore, unviable unless tied to the information services. The organizations who constitute the directorships of the bureaus have been inattentive and not overly sympathetic; the immediate management has been loyal to the bureau's employees but ill-equipped to tackle, and therefore fearful of, a major technological innovation. Somewhere in all of this a great opportunity was lost and a danger of impersonalizing credit clearance was needlessly created.

### A lesson for the '70s

In retrospect it seems that proposals to the directors should have underplayed the magic of the technology and emphasized (1) the dangers of doing nothing, (2) the use of a third party to operate an automated inquiry service, (3) the terms of the contract with this organization, and (4) the place in the new operation of the current bureau.

There is a lesson in this for the '70s which is important to the rational development and exploitation of modern information technology.

In a review of business data processing contained in *DATAMATION* of Jan. 1962, Mr. Burton Grad of IBM looked back on the beginnings of it all "some ten years ago" and reflected on the cautious approach espoused by business leaders at that time. He quoted such aphorisms as "you have to crawl before you can walk," "you can't automate a mess," and "a new system must be built one application at a time." Mr.

Grad went on to say that "only in the last two years (1960 and 1961 presumably), however, has business management begun to wonder whether it was really taking advantage of these new characteristics of speed, memory, long distance transmission, etc."

Ten years later—1970—the management in certain industries is still wondering. The reason for today's wonderment stems not so much from the educational gap which characterized the '60s as from an inability to grapple with the displacement of resources in a way which is practical, acceptable, and fair. ■



Mr. Hammerton was formerly a product planning manager with the Bunker-Ramo Corp., and has been working with real-time and time-shared systems since 1959. He holds an MS in physics from Cambridge University and an MBA in economics from New York University.

## The care and feeding of the computer in books from Addison-Wesley

**Topics in Machine Arithmetic**  
by Marvin L. Stein and William D. Munro, *University of Minnesota*

The basic algorithms of computer arithmetic are explained in this new text without going into the physical components of the arithmetic. The book follows the logical development of the digital computer and shows what it can do. Included are an analysis of mathematical meaning, and an analysis of the potential use and limitations of the results from an applications viewpoint. *February 1971*

**A View of Programming Languages**  
by Bernard A. Galler, *University of Michigan*, and Alan J. Perlis, *Carnegie-Mellon University*

A book that identifies and studies the interactions between some of the primitive elements of programming and then develops the complexities of modern programming stage by stage. Ideal for the experienced programmer or for an upper level programming course. *282 pp, 61 illus (1970) \$12.95*

**The Use of the Computer in Planning**  
by William K. Benton, *Arthur D. Little, Inc., San Francisco*

A survey of the use of the computer in identifying and evaluating planning problems and their solutions.

Means of gathering data and methods of forecasting are discussed, and the book shows how a computer can help the manager do more analysis better to produce better decisions. *February 1971*

**The Use of Computers in Business Organizations, Second Edition**  
by Frederic G. Withington, *Arthur D. Little, Inc.*

Newly revised, updated and expanded to include information on new data processing tools and techniques, this book is an introduction for managers who wish to gain an understanding of computers without undergoing extensive technical training. The author has added a series of review questions at the end of each chapter to make the book more useful as a text in management courses. *February 1971*

◆◆  
**ADDISON-WESLEY**  
Publishing Company  
Reading, Massachusetts  
01867

# Computer men, communications men: you have the same problem, now you have the same solution.

Your problem, of course, is each other. Your solution is us!

**First, the problem.** Face it squarely: your problem is each other. Even if you're the same man, chances are the problem of priorities often seems insoluble to you. On the one hand, communications assignments are tying up costly data processing equipment that could be used for more remunerative purposes. On the other hand, communications are not always being handled with optimum efficiency.

So much for our understanding of your problem.

**But why is CCS the solution?** For six convincing reasons:

1. Our understanding of your problem to begin with.
2. The hardware and software we have in operation right now, solving problems for small, medium, and big companies with precisely the same problem. We have an impressive list of blue-chip customers of all sizes — to any of which we shall be happy to refer you upon request; they are all very happy with us.
3. Our turnkey approach to a solution: We provide the equipment, install it, program it, and instruct your personnel in using it. We provide maintenance. And, since our systems are additive in the most economical manner, we can serve you now as you grow at the most reasonable cost.
4. We'll be around. We're as aware as you are (perhaps more) of the instability of even the most able and promising companies these days. But CCS enjoys the financial backing of Union Service Industries. Our maintenance — and our counseling as you grow — will remain at your service through the years.
5. You have the option of purchasing CCS equipment or leasing it, through UC Leasing, Inc., another USI subsidiary.
6. We already have offices in operation in Atlanta, Chicago, New York, San Francisco, and Dallas. We are growing.



Quite obviously now is the time to talk to us. The sooner we start talking, the sooner your problem is solved — and the less likely it is to get ruinously out of hand. Now, while it's on your mind, pick up the phone and call Dick Smith, (214) 233-2971. Or write:

**CCS** *telexwitcher*

**COMPUTER CONTROL SYSTEMS INC.** A Union Service Industries Company 13740 Gamma Road, Dallas 75240

## A conference report

# IFIP in Amsterdam

According to the Press Publicity Bureau of the City of Amsterdam, the city contains, among other things, 836,891 inhabitants, 194,678 television sets, 87 Chinese restaurants, 14 barrel organs, and 194 fashion models. These attractions provided the backdrop for the 10th anniversary celebrations of the International Federation for Information Processing, IFIP, a federation of national societies—AFIPS is the U.S. member—was founded in 1960 by a small group of dedicated men in the wave of enthusiasm for international



cooperation engendered by the success of the UNESCO-sponsored congress in Paris the year before. In the ensuing decade IFIP survived and prospered; hence, the birthday party.

The celebrations were held in conjunction with the IFIP General Assembly meeting on Oct. 29, replacing the usual day off for sightseeing. It was just as well because the weatherman had taken up the challenge of the dykes and was attempting to fill the canals with rain. As if to compensate for the leaden skies, the program was held in the Tropical Museum—it used to be called the "Colonial Museum," but one can't say *that* any more. The speeches were a pleasant surprise. Rather than the usual potpourri of technical tedium to which

one has become resigned at affairs such as this, the talks were polished, witty, and of a philosophical bent.

Following welcoming remarks and birthday congratulations on the part of representatives of the United Nations and UNESCO, the 250-odd participants were treated to seven lectures by senior IFIP officials, past and present. The international character of the gathering can be seen through a roll call of speakers: A. A. Dorodnicyn (U.S.S.R.), Isaac Auerbach (U.S.), A. Speiser (Switzerland), Dov Chevion (Israel), F. L. Bauer (Germany), A. van Wijngaarden (Netherlands), and H. Zemanek (Austria). Included in this list are the past presidents of IFIP (Auerbach and Speiser), the current president (Dorodnicyn), and the president-elect (Zemanek). Concluding the formalities of a long day was an address by H. B. Casimir, vice president of the Royal Netherlands Academy of Sciences.

Among the better *bon mots* were Bauer's observation that Pascal invented his adding machine because he was too lazy to do his father's accounts by hand, thus setting the tone for future generations; and Chevion's comment that while we have third-generation machines, they are managed by first-generation managers. Dorodnicyn illustrated the difference between the physicist and mathematician—or engineer and programmer, if you prefer—with the account of the physicist who observed all the cows in Armenia and concluded that Armenian cows are black. The mathematician demurred with the comment, "Yes, at least on one side."

In the true IFIP spirit of oneupmanship, it was left to van Wijngaarden to bring down the house

**No heat.  
No hammer.  
No noise.  
No ribbon.  
No ink.**



**Just printout at a 1MHz data transfer rate.**

The Litton Datalog MC 3000 Digital Teleprinter is a high-speed 3000 line/minute non-impact alphanumeric page printer.

It's fully computer-compatible and meets all applicable military specifications, so it's ideal for outputting teletype or telemetry data in nautical, airborne or ground-based military and commercial data systems.

The MC 3000 accepts inputs in the standard ASCII code at rates of up to 1MHz. Data may be at any level from 1 to 15 volts, positive or negative.

The printing process is electrolytic so the only moving parts are in the paper feed. Combining this with all solid-state electronics results in an MTBF of over 12,000 hours. A built-in self-test feature and replaceable modules provide a Mean-Time-To-Repair of under 10 minutes.

For the whole story on the MC 3000 and our other printers, contact Datalog Division, Litton Systems, Inc., 1770 Walt Whitman Road, Melville, New York 11746. Telephone 516 694-8300.

**DATALOG DIVISION  
LITTON SYSTEMS, INC.**

CIRCLE 45 ON READER CARD

Improving the efficiency of your computer systems in this cost-conscious economy is probably the biggest headache you have. And, that's why you should get complete information on the latest techniques in computer system performance evaluation:

For monitoring total system performance X-RAY™ is a unique hardware/software system capable of analyzing all aspects of *current system performance* including configuration utilization, system software overhead, application program efficiency, and program and data base organization.

For simulating even the most complex aspects of *planned or existing multiprogramming, real-time or time-sharing systems*, CASE is the least costly way to make system decisions . . . CASE will accept system and workload measurement data generated by X-RAY and predict the interaction of virtually any combination of hardware, software, data base and user programs.

X-RAY and CASE can be used together to provide a complete computer performance evaluation system. X-RAY and CASE are available independently or as a system under purchase, lease, license or service plans. For complete details, contact:

**APPLIED SYSTEMS**

Division of Computer Learning & Systems Corporation  
5530 Wisconsin Avenue, Chevy Chase, Maryland 20015  
(301) 652-9220

# How to cure your biggest headache

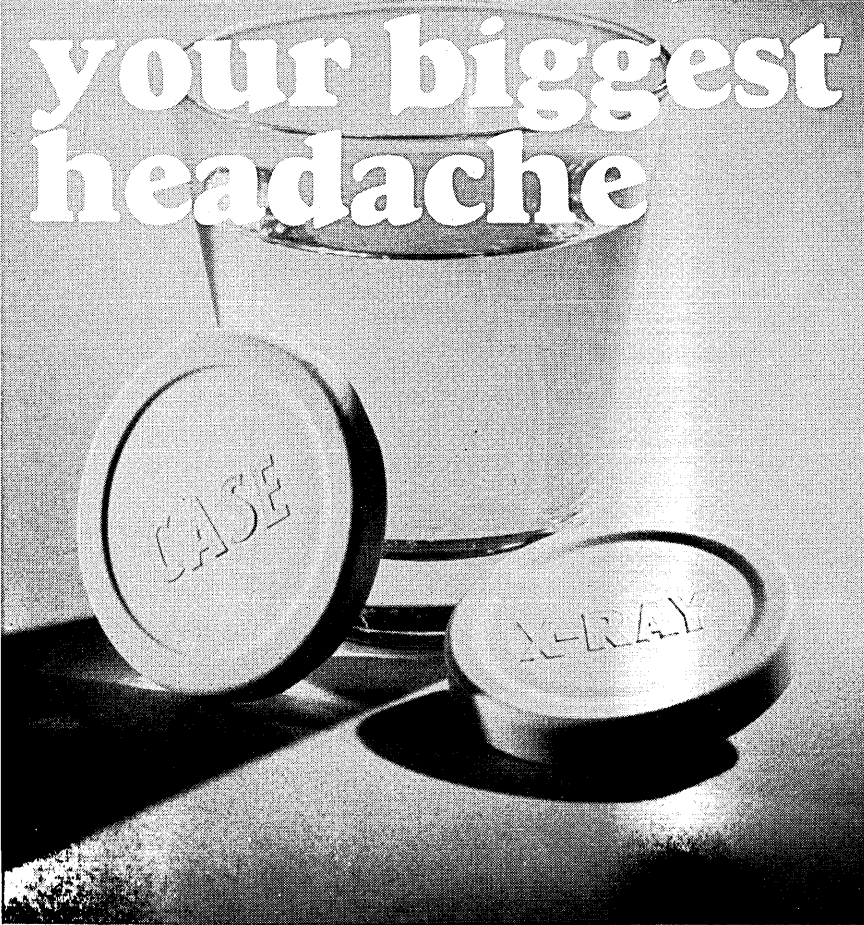

with his illustration of a recursive process. There are, of course, many ways to catch a lion, but the programmer's technique is recursive. The process is as follows: In order to catch a lion, first catch two lions and throw one away. In order to catch two lions, catch four lions and throw two away. If this process is continued recursively, it must terminate since there are a finite number of lions in the world. It follows that we have a lion-catching algorithm.

Not all was jest, however. Auerbach made a strong plea for the development of a systems theory, noting that the information processing business cannot continue with a wide-open throttle forever, with the consequence that only those having a sound foundation for their actions will survive. Speiser reminded the audience that not all the heralded devices revolutionized computing. Transistors and ferrites did, but parametric amplifiers and cryotrons have not. The papers we read do not always tell the future. Zemanek's discussion of language, logic, and philosophy emphasized the debt owed to the theoreticians by the designers, implementers, and users of programming languages and other tools. All in all, the program was a superb blend of witticism and erudition.

No birthday party is complete without refreshment. A luncheon was held at the Amstel Hotel, to which all participants were conveyed by canal boat. The JCC could learn from this; for once a conference luncheon was not only edible but delicious. Regrettably, tradition calls for a luncheon speaker, in this case G. E. Jones of IBM. Invite a senior vice president and you get a senior vice president's speech—*c'est la vie*.

The festivities were finally concluded with a reception, hosted by the Amsterdam City Council. During the 17th and 18th centuries, a period of religious intolerance, Catholics were forced to worship in clandestine churches. One of these, now a museum, with the marvelous name of Ons' Lieve Heer op Solder (Our Lord in the Attic), was the site of this soiree. The evening included an organ recital, some remarks from the pulpit by van Wijngaarden, and an ample supply of cheese, sherry, and Genever. Gin in church! In sum, IFIP gave itself a very happy birthday party and those in attendance are looking toward 1980 and the 20th anniversary.

—T. B. Steel

**IBM, the company  
behind the computer,  
brings you the  
good things to come:**



In 1970, IBM announced 101 new ways to help you get more out of your computer.

We introduced 5 new computers, 3 new files, a new printer, a new terminal, a new tape drive, a new computer channel, a new keypunch and 88 new computer programs.

In 1971, we'll be delivering all these good things to businessmen and scientists and educators to help them operate more effectively.

We say that our new products are just the beginning of a lot more good things to come.

And that's another reason we're the company behind the computer.



1. System/3 Model 6.
2. The 129 Card Data Recorder.
3. The 3330 Disk Storage Facility.
4. The 2305 Fixed Head Storage Facility.
5. System/370 Model 165.
6. The 2880 Block Multiplexer Channel.
7. The 3420 Magnetic Tape Subsystem.
8. System/370 Model 155.
9. The 2319 Disk Storage Facility.
10. System/370 Model 145.
11. The 3211 Printer.
12. System/7.
13. The 2721 Portable Audio Terminal.
- 14 to 101. 88 computer programs.

**IBM**

**The company behind the computer.**

CIRCLE 46 ON READER CARD



# right connection

**This Bunker-Ramo data terminal system gives a telephone company instant access to 2,000,000 records.**

Bunker-Ramo has the right connection for your computer, too. We have more experience placing people in direct, real-time visual contact with their computer data than anyone else.

Typical of this capability is the data entry and retrieval system installed for the Trunk Facilities Administration Staff of a major telephone company.

A slow and inaccurate punch card and paper printout system was replaced by a network of Series 2200 CRT (Cathode Ray Tube) terminals which gives instant entry and retrieval to and from the company's IBM computer.

Errors were drastically reduced as entries are visually verified and edited on the screen before transmittal. And the phone company now makes between 8,000 and 12,000 computer inquiries and entries daily, an impossible dream before this system.

To prove that Bunker-Ramo has the right connection for your computer, let us show you some of the systems we've built for utilities, manufacturers, hospitals and businesses of all kinds.

For a demonstration, contact Mr. Guy Mallery, Vice President, Business & Industry Division, The Bunker-Ramo Corporation, 407 Fairfield Ave., Stamford, Connecticut 06904. Phone (203) 348-4291.



*The real real-time people.*

**THE BUNKER-RAMO CORPORATION**

® Business & Industry Division

Branch offices throughout the U.S. and in Toronto, Canada.

CIRCLE 38 ON READER CARD



# PERSPECTIVE

an interpretive review of significant developments

## Dartmouth's Time-Sharing System Captures College, Creates Confidence

John G. Kemeny, computer genius, Ivy League college president, mathematician, philosopher, and football nut, sat down at the teletypewriter console in his office. Dartmouth College was in the last stages of its capital fund drive. The trustees were coming the next week. Kemeny needed some projections: How well was the drive going? What would Dartmouth's financial position be in five years?

Kemeny punched away at the teletypewriter and, moments later, he had the answers to his questions. "I just don't see how an American executive can get by without a computer," Kemeny told a recent visitor in describing how he uses the Dartmouth Time-Sharing System.

It is perhaps easy to understand Kemeny's use and enthusiasm for the system, since it was all his idea. But what is not quite so easy to understand is that nine out of 10 of Dartmouth's 3,000-plus undergraduates use the Dartmouth Time-Sharing System (DTSS). Furthermore, Kemeny has a sneaking suspicion that at least some of the one in 10 students



Thomas E. Kurtz

who do not show up in the user statistical tables learn to use the time-sharing system on the sly. Kemeny claims that Dartmouth students far and away have more experience with computers than students from any

other college anywhere. And this in spite of the fact that Dartmouth is primarily a liberal arts college and not a technical institution.

"From the start in 1963, Tom Kurtz and I thought that instead of training computer scientists, computers would make a fine learning tool for students at a liberal arts college," says Kemeny. "Instead of worrying about 100 students who would get computer jobs, we worried about thousands who would be able to use computers." Dr. Kemeny founded the DTSS along with Dr. Thomas E. Kurtz, who is professor of mathematics and director of Dartmouth's Kiewit Computation Center. In addition Kemeny and Kurtz are the co-authors of BASIC.

### Slow beginning

It all started in 1959 when Dartmouth obtained a Bendix LGP-30 computer with just 4K of memory and a cycle time in the millisecond range. Kemeny and Kurtz quickly discovered that Dartmouth undergraduates could be extremely adept at programming. "In that way, that little computer had a great impact on us," recalls Kemeny.

Once the decision was made to build a time-sharing system, the whole project moved quickly. The hardware — a GE-235, a GE Datanet-30 communications computer, and a disc file — arrived in early 1964. Undergraduate programmers were writing programs for the equipment even before it was installed. In the fall of 1964, the system was available for general use by Dartmouth undergraduates and a terminal was installed for high school student use at nearby Hanover High.

"We trained more than 85% of our freshman class that year," says Kemeny. "The time-sharing system was an absolute instant success with the students."

However, the system was not exactly an instant success with the Dartmouth faculty. Kemeny recalls that one "distinguished humanist" at Dartmouth delivered a lecture attacking

the "machine age" when the computer system was installed. Other faculty members resisted the computer installation, but even the staunchest holdouts among the faculty finally had to learn how to use the DTSS in self-defense, Kemeny says. Now, the computer installation — housed in the large and modern Kiewit Computation Center — is used

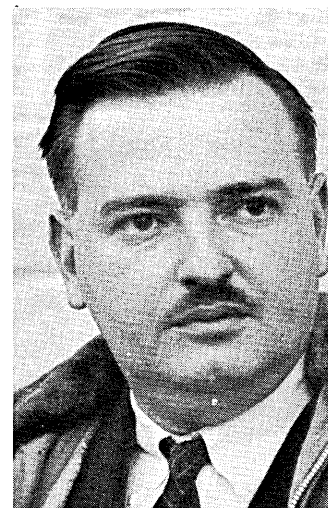

J. G. Kemeny

heavily by the faculty.

The center's hardware is now configured around a Honeywell 635 (formerly a GE 635), and the equipment has handled more than 19,000 jobs in a single day. More than 100 undergraduate courses at Dartmouth make significant use of computing and the Computation Center. Students at Dartmouth's graduate business school, the Amos Tuck School, make the most extensive use of computers.

Kemeny, who before he became president of Dartmouth taught both mathematics and philosophy, likes to tell one interesting anecdote about the system. He is an intense football fan, and in 1965 when Dartmouth won the Lambert trophy — for being voted the best football team in the East — Kemeny commemorated the achievement by writing a football program on the DTSS. The game, which has since been further sophisticated, has been a great favorite of students and alumni, and stories abound about famous visitors to Dartmouth who are lost for hours in the Computation Center playing football. But there is an

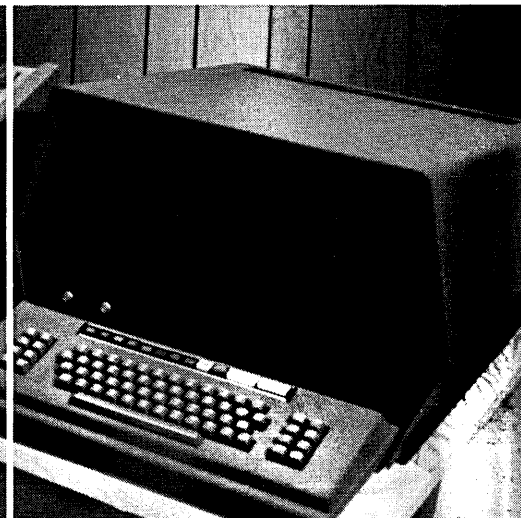
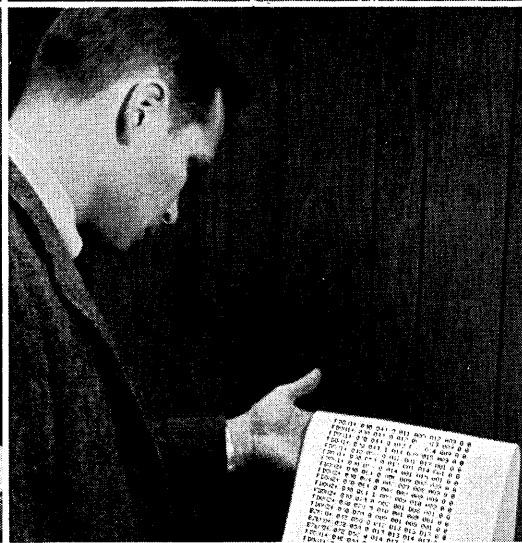
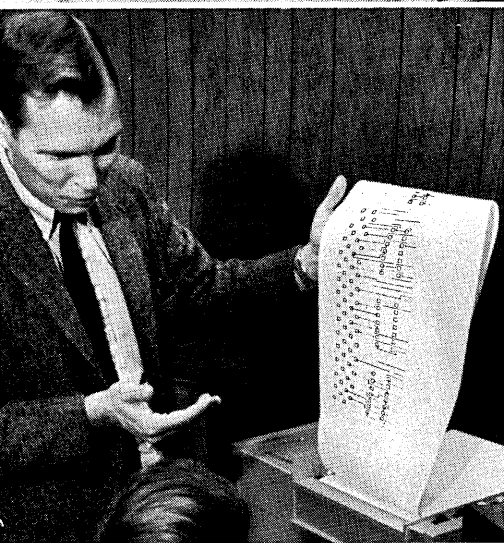
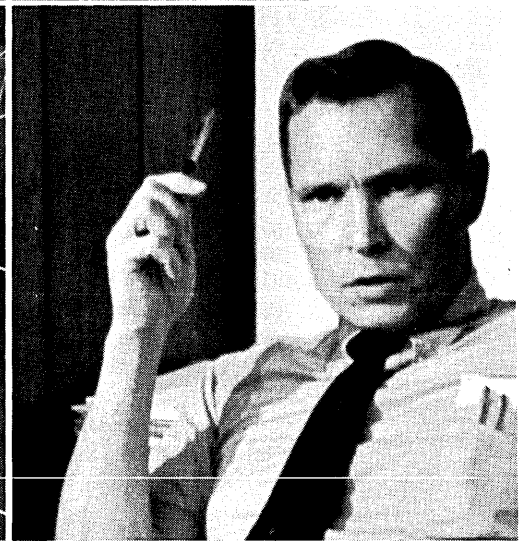
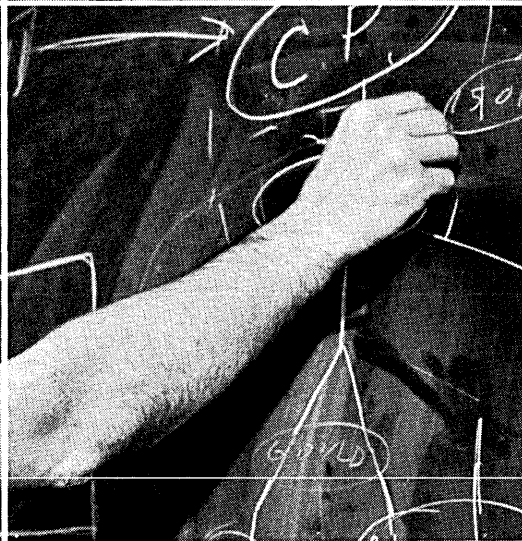
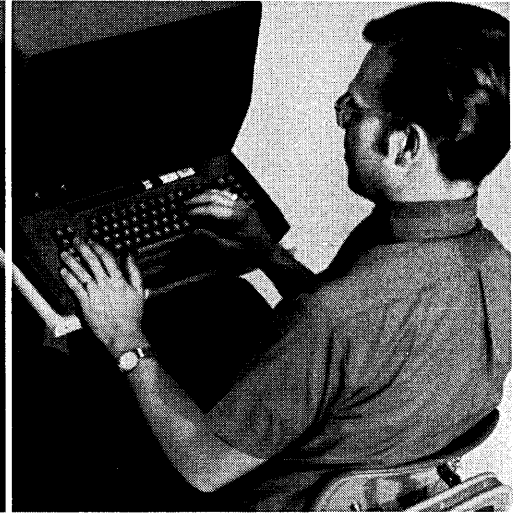
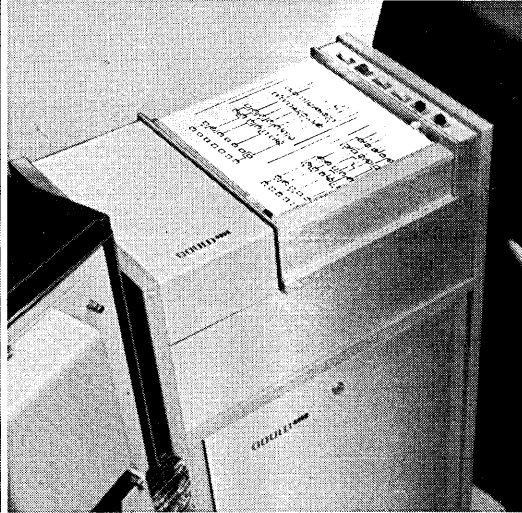

# Software systems firm slashes printout costs, compresses production schedules with Gould 4800.

Automation Technology Inc. is a specialty software systems house in Champaign, Illinois. One of their many capabilities is the design and production of the precision artwork used for making printed circuit boards. To help meet the rapidly growing demand for increasingly complex and compact circuitry, ATI uses a Gould 4800 electrostatic printer/plotter.

Art Carroll, ATI's President, provides the details:

"One of the key steps in our operation is the validation of our circuitry designs. This is done with our design automation system and requires several iterations to arrive at the optimum combination of component placement, circuit paths, interconnections and drilling patterns. Before we had the Gould 4800, we had to go to our photoplotter for these iterations. This was both costly and slow as photoplotter time runs about \$75 an hour and one iteration may take hours to produce.

"The Gould 4800 gives us both alphanumerics and graphics for pennies per page. And lets us pinpoint defective inputs and make corrections as we go.

This way, we don't have to use the photoplotter until we're ready for the production master.

"As our circuit designs grow more complex, the Gould 4800 becomes even more valuable. At the rate of 100 sq. in. per sec., it furnishes a graphic printout that superimposes the wiring patterns for several layers of a multi-layer circuit. It also provides our alphanumeric "fail" list that gives us complete details on connections not successfully completed. This permits early manual intervention.

"This sort of speed, combined with its versatility, quietness and reliability, makes the Gould 4800 ideal for our operation. Without question, it's our key piece of peripheral equipment."

All kinds of companies with all kinds of hardcopy requirements have found the Gould 4800 to be an optimum solution. This smooth, quiet electrostatic printer delivers up to 4800 lines per minute on an 8½" or 11" format. It has an optional character generator. Software and interfaces for major computers are available. And while the Gould 4800 has relatively few moving parts and little need for maintenance, there are service facilities nationwide.

**Find out what the Gould 4800 can do for you.** Give us a call. Or write: Graphics Division, Gould Inc., 3631 Perkins Avenue, Cleveland, Ohio 44114.



## PERSPECTIVE

educational advantage to the football game, too. The game helps remove the mystique that, for laymen at least, often surrounds computers. "After you have played football with the computer, you don't fear it," notes Kemeny.

### Easy did it

Dartmouth has made it easy for its students to use the DTSS. BASIC, the simple programming language, was one way — a typical student learns BASIC in two hours. When a freshman arrives at the New Hampshire college, he is given a student identification number, which is also his computer number. Further, the some 150 Teletype ports at the Kiewit Computation Center are readily accessible, much like library carrels.

DTSS' data bases are not limited to areas of technical, engineering, and commercial interests. For instance, there is a program called Project IMPRESS that provides students with data in the social sciences. In peak usage periods — usually towards the end of academic terms — there may be as many as 200 daily and 750 weekly IMPRESS runs. For example, one student was observed recently querying the data base on "faculty attitudes to coeducation." He found a substantial amount of raw data and enough information to point in the direction of finding additional information on the subject.

On the other hand, there are always a few students who turn out to be brilliant programmers. Most of the systems programming on DTSS is performed by undergraduates.

"We never know what to expect from our undergraduates," says Kurtz. "We just open our doors at Kie-

wit and we always get a couple of very bright programmers. I know of one programmer here whose talents are such that he is worth \$100,000 a year." Ironically, Kurtz points out that most of the best programmers don't go into the computer industry per se, but into one of the more classical scientific fields, although they tend to use computers heavily in their later work.

Some Dartmouth graduates are finding that they can demand more pay and better jobs because they know how to use computers. In particular, graduates of the Tuck Business School are finding that they are more in demand because of their computer backgrounds. Conversely, many Dartmouth students are asking prospective employers where their terminals are when they interview for a job. As another indication of the spread of computer know-how by the DTSS, Kemeny notes that his high school daughter, who has been interviewing colleges, has been inspecting the computer facilities offered by various schools. "She has been using computer terminals since she was in the sixth grade," says Kemeny. "She wouldn't dream of doing a laboratory experiment without using a computer."

The Kemenys have a terminal at home, but they are not exactly privileged in this regard. The Dartmouth Time-Sharing System is on-line to 15 colleges and 35 secondary schools that make terminals readily available to their students. The secondary school students are putting pressure — subtle pressure to be sure, but pressure nonetheless — on colleges to upgrade their computer facilities, while Dartmouth graduates are helping encourage more busi-

nesses and professions to improve their computer facilities.

### Horrors

In spite of the gains at Dartmouth and in spite of the fact that a few other colleges are beginning to emulate the Dartmouth program, Kemeny says he is "horrified" that the time-sharing concept hasn't spread among colleges more rapidly than it has.

One problem, he feels, is the headlong rush many in education circles made into the so-called field of educational technology and the dismal results the push in the area produced. The failure of the "teaching machine" to approach its goals has tended to give the whole educational electronics industry a black eye, Kemeny feels.

### Future dating

And what does the future hold for time-sharing? First of all, Kemeny believes there will be more regional computation centers in colleges patterned after the Dartmouth experience.

"And the long range has to belong to time-sharing, too," says Kemeny. He doesn't see minicomputers invading the home in significant numbers because minis don't have the sophistication to provide a simple language, as time-sharing can, nor can minis provide access to the large data bases that will be essential for successful home use. Nevertheless, Kemeny doesn't see time-sharing terminals as commonplace items in homes—like tv sets today—until 1990.

When asked why so few commercial time-sharing companies have been profitable, Kemeny paused a moment, then presented the idea that he felt too many companies jumped into the field too soon, creating a price-cutting environment in which practically no company makes money.

Whatever the future may hold for time-sharing, Kemeny no doubt is warmed by the sight of the stream of Dartmouth undergraduates who, on big football weekends and at winter carnival time, take their dates to the computation center. That is something of an accomplishment. Nothing against libraries, but who ever heard of college men taking their dates to a library on a big weekend?

— David Gardner

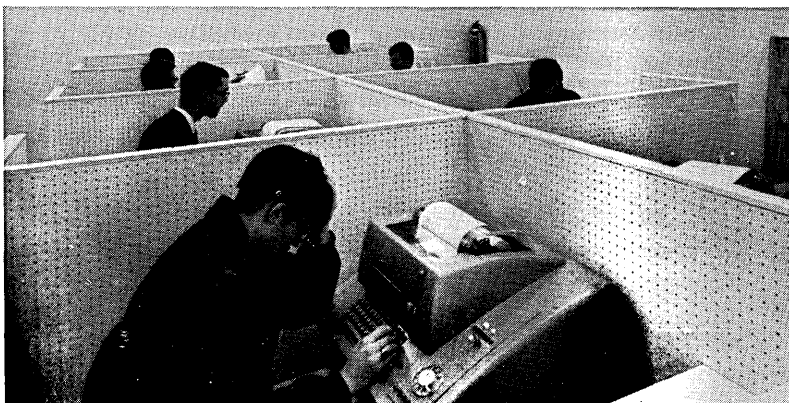

Kiewit Computation Center: Great place to take a date on a football weekend.



New Model 78 Programmed Terminal provides plug-in replacement for 360 Model 20 Terminals and configuration flexibility including Mag Tape, Displays, Card Reader and Line Printer.



Model 70 Remote Batch Terminal is plug-in replacement for 2780 units, offers increased performance at cost savings up to 25%. Delivery 90 days.

## DATA 100 offers the family of remote terminals to fit your system needs

Whatever your communication hardware requirements, Remote Batch Terminals, Interactive Keyboard Displays with optional hard copy, or a *custom tailored* Programmed Terminal, the DATA 100 Seventy Series offers highly reliable terminal equipment for commercial users, computer utilities and government communication systems. Complete technical support available Nationwide and in Europe. Call today.

Atlanta, Ga. 404/432-4555 • Boston, Mass. 617/484-8737  
 Chicago, Ill. 312/298-5188 • Cleveland, Ohio 216/247-8668  
 Dallas, Tex. 214/350-3282 • Detroit, Mich. 313/642-3383  
 Greensboro, N. C. 919/273-6789 • Los Angeles, Calif.  
 213/477-8001 • Maplewood, N. J. 201/763-1250 • Minneapolis,  
 Minn. 612/920-8800 • New York, N. Y. 212/868-7590  
 Palo Alto, Calif. 415/328-2100 • Pittsburgh, Pa. 412/833-3633  
 St. Louis, Mo. 314/872-8835 • Washington, D. C. 703/893-4356  
 London, England 01/493/7367

**DATA 100**  
**CORPORATION**

# NEWS SCENE

## Los Angeles Library Utilizing COM

It all started with a forgotten library card.

When Stan Jaskol's daughter went to a Los Angeles public library to borrow a book and forgot her card, the librarian had to call the central library to verify that she was in fact a valid card holder. Seems the list of such holders was too voluminous to be kept in more than one place. And it took time to search through it. This started Jaskol thinking. This was some two years ago. Last month, as a direct result of that thinking, the Los Angeles Public Library, largest circulating library in the world, implemented a system of computer generated microfiche record control, becoming the first public library in the world to make use of COM.

Jaskol is vice-president of Computer Micrographics, Inc., Los Angeles, which is converting library records to microfiche under a \$70K one-year contract which includes services and 100 microfilm viewers. CMI produces its fiche reports in specified quantities from magnetic tape provided by the city's Data Service Bureau.

The Los Angeles Public Library lays claim to being the first and only public library in the country developing a fully integrated automated technical services program. The system is being installed in five phases. The first two, already complete, are an automated patron registration which keeps track of 1,200,000 card holders and a book inventory update involving orders for more than 300,000 books each year. Phases 3, 4, and 5, to be integrated into the system by 1973, will cover ordering and control of more than 33,000 magazines and journals, cataloging of all books (3 million), and circulation control.

When Jaskol's daughter forgot her card, necessitating a phone call by the librarian, he began to wonder if microfilm could eliminate the need for such calls. He approached library officials and discussion began. There was interest, he said, especially after demonstrations were conducted for librarians and others concerned.

Eventually the use of microfiche was okayed and the project put out to bid. CMI was low bidder. The first viewers were delivered to library branches in December.

Pat Galati, president of the Los Angeles Board of Library Commissioners, estimated the conversion to microfiche will save the library \$1 million in 10 years. He said costs will be cut by \$82,000 the first year and \$97,000 per year thereafter.

There are the savings in phone costs first anticipated by Jaskol because each branch library can have its own constantly updated patron list in compact microfiche form, and data that formerly took 208 pages of printed output on paper costing 1½ cents a sheet can now be stored on 16 cents worth of microfiche.

Other Los Angeles city departments are considering the use of fiche, and CMI already is doing some work for one, the Board of Transportation. Others interested are the Traffic Bureau, the Board of Sanitation, the Fire Dept., and the City Clerk's office.

And the library won't stop here. While it's impractical and prohibitively expensive now because the library system covers some 300 sq. miles, officials see use of some kind of an on-line system as "some half-dozen years down the road."

## PRC Combines Divisions, Bestows Company Status

A reorganization of sorts is going on at Planning Research Corp., Los Angeles, as the firm attempts to equalize the status of its divisions with its acquisitions of the past few years, the latest of which is Realtronics of Denver, an outfit that provides computerized listing service to the real estate industry.

Divisions will no longer be divisions at PRC but will become companies at the same corporate level as the subsidiaries under the aegis of PRC hq, or Corporate Center, as it is to be called (all names subject to change).

As an example, the Computer Systems Div. and the Information Systems Div. are now the Information Sciences Co., under Jack Little. And

the Systems Economics Div. and the Systems Engineering Div. are now PRC Data Services, under George Monroe. International Reservations Corp. continues as its own entity, headed by Bill Lonergan. (Although equal in operating status to the subsidiaries, none of the former divisions will have legal entity status.)

There are now 15 companies under the PRC umbrella, each of them with its own Synergism Specialist, who communicates with all the other SS's in the various companies and with Corporate Center to find out what's going on, what each is planning, how each can help the other, and to avoid duplication of effort. PRC president Dr. Robert Krueger has a fondness for the word synergism ("It means what it means"), is convinced that the interactive functioning of the various PRC subsidiaries cannot help but effect a healthier profit stance than if they operated singly.

Of increasing concern to Dr. Krueger and his firm these days is what he considers to be the growing trend on the part of the federal government toward more FCRCs (Federal Contract Research Centers), which he cites as a sign of increased federalization of private enterprise. He thinks the government should establish a person or office responsible for seeing that the government does less than it is doing, that many of its functions revert to the private business sector. His firm will join in an effort to establish such an agency.

## First Facom Sold in U.S. . . . Conditionally

The Japanese computer invasion has established a conditional beachhead. ASI (Automation Sciences, Inc.), U.S. marketer of the Fujitsu Ltd. manufactured computer, reports a 48K Facom 230-25 has been ordered by Squibb Beech-Nut Inc.

Squibb says the order is conditional pending evaluation of maintenance and lease arrangements and was made to take advantage of an attractive price — \$400K.

Price is the main Facom attraction, according to ASI vice president, M. B.

Sargent. He said there is no discrimination over the computer's origins; potential customers merely lump it with the other IBM competitors.

## TI Says Computer Line Isn't 'General Purpose'

QUESTION: *Is Texas Instruments getting into the general-purpose computer business?*

ANSWER: *If you mean "business type" machines, "no."*

The prepared statement from Texas Instruments is in reply to questions about rumors they are entering the general-purpose computer business. The Dallas electronics company has been building computers for at least 10 years for their own use and for sale to other companies, notably some within the oil exploration industry.

The "general purpose" rumor crops up occasionally at TI and the company is understandably touchy about these because of its position as a supplier of semiconductors to IBM.

Latest rumbling along this line may be of TI's own doing, however. They recently published a brochure on the Model 980 which flatly refers to the system as a "General Purpose Digital Computer."

But TI holds to a somewhat different definition of "general purpose" than does the rest of the computer industry. The 980 was developed for real-time process control in their own manufacturing operations. One has been modified to serve as message switching center within TI's internal Telecommunications Dept. The Dallas brokerage office of Rauscher Pierce has a TI 980 which also is used as a message switching center. In all, some 100 980s have been manufactured, but only about 10 sold outside the company.

The 980 is a stored-program digital computer with a 16-bit word, one USEC memory cycle time and 400 NSEC access time. Basic memory is 4K words that can be expanded to 64K. TI makes the 980 for real-time process control, scientific data processing, and communications systems. This, then, is their General Purpose Digital Computer; a system which *can* be programmed for more than one use, but these are primarily industrial

uses. TI is *not* marketing computers to banks, insurance companies, or similar organizations for business and administrative data processing . . . and we are certain they wish the term "general purpose" had never appeared in their literature.

Another TI process control computer, the Model 960, is billed as "the manufacturing man's computer." It provides direct digital control of several manufacturing operations simultaneously, controlling such functions as monitor, test, stop, start, control, and compute. Software packages are said to be easy to set up and change. A key feature of the 960, also called "the bit pusher," is a capability of varying its effective word length from one to sixteen bits.

Both the 960 and 980 are produced by TI's Digital Systems Div. in Houston.

Meanwhile in the major leagues, TI's still-under-wraps ASC (Advanced Scientific Computer) is referred to as a "supercomputer with several times the capability of the most powerful computer now installed in the world." Development work has been under way since 1966, and the supercomputer is due for operational use in 1972. TI sources say the U.S. Army has entered into a "second study contract" which places the ASC into competition for possible application in advanced ballistic missile defense.

The ASC is also aimed at a broader scientific market wherein massive amounts of well-ordered data must be processed at very high speeds. Two possible application areas are weather forecasting and air traffic control, says TI.

The company essentially pioneered this market with the special-purpose computers they manufactured for seismic oil exploration operations and for the government's VELA UNIFORM program for the detection of distant underground nuclear tests. (Geophysical Service Inc., an oil exploration company formed in 1930 and still very much in operation as a division of TI, was actually TI's parent company.)

Among the first of these computers was seisMAC (Seismic Magnetic Automatic Computer), an analog system specifically for oil exploration operations. There followed several generations of TIAC (Texas Instruments Au-

tomatic Computer), a digital system also originally designed for seismic exploration.

TIAC and seisMAC were undoubtedly the forerunners of the ASC which "has guided the development of digital technology at TI in such areas as integrated circuits, multilayer circuit boards, design automation, data terminals, digital communications, and advanced computer memory systems."

It would appear that TI's original need to process seismic data for oil exploration has been the basis for putting the company into future contention as a supplier of "supercomputers" and peripheral hardware.

## Judge Okays IBM Decree Modification

A Federal District Court judge finally signed a Justice Dept. order modifying IBM's 1956 Consent Decree so that the computer company can sell and buy repossessed equipment at market price. Judge David Edelstein of New York's Southern District Court had held the order issued by the Justice Dept. on November 20, 1970, for 30 days in case interested parties cared to comment. There were no comments.

The modification, initiated by IBM, brings restrictions on resale of repossessed equipment in line with the Uniform Commercial Code; it also permits IBM to itself bid for the equipment.

The Uniform Commercial Code has been adopted by 49 states since the writing of the Consent Decree. Under the code a defaulting debtor can require a secured creditor to dispose of the collateral by public or private sale to insure maximum return to defray debt. The creditor can also initiate similar sales after notification of the debtor. In either case the sale must be made in method, manner, time and place, and under terms that are commercially reasonable.

The Consent Decree required IBM to solicit orders for repossessed equipment from dealers in used equipment and limited maximum price to 85% of initial price minus 10% for each year of installation.

The modification works to the advantage of both IBM and potential





# Meet George Taylor, HP Systems Analyst.

## He'll show you how to save a bundle with your own time-share system.

George is a systems analyst in our Englewood, Colorado, office. Like his fellow HP analysts throughout the country, he was specially selected and trained as a time-share expert.

His role is a simple one: to help you realize the full potential of in-house time-sharing, made possible by HP's Series 2000 Systems.

But George and company are just one part of our great new deal for in-house time-sharing. We now offer a five-year leasing plan that lets you try an HP system for up to six months — and still bail out without penalty if it doesn't live up to your expectations. All we ask is that, for one month during this trial period, you work with one of our systems analysts. Or, if you prefer, use one of your own. Either way, your people in engineering, manufacturing, marketing and accounting will learn how to make the most of the system.

Low cost is another part of our deal you'll like. In fact, if you're presently spending more than \$2000 a month for time-share rental, you should definitely

consider the advantages of going in-house.

For instance, you can get started for as little as \$2041 a month with our 2000A. It handles up to 16 terminals, is upward expandable and is backed by more than five million hours of actual user experience. Need a bigger setup? Consider our 2000B System. It handles 32 users simultaneously for just a third more cost. Or for only \$3785 a month you can have our new 2000C. This deluxe model gives you all the "bells and whistles"—including virtually unlimited data storage. And, as a bonus, it provides you with alternate use in a batch processing mode.

Add it all up—the systems analyst, the six-month trial, the low cost. You'll arrive at the only reasonable solution to spiraling time-share costs—an HP Series 2000 System. So why not give George Taylor (or any of our time-share analysts) a call and talk it over? Or write for complete information to Hewlett-Packard, Palo Alto, California 94304; Europe: 1217 Meyrin-Geneva, Switzerland.

HEWLETT  PACKARD

DIGITAL COMPUTERS

# Trying to get on-line with a "low-cost" box?

If you've been looking for a small, low-cost processing box, you might be getting yourself into one.

Anybody can sell you a box of hardware, but only with Raytheon Computer's 704 do you get all the software to do the job. All for under \$10,000.

With our software library of over 600 programs, you'll never have to write a systems program again. Raytheon Computer's 704 is operational the moment you plug it in.

And every program is fully documented and fully tested. Like our exclusive executives and monitors. And our 360-compatible superset of USASI FORTRAN IV and conversational FORTRAN. And the only small computer Sort/Merge package.

And we've got the hardware too. The 704 is a 16-bit gp computer with 74 instructions, 4k of 1.0  $\mu$ s core (expandable to 32k), a real-time automatic priority interrupt system, direct I/O to the CPU and 4 registers. Options

include hardware multiply/divide, bootstrap and direct memory access, and all the interface equipment you'll need.

So write today and ask for Data File C-194. We'll send you all the facts and figures you'll need to help you get on-line faster and cheaper. And that's our bag.

Raytheon Computer, 2700 S. Fairview St., Santa Ana, Calif. 92704. Phone 714/546-7160.



## With 600 programs, Raytheon Computer's 704 won't leave you holding the bag.

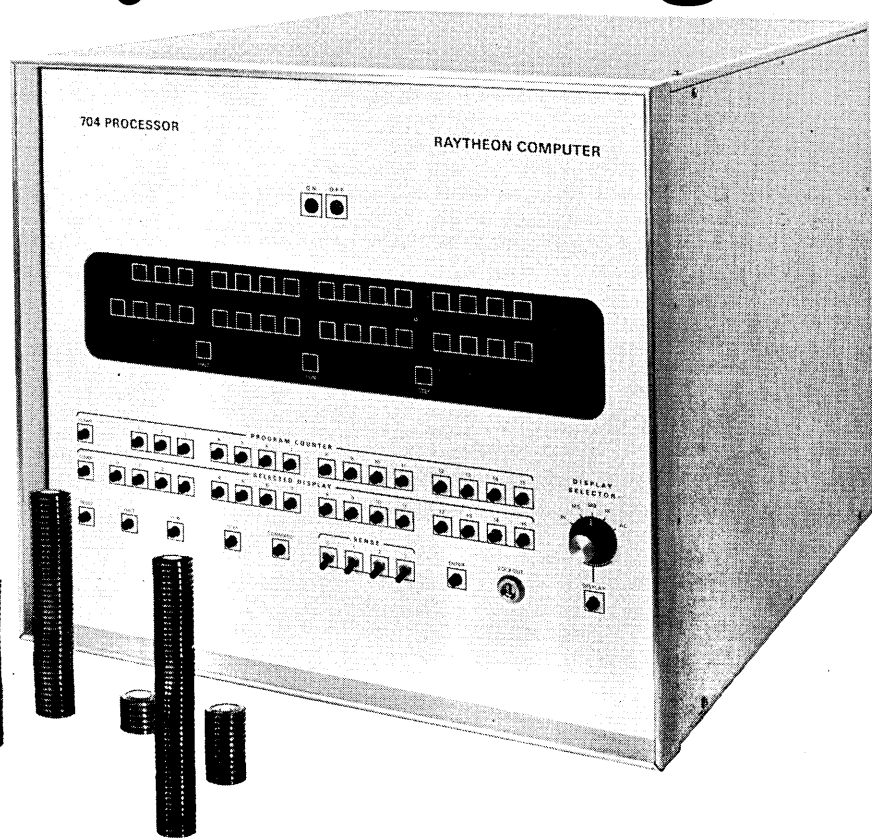

**Raytheon Computer.**  
**We give you our all.**

debtors. Its genesis apparently was the shakey situation of some computer leasing companies. The possibility of one folding and forcing IBM to repossess millions of dollars worth of equipment which it would have to sell at bargain prices must have started someone thinking.

The Levin-Townsend efforts to raise capital or find a merger partner illustrate the dilemma caused by the Consent Decree limitation. The IBM veto of an agreement in principle for Randolph Computer Corp. to buy some \$50 million worth of equipment, according to L-T president James Townsend, was due to provisions that protected Randolph from financial loss if the transaction was upset within the year. The apparent result of the provision was that financial liability and legal costs would revert to IBM.

IBM also turned down an L-T offer to transfer to IBM enough equipment to cover all present and future obligations, at the time around \$50 million. Other lessors found the Decree restrictions to advantage in refinancing their IBM debt.

The modification to the Consent Decree also states that IBM shall be considered adhering to the Decree and the Uniform Commercial Code in buying secured equipment as long as it does not bid or offer a price exceeding that stipulated in the Decree or the total indebtedness owed. If IBM gets the equipment after meeting the price limit, it is free to do whatever it wants with it.

**ACM Running Seminars for Job Seekers**

Eppers whose jobs have been rubbed out by the recession are getting an assist from the Association for Computing Machinery. The association and its New York chapter are running a series of seminars on how to go after a job.

They include resume writing, interview techniques, and general advice on where and how to look for work. People from placement agencies and personnel departments are conducting the sessions.

Not so surprisingly, people in this once lush job market know more about writing programs than writing resumes. Response in the week fol-

lowing notification of the 4,000 greater New York City ACM membership was close to 150, and five seminars were projected. The ACM said the program will continue as long as there is a demand.

**Two AFIPS Studies to Help Computers Help**

Two new AFIPS study projects on how to make computers help people are getting under way under the direction of Hal Sackman of the USC Public Systems Research Institute. Each will culminate in an invitational conference and a book by multiple authors on the subject (honorariums will be paid). The first is on the topic "Planning Community Information Utilities" (co-directed by Dr. Barry Boehm of RAND), and will be an effort to establish a blueprint for a community prototype of such a data base. The second, "Computers and Social Problems" (with Dr. Harold Borko of UCLA), will attempt to form links between AFIPS and scholars in the various professional groups, such as the ABA and the AMA, to pinpoint the social problems in their bailiwicks and determine how computers can help. They just may be able to.

**Charles B. Tompkins Dies in Los Angeles**

Computer industry pioneer Charles B. Tompkins died last month in Los Angeles at the age of 58.

A professor of mathematics at UCLA at the time of his death, Dr. Tompkins was one of the group of former Navy officer specialists who, in 1946, formed Engineering Research Associates of St. Paul, Minn., a company to which at least two of the seven dwarfs can trace some roots.

ERA, under contract to the Navy, produced one of the world's first three computers, a powerful top-secret intelligence computer known as Machine 13. The company was acquired in 1952 by Remington Rand and combined with earlier acquired Eckert-Mauchly Corp. to form the nucleus of what today is the Univac Div. of Sperry Rand Corp.

In 1953, a conflict between the former E-M group and the former ERA group led to the departure of some

**Raytheon Computer. We give you our all.**

With the Raytheon Computer 704, you'll have the only complete, efficient software library in the 16-bit class. In all, we've got over 600 field-proven programs to choose from.

- Multi-programming Systems
- Complete Math Library
- Applications Programs
- Data Processing Programs
- Diagnostic and Test Programs
- FORTRAN IV
- Conversational FORTRAN
- Array Processing
- Sort/Merge Package
- Monitors and Executives
- Utility Programs
- System Programs

For a complete listing of our software and all the facts and figures on our entire 700-Series computers, write today. Ask for Data File C-195.

Raytheon Computer, 2700 S. Fairview St., Santa Ana, Calif. 92704. Phone 714/546-7160.



CIRCLE 48 ON READER CARD

# Wiltek moves data communications three steps forward

**Step 1: A modern replacement for paper tape store-and-forward devices.**

**Step 2: A way to increase the efficiency of CRT data entry systems. Step 3: A way to make distributed storage practical and economical.**

**Wiltek's new Digi-Store® line of buffers helps achieve all three.**

The concept behind Wiltek's new buffers is simple. Take an endless loop of magnetic tape. Pass it through two heads, one to record data, the other to read it. Make the tape drives capable of operating at the same time, at different speeds. Provide a wide range of options to interface with other components in a data communications system.

The results are dramatic: low cost data-storage and buffering units that can receive data at one speed, and send it at another — simultaneously.

That can receive and transmit up to 333 8-bit characters per second.

That can store data for less than a penny a bit.

That can record over 50,000 characters on a long lived, reusable loop of tape.

That can operate totally unattended, with high reliability and low maintenance.

**As store-and-forward devices: The great replacement.**

Probably the most familiar store-and-forward devices are paper tape



units. Many are 30 years old, and show their age—bulky, chad-strewn machines that are the weak link in modern data communications.

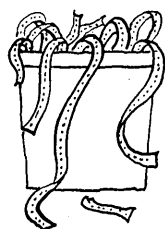

Wiltek Digi-Store units are markedly superior, yet competitively priced.

The Wiltek buffers can handle 5, 6, 7 or 8 level code ... fit neatly into drawers or racks ... are quiet and unobtrusive ... seldom need maintenance ... operate at an error rate of less than one per million characters. What's more, they're plug-for-plug compatible with communications systems currently using old-fashioned paper tape equipment.

**With CRT's: Breaking the bottleneck.**

For many CRT operators, waiting is a way of life. They enter data, then sit idle, waiting permission to transmit. Wiltek's Digi-Store buffers introduce a completely new way to enter CRT data, and an economical way to break this bottleneck. Here's a simple example.

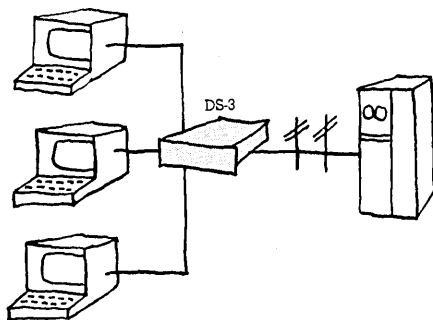

Instead of waiting for an OK to transmit, CRT operators free-wheel their data on a message-by-message basis to a Wiltek buffer-store. The data is called out of the buffer on either a single- or multi-message basis by the receiving device. The receiving unit can call data out of the buffer-store at one speed at the same time that the CRT operators are putting data into it at a different speed.

Result: Data entry and data reception are independent of each other. Operators enter data whenever they wish. There's no hand carrying of data, and no frustrating delays. Data flow is completely automatic.

**Distributed storage: Making it practical and economical.**

Until now the trend in data communications has been to allocate areas of central storage for on-line buffering of incoming data from all terminals in the network. This centralized storage approach suffers

from two basic problems: First, a breakdown in a single system component can cause all of the input stations to be out of service. Second, during peak periods a queue may develop which results in lower throughput and higher line cost.

The Wiltek Digi-Store line of buffers changes all that. The Wiltek units are economical enough to be installed at each station where data originates. They can hold data until the computer polls and asks for it. And, should one station go down, all the others in the distributed system can continue sending: Line costs are reduced by transmitting data in bursts. Should a message to the computer be garbled, a buffer can swiftly re-transmit it.

**Wiltek makes three Buffer-Stores.**

- **The DS-3** is the basic unit for store-and-forward applications and data entry systems.
- **The DS-6** provides polling or call selection for selective calling networks, or for linking computers.
- **The DS-7** supplies both polling and call selection for communications between two selective calling systems, or between computers.

Wiltek has just published a booklet covering this remarkable new family of buffers. It shows in photos and diagrams how they work and how they can help solve data handling problems in a broad range of EDP applications. For your copy, simply mail the coupon, circle the magazine reply number, or call directly — Area Code 203-762-5521.



**wiltek**  
makes the Digi-Store line

Wiltek, Inc.  
59 Danbury Road  
Wilton, Conn. 06897

D-2

Please send me a copy of your booklet on the Digi-Store buffer line.

Name \_\_\_\_\_  
 Title \_\_\_\_\_  
 Firm \_\_\_\_\_  
 Street \_\_\_\_\_  
 City \_\_\_\_\_ State \_\_\_\_\_ Zip \_\_\_\_\_



In the beginning there were only a few credit cards.



Then companies created more credit cards.



Soon almost everyone had a credit card. But some people used too much credit or credit that wasn't their own. And many companies lost money because they didn't have a sure way to check credit quickly and accurately.

So Pitney-Bowes set out to develop a credit authorization system that was better than any other system before.

They came upon a fluorescent encoding technique that was invisible, inalterable, as durable as the card and compatible with any embossing system. They even made sure the code wouldn't change the look or feel of the card. Then they designed a machine that eliminated call-ups, lists, even floor limits. The machine could read the card, register the amount, phone the computer, receive the go or no-go message and give the operator the o.k. or any one of three special signals . . . all in less than 10 seconds . . . for any amount of charge . . . for any credit card.

Pitney-Bowes had done what they had set out to do.

## The beginning of the end of credit card losses.

THE NEW  
PITNEY-BOWES  
CREDIT  
AUTHORIZATION  
SYSTEM



Pitney-Bowes

For information, write Pitney-Bowes, Inc., 9651 Atlantic Street, Stamford, Connecticut 06904 — or any of our 190 offices in the U. S. and Canada.

CIRCLE 60 ON READER CARD

## NEWS SCENE

ERA people, headed by William Norris, a co-founder with Tompkins of ERA, to found Control Data Corp. of which Norris is still president.

Dr. Tompkins in 1953 joined the UCLA mathematics department, serving as director of numerical analysis research and director of the computing facility.

## NEWS BRIEFS

### New Look at RCA

RCA last month juggled its information systems operations in the interests of cutting costs and providing "closer management control" to form RCA Computer Systems which incorporates and replaces the company's old information systems group and adds two new divisions, a new staff group, and a new manufacturing organization. L. E. Donegan Jr., vice president and general manager of the old computer group, will head the new organization as a corporate vp/gm. Operating divisions of RCA Computer Systems are Data Processing, Systems Development, Graphic Systems, Memory Products, and Magnetic Products.

### Key-Disc Growth Seen

Data preparation systems using shared processors will experience significant growth within the next four years, according to results from a study of the market by Consolidated Computer International, the Canadian company.

The firm says some 300 systems were installed last year, valued at \$30 million, and this will grow to \$200 million a year by 1973. The company says it thinks that within the next four years 15-20% of the estimated 500,000 keypunch machines now in use will be converted to the shared-processor systems. These are systems where multiple keyboards are connected to a single computer which edits the data, stores it on a disc, and outputs it to a reel of magnetic tape.

### Brandon, Creditors Agree

Brandon Applied Systems, Inc., hard hit by the recession, is continuing in business with creditor cooperation. The company pledged 100% repayment of \$450,000 to \$500,000 in trade debt at a January meeting of its major creditors. The meeting was called

when the company found it could not meet commitments on maturing debt. The creditors have given a temporary open-ended extension on payments. Brandon, with 40 people, will continue to concentrate on management consulting, software packs, and seminars.

## SHORTLINES

Semiconductor memories notwithstanding, there's no doubt about it: Core is still selling. Datacraft Corp., Fort Lauderdale, Fla., last month received a \$3.5 million order for its new DC-38 core memory systems from North Electric Co., Galion, Ohio . . . Colorado Instruments, Inc., Broomfield, Colo., obtained a \$2.5 million line of lease financing from Talcott Computer Leasing Div. of James Talcott, Inc., New York City, and set up a new subsidiary, Source-Data Leasing Co., to handle leasing of its data communication equipment . . . Levin-Townsend Service Corp. has a new name, Tolly International Corp. . . . The state of

Colorado has a new Automatic Data Processing Advisory Committee to advise its director of the Dept. of Administration on edp matters . . . Cogar Corp. said it has received a \$1 million commitment from an institutional investor . . . The state of Washington last month installed an EMR Computer computerized communications system for law enforcement use . . . Remote Console Information Corp., McLean, Va., received a contract to provide equipment to automate the library at Pennsylvania State Univ. . . . The Colorado Div. of Employment purchased a Burroughs B 3500 to process information for the Employment Service Automatic Reporting System (ESAR), a federal program involving analysis of employment service activities throughout the U.S. . . . One of the first IBM System/3 Model 6s to be delivered was installed at SI Handling Systems, Inc., Easton, Pa. . . . Auerbach Info, Inc., inaugurated a new subscription research program, Auerbach Technology Evaluation Service. ■

# Mail this coupon

See why Data Electronics had to develop a better keyboard.

DATA ELECTRONICS CORPORATION  
12 Cambridge Street  
Burlington, Mass. 01803

Gentlemen: Please send me your new booklet outlining the problems hanging up most keyboards and the solutions that make Manmachine\* unique.

NAME \_\_\_\_\_ TITLE \_\_\_\_\_

COMPANY \_\_\_\_\_

STREET \_\_\_\_\_ CITY \_\_\_\_\_

STATE \_\_\_\_\_ ZIP \_\_\_\_\_ TELEPHONE \_\_\_\_\_

Plenty of keyboards on the market, right? All reliable, all low-cost, all immediately available, right? Wrong. That's why Data Electronics developed Manmachine\*, spent 20 months getting it and its tooling ready.

A simple, conservative, flexible, modular design. You pay only for the features and the codes you need, any codes you need. Current drain is automatically limited,

and there is no voltage or temperature sensitivity to worry about. Rollover protection, of course, plus the nearest approach possible to the ideal, human-engineered key travel. Write for the full story. \* Trade-mark

**DE**  
MANMACHINE\*

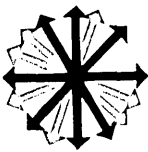

## Data Entry Terminal

Computing power, storage, and recording media are being put in smaller and smaller packages, and here a good measure of each appear in a plain wrapper. The unimintimidating exterior of the Cogar 4 shows a standard 64-character typewriter keyboard; 5-inch, 128-character crt; and two mini tape drives.

Inside is a programmable, byte-oriented processor with 2K or 4K of 250 nsec MOS read/write storage, seven single byte index registers, five processor registers, a 128-bit read only memory, an arithmetic/logic unit, and three-position hardware stack pointer. A set of 16-bit word instructions handle word and character manipulations for keyboard, tape crt, and attached peripherals.

## PRODUCT SPOTLIGHT

In the data entry mode, the prime recording media is magnetic tape, in this case 1.5 mil (as in a cassette) computer tape wound on a single plastic reel housed in a 2-inch diameter cartridge. According to the

manufacturer, reliability of the tape package is on a par with that of regular computer reels. The specially designed tape drives (one for program entry, the other for data) are self-threading. They have separate read and write heads, and interlocks both to prevent cartridge removal



except when fully rewound and to prevent tape movement when improperly seated.

Record mode for the tape packs is phase modulated, bit or byte serial, single channel at 1600 bpi. The 100-foot reel of tape holds up to 1,000 128-character records. Read and write speed is 10 ips, and rewind and search speed is 40 ips.

The manufacturer's basic data entry system configuration is four units, three with 2K storage, the other with 4K, plus an i/o channel and a 9-track tape deck. The 2K units are sufficient to store two levels of for-

mat, handle verification, and count records. An additional 2K provides more formatting and allows digital checking and batch totaling.

In operation, all functions are entered through the keyboard as assigned by the program. The expandable display provides the operator with format information, status reports, operation messages, and assists in error recovery.

The i/o interface provides for half-duplex communication and requires a modem for 1800 baud asynchronous and 2400 baud synchronous operation, plus automatic adjustment of baud rate to line condition, automatic answering, and data validity check.

A third option is a typewriter robot that fits on a Selectric typewriter keyboard and operates it at 10-15 cps to produce hard copy printout.

The data entry terminal is available at a single unit price of \$6K. A one-year lease is \$120 a month. The basic four-unit data entry system with conversion package, i/o interface, and tape deck rents for \$575 a month. Tape reel price is approximately \$5. Delivery of the unit will begin this month. COGAR CORP., Schuyler, N. Y. For information:

CIRCLE 328 ON READER CARD

## Optical Reader

The System 1000 document reader features stored program recognition using a Varian 620/i controller that allows it to learn to read any ocr alphanumeric font plus hand printing. The \$69K base price includes the minicomputer, a two-line scanner, document transport, an ASR 33 tty crt, and 7- or 9-track mag tape drive for output.

Fonts recognized include full alphanumeric OCR A and B, Farrington

7B, 1428, 407, mark read, and hand printing, with other fonts and extended character sets available upon request. A feature called document referral is said to be the only character/field insertion scheme for exception (reject) processing where the document actually stops in front of the operator and the field is displayed on a crt for keyboard entry. The minicomputer controller can drive up to three additional document transports and a page reader.

Up to three lines per document are read on the fly, and throughput—which is a function of document size—is up to 500 documents per minute. Size may be from 2.6 x 3.5-inch utility cash stubs to 8.5 x 12-inch stock certificates, and output may be sorted to three stackers. The base system rents for \$1,600 per month on a five-year lease, or \$1,800 for three years. OCR SYSTEMS INC., Hershman, Pa. For information:

CIRCLE 329 ON READER CARD

## Time-Sharing System

Anyone looking for a reasonably priced t-s system might want to consider the Alpha 1000. Among its capabilities are the ability to support 32 simultaneous users writing in BASIC, with FORTRAN IV, ALGOL, assembly language, and a macrogenerator planned a bit further downstream (but working now in batch mode). Each user can write programs of up to 13,000 bytes, with longer programs achieved by linking 13,000-byte segments.

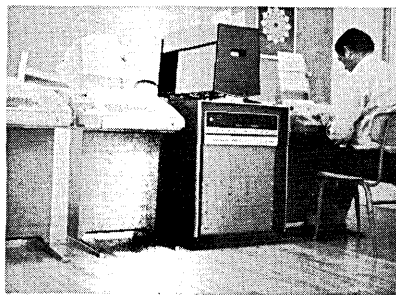

Programs and data may be loaded from time-shared terminals or from punched or pencil-marked cards; the

programs may then be debugged in time-sharing mode and processed in either batch or time-sharing mode.

A head-per-track disc unit is used to support the system, reportedly giving terminal response times of less than 0.5 seconds. The processor is a Data General Nova 1200 16-bit mini, cycling at 1.2 usec, with up to 32K of core. Price for the system starts at something under \$50K. EDUCATIONAL DATA SYSTEMS, Newport Beach, Calif. For information:

CIRCLE 330 ON READER CARD



## Honeywell Peripherals

Available to Honeywell series 200 users are a disc pack drive called the Type 171, an upper/lower case printer, two models of tape drives, and an interesting little gadget called a code translator.

The Type 171 disc pack accesses data on the average in 80 msec and transfers it at the rate of 147,500 kc. Each pack contains 4.6 million characters, and up to four packs can be configured, giving a total storage of approximately 18.4 million characters. A five-year contract on the Type 171 would start at \$287/month, or it could be purchased for \$12,875.

The upper/lower case printer, called the Type 239, prints 86 stan-

dard and special characters across 132 positions at 670 lpm. This unit is said to be designed for high-quality printing by publishing firms and for direct mail applications. Deliveries will begin in June for the 239, which will lease for \$1750 on a five-year contract, or can be purchased for \$82,950.

The only difference between the Type 204B-21 and 204B-22 tape drives, included in the same announcement, is that the 21 is a primary unit containing a control unit and electronics for up to four other drives—the 22's. Other than that, the specifications read the same: both are 200 and 556 bpi drives running at 60 ips and transferring data at 33,400 (556 bpi) or 12,000 (200 bpi) cps

rates. Rewind speed is 180 ips. The primary unit is priced at \$31,080, while the secondary unit goes for \$12,800.

Finally, the EBCDIC code translator attaches to the manufacturer's "D" series of mag tape drives, reads a 90-character font of EBCDIC and translates it into 64-character series 200 code at tape speeds, which might make it very easy for Honeywell computers to reside alongside IBM equipment. This unit will be available in the third quarter for \$100/month. HONEYWELL INFORMATION SYSTEMS, Wellesley Hills, Mass. For information:

CIRCLE 337 ON READER CARD

## 1130 Plotting

System 11 is a software and controller package that gives the IBM 1130s with at least 8K of memory plotting capability. The controller, which houses operator controls and interface circuitry for the plotting table, connects to the central processor through the storage access channel, an 1130 option.

The drafting package software can be used for real-time plotting of data generated from user FORTRAN and assembly language programs or for plotting of disc-stored data. Under System 11 control, the 1130 performs linear interpolations, dynamic look-

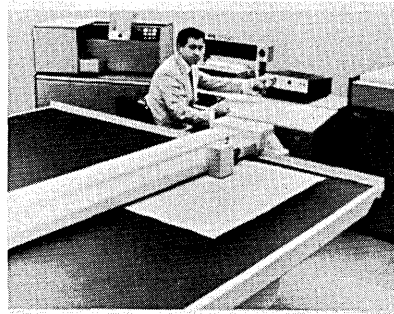

ahead, and acceleration and velocity control. Velocity optimization and transfer of arrays of bi-axis data coordinates (rather than one point at a time), are also features of the system. The package's double buffer provi-

sion allows I/O overlap, and if a disc is used for input to the user's programs, it also permits cycle stealing.

System 11 options include software to provide compatibility with present linkages to IBM plotter routines and alterations to the resolution of the standard 600 inches/minute package.

A typical system, source card deck, controller, and 48 x 58-inch fully tiltable drafting table, is priced at \$30K and can also be rented. GERBER SCIENTIFIC INSTRUMENT CO., South Windsor, Conn. For information:

CIRCLE 335 ON READER CARD

## \$2K Drum Processor

A processor using 100-200K bits of magnetic drum memory is being offered to oem's at \$1800 in quantities of 100 or more. It's the first product of a new firm founded by two former Litton new product development vp's. The processor features communications capability, including a direct memory access channel, and is aimed at use in billing machines, accounting machines, word processors, and intelligent terminals—units that often utilize more expensive and possibly unnecessarily elaborate minicomputers. Average access time is 2.5 msec, and execution time is 20 usec per instruction. Most instructions do not require access. In quantities as small as five, the price is \$3000. Deliveries begin this summer. PERIPHERAL PROCESSOR CO., East Hanover, N.J. For information:

CIRCLE 340 ON READER CARD

## Commo Concentrator

The number of full- and half-duplex communications lines that can be handled by the cc-71 communications concentrator is limited only by the baud rate of the line going to the computer. Generally 110, 150, or 300 baud lines to terminals would be plugged into the cc-71, with transfers to the computer occurring at 1800-9600 baud (or even faster if Telpak lines are utilized). The unit also provides line control and multiplexing, terminal polling, code conversion, error control, and message assembly/disassembly tasks.

A typical cc-71 which would handle 24 lines and have 16K bytes of controller memory would be priced at \$39,800. COMPUTER COMMUNICATIONS INC., Inglewood, Calif. For information:

CIRCLE 360 ON READER CARD

## Disc Storage

Interfaces for such popular minicomputers as the DEC, Hewlett-Packard, and Data General lines give the xdc-100 disc system a broad appeal. Capacities range from a minimum 623,316 fully formatted 16-bit words up to 6.6 million 12-bit words of data that can be accessed in an average of 134 msec. Track-to-track access is 2 msec, and once the data is found, it can be transferred either at 720 KHz or 2.5 MHz, and the controller can handle up to four drives.

Software included consists of a monitor, diagnostic routines, bootstrap loader, and drivers. Including a controller, software, interface, and 623,316 16-bit words, prices start at \$7500. XEBEC SYSTEMS, INC., Mountain View, Calif. For information:

CIRCLE 361 ON READER CARD

(Continued on page 71)

# We're over- whelmed

... with your great response to the TDS/Remcom-2780 Terminal.

You believed us when we said it was the remote batch terminal that is truly compatible with OS/360 and DOS/360 and all IBM 2780 software.

You ordered it. For as low as \$850 per month, including maintenance, on our new 18-month rental period.

And you carefully considered our options: 300 or 600 CPM card reader, 400 or 600 LPM printer, double buffering to 1200 bytes, and up to 80% increase in send-receive rate with our exclusive *advanced data compression/decompression*.

Now, to overwhelm you with service, we've established eight regional centers complemented by the nationwide Honeywell offices that service TDS/

Remcom-2780 Terminals.

One thing more. You have not overwhelmed our capacity. Delivery is still 60 days!

Contact Tracor Data Systems, 601 California St., San Francisco, Calif. 94108. Phone (415) 781-5455 or our regional office nearest you: Chicago — (312) 298-5090, Dallas—(214) 328-9991, San Francisco—(415) 781-5455, Washington, D.C.— (703) 820-7802.

**TRACOR** DATA  
SYSTEMS

*Quality in computer products.*

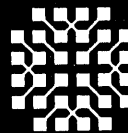

# Now you'll be overwhelmed

... with the price, performance and 60-day delivery of our 2314-compatible disc drives. Performance, it's there! Our disc drives are plug and pack compatible with the IBM 2314.

Reliability, it's unsurpassed. Advanced electronics, such as monolithic circuitry, assure you more equipment up-time. Easier and faster maintenance, too.

Price, we've got it. Monthly rental for our TDS-833 Controller and our TDS-733 Disc Drive in the 3-spindle configuration is \$2,108; in the 6-spindle it's \$2,958; in the 9-spindle, \$3,808. Of course, you can get single spindles as well. 24-hour maintenance and unlimited use are included.

Here's how sure we are that you'll keep our disc drives once you try them. We offer a 30-day no-

obligation, free test for the first system in any customer's account.

Price, performance, and 60-day delivery... there's none so overwhelming.

So come on, now. Overwhelm us. Contact Tracor Data Systems, 601 California St., San Francisco, Calif. 94108. Phone (415) 781-5455 or our regional office nearest you: Chicago — (312) 298-5090, Dallas — (214) 328-9991, San Francisco — (415) 781-5455, Washington, D.C. — (703) 820-7802.

**TRACOR** DATA SYSTEMS  
*Quality in computer products.*



CIRCLE 57 ON READER CARD

# You ought to have our printhead examined

It's so simple:

And it makes our IBM Selectric® Commercial Terminals the most reliable (they're registered in its class for Model 33 or 35 units) printers in the world. Which means you'll never have to change a printhead again.

Which means the probability of downtime and repairs.

The IBM Selectric printer generates a 64-character ASCII subset at 100/115 CPS. Full or half display mode.

You get a complete terminal plus two copies of special hard paper if you prefer.

Other options include a built-in telephone, a teletype, and your choice of teletypewriter or

parallel interface. A Retail-Only model is also available. And you can buy our software separately.

We can deliver in 60 days.

Circle 11 on Reader Service. 4201 E. 15th Avenue, Aurora, Texas 75172. Or call (512) 936-7700.

**TRACOR** DATA SYSTEMS

Quality data processing products.

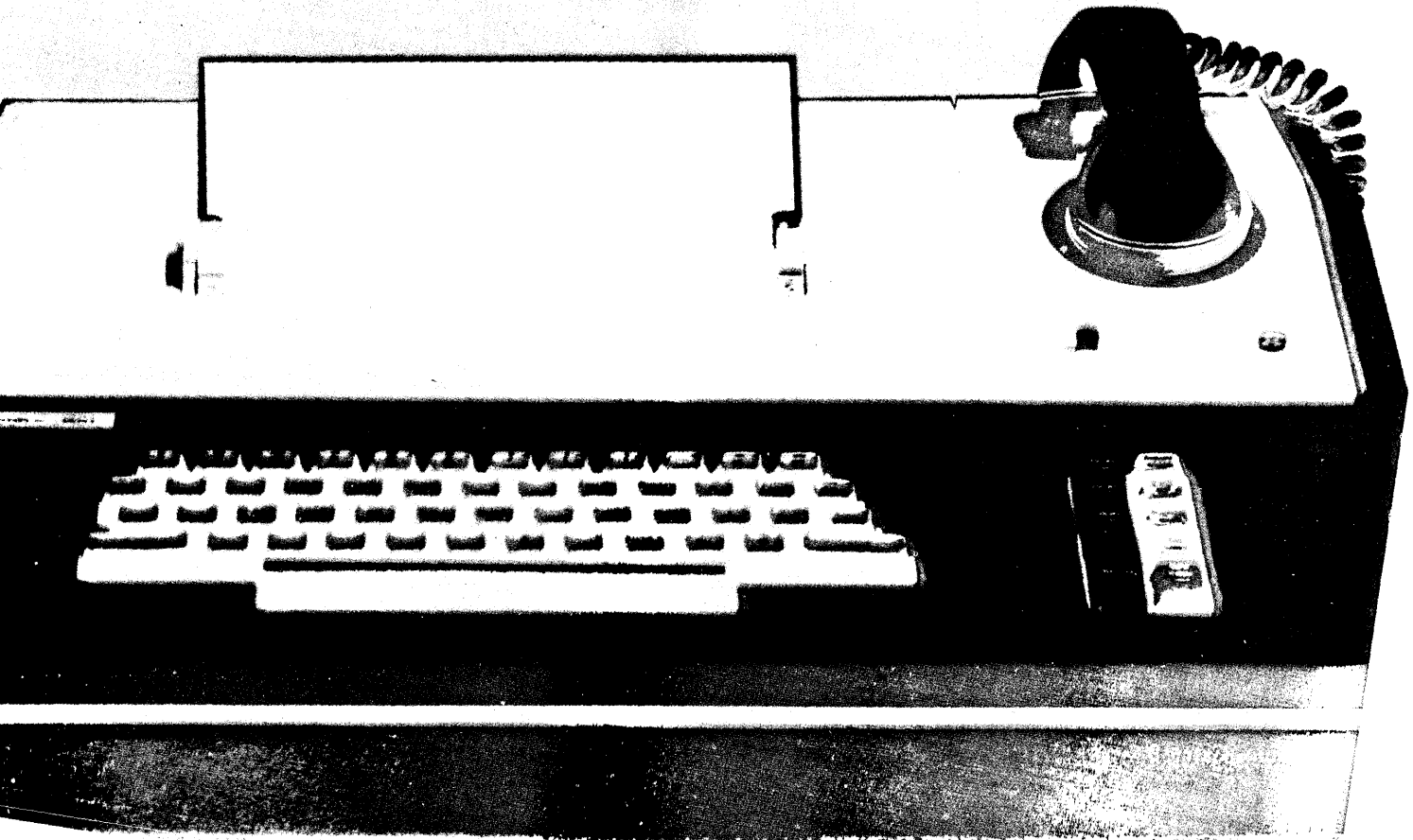
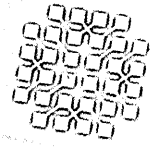

**Editing Typewriter**

An editing typewriter with peripherals is the first product of a new firm which hopes to cut into IBM's MT/ST business. Called the Data Secretary, the system uses an IBM Selectric typewriter to store data on either mag tape cassettes or magnetic cards.

Features include temporary storage of output with provision for error correction by back-spacing; when the typist completes her work, she simply pushes a button and the corrected copy is printed out. The cassettes or cards may be kept for future retyping, as for frequently used let-

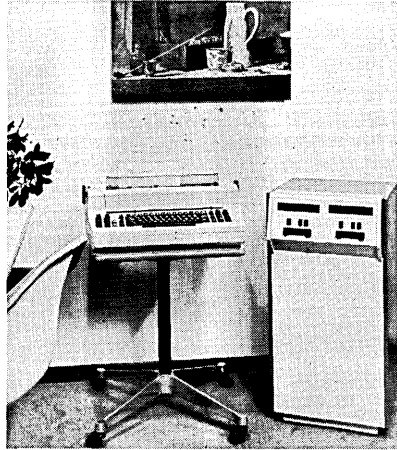

ters. Other features include automatic adjustment of margins, automatic underscoring, and the ability to search for prestored material and play it back with minimal operator intervention.

The hardware utilizes some LSI circuitry and program control, though the latter cannot be modified by users. Price is \$6-8K, depending on options. Available separately to oem's are the mag tape cassette transport, \$325; magnetic card transport, \$500; and the I/O typewriter, \$1400-1700 REDACTRON CORP., Hauppauge, N.Y. For information:

CIRCLE 333 ON READER CARD

**CRT**

The Vista tty replacement crt line is getting its horizons broadened by two new models and a brace of new options available for all units.

The Vista I-C and the Vista I-H, the two new models, are exactly like the other models in the line except they offer multispeed output as standard, 80-character line displays, and an

erase-to-end-of-line feature. In addition, the two new models have line control of page and roll mode. The price of the Vista I-C, a 10-line unit, is \$2595; the 20-line I-H is \$2995.

The new options include a printer interface, a built-in modem, an 11-key numeric pad, and an answer-back option, which generates a data stream up to 20 characters in response to a received "wru" request or

a "ru" keyboard command. The vendor is also offering a nine-speed interface card, either RS-232 or current loop, plus even/odd or logical one parity. Other new options for the Vista line include a parallel interface, a synchronous interface, and a cassette module. INFOTON INC., Burlington, Mass. For information:

CIRCLE 338 ON READER CARD

(Continued on page 72)

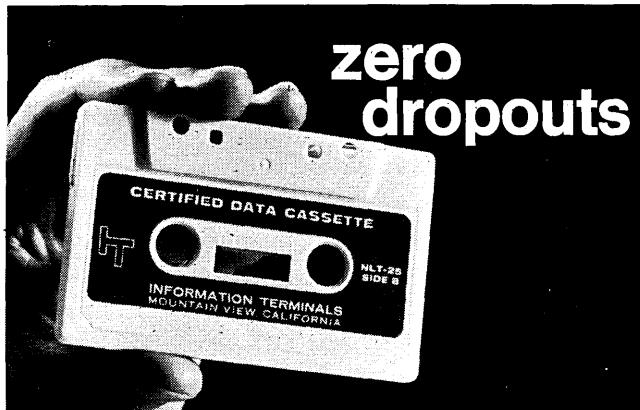

**zero dropouts**

**For terminals... mini-computers... Wang 700 calculators**

This precision cassette is the only one certified after final assembly. That's why we guarantee zero dropouts for every precision cassette: each is certified for 800 fci on two 0.056" tracks at 20 ips. 1600 fci optional.

More features: Hub design prevents tape damage, eliminates breakage and tape pullout during rapid stops and reverses, allows leaderless construction where desirable. Slip-sheet design for smooth winding and minimum static. Spring-loaded machined idlers for exact tape-position control. Dependable high-output operation with computer-grade tape. Quiet and smooth-running.

We ship your order the same day it arrives.



**INFORMATION TERMINALS CORP.**  
1160 Terra Bella Ave., Mountain View, CA 94040  
415/964-3600

CIRCLE 51 ON READER CARD

**STOP NOISE POLLUTION!**

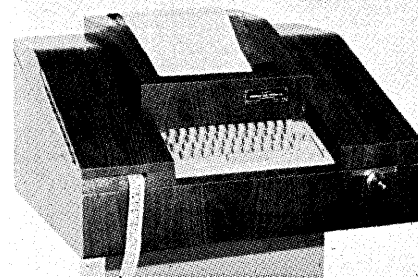

Attractive wood-grained INO-SHIELD eliminates up to 92% of office-disturbing sound.

**SCHEMATIC DRAWING SHOWS HOW IT WORKS**

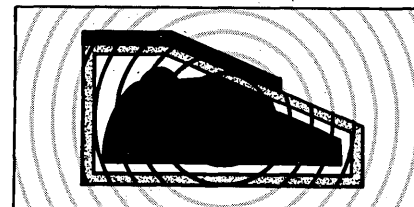

Unique "sandwich" insulation absorbs the clatter

Write for details

**in/opac** DIVISION

Numeridex Tape Systems, Inc., Dept. D  
4711 W. North Ave./ Chicago, Ill. 60639 / 312-772-6400  
**Your most complete source of supply for data processing peripherals and expendables**

CIRCLE 12 ON READER CARD

**Modem**

An installation using Bell 201B modems or equivalents might check the records to see what those units are costing them. This 2400-baud, synchronous equivalent is priced at \$1495 in single quantity, including the clocking mechanism. The unit can be used for simplex, half- or full-duplex communication, and the options available for it are field strap-pable. **COMPUTER COMPLEX, INC.**, Houston, Texas. For information:

CIRCLE 341 ON READER CARD

**Teleprinter Replacement**

Designed to replace receive-only Teletypes without modifying software, the ccs 120 chain printer produces a 64-character ASCII set at 120 lpm with an 80-column point line. It uses voice-grade lines in an asynchronous mode at up to 1800 baud via a 202C or 202D modem or its own optional self-contained modem. Features include reverse channel signaling for overflow and control. Multipart forms up to 11¾ inches can be accommodated. The price is \$11,500, and rental and lease

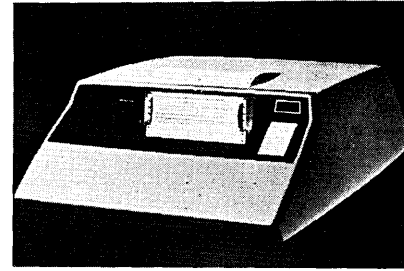

plans are available. Delivery requires 90 days ARO. **CUSTOM COMPUTER SYSTEMS**, Plainview, N.Y. For information:

CIRCLE 334 ON READER CARD

**Printer/Plotter**

A non-impact electrostatic printer designed for use with minicomputers features tty compatibility without software modifications, and graphics capability. Called the 1100, the tabletop unit prints a 64-character 5x7 dot matrix ASCII set at 180 lpm, and graphics, including charts, graphs, maps, or halftones, at three pages per minute with a resolution of 70

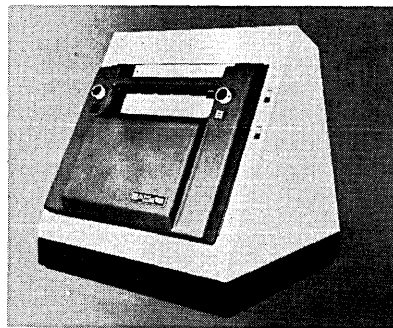

points/inch. Both 128- and 80-column models are available. The 1100 has a 256-character random access memory, organized into two 128-character buffers, and interfaces for most minicomputers are available. The price is less than \$6K. **LEIGH INSTRUMENTS LTD.**, Ottawa, Canada. For information:

CIRCLE 331 ON READER CARD ■

A GENERAL ECONOMICS CORPORATION COMPANY

**ASR**  
**paper-tape punch/reader**  
**gives you clean, sharp multi-copies at**  
**30 characters per second ...**

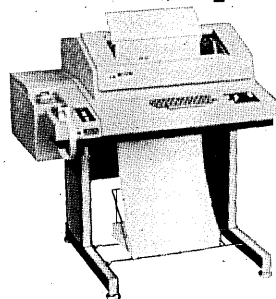

Syner-Data's ASR paper-tape punch/reader provides the low cost, high performance needed for on-line printers. Automatic sending/receiving; data-recording/playback; and paper tape interpretation, duplication, and editing. The versatile ASR is ideal for batch processing, high speed time-share or dedicated system applications. Write: Syner-Data, Inc.

(617) 927-3222



**ALPHA/BETA**

133 Brimbal Avenue, Beverly, Mass. 01915 or call

IN CANADA  
**Syner-Data Canada Ltd.**  
 367 Ormont Drive, Weston, Ontario, Canada

SYNER-DATA SALES AND LEASING/OEM SALES: SYNER-DATA, INC., 133 Brimbal Ave., Beverly, Mass. 01915, (617)927-3222 • SYNER-DATA, INC., 1570 East Edinger Ave., Santa Ana, Calif. 92705, (714)836-1944 • SYNER-DATA CANADA, LTD., 130 Rivalda Rd., Weston, Ontario, Canada, (416)742-7804 • DATABASE, LTD., 22-25 Finsbury Sq., London EC2, England, 01-638-8774 • DISTRIBUTOR LEASING/SERVICE: NATIONAL DATA COMMUNICATIONS SYSTEMS, INC., 59 Union St., Somerville, Mass. 02143, (617)623-7800 • DATA ACCESS SYSTEMS, INC., 503 Route 10, Mt. 19, Dover, N.J. 07801, (201) 361-2345.

CIRCLE 11 ON READER CARD

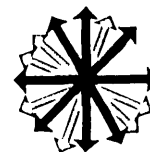

## Payroll/Labor Distribution OS/MVT Analysis

PALD (Payroll And Labor Distribution) is a COBOL package that can be tailored to any system that has at least 64K of memory. Reports produced by PALD include paychecks; the check register; employee status reports; unemployment reports; yearly W-2 statements; labor reports by project and category distribution; and monthly, quarterly, and year or project end distribution reports. Source decks and complete documentation are provided for \$2500. Installation assistance would add a "minimal" consulting fee, but it is said that installation using the documentation supplied presents no problem. INFODYNE INC., Washington, D.C. For information:

CIRCLE 313 ON READER CARD

Operators should be able to determine how to more effectively use available core with the OS/MVT Dynamic Analyzer. The analyzer prints out a chart of core utilization at any given time—every millisecond, second, ten seconds, or whatever interval is selected. The analyzer itself resides on a direct access storage device, such as a 2314 disc, and can be put into the sys1 LINKLIB data set. When requested by the user, it fits into the smallest available region (12K): It outputs on SYSOUT and so can be directed to any printer. The price is \$1500. VALUE COMPUTING INC., Cherry Hill, N.J. For information:

CIRCLE 314 ON READER CARD

## Material Planning

The MPS (Material Planning System) maintains a part master file and bill of material file for an unlimited number of parts. Listings of these two files includes a part master list, a single-level and complete bill of material list, and a where-used list. In addition, MPS uses information reflecting customer orders, open work and purchase orders, and inventory status to perform a gross to net requirement explosion and to produce the material planning report and the action report.

Basically set up for 360 OS or DOS systems, the COBOL package uses about 32K bytes; the firm is also willing to set up MPS for much of the RCA Spectra line. MPS is priced at \$22K. COMPUTER USAGE CO., Los Angeles, Calif. For information:

CIRCLE 315 ON READER CARD

## File Security

IBM installations with 360/30s and up—64K or larger, DOS or OS—can now get a direct access version of the PLUS software security and control system. The new version is written in BAL and features what the vendor says is a high degree of data compression—all of which should interest users with large program libraries who want a fast direct access capability.

Called PLUS D/A (for direct access), the new system allows users the continued use of protected or access-controlled disc files without necessitating recopying entire files. It

permits the reservation of less or more than a full disc pack, or of less than one track per program. In addition, PLUS D/A has the capability of dumping disc to tape for backup with a simple one-code key within the normal action card, and to copy out any program or portions of programs to punched cards, tape, disc, etc. The file can be easily reorganized.

The \$4000 price includes source programs, installation, training, user manuals, and full warranty. CULINANE CORP., Boston, Mass. For information:

CIRCLE 317 ON READER CARD

## Decision Tables

DETAB 70 converts decision tables to COBOL or PL/I statements. In use for over two years in four large computer centers of the major chemical company which developed it, the system is now being marketed by an independent software house. It includes all forms of condition entries and checks tables for completeness, redundancy, and contradiction. Hardware requirements are minimum 56K on a 360/30 or larger, or a Honeywell 2200. The price is \$9000. SOFTWARE ASSISTANCE CORP., Ann Arbor, Mich. For information:

CIRCLE 316 ON READER CARD

## Information Retrieval

Orbit II is a general-purpose information retrieval system for IBM OS/360 users having at least 256K of memory on a model 40 or larger. The PL/I package has a basic vocabulary of 11 English commands and can be used either in a dedicated mode or on a t-s network serving up to 150 on-line users. Search and retrieval of records from files as large as 2 million records is possible, as is the ability to update individual records. The sale price of \$22K includes installation, training, user manuals, and one year of maintenance. SYSTEM DEVELOPMENT CORP., Santa Monica, Calif. For information:

CIRCLE 318 ON READER CARD

## DOS I/O Improver

Add one card to your DOS supervisor deck and you may be able to reduce I/O overhead during the fetching or loading of core image phases. Called SUPERDOS II, the supervisor modification generates about 380 bytes of code which improve the efficiency with which program phases are read from disc. Multiphase applications such as compilers, sorts, link edit, and certain kinds of inquiry and teleprocessing may achieve a 10% or greater reduction in running time, according to the developer. The price is \$350 for the first computer. UNIVERSAL SOFTWARE, INC., Danbury Conn. For information:

CIRCLE 319 ON READER CARD

## Report Generator

The Vigor report generator handles fixed length tape, random, sequential, and index sequential input files on System/360. Marketed locally for the past year at \$2500, the package is now available nationally at only \$995, as the firm claims it has recovered its original investment. Features include free-form control cards, a control language, free-format report layout, five title lines, calculations, multiple sort breaks, and six levels of totals. Vigor control cards may be entered in any sequence and are edited prior to being executed. ARKAY COMPUTER APPLICATIONS, Lowell, Mass. For information:

CIRCLE 320 ON READER CARD

(Continued on page 76)

# NEW DATA ACTION TYPEWRITE . .

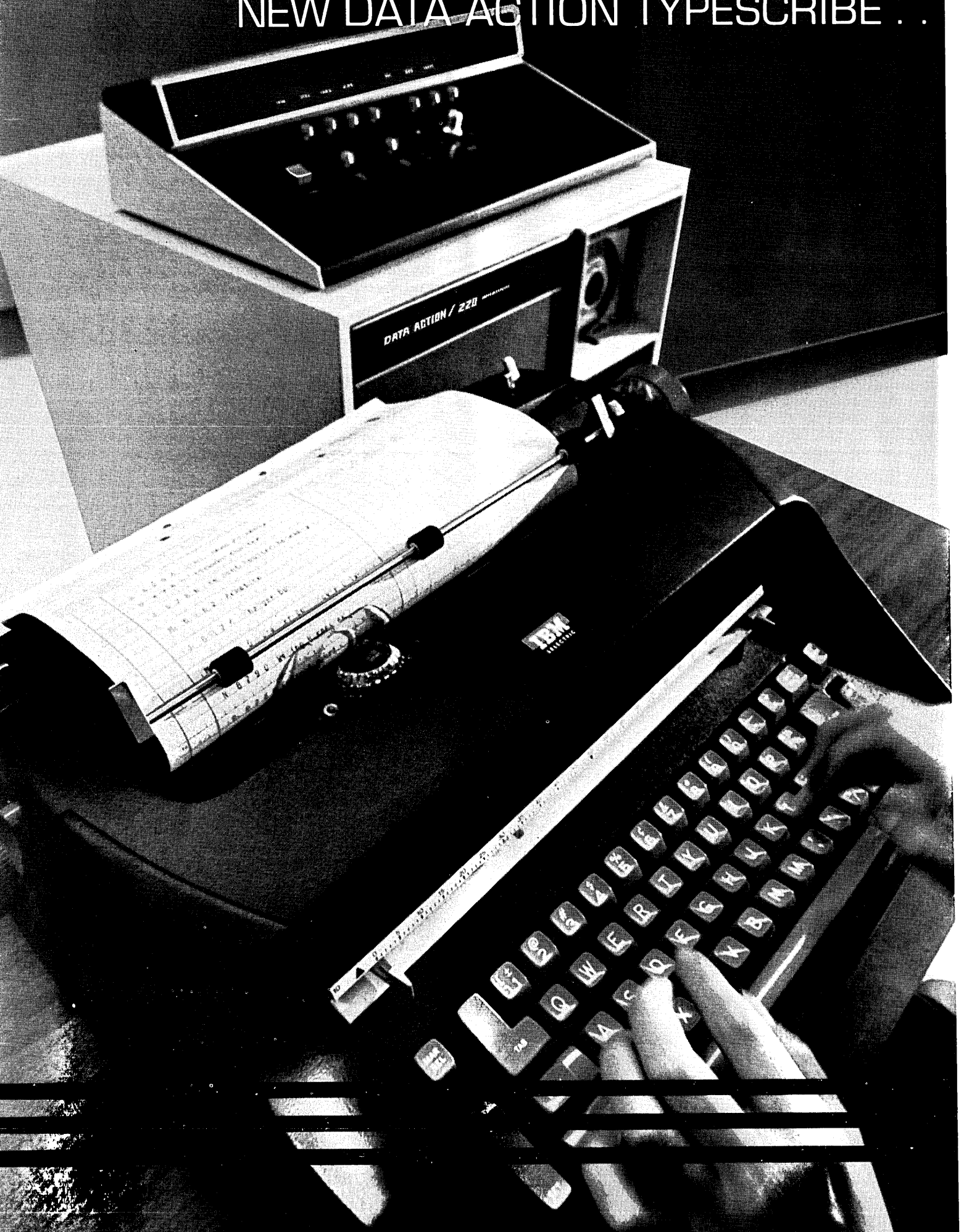



# ... TYPEWRITER TO TAPE— THE SIMPLE, LOW-COST ANSWER TO COMPUTER INPUT PROBLEMS.

## A Typescribe system replaces this:

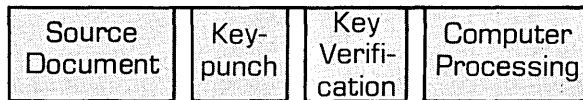

... with this:



Getting data into your computer easier, faster, at lower cost is the job performed by the Typescribe. Data is captured on magnetic tape—at its source—as it is typed for the first time.

The Typescribe uses a conventional IBM typewriter for recording data. A secretary or typist prepares the data for the computer as she types hard copy.

**Low cost, efficient.** One girl on a typewriter eliminates two costly, slow steps in standard data preparation—keypunching and key verifying. The result is faster, more efficient input because there is no chance for errors to be introduced in the keypunch and key verify operations.

**Easy to operate.** The Typescribe requires no special training. The operator can see her work as it is typed. She can correct errors by simply typing over them.

**Produces hard copy simultaneously.** All hard copies required for normal business procedures are typed as data is recorded on tape.

As flexible as a typewriter—the Data Action Typescribe can be used wherever there is a need to record input data easily, efficiently, at low cost. Compact, it can stand next to any typist's desk.

The Typescribe can be incorporated into your present data processing system. Or when combined with the Data Action Editor, it can give you a complete off-line input system.

The Editor performs editing and validating automatically—makes the data completely computer ready in your existing format without manual verification and without tying up your computer. The Typescribe and Editor can also be used with the Data Action 150 Magnetic Data Inscrber to give you the most advanced system today for computer input.

Contact your nearest Data Action sales office. Or write: DATA ACTION, Dept. B-9070, 4445 West 77th St., Minneapolis, Minn. 55435. Phone: 612/920-9200.

**DATA ACTION**  
THE INPUT COMPANY

# Bell-Compatible OEM Modems Off-The-Shelf Delivery

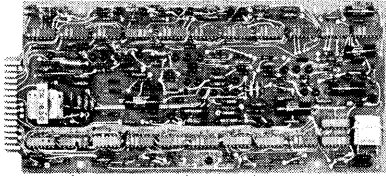

Tel-Tech OEM Modems. Hard to believe. Crystal controlled. TTL IC logic. Ultra-reliable operation. Error-free performance. Compact. Economical. And maintenance-free.

Our Bell-compatible 103 (up to 300 bps) and 202 (up to 1800 bps) asynchronous OEM modems consist of merely one small, low-profile PC card. Even an optional 5 band reverse channel can be incorporated on the same card. Should you desire synchronous operation, we'll provide another PC card for that. And, our Bell-compatible 201's (synchronous at 2000 or 2400 bps) use only two compact, low-profile PC cards. If you require a PC card of different dimensions, we're set up to reconfigure our OEM modems to your exact requirements.

And—for your central sites—up to 10 modems can be accommodated in one of our 19" racks and share a common power supply.

Prices start at less than \$200/modem in small OEM quantities. Hard to believe. But true.



11810 Parklawn Dr.,  
Rockville, Md. 20852  
(301) 933-8170

**TEL-TECH CORP.**  
In Canada: Canteltech, Ltd.

CIRCLE 37 ON READER CARD

## Bank Programs

Both daily and monthly general ledger reports can be generated using the Bank General Ledger System. It is set up for 32K 360s above the model 20 running in either os or dos environments. The COBOL package provides a set of management reports showing the financial position of the bank, highlighting abnormal conditions within operations.

A chart of accounts that allows a bank to define its own structure and

account grouping, 25 statistical ratios about the bank providing an overview of the relationship of account groups such as loans to deposits, and other similar reports are also part of the package. Several other modules, such as monthly responsibility reporting and customer general ledger, can be combined with the basic daily module, which is priced starting at \$7500. COMPUTER SCIENCES CORP., Los Angeles, Calif. For information:

CIRCLE 322 ON READER CARD

## Fixed Amount Billing

A fixed amount billing system jointly developed by the Chase Manhattan Bank and the vendor is being offered for sale at \$25K. The package consists of four phases, the first of which is now operational; the others should be ready by the next quarter. First is the billing system, which handles the billing of tenants in apartments for owners or real estate management firms. Next comes a disbursement system that distributes the owner's payables, right down to the preparation of checks. Third is an operating statement based on inputs from the first two stages. Finally, a report generator operates on each of the first three files. The package is written in COBOL and runs on System/360 under either os or dos in an 80K partition; it may be modified for other hardware at additional cost. PHI COMPUTER SERVICES, INC., Arlington, Mass. For information:

CIRCLE 323 ON READER CARD

## File Compression

Users of System/360 models 30 and up may be able to reduce their files to as little as 10% of original size with a compression package called Shrink. It can handle any file type including variable length records, and data can be characters, packed decimal, binary, or any combination of these. Compression is based on file content, and most users should realize at least 50% compression, according to the developers. It runs under either dos or os, operates as a stand-alone utility, or can be called as a subroutine from the user's program. Perpetual lease, including maintenance, \$5000; rentals are also available. Shrink is the first package from an eight-man firm that has specialized in software services for brokerages for more than two years. NEW DIRECTIONS ENTERPRISES INC., New York, N.Y. For information:

CIRCLE 324 ON READER CARD

## Curved Letter Plotting

The first product of a new three-man firm is a subroutine for plotters and crt's that will draw curved letters which, in addition, can be italicized at user option. The goal is improved legibility. Called Scribe, the subroutine can be used along with or instead of the common plotter subroutine called SYMBOL; the calling arguments are the same, so the new deck is just added or substituted. The basic \$1200 package consists of 46 characters. Extra characters and symbols are available at additional cost, and Gothic and Modern Roman fonts will be available as subsets of the original package. APPLIED COMPUTER GRAPHICS CORP., Silver Spring, Md. For information:

CIRCLE 325 ON READER CARD

## File Generator

GENIE can be used to generate temporary test data files for programs to be run on 360s. Requiring at least 32K of memory, the COBOL program generates packed or unpacked fields in sequential or indexed sequential files or unique records, in sequence, with up to five noncontiguous sequence levels or control fields. GENIE also provides a formatted dump of the output file, and a count of the generated records. The price is \$2800. APPLIED CYBERNETICS CORP., Sunnyvale, Calif. For information:

CIRCLE 321 ON READER CARD

(Continued on page 78)



# Bet Our LI/ON™ Can Make Your 1130...ROAR!

Ever see an 1130 spring to life with on-line teleprinters, teletypewriters, graphic CRT's, paper tape/card readers, even analog control instrumentation? Well, our LI/ON (Logicon Input/Output Network) can make one 1130 look like 15 rooms full of computers running rampant. Conversing fluently with up to 32 Selectrics/Teletypes/CRT terminals, and all sorts of digital/analog devices. Bounding a generation ahead into real-time data acquisition and process control. Trafficking simultaneously in the areas of data communications and digital/analog instrumentation. Interacting at the very source of data origin, R/D labs, front office, factory floor. You can even dial in and compute from home phone and remote locations. LI/ON features fast delivery; low cost; and a bundle of software in the bargain.

For complete details call Lee Eckert collect or write him today.

**ROAR**

**GET A LI/ON AND HEAR YOUR 1130  
ROAR ITS APPROVAL.**

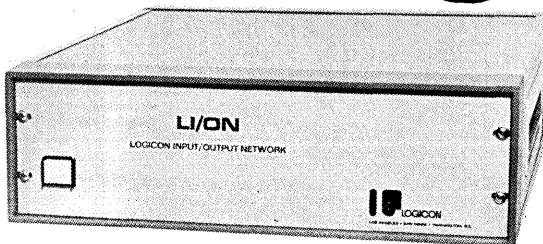

Del Amo Financial Center  
21535 Hawthorne Blvd.,  
Torrance, Ca. 90503  
Telephone (213) 542-7313

**LOGICON** LOGICON'S OTHER OFFICES ARE LOCATED  
IN SAN DIEGO AND WASHINGTON, D.C.

# How Florida can put a big upward kink in your production curve



*Read about  
a labor picture  
that can only  
spell profits...  
performance...  
productivity  
for you.*

Here's what we can deliver when you come to Florida.

- We can out-recruit anyone for skilled labor. We'll show you proof of 10-to-1 superiority in competitive recruitment.
- Our skilled work force is growing faster than in any state in the Southeast.
- We now have in Florida a larger working age population (18-65) than any other Southeastern state.

Florida is a great place to live and work. Won't you let us reveal the hidden profit potential in Florida's remarkable labor picture? Just phone (904) 224-1215 or write in confidence.

Dept. F-5

Please send information about:

- Manufacturing plant  
 Headquarters office  
 Research  
 Warehouse  
 Other \_\_\_\_\_

NAME \_\_\_\_\_

TITLE \_\_\_\_\_

COMPANY \_\_\_\_\_

ADDRESS \_\_\_\_\_

CITY \_\_\_\_\_ STATE \_\_\_\_\_ ZIP \_\_\_\_\_

## Florida

DEPARTMENT OF COMMERCE  
BUREAU OF INDUSTRIAL DEVELOPMENT  
107 WEST GAINES STREET  
TALLAHASSEE, FLORIDA 32304

CIRCLE 32 ON READER CARD

## ... SOFTWARE

### DOS/360 Accounting

Another tool to aid the dos/360 user in his confusing multiprogramming environment is the Time Accounting and Billing System. It provides a series of daily, periodic, and exception reports intended to enable the establishment of an effective job mix. Reports establish job characteristics, making it easier to find jobs with complementary requirements. A daily log of all computer activity and a summary showing the distribution of time by function and by user is generated.

The system also compares performance with user standards and reports on an exception basis jobs that were degraded by the mix, ran longer than average time, had a higher percentage of operator intervention than normal, or did not run to completion.

Billing is provided by periodic reports which show time and/or facilities used by each department or customer. The price is \$3500 for the first computer and \$1K for each additional computer at the same location. DATAChron CORP., New York, N.Y. For information:

CIRCLE 326 ON READER CARD

### Payroll

There are more than 10,000 PDP-8s in use, and this vendor has developed three payroll packages for them. The three systems, called PAY I, PAY II, and PAY III, are simple to operate and are designed for small businesses without trained computer people.

The minimal system, PAY I, generates current payroll information for manual transfer to checks, payroll journal, and other company records.

PAY II has all that PAY I has, plus a capability of printing payroll checks on-line together with a weekly journal, payroll analysis, and 941 and W-2 reports. PAY III is essentially the same as PAY II except that it replaces the paper tape capability of PAY II with magnetic tape.

One-time license fees for the products, including training, manuals and tapes, are: PAY I, \$1995; PAY II, \$2700; and PAY III, \$3100. INPUT OUTPUT COMPUTER SERVICES INC., Cambridge, Mass. For information:

CIRCLE 327 ON READER CARD

# For source data entry...



**anywhere, anytime!**

It's really portable.

The key to MSI's versatile new Source 2000 Data Communications System is the Source 2001 Portable Data Terminal. All 7½ pounds of it. Self-powered. Optional alpha capability. Magnetic tape cassette. Acoustic-coupler or modem transmission to receiver (on or offline). Use it anywhere, anytime.

I can lift 7½ pounds. Tell me more about the Source 2000 Data Communications System.

Name \_\_\_\_\_

Title \_\_\_\_\_ Phone \_\_\_\_\_

Company \_\_\_\_\_

Address \_\_\_\_\_

City \_\_\_\_\_

State \_\_\_\_\_ Zip \_\_\_\_\_

**MSI**  
DATA CORPORATION

3050 Daimler Avenue  
Santa Ana, California 92705  
Telephone (714) 540-6600

D2

Program reliability is the key to a successful minicomputer. And microprogrammed firmware is the lock. Firmware gives the CIP/2000 a memory that can't forget and a program that can't change unless the firmware package is altered.

Firmware makes the computer program reliable. Cincinnati

makes the computer reliable. Sensitive production operations are done in dust-free rooms separated from other air conditioned manufacturing areas by air locks and air showers. We designed and built our own computer controlled testing equipment to check component assemblies and finished computers.

And we do our testing in different temperatures and humidities because systems-oriented computer applications often require operation under hostile conditions.

These are some reasons our mini is the most reliable on the market. For complete information on the minicomputer that's priced lower than you'd expect, write to Cincinnati Milacron, Dept. R-53, Lebanon, Ohio 45036. For immediate action, call (513) 494-5444.

## Is Cincinnati firmware the only reason our minicomputer is so reliable?

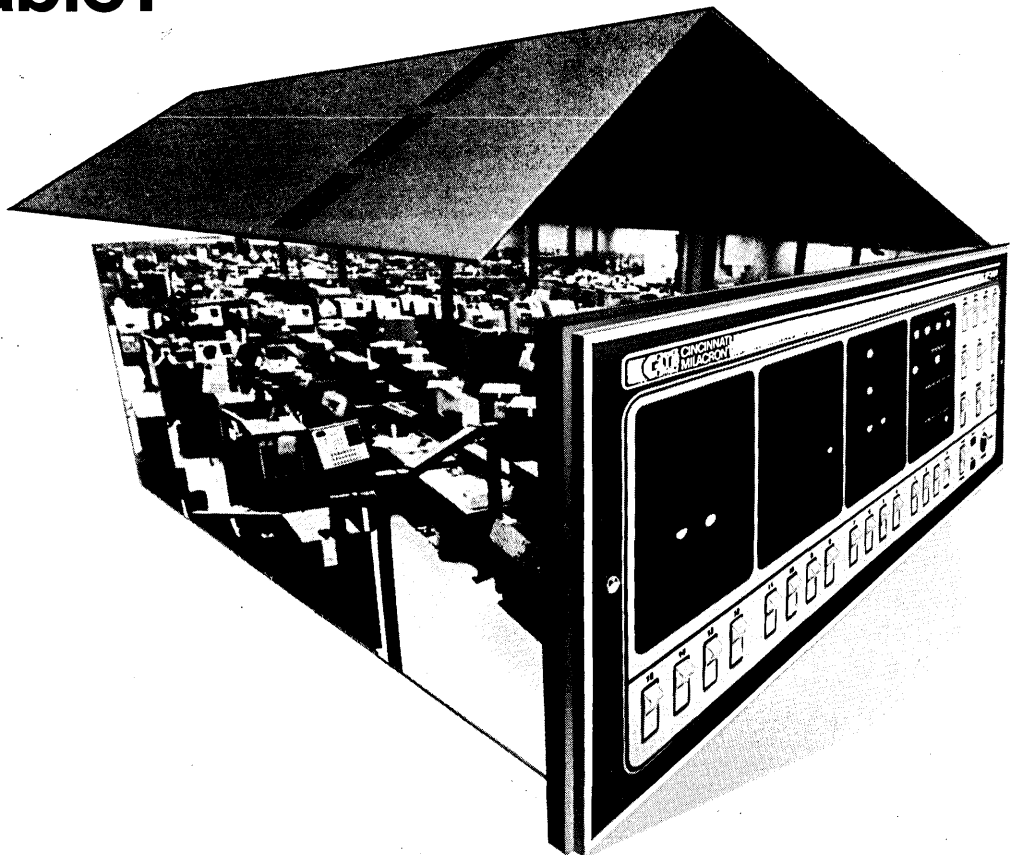

**Not the  
only reason.**

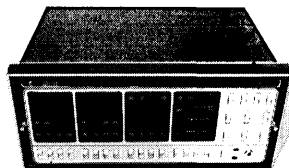

**CINCINNATI  
MILACRON**

Machine Tools | Process Controls | Chemicals | Plastics  
Plastics Processing Machinery | Abrasives

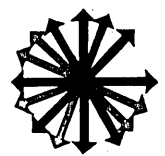

**Basic Self Taught**

Two workbooks designed to make it possible for individuals to teach themselves the BASIC language are available at \$2 apiece. "Teach Yourself BASIC, I," and "Teach Yourself BASIC, II," were written to be equally usable by students and working adults. TECNICA EDUCATION CORP., 655 Sky Way, San Carlos, Calif. 94070.

**Data's Price Tag**

Current and projected changes in data handling methods that are expected to reduce the cost of data by a factor of 10 are explained in a 16-page booklet titled "The Cost of Data." Conventional methods and associated costs are summarized and compared to recent innovations. DATA INSTRUMENTS CO., Sepulveda, Calif. For copy:

CIRCLE 300 ON READER CARD

**For Rent**

"A handy instrumentation manual and guide even if you don't have a present requirement," is the billing given by the publisher of this 108-page, 1971 Instrumentation Rental Catalog. Among the items covered are transducers, oscillographs, tape recorders, gyros, amplifiers, digital systems, and computers. DATACRAFT, INC., Gardena, Calif. For copy:

CIRCLE 301 ON READER CARD

**International Guide**

A guide to "The International Computer Industry" compiled from Dept. of Commerce reports is available for \$8.95 in soft cover volumes and at \$3.95 in microfiche format. More than 300 pages are divided into sections covering 24 countries telling how each spends its resources on computers and computer-related products. APPLIED LIBRARY RESOURCES, INC., 1343 H St., N.W., Washington, D.C. 20005.

**Small but Speedy**

"Need Small Computer SPEED?" is the title of a 12-page brochure describing Systems 82, a high-speed, small computer designed specifically for real-time operation in a system environment. Real-time capabilities described include those stemming from the vendor's larger real-time computers. SYSTEMS ENGINEERING LABORATORIES, Ft. Lauderdale, Fla. For copy:

CIRCLE 305 ON READER CARD

**Patents, Copyrights**

The Senate Judiciary Committee on Patents, Trademarks and Copyrights' annual report on activities covering the first session of the 91st Congress is dated Sept. 22, 1970, but covers the committee's activities in 1969. It includes an analysis of the major provisions of the Copyright Revision bill, among others. INFORMATION INDUSTRY ASSOCIATION, Washington, D.C. For copy:

CIRCLE 308 ON READER CARD

**Computer professionals:  
A GREAT RESUME  
DOES WONDERS.**

- It effectively communicates your marketable computer skills and experience
- It excites the interest of both personnel and technical management—a vital necessity
- And it delivers proven, guaranteed results—interviews

**\$39<sup>00</sup>**  
**gives you a Great Resume**

(... and an objective look at yourself—what you're worth, the kind of opportunities you should seek, and even advice on which job offer you should accept)

**Resume Power**

**FOR COMPUTER PROFESSIONALS**

An independent business specializing exclusively in the preparation of Great Resumes for Computer Professionals

2415 Panama Street / Phila., Pa. / (215) 732-5530

**Call us collect anytime, any day, from anywhere**

CIRCLE 65 ON READER CARD

**Mini-Based Control**

Graphic proof that General Electric is still in the computer business is available in the form of a multicolor brochure describing how the company turned a minicomputer into a complete process control system it calls GE-PAC 3010. The six-page offering describes typical applications of the complete system; functional software building blocks; and cpu with monolithic integrated circuitry, plug-in modules, and a core memory expandable to 64K bytes. GENERAL ELECTRIC CO., Phoenix, Ariz. For copy:

CIRCLE 310 ON READER CARD

**Guide to Bank Systems**

Two-volume reference guide to current literature on bank information systems is available for \$7.50. Titled "A Guide to Information Systems Literature," the set covers financial information systems, customer information files, and management information systems. THE AMERICAN BANKERS ASSN., 90 Park Ave., New York, N.Y. 10016.

(Continued on page 83)

# It will pay you to have your own personal copy of Datamation Industry Directory...



DID will be published by  
 Technical Publishing Company  
 Publishers of DATAMATION

## Order it now!

The new 1971 DATAMATION Industry Directory will place an unprecedented amount of EDP marketing and sales information at your fingertips throughout the year. You can put your name on the cover of your own personal copy and keep it within easy reach. Even when you have to retrieve it from interested borrowers, you will still save many hours of valuable time.

**DID will be the most authoritative and comprehensive single source of information about the entire EDP industry in print.**

This comprehensive directory will offer basic information on 63 product and service classifications . . . and on nearly 5,000 companies that provide them. It will include all the basic data you need about speed, price, compatability . . . plus company profiles that will enable you to screen and select those organizations, products and services most likely to meet your individual needs. Clearly organized and completely cross-referenced, the 1971 Datamation Industry Directory will put at your finger tips the vital facts you need to assess the complete range of the EDP industry's bewildering variety of hardware, software and services.

### DID listings will be divided into these 11 major categories

- |  |                             |
|--|-----------------------------|
| 1. Computers                               | 6. Communications Equipment |
| 2. Peripherals and Stand-alone Sub-systems | 7. Auxiliary Equipment      |
| 3. Input Preparation                       | 8. Supplies and Accessories |
| 4. Unit Record Equipment                   | 9. Environmental Facilities |
| 5. Media Conversion Equipment              | 10. Software                |
|  | 11. Services                |

Turn to one of these categories to find names of supplying companies. Reference to the Master Alphabetical Vendor List will quickly provide company address, and other basic information, including regional sales/service coverage. Ads in the DID will provide more detailed information about products and services.

### DID will be published in the Spring of 1971

The Datamation Industry Directory will be delivered in May to all important OEM accounts, and to more than 31,000 computer installations selected from DATAMATION's 100% 1-year qualified, 100% requested, BPA-audited circulation. A restricted overrun of copies will be sold for \$25.00 each. Why not fill in the coupon and mail it today to get a personal copy for yourself?

**Clip and Mail this coupon Today**

A. Treat Walker, Manager  
 Datamation Industry Directory  
 35 Mason Street, Greenwich, CT 06830

Here's my check for \$25.00. Reserve a personal copy of DID for me.

Name \_\_\_\_\_ Title \_\_\_\_\_  
 Company \_\_\_\_\_  
 Address \_\_\_\_\_  
 City \_\_\_\_\_ State \_\_\_\_\_ Zip \_\_\_\_\_



# New—and both free.

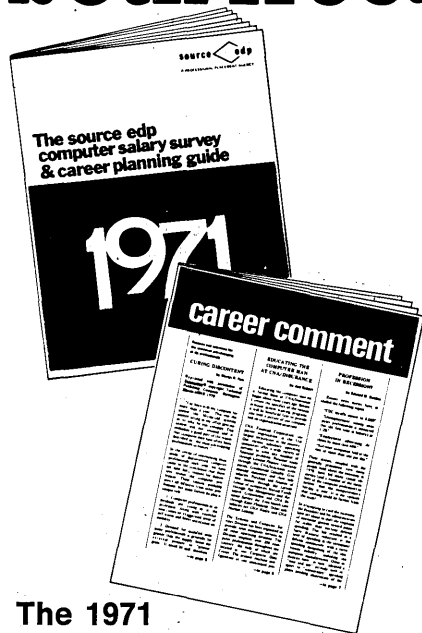

## The 1971 Source EDP Computer Salary Survey and Career Planning Guide:

comprehensive analyses by industry and position; strategy and timing in career development; latest nationwide salary figures at all computer professional levels.

### Career Comment:

a continuing line on trends and events that affect the "people" side of the computer field.

Both yours from Source EDP, the largest recruiting firm specializing solely in the computer field. For your free copies, write the nearest Source EDP office. Or circle the reader inquiry card.

- ATLANTA**—William G. Barnett, 11 Corporate Square 30329, (404) 634-5127  
**CHICAGO**—Thomas D. Walsh, 100 S. Wacker Drive 60606, (312) 782-0857 and 903 Commerce Drive, Oak Brook, Ill. 60521, (312) 323-8980  
**DALLAS**—Paul E. Dittmer, 7701 Stemmons Freeway 75247, (214) 638-4080  
**DETROIT**—Robert T. Stevens, 24500 Northwestern Highway, Southfield, Mich. 48075, (313) 352-6520  
**GREENWICH, CONN.**—Edward J. Golden, 9 Benedict Place 06830, (203) 661-3344  
**LOS ANGELES**—Wayne B. Emigh, Suite 1404, 3550 Wilshire Blvd. 90010, (213) 386-5500  
**MINNEAPOLIS**—Fred N. Anderson, 801 Nicollet Mall 55402, (612) 332-8735  
**NEW YORK**—Charles T. Stern, 1414 Avenue of the Americas 10019, (212) 752-8260  
**PALO ALTO**—Gordon F. Best, 525 University Ave. 94301, (415) 328-7155  
**PHILADELPHIA**—George P. Ramming, 1700 Market Street 19103, (215) 665-1717  
**ST. LOUIS**—Robert H. Trumbull, Suite 207, 130 S. Bemiston, Clayton, Mo. 63105, (314) 862-3800  
**SAN FRANCISCO**—Richard M. Clark, 111 Pine Street 94111, (415) 434-2410  
**UNION, N.J.**—Daniel A. Mickel, 2204 Morris Ave. 07083, (201) 687-8700

Affiliates in the United Kingdom.  
Client companies assume our charges.

**source edp**

CIRCLE 503 ON READER CARD  
February 15, 1971

## ... LITERATURE

### R&D Review

Vol. 1 in a projected series of reports on "Research and Development in the Computer and Information Sciences" contains a review of literature on the operations of information acquisition, sensing, and input to information processing systems considered in general terms. Specific topics include: source data automation and remote sensing techniques, communication systems and data transmission links, audio and graphic inputs, preprocessing operations upon input items such as image enhancement and property filtering, character recognition, speech recognition, and various other aspects of automatic pattern recognition. Copies are available at \$1.50. SUPERINTENDENT OF DOCUMENTS, U.S. Government Printing Office, Washington, D.C. 20402.

### Talking Star

A new audio response peripheral for PDP-8s called STAR (Sequential Talking Audio Response) is described in a bulletin which also covers related equipment and includes specifications and a schematic diagram showing links between STAR, computer, and data set. SPEECHMAKER DIV., COGNITRONICS CORP., Mt. Kisco, N.Y. For copy:

CIRCLE 302 ON READER CARD

### Training for Generalists

This eight-page brochure describes "The Professional Systems Course," a 51-week extension workshop that covers the 17 "major areas" of management systems and provides "training for mastery of the skills a registrant needs to become a systems generalist." SYSTEMATION, INC., Colorado Springs, Colo. For copy:

CIRCLE 312 ON READER CARD

### Reports Briefed

Sample pages from and details of two just-published multivolume "operational and tutorial information" reports on software and minicomputers are contained in a 16-page brochure which also includes a short order form. AUERBACH INFO, INC., Philadelphia, Pa. For copy:

CIRCLE 311 ON READER CARD

## Offline Plotting NOW FOR THE FIRST TIME AUTO BLOCK ADVANCE AT LOW COST

Your plotter plugs directly into MTR-2.

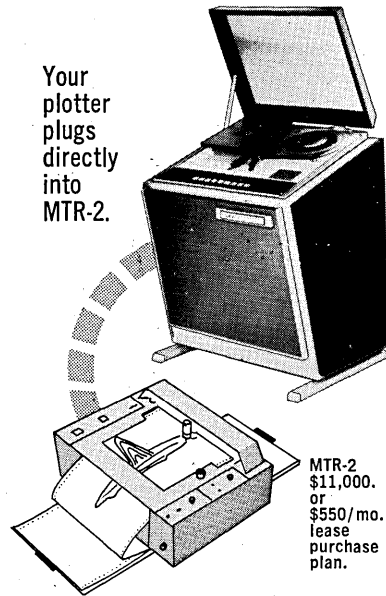

MTR-2  
\$11,000.  
or  
\$550/mo.  
lease  
purchase  
plan.

The MTR-2 is a magnetic tape reader which accepts IBM compatible 800 BPI, 9 track 1/2" tape on 10 1/2" or smaller reels.

The software, provided free of charge, utilizes a single code group which means one character will step the plotter one increment. Particularly useful with medium and large computers, the MTR-2 is a convenient means of plotting without using costly CPU time for other than writing the tape. Extra copies of the plot are obtained by simply replaying the tape — not using any CPU time.

- 800 BPI, 9 track 1/2" tape on a 10 1/2" reel (or smaller)
- Block advance
- Free housekeeping software supplied with purchase of MTR-2
- Tape speed is 1.5 IPS for 300 increment/sec. plotter or 6.0 IPS for 1200 increment/sec. plotter.
- Rewind speed is 100 IPS
- Push button switches: POWER, LOAD FWD/LOAD POINT, PLOT, BLOCK ADV/READY, STOP, REWIND, SINGLE/CONT.
- The MTR-2 costs only \$11,000. or \$550/month on lease-purchase plan.
- OEM Discounts available.



**houston instrument** | DIVISION OF BAUSCH & LOMB

4950 Terminal Avenue, Bellaire, Texas  
77401 (713) 667-7403

**houston instrument** | **European Office**

Hardstrasse 235, 8005 Zurich, Switzerland  
(051) 44 19 70

CIRCLE 41 ON READER CARD

# Introducing the Infotech State of the Art Reports

a unique new series of analytical reports on the key issues in computing during the next decade.

By arrangement with Infotech Limited, developers of the international State of the Art projects, DATAMATION introduces to its readers the most extensive continually building profile available of industry-wide thinking by the world's leading edp professionals in the form of a regular series of State of the Art Reports.

DATAMATION believes that no one with a responsible position in computing today – in Universities, manufacturers, software houses, bureaus, consultants or user departments – can afford to ignore the authoritative information on significant issues that these Reports provide. We have therefore arranged to supply our readers with State of the Art Reports direct from our own offices as soon as confirmed orders are received.

## State of the Art Reports

11 titles during 1971

**The Fourth Generation**

Feb

**Giant Computers**

March

**Real Time**

April

**The New Technologies**

May

**Computing Terminals**

June

**Computer Networks**

July

**High-Level Languages**

August

**Application Technique**

September

**Incompatibility**

October

**Interactive Computing**

November

**Software engineering**

December

Each of these subjects is analyzed in depth in an individual report, published in the month shown.

### The Background

In 1970, a group of computer professionals got together to form Infotech, an independent company solely devoted to the high level exchange of computer information on an international basis.

The first objective was to create an environment in which the top computer professionals could gather together to discuss freely and authoritatively the key unresolved issues in computing today.

To meet this objective, Infotech initiated a continuing series of high level meetings called State of the Art Lectures which are attracting the most respected names in computing both as speakers and as delegates.

The response to the State of the Art Lecture series has been, and continues to be, overwhelming. It has demonstrated clearly the immense value of an independent multi-national, multi-organizational approach to computer information.

Infotech has now built further on this successful foundation to produce a regular series of State of the Art Reports. These represent the most comprehensive, searching and up-to-date examinations ever undertaken of the significant issues in computing.

### The Reports

State of the Art Reports each deal in depth with one specific aspect of computing. The subjects of the first 11 titles of the series, to be published in 1971, cover a wide spectrum of the key issues affecting the development of hardware, software and computer usage during the 1970s.

Transcripts of State of the Art Lecture presentations are the basis of the Reports . . . but only the basis. Each Report includes an in-depth analysis of the subject concerned distilled from the mass of authoritative information gathered,

particularly the formal and informal discussions between speakers and delegates at the Lecture. It includes papers by eminent computer professionals invited to contribute. It includes a carefully researched bibliography. It includes comprehensive and cumulative indexes. Each Report is a significant work in its own field. Together, the State of the Art Reports represent the first serious attempt to present the key issues in computing today within a single, logically structured and completely authoritative framework.

### The Payoff

State of the Art Reports are designed to meet a need . . . the need for you to make sound decisions on future developments based on sound information on current experience and thinking.

They give you uniquely informed background and guidance to help you make decisions on buying equipment and services, manufacturing hardware, writing software, selecting programming languages, planning new products, researching new systems, and developing markets for equipment and services.

They provide the much needed injection of current industry-wide international awareness into research environments. Above all, Infotech State of the Art Reports present you with over 450 pages of comprehensive authoritative and intensely readable information in a form which is unattainable from any other source.

The subscription price for the 1971 State of the Art Reports is \$800. Individual Reports are available at \$95 each. Use the coupon below to specify your requirements. The first copies of the State of the Art Reports are available on immediate dispatch to subscribers sending remittance with order.

**Order** Return this order form and remittances to Datamation 35 Mason Street, Greenwich, Connecticut 06830

Name & Title \_\_\_\_\_

Organization \_\_\_\_\_

Full address & zip code \_\_\_\_\_

Payment enclosed  Bill me

Bill my organization

Cheques or orders to be made out to Infotech Limited.

### Subscription

Please enter subscription order(s) for the 11 Volumes of the 1971 series of Infotech State of the Art Reports at \$800. Send each report to me when ready on its priority mailing date (prior to general publication).

### Special Orders

Please reserve \_\_\_\_\_ copies of each title indicated below at \$95. Send each ordered report to me when published.

**The Fourth Generation**

**Giant Computers**

**Real Time**

**The New Technologies**

**Computing Terminals**

**Computer Networks**

**High Level Languages**

**Application Technique**

**Incompatibility**

**Interactive Computing**

**Software Engineering**

### Information

Please send further information on State of the Art Reports.

I am interested in attending the State of the Art Lectures. Please send details of the forthcoming programme.



# WASHINGTON REPORT

## FEDS PLAN COBOL VALIDATION CENTER

Cong. Jack Brooks' GovOps subcommittee is said to be vitally interested in establishing a Cobol validation center at NBS, serving all federal agencies. Operated by GSA, with technical support from NBS, the center would be financed initially by the adp revolving fund. It would repay this advance, and possibly return a profit, by charging Cobol suppliers to certify their compilers. The center would also validate customized compilers developed by or for a federal agency, and charge the user.

The center could limit proliferation of nonstandard compiler features. A standard aimed at doing this is now being written, but the drafters are having trouble reaching a consensus.

## NBS URGES STRONGER U.S. INTERNATIONAL POSITION

The NBS Metric Study Group warned that unless U. S. industry gives its international standards reps stronger negotiating authority and better financing it will lose out in world markets. Ninety percent of international technological standards, it said, will be established by the International Standards Organization and the International Electrotechnical Commission over the next decade. But private financial support for ANSI is diminishing at this critical time, and for that reason ANSI is considering dropping out of some ISO committees. To offset European regional programs that threaten American electronic exports, the U. S. proposed a worldwide quality control and certification scheme. IEC will answer in May.

## INNOVATION GETS COLD SHOULDER AT FAA

Thorne Data Processing, Inc., a local programming house that generates Cobol application programs on a 360/30 directly from generalized input-output specs, was turned down cold recently when it answered an FAA bid solicitation for an equipment failure reporting system. The agency refused even to evaluate Thorne's bid because it consisted of a final program instead of a proposal for developing a program. President Jim Thorne says it took his company two weeks to produce the software; by comparison, the vendor who wins the FAA contract will be allowed four months. Thorne has complained to FAA Administrator John Shaffer, and there is some chance the agency will reconsider.

## HOUSE COMMITTEE OK'S AUTOMATED MAIL SYSTEM

The House Administration Committee has recommended installation of an automated mailing and addressing system by end-1971. Design was provided by Systems Consultants, Inc., of Washington. Proposed budget includes \$790,000 for system implementation; \$1,750,000 for file creation; \$3,150,000 for equipment. Likely contracts will include software and file creation. Recommended target for prototype development is end-June. Meanwhile, Informatics, Inc. has received a \$100K contract to be systems manager for the proposed House electronic voting system.



## **(And, as always, Freedom has its price.)**

Two years ago, Electronic Memories announced its entry into the commercial systems business. Ah, the sweet taste of freedom! Freedom from military specs. Freedom to compete on an all-out free enterprise basis. Freedom to supply the major computer manufacturers with the world's best memory systems for high speed main frame applications.

Freedom for a few months. Then three major customers gave us more than twenty million dollars in commercial systems volume — and effectively took our little freedom ride right off the market.

Now, after many months, these same customers are starting to produce their own systems under our non-exclusive license agreements.

Freedom once more.

But — we are told by management — once again this freedom had better be short lived.

So, here we are. Ready to sell ourselves back into slavery. As initial inducement, here are some systems with almost immediate availability:

Our Nanomemory 2600 has 600 ns cycle time and 300 ns access time. Capacity is from 4K or 8K words by 36 bits to 16K

words by 18 bits. Our Nanomemory 3650 has a full cycle time of 650 ns and an access time of 350 ns with maximum modular capacities of 16K x 56, 32K x 40 or 64K x 20. The Nanomemory 4850 has an 850 ns cycle time and a 350 ns access time. Its module capacity ranges from 4K words by 8 bits to 32K words by 20 bits. All systems can be expanded to larger capacities by interconnecting modules.

We could go on to talk about the field replacement benefits that result from our unique plug-in stacks, our low power requirements and our low component count. Or customized core. Or stacks for virtually any digital storage application.

But you may have heard all that the last time we announced our freedom. What you haven't heard are some of our current delivery capabilities. Quoted in days rather than months.

Don't wait. Call. Write. Drive right over. It's Freedom Now.

Who knows about next month.

# **Electronic Memories. The Here and Now People.**

Electronic Memories is a division of Electronic Memories & Magnetics Corporation.  
12621 Chadron Avenue, Hawthorne, California 90250 • Telephone (213) 644-9881.



If your world is  
punched full of holes,  
and limited to  
3 1/4" x 7 3/8"...

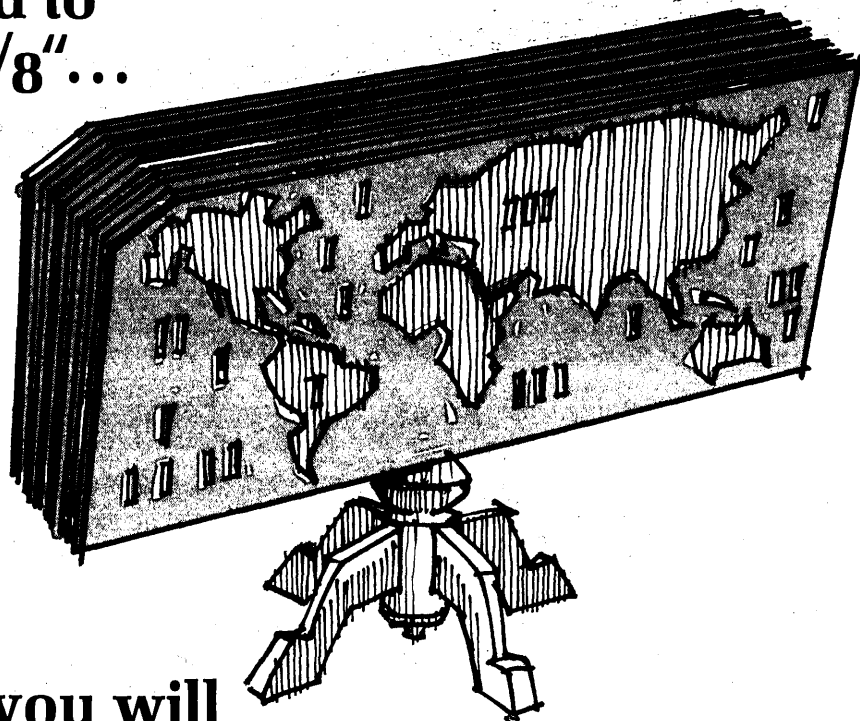

Someday you will  
change the shape of things

SOMEDAY IS HERE. NOW.

Scan-Data Corporation makes it possible with OCR systems that give real meaning to the word flexibility.

That eliminate the need for re-creation of source documents.

Part of the reason is SWAMI. Software-Aided Multifont Input. The world's first, and only self-teaching OCR system. It's designed for use with any Scan-Data system, old or new. It enables you to read virtually any consistent font, even degraded characters—directly from source documents. Combined with our superior handprint capabilities, SWAMI makes document re-creation a thing of the past.

That's only part of the reason. The rest has to do with our new 250 and 350 Page and Document Readers. Which take direct input from pages or documents from 3" x 7" through 11" x 14". On almost any weight or grade of paper.

It all adds up to practically unlimited flexibility in data processing. And that means time and money savings for you.

Ask us to tell you about the wonderful world of OCR.

Yours now. Courtesy Scan-Data Corporation.

**SAE**

SCAN-DATA CORPORATION

"Someday" is here. Now.

800 East Main Street/Norristown, Pa. 19401/(215) 277-0500



# PEOPLE

Computer Sciences Corp. named a marketing expert to head its Infonet time-sharing division, following the resignation shortly before Christmas of Marvin J. Franklin, the division's president. Succeeding him is John W. Luke, former vp-marketing, an 18-year IBM veteran.

csc, which announced last summer Infonet would be operating in the black by February 1972, said it is continuing with plans to establish networks in Australia and South Africa, in addition to those operating in 38 U.S. cities and in Canada. Franklin did not announce future business plans.

The time-sharing business saw other personnel changes. John K. Jerrehian, former head of Tymshare's northwest marketing division, was named general manager of the company's Data Services Div. in Cupertino, Calif. . . . In Washington, D.C., Leasco Data Processing Equipment Corp. held a Christmas

dinner for employees and announced the appointment of Robert P. DeStefano as president of Leasco Response, Inc., the recently formed time-sharing operation in which Leasco has a \$25 million investment.

. . . Com-Share Ltd. of Canada named Derek G. Price as president, succeeding Dr. Allan D. Waren. Price leaves GEIS in Cologne, Ger-



R. P. DeStefano Donald O. Knight

many, to head the Canadian time-sharing organization. . . . Another former GE time-sharing man, Dr. Donald O. Knight, left the company to become vp-corporate planning with Western Data Sciences, Inc., of Phoenix, a software firm.

James J. Johnson last fall was

asked to move over as IBM's corporate director of marketing to make room for F. G. "Buck" Rodgers, former head of IBM's Data Processing Div. Johnson's appointment to head IBM-DP in the eastern region didn't sit well and he was quick to accept a challenging offer from RCA to head all of its marketing activities. . . . Also at RCA, L. E. Donegan, Jr., moved up as vice president of the Information Systems Dept., after serving for a year as vp-computer systems. He succeeded James R. Bradburn, who left the company for personal reasons. . . . The Financial Services Group of Automatic Data Processing, Inc., Clifton, N.J., announced the appointment of Bruce Anderson as corporate vice president. He will direct the group's three financial service subsidiaries. . . . M. H. Schwartz, former assistant controller for information systems with the Atomic Energy Commission, has been named the AEC's director of the Management Information and Telecommunications Systems. Schwartz also is president of the Society for Management Information Systems. ■

## SYSTEMS ANALYSTS

Finance & Accounting  
with

# BECHTEL

Headquartered in San Francisco, Bechtel is an international engineering construction firm. Recent establishment of a Planning and Systems Group, within the Finance & Accounting organization, creates immediate openings for qualified systems analysts. Positions are for finance and control oriented individuals with third generation computer backgrounds who will be responsible for design, development, and implementation of integrated management information systems using advanced data communication techniques.

Candidates must have 5 to 10 years' experience in multi-division companies, including responsibility for developing sophisticated solutions to complex business systems problems. A business related degree, preferably in accounting, is required. An MBA and/or CPA is desirable. Please send resumes to William H. Chambers, Dept. 102.



Bechtel  
Fifty Beale Street,  
San Francisco, CA 94119

Bechtel is an equal opportunity employer m/f.

COMPUTER/INPUT SALESMEN, ANALYSTS, CUSTOMER ENGINEERS

## JOIN THE HOT ONE

One of the top secrets of success is being at the right place at the right time. If you're as good as you think you are, we are the right place and this is certainly the right time for you. We are a young, flexible company with a complete established product line. Opportunity for growth is wide open. Our kind of salesman has a college degree and about two years of computer or input sales experience under his belt. Chances are he has participated in the development of new business. Money? Good . . . substantial base salary and an excellent commission program. We're also looking for top-notch analysts and customer engineers to join our growing marketing organization. Want to get in on the ground floor? Let's talk about it. Write Mr. Richard Orlan.

DATA ACTION CORPORATION  
4445 West 77th Street  
Minneapolis, Minnesota 55435

Openings in our offices in these principal cities:

Boston Cleveland San Francisco  
New York Chicago St. Louis  
Philadelphia Minneapolis-St. Paul Los Angeles

AN EQUAL OPPORTUNITY EMPLOYER

**DATA ACTION**  
THE INPUT COMPANY

what!



really!

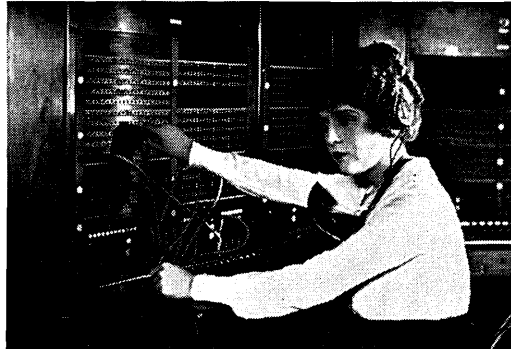

yes, mag  
tape..  
terminals



TELETYPE?

It's true.

After helping a jillion feet of paper tape wind and unwind its way through communications systems everywhere, Teletype announces the addition of magnetic tape data terminals.

There are some basic advantages in both mediums. But as you are well aware, the medium that's right for a system depends a lot on the application criteria.

The new magnetic tape data terminals have many operational features that make life less complicated for the operator.

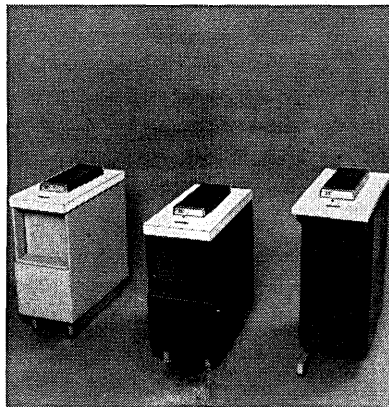

*New, modular line of Teletype® 4210 magnetic tape data terminals.*

For example, take a look at the tape cartridge, which was specifically designed for reliability required for data transmission.

Its vital statistics are: 3" x 3" x 1".

It contains 100 feet of 1/2" precision magnetic tape.

It will hold 150,000 characters of data, recorded at a density of 125 characters per inch. The equivalent of a 1000 foot roll of paper tape.

This means that your data is easier to store, easier to handle, easier to work with than ever before. And it's reusable.



# DATA COMMUNICATIONS

equipment for on-line, real-time processing

The units have a "fast access" switch which will move tape forward or reverse at a speed of 33 inches per second. A digit counter provides a reference point to help locate various areas of the tape.

Four ASCII control code characters can be recorded in the data format to aid character search operations. When the terminal's "search" button is pressed, tape moves at the rate of 400 characters per second

Also magnetic tape adds high speed on-line capability to low speed data terminals.

You can zip data along the line at up to 2400 words per minute. For example: Take a standard speed Teletype keyboard send-receive set, and a typical typist. Add a new magnetic tape unit to this combination and the on-line time savings can pay for the magnetic tape terminal in short order.

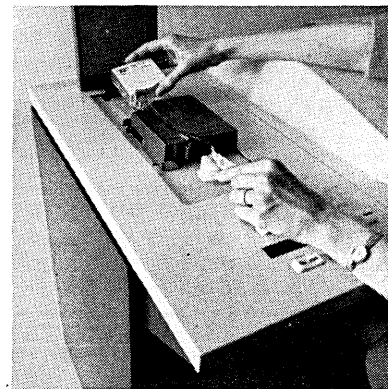

*Straight-through threading makes tape loading and unloading exceptionally easy.*

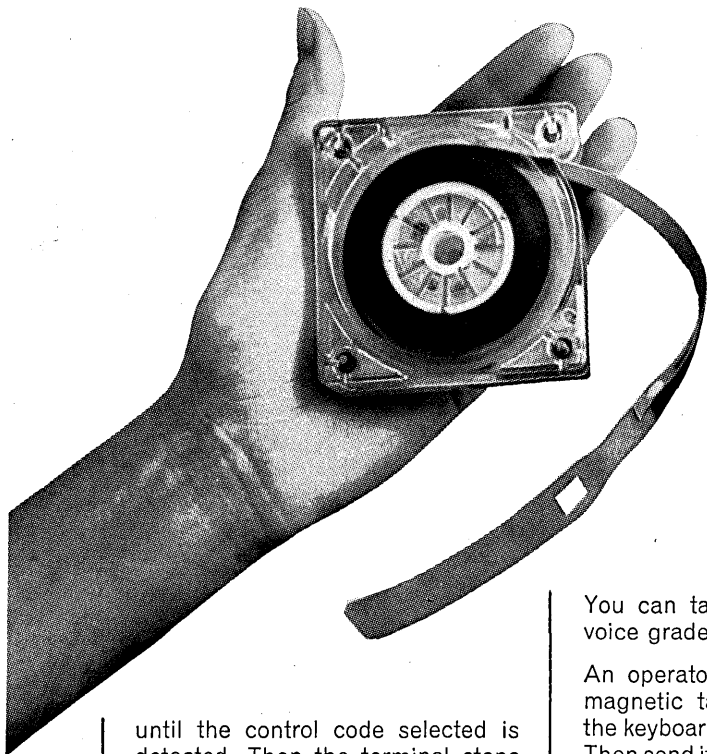

until the control code selected is detected. Then the terminal stops the tape automatically.

A "single step" switch is also provided which enables you to move the tape forward or backward one character at a time. In editing or correcting tape, you can send a single character using this feature.

You can take better advantage of voice grade line speed capabilities.

An operator can prepare data for magnetic tape transmission using the keyboard terminal in local mode. Then send it on-line via the magnetic tape terminal up to 2400 words per minute.

These new modular magnetic tape data terminals offered by Teletype are perfectly compatible with model 33, model 35, model 37 and Inktronic® keyboard send-receive equipment.

They can send or receive at high or low speed. Or can be used independently as stand-alone terminals on-line.

If you would like to know more about this new line of Teletype magnetic tape data terminals, please write Teletype Corporation, Dept 81-15, 5555 Touhy Avenue, Skokie, Illinois 60076.



*Teletype 4210 magnetic tape data terminal with 37 keyboard send-receive set.*

**machines that make data move**

February 15, 1971

CIRCLE 16 ON READER CARD



# PROGRAMMERS

Come to NCR in  
Los Angeles or San Diego for  
opportunity that  
won't quit

**Important, continuing commercial activity in:**

#### **Software Development**

Various positions exist involving origination, design, development and implementation of complex software systems; development of original functional design and processing techniques; design and implementation of state-of-the-art data base/file management software and a large-scale on-line multi-programming executive; design, flowcharting, coding and implementation of on-line executive software modules. Positions require a degree in business or science plus 2-5 years of applicable experience.

#### **Diagnostic Programming**

Work involves creative use of existing computer logic for automatic diagnosis of hardware malfunctions. Specific activities include writing programs to de-bug function specifications and/or programs to verify hardware capability; writing test outlines; coding, de-bugging and documenting programs. Positions require a degree in computer science, mathematics or electronic engineering plus 2-5 years' applicable experience and familiarity with both hardware and software.

#### **Arrange now for an interview in your area**

Confidential interviews will be held soon in various parts of the country. To arrange an appointment, please send a resume immediately, including training, experience and salary history, to the Professional Placement Office at either address below.

#### **Design Automation**

Work involves implementing a new system programmed for automated PCB layout. Experience in data definitions, automatic placement, automatic routing, or numerical control and graphic output is necessary. A background in FORTRAN and assembly language programming and a BSEE are also desired.

Additional opportunity exists in computer-aided circuit design to define program requirements and specifications. Program experience in CAD with overall knowledge in analytical techniques, modeling and data acquisition, conversion methods and user-oriented input/output is desirable. BSEE and FORTRAN experience required; assembly language background helpful.

#### **Logic Design Engineering**

Immediate needs exist in our advanced systems development and computing systems engineering groups for engineers experienced in commercial computer processor logic design. Selected candidates will assist in logic design of our current and future-generation computing systems. A BS or MSEE and 1-3 years of directly related experience is required.



#### **DATA PROCESSING DIVISION**

Los Angeles Facility:  
2837 W. El Segundo Blvd.,  
Hawthorne, Calif. 90250

San Diego Facility:  
16537 W. Bernardo Dr.  
San Diego, Calif. 92127

*An equal-opportunity employer*

Right now we're only about 18 months ahead in large time-sharing systems . . . Gap wideners welcome.

At RCA the future is not in the blue-sky or blue-print stage. Right now products and software are about 18 months ahead of the field. The field: large, time-sharing multi-function, multi-user operating systems. But we have no intention of resting

on our laurels. We are vitally interested in EDP professionals who can design computers and the software for them, so that we can stretch our substantial lead. With some emphasis on software design automation. If the idea of staying out in front of the industry has a special interest for your far-reaching mind, come help widen the gap. Your experience should be in any of the following: programming; language

processing; control systems; operating systems; utility systems; communications systems; micro-programming; field sales and system support; education or product planning.

*Write to: Mr. Thomas Beckett, Dept. 18, RCA Computer Systems Division, Bldg. 202-1, Cherry Hill, New Jersey 08101. We are an equal opportunity employer.*

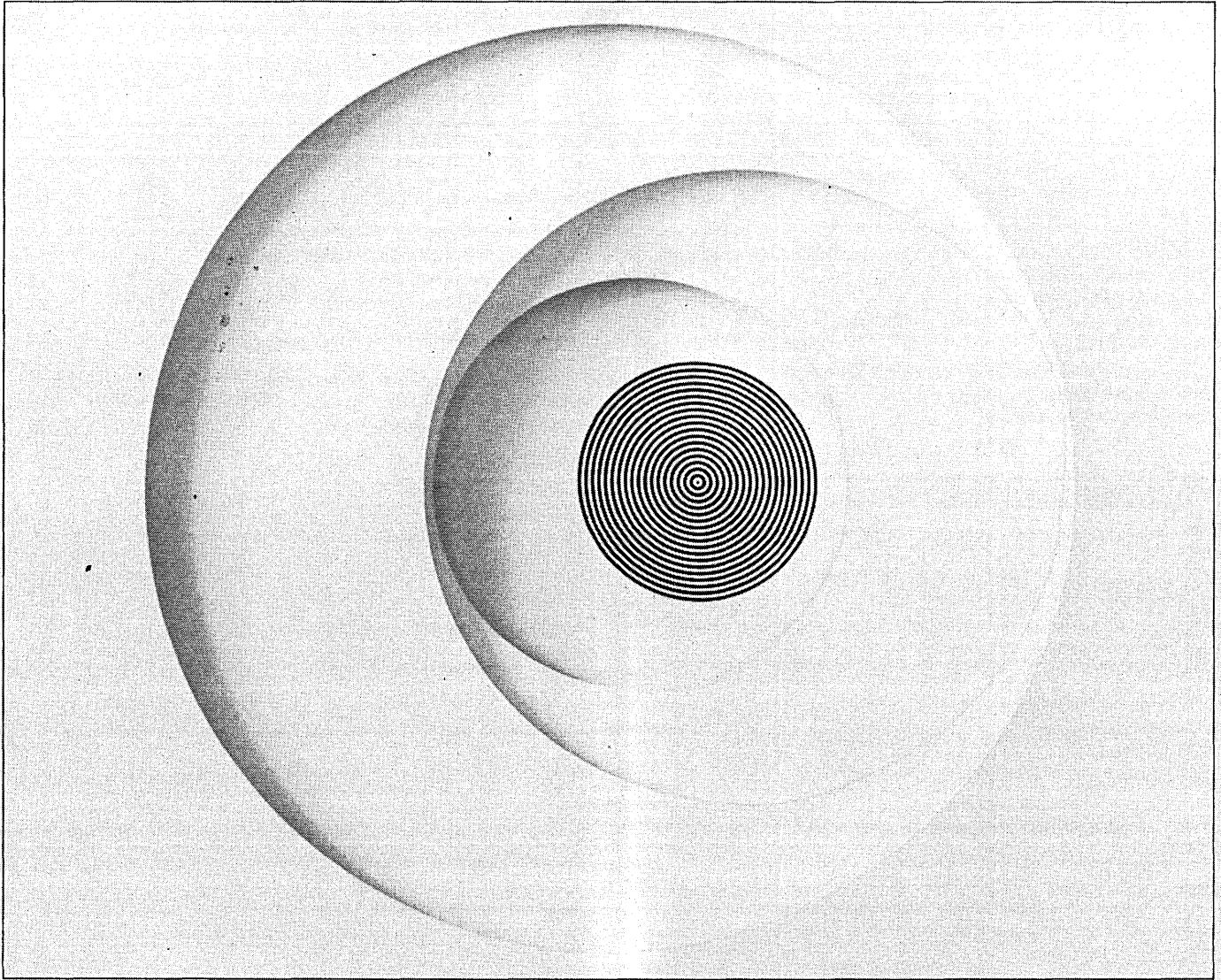

**RCA**  
COMPUTERS

# ADVERTISERS' INDEX

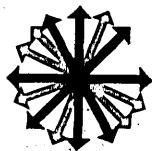

ACCO	13
Addison-Wesley Publishing Company	39
American Technological Institute	70
American Telephone and Telegraph Company	20, 21
Applied Systems Division of Computer Learning and Systems Corporation	42
Bechtel	89
Beehive Medical Electronics, Inc.	33
Bright Industries Inc.	25
The Bunker-Ramo Corporation, Business & Industry Division	46
Cadillac Associates, Inc.	94
Caelus Memories, Inc.	Cover 2
Cincinnati Milacron	80
Cogar Corp., Information Systems Div.	14, 15
Colorado Instruments, Inc.	1
Computer Control Systems Inc., A Union Service Industries Company	40
Cybercom	19
Data Action Corporation	74, 75, 89
Data Electronics Corporation	61
Data General	34, 35
Data 100 Corporation	51
Datalog Division Litton Industries, Inc.	41
Datamation Industry Directory	82
DATAMATION Magazine	67

Electronic Memories, A Division of Electronic Memories & Magnetics Corporation	86, 87
Florida Department of Commerce, Bureau of Industrial Development	78
GKI, A Division of General Kinetics Inc.	29
Gould Inc., Graphics Division	48, 49
Hewlett-Packard	54, 55
Houston Instrument, Division of Bausch & Lomb	83
Hytek Technology, Inc.	4
IBM	43, 44, 45
Information Storage Systems, Inc.	8
Information Terminals Corp.	71
Infotech	84
Logicon	77
Micro Switch, A Division of Honeywell	10
MSI Data Corporation	79
The National Cash Register Company	92
Noller, a Division of Badger Meter Manufacturing Company	16
Novar Corporation	4
Numeridex	71
Pitney-Bowes, Inc.	60
Raytheon Computer	56, 57
RCA Computer Systems Division	93
Redcor Corporation	Cover 4
Resume Power for Computer Professionals	81
Scan-Data Corporation	88
Scan Optics Inc.	2
The Singer Company, Friden Division	Cover 3
Source EDP	83
Syner-Data, Inc.	72
Tektronix, Inc.	5
Teletype Corporation	90, 91
Tel-Tech Corp.	76
Tracor Data Systems	64, 65, 66
Wilson Jones, A Division of Swingline Inc.	12
Wiltek, Inc.	58, 59
Xerox Data Systems	6, 7

## WHAT IS YOUR TRUE WORTH?

### FREE JOB OPPORTUNITIES BULLETIN

Cadillac Associates represents the nation's largest and most respected professional placement service. Our close relationship with the nation's finest firms generates continuous career opportunity information and allows us to confidentially present your qualifications to those at "decision-making" levels.

Our bulletin, published quarterly, listing available opportunities in the Systems & Data Processing field is available free of charge and will be mailed to your home upon your request.

For your free bulletin, without any obligation, circle reader service card #501. Please USE HOME ADDRESS ONLY!

### FREE CONFIDENTIAL PLACEMENT SERVICE

If you desire immediate assistance in locating an opportunity consistent with your objectives (professional/financial/geographic), CALL OR WRITE TODAY. A member of our staff of SYSTEMS & EDP SPECIALISTS will reach you by telephone to discuss your objectives and how we might help you satisfy them. A resume, or some details of background, will be appreciated.

Remember: Our client firms are located from coast to coast and assume all expenses (agency fee, interviewing & relocation).



**JACK JEROME,  
CADILLAC ASSOCIATES, INC.\***  
32 West Randolph St. Chicago, Ill. 60601  
Financial 6-9400

West coast residents—contact:  
Lon D. Barton Associates, 3325 Wilshire Blvd.  
Los Angeles, California 90010  
(213) 385-9111

\*"Where More Executives Find Their Positions Than Anywhere Else in The World."

## TECHNICAL PUBLISHING COMPANY

Arthur L. Rice, Jr., President  
Gardner F. Landon, Exec. Vice President, and President, Thompson Division  
James B. Tafel, Exec. Vice President, and President, Technical Division  
Calverd F. Jacobson, Financial Vice President  
Edwin C. Prouty, Jr., Secretary and Director of Data Processing

### ADVERTISING OFFICES

<b>Sales Manager</b>	<b>JOHN BRENNAN</b>
& Vice President	205 West Wacker Drive, Chicago, Ill. 60606 (312) 346-1026
<b>Eastern District Managers</b>	<b>JAMES M. MORRIS</b> <b>WARREN A. TIBBETTS</b> <b>IRWIN L. WERFEL</b>
	35 Mason Street, Greenwich, Conn. 06830 (203) 661-5400
<b>New England District Manager</b>	<b>WARREN A. TIBBETTS</b>
& Vice President	112 West Haven Rd., Manchester, N.H., 03104 (603) 625-9498
<b>Midwest District Manager</b>	<b>JOHN M. GLEASON</b>
	205 West Wacker Drive, Chicago, Ill. 60606 (312) 346-1026
<b>Western Manager</b>	<b>HAMILTON S. STYRON</b>
& Senior Vice President	94 So. Los Robles Ave., Pasadena, Cal. 91101 (213) 681-8486
<b>Western District Manager</b>	<b>JAMES E. FILIATRAULT</b>
	61 Renato Court, Redwood City, Cal. 94061 (415) 364-3171

# If our new alphanumeric digital printer didn't work, neither would thousands of Friden calculators.

But of course Friden\* calculators do work. Including the thousands of electronic printing models we've sold for the past 4 years.

With this ad, we're introducing 30-character and 40-character alphanumeric printers, both of which work exactly the same as the standard Friden 20-character model. A little wheel zips across the tape, printing up to 28 columns at 46 characters per second, inking itself on a roller made of solid ink.

Popping in a new ink roller when required is the only service that's needed. And there are no adjustments to make.

It's a printer you can count on. Ask anybody who owns one of our calculators.

And if you'd like complete information on all three Friden digital printers, ask Mr. Gary Dotzler, Sales Manager, OEM Products, Friden Division, The Singer Company, San Leandro, California 94577.

**SINGER**  
FRIDEN DIVISION

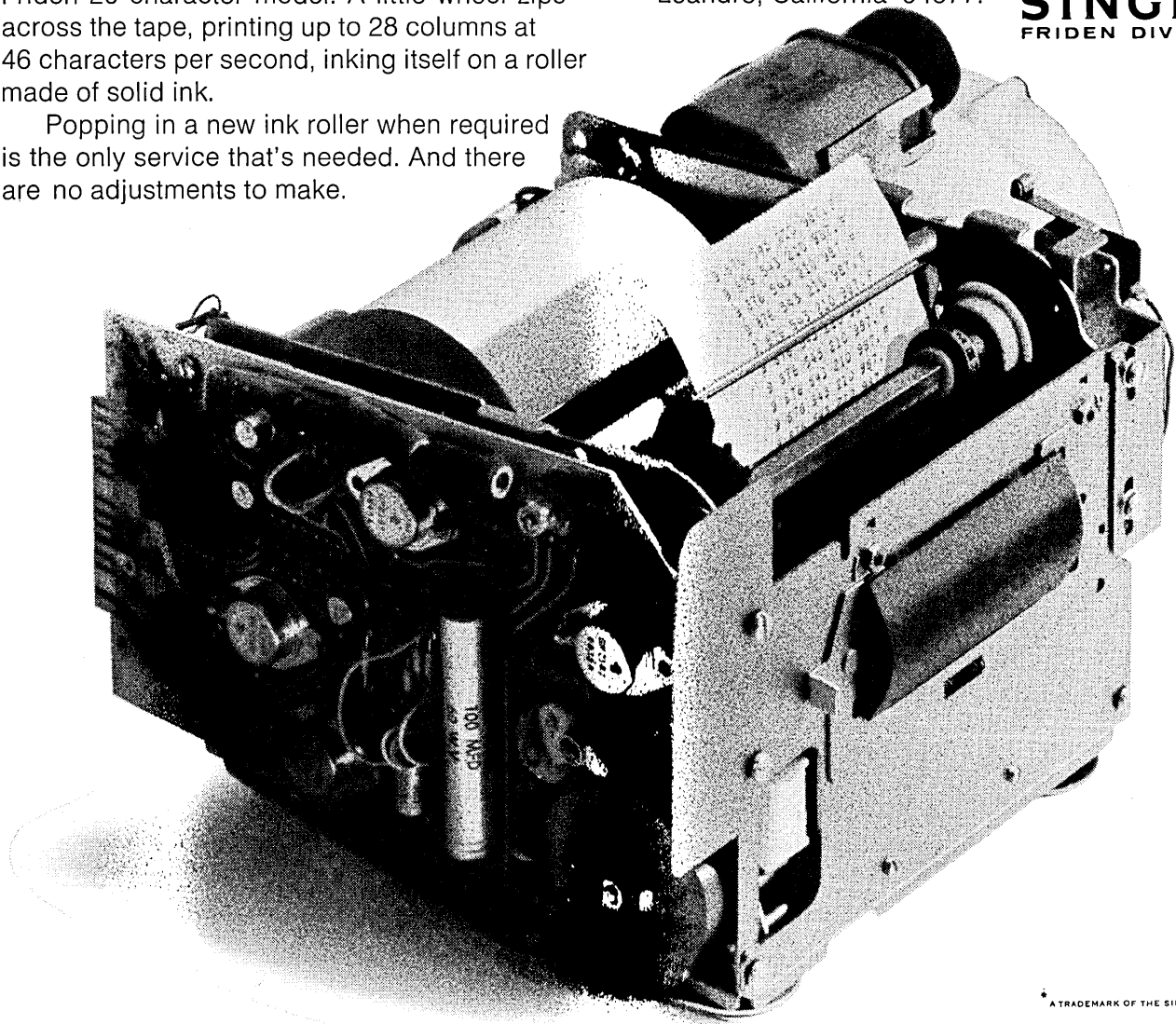

\* A TRADEMARK OF THE SINGER COMPANY

CIRCLE 54 ON READER CARD



**30/30**

**Redcor CONFIDENCE  
gives you a 30/30 deal:**

**30 day KeyLogic rental plan  
30% increased thruput**

**30% lower monthly cost for  
your "data entry" applications**

**Use KeyLogic for 30 days and  
prove the Redcor 30/30 deal  
to yourself.**

**R REDCOR CORPORATION**  
**C Telephone: (213) 348-5892**

KeyLogic gives you the lowest total dollar operating cost of any data entry system.