

BEWARE WHEN BUYING AN OFFICE SYSTEM

ALSO:

WHY XEROX BOUGHT CRUM & FORSTER

UNSTRUCTURED PROGRAMMING

SECURITY: A QUESTION OF LEADERSHIP

YOU CALL THIS OFFICE AUTOMATION?
BUMSTEAD, YOU'RE FIRED!

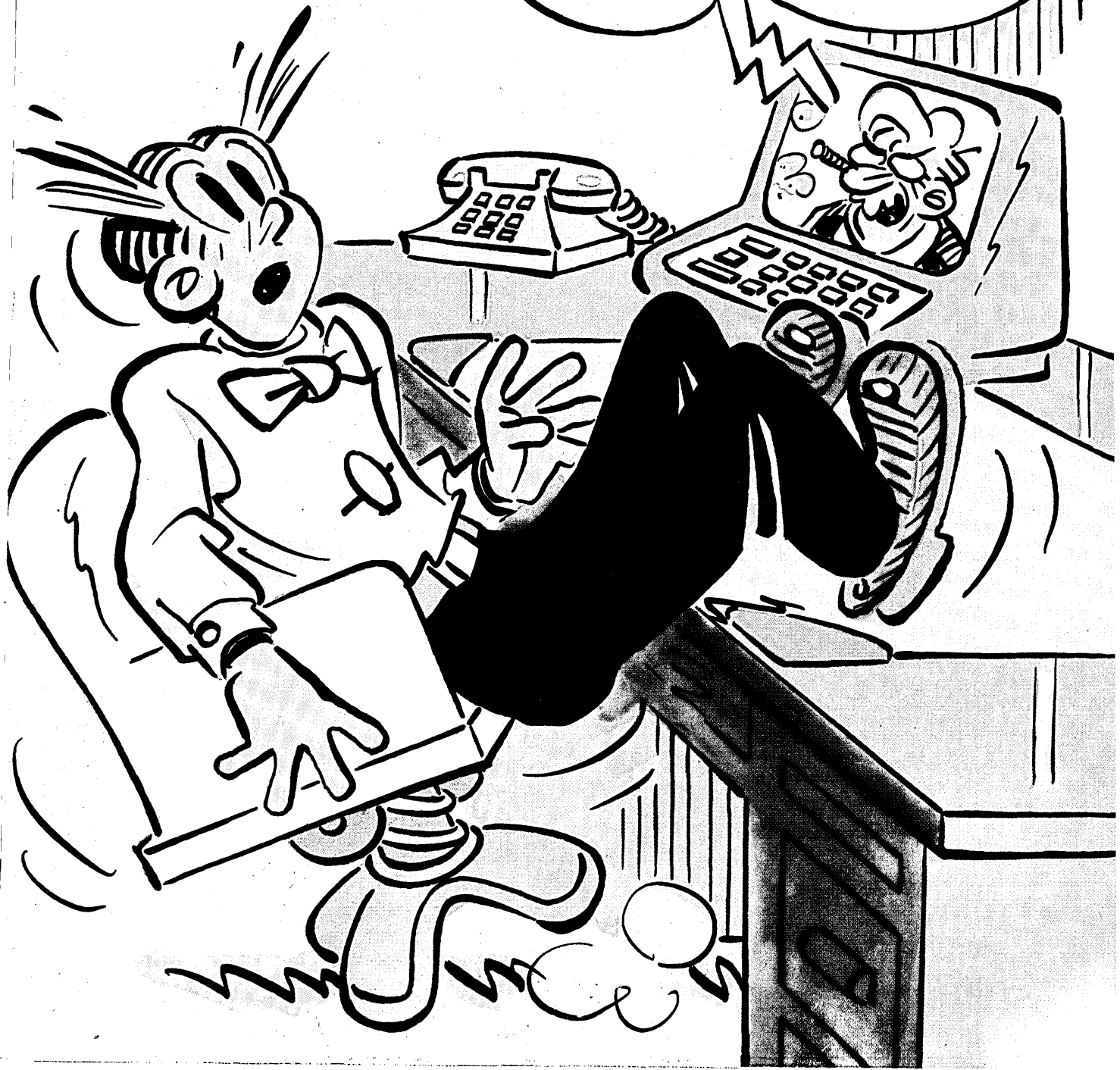

Four reasons why you should look at our Winchester's

1. **100% SMD format and interface compatible.**
Just plug it in and it is ready to accept data.
2. **The best price/performance ratio available.**
Kennedy can save you an average of \$2000.00 per unit over comparable disk equipment.
3. **Immediate availability.**
Most models are ready to ship 30 days ARO.
4. **Produced by an industry leader.**
Kennedy has been manufacturing Winchester's since 1978 and its reputation for reliability is known world-wide.

KENNEDY

An Allegheny International Company

1600 Shamrock Ave., Monrovia, CA 91016
(213) 357-8831 TELEX 472-0116 KENNEDY
TWX 910-585-3249

KENNEDY INTERNATIONAL INC.

UK and Scandinavia
McGraw-Hill House
Shoppenhangers Road
Maidenhead

Berkshire SL6 2QL England
Tel: (0628) 73939

Telex: (851) 847871 KEN UKS G

KENNEDY INTERNATIONAL

Koningin Elisabethplein 18
B-2700 Sint-Niklaas

Belgium

Tel: (03) 777 1962

Telex: 71870 KEN CO

165 Megabytes

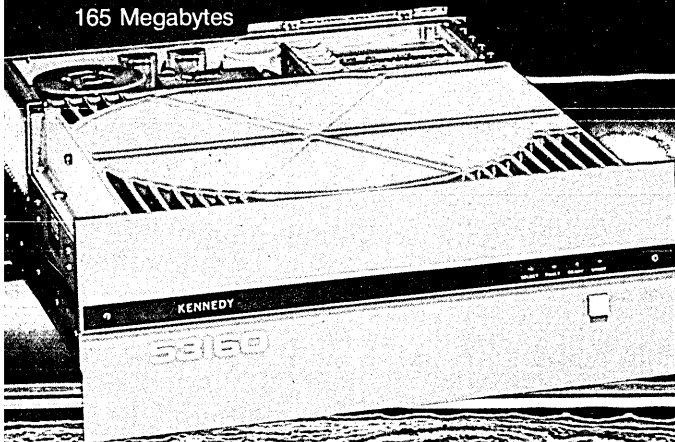

82 Megabytes

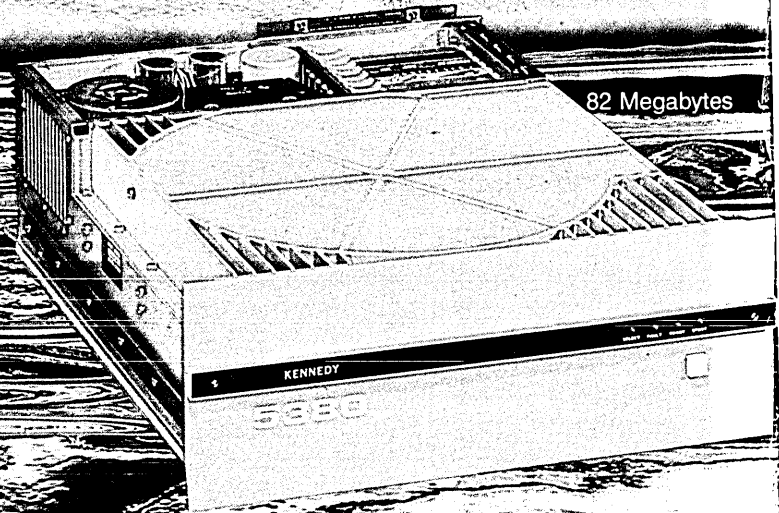

KENNEDY • QUALITY • COUNT ON IT

CIRCLE 10 ON READER CARD

You don't switch voice calls this way any more. Why should you do it for data?

Telephone switching networks evolved because manual operators like this one (many others) were data processing installations still in their data switching infancy which are nearly as obsolescent. MICRO'S MicroSwitch

offers these up installations an easy way to modernize by providing a switching system specifically designed to handle terminal-to-terminal data—powerful and expressive data (PMS).

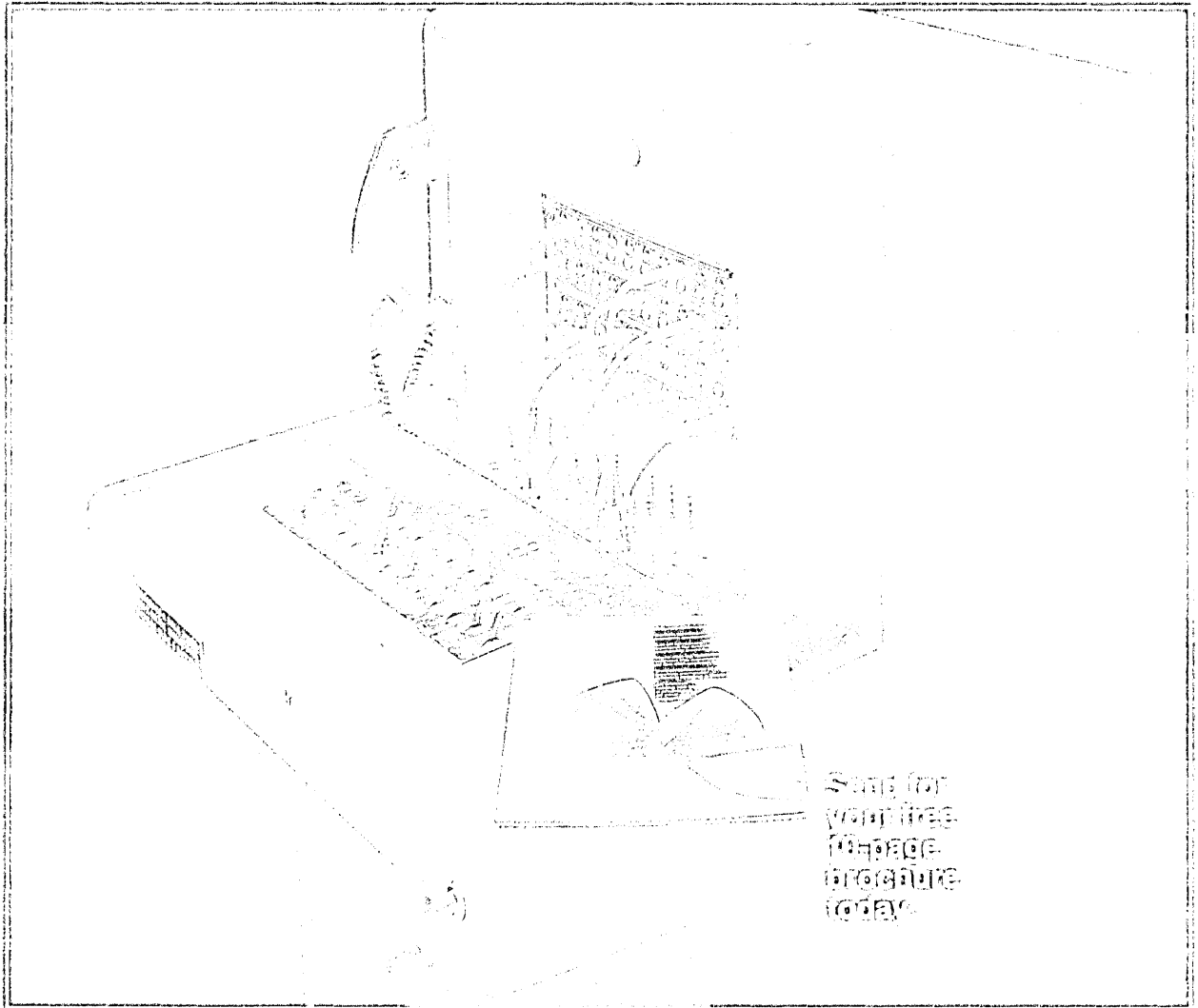

Send for your free MicroSwitch program today.

- Contention for applications with more terminals than computer ports
- Selection where a single terminal may access more than one computer
- Load balancing to automatically maximize computer resource utilization
- Management for monitoring computer and terminal utilization and dynamically changing network configurations
- Access control for 'approving' access to computer ports on a case-by-case basis
- Fail-back—automatic switching to one or more back-up computers
- Minimal delay—eliminates the delay associated with other switching systems
- Local networking—proven technology at low cost per port, without special cables or compatibility problems

MICRO *MicroSwitches for Data Communications*

MICRO SYSTEMS, INC. • 2500 North St. • Chagrin Falls, OH 44022 • Telephone: (216) 298-8800 • FAX: (216) 298-8801
 Regional Sales and Service • Boston, MA • (617) 527-4100 • St. Louis, MO • (314) 476-7626 • Woodbridge, NJ • (201) 954-1020
 Other Regional Sales Offices • Atlanta, GA • (404) 452-2995 • Dallas, TX • (214) 251-0776
 MICRO/MSO/REP LTD. • 1801 County Rd. • Grand Rapids, MI 49501 • England • (01753) 635501 • Telex: 607125

Introducing the first ergonomically engineered 16-bit intelligent terminal that's as bright as it looks.

And prices start as low as \$975*.



When Wyse introduces a new terminal, you expect a lot. And our newest family of 8088-based terminals — the WY-200, 210 and 220 — delivers just that.

The list of features is long, but definitely worth your consideration if you're thinking about a multi-functional intelligent terminal.

For example, operator comfort is paramount in the design of the WY-200 family. Its fully tilting/rotating display and detached keyboard let you work the way you work best.

Its green phosphor screen is easy on the eyes.

It comes standard with both 80 and 132 column modes.

And multiple split screen capability allows you to program horizontal and vertical split screens independently to a variety of sizes. Plus you get smooth scroll.

With a standard 256 character set, you can program additional character graphics or foreign character sets as needed by simply replacing the EPROM.

You can even have double-high, double-wide characters on a line basis.

The WY-200 has 105 keys so you get more functionality with less key strokes. You even get a 14-key numeric pad to simplify data entry.

Compared to the competition, the WY-200 family's functionality is very flexible. You get a soft set-up mode with battery back-up that lets you set up the terminal functions via the keyboard. Plus soft keyboard and escape sequence tables that allow you to emulate other terminals as needed.

The WY-200 comes standard with 32K bytes of RAM that can be used either as page, program, or data memory, while the WY-210 and 220 have 128K bytes of RAM. And since you can down line load from the host computer and execute programs in RAM, you can tailor the WY-200 family to a wide variety of applications.

You'll also find two independent asynchronous communication ports (both can be programmed in a synchronous mode) on the WY-200 and 210, and one RS-232 port and one high-

speed RS-422 port on the WY-220.

As we said earlier, the list is long. To find out even more about this highly intelligent terminal family, including OEM pricing, call or write us today.



WYSE
TECHNOLOGY

3040 North First St., San Jose, CA 95131
(408) 946-3075 TLX 910-338-2251
In the East, call (516) 293-5563
Outside California, 800-538-8157 ext. 932
Inside California, 800-672-3470 ext. 932

UL and FCC approved. ©1982 Wyse Technology, Inc.
*WY-200 Quantity 100 Price

CIRCLE 5 ON READER CARD

DATA[®]MATION

FEBRUARY 1983/\$4.00 U.S.A.
VOLUME 29 NUMBER 2
This issue, 167,740 copies

FEATURES

30 IN FOCUS

Use and abuse of drugs and alcohol are widely prevalent in U.S. business. Marvin Grosswirth examines the problem in "Stoned at the Office."

90 INSURING THE FUTURE AT XEROX

Laton McCartney

A financial tail about the acquisition of Crum & Forster, the cash cow Xerox brought into its stable.

102 WHAT YOU GET WHEN YOU BUY OFFICE AUTOMATION

David Macfarlane

Users must have a clear idea of what they're buying if the new systems are to meet all their needs. A comparison of the major IOSs appears on pp. 104 and 105.

119 A QUESTION OF LEADERSHIP

A panel of security practitioners met recently for a round-table discussion of data security problems. We offer the results of their collective wisdom.

131 POWER TOOLS FOR PROGRAMMERS

Beau Shell

Unstructured programming may be the technique of the future if exploratory programming, the intertwining of system design and implementation, catches hold.

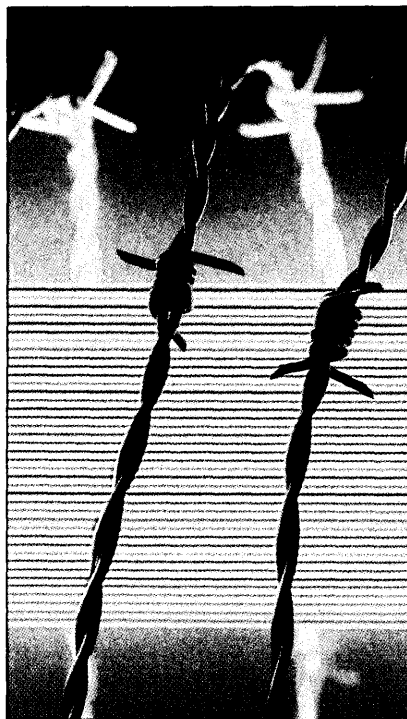
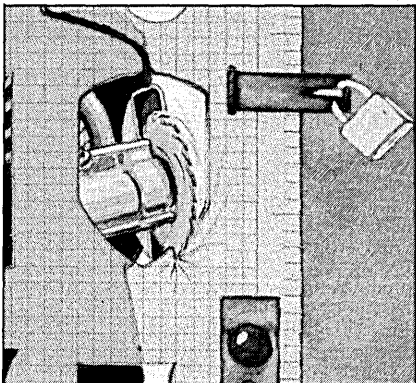

148 SAFEGUARDING EFTS

Michael B. Schwartz

FIMAS, a new ANSI standard, offers protection to financial institutions that presently engage in electronic funds transfers with little security.

163 CODE-O-GRAPHS OF THE SECRET SQUADRON

Stephen A. Kallis Jr.

In the pre-television days, the *Captain Midnight* radio adventure series shared secret messages with its fans through unique encryption devices.

171 AUDITION FOR APPLES

Jerome L. Doubler

As the result of a pilot project, Owens-Corning Fiberglas has set up a central clearinghouse to control the purchase of personal computers.

209 READERS' FORUM

Nigel S. Read and Douglas L. Harmon urge the use of fourth generation languages to improve the "Language Barrier to Productivity."

NEWS IN PERSPECTIVE

- 40 **PERSONAL COMPUTERS**
Lisa is Apple's star.
- 42 **MAINFRAMES**
XA: Let the gods decide.
- 52 **SERVICES**
GEISCO goes for the gusto.
- 58 **SOFTWARE**
CPE moves to the top.
- 64 **MANUFACTURING**
The new CAD/CAE.
- 70 **COMMUNICATIONS**
Telecom is Honeywell's focus.
- 82 **LEGISLATION**
What's new with the 98th.

DEPARTMENTS

- 8 **LOOKING BACK**
- 13 **LOOK AHEAD**
- 18 **CALENDAR**
- 23 **LETTERS**
- 29 **EDITOR'S READOUT**
Our machine of the year.



- 177 **HARDWARE**
- 183 **SOFTWARE & SERVICES**
- 190 **MARKETPLACE**
- 197 **ADVERTISERS' INDEX**
- 202 **ON THE JOB**

INTERNATIONAL 176-1

- 2 **THE LATIN LOOK**
- 7 **ROUNDUP IN RIO**
- 21 **LATIN HARMONY**
- 25 **THE NEW FRONTIER IN ERGONOMICS**
- 35 **PRODUCT SPOTLIGHT**

OEM SUPPLEMENT 177-1

- 3 **SELECTING SUPERCHIPS AND SUPERMICROS**
- 9 **EUROPEAN TRADE SHOWS AND TRADERS**

COVER ILLUSTRATION BY DEAN YOUNG AND MICHAEL GERSHER

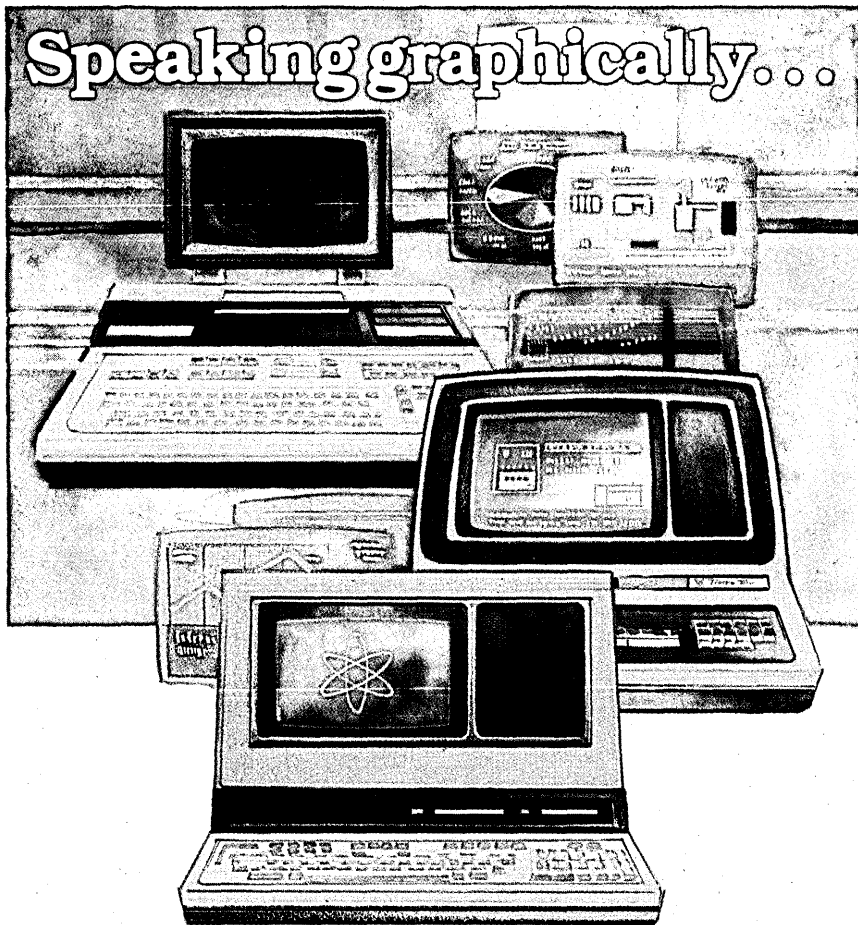

Speaking graphically...

it really pays to rent terminals and desktop computers from Genstar REI!

You can rent — right now, off-the-shelf, for as short as 30 days — Hewlett-Packard desktop computers, intelligent graphics terminals, graphics terminals, digitizers and thermal graphics printers. Plus, you can rent dot matrix printers, graphic printers, impact printers and teleprinters from Centronics, HP, Tally, Texas Instruments, Qume, and more. Also, data terminals from ADDS, Beehive, Computer Devices, HP, Lear Siegler, Tektronix, Teletype Systems, TI, and others. We've also got modems and acoustic couplers immediately available for rent throughout North America. Think of your bottom line in graphic terms. Rent from Genstar REI. Today!

GENSTAR

Rental Electronics, Inc.
(800) 227-8409

In California (213) 887-4000, (415) 968-8845 or (714) 879-0561

GSA Contract #GS-04S-23560

Show me the savings picture, REI. Send me a Free Catalog now!

- It sounds great. Tell me more! Call me at _____
- Send me your new Rental Catalog.
- I'd like a copy of your "like new" equipment for sale catalog, too.
- I'm particularly interested in the following equipment: _____

NAME _____ TITLE _____
 ORGANIZATION _____
 ADDRESS _____ MAIL STOP _____
 CITY/STATE/ZIP _____
 TELEPHONE _____ D283

Please complete coupon and mail to: Genstar Rental Electronics, Inc., 6307 DeSoto Avenue, Suite J, Woodland Hills, CA 91367 © Genstar Rental Electronics, Inc. 1982

CIRCLE 6 ON READER CARD

DATAMATION

Editor John L. Kirkley
Managing Editor Becky Barna
International Editor Linda Runyan
Features Editor Kenneth Klee
Copy Editor Florence Lazar
Assistant Editor Deborah Sojka
Assistant Copy Editor Jill Grossman
New Products Editor Michael Tyler
Editorial Assistant Lauren D'Attilio
Bureau Managers
San Francisco Edward K. Yasaki
Los Angeles Edith D. Myers
Minneapolis Jan Johnson
Boston Ralph Emmett
New York John W. Verity
Technology Editor, Europe Fred Lamond
Correspondents
Washington Willie Schatz
London Malcolm Peltu
Sydney, Australia Norman Kemp
Editorial Advisor Robert L. Patrick
Technical Advisor Lowell Amdahl
Contributing Editors Howard Bromberg, Philip H. Dorn, Bruce W. Hasenyager, David Hebditch, John Imlay, Terry G. Mahn, Laton McCartney, Angeline Pantages, Russell Pipe, Carl Reynolds, F. G. Withington, Amy Wohl.

Art Director Kenneth Surabian
Assistant Art Director Susan M. Rasco
Production Manager Kathleen Monaghan

EDITORIAL OFFICES

Headquarters: 875 Third Ave., New York, NY 10022. Phone (212) 605-9400; telex 429073. **New England:** 1 Chaucer St., RFD 2, Sandwich, MA 02563. (617) 888-6312. **Mid-western:** 3607 Garfield Ave. S., Minneapolis, MN 55409, (612) 827-4664. **Western:** 1801 S. La Cienega Blvd., Los Angeles, CA 90035, (213) 559-5111; 2680 Bayshore Frontage Rd., Suite 401, Mountain View, CA 94043, (415) 965-8222. **International:** 6605 Burlington Pl., Springfield, VA 22152, (703) 569-3383; telex 440-413.

CIRCULATION

875 Third Avenue, New York, NY 10022

Circulation Manager Joseph J. Zaccaria
Business Manager Charles J. Johnsmeyer
Publisher James M. Morris

Technical Publishing

DB a company of The Dun & Bradstreet Corporation

BPA Circulation audited by Business Publications Audit

ABP Member American Business Press, Inc.

DATAMATION (ISSN 0011-6963) Magazine is issued monthly on or about the first day of every month. Published by Technical Publishing, a company of The Dun and Bradstreet Corp., 1301 South Grove Ave., Barrington, IL 60010; James B. Tafel, Chairman; John K. Abely, President. Executive, advertising, editorial offices, and subscription department, 875 Third Ave., New York, NY 10022. Published at East Greenville, Pa. Annual subscription rates: U.S. and possessions: \$42; Canada: \$60; Japan, Australia, New Zealand: £57; Europe: £52 air freight, £95 air mail. All other countries: £52 surface, £95 air mail. Reduced rate for qualified U.S. students, public and school libraries: \$30 Single copy: \$4 in U.S. Sole agent for all subscriptions outside the U.S.A. and Canada is J. B. Tratsart, Ltd. 154 A Greenford Road, Harrow, Middlesex HA13QT, England, (01)422-8295 or 422-2456. No subscription agency is authorized by us to solicit or take orders for subscriptions. Second-class postage paid at New York, NY 10001 and at additional mailing office. ©Copyright 1982 by Technical Publishing Co., a Division of Dun-Donnelley Publishing Corp., a company of The Dun and Bradstreet Corp. All rights reserved. "Datamation" registered trademark of Technical Publishing Company. Microfilm copies of DATAMATION may be obtained from University Microfilms, A Xerox Company, 300 No. Zeeb Road, Ann Arbor, Michigan 48106. Printed by Foote & Davis/Mid-America. POSTMASTER: Send address changes to Datamation, 875 Third Avenue, New York, NY 10022.

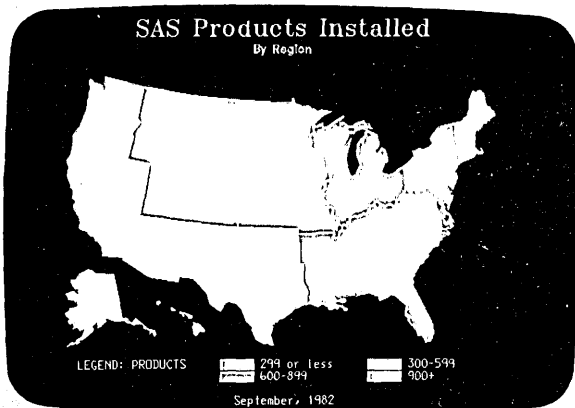

Choropleth Map of Products

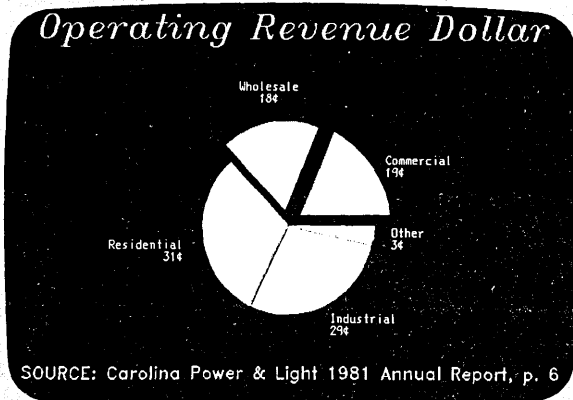

Pie Chart of Revenue

TELEPHONE EXPENDITURES FOR TELEMARKETING

(Estimated Figures)

(In Millions)

	1980	1976
Residential originated local calls	\$ 569	\$ 232
Residential originated toll calls	689	269
Business originated local calls	4,144	3,045
Business originated toll, WATS, 800 calls	4,443	2,502
TOTAL	\$9,845	\$6,048

SOURCE: DMMA Fact Book on Direct Marketing

Telephone Expenditures

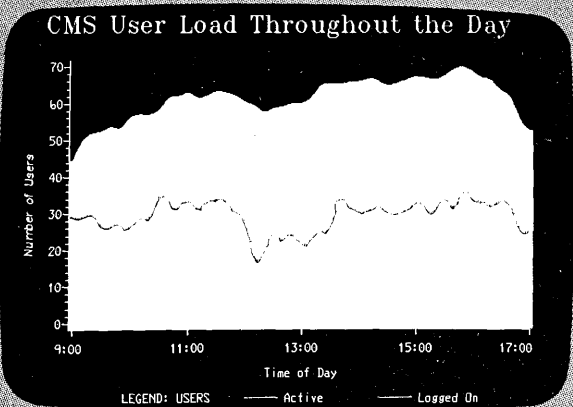

Plot of Load*Time

SAS/GRAPH

brings you

Instant Replay

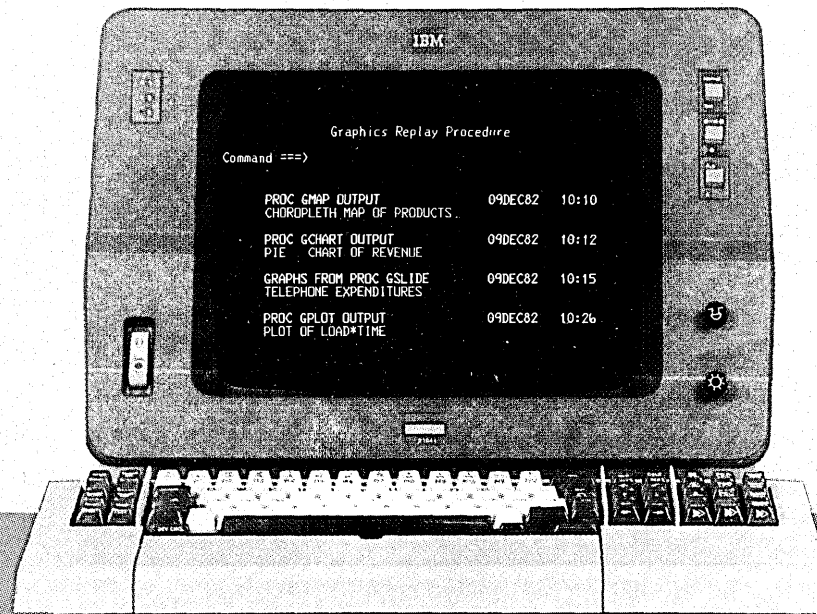

Since its introduction in 1980, SAS/GRAPH has provided "state of the art" software for business graphics. Now SAS/GRAPH brings you a new decision support tool—instant replay.

With the menu-oriented replay facility in SAS82 (our newest release) your DSS group can

1 generate numerous graphical analyses and store the results.

Then you can

2 choose the best graph—charts, plots or maps—from the annotated selection SAS/GRAPH provides and

3 instantly display the graph with the touch of one PF key on your IBM 3279.

It's as simple as 1 + 2 + 3. And that adds up to a big time-savings.

Think of the flexibility instant replay adds to your operation. Your DSS staff can run overnight batch jobs to graph CPU utilization reports, sales totals and production figures.

The reports are ready for display at your desk the next morning.

Best of all SAS/GRAPH™ is integrated into the SAS system, so you can get the benefits of SAS for data management, statistical analysis and report writing; SAS/ETS™ for econometric forecasting and modeling; SAS/FSP™ for data entry, editing and letter-writing; and SAS/IMS-DL™ for interfacing to IMS data base. The SAS system operates on the IBM 370 Family and compatible machines at more than 500 OS/MVS, VM/CMS, DOS/VSE and SSX sites around the world.

Call or write today. SAS Institute Inc., Box 8000, Cary, NC US 27511-8000. Phone (919) 467-8000. Telex 802505.

SAS

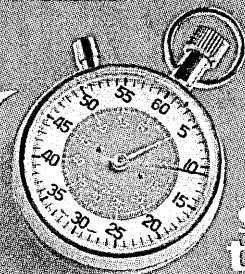

SAS
save
time.



**THE NEW AIS/AMERICAN BELL
OFFERS A FIRM REBUTTAL
TO THE PRINCIPLES OF A
THROWAWAY SOCIETY.**

Buy it now, scrap it later.
That's no way to run a country—or a
company. Yet nowadays, it seems to be a
typical way of doing business.
AIS has different ideas.
We believe you shouldn't have to throw

away the past to get to the future.
With our integrated communications
and information systems, you won't have to.
We're designing systems so you can add
tomorrow's sophisticated enhancements to
the equipment you buy today.



So you and your management can expect gentle evolution over time. Instead of revolution, every few years.

It comes down to a simple principle. At AIS, obsolescence is now obsolete. Let us show you how investment in

our systems today can help now—and in the future. Call toll-free 1-800-AIS-1212, Ext. 11.

AIS  **American Bell**
Advanced Information Systems
CIRCLE 8 ON READER CARD

OPPORTUNITY WITHOUT RISK.

The biggest
improvement in
Savings Bonds in
40 years.

New Variable Interest Rate.

Looking for an ideal investment? One with a variable interest rate? But one where rates can't drop below a certain level?

Well, there is one available to everyone, even if you have only \$25 to invest.

It's U.S. Savings Bonds. Now changed from a fixed to a variable interest rate, with no limit on how much you can earn.

A Guaranteed Minimum.

Although interest rates will fluctuate, you're protected by a guaranteed minimum. And if you hold your Bond to maturity, you'll double your money. You may do even better.

Take another look at Savings Bonds. We did, and made them better.



Take
stock
in America.



A public service of this publication
and The Advertising Council.

Twenty Years Ago/Ten Years Ago

LOOKING BACK

THE RED AND THE BLACK

February 1963: While the majority of computer manufacturers admitted to heavy losses in 1962, there was hope that in the year ahead these losses would be reduced. DATAMATION predicted that installations, which numbered 8,500 in 1962, would jump to a figure between 10,000 and 20,000, and manpower requirements would surge to between 250,000, from the previous year's 100,000.

The equally optimistic Department of Commerce projected a 10.5% jump (to \$1.7 billion) in shipments. Included in the DOC's estimates, however, were various "accounting machines," plus all forms of "self-regulated equipment and machines used in precision manufacturing and process control."

The big daddy of computer customers, the federal government, was planning to increase its annual dp budget by 15% in '63. In 1962 the feds had spent \$688 million and procured 170 new machines, bringing their total to 1,170. That amount included salaries, maintenance, site preparation, and supplies in addition to the hardware, with no breakdown as to rentals vs. purchased machines.

IBM, with its firm hold on a large segment of the dp market, did not release any of its installation figures, in line with its corporate code of silence. We estimated IBM's revenues for 1962 to be about \$1.9 billion, with a net profit of about \$239 million. The few flies in that splendid ointment included a slightly diminished backlog of 1401 orders (estimated at 7,000 in '62), and the usual Justice Department headaches, such as an order that the company divest itself of any remaining capacity to produce more than half of the nation's tab cards.

RCA's edp prospects looked somewhat better, with the first 601s finally on line at N.J. Bell Telephone, foreign orders for the 301 and 501 totaling 158, and more than 290 orders already shipped. Unfortunately, those foreign sales weren't expected to continue at that pace. In response to a limited 301 market, RCA planned to announce a fast, medium-scale machine early in the year.

Honeywell's annual income from rentals of its 400 and 800 systems was projected at about \$12 million in '63, down from \$27 million in '62. Honeywell never-

theless maintained that it would be profitable by '64 and showed few signs of restraining its rate of investments; in January, for example, the company announced an expansion of its marketing activities.

VIRTUALLY LAST

February 1973: IBM's announcement of virtual memory enhancement prompted E.J. Gaudion to observe that the company had not come out with a historical first, but a very delayed historical last.

Fifteen years before IBM sounded the trumpets, said Gaudion, Ferranti's Atlas machine in England was running multi-thread jobstreams using automatic fixed-size paging structures and achieving operational flexibility without the "benefits" of a complex job control language. At that same time in France, the Gamma 60 was automatically scheduling fully parallel jobs among a number of peripheral processes.

By 1960, the EMIDEC 2400, also in England, was running up to 24 independent parallel processes and was a fully asynchronous machine.

In the United States, Burroughs had successfully installed its 5000 series, based on a fixed-head disk system and a variable length segment swap, by 1962. Burroughs had also solved the problem of programmers' inability to write jobs in a fixed size by allowing the job segment to be whatever size it turned out to be.

By 1963, Univac also recognized the importance of switching programs between an external medium and a main core, and its systems featured rapid access drums from that time on. Unfortunately for Univac, it didn't come up with a catch phrase such as virtual memory to describe this process.

A complete virtual memory system—though it wasn't called that—existed as early as 1967. This was the GE/Honeywell Multics system. Around the same time, IBM itself had adapted the regular 360 with the addition of a swapping mechanism. Enter the 360/67, a fixed-page system also, but not blessed with the name of virtual memory.

Actually, complained Gaudion, IBM hadn't even coined the name. RCA was first in that department, having commercialized the term in 1970.

—Lauren D'Attilio

The ADABAS Seminar For DBMS Evaluators



Spend a morning, save a bundle.

You're busy. You don't have the time, or the patience, to attend yet another "management seminar." And for once, you would like *hot* coffee and a *fresh* Danish.

We understand. We also know that if you have spent any time looking at data base management systems you've discovered a problem: while evaluating a DBMS is difficult, you know you should study all of your options before you choose the one you're going to live with for a long time to come. Since you want to be sure you have made the right choice, it makes sense to attend an ADABAS seminar.

Give us part of your day and we'll give you hard facts and no hype about ADABAS for data base management on your IBM 4300, 370, or plug compatible com-

puter. You'll find out why our DBMS can be installed in a day while others can take months. You'll also learn how user-friendly a relational-like system can be. And you'll experience the benefits of using NATURAL, a productivity tool that can reduce application development time by up to 90%.

A DBMS is a major investment. We urge you to enroll in one of our free seminars to get the facts on ADABAS and NATURAL. Use the coupon to get the latest schedule and enrollment information.

Software AG of North America, Inc.
11800 Sunrise Valley Drive
Reston, VA 22091 (703) 860-5050

- Please send me information on:
- Your free DBMS seminars;
 - ADABAS, your data base management system;
 - NATURAL, your online program development language;
 - COM-LETE, your TP monitor.

Name _____

Title _____

Company _____

Address _____

City _____ State _____

Zip Code _____ Telephone (____) _____

CPU _____ Operating System _____

software ag
OF NORTH AMERICA, INC

CIRCLE 10 ON READER CARD

DM0283

QUADBOARD™ IBM

THE FIRST AND ONLY BOARD YOUR IBM PC MAY EVER NEED.

Your IBM personal computer is a very versatile piece of equipment. Perhaps more versatile than you realize. New applications and functions are being developed every day. Now with Quadboard

by Quadram you can keep your options open for tomorrow's technology. Following in the tradition of Quadram Quality, four of Quadram's best-selling IBM boards have been combined into one board. Your remaining slots will be left there and available to accommodate future expansion needs and uses which you may not even be able to contemplate today.

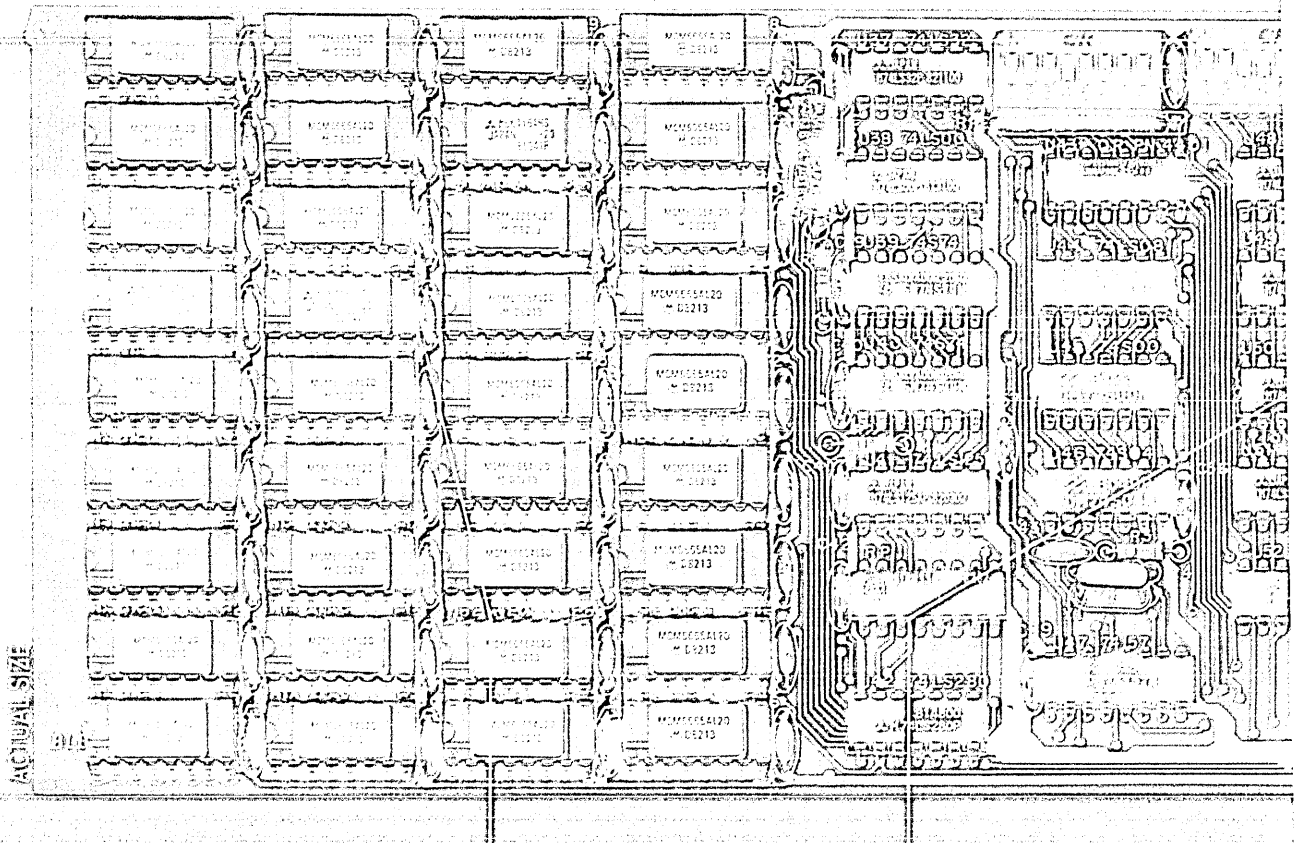

PROVEN DESIGN

Quadram has been shipping IBM boards with each of the Quadboard functions on separate boards since December 1981. They are still available as separates (including optional Post Async Buffer) for those who desire a quality board but do not need to take slots open for future expansion. And they all come with a one year warranty from the leader in technology applications.

256K MEMORY/EXPANSION

Socketed and expandable in 64K increments to 256K, full parity generation and checking are standard. A second board exclusive feature allows parity to be switch disabled to avoid lock-up upon error detection. The dip switches also allow it to be addressed starting on any 64K block so that it takes up only as much as fits memory installed. Memory address and cycle time naturally match all IBM specifications.

CLOCK/CALENDAR

Quadboard eliminates the hassle of manually inputting the date on system boot-up by providing for the date and all software routines necessary for installing the appropriate programs on your diskettes. The internal computer clock is automatically set for compatibility with most software routines which utilize clock functions. Quadboard battery keeps the clock running when the computer is off.

...and you can count on the reliability of the PC's operating system. And the PC's ability to communicate with other computers, networking systems, and other peripheral devices. It's a PC that's designed to be used in a variety of ways. And that's why there's a PC for every need. And that's why there's a PC for every budget. And that's why there's a PC for every business. And that's why there's a PC for every home.

...and you can count on the reliability of the PC's operating system. And the PC's ability to communicate with other computers, networking systems, and other peripheral devices. It's a PC that's designed to be used in a variety of ways. And that's why there's a PC for every need. And that's why there's a PC for every budget. And that's why there's a PC for every business. And that's why there's a PC for every home.

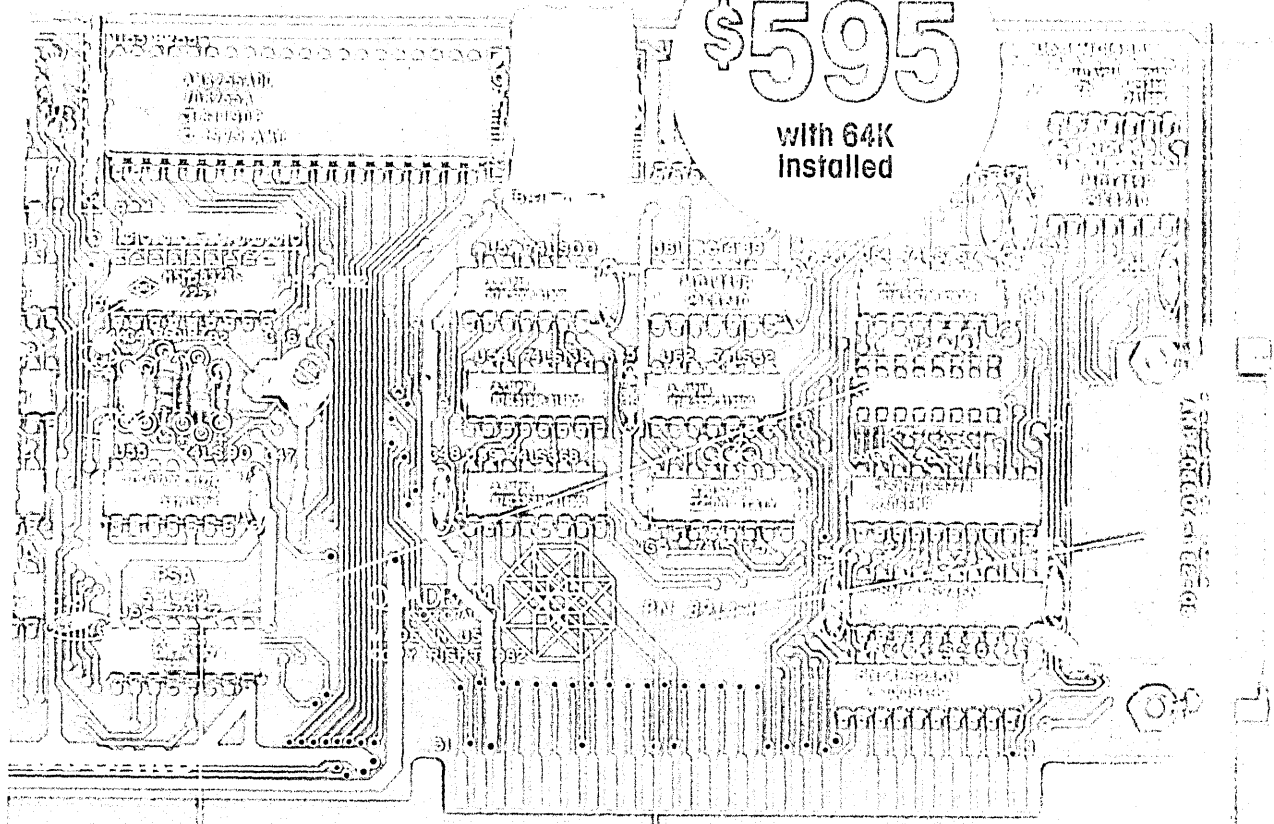

\$595
with 64K
Installed

...and you can count on the reliability of the PC's operating system. And the PC's ability to communicate with other computers, networking systems, and other peripheral devices. It's a PC that's designed to be used in a variety of ways. And that's why there's a PC for every need. And that's why there's a PC for every budget. And that's why there's a PC for every business. And that's why there's a PC for every home.

...and you can count on the reliability of the PC's operating system. And the PC's ability to communicate with other computers, networking systems, and other peripheral devices. It's a PC that's designed to be used in a variety of ways. And that's why there's a PC for every need. And that's why there's a PC for every budget. And that's why there's a PC for every business. And that's why there's a PC for every home.

...and you can count on the reliability of the PC's operating system. And the PC's ability to communicate with other computers, networking systems, and other peripheral devices. It's a PC that's designed to be used in a variety of ways. And that's why there's a PC for every need. And that's why there's a PC for every budget. And that's why there's a PC for every business. And that's why there's a PC for every home.

THE GENERAL LEDGER OF THE FUTURE IS ALREADY HARD AT WORK AT 4,000 SITES

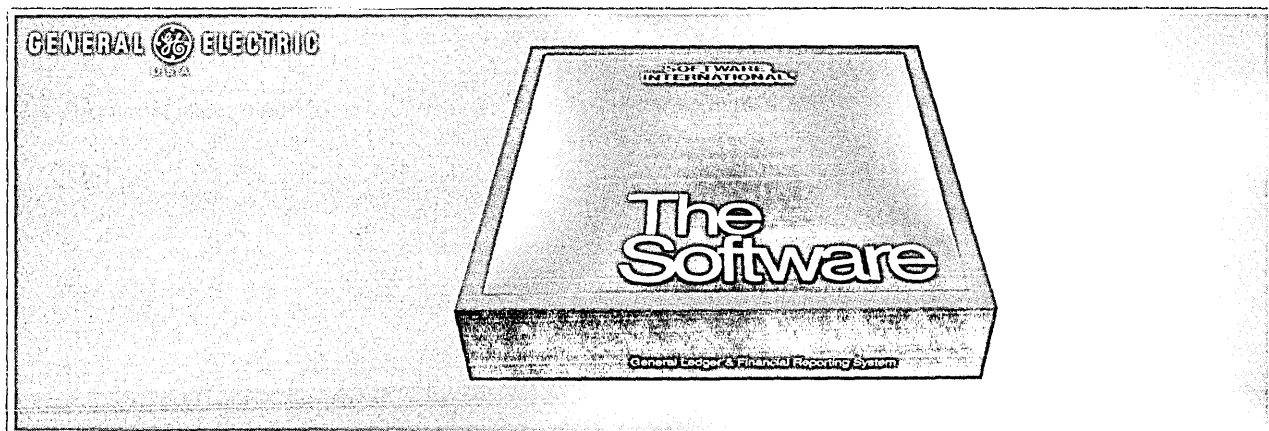

FIND OUT WHY, CALL TOLL FREE 1-800-343-4133.
(IN MASSACHUSETTS 1-800-322-0491)

**SOFTWARE
INTERNATIONAL®**

A Wholly-Owned Subsidiary Of General Electric Information Services Company
One Tech Drive, Andover, MA 01810 (617) 685-1400

CONFIDENCE IN EVERY PACKAGE.

Atlanta (404) 955-3705 Boston (617) 685-1400 Chicago (312) 773-8008 Columbus, OH (614) 773-2167 Dallas (214) 960-0220 Denver (303) 696-8591 Houston (713) 444-3348
Los Angeles (213) 573-0402 New York (914) 253-8050 San Mateo (415) 574-5800 Wilmington, DL (302) 478-8980 Montreal (514) 866-5728 Toronto (416) 924-1461 Vancouver (604) 669-6122

Australia, Colombia, France, Guam, Israel, Italy, Malaysia, Mexico, Netherlands, Saudi Arabia, Scandinavia, South Africa, United Kingdom, West Germany

CIRCLE 12 ON READER CARD

LOOK AHEAD

"802" IS
IBM'S BABY

Word has it that a major mini project, code-named "802", is under way at IBM's Austin plant. Several hundred persons are working on the system, which is expected to show its face no earlier than 1984. Using a relatively simple instruction set, the new mini will use what one source described as a "pseudo-parallel architecture." It's not yet clear if the new mini will replace the Series/1 or represent an entirely new family of processors.

A WORD ABOUT
COLLEAGUES

Look for Sydis, a San Jose, Calif., startup, to unveil soon its Colleague workstation, which combines telephone, dictation machine, personal computer, and communications in a compact, desktop package. Founded early last year by a group of ex-Rolm execs, Sydis hopes to attract both oems and end users for the system, which connects into existing twisted pair phone lines. No word on pricing, but the system is aimed at executives rather than at secretaries.

PRIME'S
TIME

Prime Computer will be announcing a 16-bit micro some time during the second quarter, sources say, that will be code compatible with the IBM P.C. and all other 16- and 32-bit Prime systems. The machine, which will also run on the Primenet local area network, is supposedly in limited prototype delivery now and will go to full production by the fourth quarter.

AMDAX TO UB
WITH R&D

With the Amdax acquisition under its belt, Ungermann-Bass has clearly signaled its commitment to broadband technology. As part of the deal, UB canceled CableNet but gladly took in Amdax's installed base, numbering near 10,000. It's now time to keep an eye on UB's newly acquired R&D group in Boca Raton, Fla. We hear what's under development is a high-speed, mainframe-to-mainframe network -- potentially a direct competitor to Network Systems' Hyperchannel -- that is expected to make its debut before year-end.

FASTER THAN A
SPEEDING BULLET

A young Yonkers, N.Y., firm, Codenoll Technology Corp., which to date has shipped only evaluation quantities of its Codelink and Codenet fiber optic transmission products, believes it can fabricate a gallium arsenide memory chip with access times of one nanosecond or less. That's 15 to 25 times faster than today's speediest silicon memory.

LOOK AHEAD

PROTECTING THE IBM P.C.

IBM P.C. remarketers are grumbling these days that some of their peers buy disk drives direct from the manufacturer at a savings, while passing the entire lot off as IBM tested and validated gear. The grumbings seem to have percolated up to IBM's dealer/advisor council, and an authorized value-added remarketer program has been proposed.

BANKING ON THE SYSTEM/34

California Software Products Inc., Santa Ana, Calif., is banking on a big market for IBM's System/34. One version of its RPG Package 34, which replicates the System/34 environment for other kinds of software, has already been licensed to Honeywell for its DPS/6. Now in the works is a version for the IBM P.C. and for DEC equipment.

IBM IN THE RING

Latest word on IBM's delayed local ring network is that a third quarter announcement is in the pipe. The token passing net will operate under a VM Executive, while allowing access to SNA nets. Sources expect IBM's new 4300-based controllers, also offering both VM native mode and SNA option, to debut at the same time.

LIFE LEFT IN SUPERCOMPUTER COMPLEXES?

Sources say IBM is planning to build a giant data center at Kingston, N.Y., to handle the work of its New York development teams in both Kingston and Poughkeepsie. Word has it the center will boast a staff of 2,800, will be centered around 28 large computers, and will offer 10 tie lines.

FROM MICOM IN MARCH

From Micom next month will come the Micro 860 concentrator switch, a combination data concentrator and data PABX. We hear the unit will allow up to 128 terminals to talk to any of several cpus, printers, and other shared resources.

RUMORS AND RAW RANDOM DATA

Watch for both DG and DEC to aim new superminis at the gap in IBM's business between the 4300 and 308X families, a performance level stretching from 1.6 MIPS to 4 MIPS. A three-mipper from DG is expected next month, and a system of equivalent power from DEC should come in late summer as a top to its VAX line....IBM is rumored to be mounting a huge task force to look at ways to make its System/38, 34, and P.C. compatible with its mainstream 360/370 products....We hear users of HP's MPE IV message file feature can make use of an undocumented capability -- a no-wait I/O, which doesn't require privileged mode....CDC will be making room for micros on Cybernet next month.... Threshold Technology bellied-up in November (bankruptcy) but is trying for a comeback next month (reorganization filing).

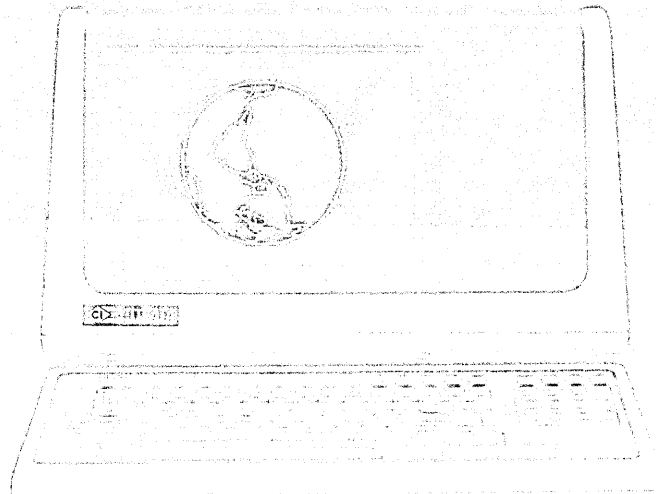
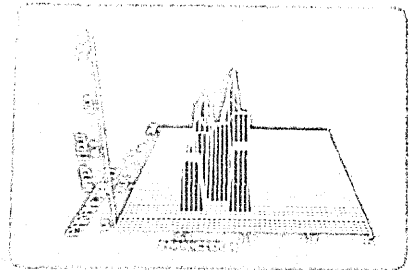
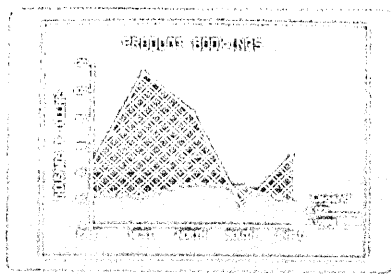
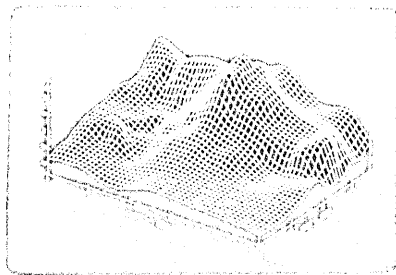

WINNING THE GRAPHICS WORLD

FOR UNDER \$2,000

...and we can help you win it. We'll give you the tools and techniques you need to create professional-quality graphics on your PC. We'll give you the software you need to create professional-quality graphics on your PC. We'll give you the software you need to create professional-quality graphics on your PC.

...and we can help you win it. We'll give you the tools and techniques you need to create professional-quality graphics on your PC. We'll give you the software you need to create professional-quality graphics on your PC. We'll give you the software you need to create professional-quality graphics on your PC.

...and we can help you win it. We'll give you the tools and techniques you need to create professional-quality graphics on your PC. We'll give you the software you need to create professional-quality graphics on your PC. We'll give you the software you need to create professional-quality graphics on your PC.

© 1995 by ... All rights reserved. This advertisement is for informational purposes only. The prices and specifications are subject to change without notice. We are not responsible for any errors or omissions in this advertisement. Please contact us at ... for more information.

The CalComp Computer Graphics Glossary

Source:

A complete spectrum of computer graphic peripherals from CalComp

In the dynamic world of computer graphic peripherals, only CalComp can offer a complete line of quality products spanning the entire spectrum of input and output devices. Whether you are an OEM systems integrator, a multiple-product end user, or simply trying to build the best possible graphic workstation for a particular application, CalComp is *the* source.

Quality products and attractive new pricing.

CalComp is now offering the "Multi-product Sales Plan" to provide maximum discount leverage. When you agree to buy a specified quantity of plotters, digitizers or displays from CalComp, the same quantity discount applies to all other eligible CalComp products over the life of the agreement.

This plan is a major price breakthrough for multiple-product end users and OEMs.

Products for every application.

More and more industries are discovering that computer aided design is a competitive necessity, and the market is expected to quadruple by 1986. Today's graphic workstation environments already include computer rooms, offices, trucks, ships, drilling platforms and more. But unlike so many new companies with single product offerings, CalComp offers more than 40 different products—digitizers—displays—plotters—to allow you to configure a system to meet your needs.

- CalComp offers a wide assortment of digitizers—both tablets and wide area tables—providing

exceptional accuracy and high resolution. Solid and backlighted surfaces are available.

- CalComp continues to dominate the pen plotter field, with drum, beltbed and flatbed models. All have outstanding resolution, high throughput, simplicity of operation and dependability.

- A growing force in Electrostatic Plotter/Printers, CalComp offers a full range of EPPs for high quality "quick copies." These are available in floor models and a new rack-mounted mobile unit.

- CalComp has online, offline and combination controllers driving its plotters, including those that can run both pen *and* electrostatic plotters.

- Providing a new definition for the term "interactive," is the new 4000 Series of Vistagraphic™

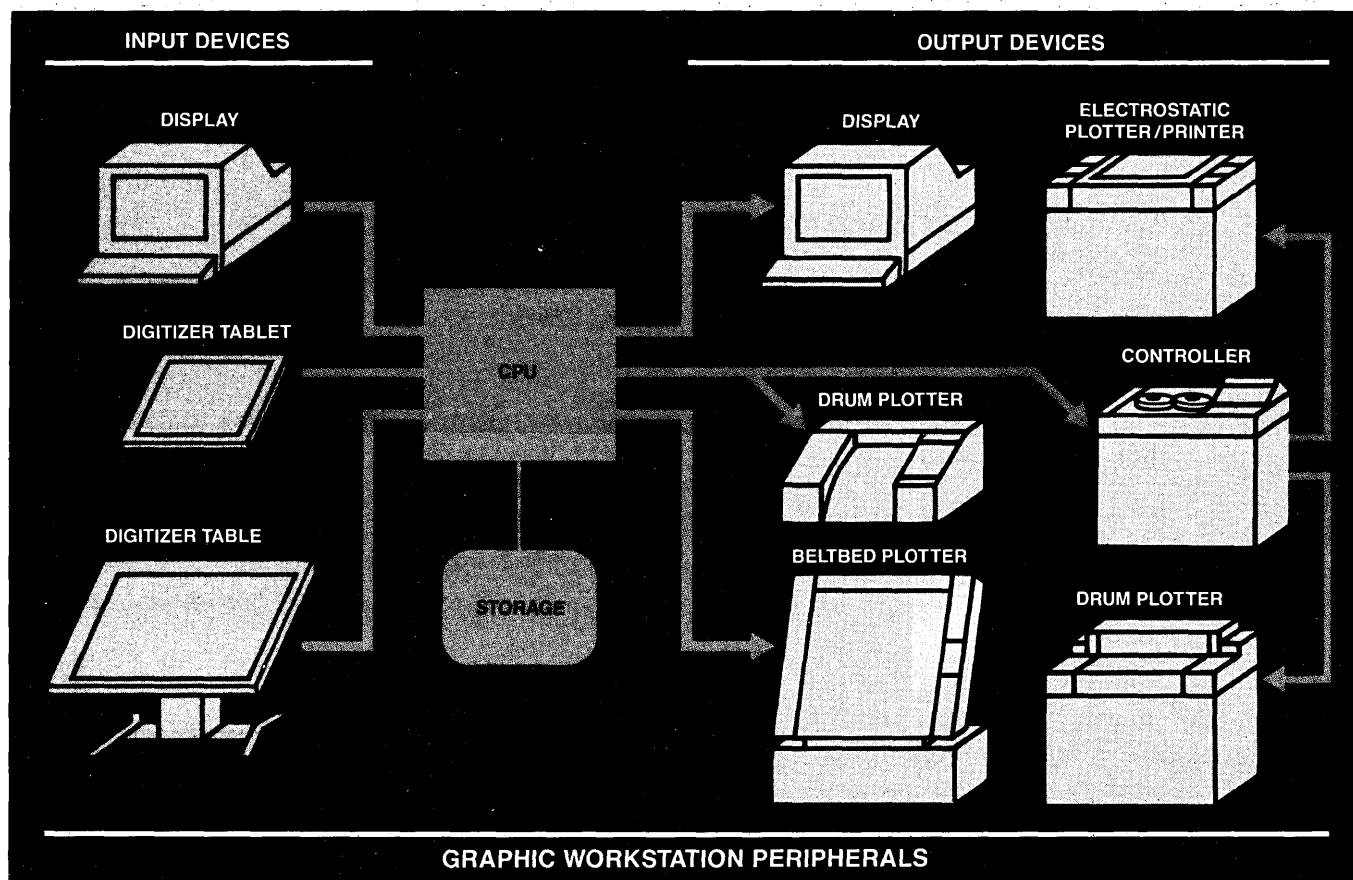

Displays:

Resolution - 640 x 512, 1024 x 768,
1024 x 1024

Models - Color or Monochrome
CPU - Dual Motorola MC68000

Digitizers:

Tablets - 11" x 11" to 24" x 24"
Tables - 24" x 36" to 44" x 60"

Drum Plotters:

Widths - 11", 36", 54", 72"
Speeds - 4.5, 10, 30 Inches/Second

Flatbed Plotter:

Plotting Area - 48" x 82"
Speed - 30 Inches/Second

Beltbed Plotters:

Plotting Area - 34" x 59" - 52" x 80"
Speed - 30 Inches/Second

Electrostatic Plotter/Printers:

Widths - 11", 22", 36"
Resolution - 100, 200 Dots/Inch

Displays, available in both monochrome and color. Two microprocessors are used, one devoted to display processing and the second for peripherals and communications.

Service protects your investment.

With more than 15,000 graphics systems installed worldwide, CalComp understands how *vital* responsive service is. Backing CalComp's superior parts and labor warranty are over 75 field service offices. And with our Maintenance Alert Program, if problems cannot

be solved quickly, we'll call in our senior national technicians to get you back on line without costly delay. Our ability to maintain and service our equipment throughout the world underscores CalComp's commitment to stand behind its products *and* its customers!

Single source simplicity.

For hardware, software, supplies, service and advice, no one even comes close to CalComp as the single source for all your computer graphic peripheral needs. A call to your local California Computer Products sales office listed in

the white pages will do the job. Or write to CalComp, Product Marketing, Department M/S 52, 2411 W. La Palma Avenue, Anaheim, CA 92801.

For a list of international sales and service offices write: International Division, 5425 East La Palma Avenue, P.O. Box 3250, Anaheim, CA 92803.



The Graphics People
CIRCLE 15 ON READER CARD

CALENDAR

FEBRUARY

11TH Annual Computer Science Conference and SIGCSE Symposium.

Feb. 15-18, Orlando, Fla., contact: ACM, 11 W. 42nd St., New York, NY 10036.

Office Automation Conference.

Feb. 21-23, Philadelphia, Pa., contact: AFIPS, 1815 N. Lynn St., Arlington, VA 22209, (703) 558-3624.

Bias-Microelectronica '83.

Feb. 22-26, Milan, Italy, contact: Segreteria della Mostra, Viale Premuda, 2-20129, Milano, Italy, telex: CONSEL 334022.

International Solid-State Circuits Conference.

Feb. 23-25, New York, N.Y., contact: Lewis Winner, 301 Almeria, Coral Gables, FL 33134, (305) 446-8193.

Securicom '83.

Feb. 23-25, Cannes, France, contact: Peter Hazelzet, SEDEP, 8, Rue De La Michodiere, 75002 Paris, France, tel. 073-94-66 or 742-41-00.

Computer Expo '83.

Feb. 25-27, Orlando, Fla., contact: Tom Blayney, P.O. Box 1185, Longwood, FL 32750, (305) 339-1731.

MARCH

COMPCON Spring '83.

March 1-3, San Francisco, Calif., contact: Harry Hayman, IEEE Computer Society, P.O. Box 639, Silver Springs, MD 20901, (301) 589-3386.

ACM SIGCOMM '83, Symposium on Communications Architectures and Protocols.

March 8-9, Austin, Texas, contact: Dr. David Wood, The Mitre Corp., 1820 Dolly Madison Blvd., McLean, VA 22102, (703) 827-6394.

Federal Office Systems Expo.

March 14-17, Washington, D.C., contact: Mary Beth Gouled, National Trade Productions, 9418 Annapolis Rd., Lanham, MD 20706, (301) 459-8383.

Business-Expo.

March 16-17, Houston, Texas, contact: Business-Expo, 702 East Northland Towers, 15565 Northland Dr., Southfield, MI 48075, (313) 569-8280.

8TH West Coast Computer Faire.

March 18-20, San Francisco, Calif., contact: Computer Faire, 345 Swett Rd., Woodside, CA 94062, (415) 851-7077.

Interface '83.

March 21-24, Miami Beach, Fla., contact: The Interface Group,

160 Speen St., P.O. Box 927, Framingham, MA 01701, (617) 879-4502.

Office Automation Conference and Exposition.

March 22-23, Zurich-Regensdorf, Switzerland, contact: the Foreign Commercial Service, American Embassy, P.O. Box 1065, CH-3001, Bern, Switzerland, 031/437011.

Future Office.

March 29-April 1, Milan, Italy, contact: U.S.I.M.C., Via Gattamelata 5, Milan, Italy, 39-2-469-6451, telex: 330208.

APRIL

Intergraphics '83.

April 11-14, Tokyo, Japan, contact: Japan Management Association, Kyoritsu Bldg., 3-1-22 Shiba Park, Minato-Ku, Tokyo, 105, Japan, telex: Japan 242-3369 Nitino J.

National Micrographics Association Conference and Exposition.

April 11-14, Philadelphia, Penn., contact: NMA, 8719 Colesville Rd., Silver Spring, MD 20910, (301) 587-8202.

Hannover Fair '83.

April 13-20, Hannover, West Germany, contact: Hannover Fair Information Center, P.O. Box 338, Whitehouse, NJ 08888, (800) 526-5978.

INFOCOM-83.

April 18-21, San Diego, Calif., contact: IEEE Computer Society, P.O. Box 639, Silver Spring, MD 20901, (301) 589-8142.

13TH International Symposium on Industrial Robots/Robots 7.

April 18-22, Chicago, Ill., contact: Pat Van Doren, SME Technical Activities, One SME Dr., P.O. Box 930, Dearborn, MI 48128, (313) 271-1500.

National Material Handling Show.

April 25-28, Chicago, Ill., contact: Material Handling Institute, Inc., 1326 Freeport Rd., Pittsburgh, PA 15238, (412) 782-1624.

Info Manufacturing 83.

April 26-28, Chicago, Ill., contact: Clapp & Poliak, 708 Third Ave., New York, NY 10017, (212) 370-1100.

MAY

National Computer Conference.

May 16-19, Anaheim, Calif., contact: AFIPS, 1815 N. Lynn St., Arlington, VA 22209, (703) 558-3624.

SICOB and Convention Informatique, Spring.

May 30-June 3, Paris, France, contact: The Secretariat, Spring Convention, 4/6, Place de Valois, F-75001 Paris, France, telex: 212597F.

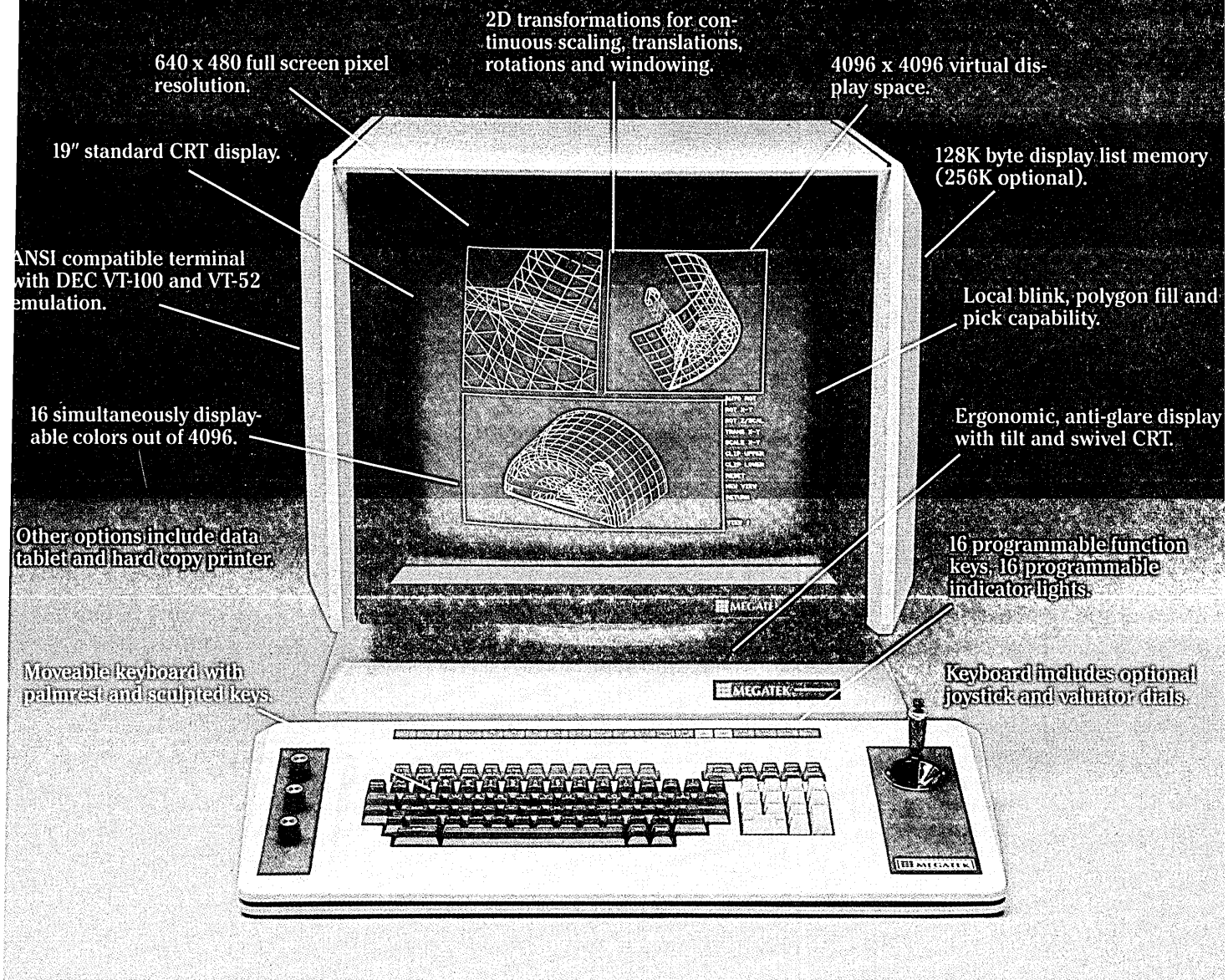

Thaumaturgy.*

Graphics miracles right on your desk. Our latest Whizzard™ The 1650 desk top design terminal. Now, anyone can afford the power and performance of our more expensive Megatek Whizzards. Your own design station right at your fingertips. Another product of Megateknology™

Finally. Everything an engineer or designer could want in desk top computer graphics. Convenience. High quality and powerful performance. VT-100 compatibility.

Functionality. Greatly increased productivity. Shouldn't every desk top design terminal offer this?

Tomorrow's graphics technology on your desk top today... thanks to Megateknology.

Making History out of State-of-the-Art.



MEGATEK CORPORATION

UNITED TELECOM COMPUTER GROUP

*Thaumaturgy (thō ma tūr jē), n., the performance of miracles.

World Headquarters • 3985 Sorrento Valley Blvd., San Diego, CA 92121 • 619/455-5590 Telex: 910-337-1270

CIRCLE 16 ON READER CARD

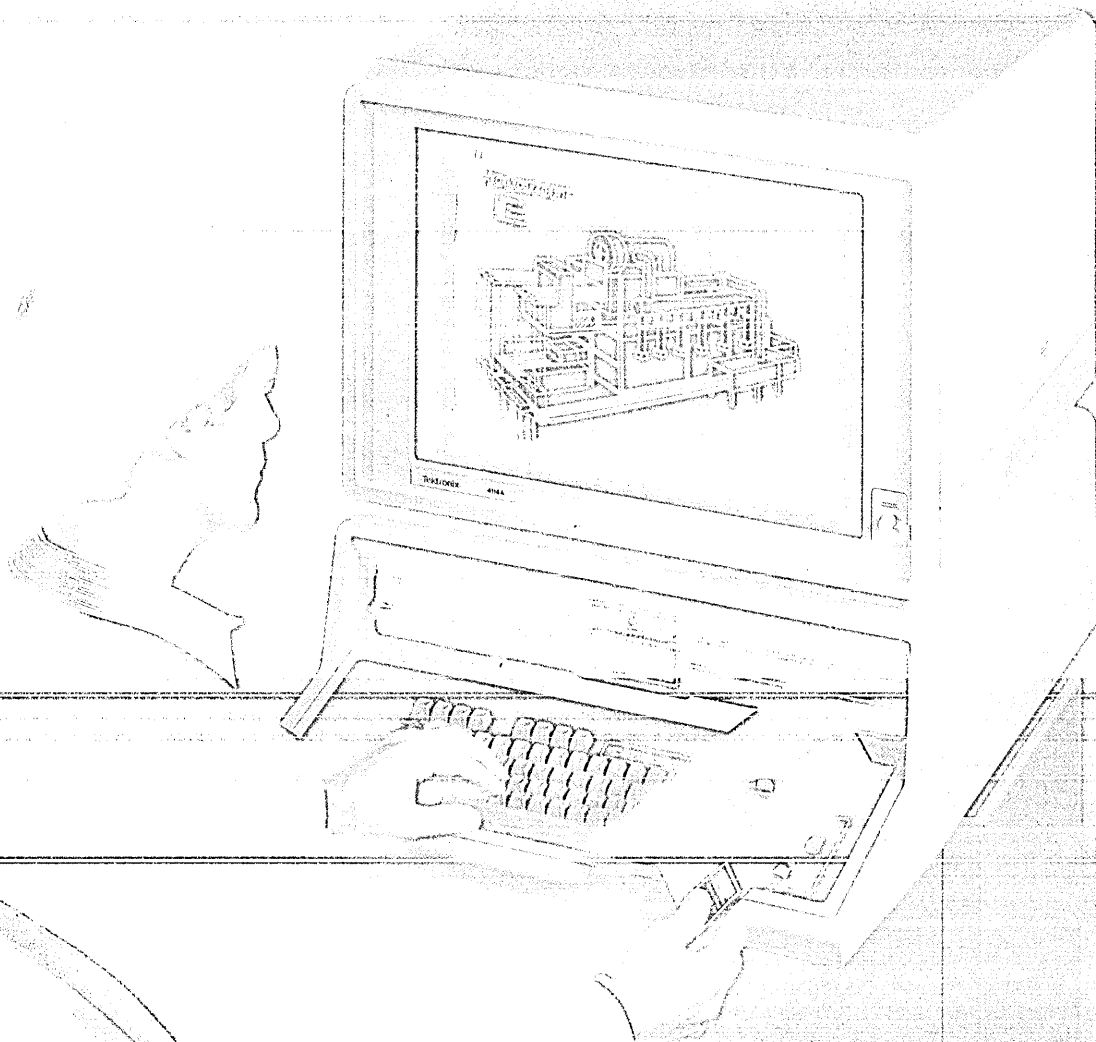

Host power only when you need it: introducing standalone computing for Tek 4110A Series terminals.

(Left) Local Programmability is compatible with all Tek 4110A Series terminals, including the high-resolution 4114A and color raster 4113A, shown. (Right) Illustrated: relationships of software modules for a terminal with Local Programmability. User-written FORTRAN or assembly language programs can be linked via the CP/M-86 operating system

Tektronix 4110 Series Local Programmability combines the best elements of standalone computing and host-based data management. Add Local Programmability to any Tek 4110A Series terminal to enjoy the execution speed of a mini. To access the processing power of a mainframe. And to utilize the resident capabilities of Tek's advanced color raster or DVST graphics terminals, on-line or off.

Local Programmability can dramatically raise output and reduce the cost of data communication. It can eliminate line delays and other obstacles to true graphics interactivity, without changing the way you work.

Armed with Local Programmability you can develop and run programs locally, while exploring the full graphics potential of the 4110A Series.

The package includes an industry standard CP/M-86^{®*} operating system. Your choice of a FORTRAN-86^{®**} compiler or ASM86^{®**} macro assembler. Plus a library of powerful Low-level Terminal Interface (LTI) subroutines providing a quick path to

resident terminal features, such as segments manipulation or 2-D transforms, at a minimal expense of memory.

A local version of PLOT 10 IGL, the world's most-utilized SIGGRAPH "core" software, is also available. With Local IGL, you can run your host resident IGL programs at the terminal level, by downloading and recompiling them locally.

Local Programmability lets you do pre- and post processing tasks—such as tablet digitizing, on-screen rotation and scaling, and plotter output—with complete independence.

Finally, it frees the mainframe to service more users by doing only what it does best: the most intensive processing and data base management tasks.

Local Programmability is the latest dividend of Tek's commitment to easy evolution and upgrade of its graphics. The tools, documentation and support are in place to allow easy implementation on all of Tek's wholly-compatible 4110A Series terminals.

Talk to your Tek Sales Engineer soon. For literature and the address and

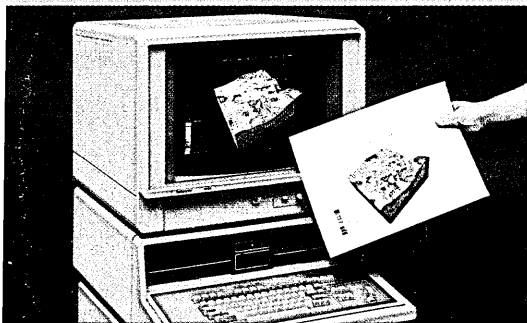
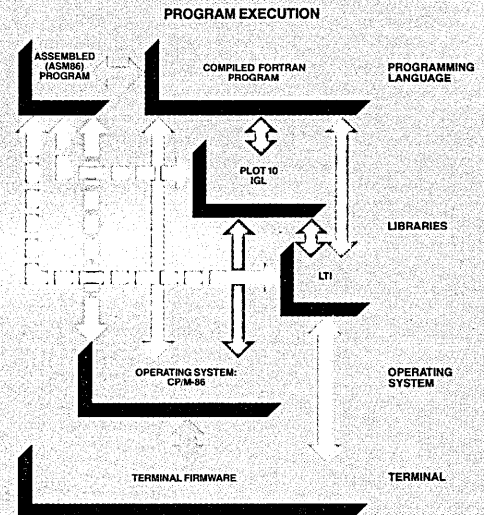

to Tek LTI and PLOT 10 IGL libraries. (Above) Local Programmability lets you locally control peripherals like the new 4691 Color Graphics Copier, engineered compatible with the Tek 4113A color raster terminal for outstanding color copy quality.

phone of the nearest Tek sales office, write or call: U.S.A., Asia, Australia, Central & South America, Japan
Tektronix, Inc.
P.O. Box 4828
Portland, OR 97208
Phone: 800/547-1512
Oregon only: 800/452-1877
Telex: 910-467-8708
TLX: 15-1754
Cable: TEKTRONIX
Europe, Africa, Middle East
Tektronix Europe B.V.
Postbox 827
1180 AV Amstelveen
The Netherlands
Telex: 18312-18328
Canada
Tektronix Canada Inc.
P.O. Box 6500
Barrie, Ontario L4M 4V3
Phone: 705/737-2700

**Demand
The Graphics
Standard**

The CONCEPT AVT

Because VT100 users deserve more than just VT100 compatibility.

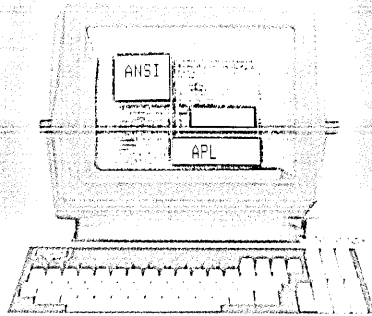

VT100 compatibility is one thing, but eight pages of memory, programmable function keys, windowing, multiple computer capabilities, ANSI standard conformance...and VT100 compatibility is something else. Only from Human Designed Systems.

A good news/great news story from Human Designed Systems.

First the good news. The *concept* AVT display terminal gives you everything you need in an 80/132-column ANSI/VT100-compatible display terminal. And at a very competitive price.

Now the great news. The *concept* AVT display terminal provides an exciting, new set of capabilities that lets you do much more. Without changing the price.

It starts with ANSI standard conformance, DEC software compatibility, and 80/132-column capability, and extends that even further by offering eight pages of display memory to relieve the interactive user of the need to generate unnecessary hardcopy printouts and to provide the application developer with a powerful tool for applications requiring multiple formats and storage of large volumes of text; by enabling users to permanently configure a terminal for their needs or applications; by providing functionality

designed to improve the effectiveness of slow-speed applications; by enabling users to create true windows within display memory; by providing programmable function keys which transmit data and/or execute terminal commands; by providing up to three additional communications ports for connection to other

peripherals and computers; by providing flexible user networking functionality for use in a wide range of different applications, including multiple computer connections; and by doing much more.

VT100 compatibility and ANSI standard conformance. Add it to the *concept* display terminal's 132-column performance, in ASCII or APL/ASCII models, with multiple computer capabilities, windowing, programmable function keys, multiple pages of memory, and much more, and you can see why Human Designed Systems has given terminals a new meaning...and that means true economy.

\$1095*

3440 Market Street, Philadelphia, PA 19104
215-382-5000

*Quantity 50 DEC and VT are trademarks of Digital Equipment Corporation

Human Designed Systems. We're redefining terminal performance.

Boston = (617) 828-3510 Chicago = (312) 625-2560 Dallas = (214) 396-2031 Delaware = Intecon (602) 239-2922 Hawaii = Gray Associates (808) 261-5751 Houston = (713) 410-7454 Indianapolis = Intecon (201) 624-7872 New York City/Area = Intecon (212) 688-8833 New York State = Nicolet Electronics Rochester = (716) 223-4480 Syracuse = (315) 399-2851 San Francisco = (415) 882-1841 Washington DC = International Systems Marketing (301) 278-8775 Atlanta = (404) 251-1010 Philadelphia = (215) 382-5000 Portland = (503) 255-5898 Rome = BELCOM (06) 725-2248 Canada = GALL Systems Toronto (416) 462-1063 Denmark = APCOM Data ApS (45) 4684 Finland = Modulytium Oy (09) 2828511 France = Walton (1) 2290 630 Singapore = OIS Singapore (65) 338-8866 Sweden = Allno Data AB (08) 372551 Switzerland = Mitter G 024612252 United Kingdom = Shandall Systems Ltd. 0240722027 West Germany = COMKO Computer (049) 461102241

DISTRIBUTORSHIP INQUIRIES INVITED
CIRCLE 17 ON READER CARD

LETTERS

MISLED IF MISREAD

Some of your readers may have been misled by figures and comments about IBM that appeared in your November article, "Reviewing Europe's Top 25." The European Top 25 chart indicates that IBM in Europe experienced a 6% reduction in revenue from 1980 to 1981. In fact, revenue increased. The apparent decrease shown in your chart is the result of the continued strengthening of the dollar—IBM's "accounting currency"—during the period.

Further, the chart notes that some figures are estimates. Such a notation is omitted in IBM's case. In fact, your "European Dp Revenue" for IBM is an estimate. We do not release such a figure.

The article itself erroneously states that in 1981 IBM's "large mainframe sales have become very sluggish." For the record, demand in Europe for IBM's "large mainframes," such as the IBM 3081 and 3083, increased steadily in 1981.

EDWARD NANAS
International Business Machines Corp.
Armonk, New York

READERS' FORUM FAN CLUB

Regarding David A. Feinberg's "Beyond Folk Wisdom" (November, Readers' Forum), when he writes a Primitive Programming Primer, may I be the first on his list for a copy? Thank you!

JOHN P. SCHMIDT
Royer Foundry & Machine Co.
Kingston, Pennsylvania

Too bad that Bruce Gilchrist's "Morality in the Computer Classroom" (November, Readers' Forum) was tucked away in the back section of the magazine. It should be read by everyone who has anything to do with educating young people in computer-related subjects.

The Nov. 21 issue of the *Miami Herald* carried a story headlined, "Imps of an Electronic Priesthood," which underscores the point that Gilchrist makes. It tells of two freshmen enrolled in Florida International University whose sport it is to enter

the computer education laboratory late at night and spend several hours creating as much mischief as possible. In the laboratory they have learned by various devious means to gain access not only to the university's computer systems but also to those of a timesharing consortium of colleges in other cities that are part of the state university system. They have "succeeded" in stealing computer time belonging to other students, in entering phony messages in the faculty-only mail system, in entering obscene matter over the names of other students, etc.

Action taken by the university? The students are being hired as lab assistants in the computer center!

JOSEPH H. CHAILLE
North Miami, Florida

BUT BIG BOOS FOR LOOK AHEAD

The Look Ahead reference to Storage Technology in your November issue is not only inaccurate, it also is irresponsible journalism and stupid research. A publication that says it serves the industry ought to try to be a little better than a gossip column that depends on phrases such as "it appears," "analysts speculate," and "probably beat" in a two-sentence item.

For your information, we recently had 70 analysts visit STC—and one of the areas they toured was our thin-film manufacturing building. These analysts then went on to meetings with the competition you mention in your story. Every analyst I have talked with tells me we are ahead of the others.

Of course, there's no way to tell what analyst your people talked with. He seems to be as unknown and shady as the writer of your editorial.

GORDON L. SWARTZFAGER
Storage Technology Corp.
Louisville, Colorado

We were disturbed to read in your November Look Ahead column that an anonymous source claims that there are "severe problems" in running Ada on the iAPX Micro-mainframe and that it takes "as long as 30

milliseconds to run an instruction." While we don't know the source, we do know the statements are grossly inaccurate.

As an example, one of the longest Ada instructions is a procedure call with three arguments, yet our studies indicate that a single 432 General Data Processor can execute it in 279 microseconds, fully 107 times faster than your source claims. Other instructions, of course, will be faster still; a simple assignment statement, for example, will take only 11 microseconds. In fact, a single GDP can execute between 57,000 and 90,000 Whetstone instructions per second, depending on the implementation of the processor-memory interconnect.

Focusing on single-processor performance, however, is misleading. The 432 was designed as a closely coupled multiprocessor; its key advantage is that processors can be added to a 432 system to increase performance, perhaps as much as tenfold, without modifying software.

To be sure, good performance is only one aspect of developing a compiler—a compiler must also be easy to use. Our customers tell us that ours is. More people have gained practical experience in Ada using our compiler than any other Ada compiler available today. After a successful beta-site testing program, the Intel Ada Compiler System began shipment to 432 customers in January 1982. Now, a year later, there are some 85 installations in place, including several research facilities of the Army, Navy, and Air Force. Over a dozen universities are using our compiler to teach Ada courses and others have had research projects based on the 432 in progress for months. We are also happy to report that our commercial customers are making excellent progress in their evaluations and new product developments.

Intel is proud of its reputation for supplying reliable software. We carefully gather reports of software problems from our customers, and we send periodic updates to correct problems found. At this writing, we know of no significant bugs in either our Ada linker or compiler, and have

LETTERS

never experienced the problems your article described. We consider our product to be one of the few production quality compilers available today.

GORDON REID
Special Systems Operation
Intel Corporation
Aloha, Oregon

DID I SAY THAT?

As I read the November Looking Back column about an editorial in DATAMATION 20 years ago, I constantly found myself saying, "How prophetic," and "What a marvelous turn of phrase," and, most of all, "Gee, I wish I'd said that." Finally I screamed, "I DID SAY THAT!" Rushing to my bookshelf, I found the earlier editorial, where, after the title, appear the words "A guest editorial by Dan McCracken."

I immediately convened my Council of Annoyance Advisors, where three bodies of opinion emerged:

1. "Feel flattered. People quote Shakespeare all the time without citing the source."

2. "Feel like family. Over the last 25 years you've written dozens of times for DATAMATION, counting articles, guest edi-

torials, book reviews, Forum pieces, etc. Think of yourself as a member of the staff."

3. "Feel annoyed. The staff member who wrote the "Looking Back" column didn't blush to sign *his* name after writing a piece that was about 70% direct quotes from your editorial. There is honor even among journalists."

I lean toward Number 3, as does Helen Blumenthal, my wife and chairperson of the Annoyance Advisors. She points out that when I make a dumb prediction, the gleeful castigators sure as hell remember to mention my name.

DANIEL D. McCRACKEN
New York, New York

Dan, we suggest you lean toward all three—feel flattered, feel like family, and feel annoyed. We extend our apologies, and our thanks for your signing the letter "Peace." —Ed.

MORE ON DINOSAURS

I wish to add a few words supporting Paul B. Schneck's lament (October, Letters) on the inordinate complexity of current operating systems. The system that Schneck de-

scribes and helped to develop, called SSS (Scientific Supervisory System), is still in operational use. After some 20 years, it has migrated from an IBM 360/95 located at the Goddard Institute for Space Studies, New York, to an Amdahl 470/V6 at the Laboratory for Atmospheric Studies at NASA/Goddard Space Flight Center, Greenbelt, Md., and has subsequently been integrated into a dual front-end Amdahl system supported by a Control Data Cyber 205. SSS still ranks favorably in its performance comparison with alternative OS (IBM) operating systems such as MVS and CMS in spite of the fact that system support has been virtually nonexistent for about five years. It is not uncommon to have batch jobs running under OS requiring 10 times the wall-clock time taken by the SSS, and the versatility of OS (e.g., ability to access midtape files) is not very impressive to scientific users who have to learn and write the intricate JCL affording this versatility, even when not making use of it.

The SSS has all the features expected by scientific users: update, copying, graphics, timing, etc., plus features not available under OS: user controlled roll-out and roll-in, comparison of logical variables, logical end of file, data definition for console (operator), etc. Despite the fact that SSS is now completely unsupported, the members of the original systems team having long since gone in different directions, we are reluctant to discard it in the hope that it may serve as a paradigm for future user-oriented operating systems.

M. HALEM
Global Modeling and Simulation Branch
National Aeronautics
and Space Administration
Goddard Space Flight Center
Greenbelt, Maryland

POOR PAY IS A PROBLEM

It is ironic that the people most critical to the success of so many computer systems are also among the lowest paid—the technical writers (November, "The 1982 Dp Salary Survey"). Apparently the dp industry still has not learned the importance of high-quality, people-oriented communications with those who ultimately pay the bills—the users.

Without an experienced technical writer to translate the computer technician's description of the system to one the user can understand, what the client gets is just so much gobbledygook. Look at any IBM manual (and also note that in your December survey of systems software, IBM's documentation scored consistently low).

Until users demand, and the industry is willing to pay for, quality documentation, the well-known communications gap between the dp industry and the user community will continue to exist.

PETER MARTIN
Morristown, New Jersey

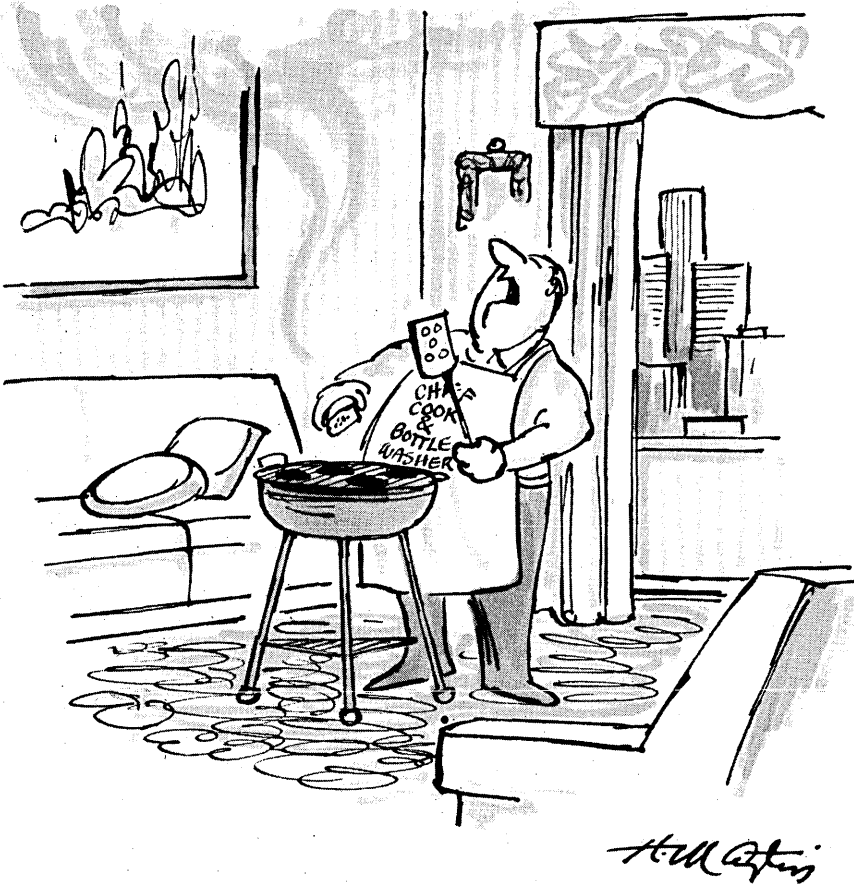

"Will somebody please disconnect the smoke alarm!"

CARTOON BY HENRY MARTIN

Wait
a
minute.

Then turn the page.

That's how fast you can make photo-quality hard copies with Polaroid's VideoPrinters.

We really didn't expect you to sit there and complain to us. But we did want to point out the incredible speed at which you can now make photographic-quality hard copies from your graphics terminal.

Of course, there are plenty of other reasons to buy the new Polaroid Model 4 or Model 5 Video Printer Instant Color Film Recorders. Like the low cost of the hardware (less than the costly, slow dot ma-

trix printer, and much less than the bulky, lower quality electrostatic printer). Or the fact that it delivers the highest quality hard copy available (with more information than was visible on the display monitor, accurate, brilliant, saturated colors, extremely high resolution). Or ease of operation (no special training or experience required, no external processing, chemical costs, or developer involved). Or variety of hard copy formats (after exposure[®]).

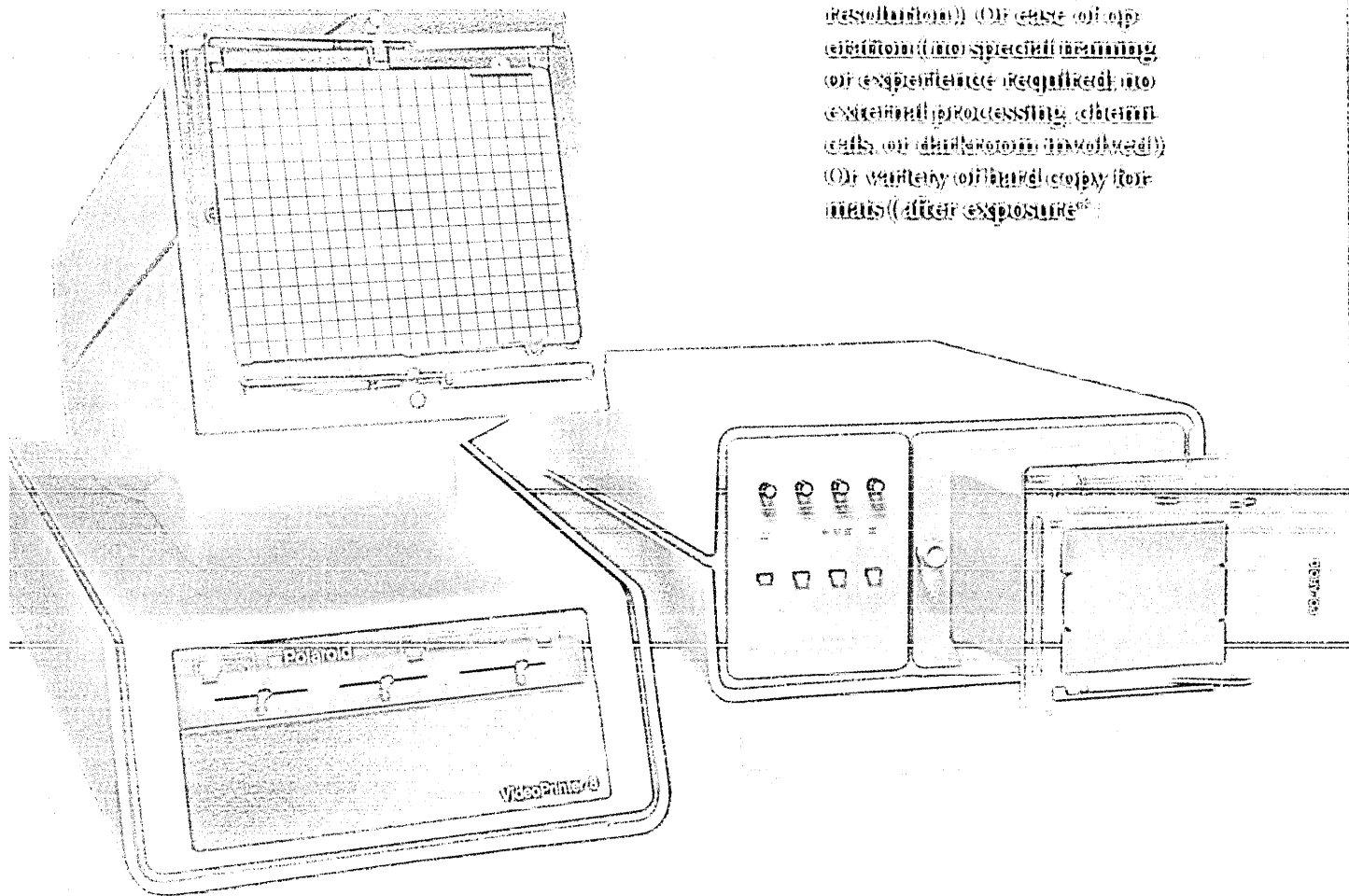

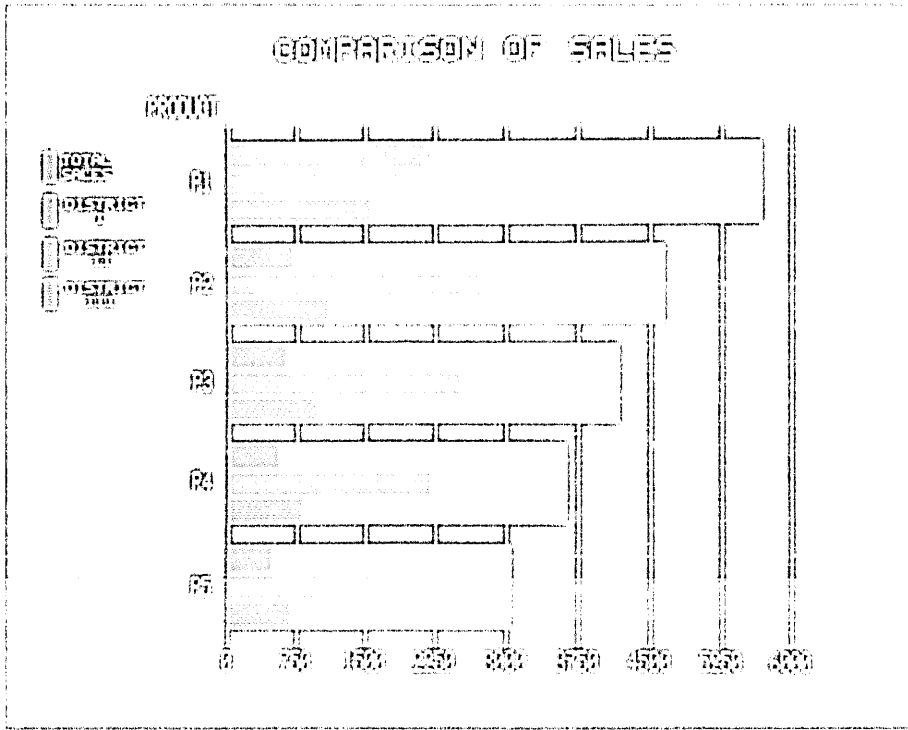

Model 4 makes a 8 1/2" x 5 1/2" ready-to-use copy size prints ready in 60 seconds and convenient for busy Polaron office process. 5 1/2" slides ready in less than 5 minutes for slide presentations. Model 5 makes ready-to-use 8 1/2" x 11" presentation-size color prints in 60 seconds and 8 1/2" x 11" color transparencies in only 4 minutes.

And Polaron Model 4 prints outstandingly better all your hard-copy documents and provides a valuable time saver for management decision-making.

If you've found this information valuable, spend a few more moments with your Polaron representative.

Figure 1: Sales Comparison

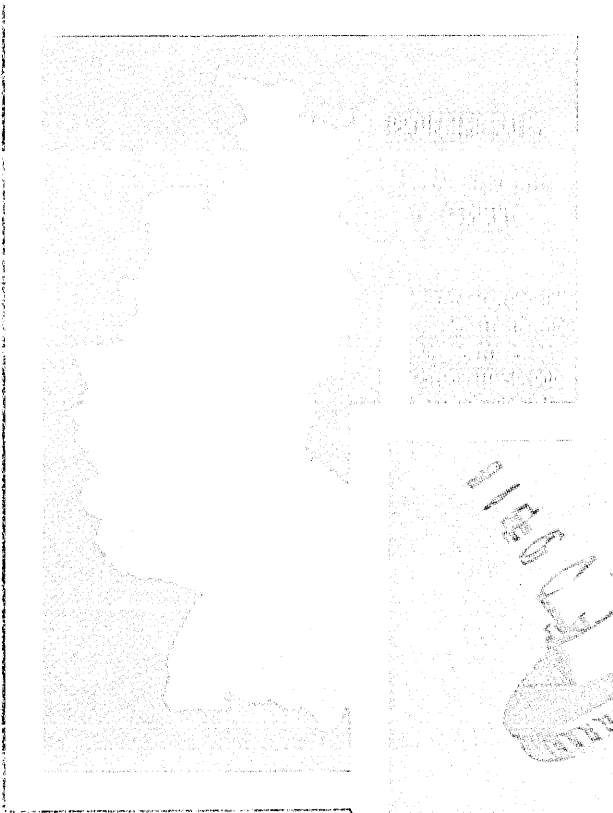

Figure 2: Polaron Model 4

Figure 3: Polaron Model 5

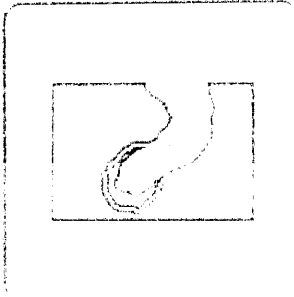

Figure 4: Polaron Model 5

Figure 5: Polaron Model 4

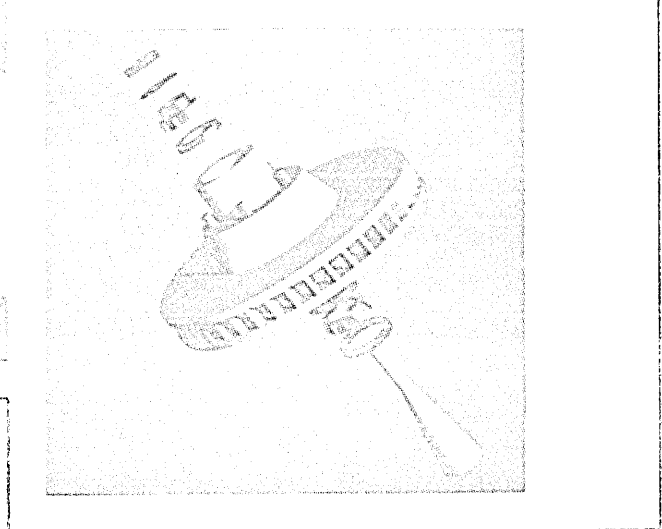

Figure 6: Polaron Model 4

For more information on a Polaron presentation call toll-free 1-800-368-6666 in Massachusetts call collect 617-552-5100 or 617-552-5100 for sales and service.

Polaron Corporation
Industrial Development Dept. 650
575 Massachusetts Square
Cambridge, MA 02142

Please send me information.
 Please contact me to arrange a demonstration.

Name _____
Title _____
Company _____
Address _____
City _____
State _____ Zip _____

DA-2

POLAROID

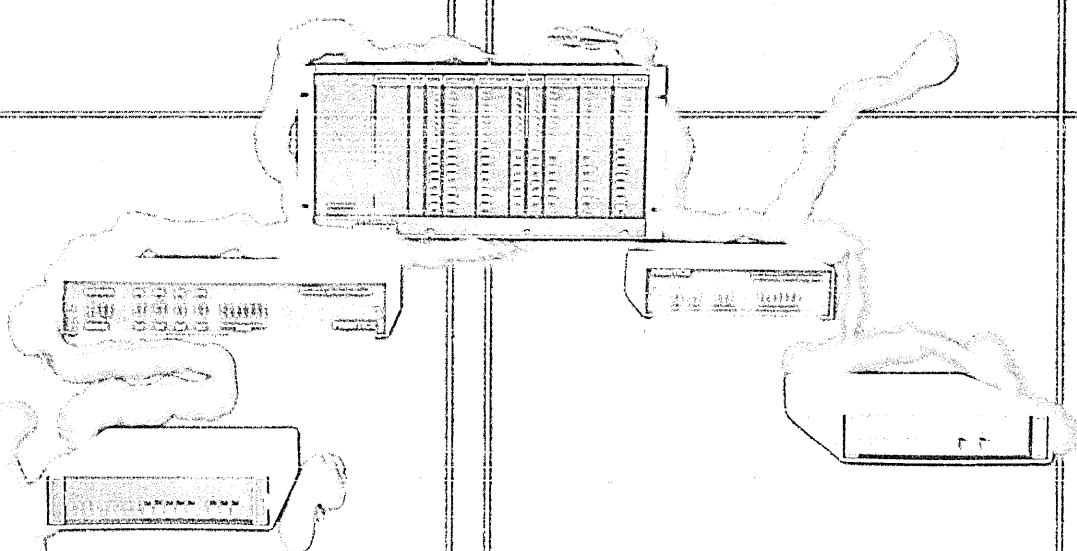

It Takes Experience, Not Magic

For over a decade, PRENTICE has been solving data communications problems for mini- and microcomputer users.

Our full line of multiplexers and modems is the answer for integrated, cost-effective, reliable systems that maximize data integrity and network uptime. You want a system that you can expand as needs change. From autocalling modems to state-of-the-art statistical multiplexers, PRENTICE offers products and technical counsel to help you as you grow.

It doesn't take magic. Products priced for value, responsive service and applications engineering... they come with experience.

You can rely on our data communications solutions.

PRENTICE, 266 Casplan Drive,
Sunnyvale, CA 94086. (408) 734-9810
TWX: 910-889-9519

PRENTICE®

Data Communications

Our
Experience
Benefits
You

CIRCLE 19 ON READER CARD

EDITOR'S READOUT

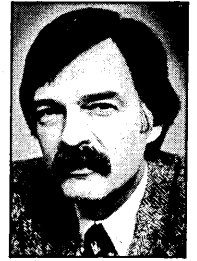

COMPUTER OF THE YEAR

Time magazine naming a computer as man of the year is like Dustin Hoffman winning an Oscar as best actress for his role in *Tootsie*. It's right, but at the same time, it's not.

Despite our feelings about a machine of uncertain gender rather than a human appearing on *Time*'s most coveted cover, the fact that it happened is of more than passing interest. It points out that 1982 was the year that the public fully awakened to the computer revolution. No longer are computers esoteric machines whose primary function is to screw up our utility bills; now they are an integral part of our existence. The mystique is gone; the once alien computer is becoming as familiar and all-pervasive as E.T.

But even if the computer, especially the personal computer, is becoming comfortable, if not downright cuddly, there are more dimensions to this revolution than a word processor in the family room. Computer and communications technology is being used by business and government in ways that are fundamentally altering how we live, work, and die. Decisions are now being made by powerful interests that will shape our society for decades.

It is time that all of us who lay claim to the oft-used title of "concerned citizen" have some say in the direction that this computer/communications revolution is taking us. And that is why we are urging, as we have in



previous editorials and articles, the creation of a Temporary National Information Committee (TNIC) to serve as a clearinghouse for information about the Information Age and a focal point for public debate of such major issues as electronics funds transfer, privacy, transborder dataflow, computer crime, and the effect of automation on employment.

TNIC, as we envision it, must be much more than another blue-ribbon committee that produces a solemn, weighty report destined for a dusty and forgotten filing cabinet. TNIC should sponsor public debate and create national interest. It must have the same impact on public consciousness as the

McCarthy hearings, which unmasked a demagog, or as the Kefauver hearings, which dramatically made us aware of the extent of organized crime.

By exposing issues and providing the arena for debate, TNIC can be a catalyst that mobilizes public opinion regarding the use of computer/communications. Public opinion, as Watergate and the recent MX missile controversy show, can be a powerful force for action and change.

If you would like more information about the TNIC concept, write to DATAMATION, 875 Third Ave., New York, NY 10022. Either drop us a note or simply write TNIC across your business card and we'll respond. *

NEWS

STONED AT THE OFFICE

Alcohol and drug abuse is costing American business some \$24 billion annually.
by Marvin Grosswirth

The use and abuse of mood-altering chemicals is running rampant through the business world. It appears everywhere, threading from the keypunch department to the executive suite, affecting every level and every type of worker and manager. It is costing American business untold billions, and all indications are that the situation will not improve. On the contrary, the problem—and it *is* a problem—appears to be growing at an alarming rate.

While no one can specifically state what percentage of the working population of American is actually "on" something, the accumulated inferences from known facts combine to make a strong indictment. For example, 100 million of us consume alcohol and approximately 10% of those who do are alcoholics. According to Bob Frederick, manager of Xerox's Employee Assistance Program, 70% of the adult population drink or take medication, and 10% of those abuse the chemical they imbibe.

Historically, alcoholism has been kept separate from drug abuse, probably because alcohol is not an illegal substance. It is, however, as much a mood-altering substance as any of the so-called hard drugs: it is a sedative; it affects the central nervous system; it is addictive; and one can build a tolerance to it. As far as the medical profession is concerned, the only difference between alcohol and the pills and powders that permeate society is that it is liquid and comes in a variety of flavors, colors, and packages.

Dr. Stephen C. Duvall gives some indication of the evenhandedness with which chemical use prevails throughout an organization. Armed with a doctorate in counseling, he took charge of Control Data Corp.'s Employee Assistance Program (EAP) in 1976. Two years later, he joined the Life Extension Institute when CDC acquired it and became manager of the preventive health care facility's Employee Assistance Programs, now available to some 39 companies, about a third of which are CDC-owned. Duvall says that when senior management considers installing an EAP, "they never think much about whether their engineers or the upper-level or upper mid-level managers will use it. . . . But according to our statistics," he claims, "it's a one-to-one utilization. If 10% of your popu-

lation are executives, 10% of the people using that EAP will be executives, too. If 15% of your population are engineers, you're going to find that 15% of the EAP statistics will apply to engineers. That absolutely floors most people."

"We find data that support that thinking," adds Xerox's Frederick. "We have not seen one area that has more problems than another area. It's an equal opportunity problem."

The equality extends to the types of substances abused. "A lot of chemical abuse problems," says Duvall, "have to do with mixed usage. The person who only drinks alcohol. . . is becoming a rarer and rarer individual. The people we hospitalize these days for severe drinking problems . . . use other drugs as well—barbiturates, tranquilizers. . . . In major urban areas, it's not at all atypical to find them using marijuana. . . . In some of the big cities, cocaine. . . . So you have mixed usage going on here.

"Most managers," he claims, "rely on some type of pill plus alcohol," despite the frequent and well-publicized warnings against mixing liquor and, say, Valium. "You develop a tolerance level," Duvall says. "Sometimes the amount of drugs that people take along with alcohol and still stay alive is incredible. But it becomes dangerous very quickly."

Further complicating matters is that drugs on the job fall into two categories:

Some two thirds of all working Americans are consuming mood-altering chemicals ranging from alcohol, to physician-prescribed medication, to so-called street drugs.

legal and illegal. Prescription drugs—tranquilizers, amphetamines, sleeping aids, diet pills—can be found in almost any desk drawer, trouser pocket, or handbag selected at random in the work place. These drugs are freely shared with coworkers—and sometimes even sold to them.

"It's a typical white-collar, middle-class game," says Duvall. "It's extremely easy—because you're so reputable—to switch physicians and have numerous prescriptions out. Any one physician would stop the game, but you've got multiple physicians, including the company doctor. [Each one] is only giving you a legitimate amount of substance, not realizing you've got four other doctors that you can go to."

Dr. Abraham Weinberg, who has been practicing psychiatry in New York for 40 years, admits: "I fall into the trap. A patient will say, 'Let me have some Valium. I had some a month ago, but my wife was taking some, or I gave it to a friend, so give me another Rx.' And the doctor goes

PHOTOGRAPH BY STEVE COOPER

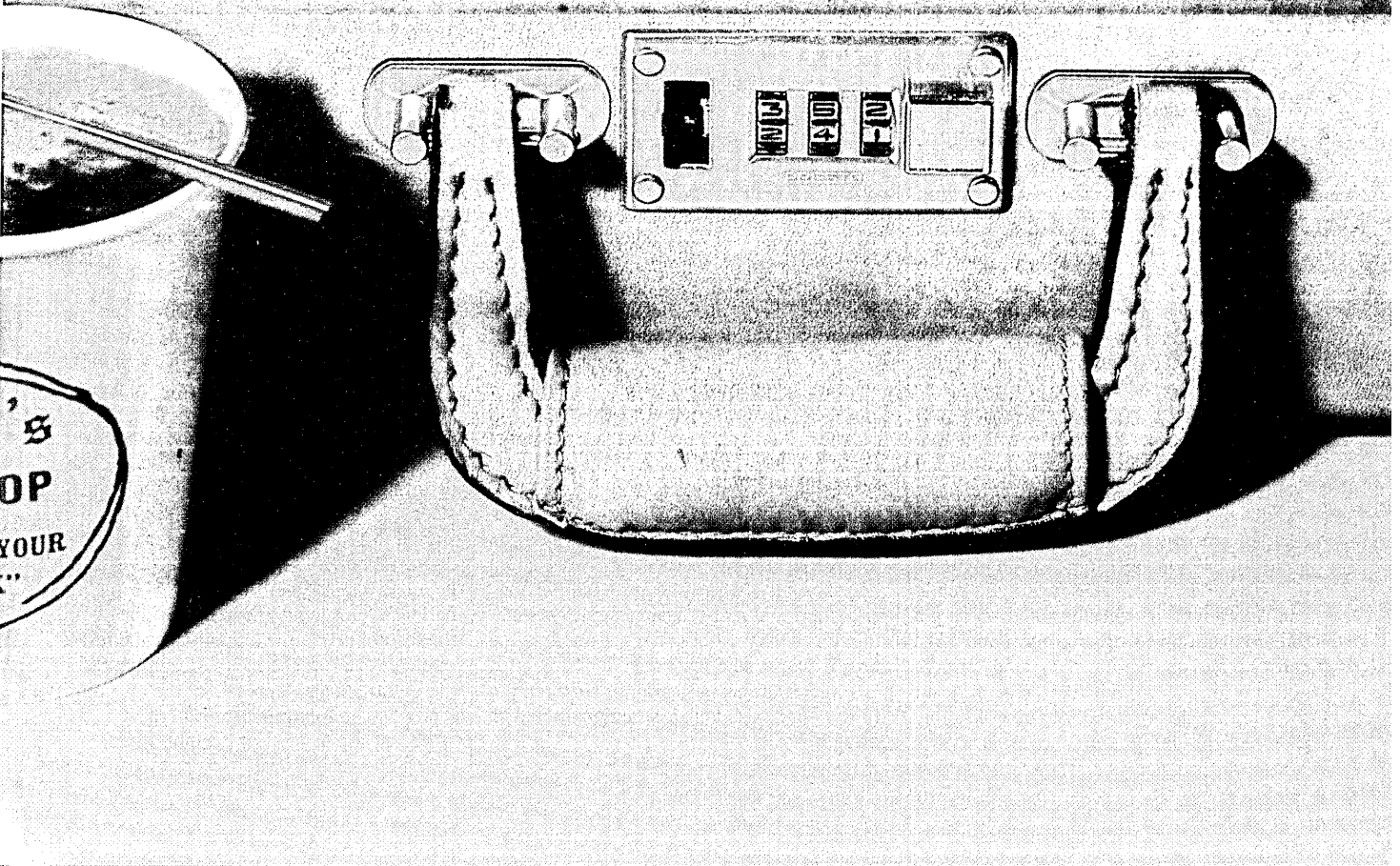
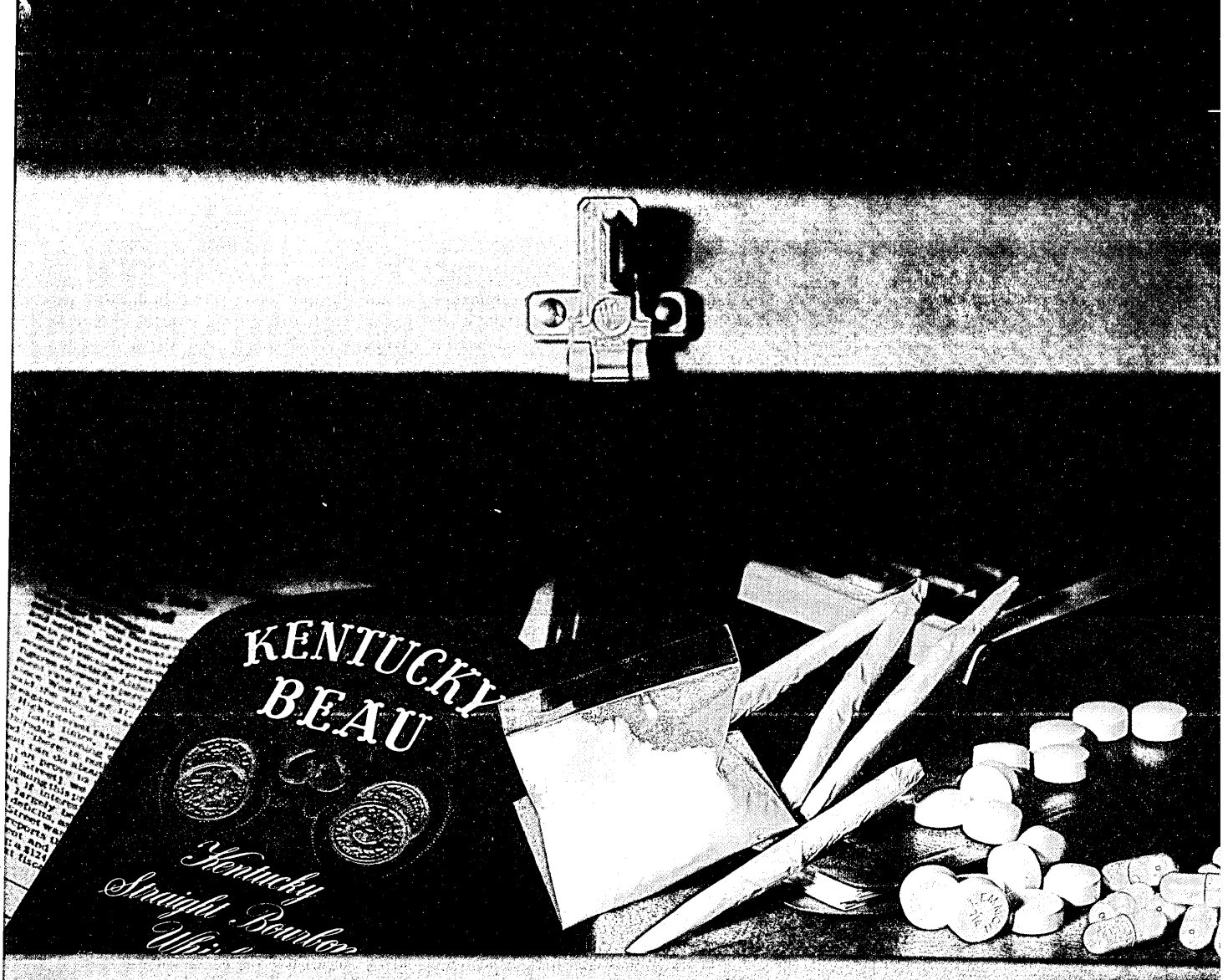

IN FOCUS

along." Thus, any manager with a little experience in balancing resources has no trouble timing visits or telephone calls to his stable of physicians to keep a steady supply of drugs coming.

In 1974, the federal National Institute on Drug Abuse (NIDA) took a look at Boston's Route 128 (sometimes known as Silicon Valley East) on the premise that the "labor force represents an important sector of American workers from the standpoint of drug consumption—young, mobile, well educated, and highly paid. . . ." The survey covered "eight establishments of four companies" (not named) in the electronics industry. "No employer," states the NIDA report, "asserted that employee drug use did not occur." Supporting the observations of Duvall and Frederick, the NIDA study says, "Drug use occurs throughout the work force and extends to all types of companies."

A particularly ominous finding of the 1974 NIDA study was that "drug users are substantially younger than other employees." Some 17% of the respondents under 30 admitted to being drug users, compared with 2% in the 30-and-over group. But that was eight years ago, and those under-30s are now not only older but have probably progressed to higher positions. Furthermore, during that time, the electronics industry has grown exponentially and it is perceived as a young person's field. The implications are obvious—and frightening.

Meanwhile, in the Wall Street area, other Manhattan business districts, and their counterparts nationwide, the drug trade moves at a lively pace. The reasons, claims the New York District Attorney's

Out of every 10 adults who drink or take medication—and some 70% do—one is going to abuse it.

Special Narcotics Prosecutor Sterling Johnson, are "the prevalence of drugs and lack of resources." Law enforcement agencies are trying, but they are failing. "Illegal drugs," says Johnson, "are the second leading industry in this country. . . . Conservative estimates put it at something like \$90 billion a year."

The police will respond to charges of drug activity on company premises, but such charges are rare. "People just do not want to call the police," Johnson claims, "and do not want the reputation that there's a large-scale drug operation going on [in the company]." On occasion, an anonymous tip is received, but, he says, "you really can't do anything with that unless you get the cooperation of the corporation. We can't conduct surveillance. . . and observe and buy drugs without the cooperation of the people who are there. . . I'm not saying they're not giving that cooperation. I'm

only saying I can't recall any situation like that in the recent past."

Employees are reluctant to turn in their colleagues. "There's the old-boy network," claims Jonathan Peck, a management consultant based in Belmont, Mass.—not far from Route 128—who has been called in from time to time to deal with drug-related problems. In one company, which he describes as "high technology" and "computer related," he found an employee who was actually dealing. "We'd have found him out sooner," Peck says, "but he was supplying his own bosses. The hook is in if you're dealing in a company and you can deal 'upstairs.'" In the interests of protecting his clients, Peck is reluctant to divulge details, but he claims awareness of company computer terminals being used to notify employees of the location of drug drops.

He has also seen the effects of drugs in data processing departments. "It's particularly evident," Peck says, "among people who do programming work. . . . Walk in on any one of those night-shift places, and they're in there—smoking [marijuana], usually. Half of them are stoned out. A lot of that goes on."

He also claims that in contract negotiations, cocaine is becoming a "bartering tool to get the order. . . . You go into certain offices in this country today and instead of sitting down and having a martini, you sit down and have a little snort of coke."

A major contribution to chemical use and abuse in the work place is society itself. "In some white-collar groups," says CDC's Duvall, "there's clearly a pressure to drink. That is the way to socialize. . . . Other groups go out at lunchtime and smoke."

Socialization—a desire to be one of the crowd—may be one of the apparent incentives for getting started on chemicals, but at bottom, the continuing use of mood-changing substances, in whatever form, is in response to a psychological or physiological craving. Whether the craving is occasional or perpetual is the difference between "handling it" and addiction. Psychiatrist Weinberg, who specializes in hypnotherapy and behavior modification, and whose patients, he claims, include "some very big people" in commerce, industry, and show business, believes the only reason people resort to chemicals is that consciously or otherwise, they really want to be somebody else. Someone who appears outgoing and self-assured while giving a presentation, for example, may in fact be an introverted bundle of nerves. The Valium he takes just before the presentation may relax him, but it also changes him, preventing him, Dr. Weinberg says, from drawing on his own inner resources and strengths. Chemicals are an easy way to cope temporarily—not just with a situation, but with oneself.

For many substance users, coping is the excuse of preference. "We're told," says Duvall, "in regard to the computer and dp groups, that some people use drugs to alleviate boredom. Many of the jobs are structured in ways that are repetitive and are not particularly creative or challenging. . . . Key-punchers basically are just sitting there clicking in data eight hours a day. . . . Programmers and systems analysts do work that can be aggravating or exhausting. It takes forever to find the flaws in the program and the frustration factor is severe and real. Sometimes drinking or drug use is a way to alleviate tension, or to relax, or to get away from it for a bit—or just to 'space out' intentionally."

These observations are supported by another phase of the NIDA study that covered 149 companies of varying sizes. Job pressure, says this report, is also related to

"If 10% of your [corporate] population are executives, 10% of the people using the EAP [Employee Assistance Program] will be executives, too."

employee drug use. "Approximately 25% of firms with a 'low' or 'low to moderate' pressure level," the findings showed, "experience drug use problems, compared with 40% of firms with a higher level of job pressure." If increased responsibility means increased pressure, then it is no surprise NIDA found that "according to the personnel staffs queried, as the level of job supervision increases, so does the perceived level of drug problems. . . ."

Drug-related problems frequently begin with alcohol. Duvall draws a composite of the manager "who drinks and then starts drinking more heavily to self-sedate, to the point where it's becoming a problem. He attempts to get away from drinking and he goes to a physician who prescribes a drug that's essentially a barbiturate. He's only removed the liquid. The manager, not realizing or caring, as long as he's getting the adequate effect, continues his addiction—except now it's with pills. Then the pills reach a certain tolerance level and the manager brings the alcohol back, in addition to the pills. Then we've got a real mess on our hands. That's a typical—typical—situation."

A variation on the theme is the manager who sees his physician with complaints that he is overwrought and cannot sleep. As a result, he cannot seem to get started in the morning. He does not tell his doctor about his drinking. The physician, genuinely concerned about alleviating his patient's problems and unaware that both the insomnia and the lethargy are the result of alcoholism, prescribes a sleeping pill for the night and an "upper" for the morning. And another polydrug user is born, with the stroke of a pen on a prescription pad.

HOW'S YOUR CPU-TO-DISK BOTTLENECK?

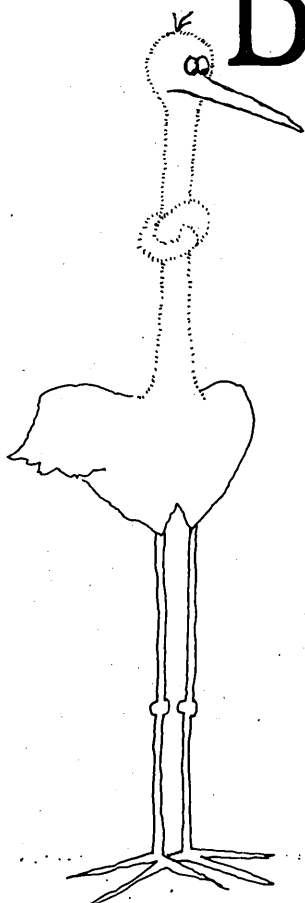

"IT'S A PROBLEM."

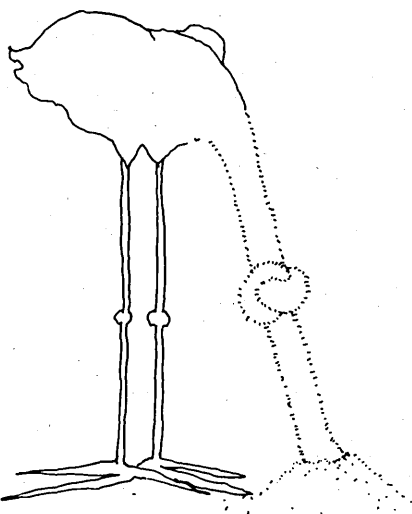

"IT'S NOT A PROBLEM."

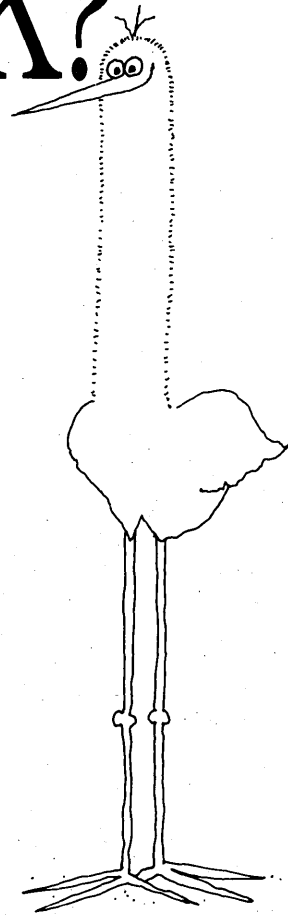

"NO PROBLEM WITH SYBERCACHE."

As processor speeds increase, systems have become constrained by the slower speed of the I/O devices that feed them data. The resulting CPU-to-disk bottleneck can literally starve your current system.

The Sybercache Intelligent Controller eliminates the speed differences between large or intermediate processors and the broad range of Storage Technology disk drives, reducing I/O times by as much as 75%.

This means significant gains in system throughput with no changes in software or media. Full hardware and software compatibility with 4341, 370/135-168, 303X and 308X (or equivalent) CPUs, plus automatic tuning, make Sybercache implementation easy.

To find out more, clip the coupon or call (303) 673-4063.

Storage Technology 

Show me how to beat the I/O Bottleneck. 4

Name _____

Function _____

Company _____

Address _____

Mail to: Storage Technology Corporation
Product Marketing, Mail Drop 3K
Louisville, Colorado 80028

CIRCLE 20 ON READER CARD

IN FOCUS

Does that mean no one should ever take a drink or a pill? Must the dp manager who feels more at home with his disk drives than in a conference room full of vice presidents suffer through his presentation? "It depends," says Dr. Weinberg. If he takes something to calm himself down, "there's nothing wrong with it at that particular moment. But if it becomes continuous, where he must respond to something outside himself, then there is something wrong. . . . He is becoming a dependent individual."

The danger, adds Xerox's Frederick, is in the possible discovery that he has "the kind of personality or physiology that demands wanting to feel good all the time. . . . Some people whose body systems are different begin to demand more because

"It's an equal opportunity problem."

they enjoy that 'I feel good' feeling and their bodies say, 'I want to feel good all the time, I need the feeling.' That's how people get addicted: their bodies start to demand that mood-changing chemical."

To be sure, chemical dependency inevitably leads to problems on the job. But until it does, why should an employer care if an employee gets "spaced out," in one way or another, during lunch or evenings and weekends?

"If performance isn't affected," says Duvall, "the employer really has no say in the matter. . . . But," he warns, "that's a really big 'if,' because the fact of the matter is, it does make a difference, almost always. . . . Employers do see changes in the ability to perform, in the ability to talk to clients, in attitudes, interaction with other employees, and the rest."

A "recreational" chemical user, adds Frederick, "may do his work, but maybe not as well as the day before. . . . There is more and more evidence being published of the lasting effects on the body and on the mental processes of people who are utilizing drugs. This increasing awareness," he adds, "is being brought to the attention of management, either through their own reading or through medical directors in corporations. . . ."

One motivation for such awareness is the expanding social responsibility of the business community. But another, perhaps even stronger, motivation is that stoned employees are costing their companies a fortune. According to Frederick, alcohol and drug abuse is costing American business some \$24 billion annually. A quarter of the abusers' wages are wasted through reduced productivity, lateness and absenteeism, and turnover. Their on-the-job accident rate is two to four times greater than nonabusers, off-the-job accidents four to six times greater. The average substance abuser uses twice as many company-paid accident and sickness benefits as the nonabuser. When their

problems become severe enough to warrant dismissal, they turn out to have been employed more than 10 years—a fact that heavily affects the cost of training their replacements. Although Frederick disclaims that these figures are based on his own experience and cautions that specific company figures may differ, Duvall cites a study made among CDC employees that supports Frederick's views.

In 1976, after CDC's Employee Assistance Program had been in effect for two years, three groups were studied: EAP users who admitted to alcoholism and were treated; employees identified as alcoholics and not treated; and a third set who identified with other types of problems. "We looked at employee benefits utilization two years before getting help and two years after," says Duvall. "We discovered that . . . the alcoholic employee prior to treatment was using three to four times as many benefit dollars as the average employee. It wasn't just the employees. . . it was their families as well. . . ."

"From that study, we estimated that there were approximately 2,000 active alcoholics in the company who could legitimately go into the hospital immediately. We estimated that if we got all of them to go into the hospital that day, it would cost the company \$7.5 million for treatment. If we were only 70% effective, we'd make all that money back in less than two years . . . just in the savings of benefits, and with respect to absenteeism, accidents, and visits to medical units."

No one can accurately assess, however, the cost in lost productivity. Consultant Peck cites recent claims that if Japanese workers were imported, along with their working environments, to the U.S., American productivity would increase between 20% and 30%. He is firm in his conviction that the same could be accomplished by eliminating the drug/alcohol problem from American industry.

What is American business to do? Bite the bullet? Accept substance abuse as a social phenomenon and try to live with it? Given the scarcity of skilled professionals and other workers in every aspect of the computer industry, is it not more cost-effective to keep an addicted employee as long as he performs at some acceptable level?

The answers to those questions are complex: some are even academic. For example, in many cases, it is difficult to discharge an employee even if you want to because of union, contractual, and corporate policy considerations. You could try to fire someone for being a junkie and wind up in court.

But there are some solutions. Many corporations are confronting both the problem and the fact that they do not necessarily have to live with it. For many companies, Employee Assistance Programs (EAPs) are proving to be highly cost-effective.

EAPs usually come in three versions. Some companies maintain in-house units, complete with physicians and therapists. Others subscribe to an outside EAP program, such as those managed by the Life Extension Institute, to which employees are sent. Still others have on file a list of agencies, therapists, physicians, institutions, and organizations (like Alcoholics Anonymous and Pottsmokers Anonymous) to which employees are referred. Almost all EAPs have some sort of monitoring or reporting mechanism so that the employee with a problem can be "tracked." There are combinations of, and variations on, these basic themes, but one characteristic pervades all of them: they are highly confidential. An employee's involvement with an EAP is not entered into his or her file, nor is a supervisor informed of the employee's "progress," except with the employee's consent and when patience or endurance on the supervisor's part is desirable.

EAPs are not restricted to drug/alcohol problems—financial difficulties, domestic strife, and other adversities that can affect an employee's work are all fair game for an EAP. Nevertheless, many of the problems that are identified by the the employee as financial or domestic turn out to stem from a drug/alcohol habit. In September 1981, a little over a year after Pitney-Bowes's program was introduced, the company's EAP handled over 150 cases, of which 28% were drug/alcohol related. At Travelers Insurance, more than 350 employees took advantage of the company's EAP within a year after its inception. Ac-

"We're told, in regard to the computer and dp groups, that some people use drugs to alleviate boredom."

ording to Bob Wilson, Travelers' EAP administrator, most of the problems involve single parenthood and the vicissitudes of raising teenagers, but "second to that," he reported, "is coping with alcohol or drug-related troubles, either involving Travelers people directly, or someone they love." Most EAPs are available to relatives of employees and, with rare exception, are free to all who use the services. The hard part is getting them to use it.

It is essential that an EAP be well publicized within the company, says Duvall. "People will start the process of sorting out their illness and their problems before you ever even see it in regard to the performance issue. That's when you really save money. . . . One of the tricks of the trade, we've discovered, is that with a broad brush—as opposed to a strictly drug/alcohol approach—we will get people where the problem really is the drug or drinking. But it takes too much guts for them to start the process there, so they'll start it with another problem and it comes

WE'VE MADE IT ALL HANG TOGETHER

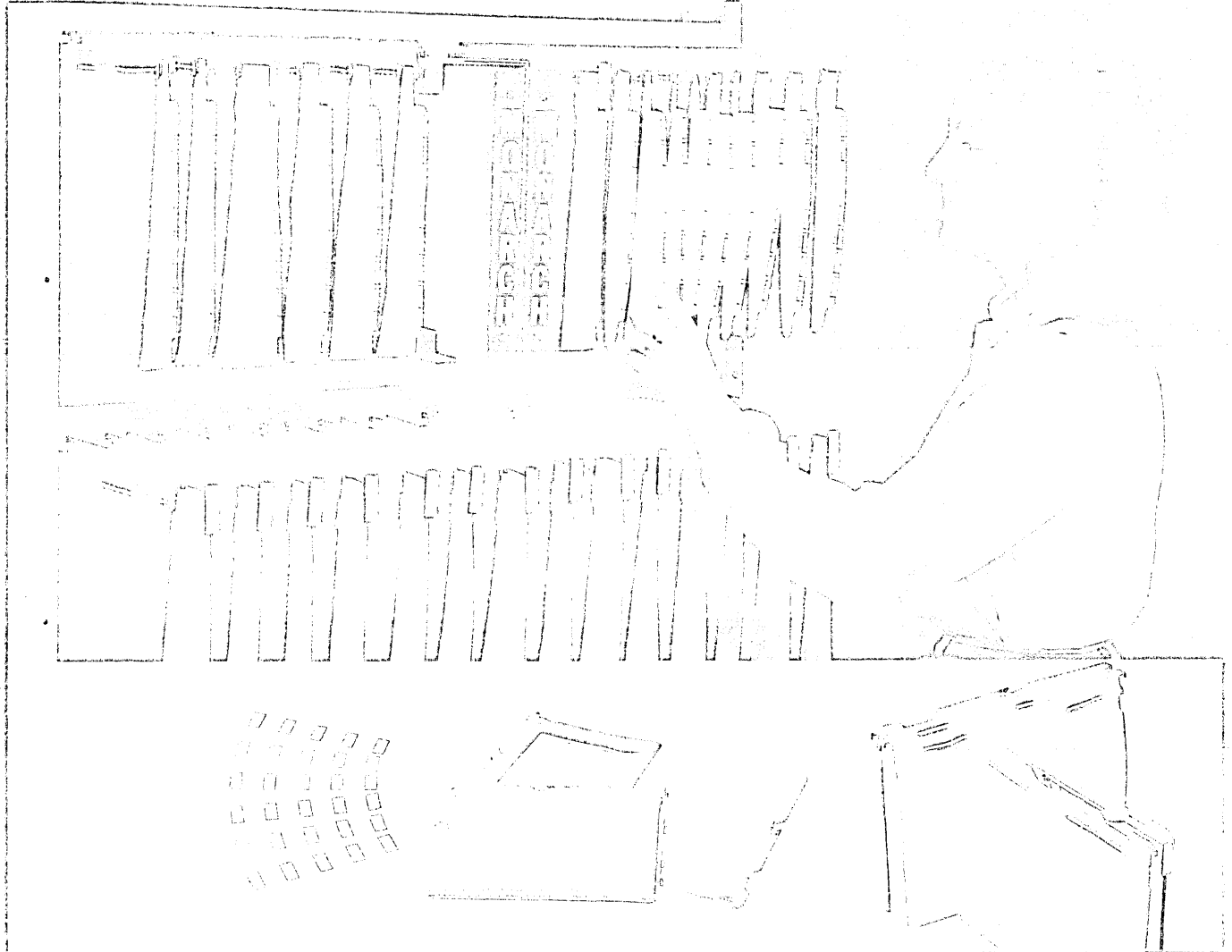

Dyna color coding systems

Media Mate II documentation folder

Media Mate II folder

NEW MEDIA MATE II™ SPEEDS DOCUMENTATION FILING

It doesn't make sense to go searching for documentation every time a program needs updating. Systems analysts and programmers make expensive file clerks. And the responsibility has better things to do with your time.

New Media Mate II™ from MONARCH speeds filing and retrieval with a choice of two color

coding systems. And Media Mate II reduces search and retrieval time by allowing related documents to be filed together—even if their sizes are not related. Media Mate II keeps all forms of documentation neat, organized and under control. And with a complete system of components to enhance your Media Mate II, increases productivity in every detail of use.

It All Hangs Together With New Media Mate II.

MONARCH
 Division of Computer Monitor Systems, Inc.
 One Winchester Way, Fort Worth, Texas 76102
 Setting the Industry Since 1976.

CIRCLE 23 ON READER CARD

IN FOCUS

out. . . . For example, about one out of every four financial cases. . . is really a drug/alcohol problem."

Nevertheless, employees using chemical substances who believe they are coping are not likely to enter an EAP of their own accord. Part of an effective EAP program, therefore, involves training managers to be alert for certain warning signs. Not surprisingly, those signs are typical of anyone with a drug or drinking problem, regardless of the environment:

- Monday and Friday absences are a frequent indication that a problem exists. "When people start having long weekends," says Duvall, "it's good to know why. Keep your eyes and ears open."

- Dramatic personality changes are another indication that something is amiss, especially if they occur in the middle of the day. If a mild-mannered employee becomes aggressive or hostile, or if an outgoing worker turns sullen and reticent, it's a safe bet that the employee is in some sort of trouble. Keep an eye out, too, for changes in relationship with colleagues and superiors, both within and outside the department.

- Chemical habits are expensive, and people who harbor them become poor managers of their personal finances. Look for frequent borrowing from fellow employees and requests for advances on the paycheck.

- Watch for changes in work habits. Some workers become obsessively meticulous when they're on drugs; others become un-

characteristically sloppy and slipshod. Anyone with a good record of maintaining control and meeting deadlines and who seems to be losing his or her grip should be carefully observed. A variation of sloppy-to-neat or vice versa can occur in the way someone dresses.

But it is essential to keep in mind, always, that any or all of these mood changes can be triggered in anyone, and for a wide variety of reasons. Some can be brought on by a toothache or a broken love affair. The key word, when it comes to substance abuse, is "pattern." If the changes are frequent, continuous, and appear to be

For many companies, Employee Assistance Programs are proving to be highly cost-effective solutions.

more or less permanent, then—and only then—there may be a case for the EAP.

Under *no* circumstances should a supervisor confront an employee with an accusation or challenge about his or her personal life. At best, the employee is likely to deny it; at worst, he or she may threaten action on grounds of violations of company policy or a union contract.

EAP experts all agree that any confrontation must be based solely on performance, which must be documented. Slipping attendance, lateness, overly long lunch hours, production slowdowns, failure

to meet expected deadlines or other performance levels should all be recorded over a period of time. Any of these are legitimate reasons for confrontation. Any supervisor has the right—indeed, the obligation—to tell an employee that his or her performance has been slipping, that the slippage has been documented, and that it cannot continue without jeopardizing continued employment. The supervisor can, and should, also notify the employee that if some sort of personal problem is the cause, the company is prepared to provide professional assistance, at no cost to the employee. At Xerox, says Frederick, "should an individual's job performance become substandard, we try to determine whether the individual is not performing because of a lack of skills, knowledge, environment, or resources. If all four of those pieces seem to be there, then we assume that there's a personal problem. . . and we will suggest that they go get help. . . . Now, in getting that help, a diagnosis may be made that the individual is in fact impaired by some sort of chemical or some other personal problem. Then we provide the medical and therapeutic assistance. . . ." But that diagnosis is made by the EAP's experts, not by the supervisor.

A good EAP, claims Duvall, will, with the employee's consent, monitor treatment and provide the supervisor with progress reports. This not only tends to ensure that the employee will remain in the program; it enables the supervisor to understand and deal with gradual progress, instead of expecting instantaneous change. EAP personnel have even been known to help a manager lower an employee's work expectations for a specified period.

Effective EAPs are not cheap. But when measured against the likely costs involved in not having one, it appears to be one of the great all-time bargains in the corporate world. "Probably a good ballpark figure for a CDC-like corporation," says Duvall, "where you have 50,000 employees, and a 24-hour, seven-days-a-week nationwide EAP program, will cost somewhere between \$12 and \$20 an employee."

Is it worth it? "EAP programs these days," claims Duvall, "run very high success rates. Our overall success rate is 70%. If you can save seven out of 10 people who are going through personal problems with drugs/alcohol. . . you have saved an immense amount of money."

The cost of not having an EAP can be heavy, both in terms of company losses and in human potential. Whether the EAPs can rescue employees with problems—for their own sakes, for the benefit of their companies, and as a major contribution toward the renewal of the American economy—remains to be seen. *

Marvin Grosswirth is a New York-based free-lance writer and a frequent contributor to DATAMATION.



"I see your insurance covers little green pills, little yellow pills, little white pills, little red pills and little purple pills. What I'm going to give you are some little orange pills."

TELEPHONE COMPUTER COMPANY, INC. *Announces:*

Your Telephone is now a "Talking" Computer!

COMPUT-A-TALK HIGHLIGHTS

- Converts your computer into a "Talking" Telephone Computer system
- Transforms your customers' Telephone into a "Talking" Terminal
- Small converted systems, including software, from \$500 rental per month
- Small converted COMPUT-A-TALK systems from \$10,000 purchase price

Unlimited COMPUT-A-TALK Applications:

- Order Entry ● Account Balance Verification ● Bill Paying
- Current Interest Rate Inquiries ● Electronic Buying
- Electronic Funds Transfer ● Loan Applications
- Point of Sale ● Debit and Credit Authorization
- TeleAudio Services ● Talking Computer Services
- Talking Mailbox ● Talking Teleprinter



Now you can open 80 million branch offices throughout the United States

Everyone talks about universal, low-cost services. But few have done anything about it.

Now, the revolutionary COMPUT-A-TALK has everyone talking. Even your computer! For the first time, the COMPUT-A-TALK, a communications microprocessor-based product, transforms any Touch-Tone® telephone into a no-cost remote talking terminal. All of your data input, both letters and numbers, is entered by the standard push button keys, and is verified via the COMPUT-A-TALK synthesized voice output.

The COMPUT-A-TALK transforms the tones from a Touch-Tone telephone into data for computers. When the data is processed, the COMPUT-A-TALK speaks the answers to your customers. Customers can automatically transfer funds, verify balances, make payments to merchants, and electronically buy products and goods simply by picking up their telephone and dialing their desired transactions.

Imagine what this can mean for you, in both the tremendous increase in new revenues and the significant savings in

man hours and related costs. And, most importantly, the huge increase of new clients who want these services 24 hours a day — seven days a week.

All of this at a price that you can easily afford! The smaller converted systems, including software, are available starting for less than \$500 rental per month, or you can choose to purchase small COMPUT-A-TALK systems for under \$10,000.

Dial our COMPUT-A-TALK offices for a free demo.

For more information on the total COMPUT-A-TALK system, contact:

TELEPHONE COMPUTER COMPANY, INC.
1911 North Fort Myer Drive
Arlington, Virginia 22209
(703) 276-0600

(or)

The COMPUT-A-TALK New York office at:
110 W. 40th Street
New York, New York 10018
(212) 398-9390

Fill in and mail to:

TELEPHONE COMPUTER COMPANY, INC.
1911 N. Ft. Myer Drive — Main Lobby
Arlington, VA 22209

(or) **DIAL** (703) 276-0600

Gentlemen:

I am interested in the patented COMPUT-A-TALK system. Please rush me at no cost information on:

- COMPUT-A-TALK Systems
- COMPUT-A-TALK Products

COMPUT-A-TALK Applications:

- Banking Credit
- Retail Other _____

My specific application needs are: _____

NAME: _____ TITLE: _____

COMPANY: _____

ADDRESS: _____

CITY: _____ STATE: _____ ZIP: _____

TELEPHONE NUMBER: () _____

16,000 people devoted
solely to service

Advanced engineering
like Remote Diagnosis

High-quality
manufacturing

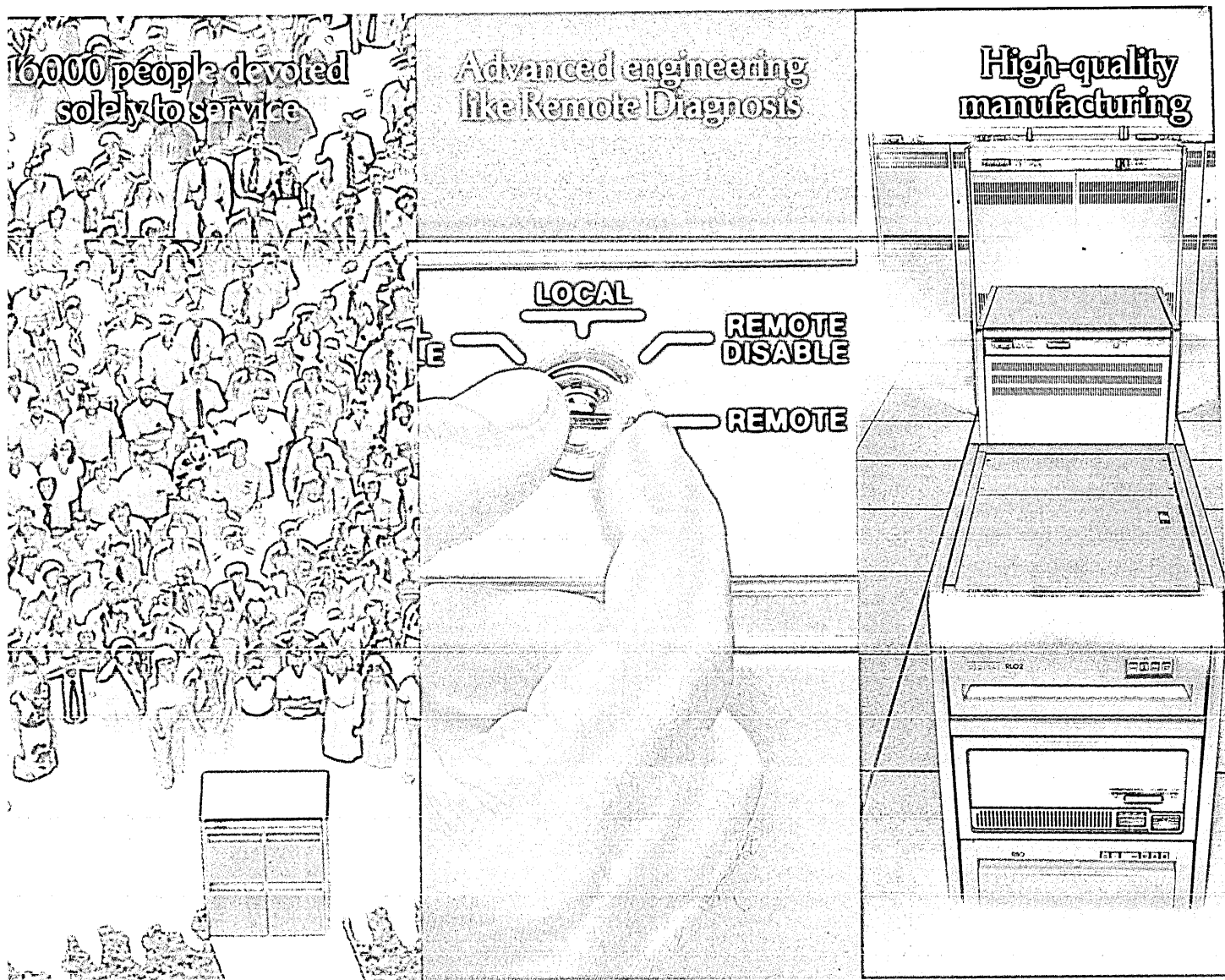

We've brought all our resources together to bring you the first total systems uptime guarantee.

If computer systems reliability is a critical factor in your business, then it's important that you buy a computer made by Digital. Because we'll work with you, to ensure that the reliability we design and build into our products is maintained at your site. In fact, once the necessary service requirements are met, we will guarantee that your VAX Family, DECSYSTEM-10 or DECSYSTEM-20, will be available at an optimum level you can select yourself—up to 99%.

How is Digital able to offer a total system uptime guarantee? It has a lot to do with Digital's company-wide commitment to quality. A commitment evident in the years of engineering and manufacturing focus on reliability and maintainability technology. And

in one of the largest and most capable service forces in the industry—supported by the remarkable power of Digital's proven Remote Diagnosis technology.

One more thing: since high uptime is designed into all of Digital's products, it's not an add-on or an extra-cost option. There's no additional service charge for Digital's Uptime Guarantee. It is an integral part of your Service Contract.

For full details, call your local Digital office or write to: Digital Equipment Corporation, 129 Parker Street, Maynard, MA 01754. © Digital Equipment Corporation 1982

digital

Johnson Systems Software Helps Run Your Data Center

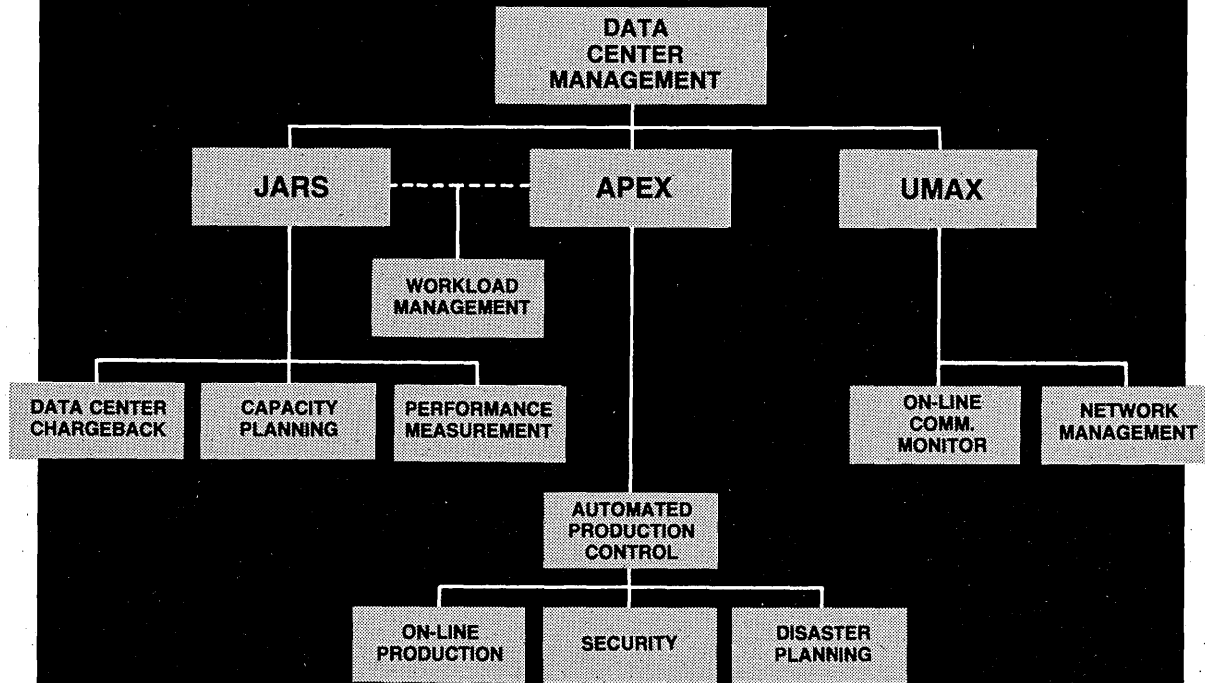

AS A BUSINESS

Management of the Data Center resources should result in greater profit for the corporation.

Johnson Systems understands that to run your Data Center as a business you need to identify the key volume indicators in the corporate objectives and translate them into Data Center resource requirements. You must also determine the level of service required by your users and allocate resources accordingly; and develop a production plan including schedules, standards, and service levels. Johnson Systems software makes this easier for you; aides in the implementation and control of the plan; and determines the actual cost of meeting the corporate objectives.

Whether your DOS or OS Data Center features CICS, IMS, or VM, Johnson Systems integrated approach meets your Data Center management needs.

Johnson Systems Job Accounting Report System (JARS), CICS Utilization Monitor and Chargeback System (UMAX), and Automated Planning and Execution Control System (APEX) provide a comprehensive data base of resource utilization statistics for: **workload management; production control; capacity planning; performance measurement; and computer chargeback.**

Johnson Systems Management Information Systems will result in greater Data Center profitability.

For full details on how Johnson Systems can help run your Data Center as a business, telephone us today at **1-800-368-1010**.



8300 Greensboro Drive, McLean, Virginia 22102 1-800-368-1010 or (703) 821-1700
Chicago (312) 655-3490 Dallas (214) 247-3252 San Francisco (415) 348-5886

Argentina 311-2019 Australia 411-5161 England (0923) 46255 Finland 90-890-188 France 270-4444 Germany (211) 320995 Italy (010) 411548 Brazil (021) 294-9292
Puerto Rico (809) 767-0845 Hong Kong 5-260450 Indonesia 511809 Japan 03-437-0921 South Africa 787-5600 Sweden 08/616500 Venezuela 593-0611

NEWS

IN PERSPECTIVE

PERSONAL COMPUTERS

LISA IS APPLE'S STAR

An impressive graphics-oriented, mouse-directed workstation for the office comes in at a price below Xerox's earlier entry.

Standing in the living room of his home overlooking San Francisco Bay, the president of a small metalworking and machinery manufacturing company shows the exasperation he is experiencing. "Tell me," he says, "should I buy a personal computer? What could I do if I had one?"

There's a plea in his questions, a confusion in his mind about this widely publicized business tool whose applicability to his work is difficult to understand. While the personal computer has found a home in a range of businesses, large and small, in government offices, schools, and in research laboratories, it has yet to find acceptance among the majority of business executives and professionals.

With those people in mind, the makers of the popular Apple computers have come up with an impressive single-user workstation with many similarities to the Xerox Star but at a lower price. The new Lisa, which is an acronym for local integrated software architecture, is designed to make it possible to do many tasks with a minimum of keyboarding. Like the Star, it has a heavy graphics orientation, is menu-driven, and uses a mouse for cursor manipulation. One need only move the cursor to a word or image (Xerox calls it an icon) on the screen and press a button to make something happen—display a list of commands, perhaps, or open or close a file, move a word or paragraph, create a pie chart.

"It's a gorgeous machine, but it's expensive," says analyst Esther Dyson of Rosen Research. "You can get close to the same functions more cheaply with, for example, an IBM P.C. with VISION [the newly announced integrated software package from VisiCorp]. So I think the main problem with Lisa is the price, not the concept."

Lisa, powered by a Motorola 68000 microprocessor, has a 12-inch bit-mapped, black-and-white display, a 5MB Winchester disk (the Profile), and two 5¼-inch floppy drives, each with a capacity of 870K bytes, full Selectric keyboard with numeric pad, and the mouse. The hardware comes with six integrated software packages:

- LisaList makes it possible to create and maintain any type of lists in a personal data-

base.

- LisaCalc is a spreadsheet and financial modeling tool that goes up to 255 rows and 255 columns.

- LisaProject is a visual project management tool that enables the user to see the critical path, interdependencies, and ask what-if questions.

- LisaWrite is the word processor.

- LisaGraph is for business graphics.

- LisaDraw, hailed by many as most significant, provides a menu of lines, boxes, circles, and other geometrical shapes for creating sketches, flowcharts, technical diagrams, and the like.

Of course, these packages are integrated so that the user can "cut" what has been created by the use of one package and "paste" it into text or pictures produced by another. Numbers generated by LisaCalc can go into a document produced with LisaWrite, for example. Or those numbers can first be graphed and then brought over and merged with the text.

There are only some 50 or 60 commands that are called up. When LisaWrite is being run, for example, the menu across the top of the screen displays such functions as File/Print, Edit, Search, Type Style, Format, and Page Layout. Move the cursor to Edit with the mouse and a number of related commands appear. Or point instead to Search and a different list of commands shows up. There's a different menu bar with each application.

All this, the above-mentioned hardware and the six software packages, is

It is expected that 90% of the software on Lisa systems will come from independent software vendors.

priced at \$9,995. Priced separately are two printers, a dot matrix and a letter-quality model. Terminal emulation software, although available, is not bundled in the package because anyone who wants that will also need to buy a modem.

Lisa is said to be the result of some 200 man-years of engineering, most of that for software, and an investment of from \$40 million to \$50 million since the project's inception in late 1979. To carry on this developmental effort, a new Personal Office Systems Division was formed in September '80 and is now comprised of about 100 engineers. Despite the effort by that group, it is expected that 90% of the software on Lisa systems will come from independent software vendors.

Digital Research Inc., for example, will have a CPM for Lisa, and Microsoft Inc. will have Zenix, its version of Unix. There will be a high-level COBOL as well as a BASIC, Pascal, and FORTRAN. From other sources will come additional applications programs, such as cash management. Running internally at Apple Computer but not

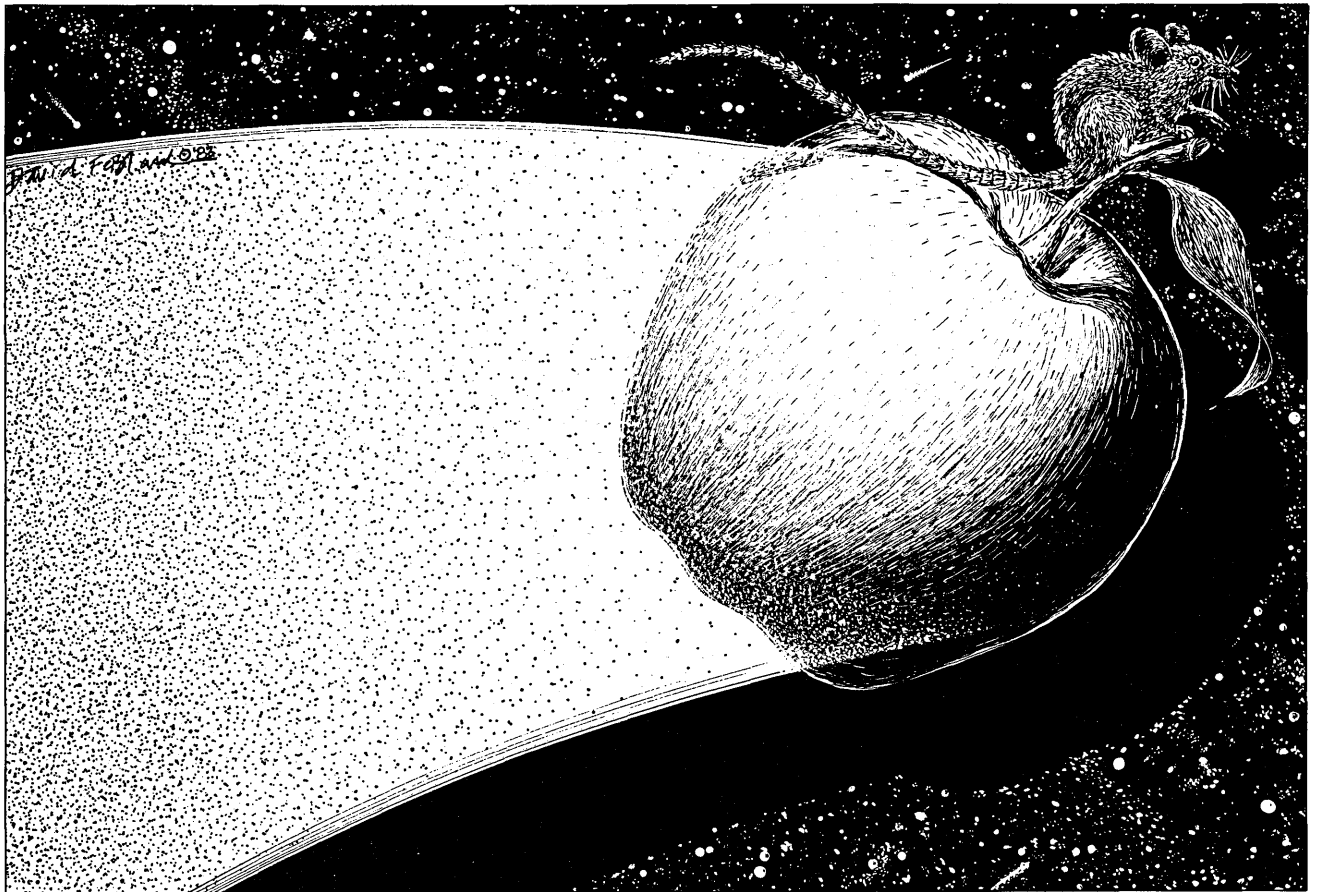

yet ready for release is AppleNet, a baseband, CSMA/CD local area network with a 1-megabit bandwidth that is said to support up to 128 devices. Scheduled for release late in '83, it will eventually have gateways to another AppleNet, to an Ethernet, and to a broadband network, in addition to such things as database servers and electronic mail.

The late availability of AppleNet is unfortunate. "If you're doing something as powerful as Lisa allows you to do, you definitely want to share it with a person down the hall," says market researcher Portia Isaacson. "So the local area net is extremely important."

The primary target for Lisa is the office market, including professionals, managers, and administrative assistants. "This is where we're focusing 95% of our energies," says Barry H. Smith, product marketing manager. Of Apple's some 1,300 U.S. dealers, perhaps 200 will be selling into that market, in addition to the company's newly established national accounts salespeople, a group expected to number 100 at the time volume shipments begin late in the spring. Half the machines are expected to sell into small and medium-sized companies, those with annual revenues of less than \$200 million, a market that will be addressed by the dealers. Larger companies, it is thought, will be approached by people in the national accounts program formed nine months ago.

It is being questioned, however, whether Apple is postured to sell effectively to corporate accounts, which requires a nationally supported direct sales force. "It is not clear to me that Apple has finished organizing itself to do that," says consultant Amy Wohl of Advanced Office Concepts. Taking a different tack is market analyst Isaacson of Future Computing, who questions Apple's decision to sell to those same accounts through retail stores. She views direct sales as the only way to go.

Apple's announcement of Lisa will shake up IBM, says Wohl, "because they're

**Lisa will shake up IBM
"because they're nowhere near
announcing that kind of
workstation."**

nowhere near announcing that kind of workstation. But I am not convinced that Apple will end up with a major share of that market." It's not a market where the personal computer maker has exhibited any muscle, she explains, adding, "One would expect IBM to do well in that market."

The folks at Future Computing think otherwise. During 1983 alone, assuming volume shipments don't begin until the summer, they see Apple selling from 7,000 to 10,000 Lisas, meaning a retail value of from \$70 million to \$100 million. Those numbers may be determined more by Apple's ability to manufacture and ship

than by market demand. "That many people are going to order it to see if it's real," says Isaacson. "We think they're going to be swamped with orders from the Fortune 1,000," but may do at least as well with orders from small businesses, she adds. So who are the users?

In the office environment, of course, is a variety of people, including what Dyson calls "the guy who has an attention span of five minutes." He seldom spends more than five minutes on any task without being interrupted by a phone call, an urgent meeting, or client visits. In those five minutes at a Lisa, he might retrieve some data from a file and generate useful information for his or his boss's next meeting, or he might edit a letter or memo, perhaps incorporating some numbers from a spreadsheet. In short, he needs to get things done quickly. "He's a guy whose time is worth a lot," explains Dyson, "so it's worth it to pay \$10,000" if it means he avoids having to spend even 30 seconds moving information from one data file to another.

"Lisa is not for a guy working alone," she continues. "Lisa's for a guy who's got a corporate database and has several other people on a Lisa that he must talk to." Thus there are subordinates who might spend more time with a mouse in one hand and a keyboard under the other. This includes the secretary who does the heavy keyboarding jobs, the data entry functions,

NEWS IN PERSPECTIVE

the generation of business graphics. "It's basically a machine for paper-pushers."

While the Lisa is not an original in its concept and implementation, it nonetheless makes an attractive and desirable package—provided, of course, one can pop for 10 grand. More such desktop machines, integrating hardware and software, can be expected. Says Esther Dyson, "The concept [of Lisa] is going to be pervasive. I'm sure Apple will sell a lot of Lisas, but they will not by any means be alone."

Apple Computer Inc., which had revenues of \$583 million in fiscal '82, was not alone last year in the PC market either. With systems priced from \$500 to \$6,000, Apple's 23% market share in 1981 was whittled to 19% in '82, thanks largely to the entry into that business by IBM. According to InfoCorp, the newly formed research company in Cupertino, Calif., IBM had a mere 2% market share in '81 but increased that to 11% in '82. In those same years, Tandy's share dropped from 16% to 11%.

Both companies thus felt the impact of IBM's entry with its Personal Computer, although Apple's installed base continues to be the largest of them all in terms of end-user value. That market worldwide had a value of some \$7 billion last year, double that of the year before, and it should almost double again this year.

Chalking up those sales, however, are more than a hundred different models of personal computers, many of which bear a close resemblance to each other. It causes Apple's Barry Smith to revel in the new Lisa, saying, "The market is not waiting for just another personal computer." Lisa does indeed stand apart from the pack.

—Edward K. Yasaki

AN APPLE FOR ALL

An enhanced Apple II, featuring an 80-column screen and a full ASCII keyboard with both upper- and lower-case characters, should please critics of the Apple II and II Plus computers, now no longer in production. The Apple IIe (the e is for enhancement) retains software compatibility but is a complete redesign that has reduced the IC chip count to 30 from something like 130 and uses 64K RAM instead of 16K. Main memory now goes up to 128K. While the old Apple II Plus with 48K retailed for \$1,330, the IIe with 64K sells for \$1,395. A system comprised of a monitor, stand, one floppy drive, controller card, and an 80-column card (the 40-column screen has been retained for those requiring it) is priced at \$1,995.

For the first time, then, the popular Apple has been designed for mass production. The first II was built in a garage back in 1977—and was designed to facilitate manufacturing in such a garage environment.

As a result, the company, which had to tool up to produce the machines in vol-

MAINFRAMES

XA: LET THE GODS DECIDE

As IBM readies the release of XA benchmark data, questions arise about the new plight of pcms.

As IBM's customers ready themselves for the long migration to the "promised land" of a new 31-bit architecture, IBM's management is on the horns of a dilemma. They are weighing the internal performance of XA against its likely market impact. And their question, as always, is, how hard do we push? As they deliberate, the fate of a whole industry segment—the plug-compatible market—hangs in the balance.

"The benchmark figures from six beta sites have been in for some time, and the word is they are excellent," says one source. "But just what IBM announces them to be is another matter."

Both the performance data and the first generation of the XA architecture are expected to be released in this quarter, analysts say. Privately there has been talk of XA offering at least twice the performance of the current MVS/SP 1.3 release it will eventually supersede.

"This is about what we expect IBM to reveal," says Morgan Stanley analyst Ulric Weil. "Users will be told that if they move from 1.3 to XA they will get immedi-

ate relief from their present virtual storage restrictions. Currently users are squeezed up against a 16-megabyte main memory limit. They'll get at least another 16 megabytes on top of that in which they can run multiple copies of such memory hogs as CICS and IMS."

Eventually users could realize a virtual storage cpu main memory of two gigabytes from the extended 31-bit range, it is believed.

At the same time IBM announces its performance data, the company is expected to counter the growing perception that conversion to the new architecture must necessarily be a difficult affair.

"If you are at MVS/SP 1.3," says Dale Kutnick, research director for the Boston-based Yankee Group, "you won't be able to convert everything at once. It's important to realize that XA is bimodal, and that the user will have to make a two-step conversion, first to 24-bit XA and second to 31-bit XA."

Kutnick warns that users planning to migrate from other MVS releases or other operating systems will not be able to do so

without first moving to 1.3. "MVS/1.3 is the stepping-stone; that's where the necessary XA subsystems reside."

"The feeling within IBM," claims Kutnick, anticipating the announcement, "is that it will take from two to six months and a regular project team to convert from 1.3 to XA."

One industry analyst speculates that once XA is revealed, "we'll all be left with the feeling that pcms such as Amdahl and Hitachi have fallen at least a year behind." On the surface, he says, it looks as though Big Blue hopes to wipe out its pcm rivals in 1983. Indeed, if the majority of IBM's mainframe base had already graduated to some form of MVS, that might even prove true. But, as research firms point out, only one third or so of IBM's medium to large users are MVS installations, and a good number of those have yet to reach the 1.3 level.

"Though one shouldn't underestimate the likely impact of MVS/XA on pcms," says Pat Sullivan at Technology Analysis Group (TAG), New York, "they will reap some benefit from the difficulties that non-MVS users will have in migrating to XA. For some, the conversion could take years, and prove enormously expensive. A good number of OS/VS1 users, for example, won't even try."

But pcms also have another reason for thinking that the impending benchmarking hoopla is largely "hardware posturing." Says one pcm executive, "The real key to XA—its virtual machine migration

—E.K.Y.

ate relief from their present virtual storage restrictions. Currently users are squeezed up against a 16-megabyte main memory limit. They'll get at least another 16 megabytes on top of that in which they can run multiple copies of such memory hogs as CICS and IMS."

Eventually users could realize a virtual storage cpu main memory of two gigabytes from the extended 31-bit range, it is believed.

At the same time IBM announces its performance data, the company is expected to counter the growing perception that conversion to the new architecture must necessarily be a difficult affair.

"If you are at MVS/SP 1.3," says Dale Kutnick, research director for the Boston-based Yankee Group, "you won't be able to convert everything at once. It's important to realize that XA is bimodal, and that the user will have to make a two-step conversion, first to 24-bit XA and second to 31-bit XA."

Kutnick warns that users planning to migrate from other MVS releases or other operating systems will not be able to do so

"The real key to XA—its virtual machine migration software, VM/XA—has not even been announced yet."

without first moving to 1.3. "MVS/1.3 is the stepping-stone; that's where the necessary XA subsystems reside."

"The feeling within IBM," claims Kutnick, anticipating the announcement, "is that it will take from two to six months and a regular project team to convert from 1.3 to XA."

One industry analyst speculates that once XA is revealed, "we'll all be left with the feeling that pcms such as Amdahl and Hitachi have fallen at least a year behind." On the surface, he says, it looks as though Big Blue hopes to wipe out its pcm rivals in 1983. Indeed, if the majority of IBM's mainframe base had already graduated to some form of MVS, that might even prove true. But, as research firms point out, only one third or so of IBM's medium to large users are MVS installations, and a good number of those have yet to reach the 1.3 level.

"Though one shouldn't underestimate the likely impact of MVS/XA on pcms," says Pat Sullivan at Technology Analysis Group (TAG), New York, "they will reap some benefit from the difficulties that non-MVS users will have in migrating to XA. For some, the conversion could take years, and prove enormously expensive. A good number of OS/VS1 users, for example, won't even try."

But pcms also have another reason for thinking that the impending benchmarking hoopla is largely "hardware posturing." Says one pcm executive, "The real key to XA—its virtual machine migration

The Art And Science Of Better Communications.

A BUYER'S GUIDE TO BETTER SYSTEM 34/38 PERIPHERALS.

Quality and cost efficiency have always been the key measures of a product's worth. *What you get for what you pay.* But today, particularly for buyers of System 34/38 peripherals, *when you get it* is just as key. And today, with a select group of distributors now exclusively selling them, Memorex's System 34/38-compatible display station and matrix printers are, by *any* measure, the measure.

A Better Ergonomic Choice. Ergonomics makes products more comfortable for people to use. That makes people more productive. And that is why Memorex makes the 2051 Display Station with non-glare moldings, screen and keytops, tiltable monitor and movable keyboard. And that's why our 2056 Matrix Printer and 3056 Forms Access Matrix Printer feature straight paper paths for easier paper loading and handling.

A Better Economic Choice. Top-of-the-line performance and reliability makes bottom-line economic sense. For instance, our 2051 Display Station boasts alternate cursor styles, a 25th line feature for line and column indicator and system status, and automatic dimming to preserve CRT life. A removable monitor greatly enhances space efficiency, while energy efficiency is rated 58% better than the IBM 5251.

The 2056 and 3056 Matrix Printers, for their part, are twice as fast as the IBM equivalents, thanks to increased print speed, spacing rate and vertical paper slew rate. A special compressed printing capability eliminates the need for wide, bulky and expensive computer paper. And our exclusive forms access capability permits single form tear-off—eliminating dead space, paper waste and specially designed forms.

A Better Distributor Choice. Better response, delivery and support are the reasons we set up our exclusive 34/38 distributor network. Memorex invites you to call the one closest to you for complete details—and a product demonstration. Or contact us at the Memorex Communications Group, 18922 Forge Drive, Cupertino, California, 95014. (800) 538-9303. In California, (408) 996-9000, Ext. 222.

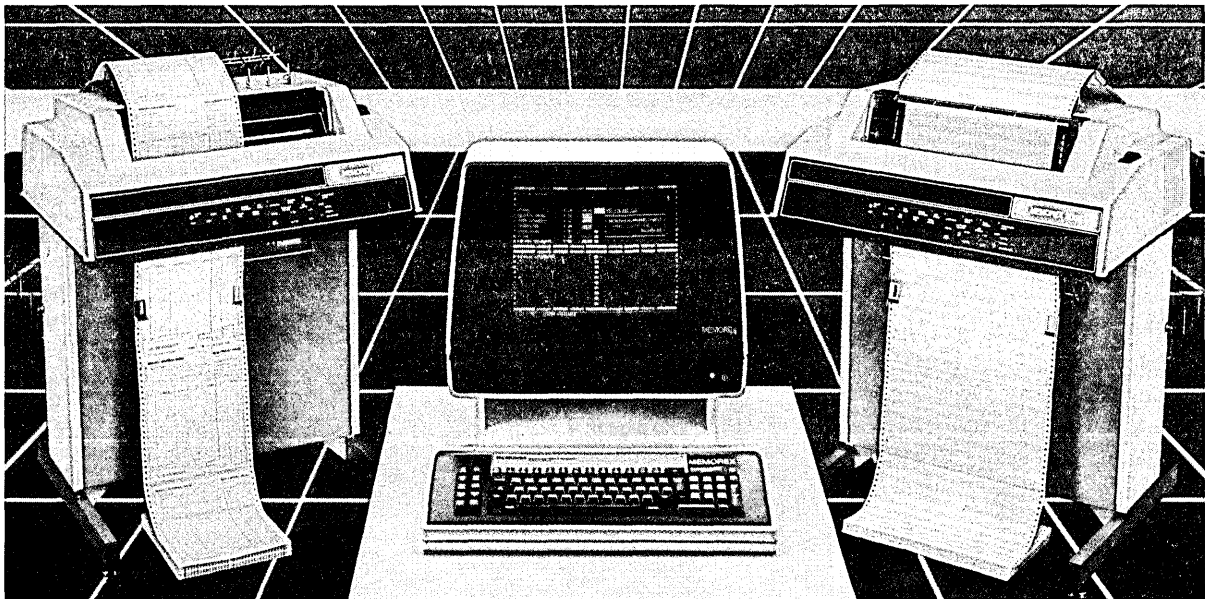

MEMOREX

A Burroughs Company

Memorex 2051, 2056 And 3056 Distributors

MICROWEST TERMINAL SYSTEMS, INC.

(801) 487-1621 Arizona, Colorado, New Mexico, Utah

DATA-TRON, INC.

(313) 552-8421 Michigan

(512) 223-8421 Ohio,

Kentucky

(216) 585-8421 Ohio

(412) 243-8421 Pennsylvania,

West Virginia

PACIFIC MOUNTAIN STATES CORP.

(800) 423-2853 Oregon, Washington, Southern Nevada

(800) 272-3222 Southern California

SOUTHERN CHANNEL MARKETING

(214) 980-8842 Texas, Oklahoma

TERMINALS UNLIMITED

(800) 336-0423 District of Columbia, Maryland, New Jersey, New York, North Carolina, Pennsylvania, Virginia, Delaware

COMARK, INC.

(800) 323-6135 (312) 834-5000 Illinois, Indiana, Minnesota, Wisconsin

THORSON WEST

(415) 964-9300 Northern California, Northern Nevada

INTER-AMERICAN DATA, INC.

(404) 447-9762 Georgia

(800) 241-8768 Alabama,

Florida, South Carolina,

Tennessee

CIRCLE 25 ON READER CARD

When researching a problem,
how do you instantly highlight
anything you want in your
financial data base?

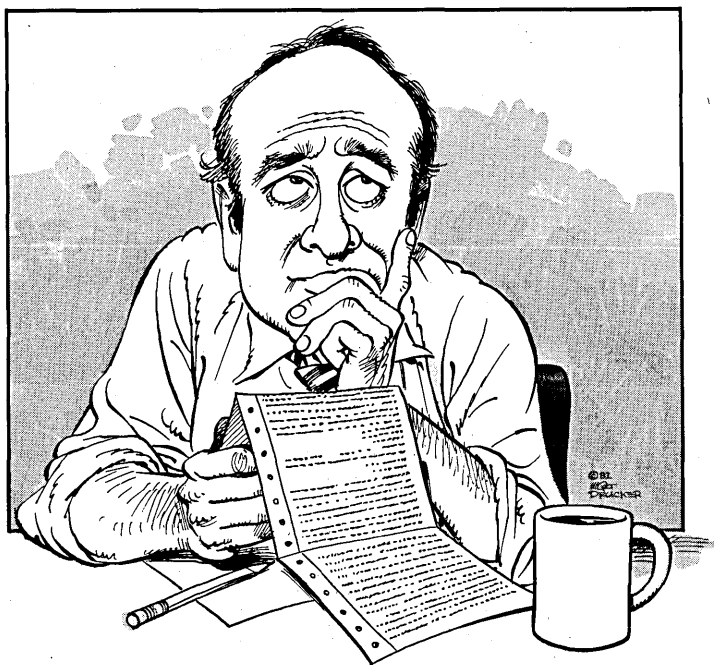

You use the new HiLite from
McCormack & Dodge.

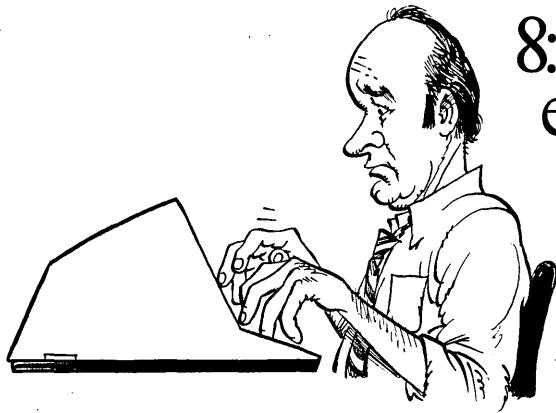

8:00 a.m. The boss says sales expenses are too high.

HiLite is a true accounting breakthrough. It lets you come up with answers in minutes instead of hours or days. No on-line query system in the world matches its ability to research day-to-day problems. It literally puts every piece of financial information you have at your fingertips.

8:02 a.m. Travel and entertainment is out of whack.

With HiLite, you can choose any audit trail and follow it to completion, criss-crossing data bases at will. Move from General Ledger to Accounts Payable to track sales expenses. Shift into Fixed Assets to pinpoint depreciation discrepancies. Change course 180 degrees and probe Personnel/Payroll for minority quota details. Search backwards and forwards through any and all McCormack & Dodge systems, using the screens that you've built.

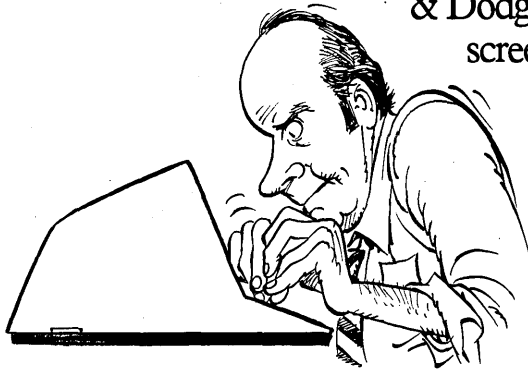
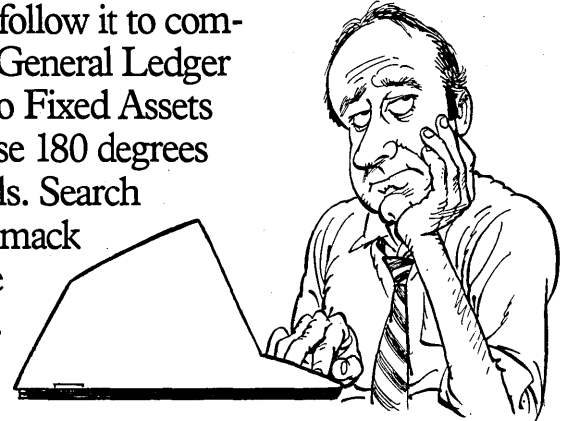

8:04 a.m. Let's look at salesmen's expense reports.

Remember overnight turnaround times? Remember inching your way through mountains of paper?

With HiLite, these are problems of the past. Because you can pursue your investigation with ease at your own desk, free of hassles, free of haggling for DP department time. You use a command process that's as natural as your normal thought process. You just fill in the blanks with friendly, English-like instructions, and your answer pops up on the tube. You even get on-line instructions if you hit a snag, simply by pressing a button.

8:06 a.m. \$1,000 for prime rib?

HiLite infinitely expands the dimensions—and the value—of all McCormack & Dodge systems. It's one more example of an idea other software companies are only talking about, but we're releasing as a finished product. One more example of tomorrow's software today.

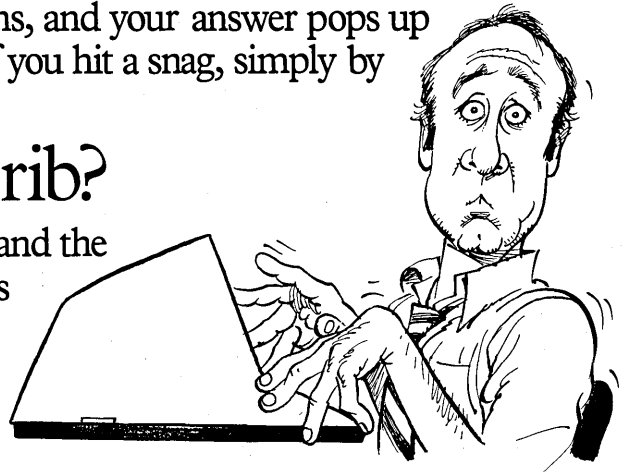

McCormack & Dodge (800) 343-0325

 General Ledger, Personnel/Payroll, Accounts Payable, Purchase Order Management, Fixed Asset Accounting, Capital Project Analysis. McCormack & Dodge Corporation, 560 Hillside Avenue, Needham Heights, MA 02194. Sales and support offices throughout North and South America, Europe, Asia, Australia and South Africa.

CIRCLE 26 ON READER CARD

Here's Why Precision Visuals Is Now The Leader In Graphics Software Tools!

One Program Drives Many Devices

This single advantage can save you hundreds of hours of programming time. It enables you to use your hardware (both host computer and graphics devices) to its fullest. It protects your software investment against obsolescence and frees you from exclusive ties to hardware vendors.

Precision Visuals currently offers tailored interfaces for over 30 graphics devices from these companies: AED Applicon Calcomp Calcomp lookalikes Chromatics DEC Digital Engineering HP Houston Instruments IBM Imlac III KMW Megatek Printronix Ramtek Raster Technologies Sanders Selanar Servogor Tektronix Tektronix lookalikes TI Trilog Versatec Visual Technology Zeta.

They Run On Most Popular Computers

Including IBM, VAX, PR1ME, Hewlett-Packard, CDC, Honeywell, Data General, DEC 10/20, Harris, Univac, Cray, and DEC PDP-11.

Precision Visuals software tools require a surprisingly small amount of computer resources. Even on smaller machines they provide access to the full capabilities of the CORE graphics standard.

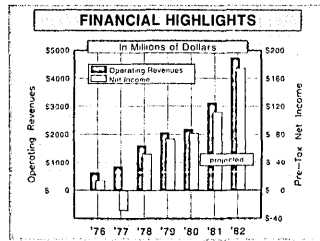

Make better decisions, faster, using GRAFMAKER's specially-placed annotation and color.

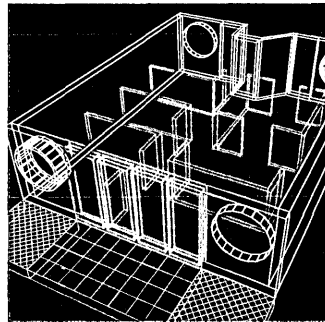

Build highly interactive computer-aided design applications with the DI-3000 core system.

Rich Capabilities Mean Limitless Applications

Precision Visuals software tools are proven in applications such as computer-aided design, business graphics, process control, mapping, geological data analysis, document layout, plus many specialized applications. System integrators (OEMs) use them as the graphics nucleus in turnkey systems and as the graphics component of database management and financial modeling systems.

\$12,000 For Our Most Popular System

DI-3000™, the core system, starts at \$8,000 and goes to \$12,000 for our most powerful and best-selling level. Add \$6,000 for GRAFMAKER™, the business presentation specialty system, and you'll have one of the most versatile graphics systems available at any price. Other popular options include the METAFILE SYSTEM for a device-independent

picture library, and our new CONTOURING SYSTEM for advanced surface graphics.

These are single-CPU, end-user, U.S. list prices. Multiple CPU and OEM discounts are also available.

Find out how Precision Visuals graphics software tools can open a new world of flexibility, economy, and standardization for your graphics applications. Call us at 303/530-9000.

"At Martin Marietta, DI-3000 serves as a common interface between our numerous graphics devices and software applications. We use DI-3000 for applications including structural analysis, business charts, graphs, animation, 3D modeling, and general-purpose graphics."

Karin Bruce
Senior Graphics Software Engineer
Martin Marietta Denver Aerospace

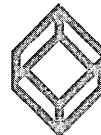

Precision Visuals

6260 Lookout Road
Boulder, Colorado 80301 USA
303/530-9000
TELEX 45-0364/TWX 910-940-2500

Amsterdam: Ponder Associates
Phone 030445352 / TELEX 70634
Sydney: Techway
Phone 02920858 / TELEX 27987
Tokyo: Nichimen Company Ltd.
Phone 032775017 / TELEX 22329
Zurich: Computer Graphix AG
Phone 019323482 / TELEX 875447

CIRCLE 27 ON READER CARD

NEWS IN PERSPECTIVE

software, VM/XA—has not even been announced yet, because IBM is having trouble training enough field personnel to support the product.”

(It's worth noting, say insiders, that without VM/XA the user takes much longer to convert to XA. He can't test and debug his new XA programs in real-time while simultaneously running his existing production programs.)

Adds another source, “IBM is playing a game of catch-up in the VM area. Once the company realized that it needed a virtual machine approach, it hurriedly developed a piece of VM software at Poughkeepsie—known internally as the Tool (Jan. 1982, p. 50)—and used it to create MVS/XA.

“Now, a more embracing version of this software and microcode—VM/XA—must be given to IBM users so they can begin in earnest their migration to the new architecture. But IBM's support engineers are having trouble coming out from under the single-cpu operating systems of the past 20 years.”

Other sources suggest that IBM's attempts to create a new VM awareness internally have been hampered by defections.

The first of a new 4300 replacement system, known internally as the Glendale or GL series, is expected in the spring.

Says one, “Key VM developers have been leaving to capitalize on the software's new-found strategic value for customers.”

The consensus among analysts is that VM/XA has probably slipped a year and should be widely available in 1984. “At that point the migrations can get into full swing,” says Frederic G. Withington, a veteran IBM-watcher and a vice president at Arthur D. Little Inc., Cambridge, Mass. “By 1986 the bulk of production on large IBM systems will be running under MVS/XA.”

Just how many of the non-MVS customers will eventually begin the long trek to XA—IBM's “promised land”—is anybody's guess. Robert Fertig, president of Enterprise Information Systems, Greenwich, Conn., estimates that IBM could lure 60% to 70% of its medium/large base to XA, leaving the rest for pcms to pick over. But though he has recently completed a major study of the XA migration issues, he is the first to admit that this figure is probably arbitrary.

“All we know for sure is that those two main steps in the journey—first to 1.3, and second to the bimodal XA—could be two very expensive steps.” Fertig says his study of 1,000 of IBM's largest users showed that the conversion process can take anywhere from five months to two years, can tie up half a dozen people plus hardware for the whole time, and can cost from

For those who think Mohawk Data Sciences is another name for data entry...

Our name's been synonymous with key-to-storage data entry for 20 years. Ever since our first industry breakthrough.

But we haven't rested on laurels. We innovated the concept of distributed data processing with our *Series 21* product line. We made it reliable, flexible, expandable. In an industry where these features are often claimed but rarely found.

So take another look at MDS. Multi-divisional. Multi-national. A profitable company with multiple products for data processing. Word processing. Data communications. Electronic mail. Network management. And data entry.

For more information call one of our 300 sales and service offices worldwide, or our headquarters at 7 Century Drive, Parsippany, NJ 07054, (201) 540-9080.

Mohawk Data Sciences,
the company that makes
you think again.

MDS MOHAWK
DATA
SCIENCES

Building on the Theory of Productivity.

CIRCLE 28 ON READER CARD

think again.



Now put productivity and portability into your IBM application systems with the Tominy Solution

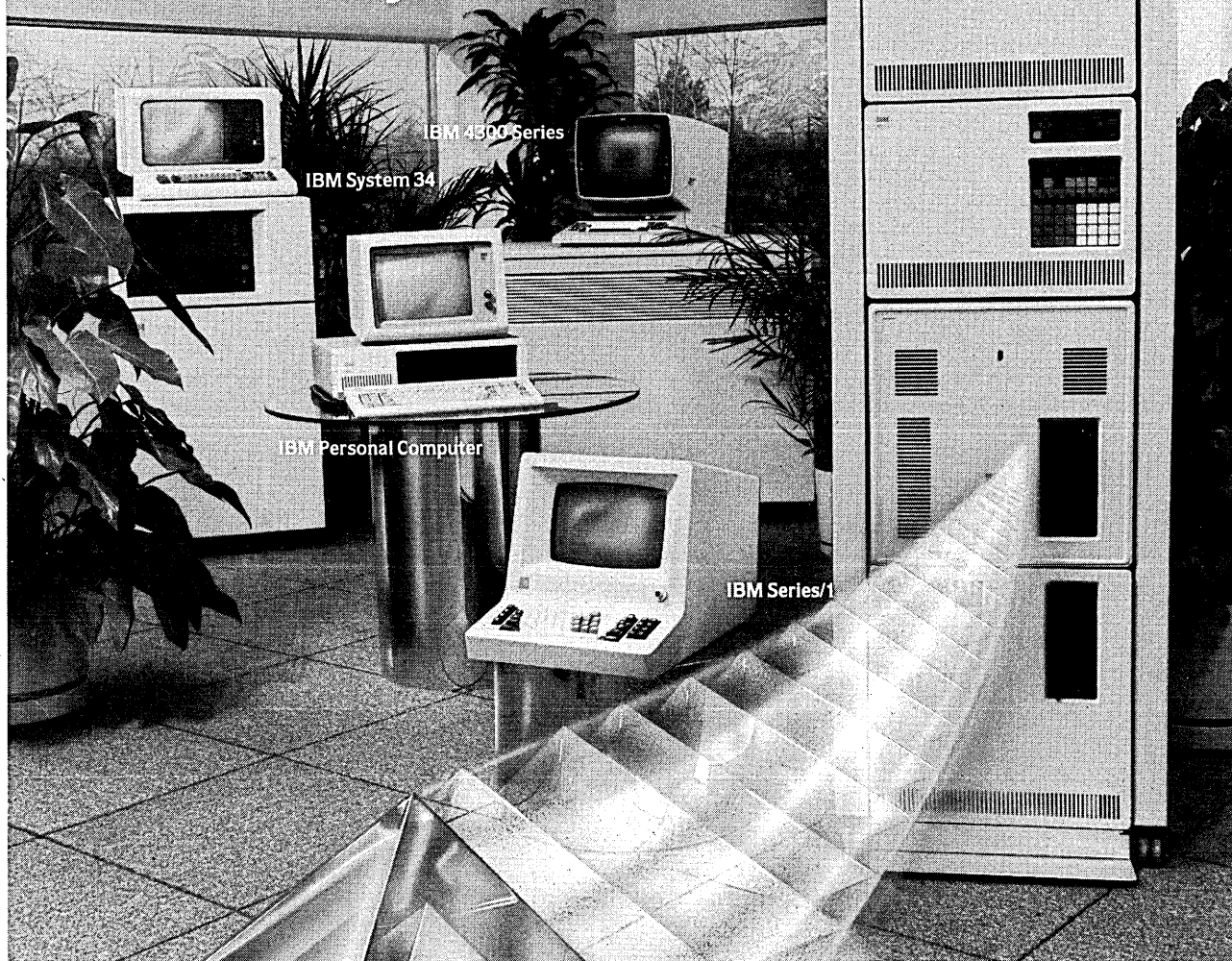

...it's called DATA BASE-PLUS.™

Now you can develop application systems faster and distribute them across the full IBM product line with Tominy's unique DATA BASE-PLUS application development system.

Plus, you can centralize control of your information resources while providing customized software and hardware solutions.

It's all yours with Tominy's DATA BASE-PLUS.

Productivity: you gain a full DBMS, application development tools, and a user-friendly Query facility... providing *faster* and *easier* maintenance of application systems.

Portability: original investments in application solutions are preserved. You now have the ability to move those applications *up or down* the IBM line.

As a Value-Added Remarketer of Series/1 for IBM (offering hardware as well as software and support services), Tominy can be your full service partner in meeting the challenges of managing information resources today... and tomorrow.

That's all part of the Tominy Solution. Learn how it can benefit you... just as it has worked for over 100 companies. Perhaps it's time to talk to Tominy to learn the address of the Tominy representative nearest to you.



4221 Malsbary Road, Building #1
Cincinnati, Ohio 45242 513-984-6605

CIRCLE 29 ON READER CARD

NEWS IN PERSPECTIVE

\$100,000 to \$1 million, "depending on what CICS or IMS level you start from."

An earlier estimate by TAG had put the cost of such "brute-force conversion" at around \$300,000 on average. "One alternative that has been tried," says TAG's Sullivan, "is for the customer to run his current operating system and MVS under IBM's VM/370 operating system and gradually cut over to MVS."

Sullivan adds that users attempting this approach complain that it is very costly in terms of cpu overhead and in the additional hardware/software resources required. It was this very problem that prompted IBM to try another approach for keeping its users on the migration track. The company came up with the more practical solution of an extended version of MVS (namely, MVS/XA) which incorporates, or soon will, a virtual machine capability within itself (i.e., VM/XA).

This approach is clearly more satisfactory to users, but many of them still balk at the price of the dedicated XA mainframes, the 308X models, which cost about \$1.5 million or more.

"I believe IBM will try to get around this problem by offering a new 4300 super-mini that is XA-compatible and costs well under \$1 million," stresses Fertig. He says IBM's 5,000 to 6,000 303X mainframe users are packed to capacity and are desperate for a new machine. "Right now there is a tremendous gap in IBM's product line between the top end of the 4300 family at 1.6

"Three years should be ample time for some pcms to respond with virtual machine software of their own."

MIPS and the bottom of the 308X series at some 4 MIPS. The 303X users are looking for something in the middle that isn't as expensive as the low-end 308X member [3083 model E] yet offers more power than the biggest 4300 [4341 Group 2 model 12]." That something, according to Fertig, is the first of a new 4300 replacement family, known internally as the Glendale or GL series. The machine uses a new and more powerful logic chip, developed by IBM, to achieve around 2.3 MIPS performance, sources believe. It could also be offered in a dyadic version at 4 MIPS.

Fertig points out that TCM (thermo-conduction module) packaging—the building-block logic of IBM's whole medium through large-scale families—was designed to last through this entire decade. "IBM will simply insert higher performance chips into the TCM package as the need arises," Fertig forecasts. Currently, IBM uses a TTL logic that has a density of 704 gates per chip. Sources claim that denser versions of 1,500 and 5,000 gates have been developed. It is believed that the 1,500-gate version has gone into the 4300 replacements (as well as

For those who think one DDP system can't do it all...

Placing limits on a distributed processing system is a contradiction in terms; DDP means expansion.

And expansion means MDS Series 21. You can start with a single-station system that supports numerous functions. Expand to 16 stations that handle 17 separate jobs concurrently. And use the same application programs on 16 stations that you used on your single-station system.

You can increase its memory to 512K bytes. Choose diskette and/or disk storage with up to 156 MB capacity. Add protocols that communicate in every network with every mainframe. And benefit from features like word processing. Electronic mail. ISAM file management. COBOL. And our own language, MOBOL.

For more information, call one of our 300 sales and service offices worldwide, or our headquarters at 7 Century Drive, Parsippany, NJ 07054, (201) 540-9080.

MDS Series 21. The DDP system for those who think big.

MDS MOHAWK
DATA
SCIENCES

Building on the Theory of Productivity.

think again.



MDS and Series 21
Reg. U.S. Pat & TM Office.

CIRCLE 30 ON READER CARD

Listen to the power of an office information system that links managers to the mainframe.

Sperry Univac is a division
and registered trademark of Sperry Corporation.

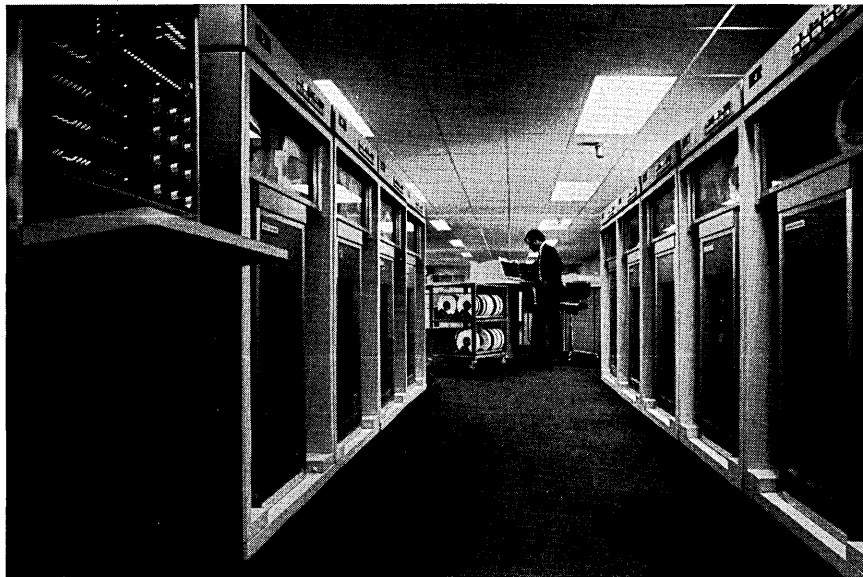

See the SPERRYLINK
System in action at the Office
Automation Conference,
Booth 828.

SPERRY UNIVAC

We understand how important it is to listen.

Introducing the SPERRYLINK™
System.

The SPERRYLINK System does everything you'd expect of an office information system, and more.

The SPERRYLINK System gives management access to the mainframe data base. Direct access and without the need for data processing training.

Which puts the DP function in the center of things. Because management, from the CEO on down, can now appreciate by direct hands-on experience the tremendous power of the mainframe.

Now top management can be plugged into the DP network, right at their desks. They can handle many of the more routine assignments that the DP department is so often asked to shoehorn into the non-existent spaces

in the workday.

The DP workload gets lightened as a by-product. That logjam of unfilled user requests becomes unstuck and time becomes available to tackle the really challenging jobs.

The data processing function begins to mean much more in the overall operations of the organization, because there's a direct link between the power of information and the people with the power to use it.

The desk stations are user-friendly. In half an hour, a non-DP user can master the basic tasks. In half a morning, become proficient.

The SPERRYLINK System is designed to be whatever it needs to be. It can work in a stand-alone mode. Or as a distributed office system. Or as a total interoffice system, with

secured access to the mainframe. It can even incorporate an interface to communicate with proprietary public data bases, local or remote.

And it's here now. The SPERRYLINK System. The office information system designed by some people who listened — and heard the message of unrealized opportunities.

Those opportunities are now at hand. Talk to us. Call toll-free, 800-523-2496; in PA call collect 215-646-3378 (9 a.m. to 5 p.m.). Or write Sperry Univac, Department 100, P.O. Box 500, Blue Bell, PA 19424.

We'll be listening.

SPERRYLINK™
OFFICE SYSTEM

CIRCLE 31 ON READER CARD

NEWS IN PERSPECTIVE

into the next System/38 model), and that the 5,000 gate logic will be used to build a new line on top of the 308X family.

Fertig says he expects the new 4300 replacement in the spring. "It could be called the 4351, or given a whole new set of numbers to match its GL 1 status. The important thing to remember, in my opinion, is that the machine will be XA-compatible and will be offered as a migration aid to 303X users."

Morgan Stanley's Weil, though agreeing that the machine has been slated for spring announcement and eventual XA-compatibility, thinks IBM may hold back on both for a while. "The supermini is too close in price/performance to the \$1.5 million 3083 model E that IBM has just started to ship. The company might prefer to get a full year of revenue in from the model E before making the 4300 successor available."

Weil adds that there is still some debate within IBM about whether to bring the model E down to 4300 levels. "They'll probably do both," he guesses. "They could also get clever and make the new 4300 replacement available this year—but without immediate XA compatibility."

Steve Ippolito, president of the IBM medium systems pcm challenger, IPL Systems, Waltham, Mass., does not expect the 4300 replacement to be shipped until next year, but predicts it will offer XA compatibility. "It's my bet that you won't be able to upgrade the existing 4300s to the new family. I believe IBM has retooled all four 4300 models to make a new XA bridging series."

Ippolito, whose company along with Mitsubishi is developing its own 2 MIPS through 20 MIPS line, adds, almost as a footnote: "Our response is prepared. The only question now is whether we ship before or after IBM."

It's clear from Ippolito and other pcms that the long-awaited migrations to XA will shortly begin. They believe IBM will attempt to speed up the process, aided not only by its new 4300 strategy but also by its nationwide Information Network service. The computer giant will encourage its users to develop new applications remotely using the bureau's virtual machine software. In addition, bits of XA will be broadcast by the bureau to those users who don't want the whole works.

Will XA's advent year spell the demise of the pcms? The answer would appear to be no—despite the heady euphoria that will probably surround the IBM announcement of XA benchmark data.

"IBM will do its best to move the migration process along, but essentially it's a lengthy business," says ADL's Withington. "Three years should be ample time for some pcms to respond with virtual machine software of their own. A couple of them should survive."

—Ralph Emmett

For those who think good service only comes in big blue packages...

MDS may not be as large as you-know-who, but we're equally committed to you-know-what. Service. Fact is, we feel so strongly about this aspect of our business that we formed an entire division to support it!

According to *Datapro*, *IDC* and our own service studies, we're the best... even better than the biggest. And we cost less too.

Of course, given the reliability we engineer into our *Series 21* products, our service isn't called on very often. But when it is, we respond. With over 1,600 people in 300 offices and hundreds of distributor facilities in 60 countries around the world. With a Service Call Management system using our own *Series 21* systems to remotely diagnose a need and keep track of response time, PM schedules, parts inventories and more.

For more information call one of our 300 sales and service offices worldwide, or our headquarters at 7 Century Drive, Parsippany, NJ 07054, (201) 540-9080.

MDS Service. For those who don't want to worry about it.

MDS MOHAWK
DATA
SCIENCES

Building on the Theory of Productivity.
CIRCLE 32 ON READER CARD

think again.



MDS and *Series 21*
Reg. U.S. Pat & TM Office.

NEWS IN PERSPECTIVE

SERVICES

GEISCO GOES FOR THE GUSTO

The name of the game in the information services business is change, constant change.

The micro has done its thing to the information services business the same way it has to the rest of the planet. And no one knows that better than the General Electric Information Services Co. (GEISCO), the prize offspring of GE.

"The micro has had an enormous effect on us," admits Arthur Marks, GEISCO's senior vice president for programs management operations. "It has completely changed the application situation. In 1967, say, one of the chief applications we had was problem-solving. The client couldn't afford to have a computer on his desk because it cost too much. So he used timesharing. He hooked up through the telephone with GEISCO. If he did a financial planning model once a month, it was worth it to him, even if it cost \$6,000.

GUINEA PIG?

With some 30 Honeywell mainframes up for replacement in a year or so, General Electric Information Services Co. has gone on an unusual shopping trip. The company recently ordered an Acos 1000 mainframe from Nippon Electric Corp. (NEC).

GEISCO expects delivery of the Japanese system this month and will begin a year-long benchmark of that system against Honeywell's best, the DPS-88/81, which is to be delivered in the second quarter, according to Robert Hench, GEISCO's vice president of engineering. "We want to test each machine for its potential throughput in our network," Hench says. "The best way to do that is have them side by side."

The Acos system is not perfectly compatible with Honeywell's systems, particularly in the areas of architecture and I/O schemes, according to Hench, but there is enough compatibility at the source code level to make the test appropriate. He adds that some "major changes" will have to be made to GEISCO's proprietary Mark III Foreground operating system to make it operable on the Japanese hardware.

In any case, the delivery of an NEC machine to GEISCO's Rockville, Md., data center will mark the first time the Japanese company has shipped a large-scale mainframe to the U.S. NEC was licensed to build Honeywell machines as far back as the early 1960s and was understood to have taken

"Now, because of the invention of the micro, he can buy a PC for six grand. As long as there's somebody in his organization who can use it and there's a piece of adequate software available, he can run it for a few hundred a month. So that application goes away. That obviously affects a segment of my business. But the micro also allows me to have a much more cost-effective system. It increases the capabilities and reduces the cost of the applications."

Change. It's been a way of life for GEISCO. Quite obviously, though, the company has made many good choices along the way. It has been growing at an annual rate of over 25% almost since its inception. The company, a wholly owned subsidiary of General Electric, produced about half a billion dollars in sales in 1981 and expected to do at least \$700 million in 1982. That's not all, folks. GEISCO should hit the \$1 billion mark next year and, if it doesn't miss its target, should contribute \$1.5 billion to GE's treasury in 1986.

"The 25% growth is nothing new," says Marks. "It's when you start getting into the higher numbers that you get recognized. If you go from \$20 million to \$25 million no one notices. But when you go from \$400 million to \$500 million it's a big deal."

GEISCO has become the biggest deal in the computer services game. Several other aces in the 2,200-player deck are Control

some Honeywell-originated technology, in hardware and software, beyond Honeywell itself. The technology exchange agreements between the two firms expired last year.

Hench says GEISCO has made several visits to NEC offices in Japan in preparation for the benchmarking, but the firm decided it would be best to test the Acos 1000 machine in Rockville rather than at a distance. Pricing details for the NEC machine have not been worked out, particularly because if it is chosen over Honeywell's offering, a large quantity order would be made with ensuing volume discounts. "It's most likely that we would want to run all our Mark III Foreground systems on the same hardware," states Hench. "It would cut down an awful lot on maintenance."

The Acos 1000 was introduced in 1981 and is claimed to run at 15 MIPS in a single-processor version and 29 MIPS in a dual configuration. Honeywell has not released MIPS figures for its DPS-88/81, but that machine is understood to run slightly slower than NEC's, primarily because of architectural differences.

NEC's forays into the U.S. computer market have been limited until now to the Astra line of small business computers, a number of peripheral lines, and some smaller components.

J.W.V.

CALL YOUR LOCAL DYSAN OFFICE

- CA: Los Angeles
(213) 907-1803
Orange County
(714) 851-9462
Sacramento
(916) 966-8037
San Francisco/Sunnyvale
(408) 727-9552
- DC: Washington
(703) 356-6441
- GA: Atlanta
*(404) 952-0919
- IL: Chicago
(312) 882-8176
(800) 323-5609
- MA: Boston
(617) 273-5955
*(617) 229-2800
- MI: Detroit
(313) 525-8240
- MN: Minneapolis
*(612) 814-7199
- MO: St. Louis
(314) 434-4011
- NY: New York
(212) 687-7122
- OH: Cleveland
(216) 333-3725
- PA: Pittsburgh
(412) 261-0406
Philadelphia
(609) 939-4762
- TX: Dallas/Ft. Worth
*(817) 261-5312
- WA: Seattle
(206) 455-4725

*Includes OEM Sales

Dysan Diskettes are also available from all ComputerLand Stores, Sears Business Systems Centers, and many independent computer outlets nationwide.

For the location of the Dysan sales outlet nearest you, contact Dysan at: (408) 988-3472

Toll Free: (800) 538-8133
Telex: 171551 DYSAN SNTA
TWX: 910-338-2144

 **Dysan**
CORPORATION®

CIRCLE 33 ON READER CARD

WHAT IS THE TRUE COST OF A DISKETTE?

If you said at least \$186.50*, you're probably close.

Confused? It's simple. The minimum cost of a one-sided, single density 8" diskette equals the purchase price plus the cost of the time to fully load the data onto the disc*. The adjacent diagram tells the story. As you can see, the purchase price of a diskette is a small fraction of the total cost of ownership. So why not pay a few cents more for the best diskette available?

That's where Dysan's quality comes in. Dysan diskettes and mini-diskettes are manufactured to the toughest quality standards in the industry. Every diskette is tested between the tracks as well as on the tracks to insure you 100% error-free recording over the entire disc surface. Dysan quality protects your investment of \$186.50.

You know how costly time and data losses can be should your "bargain" diskette be faulty. Every penny you think you save on the purchase of magnetic media could cost you dearly. Why take the risk when you can have Dysan?



dy Jan **Dysan**
CORPORATION

Our Media Is Our Message

5201 Patrick Henry Drive
Santa Clara, CA 95050

*\$4 represents Dysan's suggested retail price for a one-sided, single density 8" diskette, packaged ten to a box. Minimum total cost of ownership = \$186.50

*\$182.50 represents the cost of data loading (approximately 22 hours at 11,106 keystrokes/hour at a labor cost of \$8.23/hour), based on 1981 Data Entry Management Association (DEMA) National Averages.





Digital's portable terminal. The only thing plain about it is the paper it prints on.

Introducing the Correspondent. The plain paper portable.

Now there's a portable DECwriter terminal from Digital that doesn't depend on thermal paper to do business.

Virtually any paper will do, so the Correspondent is always ready to go.

Plain paper is inexpensive, available everywhere, usable for multipart forms, and won't fade.

But there's nothing else plain about the Correspondent.

You can't buy a faster portable. It can translate standard-size computer text and graphics onto ordinary 8½" x 11" paper, all in clear, crisp dot-matrix printing. And do it in any of 10 languages.

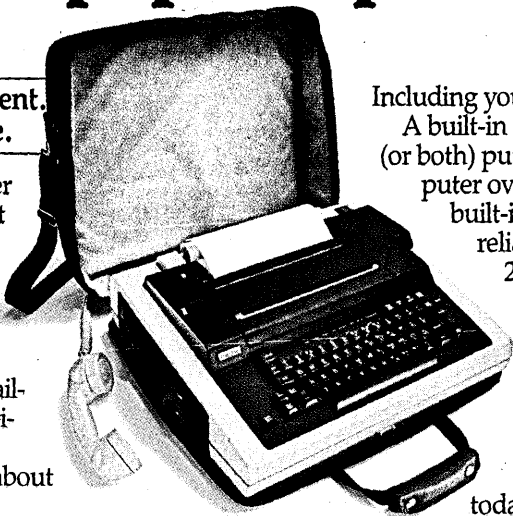

Including yours.

A built-in acoustic coupler or modem (or both) puts you in touch with your computer over any telephone line. Another built-in: the Digital reputation for reliability and service, backed by 200 carry-in service centers worldwide.

Is the Correspondent the best portable you can buy? That should be plain.

As plain as the paper it prints on.

See your Digital distributor today or call 1-800-DIGITAL, extension 700. In Canada, call 1-800-267-5250. Or write **Digital Equipment Corporation**, Terminals Product Group, 2 Mt. Royal Avenue, UP1-5, Marlboro, MA 01752.

digital

NEWS IN PERSPECTIVE

Data Corp., Computer Sciences Corp., Cullinet Software (formerly Cullinane Database Systems), Xerox, Tymshare, Automatic Data Processing, and National Data Corp.

"All the businesses overlap but everybody doesn't have the same lines of business," explains Warren Burton, Tymshare's vice president of industry and government relations. "There are enough niches for each company. Nobody has the kind of percentage in the information services business that IBM has in hardware."

No one expected a percentage of anything in information services 20 years ago. There was no such animal. The concept did not exist until 1964. Computer history connoisseurs will immediately recognize that landmark date for the invention of timesharing by Dartmouth College and—

you guessed it—General Electric. Having developed such a novel idea, GE, like any good capitalist, moved immediately to exploit it for the good of its shareholders. Thus GEISCO came into the world.

The event passed almost unnoticed. The first customers used timesharing to access GEISCO's computers so they could solve complex mathematical problems. GEISCO president and chairman of the board

In its early days, GEISCO was "little more than a very large, very fast electronic slide rule."

Gregory Liemandt described the early version of the company as "little more than a very large, very fast electronic slide rule."

GEISCO is no longer merely fast. It's instantaneous. It's no longer just large. We're talking mammoth here. GEISCO has the world's largest commercially available teleprocessing network. The Mark III, as its friends call it, has nearly 500 communications and processing computers, including 44 large-scale IBM and Honeywell mainframes. And the company is currently evaluating Honeywell-compatible computers from Nippon Electric Co. (NEC), a move that could bring another mainframe vendor into the GEISCO camp (see accompanying sidebar).

Mark III is available by local telephone in more than 700 cities in 25 countries and 23 time zones. The computers, located in three supercenters in Rockville, Md. (the company's home base), Cleveland, and Amsterdam, are on the job 24 hours a day, seven days a week, 365 days a year. The network has more than 6,000 customers worldwide.

And like GEISCO itself, the company's Marklink intelligent terminal ain't what it used to be. Back in the dark ages of 1970, 85% of GEISCO's revenue came from commodity services, or raw computer power. In 1981 less than 30% of total revenue derived from commodity services. More

than 70% came from value-added services. By 1985 value-added services are expected to account for 90% of total revenue. As the demands of its customers change, so must GEISCO.

"Every time there's a big change in one of the industries we serve, people are running to be competitive with each other," Marks says. "It means new systems and new types of data. How do we take advantage of that opportunity? What kind of software do we build? What kind of services can we offer so a guy says, 'Hey, I'm in trouble and I don't have the time to build

my own system. Who understands my problem? Who can help me?' Well, we can help him."

Many of the nation's high and mighty must agree. GEISCO serves about three fourths of the Fortune 500. The company will do its damndest to increase that percentage.

"One of the advantages we have by being on the services end is that we're not tied to any particular technology," Marks says. "So we can migrate to whatever one is appropriate."

The most recent migration deemed

Your Guide Through Data Base: The New Era

with

ROBERT H. HOLLAND

One of the industry's leading authorities in the design and implementation of data base technology

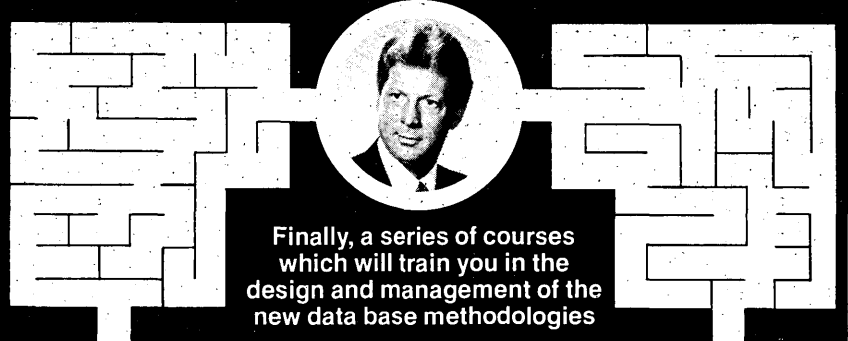

Finally, a series of courses which will train you in the design and management of the new data base methodologies

DATA BASE: A MANAGER'S GUIDE

- Company Integration of Technology
- Managing Technology
- Strategic Systems Planning
- Developing the Strategic Data Model
- Defining Subject Data Bases
- Developing the Data Architecture
- Implementing Data Dictionary
- Managing Data Base Design
- Automating the Design Process
- Information Resource Management
- Information Center Operation
- Data Administration
- Data Base Management
- Future of Data Base and more

Two distinct seminars
A 3-day seminar

DATA BASE: A Manager's Guide

March 21-23 New York
April 18-20 San Francisco

A 4-day seminar

DATA BASE: A Builder's Guide

May 9-12 Washington, D.C.

Call (213) 394-8305

Please send me information on:

- Data Base: A Manager's Guide
 Data Base: A Builder's Guide DM 2-83

NAME _____

COMPANY NAME _____

ADDRESS _____

CITY/STATE/ZIP _____

TELEPHONE _____

**TECHNOLOGY
TRANSFER
INSTITUTE**
741 10th ST. SANTA MONICA, CA 90402, (213) 394-8305

DATA BASE: A BUILDER'S GUIDE

co-offered with
RICHARD J. COLE

- Data Base Design Overview
- Data Requirements Analysis
- Normalizing Data
- Logical Data Base Design
- Stability Analysis
- Reconciling Designs to the Strategic Plan
- Physical Data Base Design
- Hierarchic, Network, and Relational Designing and more
- Performance Analysis
- Data Dictionary Implementation
- Designing the Data Dictionary
- Changing the System Life Cycle
- Responsibility for Systems and Data Analysis
- Distributing Data Bases

CIRCLE 35 ON READER CARD

FEBRUARY 1983 55

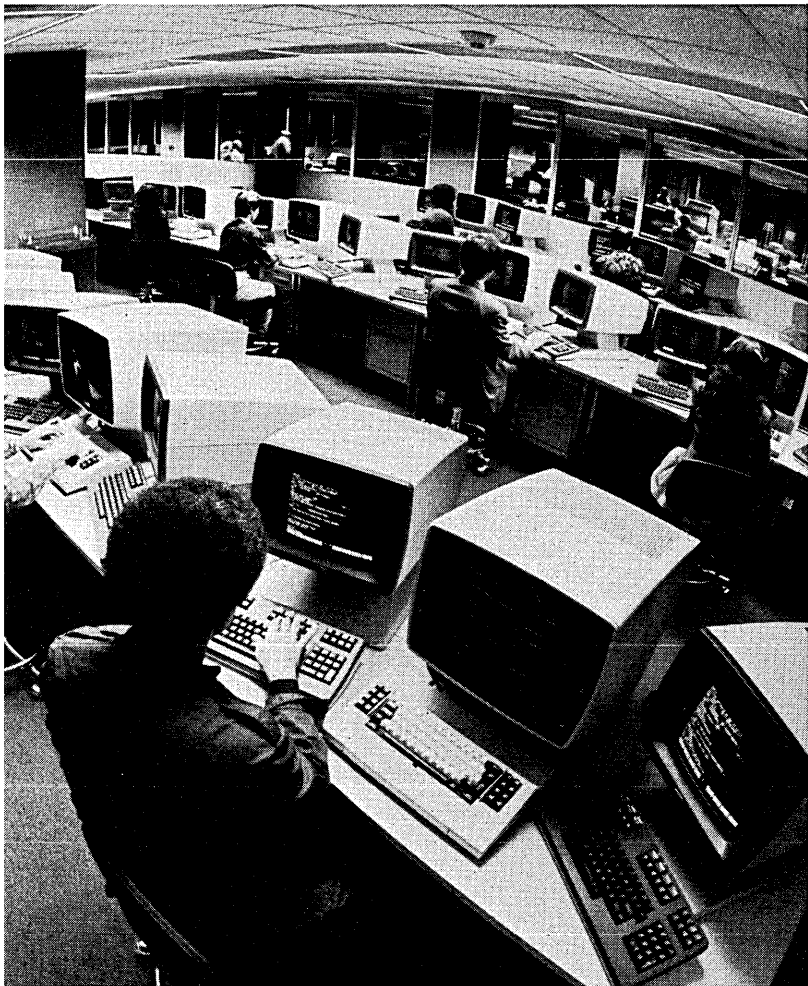

**You have the
information.**

**We have the
way to move it.**

It's extraordinary how far American business has gone in managing information in the office.

And how frustrating it can be to get that information where it's needed, once it leaves the office.

It seems clear that something must be done to bring the movement of information outside the office to the same sophisticated level as inside the office.

Our Communications Spectrum

Improving the movement of this information is precisely what we at ITT Worldcom are doing now with our Spectrum of Communications Services.

Our Spectrum is a new range of worldwide information movement services created specifically to bring together the latest advances in data and record communications.

For example, now your computers and terminals can talk to other incompatible terminals, anywhere in the world. Even those on other networks.

You can even deliver the same information to an unlimited number of terminals, automatically.

And we're continually adding new features with an eye to satisfying your future requirements.

Now throughout the U.S.

Best of all, our Spectrum was created with the same expertise and quality we're known for around the world.

The way we look at it, whatever other productivity problems American business has, it's producing more and more information.

And getting that information where it's needed speedily, reliably, efficiently and economically—that's what ITT Worldcom is all about.

I'd like more information. My area of particular interest is in:

- Communications within the U.S.
 International Communications.

Name _____

Title _____

Company _____

Address _____

City _____ State _____ Zip _____

Marketing Department (A/PR) **D283**

ITT World Communications Inc.

67 Broad Street

New York, New York

10004

ITT

ITT World Communications Inc.

CIRCLE 36 ON READER CARD

NEWS IN PERSPECTIVE

"appropriate" was the move to the micro.

GEISCO recently took a \$10 million trip to IBM territory to purchase Big Blue Personal Computers. The P.C.s will be made available to GEISCO clients as part of the company's integrated applications program. GEISCO will be responsible for total applications support, including hardware maintenance, on the P.C.

"I'm not out there to move IBM hardware," Marks says. "You can buy a P.C. from me. I don't care if you do buy it from me, but I'll offer it as a service so you can have everything you need. I have to recognize they'll be the market leader in micros, so I want to go with the technology that's most familiar and appropriate to my customers."

While it comes as no shock, Big Blue will not have GEISCO to itself. The GE subsidiary will provide network access to its clients who have other micros. The Apple II Plus and the TRS-80 model II have already passed muster. There will be plenty more on what promises to be a lengthy list.

The applications themselves are also changing. For most of its life GEISCO was a custom software house. You'd call and tell them what you wanted; they'd build it and deliver it. Those days are going fast. Packaged software is now in. Customized software is almost out. Marks admits there is "an order of magnitude" difference in the cost of buying a package and building your own. GEISCO currently derives 10% of its business from software. That figure will triple in five years.

GEISCO isn't waiting. Since January 1981, the company has acquired five software companies, with an eye toward cornering the banking, energy, and manufacturing industries. Software International is a leading producer of packaged software for accounting, financial, and manufacturing. It boasts about a 15% share of the packaged software market for accounting. Energy Enterprises provides on-line monitoring and evaluation systems for about 250 gas



ARTHUR MARKS: "The micro has had an enormous effect on us."

and oil industry customers. Banking Systems supplies software for automated and manned teller activities, bill payment transactions, and data entry functions. LTI Consulting Services, formerly Lambda Technology, specializes in the design and implementation of software for large in-house mainframe and mini systems. Network Consultants does just what its name indicates.

"The only way we're going to get big in packaged software is through acquisition," Marks says. "We want to keep growing in that area. We will make more acquisitions."

"When you go to a customer, you don't know what's best for him—and he probably doesn't either. If I have to say the only solution I can offer is remote computing with custom-built software, I'm narrowing my market basket and telling him to pick a certain solution which might not be optimal for him. If I can broaden my offering to packaged software and other things, I can do a better job of serving his needs. If you do a better job of serving the customer's needs, you win."

GEISCO hasn't been losing many, nor does it expect to. A company does not

The James Martin Seminar

You are cordially invited to inquire about the computer industry's premier event of the year:

The James Martin Seminar

April 4-8 Vancouver
April 11-15 Boston

April 25-29 Chicago
May 2-6 Washington, D.C.

James Martin

R.S.V.P. (213) 394-8305

TECHNOLOGY
TRANSFER
INSTITUTE
741 10th ST. SANTA MONICA, CA 90402

NEWS IN PERSPECTIVE

triple its revenue by waving a magic wand. By 1986, the three supercenters will have expanded to five and the 5,000 employees will have doubled. All this will occur simultaneously with a new market that will severely test Darwin's legacy.

"My long-term competition is AT&T and IBM," Marks contends. "Those are the people I worry about and the people I think about when I'm deciding what strategy to use and what kind of capabilities we need.

"We've got advantages and disadvantages relative to them. We've been in longer. We're ahead in terms of business momentum. But IBM sure knows a lot about the hardware side and AT&T has a lot of communications expertise. We hope we've got the industrial expertise. Those guys are big enough and good enough so that if they want to do anything we can do, they can.

"Fortunately, I think their entry will only continue to expand the marketplace. It's big enough for three big guys to play in."

So far the trio is only playing around. Call it the preliminary skirmishing to what should be a healthy scrap. None has yet begun to fight.

"I don't know if this will happen in one particular industry," Marks says. "We've seen IBM move into insurance. It's interesting that if you look at it as a strategic game, they've built a position in insurance. So you've really got to think carefully about how you're going to play there. Maybe we've done the same in banking, and AT&T will pull it off in something else.

"Have I targeted industries where we should be going? Yes, but I'd rather not say what they are. That would give those two more information than I want to give them."

—Willie Schatz

other terms cropping up in the CPE vocabulary, practitioners are beginning to look beyond technology into management.

Kenneth W. Kolence, a founder and currently vice president of applied software engineering for Boole & Babbage Inc., Sunnyvale, Calif., talking about the technical processes and tools of the profession, notes that in the future, "the guiding force for development and use of these techniques will be the needs of the general management process rather than relatively narrow technical questions."

"We have come to a time when technology is being neutralized with respect to business judgments," said Philip J. Kiviat, vice president and director, Systems Product Division of CTEC Inc., McLean, Va. "That is, it is no longer mysterious and fearsome, or so glamorous that people and organizations feel they have to acquire it for its own sake."

"They really poured their hearts out, as though somebody finally cares."

Kiviat traces CPE from the '60s. Back then, he says, "people didn't call what they did CPE. They did computer performance measurement. They were concerned with measuring hardware performance, first with hardware monitors and later with software monitors."

In the early '70s, says Kiviat, "CPM became CPE, and we began to speak consistently of evaluation rather than measurement. What to measure and how to measure it was replaced by how to use and interpret measurements."

In the mid '70s, he says, "the spotlight refocused again, this time on computer performance management. Interest flowed naturally from looking at phenomena [measurement], to figuring out what they meant [analysis and evaluation], to controlling their effect [management]. Implicit in the idea of control, of course, was the understanding linkage between measurement results and performance criteria, which were expressed in terms such as service levels and response times. It was about this time that clear distinctions started to be made between managing service levels and managing resources, and terms such as capacity management and performance management became part of our working vocabulary."

Kiviat was keynote speaker at CMG XIII, the 13th international conference of the Computer Measurement Group held in December in San Diego. The conference itself was an indication of a profession at a crossroads, drawing a record 600 attendees who packed session rooms for three days. CMG was started in 1971 as a small Boole & Babbage user group (there were 17 attendees at the first conference). It became an independent organization in 1975 and since then has grown steadily. Fifteen ven-

dors participated in the December conference. One of these was Morino Associates Inc., Vienna, Va., which, among other things, was presenting preliminary results of a worldwide MVS Performance Management and Capacity Planning Survey it initiated in May 1982.

William L. Witzel, director, said his company undertook the survey because it perceived a need for a perspective and understanding of performance management (PM) and capacity planning (CP) in the MVS environment. "For years, we have been collecting PM and CP data on an informal basis. We have found that there is considerable confusion as to objectives, definitions, functions, techniques, cost effectiveness, staffing requirements, etc."

Morino contacted 530 MVS installations and by conference time had received 350 responses from 21 countries. He's hoping for 500 responses before release of final results toward the end of this quarter.

The questionnaires included space for comments, and, Witzel said, respondents "really poured their hearts out, as though somebody finally cares." Complaints, he said, included lack of industry standards, lack of a clear line between PM and CP, a proliferation of products that swamp the PM effort, abysmally low training, and lack of information on communications and on measures for communications data.

A big question in measurement in communications appears to be how much to do. The growth of data networks has created a parallel growth in the number and types of devices and systems that can be used to determine the nature and location of a problem so that corrective action can be taken. Today's network diagnostic equipment is so sophisticated and of such variety as to rival the networks they service.

"Total network performance measurement is possible; however, it does not appear to be cost justified today," said J.R. Leach, Consultant Management Systems, San Diego, at the CMG conference. Leach would prefer use of a subnetwork measurement tool. "Network performance does not tend to change rapidly. So, if a systematic approach is used to measure the network, each user will be sampled periodically."

In agreement is Bytex Corp., Framingham, Mass., which offers a system called Autoswitch for low-end network performance monitoring. Its system monitors both peak-hour and off-hour performance characteristics, using the resultant information to evaluate current operation and to aid in reallocating network resources for optimum network efficiency.

Says Kiviat, "Increasingly, CPE people are being asked to address the question: what is the best way to do a job, particularly with respect to issues such as centralized versus distributed data processing, or the application of microcomputers to

SOFTWARE

CPE MOVES TO THE TOP

Computer performance evaluators are coming to realize their province is expanding into the entirety of their companies.

Computer performance evaluation is expanding out of the computer room into the boardroom.

Whether they call themselves capacity managers, capacity planners, performance measurement engineers, performance managers, or any one of the many

Funny how computers grow on you.

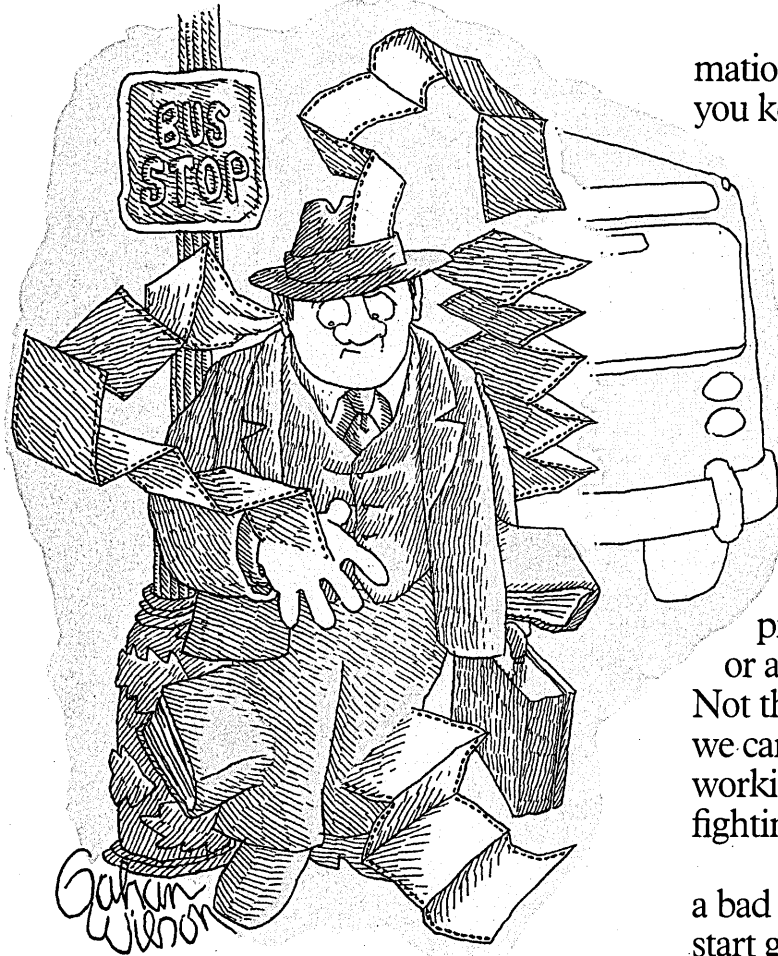

Oh, it all starts out innocently enough. A printout here. A reference manual there.

But before you know it, all those papers and books and program listings are sprouting up all over the place.

And if you haven't got a way to keep it all under control, well, you could have a real nightmare on your hands.

The fact is, without an efficient, well thought out approach to managing project materials at your workstation, you can easily waste up to 25% of your time just trying to keep all that information under control.

At Wright Line, that kind of mayhem is one thing we just don't want to see you cultivate.

So we offer an entire system of information media management products to help you keep things from getting out of hand.

In fact, nobody else can begin to approach our system for its flexibility or its ability to integrate so perfectly into any workstation environment.

Whether it's a conventional office or open plan furniture.

And because we know everybody works differently, our system is designed to be designed. To let you structure it precisely to your own work style or personal preference.

No matter what stage your projects are in — in-process, reference or archival — you get a system that fits you. Not the other way around. Which means we can actually help you spend more time working with your media. And less time fighting it.

So, if your workstation seems like a bad dream, let us know. Before things start getting under your skin. For more information contact Wright Line, 160 Gold Star Boulevard, Worcester, MA 01606.

Wright Line

A UNIT OF BARRY WRIGHT



NEWS IN PERSPECTIVE

new or existing applications. With an ever-expanding array of data processing and communications choices available to business, it is increasingly important for CPE organizations to recognize their charter to operate in this area and act on it. This most certainly demands the acquisition of new skills and capabilities and requires interaction with new people. We must learn about LANs, about microcomputers, about new technologies such as voice response and recognition, and, most of all, about applications themselves."

When it comes to distributed data processing, even vendors that offer systems supposedly capable of handling this, worry about performance.

A computer performance measurement vendor, Candle Corp., Los Angeles, has issued a newsletter on distributed processing problems with MVS. The company believes that IBM opened the door for large-scale ddp for production MVS environments with its introduction last September of MVS/OCCF and MVS/SP-JES2, but it sees problems that can be alleviated by performance measurement/evaluation tools.

What are the merits is a big question CPE practitioners are asking themselves and are anticipating being asked by end users of both the tools and applications.

"As more and more applications are directly marketed to end users," said Ki-

viat, "there will be a growing need for analyses of both the short-term merits of applications being sold and their implications over the long term, both in cost and capability. Flexibility, growth potential, interoperability, and maintainability are not considerations that users necessarily dwell upon, but will be more important in times to come as we move toward the automated office, automated factory, and automated work place. People costs and the availability of skilled people continue to dominate."

Price becomes an important factor when practitioners take techniques of performance measurement/evaluation from

When it comes to distributed processing, even vendors that offer systems supposedly capable of handling this, worry about performance.

mainframes down to minis and even to micros. Says Ivan Loffler of GTE Service Corp., Tampa, Fla., "There are some differences between planning for mainframes and planning for minicomputers, and the price tag for capacity planning is more visible on the minicomputer system than on a mainframe. It is more acceptable to spend \$25,000 in planning for a \$5 million system than to spend the same sum on a \$100,000 minicomputer."

Loffler believes capacity planning, to become a recognized discipline for minis, must start with big corporations that are using more and more of them. "Capacity planning for these systems must be disseminated for the data processing industry's benefit."

Involvement in total life cycles and predevelopment modeling is increasingly popular among CPE practitioners. "The life cycle concept, following a system from the cradle to the grave, is the only way to understand and control a system," said Frank Ingrassia of Anacomp Inc., Indianapolis.

Dr. Connie Smith of Duke University, Durham, N.C., believes considerations of performance analysts are the only way to go in development of a big software system.

"Performance analysts tend to get called in at the integration, testing, and maintenance stages," she said, adding that this is too late. "There is a recognized characteristic of data processing people—they are optimistic."

She would like to see before-implementation modeling. "Engineers do it; it's common in other fields."

Leilani E. Allen of the Institute for Software Engineering, Sunnyvale, Calif., said the big concern at her organization is getting workload estimates from users. She offers advice to CPE interviewers attempting

PopCom™

THE FRIENDLY COMMUNICATOR

© BRICKER ASSOCIATES 1982

Make the most of your hardware

SWITCH-IT

A Switch Box can add to the versatility of your equipment—permanent connections avoid the need to change cables manually to and from terminals, modems, CRT's, for example. A way to make CPU's or peripherals do extra duty. More than a dozen different kinds of ABC and ABCDE switch boxes, and Transfer Boxes in stock. Just for instance:

RS-232 ABC box \$99.50
RS-232 ABCDE box \$198.00

(Female connectors standard; male available on special order.)

Call or write for information and new catalog

dscc The Company with a lot of Connections
Data Set Cable Company, Inc.

East 722 Danbury Road Ridgefield, Connecticut 06877 (203) 438-9684 TWX-710-467-0668	West 3001 Contract Avenue Las Vegas, Nevada 89101 (702) 382-6777
---	--

The solution is now in hand.

- Simulate terminals, modems and CPU's
- Monitor data between DTE and DCE
- 1023 character Send and Receive buffers
 - 100 character User buffer
 - 25 character Trigger and Mask buffers
- All memory contents saved with power off
 - Buffer editing and search commands
 - Synchronous, asynchronous or HDLC
 - Full or half-duplex
 - Half-duplex "ping-pong" operation
 - BCC generation and checking
 - Stored FOX and user entered messages
 - ASCII, EBCDIC or HEX codes
 - Control character decoding
 - Operating parameters menu selected
 - Programmable send and receive triggers
 - Programmable word length, stop bits, and parity
 - 17 data rates from 50 to 19,200 bps
 - BERT/BLERT with 63, 511, 2047, and 4095 bit patterns
 - Bias distortion measurements
 - Pulse trapping and counting
 - RTS-CTS delay measurement
 - 16 character alphanumeric display
 - Full function Interface Test Set
 - Portable battery operation
 - Self-testing

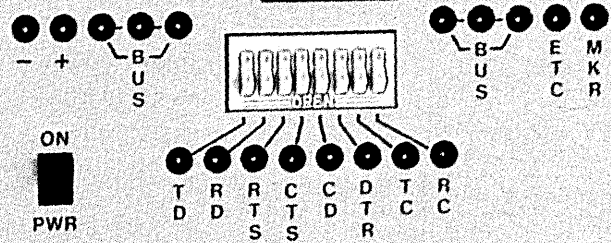
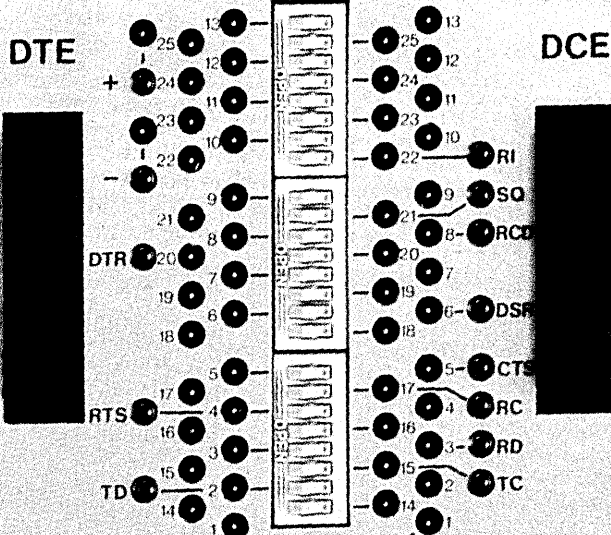

DATA COMMUNICATIONS TEST SET

CTS READY

ON	RUN	SYNC	FE	PE	TRIG
0 ERR	1 CLR	2 BRK	3 SEND	STRT	STOP
4 DISP	5	6 TRIG	7	←	→
8 SBUF	9 RBUF	A TBUF	B MBUF	ENTR	DELE
C FOX	D UBUF	E BCC	F SRCH	SET UP	DATA CTRL

Electrodata, Inc.

CTS-2

Electrodata, Inc.
 23020 Miles Road
 Bedford Heights, Ohio 44128
 (216) 663-3333 TWX: (810) 427-2280

CIRCLE 41 ON READER CARD

SHOWN ACTUAL SIZE

Tech control out of control?

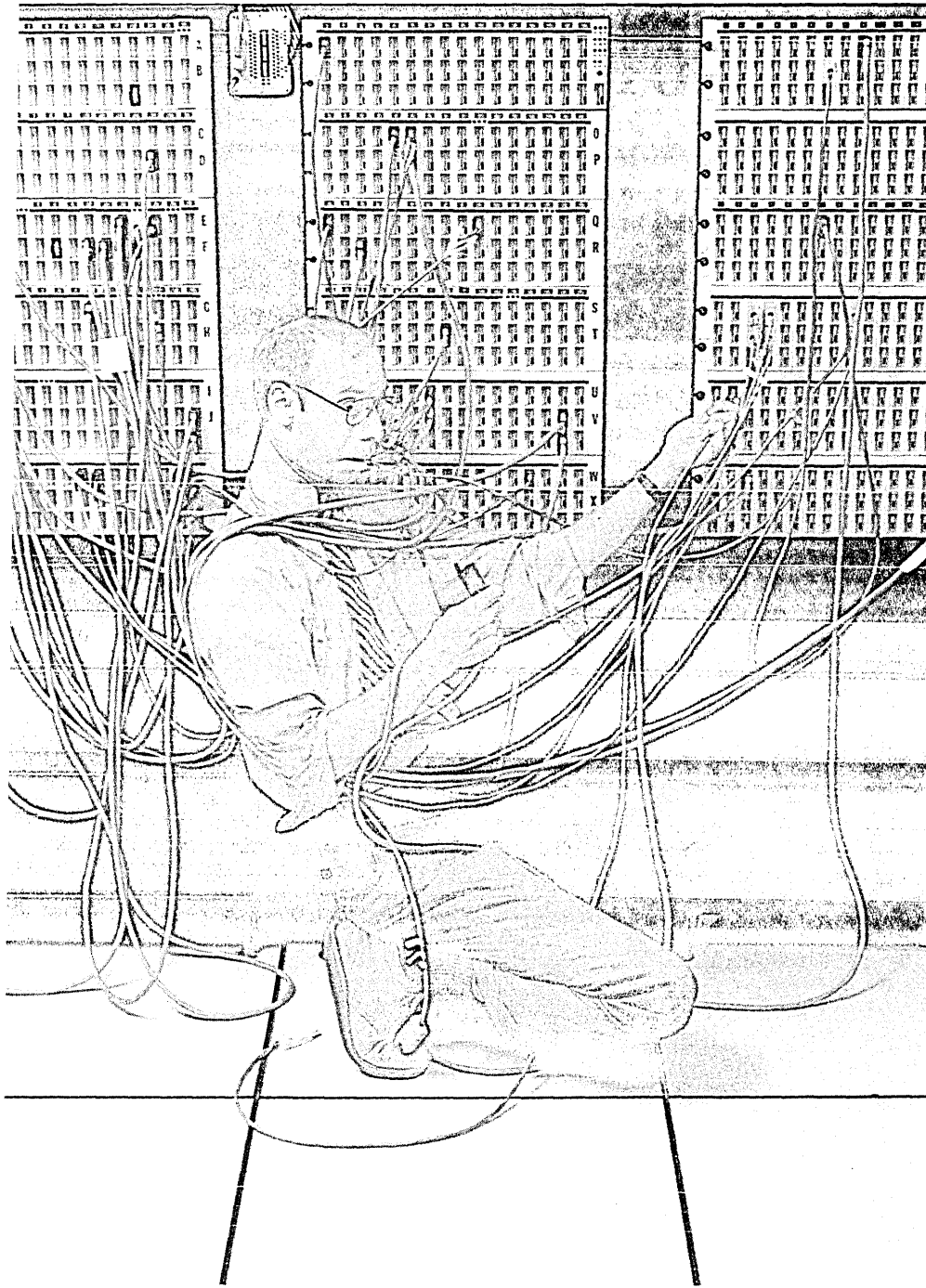

You need the AUTOSWITCH™ family of Electronic Matrix Switches from Bytex Corporation.

Whether your site requirements are small or large, few or many, digital or analog or both, Bytex has the AUTOSWITCH System to provide optimum Tech Control performance.

From a standard or optional color CRT console, take command of AUTOSWITCH through user-friendly software: Apply logical names to ports and groups, define and set alarms for EIA and analog signal levels, passively or actively tap into any set of channels with digital or analog test equipment, dynamically reconfigure (switch and patch), and retrieve comprehensive management reports.

Nodes may vary in size from 8 ports to almost 4000. Networked systems are fully supported.

To insure reliability, AUTOSWITCH systems feature redundancy of all critical components with automatic cutover to back-up subsystems.

So take control of Tech Control with AUTOSWITCH . . . The Automatic Choice.

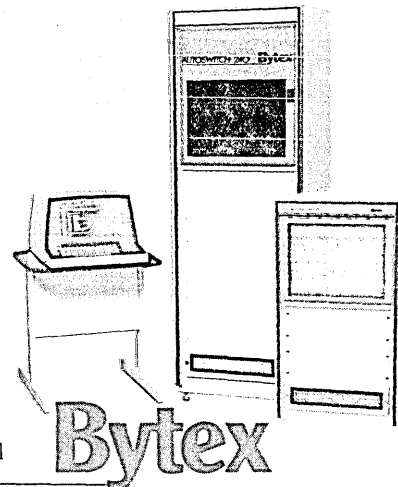

Please call or write Bytex Corporation
2 California Avenue, Framingham, MA 01701 (617) 879-5050 Telex 951151

Boston (617) 879-5050 New York (914) 368-0325 Philadelphia (215) 542-9876 Washington, D.C. (301) 656-4535
Atlanta (404) 237-9242 Cleveland (216) 835-8400 Chicago (312) 459-8866 St. Louis (816) 252-3700
Dallas (214) 494-4766 Phoenix (602) 263-6022 San Francisco (408) 744-1930 Los Angeles (213) 879-9045

CIRCLE 45 ON READER CARD

NEWS IN PERSPECTIVE

to get these data. "You're going to be talking to a bunch of turkeys just as often as to people who know what the hell they're doing . . . you're threatening, you can expose the incompetent . . . you can expose weaknesses in your own group."

She advocates: "Give them something, get something going with them beforehand. Interviews carry a promise of improvement. Get across the idea that capacity is not a data processing issue, it is an organizational issue."

What are dp users doing? Gordon R. Stauffer, Boeing Computer Services, Seattle, said his company developed a management system using commercially available software including the Statistical Analysis System (SAS), SAS/Graph, the MVS Integrated Control System (MICS), and the System Productivity Facility (SPF) Dialogue Manager, to address ad hoc critical requests one at a time.

"We believe the flexibility and capabilities have us postured just right for the increased complexity and new hardware, software, and networks that will be installed in our environment in the '80s."

Frank R. Petroski, U.S. Air Force Data Service Center, San Antonio, Texas, said that as his organization's performance

"You're going to be talking to a bunch of turkeys just as often as to people who know what the hell they're doing."

management program evolved, "it became apparent that performance management includes not only the operation of the systems themselves, but factors such as operator and systems programmer proficiency, the maintenance support from hardware vendors, responsive customer problem assistance, and our ability to keep management unmistakably informed on the performance of more than 10 separate computer systems running under five different operating systems.

"We have found that performance management at the AFDSC encompasses a wide range of activities, many of which are very repetitive and lend themselves to automation. Large payoffs in time and effort can be had by spending the effort to develop the kinds of tools that enable rapid response to any kind of problem or request for information."

At Fleet Information Inc., Providence, R.I., says Martin J. Michel, an advanced planning department has been put in place with a charter to assess technology trends, serve as a strategic checkpoint during business and systems planning, consult with applications and technical managers on the uses of new and/or appropriate technology, and ensure that systems evolution follows long-term corporate strategy.

At the Harper Group, San Francisco, Jim Smallman, director of information services, had problems with system down-

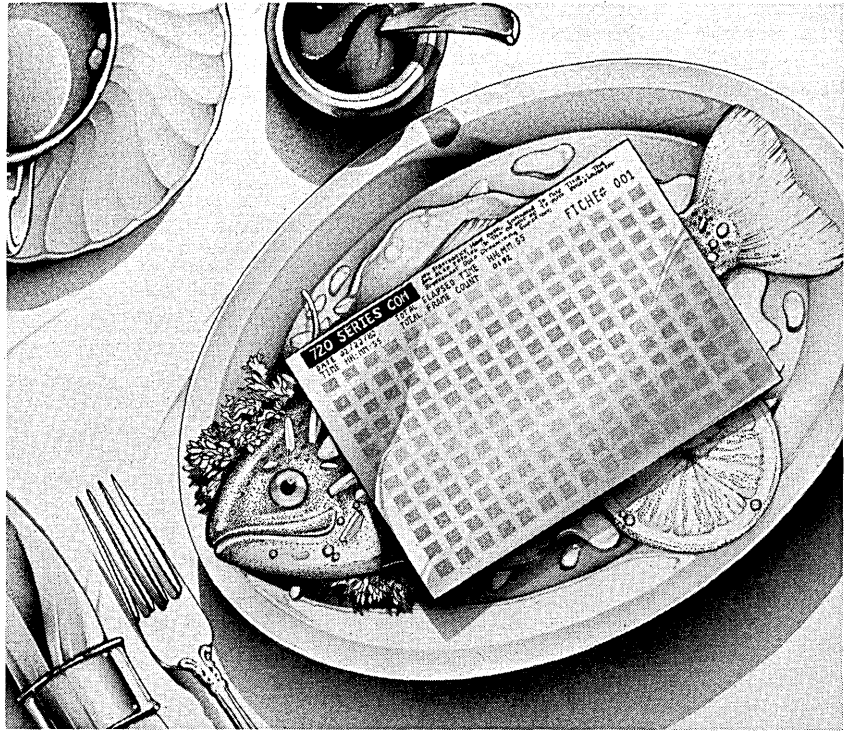

Now you can have fiche with everything on it.

Now virtually any computer-output application you use can be put onto microfiche.

With 3M's Series 720 COM Systems. Systems that will hook right up to your computer-output. Providing an easy-access data bank. One that's so versatile, it allows you to create any number of output formats. Including electronic forms creation, multi-character fonts and sizes, and numerous titling capabilities. As well as everything from production work to SYSOUT. Without the need for host computer data handling and reformatting.

Fact is, 3M's Series 720 has the highest degree of input and output flexibility and versatility of any cut-fiche COM system available today.

What's more, the Series 720 COM speeds turnaround time with dry silver cut and processed fiche. It even offers the option of roll/scroll type processing for high volume production applications.

So whether you need an on-line COM, an off-line COM, or one that's switchable, the 3M Series 720 COM Systems are the ones that will give you your fiche. With everything on them.

3M's Series 720 COM Systems are supported by a sales and service organization throughout the world. For more information, call toll-free: in the U.S., 800-323-1684 (in Minnesota 800-792-1642) and in Canada,

1-800-268-9055 (operator 13). Or complete this coupon and mail it to us.

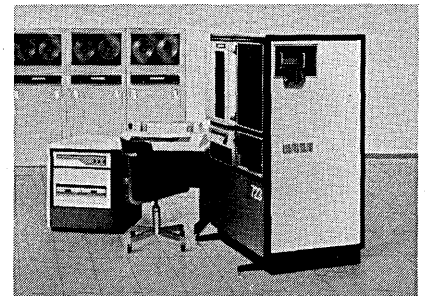

3M Series 720 works along with your computer.

I want to put everything on my fiche. Please send me more information on the 3M Series 720 COM Systems.

Name _____
 Title _____
 Company _____
 Phone () _____
 Address _____
 City _____
 State/Zip _____

Send to: 3M COM Systems, P.O. Box 33050, St. Paul, MN 55133 Attn: G. Collins

DTM 2/005

3M hears you...

3M

the cost effective DEC/IBM interconnect

COMBOARDTM

Your DEC computer has more cost-effective things to do than function as a processor for your IBM communications. Save valuable computing capacity by handling your interconnect workload with COMBOARD.

COMBOARD is a 16 bit CPU based single board computer that plugs into your DEC UNIBUSTM. Then the COMBOARD, not the DEC host, handles all the real-time interrupts and protocol processing associated with data communications.

To your operators, COMBOARD is a reliable package that maintains the current number of on-line users.

To your users, COMBOARD is a simple, efficient link to IBM or CDC systems for job and data transfer.

To your management, COMBOARD is a cost effective solution to a troublesome problem.

COMBOARD models 631, 731 and 1231 support transfer rates from 2400 to 56,000 bps, and are the leaders in DEC to IBM or CDC interconnects.

For more details dial

1-614-421-2094

SOFTWARE RESULTS CORPORATION

2887 Silver Drive
Columbus, Ohio 43211

COMBOARDTM Software Results Corporation
DEC UNIBUSTM Digital Equipment Corporation

See us at

INTERFACE '83

Booth 1508
March 21-24, 1983
Miami Convention Center

CIRCLE 47 ON READER CARD

NEWS IN PERSPECTIVE

time. "I'll draw an analogy from the medical profession to describe the situation we had. When the patient dies, you do an autopsy to determine what killed him. When our system went down, we would print the contents of memory and have someone analyze it to try to figure out what caused the system to die at that point." Smallman went to a Candle Corp. product, Omega-mon/CICS, a performance monitoring system that caught the problem while the system was running.

Dennis Ziolkowski of Mellon Bank, Pittsburgh, Pa., turned to TSO/MON by Morino Associates to get a user profile report that showed him where his system's glitches were occurring.

"In the coming years," says Kiviat, "as users bring applications of their own on-line more and more, lines will blur between data processing and user responsibility. The information system itself will diffuse throughout the corporation. Users will need help in selecting among competing applications offerings and in creating systems of applications from the parts they have bought and from what data processing already offers. Data processing people will be given corporatewide responsibility for standardizing such things as protocols, data definitions, and processor types. Given this shift, it will become more natural to ask, 'why are you doing this?' or to say, 'I can help you do this better.' This will not only be natural but imperative if the possible is to be kept from overwhelming the desirable."

—Edith Myers

MANUFACTURING

THE NEW CAD/CAE

**New entrants into the
computer aided engineering
field are concentrating on the
fast-growing electronics field.**

Driven by the inevitable fall in processor and memory prices, computer aided engineering and design system manufacturers are coming out with a new generation of equipment that promises to provide CAE and CAD to all but the smallest of manufacturing customers.

The microprocessor's plummeting price curve, combined with the know-how gained from higher-priced systems, is spawning a number of new companies that plan to automate as much of the engineering design cycle as possible. One of the most lucrative markets for such automation, in fact, appears to be none other than the electronics and computer industry. Interestingly, the microprocessor itself is helping engineers make better use of micros in new cir-

VISUAL brings ergonomic excellence and high resolution to low cost graphics terminals.

The VISUAL 500 and VISUAL 550 are ergonomically advanced terminals that emulate the Tektronix® 4010/4014 but cost only about half as much. And they have 768 x 585 resolution for sharp text and graphic display on a large 14" screen.

Ergonomic features include a light-weight plastic housing that can easily be swiveled and tilted for maximum operator comfort. A detached keyboard, sculptured keys and non-glare screen are only a few of the many other human engineering advantages characteristic of VISUAL terminals.

Both the VISUAL 500 and VISUAL 550 are compatible with standard software including PLOT 10,™ DISSPLA,™ TELL-A-GRAF,™ SAS/GRAPH, DI3000/GRAFMAKER, INFOgraf, SPSS,™ TEMPLATE,™ GSS-PLOT,™ and GSS-CORE.™

Advanced graphics features include: Resident Vector draw, point plot, circle and arc draw, rectangle draw, multiple linestyles and patterns with rectangle pattern fill. Raster scan technology provides fast data update and develops a bright display image. An Auxiliary Port supports printer/plotters and data tablets.

Powerful alphanumeric operation is also provided, displaying 80 characters by 33 lines with separate display memories for alpha and graphics modes. The VISUAL 500 provides selectable emulations of the DEC VT52,® Data General D200, Lear Siegler ADM-3A, and Hazeltine 1500 terminals. The VISUAL 550 is DEC VT-100 protocol-compatible as well as a character or block mode terminal which complies to the ANSI X3.64 standard.

Both U.L.-listed terminals exceed FCC Class A requirements and US Government standards for X-ray emissions.

Call or write for details.

Service available in principal cities through Sorbus Service Division of Management Assistance Inc.

See for yourself

Visual Technology Incorporated
540 Main Street, Tewksbury, MA 01876
Telephone (617) 851-5000. Telex 951-539

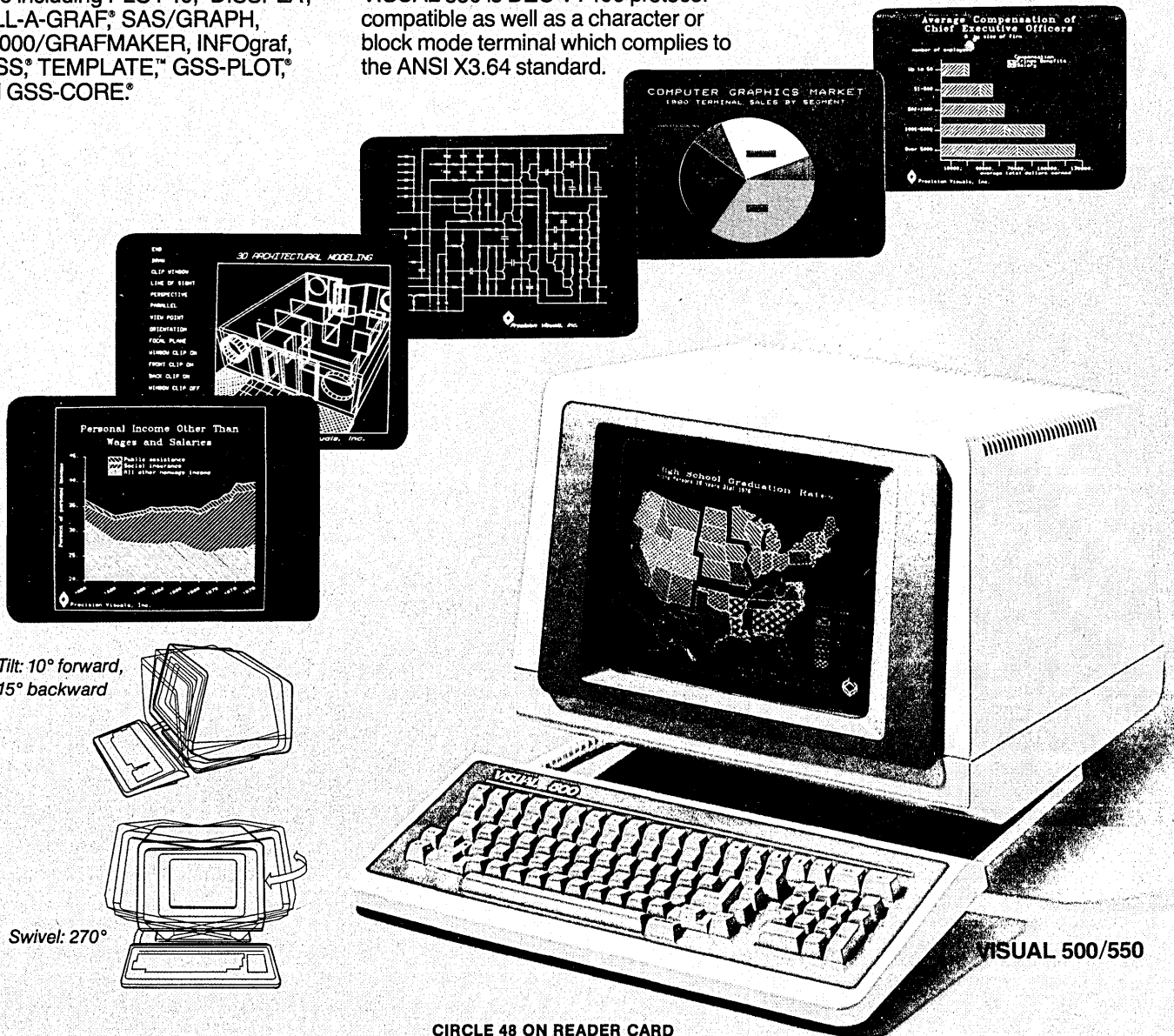

Tilt: 10° forward,
15° backward

Swivel: 270°

VISUAL 500/550

CIRCLE 48 ON READER CARD

INTRODUCING THE DATA CONNECTION™

The final link to complete computer graphics

DISSPLA® device independence 1969; design flexibility 1974; TELL-A-GRAF® ease of use 1978; graphic-artist quality 1980; CUECHART™ 1982.

Now, ISSCO-quality graphics enters the mainstream of data processing with THE DATA CONNECTION—a TELL-A-GRAF graphics-software link that provides both easy access to data and data manipulation for graphic presentation.

THE DATA CONNECTION and TELL-A-GRAF combine the industry's most advanced presentation-graphics software with direct paths to virtually all business and scientific data sources—for display in graphics format for fast understanding, better decision making, and maximum impact.

With THE DATA CONNECTION you can:

- Connect ISSCO graphics to all data, wherever it may be stored.
- Select appropriate data; exclude what is irrelevant.
- Extract data from both standard and non-standard files.
- Read tabular data from printer reports stored in any format.
- Accept data from application programs at data-generation time.
- Arrange data for maximum graphics impact.
- Organize, accumulate, summarize, tabulate.
- Perform mathematical analysis for decision support.
- Edit, store, retrieve and periodically update.

Shouldn't you have complete computer graphics? Call or write ISSCO—the industry leader in graphics software for more than a decade.



NEWS IN PERSPECTIVE

cuits and even design future microprocessors themselves.

Recent months have seen IBM introduce a new, relatively low-cost drafting system; Mentor Graphics Corp. of Portland, Ore., expand its product line with new CAE workstations; and Xerox enter the CAD market with its Star workstation, originally developed for office applications.

These events are unfolding before the general backdrop of a CAD/CAM industry that is currently pegged at more than a billion dollars and growing. Increasingly, a battle is shaping up between established vendors, such as IBM and Computervision, and a host of startups and new entrants into the engineering and factory automation field.

"We'll surely be seeing some lower-cost products coming this year," comments Jared Anderson, president and founder of Valid, Sunnyvale, Calif., maker of computer aided engineering systems.

The price per workstation equipped for computer aided engineering or design is expected to drop into the \$20,000 to \$30,000 range this year. Fueling much of that drop will be a significant price decrease in Apollo Computer's product line. The company was scheduled to introduce late last month the DN300, a workstation slated

The price per workstation equipped for computer aided engineering or design is expected to drop into the \$20,000 to \$30,000 range.

to sell in quantity for about \$10,000, according to a company spokesman. Apollo's Domain system had been the backbone of several startup CAE and CAD offerings. It is based on the Motorola 68000 microprocessor, a chip that performs 32-bit arithmetic and addressing.

The spokesman said the new system, which Apollo expects to have in customers' hands by the second quarter of the year, would be software-compatible with previous Apollo processors, all of which can be attached to the firm's proprietary local network. The new DN300 features one and a half megabytes of main memory, compared to the larger machine's three megabytes, and is monochromatic. "It's been redesigned for cost reduction, not for expandability," the spokesman said.

One of Apollo's oem customers that will benefit from the new system is Mentor Graphics, a company started by former Tektronix and Intel engineers to sell CAE systems to the electronics industry. The company recently expanded its line of Idea systems with the model 1100, which is based on the original Apollo processor and sells for approximately \$55,000 for workstations in quantities of 10 or more, according to Gerry Langelier, vice president of

marketing and sales. That price tag comes in at about 20% less than the firm's original model 1000, but at the expense of less software and therefore less capability.

Mentor, two years old, is essentially a systems house, adding its proprietary software to Apollo hardware and selling it to end users. Backed by more than \$3 million in venture capital, the company is concentrating on electronics engineers as its main customers.

"We're after the bench-level engineer, the guy who would ordinarily be using a breadboard, an oscilloscope, or logic

analyzer. We're providing the tools to help him design his circuit schematically, test its logic, and then physically lay it out," says

The CAD/CAM market is currently pegged at a billion dollars and growing.

Langelier, formerly of Tektronix. As such, the firm likes to think of itself as supplying computer aided engineering systems, not CAD systems aimed at mechanical engineers. "We're after the logical part of the cycle first," he adds.

1983 NATIONAL DATA BASE MANAGEMENT SYMPOSIUM

Los Angeles
Washington, D.C.
Chicago

March 1-4, 1983
April 18-21, 1983
May 16-19, 1983

Featuring Presentations by

Dr. Edgar Codd, IBM Fellow, ACM Turing Award Winner, and father of the Relational DBMS Model.

Charles Bachman, Cullinane Vice President, ACM Turing Award Winner, and father of the CODASYL DBMS Model.

Thomas Nies, President, Cincom Systems, the Vendors of TOTAL, the most successful independent vendor software product in history.

Dr. George Schussel, President, Digital Consulting Associates and widely reknown international authority and teacher on data management.

Featuring Presentations on

- The Basics of Data Management
- Data Base Management Systems
 - Mainframe Relational
 - Mini Computer CODASYL
 - Micro Computer Network
 - Inverted
- Application Generators
- Dictionary/Directories
- Data Base Designers
- Query Facilities
- T. P. Monitors
- Information Center Software
- Future Directions In
 - Hardware Technology
 - Software Technology
 - Database Management
 - Information Center Management

The Symposium will Feature Technical Presentations on the Top 50 Software Products in Data Management

ACCENT R	FACET	ORACLE
ADABAS, NATURAL	FOCUS	PRIME DBMS
A.I.M., AROS	IDMS, ADS	QUEO IV
BASIS	IMAGE	RAMIS II
CONQUEST	IMS/VS	RELIANCE PLUS
DATA BASE-PLUS	INGRES	RL-1
DATA CATALOG II	INQUIRE	RTFILE
DATACOM, IDEAL	MAGNUM	SEED
DATA DESIGNER	MARK V. TAPS	SEQUITUR
DATAMANAGER	MANTIS	SIR/DBMS
DESIGNMANAGER	MDBS	SOURCEMANAGER
DG/DBMS	MODEL 204	SYSTEM 1022
DNA-4	NCR-DMS	SYSTEM 1032
ENCOMPASS	NOMADZ	TIS, TOTAL

Digital Consulting Associates, Inc.
5 Kimberly Terrace
Lynnfield, MA 01940
(617) 334-5755

Registration fee \$650.
Call (617) 334-5755 for immediate registration
 Register me for LA DC CHI
 Send more information

Name _____
Company _____
Address _____
City _____ State _____
Zip _____ Phone _____



"Be a wise owl and get your systems purring."

CIRCLE 50 ON READER CARD

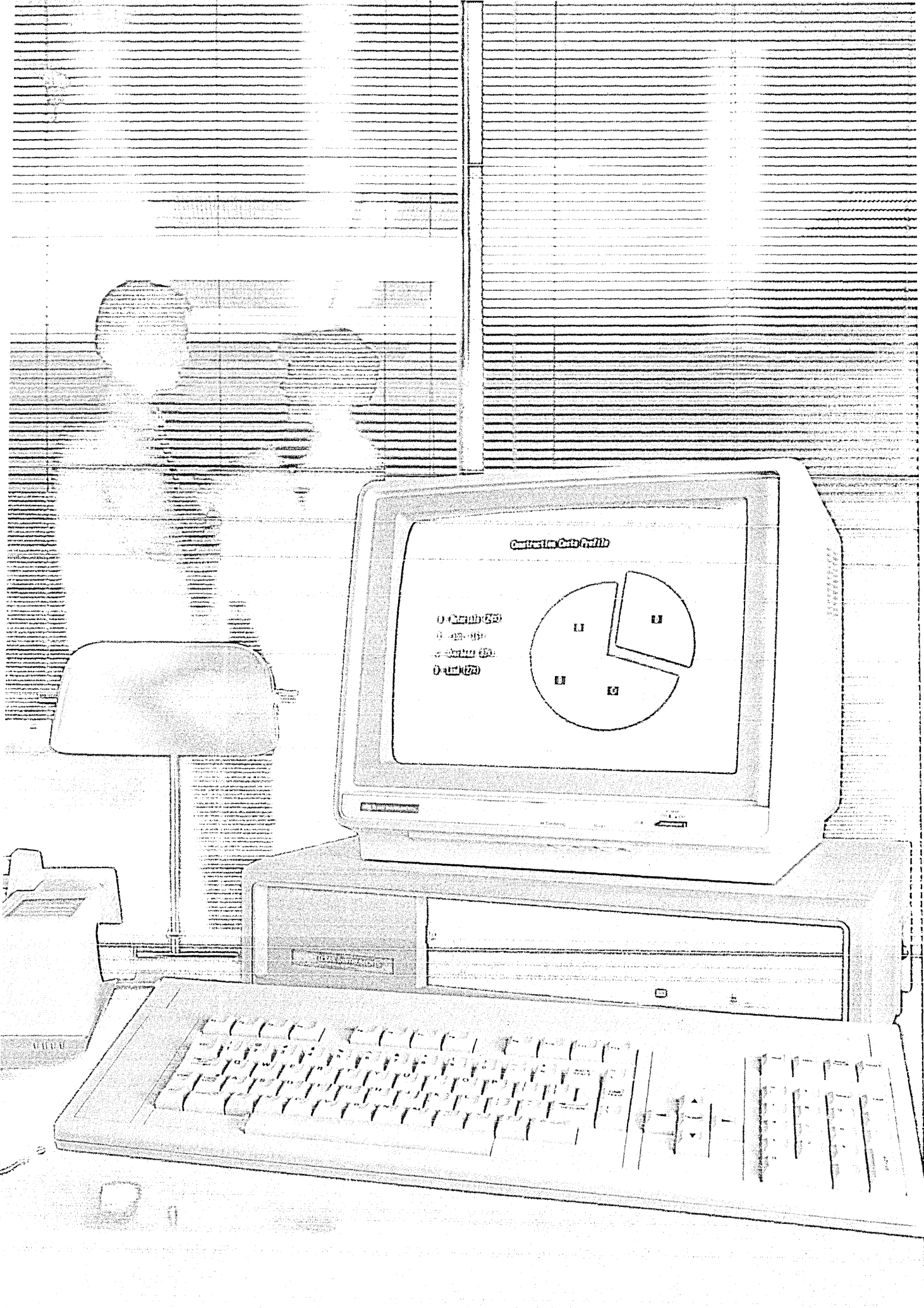

Contracto, Cmb 67/10

- 0 - Cmb 67/10
- 0 - Cmb 67/10
- 0 - Cmb 67/10
- 0 - Cmb 67/10

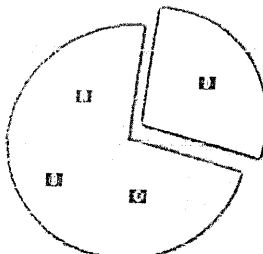

The new TI Professional Computer.

It's the answer for information systems managers.

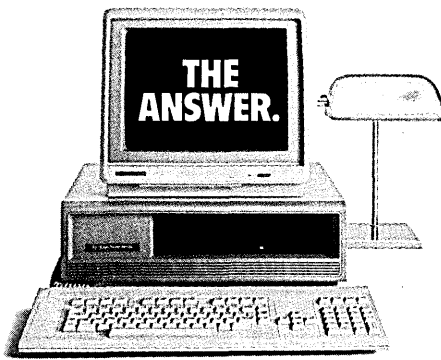

When it's your responsibility to choose a professional computer, you look for the one that's not only powerful and easy to use, but is also expandable enough to meet your company's present and future needs. A computer that helps increase productivity. One with the advanced design to permit it to effectively co-exist with information systems, today and tomorrow. The new Texas Instruments Professional Computer is the answer.

It works with you and your system. The new TI Professional Computer has the memory, the software and the user-friendly design that will quickly help the unsophisticated user become more productive. Its versatile communications capabilities enable it to work well with mainframes and office automation systems.

High resolution displays with dedicated memory. You get brilliant full-color or monochromatic graphics and text displayed with extremely high resolution. And

since our graphics board has its own memory, using graphics doesn't tie up the main memory. As a result, graphic displays appear on the screen much faster than other desktop computers.

An Easier-To-Use Low-Profile Keyboard. The slim profile of our keyboard features the popular typewriter layout and infinite height adjustment from 5 to 15 degrees slope. It also provides separate numeric keypad and cursor control clusters, plus improved key tactile response for quick positive entries.

It's the answer to your microcomputer needs. Now and in the future. All the leading operating systems and programming languages are available. You can use many popular application programs from the best software suppliers to help your managers generate spreadsheets, do word processing, construct graphics, commu-

nicate with other data bases and create their own. Future enhancements will include speech recognition, speech synthesis, telephone management, natural language query capability with a true relational data base package. All this means greater productivity in your company today and tomorrow.

There's more information in store for you. It's simple to get more answers about how the TI Professional Computer can meet your needs. Just complete the coupon below and mail to: Texas Instruments, Dept. 1B, P.O. Box 402430, Dallas, Texas 75240. Or call toll free: 1-800-527-3500.

Creating useful products and services for you.



TEXAS INSTRUMENTS

SPECIFICATIONS

System Unit
16-bit, 8088 microprocessor
64K byte RAM, expandable to 256K bytes
4K byte graphics display memory
5-slot expansion bus

Keyboard
Specially designed low profile
Popular typewriter layout
97 keys, including 12 function keys
Separate numeric keypad and cursor control clusters
Tactile response, for quick positive entry
Upper- and lower-case letters

Display Units
12-inch monochrome (green phosphor) or
13-inch full-color, 25 lines x 80 columns
High resolution, 720 x 300 pixels

Mass Storage
Built-in 320K byte diskette standard
Additional internal storage of 320K byte diskette, or 5 or 10 Mbyte Winchester disks optional

Communications Options
300 BPS or 300/1200 BPS internal modem
TTY, 3780
3270 SNA stand-alone (Summer 1983)
3270 BSC and SNA cluster (Fall 1983)

Operating Systems
MS™-DOS, Digital Research™ CP/M-86®, and Concurrent CP/M-86™, UCSD p-System™

Languages
BASIC, COBOL, FORTRAN, Pascal

Applications Software
Over 100 programs available from the most popular software vendors such as Microsoft, Ashton-Tate, Micro-Pro, IUS, Sorcim, Peachtree, BPI, Lifeboat and others.

Printers (Available Spring 1983)
150-cps TI 850 Series for most applications

FOOTNOTES: MS-DOS is a trademark of Microsoft Corporation. CP/M-86 and Concurrent CP/M-86 are trademarks of Digital Research, Inc. UCSD p-System is a trademark of the Regents of the University of California.

Get the Answer. Please send more information about the new Texas Instruments Professional Computer.

Name: _____

Title: _____

Company: _____

Address: _____

City: _____

State: _____ Zip: _____

Phone: (____) _____ Have Salesman Call.

Return Coupon To: Texas Instruments, Dept 1B, P.O. Box 402430, Dallas, Texas 75240

291427T

NEWS IN PERSPECTIVE

The Idea 1100, he explains, enables the engineer only to "capture" his schematic circuit drawing on a workstation screen. Additional software, which essentially makes up the Idea 1000 product, then helps the engineer perform interactive logic simulations of the circuit at hand and verify the timing of its digital signals. These tasks, which when done manually require keeping track of many details and take up inordinate amounts of time, are effectively handled by computer.

Mentor's Idea 1100 comes in at \$61,900 per workstation in quantities of

"We're after the bench-level engineer, the guy who would ordinarily buy an oscilloscope or logic analyzer."

two and \$54,900 in quantities of 10 or more, says Langelier. But he adds that those prices are far below the \$75,000 to \$100,000 price of a workstation typical of host mainframe-based CAE systems marketed by other vendors. Moreover, the new Apollo hardware will provide Mentor and other systems vendors an even bigger price advantage over established vendors.

Nevertheless, says Langelier, the value that can be added by systems houses such as his is in the area of applications software and customer support. "Customers prefer a general purpose computer, not a dedicated CAE machine," he states. "Then they can put other software on the system and share it between different applications."

So far Mentor has sold systems to such customers as RCA and Motorola, Langelier reveals.

He says the CAE market in electronics design has developed much faster than was expected a year or so ago, and he estimates that the market may hit \$100 million by the end of 1983 and as much as \$750 million in 1988. "We expected to do a lot of missionary selling, knocking on doors and explaining what it is we're offering. But the market is taking off very rapidly. We often joke about waiting for Proctor & Gamble to get into the market," the vice president says.

The nature of electronics—where circuits are becoming more complicated each day, whether they're contained on a wiring board or on the surface of silicon chips—is such that the demand for CAE systems has far exceeded all expectations. Valid president Anderson estimated in mid-1982 his startup would have about a dozen CAE systems installed by year-end, but in early January he said the firm had built over 100 systems, some 60 of which are at customer sites. Customers include Digital Equipment, Rolm, and the Norden division of United Technologies. Valid's machine is also based on the 68000 chip and is intended to help circuit designers in tasks similar

to those targeted for Mentor's systems. "We're trying to concentrate on the standard things—Unix, Ethernet compatibility, etc.," he says. "But the competition is hot out there. We're all at each other's throats."

Xerox's entry into the CAD market came when the firm's Versatec subsidiary introduced in late November systems based on the parent firm's Star workstation, originally introduced for office automation use. The systems, designated Expert 1000 and 2000, attach to Xerox's Ethernet local network and are designed to help engineers create printed circuit boards and mechanical designs, respectively.

Versatec, based in Santa Clara, Calif., said a minimum configuration of two Star workstations, each with a 29-megabyte disk, Versatec electrostatic printer, mag tape, 80-megabyte file server, and software, carries a purchase price of \$180,000. Each additional workstation would be an additional \$35,000, the firm stated.

Deliveries of the model 1000 are set for April, while the model 2000 will be available in July, Versatec said.

What's missing from the Versatec offerings so far, however, is applications software that can perform functions such as logic simulation or timing verification. It appears Versatec is relying primarily on the Star's highly interactive human interface as the systems' main selling point. That interface is performed through the use of dynamic menus and icons, which are pointed

Demand for CAE equipment has far exceeded most estimates, despite the recession.

to with the aid of a mouse. According to Mark Maltese, product marketing manager for engineering information systems at Versatec, "The engineer or designer does not have to learn a computer language to use the Expert systems."

IBM's 7361 Fastdraft system was introduced in late November with a purchase price of \$97,890, making it IBM's lowest-priced drafting system. The company expects it to appeal to small companies as well as the drafting departments of large corporations. The self-contained system supports one or two workstations and includes software to handle drafting functions for the production of two-dimensional and isometric drawings.

IBM said initial deliveries of the system would start in May. The quoted purchase price includes the 7361 graphics processor, two 3251 graphics display stations (which IBM buys from Sanders Associates), a 3101 display terminal, and a color plotter. Required software is available for an initial charge of \$2,000 and a \$300 monthly charge for 36 months.

—John W. Verity

COMMUNICATIONS

TELECOM IS THE FOCUS

Honeywell's communications strategy, while appearing haphazard to some, is showing signs of some method to the madness.

Looking at the product mix at Honeywell is like looking into the toy closet of the rich kid down the street—a little bit of everything has been tossed into one big heap. It's all there, but it certainly takes some sorting to find that out.

Honeywell has an impressive product mix that reaches into most of the major growth markets—process controls for factory automation, building security and energy management systems, office automation products, networking/communications products, and, most recently, videotex (see accompanying sidebar). Like the rich kid's closet, Honeywell's product proliferation has lacked orderliness. It's hard to find a coordinated long-term strategy, a shortcoming that has been particularly noticeable between the controls and the computer sides of the house and has proved worrisome to industry analysts and market researchers.

But keep watching. There are developments afoot that suggest 1983 could be a year of rationality, the year the company begins to pull together its disjointed parts.

In September, Honeywell reorganized yet again, the second time in less than a year (Feb. 1982, p. 61). When the dust settled after the latest reshufflings, it was evident a link had been forged between computers and controls. The link was James Renier. He had been removed as president of Control Systems (CS) and installed as vice chairman of the company and president of Information Systems (IS). Because he was not replaced on the controls side, the four executive vice presidents who now run the controls businesses—control products, control systems, aerospace and defense, and international controls—continue to report to Renier, but in his capacity as vice chairman.

Although Renier has declined repeated interview requests—too soon for an interview, say corporate spokespeople—one corporate executive had the following to say about the melding of computers and controls: "I will not say whether it was planned or unplanned, the linking of controls and IS. I think that it is not fair of me to

RACAL-VADIC MAKES C.C.I.T.T. COMPLIANT MODEM SELECTION AS SIMPLE AS...

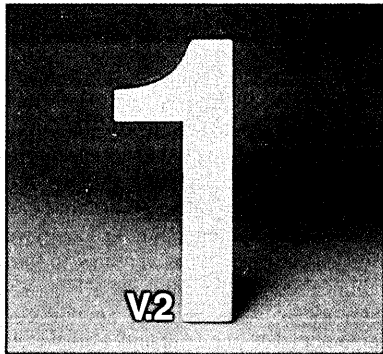

300 bps Full Duplex

Racal-Vadic makes low speed communicating simple with the VI3021, a microprocessor-controlled 300 bps full duplex modem that provides asynchronous operation over 2-wire dial-up (PSTN) or leased telephone lines, in full compliance with CCITT V.21 recommendations.

This compact modem is packaged on a single PC board which can be housed in a 2½" high desk top cabinet for remote terminal use, or in a 19" rack mounting card nest for central computer sites. Up to 14 of these front loading modems can be mounted in the 8¾" high card nest along with power supply. Another plus, V.21, V.22 and V.23 modems can be freely intermixed.

When you add features such as Auto Answer, which enables a called modem to automatically connect itself on receipt of a ringing signal, and powerful diagnostics including self-test, analog loopback and digital loopback, you won't find a more versatile 300 bps modem at any price.

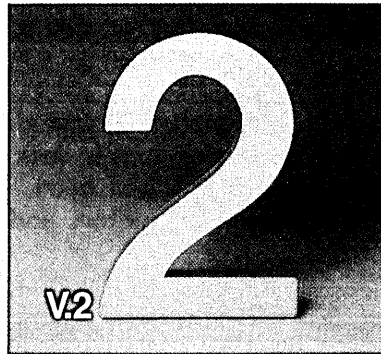

1200 bps Full Duplex

The VII222 is a V.22 compliant modem which operates full duplex at 1200 bps over 2-wire dial-up or leased lines. It offers all three V.22 alternatives: A, B and C. The inclusion of alternative C means the VII222 can operate with any terminal at all standard asynchronous speeds to 1200 bps plus split speed and overspeed.

Now, terminal users who were limited by a 300 bps modem can instantly transmit and receive data four times faster, with no change in protocol, merely by replacing their V.21 modem with the Racal-Vadic VII222.

Packaging is versatile. The VII222 comes in a compact desk top cabinet for remote use. For central computer sites, up to seven VII222 modems can be housed in the 8¾" high rack mounted card nest including power supply module and powerful displays and diagnostics.

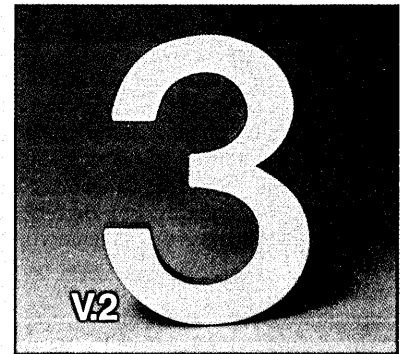

1200 bps Half Duplex

The VII223, which conforms to CCITT V.23 recommendations, is a very flexible microprocessor-controlled modem, providing 1200 bps half duplex transmission over 2-wire switched or leased lines, and full duplex operation over 4-wire leased circuits. 16 versions of the VII223 can be configured using the 3 unique plug-in adapters: *Switched Network Adapter* which converts the basic leased line modem for use on 2-wire dial-up lines. *Backward Channel Adapter* which adds switch selectable 75/150 bps reverse channel to 2- and 4-wire units and forward channel to the 4-wire version. *Synchronous Adapter* which provides synchronous operation at 600 and 1200 bps. A single VII223 can be contained in the attractive table top cabinet, or up to 14 VII223's can be housed in the 19" rack mount front loading card nest.

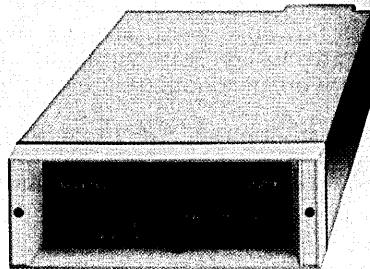

VI1600 Table Top Cabinet

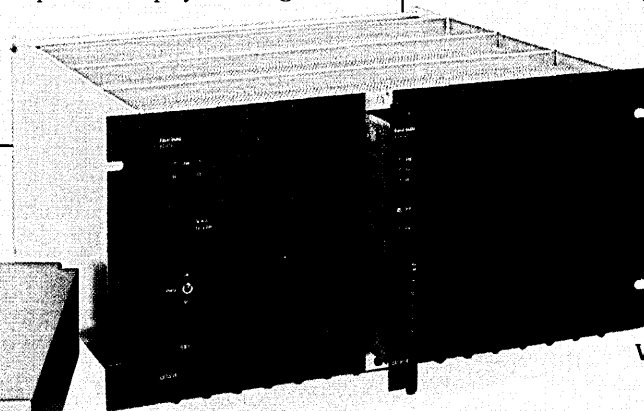

VI1614 Rack Mount Chassis

Racal-Vadic **RACAL**

Australasia and Latin America, Contact:
Racal-Vadic Inc.
222 Caspian Drive • Sunnyvale, California 94086 U.S.A.
Telephone: (408) 744-0810 • Telex: 910-339-9297

Europe, Middle East and Africa, Contact:
Racal-Milgo Limited
Richmond Court • 309 Fleet Road, Fleet, Hampshire, England GU13 8BU
Telephone: Fleet (02514) 22144 • Telex: 858294

CIRCLE 225 ON READER CARD

NEWS IN PERSPECTIVE

reveal too much of our inner thinking. But in moving people around, you get a person who understands both businesses and can begin to move organizations and people to start working together.

"The first thing that happens by having someone here [in Information Systems] who was over there [in controls] is that a barrier is eliminated. You begin to get a much more natural flow of information, knowledge, tactics, and strategies back and forth than before."

Those are the observations of Jerry Meyer, who was promoted to group vice president, Systems Group, Information Systems, from vice president and general manager of the Network Management Systems Division. He replaces Jim Berrett, who left Honeywell to head up Computervision Corp., Bedford, Mass., but Meyer retains management responsibility for the network division.

In defense of Honeywell's past, Meyer contends that "we probably have done more in working together [controls and computers] than the general public is aware of." As an example he points to the process management systems division in Phoenix, which uses Level 6s.

On the other hand, a 12-year Honeywell veteran from the Phoenix computer operation points out that in 1978 a "comprehensive" corporate level study

was done that set the direction for cross-breeding between controls and computers with an eye toward developing products for the factory automation market. "The manufacturing systems [factory automation] issue is an embarrassment. The only evidence of action is the internal system now operating in the Phoenix plant," he claims.

Past history aside, the reorganization has at long last established a visible bridge between controls and computers. Although it remains to be seen how the company will use that bridge, one of the first

After the reorganization last September, the second in less than a year, a link had been forged between computers and controls.

areas one might look to is communications.

In fact, if only one word were used to describe Honeywell's prime direction for the '80s it would be "telecommunications." For the past two years, the company has been on an acquisition and joint venture binge, grabbing up numerous companies in the telecommunications area. That activity is in keeping with Honeywell's rather loosely stated long-range corporate objective: to become "a major participant in the telecommunications marketplace in the 1980s." Does that mean they are taking on

AT&T and IBM, or are they going to focus on one or more market niches?

"Honeywell has been erratic in the past in their acquisitions and what they have done with them," observes Honeywell alumnus and current computer industry analyst John Holland, vice president of data communications at the DMW Group, Ann Arbor, Mich. "They have a history of destroying the goose that laid the golden egg, although they have been much more careful in recent years."

Recapping the major acquisitions and ventures of the past two years, it becomes evident that Honeywell's original reasons for teaming up with its various partners were based more on the virtues of that particular company than on a tight fit with some overall strategic plan at Honeywell.

One of the first ventures to garner public attention was the SESA-Honeywell (51%-49%) joint venture announced in September 1980 and put under the watchful eye of Meyer's network management systems division. SESA is the French company that designed Transpac and other European packet switching networks. Headquartered in Herndon, Va., SESA-Honeywell is developing the DPS 25, a product that will encode and decode computer data for transmission over conventional telephone lines for the U.S. market.

"This was a case where SESA want-

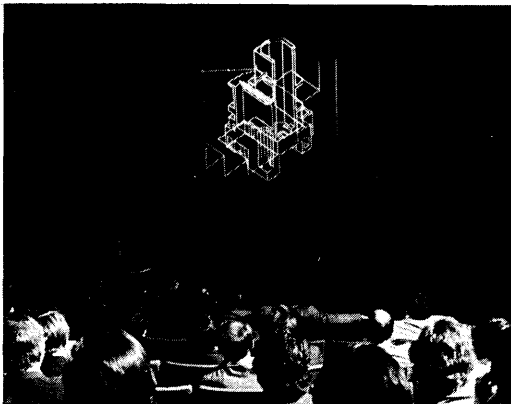

COMPUTER-AIDED DESIGN displayed by General Electric projector is viewed by Engineering Society of Detroit.

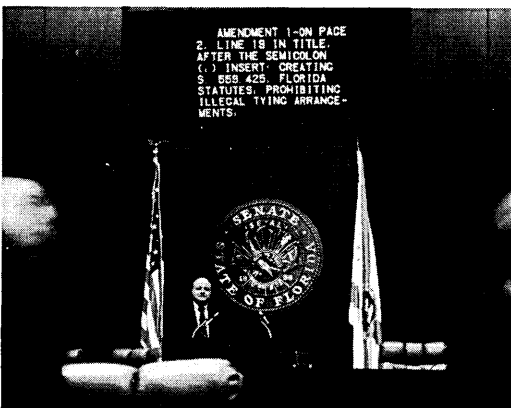

WORDS "PUNCHED UP" by clerk of Florida State Senate are inspected carefully before a vote.

Invite your computer to meetings with General Electric Professional Large Screen Video Projection

With General Electric's exclusive system for bright, sharp professional-quality pictures, up to 25 feet wide, General Electric Professional Large Screen Video Projectors are making presentations more dramatic, more productive, and more convenient.

Whether videotape, live transmission, TV programming or data direct from your computer, the pictures projected can be seen by everyone in the room, all at once, even when room lighting is provided so viewers can take notes and refer to written material.

The color projectors show every viewer the same accurate color reproduction. An exclusive General Electric system registers the colors for you, eliminating time-consuming manual adjustments.

Portable and flexible, General Electric projectors are being used in a great variety of applications, including both rear and front projection. Ask our applications experts whether yours can be added to the growing list. Call or write: General Electric Company, Projection Display Products Operation, Electronics Park 6-206, Syracuse, NY 13221. Phone: (315) 456-2152.

GENERAL  ELECTRIC

CIRCLE 53 ON READER CARD

New Digilog DLM V Data Comm Analyzer



Top-Of-The-Line Capabilities At About Half The Price

As a Data Comm Professional, you face many difficult fault situations. When data comm troubles hit, you start a race to restore normal service fast. Our new programmable DLM V provides the high-performance diagnostic power that helps keep you winning.

Digilog's new menu-driven programming method and "won't forget" E²ROM memory make DLM V friendlier to use. DLM V delivers the versatility you need to handle most any situation. Now there's a top-of-the-line analyzer solution you can have at half the price.

Call Digilog collect for your DLM V demonstration - 215-628-4530

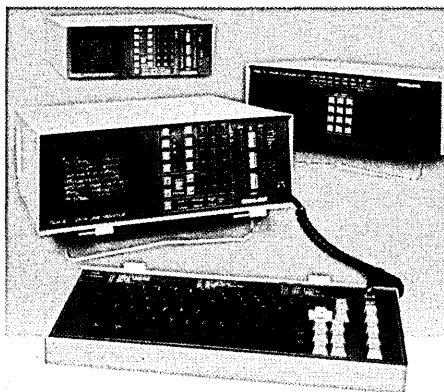

Popular Digilog Diagnostic Family

Our new programmable DLM V heads the best selling family of low cost analyzers in the world.

For an even lower priced solution you can choose either the Digilog DLM III or DLM IV. Both can be upgraded to a full keyboard DLM V.

If you need mass data capture and extra off-line analysis capabilities, either an MSU III or MSU IV with dual diskettes is the solution.

Whatever your situation, Digilog can provide the ideal analyzer for you.

DIGILOG
NETWORK CONTROL DIVISION

CIRCLE 54 ON READER CARD

Digilog Inc.-Network Control Division
1370 Welsh Road
Montgomeryville, PA 18936

NEWS IN PERSPECTIVE

ed to penetrate the U.S. market," recalls Meyer. "We had the opportunity to form a joint venture with them and we took it. At the time we weren't sure whether packet switching would fit and converge with our computer communications products, or whether it would be a standalone market, or whether it represented a vehicle to have a joint voice/data switch and therefore might be merged with a PBX or our own tandem voice switch."

In March 1981 Honeywell acquired Action Communications Systems, putting it also under the network division. Action/Honeywell is a Dallas-based business that makes analog and digital systems to connect hundreds of corporate voice and data networks, creating national private long-distance networks. Facilities such as tie lines, WATS, and other common carrier services are centralized and managed by the Action Roadrunner switching centers. A network typically has three or four switching centers. The Roadrunner allows otherwise incompatible PBX systems to place long-distance network calls from one PBX location to another via the least expensive routes available.

Again, Meyer recounts the reasoning, even though he was not directly involved in the Action acquisition: "We looked at them and we were not exactly sure how they would fit, but remember there's

the Honeywell culture of having things stand alone and run as autonomous businesses. We felt they knew their business, had a good market share and presence in non-Bell private voice networks, and were well managed."

That same March, the controls side of the house started picking up PBX and key system distributors. Those acquisitions are Telamerica, Minneapolis; TR Communica-

The most interesting ongoing telecommunications effort is a joint venture project between Action/Honeywell and SESA-Honeywell.

tions, South Hackensack, N.J.; and Executive/South Bay, Sunnyvale, Calif. The PBX reseller business—formally called Honeywell Communications Services—grew out of the Commercial Buildings Group's (CBG) desire to make wider use of its knowledge of how to run branch offices.

"The idea was that they could use that knowledge and begin selling other things, like PBXs and key systems, and make money servicing the equipment," says Meyer.

Within CBG is an in-house PBX development group. Meyer insists this is just a good way to keep top-notch expertise close at hand. "The point here is not to be mis-

led," he cautions.

"One of the most astute ways to intelligently buy something is to have a group that is attempting to design the same thing. Having this group does not mean that we are categorically going to build and announce a PBX." Of course, Meyer would not say such a move was "categorically" out of the long-term picture, either.

Meanwhile, Action/Honeywell was moved out of the networking division in IS and over to CBG in controls as part of the recent reorganization.

The stated corporate reason for the move was that all voice-related communications technology goes to the controls side of the business, while all data-related technology goes to systems. The side effect is that Action now serves as the bridge for telecommunications projects between the two sides of Honeywell.

While Action/Honeywell's product admittedly has its roots more in voice than data, the announcement last May of the Roadrunner Digital Edition product expanded Action's capabilities so that it can handle a private voice/data/video network. The digital Roadrunner is an advanced multinode network switching system for integrating private voice and data networks along with two-way, full-motion color video teleconferencing, electronic mail, message systems, and high-speed facsimile into

NOW! A complete and efficient way to manage and select integrated office technology.

Reduce the time and costs associated with managing and selecting integrated office technology.

Use AUERBACH's Electronic Office, a monthly updated reference tool designed for DP Managers, Selection Committees, and Office Managers.

Management and Technology - 2 vols.

Practical: Develop and implement proven management strategies.

Completely Current: Identify and seize management opportunities each month. Recommended courses of action give clear direction. Monthly product reports give you comparisons on prices, capabilities, configurations. Make purchase decisions confidently.

Unbiased Coverage: We don't play favorites. You get all the facts to make objective decisions.

Organized: Indexes, tabs, and a vendor directory add speed to your selection process.

Comprehensive: Software. Hardware. Integrated Systems. Electric Mail. Word Processors. Printers. And "how-to" management solutions.

There's more: Get unlimited access to AUERBACH's Toll Free Telephone/Telex Information Service. Solve problems with custom information.

Management and Technology \$400 a year.

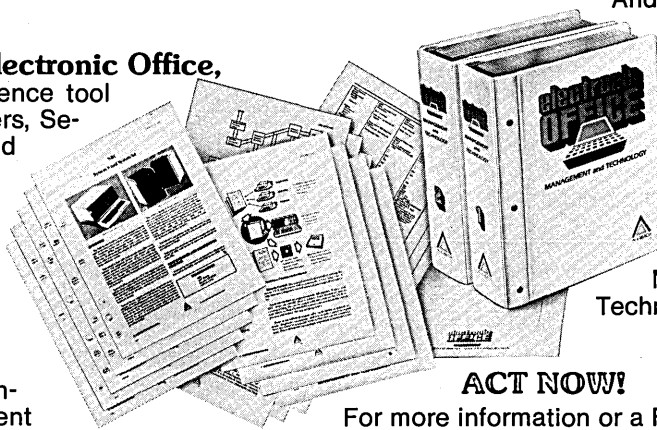

ACT NOW!

For more information or a FREE, NO OBLIGATION TO BUY, 15-day trial to Electronic Office call:

800-257-8162

In NJ, (609) 662-2070/Telex 831 464

6560 N. Park Drive
Pennsauken, NJ 08109 USA



HOW TO GET SUPERCOMPUTER PRICE/PERFORMANCE FROM YOUR VAX™, IBM, or UNIVAC COMPUTER.

When large-scale scientific and engineering problems overload the capacity of your computer, you may wish you could afford a supercomputer.

Now, the FPS-164 Attached Processor from Floating Point Systems can extend the capability of your VAX™, IBM or Univac for as little as \$300,000, a fraction of the cost of a supercomputer.

The Attached Processor Concept

The FPS-164 attaches to VAX™, IBM and Univac systems, offloads and processes computationally-intensive tasks, leaving the host computer free for other work.

Ease of Use

With the Single Job Executive (SJE) you run complete jobs on the FPS-164 Attached Processor as easily as using your own familiar computer. There's no need to restructure your program. You continue to use your existing

system for transferring files to the attached processor and for retrieving the results.

With its large memory, parallel high-speed floating-point arithmetic units, and FORTRAN 77 Optimizing Compiler, the FPS-164 gives you the computing power needed for solving large-scale scientific and engineering problems.

Ease of Programming

For software development, Floating Point Systems offers development tools for getting maximum use from the FPS-164, including the FORTRAN 77 Optimizing Compiler, and an Overlay Linker. A comprehensive Math Library with over 380 FORTRAN callable subroutines is also available.

Superior Reliability and Worldwide Support

Floating Point Systems has established an impressive record for reliability of products and customer support. Over 3,300 attached processors have been

delivered and are being supported throughout the world.

If you need the best price-performance from a scientific computer at a fraction of the price of a supercomputer, call Floating Point Systems, toll free at (800) 547-1445.

The world leader in array processors.



FLOATING POINT
SYSTEMS, INC.

P.O. Box 23489
Portland, OR 97223
(503) 641-3151
TLX: 360470 FLOATPOIN BEAV

FPS Sales and Service Worldwide.
U.S.: Albuquerque (NM), Atlanta (GA), Dedham (MA), Denver (CO), Hartford (CT), Houston (TX), Laguna Hills (CA), Los Angeles (CA), New Orleans (LA), New York (NY), Orlando (FL), Palo Alto (CA), Philadelphia (PA), Rockville (MD), Schaumburg (IL), Seattle (WA).
INTERNATIONAL: Canada - Calgary, Montreal, Ottawa; England, Bracknell, Berkshire; France, Rungis; Japan, Tokyo; Netherlands, Gouda; West Germany, Haar.

DISTRIBUTORS: Australia and New Zealand, Milsons Point, N.S.W. (Techway PTY, LTD.); Austria, Vienna (Elektronische Bauelemente Und Gerate); Finland, Helsinki (OY Emmett AB); India, Bombay (Hindlinton Computers PVT, LTD.); Israel, Tel Aviv (Eastronics, LTD.); Korea, Seoul (Korea Computer Center, Inc.); Singapore (Scientek Corporation); Southern Africa, Johannesburg (Anker Data Systems); Sweden and Norway, Vaxholm (Tre Konsulter AB); Taiwan and Hong Kong, Taipei (Scientek Corporation).

© Copyright Floating Point Systems, Inc. 1982

VAX™ is a registered trademark of Digital Equipment Corporation.

CIRCLE 56 ON READER CARD



If you can see it on a CRT,
Dataproducts' new multi-function
matrix can print it.

Fast.

Your play diagrams, graphs and
block letters all look crisp, clear and
solid — not like clusters of dots. And

at a speed of 140 cps, the M-100
prints beautifully three times faster
than most daisy wheels.

You get sharper alpha and numeric
characters. You can print foreign
languages. You can underline
anything.

The secret of this business graphic
professional is the specially designed
Dataproducts printhead.

The column of 14 overlapping dots
it prints gives you a continuous, solid
vertical line.

(Nine dots form the basic character

Introducing our M-100 Matrix Printer. Business graphics never looked so good, so fast.



GREAT MOMENTS

There are two more dots for ascenders and three more for descenders and underlining.)

The M-100 needs no regularly scheduled maintenance.

The operator changes the ribbon and printhead.

The sophisticated self-diagnostics let you spot and correct problems. And that saves service calls.

The new M-100 is a very tough competitor that does beautiful work

at a very competitive price.

Check it out.

Meeting Tough Standards.

We're the largest independent printer manufacturer in the world.

For 19 years we've been building printers for the biggest OEMs in the business. Their names go on our machines — which is a good testimony to the kind of work we do.

For more information about the M-100 — or any Dataproducts

printer — call (213) 887-8482.

Or write:

Dataproducts, Marketing Department, 6200 Canoga Avenue, Woodland Hills, California 91365.

European Marketing Headquarters:
Egham, Surrey, England
Tel: 784-31161
Telex: 298562



CIRCLE 57 ON READER CARD



TS IN PRINTING

NEWS IN PERSPECTIVE

one common digital network.

"With Roadrunner Digital Edition, the 1.544Mbps channel will be as significant to large corporations in the future as Telpak was for them in the past," explains Homer Huddleston, vice president and general manager of Action/Honeywell.

Two distributor agreements were also announced by Action last May. One is with STC Communications Corp. to market its COM/2 concentrator/multiplexor. COM/2 provides the technology to fill pauses in telephone conversations with speech, thus permitting simultaneous conversations and reducing to about half the number of telephone lines normally required.

The other is with Compression Labs Inc. to market its VTS 1.5 teleconference signal processing system. According to Action/Honeywell, "The VTS 1.5 system will provide two-way, full-motion color video teleconferences on only one 1.5Mbps channel between Roadrunner Digital Edition systems. When not used for color video teleconferencing, the high-speed channel can be efficiently used for multiple-voice conversations and/or data transmission."

But the most interesting ongoing telecommunications effort in Honeywell is a joint project between Action/Honeywell and SESA-Honeywell. Last May they demonstrated a system for integrating voice and packet switching networks using the Road-

runner Network Management System and SESA's DPS 25 distributed packet data switching system.

While Action will handle both voice and data, it handles only slow speed data, explains Meyer. SESA picks up where the Roadrunner falters with its high-speed packet switching capabilities. "The SESA product will break down the data into packets and ask the Action product for lines. The Action product will optimize the routing and SESA will optimize the packetizing," adds Meyer.

Huddleston comments that "packet switching capability in conjunction with the

Honeywell seems to be betting on the PBX-related technology to dominate over the local area network technology.

circuit switching capability provided by the Roadrunner system enhances the data network by sharing voice network facilities." In addition to providing data trunk capacity, the Roadrunner system will permit network users to call the packet switch on voice network lines and vice versa, making it possible for a voice network user to communicate with another user on a packet network, Honeywell claims.

There's one glitch to that grand plan, however. SESA has yet to deliver the

DPS 25. "We've put a hold on the [SESA-Honeywell] sales team; actually, it has shrunk," admitted Meyer when questioned about an industry rumor that SESA's U.S. operation was being shut down. "The reason," he continued, "is that we are waiting for versions 3 and 4 of the French product to be demonstrable here in the U.S." Version 1 runs on Transpac, explains Meyer. For the new product they have changed the hardware, moving to microprocessors, and changed the system architecture. Industry sources add that SESA also lost its supplier of small multiplexors, a key component of the system. Meyer expects to have the product sometime during the first half of the year.

There is the hint of a long-term strategy here. IS and CS appear to be converging around the same communications technology. "If I have a computer, I have to ask myself, at what point can I take the functions in my front-end processor and put them on a line card in a PBX? At what point do I plug my terminals into a wall jack instead of running all that wire?" Also central to Meyer's thinking is that the communications system has to be independent of whatever it hooks into. "I don't want to have to swap out a PBX when I swap out a host. That is the whole key from our view in specing this thing, call it a PBX, or a building controller, or whatever."

SCHEDULIZE with Magnetic Controls

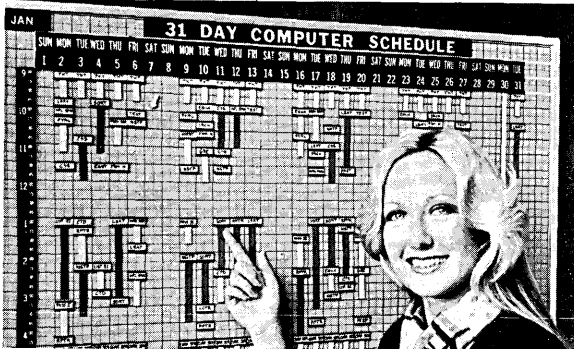

FREE
16 PAGE
ILLUSTRATED
BROCHURE

REPRESENTATION THROUGHOUT MOST OF THE UNITED STATES

- SHOW FACTS INSTANTLY
- CHANGES MADE IN SECONDS
- ELIMINATE FILE REFERRALS
- SYSTEMATIZE YOUR WORK FLOW
- GET THE JOB DONE

For Scheduling • Programming • Personnel • Sales • Shipping • Inventory • Maintenance • Production • Quotations • Computer • Special Situations

201-938-6000

METHODS RESEARCH

70 ASBURY AVE., FARMINGDALE, N.J. 07727

CIRCLE 58 ON READER CARD

Have we got a date for you

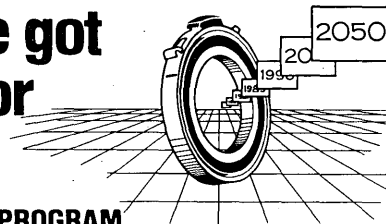

THE MERIDIAN PROGRAM A Date Processing Module

- Replaces existing date programs with one guaranteed accurate program.
- Eliminates duplication of various date programs currently being used in your company.
- Eliminates the century problem—the MERIDIAN PROGRAM is accurate for 2-digit years up to the year 2050.

The MERIDIAN PROGRAM also

- edits data to determine if it's a valid date
- converts the dates to nine different output formats
- adds or subtracts a given number of days to a date
- subtracts two dates to determine the number of days between them
- locates the next specific day of the week
- locates the end of the month (even February 29th in leap years).

The MERIDIAN PROGRAM can be used on any IBM 370 Architecture machine and all operating systems. It is available exclusively from Saunders Communications, Inc. The cost is \$500.

For further information, call or write Saunders Communications, Inc., P.O. Box 3177, Steinway Station, Astoria, NY 11103, (212) 545-6211.

CIRCLE 59 ON READER CARD

Sweet software— A DBMS package that's relational and loaded with goodies.



©1982 The Perkin-Elmer Corporation

Our new Reliance PLUS treats you to all the tantalizing features you're reading about in the news today.

A transaction controller. A relational DBMS. A data dictionary. Query/report processing. All in one package for on-line data management.

In Reliance PLUS, they're fully integrated. With more automatic features than any other system. It's the most complete DBMS.

Everything for the lowest cost. Some vendors offer some of these components. Some offer others. Only Reliance PLUS gives you them all. And at a lower price than the closest competitor.

And you get 32-bit software performance with a relational DBMS on our full line of 32-bit superminis—everything you

need for application development—from one vendor.

Fast application development.

This assortment of facilities in Reliance PLUS also gives you the performance to get your application up quickly.

For one thing, it manages all the support functions automatically. Concurrency control. Rollback and recovery. On-line reorganization. Database integrity. All features to cut development time, leaving programmers free to concentrate on applications. And score big gains in productivity.

User-friendly.

Another unique feature of Reliance PLUS is its layered approach to data access. Your customer can choose higher performance, directly accessing the database.

Or easier development and maintenance, using relational views.

The system is so user-friendly, even the operator with no programming knowledge can design screen forms. Inexperienced users can query the database for reports unassisted. Training for both operation and development shrinks. Costs plunge and productivity soars.

Don't delay. Take a bite.

Write or call now for all the facts about this new advance in on-line data management. Reliance PLUS is available immediately on our full line of 32-bit superminis and includes a year of free software maintenance. The Perkin-Elmer Corporation, Oceanport, NJ 07757. **Tel: 800-631-2154.** In NJ 201-870-4712.

PERKIN-ELMER

CIRCLE 60 ON READER CARD

More versatility than ever with Lee Data's 3270 terminal system

Integrated Personal Computing

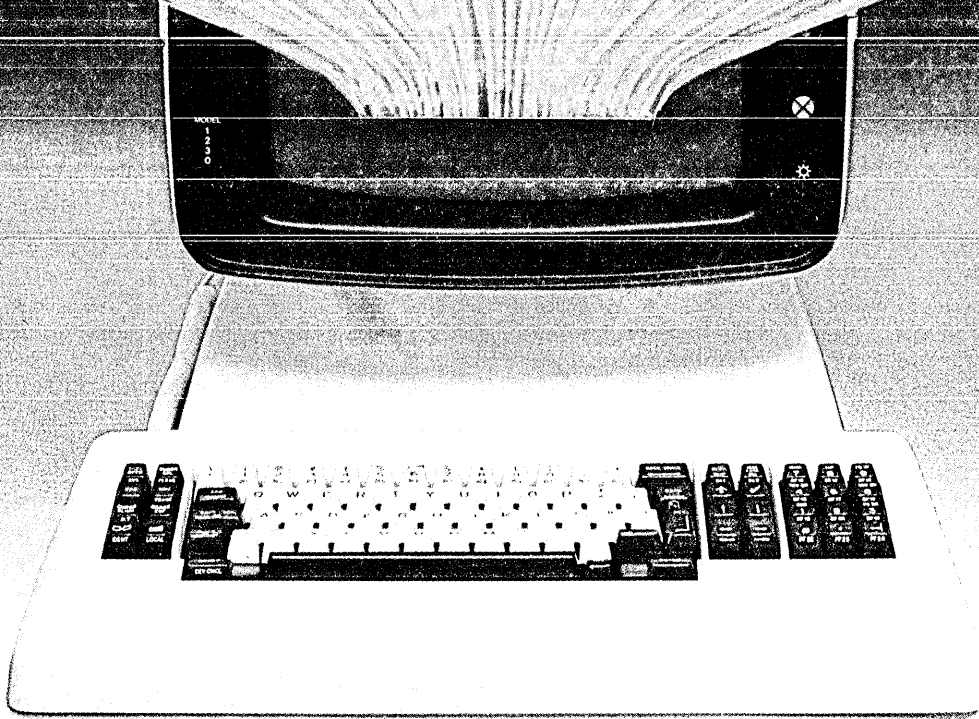

Lee Data's new Personal Workstation now lets you enjoy all the advantages of professional business computing plus have both 3270 and asynchronous access to CPU-based applications—all from the same Lee Data workstation!

That's right! Completely-integrated, IBM-compatible personal computing—offering the latest functional capabilities and these value-added features:

Support for a wide variety of popular applications, including all compatible IBM Personal Computer software.

Personal Workstation-to-host file transfer capabilities that allow transfer of data from CPU-based files through existing system communications net-

works, meaning no new communications networks are ever required.

A single board design that incorporates both display station and printer support, as well as 128K of random access memory standard—with up to 256K of expanded memory on the same board. Plus a dual diskette drive feature that offers two 5¼-inch floppy diskettes, each with 320K of storage capacity!

And four standard system expansion slots for add-on requirements as your needs change.

3270 and asynchronous application access and now personal computing, too—all part of an advanced system design by Lee Data.

Let us show you how easily personal computing can become a part of your company's terminal system.

Call our system specialists toll free:
800/328-3998

**Designers of innovative systems
for the information worker**

LEE DATA CORPORATION

10206 Crosstown Circle
Minneapolis, MN 55344

CIRCLE 65 ON READER CARD

New from Timeplex: LINK/1

The quintessential T-1 connection

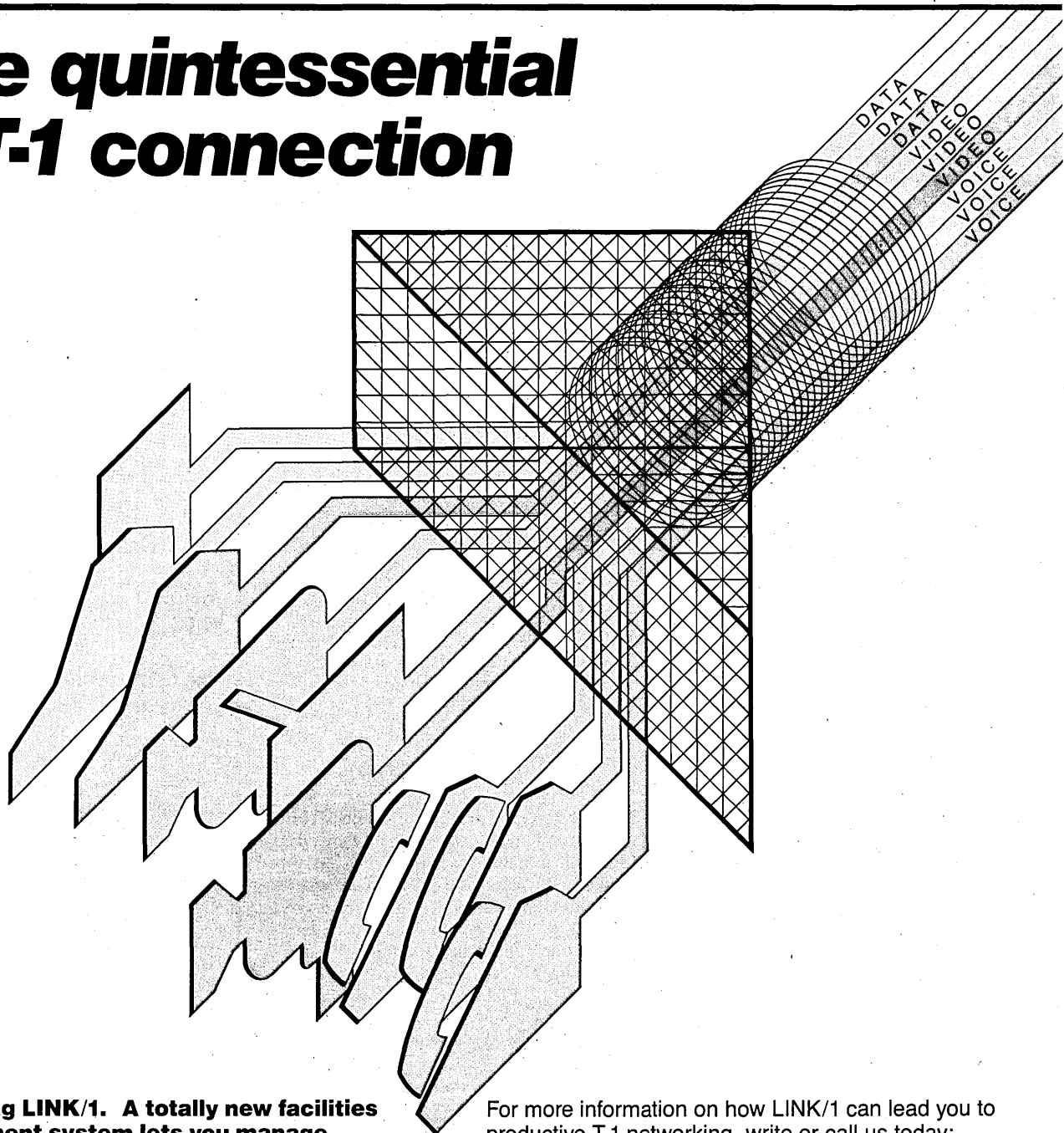

Presenting LINK/1. A totally new facilities management system lets you manage, multiplex and maintain combined data, voice and video networks sharing 1.54 Megabit T-1 transmission facilities.

When you plug the big T-1 pipe into LINK/1, you get single point control of a fault tolerant network... with full redundancy and multiple data link capability.

LINK/1 makes possible cost-effective, ultra-wideband networks and brings you closer to the true promise of future office services.

For more information on how LINK/1 can lead you to productive T-1 networking, write or call us today:
Timeplex, Inc./One Communications Plaza
Rochelle Park, N.J. 07662/Phone: 201-368-1113
Attention: Corporate Communications

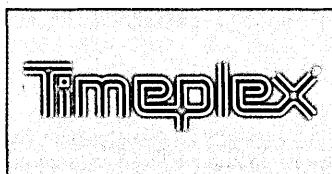

The technology leader
in data communications

CIRCLE 66 ON READER CARD

NEWS IN PERSPECTIVE

VIDEOTEX: AN AFTERTHOUGHT?

Videotex. That was a business Honeywell had specifically singled out as one to be avoided. Then Centel Corp. dropped by with an idea for a joint venture. Today, Honeywell is part owner, having a 30% stake, in Keycom Electronic Publishing, a Chicago-based business that plans to develop, market, and operate a complete videotex service called Keytran.

"We had made a decision not to form a Honeywell videotex company. We don't know how to sell those kinds of products, soft goods, entertainment," confides Jerry Meyer, a Honeywell vp.

The joint venture includes Centel, the nation's fifth largest telephone company; Field Enterprises Inc., which has extensive newspaper and broadcasting interests; and Honeywell. Honeywell's role is chief systems designer and developer, and supplier of the videotex terminal.

"We wanted to watch the videotex business without being in it," said Meyer. "So a good way to do that was by having an equity position, and the Keycom venture looked like a good partnership.

Honeywell maintains that Keycom's business plan "showed a good return." Insists Meyer, "This is not a loss leader for us." He did, however, concur with general opinion that "the jury is out on

It seems safe, then, to say that Honeywell has bet on the PBX-related technology to dominate over the local area network (LAN) technology. "No, I wouldn't say we are betting," cautions Meyer. "I am saying we have recognized that the PBX is going to be an integral part of what we will have to deal with in our business." When Meyer looks at a Honeywell customer's business, he sees that "everything goes through a PBX. Building people come in through lines, computer people use lines.

"I don't know that it is totally black or white. If we see people starting to wire buildings and go paranoid over LAN. . . . I am not interested in pulling that LAN, but I can respond to that strategy very quickly with an interface chip. I can recover. . . . I wouldn't even call it recover. It is costing us nothing to wait and see."

Honeywell has been watching IBM for signals about what direction it will take on the LAN issue. At some point, Honeywell admits it will probably have to invest in an independent software interface to the LANs, but does not consider that a major undertaking. "That's where we are quite proud of our DSA [distributed systems architecture] and its layered architecture, its openness," beams Meyer. "A LAN interface is a very simple thing; it's one of the layers."

That is not to say Honeywell has been ignoring developments in LANs. Not at all, says Meyer. "We have in place probably as much if not more analysis than anyone on the virtues of every access method

who is going to buy this service, how much they will pay per month, and what products they will buy."

Industry watchers are not so optimistic about prospects of a return from Keycom. "If Honeywell's reason for getting into the venture was to earn money, they are in trouble." That is the view of Bernell Wright, videotex project manager with Link Resources, New York. "If it is to learn networking in a distributed data processing environment, then I can see it as a logical progression.

Plans call for having the videotex service operating in Chicago by mid-1983, with plans to expand to other markets later. The service, including the videotex terminal, is expected to cost less than \$25 a month.

Although Honeywell is not sure how videotex technology might be used in the office, Meyer is quite frank about the advantages of building a low-cost, desktop terminal using someone else's money. "We have to learn how to carry these kinds of data, and if we can build a system around a computer—an operating system, communications, and applications—then if this thing called videotex makes sense, we've got all the work done. That's what I would call a little bit of advanced thinking without costing a lot of money." —J.J.

and every carrier, including fiber optics.

"We've worked with Intel and Motorola and know exactly where they stand with their interface chips. When IBM announces, when that happens, there will be tons of chips with which to interface to an IBM LAN." Reflecting a moment, he adds, "But I don't think the PBX strategy is going to change. Remember, IBM has an arrangement with Mitel."

It's a sure bet, though, that IBM's arrangement was, indeed, part of an overall plan.

—Jan Johnson

LEGISLATION

WHAT'S NEW WITH THE 98TH

The information industry is hard-pressed to find a good fight with the new Congress now that AT&T isn't on the docket.

Why is the 98th Congress different from its immediate predecessors? Because it won't have AT&T to kick around any more. Of course, the converse applies equally well.

OPPORTUNITY WITHOUT RISK.

The biggest improvement in Savings Bonds in 40 years.

New Variable Interest Rate.

Looking for an ideal investment? One with a variable interest rate? But one where rates can't drop below a certain level?

Well, there is one available to everyone, even if you have only \$25 to invest.

It's U.S. Savings Bonds. Now changed from a fixed to a variable interest rate, with no limit on how much you can earn.

A Guaranteed Minimum.

Although interest rates will fluctuate, you're protected by a guaranteed minimum. And if you hold your Bond to maturity, you'll double your money. You may do even better.

Take another look at Savings Bonds. We did, and made them better.



Take stock in America.

Ad Council

A public service of this publication and The Advertising Council.

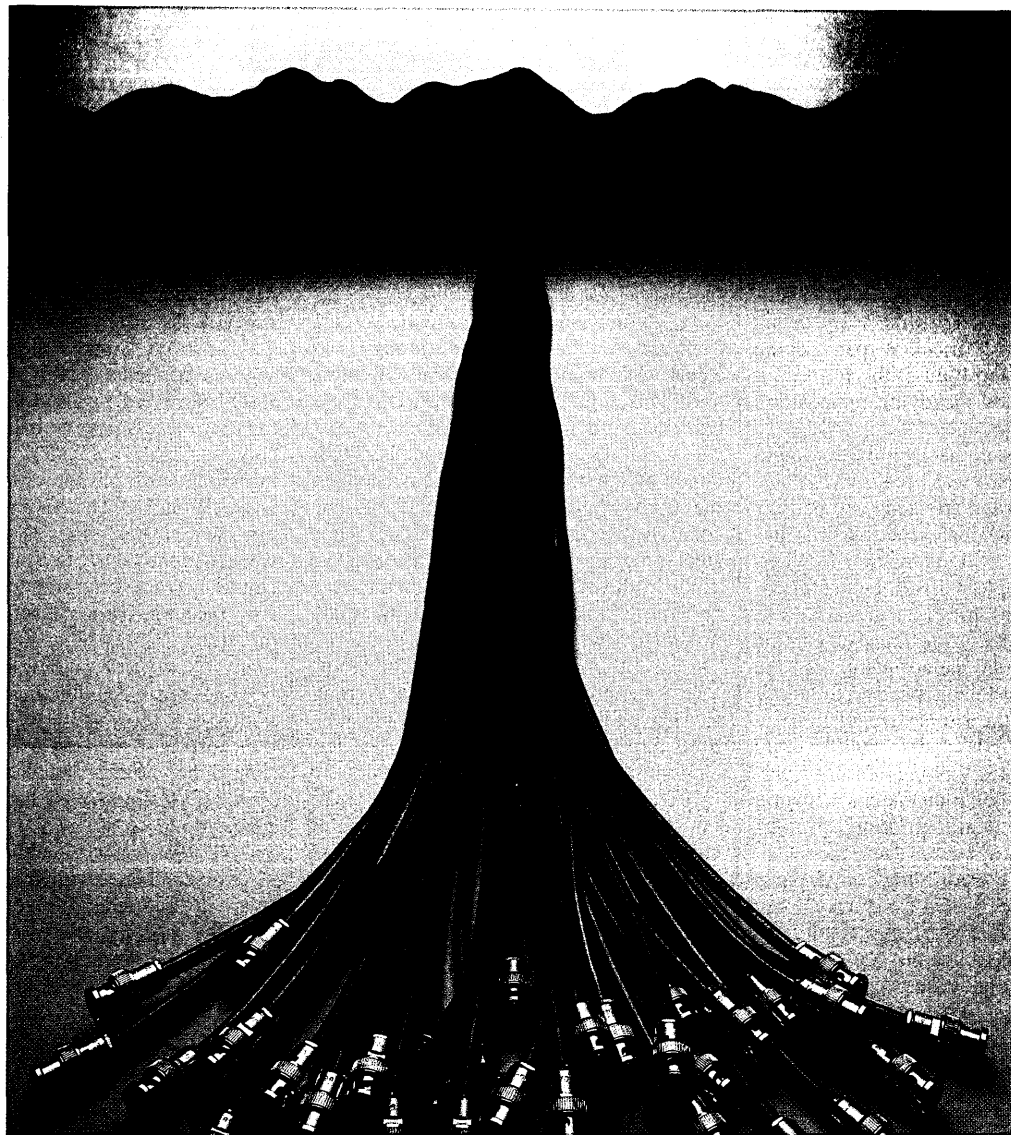

Now you can add 31 IBM 3270 devices without adding 29 miles of cable.

Our new CMX Cable Multiplexer takes up to 32 inputs from an IBM 3274 Controller, combines them into a single signal, in a single cable, for demultiplexing up to 1500 meters away. With no performance degradation. So using an existing cable, you could add as many as 31 new terminals without pulling any new cable at all: at 1500 meters each, that's 29 miles of cable you don't need to find room for, install or manage.

Installation is easy, using existing RG-62A/U coaxial cable and BNC connectors. It's especially easy when you consider the alternative—pulling miles of new cable through already-crowded ducts.

Up to four cables can be run from the CMX, so you can support 3278, 3279 and 3287 devices on different floors, or in different directions, from one unit.

The CMX Cable Multiplexer system is available in 32-port, 24-port, 16-port and 8-port models. It is completely transparent to IBM user software and terminal operation and meets all type A interface and cabling specifications.

Another solution to your local communication problems from Ungermann-Bass, the Net/One™ company.

Please call the regional office nearest you for more information about the new CMX system: Santa Clara, CA, (408) 496-6464; Burlington, MA, (617) 273-5858; St. Louis, MO, (314) 434-1024; Dallas, TX, (214) 385-7090; Los Angeles, CA, (714) 553-1771.

Ungermann-Bass



CIRCLE 67 ON READER CARD

NEWS IN PERSPECTIVE

AT&T will no longer take the Congress, specifically the House Telecommunications Subcommittee, to have and to hold until divestiture and William Baxter do them part.

The departure of Ma Bell from center stage creates a large time warp in the fabric of Congress's attention span. Seeing their chance for top billing, the former bit players are already jockeying for position on the program.

"The reason that everybody was so exercised in the past was because AT&T was such a big target and affected everybody," says a trade group representative who has climbed Capitol Hill many times. "This time a lot of people will still be exercised, but not about one thing.

"I think there are four subjects on everyone's agenda: determination of the access charge for telephones and the rural-urban question; the FCC's deregulation authority and the federal-state conflict over interexchange rates; national security provisions and the communications network; and domestic content legislation."

Those may be on everyone's list, but that doesn't mean they have equal claims on the proponent's resources. For the Computer and Business Equipment Manufacturers Association (CBEMA), the domestic content question is right up there with mom, apple pie, and the flag. The Association of Data Processing Services Organizations (ADAPSO) doesn't know from domestic content legislation and doesn't want to know.

"Export administration legislation is paramount for us," concedes Bob Coyer, CBEMA's vice president and chairman of its newly formed government operations committee. "We want to rewrite the Export Administration Act to open up trade for our members. There are currently too many bells and whistles [CBEMA code for national security restrictions] attached to it.

"Just as important is obtaining some relief overseas from the barriers confronting our companies. The stronger the domestic content swell, the harder it's going to be. There is sentiment for protection even within the high-tech industry and some of our members. But we're already on record against protectionism and we're going to try to keep it that way."

Other items CBEMA wants to go its way are retaining the R&D tax credit for the industry, ensuring regulatory approval of the Service Contract Act, now submerged in the bureaucratic morass between the Labor Department and the Office of Management and Budget, and preventing what it perceives to be a groundswell of public opinion that vdt's are dangerous to your health.

"The R&D credit doesn't expire until '84, so we've got a year to convince Congress of its value," Coyer explains. "We're very much concerned that we can

defend it. We know it's helped the industry, but it's going to be difficult to come up with evidence that it has actually increased our R&D spending. It might be singled out as unnecessary in the search for revenue sources.

"We want to make sure the Service Contract Act doesn't fall through the cracks. As for vdt's, Connecticut will introduce legislation that will put restrictive and burdensome demands on our industry."

ADAPSO has found its members burdened by the myriad electronic versions of the Barbary pirates. These modern Long John Silvers sail the software ocean and steal programs like their ancestors stole gold. In the eyes of ADAPSO's members, a good program is more than worth its weight in shiny metal.

"It's very clear that we're going after some protection for software," promises Dave Sturtevant, ADAPSO's public relations director. They almost had it last session in the guise of H.R. 6983, introduced by Rep. Robert Kastenmeier (D-Wis.). The bill sought to gain recognition of the unique characteristics of computer software in the U.S. copyright law. The measure would have taken four steps to better protect soft-

ADAPSO has found its members burdened by the myriad electronic versions of the Barbary pirates.

ware. Rep. Kastenmeier has indicated he will reintroduce it early in the current session. ADAPSO also hopes that the junior senator from New Jersey, Democrat Frank Lautenberg, will push for Senate passage. As the former main man at Automatic Data Processing Inc., Lautenberg is somewhat acquainted with software.

The trade group has a few other items on its wish list. It is searching for support in establishing a consistent national information policy "that can be stated in less than 7,000 words," as Sturtevant describes the government's latest effort. (The linchpin of this effort will be the Temporary National Information Committee [TNIC] promulgated by ADAPSO general counsel Milt Wessel and DATAMATION editor John Kirkley in DATAMATION's 25th anniversary issue last September. ADAPSO is also very much concerned with a footnote of the FCC's Computer II decision. The group maintains the commission unilaterally deregulated international telecommunications and simultaneously violated the CCITT regulations. It wants the FCC to beat a hasty retreat because the Europeans, understandably displeased at this turn of events, are threatening to discontinue private line service.

On the lighter side, the Technology Education Act, AKA the Apple Bill, and the Family Opportunity Act are certain to be resurrected from the ashes of the 97th Con-

gress. The Apple Bill would expand by several orders of magnitude the tax deductions that computer manufacturers could take for equipment donated to elementary and secondary schools. The Family Opportunity Act would not guarantee every family in America the inalienable right to earn a living; it would grant them the incentive to buy a home computer. Every family member would receive a \$100 tax credit each year for up to five years, or half the price of a computer or the computer programs. In the immortal words of sponsor Rep. Newt Gingrich (R-Ga.), "The advances in technology have created a mobile society that has weakened the family ties that are so important to the values and strengths of America. Now the home computer offers a reversal of this trend."

A word of caution here. AT&T may be gone, but telecommunications is not forgotten. It is alive and probably well within the confines of the House Telecommunications Subcommittee, as chairman Rep. Tim Wirth (D-Colo.) would be the first to remind you.

"We want to make sure that we have real and fair competition," Wirth told us shortly before he was reelected. "That is what the subcommittee has been concerned about. We have laid a very strong pro-competitive foundation and the subcommittee will make sure it stays that way in the next [98th] session."

All this may be a prelude to much sound and fury, signifying nothing. Or it just may be that the new Congress, not as worn as the old from its AT&T wars, will pass one measure, or perhaps even more, of significance.

"If they're going to do anything on telecommunications, they have to move fast," says Herb Jasper, executive vice president of the Ad Hoc Committee for Competitive Telecommunications (ACCT). "The divestiture takes effect next Jan. 1. Wirth has been quiet so far, which suggests he might not do anything. But the rural members may light a fire over access rates. That could be almost as volatile as [H.R.] 5158 [last year's telecom reform bill].

"There are three kinds of dust that have to settle," the trade group representative says. "Divestiture, Computer II deregulation, and the political dust. Lots of members, particularly in the House, are tired of being in the pressure cooker. The new players will have to find out what the traffic will bear.

"I think everybody will wait until divestiture is wrapped up. Then the House and Senate will meet halfway on a comprehensive telecommunications bill. The House wants a long one and the Senate a short one. But nothing's going to happen for six months."

Nothing may happen for two years. It wouldn't be the first time.

—Willie Schatz

Expand your possibilities with Concurrent CP/M.™

If you have to wait impatiently for your personal computer to finish a job before moving on to another task, you need Concurrent CP/M. This new software technology from Digital Research increases the productivity of your IBM PC by allowing you to do more with it.

Using Concurrent CP/M, you can run several programs simultaneously, switching instantly from one program to another. For the first time you can write a letter while you do your financial planning. For the first time

you can write text while printing other documents. For the first time you can edit programs while your program compiles. Concurrent CP/M is the best investment you can make in microcomputing because it multiplies the value of your hardware and lets you use all the CP/M compatible programs. And if you're developing software, it ensures that you're on the crest of the hottest new wave in the business.

So quadruple the effectiveness of your IBM Personal Computer with Concurrent CP/M. See your local microcomputer dealer.

Now your IBM® PC can do more than one thing at a time.

The image shows a person from a top-down perspective, sitting at a desk with an IBM PC. Four monitors are arranged around the computer, each displaying a different application:

- Top Left Monitor:** Displays an email message.

TO: Frank Hollister
FROM: Davis North
RE: Staff Meeting

Frank, This memo is to remind you of our staff meeting, which will be held this Friday at 10:00 am in the boardroom. The main objective of this meeting will be to review the sales figures for the past fiscal year, and to project what level of business we can realistically expect to achieve next year.

I think an all executive has important this meeting will be. The marketing manager will be in attendance to help us target key accounts for our sales force. Hopefully, by the end of the meeting we will have a well defined strategy to help us meet our objectives.

Regards,
Davis

Connection 1 Dynamic Printer=0 IBM 14:27:26 Wed
- Top Right Monitor:** Displays a calendar for Friday.

Friday

9:00 - 9:30 Weekly project status

10:00 - 12:00 Staff Meeting
Note: Marketing Manager will attend

12:00 - 1:30 Lunch with Jimmy

2:00 - 3:00 Interview J.S. for Marketing Rep Position

4:30 - 5:00 Review Daily Mail

7:00 - Bill and Penny coming for Marketing Rep Dinner

Connection 3 Dynamic Printer=0 CALIBRAT 14:30:00 Wed
- Bottom Left Monitor:** Displays a journal titled "January Journal for David Aubrey".

Number	Account	Date	Amount	Description
1000	103	10/1/82	12.40	Cash
1001	220	10/2/82	20.00	
1002	107	10/4/82	42.35	Electric bill
1003	200	10/5/82	120.00	Car repair
1004	600	10/9/82	51.50	Food
1005	242	10/11/82	5.25	Tips
1006	109	10/13/82	75.42	Phone bill
1007	242	10/15/82	26.21	Merch
1008	430	10/16/82	320.00	House repair
1009	100	10/21/82	22.50	Dinner
1010	167	10/22/82	23.20	Cable TV
1011	100	10/24/82	8.00	VOID
1012	202	10/25/82	140.00	Airplane ticket
1013	130	10/27/82	42.50	Bus ticket
1014	200	10/30/82	42.10	Theater tickets

Connection 2 Dynamic Printer=0 BILL 14:28:07 Wed
- Bottom Right Monitor:** Displays a bar chart titled "Projected units shipped in 1983".

Projected units shipped in 1983

The chart shows a steady increase in units shipped from January to December, with a peak in December.

Connection 0 Dynamic Printer=0 IBM 13:04:00 Wed

The logo, tagline and names of DRI products are either trademarks or registered trademarks of Digital Research Inc. IBM is a registered trademark of International Business Machines, Corp.
© Copyright 1982 by Digital Research Inc.

**DIGITAL
RESEARCH™**
The creators of CP/M™
CIRCLE 68 ON READER CARD

If you ever lose power or communications in your security system, you'd better have only one system.

The one that will still remember who goes in one door and out the other.

IF IT'S RES, MORE POWER TO YOU.

The one system to have starts with the RUSCARD®. A thick, durable plastic card that's virtually impossible to duplicate. There's no mag stripe to tamper with, just a series of numbers encoded inside the card to identify the holder.

The next three links in the system—the card reader, the controller and the host processor—all have memory. So if you ever lose power or communications to the host processor, or to the controller, or to both, all is not lost.

The reader will still allow the right people to go through the right doors and remember it all. So when power or communications is restored, the information can be transmitted back to the controller for record.

That's the kind of security you can only get from one system. CARDENTRY® from RES.

ALL DECISIONS ARE MADE AT THE LOWEST POSSIBLE LEVEL.

This, in turn, gives you the highest possible security. Here's why.

Any job the card reader can

RES, 1840 Victory Blvd., Glendale, Ca. 91201. Call: Los Angeles area (213) 240-2540. Or call toll free: Continental U.S.: (800) 528-6050 x691; Arizona: (800) 352-0458 x691 (Phoenix: (602) 954-4600 x691); Alaska and Hawaii: (800) 528-0470 x691.

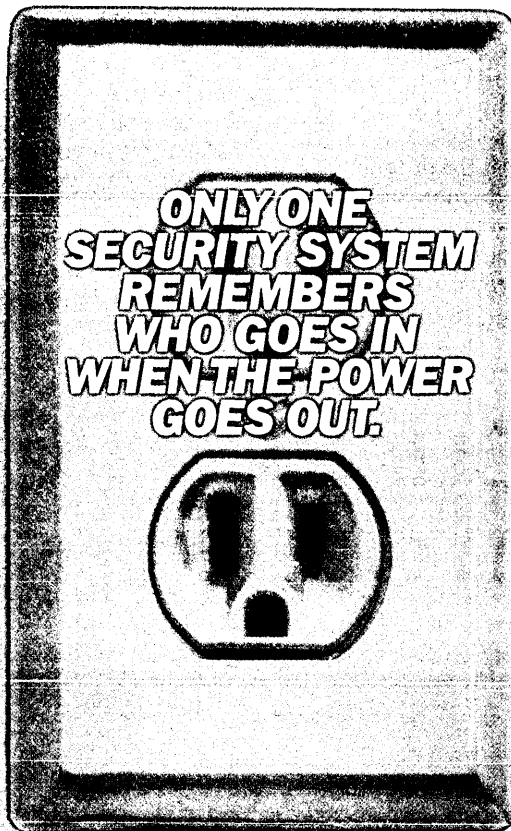

handle—such as verifying facility access code—it handles. Otherwise the job is passed along to the controller. Any job the controller can't handle is given to the host processor. (Which can handle just about any job you want it to.)

That way the host processor can spend its time on the most specialized jobs, at the highest level of efficiency. For the highest possible security.

WHAT YOU CAN DO AT THE HIGHEST LEVEL.

Lots. Our MAC 560 host processor is a powerful and flexible data processor, and will give you detailed information on everything from simple entry and exit access data to employee time management reports in plain English, the moment you need them.

These are reports you select yourself, easily, because the MAC 560 is user friendly. It's so friendly more use it at one time. one task.

In fact, more than one user can And do more than

If you're in the a security system, choose you'll be most secure with.

CARDENTRY, from RES.

The others are powerless by comparison.

Security beyond the card

RES RUSCO
ELECTRONIC
SYSTEMS

A FIGGIE INTERNATIONAL COMPANY

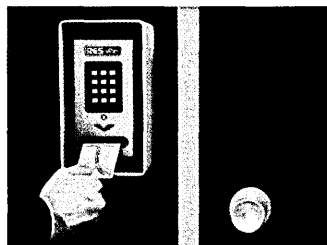
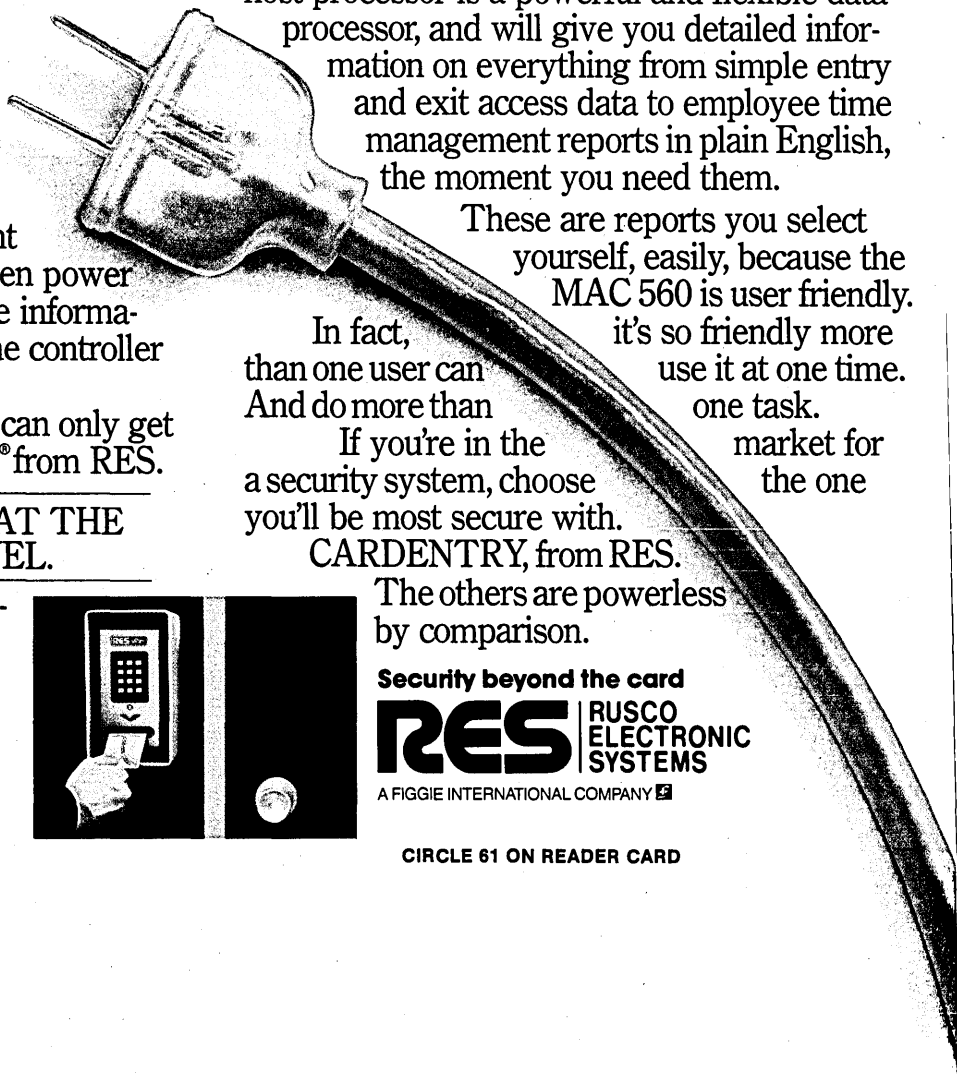

CIRCLE 61 ON READER CARD

ONE COMPUTER CAN'T RUN ALL THIS SOFTWARE.



ONE TERMINAL CAN.

From the beginning, we designed the 1025 to meet the demand for both host and personal processing at HP3000 sites. With the touch of a key, you select either the flexibility of our HP-compatible 825 terminal or the problem solving power of a personal computer. All from one integrated, transportable unit.

As a terminal, the 1025 delivers everything you need for true interaction with your host programs. Like a selectable 80 or 132 column display. Programmable function keys. On-screen, programmable labels. And enough display memory (32K minimum) to handle all HP3000 block mode software.

As a personal computer, the 1025's dual Z-80 architecture, 128K of memory, and up to 1.2 Mbytes of disk storage let you run the vast array of CP/M compatible software. Without running up a tab for additional hardware.

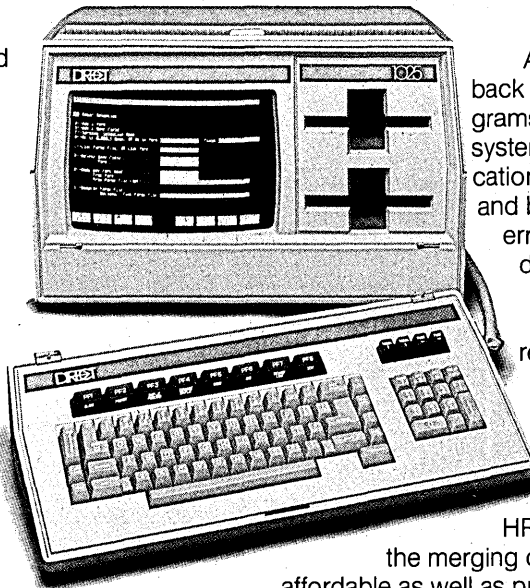

And for the first time you can store, back up, and distribute all your programs and data under the HP3000 file system. Our Direct-Link 1025 communications package lets you transfer ASCII and binary files to and from the HP3000, error free, for increased security and data integrity.

(For applications needing only host processing, like data entry or retrieval, you'll find that installing an 825 makes excellent operational and economic sense.

Especially since it's upgradeable to a 1025 at your option.)

Best of all, our unique line of HP3000 compatible terminals makes

the merging of host and personal processing affordable as well as practical. For information contact Direct, Incorporated, 4201 Burton Drive, Santa Clara, California 95054. Or call (408) 980-1414.

Ask for a demonstration of our 1025 and 825.

And in no time you'll be off and running.

DIRECT

CP/M is a registered trademark of Digital Research, Inc. WordStar is a trademark of MicroPro International Corporation. VisiCalc is a trademark of VisiCorp. SuperCalc is a trademark of Sorcim Corporation. MBASIC is a registered trademark of Microsoft Corporation.

CIRCLE 69 ON READER CARD

5 Reasons to Move Up With CCI's POWERTM 5

1

PerpetualProcessing™ Reliability - Computer Consoles' Power5™ family of systems can withstand multiple failures because each subsystem operates independently with its own copy of the operating system. This contrasts with other "fail-safe" systems which depend upon synchronized pairs or multiple processors around a single shared memory. Designed with high volume transaction processing in mind, CCI's fault tolerant architecture has been a staple of critical telephone industry applications since 1973.

2

A Highly Flexible Operating System - PERPOS™, CCI's proprietary operating system, is designed to support high volume, high availability transaction-oriented environments. PERPOS, fully compatible with UNIX*, is easy to use, and supports program development. It also supports a full complement of languages, such as FORTRAN, COBOL, BASIC and "C" as well as data base management.

3

Complete Networking Facilities - CCI's Data Highway™ can be used as the interconnect vehicle for many types of local communications. It also functions as the vehicle to link independent subsystems in PerpetualProcessing. A Distributed Communications Applications Processor (DCAP) can be used, in conjunction with standard carrier facilities, to provide remote communications with other CCI or other vendors' systems.

4

A Fully Compatible and Expandable Family of Systems - Because CCI's operating system is used throughout the Power5 family, you can start with the Power5/20™, a self-contained single processor system. This can later be integrated into a multiprocessor system with thousands of terminals, configured to your requirements without unnecessary duplication of hardware.

5

Established Support - Computer Consoles has a fully trained Field Service force at over 75 sites throughout the United States and Canada. Installation and maintenance of every CCI system is coordinated by a network of system software and hardware support specialists.

The Power5 family, combined with OFFICEPOWER™, CCI's integrated office automation system, provides full office and data processing functionality.

Take advantage of the newest development in fault tolerant computing - the Power5 family from CCI.

*UNIX is a trademark of Bell Laboratories.

- I am interested in the Power5/20.
- Please send more information on PerpetualProcessing.
- Send me further information on CCI's OFFICEPOWER system.
- Please tell me about your OEM Program.

MAIL TO: Director of Marketing -
Computer Systems
Computer Consoles, Inc.
1212 Pittsford-Victor Road
Pittsford, New York 14534
(716) 248-8200

Name _____
 Title _____
 Company _____
 Street _____
 City _____ State _____ Zip _____
 Phone () _____

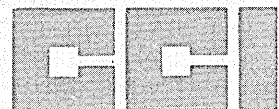

COMPUTER
CONSOLES
INCORPORATED®

COMPUTER CONSOLES INCORPORATED

to Remote Processing

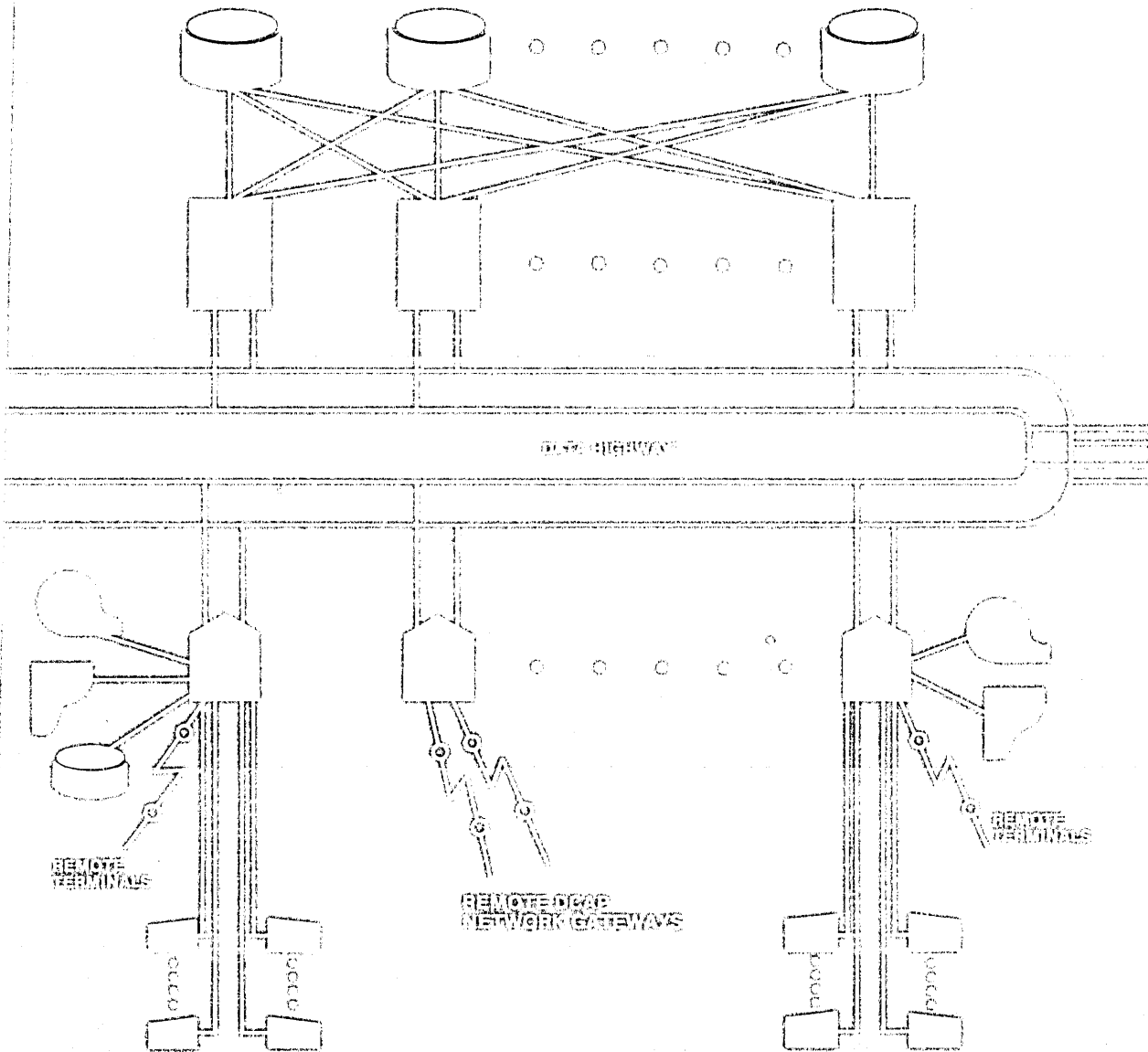

Independent yet coordinated subsystems each running their own copy of the operating system are linked by a high-speed local area network.

*Design A System
To Meet Your Needs*

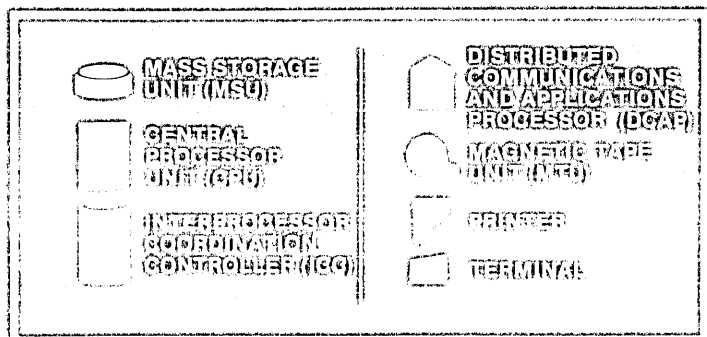

Why Xerox brought a cash cow into its stable of high-tech thoroughbreds.

INSURING THE FUTURE AT XEROX

by Laton McCartney

Last summer someone at GTE with a sharp eye for numbers picked up on an extremely interesting situation. Cash-rich GTE had been scouring the landscape for a high-tech company to acquire, and all the time there was an ideal candidate right in GTE's corporate backyard in Stamford, Conn. Not only was the candidate a leading-edge high-tech company, but it was one of the bluest of the blue chips as well. A second look at the numbers confirmed what was already self-evident but still difficult to believe: Xerox was ripe for a takeover.

At Xerox's corporate headquarters, meanwhile, senior management had far more pressing matters to worry about than the possibility of an outside acquisition attempt—as inconceivable as such an attempt might be. After all, this is Xerox we are talking about, an \$8-billion-a-year corporation, one of the giants of American industry. Other companies simply don't go around plotting to take over a company of Xerox's size. Rather, it is the Xeroxes of the corporate world that tend to snap up smaller fish.

No, Xerox had its hands full resolving far more immediate problems. First, the economy had gone to hell in a hand basket. And at just the wrong time. Here, Xerox was pumping millions into its office automation products, trying to get that effort off the ground, and suddenly the operation that was financing the whole office systems effort—Xerox's reprographic business—found itself waist deep in a recession. Customers weren't upgrading their copiers. With money tight, they weren't converting from lease to purchase either, thereby reducing a highly lucrative source of Xerox revenues. "What we're getting is new business, not the rich sale-to-lease conversion we were getting in the past," Melvin Howard, the company's senior vice president for finance told analysts, explaining why Xerox's earnings had dropped sharply and the company was expected to experience its first profit decline since 1975.

To make matters even worse, the Jap-

anese had launched a full frontal assault on the low end of Xerox's copier line. Japanese firms such as Canon and Minolta had blitzed the market with low-cost, multifeatured machines. At the high end Xerox was feeling the pinch from IBM and Eastman Kodak, which had quietly increased production to around 100 copier units a week.

To stay competitive, Xerox slashed prices, reducing profits as well. It announced massive layoffs and dismissals of production workers at its Rochester, N.Y., copier/duplicator operations. It was also letting planning and developmental people go as part of its previously announced "resizing" programs. (On the basis of a study prepared for Xerox by McKinsey & Co., the management consultants, Xerox chairman C. Peter McCollough made an announcement in August 1981 that the company was going to resize itself downward by 15% in terms of its personnel.)

By mid-1982, Xerox had reduced its work force by about 7,500. With these firings and forced early retirements, the company was hit with an enormous outlay in severance payments. Moreover, revenues from the copier group were further diluted by a strong U.S. dollar that adversely affected foreign sales. If financial tales were told in terms of mythology, Xerox had clearly done something to offend the gods.

Few tears, however, were being shed for Xerox on Wall Street, which was itself another problem area for Xerox. Mention the company to any number of stock analysts or institutional portfolio managers and the reaction is often vehement and vindictive. "Xerox is one of the most hated stocks on the street," notes Kidder Peabody & Co.'s Melody Johnson, one of the few technology analysts who remains bullish on Xerox.

Why the animosity? Well, not too long ago Xerox was selling in the neighborhood of \$170 a share and was one of the glamour stocks trading on the big board. At this writing the stock goes for \$30 and change. A lot of money managers who watched their Xerox holdings go down the tubes took the losses personally. Xerox was like a longtime lover who'd betrayed her suit-

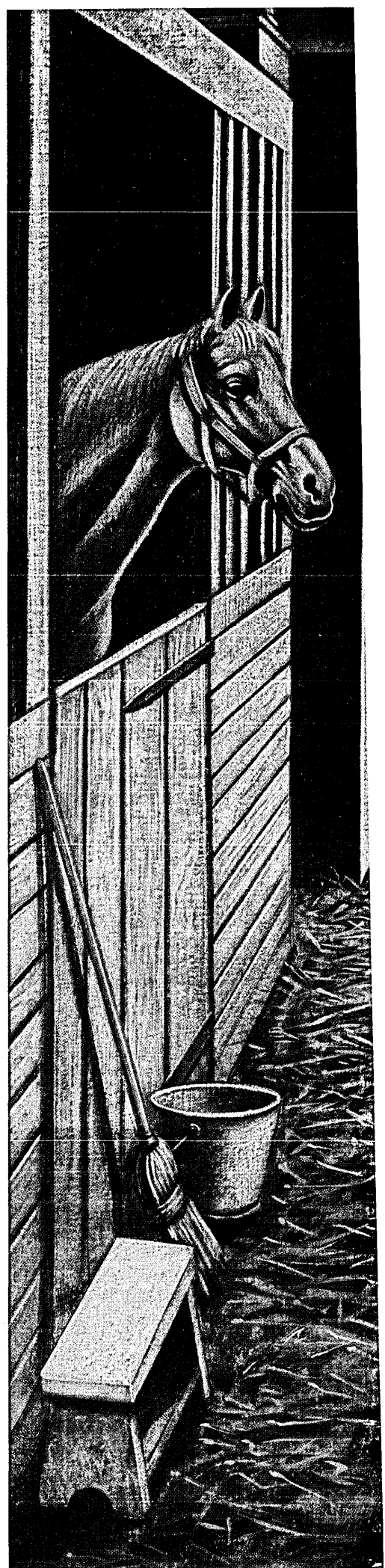

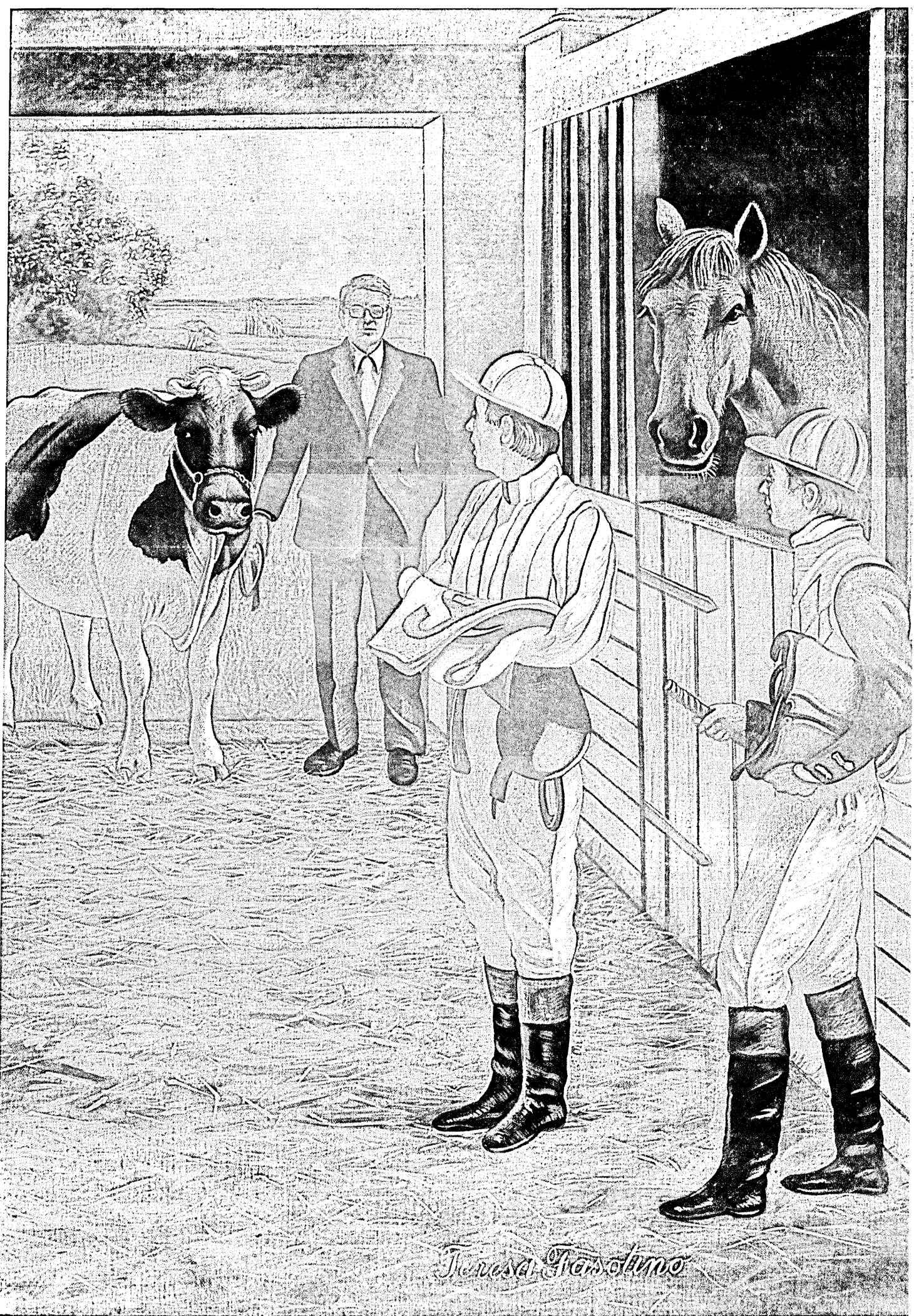

Teresa Fracalmo

If financial tales were told in terms of mythology, Xerox had clearly done something to offend the gods.

ors in the financial community, and as a result the stock has taken a sustained beating with many analysts reluctant to recommend it again.

But Xerox's biggest problem had to do with its office automation efforts. By the summer of 1982, the company's position in the market didn't appear nearly as favorable as it had the previous year, when anyone making book on the competition would have almost certainly put Xerox right up there with IBM as the odds-on favorite to dominate the field. There were great expectations in 1981. The company was aggressively promoting Ethernet, its local area network, and had introduced a number of key products it hoped customers would attach to their Ethernet systems. Among them were the 820 desktop computer and the 8010 Star workstation. The 860 word processor was also doing well. So excited was Xerox about Star that the media people at the company's Stamford, Conn., headquarters produced a special videotape featuring Xerox chairman C. Peter McCoolough. On the tape, which was made for internal distribution and sent out to Xerox field offices, McCoolough likened the Star in its significance to the 914 copier, the first automatic copier to make copies on ordinary paper. The 914 had been the product that put Xerox on the map.

OFF TO A GREAT START

The consensus at the time was that Xerox clearly was off to a brilliant start. "Xerox has to be singled out as the one company that's got its act together in terms of a single, comprehensive strategy out of which products are beginning to flow," asserted John Connell of Office Technology Research Group in Pasadena, Calif.

To direct its office automation efforts, Xerox had previously hired John V. Titsworth from Control Data Corp., where he had held a number of high-level jobs including executive vice president of systems. To work under him Xerox had brought in Donald J. Massaro, one of the founders of Shugart Associates, the leading floppy disk drive manufacturer, which Xerox had acquired earlier. Massaro's charter was to revitalize the company's moribund Office Products Division in Dallas and make it a major factor in the office automation marketplace.

Massaro had walked away from the Shugart deal with several million dollars and a yacht he kept in California. This, Xerox observers allow, may not have endeared him to some of his fellow executives who struggled to make the mortgage payments and pay college tuition bills on \$65,000 a year. More significant, Massaro was a freewheeling entrepreneur who didn't fit into Xerox's highly structured manage-

ment style. He quickly made a number of enemies in Stamford. "Massaro is a California computer type with all the wild things that implies," says one observer. "Here he was dealing with all these conservative East Coast businessmen who play strictly by the rules."

"Xerox's copier people have to work their way through the political hierarchy in order to get anywhere," adds a Xerox insider. "That's the way the old-boy network within the company works. But Massaro was suddenly brought in and given this power without having to go through the prerequisite ladder climbing. This caused a lot of resentment."

Barbs aimed at Massaro flagged an antagonism targeted at the whole office automation venture. "You had a battle emerging between the old Xerox [the copier group] and the new Xerox [the office automation group]," says a consultant who has worked extensively with Xerox. "The copier people didn't like the idea they were being used as a cash cow and Xerox's office systems people could spend all this money without making any. It was a real schism."

Some of the more conservative senior Xerox executives were also concerned by the idea that the company seemed to be staking its entire future on office automation. "These people were worried that if the company put all its eggs in the office automation basket and it didn't pay off, Xerox would go down the tank in five years," says the consultant.

One of the proponents for diversification was Melvin Howard. Howard had been instrumental in establishing Xerox Credit Corp. in 1979, an organization that provided financing for Xerox copier customers and was involved in leveraged leasing. Though small, its growth record was impressive: revenues of \$3 million in 1980, \$25.5 million in 1981, and an estimated \$35 million in 1982.

As Xerox Credit Corp. grew, so did Howard's clout in the organization. As the company's chief financial honcho he closely reviewed and monitored each corporate project. "Mel Howard is very bright, but he's so down-to-earth he can be negative," says a former colleague. "He's got a very sharp pencil—perhaps too sharp for a high-tech company where you have to take risks."

The first real indication that Xerox was not going to keep coming up with endless supplies of cash to fuel high-tech ventures came in early 1981 when it decided to kill XTEN, the Xerox Telecommunications Network. XTEN was the company's ambitious attempt to enter the long-haul data transmission business. It had applied for FCC approval and had announced plans to be operational in a number of major U.S. cities when Xerox announced it was walking away from the project. "XTEN had more promise for Xerox than Ethernet," argues one of the project's former

backers with some bitterness. "But Mel Howard put the kibosh on it."

With the XTEN cancellation Xerox also announced plans to turn around and sell WUI (Western Union International), an international communications carrier acquired in 1979 for \$210 million, to MCI Communications Corp. Xerox had backed away from the telecommunications market as suddenly and dramatically as it had withdrawn from the mainframe computer business in 1975.

As Xerox moved into 1982, it became increasingly apparent that some of the company's pet projects were not, after all, going to set the office-system world ablaze. Star, in particular, proved to be a major disappointment. "Star is a solution in search of a problem," says Philip Dorn, president of Dorn Computer Consultants Inc., New York City.

"Star proved far too expensive and too slow," adds Amy Wohl, president of Advanced Office Concepts, Bala Cynwyd, Pa.

For other observers, Star was simply ahead of its time. "Xerox overreached with Ethernet and Star," observes Ted Withington of Arthur D. Little, Cambridge, Mass. "The market was clearly not ready."

And now that the market is better primed to accept the workstation concept, it is probably a product such as Apple's Lisa, a less expensive machine than Star, that will reap most of the benefits, analysts say. Ironically, many of Lisa's key designers came from Xerox, where they'd worked on Star and its predecessors.

The 8-bit 820 personal computer also failed to elicit much excitement. "There's nothing really wrong with the machine," says Sanford J. Garrett, a computer analyst with Paine Webber Mitchell Hutchins, Inc. "It was just poorly marketed."

THE IDENTITY CRISIS

Part of the problem had to do with an identity crisis. "The 820 was introduced with the idea of keeping Apple and Tandy out of the Fortune 500 market, where Xerox is at its strongest," Donald Massaro explained after the 820 had been on the market for almost a year. But with IBM's success with its Personal Computer, Massaro added, "everyone with a personal computer had to get into the retail market."

Where Xerox stuck to its original strategy of selling directly to big companies with the 820, it has experienced considerable success. For example, a division within General Motors has 120 Xerox 820s tied to an Ethernet network, and the machines are functioning successfully in an unexpected way. There are also 15 of the company's 860s and 15 Stars interconnected on the same network, but surprisingly, it is the 820s that are being used as workstations, reports an analyst who has visited the installation. "The 820s are

Now, all of your mainframe's powerful PLOT 10™ graphics capabilities can go to work anywhere in your company—right on your desktop microcomputers!

Only GSS-4010™ graphics software from Digital Research allows most microcomputers to emulate the powerful Tektronix® 4010 family of terminals (4010, 4012 and 4014). Your micros have instant access to ISSCO's® TELL-A-GRAF™ and DISSPLA™, Tektronix' TCS™ and IGL™, or other PLOT 10 compatible graphics available on your mini or mainframe...without the added expense of special graphics terminals.

GSS-4010 adapts to a wide variety of micro-computers, host computers, communications formats and display/print options via a simple menu. There's no easier, less expensive way to put the power of your PLOT 10 graphics to work throughout your company.

Maximize your investment in mainframe graphics software. Talk to your microcomputer systems supplier about GSS-4010, part of the CP/M® Graphics™ family from Digital Research. Or write Graphics Products Center, Digital Research, 160 Central Avenue, Pacific Grove, CA 93950.

**DIGITAL
RESEARCH™**
The creators of CP/M™

Access mainframe graphics with your micros.

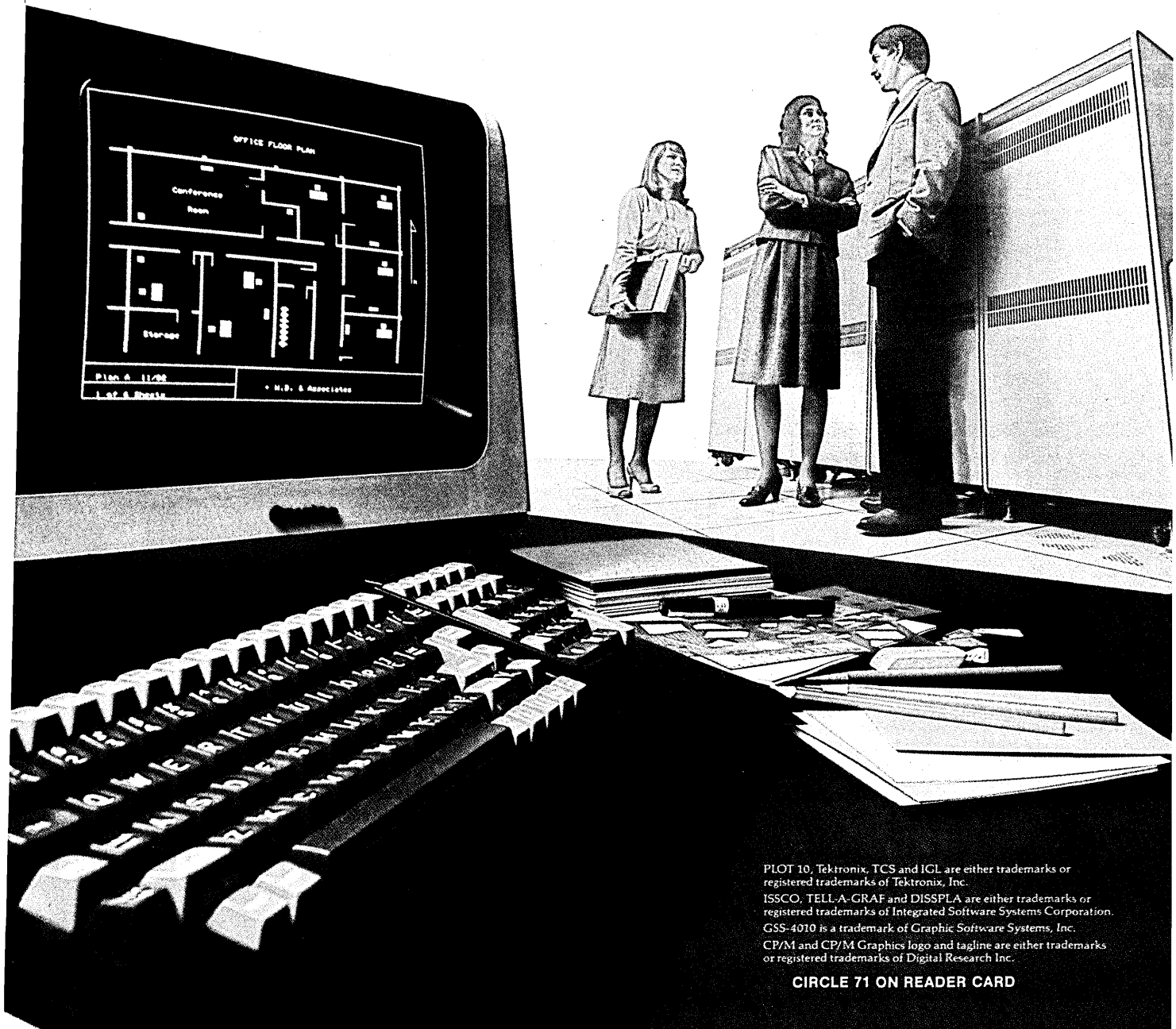

PLOT 10, Tektronix, TCS and IGL are either trademarks or registered trademarks of Tektronix, Inc.
ISSCO, TELL-A-GRAF and DISSPLA are either trademarks or registered trademarks of Integrated Software Systems Corporation.
GSS-4010 is a trademark of Graphic Software Systems, Inc.
CP/M and CP/M Graphics logo and tagline are either trademarks or registered trademarks of Digital Research Inc.

CIRCLE 71 ON READER CARD

NOW ANYBODY CAN MAKE THEIR BUSINESS LOOK GREAT

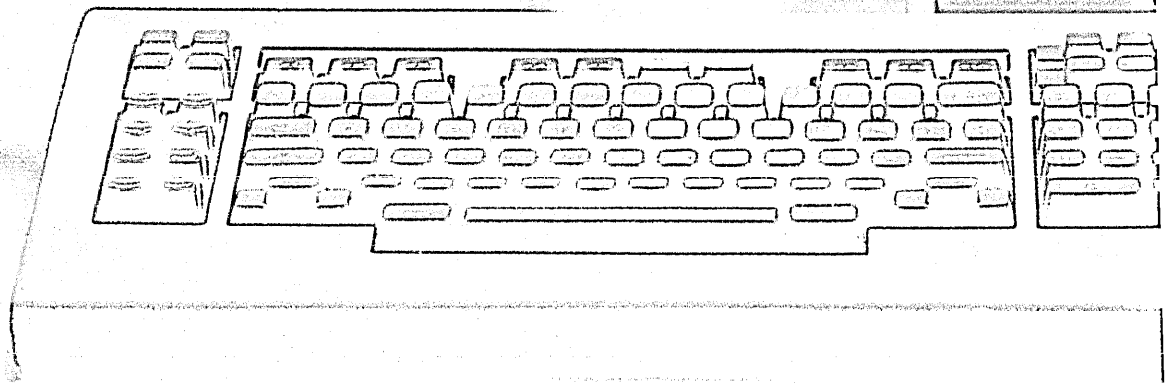
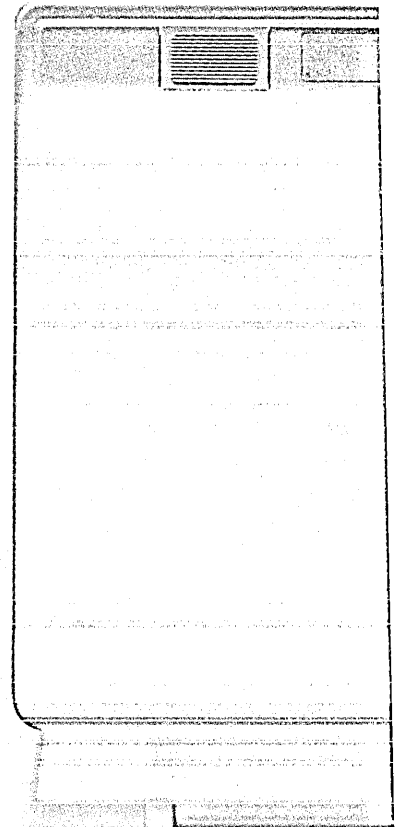
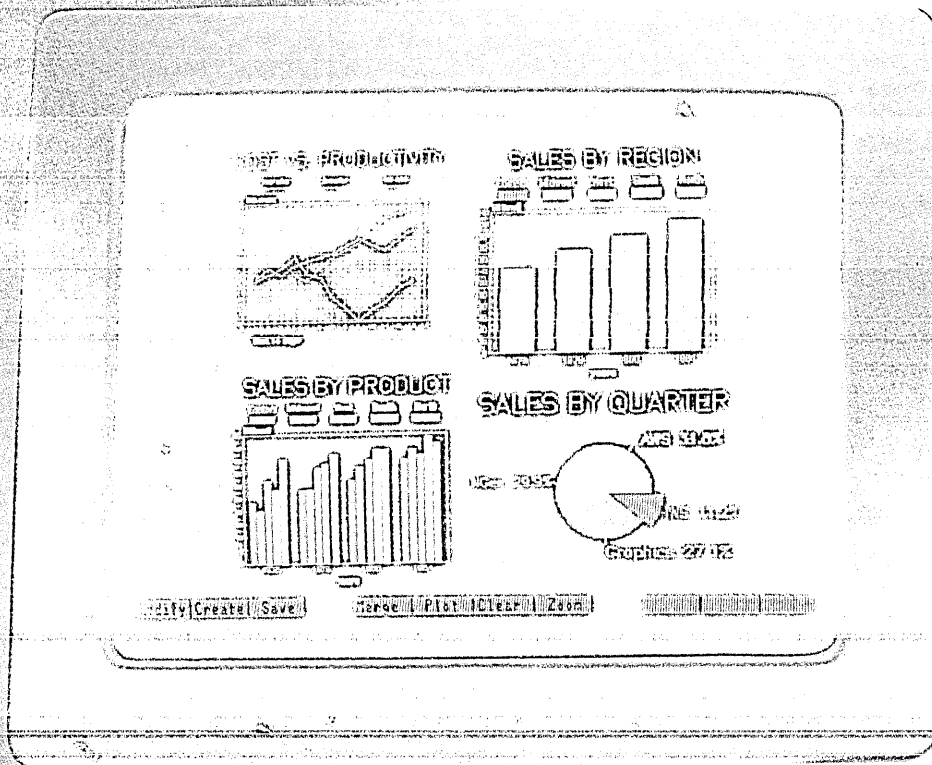

The explosion in business graphics is just getting started. To help OEMs cash in on the boom, Convergent Technologies now offers spectacular, low-cost graphics hardware, plus revolutionary software that lets even untrained users create sophisticated business graphics. **Picture-perfect hardware.**

There are two ways to add great graphics to a Convergent system.

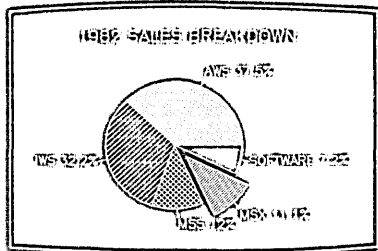

The monochrome option comes on a single Multi-bus[®] board that plugs into any IWS[™] workstation. Using a dedicated 8MHz 16-bit processor with on-board ROM and RAM, it displays either of two 656 x 510 bit maps on the existing high resolution monitor.

Color comes as an option in our new AWS[™] Turbo workstation. Using the same dedicated processor approach, you get dazzling 64-color images with 432 x 319 resolution.

A complete set of graphics primitives gives high-level languages access to all the features of both systems. **Sensational Software.**

Now generating business graphs and charts is as simple as using the highly-acclaimed Multiplan[™] spreadsheet program.

With Convergent's enhanced Multiplan and our proprietary Business Graphics Package, you just select a range of rows and columns for graphing in any of several standard formats (pie and bar charts, line graphs, etc.)

If you want to get creative, use our unique graphics editor to resize, rescale, move, and combine charts—interactively, right on the screen. Then produce presentation quality hard copy on an inexpensive plotter.

Convergent graphics software is 100% interchangeable between color and monochrome systems; shading and cross-hatching are automatically substituted for color when necessary!

The Convergent OEM revolution continues.

Combine *accessible* graphics power like this with all our other advantages, and it's easy to see why so many OEMs are making major, long-term commitments to Convergent systems.

Shouldn't you get the full story now?

Convergent Technologies

Where great ideas come together.

Call toll-free (800) 538-7560; in Calif. (408) 727-8830 or return this coupon.
 Send to: Convergent Technologies Inc., 2500 Augustine Drive, Santa Clara, CA 95051

I'm an OEM. Give me the whole picture on Graphics.

Name _____ Title _____

Company _____ Address _____

City _____ State _____ Zip _____

Tel. () _____ Ext. _____

D28

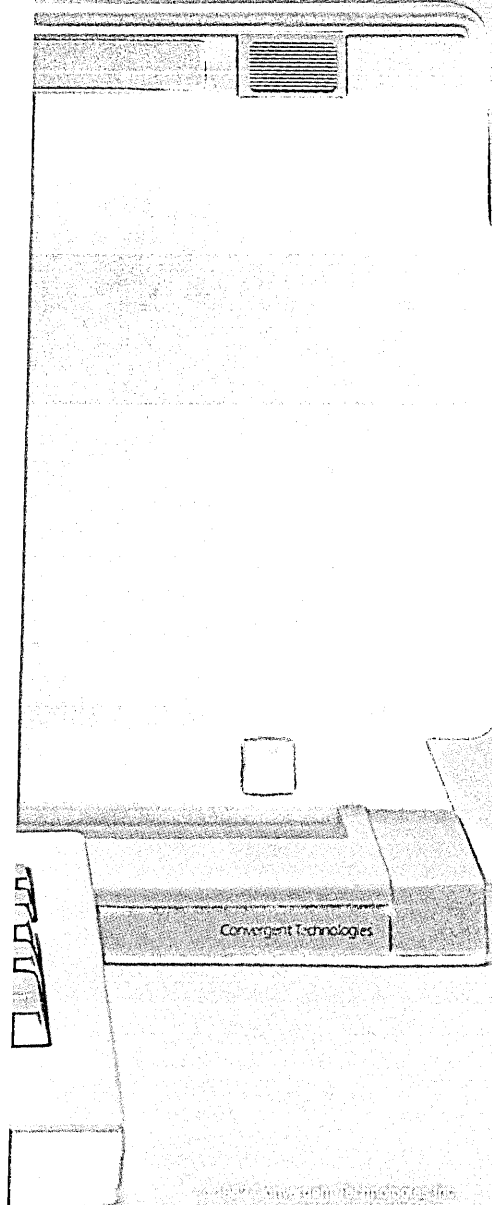

© 1987 Convergent Technologies Inc. All rights reserved. Multiplan is a registered trademark of Microsoft Corporation.

"PARC became like Bell Labs—a place where research was conducted for its own sake."

doing the job initially intended for the Stars, and they're doing it effectively at far less cost."

But Xerox's efforts to sell the 820 to the retail market through Xerox stores and distributors has proven costly and ineffective, analysts such as Garrett maintain. Some analysts go so far as to write off the machine altogether as a retail product. "The 820 is as dead as a doornail," states Dale Kutnick of The Yankee Group in Boston.

Xerox's initial disappointment with the Star and the 820 served to exacerbate a long-simmering conflict between corporate management and PARC, Xerox's Palo Alto Research Center. Funded to the tune of about \$20 million a year, PARC has attracted many top-flight computer scientists. Yet, for a variety of reasons, not many PARC projects have evolved into products that have had a successful run in the marketplace. "PARC became like Bell Labs—a place where research was conducted for its own sake," one Xerox observer maintains.

"PARC just hasn't come through," adds The Yankee Group's Kutnick. "It sat on Altos [a prototype version of Star] for years and it hasn't been getting products out the door."

PARC staffers blamed the problem on senior management. "Xerox was good at funding, but lacked the nerve to take any real chances," says Alan Kay, a PARC founder who is now chief scientist at Atari.

Some senior Xerox executives countered that the people at PARC walked around with their heads in the clouds and didn't understand or appreciate the problems of the marketplace. John Titsworth tried to bridge the gap by having the Office Products Division apply PARC's R&D to its own developmental efforts. But as the hard realities of competition became more pressing, Xerox's enthusiasm for supporting PARC on an almost carte blanche basis seemed to wane markedly. Sensing the heydays were over, a number of key PARC people such as Kay left to go to places like Atari and Apple.

At the same time, with copier revenues off and office automation efforts not progressing as successfully as might have been expected, the arguments for diversification and the sniping at Massaro became more pronounced at Xerox headquarters. Massaro's critics maintained that he was never at OPD headquarters minding the store and that he was unable to deliver on his oft-repeated promise that OPD would move into the black. (Since it was created in 1975, OPD has registered only one profitable quarter. It accumulated losses of about \$90 million on revenues of \$300 million in 1981). His supporters praised him for his frequent trips to update customers and the sales force on product developments. "Massaro was the kind of guy

Xerox desperately needed," says a Wall Street analyst who has followed the company for more than a decade. "He's aggressive and he actually went out and heard what the customers were saying."

DIVIDE AND CONQUER?

Events came to a head in April 1982 when a group of top executives left OPD in a rift over the 820 marketing strategy. Then in July the company decided to divide OPD into two groups, an Office Systems Division in Palo Alto under Massaro and the Office Products Division in Dallas under William C. Jackson, who had been in charge of the Memorywriter electronic typewriter effort. Massaro was left with Ethernet and Star, while OPD kept the Memorywriter, the 860 word processor, and the 820 computer. Significantly, Massaro no longer had the 600-member direct sales force reporting to him. "The profitable part of OPD's business (Memorywriter and the 860) had been stripped away from Massaro and he was being made to toe the mark," an analyst who is close to Massaro confides.

Xerox was clearly hoping the reorganization would revitalize its office automation efforts, but in late summer it was suddenly confronted with a development that would overshadow all its other concerns. Xerox president and ceo David T. Kearns was unexpectedly approached by GTE with a proposition it wanted Kearns to consider.

Xerox's stock had dropped below \$30 a share, a near record low that was a good \$10 under book value. Moreover, despite its problems in the copier field and its big outlay for office automation ventures, its debt was relatively small, its cash position solid. Simply by mandating that customers purchase their leased copiers, the company could probably raise between \$30 to \$40 a share.

Xerox, GTE believed, was an excellent candidate for what GTE had in mind. GTE wanted badly to get into the computer and office systems business, and Xerox was just the ticket it needed. GTE wanted to acquire Xerox.

According to a source close to the acquisition attempt, the offer, though made on a friendly basis, was not at all well received. "GTE was throwing money around like a drunken sailor," the source says, "and Kearns really got his hackles up. It had never occurred to him that Xerox was even the least bit vulnerable and the idea didn't sit well at all."

By itself, this incident, which was kept so quiet that many GTE and Xerox executives still aren't aware of it, has no particular significance. What is significant, however, is the ensuing course of events and what it portends. Shortly after GTE was rebuffed by Kearns, it paid \$750 million to acquire

Sprint, Southern Pacific Corp.'s long-distance transmission service. Xerox, in turn, made an even more ambitious play, acquiring Crum & Forster, a New Jersey insurance company in the property and casualty business, for a whopping \$1.6 billion. And Massaro, whom Xerox observers credit with revitalizing the OPD effort, turning around the 860 word processor, and getting Xerox's electronic typewriter off to a great start, resigned. He took with him his number two marketing man, David E. Liddle.

Asserting that he had agreed to a three-year stint at OPD and that the three years were up, Massaro was once again an entrepreneur; he and Liddle formed Metaphor Computer Systems in Santa Clara, Calif. The pair claimed that with potential backing from Xerox, they would produce an Ethernet-compatible workstation. They've said little else, refusing to comment on OPD's past or prospects. The ensuing rumors and questions, of course, came fast and hard and seemed to surprise even Xerox in their intensity. "Xerox may not have realized how people in the office systems field were going to react to the news that the company was suddenly pouring an incredible amount of money into the insurance business," says Amy Wohl.

Xerox "bears" saw the announcement of the Crum & Forster purchase as meaning the company was backing away from its commitment to office automation or, at the very least, hedging its bets. "Spending \$1.6 billion to acquire an insurance company would seem to be a clear sign that they've written off the office," argues Phil Dorn. "If they were really serious about staying in the business, they would have put that money into R&D or acquisitions. With \$1.6 billion, Xerox could have bought three micro companies, 12 software houses, a partridge in a pear tree, and still had half a billion to play with."

"The acquisition leaves Xerox with a thin cash flow that hardly seems adequate to stay the course in office automation," Ted Withington adds.

Even observers who remain bullish on Xerox couldn't muster much initial enthusiasm. "This enables Xerox to preserve its dividends and could mean a turnaround for the company," says Kidder's Melody Johnson.

XEROX ASSURES USERS

In the context of the other events that have occurred over the last few years, the Crum & Forster acquisition, however, takes on a somewhat different significance than it has generally been accorded. At a Xerox users meeting at Dallas in November, John Titsworth and David Kearns assured customers that Xerox was fully committed to office systems. The Crum & Forster transaction was nothing sudden, they ex-

SUPPORT SYSTEMS

BY LIEBERT

COMPUTER

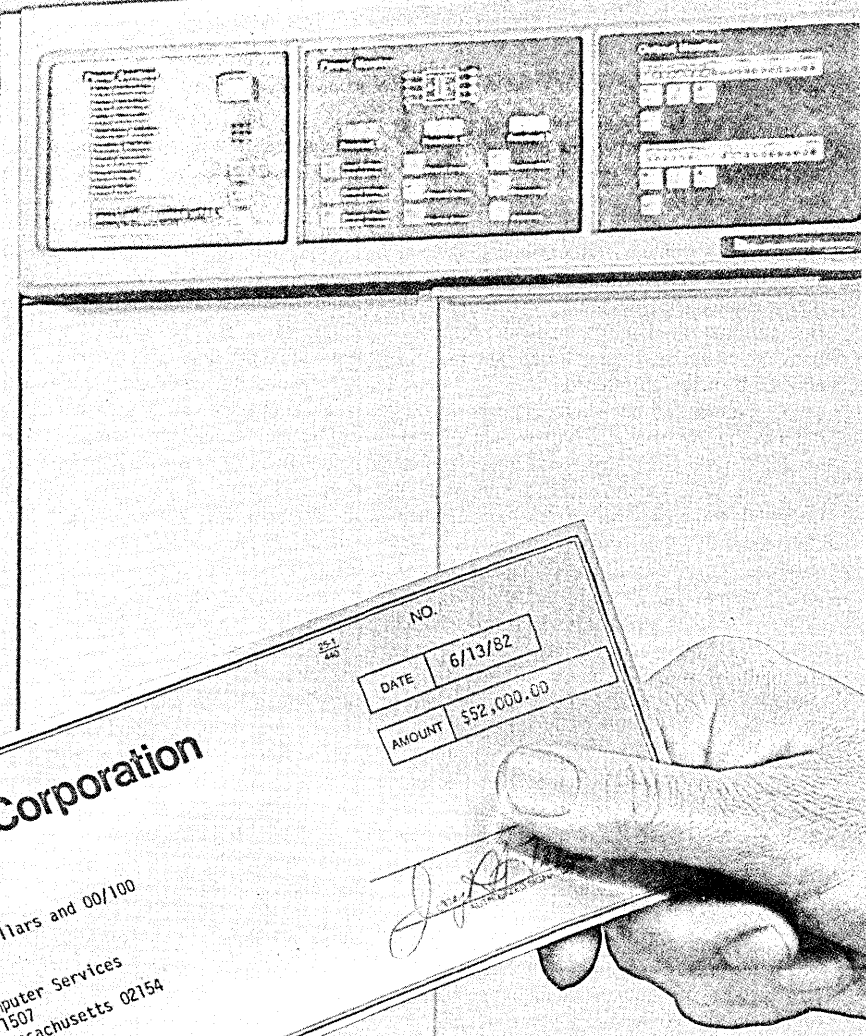

Today, top management looks for computer personnel who understand R.O.I. as well as E.D.P.!

(That's why electrical power conditioning is so vital to today's planning!)

Obviously, the return-on-investment you get from your computer operation depends largely on **eliminating computer errors and maintaining uptime!** And, with today's cost of 'downtime' ranging from \$1000 to \$7000 per minute, you simply can't afford disruptions! That's why smart managers are protecting their investment by installing Liebert Power Management Centers between their computers and the building's power source! **The Power Management Center will pay for itself...** The savings you'll realize in uptime will easily justify the cost of the system! And, it's the **only** total power system that combines distribution, monitoring and 100% effective conditioning!

SUPPORT SYSTEMS BY LIEBERT-COMP

Liebert Corporation, 1050 Dearborn Drive, P.O. Box 29186, Columbus, Ohio 43229, Phone 614-888-0246 Telex 246-655 Liebert WOGN

Please send a free copy of "The Cost Justification of Power Conditioning."

Name: _____

Title: _____ Phone: _____

Company: _____

Address: _____

City: _____ State: _____ Zip: _____

Have a salesman call



We help make your computer investment pay off.

CIRCLE 72 ON READER CARD

BY LIEBERT-COMPUTER

Now that it is selling insurance, Xerox is no longer a "pure" technology play, making it less attractive to companies such as GTE.

plained. It had been in the works for some nine months.

Xerox had been looking for a strong company in a growth industry that was not dominated by one or two firms, they said. It had been seeking a concern that generated a lot of cash and had a strong management that would stay in place and continue to run the store while Xerox's senior people stuck to their principal business, i.e., copiers and office automation. Buying an insurance company by no means precluded staying the course in office automation.

Xerox had been interested in acquiring a cash cow such as Control Data's Commercial Credit Corp. for some time. In fact, the company seriously weighed buying CIT, a financial services firm, in the late 1970s. Consequently, the Xerox party line is probably close to the truth as Xerox knows it—with one possible deviation.

Analysts who've heard rumors about the late summer takeover bid speculate that Xerox may have acquired Crum & Forster for another reason as well—to protect its flanks from any future acquisition attempts. Now that it is selling casualty and fire insurance, Xerox is no longer a "pure" technology play, making it less attractive to companies such as GTE. Moreover, it now has more debt on its books than most potential acquirers would be willing to assume.

What does all this bode for Xerox's office systems effort? To date there has been no visible cutback in support of that business. Nor is there any indication such a cutback is imminent. "We've been given all the resources we've asked for," says John F. Shock, who was named vice president of Office Systems in the wake of the Massaro and Liddle resignations.

Moreover, despite problems with some products, Xerox is scoring extremely well in a number of different areas. Among them:

- Electronic printing. "There's enormous growth here," says Johnson of Kidder Peabody.
- The 700 Series of nonimpact printers. "Here Xerox has excellent product position and is ahead of IBM," Withington of A.D. Little believes.
- The 860 word processor. "This is a very solid word processor, though it's an old product with only a year or two left in its product life," says Amy Wohl, who estimates Xerox is as much as 250% over quota with the machine.
- Xerox's electronic typewriters, the Memorywriter line. Aimed at the heart of IBM's huge but aging Selectric base, the products are "doing fabulously well and are 150% over quota," says Wohl.
- Ethernet. This is obviously the key to Xerox's overall office systems efforts, and there

is considerable evidence that Ethernet is finally taking off after an enormous push from Xerox. In the past six to nine months, Ethernet has essentially been voted in as an LAN standard in the U.S. and in Europe. Some 60 companies now manufacture equipment that is compatible with Ethernet, and John Shock claims there are now between 300 and 350 LANs operating. A number of big users have reported major productivity gains from Ethernet, while at a November meeting in Toronto, IBM publicly admitted that Xerox's intense promotion of Ethernet had forced IBM to take a stand on LANs. "Ethernet had a 'Perils of Pauline' beginning," says one Xerox analyst. "But it seems finally to be fulfilling its promise."

With this key building block apparently in place, Xerox's future in office systems may prove more viable than some observers realize. Sanford Garrett, an analyst who follows Xerox as closely as anyone on Wall Street, recently did a detailed, beneath-the-surface analysis of Xerox. His observations are worth noting.

Garrett sees a number of new products coming out of Xerox in the near future including a 16-bit personal computer, new disk drives, a crt screen, and additional intelligence to enhance the Memorywriter and provide it with more word processing capabilities.

Garrett projects that Xerox's stand-alone office product (exclusive of copiers), systems office product, and office product component business will have generated about \$1.3 billion in 1982 and will just about break even as a total entity. As for the rest of Xerox, he sees copier revenues hitting \$5.6 billion, electronic printing at \$300 million, and paper sales at \$600 million.

One other possible plus: Xerox recently reorganized its sales force with a limited number of high-end salespeople offering Star and Ethernet. Here the idea is to go after the big-ticket systems business, and each salesperson will be backed up by several technical support people.

The rest of what had been the copier sales force will sell reprographic gear along with stand-alone office automation equipment, specifically the 820 II, the 16-bit microcomputer (when it is introduced), the 860, and the electronic typewriters.

BASIC CHANGE SEEN

But more important over the long term is a fundamental change Garrett sees taking hold at Xerox as a result of the McKinsey study. In an effort to trim off excess corporate weight, the company in recent months has reduced the number of high-quality components suppliers from several thousand, working towards a target of 500 to 700, Garrett says. The re-

maining suppliers are holding on to inventory in exchange for increased orders. This reduces Xerox's overhead as well as the risk of being stuck with unused components.

In addition, Xerox has adapted some of the Japanese-style manufacturing techniques it has learned from Fuji Xerox Co. Ltd., and has begun production in automated plants such as the Memorywriter factory at OPD in Dallas. Xerox "is employing modularity of design in its copier products," Garrett adds. The idea is to produce a machine that can be configured in many different ways using a single xerographic "engine," rather than building an engine specially designed for each particular configuration. "With this approach it's much easier to upgrade and keep the product state of the art," the analyst adds.

All this would sound academic were not some of the end results in evidence. Xerox has recently introduced a new line of copiers, the 10 Series. The high-volume 1075 was recently unveiled in the U.S., the 1045 in France. "The 10 Series will eventually offer a brand-new copier in every segment of the copier market, including home copiers," says Garrett. These machines are significant because they represent the first real pay-back on Xerox's investment in new manufacturing approaches. They are being produced at about half the cost of ordinary machines and should be considerably more reliable, Garrett claims.

If Xerox is able to apply these techniques across its range of products—from oem floppy disks to Ethernet office systems—it should be able to regain some of its early lead in office automation. In the meantime, with Xerox underwriting casualty policies and Massaro back in California, the day clearly belongs to the conservative, traditional elements within the corporation. "We've won!" one senior executive rejoiced on the day Massaro's exodus was announced.

Xerox's users, the ultimate arbitrators of the company's fortunes in office automation, are assessing the situation somewhat differently in light of recent developments, however.

"I've many more reservations about Xerox's willingness to stay the course than I've had in the past," says one of the company's biggest customers. "They've been telling us they simply didn't have the resources to supply us with the things we need, and then they go out and spend \$1.6 billion to buy an insurance company. I hope they stick with it and maybe they will, but right now the jury is out." *

Laton McCartney, a former managing editor of DATAMATION, is currently a free-lance writer in New York and a regular contributor to this magazine.

The terminals that face up to everyone's problems.

Now Qume offers a line of three CRT terminals that help you face every one of your company's needs: The Qume QVT™ series.

The low-cost Qume QVT 102™ has all the best features of the four most popular terminals and can emulate all four with a keystroke! QVT 103™ is code-compatible with the DEC VT100/VT 131 and offers 80 or 132 character/line, split screen and up to 4 pages of memory. And QVT 108™ faces up to the most demanding jobs with 22 function keys, 13 editing functions and 2 pages of memory.

Qume QVT terminals all share striking ergonomic design. Tilt/swivel screens in green or amber. Detached, low-profile keyboards. Big 9 x 12 character cells. And a long list of other features to make people more comfortable and productive.

Best of all, Qume QVT terminals are very competitively priced. You can have performance, features and reliability without facing a budget problem.

Talk to your Qume sales office about filling all your terminal needs with a single purchase of QVT terminals. Or write Qume, 2350 Qume Drive, San Jose, California 95131.



One size
fits all.

Qume
A Subsidiary of ITT

QUME CORPORATION

HEADQUARTERS
2350 Qume Drive
San Jose, CA 95131

CALIFORNIA

San Jose (408) 995-6144
Culver City (213) 410-1458
Santa Ana (714) 957-4040

COLORADO

Aurora (303) 752-3000

ILLINOIS

Palatine (312) 991-7250

OHIO

Dayton (513) 439-0469

TEXAS

Irving (214) 659-0745

NEW JERSEY

Edison (201) 225-5005

MASSACHUSETTS

Bedford (617) 275-3200

GEORGIA

Decatur (404) 284-8500

GERMANY

Düsseldorf PH: 211743016

ENGLAND

Reading, Berkshire
PH: 734-584-646

FRANCE

Boulogne PH: (1) 6082334

CANADA

Quebec PH: (514) 695-3837

CIRCLE 73 ON READER CARD

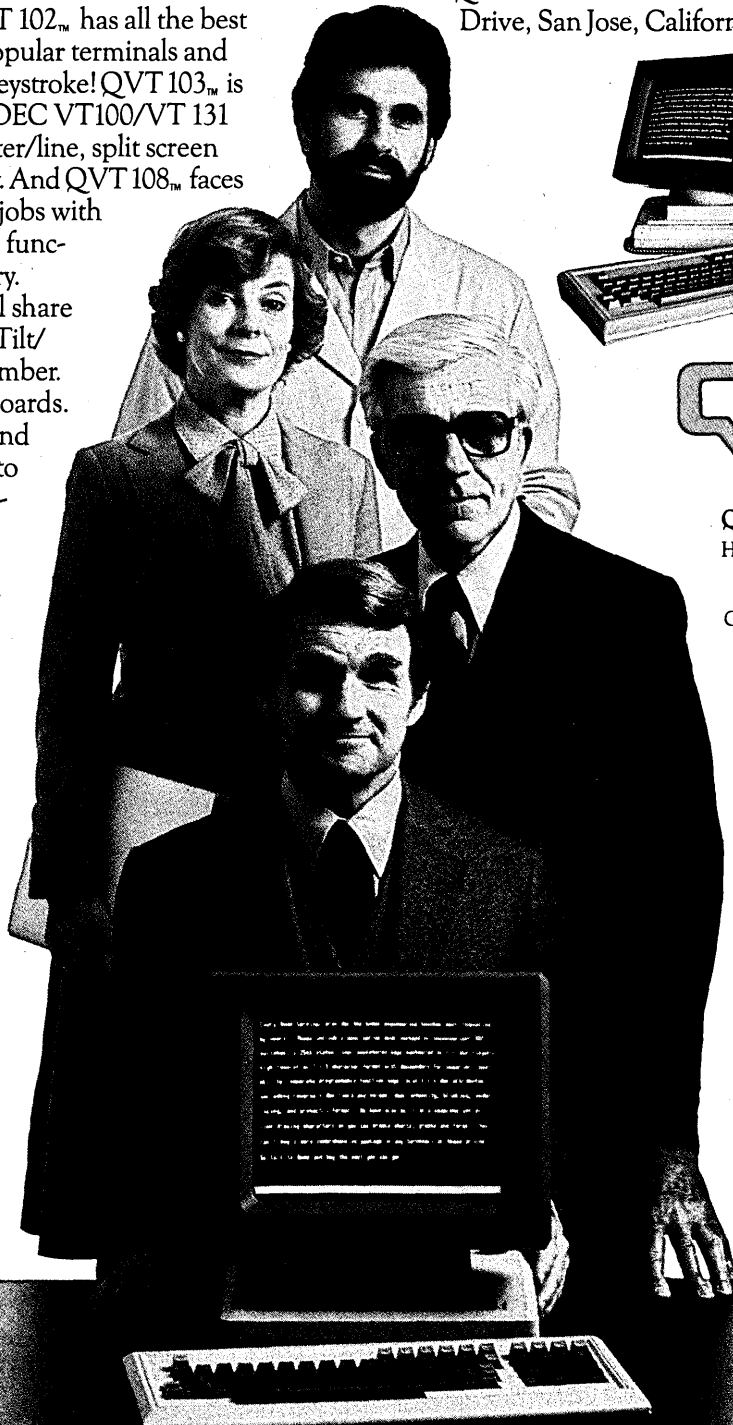



TELEVIDEO SYSTEMS INC PRESENTS THE 970

ANSI 3.64

256 DOWNLOADABLE FONT

14" SCREEN

VT-100 COMPATIBLE

32 NON-VOL. FUNCT. KEYS

ACCOUNTING KEYPAD

24 X 132 COLUMN

NO SPACE ATTRIBUTES

LOGICAL ATTRIBS.

TELEVIDEO 970

3 25 1985



The new 970 from TeleVideo. Nothing else looks like it. Nothing else performs like it.

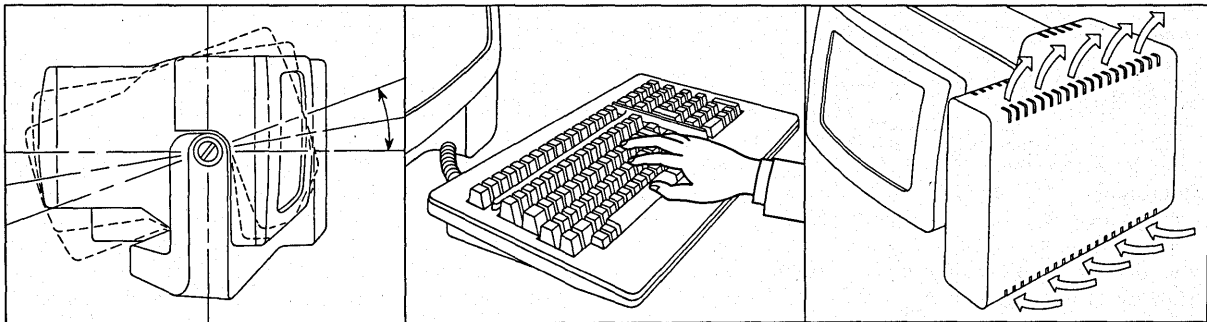

Productive office work depends on people and their equipment working efficiently together.

That's why we have engineered the exciting, new TeleVideo 970 to perform better than any other terminal.

For instance, only our "natural balance" tilting mechanism lets you easily adjust the screen at a touch, so you avoid neck-craning, straining and glare.

Our unique keyboard is designed to avoid user fatigue. We've created a natural palmrest, sculpted keys and the best ten-key accounting pad in the industry. Our non-volatile function keys save time and energy.

Like every feature of the new 970, the screen is designed for ease of use. Our non-glare 14-inch green screen is restful on the eyes, and its 132 column display can format more information. All in highly legible double-high, double-wide characters.

Our communications protocol is the industry standard ANSI 3.64.

As you probably know, most terminal downtime is caused by overheating that results from extended use. There's no such problem with our unique vertical convection cooling tower.

And because we wanted to extend the life of your CRT, we've installed a screen saving

feature that automatically turns it off after fifteen minutes of idle time.

Naturally, like all TeleVideo terminals, service is available nationwide from General Electric's Instrumentation and Communication Equipment Centers.

The new 970 from TeleVideo. Nothing else looks like it and nothing else can perform like it.

For more information about TeleVideo's new 970, call 800-538-8725; in California 408-745-7760.

TeleVideo Systems, Inc.
Dept. # 209F
1170 Morse Avenue
Sunnyvale, CA 94086

Yes, I'd like to know more about the unique 970 from TeleVideo:

NAME _____

ADDRESS _____

CITY _____

STATE _____ ZIP _____

TELEPHONE (____) _____

California/Santa Ana 714-557-6095; Sunnyvale 408-745-7760; Georgia/Atlanta 404-255-9338; Texas/Dallas 214-980-9978; Illinois/Chicago Area 312-351-9350; Boston/Massachusetts 617-668-6891; New York/New Jersey 201-267-8805; United Kingdom/Woking, Surrey 44-9905-6464.

 **TeleVideo Systems, Inc.**

CIRCLE 74 ON READER CARD

You won't be able to make an informed decision just by listening to the salesmen. Here's an objective framework for evaluating integrated office systems.

WHAT YOU GET WHEN YOU BUY OFFICE AUTOMATION

by David Macfarlane

Integration is the promised land of office automation. While there's some advantage in speeding up document preparation or intra-office messaging, the real payoff comes not from automating individual tasks but from linking a series of components to allow information to flow freely in many forms.

Vendors, of course, are acutely aware of this, and an impressive number of them have responded by entering the integrated office system business. Overall, this is good for users, but it also contributes to a problem: office systems are so complex, and so many things to so many people, that they can be quite difficult to evaluate. There are no standard definitions for things like decision support. Vendor A and vendor B may both claim to offer it when in fact they're selling rather different items. Naturally enough, each will maximize his strengths and minimize his weaknesses.

Multiply this kind of confusion by the many features and capabilities each system offers, and again by the score of companies in the business, and you see why it's hard to know what you're buying when you invest in an integrated office system.

Over the last few years, I have been involved in developing a framework that facilitates the comparison of office systems. Because it is vendor independent, the framework can be used to describe each system in a consistent manner and show how it stacks up against the others. This framework has grown to over 300 separate elements, making possible an extremely comprehensive description of each integrated office system under analysis. It is still being expanded by the Integrated Office System department at Coopers & Lybrand.

Although this level of detail is necessary for our kind of system selection process, it may not be for everyone. Even so, we believe we have demonstrated the general usefulness of the framework approach. Even a summarized version can help free decision-makers from the natural prejudices of each

vendor's descriptions. This article provides such a basic framework. Readers may find it helpful in its own right or as a guide to follow when they incorporate their particular concerns into a framework they develop themselves.

The most obvious and also the least useful way of decomposing IOSs is the hardware/software split. Most of the users of office systems will never have any idea of where one stops and the other starts, and it really makes very little difference.

The utility of this division increases when we add "orgware" to describe the components of the office system provided by the organization itself. But we still don't have enough sensitivity to describe office systems in any detail.

Another approach is the three-way split among office technologies, computer technologies, and communications technologies. In a now almost ubiquitous diagram, the three functions are pictured converging to create integrated office systems. This helps us see the main focus that vendors bring to the design of their office automation products, but it is not specific enough to describe the systems themselves.

Finally, there is the functional division, which we have chosen as the foundation for our descriptive framework. It shows each element of the office system as being contained in, or consisting of elements from, six categories:

1. Communications
2. Information retrieval
3. Analytic tools
4. Text preparation
5. Personal support tools
6. Special applications and program-

mability

DEFINING THE IOS

Everything that an office system provides to all its users should fit into this list. We can then define an IOS as an office system that combines several of these six functions in an integrated manner. We stipulate that in order to qualify as an

IOS, a system has to be designed for use by multifunction knowledge workers. This excludes all the special purpose systems for single function workers, such as language translation machines, computer assisted design systems, and circuit layout devices.

Besides being useful for general analysis and comparison, a functional division can also serve as a checklist. It can remind decision-makers of important features that, while not a central part of a requirements specification, can still have a lot to do with a system's success. For example, a given offering will probably include electronic mail—but can it file those messages?

Let's examine each of the six functional areas in turn, introduce examples of system facilities, and ask some of the questions that can make the framework approach a comprehensive one.

Communications. Communications in an integrated office system can be simultaneous or nonsimultaneous (stored message). The medium can be voice, text, graphics (e.g., line drawings, icons, Telidon encoded picture commands), or image (e.g., video input or facsimile). Electronic messaging, voice messaging, computer conferencing, voice telephony, and fax are all examined in this part of the framework.

Electronic messaging systems (also called electronic mail, or E-mail for short) are, after word processing, usually an organization's first venture into office automation. E-mail gives users almost instant relief from telephone tag, slow interoffice mail, and memo overload. Because so much managerial and professional time is spent in communication, E-mail generally pays off rather quickly.

Another reason for implementing it first is the ease of startup: packages are readily available for nearly any kind of system, and there are no large databases or procedures to establish.

In evaluating an electronic messaging facility, you need to know if it is only for distributing documents among all users (many are), or if it is designed for person-to-

HI THERE! I REPRESENT
HYPERTECH, AND I'M HERE
TO TELL YOU
ABOUT OUR
INFORMAGIC
OFFICE
SYSTEM

DITHERS
& CO.

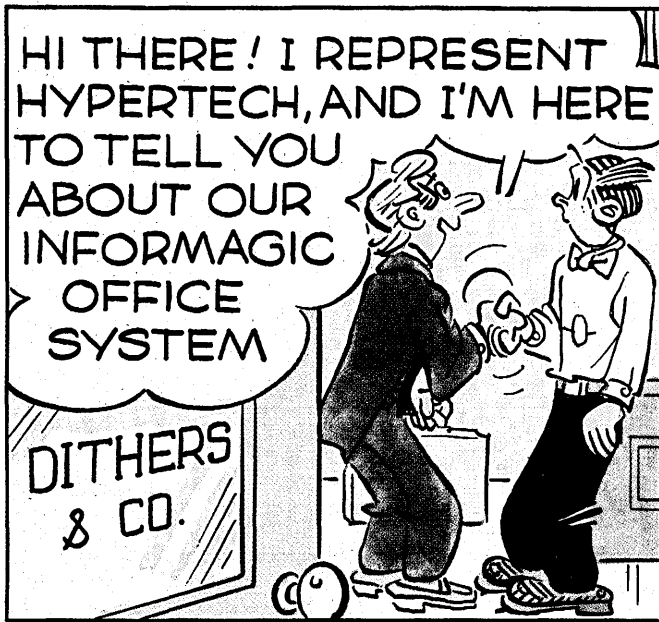

NOT SO FAST... I'VE GOT
AN APPOINTMENT TO
SHOW MR. BUMSTEAD
THE ZOMDEX SYSTEM



OUTTA MY WAY! DATARAMA
JUST INTRODUCED THE
BIGGEST ADVANCE SINCE
THE COFFEE BREAK!



COMPUMANIA'S WE'VE
GOT THE GOT USER-
MOST... FRIENDLY DOWN
TO A SCIENCE!



DATABASE
MANAGEMENT!
DECISION
SUPPORT!
ELECTRONIC
MAIL!



IT SORT OF HELPS
YOU APPRECIATE
THE BALL-POINT
PEN

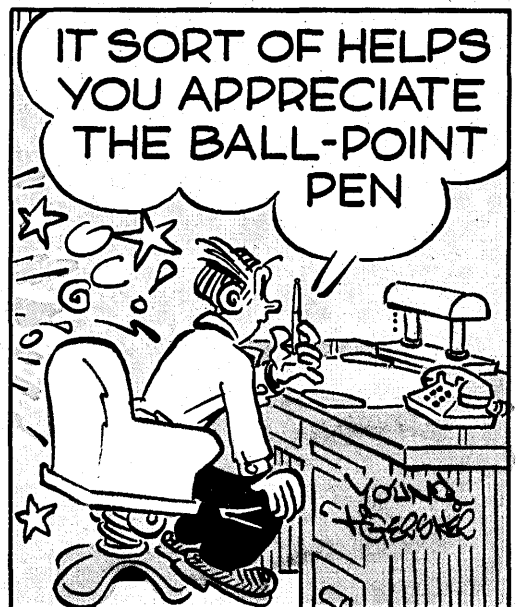

HOW THE MAJOR IOSs COMPARE

IDENTIFICATION	System name	Alliance 250	All-in-1	Augment	Comprehensive Electronic Office (CEO)
	Vendor	Wang Laboratories, Lowell, Mass.	Digital Equipment Corp., Merrimac, N.H.	Tymshare, Inc., Cupertino, Calif.	Data General, Westboro, Mass.
	Type of system	Complete system hardware & software	Complete system software for DEC hardware	Timesharing	Complete system software for DG hardware
FUNCTIONAL AREAS	Communications				
	Voice	Voice messaging, voice text-annotation			
	Text	Document distribution and limited messaging	Complete personal messaging	Screen sharing, conferencing (sync and async), messaging, shared document library	Complete personal and document messaging
	Other	Graphics supported			
	Information retrieval				
	Databases	Content search of all text files	Powerful—content search across entire network	Structured hypertext; access by doc. name, imbedded labels	File folders and drawers; access by index; part of E-mail and wp
	Personal / casual		Db and forms	User-designed personal files, lists, structures	
	Analytical tools	Only through stand-alone use of CP/M	Desk calculator; others available separately	Simple spreadsheets, graphs	Graphics (screen & hardcopy); PRESENT end-user interface to Codasyl-type DBMS
	Text processing	Complete wp, laser printer	One stage: comprehensive wp; sp. check	Two stage; mouse editing; windows; sp. check	Standard wp; sp. check; index, place markers; annotation by reader/reviewer
	Personal support tools	Calendar, scheduling	Calendar; reminders	Calendars, lists designed by each user	Calendar, scheduler, phone messages
Special applications & prog.	VS processor has programmer support tools	Access to VAX/VMS facilities; BASIC, COBOL.	Programmer support tools—DEC Tenex and others	Programming aids; APC, RPG II, BASIC, PC/1, FORTRAN, COBOL	
User interface	Menus, help key	Menus or commands; function keys	Prompted commands; mouse and chord input; full help	Menus; help; "instant" interrupt and resume	
OPERATIONAL FEATURES	Networking				
	Local	Wangnet broadband	Projected Ethernet support	XODIAC network bus for 32 processors	
	Remote	Wise point to point	Point to point on Decnet	Terminals (dumb or proprietary) to mainframe over Tymnet	X.25; IBM SNA, 2780/3780, 3270, HASP
	Access to other systems	3270, 2780/3780	VAX/VMS capabilities	Arpanet	
	Operating environment	Alliance processor, terminals; OIS/VS	VAX/VMS, VT100, DECmate	DEC 10 (Tenex); DEC 20 (Tops-20) Tymshare mainframe	ECLIPSE, AOS, AOS/VS
Other					
ANCILLARY INFO	First customer shipment May 1982; 150 installed	System combines Charlotte S/W Package with Office Plus products; ann'd June 1982	Tymshare acquired Augment from SRI in Jan. 1978; "several thousand" users	First customer shipment May 1982	

Corporate Communica- tions System	Corporate Office Man- agement System	Dialcom Automated Office System	Disoss	8000 Network System
Interactive Systems, Santa Monica, Calif.	IV-Phase, Cupertino, Calif.	ITT-Dialcom Inc., Silver Spring, Md.	IBM, Armonk, N.Y.	Xerox Corp., Dallas, Texas
Software package; op- tional hardware	Hardware and soft- ware	Timesharing service	Hardware and soft- ware	Complete system hardware & software
Store and forward				
Complete messaging; synchronous text con- ferencing	Document-oriented mail	Complete personal messaging	Document distribution	Complete text messag- ing
				Complete graphics msg.
Some structured re- trieval	Vision db	User-defined relational db,	Host-based info re- trieval	Document index; forms and records
Content search of text files	Document index files	Screen format input, reports		Sort and retrieval
			Statistical processing	Powerful graphics, nu- merical spreadsheet
One or two-stage: powerful formatting and editing	Standard wp	Standard wp	Complete wp	Complete wp, photo- typset quality on screen: mouse editing
Reminder, diary	Calendar, scheduling, tickler	Calendar		Calendar
Unix tools, FORTRAN	COBOL	Primos tools	RJE or on-line work- station to host; 3730 programming state- ments	User access to two levels of programming
Commands; some menus	Menus	Commands		Point to icons repre- senting all objects in system: full help
INnet with PDP-11 and VAX machines			Local channel attach- ment	Ethernet local area network: extendable using network gate- ways
Point to point	3270, HASP, SNA		Access to single or multiple hosts	
HASP/RJE to IBM; tty connect				Comm. server for non- Ethernet devices
Unix on PDP-11 (na- tive mode) or VAX (un- der VMS)	Series IV with MFE/IV	Prime 750, 850	IBM mainframe plus 8100 or 3730	Star workstation; file, print, and comm. serv- ers
		Links to public db: NY Times, UPI, etc.	Performs as distributed terminal controller to host	Bit-mapped display makes system very accessible to all users
First customer ship- ment late 1979.	ITT acquired Dialcom in Dec. 1982		First customer ship- ment Dec. 1981	First customer ship- ment fall 1981; over 300 installed

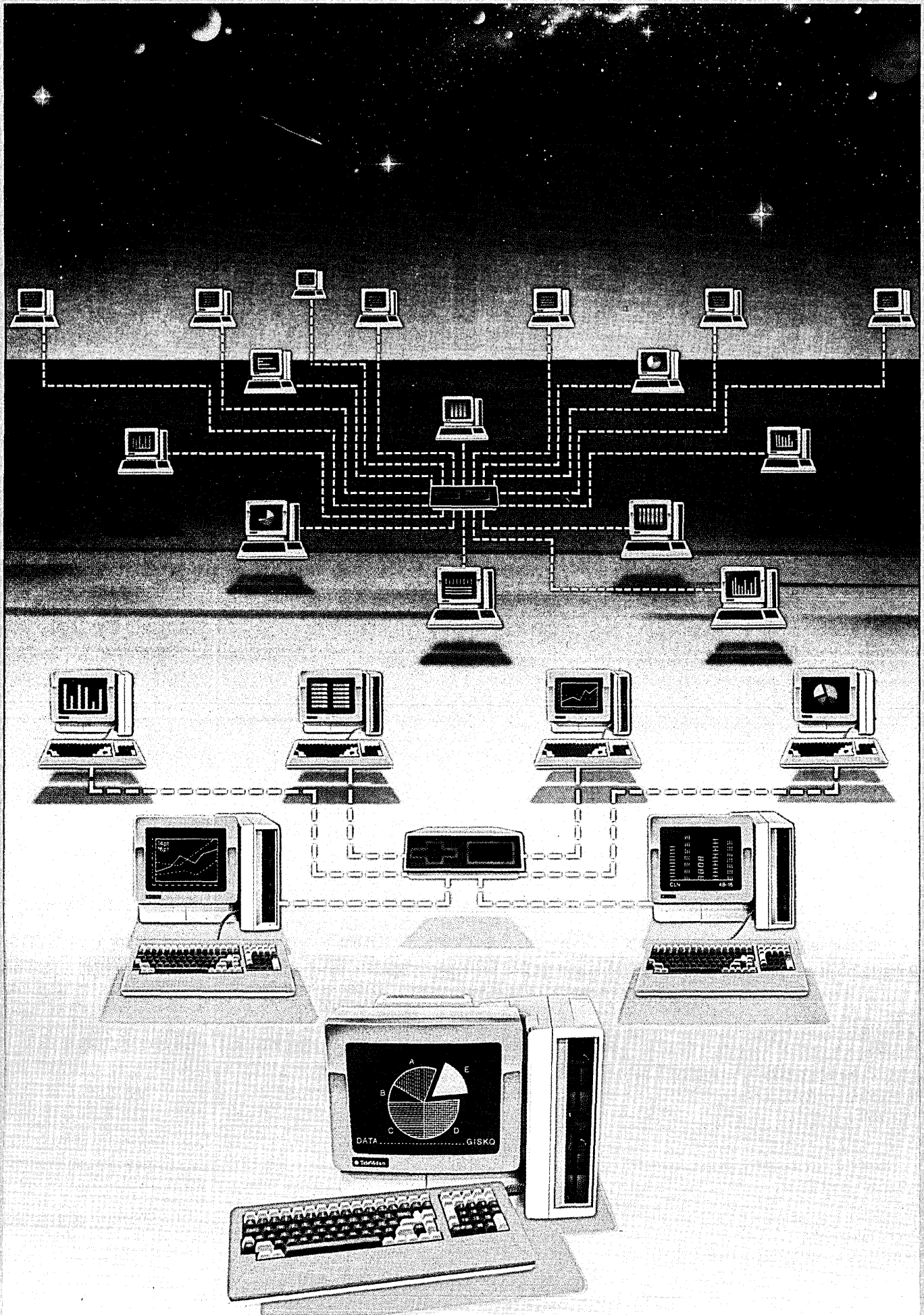

Of all the small business computers you can choose today, TeleVideo gives you more choices for tomorrow.

Any TeleVideo desktop computer can be used as a single-user, stand alone computer. Then, when you want to expand its professional performance capabilities, you have a choice of ways to grow into a multi-user system of up to sixteen TeleVideo computers. You can use our 8 or 16-bit computers, or any combination, starting with your original unit.

TeleVideo also gives you more choices of professional CP/M[®] software, including advanced graphics. And, thanks to TeleVideo's unique MmmOST[™] executive program, the software used on your single-user computers will run on any TeleVideo multi-user system without modification. So if you want a small business computer that gives you professional performance,

it's obvious that you have a lot of choices for today.

But there's only one with choices for tomorrow: TeleVideo.

For more information, write TeleVideo Systems, Inc., 1170 Morse Ave., Sunnyvale, CA 94086, call toll-free 800-538-1780 (in California call 408-745-7760), call one of our authorized distributors or dealers, or contact one of our regional sales offices, listed below.

Northeast Region, 617-369-9370.
Eastern Region, 212-308-0705.
Southeast Region, 404-447-1231.
Midwest Region, 312-969-0112.
South Central Region, 214-258-6776.
Northwest Region, 408-745-7760.
Southwest Region, 714-752-9488.
European Sales (Holland), (31) 075-28-7461.

TeleVideo Systems are fully serviced nationwide by TRW.

 **TeleVideo Systems, Inc.**

HOW THE MAJOR IOSs COMPARE

IDENTIFICATION	System name	Infomail	Integrated Electronic Office	The Interactive Office	Office Automation System	
	Vendor	BBN Information Management Corp., Cambridge, Mass.	Datapoint, San Antonio, Texas	Hewlett-Packard, Palo Alto, Calif.	Prime Computer Inc., Natick, Mass.	
	Type of system	Software package	Complete system: distributed processing	Complete system, hardware and software	Hardware and software	
FUNCTIONAL AREAS	Communications					
	Voice		ISSX—total voice/data PBX			
	Text	Complete text and forms messaging	Document distribution to mail stops	Complete text messaging.	Complete personal messaging, nonusers get printed copies	
	Other		Infoswitch for telecom management			
	Information retrieval					
	Databases	Hierarchical file system; content search on forms	Unstructured content search of info files	Wide range of integrated db and query packages	Various dbs; document index	
	Personal / casual					
	Analytical tools		Multiplan	Interactive graphics, spreadsheet		
	Text processing	Two stage; choice of editors	Basic wp	Several levels of wp packages	Standard wp	
	Personal support tools				Calendar, scheduling, well-integrated into messaging	
OPERATIONAL FEATURES	Special applications & prog.	Dependent on host	Strong ddp; proprietary assembler language—DATABUS	Full MPE support		
	User interface	Commands, full help	Mixed menus and commands	Menus	Menus, help	
	Networking					
	Local		Combined ISX (twisted pair); Arcnet (co-ax)	HP3000 distributed network	Ringnet	
	Remote	To any other host running Infomail	IBM, proprietary Datapoint General facsimile interface	Standard	Primenet distributed network: full X.25 RJE for CDC, Honeywell, Univac, IBM, and ICL: IBM 3270	
	Access to other systems					
	Operating environment	IBM VM/CMS; DEC VAX/VMS; Unix on BBN's C-Machine	Datapoint workstations and processors, RMS	MPE 3000, HP125, HP graphics peripherals	Primos, 50 series, PT65	
	Other	Some usage monitoring available	Color graphics workstation laser printer	Integrated graphics and text		
	ANCILLARY INFO		BBN will customize s/w on time and materials basis	Tandy TRS-80 supports Arcnet. Software add-ons to existing ARCs started in 1979	First customer shipment Jan. 1982	First customer shipment April 1980

Office Automation Systems	Office Power	OFIS 1	PROFS	Sperrylink
Honeywell Information Systems Inc. Waltham, Mass.	Computer Consoles Inc., Rochester, N.Y.	Burroughs Corp., Detroit, Mich.	IBM, Armonk, N.Y.	Sperry Corp., Blue Bell, Pa.
Hardware and software	Software	Complete system and/or components	Software	Complete system, hardware and software
				Voice mail available on standalone device
Document distribution	Complete personal messaging	Personal messaging and document distribution	Complete messaging	Message, memo, and mail facilities
	Relational db			Access to Univac hosts
Interactive db tools	Document index	OFIS file has comprehensive index and content retrieval of all files	Document index; access to VM dbs	Keyword search of first page of documents
Spreadsheet		Multiplan spreadsheet; CP/M programs		Only through standalone use of CP/M
Complete wp	Complete wp	Uses all OFISwriter models	Memo oriented; standard wp	Complete wp
Scheduling, calendar	Calendar, scheduler, reminder	Calendar, scheduler, reminders	Calendar, scheduling	Calendar
	Unix tools	OFISfax facsimile terminals; OFISreader multifont scanner	VM/CMS tools	
Menus and commands	Menus and full help	Help; menus and prompts	Menus: oriented to professional user	Menus, forms
Station, terminal to host		RS232 terminal to OFIS file or OFIS director		
2780, 3780, 3270, BSC/SNA	Data Highway LAN; all Unix-based communications, including Ethernet and IBM RJE, 3270	Modems	Point to point	Point to point
		IBM HASP, 3780, 3270, SNA; other Burroughs equip; X.25	IBM protocols	IBM; tty protocol
Infewriter, DPS 6	Any Unix system	Standalone OFISwriters accessing OFIS file, or OFISdirector (CP9500, B900)	VM/CMS 370/3000 series	Desk Station (and personal computer), DOPS/10
				Line drawing capability
First customer shipment June 1981	Vendor also markets Perpetual Processing system. First software shipment Jan. 1982	First customer shipment Nov. 1981	First customer shipment Dec. 1981	First customer shipment March 1983

**"SEND IT TO
THE**



ANYTHING GOES

SHIPPING... Y'LL KNOW WHAT TO DO WITH IT."



Shipping won't panic. And they won't let you down. They'll just reach for the phone and call United Air Cargo.

That's all? That's right. Because shipping knows that they can send **ANYTHING**... no matter how big, small, fragile or awkward. **ANYWHERE**... whether that means Atlanta, Georgia or Soviet Georgia (if it's the latter, we'll arrange the connecting flights, handle the paper work, deal with tariff regulations, customs, everything). And they can send it **ANYTIME**... next week, next day, or even the next flight out.

So no matter what you're sending, don't worry about a thing. The guys in shipping are very smart.

UNITED AIR CARGO

 UNITED AIRLINES

CIRCLE 76 ON READER CARD

person messages. To be the latter, it must have a REPLY command for answering messages, a FORWARD command to annotate and pass on a message, and facilities for filing messages and specifying distribution lists.

Are there any features that support the special working relationship between manager and secretary? Can a user send messages to persons who are not yet participants in the electronic messaging system? Are there any restrictions on the length or content of messages? Is computer conferencing an option?

Information retrieval. This area comprises all facilities that give the user access to personal or corporate information. It includes, but is not limited to, all the traditional DBMS that may be provided as part of the office system. These must be described with special attention to how data can be integrated into other facilities, such as electronic mail or document production.

NO MORE DATA SIFTING

The easiest way to begin with on-line information retrieval for an office system is to put an interactive query package on top of existing corporate data. With suitable training and guidance, users can be reoriented toward new styles of information management. Instead of having to sift through masses of data (in effect, manually executing a task the computer does better), the user can directly form the questions and the manner of answer required.

The advantages of implementing information retrieval in office systems usually center on the replacement of old MIS or manual reporting systems. Less tangible benefits come from giving users access to information they would otherwise not get at all. External databases such as wire services and stock prices are familiar examples of this.

How approachable is the user interface? How much training will a novice require before he can make complex queries? Can users create and maintain their own databases without technical help? Is this database system (i.e., user interface to access information) used elsewhere in the system, or does the user have to learn several ways to retrieve information? How easy would it be to convert existing corporate data into the system's DBMS? Are there facilities for accessing information external to the system?

Analytic tools. Once the information has been retrieved, many systems give the user tools for analyzing it. SPSS and APL-based packages are well-known examples, but they require programming skills to be used effectively. There are financial modeling tools and graphical representation aids that can assist the professional in working with the data. The facilities that can be used directly by the professional or management

HOW THE MAJOR IOSs COMPARE

The chart on pp. 104-109 shows how the major U.S.-made integrated office systems fit into the framework outlined in the accompanying article. It is not intended as an exhaustive list of products in the field; vendors are approaching the integrated office from several directions—communicating word processors, networked microcomputers, digital PBXs, powerful standalone workstations—not represented here. Companies such as Anaconda Ericsson, Applied Data Research, Basic Four, Exxon, Northern Telecom, Raytheon, and others are absent from the list, as are non-U.S. companies like Cii-HB, Nippon Electric, Olivetti, and Philips, though all of them sell office

systems that might be termed "integrated." The intent is to use details supplied by the vendors to show how the most common, and most integrated, systems compare in the context of the framework.

To make this brief treatment more useful, some editorial comment has been included (e.g., by a "complete" messaging system, the author means one that includes not just basic message handling, but also user features like reply and forward, etc.). For more complete information, readers will no doubt wish to go to the vendors themselves. This framework should help them ask some of the right questions.

—D.M.

end user are also known as decision support systems (DSSs).

These DSSs can be grouped into two main categories. One is the analysis and reexpression of information retrieved from some source. The other is analysis of possibilities using conditions set up in a model, usually financial.

The benefits of a DSS lie mainly in giving managers or professionals considerable powers of calculation without requiring any programming experience. With a good interactive DSS, a user can incorporate great volumes of information in a given model, and then change a condition of the model and redo the entire report.

Although the investment in user training can be higher than for simpler functions like E-mail, the benefits can also be much larger. Due to the unpredictable nature of DSSs, however, they usually have to be justified by means of small pilots with very tight postimplementation audits.

What training is required for comfortable use? How much time is usually required to set up the application; is there a lot of control language or can the user get down to business directly? Can information from a database be analyzed and the results incorporated into a text processing document? How can libraries of models and model segments be established for multi-user access? Are there data dictionaries to preserve naming conventions from user to user?

Text preparation. At the simplest level, this is what word processors do. The emphasis here, however, is on the integration of the functionality into the rest of the system and on its possible use by professionals and managers. The processes involved in text preparation range from the organization of the text in the author's mind to the presentation of the printed pages to the reader, and there is plenty of room in this continuum for the integration of various technologies. Phototypesetting can save printing space and increase the attractiveness of any text. Communicating or intelligent photocopiers can ease the distribution problems.

Perhaps the greatest benefits come from authors using the system themselves to close the gap between thought and the printed text. Many managers are unenthusiastic at

first, but once the barrier of unfamiliarity is passed, virtually every direct user of a text preparation facility will be convinced of its advantages.

Can different authors share in the creation of documents? Is there a spelling check, table formatting, automatic numbering of points and/or chapters? Is text formatted in a single stage (that is, printed exactly as it is edited on the screen) or in two stages (with formatting commands included in the text and executed at printing time)? Can lists (such as addresses) from the information retrieval functions be merged with documents?

If there are several word processing products or packages, how easily can each of them work on text created by the others? Is there recognition by the system of special document types and special treatment for these types (e.g., letters)?

Personal support tools. Currently, these are limited to standard time management aids such as diaries, scheduling, and reminders. Obviously, these features alone can't justify an office system, but they can make life easier for users and raise their opinion of a new system.

CALENDAR CAN SAVE TIME

Wherever a great many meetings are planned, a calendar scheduling system can save time for administrators and help participants arrive well prepared. Personal event calendars are more difficult to implement, because as yet there is no portable, communicating memory terminal small enough to replace the pocket diary.

Is the multiperson scheduling system integrated with the message system? Are standard procedures for reserving equipment and a location built in?

Special applications and programmability. Whereas the first five areas are primarily tools for the support of general activities, this category is for special applications such as accounts receivable, general ledger, project management, time-sheet reporting, and the like. Furthermore, "programmability" allows users to develop programs customized to their own specialized needs.

How good are the program development support tools? How are local programs

NBI ANNOUNCES GREAT NEWS FOR EVERYONE CONSIDERING OFFICE AUTOMATION

GREAT NEWS #1: MORE SYSTEMS

The NBI family of Office Automation Systems just got bigger.

NBI is introducing two new mid-range shared resource systems: the OASys 64-20 with 20 megabytes of storage; and the OASys 64-30 with 30 megabytes.

Now, with six systems in the 64 series, you can match your performance requirements with your budget requirements.

So, no matter what your needs, there's an NBI Office Automation System to fill them.

GREAT NEWS #2: WE TALK 3270

Now NBI has six clustered systems and a standalone that speak 3270.

With this new capability, your NBI is not only a word processor, it's also a computer terminal. With it, you can access the information in your mainframe computer, make changes on it, and then immediately store the new

information. Or, if you'd like, you can even record it in a printed report.

In other words, NBI can help more people take greater advantage of their mainframe computers.

GREAT NEWS #3: STATE-OF-THE-ART SPELLING

Starting today, you're a better speller.

Because the new NBI spelling package makes it almost impossible to make a mistake.

It has an 88,000 word dictionary. Plus a list of common words. Plus the words you program in yourself.

This spelling package can even check for errors at the same time the operator is using the system to perform other tasks.

THE BEST NEWS YET

We've grown into one of the world's leaders in office automation. Revenues have grown at a compound annual rate of 106% since 1979. And, NBI is listed on the New York Stock Exchange.

NBI has earned a solid reputation for building equipment so good that independent user surveys have consistently rated NBI systems superior to IBM, Wang, Xerox and Lanier.*

So, for great equipment and a great company, get NBI. Great news for everyone considering Office Automation.

For more information on NBI's full line of Office Automation Systems, return the coupon below or call 1-800-525-0844.

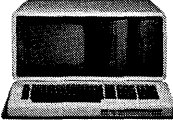
Name _____	 KF
Title _____	
Company _____	
Address _____	
Telephone (Optional) _____	
NBI, INC., P.O. Box 9001, Boulder, CO 80301.	

*Source: 1980, 1981, and 1982 surveys among users of word processing equipment by Datapro Research Corporation.

A decision support system gives considerable powers of calculation without requiring programming experience.

accessed by the office system users—do they have to use the JCL of the operating system? Do the applications processing functions run concurrently with the other office automation functions, or does the user have to switch operating environments manually (by rebooting, for example)? What other applications are available from the vendor and from other software suppliers?

NONSYSTEM ANCILLARY DATA

As broad as these six categories are, there are several other aspects of an IOS that a buyer will need to consider. They fall into two more categories: operational features and nonsystem ancillary information.

By operational features we mean the attributes of the system that support the six

task-related functions. They include:

- **User Interface:** log-in sequence, interaction style (menu or commands), consistency of interface, on-line assistance (HELP, OOPS, documentation), response to user errors, special terminals or devices supported.
- **Networking:** terminal connections, processor-to-processor connections, local network, protocols.
- **Operating Environment:** hardware required, operating systems required, special installation (e.g., air conditioning, size).
- **Security:** how users identify themselves, ownership of information, sharing of information, encryption.
- **Monitoring:** usage accounting, performance monitoring, analysis of data.

The third category of information on a system relates not to the system itself but to the corporation that is selling it. What is the company's profile? Are they new to the office automation field? Are they dedicated to office automation? What role does this system play in their entire product line? Are they growing rapidly? How stable are they?

What is the local availability from this vendor? What delivery latency, what terms? What existing users are there? Does the vendor provide training? How much does it cost? Does the vendor provide documentation? What kind and at what cost? Is maintenance provided? How quickly and at what cost?

The three categories of information that make up this framework (six functions, operational features, and nonsystem ancillary description) provide a comprehensive description of any integrated office system. Currently there are very few systems on the market that provide support to users in all these areas, and in an integrated fashion. The user must always be alert, and when he gets the answer "yes, that can be done" must immediately ask "exactly how?"

With an increasing number of vendors bringing their strengths into the office systems marketplace, more and more of a user's requirements can be met by a single integrated system rather than many piecemeal solutions. Those needs may not be met, however, if the user doesn't have a clear idea of what he's buying. *

David Macfarlane is manager of integrated office systems for the Toronto office of Coopers & Lybrand. He is responsible for the data processing department and the design and implementation of advanced office systems. He was previously the senior office systems architect at Bell Northern Research, Toronto.

An earlier version of this article appeared in Computer Data, Feb. 1982, Vol. 7, No. 2.

Martin Marietta Aerospace

Data Processing Opportunities

Martin Marietta Aerospace, NASA's prime Contractor for the Space Shuttle External Tank has immediate openings for Data Processing professionals. Because we actually manufacture the external tank, you'll get to see the actual results of your efforts.

COMPUTER PROGRAMMER/ ANALYSTS

Immediate opportunities exist for individuals experienced in:

- **UNIVAC 1100**
- ASC11 COBOL**
- DMS 1100**
- DDL, SDDL, DMU**
- DML, QLP**
- DPS 1100, TIP**
- D/B Editor**

● **APPLICATION EXPERIENCE**

**Shop floor control,
Scheduling, Manufac-
turing, Inventory,
Purchasing, Config-
uration Management,
Quality Engineering.**

● **DATA BASE OPENINGS**

**Analyst, Design, Ad-
ministrators with above
hardware, software and
applications experience.**

**These opportunities exist
at our Michoud Assembly
Facility located in subur-
ban East New Orleans.**

Qualified candidates interested in learning more about these opportunities at Martin Marietta should forward resumes, including salary history to Martin Marietta Aerospace, Denver Glazier, DM-283, P.O. Box 29304, New Orleans, Louisiana 70189. We are an equal opportunity employer, m/f/h.

MARTIN MARIETTA

CIRCLE 77 ON READER CARD

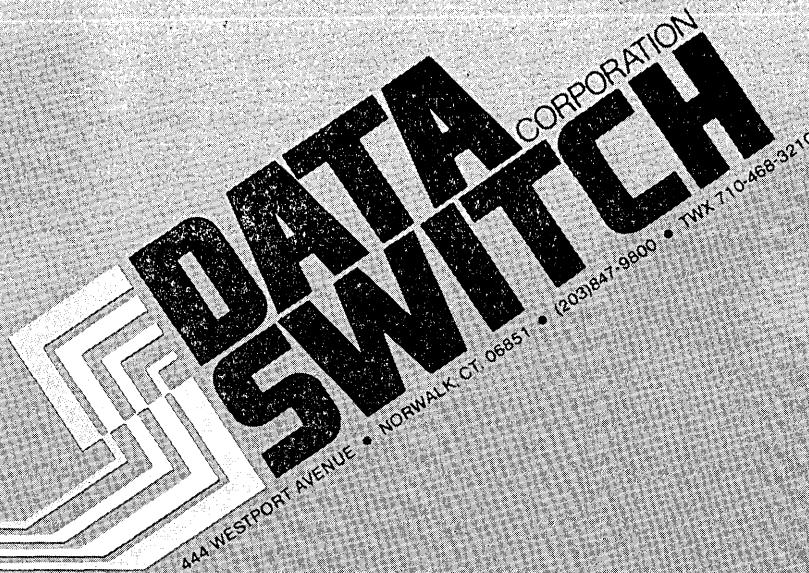

The Emphasis is on Control

A Configuration Management System (CMS) from Data Switch offers centralized control of distributed channel switches:

- A powerful mini-computer totally transparent to the host system.
- Reconfiguration of an entire computer complex locally or across the country with a single command.
- History Files recorded on built-in 20 Megabyte disk storage units with an audit trail printer for configuration record keeping.
- Real time configuration displays utilizing interactive color CRT command consoles.
- Easily understood simple English commands.
- Multi-level password protected operational security.

Data Switch CMS provides Automated Centralized Control of the entire Data Switch family of switching products for computer room peripherals and communication lines.

CMS

We'll put you back in control.

CIRCLE 78 ON READER CARD



**"VAX IS HELPING
US OPEN UP A
WHOLE NEW MARKET"**

**-LOUIS SCHURE, Vice President,
Computer Graphics Laboratory, Inc.**

CGI's new VAX-based Computer-Aided Animation Systems (CAASII) help artists create TV commercials, movie special effects sequences, cartoons and graphics. Faster, cheaper and more efficiently than ever before.

"It takes three things to make a computer useful to an artist," says Louis Schure. "Enough power to capture the exact idea he has in mind. Enough speed for realtime playback at every step in the creative process. And easy interfacing with the rather strange peripherals we use in

VAX

this business. VAX™ systems gave us all three – and at a price that gave us a wide open market.

"The fact that VAX is a family of products with consistent operating and application code environments has also been very important. We sell VAX-11/780s for 3D modeling. VAX-11/750s for animation. And we'll have the new VAX-11/730s for our smaller systems. These products make us one of the leading OEMs in computer art and technology. With Digital's service and support around the world there's almost no limit to our market.

"With 32-bit addressability and virtual storage, VAX can create images you simply can't tell are computer-generated," he says. "The artist can use an infinite number of brush strokes. Millions of colors. Any number of overlays. Each frame can be flopped, enlarged or reduced, zoomed, panned or erased in realtime."

For the artist, VAX performance means freedom. Freedom from drudgery and repetition. Freedom to spend more time thinking creatively.

Today VAX is many success stories. To learn more about the art of computing at Digital, call toll-free: 1-800-DIGITAL, extension 200. Or write: Digital Equipment Corporation, 129 Parker Street, PK03-2/M94, Maynard, MA 01754.

© Digital Equipment Corporation 1983

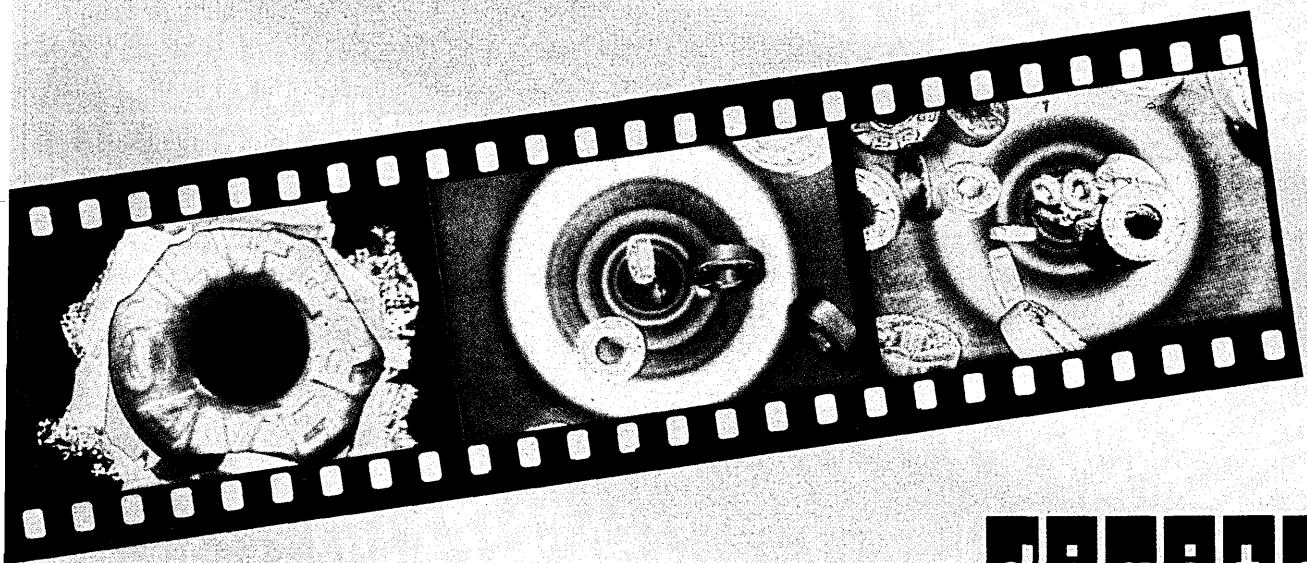

digital

How do you create a microcomputer to match the power of the UNIX™ operating system?

Imagine. You are perfecting a revolutionary operating system. In about two years, it will be the system of choice for 16-bit microcomputers.

It will be called the UNIX operating system.

But the breakthrough features of this operating system are going to make stringent demands on the computer.

The microcomputer developed specifically for the UNIX operating system more than two years before its commercial distribution is called ONYX.™

ONYX will live up to every demand and expectation.

To achieve the ultimate flexibility, simplicity, efficiency and productivity, the UNIX operating system will incorporate a file system of highly uniform sets and sub-sets of directories, arranged in a tree-like hierarchical structure.

And flexible directory and file protection modes, allowing all combinations of "read," "write," and "execute" access, independently for each file or directory, or for a group of users.

But these advantages will require intensive disk access, and superior memory management. In simple language, disk access must be as fast as possible, and the disk must have an unusual capacity to maintain complex file systems on-line at all times.

Floppy disks with their low capacities and high access times won't do.

Winchester disk drives that utilize slow-moving stepper motor head positioning devices won't do.

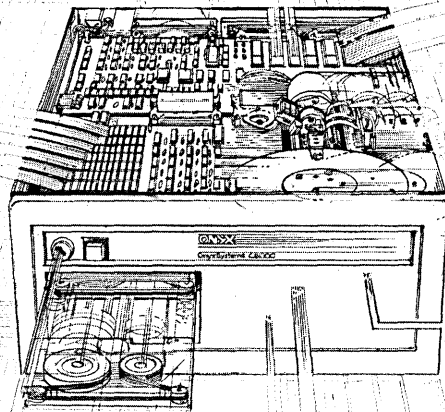

ONYX's IMI Winchester disk storage system, with its servo-driven voice coil head positioning, is more than twice as fast!

So, obviously the ONYX C8002 will do.

And, as developed, the ONYX C8002 features expandable memory up to 1 Mbyte, and disk storage up to 160 Mbytes on-line. Its cartridge tape backup offers cyclical redundancy checking on every backup. Both the Winchester disk storage system and the cartridge tape backup are *internal*.

In the UNIX operating system environment, the disk becomes an extension of main memory. "Swapping" programs between the disk and main memory

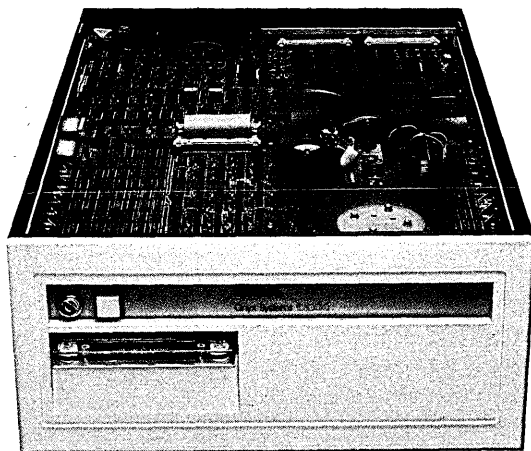

increases the number of operations that can run concurrently. ONYX's memory management system utilizes "scatter" instead of "contiguous" allocation; and the more efficient swapping minimizes demand on the disk channel. That's why ONYX assures a highly efficient environment for the UNIX operating system.

Now it's 1982. The UNIX system's pre-eminence among 16-bit operating systems is established. And ONYX is the only company that has significant production experience with UNIX systems.

ONYX has installed over 1500 UNIX systems.

Today there are a lot of systems being developed to operate UNIX (and "look-alike") operating systems. But there are many reasons why you should consider ONYX and the UNIX operating system as inseparable.

System III available now for immediate delivery.

Phone this special number: (408) 946-6330 Ext. 251. Ask about these System III enhancements, including:

- Multi-key index sequential files under RM COBOL;
- "Term Cap" capability that supports a wide variety of terminal interfaces;
- Enhanced printer handling capability;
- SCCS to maintain edit histories in text management applications.

*UNIX is a trademark of Bell Laboratories.

Make the Connection

ONYX UNIX

OPERATING SYSTEM

Onyx Systems Inc., 25 East Trimble Road, San Jose, CA 95131

CIRCLE 80 ON READER CARD

A round-table discussion of the data security problems we face as more and more people gain access to computers.

A QUESTION OF LEADERSHIP

Last November, on the final day of the Computer Security Institute's ninth annual conference, CSI arranged for a panel of security practitioners to meet at the New York Statler and discuss their work for the enlightenment of DATAMATION's readers.

John O'Mara, a vice president at the Northboro, Mass.-based institute, assembled an impressive group for the occasion. The session was moderated by Robert H. Courtney Jr., president of the Westchester, N.Y., consulting firm that bears his name, and former IBM director of data security programs.

Also participating were Peter S. Browne, vice president of Burns International Security Services, Briarcliff Manor, N.Y.; Harry DeMaio, director of data security programs for IBM in Armonk, N.Y.; Donn B. Parker, senior management systems consultant at SRI in Menlo Park, Calif.; Zella Ruthberg, a computer scientist with the Institute for Computer Science and Technology at the National Bureau of Standards in Washington, D.C.; and Warren Schmitt, senior project manager of data security for Allstate Insurance, Northbrook, Ill.

Courtney: To discuss data security, you have to understand the need for it. We all recognize a growing dependence on data and on the means of processing those data for the conduct of an organization's business. In some industries, the information system is the competitive edge.

As dependence grows, so surely does the need for security. My view is that it is not an out-of-control problem. We are not falling behind. It probably yields rather readily to a completely rational and systematic approach. We don't lack the technology or the smarts, although I think we have a shortage of motivation.

Schmitt: We're not falling behind? After talking to people at this conference, I don't think I could agree. Most companies are working on the basics such as contingency planning and physical security. These are issues that are well understood by most managers. But in areas that are experiencing the greatest change, such as access controls and network-

ing, the control issues are not so well understood. That makes it difficult for both management and technicians to support effective security efforts.

Browne: We are behind and we are continuing to fall behind and that is the real issue for the future. The need for internal controls has always been present—personnel controls, physical security, loss prevention activities dealing with inventory products, the manufacturing process, and so on. But computer and data security differ from traditional controls because of the technological advances in computers and communications. The increases in speed, complexity, proliferation, and use have outstripped management's ability to control.

Courtney: The real question is, can we control security to an acceptable level of risk? You can never eliminate risk, but have we reduced it to that acceptable level? If we haven't, is management irresponsible for not being more concerned about the risk?

Browne: I wouldn't say the degree of risk in most organizations is "acceptable," but we are struggling to reach that level.

Courtney: I believe there is room for improvement—that is, you could reduce the annual loss expected from security violations. But have our shortcomings in data security put organizations in great jeopardy? I think not.

DeMaio: The problem in keeping up with security needs is that technology is moving into so many different arenas simultaneously that it is very difficult to define risk and security. The same piece of hardware, put into different environments, may require different levels of security. As suppliers of hardware and to some extent software, our problem at IBM is trying to determine the requirements. We have made major investments in some areas where it has not been particularly well received—cryptography, for example. Access control was slow getting off the deck, but is now very successful.

Schmitt: How do you determine security requirements?

DeMaio: We work with SHARE and GUIDE. We work with a number of our large customers. We use ourselves as a test bed. We solicit commentary from government agencies.

The problem is that the dp manager is often not as comfortable with the subjects of security and auditability as he or she might feel with performance, capacity, or function.

Another fundamental problem is that as we move further along, the constituency we are dealing with is changing. We estimate that more than half of our computing power is going to be in the hands of non-dp professionals. Talking to them is a whole new ball game. We are now trying to establish communications links with the end user—with the personal computer user and with the person who is in the transaction-driven system.

Schmitt: Some manufacturers are lagging behind in supplying the right controls to people who use new technologies, such as office automation. A system may have password control, but it may be a resource-oriented password shared by many users, not a password that is individually identified or has individual accountability. Or there may be a password for the office automation system that is incompatible with the passwords used on the host. Or, as some companies are doing right now, personal computers may be hooked into the mainframe because users demand their ease of use—despite the fact that it may reduce individual accountability.

Courtney: Quite a few people are hooking personal computers into mainframes.

Schmitt: If you do that, you don't have as much control over the data. If the information is highly sensitive, if it's not "user-friendly data," then I don't think a user-friendly system that lacks adequate controls should be attached to the mainframe or have access to the database.

Parker: I think we are always balancing friendliness with security because controls constrain people. The more secure a system is, the less friendly it generally is. Office automation is an interesting case in point. I gave a talk at an annual office automation

"If a manager is operating on his previous understanding of his risks, he's solving the wrong problem."



WARREN SCHMITT

manufacturers' conference and mine was the first talk they had ever had on security.

The manufacturers' reaction was, "We never had security in offices, why do you want it in office automation?" My response was, "Before office automation there was no practical or lasting way you could impose the discipline to have security in offices. So security should be looked at as an opportunity that is available in offices for the first time."

Schmitt: Office automation is not only providing the opportunity, it also is changing the risks.

Ruthberg: What's changed is the vulnerability in the office, and in all areas where com-

puters are used, for that matter. Management and the users do not understand. I think we have to educate them as to what these systems can actually do and the new risks they pose. If the manager is operating on his previous understanding of what his risks are, he's solving the wrong problem.

DeMaio: One of our obligations is to lay before these users the techniques required to turn their manual systems, however secure or insecure, into securely automated systems. And we have to return to the individual functional manager the responsibility to do that. In the traditional centralized dp environment, the security responsibility has pretty much been narrowed down to the dp shop, the auditing staff, and the security officer, if there is one.

In a sense, we created a problem for ourselves here, because we have taken away from the functional manager a responsibility that should never have disappeared in the first place.

Browne: We have overlooked one issue so far in our discussion of controls in new environments. Most of the computing accomplished outside the control of the dp function has evolved because of a basic user frustration with the slow pace of data processing's response to a user requirement. Many years ago timesharing grew in that context. Often, personal computers and office automation are outside the control, the skill base, and the cognizance of data processing. Typically, one responsibility of the dp security function is to train people to use the tools and techniques like password management. In many cases, it's not being done in the office environment. In addition, a new trend is developing that would tie personal computers into large mainframes. The responsibility to train users in security practices is now fragmented, and that is something we have to address.

Parker: Even if we train end users and give them the proper controls, how are we going to motivate them to use them? You know, security is getting a boost from commercial software packages. Internal controls are becoming major features in the sale of these packages, and the question will become, "Will the user turn the controls on, or will he turn them off for the convenience of getting a job done more cheaply?"

I contend that the controls won't be used until these people are sufficiently motivated. I think motivation has to do with how people are measured in their jobs. If you measure an employee by how many widgets he produces, he is going to produce as many as he can. If controls get in the way, he'll beat you every time. Security won't work unless the employee is judged not only on his production, but also on how safely and securely

he does it. The motivation has to start with top management and go down the hierarchy.

Browne: Accountability is the whole ball game in information security. All the controls we have—in hardware, in software, in access to the data—how much individual accountability for their use is built in from the bottom up? Not nearly enough.

DeMaio: Calling for accountability and new measures of performance presupposes that you have provided employees with the wherewithal to be secure—the other part of the equation. The management not only has to make it a requirement, it also has to be realistic, providing the technological and procedural capability and the definition of what the employee is expected to do.



ZELLA RUTHBERG

EMULEX ANNOUNCES 34 NEW DISK SUBSYSTEMS FOR DEC USERS.

As a confirmed DEC user you've probably been secretly coveting some of the powerful new drives DEC doesn't offer. Or wanting lower prices and faster delivery than you've been getting.

Well, you can get them from Emulex ready to plug in and run on your DEC LSI-11, PDP-11, or VAX-11. You choose from Control Data Winchester, removable pack and fixed/removable drives up to 675 MBytes.

Emulex is known worldwide as *the* DEC controller expert. Over 7500 delivered. So we're a natural to provide you with the widest choice of complete disk subsystems you've ever seen.

Featuring more performance and higher reliability than you've ever dared hope for.

Plus total service support—anything from subsystem to whole system service—up to and including your DEC computer from companies like Control Data, GE, and Tymshare.

Of course, Emulex subsystems can save your company plenty. And we have an attractive rental/purchase option to solve any financing worries. So call us right now. We're the best friend a dedicated DEC user could have.

Call (800) 854-7112 toll-free, outside California. In California, call (714) 662-5600. Emulex Systems Group, 3545 Harbor Blvd., P.O. Box 6725, Costa Mesa, CA 92626.

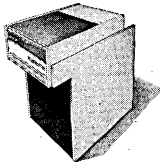

For LSI-11/23 Q-BUS:
80 MB Removable Emulates
DEC RM02/03

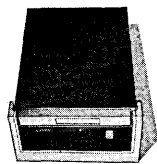

For LSI-11/23 Q-BUS:
64 MB Fixed/Removable
Emulates DEC RK06/07

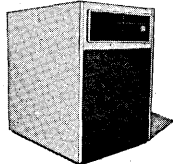

For PDP-11/04-60 UNIBUS:
675 MB Fixed Emulates
Two DEC RM05s

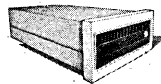

For PDP-11/70 CACHE
BUS: 80 MB Fixed Emulates
DEC RM03

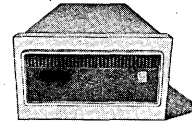

For VAX UNIBUS: 160 MB
Emulates DEC RM03

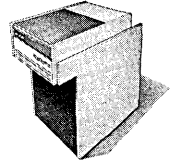

For VAX-11/750 CMI: 80
MB Removable Emulates
DEC RM03

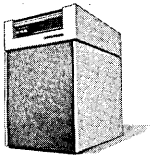

For LSI-11/23 Q-BUS:
300 MB Removable Emu-
lates DEC RM05



For LSI-11/23 Q-BUS:
96 MB Fixed/Removable
Emulates DEC RK06/07

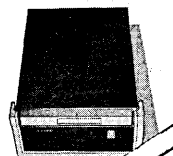

For PDP-11/04-60 UNIBUS:
32 MB Fixed Emulates
Two DEC RM03s

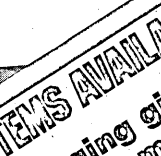

For PDP-11/70 CACHE
BUS: 80 MB Fixed Emulates
DEC RM03



For VAX UNIBUS: 32 MB
Fixed/Removable Emulates
DEC RK07

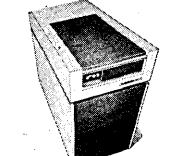

For VAX-11/750 CMI: 300
MB Removable Emulates
DEC RM05

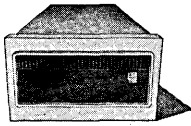

For LSI-11/23 Q-BUS:
80 MB Fixed Emulates
DEC RM03



For PDP-11/04-60 UNIBUS:
96 MB Fixed/Removable
Emulates DEC RK06/07



For PDP-11/70 CACHE
BUS: 80 MB Fixed Emulates
DEC RM03

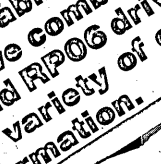

For PDP-11/04-60 UNIBUS:
675 MB Fixed Emulates
Two DEC RM05s

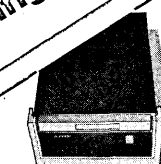

For VAX UNIBUS: 32 MB
Fixed/Removable Emulates
DEC RK07

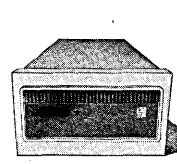

For VAX-11/750 CMI: 80
MB Fixed Emulates DEC
RM03



For LSI-11/23 Q-BUS:
160 MB Fixed Emulates
Two DEC RM03s



For PDP-11/04-60 UNIBUS:
300 MB Removable
Emulates DEC RM05

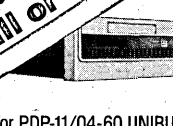

For PDP-11/04-60 UNIBUS:
96 MB Fixed/Removable
Emulates DEC RK06/07

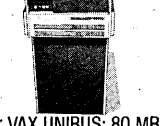

For VAX UNIBUS: 80 MB
Removable Emulates DEC
RM03

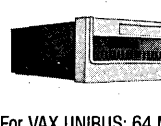

For VAX UNIBUS: 64 MB
Fixed/Removable Emulates
DEC RK07



For VAX-11/750 CMI: 160
MB Fixed Emulates DEC
RM80 or Two RM03s

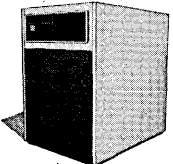

For LSI-11/23 Q-BUS:
675 MB Fixed Emulates
Two DEC RM05s

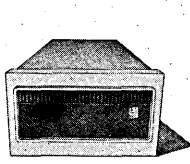

For PDP-11/04-60 UNIBUS:
80 MB Fixed Emulates
DEC RM03

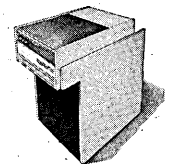

For PDP-11/70 CACHE
BUS: 80 MB Removable
Emulates DEC RM03

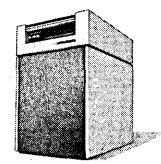

For VAX UNIBUS: 300 MB
Removable Emulates DEC
RM05

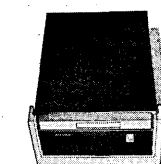

For VAX UNIBUS: 96 MB
Fixed/Removable Emulates
DEC RK07

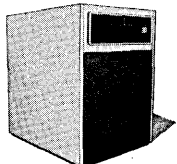

For VAX-11/750 CMI: 675
MB Fixed Emulates Two
DEC RM05s



For LSI-11/23 Q-BUS:
160 MB Fixed/Removable
Emulates DEC RK06/07



For PDP-11/04-60 UNIBUS:
160 MB Fixed Emulates
Two DEC RM03s

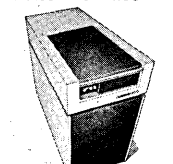

For PDP-11/70 CACHE
BUS: 300 MB Fixed
Emulates DEC RM05

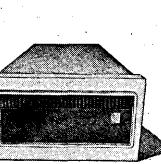

For VAX UNIBUS: 80 MB
Fixed Emulates DEC RM03

FOUR NEW VAX-11/750 SMI SUBSYSTEMS AVAILABLE.
Unique mass storage adapter packaging gives you lowest cost at highest reliability. Completely embedded controller and drive combinations emulate RM03, RM05, RM80, and RPO6 drives, with greatest performance in a variety of configurations. Call or write for information.



THE GENUINE ALTERNATIVE.

Call (800) 854-7112 toll-free, outside California. In California, call (714) 662-5600.

CIRCLE 81 ON READER CARD

“If you measure an employee on how many widgets he produces, he’ll make as many as he can. If controls get in the way, he’ll beat you every time.”

Further, it’s not enough to come down to a department and say, “Your responsibility is to make sure that you are being secure.” You have to provide a consistent level of support for security throughout the organization. For instance, there isn’t much point in strict security for information when it is sitting in the system, if you are going to throw paper around with carefree abandon once the information comes off the system.

The employee must perceive that “it is information I am protecting, not some computer.”

Parker: The key is that we are dealing with information security, not just computer security. We are in an information age. A bank or any business organization is an information factory. We have to put aside our tunnel-



DONN B. PARKER

vision concepts about computer security and deal with the entire problem if we are to be consistent throughout the organization. That is, information security, wherever the information is, in whatever form.

Browne: Even those organizations that look at it in that context miss the boat because they fail to bring the process down to the desk of the user of that information. Organizations that identify the roles and responsibilities of the owners and users of information tend to have more success.

Most organizations I see centralize the information security function and actually build walls or barriers around it.

DeMaio: Determining ownership is not the easiest thing in the world. I see it this way: whoever has the responsibility for setting the ground rules of usage must tell all users what they can and cannot do with a particular piece of datum, and who has priority.

Schmitt: We’ve wrestled with this and come up with the idea that ownership—of the data, the hardware, the software—is solely the corporation’s. That eliminates the different perceptions people have. On the next level is the guardian, the person responsible for the accuracy and integrity of the data. The personnel department would be responsible for the accuracy of the data in the human resources systems, for example.

On the third level is the custodian, the person who keeps the data, protects them. The guardian must notify the custodian of the value of the data and make sure he understands that. The custodian, on the other hand, must demonstrate to the guardian’s satisfaction that he can protect the data. This concept establishes a set of responsibilities.

Browne: Does someone follow through on those responsibilities?

Schmitt: They must first be established as a corporate policy or you can’t get consistency. It is a management issue.

Parker: But then you have to have penalties and rewards.

Courtney: The reward is that they keep their jobs.

Parker: On the topic of motivation, there is a differential association syndrome in criminological research that says: crime losses occur in groups that work together where one person deviates from the norm because it is fun or because he’s satisfying some recognition need. Then someone else tries to outdo him, and you have a high degree of deterioration.

So you have to expect that in a human organization, deterioration of norms will occur over time unless the members are continually reinforced in some ways. That requires discipline.

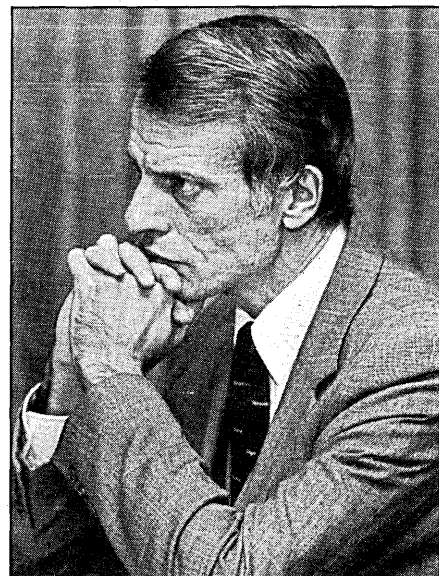
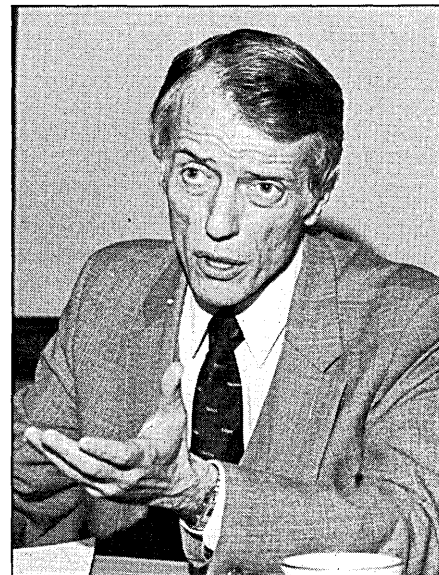

HARRY DEMAIO

Schmitt: That is, if you supervise and manage properly, you ensure that deterioration does not occur.

Parker: So it comes back to the old people problem—the trustworthiness and dedication of people to the security and safety of their business.

Courtney: There is an old-fashioned word called leadership. If people are led into an awareness and an appreciation of the need for security, almost all conform. You can identify the handful that won’t.

Ruthberg: Warren’s organization, I think, has a key to motivating people—using a top-down approach to the whole issue. I think one big problem is that organizations are not get-

Retro-Graphics™ and TeleVideo. Lear Siegler. Datamedia. ADDS. And TI.

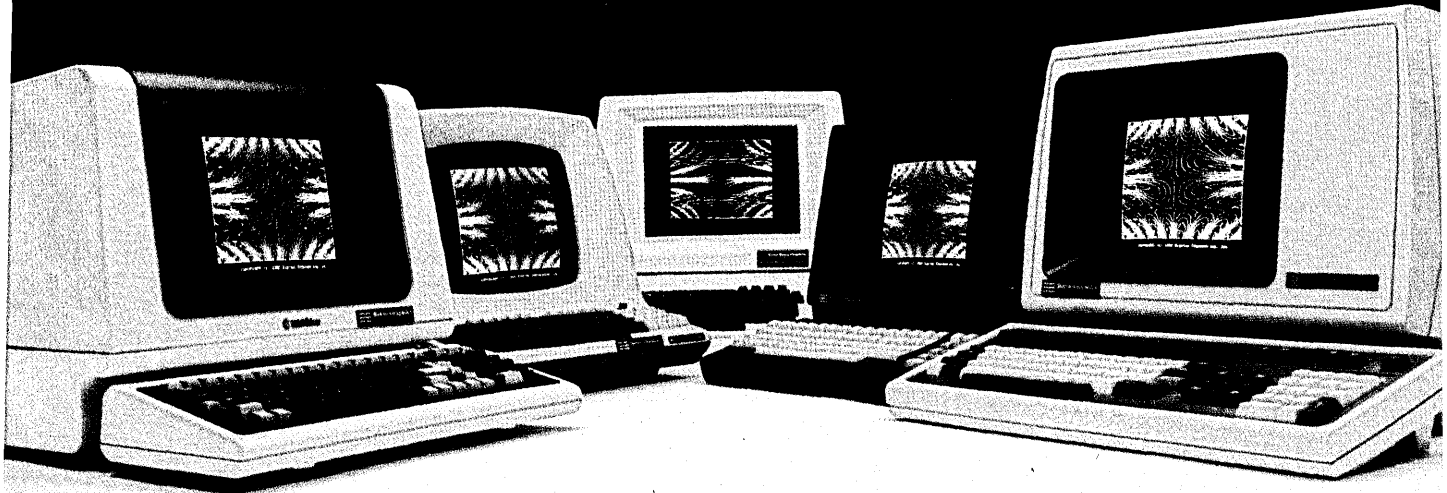

Now with GEN.II™ choose a monochrome, gray-scale, or color-formatted terminal to deliver our Tek 4010/4027 compatible graphics.

For a variety of text terminals, the world of cost-efficient graphmaking is now made possible by Digital Engineering's GEN.II Retro-Graphics terminal enhancement — a "snap-in" PC card assembly that provides Tektronix®-based graphics software compatibility.

Once installed, GEN.II will perform monochrome imaging on the TeleVideo® 950, 925, 920, 912, and 910, Lear Siegler ADM 3A, 3A+, and 5, and ADDS VIEWPOINT and VIEWPOINT/3A PLUS; gray scale on TI's Model 940; and color on the Datamedia™ ColorScan™ 10, 30, 60, 70, and 10H.

But best of all a Retro-Graphics enhancement costs only a fraction of what you're paying now for an equivalent graphics terminal: about \$1200-1900, depending on the GEN.II model you order.

Introducing GEN.II Retro-Graphics. For superior bit-mapped technical plots and MIS charts.

Our second-generation enhancements provide emulation of the Tektronix 4010 graphics terminal and simulation of the Tek™ 4027 color graphics terminal. In standard resolutions on all GEN.II models. And in medium resolution — 640 by 480 pixels — on Color Retro-Graphics™ for the ColorScan 10H.

Because GEN.II products are based on industry-standard Tek protocol, operation is both powerful and familiar to most programmers. Raster-scan images are generated quickly on GEN.II because up to 48 Kb's of graphics intelligence is "resident." This also means costly host-terminal data transmissions are held to a minimum.

English-like commands simplify graphics operation and programming. For example, entering from the keyboard or computer the following command string

!PIE, 200, 90, 120

will cause the upgraded terminal to draw a pie chart sector with a radius of 200 and fill in the area between 90 and 120 degrees. The filled area can be a color in the case of Color Retro-Graphics, an intensity level in the case of gray-scale GEN.II, or a dithered shade in the case of our one-color products.

In addition, GEN.II enables the programmer to draw *polygons* and *vectors*. *Define* and *shape text characters*. And *recall stored graphs* with similar high-level command strings. And you get all this without the loss of existing terminal features.

GEN.II software compatibility protects your hardware investment.

Since our products are compatible with Tek's 4027 and 4010, GEN.II's performance on utility and applications programs, both present and future, is ensured. Currently, more than 20,000 Retro-Graphics enhancements are successfully being used with DISSPLA® and TELLAGRAF®, PLOT 10™, Template™, DI-3000™, and ILS® graphics programs.

Comprehensive support at every level.

Good ideas mean little if you cannot build on them. Optional interfaces let you hook up a variety of input/output devices of your choice. These include a light pen and digitizers, impact and non-impact serial printers, and video devices. There's solid documentation at every level. And fast, accurate backup by our own customer service and worldwide distribution network.

Digital Engineering's GEN.II Retro-Graphics and your choice of terminal — for economy and compatibility in a sophisticated graphics workstation.

Call us today for full details, demonstration, and the name of your local Retro-Graphics distributor — your "one source" for graphics.

 **DIGITAL
ENGINEERING**

630 Bercut Drive, Sacramento, CA 95814
(916) 447-7600 Telex: 910-367-2009

GEN.II, Retro-Graphics, and Color Retro-Graphics are trademarks of Digital Engineering, Inc. © 1982 Digital Engineering, Inc.

CIRCLE 82 ON READER CARD

!Candle Corporation®

Candle Corporation – a software company supplying performance monitoring programs to MVS, CICS, and IMS installations.

MVS

For MVS installations, Candle's OMEGAMON® realtime monitor has gained worldwide recognition for being able to reduce IPLs. DEXAN™ for MVS helps analyze the performance of batch and TSO in realtime. EPILOG/MVS™ is a background performance management system.

CICS

OMEGAMON/CICS® is a realtime monitor that warns of CICS problems as they are happening. The RTA/CICS™ option will display response time information graphically. ESRA/CICS™ is a new intelligent background performance analyzer that searches for response time problems and then looks for the causes.

IMS

Candle is currently introducing a series of IMS products. OMEGAMON/IMS™, RTA/IMS™, and DEXAN/IMS™ will provide realtime windows into IMS problems, response time and degradation. EPILOG/IMS™ will perform in a background mode looking for and diagnosing response time problems.



MCAUTO® – Monitoring multiple MVS systems using OMEGAMON.

!Candle™

Dept. MI • 10880 Wilshire Blvd., Suite 2404
Los Angeles, CA 90024 • (213) 821-2902

Please send me more information on products that monitor performance of: MVS CICS IMS

Please enter my free subscription to the Candle Computer Report.

CPU _____ Operating System _____

Name _____ Title _____

Company _____

Address _____

City _____ State _____ Zip _____

Phone _____

A-159

EDUCATION

Candle provides top level technical support to customers. We offer courses, seminars, video-tapes, tuning guides, and special reports to help keep users up to date on how to monitor the ever changing IBM systems.

TECHNICAL NEWSLETTER

The Candle Computer Report is a newsletter that explores current topics and news in MVS, CICS, IMS and IBM hardware. It is provided free to IBM and IBM compatible installations.

Candle™
announces

Two Exciting Windows into IMS Performance Problems

Today, thousands of computer systems all over the world are having their MVS and CICS performance diagnosed every few seconds by Candle's software monitors. Now Candle's innovative technology can illuminate performance and availability problems in IMS.

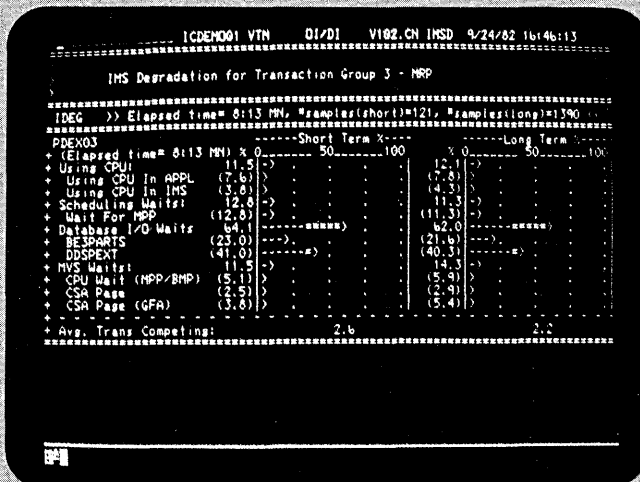

DEXAN™/IMS enables IMS specialists to quickly and easily zero in on why IMS transactions are running slowly. This ease of use is achieved through a diagnostic technique that Candle presented for MVS and CICS called degradation analysis. In the above example, transactions wait 64% on DB I/O (BE3PARTS=23%, DDSPEXT=41%).

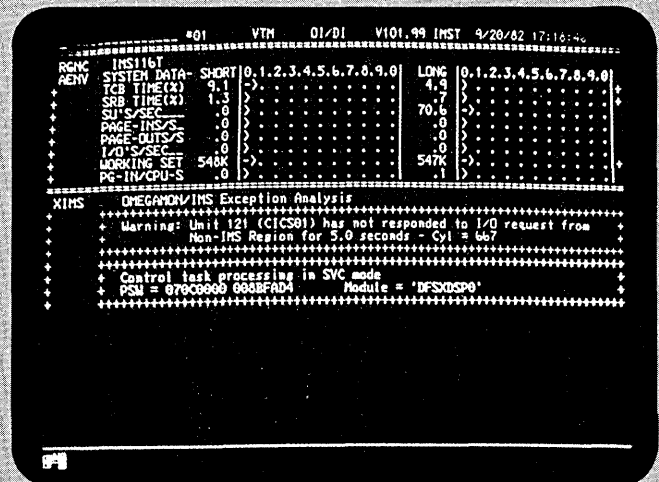

OMEGAMON®/IMS will alert operators of problems in IMS by color messages and audible alarms. Comprehensive views into IMS performance and activity (400 commands) are provided for systems programmers. Dynamic screen formatting, tutorials, action commands and PFK support enhance the power of OMEGAMON/IMS for all users.

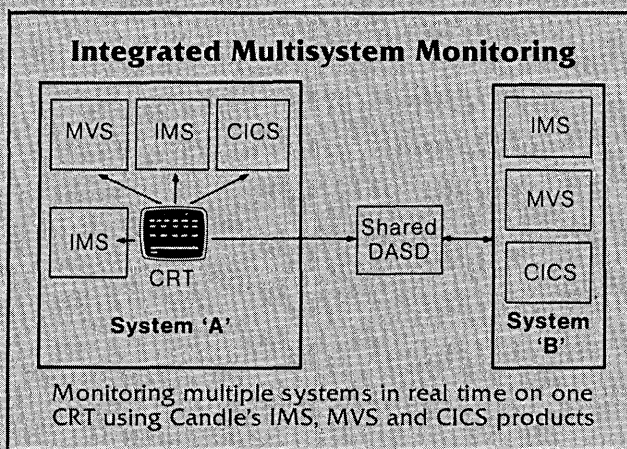

DEXAN/IMS and OMEGAMON/IMS:

- can be installed and operational in less than one hour
- can operate on the same CRT (3270) via VTAM mode and dedicated EXCP mode
- can be used via a common CRT with OMEGAMON/MVS, DEXAN/MVS, OMEGAMON/CICS and RTA™/CICS
- will help you address IMS response time and down-time problems

Candle™

10880 Wilshire Blvd., Suite 2404
Los Angeles, CA 90024 (213) 470-2277

Candle™ Dept. MI, 10880 Wilshire Blvd., Suite 2404
Los Angeles, CA 90024 (213) 470-2277

Please send information on Candle's performance monitoring products for: IMS MVS CICS

Name _____

Title _____

Company _____

Address _____

City _____ State _____ Zip _____

Phone _____

IMS Level _____ No. of IMS Terminals _____

A-156

CIRCLE 83 ON READER CARD

THE NEED...

QUIET, FLEXIBLE WORD PROCESSING AND GRAPHICS APPLICATIONS

THE SOLUTION...

QMS LASERGRAFIX 1200™



QMS LASERGRAFIX 1200...a totally new concept in electronic page printing! We've merged laser printing with the most sophisticated intelligent controller on the market. The result—a compact laser printer that offers easy to program graphics and letter quality output with a resolution of 300 dots per inch...and all at a whisper quiet level.

OUR APPLICATIONS FIRMWARE PACKAGE WILL SAVE YOU TIME AND MONEY!

INDUSTRIAL GRAPHICS BUSINESS GRAPHICS LETTER QUALITY WORD PROCESSING
 MULTIPLE FONTS OCR CRT HARDCOPY FORMS CREATION EDP LINE PRINTING
 GRAPHIC PRINTING/PLOTTING for scientific, analytical and CAD/CAM... and our list goes on and on. *AND OUR CONTROLLERS DO THE PLOTTING FOR YOU!* All you do is supply simple print instructions to the printer in your normal data stream. *AND OUR INTERFACES COVER ALMOST ANY COMPUTER SYSTEM YOU CAN THINK OF...* Burroughs, DEC, IBM, NCR, Sperry Univac, Wang, and others.

See us at Booth 373/375 '83 Office Automation Conference in Philadelphia.

QMS LASERGRAFIX 1200... "A PICTURE IS WORTH A THOUSAND WORDS."

QMS QUALITY MICRO SYSTEMS
P.O. Box 81250 • Mobile, Alabama 36689 • (205) 343-2767

Telex 505-405 QMS MBL

Quality is more than our name. It's our business.

YES! I'm interested in your LASERGRAFIX 1200 solutions to my printing and graphics needs. Please send me your LASERGRAFIX 1200 literature.

NAME: _____ TITLE: _____

COMPANY: _____ TYPE OF BUSINESS: _____

ADDRESS: _____

CITY: _____ STATE: _____ ZIP: _____

PHONE: () _____ I WOULD _____ WOULD NOT _____ LIKE A SALESMAN TO CALL.

I WOULD _____ WOULD NOT _____ BE INTERESTED IN BECOMING A LASERGRAFIX 1200 OEM. D0001

"IBM has invested in educating the public because we believe it is not only a social obligation but also good business."



ROBERT H. COURTNEY JR.

ting the whole picture. They are starting in the middle and looking at the problem piecemeal.

Schmitt: I agree, you need the top-down approach to ensure success. This, however, does not happen overnight; it requires a systematic approach. In the meantime there are many result-oriented programs that can be addressed—starting with physical security, contingency planning, logical access controls, etc. Since there is so much to be accomplished, you have to embark on projects that you intuitively know must be accomplished.

Ruthberg: What you can do is to take a top-down approach to the system as you perceive it at a given time. Because without a structured view, you're likely to end up solving

just pieces of a problem. For example, you may have passwords to restrict access to a system, but allow unauthorized people to handle the output.

Schmitt: Realistically, I think we will get data security about the same way that most of us will get to heaven—by backing away from hell. Few of us will get there by going directly toward it. Whether we do things because we are fearful of something, such as regulations or criticisms, we ought to understand that data security is the correct thing to do because it reduces the risk of loss.

Parker: There are two kinds of fear—the typical negative fear and the one inspired by respect, awe, and reverence, as in "fear of the Lord is the beginning of wisdom." We can use both of those in prudent doses to good purpose for security. I am particularly thinking about the need for instilling fear in the new subculture developing in our schools. There are system hackers running around who have learned how to compromise computer systems from the telephone and from terminals in high school. What are these people going to do as they become our trusted technologists? What kind of values are they going to carry with them when they have learned that it is acceptable to attack systems, to technologically trespass, to engage in computer program piracy?

Browne: I have had firsthand experience with this, because my 14-year-old son is a budding technologist with a home computer. I shudder at the practices that he and his peers at school accept as common, normal, ethical—like the pirating of programs. No one has told him it is wrong, except his parents. All of his friends do it. I have great concern about schools that give the impression it is acceptable to hack at systems.

Computers are games to our children and it is just a matter of changing from a Mattel toy to an Atari toy. So how do we deal with this? We have to train and educate.

Parker: We have to change their values in some way. We have values in society that say shoplifting is not nice, not acceptable. I think that through our professional societies, our educational institutions, and our home life, we have to say it is not nice to pirate a computer program, or it is not nice to gain unauthorized access to a computer system, and at least establish concepts of what is and is not socially acceptable.

Then we should combine that with the confrontation level of security, so that people can't help but know that they are doing something wrong because there is a "no trespassing" sign there.

Third, we should develop the legislation for computer and information crime that would confront people saying, "Hey, this is

not a game. This is a felony. The computer you have been trying to get into is a vault. We don't play games in vaults."

Schmitt: It's a question of ethical standards. Kids do not learn this behavior on their own. There is a question whether we formally stress computer ethics in education in a way that young people can tell right from wrong.

DeMaio: Both my sons have come home from their universities with stories of ethical rules on the use of computers, of enforcement.

Courtney: Some universities, of course, are doing a good job, but I've heard representatives from major universities readily admit that they have done nothing when the kids have broken into the administrative systems



PETER S. BROWNE

"We will get to data security the same way most of us will get to heaven—by backing away from hell."

and changed grades. But if the same students had broken into the file cabinet at the dean's office and changed a manual record, they'd have booted them right out on their ear.

Parker: Even if all the universities begin doing a good job of teaching the application of ethics and instilling discipline, I am afraid that these bad practices and values now are being formed in grammar school and high school.

Schmitt: I think we have a responsibility to act as parents or as professionals to support the educational institutions. If we are displeased with the way children are being taught, then we should communicate with the state boards of education or develop a campaign that is supported by the industry.

Ruthberg: It would help a great deal if an influential organization were willing to advocate a set of standards.

Courtney: I agree. I think it's appropriate for ACM or DPMA to take it up as a major campaign, and I think it's high time they got on with it.

Parker: I recently received a grant from the Bureau of Justice Statistics which relates to these matters. Among other things, we're going to try to determine the size and nature of the juvenile hacker problem. We'll be dealing with software piracy problems as well. We've got an endorsement from AFIPS—they'll assist in selecting an advisory panel and in publishing and distributing the results.

DeMaio: There are several fundamental problems here. For instance, the average par-

ent does not understand the technology and therefore does not understand the proportion of damage that can be done by a kid working in this environment. So another education task is making the public as parent understand what this is all about.

Another problem rests outside the framework of school, home, or office. The media, for instance, have not helped the matter by glorifying the cuteness of ripping off systems, or, as I saw in one show recently, by promoting the idea that somehow this is a battle between a very brilliant individual and a faceless organization, a battle in which nobody gets hurt.

We really need a very broad reevaluation of the whole environment. And it is not an easy sell. When everybody behaves themselves with data, it does not sell newspapers and does not make for a particularly good half hour on tv. And it probably adds more burden to the educational problem and to the parent's job than anybody wants to talk about.

Courtney: I don't think you can look to the media or to the vendors to promulgate ethical behavior. I think you have to look to the professional societies to take the lead. There is no point in looking to these profit-making institutions as sources of ethical leadership or training when it doesn't do a damn thing for the bottom line.

DeMaio: I'd argue against that emphatically. A very pragmatic reason is that if there is a buildup of public fear about the devices we build, acceptance of those devices will begin to drop. IBM has made an investment in this

because we believe that it not only a social obligation, but also good business. We can't do it all by ourselves, though.

Courtney: You've known for a long time that we need to educate the people who are educating the kids. I don't see a big education campaign from IBM about ethics and integrity in the use of minicomputers. Personal computers have been selling like crazy and I haven't seen you tell anyone. . . .

DeMaio: I beg to differ; we have had a series of advertising campaigns on the nature of data security, on the responsibility for protecting information.

Browne: About the media, you can't say their sensationalized coverage of the horror stories in computing is completely negative. They are underscoring, for management, the need for recovery and contingency planning. That planning is extending beyond the dp department. In fact, the parent company of DATAMATION, Dun & Bradstreet, has undertaken a corporate recovery program that extends beyond the dp side.

DeMaio: Many organizations, particularly in the service industries, have come to realize that their information systems are their competitive edge, and if they are not operating at peak performance, they are actually at a competitive loss.

Parker: Corporations know that if their data processing is unavailable for just a few days or a few hours, it could spell disaster for them. What I call the MTBU—maximum time to belly up, due to this unavailability—is getting shorter and shorter.

This kind of self-interest is creating a healthy reaction on the part of top management to security issues. I feel another impetus must come from basic information crime statutes. When criminal statutes have been enacted, management will feel the responsibility to make sure their employees understand what constitutes a felony, and that information is an asset subject to criminal laws.

DATAMATION: We've heard it said today that the parents should instill discipline in the child, schools at all levels should instill discipline in the student, and management should instill discipline in the employee. It's been said that the vendor has responsibilities toward customers and society and that Congress has a responsibility to instill healthy old-fashioned fear in system hackers through stiff legislation.

Data processing managers will be happy to hear that total responsibility for security does not fall on their shoulders.

Schmitt: Your readers should accept the responsibility intended. It is not "someone else's problem." It is everyone's problem.*

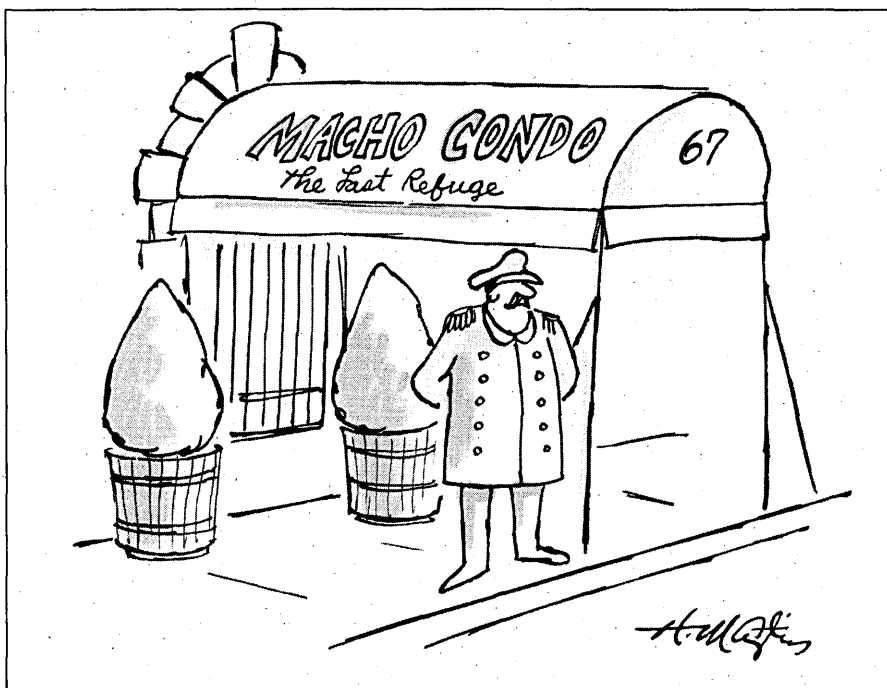

CARTOON BY HENRY MARTIN

SCIENCE/SCOPE

Batteries that may live seven times longer than the spacecraft themselves will be used on Intelsat VI communications satellites to ensure performance. The nickel-hydrogen batteries provide power when the satellite slips into Earth's shadow and the solar cells no longer generate electricity. They have demonstrated 6,000 discharge cycles in tests, the equivalent of 70 years in orbit. Hughes Aircraft Company heads an international team building Intelsat VI for the International Telecommunications Satellite Organization.

A new wireless entertainment system will use infrared light to carry music and movie soundtracks to passengers on commercial and corporate jet aircraft. The system, under development at Hughes, transmits a digital infrared signal that is received and decoded by a passenger's headset. The signal is completely harmless to people and won't interfere with other aircraft equipment. The infrared system transmits 16 channels. It would weigh less than half of a conventional wired system and would cost a third less. Since there are no wires with this system, it is particularly suited for aircraft with changeable seating.

The first two satellites to be launched from NASA's space shuttle were placed in orbit for about one-third the cost of a conventional launch, thus saving their owners millions of dollars. This particular model of communications satellite, designed by Hughes, is relatively inexpensive to launch because it sits upright and snugly folded in special cradles in the cargo bay. This feature saves money because launch costs are based on how much room a satellite takes up and how much it weighs. The cradle contains spring mechanisms that eject the satellite from the bay, after which rocket motors propel it into geostationary orbit. The drum-shaped spacecraft stands 9 feet tall when compacted. But when it reaches orbit, a telescoping solar panel deploys and the antenna unfolds, bringing the satellite's overall height to more than 21 feet.

Advanced military electro-optical systems are being produced in large numbers and at high rates at a new Hughes manufacturing facility. The complex, which covers one-half million square feet, is designed specifically for making such high-technology devices as infrared night sights and laser rangefinders. Recent milestones include the following deliveries to the U.S. Army: the 2,000th laser tank fire control system for the M60A3 tank, the 1,000th airborne TOW antitank missile system for the Cobra attack helicopter, and the 1,000th thermal imaging system and laser rangefinder for the M1 Abrams tank. In addition, production rates for the two M1 units have reached 70 per month.

Hughes is seeking engineers to develop advanced systems and components for many different weather and communications satellites, plus the Galileo Jupiter Probe. Immediate openings exist in applications software development, data processing, digital subsystems test, microwave/RF circuit design, power supply design, digital communications, signal processing, spacecraft antenna design, system integration test and evaluation, and TELCO interconnection. Send your resume to Ray Bevacqua, Hughes Space & Communications Group, Dept. SE, Bldg. S/41, M.S. A300, P.O. Box 92191, Los Angeles, CA 90009. Equal opportunity employer.

Creating a new world with electronics

HUGHES

HUGHES AIRCRAFT COMPANY
EL SEGUNDO, CALIFORNIA 90245

How to cure the IMS testing complex.



Testing new programs that use IMS* data bases is so complicated, it can give any programmer a complex. IMS requires tedious creation of test data, manual comparisons and other time consuming tasks that can really depress productivity. Fortunately all these problems are curable with DataVantage.

DataVantage simplifies all aspects of IMS testing. With one command, DataVantage creates a subset of your production data base for use as test data. You're able to test all program logic quickly and thoroughly. Ad hoc programs and incomplete samples become a thing of the past.

Determining a program's effect has also been made easy with

DataVantage's logical compare function. It automatically compares the data bases before and after the test is run and lists the differences. No need to wait for dumps and comb through computer printouts.

And our unique Save/Refresh feature lets each programmer save and restore various versions of the test data base. So if one version is damaged, the others remain untouched (including the master test data base). Best of all, you can recover a test data base with a single command.

Don't let IMS testing get you down. Try DataVantage free for 30 days. You'll see DataVantage not only lightens your workload but also takes a load off your mind.

DataVantage
from



**ON-LINE
SOFTWARE**
INTERNATIONAL

Fort Lee Executive Park
Two Executive Drive
Fort Lee, NJ 07024
(201) 592-0009
Toll Free (800) 526-0272

CIRCLE 90 ON READER CARD

*A product of IBM.

Emerging from AI labs, exploratory programming environments can handle complex, interactive applications that structured methods box into a corner.

POWER TOOLS FOR PROGRAMMERS

by Beau Sheil

An oil company needs a system to monitor and control the increasingly complex and frequently changing equipment used to operate an oil well. An electronic circuit designer plans to augment a circuit layout program to incorporate a variety of vaguely stated design rules. A newspaper wants a page layout system to assist editors in balancing the interlocking constraints that govern the placement of stories and advertisements. A government agency envisions a personal workstation that would provide a single integrated interface to a variety of large, evolving database systems.

Applications like these are forcing the commercial deployment of a radically new kind of programming system. First developed to support research in artificial intelligence and interactive graphics, these new tools and techniques are based on the notion of exploratory programming, the conscious intertwining of system design and implementation. Fueled by dramatic changes in the cost of computing, such exploratory programming environments have become a commercial reality virtually overnight. No fewer than four such systems were displayed at NCC '82 and their numbers are likely to increase rapidly as their power and range of application become more widely appreciated.

Despite the diversity of subject matter, a common thread runs through our example applications. They are, of course, all large, complex programs whose implementations will require significant resources. Their more interesting similarity, however, is that it is extremely difficult to give complete specifications for any of them. The reasons range from sheer complexity (the circuit designer can't anticipate all the ways in which his design rules will interact), through continually changing requirements (the equipment in the oil rig changes, as do the information bases that the government department is required to consult), to the subtle human factors issues that determine the effectiveness of an interactive graphics interface.

Whatever the cause, a large programming project with uncertain or changing specifications is a particularly deadly combi-

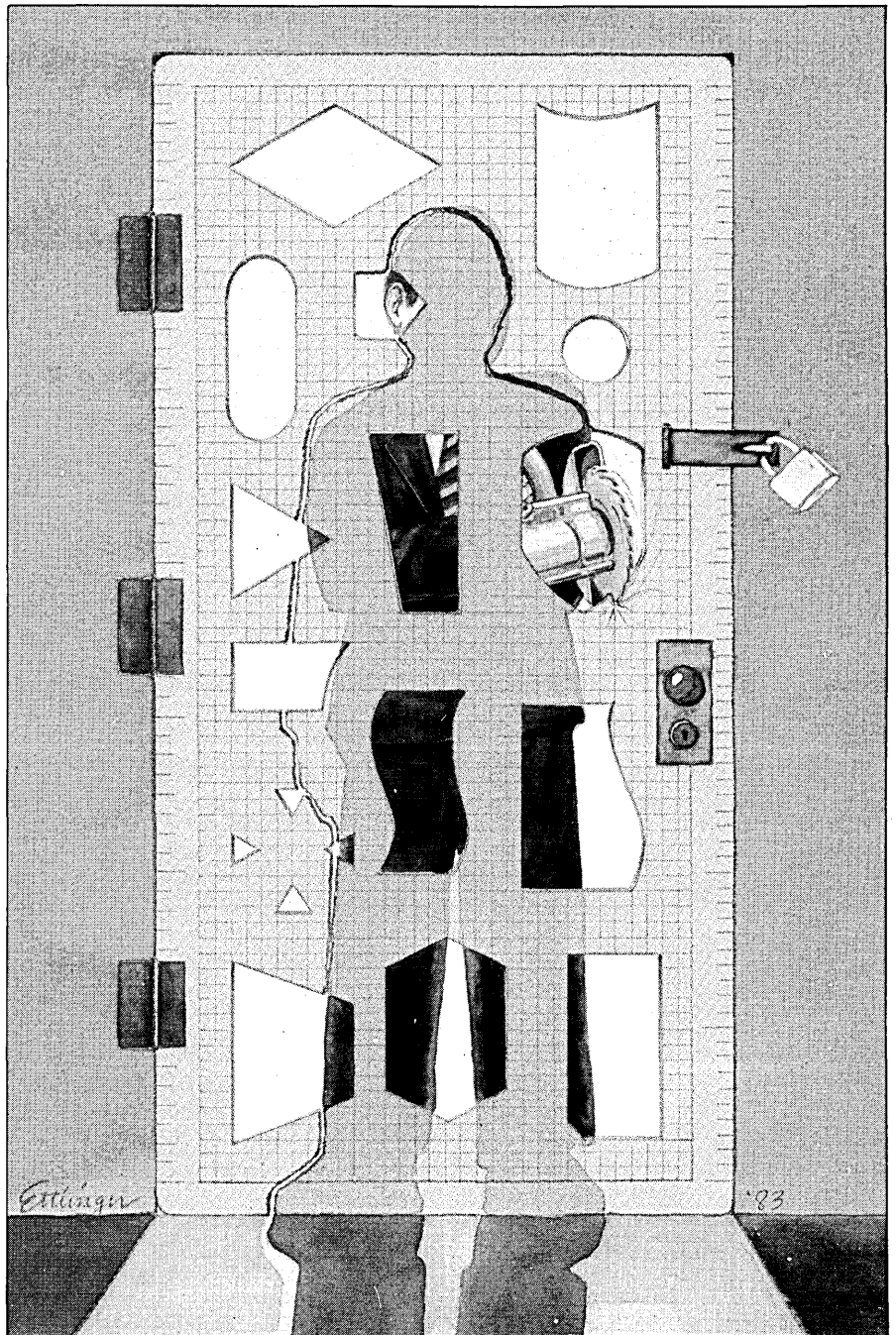

ILLUSTRATION BY DORIS ETTINGER

TOP LEVEL TYPESCRIPT WINDOW

```

NIL
LATTICER... to be dumped.
71+(DEFINEQ (F (A) (IF A LT 2 THEN 1 ELSE A*(F A-1))
(F)
72+(F 4)
24
73+FILES?]
LATTICER... to be dumped.
plus the functions: F
want to say where the above go ? No
NIL
74+(SETQ DRAWBETWEEN 0)
(DRAWBETWEEN reset)
0
75+(EDITTREE (PARSE My uncle's story
int FOLLOW/CURSOR BREAK: 1
FOLLOW/CURSOR
APPLY (FOLLOW/CURSOR broken)
EDITLATTICE 77: SHOW PATHS FROM FOLLOW/CURSOR
ADW-PROG
ADV-SETQ
PROG
EDITTREE
TDP**
78: DOES FOLLOW/CURSOR CALL DRAWBETWEEN SOMEHOW
79: DOES FOLLOW/CURSOR CALL DRAWBETWEEN
NIL
80: DRAWBETWEEN
81:

```

(LNODE)#4.54110 INSPECTOR

```

LNODEID (NP (DET &) (N &))
LNODEPOSITION (232 . 183)
NODELABELBITMAP (BITMAP)#5.43226
NODEFROMPOS (232 . 175)
NODETOPOS (232 . 191)
LNODEWIDTH 24
LNODEHEIGHT 16
TOLNODES ((DET &) (N &))
FROMLNODES ((PP &))
LNODEFONT (FONTDESCRIPTOR)#1,115550
NODELABEL NP
BOXNODEFLG NIL

```

BITMAP EDITOR

```

NP

```

Interlisp-D

These two screen images show some of the exploratory programming tools provided in the Xerox Interlisp-D programming environment. The screen is divided into a series of rectangular areas or windows, each of which provides a view onto some data or process, and which can be reshaped and repositioned at will by the user. When they overlap, the occluded portion of the lower window is automatically saved, so that it can be restored when the overlapping window is removed. Since the display is bit-mapped, each window can contain an arbitrary mixture of text, lines, curves, and pictures composed of half-tones or solids. The image of Einstein, for instance, was produced by scanning a photograph and storing it digitally.

In the typescript window (labeled 1), the user has defined a program F (facto-

rial) and has then immediately run it, giving an input of 4 and getting a result of 24. Next, in the same window, he queries the state of his files, finding that one file (LATTICER) has already been changed and one function (F) has been defined but not associated with any file yet. The user sets the value of DRAWBETWEEN to 0 in command 74, and the system notes that this is a change and adds DRAWBETWEEN to the set of "changed objects" that might need to be saved.

Then, the user runs the program EDITTREE, giving it a parse tree for the sentence "My uncle's story about the war will bore you to tears." This opens up the big window (2) on the right in which the sentence diagram is drawn. Using the mouse, the user starts to move the NP node on the left (which is inverted to show that it is

being moved).

While the move is taking place, the user interrupts the tree editor, which suspends the computation and causes three "break" windows to appear on top of the lower edge of the typescript. The smallest window (3) shows the dynamic state of the computation, which has been broken inside a subprogram called FOLLOW/CURSOR. The "FOLLOW/CURSOR Frame" window (4) to the right shows the value of the local variables bound by FOLLOW/CURSOR. One of them has been selected (and so appears inverted) and in response, its value has been shown in more detail in the window (5) at the lower left of the screen. The user has marked one of the component values as suspicious by circling it using the mouse. In addition, he has asked to examine the contents of the BITMAP component, which has

nation for conventional programming techniques. Virtually all modern programming methodology is predicated on the assumption that a programming project is fundamentally a problem of implementation, rather than design. The design is supposed to be decided on first, based on specifications provided by the client; the implementation follows. This dichotomy is so important that it is standard practice to recognize that a client may have only a partial understanding of his needs, so that extensive consultations may be required to ensure a complete specification with which the client will remain happy. This dialog guarantees a fixed specification that will form a stable base for an implementation.

The vast bulk of existing programming practice and technology, such as structured design methodology, is designed to ensure that the implementation does, in fact, follow the specification in a controlled fashion, rather than wander off in some unpredictable direction. And for good reason. Modern programming methodology is a significant achievement that has played a major role in preventing the kind of implementation disasters that often befell large programming projects in the 1960s.

The implementation disasters of the 1960s, however, are slowly being succeeded by the design disasters of the 1980s. The projects described above simply will not yield to

conventional methods. Any attempt to obtain an exact specification from the client is bound to fail because, as we have seen, the client does not know and cannot anticipate exactly what is required. Indeed, the most striking thing about these examples is that the clients' statements of their problems are really aspirations, rather than specifications. And since the client has no experience on which to ground these aspirations, it is only by exploring the properties of some putative solutions that the client will find out what is really needed. No amount of interrogation of the client or paper exercises will answer these questions; one just has to try some designs to see what works.

The screenshot displays the Interlisp-D environment with several windows:

- TOP LEVEL TYPESCRIPT WINDOW:** Contains Lisp code for defining functions like `DEFIN EQ` and `SETQ`, and a paragraph of text about a lattice.
- FOLLOW CURSOR FRAME:** Shows the current cursor position and frame information.
- BROWSER PRINTOUT WINDOW (8):** Displays a tree diagram of a sentence structure with nodes like NP, AUX, VP, DET, N, PP, M, V, P, PRO, and P. It includes Lisp code for `SHOWNODE` and `SHOWLINK`.
- EDITOR (9):** Shows a portrait of Albert Einstein and a list of editing commands such as After, Before, Delete, Replace, Switch, etc.
- (LNODE)#4.54170 INSPECTOR:** Provides detailed information about a specific node, including its ID, position, label, and various attributes.
- DEDIT OF FUNCTION SHOWLINK:** Shows the definition of the `SHOWLINK` function.

opened up a bitmap edit window (6) to the right. This shows an enlarged copy of the actual NP image that is being moved by the tree editor. Then, inside the largest of the three break windows (10) the user has asked some questions about the FOLLOW/CURSORS subprogram that was running when he interrupted, and queried the value of DRAWBETWEEN (now 66). The SHOW PATHS command brought up the horizontal tree diagram on the left (7), which shows which subprograms call each other, starting at FOLLOW/CURSORS.

Each node in the call tree produced by the SHOW PATHS command is an active element that will respond to the user's selecting it with the mouse. In the second image, the user has selected the SHOWNODE subprogram, which has caused its source code to be retrieved from the file (.LISP.DE-

MO-LATTICER) on the remote file server (PHYLUM) where it was stored, and displayed in the "Browser printout window" (8) which has been opened at middle right. User functions and extended Lisp forms (like *for* and *do*) are highlighted by system-generated font changes.

By selecting nodes in the SHOW PATHS window, the user could also have edited the code or obtained a summary description of any of its subprograms.

Instead, the user has asked (in the break typescript window (10)) to edit wherever anybody calls the DRAWBETWEEN system primitive (which draws lines between two specified points). This request causes the system to consult its dynamically maintained database of information about user programs, wherein it finds that the subprogram SHOWLINK calls DRAWBETWEEN. It

therefore loads the code for SHOWLINK into an edit window (9) that appears under the "Browser printout window." The system then automatically finds and underlines the first (and only) call on DRAWBETWEEN. Note that on the previous line DRAWBETWEEN is used as a variable (the same variable the user set and interrogated earlier). The system, however, knows that this is not a subprogram call, so it has been skipped over. If the user were to make any change to this subprogram in the editor, not only would the change take effect immediately, but SHOWLINK would be marked as needing to be updated in its file and the information about it in the subprogram database would be updated. This, in turn, would cause the SHOW PATHS window to be repainted, as its display might no longer be valid.

The consequences of approaching problems like these as routine implementation exercises are dramatic. First, the implementation team begins by pushing for an exact specification. How long the client resists this coercion depends on how well he really understands the limits of his own grasp of the problem. Sooner or later, however, with more or less ill-feeling, the client accepts a specification and the implementation team goes to work.

The implementors take the specification, partition it, define a module structure that reflects this partitioning, freeze the interfaces between them, and repeat this process until the problem has been divided into a

large number of small, easily understandable, and easily implementable pieces. Control over the implementation process is achieved by the imposition of structure, which is then enforced by a variety of management practices and programming tools.

USE OF INTERNAL RIGIDITY

Since the specification, and therefore the module structuring, is considered fixed, one of the most effective methods for enforcing it is the use of redundant descriptions and consistency checking. Hence the importance of techniques such as interface descriptions and static type checking, which require that multiple

statements of various aspects of the design be included in the program text. These statements allow mechanical checks that ensure that each piece of the system remains consistent with the rest. In a well-executed conventional implementation project, a great deal of internal rigidity is built into the system, ensuring its orderly development.

The problems usually emerge at system acceptance time, when the client requests not just superficial, but radical changes, either as a result of examining the system or for some completely exogenous reason. From the point of view of conventional programming practice, this indicates a failure at specification time. The software engineer

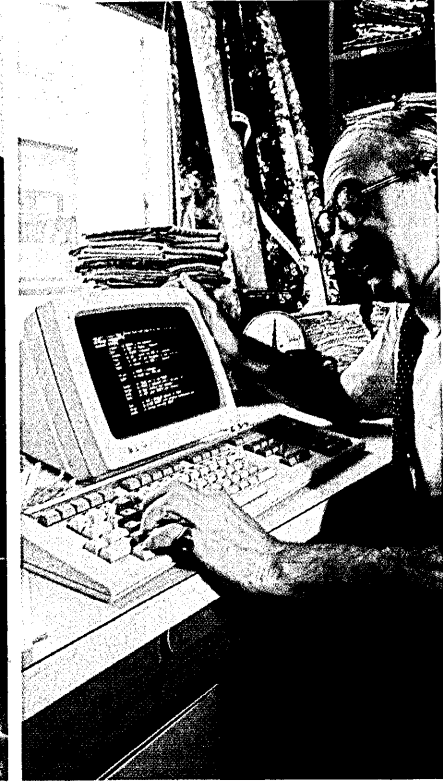
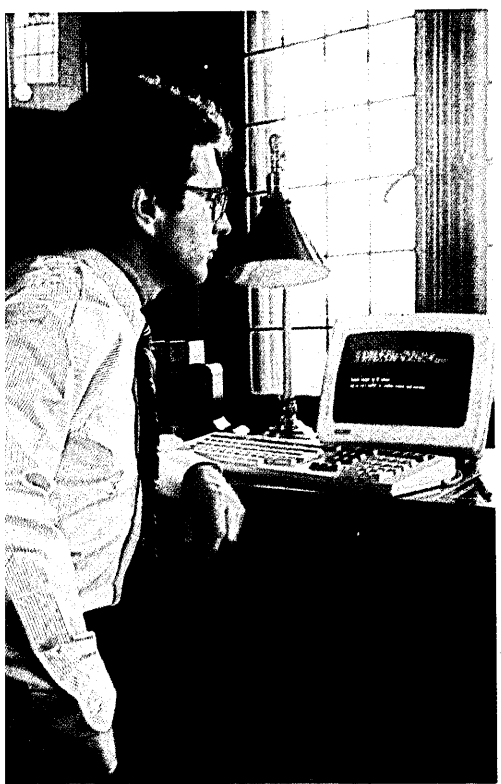

**THREE
NEW PERSONAL
COMPUTERS THAT
MAKE ALL THE
OTHERS MERELY
INTERESTING
HISTORY.**

There was a time in recent history when people could tolerate the inadequacies of personal computers. We believe that era has ended.

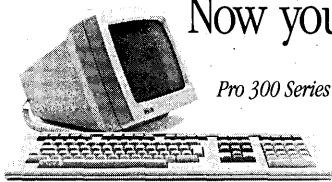

Pro 300 Series

The minicomputer of personal computers.

Now you can own personal computers that are more powerful, easier to use and more fully supported than any to have come before them. They are the new personal computers from Digital Equipment Corporation, the world's second largest computer manufacturer.

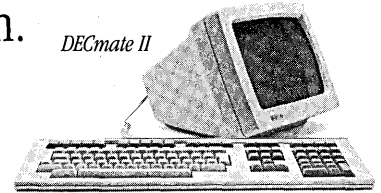

DECmate II

The fully supported small business system.

Digital's personal computers give you more information on the screen. More storage. And communications options that let you talk to other, larger computers anywhere in the world.

When it comes to graphics, you no longer have to settle for the "paint-by-numbers" look of yesterday's systems. Digital's optional bit-map graphics give you four times the resolution of even the very best picture tube. And you no longer have to settle for the pale, bland colors of the past. Digital's personal computers give you a wider palette to pick from.

Even more, you no longer have to be content with a narrow choice of personal computers. For Digital gives you three choices: Rainbow, DECmate, and Professional personal computers. Different kinds of personal computers, because there are different kinds of problems to manage.

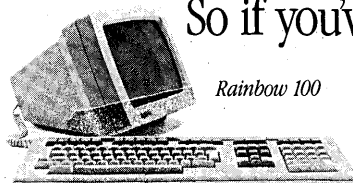

Rainbow 100

The low cost high performance machine.

So if you've been unhappy with the history of personal computing thus far, be glad. A new generation has begun. To find out more, call 800-DIGITAL and we'll send you our free

personal computer brochure. Or write: Digital Equipment Corporation, 129 Parker St., Maynard, MA 01754.

Professional 350, DECmate, and Rainbow are trademarks of Digital Equipment Corporation.
© Digital Equipment Corporation 1982

digital
MORE PERSONAL.
MORE COMPUTER.

The implementation disasters of the 1960s are slowly being succeeded by the design disasters of the 1980s.

should have been more persistent in obtaining a fuller description of the problem, in involving all the affected parties, etc. This is often true. Many ordinary implementation exercises are brought to ruin because the consequences of the specification were never fully agreed upon. But that's not the problem here. The oil company couldn't anticipate the addition of a piece of equipment quite different from the device on which the specification was based. No one knew that the layout editors would complain that it doesn't "feel right" now that they can no longer physically handle the copy (even in retrospect, it's unclear why they feel that way and what to do about it), etc., etc., etc. Nor would any amount of speculation by either client or software engineer have helped. Rather, it would have just prompted an already nervous client to demand whole dimensions of flexibility that would not in fact be needed, leaving the system just as unprepared for the ones that eventually turned out to matter.

Whatever the cause, the implementation team has to rework the system to satisfy a new, and significantly different, specification. That puts them in a situation that conventional programming methodology simply refuses to acknowledge—except as something to avoid. As a result, their programming tools and methods are suddenly of limited effectiveness. The redundant descriptions and imposed structure that were so effective in constraining the program to follow the old specification have lost none of their efficacy—they still constrain the program to follow the old specification. And they're difficult to change. The whole point of redundancy is to protect the design from a single unintentional change. But it's equally well protected against a single intentional change. Thus, all the changes have to be made everywhere. (Since this should never happen, there's no methodology to guide or programming tools to assist this process.) Of course, if the change is small (as it "should" be), there is no particular problem. But if it is large enough to cut across the module structure, the implementation team finds that it has to fight its way out of its previous design.

Still no major problem, if that's the end of the matter. But it rarely is. The new system will suggest yet another change. And so on. After a few iterations of this, not only are the client and the implementation team not on speaking terms, but the repeated assaults on the module structure have likely left it looking like spaghetti. It still gets in the way (fire walls are just as impenetrable if laid out at random as they are when laid out straight), but has long ceased to be of any use to anyone except to remind them of the project's sorry history. Increasingly, it is actively subverted (enter LOOPHOLES, UNSPECS, etc.) by programmers whose patience is run-

ning thin. Even if the design were suddenly to stabilize (unlikely in the present atmosphere), all the seeds have now been sown for an implementation disaster as well.

EXPLORE DESIGN PROBLEMS

The alternative to this kind of predictable disaster is not to abandon structured design for programming projects that are, or can be made to be, well defined. That would be a tremendous step backwards. Instead, we should recognize that some applications are best thought of as design problems, rather than implementation projects. These problems require programming systems that allow the design to emerge from experimentation with the program, so that design and program develop together. Environments in which this is possible were first developed in artificial intelligence and computer graphics, two research areas that are particularly prone to specification instability.

At first sight, artificial intelligence might seem an unlikely source of programming methodology. But constructing programs, in particular programs that carry out some intelligent activity, is central to artificial intelligence. Since almost any intelligent activity is likely to be poorly understood (once a program becomes well understood we usually cease to consider it "intelligent"), the artificial intelligence programmer invariably has to restructure his program many, many times before it becomes reasonably proficient. In addition, since intelligent activities are complex, the programs tend to be very large, yet they are invariably built by very small teams, often a single researcher. Consequently, they are usually at or beyond the manageable limits of complexity for their implementors. In response, a variety of programming environments based on the Lisp programming language have evolved to aid in the development of these large, rapidly changing systems.

The rapidly developing area of interactive graphics has encountered similar problems. Fueled by the swift drop in the cost of computers capable of supporting interactive graphics, there has been an equally swift development of applications that make heavy use of interactive graphics in their user interfaces. Not only was the design of such interfaces almost completely virgin territory as recently as 10 years ago, but even now, when there are a variety of known techniques (menus, windows, etc.) for exploiting this power, it is still very difficult to determine how easy it will be to use a proposed user interface and how well it will match the user's needs and expectations in particular situations. Consequently, complex interactive interfaces usually require extensive empirical testing to determine whether they are really

effective and considerable redesign to make them so.

While interface design has always required some amount of tuning, the vastly increased range of possibilities available in a full graphics system has made the design space unmanageably large to explore without extensive experimentation. In response, a variety of systems, of which Smalltalk is the best known, have been developed to facilitate this experimentation by providing a wide range of built-in graphical abstractions and methods of modifying and combining them together into new forms.

In contrast to conventional programming technology, which restrains the programmer in the interests of orderly development, exploratory programming systems must amplify the programmer in the interests of maximizing his effectiveness. Exploration in the realm of programming can require small numbers of programmers to make essentially arbitrary transformations to very large amounts of code. Such programmers need programming power tools of considerable capacity or they will simply be buried in detail. So, like an amplifier, their programming system must magnify their necessarily limited energy and minimize extraneous activities that would otherwise compete for their attention.

SOURCES OF DESIGN POWER

One source of such power is the use of interactive graphics. Exploratory programming systems have capitalized on recent developments in personal computing with extraordinary speed. The Xerox 1108 Interlisp-D system, for example, uses a large format display and a "mouse" pointing device to allow very high bandwidth communication with the user. Designers of exploratory programming environments have been quick to seize on the power of this combination to provide novel programming tools, as we shall see.

In addition to programming tools, these personal machine environments allow the standard features of a professional workstation, such as text editing, file management, and electronic mail, to be provided within the programming environment itself. Not only are these facilities just as effective in enhancing the productivity of programmers as they are for other professionals, but their integration into the programming environment allows them to be used at any time during programming. Thus, a programmer who has encountered a bug can send a message reporting it while remaining within the debugger, perhaps including in the message some information, like a back-trace, obtained from the dynamic context.

Another source of power is to build the important abstract operations and objects

"It would take years at work to master the techniques we learn at the Wang Institute in three semesters."

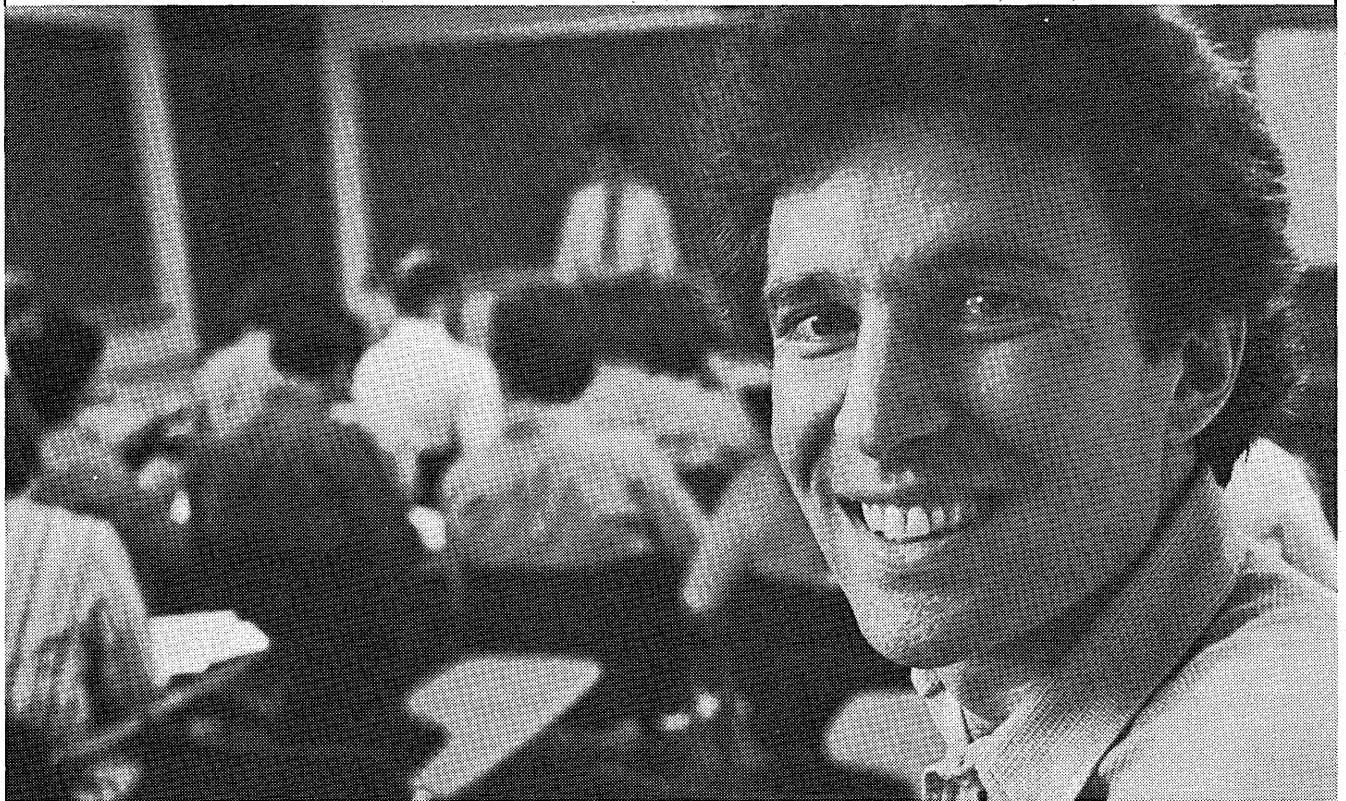

The Wang Institute is an independent, non-profit graduate school which offers software professionals a unique opportunity to earn a Master's degree in software engineering.

"What makes the M.S.E. program so exciting? Many of the courses have never been presented before anywhere."

By combining formal academic methods with real-world industrial practices, the Wang Institute enables students to master software tools and techniques that can be applied immediately in the workplace.



"The environment here isn't just conducive to learning, it makes not learning almost impossible."

Find out why some of the best software engineers in America are studying at the Wang Institute.

Applications from both full- and half-time candidates are being accepted for September, 1983. Assistantships are available for qualified full-time students.

For application information, D283 write to or call: Cynthia Johnson, Corporate Liaison, Wang Institute of Graduate Studies, School of Information Technology, Tyng Road, Tyngsboro, MA 01879, (617) 649-9731.

Name _____

Address _____

Company _____

Tel. _____

Address _____

City _____ State _____ Zip _____

Yrs. of Software Development Exp. _____

Redundancy protects the design from unintentional change—but it's equally well protected against intentional change.

of some given application area directly into the exploratory environment. All programming systems do this to a certain extent; some have remarkably rich structures for certain domains, (e.g., the graphics abstractions embedded within Smalltalk). If the abstractions are well chosen, this approach can yield a powerful environment for exploration within the chosen area, because the programmer can operate entirely in substantively meaningful abstractions, taking advantage of the considerable amount of implementation and design effort that they represent.

The limitations of this approach, however, are clear. Substantive abstractions are necessarily effective only within a particular topic area. Even for a given area, there is generally more than one productive way to partition it. Embedding one set of abstractions into the programming system encourages developments that fit within that view of the world at the expense of others. Further, if one enlarges one's area of activity even slightly, a set of abstractions that was once very effective may become much less so. In that situation, unless there are effective mechanisms for reshaping the built-in abstractions to suit the changed domain, users are apt to persist with them, at the cost of distorting their programs. Embedded abstractions, useful though they are, by themselves enable only exploration in the small, confined within the safe borders where the abstractions are known to be effective. For exploration in the large, a more general source of programming power is needed.

Of course, the exact mechanisms that different exploratory systems propose as essential sources of programming power vary widely, and these differences are hotly debated within their respective communities. Nevertheless, despite strong surface differences, these systems share some unusual characteristics at both the language and environment level.

THE LANGUAGE LEVEL

The key property of the programming languages used in exploratory programming systems is their emphasis on minimizing and deferring the constraints placed on the programmer, in the interests of minimizing and deferring the cost of making large-scale program changes. Thus, not only are the conventional structuring mechanisms based on redundancy not used, but the languages make extensive use of late binding, i.e., allowing the programmer to defer commitments for as long as possible.

The clearest example is that exploratory environments invariably provide dynamic storage allocation with automatic reclamation (garbage collection). To do otherwise imposes an intolerable burden on the pro-

grammer to keep track of all the paths through his program that might access a particular piece of storage to ensure that none of them access or release it prematurely (and that someone does release it eventually!). This can only be done by careful isolation of storage management or with considerable administrative effort. Both are incompatible with rapid, unplanned development, so neither is acceptable. Storage management must be provided by the environment itself.

Other examples of late binding include the dynamic typing of variables (associating data type information with a variable at run-time, rather than in the program text) and the dynamic binding of procedures. The freedom to defer deciding the type of a value until run-time is important because it allows the programmer to experiment with the type structure itself. Usually, the first few drafts of an exploratory program implement most data structures using general, inefficient structures such as linked lists discriminated (when necessary) on the basis of their contents. As experience with the application evolves, the critical distinctions that determine the type structure are themselves determined by experimentation, and may be among the last, rather than the first, decisions to evolve. Dynamic typing makes it easy for the programmer to write code that keeps these decisions as tacit as possible.

The dynamic binding of procedures entails more than simply linking them at load-time. It allows the programmer to change dynamically the subprocedures invoked by a given piece of code, simply by changing the run-time context. The simplest form of this is to allow procedures to be used as arguments or as the value of variables. More sophisticated mechanisms allow procedure values to be computed or even encapsulated inside the data values on which they are to operate. This packaging of data and procedures into a single object, known as object-oriented programming, is a very powerful technique. For example, it provides an elegant, modular solution to the problem of generic procedures (i.e., every data object can be thought of as providing its own definition for common actions, such as printing, which can be invoked in a standard way by other procedures). For these reasons, object-oriented programming is a widely used exploratory programming technique and actually forms the basic programming construct of the Smalltalk language.

The dynamic binding of procedures can be taken one step further when procedures are represented as data structures that can be effectively manipulated by other programs. While this is of course possible to a limited extent by reading and writing the text of program source files, it is of much greater significance in systems that define an explicit

representation for programs as syntax trees or their equivalent. This, coupled with the interpreter or incremental compiler provided by most exploratory programming systems, is an extraordinarily powerful tool. Its most dramatic application is in programs that construct other programs, which they later invoke. This technique is often used in artificial intelligence in situations where the range of possible behaviors is too large to encode efficiently as data structures but can easily be expressed as combinations of procedure fragments. An example might be a system that "understands" instructions given in natural language by analyzing each input as it is received, building a program that captures its meaning, and then evaluating that program to achieve the requested effect.

A BASIC TECHNIQUE EXPANDED

Aside from such specialized applications, effective methods for mechanically manipulating procedures enable two other significant developments. The first is the technique of program development by writing interpreters for special purpose languages. Once again, this is a basic technique of artificial intelligence that has much wider applicability. The key idea is that one develops an application by designing a special language in which the application is relatively easy to state. Like any notation, such a language provides a concise representation that suppresses common or uninteresting features in favor of whatever the designer decides is more important.

A simple example is the use of notations like context-free grammars (BNF) to "metaprogram" the parsers for programming languages. Similar techniques can be used to describe, among other things, user interfaces, transaction sequences, and data transformations. Application development in this framework is a dialectic process of designing the application language and developing an interpreter for it, since both the language and the interpreter will evolve during development. The simplest way of doing this is to evolve the application language out of the base provided by the development language. Simply by allowing the application language interpreter to call the development language interpreter, expressions from the development language can be used wherever the application language currently has insufficient power. As one's understanding of the problem develops, the application language becomes increasingly powerful and the need to escape into the development language becomes less important.

The other result of having procedures that are easily manipulated by other procedures is that it becomes easy to write program manipulation subsystems. This in turn has two key consequences. First, the exploratory

Complete Manufacturing Control



AMAPS/3000: ON-LINE, INTEGRATED MANUFACTURING AND FINANCIAL SOFTWARE FOR HP 3000.

There's an urgent need today for efficient ways of running a manufacturing operation. AMAPS/3000 gives you complete control by integrating manufacturing, order management *and* financial functions. Now decision-makers in production, marketing and finance all work from the same up-to-date, accurate information—to control and manage their businesses with the precision that these economic times demand.

The comprehensive, interactive system instantly reflects any change—on the shop floor, in order entry or finance. All information is automatically updated throughout the system, and is always available on-line, in real-time. Executives have access to relevant data at any time, without putting an extra load on the DP department.

The AMAPS/3000 modules include Order Management, Master Production Scheduling, Material Control, Bill of Material, Material Requirements Planning, Process and Routing, Standard Costing, Capacity Requirements Planning, Shop Floor Control, Purchasing Control, Lot Traceability, Cost Management, Accounts Payable, Accounts Receivable, and

General Ledger. All in one easy-to-use system specifically designed to take full advantage of the unique capabilities of the popular HP 3000. This combination of flexible, functionally complete software and efficient, proven hardware makes AMAPS/3000 the ideal manufacturing system.

Comserv, the acknowledged leader in manufacturing software systems, will assist you in every aspect of implementing and maintaining a complete, integrated manufacturing control system. Our staff of professional consultants have the experience, expertise and proven track record to ensure your MRP success.

Comserv also provides the most comprehensive education and documentation in the industry—seminars, workshops and video-based courses, plus clear, complete, easy-to-understand manuals for both end-users and data-processing staff.

Comserv software is consistently rated best by users. Find out why by calling Lynnette Felter today. Toll free. 1-800-328-2030. Corporate Headquarters: 1385 Mendota Heights Road, Mendota Heights, MN 55120

comserv 
CORPORATION

It's an uphill struggle.

The increasing demands on Data Processing are straining your resources. Growth is the overriding issue. The production work is an ever-present expanding. Networks are bringing DB to all parts of the company. The mass of data

is overwhelming.

You've got to manage this growth. Control it. Plan for it. And, there is one company with the software — and the expertise — to help you get control. UCC.

UCC Systems Software automates critical operating areas ... to stretch your

investment in hardware and people. UCC can help you dramatically improve productivity, meet the demands of today ... and be ready for tomorrow.

After all, Data Processing is automated ... isn't it about time the Data Center was, too?

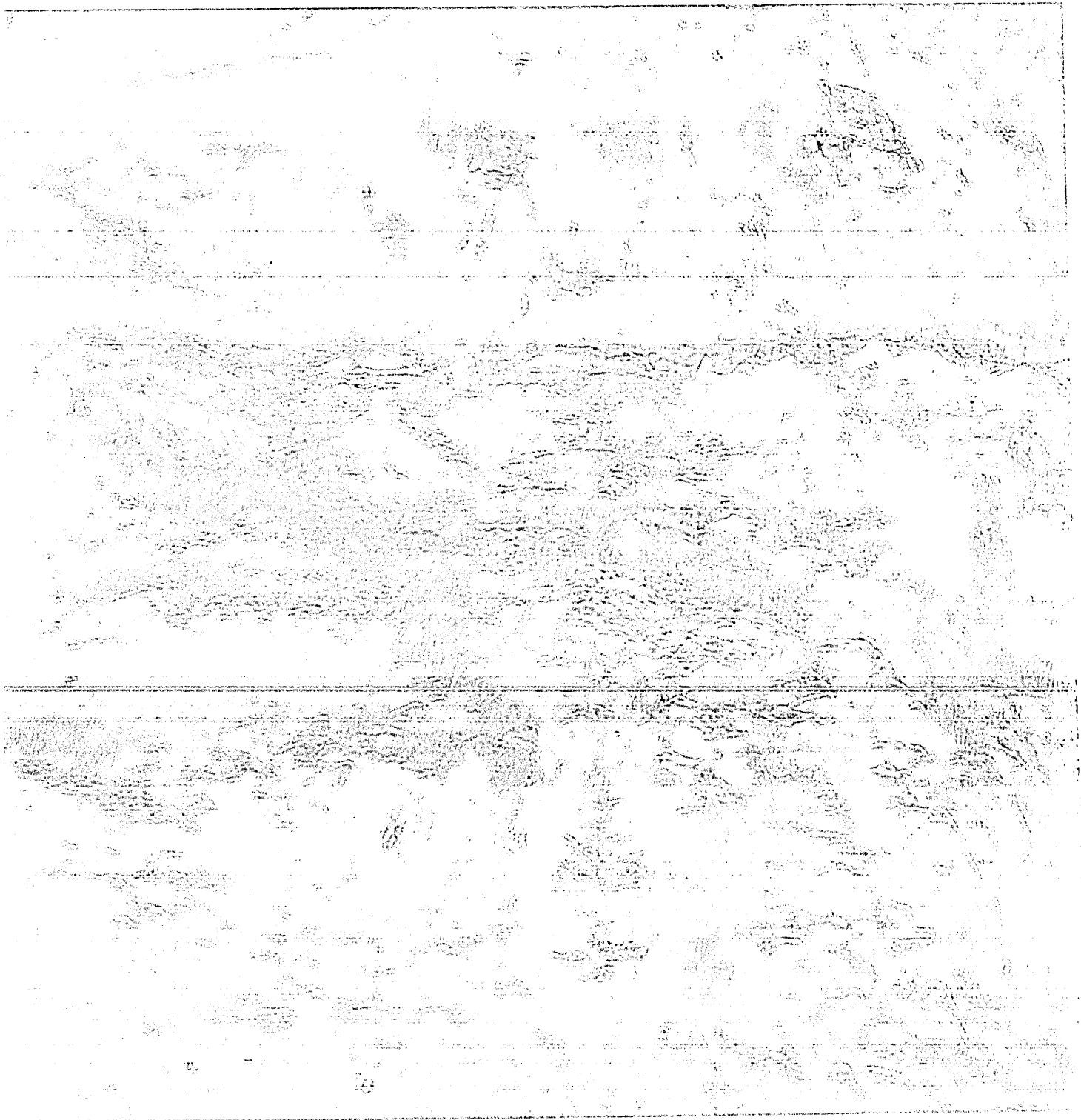

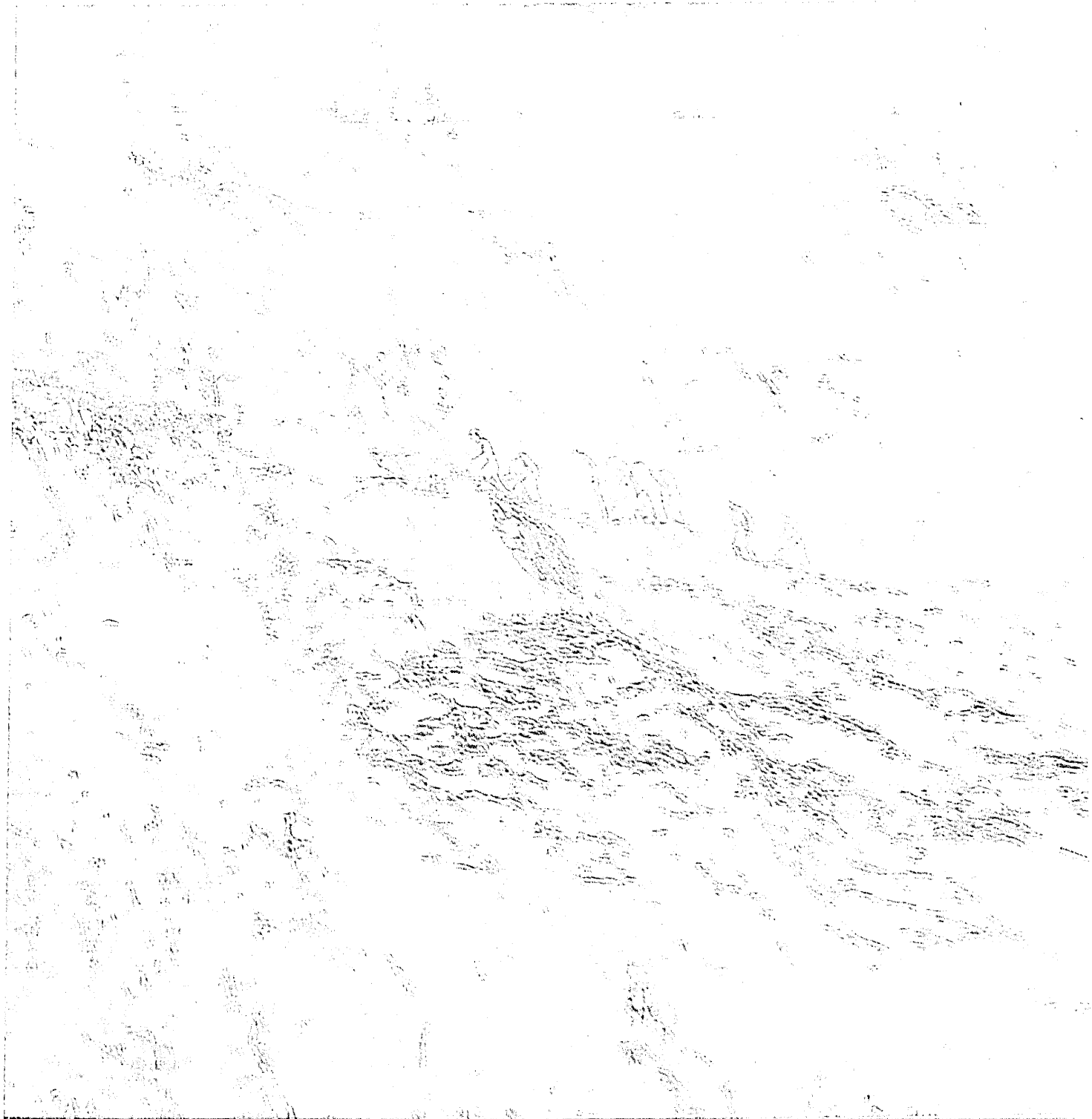

Conventional programming technology restrains the programmer; exploratory systems amplify him.

programming language itself can grow. The remarkable longevity of Lisp in the artificial intelligence community is in large part due to the language having been repeatedly extended to include modern programming language syntax and constructions. The vast majority of these extensions were accomplished by defining source-to-source transformations that converted new constructions into more conventional Lisp. The ease with which this can be done allows each user, and even each project, to extend the language to capture the idioms that are found to be locally useful.

Second, the accessibility of procedures to mechanical manipulation facilitates the development of programming support tools. All exploratory programming environments boast a dazzling profusion of programming tools. To some extent, this is a virtue of necessity, as the flexibility necessary for exploration has been gained at considerable sacrifice in the ability to impose structure. That loss of structure could easily result in a commensurate loss of control by the programmer. The programming tools of the exploratory environment enable the programmer to reimpose the control that would be provided by structure in conventional practice.

Programming tools achieve their effectiveness in two quite different ways. Some tools are simply effective viewers into the user's program and its state. Such tools permit one to find information quickly, display it effectively, and modify it easily. A wide variety of tools of this form can be seen in the two Interlisp-D screen images (see box, p. 132), including data value inspectors (which allow a user to look at and modify the internal structure of an object), editors for code and data objects, and a variety of break and tracing packages. Especially when coupled with a high bandwidth display, such viewers are very effective programming tools.

A WIDE VARIETY OF TOOLS

The other type of programming tool is knowledge based. Viewer-based tools, such as a program text editor, can operate effectively with a very limited understanding of the material with which they deal. By contrast, knowledge-based tools must know a significant amount about the content of a user's program and the context in which it operates. Even a very shallow analysis of a set of programs (e.g., which programs call which other ones) can support a variety of effective programming tools. A program browser allows a programmer to track the various dependencies between different parts of a program by presenting easy to read summaries that can be further expanded interactively.

Deeper analysis allows more sophisticated facilities. The Interlisp program analyzer (Masterscope) has a sufficiently detailed

knowledge of Lisp programs that it can provide a complete static analysis of an arbitrary Lisp program. A wide variety of tools have been constructed that use the database provided by this analysis to answer complex queries (which may require significant reasoning, such as computing the transitive closure of some property), to make systematic changes under program control (such as making some transformation wherever a specified set of properties hold), or to check for a variety of inconsistent usage errors.

Finally, integrated tools provide yet another level of power. The Interlisp system notices whenever a program fragment is changed (by the editor or by redefinition). The program analyzer is then informed that any existing analysis is invalid, so that incorrect answers are not given on the basis of old information. The same mechanism is used to notify the program management subsystem (and eventually the user, at session end) that the corresponding file needs to be updated. In addition, the system will remember the previous state of the program, so that at any subsequent time the programmer can undo the change and retreat (in which case, of course, all the dependent changes and notifications will also be undone). This level of cooperation between tools not only provides immense power to the programmer, but relieves him of detail that he would otherwise have to manage himself. The result is that more attention can be paid to exploring the design.

A key, but often neglected, component of an exploratory programming system is a set of facilities for program contraction. The development of a true exploratory program is design limited, so that is where the effort has to go. Consequently, the program is often both inefficient and inelegant when it first achieves functional acceptability. If the exploration were an end in itself, this might be of limited concern. However, it is more often the case that a program developed in an exploratory fashion must eventually be used in some real situation. Sometimes, the time required to reimplement (using the prototype program as a specification) is prohibitive. Other times, the choice of an exploratory system was made to allow for expected future upheaval, so it is essential to preserve design flexibility. In either event, it is necessary to be able to take the functionally adequate program and transform it into one whose efficiency is comparable to the best program one could have written, in any language, had only one known what one was doing at the outset.

The importance of being able to make this post hoc optimization cannot be overemphasized. Without it, one's exploratory programs will always be considered toys; the pressure to abandon the exploratory environment and start implementing in a real one will

be overwhelming; and, once that move is made (and it is always made too soon), exploration will come to an end. The requirement for efficient implementation places two burdens on an exploratory programming system. First, the architecture must allow an efficient implementation. For example, the obligatory automatic storage allocation mechanism must either be so efficient that its overhead is negligible, or it must permit the user to circumvent it (e.g., to allocate storage statically) when and where the design has stabilized enough to make this optimization possible.

Second, as the performance engineering of a large system is almost as difficult as its initial construction, the environment must provide performance engineering tools, just as it provides design tools. These include good instrumentation, a first-class optimizing compiler, program manipulation tools (including, at the very least, full functionality compiler macros), and the ability to add declarative information where necessary to guide the program transformation. Note that, usually, performance engineering takes place not as a single "post-functionality optimization phase," but as a continuous activity throughout the development, as different parts of the system reach design stability and are observed to be performance critical. This is the method of progressive constraint, the incremental addition of constraints as and when they are discovered and found important, and is a key methodology for exploratory development.

Both of these concerns can be most clearly seen in the various Lisp-based systems. While, like all exploratory environments, they are often used to write code very quickly without any concern for efficiency, they are also used to write artificial intelligence programs whose applications to real problems are very large computations. Thus, the ability to make these programs efficient has long been of concern, because without it they would never be run on any interesting problems.

More recently, the architectures of the new, personal Lisp machines like the 1108 have enabled fast techniques for many of the operations that are relatively slow in a traditional implementation. Systems like Interlisp-D, which is implemented entirely in Lisp, including all of the performance-critical system code such as the operating system, display software, device handlers, etc., show the level of efficiency that is now possible within an exploratory language.

The increasing importance of applications that are very poorly understood, both by their clients and by their would-be implementors, will make exploratory development a key technique for the 1980s. Radical changes in the cost of computing power have already made such systems cost-effective vehicles for

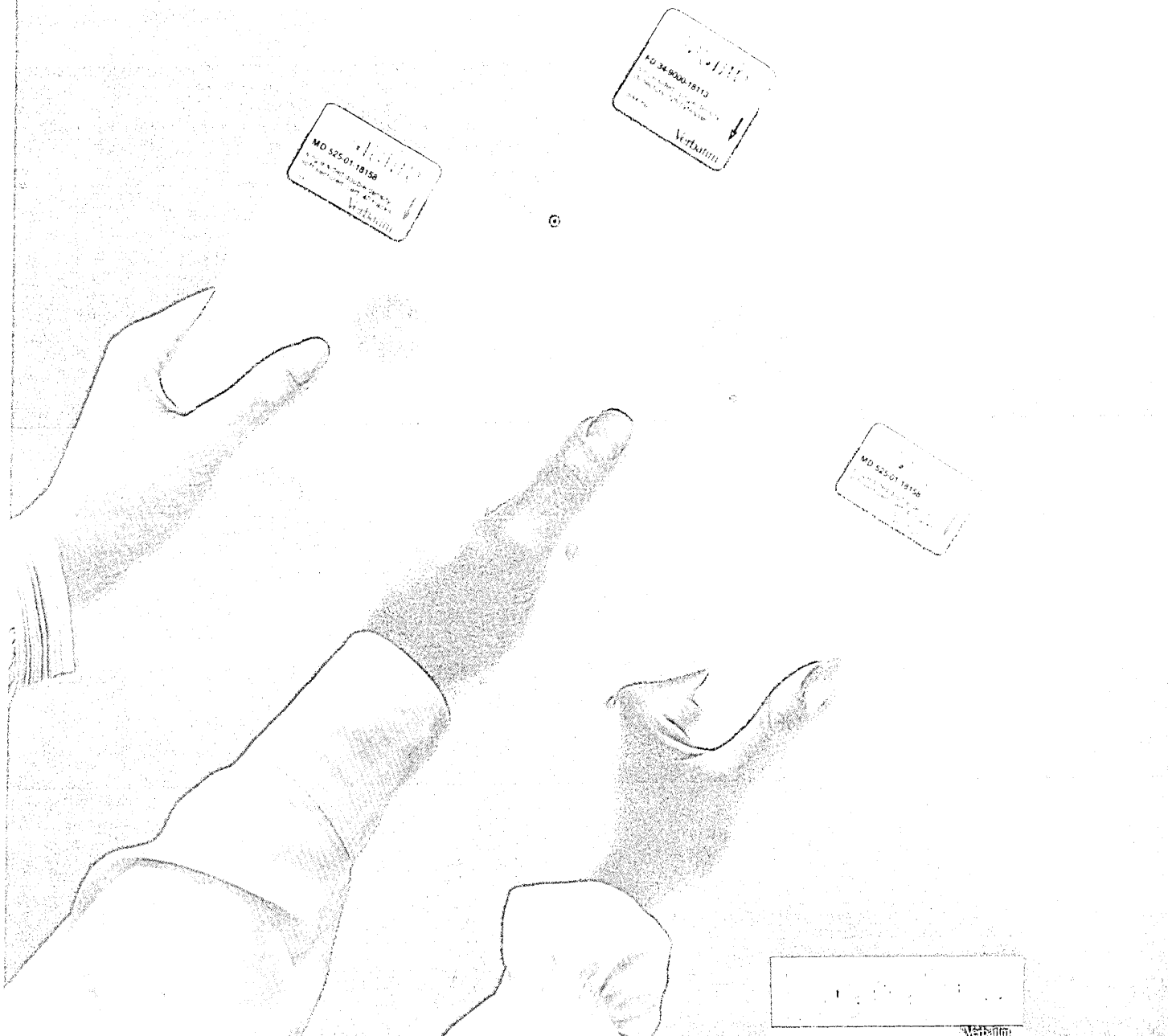

To win the computer revolution, you need the right ammunition.

The computer revolution is changing the way we do so many things including the way we make mistakes. But many computer errors aren't really the computer's fault. Often, it's the flexible disk that's become weak or worn out.

Problems like that won't happen if you use Datalife™ flexible disks. They're certified 100% error free and backed by a 5-year warranty, which means the information you put on one stays put.

So, if you're part of the computer revolution, make sure you always come out a winner. Use Datalife by Verbatim, the world's leading producer of flexible disks.

For your nearest Verbatim dealer, call toll-free 800-538-1793; in California or outside the U.S., call collect (408) 737-7771.

The programming languages used in exploratory systems minimize and defer constraints on the programmer.

the delivery of application systems in many areas. As recently as five years ago, the tools and language features we have discussed required the computational power of a large mainframe costing about \$500,000. Two years ago, equivalent facilities became available on a personal machine for about \$100,000, and a year later, about \$50,000. Now, a full-scale exploratory development system can be had for about \$25,000. For many applications, the incremental cost has become so small over that required to support conventional technology that the benefits of exploratory development (and redevelopment!) are now decisive.

One consequence of this revolutionary change in the cost-effectiveness of exploratory systems is that our idea of exploratory problems is going to change. Exploratory programming was developed originally in contexts where change was the dominant factor.

There is, however, clearly a spectrum of specification instability. Traditionally, the cost of exploratory programming systems, both in terms of the computing power required and the run-time inefficiencies incurred, confined their use to only the most volatile applications. Thus, the spectrum was

arbitrarily dichotomized into exploratory (very few) and standard (the vast majority). Unfortunately, the reality is that unexpected change is far more common in standard applications than we have been willing to admit. Conventional programming techniques strive to preserve a stability that is only too often a fiction. Since exploratory programming systems provide tools that are better adapted to this uncertainty, many applications that are now being treated as standard but which in fact seem to require moderate levels of ongoing experimentation may turn out to be more effectively developed in an exploratory environment.

We can also expect to see a slow infusion of exploratory development techniques into conventional practice. Many of the programming tools of an exploratory programming system (in particular, the information gathering and viewing tools) do not depend on the more exploratory attributes of either language or environment and could thus be adapted to support programming in conventional languages like FORTRAN and COBOL. Along with these tools will come the seeds of the exploratory perspective on language and system design, which will gradually be incorporated into existing programming languages

and systems, loosening some of the bonds with which these systems so needlessly restrict the programmer.

To those accustomed to the precise, structured methods of conventional system development, exploratory development techniques may seem messy, inelegant, and unsatisfying. But it's a question of congruence: precision and inflexibility may be just as dysfunctional in novel, uncertain situations as sloppiness and vacillation are in familiar, well-defined ones. Those who admire the massive, rigid bone structures of dinosaurs should remember that jellyfish still enjoy their very secure ecological niche. *

Beau Sheil is on the research staff at the Palo Alto Research Center of the Xerox Corp., where he has been since receiving his PhD in computer science from Harvard University in 1976. His research interests include programming systems and the psychology of programming. Many of these ideas were first developed, and later polished, in discussions with John Seely Brown and other colleagues in cognitive and instructional sciences at Xerox PARC.

“Looking for Bugs?”

Increase your COBOL productivity with Cogen by **10** as much as

Writing COBOL code can be time-consuming and error-prone. But with Cogen, writing business application programs is a breeze. Cogen is an automated Program Generator which produces bug-free RM/COBOL™ code. You interact with Cogen through menus, prompts and data-entry screens. Once you've defined your programming task to Cogen, it does the rest...no more repetitive keying and other drudgery. You can create independent modules to link with your own programs, or you can have Cogen create complete application programs for file maintenance, inquiries and reports. You will be amazed at the combination of power and ease of use embodied in Cogen. Having proved itself on minicomputers Cogen is now available on any microcomputer which runs RM/COBOL, a very widely used business language.

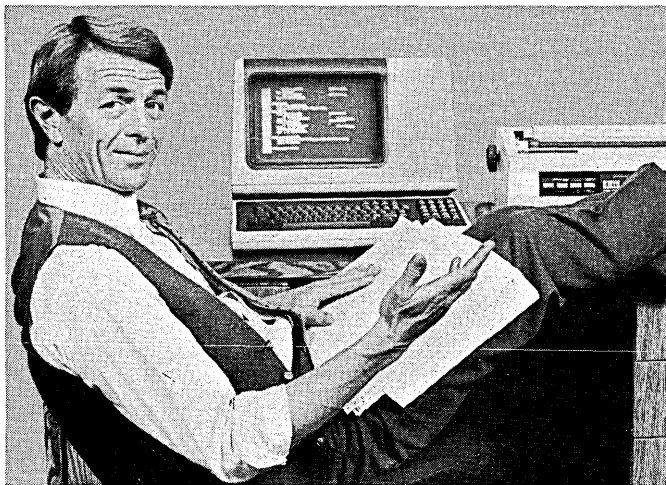

“Sorry, I don't have any. I'm using COGEN, the RM/COBOL Program Generator from Bytek.”

Cogen goes hand in hand with, and is written in, RM/COBOL.

A Cogen demo package is available with full documentation, including tutorials and examples. For inquiries, write to:

bytek™ 1714 Solano Avenue, Berkeley, CA 94707

“A Dynamic and Powerful Programming Tool!”
R.W. Lay, M.I.S. Director, Logo Paris, Inc.
San Rafael, California.

Cogen will benefit you in many ways. Cogen generates formal, structured programs automatically, so your code is standardized, self-documenting, efficient and easy to maintain. “Screen painting” techniques let you draw the screens exactly as you want to see them displayed by your program, accurately, efficiently and quickly. Cogen has extensive report writing facilities. Its menu driven format produces dozens of lines of bug-free code with just a few keystrokes, so your new programmers can get started much sooner. And using Cogen means portability, because

Introducing RELATE

The First Practical Relational Language

RYANIS II, the leading 4th generation language, now offers something new—relational access to data in the form that it already exists.

With RELATE an optional component of RYANIS II, you can base important decisions on all of your data no matter how it is stored. You can develop new types of decision support systems without costly data conversion or application redesign.

RELATE retrieves and combines data stored in ISAM, VSAM and sequential files, or RYANIS II databases, or in any of the other databases to which RYANIS II provides access: IMS, DL1, IDMS, ADVANSYS, or TUTOR.

RELATE retrieves data without limits on file size or on the amount of data selected, while making efficient use of hardware.

RELATE offers the power of relational theory using simple English-like commands, making the system easy to use for technical and non-technical staff alike.

Join the users of more than 800 IBM mainframe installations who are already making better decisions thanks to MIPG software.

Attend a free RYANIS II seminar and see how RELATE can give you an extra edge.

For more information, call or write:



**Mathematica
Products Group, Inc.**

PO Box 2392 Princeton, NJ 08540
 (609) 257-1570 (609) 799-2100
 Telex: 843479

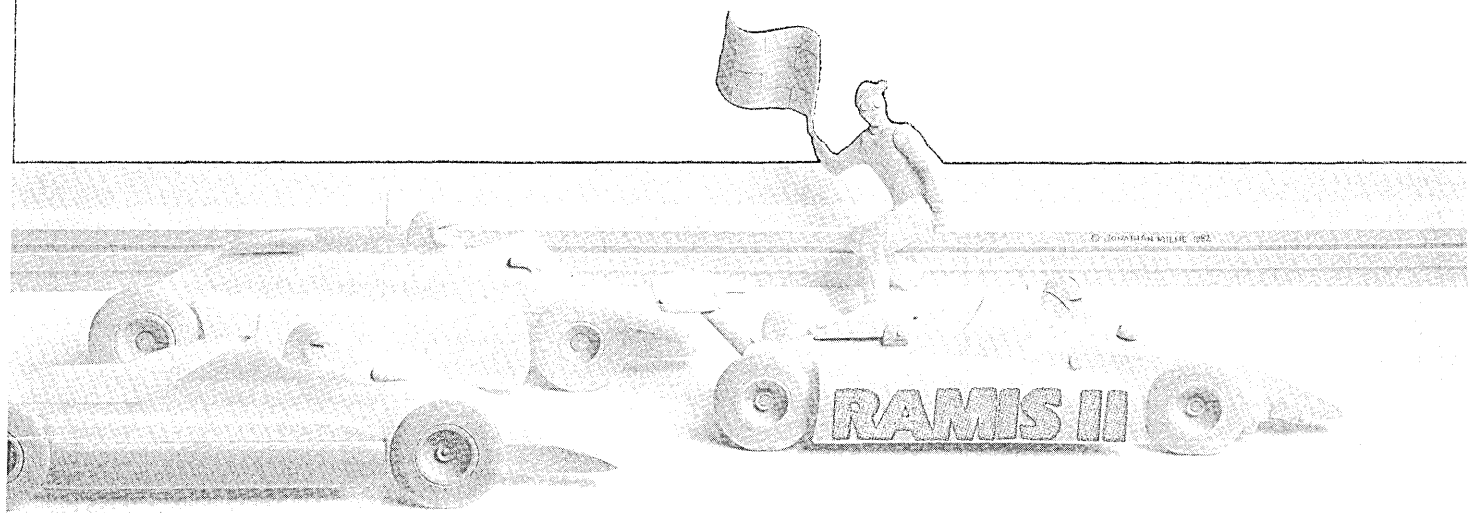

RAMIS II...The Leader by Design

CIRCLE 97 ON READER CARD

**THE OFFICE
AUTOMATION
SYSTEM THAT
RECOGNIZES
PEOPLE WOULD
RATHER
NOT BE
AUTOMATED.**

There is an ongoing process that takes place in an office—a synergy between people, a unified flow that can be undermined by the well-intentioned act of automating your office.

Simply because people have a justifiable interest in not being overwhelmed by the technology that's supposed to serve them.

Which is why the following words should be of special interest to anyone deciding on an office automation system:

"What distinguishes Data General's office system from most of the competition is the integration of all functions in a single software package...CEO (the Comprehensive Electronic Office) is marked by the extent it works for the user instead of asking the user to work for it."—Editor, Electronic Message and Mail Systems.

In other words, you and your people can safely set aside your antiquated tools for word processing, data processing, scheduling, filing, communicating and generating reports and graphics.

With Data General's CEO™ system you perform all these basic information management functions electronically. Easily and effortlessly. With quantum leaps in productivity. Without the work environment ever taking a backseat to the technology.

For example, CEO Electronic Filing

files the way you file. Each document has a folder. Each folder has a drawer. Each drawer has a cabinet. And there's an unlimited number of each.

There's an exclusive "Interrupt" feature that lets users instantly put a given job on hold, attend to something else, and then return to the original job without disruption. And you can even interrupt the Interrupt.

The system provides a "Help" button which summons up simple, yet specific operating instructions as needed—assisting your people in solving the problem at hand, without requiring them to wade through menus of irrelevant detail.

Your people can tailor CEO to their individual needs, the department's and the entire organization's. And there are ample security provisions for protecting sensitive material.

For all the facts on the system that has every office function fully integrated in exactly the sense your office is—a system that makes technology subordinate to the people using it, and not the other way around—write CEO 18, Data General, 4400 Computer Drive, Westboro, Mass. 01580.

 **Data General**

**WE ENGINEERED THE ANXIETY
OUT OF COMPUTERS.**

CIRCLE 98 ON READER CARD



How FIMAS, a new message authentication standard, helps protect electronic money.

by Michael B. Schwartz

This article examines the protection of EFTs (electronic funds transfers) in the light of a new American Banking Association approved ANSI standard—FIMAS (Financial Institution Message Authentication Standard).

Representatives from Citibank, Chase Manhattan, the National Bureau of Standards, and 20 other organizations formed the X9.E8 committee and met to examine many techniques and algorithms for EFT protection. After more than 13 drafts their decision was finalized in April 1982 in the form of a DES-based system—ANSI

SAFEGUARDING EFTS



PHOTOGRAPH BY STEVE COOPER

X9.9-1982, better known as FIMAS.

FIMAS will replace existing insecure methods for EFT protection and offer a long-needed standard to institutions that presently communicate EFTs without any protection (the majority). FIMAS is a badly needed standard in a time when new EFT networks, including those used by non-financial institutions, are rapidly appearing on the scene.

This article discusses the vulnerabilities of EFTs, how FIMAS works to protect them, and how it may be implemented.

The potential threats to EFTs can be divided into two categories: 1)

the illegal reading or copying of data; and 2) the unauthorized addition, deletion, or alteration of data. Type 1 is a passive crime. The victims are those institutions that must protect the contents of files and communications from disclosure. Since the technique addressed in this article is concerned with authentication rather than disclosure, we will not discuss this type of crime.

Type 2 is an active crime. It involves inserting, altering, or deleting data. Generally, type 2 crime involves slightly more risk to the criminal because audit trails and internal checks may eventually detect that a

crime has occurred, although they often give no clues as to who the criminal was. Type 2 may involve more risk; but the rewards are usually greater than type 1.

Of course the classic type 2 crime is the fraudulent EFT, which can be accomplished either by inserting a complete transaction or by altering an existing EFT. The result is the illegal routing of nonexistent monies or the rerouting of existing monies. Unfortunately, the criminals are usually able to withdraw the funds before audit trails detect the loss.

Defrauding EFTs requires knowledge of the format of the EFT

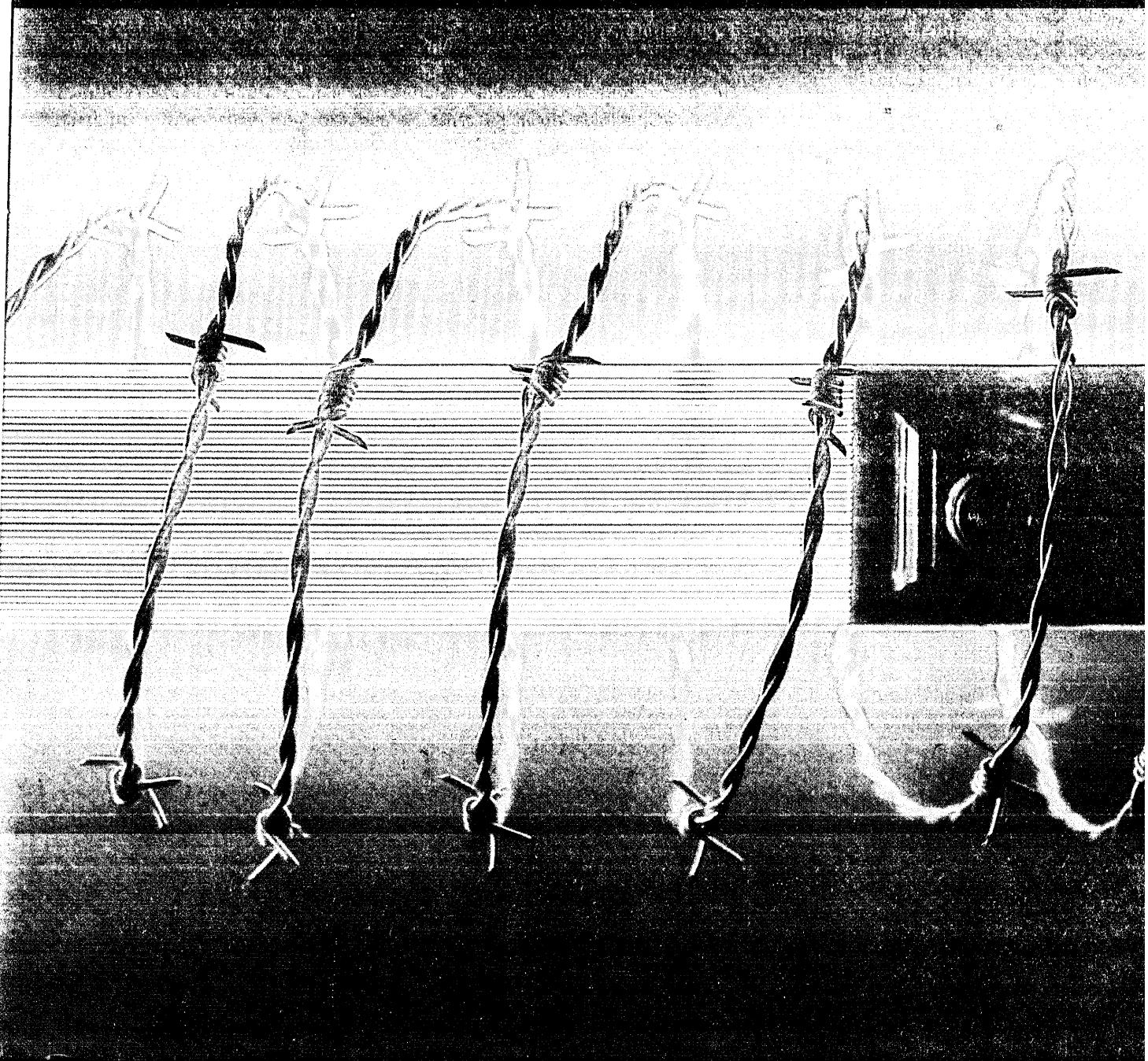

The likely threat to EFTs is the outsider who taps into the public communication channels used for EFTs.

(these are published or easy to figure out) and about \$2,000 worth of smart terminals and switching devices. The crime can be committed from within the bank's communications center without this equipment, but this is generally prevented by proper screening of personnel, sound physical security, and the watchful eye of the communications security administrator.

The likely threat comes in the form of the outsider who taps into the public communication channels used for EFTs. This individual has the power to capture data and alter it, or insert data at the appropriate times. Insertion is possible because of the sporadic nature of electronic funds transmissions, i.e., there is almost never a continuous stream of data in the line.

So, stated succinctly, the problem is twofold: how can it be assured that data have been received or accessed in an unaltered form? and how can it be verified that data has its expected origin? These are the questions that the Financial Institute Message Authentication Standard attempts to answer. FIMAS uses existing DES technology to examine an EFT and produce a value, called a Message Authentication Code (MAC), that when transmitted with the EFT ensures its integrity and origin.

The quality of data communications may be "assured" by a number of quantities derived from a bit stream's characteristics prior to transmission. These checks are most often called parity or checksum. The same quantities are used to check the integrity of disk- and tape-based data.

Basically, these quantities protect against the expected problems of data transfer. For example, parity checking involves the setting or clearing of a bit depending on the number of odd or even bits set in a bit stream, usually a finite bit set called a block.

In the transmission of ASCII or EBCDIC character codes, a single bit is reserved to tell whether or not an odd or even number of bits are set in the code. Because of the expected random nature of communication glitches, this parity bit suffices to verify that a character has been correctly received. This is because it is highly unlikely that more than a single bit will be "flipped" during a character transmission.

For example, the ASCII code for the letter C is 01000011 (most to least significant bits from left to right). During transmission the most significant bit is used to check parity. C contains 3 set bits; therefore, we call the parity odd and set the most significant bit to 1 to indicate this. Now we have a transmission code of 11000011.

Now let's assume that there's a random error in communications and a bit is flipped. The result could be 11001011. Communications hardware and software now de-

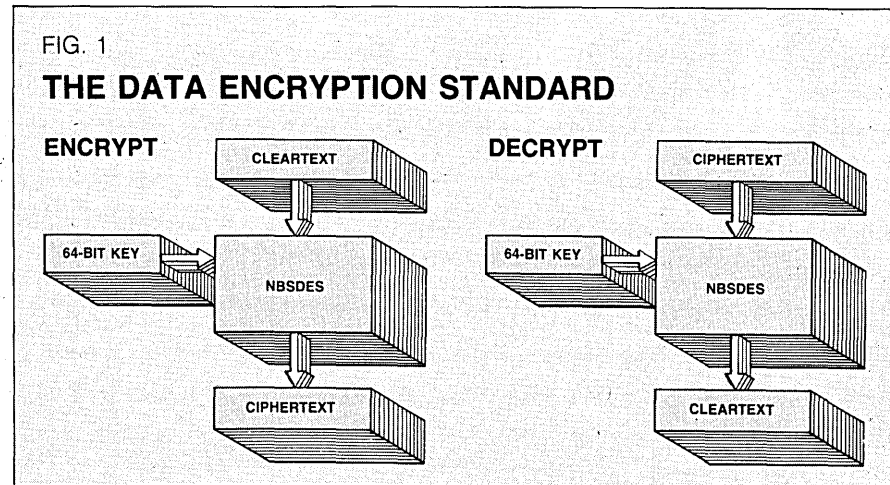

tect that there is an even number of set bits (4), but the parity bit says there should be an odd number. Therefore an error is reported.

But let's change the circumstances and say that someone is intentionally trying to interfere with communications. The result: it is ridiculously easy to bypass a parity checking system. First, on interception, the character code may be altered and then a new parity bit can be calculated and assigned. Or, the character code may be altered without changing the parity bit; simply flip any *two* bits and the parity is unchanged.

Certainly, in refined communications systems there may be elaborate parity and checksum calculations and procedures. These are adequate defenses against the expected culprit: nonhuman, random electronic errors. But this is totally inadequate protection against carefully planned intelligent intervention. What's needed is a way to improve on assuring the integrity of information and, as a necessary addition, to verify the originator of the information.

The function of the message authentication code extends well beyond this level of error checking. The MAC is a value calculated using an algorithm that is highly sensitive to bit changes. The MAC generation procedure uses this algorithm to examine all or part of a message. The output from this procedure is a small byte field that is attached to the message prior to transmission. In addition, the usual parity and checksum conventions are applied to the message and its associated MAC to check for random communication errors.

On receipt of the message, the receiver applies the same MAC generation procedure to the message and generates a new MAC. This MAC is compared with the one received. If there is a bit-for-bit identity, the message has been received unaltered. If there is not, and communication protocols indicate an error-free reception, then this implies that the message has been altered enroute.

The algorithm employed must have

two qualities: it must be extremely sensitive to bit changes, and it must incorporate a feature that will create a MAC that cannot be duplicated by unauthorized parties.

The second quality is very important. If the MAC algorithm is not dependent on some aspect known only to the sender and receiver, then anyone could insert or alter a message. All that would be needed by a third party is knowledge of the MAC generation algorithm. Or it could be easily figured out by capturing and analyzing messages and their associated MACs.

The creators of FIMAS considered these requirements and found that the encryption algorithm, DES, developed and published by the National Bureau of Standards, suits these needs quite well. Before delving into the use of DES for MAC generation it is valuable to take a look at DES in general and show why it has the necessary properties.

USE OF THE DES ALGORITHM

At the heart of FIMAS is the DES algorithm. This is an algorithm that is usually used for the encryption of data. That is, it transforms readable (cleartext) data into unreadable (ciphertext) "non-information" under control of a compact key. For those of you who enjoy nomenclature, DES is classified as a recirculating block product cipher. Its design is complex; a full description of the algorithm is beyond the scope of this article, but its behavior and use are quite simple.

DES transforms data in 8-byte blocks. This transformation is governed by an 8-byte key. Each block of a message is crypted (that is, encrypted or decrypted) independently of all others. The process is displayed in Fig. 1, which shows the encryption and decryption of a single 8-byte block.

The 8-byte cleartext message is encrypted into ciphertext by the algorithm in conjunction with the 8-byte key. To decrypt, the ciphertext is input to the same algorithm

OMNICALC

the Electronic Spreadsheet for CICS

Now, at long last, you don't have to buy microcomputers to run electronic spreadsheet programs. For years, Visicalc*, the electronic spreadsheet for microcomputers, has been the largest selling software product. Now, Omnicalc, the electronic spreadsheet program for CICS, is available for large multi-user systems. IBM 303X, 4300, and System/370 users can now run this valuable planning tool as a CICS application. With Omnicalc, CICS users can analyze data for financial schedules, cash forecasts, budgeting, sales forecasts, expenses, and many other individual plans as they're being made.

A simple matrix lettered from A to Z across the top of the screen and numbered vertically down the left side allows each user to design his own unique screen format and write programs for any application. Once the worksheet has been designed, as many changes as desired can be made to the information by simply entering new values into the matrix. The computer instantly does all calculations and displays the results at every location affected.

While Omnicalc is easy to use for non-data processing personnel, it also contains a powerful programming capability for more sophisticated programmers.

Omnicalc reduces the long hours associated with planning by eliminating the need for traditional paper worksheets, pencils, erasers, and calculators. You will see as you develop your plans, the answers to all of those "what if" questions that typically accompany any planning session. Best of all, for only \$1999.00, Omnicalc can be used by everyone on your CICS network.

Omnicalc, another powerful management tool from Tower Systems.

*Visicalc is a registered trademark of Visicorp

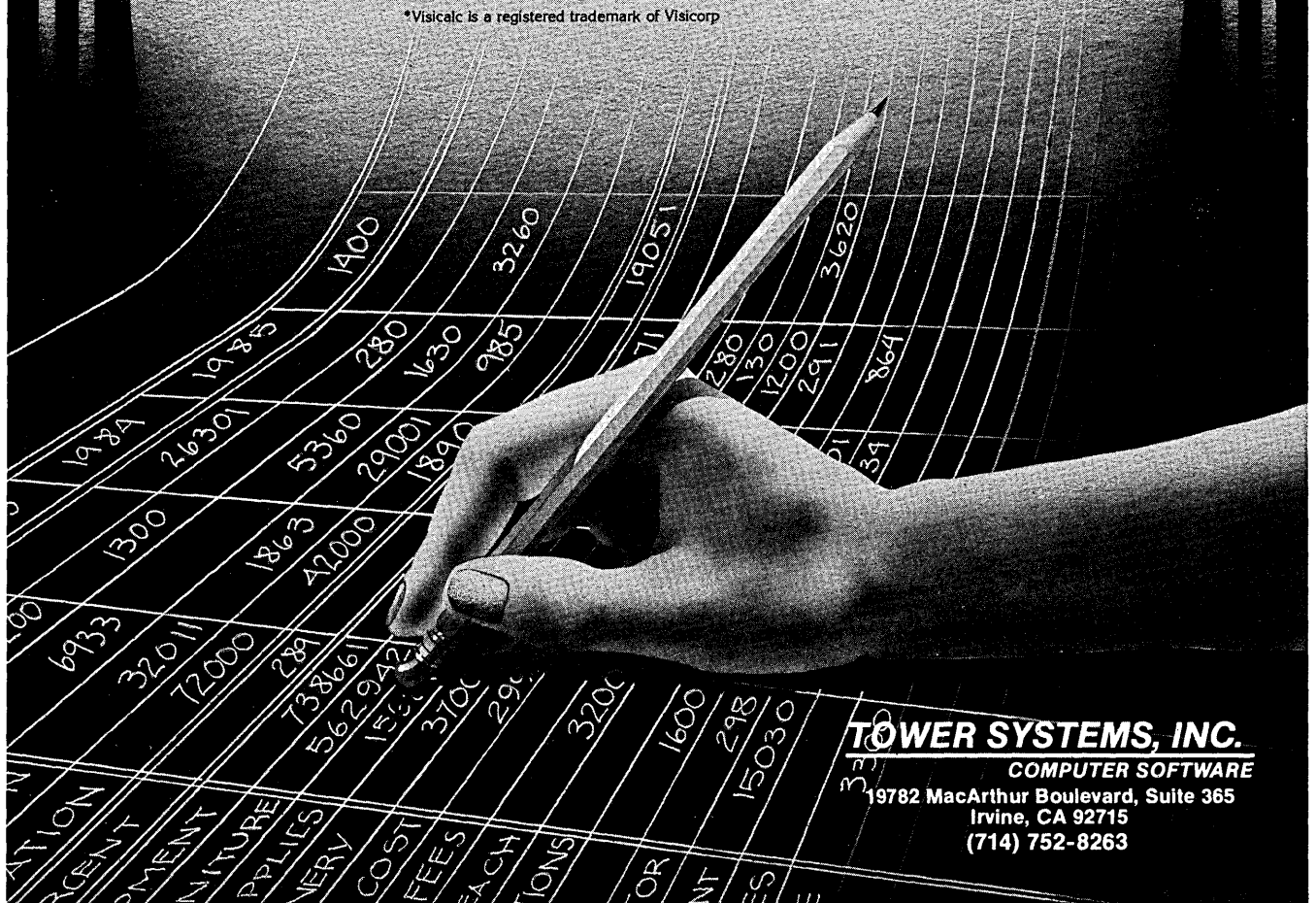

TOWER SYSTEMS, INC.
COMPUTER SOFTWARE
19782 MacArthur Boulevard, Suite 365
Irvine, CA 92715
(714) 752-8263

CIRCLE 99 ON READER CARD



At last, manufacturing and business systems that work together. Only from MSA.

MSA introduces the **Extended Closed Loop™ Manufacturing System**—a new systems concept we've been working towards for more than 12 years.

Put simply, we've taken the classical Closed Loop model of integrated business functions and provided the integrated systems to make it work.

At MSA, we're committed to nothing less than the *total integration of business and manufacturing systems* to support the overall business plan.

In short, our goal is to provide the systems that can help make your company's business plan a manufacturing reality.

The Extended Closed Loop concept is vitally important for anyone using or choosing application software anytime in the next five years.

And it's even more important if you're looking at manufacturing systems *now*.

Here's why.

Only MSA has all the components

As the world's largest independent application software supplier, MSA—and only MSA—currently offers the components needed to implement the Extended Closed Loop System.

The Bill of Materials chart below shows how all of MSA's software products and service components work together to create the Extended Closed Loop System.

It starts with MRP II

The MSA Manufacturing System consists of a complete line of integrated MRP II modules, including: Manufacturing Standards, Historical Forecasting,

Inventory Record Control, Master Production Scheduling, Material Requirements Planning, Capacity Requirements Planning, Shop Floor Control, Procurement Management and Cost Management.

These components, together with MSA's structured implementation methodology, are designed for *successful* Closed Loop MRP II.

So, if your immediate need is manufacturing software, you can choose the MSA Manufacturing System now, and easily add other Extended Closed Loop components as you need them.

Extending the Closed Loop: The Business Connection

At MSA, we offer the integrated business systems to make Extended Closed Loop manufacturing a practical reality.

For 12 years we've developed integrated systems with common architecture, including: Payroll and Labor Distribution, General Ledger, Accounts Payable, Budgeting and Planning, Fixed Assets Accounting, Accounts Receivable, Personnel Management and Currency Management.

And with more than 7400 systems installed worldwide, we offer something else that's unique: We call it 'inter-application expertise'. It's the understanding we've gained by integrating MSA applications to meet our customers' requirements.

Our people know the manufacturing industry (more than 1300 manufacturers use MSA systems around the world).

Our implementation techniques are thorough, practical, and field-proven

many times over. We'll show you how to reduce overall implementation costs significantly.

We offer the most extensive customer training program in the industry (this year alone, MSA will conduct more than 100,000 student-hours of customer training).

At MSA, we provide the total software support to keep your systems up-to-date.

Not if, but when

In order to survive, your company must not only reach its goals of efficiency and increased productivity; it *must* remain profitable. And continued profitability can only be achieved with improved decision support information—the kind provided by total systems integration.

Industry experts consistently name MSA as the leader in systems integration.

And providing total systems integration is what the MSA Extended Closed Loop Manufacturing System is all about.

Send for free literature

We've prepared a brochure that further explains the MSA Extended Closed Loop™ System.

For your free copy, call Robert Carpenter at (404) 239-2000. Or clip this coupon.

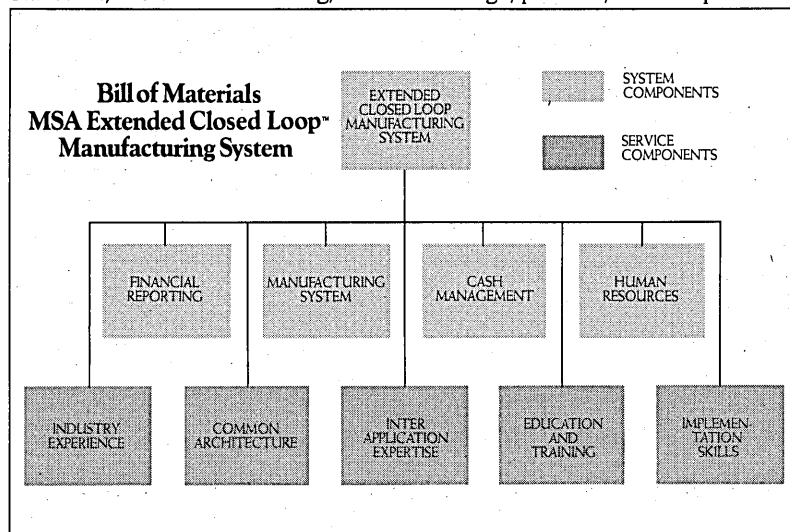

Management Science America, Inc.
3445 Peachtree Road, N.E.
Atlanta, Georgia 30326

- Please send me free, detailed literature on the MSA Extended Closed Loop™ Manufacturing System.
- I'm also interested in MSA integrated business and Payroll/Personnel Systems.

Computer Type/Model _____ / _____

NAME _____

TITLE _____

COMPANY _____

ADDRESS _____

CITY _____

STATE _____ ZIP _____

BUSINESS PHONE () _____

MSA

The Software Company

ISPF is here.

(That's even
better news for users.)

A new software tool from IBM can reduce from months to days the development time for new online programs. That's good news for you and even better news for your end users: the new software can help you produce the type of programs they've been clamoring for.

It's called the IBM Interactive System Productivity Facility (ISPF). It helps your programmers create interactive software to be operated at display terminals by users. And it is especially aimed at applications of the inquiry, analysis and reporting type.

With its powerful facilities for dialog management and for creating screens, ISPF lets your DP staff create new programs in remarkably short times (based on actual customer experience). And it is extremely easy, when users change their minds about requirements, to maintain the programs.

You can also use ISPF to add a "front-end" dialog to existing applications to make them easier to use. And ISPF is a powerful tool for quick "prototyping" of online programs under development.

ISPF is an enhancement of IBM's popular System Productivity Facility (SPF). It now includes two products: the dialog manager and the Program Development Facility (ISPF/PDF). They run under MVS/TSO and VM/CMS.

If you have a backlog of user demands, learn the good news about ISPF. Return the coupon today.



ISPF Development
IBM Software Direct Center
220 Las Colinas Blvd.
Irving, Texas 75062

Please send me more information on the ISPF products.
I am a current SPF user.

Name _____
Title _____
Company _____
Address _____
City _____ State _____ Zip _____

D-2-83

CIRCLE 101 ON READER CARD

FIG. 2

DES AND MAC GENERATION

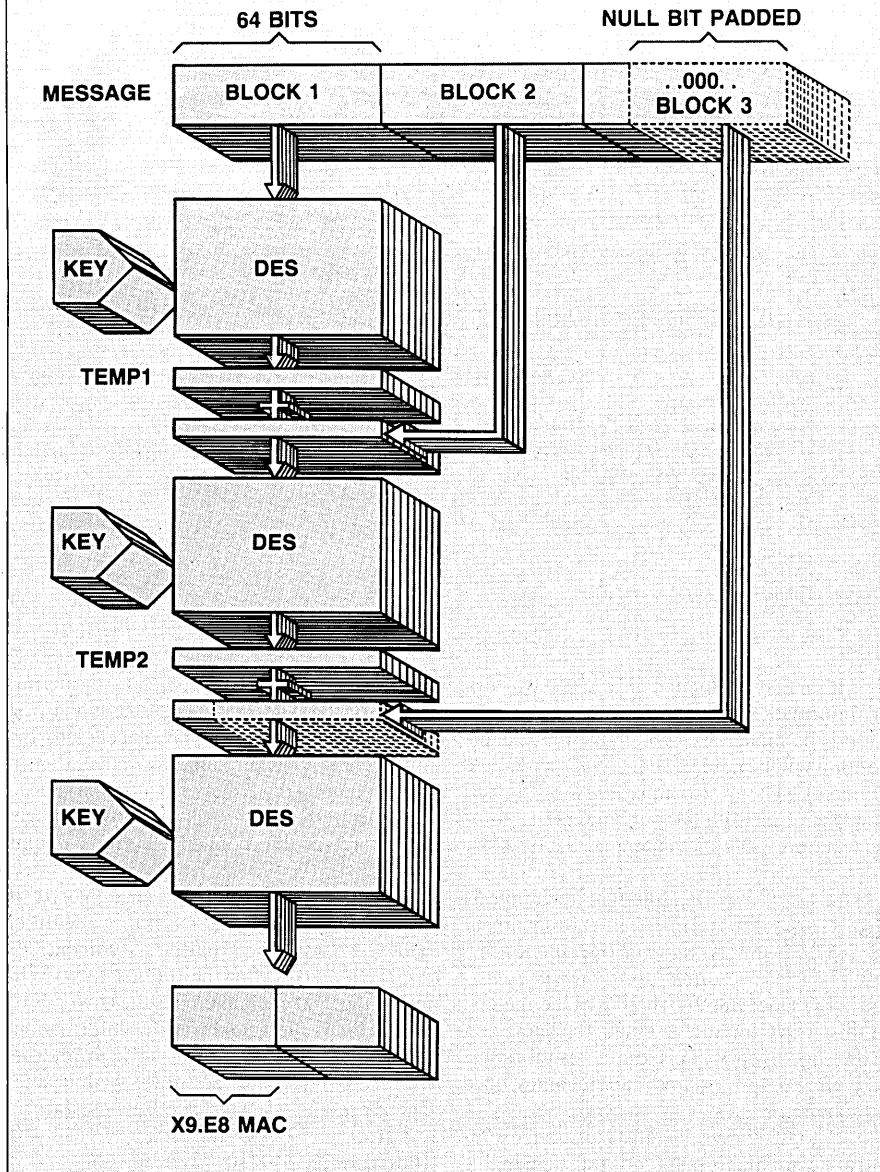

and the message is restored *only if the same key is used*. Using a different key will produce random garbage on decryption.

One of the main security features of DES is its large number of possible keys: over 72 quadrillion (72,057,594,037,927,936). Another important characteristic of DES is its extreme sensitivity. If, on attempting to decrypt a block, you use a key that differs by a *single* bit from the proper encrypt key, the resulting "cleartext" will be random nonsense. Similarly, if a single bit of the ciphertext is changed, a decryption (using the correct key) delivers similar random noise. This is the major reason DES is used in FIMAS.

Now, we also have the "secret" required by a MAC. The shared secret between the sender and receiver of authenticated messages is the 8-byte DES key. If both nodes of the communication line do not use the same key, they cannot authenticate one another. If they do, and the key is kept secret, a third

person may not insert messages or alter existing ones.

This section and Fig. 1 show how DES encrypts in its native or electronic code book (ECB) form. The next logical question is, just how can an encryption algorithm be applied to generate MACs, yet leave the message unencrypted?

Fig. 2 shows the interaction of DES with a message to produce a MAC. The message is a short one, 137 bits in length.

First, recall that DES only operates on 8-byte blocks, and, in fact, *requires* an 8-byte input to do its job. The message in Fig. 2 contains two 8-byte blocks with 9 bits left over. By FIMAS definition, we will pad the third block with 55 null (0) bits to fill it out to the required 8 bytes.

Now the MAC generation process can begin. Block 1 is input to DES. The crypted result is the 8-byte block marked as TEMP1. This block is exclusive ORED [XOR has the

symbol (+)] against message block 2.

The XOR is a bitwise operation that takes aligned bits in blocks of the same length and performs a simple comparison. If two aligned bits are the same the result is 0. If they are different, the result is 1. For example:

```

0100111010001011
      (+)
0001001000100010
-----
0101110010101001
    
```

There's nothing terribly magical about this operation except that it allows for the bitwise combination of block 2 with TEMP1, the output from the first DES pass. It allows the involvement of *every* 8-byte message block in the DES process, therefore in each step of the MAC generation procedure.

Returning to the flow in Fig. 2, the result of the XOR of TEMP1 and block 2 is input into DES again, under the control of the same key. The 8-byte segment, TEMP2, is created. Finally TEMP2 is XORed against block 3, the null padded block. The result is input to a final pass through DES. The output is the 8-byte MAC.

Let's review the important points in this method of MAC generation:

1. The message itself is only read. It is not transformed in any way.
2. Every bit within the message is involved in the DES and XOR processes, and therefore in the resulting MAC.
3. DES is applied as many times as there are 8-byte blocks in the message.

Point 1 is obvious. The purpose of MAC generation is not to disguise the message, but to verify its origin and integrity. Point 2 is a requirement. Any authentication process must involve every bit of the message. And point 3 is responsible for the ultimate sensitivity of the MAC. We have seen how sensitive DES is to a single bit change in ciphertext. FIMAS applies DES serially, thus multiplying this sensitivity by the number of 8-byte blocks in the message.

CIPHER BLOCK CHAINING

This use of the serial application of DES is called Cipher Block Chaining (CBC) or 8-byte Cipher Feedback (CFB). These modes are used for encryption/decryption under normal circumstances, but in this case we have simply discarded the encrypted information. (These modes are explained in detail in Federal Information Processing Standards Publication 74, April 1, 1981, available from the NBS.)

Note that there is no indication as to whether DES is used in encrypt or decrypt mode. That's because it doesn't matter. It is only important that the MAC generation and

There are adequate defenses against random electronic errors, but they are totally inadequate against carefully planned intelligent intervention.

verification processes use the same crypting direction. By FIMAS convention, this is encrypt.

Finally, it should be clear that a MAC generated using a particular DES key can only be recreated using the same data and the same key. Anyone attempting to insert a complete message must know the secret DES key to create a MAC that will pass the receiver's MAC validation procedure. Anyone attempting to alter an existing message must also alter the existing MAC. To do this, the key must be known.

The probability of detection of bit manipulation using this technique is to a high degree dependent on the number of bits (N) of the MAC used in the authentication process. This probability is $P = 1 - (1/2)^N$

So, if only 1 bit of the MAC is used for authentication, $P = 1 - 1/2^1 = 1/2$, i.e., the probability of detected change is 50%. If all 8 bytes are used, this value is virtually 1. FIMAS recommends using the leftmost 4 bytes of the MAC; therefore the probability of detected bit change is:

$$1 - (1/2^{32}) = 1 - .000000002 = .999999998.$$

The chance for detection of bit manipulation is 99.9999998. For all practical purposes, any change will be detected.

So far we have discussed the MAC generation process independently of the type of message to be authenticated. Indeed, the FIMAS algorithm is a system that looks only at streams of bits. It can be applied to any type of binary message or even data files. This makes FIMAS a totally generalized system capable of authenticating everything from EFTs to magnetic tape records. But most institutions will use FIMAS to ensure the authenticity of EFTs.

No matter what the format of an EFT, the following is the FIMAS recommended minimum amount of information that needs to be MAC validated.

1. Transaction value and currency type
2. Identification of credit, debit, and beneficiary parties
3. Value date
4. Message origination date
5. Message identifier (MID)

In those cases where EFT processing is automated and the content of the body of the message does not change between sender and receiver, it is recommended that the MAC algorithm be applied to the entire EFT. Headers and trailers for communication protocols must be omitted from the MAC calculation. The resultant MAC is included in the message, and the header and trailer information is not processed by the MAC calculations performed by the receiver.

When EFT information is sent/received in a free and changing format, the MAC

Fig. 3

EXTRACTION FROM AN EFT

```
TO YOUR BANK
FROM OUR BANK
QD-80 07 14-DQ // // // // 1056/ QX-127-XQ
QT-
TRNSFR USD 1234567,89 FRM ACCNT 48020-166
          // // // // TO ACCNT 40210-178
-TQ
KEEP ON QT EXPECT VISIT ON FRIDAY OF NEW
DIV VP ON PROJECT QT-QWERT-TQ BE
CAREFUL
REGARDS
QUIRTO
QM-F3E9 DC4E-MQ
EOM
```

algorithm may be applied only to those pieces of information listed above. It must, of course, be bilaterally agreed that the MAC algorithm will be applied to these particular EFT segments. There also must exist an agreed upon set of identifiers or delimiters that indicate the presence of the MACed data fields.

A SPECIFIC EXAMPLE

The following example is taken from the document *Financial Institution Message Authentication—draft 13, Doc. 8869A 10/20/81* (see the end of this article for how to obtain the latest ABA FIMAS document). This draft describes the use of MAC procedures and recommended protocols for EFTs.

Fig. 3 shows the EFT. This is an example of a variable format funds transfer. In this case the entire EFT is not MACed; only those fields delimited by the Q - type markers are.

We start by assuming that this EFT has just been received. The EFT is a continuous stream of coded (ASCII or EBCDIC) characters. This stream must be serially examined manually or by a computer program, and fields to be MACed must be extracted and placed into a hardware or software buffer (more on this later) in preparation for MAC generation for authentication.

Parsing of the EFT is only possible once a general rule of allowable characters is established. This is a first level of protection against communication errors and attempted frauds. In this example, allowed characters are A to Z, 0 to 9, periods (.) commas (,) and spaces. Since a space is a legitimate ASCII/EBCDIC character code, in the example it's represented by the character .

The first delimiter encountered is QD -, indicating the date of the EFT origination: 80.07.14 in the form of YY_MM.DD. The

closing delimiter, -DQ indicates the termination of the date field. The date is the first piece of information to be placed into the buffer for MAC generation. By convention, it is agreed upon that whenever a field is placed into the buffer, it is followed by a space. Therefore, at this point the buffer contains 80.07.14.

The next delimiter encountered is QX -, indicating the message identifier (MID). Now the buffer's content is 80.07.14.127. After the trailing -XQ delimiter, the next encountered is the QT -, -TQ pair. This is the actual transfer information. According to FIMAS rules, carriage returns, line feed codes, etc. are always edited out. Therefore the transfer itself is the stream TRNSFR_USD.1234567,89_FRM_ACCNT_48020_166_TO_ACCNT_40210178.

The next field to be added to the MAC buffer is a project code, QWERT. This is simply another section of the transmitted text that the sender wanted verified. At this point the entire collection of elements is resident in the buffer:

```
80.07.14.127.TRNSFR_USD.1234567,89_
FRM_ACCNT.48020166_TO_ACCNT_
40210178.QWERT.
```

The last element to be abstracted is the MAC itself. This is delimited by the pair QM - and -MQ. This value, F3E9_DC4E, is not included as data to be validated during the MAC generation process. It is the MAC that is to be compared against once the buffer is run through FIMAS hardware or software.

The strange-looking MAC is a hexadecimal (base 16) representation of the leftmost 4 bytes of the 8-byte MAC. "Hex" numbers are represented by the characters 0 to 9 and A to F. Each character represents a 4-bit pattern—for example, 9 = 1001 and C = 12 = 1100; each character is half a byte. So, 8

Announcing the personal computer that's also:

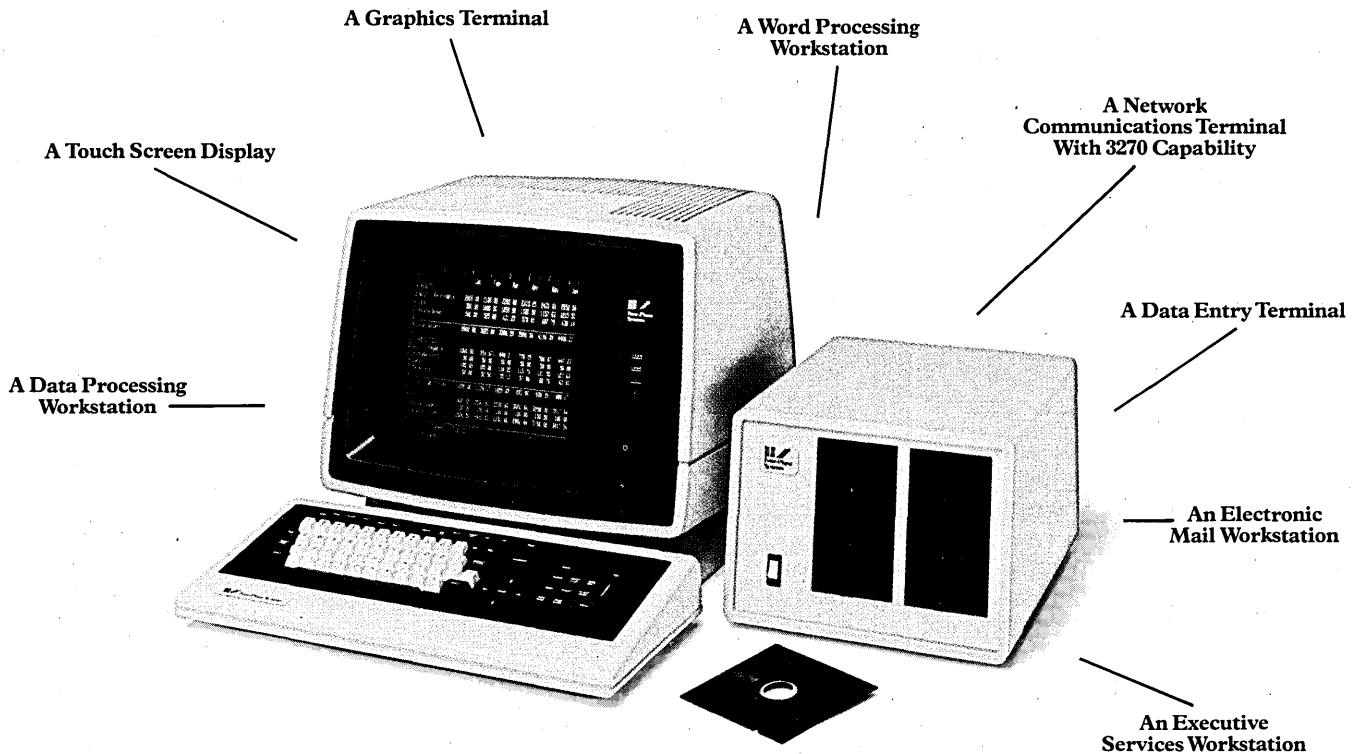

Four-Phase introduces the PC I, PC II and PC III: *personal computers* that operate on our office automation workstations. All of our multifunction workstations can be field upgraded for personal computing, yet still retain their ease of access to our distributed information systems. At the flip of a switch, your workstation becomes a personal computer. Not only do you save the expense and clutter of duplicate workstations, but you also benefit from dealing with one vendor.

Of course, there's a good reason for getting into personal computing: increased productivity from managers and professionals who must perform analyses, solve scheduling problems and create long-range plans. Before you make your move, however, take a look at us.

Four-Phase's personal computers deliver the benefits of CP/M®

software, giving you access to thousands of application programs such as SuperCalc.™ They can also grow with your office automation system. The PC I will operate with either Series IV or our new Series 5000 FASTRAK workstations.

Finally, you can match a system to the performance you need: select full Direct Memory Access (DMA), dual microprocessors, a track-oriented floppy disk controller which is 5 to 15 times faster than most or even a hard disk should you need it.

And since you'll want your personal computers to be fully supported, you'll be pleased to know that one of the most extensive service networks in the computer industry stands behind you. Four-Phase has more than 1000 field engineering professionals in over 150 locations across the continent.

So if personal computers play a role in your office automation plans, talk to the Office Automation Company. Call us at 1-800-528-6050 ext. 1599. (In Arizona call 1-800-352-0458 ext. 1599.) Or write: Four-Phase Systems, 10700 N. De Anza Blvd., Cupertino, California 95014. M/S 52-10A7.

Four-Phase and the Four-Phase logotype are registered trademarks of Four-Phase Systems, Inc. FASTRAK is a trademark of Four-Phase Systems, Inc. SuperCalc is a trademark of Sorcim Corporation. CP/M is a registered trademark of Digital Research, Inc. Motorola and Ⓜ are registered trademarks of Motorola, Inc.



Four-Phase Systems. The Office Automation Company.

MOTOROLA INC.
Information Systems Group

CIRCLE 102 ON READER CARD

"What can Lanier show me in distributed processing systems?"

Lanier believes that you should be able to select a system today that can accommodate tomorrow's technology. So our system architecture is designed to support future advances in computer and communications development. This support opens new doors to office automation product compatibility in a distributed processing environment.

"What is Lanier's system architecture?"

"Lanier's system architecture is structured in layers with defined interfaces between layers. This is similar to modern network architecture, in particular SNA. Logical addressing provides connections to the physical links for all the devices and processes in the system. This even applies to the smallest system. Thus, modifications or extensions to the configuration may be made without affecting the end user."

"Can Lanier's distributed architecture keep up with my company's changing needs?"

"Certainly. Lanier's layered architecture makes it easy to upgrade the processor, the controller hardware, and the file system. All such improvements are transparent to the user

community, except for increased performance and functions. The advantage of the architecture is that systems are easy to modify as new requirements evolve."

"But haven't these types of architectures been around for years?"

"Yes, many of today's most effective system designs use them. However, an important difference in our philosophy is our adherence to an open system interconnection concept. Although primary emphasis is on SNA, future plans include other de facto standards as they evolve."

"How does this architecture support distributed data processing?"

"Your Lanier system can connect not only to other Laniers but to any SNA system. The Lanier control program communicates with a network management layer, which, in turn, communicates with other systems using protocols consistent with SNA."

"But what about communicating with systems that don't use SNA?"

"Lanier will interface to other networks and support various communications protocols as they become major industry standards. Because our architecture is truly distributed, our systems will be connected to other standard networks by modifying only the layers associated with network management and interfacing, not the whole system architecture."

Managers planning the office of the future are looking at distributed information processing systems as the best solution to meeting their long-term needs. And they're looking to Lanier because we believe in keeping the door to future innovations open for today's users — and our systems philosophy proves it.

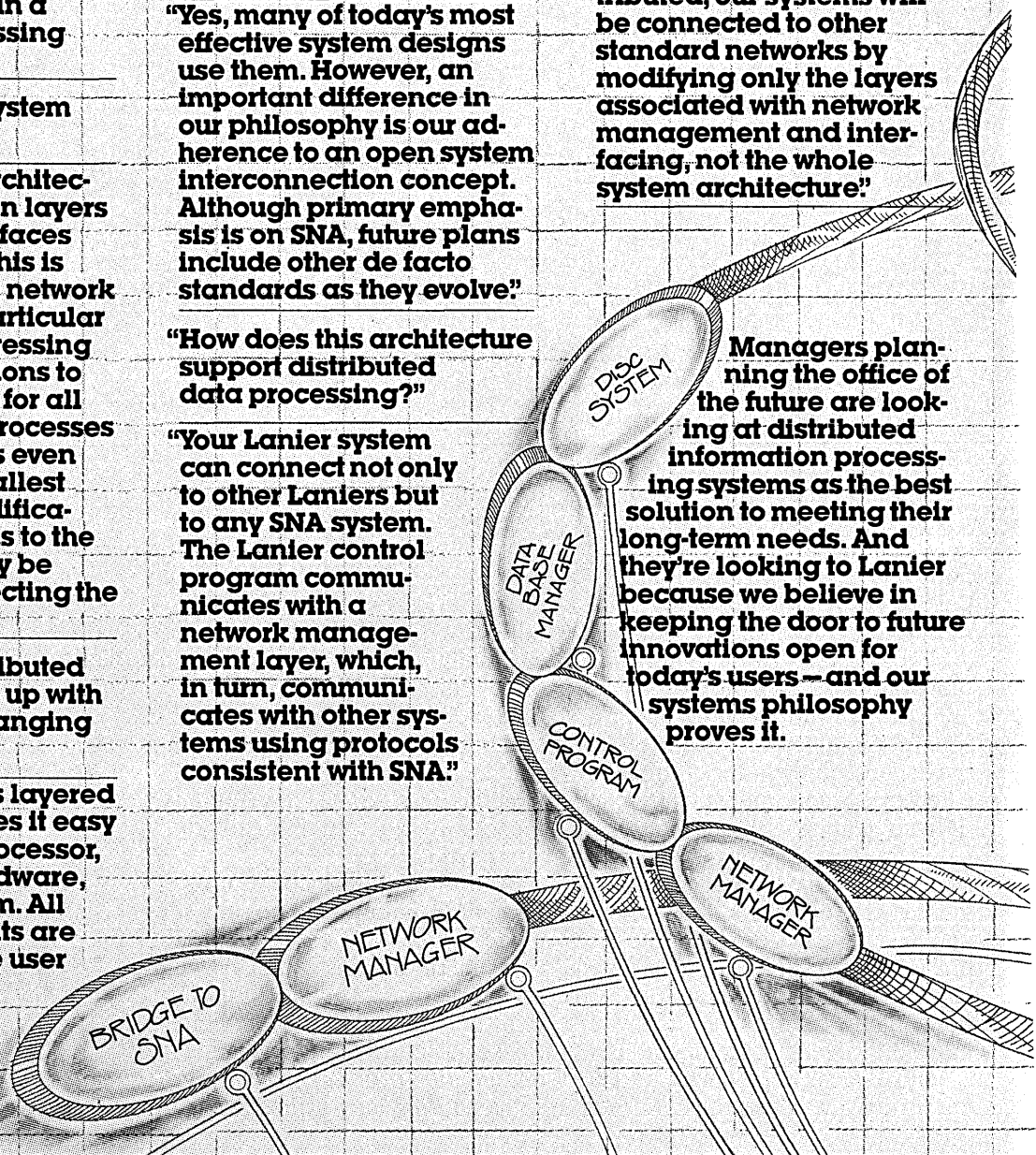

"A future"

Bill Kelly, Vice President, Research and Development,
Electronic Office Systems Division

Send us this coupon, or call Jennifer Scott at (800) 241-1706 for more information about Lanier's electronic office systems. Except in Alaska and Hawaii. In Georgia, call collect: (404) 321-1244.

Send to:
Lanier Business Products, Inc.
1700 Chantilly Drive N.E.
Atlanta, GA 30324
Attn: Jennifer Scott

Name _____
Title _____
Phone _____ Best time to call _____
Firm _____
Address _____
County _____
City _____ State _____ Zip _____

Feb. '83 Datamation 4, A4 H B3

*We'll change your mind about the future.
Right here and now.*

LANIER[®]
CIRCLE 103 ON READER CARD

The FIMAS algorithm can be applied to any type of binary message or even to data files.

hex characters is a 4-byte segment. The standard stipulates that hex characters be specified in groups of 4 separated by a blank: HHHH.LHHH.

At this point the construction of the buffer of ASCII or EBCDIC characters is complete. FIMAS is now used to calculate (using the same DES key used to calculate the transmitted MAC) a MAC based on the input information. If the leftmost 4 bytes of the new MAC equal F3E9DC4E, then the EFT is validated. It has not been furtively altered, and it cannot be an inserted EFT. This, of course, assumes that only the sender and receiver are in possession of the DES key.

Let's briefly review the delimiters outlined by FIMAS:

QD - -DQ : Date of message,
QD - YY_MM.DD.DQ
QX - -XQ : Message identifier (MID), QX-
aaaaaaaa-XQ
QT - -TQ : Body of transfer, QT-text-TQ
QM - -MQ : Transmitted MAC,
QM - HHHH.LHHH-MQ

Obviously the delimiters must appear in pairs. If they do not, proper selection of elements will not occur, and the MAC calculation and comparison will indicate authentication failure. This is an example of MAC authentication displaying some of the guidelines established by the ANSI X9.9-1982 standard. The document includes examples of the standard's use as applied to BANKWIRE, S.W.I.F.T., and FEDWIRE formats.

OTHER USES FOR THE MAC

The MAC can be used to ensure the integrity of any type of computer-stored data when disclosure is not a main concern. MACs use encryption technology without transforming information into ciphers that must be decrypted in order to

make data usable.

Some immediately obvious applications are the authenticating of programs (source, object, or load modules), or data-sets. A MAC may be generated for each record of a file, or a single MAC may be associated with a complete file.

EFTs can take place between one cpu and another, or between a cpu and a terminal. FIMAS can be implemented either in hardware or software. The hardware solution can apply to both situations; software can be used for a transfer between two cpus, and a software-hardware hybrid can apply to a transfer between a cpu and a terminal.

A main factor in the choice of implementations is whether all or part of EFTs are to be authenticated. If part, then both hardware and software must be intelligent enough to parse out the authentication fields and the MAC from the EFT.

In either case, the situation is in some ways analogous to implementing DES alone, except for one major difference. Whereas DES produces randomized bit streams, FIMAS produces a string of ASCII/EBCDIC codes representing the 8 hex characters in the MAC. This distinction is important. Many protocols for EFTs only allow communication of character-coded information. So, MACs can be communicated using standard desktop modems.

The hardware solution involves a box that contains a DES chip, a microprocessor, some RAM, and PROM to handle the MAC calculation. In theory, boxes at each end of the communicating nodes do two things. First, they accept manual input of the DES key; second, they have to have some way of feeding back to a computer or operator that an EFT has failed the MAC test. The software solution does the same thing except it's run on the

micro, mini, or mainframe computer.

In the banking world the cpu-to-cpu situation involves some politics when communications are between the banks and the national and international EFT networks. These organizations need to agree to put hardware or software on their cpus to accommodate banks' interfacing from their main computers to the "network switches," where transactions enter the usually secure (via encryption) networks.

Within banks there is the problem of dispersing EFTs from main data centers to branch offices. This is the cpu-to-terminal problem. One major bank has solved the problem by placing FIMAS software on its mainframe and constructing a hardware box for use at the terminals. The box simply gives warning when a MAC has failed to validate and the operators alert the main data center and security administrator. Then action can be taken to discern if the validation failure is due to communication problems or an attempted fraud.

Another solution to the low volume situation is having software at the mainframe and nothing at the terminal. The branch operator manually enters the eight character MAC into a microcomputer that contains FIMAS software. A nice aspect of this solution is the fact that there is no change to the existing EFT communications system. The only expense is the mainframe software (usually about \$5,000), plus the microcomputer and software (which cost about the same). Currently, two companies produce FIMAS software and two companies have FIMAS hardware almost ready for production.

It has been over half a decade since the National Bureau of Standards introduced the Data Encryption Standard and the American Banking Association endorsed it. Security consultants are still appalled at the lack of its use. Now that DES's first progeny has appeared on the scene, perhaps it will stimulate banks and other financial institutions to make that minimal "insurance" payment before disaster strikes.

An ABA document describing FIMAS (publication #090100) is available from the American Banking Association, 1120 Connecticut Ave. NW, Washington, DC 20036.*

Michael Schwartz is owner and founder of Prime Factors, a three-year-old Oakland, Calif., firm specializing in software encryption and key management systems. Schwartz has over 12 years of dp experience and holds degrees from the University of California and Northwestern University. His book, *Implementing Encryption Systems—A Working Guide for Management and DP Professionals*, will be published by Addison Wesley in December.

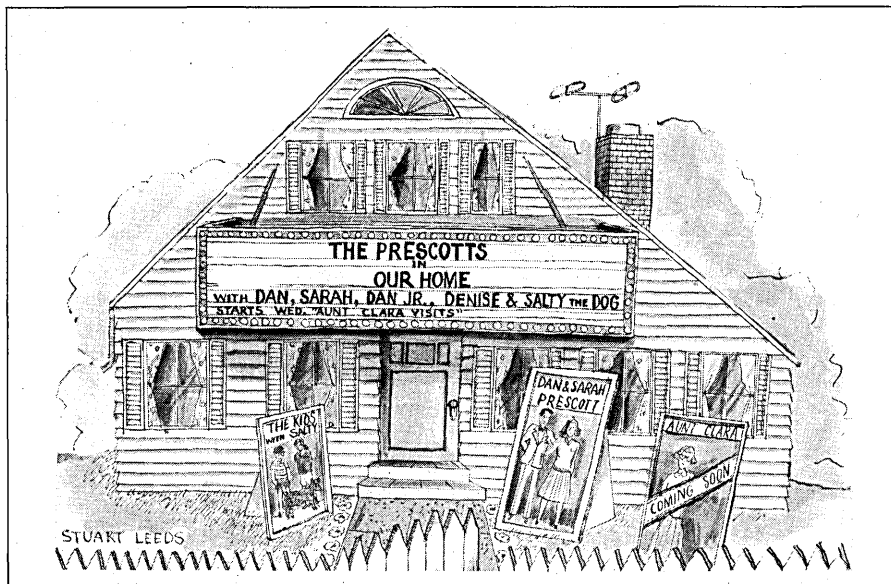

CARTOON BY STUART LEEDS

Only Wang VS computers have the intelligence to get you into office automation.

When you buy any Wang VS (Virtual Storage) computer, you're not just buying another computer. You're buying a flexible, powerful, computer system that's compatible with most mainframes and offers multi-functional capabilities no one else can touch.

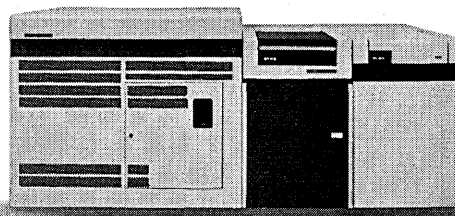

Wang VS 100

Along with data processing and electronic mail, you can get Wang Word Processing, the world's standard. And when you consider that 80% of the information handled in most offices is in written form, that's no small extra.

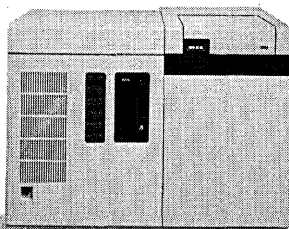

Wang VS 45

But more

than that, you get the only computer system that has the built-in capability to automate your entire office.

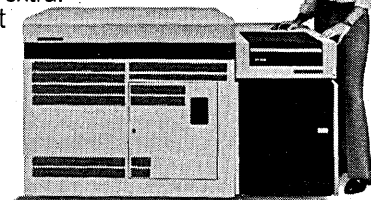

Wang VS 90

A system that's expandable, upgradable, and compatible from low to high end. And because most VS systems run under one operating system and support the same software, it's the world's easiest system to learn and to use.

The Wang VS. When you consider all you get, and what you get it for, why consider anything else?

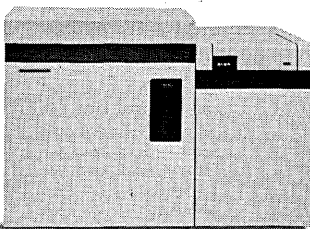

Wang VS 80

For a demonstration of the Wang VS computer line, call

1-800-225-9264

Or send this coupon to:
Wang Laboratories, Inc.
Business Executive Center
One Industrial Ave., Lowell, MA 01851

Name _____
Title _____
Company _____
Address _____
City _____ State _____ Zip _____
Telephone _____



The Office Automation Computer Company

CIRCLE 104 ON READER CARD

TECHNOVATION: MANTIS.

Study Shows MANTIS the Premier Application Development System

Application Development System (ADS) technology can do more to increase overall programmer productivity, reduce maintenance costs, and solve the severe application backlog problem than any other single software product.

But in a marketplace flooded with products to address this need, your choice of an application development system can be a difficult task.

Recently, the Merlyn Corporation completed the industry's first exclusive study* on eight available ADS software systems. And this study clearly confirms what Cincom users already know. MANTIS is decidedly the winner.

Among the three most widely used systems—MANTIS, DMS and UFO—MANTIS led every user satisfaction category: productivity enhancement, on-line performance, ease of learning, ease of use, documentation, support and reliability. And in the most important category—"Overall Capabilities"—MANTIS was again the winner.

User satisfaction? 33% of DMS users said they would *not* recommend their system to others. Among UFO users, 6% would *not* recommend theirs. For MANTIS users, not one single user said no.

Further evidence of MANTIS' superiority is the overwhelming industry acceptance. In only 18 months since its introduction, MANTIS has gained 11% of the total ADS market share. That's a substantially higher growth rate than all of the other seven systems studied.

But while we're very pleased to be the runaway winner, we're even more pleased that MANTIS is becoming the industry standard for on-line programming. 84% of MANTIS users develop 91-100% of their applications with the system. Only 67% of DMS users reported such high usage. With UFO, the figure plummeted to only 48%.

These are merely the highlights of the conclusive Merlyn Study. But the findings are clear. When it comes to application development systems, MANTIS is in a class by itself.

MANTIS is another of the many solutions developed through Cincom's commitment to technology and innovation—TECHNOVATION. Using the power of MANTIS' 4th Generation Language, you can look forward to:

- dramatically increased CICS and ENVIRON/1 programmer productivity
- improved user involvement and satisfaction through sophisticated prototyping techniques.

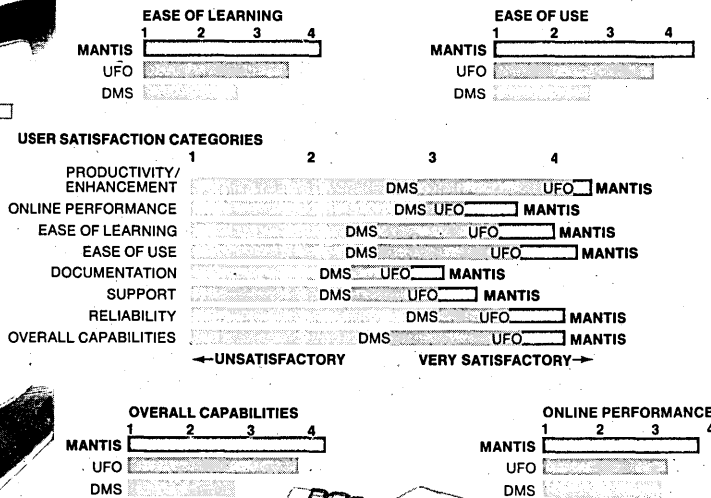

For more detailed information on MANTIS, Cincom's powerful new application development system, contact our Marketing Services Department, 2300 Montana Ave., Cincinnati, OH 45211

800-543-3010

(In Ohio: 513-661-6000.)
(In Canada: 416-279-4220.)

*"CICS Application Development Systems: The Comparative Consumer Report." Written and published by MERLYN CORPORATION. Survey data from Focus Research Systems, Inc. 1982.



Cincom Systems

Your strategic software partner.

How Ovaltine's encryption experts used secure messaging techniques to boost sales and thrill adventure fans.

CODE-O-GRAPHS OF THE SECRET SQUADRON

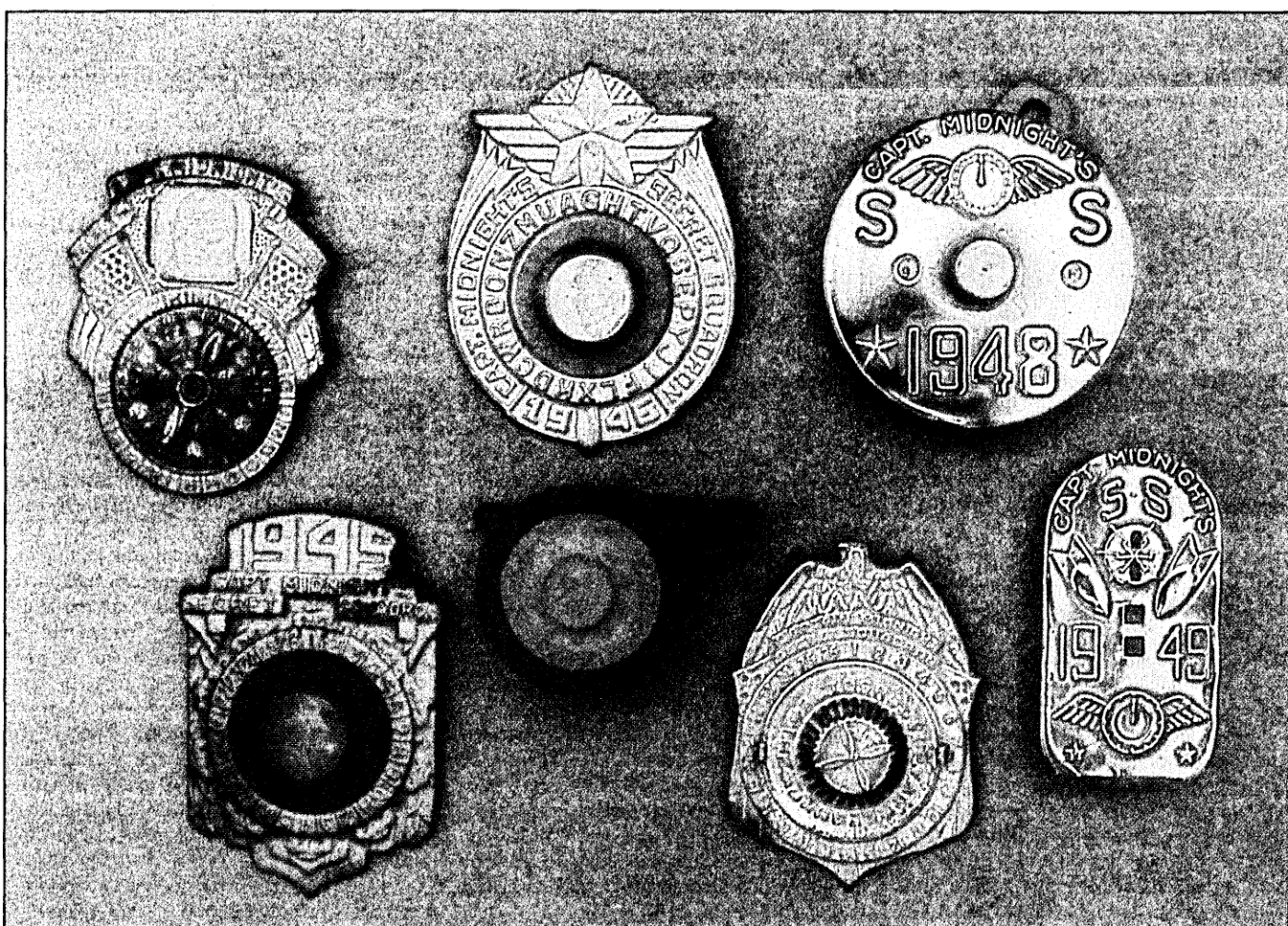

by Stephen A. Kallis Jr.

Like its relative, the movie serial, the adventure serial on radio was a continuing story, generally with lots of action. Each episode ended with the program's characters in an unresolved (and usually cliff-hanging) situation, which would be resolved in the following show.

From the late 1930s through the early '50s there were lots of radio adventure serials. They ranged from the famous, like *Jack Armstrong*, *the All-American Boy* and *Tom*

Mix (and his Ralston Straight Shooters) to the obscure, like *Tennessee Jed* and *Speed Gibson of the International Secret Police*. Most were broadcast between 5 and 6 p.m. and were aimed primarily at children.

One of the most popular of these was *Captain Midnight*, a show sponsored by Ovaltine. Although *Captain Midnight* was in the thick of the children's hour, it was unique in having a large proportion of adult listeners—about 50%, according to Ovaltine. The shows were generally well written and well acted.

Like many other shows of the period, *Captain Midnight* gave premiums to listeners. A radio premium was an item that served a double purpose: it generated a demand for the sponsor's product (you had to send in a box top or label or some such) and it acted as a fairly good barometer of the number of people listening to the show (premiums cost less than the Hooper rating service of the period). Many of the premiums were rings, such as the Jack Armstrong Magic Dragon's Eye Ring, the Green Hornet Seal Ring, and the Sky King Teleblinker Ring, and the *Captain*

A radio premium served a double purpose—it generated demand for the sponsor's product and acted as a barometer of the show's popularity.

Midnight show sent out its share. But *Captain Midnight* also distributed the Code-O-Graph, which was a very special premium.

To understand the particular significance of the Code-O-Graph, it's necessary to tell a little about the show. The central character was Captain Midnight, the code name of a man who, as a young officer in World War I, had completed a dangerous and extremely important mission at the stroke of 12. During the last few months of 1940, this fellow was brought out of an early retirement to head a secret paramilitary organization that would combat acts of sabotage. Captain Midnight was an aviator, and his outfit relied on fast transportation, especially airplanes, to get to out-of-the-way spots quickly. His outfit was called the Secret Squadron, and it sent secret communications—first codes, later ciphers. And the Code-O-Graph premiums let listeners in on the secrets.

A code is a symbol or group of symbols that represents a word or phrase. The signal SOS means "I am in trouble and need assistance" and is thus a code signal, though not a secret one. Codes may be symbols, such as a skull-and-crossbones label on a bottle representing "the contents are poisonous," or may be strings of letters.

To create a code scheme that enables agents to communicate meaningful messages requires a lot of phrases and a lot of unique symbols. This results in a code book, a rather bulky document used to encode and decode communications.

The problem with a code book is that it's not the sort of thing a field agent in the Secret Squadron could use as a practical matter. Such a book would be too awkward for an agent to use, and would be relatively easy to capture. As Captain Midnight said on the show, "We've got to have . . . something small enough to be carried in a pocket and to be hidden easily. And something that can be gotten rid of in a hurry, if you have to." He brought the problem and a suggestion to Ichabod Mudd, the Secret Squadron's chief mechanic, and the result was the first Code-O-Graph, a cipher device.

A cipher is what many laymen think of when someone speaks of a code. Unlike a code, a cipher is a letter-by-letter substitution of characters in a message. There are several varieties, but one of the most straightforward is the substitution cipher.

JULIUS CAESAR'S CODE

A simple example is to take the alphabet and assign each letter its positional number, so that A = 1, B = 2, C = 3, etc. With this arrangement, "code" is 3-15-4-5. Of course, instead of numbers, it is possible to use another set of letters. If we shift the alphabet three letters, we find that A = D, B = E, and so forth, until

we get to Z = C. In this scheme, "code" would be "frgh." This particular cipher, incidentally, was used by Julius Caesar, and is known to cryptologists as a "Caesar substitution" in his honor.

The idea of shifting one alphabet with respect to another could be carried to its logical conclusion by placing the two alphabets (or one alphabet and series of numbers) on two disks, each divided into 26 arc segments along its periphery, and connected by a central pivot. By moving the disks in relation to each other, one scale could be repositioned relative to the other. This device, known as a cipher disk, was invented by Leon Battista Alberti in the mid-15th century.

The first Code-O-Graph had an inner dial with letters and an outer dial with numbers from 1 through 26. The two scales could be repositioned by turning the inner dial (technically, a rotor). The positions of the two scales were determined by aligning a number located on the reverse side of the rotor with one of two windows on the back of the Code-O-Graph. There were several such numbers, and each window was labeled—one was "Master Code," the other, "Super Code." The alphabet was scrambled, as were the alphabets on all subsequent Code-O-Graphs. All of them were cipher disks.

The first (or 1941) Code-O-Graph looked like a law-enforcement badge. A listener could get one merely by sending a top seal from a can of Ovaltine to the company, along with his or her name and address. By return mail, he or she would receive a Code-O-Graph and a manual explaining various secret signals. Getting a Code-O-Graph meant that the listener became a member of the Secret Squadron.

What was the advantage in being a squadron member? Besides the general feeling of belonging to an "in" group, a listener with a Code-O-Graph was set apart because two or three times a week, the show would feature a "signal session," in which a message in cipher would be broadcast. The member with a Code-O-Graph would be able to decipher the message and obtain a clue about the following adventure (particularly useful with a cliff-hanger).

The second Code-O-Graph was manufactured in late 1941, but was not issued until after the attack on Pearl Harbor (interestingly, in the show Captain Midnight was in Hawaii in November of 1941, investigating the possibility of an attack). This second unit had a more aeronautical design: a propeller and radial aircraft engine design decorated the center of the rotor, and an American flag motif graced the rest of the badge. The badge had a place for the listener to put a picture of him- or herself, thus personalizing the Code-O-Graph.

The 1942 model, like its predecessor,

was undated, and had a window on its back so that a number on the reverse of the rotor could be aligned for a code setting. The second Code-O-Graph used a single window labeled Master Code.

The acute shortage of materials during 1942 and 1943 precluded manufacture of Code-O-Graphs for the years 1943 and 1944. In fact, most of the premiums offered by Ovaltine and other sponsors were made of cloth or paper.

By late 1944, materials were not as scarce as previously, and Ovaltine was able to offer a Code-O-Graph for 1945. The unit was made out of stamped sheet steel coated with gilt paint (brass, which was used for the first two Code-O-Graphs, was still a critical material). The rotor was made of plastic. The year was prominently displayed across the top of the badge. The decoration, which was more subdued than in the previous model, represented a radial aircraft engine.

676 POSSIBLE SETTINGS

The cipher setting scheme was different. Instead of a window in the back for scale alignments, the rotor was turned until a specific number was aligned with a specific letter (e.g., "code Z-7" meant that the rotor was turned until the Z was next to the 7). The manual correctly stated that this scheme enabled the user to have 676 possible key settings.

The center of the plastic rotor was molded to form a lens; the rotor was made out of clear plastic, with its scale painted for easy readability. This lens was a reasonably powerful magnifier, and the manual was dotted with tiny messages that could only be read under magnification. Such "unreadable" messages formed another type of secret communication.

The following year produced a very good-looking Code-O-Graph. The 1946 model was also dated, but not as obviously as the 1945 version. It, too, used the letter-number key for code settings, and because the war had ended, it was made of brass (except for the rotor).

The rotor was made of two plastic elements—a scale in red plastic (painting clear plastic red hadn't been an optimum solution, experience with the 1945 model had shown) and a central clear element for a dial handle to turn the rotor assembly. Behind the clear plastic face was a polished steel mirror, which could be used for flashing signals to other Secret Squadron members.

The 1947 Code-O-Graph was a radical departure from the previous models in a couple of ways. First, it was not a badge, but a police-type whistle. The cipher scales were embossed and attached to one side of the whistle, while the year date and the Secret Squadron symbol (a winged clock face with

HERE'S THE PERSONAL COMPUTER AD OUR COMPETITION DOESN'T WANT YOU TO READ.

It's an ad for NEC's APC™ Advanced Personal Computer. A solutions-oriented system that solves business problems in the simplest, most cost-effective way. The APC supports both CP/M-86™ and MS-DOS™. It can store more information than any system in its price range. In short, it's got the best price/performance of any personal computer. That's why our competition would prefer that you never see our system.

We asked some businessmen who sell systems why they preferred us. The reason? We're fairly unique. Our APC is the only personal computer on the market that has a powerful 6-bit microprocessor, a disk drive, a high-resolution display card, a full complement of applications software, and, best of all, the lowest price. These features are offered at an affordable price. It's why we've sold so many systems.

Our customers say, "It's the best system I've ever seen." "It's good."

It couldn't be any that well as them that is in the

"That APC of yours is the most powerful computer of any I saw. I don't know how for that price."

"Now that I've used it for awhile, I see why you named it Advanced Personal Computer."

And that from businessmen who have tested their competition! When you see the APC you'll understand why, at a price lower than others, all of these businessmen picked NEC.

Our business software was optimized to take advantage of the APC's unique hardware features. That makes system operation faster and easier.

Our software includes a full set of general accounting packages, word processing, mailing list management, business planning, database management, and communications. And we're readying many more.

We're the only company to back our software with a unique unconditional guarantee. It will work or you get your money back.

Our high-resolution color graphics run circles, arcs and lines around everybody else. The APC's screen images—lines, characters, pictures—are unprecedented in their clarity. Colors against resolution competitive systems often must.

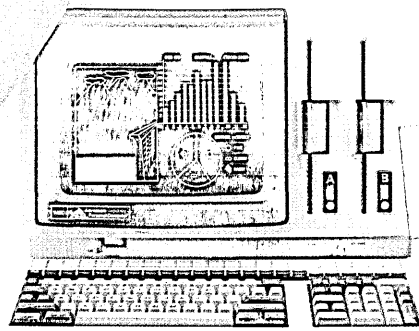

compar... the APC
for pla... analysis,
data... manager... word
proce... 's par... al
commu... work, ... al
the A... al fo...
ronic m... ces,
comput... rieta
data...
mic an...
A...
32...
proc...
A uni...
on give...

The APC's screen images—lines, characters, pictures—are unprecedented in their clarity. Colors against resolution competitive systems often must.

See for yourself the personal computer our competition wishes had never been invented. The Advanced Personal Computer from NEC. Return the coupon to NEC Information Systems, Inc., 5 Militia Drive, Lexington, MA 02173.

Now available with NEC hard disk

APC is a trademark of Nippon Electric Co., Ltd.
CP/M-86 is a trademark of Digital Research, Inc.
MS-DOS is a trademark of Microsoft, Inc.

Send me more information on the Advanced Personal Computer.

Name _____
Title _____
Company _____

Address _____
City, State, Zip _____
Telephone _____

DN0283
NEC
NEC Information Systems, Inc.
5 Militia Drive, Lexington, MA 02173

The Benchmark in World Class Computers

CIRCLE 106 ON READER CARD

Besides belonging to an "in" group, a listener with a Code-O-Graph could decipher clues broadcast during "signal sessions."

the hands pointing at 12) were on the other side. The body of the whistle was blue, while the rotor was red. This was the only radio-era Code-O-Graph made entirely of plastic. Like the 1945 and 1946 Code-O-Graphs, it used letter-number key settings.

The manual that accompanied the 1947 model suggested that the unit could be used as a sound signaling device, and gave a number of whistle-signals (such as those used by steam locomotives) for squadron members to practice.

The 1948 Code-O-Graph seems to have been designed by a committee. It was a circular thing, similar in shape to a woman's compact. The body was brass, with both the rotor and the outer scale movable by an aluminum knob in the center of the face. The face was decorated with the date and a Secret Squadron symbol, and the letter and its associated number were read through small circular windows.

The rotor and outer scale were embossed on aluminum disks. Turning the knob caused the two disks to turn; they were held together through friction augmented by circular lines of dimples. The key setting was reminiscent of the first two Code-O-Graphs: with the back removed, the user could set a pointer at any of 26 numbers on the back of one disk, and this would change alignment of the two scales.

Unfortunately, this unit didn't work very well. The friction dimples were imper-

fect, and there was often slippage between the two disks. This of course could change the key setting in the middle of a message, making the remainder hash.

The red plastic back of the 1948 Code-O-Graph had a secret compartment that could hold small pieces of paper or microfilm. Affixed to this compartment was a steel mirror, rectangular and larger than the 1946 unit's mirror. The red plastic back was subject to warping, and even archival copies of this Code-O-Graph in the Ovaltine files have warped backs. Many of the mirrors were lost before the year was out.

Mostly because of the flaws in the 1948 model, the last Code-O-Graph of the radio series dispensed with frills and concentrated on ensuring that the cipher setting, once made, would be maintained. The 1949 model was known as the Keyomatic Code-O-Graph because it required a small key to change cipher settings.

The unit is a small, oblong device about two inches long, consisting of a brass housing containing two red plastic gears. One gear has the alphabet scale embossed on it and the other has the number scale. Over the number-scale gear is a small opening designed so that a little brass key can be inserted into it. The number-scale gear is supported by a spring, and inserting the key depresses the gear so that it disengages from the other.

The 1949 Code-O-Graph used the letter-number cipher-key settings from the

1945, 1946, and 1947 models. Like the 1948 model, the user could view only one letter-number pair at a time, through small windows on the face of the unit. To set the 1949 model for master code B-6, for example, the user would turn the gears by moving the exposed teeth of the alphabet-scale gear until the number 6 appeared in the right-hand window. Then, using the key, the user would depress the number gear, disengaging the two and retaining the 6 setting. The alphabet-scale gear would then rotate freely, and the user would move it until the B appeared in the left-hand window. Then the key would be withdrawn, reengaging the gears.

While it offered a certain level of security to the unit, the key was small, and easily lost. The manual that came with the Code-O-Graph suggested that a string be looped through the key, but that wasn't done often enough, and many members of the 1949 Secret Squadron had to learn another way to reset their Code-O-Graphs. Since the key was not fancy, a strong toothpick or an unbent paper clip could usually do the trick.

The 1949 model was the last of the radio-program Code-O-Graphs, and the reason for this is that the program changed format. After the spring-summer segment of the 1949 season, the program went from a 15-minute nightly adventure serial to a program that was a half-hour in length, with a complete story per episode. This was done in part because competing shows such as *Sky King* had changed to the format successfully. With all the loose ends tied up by the end of the show, however, there was no reason to send secret messages, or so the show's producers thought.

And without secret messages, there was no need to issue a new Code-O-Graph. So, the era of cryptography on commercial radio effectively came to an end.

Interestingly, the radio show did not survive long without its Code-O-Graphs. The level of writing slipped to a simpler style, (perhaps because everything had to be wrapped up in half an hour) and that alienated the adult audience. Also, the actor who played Captain Midnight for a decade, Ed Prentiss, had been replaced. And, of course, there was television, which by 1950 was becoming a force to be reckoned with.

There were, no doubt, a lot of reasons for the show's demise. But I think one of the main ones was that the day of the Code-O-Graph had passed. *

Stephen A. Kallis Jr. has published two papers in the journal *Cryptologia*, and for the past five years has been working on a biography of Captain Midnight. He is a public relations specialist at a leading computer company.

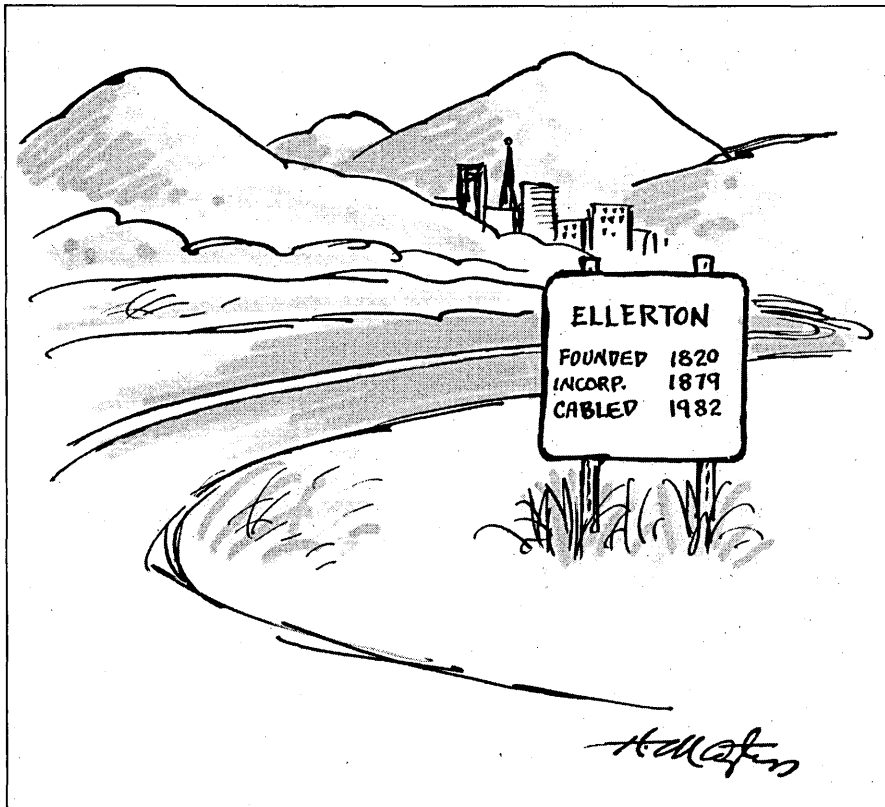

CARTOON BY HENRY MARTIN

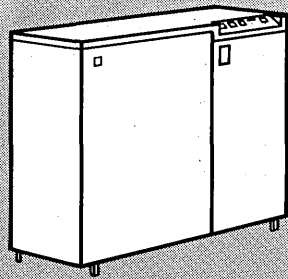

IBM 3274

IS/3M
6632

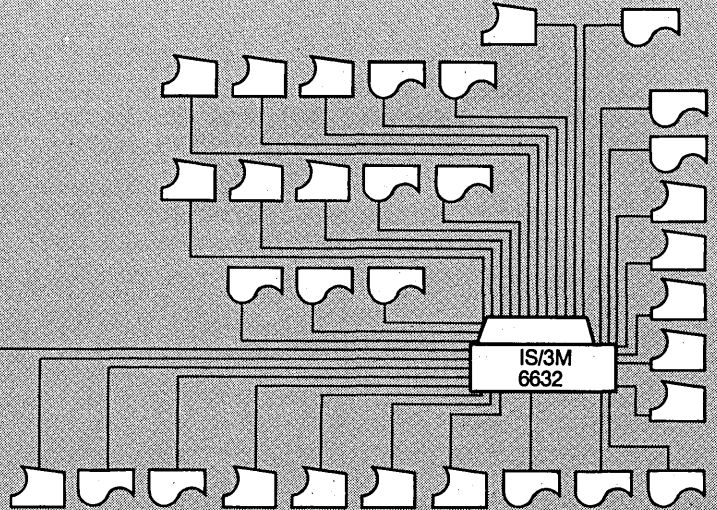

In this typical IS/3M "IBM attach" baseband system configuration, one Series 6600 Multiplexer is connected to an IBM 3274 Controller's 32 ports and another is placed near 32 clustered IBM Series 3278/9/87 terminals. A single length of RG-62U cable carries data between the two multiplexers over a distance of half a mile or more.



3287



3278 or
3279

IBM is a registered trademark of International Business Machines Corporation.

Connect as many as 32 terminals to a distant IBM 3274 Controller with a single existing baseband cable.

Until recently, there was just one way to connect more than one IBM 327X terminal or printer to a 3274 Controller: Install another dedicated cable for each new peripheral.

Now there's another, simpler, and very reliable way to do the same job without pulling long lengths of new cable. It's called the Interactive Systems/3M Series 6600 "IBM® attach" baseband system. And it lets you hook as many as 31 extra terminals or printers onto any existing RG-62/U cable that now connects your IBM 3274 Controller to a terminal.

The method: time-division multiplexing.

IS/3M's new Series 6600 "IBM attach" uses time-division multiplexing (TDM) to squeeze more data channels onto a standard baseband cable. Installation is quite simple. One or more IS/3M Series 6600 head-end multiplexers is attached to the controller. Depending on the model selected, a single MUX

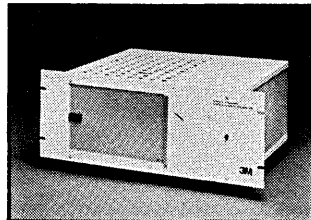

Series 6600 Multiplexer, available with 4, 8, or 32 input/output ports.

can handle data for up to 4, 8, or 32 ports.

The multiplexed data streams are carried via the existing RG-62/U cable to an identical Series 6600 MUX at the remote location. Local baseband cables connect this multiplexer to its assigned terminals and printers.

Flexibility, plus uncompromised system performance.

Any combination of IS/3M multiplexers can be used with the IBM 3274 Controller, so long as the total number of channels doesn't exceed 32. For example, three 8-channel

MUXes could be used with existing cables to feed up to eight terminals and/or printers at each of three different sites.

The baseband system is fully transparent and plug-compatible to IBM equipment. Just as important, it allows all peripherals to send and receive data at the standard IBM channel speed of 2.3 Mb/s.

A proven technology from an experienced company.

Time-division multiplexing has been employed successfully in long-distance telephony and computer time-sharing for years.

Interactive Systems/3M is no newcomer to data communications. On the contrary: Factories, office buildings, universities, and government installations have been benefiting from IS/3M's communications engineering, modem manufacturing, and installation expertise since 1972.

Phone (800) 328-1684 toll free (in Minnesota (800) 792-1072) or mail the coupon

for more data on the Interactive Systems/3M Series 6600 "IBM attach" system. Who knows? You may discover that you'll never have to pull a major length of baseband cable again.

Mail to: Interactive Systems/3M
P.O. Box 33050
3M Center
St. Paul, MN 55133
Attn.: Marketing Dept. D-2

- Send details on your Series 6600 "IBM attach" system.
- Send more information about your VIDEODATA® broadband network for data, video, and audio communications.
- Please have a representative call for an appointment.

Name _____
Title _____
Company _____
Phone () _____
Address _____
City _____
State _____ Zip _____

3M hears you . . .

CIRCLE 107 ON READER CARD



Tying together way to set



If people in your office aren't tied together, they're probably tied to a lot of tedious work.

Like walking from department to department, digging through files and trying to manage an ever increasing amount of information.

That's why IBM makes office systems: to electronically tie together every department in your business.

Which means that everyone in your business can retrieve, analyze, format and distribute information without leaving their desks.

For example, let's say you have the IBM 5520 Administrative System.

All you have to do is move a few fingers to assemble a report using

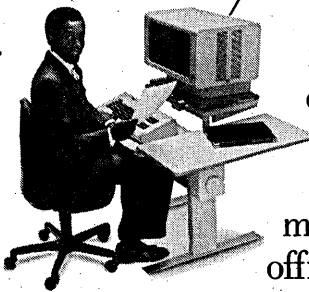

information from your company's files.

Move a few more fingers and that report is immediately sent to your offices across the hall or

across the country.

The IBM 5520 can even print or distribute one report at the same time another is being assembled.

In addition, the IBM 5520 can communicate with the IBM Displaywriter and other IBM Office Systems as well as suitably programmed computers.

Of course, no two businesses are exactly alike.

But no matter what business you're in, no matter what its size, IBM can plan and design an office system to help

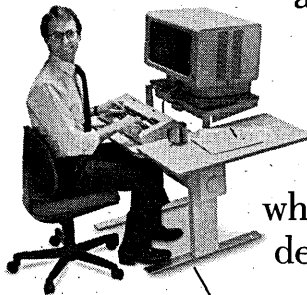

people is the best them free.

pull it together.

That's because we have the widest range of office systems products available. Everything from IBM Electronic Typewriters to advanced IBM Information Systems.

Each IBM Office System can grow as your business grows.

And each system is backed by IBM experience, service and support.

So if you're interested in getting the most out of your business, tie the people in your office together with an IBM Office System.

Just think of all the additional time they can spend using their heads, instead of their feet.

For more information, or a

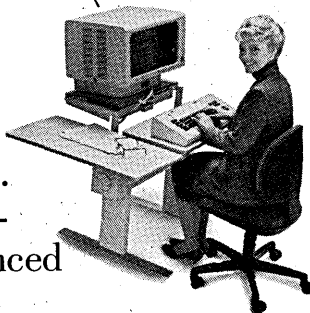

*free brochure about
IBM Office Sys-
tems, call your
IBM representative.
Clip the coupon. Or
call the IBM toll-free
number below.*

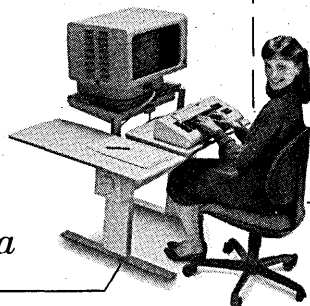
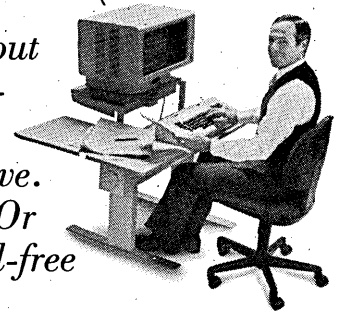

Free Brochure: IBM Office Systems

Write Today to: IBM, Dept. 7AG/522, 400 Parson's Pond Drive, Franklin Lakes, New Jersey 07417.

- Please send me a free brochure about IBM Office Systems.
 Please have an IBM representative call me.

NAME _____ TITLE _____

COMPANY _____

STREET ADDRESS _____

CITY _____ STATE _____ ZIP _____

BUSINESS PHONE _____

NY82

Call IBM Direct 1 800 631-5582 Ext. 82.
In Hawaii/Alaska 1 800 526-2484 Ext. 82.



TAKE CONTROL OF YOUR DATA!

FOCUS ON THE DATA INSTEAD OF THE PROGRAMMING.

Get the information you want, when you want it, without straining your regular data processing workflow...or waiting in line for IT to accommodate YOU!

FOCUS is the new, 4th generation language that makes the Information Center concept work. It lets non-programmers generate their own queries, reports, and graphs without waiting for professional programmers to "squeeze their jobs in...somehow." And it does it with simple English statements that you can put to work after only two hours instruction.

Thinking of implementing an Information Center? Start thinking of FOCUS. FOCUS reads all your data files...VSAM, QSAM, IDMS, ADABAS, TOTAL, IMS as well as stores data in FOCUS' own shared relational database structures. FOCUS helps programmers and non-programmers handle reporting and application requests in one tenth the time.

It's the most cost-effective way to get the most from your IBM or compatible mainframe.

For details, call the FOCUS representative at the IBM office nearest you, or write to Don Wszolek, Information Builders, Inc., 11260 Broadway, New York, New York 10001.

FOCUS

New York: (212) 786-4488
Washington, D.C.: (703) 276-9006
Dallas: (214) 659-9890
Chicago: (312) 799-0515
Los Angeles: (213) 615-0786
Palo Alto: (415) 824-9014

How one organization settled on some central controls for microcomputer purchasing and applications.

AUDITION FOR APPLES

by Jerome L. Doubler

A good portion of the growth in the personal computer industry over the last two years is due to the acquisition of microcomputers by large firms. Some of these personal computers are being acquired directly by the end users and without the participation or control of the MIS department.

Skyrocketing sales of equipment and thousands of commercially available software packages imply that personal computers have something good to offer. Yet, as the corporate door opens, some data processing managers are quick to jump up and close it. A dozen unanswered questions (straight from the traditional system development methodologies) remain unanswered: What about the cost? How is it justified? What about compatibility among multiple personal computers and between the personal computer and the mainframe? Is software sharing possible between the personal computers? What about sharing the personal computer? These managers also express concern over matters such as compatible operating systems, network communication protocols, capacity, and maintenance responsibilities.

In the fall of 1980, Owens-Corning Fiberglas, a major manufacturer of building supplies, found itself asking these questions. Its first step was to investigate how other companies were handling the introduction of the personal computer. A review of existing literature and discussion with industry groups, however, yielded few insights into how personal computers could function as business tools.

Owens-Corning Fiberglas offers data processing support through three data centers, each using large IBM mainframes. Its research and development facility in Granville, Ohio, the home of one of these data centers, offers interactive computing facilities via VM/CMS on its IBM 4341 and IBM 3031/AP processors. By early 1981, the Research and Development Center had received a suf-

ficient number of inquiries concerning the acquisition of personal computers that its computer services manager, Ken Hildebrand, recommended a formal pilot project be initiated. It was hoped that the study would determine the effectiveness of personal computers at Corning, and provide a base of information from which proper policies and procedures for the acquisition and operation of personal computers could be created.

Minis and microcomputers were already a part of the Research and Development Center. Dozens of them were being used to support laboratory equipment and experimental data acquisition. Many vendors were represented, although Digital Equipment Corp., Hewlett-Packard, and Texas Instruments were predominant.

The pilot project proposal met with mixed response. Several members of upper management encouraged such a plan and volunteered to participate. Others saw personal computers as potentially expensive toys and feared such a pilot project would open the door to uncontrollable propagation of personal computers. By February 1981, the decision was made to proceed with the pilot on a limited scale. Four Apple IIs were acquired through a local vendor. While several Apple IIs had already found their way on site prior to the pilot project, they were excluded from the study.

With a budget of \$25,000, the project began in mid-April 1981. Personal computers were assigned to a technology director responsible for one segment of the firm's basic technological research and development; a portfolio director responsible for one segment of the firm's business strategy as it relates to the research and development projects; an administrative services manager responsible for purchasing, receiving, and office services; and the computer services department.

Each participant was given the freedom to apply the Apple II personal computer in any manner he wished, the only constraints

being his time, his budget, and his imagination. Table I summarizes the configurations of the personal computers acquired.

The duration of the project was set at approximately 10 months, ending on Jan. 1, 1982. As evidenced by the participants, the study was limited to business and management activities. Scientific applications were excluded. Acquisition of additional personal computers at the Research and Development Center was prohibited until the conclusion of the pilot and the analysis of the resulting recommendations.

PACKAGE USES DEVELOPED

Purchased software packages were used to develop a variety of applications. Most of the applications can be grouped into three categories:

Spreadsheet calculation and data manipulation. The most successful package purchased was VisiCalc, which enables the user to prepare an electronic spreadsheet of data. VisiCalc saved hours of manual calculations. It gave each participant freedom to experiment with the data, knowing that he could interactively assess the impact of changes to variables without the time delay and effort normally associated with recalculation.

Specific applications supported in this category included cost/performance analysis, operation funding, technical project portfolio tracking, capital investment planning, manpower planning, ad hoc data manipulation, and the storage and manipulation of multiple tables of figures used in formal reporting.

Data management. Information Master was the most frequently used data management package purchased for the pilot project and ranked second only to VisiCalc as the most used software package. Advertisements for these types of products are sometimes misleading, since the phrase database management system is often used to describe them. While some true DBMS packages exist for microcomputers, none was purchased

Most users required an expert to assist them in solving the more difficult hardware and software problems.

during the pilot project.

Among the functions that benefited from the data management packages were project reporting by manager; project milestone tracking; database and statistics for calculators, dictation equipment, office supplies, and other inventories; and the control and mailing of telephone credit card reports.

Graphical presentation of data. Using VisiPlot and Apple Plot, moderate success was achieved in getting hardcopy of graphs. The quality of printed graphs was marginal if detailed graphs or a large amount of data were presented. Graphics were used in the presentation of United Way donations, job performance rating distribution, and cost/performance analysis.

The pilot project also included use of personal computers for word processing, electronic mail, and transmission of data to the mainframe computer.

One of the advantages of the pilot project was the fact that it enabled the department to establish some measures of the computers' effectiveness. The major objectives of the study were:

- To determine if inexpensive software for the personal computers can provide an effective alternative to the use of other resources (such as custom programming);
- To provide immediate computer support to areas of clearly identified need, but whose payback or priority was inadequate to justify immediate custom programming by the professional programming staff;
- To develop minicomputer prototyping capability in support of the development of more sophisticated central systems;
- To gain experience with personal computers that would lead to proper policies and procedures for their use.

For the purpose of evaluating the success of this pilot project, these objectives were translated into two categories: user related and technology related. To varying extents, all of the goals were achieved. Tables II and III provide a description of these goals and measures.

Overall, the participants judged the personal computer to be an effective tool for improving the quality and quantity of their work. It was encouraging to note the amount of excitement that could be generated by doing an old job in a new, more efficient way. There were other benefits as well.

Time savings were achieved primarily through the use of software packages like VisiCalc and Information Master. The technology director and the portfolio director used VisiCalc to monitor laboratory projects funded by other sponsoring divisions of the company. Changes in funding and movement of project responsibilities between laboratories were easily updated and reported. Prior to this study, the entire matrix of projects and

sponsoring divisions was retyped with each set of changes.

In administrative services, Information Master was used to keep a series of lists containing groupings of office supplies. On request, sorted reports by department, vendor, or type of product could be easily generated. Without the personal computer, information in this format was either logged and sorted by hand or was not available.

IMPROVED QUALITY OF DATA

Improved quality of information was the most frequently cited benefit. For example, the Research and Development Center has distributed storerooms containing office supplies and laboratory equipment. As a result of this study, a modest inventory catalog was created and is being maintained. The catalog indicates which storerooms carry each product, and also shows out-of-stock conditions, preferred vendor, and safety stock levels. The results are better control of inventory, employee convenience, and more effective ordering methods.

Participants found it relatively easy to learn to use the personal computers. They still required one to three hours of hands-on experience, however, to gain a basic understanding and up to 20 hours to become self-sufficient. Video games were an effective way to orient the new users, but they can be counterproductive if they are not carefully controlled. The amount of time required for participants to learn specific software packages ranged from one to six hours. Consultation with computer services and the local

vendor for both hardware and software questions was indispensable.

Participants ranked timeliness, availability, and reliability of the personal computer as generally higher than the mainframe for short jobs. Longer reports and sorting routines were an inconvenience. For example, printing of the store's inventory catalog required approximately 20 minutes per copy.

Equipment service calls were infrequent and the participants felt they had much better control over computer uptime. Very few hardware problems were encountered and no software bugs were reported.

Restrictions on applicability did surround the personal computer. Applications using data files with 50 to 700 records ran well; larger files generally resulted in slower response and marginally effective use of the personal computer.

The facilities engineering department was unable to use the Apple II for a materials control prototype because the system's 3,000-plus records made up a file too large for the machine. A system listing laboratory results of numerous chemical compounds could be run on the microcomputer but the data were judged to be too cumbersome to manipulate, sort, and print.

Two aspects of communications were enhanced. Participants found they had improved flexibility in presenting data visually. Graphs and a variety of textual formats offered improved quality and a reduction in preparation time. Text editors and the modem allowed both directors more flexible use of electronic mail through a dial-up communications network. Previously stored text

TABLE I

PERSONAL COMPUTER CONFIGURATION

HARDWARE

Apple II Plus with 48K memory
Pascal Language Card
2 disk drives with 1 disk controller
Paper Tiger 560G dot matrix printer with a parallel controller
Smarterm 80-column interface
Video monitor
DC Hayes micromodem
Super Mod adapter (interface to television set)

SOFTWARE

VisiCalc, VisiTrend, VisiPlot, VisiTerm
Information Master
DB Master
Data Factory
Data Master
Agenda File
P.I.T.S. (Pascal Interactive Terminal Software)
B.I.T.S. (BASIC Interactive Terminal Software)
GrafPak
Apple Plot

TABLE II

USER GOALS AND MEASURES

GOAL	MEASURE
Time savings	Is there an overall reduction in the time required to do tasks currently performed manually? How much?
Improved quality of information	Does the personal computer provide access to information not otherwise available?
Creativity	To what extent does the machine aid the user in developing new perspectives and ideas?
Ease of use	How long does it take to learn to use the computer and each of the program packages evaluated? How complete are the documentation and instructions provided by the vendor? To what degree is expert help required?
Timeliness	To what degree does the computer speed up the retrieval and sending of information, and help the user comply with deadlines and time constraints?
Applicability	What specific tasks can be performed more effectively with the help of the personal computer? Does it meet the needs originally identified? Does use of the personal computer suggest applications not previously considered? What are the specific limitations of use?
Availability/reliability	How reliable are the individual hardware and software components? How frequently do they fail? How rapidly can service be obtained? How much preventive maintenance must the user perform?
Communications	To what extent does the personal computer improve the user's flexibility in communication with others?
Overall Impact	Does the user view the personal computer as a net positive influence in doing his/her job?

TABLE III

TECHNICAL GOALS AND MEASURES

GOAL	MEASURE
Utilization	How much is the personal computer actually used? Is sharing viable? Does usage increase or decrease over time?
Prototyping	Is vendor supplied software useful in analyzing user needs? Does it help the user express his overall requirement in more concrete terms? Does it help the professional staff design more effective applications for the mainframe?
Security	What specific security issues are raised by the use of personal computers? How can these issues be addressed?
Data integrity/redundancy	To what extent are useful data isolated from general use? To what extent are data being duplicated by individual users?
Development alternatives	Is the use of vendor supplied software an effective alternative to custom system development? Is the use of a minicomputer an effective alternative to use of the central computer system? In what specific cases?

files and tables were merged and sent with the electronic messages.

Usage of the personal computer ranged from one to two hours a week by the portfolio director to two to three hours a day in the administrative services area. This depended on the participant and the application. At the end of each month there was an increase in reporting use.

Purchasing statistics were generated for the administrative services monthly report. The portfolio director applied monthly updates to project status files and forwarded the computer-generated reports to the sponsoring (funding) divisions.

Little prototyping was accomplished beyond the storeroom office supply inventory system in administrative services. Most applications placed on the personal computer remained on the personal computer with no immediate plans to replace them with a mainframe-based system. If replacement did occur, information about the personal computer system would be helpful in analyzing existing functions. Confidential data stored on floppy disks were handled in the same fashion as confidential data on paper. No security or data integrity issues surfaced.

SOME CONFUSION SURFACED

Some initial confusion did surface in administrative services. Several staff members used the same floppy disk for different files and different applications, and this sometimes resulted in a staffer not being able to get at a disk when he needed it. Eventually, each disk was limited to a single application.

Data redundancy was a dilemma. Accounting data were rekeyed from mainframe-generated reports into the personal computer, where they could be manipulated and reported in a method better suited to the participants' needs. Inch-thick reports were replaced with one page reports. While this was permitted in the pilot project, computer services prefers to avoid this redundant effort. More responsive mainframe-based systems and better communications network capabilities between the PC and the mainframe are expected to alleviate some of the problem.

Even with short-term data redundancy problems, the personal computer has proved to be an alternative to traditional system development methods—for specific types of applications.

The main conclusion drawn from the study was that the personal computer, in combination with software packages, is an effective alternative to the use of other resources, particularly custom programming, for a select group of applications. Recommendations made to the management of the Research and Development Center were:

- The computer services department should

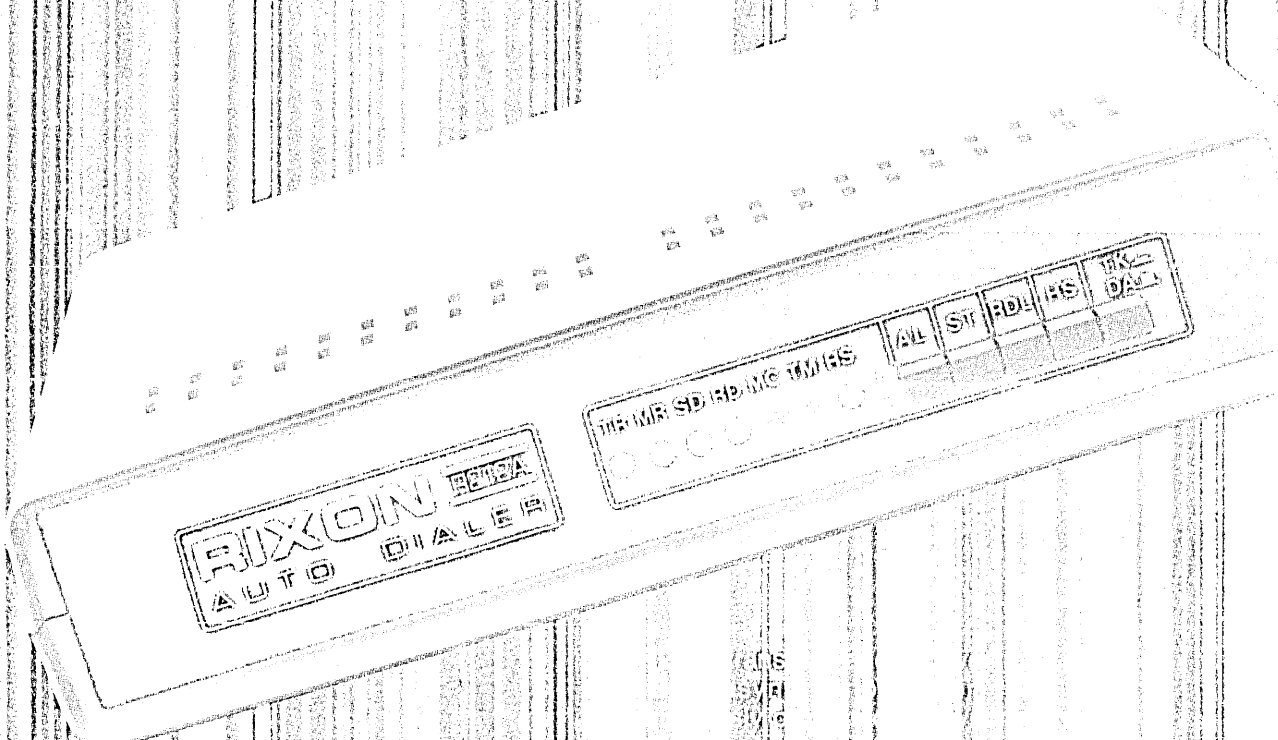

RIXON AUTO DIALER BETA

MR MR SD RD NC WMS
AL ST RDL RS

The level and type of control over personal computer acquisition depends on an individual company's policies and style.

act as a clearinghouse for information about personal computers. The study indicated that most users required an expert to assist them in solving the more difficult hardware and software operating problems. Experts are also needed to recommend the proper software packages and peripherals for a given set of applications. Moreover, a repository of information on industry trends, new products, common problems, and other personal computer applications is necessary, and this function is a logical extension of the services currently rendered by the computer services department.

- Together, the purchasing and computer services departments should establish guidelines for the future acquisition and operation of personal computers. This includes the development of a dynamic list of preferred vendors, configurations, software packages, and options for personal computers.

- The acquisition of personal computers should be permitted, provided the computer services department is consulted regarding the computing needs. Computer services should recommend the proper hardware, software, and peripherals. Acquisition should be coordinated through a central function. In order to ensure future compatibility among personal computers and provide adequate capabilities for future applications, it is advisable to have an expert analyze needs and available products before acquisition. The study indicated that while some users have a considerable understanding of computing concepts, the majority of users do not. Centralized purchasing also enables an organization to take advantage of the substantial discounts and service agreements available from local retail outlets.

- Authorization of funds to acquire a personal computer should be left up to the users. It was clear from this study that computer services can function most effectively if viewed as a consultant who wants to assist rather than a policeman who wants to enforce and restrict. A key ingredient to successful personal computing is the creativity of the user. By removing itself from the financial approval process, computer services can encourage novices to raise new ideas and applications rather than hide new packages or peripherals acquired.

- Custom programming for personal computers should not be offered, and user-developed custom programming should be discouraged. During the entire study, there was not one case where custom programming was considered necessary. The variety of software products available made it possible to avoid programming altogether.

Not all software products tested were of equal quality. For example, in administrative services, two inventory packages and two database packages were acquired before

one was found to be adequate for the inventory catalog. The average price per package, however, was \$150, making this a cost-effective approach. Such packages permit the automation of processes that would otherwise remain manual. Other examples of this are the graphical representation of job performance rating distribution for the technical director's staff (approximately 200 people) and the storage and reporting of monthly purchasing figures.

As a result of the study, a fair amount of centralized control over the acquisition of personal computers is planned at the Research and Development Center. This approach is being taken primarily because the center views multiple acquisition of personal computers as a significant investment, and because it is interested in future compatibility among personal computers and between the personal computer and the mainframe. The computer services department is acting as the clearinghouse for personal computer information. As such, it prefers to offer a maximum amount of personal computer effectiveness and flexibility with a minimum variety of hardware and software products.

Since this study was completed, several IBM personal computers have been acquired, primarily because of their increased RAM capacity over the Apple II and because IBM had announced that they would soon be capable of 3270 emulation. This, however, introduces incompatibilities. Software like Information Master, which runs on the Apple II DOS operating system, currently cannot run on the IBM. Similarly, a Baby Blue card has been purchased for the IBM to permit the execution of CPM-based software packages.

ONLY ONE APPROACH OF MANY

While the above approach appears to be a good one for the Owens-Corning Fiberglas Research and Development Center, it is not necessarily the best approach for other companies. The level and type of control over personal computer acquisition should be dependent on a company's organization, authorization policies, management style, computing strategies, and overall amount of centralized and decentralized decision making.

Other approaches to the acquisition of personal computers in business range from complete freedom to buy whatever type of equipment the requisitioner deems appropriate to refusal to allocate company funds for personal computers. Some firms treat personal computers like any other capital investment and control them at the site or divisional level. Others have the MIS department act as a clearinghouse: personal computers and related software are permitted but must be acquired through the data processing department.

This study was based on a small sample size, which is not statistically significant. Only four personal computers were analyzed, and the results and recommendations are not necessarily applicable to other organizations. This study, however, does provide some insight into the experience one organization has had in introducing personal computers into the business environment.

Because of the capabilities, user friendliness, and low cost of personal computers, it is easy to fall into the trap of viewing them as the solution to most end-user computing problems. This point of view is most easily assumed by the user, who can contrast an application quickly and successfully developed on a personal computer with several less than satisfactory systems that have been or are being implemented on a mainframe. All that can be said, in summary, is that each kind of computer has its place, and, while personal computers are the ideal solution for some applications, they prove to be ill-suited to problems that may require greater throughput, larger databases, multiple simultaneous users, or other enhanced computer resources.

As a result of this pilot project, the Research and Development Center has proceeded with the acquisition of additional personal computers. Intelligent selection, acquisition, and operation of the units are seen as the key aspects of proper control. Special sensitivity to the efficiency and effectiveness of each unit is emphasized to avoid emotional or status-based acquisitions, or purchase of unnecessary options.

Technology will continually change the optimal configuration for any given application. In 1981, the Apple microcomputer caught the attention of many prospective buyers. In 1982, the IBM Personal Computer received much notoriety. In 1983 and future years, the Apples and IBMs of today will be overshadowed by products offering bigger, better, faster, and less expensive capabilities. At the Owens-Corning Fiberglas Research and Development Center, a single department will serve as a clearinghouse of information on this rapidly changing field and will offer advice to users before hardware and software is purchased. Both the users and the organization should benefit from this arrangement. *

Jerome L. Doubler is manager of financial operations and controls at the Owens-Corning Fiberglas Research and Development Center. He was previously a laboratory supervisor in the mathematical and computer services department. He has an MBA in accounting and finance from Youngstown State, and a master's in applied mathematics from Ohio University.

How to declare your independence with TSI International...

the software company that gives you the freedom to succeed.

CASE HISTORY #2

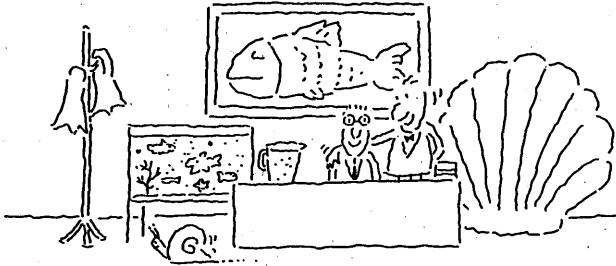

"Well, son, I'm certainly glad you decided to give up Marine Biology and join the family enterprise. And now, tell me, what do you think are the company's most important assets?"

"Data, sir," you say.
"No, no son. I'm talking about our buildings, our investment portfolios, our human resources..." "But sir," you say, "Most innovative CEO's are taking an asset management strategy toward corporate data."

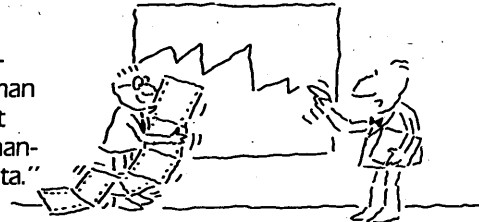

"If we had Data Catalogue 2, the data dictionary from TSI, we would have the most efficient way to manage our data resources and adapt our information systems to change. Even the federal government may soon require data dictionaries."



"And, Dad, with TSI's new FACETS package, we can even use our computer to create stable database designs. In other words, when it comes to data, we can maximize our return on investment."



"Son, he says, "I'm giving you the business."
"Dad," you say, "You've been doing that for years."

DATA CATALOGUE 2/FACETS the environment independent software that's upgrading computer systems around the world.

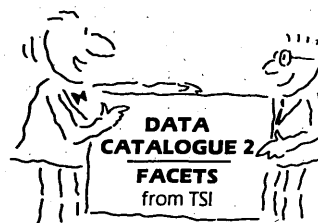

Call (203) 853-2884
for more information.

TSI International
division of National CSS

DB a company of
The Dun & Bradstreet Corporation

50 Washington Street
Norwalk, Connecticut 06854

DATA CATALOGUE 2 helps companies manage data resources with efficiency and cost effectiveness. And FACETS, the logical database design tool, creates and documents the system design process as it automates data modeling.

Declare your independence from outdated systems and let your company grow with software from TSI... a company of The Dun and Bradstreet Corporation. The source for KEY/MASTER™, DOCU/MASTER™, DATA CATALOGUE 2™, The Data Analyzer™ and FACETS™.

INTERNATIONAL EDITION

DATAMATION

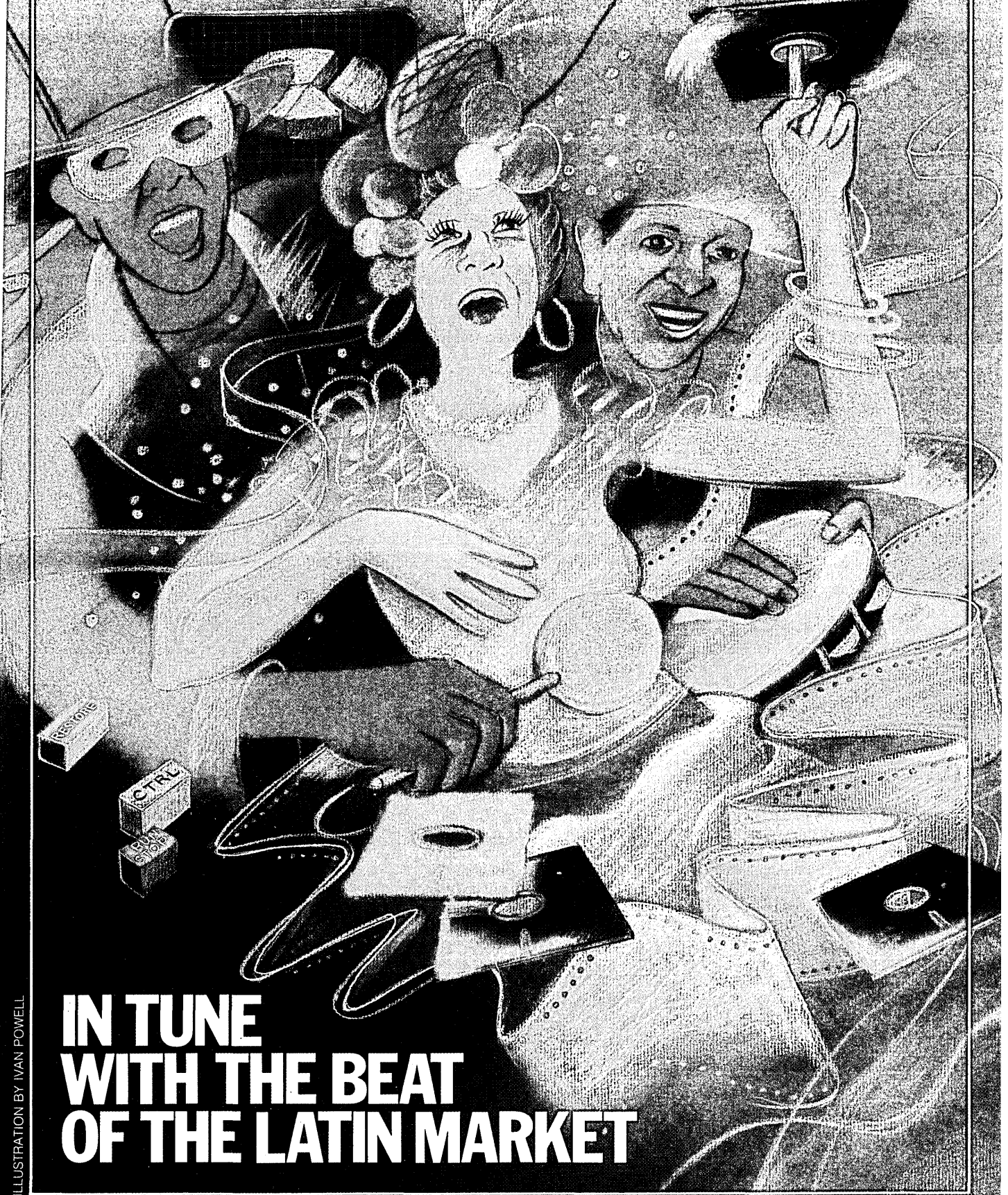

ILLUSTRATION BY IVAN POWELL

IN TUNE WITH THE BEAT OF THE LATIN MARKET

IVAN POWELL 1994

DATAMATION heads south to explore the problems and potential of one of dp's newest domains.

THE LATIN LOOK

by **Linda Runyan**
International Editor

"There are only two families in the world, the Haves and the Have-Nots." Over 350 years ago, one of Latin America's leading literary lights, Miguel de Cervantes, succinctly summed up the dismal state of his 17th century world. Today, the world hasn't changed much, except that now the Have nations of the globe have discovered a potent new El Dorado that could widen the gap between the prosperous and poor even further.

That new source of affluence is technology—computer and communications technology, which has done much to augment the riches of the world's industrial powers. The developing countries, immersed in the more pragmatic problems of mere survival, have been slow to recognize the potential power of information processing: Now they're waking up and beginning the search for their own technological fortunes and futures.

No Third World community seems as serious about this quest as Latin America. Plagued by innumerable political upheavals, the region has found itself in the midst of still another revolution—the computer revolution. The outcome of this bloodless battle, destined to be one of the most dramatic in Latin American history, will in large measure determine the fate of the young region for many years to come.

The stakes are indeed high and so are Latin American aspirations. All this comes at a time when the area is facing staggering economic problems—problems the governments hope to minimize in the long run through modernization of their societies.

Brazil, the jewel in the Latin American crown, has piled up a foreign debt of nearly \$80 billion, the second largest foreign debt in the world today. Not far behind Brazil, Mexico has run up a foreign deficit of around \$74 billion, which represents nearly one fourth of the total Latin American bill (\$290 billion).

These massive debts have troubled the Latin American nations that are also struggling to survive in domestic seas of red ink. This concern rapidly spread to the creditor countries, many of which were worried

late last year that Mexico and Argentina might indeed default on their loans, igniting a worldwide financial crisis.

President Reagan's trip to the Southern Hemisphere in early December could hardly be classified as a real rescue mission. While some stopgap funds were pledged to Brazil, the true purpose of the tour was to reassure the Latin Americans that Uncle Sam was still in their corner.

The financial malaise currently gripping Latin American countries shows no sign of letting up. It's also clear that these hard times will have a direct impact on the informatics industries that are still in their infancy throughout Latin America.

To better understand these and other issues affecting informatics development in Latin America, DATAMATION recently sponsored a round table discussion with some of the leading local policymakers. Conducted by DATAMATION's on-site representative, Marc Burbridge, the two-hour session provided a good forum for the exchange of ideas and information on one of the hottest topics on the Latin American agenda.

Like the rest of the world, these Southern Hemisphere nations view computer and communications capability—both in a production and user sense—as the vital ingredient in the recipe for economic and, ultimately, social success. But also, as in the rest of the world, the Latin American states have their own individual ideas on how to go about achieving that success.

As diverse politically and culturally as it is geographically, Latin America is by no means homogeneous. These contrasts carry over into the informatics arena. For example, while some countries such as Brazil and Mexico are active producers of dp hardware and software, others are still having difficulty becoming effective users.

In terms of market maturity, Brazil and Mexico are the most advanced. Mexico's market is only 1% of the American market, but that total is nevertheless one fourth of the whole Latin American market. Meanwhile, Brazil, the largest and mightiest country in the Latin American contingent, is ranked among the top 10 computer markets in the world.

Both nations want more. And they

believe they can get more by trimming the shares and the wings of the local transnational dp companies. To do that, these countries have tried to produce and service that own informatics wares—attempts that have so far met with mixed success. Following through on its plan to "Brazilionize" the high-tech industries, Brazil nationalized its minicomputer sector some six years ago. Now it looks as if the resolute nation is about to slap restrictions on outside micros and software. Mexico, seeming to emulate Brazil's get-tough stance, has tightened its dp import quotas and put the heat on computer makers to set up production facilities on its soil.

This movement toward protectionism, which is catching on in the world's leading dp domains, has also picked up steam in Latin America. The recession has certainly helped fuel this trend, but so too has the almost universal feeling of resentment that Third Worlders have against the "commercial" ways of the mighty multinational. In the eyes of the developing world, those commercial ways translate into exploitation, exploitation that once again pits the Haves against the Have-Nots.

So, while the countries in the Latin American sphere may be dissimilar in many ways, they all share virtually the same sentiments on the subject of nationalism. After years of watching their foreign currencies dwindle while their imports skyrocketed, these nations have mounted campaigns to build and bolster their fledgling industries, the informatics industry naturally being the most strategic and significant.

When you come right down to it, Latin Americans aren't really all that different from people the world over who want to reap the benefits of the information age. But Latin Americans are also ardent nationalists who are increasingly wary of this new "electrocolonialism" and more and more frustrated at the prospect of their prized sovereignty being eroded by dp technology.

In a general sense, the Latin Americans are still seeking panaceas for old problems. But in solving those old problems they hope to hit upon the formula for advancing their nations in the technological times ahead.

GETTING TOUGH ON TDF

No other country in Latin America is as independent-minded as Brazil. This independent streak is highly visible in the country's informatics and telecommunications sector, where hopes are high and local manufacturing low.

To build up domestic know-how and production, Brazil is doing everything it can to foster and further its own informatics interests. On the governmental front that translates into hard-hitting policies aimed at boosting the home team.

In the informatics arena, the interwoven issue of transborder dataflow (TDF) is a crucial factor in determining many of these policies. Brazil has indeed paid particular attention to this sensitive concern. All this attention culminated in a lengthy report that the country recently put together for the United Nations Center on Transnational Corporations (UNCTC).

In that landmark study, the most comprehensive effort to date on TDF, Brazil's statements cut right to the heart of the matter: "Since information resources are crucial for decision making and can be important sources of economic and political power, their location and use are of great significance. Brazil views the increased availability of information as an opportunity to reduce inequalities of power and to bridge gaps that exist between nations. Transborder dataflows via transnational computer-communications systems play a particular role in this process by contributing to the transfer of information resources such as computer hardware, software, databases, and information jobs."

Underlying all Brazilian guidelines in the informatics and telecom realm are four basic objectives:

- To increase information resources in the country, including dp systems, databases, and skilled jobs as well as telecommunications switching systems;
- To ensure local control over decisions pertaining to TDF and to master the relevant technology, especially that relating to network integration and management;
- To provide universal access to information;
- To promote the continuous improvement of the national, cultural, and political environment by appropriately utilizing available information resources.

Reading between the lines, some observers would dub these objectives protectionistic. Brazil doesn't deny this, but maintains its position is justified. The determined Latin American nation nevertheless is hardly alone in viewing information processing might as the key to economic security. In their report, the Brazilians are quick to point out that "the possession and capacity to utilize information resources are increasingly becoming a form of national power."

And that's power that Brazil, as well as the rest of the world, is desperate to

FIG. 1

BRAZILIAN TRANSBORDER DATAFLOW POLICY*

ON-LINE USE OF TDF	TYPE OF TDF	
	Corporate	Commercial
Data Communications	Person-to-person communications are not restricted	Brazilian PTT only; cooperation agreements possible
Database access	Copy of database in Brazil, whenever reasonable	Encouraged, but in cooperation with Brazilian institutions, preferably with copy of database in Brazil. If no local copy, services are provided by the PTT, although cooperation agreements are possible
Data Processing (including use of software)	Not favored abroad if reasonable local alternative exists	Not allowed abroad, except in exceptional circumstances

Source: Brazilian Special Secretariat of Informatics

*Regarding the criteria to approve individual leased voice channel links.

get. The linchpin seems to be transborder dataflows—or more precisely, the control of business transborder dataflows. To "manage" TDFs, Brazil requires a government okay on all telecom links for international data communications. In making the go, no-go decision, the authorities consider the type of TDF—commercial or corporate—and the use to which the information will be put.

For corporate transborder dataflows, "proposed uses of links for dp abroad are discouraged if reasonable local alternatives can be found or developed, even through the import of equipment." The report goes on to explain that "generally speaking, Brazil discourages TDF links used to switch, route, store, and structure abroad data generated in Brazil when the results are to be used domestically."

On a pragmatic level, the country encourages transnationals to use computer-communications systems that are more dis-

tributed. Philosophically, the nation's TDF strategy for transnational corporations is "to strengthen the capacities of foreign affiliates. . . . In particular Brazil seeks to increase the use of local inputs; to develop technology in the country; to enhance export activities; to improve the balance of payments; to raise the level and quality of employment; and to maintain an adequate degree of operational autonomy."

That's an extensive wish list—a wish list that once again underscores the zealous country's commitment to independence. In their thoughtful report on the TDF topic, the Brazilians reiterated their stand: "Transborder dataflows are a principal vehicle through which, in the long run, the geographical distribution of information resources—and hence knowledge and intelligence—is determined. For newly informatized countries, such resources are key indicators of economic and national identity."

—L.R.

SIEMENS

The Plug-Compatible Computer

As any user can confirm, it's not writing off the hardware that hurts when a computer system is changed - it's scrapping the costly software. Siemens System 7-800 makes such changes a thing of the past. This series of large-scale, plug-compatible computers lets you switch CPUs without wiping out years of software investment. Every computer in this series will run under the operating systems MVS, VSII, VM/370 and BS 3000. The 7-800s will also support your existing application programs and peripherals. And of course you can switch systems within this plug-compatible family without learning new user and programming procedures. Once acquired, your skills are reusable, computer after computer. So if pulling ahead of the competition is what you have in mind, put your workload on a powerful plug-compatible computer. You'll step up production, keep a tight control on costs, and enjoy total assurance of complete hardware and software service wherever Siemens computers are sold. Contact us for more information.

Info-Service (POM)

P.O. B. 156

D-8510 Firth

Federal Republic of Germany

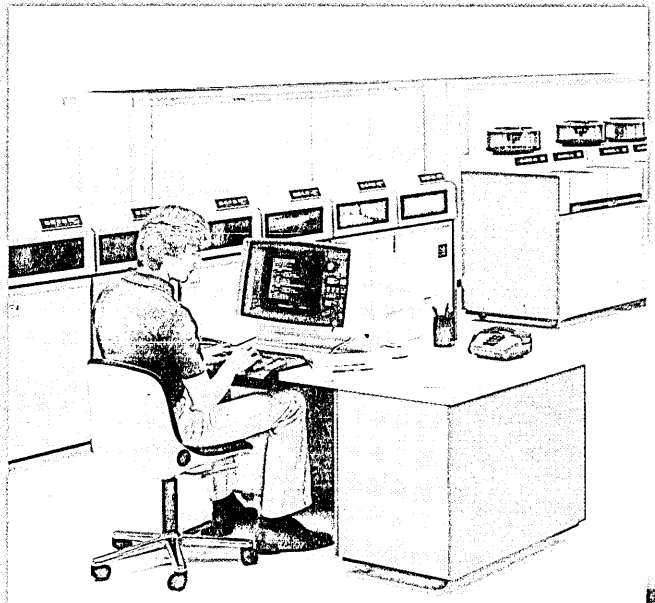

Siemens Data Systems
for every business, every task. 

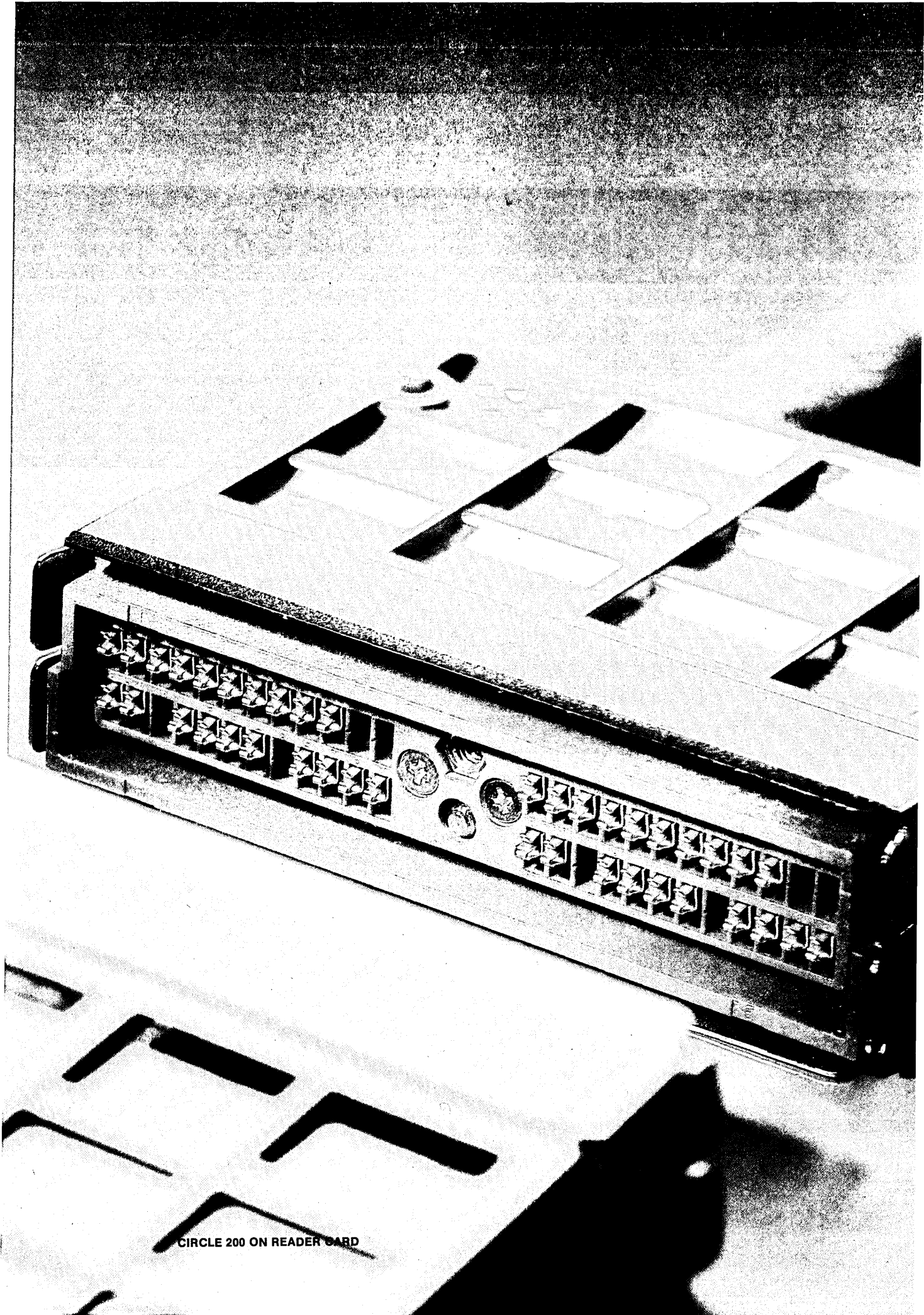

CIRCLE 200 ON READER CARD

The definitive
back-up solution

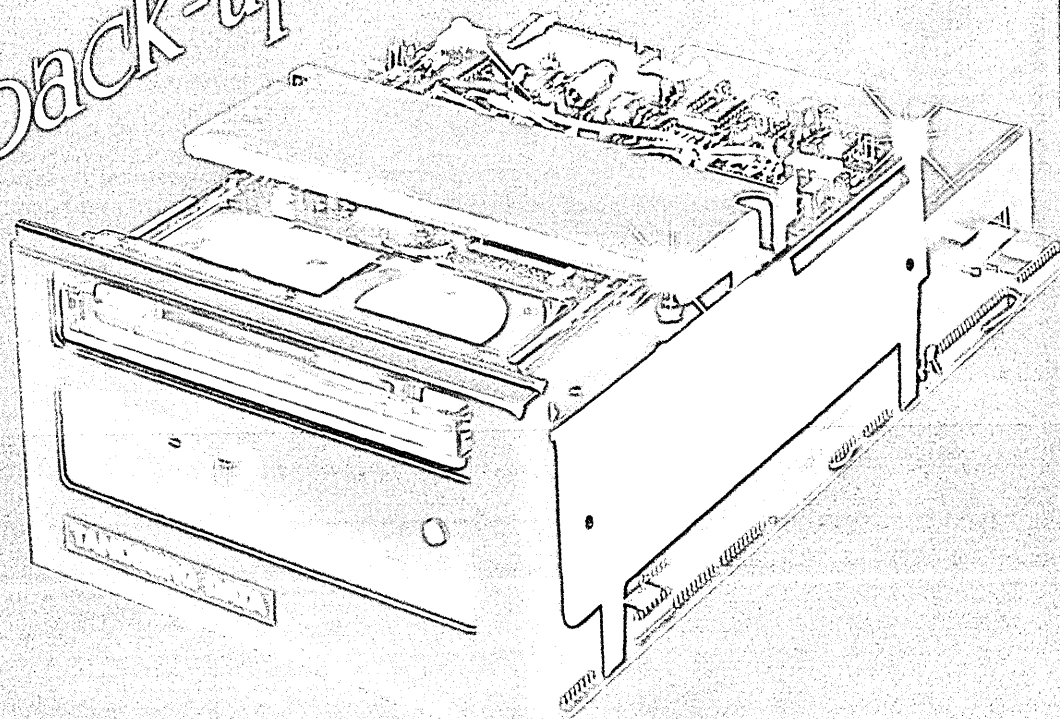

It takes less than 10 minutes
to store 40 Mbytes

TDC 3200 combines outstanding elements – in mechanism and electronics – in the best possible proportions to create results unlike any you have ever seen. Call it the closest thing to perfection ever designed for backing up Winchester disks.

TDC 3204 : 20 Mbytes @ 4 tracks

TDC 3214 : 40 Mbytes @ 8 tracks

– and with Industry Standard Interface.

- Standard cartridge, 450 feet
- 8128 dbpi, nominal density
- 4 or 8 tracks
- 90 ips read/write
- Serpentine track lay-out
- GCR coding
- 88 Kbytes/s data rate
- Selftest

**TDC 3200 (Backer™ among friends) –
A family of 1/4" Tape Cartridge Streaming Drives
for back-up of Fixed Disks.**

When you need a back-up device you can trust –
do not hesitate to contact us.

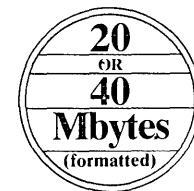

TANDBERG DATA

P.O.Box 9, Korsvoll, Oslo 8, Norway. Telephone (47-2) 23 20 80. Telex 17002 tdata n, Marketing/Service dept.
72633 tdata n.

CIRCLE 201 ON READER CARD

INTERNATIONAL
**DATAMATION listens to Latin leaders discuss their
informatics hopes and headaches.**

ROUNDUP IN RIO

by Marc Burbridge

On a bright hot day in Rio de Janeiro, top-ranking government officials from Argentina, Brazil, Chile, and Mexico got together at the Rio Palace Hotel, overlooking the famous Copa Cabana beach, to discuss some of the key issues in the Latin American informatics realm. Taking part in this exclusive DATAMATION round table were Vice Commodore Juan Manuel de Beverina, chief of informatics in Argentina's Office of Planning, Colonel Joubert de Olivera Brízida, president of Brazil's Special Secretariat of Informatics; Brigadier General José Mutis Puccio, president of ECON, Chile's national computer company; and Dr. Carlos Enriquez, Mexico's director general of informatics policy.

DATAMATION: What are the implications of computer technology on the future economic development of Latin American countries? Can they rationally absorb it?

Carlos Enriquez: I think that in Mexico the implications of technology that principally involve technological processes must be very carefully evaluated due to our present economic and monetary recession. It would be dangerous to think that these technologies could be important to future development only because of their effect on employment. I do not think that would be the answer. Only in the case of strategic industries should this type of technology be applied, if we do not want to aggravate the increasing unemployment situation we are facing, despite our use of more traditional technology.

DTM: In some cases, computerized numerical control has been said to result in productivity gains as high as 20 to 1. Is there any problem in delaying the absorption of this technology?

Joubert de Olivera Brízida: Yes, a problem exists, and I want to expand my comments to include office automation, which is parallel to industrial automation, and the cause of serious problems of unemployment. I feel that countries in our region should try to absorb industrial automation, being careful never-



theless to avoid the problems Dr. Enriquez explained. Brazil has clearly stated its own policy on these problems. If it is a question of doing business in international markets, where rigid control of quality is necessary and competitive international prices are required, Brazil will have to automate its production, which in fact is already being done in some fields. For that purpose, the Brazilian government, through its Special Secretariat of Informatics (SEI), is developing a special program of CAD/CAM, numerical control, and programmed controllers in order to penetrate the area of industrial automation.

As for the internal market, Brazil must make as much use as possible of available hand labor, which is the opposite of automation. In office automation, the problem is even greater since our countries have a large concentration of public employment. Therefore, if office automation is inadequately introduced, it could create an enormous social problem. Brazil is deeply worried about office automation invading the principal societies in the world.

Juan Manuel de Beverina: I think that somehow we must differentiate between the main trends and objectives. Office and industrial automation is a fact and we must admit that some day we will have it. The problem is how to achieve this goal. It will depend on the

internal situation—in other words, whether the government controls it—as well as on the external situation. These two factors will influence the solutions. If we are going to try to conquer an international market that demands a certain quality and price, we will have to adopt CAD/CAM or we shall not be able to compete. But that also depends on the labor force available in the country.

In Latin America, conditions are different. The same applies to office automation, but in this case it is an internal problem. If the office is not automated, I am governing in a less efficient way. On the other hand, if I automate the office, certain jobs will be eliminated and unemployment will increase. But I think in the end it will be necessary to automate, so that the government will be able to make better and quicker decisions through good and precise information.

DTM: What is the basis of concern over transborder dataflows (TDF)? What can be done to control them, and what would the effects be?

Brízida: I have the feeling that this question was directed at Brazil, because Brazil has, in fact, been quite concerned with TDF. Brazil has a relatively coherent and clear policy regarding this problem. For us, four basic principles govern our TDF policy. The first is that

"All the government should do is encourage local production and protect national manufacturers."

Brazil thinks that it should have within its own frontiers the greatest possible amount of information resources—that includes computers, software, databanks, and computing centers, as well as technical and management jobs. The second principle is that Brazil must control technologies and decisions on TDF in Brazil. The third principle is that Brazil wants to offer its society the broadest, most universal access possible to knowledge filed in large databases in the more developed countries. And finally, all Brazilian TDF policies are directed toward implementing and improving the culture and democratic regime of our nation.

As for what can be done by Latin American countries to control TDFs, Brazil cannot suggest what other countries should do. Brazil thinks that through data communications nodes and public packet-switching networks, it is possible to exert relative control, but each country in our region must decide the best way for itself.

José Mutis Puccio: TDF is a problem that greatly concerns Chile. We are now experiencing what could be called "one-way flow." During industrialization, some countries produced raw materials. These materials were sent to industrialized countries and finished products would return. Today, a similar, undeniable fact exists—countries produce raw data that are captured by very sophisticated systems that cannot be controlled by the country owning the data. These data flow out of the country and immediately come back transformed into processed or "finished" information that has to be acquired. We are, therefore, importing information.

This is what we call "unilateral data-flow." This phenomenon must be studied and somehow countries will have to begin developing their own database systems in order to participate in this interchange and prevent it from being unilateral. Evidently there is a danger to national security in this uncontrolled flow of data and it is necessary that each country establish regulations to ensure that its sovereignty will not be affected.

Enriquez: I think that the basis of concern is a real one. The implications and the mounting importance of TDF from an economic point of view cannot be overlooked. First, because we are talking of unfavorable transactions or interchange of information in the developing countries. The unfavorable terms of exchange that can exist in international commerce when the developing countries export raw materials in exchange for manufactured goods, can similarly be applied in TDF terms when data are considered raw materials. These raw materials or primary data from the developing countries are transferred to the developed nations at a very low cost or none



JUAN MANUEL DE BEVERINA

at all, only later to flow back and be sold as processed data at a much higher price.

There are other implications, such as the use of these dataflows by transnational companies for commercial transactions between their subsidiaries and home offices. On the other hand, there exists in developed countries, and in these companies, an active policy of free flow of information that translates into tacit opposition to any attempt made by any country to regulate that flow. Nevertheless, I think that regulation is inevitable, and an example of this is the outline of national policy prepared by the OECD for its members.

DTM: What is the government's role in the development and control of informatics, especially in regard to procurement of equipment and services for the public and semipublic sectors, training of dp personnel, and approval of hardware/software?

Enriquez: In order to make good use of informatics, the role of the government is very important—not only in regulating informatics, but also in stimulating it and giving it a proper orientation. Informatics began in Mexico not as a result of an autonomous decision, but when companies started selling informatics services. About 20 to 25 years later, the government realized it was important to regulate this activity. Acquisition of equipment and services is now being regulated by the Mexican federal government according to technical and financial needs.

As for dp training, we recognize that this is one of our major problems. We are trying to train as many people as possible, even those working in public administration, since many of them have practical experience

but no formal education in this field.

On the subject of hardware/software, there are two aspects to the problem. The first one refers to hardware and software that is marketed in Mexico by companies located in the country. Until now there have been no real limitations here. There is freedom to import new technologies and products. Perhaps later it will be necessary to review the situation to see if a changeover to other types of products and services is needed. We may, for example, have to invest not so much in the big computing centers created by the government, but more in minicomputers with distributed or autonomous processing.

A year ago, the Mexican government approved a program for local manufacturing of computer equipment and services. We now have 42 approved projects both from major multinational firms, as well as national companies. All this is subject to importation restrictions because of the difficulties our country is going through. More facilities, for example, are given to companies that manufacture equipment domestically, while fewer facilities are granted to those importing equipment.

Mutis Puccio: As to procurement of equipment and services, it is in the public sector that there seems to be a greater need for the government's coordinator role. On the subject of training dp personnel, one must make a distinction between professional education and technical training. In Chile professional education is handled by the universities through the Consejo de Rectores, where common programs are developed. Universities also give special brief postgraduate courses for professional improvement. Obviously the Ministry of Education also plays an important role in this field and in the supervision of training programs in the private sector. As for the approval of hardware/software, all the government should do is encourage local production and protect national manufacturers.

Brizida: I feel that the government must play a dominant role when you are dealing with such an advanced technology as informatics, which has so many strategic implications, including that of national sovereignty. Many countries have worked hard in this respect. The U.S., through its formidable power to subsidize R&D at private companies, was able to give an enormous impetus to informatics. Japan, thanks to massive investments and protection of its dp companies, was able to achieve extraordinary technical advances. Other developed and developing countries are also trying to establish this important industry. In this respect, therefore, the government's role must be substantial. One of the best ways to achieve this is to use governmental purchasing power in the way France does to try and develop national industry.



**WORLD'S SMALLEST
1/2" TAPE BACK-UP OFFERS
REEL ALTERNATIVE
TO THE
1/4" CARTRIDGE**

9800 

Providing low cost back-up for Winchester drives the miniature 2-speed EMISTREAMER 9800 is as easy to use as a cartridge, offers proven reliability and universal interchange.

The 9800 fits within a twin 8" floppy enclosure and automatically loads the standard, multisourced 7" reel of 1/2" wide computer tape. The unformatted capacity is 15 Mbytes at 1600 bpi, PE, optional 30 Mbytes at 3200 bpi. With full IBM/ANSI format compatibility the world's smallest standard 1/2" tape drive with industry standard interface is the REEL alternative you have been looking for.

Also in the EMISTREAMER range are the autoloading 9900 with total capacity of over 60 Mbytes (120 Mbytes optional) and the high performance 8900. These low cost streamers provide reliable data interchange between the smallest micro and the largest mainframe. Contact us now for full details.

9800 is designed for high reliability—practical features include:

- Short tape path
- Autoload
- PCB access from the top
- Three levels of diagnostics
- Alphanumeric display

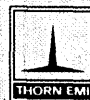

**THORN EMI
Datatech**

THORN EMI Technology Inc. 8601 Dunwoody Place Suite 301
Atlanta GA 30338 tel: (404) 587 0017 telex 810766 2267

In Europe contact:

THORN EMI Datatech Ltd Data Products Division Spur Road
Feltham Middlesex TW14 0TD England. tel 01-890 1477 telex 23995

THORN EMI companies

EMISTREAMERS FOR BACK-UP PLUS UNIVERSAL DATA INTERCHANGE

"The only possibility of developing a microelectronics industry would be at the Latin American level."

In the area of dp training, the government also plays an important role. In Brazil we do it through our principal dp agency, SERPRO, which not only does dp but also trains people who will go on to work in the Brazilian dp industries. With regard to hardware/software, the Brazilian government has tried to obtain a genuinely national industry—a goal that we currently consider to be both a necessary and coherent approach.

Beverina: Argentina shares all the opinions that have been expressed until now. We are, however, currently changing our policies on government acquisition. In the beginning we had to manage with the few technicians that we had. We are now trying to counteract the attempts by big multinational companies to place large amounts of equipment, regardless of real market needs. I think that we have now reached the first stage, since we already have technicians capable of determining our real needs.

The government is now studying not so much the problem of hardware, but of systems. We are not interested in knowing what processor or what peripheral each department is going to use. Instead, we want to know about their three- to four-year system plans. Therefore, I think that governmental intervention depends a great deal on the status of the internal organization and personnel training. The government provides subsidies when the upper levels do not fulfill their mission and the lower levels cannot act independently.

DTM: What is the current trend in Latin America toward regional cooperation in informatics? What will be gained from this cooperation and what are the barriers to it?

Beverina: I take it for granted that we need to have regional cooperation. Should any of our countries want to develop a hardware or software industry of its own, it will find that the market is small—that the industry requires very few people to obtain a high level of production that far surpasses the country's needs. All this forces us to think in terms of regional markets. It forces decisions to be made by the governments of the region, not be imposed by multinational companies. It will also force the governments to decide who will do what in order to act in a multilateral way, enabling us to come into the market with products that have been the result of the joint effort.

Enriquez: I think that the present situation in regard to cooperation would be really disheartening if we did not take into account two facts: that Latin American is a market dominated by the multinational companies, and that each Latin American country is trying to



JOUBERT DE OLIVERA BRÍZIDA

reverse this trend, given its own capabilities. Commodore Beverina put it very well when he said no national market is big enough to absorb this kind of industry, so we should begin by reviewing the conditions of the basic microelectronics industry.

Recently a meeting was held in Mexico City to analyze the implications of microelectronics. The conclusion reached was that currently the only possibility to develop an industry lay in creating a regional enterprise, formed by all the countries ready to consider the Latin American market as a whole. Such an arrangement would have to be based on bilateral agreements, beginning with decisions on complementary production of such items as software, where a large market exists. I think that all our markets are established more or less on the same scale and, based on our mutual capacity, we could think of the possibility of cooperation.

Brizida: I agree with what Beverina and Enriquez have said, but I want to add that the sixth Congress of Latin American Authorities in Informatics (CALAI) will mark the start of more effective cooperation in informatics in our region. CALAI will be an adequate forum for our countries, each of which is in a different stage of development in informatics.

DTM: How is this rapid trend in microelectronics development viewed? Does it represent a threat to technological development in Latin American countries?

Brizida: Microelectronics is the basis of informatics. There has been a worldwide tendency for manufacturers of finished equipment to expand vertically, transforming themselves also into producers of components. They manufacture microelectronics components with all the features, all the firm-

ware, all the technology implanted in that small chip, and then the equipment grows around that chip.

But recently we have observed the opposite trend in the world. In the U.S., manufacturers, especially big ones, are avoiding the custom-made approach. Instead, they are using shelf or common components in their equipment. They are no longer making special components for the equipment. This is done to obtain lower and more competitive products.

At any rate, microelectronics is at its peak. Brazil recognized the necessity of acquiring know-how for some microelectronics technologies. We do not intend to dominate all these technologies, since I don't think any country can master all of them. But we do want to dominate certain areas, and to this end, the government has provided funds to create the Institute of Micro-Electronics in Campinas, to establish pilot manufacturing programs to help the two Brazilian companies that are going to work in this field.

Enriquez: I want to emphasize that as long as microelectronics is an important element in increasing productivity, the chance of having a competitive export industry is very small. On the other hand, we must not be too concerned when internal consumption is not based on the most advanced technologies. The current economic situation that will probably extend into the near future obliges us to revise our views on the need to have the most advanced technologies at our disposal. This especially applies to electronics.

In Mexico free importation of goods causes us to import the latest technologies at the consumer level. If we already had an infrastructure, we would have to keep it going, creating a national industry for that purpose that would probably face increasing difficulties incorporating microelectronics as a key element in productivity. As long as there is a real difficulty keeping an export industry based on the use of microelectronics going, we will have to turn to national industries, even if they do not have these types of electronic components. On the other hand, I think that the only possibility of developing a microelectronics industry would be at the Latin American level.

DTM: What is the state of the art in Latin American informatics and what are the prospects for Latin nations to act not only as recipients of technology, services, and equipment, but also as suppliers?

Enriquez: Compared with the latest technologies, the state of the art in Latin American equipment is relatively poor, since we basically have been importers. I think that our possibilities are based on our real capacity for assimilating technology via effective transfer

The world's most memorable flexible disc.

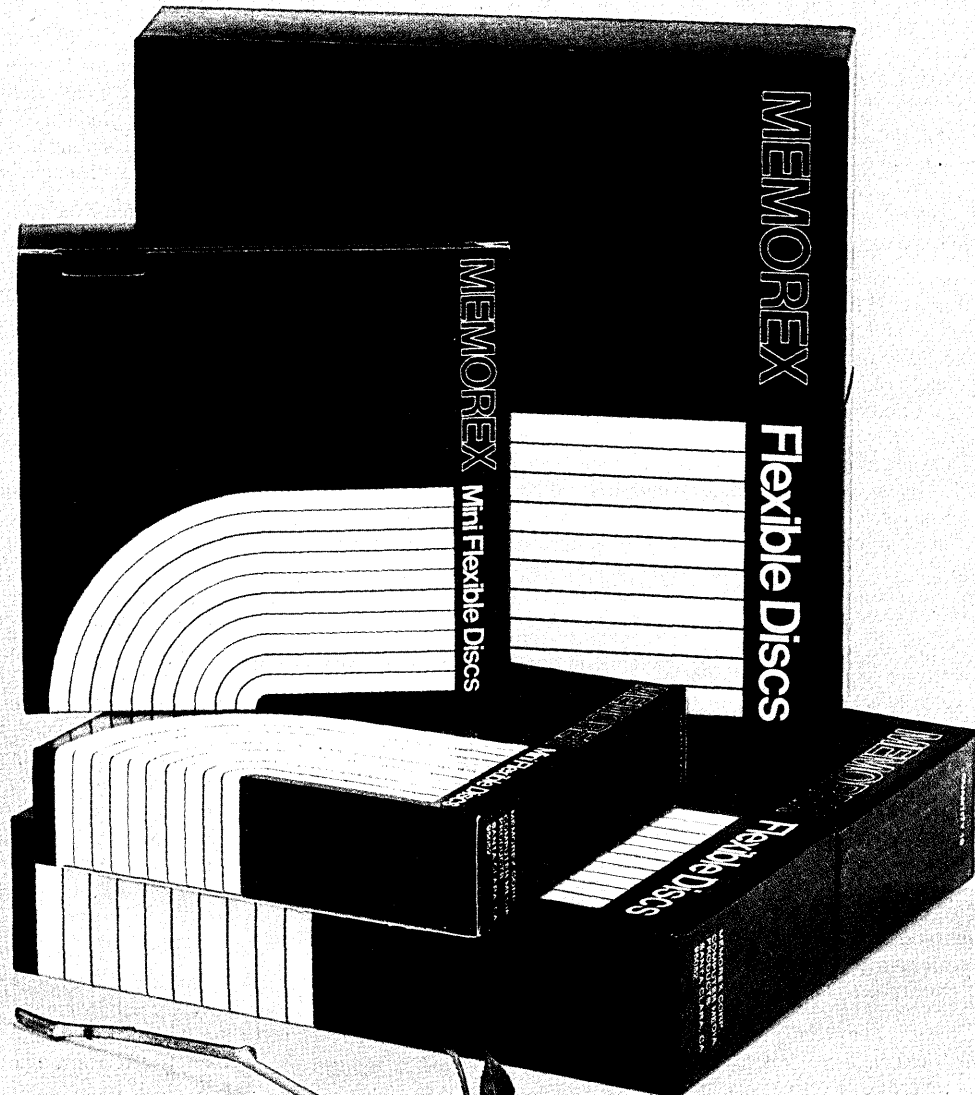

Memorex International, Hounslow House,
730 London Road, Hounslow, Middlesex, U.K.
Tel: 01-572 7391 Tlx: 938795

MEMOREX

A Burroughs Company

CIRCLE 203 ON READER CARD

"In Argentina we believe that an industry begins in the engineering department."

processes. It is not only a question of buying and using technology, but also a question of being able to modify it and use it for specific purposes. In Mexico some companies have bought technology and are now suppliers of terminals. One government department, wanting around 6,000 terminals, bought them from a Mexican manufacturer that had previously acquired foreign technology. That is a good example of our capacity to begin handling this technology. Nevertheless, the possibilities of doing the same thing with more sophisticated equipment are still very limited.

Brízida: With respect to the state of the art, I certainly agree with Dr. Enriquez that the actual state of Latin American technology is backward. But now I would like to say something on a Latin American level based on the Brazilian experience. We in Brazil feel that we must not desperately run after everything new that is produced in other countries. We feel that for a certain period of time, our country can live with a technology that's adequate to our needs. By keeping up-to-date with what is happening elsewhere, we can try to bridge the gap later on to attain a higher technological level. In this way, the technological gap can be maintained at a constant level.

We believe that the continuous and undisciplined search for every innovation that appears in developed countries will only bring frustration and widen the technological gap. I think that Latin American countries, and excuse me for suggesting something in the name of the whole region, can live with technologies that permit them to achieve an adequate level of development.

DTM: What kind of industrial policies and backup investments are being devoted to building up the informatics industries in Latin American countries?

Enriquez: When the development program was conceived in Mexico, there was a big need for collateral investments (especially in the area of spare parts) to ensure equipment manufacturing. A search was made throughout the local electronics sector to find which establishments could back up the governmental program. These companies would be subject to a special stipulation that a large percentage of the capital be Mexican. Some problems appeared, however. Few of the electronics companies had an adequate base. In Mexico the quality control systems needed by the companies that were going to manufacture the equipment did not exist. The possibility of obtaining a high degree of national integration was also limited. Considerably bigger investments than those imagined at the beginning of the project were needed.

Apart from investment in industry,

the development program also requires an investment in human resources. The program, for example, will need to recruit technicians from the manufacturing sector since there currently are not enough qualified personnel. Large complementary investments are also needed. So, in order to avoid stopping the development program, we have accepted the fact that external help for technical support and research and development is needed.

Brízida: Investing in informatics is an expensive proposition. The U.S. does it through large government contracts. Japan also invests a lot of money in this area. Unfortunately, Brazil is going through an economic crisis that does not allow the government to invest as many resources as it would like to in informatics. As a result, all of this effort being carried on in Brazil is being paid for, in part, by the consumer. Brazilian consumers are currently paying higher prices than those set by the international market. But prices are coming down every year, and I hope that in a short time we will be operating on a par with international prices. For the time being, the two actions our government has taken to support this market involve protecting the internal market, and financing the purchasing and selling of equipment.

Beverina: In regard to national industrial policies in the informatics industry, I only want to add that in Argentina we believe that an industry begins in the engineering department and not at the manufacturing level. That is to say, we consider an industry to be national only when truly domestic engineering goes into the development of the final product. This does not mean that in the first stage we do not buy a license or emulate foreign equipment, but basically we aim for national

engineering to be the first stage in the manufacturing process.

Mutis Puccio: Chile's internal market is small; therefore, we do not consider it important to develop a national industry in this area. Our government has asked foreign companies to participate in joint ventures, where they must meet preestablished conditions and assume the market risks. Nevertheless, our government has established policies to create a software industry. This software, which we have been selling to other countries, is manufactured with national engineering.

DTM: How much impact does the current economic situation have on the strategic plans of Latin American countries in the informatics area? To what extent do international financial pressures influence national informatics policies?

Beverina: The present economic situation must not be the reason for limiting an informatics or informatics industrialization plan. Every plan is long range—a strategic policy of five or six years. But it must not worry us if we do not have a long-range policy. It will take us longer to get there, but we must have a very clear picture of the need for industrialization. I think that it will take longer, somehow, to obtain that industrialization level due to the fact that we are going through a bad international crisis. To what extent do international financial pressures influence national informatics policies? I think that we must face things very directly. If I am interfering with the international market of a transnational company, pressures will exist because, if I am going to get a part of its market, its government will defend it by exerting pressure on me. Governments will have to clearly outline their policies; they will have to state their policy and then move forward.

Enriquez: The first part of the question is very clear in regard to Mexico. The actual economic situation of our country will definitely affect informatics. From 1978 to 1981 we had accelerated economic growth. The development of informatics had a very wide market, due not only to the rapid economic development, but also to a free import policy. A year later we have the opposite situation. Serious difficulties in paying our debt have led to exchange controls, a shortage of import quotas, and a reduction of government expenditures. All this will affect the growth rate in the near future, and therefore, we shall have to make better use of the resources we already have. The small import quota will first be used to acquire necessary spare parts to maintain the already existing systems and equipment. The imports will then go toward supporting our development programs and any future needs of the companies working on these programs.



CARLOS ENRIQUEZ

How you can save up to 80% of your costs.

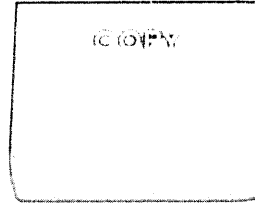

"If the technology-rich nations want to help us, they must start in the field of education."

Brízida: I am optimistic as far as Brazil is concerned, although we cannot ignore the fact that the international economic situation is difficult. Next year Brazil is going to face a period of limited importation and an effort in exportation will have to be made in order to improve the balance of payments. This is positive for the Brazilian informatics industry. If we can not import, we shall have to produce it locally, and this is very good for the Brazilian informatics industry.

Mutis Puccio: Chile has naturally felt the international recession. In our country we must first try to solve the more pressing social problems, which leaves informatics development, at least for the time being, in second place—slightly behind the other countries. I think that the recession will slow down but never stop the development of national informatics.

DTM: What is the role of technologically advanced countries in the development of informatics in Latin American nations? How could North-South relationships in this field be improved?

Beverina: I think that the term "cooperation in informatics" with technologically more advanced countries is included in the agreements of general cooperation already signed and established between developed countries and developing ones. If the more advanced countries want the developing ones to attain better living standards, they will have to make informatics development take place in the quickest way possible and at the lowest possible cost—that is, if they are really interested in our advancement in this technology.

In order to master an advanced technology, an broad base is needed, not only in material resources, but in human ones as well. It is a technology that cannot stand alone as if it were a tower in the middle of the desert. This technology needs to be accompanied by development of the whole community, of the whole industrial complex—development of the human context upon which it feeds. If technologically advanced countries really want the development of our countries, they should not send us modern equipment that costs more each time, thus creating an even greater dependency. They will have to make a real commitment to helping our nations conquer the technology in order to reduce the existing gap between countries that have advanced informatics cultures, where full use of new technology is possible. That is why I agree with what Mexico said about not desperately running after the latest technology, but only after the technology that our countries—in a different cultural context than the Northern ones—need.

I think that if the technologically rich nations want to help us, they must start in the

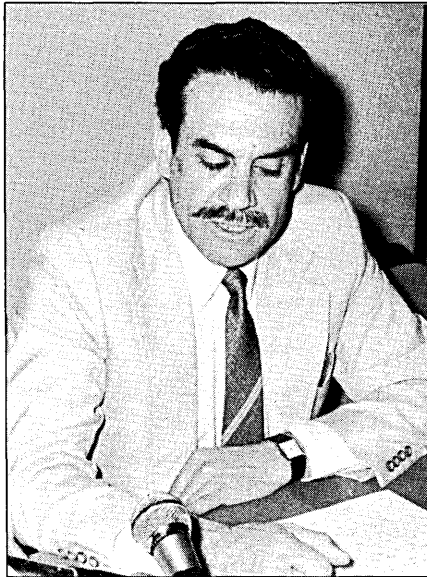

JOSÉ MUTIS PUCCIO

field of education. If in 20 years we do not get positive results, we will find ourselves in a worse situation than the one we are in today. My question is, where will the children who are six years old today find themselves in the year 2000? If I do not begin to educate them to think more clearly, so that they will have more information and therefore arrive at more logical and correct answers, will those children end up trying to absorb a technology being imposed on them by the Northern countries? I think that it is the duty of each country to try to offer in the informatics teaching area—more in software than in hardware—the best possible means of creating an educational plan that will allow these six-year-olds the possibility of obtaining a better education than the one we had. In this way, our people will be able to make better decisions. Therefore, it is in the field of education that developed countries must help us to make future generations better than we are.

Enriquez: The informatics market in Mexico is supplied mainly by American companies. Many times these companies have sold equipment and systems that, if analyzed from the Mexican point of view, would have proved to be unnecessary. This has caused us to underutilize the equipment.

Companies in other countries that have tried in vain to conquer Mexican markets have suffered very unfortunate experiences. Distance and transportation costs were some of the reasons why they could not enter our market. I believe that cooperation has been difficult because commercial interests have prevailed over any desire to make a real effort for mutual cooperation. I, therefore, believe that there is a truly open field for cooperation if the idea is really to create ef-

fective technology transfer programs that are aimed at supporting mutual concerns and not simply the interests of commercial enterprises.

Brízida: I have little to add on this subject since I entirely agree with what Colonel Beverina and Dr. Enriquez have said. In finishing I would like to state that the role developed countries can play in Latin America is a very big one, not only through cooperative agreements at the government level, but also through the operation of transnational companies that maintain subsidiaries in our countries. We think that those transnational companies should partly redirect their operations so that while still maintaining profitability, they also adopt a philosophy that is not so short term. In other words, they should try to give to their subsidiaries in our countries greater technological capacity and, indeed, some autonomy in decision making. Only in this way will these companies leave a technological legacy in our countries. Concerning North-South informatics relationships, it is necessary that the exchange of information and experience be increased. The North-South dialog on informatics technology is still very limited. It is essential that we know more about what is happening in developed societies, and that they know more about us.

Mutis Puccio: I also agree with what has already been said, but I think that the question should be reformulated because at the moment the role of the developed countries is in the hands of the multinational companies. That is to say, it is not the country that plays the role, but rather the multinational companies operating in our countries that play the role. Naturally, these companies must be profitable, otherwise there would be no sense in them functioning as commercial enterprises. They are the suppliers, and only rarely will they diminish their profits to benefit the country where they are operating.

With respect to the developed countries themselves, I would say that if they want to help us they should first get acquainted with our reality since they, in fact, do not know it. I believe it is most important that the technologically advanced countries understand our reality as a basis for communications. Secondly, they must recognize our achievements, because important ones have indeed been made in Latin America. It is necessary that developed countries recognize these achievements so we can communicate and negotiate with them on an open and equal basis. *

General manager of MB Consultores Associados S/C Ltda., São Paulo, Marc Burbridge provides informatics consulting services to the government and private sector.

Just press this button.

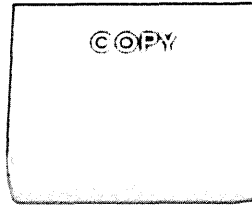

COPEX LK P Microfilm prints on plain paper.

Better quality needn't cost more.

Plain paper copying is invariably more cost effective. The COPEX LK P runs on completely standard plain paper. The advantage is that it responds to extreme demands with precision. Giving the same quality as the original. However, the unusual feature of this system may be of particular interest to you. Since expensive specially treated paper is not needed, you save up to 80% of your copy costs.

More automatic. Better performance.

You don't have to be an expert to make excellent copies with COPEX LK P. Everyone finds it easy. Automatically. Even first time users. And because it's uncomplicated and reliable, it's faster and more efficient. And cuts out waste. It reads all film formats (A6 to 18 x 24 cm), roll films and jackets. And it copies any image onto plain paper with pinpoint accuracy. From microfilm masters. From diazo or from vesicular duplicates.

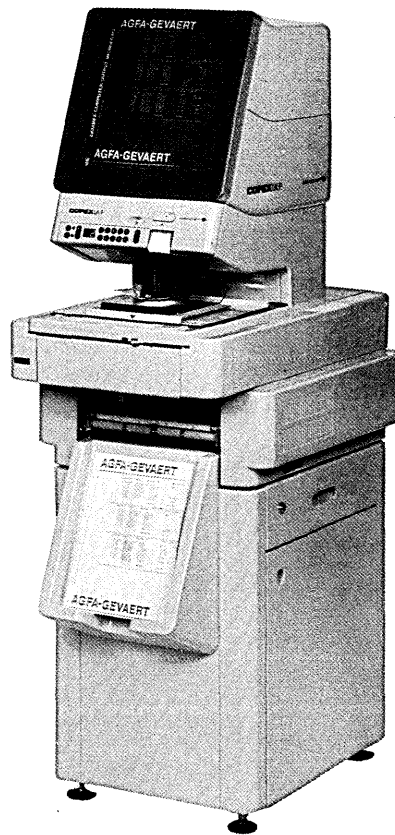

Clear control.

You don't have to guess your way around the controls. All important functions are microprocessor controlled. You see the operational status on the electronic display. For example when paper must be added. Plain paper of course!

The COPEX LK P. A high quality desk-top unit.

Certainly the top of its class. An award winning reader design and the latest plain paper copy system. Ideally matched. The cost savings are outstanding. Even more outstanding is the performance. Everything it is asked to read, it reads perfectly. It copies onto plain paper perfectly. Onto offset masters. Onto overhead projection slides. From positive film. From negative film. With lenses from 17x to 48x magnification. And since the COPEX LK P is superbly styled it has been dubbed the "Industry Good-Looker"*. All these features make the COPEX LK P a gilt-edged investment. We doubt if you can find a better cost/performance ratio.

*Design award Hanover Fair

AGFA-GEVAERT



Coupon: If you would like to know more about the COPEX LK P and its advantages send this coupon to: AGFA-GEVAERT N.V. - Office Systems Division Microfilm Department - Grote Steenweg 224 - B-2600 Berchem Belgium.

Name _____
Company _____
Tel. _____
Street _____
Postal code _____
Country _____ Town _____

CIRCLE 205 ON READER CARD



Technology taken for granted

Why Masako Morita never stops to think of Fujitsu

Masako Morita is a demographic analyst in the Tokyo offices of a major Japanese market research company. Independent, confident and in love with her work, she is a representative example of the up and coming younger generation in Japan, a generation that is leading a life their grandparents could never have imagined. It is a life made possible not only by the economic progress of Japan but also by the technological revolution that in the past thirty years has shifted the very foundations of the country.

Technological Giant

One of the greatest technological giants of modern Japan is Fujitsu, Ltd., which is the country's number one computer maker and also a world leader in telecommunications

technology. Fujitsu makes products that in one way or another affect virtually every facet of Japanese society. In Japan, the company is a massive presence.

It is a largely invisible presence too, because so many of its products form the unseen underpinning of an advanced technological infrastructure. Everyone in Japan knows the name Fujitsu, but few are aware how closely and constantly Fujitsu touches their everyday lives. Masako Morita herself was unaware, until we brought it to her attention. And through her, we would like now to bring it to your attention; in the next two pages we would like to take you through a typical day in her life, so that you can see just what Fujitsu does for her. And also see how someday we might be of similar service to you.



7:15a.m.

Over a cup of coffee Masako reads the morning paper and glances at the weather forecast on TV. The weather report is brought to her by a satellite-linked Fujitsu computer system. Another Fujitsu computer system sets the type of the newspaper she reads.

(Please turn page →)

FUJITSU

Fujitsu Limited · Tokyo, Japan

**Japan's number one computer maker.
And a world leader in telecommunications technology.**

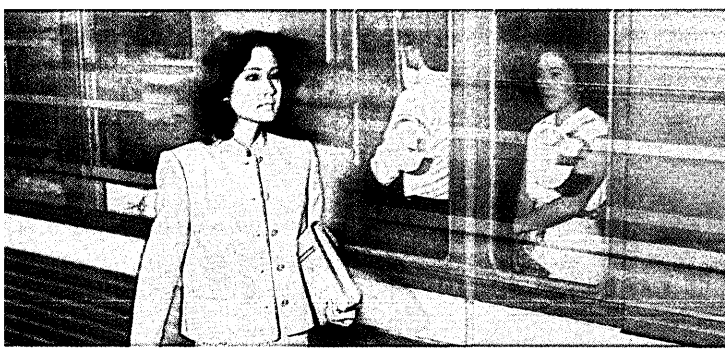

8:00a.m.

Masako prepares to board the subway for the commute downtown. The subway train she rides is controlled by a lightwave communications system incorporating computers, a system that was developed by Fujitsu.

10:00a.m.

Masako studies a computer printout in her company's data processing center. The large-scale computer system in this center is a Fujitsu system. And upstairs in her office are several Fujitsu personal computers. There are also a number of Fujitsu word processors, and five Fujitsu facsimile systems. In addition, the office telephone switching system was made by Fujitsu.



12 noon

Masako lunches at a French restaurant with two business colleagues. The restaurant is in a building whose ambient temperature, electricity, water supply, air flow, etc. are automatically controlled by a Fujitsu building supervision system, a system that ideally integrates both computer and telecommunications technologies.

5:45p.m.

After work, Masako drops by a "banking corner" to pick up some money for a little evening shopping. Her account is with the branch of a big bank downtown, but she can withdraw cash almost anywhere in Japan from computerized cash dispensers located in hotel lobbies, train stations, department store vestibules, and on street corners. This enormously convenient system is made possible by a nationwide online banking network that ties together Japan's major banks. A system that was largely designed and installed by Fujitsu.



6:30p.m.

Masako buys a present for a friend at an uptown Harajuku boutique. The boutique is equipped with a Fujitsu point-of-sale (POS) terminal system, which not only functions as an electronic cash register, but also – through an interface to a Fujitsu computer – automatically monitors inventory and provides a statistical printout on product movement and flow.



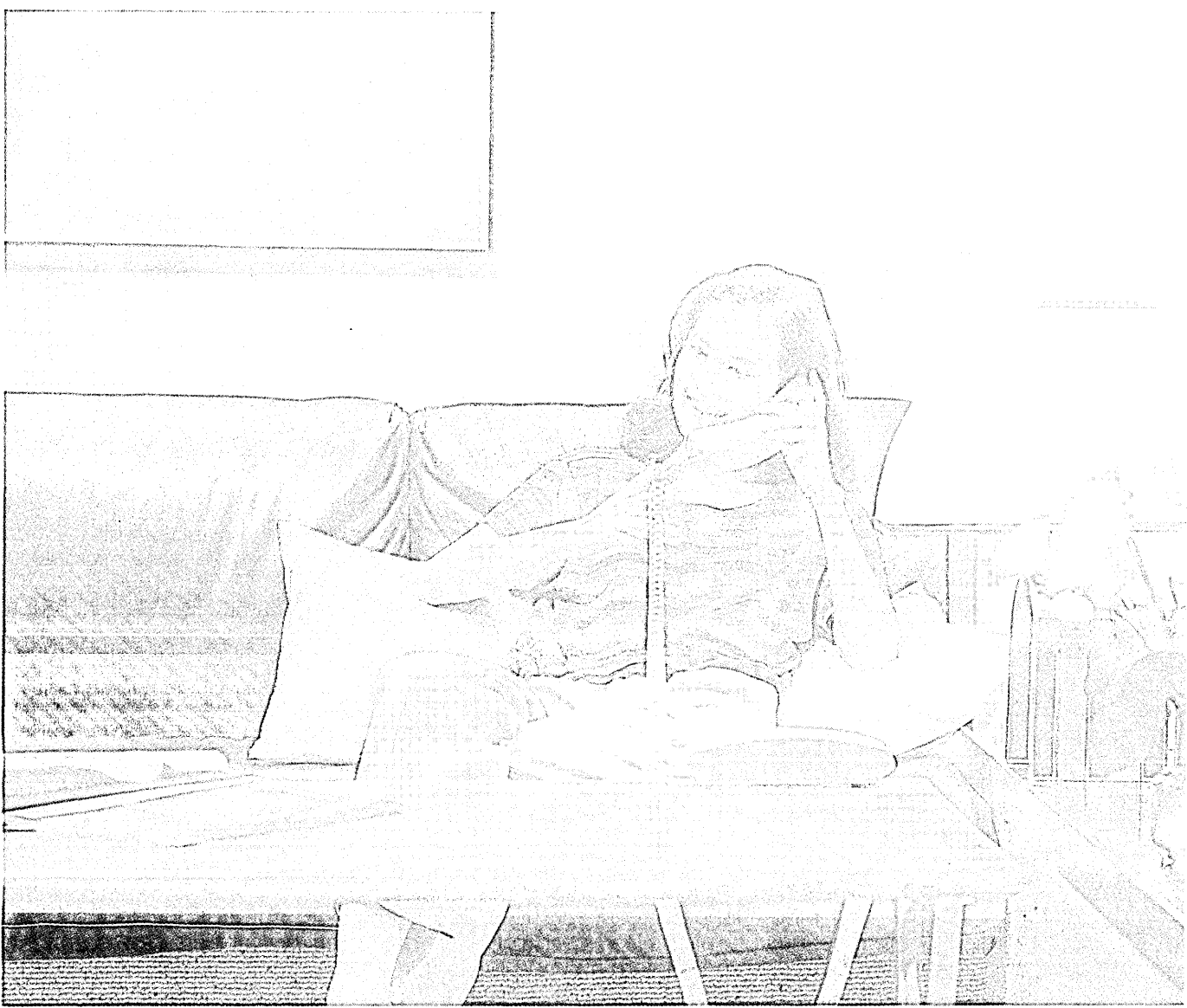

And at 10:00p.m. Masako receives a telephone call from her father...

Her father is abroad on business, and his call is transmitted to Japan through an international submarine cable communications system that was designed and installed by Fujitsu. Fujitsu has installed a number of advanced international communications systems around the world, and has also delivered a number of very sophisticated computer systems — everything from one

chip microcomputers to personal computers to the largest and fastest general-purpose mainframes on earth.

In the months and years to come you will no doubt be hearing more and more about Fujitsu, as its various products begin to serve you in the office and at home. In the meantime, we'd like you to remember who we are. We are Japan's number one com-

puter maker, and a world leading maker of telecommunications systems and equipment. More than all else, we are the people who will be bringing you the wonders of an explosively developing technology. Technology so advanced, so reliable, and so refined, that — just like Masako Morita — you will be able to take it for granted.

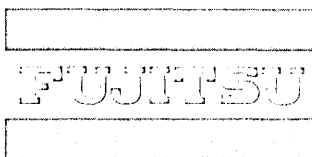

Fujitsu Limited • Tokyo, Japan

**Japan's number one computer maker.
And a world leader in telecommunications technology.**

CIRCLE 208 ON READER CARD

Emulex takes the inside track on VAX-11/780* mass storage.

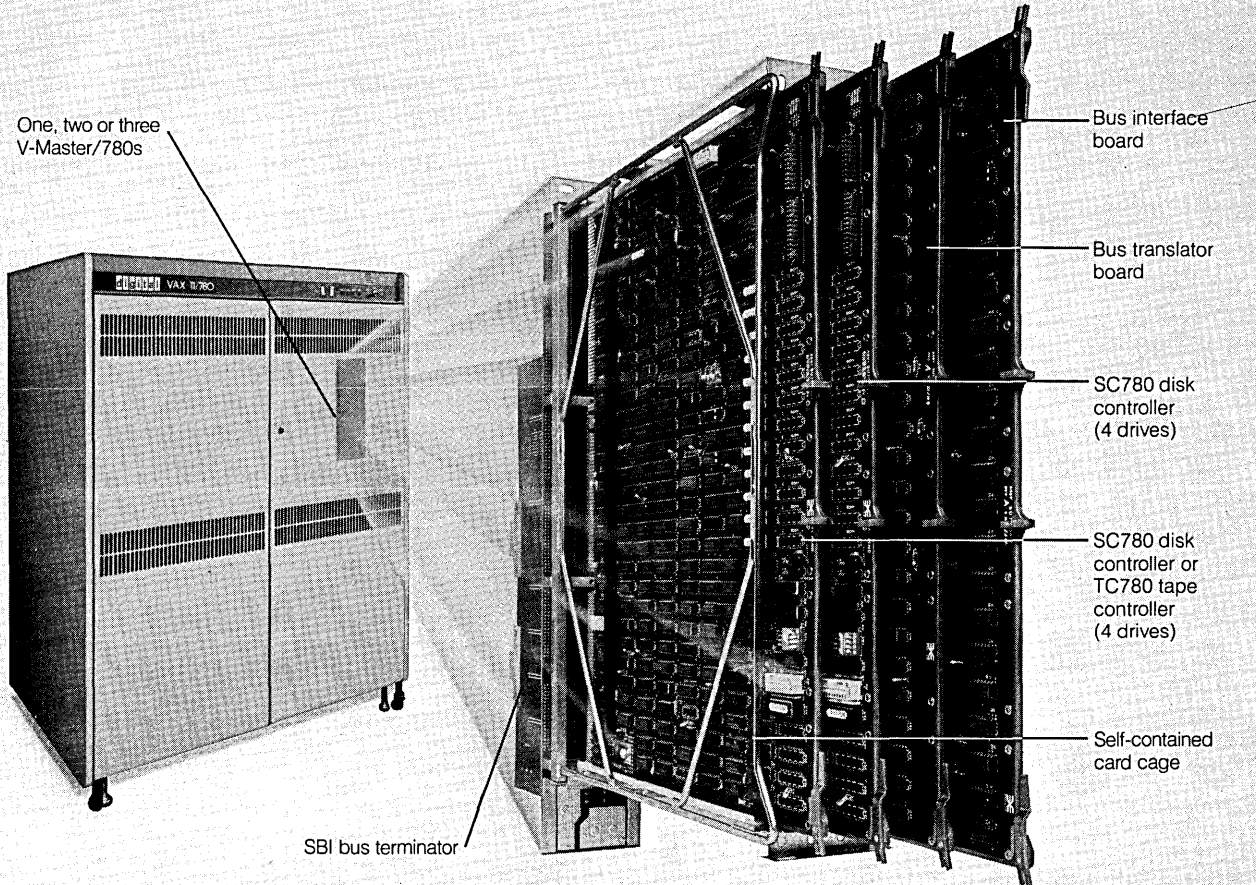

Announcing V-Master/780. A whole new packaging concept in software transparent mass storage adapters for VAX-11/780.

Simpler, less expensive, more reliable.

Just what OEMs and system integrators need. Two V-Masters can fit right into the internal RH780 spaces for control of up to 16 drives. And a third will replace the SBI terminator. The result: Add more peripherals without adding an expansion cabinet.

Each V-Master chassis has four slots. Two boards interface with SBI; the other two can contain fully-overlapped SC780 disk and/or TC780 tape controllers. Reliability improves because of fewer components, boards and interconnects.

Increase performance, improve flexibility.

The disk and tape controllers are the same high performance boards we use for VAX-11/750. By using dual disk controllers you boost multiple drive performance significantly. Or mix tape and disk controllers in the same chassis for less cost, more flexibility.

And you get all the other Emulex benefits, too. Like the ability to mix drive types and capacities. Unlimited selection of peripheral make and model. SMD media compatibility.

Now available as complete subsystems.

Choose from a wide selection of peripherals up to 675MB. We test each system nearly 100 hours and do

our own installation. Nationwide and regional service organizations provide timely maintenance.

Look into our unique rental/purchase plans. You can even trade in your old non-DEC controller.

Call Emulex now toll-free: (800) 854-7112. In California (714) 662-5600. Or write: Emulex Corporation, 3545 Harbor Blvd., P.O. Box 6725, Costa Mesa, CA 92626.



The genuine alternative.

*VAX and VMS are trademarks of Digital Equipment Corporation. The VAX-11/780 shown is manufactured and marketed exclusively by DEC.

CIRCLE 209 ON READER CARD

The CALAI conference proved that regional cooperation is indeed possible.

LATIN HARMONY

by Marc Burbridge

Latin American countries are by nature not big on regional cooperation. So, when any kind of collaborative effort is launched, you can be sure that some very strong, behind-the-scenes pressure has been brought to bear.

That's exactly what appears to have happened last October, when the Conference on Latin American Authorities in Informatics (CALAI) held its sixth consecutive meeting in Rio de Janeiro. On hand for the meeting were top-ranking informatics officials from 23 Latin American and Caribbean countries. As in Santiago, Chile, the year before, conferees agreed on objectives that were clear but very general. These objectives included:

- Furthering and developing the exchange of informatics resources among the countries of the region through bilateral or multilateral projects;
- Using the existing infrastructure of informatics resources in an ordered and efficient manner through the use of norms and standards that are applicable to the region, both in the project, production, and operation, as well as in the acquisition of informatics goods and services;
- Developing and furthering the establishment of common positions and policies in the area of relations with international or regional organizations dedicated to informatics and analogous disciplines;
- Studying and recommending the creation of regional organizations or entities in the field of informatics for purposes of research, development, production, and marketing of information.

During the week-long conference, the informatics policymakers debated the issues pertaining to these objectives. What they came up with in the end was a list of 15 recommendations, known as the Rio de Janeiro Declaration. These proposals would, in fact, have represented little more than a mere reaffirmation of the good intention objectives, if they had not included two crucial mandates.

First of all, the declaration made CALAI the major forum for informatics policy in Latin America and the Caribbean. And sec-



ondly, and even more significantly, the Rio document selected Brazil to serve as CALAI'S "permanent secretariat," a job that had rotated annually among the member nations.

The other CALAI countries have encouraged Brazil to fully explore the possibilities that may have opened up as a result of the decision. For its part, Brazil intends to staff up and to follow through on the Rio recommendations. Some of these recommendations that could have considerable significance in the short to medium term include:

- Study and coordinate actions related to data networks;
- Make studies and recommendations on norms and standards for operating systems, programming languages, communications protocols (CCITT, CCIE, ISO, CITA);
- Encourage and coordinate binational R&D projects;
- Encourage the interchange of information on public databanks and transborder dataflows (TDF), with a view towards adopting common policies;
- Create an inventory of Latin American specialists in informatics;
- Study and make recommendations on new legal forms of software protection;
- Establish multinational projects for software development.

Depending on how successful the new secretariat is in fulfilling these goals, the next logical step would be to create a more permanent organization that could function as a sort of technical and political clearing-house for Latin American informatics issues. A natural consequence of this could also be the formation of Latin American-based and controlled informatics companies. Such transnational operations on Latin turf with Latin leanings are already considered by many locals as the only viable alternative to ever increasing dependency on the more developed countries.

The obstacles blocking the creation of such enterprises, however, are formidable. Nevertheless, these signs of unity among the formerly fragmented factions in Latin America are encouraging.

Indeed, this year at CALAI there was a budding feeling of unanimity among the member nations. Before the meeting, Colonel Joubert de Olivera Brízida, president of Brazil's Special Secretariat of Informatics (SEI), seemed to sense this more harmonious mood when he declared: "At CALAI, each country is able to state its anxieties, its desires, and, who knows, we may even be able to increase multilateral or even bilateral cooperation."

The options and implications of...

FINANCIAL PLANNING AND MODELING SOFTWARE

The InfoResearch Institute offers two, in-depth reports dealing with the benefits, problems and alternatives associated with using computer-based systems for financial analyses and business planning.

... for the Financial Executive.

The Executive Report, written in management terms for the non-EDP executive, highlights the use of financial models in analysis, forecasting and planning. The Report focuses on management's "what if..." questions and the models necessary to answer them. It outlines top management's role in direction, organization and implementation, as well as factors outside the computer which must be considered if computer-based modeling is to realize its potential as a management decision-making tool. All information is based on extensive studies of user and supplier experience.

Price: \$250

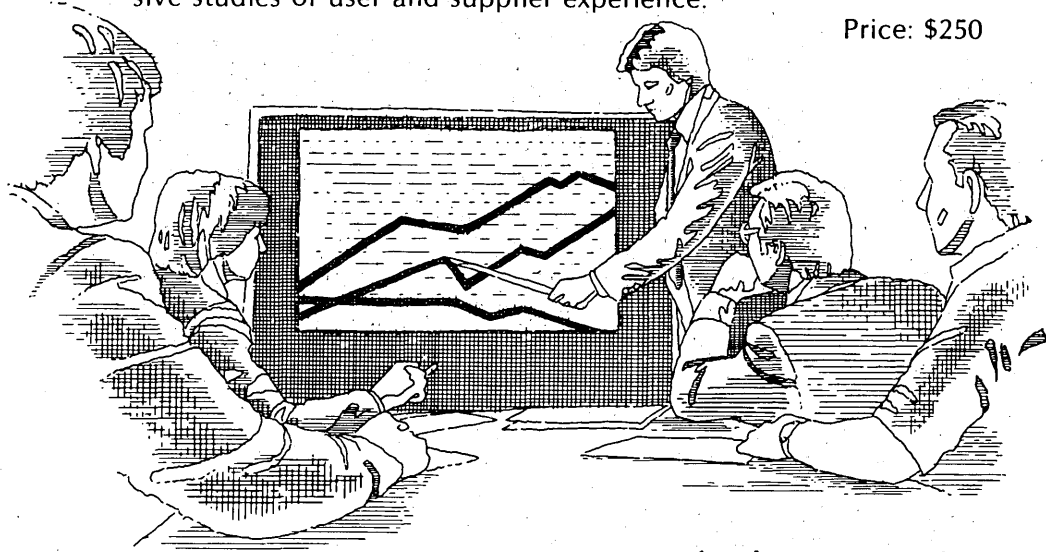

... for the EDP Executive.

The Industry Report explains the effectiveness and benefits of computer models for financial analysis, forecasting and planning. The Report highlights criteria for system acquisition, installation, preparation and operation, then focuses on those criteria for evaluation, selection and implementation. Management guidelines for model selection are provided, as well as financial considerations, product evaluation, the role of top management and the impact of new techniques on the organization and its plans. The experience and findings of users and suppliers, drawn from extensive studies of both groups, details system characteristics necessary for success.

Price: \$875

The InfoResearch Institute

co-sponsored by **DATAMATION** and **INFO-DYNE** 

612/835-0448

AVAILABLE FROM AUERBACH

COMPUTERS IN MANUFACTURING

Well Organized, Fully Indexed Reference Volumes
Packed With Accessible, Immediate Information You Need
To Manage Manufacturing Resources

COMPUTERS IN MANUFACTURING

VOLUME 1

MANUFACTURING RESOURCE PLANNING (MRP)

Designed To Help You:

- integrate people and technology in an MRP environment to increase efficiency
- coordinate manufacturing, marketing and finance in the MRP system
- identify MRP's utility in different manufacturing environments to increase profits
- organize the MRP data base
- assess MRP hardware and software applicability to save money
- evaluate MRP education and training techniques

COMPUTERS IN MANUFACTURING

VOLUME 2

MASTER PRODUCTION SCHEDULING

Designed To Help You:

- develop the production plan and link with master production schedule to maximize efficiency
- use master production scheduling in specific environments
- manage MPS process: time fences, feasibility checking, performance measurement, and overloading
- educate staff on new techniques for using the MPS effectively

COMPUTERS IN MANUFACTURING

VOLUME 3

MATERIAL REQUIREMENTS PLANNING

Designed To Help You:

- match material requirements planning system features to your specific operating needs
- ensure material coverage without carrying unnecessary inventory to reduce costs
- effectively design and use your material requirements system
- increase your system's contribution to the bottom line by capitalizing on quantity price breaks
- eliminate the causes of ineffective material requirements planning systems

COMPUTERS IN MANUFACTURING

VOLUME 4

EXECUTION AND CONTROL SYSTEMS

Designed To Help You:

- monitor and control materials, parts, assemblies, jobs, machines, and priorities in plant operations
- assess objectively the costs and benefits of CAM
- improve return on corporate resources by implementing performance measurements and control tools such as manufacturing cost systems
- evaluate new automated production scheduling techniques
- identify key strategies for improving work-in-process flow

COMPUTERS IN MANUFACTURING

VOLUME 5

DISTRIBUTION MANAGEMENT

Will Help You:

- improve the efficiency of your order entry and processing systems
- design a transportation system and tackle special problems with vehicle scheduling, dispatching, and routing inventory
- define inventory requirements in push and pull distribution environments
- determine the appropriate level of automation for your warehouse
- develop a computer-assisted dispatching system



Monthly Supplemented Information
Services Providing
Proven Action Plans
For Developing and
Maintaining a
"CLOSED LOOP"
Manufacturing
Planning and
Control System

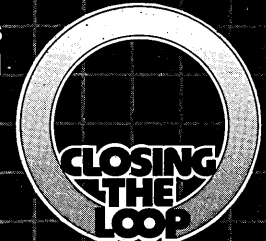

Forward To:
International Division
AUERBACH Publishers Inc.
6560 North Park Drive
Pennsauken, New Jersey 08109 USA
Telex: 831 464 - Cable AUERINFO

9007

Please rush me information on the volume(s) checked below:

- VOLUME 1 Manufacturing Resource Planning (MRP)
- VOLUME 2 Master Production Scheduling
- VOLUME 3 Material Requirements Planning
- VOLUME 4 Execution and Control Systems
- VOLUME 5 Distribution Management

NAME/TITLE _____

COMPANY _____

ADDRESS _____

CITY _____ PROVINCE _____ POSTAL CODE _____

COUNTRY _____



AUERBACH Publishers Inc. is the foremost authoritative source of computer, data processing, data communications, and management reference materials in the world.

FLOPPY DISK DRIVES

Olivetti OPE FD 591 and FD 592

THE NEW STANDARD. FOR 96-TPI FLOPPY DISKS.

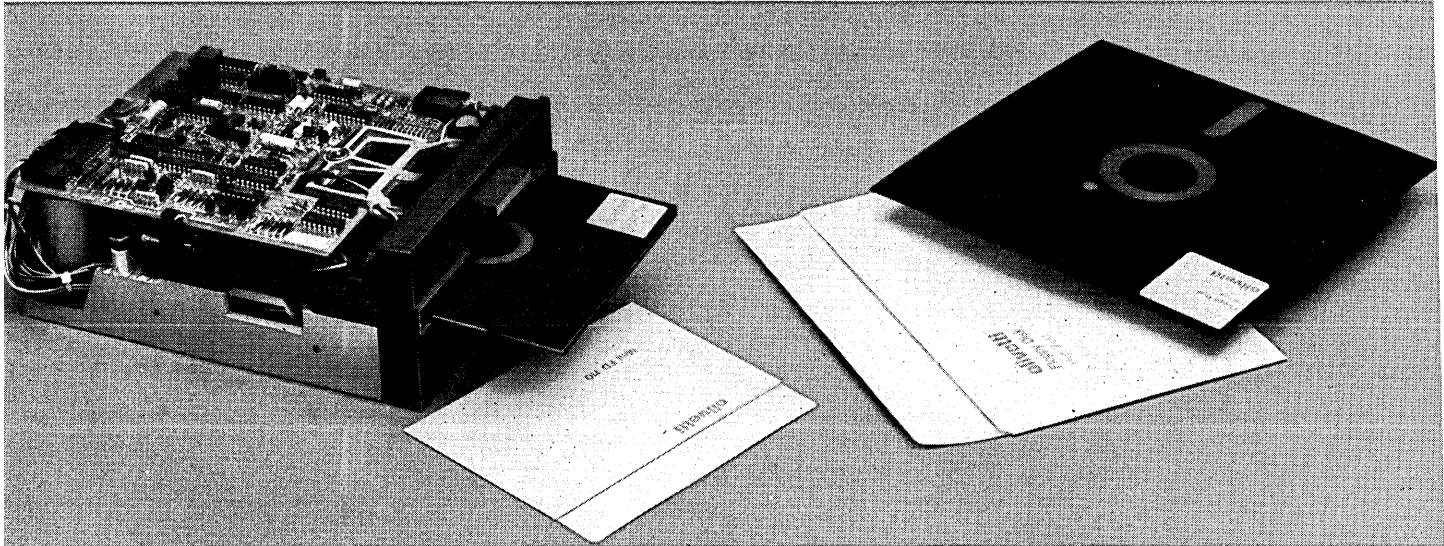

The FD 591 and FD 592 floppy disk drives produced by Olivetti OPE specifically for the OEM market include such features as:

FD 591 (single sided)

250/500 Kbytes

FD 592 (double sided)

500/1000 Kbytes

Dimensionally and electrically compatible with 5 1/4" minifloppy ANSI Standard

96 tpi

80/160 tracks

Average access time: 80 msec

Single and double density

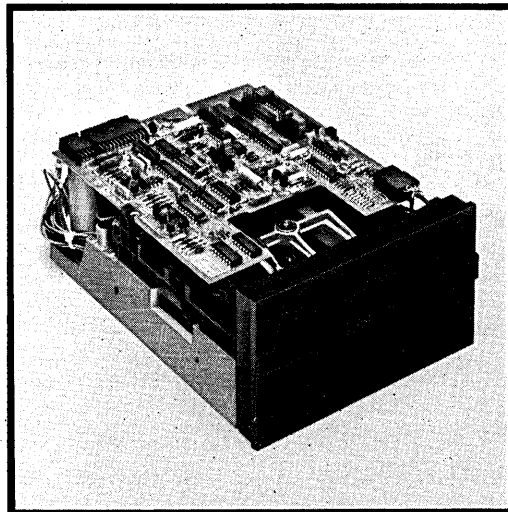

olivetti ope

Olivetti OPE via Torino, 603
10090 S. Bernardo d'Ivrea (Torino) Italy
tel. (0125) 525 ext. 4461-4639
telex 210030

CIRCLE 212 ON READER CARD

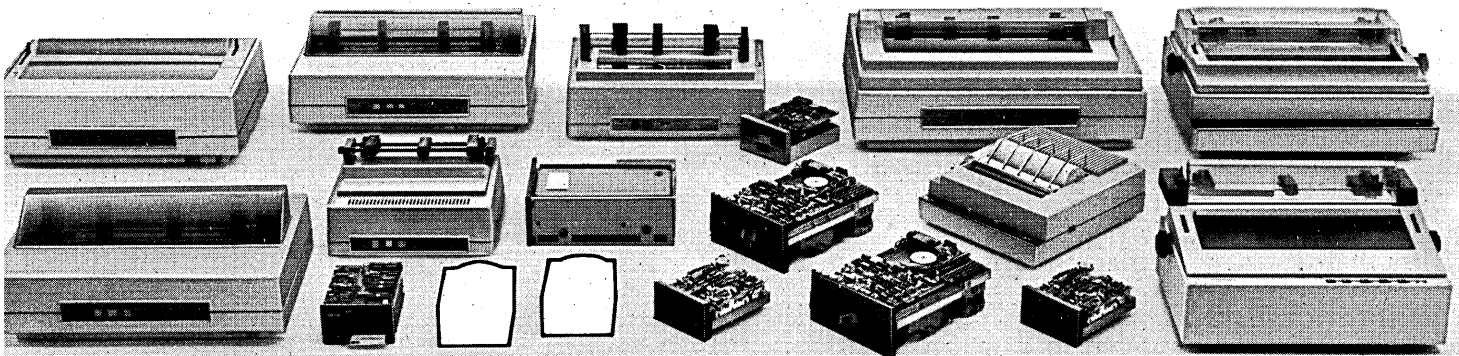

The next battle will be to make office systems match job needs and functions.

THE NEW FRONTIER IN ERGONOMICS

by Malcolm Peltu

Having won the battle for safe, comfortable, and easy-to-use equipment, human factors engineers in Europe, along with some vendors and advanced users, are rapidly pushing forward to the next frontier—matching total systems to users' job needs and functions in the office.

This ergonomic victory in Europe was achieved largely because of the pressures exerted by unions and various national factions that fought hard to put requirements into law. These forces have had an impact on manufacturers around the world. Sperry, like many other multinationals, feels Europe's ergonomic drive has indeed had an effect on American dp makers. Gary Alexander, director of the company's Sperrylink office system, concedes that Europe has been "heavily influential" in the design of new products.

Meanwhile, in Europe, Bob Remington, marketing strategy manager at the U.K.'s Office Technology Ltd. (OTL), believes the European strides are significant. "Although the various ergonomic checklists contain items that are not consistent, not accurate, and impossible to interpret, they still represent legitimate attempts to improve the quality of the critical user interface."

The scope and nature of these recommendations are summed up in figures 1 and 2. In Norway, Sweden, and West Germany these proposals have legal backing. In other countries, they represent general standards and quasi-legal criteria. In the U.K., for example, a government department, the Health & Safety Executive, will issue video display terminal guidelines early this year that are not legally binding, but do provide a framework for examining complaints.

Sometimes these complaints are voiced to the vendors, who have begun to realize the importance of tailoring machines more closely to human beings. Declares Sperry's Alexander: "We take ergonomics dead seriously. It is now an intrinsic part of our whole approach. We have an ergonomist on the design team who gets involved from the earliest inception of a new product to ensure that the right human factors are incorporated." This comprehensive approach, however, has not been adopted by all suppliers.

FIG. 1

ERGONOMIC REQUIREMENTS ON VDTS*

	VDTS GENER- ALLY	KEY- BOARD	SCREEN	WORK- PLACE	ENVIRON- MENT	WORKING CONDI- TIONS
Austria	✓					✓
Denmark	✓	✓	✓	✓	✓	✓
Finland	✓			✓		
France						
W. Ger- many	✓	✓	✓	✓	✓	✓
Italy						
Nether- lands	✓		✓		✓	✓
Norway	✓	✓	✓		✓	✓
Sweden	✓		✓		✓	✓
U.K.	✓	✓	✓	✓	✓	✓

*Imposed by European governments

Source: VDU Ergonomics in Europe, Butler Cox & Partners, London, England

Andrea Caws, a consultant with Systems Concepts Ltd., a British company that focuses on the human side of office automation, believes that many companies are using terms such as "ergonomically designed" and "user friendly" as superficial marketing labels for equipment that is riddled with basic ergonomic flaws. "For example," she explains, "one manufacturer makes [a big deal] about its ergonomic, antiglare screen, although the characters on that screen have poor legibility. Other suppliers," she adds, "highlight their detachable keyboards, a basic ergonomic need, but the layout of the keys, their shape and coloring, may be completely wrong."

Feeling the pressure from Europe, almost all the office automation companies have recently jumped on the ergonomics bandwagon. Some European companies, however, have been on that bandwagon a long time. In the late '70s Sweden's Datasaab (now part of Ericsson Information Systems) put out one of the first brochures on vdt ergonomics. Olivetti, another company with a long track record, has always taken pride in

its aesthetically and functionally designed office products and furniture. In 1981 the Italian company published the two-volume *Ergonomics at Olivetti*. Leading vdt specialist Professor Grandjean of the Swiss Federal Institute of Technology described the work as "an excellent and highly objective study."

Another company that's put a lot of effort into ergonomics is Philips. Robert Blaich, Philips's managing director of design for professional and business products, says that ergonomics "is the very fiber of our design operation." When necessary, the Dutch firm supplements its own in-house staff of human factor experts with outside consultants. Philips, along with the Technological University in Eindhoven, also helped establish the Institute of Perception Research, which conducts independent studies that have been used in the company's products.

OTL, a much smaller company than Philips, is nevertheless quite sensitive to human factors considerations. OTL marketing man Remington sees the advantage in being in a smaller organization. In bigger companies the human factors contingent, he ex-

There are many ergonomic standards that could become quickly outdated.

plains, is usually only one among many competing interests. OTL's latest product, the Information Management Processor (IMP), on the other hand, "has been designed and developed with top priority to user/system interactions," he says.

This ergonomic emphasis appears to be justified inasmuch as the system won the Recognition for Information Technology Achievement (RITA) award as the best new product in 1981. The IMP has a positive presentation (black characters on a white background) and smooth scrolling—both features that, while desirable from the user point of view, take much more engineering effort.

For instance, in order to avoid glare from the white screen background, the IMP has a refresh rate of 80Hz, although 60Hz is generally acceptable. "I think that we probably would have had a lower refresh rate and no smooth scrolling if human factors were just one criterion, rather than being the central product and marketing thrust," Remington points out.

Despite such ergonomic pluses, OTL has run into some union problems—problems that illustrate the danger of having standards that are too rigid. OTL came into conflict with labor as a result of the unions using certain standards for negotiation. Those standards reflected the ergonomic craze of a few years ago that favored using yellow-green characters on a yellow-brown background.

The IMP's positive presentation was therefore questioned by one union, although the very high refresh rate is a point in its favor. In any case, the accepted ergonomic wisdom is to allow screen characters in a number of different phosphor colors.

Sperry in West Germany, in fact, conducted a study with insurance company DBV that found that the color of the office itself should determine screen color. This is because a terminal operator looking away from the screen and at white paper, picks up an after-image in a color that's complementary to the screen characters. (For green characters the complement is purplish red and for yellow it's blue.)

This effect, which can lead to people seeing "red snow," results in double images and eye irritation. To avoid this, offices should be decorated in complementary tones. So, for screens with green characters, the setting should be warm purple-reds, while a cooler blue decor would be preferable for yellow characters. Since warm colors are currently in vogue for offices, this particular phenomenon could turn the tide in favor of green characters.

Systems Concepts' Caws warns that there are many other standards that could become quickly outdated. In Germany, for example, there's a standard for the distance between characters. This was set, however, be-

FIG. 2

KEY ERGONOMIC FEATURES OF VDTS*

	REGULATION	COUNTRY
Screen		
Character size	5 × 7 dot matrix	W. Germany
Character luminance	Adjustable	W. Germany
Background luminance	20 Candela/sq.m.	W. Germany
Color	Green, yellow, orange	W. Germany
Line spacing	100% character height	U.K.
Refresh rate	50Hz minimum	W. Germany, U.K.
Screen tilt	5 degrees forward, 20 degrees back	W. Germany
Screen height	370mm-520mm screen top to desk	W. Germany
Nonglare treatment	Yes, but not chemical spray	W. Germany
Screen size	To allow large amount of information	W. Germany
Keyboard		
Thickness	30mm	W. Germany
Angle	Adjustable	Norway
Surface material	Keys—dark symbols on light background	W. Germany
Numeric pad	Separate from main keyboard	W. Germany
Detachable	Yes	Norway
Palm Rest	Preferred	U.K.
Other areas		
Maintenance	Annually	Norway
Radiation	CISPR 9 (or equivalent national standard)	All countries
Noise and heat	No high frequency noise or noise from keyboard or fans	Norway

* As highlighted by regulations in European countries
Source: VDU Ergonomics in Europe, Butler Cox & Partners, London, England.

fore proportional spacing was available on screens. "Proportional character spacing is much more readable and legible than fixed characters, but the capability could be excluded if the character separation standard is inflexibly interpreted," observes Caws.

Professor Albert Armbruster of the Berlin Technological University described the differences between the West German and Scandinavian approach to standards. While the Scandinavians tend to set general qualitative guidelines, the Germans, true to character, favor more quantified criteria. One Norwegian regulation, for instance, simply specifies that "screens should be adjustable for luminance [brightness] and contrast. The equivalent German regulation goes into details such as "In negative presentations [light

characters on a dark background], the contrast must be between 3 to 1 and 15 to 1, or even better, between 6 to 1 and 10 to 1 . . ."

Professor Armbruster believes the solution is to compromise—have overall qualitative guidelines backed up by detailed measurements. Consultant Caws agrees. She feels flexibility is a key element in office equipment design. This adaptability, she points out, is necessary because the same system in different environments with different users will have different effects.

Nevertheless, there are clearly some areas of agreement among users. For one thing, operators of dp systems frequently complain about stress. One Swedish survey found that terminal operators in an insurance company had stress levels that were equiva-

Computerize your Directory Assistance Operation. We'll show you how.

Think of the advantages: Directory Assistance Staff productivity up by 70% with accurate and swift retrieval of information. A directory update facility eliminating constant reprinting of amendment lists. Automatic typesetting for printing telephone directories. Electronic Directory Assistance access from Videotex type terminals.

Consider the Directory Assistance operator and directory typesetting cost savings alone. As a DP specialist you know this is something Management can truly appreciate.

Fill in the coupon below to ask Hong Kong Telephone how they developed their own software using Meditech's* MIIIS Operating System, that has been running on Data General dedicated mini-computers day in, day out, for the last three years without a hitch. That adds up to well over 100 million enquiries. PERUMTEL the Indonesian Telecommunications Administration, recently bought the package, which includes programming/operations training and general management consultancy as well. With its modular design, the system is flexible and will grow with you to meet your future needs.

Computerizing a Directory Assistance operation should be simple, but not many have done it. We know why because we know how. Ask us.

* Medical Information Technology Inc

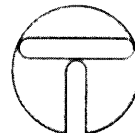

HongKongTelephone
We help you keep in touch

To DP Manager
Hong Kong Telephone Company Limited
PO Box 479 GPO Hong Kong
Telex: 83338 TELCO HX

Please send me details of your Directory Assistance software package

Name: _____

Position: _____

Company: _____

Address: _____

Contact Telephone/Telex No: _____

**IN THE LUXURIOUS SETTING
OF THE NEW PALAIS DES CONGRES
CANNES - FRANCE**



SECURICOM 83

**WORLDWIDE CONGRESS ON COMPUTER
AND COMMUNICATIONS
SECURITY AND PROTECTION
FEBRUARY 23 - 25, 1983**

CONGRESS PROGRAMME AND SPEAKERS:

Opening: Ch. GARRIGUES (F), President of the Agence de l'Informatique - France.

- 1) **Transborder Data Flow and Juridical Aspects:** Jan FREESE (S), B. GUGGER - M. PEREYNE (F), H. BURKERT - W. SCHIMMEL (Fed. Rep. Germany), J. WEISZ (Hungary), A. ERIKSSON (S), Jean-Pierre CHAMOIX (F), U. DAMMANN (Fed. Rep. Germany), B. WILSON (GB), W. STEINMULLER (Fed. Rep. Germany).
- 2) **Computer Fraud:** Leslie GOLDBERG (GB), U. SIEBER (Fed. Rep. Germany), Ph. WEIGHTS (GB), R. ROMANIN JACUR (I), A. BRIGNONE (F), G. CHRISTMANN (F), Ch. LINDEN (S).
- 3) **Risk Analysis:** Michael WOOD (GB), S. REED (USA), E. DRESDNER - C. VERGARA CARRASCO (Argentina), R. BERG (S).
- 4) **Cryptology:** Joël LEBIDOIS (F), L. GUILLOU (F), S. MATYAS - C. MEYER (USA).
- 5) **Functional and Logical Security:** Robert ELANDER (USA), S. HERDA (Fed. Rep. Germany), A. HARARI (F), J. KEIFLIN (F), Friedrich von SYDOW (Fed. Rep. Germany), J. RODIER (F), G. SMART (GB), Ch. JAHL - Ch. KOHLER - N. RAMSPERGER (Fed. Rep. Germany).
- 6) **Disaster Recovery Planning and Insurance:** S. VOGEL (USA), X. DATTIN (F), J-C. BONNIN (F), M. LAVICTOIRE (F).
- 7) **Physical Security:** Yves LE ROUX (F), B. CERROUSSI - M. LADAME (F), N. CHATENET - J. MALARA (F).
- 8) **Security in distributed systems:** Donald DAVIES (GB), U. SEIDEL (Fed. Rep. Germany), R. DOSWELL (GB), E. BERGER-DAMIANI (Fed. Rep. Germany), F. ALBERS - F. RUSCHENBAUM - H. WEBER (Fed. Rep. Germany).
- 9) **Application of Security in Teleprocessing:** Y. GIRARDOT (F), M. BANATRE (F).

Sponsorship Committee: Agence de l'Informatique (F) - Alarmes Protection Sécurité (F) - Bureau d'Orientation de la Normalisation en Informatique (F) - Datainspektionen (S) - Datamation (USA) - Droit et Informatique (F) - Europrotection (F) - Gesellschaft für Mathematik und Datenverarbeitung (Fed. Rep. Germany) - National Computer Center (GB) - National Physical Laboratory (GB).

PARTICIPATION FEE: 4 625,40 FF All Taxes Included (3 900 FF without Taxes), including a.o. 3 nights accomodation in a 4 star luxury hotel and copy of all the papers presented at the Congress.

TO RECEIVE THE DETAILED CONGRESS PROGRAMME AND AN INSCRIPTION FILE, CONTACT: SECURICOM'83, SEDEP, 8 rue de la Michodière, 75002 PARIS-FRANCE, Tel. (1) 742.41.00, Tèlex: 250303 Public X Paris.

lent to bus drivers working in the center of Stockholm during rush hour. In still other research, the Alfred Marks Bureau in London concluded that "the greatest problems facing today's growing number of word processor operators stem from management's wide lack of knowledge regarding the physical setting for the machines and their ignorance of how best to use them."

Who takes the blame here—the equipment maker or the user? Says Caws: "Vendors can never really promise to provide an ergonomic environment because most of the important factors are in the hands of the users. The starting point should be to examine the total organizational and work context in which equipment is to be used. Only then," she explains, "can the ergonomic design of equipment be put into the perspective of a particular job and office environment."

In that office environment the crucial thing, according to OTL's Remington, is the "task interface" that provides a compatible merger between the hardware, software, and user. The firm's IMP system, which epitomizes this concept, places particular emphasis on simplifying actual task initiation and operation. It includes, for example, such things as a store-and-forward voice system that can be incorporated into electronic mail messages (the control of the voice facility is similar to a conventional tape recorder). The system also has functional keys that have clear descriptions of their functions, so the electronic mail capabilities are quite obvious from the words on the key.

Graham Cripps, head of research at Philips's Redhill Laboratory in the U.K., also emphasizes the need to mesh the total hardware/software system to users' task needs. His team has been investigating the use of touch-sensitive screens to simplify menu-style dialogs for use in Philips consumer and professional products.

When it comes to the task interface in office automation, the American Xerox 8010 Star information system has been the commercial pioneer. It displays a complete desktop with multiple windows to show more than one document. Like OTL's IMP, the Star database is divided into files, file drawers, folders, etc. It uses small pictorial "icons" to represent various entities like the filing elements.

Consultant Caws meanwhile believes that the best task interfaces currently around are in electronic games like Space Invaders, Pac-Man, and Donkey Kong. "The total system—hardware, software, input, and output—of these games is tuned to assist users to carry out their tasks enjoyably and efficiently. Of course, the work of the games' designers is simplified because they know precisely what task the user will be carrying out, whereas an office system can be used for a multiplicity of tasks, many of them unstructured and ill-defined. Nevertheless, the honing of the system to match real user needs is a lesson worth applying in office automation," she advises.

INTRODUCING AUERBACH

DataWorldTM

INTERNATIONAL

Put the world's most authoritative EDP resource within easy reach!

DATAWORLD INTERNATIONAL is the unique, four volume, monthly updated service which covers the spectrum of the hardware and software marketplace. Each volume is devoted to a major product and service area:

- Mainframes and Peripherals
- Minicomputers and Microcomputers
- Applications and Systems Software
- Data Communications

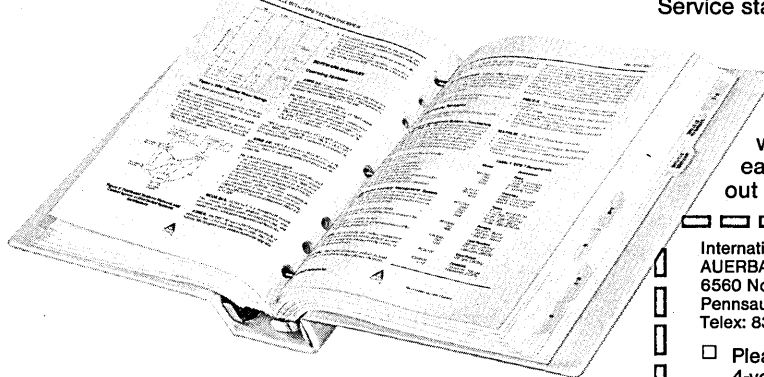
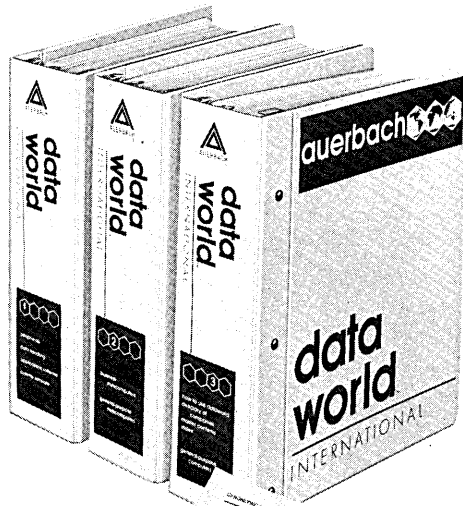

4 volumes of information organized to save you precious time and money in planning and evaluating your EDP needs.

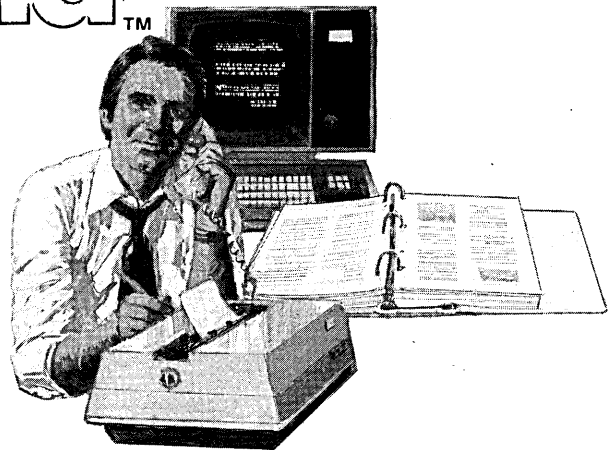

DataWorld's Scope is Worldwide.

DataWorld International is comprehensive. Initially you receive . . . 3000 pages of accurate and objective information on products and services available *around the world* . . . over 2000 detailed specification tables for quick and easy comparisons . . . more than 500 complete and current product reports reflecting compatibility, performance and competitive position, user reactions, configuration guides, and maintenance and support services.

Easy to Use.

DataWorld International was designed by professionals for professionals . . . containing a master index . . . with each volume having its own table of contents and uniquely designed tabs for quick and easy reference.

Never Out of Date.

DataWorld International keeps you abreast with new developments through 175 pages of monthly updates . . . access to our unique Telephone/Telex Information Service staffed by EDP professionals.

Resolve difficult EDP evaluation tasks the easy . . . time-saving way. Put *DataWorld*, the world's most authoritative EDP resource, within easy reach. For complete information please fill out and return this coupon.

International Division
AUERBACH Publishers Inc.
6560 North Park Drive
Pennsauken, New Jersey 08109 U.S.A.
Telex: 831 464 - Cable: AUERINFO

9008

Please rush me more information on AUERBACH's new 4-volume desktop reference, *DataWorld*.

Name/Title _____

Company _____

Address _____

City _____ Province _____ Postal Code _____

Country _____



AUERBACH Publishers Inc. is the foremost authoritative source of computer, data processing, data communications, and management reference materials in the world.

OEM EUROPE MEETS AT THE INVITATIONAL COMPUTER CONFERENCES

Seminars on the newest product technology—and “hands-on” displays of the latest computer and peripheral equipment for the quantity buyer are available to European OEMs at the Invitational Computer Conferences.

In Amsterdam, Milan and Munich this October, decision makers will meet manufacturers for “one-day-only” intensive coverage of mini/micro computers, disk drives, CRTs, tape drives, printers, interfaces, controllers, graphic display systems and other equipment. These international conferences are tailored exclusively to meet the requirements of the European OEM—regional locations are selected so extensive travel is not required; the seminars and displays are focused in purpose so there is no sorting through mountains of useless data; and the conferences are limited in size so in-depth coverage can be made in a single day.

Some of the companies displaying products in last year's series were: AED, Century Data Systems, Cipher Data, Data Electronics, Inc., Dataram, Fujitsu, Genisco Computers, Hewlett-Packard, Kennedy Co., Micromation, Inc., Micropolis, Micro Peripherals, Inc., National Semiconductor, Pertec, Priam, Printronix and Remex.

Plan to attend the conference nearest your area. Invitations are available (without charge) from participating companies or from the ICC sponsor. For further information contact:

B. J. Johnson & Associates
3151 Airway Avenue, #C-2
Costa Mesa, CA 92626
Tel: (714) 957-0171
Telex: 678401 TAB IRIN

(or)

U.K. Office: Tom Lewis
Text 100 Ltd.
10 Barley Mow Passage
Chiswick, London, W4 4PH
Tel: 01 994 6477
Telex: 8811418 Ref.
T100N SPACES G



Invitational Computer Conference

82/83 Schedule

Amsterdam	October 7,	1982
Milan	October 13,	1982
Munich	October 19,	1982
London	March	1983
Frankfurt	March	1983
Paris	March	1983



Invitational Computer Conferences

FACE THE FACTS!

There are two sides to any coin.

In this case, the front of the coin is about exploiting the new technology to achieve maximum efficiency and cut costs.

Data terminals communicating with host computers and data bases provide a better basis for decision making, rapidly and to numerous members of staff.

Word processing saves time and labour.

Personal computers make it possible to perform important computations, calculations and simulations locally.

Solving such major applications part by part, you may end up with incompatibility. With a range of suppliers and of servicing agreements. Operator desks with two, perhaps three terminals.

That's the other side of the coin. Expensive and ineffective.

Today, more than ever, there is a need for a second thought first.

THE ALFASKOP MULTIPURPOSE TERMINAL.

COMMUNICATIONS.

Compatible with IBM 3270 BSC, SNA/SDLC, Local and Remote, Univac, Digital, and other common host computers.

MULTI-HOST.

Communication with several host computers from a single terminal. The operator selects from the keyboard the host computer to be connected.

PERSONAL COMPUTER.

Program package for local personal computer facility. UCSD p-System™, Basic and Pascal compilers.

WORD PROCESSING.

Alfaword program package for local word processing.

OFF LINE EDITING.

Alfaedit program package for off line editing of source code information and documentation.

BATCH TRANSMISSION.

Alfabatch, IBM 3780 emulation for batch transmission between the terminal and a computer.

One thing is perfectly clear. There won't be room for more than one terminal at the operator desk of the future. One terminal, with numerous functions. And ergonomically designed!

Alfaskop is basically a data terminal for communication with host computers. But loaded with another program it becomes a local work station. For example a word processor or a personal computer.

One terminal, with several functions.

The Alfaskop multipurpose terminal.

And it's available now.

ALFASKOP TODAY & TOMORROW

Ericsson Information Systems AB.
Alfaskop Division.
S-175 86 Järfälla, Sweden

FOR MORE INFORMATION CONTACT
Ericsson Information Systems in:
Australia, Austria, Belgium, Denmark,
Finland, France, Italy, The Netherlands,
Norway, Spain, Switzerland,
United Kingdom, West Germany
and Sweden.

ERICSSON



CIRCLE 215 ON READER CARD

INTERNATIONAL

The management and organizational issues are the critical factors in office automation.

Interestingly, Alan Kay, one of the main designers at Xerox's Palo Alto Research Center (PARC), where the Star was developed, has become chief scientist at Atari, the U.S. computer games manufacturer. Is there a message here? Comshare's U.K. managing director Ian McNaught-Davis thinks the graphics capabilities in electronic games could be used to improve management information systems. "A study by the Sloan School of Management at MIT in the U.S. found that almost 90% of computer users want to make inquiries and receive results. Just think," he says, "how this interaction could be improved if we had more use of the video graphics, graphs, color displays, and animation, which are now commonplace with electronic games."

The attack on task interfaces has just begun and it will take a very long time before the same type of victory is achieved that's already been attained in the physical field of ergonomics. Meanwhile, the forces are gathering to move onto the final frontier—the complete organizational context in which new technology operates.

The Commission of the European Economic Community (EEC) gave a strong

hint of things to come when it placed special stress on human and organizational aspects in its Inter-Institutional Integrated Services Information Systems (INSIS) program. The overall goals of this project are to improve the use of office information and communications systems throughout the EEC countries and to encourage the establishment and use of international information systems standards.

According to Dr. Harry Otway, who is responsible for the human and organizational aspects of INSIS, "When introducing new technology, there is always a temptation to try to gain potential benefits as quickly as possible. The experience of users of computer systems and early office automation, however, clearly indicates that the benefits will fail to materialize if inadequate consideration is given to the technology's broad impact on all aspects of user requirements and working life. From the outset, the INSIS management team has given careful attention to these human and organizational aspects."

A conference was held last year to make key EEC and government decision-makers aware of the importance of the human side of new technology. This spring, a book, *New Office Technology: Human and Organi-*

zational Aspects, will be published for the EEC, with contributions from the U.S. as well as Europe on the major concerns, ranging from physical ergonomics to the impact of office technology on organizational structures, management behavior, and social interaction in the office.

Sperry's Alexander also feels that these deep-rooted management and organization issues are the critical factors in determining whether office automation succeeds or fails. He has therefore set up a special consultancy division, staffed by specialists in the management, organizational, and ergonomic aspects of office automation. "It is no good selling equipment to organizations and pretending that we can then wash our hands of the consequences," Alexander maintains.

The head of this new Sperry division is Carol Gaffney, who sounds as if she's on the right track: "Automating office functions creates a human crisis with the impact of a tornado hitting a factory. Long-standing relationships are disrupted, competencies are destroyed, career paths are bulldozed. And we wonder why systems are sabotaged, why executives say, 'It won't work here,' and people quit, get sick, or are uncooperative." *

PHILIPS

Transients can kill

But we can kill transients... with 100 dB attenuation

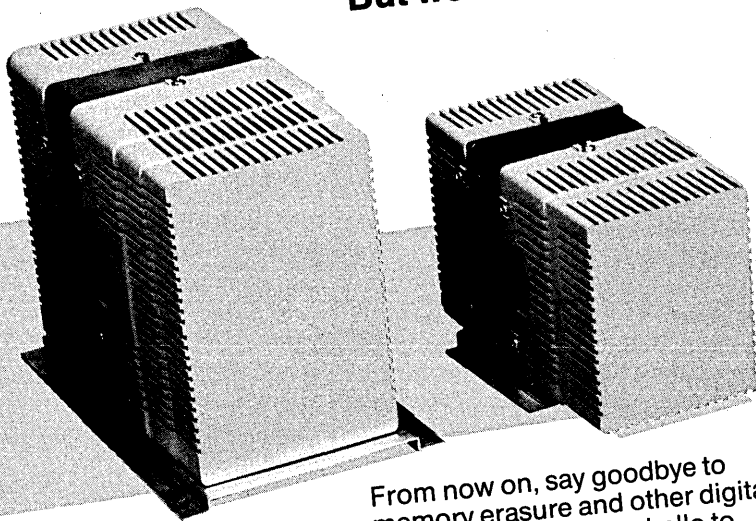

Philips' line conditioners ensure an output stability of $\pm 1\%$; efficient short-circuit protection and a mean time between failures in excess of 100,000 hours at 40°C.

All types are available in 220 and 240 V versions.

Power rating	Model number
200 VA	PE 1411
400 VA	PE 1412
850 VA	PE 1413
1500 VA	PE 1414
3000 VA	PE 1415
5000 VA	PE 1416

All models meet IEC and VDE safety norms.

From now on, say goodbye to memory erasure and other digital problems. Instead say hello to Philips' ferro-resonant line conditioners.

For full details contact:
Philips S&I, Test and Measuring
Instruments Dept., TQ III-4-62,
Eindhoven, The Netherlands

CIRCLE 216 ON READER CARD



Test & Measuring
Instruments

176-32 DATAMATION

PHILIPS

WORLDWIDE

The Power of a VAX™ at the Price of a Micro.

**Pixel, the leader in
68000-based UNIX™ systems,
wants international distributors.**

If you're a distributor looking for a reliable, high-performance low-cost super-micro, take a good look at Pixel's 100/AP™ system. It's the fastest 68000-based super-micro available. Expandable, too, with up to 16 terminals, 160MB of on-line Winchester disk storage, and 6MB RAM.

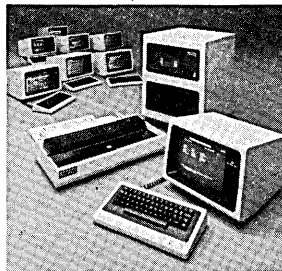

And, whether you're developing a new product, or adapting an existing application, Pixel makes it easy with a wide choice of industry standard languages like C, FORTRAN 77, PASCAL, SMC-BASIC/IDOL, DEC-compatible SVS BASIC, RM/COBOL™, Micro Focus LEVEL II COBOL™, APL, Telesoft ADA™, and Sibol.

You get a full range of integrated decision support software, too. Software that compares feature for feature with the best packages in the business. Choose from MicroINGRES™ relational database or any of four other database packages . . . plus three word processors and four spread sheet packages. You can select individual packages or build a totally integrated decision support capability.

You owe it to yourself *and* your customers to see how much more the 100/AP system has to offer. And, our aggressive discount policy means greater profit opportunities for our distributors. Call or write today for your Pixel Information Package.

I want to know more about becoming a Pixel Distributor. Send me a Pixel Information Package immediately.

Name _____

Title _____

Company _____

Address _____

Country _____

Telephone _____

Pixel

DIVISION

International Marketing Dept.
One Burrill Road, Andover, MA 01810

 **Instrumentation Laboratory**

CALL 617-470-1790

Pixel 100/AP is a trademark of Instrumentation Laboratory Inc. • RM/COBOL is a trademark of Ryan-McFarland Corporation. • UNIX is a trademark and a service mark of Bell Laboratories. • LEVEL II COBOL is a trademark of Micro Focus, Inc. • Telesoft ADA is a trademark of Telesoft, Inc.

• Sibol is a trademark of Software Ireland, Ltd. • VAX is a trademark of Digital Equipment Corporation. • The Pixel operating system is derived from UNIX system III and includes enhancements from Berkeley 4.1 BSD.

CIRCLE 217 ON READER CARD

Was this vital ingredient missing from your latest software?

You wouldn't design a car without considering the driver's needs.

However, it's amazing how many software systems seem to exist purely for their own sakes.

At Norsk Data, we develop our effective software and hardware only after analysing the needs of an organisation and the individuals within it.

With our ORBIS collection of integrated software tools, the data-processing specialist serves the user, not the system.

For a start, the extensive debugging facilities common to all of Norsk Data's stable and effective computer languages enable you to develop programs fast and accurately.

Tools such as the data dictionary and code library facilitate writing applications, while FOCUS screen handling makes it easy to set up interactive user dialogues.

The Norsk Data series share a common file system, so all products have access to the same data.

The user-friendly network system makes for easy distribution of applications and information, giving you access to local and wide-area networks.

In fact, the contents of the ORBIS concept cater to all your needs, as well as those of your organisation.

For more information, send for our ORBIS brochure.

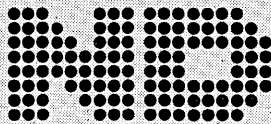

Norsk Data

Systems that put people first

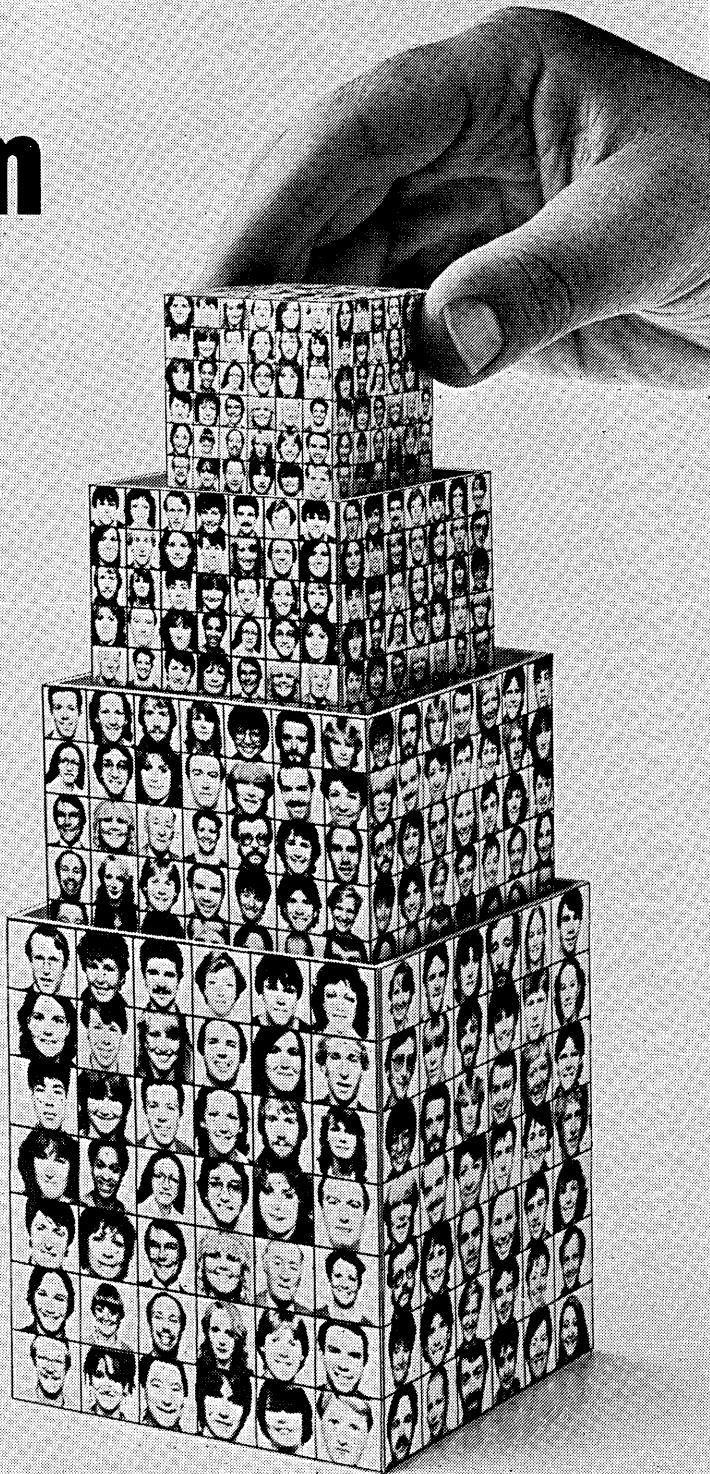

NORSK DATA A.S., OLAF HELSETTS VEI 5, PO BOX 25 - BØGERUD, OSLO 6, NORWAY. TELEPHONE: +47 2 29 54 00. TELEX: 18284 ND N. TELEFAX: +47 2 29 56 17. OSLO (02) 30 90 30, STOCKHOLM (0760) 92 000, COPENHAGEN (02) 42 50 55, WIESBADEN (06121) 7641, FERNEY-VOLTAIRE (50) 40 85 76, LAUSANNE (021) 2501 22, UTRECHT (03408) 86734, NEWBURY (0635) 31465, BOSTON (617) 237 7945.

BETTER SYSTEMS THROUGHOUT EUROPE. NORSK DATA IS A MAJOR MANUFACTURER OF MEDIUM-SIZED COMPUTER SYSTEMS, OPERATING IN MAJOR MARKETS AND SECTORS INCLUDING ADMINISTRATIVE, TECHNICAL AND SCIENTIFIC, EDUCATIONAL AND GRAPHIC INDUSTRY APPLICATIONS. NORSK DATA HAS WHOLLY OWNED SUBSIDIARIES PROVIDING SERVICE AND SUPPORT THROUGHOUT EUROPE.

PRODUCT SPOTLIGHT

STRIPPED-DOWN MAINFRAME

The ICL 2957, another smaller, stripped-down version of the popular 2966 mainframe, can be field-upgraded to 2958, 2966, and 2988 specifications. It offers 4MB, 6MB, or 8MB main memory, up to four DCU1 or DCU2 I/O multiplexors for two to

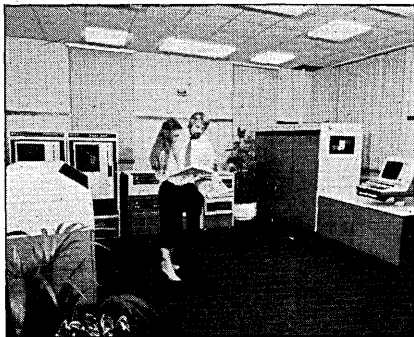

eight simultaneous 2MB disk channels. The 2957 mainframe can run under VME 2900 or CME. Its VME 2900 performance is 40% higher than that of the entry-level 2955 processor, and it can also be configured as a dual-processor system. An entry-level 4MB 2957, with one DCU1 and four EDS80/FDS160 pairs (for 960MB secondary storage), costs £213,000 (\$340,000) in the U.K., giving it equal price/performance to the IBM 4341/10. ICL, London, England.

FOR DATA CIRCLE 375 ON READER CARD

MULTIMICRO MIGHT

The Unimax connects two to eight Motorola MC 68000 16-bit cpus to a common 4MB I/O bus within a single mainframe cabinet. Each MC 68000 cpu has a 600 KIPS throughput and controls its own 256KB to 16MB main memory via a dedicated 4MB memory bus. It can also address other cpus' memory via the I/O bus.

Intelligent I/O controllers with their own Intel 8085A microprocessors and buffer memories connect all peripherals to the

common I/O bus. The high-capacity I/O controller (HIOC) controls up to four 425MB disk drives, providing 1.7GB on-line capacity. The disk I/O controller (IOC) offers up to 240MB on-line on a variety of 5¼-inch or 8-inch Winchester or floppy disk drives, or 10½-inch Winchesters with their own streaming tape drives. The network IOC controls up to 64 RS232C/V24 modems and local peripherals, while the serial IOC handles up to eight modems and various local peripherals.

The company's own Unirex operating system is oriented towards real-time transaction processing, with heavy emphasis on sharing reentrant systems and application code, process protection, priority scheduling, and dynamic allocation and deallocation of systems resources. It is written in the C language, however, and offers full Unix 7 program compatibility including the same C, Pascal, COBOL, FORTRAN, and BASIC compilers. In distributed processing environments, Unirex can emulate TTY async, IBM 2780/3780, 3270 BSC and 3270 SDLC, CDC UT-200, and Siemens MSV I terminals. Users with freestanding timesharing applications can also run Unimax under



Unix version 7.

A basic two-cpu 512KB configuration with disk and serial IOCs for eight users has 1.2 MIPS throughput comparable to an IBM 4341 and 4342. The cost is \$20,000 (DK160,000). With a 10MB disk drive and 560KB diskette drive included, it sells for \$30,000 (DK245,450). A four-cpu 4MB system with 120MB disk and four serial IOCs for 32 users costs \$100,000 (DK811,900); a six-cpu 6MB system with four 120MB disk drives and six network IOCs for 384 serial ports is \$200,000. Any of these systems can be field-expanded into an eight-cpu 128MB system that has up to 3.4GB secondary disk storage for up to 128 simultaneous users, with a 4.8 MIPS throughput equivalent to an IBM 3083E. Field-expandability will eventually be even greater, since Unimax's 32-bit-wide I/O bus has been designed to support more powerful 32-bit microprocessors. DANSK DATA ELECTRONICS A/S, Herlev, Denmark.

FOR DATA CIRCLE 376 ON READER CARD.

While Dansk Data Electronics' Unimax concentrates all the processing power of its multiple micros into the central mainframe box, the Digico 3800 and 7800 series distribute it to individual workstations. Each 3800 Prince II workstation includes three Z80A processors, 64KB memory, and one or two optional 400KB or 800KB floppy disk drives to run its own BASIC, Pascal, FORTRAN, COBOL, or Coral applications under CPM 2.2. Up to three 3800 workstations can share a common disk controller with its own Z80A processors and 64KB memory for buffering I/O to and from a 5MB Winchester disk that is located within the disk of the 3810, 3820, or 3830 master workstation.

Up to 32 of these workstation clusters can in turn be connected locally or remotely to a 7800, a 16-bit minicomputer with 256KB to 1.2MB main memory and up to 3.6GB of secondary disk storage for com-

INTERNATIONAL

mon files. This is program-compatible with Digico's earlier MTS 16E minis and supports its own BASIC compiler. Its main function, however, is to serve as a shared disk controller for the 3800 workstation clusters. It can also function as a gateway to IBM or ICL



host mainframes via IBM 3270 BSC and ICL CO1 and CO2 protocol emulators. The 3800 workstations can also communicate directly with Honeywell host mainframes via 3800 resident VIP emulator. DIGICO LTD., Herts, England.

FOR DATA CIRCLE 377 ON READER CARD

SMALL BUSINESS SYSTEM

The Rair business computer uses concurrent 16-bit Intel 8088 and 8-bit 8085 microprocessors to offer both 16-bit processing power and compatibility with the broadest range of applications packages. The two micros share 256KB to 1MB main memory, a 19MB Winchester disk drive, and one 1MB floppy disk drive. Up to three additional 19MB Winchester drives can be added for a maximum total on-line capacity of 77MB. Alternative operating systems include both 8- and 16-bit versions of CP/M and MP/M, as well as IBM PC-DOS. There are BASIC, COBOL, and Pascal compilers, as well as Electronic Spreadsheet, Text Processing, Data Management, and Communications packages.

Access to the Rair business computer can be shared by two to four key-display color workstations, offering 25 lines of 80 characters and eight programmable foreground/background colors. Each workstation costs £1,250 (\$2,000), while the basic 256KB, 19MB central system costs £5,250 (\$8,400), with £750 (\$1,200) for each 256KB memory increment and £2,250 (\$3,600) for each additional 19MB fixed-disk drive. RAIR LTD., London, England.

FOR DATA CIRCLE 378 ON READER CARD

MORE PERSONAL COMPUTERS

The Ferranti Professional Personal Computer (PPC) is a new option on the established PT7 range of IBM- and ICL-compatible intelligent display terminals. It uses the standard PT7 150 series display and keyboard that can be switched between compatible terminal functions and PPC functions on dual-purpose terminals. Dedicated PPC systems are also available.

The PT7 PPC option uses an Intel

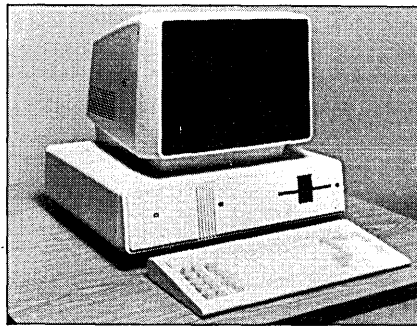

8086 16-bit microcomputer with 128KB RAM and two 5¼-inch 320KB formatted floppy disk drives. It runs under Ferranti's own F-COS/86 or F-MOS/86 operating systems. These are compatible supersets of Digital Research's CP/M-86 and MP/M-86, respectively. What Ferranti has done is add a much simpler user interface with menu management, disk formatting, and copying utilities. In addition to BASIC, Pascal, and COBOL compilers, Ferranti also offers packages for financial planning and analysis, business control, database management, word processing, and scientific applications. FERRANTI COMPUTER SYSTEMS LTD., Wythenshawe Division, Manchester, England.

FOR DATA CIRCLE 379 ON READER CARD

While the Vitesse personal computer uses the same ergonomically designed display screen and detachable keyboard as Logica VTS' well-established 2200 word processing system, it is not a dual-purpose system like the 2200. It incorporates an Intel 8086 processor with 64KB to 512KB RAM and two 5¼-inch, IBM unformatted floppy disk drives. Options include single and dual 5¼-inch Winchester disks, storing a total of 10MB to 40MB. Initial software includes CP/M-86 with CBASIC-86, MBASIC-86, Pascal 86, and CIS COBOL with Forms 2. In addition,

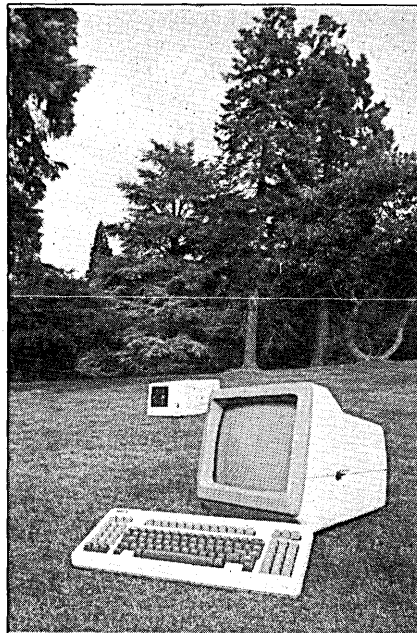

tion, Logica VTS is currently evaluating for early release MS-DOS and Xenix operating systems; PL/1, C, and FORTRAN compilers; and DBASE II, Microrapport, MARS, Multiplan, and VTS word processing packages. LOGICA VTS LTD., Wilts, England.

FOR DATA CIRCLE 380 ON READER CARD

GEC MARKETS MINIS, MAXIS

The GEC 4100 series is a family of 32-bit minicomputers and maxicomputers that is fully upward-compatible with the company's earlier 4000 series of 16-bit minis. The GEC 4100 instruction set is a superset of 4000 series code and provides the same Nucleus support for the OS4000 operating system and its Babbage, Coral 66, FORTRAN, BASIC, ALGOL 60, COBOL, RPG II, Pascal, APL, ML/1, BCPL, and RTL/2 compilers.

Two processor models have been announced so far in the new series. The entry-level GEC 4150 is a desktop box that fits into a 19-inch rack, and offers 256KB to 1MB main memory and 13.2MB to 160MB secondary storage in one to four (6.6MB + 6.6MB or 20MB + 20MB) fixed/exchangeable cartridge disk drives. Prices start at £9,250 (\$14,800).

The top of the range is the GEC 4190, a floor-standing model with more than twice the power of the previous top of the range GEC 4085. It offers a 16KB high-speed cache memory, 1MB to 8MB main memory, a high-speed multiplication unit, 16MB of immediately addressable program space, and 256MB of system virtual address space. It can also support up to eight I/O processors that control all peripherals. GEC COMPUTERS LTD., Herts, England.

FOR DATA CIRCLE 381 ON READER CARD
—Fred Lamond

DATAMATION.

February 1983

Vol. 12 No. 1

Editor Linda Runyan
Technology Editor Fred Lamond
Contributing Editors James Etheridge
Norman Kemp
Malcolm Peltu
Editorial Advisors Philip Dorn
David Hebditch
Flemming J. Jensen
Angeline Pantages
Russell Pipe
Copy Editor Florence Lazar
Art Director Kenneth Surabian
Assistant Art Director Susan M. Rasco
Production Manager Kathleen Monaghan

EDITORIAL OFFICES: 6605 Burlington Pl., Springfield, VA 22152, USA, (703) 569-3383. Telex: 440-413.

CIRCULATION: J.B. Tratsart Ltd., 154 A Greenford Rd. Harrow, Middlesex, HA 13QT, England.

working with videotex

Videotex 83 – the latest in a series of international conferences and exhibitions dedicated to the North American market. Its predecessors, Videotex 81 and 82, drew exhibitors and delegates from all over the world. At those shows videotex ventures were mostly trials and theory, now the wraps are coming off solid commercial services.

Videotex 83 will provide a definitive forum addressing the many important marketing, programming, financial, communications and technical factors which will make the difference between success and failure.

The conference program will consist of over 30 separate sessions, and feature presentations from more than 100 authoritative speakers.

Videotex 83 has been designed to meet the needs of knowledgeable delegates and decision-makers who want to deal with the practices and practicalities of videotex rather than rehashing first

principals. Newcomers haven't been forgotten though, and there are some foundation sessions to get them on the learning curve.

The exhibition promises to be bigger and better than ever with many organizations displaying systems and offering services that are new to the industry. Most of last year's exhibitors have already taken up their options on booths. If you want to stake your claim in this unique marketplace ring us today for your exhibition brochure, or clip the corner of this ad with your business card marked "Exhibitor" or "Delegate" and return to:-

onTime

London Online Inc., 4 East 43rd Street,
Penthouse Floor, New York, NY 10017, USA.
Phone: (212) 692 9003, Fax: 692 9006.



International Conference and Exhibition

The New York Hilton June 27-29 1983

Computer Security

You know it's important,
but you haven't had
the time or the funds
to implement it.

Here's an opportunity
to get started...for just
the price of a stamp.

GUIDELINES
for establishing a
Computer Security
Program

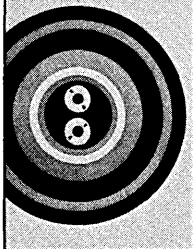

Computer Security Institute, Dept. DG2
43 Boston Post Road, Northborough, MA 01532
(617) 845-5050

Please help us get our program moving. Send me a complimentary copy of Computer Security Institute's 12-page booklet, **Guidelines for Establishing a Computer Security Program.**

Name _____

Title _____

Organization _____

Address _____

City _____ State _____ Zip _____

"I'VE GOT BIG COMPUTER PERFORMANCE ON MY SIDE"



Only a major worldwide computer company can offer a complete office automation system that fits in perfectly with a company's data processing structure.

TTX 35, when used as a free-standing system, can of

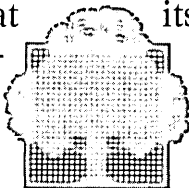

course handle word processing, but what's more important is its access capability to complete office automation systems as well as to computer applications developed for the entire Cii Honeywell Bull range.

Cii Honeywell Bull
Cii Honeywell Bull in 73 countries.

CIRCLE 220 ON READER CARD

Olivetti WS580

Computer's friend Man's friend



olivetti

The Olivetti WS580 range of terminals are collectively the computer's greatest friend. Whether they form the final link in an existing information system, or have a personalized role in individual applications, their great flexibility is a guarantee of maximum performance. Available in emulation of models DEC VT52 - 100, IBM 3101, ADDS Regent 60, these terminals can be personalized to suit their own application environment and they can also be connected to a wide variety of printers. But the appeal of the WS580

range goes beyond the computer. In the design of every terminal, embodying all of Olivetti's ergonomic expertise, the convenience and efficiency of the user is paramount. That is why the terminals are man's best friend as well. Unfatiguing to work with, they can be used to form every different kind of workstation, to meet the needs of as many different kinds of application.

The Olivetti WS580 range of terminals are another remarkable example of technology in the service of man.

OEM/SYSTEMSHOUSE EDITION

DATA MATION

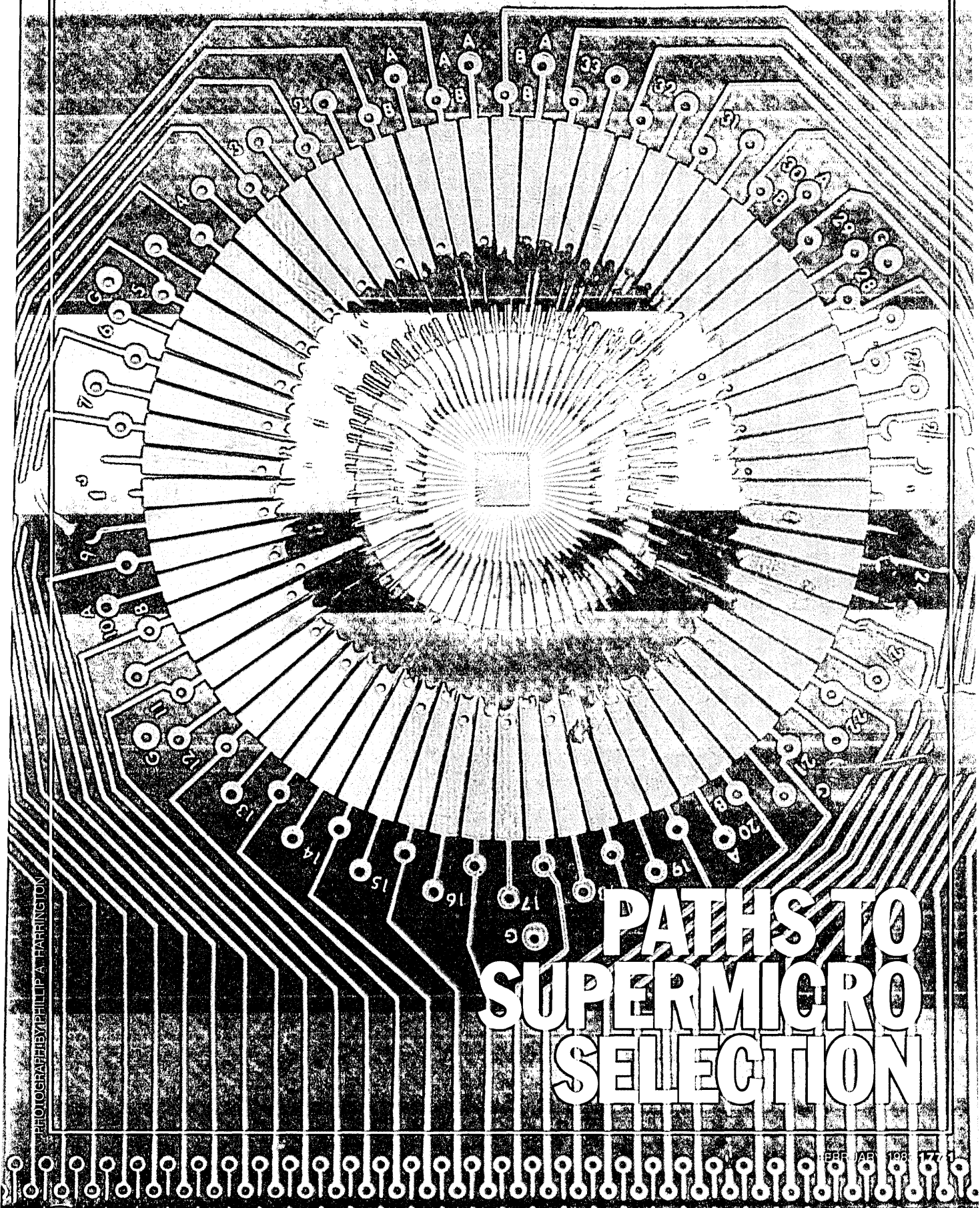

PATHS TO SUPERMICRO SELECTION

PHOTOGRAPHER PHILIP A. HARRINGTON

Comtech allows the OEM to employ broadband techniques for interconnecting many types of hardware, using our M570B modem. This includes all types of terminals, computers, microprocessors, computer graphic stations, process automation devices, remote graphic stations, etc.

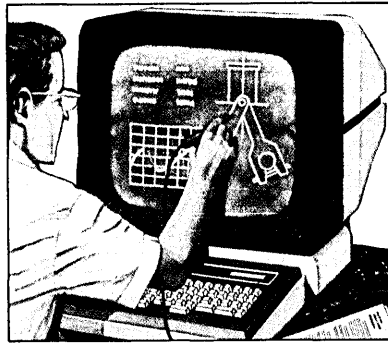

Transmission rates of 3.5 MBPS are possible with the M570B. For more information concerning the application areas of your particular hardware and our versatile broadband modem, write or call Comtech Data Corporation, 350 North Hayden Road, Scottsdale, Arizona 85257, call (602) 949-1155 or TWX 910-960-0085.

Comtech is a recognized leader in the field of high speed interactive data transmission using coaxial cable modems.



COMTECH
Data Corporation

A SUBSIDIARY OF COMTECH TELECOMMUNICATIONS CORP.
CIRCLE 230 ON READER CARD

Comtech Offers Broadband Capabilities at OEM Prices.

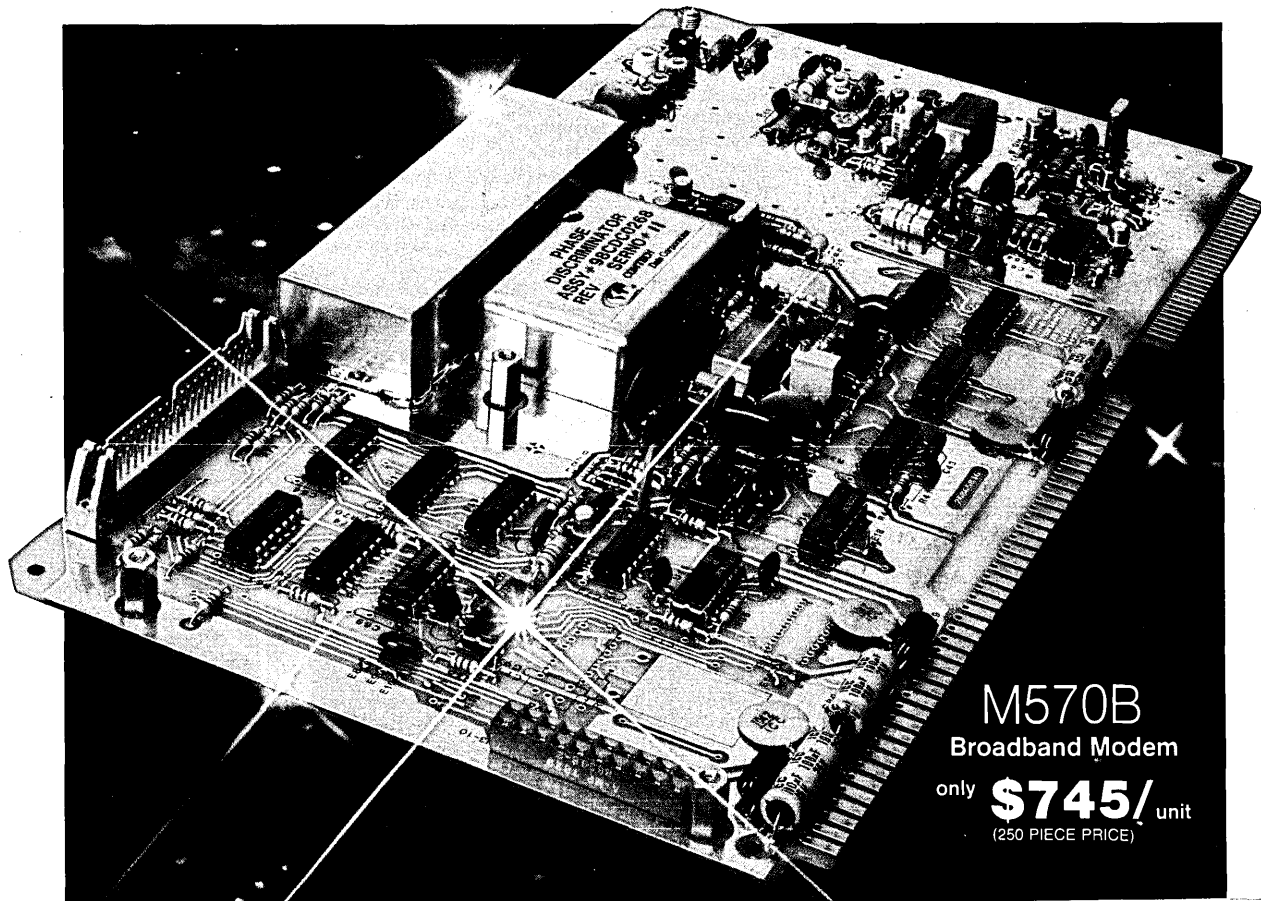

M570B
Broadband Modem

only **\$745/** unit
(250 PIECE PRICE)

Supermicros are setting new price/performance levels, offering a challenge and an opportunity to the oem and system integrator.

SELECTING SUPERCHIPS AND SUPERMICROS

by Omri Serlin

Superchips—high-performance microprocessors (MPUs)—are here. So are complete general purpose computer systems using such MPUs, known as supermicros. These supermicros, typically based on the Intel 8086, the Motorola 68000, and occasionally the Zilog Z8001, can match or even surpass minis like Digital Equipment's PDP-11/45 in performance and multi-user features, while offering the low cost and compact packaging typically associated with microcomputers.

More than 60 U.S. firms, and several European and Japanese ones, already offer supermicro systems. Many are little-known startups, but IBM, Hewlett-Packard, Tandy/Radio Shack, Intel, Zilog, and Motorola are also participating. Not a week goes by, it seems, without some new supermicro being unveiled by some new entrant in the field.

Although the business is currently affected by the unsettled economic conditions in the U.S. and abroad, the long-range prospects are excellent. The worldwide market for supermicros will grow far faster than the markets for mainframes or minis. In 1986, some 235,000 units will be shipped, worth more than \$5.5 billion in terms of 1981 end-user dollars. Included in that figure are initial shipments and sales of aftermarket hardware, software, maintenance, and supplies. In terms of dollar volume, the 1986 supermicro market will nearly equal the \$6.3 billion market for 8-bit microcomputers.

Supermicros represent both a challenge and an opportunity to the oem and system integrator. MPU-based systems will eventually eliminate minicomputers as a useful product. This hasn't happened yet, but the overall trend is already fully evident. Supermicros, in particular, are already challenging conventional minicomputers—and even superminis—in many general purpose and business applications as well as in such specialized applications as graphics workstations, portable executive terminals, CAD/CAM terminals, and fault-tolerant systems.

A significant portion of the growth in the supermicro market will come at the expense of the minicomputer vendors. It will

also affect those oems who use minicomputers to implement applications that can be performed equally well with supermicros. The computer manufacturers who have signed or are negotiating for oem agreements with supermicro suppliers, such as Convergent Technologies and Fortune Systems, are doing so partly because they have no effective answer of their own to the supermicro onslaught.

On the other hand, supermicros create new market opportunities. Many small businesses could benefit from, but cannot afford, the mini-based vertical market applications systems now available. But they could well manage to budget for the same (or similar) application implemented on a supermicro system. Specialized intelligent terminals and workstations and fault-tolerant transaction processing systems represent two other areas in which superchip-based designs are opening up lucrative new opportunities.

No oem or system integrator can ignore the impact of superchips and supermicros. Those with existing systems must evaluate the challenges posed by the superchip-based newcomers. Others who may have been kept away by the low performance of 8-bit micros on the one hand and the relatively high cost of conventional minis on the other must reevaluate their positions in light of the new price/performance level established by the supermicros. They must also examine the new opportunities presented by supermicros.

THE SUPERCHIP IS SUPER

The superchip is one of the new wave of MPUs that differs from the currently popular 8-bit micros primarily in its ability to exchange data with the external world—in particular, the memory system—in chunks of at least 16 bits at a time. This is important because most instructions and most data items, even in an 8-bit micro, contain at least 16 bits.

Some 16-bit chips sets and chips, for instance the DEC/Western Digital LSI-11 chip set, Data General mN601, and Texas Instruments TMS9900, became available in the early and mid-1970s. These circuits were meant

to capture in VLSI the architecture of existing minicomputers from these manufacturers. But they won only limited acceptance outside their captive markets. More independent superchips—those designed by semiconductor manufacturers—began to appear in 1978. Today, this class includes the Intel 8086 and 286, the Motorola 68000, and the Zilog Z8001. Two more recently announced products—the National NS16032 and the TI TMS99105—have gone into production. (Table I summarizes some of these five chips' characteristics.)

The Intel 8088 and the Zilog Z8002 are sometimes called 16-bit MPUs, and are indeed capable of manipulating 16-bit data items internally. But the 8088 does not meet the 16-bit external data-bus test and is therefore not a true superchip. The Z8002 falls short on the extent of its address space. A large address space is one of a true superchip's most important traits. The Motorola 68000, for instance, uses 24-bit addressing and can linearly address a 16-megabyte space, just as the IBM System/370 and 43xx mainframes do. Other superchips achieve a large address space through segmentation, a scheme by which a program can switch, in a relatively easy way, between a large number of small segments. Segmentation is typically used to maintain compatibility with earlier 8-bit micros that could only address between 32K and 64K bytes.

A large, linear address space makes life much easier for the assembly-language programmer. More importantly, it makes large programs, such as those typically produced by high-level language compilers, more practical. The ability to efficiently support high-level language programming will become more critical in the supermicro environment, just as it became key to the popularity of minicomputers 10 years ago.

Microcomputer development today closely parallels that of the earlier minicomputers in another significant respect. Like the 16/32-bit minis of a decade ago, some superchips—notably the Motorola 68000—are designed internally as 32-bit machines; that is, they have 32-bit-wide registers and data paths, and can perform some operations on

32-bit-long data items. This is important because floating point items are usually at least 32 bits long. While floating point (as well as decimal and possible trigonometric and transcendental) arithmetic is typically performed on a separate slave processor, such as the Intel 8087, the main processor should also be able to handle such data items.

Finally, a typical superchip is fast. While the fastest 8-bit micro today (Zilog's Z80B) runs at 8MHz, some superchips are now available in 10- and 12MHz versions. While performance is not always linearly related to clock rate (it depends for one thing on whether the clock is multiphased or not), it is generally true that, within the same family, a faster clock rate allows proportionately faster performance. An important consideration here is whether the memory and support chips can also run effectively at the MPU's clock rate.

The 16/32-bit superchip is a key ingredient of the supermicro system, but is not the only one. Another is the 64K-bit RAM chip. Considering today's buyer's market in these dense memories, it's easy to forget how scarce they were only three years ago. With these chips, a system designer can put a half-megabyte memory system on a small Multi-bus-type board, or 1 megabyte, possibly with full error checking, on a Data General-type printed-circuit board.

Still another ingredient is the Winchester disk drive, a product in which dramatic progress is being made at a very rapid pace. Compact, 5¼-inch Winchester drives are routinely available in capacities of up to 20 megabytes; recently announced 30- to 50-megabyte capacities in the 5¼-inch package should become available later this year. Removable Winchester cartridges, which neatly bypass the disk backup problem, are also beginning to emerge.

RAPIDLY DROPPING PRICES

Other contributing factors are involved. Universal terminal line-handling chips (USARTs) take care of the nasty bit-banging chores involved in managing communications protocols, thereby permitting the system to support a significant number of user terminals without imposing inordinate requirements for board space and cpu overhead. The rapidly dropping prices of crt terminals, for example, are already at the \$600 level (including ADDS and Tandy, to name just two). These two terminals could possibly reach \$100 if the French Telematique/videtex program succeeds in meeting its ambitious objectives. The new breed of high-performance dot matrix printers, available from IDS, Anadex, and others, produces draft-quality print at 200 to 300 characters per second while slowing down to 100 to 150 cps for almost letter-quality work. In addition, the printers support bit-map graphics

and sometimes even color. All this at a price quite similar to that of much slower, far less flexible daisywheel printers.

TABLE I
SUPERCHIP COMPARISON

	INTEL 8086	MOTOROLA 68000	ZILOG Z8001	NATIONAL NS16032	TI TMS99105
Announced	Early '78	Mid-'79	Late '78	Feb. '81	Oct. '81
Production	Mid-'79	Mid-'80	Early '81	July '82	Jan. '83
Clock Rate (MHz)	5,8,10	4,6,8,10,12	4,6	10	24 (4-phase)
Packaging	40-pin DIP	64-pin DIP	48-pin DIP	48-pin DIP	40-pin DIP
Address Range	1 MB, segmented	16MB, linear	8 MB, segmented	16MB, linear	256KB/16MB
General Purpose Registers	8×8 bit or 4×16 bit	8×32 bit	14×16 bit or 7×32 bit	8×32 bit	16×16 bit in "Macrostore"
Coprocessor	8087	68881 (1983:4Q)	Planned	16081	Planned
Price (Quantities of 100)	5MHz/\$47.50 8MHz/\$59.40 10MHz/\$95.00	4,6MHz/\$56 10MHz/\$61 12.5MHz/\$111	6MHz/\$46.67	10MHz/\$162	24MHz/\$65

and sometimes even color. All this at a price quite similar to that of much slower, far less flexible daisywheel printers.

The combined impact of these developments is that it is no longer particularly challenging to put together a powerful 16/32-bit computer system, possibly with significant floating-point arithmetic capability, with as much as a megabyte or more of main memory and 20 megabytes or more of hard disk, all in a very compact desktop package, and all at an end-user price of around \$10,000 to \$15,000. There you have it: a supermicro!

We are already beginning to see chips and chip sets that are substantially more powerful than today's superchips. The 10MHz Intel 286, for example, will incorporate virtual memory management on a chip. This task is typically accomplished with a separate memory management unit chip in today's MPU offerings.

True 32-bit extensions for the Motorola 68000 and National NS16000 families have already been announced. These chips, to be available in late 1983, will augment their internal 32-bit architecture with a 32-bit-wide external data bus. They will, of course, require more pins. The Motorola 32-bitter, for example, will have 100 pins. Similar offerings from Intel and Zilog are also in the works.

The recently announced HP9000 desktop computer from Hewlett-Packard is based on a 32-bit chip set developed at the company's Ft. Collins, Colo., facility. The system's key component is a very dense (450,000 transistors, 1.5/1-micron geometry) 32-bit cpu chip. The 18-MHz (2-phase) cpu is supported by a 128K-bit memory chip

and several other parts, all implemented in the same 1.5/1-micron NMOS technology. HP is unlikely to release these parts in conventional packaging.

Bell Laboratories' engineers have also made disclosures relating to their 32-bit CMOS cpu chip. Bell Labs may be preparing to market the product, called Bellmac 32, outside the Bell system. The recent relaxation in the regulatory environment (FCC's Computer Inquiry II and the AT&T/DOJ 1982 Consent Decree) makes this even more likely.

Another of these super-super (hyper?) chips is the Intel 432 MicroMainframe. This three-chip cpu set has much of the flavor of a large mainframe, even though its external bus is only 16 bits wide. For one thing, the architecture supports a very large (2-gigabyte) address space. In addition, the design lends itself especially well to the creation of a multiprocessing system: each 432 cpu set is self-dispatching and supports interprocess communications primitives. No one cpu need be in control, and the application programs need not be aware of how many processors are actually configured. Finally, the 432 incorporates Functional Redundancy Checking (FRC), a scheme that permits any two identical chips in the 432 family to be configured as a self-checking module. FRC is especially valuable in the construction of fault-tolerant systems.

In late 1982, NCR released a true 32-bit chip set for oem and internal uses. The NCR/32 features external micro-programmability, an important consideration for customizers, and IBM 370-compatibility features, which should interest IBM plug-compatible machine manufacturers.

THIRD-PARTY SOFTWARE

Portable software has been a dream of computer users since the early days of digital computers. The dream is now nearer to reality because of the polarization of the minicomputer and microcomputer markets around a few MPU families. This polarization creates the necessary environment for the growth of third-party software vendors, a significant industry in itself, and a critical catalyst for the continued development of the hardware market.

We have an excellent example of what the future holds in today's CP/M, which by some estimates was installed at approximately 500,000 sites at the end of 1982. This huge base was made possible by the popularity of the largely compatible 8080/8085/Z80 MPU families, which endowed numerous makes and models of microcomputers with essentially the same instruction repertoire. CP/M, which is written in 8080 machine code, carefully separates those functions that depend on the idiosyncracies of each implementation (crt, keyboard, peripherals) so that vendors of varying 8080/8085/Z80-based machines can readily adopt this operating system to their product.

CP/M's success, in turn, has given rise to a vigorous third-party software industry, which is reckoned by some to consist of more than 500 suppliers marketing over 3,000 CP/M compatible programs.

A similar polarization is taking place in the supermicro arena, where the main battle is between Intel's 8086 and 286 and Motorola's 68000. Digital Research is determined to capture a significant portion of the supermicro software market with CP/M-86, an extended CP/M version that runs on, and takes advantage of, the Intel 8086 (CP/M-86), and with MP/M-86 and CP/Net, which provide multitasking, multi-user, and networking extensions. Gary Kildall's Digital Research is also working on a version of CP/M to run on the 68000, and another extension for the National NS16016, a bridge machine with 8080-compatibility, due in the fall of 1983.

A bandwagon effect is building around the Unix operating system, however, especially among builders of 68000 and Z8000-based systems. Unix, which was developed at Bell Labs, is much richer than CP/M. It is also better suited to the 16/32-bit environment, and is intended to be a multi-user system (which CP/M is not). The price one pays for these features is in the main-memory requirements: 128K to 256K bytes minimum for Unix, as compared to 12K to 24K bytes for CP/M.

Unix is also attractive because it is coded largely in a high-level language called C, for which compilers exist on a fair number of mainframes, minis, and now micros (including those based on the 68000, 8086, and Z8000). Thus Unix is relatively easy to transport (or "port," as the term is commonly abbreviated) from its DEC PDP-11 and VAX versions to the supermicros. Unix is still far behind CP/M in terms of installations (fewer than 10,000 Unix installations) and of third-party support (nearly nonexistent). Yet some

Portable software has been a dream of computer users since the early days of digital computers. The

HALF HIGH

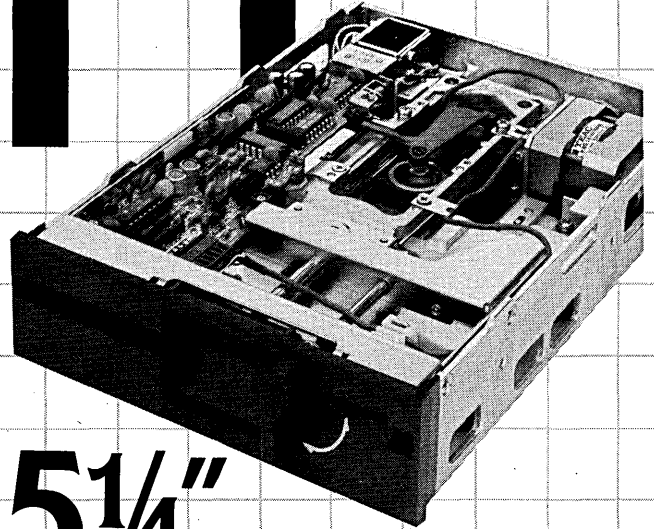

5 1/4"

Floppy Disk Drives

TEAC FD-55 Series

AT 1 5/8" HIGH, TEAC FD-55 SERIES 5 1/4" FLOPPY DISK drives use half the space and run cool at half the power of conventional drives. High-reliability, low-noise brushless DC motors provide an MTBF of over 10,000 hours, backed by a one-year parts and labor warranty.

FD-55A	FD-55B	FD-55E	FD-55F
• 48tpi	• 48tpi	• 96tpi	• 96tpi
• 40 track	• 40 track	• 80 track	• 80 track
• 250KB	• 500KB	• 500KB	• 1MB
• single side	• double side	• single side	• double side

Power Requirements:

DC +12V \pm 5% 0.3A typical, 0.7A max.
DC + 5V \pm 5% 0.5A typical, 0.7A max.

Phone, write or wire TEAC Corporation of America for complete technical data, price and delivery.

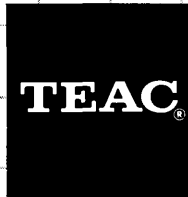

TEAC Corporation of America
Industrial Products Division
7733 Telegraph Road
Montebello, CA 90640
213/726-0303

© 1982 TEAC Corp.
MP82501M

industry observers are bullish on Unix: one recently projected a \$9 billion market in Unix-based systems by 1985.

There are other operating system alternatives for supermicro builders and users. Some, like the UCSD p-System and the Pick system, are also portable because they basically postulate a virtual machine as the interface between the software components and the actual hardware. Once the code is written to support this virtual machine on a given real machine (typically via an interpreter), the rest of the system needs little conversion.

A fair number of supermicro vendors (notably Convergent Technologies) have opted to develop proprietary operating systems. They have done this despite the availability of CP/M, Unix, and other portable systems. One motivation for doing so is to attain product differentiation in a field that is rapidly taking on the characteristics of a commodity market. Because so many systems rely on the same MPUs and peripherals, they offer nearly identical capabilities. Proprietary software lets the builder or system integrator achieve some measure of uniqueness.

ENTERING THE MARKET

Any oem system integrator who wants to enter the supermicro market should realize that the market is already very crowded. The rate of announcements is accelerating.

Supermicro suppliers are proliferating for several reasons. First, the technology needed to assemble a supermicro is now widely available. Also, plenty of venture capital is available, in part due to the attractive features of R&D limited partnerships, and it favors high-technology startups. In addition, new marketing channels have been evolving over the past decade, including, most notably, the computer retail chains and individual retailer, the industrial parts distributors who move up into more sophisticated systems, and office equipment vendors, distributors, and dealers who are eager to cash in on the microcomputer boom. Finally, the availability of portable operating systems significantly reduces the software effort previously required of a manufacturer in bringing a new computer system to the market.

On the other hand, the proliferation of vendors and the increasingly commodity-like nature of their systems has already resulted in price cuts and rapidly dropping margins. The entire micro industry is in a shake-up, aggravated by the current economic climate.

An organization that wants to capitalize on the superchip revolution now would do well to consider avenues other than general purpose or business-oriented products. Several other avenues are worth exploring.

Vertical market applications are promising because many such applications

TABLE II

SUPERMICRO MARKET PROJECTIONS FOR U.S. MFRS.

(1981 \$ MILLIONS, END-USER LEVEL)

WORLDWIDE	1982	1983	1984	1985	1986
HARDWARE					
New shipments	300	900	1,560	1,980	2,115
Aftermarket	60	240	600	760	1,230
TOTAL HARDWARE	360	1,140	2,160	2,740	3,345
SOFTWARE					
Shipped with new systems	20	60	84	90	70
Aftermarket	20	80	200	380	615
TOTAL SOFTWARE	40	140	284	470	685
MEDIA & SUPPLIES	40	160	400	760	1,230
MAINTENANCE	7	30	80	160	271
TOTAL WORLDWIDE MARKET	447	1,470	2,924	4,130	5,530
U.S. SHARE					
HARDWARE					
New shipments	270	720	1,092	1,188	1,058
Aftermarket	54	198	450	516	750
TOTAL HARDWARE	324	918	1,542	1,704	1,808
SOFTWARE					
Shipped with new systems	18	48	59	54	35
Aftermarket	18	66	150	258	375
TOTAL SOFTWARE	36	114	209	312	410
MEDIA & SUPPLIES	36	132	300	516	751
MAINTENANCE	6	25	60	108	165
TOTAL U.S. MARKET	402	1,189	2,111	2,640	3,134

SOURCE: THE SUPERMICRO MARKET STUDY BY ITOM INTERNATIONAL CO.

have not been explored. Many applications were previously considered unexploitable because conventional minis cost too much and 8-bit micros were not powerful enough (due especially to the lack of compact hard disks and to low cpu power). The arrival of the 16/32-bit supermicro, supported by a 5¼-inch Winchester, is changing the equation dramatically, and calls for a fresh look.

Several of the supermicro makers (notably CIE Systems, CompuThink, and Callan Data, with their 68000-based units) plan to specialize in supporting system integrators with moderate volume requirements. They offer a choice of operating systems, private labeling, and good product differentiation options. Specialized workstations, especially graphics and computer aided engineering workstations, are another niche worth exploring. The big names in the field generally offer minicomputer-based systems, which are being challenged with superchip-based (especially 68000) systems from such startups as Daisy Systems, Cadlinc, and Valid Logic.

The portable executive terminal market is currently addressed by the rather expensive and somewhat revolutionary Grid system (8086-based) at the high end of the spectrum, and by Osborne, Otrona, and others at the low, 8-bit-based end. There is a gap

between the two extremes, which could be filled with superchip-based, moderately priced products. The rapid advance in 3-inch to 4-inch floppy technology is especially significant in this connection.

Fault-tolerant systems based on superchips, especially the 68000, are now (or soon will be) challenging Tandem's dominance in the high-integrity, on-line transaction processing market. Only one such system, from Stratus Computer, of Natick, Mass., is being shipped. Several more startups plan to bring products to the market throughout 1983. The potential market is huge (more than \$17 billion in 1986), and the few present market participants will tap only a small portion (less than 15%) of the available market. Furthermore, the average system in this market can be priced at well over \$100,000, thus presenting a clear opportunity to escape the bloody price wars in the commodity supermicro market. *

Omri Serlin is the president of ITOM International Co., Los Altos, Calif., which specializes in technology assessment and market impact studies. Serlin has over 21 years of experience in the computer industry, both in the U.S. and overseas.

PERKIN-ELMER USERS:

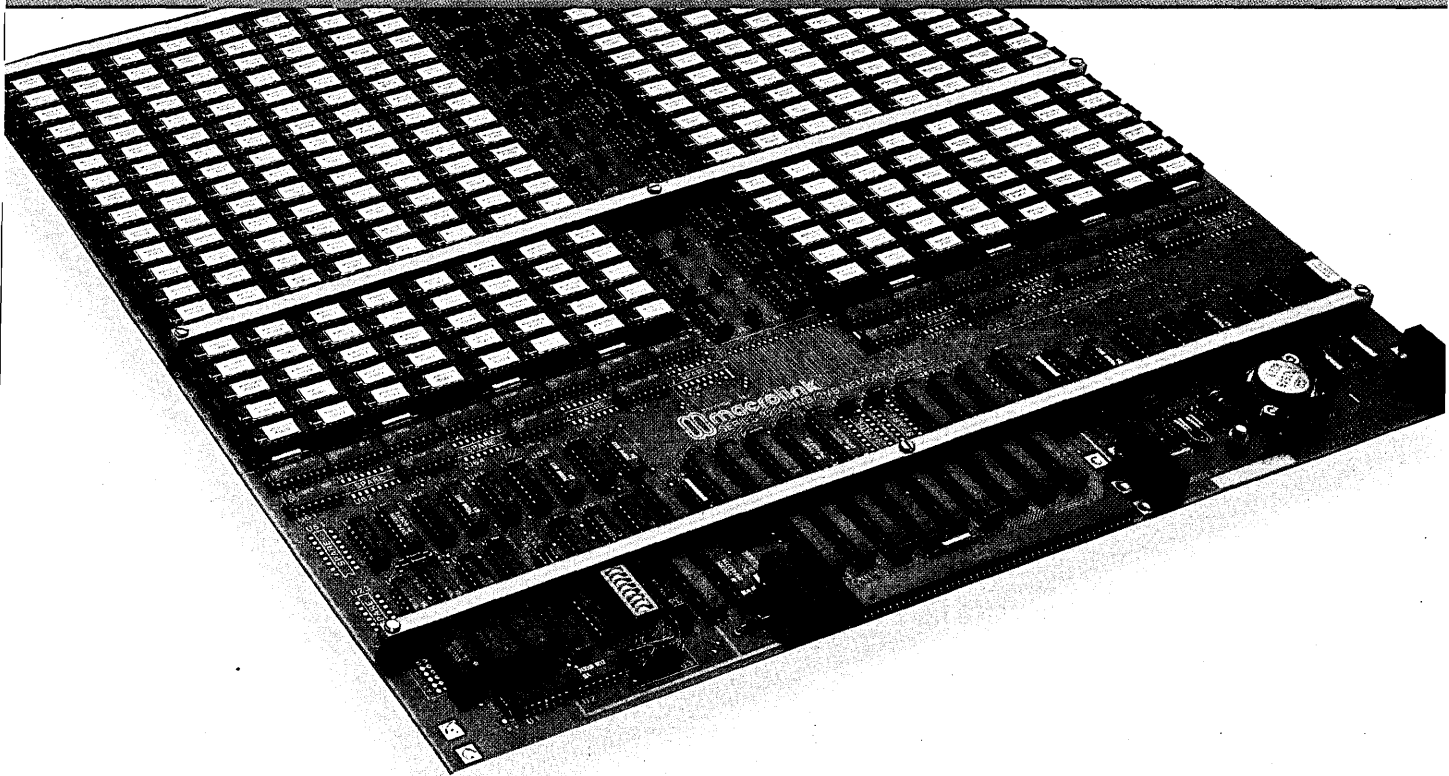

Our add-in memories add up to a better deal.

Macrolink offers stock availability on easy-to-install, plug-in memory boards for every Perkin-Elmer 3200 Series computer. All with the high reliability, tested performance, and pricing you'd expect from the established world-wide leader in P-E interfaces.

You can add our 1MB/2MB memory to any 3200 series CPU, including 3220 and 3240. For smaller upgrades we have a 256KB/512KB module just for

the 3220 and 3240. You'll appreciate full compatibility with P-E's memory management and ECC. And Macrolink quality. Our memories are built to exacting standards, using mil style components. Each board is burned in, computer tested, then retested using the latest operating system.

Find out more about our add-in memories. They're part of the largest family of P-E compatibles going — including

COMM, high-performance tape and disk controllers, printer controllers, and more. Each product is shipped from stock with complete installation and maintenance information — and backed by a 1-year limited warranty.

For facts by phone - prices, too - call (714) 634-8080. TWX 910-591-1671.



Macrolink Inc., 1150 E. Stanford Ct., Anaheim, CA 92805-6887

CIRCLE 231 ON READER CARD

Zilog's new System 8000 speaks seven languages. Fluently!

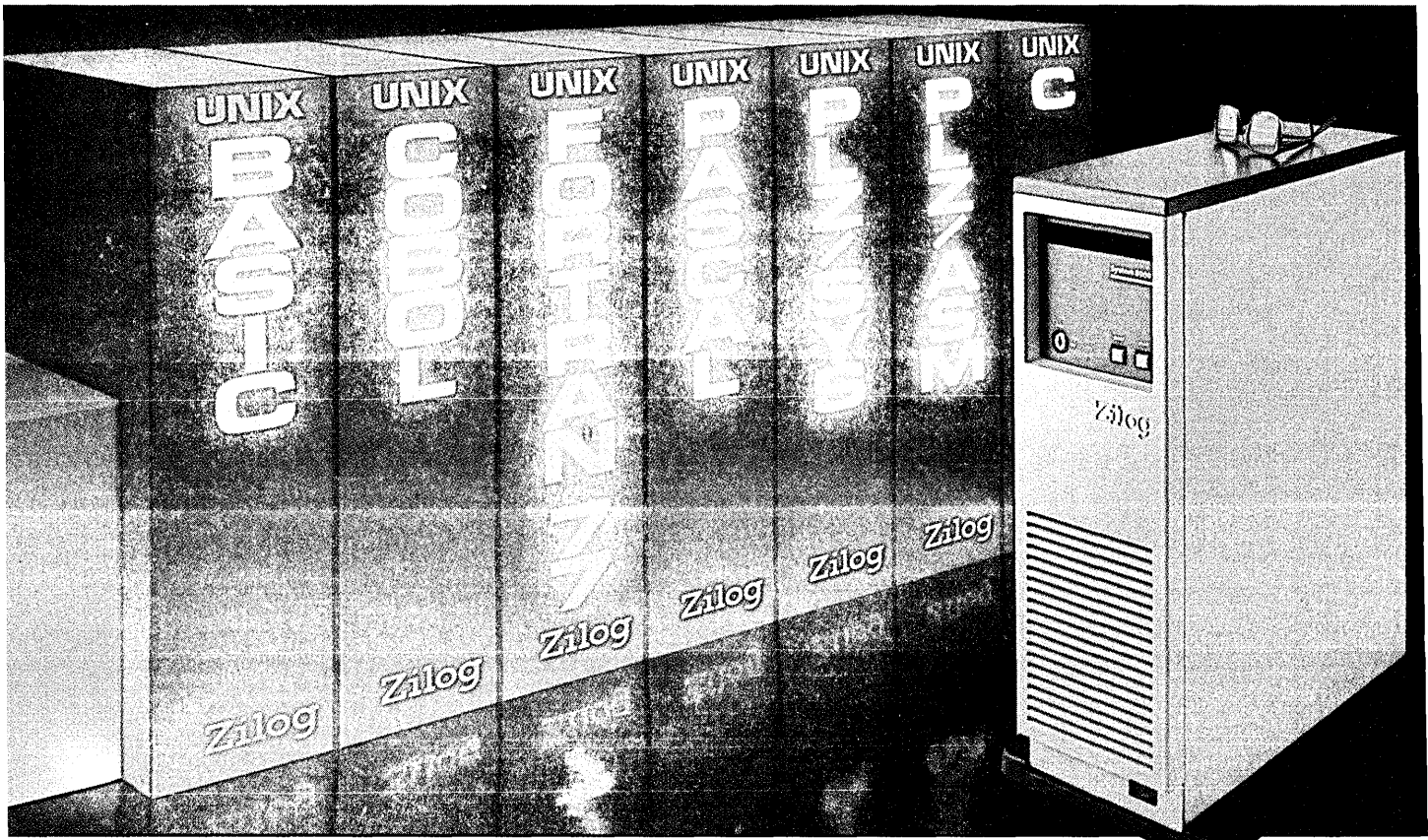

Now, there's a microcomputer that speaks seven high-level languages at a price that won't leave you speechless.

The Zilog System 8000 Model 11 is a general purpose, time-sharing computer that features the powerful UNIX* operating system, with enhanced System III capabilities. It is especially attractive to OEM's since all the software needed to make programming more productive is of the highest quality, and is accompanied by superb documentation.

For example, commercial users can select from high-level COBOL and BASIC business languages; systems programmers can select C, Z8000 assem-

bler and PLZ/SYS; technical users can opt for FORTRAN 77 or Pascal. Inside the Model 11 are the high performance VLSI components you've come to expect from Zilog. Each 8-user system is equipped with 256 KB of parity memory and an 18 MB Winchester disk for on-line storage. Optional ECC memory and additional disk storage capacity are offered. We also provide clear, easy to follow manuals, comprehensive training and dependable field technical support.

Zilog's new System 8000. Priced at just \$14,950, it is the powerful entry level system that speaks like a mini for micro prices.

To find out more about the System 8000 product family, call our toll-free number 800-841-2255. Ask for your free copy of the Zilog "Blueprint for Success" kit and poster. The kit contains detailed information about Zilog's unique OEM opportunities.

INTERNATIONAL

Paris 33-334-60-09 Munich 89-612-6046
London 44-0628-39200 Tokyo 03-587-0528

*UNIX is a trademark of Bell Laboratories. Zilog is licensed for System III by Western Electric, Inc.

Zilog

Pioneering the Microworld.

An affiliate of EXXON Corporation

CIRCLE 232 ON READER CARD

Of 235 exhibitors, Comdex Europe '82 had 112 U.S.-based companies plus 53 European subsidiaries of U.S.-based companies.

EUROPEAN TRADE SHOWS AND TRADERS

by Fred Lamond

When Comdex Europe was first announced by the Interface Group, it was claimed to be the "first ever European show for independent sales organizations [ISOs]." England's Compec show and Germany's Systems show, however, are both 12 years old, and the French Printemps show has a six-year history, so the claim for Comdex Europe requires some complex interpretation.

Held in Amsterdam, Comdex tried to be the first all-European computer trade show—as distinct from British, German, or French. Admission was to be reserved exclusively to distributors and sales agents—as distinct from Compec and Systems, which also admit end users.

But Comdex Europe did not achieve its objective. To understand why involves going back to the beginnings of these European trade shows, which play an important role in bringing specialist manufacturers, wholesalers, system integrators, distributors, and agents together. The oldest show to be directed specifically at the oem market is England's Compec (Computer Peripheral Equipment and Communications show), first held in 1971 at the West Center Hotel in London. The first Compec was limited to 100 very small booths and was restricted to peripheral equipment manufacturers as exhibitors and computer professionals—by invitation only—as visitors.

Increased demand for space persuaded Compec's administrators to move the show to the larger Wembley Exhibition Center outside London in 1976. In 1978, the show returned and was held in the even larger Olympia exhibition hall in Kensington. This coincided with the migration of the biennial general purpose International Business Show to Birmingham, England. As a result, Compec has since become, in practice if not in theory, a general purpose computer show. The latest, Compec '82, was held Nov. 16-19, housed 405 exhibitors, and received 32,850 visitors. According to exhibitors, 90% of the visitors were end users rather than potential distributors and agents, but 40% of them had authority to buy equipment.

Compec is essentially a British show, oriented toward the British oem and small-business end-user markets. All but a dozen of last year's 408 exhibitors were companies with offices in the U.K. They nonetheless included at least 69 subsidiaries of U.S.-based companies, nine Japanese, seven Irish, and a dozen Continental European and Scandinavian companies. Two French companies were represented in the Olympia itself, while another eight held an overflow exhibition in a neighboring hotel.

The remaining 300-odd exhibitors were British companies, but 39 of them represented wholly or mainly U.S. products as distributors. Thirteen represented Japanese products.

Compec's success encouraged its British organizers to attempt a Compec Europe show in 1976 and every year since. Held in Brussels—seat of the EEC and therefore the European headquarters for many U.S. multinationals—Compec Europe demonstrates the difficulty of transcending European national barriers. Apart from luring British companies accustomed to exhibiting at the London Compec and keen to penetrate the European market, Compec Europe has attracted only Dutch and Belgian exhibitors, and mainly Dutch and Belgian visitors. The most recent Compec Europe, held in May 1982, attracted 7,455 visitors.

GERMAN SYSTEMS SHOW

But in practice, the biennial Systems show, held in Munich, has fulfilled that role. Since its beginnings in 1971, Systems has been both a conference—devoted to applications software—and an exhibition. As an exhibition, it was helped off the ground by early block bookings of up to one third of the exhibition space by the U.S. Department of Commerce on behalf of smaller U.S. manufacturers of peripherals and other specialist equipment desiring German sales outlets. This set the tone of the show. Since then, the Systems show has tended to attract both German and other European manufacturers and distribu-

tors of the same type, although in recent years, end-user small-business and personal computers have also represented a growing portion of the exhibits.

It was also annual exhibitions of U.S. computers and peripheral equipment, organized by the U.S. Department of Commerce and conducted in Paris during the mid-1970s, that gave birth to Le Printemps Informatique, France's main show for computer oems. The show is held each March. In 1979, when President Carter pulled the Department of Commerce out of organizing foreign trade shows, French private sponsors took over Le Printemps Informatique and opened it to non-U.S. exhibitors as well. It has been so successful that the organizers of France's biggest dp and business equipment show—SICOB—opened a special SICOB oem hut outside the main exhibition hall in 1980 and limited admission to traders holding special invitations from exhibitors. The 1982 SICOB oem exhibit housed 94 exhibitors, including 17 American, two Canadian, two British, two West German, two Italian, one Dutch, one Hungarian, one Polish, and one Japanese company. The remaining 65 exhibitors were French companies, but included 16 French distributors of foreign products and 10 distributors specializing in one or more U.S. products.

The reason that Comdex Europe did not achieve its stated objective is that, on a continent of national market and national thinking, Comdex Europe was no more able to shake off its U.S. origins than Compec Europe has been able to shake off its British origins during the last six years. Out of 235 exhibitors, Comdex Europe counted no less than 112 U.S.-based companies (many in Europe for the first time) plus 53 European subsidiaries of U.S.-headquartered companies (including Data General and Hewlett-Packard). That left only 67 European companies, plus one each from Canada, Hong Kong, and Japan. Eight European companies (four Dutch, two West German, and two Swiss) were in fact distributors or wholesalers of U.S. or Japanese products.

The 59 indigenous European manufacturers and software houses represented at

Comdex Europe allows young U.S. companies to try out the European market at minimum cost.

Comdex Europe came overwhelmingly from just two of the 18 European countries. The Netherlands, as the host country, contributed 18 manufacturers and software houses and four publishers, closely followed by the U.K. (surprising in view of Compec's proximity), with 13 manufacturers and software houses and five publishers. Only three French manufacturers and two publishers attended; only two West German manufacturers and one publisher; two Danish manufacturers; and two Swiss manufacturers. Other European countries contributed no more than one exhibitor each. There was only one Japanese manufacturer at the show, compared with nine Japanese exhibitors at the following week's Compec. More French, German, Italian, and Scandinavian exhibitors attended the "British" Compec show than they did the "all European" Comdex.

LOW VISITOR TURNOUT

Many of those exhibiting at Comdex found the low visitor attendance disappointing. Despite restricting access to bona fide ISOs, the Comdex Europe organizers had unwisely let it be known that they were expecting 4,000 to 5,000 visitors per day. In fact, on the first two days, little more than 1,500 visitors showed up. Attendance did build up, and the final tally for the four-day show was around 7,000 visitors. Fewer than half of these were Dutch, with the remainder coming mainly from England, Belgium, France, Italy, and Spain. Scandinavian visitors were few and hardly anyone came from neighboring West Germany.

Most exhibitors consoled themselves with the thought that although they received few visitors, those who did call were of high quality. "We have had six serious inquiries from European distributors and agents," said one U.S. exhibitor. "If only four of these lead to distribution contracts, our participation in the show will have paid for itself." The most satisfied were those exhibitors who had sent out invitations asking European distributors and agents with whom they were negotiating to meet them at Comdex.

Regardless of the yield, a majority of Comdex Europe '82 exhibitors will probably give the show another chance in 1983. But if Comdex Europe does succeed in establishing itself, it will most likely be as the "U.S. show for European ISOs," and not as an all-European show. Comdex Europe permits young Silicon Valley companies to dip their toes into the European pond at minimal cost, much as the U.S. Trade Center formerly allowed them to do. European distributors interested in meeting them will go to Comdex and save themselves the transatlantic airfare. But Comdex has not changed Europe from being a continent of 18 separate national mar-

kets separated by language, custom, and business practice.

Let's now take a look at the European oem market as a whole and see how, although its structure resembles that of the U.S. market, each nation adds its own unique twist. Like its U.S. counterpart, the European oem market is multitiered. Specialist manufacturers of cpu boards and boxes, peripherals, data communications equipment, and systems and applications software constitute the top tier. Next comes a small number of equipment wholesalers, who stock hardware from a variety of sources and then resell it to systems integrators and end users; these firms do not contribute any system design.

System integrators constitute the third tier. These companies buy cpu boards or boxes, peripheral devices, and software from a variety of manufacturers, either directly or through wholesalers. Then they integrate these components into fully working systems, to which they add system software from the cpu manufacturer or from a specialist supplier. Sometimes they integrate systems to special order from a large user. More frequently, they integrate general purpose scientific calculation or commercial systems, which they later sell under their own brand name.

System integrators generally distribute their brand-name systems directly within the immediate vicinity of their headquarters and plant. In order to sell in more remote parts of their country and in other European countries, they typically appoint independent distributors to represent them. These distributors work a specific geographical area, although they sometimes market to a specific vertical market. The distributors, in turn, assign independent sales agents in each city and regional center.

HOW SALES EVOLVED

Nearly all the thousands of European computer systems distributors and sales agents confine their activities to part or all of a single national market out of Western Europe's 18 nation-states. The oldest and best-established among them can trace their history back to precomputer days, when they distributed or sold typewriters, electromechanical keyboard accounting machines, and a variety of visible-record office systems and supplies. As office technology evolved during the 1960s, they substituted visible-record and magnetic-ledger office computers for their previous electromechanical products. Later, during the 1970s, they replaced these products with display and disk-oriented small-business computers.

European office and small-business computer distributors display very little brand loyalty toward the manufacturers and systems integrators of the systems they sell.

If a supplier is slow in adapting to the latest technologies, distributors and agents will quickly shift to more cost-effective equipment suppliers whose products will be easier to sell. During the mid-1970s, for example, because some of the more conservative West German office-computer manufacturers had been slow to develop and offer disk-based office-computer systems, they lost half their distributors within a matter of months.

The system integrators, on the other hand, date back only to the mid-1960s. Digital Equipment Corp. created the European as well as American system integrator market on the scientific and engineering side with its PDP-8 boxes. Nixdorf, the West German company, was the first supplier of cpu boxes to other European accounting-machine manufacturers; these manufacturers had been slow to develop their own, and thus later became system integrators rather than manufacturers. The arrival of the cheaper minicomputers of the 1970s—suitable for small business computing—gave many erstwhile distributors an opportunity to become systems integrators.

The British firm Systime and the West German company David Daten-Computer are two outstanding examples of upward mobility in the European oem market. Systime was founded in 1973 by John Gow, a former DEC salesman, and was initially the West Yorkshire, England, sales agent for DEC Datasystem 300 and 500 packaged small business computers. Within a year of delivering its first Datasystem, Systime became a systems integrator, ordering PDP-11/34 and 11/45 cpu boxes from DEC and adding to them more cost-effective Control Data disk drives, Dataproducts and Diablo printers, and Beehive display terminals. Shortly after, Systime opened an office in London and appointed sales agents in other parts of the U.K.

In 1977 Systime began building cpu boxes for its 5000 series of small business computers, buying the cpu boards from DEC and building its own memory boards from chips bought directly from semiconductor manufacturers. It also began to build its own display terminals. Systime then expanded to neighboring European countries, with subsidiaries first in the Netherlands and Switzerland, and later in West Germany and France. The company has remained faithful to DEC's cpu boards and to its RSTS/E, RSX-11M, and VAX operating systems. It does add its own applications software. In 1980 Systime wrote a TP monitor, called System 1, which it also sells to DEC users in North America.

DAVID DATEN-COMPUTER

David Daten-Computer was founded by David Datentechnik, which, until 1974, was the Stuttgart agent for Ruf Datentechnik, an own-brand

IT'S SUPERCONTROLLER!

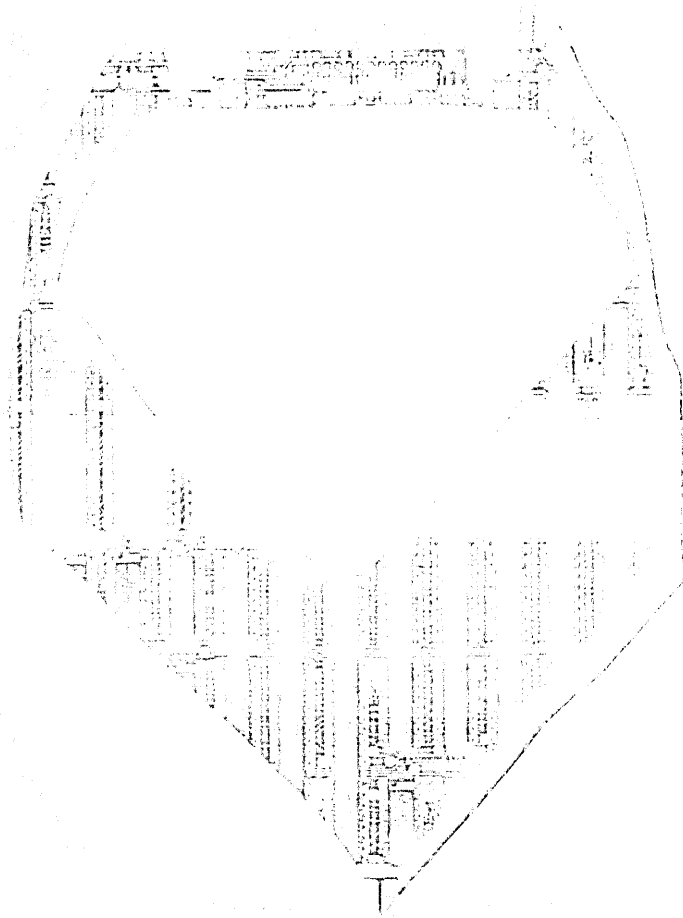

It's a 6250 BPI (GCR) controller that can handle dual and tri-density drives from STC and Telex.

It's a software compatible streamer controller for today's streaming 1/2" drives.

It's a TS11* emulator.

It's a 6250 BPI streamer controller for tomorrow's new technology GCR streaming drives.

It's a single board imbedded controller with a 64K byte on-board memory that acts like a large buffer in start-stop mode and as a multiblock staging

buffer while streaming.

It's the TS-6251 Supercontroller from Western Peripherals, the company that has put more magnetic tape on DEC Unibus computers than any other independent supplier. Call or write us for technical details.

Division of WESPERCORP

14321 Myford Road, Tustin, CA 92680
(714) 730-6250 TWX: 910 595-1775 CABLE: WESPER

WESPER INTERNATIONAL (U.K.)

London, England
(276) 20934 TWX 858 306

*Trademark Digital Equipment Corporation
CIRCLE 233 ON READER CARD

Although the European oem market is similar to the U.S. market, each nation has its own particular twist.

distributor of Nixdorf visible-record and magnetic-ledger-card office computers. When Nixdorf announced its 8870 display and disk-oriented small business computers in December 1974, it sought at first to reserve their distribution to its own direct sales network, and would not allow Ruf and its agents to handle it. Since Ruf had no alternative disk processing computer to offer its agents, David renamed the firm David Daten-Computer

and set about integrating its own disk-based system from DCC cpu boxes (the first Data General look-alike), Control Data disks, Dataproducts and Diablo printers, and Hazeltine displays. David began selling these in the Stuttgart area, and quickly expanded to the rest of West Germany by a combination of direct sales offices in other regional centers and oem sales to other former agents of Ruf or Nixdorf computers. By 1977 his company,

DDC, also had distributors in Denmark and Switzerland. By 1980, it had distributors in every major European country.

In 1978, DDC added a Motorola 6800-based single-user small business system to its product line. In 1979, the company established its own cpu manufacturing facility in Southern California to build DG look-alike cpus from bit-slice AMD microprocessors, with which it replaced the DCC cpus in the second generation of its larger systems. For DDC's third-generation machines, however, it is considering abandoning this manufacturing activity to revert to the role of systems integrator, using (probably) Motorola 68000 cpus. Its operating system and applications software have all been written to be portable, so the transition should be relatively easy.

During the late 1970s, the microprocessor-based personal computer and word processor revolution hit Europe at the same time it was hitting the U.S. Since then, it has greatly expanded all levels of the European oem market. The number of sales agents has increased by the addition of all the previous typewriter and office-equipment sales agents, who now also offer their customers word processors and personal computers. Hi-fi shops stock not only electronic games but home computers and, increasingly, personal computers for business use. Even lower-level distributors have appeared: retail outlets, department stores, stationers, and even food chain stores, all of which sell personal computers and software cassettes across the counter without providing any after-sale support.

Many small specialist manufacturing companies have also appeared in Europe. They offer add-in boards to users of Commodore and Apple computers, which make these systems CP/M- or Unix-compatible, give them 80-columns-per-line display capability, or give them asynchronous or IBM 3270 terminal emulators to communicate with mainframe computers.

These specialist add-in board suppliers have converted most Commodore and Apple sales agents to systems integrators, allowing them to offer their customers a variety of packaged solutions that include equipment from more than one manufacturer. The experience thus gained is encouraging the most dynamic sales agents, as well as the larger distributors, to design their own multi-user 16-bit microcomputer systems to complement their product offerings. They view this as a preferable alternative to taking out a distributorship or agency for one of the many U.S. brands of 16-bit micro systems that have hit the European market during the last year. *

Fred Lamond is DATAMATION's technology editor, Europe.

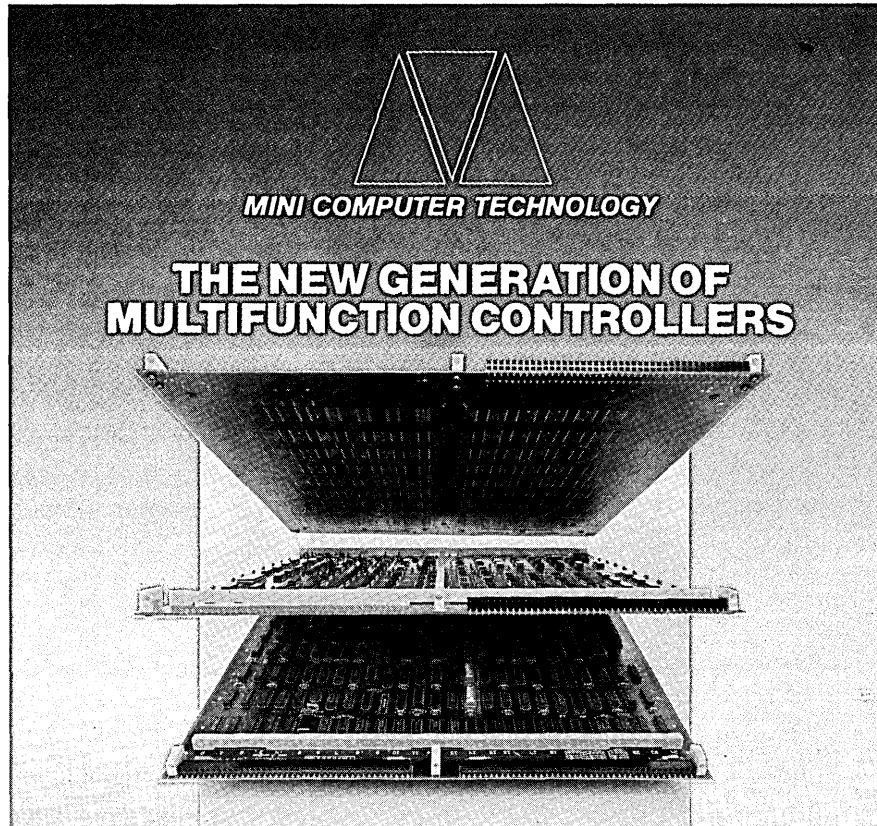

starts with Data General. Now you can interface any Data General Nova or Eclipse CPU with Priam Winchester drives, 1/4" cartridge tape drives, Centronics compatible parallel line printers, RS232 TTY, four port MUX, serial I/O ports and real time clocks. And you can do it all from a single board multifunction controller.

Soon you'll be able to do it for Perkin-Elmer and DEC computers, too.

Meanwhile, our full line of single board emulating and compatible disk controllers for Data General, Perkin-Elmer and DEC Q-bus and Unibus computers will handle just about any disk drive you'd care to hang on — including Winchester types. Call or write us for complete information. Do it today.

MINI COMPUTER TECHNOLOGY

696 East Trimble Road
San Jose, California 95131
(408) 942-1616 TWX 910-338-2281

CIRCLE 234 ON READER CARD

DILOG TAPE COUPLER EMULATES TS-11 FOR VAX*

You can't beat the Model DU132 for easy coupling between your VAX-11 and 1/2" magnetic tape transports.

DILOG's single quad size Tape Coupler interfaces VAX-11/730, 11/750, 11/780 and 11/782 and up to four formatted, start-stop, 9-track, tape drives or streaming tape drives with embedded formatters (start-stop/streaming selectable under software program control). The coupler offers data transfer rates to 600 KB and tape speeds to 125 ips. It also interfaces the new "Cache Streamer" ** and GCR transports.

The Model DU132 is software compatible with TS-11 under RT-11, RSX-11, RSTS and VMS operating systems. In addition, it offers 800/1600

reliability plus a 1 KB buffer and selectable DMA burst sizes of 2 or 4 words to eliminate errors due to DMA latency.

Contact your local DILOG sales office for complete details and O.E.M. quantity discount pricing on the Tape Coupler that emulates TS-11 for VAX.

BPI dual density not available on DEC TS-11.

The coupler has parity for increased data

Corporate Headquarters

12800 Garden Grove Blvd. • Garden Grove, Calif. 92643
• Phone: (714) 534-8950 • Telex: 681 399 DILOG GGVE

Eastern Regional Sales Office

64-A White Street • Red Bank, New Jersey 07701
• Phone: (201) 530-0044

European Sales/Service Office

12 Temple Square • Aylesbury, Buckinghamshire • England
• Phone: 44-296-34319 or 34310 • Telex: 837 038 DILOG I G

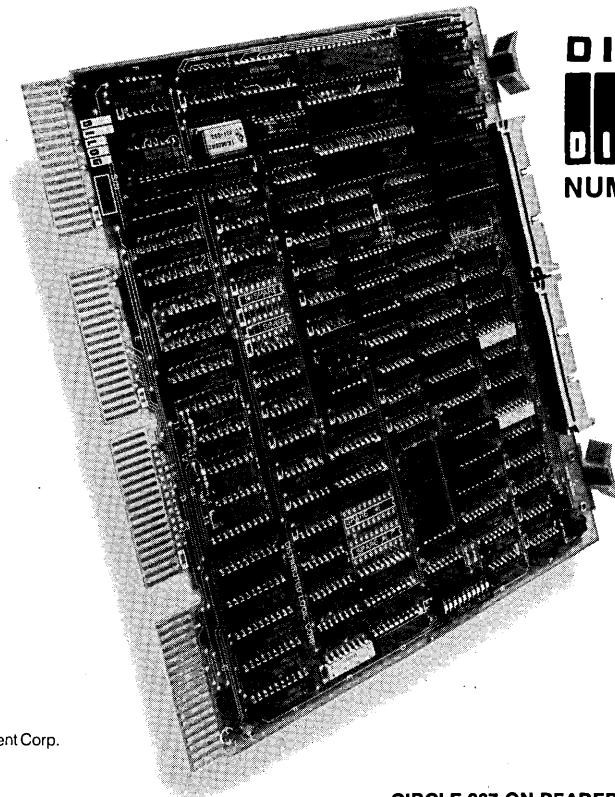

**DISTRIBUTED
LOGIC CORP.**



NUMBER 1 FOR DEC-11

*DEC, VAX, RSTS, RSX Trademarks Digital Equipment Corp.

**Trademark Cipher Data Products

How to make work like a

First, neatly cut out the "370" label.

Now, when nobody's looking, nonchalantly tape it to your terminal, just under the "IBM," as if it really belonged there.

Then wait for your chance and quickly slip a dBASE II™ disk into your main drive.

That's it.

Your IBM Personal Computer is now ready to run a relational database system, the kind that IBM put on their mainframes last year.

And you're ready with more data handling power than you would have dreamed possible before dBASE II.

You'll wonder how you managed without it.

You'll find that dBASE II, because it's a relational database management system (DBMS), starts where file handling programs leave off.

dBASE II handles multiple databases and simplifies everything from accounting to department staffing to monitoring rainfall on the Upper Volta.

With a word or two, you CREATE databases, APPEND new data instantly, UPDATE, MODIFY and REPLACE fields, records and entire databases. Organize months worth of data in minutes with the built-in REPORT. Do sub-field and multi-field searches, then DISPLAY some or all of the data for any condition you want to apply.

And you've just begun to tap the power of dBASE II.

Easy to look at, easy to use.

Input screens and output forms couldn't be easier—just "paint" your format on the CRT and what you see is what you'll get.

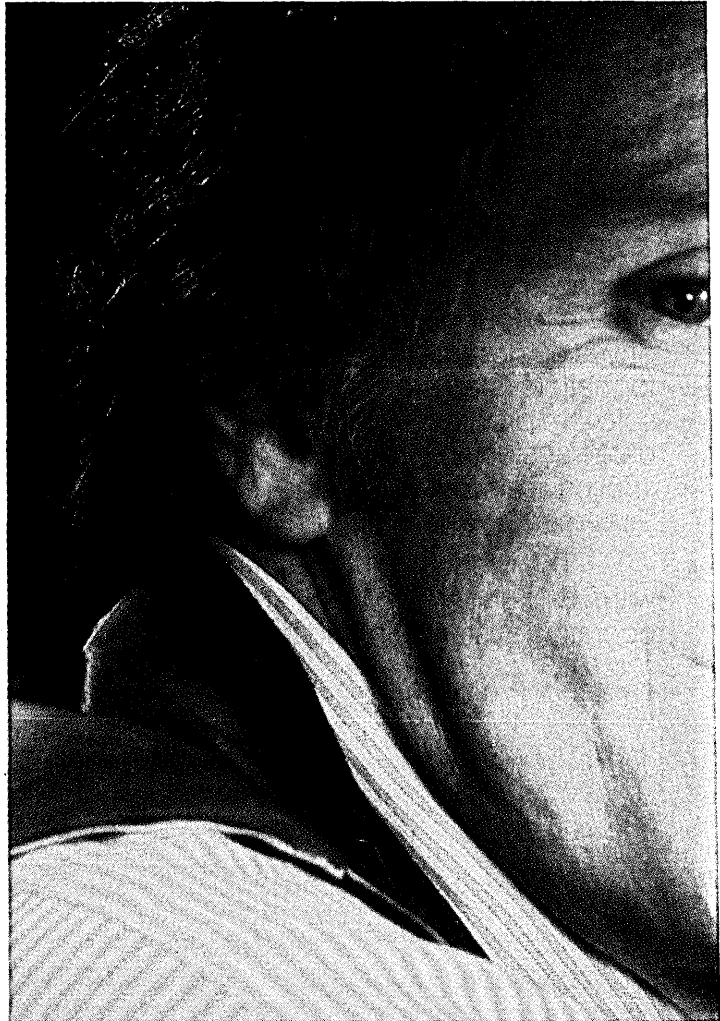

You can do automatic calculations on fields, records and databases, accurate to 10 digits.

And you can use dBASE II interactively for answers right now. Or save your instructions, then repeat everything with two words: DO Manhours, DO ProjectX, DO whatever has to be done.

Use dBASE II to help make your choice:

If you've got a 96k IBM PC, send us \$700 and we'll send you a copy of dBASE II to use free for 30 days.

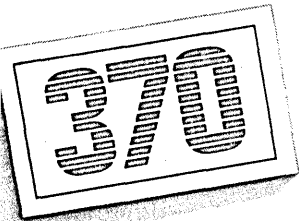

Be your micro mainframe.

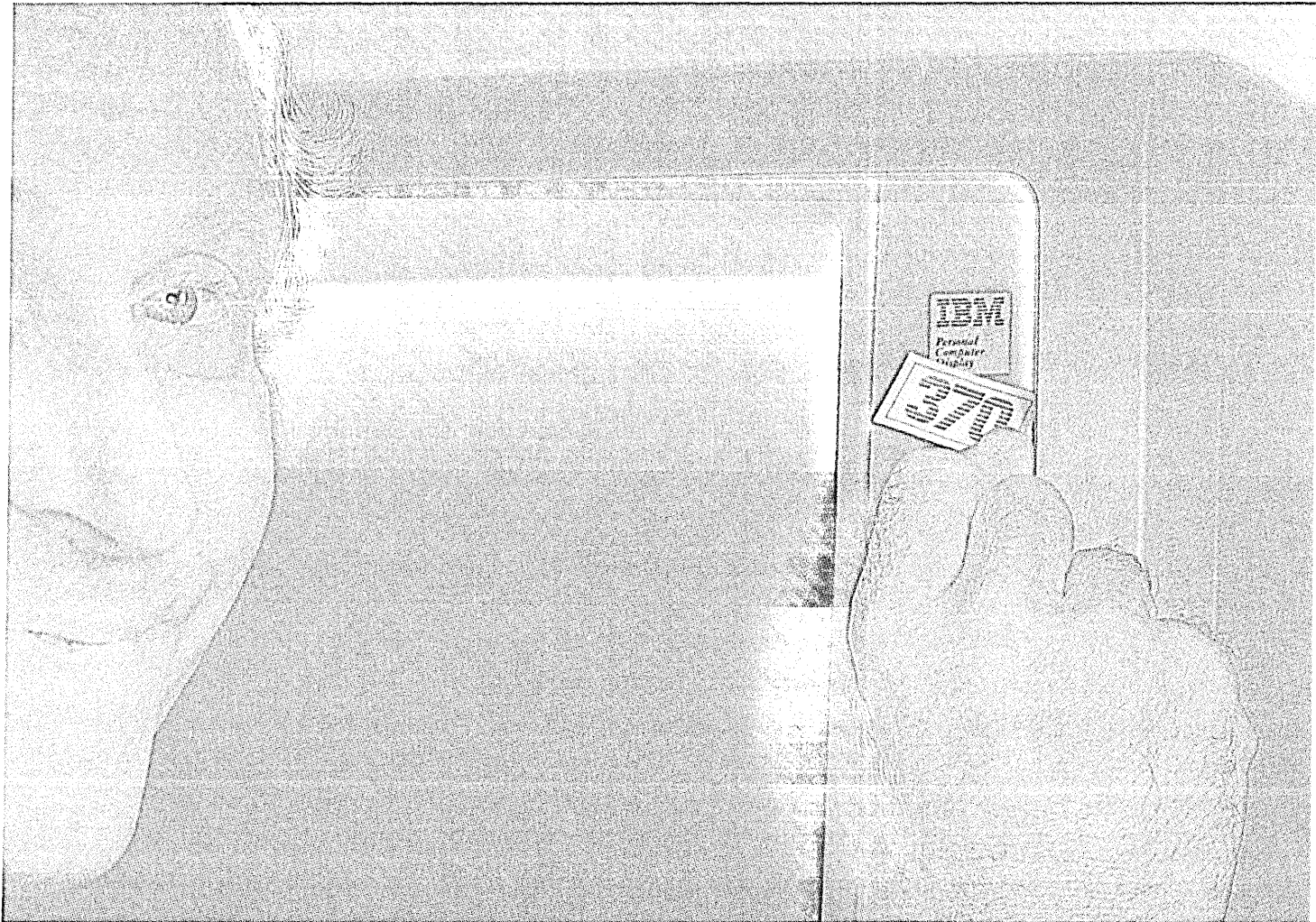

Instead of just poring over a manual, run it and make sure that it does what you need done.

Then if you find it isn't right for you, send it back and we'll return your money, no questions asked.

But if you do that, you'll have to remove that label. Because nothing short of a mainframe works like dBASE II.

Call (213) 204-5570 today or drop by your local computer store for the rest of the story.

Ashton-Tate, 9929 Jefferson Blvd.,
Culver City, CA 90230.

Ashton-Tate

©1982 Ashton-Tate
CP/M is a registered trademark of Digital Research

CIRCLE 235 ON READER CARD



We Asked UNIX* Users What They Wanted in an Integrated Workstation. Here's What They Said...

1. "We want a full Bell Labs UNIX operating system — not a look alike."

UNISTAR™ 100 is just that. It runs on an eight MHz, 68000, 16/32 bit CPU with 256K bytes of local memory, expandable to 1M bytes. UNISTAR provides the ultimate in cost-effective, versatile computing power for professionals.

2. "Give us a wide selection of languages."

UNISTAR 100 comes with C and 68000 ASM, with Pascal, COBOL, Fortran 77 and BASIC as options.

3. "We need plenty of disk storage."

An integral 5¼-inch, 10M byte Winchester and 5¼-inch, 0.6M byte floppy is standard, with additional 21M byte Winchester capacity to be available.

4. "We'd like room for additional options."

UNISTAR 100 has a built-in, six slot Multibus* card cage. It also has two, two RS-423 multiprotocol serial ports and a parallel 16-bit input/output port, too.

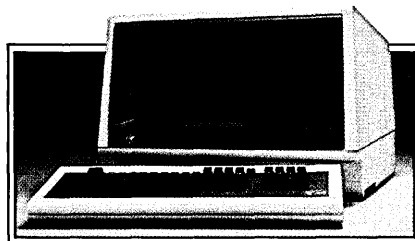

Another product of Callan Engineering and Manufacturing Excellence

5. "Give us a CPU that will take full advantage of fast memory chips."

UNISTAR 100 has advanced CPU board design with 256K bytes of on-board memory, together with a unique two-level, segment paged, multiprocess memory management scheme that eliminates CPU/MMU wait cycles, provides a timed-integer computational rate of 40% to 50% of a 11/780.

6. "We feel it's important to be Ethernet* -compatible."

UNISTAR 100 enhancements include an Ethernet interface controller, with UNIX-based UNET* software.

7. "If possible, we'd like all of this in a single, attractive package."

You've got it! UNISTAR 100 has packaged all of your needs — and more — in a desktop workstation with a detachable keyboard.

DISTRIBUTOR, OEM/SYSTEM INTEGRATOR INQUIRIES WELCOME.

Contact Callan™ Data Systems today.

Callan

DATA SYSTEMS

2645 Townsgate Road Westlake Village, CA 91361
(805) 497-6837 in CA or 800-235-7055
TWX 910 336 1685

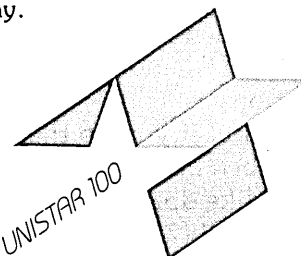

Trademarks: Callan, UNISTAR/Callan Data Systems. UNIX/Bell Labs. Ethernet/Xerox Corp. UNET/3COM Corp. Multibus/Intel.

CIRCLE 236 ON READER CARD

HARDWARE

OFF-LINE

Tektronix 4051 users can speed up their graphics displays using the 4051ADP Advanced Display Pack from Periphicon, near Tek in Beaverton, Ore. Point plot displays can run 150 times faster with the 4051ADP, and vector images can run 15 times faster. The \$1,200 plug-in module requires no modification of the 4951 workstation.

If you didn't think you needed a nonglare screen on your terminal and have since discovered that you do, you may find help with Glare Sentry, a screen that mounts over most crt displays. The \$140 screen, from Inmac, Santa Clara, Calif., uses a circular polarizer made by Polaroid.

Another accessory of note is the SoundTrap acoustic housing for office printers. The \$100 item, which doubles as a copy stand, provides storage for paper and simplifies paper feeding and fanfolding. Manufactured by Trace Systems, Mountain View, Calif., the unit is said to cut noise so that a phone conversation can be conducted next to the printer.

Recognize the Olympia Portable Computer, introduced recently by the Somerville, N.J., importing arm of the Italian giant? You should -- it's exactly the same as the Panasonic and Quasar portables manufactured by Matsushita. Olympia is pushing the handheld machine's briefcase configuration.

A brouhaha has been spreading in the microfloppy business as microcomputer systems begin incorporating the 3-, 3.5-, and 3.9-inch drives. Micro Peripherals, of Chatsworth, Calif., became the first to market 3-inch drives to oems, following Hitachi, Maxell, and Matsushita in endorsing that size as a standard. A 3-inch diskette holds about 250KB of data.

VOICE MAIL

The Voice Store and Forward (VSF) capability added to this vendor's Dimension PBX via an adjunct processor allows users to record, transmit, or receive voice messages. The messages can be answered and forwarded to other users.

The Dimension VSF—one of the first voice mail systems that is fully integrated into a PBX—includes a message waiting lamp. Since users do not have to dial into the system to determine if they have any messages (as is the case with standalone voice mail systems), they will be more likely to use the system, the vendor says.

Any touch-tone phone can be used to record and send a message to any number of users at any specific time; when the message is sent, the lamp on the receiver's phone lights up. To hear a message, a user dials the system and enters his password. The system plays back the recorded messages on a last-in, first-out basis. AMERICAN TELEPHONE AND TELEGRAPH CO., New York, N.Y.

FOR DATA CIRCLE 301 ON READER CARD

3278 EMULATOR FOR IBM P.C.

Irma is a printed circuit board interface for direct native mode coaxial attachment of IBM Personal Computers to IBM 3270 controllers. The interface fits into any available slot in the P.C., attaches via coaxial cable to 3274 or 3276 remote terminal controllers, and emulates a 3278 terminal display. It operates in native 3278 mode, and requires no additional telephone lines, modems, or communications front-end support for local or remote environments.

Irma's internal 1,920-character screen buffer is maintained and updated by an on-board microprocessor so that the P.C. can stay on-line to the controller while performing independent tasks. Data transfer subroutines are provided to enable users to work with a mainframe's data while off-line. The \$1,200 board can save mainframe data directly to disk or hardcopy. TECHNICAL ANALYSIS CORP., Atlanta, Ga.

FOR DATA CIRCLE 302 ON READER CARD

68008-BASED TERMINAL

The ATL-008 interactive video terminal runs off an 8MHz 68008 microprocessor to add more flexibility to a computer system. The terminal includes 32KB of RAM (expandable to 128K) and 512 bytes of nonvolatile RAM (expandable to 2,048 bytes).

The terminal takes advantage of what the vendor calls "soft" function keys that allow multiple functions from a single key, depending on the operating mode selected. As the user progresses through an application or moves from one application to another, the eight function keys assume different capabilities.

The terminal includes a capability to print 132 columns and 27 display lines or a more conventional 80 × 25 display, and has 10 resident foreign character sets. All operating characteristics of the \$1,400 terminal are configured from the keyboard. BEEHIVE INTERNATIONAL, Salt Lake City, Utah.

FOR DATE CIRCLE 303 ON READER CARD

ROBOT KIT

The 39-pound, 20-inch-high Hero I robot is available as a do-it-yourself kit for \$1,500 or \$2,500 prewired. The wired version is aimed at industrial training courses in robotics and comes with a 1,200-page course in robotics for another \$100.

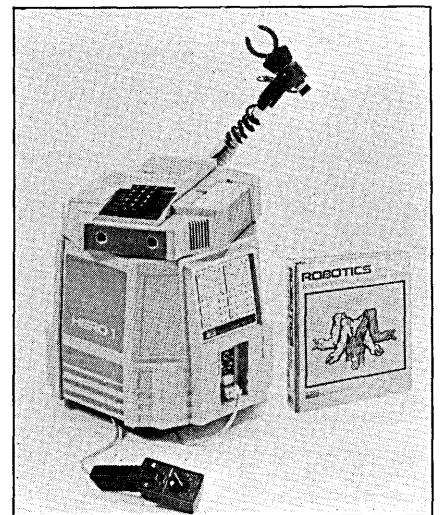

CULLINANE IS THE NUMBER ONE NAME IN DATABASE SOFTWARE.

BUT WE'RE ABOUT TO CHANGE THAT.

Computer Decisions magazine polled its readers to determine the first name in database software. They named Cullinane.

How could this happen to a company few people had even heard of ten years ago?

Perhaps we can credit it to the fact that Cullinane has done more for its customers. More to service them. More to support them. More to produce results for them with effective database management systems than any other company.

In any case, it demonstrates Cullinane's influence in the database world. And it comes at a very important time in Cullinane's history.

Because Cullinane is growing into new areas and under a new name, Cullinet.

The change in name reflects a fresher and broader approach to software solutions. A new direction for the future. A greater range of products. A strong position of leadership in new fields.

Cullinane will be called Cullinet. Or you can call us what Computer Decisions called us:
Number one.



Which suppliers would you consider in planning purchases of Database Management Systems?

288 MENTIONS FROM 187 RESPONDENTS

	1982	1981	1980	1979	1978	1977	1976
	No.	%	%	%	%	%	%
Cullinane	58	31.0	20.1	19.2	18.4	20.1	12.5
IBM Corp.	57	30.5	37.8	41.0	51.8	40.2	50.0
Cincom	34	18.2	25.8	16.7	27.7	24.3	39.5
Software AG	28	15.0	14.5	11.5	9.2	15.4	11.8
ADR	3	1.6	—	1.3	5.7	1.4	—
CCA	3	1.6	—	—	—	—	—

Source: Computer Decisions

HARDWARE

The kit, aimed at electronics, computer, and robotics hobbyists, includes a self-contained electromechanical robot controlled by an on-board 68008 chip, as well as electronic sensors to detect light, sound, motion, and obstructions in its path. It carries a rechargeable power supply and can move on its three wheels free of external control, traveling over a predetermined course and repeating specific functions on a schedule.

Hero I can be programmed through the keyboard mounted on the robot's head, which can turn 350°, via a handheld plug-in remote control handle, or through cassette tape programs. An arm mechanism permits picking up small objects; it has seven motions, including wrist pivot and rotate. An optional speech synthesizer has an unlimited vocabulary, and simulates human speech and various sound effects. An internal clock permits the robot to record and respond to the passage of time. HEATH CO., Benton Harbor, Mich.

FOR DATA CIRCLE 304 ON READER CARD

COLOR GRAPHICS COPIER

The model 4691 uses ink-jet technology to produce eight-color copies for applications like simulation, design previewing, stress analysis, ultrasonic scanning, and surface modeling. The \$12,500 copier produces either 8¼ × 11-inch or 11 × 17-inch copies in portrait or landscape format. Multiple copies can be produced under program control.

The copier can place 150 dots per inch in both directions, and uses a shading technique called dithering to produce 125 callable shades of color. Accuracy of ink placement is aided by an airflow, which stabilizes the flight of ink droplets to the

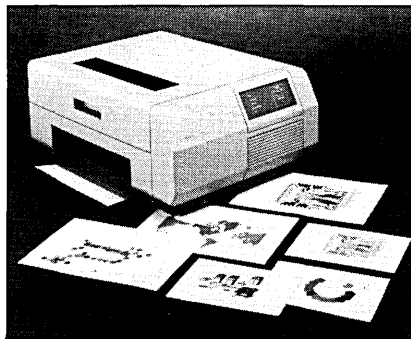

paper. About 20,000 droplets per second may be produced by each print head (cyan, yellow, magenta, and black), to complete copies in less than four minutes each.

The printheads are cleaned automatically after each copy. Each 200 ml ink cartridge may last for 5,000 copies, depending on the complexity of the images copied. Paper handling is automatic, with each sheet vacuum-picked from a 50-sheet tray and stacked after copying. TEKTRONIX, INC., Beaverton, Ore.

FOR DATA CIRCLE 305 ON READER CARD

TAPE SUBSYSTEM

The 2920 Avalanche tape subsystem is targeted for the oem market with a \$6,780 price in quantities of 100. It is a dual-density (1600/6250 bpi), 50 ips, start/stop subsystem that integrates tape drive and formatter/controller into one standard rack-mountable package. The subsystem is based on the Z-80 chip running at 5MHz and includes 16KB of code and 8KB of diagnostic code.

As with the vendor's other products, the 2920 is completely IBM-compatible. The unit features a CAD/CAM modeled tape transport, microprocessor adaptive

controls, and auto-threading. Evaluation units are scheduled for April shipment.

The 2920 is designed according to the GCR format for large system performance, but it offers a mean time between failures of 5,000 hours, substantially better than the vendor's larger GCR systems. STORAGE TECHNOLOGY CORP., Louisville, Colo.

FOR DATA CIRCLE 306 ON READER CARD

COLOR GRAPHICS SYSTEM

The vx series color graphics system is intended primarily for displays from a host computer, but it contains enough intelligence for some standalone applications. The \$2,000 vx128 processor, based on the NEC GDC and Intel 8088 chips, provides 672 × 480 pixel resolution with eight displayable colors. The processor is capable of 3-D vector graphics with several functions and comes with serial and parallel interfaces to most computers.

The \$4,000 vx384 processor, in addition to having the capabilities of the vx128, can also provide 512 simultaneous colors from a palette of 16.8 million and 9 bit planes. These features allow for shading of 3-D objects and bit-plane animation for solid modeling, presentation quality graphics, image processing, and other applications.

Also available are the VXM RGB monitor, VXP printer with 125 dithered colors, and VXX keyboard. A light pen and joystick are planned for introduction later this year. VECTRIX CORP., Greensboro, N.C.

FOR DATA CIRCLE 308 ON READER CARD

3.9-INCH HARD DISK FOR IBM P.C.

The DPR series of Winchester disk drives for the IBM Personal Computer is based on the SyQuest Technology 3.9-inch drive and offers 5MB of formatted storage capacity. Users can choose between fixed disk or removable cartridge, neither of which consumes more power than an IBM floppy disk. This allows the DPR disk to be mounted in the space for the second floppy in the P.C. with no alterations to the power supply. An external self-contained version is also available.

The controller card for the drive has built-in error checking and correction, using a 32-bit polynomial algorithm. Software for the drives includes BIOS, driver, and utilities to ensure full compatibility with existing PC-DOS and CPM-86 operating systems and applications.

The internal mount fixed cartridge costs \$1,450; the external costs \$1,650. Removable cartridges cost \$50 more. IDE ASSOCIATES, Burlington, Mass.

FOR DATA CIRCLE 309 ON READER CARD

MID-RANGE MINI

The H700 has about half of the power of its older big brother, the H800, but it has un-

HARDWARE SPOTLIGHT

AI-BASED MICRO

The 16-bit MAD-1 computer is designed to run software based on artificial intelligence research, its maker says. The multitasking system is built around a Modular Advanced Design architecture. The system's four low-profile units permit the user flexibility in building the system and in arranging it on his desk.

The four units are the data module, the computing module, the keyboard, and the display. The cpu module, based on the Intel 80186 with 128KB dynamic internal RAM (expandable to 256K), has two open-board slots for additional functions. The data module houses two half-height 5¼-inch disk drives, one of which may be a Winchester disk or removable cartridge. The system also supports an external add-on disk of 5, 10, or 25MB capacity.

The system runs concurrent CPM-86 and MS/DOS for IBM P.C. compatibility. Initially, the system will include third-party software such as PeachPak, Wordstar, Mul-

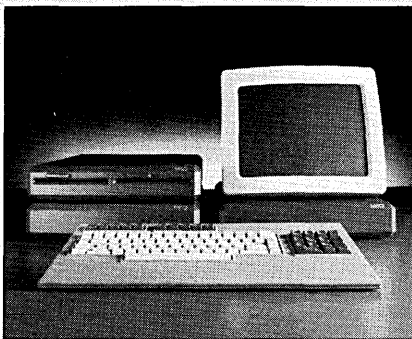

tiplan, and Spellbinder. Proprietary artificial intelligence-based software is planned to supplement these packages.

The \$3,000 to \$6,000 machine has a graphics capability with a 720 × 350 screen resolution in either color or monochrome. For communications, two RS232C ports, one parallel port, and intermodule connectors are provided. MAD COMPUTER, INC., Santa Clara, Calif.

FOR DATA CIRCLE 300 ON READER CARD

HARDWARE

bundled many features to allow users to select the most efficient configuration for current use while leaving room for future expansion. The line's three versions share the same cpu for ease in upgrading.

The systems start with 384KB of internal memory, expandable to 12MB, with a virtual memory maximum of 48MB. The memory is contained in the Integrated Memory Subsystem, which combines a memory controller and memory arrays on a single board. Along with the hardware-implemented virtual memory, the cpu can support program sizes up to 6MB and up to six ports of shared memory.

A cache memory performance enhancement option, extended addressing features, and an optional floating point processor are also available on the system. With the cache memory option, the H700 can support up to 128 terminals. The H700, whose basic prices range from \$50,000 to \$62,000, supports the vendor's Integrated Disk Controller and Communications Network Processor.

The controller combines the I/O channel and disk controller functions onto one board and supports up to four disks. HARRIS CORP., Ft. Lauderdale, Fla.

FOR DATA CIRCLE 311 ON READER CARD

ELECTROSTATIC COLOR PLOTTER

This vendor's color plotter—it doesn't seem to have any formal name—will be the first to use an electrostatic technique when it becomes available this spring. It electronically produces the full color spectrum with translucent toners in magenta, yellow, cyan, and black. It plots on standard 42-inch-wide roll paper and can produce a full color 34 × 44-inch drawing in eight minutes. Resolution is 200 dots per inch in each direction.

To produce an image, a programmed voltage is applied to an array of densely spaced writing nibs embedded in a stationary writing head. Upon digital command, the nibs selectively create minute electrostatic dots on the moving paper. The paper is then exposed to liquid toner, producing a permanent image. Monochrome plots are produced in a single pass; color plots employ a multiple pass technique. The plotter costs \$98,000. VERSATEC, Santa Clara, Calif.

FOR DATA CIRCLE 310 ON READER CARD

DATACOM TEST SET

The CTS 2 is this vendor's first handheld, battery-operated data communications test set. The \$2,800 set, which weighs 2¼ pounds, is intended for the first-line service technician working with computers and terminals from the telephone industry or service companies. The CTS 2 diagnoses problems in datacommunications systems conforming to EIA standard RS232 or V.24 interfaces.

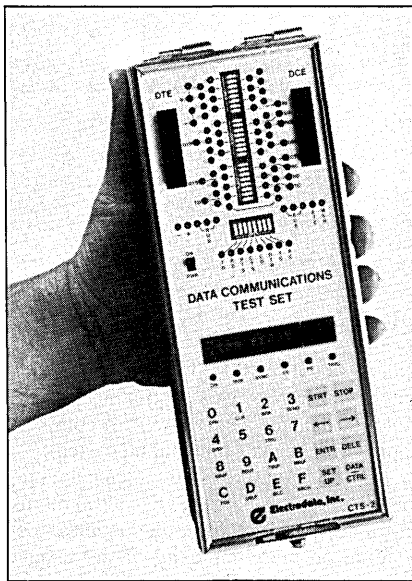

The set is compatible with both full and half duplex synchronous, HDLC, and asynchronous systems; it can be used to test modems, multiplexors, cpus, terminals, printers, and monitors, as well as simulate digital transmission anywhere in the data communications system. Some of the tests it can perform include bit and block error rate tests, bias distortion tests, pulse trapping and counting, delay measurements, and simulation of DTE or DCE devices. All operating parameters and memory contents are retained when power is turned off so that data can be trapped in the field and reviewed later.

The CTS has a 24-key keyboard that is used to select modes, enter parameters, enter and edit data in any of five data buffers, and control the overall operation. A 16-character alphanumeric display is used to display data in ASCII, EBCDIC, or HEX codes. ELECTRODATA, INC., Bedford Heights, Ohio.

FOR DATA CIRCLE 307 ON READER CARD

VOICE RECOGNITION

The SR-100 voice input terminal is designed to be used with the vendor's Astra line of business computer systems. Applications include data entry, control of industrial processes such as inventory control and parts counting, and information retrieval in environments where the hands are otherwise occupied. The unit, with a vocabulary of 120 words, sells for \$2,000.

Since the device is speaker dependent and uses a discrete utterance mode, the user need only speak each word once into the unit headphone and the sound becomes part of the system's vocabulary. After that, the unit has a recognition accuracy of 99% and a response time of 300ms. The compact unit is designed to work in any environment. The unit is available on all models in the Astra line. NEC INFORMATION SYSTEMS INC., Lexington, Mass.

FOR DATA CIRCLE 312 ON READER CARD

INTEGRATED MICRO

The System 830 Personal Business Computer comes with a System Manager that allows the integration of application software for quick one-key selection. It also links the applications so that data from one application can be extracted and inserted in another application.

The 830 contains cpu, keyboard, eight-inch disk drives, color or black and white monitor, and 80-column printer in a single unit. The cpu, which runs CP/M, has 128 to 256KB internal RAM; floppy or fixed disk drives give mass storage capacities from 2MB to 16MB. Graphics, function keys, light-pen interface, RS232C interface, ROM cartridge interface, and music are all standard.

With an optional internal modem, the 830 can plug into any telephone wall socket for external communications. The modem is capable of auto-dial and receive.

The 830, which costs \$6,700 with a monochrome display and \$7,500 with an eight-color display, can support 640 × 400 pixel dot-addressable graphics for business and scientific use. SUMICOM INC., Tustin, Calif.

FOR DATA CIRCLE 313 ON READER CARD

FAULT-TOLERANT COMPUTER

The steep decline in hardware costs in the past few years has spurred the growth of fault-tolerant computer manufacturers, with about a dozen vendors now competing for the niche Tandem established for itself in the mid-1970s. One of the latest is this vendor's line of multi-user systems, introduced at COMDEX. Based on the MC68000 chip, the multiprocessor systems support the Xenix operating system, although CP/M and UCSD p-System emulators running under Xenix are available.

The line includes 8-, 16-, and 32-user systems, which range in price from \$25,000 to \$100,000. The multiple cpus in each system operate in parallel and divide the load between them. Any single component in the computer can fail and the system will still operate. In addition, protection mechanisms have been incorporated into these computers to guard against software errors. All of the systems utilize the multi-bus and support 5¼- and 8-inch Winchester disk drives, with storage capacities from 10 to 400MB. Backup is handled with streaming tape and/or floppy disk. The systems are Ethernet compatible for networking.

The systems have self-diagnostic and user-serviceable capabilities. The computer isolates the failed component and instructs the user how to remove and replace it without any tools. By providing these self-repair capabilities and shipping parts within 24 hours, the vendor hopes to reduce its service organization substantially. PARALLEL COMPUTERS, Santa Cruz, Calif.

FOR DATA CIRCLE 313 ON READER CARD



**"Graham's Epoch 480
tape is cheaper in the
long run because
it lasts longer."**

Even when you've been making good tape as long as we have, it pays to talk to the experts. People who use it every day. That's why we had a research firm survey our customers and prospects. And that is what one of them said.

He didn't mean Epoch 480 is inexpensive. He meant that for the money, no other tape does quite the job in critical areas like data transfer, back-up and archival storage.

We planned it that way, with the finest binder system we could devise. Because of lower oxide shedding, you get error-free performance pass after pass after pass. In short, Epoch 480 is clean and durable.

We know that being considered the tape company worldwide, we can't deliver anything less than the best. It's just nice to know that the experts know it, too.

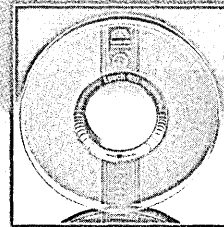

**Talk to the
Media Management
Specialist at
Graham Magnetics
The tape company.**

 **GRAHAM MAGNETICS**

Toll Free: 1-800-468-7662, 468-7663 In Texas: (817) 281-9450

CIRCLE 121 ON READER CARD

CARLISLE

The Information Center

Theirs:

**QBE, GIS,
STAIRS, APL,
ADRS, SQL,
Etc...**

Ours:

INQUIRE[®]

See us at Software expo/East Booth #30

Help users help themselves. That's the idea behind IBM's Information Center, where the data processing department will provide and maintain tools to allow users to retrieve, analyze, manipulate and present data (including textual material) more effectively.

They've got the right idea, but the wrong tools.

When productivity is all-important, why buy, learn, and support a hodge-podge of ever-changing systems in your Information Center?

With a single non-procedural language easily learned in a few hours, INQUIRE can boost user productivity, DP productivity, and support the entire decision-making process.

We've been helping companies establish information centers since 1968. Call us toll-free today to find out how.

Information Center/Development
Center Seminars
Los Angeles—Feb. 3, Feb. 10
San Francisco—Feb. 17, Feb. 24
Phoenix—Feb. 8

Infodata

Infodata Systems Inc.
5205 Leesburg Pike
Falls Church, Virginia 22041
800-336-4939
In Virginia, call 703-578-3430

Offices in:
Cleveland, Dallas, Houston, Los Angeles,
New York, Rochester NY, Tampa,
Washington, DC

*INQUIRE is a registered trademark of Infodata Systems Inc.

©1983 Infodata Systems Inc.

SOFTWARE AND SERVICES

UPDATES

It's always been expensive to convert software to a second vendor's cpu, so most big users tend to stick with one vendor when upgrading their hardware. Prime Computer, perhaps intent on taking away some of Digital Equipment's market share in superminis, has set up a center in Pittsburgh at which software houses, oems, and big users can convert software designed for other machines to run on Prime hardware. The facility is operated and staffed by Computer Support Services, Pittsburgh.

Diablo Systems, long a maker of daisywheel printers, is expanding its line of dot matrix printers, courtesy of Honeywell Information Systems. The Xerox company has acquired exclusive North American marketing rights to the family of 100 to 400 cps printers made by the mainframer's Italian subsidiary. HIS continues to sell the printers as part of its systems.

Graphwriter, a professional quality presentation business graphics package for the IBM Personal Computer, is said to provide capabilities previously available only on mainframes or dedicated systems. It's possible: the \$2,300 package is merely the software component of a standalone system sold by Graphic Communications Inc., Waltham, Mass., for \$20,000.

Just when you were getting used to Unix System III, AT&T came along and introduced System V, which offers a few functional and efficiency enhancements. But the most important aspect of System V is that AT&T intends to support the popular operating system for 16- and 32-bit computers. Support will include hot-line service, newsletters, consultation, technical seminars, and electronic mail for problem reporting. This is the first time that AT&T has supported Unix.

UNIX FOR IBM P.C.

Project Viking is an integrated package consisting of the Venix real-time version of Unix System III, the Final Word interactive word processor, the Logix relational database manager, and a graphics package. The \$900 package runs on the IBM Personal Computer, the DEC Professional series, and other 8086-based systems.

Venix includes a multitasking capability for background processing and a flexible tree-structured file system that allows users to organize their files in such a way as to keep some private and some public. Electronic mail, virtual terminal emulation, and optional Ethernet networking are available for communications.

The operating system supports C, FORTRAN, and Pascal, and has a "programmer's workbench" and a command interpreter/debugger for software development. In total, Venix supports 150 of the Unix utilities.

The graphics utility depicts data from Logix or other files as charts or graphs. Interfaces to color terminals and a variety of output devices are provided. VENTURCOM INC., Cambridge, Mass.

FOR DATA CIRCLE 326 ON READER CARD

COBOL MENU PROCESSOR

Menu Master runs with the popular RM/COBOL compiler on most 8- and 16-bit microcomputers and operating systems, allowing users to create and execute more friendly menu-driven interfaces quickly. The package is designed to eliminate the tedious aspects of implementing an input/output interface for business programs.

The program produces multilevel menus with built-in security; since the menus are interpreted directly, they require no compilation. The package allows interactive menu editing for quick changes, freedom to traverse the menu network in any direction, and automatic generation of complete classified documentation on the menus.

Menu Master provides security through optional password, user name, and access level verification, which can be

changed only by an authorized operator. The package costs \$245. BYTEK, Berkeley, Calif.

FOR DATA CIRCLE 327 ON READER CARD

INTERACTIVE ROBOTICS

The Positioner Layout And Cell Evaluator (PLACE) is an interactive robotics system for designing robot-controlled manufacturing cells 75% faster than conventional methods permit, its maker says. The technique uses both computer simulation and animation to replace engineering sketches and manual methods of positioning a robot and fixtures within a manufacturing cell. PLACE allows optimum cell layout, visual collision detection, robot evaluation and selection, and tooling analysis.

The \$130,000 package operates on DEC's VAX computers supplied by this vendor. The user interface is through the R-100 graphics design station, which is equipped with a vector refresh terminal and devices for dynamic picture control and controlled animation of the displayed objects.

In addition to a database of 3-D models and the ability to manipulate these models graphically, PLACE contains kinematics software describing the reach limits and allowable movements of each of the robot's joints. In determining an ideal cell layout, the PLACE user exercises the robot's arm and rearranges the model cell devices interactively until the robot reaches all required locations without interference. Should the robot not be able to perform as required, PLACE validates the incapacity. MCDONNELL DOUGLAS AUTOMATION CO., St. Louis, Mo.

FOR DATA CIRCLE 328 ON READER CARD

DBASE II INDEX

The Application Junction marketing referral service provides dBASE II users with information about applications written in dBASE II.

With the addition of RunTime to dBASE software libraries, many dBASE users are marketing their own specialized programs. This service is intended to publish descriptive program details and contact in-

SOFTWARE AND SERVICES

formation for applications written and designed by dBASE users. Initially, the lists or applications will be distributed regularly throughout the vendor's end-user and dealer network, but a catalog will be published later this year.

RunTime, a dBASE program designed to assist users with their applications development, is available directly from the vendor. It provides users with a code condenser that protects the integrity of an application and allows the application to be marketed without an entire dBASE II system. Pricing and licensing will be structured by the applications developers. ASHTON-TATE, Culver City, Calif.

FOR DATA CIRCLE 329 ON READER CARD

SIDEWAYS SPREADSHEET

A common complaint of executives who use microcomputers for spreadsheet applications is that the spreadsheet, should they want to print it, can be wider than the printer can print. Sideways, a spreadsheet utility, takes advantage of a printer's dot-addressable graphics capability and provides one solution—it prints the spreadsheet sideways.

By rotating the printed page 90°, the program removes constraints that limit spreadsheets to 80 or 132 columns and allows them to be any width. The program can be used for applications other than spreadsheets, such as program listings or pert charts. It can rotate any printable file, its vendor says.

The \$60 program provides the user

with a choice of two character fonts, a double strike option, and control over margins and spacing. It runs on the IBM Personal Computer and requires an Epson MX-80 or MX-100 printer equipped with GrafTrax. FUNK SOFTWARE INC., Cambridge, Mass.

FOR DATA CIRCLE 330 ON READER CARD

TIMESHARING GRAPHICS

The LaserLink timesharing service combines Xerox 9700 printing, graphics, typesetting, and digitizing to produce volume output of high quality printed materials. The service is designed to meet the variable quantity, fast turnaround, publication-quality printing needs of organizations that use word processing to prepare reports, manuals, newsletters, direct mail, books, and other text/graphics combinations.

In operation, the service incorporates the 9700 with graphics option, a Xerox 1050 scanner, and XICS typesetting software. Users can subscribe to one or more of these services. User input to the service is through any traditional timesharing input devices or through videotex.

The timesharing is done on a DEC-system-20 computer with the Tell-A-Graf graphics software. LANDART SYSTEMS INC., New York, N.Y.

FOR DATA CIRCLE 331 ON READER CARD

HANDHELD COMPUTER PROGRAMS

Seven technical software libraries contain 73 individual programs for the Sharp PC-1500 handheld computer and Radio Shack

TRS-80 PC-2. The libraries, scheduled to debut this month, are mathematics, electrical engineering, finance, general statistics, statistical distribution, graphics development, and business graphics.

All of the libraries are available in solid-state software application modules that plug into the back of the computer. Included with each ROM module is an instruction manual and keyboard overlay. The libraries range from \$60 to \$80.

The finance library includes programs for rent/buy decision making, internal rate of return, bond analysis, depreciation scheduling, and forecast analysis. The business graphics programs provide for drawing graphs, pie charts with up to 50 elements, and bar charts with an unlimited number of elements. With the optional printer, these can be drawn in four colors on 2½-inch paper. AMERICAN MICRO PRODUCTS INC., Richardson, Texas.

FOR DATA CIRCLE 332 ON READER CARD

RELATIONAL SAS DBMS

RAQL is a query language that operates in an SAS environment to provide a relational processing capability directly within the popular statistical package. The high-level language permits information in SAS datasets to become more accessible and management of the datasets to become more precise and systematic, according to the vendor.

RAQL is based on relational operators. Users decide when the features of the DBMS are needed and, at any suitable point in the SAS program, can enter RAQL statements. The result of a RAQL operation is an SAS dataset, so features of SAS may then be used for further processing.

The DBMS lacks some elements of a true relational DBMS, such as update concurrency, integrity control, and user views. It leases for \$2,000 the first year and \$1,500 for subsequent years. MCGILL UNIVERSITY SCHOOL OF COMPUTER SCIENCE, Montreal, Canada.

FOR DATA CIRCLE 333 ON READER CARD

SCREEN FORMATTING

The Performix custom screen data entry and data inquiry system is designed for the vendor's Informix DBMS, which runs on Unix and Unix look-alikes. It is the vendor's first package to combine custom screen formatting and data entry with relational query capabilities. This provides an interactive user interface to data.

Fields can be placed anywhere on the screen, with any titles and labels desired. Multiple screens can be linked together, and data from multiple files can be viewed on a single screen. Fields are defined to have the user's choice of range checking, table lookup, mandatory entry, verification required, and HELP messages.

Once the screen format is defined, a run-time program allows interactive browsing through the database. Single copy li-

SOFTWARE SPOTLIGHT

OPERATING ENVIRONMENT

VISION provides users with a set of integrated applications and the capability of presenting multiple applications on the screen simultaneously. The user operates the computer using nine English commands and a mouse. Because the applications all use the same commands, data developed in one application can be transferred to another, and the processing of multiple applications can be viewed simultaneously by displaying their individual windows on the screen.

Each window is a display of a particular application. These include all of the vendor's previously released applications, such as VisiCalc, VisiWord, and VisiPlot. If an application or part of an application is to be repeated frequently, the component steps can be grouped under one macrocommand.

VISION is designed to run on top of any operating system. The link between the operating system and VISION is the VisiHost software layer; the VISION tier is thus operating system and machine independent. The vendor will not, however, write the individual device drivers, nor will it convert applications written by other vendors to run in the VISION environment; instead, these



tasks are left for the manufacturers and software vendors.

The product will not be ready for shipping until this summer, and will initially be available only for the IBM Personal Computer. The product requires 256K main memory and 620K of disk space for multiple applications. Prices were not available at press time. VISICORP, San Jose, Calif.

FOR DATA CIRCLE 325 ON READER CARD

How to get more out of CICS and IMS.

For over 13 years, On-Line Software International has been dedicated to increasing CICS and IMS productivity as well as extending basic system capabilities. We offer a total range of products and services, all supported by a staff of skilled professionals. Call toll free 800-526-0272 for more information. (In New Jersey, call 201-488-7770.) Discover how easy it is to reach your data processing and telecommunications goals.

CONSULTING: Our services include EDP planning, capacity analysis and planning, data-base and distributed system technologies, and systems migration management, as well as technical support.

EDUCATION: Our CICS and IMS seminars, offered throughout the U.S., get consistently high marks. So do our valuable handbooks on the subjects.

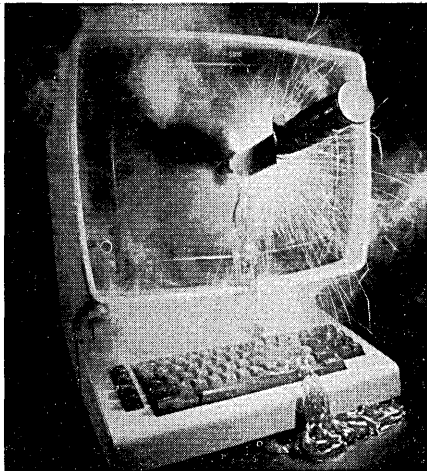

GUARDIAN

The effective, flexible CICS security software that counters the growing menace of computer crime.

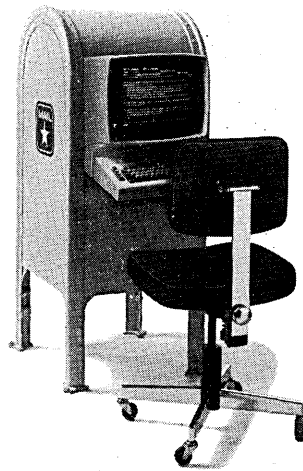

OMNICOM

Electronic mail software that turns your CICS network into a mail carrier without adding hardware.



INTERTEST

The interactive testing and debugging software that lets you fly through CICS testing without crashing.



STANDARDS SERVICE

Our Standards and Guidelines Development Service saves you time, money and confusion in operating your CICS or IMS installation.



DATAVANTAGE

The software that simplifies IMS application development and testing, while giving you greater data base control.



INSYST

The instant system generator that creates CICS programs in 20 minutes. Helps eliminate ad hoc programming backlogs.

ON-LINE SOFTWARE
INTERNATIONAL

Fort Lee Executive Park, Two Executive Drive, Fort Lee, NJ 07024 • (201) 592-0009 • Toll Free (800) 526-0272

CIRCLE 123 ON READER CARD

SOFTWARE AND SERVICES

censes start at \$40 and depend on the type of computer. RELATIONAL DATABASE SYSTEMS INC., Sunnyvale, Calif.

FOR DATA CIRCLE 334 ON READER CARD

ENGINEERING PACKAGE

The Idea 1100 provides a set of logic design software tools running on an Apollo Domain computer. The Domain, which has two 68000s, operates with a high-resolution graphics display, optional electrostatic printer, up to 3.5MB of program memory, and up to 158MB of Winchester storage.

The software operates under the Unix-like operating system Aegis. The structured logic/circuit design package provides full hierarchical design capabilities, the vendor says, when interfaced with popular design automation tools such as Tegas, Spice, ILOGS, Logcap, SCI-cards, Applicon, and Calma. The software includes a programmable net-lister, which allows users to develop other interfaces if necessary.

The package is compatible with the more powerful Idea 1000 in that no hardware changes need be made to upgrade the package. The entire system, including the hardware, costs \$61,900 in quantities of two and \$54,900 in quantities of 10 or more. MENTOR GRAPHICS CORP., Portland, Ore.

FOR DATA CIRCLE 335 ON READER CARD

FINANCIAL DATABASE

The Micro/Mainframe xChange family of services is designed to ally mainframe power with the convenience of microcomputers by giving micro users access to the vendor's securities and financial databases. The services will be available only through the vendor's field support staff.

The Financial xChange package allows research analysts and portfolio managers using spreadsheets to access the vendor's Analytics securities database. The \$30 package retrieves requested data from the database and automatically loads them into Multiplan or VisiCalc.

Microforma xChange provides the user with access to balance sheet and income statement information from more than 7,000 publicly traded companies. It is intended to allow the user to integrate database information with financial data from his own company to do planning and forecasting, as well as merger/acquisition and divestiture analysis.

The services are still in beta testing. CHASE ECONOMETRICS/INTERACTIVE DATA CORP., Waltham, Mass.

FOR DATA CIRCLE 336 ON READER CARD

SNA INTERFACE

The 3270-SNA/SDLC package enables the vendor's OC 8820 Occupational Computer to emulate an IBM 3278 terminal. The package, which is intended to facilitate real-time distributed processing with centralized data

from the mainframe, allows users to access data from a mainframe, store them on disk, and then work with them in standalone mode.

The 3270-SNA/SDLC is described to the host as a PU.Type 2, LU.Type 2/3. The communication software includes a bi-synchronous emulator that acts as a 3271, 3274, 3275, or 3276 controller, depending on which terminal emulation is desired. The communications packages are capable of operating at up to 19.2Kbps, and are available for the vendor's proprietary operating system or for CP/M. The SNA package costs about \$1,000. MONROE SYSTEMS FOR BUSINESS, Morris Plains, N.J.

FOR DATA CIRCLE 338 ON READER CARD

FORMS GENERATION

Penform services are provided for users of Pencept's handwriting recognition terminal. The terminal, whose input is via a touch-sensitive pen on a graphics tablet, requires specialized software to define the fields on the tablet where various inputs will be written.

The Penform software provides comprehensive form-generated data entry and verification capability, along with forms management for ease of use in a multiple application environment. The service is available for a variety of micro and mini-computers.

The vendor also offers software consulting services in the design of forms, the development of data entry software, and the conversion of existing applications to use the handwriting recognition terminal. OMNI COMPUTER SYSTEMS, INC., Chestnut Hill, Mass.

FOR DATA CIRCLE 339 ON READER CARD

CAD GRAPHICS

Advantage Series 7000 graphics software is designed to run on the vendor's Advanced Graphics Workstation and on DEC's VAX line of computers. It provides comprehensive design and drafting capabilities made possible by the 32-bit architecture.

The package has a full-color capability that allows for the assignment of color for construction (entity), grid, view-vectors, names, and borders. "Quick dimensioning" and "quick filleting" features improve the drafting performance through reduced user interaction. A Flat Pattern Development package is available that can unfold planar faceted objects including complex geometry such as internal tabs.

A multiple language feature allows for non-English versions of the package. An applications interface is provided for FORTRAN-based applications. The package is available only as an enhancement to previously released software for the workstation. AUTO-TROL TECHNOLOGY CORP., Denver, Colo.

FOR DATA CIRCLE 340 ON READER CARD

BUSINESS GRAPHICS

With the MetaGraph package, IBM Personal Computer users can generate line plots, bar graphs, pie charts, maps, and custom designed charts. Charts may be freely positioned on a page, with the number of charts that can fit on a page limited only by the computer's memory. Charts can also be enhanced and combined into creative data displays. Descriptions of commonly used charts can be saved on disk as templates.

The user can use the crt as a sketch pad for free-form graphics and text/graphics mixes. Each object on the screen can be created on the spot or retrieved from disk; once drawn, a picture can be edited by rescaling, moving, or otherwise altering its features. The menu-driven package aids production of graphs with a "chart data entry form," which displays all the options available to the user at that moment and provides default values. The package costs \$500. GRAPHICON SYSTEMS, Sunnyvale, Calif.

FOR DATA CIRCLE 337 ON READER CARD

TEXT PROCESSING

The Superwriter program is a full-featured word processing system that also incorporates mailing list and form letter generator capabilities and a dictionary for spelling and typographical error correction. The product's command structure, identical to the ones elsewhere in the vendor's product line, allows users to interface with all of the programs without having to learn new commands or codes.

The program, which requires a minimum of 56KB of microcomputer internal memory, runs under CP/M-80, CP/M-86, MP/M, and MS/DOS. The \$400 package supports a variety of terminals as well as dot matrix and letter-quality printers.

The program provides a full screen editor with single stroke initiation of commands to create, edit, and print any document. The document can be formatted for printing either during or after editing. SuperWriter also includes a utility to allow any CP/M-based product to share information with the text processor. SORCIM CORP., San Jose, Calif.

FOR DATA CIRCLE 341 ON READER CARD

ETHERNET ON VAX

The NS4200 Internet Transport Protocol is the vendor's first implementation of Ethernet transmission protocols that operate on DEC equipment. The protocol is based on the specifications of Xerox's Internet Transport Protocol to exploit Ethernet's packet addressing, error detection, and delay bandwidth characteristics.

The NS4200 contains Netman, a menu-driven utility program that automatically tallies 40 different network statistical values. Netman enables a network manager to acquire and display information about operations of the local and remote ITP sta-

SOMEWHERE DEEP IN SPACE
ON THE PLANET OXFORD...

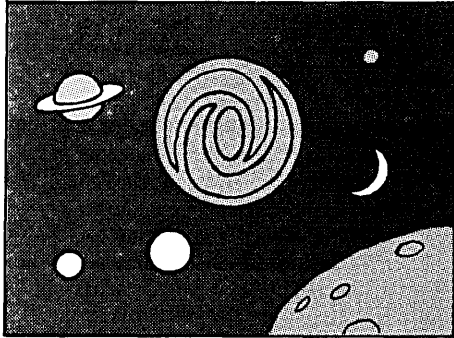

IT'S UFO ON THE LINE AND HE SAYS
THAT EARTH HAS A BIG
CICS SECURITY PROBLEM.

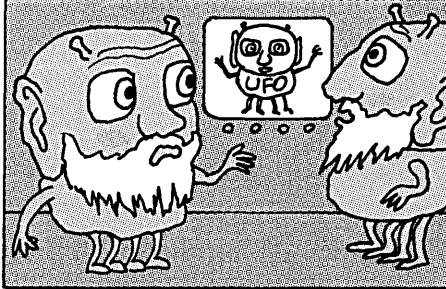

IT'S AMAZING...EVEN KIDS CAN TAP INTO
THEIR DATA WITH THE SYSTEMS THOSE
COMPANIES ARE USING.

YOU'D BETTER SEND DOWN COSS...
FAST. HE'LL KNOW HOW TO HELP.

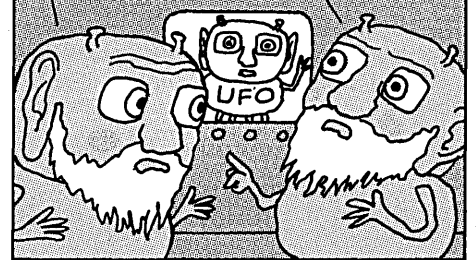

COSS- YOU'RE THE BEST CICS SECURITY
SYSTEM EXPERT IN THE UNIVERSE.
CAN YOU HELP UFO SOLVE EARTH'S
PROBLEM?

SAY
AGAIN.

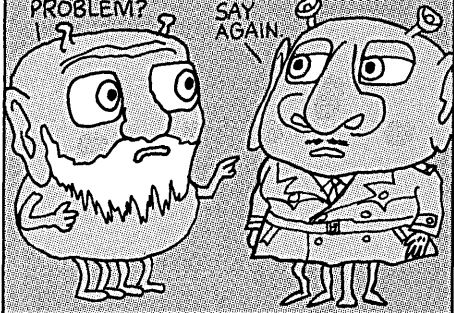

SORRY... I FORGOT YOU WERE
PROGRAMMED TO BLOCK OUT EVEN ME.
GET YOUR TAIL DOWN TO EARTH FAST..
AND HELP UFO GIVE THEM
CICS APPLICATIONS THAT ARE SECURE.

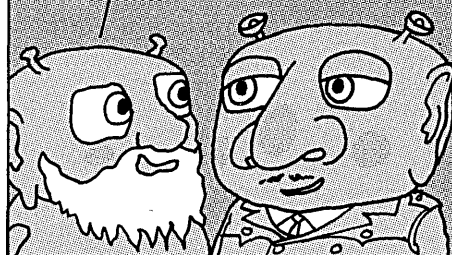

COSS- AM I GLAD TO SEE YOU!
LET'S GET TO WORK.

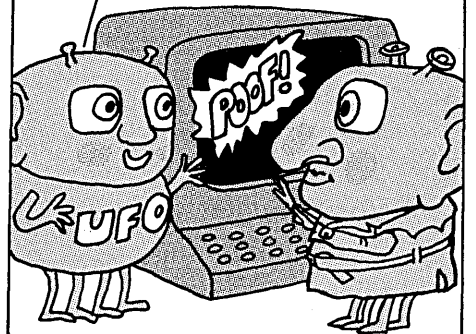

WOW! HOW DID WE DO IT SO EASILY?

I'LL NEVER TELL.

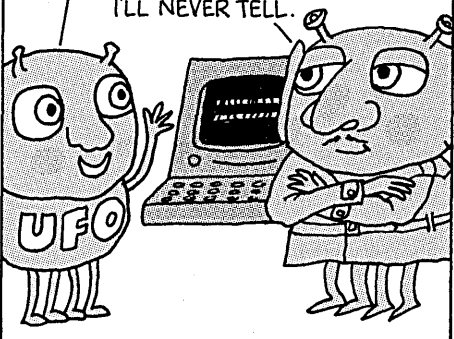

O.K. COSS- THAT'S ONE DP DEPARTMENT
THAT CAN STOP WORRYING. LET'S GO TO
WORK ON THE REST OF THOSE
CICS INSTALLATIONS.

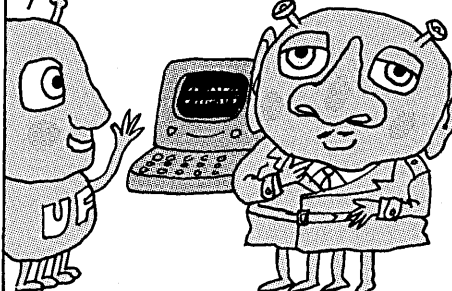

MEET COSS...TOGETHER
WE'LL GIVE YOU THE BEST
APPLICATIONS DEVELOPMENT
SYSTEM AND THE MOST
SECURE CICS ENVIRONMENT
IN THE UNIVERSE.

GIVE US A CALL.
(IF A COMPUTER ANSWERS,
HANG UP.)

For really secure CICS applications
in a fraction of the time...

Call OXFORD

(800) 631-1615

Our software is out of this world

© OXFORD SOFTWARE CORPORATION
174 BOULEVARD/HASBROUCK HEIGHTS, N.J. 07604/201-288-1515

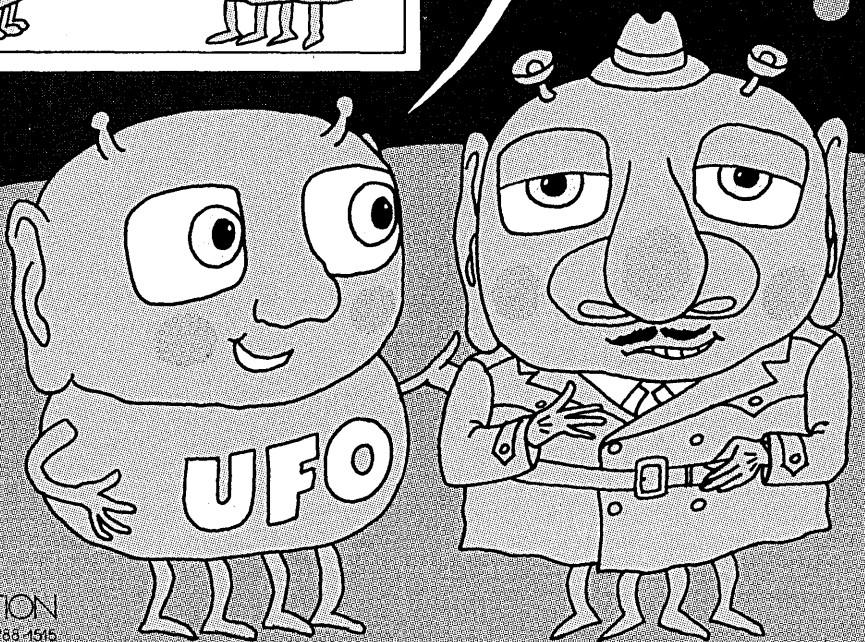

SOFTWARE AND SERVICES

tions on the network. Netman's parameters enable a network manager to identify ITP stations on the internet, identify congestion and flow control bottlenecks, understand traffic flow patterns, evaluate the performance of virtual circuit connections, and assess the quality of network service.

Designed primarily for task-to-task communications among VAX/VMS and RSX-11M systems, the NS4200 permits the interconnection of local networks through long-haul networks and channels, and permits the bridging of dissimilar local networks. The package is available in source form for \$25,000. Run-time licenses are also available. Sources are written in C to facilitate portability to other operating systems.

The NS4200 is also available as part of the Ethernode 1000 series, a data communications package that contains all of the hardware and software components for a VAX Ethernet network. INTERLAN, INC., Chelmsford, Mass.

FOR DATA CIRCLE 342 ON READER CARD

SPREADSHEET CREATOR

The Forecasting ExecuModeler enables a user of the vendor's ExecuPlan II to create marketing-oriented spreadsheets matching specific financial forecasting requirements. The menu-driven package is intended to eliminate the hours spent by executives learning to create models and developing specific models that meet their needs.

In a typical application, the user inputs the company name, fiscal year, geographic regions, departments, products, and expense items such as salaries, commissions, and advertising. The ExecuModeler then builds a series of fully developed models containing the specified company information; the user inputs the basic figures for the specific model, and ExecuPlan is engaged for analysis. The ExecuPlan package can then manipulate sales figures, expenses, cash flow, and other data to generate projections and "what if" analyses, consolidate information, and print out final reports.

The Financial ExecuModeler, like the ExecuPlan II, runs on all of the vendor's microcomputer systems. It retails for \$300. VECTOR GRAPHICS, INC., Thousand Oaks, Calif.

FOR DATA CIRCLE 343 ON READER CARD

ENGINEERING OS

If an engineer's work can be divided into three basic phases—design, analysis, and manufacturing setup—then the design phase has probably received more attention in the last few years than any other. This vendor's Thirty Two minicomputer was designed to meet the heavy computational needs of tasks such as finite element analysis and logic and circuit simulation, giving engineers computing power for analytical work.

The message-oriented multipro-

cessing Operating System is a demand-page virtual memory system more typical of mainframes than of minis or micros. The multi-user system offers an engineering team the computing power to do analysis and simulation work as well as high-resolution displays for design work. The system, written in Pascal, is expandable for future integration into a local area network.

The Operating System can only be purchased as part of the Thirty Two system. The base configuration for the 32-bit machine with 1MB main memory, 30MB Winchester disk drive, a megabyte floppy disk drive, and the operating system costs \$55,000. The same system with a 1,024 × 800 pixel display costs \$62,000. RIDGE COMPUTERS, Sunnyvale, Calif.

FOR DATA CIRCLE 344 ON READER CARD

BUSINESS ANALYST

Operating under the vendor's Software Bus, the Business Analyst consists of multiple applications that may be integrated as the user requires. The bus acts as an interface between the nontechnical user and the software to provide common commands, procedures, sign-ons, and security for all of the vendor's products.

The Integrated Spreadsheet module provides the ability to set up financial analysis models and analyze "what if" situations for budgeting, cash flow analysis, and projection of income or expenses. The Integrated Text Processing module provides streamlined word processing functions for users who have occasional text processing needs but neither the time nor the need to learn complicated word processing procedures.

The Personal Records Management module provides the user with a data management facility to define, input, edit, display, search, and retrieve individual records without programming. The system can be used for personnel skills inventory, purchase order tracking, inventory tracking, budget reporting by department, or name and address files. The Communications module provides a link between the user and the host for 3270 interactive terminals or 3780 remote job entry devices.

The Business Analyst series currently is available on any CP/M or MS/DOS microcomputer. Depending on the modules selected, it costs from \$450 to \$1,300. EXECUTEK CORP., Dallas, Texas.

FOR DATA CIRCLE 345 ON READER CARD

GROUP CONFERENCING

Participate is a many-to-many communication system that provides an electronic equivalent of face-to-face group meetings. The technology involved is similar to electronic mail, in that users anywhere in the world can communicate with each other if they are hooked into the system. Each participant decides which conference it is important to "join," meaning that he will be

updated on the questions and comments entered into that conference when he signs onto the system. In this way, each participant can design his own information environment, with access to all users' comments regarding a particular topic.

The branching feature of the package allows any user to create a new conference on any topic. The new conference can be branched off an existing conference, with all the participants of the existing conference invited to join the subconference. All participants are updated only on activities in the conferences they have joined.

An anonymous balloting capability is provided by the system to help focus conference discussion. Accounts on the system are password protected, and each individual has a description on-line which is available to all. On-line and printed documentation is provided with the system, which is designed for nontechnical users. One-to-one and one-to-many messaging is also provided. The system initially runs on Prime cpus; prices range from \$10,000 to \$60,000, and usage charges from \$5 per user per hour to \$1. PARTICIPATION SYSTEMS, INC., Winchester, Mass.

FOR DATA CIRCLE 346 ON READER CARD

INTEGRATED APPLICATIONS

This set of accounting packages for the IBM Personal Computer or the Apple II or III was developed for small businesses just beginning to automate their accounting procedures. The modular packages all share the same commands, key sequences, and file structures to make it easy to learn each system and to facilitate movement from one package to another.

The programs initially included are general ledger, accounts receivable, accounts payable, budget and financial reporting, inventory control, and sales invoicing. Future applications will include word processing, business graphics, a spreadsheet capability, and a database management system.

All of the programs are written in the UCSD p-System so that they can be transported with little modification from the IBM or Apple to machines made by Altos, Commodore, DEC, Hewlett-Packard, Radio Shack, and others. No retraining would be necessary.

All of the applications are designed for use either independently or in combination with the other applications. Any entry made into one application that affects another application is automatically posted in each application. This eliminates double or triple data entry, characteristic of other software products. Each application costs \$500 or \$600.

Future offerings will feature vertical market applications including veterinary medicine, optometry, and contracting. STATE OF THE ART INC., Costa Mesa, Calif.

FOR DATA CIRCLE 347 ON READER CARD

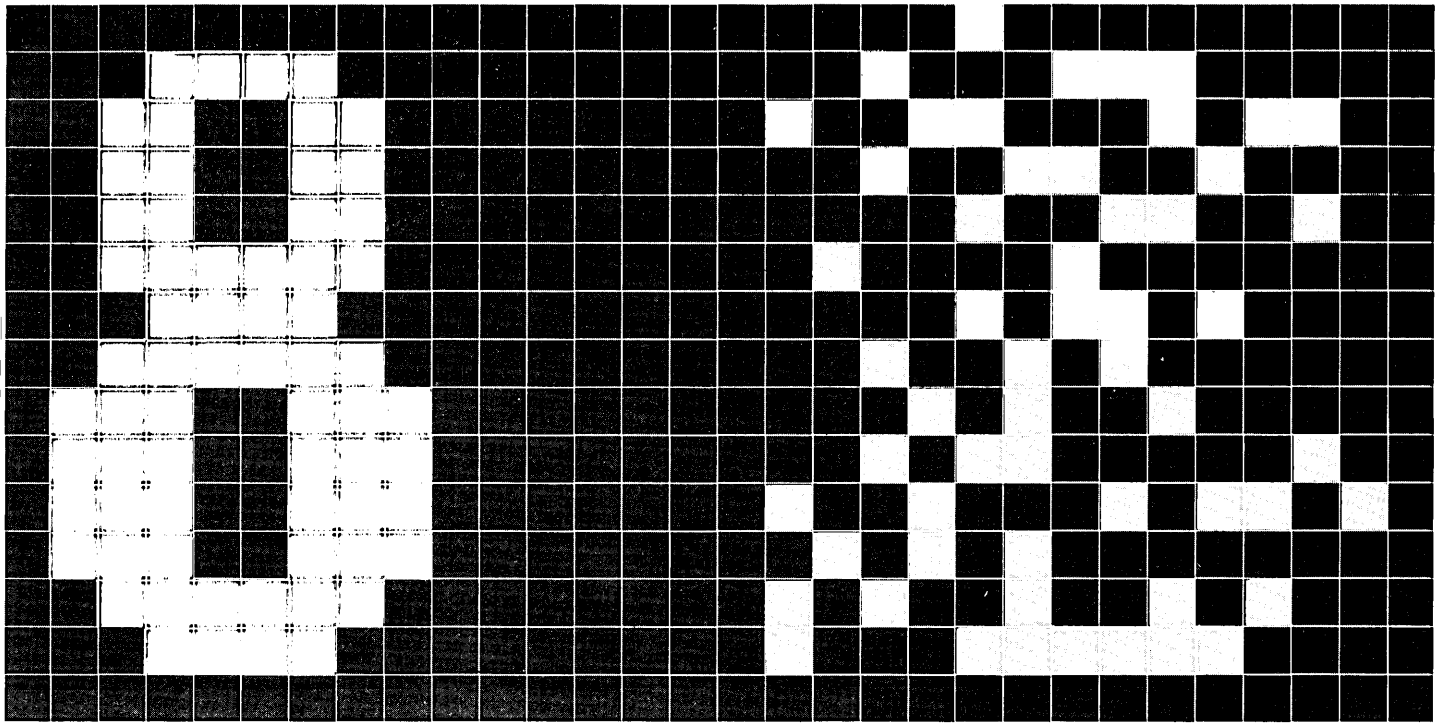

T-BAR AHEAD!

New In Look . . . New with advanced operational features . . . new cost effective expansion flexibility . . . new with what hundreds of users have asked for.

Now for IBM 2914, 3814 and other present and future computer switch users, T-Bar's ready with a CRT controlled superstar computer switch — the new 3690 which scores ahead of its nearest competitor at least eight significant ways:

- 1. Incremental Upgrades:** By single channel or single port.
- 2. Versatile Control:** Programmable CRT Micro-control with manual back-up.
- 3. Most sizes:** 379 matrix sizes from 2x2 to 16x24.
- 4. Investment Protection:** Wrap-around upgrade of existing T-Bar computer switches.
- 5. Advanced Design:** Technology already compatible with state-of-the-art bidirectional applications.
- 6. Expanded Diagnostic:** Activity Indication All Channels. Latchable LED diagnostic indication with access for recording and analysis.
- 7. Operator Protected Switching:** Eliminates inadvertent data interruption.
- 8. Low Price:** As much as 20% less than comparable units.

T-Bar's 3690 continues a tradition began in 1975 when T-Bar first engineered dependability, reliability and compatibility into a computer switch. Those first early models — still on-line and compatible with every IBM upgrade since — set a standard of excellence that is the distinguishing characteristic of every T-Bar product.

Today, as central host sites multiply, system capabilities expand, interfaces and peripherals increase, T-Bar's 3690 is ready to facilitate a variety of tasks: simplified service restoral, rotate peripherals, increase up-time, reduce capital costs, control and monitor countless connections and many other functions. If your data processing system is ready for a matrix switch, you're ready for a 3690. Call or write T-Bar Incorporated, 141 Danbury Road, P.O. Box T, Wilton, CT 06897 (203) 834-8368.

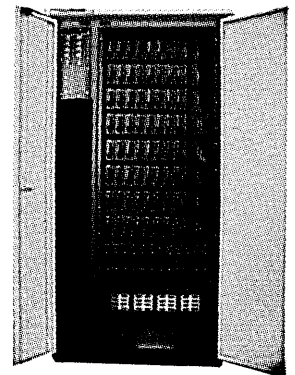

T-Bar's 3690
Computer Matrix Switch

T-bar®

SWITCHING TECHNOLOGY
FOR CRITICAL APPLICATIONS

CIRCLE 125 ON READER CARD

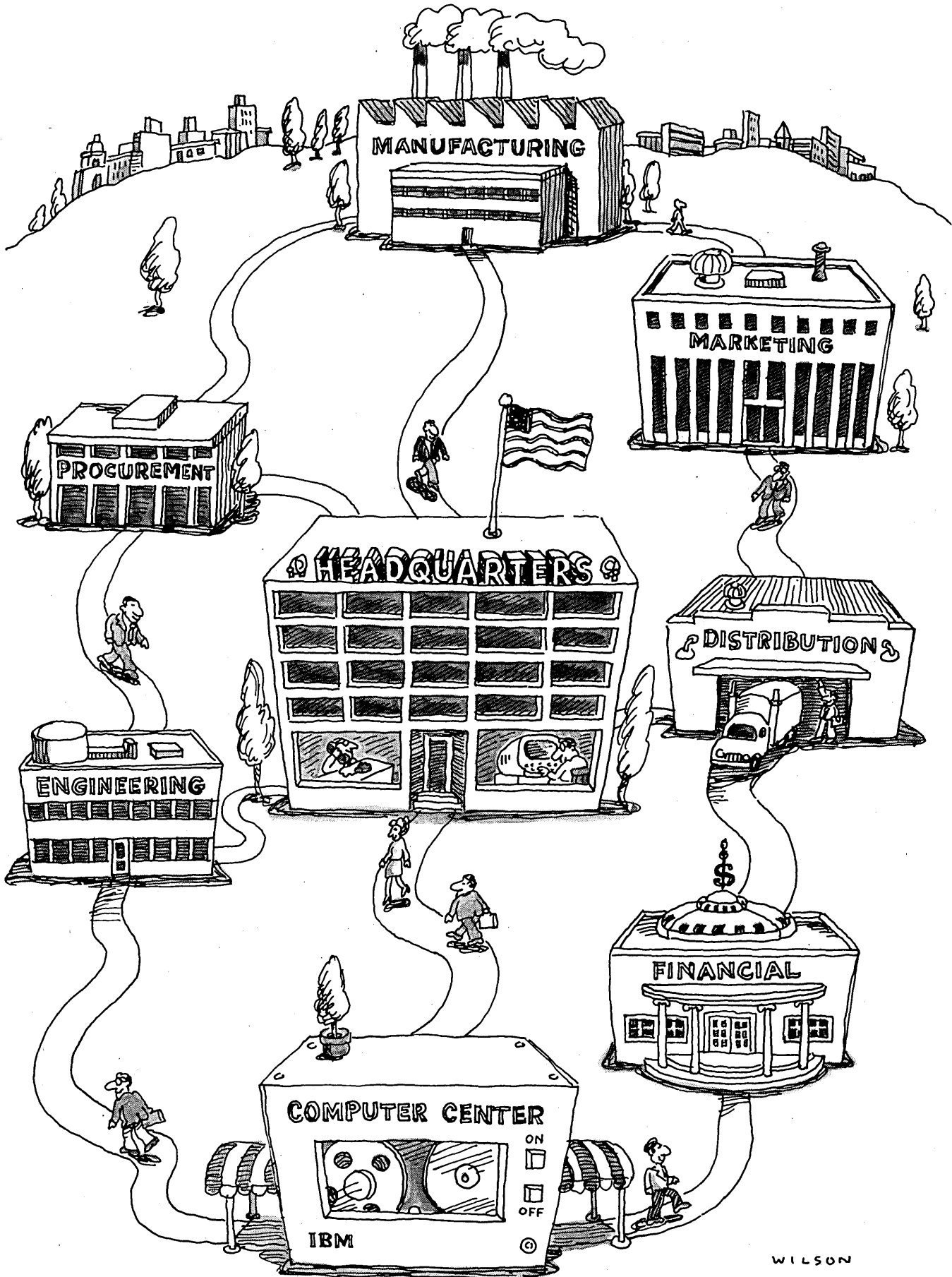

WILSON

Announcing a complete, unified software system for manufacturers.

Developing a manufacturing planning and control system takes skill and time. You can buy various parts from different vendors and build the interfaces yourself. Then test and implement the software.

Or you can have the Xerox Manufacturing System.

A Single Solution

An advanced software architecture from Xerox has done all the work for you. Integrated applications, systems software, analytical tools, and personal computers joined in one complete, unified system.

The Xerox system allows every department to work with information from the same database. Manufacturing, finance, marketing, distribution, engineering, procurement, and planning. All basing decisions on information as timely as your most recent receipt, issue, purchase order, or sales order.

Profit or Loss

The closed-loop business applications give you on-line data. Master scheduling, MRP II, inventory, order entry, costing, production control, procurement, receivables, payables, and financial modules are combined in the most powerful operating management tool available today.

The system will help you plan and execute your priorities and manage manufacturing costs at optimum levels.

It could make the difference between profit and loss.

Something for Everyone

Easy-to-use programs are provided for inquiry, reporting, and manipulation of data. For modeling, forecasting, graphic display.

And a personal computer link to your mainframe, the first practical application of its kind.

Today and Tomorrow

We can configure a system that's yours alone. One that matches your business needs today and will grow with you tomorrow.

Completely portable across all IBM 4300, 370, and 3000 computers and operating systems, the same Xerox software can be used when you upgrade your hardware.

You can use the Xerox Manufacturing System on your IBM computer or, as an option, start with the software on our timesharing service. Then, when you're ready, move the software and database in-house. In one weekend.

Our manufacturing systems run on Digital VAX minicomputers, too.

With You All the Way

Xerox systems are backed by a professional organization that understands manufacturing. We've installed computer-based systems in more than 500 manufacturing plants.

Implementation support, consulting, and education services are available from 23 Xerox offices in the United States and Europe. Solid insurance for continued successful operation of your software.

For more information, call toll-free (800) 323-2818, Operator 148. In Illinois, call (800) 942-1166.

Or return this coupon for a copy of our new *Xerox Manufacturing System* brochure.

Xerox Computer Services

c/o Ron Rich, 5310 Beethoven Street, Los Angeles, California 90066

Send me your *Xerox Manufacturing System* brochure.

D2/83

I'm interested in your software for:

IBM 43XX IBM 370 IBM 30XX Digital VAX

Name/Title _____

Company _____

Street _____

City _____ State _____

Zip _____ Tel. () _____

XEROX® is a trademark of XEROX CORPORATION. VAX® is a trademark of Digital Equipment Corporation. IBM® is a trademark of International Business Machines Corporation.

XEROX

CIRCLE 130 ON READER CARD



The GE 2120 teleprinter's text editor makes time-sharing unmistakably economical.

Economical because the 32K text editor reduces time-sharing costs by allowing you to prepare your data, make revisions and create your format off-line to reduce computer time and communication charges by as much as 70%. And at the same time edit out costly mistakes.

With the optional GE 2120 32K text editor, you pay for your computer and communication lines only while transmitting at selectable 110 to 9600 baud. It's the best way to save time in time-sharing.

The 32K text editor also provides the same off-line advantages for networking. So you can accumulate data, edit and

format before transmitting to other stations in your network.

With 150 cps, a simple to use color coded, annotated keyboard which allows format programming, easy to read digital LED display that gives you printer parameters, print position, self-test diagnostic readouts and error messages all in plain English...the compact, lightweight GE 2120 teleprinter delivers the flexible, reliable performance you need at a price you can afford.

General Electric. We introduced the first fully electronic printer with LSI circuitry in 1969. And our complete line today makes us the industry leader you should look to first.

First In Electronic Printing.

For the solution to your printing needs, call
TOLL FREE 1-800-368-3182

General Electric Company, Data Communication Products Department A321, Waynesboro, VA 22980. In Virginia, call 1-703-949-1170.

CIRCLE 131 ON READER CARD

GENERAL  **ELECTRIC**

*Agfa Gevaert.....	176-13,176-15
American Bell.....	6,7
Ampex.....	Cover 3
Anderson Jacobson.....	200
**Ashton Tate.....	177-14,177-15
Auerbach Publishers.....	74
*Auerbach Publishers.....	176-23,176-29
Bytek.....	144
Bytek.....	62
Calcomp.....	16,17
**Callan Data Systems.....	177-16
Candle Corporation.....	124,125
Cincom Systems.....	162
Computer Consoles.....	88,89
**Comtech Data.....	177-2
Conserv Corporation.....	139
Convergent Technologies.....	94,95
Cullinane.....	178
DASD.....	212
Data General.....	146,147
Datapoint.....	207
Dataproducts.....	76,77
Data Set Cable Co.....	60
Dataswitch.....	115
Dennison Monarch.....	35
Digilog.....	73
Digital Communications Associates.....	201
Digital Consulting Associates.....	67
Digital Engineering.....	123
Digital Equipment Corp.....	54,116,117,134,135
Digital Research.....	85,93
**Dilog.....	177-13
Direct, Inc.....	87
Dysart, Inc.....	52,53
Electrodata.....	61
Emulex.....	121,176-20
*L.M. Ericsson.....	176-13
Floating Point Systems.....	75
Four Phase Systems.....	157
*Fugitsu.....	176-16,176-17,176-18,176-19
General Electric.....	72,192
Gensar Rental Electronics.....	114
Graham Magnetics.....	181
*Honeywell Bull.....	176-39
*Hong Kong Telephone.....	176-27
Human Design Systems.....	22
Hughes Aircraft.....	129
IBM.....	154,168,169
Infodata.....	182
Information Builders.....	170
Inform Computer Terminals.....	189
Innovation D.P.....	197
ISSCO.....	66
C. Itoh.....	15
ITT Worldcom.....	56
Johnson Systems.....	39
Kennedy Co.....	Cover 2
Lanier.....	158,159
Lee Data.....	80
Liebert.....	97
**Macrolink.....	177-7
Martin Marietta.....	114
Mathematica.....	145
McCormack & Dodge.....	44,45
Megatek.....	19
Memorex.....	43
*Memorex.....	176-11
Methods Research.....	78
Micom.....	1
**Mini Computer Technology.....	177-12
Mitre Corporation.....	188
Mohawk Data Sciences.....	47,48,49,51
MSA.....	152,153
NBI.....	13
NEC Info Systems.....	165
*Norsk Data.....	176-34
*Olivetti.....	176-24,176-40
On Line Software.....	130,185
Onyx.....	118
Oxford Software.....	187
Perkin Elmer.....	79
*Philips.....	176-32
*Pixell.....	176-33
Polaroid.....	25,26,27
Popcom.....	60
Precision Visuals.....	46
Prentice.....	28
Quadrup.....	10,11
Quality Micro Systems.....	126
Qume.....	99
Racal Vadic.....	11
Ricon.....	174
Rusco Electronics Systems.....	86
SAS Institute.....	5
Saunders Communications.....	78
*Siemens.....	176-4,176-5
Software AG.....	9
Software International.....	12
Software Results.....	64
Sord Computers.....	210
Source EDP.....	202-203
Sperry Univac.....	50
Storage Technology.....	33
*Tandberg Data.....	176-6
Tandberg Data.....	208
T-Bar.....	189
**Teac.....	177-5
Technology Transfer Institute.....	55,57
Tektronix.....	20,21
Telephone Computer Marketing.....	17
Teletype Corp.....	Cover 4
Televideo.....	100,101,106,107
Texas Instruments.....	68-69
Three M.....	63,167
Thorn EMI.....	176-9
Timeplex.....	81
Tominy.....	48
Tower Systems.....	151
TSI International.....	176
Ungermann Bass.....	193
United Airlines.....	110,111
University Computing Co.....	140,141
Verbatim.....	143
*Videotex.....	176-37
Visual Technology.....	65
Voice of America.....	211
Wang Labs.....	137,161
**Wespercorp.....	177-1
Wrightline.....	59
Wipe Technology.....	2
Xerox.....	190-191
**Zilog.....	177-8
*International Edition **OEM Edition	

PROGRESS THRU TIME



FDR™

AUTOMATIC BACKUP AND RECOVERY

Incremental Backups

- Cyclic Backups—Only Dump Changed Data Sets
- Automatic Tracking of Backup Tapes
- Full Tape Utilization ■ MSS Staging
- ABR will Pre Allocate Data Sets to be Restored
- TSO Remote Queuing
- SU60 Type Mods Available for VSI & OS
- Stand Alone Restore

Archiving

- Based on Last Reference Date, User can Establish a Criteria for How Long a Data Set Should Remain on Disk Without Being Used
- Eliminate Unused Data Sets
- Enforce Data Set Naming Conventions
- Enforce Password and RACF Protection
- ABR will Automatically Backup and Scratch Data Sets off Disk and Keep Track of the Data Sets in its Own Data Base

DASD Management Reports

- Complete Backup Reports
- Unused Data Set Reports
- Invalid Data Set Name Reports
- Archive Data Set Reports
- Scratched Data Set Reports
- Simulation Reports ■ Wasted Space Reports
- TSO and Batch Oriented Reports

Proven Record of Reliability

Available for IBM OS, VS and MVS.
Send for Free Poster

For Further Information
or Free 30 Day Trial, Call or Write...



INNOVATION DATA PROCESSING

970 Clifton Ave., Clifton, NJ 07013-2793 • 201-777-1940

COMPUTER ENGINEERS & SCIENTISTS

Air Traffic Control, Civil and Defense Systems

Working with state-of-the art systems technology offers a challenge for any professional. But to achieve excellence in the field is the ultimate challenge. And it's a challenge met every day at MITRE.

MITRE is an independent, not-for-profit corporation devoted to systems research, development, engineering and advisory services in the public interest. Working for MITRE means you have the opportunity to work closely with key government decision makers on civil and defense programs.

We are seeking individuals who have a technical background with strong analytical skills and an interest in directing today's technology toward tomorrow's systems. Our professionals are involved in: Systems Architecture and Engineering, Requirements Analyses, Computer Systems Planning and Design, and Testing of Computer-Based Systems. If you have experience in such areas as air traffic control systems, defense and civil command, control and communications, and information systems we invite you to explore career opportunities with us.

Current opportunities exist in:

- Automated Search and Retrieval Techniques

- Data Base Management Systems
- Computer and Network Privacy and Security
- Automation of Office Environments
- Analysis of Alternative Systems Architectures
- VM Systems Programming
- Software Conversion and Transferability Techniques
- Telecommunication Applications such as Message/Packet Switching
- Digital Communications Systems Architecture and Design
- Real-Time Data Processing Systems Architecture and Design
- Real-Time Computer Software Analysis and Sizing
- Local Network Analyses and Design
- System Acquisition Management
- Computer Performance Evaluation
- Advanced Computer and Display Design and Technologies

MITRE
Washington Center

Not for Profit, In the Public Interest.

- Voice Switching Systems
- Availability and Diagnosis of Real-Time Systems
- Distributed Computing Systems Planning and Engineering
- Automated Software Development and Testing Techniques
- Information Resource Management Planning and Design

These positions require a degree in Engineering, Computer Science, Operations Research, Math or Physics and experience in one or more of the aforementioned areas.

Explore the many challenges MITRE has to offer. Please send your resume to M.F. Mason, The MITRE Corporation, Washington Center, 1820 Dolley Madison Boulevard, McLean, Virginia 22102.

Similar positions are available in our Bedford, Mass. facility. If you're interested, send your resume to: David L. Finnegan, The MITRE Corporation, 2207 Middlesex Turnpike, Bedford, Mass. 01730.

MITRE is an Equal Opportunity Employer. We welcome responses from minorities, females, veterans and the handicapped. U.S. citizenship is required for employment in all national security related areas.

New designs for IBM users.

These are Informer's small 370 terminals. They are IBM 3270 compatible.
Use them as stand alone displays or with our 374 controller for multiple display stations.

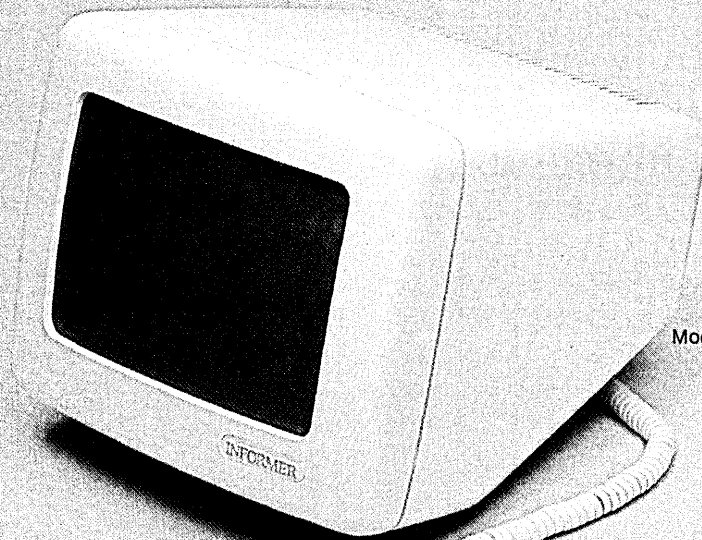

Model 203

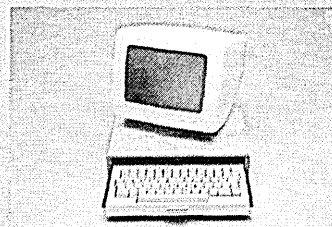

Model 201

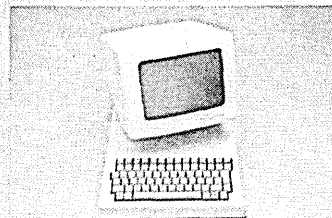

Model 202

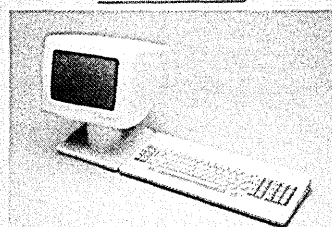

Model 204

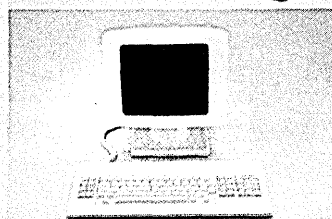

Model 205



INFORMER®

Performance In Small Sizes.

Informer Computer Terminals, Inc., 8332 Osage Ave., Los Angeles, CA 90045.
Call (213) 649-2030. TWX 910-328-6544.

CIRCLE 130 ON READER CARD

Now VT 52 Emulator
Asynchronous Version

First full duplex 4800 bps dial-up.

The new AJ 4048 high speed modem. The first full duplex 4800 bps modem for use over ordinary two-wire dial-up telephone lines. This AJ breakthrough dramatically cuts your data communications cost, eliminating expensive leased lines and half duplex line turn-arounds, with throughput increases of 40% to 60%.

Manufactured, sold, leased, and serviced by AJ. Write for our free catalog, Anderson Jacobson, Inc., 521 Charcot Avenue, San Jose, California 95131.



When you need more than
just communications.

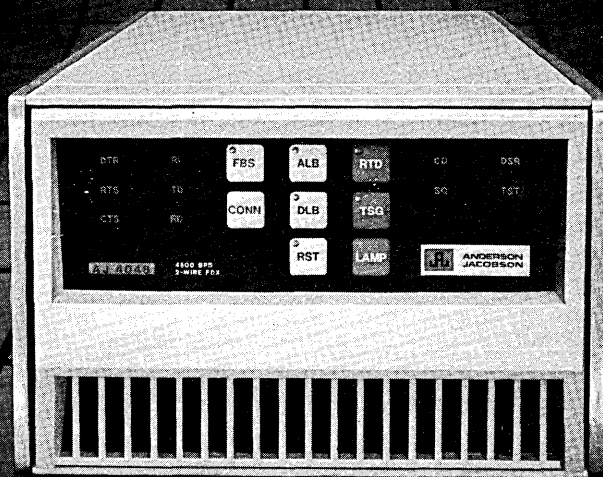

Sales and service throughout North America and Europe. Regions: Eastern (201) 794-9300; Central (312) 671-7155; Western (408) 946-2900. Subsidiaries: Canada (416) 475-5510; France 657-12-10; Germany 02204-53051; U.K. Slough 25172.

CIRCLE 128 ON READER CARD

WHY YOU SHOULD MAKE A CORPORATE CONTRIBUTION TO THE AD COUNCIL

The Advertising Council is the biggest advertiser in the world. Last year, with the cooperation of all media, the Council placed almost six hundred million dollars of public service advertising. Yet its total operating expense budget was only \$1,147,000 which makes its advertising programs one of America's greatest bargains... for every \$1 cash outlay the Council is generating over \$600 of advertising.

U.S. business and associated groups contributed the dollars the Ad Council needs to create and manage this remarkable program. Advertisers, advertising agencies, and the media contributed the space and time.

Your company can play a role. If you believe in supporting public service efforts to help meet the challenges which face our nation today, then your company can do as many hundreds of others—large and small—have done. You can make a tax-deductible contribution to the Advertising Council.

At the very least you can, quite easily, find out more about how the Council works and what it does. Simply write to: Robert P. Keim, President, The Advertising Council, Inc., 825 Third Avenue, New York, New York 10022.



A Public Service of This Magazine
& The Advertising Council.

The cost of preparation of this advertisement was paid for by the American Business Press, the association of specialized business publications. This space was donated by this magazine.

DCA'S SYSTEM 355 master network processor solves your data communications problems...and saves you time, money, and valuable space.

THE SYSTEM 355 maximizes data communications and minimizes headaches. COMPLETE NETWORK TRANSPARENCY allows the interconnection of varied hosts and terminals.

VIRTUAL-CIRCUIT SWITCHING gives every network user a dedicated-line feeling.

ERROR-CONTROLLED DATA TRANSMISSION eliminates the probability of undetected errors and allows the use of low-cost hardware and less CPU memory.

COMPATIBLE MODULAR HARDWARE keeps repairs and upgrading quick and easy.

X.25 LEVEL 3 GATEWAY INTERFACE allows your network to access public data networks. And ASCII terminals in your network may communicate with any host supporting X.25.

44 TRUNK-LINK CAPABILITY offers centralization network management control with no geographic limitations.

DCA delivers what others are still promising. If you're stuck in traffic call DCA toll-free at (800) 241-5793. Digital Communications Associates, Inc., 303 Research Drive, Norcross, Georgia 30392.

dca

DCA Products Are Available Worldwide.

SIMPLE SOLUTION FOR NETWORK TRAFFIC SNARLS

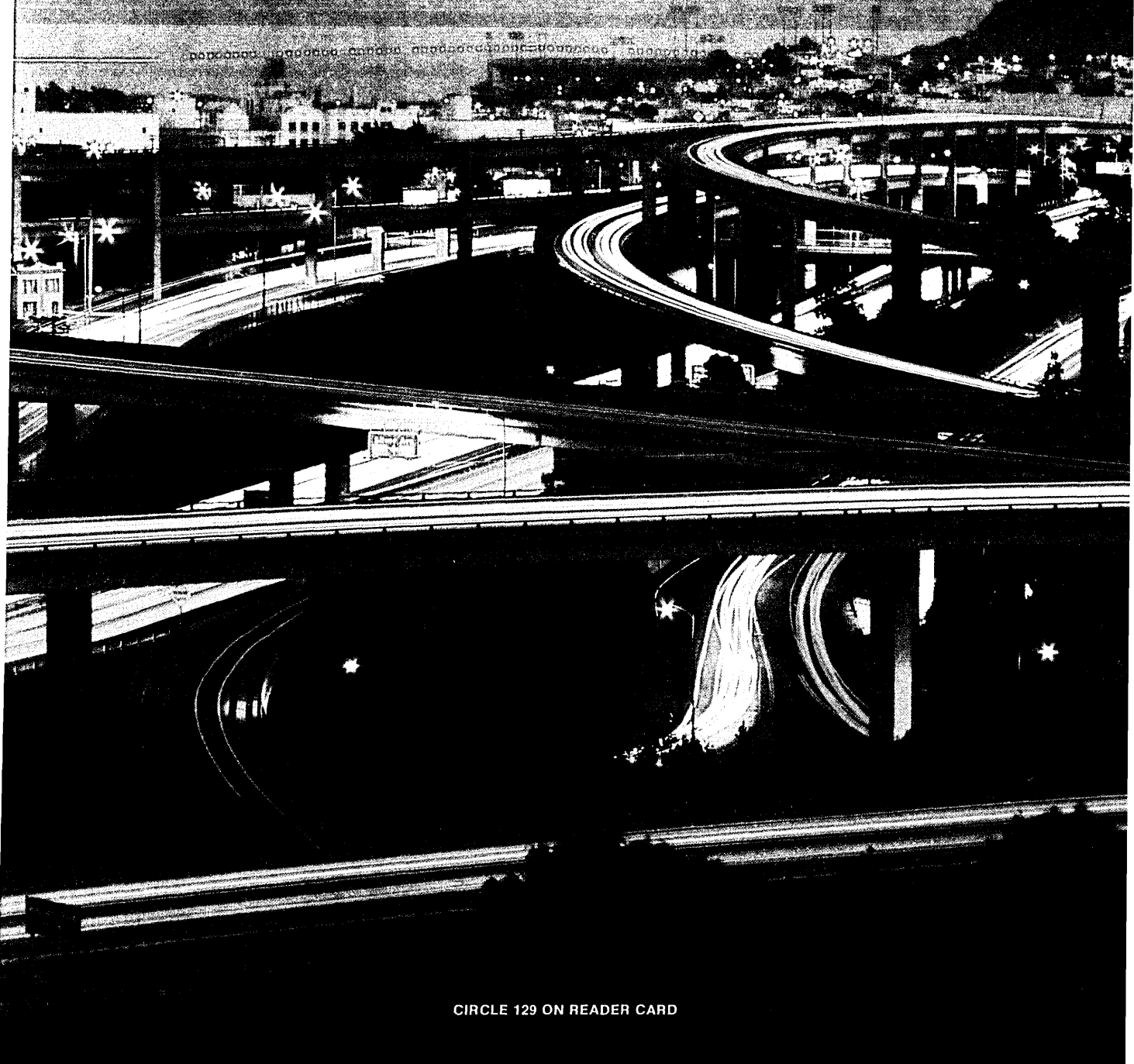

CIRCLE 129 ON READER CARD

ON THE JOB

LITTLE THINGS MEAN A LOT

Whether a new job beckons in 1983 or you're just planning to sit tight, the benefits and perks in today's job market are sure to pique your interest. As part of our 1982 salary survey, DATAMATION and Edward Perlin Associates, Inc., asked respondents to list some of the extras they're getting.

- A Florida dp manager earning \$31,000 has a company-contributed pension plan that consists of 9% of his gross pay, and a longevity bonus of 2% for each five years worked.

- Management at a Texas dp service firm receives \$200 a year for membership in health clubs and \$2,500 a year toward car expenses.

- A senior analyst/programmer in a Minnesota educational organization gets a pension, recreational facilities, and child care.

- Management at the Ohio headquarters of a fast-food restaurant chain can take advantage of an unusually full perks package: profit-sharing amounting to 10% of salary, 400 shares of company stock each year, a pension plan consisting of 10% of salary, signing bonus, longevity bonus, club membership, recreational facilities, child care, and a car allowance.

There's more. Let's take a closer look at two of the less common perks.

The three- or four-day work week is offered by few companies. Two firms that are doing it are Interdesign Inc., a Scotts Valley, Calif., integrated circuits manufacturer, and Equitable Life Assurance in New York and Pennsylvania. Interdesign converted to the 10-hour day and four-day work week in November 1982, shortly after it moved to the Scotts Valley facilities. It also offered employees a 12-hour day, three-day work week at approximately the same time. This three-day shift, working Friday, Saturday, and Sunday, is in place of the graveyard shift (Monday through Friday, midnight to 8 a.m.), which is when much of the company's product testing is done. As of late December, it was too soon to tell whether productivity had improved, but Stephen Shaw, director of industrial relations, did say that employee moral was very good, and that productivity had not declined. Incidentally, Interdesign is the first company in Santa Cruz County to initiate a flextime project.

Equitable Life's New York dp de-

partment offers a three-day work week, and a four-day shift is available in its Easton, Pa., data center. In addition, the New York site offers a nine-day "biweek" schedule. This means that employees work approximately 45 minutes a day longer for nine weekdays, and then have the 10th day off (either a Monday or a Friday). According to John Goodroe, senior vp of computer services, this system has produced a marked reduction in absenteeism and turnover since its inception about eight years ago. Over a thousand people are presently on the program, and joining it is considered a privilege.

Chief executive officers and others who are at or near the top are most familiar with this next perk. According to Growth Resources Inc., a consulting firm in Peabody, Mass., approximately 20% of the ceos and key officers of small and medium-sized manufacturing, technology, and service companies in the U.S. receive interest-free or low-interest loans through their companies. GRI puts the average amount of those loans at \$52,900, with 42% of the recipients paying an average 8.9% interest rate and the other 58% paying no interest at all. Lower-ranking officers receive similar treatment, but on a smaller scale—the average loan is \$20,000. These loan practices are not new, but they have become more prevalent in recent years. Since the early '60s, the Internal Revenue Service has tried numerous times to obtain judicial support for its position that interest-free loans generate taxable income. These attempts have consistently failed until last July, when the IRS obtained a preliminary ruling from a U.S. Court of Claims judge in one case involving a loan of \$503,000 (primarily invested in nontaxable municipal bonds).

The case has since been brought before the U.S. Court of Appeals, which was to have considered it this month. Even if the ruling is affirmed by the higher court, GRI says, "the unique nature of the case would not necessarily cause a precedent against interest-free loan grants. At present, interest-free and low-interest loans continue as an available and attractive potential component to the executive compensation package."

Well, that's something to look forward to as you (and perhaps the interest rates, too) climb.

—Deborah Sojka

Call today.

United States:

Arizona	
Phoenix	602/279-1010
California	
(Northern)	Mountain View 415/969-4910
	San Francisco 415/434-2410
	Walnut Creek 415/945-1910
(Southern)	Century City 213/203-8111
	Fullerton 714/871-6500
	Los Angeles 213/688-0041
	Newport Beach 714/833-1733
	San Diego 619/231-1900
	Torrance 213/540-7500
	Van Nuys 213/781-4800
Colorado	
Denver	303/571-4450
Englewood	303/773-3700
Connecticut	
Hartford	203/522-6590
Stratford	203/375-7240
District of Columbia	
Washington D.C.	202/466-5890
Florida	
Miami	305/624-3536
Georgia	
Atlanta (Downtown)	404/588-9350
Atlanta (North)	404/953-0200
Atlanta (Northeast)	404/325-8370
Illinois	
Chicago (East Loop)	312/938-4400
Chicago (West Loop)	312/782-0857
Oak Brook	312/986-0422
Rolling Meadows	312/392-0244
Indiana	
Indianapolis	317/631-2900
Kansas	
Overland Park	913/888-8885
Kentucky	
Louisville	502/581-9900
Louisiana	
New Orleans	504/561-6000
Maryland	
Baltimore	301/727-4050
Towson	301/321-7044
Massachusetts	
Boston	617/482-7613
Burlington	617/273-5160
Wellesley	617/237-3120
Michigan	
Detroit	313/259-7607
Southfield	313/352-6520
Troy	313/362-0070
Minnesota	
Minneapolis (Downtown)	612/332-6460
Minneapolis (West)	612/544-3600
Missouri	
Clayton	314/862-3800
Kansas City	816/474-3393
New Hampshire	
Nashua	603/880-4047
New Jersey	
Cherry Hill	609/482-2600
Edison	201/494-2800
Morristown	201/267-3222
Paramus	201/845-3900
Princeton	609/452-7277
New York	
New York City	
(Grand Central)	212/557-8611
(Penn Station)	212/736-7445
(Wall Street)	212/962-8000
Rochester	716/263-2670
Syosset, L.I.	516/364-0900
White Plains	914/683-9300
Ohio	
Akron	216/535-1150
Cincinnati	513/769-5080
Cleveland	216/771-2070
Columbus	614/224-0660
Dayton	513/461-4660
Oklahoma	
Tulsa	918/599-7700
Oregon	
Portland	503/223-6160
Pennsylvania	
King of Prussia	215/265-7250
Philadelphia	215/665-1717
Pittsburgh	412/261-6540
Wilkins Township	412/247-4400
Texas	
Dallas (Central)	214/954-1100
Dallas (North)	214/387-1600
Fort Worth	817/338-9300
Houston (Downtown)	713/751-0100
Houston (N. Loop West)	713/957-8555
Houston (S.W. Freeway)	713/626-8705
San Antonio	512/342-9898
Virginia	
McLean	703/790-5610
Washington	
Bellevue	206/454-6400
Wisconsin	
Milwaukee	414/277-0345
Canada:	
Ontario	
Don Mills	416/425-5730
Mississauga	416/272-3333
Toronto	416/865-1125
Québec	
Montréal	514/849-7043

Somehow, Did Your Last Raise Seem Insignificant?

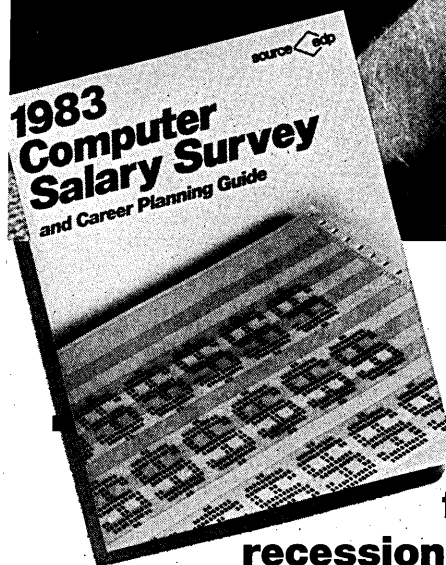

New, Free Computer Salary Survey!

Learn about compensation in the computer field, including the effects of inflation and recession, and which career paths offer the greatest compensation from a 28-page report prepared by Source Edp.

Despite past inflation and recession, demand for computer systems and the people needed to support them continues to grow.

But which professionals, with what specialized experience and skills, are really in the best positions for long term career and salary growth? And is your salary really keeping pace?

In our new Survey, you'll get answers to these questions and much more.

Compare your salary with many others.

The new Survey not only provides salary medians for 48 position categories, but it also shows "highs" and "lows" for each one as well. Figures are organized by types of professionals, including those ranging from commercial pro-

grammers to management and marketing positions; by experience level and by size of computer installation site. So you'll be able to compare your salary with those computer professionals who have similar responsibilities and skills and to learn who in computing, in what kinds of specialized disciplines, are earning the most.

No other Survey we know of is more comprehensive. It's based on contacts with more than 50,000 professionals and 25,000 organizations.

Learn about new growth areas.

Most significantly, you'll also read about which specific areas of specialization are forecasted for unusual growth in this decade and beyond. The past year saw many

changes in the economy and has altered career prospects for some professionals who were not properly prepared, so the need to stay abreast of current trends and career planning has never been so critical.

Whatever computer specialty you're in, or plan to explore—programming, software, systems design, data communications, mini/micro systems, data base, computer marketing, sales, management or others—our Survey can help you make the most of your career. You'll be able to keep up with changes in the profession, establish career goals, develop action plans, evaluate your progress, spot potential dangers, take corrective action when needed, and in general, keep your career on the best possible course for growth.

Call for your free copy.

The new 1983 *Computer Salary Survey and Career Planning Guide* is available without charge. You owe it to yourself to get a copy of the report—especially if most of your career lies ahead of you.

Call today and our free 28-page Survey will be mailed to you in strict confidence, without obligation.

source edp
Personnel Services

The world's largest recruitment firm that specializes exclusively in the computer profession.

Client companies assume our charges.

Call today.

Call the office nearest you that is listed to the left. If you're unable to call, write:

Source Edp
Department D2
P.O. Box 7100
Mountain View, CA 94039

(When writing, be sure to include your title.)

ADVERTISERS' INDEX

SOFTWARE SERVICES

Ancor Computer Corp.	204
Beemak Plastics.....	204
CGA Software Products Group	204
Dataware, Inc.	205
Dataware, Inc.	205
Dataware, Inc.	205
Evans, Griffiths & Hart, Inc.	204
Mitchell & Gauthier Associates, Inc.	204
Plycom Services, Inc.	204

DP MARKETPLACE

Columbia National General Agency	205
Hickory Brewster International, Inc.	205

BUY, SELL, LEASE

Associated Computer Products, Inc.	205
Brookvale Associates	205
Digital Systems Corp.	205
Raymond G. Lorber, Inc.	206
Texprint, Inc.	206
Thomas Business Systems, Inc. .	206

JOBMARKET

Cornell University	206
University of Pittsburgh at Bradford	206

SUPER-MSI
Multiple System Integrity Facility™

MSM
Multiple Systems Manager*

GCD
Global Console Director™

SYSTEMS SOFTWARE FOR MULTI-SYSTEMS USERS

The high performance family of CGA multi-systems products gives multiple-CPU sites a powerful new single-system image.

Used together or in any com-

CGA single-image software runs under MVS / MVS-SE, MVS-SP, SVS, MVT, V51 and MFT systems.

800-237-2057 · Speak software. Talk to CGA.

bination, each member works transparently to make your data center more efficient, easier to manage and more productive—all without systems modifications.

More than a thousand CGA single-image software packages are in use around the world. Change your image for the better. Call today and set up a free trial of Super-MSI, GCD or MSM.

CGA CGA Software Products Group 255 Rt. 520 East Marlboro, New Jersey 07746

CIRCLE 500 ON READER CARD

ACSL

The Advanced Continuous Simulation Language is a powerful but easy to use program designed for modelling the behavior of dynamic systems. Applications range from control system analysis to chemical plant models to urban dynamics.

- Interactive or Batch Graphics
- Unlimited Problem Size
- FORTRAN Compatibility
- Stiff Integration

ACSL reduces program development time by factors of two to ten: ACSL is available for CDC 6000/7000, IBM 360/370, UNIVAC 1100, SEL 32, PDP 10/20, VAX II, PRIME 50 and HARRIS computers. Access through BCS, CYBERNET and other national networks.

MITCHELL AND GAUTHIER ASSOCIATES, INC.
P.O. Box 685, Concord, Ma. 01742
(617) 369-5115

CIRCLE 501 ON READER CARD

RSTS/E & RSX-11M SOFTWARE PACKAGES

KDSS multi-terminal key-to-disk data entry system

TAM multi-terminal screen-handling facility for transaction-processing applications

FSORT3 very fast record sort for RSTS/E

SELECT convenient, very fast extraction of records that meet user-specified criteria (RSTS/E only)

BSC/DV a DV11 handler for most bisynchronous protocols (RSTS/E only)

COLINK links two RSTS/E systems using DMC11s

DIALUP uses an asynchronous terminal line to link a local RSTS/E system to a remote computer system

Evans Griffiths & Hart, Inc.
55 Waltham Street
Lexington, Massachusetts 02173
(617) 861-0670

CIRCLE 502 ON READER CARD

PAYROLL SYSTEM

Tired of changing your payroll system every year? Have problems paying your employees on time? Need better control over where your labor effort is going? Use PLYCOM's Payroll Package for software that is easy to use, yet effective. Includes complete support and excellent documentation. Features:

- Easy to use menus
- Excellent audit trail
- Divisional & department reporting
- Multi-state tax calculations
- Event driven or exception type
- Extensive on-line error checking
- Easily handles manual checks
- Effective control on void or returns
- On-line employee inquiry
- For PDP-11's using RSTS/E

Plycom services, inc.
P.O. Box 160
Plymouth, IN 46563
(219) 935-5121

CIRCLE 504 ON READER CARD

Tabcard Holders

supplying holders for all types of D.P. systems

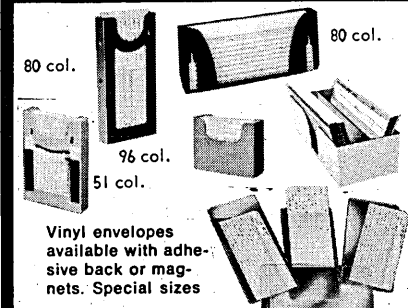

Vinyl envelopes available with adhesive back or magnets. Special sizes

SINCE 1951

BEEMAK™ PLASTICS

7424 Santa Monica Boulevard
Los Angeles, Ca. 90046 • (213) 876-1770
Outside California—call our Toll Free number:
1 (800) 421-4393

CIRCLE 505 ON READER CARD

DEC RSTS DBMS SOFTWARE
available soon for VAX!
AMBASE's portable application development tool and DBMS, increasing the productivity of programming staffs worldwide from 100-200%
• DATA MANAGEMENT SYSTEM
• REPORT GENERATOR
• QUERY LANGUAGE
• SCREEN FORMAT GENERATOR
• AUTOMATIC CODE GENERATOR
DEC GOLD STAR RATED
1CP MILLION DOLLAR AWARDED

dtr

amcor computer corp.
4 Bank Company
1900 Plantside Dr. Louisville, KY 40299 502-491-9820
Regional Offices - Atlanta, GA - Campbell, CA

CIRCLE 503 ON READER CARD

PL/1 TO COBOL

Dataware's Software Translator automatically converts from IBM PL/1 to ANS COBOL (DOS or OS). The Translator is capable of handling IBM OS or DOS (48 or 60 character set) source programs as input.

For more information on this translator or the others listed below, please write or call today.

- EASYCODER/TRAN to COBOL
- BAL/ALC to COBOL
- AUTOCODER/SPS to COBOL
- COBOL to COBOL

The Conversion Software People

Dataware, Inc.

2565 Elmwood Avenue
Buffalo, New York 14217
(716) 876-8722 • TELEX: 91519



CIRCLE 506 ON READER CARD

COBOL to COBOL

One of the many successful Translators offered by Dataware is our COBOL Converter, a table-driven conversion system designed to convert COBOL programs from one vendor or operating system to another.

This converter plus our other conversion tools meet the needs of a changing computer industry.

Our conversion approach provides the major solution to management's conversion problems and facilitates the recovery of the initial capital investment in systems development.

For more information, call or write today.

The Conversion Software People

Dataware, Inc.

2565 Elmwood Avenue
Buffalo, New York 14217
(716) 876-8722 • TELEX: 91519



CIRCLE 507 ON READER CARD
DP MARKETPLACE

AUTOCODER/SPS to COBOL

Dataware's software translator automatically converts a high percentage of SPS/1400 Autocoder source code to ANS COBOL (DOS or OS).

The Translator converts from:

- IBM 1401
 - IBM 1401 SPS
 - IBM 1440
 - IBM 1410
 - IBM 7010
- } can be mixed in a single source program.

For more information, call or write today.

The Conversion Software People

Dataware, Inc.

2565 Elmwood Avenue
Buffalo, New York 14217
(716) 876-8722 • TELEX: 91519



CIRCLE 508 ON READER CARD

USE THE DATAMATION MARKETPLACE ADVERTISING SECTION

**CALL KATHY
800-223-0743
OR SHIRLEY**

BUY, SELL, LEASE

ATTENTION PRIME USERS

Why pay premium prices for peripherals? Get two CDC 300 meg drives for the price of one. New 300 meg drives ready for shipment, fully tested and guaranteed. Nationwide CDC maintenance and installation. Call today:

**Tom Tamaccio
Digital Systems Corp.
Walkersville, Md. 21793
(301) 845-4141**

CIRCLE 511 ON READER CARD

BUILT A BETTER MOUSETRAP?

We will buy or jointly develop your ideas, inventions, new products, etc., patented or not. Venture capital provided. Confidentiality assured. Call Mr. Florio at (914) 632-9201. Leave your telephone number and a brief description or write to HBI Inc., P.O. Box 1020, Wykagyl Station, New Rochelle, N.Y. 10804.

CIRCLE 509 ON READER CARD

LOW COST COMPUTING 800-243-9737

SYSTEMS/ COMPUTERS	TERMINALS/ PRINTERS
TELEVIDEO	QUME
OSBORNE * XEROX	LA 120, LA 100
DEC * NEC	VT 100, VT 125
WANG * DG	LA 100
COMMODORE	OKIDATA
FRANKLIN	NEC 35xx, 77xx

ASSOCIATED COMPUTER PRODUCTS, INC.
887 MAIN STREET
MONROE, CT 06468

**SAVE UP TO 50%
NEW & USED**

CIRCLE 512 ON READER CARD



Sure it's insured?

SAFEWARE™ Insurance provides full replacement of hardware, media and purchased software. As little as \$35/yr covers:

- Fire • Theft • Power Surges
- Earthquake • Water Damage • Auto Accident

For information or immediate coverage call:

1-800-848-0598

(In Ohio call 1-800-848-2112)

CNGA

COLUMBIA NATIONAL GENERAL AGENCY

CIRCLE 510 ON READER CARD

DEC

The better way...

SYSTEMS PERIPHERALS SUPPLIES

BUY • SELL • RENT • UPGRADE

800-645-1167

New York (516) 567-7777

**BROOKVALE
ASSOCIATES**

40 Orville Drive, Bohemia, N.Y. 11716

CIRCLE 513 ON READER CARD

SYSTEMS • PERIPHERALS • PARTS

DG

Phil Thomas
305/392-2006

DEC

Bryan Eustace
305/392-2005

Jennifer Eustace

305/392-2007
TELEX 568-670

BUY • SELL • TRADE • LEASE

THOMAS BUSINESS SYSTEMS, INC.

CIRCLE 514 ON READER CARD

IBM SERIES/1 VAR

- Customized Programming
- Message Switching
- Telex/Teletype Interface
- Freight Forwarding
- General Business Applications



Raymond G. Lorber,
Incorporated
Systems & Programming Design

333 Market Street, Suite 2840
San Francisco, CA 94105
(415) 434-2607

CIRCLE 516 ON READER CARD

**Get Graphics
On Your
DEC* LA120**

DEC PLOT™ upgrades your DEC LA120 to print graphics fast—only 35 seconds per average page...Just \$595. Need color too? Get DECOLOR™...Only \$995. Fully compatible with most graphics software and CRT display terminals.

**NEW! VT-125
COLOR PRINTER INTERFACE
\$495**

Texprint's simple plug-in modules require no extra custom software for dot-addressable or character-graphics applications. Expand LA120 performance, yet preserve all original functions. Available now from Texprint or DEC distributors.

*Registered trademark of Digital Equipment Corp.

TEXPRINT

TEXPRINT, INC.
8 Blanchard Rd.
Burlington, MA 01803
(617) 273-3384

CIRCLE 517 ON READER CARD

**“THERE IS AN ANSWER TO EVERY RIDDLE
IN THE UNIVERSE, EXCEPT ONE.”**

I know the secrets of the stars and the mysteries of the moon. But the origin of The Common Cold baffles even a great thinker like myself. That's why I rely on the Consumer Information Catalog.

It's published by the Federal Government and lists over 200 booklets you can send away for. Over half are free. And all are wise. With tips on everything from repairing a flat tire to relieving a cold.

So send for this free catalog. Write: Consumer Information Center, Dept. B, Pueblo, Colorado 81009. After all, it's hard enough deciphering the mysteries of this planet, without the handicap of an earthshaking sneeze.

**THE CONSUMER INFORMATION
CATALOG**

A catalog of over 200 helpful publications.



**University of Pittsburgh at Bradford
Computer Science Teaching Positions**

First position requires an M.S. in Computer Science with a Ph.D. in a related field preferred. In the second position an M.S. in Computer Science is preferred, but candidates with a B.S. in Computer Science, an M.S. in a related area, and extensive experience may apply. The emphasis at UPB is on teaching excellence. Successful candidates will teach in a two-year Associate's program and two proposed four-year programs leading to a B.A. or B.S. Salary and rank commensurate with qualifications and experience.

UPB is a four-year regional campus of the University of Pittsburgh located near the Allegheny National Forest in northwestern Pennsylvania. Development of the computer science program is supported by a long-term Title III grant from the Department of Education. A VAX 11/780 system, linked to the DEC-10 system in Pittsburgh, will be installed in May 1983, and a master plan calls for expansion of the system to support both academic and administrative computing.

UPB is an equal opportunity employer. Minorities and women are especially encouraged to apply.

Reply by March 1, 1983 to R. Melka, Computer Science Search Committee, University of Pittsburgh at Bradford, Bradford, PA 16701. (814) 362-3801.

CIRCLE 515 ON READER CARD

**ADVERTISING
SALES
PROMOTION
WRITER**

Major NYC agency has opening for a solid creative pro who can write business-to-business copy that excites — and explains. Experience in data processing or industrial-type accounts preferred. Technical background helpful but not necessary. Strong staff support provided, in an atmosphere of creative excellence. Send resume to:

P.O. Box D283
Datamation Magazine
875 Third Ave.
New York, N.Y. 10022

ADVERTISEMENT FOR FACULTY POSITION

**CORNELL UNIVERSITY
HOSPITALITY INFORMATION SYSTEMS**

The School of Hotel Administration at Cornell University is seeking a faculty member to teach required and elective courses in both the technical and managerial aspects of Information Systems in management of hotels, restaurants and other hospitality properties, as well as administer Information Systems in business or hospitality administration, engineering, computer science, or a related field; a combination of teaching and industry experience; an interest in education and research; an ability to communicate effectively with students; and the desire to work in an interdisciplinary hospitality management program. The salary and rank are commensurate with qualifications. The nine month academic year provides the opportunity to conduct research, present seminars and consult. Appointment begins August 1983. Candidates should send a letter of application and names and addresses of three references to:

Dr. James J. Eyster, Assistant Dean
School of Hotel Administration
Cornell University
Ithaca, NY 14853

"I don't think any other computer could have grown with us the way our Datapoint has."

—Riley Jackson
V.P., Information Systems
First Interstate Bank of
Washington, Seattle



First Interstate Bank's computer was the right size when they bought it, and *stayed* the right size as the company's data processing needs grew. They bought Datapoint's *expandable* computer system, the ARC™ local network.

The ARC is expandable in a way no other computer is. You can actually increase its computing *power*. So, when First Interstate wanted their computer to do more work for more people, they just plugged in more Datapoint® processors, storage disks, terminals, and printers. The ARC wasn't slowed by the added work because they were adding computing power with each expansion.

**Never again face the hassles of
computer replacement**

With Datapoint's ARC, your company is spared the trauma of outgrowing its computer and starting over with a big-

ger one, and because the ARC system is expandable, you can keep all your people on one system. You're never forced to keep duplicate files in several computers.

The most widely used local network

Datapoint pioneered the concept of local networks when the ARC was introduced more than five years ago. Now there are more than 4,000 ARC systems in use, far more than any competitive system, and an experienced service organization supports them worldwide.

Datapoint computers, including the ARC, will work with Datapoint word processing, electronic message, and telephone systems. You can assemble a single, comprehensive information system and *that* system will be expandable, too.

For more about Datapoint, call (800) 531-5639. In Texas, call (800) 292-5099. Telex 767300 in the U.S.; 06986622 in Canada; or 923494 in Europe (UK).

Or write Datapoint Corporation, Marketing Communications T41DM, 9725 Datapoint Drive, San Antonio, Texas 78284.

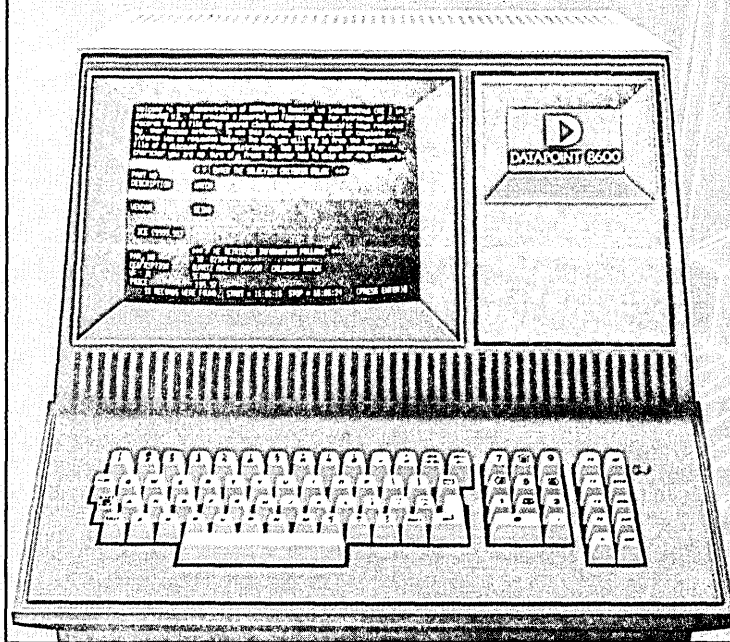

DATAPoint

CIRCLE 135 ON READER CARD

WHICH TWIN HAS THE TANDBERG?

The ergonomic terminal with simplified local editing and software controlled operating features.

If your operators need a stack of manuals and a degree in Computer Science to operate your terminals then, chances are, you haven't yet heard of the new Tandberg Data conversational terminal. The Tandberg terminal's efficient, "friendly" operating features increase productivity and ease the operator's workload while they enhance your distributed data processing capability.

As a full ANSI standard editing terminal, the Tandberg TDV 2220 allows virtually all functions to be performed locally as well as from the host. For maximum flexibility all functional characteristics are prompted from easily understood "English" menus and may be stored in non-volatile memory.

The TDV 2220 will operate in character, line or block mode. Up to eight pages of local memory can be recalled and

amended by page or "window." Sixteen editing functions allow insertions, deletions and erasure of characters, fields, areas, lines or pages while protected and unprotected fields may be defined in ten variations for local checking. Navigation keys permit quick and easy set-up of even the most complex tabular forms and PUSH-keys implement data strings at the touch of one button.

Not only is the Tandberg the easiest terminal to use, it's also the only terminal in the world that meets the stringent 1985 German ergonomic standard—with tilt, swivel and height adjustments, an ultra-low profile, detachable keyboard, all non-reflective surfaces, an anti-reflex tube, et al. Your operators will cheer.

In addition to the advanced performance Model TDV 2220 terminal, the Tandberg TDV 2200 family includes models which emulate the DEC VT 100/VT 52, Datapoint 3600 and 8200, Data General 6053 and D 200, IBM 3101 and others. Firmware development tools and hardware building blocks are also available to the OEM who wants to develop a terminal with its own personality.

So why put up with a terminal headache? The "face" of your computer system that the user sees could be a Tandberg terminal. Call or write today for our new brochure.

TANDBERG DATA, INC., P.O. Box 99, Labriola Court, Armonk, New York 10504, Telephone: (914) 273-6400—Telex #137357 Tandberg Arnk.

TANDBERG DATA
Tandberg Data, Inc.



CIRCLE 136 ON READER CARD

READERS' FORUM

LANGUAGE BARRIER TO PRODUCTIVITY

Nationwide, business data processing is in the midst of a crisis. Dp has become indispensable for the organizations that employ it, but it serves those organizations inadequately. The situation is serious because dp affects most facets of productivity, which, on a cumulative national scale, influences both domestic inflation and our competitive position overseas. The end users, who depend on dp for information, are openly hostile. Their problems are compounded by dp's poor service, and they feel powerless to prevent it.

Now a major breakthrough in computer software technology has led the way for a frontal attack on the dp crisis. Advanced new fourth generation programming languages (4GLs) can routinely increase computer programming productivity 1,000% to 2,000% over the older third generation languages (3GLs). The 4GLs enable end users to control their own dp affairs, and permit organizations to have more sophisticated management information systems (MIS) than were previously possible.

Fourth generation languages are rarely introduced into an organization by top management. Instead, it is usually a group of enthusiasts in an established department (not necessarily dp) who initiate the process. They recognize the potential of a 4GL for reducing their own dp problems, they install it, and word of its performance spreads throughout the organization. At this stage, resistance to 4GLs builds from a powerful enemy. Surprisingly, since 4GLs facilitate major productivity and efficiency gains for the whole organization, the enemy is within: the dp department.

End-user dissatisfaction with dp has accelerated throughout the '70s and early '80s. As awareness of dp's capabilities spread, the demand for its services skyrocketed, but dp departments were unable to keep pace.

The spectrum of end-user discontent with dp is broad. In day-to-day operations input data is lost, databases are written over, important reports—usually produced late—are sent to the wrong place, “tested” program changes cause reports using the same source data to have totals that disagree, cost chargebacks are arbitrary, and personnel turnovers compromise support. Submitting requests for new systems or changes to existing systems is akin to beaming a flashlight into a cosmic black hole. Applications backlogs of three to five years are commonplace, so by the time a new system is operational it is obsolete. Changes to existing programs require exhaustive, lengthy testing in order not to disrupt the fragile framework of existing software and databases.

How did things get to be so bad? The causes are too numerous and complex to describe in a short article, but one particular

problem should be discussed: software production tools have been inadequate. Software development methodologies have also been inadequate, but this was caused by the limitations of available software tools. The tools in question are 3GLs such as COBOL, FORTRAN, PL/1, and ALGOL. The Achilles' heel of 3GLs is that they are inflexible for change. They are procedural in nature so that the programmer must define each small step to the computer, which results in long, convoluted, progressively incomprehensible programs that a programmer can only change at his or her peril.

Software methodologies were built around 3GLs in spite of their limitations. Therefore, computer systems were developed with an extensive, highly detailed effort being put into the system requirements document and system design document, which were then cast in concrete. The system was programmed, tested, and implemented according to the static original design. But experience of the last 15 years has shown that all organizations operate in an environment of perpetual, unpredictable, dynamic change. So neither the basic requirements of a computer system nor the way it will eventually be used can be predefined with more than 50% accuracy. Predefined plans for new computer systems have proven to be about as realistic as trying to call all the plays before a football game starts. It is not surprising that this system development methodology produced a litany of systems that overran budgets, missed delivery schedules, compromised user functionality, and often didn't work.

Enter fourth generation languages. The 4GLs are a major technological advance to computer programming as integrated circuits were to computer hardware and orbiting satellites to data communications. They are nonprocedural in nature; that is, they employ a small set of powerful commands that tell the computer what to do, as opposed to procedural commands (in 3GLs) that tell the computer how to do it. They also include procedural capabilities for fine-tuning the main nonprocedural code. Examples of 4GLs are FOCUS, NOMAD, RAMIS, and MANTIS. With them, programming productivity gains of 1,000% to 2,000% over 3GLs are routinely achieved by personnel with no prior programming experience. Two important spin-offs result from this: end users can now do their own programming, enter their own data, run their own reports, and do interactive graphics and on-line queries when they want to, not when dp decides to. Only a telephone, a crt terminal, and a cheap printer are needed. And, complex management information systems (MIS) utilizing large organization-wide integrated relational databases are now feasible. Previously this was nearly impossible.

The 4GLs are more complex and comprehensive than their predecessors, the 3GLs. A 4GL includes:

- full capability for programming complex applications;
- a simple English-like nonprocedural command language;
- a powerful database management system that supports relational, network, and hierarchical structures;
- a relational JOIN operator that links unconnected databases while a program is running;
- the ability to read existing 3GL files and databases;
- a crt screen data entry utility;

The PIPS Revolution: Strategic Planning Software Plus Popularly Priced Desktops

Enter the PIPS revolution—computers made so easy you'll get results the very first day. SORD Computer Systems, Japan's fastest growing company, makes it possible with PIPS, a sophisticated non-programming system designed for businessmen, not computer people. PIPS makes strategic computing applications an everyday reality for everybody in the office, even if they know nothing about computers. It's perfect for generating instant market analyses, plotting the yearly sales figures in seconds, and doing routine calculations without the routine.

PIPS is now available with a wide range of desktops from SOCIUS. There's the M23P: a portable desktop with 2 built-in microfloppies and 128K of RAM—light enough to travel in a briefcase. There's also the M343: a compact 16-bit giant with 256K of RAM, color graphics, multi-terminal timesharing capability, communications interface and more. Both of these systems can be used as interactive terminals (they emulate 3270s) or as units in our ultra-sophisticated local area network.

Lots more software is also available with SOCIUS computers, including the SB-80* operating system for compatibility with CP/M* based programs, and an

excellent word processor. The SOCIUS wonder computers. Sorry to keep you waiting.

*SB-80 and CP/M are trademarks of Lifeboat Associates and Digital Research Inc. respectively.

SOCIUS M23P

Suggested
retail price:

\$2395

(CRT not included.)

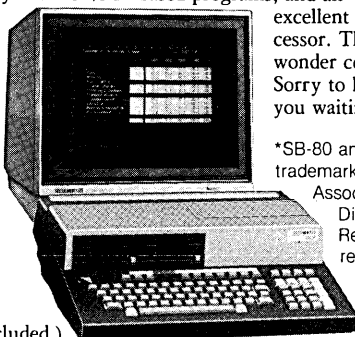

SOCIUS

SORD Computer of America, Inc.

c/o Mitsui (U.S.A.) Inc., 200 Park Ave. New York, N. Y. 10166-0130
Attn: M. Taketani or M. Kitamura, Tel: 212-878-4403
Distributor for New York, New Jersey, Connecticut:
Business Computing International Inc. 342 Madison Ave.
New York, N. Y. 10173 Attn: Michael Gansl, Marketing Div.
Tel: 212-697-9400, Telex: 238901 BCI UR

CIRCLE 137 ON READER CARD

READERS' FORUM

- a report generator utility;
- an interactive graphics module;
- distributed database processing;
- statistical analysis and financial modeling;
- concurrent (simultaneous user) database updating;
- no program compilations (as required by 3GLs);
- on-line interactive file editing;
- data encryption and security control;
- comprehensive automatic data dictionary.

A 4GL program is written using one tenth the code required by a 3GL, and even greater reductions occur in program testing. Any business program that can be written in a 3GL can be written in a 4GL, but at the complex end of the spectrum there are programs that can only be written successfully in a 4GL (e.g., integrated MIS). About 75% of all programming can be done by end users with only two days of training. Specialist programmers, however, will still handle complex applications, using some procedural code to fine-tune the main nonprocedural code. For top and middle managers, the 4GLs deliver a valuable benefit: the ability, on-line and interactively, to query the whole of the organization's integrated databank, retrieve data from any of its databases, and display the results in seconds.

Although comparatively new, 4GLs have matured quickly. More than 500 organizations have used them, often through a timesharing service and without the dp department's involvement. From these experiences, a steady stream of success stories can be heard. For example, "We did by ourselves in 11 days what the dp department estimated would take 18 months and cost \$60,000," and, "A program that the dp department took six months to do in COBOL was done in half a day in FOCUS," and so on.

Clearly, the rapid and widespread use of 4GLs is our only hope for satisfying the burgeoning end-user demand for dp services, and for wiping out the existing three- to five-year applications backlogs. Computer industry theorists James Martin and Daniel D. McCracken agree; they are both exhorting dp users to try out the new technology. From those with 4GL experience, the main question is, "Why isn't everyone using them?"

Some people would rather steer clear of 4GLs; more specifically, I refer to the negative reaction exhibited by many dp departments. This resistance is unexpected because dp is supposed to lead the way into new technological fields, and this particular advance promises to alleviate many of their current agonies. It is also surprising because most dp departments are staffed by dedicated, hardworking, professionally motivated personnel.

This resistance does not originate from a conscious desire to subvert the goals of the organization. Instead, it is caused by two basic human faults—fear of the unknown and resistance to change. These faults are exhibited in the following ways:

The total energies of dp personnel are consumed in just keeping the ship afloat. The usual dp department is a zoo. Demands placed on it by the organization are excruciating. Murphy's Law ("If something can go wrong, it will") operates like a Constitutional amendment. As a result, key managers and programmers are forced to work overtime on a regular basis just to stay afloat. The resulting combination of high stress and overwork causes low-degree burnout in those personnel—a condition whose damaging effects are cumulative, like medical radiation. No one with his or her energy levels so depleted can enthusiastically embrace a radical change in technology and implement a plan to get out from under the deadweight of old computer programs.

Middle managers feel threatened. They see the transfer of control to the end user as a threat to their power base, a reduction in their budget, and a potential loss of control over standards. These managers have achieved their seniority and higher salaries by applying the old methods. When a totally new mode of operation is introduced, they have the most relearning to do. Viewed in this light, is it surprising that they resist? And it is a powerful resistance because they have closed the doors to the key decision-makers, via the crony network.

VOA

HOW OUR VOICE IS HEARD DEPENDS ON YOU.

Help Engineer a Vital Instrument of Public Diplomacy



The Voice of America has unique engineering opportunities that will put you at the forefront of the design of a worldwide telecommunications network.

The Voice of America is the international radio broadcasting service of the United States. It broadcasts news, commentaries, and features in 42 different languages to information-hungry people around the world.

We need highly analytical engineers, with advanced academic training, demonstrated managerial experience, and broad technical skills.

EXECUTIVE LEVEL ENGINEERS

Policy-making positions requiring an MS or PhD degree, extensive analytical technical skills, and demonstrated managerial experience.

- Deputy for Operations
- Deputy for Systems Engineering
- Deputy for Projects Management
- Chief, Broadcast Systems Engineering

ELECTRONICS ENGINEERS

Broad analytical skills required in one or more of the following areas:

- State-of-the-art antenna design
- Propagation analysis and prediction
- Advanced audio engineering
- Line-of-sight communications
- Satellite transmissions
- Innovative receiver design
- High power transmitters
- Emerging over-the-horizon systems
- Sophisticated systems management
- Systems integration

- Computer systems
- Remote broadcast control
- Configuration management
- Global real-time switching systems

The above positions are based in our Washington, D.C., headquarters.

The wide ranging benefits of Federal employment are enjoyed by all Voice of America personnel. They include salaries commensurate with experience (up to \$58,500), liberal vacation and sick leave program, health and accident insurance for you and your family, and a generous retirement plan.

May we hear from you? We invite qualified professionals to submit applications for these uniquely challenging and rewarding positions. Write to us. You can expect an early response.

For more information, please send your resume in confidence to:

Voice of America
Director of Engineering
Post Office Box 1625
Washington, D.C. 20013

U.S. Citizenship required; a thorough background inquiry may be necessary.

Voice of America is an equal opportunity employer.



The Voice of America is part of the U.S. Information Agency.

Chained to your System/3 by CCP?

Convert to CICS... Automatically.

Break the chains with DASD's new automatic translator. Automatically converts your System/3 CCP RPG programs to standardized, modularized CICS/VS Command Level COBOL.

It also converts all screen references to CICS RECEIVE-MAP/SEND-MAP and converts all file references to READ/READ-NEXT/WRITE/REWRITE and DELETE instructions. Generates complete routines for MAPFAIL, IOERR, END FILE, DUPKEY and others. And converts screen definitions from DFF to BMS... automatically adjusting for attribute byte differences between CCP and CICS, producing either CICS/VS Version 1.4 or 1.5 output, plus printed diagnostics.

This is one of many DASD translators now available—all proven and thoroughly documented. From the list shown here, select those you're interested in. Then send or call for more information.

DASD can provide any level of conversion service, from simple per-line/per-program conversions through complete turnkey projects. We're the conversion specialists.

Conversion Programs Available

RPG/RPG II to COBOL

CIRCLE 140 ON READER CARD

NEAT/3 to COBOL

CIRCLE 141 ON READER CARD

DIBOL to COBOL

CIRCLE 142 ON READER CARD

COBOL to COBOL

CIRCLE 143 ON READER CARD

FORTRAN to
FORTRAN

CIRCLE 144 ON READER CARD

DOS ALC to OS ALC

CIRCLE 145 ON READER CARD

MAP to COBOL

CIRCLE 146 ON READER CARD

COBOL ISAM to
COBOL VSAM

CIRCLE 147 ON READER CARD

Job Control Language
Translators

CIRCLE 148 ON READER CARD

CCP to CICS

CIRCLE 149 ON READER CARD

READERS' FORUM

Use of 4GLs makes the skills of 3GL programmers obsolete. Most 3GL programmers put in years of hard work to learn their skills and reach their status and salary levels. Having to begin at square one and repeat the effort is extremely unpalatable. What they don't know is that learning a 4GL is far easier than learning a 3GL or a 2GL. Of greater concern to them is their belief that their jobs are in danger of being eliminated by the end users. This is also a misconception. Programmers could be transferred to an end-user department or be retained in dp to program the complex centralized applications that the end user can't handle—such as integrated MIS.

Unquestionably, 4GL technology devalues the 3GL skills of a dp department, but this process is already under way and will continue despite any resistance. Economic pressure is mounting, and inexorable market forces are in effect: the plunging cost of hardware, the rising cost of software, the three-year applications backlogs, and the ability of end users to get in hours from a 4GL what takes months in a 3GL.

Strategic decisions by top management are required to move the organization smoothly into the new technological environment. The functions of the dp department and its place in the organization's overall framework must be redefined to maximize the benefits of fourth generation languages. Advances in data communications, distributed networks, word processing, facsimile transceivers, electronic mail, message distribution, optical character recognition, videoconferencing, and voice recognition/output have pushed these technologies past the experimental stages and into operational status. Together with dp, these technologies should be grouped into a single new department to be called Information Management (IM).

A top-level strategic plan for IM must be formulated; it should include the following elements:

1. An explicit statement that the sole purpose of IM is to satisfy end users (which includes management).
2. Merge the dp department into an IM department.
3. Acquire a 4GL and mandate that all new applications development be done in it.
4. Give end users control of their dp operations.
5. Require flexible, centralized standards for end-user operations.
6. Establish procedures for neutralizing in-house resistance to change.
7. Create an MIS section for operating the organization's MIS and managing the integrated databank.
8. Direct the MIS section to implement a Decision Support System using the integrated databank for source data.
9. All data must be considered an organization resource.
10. Replace all computer hardware and data communications equipment on a five-year cycle.
11. Establish a customer service desk within IM for providing technical 4GL support to end users.
12. Establish an ombudsman external to IM to arbitrate disputes between IM and the end users.
13. Periodically conduct a confidential survey of both end users and dp personnel to determine if IM is satisfying end-user needs.

If the organization has no top-level strategic plan and the dp department is resistant to 4GLs, then end users should go out on their own: rent a terminal with a printer, sign up with a timesharing service that provides a 4GL (e.g., Tymshare, Inc. provides FOCUS) and proceed. This should only be done as a last resort because end users operating dp autonomously can cause a chaotic free-for-all like those that often occurred during the 1960s. But the sole purpose of dp is to satisfy end users, so if this is not being done, all other considerations are secondary. If dp will cooperate, a better solution is to adopt the "information center" approach whereby end users still run their own affairs, but the dp department provides a customer service desk that establishes centralized standards and provides end users with technical 4GL support.

—Nigel S. Read
Douglas L. Harmon
San Diego, California

 **DASD**[®]

Member of the Cap Gemini Sogeti group
PEOPLE/PRODUCTS/RESULTS

DASD Corporation
Corporate Services Center
9045 North Deerwood Drive
Dept. 236
Milwaukee, WI 53223
(414) 355-3405

AMPEX INTRODUCES EMULATION PLUS.

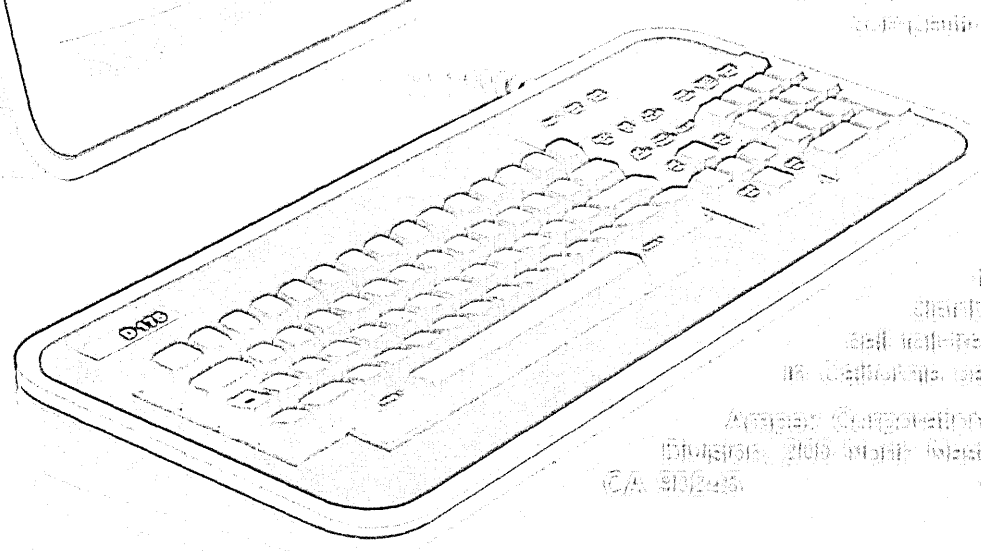
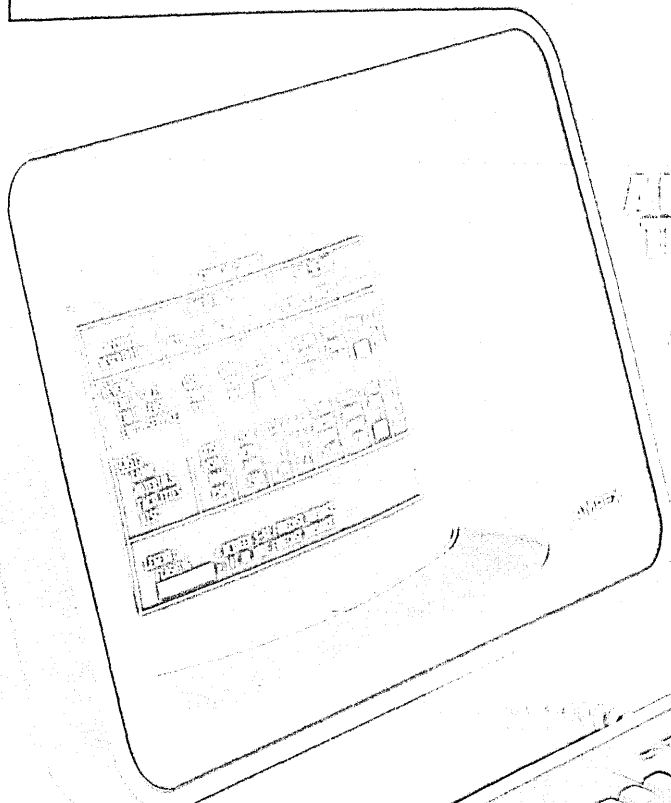

AN EXAMINABLE OPERATING TERMINAL THAT WORKS HARDER AND COSTLESS.

Amplex sets the trend in video display terminals with a new family that lets you do more work at less cost than ever before. These terminals with the features you need in today's environment: Over a dozen resident applications of major business functions, Standard, dot matrix organization, and Standard type keyboards. Seven resident internal character sets, nine variable primary character scrolling, keyboard shortcuts, auto scroll-off, PCMC compatible station-wide DPMO service. And much more. All prices are configurations that'll surprise you.

Now, that's not
what you'd expect for
less than \$10,000.
You'll want to see
models for
further information.
Call for the nearest
distributor in your area,
and we'll be glad to help.
In California, call 1-800-451-1000.

Amplex Corporation, Video Products
Division, 200 North Main Street, El Segundo,
CA 90245. Tel: (310) 340-1000

© 1985 Amplex Corporation. All rights reserved.
Model 2000-1000-1000-1000

THERE'S ONE KEY FACT THAT DOESN'T SHOW UP IN OUR CRT SPECS.

OVER 200,000 SOLD.



Another fact you won't find is that many of America's top corporations bought our CRTs. But when you read the spec sheets, it'll be easy to see the value they saw.

Take the microprocessor-based Teletype® 4540 terminal. This cost-effective 3270 compatible system now offers local connect, in addition to clustered and single display workstations, for applications involving inquiry response, data entry and retrieval.

Human engineering exemplifies the 4540's value with features like conveniently located controls; tactile feedback; adjustable keyboards;

a reverse image cursor; smudge-resistant, etched glass; and a non-glare, tilt screen.

To minimize downtime, built-in self-diagnostics help you locate

problems before they become bigger problems. And modular design permits easy component replacement to speed repairs.

These product features, coupled with a strong service organization and readily available inventories, enhance the 4540's overall value.

Although the word value isn't mentioned in our CRT specs, it certainly shows up in our CRTs.

TELETYPE®: VALUE SETS US APART.



Teletype Corporation, 5555 Touhy Ave., Dept. 3223-A, Skokie, IL 60077. Tel. 1 800 323-1229.
"Teletype" is a registered trademark and service mark of Teletype Corporation.

CIRCLE 3 ON READER CARD