

# DATAMATION®

OCTOBER 1, 1987  
A CAH-NERS PUBLICATION  
INTERNATIONAL EDITION

THE GEORGE E. FREEMAN LIBRARY  
STATE TECHNICAL INSTITUTE AT MEMPHIS  
5983 Macon Cove at Interstate 40  
Memphis, Tennessee 38134

## What Are You Worth? Annual Salary Survey

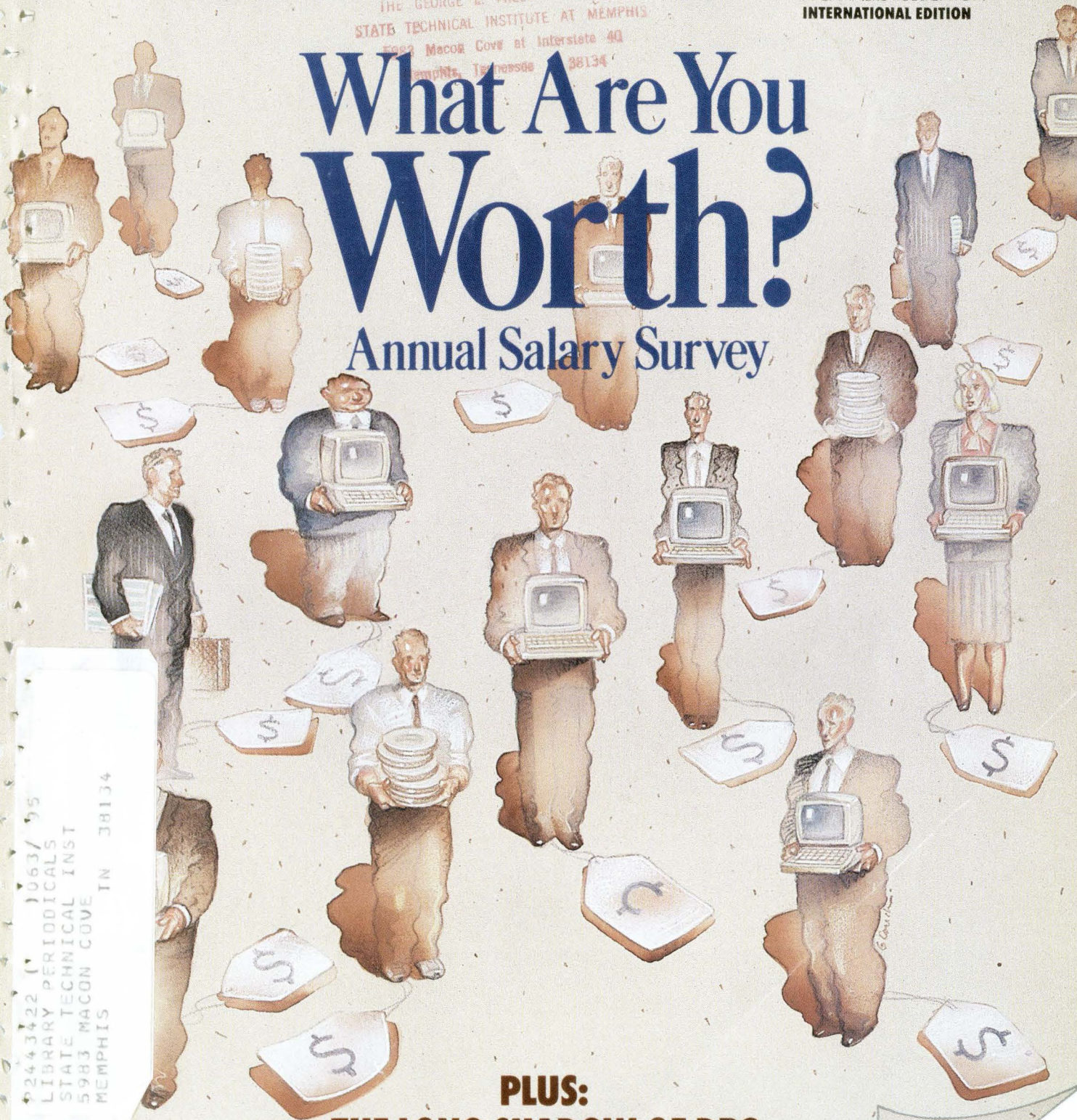

92443422 (1) 1063/ 95  
LIBRARY PERIODICALS  
STATE TECHNICAL INST  
5983 MACON COVE  
MEMPHIS TN 38134

**PLUS:**  
**THE LONG SHADOW OF DB2**  
**WHAT USERS THINK OF UNIX**  
**SEVEN RULES OF**  
**GLOBAL NETWORKING**

  
KEEPING AMERICA  
COMPETITIVE  
A SPECIAL REPORT

# The Others Just Don't Stack Up!



**Tall claims.** Many companies say they offer the fastest printer with the best value for your money. At OTC, we decided to challenge those claims . . . and we won! We clearly deliver more throughput for your money.

We took five competitors and ran a Lotus<sup>®</sup> 1-2-3<sup>™</sup> spreadsheet under the exact same conditions, to let you be the judge.\* The OTC 850XL delivered a throughput 58% higher than its closest competition. Sure, it's easy to make tall claims. But the others just don't stack up to Output Technology!

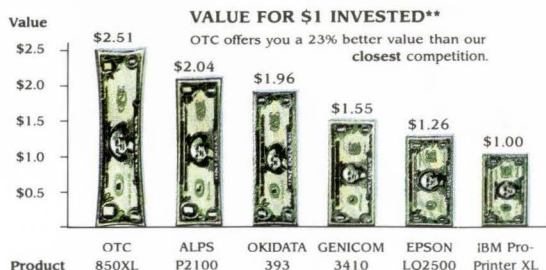

Take a good look at who's standing tall above the rest . . . call OTC today!

**1-800-422-4850**

\*All printers run in 10 cpi, 6 lpi, 136 columns. Contact OTC for full benchmark details.

GENICOM is a trademark owned by Genicom Corporation.  
ALPS is a trademark owned by Alps America, Inc.  
OKIDATA is a trademark owned by Okidata Corporation.  
EPSON is a trademark owned by Epson America Corporation.  
IBM is a trademark owned by IBM Corporation.

\*\*Value = Retail Price ÷ Throughput

**OTC** OUTPUT TECHNOLOGY CORPORATION

E. 9922 Montgomery, Suite #6, Spokane, WA 99206  
(509) 926-3855, 800-4-OUTPUT (468-8788)  
Telex #15-2269 OUTPUTSPOK FAX #922-4742

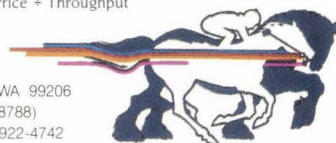

Circle 1 on Reader Card

See us at PC Expo Chicago Booth #130

"...In summation, our voice and data communications problems can be solved by using the newest high-speed networking system with the most powerful switching capabilities for maximum connectivity, worldwide standards compliance and network management, all backed up by comprehensive service and support."

"He means we've discovered the Infotron NX4600 Network Exchange."

**The NX4600. A global high-speed networking system unmatched by any other T1 product in the world. Five distinct strengths make it uniquely Infotron —**

**Connectivity.**

Infotron's new Infostream® NX4600 provides a single, controllable data and voice network that gets any user from any one resource to another. Anywhere. Around the corner or around the world. Regardless of data speed or format, or the speed of interconnecting links.

**Worldwide standards compliance.**

The NX4600 handles both T1 (1.544 Mbps) and CCITT/CEPT (2.048 Mbps). Its compatibility with D4 channel banks, M-24, Accunet Switched 56k, Megacom 800,

DACS/CCR, Accunet T1.5, Accunet T1.5 Reserve, CCITT G.703 and G.732 makes large, geographically-dispersed networks cost effective. PCM voice ensures toll quality and carrier compatibility. And Infotron's pure ADPCM approach gives you quality that you can't get anywhere else, as well as increased bandwidth efficiency.

**Integrated network management.**

The NX4600, in tandem with Infotron's Integrated Network Manager (INM®), gives you single-site control over your *entire* Infotron network. Monitor. Diagnose. Restore. Control everything using an easy-to-understand graphics display.

**Total networking solution.**

Network growth comes easy. The Infostream NX4600 handles up to 96 high-speed links per node or as many as 4,000 local channels. Compatibility with all Infotron products means that, as your needs grow, your NX network grows with you to meet those needs.

**Comprehensive service and support.**

Count on Infotron as your partner. Network design assistance. Training. Installation. Maintenance. Emergency service. Anywhere, anytime.

Compare the NX4600 with our major competitors. **Call for our new brochure "The NX4600 Takes on the Competition"** at 1-800-345-4636 (1-609-424-9400 in New Jersey).



**You're in Control.**

# DATAMAT

## NEWS

### 9 Look Ahead

DB2 user group heads were scheduled to meet to try to form a national group.

### 17 Service

Recurring VAX 8700 crashes lead users to question DEC's support and its ability to erode IBM's user base, Gary McWilliams reports.

### 19 Networks

Jeff Moad explores IBM's removal of SNA protocols from the public domain amid concern that it will limit non-IBM customer access.

### 22 Taxation

Susan Kerr writes that state tax agencies are targeting custom software, sending users in search of offsetting discounts.

### 28 Software

Leading banks are teaming up with software suppliers in joint development efforts. Bob Francis investigates the mutual benefits.

### 32 R&D

A congressional funding proposal has NSF Phase II supercomputer centers pitted against their Phase I predecessors. Willie Schatz reports.

### 35 Benchmarks

IBM has reduced its stake in Intel to 7.1%.

### 39 STAFF REPORT Behind the News

How competitive is the U.S. computer industry? DATAMATION examines the industry's standing in five important product areas and probes its health as diagnosed in Washington and Tokyo. Also reported are the results of an exclusive poll of readers' perceptions of U.S. competitiveness.

## FEATURES

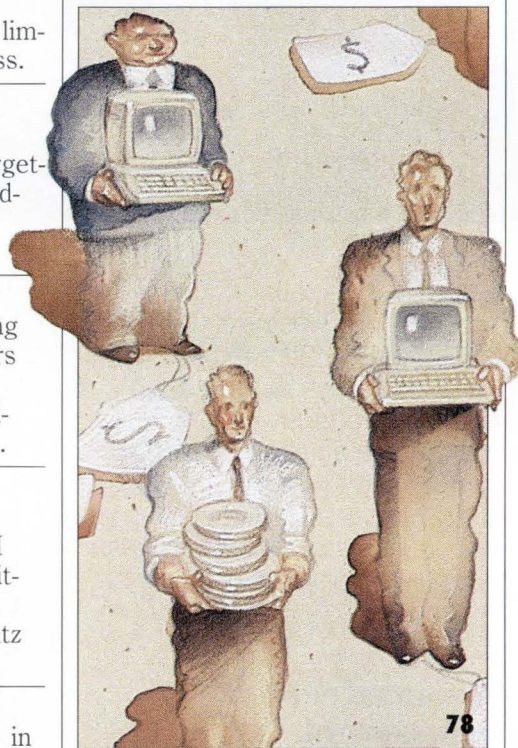
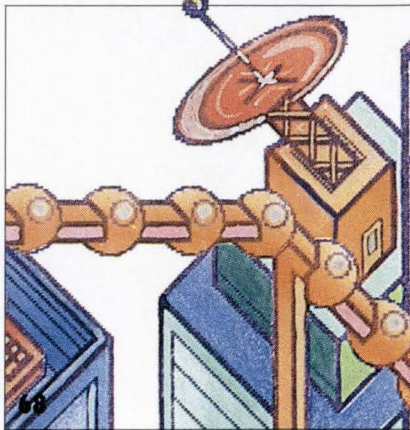

### 68 The Golden Rules of Global Networking

BY GEOFF WIGGIN

For a network manager setting up a global network, it's either a world of pleasure caused by a successful strategy or a world of tears over a very expensive disaster. These rules will help to determine which world will be yours.

### 78 What Are You Worth?

BY PARKER HODGES

Money can't buy you love, but DATAMATION's salary survey shows that is pros, with overall average raises of 5.8% last year, could purchase 4.1% more of anything else than they could the year before. See how your salary stacks up against the average for your job and geographic area.

### 97 Unix: What Users Are Saying

BY MARY JO FOLEY  
AND DON LEAVITT

Unix, once expected to be merely a software developer's tool, is now turning up in an array of applications. Four users at multivendor shops offer their views of its pros and cons. Also, the Posix standard's potential to heal some of Unix's ills is explored.

### 110 The Long Shadow of DB2

BY EDITH D. MYERS

What feelings about DB2 lurk in the hearts of users? Their kudos, particularly for SQL, are the envy of independent database vendors, who now seem to be saying, "If you can't beat 'em, join 'em," hoping to ride into shops on the IBM product's coattails.

# ION

## REAL TIME

- 4 **Letters**  
A Floating Point Systems designer comments on a misconception; a reader describes his dislike for Unix.
- 119 **Hardware**  
Prime Computer Inc.'s new supermini debuts.
- 125 **Software**  
New DB2 tools from Udata Software.
- 133 **Advertisers' Index**
- 133 **The Marketplace**
- 137 **People**  
Computer Sciences' Jose Collazo takes a global view.
- 141 **Books**  
*Manufacturing For Competitive Advantage* by Thomas G. Gunn is reviewed.
- 141 **Calendar**  
World Conference on Electronic Printing and Publishing.
- 145 **Readers' Forum**  
Louise E. Scott reveals an untapped resource.

## INTERNATIONAL 76-1

Does not appear in all copies.

- 1 **Volvo's Net Gains**  
BY JOHN LAMB  
The Swedish automaker drives a complex global network that is essential to its success.
- 13 **Telecom '87: Crisis and Convergence in Geneva**  
BY PETER PURTON  
For the first time, computer makers and telecom manufacturers will have equal space at Telecom '87.
- 21 **Japan's TRON Tactics**  
BY ROBERT POE  
The first TRON OS products are on the way amid Japanese enthusiasm.
- 26 **Counting the Cost of ISDN**  
BY CHRIS BUCKLEY  
The question is, what's ISDN worth?

Cover Illustration by Greg Couch

INTERNATIONAL  
EDITION

OCTOBER 1, 1987  
VOLUME 33  
NUMBER 19



1987 JESSE H. NEAL  
AWARD

## Editorial

### Competitiveness: The Challenge Is Yours

The challenge of keeping America competitive, as well as the task of keeping up with America, falls squarely on you—the executives and professionals who manage IS for the nation's companies, institutions, and agencies. Everybody, from the ceo to the clerk, is counting on you to choose and run the systems that will create and sustain a competitive advantage for their enterprises in the world marketplace.

Such an advantage is sought in nearly every sector of the information business. Manufacturers demand factory automation solutions that will lower production costs. Government agencies insist on communications networks that will improve their efficiency. University heads require state-of-the-art computing environments that will attract the best and brightest professors and students. All are motivated by a single goal: to improve the standard of living for their constituencies—be they shareholders, taxpayers, or society in general.

The challenge is made all the more difficult by nationalistic sentiments. Should you buy products and services only from vendors headquartered in your native country? Or should you choose the best systems and software, regardless of their country of origin?

The choice is not an easy one to make, as reflected in the responses of customers and vendors interviewed in the course of compiling this issue's special report on U.S. competitiveness (p. 39). "My role is to get the most cost-effective solution to a business problem. If that means an NEC drive, so be it," says an MIS director at Morton Thiokol Inc. "Can we afford to let everything go?" worries the chairman of U.S.-based vendor Harris Corp., who has seen his company resort to offshore sourcing in computer terminals and some communications equipment in order to stay competitive.

You have an obligation to your employer to see that it buys the best information technology products—whether they are from North America, Asia, or Europe. But you also owe it to your company to devise an intelligent purchasing strategy—one that takes into account more than just pricing. You must consider how much different vendors are spending on R&D, what level of service and support can be expected, and the longevity of the product line.

Such a strategy only stands to make your organization more competitive.



TIM MEAD  
EDITOR-IN-CHIEF

# DATAMATION

**Editor-in-Chief** Tim Mead  
**Senior Editor** Linda Runyan  
**Managing Editor** Parker Hodges  
**Senior Writer** Ralph E. Carlyle  
**News Editor** David R. Brousell  
**International Editor** Paul Tate  
**Copy Chief** Eric Brand  
**New Products Editor** Theresa Barry  
**Associate News Editor** Karen Gullo  
**Copy Editors** Steven Korn, John Quain  
**Assistant Editor** Mary Kathleen Flynn  
**Editorial Assistant** Karen J. Scher  
**Editorial Secretary** Suzanne Jones

## Bureau Managers

**Boston** Gary McWilliams  
**Dallas** Robert Francis  
**Los Angeles** Tom McCusker  
**San Francisco** Jeff Moad, Susan Kerr  
**Tokyo** Robert Poe  
**Washington** Willie Schatz

**Editorial Assistant, Europe** Lauren Murphy  
**Technology Editor, Europe** Fred Lamond  
**Foreign Correspondents** James Etheridge, Paris; Janette Martin, Milan

**Art Director** Robert L. Lascaro  
**Assistant Art Director** Doreen Austria  
**Production Editor** Susan M. Rasco  
**Art/Production Assistant** Hernalee Walker

**Contributing Editors** Joseph Kelly, Laton McCartney, Hesh Wiener  
**Advisory Board** Lowell Amdahl, Philip H. Dorn, Joseph Ferreira, Bruce W. Hasenyager, David Hebditch, John Imlay, Irene Nesbit, Angeline Pantages, Robert L. Patrick, Malcolm Peltu, Russell Pipe, Carl Reynolds, F.G. Withington

**Publisher** James M. Morris  
**Associate Publisher** William Segall  
**Promotion Manager** Stacy Aaron  
**Production Manager** Dottie Viebig  
**Director of Research** Mary Connors  
**Director of Production** Robert Elder  
**Director of Art Department** Barrie Stern  
**Circulation Manager** Ruben Natal

## EDITORIAL OFFICES

**Headquarters:** 249 W. 17 St., New York, NY 10011, (212) 645-0067; telex 429073. **New England:** 199 Wells Ave., Newton, MA 02159, (617) 964-3730; **Washington, D.C.:** 4451 Albemarle St. NW, Washington, DC 20016, (202) 966-7100; **Central:** 9330 LBJ Freeway, Suite 1060, Dallas, TX 75243, (214) 644-3683; **Western:** 12233 W. Olympic, Los Angeles, CA 90064, (213) 826-5818; 2680 Bayshore Frontage Rd., Suite 401, Mountain View, CA 94043, (415) 965-8222. **International:** 27 Paul St., London EC2A 4JU, England, (44-1) 628-7030, telex 914911; 3-46-10 Sekimachi-Kita, Nerima-ku, Tokyo 177, Japan, (81-3) 929-3239.

DATAMATION (ISSN 0011-6963) Magazine is issued twice monthly on the 1st and 15th of every month by The Cahners Publishing Company, A Division of Reed Publishing USA, 275 Washington St., Newton, MA 02158-1630. William M. Platt, President; Terrence M. McDermott, Executive Vice President; Frank J. Sibley, Group Vice President; Jerry D. Neth, Vice President/Publishing Operations; J.J. Walsh, Financial Vice President/Magazine Division; Thomas J. Dellamaria, Vice President/Production and Manufacturing. Editorial offices, advertising and subscription departments, 249 W. 17 St., New York, NY 10011. Published at East Greenville, Pa. Annual subscription rates: U.S. and possessions: \$55; Canada: \$75; Japan, Australia, New Zealand: \$145 air freight; Europe: \$130 air freight, \$235 air mail. All other countries: \$130 surface, \$235 air mail. Reduced rate for qualified U.S. students, public and school libraries: \$40. Single copy: \$3 in U.S. Sole agent for all subscriptions outside U.S. and Canada is J.B. Tratsart Ltd., 154 A Greenford Rd., Harrow, Middlesex HA13QT, England, (01) 422-8295 or 422-2456. No subscription agency is authorized by us to solicit or take orders for subscriptions. Second-class postage paid at Denver, CO 80206 and at additional mailing office. DATAMATION copyright 1987 by Reed Publishing USA; Saul Goldwitz, Chairman; Ronald G. Segel, President and Chief Executive Officer; Robert L. Krakoff, Executive Vice President. All rights reserved. DATAMATION is a registered trademark of Cahners Publishing Co. Reprints of articles are available; contact Frank Pruzina (312) 635-8800. Microfilm copies of DATAMATION may be obtained from University Microfilms, A Xerox Company, 300 N. Zeeb Rd., Ann Arbor, MI 48106. Printed by Brown Printing Co. POSTMASTER: send address changes to DATAMATION, 44 Cook St., Denver, CO 80206.

ABP



V BPA

# Letters

## Misconception

As one of the principal designers of the Floating Point Systems' T Series parallel supercomputers, I feel both qualified and compelled to correct a prevalent misconception about the machine, one that is reflected in a recent Look Ahead item (July 15, p. 12).

While the Inmos Transputer chip is a most critical element of the machine, and Inmos gave prompt and thorough support in order to help us in the use of their excellently engineered and nearly indispensable computer, major products of other companies are also essential parts of the machine. These companies also gave great assistance in helping us design with their new and innovative parts, none of which was available when the design was started.

Weitek 64-bit floating point multipliers and accumulators give the machine its fast floating point arithmetic, which peaks at 16MFLOPS per node. Texas Instruments supplied memory and a most flexible micro sequencer, both of which provide for the full use of the speed of the arithmetic parts. The use of higher-performance Weitek parts was designed long before the original chips were even available. Higher-speed Texas Instruments memory was also planned long in advance. Faster parts from any or all of these companies can be incorporated with either minor or no changes in design or to the boards. For example, the new floating point Transputer, just coming on the market, will increase performance in several ways.

The installation of one of the largest—if not the largest—computers in the world, a T-100, seems also to have been the computer media's biggest non-event. A 128-node T-100 with 16MFLOPS peak per node for a total of 2.05GFLOPS peak and a possible effective performance of three fourths of that speed, was installed this year at Los Alamos, N.M.

This machine is, as are all other T Series computers, expandable, without any change, to a maximum of 16,384 nodes or 200,000,000,000FLOPS. The standard connectors already installed on every cabinet, as well as the standard cables delivered with every cabinet, already allow for such an expansion, but a large, specially designed building, more properly termed a metacabinet, is required.

ROBERT F. BENNION  
Computer System Architects  
Provo, Utah

## Inappropriate

I appreciated very much the Readers' Forum by Daniel P. Dern, (June 15, p. 174) explaining why he likes Unix. It was full of a contagious sense of fun, and crystal clear in its presentation of his reasons for liking Unix. The revelation for me was that these are the same reasons I would use to say why I don't like Unix. (Different men swear by and at jockey shorts for exactly the same reasons.)

Even after 18 years at the keyboard, I find myself strongly aligned with the other (or is it just another?) large, legitimate group of computer users: those who appreciate, perhaps even need, "user-friendly" behavior from their tools. To call an operating system "a tinkerer's delight," a challenging amusement that makes "Adventure" pale by comparison; to describe its rules as "so copious that you can't digest it all," with learning driven by mistakes; to describe it as "a box full of mysterious powers" that "increase your chances of creating new and more esoteric technical disasters" is to scare the daylight out of us.

There, I've said it. Unix scares me. Its command names are cryptic, it is "a continual gedankenexperiment," it does take Sherlock Holmes to figure out what it did with your data. To say that these criticisms may be muted because Unix was not developed for the casual end user is to miss the blind promotion of Unix in some quarters as the be-all and end-all. It is neither (and Mr. Dern did not say it was.) Maybe AT&T has recognized the two-edged nature of this thing called Unix, and that is why they are sometimes such reluctant parents.

I am not saying that Unix is wrong, just that it is inappropriate for many users. Those of its champions who insist on installing it in inappropriate places (the office environment, for instance), without an ameliorating shell or interface, will eventually fade away without any push from me. Those of its champions who use it well and properly will forever drop my jaw in astonishment at what they can do "on the fly." I do, however, make a plea for intelligent discrimination, and for tools that are all the more powerful because they are clear, all the more elegant because they are simple, all the more usable because they are friendly and consistent. Surely there is room for both kinds. Surely I should have a choice.

JOHN A. TROTTER JR.  
Abacus Programming Corp.  
Van Nuys, California

\*Source: International Data Corp. © 1987, Informix Software, Inc. INFORMIX is a registered trademark of Informix Software, Inc. Other names indicated by TM are trademarks of their respective manufacturers.

INFORMIX.\* It's the fastest RDBMS for UNIX.™ And now it has a high-performance option that makes it even faster.

Introducing INFORMIX-TURBO, the first fault-tolerant transaction processing database server for UNIX.

It lets INFORMIX-SQL and INFORMIX-4GL fly through large databases. With features like optimized data layout. Adjustable-size shared memory. And tunable performance parameters.

And to keep even the most demanding multi-user databases flying, there's our fault-tolerant feature. Which makes for speedy recovery from system crashes.

Of course, it's technology like this that has made INFORMIX the best-selling RDBMS for UNIX.\* And a leading contender in MS™-DOS, VMS™ and networked systems.

For our latest benchmarks, graphs and more on INFORMIX-TURBO, write Informix Software, 4100 Bohannon Drive, Menlo Park, CA 94025. Or call 415/322-4100. And bring your database up to speed.



The RDBMS for people who know better.™

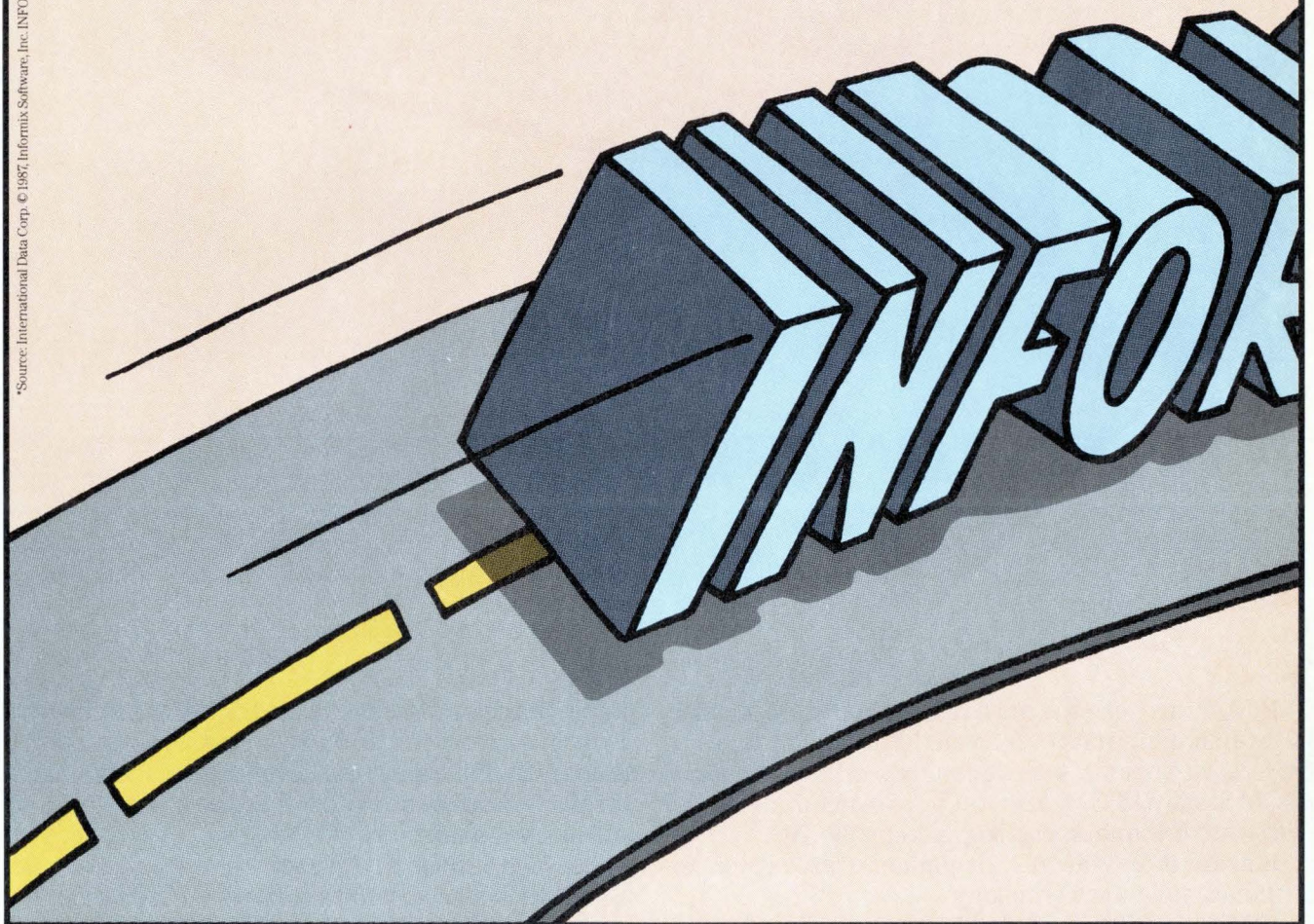

**NOW  
SHIPPING**  
IRMA 2 for PS/2 Models 50, 60 and 80  
with Micro Channel Architecture.

IRMA™ has been the most reliable and most popular PC-to-mainframe link ever created. But as good as our IRMA is, we've never said we couldn't do better. Fact is, a PROM is still a PROM. And you have better things to do with your time than spend it upgrading PROMs.

But now there's IRMA 2™; it marks a whole new era in terminal emulation technology.

IRMA 2 is software-loaded. So you can upgrade by

simply changing diskettes instead of PROMs. What you also gain is an easy path to multiple host sessions, sophisticated mainframe graphics, and all that DFT technology can offer you down the road. And with our new E78 Plus™ software, you gain even more.

Like Mod 5 support. And easy-to-use menus for quick custom-configurations. And keyboard-remapping and key programmability. And perhaps best of all, you gain speed.



# Introducing IRMA 2. The most reliable software-loaded PC-to- mainframe link.



All this new power of IRMA 2 is available right now for the IBM® PC™, XT™, and AT™ and the PS/2™ Model 30. And soon for all other PS/2 Models.

There's some especially good news for our current IRMA and Forte PJ customers, too. Because they can also take advantage of the new power of E78 Plus software. For not a lot of money.

For a limited time, you can get E78 Plus at a special

low conversion price. But you'll have to act soon.

Contact your local DCA distributor for all the details of IRMA 2 and E78 Plus software. Or call 1-800-241-IRMA, Ext. 507. In Georgia, call 1-404-442-4500.

**dca**®

IRMA, IRMA 2, E78 Plus and Forte PJ are trademarks of and DCA is a registered trademark of Digital Communications Associates, Inc. IBM is a registered trademark of and PC, XT, AT and PS/2 are trademarks of International Business Machines Corp. © 1987, Digital Communications Associates, Inc.

Circle 6 on Reader Card



## With some 4GLs, training users can be a real challenge.

**W**ith FOCUS, users can have real success. Fast.

FOCUS is the ultimate in fourth-generation technology. It is designed to let users do useful work immediately.

For example, there is a window-driven point-and-pick interface that lets beginners generate a report or graph, make inquiries—even create an entire application—without learning any syntax. In fact, the system displays the syntax so the user can learn the language while creating the application.

### Lots of Help for Users

Your programmers can create extremely easy-to-use, window-driven applications using FOCUS. Or casual users can help themselves to information through the English Query Language (EQL)—the self-explaining natural-language interface to PC/FOCUS®.

For anyone who wants to learn the FOCUS fourth-generation language, complete, professionally developed learning resources are available. Just take a look at the box to the right.

### Other Environments

FOCUS runs in IBM's 370, PC and PS environments, on the DEC VAX, under Wang VS, and under UNIX. Learn FOCUS in any one of these environments and you can write an application in any other, and it will run in all of them.

### Most Widely Used

Around the globe, more than 4000 sites have FOCUS installed, making it the most widely used fourth-generation language in the world. And we've been involved in training at every site.

FOCUS has a large and independent user group. And Information Builders backs FOCUS with the support you'd expect from an industry leader: local help lines in 12 regional offices, a central hotline, and a national network of technical support and training centers.

### FOCUS Education

- Over 200 certified staff trainers
- Scheduled classroom education at 40 North American centers
- Customer-site training
- Courses and training materials customized to environment and application
- Computer-based training materials for the PC or mainframe at current release levels
- Self-study primers
- A Train-The-Trainer program

If you want your users to be pussycats, get more information on FOCUS. Call 1-212-736-4433, Ext. 3700. Or write Information Builders, Inc., Dept. B4, 1250 Broadway, New York, NY 10001. We'll send you something meaty.

PC/FOCUS is a registered trademark of Information Builders, Inc.

  
Information Builders, Inc.  
Circle 7 on Reader Card

# Look Ahead

---

## UNITED THEY STAND

CHICAGO -- "IBM DB2 users unite!" may have been the battle cry sounded last week in the Windy City. Fifteen independent U.S. regional DB2 user group heads were scheduled to meet for the first time to try to form a national group. Shirley Evemeyer, who founded and heads the 30-member San Francisco area group, says that among the topics on the agenda is a newsletter and the formulation of the most comprehensive list possible of third-party vendor products. But more important is the chance to further a much needed "information exchange between users," she says. The database product is so new by IBM standards that "customers are more knowledgeable than IBM."

---

## IN WITH THE NEW, AND DB2?

BOSTON -- Who says being acquired produces MIS cut-backs? Allied Stores Corp., which operates the Stern's, Jordan Marsh, and Brooks Brothers retail chains, is getting a multimillion-dollar IS infusion following its acquisition by Campeau Corp., the Canadian real estate company. The three-year project calls for a new Boston-area data center with dual IBM 3090 600Es and a complete rewrite of all applications. Previously separate systems will be integrated, perhaps by means of IBM's DB2 database, a spokesman says. A final decision on the database has not been reached yet, he says. The project stems from Campeau's review of computer operations at other retail chains.

---

## A TIDAL WAVE, SUPER-CPU STYLE

EDMONTON, ALBERTA -- Move over, Cray competitors. Here comes another one that thinks it can whip up on the supercomputer leader. According to the creators of Myrias Research Corp., the Myrias Parallel Processing System "is the first flash in a new wave" of supercomputing. Funded mostly by private investors, with assistance from the U.S. and Canadian defense departments and the province of Alberta, the machine has a minimum of 64 processors and can max out at 1,024 processors. In its larger configurations, Myrias supposedly outperforms the biggest Crays. Reportedly, Myrias also is bigger and easier to use than the Connection Machine, the Butterfly, or the N-Cube. The first hint of whether all this is true or false will come in October when the prototype, which has been running benchmarks, is unveiled. If all goes well, Myrias will be formally announced next April.

---

## HP SHOPS FOR DBMSs

CUPERTINO, CALIF. -- Now that Hewlett-Packard is finally shipping its first Spectrum system for the commercial market, the company is doing whatever it can to make the product interesting to new MIS users. The

# Look Ahead

company recently said it had signed a deal to have Oracle Corp.'s relational DBMS modified to run on the HP 3000 models 930 and 950, and officials say HP has its eye on at least three other outside DBMSs: Focus, from Information Builders; ADABAS, from Software AG; and IDMS, from Cullinet. Although HP hasn't yet signed a deal with any of those vendors, it's pretty clear the company has come a long way from the days when it bundled its own proprietary Image DBMS with each of its HP 3000 operating systems.

---

## **ORACLE SETS TRANSACTION DATABASE**

BELMONT, CALIF. -- Relational DBMS vendor Oracle Corp. will soon jump into the fray that is developing among suppliers of transaction-oriented database management systems. Oracle is planning to unveil a transaction-oriented version of its current DBMS soon after the first of the year. The new product will be positioned to compete with Tandem Computer Inc.'s Non-Stop SQL high-performance transaction DBMS and a database system from Berkeley startup Sybase Inc.

---

## **WITH MSA, YOU GET AIRCRAFT**

SHANGHAI, CHINA -- By early 1988, U.S. software from MSA International will begin to help the Chinese build aircraft. Shanghai Aviation Industrial Corp. (SAIC) has ordered \$270,000 worth of manufacturing software to run on its IBM 4381, including applications for inventory control, materials requirement planning, quality control, and production scheduling. SAIC is currently coassembling MD-80 airliners with McDonnell Douglas of St. Louis and plans to become the main passenger aircraft manufacturer in China.

---

## **QUEUING UP FOR SUPERS**

BURLINGTON, MASS. -- Honeywell NEC Supercomputers Inc. (HNSX Supercomputers) seems to be edging closer to the magic day when a customer might actually sign on the dotted line and fork over some money. Sources say that the company, a combination of Honeywell's marketing and NEC's SX-2 supercomputer, "expects to close" deals with Boeing Computer Services, Bellevue, Wash.; Los Alamos National Laboratory, N.Mex.; and Westinghouse's corporate headquarters in Pittsburgh. Los Alamos denies that any deal is close. Boeing and Westinghouse couldn't be reached by press time.

---

## **GET ALONG, LITTLE DOGGIE**

DALLAS -- The perception of stability is always a major factor in users' minds when considering either a hardware or software vendor. One in-the-know cowpoke south of the panhandle tells us this factor may have been operative in Cullinet Software's recent win over  
(continued on p. 12)

# The SAS<sup>®</sup> System

## The Data Analysis Tool You Won't Outgrow.

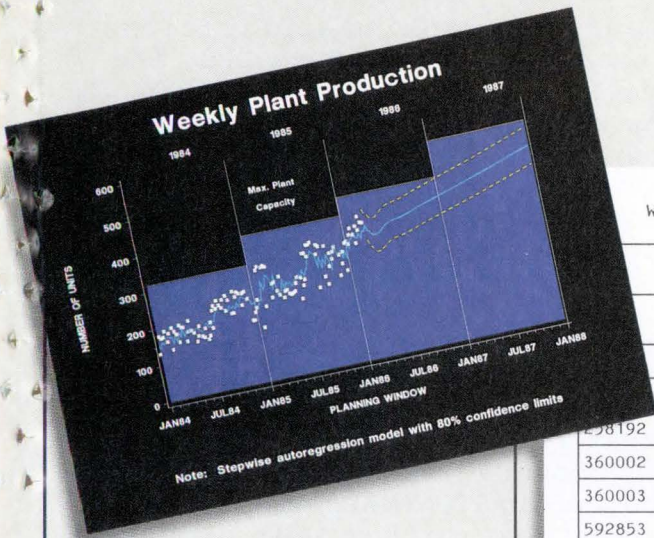

Warehouse Inventory Report - 16JAN87

	Quantity on Hand	Quantity on Order	Projected Reorder Date
	123980	10000	THU, FEB 12, 87
	89450	5000	FRI, FEB 20, 87
	20110	1000	MON, MAR 30, 87
360002	8585	0	TUE, FEB 10, 87
360003	15985	500	TUE, FEB 10, 87
592853	469120	20000	WED, FEB 18, 87

For details, send us your name and address. Or call a Software Sales Representative today.

**The SAS System. It's the most widely installed tool for data analysis among VMS users\*... And more.**

If your job demands a powerful data analysis tool, the SAS<sup>®</sup> System is your solution. The SAS System gives you ready-to-use procedures for performing every kind of analysis—from simple descriptive statistics to advanced regression, analysis of variance, discriminant analysis, clustering, scoring, and more.

The SAS System reads data in any structure from any kind of file. You can create new variables, modify old ones, combine files, detect errors, and accumulate totals. Once your analysis is complete, you can report your results in lists, tables, charts, or plots.

And as your needs grow, the SAS System grows with you. All the tools you need for color graphics, forecasting, modeling, "what if" analysis, project management, optimization, and quality control are available in the SAS System. You choose the products you need, and enjoy the same easy-to-use language and syntax in each. Plus, you can use the same software on your personal computer.



SAS Institute Inc.  
Box 8000 □ SAS Circle  
Cary, NC 27511-8000  
(919) 467-8000  
Fax (919) 469-3737

\* Computer Intelligence, January 1986.

The SAS System runs on these minicomputers: Digital Equipment Corp. VAX<sup>™</sup> 8xxx and 11/7xx series under VMS<sup>™</sup> and MicroVAX II<sup>™</sup> under MicroVMS<sup>™</sup>; Prime Computer, Inc. Prime 50 series under PRIMOS<sup>®</sup>; and Data General Corp. ECLIPSE<sup>®</sup> MV series under AOS/VS. The SAS System also runs on IBM 370/30xx/43xx and compatible machines under OS, CMS, DOS/VSE, SSX, and ICCF; IBM XT/370 and AT/370 under VM/PC; and IBM PC XT and PC AT under PC DOS. Not all products are available for all operating systems.

SAS is the registered trademark of SAS Institute Inc., Cary, NC, USA. Copyright © 1986 by SAS Institute Inc. Printed in the USA.

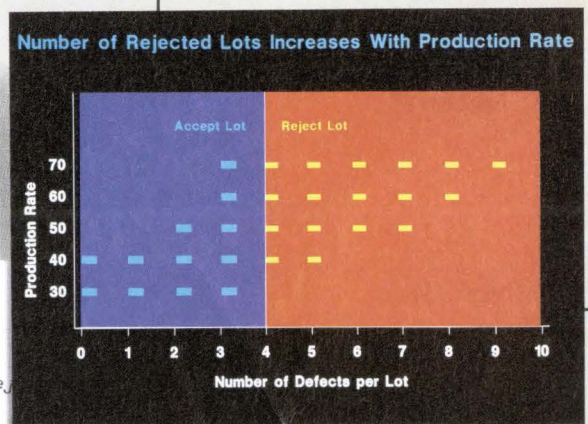

Rate	Lots Tested	Rejected Lot Statistics		Mean	Percent
		Lowest	Highest		
30	4	1	4	2.5	0
40	6	1	6	3.5	33
50	6	3	8	5.5	66
60	6	4	9	6.5	83
70	7	4	10	7.0	85

# Look Ahead

Dallas-based Hogan Systems for a banking applications software contract from American Express Bank Ltd. The source says that the sudden ouster of Hogan chairman George L. McTavish by the Hogan board was one reason American Express chose Westwood, Mass.-based Cullinet. Hogan officials deny this, saying the company pulled out of the competition when American Express decided it wanted a custom program. American Express declines to comment.

---

## COVERING BOTH BASES

PHOENIX -- Intel Corp.'s Systems Interconnect Operation (SIO), maker of the Fastpath channel-attached connectivity products for IBM mainframe environments, has gotten word that it's the newest member of Digital Equipment Corp.'s cooperative marketing program. This summer, SIO became an IBM IMAP member, so now it can enter customer sites on either IBM's or DEC's arm. Or arm and arm with both, since a major product focus for SIO is connecting IBM and DEC. On the subject of big names, SIO's deal with UniSoft Corp. to sell Fastpath into Unix environments apparently is beginning to bear fruit: AT&T recently bought the product.

---

## PASSING THE TORCH

COLORADO SPRINGS -- David J. Eskra, chairman and chief executive of Pansophic Systems Inc., Oak Brook, Ill., is expected to be elected chairman of the Computer Software and Services Industry Association (ADAPSO) during the trade association's annual meeting this week here. He would succeed Jay Goldberg, ceo of Money Management Systems, New York.

---

## SPECS SET ON SYSTEM FOR PATENTS

TOKYO -- Japan's patent office has decided on preliminary specifications for an all-electronic patent application system to be in operation by 1990. The specs are based on the OSI protocol, ISDN communications lines, and Japan Industrial Standard floppy disk standards. Industry and government consensus is being sought before the specs are officially adopted.

---

## RUMORS AND RAW RANDOM DATA

A little birdy tells us Electronic Data Systems Corp. may be in line for a \$100 million contract from a major Japanese manufacturer. No details yet, but stay tuned. . . . Network Equipment Technologies Inc., Redwood City, Calif., which recently formalized an agreement to comarket its T1 multiplexor gear with IBM, is finding that it's getting more than big bucks from Big Blue. Buck Rodgers, Mr. IBM Salesman himself and author of a book glorifying the IBM way, recently paid a visit to NET president Bruce Smith--no doubt to pass on some tips on Blue-suited marketing techniques.

# The SAS<sup>®</sup> System

## The Graphics Tool You Won't Outgrow.

When you've got to turn those numbers into a presentation, turn to the SAS<sup>®</sup> System. The SAS System includes easy-to-use procedures for charts, plots, maps, and three-dimensional displays. At a glance, you can grasp detailed statistics, spot relationships among items, and trace emerging trends. And when your manager wants more, the SAS System lets you customize your graphs and present multiple displays on the same page for easy comparison. You can produce your graphs on terminals, plotters, transparencies, or slides.

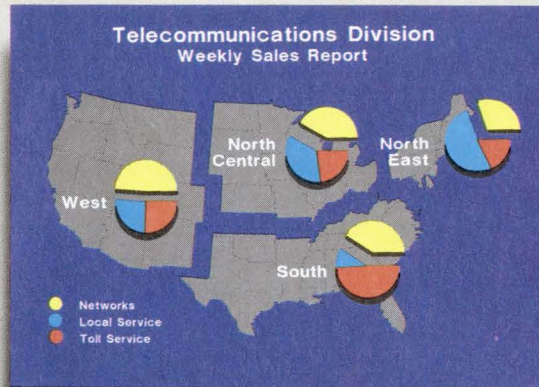

You can even use the SAS System to analyze your data before you present them. We've got tools for every kind of analysis—from simple descriptive statistics to advanced regression, analysis of variance, discriminant analysis, clustering, scoring, and more.

And as your needs grow, the SAS System grows with you. All the tools you need for full screen data entry, modeling, forecasting, "what if" analysis, project management, optimization, and quality control are

available in the SAS System. You choose the products you need, and enjoy the same easy-to-use language and syntax in each. Whether you license one product or several, you'll enjoy the same high-quality software, training, documentation, and

support we've offered for more than ten years.

For details, send us your name and address. Or call a Software Sales Representative today.

**The SAS System. It's for those who need a graphics package today, and for those who have an eye on tomorrow.**



SAS Institute Inc.  
 Box 8000 □ SAS Circle  
 Cary, NC 27511-8000  
 (919) 467-8000  
 Fax (919) 469-3737

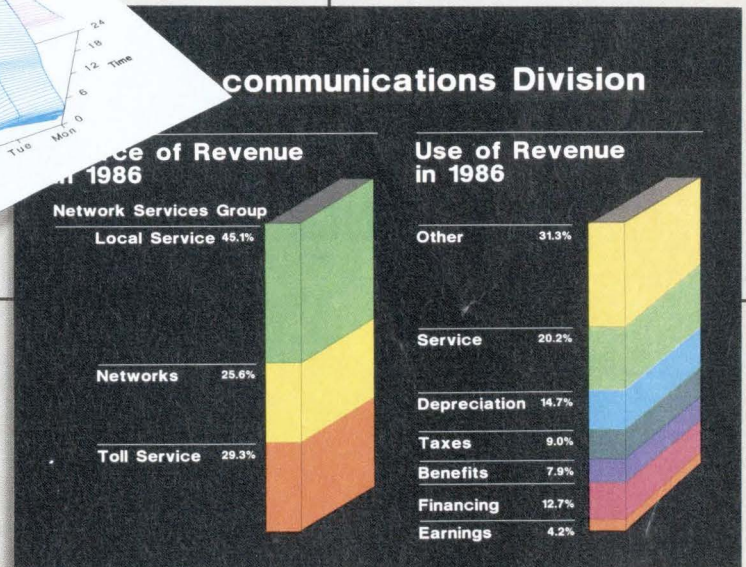
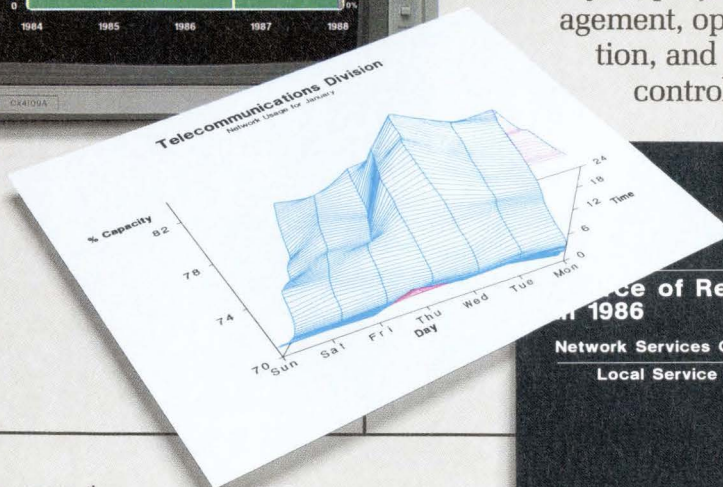
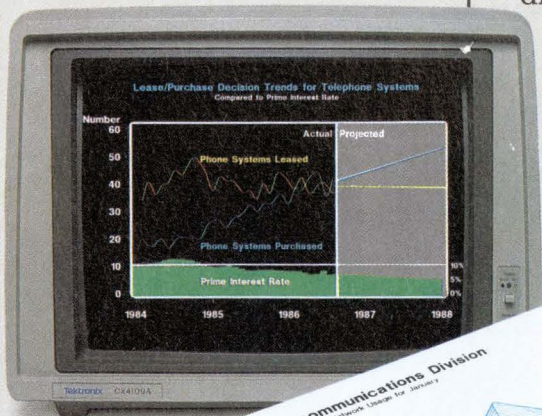

The SAS System runs on these minicomputers: Digital Equipment Corp. VAX<sup>™</sup> 8xxx and 11/7xx series under VMS<sup>™</sup> and MicroVAX II<sup>™</sup> under MicroVMS<sup>™</sup>; Prime Computer, Inc. Prime 50 series under PRIMOS<sup>®</sup>; and Data General Corp. ECLIPSE<sup>®</sup> MV series under AOS/VSE. The SAS System also runs on IBM 370/30xx/43xx and compatible machines under OS, CMS, DOS/VSE, SSX, and ICCF; IBM XT/370 and AT/370 under VM/PC; and IBM PC XT and PC AT under PC DOS. Not all products are available for all systems.





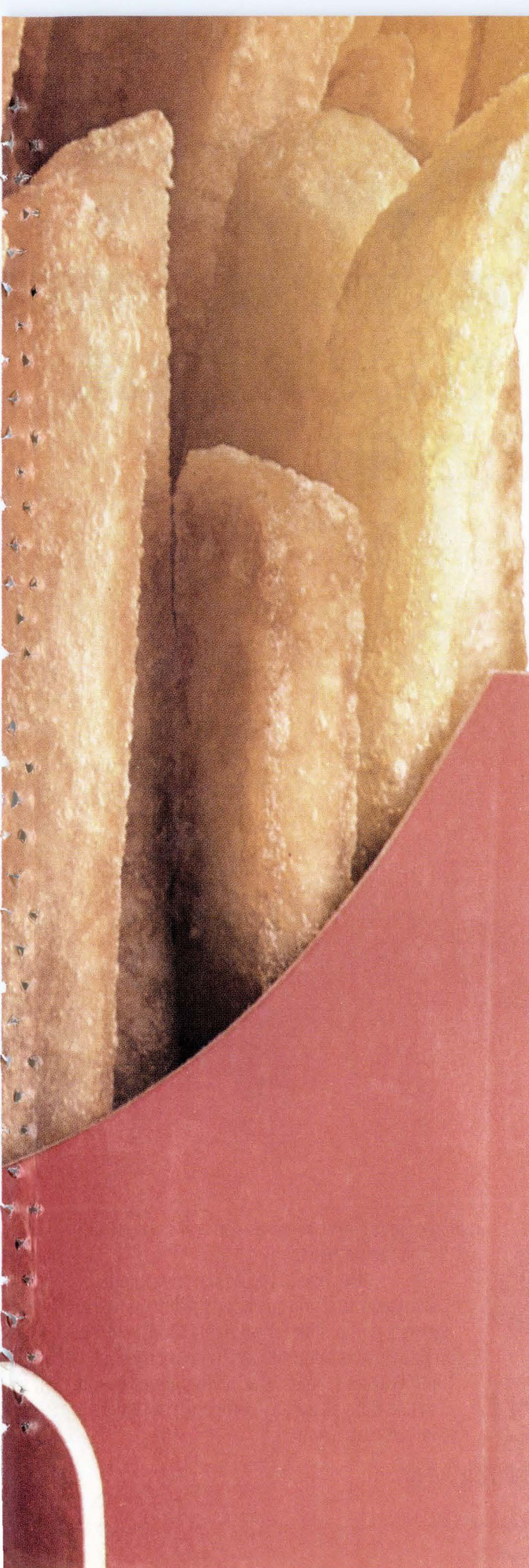

## What ISDN is doing for McDonald's data networking capabilities is no small potatoes.

When McDonald's Corporation took a hard look at its telecommunications needs a few years ago, it saw 9400 restaurants in 46 countries, served by more than 20 networks. And a new restaurant opening every 17 hours.

McDonald's needed a telecommunications system that could grow with it, but one simple enough that the company could concentrate less on telecommunications and more on talking to customers.

The solution: the nation's first customer application of ISDN, the Integrated Services Digital Network, made possible by the cooperation of Ameritech's Illinois Bell and AT&T Network Systems.

McDonald's will use ISDN to send voice, data and video over ordinary telephone lines simultaneously. An AT&T 5ESS™ switch at Illinois Bell will support digital phones, integrated voice/data terminals, facsimile, voice mail, host access and modem pooling, giving McDonald's a real competitive advantage in its data networking capabilities.

"In business language, this means we're going to do an even better job for the 30 million customers that we serve every day," said Bonnie Kos, McDonald's Vice President of Facilities and Systems.

"ISDN provides an information outlet to every workstation, thereby eliminating time-consuming and costly wiring, as well as enhancing messaging and network control capability."

Thanks to ISDN, McDonald's will enjoy better customer service, more current market information, better tracking of product promotions, more efficient inventory control, and reduced administrative workloads.

Ultimately, higher level applications of ISDN on the public switched network will replace most of the company's myriad networks, linking all its offices and restaurants around the world.

As we are doing for McDonald's, AT&T and your telephone company can help your business realize the networking efficiencies and cost savings of ISDN. To find out all that ISDN can do for you, write on your business letterhead to: AT&T Network Systems, P.O. Box 1278, Room 2968, Morristown, N.J. 07960-1278.

© 1987 AT&T



**AT&T**

The right choice.



# There's more to networking than just hooking things up.

It can be hard enough just to get all of your PC's connected. But getting them all to work together can be nearly impossible.

Banyan has a solution. Our network servers are designed to make your network run smoothly, whether it covers a cluster or a continent. Because our StreetTalk™ naming system makes world-wide resource sharing utterly transparent. And our network



management software gives you control from any PC on the network.

But one of the best things about Banyan is that you can keep adding on to the network without interrupting it. That's one reason Banyan has been chosen by so many Fortune 1000 companies. And a very good reason to use Banyan for any company that hopes to become one someday.

Networks for those who think big.

Banyan Systems Inc., 115 Flanders Road, Westboro, MA 01581 617-898-2404

**Circle 9 on Reader Card**

# News in Perspective

## SERVICE

### Users Report Service Problems With Digital's High-End Systems

While conceding certain errors, Digital defends its customer service record. But unfavorable comparisons with IBM's service are being made.

BY GARY McWILLIAMS

After struggling for months with recurring system crashes, a group of New York area Digital Equipment Corp. VAX 8700 users called a meeting in June to swap notes. What they discovered has raised questions about DEC's customer support policies and its preparedness to attack IBM's mainframe user base.

The VAX 8700 crashes turned out to be a common problem for many of the academic, banking, and financial users who attended the meeting. Moreover, while many users were being told by Digital that no help was available, others were receiving Digital-developed fixes, according to Leslie Maltz. Maltz is the director of computing and communications resources at the Stevens Institute of Technology, Hoboken, N.J., and was the organizer of the New York meeting.

#### Not Informed of Fixes

The complaints were prompted by a number of problems: console-related crashes attributed to faulty console disks, or use of remote consoles, or inaccurate time of day reporting; local area transport sessions inexplicably dropping user sessions; recurring crashes every 18 hours under VMS version 4.4; crashes related to a faulty VAX 8700 memory controller; and crashes that blamed Unibus peripheral interrupts when no Unibus existed.

Now, the bugs are readily corrected by firmware up-

grades and hardware replacements, says Maltz. In fact, those who received their VAX 8700 computers after June do not appear to have suffered from the same problems, she says. What remains is the question of why a number of users were not informed of the fixes in a timely fashion and the broader issue of the support operation's competence.

"What I object to is Digital not going out and actively relating the known fixes," says Maltz. "We were experiencing [crashes] over and over and nobody was saying the fixes were known."

Another New York area VAX 8700 user, who asked that his company and name not be mentioned, says that despite the uproar created by the meeting, Digital has not attempted to directly inform users of the problems or fixes. The latter is especially irksome given a past wholesale disk swap that occurred when faulty heads were discovered to be contaminating some RA 81 disk drives.

"They [Digital] told us, 'We're moving towards coming out with one package of fixes,' [because] they didn't want to trickle them out," says the financial user. "I haven't seen yet an announcement of that package. We're going on a year now, and they still haven't publicized the fixes."

For its part, Digital says one user might receive a temporary solution while a fully tested fix is prepared for all to receive. "First of all," says Adrian J. Flatgard, Digital's

manager of high-end services, U.S. Field Service, "these [fixes] may be unique to a user's environment; secondly, these may be a 'work-around' or temporary fix" requiring further testing before general release.

Flatgard concedes that VAX 8700 users were never universally informed of the problems or solutions. "We notified all of our field offices so when in the course of taking calls or visiting customers, if they became aware of a problem then those 'work-arounds' would be sched-

uled." Owing to scheduling constraints, not all sites would have received the fixes immediately, he says.



STEVENS INSTITUTE'S MALTZ: DEC should have related known fixes.

uled." Owing to scheduling constraints, not all sites would have received the fixes immediately, he says.

In the view of some analysts, the support issue bears on Digital's ability to establish itself as an alternative to IBM. No longer confining itself to departmental or midrange systems, the company readily positions its four- and eight-processor VAX 8974 and 8978 as alternatives to IBM's 3090.

Given that ambition, the support problems that in-

volved Digital's largest uni-processor are viewed as more than simply bugs associated with a new machine. According to some large VAX users, the problems illustrate the downside of Digital's recent success in penetrating large computing installations: its support has been lagging behind in meeting the demands of these customers.

"I'm impressed with the machines and the facilities like the HSC [Hierarchical Storage Controller], but the support organization is not what it should be," says William Needler, a Digital systems supervisor for a large Midwest industrial company who asked that the company's name not be used. "They deal very well with engineers but haven't learned how to deal with the business side of the organization; that's where IBM knows how to deal."

Irv Shapiro, a former

DEC employee and now president of a Chicago consulting firm that bears his name, says that despite great strides in bringing out products for its customers and reorienting its sales force toward commercial users, DEC hasn't similarly redirected its support organization.

"Although Digital is doing everything it needs to do to sell the gear, once the sale is made the people in support are all the old-timers who are used to dealing directly with

engineers," says Shapiro. "They're starting to close one hole, the sales force. The question is, can they close the other hole, the support organization?"

Digital's Flatgard says such characterizations miss the mark. "Very frankly, our support organization is leading [Digital] when it comes to customer satisfaction. The satisfaction ratings we've received over the past years, and especially the past two years, very dramatically show we're making a lot of good progress in bringing a very good level of support in software and hardware."

For instance, Digital combined its hardware and software support organizations to remove the onus of determining responsibility for customer problems, he says. "From what we hear in customer surveys . . . we understand they've been increasingly happy with overall support," says Flatgard.

Sohio Oil Co., which is in the process of converting its Cleveland data center from a centralized IBM mainframe

**"NOBODY  
WAS SAYING  
THE FIXES  
WERE  
KNOWN."**

operation to decentralized minis, consisting of Digital, Prime, and Hewlett-Packard machines, backs Flatgard's stance. "We have extremely good field support from our local organization and good support out of Colorado," says Dennis Brixius, Sohio's manager of IS technology. Digital operates a remote software diagnostics center in

**FIGURE 1 DEC's Process for Handling Service Calls**

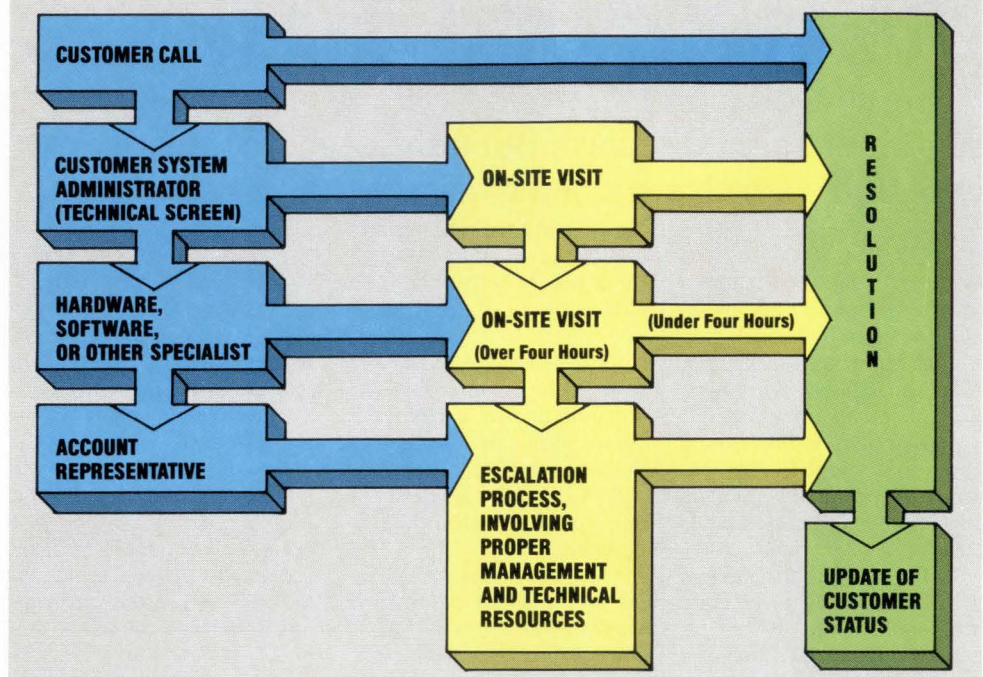

Colorado Springs.

Others, however, do not see support, especially for software, ironed out yet. Shapiro speculates that the two recent price hikes on high-end VAX computers may reflect an attempt to raise profit margins to finance improved support for those systems. Such a tack would enable Digital to offer more service with its large systems without associated service charges, he says. The company recently raised by 30% to \$150 the hourly fee it charges for services not covered by maintenance contracts. Under a service contract for the 8650, for example, a user would pay \$1,839 per month for basic service.

"Digital takes a much more hands-off approach [to support] than IBM. It takes the approach that if a customer wants help, he has to pay for it," Shapiro says. IBM appears to offer users much more free support, although the cost likely is bundled into mainframe prices, he says.

Needler believes Digital's support already is more expensive than IBM's. Although he credits both with equivalent hardware reliability, "any failure that requires a customer engineer to come in and fix is going to cost you more when Digital comes in."

The difference between the two companies amounts to "culture shock" for those, like Needler, who are familiar with IBM environments. "The [Digital] salespeople were willing to bend over backwards to help us, but the support people . . . If I were making that choice now, I'd select the IBM machine over Digital mainly because of the support issues."

#### Problem Escalation

His company's operations are now running smoothly, due, in part, to the free replacement of a VAX 8800. But the help came only after "we raised the roof," says Needler. "You have to scream and yell." That need to vigorously complain is an

aspect of Digital's culture that chafes those accustomed to IBM's more readily available support, say analysts.

For example, Shapiro says shops don't appreciate having to request that a support manager or senior executive become involved in issues that could be solved locally. Called "problem escalation," the policy encourages users who are dissatisfied with their situation to formally request help from a more senior employee, says Shapiro.

"The guys who go through the formal process and get to the Digital vp will get a solution," he says. In addition to users requesting senior help, Digital internally brings unresolved complaints to the attention of upper-level managers. Yet, local support offices are prone to treat customers "in a pacification mode," says Shapiro.

"The automatic escalation process is supposed to escalate it internally, but I sometimes wonder if they [lo-

## NETWORKS

# Users, Vendors Concerned About Access to SNA

Removal of SNA protocols from the public domain has customers worried that IBM is attempting to limit access to the environment.

cal managers] really do," says Carlos Gomez, director of hardware at HCS Inc., the information processing arm of Los Angeles-based Maxicare Health Plans. He says problem escalation only begs the question: "If these [technical] resources are available, who's using them?"

### Eight-Month-Old Bug

When interviewed, Gomez was in his eighth month of wrangling with Digital over a bug found in Record Management Services, a file management package. "We keep escalating the problem in their organization to get a resolution," he says.

Gomez, who runs an exclusively Digital shop with 26 VAX 8650 computers, credits the company with solid hardware support. But he adds, "I don't know if Digital has the depth they need in software support."

Digital's Flatgard says automatic problem escalation "was intended not to require customer intervention . . . it was designed to keep that transparent to the customer." Moreover, support center records show 85% of all software assistance calls "are resolved in an hour. That fact tells me that the real story is there is a lot of effective support going on."

Needler, who spent 18 years in IBM environments, describes the difference between IBM and Digital support as "a culture shock. At IBM, I can phone the first level of support and get to the higher levels very quickly; at Digital . . . they have a lot of defenses."

The Stevens Institute's Maltz is more blunt. "[Digital] was not worrying about the customer; it was not worrying about service delivery," he says. "I hope this is not a sign of how Digital is going to be over the next few years. Our fear is that maintenance is not what it used to be." ■

BY JEFF MOAD

IBM's Systems Network Architecture (SNA) environment, with its profusion of odd acronyms and multiple software layers, has always seemed like black art to some people. Maybe that's why it appeared fitting when IBM decided to pull off a neat SNA magic trick: it made some protocols disappear.

Earlier this year, IBM removed from the public domain SNA protocols for host and front-end communications processors, but only now are the possible implications of this action becoming a concern to vendors and their customers.

The protocols for what IBM calls PU (Physical Unit) 4 and 5 devices are used by mainframe companies, communication processor vendors, and end users to tie their equipment into SNA networks and to test network performance. After IBM quietly changed its protocol publication practice earlier this year, those PU 4 and 5 formats are now available only to licensed customers as supplemental documentation to ACF/VTAM product manuals.

With the protocols no longer in the public domain, vendors and users are worried about whether SNA will remain open for use by non-IBM vendors and their customers. Is IBM preparing to take control of important mainframe portions of SNA, allowing competitors free access to detailed protocol information only relating to low-end devices such as ter-

minals and cluster controllers?

"IBM is sending out a message that they want to control PU 4 and PU 5," says SNA customer John Young, systems programming manager for computer services company Data Ten Inc., Irvine, Calif. "They're saying that's their domain, and DEC and other vendors should stay out."

Young and other observers note that IBM continues public domain publishing of protocols for low-end devices such as terminals and cluster controllers (called PU 2 and PU 2.1 devices) in nonlicensed documents, which suggests that IBM is attempting to steer outside vendors toward those protocols and away from PU 4 and 5.

"IBM clearly has a preferred way for us to tie into SNA, one that would allow them to have more control,"

says Eric Birkeland, director of product marketing for communications processor vendor Comten, an NCR subsidiary. Comten and many other non-IBM vendors say they want to continue using the PU 4 and 5 protocols that support functions such as resource sharing on a network.

They also don't want to force their customers to rewrite networked applications. So, says Birkeland, Comten will continue to tie into SNA as a PU 4 device and hope IBM doesn't clamp down further on releasing PU 4 and 5 information.

### A "Bookkeeping Matter"

IBM says its decision to remove the PU 4 and 5 formats from the SNA Reference Summary was simply a bookkeeping matter. The formats had been published in more than one document. IBM decided to simplify matters by removing

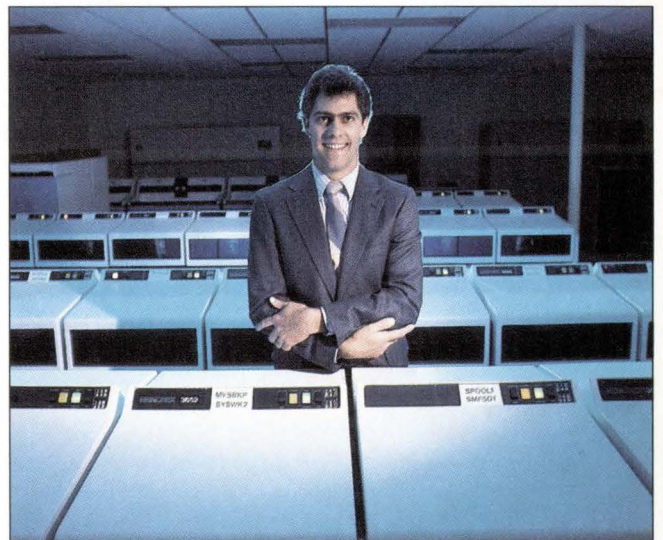

DATA TEN'S YOUNG: IBM wants to control PU 4 and PU 5.

## SNA Seven-Layer Model

	SNA PROTOCOL	FUNCTION	LAYER
END-USER INTERFACE	Applications	End User	7
		Presentation Services	6
LOGICAL SERVICES	Program-to-Program LU 6.2	Data Flow Control	5
		Hierarchical LU 1-3	Transmission Control
PHYSICAL SERVICES	Device-to-Device Control	Path Control	3
		Data Link	2
		Physical	1
	Peer PU 2.1 Hierarchical PU 2,4,5		

Source: International Technology Group, Los Altos, Calif.

it from one of those documents, a spokesman says.

"The source material is still available to IBM-licensed customers," says the IBM spokesman. "And we feel the material is sufficient to ensure serviceability by our customers." The spokesman adds that IBM is not currently requiring outside vendors to sign new license agreements or imposing other new restrictions on how third parties can use the PU 4 and 5 protocols.

Nor is IBM indicating that outside vendors should tie into SNA as PU 2.1 devices rather than PU 4 and 5 nodes. "A lot of people are reading more into this than is there," the IBM spokesman says. He was unable to say, however, why only the PU 4 and 5 formats were removed from the public summary while the PU 2.1 formats remained.

Despite IBM's reassurances, vendors and users are worried. Control Data Corp. and communications processor maker NTX Corp., Sunny-

vale, Calif., have sought an explanation from IBM, as have several large users of CDC's proprietary DNS network, which attaches to SNA as a PU 5 device via a microprocessor-controlled gateway called the XDI. At press time, IBM had not responded to CDC or to NTX.

Several Bell operating companies, including BellSouth, currently use the DNS network, tying together large numbers of synchronous terminals dynamically and interfacing them to an SNA network.

An official at BellSouth who asked not to be identified says the operating company is concerned about IBM's move to pull PU 5 public domain documentation. A data communications manager at Pacific Bell shares the concern. "We use both the DNS network and Comten," says PacBell's Rick Hronicek. "Any move by IBM that would make it more difficult for our vendors to interface to VTAM would be a problem for us."

Other users are taking the change in stride. Typical is Richard Moschler, MIS director at CSX Corp. in Richmond, Va., which is integrating Data General and Prime minicomputers into an SNA network using DG software. "We haven't seen any problems yet," says Moschler, adding, "so far I don't know of anybody in this industry who has created something that somebody else hasn't been able to copy. And sometimes

it doesn't take that long, either."

### PU 4 and 5 as Standards

Outside vendors and their customers concede IBM's point that the PU 4 and 5 protocols are still available on a licensed basis. The problem, they say, is that since the PU 4 and 5 protocols are no longer part of the public domain documentation but are considered part of an IBM product, IBM may no longer feel obligated to treat those protocols as industry standards that must evolve consistently.

The PU 4 and 5 issue comes at a time when most SNA protocols and interfaces are going through a series of rapid changes and upgrades. In June, IBM announced a new version of ACF/VTAM, which, among other things, adds native LU 6.2 interface support and dynamic network reconfiguration and front-end communications processor support for PU 2.1 nodes.

Most observers expect IBM to follow that up with a new version of its Network Control Program and similar upgrades to PU 4 and 5 plus new inter-node communications capability between PU 2.1 and PU 4 and 5. If IBM departs significantly from current PU 4 and 5 protocols in achieving those upgrades, competing vendors could

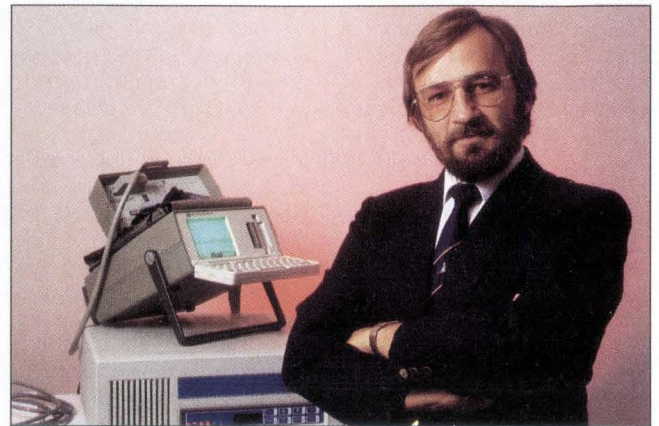

NETLINK'S BUCKLE: "We're staying away from PU 4 and PU 5."

# How to survive your S/3X without Decision Data.

Alright. You might be able to survive without us. But why make things tougher than they need to be?

With over 17,000 satisfied customers in many different industries, we're the largest, independent, worldwide supplier of compatible peripherals for the System/36, /38 and /34. But our experience with—and commitment to—the S/3X marketplace extends well beyond individual products to total systems solutions and support.

When you work with us, you work with a Decision Data representative who knows our products inside out; who takes a personal interest in your business and your needs; and who specializes in giving



*So nobody knows who purchased the problem.*

you more for less. You get direct support from our own Decision Data Service, Inc. with 120 locations and over 500 field engineers ready to help when you need them.

You get products backed by an annual R&D investment of nearly \$9,000,000 to ensure complete compatibility and outstanding price/performance features; products that are proven reliable by countless, rigorous testing procedures.

And you get the kind of product selection that results in the most successful solutions. Our product family includes everything

from matrix, band and laser printers to multi-user systems, ergonomically designed terminals and personal workstation systems for decision support applications. Even memory enhancements and uninterruptible power supplies.

All of which means when your solution includes Decision Data, you can feel very comfortable knowing you'll never have to mask your decision. Ever.

For more information, simply call 1-800-523-6529, or in PA, (215) 757-3322. In Canada, call (416) 273-7161.

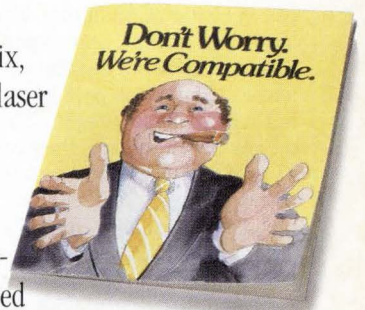

*You should have worried.*



*In case your supplier does not supply service.*



A Decision Industries Company

COMPATIBLES ENGINEERED TO SURVIVE THE FUTURE.

have a hard time keeping up with IBM.

"It's very important where IBM draws the line," says Ivan Jellinek, president of Evergreen Consulting, also in Irvine, and an SNA expert. "Now they're saying that PU 4 and PU 5 are not part of SNA but part of ACF/VTAM. That means down the line they can say, 'That's part of a proprietary product, and we don't make that available anymore.' They've already done that with a lot of source code."

At least one vendor has stayed away from PU 4 and 5 protocols in part because of its belief that IBM is steering vendors toward PU 2.1. Netlink Inc., Raleigh, N.C., is developing its own PU 2.1 controller that it says can replace PU 5 communications processors and also support PU 2 devices such as 3274 controllers. "But we're staying away from PU 4 and PU 5," says Netlink product marketing director Richard Buckle. "It's pretty clear that IBM wants to shut down the interfaces to PU 4 and 5. That's the realm where IBM wants to enforce control."

### Locked into Protocols

But some vendors and their customers have little choice but to stay with the PU 4- or PU 5-based SNA gateways used on their current products. Unisys, for example, is currently marketing two PU 4-type gateways into SNA, one for its Burroughs hardware line and one for its Sperry DCP front-end communications processor.

The change in PU 4 and 5 format availability has given some vendors who are not yet committed to using those protocols something new to think about. Digital Equipment Corp., for example, does not currently market PU 4- or PU 5-based interconnect products. According to DEC interconnect products marketing manager Mike Gayowski, "Of

course the change in status of PU 4 and 5 concerns us. I think it shows that from the viewpoint of getting protocol information, long-term OSI will be an easier path for building backbone solutions. From the standpoint of our current products, it doesn't affect us."

Currently, DEC's VAX-to-SNA products use the PU 2.1 protocols and support interfaces including LU 6.2. Gayowski says that at least for the time being, DEC will continue to focus on adding functions to its PU 2.1 and LU 6.2-related interconnect products rather than adding PU 4 or 5 support.

One such user is Aetna Life and Casualty Co. in Hartford, Conn., which earlier this year went with the VAX over IBM's 9370 and is now contemplating installing DECnet in its commercial insurance division, with a PU 2.1 gateway connection to the corporate SNA network. According to Aetna director of telecommunications Andrew Benko, the company had been concerned about whether DEC could keep up with additions to SNA-related facilities such as IBM's DISOSS. He says that recent DEC announcements have reassured Aetna.

Vendors who have committed to the PU 4 and PU 5 SNA protocols have much less reason to be sanguine, however, say some observers. IBM's decision to stop publishing PU 4 and 5 formats in public domain documents shows that there are limits to IBM's idea of openness, according to John Pickens, director of communications architecture for SNA services provider Communications Solutions Inc., Sunnyvale. Says Pickens, "IBM wants to be open only in terms of interfaces such as LU 6.2. But they are less and less interested in letting people have access to internal protocols like PU 4 and PU 5." ■

## TAXATION

# Tax Collectors Eye Custom Software

## Although the impact of the fees hasn't hit home yet, some users are beginning to look for discounts.

BY SUSAN KERR

As state governments look for new ways to pay their bills, several have turned their hungry gazes upon a fertile and still relatively untapped source of tax income: custom software and service purchases.

Although computer industry trade groups are beginning to realize the truth behind the old maxim that taxes are as inevitable as death, they're lobbying hard to gain political leverage now before this custom software taxation becomes a trend. Two of the nation's most populous states, Florida and Texas, have brought the issue to a head by deciding to tax customized software. Several other states, most notably Washington, are seen as potential followers. Nevertheless, antitax lobbying efforts have taken place with little aid or even awareness from the group of citizens seemingly with the most to lose from the tax legislation.

"I hate to say it, but we're really uninformed here. There's nobody dealing with it," says an MIS manager at a large Florida defense company. He may soon find himself with little alternative other than to deal with it. This summer, in the most sweeping of all state taxation moves, Florida decided to impose a 5% sales and use tax on almost all service industries, including custom software developers. The scope of Florida's taxation has met with so much service industry opposition, however, that in next March's

primary, voters may get the chance to decide on whether or not the tax stays.

While Florida may have tried for legislation too radical and far-reaching, many other states are watching closely and picking up pointers from the sunshine state's experiences. Almost all states already tax packaged software. Yet, as many economies become more service oriented, taxing such previously taboo service products as customized software is seen as a relatively painless way for states to deal with deficits. It's certainly a more palatable political move than raising the income tax.

The result could be that some users of custom software and services will suddenly find the price of their purchases increased by a few percentage points. Taxes "wear down people's budgets," says Hank Post, chairman of Comp-U-Staff Corp., Towson, Md., and state sales tax committee chairman for

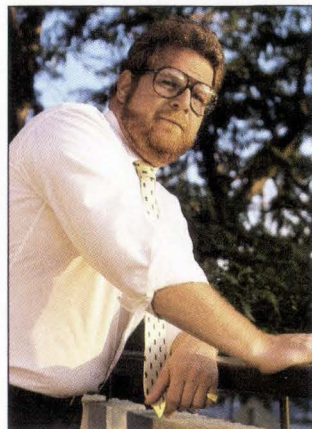

COMP-U-STAFF'S POST: The tax cuts into users' budgets.



# YES

Software is no longer a cottage industry. To be a leader, the drive to be inventive must be backed by substantial resources. As part of Ameritech, a FORTUNE 50

# WE

company, ADR has both. In the nearly 30 years since we invented the software business, ADR has been directly responsible for the way business uses

# CAN.

computers. The way programmers work. The way computer applications are written and managed. The way corporate information is managed. And the

way future software systems will evolve. Today, ADR continues to lead the

industry. And will continue to answer the needs of business. But now in greater

diversity than ever before. To take a look at what we've done, turn the page.

**ADR PERFORMANCE SOFTWARE.**

Unlock the potential.

© 1987 ADR

**ADR**

AN AMERITECH COMPANY

# News in Perspective

ADAPSO. "All of a sudden, he [the customer] has 5% less—and he's going to spend 100%, not 105%." ADAPSO is opposed to the taxation of any software products.

## Debate Over Effect

Yet, what goes around comes around. While software companies will be forced to charge customers tax (as well as be responsible for all the resulting paperwork), some consumers believe they'll be able to squeeze some of that price increase out of their suppliers' pockets. This may be at least one good reason for the markedly different level of activism when comparing users to vendors.

"We haven't started our budget for 1988 yet, so it hasn't hit us yet," says an MIS director in Miami, who, like several others contacted by DATAMATION, asked that neither he nor his employer be identified. "Yes, we always think a 5% jump is a lot. Yes, it's something distasteful, but hopefully we'll get a larger discount from our vendors to compensate."

Likewise, some vendor advocates acknowledge the fear that large consumers of software products have a big bargaining chip. If taxes mean getting less software for your money, some corporations may decide to bring programming in-house—and away from third-party suppliers.

Others don't see it this way at all. Lawrence J. Schoenberg, chairman and chief executive of AGS Computers Inc., Mountainside, N.J., which does a lot of custom work, says customers are always looking for ways to bring down prices. Schoenberg finds it "fanciful," however, that users would threaten to bring programming in-house on the basis of tax increases. "The problem is not an issue of in-house versus outside," he says. "They

[customers] could always pull it in-house and get a lot bigger savings than 8%. Then why haven't they already?"

Although big corporations may believe they have a bargaining chip, it's unlikely that smaller concerns have the same sway over vendors. Unfortunately, say tax lobbyists, small companies are not complaining either.

"Major users are aware of the tax," explains Ray Kudisch, a tax consultant for Racal-Milgo Inc., Sunrise, Fla., and the chairman of the American Electronics Association's Florida Government Affairs Committee, "but if you look at the number of large companies in Florida versus the number of small companies, the ratio is unbelievable [in favor of small companies]." No matter what the size of the company, including ones in Racal-Milgo's range, "the cost of doing business in Florida has just gone up."

In the case of Florida, certain highly visible consumer industries, such as barber-shops, were exempted from the service tax. Likewise, in Texas, where customized software products will face a new tax as high as 8% next January, many highly vocal service providers, including accountants and lawyers, won't have to charge sales tax on their services, according to L. Fredrik Buss, executive director of the 185-member Texas Computer Industry Council in Austin.

"A lot of people in the computer industry like to pretend politics don't exist," Buss charges. "I think this [tax law] has increased their political awareness. This 8% is a heavy, heavy load to drop on customers."

## A Hunger for Revenue

While no one wants to pay more tax, the responsibility issue has thrown some of the industry groups into slightly different stances.

## Which States Impose the Software Levy

The following chart shows how the various states generally apply their sales tax provisions, by law, regulation, or ruling, to sales of canned and custom computer software. (Alaska, Delaware, Montana, New Hampshire, and Oregon do not impose sales taxes.) "T" indicates that such sales are taxable; "E" indicates that such sales are exempt.

STATE	CANNED PROGRAMS	CUSTOM PROGRAMS
Alabama	T	E
Arizona	T	E
Arkansas	T	T
California	T	E
Colorado	T	E
Connecticut	T	T
Washington, D.C.	T	E
Florida	T	T
Georgia	T	T
Hawaii	T	T
Idaho	T	T
Illinois	E	E
Indiana	T	E
Iowa	T	E
Kansas	T	T
Kentucky	T	T
Louisiana	T	E
Maine	T	E
Maryland	T	E
Massachusetts	T	E
Michigan	T	E
Minnesota	T	E
Mississippi	T	T
Missouri	T	E
Nebraska	T	T
Nevada	T	T
New Jersey	T	E
New Mexico	T	T
New York	T	E
North Carolina	T	E
North Dakota	T	E
Ohio	T	T
Oklahoma	T	E
Pennsylvania	T	E
Rhode Island	T	T
South Carolina	T	T
South Dakota	T	T
Tennessee	T	T
Texas	T	T
Utah	T	E
Vermont	T	E
Virginia	T	T
Washington	T	E
West Virginia	T	T
Wisconsin	T	T
Wyoming	T	T

# SQL. PDQ. ADR.

ADR announces the most far-reaching SQL strategy in the business. A commitment to open architecture and applications portability. DATACOM/DB® Version 8. SQL is key to taking advantage of future technologies. And ADR will fully support the industry standard. Which means choosing a DBMS is now a matter of choosing the system that satisfies your current needs best. Without the fear of being locked out tomorrow. So if you need a relational DBMS with proven production capabilities, we've made your decision a rather simple one. In fact, the choice is the same as it's been all along. DATACOM/DB.

**ADR PERFORMANCE SOFTWARE.**

Unlock the potential.

© 1987 ADR

**ADR**

AN AMERITECH COMPANY

"We went into it [knowing] that the service industry hasn't been taxed for a long time and it will be taxed," Kudisch reluctantly agrees. Thus, in the Florida fight, the American Electronics Association (AEA) focused more on "generic issues," such as how the bill was structured.

Two years ago, the computer industry was able to persuade the Texas government not to go ahead with a tax bill. That didn't work this year, although the council has had a few successes, including preventing legislation that would have taxed software sold inside Texas but used outside the state.

## An Air of Inevitability

"I'd rather not pay it," comments Bill Pfeiff, manager of hardware and software planning at FMC Corp., Dallas. But, he adds realistically, "If it comes, it comes. And I'll just have to budget for it. It's inevitable. All the states are looking for more money."

Also at issue in some state capitals is the taxing of

companies such as Hewlett-Packard object to as well. Gary Fazzino, HP's state government affairs manager in Palo Alto, says that while HP has no companywide lobbying stance, the pyramiding approach favors big, vertically integrated corporations that do most of their own work.

Taxing software developers, though, took a step backward in a recent California decision. The state's Board of Equalization ruled in favor of the AEA and other groups over a state rule formally titled regulation 1502, Automatic Data Processing Services and Equipment. Although 1502 has been on the books for years, state auditors recently reinterpreted the rule to mean that software developers were to be taxed on their royalty fees and licensing arrangements. Under a new board, the rule has been changed so that developers are no longer taxed.

"That was a tax that the little guys were getting killed on," says Terry Ryan, tax manager at Apple, a vocal opponent of 1502. Ryan notes that the big companies were able to get around the law by going out of state to copy programs. While that's no longer needed in the wake of this past summer's rulings, questions still remain. In addition to problems defining different areas of software, state comptrollers typically have different opinions as to what constitutes a computer. For example, under 1502, microprocessors are not viewed as computers, thus their code is still taxable, says Ryan.

## Delaying Tactics

The software industry is healthy, thus taxing may be inevitable. The big guessing game concerns the question of how long taxation can be delayed. One lobbyist against the old 1502 interpretation says that now the trick is not to make a big deal about the

## A Challenge Webster Wouldn't Relish

So, just what is the correct definition of "custom" software? Trade organizations as well as the various states have taken their own tacks.

Traditionally, battle lines have been drawn on the basis of tangible versus intangible property or canned versus custom. The American Electronics Association (AEA) recently struggled to go one step further with the definition of custom versus canned software at the behest of the Multistate Tax Commission, a 19-state advisory board that is comprised of high-level state government staffers and which makes suggestions to state legislatures on tax issues. Its proposals, however, are not binding.

The AEA's director of state government affairs, John Mancini, settled on a lengthy statement to the effect that a custom program is one that is developed in-house, or by special order, and is unique. However, Mancini wrote to the commission, "it may incorporate preexisting routines or program components." Conversely, while a canned program originally may have been developed on a custom basis, Mancini described canned software as the "identical program [that] has been licensed, sold, or leased more than once."

At the moment, there is no uniform approach to state taxation. Each state tends to have its own method of imposing sales and use taxes on computer software. Among those states that do tax custom software, Wisconsin and Rhode Island each make exceptions for those "programs in the form of written procedures such as program instructions listed on coding sheets." Georgia, another custom software taxer, exempts software written to a customer's specific needs and at his place of business.

change in the bill. "We're trying not to play it up or to show there's a real tax shortfall because of it," he says. Some of the big California software concerns are likely to save millions of dollars because of the change.

It is equally unlikely, however, that any software consumers will see a corresponding drop in prices following the changed ruling. The software industry is getting older and wiser, and it senses the voracity of the tax board. Thus, many companies are taking great pains to write contracts with customers that protect themselves if cited for tax liability, says Post. Still, one of the biggest fears is that states will reinterpret laws, as did California, and attempt to collect money retroactively.

Along with the fear of retroactive taxes, the most

common complaint on the part of vendors is the inconsistency among states and the chore of keeping track of different rules.

The Multistate Tax Commission is looking into that, says AEA's director of state government affairs, John Mancini. This advisory board, which consists of high-level state government staffers, makes suggestions to member state legislatures on tax issues. Its proposals, however, are not binding. "They're trying to develop some conformity so companies are not at cross-purposes state to state," says Mancini. "But even if the distinction is maintained between canned and custom programs, it will be increasingly difficult. States are putting a wide brush across services and taxing them." ■

## WASHINGTON MAY BE THE NEXT STATE TO TAX CUSTOM PROGRAMS.

software licensing fees—such as those paid by the original developers and/or resellers of software packages. If the whole product development process is taxed and then the end user also has to pay taxes, that's double or triple taxation, they complain. Florida, for one, does have such pyramiding sales taxes.

This pyramiding is what

# THE IDEAL DB2.

ADR announces the advanced application development system that's ideal for DB2. IDEAL®. Because the dramatic leaps in productivity experienced by the more than 1000 IDEAL users are now available to those with DB2. IDEAL is designed with the needs of MIS in mind. Professional, powerful and quick. The only system with everything you need to build corporate applications on DB2. Including static and dynamic SQL functionality, an active dictionary tied to the DB2 catalog and a complete application development environment. Or in other words, everything you need to get the most from your investment in DB2.

**ADR PERFORMANCE SOFTWARE.**

Unlock the potential.

**ADR**

AN **AMERITECH** COMPANY

## SOFTWARE

# Joint Development Deals Lure Banks, Software Vendors

Preferred access to new products and the ability to influence development attract many in the banking industry.

BY ROBERT FRANCIS

The development of banking applications software has never been an easy chore. Once largely the domain of the banks themselves, a number of third-party banking software companies, particularly in the IBM arena, have sprung up over the years, providing alternatives for information processing professionals in financial institutions.

Today, in the consumer-oriented, deregulated climate that characterizes the financial world, the potential benefits of more and better software have become even more attractive to users. But it doesn't mean the development task has become any easier.

So it comes as little surprise that a number of leading financial enterprises have teamed up with some of the key applications software suppliers in joint development efforts. The latest of these is Cullinet Software's agreement with Westwood, Mass.-based American Express Bank Ltd. to develop a version of Cullinet's Banking System for the international market.

This deal follows others such as the joint development agreement between Electronic Data Systems Corp. (EDS), Dallas, with Bank One Corp. of Columbus, Ohio, and Norwest Corp. of Minneapolis to develop programs for large-scale banks; and Dallas-based Hogan Systems Inc.'s arrangement last year with Midland Bank plc, London, to

write software for banks in the international market.

Many of these teaming arrangements come on the heels of a six-year spate of banking consolidations and mergers, brought on by government deregulation of the banking industry. Since 1981, more than 1,700 bank mergers have taken place, and most analysts expect this trend to continue.

Many more changes may be in the offing, analysts say, as newly merged banks head back to the market to purchase new products, geared more toward the customer than in the past. Inside these new, larger banks, a vast array of financial service systems, each with many diverse networks, terminals, and other systems, are discretely co-existing, waiting to be integrated.

### Marketing Focus Takes Hold

Other changes in the banking industry are affecting the banking software industry. An information systems official with Dallas-based Republicbank Corp., who requests anonymity, says, "We've started to focus on systems we can use in marketing terms. That's a change from the early days when our data processing systems were automating things like check processing."

According to another banking industry official, banks are using their financial services systems to offer customers more services. As the competition for customers heats up, many banks will want their own systems so as

to differentiate themselves from their competitors; at the least, they will want software that is flexible enough to allow for some in-house customizing. These changes will provide the financial services software industry with new challenges in the coming years, according to David Thomas, an analyst at Hambrecht & Quist Inc., New York.

Though the bank-vendor agreements come in all shapes and sizes, this sharing of costs to develop new systems gives the banks valuable input into new software systems, as well as first dibs on the latest products. Brian Phillips, executive vice president for technical services at Norwest, says, "Joint development agreements give us several things: it means that we will have immediate access to a new system developed in conjunction with a major player in the banking software industry, and it means we will have a say in how the system develops, so we will know from the start what it can do."

But these recent joint development agreements may also mark a renewed confidence in this form of development, although now these agreements are more customized and specific. Some of the earlier jointly developed banking software systems simply did not work out as promised. One of the more notable failures was the attempt in the early 1980s by Carmel, Ind.-based Anacomp Inc., to develop jointly with a group of banks a comprehen-

sive set of programs for IBM machines.

For the banking software vendor, the input from banks may help eradicate some of the troublesome bugs inherent in many systems developed in the past. According to Coley Clark, vice president and general manager of EDS's financial services division, the banking industry's input can result in the development of a first-rate system. "If we designed it ourselves, it might be a good system," says Clark. "But on the other hand, we're not in the banking industry, and if you have the banking industry involved in this, you've got some banking expertise, some 'live' input into your system."

### Deals Pave the Way

For each of the partner companies, the joint development agreements will, they hope, pave the way for future growth. At EDS, the Bank One-Norwest agreements signal a move into competition for large money center banks. Previously, the company had concentrated on



**SOME  
EARLIER  
JOINT  
SYSTEMS  
DIDN'T WORK  
AS PLANNED.**

smaller institutions such as credit unions, and has a foothold in approximately 4,200 such outfits. A little over a year ago, it purchased the rights to CIS, Anacomp's banking software package. While the software vendor's program never succeeded in the marketplace, the basic ar-

# COMPUTER HEAL THYSELF.

ADR announces one of the first practical implementations of artificial intelligence. MINDOVER MVS™. An advanced expert system for MVS performance management. It emulates the deductive reasoning of human experts and shows how to improve the performance of your system. MINDOVER MVS thinks like a computer scientist. In fact, it even gives the rationale for its advice. And can tailor its recommendations to the requirements of your system. Which easily makes MINDOVER MVS the most intelligent expert system available.

**ADR PERFORMANCE SOFTWARE.**

Unlock the potential.

© 1987 ADR

**ADR**

AN AMERITECH COMPANY

## News in Perspective

chitecture of the system was sound, EDS's Clark says. So EDS purchased the rights to the system. EDS doesn't, however, expect to have a CIS-based product developed for several years.

For Hogan, the agreement with Midland Bank gives the company entrée both into the international banking market and into one of the world's largest financial institutions. Midland is a so-called megabank, which in the banking industry means a bank with deposits in excess of \$70 billion. Hogan, which values the deal at about \$10 million, will supply its entire product line to Midland as well as jointly developing an integrated program for the megabank. Midland is in the process of replacing its Burroughs computers with IBM mainframes.

### Cullinet, Hogan Competed

Cullinet's deal with American Express Bank may put the company on the international banking community map, since Cullinet will have the rights to market the software developed for American Express. The contract, for which Cullinet had competed with Hogan, calls for the two companies to jointly develop

### USERS WANT A SAY IN HOW A PROGRAM DEVELOPS.

a customized version of Cullinet's Banking System software for the international market, with Cullinet holding the rights to the program. A product is expected within two years.

The international banking market differs from the domestic market because it involves more work with foreign exchanges, letters of credit, and commodity exchanges, according to Dave Iacino, senior product manager for banking software at Westwood, Mass.-based Cullinet.

Cullinet began its venture into the banking software market three years ago, when it purchased Bob White Computing & Software, Oak Brook, Ill. Cullinet's Banking System, which is priced at \$450,000 per module, consists of modules for liabilities, assets, electronic banking, and portfolios. The price includes Cullinet's database management system, which must be used with the banking software.

At least one major banking software company is not jumping on the joint agreement bandwagon, however. Computer Associates International Inc.'s new Uccel division uses a variety of input from an array of banking industry advisors in developing its products, and it has been satisfied with the results. "Uccel has, unlike some other companies in this industry, not operated with a leading edge philosophy that forces our customers to have the latest, most high powered computers to use our products," explains a Uccel spokesman. "We use the latest technology of course, but it's not so far ahead of our customers that they can't use it."

Meanwhile, some banks have been so busy acquiring that they haven't had the time to see what's going on in the banking software industry that serves them. "We've been involved in acquisitions for a year or so, so we've not gone out and looked at what's there," says Ray Dwyer, senior vice president at the Bank of New England, Boston. "In the last year, we've

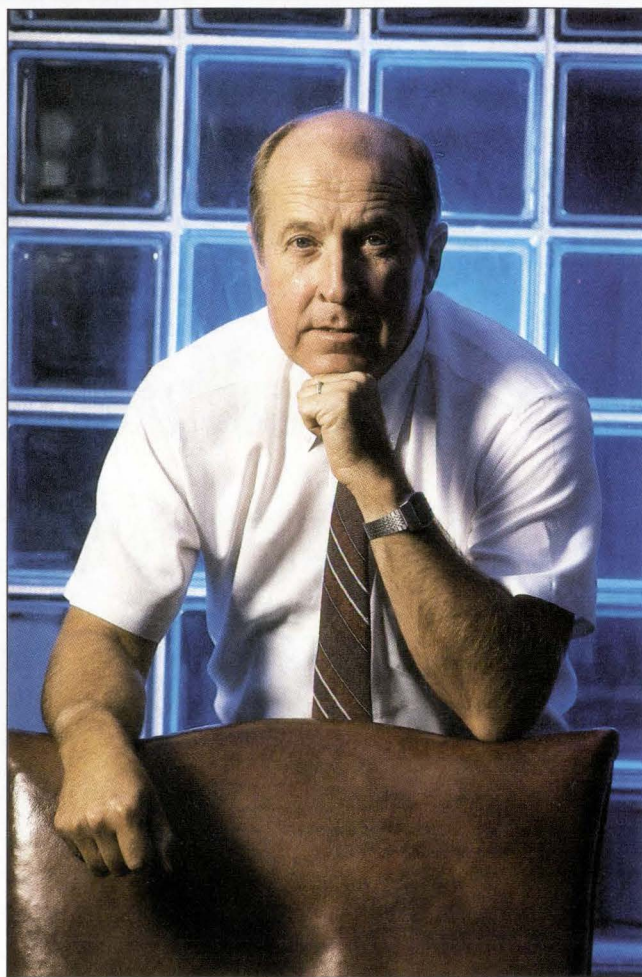

**BANK OF NEW ENGLAND'S DWYER:** Banks involved in merger mania are taking stock of their systems and looking for integration solutions.

gone from being a \$6 billion bank to being a \$27 billion bank. That's a big change and now we've got to look at what's out there in the market. That's what we're starting to do now, once we see what's in-house today."

Dwyer thinks that many of the banks involved in the merger mania of the past six or seven years will be taking stock of their systems and figuring out the best solutions for integration. EDS's Clark agrees. "It's a high priority to merge those data processing systems to cut costs," he says. "For us, our GM experience has served us well, where we merged about 100 data processing centers down

to 14 in a two-year period of time."

Merger mania is not likely to stop, either, predicts Cullinet's Iacino. "There will still be the smaller community banks," he maintains, "but for some of the \$4 million, \$5 million, or \$6 million banks, that's the only way they're going to survive." Richard Aldridge, president and chief operating officer at Hogan, says that the trend can mean only good things for his company and for the industry. "When these banking operations combine, they need state-of-the-art software to integrate these operations and they're looking to us and the industry for that." ■



# WHEN eMAIL SPEAKS PEOPLE LISTEN.

ADR announces electronic mail that speaks. ADR/eMAIL Voice. We created it because it's not always easy to get to a terminal. So now you don't need a terminal. You can use a telephone. Call the computer and eMAIL's synthesized voice reads your mail to you. Reply and it digitizes your voice to be replayed later. And eMAIL isn't limited to just mail. Since it integrates with DATACOM/DB, information from the corporate database, including reports and documents, can also be read over the phone. So now the company computer is just a phone call away.

**ADR PERFORMANCE SOFTWARE.**

Unlock the potential.

© 1987 ADR

**ADR**

AN AMERITECH COMPANY

## RESEARCH & DEVELOPMENT

# NSF Supercomputer Centers Embroiled in Funding Dispute

The House has proposed continued funding for Phase I centers, which has Phase II users—who say they are barely surviving on current funding levels—up in arms.

BY WILLIE SCHATZ

For entities that were supposed to have been history this year, the National Science Foundation's Phase I supercomputer centers are really hanging in there.

The proposed continued funding of Phase I centers, however, has university scientists wondering about the present and future course of the NSF's advanced scientific supercomputing program. If Congress resurrects Phase I centers at the expense of Phase II centers, these scientists say, their ability to conduct advanced research and purchase state-of-the-art supercomputers will be severely hindered.

You remember the Phase I centers. They're the supercomputer facilities at the University of Minnesota, Colorado State University, and Purdue University from which the NSF was buying cycle time for its researchers back in the dark ages of 1984. When the NSF developed its advanced scientific computing initiative and established what it called Phase II centers that same year, part of the deal was that the agency's monetary support for those three Phase I centers would gradually fade to nothing.

Earlier this year, NSF canceled funding for Phase I centers (see "Render Unto Caesar," March 1, p. 19). Since then, the centers have eked out a subsistence from non-NSF funding sources.

Now, they're back, with funding to the tune of \$3.5 million. That's what the

House Appropriations Committee proposed this summer in its funding bill for fiscal year 1988. And Phase II center directors are howling.

"We've got a real crisis on our hands," says Larry Smarr, director of the NSF's Phase II National Center for Supercomputing Applications at the University of Illinois, Champaign. "Someone in the country has to stand up and take extraordinary action. If Congress and the NSF follow business as usual, they might as well shut the Phase II centers right now."

"The next six months is make-or-break time," Smarr emphasizes. "There's going to have to be a restructuring of the whole program. Otherwise you're going to see the painful dying away of the Phase II centers within a year."

Smarr and others are miffed because the proposed continued Phase I funding comes at a time when budget pressures are causing a lack of cooperation between Phase II centers. Says Sid Karin, director of the Phase II San Diego Supercomputer Center, "There could be much more [work done] than we're doing. But the system says, hey, don't go too far. That lack of cooperation negatively affects the centers."

### Competing with Each Other

Even though all the centers have the same NSF advanced scientific computing mission, they must compete with each other for a very finite number of dollars. The House appropriation bill, sub-

ject to Senate approval, reduces NSF's \$1.89 billion budget request by \$50 million. Of the proposed \$1.84 billion for NSF, \$51.7 million is set aside for the advanced scientific computing program, under which the supercomputer centers fall. And the bill states that the NSF should use \$3.5 million for the Phase I centers.

The House committees' moves have left a very bad taste in a very large number of mouths. "They set this aside by pure pork barrel," says the director of a Phase II center who requested anonymity. "If they pass this, it's an absolute scandal. It's criminal."

While Phase II supporters were distressed that science was no more exempt from pork barreling than any other government program, Phase I supporters in the legislature claimed to be merely protecting their constituents.

"I feel the Phase I centers have been very badly treated by NSF, and I urge you to remedy this injustice," Rep. Martin Olav Sabo (D-Minn.), in whose district the University of Minnesota just happens to be located, told the House Subcommittee on Housing and Urban Development and Independent Agencies. "These centers were created through local initiatives with local funds. They provided needed support to NSF researchers when they had nowhere else to go. I urge you to include some funds for Phase I centers so that NSF researchers who want to work at these centers can continue to do so."

Sabo buttressed his position with letters from a mathematician and an astronomer. The former touted the Cray-2 at Minnesota as being the only machine with a large enough memory to handle "a large class of problems which cannot be done on the other machines in a reasonable amount of time." He then took NSF to task because "it has not just cut off one of a number of centers, it has removed the only state-of-the-art machine from the basic science community." The astronomer, clearly not an expert in Washington ways, wrote that "it is very ironic that the Astronomy Division at NSF has funded our project for the next two years . . . but another division [advanced scientific computing] is prevented from giving us the money to use the Cray-2."

Offering time on that machine is exactly why the University of Minnesota believes it should be resurrected as a Phase I center. When the NSF cut off its funding, the centers' users took their money for cycle time elsewhere. The university managed to retain some of its local users and industrial partners, but overall use of the Cray-2 dropped precipitously. None of the other NSF centers—or non-NSF centers, for that matter—offers its users a Cray-2.

## NSF's Budget

Proposed budgets for the next five years, in billions of dollars (actual budget for 1987 is \$1.62 billion).

### FISCAL YEAR

1988	1.84
1989	2.16
1990	2.47
1991	2.83
1992	3.25

Source: National Science Foundation Authorization Act for FY '88.

# JUST IN CASE.

ADR announces CASE technology for mainstream MIS. The DEPICTOR Series. Using the power of the computer, DEPICTOR™ automates the early stages of applications development. The first DEPICTOR product automates data modeling and database design. DEPICTOR is built around an advanced, centralized data dictionary that integrates its mainframe and PC components. And offers software designers a CASE system that works the way they do. DEPICTOR is just another example of ADR's commitment to helping business get more from its people and computers. A commitment that has made ADR the leader. To learn more about ADR Performance Software, call 1-800-ADR-WARE.

## **ADR PERFORMANCE SOFTWARE.**

Unlock the potential.

©1987 ADR

Applied Data Research, Inc. Orchard Road & Rt 206,  
CN-8, Princeton, NJ 08540 1-201-874-9000.

Circle 18 on Reader Card

# **ADR**

AN AMERITECH COMPANY



I do love...  
Although thou art...  
And yet love knows it is a g...  
To bear love's wrong than hate's known...  
Lascivious grace, in whom all ill well shows,  
Kill me with spites; yet we must not be foes.

## AT&T gives your data the royal treatment.

It's red carpets and gold service when your data travels with AT&T. Because we believe there's no substitute for quality. Our International DATAPHONE® Digital Service, for example, offers you high speed, high performance transmission to great Great Britain. It's supported by one of AT&T's 15 overseas offices. And it's just one of the many fine services we offer to transmit data to a variety of locations. So that no matter where you do business, domestically or internationally, **AT&T comes through.**

Call now to find out how: **1 800 448-8600 Ext. 955.** From equipment to networking, from computers to communications, AT&T is the right choice.



**AT&T**

The right choice.

## News in Perspective

"Our [NSF] users had to leave because we couldn't support them any longer," admits Jim Infante, dean of the University of Minnesota's Institute of Technology. "But we will try to woo those users back if we get funded for FY '88. We recognize that it will require a fairly high level of inconvenience for most of them. Many people who want a Unix and [Cray's Unix-like] Unicos operating system are going to have to make a really serious decision about whether to come back. And it's going to be tempered by their wondering whether the same funding crisis is going to happen again next year.

"Why should we be funded again? Because we've got something to offer that doesn't duplicate what's available anywhere," claims Infante. "No one else has a Cray-2. And if NSF's policy is to offer state-of-the-art supercomputing to as many people as possible, it's certainly counterproductive to go to exclusively Phase II centers. I hope this \$3.5 million triggers a serious rethinking of NSF's present policy."

The current NSF university supercomputer initiative is a far cry from what the agency had envisioned. The original plan for supercomputing approved by Congress in 1984 called for the creation of eight to 10 centers requiring annual funding of nearly \$100 million.

### Fighting Over the Scraps

As FY '88 dawns, the reality isn't even close. There are five national centers with a budget of \$51.7 million, give or take the \$3.5 million which may or may not go to the Phase I centers. Their fate currently rests with the Senate Appropriations Committee, and then possibly with a conference committee. And forget eight to 10 centers. There are no more in sight.

The five current centers

are also fighting among each other for the largest share of the money. Each center recently put its best foot forward before a program plan review panel of outside experts appointed by the NSF, which included members from the Lawrence Livermore and Los Alamos national laboratories, Goddard Space Flight Center, and the National Center for Earthquake Engineering Research. The panelists will make recommendations to NSF as to which center gets how much. NSF isn't bound by the panel's

**"OUR USERS HAD TO LEAVE; WE COULDN'T SUPPORT THEM."**

views, but the agency isn't about to ignore them either.

"This is the only peer review in the history of the program," a supercomputer center director said after his presentation. "They've needed it for a long time. If the panel told me to shut down my center, I couldn't argue with them. That's how much respect they've got in the scientific community.

"But sometimes I think NSF is more concerned with money than science. They told me in July that I'd have to take a \$500,000 cut in FY '87. I'm already \$4 million short for basic services in FY '88. I could put an upgrade in this place that would blow your mind. I've got a deal in place with four major computer vendors. But with the kind of money they're giving us, they're crippling the pro-

gram. Fifty million is a joke. It needs to be doubled to \$100 million annually."

So, if NSF practices what it preaches, we're talking about some serious money. The prevailing sentiment on Capitol Hill is very much in favor of substantially increasing NSF funding. The House Science Committee has already authorized a doubling of NSF's budget by FY '92 to \$3.25 billion (see "NSF's Budget").

Meanwhile, Phase II center directors say they are tired of acting like fund-raisers instead of scientists.

"We spend an unbelievable amount of time fund-raising," San Diego's Karin says. "Is my time or Prof. Larry Smarr's time or [director of the Phase II Theory Center at Cornell University] Prof. Ken Wilson's time well spent fund-raising?"

#### Phase II May Self-Destruct

"The \$3.5 million for the Phase I centers isn't going to make or break us," Karin says. "But it's an indication of what NSF's thinking. I think they want to open the program up again and not even restrict supercomputer usage to Phase I centers. If they do that, the whole program's going to self-destruct. I hope the Senate kills it [the \$3.5 million Phase I allocation]."

"We're talking downstream costs of multibillions if we're going to do this right," says Smarr of the University of Illinois. "But I don't even have enough to cover my cooperative agreement right now. And when that expires in April 1990, I'm dead."

"With all this talk about U.S. competitiveness, we could have a significant impact on it. We could be in the forefront," he says. "We're like a loaded gun. But they keep pulling out the bullets. We want to get on with saving the country, but the country's not backing us up. The country had better wake up." ■

## BENCHMARKS

### AT&T Wins GE Contract

Following approval from the Federal Communications Commission and complaints from unhappy competitors, AT&T was awarded a \$300 million, five-year telecommunications contract by General Electric Co. The plan calls for Fairfield, Conn.-based GE to replace old analog phone systems with a new digital network that integrates voice and data. The network will serve more than 700 locations. After a consortium consisting of U.S. Sprint, Network Equipment Technologies Inc., and Northern Telecom Ltd. lost out, complaints were filed that the AT&T bid violated FCC rules. The FCC didn't agree.

### Cray Architect Resigns

Steve S. Chen, senior vice president for systems design at Cray Research Inc. and architect of the Minneapolis company's best-selling supercomputer, the X-MP, has resigned following Cray's decision to cancel a next generation supercomputer development project he headed. Cray will take a \$3 million to \$4 million write-off for the three months ended Sept. 30 to cover the costs related to the shutdown.

### Datapoint Exec Resigns

Doris D. Bencsik, who briefly held the distinction of being one of the few women to head a Fortune 500 computer company, and who guided Datapoint Corp. through a major reorganization earlier this year, has resigned from the San Antonio company. Bencsik's resignation as chief operating officer followed close on the heels of the appointment of Robert Potter as chief executive officer. Potter was recruited from Northern Telecom Inc. in June to head the company, while Bencsik, who had been appointed acting ceo in January, was passed over for the position. ■

## AT&T helps your data get oriented.

Travelling to far away places can sometimes be unsettling. But with AT&T, your data is assured of safe arrivals, all over the world. Our International ACCUNET® Packet Service, for example, offers you high performance—virtually error-free transmission to places as far away as Japan. And AT&T has more, equally impressive services to other destinations as well. So that no matter where you find yourself, domestically or internationally, you can always count on one thing.

### AT&T comes through.

Call now to find out how. **1 800 448-8600 Ext. 955.**

**From equipment to networking, from computers to communications, AT&T is the right choice.**



**AT&T**

The right choice.

# Digital has it now.

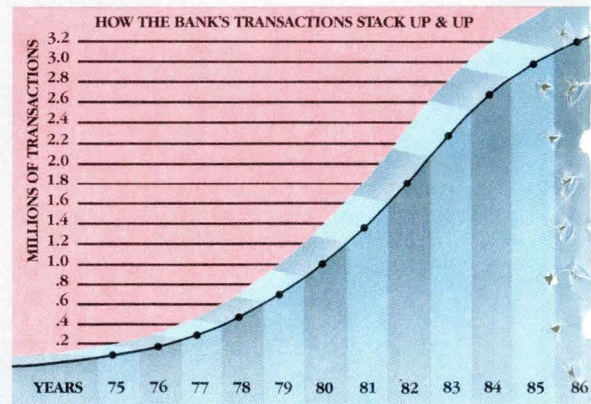

In the business of government securities clearance, if you can't complete a transaction on demand, you stand to lose thousands, even millions, of dollars. And sometimes clients as well.

So it's not surprising that a predictable, responsive computer network can be a huge asset. The Bank of New York knows it for a fact. With the help of a network from Digital, they've become one of the leading banks in the government clearance business.

According to the bank's Jorge Brathwaite, Senior Vice President Government Securities Clearance, "We compete by serving the client faster, better, and more dependably. There, the network is critical."

In effect, the bank's network hooks up to their clients' own back office systems. Even multi-vendor systems. This way, clients can enter trades directly, have instant access to clearance information, and make better decisions, faster than ever.

Of course, the network's flexibility is also something the bank has come to count on. As Brathwaite

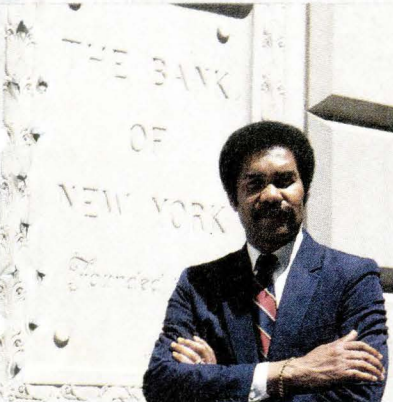

**“A computer network  
that helped yield a 3000%  
increase in government  
securities transactions for  
The Bank of New York.”**

points out, "Digital's single architecture lets us add computers by simply plugging them in. And their VMS™ operating environment lets us streamline the process of modifying applications software. All very crucial when you have to react quickly to growth and new opportunities."

And The Bank of New York has been fast on the uptake. In fact, Brathwaite remarks, "Every day, we handle over 20,000 transactions and clear more than \$100 billion. That's thirty times the volume we did ten years ago. What's more, we just had our ninth consecutive year of record earnings. And that's why I say a network from Digital is money in the bank."

To find out how a network from Digital can give you a competitive advantage, write: Digital Equipment Corporation, 200 Baker Avenue, West Concord, MA 01742. Or call your local sales office.

**digital™**

“Of course my customers need a choice of modems, but my reputation depends upon accurate transmission.”

Henry Fischer, NGS, Inc.

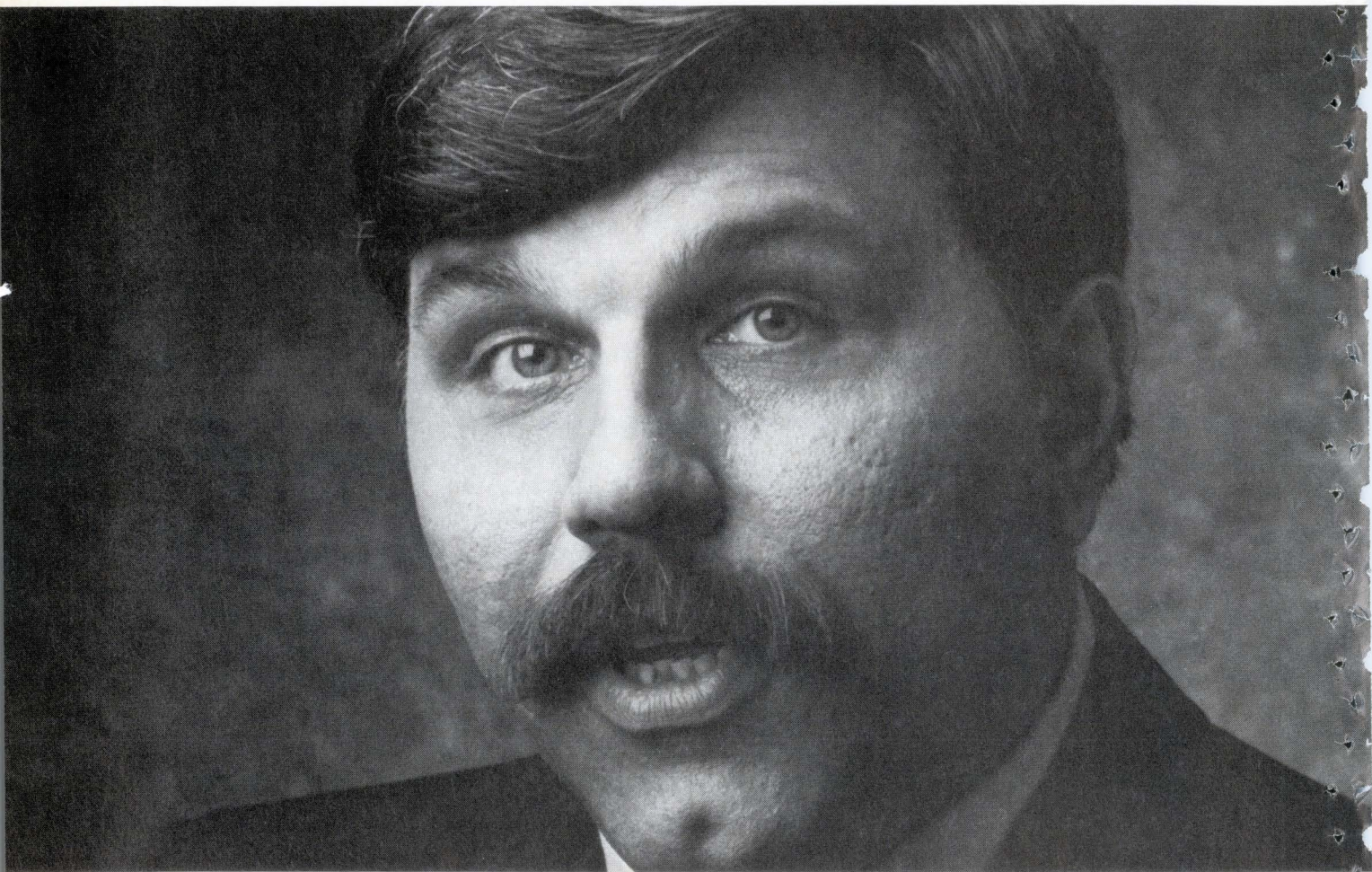

Our modems let NGS confidently manage automated claims processing for over 110 healthcare plans. The Concord Data family of modems gives NGS's customers a rich variety of options, including *the* best error protection. Because data transmission errors could be very costly to NGS's clients, in

legally supported claims, NGS authorizes Concord Data error-free modems *only*. If you can't afford errors, doesn't your network need our superior modems? Of course. Concord Data Systems, Inc., P.O. Box 737, Marlborough, MA 01752, (617) 460-0808. TELEX 951793. Call **1-800-CDS-BAUD**.

 **Concord Data Systems**

Circle 22 on Reader Card



# Behind the News

## STAFF REPORT

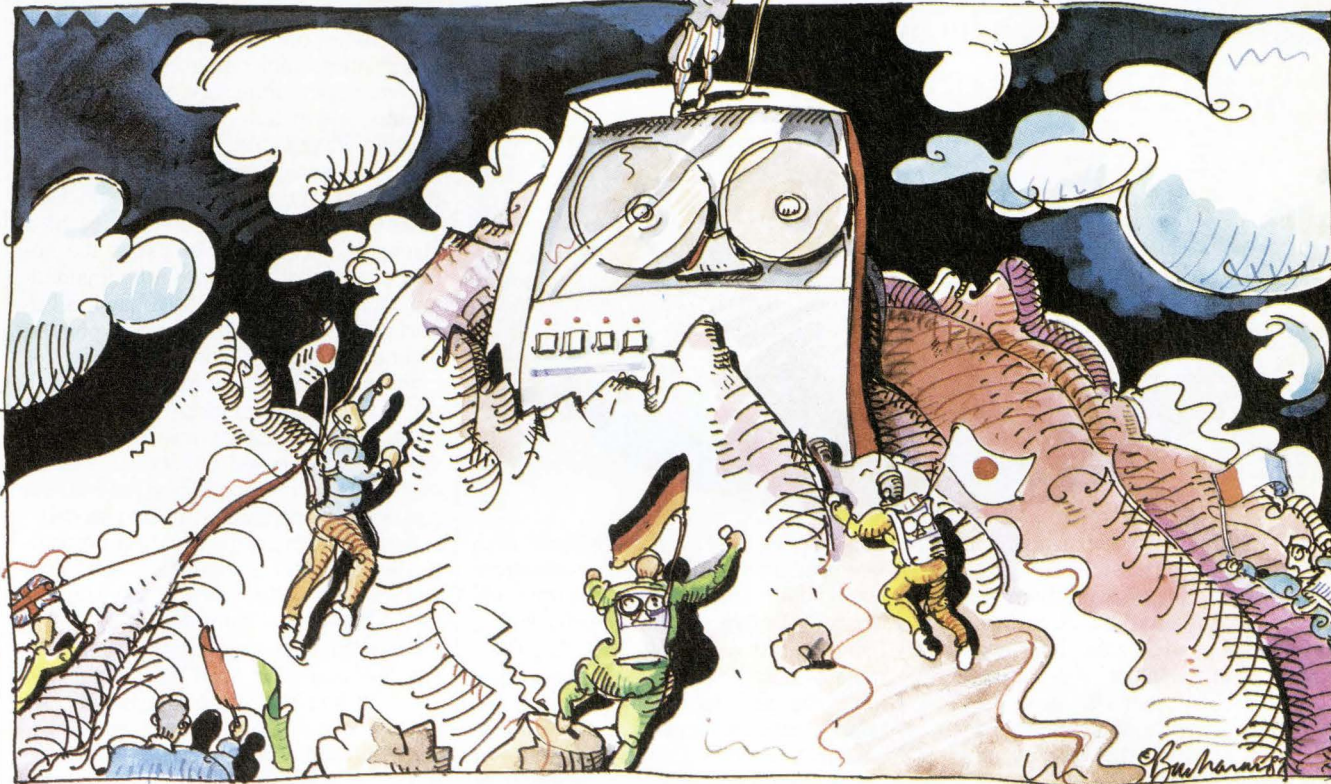

## How Competitive Is the U.S. IS Industry?

Though challenged, it still leads in most technologies. An exclusive poll reveals that computing pros want a strong U.S. industry maintained.

BY DAVID R. BROUSELL

Competitiveness. From Route 128 in the Northeast to the software factories of California, the word has become corporate America's new battle cry. In nearly every speech by a corporate chief executive, in nearly every announcement heralding a new product, this cry can be heard. Business has awakened from its torpor, first induced by the successes of the mid-1970s and later sustained by the recession of the early '80s, and has renewed its sense of self-worth after enduring a stinging series of industrial embarrassments, most notably in electronic components. Yankee pride has been piqued; the old juices are flowing again.

For U.S. industry, the word "competitiveness" does not mean merely more sales or market share. Having and keeping a technological as well as a marketing edge is the reward, not the motivation. This drive for competitiveness can perhaps be found in a deeper desire

### CONTENTS

Japan.....	42
Washington.....	46
Mainframes.....	53
Midrange Systems.....	58
Communications.....	60
Microcomputers.....	62
Supercomputers.....	62



KEEPING AMERICA  
COMPETITIVE

to preserve a uniquely American identity, as well as to turn back a perceived threat to the American standard of living.

That threat is reflected, at least partially, in the U.S. Commerce Department's U.S. Industrial Outlook report for 1987. It says, "In 1987, the [U.S.] computer equipment industry's historically ample trade balance could turn into a deficit, eroded by continued sluggish exports and strong import growth."

The Commerce Department reported that, in 1986, computer product exports from U.S. manufacturers, at about \$13.26 billion, were down about 5% from the year before. Over the same period, imports of computer equipment into the country were up 26% to about \$10.4 billion worth. Commerce predicts that, by the end of 1987, exports will have increased 5%, but computer imports will have grown another 30%. In 1986, the U.S. trade deficit with Japan grew to \$3 billion from \$2 billion in 1985.

The Commerce Department report

**FIGURE 1 Is It Important to Buy American?**

(BY PERCENTAGE OF DATAMATION READERS POLLED)

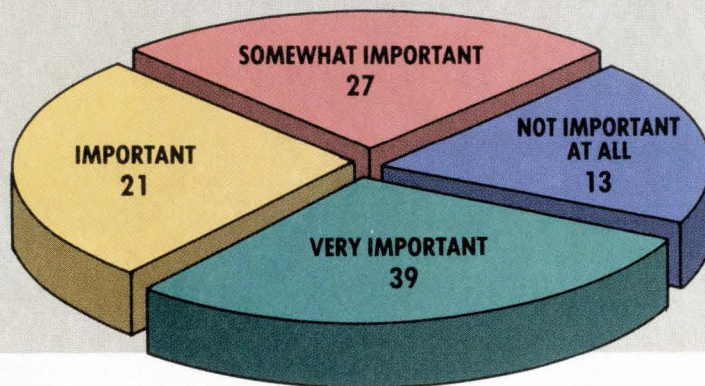

said the shifting trade balance, coupled with a continued trend for U.S. manufacturers to go to offshore production themselves, has cut into the U.S. computer industry's employee count. The number of employes in the industry dropped 9% in 1985 and fell another 7% last year.

In many ways, the U.S. information systems industry, that cutting edge of the nation's technological prowess, is leading the charge in the campaign for competitiveness. Everything from microelectronics to supercomputers to the trade deficit in high-technology goods to the number of computer science graduates projected to emerge from colleges and universities is under scrutiny by the government, industry, and the public at large. Clearly, computer and electronics technology together are regarded as the key to remaining competitive for all American industries.

Coincident with this technological call to arms are fundamental shifts in the economic terrain. Corporate consolidation has swept through U.S. industry, and the computer arena is no exception. The creation of Unisys from Burroughs and Sperry, the triumvirate Honeywell Bull, the formation of the Microelectronics and Computer Technology Corp. and the proposed Sematech, the wave of mergers in the software industry—all reflect the need for greater efficiencies and market staying power. Big is now considered good—and necessary.

An exclusive DATAMATION poll of its readers, the users of information processing technology and equipment, presents perceptions of the state of U.S. computer industry competitiveness. A large majority of those surveyed believe

that, overall, the U.S. is still a leader in all key product areas, from microelectronics to supercomputers and software and services. But they also believe the U.S. is facing serious competitive threats—most notably from Japan—in many product areas, and that the U.S. must maintain a strong industry. The concern represents a bread and butter issue: 87% of those polled say that high-technology goods and services have made their companies more competitive.

### A Close Look at Competitiveness

This poll is only one part of a comprehensive DATAMATION review of U.S. computer industry competitiveness. The review itself is part of a continuing effort by the Electronics & Computer Group of Cahners Publishing Co., of which DATAMATION is a part, to report on American industrial competitiveness. In this, the first installment of a DATAMATION series

that will appear from time to time, sections focus on such product areas as mainframes, minicomputers, microcomputers, supercomputers, and communications, and include views from both Japan and Washington, D.C.

A powerful sentiment culled from the poll is that IS professionals in the U.S. believe deeply in the necessity of a strong U.S. computer industry, the notion of a global economy notwithstanding. Of those surveyed, 98% say it is important for the U.S. to have a strong, indigenous computer industry. Only 1% indicate that it is unimportant because the U.S. is part of a global economy. At the same time, in what may reflect a sensitivity to price and quality, as well as such factors as compatibility, ease of use, and performance, 60% indicate an overriding commitment to buying American-made computer equipment, software, and services—39% say it is "very important," 21% call it "important," 27% say "somewhat important," and 13% answer it is "not important at all" (see Figure 1).

The spirit of nationalism is alive and well, as is a commitment to free market forces, despite the often touted Japanese model of cooperation between government and industry. The reason most often cited by poll respondents concerning the need for a strong U.S. computer industry was economic prosperity and maintenance of the general welfare; keeping up with other countries, and national security were each cited less than half as often as was prosperity. Mentioned even less often was the specific need to keep Americans employed. One consistent theme running through these readers' explanations, however, was the crucial role information technology is

**FIGURE 2 Areas of Vulnerability**

(PERCENTAGE OF DATAMATION READERS WHO PERCEIVE A THREAT TO THE U.S. COMPUTER INDUSTRY IN THE FOLLOWING AREAS)

Microelectronics	64
Mainframes	43
Microcomputers	53
Minicomputers	31
Supercomputers	40
Data Communications	36
Applications Software	24
Systems Software	17
Computer Services	13

### FIGURE 3 Rating the Competition by Country

PERCENTAGE OF DATAMATION READERS WHO PERCEIVE A COMPETITIVE THREAT TO THE U.S. COMPUTER INDUSTRY IN THE FOLLOWING AREAS BY THESE FOREIGN INDUSTRIES

	SOUTH			WEST		
	JAPAN	KOREA	TAIWAN	EUROPE	GERMANY	ISRAEL
Microelectronics	94	12	4			
Mainframes	100	3		3		
Microcomputers	90	4	4	4		
Minicomputers	54	3	3	8		
Supercomputers	63					
Data Communications	100			7	11	
Applications Software	50	39				12
Systems Software	78		15			
Computer Services	60		36			

perceived to play in keeping the nation, and their companies, first rate.

The fundamental model on which the U.S. should base its competitive strategy, the poll showed, is the free market. In a similar vein, U.S. computing professionals firmly believe that large corporations are necessary for successful international competition.

On the question of whether the U.S. should have a national high-technology industrial policy formulated and implemented in concert by government and industry, 77% say no, that the industry should be controlled by free market forces. Only 20% are in favor of such cooperation; 3% had no answer. Meanwhile, 64% of those polled say that the U.S. should relax and/or modify antitrust laws to encourage the formation of high-tech corporate combinations to promote competitiveness. Thirty-three percent say the laws should not be changed; 3% had no answer.

In regard to specific product categories, 81% of those polled say that they believe the U.S. is still a leader in microelectronics despite the apparent dominance Japan has achieved in the markets for some electronic parts. Ninety-six percent say the U.S. is a leader in mainframes, but only 76% feel this is true of the U.S. position in the microcomputer market. Ninety-five percent perceived U.S. leadership in minicomputers; 88% in supercomputers; 85% in data communications equipment; 92% in applications software; 95% in systems software; and 88% in computer services.

The poll asked about specific product areas in which respondents perceived a potential threat from foreign competitors and from which countries in particular. The respondents indicate

that, overall, the competitive threat to the U.S. is to be found in the hardware market. Software and services, on the other hand, scored highest in competitive strength.

#### Japan Threatens; Micros Threatened

Of all the categories, the area seen as most vulnerable is microelectronics; 64% believe the U.S. is threatened in components. Japan is picked as the chief antagonist by 94% of those who believe the U.S. faces a competitive threat in this area; South Korea is mentioned by 12%; and Taiwan is mentioned by 4%. In the mainframe market, 43% of those polled believe there is a threat to U.S. leadership, with 100% of those respondents mentioning Japan. South Korea and Europe were each mentioned by 3% of those polled as posing a threat (see Figures 2 and 3).

In regard to microcomputers, 53% believe that the U.S. faces a competitive threat, with 90% of them mentioning Ja-

pan and 4% each mentioning South Korea, Taiwan, and Europe. Only 31% say they see a challenge in the minicomputer arena, with 54% of them believing it comes from Japan, 3% each naming South Korea and Taiwan, and 8% picking Europe. Forty percent of DATAMATION readers polled see a threat in the supercomputer market, with Japan the one and only force to be reckoned with. Thirty-six percent see a threat to datacom, with 100% picking Japan, 7% naming Europe, and 11% citing West Germany.

Applications and systems software are seen by only 24% and 17%, respectively, as being threatened. In applications, 50% mention Japan as a competitor, 39% say South Korea, and 12% name Israel. In systems software, Japan is mentioned by 78% and Europe by 15%. Computer services came up strongest, with only 13% seeing a threat. Sixty percent of those respondents see a threat from Japan and 36% from Europe.

Even though the overwhelming majority of those polled indicate that computer equipment and services have made their companies more competitive, about 10% fewer, or 77%, say the technology is being used to its fullest potential in their companies. Seventeen percent say the equipment is not being used to the greatest possible extent; 6% had no answer. One reason often cited for this shortfall is poor management. Of those claiming success in using high-tech products to enhance competitiveness, the reason cited most often is that their enterprises are information processors and therefore these goods and services are integral to their businesses. The availability of information, and timely access to it, are also mentioned. ■

### FIGURE 4 Should the U.S. Relax Antitrust Law?

(BY PERCENTAGE OF DATAMATION READERS POLLED)

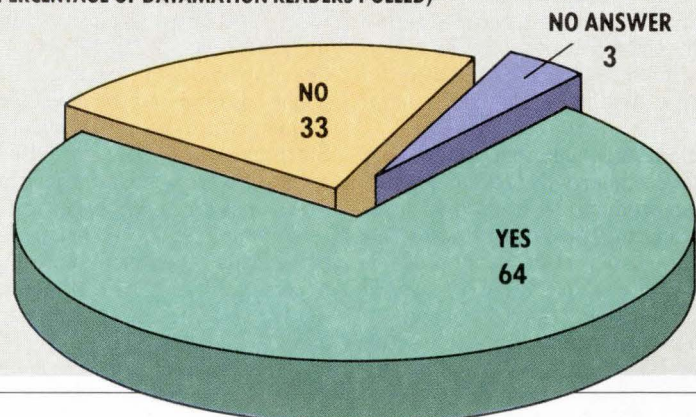

## STAFF REPORT



### Japan: The View is Blue

BY ROBERT POE

Viewed from across the Pacific, the U.S. computing industry doesn't seem to be in much danger. To a large extent, that's because from this part of the world, the industry looks distinctly blue. According to Gene Gregory, who is the chairman of the comparative culture department of Tokyo's Sophia University, an author, and an authority on Asian electronics, the question should be, "Is the U.S. computer industry, as represented by IBM, becoming less competitive?" Gregory's answer to his own question is succinct: "In a word, no."

Although IBM's continued dominance of world computing seems safe, U.S. manufacturers in some market segments clearly are vulnerable to Japanese competition. The results won't appear soon, and may not be as overwhelming as the Japanese semiconductor triumph has been; the impact on the user is even harder to predict. There are indications, however, that Japanese inroads into certain U.S. information systems fields eventually will affect not only the manufacturers that are displaced but also the competitive position of end users themselves.

Computing equipment, due to its complexity, is inherently less responsive than most products to traditional Japanese cost-cutting, manufacturing-oriented strategies, but price cannot be ignored. John Stern, executive director of the U.S. Electronics Industry Japan Office in Tokyo, which represents the American Electronics Association and

the Electronic Industry Association, warns that "the Japanese are showing an increasing determination to market mainframes and personal computers overseas, using pricing as a major marketing tool to make up for a lack of name recognition."

Hardware remains the key. For most Japanese mainframe and pc makers, industry-standard operating systems courtesy of IBM permit them to emphasize their manufacturing skills. NEC Corp., though it doesn't offer IBM-compatible mainframes, has concentrated on supplying hardware to Honeywell, and will do so for the new Honeywell Bull joint venture, of which it owns 15%. Even supercomputers are being brought into the cost-cutting game.

#### First in Line for Semiconductors

One of the most important elements in the vertical integration of the Japanese electronics industry is its semiconductor manufacturing capability. This has at least two major effects. The most obvious is that when it comes to purchasing semiconductors, as Sophia University's Gregory puts it, "They don't have to pay the same price" that their nonintegrated competitors do.

Japanese vertical integration carries a more subtle effect as well. Observes U.S. electronics industry representative Stern, "There is an increasing dependence of the U.S. industry on Japanese components." He has heard "quite a number" of complaints from U.S. mainframe and workstation manufacturers about instances where "the first generation of components goes to Japanese computer manufacturers."

When it comes to software, observers in Tokyo assert that acknowledged U.S. expertise may not provide an insurmountable competitive advantage. "Japan isn't inherently weak in software, it just is investing less in packaged software," declares Gregory, referring to the preference of Japanese end users to develop custom software in-house, which has hindered the development of a domestic third-party software industry. Stern agrees, noting that 80% of packaged software used in Japan is imported. Stern does not think this indicates inferior software skills. "Too many U.S. companies think they can ignore Japan," he observes, "living under the illusion that the U.S. lead in software will remain forever."

The several projects under way to

help Japan catch up in software may not overcome its current deficit, however. For example, few observers feel that the fifth generation computer project, a major part of which involves the creation of an entirely new type of computer architecture, will yield any commercially significant results in the foreseeable future. The most favorable endorsements are little more than lukewarm. An analyst with a major Japanese securities firm, in a typical remark, observes, "ICOT [the Institute for New Generation Computer Technology] is stimulating interest in artificial intelligence."

#### Effect of Sigma Downplayed

The more tightly focused Sigma project for the creation of Unix-based software development tools also elicits yawns. Hajime Karatsu, who is a professor at the Research & Development Institute of Tokai University in Tokyo, a retired Matsushita executive, and a noted authority on manufacturing and quality control, states, "In my opinion, Sigma's plan will not be as effective as MITI [Ministry of International Trade and Industry] expects. The target is to improve the productivity of programmers, but when a different concept of programming becomes popular, it will collapse." Karatsu is vague about what new concept might come along, except that it would probably not involve Unix.

The software wild card is TRON (The Real-time Operating Nucleus), a made-in-Japan computer architecture and operating system for 32-bit microprocessor-based products, including not only pcs and workstations but also consumer appliances and office and industrial automation equipment (see "Japan's TRON Tactics," p. 78-21). Unlike most Japanese efforts to surpass Western technology, TRON is the product of university-in-dustry collaboration.

There are several ways TRON could affect the U.S. industry. Most obvious would be the increased difficulty that foreign manufacturers would have in penetrating the Japanese market if TRON-based products became a domestic but not an international standard.

U.S. electronics industry representative Stern sees in TRON the possibility of an entirely new approach to selling hardware in the U.S. According to Stern, TRON's significance is that "it permits the user to connect test, process control, and data display equipment without the need to write bridge software." He adds,

# ON YOUR WAY TO YOUR NEXT NETWORK MANAGEMENT MEETING?

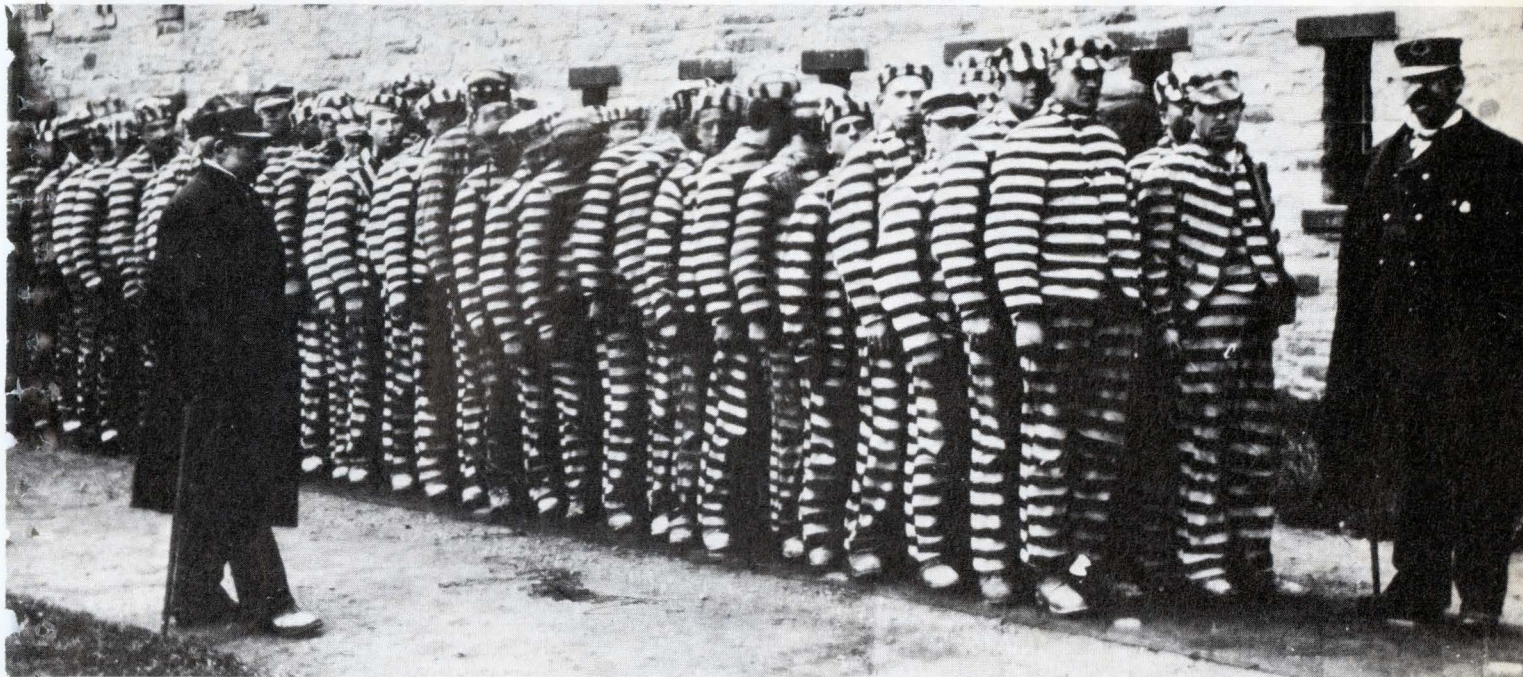

**Call Peregrine Systems — The leader in inventory, problem, change, and financial management systems.**

#### **Base System**

MVS/VTAM  
Menu & PF Key Driven  
Screen Painter  
Field Editing  
Data Dictionary  
Relational Database  
Report Writer  
Electronic Mail  
Background Tasks  
Despooler  
JES/VTAM Printers  
Security  
Help  
4GL

#### **Inventory**

Unlimited Screens  
Unlimited Files  
Unlimited Fields  
Unlimited Keys  
Query By Example  
SQL  
Online Update  
SNA Starter System  
Mass Update  
Import External Data  
Ad Hoc Query  
Interfile Links  
Predefined Reports  
Unlimited Flexibility

#### **Problem**

Automatic Notification  
Automatic Escalation  
Availability Calculated  
Complete Audit Trail  
Unlimited Types  
Extract From Database  
Check for Duplicates  
Minimum Keystrokes  
Change Problem Type  
Online Historical Data  
Reopen Closed Problem  
Ad Hoc Search  
Complete Reporting  
Buck Passing Alert

#### **Change**

Automatic Notification  
Unlimited Change Types  
Reviewer Lists  
Unlimited Tasks  
Approval Groups  
Minimum Keystrokes  
Change Prototypes  
Implementors  
Coordinators  
Deferred Changes  
Unsuccessful Changes  
Cancelled Changes  
Complete Reporting  
Time Analysis

#### **Financial**

Order Tracking  
Link to Inventory  
Online Audit Trail  
Depreciation  
Choice of Methods  
Contract Detail  
Multiple Vendors  
Tax Calculation  
Frequencies  
Budgeted Items  
Forecast Reports  
Reconcile Invoices  
Complete Reporting  
Export Data



**Topdata, Denmark**  
Hanne Niensens Vej 10  
DK-2840 Holte  
Copenhagen  
Tel. 02-424061

**Progilog, France**  
24-26, rue Louis-Armand  
75015 Paris  
Tel. 40-60-05-12

**Peregrine Systems, USA**  
15707 Rockfield Blvd.  
Suite 320  
Irvine, CA 92718  
Tel. 714-855-3923

**O. Dati, Spain**  
P. de Gracia 2, 4  
08007 Barcelona  
Tel. 301-3999

**Paragon Technology, UK**  
Mountbatten House  
Victoria Street  
Windsor, Berkshire  
Tel. 853-857-181

**O. Packages, Italy**  
via Menabrea 18  
20159 Milano  
Tel. 02-60-70-941

# IF THE REASON YOU A 24-PIN PRINTER YOU'VE LOST YOUR

You've also lost your last reason for buying a 9-pin printer. Our new Pinwriter® P2200 dot matrix printer is the first 24-pin printer that is priced lower than many of today's 9-pin printers.

However, we didn't strip the price by doing

the same thing to features. In fact, we gave the P2200 a few features you won't find on any other printers at any price.

9-pin printer

24-pin printer

Like more software support than any other 24-pin printer and unrivaled paper-handling capabilities. It feeds from both the rear and the front. And you can print a single sheet without removing your continuous paper. You can also produce up to 128 type variations within a single document.

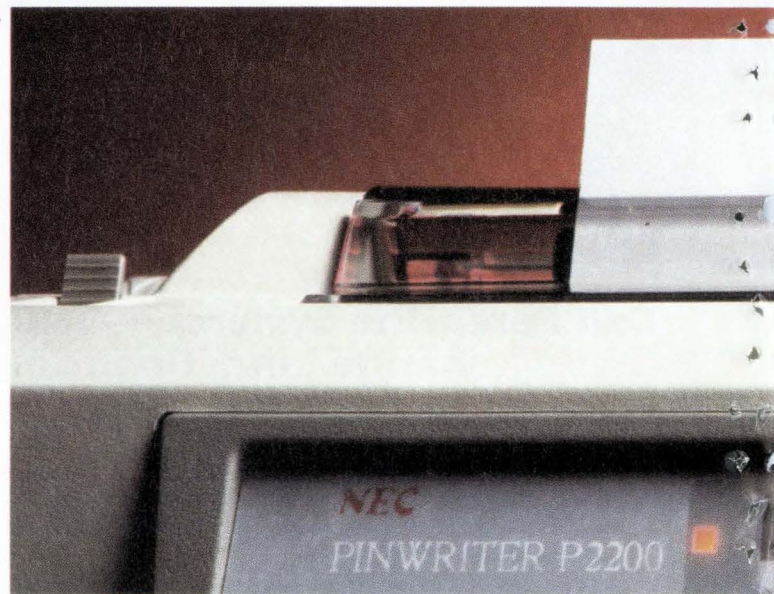

# HAVEN'T BOUGHT IS PRICE, REASON.

AVAILABLE FOR UNDER \$500.



We also didn't get the price down at the expense of speed. The P2200 prints 55 cps in LQ mode – that's faster than any other printer in its price range. And in draft mode, it speeds along at 170 cps.

So see your  
thing else  
would be  
thoroughly  
unreasonable.



NEC dealer today. Any-

**NEC PRINTERS. THEY ONLY STOP  
WHEN YOU WANT THEM TO.**

# NEC

For more information, and the name of the NECIS dealer nearest you, call 1-800-343-4418 (in MA 617-264-8635). Or write: NEC Information Systems, Dept. 1610, 1414 Massachusetts Ave., Boxborough, MA 01719.

Circle 24 on Reader Card

## Behind the News

"Lots of Japanese testing and process control equipment is being sold in the U.S.," including that of such companies as Anritsu, Advantest, and Hitachi. In Stern's opinion, "The idea is new—to go after the computer market not through the strength of the computer but on the strength of the equipment you can hook up to it." He warns, "Too many U.S. companies have dismissed TRON."

### Unix Workstations a Target?

More mundane is the possibility that TRON may serve as the basis for a Unix workstation export offensive. Hitachi and Fujitsu are writing a version of Unix to run on the powerful 32-bit TRON mpus they are developing, with the intention of exporting Unix machines to the U.S. while domestic products are built that run the full TRON OS.

Even if Japanese manufacturers were successful in capturing large shares of the U.S. computing market, the question would remain whether or not that would be harmful to the end user. Proponents of such ideas as the "borderless economy" espoused by NEC president Tadahiro Sekimoto naturally feel not. Sophia University's Gregory, for example, feels that "the computer industry isn't a national industry, it's a global industry, so we'll see a global rationalization and division of labor. I don't think we should worry about it."

On the other hand, if U.S. users become dependent on Japanese-made hardware, whether it be supercomputers, workstations, or factory control systems, they may be vulnerable to the same problem some semiconductor purchasers are now facing: the most advanced new products go to their Japanese competitors. This may pose more of a problem for small users than for larger ones. Explains Stern, "A [Japanese] domestic client ordering large quantities will always get priority over overseas companies ordering a smaller quantity. This is a danger whenever U.S. manufacturers are overly dependent on foreign suppliers."

Many Japanese computer companies are themselves manufacturers of heavily IS-dependent industrial machinery, which would naturally have first call on new computer technology. Given such possibilities, it becomes clear that the fate of much more than computer manufacturing is at stake in the Japanese challenge to the U.S. computing industry. ■

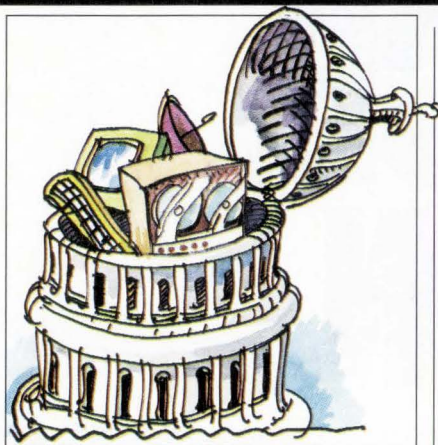

## Washington: The Official Story

BY WILLIE SCHATZ

"Competitiveness" has achieved the same exalted status as the weather. Everybody talks about it, but no one seems able to do anything about it.

"I told my staff I didn't want to hear the word anymore," says Sen. Bill Bradley (D-N.J.), the main man behind the Tax Reform Act of 1986. "So now they call it 'the C word.' It's used so often that it's nothing more than mush. That makes it the politician's dream."

And everyone else's. You want something from someone in Washington, D.C.? Just say the C word.

The National Science Foundation (NSF) requested a 17% budget increase for fiscal year 1988 and a doubling of its budget by 1992 in what it admitted is "a period of serious fiscal constraints." Why does NSF deserve these precious bucks? "The answer, in a word, is competitiveness," the agency said in its budget request. Rep. Richard Gephardt (D-Mo.) wanted to force countries that gained "excessive" trade surpluses through unfair trade practices—of which everyone has a different definition—to reduce their surpluses by 10% annually or confront U.S. retaliation. It was an incredibly controversial piece of the House comprehensive trade bill, but citing competitiveness helped the measure pass by four votes.

Has calling the subject "competitiveness" made any difference for the computer industry? As always, there's good news and bad news. Competitiveness, like beauty, is in the eye of the beholder.

The good news is that, according to the Computer and Business Equipment Manufacturers Association (CBEMA), the information systems industry finished the first half of the year (the last period for which statistics are available) with a \$2.2 billion surplus in computers. Not many other industries were in the black at the end of June.

There was much more bad news. The surplus decreased by 32.5% compared with the \$3.3 billion chalked up in the first half of last year. Imports for the half rose 63%, while exports increased 19.6%. The business equipment and telecommunications sectors were \$1.1 billion in the red and telecommunications was \$1 billion in the red. The computer industry's positive cash flow allowed the three combined sectors, including forms and supplies, to finish with a positive trade balance of \$269.6 million, but that was 81.1% less than the comparable half in 1986. Forms and supplies accounted for a \$221.8 million trade surplus in the first half of this year.

### A Definition of Competitiveness

There's a theory making the rounds in Washington, however, suggesting that the trade deficit is neither the only nor the most accurate measure of competitiveness.

"There are three phases to competitiveness," Sen. Bradley says. "In the short term, we're talking about the trade deficit. For the middle term, we need to concentrate on pooling our resources for research and development. But the thing that's really going to affect our ability to regain what we've lost is a long-term attitudinal change. We've got to start thinking globally, not just nationally. And to do that we've got to change the educational system."

No piece of that triumvirate is anything to write home about. While the trade deficit has been around awhile, it has never looked this grim. In 1986, the U.S. imported \$170 billion more in goods than it exported. And for the first time, the U.S. imported more high-tech products than it exported.

Why? Take your pick: decreased productivity of U.S. workers; stringent export controls that make it at best difficult and at worst impossible for U.S. firms to compete abroad; a rather large budget deficit, which skews the entire international monetary scales; unfair trade practices.

"We still act as though we have to



Think smaller.  
Think faster.  
Think versatile.



# The Hall-Mark solution:



## The Unisys PC/microIT Personal Computer.

The Unisys PC/microIT is ideal for users who require high performance and quick response. Now with its new 40 mb hard disk, it holds even more information than before and works much faster. The PC/microIT occupies slightly more than a square foot of space on your desk but is built with a broad range of configurations.

The powerful yet compact PC/microIT combines the speed and features necessary to operate either as a stand-alone personal computer or as an intelligent workstation attached to the Unisys USERNET system.

The PC/microIT can handle the growing demand for communications, graphics, data processing and office automation, as well as engineering and business analysis applications.

Call Hall-Mark today for more information on the Unisys PC/microIT. We have the solutions to your computer systems needs.



A COMMITMENT TO EXCELLENCE

© 1987 Hall-Mark Electronics Corp./211-1027  
Hall-Mark Electronics is a subsidiary of the Tyler Corp.

**Alabama**  
Huntsville (205) 837-8700  
**Arizona**  
Phoenix (602) 437-1200  
**California**  
Bay Area (408) 946-0900  
Orange County (714) 669-4100  
Sacramento (916) 722-8600

San Diego (619) 268-1201  
San Fernando Valley (818) 716-3300  
West Los Angeles (213) 217-8400  
**Colorado**  
Denver (303) 790-1662  
**Connecticut** (203) 269-0100  
**Florida**  
Ft. Lauderdale (305) 971-9280

Orlando (305) 855-4020  
Tampa Bay (813) 855-5773  
**Georgia**  
Atlanta (404) 447-8000  
**Illinois**  
Chicago (312) 860-3800  
**Indiana**  
Indianapolis (317) 872-8875

**Kansas**  
Kansas City (913) 888-4747  
**Maryland**  
Baltimore (301) 988-9800  
**Massachusetts**  
Boston (617) 935-9777  
**Minnesota**  
Minneapolis (612) 941-2600

**Missouri**  
St. Louis (314) 291-5350  
**New Jersey**  
Fairfield (201) 575-4415  
**New York**  
Long Island (516) 737-0600  
**North Carolina**  
Raleigh (919) 872-0712

**Ohio**  
Cleveland (216) 349-4632  
Southern Ohio (614) 888-3313  
**Oklahoma**  
Tulsa (800) 231-0253  
**Pennsylvania**  
Philadelphia (215) 355-7300

**Texas**  
Austin (512) 258-8848  
Dallas (214) 553-4300  
Houston (713) 781-6100  
**Utah**  
Salt Lake City (801) 972-1008  
**Wisconsin**  
Milwaukee (414) 797-7844

Circle 25 on Reader Card

# Behind the News

worry about internal competition," Carnegie-Mellon University president Richard Cyert told the American Society of Mechanical Engineers' (ASME) recent conference on supercomputers. "The real problem is to make ourselves capable of competing in the international marketplace.

"How do we do that?" he asks. "By realizing our economy is on the frontier and we have to work as hard on it as we did in settling this country. And by changing our way of thinking."

And how are we going to do that? By altering our educational system. It seems that the competitiveness fault lies not in the factories or shipyards or the backyard garages where they're creating the next Apple, but in the classroom.

"Basic research is the underpinning of everything," says Erich Bloch, director of NSF. "It's no longer natural resources that determine how competitive a country is. It's intellectual resources. The transfer to the private sector of new knowledge gained through basic research is the foundation of economic

competitiveness."

That's a given, right? After all, this is the Information Age. But you'd have a hard time determining that from the bottom line. When money talks, basic research walks.

Bloch says that Japan spends a higher percentage of its total R&D budget on basic research than the U.S. Japan also turns out twice as many engineers per capita as the U.S. Last year, more foreign students than American students earned their doctorates in engineering from American universities. Most of those foreign graduates went back home to contribute to industry.

So U.S. students aren't exactly having pleasant dreams about becoming a scientist or engineer. They'd rather make a quick five or 10 million bucks on Wall Street.

"The incentive to go into science and engineering research is not as great here as it is in other countries," says Ed Zschau, a partner in Brentwood Associates, a Mountain View, Calif., venture capital firm. The former computer exec-

utive and head of the House Republican Task Force on High Technology is now chairman of the American Electronics Association's Council on Competitiveness.

If the federal budget is any indication of where the government's head is at, someone else is going to have to do the job. According to ASME, industrial R&D and federal R&D will each total \$60 billion this year. That's an all-time high for industry, but its annual R&D growth has fallen considerably behind the government's. Annual growth for industrial R&D for 1985-1987 is estimated at 2%, compared with about 6% annual increases in 1975-1985.

Total federal R&D support grew about 12% in 1986 and will increase almost 16% this year. Federal civilian R&D, however, was practically flat in real dollars between 1979 and 1984, while military R&D shot the moon. It's now about 72% of federal R&D, compared with 48% in 1979.

"We must turn ourselves around," said Paul Gray, president of the Massa-

**FIGURE 5 From Components to Computers, Imports Grow Faster Than Exports**

(IMPORTS, EXPORTS, AND TRADE BALANCE IN \$ BILLIONS)

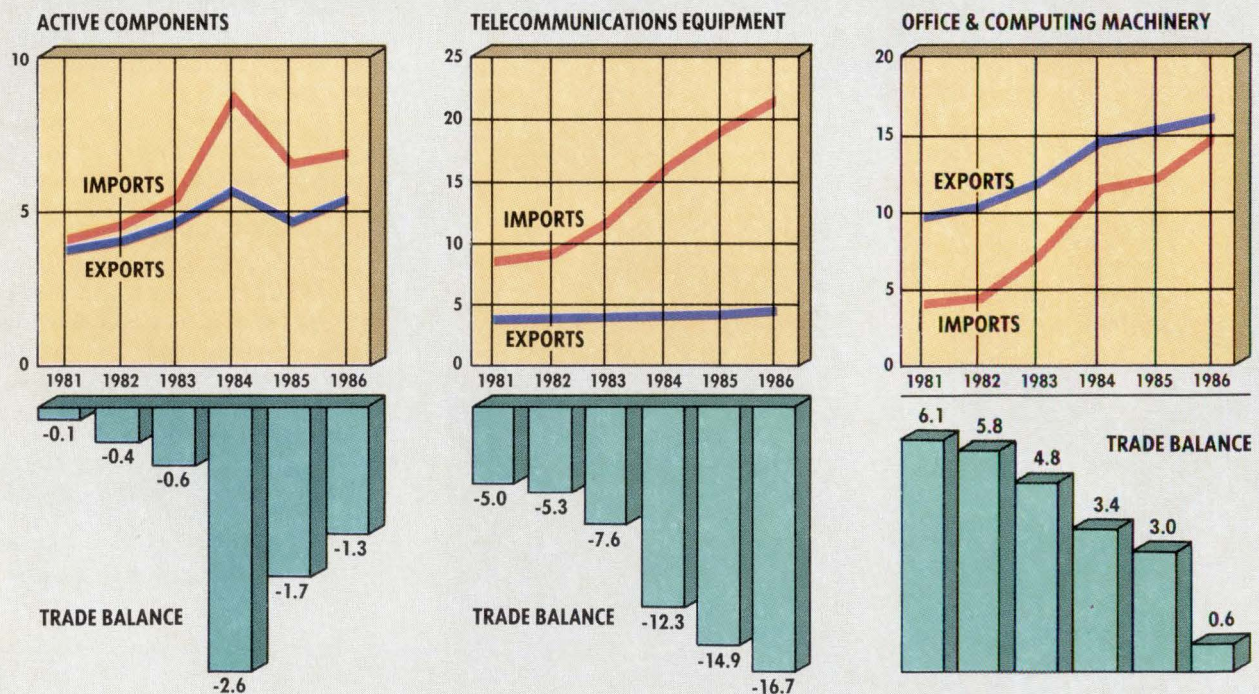

Source: Dept. of Commerce

# Auto-Dialing In The New Frontier.

## SADL

The Synchronous  
Auto-Dial Language

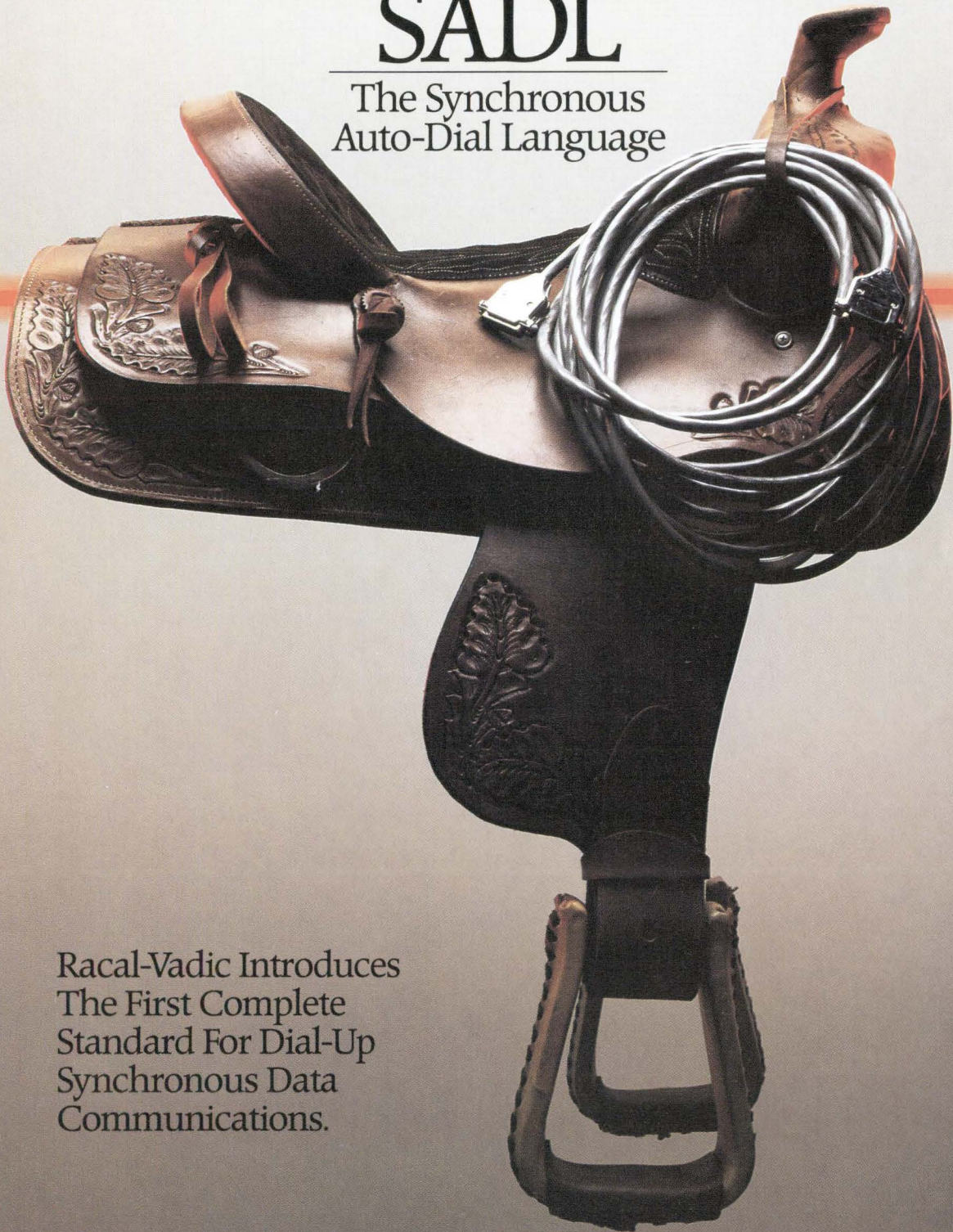

Racal-Vadic Introduces  
The First Complete  
Standard For Dial-Up  
Synchronous Data  
Communications.

# Put Our SADL On Your Sync Network And Dial Up Any Host On The Range.

## The Rewards Of Remote Synchronous Auto Dialing

Synchronous auto-dialing has been on the Datacomm "most wanted" list for years. Unfortunately, you nearly had to sell the ranch to afford it.

Now Racal-Vadic comes to the rescue with SADL, short for Synchronous Auto Dial Language.

And with the first modems to incorporate it.

Together they open a whole new frontier of cost savings.

Starting with mainframe hardware. Because now you don't need to pay up to \$10,000 for RS-366 ports, or \$500 for 801 auxiliary calling units. SADL-equipped modems use inexpensive RS-232 interfaces, and have built-in dialers.

And with SADL, your remote sites can call in on the public switched network—where you only pay for the time you use, and the rates go down with the sun.

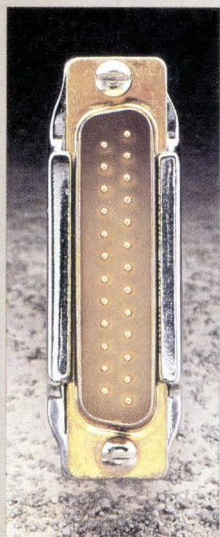

## The Auto-Dialing Protocol That Won't Fence You In

At Racal-Vadic, we've sold more mainframe-site dial-up modems than anybody else in the world. So we know what it takes to auto-dial over all kinds of sync lines. Standards.

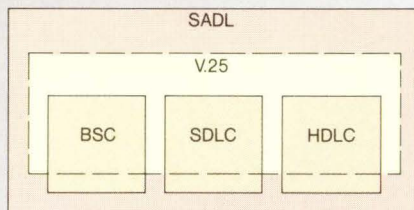

And the CCITT's V.25 *bis* wasn't quite enough. So we enhanced it with SADL, which is modeled after V.25 *bis*, but covers all three synchronous protocols—BSC, SDLC and HDLC. And all the standard dial-up modem specifications, from 2400 to 9600 bps.

Then we field-tested it for almost two years. SADL is long since up-and-running on IBM mainframes under VTAM, IBM Series 1 and System/3X mid-range systems, DEC's VAX, NCR's Tower, Hewlett-Packard's Series 3000, Altos' systems, and the IBM PC.

And now we've released SADL to the public domain, so everybody can get aboard.

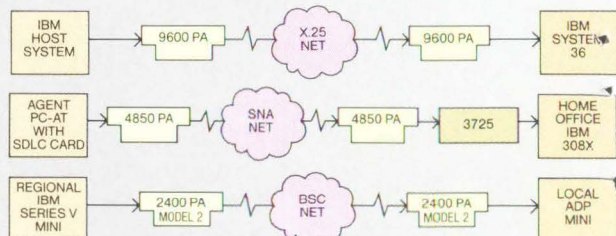

## Any Application Sits Pretty When It Rides On SADL

SADL fulfills a whole wish list of dial-up applications for sync networks.

Such as automated, on-demand remote communications between computers of all sizes. Hot stand-by auto-dial back-up for leased lines. Network diagnostic links. Automated tandem and cross-network dialing. Automatic call reconnection. Sync modem pools on LANs and PBXs. And unattended off-hours dialing for collection of PC files or point-of-sale data.

## Riding High In The Fortune 500

SADL has already been pioneered by some pretty impressive customers. And with pretty impressive results.

A major American automotive company now exchanges credit information between System/36 computers at their dealerships and headquarters, using SADL-equipped modems and an X.25 packet switching network.

Branch agents at a large insurance company can now directly access the home office's IBM 308X mainframe data base with their PCs, using SADL modems over an SNA/SDLC network.

And at a Canadian parts and inventory operation, SADL-equipped modems eliminated the need for \$218,000-worth of RS-366 ports and 801 ACUs on a 400-line BSC dial-up network.

## Remote Site Thoroughbreds And Central Site Workhorses

With a pedigree that goes



units continuously monitors signal quality and receive-signal levels, and reports all deviations, as well as summary statistics, to the System Controller.

And MDS-II does all this, and more, with an open architecture

that won't sacrifice performance today or opportunity tomorrow.



## The Race To A New Auto-Dialing Standard

A lot of dial-up sync frontiers have already been settled. SADL software drivers have been

written for hardware systems from IBM, DEC, NCR, Altos, and Prime, to name a few.

SADL-enhanced application software is available from a wide range of vendors: APT Software; AST Research, Inc.; Cleo Software; CQ Computer Communications; IMC; Intrepid Communications; Megadata Corp.; Moisey Systems, LTD.; Network Software Assoc.; On-Line Software International; Pathway Design, Inc.; The Software Group; and Winterhalter, Inc.

And SADL networks are already up and running for a large number of blue chip end users, including Ford Motor Company, Shell Oil, Ralston Purina, General Motors, ADP Dealer and Employer Services, Pizza Hut, Federal Reserve Bank, Tektronix, and GTE Telecom.

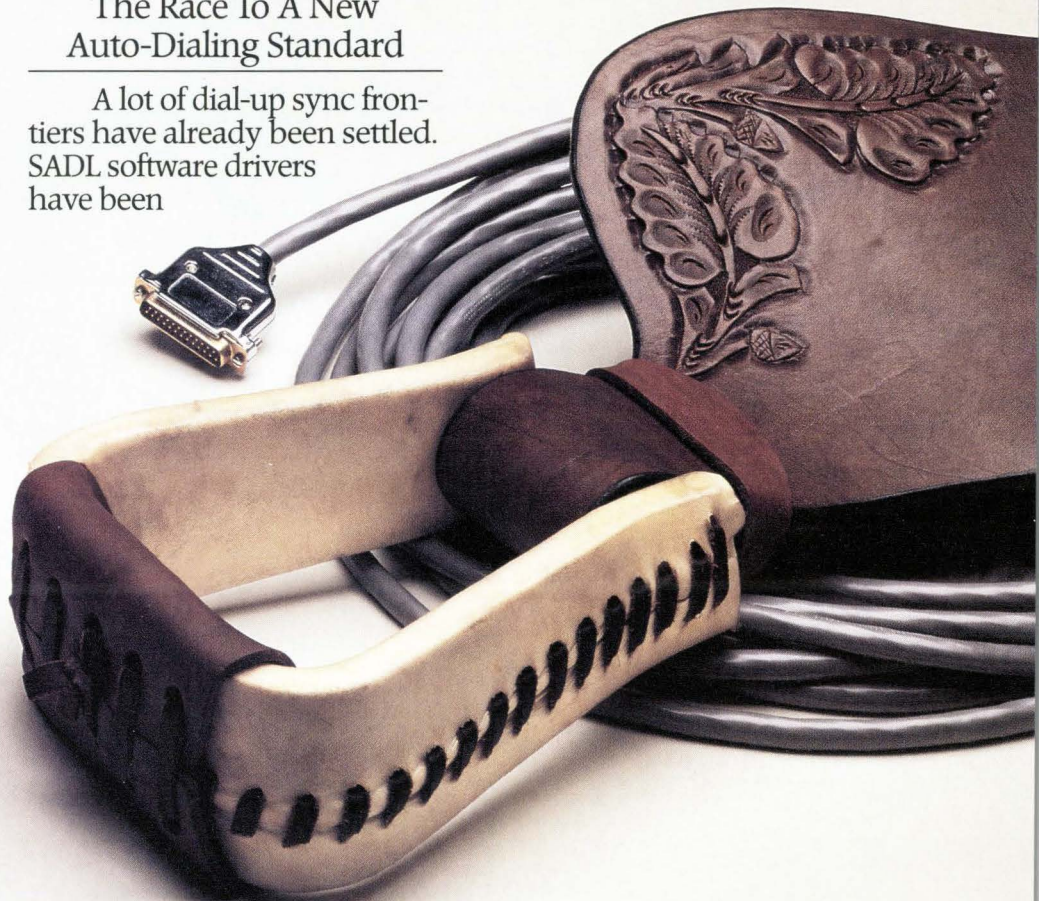

back almost two decades, today's Racal-Vadic breed includes the finest line of synchronous remote dial-up modems ever developed.

At 2400 bps, there's the V.22 *bis*-compatible 2400 PA Model 2. At 4800 bps, the 208B and V.27 *ter*-compatible 4850 PA, which can also be upgraded to 9600 bps. And at 9600 bps, the V.29 and V.27 *ter*-compatible 9650 PA.

At the central site the 208A/B and V.27 *ter*-compatible VA4891 runs at up to 4800 bps, and the V.29 VA9691 at up to 9600 bps.

More importantly, these are *networking* modems, perfectly suited for centrally-managed dial-up networks.

## Riding Herd With A Dial-Up Network Management System

MDS-II is the world's first network management system for dial-up modem networks.

With MDS-II, you can build a network with dozens or even hundreds of modem chassis. You can mix sync and async modems. And thanks to SADL, different dialing protocols, too.

Each MDS-II chassis has space for up to 16 VA4891 and VA9691 modems. Each of these

# Hitch Up For A Free Ride.

---

## The SADL Implementation Program

---

Whether you're a communications programmer in a Fortune 1000 corporation, a third party developer of synchronous emulation products, or anybody else with synchronous dial-up needs, it's easy to jump on the SADL bandwagon.

Because we'll give you a free ride.

In fact, we'll give you everything you need to implement SADL anywhere you like.

Starting with a free Designer's Guide, to help you integrate SADL into your synchronous networks and products.

Then, so you can test your products in the real world, we'll loan you six SADL-compatible Racal-Vadic modems for up to 60 days.

And when you purchase, special price discounts on those same modems.

Finally, we'll back you up with Complete Technical Support, including a full time, toll-free hot line.

---

## So SADL up today

---

Call **800-482-3427** and ask for your free Designer's Guide. Then get on the trail to full SADL implementation.

You may round up a lot more than savings.



**RACAL**  
The Electronics Group

**Racal-Vadic**  
SADL is a trademark of Racal-Vadic.

1525 McCarthy Boulevard, Milpitas, CA 95035  
Tel: (408) 432-8008 • TWX: 556-409 RAVA MLP

# Behind the News

## STAFF REPORT

achusetts Institute of Technology, at the 1987 IEEE Technology Policy Conference. "We must teach engineering students and the employers of engineers to value people who worry about how things are made and about how well things are made. Beyond that, for our own part, we must learn how to teach manufacturing skills in ways that capture the imaginations of our best students, and we must recast the frontiers of manufacturing research in ways that will attract our best engineering faculty."

What's the first step in this long march? Would you believe the Computer Education Assistance Act of 1987?

According to one of its sponsors, Sen. Tim Wirth (D-Colo.), the bill would target funds to low-income and rural school districts that haven't had the dollars to buy the hardware and software their students need. Wirth says they need that equipment to "ensure that the next generation of graduates is adequately prepared to meet the challenges of tomorrow's technologically advanced workplace." That, of course, will ensure "improving America's competitiveness at home and abroad."

The bill has the support of a broad spectrum of the computer industry, including CBEMA and ADAPSO. But who could be against this legislation? No one. Let the record reflect that we're talking elementary and junior high school students here. That's as close to apple pie and motherhood as you can get without the real things. It's also as good an indication as any of how deeply "competitiveness" has permeated U.S. society.

"We have it within our power to restore the trade deficit and go toe to toe with other countries," Zschau continues. "But the responsibility for competitiveness lies with the companies, not the government. It's always best if you can blame somebody else, though. Politicians don't want to tell constituents they can help themselves."

And if they don't?

"Should this nation fail to meet the challenge of slow growth in productivity," Gray said to his IEEE audience, "there is significant danger that America will lose its economic—and eventually its political—leadership in the world. Sadly, there are few present indications that this nation either understands the threat or has begun to take the steps required to reverse the trend."

There's still time, but the zero hour may not be too many ticks away. ■

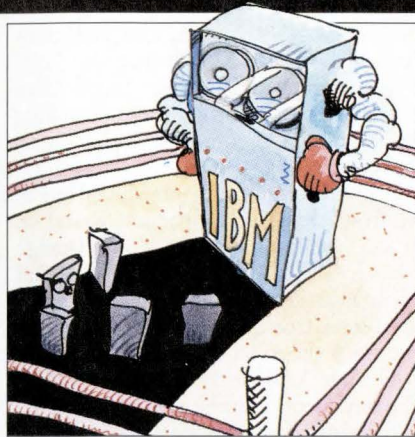

## Mainframes: Still a Big Blue Game

BY JEFF MOAD

The U.S. Commerce Department's report on the industrial outlook for 1987 reveals quite clearly the negative trend of increasing computer equipment imports. Most U.S. market share losses, however, seem to be coming in the micro-computer and smaller peripherals product areas. U.S. vendors of large-scale commercial computers, storage, and software appear to be holding their own against competitive pressure that is coming, primarily, from Japan. While commercial mainframe computer and large-scale storage vendors Hitachi and Fujitsu have made some small market share gains versus U.S. suppliers, American companies, led by IBM, still retain their leadership roles in key software and architecture design areas.

According to Donald Powers, research and development vice president at Control Data Corp., the Japanese "have been strong in hardware areas such as developing semiconductors and packaging them so that they get all the performance possible out of the silicon." But when it comes to software innovations or new hardware architectures, Japanese vendors "aren't as competitive as they are in building hardware."

In recent years, on the strength of advanced semiconductor and packaging technologies, Japanese vendors have succeeded in making sporadic market share headway. With a commercial mainframe uniprocessor that is significantly faster than IBM's and with more main memory, Hitachi was able to double its share of the IBM-compatible mainframe market in 1986 to 4% through its San

Jose-based National Advanced Systems and Comparex European marketing partners, according to the 1987 Computer and Telecommunications Survey conducted by DATAMATION and Cowen & Co., Boston. Amdahl Corp., Sunnyvale, Calif., which sells IBM-compatible mainframes based on Fujitsu subsystems, also was able to make significant market share gains this year.

Those pcm vendors, however, never have been able to increase their combined share of the huge IBM-compatible mainframe market above 15%, according to the survey, nor have their Japanese partners been able to gain much mainframe market share on their own outside of Japan. The reason continues to be that U.S. vendors control most of the key operating system and applications software. Most users are reluctant to stray too far from the hardware vendors that can promise continued support of the existing software in which most of them have invested heavily.

### The Effect of Software Dependence

That leaves the Japanese and other non-U.S. vendors of commercial mainframe hardware little choice but to remain compatible with IBM software. As a result, many overseas mainframe competitors, in the interest of maintaining IBM compatibility, cannot make use of some advanced technology—such as denser memories, dedicated database management hardware, or faster channels—until IBM does.

According to Unisys program management vice president Fred Meier, "The problem for the Japanese mainframe vendors is that currently the world won't consider another new mainframe operating system." Many European vendors and, to a lesser extent, the Japanese, have sought in Unix an open operating system alternative and a solution to their strategic software problems. Unix, however, still lacks many of the security and record-locking features found in mature mainframe operating systems such as IBM's MVS/XA. Although there have been efforts to upgrade Unix and develop a Unix standard, Meier points out that "there is no unified approach."

Observers note that U.S. vendors and researchers also continue to lead in other key mainframe software areas such as database management systems, hierarchical storage management, and performance measurement. In spite of Japanese government-sponsored re-

# Behind the News

## STAFF REPORT

search efforts such as its Institute for New Generation Computer Technology, most U.S. vendors say they see no competitive software threats from Japan yet.

U.S. vendors do acknowledge that the presence of advanced mainframe hardware from Japan has made it more difficult to compete profitably. Meier of Unisys says, "Whenever the plug-compatible mainframe vendors are in there bidding for a deal, the environment is more competitive, and prices generally come down."

When Sperry and Burroughs merged last year to form Unisys, part of the goal was to better leverage the company's \$1 billion annual research and development spending. Prior to the merger, Unisys officials now acknowledge, Sperry had fallen behind and was forced to turn to Japanese semiconductor technology for its as yet unannounced next generation mainframe. Since the merger, Meier says, Unisys has hoped to return to internal research or to technology from U.S. partners for its subsequent products.

While some mainframe users have switched to hardware from non-U.S. vendors, most customers seem satisfied that American companies—particularly IBM—are staying competitive. An example is J.M. Graziani, MIS vice president at San Francisco-based Southern Pacific Transportation Co. He says that "IBM seems to be keeping up very well. They've been going out of their way in a series of meetings with users to open up and tell us more about where their products are going. That's made us more confident that IBM will stay competitive."

Specifically, Graziani says, IBM has reassured him that it will keep up with the competition on price/performance. He also feels that investments he makes in new hardware now will carry over into the next generation of IBM mainframes. Based on that, Southern Pacific has decided to upgrade from its current 3084QX to a 3090 mainframe.

Japanese government-financed research such as its fifth generation project may not have resulted in many commercial products so far, but it has encouraged some U.S. companies to coordinate research efforts themselves. One result is the four-year-old Microelectronics and Computer Technology Corp. (MCC) in Austin, Texas. MCC is a cooperative research effort between U.S. computer and electronics vendors that is focused on knowledge-based systems technology.

"In a sense," says MCC vice president Eugene Lowenthal, "we owe the Japanese a debt because their cooperative research efforts got us started thinking about combining on new architectural perspectives."

In June, NCR Corp. introduced one of the first commercial products based on an MCC research project. NCR's Design Advisor is a logic circuit design tool that employs artificial intelligence techniques borrowed from MCC's Proteus expert system project. MCC's supporters point to Design Advisor in answer to critics who say a cooperative research and development effort won't lead to significant new commercial products.

### Vendor Nationality Not Crucial

Many politicians and some industry officials voice concern over the competitiveness of the U.S. computer industry, while others question whether IS users care where their hardware and software comes from or even if the distinction between U.S. vendors and overseas vendors is valid. As a DATAMATION reader poll on competitiveness shows, the preference for buying "American-made" is very strong for nearly 40% of IS professionals.

Officials at National Advanced Systems acknowledge that, infrequently, they will lose a mainframe order because a user is philosophically opposed to buying from a foreign vendor. Far more often, says NAS senior vice president David Turner, "The guy is just out there looking for a product to solve a problem. Usually, once we sit down with him and explain our relationship with Hitachi, what we do in terms of product specification, he understands that he's doing business with us, not them [Hitachi]."

In any event, Turner says, once you add up software, maintenance, and service contracts over the five-year life of an installed product, NAS figures that 70% of the revenue generated by the product goes to NAS and parent company National Semiconductor Corp., with 30% going to Hitachi. "If you compared that figure to IBM, which sources a lot of components overseas itself, I'll bet we wouldn't be that far apart," says Turner.

Surprisingly, most U.S. vendors seem to agree with Turner. According to CDC's Powers, most users planning merely to upgrade or grow existing applications "don't really care where the products come from. They simply want to find a solution." Therefore, says Pow-

ers, "We can't afford to rest on our laurels. The basic competitiveness of many of our users is more and more directly tied to the effectiveness of their operations."

Ironically, says mainframe pioneer Gene Amdahl, that willingness on the part of users to seek out the best solution is also the best way to force IBM and other U.S. vendors to innovate. "IBM is very much concerned about its own self-interest," he says, and "in continuing to grow its revenues while maintaining its margins. IBM is not interested in getting into a technology race because that costs money and cuts profits. The best way users can stimulate innovation from IBM is to stimulate competition in the market," according to Amdahl. "At times, that may mean the best product alternatives are to be found offshore."

In the area of large-scale storage, foreign vendors—primarily the Japanese—have made more headway than they have made in the mainframe area. Nevertheless, as disk storage consultant James Porter points out, "In the large disk area, foreign competitors are still pretty much marching to IBM's tune, and IBM controls the interfaces and most of the market."

By focusing on good packaging of existing technology to produce reliable, high-performance products, plug-compatible vendors led by Fujitsu and Hitachi captured 13.3% of IBM's worldwide large storage market in 1985, according to Porter's estimate. That figure, Porter says, should grow to 17.8% this year.

Still, observers say, there's a lot IBM can do if the competition gets too close. For example, IBM recently boosted channel data transfer rates and disk storage capacities, a move which could stall the market share gains of foreign competitors.

Porter and others say that in the long term, Japanese vendors may attempt to apply lessons they've learned in the small, oem disk market to the mainframe storage market. Specifically, Hitachi and others are said to be thinking about marketing clusters of smaller, high-capacity drives that are cheaper to build in order to compete against IBM's larger storage devices that put more data under one recording head. "IBM is vulnerable to this kind of flank attack right now," Porter says, "because they've stayed too long with their current 3380 technology in order to try to squeeze more profit out of it. Undoubtedly, IBM



# There are still a few communications systems we can't connect to DEC/VAX.

Luckily, precious few. Thanks to ITT Worldbridge.<sup>SM</sup>

ITT Worldbridge is an integrated electronic messaging service that can connect your DEC VAX/VMS users to incompatible systems worldwide.

Whether these systems are IBM DISOSS, Wang VS or other VAXes.

Whether they're corporate information systems, office automation systems, private message networks, public and private electronic mail systems (including ALL-IN-1<sup>®</sup>), or the public telex network.

Best of all, ITT Worldbridge OfficeAccess<sup>SM</sup> service can do this using the VAX system you already have in place. It requires no additional programming. No special equipment.

And because many messages are switched directly from one sys-

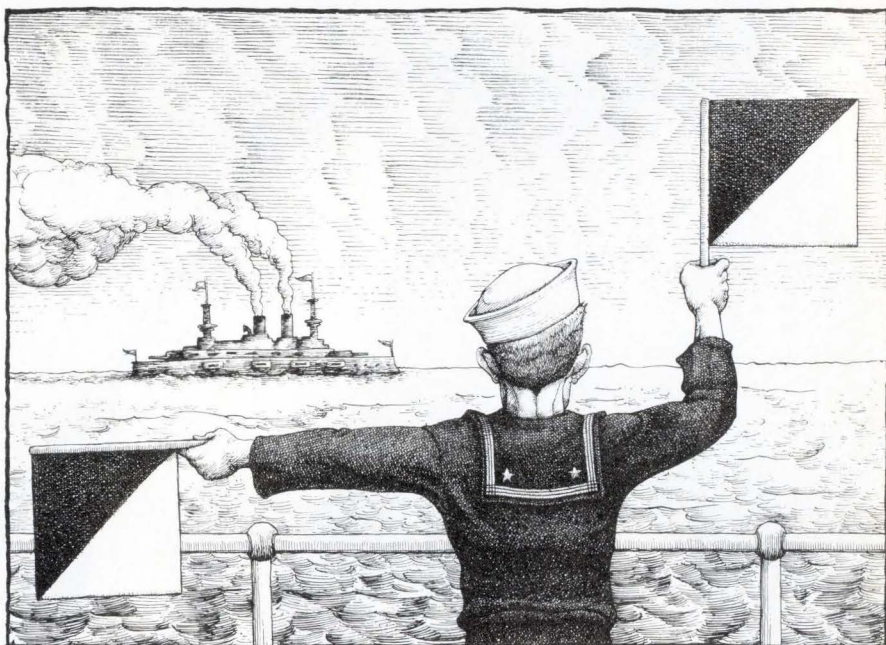

tem to another, without passing through the telex network, they can be sent and delivered at much higher speeds and without any rekeying. Equally important, at significantly lower costs.

In short, Worldbridge can increase your company's communications capabilities almost beyond measure.

But that should come as no surprise. Because from 50 baud telex, to 2.048 megabit satellite transmission, to digital packet switching, ITT Worldcom offers a spectrum of communications services to

meet the needs of any company.

To find out more about ITT Worldbridge, or arrange for a free demonstration, call us at 1-800-922-0184.

Or write: Director, ITT Worldbridge Marketing, 100 Plaza Drive, Secaucus, NJ 07096.

We may not be able to connect you to every communications system in the world. Just every one that's worth the connection.

Trademarks: DEC VAX/VMS, ALL-IN-1<sup>®</sup>—Digital Equipment Corporation. Wang and Wang VS—Wang Laboratories, Inc. IBM DISOSS—International Business Machines Corporation.

COMMUNICATIONS SERVICES VIA **ITT**





**D**iscover powerful new communications tools for business wherever Meridian\* business services are offered by your local phone company.

"Smart" phones that help you work more efficiently. Data connections that improve your information management. Communications that position your business for a future where sharing voice, data, text and image is as easy as using a phone.

**nt** northern telecom

IBM CONNECTIVITY

800 # SERVICE

EQUAL ACCESS

NETWORK

meridian

**NETWORKING**

# Behind the News

## STAFF REPORT

has pinpointed this as a hazard down the road also."

Industry observers believe that U.S. storage vendors, such as IBM and CDC, also are doing well at keeping up with research and development on key new storage technologies such as erasable optical disk drives, sputtered thin-film media, magnetoresistive recording heads, and higher-density recording technologies such as zone density recording.

According to Bill Miller, who is data storage products vice president at CDC, "We feel that we are the leader or are holding our own in many of these technologies and that we can also compete on a cost-of-manufacturing basis with the Japanese." ■



## Midrange Systems: Overseas Business Is Strong

BY GARY McWILLIAMS

To NCR Corp. president Charles Exley, competitiveness is easily measured. Exley judges his company's standing by calculating revenues from abroad. If revenues are up, NCR has improved its competitiveness.

By such a yardstick, U.S. midrange vendors are in an enviable spot. Higher sales abroad are buoying many U.S. vendors. At Digital Equipment Corp., for the quarter ended June 27, international sales rose above 50% for the first time in the company's history. Strong international revenues also boosted recent results from Wang Laboratories Inc. and Prime Computer Inc., Natick, Mass.

The sales gains have made many—

but not necessarily everyone—feel confident. Says Exley, "There is no question that competition from other than U.S. companies is increasing and [foreign suppliers] will play a role of importance in the industry. But the fact is the U.S. industry today sets the standards. As long as that remains the case, we are the strongest."

Users are equally confident. Dennis W. Pyburn, MIS director at Morton Thiokol's Ventron Division, Danvers, Mass., says, "I don't see that there is any real threat to the midrange computer; I don't see it happening." In addition, says Pyburn, use of foreign-made disk drives and other components help U.S. computer vendors increase their competitiveness.

The confidence also stems from the unique position of the midrange. In many respects, competition to U.S. vendors has come almost exclusively from Europe. Many European computer vendors have maintained low profiles or modest U.S. operations, preferring to target niche applications rather than make a broad-based push. The larger vendors, such as ICL, Nixdorf AG, and Bull, used acquisitions to gain footholds, but they too have focused on niche markets such as computer aided design, data entry, and discrete manufacturing.

### Japan Is Not a Factor

Japanese vendors, in large part reflecting their domestic market, are virtually absent from the ranks of midrange suppliers to the U.S. The Japanese lack a domestic market for the class of 32-bit computers that make up the midrange. Analysts say computer suppliers Fujitsu, NEC, and Hitachi traditionally are loath to use a market as important as the U.S. to test unproven products.

Despite the lack of a strong local market, the Japanese shouldn't be counted out. The strong position of U.S. suppliers today doesn't necessarily mean it will always be so. "There is nothing unique about the midrange that the Japanese can't do," says Joseph A. Boyd, chairman of Harris Corp., Melbourne, Fla., and a member of the President's Export Council. "They just haven't gotten around to concentrating on it yet."

The sentiment that the midrange will remain a U.S. preserve because it always has been one is widespread among users. "When I look at hardware and software I don't look at whether it's U.S. or non-U.S. made; I look at risk and opportunities," says Morton Thiokol's Py-

burn, who manages an IBM System/38 and DEC VAX computer shop. "To do otherwise would be unfair of me as an MIS director. My role is to get the most cost-effective solution to a business problem. If that means an NEC drive, so be it."

The same is true elsewhere. Says James Welbourne, director of information resources at Crowe, Chizek & Co., a South Bend, Ind., CPA firm and DEC VAX user, "The majority of our equipment, except printers, is [supplied by] U.S. vendors."

### Slight Preference for U.S. Goods

While agreeing that a strong U.S. computer industry is important to users, Welbourne believes that "the industry shouldn't get a free ride because competition is coming in." He says the nationality of a manufacturer has a minor impact on his purchases. "I look at the product—what it will provide and the cost—not the manufacturer," he says. "If I had two pieces of equipment, one U.S. and the other foreign, and they were equal functionally, I'd be willing to pay a little more for the U.S.-manufactured product. A little more—not a great deal more."

The practice is one that most U.S. vendors also espouse. Harris's Boyd says, "We used to be one of the nation's largest exporters; today, we're one of the nation's largest importers. We don't have any choice as a company. But as individuals we have to understand where it's going."

Boyd argues that competition in its larger context will not have much of an impact on users. While midrange systems may be a stronghold, competition in adjacent markets will affect what happens in the midrange. He says, "There is a theory of comparative advantage that says, 'We'll do those things we do best and they'll do the things they do best.' The trouble is, they can do everything we can do. The Asian rim countries have learned to do the things that we do best. The best example is semiconductors. Some people say let them go; well, that brings up the next question: can we afford to let everything go?"

"The free world depends on America as its real basis. We support the free world economically; we absorb the products; we support Europe and NATO. If we lose the ability to do that, and the center of power shifts to Russia, Japan, or somewhere else, then Americans are going to have to suffer more than anybody has stopped to think about." ■

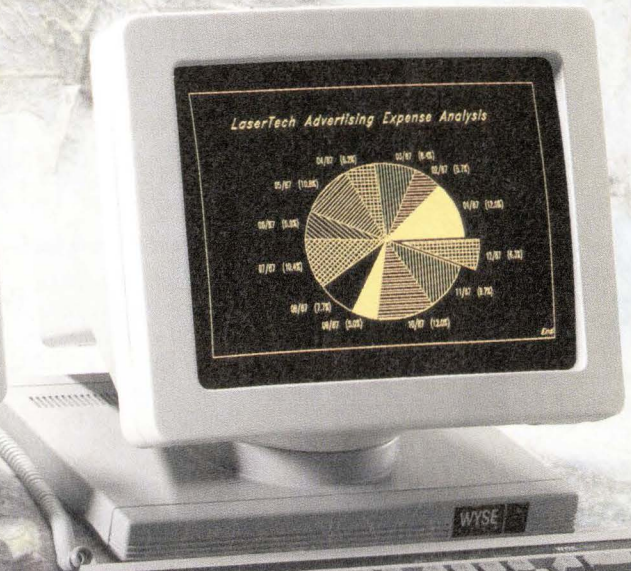
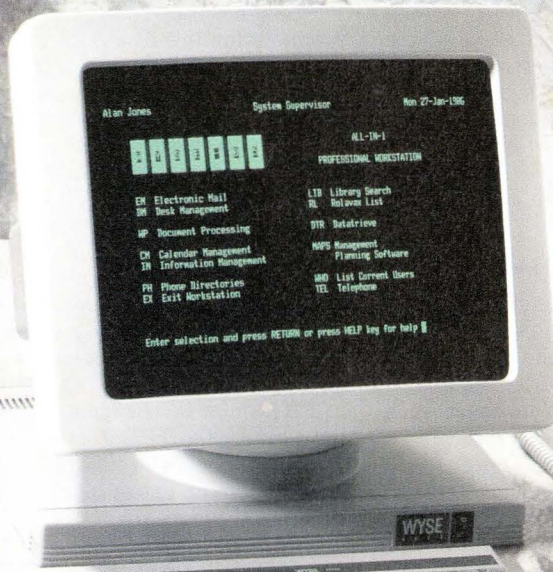

# Now the best seller comes in an illustrated edition.

With the WY-85 at left, Wyse authored the best selling alternative to DEC's VT-220. It's fully compatible with the VT-220, but loaded with features that make it even more compatible with the people who use it.

Like a larger 14" screen. Tilt and swivel base. An easier set-up mode.

And while our keyboard is identical to DEC's in layout, they can't touch our touch.

Our new WY-99GT at right further illustrates Wyse's continuing drive to improve on a standard. It features the same advantages as the WY-85. Plus graphics, with full Tektronix 4010/4014 compatibility, and high resolution characters.

Our dual resolution mode lets you retain full VT-220 compatibility and shift from DEC resolution to hi res.

And there's a happy ending. The WY-85 is just \$599, the WY-99GT \$649. Both are made, serviced, and supported by the company that ships more terminals than anyone but IBM.\*

Wyse. When it comes to quality and value in terminals, we wrote the book. For more information, call 1-800-GET-WYSE.

## WYSE

We make it better, or we just don't make it.

Trademarks / Owners: Wyse, WY-85, WY-99GT / Wyse Technology; DEC, VT-220 / Digital Equipment Corporation; Tektronix, 4010, 4014 / Tektronix. Screen image on WY-99GT created using Cognos Power House. © IDC 1986 U.S. Terminal Census.

## STAFF REPORT

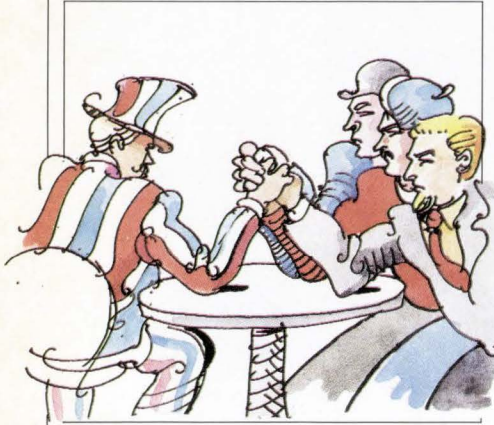

### Communications: The Challenge Is Europe

BY SUSAN KERR

The U.S. leads the world in an important facet of the communications industry—software—and that's not expected to change during the coming years. Two weak spots exist for American communications vendors, however. One is hardware manufacturing, which in many cases has been conceded to the Far East countries. The other is European vendors' potential to take advantage of upcoming changes in the European Economic Community, which could result in a challenge to U.S. companies.

According to the leading players, the U.S. has a comfortable lead in the essentially unregulated local area network industry, but a less clear-cut role in the wide area network realm.

Ralph Ungermann, the head of networking leader Ungermann-Bass Inc., Santa Clara, says the reason for the lead is that "hardware development is a very well-defined process and software is still more of an art, where individual contributions are more critical. In hardware, it's more of a team effort. Cultural differences lead to this, and I don't see any shift in the near future."

As hardware becomes better defined and more cheaply produced, added value—i.e., software—becomes more important. Ungermann gives the example of "translating information from an IBM database to use in a Lotus 1-2-3 format. That's well tuned to U.S. capabilities."

French-born Bernard Guidon, group marketing manager of Hewlett-Packard's Information Networks Group,

and still a French citizen, counters that it's not so much that Americans are more creative than others. "On average," he says, "the European people are more creative, but don't know how to industrialize. . . . In Europe, because of the structure, it's such a pain in the neck to put a company together."

#### Plenty of Venture Capital Available

Startups are certainly a U.S. specialty, particularly in Guidon's new home of Silicon Valley. Despite the cries that venture capital has all but dried up, Richard Shaffer, head of New York-based Technologic Partners, which tracks venture funding, believes there's plenty of money out there. Telecommunications, in particular, is a hot investment. Of 17 computer industry sectors receiving funding, telecommunications jumped to second place in 1986 from fifth place in 1985, with an almost 50% increase in dollars to \$168.4 million (computer systems remained number one, but total dollars invested in systems fell dramatically, to \$187.3 million from \$212.6 million).

Once formed, communications companies spend a great deal on research and development. Many of the relatively mature communications vendors spend between 10% and 15% on R&D, higher than the average spent by many systems companies.

Though many mergers and acquisitions are taking place in the U.S., innovation won't die, say vendors at some of the bigger concerns; if someone has a good idea that's not finding a home, he or she can still find capital.

But do users buy based on whether or not equipment is American born and bred? "From a company standpoint, I'd say yes, right now it matters to a reasonable degree," says Ray Pardo, manager of information services at Bechtel Eastern Power Corp., Gaithersburg, Md., and an active member of the Corporation for Open Systems.

Still, Pardo has noticed that in the past 12 months more Japanese and European communications vendors are knocking on his door. "A couple of Europeans are coming in with pretty decent PBX gear, and we're seeing the Japanese more in the data modem area," he says. Pardo, however, backs the commonly held vendor assessment that Americans are ahead in the LAN industry. "It's a very young technology, changing very rapidly, which makes it hard to target."

American vendors tend to make

products for the American market. "If you look at the way most U.S. manufacturers develop product," says Bob Reed, international sales vice president for Alpharetta, Ga.-based Digital Communications Associates Inc.'s micro-to-mainframe product lines, "they build it to U.S. requirements and try to convince the world they want it." One explanation may be that it's tough to get certain communications products approved outside the U.S. The European countries in particular have different regulations for gear such as modems.

This may be changing, however. In the early 1990s, the European Economic Community hopes to build one set of regulations for the entire block of nations. American vendors are looking forward to this event, believing that U.S. equipment will do well. T1 multiplexors, for example, are seen as a product type in which U.S. companies are way ahead technically. T1 muxes are a booming business in the U.S., says Reed, but otherwise they are "really just in England and Australia." Because of the PTTs controlling grip in individual European countries, Reed adds, "By the time these countries open up to provide these services, only American countries will know how to do it." The sheer size of the U.S. has led to a competitive advantage, points out Carol Barret, Reed's counterpart at DCA's network communications product group. "The U.S.," Barret says, "has greater requirements in networking because U.S. companies have nationwide networks thousands of miles long."

#### Europe Ahead in ISDN and MAP

In telecommunications that are more established—particularly voice networks and gear such as PBXs—the U.S. is in the lead, HP's Guidon agrees. Because of that, however, European startups have had to look at new technologies with which to make a mark. For example, he says, Europe is ahead in implementing ISDN and MAP.

If Europe actually does succeed in putting together one suite of regulations across boundaries, Guidon warns, "It could work both ways. European companies could work as a block. Also, U.S. companies could compete across Europe and I'm sure some will do so. I believe that, at first, U.S. companies will have the advantage. It'll get much tougher."

Strangely enough, despite all the trade bill hoopla, U.S. vendors seem not to fear the Japanese to any large extent.

we never  
stop  
asking

"What if..."



*HP LaserJet  
Series II Printer*

For 600 titles of software,  
this is the hardware.

Over 600 software products have been tailored specifically for HP's industry standard Printer Command Language.

With PCL, you can do even more

with the LaserJet Series II Printer.

From simple memos to sophisticated text and graphics.

And, with expandable memory, 300 DPI full-page graphics.

No wonder more people choose Hewlett-Packard over all other laser printers combined.

For your local dealer or a brochure, call 1 800 752-0900, Ext. 900C.



**HEWLETT  
PACKARD**

Circle #29 on Reader Service Card

# Behind the News

## STAFF REPORT

Companies such as DCA and Ungermann-Bass also say that there are no real restrictions to selling in Japan. "Japan is a very assimilating country," says Ungermann.

In turn, Japanese vendors have had little success selling networking solutions in the U.S. because of the software and service issues. One technology in which the Japanese may have an edge, Ungermann notes, is optical fiber.

There is one cultural affliction common to the U.S. user base that is not always present elsewhere, says DCA's Reed. "The biggest problem going into Japan and even into West Germany is that they believe their country turns out the best product. On the other side is the U.S. We don't have the same loyalty sentiment at home." ■

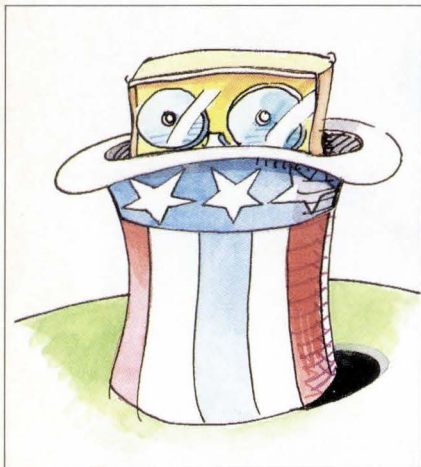

## Microcomputers: PS/2 Will Widen the Lead

BY JEFF MOAD

The combined effect of large users shifting to IBM's new PS/2 and of ongoing U.S. government trade sanctions against Japanese pc vendors should serve to reverse what in recent years have been major microcomputer market share gains by non-U.S. vendors.

Research firm Dataquest Inc. of San Jose, expects that in 1987, U.S. vendors actually will begin to regain worldwide market share from Western European, Japanese, and other Asian producers that made strong moves into the market in the early 1980s with the establishment of the open IBM/Microsoft MS/DOS 8088 pc standard.

Dataquest predicts that U.S. ven-

dors, led by IBM and Apple, will claim 62% of the worldwide market of 17.2 million pcs sold in 1987, up from the 58.7% that U.S. vendors controlled in 1986. At the same time, Western European vendors will see their market share slip to 10.2% in 1987 from 14.5% in 1986, and Japanese vendors' share will drop to 19.5% from 20.7% over the same period.

A similar pattern is expected to carry into 1988, predicts Dataquest analyst Bill Lempeis. "Market share gains by non-U.S. manufacturers basically have come to a stop," he says. "In 1987, that has a lot to do with the trade sanctions against the Japanese. In 1988, we'll start to see the impact of the PS/2."

One of the PS/2's principal charms for IBM is that it will give the company a chance to set its PC offerings apart from the competition, not just in terms of functionality but also connectivity into IBM's general product line. Key new hardware features are the PS/2's faster internal microchannel and a more powerful graphics processing card.

### An Earlier Strategy Repeated

On the software side, IBM has borrowed a page from its long-standing mainframe market strategy by attempting to take control of the PS/2 operating system. Initially, the PS/2's OS/2 operating system will include new user and programming interfaces that eventually will become standard up and down IBM's product line via its Systems Application Architecture efforts. Later, with the shipment of an extended version of OS/2 with proprietary features such as integrated database management, IBM will continue to make it difficult for other vendors to keep up.

As a result, observers are predicting market share gains for IBM this year and next, particularly among large corporate pc users. A recent report on IBM by New York research house Sanford C. Bernstein & Co. Inc. predicts that several U.S. vendors such as Compaq and Zenith will be most successful in keeping competitive with PS/2 because of their strong development resources and installed user bases. Offshore vendors such as Daewoo, Samsung, and Blue Chip, with less development experience and less user loyalty, will fall between one and two years behind IBM and the others. The report predicts, "The smaller companies will probably be forced out of the mainstream pc market . . . while many of the third-tier clones relying on

reverse engineering are likely to go out of business."

On the technical and engineering side of the microcomputer market, U.S. vendors continue to compete primarily with one another, with little or no competition coming from non-U.S. vendors. Digital Equipment Corp. has been able to retain its strength in the market by driving its popular VAX architecture down to the desktop level with the MicroVAX II line. Smaller U.S. technical microcomputer vendors such as Sun Microsystems Inc., Mountain View, Calif., and Apollo Computer Inc., Chelmsford, Mass., have kept potential offshore competitors out by continually improving the price/performance characteristics of their products. Most recently, Sun unveiled an internally developed RISC-based microprocessor that the company claims will operate at up to 10MIPS—the equivalent of 10 VAX 11/780s. ■

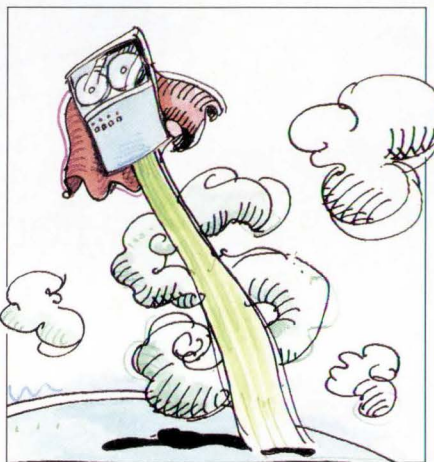

## Supercomputers: Pricing, Market Access Are Key

BY KAREN GULLO

With the exception of semiconductors, no other technology today provokes as much debate about competitiveness as supercomputers. The U.S. and Japan have been embroiled in trade disputes concerning market access and predatory pricing for the last year-and-a-half. The two countries reached an accord in August that promises to open the Japanese public sector market to U.S. vendors, which may quiet the protests, at least for a while. But pricing—which is at the core of the debate—has yet to be addressed



# AMPLIFY THE SIGNAL FROM YOUR COMMUNICATIONS DATA

**UNIRAS GRAPHICS  
SOFTWARE DISPLAYS  
YOUR DATA WITH  
THE ACCURACY AND  
IMPACT YOU  
REQUIRE TO MAKE  
DECISIONS FASTER.**

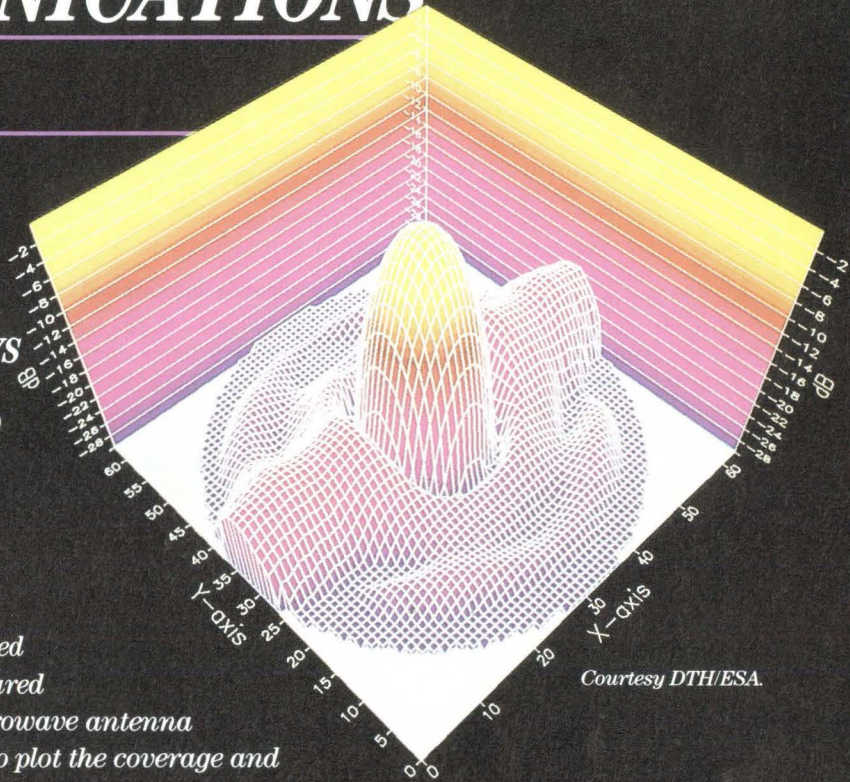

Courtesy DTH/ESA.

*UNIRAS software was used to display this 3D contoured representation of a microwave antenna radiation pattern, and to plot the coverage and interference between two stations in a mobile telephone network.*

*UNIRAS' graphics range from simple monochromatic XY plots to complex 3D and 4D color shaded models. For presentations, or as a permanent record, any display can be hard copied in the form of high quality plots, overheads and slides.*

Courtesy Televerket Radio, Stockholm

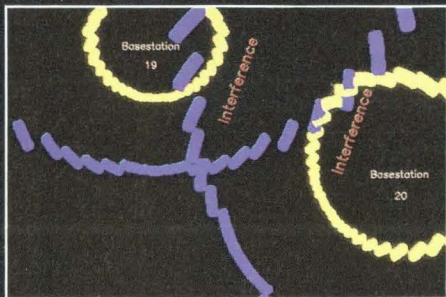

*UNIRAS makes its software available in two forms to benefit different user groups. Interactive, user-friendly packages enable non-specialists to apply the extensive facilities quickly and easily, while the wide range of subroutines provide the professional programmer with an impressive choice of tools*

*for integrating color graphics with new and existing applications.*

*UNIRAS software runs on most mainframes, minicomputers and workstations, plus the IBM PC/AT. It supports the many graphics terminals and hardcopy devices at work on over 1,000 computers worldwide.*

*Call us today and let us show you how UNIRAS software can help you analyze data, interpret trends and make those critical decisions.*

**Copenhagen (01) 67 22 88**  
**Dusseldorf (0211) 596 1017**  
**London (0753) 79293**  
**Paris (01) 4225 3314**  
**Dallas (214) 980 1600**  
**Boston (617) 272 7260**  
**Chicago (312) 576 0055**  
**Los Angeles (818) 407 1711**

Circle #30 on Reader Service Card

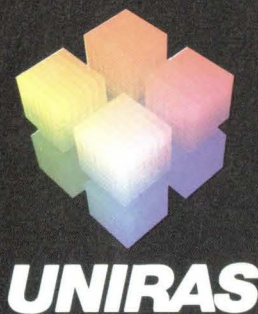

## Behind the News

and will surely emerge as an issue again in the future.

Early this year, reports from Washington, D.C., were that Japan's vice chief of the Ministry of International Trade and Industry (MITI) had targeted the supercomputer industry for Japanese dominance and said that Japan would never buy a U.S. supercomputer. This supported, in the eyes of many observers, U.S. manufacturers' claims that Japanese procurement practices essentially lock them out of the Japanese public sector supercomputer market. To date, no Japanese universities or government agencies have acquired a supercomputer made in the U.S.

The dispute, however, goes back even further, to April 1986, when the installation of a discounted NEC Corp. supercomputer (the only Japanese installation in the U.S.) at the Houston Area Research Center (HARC) sparked an investigation by the International Trade Commission of possible dumping violations. The investigation found no evi-

dence of dumping.

The waters have been calmed by the new accord and by hints that Japan will soon purchase a supercomputer from a U.S. manufacturer, but the pricing issue continues to smolder. Reports that the Japanese are offering deeply discounted machines to U.S. universities provide the most recent example that the debate drags on.

### Scientific and National Defense Issues

There's no question that U.S. manufacturers dominate the world market for supercomputers. Minneapolis-based Cray Research Inc. has installed 70% of the world's supercomputers. The three Japanese supercomputer manufacturers, NEC, Hitachi, and Fujitsu, along with Control Data Corp./ETA Systems, have installed the rest (the majority of the Japanese machines are installed in Japan).

Despite the U.S.'s comfortable lead, supercomputers are the focus of high-tech trade tensions with Japan, for a couple of very good reasons. First, super-

computers are a strategic research tool in the advancement of science. Whether you're talking about the makeup of galaxies, weather prediction, or the airflow over a plane's wing, supercomputers are vital tools that allow scientists to tackle highly complex problems. Moreover, having moved out of government research labs and into the commercial/industrial sector (supercomputers are used for design and simulation in such industries as automotive and aerospace) they also serve as a productivity tool.

"Supercomputers enable us to advance the kind of science that's essential for our economic well-being," says Frank Baily, manager of the Numerical Aerodynamics Simulation Systems Division at the NASA Ames Research Center, Moffet Field, Calif. "People tend to focus on the balance of trade in supercomputers. What's more important is the balance of supercomputers as a tool. We've got the advantage there and we can't let that get out of our grasp."

Second, and probably more impor-

# BENCH WARMERS.



We'd be glad to tell you how fast the SCS-40 is.

But we'd rather have someone else tell you.

Like the Argonne National Laboratory. Which tested the SCS-40 from Scientific Computer Systems against other

computers in the LINPACK Benchmark.\*

The results? The SCS-40 performed faster than any computer on this page.

And while they're all in the same price range, the SCS-40 can't be beat when it comes to

price/performance.

Performance that starts with a 64-bit system offering 44 MFLOPS peak vector and 18 MIPS scalar performance. 128 megaword (1 gigabyte) main memory. Independent high-speed bus structures for

\*Published by Jack J. Dongarra, June 1, 1987, LINPACK 300x300 Benchmark. Cray X-MP is a registered trademark of Cray Research, Inc. SCS and SCS-40 are trademarks of Scientific Computer Systems Corp. ©1987 Scientific Computer Systems Corp.

tant, is the role supercomputers play in national defense. Supercomputers are crucial to the development and testing of the Strategic Defense Initiative. They are used to develop and decipher codes, to simulate battles, and to design the latest fighter jets. Put simply, "Supercomputers are essential to national security and the state of the nation," says Marcelo Gumucio, executive vice president of marketing at Cray.

Given the sensitive role that supercomputers play, government and computer industry officials say the U.S. must retain its dominant position in the market. The U.S. has won the first round of competition, says Jack Worlton, laboratory fellow and former head of the computing division at Los Alamos National Laboratory. "Cray has won, because it's maintained its market share [over the last three years]," Worlton told a group of analysts this spring. "It's the longer term that is the threat. The next round will be what happens in the next three years."

There are a number of factors working in the U.S.'s favor. The Japanese will have a hard time catching up to the U.S. in technology when it comes to compatibility and software development. Large market share is self-perpetuating; those supercomputer users who have invested in Cray X-MPs and Cray-2s, and have spent time and money writing software for those systems, are certainly likely customers for Cray's future products, the first of which is due out next year. Furthermore, Cray's multiprocessor design is basically an architectural standard in the supercomputer world.

Cray's most formidable competitor, Honeywell NEC Supercomputers Inc., a 50-50 joint venture formed in Fall 1986, offers a very powerful single-processor vector and scalar machine. Its SX 2 is recognized as the fastest single-processor system now on the market, performing better than even the Cray-2 under some conditions. However, the SX 2 is software poor, with very little commercial software available.

Cray's next offerings are a follow-on to the X-MP family called the Y-MP, and the Cray-3. Peak performance of the Y-MP, to be released next year, is estimated at 3GFLOPS; for the Cray-3, scheduled to be introduced in 1989, it's 10GFLOPS, outdistancing the SX 2 (on a multiprocessor basis).

The supercomputer market will become more interesting as new players—American, European, and Japanese—enter the fray. New U.S. companies, such as Chopp Computer Corp., San Diego, are readying products. European supercomputer development based on Transputer technology is also on the horizon.

#### Steps the Japanese Could Take

There are two things the Japanese could do to increase their competitiveness, says Worlton. They could switch gears and move quickly into multiprocessor architectures and/or more advanced parallel processing architectures (some analysts believe Japanese companies are already doing just that). "Or they will use

# BENCHMARK.

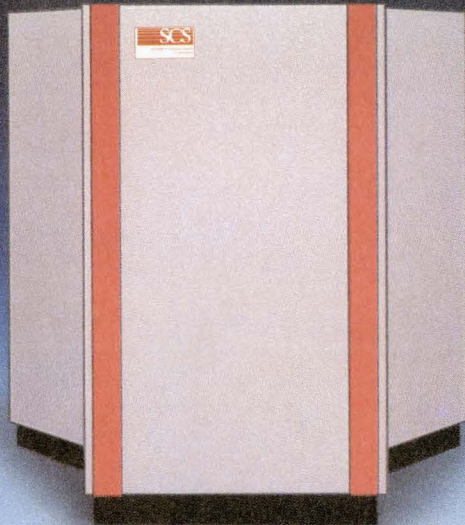

throughput of greater than 1 gigabyte per second. And a VME-based open I/O architecture that connects the SCS-40 to high-speed peripherals and networks.

All with an instruction set and software compatible with

the Cray X-MP. Not to mention a wide range of Cray-compatible applications programs with near-Cray performance.

So if you're looking for a computer that can handle your

numerically-intensive applications without a numerically-intensive price, look to the SCS-40.

Because anything else is simply second string.



THE POWER YOU NEED  
FOR THE WAY YOU WORK.

Scientific Computer Systems Corp., 10180 Barnes Canyon Road, San Diego, California 92121, (619) 546-1212

Circle #31 on Reader Service Card

## Behind the News

their financial latitude to price Cray out of the market," says Worlton.

Again, the issue of price is at the forefront. There's already evidence to suggest that attacking U.S. manufacturers by cutting prices is Japan's short-term strategy. It's an advantage that U.S. companies don't have. NEC, Fujitsu, and Hitachi are financial giants compared to Cray, and they have the economic girth to support the discounting of supercomputers. Fujitsu finished first and NEC second in DATAMATION's list of the top 10 Japanese IS companies, with Hitachi coming in fourth. Those three companies have revenues of \$6.5 billion, \$6.3 billion, and \$4.7 billion, respectively. Cray's revenues last year were \$597 million. Cray's Gumucio says the company will not discount supercomputers because of its belief that systems should be judged on the basis of their performance. It's obvious, however, that the company can't very well afford to start discounting products—especially now. Last year, Cray's average system value slid to \$13 million

from \$15 million, due partly to customers delaying purchases in anticipation of new machines and partly to competitive pressures from U.S. minisupercomputer makers.

The U.S.'s ability to maintain its leadership position in the future will be affected by other factors. U.S. dependence on Japanese semiconductors puts the country at a distinct disadvantage, says Lloyd Thorndyke, president of ETA Systems, Minneapolis. The Japanese will be producing more and more advanced chips in the coming years, and the fear is that they will save the best for themselves or that only after they have built more powerful computers with those chips will they make them available to U.S. manufacturers.

Central to this issue is the heavy role that government funding plays in Japanese industry. R&D projects funded by MITI—in gallium arsenide chips, advanced ECL logic, parallel processing, artificial intelligence, and new architectures—are going on right now at several

major Japanese computer manufacturers. Government-funded and/or defense-funded research projects exist in the U.S. as well, but not in as great a number.

"Japan is not market driven, it's partnership driven," says Worlton. "It's a myth to think that they are market driven."

Government funding of semiconductor consortiums such as Sematech should be accelerated in order for the U.S. to stay competitive, say observers. "We are willing to work with the government," says Grant Dove, chairman of Microelectronics and Computer Technology Corp., the Austin, Texas-based research consortium. "We are in discussions with the U.S. government for support in our projects. We think it would make sense to take advantage of government funding in the areas where it makes sense for our members. But," Dove adds, "we don't think it will be a major source of funding."

The National Security Agency has



set up a center for supercomputer research and is reported to be pumping \$20 million a year into it. The effort began because NSA says that advances in supercomputers are developing too slowly to meet the agency's needs. The center is developing supercomputers for use in defense work. Many scientists, including David Kuck, the noted supercomputer architect at the University of Illinois in Champaign, say the government and the supercomputer industry would have been better off if NSA had funded several university-based and industry-based projects instead of setting up its own center.

In other areas, American manufacturers have complained that strict export licensing requirements have crippled their efforts to compete for customers in Europe and East Asia. It can take between 140 and 300 days to acquire an export license, says Cray's Gumucio—enough time for the Japanese to move in. Government officials acknowledge that acquiring export licenses takes time and

that export controls in general are an issue in the computer industry. "Some Department of Defense officials are becoming more concerned with the issue of trade as opposed to security," says Fred Weingarten, manager of the communications and information technologies program at the federal Office of Technology Assessment. "But I don't see the issue being solved very soon."

In the short term, American dominance in supercomputing seems secure, but the long-term situation is uncertain. The next few years will see more and more customers around the globe buying supercomputers from the Japanese, including some in the U.S. The opening of markets to foreign competitors is a two-way street, points out Jim Berrett, chairman and ceo of Honeywell NEC. "Twenty-five percent of all supercomputers installed [in the private sector] in Japan are from U.S. companies. There's one Japanese supercomputer installed in the U.S. out of over 100 installations," he says. "Protectionism is a growing problem

here. If you want things to change, it must go in both directions. You have to put the shoe on the opposite foot."

Though it's politically unpopular to buy a Japanese supercomputer these days, money talks and there are plenty of university scientists without much of it who want supercomputers. As for the well-moneyed, if the Japanese, with the help of their own R&D efforts and advanced chips, made supercomputers that were faster and better than those made by American vendors, would NASA, for instance, buy them? Yes, says an official at the space agency's Numerical Aerodynamics Simulation Systems Division who requested anonymity. "We are interested in getting the fastest computing power available, regardless of who makes it," the official says. Realistically, any government agency or lab contemplating such an acquisition would encounter political pressure. Says Victor Peterson, director of aerophysics at NASA, "We hope we won't have to cross that bridge." ■

## Control the variables and enhance the power in your 3270 network.

Your 3270 environment is changing, encompassing intelligent as well as non-intelligent devices. To achieve the degree of connectivity and enhanced capabilities you need, you've got to have a control unit that's more powerful and flexible. You need a Telex control unit.

With a Telex controller, you can connect LANs, ASCII hosts and devices, 3270 products, intelligent workstations and more. You can even add windowing and multi-session

capability to low-end IBM and compatible terminals.

Compatibility, flexibility and capability—these are the hallmarks of a Telex control unit. Telex helps you protect your past investment in hardware while you evolve with the new 3270 technologies. For more information about controlling the variables in your 3270 network, call Telex. USA: 1-800-331-

2623, ext. 4530 (Oklahoma,

1-918-624-4530). CANADA:

1-800-268-3233.

WORLD TRADE:

1-617-769-8000.



# TELEX

TELEX COMPUTER PRODUCTS, INC.

Circle #32 on Reader Service Card

In many industries, doing business is becoming an international networking game. Running a worldwide network isn't easy though. Unless corporate network managers understand the rules of going global, the network could turn out to be a very expensive disaster.

# The Golden Rules of Global Networking



**T**BY GEOFF WIGGIN  
he growth in global industries, particularly in finance, transportation, and manufacturing, has presented corporations with great challenges in setting up successful communications links. Those challenges must be met if companies are to improve the management of their international operations and provide enhanced services. Setting up an international network, however, is not easy. It is essential that corporations understand the golden rules of global networking, since international business is fast becoming a networking game.

The network budget for multinationals represents a major investment of strategic importance. The decision to set up a global network must rest on solid business reasons; otherwise, there is no point to the strategy. Those business reasons can be identified by working out what the network will be used for, how the applications can benefit the corporation, and where the company is headed. The installation of each new access node must be based on an analysis of cost versus anticipated traffic.

In most firms, initially, the net will connect international sites and offices. Ultimately, it may link these sites to the firm's trading partners—agents, suppli-

ers, and customers. That means it has to be a true multiuser network supporting different computing hardware and carrying a wide range of information, with a great diversity of transmission sizes, transmission frequency, and "value" or "importance" of content.

The underlying applications will be equally diverse, but fall into three main categories:

- *Batch transfers between major sites.* This usually includes financial reports, orders from distribution sites to factories or central warehouses, CAD and similar design information from design offices to factories, and feedback on sales, product quality, and customer and supplier performance. In each case, the source and destination of the material are fixed. Volumes tend to be high and transfers are regular, often scheduled.

- *Interactive consultation with central databases or application programs.* This includes user requests for information, perhaps on prices or stock quantities or shipping schedules, updating central files to record new sales and orders, the completion of safety checks, and so on.

- *Messaging systems.* This includes electronic mail for direct communication between people at different sites, often in different countries. This type of application will also cover electronic data interchange (EDI), which links the company and its trading partners.

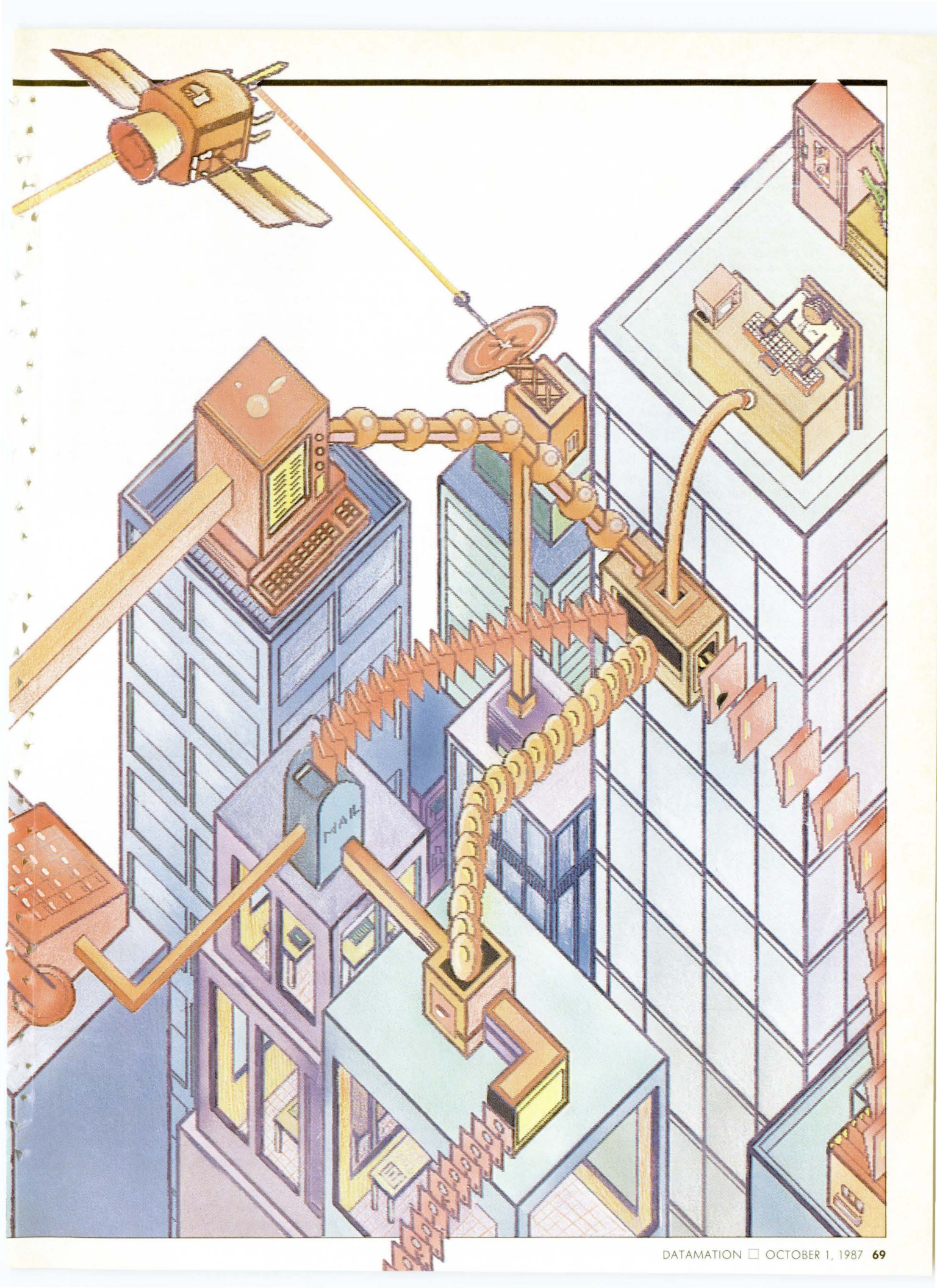

Batch transfers and, to a lesser extent, inquiry systems are the more traditional communications activities. The third type, messaging, is relatively new and it is growing rapidly. The network must be able to handle the random volumes and routing of traffic that messaging applications require. With batch transfers and interactive database access, either one or both ends of the communication is known. With messaging systems, the sender usually has no idea of the location of the recipient, and network managers are unable to predict anything much more than a tendency for traffic to grow . . . and grow.

The following rules cover only the basic concerns of setting up a global network. If a corporation doesn't abide by these rules, then its networking effort at best will be only partially successful; at worse, it will be a very expensive disaster.

*Reach Out to the Users.* The network must clearly reach out to every user. For the multinational corporation, this means

**USER SUPPORT  
MUST BE PROVIDED ON A  
LOCAL, FACE-  
TO-FACE  
BASIS.**

most countries in the developed world and a growing number of developing nations.

Networks are expensive to deploy, so there will be an element of compromise between internal and external network links. Users have demands and network managers must arrange links with public data networks and perhaps the international telex network to provide service in areas they are unable to link up quickly or directly.

As more devices are connected, and more users join in electronic mail and EDI communities, the network must expand its capacity in two ways. There must be an adequate number of access ports, so users can get into the network when they need to, and there must be enough capacity to handle increasing volumes.

Thousands of electronic mail users will require their incoming mail at 9 a.m. on workday mornings, and will then make but sporadic use of the network for the remainder of the day. The interactive users will be busy during much of the working day, while the batch users possibly will be more active before and after normal office hours. Their port requirements are different, and network managers must understand this and provide equally good service for everyone. Fortunately, e-mail and interactive users tend to be clustered into office buildings, so that by extending the network to a multiplexor in the building and hardwiring the terminals to the multiplexor, the need for huge numbers of dial-in ports can be controlled.

The second aspect of capacity covers the volume of material to be moved from node to node. The very existence of the network will enable corporate communications to flow sideways through the organization rather than predominantly up and down. The network suddenly has to cope with unplanned and sometimes unforeseen information flows that may dwarf the volumes of conventional information traffic.

*Establish a People Network.* Global network users speak different languages, their working hours are different, and they probably know nothing about computers. A fairly typical new user works in a small office and is introduced to the network by a memo or telex from his corporate hierarchy that says, "Here's your user ID and password. Have fun."

They won't. Users need advice on the choice of terminal or on the communications hardware and software required for their existing device. They need to be shown, or at least told, how to access the network, how to drive whatever application they are expected to use, and what to do when things go wrong. From time to time they will hit snags and will require advice and reassurance. This user support is needed locally and preferably should be through face-to-face contact.

It is not practical for the corporate network team to offer this level of support. They do not know the local regulatory environment—for example, some telephone authorities have monopolies on the supply of modems. The corporate team does not know what equipment will work in each country, which is the best value for the money, or how it will connect to the local access node. They do



## The Seven Golden Rules

not speak the language and will often be asleep when the user gets to the office.

Thus, support must be local and can only be supplied by a people network that understands the problems. In many cases, unless this type of support is made available right from the start, a new application is likely to be a complete failure. For many networked applications, the installation process—getting terminals to work and familiarizing the staff with its new duties—is more onerous than designing and writing the underlying software. A smooth installation is also more important to the success of the project as a whole and is utterly reliant on local network support staff.

*Find Friends in the PTTs.* The people network, in fact, has two tasks. The second is the support of the network itself.

When a new node is planned in a foreign country, the local team must ensure that those plans conform to local regulations. They have to negotiate for operating licenses and circuits with the local PTT, working in the language and according to the customs of the country concerned. Such negotiations often have an educational aspect, because PTT officials and engineers may be involved in an international network for the first time and they may not be able to answer apparently simple questions. Negotiators who are aware of the rules in comparable countries may be able to help shape the telecommunications policy of the new host country. This implies staff of a very special nature; there are few of them around.

PTT regulations don't cover only the physical network, but also the applications running on it. Once again, the network support staff is in the best position to become acquainted with new or modified regulations, and to ensure that everyone is informed.

Once the network is set up and running . . . it will break down. The local support staff then has to pinpoint the fault and persuade the PTT engineers to repair anything under their jurisdiction.

In all these areas, it is a clear advantage if the network staff can establish good working relations with the local PTT management and engineers.

*Success is the Ability to Cope with Failure.* When a network is set up, users expect to be able to press a button and



# BUY THE NUMBERS.

There's only one way to make sure that you're buying a genuinely high-performance system and that's to evaluate the competition by the real numbers.

And when you compare Tandon's numbers against our major competition there's no doubt who's really selling the systems of the future.

	TARGA 20	PS/2 MODEL 30	TARGA 40 PLUS	PS/2 MODEL 50
<b>1</b> PROCESSOR:	80286 6/8 Mhz dual speed	8086 8 Mhz	80286 8/10 Mhz dual speed	80286 10 Mhz
<b>2</b> MEMORY: Standard Memory Management	1 MB Yes	640 KB No	1 MB Yes	1 MB No
<b>3</b> DISK STORAGE: Capacity Effective access time	20 MB 85 ms	20 MB 85 ms	40 MB 35 ms	20 MB 85 ms
<b>4</b> COMPATIBILITY: 5¼" floppy Runs OS/2	Yes Yes	No No	Yes Yes	No Yes
<b>5</b> PRICE:	\$1,999	\$2,295	\$2,995	\$3,595

Take the excitingly priced Targa 20. Thanks to its powerful 80286 processor it dramatically outperforms the PS/2 model 30. And it supports Microsoft's OS/2, the operating system standard of the future.

Or put the Targa 40 up against their PS/2 model 50. Double the storage capacity, innovative disk cache technology, and a Tandon

low price.

So whether you need a powerful system to help you manage your business, or else a high-performance file server at the heart of your network, the Tandon Targa is the ideal fit.

For more details on the powerful Tandon Targa family call: National 1-800-556-1234 ext. 171, California 1-800-441-2345 ext. 171.



## Tandon

Please send me your Tandon Fact Pac,  
a comprehensive set of literature and product reviews:

Name \_\_\_\_\_  
Company \_\_\_\_\_  
Address \_\_\_\_\_  
City/State/Zip \_\_\_\_\_  
Telephone \_\_\_\_\_

Tandon Computer Corporation  
405 Science Drive  
Moorpark, CA 93021  
(805) 378-6104

DATA10/11

PS/2 and OS/2 are registered trademarks of IBM Corporation. Microsoft Windows is a registered trademark of Microsoft Corporation. Prices displayed do not include monitor.

Circle #33 on Reader Service Card

connect to wherever or whatever they want. The network must be ready and waiting.

Network managers need to satisfy this expectation and make every effort to ensure that the network will be available 24 hours of every day. That's almost impossible, but it is a worthwhile goal and often involves a large "invisible" investment. For a reliable network this means duplicating or even triplicating every communications link, ensuring that the secondary links are routed over completely different paths. The aim is to protect the user from dredging operations near underwater cables, broken land lines, malfunctions in satellites, and every other possible disruption. The pairs of communications links should arrive in the country at separate communications computers. These must be interconnected to ensure that there is always at least one clear path from the user to his desired destination.

All of these communications de-

## IN THE FINAL ANALYSIS, SECURITY IS IN THE HANDS OF THE USERS.

vices and links have to be managed. The network must detect broken elements, reconfigure itself to bypass them, reconstruct or retransmit data that was in transit at the time, and inform the operators of the nature and location of the problem. This must be done in real time, automatically, and without affecting the users who are on-line at the time. As the components are returned to service, the reconfiguration must be reversed; again, it must be transparent to the users.

*Security is a Dual Responsibility.* Modern global communications networks are used for a wide variety of applications, some containing information of great commercial value. That means it must be secure.

The network has to keep unauthorized users out and prevent third parties from reading, copying, repeating, or changing transactions either while en route or while stored in central comput-

ers. Data can often be encrypted and access controlled by tamper-resistant authorization codes. Network managers must realize, however, that this imposes greater processing loads on the network.

Almost every link in the network will be carrying traffic belonging to a number of users. Therefore, each packet must be labeled and great care taken to ensure that it cannot be misrouted. This is especially important when third parties such as dealers or suppliers are using the net. The virtual circuits between sender and recipient must always be completely isolated, even though they share physical circuits, computers, or disk space.

Also, user data must never be garbled, truncated, duplicated, or missequenced. Every packet, over every link in the end-to-end communications path, must be checked to ensure that what went up came down. In cases of error or doubt, the suspect packets must be retransmitted, with the entire message being correctly and completely recreated before the receiver gets it.

Since whatever can go wrong usually does, the integrity aspect of data communications must be complemented by comprehensive rollback and recovery procedures. Like the network management and reconfiguration facilities, these procedures must, as far as possible, be transparent to the user. When data loss is unavoidable, the loss, and as much descriptive information as possible, must be provided to the user so that he or she can bring personal recovery procedures into action.

The majority of applications that run over international networks involve programs running in the computers that form the hub of the network itself. Most security and integrity procedures therefore can be duplicated, with the network procedures backed up by others within the application. These will be under the control of local managers, and this underlines the fact that, in the final analysis, security is in the hands of the users.

*Know the Costs and All the Options.* The costs of setting up a network are split three ways.

There is an up-front design and construction cost necessary to provide a network covering users' needs over the medium term. The equipment costs are high, and the controlling software is not necessarily available off the shelf, which can mean considerable additional investment. A hidden factor is the need for people who are able to design such sys-



## The Seven Golden Rules

tems—and people who can negotiate with the PTTs. These people are difficult to recruit and difficult to retain—and they expect to be paid accordingly.

Ongoing costs include leases on premises and circuits; keeping a close eye on changes in line tariffs around the world is therefore important. These costs also cover the detection and correction of faults in both hardware and software, often involving expensive and sophisticated test and diagnostic equipment. There must also be well-trained and experienced operational staff both to maintain the network service and to support the users.

Finally, there are the less easily quantifiable costs to the company: maintaining flexibility and independence. Most multinationals regularly sell off operations or acquire new ones. The architecture and scope of the network should not be a limiting factor in these decisions. There is also a built-in risk with a network that any new applications or extensions won't work out well.

One option is to restrict internal developments to those areas that are regarded as safe and easy. This can be done using the local public data network and leased intersite links connecting major in-house computer centers. There are also applications where external network services are inappropriate. These cover high-security applications where cost is a secondary concern, such as military and diplomatic systems, and networks where very fast response times are needed. The airline reservations systems and interbank message systems are good examples.

### Third-Party Benefits in General

For more general use, third-party network suppliers may offer a better deal, since they already will have amortized the up-front cost, spread the operational costs over a large number of users, and invested in new technologies in order to stay competitive. The costs associated with the use of a third-party supplier are not negligible, but they are controllable. They are, in general, volume dependent, and users are provided with detailed breakdowns of the traffic for which they are charged.

*Invest in the Future.* The network has to serve many types of users, and must be able to handle a wide range of

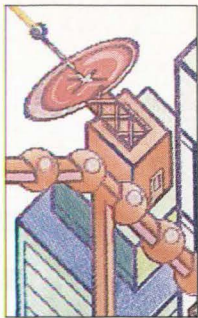

### The Seven Golden Rules

terminal equipment. The magnitude of this task grows over time as new technologies, higher transmission speeds, and

new techniques are introduced. The network must grow to accommodate all of these technologies without affecting the existing user base.

At any given time, some users will be pondering their next generation of equipment, and some will choose the most modern, most cost-effective machines. These may well be the first commercial offerings of equipment using some new protocol. The user will expect the network to handle it.

The effect is to force network managers to stay one step ahead and attempt to figure out what users will need next year—then to make the needed investment that allows the network to cope.

New types of applications will also make demands. The network will probably offer a native electronic mail system, which will be fine for itinerant users and for connecting small sites equipped with dumb terminals or microcomputers. The big sites may well have large communities using the proprietary e-mail systems provided by their hardware manufacturers. It is incumbent upon the network manager to provide the interfaces between the on-site and the international systems.

The need for these application-level interfaces will grow as networks carry more material between sites, and, particularly, between companies. The increase in electronic data interchange systems is, to a certain extent, dependent on the ability of the network to convert business documents into different formats. More specialized applications include the conversion of revisable-form word processor documents so that, for example, contracts may be reviewed and revised by people in sites with incompatible equipment. What's more, there is a growing demand for the exchange of CAD/CAM files between sites with incompatible machines.

In this changing world of global networking, managers must make continuing and forward-looking investments to cope with what the users, and the corporation, need to do. ■

*Geoff Wiggin is director of technical services at GEISCO in London. He is responsible for the support, the management control systems, and the software development of GEISCO's international network.*

# It's not a minicomputer you will outgrow. It's not a PC network that promises more than it can deliver. It's not a mainframe you can't afford...

# Unisys announces the birth of the Smallframe.

You're invited to celebrate the arrival of the newest member of the Unisys product family, as well as the birth of a new concept: The Unisys Smallframe.

It's three different tiny computers: A1, A4 & A6. Each built to fit in the same size cabinet, each with a small footprint and a low price. (That's what we meant when we said "Small.")

But each starts you running true mainframe applications economically and quickly. Plus, Smallframes use the same operating system as our biggest A Series mainframe—and every machine in between—without any software conversion. (That's what we meant by "frame." As in *mainframe*.)

## What potential!

With the newborn A1, the smallest of the Smallframes, Unisys now gives you a clear, continuous growth path of more than 100 times in computing power.

That means if you're running a small business or department with the A1, you can use proven

mainframe software on a computer that costs about the same as a mini. And because the A1 is part of a broad line of compatible machines, your data and software investments are safe as you grow.

## Meet the family.

The A1, A4 & A6 are the youngest and smallest members of the respected Unisys family of A Series mainframes. The series includes machines that run major banks, governments, schools, hospitals and businesses all over the world. An independent survey of mainframe owners found Unisys systems scored the highest five year average in overall satisfaction.\*

While Smallframes are about the size and price of minis, the top of the A Series isn't a set of minicomputers playing together. It's the A15, one of the largest and most powerful true mainframes money can buy.

Between the A15 and the A1, there are 12 other models. All compatible over the line—and over time.

\*Computerworld, June 15, 1987, survey by Datapro Research Corporation.



Software written for any model or generation over the last 17 years is compatible with any current A Series model.

Since all three are built for the same size cabinet, the A1 itself is field upgradable to A4 and A6 levels—a better than 3 times increase in computing power.

### Doesn't cost much.

You already know the A1 gives you mainframe quality for about the price of a mini.

But what about the rest of the A Series? From the moment of conception, every computer in the family is designed to be easy to get along with and cost very little to run.

That means reasonable purchase price. Low operating costs. Low training costs. Even low software development costs, thanks to the powerful A Series operating system and LINC—the well-known fourth generation language from Unisys that can cut programming time by a

factor of ten or more.

### Grandpa's eyes.

All in all, the best thing about the Smallframe is that it sees the world the same way the powerful A15 and the whole A Series do. You might even call it a "chip off the ol' box." It's got the same operating system. Same interfaces. And it will even communicate with IBM machines.

So whether you want a small computer with a virtually unlimited conversion-free expansion path, or you've got a large Unisys computer and need a smaller yet fully compatible department level system, call the proud parents at Unisys.

We'd love to stop by with all the information you need. And show you pictures. After all, a new arrival like this is worth celebrating.

Call 1-800-547-8362, extension 50.

Unisys and innovation. The power of <sup>2</sup>.

# UNISYS

The power of <sup>2</sup>

# GATEWAY TO THE WORLD

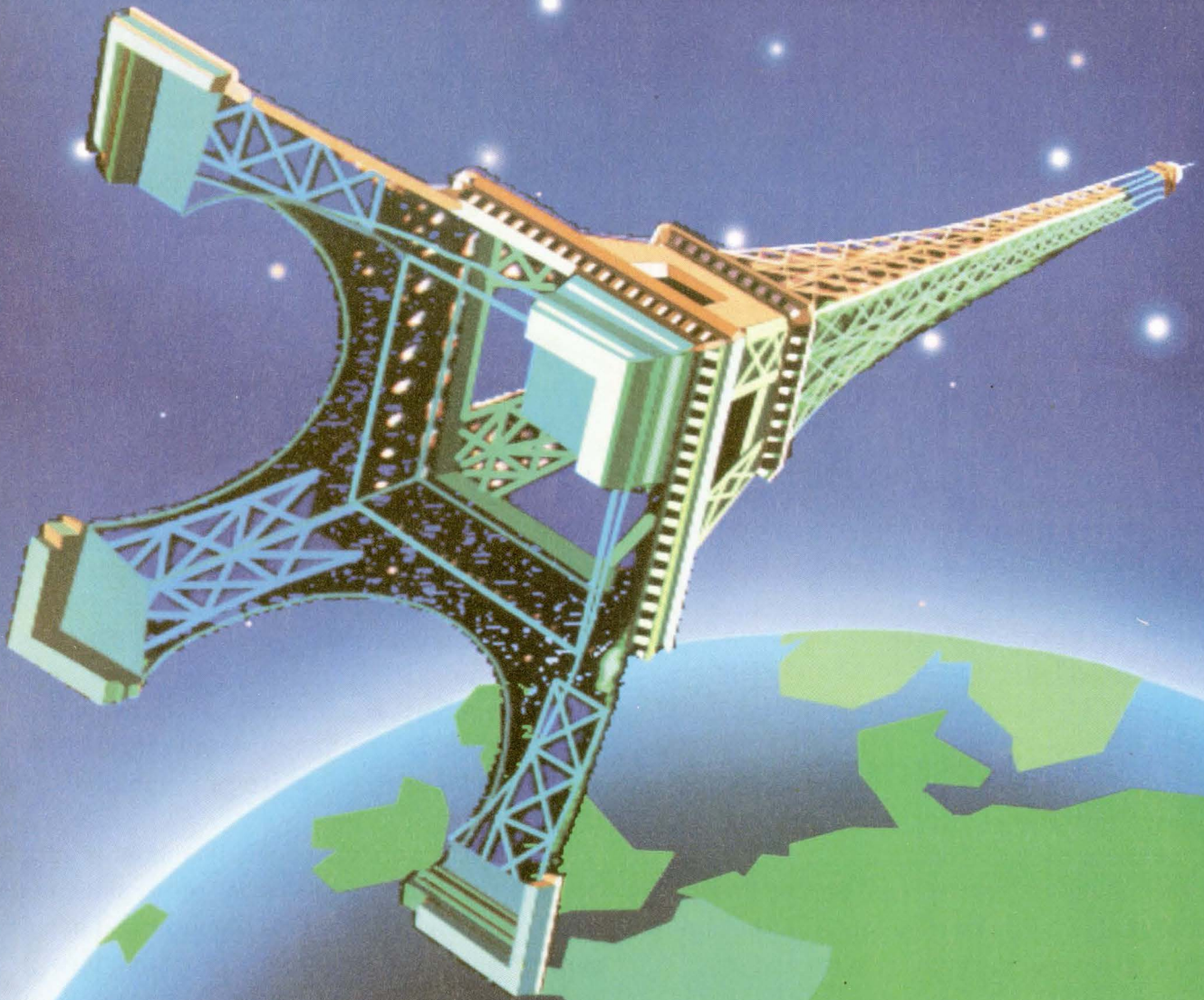

Editors DAIL-87/M. MICHEL & GRAFY ©

FRANCE TELECOM INTERNATIONAL



**Telecom 87 - 5<sup>th</sup> world telecommunication exhibition**  
**Palexpo - Geneva - October 20 to 27<sup>th</sup> 1987**

Circle #36 on Reader Service Card

Volvo's global network is a major factor in the Swedish automaker's success in international markets. It links 10 data centers, 25 mainframes, and 20,000 terminals around the world across 500 leased lines. It has also provided the company with a range of networking software products that are now on sale across Europe.

# Volvo's Net Gains



BY JOHN LAMB

Data communications is the lifeblood of Swedish auto manufacturer Volvo. The company relies on foreign sales for 85% of its Skr84 billion (\$12.5 billion) revenues. Consequently, its business, more than many of its rivals, depends on an effective means of keeping in touch with its far-flung operations.

"We differ from other manufacturers in that we don't have a large home market. So it's very important to us that we have good communications," says Karl H. Hubinette, president of Volvo Data AB, the company's IS subsidiary that is responsible for running Volvo's corporate network.

The network is based on IBM systems and SNA, and it is one of the most sophisticated IBM setups outside the U.S. Volvo has been working with SNA since 1978 and now operates a backbone

network that links 20,000 terminals and some 25 mainframes located at more than 10 data centers. Over 500 leased lines connect the boxes. The bulk of Volvo's IBM-compatible terminals—13,000 of them—are in Sweden.

In addition to the IBM systems, Volvo boasts another 200 processors and 3,000 workstations with Digital Equipment Corp. badges on them. These systems, connected to the SNA network either by protocol converters or via dial-up lines to central systems in Sweden, are mainly involved with engineering applications. Operational costs alone for the network amount to some Skr30 million (\$5 million) for data and Skr60 million (\$10 million) for voice.

Hubinette is quick to sketch out the business advantages of data communications. "The network helps us primarily in two areas: product development and marketing," he says. As far as product development is concerned, Volvo wants to cut by 25% the lead time between the design of a product and its appearance in showrooms.

Hubinette says data communications will play an important role in achieving this by smoothing the transfer of data between designers in Gothenburg (Volvo's headquarters) and production staff either in Sweden or in one of Volvo's overseas plants. When a component needs modification, the files can be updated at headquarters and transmitted to production systems with less risk of the errors and delays associated with traditional blueprints and machine tapes.

The best results will come when Volvo's suppliers can also send information electronically. Volvo is already exchanging files with West German component makers, such as Bosch, using a standard format called RVS, devised by

# The new COMPAREX 8/8X Processor-Series.

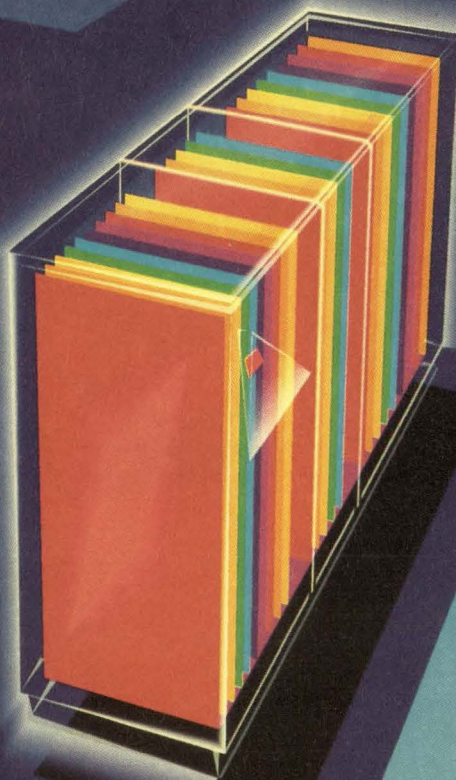



**COMPAREX – the newest and largest alternative to IBM in Europe.**

# The biggest thing about the COMPAREX 8/8X processors: How small and economical they are.

If you're committed to the IBM\* world – software, hardware and applications – but your 4381 just can't cope any more then all IBM can offer is an additional 4381 or a leap of faith to a 3090: the devil or the deep Blue sea.

COMPAREX can now offer you a real solution.

## **The COMPAREX 8/8X family – 4381 size and convenience 3090 performance.**

The COMPAREX 8/8X family is ideal for users who need the power and capabilities of the low-end 3090s but don't have the space. Like the 3090s the first three members of the 8/8X family are uniprocessors. But unlike the 3090s they really are small about 1.5 square metres (16 square feet) – roughly the size of a non-executive desk. That's less than a fifth of the space required by a "small" 3090, with similar savings in weight, power consumption and air conditioning.

## **Power – wherever you look.**

The 8/8X processors are powerful enough, but that's not all. Up to 32 channels can be attached to each system, with support for 6 MB/sec transfer to and from selected COMPAREX peripherals. This feature provides channel constraint relief for many users, revitalising on-line operation and re-opening the batch window.

But the real power behind the COMPAREX 8/8X comes from BASF and Siemens, two European giants who have combined to launch COMPAREX a new alternative to IBM.

## **A commitment to compatibility.**

COMPAREX is already the leading compatible alternative to IBM in Europe. With a complete range of hardware products for the medium and large scale user. Our strategy rests solidly on four cornerstones:

- an open-ended commitment to IBM compatibility,
- a product and pricing policy designed specifically to result in improved price/performance for users,
- the development of technically superior products using state-of-the-art-technology wherever appropriate,
- outstanding customer support for COMPAREX and non-COMPAREX hardware and software products, including assumption of overall responsibility for complete installations.

Over 3,000 customers have installed 30,000 COMPAREX products. If you would like to know more about COMPAREX or the 8/8X family please contact us at one of the following:

Great Britain (44) 01-908-3100

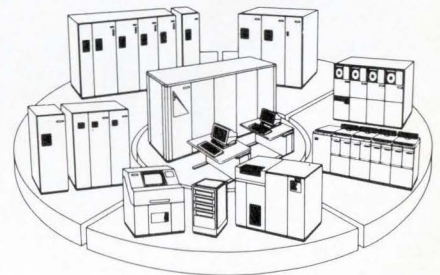

COMPAREX  
Informationssysteme GmbH  
Gottlieb-Daimler-Straße 10  
D-6800 Mannheim  
West-Germany

Tel. 06 21/40 09-0

**COMPAREX**  
A BASF and Siemens Company

\*IBM is a registered trademark of International Business Machines Corp.

IN THE TIME  
IT TAKES YOU  
TO READ  
THIS HEADLINE  
YOUR PC COULD  
HAVE SENT IT  
TO A TELEFAX  
IN WHITE PAPER,  
TEARS.

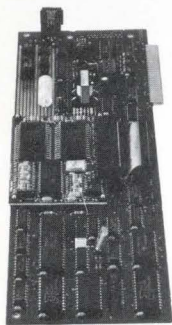

Today, virtually any PC can be made to function as a telefax, transmitting documents to telefax machines anywhere in the world within seconds.

All this, thanks to a single, low-cost plug-in board called LexiFax. LexiFax has been developed by the leading hard-disk manufacturer Lexikon. And it's more than just a simple bare-board.

LexiFax is a complete software package that permits a whole range of useful functions, including document

management in WYSIWYG mode, merging of text and graphics, cut and paste, automatic calls linked with your telephone agenda data base, and automatic receiving without interrupting work in progress. It offers full compatibility with G2/G3 facsimiles, transmitting an A4 page in about 30 seconds.

LexiFax is the latest addition to the Lexikon product range, which currently includes several models of hard disk, from 20 to 86MB formatted.

Lexikon disks are widely exported, both in Europe and the United States.

To know more about LexiFax and Lexikon hard disks, contact:

**LEXIKON**

Centro Commerciale  
Quartiere San Felice  
20090 SEGRATE (Milano)  
Tel. 02/7532441 - ITALY



## **A force to be reckoned with.**

*At the heart of the fourth generation family of modems lies a concept that makes it without equal amongst its competitors.*

British  
**TELECOM**  
Datacomms

British Telecom Datacomms, 23 Howland Street, London W1P 6HQ.  
Tel. 01 631 2110/International +44 1 631 2110. Fax 01 631 2195. Telex 24339 DATEL G.

Circle 38 on Reader Card

**TELECOM '87-GENEVA**  
See the 4th generation modem family on British Telecom's stand no. 208 in hall 5

# Great things can be done by the right people

At Telecom '87 in Geneva, Southwestern Bell Corporation wants to share ideas and information with you that could lead to profitable relationships. Come visit us at exhibit 1.306 in the USA Pavilion, October 20-27 so we can learn more about each other.

Southwestern Bell is a successful, innovative, worldwide communications company with a 100-year heritage of delivering quality products and services. We would like to talk to you about our major areas of business.

## Network Technology

Southwestern Bell provides network telecommunications services for a large area of the U.S. and offers advanced capabilities in voice, data and video transmission. We're a leader in ISDN,

fiber optics and packet switching.

## Directory Services

As a major telephone directory publisher in the U.S., we produce more than 1,200 directories and related publications across 46 states each year. Through joint ventures, we market Yellow Pages directories in Australia and will produce a number of multi-language publications for the 1988 Summer Olympics in South Korea.

## Directory Systems

AMDOCS, Inc., a Southwestern Bell affiliate, developed and markets advanced systems that automate and integrate directory production functions, including marketing, production and billing.

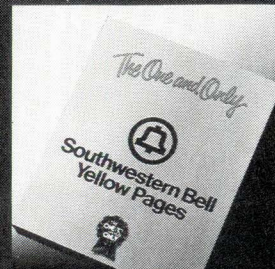

# n happen when le get together.

## Freedom Phone™ Products

Our line of consumer and small business telecommunications products includes corded, cordless and special feature phones, even a voice-activated model. They are marketed through 12,000 retail outlets and catalogs in the U.S. And, we recently announced an agreement to market Freedom Phone products in the United Kingdom.

## Cellular and Paging

We're one of the largest cellular providers in the U.S., and soon, the largest provider of paging services. We offer end-to-end support in the provision of cellular service, from planning and engineering to systems

management.

Let's get together at 'Telecom '87. Or, contact our International Group at One Bell Center, 40th floor, St. Louis, Missouri 63101, USA. Telephone: 314-235-5043. Telex: 324212 SBCORPSTL 1. Facsimile: 314-235-6082.

*Let's share success.*

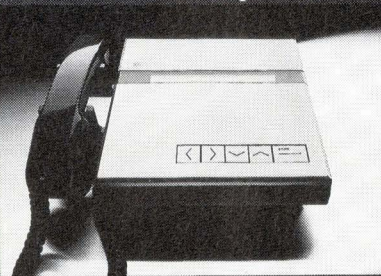

**Southwestern Bell  
Corporation**

Volkswagen. Volvo is also taking a keen interest in the European document interchange standards sponsored by motor manufacturers and named Odette for the Organisation for Data Exchange through Teletransmission in Europe. The Odette formats for the paperwork involved in trading are already being tested within the company using Perkin Elmer software on a pc. They could be implemented at Volvo within a year.

The other parts of Volvo's business—marketing, distribution, and sales—are equally important: they account for half the cost of producing a vehicle. Volvo's corporate network is already used by the company's importers and dealers to check out the availability of spare parts. The application, called the Volvo Dealer System, is still being installed on the System/36 and 38 machines that run the software.

With a team of 15 technicians assigned to the network, Volvo Data is responsible for about half of the data and voice traffic within Volvo companies. The firm's businesses cover trucks, cars, aerospace, marine engines, energy, and food (the company owns Sweden's only sugar producer). During the early '80s, networking grew apace. Now, the growth is bottoming out as Volvo's corporate network matures.

Computing and data communications are democratic affairs at Volvo. Companies are not forced to install any particular kinds of equipment. They are free to put in their own local and trunk equipment. But standards bring desirable savings, so, some years ago, Volvo Data began a process of weeding out duplicate connections and persuading local IS staffs to abandon their own communications links in favor of those provided by the corporate network.

"It took some time to convince companies to share the same physical link," admits Roland Linderoth, Volvo Data's director of product development. Many companies were unaware that they already shared central systems.

Volvo set up a network board with 10 general managers drawn from the main subsidiaries of the company. The board's role is to settle strategy for the network. Volvo Data's job is to provide the service. Often the board has to decide whether a newcomer to the group should be allowed to use the network. That was no problem with the recently acquired heavy truck division of General Motors with its 200 North American dealers. Since it was wholly owned, the risks were minimal. But the decision was



Volvo's network is particularly important to product development and marketing.

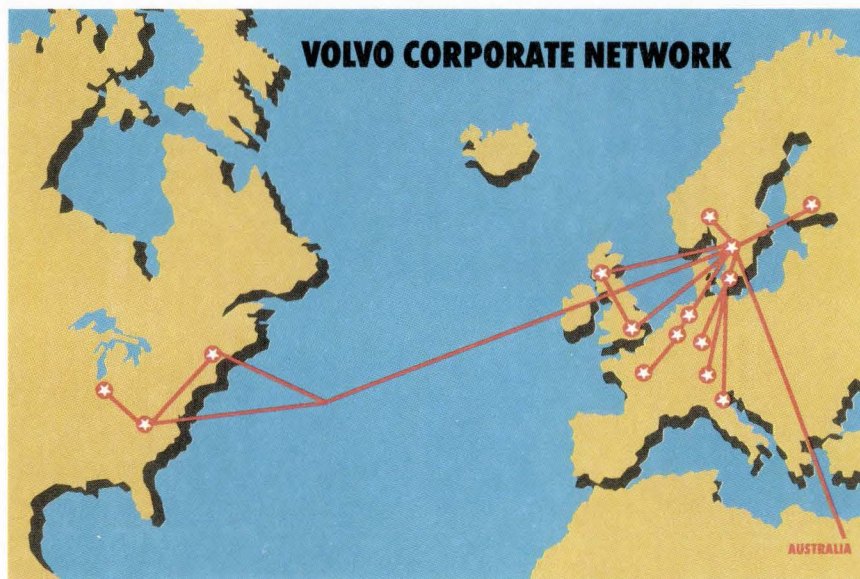

Security and foreign data regulations are two problems facing any international network.

tougher with an associated truck company, Clark Michigan, in which Volvo has only a 50% stake. Volvo eventually decided that the business benefits outweighed the risks to proprietary data on the network and linked up with the U.S. firm.

There are other problems to overcome with a global net, particularly national data regulations. Unable to hook Brazil directly into its corporate network because of the country's restrictive laws on transborder data flow, Volvo has resorted to dial-up connections and transporting floppy disks on a regular Luft-

hansa flight from Europe to Brazil in order to keep the information flowing.

One of the big spurs to network growth was the arrival of Memo, an electronic mail system developed by Volvo Data in the early days of mailboxes. The system, unique when it was developed in the late '70s, sneaked out of Volvo Data, Linderoth recalls. "We had two bright guys in technical support who had the idea and designed a simple tool. There was no high-level management decision involved."

The product is now used by some 300,000 people and is sold as a commer-

cial product (see "Take A Memo . . ."). But it was senior management who got to try it first. "You can only introduce something like this from the top down," maintains Linderoth.

Other products from Volvo Data have followed Memo, and although it can supplement its annual internal revenues of Skr540 million (\$83 million) with external commercial activities, the company itself is not allowed to divert manpower to these external money-making schemes. That must be done by outsiders.

Selling time on the corporate network to third parties is out for Volvo, too. Most countries will not allow the resale of leased lines to third parties. Even internally, there is no exact accounting for time on the network spent by Volvo's subsidiaries. "For one thing, there is no good software to measure traffic or to measure it cheaply enough, at any rate," says Linderoth. "Lines used by more than one organization are paid for according to how much each one uses the link. We tell our customers what the fair deal is by taking a snapshot of their usage of the lines."

Users have a chance to air their grievances in weekly reports. At present, network availability is running at 99.7%. Even so, that means that each of those 500 lines is going to be down for an average of 10 minutes each week. The monitoring is, once again, done by Volvo-created software, one of a number of tools that the company has added to SNA.

Volvo is not always so keen to get involved in in-house developments. At one time, the company was the largest user of IBM's mainframe-based answer to the personal computer, VSPC. But that was before the little blue boxes appeared. Volvo was left in the lurch when IBM abandoned the VSPC product. There was nothing for Volvo to do but to develop an alternative based on IBM's Time-sharing Option Extension (TSOE). "We were very unhappy about it," comments Linderoth. TSOE now delivers Volvo Information Customer Services (VICS), once destined for VSPC, with a Volvo-designed user interface. Significantly, personal computers play little part in the Volvo corporate network today. There are fewer than 1,000 of them.

Keeping the network up is often a matter of good relations with the local PTTs. A manager has been assigned to this public relations task in each country where Volvo operates. "I would very much like to see an open, international network with quality and reasonable

## Take a Memo . . .

Last month, Scandinavian Info Link AB opened its doors for business in Stockholm with backing to the tune of Skr20 million (\$3 million). The joint venture is owned by three of the country's top companies: Volvo, Ericsson, and Scandinavian Airlines.

Scandinavian Info Link's first product is an electronic mailbox service called Memolink. Developed by Volvo Data, the company's in-house computing service, Memolink is based on Volvo's Memo package, which already commands a major slice of the Swedish market for internal electronic mail. "We think we'll do well with the new service because we already have a unique monopoly penetration with Memo, amounting to 75% to 85% of the MVS installed base in Sweden," says Bjorn Stattin, president of Info Link.

Mailboxes are only the beginning for Scandinavian Info Link, says Stattin. Plans are afoot to offer electronic data interchange and database retrieval services as well. The initial Stockholm node, run by Ericsson Data Services, will be joined by others in Gothenburg (Volvo's home town, in Sweden), Oslo, Norway, and Copenhagen, Denmark.

The Memo software has a pedigree dating back to 1979, when Volvo started to develop an electronic mail package to run under VTAM communications software on its IBM kit. It was not long before Volvo Data was supplementing its income by selling Memo licenses. By 1984, the software had built up a strong following in Sweden with some 30 companies owning copies of Memo.

That was the year that Volvo decided to spin off its money-maker. "Volvo Data was in a bit of a dilemma," explains Stattin, "it was not policy for it to sell software." To begin with, the automaker struck a deal with the local software firm CACI, but within three months the distribution agreement was off when CACI decided to scrap all marketing contracts for software developed outside the company.

Undeterred, Volvo Data turned to one of its largest Memo customers, Ericsson, and hammered out a 50-50 joint venture with the telecommunications giant's Data Services division. The company they founded, Verimation AB, has gone on to sell more than 350 copies of the mailbox system supporting 300,000 users worldwide, 150,000 of them in Sweden. Stattin left his post as president of Verimation in Gothenburg to head up Scandinavian Info Link. In the meantime, he retains his position as chairman of Verimation.

Verimation, which last year earned Skr30 million (\$5 million), has added two more products from the Volvo Data stable. The first is Sesam, a session manager for corporate communications that gives users a single interface to network services while at the same time providing IS departments with a tool for tracking network usage. The other is Dialout, a product that enables 3270 terminals to interface to X.25 packet switched networks. Next year, Verimation will add a fourth product to its portfolio, Lexi. Lexi is a tool that helps users search databases. It draws on the search software written to help Memo users look up subscribers' mailbox numbers.

Volvo is not the only source of developments at Verimation, Stattin stresses. Last year, Ericsson produced a PC version of Memo that allows spreadsheet and other applications files to be passed from user to user via the electronic mail system.

prices," says Linderoth. "I don't have the impression that unit costs are going down. Hardware is cheaper, but you need more and more of it, and software is getting more expensive, too. I'd prefer a public network to our private one. But today it is better to have leased lines because you have total control and can help your PTT to find faults on them."

For all that, Volvo has dipped its toe into X.25 networks and even uses value-added networks for some communications. GEISCO, for example, provides the only route for Volvo to its Middle East

subsidiaries. According to Linderoth, however, Volvo has been discussing quality with PTTs since 1979, "and we still have not finished."

In the end, it's quality not quantity that counts, says Linderoth: "Data communications is nothing to the end user unless you maximize the availability of the right information at the right time." ■

*John Lamb is a freelance technology journalist based in London. He has been a regular contributor to DATAMATION over the last four years.*

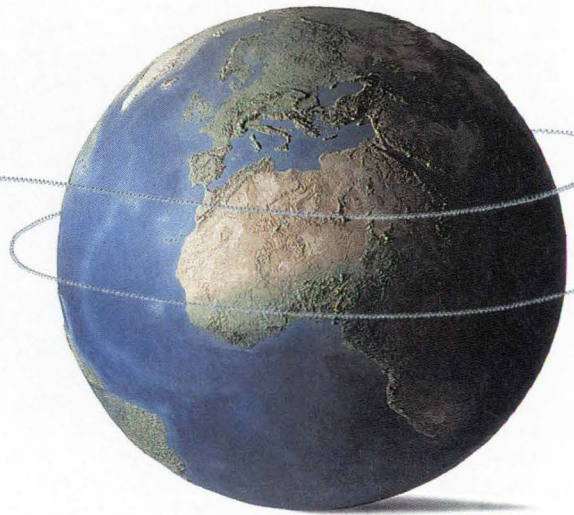

Visit Northern Telecom  
Hall 4, Stand 4.100, Oct. 20-27, 1987  
PALEXPO, Geneva.

Northern Telecom sales offices and distributors are located throughout North America, Europe, Latin America, and Asia: In Europe, Near East and Africa contact: Northern Telecom Europe, Berkeley Square House, Berkeley Square, London W1X 5LB, England, Tel: (44-1) 491-4599. In Pacific Region contact: Northern Telecom Pacific, Oak Minami-Azabu Building, 19-23 Minami-Azabu, 3-chome, Minato-ku, Tokyo 106, Japan, Tel: (81-3) 441-1811. In the Caribbean and Latin America contact: Northern Telecom (CALA) Corporation, 14701 NW 77th Avenue, Miami Lakes, Florida 33014, USA, Tel: (305) 558-4858.





**S**uccess through networking.  
When the world wants to network voice, data, text or images it calls on Northern Telecom.

With over 35 million digital lines in service, or on order, we're the world's leading supplier of fully digital telecommunications systems for both public and private networks.

So whether it's advanced digital switching, high speed data transmission, telephone systems or data terminals look to Northern Telecom for cost-effective solutions to your networking needs.

**nt** northern telecom



**NETWORKING**

# There's more than meets the eye.

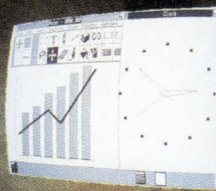

**NOKIA**  
INFORMATION SYSTEMS

**FINLAND**  
Box 780  
SF-00101 HELSINKI  
Tel. +358 0-5671  
Tfx +358 0-5673292  
Tx 124563  
Ttx 1001003

**DENMARK**  
Nokia  
Information Systems A/S  
Hørskæften 3  
DK-2630 TÅSTRUP  
Tel. 02-525555  
Tfx 02-525166  
Tx 9126958  
Ttx 126958

**GERMANY**  
Nokia GmbH  
Information Systems  
Box 1567  
D-8130 STARNBERG  
Tel. 08151-7740  
Tfx 08151-3792  
Tx 526481  
Ttx 8151810

**NORWAY**  
Nokia  
Information Systems A/S  
Box 173  
N-2013 SKJETTEN  
Tel. 06-840 210  
Tfx 06-842620  
Tx 77408

**SWEDEN**  
Nokia  
Information Systems AB  
Box 42037  
S-12612 STOCKHOLM  
Tel. 08-7447500  
Tfx 08-7442436  
Tx 11029

Technological leadership coupled with close cooperation is the hallmark of Nokia Information Systems built on the traditions of the century-old Nokia Corporation. Today Nokia Information Systems, as a supplier of total system solutions, is well respected in the Scandinavian market. To our customers:

### **Nokia means tailor-made systems**

At Nokia we understand the unique needs of our customers. And therefore work in close cooperation with them on tailor-made office, retail, banking and artificial intelligence-based expert systems. Systems that have potential to grow.

### **Nokia means expertise**

Nokia offers so much more to give you the competitive edge: long experience, Extensive R & D. The highest standards. Rapid application of latest technology. Communication know-how. Total solutions.

### **Nokia is ergonomics**

Nokia's serious commitment to ergonomics is found throughout the system. We are pioneers in positive display technology. And one of the first suppliers to minimize electromagnetic radiation in a display unit. In software, Nokia is known for its user-friendly solutions. Ergonomics also means productivity.

Let's be successful together. Nokia can help you see the future – and increase productivity – more clearly. This is Nokia's way of doing business.

Circle 40 on Reader Card

I N T E R N A T I O N A L

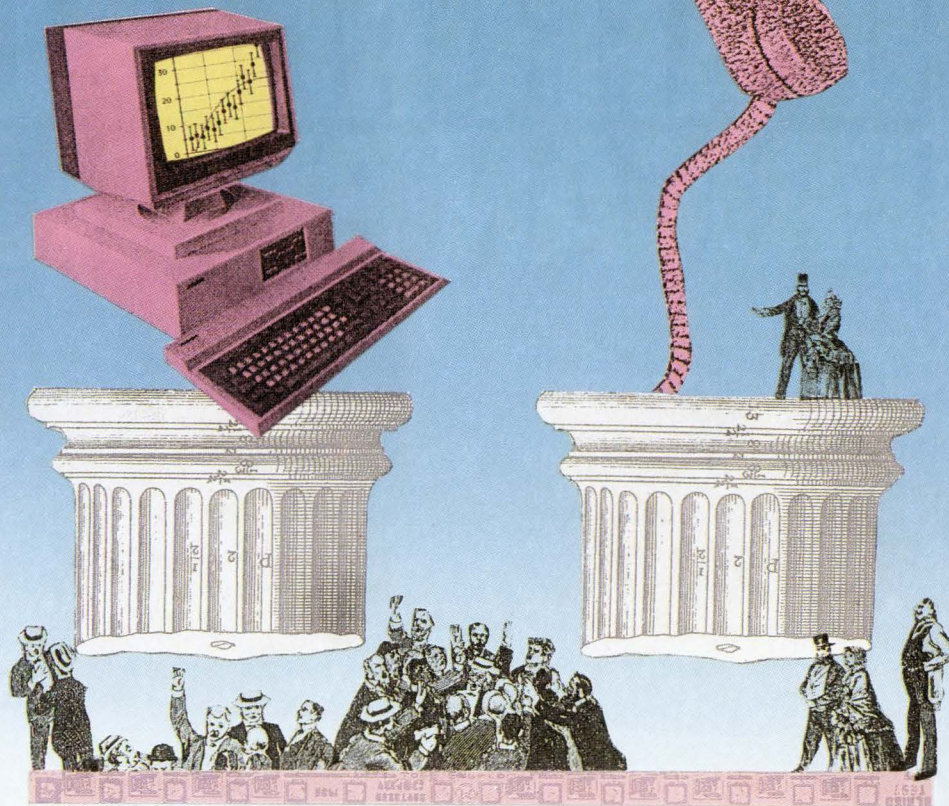

# Telecom '87: Crisis and Convergence in Geneva

BY PETER PURTON

Later this month, the movers, shakers, and hangers-on in the world telecommunications industry will meet in Geneva to debate hot telecom topics and reveal the latest products and services on offer in international markets. Telecom '87, which runs Oct. 20-27 at the city's main Exhibition Center, promises to be the biggest event in the show's 16-year history.

Over 200,000 visitors are expected to turn up at Telecom '87, representing suppliers, users, carriers, and governments from all over the world. Some 35,000 are expected to be from the banking and finance fields alone.

Held every four years, this month's show will also mark a significant shift in

emphasis. For the first time, the exhibition space allocated to computer companies will equal the space taken up by telecom firms. In the exhibition halls at least, the convergence of telecom and computing technologies has become a reality.

"No one had envisaged the full extent to which the digitalization of networks would proceed," remarks Richard Butler, the Secretary General of the International Telecommunications Union, "nor was there any recognition of the enhanced role the user must play."

The Telecom exhibition, which is backed by the International Telecommunications Union (ITU)—the United Nation's oldest standing organization—was first held in 1971, and at that time just 15% of the floor space was allocated

Later this month, the world telecommunications industry will meet in Geneva for Telecom '87. ISDN will be the main theme in the exhibition halls, while the conference sessions will focus on worldwide telecom developments and the crisis of convergence with the IS industry. That convergence will be obvious to a Telecom '87 visitor. For the first time, computer firms have as much space as telecom companies at the show.

# REACH EUROPE ON THE AFFORDABLE AMERICAN PLAN.

Now there's an economical alternative to the out-of-sight cost of reaching Europe's MIS professionals in the "a la carte" single country books. Only Datamation lets you buy strong pan-European circulation, all across the Common Market...in just one book. We're the proven way to reach the key MIS buying influences at the largest industrial companies, banks, utilities, retailers, and service and financial companies. And with Datamation, you can buy Europe and our international circulation. Or you can reach our full run, including in-depth penetration of the Fortune 1000 in the U.S.

If Europe "a la carte" is looking more and more out of reach, get complete details on our affordable American plan. For your copy of the Datamation media kit, call Jim Morris, Publisher, at (212) 463-6553. **DATAMATION**

**Cahners Publishing**  
A Division of Reed Publishing USA



# CO-OPERATE WITH THE LEADER OF MODULAR CONNECTING EQUIPMENTS !

IF YOU WANT TO OPTIMIZE  
YOUR NETWORKS FOR :

- DATA
- TELEPHONE
- BUILDING AND HOME AUTOMATION
- FIBRE OPTICS

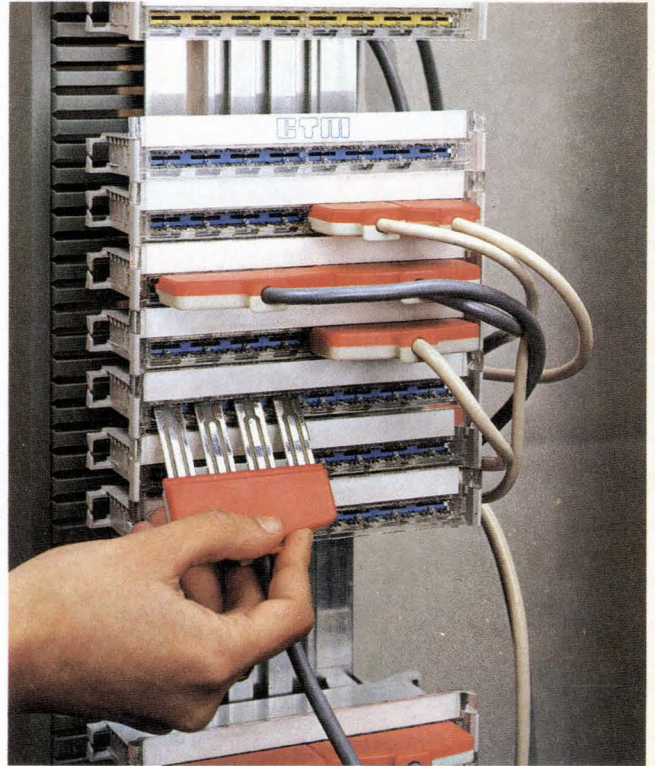

CTM, THE MOST COMPLETE RANGE  
OF EQUIPMENTS FOR CONNECTION,  
PROTECTION, AND DISTRIBUTION

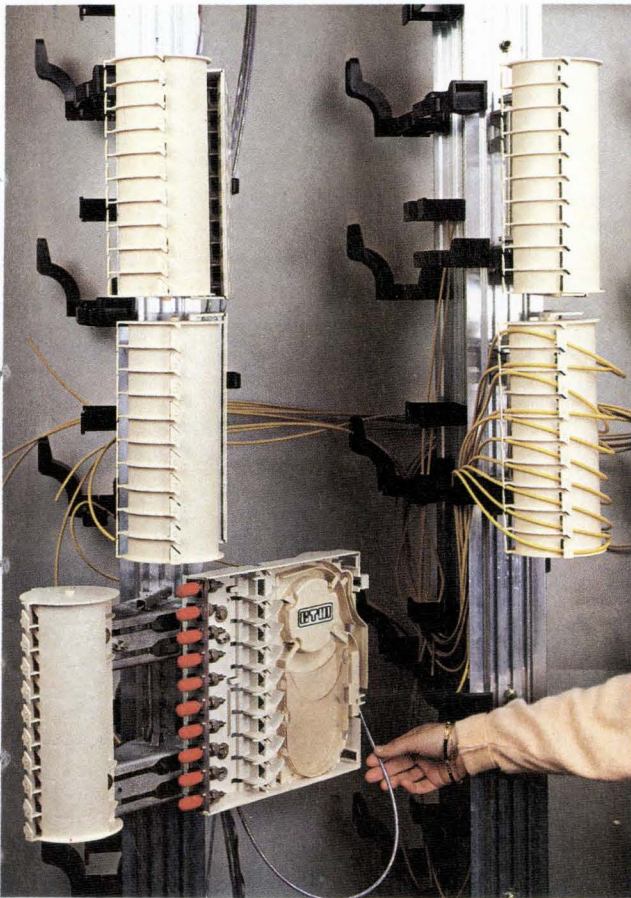

**INVENTOR OF B.C.S.,**  
**BUILDING PRE-WIRING SYSTEM**  
**FOR COMMUNICATION NETWORKS**

Circle 41 on Reader Card

FOR ANY ADDITIONAL INFORMATION,  
PLEASE COMPLETE THIS REPLY COUPON

Ste .....

Address .....

.....

Name ..... Tel .....

Subject .....



**28, rue Broca 75005 Paris FRANCE**

Tel. 33 (1) 47.07.63.12 Telex. 260 909 F FAX 33 (1) 43.36.02.65

CTM 28, rue Broca 75005 Paris FRANCE

to computer makers. This year it will be a clean 50-50 split. "There's not so much an increase in the number of computer companies but in their size," explains Werner Wolter, the ITU's man responsible for organizing the Telecom shows.

The original reason for the quadrennial cycle for the show was that the ITU's international telecom standards-setting bodies—the International Telephone and Telegraph Consultative Committee and the International Radio Consultative Committee—also work over four-year study periods. Because of the merger of computer communications and telecommunications, and the reliance of this process on international standards, the four-year gaps became significant staging points along the path of convergence.

## THE MERGING TECHNOLOGIES HAVE CAUSED PROBLEMS FOR THE ITU.

These merging technologies have, however, caused problems for the ITU. Some call it a crisis. Although computer communications and telecommunications share the same technical base, the computer market has developed in a fairly free competitive environment. The telecommunications industry, however, has been developed monopolistically under a comprehensive regulatory structure. As the two industries merge, with their two greatly differing philosophies, there are inevitable institutional, and even social, problems.

As the world's ultimate telecommunications regulatory body, the ITU is particularly susceptible to the strains of this merger. This is largely due to its role as a world forum and to the differing effects this convergence is having in different countries.

The Telecom '87 conference, which runs alongside the exhibition, reflects these concerns. The conference is divided into five areas: the problems of developing telecom infrastructures; technology issues; new legal frameworks for telecommunications; the economic and commercial consequences of such legal frameworks; and regional de-

velopment and cooperation. The speakers at the conference will include James Olson, chairman of AT&T, George McKendrick, chairman of the International Telecommunications Users Group, Christian Schwarz-Schilling, minister of Posts and Telecommunications in West Germany, Harold H. Greene, the U.S. district judge who presided over the breakup of AT&T, and Richard Butler, Secretary General of the ITU.

The papers and debates at the Telecom '87 conference will raise issues about telecom trade and development, which will form the basis of the agenda for next year's World Administrative Telegraph and Telephone Conference (WATTC '88). This will be held in Melbourne during December 1988, and the results will affect telecommunications regulations well into the next century. "This conference [WATTC '88] could be a watershed in the history of the [International Telecommunications] Union," Butler admits. "The decisions made there will not only affect the telecommunications environment but also the future ability of the union to keep up with the changing environment."

At the time of the last conference in 1973, data communications was only just on the horizon. It was obvious then that the transmission of data, if it was to be dealt with efficiently, had to be executed separately from voice. Now, with the coming of digital streams, the different types of information will be fused together. The new technical scenario calls for a different regulatory environment.

The new international telecommunications environment will certainly be different. Alongside the traditional service providers, there will be numerous additional suppliers and operators cashing in on the new technologies. The conditions under which these new firms will evolve depends to a large degree on the regulatory environment.

The issue of what relationship, if any, the ITU should have to the newcomers has not even been discussed yet. This will be the crucial theme at WATTC. If the decision is to have little or no contact with the newcomers, a new question arises: in a world of telecommunications where the importance of the PTT is diminishing and the role of private companies and users is rapidly expanding, where will that leave the International Telecommunications Union? ■

*Peter Purton is the European editor of Telephony magazine and is based in Bath, England.*

## What To See At Telecom '87

In the Geneva exhibition halls of Telecom '87, the Integrated Services Digital Network (ISDN), will undoubtedly dominate the products on display.

That is the subject of one of the special events presented by the International Telecommunications Union (ITU), demonstrating its coordinating work as a standards-setting organization. Under the banner of "One World—One Network," the ITU exhibit will greet visitors as they enter the Palexpo main hall. It is designed to be a working demonstration of ISDN with terminals and transmission and switching equipment from all of the world's major telecommunications manufacturers. This equipment, the ITU hopes, will all be linked together.

The ITU's other centerpiece is the largest demonstration ever of equipment using the X.400 messaging standard. Of the 25 ISDN participants from Asia, Europe, and North America, nine will be carriers; the rest will be manufacturers. The list includes Digital Equipment Corp., the Deutsche Bundespost, Hewlett-Packard, British Telecom, Nippon Telephone and Telegraph, Nixdorf, Olivetti, and Philips.

Among the other major exhibitors will be IBM and AT&T, which have both managed to negotiate the maximum space allocated to individual exhibitors—8,600 square feet each.

IBM's theme will be connectivity. The prize showing is expected to be a European version of its Rolm subsidiary's CBX integrated voice and data digital PBX. After prolonged delays in gaining approval in the U.K., IBM is now close to a formal launch and is known to have offered the exchange for inclusion in ISDN trials in Norway.

The two-story stand, described quaintly by IBM as an "architectural evocation of the connectivity theme," will be divided into seven interconnected demonstration areas. These will cover value-added network services, local area networks, network management, heterogeneous networks, voice and data connectivity, departmental system communications, and support to telephone operating companies.

Other communications products that are expected to be exhibited for the first time include the range of leased line (T1) multiplexors and associated communications software recently unveiled in the U.S. There are also rumors that IBM will announce cards for the PS/2 range of personal computers that will allow them to be used as ISDN terminals.

Thirty workstations and a glass-walled network control center will sup-

port DEC's theme of the network at work. The center will actually be the hub of DEC's European network, usually located at its Geneva headquarters. DEC's approach to ISDN will be unveiled under the heading of Computer Integrated Telephony (CIT). New products to be launched under this banner are a computer-PBX link that will supplement and exploit the ISDN services and a PBX network management system. These products are rumored to be under joint development with British Telecom.

Hewlett-Packard will be using Geneva to launch itself as an ISDN company. HP's European headquarters in Geneva will be used as an extension to its 8,600-

also plans to launch a new range of multiplexors and optical line drivers.

At the heart of Nixdorf's 2,350-square-foot, two-story stand in the West German national section will be the first public demonstration of an ISDN version of its highly successful 8818 digital PBX. The automatic switchboard is currently being used in the Deutsche Bundespost's ISDN trials in Mannheim and Stuttgart. As well as featuring the ISDN DSO user interface, the 8818 also handles the full 64+64+16Kbs ISDN channel formats. In various demonstrations, the PBX will be used to switch data between a Nixdorf Targon Unix system and the company's range of multifunc-

only fully integrated voice and data business communications system.

Canada's Northern Telecom, meanwhile, will show how computers can supplement and complement ISDN. Here—as with similar offerings from DEC, HP, and Mitel—a computer will be used to display details of incoming callers, and to search automatically for telephone numbers in a directory. The application is aimed at users with telephone-based jobs, such as those working in a sales room.

Another theme being promoted by Northern Telecom will be virtual private networking—a fancy name for Centrex. The difference will be its pro-

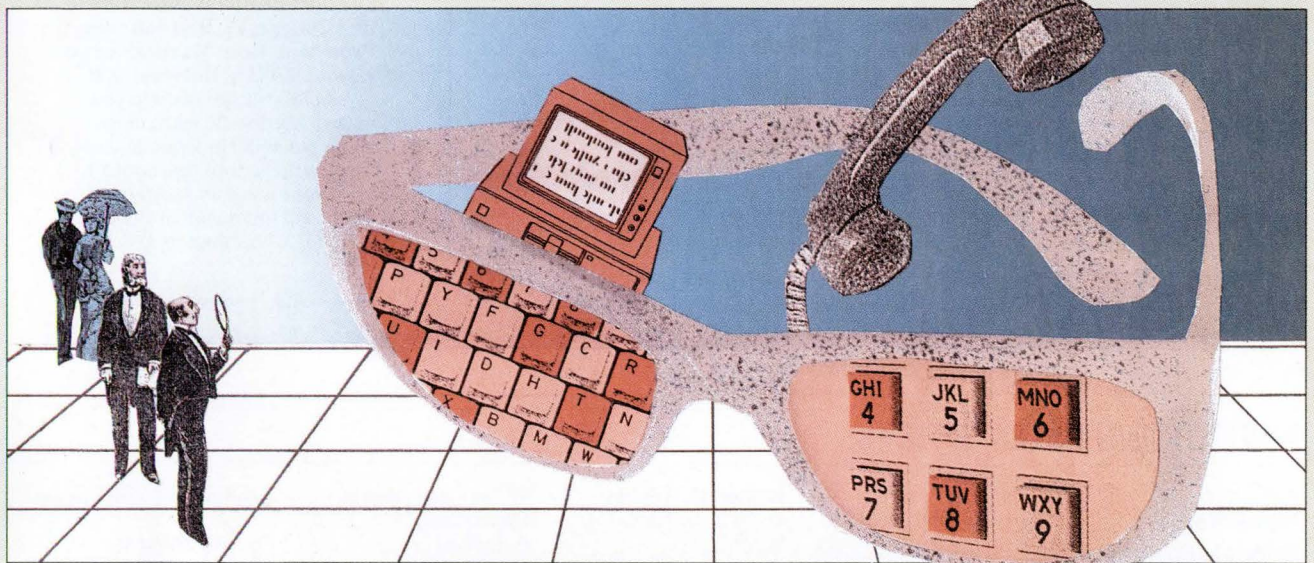

square-foot stand, hosting over two dozen technical seminars.

In terms of products, HP plans to launch an ISDN strategy based on helping customers to both use and manage ISDN lines. The core of this strategy is cooperation with telecommunications equipment manufacturers. This will be most graphically demonstrated by a high-speed link between HP's Digital Multiplexed Interface computer and a PBX. More important, the company will use the show to launch an active certification program with telecommunications equipment manufacturers to ensure that HP equipment connects to their integrated voice/data PBXs. HP is ruling out the development of its own ISDN PBX, but is expected to announce a cooperative deal with a European PBX maker to develop ISDN terminals.

Sweden's Ericsson will be launching a Centrex version of its AXE public telephone exchange. In networking, it plans to offer a fiber-optic multiplexor that should vastly increase the capacity available to users of short-range data communications links. The company

tional workstations.

Also on display will be the Nixdorf broadband public switching equipment that the company has been using in the Bundespost's broadband ISDN (ISDN-B) trials. This will demonstrate both video telephone and videoconferencing applications.

Italy's Olivetti, AT&T's European partner, will be showing off its own products—as well as AT&T's—including PBXs, digital phones, facsimile machines, Unix systems, X.400 software, and file transfers between different systems using the Open Systems Interconnection standards.

France's Jeumont Schneider is to display its new ISDN-compatible PBX, which is currently being tested by France's armed forces. It will be commercially available in 1988, and it represents a further step in the development of an ISDN switch based on its Logistel 6000 integrated voice and data PBX.

Matra will show its new Matracom 6500 range of ISDN PBXs with capacities ranging from 200 to 6,000 lines. The French company claims that this is the

proposal to supply ISDN as a private network managed by a public carrier. Among the products expected are an integral data packet handling facility on the company's DMS ISDN public telecommunications switch.

Philips will have its Sophomation range at the show, and will demonstrate a network based on its Sopho S digital switch. This will be supporting 30 B+D optical links between the central switch and a remote node, and two B+D standard links that will have pcs and telephones sharing the same lines. The U.K.'s ICL will be at the exhibit of its parent company, STC. ICL's contribution will be to the business section. STC's theme is collaboration. The company already has an established deal with Fujitsu in both the computing and transmission areas. Technology transfer deals have also been included with companies in India and China. STC is expected to announce a new joint venture in the Eastern Mediterranean. Products on display will include ICL's X.400 software and ISDN interface chips.

BY PETER PURTON AND LAUREN MURPHY

# ASCII—IBM NETWORKING

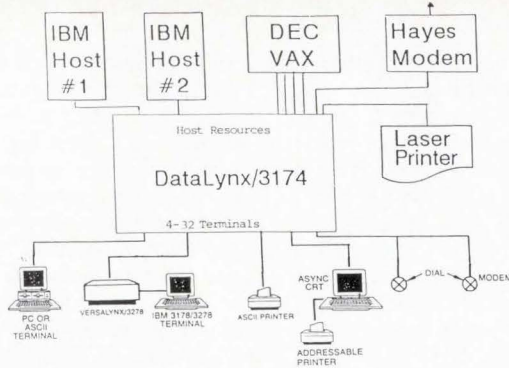

## APPLICATIONS

- PC & ASCII terminal cluster controller.
- LAN/PABX/Data PABX/X.25 gateway to IBM.
- Low cost IBM and ASCII host networking.
- Dialup from laptop/portable PC's.

## FEATURES

- IBM 3278/9 and 3287 terminal emulation.
- IBM 3270 BSC or SNA protocols with REQMS.
- 4-32 terminal or ASCII host ports.
- 32 LU's with interleaved/auxiliary print.
- IBM 3270-PC compatible file transfer software.
- Efficient support for X.25 connected PC/terminals.
- Terminal configurator to customize emulations.
- 8-bit languages and codes supported on menus.
- Fully buffered pass-thru to ASCII hosts/modems.

Argentina 312 3419 • Australia 02 4516655 • Austria 0222 8426310 • Barbados 809 4251237 • Belgium 02 673 4105 • Canada 800 2671821 • Colombia 2365937 • Cyprus 02 451088 • Denmark 03 652345 • Finland 80 5214151 • France 1 4534 7535 • Germany 06192 21343 • Hong Kong 05 8933386 • Iceland 91 687220 • Italy 02 2046047 • Mexico 05 531 8204 • Netherlands 015 609546 • New Zealand 09 394212 • Norway 02 688970 • Puerto Rico 809 7645577 • Singapore 4438277 • South Africa 011 7922000 • Spain 91 4332412 • Sweden 08 830155 • Switzerland 031 362236 • Trinidad 809 • Turkey 04 1172520 • U.K. 04867 4555 • U.S.A. 213 320 7126 • Venezuela 02 310357 • Yugoslavia 082 23635. Local Data also manufactures ASCII to IBM 36/38 (SNA or Twinax) and 3278/3287 coax models.



696 Stirling Road, Slough, Berks SL1 4ST,  
United Kingdom. Tel: +44 753 76537.  
Fax: +44 753 825211. Telex: 94011143

CIRCLE 42 ON READER CARD

# Small colleges can help you make it big.

Just ask: Ronald Reagan, President of the United States, Eureka College, IL; Pierson Mapes, President, NBC Television Network, Norwich University, VT; Robert Noyce, Vice Chairman of the Board, Intel Corporation and Microchip Inventor, Grinnell College, IA; Red Johnson, President, Borg-Warner Corporation, Millikin University, IL.

A small college can help you make it big, too. To learn more about our small independent colleges, write for our free booklet. Send your name and address to Council of Independent Colleges, Box 11513, Washington, D.C. 20008.

Sponsored by CIC The Council of Independent Colleges

## ADVERTISING SALES OFFICES

**Publisher**  
**James Morris**

**Associate Publisher**  
**William Segallis**

**Production Manager**  
**Dolly Viebig**

### EASTERN REGION

**Eastern Regional Sales Manager**

**Frances E. Bolger**

249 W. 17<sup>th</sup> St.  
New York, NY 10011  
(212) 463-6552

**Middle Atlantic**  
**John M. Gleason**

8 Stamford Forum  
P.O. Box 10277  
Stamford, CT 06904  
(203) 328-2547

**Tom Carey**

487 Devon Park Dr.  
Suite 206  
Wayne, PA 19087  
(215) 293-1212

**Northeast**  
**Edward Rappaport**

**Michael W. Andrea**  
199 Wells Avenue  
Newton, MA 02159  
(617) 964-3730

**Southeast**

**Larry Pullman**

6520 Powers Ferry Road  
Suite 395  
Atlanta, GA 30339  
(404) 955-6500

**Midwest**

**John Stellwagen**

1350 E. Touhy Avenue  
Des Plaines, IL 60018  
(312) 390-2967

### WESTERN REGION

**Western Regional Sales Manager**

**James E. Filiatrault**

3031 Tisch Way  
Suite 100  
San Jose, CA 95128  
(408) 243-8838

**West**

**Janet Engelbrecht**

582 Market St.  
Room 1007  
San Francisco, CA 94104  
(415) 981-2594

**Robert J. Rielly**

12233 West Olympic Blvd.  
Suite 236  
Los Angeles, CA 90064  
(213) 826-5818

**William M. Wilshire**

18818 Teller Avenue

Suite 170  
Irvine, CA 92715  
(714) 851-9422

**Texas**

**Richard W. Sheehan**

9330 LBJ Freeway  
Suite 1060  
Dallas, TX 75243  
(214) 644-3683

### INTERNATIONAL

**Cahners Publishing Company**

27 Paul Street  
London, EC2A 4JU,  
England

Tel: 44 1 628-7030  
Telex: 914911 TEC PUB G  
Fax: 44 1 839-6626

**Managing Director—Europe**

**Sal Massimino**

U.K., Benelux

**Jan Dawson**

**Tracey Lehane**

Scandinavia

**Martin Sutcliffe**

France, Italy, Spain

**Alasdair Melville**

W. Germany, Austria,  
Switzerland,

E. Europe

**Uwe Kretzschmar**

Israel

**Roseline Lewin-Wainberg**

Cahners Publishing

Company

68 Sokolov St.

Ramat Hasharon 47 235

Israel

Tel.: 03-49 12 69

Japan

**Hiroshi Sato**

IRM, Inc.

Rosei Building, 4-2

Higashi Azabu 1-Chome

Minato-Ku

Tokyo 106, Japan

Tel: 03-584-1241

Telex: 242-2588 IRMTOK J

Taiwan

**Parson Lee**

Acteam International

Marketing Corp.

6F, No. 43, Lane 13

Kwang-Fu South Road

Mailbox 18-91

Taipei, 10594,

Taiwan R.O.C.

Tel: (02) 760-6209

Telex: 29809 ACTEAM

### RECRUITMENT ADVERTISING

**Roberta Renard**

National Sales Manager  
103 Eisenhower Parkway  
Roseland, NJ 07068  
(201) 228-8602

### INFORMATION CARD DECKS

**Joanne Dawson**

Department Manager  
1301 S. Grove Avenue  
P.O. Box 1030  
Barrington, IL 60010  
(312) 381-1840

### CAHNERS MAGAZINE DIVISION

**William M. Platt**

President

**Terrence M. McDermott**  
Executive Vice President

**Frank Sibley**  
Group Vice President

**Jerry D. Neth**  
Vice President  
Publishing Operations

**Tom Dellamaria**  
VP/Production &  
Manufacturing

**Cahners Publishing Company**  
A Division of Reed Publishing USA

Specialized Business and Consumer Magazines for Building & Construction, Interior Design, Electronics & Computers, Foodservice & Lodging, Manufacturing & Libraries, Medical/Health Care, Child Care & Development.



# Rapid movement in the stock

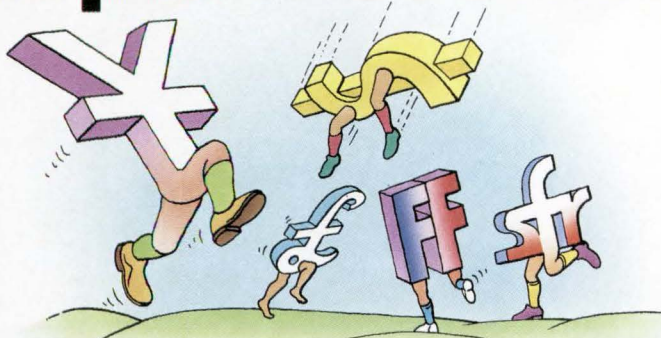

markets, today's production figures,

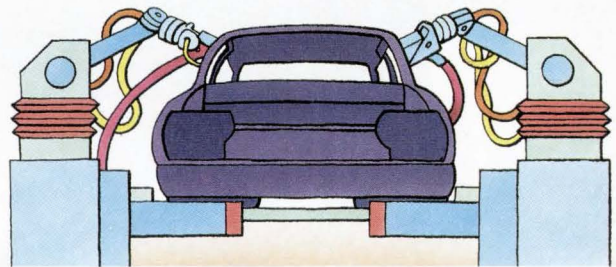

confirmed passenger and freight loading lists,

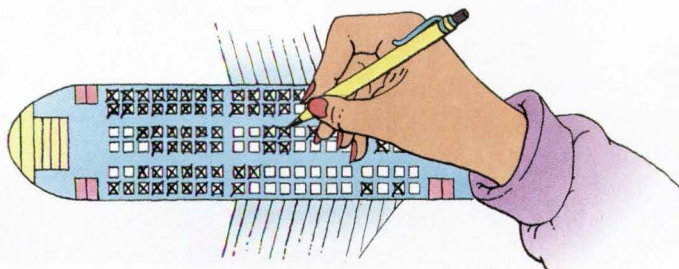

whatever information you are transmitting:

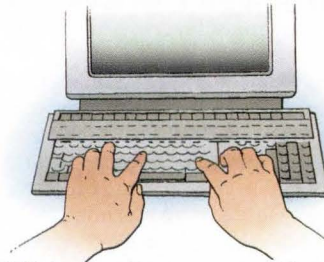

## DNE systems increase the availability of your data network.

Different organisations, different applications, but the same problem: data communications must be reliable, economical and always available. This can be achieved by constant monitoring, measurement and maintenance of the system. Decades of meeting customers' needs in comms test equipment have given Wandel & Goltermann the experience to develop the DNE system – tech control, network control and network management systems. DNE allows you to react quickly to a problem and reduce down time no matter what the size of your network. Send off the coupon for more details about DNE and the W & G datacoms test sets.

Wandel & Goltermann, Dept. VMW, Pf. 12 62, D-7412 Eningen, FRG  
Tel.: +(49) 71 21 86-0 · Telex 729833 · Fax: +(49) 71 21 8 84 04

Please send me a free copy of  
 the DNE colour brochure  the data test equipment product guide

Name \_\_\_\_\_

Company \_\_\_\_\_

Address \_\_\_\_\_

Postcode \_\_\_\_\_ Telephone \_\_\_\_\_

# Introducing the Software Architecture to Program Business Success.

## ISA: The Open Integrated Software Architecture

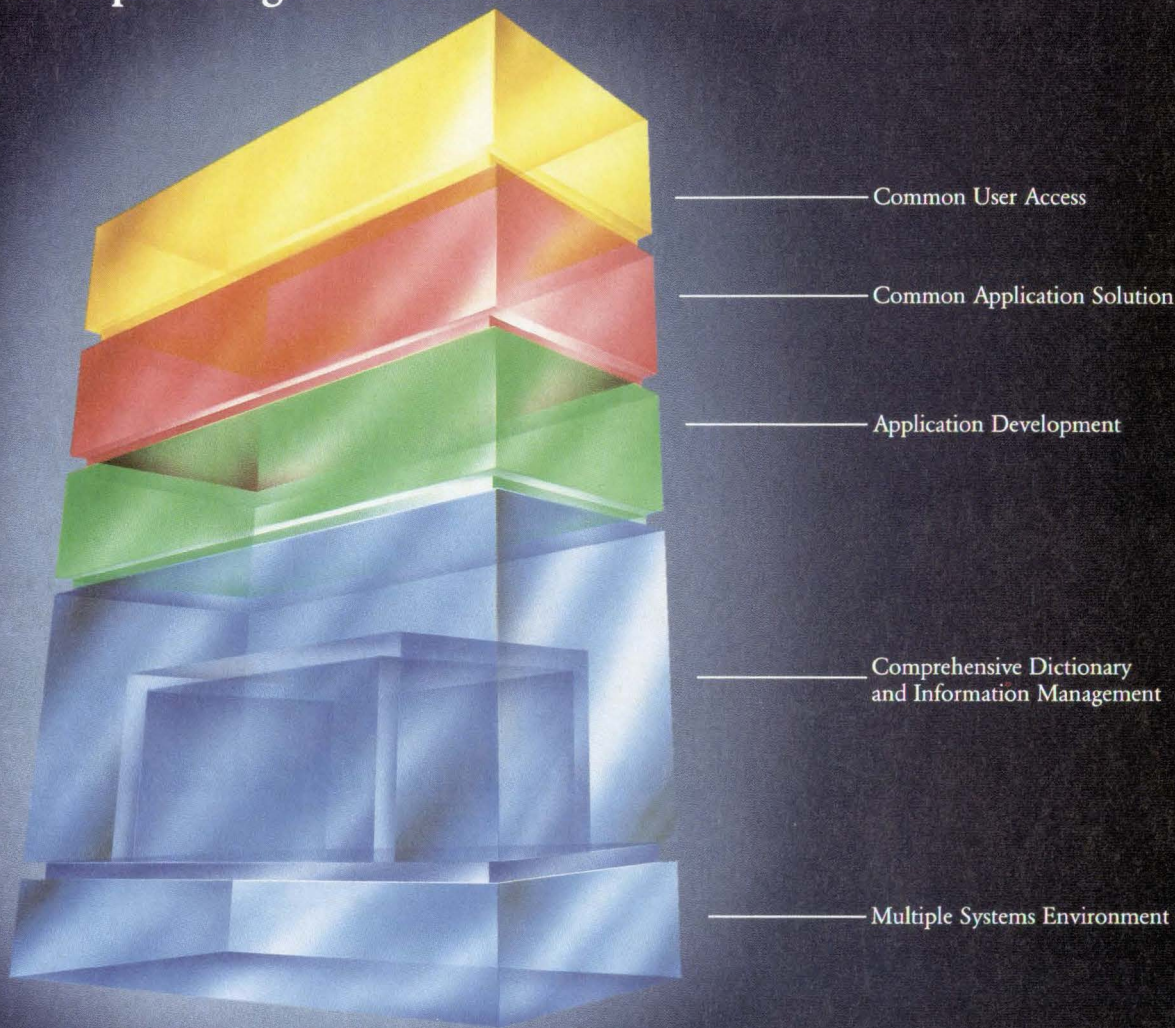

Your organisation has discovered that if it is to overcome the ongoing problems of an ever-changing DP environment, it must first enjoy the advantages of an integrated software architecture.

NOW – it can! Starting today, your organisation can satisfy even the most elaborate demands for information, while being fully prepared to meet the unforeseen challenges of tomorrow. ISA – The Open Integrated Software Architecture – from Software AG is here!

NOW – the advantages of an open software architecture, portable across IBM, DEC and Siemens hardware, can be yours. Instead of worrying about which operating, TP and data management systems you “have” to use, now you can incorporate the technology that’s “best” to use. All this, while taking advantage of evolving standards and technologies – such as SQL, DCA or CASE. ISA from Software AG is here!

NOW – all you need to integrate 4th generation applications, true end-user computing, relational data management, a universal office system and the optimum distribution of data and processes, is one consistent architecture. With one common user surface. ISA from Software AG is here!

NOW – you too can profit from the advanced technology and customer support already enjoyed by thousands of successful organisations the world over. ISA from Software AG is here!

Don't keep the future waiting. Call or write for complete details – NOW.

**ISA is here! It's your guarantee for a high return on a secure investment. Use any of its comprehensive, powerful solutions to vitalise the most crucial functions of your day to day operations. Or, to integrate your entire DP environment.**

IBM is a registered trademark of International Business Machines, Inc.

DEC is a registered trademark of Digital Equipment Corporation.

**SOFTWARE AG**  
Programming Business Success

Circle 44 on Reader Card

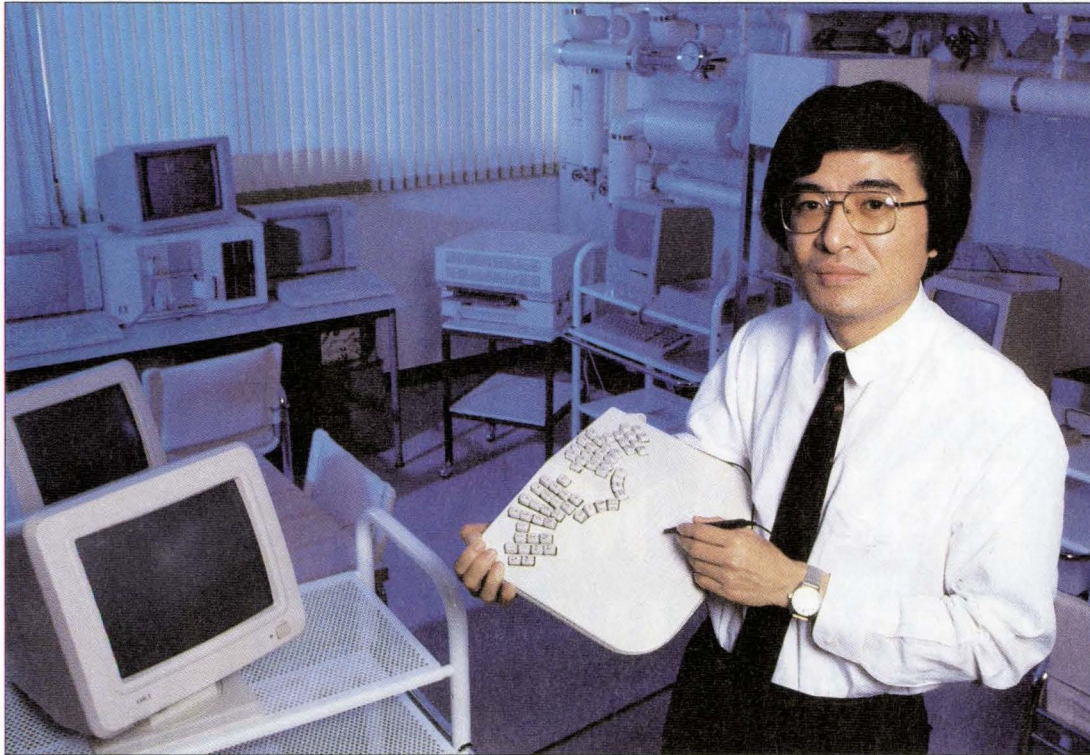

Japan has developed its first all-Japanese operating system, called TRON. Though the Japanese are offering it as a contribution to the global development of computing, TRON may also have a more basic commercial impact on the worldwide workstation market. Japanese manufacturers are jumping on the bandwagon, and the first products are on the way.

# Japan's TRON Tactics

BY ROBERT POE

It began as an attempt to disprove the notion that Japan lacks the creativity to do anything original in software. Now it is beginning to lay the foundations of a Japanese export drive in Unix workstations.

"It" is TRON, and though Disney made a movie with the same name, this TRON stands for The Real-time Operating Nucleus, the object of Japan's national research project to develop a new, all-Japanese, operating system. The results of the research project are now being implemented in products that, over the next few years, may have a huge impact on the fast-growing workstation markets in Japan and abroad.

TRON began life in 1981 when Prof. Ken Sakamura of Tokyo University's information science department developed the basic TRON architecture with the help of grad students and computer researchers. In June 1984, a TRON association was formed, under the auspices of the Japan Electronic Industry Development Association (JEIDA), to push the development of commercial TRON products. Sakamura was chairman of JEIDA's microcomputer application committee at the time. Fujitsu, Hitachi, Matsushita,

NEC, NTT, Oki, and Toshiba are now among the members of the association, which costs ¥500,000 (\$3,450) to join.

At its present stage of evolution, TRON architecture is divided into several distinct layers. The association merely defines the specifications. Manufacturers are then free to implement TRON systems in any way they choose.

At the most basic level is the instruction set processor (ISP). This is a 32-bit microprocessor that can execute a specified instruction set and is the actual nucleus for which the TRON name was chosen. Two operating system kernels—ITRON, for industrial applications, and BTRON, for business applications—will be able to run on the ISP. There is also a CTRON (central) kernel specification, designed for large (non-ISP) computers used as central file servers. Communication among all of the TRON types will be through MTRON (macro) kernels residing on each machine. TRON's highest level is the applications and man-machine interface layer, while an OS shell fits between this and the OS kernels.

The advantage of the TRON architecture, claims Sakamura, is that it is "tailored to take advantage of the technology of the 1990s," especially high-density

PHILIPS ADDS NEW DIMENSIONS

**GUESS  
WHAT'S MISSING  
FROM MOST  
COMMUNICATION  
SYSTEMS?**

Read on and discover how the missing pieces fit together to form one of the worlds most advanced business



TO INFORMATION MANAGEMENT

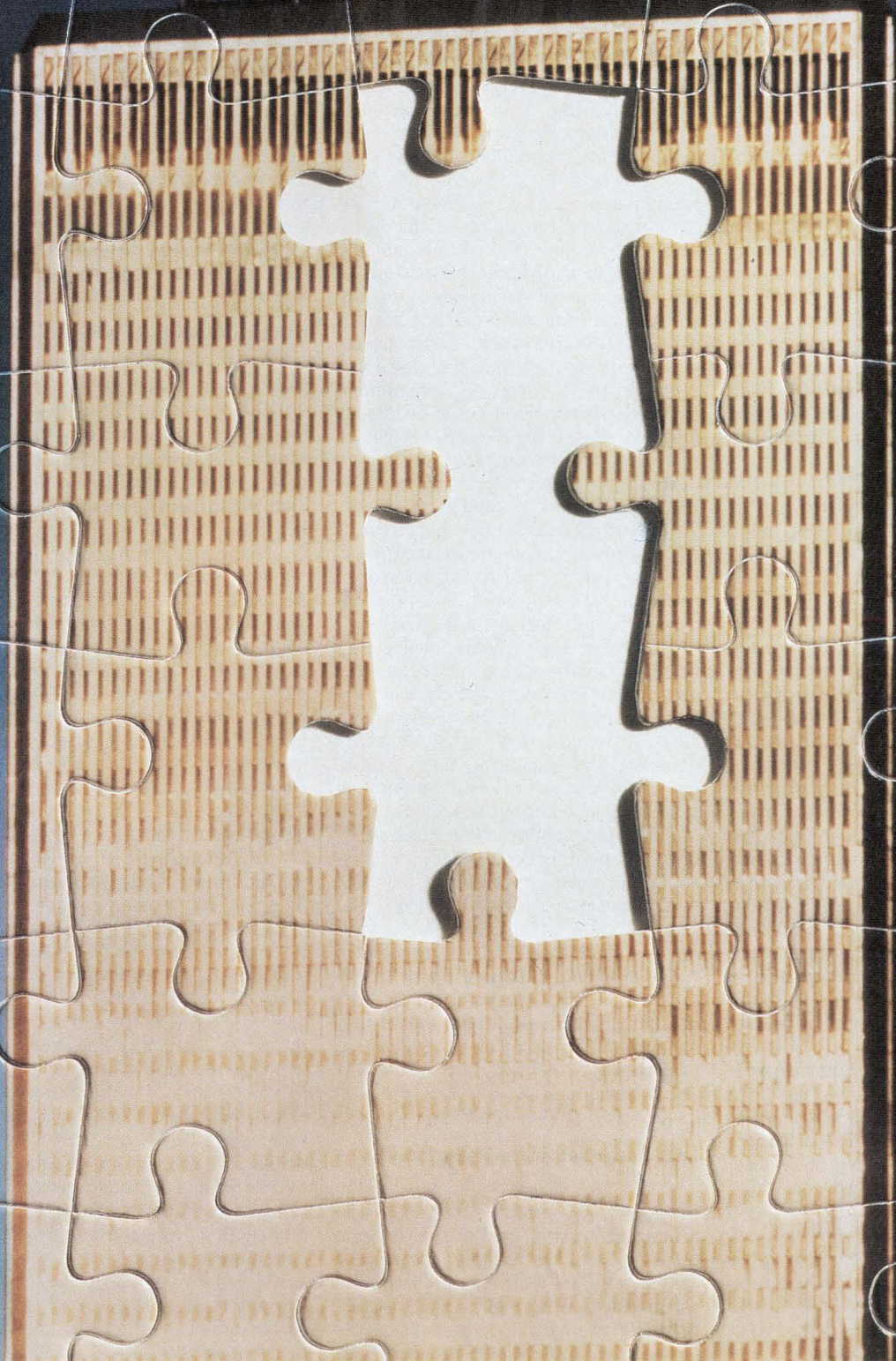

communications systems. And then see it in action. On stand 2350 . . . **COMPETENCE IN COMMUNICATIONS**

**PHILIPS**

VLSI fabrication techniques. More important, it was designed from the start as a 32-bit architecture, with provisions for future upward compatibility to 64 bits. This will make TRON chips much more efficient than current commercial 32-bit chips, which must maintain backward compatibility to 8-bit or even 4-bit versions, asserts Sakamura.

In addition, the ISP specification contains some instructions specifically designed for multitasking, multiwindow applications, such as context switching, bit map manipulation, and queue manipulation. Two-byte coding, necessary for representing Japanese ideographic characters, as well as other languages, such as Chinese and Arabic, is also a standard feature rather than an inefficient add-on.

#### Specifications are Far-Reaching

TRON specifications will extend far beyond coding, however. Even such things as the keyboard, a bulging surface with keys arranged in curved lines, and alternate graphics input by electronic pen, have been decided on. In the longer term, Sakamura also envisions the extension of TRON specs to cover the man-machine and machine-machine interfaces, both hardware and software, for virtually all home and industrial appliances, including optical disks, vcrs, and robots.

One of its biggest selling points is that TRON is an open architecture available without charge—other than the association membership fee—to anyone who wants to use it. The only requirement is that those wishing to display the TRON trademark must submit their products to be verified for conformance to the TRON specifications. It is not limited to Japanese companies—any foreign company can join the association and will receive equal treatment.

TRON has received an enthusiastic reception from the big names in Japanese computers. Mitsubishi, Hitachi, and Fujitsu are cooperating to develop a three-level set of TRON microprocessors. Mitsubishi's M/32-100, still a working name at the moment, will be a 4.5MIPS chip for pcs and business workstations. The 6MIPS Hitachi H/32-200 is targeted at engineering workstations, while Fujitsu's F/32-300 will average 12MIPS with a 20MIPS peak speed and will be aimed at top-end business workstations.

The three companies have worked out performance specs and are writing the chips' documentation together, but they are developing the simulation logic and circuit layout patterns individually. Fujitsu and Hitachi have been working

together since last October; Mitsubishi joined this spring. Initially, the Hitachi version will be the standard; after it is debugged, all three companies will manufacture the chip from the same mask patterns. Matsushita and Toshiba are developing TRON chips independently.

The real reason behind the Japanese manufacturers' enthusiasm for TRON may be strategic rather than technological. A major factor is undoubtedly the reluctance of U.S. chip makers to supply their latest technology to the Japanese—Intel and Motorola have refused to second-source their 32-bit microprocessors through their traditional Japanese partners. Japanese development of TRON workstations could become a means of pressuring the U.S. companies to release their technology or, if they continue to refuse, of creating products that will cut into U.S. suppliers' sales.

How much pressure could be exerted depends on the commercial potential of TRON products, which remains an open question. "It's too early to reach a conclusion about how it will turn out," remarks Toshiakira Ikeda, manager of Hitachi's small-systems marketing department. "For now, Hitachi will continue developing both conventional and TRON systems. I don't think TRON will dominate the [Japanese] micro world, but will be just one of several [operating systems], including MS/DOS and Unix."

The most important strategic point, however, may not be the overall TRON architecture itself but one of its features: its division into layers. This means that the TRON chip can run a non-TRON operating system, while TRON OS kernels can run on conventional chips. In fact, the latter has already happened. Matsushita has introduced a prototype BTRON personal computer based on the 80286 chip because its TRON chip is not yet ready. NEC is developing an ITRON OS to run on its proprietary V60 processor.

#### Interchangeable Operating Systems?

Industry executives downplay the point. Declares Hitachi's Ikeda, "We are producing the chip and the OS as a single project. By taking this approach, if there are chip and OS interface problems, we can modify the chip itself." The possibility of interchangeable operating systems has serious implications, particularly in light of the persistent questions about TRON's propagation outside of Japan.

On the one hand, there is Prof. Sakamura's optimistic outlook. One of the most appealing aspects of the entire effort, in fact, is his idealism in promoting

the new architecture as a sort of Japanese gift to the rest of the world. "I am sorry to say that the extent of Japan's contribution to industrial standardization in the world does not match its industrial clout," declares Sakamura. "I would like to see the trend reversed, at least in the case of computer architecture." He sees the TRON project as a manifestation of the spirit of volunteerism, contributing to society as a whole. "I sometimes describe the TRON project as a volunteer organization like the Red Cross," he says.

#### A Compromise Chip Is in the Offing

The companies aren't so idealistic, however. They appear, in fact, to have little hope that the TRON OS will become important overseas. Both because of Motorola's strength and AT&T's plans to deliver Unix for the Intel 80386, "I think Unix will become dominant in the world market in the future," says Tsuyoshi Watanabe, general manager of Fujitsu's microcomputer development division. Accordingly, Hitachi and Fujitsu are creating a version of Unix for their TRON chips for delivery next spring. It's uncertain whether a single machine with a TRON chip will be able to run both Unix and a TRON OS, or if there will be some minor hardware differences. The target markets are certain, however. "Our—Hitachi and Fujitsu's—main target of Unix is for the U.S.," says Watanabe. "The TRON OS main target is Japan."

If Watanabe's vision is borne out, it will give Japan a competitive advantage. At home, its workstation market would become less penetrable, since it would be dominated by a unique operating system. Foreigners would find it difficult and financially unrewarding to create TRON-compatible hardware and software. On the export side, Japanese manufacturers would have a high-speed chip running an industry-standard operating system, around which they could build their usual outstanding, low-cost hardware. This would give them a hot product for the overseas Unix workstation market.

On the other hand, if Prof. Sakamura gets his way, the complete TRON architecture will be spread throughout the world as Japan's contribution to the development of the computer. The TRON association is considering making and distributing short promotional movies in various languages to explain to the world the role it envisions for TRON in the computer industry as a whole.

Either way, if TRON is a commercial success, it is likely to have a major impact on the world workstation market. ■



**VOICE AND  
DATA  
HANDLING**

## **Philips Voice Communications.**

Integrating voice communications with data, text and image should be the ultimate aim of any large organisation.

Philips has an extensive range of voice and data handling equipment - from the most sophisticated Sopho-S PABX to the simplest key phone.

### **Sopho-S Telephone Systems.**

When it comes to networking, Sopho-S can be connected to provide true transparency when communicating voice or data, no matter how far flung offices and depots might be.

It's also the first system to be specifically designed for ISDN, when it comes on-line.

In fact, the system is so flexible, it can be adjusted to accommodate staff or departmental changes whenever they occur.

### **Sopho-K Key Systems and Telephone Terminals.**

Using Sopho-S in conjunction with Philips Sopho-K key systems, you can achieve maximum flexibility.

With an extensive range of facilities and features, Sopho-K key systems can be "piggy-backed" onto the main Sopho-S or act as a stand-alone telephone system (they are ideal for a small company not requiring a full PABX).

Sopho-S and the Sopho-K key telephone range are part of a totally integrated communications system that gives you complete control over your voice and data handling.

Now turn over and see how the pieces fit together.



# **PHILIPS**

**In one form or another, ISDN is imminent, but so far nobody has worked out what it will cost. Users must take a hard look at the benefits and what they are prepared to pay to use ISDN.**

# Counting the Cost of ISDN

BY CHRIS BUCKLEY

It is surprising but true: despite all the ballyhoo about the Integrated Services Digital Network (ISDN), no one in the telecommunications industry seems to know what the rates will be for using it. Perhaps telecom carriers are just keeping the costs a secret from the rest of us. Perhaps they just don't know.

**THE VISION OF  
A UNIVERSAL,  
CARRY-  
ANYTHING  
NETWORK IS  
CLOUDED.**

What is certain is that there's an enormous amount of investment going into the development and implementation of ISDN. If it provides lower operating costs, better facilities, or better quality communications, it will obviously be worth paying something extra to use it. All that potential users can do at this stage, however, is to hope some-

one has done the addition right. The time has come for those users to take a hard look at what the real advantages of ISDN will be—and how these can be cost-justified.

Most descriptions of ISDN concentrate upon the technical characteristics of access channels. In general, users will be offered basic access lines at 144Kbps, split into two channels at 64Kbps (B

channel) and one channel at 16Kbps (D channel); and primary access lines at 2Mbps, split into 30 different B channels plus a 64Kbps D channel and a further 64Kbps channel that may be used for synchronization purposes.

In the U.S., primary access will generally offer 23 different B channels, in order to adhere to the T1 digital rate of 1.544Mbps. Multiplexors are already available that can interconnect 2Mbps and 1.544Mbps systems. Each B channel will be available for voice, data, facsimile, or other services, and some services may be able to use capacity on the D channel.

This pattern seems simple, yet the vision of a universal, carry-anything network is badly clouded by a diversity of implementations.

Many countries have tested ISDN services. Japan's pilot at Mitaka in 1984, however, used 88Kbps, and the U.K.'s Integrated Digital Access pilot ran at 80Kbps. In Italy, two methods are being piloted, at 144Kbps and at 80Kbps. In addition, several countries have set up trial services using burst-mode transmission techniques that do not match standards issued by the world's telecom standards body, the Comité Consultatif International Télégraphique et Téléphonique (CCITT) in Geneva.

The picture does not reassure observers looking for concerted international action, in spite of carriers' general policy agreements on longer-term stan-





**MESSAGE  
HANDLING**

## **Philips Text Communications.**

### **Sopho-Text Server.**

Through the use of a Sopho-Text server, Sopho-S can be connected to message-handling equipment for the transmission of internal electronic mail. Sopho-Text also provides connection for these terminals to the public telex network and has a store and forward facility. This is Philips answer to your internal and external message-handling needs.

### **Pact 250.**

Pact 250 gives you a dedicated connection to the public telex network. The Pact 250 teleprinter

has a minimum electronic message memory of 42,000 characters, easily expandable to 170,000 characters. Optional flexible disc units provide unlimited memory and long-term storage on diskettes. It has a user-friendly keyboard and an excellent text-editing facility, using the VDU attachment or telex printer.

The Pact 250 also provides an integrated telex message-handling facility for other electronic office equipment, such as word processors. It has the ability to send and receive at the same time, automatically if required. The teleprinter system is designed to cope with a high volume of data, ensuring reliability at all times.



dards. The only thing that does seem clear, is the complete agreement upon the use of a single plug and socket on a single line for access to all services. But what is this worth to users?

While the single connection is presented as a major benefit, when all is said and done, all it means to the user is a few less wires, and fewer different types of interface. That's not really an enormous benefit, since the connection will be invisible once installed, and the supplier usually takes care of most of the problems at that stage. Certainly not something to pay much extra for.

What about the services? These promised new services are potentially very valuable. They are what users are willing to pay for, provided they make business more profitable. The clear success stories of the past may give some indication of true market value.

About 100 years ago, telegraphy began it all, telescoping message delivery times from weeks to minutes. Telephony added the key benefit of interactive voice. Telex gave messages with added benefits such as confirmation of receipt. Data communications, both as dedicated channels and as switched services, are expanding computing from a local process to a worldwide interprocessing facility.

More recent developments, such as those in the field of value-added services, are only successful if they provide some clear user benefit. In some cases, such as public packet switching in France, the relative pricing of different transmission networks helps direct the service over a particular medium. Nevertheless, the French Transpac service would not have been successful if it had not given market value, in this case by a combination of cost and performance benefits.

Correspondingly, ISDN must offer a real business benefit if it is to command premium rates. This means either lower costs to users or better services. Proposed services for telephony include identification of the calling party, more detailed billing, call-waiting advice, call diversion, and call forwarding. But these can be achieved already on private networks at a fairly low cost; there must be considerable doubt about whether these will command premium prices on the public network. To date, the indications are that ISDN will offer few services that cannot be achieved by less dramatic developments.

For nonvoice services, the proposals include high-speed data, up to 64Kbps; high-speed teletex, whose fu-

ture must be doubtful in view of the mixed fortunes of public teletex services; and high-speed facsimile.

High-speed facsimile could be a great benefit and a further boost to the thriving service in picture transmission. This would be great if it were full moving color pictures, but that is likely to require at least the equivalent of six channels at 64Kbps. No such switched service is proposed for many years. Meanwhile, 64Kbps slow-scan picture transmission probably will be useful only for security applications. The difference between ex-

of voice onto a new network, with consequent problems such as signaling and interfacing changes, and complex standards development work. It would also preclude the need to develop complex interconnections between ISDN and existing networks, new numbering schemes, and so forth. The more limited objective of a high-speed public digital network could be achieved much more rapidly than with ISDN.

Such discussion is probably pointless, however, because ISDN is coming, like it or not. But it does put the value of

FIGURE 1 Typical Sites in the Early 1990s

	NUMBER OF PEOPLE	TELEPHONE STATIONS	DATA TERMINALS
Site A	25	22	12
Site B	50	45	25
Site C	100	90	50
Site D	500	450	250
Site E	1,000	900	500

FIGURE 2 Lines Required at These Sites

	PHONE EXCHANGE LINES (64Kbps)	DATA LINES (9.6Kbps)	DATA LINES (64Kbps)	RATIO OF VOICE TO DATA (64Kbps)
Site A	5	2	1	5:1
Site B	9	3	1	9:1
Site C	17	5	1	17:1
Site D	55	25	5	11:1
Site E	90	50	10	9:1

Note: lines at 56Kbps instead of 64Kbps would require virtually identical numbers.

isting analog alternatives and ISDN is therefore limited to the difference between, say, 9.6Kbps and 64Kbps, which is unlikely to have much impact.

Quality improvement, in clearer transmission terms or faster call setup times, might be claimed as a benefit of ISDN, but since similar improvements could be achieved by simply going digital without ISDN, that claim would be unfair.

That leaves us with two real winners—high-speed data and high-speed facsimile—plus minor benefits on other services, including telephony.

An existing digital data network at 64Kbps, however, could deliver these very effectively. This approach would be simpler than ISDN because, first, it would avoid the need to transfer large volumes

of ISDN to the user in perspective.

Overall, the charges for ISDN must offer a cost-effective choice to a user. If the supplier is offering a novel new service and there are no alternatives, then the cost of ISDN needs to be compared directly to business benefits.

Voice traffic in 1987 probably accounts for 85% to 90% of a typical company's total telecommunications costs. The other 10% to 15% is likely to be from 8% to 12% data, plus from 3% to 5% other services. Looking to the future, growth in data communications will tend to make the data percentage higher, but this rise will be offset by more distributed processing and higher line utilizations. Even in 10 years' time, data costs are unlikely to rise above 10% to 15% of



## NETWORKING

### **Philips Data Communications.**

Networking is an essential feature of multi-site communications, giving the necessary flexibility and cost savings a large company needs.

Through the use of TRT's Standard Networking Products (SNP), SEMATRANS modems and COMPAC network processors, Sopho-S can connect scattered plants and offices into one integrated voice and data communications network.

#### **Modems.**

TRT's range of VLSI modems can prevent data, even transmitted over long distances, from being garbled by noise and line distortion.

Some models also incorporate an echo cancellation facility, which ensures significantly higher quality and faster transmission.

#### **COMPAC network processors.**

With Philips COMPAC network processors, affordable networking is now within everyone's reach.

The full range of Compac processor equipment protects your networking investment because they fully comply with available standards.

They offer wide-ranging connectivity, enabling X25, SNA and async terminals and hosts to be integrated into a single optimised network, using leased terrestrial or satellite links, and public X25 networks.

See how they fit together. Talk to TRT, the Philips competence centre for SNP.



Circle 48 on Reader Card

# PHILIPS

# FREE TRIAL SUBSCRIPTION TO

“...the only journal I've found which provides good financial information for making DP decisions”.

Dr. Carol Sharer, Ph.D.  
Manager, Marketing Administration  
Burroughs Wellcome Company

## COMPUTER ECONOMICS report

Consider these actual quotes  
from our newsletter subscribers:

- “...assists in computer acquisition”.
- “I use the information in support of internal financial analysis”.
- “It's the best analysis of market trends...I receive”.
- “...a ready reference of computer capacities and costs”.
- “It lends authority to conclusions presented to management”.

Readers' favorite features include:

- “accurate, concise charts and graphs”
- “price/performance and vendor analysis”
- “equipment forecasts, analysis, and comparisons”
- “residual value forecasts - much better than others”
- “information I can't find consolidated anywhere else”

“Concise, easy to read, but a lot of information... we recommend it”.

USED IN 82% OF AMERICA'S MAJOR CORPORATIONS AND 71 COUNTRIES  
This unusual introductory offer is limited, so choose today!

FREE 3-month introductory subscription.

Full 12-month subscription for  
US\$295, plus an introductory  
bonus of 3 more months for free.

NAME \_\_\_\_\_

TITLE \_\_\_\_\_

ORGANIZATION \_\_\_\_\_

ADDRESS \_\_\_\_\_

CITY \_\_\_\_\_

COUNTRY \_\_\_\_\_

**COMPUTER ECONOMICS** report

2121 Palomar Airport Road  
Carlsbad, CA 92009 USA  
Telephone (619) 438-7457

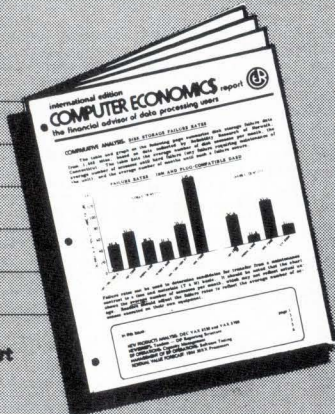

OR CIRCLE THE READER CARD FOR YOUR FREE INTRODUCTORY SUBSCRIPTION  
CIRCLE 50 ON READER CARD

## Counting the Cost of ISDN

a typical company's total communications costs.

The mix of traffic is also important. The numbers in Figure 1 show the likely allocation of telephone stations and data terminals at five typical sites of variable sizes, with voice and data requirements at a time in the early 1990s when ISDN should be widely available. Data terminals are assumed for 50% of staff at each site, telephone extensions for 90%.

Figure 2 shows likely line requirements for these sites, assuming there are 10 data terminals per line at 9.6Kbps, and that there's one voice line per 10 extensions at the larger sites, increasing to one per five extensions at smaller sites. At these levels, which are reasonable for most organizations, the total line capacity needed is heavily dominated by the voice requirements.

Facsimile and other services could well have a significant impact, of course, but it seems unlikely that they would reach more than, say, half the capacity required for data.

At small sites (with fewer than 50 people), a single 64Kbps line will easily cover all nonvoice needs. For 50 to 100 people, two 64Kbps lines will suffice. At larger sites, a ratio of one nonvoice line to five voice lines seems adequate. This pattern could be upset, of course, if new 56Kbps or 64Kbps services emerge, but these have not yet been proposed.

The pattern leaves ISDN heavily dependent upon voice for its justification. If, as seems likely, data will increase to only 20% of total line capacity, data traffic (even at a high premium relative to other networks) will result only in a small amount of extra total revenue to the network supplier.

Since the benefits that ISDN offers for voice traffic are small, very little premium on cost would be realistic. Hence the overall ISDN charge, if it is to gain user acceptance, must be virtually the same as the charge for the corresponding number of non-ISDN voice channels, plus an extra premium for high-speed data. Of course, it might be cheaper—which would be most welcome, and would lead to an enormous success for ISDN.

Let's hope that the other alternative, of making non-ISDN lines very expensive to make the new system seem more attractive, is not considered. ■

*Chris Buckley is a telecommunications specialist based in London. He is in charge of the Telecommunications Networking Group at Pactel, a U.K. consulting firm.*



**VOICE AND  
DATA  
HANDLING**

**MESSAGE  
HANDLING**

**NETWORKING**

## **Philips Integrated Communications.**

There is a secret to successful integrated communications. Standards. That is why Philips is at the forefront of today's telecommunication industry.

Our commitment to ISDN has given Philips communication products a unique edge. By building in this technology we have paved the way for an 'open architecture' in the design of integrated communications systems.

From office automation networks to voice and text transmission, Philips technology meets the

needs of the future with flexibility, consistency and economy. It is a philosophy which encompasses all our products, from computers to telecommunications. We call it Sophomation.

**Philips Integrated Communications.**

**See how it all fits together on  
Stand 2350.**



**COMPETENCE IN COMMUNICATIONS.**

**Philips Telecommunication and Data Systems, PO Box 32,  
1200 JD Hilversum, The Netherlands, Telex 43712.**



Circle 49 on Reader Card

# **PHILIPS**

# How to find total network solutions at Geneva Telecom.

**START**

GENEVA  
**TELE  
COM**  
20-27 OCTOBER

Start at the Geneva  
Telecom Exhibition

Move on to  
the  
STC stand

(it looks like a  
pyramid)

See the  
leaders in both  
telecommunications  
systems...

...and  
information  
systems

**ICCL**

Together we're on the  
stand that provides...

*Communication  
& Information  
Systems*

**FINISH**

ALL OF THE TOP COMPUTER MAKERS ALREADY KNOW—

# THE DIFFERENCE BETWEEN HAVING AN EXIDE ELECTRONICS UPS AND NOT HAVING IT IS LIKE DAY AND NIGHT.

Each of the top 10 computer manufacturers uses Exide Electronics Uninterruptible Power Supplies for their power protection. Because they know that not having Exide Electronics' quality of protection can leave their computers in the dark.

Reliability is the biggest reason for choosing Exide Electronics—because you want to know that your UPS will work before you need it to work. But that's not the only reason.

Just look at our Series 1000... from 3 kVA to 10 kVA, no other manufacturer can pack this much power protection into such a small package. In fact, there are thousands of Series 1000 UPS's already installed. You can choose from six different capacities, with multiple voltage options and receptacles. And

each model is about the size of a two-drawer filing cabinet. So it fits nicely into your office or computer room, quietly protecting your power.

These distinguishing features are the result of more than

twenty years of power protection leadership. And a commitment to making sure that our products are exactly what we say they are.

*Uninterruptible Power Supplies.*

If you want a UPS you can really depend on, buy it from the company you can really depend on. Exide Electronics. Call us today at 1/800/554-3448. In North Carolina, call 1/800/554-3449.



**Series 1000  
Uninterruptible  
Power Systems**

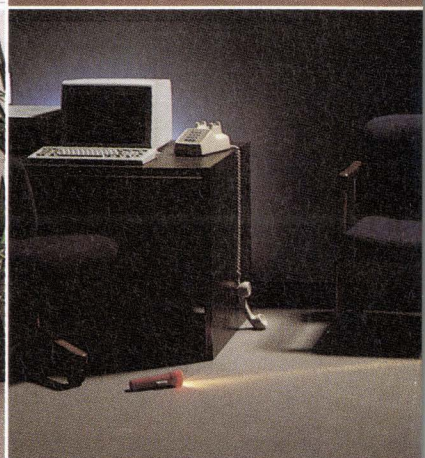

## EXIDE ELECTRONICS

P.O. Box 58189, Raleigh, NC 27658, 919/872-3020, TLX 289968  
In Canada, 5200 Dixie Rd., Suite 20, Mississauga, Ontario L4W 1E4

Complies with applicable FCC requirements.



Are you underpaid? Does the vice president of MIS at the company around the corner make more than you? How much should you ask for in your next raise? DATAMATION's annual salary survey reveals that increases in 1986 were up an average of 5.8%, a handsome margin above the inflation rate. Next year might not be as kind, though. Better news: turnover is down.

# What Are You Worth?

BY PARKER HODGES

"The last two people I lost left to get more money," says William Foulds, director of information systems for St. Anthony's Ancillary Services at St. Anthony's Hospital in St. Petersburg, Fla. Foulds, like virtually every other manager in the MIS business, must deal with a feeling apparently universal among the salaried: "I'm underpaid."

To see where you stack up on the pay scale, take a look at the two large tables on pages 84 and 86. But even if you don't beat the average for your job or your geographical area, don't feel too bad. According to the Bureau of Labor Statistics, the average yearly wage for U.S. workers in the private, nonagricultural sector was \$16,253 in June 1987. Only three jobs out of the 47 surveyed came in lower than this: magnetic media librarian, data entry operator, and word processing operator.

This year's DATAMATION Salary Survey found a better paid population expecting to be even better paid by this time next year. Fully 42 of the 47 job categories report higher salaries than in last year's survey. Just over half the positions in the survey reported salaries at least 5% higher than a year ago. The jobs reporting the highest increases over last year were directors of security, pc evaluators, microcomputer user services specialists, consultants, and junior systems programmers: the average salaries for our sample in these positions were more than 20% higher than the salaries reported in last year's survey.

Two of the three losing job categories were in word processing shops: salaries for wp supervisors and wp operators were reported off 3.8% and 2.5%, respectively. The other losing job was intermediate applications programmer, reporting an average salary 8.9% lower than last year's sample. Two jobs were reported paying exactly the same as last year: junior applications programmers and lead systems analyst/programmers.

Overall, the DATAMATION sample reported that, during 1986, raises throughout the industry had averaged 5.8%, just shy of the 6% that participants in last year's survey had expected. Since inflation hit a longtime low—1.7%—in the year ending June 1986, when the last survey was conducted, those raises represented a handsome 4.1% increase in purchasing power for MIS professionals. This year will apparently see a smaller increase in spendable cash. Respondents to the survey expect increases this year to average 5.9%, just 2.1% over the 3.8% inflation rate in the year since June of 1986. While the government predicts infla-

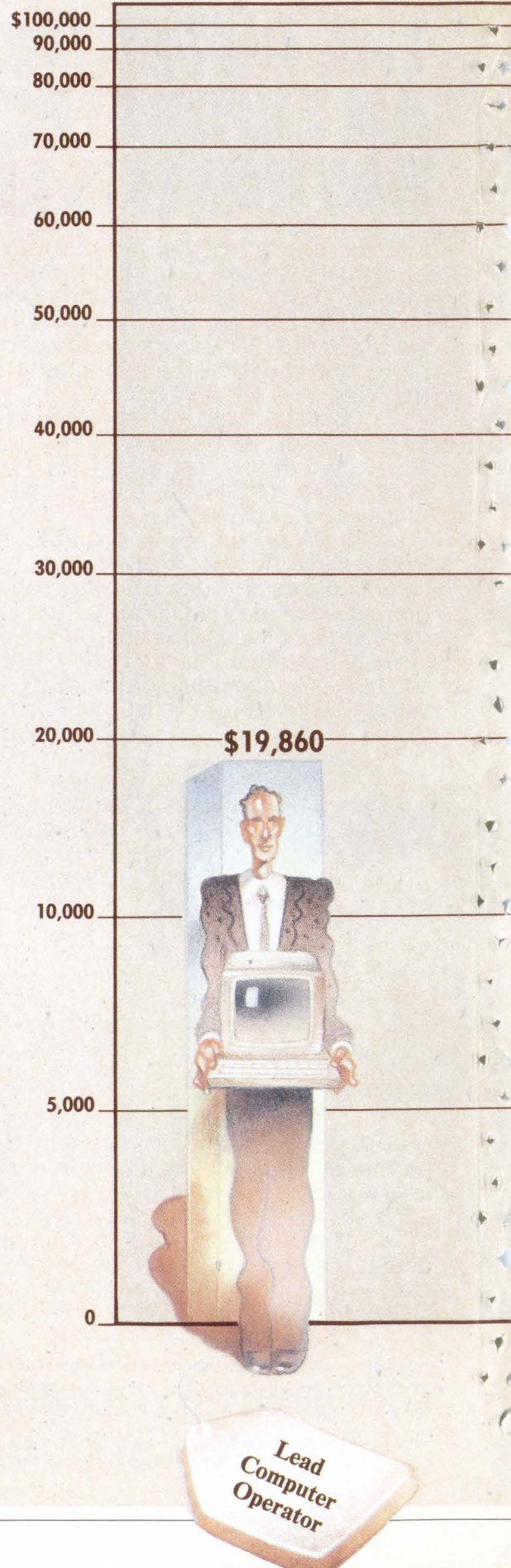



**\$61,500**



**Vice  
President**

**\$22,021**



**Junior  
Systems  
Analyst**

**\$43,753**



**Manager,  
Applications  
Program**

# For years we've been network management p a revolutionary network

Back in 1978, Codex introduced the first independent network control system. And since then we've been busy introducing one network management innovation after another.

Now it's time for another revolutionary innovation. But this time, it's not simply a new network management product we're developing. It's an entirely new network management concept.

A concept unlike anything you've ever seen before. And a concept you've needed for quite some time.

## Why a New Concept?

In today's multi-technology environments, even the best of today's traditional schemes can't keep pace with user demands for comprehensive network reliability, serviceability, and growth.

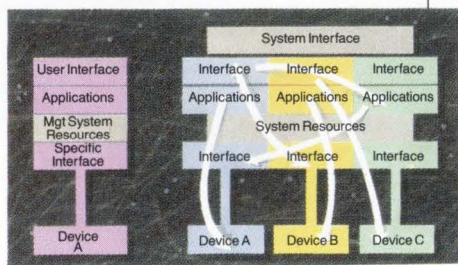

When your network is simple, so is managing it. But when it grows with multiple technologies, most network management systems simply run out of steam.

To get maximum network performance in these complex environments, a new level of integration is required. Which requires a new concept. One that allows you to address current network management needs, yet ensures you of optimum control over your network, no matter how complex it may be, or may become in the future.

## Codex to the Rescue.

We're responding to your needs with a revolutionary system that's modular, incredibly easy to use, and offers an extraordinary user interface that provides an integrated systems view of your entire network.

To accomplish this, we've moved from today's proprietary era to our new direction for the entire network management industry. By creating a system based

on user demands for open architecture in a standardized environment.

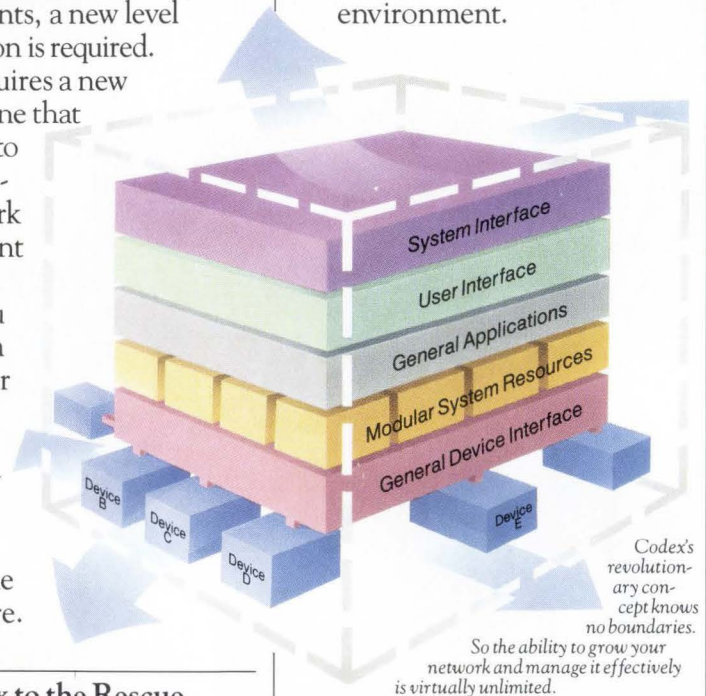

## A System Architected for Growth.

Because our new system is based on open architecture technology, consistent with emerging OSI standards, it provides unmatched user flexibility, and unmatched potential for growth.

Within our new network management concept, all network devices are treated consistently. In fact, it defines a relationship between all

# introducing innovative products. Now it's time for network management concept.

network devices and the management system – a relationship never before established. So one system will handle all architected devices, as well as give you the structure to manage unarchitected devices.

## Standards Are the Roadmap.

As protocols and applications proliferate, the demand for standardization is greater than ever before. Everyone is talking about standards – they're critical to the future because they facilitate integration, choice and flexibility.

As the leading proponent of vendor-independent networking, Codex has always been an active contributor to the evolution of network

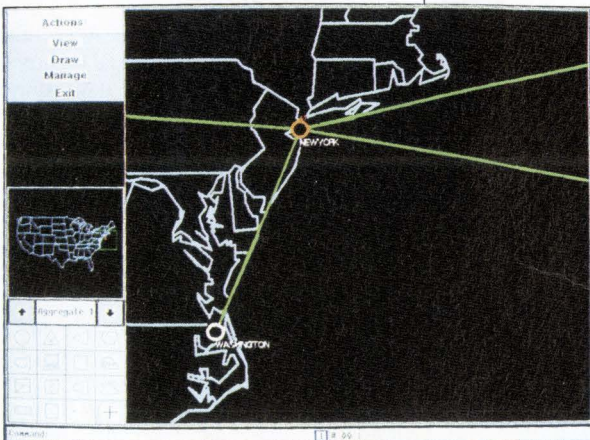

Our new network management concept allows you to control your network no matter how far it reaches.

## CURRENT PORTFOLIO

Complete range of network management and control systems
Extensive line of modems (up to 19,200 bps)
Complete selection of multiplexers, switches, and digital transmission devices
X.25 products, SNA gateways, experimental ISDN gateway
Network design and applications engineering support
National and multinational account management
Field service and customer education/training
Lease arrangements

*No matter what your networking needs,  
Codex has the solutions.*

management standards. So naturally, we designed our integrated network management system to be fully consistent with emerging OSI standards.

## True Integration Is Here.

Now you'll get one consistent view of the entire network topology. With a single management system you'll have the potential to manage and control your entire network – statistical and time division multiplexers, T1 muxes, modems, X.25 concentrators – and other network devices. And that includes access to your computing equipment.

And we've engineered a nonproprietary

technology that can work with other systems – in conjunction with IBM's NetView, for example – to give users truly integrated control of their network.

Because the information and management commands are integrated, you can *take decisive corrective action*. So you get a unified database, one system that provides full problem, fault, event and performance management – with extensive diagnostic, restoral, reconfiguration and reporting capabilities to maximize overall network availability.

## Call for More Information.

Obviously, there's lots more to tell. To obtain a free brochure outlining our revolutionary approach to network management, call **1-800-426-1212, Ext. 246**. In Europe, call 32-2-6608980. Or write to Codex Corporation Dept. 707-46, Maresfield Farm, 7 Blue Hill River Road, Canton, MA 02021-1097. We promise it will change the way you look at network management forever.

**codex**  
M MOTOROLA

The Networking Experts

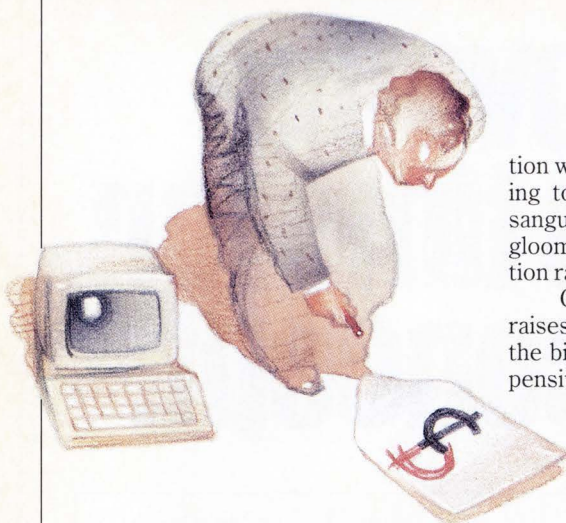

tion will ebb a bit in the coming year, falling to 3.2%, a minority group of less sanguine economists have painted a gloomier picture, seeing an annual inflation rate approaching 7% by early 1988.

Geographic differences in 1986 raises were perhaps predictable, with the biggest increases to be found in expensive places: New York and its metropolitan area and Los Angeles reported average raises of more than 7% (see Figure 1). The lowest average increases—under 5%—were found in Seattle, St.

## What are you Worth?

Louis, and Cleveland. The remainder of the country reported average raises between 5.1%—in Chicago—and 6.4%—in Washington, D.C.

Compared with other U.S. workers, these increases look healthy indeed. According to the Labor Department, in private industry, union-represented workers who signed contracts during the first six months of 1987 received pay increases of only 2.5%. Union-represented employees of state and local governments did better, averaging 5.4%. Primary and secondary schoolteachers did best, their raises under contracts signed this year averaging 6.9%. Except for the teachers, who had gotten 6.3% raises in contracts negotiated last year, this year's raises aren't what American workers have grown to expect. In June 1987, white-collar workers were averaging 3.3% more salary than they'd made a year earlier; but in June of 1986, white-collar workers had averaged 4.5% higher than in 1985. The same trend held true for professional and technical workers: 1987 wages were 3.8% over 1986; in 1986, the increase had been 4.1%.

Some studies of information systems workers seem to indicate that DATAMATION's readers are doing better than their colleagues as a whole: according to Jeff Long, a spokesman for the Administrative Management Society in Willow Grove, Pa., IS workers' raises in 1986 averaged only 3.5%, down from 1985's 5.3%.

Another area in which DATAMATION's sample seems to be doing better than many in the industry is in the expensive matter of staff turnover. Last year, the survey found that managers had expected they'd have to replace 7.1% of their employees during 1986. According to this year's survey, the actual turnover rate for 1986 was 8.8%. For 1987, these managers expect a turnover rate just a bit higher, 9.1%. The expectation of higher turnover rates confirms findings in other surveys, particularly those that show rising consumer confidence.

Roger O'Connor, a spokesman for Edward Perlin Associates, a New York firm specializing in compensation management, told DATAMATION that its studies of "the 40 or 50 largest companies" in various markets show higher turnover rates especially in New York and Boston, where business is good and jobs are easy to come by. "In large companies in New York," says O'Connor, "turnover rate in systems is running 21%. In operations it is 14%." O'Connor says turnover rates are lower in areas where employees feel

## Detailed Job Descriptions

Respondents to the survey used this job description guide.

*Corporate staff:* reports to senior management within corporation.

*Applications programming:* develops, designs, and prepares computer programs.

*Systems analysis/programming:* systems analysis and applications programming.

*Operations systems programming:* programs and maintains systems software.

*Database administration:* plans, organizes, and schedules the activities of the database section; establishes standards, maintains dictionary.

*Datacom/telecom:* develops and designs data communications networks and the installation and operation of data lines.

*Computer operations:* in charge of equipment, data entry, production control, and postprocessing, but not systems analysis, or other development functions.

*Production and I/O control:* sets up and schedules jobs for processing so as to maximize utilization and meet turnaround requirements.

*Data entry:* performs data entry and verification functions.

*Office automation:* operation of word processing equipment, intelligent typewriters, and terminals for text editing/word processing.

### Job Levels

*Manager:* advanced degree and minimum five years' experience or equivalent combinations; strong management skills, performs personnel evaluations, budgeting, progress reporting, and project management.

*Lead:* bachelor's degree or equivalent and minimum four years' experience with two years in supervisory capacity; performs supervision as a project manager.

*Senior:* bachelor's degree or equivalent and minimum three years' experience, including some supervisory functions.

*Intermediate:* bachelor's degree or equivalent and minimum two years' experience; requires direction on some activities.

*Junior:* two to four years' college and six months' experience; directly supervised.

## Methodology

The 1987 DATAMATION Salary Survey began in June with a questionnaire sent to 10,000 IS officials in the United States, drawn at random from the magazine's list of 64,000 top managers at computer sites throughout the country.

A total of 596 key officials returned completed questionnaires, providing information on salaries, benefits, and perquisites for 47 discrete IS positions in various industries and metropolitan areas. Half of the respondents are from Fortune 1000 companies; the other half were chosen at random and could represent companies of any size, from the smallest to the largest.

As shown in the accompanying tables, the most important labor pools covered by the survey were those in Boston, New York (divided into Manhattan and its environs), Philadelphia, Washington, D.C./Baltimore, Atlanta, Denver, Houston, Dallas/Fort Worth, Chicago, Minneapolis/St. Paul, Cleveland, Cincinnati/Columbus, Detroit, St. Louis, Seattle, San Francisco/Silicon Valley, and Los Angeles. The salary and other data were also broken down by industry category.

"more anxiety" about job availability, citing San Francisco in particular.

Of course, some companies' employees choose to stick around because they like their jobs. David Dahlke, director of data processing for Harris Farms in Coalinga, Calif., told DATAMATION that his company's longtime zero turnover rate is due to several factors, among them good pay. "We try to pay Bay Area/Los Angeles salaries in an area where the cost of living is about half." But Dahlke stresses that "the challenge of the job" can be as important as pay. The agricultural marketplace is "an unusual one" says Dahlke. "Not much has been done to develop systems in this area." In addition to intriguing problems, Dahlke's staff has also been given interesting resources with which to solve them. "We've got a lot of nice stuff to work with," says Dahlke, noting that Harris has served as a beta site for software houses and that it had the first local installation of a VAX cluster. Dahlke also adds that Harris has been "generous with training."

Equipment changes can also affect turnover rates. Dennis Foreman, data processing manager at Nico Construction Co., New York, had a zero turnover rate in 1986. This year, he's got problems: with his staff growing by a third, he'll also face a 20% turnover rate. Staffing is one reason Foreman's shop is

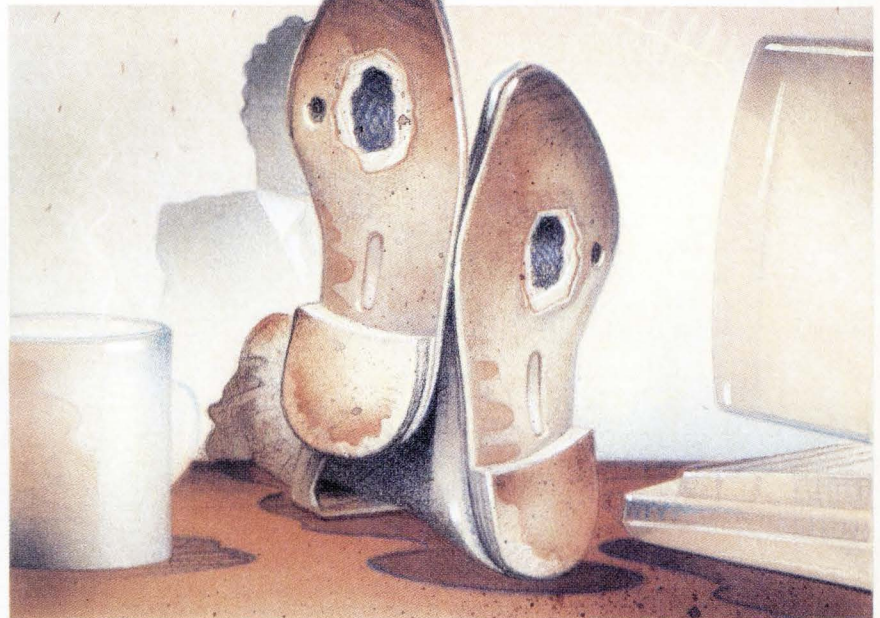

changing vendors, moving to IBM from an old Sperry system. "It is easier to get staff for IBM systems," he says.

Ashby Lincoln is vice president of dp at Consecro Inc., an insurance holding company that owns Bankers National Life Insurance Co., Lincoln American Life Insurance Co., Lincoln Income Life Insurance Co., and Western National Life. Last year, he dealt with a 20% turnover rate. This year, he expects turnover

to plunge to 5%. The reason? "We moved from New Jersey to Carmel, Ind., a northern suburb of Indianapolis." Lincoln says his new location makes hiring staff much easier than it had been in New Jersey. "In Indianapolis, we can hire from all over the Midwest." In New Jersey, says Lincoln, high housing costs in the New York metropolitan area discourage people from moving there. He adds that in New Jersey, "there are too many

**FIGURE 1 Annual Salary Increases**

(IN PERCENT)	EXPECTED IN 1986	ACTUAL 1986	EXPECT IN 1987
Boston	6.0	5.6	5.6
Manhattan	8.3	7.2	11.3
NYC Metro	6.8	7.3	7.6
Philadelphia	5.9	5.6	5.5
Wash./Balt.	8.5	6.4	6.6
Atlanta	6.0	5.5	6.3
Denver	5.2	6.8	6.3
Houston	4.5	5.4	4.6
Dallas/Ft. Worth	5.6	5.5	5.5
Chicago	5.6	5.1	5.6
Minn./St. Paul	5.5	5.4	5.2
Cleveland	5.4	4.4	5.0
Cin./Columbus	6.6	5.5	5.3
Detroit	6.6	5.9	6.1
St. Louis	5.2	4.5	4.7
Seattle	6.6	3.9	3.3
San Francisco	7.2	6.3	6.4
Los Angeles	5.9	7.2	6.3
Total Sample	6.0	5.8	5.9

**FIGURE 2 Turnover Rates**

(IN PERCENT)	EXPECTED IN 1986	ACTUAL 1986	EXPECT IN 1987
Boston	7.4	7.3	10.5
Manhattan	6.8	2.8	2.3
NYC Metro	6.1	15.6	10.7
Philadelphia	4.6	11.4	14.9
Wash./Balt.	13.7	6.2	8.2
Atlanta	4.9	14.3	6.8
Denver	11.4	4.0	5.1
Houston	2.5	8.3	5.8
Dallas/Ft. Worth	4.9	10.4	7.5
Chicago	6.6	8.0	6.0
Minn./St. Paul	4.2	7.1	4.2
Cleveland	2.3	14.7	2.9
Cin./Columbus	1.9	5.6	7.8
Detroit	6.4	3.6	4.9
St. Louis	12.8	3.2	6.5
Seattle	6.7	1.3	2.5
San Francisco	6.1	9.3	5.0
Los Angeles	7.5	11.1	13.9
Total Sample	7.1	8.8	9.1

**FIGURE 3 Average Salary by Region (in \$)**

	ALL	BOSTON	MANHAT	NYC AREA	PHILA	WASH/ BALT	ATLANTA
<b>CORPORATE STAFF</b>							
■ Vice President	61,505	75,000	99,999	66,938	65,000	51,875	54,260
■ Director of Dp/MIS	49,754	57,019	63,667	57,471	51,032	54,277	46,310
■ Technical Services Manager	47,450	47,500	90,000	48,111	43,307	48,591	50,200
■ Information Center/Data Center Manager	41,029	50,667	NA	43,917	35,000	44,060	45,967
■ Director of Security	45,026	NA	NA	NA	NA	46,250	39,300
<b>SYSTEMS ANALYSIS</b>							
■ Manager	44,505	52,000	40,000	51,000	42,733	46,667	36,333
■ Senior Systems Analyst	38,852	45,667	35,000	38,667	41,000	46,713	44,000
■ Lead Systems Analyst	36,381	44,750	53,800	35,000	40,560	41,200	46,000
■ Systems Analyst	32,197	35,600	NA	36,000	37,000	34,643	36,625
■ Junior Systems Analyst	26,003	27,750	NA	28,500	NA	29,200	28,000
<b>APPLICATIONS PROGRAMMING</b>							
■ Manager	43,753	44,125	50,000	44,100	53,333	51,000	49,250
■ Lead Application Programmer	34,003	28,350	45,000	36,333	43,500	41,717	33,750
■ Senior Application Programmer	31,856	25,026	NA	33,900	38,250	39,333	31,100
■ Application Programmer	25,926	23,492	28,000	28,900	29,000	32,038	25,867
■ Intermediate Application Programmer	23,495	18,010	NA	25,000	24,000	29,200	31,000
■ Junior Application Programmer	20,410	16,406	NA	21,833	28,000	23,167	21,500
<b>SYSTEMS ANALYSIS/PROGRAMMING</b>							
■ Manager	44,229	47,975	65,000	47,250	46,090	50,630	44,500
■ Lead Systems Analyst/Programmer	36,545	29,260	NA	39,750	41,970	46,675	31,883
■ Senior Systems Analyst/Programmer	33,514	24,461	36,000	34,129	31,620	38,000	35,817
■ Systems Analyst/Programmer	29,854	25,505	NA	31,650	31,363	31,650	30,606
■ Intermediate Systems Analyst/Programmer	25,632	17,276	NA	28,890	26,600	28,965	23,538
■ Junior Systems Analyst/Programmer	22,021	23,450	NA	25,367	24,750	21,177	20,100
<b>OPERATING SYSTEMS PROGRAMMING</b>							
■ Manager	48,453	58,300	62,500	NA	47,000	52,667	46,675
■ Senior Systems Programmer	40,773	43,825	51,000	34,500	39,965	44,856	41,931
■ Intermediate Systems Programmer	33,006	40,500	NA	33,500	NA	35,653	31,013
■ Junior Systems Programmer	27,693	29,975	28,000	NA	NA	27,250	22,675
<b>DATABASE ADMINISTRATION</b>							
■ Manager	47,255	51,500	65,000	44,000	48,843	46,800	33,100
■ Database Administrator	37,357	47,000	51,000	NA	25,200	39,500	37,250
<b>DATACOM/TELECOM</b>							
■ Manager	45,417	51,500	50,000	42,000	NA	42,840	42,000
■ Analyst	33,087	39,000	20,000	37,500	NA	41,600	37,000
<b>COMPUTER OPERATIONS</b>							
■ Manager	32,958	31,800	44,000	28,750	42,520	45,219	30,100
■ Shift Supervisor	26,236	24,934	25,000	26,000	33,500	32,000	29,667
■ Lead Computer Operator	20,563	19,991	NA	22,167	23,122	25,776	21,467
■ Computer Operator	17,699	15,831	18,000	19,068	20,075	20,339	16,923
■ Magnetic Media Librarian	15,753	10,008	14,000	18,000	NA	28,000	18,000
<b>PRODUCTION AND I/O CONTROL</b>							
■ Supervisor	28,499	36,500	32,000	28,000	NA	29,120	25,400
■ Lead Production Controller	24,309	25,000	50,000	25,000	16,200	26,667	29,000
■ Scheduler	21,814	35,000	22,000	16,000	NA	26,500	19,580
■ Control Clerk	16,359	20,000	NA	13,580	17,400	20,450	16,446
<b>DATA ENTRY</b>							
■ Supervisor	20,720	22,400	30,000	26,400	24,959	22,346	16,737
■ Operator	14,958	16,617	17,000	14,917	16,064	15,447	13,995
<b>OFFICE AUTOMATION</b>							
■ Word Processing Supervisor	24,144	21,000	NA	35,000	22,460	31,000	35,000
■ Word Processing Operator	15,495	15,167	NA	25,000	14,867	19,728	13,625
■ Microcomputer User Services Specialist	27,578	NA	NA	34,000	31,002	26,865	32,117
<b>DOCUMENTATION</b>							
■ Specialists	23,707	22,750	NA	31,500	25,667	36,000	24,000
■ Consultant	43,512	NA	50,000	NA	64,000	55,000	46,125
■ Pc Evaluator	29,739	26,000	NA	25,000	NA	50,000	45,000

HOU- TON	DENVER	DALLAS	CHI	MINN/ ST. PL	CLEVE	CIN/ COL	DTRT	ST. LOU	SEATL	SAN FRAN	LOS ANGEL
64,000	51,500	67,000	69,750	74,300	99,000	71,000	60,000	99,999	NA	56,333	65,343
63,025	37,900	50,667	54,458	56,271	72,500	47,714	51,332	50,286	50,443	65,520	55,282
58,000	30,000	55,252	44,714	50,380	75,000	48,500	43,000	48,500	NA	NA	50,000
40,000	32,000	36,076	51,857	50,292	31,384	35,000	NA	39,500	39,850	39,667	39,500
NA	NA	32,500	67,000	35,550	75,000	NA	NA	48,000	NA	NA	40,000
48,500	NA	NA	45,333	41,000	75,000	45,500	45,195	NA	NA	56,333	46,500
41,833	25,500	48,800	39,000	37,500	49,250	20,000	39,138	35,000	39,000	33,000	42,371
NA	NA	38,000	NA	31,667	45,000	35,000	32,500	NA	NA	NA	NA
32,000	NA	32,750	31,894	29,667	35,000	31,500	33,530	21,000	NA	35,000	38,600
30,000	NA	NA	25,500	23,500	28,000	NA	NA	NA	NA	NA	24,000
44,750	NA	45,250	39,750	42,000	41,867	39,000	44,276	38,000	48,376	62,000	37,500
43,200	NA	30,000	36,500	34,333	NA	26,500	36,406	NA	45,000	NA	41,000
37,700	26,400	25,000	35,000	32,674	24,000	28,000	35,302	35,000	38,000	32,750	32,500
32,067	26,033	24,000	26,300	29,500	22,750	24,083	31,000	23,000	28,967	34,250	27,000
NA	24,300	26,400	24,000	25,500	NA	NA	29,198	18,000	NA	33,125	29,333
NA	NA	NA	26,000	21,000	NA	18,500	26,403	20,000	22,435	NA	23,750
52,500	42,500	48,200	45,638	44,820	NA	NA	40,000	38,067	32,618	45,125	49,375
43,500	42,000	42,000	41,600	37,739	NA	37,333	NA	41,000	NA	45,004	45,500
37,000	32,750	38,076	36,188	33,793	NA	32,750	33,750	43,500	36,000	35,000	35,267
30,000	32,000	30,606	29,455	32,600	28,000	26,000	27,750	26,650	28,427	32,167	36,120
26,000	NA	NA	29,625	29,263	25,000	NA	24,750	26,000	26,640	NA	30,450
NA	24,500	26,250	26,140	22,540	NA	NA	NA	24,500	NA	NA	23,250
40,000	50,000	56,785	54,225	43,335	75,000	NA	NA	50,000	29,082	56,000	55,833
37,000	32,000	47,050	41,667	46,440	NA	33,000	45,000	42,750	NA	35,000	46,800
30,000	37,000	42,050	30,833	39,856	NA	26,000	28,000	31,333	25,121	30,000	48,000
NA	20,400	35,762	26,417	28,887	NA	NA	25,000	NA	NA	25,000	32,000
NA	NA	NA	44,450	48,000	28,000	37,000	NA	NA	NA	52,500	56,000
NA	28,500	NA	35,200	40,925	NA	NA	NA	30,000	39,500	32,000	41,000
60,000	NA	42,000	57,300	44,015	NA	40,000	52,000	45,000	25,000	55,000	50,333
38,000	26,500	39,003	40,750	31,250	NA	22,000	28,079	29,000	NA	30,000	31,000
29,750	32,000	32,750	33,885	37,483	38,500	36,667	29,851	48,000	31,626	43,448	38,727
28,000	30,000	22,500	28,500	30,073	NA	22,333	NA	28,233	27,444	25,750	28,617
26,333	22,738	19,462	21,580	24,256	20,000	21,000	19,251	22,320	18,980	21,569	21,844
24,000	17,767	17,750	18,907	18,693	16,283	16,710	16,063	16,771	22,055	21,821	21,606
NA	NA	18,200	13,100	16,500	NA	NA	NA	15,000	15,528	NA	NA
36,750	28,000	26,360	55,600	38,268	NA	29,500	25,000	26,000	NA	36,000	29,000
24,000	25,000	25,900	17,500	24,258	NA	NA	NA	25,000	NA	NA	NA
20,000	22,000	22,880	NA	26,750	NA	26,000	12,000	NA	16,334	NA	26,000
NA	19,000	13,236	15,333	22,581	NA	NA	20,074	19,083	NA	15,120	19,467
20,500	NA	26,484	22,000	31,741	25,000	17,000	20,820	22,167	20,198	17,050	23,600
19,000	16,722	15,848	16,690	15,772	14,100	15,250	15,562	17,813	16,193	17,667	16,589
NA	NA	35,452	23,167	24,659	NA	19,750	19,600	16,000	19,500	27,000	31,000
14,000	NA	15,300	14,833	17,467	14,000	16,000	13,750	13,500	13,250	19,200	19,000
38,000	22,750	36,367	18,833	NA	NA	NA	29,967	36,000	NA	26,000	27,000
27,000	25,500	22,250	30,000	NA	NA	10,000	NA	18,000	NA	18,000	37,250
40,000	38,500	34,152	50,000	NA	NA	NA	NA	NA	15,418	48,000	27,500
NA	NA	31,774	39,733	23,000	NA	NA	NA	15,000	27,000	NA	25,000

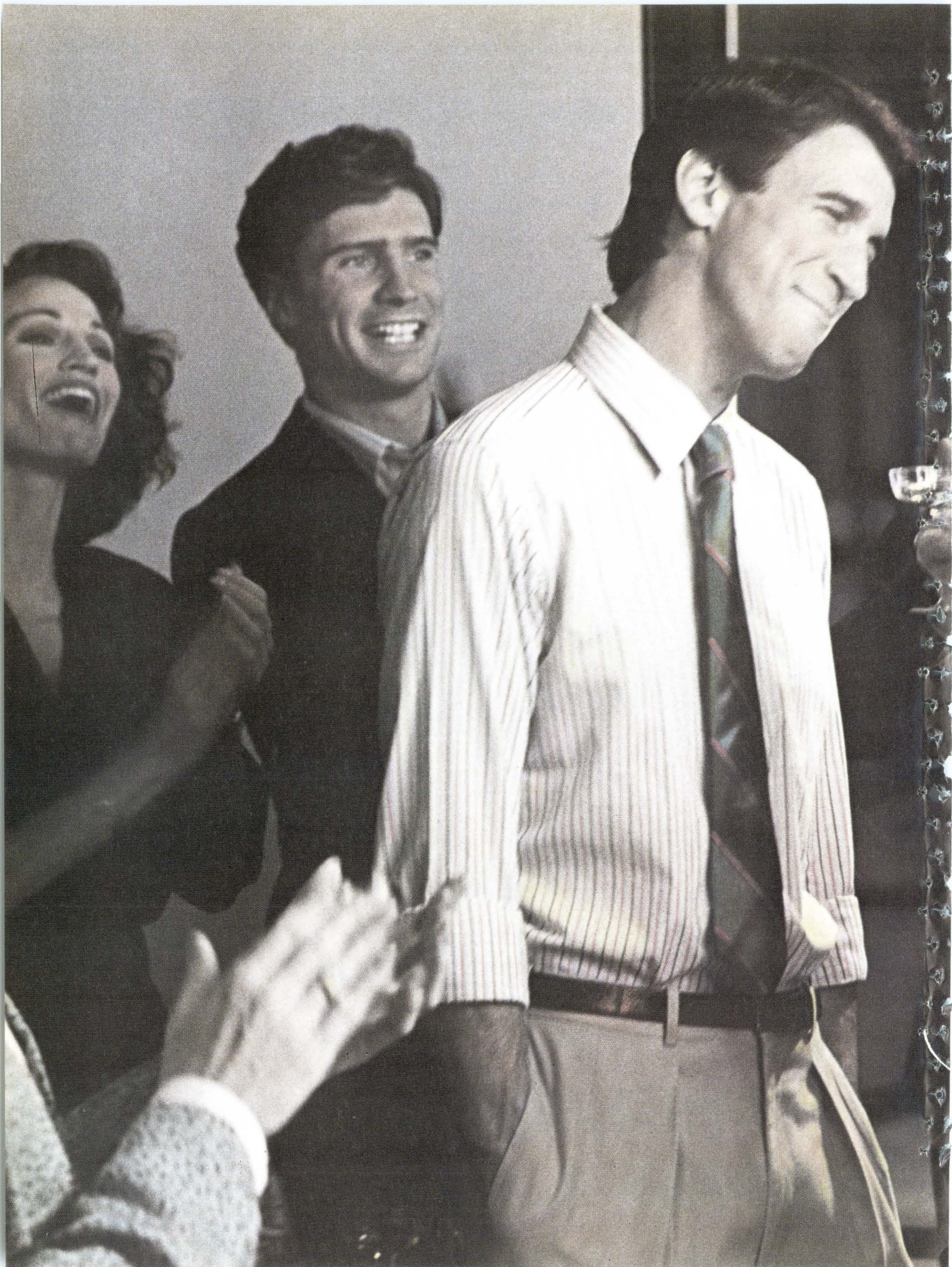



**“I'm told they don't throw many parties down in DP.**

*So I asked Doug to come up to ours. Doug's the real brains behind our new 3B system. He's the reason our computers can now talk to the IBM in Accounting and the DEC in Manufacturing. If you know anything about DP, that amounted to doing business across the Berlin Wall. Doug had a brainstorm and suggested AT&T. Their approach is standardizing communications between different systems. I don't have to tell you that's opened some doors around here. We owe Doug a lot.*

**AT&T comes through.”**

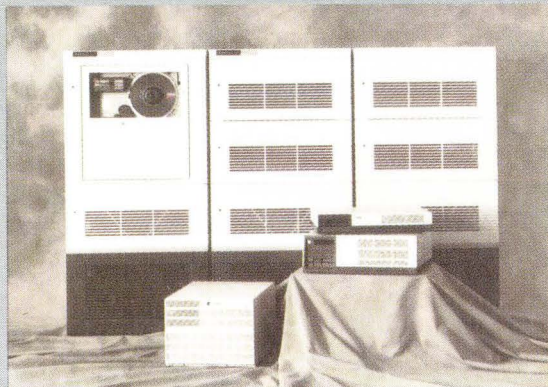

**The AT&T 3B Computers**

AT&T now offers a full line of departmental workgroup computers serving up to 300 users. A rich library of system and applications software includes host connectivity, development tools, programming languages, database management, OA, and a world of other **UNIX**<sup>®</sup> System programs.

*LAN standards:* Interfaces to Ethernet\*, AT&T ISN, STARLAN Network, DECnet\*\* and more put different departments in touch.

*Industry standards* including IBM† 3270, SNA†, BSC and X.25 link mainframe, midrange and micro environments.

*Communications software* moves data transparently between applications via packages like LU 6.2, AT&T Document Exchange and others. For the full story on AT&T's surprising 3B Computers, call now: 1 800 247-1212.

From equipment to networking, from computers to communications, AT&T is the right choice.

\*Ethernet is a trademark of Xerox Corp.

\*\*DECnet is a registered trademark of Digital Equipment Corp.

†IBM is a registered trademark and SNA is a trademark of International Business Machines Corp.

©1987 AT&T

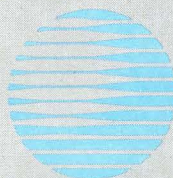

**AT&T**

The right choice.

**FIGURE 4 Average Salary by Industry (in \$)**

	ALL	CONSUM MFG	INDUS MFG	BANK	FINAN	DP SERV	OTHER SERV
<b>CORPORATE STAFF</b>							
■ Vice President	61,505	64,500	82,500	54,406	64,367	60,059	64,167
■ Director of Dp/MIS	49,754	51,814	50,828	59,900	51,254	54,219	45,043
■ Technical Services Manager	47,450	49,789	48,317	50,429	52,378	51,050	NA
■ Information Center/Data Center Manager	41,029	42,211	41,586	52,463	37,630	50,000	43,000
■ Director of Security	45,026	43,033	38,000	50,000	33,750	45,000	NA
<b>SYSTEMS ANALYSIS</b>							
■ Manager	44,505	40,400	45,609	37,098	46,000	44,300	45,000
■ Senior Systems Analyst	38,852	34,333	39,761	34,077	37,980	38,643	39,000
■ Lead Systems Analyst	36,381	41,933	35,927	36,250	28,500	40,600	NA
■ Systems Analyst	32,197	32,250	31,900	25,194	28,840	33,111	30,500
■ Junior Systems Analyst	26,003	25,000	26,000	25,545	26,500	27,000	NA
<b>APPLICATIONS PROGRAMMING</b>							
■ Manager	43,753	44,330	43,517	42,860	40,679	46,900	36,000
■ Lead Application Programmer	34,003	31,011	37,190	35,333	33,400	39,167	34,000
■ Senior Application Programmer	31,856	28,933	33,001	34,625	29,500	32,904	26,250
■ Application Programmer	25,926	26,546	26,533	23,063	24,558	28,344	24,198
■ Intermediate Application Programmer	23,495	22,500	23,983	23,333	23,250	26,400	20,580
■ Junior Application Programmer	20,410	16,833	22,756	21,500	20,000	20,936	30,000
<b>SYSTEMS ANALYSIS/PROGRAMMING</b>							
■ Manager	44,229	41,618	43,204	49,422	51,567	47,750	40,500
■ Lead Systems Analyst/Programmer	36,545	33,646	37,548	39,263	42,875	55,000	34,500
■ Senior Systems Analyst/Programmer	33,514	31,022	35,105	32,892	31,460	38,444	31,360
■ Systems Analyst/Programmer	29,854	26,967	31,730	27,725	28,444	32,117	27,667
■ Intermediate Systems Analyst/Programmer	25,632	26,983	26,037	25,248	27,350	25,286	23,000
■ Junior Systems Analyst/Programmer	22,021	22,311	21,611	21,330	25,500	24,375	NA
<b>OPERATING SYSTEMS PROGRAMMING</b>							
■ Manager	48,453	49,256	45,090	51,813	58,118	50,000	50,000
■ Senior Systems Programmer	40,773	40,310	41,154	38,514	44,171	43,500	36,750
■ Intermediate Systems Programmer	33,006	31,354	30,792	31,011	39,000	35,833	37,000
■ Junior Systems Programmer	27,693	25,238	28,258	28,000	30,671	23,500	NA
<b>DATABASE ADMINISTRATION</b>							
■ Manager	47,255	46,243	49,414	52,000	48,000	52,500	NA
■ Database Administrator	36,818	32,356	34,778	44,304	47,500	40,286	36,000
<b>DATACOM/TELECOM</b>							
■ Manager	45,417	50,675	54,787	42,978	42,250	46,250	NA
■ Analyst	33,087	30,700	33,167	26,899	33,784	35,200	31,000
<b>COMPUTER OPERATIONS</b>							
■ Manager	32,958	33,288	34,216	33,908	31,370	36,000	32,167
■ Shift Supervisor	26,236	29,475	29,080	23,069	25,600	31,000	30,000
■ Lead Computer Operator	20,563	20,470	20,818	18,114	19,457	25,286	20,511
■ Computer Operator	17,699	18,490	18,724	14,681	17,210	20,222	19,589
■ Magnetic Media Librarian	15,753	14,000	16,500	14,167	17,900	22,500	NA
<b>PRODUCTION AND I/O CONTROL</b>							
■ Supervisor	28,499	28,000	34,007	38,070	30,270	32,400	28,000
■ Lead Production Controller	24,309	21,250	22,243	28,021	29,760	32,000	25,000
■ Scheduler	21,814	20,333	16,000	30,355	23,376	27,333	22,000
■ Control Clerk	16,359	16,719	17,269	14,113	15,559	19,000	16,500
<b>DATA ENTRY</b>							
■ Supervisor	20,720	20,153	21,112	20,268	23,771	22,953	16,500
■ Operator	14,958	14,915	15,867	12,905	15,547	17,042	17,000
<b>OFFICE AUTOMATION</b>							
■ Word Processing Supervisor	24,144	24,189	25,980	24,500	25,804	30,800	NA
■ Word Processing Operator	15,495	15,711	16,367	10,750	16,929	16,627	NA
■ Microcomputer User Services Specialist	27,578	28,125	33,000	24,300	31,475	30,000	34,000
<b>DOCUMENTATION</b>							
■ Specialists	23,707	23,400	22,900	21,103	20,870	28,500	19,000
■ Consultant	43,512	38,000	NA	30,000	34,152	52,500	49,500
■ Pc Evaluator	29,739	NA	28,000	29,100	23,399	41,000	25,000

DISTRB	GOVT	MED/ LEGAL	TRANS/ UTIL	EDUCA	ANNUAL SPENDING	
					< \$1 MIL	> \$1 MIL
61,708	37,700	48,633	72,500	46,000	51,271	71,803
50,058	44,951	45,054	49,083	41,528	44,503	58,653
43,167	43,983	41,000	51,875	36,775	41,159	49,646
39,629	33,550	36,260	44,875	37,451	37,209	44,251
NA	75,000	NA	40,000	25,950	46,750	42,464
52,500	43,257	25,000	47,600	38,750	39,472	48,459
36,250	40,095	32,500	39,833	28,800	35,727	40,960
30,000	35,700	NA	37,500	20,000	32,654	38,400
33,000	32,734	35,500	33,000	31,600	30,793	33,333
NA	27,389	NA	26,000	28,000	25,427	26,419
57,500	44,110	32,250	53,000	30,584	41,673	44,749
30,508	37,846	24,000	29,130	27,667	30,769	35,568
29,016	35,071	30,530	25,311	27,880	29,327	34,061
26,875	28,348	22,675	21,488	23,307	24,819	27,298
15,300	27,733	18,500	18,010	23,257	22,406	24,352
17,274	22,343	19,600	13,674	19,232	20,680	20,233
36,750	35,817	35,613	44,600	45,084	38,256	48,454
39,320	32,978	22,000	33,262	31,507	33,211	39,787
35,167	31,324	31,000	31,309	28,804	31,970	35,161
29,833	25,493	27,500	26,605	27,751	28,480	30,912
24,000	24,585	23,000	20,507	23,628	24,401	26,345
17,567	17,493	NA	23,400	21,124	20,316	23,386
42,500	31,760	39,000	50,000	37,416	36,756	50,876
36,500	38,591	31,200	41,720	35,196	39,099	41,300
30,000	29,384	28,000	37,500	26,029	31,600	33,292
20,000	26,077	22,500	33,533	27,233	26,108	28,444
51,000	43,600	18,000	53,467	30,650	35,600	50,393
37,250	35,389	40,500	38,560	36,100	33,393	37,959
31,500	40,733	32,000	50,000	33,000	41,171	45,876
NA	32,040	NA	36,000	NA	31,833	33,101
26,111	36,646	27,083	31,755	29,824	28,469	36,500
23,250	25,176	19,750	26,679	23,631	25,389	26,705
19,001	21,169	19,082	21,828	17,822	19,348	22,162
16,639	17,254	15,835	18,780	16,452	16,824	18,877
17,000	15,000	NA	12,005	12,764	22,000	15,254
25,000	24,574	20,225	33,000	21,000	25,067	29,704
19,000	28,000	20,000	NA	15,333	22,417	24,849
18,000	21,075	NA	26,000	17,411	20,400	22,167
15,500	17,089	15,500	24,000	15,467	15,775	16,578
20,200	18,152	19,767	21,250	15,599	18,837	22,623
14,351	14,293	13,534	17,900	13,013	14,766	15,404
NA	17,931	27,500	19,000	NA	22,825	25,094
13,756	14,525	17,167	16,500	20,000	14,870	16,485
23,000	28,009	31,226	21,000	23,006	27,529	27,787
19,000	NA	14,800	NA	28,000	19,693	25,715
25,000	40,000	30,000	65,000	23,934	48,214	37,902
27,000	21,005	NA	50,000	18,000	26,225	30,617

jobs and not enough people."

For other jobs in other places, there are plenty of people. Foulds of St. Anthony's Hospital told DATAMATION that he has just finished hiring an operations manager. "We put the ad in the paper just locally and I must have gotten at least 80 résumés." Foulds says that most of the applicants already had jobs.

He points up one constant in the salary data: some industries pay a lot better than others. "The hospital pay rate for dp people is a tad bit lower than in general manufacturing," he says. Indeed it is. Looking at the 47 job titles surveyed, in 13 job positions the lowest average salaries were found in education. In nine positions, the lowest average salaries were in the medical or legal fields. Government pays the lowest average in six job positions. Banking is lowest payer in six others. The bottom payers in the other 13 positions were split between transportation with six; distribution with four; consumer manufacturing with two; and industrial manufacturing with one.

The survey revealed that perks remain important in the overall scheme, with some improvement in their availability from previous years. Almost 95% of all IS workers are covered for medical and dental expenses and get paid vacations. Almost 90% get company-provided life insurance, and are eligible for company disability and pension plans. About 60% get overtime pay. A significant change in the results of this year's survey is found in the response to questions about profit sharing and investment plans: in the 1986 survey, only about 40% of the companies sampled offered these incentives; this year, almost 90% offer investment plans and more than 70% offer profit sharing.

A striking difference in this year's sample is in the average number of full-time employees in MIS departments. In last year's survey, the average was 65.6; in this year's it is 78.3. Foulds at St. Anthony's reports that his staff grew last year because the hospital had gotten rid of a facilities management team and replaced independent contractors with full-time employees. "The hospital wanted to take internal control of its data processing," he explains.

Foulds is not the only MIS chief to replace temporary employees with full-time employees. This trend was one of the most vividly apparent in this year's survey. In last year's survey, managers reported that in 1985 they had employed an average of 11.5 temporary employees per site. For 1986, they didn't plan much

# 14<sup>th</sup> Annual

The "Computer Security Event of the Year"

# Computer Security

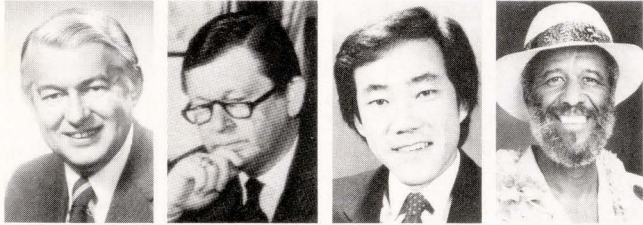

L. John Rankine   Senator John Tower   Charles B. Wang   Wally Amos

## GENERAL SESSIONS

This year's lineup of General Session Speakers includes:

- L. John Rankine, IBM Director of Standards and Data Security
- Former Texas Senator John Tower, who has served on a Presidential panel which studied computer crime.
- Charles B. Wang, President of Computer Associates, vendor of Top Secret and ACF2
- Wally Amos, originator of the "Famous Amos Chocolate Chip Cookie"

## WORKSHOPS

60 workshops will be offered over the three-day conference. Participants can attend 6 of these 1 1/4 hour sessions. You'll find something useful no matter what you area of interest or level of experience. See the workshop selections listed below.

## THE "GRADUATE PROGRAM"

A special 2-day program designed to meet the needs of the advanced computer security professional with at least 5 years experience. There is no extra cost for this program, but space is limited.

## EXHIBITION

Don't miss the world's largest computer security show — the National Computer Security Exhibition. You'll see the latest in security products and services.

**TOUR PROGRAM** . . . This optional 2-day program gives family and friends a chance to see some of the highlights of Southern California . . . and it's made available at CSI's cost of \$69.



## Plus These Program Enhancements . . .

- **Security Software Tracks** — ACF2, RACF, CA-Top Secret will be covered in six workshops.
- **All activities "under one roof"** — i.e., all workshops, general sessions, the Graduate Program, and the Exhibition.
- **More hotel rooms** — 1,450 reserved at the Hilton.
- **Economy** — we've negotiated hard to keep your costs way down. Hotel rates are exceptionally low. A BEST BUY: Fly United Airlines and you'll receive a minimum discount of 50%... *with no restrictions!*
- **Hospitality Hour** on Sunday evening.
- **Individualized schedule** — Your personal agenda for the entire Conference.
- **Conference workbook** — "not for sale" and available only to attendees.

## Here's What Conferees Say . . .

**Excellent! Best computer security conference I've been to. If I had to choose to come to only one security event each year this would be the one.**" Graham J. DeGottal, DS Analyst, Chemical Bank

**By far the most important source of security information & training in one place, in the industry. A must for the computer security professional.**" John T. Devall, Jr., Sr. Security Spec., Tenneco Oil Exploration/Production

**This conference is the most information-packed, valuable and focused I have ever attended. Almost too much input to process! Keep up the good work.**" Claudia Deaton-Glover, Computer Security Analyst, General Services Administration

**Fascinating. Stimulating. Without question a required event for anyone charged with information security responsibilities.**" G. Mark Hardy, Sr. Consultant, Booz Allen & Hamilton

# Conference & Exhibition

**November 9-11, 1987**  
**Anaheim Hilton**

## WORKSHOP PROGRAM

1. Developing & Implementing a Successful Data Security Policy
2. New Security Strategies for Computers & Networks
3. Developing a Data Processing Security Manual
4. Tying Access Control into Overall DP Security
5. ACF2, Part I: An Introduction
6. Computers and Your Legal Liability
7. Principles of Secure Operating Systems
8. AT&T's Security Compliance Program
9. State-of-the-Art Facility Design
10. Planning the Organization's Recovery: Not Just DP
11. Information Classification
12. A "Single-Point Security Approach for the LAN
13. Administrative Policies and Standards for Access Control Systems
14. Building Security into the Application Development Process
15. RACF, Part I: An Introduction
16. VAX/VMS Security Techniques
17. Software Sabotage — Viruses, Trojan Horses, & Logic Bombs
18. Recent Developments in Database Security
19. Auditing Data Security — "Win-Win" for the Auditor & Auditee
20. End-User Responsibilities in a Recovery Operation
21. On Making Data Security a "Standard Operating Procedure
22. Communications Security in the Information Age
23. Managing Dial-Up Access
24. An Overview of Risk Management Tools
25. CA-Top Secret, Part I: An Introduction
26. Security and Audit Considerations in the DB2 Environment
27. MVS Systems Programming "Secrets": Loopholes and Safeguards
28. Security Standards for the Civil & Private Sectors
29. The Impact of International Terrorism on Information Security
30. How to Choose a Disaster Recovery Services Vendor
31. Career Planning for Information Systems Security Officers
32. PC Security: A Primer
33. Applying Policies and Procedures in a Small Systems Environment
34. Computer Crime Legislation
35. ACF2, Part II: Advanced Topics
36. Ethernet Security
37. The State-of-the-Art in Information Security Technology
38. Computer Security in the Academic Environment
39. A Case Study in Data Center Design & Relocation
40. Strategies for Negotiating a Disaster Recovery Backup Contract
41. Lessons Learned, and Other "Pearls, from a Veteran DSO
42. Security in Open Systems Interconnection (OSI) Networks
43. Decentralization of Computer Security Management
44. Implementing a Microcomputer Security Program
45. RACF, Part II: Advanced Topics
46. Wang System Security
47. Audit, Control, and Security of MVS System Software
48. Advanced Security Awareness Techniques
49. Personnel Security — Pre- & Post-Employment Safeguards
50. Planning and Executing a Mock Disaster Drill
51. A Comprehensive Information Protection Program
52. Securing the Micro-to-Mainframe Link
53. New Issues & Technologies in the Banking Industry
54. Passwords & Encryption — The Heart of Effective Security
55. CA-Top Secret, Part II: Advanced Topics
56. DECnet Security
57. AI: Using an Expert System for Data Security
58. Developing Awareness of Computer Ethics
59. New Audit Tools & Techniques
60. Conducting the Largest-Ever Disaster Recovery Test

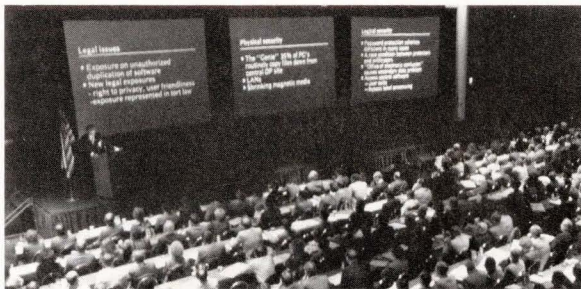

## OPTIONAL SEMINARS

You can attend one or two of the optional full-day seminars offered Sunday and Thursday, November 8th and 12th:

1. Introduction to Computer Security
2. Computer Security Basics for the Business Professional
3. How to Become a More Effective Data Security Officer
4. A Blueprint for Establishing Security Policies, Standards, & Guidelines
5. How to Conduct a Security Review of the DP Function
6. Introduction to Communications Security
7. Workstation Security
8. Computer Crime Investigation: A Practical Approach
9. Network Security in a Digital Environment
10. EDP Disaster Recovery Planning
11. Building Information Security Awareness
12. Computer Security for the Auditor

## ABOUT COMPUTER SECURITY INSTITUTE

CSI, established in 1974, is a full-service membership organization dedicated to helping its more than 3,000 members safeguard their information assets. Services include the bimonthly newsletter *Computer Security*; the Annual *Computer Security Buyers Guide*; a "Hot Line" telephone referral service. CSI also sponsors the Summer IBM/DEC Users Computer Security Conference.

CSI publishes the semiannual *Computer Security Journal* and the 500+ page *Computer Security Handbook*. CSI offers in-house training courses as well as a full program of regional public seminars throughout the U.S. and Canada.

### ACTION

For an immediate registration, call Dianne Monroe at (617) 393-2600, or write her at Computer Security Institute • 360 Church Street • Northborough, MA 01532.

**One of the conferees indicated that this is the 'Cadillac' of security conferences. I would agree completely with that assessment."** Richard F. Perry, Mgr. Internal Auditing, State Mutual Life Assurance Co.

**A necessity for security professionals."** John Miller, Security Admin., General Dynamics

**Best forum on computer security I have attended."** Bruce Goldstone, Mgr. Data Security, Databank Systems Limited

**Conference format allows maximum interchange between attendees. I've never failed to bring home one or more ideas or solutions that more than covers the time/expense investment."** Nicholas M. Saxonis, Fac. Services Off., New England Mutual Life Ins. Co.

**You are providing a valuable service to the data security profession. So many conferences are narrow in scope. Yours is a truly global approach. Keep up the good work."** William Faller, Systems Officer, City Trust

**It's one of, if not the best conference that enables representatives from government, industry & education to gather & exchange ideas and goals."** Leon Cooper, Computer Security Spec.,

**Outstanding! Offered an excellent forum for both gathering and exchanging ideas. Well worth the trip. A must for anyone interested in data security."** Vincent J. Spagnolo, EDP Audit Mgr., M/A-Corn, Inc.



# WINGS™ PROVIDES EXACTLY WHAT YOUR PROJECTS NEED.



## IMMEDIATE ANSWERS, RIGHT ON SCREEN.

**RELY ON AGS** WINGS is an on-line, shared database-oriented mainframe project management system. Fully interactive, it provides you with the speed and performance no other system can match. Now you can easily create, edit and collect information for planning, simulation, and project status updating; you can accurately report time, cost and progress to the System; and you can retrieve, *immediately*, any information contained in the System—right on screen.

WINGS was created to minimize your input burden while maximizing your feedback so that you spend less time entering data, and more time analyzing schedules and costs before you act on them.

Planning, budgeting, "what if" simulation, scheduling, resource management in a multi-project environment, skill scheduling, progress tracking, cost management, graphics, on-line help screens—WINGS is equipped with everything you need for effective project and resource management for projects of any size or complexity.

WINGS is backed by a complete program of training and support to help you utilize the System to bring your projects in on time, within budget, and with optimum resource utilization.

If immediate response is one of your requirements in a project management system, call or write today. We'll respond immediately.

**AGS**  
**Management**  
**Systems** INC.

*The world's leader in project management systems*  
880 First Avenue, King of Prussia, PA 19406  
(215) 265-1550 Telex: 510-6603320



CIRCLE 56 ON READER CARD

### What Are You Worth?

change, predicting they'd have used 11.6 temporary employees by year's end. But the 1986 survey showed that each sampled site had actually averaged 7.6 temps, more than a third fewer temporary employees than had been reported in last year's survey. Forecasts for 1987's total—8.6 per site—are a bit up from this year, but still nowhere near the 1985 high point.

Some of this shift may be due to managers seeking—like Foulds—to "take control" of their staffs. But Joe Mohen, who runs Teleprocessing Connection, a small, five-person firm in Garden City, N.Y., that specializes in LU 6.2 implementation, says the Tax Reform Act is to blame. Section 1706 of the reform bill effectively removed the "safe harbor" in which so-called independent contractors were able to shelter some tax advantages over their salaried co-workers.

"An element of risk is perceived," says Mohen. "If you utilize temporary help from a small contracting firm, you now must fear that the independent contractors could be deemed your own common-law employees, the IRS holding you retroactively responsible for the personal income tax payments. It is only going to get worse. The Pandora's box of IRS witch-hunts has been opened."

George Werner, owner of GMW Associates in New York, a company that used to supply independent contract workers to IS operations, thinks some of the drop in temporary workers is due to business conditions. "When the banks took write-offs for bad debts, they cut costs. When people cut back, the first to go are independent contractors." But Werner adds that many IS people who once sold their services as independent contractors are now taking full-time jobs with primary employers.

One final note. If you're thinking of looking for big bucks as a high-tech exec, this might not be the year to move: according to the National Index of Executive Vacancies released by Korn/Ferry International, a New York executive search firm, high-technology hiring at the upper levels is down slightly from last year. In the survey released in late July, executive demand at technology companies accounted for 13% of total national executive demand; last year at this time, high technology accounted for 14% of demand. ■

*For reprints of articles in this issue,  
call (312) 635-8800.*

All clone-priced terminals  
are not created equal.

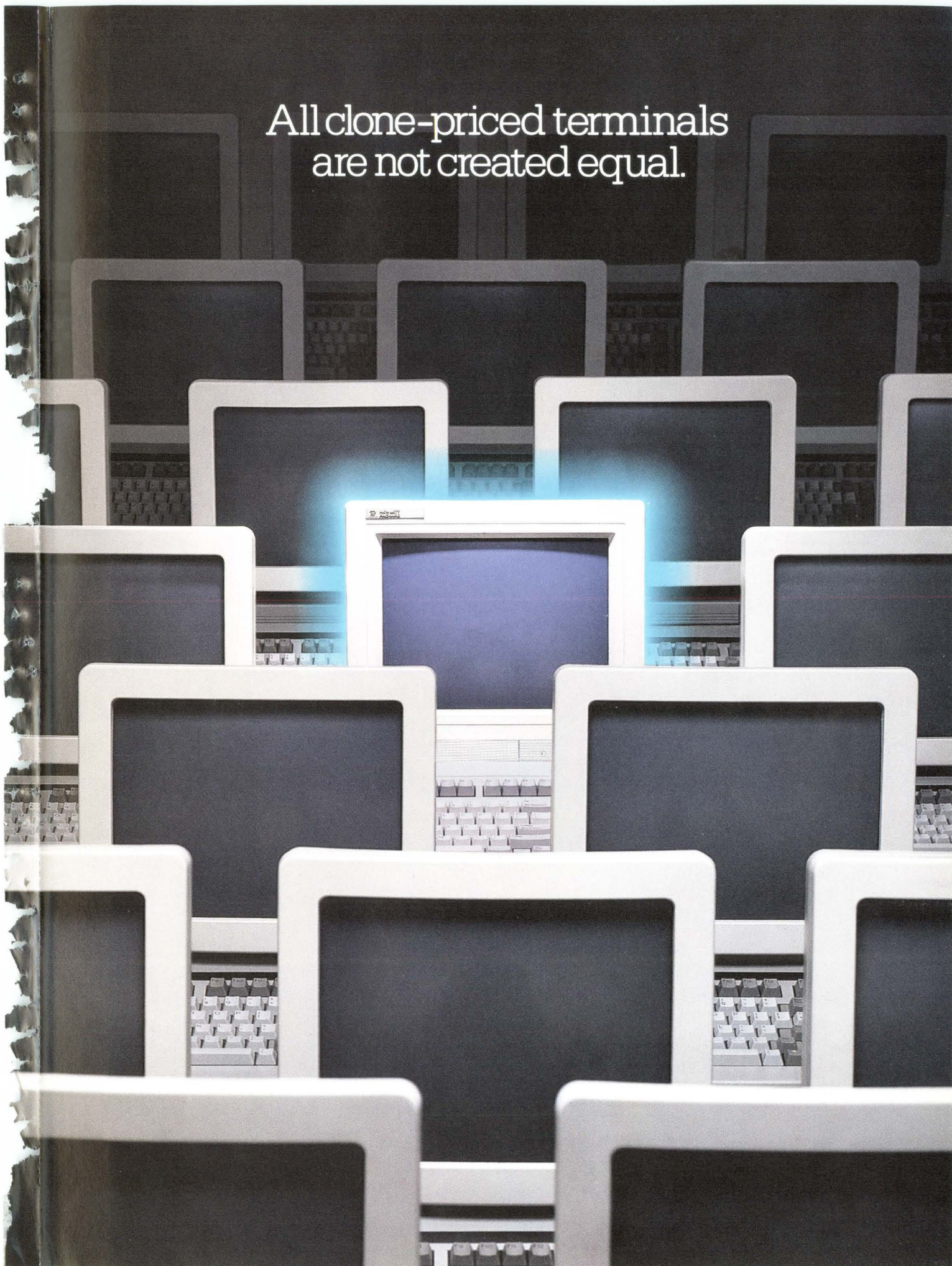

# Introducing HP terminals for your DEC, IBM or ASCII system.





Into a world of sameness comes a world of difference.

Until now you could pick a terminal on price alone. Now you can pick a name. A name that stands for design and engineering excellence.

And still get a clone price.

With all the reassurance of knowing that in consecutive Datapro surveys from 1982 through 1986, Hewlett-Packard users gave us top ratings in overall display terminal performance.

That's the difference we make.

**HP 700/22 for your DEC/ANSI system.**

VT220 compatible with VT220 keyboard layout; 4 pages of memory; choice of screen color including soft-white.

(See next page for more.)

\$575\*

**HP 700/71 for your IBM system.**

3191 compatible with 3191 keyboard layouts; 14" diagonal display with easier-to-read characters; choice of screen color.

(See next page for more.)

\$695\*

**HP 700/41 for your ASCII system.**

9 emulation modes; 14" diagonal display with easier-to-read characters; full-function keyboard; choice of screen color.

(See next page for more.)

\$375\*

**Call 1 800 752-0900, Dept. 751E**

Call us toll-free for more information about the new HP 700 family of terminals. And for details of our introductory **half-price offer** on your first evaluation unit, call before December 31, 1987.



*we never  
stop  
asking*

*What if...*

**HP 700/22****DEC VT220 Compatible Terminal****Compatibility Modes**

VT220 mode, 7-bit controls  
 VT220 mode, 8-bit controls  
 VT100 mode  
 VT52 mode

**Keyboard**

VT220 style 106-key layout  
 Tactile feedback

**Ergonomics**

14-inch anti-glare screen  
 Green, amber or soft-white display  
 Tilt and swivel  
 Selectable 50, 60 or 72 HZ refresh rates

Front panel controls

Detached adjustable keyboard

**Additional Features**

4 pages of display memory  
 80 or 132 column display  
 30 programmable function keys  
 Easy setup menus  
 RS232C and 20m current loop interfaces  
 9-pin RS232C printer port

**Other**

1 year warranty  
 Jump or smooth scroll  
 Compose character capability  
 Nonvolatile memory for saving setup  
 National language layouts available

DEC VT220, VT100 and VT52 products of Digital Equipment Corporation  
 DEC is a registered trademark of Digital Equipment Corp

**HP 700/71****IBM 3191 Compatible Terminal****Compatibility Modes**

IBM 3191 Models A and B, Display Station  
 IBM 3270 Information Display System, coax connection

**Keyboards**

IBM style 102 and 122 key layouts  
 24 programmable function keys for application use  
 Tactile feedback

**Ergonomics**

14-inch anti-glare screen  
 Green or amber display  
 Tilt and swivel  
 Front panel controls  
 Detached adjustable keyboard

**Additional Features**

Security lock and keys  
 Automatic screen saver  
 Easy setup menu

**Other**

1 year warranty  
 Nonvolatile memory for saving setup information  
 National language layouts available

IBM 3191 Display Station and IBM 3270 Information Display products of International Business Machines Corp.  
 IBM is a registered trademark of International Business Machines Corp.

**HP 700/41****Entry Level ASCII Terminal****Compatibility Modes**

Wyse WY-30  
 TeleVideo 905, 910+, 925E  
 Lear Siegler ADM 3A, ADM 5  
 Hazeltine 1500  
 ADDS Viewpoint A2  
 Qume QVT-101

**Keyboard**

Enhanced 106 key layout  
 16 function keys (32 shiftable)  
 58 programmable keys  
 Tactile feedback

**Ergonomics**

14-inch anti-glare screen  
 Green or amber display  
 Tilt and swivel

Front panel controls

Detached adjustable keyboard

**Additional Features**

2 standard RS232C ports  
 Split screen capability  
 Easy setup menus

**Other**

1 year warranty  
 Variable smooth scrolling  
 Copy and transparent print modes  
 Nonvolatile memory saves setup, programmed key info  
 National language layouts available

WY-30 product of Wyse Technologies Systems  
 TeleVideo 905, 910+ and 925E products of TeleVideo Systems, Inc.  
 ADM 3A and ADM5 products of Lear Siegler Corp.  
 Hazeltine 1500 product of Esprit Systems, Inc.  
 ADDS Viewpoint AZ product of Applied Digital Data Systems, Inc.  
 QUME QVT-101 product of Qume Corp.

**For more information, call  
 1 800 752-0900, Dept. 751E.**



Unix, AT&T's operating system, has freed some users from single-vendor straitjackets. Many like it as a programming environment. Multiuser capabilities sold other users. But the operating system has yet to fulfill its promise as the cure for the ills of the software development process. An IEEE committee has recently developed a new standard called Posix, which may prove to be the answer. Meanwhile, users at NASA, Berkeley, Citibank, and Sheraton Corp. are embracing Unix in innovative ways.

# Unix: What Users Are Saying

BY MARY JO FOLEY  
AND DON LEAVITT

Some users believe Unix approaches that elusive generic solution we've all been hoping for, in stark contrast to the proprietary environments of industry leaders IBM and Digital Equipment Corp. Although no one claims that Unix is the panacea for all the ills of the software development process, its traditional promise of openness draws users and vendors alike, as bees to nectar. Nevertheless, even the most enthusiastic devotees of Unix are concerned about the software's inability to handle the development and transaction processing environments with equal efficiency.

Still, the momentum that has carried Bell Labs' Unix from its lowly origins as a simple tool for software developers to a jack-of-all-trades operating system continues unabated. Unix is showing up in some strange places, mooring an increasing range of tasks never envisioned by the software's originators. A litany of familiar business applications—accounting, inventory control, job costing, order processing—have come under its aegis, on hardware platforms as diverse as Atari personal computers, Amdahl mainframes, and Cray supercomputers.

To explore how users are employing Unix, DATAMATION interviewed managers at four multivendor shops: NASA's contractor Michael Tankenson, University of California's Raymond Neff, Citibank's Barry Gilbert, and Sheraton's Carl Giallombardo.



## **SICK OF SINGLE-VENDOR STRAITJACKETS.**

*User: Michael Tankenson, contractor  
NASA/Jet Propulsion Laboratory  
Application: Space Flight Operations  
Center based on BSD 4.2 Unix  
Primary vendor: (anticipated) Sun  
Microsystems*

Despite all the government talk of supporting Unix, the lengthy and complicated federal procurement process favors entrenched, existing suppliers, which means that few agencies (with the exception of the Department of Defense) are switching from proprietary operating systems to Unix. The National Aeronautics and Space Administration, however, has been experimenting with Unix in several different projects at various sites for some time now.

# COMPUTERWORLD

## INSIDE

In Depth — Sizing up IBM's manufacturing empire. **Page 69.**

An Wang approved a decision to ship Wang Laboratories products to South Africa in 1986 through a conduit despite his own claim to have terminated all business that nation. **Page 2.**

Uccel's integrated ba package will ship almost a year late. **Page 4.**

The DPS 8000 line the DPS 8 amid Ho Bull announcements include a relational? **Page 8.**

Tariffs continue micro imports despite easing of sanctions. **Page 49.**

Network ven link up IBM? **Page 49.**

Manager board divi pension c PS/2 line

Connec expect annou Page 1

BUL RYF last er

## Production-oriented VM/XA

for multiple operating systems

of XA hardware, 1990s.

# SYSTEMS & PERIPHERALS

## Users say DPS 7 top system

### Survey shows Honeywell boosts overall satisfaction; Amdahl posts gains

BY JAMES CONNOLLY  
CW STAFF

DELTRAN, N.J. — Once the lowest ranking vendor in user satisfaction, Honeywell Bull, Inc. continued a climb to the top, where it joined Amdahl Corp. at the head of the list, in the 1987 Datapro Research Corp. report on mainframe user satisfaction.

Honeywell Bull's gains came from the strength of its DPS 7 small mainframe and took place four years after the company sat at the bottom in overall satisfaction. Five of the six vendors rated by users received higher overall satisfaction scores than they did in the 1986 survey. The only company that saw its score slip was Unisys Corp., which scored better as Sperry Corp. in 1986 as the combination of this year. How- ever, Unisys had the best scores and the worst re-

fraction score of at least 3.2 on a four-point scale, at least 20 user responses and no ratings lower than 2.8.

Datapro, a market research firm, said users on questionnaires as part of the 14th annual Datapro user-satisfaction survey.

A five-year average of overall satisfaction scores showed Unisys on top at 3.239, followed by National Advanced Systems Corp. (NAS) at 3.205, Amdahl at 3.202, IBM at 3.169, Honeywell Bull at 3.14 and NCR Corp. at 3.077.

Datapro analyst Marilyn Courtney noted that the Honeywell Bull DPS7 scored better this year than it had in the past, climbing from a rating of 3.59 to 3.83 among systems mentioned by 20 or more users. The DPS 7 also scored well in ease of operation (3.59), reliability of the main-

frame operation (3.62), reliability of the mainframe and services such as maintenance, technical support, education and documentation. Amdahl also led the field in user recommendations; 97% of its users said they would recommend Amdahl systems to other users.

NAS finished second in that category and scored well in other areas but fell short of the 20-year special minimum for finished last in overall satisfaction at 3.13.

Unisys systems and the corporation as a whole posted the highest scores or tied for the highest in 17 categories, with the high-end Aries, with the high-end Aries, used by eight respondents, leading 10 of those categories. On the negative side, Unisys had the lowest scores in 21 areas, with the Aries

of the company's older systems: the 8500, 8600 and 8800. The NCR 9800, introduced last year, was not mentioned by users.

The poorly rated Unisys 1100/60 was the oldest single system, with an average life of 58 months.

### Trend in buying pattern

Datapro detected as trend in the pattern of system acquisition; only 52% of the respondents said they own their computers, compared with 54% in 1986 and 56% in 1985. The number of users leasing systems from the manufacturer inched upward from 14% to 15%, while 32% of the users said they lease systems from third parties.

frames increasing, with 53% of the systems supporting more than 60 local terminals and 46% more than 60 remote terminals. Last year, 50% supported 60 local terminals, and 45% supported 60 remote users.

Datapro also noted that users continued an alternating pattern in expansion plans for this year. Expansion to current hardware configurations, indicated by 63% of users, surpassed expansion of data communications facilities, named by 62%, to head the list for 1987 acquisitions.

### Software growth stunted

Communications expansion had moved ahead of

# You said it, not us.

Nothing beats word of mouth advertising. And the word being spoken by users of Honeywell Bull systems is "satisfaction."

In a recent Datapro Research Corp. report, Honeywell Bull scored highest in overall user satisfaction.

Not second highest, or third highest.

Highest.

Period.

And users gave our DPS 7 mid-range computer high marks for its ease of operation and reliability. They also praised its operating system, GCOS 7, that allows it to perform a wide range of functions, such as high-volume transaction processing, office applications, sophisticated networking and communications, and program

development. In short, they rated the DPS 7 the best system available.

Again, not second best or third best. *The best.*

For months now, we've been telling you that, to Honeywell Bull, customers are more important than computers. That means we don't develop technology for technology's sake. We develop reliable systems that solve problems. And we don't give lip service from 9 to 5. We give prompt service 24 hours a day, anywhere in the world.

Apparently, that philosophy has paid off. Because the same customers that we put first, have now put us *in* first.

## Honeywell Bull

Customers are more important than computers.

## Unix: What Users Are Saying

One of its first major Unix test cases, the Space Flight Operations Center (SFOC), a project of the Jet Propulsion Laboratory (JPL) in Pasadena, Calif., is about to get off the ground.

"JPL got tired of single-vendor straitjackets," explains JPL contractor Michael Tankenson. "Unix was really the only operating system available on multiple types of hosts."

Since Unix lacks the ability to handle processing in real time—an absolute necessity for the data collection and on-line database access capabilities that JPL plans to build into the Space Flight Operations Center, JPL was torn between choosing a "real-time Unix" (a version of Unix with proprietary, real-time processing features built in), and one or more real-time operating systems for front-end processing, with Unix everywhere else. Eventually, JPL decided on the second solution.

While its prototype group has been testing every combination of front-end real-time and back-end Unix processors imaginable, right now it looks as though JPL will go with some type of workstation from Sun Microsystems Inc., Mountain View, Calif., as its Unix workhorse. (The final award will be announced sometime before year-end.) The initial configuration of the system used to develop the SFOC telemetry and database software probably will include from 15 to 20 Unix workstations.

Once the system is up and running, Tankenson elaborates, the Unix workstations will be connected with various vendors' micros, minis, and even symbolic processors over a local area network.

Scientists and engineers will be able to download information, which will be stored in a central database, on any of the space missions monitored by SFOC.

If Sun is selected as the primary contractor as anticipated, JPL can be expected to employ Sun's Network File System software and NeWS windowing package, and the Sybase database management system from Sybase Inc., Berkeley, Calif. All of these will run under Sun's version of Unix, SunOS, an amalgamation of Berkeley 4.2 and AT&T System V Unix variants.

SFOC will evolve gradually during the next five to 10 years. The ground-based center will support six upcoming missions, including Magellan, a Venus mapping radar mission; Galileo, a probe of Jupiter's atmosphere; a solar/polar probe of the earth; and a comet rendezvous mission.



### **PUBLISHER OR PERISH?**

*User: Raymond Neff, former assistant vice chancellor for IS, University of California at Berkeley*  
*Application: campuswide Unix network, primarily BSD 4.2 based*  
*Primary vendor: none (Berkeley's configuration includes hardware ranging from a Cray supercomputer to Apple Macintoshes)*

Few would be surprised to learn that the University of California at Berkeley, the creator of the Berkeley 4.2 version of Unix, is an avid Unix user.

Berkeley's network was designed for 40,000 Unix ports. To date, 4,000 machines—ranging from an X-MP/14 supercomputer from Cray Research Inc., Minneapolis, to various Apple Computer Corp. and IBM micros—are on-line.

"Berkeley has developed a comprehensive computer strategy, with Unix as the multitasking operating system," explains Raymond Neff, former assistant vice chancellor for Information Systems and Technology. Clusters of Unix-based workstations—including Sun Microsystems Sun 3s, DEC VAXstation IIs, and IBM RT PCs (based on reduced instruction set technology)—form the base.

For a modest fee, and after giving

the university suitable notice, students, and faculty members may plug into the network. Once on-line, Berkeley users are free to access any of the multiple, extensive databases that the university is in the process of building.

Humanities students can call up al-

**UNIX IS  
BERKELEY'S  
MULTI-  
TASKING OS.**

most anything in ancient Greek literature by using the exhaustive collection of data that Berkeley obtained from Harvard University and from the University of California at Irvine. Biology majors may search the Intelligenetics DNA database (to which more sequences are being added constantly). Students of chemistry, physics, astronomy, and other fields can interface directly to the university's Cray or its IBM 3090 mainframes.

# WITHOUT MIS SUPPORT, EXECUTIVE DECISION MAKING IS TOUGH, LONELY BUSINESS.



## HERE'S HOW YOU CAN HELP.

Choose IFPS/Plus 3.0 from Execucom. It's the one and only management support system that satisfies the information needs of both executives and analysts. Without adding to the MIS development burden.

IFPS/Plus is the optimal foundation for building Executive Information Systems. With little or no training, executives gain direct access to critical business information. Customized reports and charts can be generated at the touch of a button. And details on any aspect of business are available to senior management with total ease and flexibility.

IFPS/Plus is also a powerful tool for analysts. Using common business terms, analysts can perform sophisticated modeling tasks, such as what-if and risk analysis, goal seeking and optimization. And the system's built-in artificial intelligence provides instant conversational explanations of how, why and where business variances have occurred.

From ad hoc analytical graphics to executive presentations, analysts can draw on the power of Execucom software to create a full range of charts and graphs, including logos and other free-form images. All produced with minimal time and effort.

IFPS/Plus also makes life easier for MIS. IFPS/Plus applications are built and maintained by using a descriptive, non-procedural language. Executive display systems can be developed quickly with menu-driven development capabilities. And with IFPS/Plus, there's only one integrated system to support for both executives and analysts.

Call us today. And discover why Execucom is the leader in management support systems for executives and analysts. You'll receive a free information packet when you call Evan Greer toll free at 1-800-531-5038. In Texas and Canada, call 512-346-4980.

 **EXECUCOM**

For IBM TSO and CMS, Digital VAX, Prime, selected Unisys environments, Digital's MicroVAX series and the IBM 9370.  
IFPS/Personal for IBM PCs and compatibles.

Circle 59 on Reader Card

## Unix: What Users Are Saying

Among those tapping into the various services are members of the Berkeley Unix Project, who are working on version 4.4 of their operating system. The new software is slated for release sometime next year. As expected, their brainchild is the primary operating system on the network. But several of the machines that are part of the network, including the Cray, IBM mainframes, and various IBM and Apple micros, are running AT&T System V and/or a hybrid of BSD 4.2 and System V.

Besides maintaining the network, the university is playing an active role in improving the type of standard applications software available under Unix. "If you're going to have a high-quality [computing] environment, you need high-quality word processing," Neff points out. "But there hasn't been an excellent Unix word processor to date." The university put out a technical request for quotations for such a product over a year ago. Twelve software developers bid on it.

The university is now beta testing its selection, The Publisher, a package from the Ann Arbor, Mich.-based firm Arbor Text, which the university helped modify to its specifications. Neff says Berkeley hopes to engage in a similar development and testing process in the database management area in the near future.

### IN-HOUSE UNIX, MICRO STYLE

*User: Barry Gilbert, vp for platform automation, Citibank NA*

*Application: System V-based customer service system*

*Primary vendor: NCR*

For the past two years, when New York-based customers of Citibank NA, wanted to open checking, savings, money market, or virtually any other type of account, they have had the option of doing it themselves immediately by computer, rather than waiting around for customer service representatives.

Simultaneously, Citibank customer service representatives now have the capability to generate instantaneous demographic profiles of these same customers almost at a touch of a button. Both of these feats have been made possible thanks to a single Unix-based system called Micro-ROM, which is currently accessible in 230 Citibank branches.

Micro-ROM was designed in-house using Unix by Citibank's northeast division's systems and technology group. It is one of a handful of Unix projects recently undertaken by Citibank. That

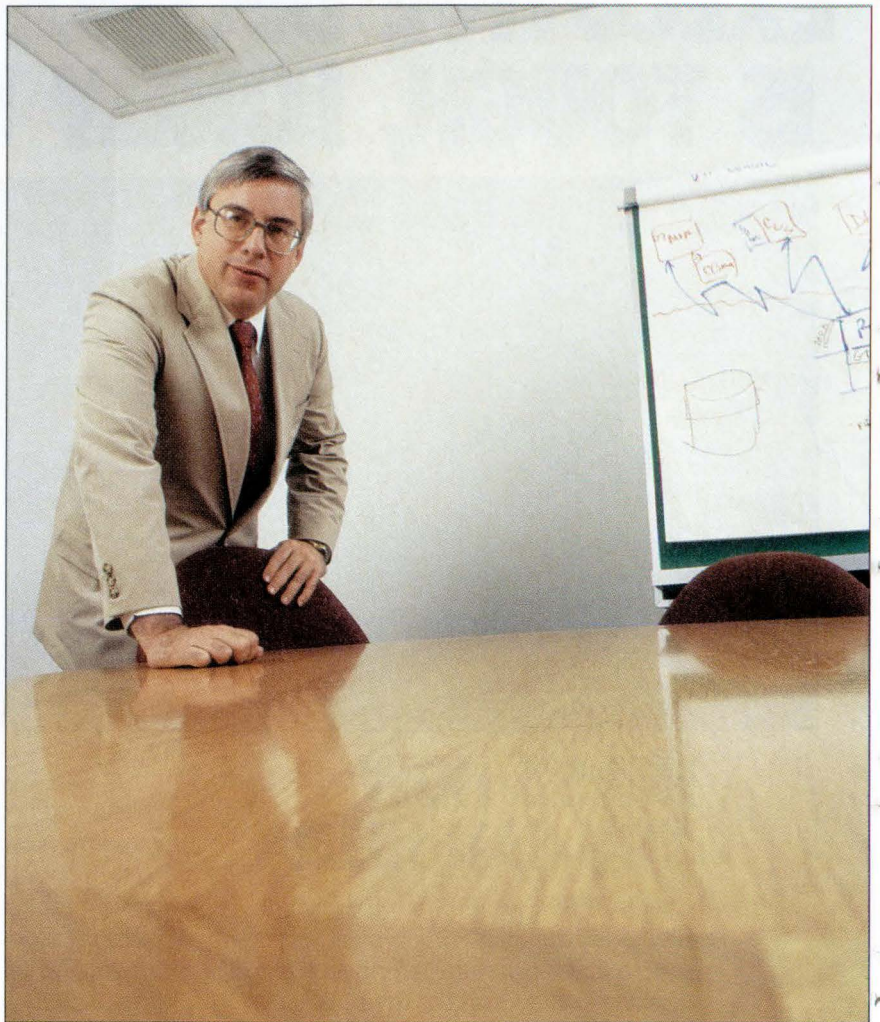

Unix could be used as both the design and execution environment for Micro-ROM was a major selling point for Unix System V, according to vice president for platform automation Barry Gilbert.

Development of the system began three years ago, on various models from Altos Computer Systems, San Jose. Design and testing was completed on NCR Corp. Tower 32 minicomputers. The system currently runs on 300 NCR Tower XT's, one or more of which have been installed at each of Citibank's New York branches. Each XT is capable of supporting up to 10 of the Altos dumb terminals that are hooked up to it. Currently, each supports two or three.

Information that the customers or customer service representatives enter into the system is uploaded to Citibank's various IBM front-end processors. In turn, these processors send data to Citibank's central IBM 3080 and 3090 mainframes, located at its Wall Street headquarters and at its Secaucus, N.J.,

data processing center. The customer account data is stored and accessed via a central database that is based on a database management system from Informix Software Inc., Menlo Park, Calif.

**IN-HOUSE  
UNIX MAY  
IMPROVE  
SERVICE.**

As part of the Micro-ROM redesign that Citibank began in January, another off-the-shelf Unix application package is planned for its repertoire: a screen and window manager called Formmaker from Jyacc Inc., New York.

Photograph by Rick Browne



How our storage products' technology can boost your systems' productivity. No. 2 in a series.

# Fully sealed. Runs cool. Fits under an airplane seat. And comes 4 to a box.

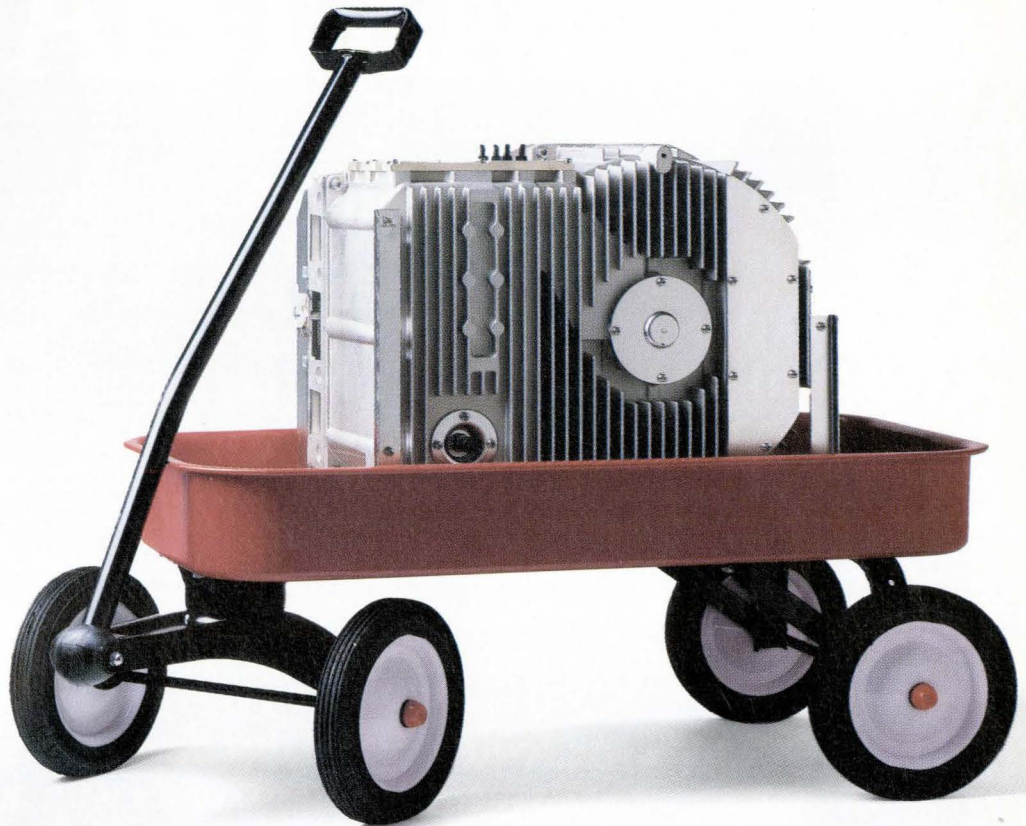

## Do you know what it is?

It's one of our direct access storage device's (DASD) disk enclosures, and it delivers improved reliability, improved availability and greater compactness.

## Here's why:

It's small — 60 lbs. vs. 140 for the industry standard's — because its disks are small — 10.5" in diameter vs. 14" for the industry standard's.

This is why these disks can be sealed inside their enclosures... which makes them less susceptible to environmental contamination.

It's also why our DASDs' footprints are up to 40% smaller than their rivals'... which conserves floor space.

And it's why we're able to service our DASDs fast... which reduces downtime, increases availability.

## It all adds up to greater productivity.

That's our DASD technology's ultimate value to you. And you can't get it anywhere else.

For specs on our full line, call your local Amdahl representative.

Amdahl Corporation  
1250 East Arques Avenue  
Sunnyvale, CA 94088-3470

**amdahl**<sup>®</sup>  
The VALUE Choice

Circle 60 on Reader Card

# HAYES ANN TECHNOLOGICAL MODEMS THAT IM

It's long been thought that even the best of technology eventually becomes obsolete. A notion that we at Hayes could never really understand. And certainly never accept. So in defiance of it, we created the V-series Smartmodem 9600™ and V-series Smartmodem 2400.™ Modems that actually get better as they get older. Because they not only incorporate the most intelligent features found in modems today, they also possess the capability to provide a long-term growth path into the communications environments of tomorrow.

## V-SERIES SMARTMODEM 9600

This is the fastest modem we've ever made. It can send and receive data at 9600 bps and with adaptive data compression achieve an effective throughput of up to 19,200 bps. Point-to-point error control, forward error correction and data flow control ensure that data gets there accurately.

The V-series Smartmodem 9600 also comes with automatic feature negotiation, a self-operating capability that analyzes all options for modem link and then selects the optimum feature set with any Hayes modem for the most efficient transmission at the highest shared speed.

Synchronous and asynchronous communications modes as well as simulated full-duplex employing advanced CCITT V.32 trellis code modulation and fast turnaround ping-pong technology are also part of the package. Plus you'll get the capability to link up with a range of networks, including SNA. And soon V-series technology will offer an X.25 PAD option to further accommodate network environments of today. And the future.



# OUNCES A CONTRADICTION: PROVE WITH AGE.

## V-SERIES SMARTMODEM 2400

With adaptive data compression this modem can achieve an effective throughput of up to 4800 bps. Of course, it too offers point-to-point error control, forward error correction, data flow control, automatic feature negotiation and synchronous as well as asynchronous communications modes. And like the V-series Smartmodem 9600, it can link up with a wide range of networks, such as SNA, and be enhanced with an X.25 PAD option.

V-series modems come in stand-alone versions and internal versions (V-series Smartmodem 9600B™ and V-series Smartmodem 2400B™). Internal versions are bundled with our powerful new Smartcom III™ communications software.

And as yet another rebuttal to the argument for obsolescence, we developed the V-series Modem Enhancer™. A separate stand-alone device that will upgrade current Smartmodem 1200™ and Smartmodem 2400™ external modems to the new standards set by the V-series products.

A closer look at the V-series product line will reveal to you a revolutionary technology designed to be the beneficiary of time, not its victim. So contact your Hayes Advanced System Dealer or call **800-635-1225** for the one nearest you.



## Unix: What Users Are Saying

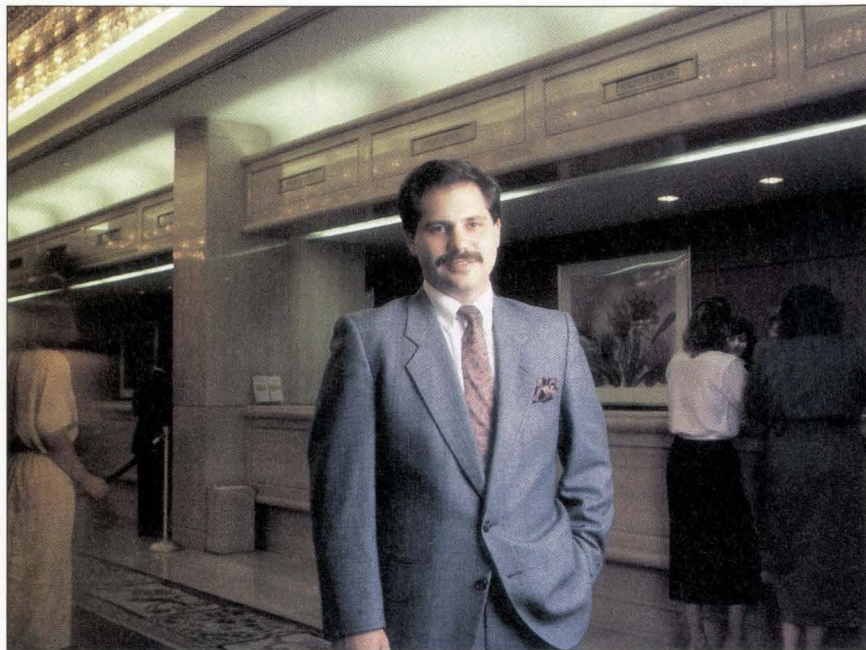

### **NOBODY KNOWS MUMPS**

*User: Carl Giallombardo, manager of distributed systems  
Sheraton Corp. of America*

*Application: Unix System V-based reservation system*

*Primary vendor: NCR*

Nearly two years ago, when the Boston-based hotel chain Sheraton Corp. of America was deciding on a new development environment for its revamped reservation system, the choice came down to Unix or Magic (a system based on the MUMPS programming language). The hotelier's technical experts decided that no other operating system offered the portability, the communications capabilities, and a development environment ready-made to build an advanced system. Unix prevailed.

Carl Giallombardo, Sheraton's manager of distributed systems development and support, attributes that decision, in part, to the wide acceptance of Unix's C programming language. "Nobody knows MUMPS," he explains. "The power and options available under Unix really support a development environment."

Once the software decision was finalized, Sheraton selected its hardware: NCR Tower 32, Model 600 minicomputers, with Qume QBT terminals attached. The NCR machines run Sheraton's own version of AT&T's Unix System V, version 2.0. The group added Informix Software's database/4GL programming environment (also called Informix), to the mix.

To write the software for the reservations system, Sheraton connected Towers within its Braintree, Mass., operations and development office through an Ethernet LAN. The new software will manage the availability of rooms for each hotel in the chain. Tower minis and Qume terminals are now being installed in each of Sheraton's nearly 500 hotels worldwide to run the reservation system.

Fifty hotels—mostly on the East Coast—already are on-line. Giallombardo expects the rest to be up and running by the end of 1988. Ultimately, the entire system may support as many as 15,000 users, he explains.

Sheraton's central IBM 4381 mainframe is used to track all reservations worldwide. Under the new reservation system, once a reservation is confirmed, the information is downloaded to the appropriate Tower minicomputer. (Giallombardo acknowledges that Sheraton is looking at alternatives to this current star configuration.)

In addition to providing intelligent terminal services via the front-desk Qumes, each Tower also will be linked up to other devices in individual hotels, such as point-of-sale terminals and property management systems, the minicomputer-based monitors of everything from air conditioning to building security to movie rental fees.

Giallombardo says Sheraton is basically content with its choice of Unix. The only stumbling block, he notes, has been the operating system's inability to handle

both the development and transaction processing environments with equal aplomb. He claims, however, that the Informix software has enabled Sheraton to make a fairly smooth transition to transaction processing.

"For Unix to be accepted by MIS departments, it will need a database management system that is more tightly coupled to the operating system," Giallombardo warns. "Right now, this is available only through third parties."

### **THE PROMISE OF POSIX**

While real time, DBMS, and other extensions are emerging to make the operating system more palatable to commercial users, the vision of Unix as a portable system is still seriously flawed.

"Currently, there are so many dialects that the idea that there is one Unix is silly," argues P.J. (Bill) Plauger, president of Concord, Mass.-based software company Whitesmiths Ltd. and a former employee of Bell Labs. "Look around at the store shelves. There's not enough of any one flavor of Unix to warrant mass production of Unix-based software for any given environment."

In more a poetic vein, he adds, "Right now, Unix is a constellation, a cluster of stars that are certainly closer to each other than they are to any other operating system." Most of the programs are written in C so that means they are "essentially portable" across Unix system lines, even if the porting requires a recompilation. Perhaps more important, Plauger says, is the fact that programmers are becoming "portable" as well. They can be moved if the need arises, or they can quickly become productive in the event the company upgrades its hardware, as long as Unix is available on the new equipment.

AT&T has come under fire from customers because of the many Unix variants. The cry has been for a single standard. So the telephone giant came up with its System V interface definition (SVID) and validation tests to ensure that the interfaces were complied with. This led to further accusations from customers and competitors that AT&T was attempting to control the Unix marketplace and to suggestions from DEC and others that control of the user interfaces to Unix be given to a standards organization with no vested interest in the OS.

An alternative set of interfaces largely based on AT&T's SVID has since surfaced within the IEEE, and has become a rallying point for AT&T's competitors, as well as a sincere attempt to create a



## The bigger they come, the harder you fall.

Sorbus<sup>SM</sup> services the IBM® 308X series:\* Enjoy all kinds of power, without all kinds of trouble.

It only makes sense to call us for 308X service. After all, we already maintain more IBM equipment than anyone but IBM.

And we do it so well that a recent reader survey by *Data Communications* judged us the "Best Service Organization." Period. (Our price/performance ratio had been the best for years.)

Those readers have come to rely on our two-hour average response time, our 230,000 part-number inventory, and our reliable on-site service. Not only for computers, but for just about any peripheral you might have connected to it, including StorageTek<sup>TM</sup> hardware.

The bigger your mainframe, the more you need Sorbus.  
Call today. 1-800-FOR-INFO.

**Sorbus**<sup>SM</sup>  
A Bell Atlantic<sup>TM</sup> Company

50 E. Swedesford Road  
Frazer, PA 19355

IBM is a registered trademark of International Business Machines Corporation.

Sorbus is a service mark of Sorbus Inc.

\*Available in most metropolitan areas.

StorageTek is a trademark of Storage Technology Corporation.

Circle 62 on Reader Card

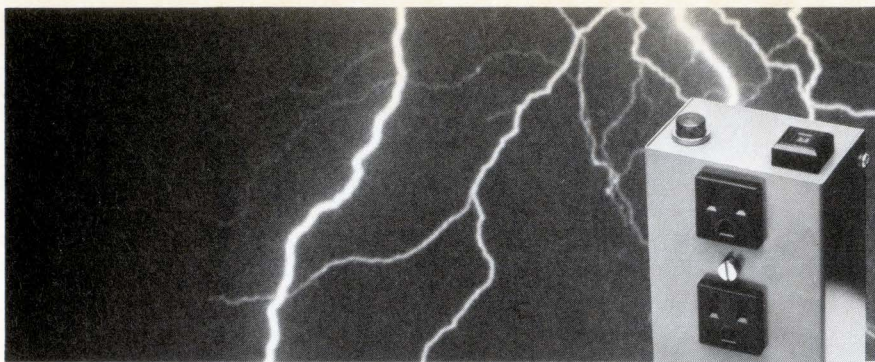

# New Dual-Purpose Transient Protection For Computers and Systems

Now, you can have *dual* transient voltage protection in a *single* low-cost wall-mounted package. If you're working with telecommunications, computers, or data acquisition, and need complete protection for both AC Power and Data, you'll like the convenience and high-level protection these new modules offer.

Each module contains two protective networks... one for the data, telephone, or 50Ω coax line, and another for the AC power. You'll get dual protection at a very affordable price. And, you'll get built-in quality and long-lasting performance from General Semiconductor, the acknowledged world-wide leader in transient protection devices for the past 19 years.

- **Model 120K232—Protects AC Power and RS-232 Data Lines.**

Custom pin configurations available.



120K232

- **Model 120KMP—Protects AC Power and Modems/Telcom Lines.**

Meets all applicable FCC regulations and operates up to 50kbaud. Available for MP11 or MP45 interconnects.

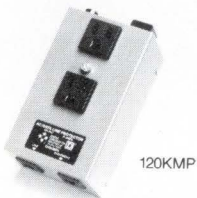

120KMP

- **Model 120KCX—Protect AC Power and Coax Lines**

Protects 50Ω coaxial lines and AC power lines feeding video or high-speed data/communications equipment. Operates to 25MHz. Available with BNC- or F-type connectors.



120KCX

Our new brochure details these and other cost-effective transient suppressors designed to keep your systems up and running. For your free copy, write us, call us on our Hot Line (800) 642-0424 (Ext. 511), or contact our local Distributor.

Wherever Electricity is Distributed and Controlled



**General Semiconductor Industries, Inc.**

**SQUARE D COMPANY**

2001 West Tenth Place • Tempe, Arizona 85281 • (602) 968-3101 • TWX 910-950-1942

Available from: ACI Electronics • All American Transistor • Aztech Electronics  
 Bell/Graham Electronics • Century Electronics • Cetec/Future Electronics • Deeco  
 Electronics Marketing Corp. • General Components • Hammond Electronics • Jaco Electronics  
 LComp • Merit Electronics • Nu Horizons • Ohm Electronics • Pioneer-Standard  
 Pioneer-Technology • Schuster • Texcomp • Western Microtechnology • Zeus Components  
 Canada—Future Electronics • Zentronics

**CIRCLE 63 ON READER CARD**

## Unix: What Users Are Saying

new portable standard. This IEEE committee, organized under the project number P-1003, has published a "trial use" standard for what is called Portable Operating System (or Posix), to avoid any kind of conflict with AT&T's trademark.

Although AT&T has said it will support the Posix initiative, it has also expressed concern about "one or two" differences between its SVID and IEEE's baby, which, if implemented, could inhibit upward compatibility between releases of System V.

Meanwhile, P-1003 has added various specialized areas to its assignment, with subcommittees currently working on the makeup of the Posix shell, or command interpreter, on what kind of tests would be appropriate in order to validate compliance with the standard, and on extensions to the system that are needed in order to support real-time operations.

The promise of Posix, according to P-1003 committee cochairman Jim Isaak, could lie in a host environment feature that will eventually enable the standard to run with other non-Unix operating systems, such as DEC's VMS or IBM's VM.

Helen Wood, deputy director of the National Bureau of Standards Institute of Computer Sciences and Technology and vp of standards for IEEE's Computer Society, claims that "Unix is too dynamic to be standardized at this point."

DEC has gone further by claiming that the Unix operating system should never be "frozen" or standardized. By just standardizing the interfaces to the operating system, the company argues, users can use whatever variant of Unix they want, and its future evolution won't be controlled by just one company.

Strangely enough, the promise that was Unix—that is, its openness and portability—may now be fulfilled only if Posix is successful and if the Posix validation tests that are expected from the National Bureau of Standards next year can at the same time be used by those wishing to comply with AT&T's SVID.

Even the promised land of a portable standard carries with it a threat. Helen Wood notes that the security and integrity of data under Posix have not yet been addressed by an IEEE committee. To an extent, the very openness of Unix/Posix almost seems to preclude the insertion of security measures and that, she notes, is a real puzzler. ■

*Mary Jo Foley is a Washington, D.C.-based business and technical writer. Don Leavitt is a freelance writer in Southboro, Mass.*

# MORE BITS FOR YOUR BUCK!



## Performance™ 1000 14.4Kbps Modem

### Emulex® introduces the 36-hour day.

Not enough hours in the day? Emulex's Performance 1000 14.4Kbps leased line modem can give you more.

Replacing your 9600bps modem with a V.33-compatible model that runs 14,400bps is like installing a bigger pipe to carry 50% more data per hour... which is like having 50% more hours per day.

Adding that much throughput to your existing lines means you can cancel your telco order for more. It also means faster response for your users. So why hasn't everyone upgraded? Because until now, 14.4K modems have been very expensive—typically over \$3,000 each.

### More Performance for the money.

An advanced design constructed around a few key proprietary VLSI chips, the Performance 1000 is changing the rules of the game for modems, as new technologies always do. At \$1795, it delivers 14.4 at about the old cost of 9600, in a package half the size of its competitors.

### Automatic speed adjustment both ways.

The CCITT V.33 spec calls out trellis coding for 14.4Kbps transmission and for its primary fallback rate of 12Kbps. The Performance 1000 extends that to 9600bps—to deliver an error rate 100X better than a V.29 modem would at the same speed.

The modem can automatically fallback to either speed, and later automatically speed up.

### Don't leave home with it!

Operating parameters are set by selecting from English-language options displayed in LCDs. What's more unusual, the remote unit also can be configured and tested through the local one, without an operator at the far end.

### 9.6 is enough?

There may be applications which can't take advantage of more speed, but could use more functions. For these, there's the Performance 1000/9.6, for \$500 less.

**Call toll-free (800) EMULEX-3,**  
(714) 662-5600 in California.

*Communications*  
by **EMULEX**

#### Send more information on the Performance 1000.

Name: \_\_\_\_\_

Company: \_\_\_\_\_

Address: \_\_\_\_\_

City: \_\_\_\_\_ State: \_\_\_\_\_

Zip: \_\_\_\_\_ Phone: \_\_\_\_\_

Emulex Corporation, 3545 Harbor Blvd., Costa Mesa, CA. 92626

In the four years since DB2 hit the market, IBM's relational database management system has made quite a splash. Many users are enthusiastic fans. Independent database vendors are busy trying to prove how their products either enhance or surpass Big Blue's RDBMS. But some IS managers remain immune to DB2's charms, criticizing its lack of essential features, such as referential integrity and a data dictionary.

# The Long Shadow of DB2



BY EDITH D. MYERS

Take a glance at the agenda of any major software product's user group meeting and chances are you'll find a session on DB2.

After a shaky start four years ago, DB2—IBM's relational database management system—has become a legend in its own time. As is the case with most legends, however, it's hard to separate DB2 fact from fantasy (see "DB2: Dressed for Success," March 1, p. 59).

Independent database vendors are busily scrambling around, trying to prove how their products either enhance or surpass DB2. According to industry analysts, however, DB2 frequently has a greater impact on other, older IBM DBMS products than it does on those of IBM's competitors.

Still, only a fool ignores IBM. And it's hard to ignore some of the glowing reviews that DB2 is receiving from its user base.

"I believe it's the database of the future," attests Richard Fox, manager of internal systems for Philip Morris Co. Inc., Richmond, Va., which has been using DB2 on an IBM 3090 for the past year. He notes that his company has one "major" DB2 application in production, with plans to add two or three in the near future.

Bob Venable, systems programmer with Provident Life & Accident Insurance Co., Chattanooga, Tenn., declares that he's "thrilled" with DB2. Provident has been using DB2 since early 1985.

That kind of endorsement scares independent software vendors. Bob Burris, an analyst with International Data Corp., Framingham, Mass., calls the impact of DB2 an "onslaught which is causing independents to reposition themselves."

IBM's marketing strategy may have more to do with this onslaught than does user support. While Big Blue is reluctant to provide the hard, cold number of DB2 sites, outsiders guess that DB2 has been installed at anywhere between 1,200 and 1,800 sites since its introduction in 1983. George Schussel, president of Digital Consulting Inc., Andover, Mass., estimates that DB2 "will be installed at a rate greater than that for products of the independent vendors, at least in the near term." Yet he notes that the total number of DB2 sites is less than that of products from most independent software vendors, and, in MVS sites, DB2 accounts for less than 10% of DBMS installations.



DB2

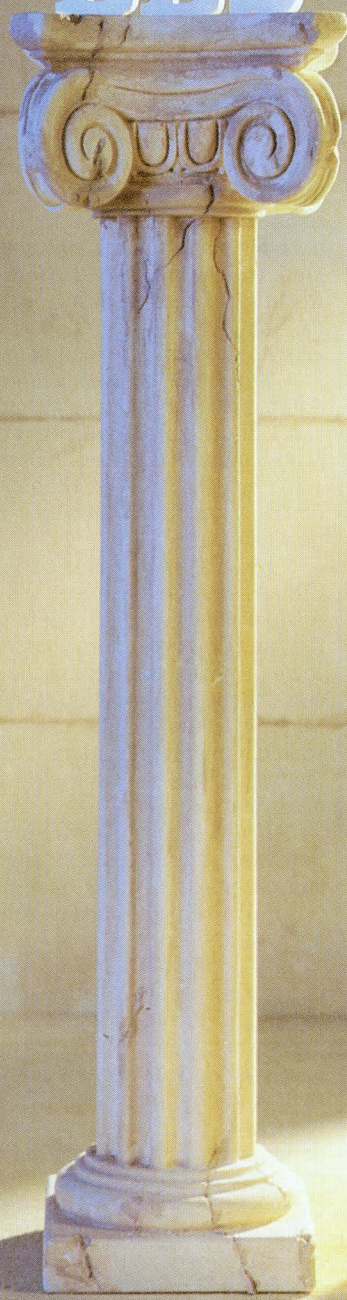

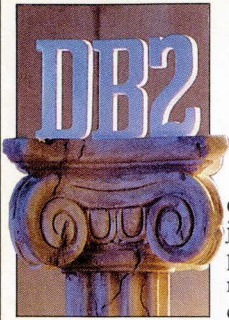

## The Long Shadow of DB2

Delving even deeper into the subject, the 1987 Computer and Telecommunications Survey conducted by DATAMATION and Cowen & Co., Boston (see "Mainframe Users Survey: Tough Times for IBM," May 15, p. 69), indicates that DB2 is having—and will continue to have—its biggest impact on other IBM products.

Survey respondents were asked if they were using a DBMS software package with their IBM mainframe, and, if so, which one. The percentage of installations with other DBMSs (which included Supra, from Cincom Systems Inc., Cincinnati; Model 204 from Computer Corp. of America, Cambridge, Mass.; Oracle from Oracle Corp., Belmont, Calif.; and others) was 29% in 1987. Interestingly, the percentage in 1984 was the same, which testifies to DB2's limited effect on the marketplace.

Since DB2's introduction in 1983, three packages have edged up in support. ADABAS from Software AG, Reston, Va., rose to 10% from 8% in the '84 to '87 period, while Datacom DB, from Applied Data Research (ADR), Princeton, N.J., increased to 6% from 4%. IDMS and IDMS/R from Cullinet Software, Westwood, Mass., increased to 16% from 15%.

In 1984, among IBM products, DB2 showed no use by respondents and moved up only to 6% in 1987. IBM's SQL (Structured Query Language) also increased, moving up to 5% from 2%. But both DL/1 and IMS dropped dramatically; the former to 11% from 19% and the latter to 17% from 23%.

"If it's the latest and greatest from IBM, we get it," says Jake Feuchtwanger, director of systems and computing, Depository Trust Co., New York, a DB2 user since last April. "Development time and access time are very good."

### Some Resist DB2's Good Notices

Nevertheless, there are plenty of IS managers immune to the allure of DB2. Jim Waters, manager of MIS at Tropicana Products Inc., Bradenton, Fla., studied DB2, Datacom DB, and "several others. We are migrating from Burroughs to IBM," he explains. "My goal is to use as much purchased application software as possible. Datacom DB looked best for supporting purchased software."

Likewise, Tony Gambatese, vice president for information services, St. Vincent Charity Hospital & Health Center, Cleveland, ran four DBMS products

for 30 days, beginning last December—CCA's Model 204, Cincom's Supra, DB2, and Datacom DB. Datacom DB won.

Yet there's no denying that DB2's importance goes far beyond numbers of users.

One aspect of DB2 that's getting critical acclaim is SQL. Digital Consulting's Schussel calls SQL the "most salient feature of DB2." Both ANSI and ISO have adopted SQL as a standard. Thus, Schussel predicts that those independents who have been slower to support SQL "will be hurting over the next two or three years, or until they are able to support SQL."

That doesn't come as news to some independents that feel they are well positioned. Cincom has had partial SQL support for Supra almost from the beginning. Oracle has had SQL from day one. Relational Technology Inc. (RTI), Alameda, Calif., has had SQL support for its Ingres RDBMS for more than a year.

Moreover, those companies that don't have it now say they soon will. William Clifford, executive vice president of ADR, claims his company "has extremely ambitious plans. We are adding major functions to Ideal [ADR's fourth generation language]."

Ideal already has a DB2 interface. Clifford says new features will allow users to write their Ideal code in SQL or use the fourth generation constructs that Ideal provides and have those generate SQL. "Based on market research," he says, "we know many users want SQL visible in their applications." These new features will be available early next year, according to Clifford.

Bruce Mancinelli, vice president of Software AG, says his company "has two approaches to linking our 4GL [called Natural] strategy to IBM products or the SQL world.

"The first implementation at the end of the year," he explains, "will allow for applications developed in Natural to dynamically generate the necessary SQL in a run-time environment to support DB2. A subsequent release in mid-1988 will allow for SQL statements to be coded within the body of a Natural program. Our idea is to offer both and let users choose the one that best fits their needs. Some may mix the two. We also have every intention of coming out with ADABAS SQL and will announce a release at our user conference in November."

### Tools and Connectivity

Clearly, some competitive RDBMS vendors are positioning themselves in various permutations of the "If you can't

beat 'em, join 'em" strategy. Or, put more diplomatically, "It's aggressive *dé-tente*," as RTI product line marketing director Bob Williams describes his company's DB2 competitive strategy.

"We know that 50% or more of the market will have DB2 as a first choice," he adds, "but, in the longer term, we know few users can exist with simply one database environment. DB2 and SQL alone will not be enough. We'll come in with tools and connectivity. It's perfect ground for us."

"Everybody wants to support DB2," says Mike Cohn of Input, a Mountain View, Calif., research house. "Bridges are being built everywhere. Everybody's doing something to ride the coattails of DB2."

Coexistence is nothing new to these vendors, and, particularly in regard to DB2, IBM is seen as vulnerable in terms of tools that work with the RDBMS.

Giving credence to that belief is Bill Werben, development manager for Manufacturers Hanover Trust. The New York-based bank went with DB2 because



**"EVERYBODY'S DOING SOMETHING TO RIDE THE COATTAILS OF DB2."**

it is "open-ended, available for use with third-party tools." Werben uses IBM's QMF and CSP (Cross System Product, an application development tool). He notes that while "we'll use primarily IBM, we'll use other [tools] as well. We're evaluating two others right now." He declined to name which two.

Software AG's Mancinelli, who says his company will both compete with and live with DB2, claims that "there is still room for substantial improvement in DB2 and in areas where users are well satisfied by ADABAS . . . there is an expansion of data types, getting into graphics and images." ADABAS already handles text, and Mancinelli says that graphics and images are on the way.

Pete Tierney, marketing vice president of Oracle, says that it's "a reality of

# Something keeping you from changing DB2 data structures?

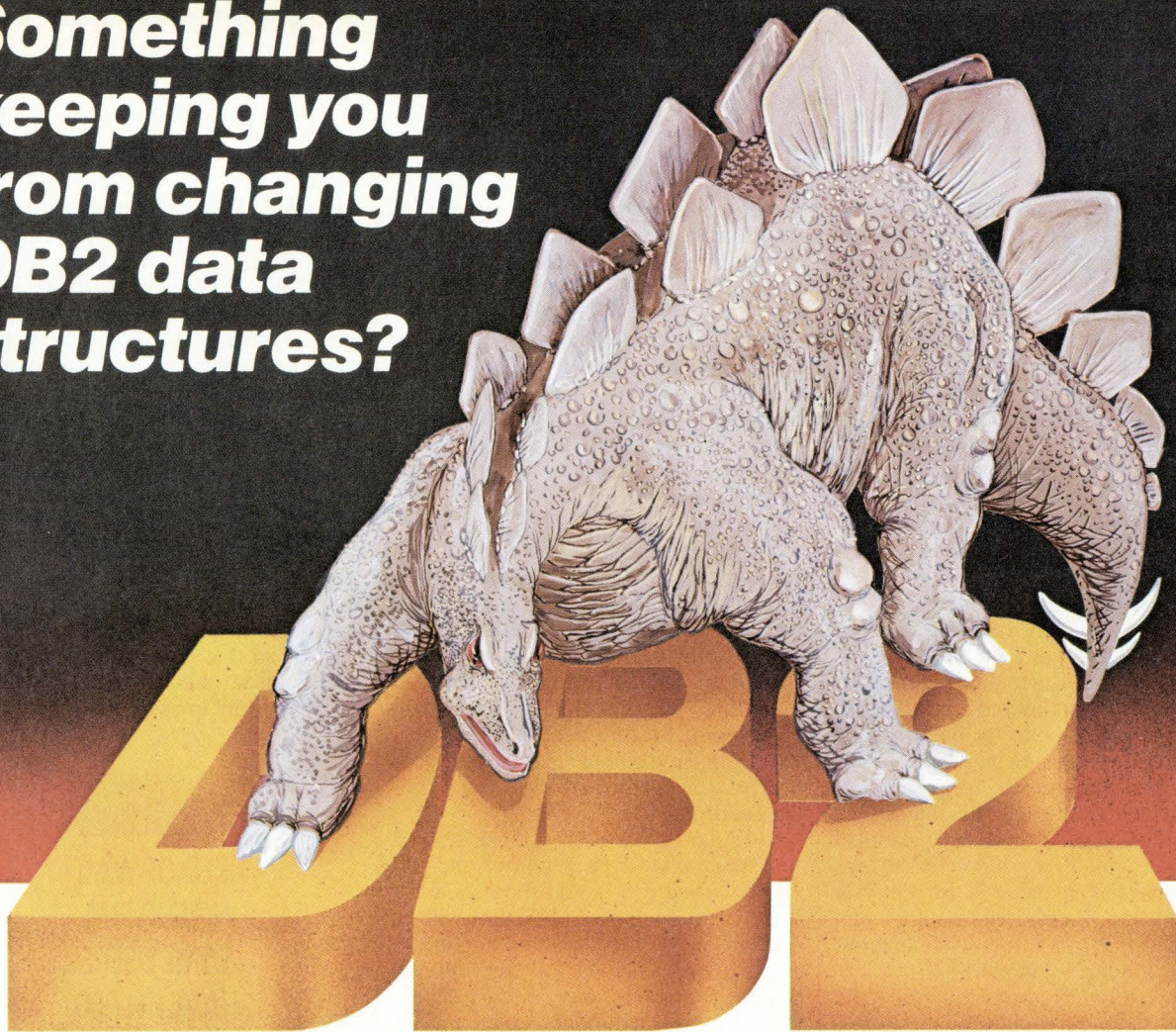

Changeasaurus—(CHANGE-a-SAU-rus)

It's not that you can't make a change; it's what happens when you do make a change. Changeasaurus, that jealous guardian of the DB2 catalog, is dangerous when provoked. Because of the demands of Changeasaurus, DBAs have spent upwards of 50% of their time battling complex change procedures.

But those days are gone. Now there's DB2 ALTER from BMC Software, which supports all changes to attributes of objects. DB2 ALTER automatically restores data, dependencies and authorizations. It features commit-point control and restart capability, and Rename, Migrate and Create Like commands.

DB2 ALTER provides:

- Complete control of the change process
- Reduced development and maintenance costs
- Elimination of costly user coding errors

For more information, or to begin a 30-Day-Plus Free Trial on DB2 ALTER, mail

Circle 65 on Reader Card

the attached coupon, or call BMC Software.

1-800-841-2031 in the USA  
or (713) 240-8800  
1 800 231-2698 in Canada  
(0276) 24622 in the United Kingdom  
(069) 66 4060 in West Germany  
(02) 7382213 in Italy

**BMC**  
SOFTWARE

**BMC Software, Inc.**

P.O. Box 2002 • Sugar Land, TX 77487-2002

- Contact me about a 30-Day-Plus Free Trial of DB2 ALTER.
- Contact me with more information on DB2 ALTER.

Name \_\_\_\_\_

Title \_\_\_\_\_

Company \_\_\_\_\_

Address \_\_\_\_\_

City \_\_\_\_\_ State/Prov. \_\_\_\_\_ Zip/PC \_\_\_\_\_

Telephone \_\_\_\_\_

DM

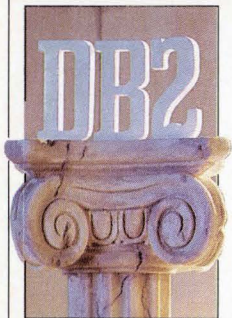

## The Long Shadow of DB2

life that certain market segments will go with DB2. Historically, IBM has had 52% of the database market, but that still leaves 48% for the rest of us."

With the advantage of its solid SQL background, one chunk that Oracle plans to carve out is the SQL MVS market. "It's available to Oracle and only to Oracle at this time. Over time, though, other companies may decide they can afford the investment" in developing something for MVS, Tierney predicts.

But, according to Digital Consulting's Schussel, while Oracle perhaps has the only RDBMS other than DB2 that runs with MVS, to date the number of installations is small. That limited market penetration doesn't seem to be stopping others from expressing interest.

RTI has entered into an agreement under which Pansophic Systems, Oak Brook, Ill., will use Ingres as a relational database engine in products for the MVS environment. Pansophic is currently in beta with the Ingres MVS implementation. Eventually, RTI itself will come out with MVS implementations.

"We're being careful," states RTI's Williams. "We have one shot at MVS and we don't want to make a mess of it." Although he is unsure as to when RTI will begin beta testing its own MVS implementation, the company hopes it will be sometime next year.

Another alternative is ADR's Datacom DB, which some say is only relational-like. Datacom DB runs with MVS, which was one reason it was put in place last March by Stan Hill, manager of systems and programming for Gifford-Hill, a Dallas construction firm. "We looked at DB2," he says, "but we didn't think it fit well with MVS. . . . I'm pleased with [Datacom DB]."

That's the type of sale ADR's Clifford hopes his company can increase, but it means that ADR has to convince users to make a "tactical versus a strategic decision." He equates the word strategic with what he calls "IBM's use of it during the FUD [fear, uncertainty, and doubt] of the early days of DB2. IBM was selling the notion of strategic. We sell tactical: hard dollar savings, DASD consumption savings, a full-function data dictionary."

### Added Functions Wanted

Tactical talk may work given some of the rather large holes in DB2. IBM announced release 3 of DB2 last May without a number of added functions people

were hoping to see. Heading up the list of wants are referential integrity and a data dictionary (see "DBMS: Adding Value to Vanilla," March 1, p. 50). Other vendors are there to fill in IBM's gaps.

Boris Katsnelson, systems developer for Con Edison, New York, a DB2 user since last May, also uses On-Line Systems' Ramis 4GL and Uccel's UCC 10 data dictionary with it. "We'll go for third-party software if it's something IBM doesn't offer," he says.

In mid-August, On-Line, Fort Lee, N.J., announced CasePac, which the software vendor claims is the only mainframe-based CASE facility with a DB2 data dictionary. On-Line developed the tool with Fireman's Fund Insurance Corp., San Rafael, Calif., a DB2 user grown tired of waiting for Big Blue. Ronald Voell, project director for CasePac at the insurance company, complains, "Three years ago, IBM told us they'd have a data dictionary in three years."

Either one or both of these desired DB2 functions—data dictionary and referential integrity—could show up in release 4, but no one is sure if they will, or even when release 4 will be announced. Shaku Atre, president of Atre International Consultants, Rye, N.Y., calls release 3 "a step in the right direction," but she feels that "IBM still has a long way to go." She doesn't think referential integrity will show up until release 5.

Release 3 of DB2 did include a Database Relational Application Directory (DBRAD) for MVS and VM and a DB2/VSAM Transparency program. Both have met with positive response from users and analysts, although DBRAD has been viewed by some as a stopgap solution.

Barry Brown, a founding partner of Brownstone Solutions, a New York marketer of Data Dictionary Solution, a product for the DB2 environment, says, "I've had no hands-on experience with DBRAD, but I don't think it will affect the needs of the people developing applications under DB2. Possibly it will be helpful to those closer to the machine, the systems programmers." Brownstone Solutions, a consulting company for DB2 users, fell into offering the product after developing it for the firm's own use.

Beyond the specifics of DB2 versus the rest of the offerings, there is a strong feeling among RDBMS vendors that the very fact that IBM has a relational product sprinkles holy water on the concept. "DB2 indicates an acceptance of the relational concept by IBM that helps us all," says Oracle's Tierney.

Some users want relational for its

own sake. "I wanted a relational database management system," comments Hill of Gifford-Hill. "I'd been studying it for some time and decided that was the way to get into a fourth generation environment. I wanted to move away totally from doing applications development in the third generation."

It's clear that IBM is making sales on the basis of the relational model. Werben of Manufacturers Hanover picked DB2 in January 1986. "We felt we needed a relational view of things for the bank's global exposure system," he says. "It gives us a better understanding of information from our overseas units and how it fits in with domestic data."

While IBM has a support base for DB2 that is strong and growing stronger, clearly it is not unassailable. Digital Con-

## TIRED OF WAITING FOR IBM, SOME USERS HAVE HELPED DEVELOP DB2 ADD-ONS.

sulting's Schussel explains that "it's IBM's goal to grow its software business as much as possible because of higher profit margins [than hardware]. It is their greatest chance for significant profit increase. If they ever achieve a dominant position with DB2, its prices will go up significantly. They'd love to be a monopoly vendor." But heterogenous, not homogenous, environments are becoming more common, he notes. Just look at some of DB2's customers.

Provident Life considered DB2 and Cullinet's IDMS/R. Says Venable, "We couldn't decide, so we got both." ■

*Assistant editor Mary Kathleen Flynn assisted in the reporting of this article.*

*Reprints of all DATAMATION articles are available in quantities of 500 or more. Details may be obtained by telephoning Frank Pruzina at (312) 635-8800, or by writing to Cahners Reprint Services, Cahners Plaza, 1350 E. Touhy Ave., Des Plaines, IL 60013.*

# Our new line on Intelligence is systematic.



The problems you may face merging and managing your information needs can now be solved – systematically – by our new, full line of Telex Intelligent Workstations.

Start with our already-popular AT-class system, the **1280**. Then move to the **1285**, our 80386-based system, which is also available as an upgrade to current 1280 users.

Also new are three 80286-based systems. The **1240**, an entry-level workstation. The **1220**, a slimline unit with optional 3.5-inch media, ideal for a variety of network environments.

And last but not least, there's the **1210**, our new diskless network terminal, a testimonial to cost-effective high performance.

Telex offers intelligence for any work environment, be it 3270, S/3X, Airline or PBX. Call us for more information about our systematic approach to intelligence. USA: 1-800-331-2623, ext. 4530 (Oklahoma, 1-918-624-4530). CANADA: 1-800-268-3233. WORLD TRADE: 1-617-769-8000.

## TELEX

TELEX COMPUTER PRODUCTS, INC.

Circle 66 on Reader Card

IBM and IBM AT are registered trademarks of International Business Machines Corporation. Telex is a registered trademark of The Telex Corporation.

*It's a fast,  
powerful,  
self-configuring,  
self-diagnosing,  
multi-user  
supermicro  
that runs both  
DOS and UNIX  
simultaneously.*

Keep  
reading,  
it gets  
better.

If you're having difficulty cost-justifying minis for your distributed resource sharing, but your company has outgrown the personal computer network route...

If you're looking for Intel's industry-leading, 32-bit 80386 chip for unmatched speed and power; a CPU board housing 64Kb of cache memory (3.2 MIPs system performance rating), plus up to 1 Gbyte of disk storage; and up to 58 asynchronous lines to handle all your communications needs...

If you're thinking about a user-installable, self-configuring, self-diagnosing system that gets – and keeps – itself up and running with a minimum of maintenance and downtime and a maximum of performance and productivity...

If you're demanding standards, so that you can run both a SVID-compliant UNIX® V.3 and an MS-DOS® operating system – with a transparent interface that enables users to stay in one environment while quickly and easily accessing files, commands, and software in the other...

If you're interested in taking advantage of MULTIBUS II™, the most advanced system bus for connecting to most industry standard peripherals and TCP/IP over ETHERNET® for communicating in a multiple-system environment...

...then you should know more about the new PRIME EXL™ 316 supermicro. Starting at under \$24,000, it defines the term "price/performance".

**Call or write today for all the details.**

As you'd expect from Prime Computer – the world-wide, Fortune 500 company that was voted as one of the top vendors in terms of customer support by Datapro – we've prepared a complete information kit for you, including a special report on, "The Advantages of the 80386 in an MS-DOS and UNIX Operating Environment." Send for it today by calling toll-free 1-800-343-2540 (in MA call 1-800-322-2450). Or fill in, detach and return this coupon.

The PRIME EXL 316 supermicro. Think of it as your MIS wish list.

It sounds like something we should know more about. Please send us your comprehensive information kit on the PRIME EXL 316 supermicro, including a special report on, "The Advantages of the 80386 in an MS-DOS and UNIX Operating Environment." No cost or obligation, of course.

Name \_\_\_\_\_  
(Please Print)

Title \_\_\_\_\_

Company \_\_\_\_\_

Address \_\_\_\_\_

City, State, ZIP \_\_\_\_\_

Telephone \_\_\_\_\_

Send to:  
Prime Computer, Inc.  
Prime Park MS 15-60,  
Natick, MA 01760.

 **Prime**®

AD0030009

PRIME and the Prime logo are registered trademarks, and PRIME EXL is a trademark of Prime Computer, Inc., Natick, MA. UNIX is a registered trademark of AT&T Information Systems. Ethernet is a registered trademark of Xerox. MS-DOS is a registered trademark of Microsoft Corp. Multibus II is a trademark of Intel Corp.

Circle 67 on Reader Card

# WHERE ARE TODAY'S MOST SOPHISTICATED BUSINESS CUSTOMERS HEADED?

To NYNEX, one of the leading information management companies in the country. A company with a long heritage in communications. A company with \$11 billion in revenues, \$21 billion in assets. NYNEX, builder of information superhighways for companies large and small. NYNEX. Telecommunications, information systems and software. Everything you need to use informa-

tion more efficiently. Everything you need to solve whatever communications problem you may encounter. To help you be more productive. That's our calling.

**Come to booth #1041 at INFO '87, September 29–October 2, at the Jacob Javits Convention Center in New York to find out more about NYNEX and about the answers we can provide your business.**

**For referral information, 1-800-535-1535.**

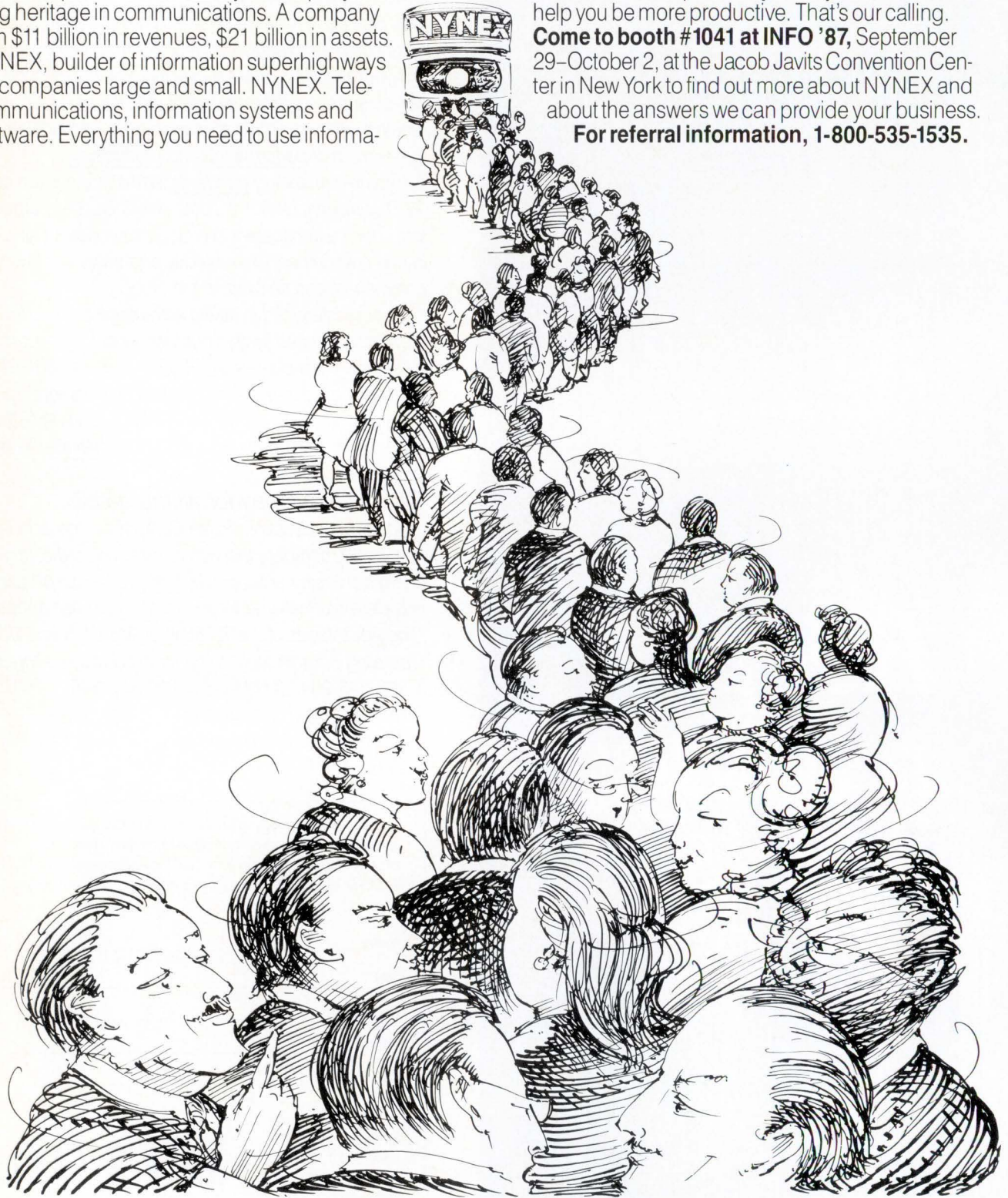

## THE ANSWER IS NYNEX

Telecommunications



Information Systems



Software



Publishing



Business Services

© NYNEX Corporation 1987

Circle 68 on Reader Card



# Real Time

## OFF-LINE

THE COST OF OWNING an IBM departmental computer system generally is lower than the cost of owning comparable machines from Digital Equipment Corp., Data General, and Wang Laboratories, according to the Sierra Group, the Tempe, Ariz.-based industry research and consulting firm, which recently completed its second annual cost-of-ownership study. The perception that IBM is "pricy" is a misperception, according to the study, and it's Digital that deserves the description.

The study compared the one- and five-year costs of owning four-, eight-, 32-, 50-, and 100-user systems. The Sierra Group evaluated IBM's 9370, System/36, and System/38; Digital's MicroVAX 2000, MicroVAX II, and Local Area VAXcluster; Data General's MV/2000 DC, MV15000, and MV7800; and Wang's VS 5, VS 6, and 7000 series. (Hewlett-Packard did not participate in the study.) Sierra uses its proprietary Sierra 1000 DataBase in compiling its studies.

IBM outshone the competition in all but the 50- and 100-user levels, where Data General rose to the top as the most economical.

Sierra's vice president Marty Gruhn states that the study reflected "major changes" in the departmental systems marketplace. This year, she says, vendors are recommending different systems from those that they recommended last year to meet the same user requirements. For instance, Digital this year recommends networks of smaller, application-specific systems for integrated office systems, while last year it recommended centralized VAX systems. Gruhn also notes that the gap between the least and the most expensive 100-user system was \$500,000.

Software maintenance costs are playing a bigger role in vendor's pricing strategies, says the study. In fact, states Gruhn, "It's not unusual for overall hardware/software maintenance to double the cost of a system."

The study contends that all four players are underpricing hardware at the low end in order to capture customers, and then overpricing software.

## HARDWARE

# Prime Adds a New Desk-side Superminicomputer to Line

New 50 Series machine provides 1.6MIPS and supports 40 users.

BY THERESA BARRY

The 2455 is Prime Computer Inc.'s newest superminicomputer.

The new machine operates at up to 1.6MIPS, supports 255 simultaneous processes for up to 40 users, and stores up to 774MB. Prime claims the 2455 provides a 50% increase in main memory compared with Prime's existing desk-side systems, the 2350 and the 2450. In addition, internal cabinet changes allow for the incorporation of three 258MB 5¼-inch Winchester disks, which is up 50% from the 2350 and the 2450. The 1.6MIPS performance is a 23% increase over the 2450 and an 88% increase over the 2350.

The 2455, like other 50 Series machines, runs the Primos operating system and can be upgraded to more powerful systems. (The high-end 50 Series is the 6550 dual-processor system rated at 23.6MIPS.) Among the other features of the 2455 are 64KB of cache memory and an internal diagnostic processor. It can be linked to other vendors' computers via Prime's LAN300, which allows

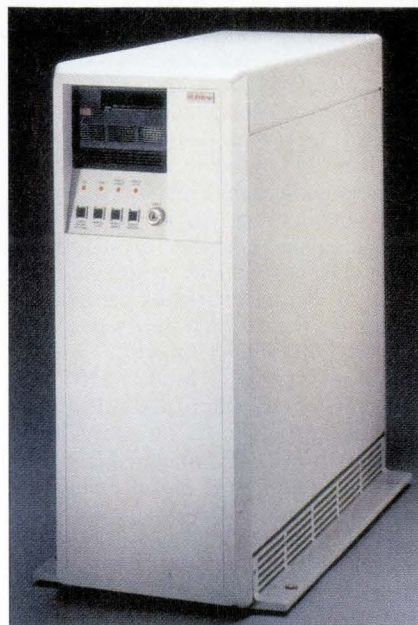

Prime's new 2455: more storage and power.

50 Series systems to communicate via Ethernet/IEEE 802.3 and SNA networks.

The 2455 is priced at \$62,810 and includes the cpu, a three-disk cabinet, 4MB of ECC MOS memory, a 258MB 5¼-inch Winchester fixed disk, a 60MB cartridge tape, an intelligent communications controller with four async lines, a disk/tape controller, a system console, and a Primos license.

The Model 4592 GCR Magnetic Tape Subsystem for the 50 Series high-end systems—9755, 9955II, 6350, and 6550—was also introduced by Prime. The price is \$28,800. PRIME COMPUTER INC., Natick, Mass. CIRCLE 260

## Mainframes

NAS unveils family of four intermediate mainframe systems.

The AS/VL Series of mainframes from National Advanced Systems consists of four models: the AS/VL 40, 50, 60, and dual-processor 80. The series uses the same semiconductor and packaging technology as the NAS AS/XL Series.

The AS/VL 60 series range in performance between 5MIPS and 18MIPS. All AS/VL systems are field upgradable, says SAS, and all include standard channels that can transfer data at 6Mbps.

The AS/VL 40, 50, and 60 are available now, and the 80 will be available later in this quarter. A typically configured AS/VL 60 is priced at \$1,276,000.

NAS also announced that it will no longer sell the AS/6660, which the company had introduced back in the early '80s. NATIONAL ADVANCED SYSTEMS, Santa Clara. CIRCLE 261

## Pc Fax

Dest introduces its first product since acquiring Gulfstream.

In July, Dest Corp. purchased Gulfstream Micro Systems Inc. of Boca Raton, Fla., which markets the EZ-Fax micro facsimile product. Dest now has introduced its version of that product under its own label. The Facsimile Pac

# Real Time

enables the IBM PC, XT, AT, and compatibles to communicate with digital facsimile machines. Hardcopy documents are entered using Dest's PC Scan or PC Scan Plus personal computer document scanners. PC-generated documents can be directly transmitted using Facsimile Pac software.

Facsimile Pac consists of a circuit board and software and provides full CCITT Group III facsimile compatibility. Pac features include automatic dialing and delayed transmission, store-and-forward transmission, and serial broadcasting. Background capabilities include send, receive, print, and scan functions.

Facsimile Pac is priced at \$1,495. Optional features are a DES Encryption chip, which costs \$195, and a 300-baud/1,200-baud Hayes-compatible modem, priced at \$129. DEST CORP., Milpitas, Calif. **CIRCLE 262**

## Flexible Drive Adapter

Allows 3½-inch drives to be fitted into 5¼-inch slots.

Mitsubishi Electronics America has announced an adapter for its 3½-inch flexible disk drive models MF353B and MF355B that enables installation into

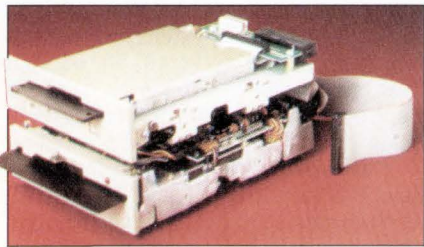

standard 5¼-inch pc system slots. The housing for the adapter is compatible with the IBM PC, XT, AT, and compatibles.

In oem quantities of 1,000, the MF353B with adapter is priced at \$101 each; the MF355B costs \$118 each. MITSUBISHI ELECTRONICS AMERICA INC., Torrance, Calif. **CIRCLE 263**

## AT Compatible

NBI's newest micro offers fast processing speed and high storage.

The NBI 4200 is fully compatible with the IBM AT, says the company. It uses an Intel 80286 microprocessor and users can switch from a normal clock frequency of 6MHz to 10MHz with one command. NBI claims that this allows the 4200 to run MS/DOS applications twice as fast as an AT. Other features include two internal



40MB hard disk drives, a 1.2MB floppy disk drive, and an 84-key standard keyboard that can be upgraded to an NBI extended keyboard. A high-resolution monochromatic amber monitor with a resolution of 720 by 348 pixels is offered, as are two standard color graphics and enhanced color graphics monitors. The 4200 supports up to 16MB of RAM.

The NBI 4200 is priced at \$3,195. A standard configuration comes equipped with 512KB of memory, eight expansion slots, one parallel port, and two serial ports. NBI, Boulder, Colo. **CIRCLE 264**

## Graphics

Metheus introduces new graphics tools using VLSI technology.

Metheus Corp.'s new 1000VM Series of display controllers consists of four models, all built using VLSI components and surface mount technology, which allows them to occupy one standard-height VME slot. Resolutions offered in the series are 1,024 by 768 and 1,280 by 1,024 pixels with either four or eight bits per pixel and, optionally, four bits of overlay. The components of the controllers are the graphics processing unit, a single-chip general purpose processor optimized for graphics and rated at 4MIPS, and the memory control unit chip, which controls raster memory and carries out low-level graphics tasks. Together, says Metheus, they achieve random vector drawing rates of 13 million pixels per second. Prices for the 1000VM Series range between \$2,495 and \$3,995.

The Metheus Model 1104 Advanced Graphics Coprocessor has a displayable resolution of 1,024 by 768 by four bit planes, 60Hz noninterlaced from a pixel memory array of half a megabyte of high-speed video RAM. It occupies one-half of an eight-bit slot in most micros, says Metheus. The VLSI technology used for the Metheus chip set allows for the compact size and provides the performance, says the company, and it is the

same chip set used in the VME bus products. The Model 1104 graphics coprocessor is priced at \$1,395. METHEUS CORP., Hillsboro, Ore. **CIRCLE 266**

## 3-D Graphics Workstations

CDC expands Cyber line with four machines, two that are RISC based.

Control Data Corp. has expanded its Cyber 190 family of workstations with four new models, oemed by Silicon Graphics.

Two new high-end machines comprise the 500 series of the Cyber 190. The Model 537 and Model 520 each have a 12.5MHz RISC processor, which CDC claims delivers 10MIPS of power. They also feature a 12.5MHz floating point coprocessor and provide 1.9 single-precision or 1.08 double-precision Linpack MFLOPS. The 537 comes standard with 8MB of RAM, a 182MB hard disk, eight system bit planes and eight user planes, and a 19-inch monitor with 1,280 by 1,024 resolution. The Model 537 is priced at \$72,400.

The Model 520 is the same as the 537 except that the 520 includes 16 user and eight system bit planes and two 182MB disks. It comes with ICEM Design and Drafting and ICEM EMS software for CAE, mechanical, and electronic design and manufacturing. The price of the Model 520 is \$84,900.

The two new 300 series Cyber 910 models replace two discontinued models. The 315 features 4MB of RAM, a 182MB disk, eight bit planes, an Ethernet



controller, and a 15-inch monitor. The 315 is not upgradable, says CDC, and a cartridge tape is optional. The price is \$24,900.

The Model 320 has 8MB of RAM, a floating point accelerator, a 182MB disk, 12 bit planes, a 19-inch monitor, and a price of \$48,545. CDC says it has a "limited" upgrade capability and comes with both ICEM software packages. CONTROL DATA CORP., Minneapolis. **CIRCLE 265**

# Cut your line costs in half with Fujitsu's 19.2 Kbps modem.



Now there's an easy way to increase your throughput without increasing your line costs.

With Fujitsu's new two-channel, stand-alone modem, you can send twice the information of a 9600 bps modem without adding additional lines. This can save you up to \$1500 per month for each leased line used for coast-to-coast communications.

Fujitsu's 19.2 Kbps modem is Trellis-coded and available with an optional six-channel TDM that supports up to eight channels of data, with speeds ranging from 2.4 to 19.2 Kbps.

Advanced diagnostics allow the user to monitor the phone line to ensure that critical standards such as

S/N ratio, receive level and phase jitter are maintained. The 19.2 Kbps modem is covered by the most outrageous guarantee in the modem business: Fujitsu Modem Insurance.

If your modem fails during the first year, we'll give you another modem. For free. And we'll fix the first one. Also for free.\*

Now you can cut line costs and increase throughput with the surprisingly affordable Fujitsu 19.2 Kbps modem.

For the name of a Fujitsu distributor near you, call 800-422-4878; in California, 408-434-0460.



**FUJITSU AMERICA**  
DATA COMMUNICATIONS

\*This limited offer for Fujitsu Modem Insurance is only open to new purchases of 19.2 Kbps modems from an authorized Fujitsu America distributor and is subject to the terms of our Modem Insurance Policy.

Please send me more information about the **Fujitsu 19.2 modem.**

Name \_\_\_\_\_ Title \_\_\_\_\_  
Company \_\_\_\_\_ Address \_\_\_\_\_  
City \_\_\_\_\_ State \_\_\_\_\_ Zip \_\_\_\_\_  
Phone # \_\_\_\_\_

FUJITSU AMERICA  
DATA COMMUNICATIONS  
3055 Orchard Drive  
San Jose, CA  
95134

# ANNOUNCING THE BIRTH

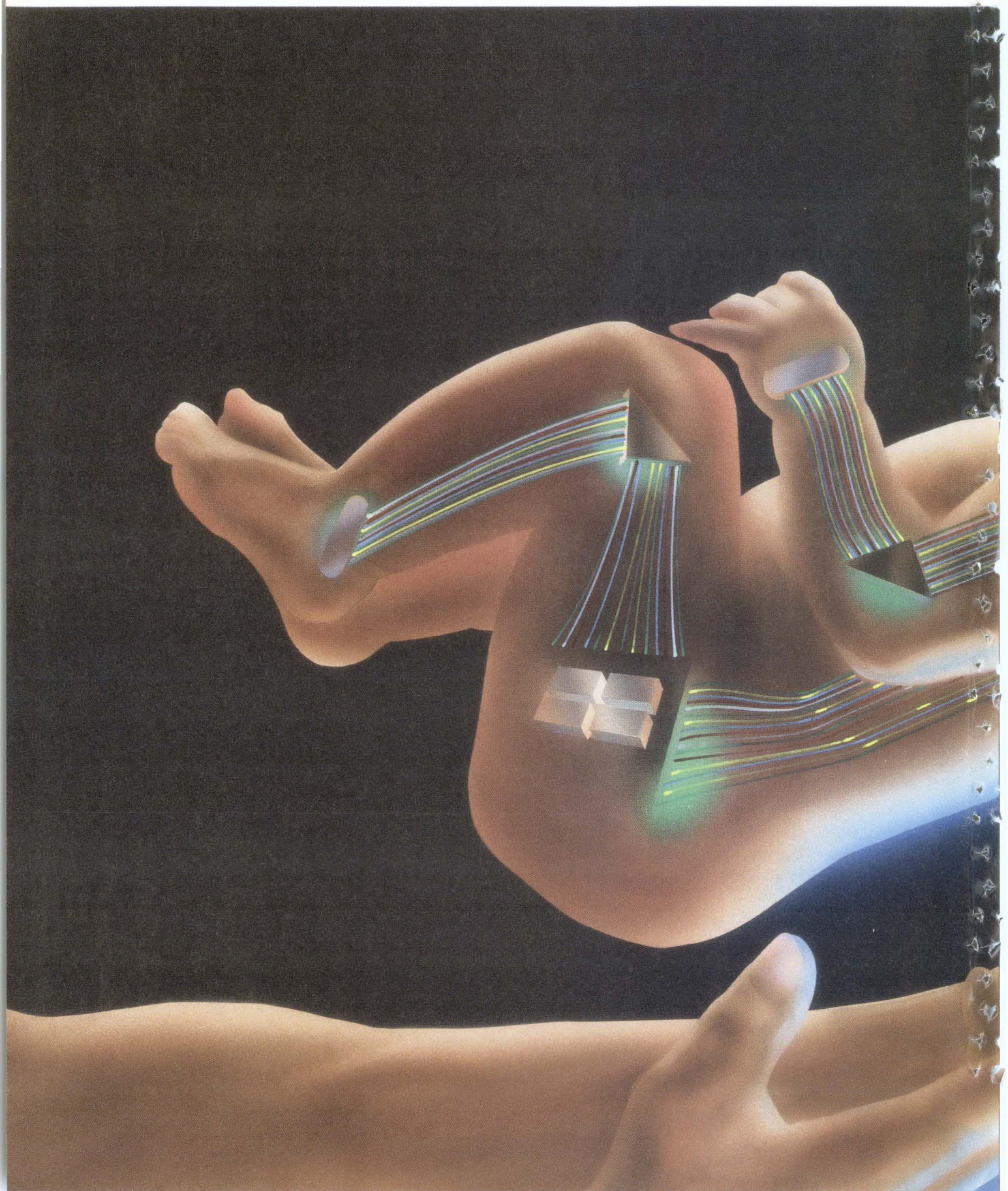

# OF A NEW CONNECTION.

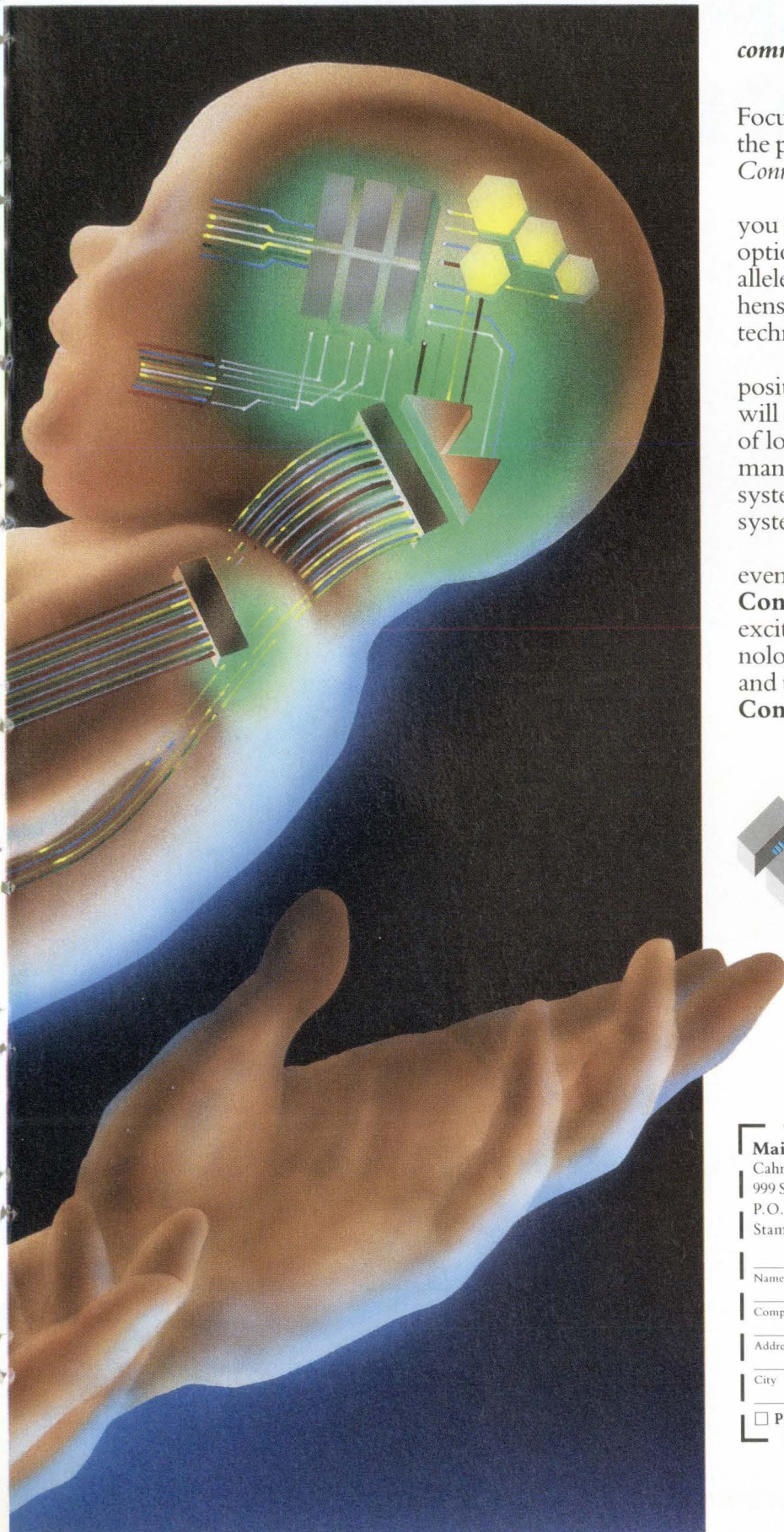

*The singular event for computer and communications professionals.*

Finally, an event that fits the times. Focused on the single topic that is impacting the present and helping to shape the future. *Connectivity.*

Only **Connect '88** is dedicated to give you a first hand look at the latest connectivity options and integration solutions. Our unparalleled three day schedule includes comprehensive conference sessions and invaluable technical seminars.

In addition, a landmark strategic symposium, presented by **THE GARTNER GROUP**, will cover such important issues as the futures of local area communications, software management strategy, office information systems, enterprise networks, mid-range systems and personal computers.

You can't afford to miss the singular event everyone is already talking about. **Connect '88**. Plan now to be a part of the excitement and learn what the emerging technologies can mean for your business today and tomorrow. For more information about **Connect '88**, call (203) 964-0000.

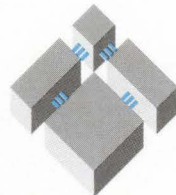

## **Connect '88**

*The Technical Conference and Exposition for the MIS/DP Professional*

### **March 8-10, 1988**

Jacob K. Javits Convention Center  
New York, N. Y.

**Mail to:**

Cahners Exposition Group  
999 Summer Street  
P.O. Box 3833  
Stamford, CT 06905-0833

**Yes, I'm interested in attending the "Connect '88" conference and technical showcase. Please send me full details.**

Name \_\_\_\_\_

Company \_\_\_\_\_

Position \_\_\_\_\_

Address \_\_\_\_\_

City \_\_\_\_\_

State \_\_\_\_\_

Zip \_\_\_\_\_

Telephone \_\_\_\_\_

**Please send me information on being an exhibitor at "Connect '88."**

Circle 70 on Reader Card

# "I'M TIRED OF SPOOLING AROUND"

I can't tell you how many times I almost lost control!

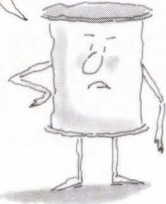

All you did was dump on me without ever asking what effect it had on me!



I'm like everyone else... I've got limits to how much I can take!

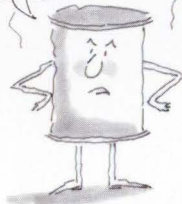

Okay, smooth operator, if you don't start paying attention to me, we're going to reach a crisis.

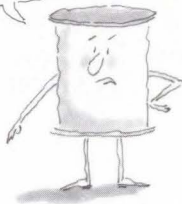

Sure, I've had ideas, I could have helped... but we just weren't communicating!

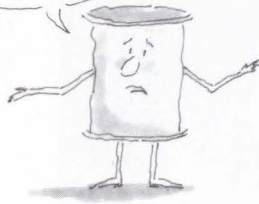

You didn't want a spool, you wanted a warehouse!

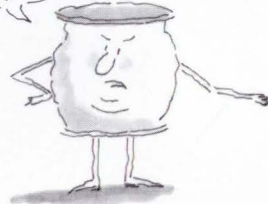

If you want this relationship to work, you'll have to get to know me better.

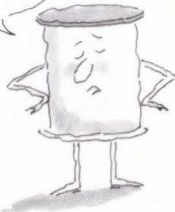

We need VMSPPOOL!

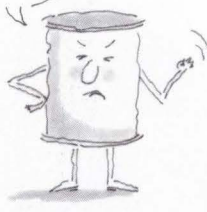

I've been such a FOOL, spool.



## GET THE HELP YOU NEED WITH VMSPPOOL

**P**ity the poor spool system. Overworked, misused, and ignored. This can be dangerous. A misunderstood spool system is a crisis just waiting to happen. But you can change all that with VMSPPOOL from VM Software, Inc.

VMSPPOOL monitors spool usage and gives you the tools you need to manage it efficiently. You choose the capacity threshold that makes sense for your organization. VMSPPOOL not only warns you when you've reached that point, but gives you advance warning in the form of trend information, so you know just how much time you have to clear spool space.

The "state-of-the-spooling-system" display shows you the biggest users and the biggest files, so you know right where the problem is. And this information is available to you anytime you want or need it, not just

when VMSPPOOL has identified a problem.

VMSPPOOL gives you complete information on spool usage by owner, date, type of spool file, queue, filename, etc. and it gives you comprehensive selection, sorting, and summarization capabilities. VMSPPOOL also creates complete CP accounting records, performs automatic file purges by criteria you set, and lets you move selected files to tape.

Like all VM Software products, VMSPPOOL puts you in control of critical aspects of your system. For more information, please call **800-562-7100** (In Virginia or outside the Continental U.S. 703-264-8000). Or write VM Software, Inc., 1800 Alexander Bell Drive, Reston, Virginia 22091. Copyright © 1987 VM Software, Inc.



**SPECIAL INTRODUCTORY DISCOUNTS AVAILABLE BEFORE NOVEMBER 30, 1987.**

Circle 71 on Reader Card

## UPDATES

**FINANCIAL APPLICATION SOFTWARE**, traditionally based in mainframe and mini computer environments, is moving onto the microcomputer. Two vendors recently have introduced microcomputer-based financial packages.

Global Software Inc. of Raleigh, N.C., a producer of financial application software for IBM mainframes and minicomputers, has announced a PC version of one of its 11 mainframe modules. Global says that with its Cooperative Processing System, all application data is maintained on the mainframe so the power of the larger system can be deployed for such tasks as database management, telecommunications, and batch processing. The intensive processing of the data is done on a pc.

Global provides both the mainframe and pc application software as a complete system. The first package, PC Budgeting, which will be available by year's end, ranges in price between \$10,000 and \$30,000. Global has plans to evolve the remaining 10 modules to the pc version.

IMRS of Stamford, Conn., has been marketing its Micro Control pc-based financial reports software product since 1982. Micro Control can be configured on standalone or distributed pcs, on LANs, or as a data-exchange interface to mainframes. IMRS recently introduced its Retrieve-MC, a Lotus 1-2-3 add-in that provides a "seamless" integration of Micro Control's data with the spreadsheet.

The company claims that Retrieve-MC's menu and range definitions look and function the same as 1-2-3's do. The data-sharing operations of Retrieve-MC are bidirectional, which means that a user is able to load data from Micro Control into a 1-2-3 worksheet or that a 1-2-3-developed application could be loaded into a Micro Control data file for consolidation. Micro Control is priced between \$70,000 and \$200,000, depending on the number of sites and configuration. Retrieve-MC is priced at \$15,000 for a site license.

## SOFTWARE

```

BROWSE -- DA2GH.SPFTEMP1.CNTL ----- LINE 000005 COL 001 000
COMMAND ==> SCROLL ==> CSR
Explain Information *****
Query Number : 1 DBRM Name: DBCLIST
Query Block Number: 1 Timestamp: 1987081915220017
Plan Number : 1 Plan Name:

Table Name: SYSIBM.SYSDBAUTH
Table Number : 1 Pages with Rows: 7
Table/View: T # of Columns: 24
Pct Pages: 100 Row Length: 84

Tablespace: DSNDDB03.SYSDBAUT
Active Pages: 8 # of Tables: 1
Page Size: 4 Eraserule: N
Lockrule: P Closerule: N

** Tablespace Scan - First Table Accessed ***
** No Index will be used. ***
** Tablespace Lockmode is INTENT TO SHARE ***

Explain Information *****
Query Number : 1 DBRM Name: DBCLIST
Query Block Number: 2 Timestamp: 1987081915220017
    
```

Udata's translation of the IBM DB2 Explain table.

## Udata Software Releases DB2 Productivity Tools

A library of free CLIST tools is available with the product.

BY THERESA BARRY

DB/CLIST is a productivity tool for IBM's DB2 mainframe database that allows access to DB2 from a TSO CLIST (command list). Udata says managers can, for example, use DB/CLIST to build prototype applications for their users or to develop CLIST tools to monitor usage of DB2.

Udata is offering a CLIST library of free DB2 tools that already have been developed by Udata and other DB/CLIST users. Five tools, which allow users to obtain information on DB2 objects from the system catalogue, build prototype applications using CLIST, rebind plans automatically for DB2 tables, translate information from the DB2 Explain table into readable format, and create datasets to grant authority, will be available in the initial release.

Udata says the library will continue to grow as additional tools are de-

veloped. Users will be kept informed through an electronic bulletin board, which users can access via their personal ID cards, pcs, and modems. The price is \$3,800, and it's available now. UPDATA SOFTWARE CO., Holmdel, N.J. CIRCLE 254

### Productivity Package

Atherton gears first product toward large development sites.

The Software BackPlane from Atherton Technology is the company's first product. Atherton is calling Software BackPlane an Integrated Project Support Environment (IPSE) product.

Atherton claims that Software BackPlane enables incompatible software development tools to coexist in one integrated environment and to run on incompatible hardware. This is achieved through an X Windows-based standard common project database that includes

version management, configuration control and cross referencing, and generic operating system services. The company says the product is geared specifically toward large engineering-oriented software development projects, particularly those with millions of lines of C or Ada code.

This first release of Software BackPlane supports Digital Equipment Corp.'s VAX line running VMS and Sun Microsystems' workstations, including the recently introduced Sun-4. Atherton says that development of ports to other workstations is in progress. Interactive Development Environment (IDE) of San Francisco has moved its structured analysis and design tool, Software Through Pictures, to Software BackPlane.

The workstation version is priced at \$8,000; a terminal-based version costs \$5,725. The Sun version is available now, and the Digital version will be available by the year's end. ATHERTON TECHNOLOGY, Sunnyvale, Calif. CIRCLE 255

## The Third Chart

Microsoft releases version 3.0 of its data and text charting program.

Microsoft Chart version 3.0 features an expanded set of data analysis tools and direct lines to external data and peripherals via a new local area network support capability. Also, Chart now has mouse support.

Chart has a gallery of eight major chart types and 48 predesigned formats. It's been extended to include 3-D effects for bar, column, line, and pie charts. Added text charting capabilities include text alignment, line spacing, text rotation, bullet symbols, and line drawing. Word-only text charts and tables or integrated text and graphics charts can be generated. A new color-dithering feature with an IBM EGA or VGA card allows for on-screen display in up to 64 colors. Chart 3.0 can work with 177 colors for output as 35mm slides, plots, prints, or video images. Supported peripherals include PostScript printers; all HP laser printers, plotters, and the new color Paint-Jet printer; the General Parametrics VideoShow; and the Matrix film recorder. The data capacity of Chart 3.0 has been increased to accommodate up to 8,000 data points per series and up to 32,000 data points per chart.

Microsoft Chart 3.0 is \$395. More users can be added by licensing a Workstation Pack for \$195. The upgrade

charge is \$75. MICROSOFT CORP., Redmond, Wash. CIRCLE 256

## VTAM Session Manager

Software AG upgrades Net-Pass multiple applications manager.

Net-Pass version 1.5 from Software AG is a session manager that enables a user at a standard VTAM terminal to be logged on concurrently to multiple VTAM applications such as IBM's TSO, CICS, and IMS/DC, and Software AG's Com-plete, and to switch between any session with one keystroke.

Net-Pass is window-driven and offers a windowing capability that allows si-

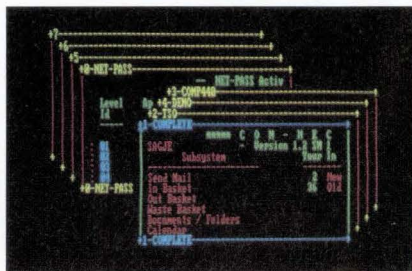

multaneous interaction with up to 10 VTAM sessions; a transmission optimizer that allows it to compress the data being sent to the terminal, examine the contents of each field, and only transmit those fields that actually change, or to examine each character and transmit only changed characters; and a response time monitor. Additional broadcast and message capabilities are included, as well as an auto log-off facility.

The product runs on all IBM mainframes and compatibles under MVS/XA, MVS, VS1, DOS, and DOS/SP2. The perpetual license fee for Net-Pass is \$15,000 for DOS/VSE, \$20,000 for VS1, and \$25,000 for MVS and MVS/XA. SOFTWARE AG, Reston, Va. CIRCLE 258

## Electronic Form Package

EFS unveils interactive electronic form processing product.

E-Form from Electronic Form Systems allows a user to see both form and data as an electronic form is being filled in. The field attributes of E-Form are predefined. In multiple-page forms that require the same information, such as income tax returns or mortgage loan forms, the information need be entered only once.

E-Form does not allow entry of the wrong type of information into individual fields, e.g., alpha data cannot be entered

into a numeric data slot. Data are entered from field to field in a logical sense. For example, on a sales order worksheet, the "ship to" name, address, and phone number are entered vertically first and then the cursor returns to the top to enter the "bill to" name, address, and phone number.

The program can be set up to include mathematical constants for immediate computation and the display of results in predefined fields. Form mapping, which can be accomplished using EFS's Formcoder hardware/software product, allows users to define individual field attributes and relationships so that when information is entered, E-Form performs the necessary calculations. Information from databases or spreadsheets can be imported to fill in a form automatically, and new data can be exported to revise those data files. Data are imported and exported using DIF (document interchange format), comma-delineated ASCII, and SDF (system data format).

E-Form runs on an IBM XT, AT, or compatible. The single-unit price is \$495. MVS versions of the product are priced between \$25,000 and \$30,000. ELECTRONIC FORM SYSTEMS, Carrollton, Texas. CIRCLE 257

## VTAM Application Program

Simware provides SNA terminals access to X.25 and ASCII cpus.

Sim/Dialout from Simware is a menu-driven system that provides SNA 3270 terminals access to X.25 networks and ASCII host cpus. It supports direct communications from SNA networks to external on-line information services such as Western Union's EasyLink and Dow Jones Financial Services.

A VTAM application program, Sim/Dialout, eliminates the need for hardware switching devices or asynchronous terminals for 3270-to-ASCII communications, according to Simware. While accessing an external application, users can capture all or part of the information displayed in an MVS dataset, which users can edit or process at the end of the session. Outgoing information can be stored in an OS dataset before connecting. The application selection menu can be tailored to display the accessible services and applications, or users can customize their log-on procedures.

Sim/Dialout is priced at \$10,000 U.S. and \$12,500 Canada. SIMWARE INC., Ottawa, Ont. CIRCLE 259



# MOST DBMS PRODUCTS ARE BUILT ALONG THE SAME LINES. HOW THEY PERFORM IS SOMETHING ELSE.

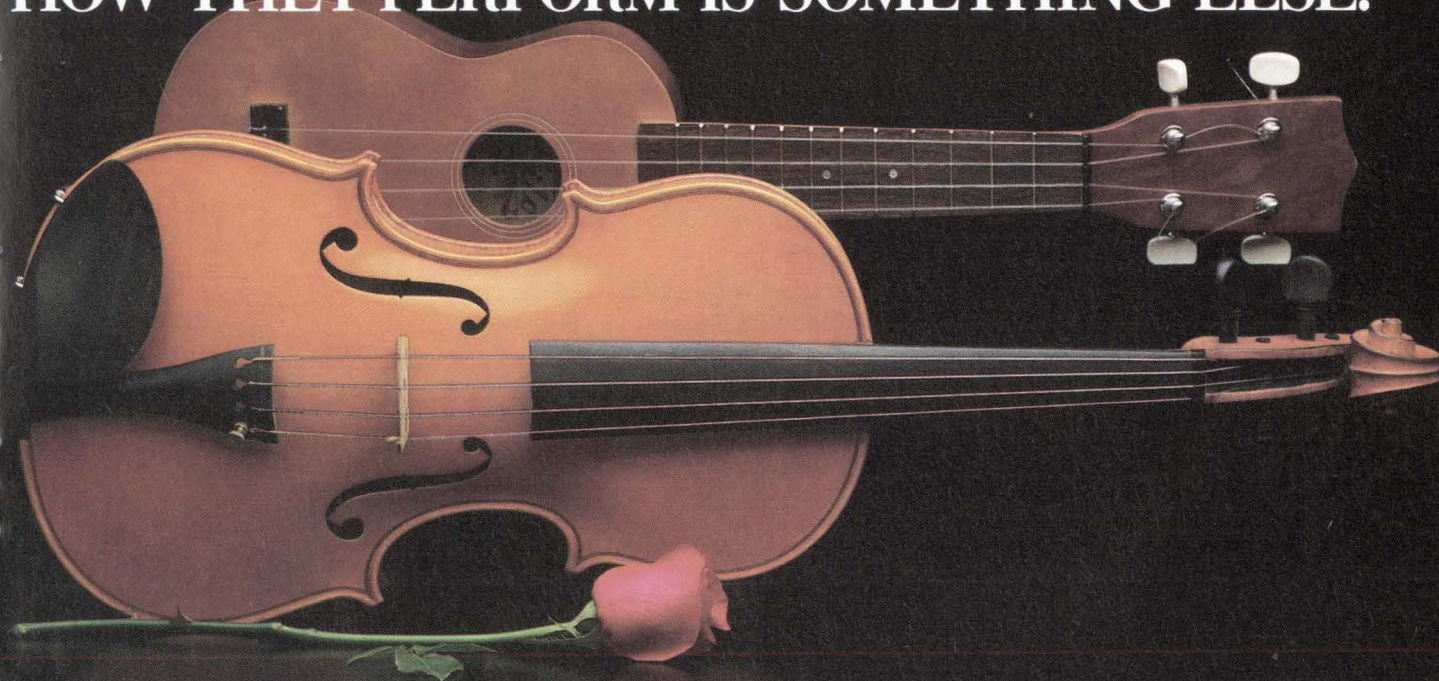

When you first look at relational DBMS products, the similarities are obvious. They're all built around SQL. Most include 4GL tools. They all have an impressive range of features and functions. And they all claim to deliver performance.

But once you get your hands on these products, the differences are dramatic. It's the craftsmanship in designing, building, and assembling quality components that differentiates a master's instrument from a beginner's.

That's why professionals from the world's most discriminating organizations are selecting INGRES as their instrument of choice.

And why INGRES was voted "best DBMS/4GL" by *Digital Review* for two years running.

No wonder. INGRES has been designed from top to bottom to support developers of performance-critical applications.

It offers a superb 4GL environment that helps you get applications running quickly. And makes them easy to maintain. Better yet, with INGRES/STAR you can orchestrate applications across your organization including data on mainframes, minis, workstations, and PCs.

To boost performance, INGRES uses the industry's most sophisticated query optimizer and other performance tuning facilities to ensure your applications run at top speed.

With this kind of performance, INGRES attracts a lot of new customers. But it's our reliability and support, that keeps them. INGRES delivers such a high level of satisfaction that 99% of

our customers stay with us, year after year.

The most important thing about a DBMS is the way it performs for you. And that's why we'd like you to experience INGRES.

Just send this coupon or call us. And we'll show you what a fine instrument INGRES really is.

- Yes, I'd like to see how INGRES performs. Please: 108
- Send me more information about INGRES.
  - I'd like to attend a free INGRES seminar in my area.
  - I'd like to know more about the INGRES sampler.
  - Have a salesperson call me.

Name \_\_\_\_\_

Company \_\_\_\_\_

Title \_\_\_\_\_

Mailing address \_\_\_\_\_

City \_\_\_\_\_ State \_\_\_\_\_ Zip \_\_\_\_\_

Telephone \_\_\_\_\_

Mail to: INGRES,  
Relational Technology Inc.  
1080 Marina Village Parkway  
Alameda, CA 94501-9891  
Or call: 1-800-4-INGRES

**INGRES**  
Relational Technology Inc.

© 1987 Relational Technology Inc.

# When connecting IBM® 37X5 to 3274...

# The smaller they are

# The harder they play

You don't have to be big to do great things. Note our miniature solutions for your IBM networks: Sync Short-Range Modems, Sharing Devices and Modem Eliminators.

Compact, easy to install, operating without AC power supply, and featuring data rates up to 19,200 bps, our miniature products are master performers.



**Modem Eliminator** replaces 2 synchronous modems in a local environment. It enables direct connection between the 37X5 communications controller and the 3274 terminal cluster controller.



**Sync Short Range Modems** connect the 3274 terminal cluster controller to the IBM 37X5 communications controller in a point-to-point or multi-point environment. Modems are transformer-isolated and conform to Bell Specs 43401, with distances up to 10 miles. The range of modems includes constant carrier or switched carrier models and allows for internal, external or loopback clocking.



**Sharing Devices** enable up to 8 IBM 3274 cluster controllers to share one channel of a 37X5 communications controller. Operating locally or over distances with long haul modems, the sharing devices save the cost of additional modems, ports and lines.

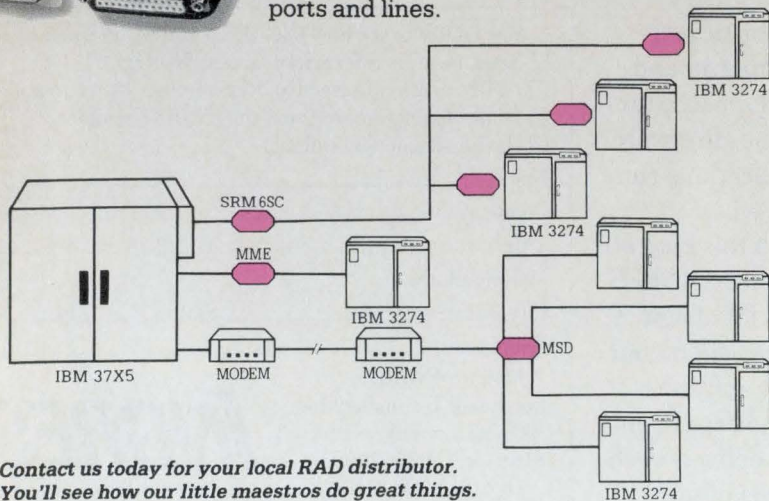

Contact us today for your local RAD distributor. You'll see how our little maestros do great things.

IBM is a registered trademark of International Business Machines Corporation



*From the Rad family*



**data communications Ltd.**

**RAD Data Communications  
U.S. Headquarters**

151 West Passaic St., Rochelle Park, NJ 07662  
Tel: (201) 587-8822, Telex: 6502403647 MCI, Fax: (201) 368 2102

**International Headquarters**

8 Hanechoshet St., Tel Aviv 69710, Israel  
Tel: 972-3-483331, Telex: 371263 RADCO IL, Fax: 972-3-498250

# Advertisers' Index

Circle		Page
18	ADR	23,25,27,29,31,33
56	AGS Management Systems, Inc.	92
60	Amdahl Corp.	103
—	AT&T	34-35
—	AT&T Technologies	14-15
—	AT&T Technologies	142
—	AT&T 3B Computers	86-87
9	Banyan	16
65	BMC Software	113
38	British Telecom*	76-5
70	Cahners Expo Group	122-123
80	Candle Corporation	144
—	Codex Corp.	80-81
37	Comparex Information Systems GMBH*	76-2-76-3
50	Computer Economics Report*	76-30
—	Computer Security Conference	90-91
202	Computer Task Group/Dataware Inc.**	133
22	Concord Data Systems	38
41	CTM*	76-15
6	DCA	6-7
10,11,12	Decision Data Computer Corp.	21
—	DEC	36-37
77	Duquesne Systems	140
81	Electronic Systems Products	145
64	Emulex	109
52	Exide	77
59	Execucom	101
73	Fujitsu—Data Products Division	121
63	General Semiconductor Industries, Inc.	108
61	Hayes Microcomputer	104-105
25	Hall-Mark/Unisys	47
29	Hewlett Packard	61
—	Hewlett Packard	93-96
58	Honeywell Bull	98-99
—	IBM	134-135
7	Information Builders, Inc.	8
5	Informix Software, Inc.	5
4	Infotron Systems Corp.	1
27	ITT	55
42	Local Data	76-18
75	McDonnell Douglas	136
200	Micro Electronic Products**	133
36	Ministere Des PTT/LA DGT	76
—	MSA	C4
24	NEC Information Systems	44-45
40	Nokia Information Systems*	76-12
—	Northern Telecom Inc.	56-57
—	Northern Telecom Inc.*	76-10-76-11
68	Nynex Corporation	118
54	Olivetti*	76-4
85	On-Line Software	138
78	On-Line Software	143
1	Output Technology Corp.	C2
23	Peregrine Systems	43
46,47,48,49	Phillips TDS*	76-22-23,-25,27,-29,-31
2	Porelon Corporation	C3
201	Precision Data Products**	133
67	Prime Computer	116-117
69	Racal-Vadic	49-52
76	Rad Data Communications Ltd.	128
72	Radio Shack	139
—	Relational Technology	127
—	SAS Institute Inc.	11,13
31	Scientific Computer Systems	64-65
62	Sorbus	107
39	Southwestern Bell	76-6-76-7
51	STC*	76-32
33	Tandon	71
32	Telex Computer Products	66-67
66	Telex Computer Products	115
30	Uniras	63
35	Unisys	73-75
71	VM Software Inc.	124
43	Wandel & Golterman*	76-19

# Marketplace

**Brand Name DISKETTES**

**29¢** EACH **49¢** EACH **79¢** EACH

5 1/4" DS/DD Min. 100 39¢ Min. 50    Color 5 1/4" DS/DD Min. 50    5 1/4" IBM-AT HD Min. 50

**2 for 1 Replacement Guarantee** if found initially defective within six months  
With sleeves, tabs, labels For TYVEC sleeves, add 2¢

**99¢** EACH **\$1.09** EACH **\$4.29** EACH

3 1/2" SS/DD Min. 25    3 1/2" DS/DD Min. 25    Box of 10 5 1/4" DS/DD Min. 10 boxes

**\$5.99** EACH **\$19.20** EACH    Min. 5 600 120 MB Data Cartridge

**\$15.90** EACH    Min. 5 205 40 MB Mini Cartridge 3M/DEI Compatible

Box of 10 Color 5 1/4" DS/DD Min. 5 boxes Free Plastic Case

Immediate shipping — Guaranteed satisfaction 100% Lifetime Warranty  
Call for greater discounts on larger orders MC/VISA accepted  
Shipping: \$3.50 per min. order \$1.50 each addtl. lot

**1-800-537-1600 OPERATOR NO. 39**  
MICRO ELECTRONIC PRODUCTS

CIRCLE 200 ON READER CARD

**HIGH QUALITY LOW PRICE**

**5 1/4" DISKETTES**

**MADE IN U.S.A.**

- 80% Clipping Level
- Sturdy Blank PVC Jacket
- Lifetime Warranty
- Error Free
- With ID Label
- With Write Protect Tabs
- With Envelopes
- In Factory Sealed Poly Packs

**CALL FOR FREE SALES CATALOG!**

<b>36¢ EACH</b>	<b>89¢ EACH</b>
Double Side Double Density (W. HUB RINGS)	Double Side High Density

*SOLD IN LOTS OF 100*

**SONY POLYPACK 3 1/2" DISKETTES**

<b>\$1.09 EACH</b>	<b>\$1.21 EACH</b>
SS 135TPI	DS 135TPI

*SOLD IN LOTS OF 50*

Min. Order \$25.00. S & H: Continental USA \$4.00/100 or fewer disks. Foreign orders, APO/FPO, please call. MI residents add 4% tax. Prices subject to change without notice. Hours: 8:30 AM-7:00 PM ET.

**Precision Data Products™**  
P.O. Box 8367, Grand Rapids, MI 49518  
(616) 452-3457 • Michigan 1-800-632-2468  
Outside MI 1-800-258-0028  
FAX: (616) 452-4914

CIRCLE 201 ON READER CARD

Circle		Page
203	Westex**	133
28	Wyse Technology	59
Recruitment Section		
	Aramco	156
	Computer Sciences Corp.	149
	Digital Equipment	146
	Eastern States	156
	Mitre	150
	NEC	151
	Systems Research Lab	155
	TRW Systems Research	147
	Unisys/Utah	148
	Unisys/Fed Info Systems	152

\*International Edition  
\*\*Marketplace

# Smooth Conversion with CTG/DATAWARE

Save money, time, and manpower on your conversion project with CTG/Dataware. Our skilled specialists work with you to ensure a smooth, timely, cost-effective conversion.

**COBOL TO COBOL  
RPG TO COBOL  
ASSEMBLER TO COBOL  
AUTOCODER TO COBOL  
EASYCODER TO COBOL  
PL/1 TO COBOL  
RPG TO PL/1  
DOS TO MVS**

CTG/Dataware has the total solution — software, methodology, and support services — to help you change hardware, programming languages, or operating systems smoothly and quickly. Call the conversion specialists, CTG/Dataware:

**1-800-367-2687**

**CTG**

**COMPUTER TASK GROUP INC.  
DATAWARE CONVERSION SERVICES**

3095 Union Road  
Orchard Park, New York 14127-1214  
(716) 674-9310 TELEX: 510-100-2155

CIRCLE 202 ON READER CARD

**CAPITAL AVAILABLE**

**\$1,000,000 Min.**

**Will assist with financial plan, for information call**

**Mr. ADAMS at WESTEX**

**714/964-2386**

CIRCLE 203 ON READER CARD

# Five ways to improve

No matter what your printing needs or budget, IBM® has a personal printer to help see that your ideas look great on paper, and in the public eye.

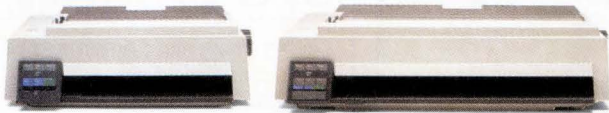

The popular IBM Proprinter II (left) and the IBM Proprinter XL24, ideal for printing on wide paper (right).

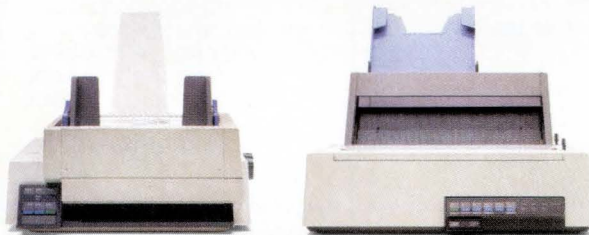

The IBM Proprinter X24 with optional sheet feed (left) and the IBM Quietwriter III Printer with single-drawer sheet feed (right).

To begin with, there's the newest member of the best-selling Proprinter™ family—the IBM Proprinter II. With Fastfont™, an extra-fast draft mode, this economical, hardworking printer handles general printing chores faster than ever.

With the IBM Proprinter X24 and wide-carriage Proprinter XL24, you can produce letter quality text and superb graphics in a hurry. When compared to best-selling, comparably priced 24-wire printers, they printed 1½ to 2

times the draft output in the same amount of time.\*

For even higher quality text and graphics, consider the IBM Quietwriter III Printer. It whispers along at nearly twice the speed of its predecessor and is available with either a single- or dual-drawer sheet feed, for added paper-handling convenience.

If you're looking to design and print documents with a professional look, we offer the IBM SolutionPac™ for Personal Publishing. This compact, desktop publishing system comes with everything you need—the hardware, software, service and support—to design and print eye-catching presentations, newsletters, memos and more.

For further details, visit an IBM authorized dealer (ask about the IBM Credit Card), or call your IBM Marketing Representative. For the name of a dealer near you, call 1-800-447-4700, ext. 51. (In Canada, call 1-800-465-6600.)

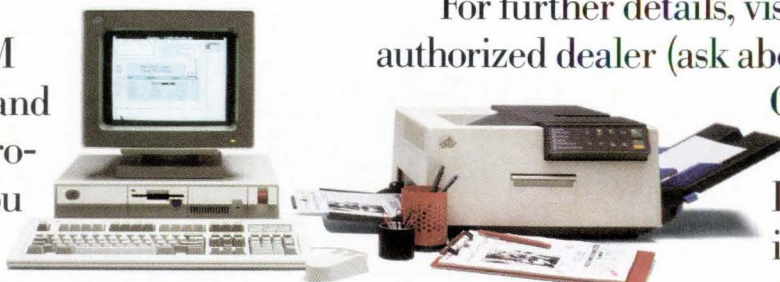

The IBM SolutionPac for Personal Publishing includes IBM's high-quality laser printer, the Personal Pageprinter.

# your public image.

## Full Court Press - 4th Quarter Report

### U.S. SALES - DEMOGRAPHICS

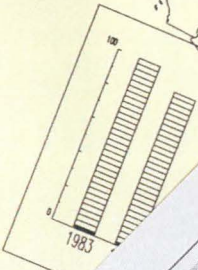
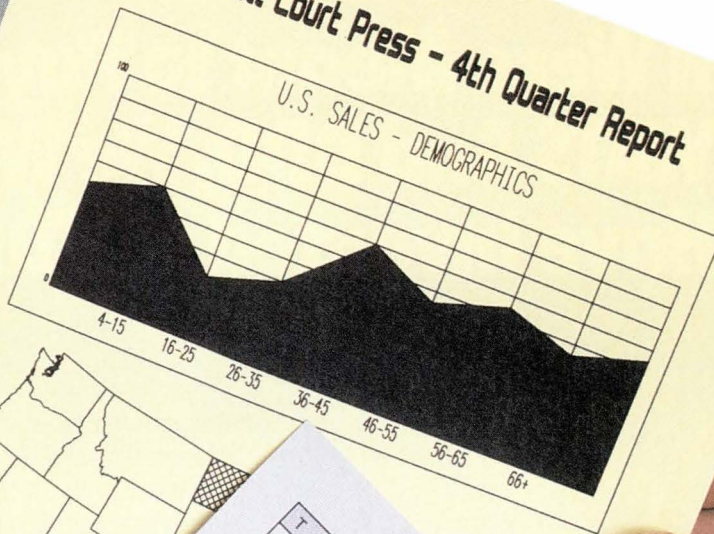

## All-Stars Clinch Division Title

### Heavy hitting powers All-Stars to the top



Last night, the All-Stars won the title and a chance to shuffle off to Buffalo next week for the championships. The All-Stars powered themselves to the top with a 9-5 victory over the Grass Starns, who had been tied with the All-Stars for first place. The game was tight until the bottom of the fourth when the All-Stars biased into the lead with two home runs to the upper deck in left field.

The game was highlighted by a most improbable play in which three All-Star players, each running at different speeds, ended up on third base at the same time. Fortunately, the third baseman missed the throw from centerfield, allowing two of the runners to score.

"I can't believe we pulled it off," exclaimed the All-Star manager. "A three-man pileup near first base, and they didn't even get one man out!"

The company will hold a pep rally for the All-Stars on Thursday at 2:00 p.m. in the conference room.

### TWO RUNS, THREE HITS, ONE ERROR AND A COW

During the Bruise-Runner game last week, three brown cows wandered onto the field through a hole in the fence. When the starting umpire refused to allow the animal on the field, it was an automatic double for a ball hit the cow. The cow was taken from the field and the game resumed.

## All-City League Final Standings

Team	W	L
Warlords	15	1
Bruisers	14	2
Watercoolers	14	2
Print Outs	10	7
Batmen	7	9
Overachievers	4	12
Stuffers	3	13

East Division	W	L
All-Stars	14	2
Grass Starns	13	3
Maulers	9	7
Backstops	8	8
Smashers	9	9
Generals	5	11
V.I.P.'s	2	14

North Division	W	L
Coffee Spills	14	2
Crunchers	7	8
Ramblers	10	7
Hot Shots	12	4
Go-Getters	11	5
Treppers	8	8
Operators	5	11



Dear Miss Madigan,  
We were happy to receive the Month offering for by Nancy Bink.

We hope that the hours of reading.

Since February including a desk case with all selected from listening

If you fill out

The Page by D Two

Daniel Director



# If Man Were Meant to Pay So Much For WATS And DDD, We Wouldn't Have Invented **OUTDIAL**.™

OUTDIAL Service is Tymnet's lower-cost replacement for centrally-initiated DDD and WATS. Now your computer can call out to remote async devices directly through the TYMNET® network.

If your central computer places calls to remote async devices for information collection and distribution, we can save you 40% or more by

- Eliminating DDD and WATS charges
- Allowing unattended nighttime operations that use lower rates
- Offering discounted rates for large-volume users.

Tymnet's OUTDIAL Service was created to save big money for companies with big data communications needs.

Call (800) 872-7654 and let Tymnet show you how much we might save you.

TYMNET  
2560 North First Street  
P.O. Box 49019  
San Jose, CA 95161-9019

**TYMNET**  
The Network Technology Leader

Outdial is a trademark of Tymnet, McDonnell Douglas Network Systems Company.

**MCDONNELL DOUGLAS**

Circle 75 on Reader Card

## PEOPLE

# Lowering the Barriers To Global Trade

Doing business on an international scale is more difficult than it should be, contends Jose Collazo.

BY EDITH D. MYERS

Having lived in four countries on three continents, it comes as no surprise that Jose Collazo is engaged in ventures of a global nature.

He is president of the Infonet Div. of Computer Sciences Corp., El Segundo, Calif., having joined the corporation in 1969. In its infancy, Infonet was fast developing into a network service for large corporations that were building their overseas business. Subsequently, Infonet became one of the first network organizations to focus on international operations. Collazo headed up the company's international activities before ascending to the presidency in 1985.

The trend toward internationalization in business continues, but, says Collazo, it's been slowed by government bureaucracy and trade regulations. Collazo has become an outspoken advocate of trade deregulation and would like to see companies both here and abroad be able to conduct international business more easily.

"Today," he says, "though it takes less than 24 microseconds to get a handshake from a computer-communications link between Tokyo and New York, it still may take 24 weeks or more to put all the paperwork in place to effect that link. We have regulations that are still primarily local, while business has become decidedly international. And spurring that internationalization is the development of powerful and effective computer and communications capabilities.

"But while computers and communications exponentially improve the abilities of efficient businesses to create new products and services, open up new markets, and meet on different playing fields with new competitors, these businesses still encounter inefficiencies that hamper growth. These are local regulations and other barriers to international trade."

Collazo spends a third of his time traveling to the 27 countries in which Infonet does business, always observing

the impact of regulation, which he calls "bureaucracy in a tangible form, representing an insidious, invisible barrier to free, fair, and true international trade. Paperwork, licenses, quotas are the physical evidence of regulation."

Collazo often speaks to industry groups, both as a personal endeavor and on behalf of Infonet, on the issue of deregulation. He is optimistic about the future, and says, "A spirit of deregulation is taking place in many economies today. As deregulation gains momentum, some of the paperwork is beginning to vanish,

field. From Pepperdine University, Malibu, Calif., he later received an MBA.

After college, Collazo went to work for Pacific Lighting Corp., Los Angeles, in the engineering computing department. He stayed there for two years after which he and a partner ran their own computer service company. He sold his share to his partner when he joined Computer Sciences Corp. in 1969.

"The Infonet organization was just beginning to be put together," Collazo recalls. "Early on, it developed a dual orientation, in government services and in services to large corporations that were beginning international expansion. Our international expansion was natural and inevitable." Today, overseas business accounts for 20% of the company's revenues.

Collazo speaks highly of Infonet's effort to facilitate the business of doing business internationally. "When we invoice a company, we do it in a single cur-

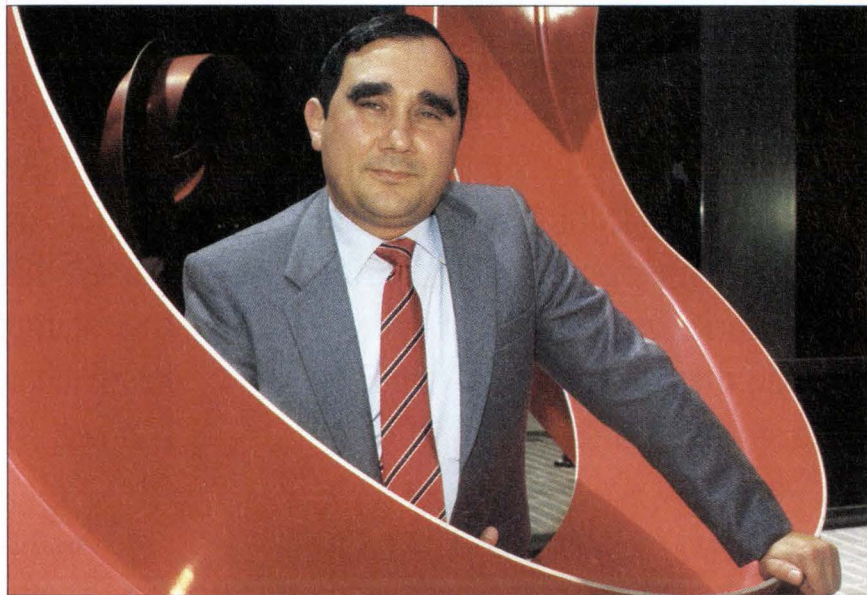

**COLLAZO:** Infonet is benefiting from a global economy.

and with it comes the opportunity for many more business ventures to further the internationalization of commerce."

Collazo's father was in the military, so Collazo spent much of his childhood living abroad in countries such as Cuba, Panama, and West Germany, where he received his secondary education. He came to California for college, attending Northrop University in Inglewood, where he earned two degrees in 1965, in astronomical and aeronautical engineering. He never worked in either

rency, that of the country where the company is headquartered. This is difficult to do and adds to the complexity of our billing system, but it eases the business burden of our international clients."

Organizations such as Infonet, says Collazo, will play a major role in making it easier for companies to expand their international operations. "As computer and communications technology tear down international business boundaries, we're benefiting from the positive qualities of global companies." ■

# OUR CICS SECURITY IS THE MOST EFFICIENT. OR IT'S FREE.

With most security software products—no matter what they cost—on-line security comes at too high a price. Heavy overhead.

But with OMNIGUARD®/CICS, you get the most comprehensive CICS security on the market *without* the crippling overhead that disrupts your systems—or forces you to invest heavily in new hardware.

When you select OMNIGUARD/CICS to secure the same resources as any other security product, you'll use up to 30% less of your machine cycles.

We're so sure of this, in fact, we're willing to stake a permanent license on it.

Try OMNIGUARD/CICS free for 30 days, and if it doesn't live up to our claim, we will *give* you a permanent license at no charge.

Call or write today—and see for yourself that CICS security doesn't have to cost too much. On-Line Software International, Inc., Two Executive Drive, Fort Lee, NJ 07024.

**800-642-0177**

In Canada: 416-671-2272/In Europe: 44-1-631-3696



**On-Line Software International**  
Authorities in IBM® Software

**OMNIGUARD.** *High Security, Low Overhead.*

Offer expires December 31, 1987, and is contingent upon the execution of our standard software license agreement.

Circle 85 on Reader Card



Tandy Computers:  
Because there is  
no better value.™

# Tandy® Workgroup Solution

People and PCs  
working together.™

Now you can use your PC to share information with your colleagues, update files in a common data base and route messages and other mail—electronically.



Just connect your Tandy computers and other PC compatibles on the proven 3Com® network. People in your office will still be able to work independently, but they'll have the added advantage of working together as a group—a workgroup.

You can share printers and communicate with other workgroups in your office. And since 3Com's network software is based on IBM® standards, you can use today's leading business software packages.

Installation is simple and worry free because Radio Shack handles all of the details. We'll even arrange to train your employees, as well as provide the professional service and support your business can rely on.

Come into a Radio Shack Computer Center and see how your business can benefit from a Radio Shack/3Com workgroup.

Send me a new  
1988 computer  
catalog.

Name \_\_\_\_\_

Company \_\_\_\_\_

Address \_\_\_\_\_

Mail To: Radio Shack  
Dept. 88-A-38  
300 One Tandy Center  
Fort Worth, TX 76102

City \_\_\_\_\_ State \_\_\_\_\_

ZIP \_\_\_\_\_ Phone \_\_\_\_\_



*A Tandy 4000 computer with hard disk acts as the file server, providing information to Tandy 3000, 1000 and other PC compatibles functioning as workstations.*

*Each workstation can run a variety of applications: write memos and letters, send messages, do spreadsheet planning and more.*

## Radio Shack®

### COMPUTER CENTERS

A DIVISION OF TANDY CORPORATION

# Discover Your Total Network Performance



With NetSpy, you get the information you need to determine if your network is being used most effectively. It is the most complete VTAM network performance and end user response time monitor for MVS environments. And, it's the only VTAM monitor that has interfaces for session manager systems such as TPX (Terminal Productivity Executive). These interfaces measure true "end-to-end" response time for each application you access. NetSpy also helps with network control, management, capacity planning, and systems programming by addressing the areas of:

## END-TO-END USER RESPONSE TIME

NetSpy's real-time displays show:

- Current, average, and worst response times for the host and network
- CICS and TSO network times without the need for special applications coding (definite response mode)
- Response time by terminal, cluster, or line

## NETWORK TRAFFIC AND CAPACITY PLANNING

NetSpy's SMF records can be used to:

- Model or project network activity and growth
- Determine network performance and equipment usage
- Tune network performance

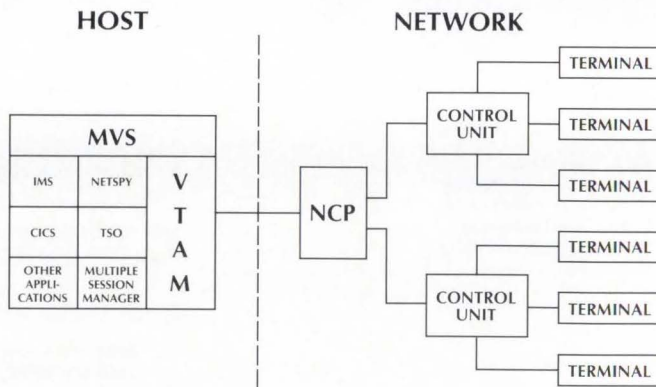

*NetSpy lets you report on both your host and network by providing accurate session, hardware, and traffic statistics.*

Call us today at (800) 323-2600 or (412) 323-2600 in Pennsylvania to arrange a **FREE** 30-day trial, and discover how NetSpy can improve your network's performance.



**DUQUESNE  
SYSTEMS**

Two Allegheny Center  
Pittsburgh, PA 15212

## BOOKS

# World-Class Manufacturing

MANUFACTURING FOR COMPETITIVE ADVANTAGE: BECOMING A WORLD CLASS MANUFACTURER

by Thomas G. Gunn, Ballinger Publishing Co., Cambridge, Mass. (1987, 240 pp., \$29.95).

BY SHARON E. BRADY

There's no such thing as a shake-and-bake high-tech factory manager. And there's no such book as *Everything You Ever Wanted to Know About Factory Automation*—the subject's just too complex. In Thomas G. Gunn's recent book, *Manufacturing for Competitive Advantage*, the author nevertheless extends a helping hand to managers of manufacturing companies struggling for profitability in a fiercely competitive world.

Gunn, national director of the manufacturing consulting group of Arthur Young & Co., Chicago, uses the language of top management and displays a keen understanding of the manufacturing business. Before joining Arthur Young, Gunn worked at Arthur D. Little Inc., the Cambridge, Mass., consulting company that practically coined the term CIM (computer integrated manufacturing). He has made a career out of teaching managers to think systematically about manufacturing technology and the people who implement it.

In this book, Gunn strives to plant the reader's feet firmly on the ground, offering a crop of strategic suggestions and specific examples of how new techniques have succeeded. Although not a primer on CIM, Gunn's book does define some components of the "factory of the future." He assumes his reader has at least heard all the latest buzzwords. The book is rife with such acronyms as JIT (just-in-time), TQC (total quality control), CAD (computer aided design), CAPP (computer aided process planning), and GT (group technology).

Adding to the jargon, Gunn introduces the world-class manufacturer, or WCM. He asserts that achieving WCM status should be the overarching goal of manufacturing companies.

In the past, Gunn writes, managers have set narrow goals such as installing a robotic work cell, or bringing up a material requirements planning software package; this narrow view does not force managers to make necessary changes in the way they run manufacturing opera-

tions, and it invites companies to "throw money at problems." Before deciding where precious resources should be invested, Gunn believes that managers must rethink the way in which they do business.

The factory should be run as a living system, with communication among all its elements. Production processes should be integrated, rather than compartmentalized, Gunn advocates. Managers must implement at one time all the modern pieces of a manufacturing operation such as CIM, JIT, and TQC. Although it's possible for a company to focus solely on one element, the author warns: "It would be like a football team's practicing blocking one year, tackling the next, and passing the third year. The team would play football, but it wouldn't play world-class football."

Gunn believes that most line managers pass off the responsibility of planning onto the "MBAs and consultants and sissies." Factory people must be involved in the planning aspects of a project once senior management has established the framework for developing good production practices.

Gunn's method for implementing new ideas is straightforward: define objectives, establish strategies, determine ways to implement those strategies, and then assign responsibility throughout the company for getting the plan carried out. Gunn advises managers to build a planning team and suggests ways to foster support for projects up and down the halls of a company, as well as on the factory floor.

Although this book attempts to demystify technology and tout less capital-intensive ways to improve productivity, its major weakness is that Gunn glosses over the problems and expenses of installing the technologically exotic elements of his grand scheme. Listing the benefits of technologies like CAD workstations, vast networks of computers, and armies of robots, isn't enough. Gunn still owes his readers a more complete discussion of technology's concomitant costs and problems. ■

*An editor at Technology News of America Co. Inc. and a frequent contributor to DATAMATION, Sharon E. Brady has produced extensive studies on factory automation.*

## CALENDAR

### OCTOBER

#### World Conference on Electronic Printing and Publishing.

Oct. 28-30, Washington, D.C. Contact Henry Freedman, Electronet Information Systems, 1605 King St., Alexandria, VA 22314, (800) 433-8968 or (703) 739-5510.

#### Conference on Departmental Computing.

Oct. 29-30, St. Louis. Contact Donna Skaggs, CSDP, Washington University, Campus, Box 1141, 1 Brookings Dr., St. Louis, MO 63130, (314) 889-5380.

#### ICCC '88 (International Conference on Computer Communication).

Oct. 30 - Nov. 3, Tel Aviv. Contact Jehuda Kella, 9th International Conference on Computer Communication, P.O. Box 50006, Tel Aviv, 61500, Israel, 03-654571.

### NOVEMBER

#### COMDEX/Fall.

Nov. 2-6, Las Vegas. Contact Richard Schwab, The Interface Group Inc., 300 First Ave., Needham, MA 02194, (617) 449-6600.

#### International Conference on the Entity-Relationship Approach.

Nov. 9-11, New York. Contact Kathi Davis, Dept. of Computer Science, Northern Illinois University, De Kalb, IL 60115, (815) 753-6945.

#### 5th Annual Conference of the Office Automation Society International.

Nov. 10-14, Atlantic City, N.J. Contact the Office Automation Society International, 15269 Mimosa, Suite B, Dumfries, VA 22026, (703) 821-6650.

#### International Hard Copy Supplies Conference.

Nov. 18-20, Amsterdam. Contact Jean O'Toole, CAP International, One Snow Rd., Marshfield, MA 02050, (617) 837-1341.

### DECEMBER

#### Unicom I - NATA '87 (North American Telecommunications Association Exhibition).

Dec. 2-4, Dallas. Contact Karen Palermo, 2000 M St. NW, Suite 550, Washington, DC 20036, (202) 296-9800.

# The most up-to-date training in the UNIX<sup>®</sup> System, from the people who keep the UNIX System up-to-date.



What could make more sense than UNIX System training from the people who invented the UNIX System—the people responsible for all its updates and revisions. AT&T.

Created to train AT&T's own professionals, our curriculum is the most comprehensive available—including C language as well as the UNIX System. And every course is practical and job-related.

#### Training for everyone

- Systems developers
- Applications programmers
- Technical specialists
- System managers and users

Whatever your specialty, AT&T has the right curriculum, from basic overviews to programming to business applications and data communications. And every course is kept up-to-the-minute with such recent advances as System V Release 3.0.

#### Individual attention

Classes are limited in size, so that each student can be given individual instruction and supervision. In laboratory classes, each student is assigned his own terminal. Instruction is by AT&T UNIX System veterans and is personal,

thorough, productive.

#### Classes forming now

Reserve as quickly as possible for preferred dates at our completely equipped

training centers in Atlanta, Chicago, Dublin, OH, Los Angeles, Princeton, NJ, and Sunnyvale, CA. Or we'll arrange instruction on your site at your convenience. But don't wait—call or write now for information and seat reservations.

© 1987 AT&T

**Free fact-packed training catalog:  
Call 1 800 247-1212, ext. 1002, or mail this coupon.**

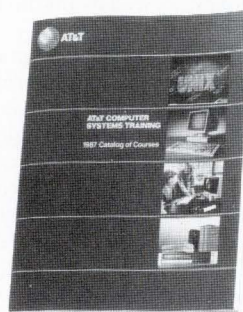

#### Registrar, AT&T Training,

P.O. Box 45038, Jacksonville, FL 32232-997

Please rush me your course catalog with information on:

- UNIX System training
- UNIX System video training
- Data communications and networking training

Name \_\_\_\_\_

Title \_\_\_\_\_

Company \_\_\_\_\_

Address \_\_\_\_\_

City \_\_\_\_\_ State \_\_\_\_\_ Zip \_\_\_\_\_

Phone (\_\_\_\_) \_\_\_\_\_



**AT&T**

The right choice.



## When was the last time you had this kind of passion for programming?

If you can't remember, it may be time to ask yourself why.

When you started your career as a computer specialist, you probably didn't envision yourself as a detail checker. But since applications require extensive coding, debugging, and documenting, your job became that of a proofreader—albeit a highly paid one.

Now you can break free from much of the tedium, and find the passion in your job again.

### **Introducing IntelGen™ The Programmer's Source-code Generator.**

IntelGen automatically generates all the COBOL or PL/1 code for applications in both on-line and batch environments—including BMS maps (for CICS) and MFS formats (for IMS/DC).

What's more, applications developed with IntelGen are 100% stand-alone.

IntelGen also takes care of other routine work, such as verifying your screen input fields and automatically generating your program documentation.

### **Become Productive with IntelGen in Record Time.**

IntelGen allows you to intermix COBOL or PL/1 with its own simple—yet powerful—4GL command language. So you can continue working with the languages you're accustomed to—and incorporate IntelGen's full capabilities as you become familiar with them.

The learning curve is made even shorter by the COBOL-to-IntelGen cross reference, which tells you what command produced each line of generated COBOL. This makes your transition to using IntelGen as smooth as possible.

Once you know IntelGen's English-like commands, your work will continue to be

made easier by such features as fill-in-the-blank screens, an on-line syntax editor, and an on-line help facility.

### **Reseller Programs and No-obligation Trials Available.**

To set up your free, 30-day trial of IntelGen, call us toll-free. Ask about our OEM, VAR, and Service Bureau programs—and about free IntelGen seminars offered in your area.

**800-642-0177**

In Canada: 416-671-2272/In Europe: 44-1-631-3696

Circle 78 on Reader Card



**On-Line Software International**  
Authorities in IBM® Software

## *IntelGen. The Programmer's Source-code Generator.*

*See us at the Info '87 Show in New York, NY. September 29-October 2. Booth #641.*

# Move Up In The World With Candle Education.



It's a smooth ride to the top of performance management expertise with Candle Education courses. Because to reach the top, you need *practical* knowledge. And practical knowledge is what Candle Education is all about.

#### **Informal, Interactive Environment**

Taught by experts, our courses are conducted in an informal, interactive environment: You and your peers analyze case studies and share information and experiences. So you get real world answers to the problems you face every day. And practical solutions to those "odd ball" situations that sometimes crop up.

#### **Small Class Size**

What's more, we don't pack you in. Classes average about twenty people. And our curriculum is highly comprehensive. With more than sixty courses geared to every IBM environment (MVS, IMS, CICS, DOS, and VM) and every level of experience. From novice to expert.

#### **The Latest Trends**

Special Topics Seminars focus on the latest trends in performance management. And other classes enhance your use of

Candle's many performance management products. Plus, you earn continuing education units (CEU) with all courses.

#### **Practical Knowledge**

In short, ours are practical, down-to-earth courses that you'll start using right away to increase the productivity and profit of your data center — and to enhance your value as a member of your DP team.

So why not move up in the world? Escalate your performance management expertise with Candle Education... It could make a measurable difference in your performance. And in your data center's.

For catalogs outlining our 1987 and 1988 curricula and schedules, call (213) 442-4180. But hurry... Classes fill up fast.

**!Candle®**

Candle Education

1999 Bundy Drive

Los Angeles, California 90025

Copyright © 1987 Candle Corporation. All rights reserved.



# Real Time

## READERS' FORUM

### Untapped Expert System Resource: Your M&P Department

Much has been written about expert systems, but often overlooked is how your company's methods and procedures department can provide you with the basis for an expert system.

At Protection Mutual Insurance Co., we're developing an expert system to process our commercial/industrial property casualty transactions, such as orders for new policies and changes to existing ones. Manuals we've developed in the methods and procedures department help to create that expert system.

Insurance contracts are extremely complex because so many aspects of our client's company come into play: its size and number and location of buildings, the type of construction of the buildings and equipment, the amount and type of materials that are used or stored on the premises, the amount and type of protection against fire, explosions, and loss.

When insuring a client, we also have to take into account the multitude of coverages available for each location, endorsements or other requirements mandated by state insurance departments, and mortgagees or loss payees.

The insurance business is very dynamic, and changes to existing contracts are the norm rather than the exception. Large policies literally may require that hundreds of forms be filled out by hand or with some word processing assistance, checked, rechecked, processed, corrected, printed, mailed. And a fair portion of the data on these forms is repetitive. Mistakes or incomplete information can cost millions of dollars.

While automating this process may seem an ambitious application, we feel it is an ideal area for expert systems. To help with the design, some of our main resources are our procedure manuals that detail what forms to complete, how to complete them, and what information is required in specific situations. These procedures help make sure we've got complete and accurate data so the home office can generate an explicit professional product.

Whatever you may call your written rules—Standard Operating Procedure (SOP), Operational Guidelines, or Work Step Instructions—they are manual expert systems. They detail how to process or execute a function or work step(s) within your company. A procedure manual containing the various SOPs

that document a complete operational system can provide the application designer with invaluable help in setting up the rules for an on-line function.

One of the duties of a methods and procedures analyst is to talk with users and listen to what they say about how they're doing their jobs. The end result of these discussions is to produce an SOP that will be used as a training aid by new employees and as a reference manual by clerks when problems arise. The benchmark for a good procedure is, "Just from reading this and following the procedure, I can do this job. I may be slow because of inexperience, but I will be correct."

We all know the shortcomings of procedures. For one thing, they are not the most interesting prose to read. The fact remains that complete procedures—and I stress the word complete—can give you the basis for your expert system rules, no matter how complicated the step, function, or process.

Complete procedures should break down complicated processes into

the smallest logical and understandable work steps. They should define all variables that may arise in a given situation and what facts or criteria are used to make the correct decision.

The next time you need to design an expert system, look for the operational manuals in your company. I believe you'll find a valuable resource—a resource that will not only help you understand the scope of the task before you, but that will also give you the hooks necessary to create the system design you are weaving.

LOUISE E. SCOTT  
Manager

Methods and Procedures  
Protection Mutual Insurance Company  
Park Ridge, Illinois

*If you'd like to share your opinions, gripes, or experiences with other readers, send them to the Forum Editor, DATAMATION, 249 W. 17th St., New York, NY 10011. We welcome essays, poems, humorous pieces, or short stories.*

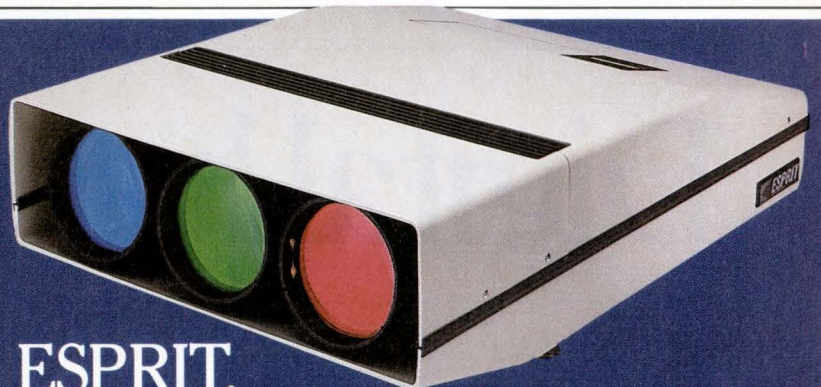

## ESPRIT, a new generation of computer/video displays

The ESPRIT series of projection systems sets new standards with advanced technology that is years ahead of anything in the industry.

- The brightest image with 600 lumens peak white light output
- The sharpest picture with video bandwidths up to 100 MHz
- The highest resolution with sweep frequencies to 75 kHz
- A user-friendly infrared remote control
- Modular design featuring fully upgradeable models
- Built-in interfaces for computer graphics and video formats

Call or write today for information on the complete ESPRIT line.



**ELECTRONIC  
SYSTEMS  
PRODUCTS**

1301 Armstrong Drive  
Titusville, FL 32780  
(305) 269-6680

# Career Opportunities

## 1987 Editorial Calendar and Planning Guide

Issue Date	Recruitment Deadline	Editorial Emphasis
Oct. 1	Sept. 11	Unix
Oct. 15	Sept. 25	Departmental Computing
Nov. 1	Oct. 13	Printers
Nov. 15	Oct. 26	Mini/Micro Survey
Dec. 1	Nov. 12	PBX Breakthroughs
Dec. 15	Nov. 30	Systems Software

Call today for information:

East Coast  
**Janet O. Penn**  
**(201) 228-8610**

West Coast  
**Dan Brink**  
**(714) 851-9422**

National  
**Roberta Renard**  
**(201) 228-8602**

H I G H P E R F O R M A N C E S Y S T E M S

# Digital has it now.

## High Performance

High performance computer products demand high performance professionals to bring them to market. We are in the business of developing, enhancing and integrating high performance systems for worldwide science, engineering and commercial markets.

Join Digital's High Performance Systems, a premier engineering organization that offers exceptional growth and visibility.

## VAXcluster\* Program Business Office

Senior and Principal Engineer positions available. You will define the marketplace for VAX-clusters, apply systems engineering expertise to the development of system solutions, and participate in developing new generations of VAX\* systems, developing capacity analysis services and defining future product requirements. A BSEE/CS or equivalent, excellent project/negotiation skills and thorough (at least 5 years') knowledge of VAX/VMS systems.

Desired mix of VAX experience would include: system-level software definition, system management/technical support, user training, network support, and capacity planning.

## System Performance Engineering

We seek Senior and Principal Engineers to support a variety of high performance products at the hardware and software systems level. Activities include advanced development of performance analysis techniques, performance measurement analysis, modeling and simulation of CPUs, ICs, ports and VAXcluster applications.

To qualify, you should have an MSCS/BSCS or equivalent and at least 3 years' closely related experience. PhDs without work experience having related thesis/research activities and interests will be considered.

Call (617) 467-5563 COLLECT or write to: Linda Marston, Digital Equipment Corporation, Dept. 1001 7807, 200 Forest Street, MRO1-1/M5, Marlboro, MA 01752.

\*Trademark of Digital Equipment Corporation.

We are an affirmative action employer.

**digital**



# Speak Soft.

*Superior software. Nowhere is it more important than in the service of national security. That's why when the people of TRW's Systems Division speak software, we speak softly. And have a bigger impact on the future of data/message processing. Join us.*

## Data/Message Collection And Handling System

We are currently developing a large, IBM mainframe based system for data and message handling and dissemination. The system utilizes IBM 3xxx and 43xx, PL/1 programming, MODEL 204 and INQUIRE DBMS, and IBM Systems Programming. All positions call for a BS in Computer Science or a related degree.

### Staff Engineers

- software system lifecycle engineering, including task leadership
- five years minimum experience required

### Applications Programmer/Analysts

- coding, unit testing, and integration testing
- requires at least two years related experience

### Software Test Analysts

- design and document test cases and procedures
- conduct and evaluate tests
- perform related integration and test activities
- one to two years experience

### Senior Software Test Analysts

- maintenance release testing
- system performance monitoring

- test documentation
- three to five years experience required

### Software Performance Analysts

- develop automated test tool, test case, and procedures
- calls for two to five years of experience

### Systems Engineers

- systems specification
- concept design
- requirements traces
- performance, analysis, architectural definition, interface design, and tradeoff studies
- five years of experience required

### Software Systems Security Engineers

- security engineering
- analysis of large mainframe systems (requirements definition through deployment)
- security documentation, audits, and related tasks
- at least four years of experience

### Database Applications Engineers

- IDMS/R, BIMS DBMS, and PL/1 applications and programming
- two years experience required

### Management Information System

This exciting project involves the development of a large, VAX-based MIS to provide top decision-makers in the DOD with contracts management, cost reporting, personnel status, logistics and program management services. The system operates under

VAX/VMS, is programmed in Fortran, and utilizes ORACLE DBMS with ISSCO graphics. Positions require a BS in Computer Science or related degree.

### Work Package Managers

- manage cost and reporting of Software Maintenance Tasks
- manage two to four programmer/analysts
- ensure adherence to task schedules and budgets
- requires four years minimum experience

### Programmer Analysts

- design, code, test, document, and maintain software
- two years experience required

### Senior Programmer/Analysts

- take leadership role in the development of software and systems analysis activities
- requires at least eight years of experience

### Requirements Management System

We are presently developing enhancements to Management and maintaining a large interactive and batch system operating in an IBM 308x and 309x environment in support of requirements management. On-going work involves PL/1 applications programming, Teradata (DBC/1012) and GIM DBMS, VM/CMS systems programming, and software

integration testing. A BS in Computer Science or related degree plus 2-5 years experience required.

### Systems Programmers

- design, develop and test enhancements to IBM mainframe based data management systems, including IBM, ATM, IDMS R, SOL and NOMAD

### Programmer/Analysts

- design, develop, test, document, and maintain software to a large IBM mainframe environment operating under VM and MVS, and PL/1 programming

The hard work of developing superior software has super rewards. We can offer competitive salaries, complete benefits including flexible scheduling, complete health coverage, and much more. For consideration, send your resume to: **TRW Systems Division, Department DA 1087, 2721 Prosperity Avenue, Fairfax, Virginia 22031.**

An Equal Opportunity Employer.  
U.S. Citizenship Required.

Get The Big Picture At A Company Called TRW.

# TRW

Systems Division  
TRW Federal Systems Group

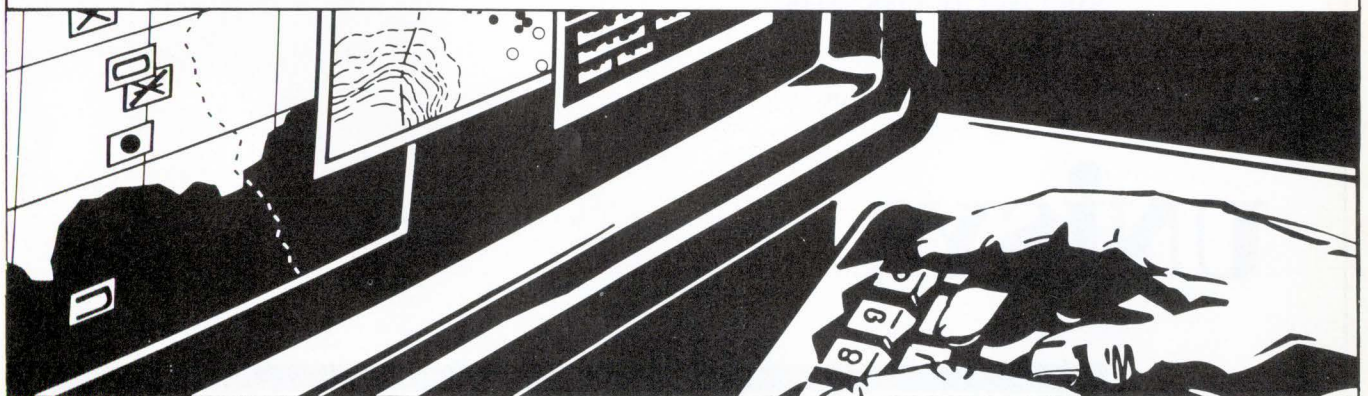

# Programmers

Discover a new degree of satisfaction with your work and your lifestyle at Unisys, Salt Lake City. Living in the heart of the Rocky Mountains, close to the majestic western deserts, you'll breathe a fresher air. The outdoor recreation is exhilarating. The variety of cultural activities is stimulating and rewarding. There's a world of difference for you to explore at Unisys.

## Programmers UNIX\* (Languages)

Positions require strong UNIX\* background, UNIX\* V internals preferred. Must also have experience in compiler development, compiler support or software product porting in the UNIX\* V environment. Also requires software quality assurance experience for UNIX\* based software products.

Positions require 1-2 years RPG experience for System 34/36 along with 1-2 years experience with UNIX\* and "C" language.

## UNIX\* (Operating Systems)

Positions require strong background in UNIX\* operating systems, and "C" language is necessary. Product development experience is desirable. UNIX\* internals experience is also helpful.

## UNIX\* (Relational Database)

Positions require 1 to 3 years' experience with Relational Database management software running under the UNIX\* operating system (e.g., Oracle, Ingres, Unify, or Informex).

## UNIX\* (Data Communications)

Positions require background in UNIX\* and "C" and a knowledge of device drivers. Must have experience in one or more of the following areas, async/sync host communications (e.g. IBM, Sperry, Burroughs); LAN's; Wide Area Networks (PDN/DDN) including protocols such as TP-4, TCP/IP, or ISO/OSI standards.

## Secure UNIX\*

Senior and intermediate programmers are required for challenging positions in the implementation and productization of secure UNIX\* systems. Working knowledge of UNIX\* internals and the DoD "Orange Book" Trusted Computing Base (TCB) is required. Implementation experience with a secure operating system is highly desirable.

For consideration, send your resume in confidence indicating your area of interest to:

**Unisys Corporation**  
**Attn: Ms Lynne Tibolla**  
**Employment Dept. 1v, Bldg. C**  
**322 North 2200 West**  
**Salt Lake City, Utah 84116**

Equal Opportunity Employer  
\*Trademark of AT&T BELL LABS

# UNISYS

# CSC Putting Good Ideas To Work

At Computer Sciences Corporation's Systems Division, we've been putting good ideas to work for over 25 years. We're one of the world's largest information services companies specializing in areas like systems engineering, software development and turnkey implementation. We've made continuous strides towards improving the speed, accuracy and economy for a variety of information processing systems. Our continued growth has created immediate opportunities at our Falls Church and Herndon, VA locations.

## SOFTWARE ENGINEERING

Current opportunities exist for technical professionals with at least two years experience in one or more of the following:

- IBM/VAX/FORTRAN Programming
- IBM/COBOL/VSAM/CMS Programming
- DEC VAX/VMS/Ada software language or Pascal with real-time systems programming
- UNIX/"C" language
- Systems Programming — DEC VAX/Honeywell/IBM/WANG systems
- Software Test Manager — VAX & IBM system with UNIX/"C", and Fortran languages

## NETWORK ENGINEERING

Our Virginia Technology Center located in Falls Church, VA is seeking Systems Engineers with a BSEE or equivalent and a minimum of two years professional experience. Qualified candidates must also possess background in the following:

- DCS Network Control
- PABX Acquisition and Implementation
- Voice Network Engineering
- ISDN Standards Engineering
- CCS Standards Engineering
- Voice-Switched Hardware Engineering
- Voice-Switched Network Engineering & Simulation
- Voice Digital Switch Network Test Procedures
- DCS Secure Voice Engineering

Join CSC. Our high-tech, state-of-the-art laboratory setting allows you to maximize your productivity within a supportive, team-oriented atmosphere. We provide competitive salaries and a comprehensive benefits package. If qualified, please send your resume to: Computer Sciences Corporation, Systems Division, (MC 218 — JEL 733), 6565 Arlington Blvd., Falls Church, VA 22046. An equal opportunity employer. U.S. Citizenship Required.

**CSC**  
**COMPUTER SCIENCES**  
**CORPORATION**

# MITRE

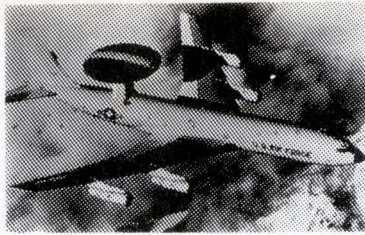

## The Right Time . . . Place . . . Projects

### RadAR Systems

Digital Signal Processing • Radar System Surveillance Techniques • Radar System Analyses • Anti Jam Analyses • Intelligence Operations Analyses • Embedded Computer Hardware and Software

### System Software

On VM • CMS • VCNA • RSCS • VS1 • RSTS • RSX 11-M • UNIX • VAX/VMS • Design, Implement and Document System Software • Performance Monitoring • Software and Hardware Evaluations • Enhance User Facilities • Applications Software—Corporate, Financial & Administrative Applications; MVS/COMPLETE/ADABAS Environment; PL/1 & NATURAL Programming Languages

### Software Technology

Knowledge Based Expert Systems • Automatic Programming • Fault Tolerant Systems • Reusable Software

### Software Engineering

Prototype Development • Performance Simulation • Ada Compiler Evaluation • Software Cost Estimation • Project Management Tools • Artificial Intelligence

### Civil Programs McLean, VA Only

Computer Systems Architecture & Engineering • Systems Acquisition Management • Systems Planning & Analysis • Requirements Analysis & Definition • Computer Technology • Real-Time Computer Software Analysis & Sizing • Display Technology • Bus-Oriented System Architectures • Local Network Design • Radar System Design

### Communications

System Design and Analyses • Digital Communications • Microprocessor Applications • Communications Processors (Hardware and Software) • Local Area Network • Protocol Development/Evaluation • Modulation/Coding Techniques • Secure Communications • Systems Test and Evaluation • Switching and Control Systems • Satellite and Terrestrial Transmission • Survivability/Vulnerability and Electromagnetic Pulse • Line of Sight, Tropo, Millimeter Wave and Fiber-Optics

### Command And Control

Air Defense Systems (Deployable and Fixed) • Tactical Air Traffic Control Systems (Deployable and Fixed) • Foreign Air Command and Control • Missile Warning Systems • Satellite Surveillance Systems • Systems Analyses and Specifications • Software Development

### Computer Systems

Requirements Analyses • Systems Analyses • Technology Assessment • System Acquisition • Performance Analyses • Simulation and Analytical Modeling • Artificial Intelligence • Image Processing • Fault Tolerant Systems • Ada • Software Cost Estimation • Computer Security • Software Metrics • Distributed Data Base Systems • Program Verification

### Systems Architecture

Advanced Systems Design • Advanced Planning • Intersystems Engineering • Functional/Operational Analyses • Systems Inter-Operability • Cost Analyses

U.S. CITIZENSHIP REQUIRED.

# C<sup>3</sup>I System Engineering

MITRE's System Engineers know their projects are truly important, extremely timely, and in an environment where they can depend on superb support. Because our primary mission is system engineering of crucial Command, Control and Intelligence (C<sup>3</sup>I) projects for the U.S. and the Free World.

At MITRE's suburban Boston and Washington D.C. facilities, we're engaged in major defense projects including jamproof voice communications, airborne warning and control systems, nuclear hardness and survivability, satellite communications, and select civil programs including national and international air traffic control and advanced information systems.

MITRE has over 150 timely, vital projects across the broadest spectrum of advanced technologies. In an environment where jobs become careers as you advance on our dual career ladder. You'll also enjoy outstanding

opportunities for project mobility and advancing your education with tuition advancement and the unique MITRE Institute.

If you have a personal computer or terminal with a telephone connection, explore MITRE's opportunities in Massachusetts on line by calling (617) 271-8000. Use the login name 'mitre' followed by a carriage return. For information about defense and civilian opportunities in the Washington area call 1-800-336-0430.

An Equal Opportunity Employer

**BOSTON**

Please send your resume to:  
David L. Finnegan  
The MITRE Corporation  
6109 Middlesex Turnpike  
Bedford, MA 01730

**WASHINGTON**

Please send your resume to:  
M.K. Mason  
The MITRE Corporation  
7525 Colshire Drive  
McLean, VA 22102

# Run With A Frontrunner

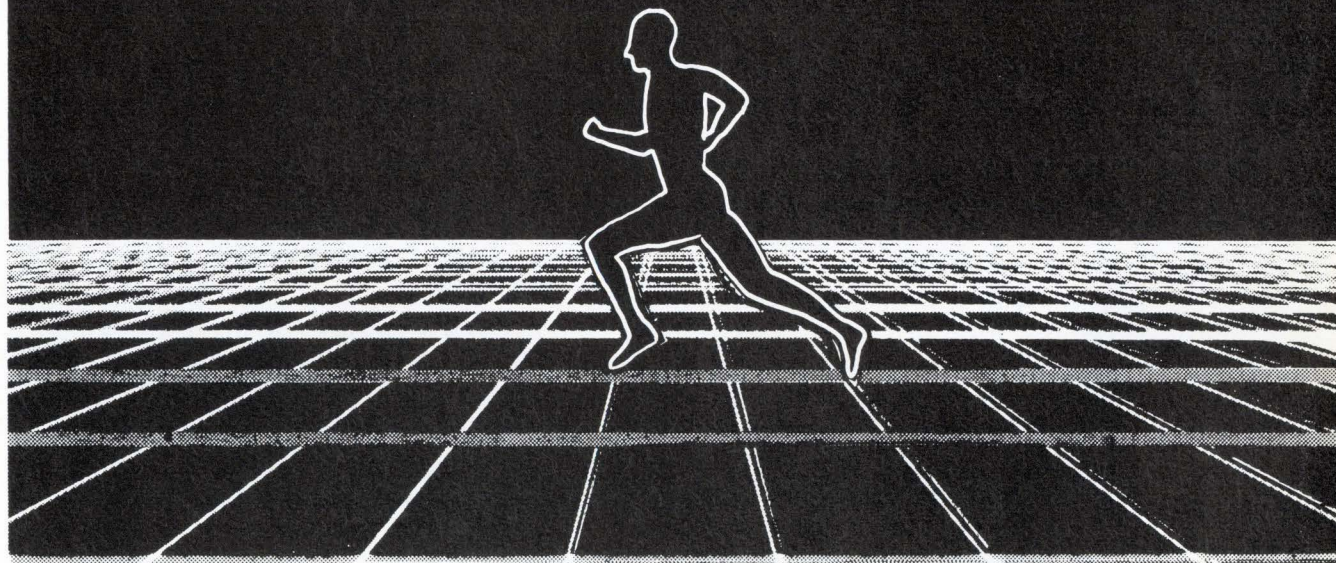

The team at NEC America is setting a leading pace in telecommunications technology. You've heard the buzzwords—ISDN, ATTENDANT CONSOLE, CALL PROCESSING, BX.25, CSS7, DBMS—now join the team that turns those industry buzzwords into technological reality. All of this takes place in a setting that encourages individual contribution AND teamwork. That's why many Software Engineers are making the switch to NEC America. We have the open-ended growth plans and quality technical teams to make your career both professionally and personally rewarding. Combine that with a move into new, progressive facilities by September, 1987 and you have great improvement on an already exceptional work environment.

The Switching Systems Division and Business Systems Division are now recruiting fresh thinking, creative Software Engineers in all areas except entry level.

## SOFTWARE DESIGN ENGINEERS and MANAGERS SWITCHING SYSTEMS DIVISION

Our phenomenal growth rate makes this the perfect time to get on board. Our design teams are involved in:

- ISDN
- CENTREX
- BX.25
- Attendant Console

To find out more about these opportunities, call Renee Kellow at (214) 580-9670. Or, if you prefer send your resume to the address below.

- Central Office-Call Processing
- CSS7
- Switch Administration and Diagnostics
- AMA Teleprocessing
- Traffic Measurements
- OSS Interfaces
- Application Processor Features/ Intelligent Network

The experienced engineers we are looking for will possess a minimum of a BSCS and 3+ years experience to include any of the above and high level languages.

## SOFTWARE ENGINEERS and MANAGERS BUSINESS SYSTEMS DIVISION

This start-up group has rapid expansion plans! With responsibility for software development, our teams are searching for Managers and Engineers to perform in all areas, from high level design all the way to detail design. Our areas of involvement are:

- Applications Programming using "C" and UNIX
- PBX-Call Processing
- OSI
- HDLC
- System Analysis
- PC or Mainframe

If you possess a minimum of a BSCS and 3+ years experience in any of the above, we want to hear from you.

This is your opportunity to run with a frontrunner in telecommunications technology. NEC America offers a highly competitive compensation package that includes outstanding benefits and great work environment surrounded by a high quality technical staff. And our Dallas, Texas location offers no state income tax and a great lifestyle for both single and family living. Get in touch with us today. Call the number above or forward your resume, complete with salary history, to: Renee Kellow, Personnel Specialist, NEC America, Inc., Dept. DAT, 1525 Walnut Hill Lane, Irving, Texas 75038.

# NEC NEC America, Inc.

An Affirmative Action Employer.

# Systems Analysts Systems Programmers

Are you at a point in your career where you feel stifled and not challenged by the day-to-day tasks expected of you?

The Federal Information Systems organization of Unisys Corporation may have the right opportunity for you if you have the skills and the desire to grow in your career. We offer the opportunity to work with state-of-the-art hardware and software systems with one of the most sophisticated computer users, the Federal Government. Unisys' FIS organization employs over 2,000 people and is headquartered in McLean, Virginia, a high-tech center in its own right. Currently, positions are available at our headquarters location as well as at selected sites across the country.

Our systems analyst/programmer positions involve **marketing support of large-scale systems and complex mini and micro networks or on-site customer support of similar installations.**

If you have five to seven years of professional experience in any of the following areas, we should be talking:

**UNISYS 1100 Series systems software (OS/1100, System Generation, MASM; Performance Analysis; DMS-1100; TELCON; CMS; MAPPER)**

**UNISYS A Series (or predecessor B5000/6000/7000 systems) systems software (MCP; DMS-II; LINK; BNA, NDL)**

**UNIX\* based minicomputer systems software, marketing support, installation, and customer support**

**UNISYS B Series microcomputer systems software**

**Micro-based networks, LAN's and database systems**

Immediate opportunities are available at the following locations: **Asheville, NC; Ft. Collins, CO; Jacksonville, FL; McLean, VA; Pensacola, FL; Suitland, MD; and Washington, D.C.**

For prompt confidential consideration, forward your resume (or letter) to:

**Unisys Corporation  
Federal Information Systems  
Attn: Greg Brown  
8008 Westpark Drive  
McLean, VA 22102  
(703) 556-5000**

\*UNIX is a trademark of Bell Laboratories.  
An affirmative action employer. Principals only, please.

# UNISYS

# “YOU CAN'T DO THAT”

---

**B**uild a large scale mainframe computer that will outperform the competition's leading model?

“Impossible!” they said.

But Amdahl did it back in the early 1970's. And today we are a leader in the development, manufacturing, marketing and support of general purpose and scientific computer systems, storage products, communications systems and software.

---

## MARKETING

**YOU CAN** support Amdahl's marketing, sales and product management efforts by using your 8+ years' 370 compatible large mainframe data processing, marketing and/or sales experience to define requirements for new communications products, future storage products or future processor products.

- **PRODUCT MANAGERS—MVS, UNIX\***
- **THIRD PARTY SOFTWARE SPECIALISTS**
- **STRATEGIC MARKET PLANNERS**
- **STRATEGIC PRODUCT PLANNERS**

If interested in any of these positions, please call Ranell Durgan at 800-538-8460, ext. 6216, between 8:00am and 5:00pm Pacific Time.

---

## SOFTWARE DEVELOPMENT—MVS/VM

**YOU CAN** develop a new, large mainframe operating system that is self-tuning and does not require systems generation. Use your 3+ years' operating system development and Assembly language coding experience to join us as a manager or individual contributor in one of the following key areas:

- **NETWORKING—Manager**
- **TERMINAL SUPPORT**
- **CERTIFICATION & VALIDATION**
- **APPLICATIONS SERVICES**
- **SUPERVISOR SERVICES**

If interested in any of these positions, please call Charlotte Mudd at 800-538-8460, ext. 8648, between 8:00am and 5:00pm Pacific Time.

---

## SOFTWARE DEVELOPMENT—UNIX\*

**YOU CAN** “make” the kernel in 3 minutes! Use your 3+ years' development experience in UNIX\* and/or 370 operating systems to join our UTS\*\* development team in the following positions:

- **PERFORMANCE MEASUREMENT & MONITORING TOOLS DEVELOPERS**
- **MANAGER — Languages Development**
- **UNIX\* INTERNALS DEVELOPERS**

If interested in any of these positions, please call Bill McCarthy at 800-538-8460, ext. 8843, between 8:00am and 5:00pm Pacific Time.

**YOU CAN** enjoy the benefits and competitive salary you would expect from an industry leader. To apply, call the appropriate individual listed above, or send your resume to their attention: **Amdahl Corporation, Employment Department, Dept. 9-3, P.O. Box 3470, M/S 300, Sunnyvale CA 94088-3470.** Principals only please.

**YOU CAN** call on your PC or terminal, 24 hours a day, for job opportunities or to enter your resume. Dial 612-941-5723 and enter the password “AMDAHL”.

**YOU CAN AT**  
**amdahl**

\*UNIX is a trademark of AT&T \*\*UTS is a trademark of Amdahl Corporation

Amdahl is proud to be an equal opportunity employer through affirmative action.

# Datamation Databank

## Professional Profile

### Announcing a new placement service for data processing professionals!

Datamation feels an obligation to help its readers advance their careers. So, Datamation has affiliated itself with Placement Services, Ltd. to form the **Datamation Databank**. What are the advantages of this new service?

- Your qualifications and career goals are entered into PSL's computer system. And the computer never forgets. When your type of job comes up, it remembers you're qualified.
- It's absolutely free. There are no charges,

fees or obligations to you as a Datamation reader.

- Service is nationwide. You'll be considered for openings across the U.S. by PSL and their affiliated offices.
- Your identity is protected. Your resume is carefully screened to be sure it will not be sent to your company or parent organization.
- Your background and career objectives will periodically be reviewed with you by a

PSL professional placement person to ensure current information.

We hope you're happy in your current position. At the same time, chances are there is an ideal job you'd prefer if you knew about it.

That's why it makes sense for you to register with the **Datamation Databank**. To do so, just mail the completed form below (with a copy of your resume) to **Placement Services, Ltd., Inc.**

#### IDENTITY

Name \_\_\_\_\_ Parent Company \_\_\_\_\_  
 Home Address: \_\_\_\_\_ Your division or subsidiary: \_\_\_\_\_  
 City \_\_\_\_\_ State: \_\_\_\_\_ Zip: \_\_\_\_\_ Location (City, State) \_\_\_\_\_  
 Home Phone (include area code): \_\_\_\_\_ Business Phone if O.K. to use: \_\_\_\_\_

#### PRESENT OR MOST RECENT EMPLOYER

#### EDUCATION

Degrees (List)

Major Field	GPA	Year Degree Earned	College or University

#### POSITION DESIRED

#### EXPERIENCE

Present or Most Recent Position \_\_\_\_\_ From: \_\_\_\_\_ To: \_\_\_\_\_ Title: \_\_\_\_\_

Duties and Accomplishments: \_\_\_\_\_ Industry of Current Employer: \_\_\_\_\_  
 \_\_\_\_\_  
 \_\_\_\_\_

Reason for Change: \_\_\_\_\_

#### PREVIOUS POSITION:

Job Title: \_\_\_\_\_  
 Employer: \_\_\_\_\_ From: \_\_\_\_\_ To: \_\_\_\_\_ City: \_\_\_\_\_ State: \_\_\_\_\_  
 Division: \_\_\_\_\_ Type of Industry: \_\_\_\_\_ Salary: \_\_\_\_\_  
 Duties and Accomplishments: \_\_\_\_\_

#### COMPENSATION/PERSONAL INFORMATION

Years Experience	Base Salary	Commission	Bonus	Total Compensation	Asking Compensation	Min. Compensation
Date Available	I Will Travel <input type="checkbox"/> Light <input type="checkbox"/> Moderate <input type="checkbox"/> Heavy			I own my home. How long? _____		I rent my home/apt. <input type="checkbox"/>
<input type="checkbox"/> Employed <input type="checkbox"/> Self-Employed <input type="checkbox"/> Unemployed	<input type="checkbox"/> Married <input type="checkbox"/> Single		Height _____ Weight _____			
Level of Security Clearance	<input type="checkbox"/> U.S. Citizen	<input type="checkbox"/> Non-U.S. Citizen	My identity may be released to: <input type="checkbox"/> Any employer <input type="checkbox"/> All but present employer			
<input type="checkbox"/> WILL RELOCATE <input type="checkbox"/> WILL NOT RELOCATE <input type="checkbox"/> OTHER _____						

# Datamation Databank

A DIVISION OF PLACEMENT SERVICES LTD., INC.

265 S. Main Street, Akron, OH 44308 216/762-0279



# EASTERN STATES IS THE KEY.



## SENIOR PROGRAMMER/ANALYST

As part of a small, congenial, forward-thinking team, you'll use your 4 years of TANDEM and TAL experience to create original, effective solutions to a wide variety of problems. Independence and incisiveness are essential; familiarity with ENVOY is required.

Eastern States is one of the nation's largest and most progressive financial and credit card service organizations, providing services to some of the most prestigious banks in the world. Which puts us in the position to offer a number of key compensations, including a very attractive salary, liberal benefits including tuition reimbursement, high visibility, tremendous growth potential, and a convenient location on the Nassau/Queens border. For confidential consideration, please send your resume, indicating salary history and requirements, to: **Mary Mackinnon, Technical Recruiter, Eastern States, 3 Dakota Drive, Lake Success, NY 11042.** We are an equal opportunity employer M/F.



## COORDINATOR, MEDICAL DATA PROCESSING

The Aramco Health Center in Saudi Arabia has an immediate opening for a Coordinator, Medical Data Processing for the Dhahran Hospital that recently expanded to 482 beds. The medical organization also includes four district clinics, one with a new 80 bed hospital.

Requires Bachelor's degree in Computer Science, Hospital Administration, or business equivalent. M.S. degree preferred. Ten to twelve years experience in data processing systems, analysis and design, including three years exposure to EDP operations and two years medical record systems, clinic operations, or medical computer applications. Candidate must have sound knowledge of all aspects of EDP as related to a major health care organization and ability to supervise, review, and solve diverse EDP related problems.

These overseas assignments offer excellent opportunities along with competitive salary and benefit package. For immediate consideration, call **Velma Guy at 1-800-231-7577, Ext. 8060 or 713-432-8060.** Or send resume to: **Velma Guy, Dept. 06G-039-7, P.O. Box 4530, Houston, Texas 77210-4530.**

# ARAMCO



## The future holds a challenge for you. And it's at SRL.

We're Systems Research Laboratories, a division of Arvin/Calspan. We're a growing company where the results of high technology research and engineering efforts are applied creatively to solve complex problems for government and industry. Because of our continued growth, we are seeking several professionals to join our high technology team.

knowledge of modern control theory principles, and 1-3 years of systems level engineering experience in a real-time environment. Knowledge of DEC VAX hardware, UNIX, VMS and interactive graphics desirable.

### Systems Analyst

Responsible for developing software for avionics, defining software standards and the review/control of project status. Requires BSEE or BSCS with 3-5 years of experience writing assembly language software for micro-processor based systems. Familiarity with ADA and JOVIAL desired.

### Systems Analyst

Responsible for overall systems support and development of interfaces/device drivers of DEC PDP and VAX systems. Requires BSCS and 3-5 years of related experience in a DEC environment. Knowledge of digital signal processing hardware desirable. Working knowledge of UNIX, C desired.

### Software Quality Assurance Engineer

Responsible for assuring high standards of software quality for aircraft electronic systems and subsystems and for performing software reviews/audits as part of the QA engineering effort. Requires a four year degree, knowledge of DoD-2167 and MIL-S-52779, familiarity with military software data items and five years of related experience in a military systems environment.

### Systems Analyst

Responsible for overall systems support and development of interfaces/device drivers for DEC PDP and VAX systems. Requires BSCS and 3-5 years of related experience in a DEC environment. Knowledge of digital signal processing hardware desirable.

### Systems Engineer

Responsible for designing control systems and drive algorithms for flight simulators. Also develop and document real-time software for derived control equations. Requires BSEE

We offer an excellent compensation and benefits package and a working atmosphere that encourages career growth and responsibility. For immediate consideration, please submit your resume in confidence to **SRL, Dept. DM**

U.S. Citizenship Required

EOE/MFHV  
Principals Only

**SRL** SYSTEMS RESEARCH LABORATORIES  
2800 INDIAN RIPPLE RD., DAYTON, OH 45440-3696 • (513) 426-6000  
A DIVISION OF ARVIN/CALSPAN

## DID YOU KNOW? . . .

- 77% of over 160,000 of the most qualified Computer Systems/Operations/Data Processing and Software Engineering Professionals read **DATAMATION** regularly; at least 3 out of 4 issues.
- The **DATAMATION** reader spends 1 hour 14 minutes reading each issue, and has been doing so for 8 years.
- More than 64% of these readers go through each issue page-by-page, and pass the magazine along to an additional 5 people.

NOW, the **DATAMATION CAREER OPPORTUNITIES** section will bring you the latest in current job opportunities!

For more information, and to reserve your ad in our next issue call:

**Roberta Renard** 201/228-8602  
National Recruitment Sales Manager

**Janet O. Penn** 201/228-8610  
East Coast Recruitment Manager

**Dan Brink** 714/851-9422  
West Coast Recruitment Manager

LIMITED TIME OFFER

## Read This New Study Before You Make Another Marketing Decision —

### **Datamation's 1986 Mainframe/Minicomputer Purchasing Study** can help you assess your

company's . . . and your competitors' . . . present and future growth.

End User and OEM buyers of 26 categories of mainframe and mini equipment and software report in detail what, how much and from whom they bought during 1985.

You'll receive invaluable inside information, including:

- ▶ pricing and unit volume data
- ▶ geographic breakout of purchases
- ▶ share-of-market as percent of dollar volume
- ▶ demographic profile of buyers

### **Order your copy now!**

Send your company purchase order or check for **\$250 per copy** to: *Datamation/Cahners Publishing*, Attention: Mary Connors, 249 W. 17th Street, New York, NY 10011. Or call Mary at (212) 645-0067 for more information.

**DATAMATION**

## ADVERTISING SALES OFFICES

Publisher  
**James Morris**  
Associate Publisher  
**William Segallis**  
Production Manager  
**Dolly Viebig**

### **EASTERN REGION**

Eastern Regional  
Sales Manager  
**Frances E. Bolger**  
249 W. 17<sup>th</sup> St.  
New York, NY 10011  
(212) 463-6552

Middle Atlantic  
**John M. Gleason**  
8 Stamford Forum  
P.O. Box 10277  
Stamford, CT 06904  
(203) 328-2547

**Tom Carey**  
487 Devon Park Dr.  
Suite 206  
Wayne, PA 19087  
(215) 293-1212

Northeast  
**Edward Rappaport**  
**Michael W. Andrea**  
199 Wells Avenue  
Newton, MA 02159  
(617) 964-3730

Southeast  
**Larry Pullman**  
6520 Powers Ferry Road  
Suite 395  
Atlanta, GA 30339  
(404) 955-6500

Midwest  
**John Stellwagen**  
1350 E. Touhy Avenue  
Des Plaines, IL 60018  
(312) 390-2967

### **WESTERN REGION**

Western Regional  
Sales Manager  
**James E. Filiatrault**  
3031 Tisch Way  
Suite 100  
San Jose, CA 95128  
(408) 243-8838

West  
**Janet Engelbrecht**  
582 Market St.  
Room 1007  
San Francisco, CA 94104  
(415) 981-2594

**Robert J. Rielly**  
12233 West Olympic Blvd.  
Suite 236  
Los Angeles, CA 90064  
(213) 826-5818

**William M. Wilshire**  
18818 Teller Avenue  
Suite 170  
Irvine, CA 92715  
(714) 851-9422

Texas  
**Richard W. Sheehan**  
9330 LBJ Freeway  
Suite 1060  
Dallas, TX 75243  
(214) 644-3683

### **INTERNATIONAL**

Cahners Publishing  
Company  
27 Paul Street  
London, EC2A 4JU,  
England  
Tel: 44 1 628-7030  
Telex: 914911 TEC PUB G  
Fax: 44 1 839-6626

Managing Director—Europe  
**Sal Massimino**  
U.K., Benelux  
**Jan Dawson**  
**Tracey Lehane**  
Scandinavia  
**Martin Sutcliffe**  
France, Italy, Spain  
**Alasdair Melville**

W. Germany, Austria,  
Switzerland,  
E. Europe

**Uwe Kretzschmar**

Israel  
**Roseline Lewin-Wainberg**  
Cahners Publishing  
Company  
68 Sokolov St.  
Ramat Hasharon 47 235  
Israel  
Tel.: 03-49 12 69

Japan  
**Hiroshi Sato**  
IRM, Inc.  
Rosei Building, 4-2  
Higashi Azabu 1-Chome  
Minato-Ku  
Tokyo 106, Japan  
Tel: 03-584-1241  
Telex: 242-2588 IRMTOK J

Taiwan  
**Parson Lee**  
Acteam International  
Marketing Corp.  
6F, No. 43, Lane 13  
Kwang-Fu South Road  
Mailbox 18-91  
Taipei, 10594,  
Taiwan R.O.C.  
Tel: (02) 760-6209  
Telex: 29809 ACTEAM

### **RECRUITMENT ADVERTISING**

**Roberta Renard**  
National Sales Manager  
103 Eisenhower Parkway  
Roseland, NJ 07068  
(201) 228-8602

### **INFORMATION CARD DECKS**

**Joanne Dawson**  
Department Manager  
1301 S. Grove Avenue  
P.O. Box 1030  
Barrington, IL 60010  
(312) 381-1840

### **CAHNERS MAGAZINE DIVISION**

**William M. Platt**  
President  
**Terrence M. McDermott**  
Executive Vice President  
**Frank Sibley**  
Group Vice President  
**Jerry D. Neth**  
Vice President  
Publishing Operations  
**Tom Dellamaria**  
VP/Production &  
Manufacturing

**Cahners Publishing Company**  
A Division of Reed Publishing USA

Specialized Business and Consumer Magazines for Building & Construction, Interior Design, Electronics & Computers, Foodservice & Lodging, Manufacturing, Book Publishing & Libraries, Medical/Health Care, Child Care & Development.