

Electronic Design 11

VOL. 17 NO.

FOR ENGINEERS AND ENGINEERING MANAGERS

MAY 24, 1969

Laser camera freezes light rays into a hologram for promotional display. Improved lasers, films and recording techniques topple one barrier after another to 3D

pictorial applications. Computer makers are forming high-density holographic memories in crystals, thermoplastics and photographic emulsions. Report starts P. 43.

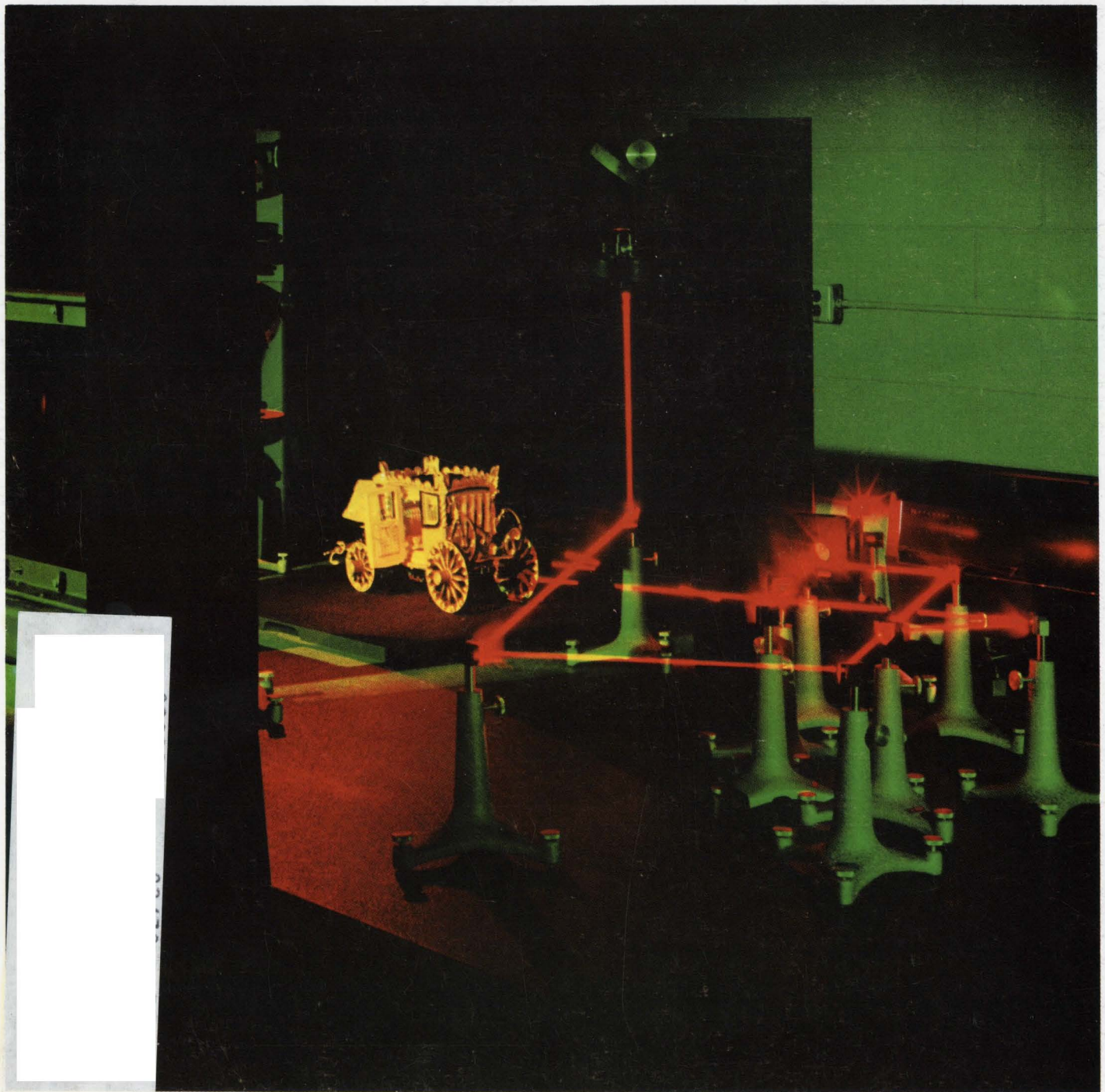



**TRW/Globe
sells motion**

Application #2: cooling and blowing.

Globe won't make you "bend metal" around an off-the-shelf design. You won't be asked to repackage everything in your system—except the blower—to make our job easier. Globe will give the performance your system needs.

The difference at Globe is how blower and motor designers work together to match the elements of your system. Globe designs AC, DC or DC to AC at any voltage. If a new impeller

design is the answer we'll begin delivery within eight weeks.

Behind every Globe blower is a Globe motor already tooled and tested. Globe has been making motors longer than other blower people have been in business. Until you call in Globe, don't lock yourself into a solution.

TRW Globe solves problems in motion. Any kind of motion: intermittent or continuous, rotary or linear, air or liquid or mechanical linkage. If you

have a problem in motion, let Globe's *system engineers* make your job easier. Contact TRW Globe Industries Div. of TRW Inc., 2275 Stanley Avenue, Dayton, Ohio 45404 Phone: (513) 228-3171

TRW®

THE COUNTER REVOLUTION GOES ON AT HP

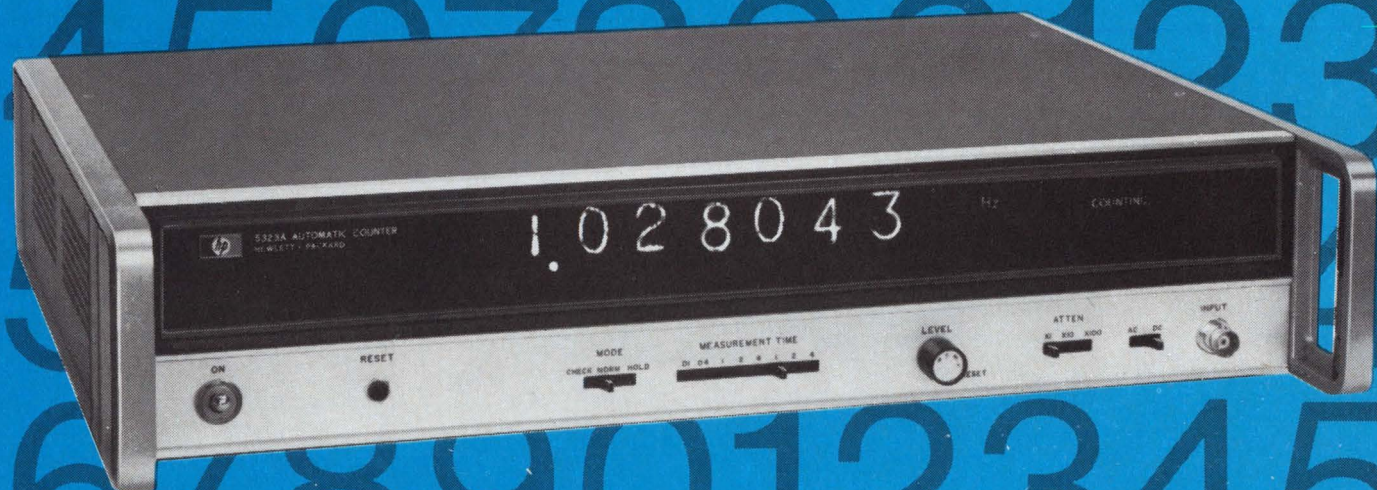

the automatic counter's automatic counter

The new Hewlett-Packard 5323A Automatic Counter gives you a more useful automatic instrument than you've ever had before for either automatic systems or visual readout uses. It's considerably ahead of its class — the new class of "reciprocal taking" counters. It provides a greater speed-resolution combination of period measurement for making low frequency measurements (about 1000 times greater for clean signals below 1 kHz). Then, for rapid convenient readout, computing circuits invert period for direct display as frequency. It automatically provides the maximum resolution possible, regardless of measurement time, over the entire 0.125 Hz to 20 MHz range.

But the 5323A provides even more. A host of unique "extra duty" features gives you exceptionally higher performance for a lower price. For example, it can

automatically measure the carrier frequency of pulsed signals. It also has measurement times from 0.01 to 4 seconds, selectable in steps of 1, 2 and 4. Controllable hysteresis prevents jittering about range change points. Remote programming and digital output are standard. Better integrated circuit design keeps input power at a low 35W so there's no fan, and it'll use 50 to 400 Hz power.

This significant new speed, accuracy and convenience in frequency measurement is provided at less cost than similar counters, too. Price is \$2150 — for a uniquely useful instrument for: rapid confident use at the bench or for greater accuracy, speed and automaticity in data acquisition systems, mechanical or electrical testing, control systems or physical, earth or life science investigations.

For more information about an automatic counter worth your immediate attention, call your local HP field engineer. Or write Hewlett-Packard, Palo Alto, California 94304; Europe: 1217 Meyrin-Geneva, Switzerland.

02826

HEWLETT  PACKARD

ELECTRONIC COUNTERS

Systron-Donner's Model 6316A gives you automatic final-answer frequency readings non-stop from dc through X band.

It's the perfect systems counter — a completely programmable unit that mounts in a slim 1¾ inches of panel space and costs only \$4750. Before now you needed a collection of instruments totaling five times the bulk and costing half again as much to do the same job.

Model 6316A covers the full range by combining a dc-to-100 MHz counter with built-in automatic frequency extenders. Readings can be taken in milliseconds, and the extenders lock in phase with the input to preserve counter accuracy to 12.4 GHz. That accuracy depends only on time base stability—which can be an ultra-high 5 parts in 10^{10} per 24 hours.

Reliability is superb—proven by more than a year's operation in the field. For a prompt demonstration, phone or write Measurements Division, Systron-Donner Corporation, One Systron Drive, Concord, California 94520. Phone (415) 682-6161.

First counter to measure automatically from dc to 12.4 gigahertz!

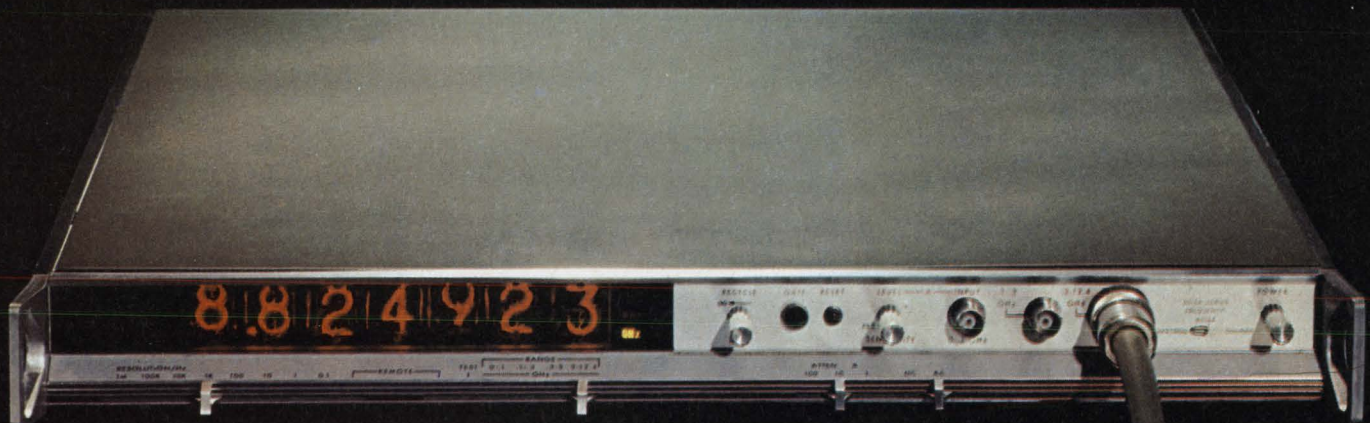

SYSTRON  DONNER

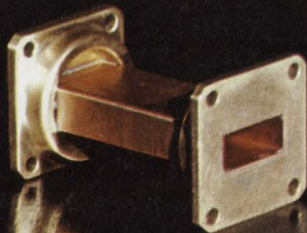

Another first. One of 144 Systron-Donner instruments

Electronic counters	Digital voltmeters
Pulse generators	Digital panel meters
Microwave frequency indicators	Microwave signal generators
Digital clocks	Laboratory magnets
Memory testers	Data acquisition systems
Analog computers	Microwave test sets
Time code generators	
Data generators	

NEWS

- 21 News Scope
- 25 **Scientists choose sides in ABM debate**
Top technologists argue pros and cons of Safeguard system at tumultuous meeting of physicists in Washington, D. C.
- 28 Wide-angle antenna uses circular polarization
- 30 **Wanted: Better materials for MICs**
Designers are seeking improved thermal properties and smoother substrate surfaces—at lower cost
- 32 30-day astromonk flight to study space perils
- 34 The artificial heart: Problems, Problems
- 39 Washington Report
- 43 **Holography: The reality and the illusion**
An Electronic Design special report
- 66 Sidelights of the Issue
- 69 **Editorial: A fresh breeze of iconoclasm blows into the Pentagon**

TECHNOLOGY

- 72 **Design wideband uhf power amplifiers** with techniques for broadband matching, gain compensation and parasitic-inductance reduction.
- 80 **Simplify op-amp parameter tests.** An oscilloscope and a special test circuit check bias current, offsets and transfer function.
- 90 **Select air movers without guesswork.** Use impedance-measuring to determine the type and size of air mover required.
- 96 **Hire the bright engineers** and let them develop the design on their own, says Dr. C. Lester Hogan of Fairchild in this exclusive interview.
- 102 Ideas for Design

PRODUCTS

- 114 **Data Processing:** Computer terminal tapes up to 10 characters/s.
- 126 **Microwaves & Lasers:** Infrared laser diode doubles output power.
- 148 **Instrumentation:** Logic pulse indicator identifies 50-ns pulse widths.
- 119 Components
- 134 ICs and Semiconductors
- 140 Modules and Subassemblies
- 144 Packaging and Materials
- 152 Production

Departments

- | | |
|-----------------------------------|------------------------|
| 14 Designer's Datebook | 158 Application Notes |
| 154 Evaluation Samples | 162 New Literature |
| 156 Design Aids | 174 Advertisers' Index |
| 176 Information Retrieval Service | |

Information Retrieval Service Card inside back cover

COVER CREDIT: Photo by David Bacon, Conduccion Corp., Ann Arbor, Mich.

Laser setup for a hologram used by General Motors. For details on the prize-winning picture see pages 43 and 66.

ELECTRONIC DESIGN is published biweekly by Hayden Publishing Company, Inc., 850 Third Avenue, New York, N.Y. 10022. James S. Mulholland, Jr., President. Printed at Brown Printing Co., Inc., Waseca, Minn. Controlled circulation postage paid at Waseca, Minn., and New York, N.Y. Copyright © 1969, Hayden Publishing Company, Inc. 77,314 copies this issue.

lev-er-wheel™

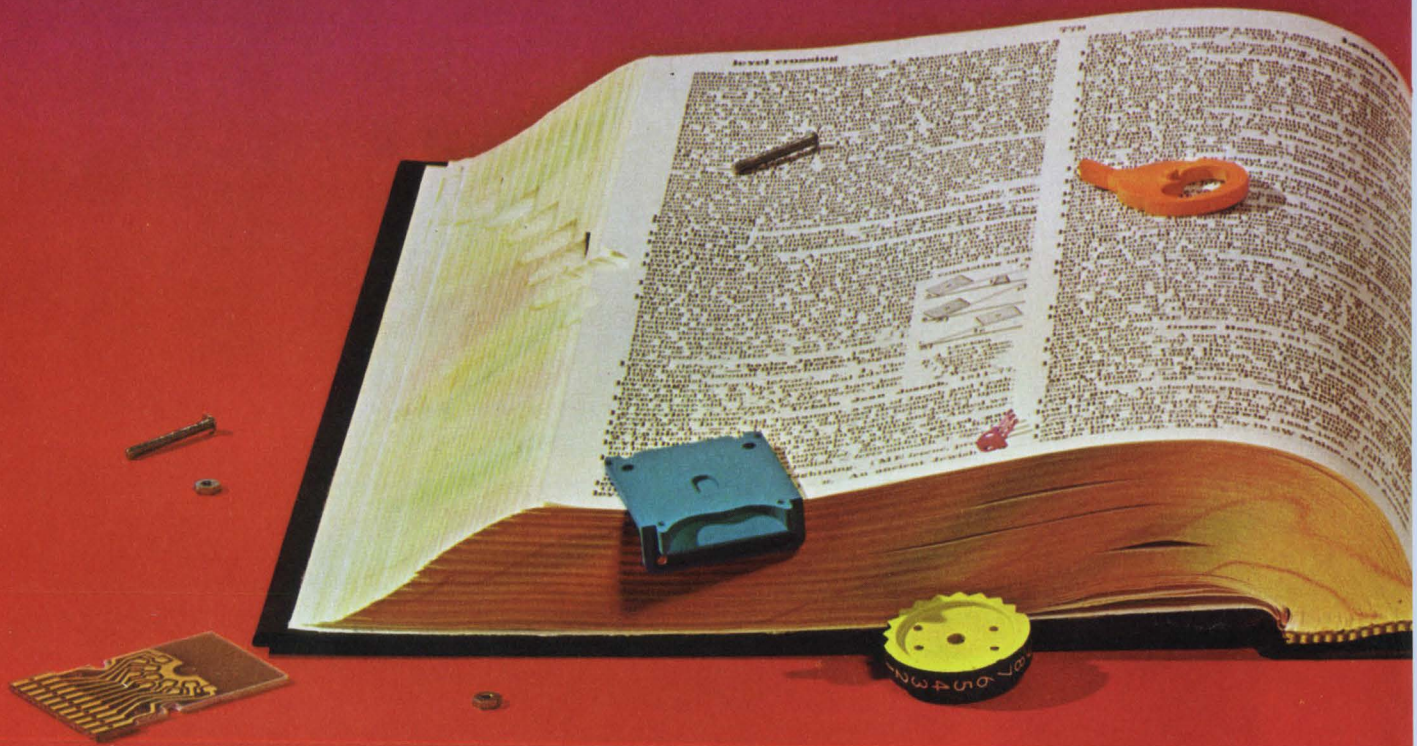

LEVERWHEEL SWITCH a brand new concept...

Since when does Cherry make rotary thumbwheel switches? Since we figured out how to make them *better*. Which is right now with the new Cherry "Leverwheel" Thumbwheel Lever-Action switches that set in half the time of conventional thumbwheels.



THE SLOW PLUNK VS. THE FAST SET

A single movement of the Leverwheel lever through its 60° arc is all that's necessary for a complete 10-position cycle. (Compare *that* to plunking through the 360° rotation on conventional thumbwheels!)



EVERYTHING'S COMING UP ZERO

There's instant reset at no extra cost. A simple sweep with the hand and all levers return to home position with every switch in the bank returned to "zero".

LEVERWHEEL
TM

From the makers of famous, dependable precision Snap-Action Switches...

CHERRY 

▪▪ so new you can't look it up
in your Funk & Wagnalls



...Thumbwheel Lever-Action by CHERRY...

SEND TODAY for a free copy of the new eight-page brochure describing the complete line of Cherry Leverwheel and Thumbwheel Switches.
For immediate action
phone: 312|831-5024

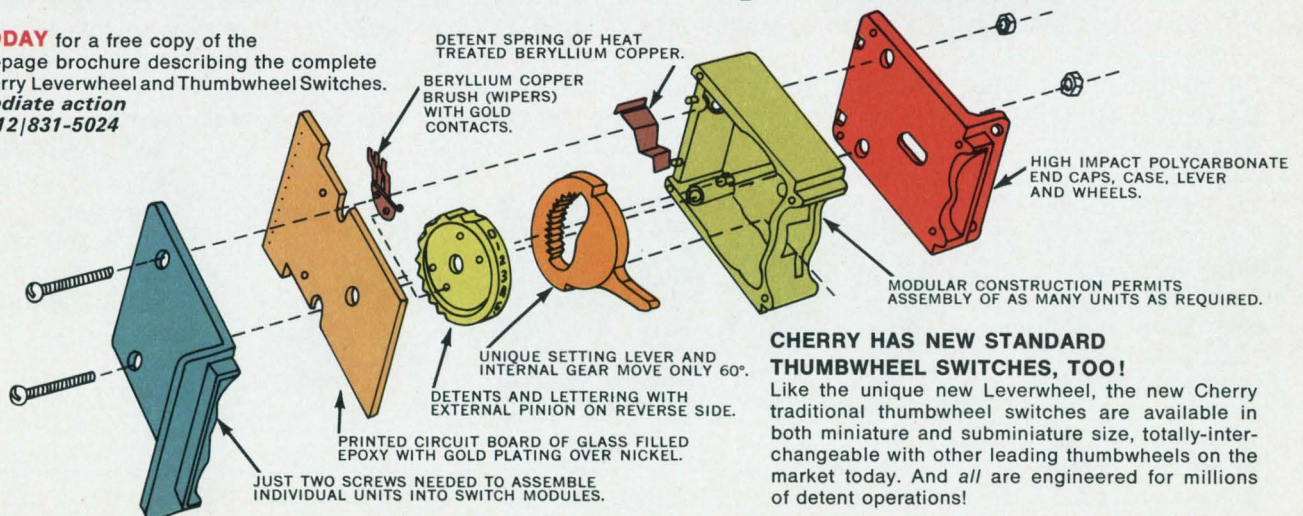

CHERRY ELECTRICAL PRODUCTS CORP. 1667 Old Deerfield Road, Highland Park, Illinois 60035
INFORMATION RETRIEVAL NUMBER 4

Standard Circuit of the Month

MINIATURE
HYBRID
CIRCUITRY
IN TO-8 CAN

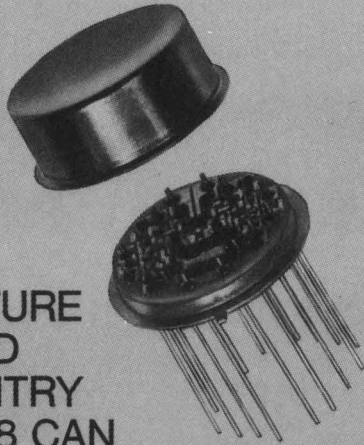

- Offset Voltage as low as -1mv
- Typical Speed: 380ns
- Choice of Input Logic Levels
- Switch Impedance typically 2.0 ohms
- 2 Switches per TO-8 Can

Precision High Speed Ladder Switch

MAXIMUM RATINGS

Power Dissipation: 360mw/bit
Operating Temperature: -55°C to $+125^{\circ}\text{C}$
Storage Temperature: -65°C to $+175^{\circ}\text{C}$

Positive Supply Voltage (+Vcc): +20v
Negative Supply Voltage (-Vcc): -20v
E Reference Maximum: Vcc -5v

Mepco Precision Ladder Switches are available from factory stock in eight types, to meet a variety of requirements. All are encased in hermetically sealed TO-8 cans. No special power supply is required. These circuits can provide a switching accuracy of $\frac{1}{2}$ LSB without external switch compensation in the ladder network.

The various Mepco types provide a choice of high or low ladder currents; positive or negative reference voltages; RTL, TTL, DTL or ECL/ECCL input logic levels. Turn on and turn off times are closely matched — typically 80ns (120ns maximum), with still closer

matches available in selected units. Typical switching speed (delay plus transition time) is 380ns. Maximum is 600ns. Offset voltages are prebalanced to two different ladder current ranges — 1.6 to 3.5 ma, or 0 to 1.6 ma — maximum offset is ± 2 to ± 4 mv depending on type. Still lower offset voltages may be obtained using selected units. The current ranges refer to worst case current through one ladder switch.

For complete information, write or phone for Data Sheet MC4-469 or discuss your requirements or special problems with the Mepco representative in your area.

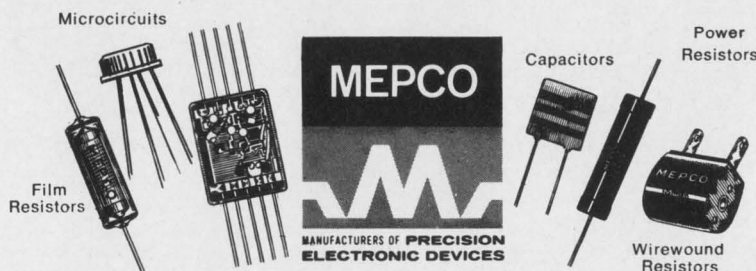

MEPCO INC., COLUMBIA ROAD, MORRISTOWN, N.J. 07960 • (201) 539-2000 • TWX: 710-986-7437

INFORMATION RETRIEVAL NUMBER 5

INFORMATION RETRIEVAL NUMBER 6 ▶



Ultramation: the memory that helps you forget.

Ultramation: the ultimate in automation with Honeywell. It means a new core memory system that helps you forget about initial costs – the Honeywell ICM-160. It delivers 4,096 words with 8, 12 or 16 bits per word for under 5¢ per bit and is field expandable.

And you can forget about downtime, too.

The ICM-160 has a calculated 40,000 hour MTBF from 0° to 50° C.

You can forget about space and maintenance problems. The ICM-160 is the smallest (2¾" x 5" x 9"), fastest (1.6 µsec full cycle time, 550 nsec access time), 4K-word memory in the under \$5K price range. Modular construction makes it

fast and easy to maintain.

No wonder it's a logical choice for use in mainframe applications as well as special systems – digital controllers, computer peripherals, data communication buffers. Delivery? 30 days is standard. And it arrives with complete documentation – the kind of detailed information you'd expect from a supplier who's been designing and producing core memory systems for over 10 years.

Find out about the memory that helps you forget. Write for complete specs.

Honeywell, Computer Control Division, Framingham, Mass. 01701.

Honeywell
AUTOMATION

Five ways to improve communications

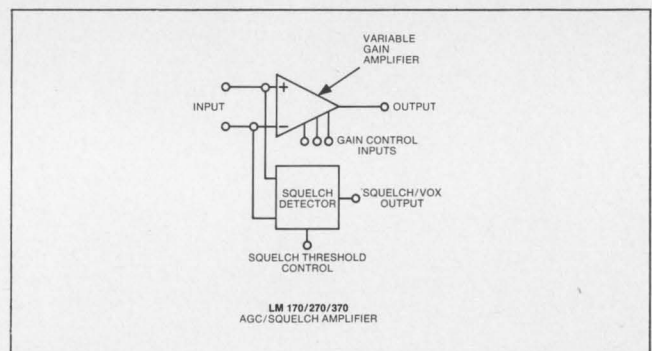

LM370. A simple squelch and AGC circuit. Gain reduction range is 80 dB typical. Supply voltage from +4.5 to +24V. Supply drain is 18mW at +4.5V. For airborne or mobile communications systems. Also doubles as a constant amplitude audio oscillator, transmitter or tape recorder VOX, or variable gain DC amplifier for analog computation.

Price \$2.95.*

*In hundred up quantities. Also available in full military temperature ranges.

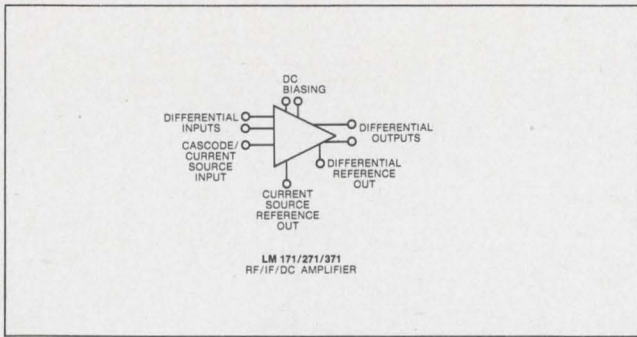

LM371. An RF/IF amp with 100 MHz power gains of 24.6 dB as an emitter coupled limiting amplifier and 27.5 dB as an AGC'd cascode. Versatile. Thousands of applications beyond its basic tuned RF/IF functions. Ideal as monolithically matched building blocks in DC, audio, video and logic applications. Priced at \$2.75.*

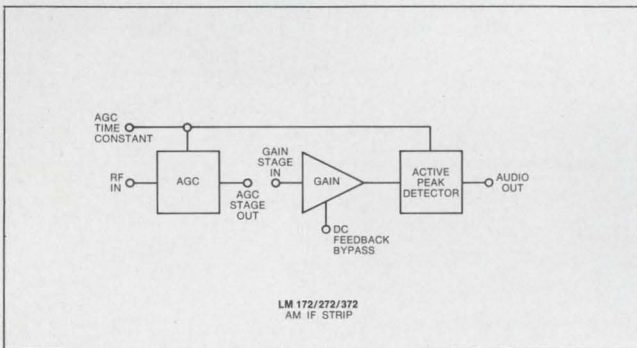

LM372. A very efficient, low power drain, AM/IF strip. 60 dB AGC range at frequencies up to 2 MHz. Draws only 8.4 mW from a +6V supply. 50 μ V AGC knee. Self contained detector and AGC loop. Ideal for AM/IF below 2 MHz, or audio/sonar untuned applications. Priced at \$2.50.*



SPEAK Call your National representative or distributor for parts off the shelf and for full specification and applications information. We've got sheafs of applications notes on each of these outstanding communications circuits. Drop the word and they're yours. National Semiconductor Corporation, 2975 San Ysidro Way, Santa Clara, California 95051. (408) 245-4320 TWX: 910-339-9240. CABLES: NATSEMICON.

National/Linear

INFORMATION RETRIEVAL NUMBER 7

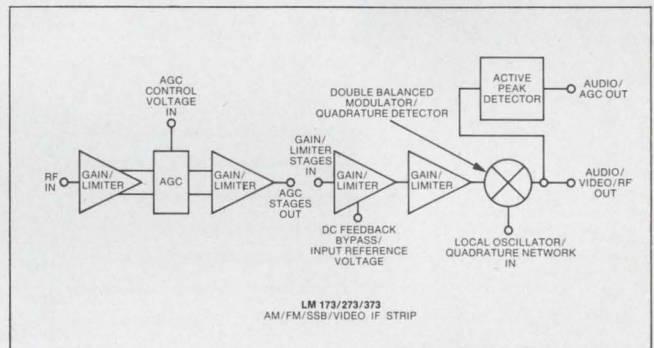

LM373. A single IF strip that can be externally connected to do all the things needed in AM, FM or SSB reception at IF's up to 12 MHz. Versatile. Connected for AM, it amplifies, detects and performs AGC with few external components. Four emitter coupled limiting stages for FM. A quadrature detector with large audio outputs for very narrow band deviations. Provides balanced product detector and audio-operated AGC in SSB mode. Makes a good video amp with built-in AGC or gating. Priced at \$2.73.*

New from United Aircraft

control logic

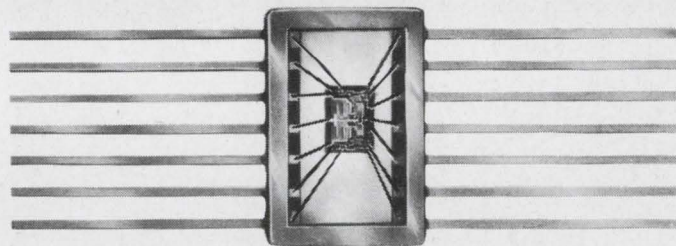

A family of 28 volt integrated circuits including dual and quad gates, expandable gates and gate expanders, set-reset flip flops, 5 volt to 28 volt converters and 28 volt to 5 volt converters, featuring:

- **Large supply variation tolerance** – 16 to 40 volts
- **High A.C. noise immunity** – rejects 2 u sec pulses of up to 90 V
- **High D.C. noise immunity** – 8.5 volt input threshold
- **High current sinking ability** – 100 mA steady state, 1 ampere transient
- **High output signal swing** – up to 90 V
- **Full military temperature operating range** – -55°C to $+125^{\circ}\text{C}$
Also available in industrial range from 0°C to $+85^{\circ}\text{C}$
- **Packaged** in $\frac{1}{4} \times \frac{3}{8}$ flatpack

United Aircraft control logic, operates from 16 to 40 volt sources and is ideally suited for directly driving indicators and actuators. Control logic replaces relays and discrete device circuitry and provides significant reduction in size and weight. For more information, contact:

Electronic Components DIVISION OF **United Aircraft**

TREVOSE, PENNSYLVANIA Tel. 215-355-5000 TWX: 510-667-1717
IN THE WEST: 128 E. KATELLA AVE., ORANGE, CALIF., (714) 639-4030

INFORMATION RETRIEVAL NUMBER 8

ELECTRONIC DESIGN 11, May 24, 1969

Pick the
BEST IC
for the job

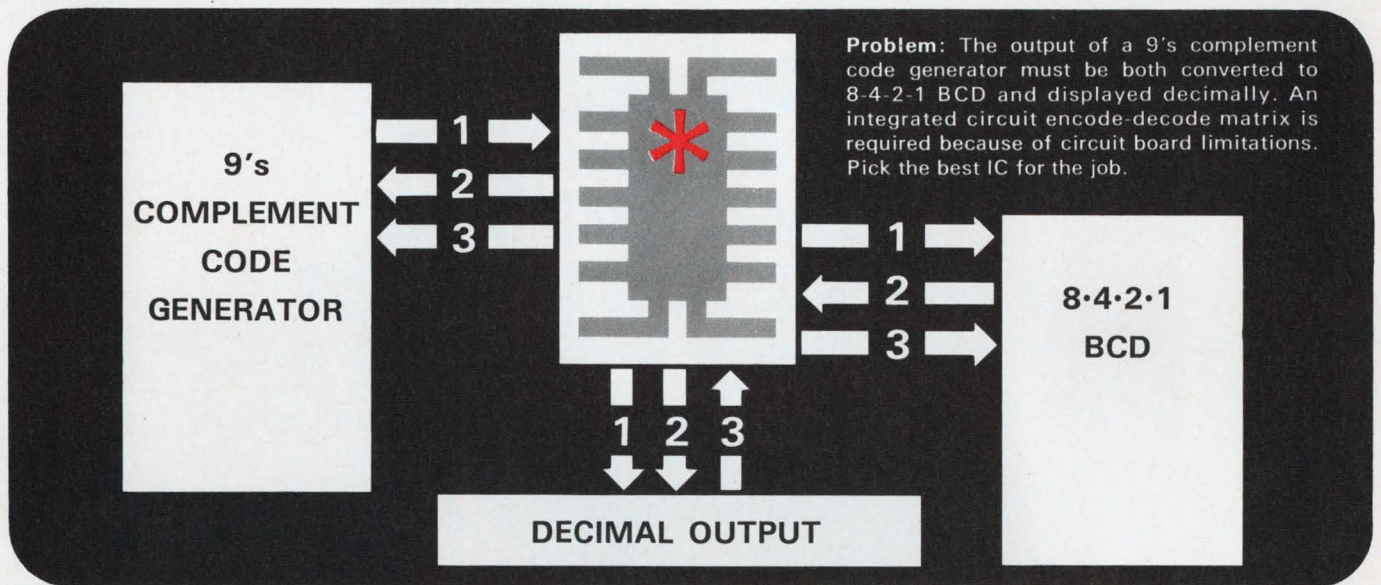

the **BEST** Solution:

THE RADIATION RM-84 DIODE MATRIX



Solve the problem easily. Combine only *four* * RM-84 diode matrices from Radiation and form a 16 x 10 matrix array. Six code conversions can be performed by this single bi-directional array to replace approximately 80 logic elements. The code pattern will be customized quickly from our complete stock of standard matrices.

Radiation diode matrices are dielectrically isolated, eliminating cross-coupling and allowing easy customization. These circuits can be combined with Radiation interface circuits to provide the most economical, convenient and reliable diode logic available.

Contact your nearest Radiation sales office. Ask about our diode matrix line. Let us help you pick The Best IC for The Job.

WE MAKE THE **BEST** IC FOR THE JOB



RADIATION
INCORPORATED
SUBSIDIARY OF HARRIS-INTERTYPE CORPORATION
MICROELECTRONICS DIVISION

RADIATION SALES OFFICES: P. O. Box 476, Lexington, Mass. 02173, (617) 862-1055 • 600 Old Country Road, Garden City, N.Y. 11530, (516) 747-3730 • 2600 Virginia Avenue N.W., Washington, D.C. 20037, (202) 337-4914 • P. O. Box 30667, Dallas, Texas 75230, (214) 231-9031 • 6151 W. Century Boulevard, Los Angeles, California 90045, (213) 670-5432 • P. O. Box 37, Melbourne, Florida 32901, (305) 727-5430 • International Sales: Marketing Department, P. O. Box 37, Melbourne, Florida 32901, (305) 727-5412

INFORMATION RETRIEVAL NUMBER 9

**TEFLON: all by itself
the most thoroughly proven,
high-reliability
insulation**

**Now, look at the
extras you get
with TEFLON plus
polyvinylidene fluorides**



Wire insulations of Du Pont TEFLON fluorocarbon resins have long provided highest reliability under extremes of temperature and adverse environments. But did you know there are composite insulation constructions of TEFLON plus polyvinylidene fluorides which offer you additional benefits for all wiring applications?

TEFLON plus polyvinylidene fluoride constructions protect against installation damage because of their extra toughness and abrasion

resistance. They are available in two forms: PVF₂ extruded over the primary insulation of TEFLON, or with PVF₂ as an enamel coating on the TEFLON.

In either form, these "TEFLON plus..." constructions are easily printed and potted, available in a wide range of colors. They are lightweight, small-diameter, nonflammable and chemically resistant, with optimum dielectric quality, and operable over a wide temperature range.

If you would like additional information on composites of TEFLON plus polyvinylidene fluoride (or composites using polyimides or mineral fillers with TEFLON), write to Du Pont and let us know about the application you have in mind. Address: Du Pont Company, Room 7295-B Wilmington, Del. 19898.

DU PONT
REG. U. S. PAT. OFF.
TEFLON[®]
fluorocarbon resins



FOR CONNECTOR CONFIDENCE

CINCH ROYAL D MARK III SUBMINIATURES

There is an added feeling of confidence that comes with knowing that your D-subminiature connectors will be delivered on time and meet all your specifications at competitive prices.

Cinch Royal D MARK III* rack and panel connectors are confidently used in a wide range of military and industrial applications. They are precision, high density connectors with 0.109" contact centers, meet MIL-C-24308 specifications, and are available in 9, 15, 25, 37 and 50 contact configurations.

The Royal D MARK III incorporates a rear release crimp-on, snap-in contact assembly. A diallyl phthalate insulator provides a hard, closed entry socket for positive contact alignment and high bend resistance. A simple plastic tool permits quick contact removal and replacement without damage to the contact or insulator.

Be confident! Let Cinch supply your Royal D MARK III on fast, dependable delivery schedules. Call your local Cinch Electronics Group Sales Office or write to Cinch Manufacturing Company, 1501 Morse Avenue, Elk Grove Village, Illinois 60007.

IMMEDIATE DELIVERY from stock—can be made through Cinch Electronic distributors.

*Manufactured under license agreement with ITT Cannon Electric, Inc.

C-6912

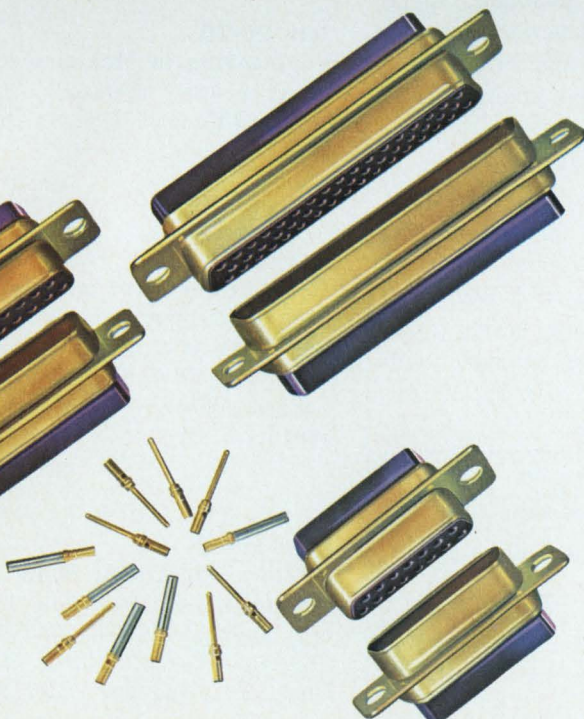

CINCH
ELECTRONICS
GROUP.

CINCH MANUFACTURING, CINCH-GRAPHIK, CINCH-MONADNOCK, CINCH-NULINE AND PLAXIAL DIVISIONS OF UNITED-CARR INC., A SUBSIDIARY OF TRW INC.

CINCH
DIVISION OF UNITED-CARR

Designer's Datebook

JULY 1969						
Sun	Mon	Tue	Wed	Thu	Fri	Sat
		1	2	3	4	5
6	7	8	9	10	11	12
13	14	15	16	17	18	19
20	21	22	23	24	25	26
27	28	29	30	31		

AUGUST 1969						
Sun	Mon	Tue	Wed	Thu	Fri	Sat
					1	2
3	4	5	6	7	8	9
10	11	12	13	14	15	16
17	18	19	20	21	22	23
24	25	26	27	28	29	30
31						

For further information on meetings, use Information Retrieval Card.

June 17-19
Computer Conference (Minneapolis) Sponsor: IEEE, D. L. Epley, Dept. of EE, Univ. of Iowa, Iowa City, Iowa 52240

CIRCLE NO. 401

June 17-19
Electromagnetic Compatibility Symposium (Asbury Park, N.J.) Sponsor: IEEE, C. Joly, Honeywell, Inc., POB 54, Eatontown, New Jersey 07724

CIRCLE NO. 402

July 7-11
Nuclear & Space Radiation Effects Conf. (Philadelphia) Sponsor: IEEE, NASA, et al, E. A. Burke, Air Force Cambridge Research Lab., Hanscom Field, Bedford, Mass. 01730

CIRCLE NO. 403

July 20-25
Engineering in Medicine & Biology (Chicago) Sponsor: IEEE, L. Stark, Univ. of Illinois, Chicago 60612

CIRCLE NO. 404

Aug. 5-7
Joint Automatic Control Conference (Boulder, Colo.) Sponsor: IEEE, G-AC, W. E. Schiesser, Dept. of Chemical Engineering, Lehigh Univ., Bethlehem, Pa. 18015

CIRCLE NO. 405

Aug. 19-22
Western Electronic Show & Convention (Wescon) (San Francisco) Sponsor: IEEE, WEMA, T. Shields, Wescon, 3600 Wilshire Blvd., Los Angeles, Calif. 90005

CIRCLE NO. 406

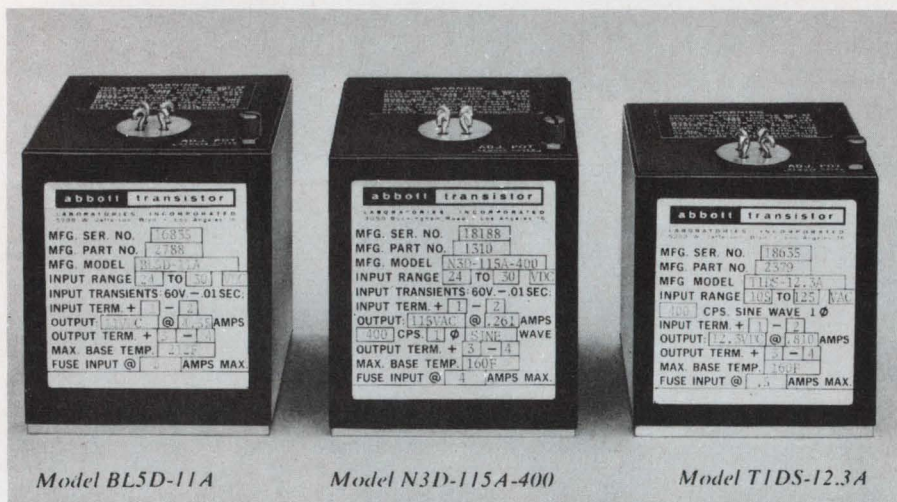

129,379 hrs.
28 VDC to DC (Reg.)

119,617 hrs.
28 VDC to 400 \sim (Reg.)

198,413 hrs.
400 \sim to DC (Reg.)

Now Abbott Predicts— Mean Time Between Failures

Yes! Abbott engineers have calculated the MTBF (mean time between failures) on many of their standard line of power supplies. In accordance with the MIL-HDBK-217 handbook, the failure rates of each of the component parts, transistors, resistors, etc. have been carefully calculated for their worst case operation and then added up and converted into the expected hours that the power supply will satisfactorily operate before a failure will occur. Copies of the results are available to you by phoning or writing Abbott, at the address below, and giving the general type of power supply in which you are interested.

28 VDC to DC (Reg.)

Many of these DC to DC converters are as small as a package of cigarettes and weigh less than a pound. Any output voltage from 5 volts to 10,000 volts is available as a standard model.

These converters feature close regulation, short circuit protection, and are hermetically sealed to meet Mil-Specs.

28 VDC to 400 \sim (Reg.)

This inverter changes 28 VDC to 400 cps and is available in sizes of 5, 10, 20, 30, 60, and 120 volt-amperes, as well as output voltages 115 VAC or 27 VAC. Both single phase and three phase outputs are available. All of these solid state inverters are ruggedly constructed and hermetically sealed to meet severe environments.

400 \sim to DC (Reg.)

These power modules have been designed especially for 400 cps input power and are available with any output voltage desired — from 5 volts to 10,000 volts DC. Well regulated and hermetically sealed, these power supplies are available with power outputs of 5, 10, 20, 30, 60, 120, and 240 watts.

Please write for your FREE copy of this new catalog or see EEM (1968-69 ELECTRONIC ENGINEERS MASTER Directory), Pages 1727 to 1740.

abbott transistor

LABORATORIES, INCORPORATED

5200 W. Jefferson Blvd./ Los Angeles 90016
 (213) WEBster 6-8185 Cable ABTLABS

TO: Abbott Transistor Labs., Inc., Dept. 77
 5200 West Jefferson Blvd.
 Los Angeles, California 90016

Sir:
 Please send me your latest catalog on power supply modules:

NAME _____ DEPT. _____

COMPANY _____

ADDRESS _____

CITY & STATE _____



**FLYING TIME
RECORD HOLDERS**

CINCH-NULINE MIL-C-26500 CONNECTORS

Whatever you need, we can deliver. In MIL-C-26500 connectors, the connector with more hours in the air than any other cylindrical, we can supply any shell style, contact size or insert configuration. This includes G-Type conductive shells and lanyard release assemblies. Our delivery cycle runs about 3 to 6 weeks—less in many situations.

Quality? Our connectors exceed the stringent requirements of the MIL spec for performance and reliability. These Cinch-Nuline round connectors operate continuously at 200° C., take short exposures to 800° C., withstand violent thermal shock and vibration, and resist corrosion, ozone, sand, and dust.

Prices? Strictly competitive. Get a quote from Cinch-Nuline, 1015 South Sixth Street, Minneapolis, Minnesota 55415, or from your Cinch Electronics Group sales office. For small quantities call your Cinch-Nuline distributor for immediate delivery. CN-6970



CINCH-NULINE

DIVISION OF UNITED-CARR



CINCH MANUFACTURING, CINCH-GRAPIK, CINCH-MONADNOCK, CINCH-NULINE AND PLAXIAL DIVISIONS OF UNITED-CARR INC., A SUBSIDIARY OF TRW INC.

Our newest recording star : Honeywell's 5600.

Versatility · price · portability · all the makings of a great performer.

This "Jet-Pack" portable offers full-size 14-channel, 16-track recording capability yet fits easily under the seat of a commercial jet.

And its versatility is in true 7600 tradition: the 5600 converts from tape widths of $\frac{1}{4}$ ", $\frac{1}{2}$ " and 1" on all standard reels up to $10\frac{1}{2}$ " and provides a choice of FM, direct and digital electronics. *Plus* seven electrically switched speeds.

Low-mass, high-performance capstan servo drive delivers a faster response than is



found with other drive systems. And the 5600 may be powered from virtually *any* commercial source as well as two different battery voltages: 12 volts and 28 volts.

These features were previously found only in large recording systems. Now, they can be yours for half the price, starting at \$6,500.

For more information on this "go anywhere, do anything" portable tape recorder, call Bud Corbin (collect) at (303) 771-4700 or write: Mail Station 222, Honeywell, Test Instruments Division, P. O. Box 5227, Denver, Colorado 80217.

Honeywell



Honeywell engineers sell solutions



Automate Your Measurements . . .

. . . with these NEW Tektronix products.



Digital Oscilloscope

The Type 568/230 Digital Oscilloscope System provides digital readout of measurements that are displayed in analog form on the CRT. They enable the engineer, technician or production worker to make dynamic switching-time measurements with greater speed, convenience and repeatability than is possible by making measurements directly from the cathode-ray oscilloscope display. Typical measurements include pulse voltages, risetime, falltime, delay time, storage time, pulse width and many other specific measurements.

With the NEW programmable plug-in units and Sampling Heads, all of the measurement functions of the Type 568/230 can be externally programmed for use in high-speed automated measurement systems. The Type 568/230 can make more than 100 dynamic measurements per second, and data output connectors provide measurement results in convenient BCD code. Programming is easily accomplished with the use of new Tektronix Program Units.

Type 568/230/3T6/3S6/S-1/S-1 \$7875

Automatic Measurements



NEW Type 241

Add the NEW Type 241 Programmer to the Type 568/230 Digital Oscilloscope and obtain up to 15 automatic measurements. The Type 241 will automatically sequence through 15 programs, stopping on out-of-limit measurements. Programs are easy to setup and change, enabling a person having minimum training to program the Type 241.

Type 241 \$2000

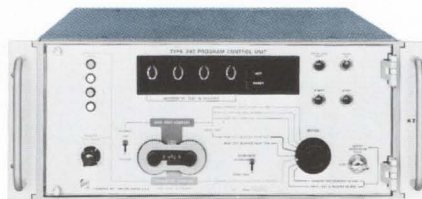

NEW Type 240

The NEW Type 240 Program Control Unit and NEW Disc Memory program the Type 568/230 at speeds up to 100 measurements per second and provide local storage of 1600 independent measurements. Sorting, classifying and diagnostic test routines are also obtained using the Disc Memory. A Punched Tape Reader is used with the Type 240 in low-speed systems, providing a maximum of 6 measurements per second.

Type R240 \$4050
Disc Memory \$6600
Punched Tape Reader \$1250



NEW Type R250

The NEW Type R250 Auxiliary Program Unit adds additional programming capabilities to the Type 240 and provides programming and buffering for pulse generators, power supplies and other equipment. System engineering and design is required with the Type R250. The NEW Type R116 MOD 703L and Type R293 MOD 703M Programmable Pulse Generators are designed specifically for use with the Type R250 in automated systems.

Type R250 \$1550
6 Shift-Register Cards \$ 420
Type R116 MOD 703L \$2800
Type R293 MOD 703M \$1310

U.S. Sales Prices FOB Beaverton, Oregon

TEKTRONIX PRODUCT REPORT—DIGITAL INSTRUMENTS

Making the Measurement Tektronix Measurement Systems

Tektronix Measurement Systems use Tektronix Catalog products and additional equipment such as programmable power supplies, test stations, equipment racks and other equipment. Tektronix does the systems engineering and supplies a digital measurement system ready to do your measurement job. Your requirements to test integrated circuits, transistors, circuit boards and subassemblies can be met with a Tektronix dynamic measurement system.

NEW



Type S-3110 Pulse Testing

The Type S-3110 provides up to 15 measurement programs and eliminates operator interpretation and error when testing pulse generators and other pulse sources. Programmable measurements provide consistent GO, NO-GO readings with the speed and repeatability required for production testing and QC. Measure pulse period, pulse width, risetime, falltime, pulse amplitude, overshoot, DC offset and many other specific pulse parameters. Sampling Heads provide a choice of system measurement capabilities. Select the measurement performance you need today and update your performance with future Sampling Heads.

Type S-3110 \$12,000

NEW

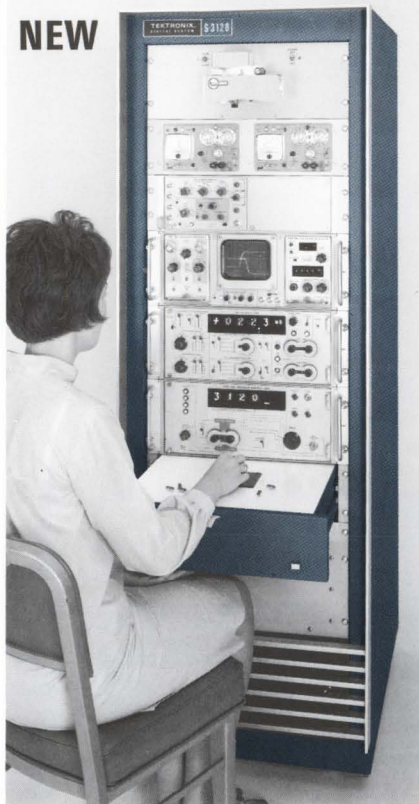

Type S-3120 Switching-Time Measurements

The Type S-3120 is designed to verify the switching-time performance of transistors, diodes and IC's. The Type S-3120 is intended for use where power supply voltages and pulse parameters do not require programming. Program branching with the Type S-3120 permits sorting and classifying of semi-conductors. For example, when making a risetime measurement, a within-limits measurement will continue the normal measurement sequence; an above-limit measurement (slow risetime) can stop the sequence to reject the component; and a below-limit measurement (fast risetime) can branch to a new measurement sequence for reclassifying the transistor.

Type S-3120 \$29,500

NEW



Type S-3130 Integrated Circuit Testing

Tektronix Type S-3130 Digital Measurement System makes 100% dynamic testing feasible for incoming inspection of IC's. Dynamic testing now can check the performance of your IC's under simulated operating conditions at a low cost per unit tested. Measurement speeds of 100 measurements per second with local storage of 1600 independent measurements provides the flexibility and versatility required of a dynamic IC tester. Measurement programs change power supply and pulse generator parameters over a wide range; extra program lines from the Type R250 can be used to switch test point and operating and load conditions.

Type S-3130 \$42,500

U.S. Sales Prices FOB Beaverton, Oregon

For a demonstration, call your local Tektronix field engineer or write: Tektronix, Inc., P. O. Box 500, Beaverton, Oregon 97005.



Tektronix, Inc.

committed to progress in waveform measurement

HAPPENING IN ELECTRONICS

June, 1969

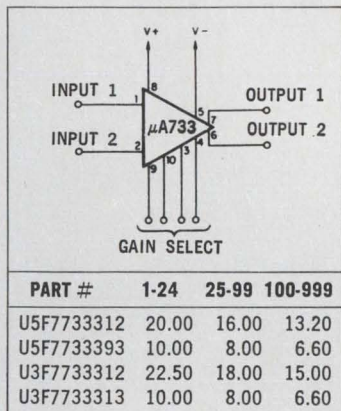

Fairchild's Diff Amp marches to a different tune

Fairchild's μ A733 is a Wideband Differential Video Amplifier with a difference. What's different about this device? **GAIN:** You get selectable fixed gains of 10, 100, or 400 without external components, and adjustable gains of the same magnitude by using a single external resistor. As for frequency compensation, none is needed externally for any gain option, and excellent gain stability is achieved with internal series feedback circuitry. So much for gain. **BANDWIDTH:** You get bandwidth of breakthrough proportions. Typical closed loop gains are 10 at 120 MHz; 100 at 90 MHz; and 400 at 40 MHz. All bandwidths —3 dB. Shunt feedback is used to obtain wide bandwidth and low phase distortion. **AREAS OF APPLICATION:** These include bulk computer memory systems, very high speed random access computer memory systems, communication systems, nuclear event instrumentation, frequency counters, and other video and high speed pulse systems. And most important news of all: they are shipped from Schweber stock. Circle No. 241.

Hybrid designs can now be internally regulated

Unencapsulated zener diode chips have been selling on special order so well that Motorola has standardized the line and made the chips available from Schweber stock in order to better serve the customer. They are used primarily in hybrid circuits where packaged components are too large. The standard type designation is MZC and the nominal zener voltages range from 2.4 to 200 v for Series A and 1.8 to 200 v for Series B chips. Series A are electrically equivalent to the 1N5221 family and Series B to the 1N4099 and 1N4614 families. Both series are available in tolerances of ± 5 and $\pm 10\%$. All chips feature a silicon dioxide-passivated junction and a gold-coated back to facilitate thin or thick film assembly operations. Special plastic chip carriers have been developed to minimize damage in handling and storage. The clear polystyrene cover also allows the customer to inspect the chips under a microscope. Data sheets available. Stocked at Schweber. Circle No. 242.

New Coaxial Connector uses beryllium copper as shell material

Kings Electronics has come up with a miniature RF connector using beryllium copper as the shell material for the first time. Stainless steel will also be available. Designated SMA, this series will feature threaded coupling and crimp-styled assembly to eliminate vibration and noise, thus providing greater stability, particularly at microwave frequencies. A proposed detail specification is being added to Mil-C-39012. Frequency range 0 to 12.4 GHz.; voltage rating 500 vRMS Crimp construction design utilizes the unique 3-piece configuration of the K-grip Jr[®] which can be assembled in one fifth the time required for conventional types. The SMA series offers you a choice of shell material, a choice of flexible or semi-rigid cable, a choice of regular or weatherproof types. Order from Schweber stock. Circle No. 243.

D Subminiature Connectors now covered by mil spec

ITT Cannon's well-known rectangular Model D connector is the subject of a new military specification Mil-C-24308 (Navy). The specification covers the five standard shell sizes and power contact arrangements 9, 15, 25, 37, and 50 in the MK I and MK III series and includes a choice of non-magnetic shell material. The contact material for both types is gold over copper; the MK I contact class uses non-removable solder type and the MK III uses crimp snap-in contacts. The insulator material for both series is the same flame resistant glass-filled diallyl phthalate used in the standard MK III. Hermetic sealing is available in all the same contact layouts, but not in the same contact material. Hermetic contacts are made of steel, plated with tin over cadmium over copper flash. In stock at Schweber. Circle No. 244.

Review of new catalogs: RCA Quick-Reference Thyristor Guide

This is a useful 12-page guide to the selection of RCA Diacs, Triacs, and SCRs. Also included is a cross-reference directory listing popular industry types and their nearest RCA equivalents made on the basis of electrical similarity. There are two pages of terms, symbols, and their definitions in back of the catalog. Take note of the list of application literature for RCA thyristors on the last page. Any of these that are of interest to you can be obtained by writing to Schweber's Information Center. Circle No. 245.

Thyristor power circuits using bilateral triggers

An application note prepared by Motorola's Applications Engineering section describes the design of simple control circuits using different kinds of thyristors. Applications such as incandescent-lamp dimming, control of universal and shaded-pole motors, and control of DC output are covered. The triggering circuits have been modified to use a bilateral trigger device rather than the more complex unijunction transistor. Circle No. 246.





Sprague Semiconductor Chips and Packages. Illustration: 3 wafers, 8 packages, many chips

Semiconductor chips. Packages. One source. Sprague.

Every device in the Sprague Semiconductor line is available in chip form. Transistors. Integrated circuits. Even precision nickel-chromium resistor networks. Just about everything you need to build your own hybrids.

And from the Hermetic Seal Department, flatpacks to put them in. From $\frac{1}{4}$ " x $\frac{1}{4}$ " to 1 inch square. From

6 leads to 40. Standard and ready for off-the-shelf delivery. Your custom package design can be made to order, too.

Make Sprague your one source when you're making your own hybrids. If you're going to put down our chips, put them in our packages.

Call Sprague Info-Central (603) 224-1961 extension 255

Get data on Sprague's chips and packages. Write to: Semiconductor Division, Sprague Electric Co., Pembroke Road, Concord, N.H. 03301.

Or circle the reader service number below.



News

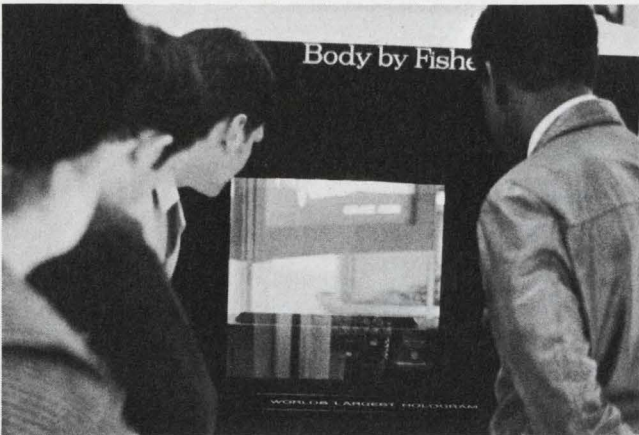

The world's largest hologram draws viewers at GM headquarters in New York. p. 43.

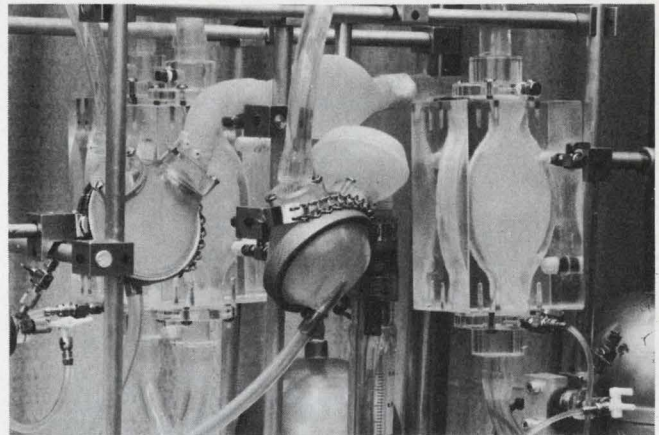

Artificial heart design—it's more complex than space electronics. p. 34.



Crowds flocked to the spring meeting of the American Physical Society in Washington to

hear top scientists debate the merits of ABM—and some to protest. p. 25.

Also in this section:

Wanted: Better materials for MICs. Designers also seek lower cost. p. 30

Wide-angle antenna uses circular polarization. p. 28

News Scope, p. 21 . . . Washington Report, p. 39 . . . Editorial, p. 69

Something *New* Has Been Added!

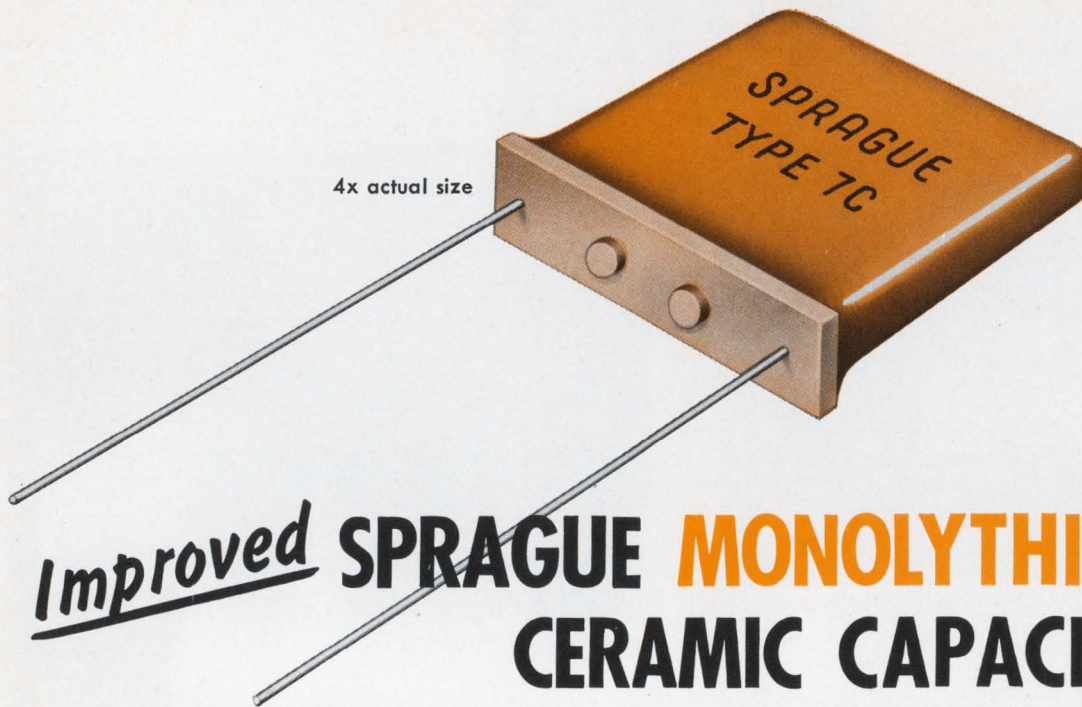

Improved SPRAGUE MONOLYTHIC[®] CERAMIC CAPACITORS

now have a phenolic terminal base

Type 7C Radial-lead Capacitors are made with alternate layers of sprayed ceramic dielectric material and screened metallic electrodes, fired into a solid homogeneous block and coated with a tough phenolic resin. Their new bossed terminal base construction provides these advantages: (1) No resin run-down on leads. (2) Uniform lead spacing is automatically maintained. (3) No dirt and moisture entrapment; degreasing fluid flows freely between capacitor and board.

Body Code	EIA Characteristic	Operating Temperature Range	Maximum Cap. Change over Temp. Range	WVDC	Capacitance Range	Capacitance Tolerance
082	NPO	-55 C to +125 C	±60ppm/°C	50 100 200	51 pF to .024 μF	±20% ±10% ±5% ±2%
075	N750	+25 C to +85 C	-750 ±120 ppm/°C	50 100 200	.001 μF to .082 μF	±20% ±10% ±5% ±2%
		-55 C to +125 C	Meets MIL-C-20 Char. UJ			
067	X7R	-55 C to +125 C	±15%	50 100	.0018 μF to 1.5 μF	±20% ±10%
023	Z5U	+10 C to +85 C	+22%, -56%	50	.01 μF to 3.3 μF	+80, -20% ±20%



Also made with axial leads, Monolythic[®] Ceramic Capacitors are available in four body formulations, including a newly-developed 075 ceramic material, as described in the adjacent chart.

For complete technical data write for engineering bulletins on Monolythic Ceramic Capacitors to: Technical Literature Service, Sprague Electric Co., 347 Marshall St., North Adams, Mass. 01247.

SPRAGUE COMPONENTS

CAPACITORS
TRANSISTORS
RESISTORS
INTEGRATED CIRCUITS
THIN-FILM MICROCIRCUITS

PULSE TRANSFORMERS
INTERFERENCE FILTERS
PULSE-FORMING NETWORKS
TOROIDAL INDUCTORS
ELECTRIC WAVE FILTERS

CERAMIC-BASE PRINTED NETWORKS
PACKAGED COMPONENT ASSEMBLIES
BOBBIN and TAPE WOUND MAGNETIC CORES
SILICON RECTIFIER GATE CONTROLS
FUNCTIONAL DIGITAL CIRCUITS



[®]'Sprague' and '®' are registered trademarks of the Sprague Electric Co.

INFORMATION RETRIEVAL NUMBER 16

Insulator-to-conductor discovery reported

For years, a sprinkling of scientists in this country and abroad have researched the provocative phenomenon whereby an insulator can be changed into a conductor when an electric field is applied. This month Dr. Daniel C. Mattis of Yeshiva University reported new findings in this area of physics. He called his discovery "polyconductivity."

A large group of metal oxides and some organic materials, Mattis noted, can be switched electrically in microseconds from insulators to conductors. Moreover, the Yeshiva physicist reported, a mathematical model that he has formulated explains not only polyconductivity but also what happens in general when insulators are transformed into conductors and vice versa.

Mattis told ELECTRONIC DESIGN this kind of switching is not an isolated phenomenon but a principle of matter that is found in many materials.

Earlier researchers in this field, pioneered by Sir Nevill Mott of Cavendish Laboratories, Cambridge University, include A. D. Pearson of Bell Telephone Laboratories, Murray Hill, N.J.; Stanford Ovshinsky of Energy Conversion Devices, Troy, Mich., and a number of other American and Russian physicists.

Who discovered what first is in dispute, and the researchers do not agree on whether the change from insulator to conductor is caused electrically or thermally or what materials produce the effect. But Ovshinsky, who has worked mainly with semiconducting glasses, predicts this process will revolutionize electronics.

Mattis and a colleague, Dr. Max Lipsicas, chairman of the Chemistry Department at Yeshiva's Graduate School of Science, have built a 10-MHz oscillator using

polyconductive iron oxide at low temperatures.

Mattis cites a number of potential applications for polyconductors:

- "Shutters" for lasers that can operate at 10 MHz. Because the change from insulating to conducting state means that the material goes from opaque to reflective, laser mirrors made of polyconductors could modulate signals either within a laser cavity or as they pass through a mirror.

- Acoustic switches. A change in conductive state is accompanied by a change in the crystal lattice of the material, which in turn would produce acoustic signals.

- Optical switches, particularly for memories where a strong light releases electrons to change the conductivity of the switch.

- Space hardware, because polyconductors will operate, according to Mattis, at liquid helium temperatures (-452 degrees F), whereas transistors operate best at from about 30 to 200 degrees F.

- Amplifiers and oscillators with a frequency band significantly above that of transistors, which cut off at about 3 GHz.

Mattis has published his findings in the May 5 issue of Physical Review Letters.

Problems in insulator-conductor transitions were discussed last week in New York City at the Semiconductor Effects in Amorphous Solids Symposium, sponsored by the Picatinny Arsenal and the Army Research Office.

A national computer network called feasible

Major computer networks in the United States would be tied together much as the nation's telephone system is today under a pro-

posal put forth last week by the Stanford Research Institute.

The institute, which studied the feasibility of such a setup for the Federal Communications Commission, envisions the use of existing data channels, such as microwave links and coaxial cables, in addition to the future channels to be provided by communications satellites.

The advantages? According to Leonard H. Marks, former chairman of the U.S. delegation to the International Telecommunications Satellite Consortium, "Doctors in remote towns and villages should be able to immediately tap the resources of our great medical libraries."

Dr. Donald A. Dunn, Senior Systems Analyst at the Stanford Research Institute in Menlo Park, Calif., foresees a "checkless society, wider instant reservation services and remote meter reading," among other possibilities.

Dr. Dunn believes that the greatest impact on the electronics industry would be that many private companies would join such a network under new FCC rules and that there would be new markets for electronic products.

IC transmission line said to top microstrip

A new type of integrated-circuit transmission line, with all conducting elements on the same side of a dielectric substrate, was described at the recent IEEE International Microwave Symposium in Dallas. Called coplanar waveguide by its designer, Cheng P. Wen of RCA Laboratories, Princeton, N.J., the new line consists of a center strip and two parallel adjacent ground strips.

The coplanar configuration is

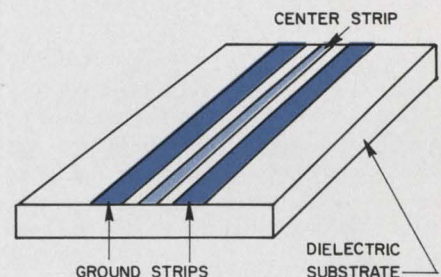

Coplanar waveguide has all conductors on one side of substrate.

News Scope

CONTINUED

ideal for connecting shunt devices into a circuit; it does not require the drilling of a hole in the substrate, as in the case of microstrip.

More important, perhaps, the waves propagating along a coplanar waveguide have the elliptically polarized magnetic fields that are needed to make such nonreciprocal gyromagnetic devices as resonant isolators and differential phase shifters. In microstrip, the elliptical polarization must be created artificially with such devices as meander lines.

Laser to help explore earth-moon riddles

Can earthquakes be predicted? What is the mass distribution of the moon? How much continental drift is there on earth?

Answers to questions like these may emerge when the astronauts of Apollo 11 place an experimental package on the lunar surface in July. The experiment will provide point-to-point ranging by laser between the earth and the moon with an accuracy of six inches.

According to Dr. Carroll Alley of the University of Maryland, designer of the experiment, an array of a hundred corner reflectors will be set up on the moon several feet away from the Lunar Module. A 10⁹-watt pulsed laser will then be focused on the array through the 107-inch telescope in the McDonald Observatory, University of Texas. Measurements will be made of the time that the laser pulse requires to go to the moon and back. Atomic clocks will be used to measure the time precisely.

A significant area of investigation is that of Chandler Wobble and its relation to earthquakes. Chandler Wobble is the periodic variation of the direction of the earth's axis with regard to the magnetic poles. Several physicists have found a correlation between Chandler Wobble and the occurrence of earthquakes. Recent studies have suggested that significant changes in the polar motion

take place at the times of major earthquakes.

Two pulsed ruby lasers have been built for the experiments—by Korad of Santa Monica, Calif., and Spacerays, Inc., Burlington, Mass.

TV market swinging to solid-state designs

This is the big year for a start on pushing vacuum tubes out of the TV market, according to Howard Bonner, director of the Application Group at Texas Instruments, Dallas.

Last year, he notes, only 5 per cent of the circuitry in the nearly 11 million TV sets made in this country used transistors. By 1971, he predicts, that percentage will reach 70. Price is the big factor, Bonner says—transistor costs "have dropped so far below those of vacuum tubes that the wholesale redesign of TV circuitry is now justified."

Motorola has come out with a fully transistorized TV set. All components except the picture tube have been replaced with transistors—even the high-voltage rectifier (which is still the size of a vacuum tube.) But generally, so far as solid-state circuits in TV sets are concerned, American industry lags far behind the Japanese competition. And Japanese imports constitute more than 15 per cent of the total TV market in the U.S.

All TV imports use transistors to a great extent. Among the reasons:

- TV sets shipped across an ocean and a continent must work in order to sell. Transistors provide reliability.

- Most Japanese manufacturers have virtually no service organizations in the U.S. Long-term reliability eliminates the need for service.

Component firms urged to expand markets

The U.S. components industry is in a worldwide fight for markets and joint action is needed to overcome discriminatory international trade practices, the president of Sprague Electric Co. has warned.

Addressing the recent Electronic Components Conference in Washington, Bruce Carlson, head of the North Adams, Mass., company, noted that markets for electronics abroad are now nearly equal in size to the U.S. market and are growing about twice as fast. He urged the components industry to abandon the "parochial view" of its markets.

"We have allowed other governments to discriminate against the importation of U.S. components," he asserted, "while at the same time our own government has been following tariff and trade policies that have encouraged the importation of foreign components to the detriment of the U.S. manufacturer."

"The result has been that while our imports of components were increasing 39 per cent a year between 1964 and 1968, our components exports increased only 20 per cent per year."

The Sprague president suggested three things components manufacturers should do to expand their export opportunities:

1. Continue to oppose U.S. and foreign government policies that place American manufacturers at a competitive disadvantage.

2. Stop exporting U.S. technology for a "fraction of its real worth."

3. Establish facilities in other countries "where manufacturing costs will permit us to compete not only for component sales in foreign markets, but with the importation of foreign components into our markets here at home."

Computer to help run World Trade Center

The twin 110-story towers of the World Trade Center, now under construction in New York City, will rely on a \$7-million computer control center to monitor and control the buildings' mechanical and electrical systems.

The Honeywell DDP-516* system will analyze data from thousands of checkpoints in the 10-million-square-foot trade center. Systems to be controlled include 200 air-handling units and what are said to be the seven largest refrigerating machines in the world.

Wirewound

Because...



... **Because** the noise in wirewound potentiometers is low—typically 10 ohms ENR in *all* resistance ranges!

... **Because** with temperature coefficient of 50 ppm/°C or less you get exceptional stability!

... **Because** if it's power you need, wirewounds score again and surpass other elements!

... **Because** there's over 20 years of field experience with wirewounds so their reliability can be statistically verified!

... **Because** there's off-the-shelf delivery. We at Bourns stock 500,000 units at the factory while our 63 distributors stock 1,500,000 pieces. Remember . . . whether from factory or distributor stocks *you get the potentiometers you need . . . when you need them* by specifying Bourns wirewound potentiometers—the best in the industry!



winning form



from the
form-factor
specialists
at Damon

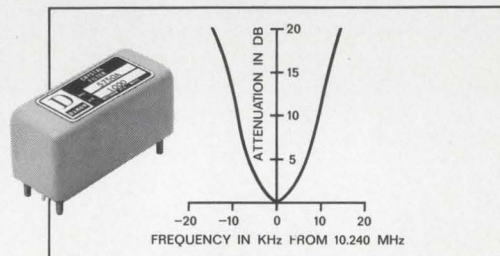

If flat time delay is a requirement in your FM communications or radar system, specify the **Damon line of Gaussian Crystal Filters**. For example, in a coherent pulsed radar system, the Damon Model 5750A can minimize return-pulse overshoot. And its well-behaved impulse response can reduce ringing in frequency scanning applications. In an FM application, the versatile 5750A provides 4-pole selectivity with a linear phase characteristic to eliminate delay distortion.

Model 5750A Specifications: Center frequency (f_0): 10.240 MHz \pm .005%. Bandwidth at 3 db: 10 KHz nominal. Selectivity: 4-pole Gaussian approximation. Pulse response: ringing at least 25 db below main response, with input pulse of 100 microseconds at nominal f_0 . Source and load impedance: 95 ohms. Insertion loss: 3 db max. Operating temperature: 0° to +55° C.

Whatever your signal-shaping needs . . . from a uniformly rounded Gaussian curve to a sharp rejection notch . . . rely on the form-factor specialists at Damon. Write: Electronics Division, Damon Engineering, Inc., 115 Fourth Ave., Needham, Mass. 02194, or call (617) 449-0800.

 **DAMON**

Scientists choose sides in ABM debate

Physical Society analyzes the need for Safeguard and system's vulnerability at an explosive meeting

Charles D. LaFond, Chief
Washington News Bureau

It was the annual spring meeting of the American Physical Society in Washington, and it was a session like none ever held before by the society. The Sheraton Hall of the old Sheraton Park Hotel was jammed to the rafters, with an overflow crowd of 3500 spilling into the hall's long double stairway and large foyer. They came to hear some of the nation's top scientists debate ABM—the merits and demerits of the Safeguard antiballistic missile system.

Speaking for deployment were Dr. Eugene P. Wigner, professor of physics at Princeton University, and Dr. Donald G. Brennan, senior staff scientist at the Hudson Institute. In firm opposition were Dr. Hans A. Bethe, professor of physics at Cornell University, and Dr. George W. Rathjens, professor of political science at the Massachusetts Institute of Technology.

The debate, which many felt resulted in a near draw on the technical arguments, drew noisy response from the audience, composed not only of staid scientists and Washington politicians but also long-haired college students and miniskirted coeds. When it was over, the major arguments boiled down to these:

PRO

- Because it employs massive launching vehicles and heavier nuclear warheads than the U.S., the Soviet Union's missile program is now ahead in destructive capability. It can deliver 5000 megatons, compared with less than 2000 megatons by the U.S. It's essential that we defend our second-strike capability.

- Safeguard, as presently conceived, is really an "extended experiment." Ample opportunities will be afforded to refine and im-

prove the system as it is developed. The system that is deployed will function reliably and as intended.

- The Soviet is developing and deploying an ABM system, and we must match this technical advance. In any future negotiations to reduce nuclear arms, we must have something to bargain with.

CON

- Safeguard is a meaningless defense, because it could easily be foiled. The heart of the system, as presently conceived, is one tracking radar at each missile site to be defended. This radar could be knocked out, thus neutralizing the defense.

- The U.S. nuclear missile strength is overwhelming. It could not possibly be wiped out completely in any first strike by Soviet offensive missiles. The surviving missiles could inflict unacceptable losses on the Russians; so they aren't about to start a nuclear war.

- The Safeguard concept is a good one, and R&D should be continued. But deployment isn't necessary now.

Soviet threat cited

Dr. Wigner, a civil-defense theoretician, centered his arguments on what he believes are two Soviet policies: (1) The Russians are steadily increasing their ICBM offensive capability, with emphasis on high-megatonnage delivery and multiple warheads, and (2) They are developing a significant military and civil defense capability, and thus would not consider an equally strong U.S. defensive posture as a threat.

Wigner presented some startling comparisons of U.S. and Soviet offensive strength, based heavily on British intelligence data. It was he who estimated that the Russian

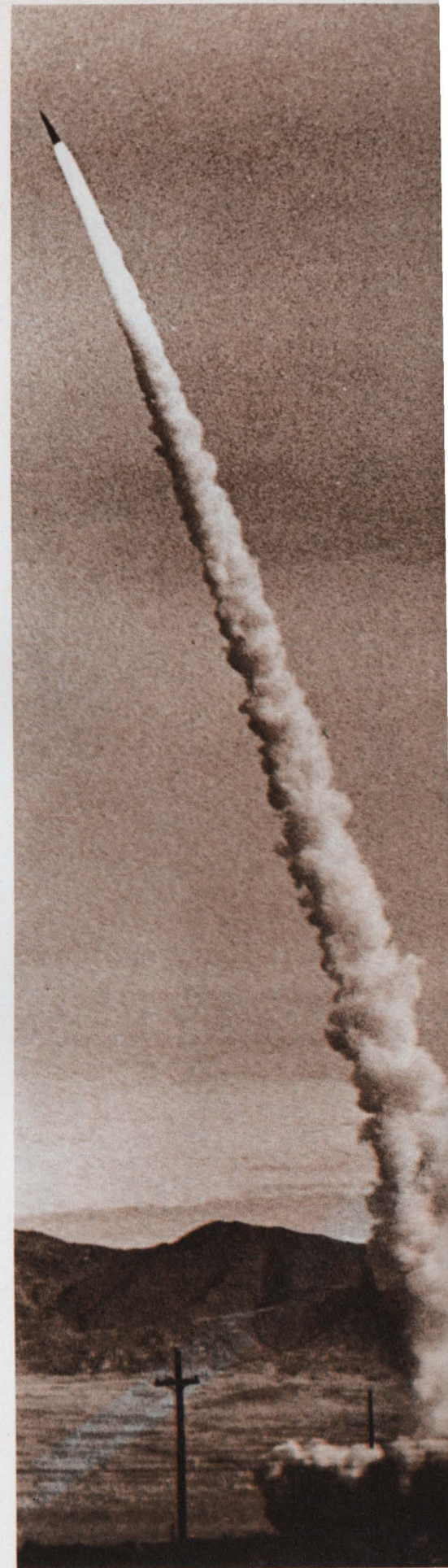

A Sprint ABM missile leaves the pad.

nuclear delivery capability exceeds 5000 megatons, against less than 2000 megatons for the U.S. The U.S., he agreed, has a larger number of deliverable warheads but the Soviet, with its heavier warheads, can destroy more.

"More important," he continued, "while the U.S. missile launcher level has remained constant for the last two and a half years, the USSR has steadily increased its missile deployment."

Because of higher deliverable megatonnage, Wigner estimates one Soviet warhead could destroy three Minuteman missiles in hardened silos.

He also asserted that the Soviet has a viable civil defense program that is steadily being improved.

Because of this combined offensive-defensive capability, Dr. Wigner declared without reservation: "Russian strength is now superior to that in the U.S."

In addition to its civil defense efforts, Wigner noted, the Soviet has developed and is deploying an ABM system. A similar system deployed by the U.S. "cannot be considered provocative if it is designed to save lives," he argued.

ABM vulnerability stressed

Dr. Bethe, for 12 years a consultant to the Pentagon on advanced strategic warhead penetration aids and techniques, emphasized that Safeguard's vulnerability rests primarily with its radar systems. He emphasized that the Spartan long-range interceptor is designed for detonation in space at some 400 miles in range and that it destroys incoming missiles through massive X-radiation which causes possible structural damage to the warhead re-entry shield. The short-range Sprint kill potential, Bethe said, is essentially neutron bombardment, which either melts or evaporates fissionable warhead material.

"It is my conclusion that any ABM defense system is doomed to failure—any can be overcome by existing offensive systems," Bethe asserted. "It is impossible to win this arms race if you attempt to save a significant portion of the

population. The offense can overcome at an expenditure of one-quarter the defensive expenditure."

He then described standard techniques that the Russians could be expected to employ to either confuse or jam the vital Safeguard perimeter acquisition radars and missile site radars.

Tank fragments from the booster following the warhead trajectory, he said, would present multiple targets to ground radars. The use of balloons with radar reflective surfaces might also be used, as well as smaller ejected decoys.

Chaff is also extremely effective in space, Bethe said, although sophisticated techniques are required. He gave this illustration: "One hundred million pieces of one-mil copper wire can be contained in a 200-kilogram package, and when deployed along the warhead trajectory, they would spread out over a broad path hundreds of kilometers long."

Moreover, Bethe stressed that the two most effective penetration techniques involve the use of either multiple warheads from a single vehicle or a high-altitude nuclear burst causing total radar blackout.

The U.S., he estimated, is well ahead of the Soviet Union in development of multiple independently-targeted re-entry vehicles. The Russians are just beginning testing of such systems, probably in their SS-9 weapons. But, he declared, accurately directed multiple warheads would both confuse and saturate planned U.S. phased-array defensive radars.

An 'extended experiment'

But Dr. Brennan, who took part in the early development of phased-array antennas and has for years been an adviser to the military on weapons strategy and techniques, expressed confidence that Safeguard would be a success.

"I believe we need a shift from deterrence to defense," he said.

The first deployment phase of Safeguard is essentially an "extended experiment," Brennan said. Further work would continue on future system expansion.

Brennan took sharp issue with those who say that, at best, ABM deployment would cost too many

billions to reduce casualties only to the 20 per cent level.

"This is what I call focusing your eye on the hole and not on the doughnut," he said. The real gain, as he saw it, is that Safeguard could "save 60 million lives."

Brennan also drew a frightening possibility that might be avoided with even a limited ABM system. He called attention to the U.S. response during the Cuban missile crisis. At the height of that confrontation, he recalled, the U.S. Government warned the Soviet that this country would regard a missile launching on the U.S. by Cuba as an act of war precipitated by Russia and would respond with massive nuclear retaliation on the Soviet Union.

What, Brennan asked, if at that time a smaller power had launched a missile against the U.S. from a submarine in the vicinity of Cuba? This is a possibility in the future, he argued—possibly by a Red Chinese craft firing from the polar region into the U.S.

An ABM system, he indicated might prevent a nuclear world war.

Catastrophic failure feared

Dr. Rathjens countered that the funds to deploy Safeguard "might be better spent elsewhere."

A former Chief Scientist and then director of the Pentagon's Advanced Research Projects Agency, Rathjens contended that no ABM system presently contemplated can prevent damage, and whatever system is deployed might fail catastrophically when needed. Like Bethe, he cited the vulnerability of the Safeguard radar setup. The system would employ only one radar at each defensive site, he noted, and while the hardened Minuteman silos might readily withstand a near hit, the missile site radar would be more easily destroyed.

With the large Minuteman and Polaris-Poseidon missile force now—or soon to be—deployed, Rathjens said, if only 2 to 5 per cent survive a first strike, "that would be enough to inflict unacceptable damage on the USSR."

The American Physical Society meeting ran from April 28 to May 1. ■■

Three unprintable words:

The three words are — brace yourself —
1) Military, 2) Standard, and 3) 883.

Or so it seems, because almost everyone
who makes integrated circuits is up in arms
over MIL-STD-883.

Except us. Signetics.

We're geared up for it; we understand it;
we can supply to it.

Matter of fact, our S.U.R.E. program

(Systematic Uniformity and Reliability Eval-
uation) uses pretty much the same hard-nosed
testing philosophy. And has for five full years.

So: if you want 883, we're one company
that can deliver. Cheerfully.

And what our competition says about that
is unprintable too.

P.S. Want a comprehensive package on
883? We'll rush a free copy — in plain envelope.

Signetics

Signetics Corporation/811 E. Arques Ave., Sunnyvale, Calif. 94086/A subsidiary of Corning Glass Works

INFORMATION RETRIEVAL NUMBER 19

Wide-angle antenna uses circular polarization

Ordinarily extremely wide-angle antennas call for vertical polarization. But engineers in the nation's Nimbus weather-data program have swung to circular polarization—and for good reason.

The antenna, built by Radiation, Inc., Melbourne, Fla., will be suspended from a balloon and floated around the world at about 80,000 feet, gathering data in the atmosphere. The antenna must allow constant, line-of-sight communications between the balloon and the satellite regardless of the orientation of the satellite.

The system will become operational with the launching of the Nimbus D satellite in early 1970.

By employing circular polarization, the antenna was made insensitive to random orientation of

the satellite antenna and also to Faraday rotation of the electric field through the atmosphere.

Nearly constant communications are achieved with an omnidirectional bifolium antenna pattern. According to Edmund Case, Senior Engineer at Radiation, "We are concentrating the gain of the antenna at low elevation angles in order to insure constant communications from zenith to horizon."

Minimum weight was another requirement for the balloon-borne package. With lightweight but strong materials, the weight was held to 0.7 pound. In effect, the design is that of a Turnstile antenna, with two crossed horizontal dipoles and a four-element vertical array. The elements are made of

glass epoxy tubing, each plated with 2-mil thick copper and painted with enamel to prevent tarnishing. A 46-inch round reflective—or ground—plane, made of a vacuum deposit of aluminum over Mylar and topped by a wire mesh, serves as a reflective surface.

The transmitter puts out about 6 watts of power. Up-link transmissions from the balloon antenna to the orbiting satellite are at 466.0 MHz; the down-link frequency is 401.5 MHz.

A Mylar balloon is being used because it is transparent to electromagnetic radiation and transmitted and received signals pass freely through it.

The program is supported by the NASA Goddard Space Flight Center, Greenbelt, Md. ■■

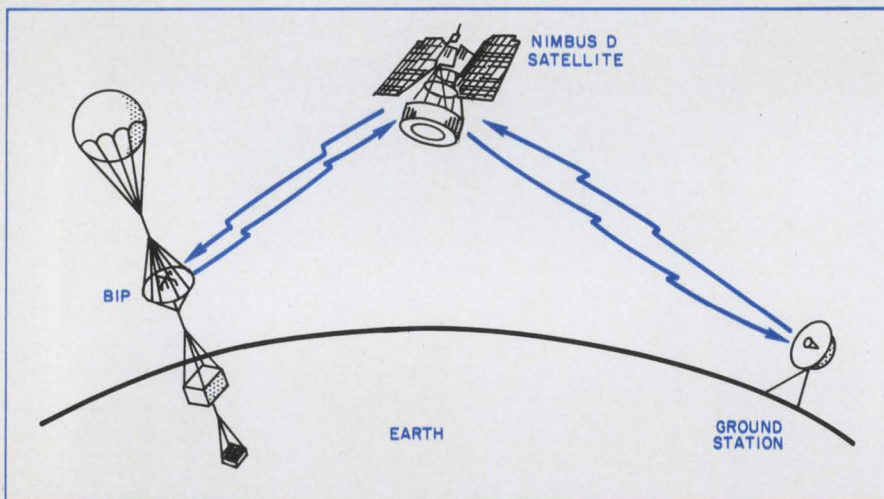

NASA's 1970 weather-data system: A balloon-interrogation package (BIP) will circle the globe gathering atmospheric data at about 80,000 feet. Nimbus D will interrogate the BIP and store the data for later release to computers at ground stations in Fairbanks, Alaska, and Greenbelt, Md. The BIP package weighs just 0.7 pound.

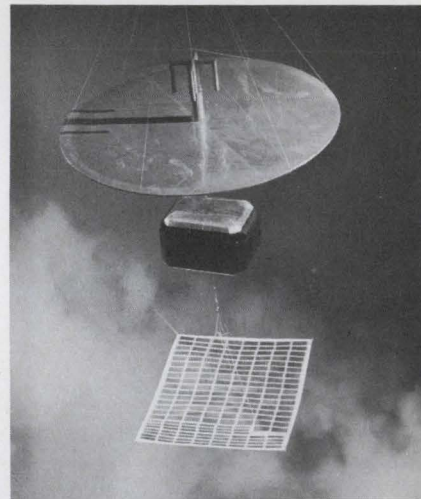

Turnstile antenna and its circular reflector hang from a balloon in NASA's new weather-data system. Below the reflector is an electronics package and a solar-cell panel.

Infrared camera spots offshore oil leaks

An infrared camera to detect oil leaks from offshore drilling operations has been developed by the University of Michigan. Since oil is cooler than water, a contrast image is obtained by the heat-seeking sensor. The system, according to project director Prof. Donald Lowe, takes picture images in 18

different wavelengths from the ultraviolet through the blue, green, yellow, red and thermal infrared spectra. It detects thin slicks of oil from water better than normal photographic techniques, and it is effective at night as well as during the day.

After tests of all 18 channels,

it was found in a recent experiment over the huge slick near Santa Barbara, Calif., that the thermal wavelength was the most revealing. Images were formed in some of the other wavelengths, but they dropped off drastically in the green and yellow wavelengths, Lowe said. ■■

**The industry's tiniest 5 watt zener...
has double
the
surge capacity
of an
ordinary
10 watt...**

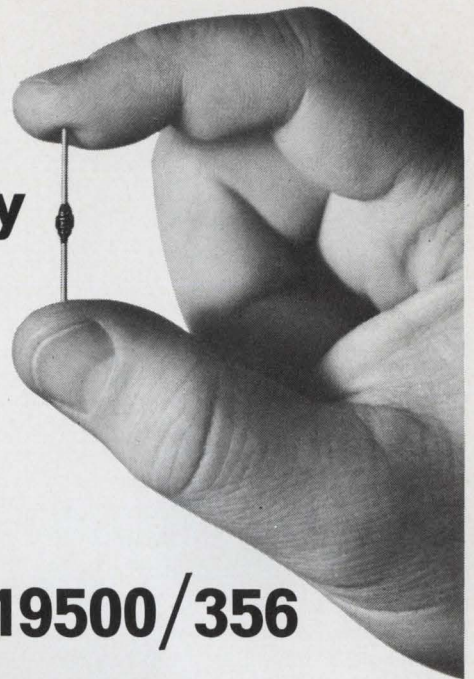
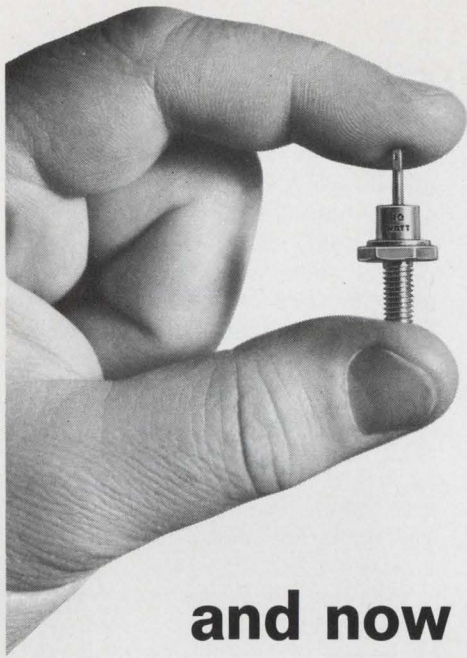

and now meets MIL-S-19500/356

**Unitrode's tough JAN Type 1N4954 Series
has fused-in-glass reliability,
voltage ratings from 6.8 to 400V,
and is available from stock**

- Surge capacities to 10,000 watts — 1 microsecond
- Surge current capability up to 40 Amps
- Sharp knees, voidless glass construction
- Price competitive to conventional 10 watt zeners
- Solves MIL-STD 704 surge problems
- No plastics, epoxies, silicones, oxides, gases or solders are used.
- ... and TX soon to come

580 Pleasant Street, Watertown, Mass. 02172 (617) 926-0404

UNITRODE

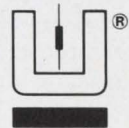

**TOUGH AS ALL GET-OUT
FROM THE INSIDE OUT**

With the silicon die metallurgically bonded between terminal pins of the same thermal coefficient, the hard glass sleeve is fused to the entire outer silicon surface.

Result — a voidless, monolithic structure.

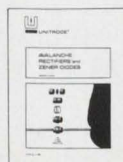

For fast action call Fred Swymer COLLECT at (617) 926-0404
Or if you're not in that big a hurry, check off the reply card
and get our new complete diode catalog C-107.

INFORMATION RETRIEVAL NUMBER 20

Wanted: better materials for MICs

The wants of designers of microwave integrated circuits (MIC) are specific—and hard to satisfy. They are asking for substrate materials with perfectly flat and smooth surfaces, high density, good dimensional stability, uniform dielectric constant, and infinite thermal conductivity. They'd also appreciate it if the cost could be kept down to a few pennies per wafer.

These sentiments were expressed by Donald H. Temme of the MIT Lincoln Laboratory, Lexington, Mass., during an audience-participation panel session at the Electronic Components Conference held earlier this month in Washington. The panel session was organized by Dr. Harold Sobol, manager of microwave microcircuits, RCA Electronic Components, Somerville, N.J.

Since no known material can give the engineers exactly what they want, they are constantly searching for optimum trade-offs between competing materials to find the best one for each job. In addition, they are also combining materials in an effort to obtain a system that contains the best properties of each material.

Why these requirements?

- Flat parallel surfaces are needed because the impedance of a microstrip transmission line is a strong function of the thickness of the substrate material. (See "Parley analyzes 3 paths to world of MICs," ED 23, Nov. 7, 1968, pp. 25-30). Since variations in line impedance lead to excessive SWRs, surface flatness is essential.

- The smoothness of a microstrip surface directly affects the lossiness of the transmission lines deposited on it. Smooth surfaces are essential to low loss.

- High-density materials are needed to prevent water absorption and thus make the materials more tolerant of changes in the ambient humidity.

- Since the electrical properties

of microwave circuitry are largely determined by the geometry of the conductors, it is clear that a rigid, dimensionally stable substrate material is essential to reliable, repeatable performance.

- By a "uniform" dielectric constant, MIC engineers mean that the dielectric constant should not vary with frequency. If it does, the velocity of propagation of the waves will depend upon their frequency, and dispersive distortion will result.

- High thermal conductivity is needed for cooling in high-power applications. If a Gunn or Impatt diode is incorporated into an MIC as a power source, the substrate

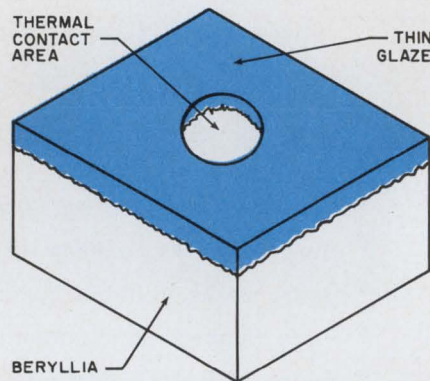

Good surface finish and high thermal conductivity are achieved by coating beryllia with a thin glaze. The glass is selectively removed where a good thermal bond is required.

material will have to provide the thermal path for carrying away the heat that the device generates.

Cost factor is most important

The desire for low cost is universal. Is cost, then, particularly significant in regard to MIC substrates? The answer is a resounding "yes."

As Temme and others at the session pointed out, the main motivation behind all of the development work on MICs is not miniaturization or performance enhancement—although these are important—it is cost reduction.

MICs can lower the cost of microwave equipment because they are produced by the same photolithographic mass-production techniques that are used to make ordinary transistors and ICs. This type of manufacturing is very cheap. In fact, as Temme noted, the cost of the printed circuitry is often much less than the cost of the substrate.

Besides asking ceramists for better materials, what are MIC makers doing about the substrate situation?

For one thing, they are combining materials for improved performance. There aren't too many thermally conducting ceramics around, and when high thermal conductivity is needed, beryllia (BeO) is usually first choice. Unfortunately, beryllia cannot be polished down to the smoothness required for most MIC work.

The solution to this problem, as shown in the drawing, is to coat the rough surface of the beryllia with a layer of glass and then to lap the glazed surface down to the thickness of a few microns. Then, at any point in the circuit where a heat-producing device is going to be mounted, the glaze can be removed, allowing a good thermal bond between the beryllia and the device.

Another similar technique is to mount the heat-producing devices directly onto small beryllia blocks, which are then incorporated into a larger MIC.

These are fairly exotic techniques, however. The more usual approach to the problem is a compromise: a substrate material is chosen that satisfies the most pressing requirement of the system under consideration. For example, if very low SWRs and low losses are essential to the operation of a system, a sapphire substrate may be selected because of its extremely smooth surface finish. On the other hand, if a high dielectric constant is required, magnesium titanate might be the choice. ■■



Optima enclosures...

For information, call or write,
Optima, Box 13654,
Atlanta, Georgia, 30324
Telephone 404-938-2930

A product of
Scientific-Atlanta

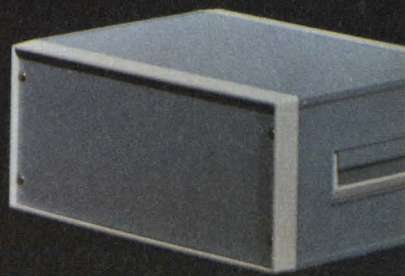

30-day astromonk flight to study space perils

Space flights conducted so far have shown that men, plants and animals can tolerate an absence of gravitational stress for a short time without dramatic ill effects. But what about extended journeys into space? Hints of potential physical hazards have caused sufficient concern to prompt NASA to schedule a 30-day test flight for a monkey during which instruments will keep constant check on the animal's physical and mental functions.

The flight, scheduled for launching into an equatorial orbit from Cape Kennedy sometime next week (or thereabouts), will give scientists a chance to study the effects of prolonged weightlessness and, hopefully, to devise ways of making life in space safer for men.

Among the physical hazards that worry NASA are these:

- Even on short flights, astronauts have experienced a loss of calcium from their bones. Does this decalcification continue as long as the body is weightless or does it stabilize itself?

- Inactivity, and possibly weightlessness, cause temporary weakening of the muscular system. How serious is this if prolonged?

- Weightlessness contributes to deterioration of the circulatory system, which normally pumps blood against gravity. On long space trips might the heart muscles undergo such loss of tone as to fail under the stress of re-entry into the atmosphere?

- Ordinarily the body metabolism—man's biological clock—varies in cycles of approximately 24 hours. Can prolonged weightlessness upset this mysterious mechanism?

Self-feeding planned

The experimental monkey, a macaque nemestrina, will feed itself from a dispenser containing a 30-day supply of banana-flavored pellets. It knows that when a light comes on, it can pull a handle and make a pellet appear. Once a day the light will come on and stay on for an hour, and the monkey will be able to collect enough pellets to sustain life. Twice a day, the animal will play games that test its mental faculties and its coordination. If it does well, the familiar light on the food dispenser will turn on, and it will be able to help itself to extra pellets. Twelve

hours out of every 24, the lights will dim, simulating the night the animal knew on earth.

The monkey will be partly restrained on a couch, 230 miles above the earth. The antennas of 21 ground stations around the world will track the spacecraft. During the four to 10 minutes that the craft is above each station, it will telemeter data on the state of the monkey's health—its brain waves, heartbeat, eye and muscle movements, blood pressure and urine content. The data will be forwarded to the Goddard Space Flight Center, Greenbelt, Md.

Research workers from the University of California at Los Angeles and Berkeley, the University of Southern California, and the California Institute of Technology's Jet Propulsion Laboratory, and Texas Women's University will analyze the data to determine the condition of the animal's brain functions, cardiovascular system, bones and muscles.

A signal conditioner will amplify the output from body sensors as much as 10,000 times. The signals will be digitized and sampled up to 100 times a second by a PCM system.

The spacecraft will carry two sets of 2-watt telemetry transmitters plus digital sampling and coding equipment. One set of transmitters—in an adapter chamber behind the animal's capsule—will send data to the ground during flight, and the other—attached to the capsule—will be used for communication during re-entry. The transmitters will be commanded by ground stations.

Selected samples of the data will be recorded on tape for later recovery. In addition a camera will take still photos of the monkey every 10 minutes and motion pictures during periods of greatest activity.

If all goes well, the capsule will be brought down near Hawaii at the end of the 30-day period and caught in mid-air by an Air Force plane. ■■

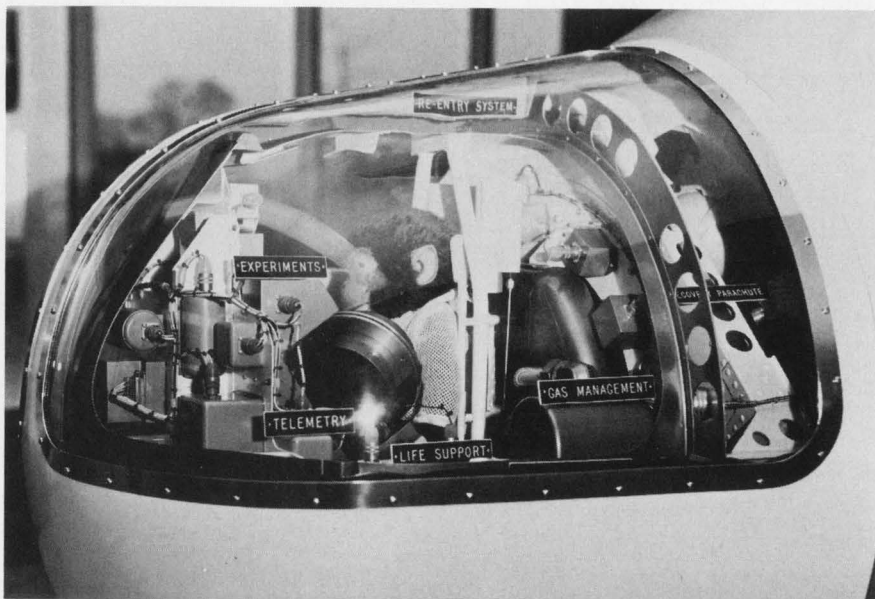

NASA's monkey experiment will be conducted in an instrumented space capsule like this. The thirty-day flight is scheduled for next week.

EL DEVICES

ICs cut decoder/driver size and cost.

Two integrated circuit packages handle memory and decoding functions in new driver for electroluminescent devices.

All of the switching and memory functions required to drive seven-segment electroluminescent readouts are wrapped up in two integrated circuits in Sylvania's new SM-158, SM-159 decoder/driver. In the decoder section, the integrated circuit replaces 34 diodes and 21 resistors. The memory IC unit takes the place of eight discrete transistors, four

diodes and 36 resistors.

But replacing a large number of discrete components is only part of the advantage of this new IC design. The ICs also provide higher reliability, greater versatility, smaller size and lower cost. Among the new versatile features are a lamp test facility, lamp intensity modulation capability, leading/trailing edge

zero suppression and full decoding of all 16 BCD input combinations. The decoder/driver is completely TTL and DTL compatible.

The SM-158 and SM-159 come ready to use on a 1 $\frac{7}{8}$ " x 1 $\frac{3}{4}$ " modular printed circuit board. The complete device package measures only $\frac{1}{2}$ " high with flying leads. Both models can be supplied with either sockets or flying leads. The SM-158 is a decoder/driver without memory and the SM-159 is a complete package with memory included. The memory IC can be added to the SM-158 at a later date if it is desired. The memory unit is a clock gated 4-bit storage register and data transfer through the register may be accomplished when the clock is in a high state.

Both the SM-158 and SM-159 can be supplied in Mil-spec versions.

CIRCLE NUMBER 300

Small size and higher reliability are among the features of Sylvania's new EL decoder/driver.

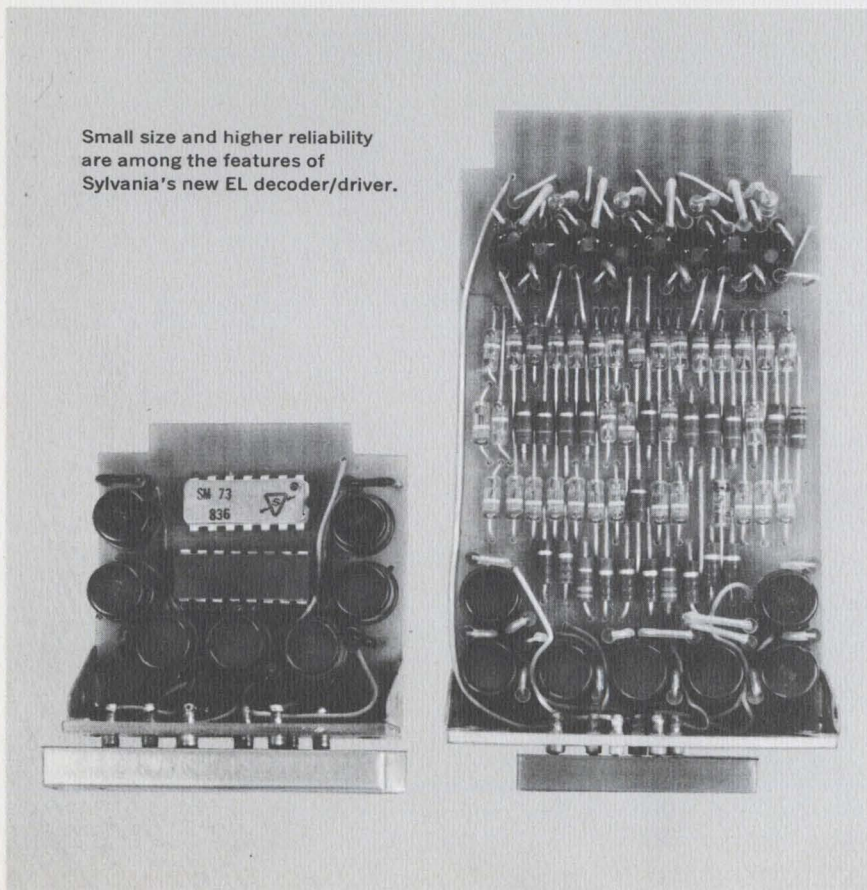

This issue in capsule

Microwaves

Parallel junctions boost varactor performance.

Television

Now, series-string for color picture tubes.

CRTs

Multibeam tube gives brighter characters.

Circuit Modules

Designing with NAFI modules? Talk to us.

Integrated Circuits

How to use the SM-60 for bidirectional data transmission.

Hybrid Microelectronics

IF amplifiers pack high gain into a small package.

Manager's Corner

What is good customer service?

MICROWAVES

Parallel junctions boost varactor performance.

Family of tuning devices offers high Q, high capacitance and low inductance.

Instead of building varactor diodes with large-capacitance junctions, we've come up with a method of paralleling a number of smaller junctions on the same chip. This gives us a higher Q and lowers the inductance of the device as well.

Take for example, our new D5940 and D5950 varactor diode families listed in the tables. The D5940 devices have a Q of 1400 at 50 MHz and -4 Volts DC. At 1 GHz, the Q is a minimum of 70. The circuit used to make the Q measurements is shown in Fig. 1. The range of capacitance variation is better than seven to one.

The D5950 family of varactors has a Q of 1000 at 50 MHz and -4 Volts DC, and the capacitance tuning range is eight

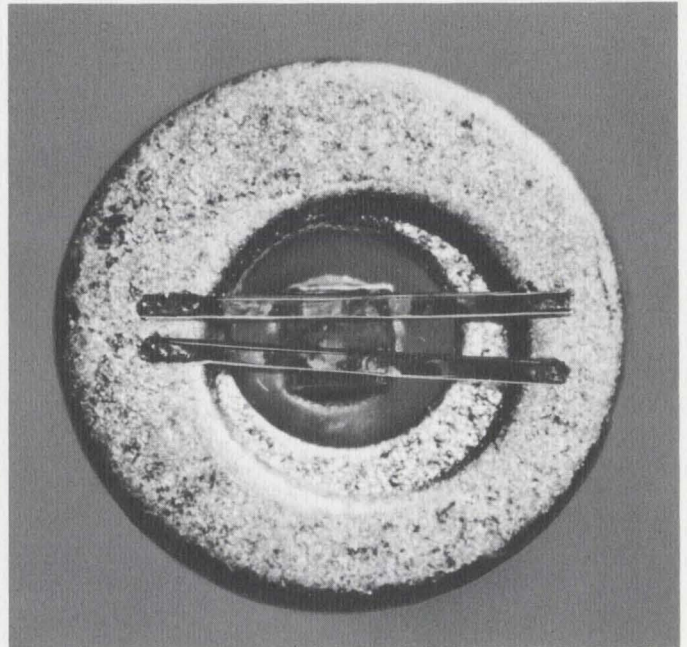

Construction of tuning varactor junction.

Fig. 1. Test circuit used for measuring Q of microwave varactors.

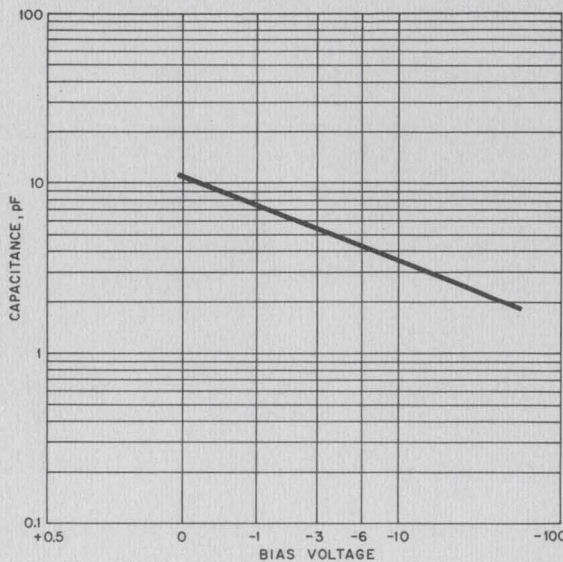
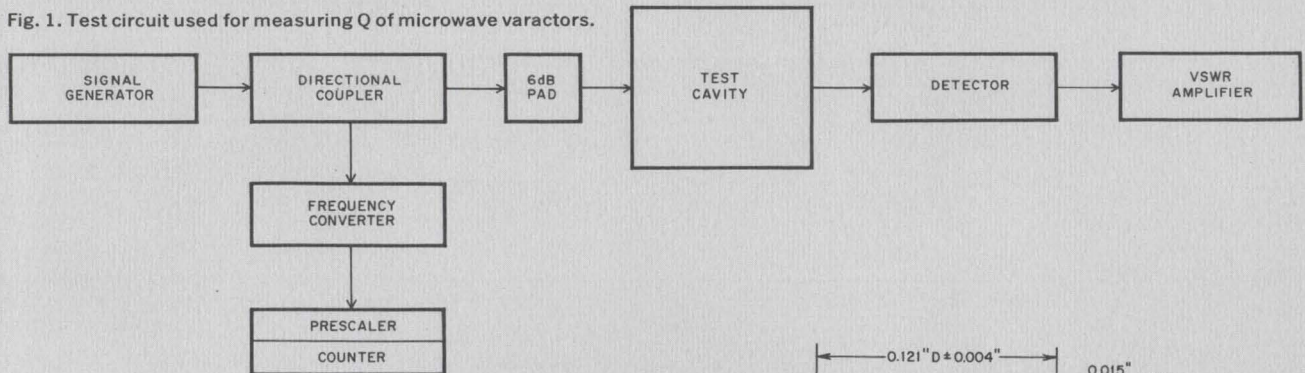

Fig. 2. Typical performance curve for microwave tuning varactor.

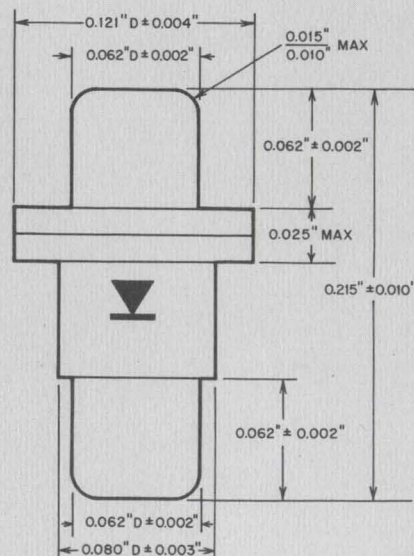
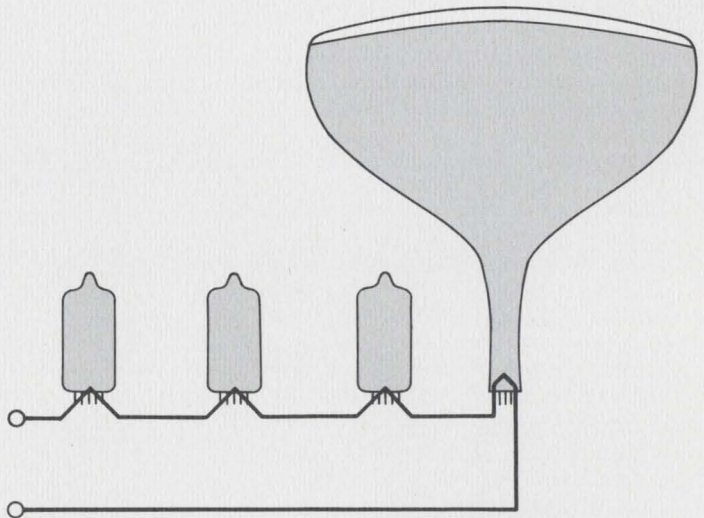

Fig. 3. Microwave tuning varactors are available in O23 package.

TELEVISION

Now, series-string for color picture tubes.

Our entire *color bright 85*[®] picture tube line is now available with a weight and cost saving series-string filament.



You can eliminate an expensive filament transformer and associated circuitry by designing your new color TV sets around Sylvania's *color bright 85* series-string picture tube. This new 12.6 Volt, 450 mA heater is available in all color tube sizes.

Now, you can have all of the advantages in color sets that have been previously limited to black-and-white sets. These advantages include getting rid of the bulky filament transformer with an overall chassis weight reduction. Although the new filament design will have its biggest advantages in the design of lightweight portables, it can also bring cost cutting advantages to larger sets.

When you order our series-string color picture tube, the only thing that is changed is the filament. You still get Sylvania's high-quality *color bright 85* picture tube design.

That means you are getting the brightest phosphor system—the Sylvania-developed europium-activated yttrium-vanadate phosphor treated with selected activators.

And to make the tube brighter still, you get a phosphor deposited by Sylvania's patented dusting technique. Putting the phosphor down by dusting permits the use of larger phosphor particles—and larger particles mean brighter dots.

Dusting also minimizes the chances of contaminants entering the phosphor system during processing. It also helps prevent phosphor deterioration and crackup of the crystal structure.

With all of these advantages plus the added feature of series-string operation, Sylvania's *color bright 85* picture tubes are your best bet for a high-quality picture at the lowest possible cost.

Microwave Tuning Varactors

D5940 series, 023 package, BV=60V

Type Number	Total capacitance (0 VOLTS) C _{T0}	C _{J0} C _{J-60}	Q (50 MHz -4v dc)
D5940	1.0	≥7:1	≥1400
D5940A	2.0	≥7:1	≥1400
D5940B	3.0	≥7:1	≥1400
D5940C	4.0	≥7:1	≥1400
D5940D	5.0	≥7:1	≥1400
D5940E	6.0	≥7:1	≥1400
D5940F	10.0	≥7:1	≥1400
D5940G	15.0	≥7:1	≥1400
D5940H	20.0	≥7:1	≥1400
D5940J	30.0	≥7:1	≥1400

Microwave Tuning Varactors

D5950 series, 023 package, BV=90V

Type Number	Total capacitance (0 VOLTS) C _{T0}	C _{J0} C _{J-90}	Q (50 MHz -4v dc)
D5950	1.0	≥8:1	≥1000
D5950A	2.0	≥8:1	≥1000
D5950B	3.0	≥8:1	≥1000
D5950C	4.0	≥8:1	≥1000
D5950D	5.0	≥8:1	≥1000
D5950E	6.0	≥8:1	≥1000
D5950F	10.0	≥8:1	≥1000
D5950G	15.0	≥8:1	≥1000
D5950H	20.0	≥8:1	≥1000
D5950J	30.0	≥8:1	≥1000

to one. Both families are available with total capacitances in a range from one to thirty pF.

A typical performance curve for both families of varactor diodes is shown in Fig. 2. Note that the capacitance variation with voltage is a log-log linear plot. That's no accident. We grow our own diode wafers in our own epitaxial furnace to achieve this characteristic. We also use glass passivation techniques to protect the finished product.

Packaging of microwave products is a key factor in obtaining good performance. Both of our varactor diode families are available in an 023 package (shown in Fig. 3), an 023 package without tabs, or in an 075 picomin package. A LID (leadless inverted device) package will be available in the near future.

Both the D5940 and D5950 varactor diode families will find wide application in microwave systems. You can use them anywhere you have a circuit to tune—in local oscillators, tunable filters and phase shifters, avalanche diode and Gunn diode oscillators.

CRTs

Multibeam tube gives brighter characters.

New seven-beam, single-gun CRT gives a seven-times increase in display brightness.

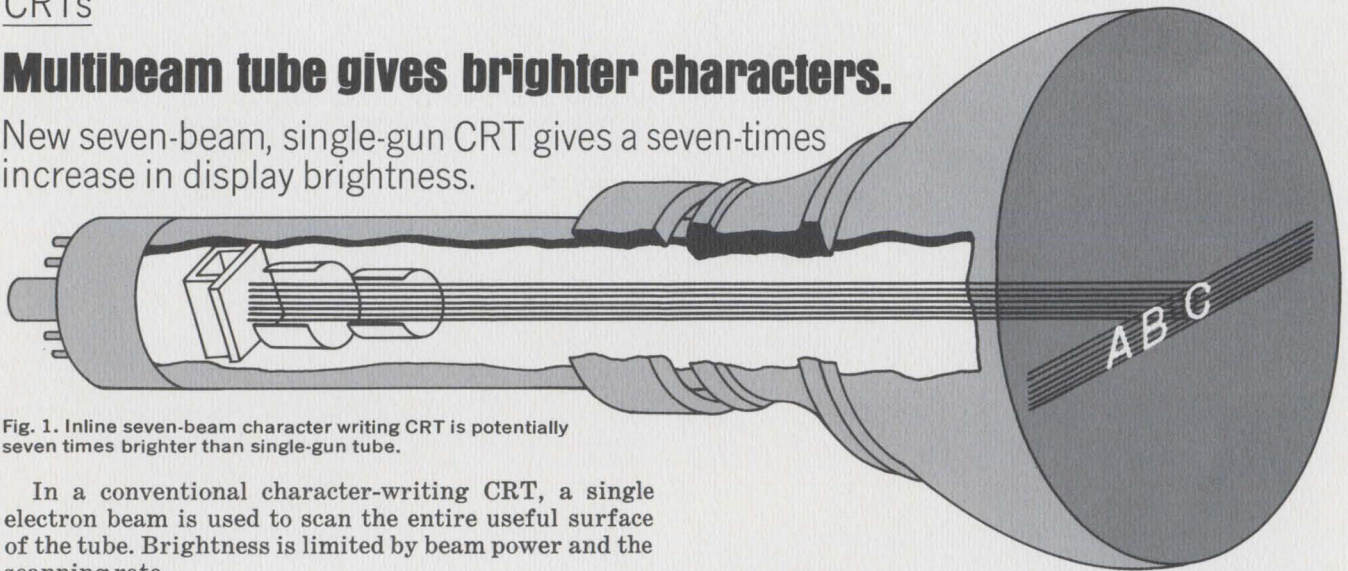

Fig. 1. Inline seven-beam character writing CRT is potentially seven times brighter than single-gun tube.

In a conventional character-writing CRT, a single electron beam is used to scan the entire useful surface of the tube. Brightness is limited by beam power and the scanning rate.

In our new SC-5239 five-inch CRT we've come up with a new technique for increasing brightness or scanning speed. The SC-5239, shown in Fig. 1, is a single-gun cathode-ray tube having seven electron beams. These multiple electron sources increase the brightness potential of a particular display tube by a factor of seven.

Each electron beam can be individually modulated and all may be simultaneously varied in intensity with a single variable control grid bias.

A typical application of the SC-5239 is shown in Fig. 2. A filament is used to heat the cathode which is common to all of the electron beams. An individual control grid element is returned to a bias control potentiometer. Separate video amplifiers are used for each of the seven control grids. Modulation levels on the order of 20 Volts are typical.

The accelerating grid, G_2 , is maintained at approximately 300 Volts, but since it is a factor in the electron optics system it may be desirable to provide a variable potentiometer with a range of about 20 percent of the design center value.

Since alphanumeric character writing is done simply by scanning lines across the face of the CRT and blanking and unblanking each beam at appropriate points, high-speed "diddle" is eliminated. The yoke current for horizontal scan which is normally a step function, now becomes a sawtooth current. This eliminates the step and settling-time problem commonly associated with single-beam operations.

The multibeam CRT is designed to form characters by a 7-dot-high matrix. Because seven separate beams contribute to the writing of each character, the tube has a potential brightness seven times that of a single-beam tube. Or, to look at it another way, the multibeam tube, maintaining the same brightness, can write characters seven times as fast.

We can also produce tubes with more than seven beams for other matrix forms. Typical applications for these tubes include computer and graphic displays for viewing under high ambient light conditions, hard copy readout of information, and film recording of data.

CIRCLE NUMBER 303

Fig. 2. Circuit arrangement for using seven-beam CRT.

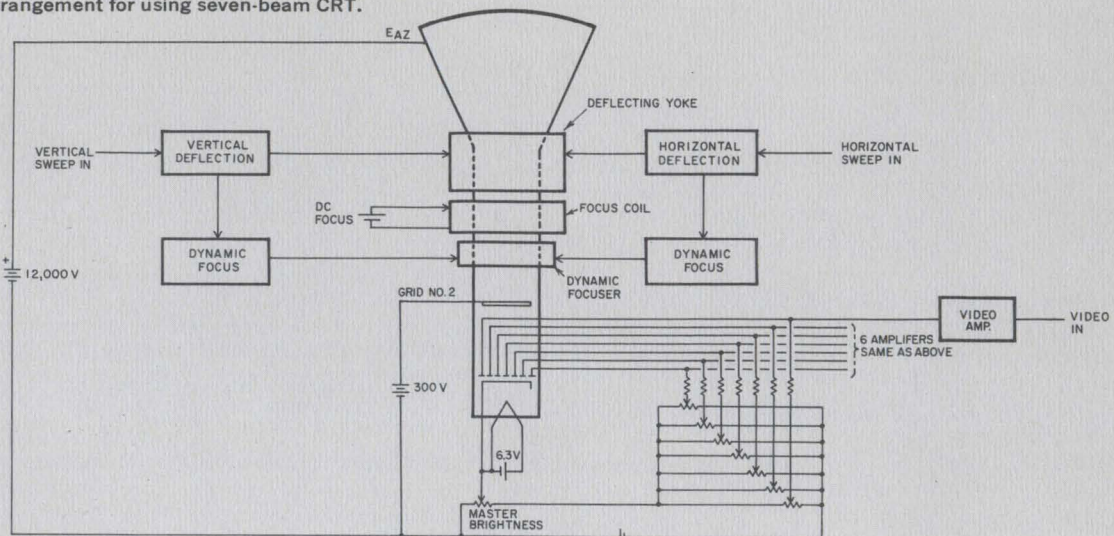

CIRCUIT MODULES

Designing with NAFI modules? Talk to us.

We have seventy-eight types of modules for use in the Navy's standard hardware program.

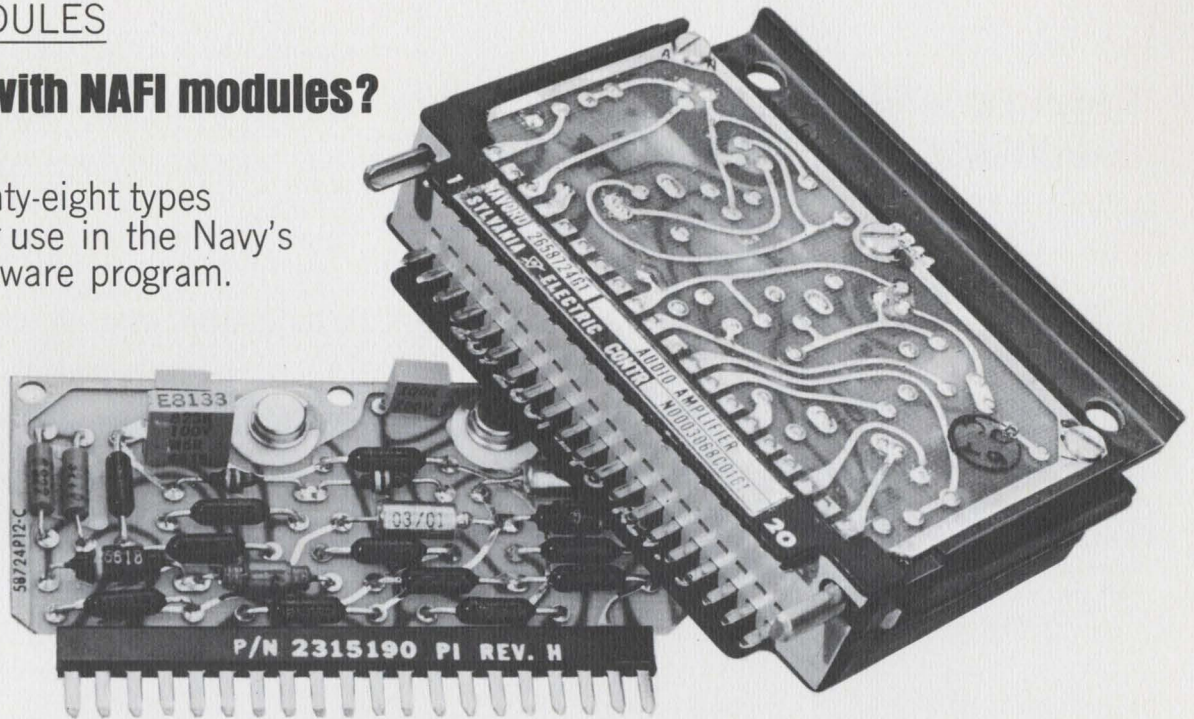

Typical NAFI module is built to Navy specifications.

NAFI modules have been developed under the Navy's standard hardware program and are being used in the Poseidon program. They're also finding wide acceptance for use in other systems.

As a qualified supplier in the Poseidon program, Sylvania has developed a broad line of modules including digital, linear and power functions as well as passive devices. Since this family of modules is already developed, you will find many advantages including time saving in breadboarding new systems.

Other advantages include reduced parts inventory, since the same types of modules are used over and over in many systems. Lead time is also reduced due to established manufacturing processes, common tooling and production techniques as well as utilization of existing circuits. Development costs and time for new systems are also decreased.

Since many thousands of modules have been produced under the standard hardware program, users gain increased and established reliability. (Reliability requirements on NAFI modules are 30,000 hours' minimum operating life.)

Another advantage gained in the quality area is that makers of NAFI modules must maintain their qualification through periodic testing by government quality assurance personnel. This relieves the systems user of this costly task.

If you are considering the use of NAFI modules in your system design it will pay to talk to us. Using Sylvania as your source of supply has many advantages. For one thing, we've got a lot of background in producing circuit assemblies. We've supplied more than 68,500 Type III modules for the Polaris program. We've made over 400,000 circuit logic assemblies and over 8,000,000 cordwood modules for secure communications equipment. And we've also produced more than 525,000 circuit assemblies for the Navy Technical Data System.

With that kind of experience you can be sure that we can produce the modules you need when you need them.

Not only do we have an outstanding reputation as a large volume producer of circuit assemblies, but we have design capabilities as well. Actually, we've designed a number of the functionally specified types in the series.

The table shows just a few of the many NAFI modules now in production. If you would like full information on all seventy-eight units, let us know. We will be glad to tell you all about them.

CIRCLE NUMBER 304

Typical Standard Hardware NAFI Modules

Key Code	Part Number	Module Name	Description
ADE	2658626	Diode Module	20 Diodes, Forward Volt. 1.20 VDC at 200 mA. 75 V Reverse Voltage, Reverse Recovery Time 8ns
ADF	2658627	Driver, Lamp/Relay	Load 280 mA; Programmable Output Grounds; Four Circuits Per Module
ADH	2658629	J-K Flip Flop	5 Per Module Inputs: J, K, C, S, R, Output: QQ Logic (1) 3.8 Min; Logic (0) 0.4 Max.
AAJ	2658630	Amplifier, Buffer	Gain 1.0, 1.43, 6.6, 8.14 V/V (Adjustable Gain); Phase Shift at 400 or 800 Hz 0.1 Deg.
BDA	2658634	Nand, 12-2 Input	12 Independent 2 Input, Oper. Freq. 4 MHz V Out Logic (1) Min. 3.8V, V Out Logic (0) Max. 0.4V
BDD	2658637	One Shot, 0.10 to 1.5 μ s	Pin Programmable: 0.1 μ s to 1.5 μ s In Increments of 0.1 μ s. 2 Circuits per Module
CDC	2658644	Receiver, Line DC	Differential Input, Standard Logic Level Output: \pm 5V \pm 10% P.S.
HRP	2658658	Relay Module	25 V Coil, Relays Replaceable; 5/Module
TAY	2658693	Gate, or Read/Write	Supply Voltages \pm 6 and -36VDC, Input Signal; Frequency 280-840 KHz at 0.25 to 20 mVPP
WDV	2658707	Write Gate Generator	DC Supply, Volt +5.0, -36.0VDC; Input 0 to 5.5V Write Current Output Logic (1) -27.9 to -37.75V

INTEGRATED CIRCUITS

How to use the SM-60 for bidirectional data transmission.

Versatile integrated circuit controls data flow in two directions over single line.

Here's an unusual application for our SM-60 four-bit storage register. It takes advantage of the many special features built into this device.

The diagram shows how four SM-60s can be used to transmit and receive data in two directions over a single line. The circuit works like this: When the enable line (E) of the left transmitter is at "1", data from Q₄ is entered on the line and transmitted to the right receiver. At this time the clock for the left receiver is held at "0", thus preventing the data from the line from entering the left receiver.

At the same time, the clock for the right receiver is in

a "1" state, permitting the data to enter. The enable for the right transmitter is at "0", preventing the data in the right transmitter from going out on the line.

To change the direction of transmission the right transmitter is enabled and the clock is raised on the left receiver. Both the left transmitter and the right receiver are held in the "0" state to block them from transmitting or receiving data.

The features of the SM-60 that make this simple circuit application possible include the fact that it has a free collector output. This enables you to tie directly to a bus. The enable control gives you the ability to remove a logic "0" from the line so that other devices can use the line. Another feature, the buffered latch, prevents signals from other sources on the output line from feeding into the inputs of a device and changing the latched information. The high sink capability of the SM-60 allows the use of appropriate terminations to cut down on reflections on the line.

Because of its versatility, the SM-60 storage register can be adapted to a variety of functions. Why don't you try it out in your system? It might just turn the trick.

CIRCLE NUMBER 305

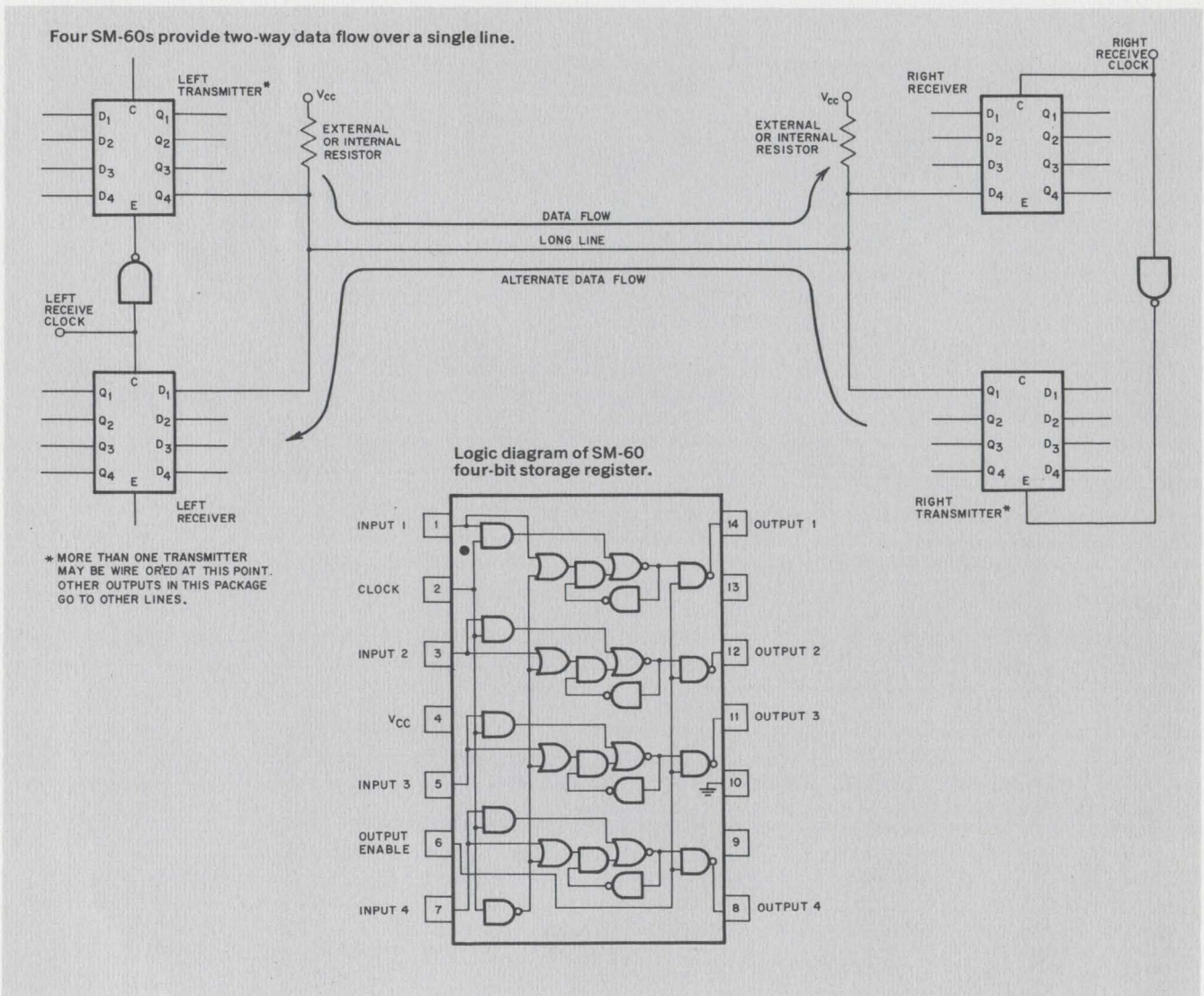

HYBRID MICROELECTRONICS

IF amplifiers pack high gain into a small package.

One-inch-square hybrid microcircuit gives gains up to 50 dB without instability.

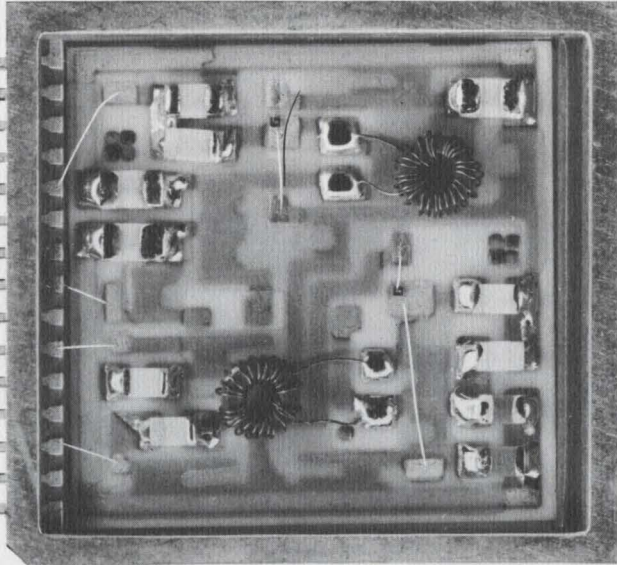
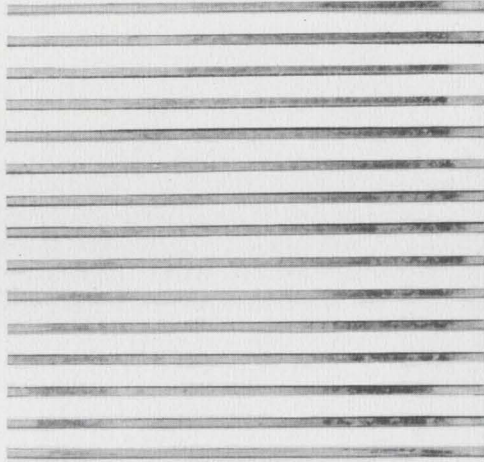

Hybrid microcircuit IF amplifier is packaged in a 1" x 1" x 1/8" module.

When you've been building IF amplifiers for communications and video systems for over six years, you develop quite a bit of expertise. We know, because we've been doing it.

We can tailor our hybrid microcircuit designs to meet your requirements in bandwidth, phase response, center frequency, skirt shape, gain and AGC characteristic. And we can do it anywhere in a frequency range from 10 to 250 MHz.

Typical IF amplifier characteristics (MS-500)

Center frequency	30 MHz
Bandwidth	7 MHz
AGC range	50 dB
Gain	26 dB
Noise figure	14 dB
Input impedance	68 ohms
Output impedance	150 ohms max.
Environment—full MIL range	
Package: 1" x 1" flat pack	

Take for example, the MS-500 30-MHz IF amplifier shown in the photograph. This little (1" square) gem has a lot of features that make it the circuit to use. For instance, built-in ground planes, top and bottom, make it a fully shielded package.

Electrically speaking, it provides 26 dB of gain without instability. Automatic gain control covers a range of 50 dB, giving 24 dB of attenuation with full AGC. The unit has a 7 MHz bandwidth and a 14 dB noise figure. These characteristics make it an ideal unit for use in AM and FM communications systems.

And what's more, our 30-MHz IF amplifier meets Mil-spec 750 and will withstand up to 20 g shock and 1500 g vibration.

Why don't you talk to our engineers about your IF amplifier design requirements. Our microcircuit know-how and support technology allow us to develop many variations of basic IF amplifier designs.

CIRCLE NUMBER 306

SEE OUR SPECIFICATIONS IN
VSMF
MICROFILM CATALOG FILE

BUSINESS REPLY MAIL
No Postage Stamp Necessary if Mailed in the United States

FIRST CLASS
Permit No. 2833
Buffalo, N. Y.

Use Sylvania's "Hot Line" inquiry service, especially if you require full particulars on any item in a hurry. It's easy and it's free. Circle the reader service number(s) you're most interested in; then fill in your name, title, company and address. We'll do the rest and see you get further information by return mail.

POSTAGE WILL BE PAID BY
Sylvania Electric Products Inc.
Sylvania Electronic Components
1100 Main Street
Buffalo, New York 14209

Dept. D 4 4 4

MANAGER'S CORNER

What is good customer service?

It is easy to provide good customer service when everything is going smoothly. It is when things go wrong that a supplier's customer service gets put to the test.

At Sylvania Semiconductor Division we are very conscious of our reputation for good customer service and we are constantly working to maintain this reputation. It would be a lot easier to provide good customer service if all of the responsibility for it could be placed on one man in the organization. However, in the dynamic semiconductor business that just isn't possible. Customer service requires the active cooperation of many people and many departments. Marketing and sales must translate the customer's need for the other departments. Production people must be ready and willing to alter production schedules to meet customers' needs. The engineering staff must accept the challenge of meeting difficult specifications. Quality control people must be able to devise test programs and equipment which will assure that desired quality levels are maintained.

An example of this type of cooperative effort occurred recently in our plant. A manufacturer could not get delivery on integrated circuits from his supplier. His production line was in danger of shutting down and he came to Sylvania for help.

Helping him involved making some engineering changes in one of our standard circuits, revising produc-

tion schedules to fit his product on the line, and modifying our test procedures to meet his specifications.

Through the cooperation and coordination of the marketing engineering, quality control and production departments the needed circuits were flowing off the production line within three days after the problem was handed to us. That's what we think of as good customer service.

Of course, not all service problems are caused by the customer. Sometimes, the sources of the problems are on the manufacturer's side. What the manufacturer is willing to do about these problems is also a good measure of customer service.

For example, a recent snowstorm in the Boston area closed down the airports for three days. We had one customer with an urgent need for delivery.

Our solution? One of our engineers hand-carried the needed circuits to the nearest operating airport—in New York City. Delivery was made on schedule. But it took that little bit of extra effort by an individual to carry the job through. It is that little bit of added effort that marks the difference between good customer service and bad.

Good customer service requires taking an aggressive stand on solving problems, whether created by the customer or the supplier.

We like to think that all our people take this requirement seriously and supply the extra effort that makes good customer service.

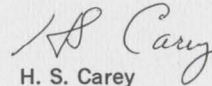

H. S. Carey
Supervisor of Distribution Services, Semiconductor Division

This information in Sylvania Ideas is furnished without assuming any obligations.

SYLVANIA

GENERAL TELEPHONE & ELECTRONICS

NEW CAPABILITIES IN: ELECTRONIC TUBES • SEMICONDUCTORS • MICROWAVE DEVICES • SPECIAL COMPONENTS • DISPLAY DEVICES

D 4

NAME _____

PLEASE PRINT

TITLE _____

COMPANY _____

ADDRESS _____

CITY _____ STATE _____ ZIP _____

Circle Numbers Corresponding to Product Item

300	301	302	303	304
305	306			

Please have a Sales Engineer call



HOT LINE INQUIRY SERVICE

Need information in a hurry? Clip the card and mail it. Be sure to fill in all information requested. We'll rush you full particulars on any item indicated.

You can also get information using the publication's card elsewhere in this issue. Use of the card shown here will simplify handling and save time.

This new Burr-Brown multiplier has really got it

Multiply Mode

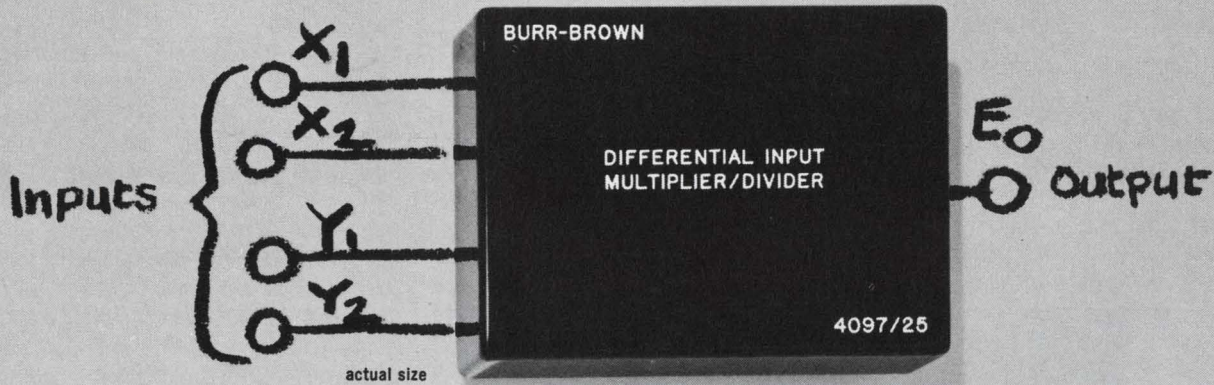

$$E_0 = \frac{(X_1 - X_2)(Y_1 - Y_2)}{10}$$

high performance, versatility and a low, low \$75.00 price

Here's a unique new series of Burr-Brown multipliers that opens up a broad range of circuit possibilities. For the first time, you have a top-performance multiplier available at a price low enough for your most cost-limited application.

These 4-quadrant units will perform multiplication, division, and square-rooting and will accept both differential or single-ended inputs. The differential-input feature means that one of these new units can often take the place of a conventional multiplier and one or two operational amplifiers at considerable savings.

Check the specs! Then consider the possibilities for such applications as voltage-controlled oscillators and active filters . . . as well as true-product modulators for AM modulation, phase detectors, FM modulators, frequency doublers and automatic gain controllers. They can also be used in a variety of instrumentation and measurement applications.

HIGHLIGHT SPECIFICATIONS

	4097/25	4098/25
Accuracy, % of full scale (MAX) ¹	±2%	±1%
Input Impedance	1 MΩ	1 MΩ
Frequency Response, -3 db small-signal	1.2 MHz	1.2 MHz
Frequency Response, full power output	200 kHz	200 kHz
Accuracy Drift, (MAX) ²	±0.05%/°C	±0.05%/°C
Temperature Range	-25°C to +85°C	-25°C to +85°C
Power Supply	±15 V	±15 V
Price, 1-9	\$75.00	\$95.00

(1) includes offset, scale factor (gain) error, and nonlinearity.
(2) includes all drift error for any combination of inputs.

FOR EIGHT-PAGE PRODUCT BULLETIN

on the 4097/25 - 4098/25, plus information on price reductions on other Burr-Brown multipliers, contact your Burr-Brown Engineering Representative or use this publication's reader service card.

BURR-BROWN
RESEARCH CORPORATION

International Airport Industrial Park • Tucson, Arizona 85706
TELEPHONE: 602-294-1431 • TWX: 910-952-1111 • CABLE: BBRCORP



Operational Amplifiers
Instrumentation Amplifiers
Function Modules
Active Filters
Power Supplies

The artificial heart: Problems, problems

The recent controversial operation by Dr. Denton A. Cooley, in which he implanted a completely artificial heart in a man patient, has raised some challenging questions: Will it lead to further surgery of this type? And what role can electronics play in medical developments like this?

The patient, Haskell Karp, survived more than 60 hours with the artificial heart before receiving a human-heart transplant. Subsequently he died, and Dr. Cooley, the noted heart surgeon of Baylor

University Medical School in Houston, was criticized in the medical profession for implanting the artificial heart—a technique tried previously only in animals and then without full success.

At a recent annual meeting of the American Society of Artificial Organs in Atlantic City, N.J., Dr. Cooley described his operation as "a beginning; I now say it is time for us to proceed." He stressed that it proved that full circulatory support can be provided by an artificial organ and that develop-

ment of all prosthetic organs should be vigorously pursued.

But for electronics, the problems in regulating fully artificial organs are still formidable: It's tougher than designing electronics for the moon.

The environment in the human body is more hostile than that of space, Dr. F. W. Hastings, chief of the artificial heart program at the National Heart Institute, Bethesda, Md., points out. Essentially, he told ELECTRONIC DESIGN in an interview at the Atlantic City meeting, it is comparable to that of diluted sea water. On top of that there are powerful body enzymes. The effect on encapsulating materials can be devastating.

Weight and space limits for internal equipment are also more stringent than those for space applications; they are rigidly fixed by the structure of the human body.

Still, Dr. Hastings said, present researchers are striving to develop a relatively simple type of electronic heart control, similar to the Pacemaker device, with a fixed rate. With the fixed-rate Pacemaker the heart adapts to an increase in body activity by pumping more blood per heartbeat.

The artificial heart that Dr. Cooley used had relatively elementary pumping and control systems to regulate the carbon-dioxide pressure in flexible chambers of the heart. The controls were not self-regulating but required an around-the-clock watch to monitor them. The patient had to remain in bed.

Electronics could change that, both Dr. Cooley and Dr. Hastings noted, by introducing automatic controls. But one of the big problems, Dr. Hastings said, is development of a suitable source of energy to power the hydraulic system of the implanted organ (see "Problem: How to Power the Artificial Heart," ED 25, Dec. 5, 1968, p. 25).

Another immense task is the development of a suitable transducer system for measuring venous pressure, which is low—about 15 or 20 millimeters of mercury. ■■

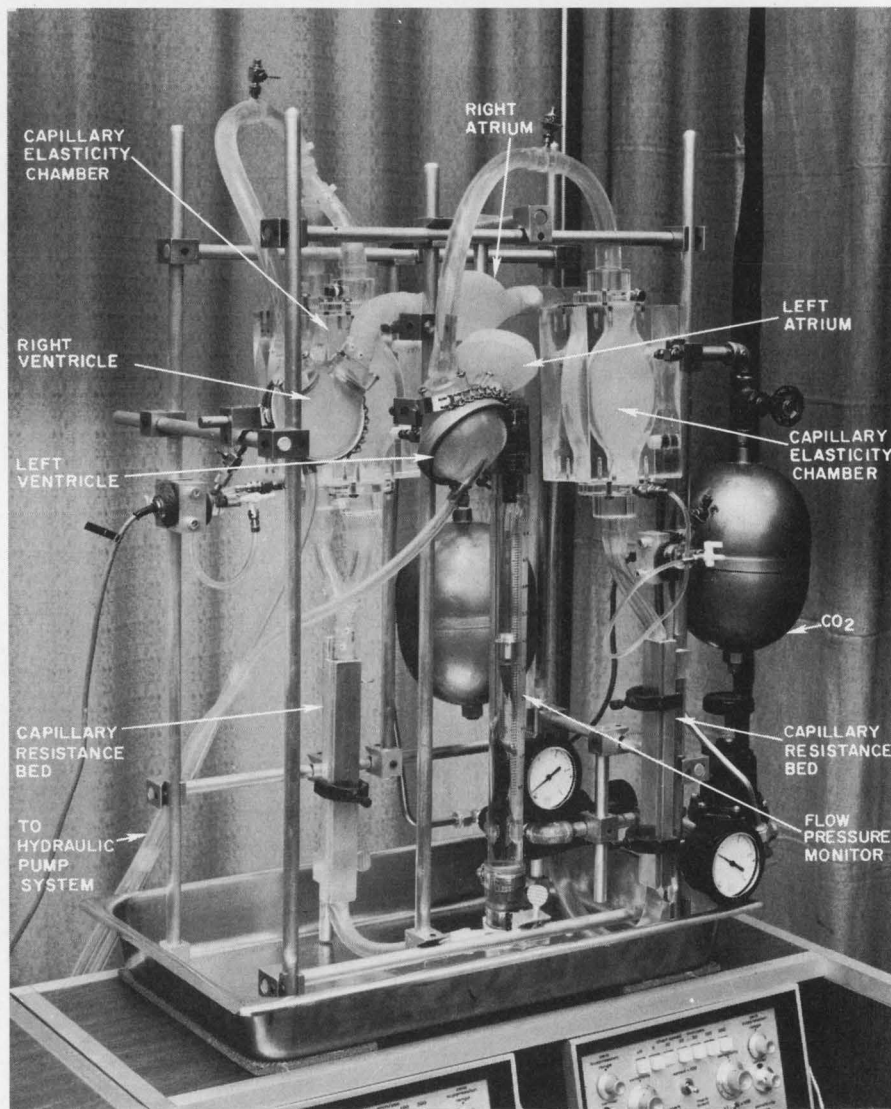

An artificial heart test stand like this was used to check out the device used by Dr. Denton A. Cooley. This setup combines an artificial heart with a mock circulatory system, and was designed by Dr. W. W. Akers and William O'Bannon, research engineer, both at the Biomedical Engineering Laboratory, Rice University.

General Purpose Diodes



12 needles from the haystack

From the haystack of 1,637 general purpose diodes now available,* TI has selected 12 that cover 90% of all circuit requirements.

They're part of TI's line of 285 preferred semiconductors, selected after months of computer demand analysis to save you time and money in specifying discrete components.

TI's preferred dozen diodes are popular, proven and readily available from TI distributor and factory stocks. Volume production assures you the most competitive prices.

All of TI's low conductance di-

odes are now of planar construction, providing better stability and extremely low leakage. They are offered in the industry's first double-plug DO-7 package.

The high conductance types are supplied in an improved DO-7 package offering higher reliability than ever before.

If one of TI's preferred diodes doesn't fit your specific needs, remember TI makes a complete line of diodes to choose from.



TI Preferred General Purpose Diodes	
Low Conductance	High Conductance
1N456	1N645**
1N457**	1N646
1N458**	1N647**
1N482	1N648
1N483**	1N649**
1N484	
1N485	

**Also available in JAN and JAN TX types.

Write for TI's new *Preferred Semiconductors and Components* catalog: Texas Instruments Incorporated, PO Box 5012, MS308, Dallas, Texas 75222. Or just circle reader service card No. 248.



*1969 worldwide figure from D.A.T.A. Inc., publisher of *Electronic Data*.

TEXAS INSTRUMENTS
INCORPORATED

We make guys who can't



components for stand failures.

Picture yourself in your living room in front of the TV on a quiet Sunday afternoon. It's the bottom of the ninth and the bases are loaded. Your team trails by two runs, but your star hitter is up.

That's when your set decides to burn out. And that's when you first mutter the words that officially put you in the group of enraged guys that our components are designed to stamp out.

At Corning we make components to please guys who can't stand failures. We build an extra measure of performance into all our resistors and capacitors to help you build extra reliability into all of your systems. Like you and the guys who use your equipment, we have to admit that we can't stand failures either.

Consider our tin oxide resistors, they're the best of the metal film class. Because the resistive tin film is completely oxidized and molecularly bonded to the glass core, our tin oxide resistors are impervious to moisture and environmental degradation. No other resistor can deliver the same stability and reliability over load life. They offer guaranteed moisture resistance across all ohmic values to set a standard of

reliability that can't be matched by metal film, wire wounds, carbon comps or metal glaze resistors.

No other resistor can give the same value. Our tin oxide resistors offer long term economy over metal film, precision wire wound and metal glaze resistors. And our new C3 resistors, in addition to the benefits of small case size, compete costwise with carbon comps.

Another important Corning development for men who can't stand failures is our flame proof tin oxide resistor. Ideal for circuitry where functions, environments and duty cycles demand low power resistors with excellent frequency characteristics, our flame proof resistors can withstand overloads of up to 100 times rated power without any trace of flame. And because they open under overload, they provide protection for your other, more expensive components. For this reason, plus safety, CORNING® Flame Proof Resistors are now being widely used in Color and Monochrome TV receivers.

And consider our Glass-K™ capacitors. We developed them to give you the volumetric efficiency and economy of monolithic ceramic capacitors, but with the much

improved stability and reliability that only a glass dielectric can add. Our Glass-K™ capacitors are extremely reliable for bypass and filtering applications—the traditional capacitor failure spot.

Then consider our glass capacitors. There's only one reason why they've been designed into so many major aerospace and missile programs. Only glass capacitors could give their designers the proven stability and reliability that these important systems demand.

At Corning we make components for guys who can't stand failures. Guys like your customers. Guys like you. Next time you're designing a system, reach for your Corning capacitor and resistor catalogs and call your local Corning authorized distributor for off-the-shelf delivery. They'll help you design-in an extra measure of performance.

If you don't have our catalogs, ask your Corning distributor for copies or drop us a line at: Corning Glass Works, Electronic Products Division, Corning, New York 14830.

CORNING
E L E C T R O N I C S

Digitally Controlled Power Sources

*described in
a NEW
16-page
brochure*

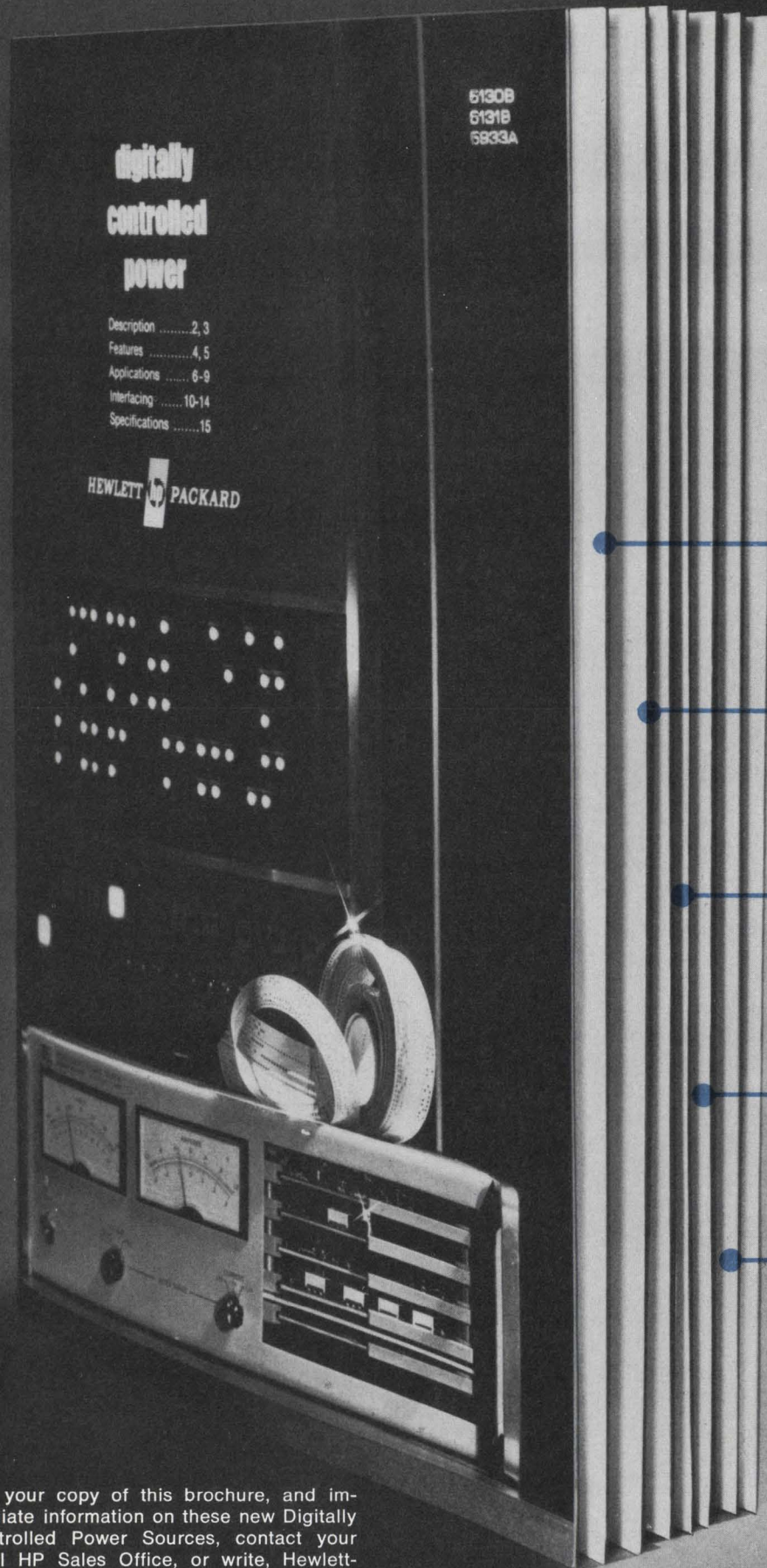

**digitally
controlled
power**

Description 2, 3
Features 4, 5
Applications 6-9
Interfacing 10-14
Specifications 15

HEWLETT  PACKARD

6130B
6131B
5833A

DESCRIPTION

How they work, what they do . . . computer interface, input/output isolation, storage, voltage and current D/A conversion, bipolar power amplification.

FEATURES

Full-sized photos illustrate operational controls and describe functions of the five interchangeable plug-in boards.

APPLICATIONS

Detailed description and schematics of applications ranging from simple to complex; automatic component testing, computer curve-plotter, digitally controlled modulator, and more.

INTERFACING

Every DCPS is factory pre-interfaced to your computer or programmer. Section describes in detail, interfacing with HP and other computers.

TECHNICAL DATA

All details of three models: -10 to +10V @ 10mA, -50 to +50V @ 1A, -100 to +100V @ 0.5A. . . . Prices start at \$1200.

For your copy of this brochure, and immediate information on these new Digitally Controlled Power Sources, contact your local HP Sales Office, or write, Hewlett-Packard, New Jersey Division, 100 Locust Avenue, Berkeley Heights, New Jersey 07922. In Europe: 1217 Meyrin, Geneva, Switzerland.

HEWLETT  PACKARD

COMPUTER INSTRUMENTATION

Circle for details 211



Washington Report

CHARLES D. LAFOND
WASHINGTON BUREAU

Earth Resources satellite in 3 years?

All the technology needed to develop an operational Earth Resources Technology Satellite System is available now, says a panel of U.S. scientists. The sensors can be produced, and the needs are known. This was the result of the panel discussion on "Earth Resources Survey—Promises, Progress, Plans, and Problems," held at the recent Annual International Geoscience Electronics Symposium in Washington.

Dr. William Nordberg, assistant chief for Atmospheric and Biological Sciences at NASA's Goddard Space Flight Center, and experiment director for the planned ERTS program, stated, "We will not develop new space craft; we will use essentially an existing structure." The NASA scientist estimated that first launch of an ERTS will occur within three years. The principal instrumentation will include TV cameras and photometric point cameras having very high spectral resolution and relatively good visible resolution (to within 200 feet). "There are problems now," he said, "in determining specifically what sensors to use, for example, whether or not to include microwave radiometers." (See "Big Eye" in the sky: sensors to monitor earth," ED 7, April 1, 1969, p. 25).

Dr. Carl Graves, manager of the Experimental Space Division of TRW Systems Inc., revealed that the NASA request for industry proposals on the ERTS is imminent. He indicated that some engineering development would be needed to improve vehicle attitude control and data handling and relay to ground stations. He also suggested that the ERTS, because of the large volume of data accumulated in the craft, would require onboard data processing.

Dr. Arthur Anderson, director of the Research Division of IBM, noted that the potential of thousands of sensors spread

around the globe would require frequent data collection. This load, he said, is not too high for processing, but the dissemination of data to the ultimate users will be a problem. TV imaging, he stated, will require high data rates, and at full capacity it is doubtful that the system could handle the data in real time. Procedures probably will be instituted "to farm out data from central receiving stations to user agencies for subsequent processing." Much of this, he said, could be handled in photographic form.

One question was not answered by the panel. There was no agreement on the need for establishment of a central national data-processing center for the ERTS network. The panelists did agree, however, that at least some form of intermediate center would be required to disseminate data from the ground collection centers to the ultimate user. They also agreed that an ERTS can perform observations not attainable by aircraft, and in comparable tasks can perform over the long term better and at a lower cost.

NASA planners are kept guessing

The suspense deepens for NASA program planners. They have been tightening their belts in response to budget cuts made by the Nixon Administration—now they may, hopefully, have to let them out a few notches as House subcommittees recommend some increases.

With the Nixon budget adjustments in mind, manpower reductions were continued by NASA. For example, the \$45 million cut by the new administration resulted in a plan to reduce the employe level at Cape Kennedy Space Center by nearly 5,000 during the year. This reduction largely affects aerospace contractors at the Center

with only minimal cuts to be handled by attrition of Civil Service personnel.

Meanwhile, the House Space Committee is recommending a \$243 million increase in the NASA R & D budget. The total sought by NASA was \$3.124 billion. The three subcommittees of the full House Space Committee responsible for manned space flight, space science and application, and advanced research and technology each recommended increases. The major additions include the Apollo and Apollo Applications Program, \$162 million; Saturn V improvements and added production, \$38.3 million; Earth Resources Technology Satellite Program, \$10 million; an additional biosatellite, \$12 million and for the NERVA nuclear rocket program—\$13.5 million.

If these increases survive the Senate and appear in the final appropriation, NASA officials will have to revamp their plans drastically. But they'll enjoy it.

U. S. air-show plans a big step closer

The U. S. took a giant stride closer to having an International Aerospace Exposition when President Nixon endorsed plans for a National Air Exposition at Dulles International Airport near Washington this year. The three-day show (August 15-17) is, in fact, a dress rehearsal for what many government and industrial enthusiasts hope will become a major international project in the Washington area in 1971.

The U. S. has never had a show, comparable to the Paris Air Show held every two years, to serve the needs of this country's massive aerospace industry. The exposition this summer will be mainly limited to large-scale static displays, on a taxi strip two miles long, of industry products and R & D advances. It also will feature traditional aerobatic activities of U. S. military and commercial craft.

Rep. L. Mendel Rivers (D-S.C.), chairman

of the House Armed Services Committee, has agreed to serve as honorary chairman of the August exposition. The National Aviation Club, headquartered here, will sponsor the program. Rep. Rivers introduced a bill, two years ago, for federal support of an International Aeronautical Exposition to encourage global interest in U. S. aerospace systems and equipment.

FAA and NASA to test L-band relay

Working in joint project, late this year, the Federal Aviation Administration and NASA will make a test of aircraft communications relay via satellite, using L-band. In anticipation of the project, FAA has selected the Boeing Company to perform a study of satellite use for air traffic communications and for navigation over international routes. The \$350,000 contract will probably concentrate on the North Atlantic route between the U. S. and Europe.

The craft to be used is the Applications Technology Satellite ATS-E, now scheduled for launch in September. This will be the first comprehensive test of L-band (1540-1660 MHz range) for long-range communications relay to commercial types of aircraft.

Litton to build 4-in-1 ships for Navy

Nine general-purpose amphibious assault ships called LHAs are to be built by Litton Industries under a fixed-price incentive contract that could read more than a billion dollars if Congressional approval of the program continues. LHA is the first combatant ship to be designed and manufacturer for the Department of Defense as a total package.

The 820-foot-long ship, which resembles an aircraft carrier in size and appearance, was designed as a unit with its electronic support systems. The complex command, communication and control system for directing assault was principally designed by Litton's Data Systems division, which will participate in the project throughout. The LHAs will perform duties now handled by four different types of assault vessels.

Designed by Litton's Advanced Marine Technology division, the LHAs will be produced on an assembly-line basis in the company's Ingalls Shipbuilding division in a new \$130 million facility in Pascagoula, Miss.



Ultramation...the end of the illogical module

Don't let illogical modules foul up your system.

Go the most logical route . . . with Honeywell μ -PAC logic modules. They can bring your system one step closer to ultimate efficiency.

That's Ultramation.

What makes Honeywell modules your logical choice? Plenty. Like a dedicated engineering staff with over 14 years' experience in building logic modules. Like documentation that doesn't quit: complete instruction manuals; application, wiring, and assembly notes; comprehensive schematic diagrams, parts lists and logic design aids.

Like a company that offers more than 135 standard modules and accessories (plus hundreds of specials) . . . builds them, stocks them, and offers 72 hour delivery on most. Like quality control and automated testing that results in an unconditional one year warranty on every μ -PAC. Like custom design. Like field trained engineers. Like applications assistance.

Enough logic for you? Then write for complete details . . . and get closer to Ultramation. Honeywell, Computer Control Division, Dept. 16, Old Connecticut Path, Framingham, Massachusetts 01701.

Honeywell
AUTOMATION

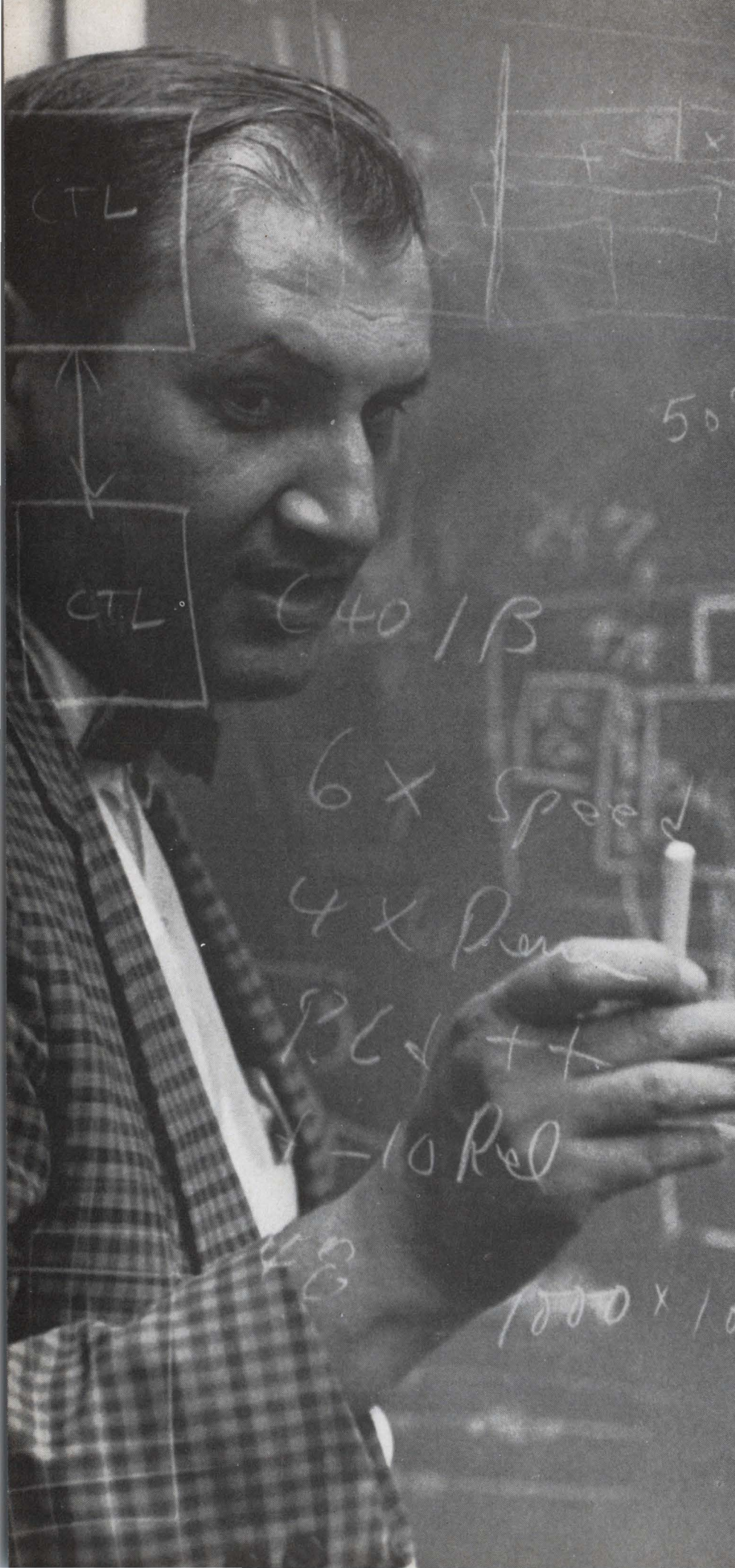

Electrical Engineers:

Join a small, hard-hitting logic design team at IBM.

Here's your chance to really get involved with designing the logic for sophisticated new systems for both military and commercial projects.

New Engineering Center

Here at IBM's new Communications and Engineering Sciences Center, near Washington, D.C., we work in small groups. This allows each member to dig into the project from the very beginning—from sitting down with the customers before we begin to conducting the maintenance training after we finish.

The entire group is involved with everything from hardware design to systems acceptance and program management.

You should have a degree in electrical engineering. Experience in logic design, digital systems or some other data processing area would be helpful.

Projects now underway

Several high-priority projects are already underway. They range from an advanced reservations system for commercial airlines to highly classified ground-based military systems.

We are also helping to develop greater mission capability for the post-Apollo period.

Why choose IBM?

Today's major growth industry is information handling and control. And IBM is a leader in that field. This growth environment can bring out the best of your talents and abilities, because in a growth company like IBM you can work constantly toward greater achievement. This means more opportunities to achieve distinction and personal recognition.

So if you're a problem-solver who wants a personal sense of achievement and recognition for your hard work in an exciting growth company, consider IBM.

Call or write

If you are an Electrical Engineer and want to join a small, hard-hitting team, call Jim Dunn at (301) 921-7724 collect any weekday between 9 and 4:30. Or, send a brief letter or resume to him at IBM Corporation, Federal Systems Division, Dept. CE1018, 18100 Frederick Pike, Gaithersburg, Maryland 20760.

An Equal Opportunity Employer

IBM®

ON CAREER INQUIRY FORM, PAGE 101, CIRCLE 925

HOLOGRAPHY:
The reality and
the illusion

A complex, multi-colored geometric structure, possibly a hologram or a physical model, set against a dark background. The structure is composed of numerous thin, intersecting lines in shades of red, blue, yellow, and black, forming a dense, three-dimensional lattice. The lines radiate from a central point, creating a star-like or crystalline appearance. The background is a dark, textured greenish-blue.

Richard N. Einhorn, Science Writer

The magic of holography

At the General Motors Corp. new skyscraper headquarters in New York, a set of four of the world's largest holograms—each 18 by 24 inches—is on display.

The observer can look through one of four windows into the darkened interior of an octagonal box. A light goes on, revealing a model of a Napoleonic coach—the Fisher Body symbol. As the observer moves his head, he notices details that were obscured before. He can see now the inside, now the outside, of the partly open door. Unlike an ordinary photograph, for which the observer's mind fills in the three-dimensionality from certain visual cues, here he actually gets a different perspective. Then the entire display case is lighted, and that very solid-looking coach vanishes without a trace.

A moment later a model of a Cadillac Eldorado pops into view. After a few seconds the Cadillac, too, disappears.

Curious observers inspect the display case. There are no trapdoors. Finally, reluctantly, the knowledgeable ones accept the notion that those realistic, three-dimensional objects exist only as light waves that fill a volume of space. It may be their first exposure to a hologram or their 50th, but many go away with an eerie feeling, because they know they can't dismiss it as stage magic.

Perhaps some day holographic advertising displays will be commonplace in the waiting rooms of every major transportation terminal, but the entertainment value of holography has been ballyhooed so much that one tends to overlook the great potential it holds for almost every branch of practical engineering. Among the applications predicted for holograms are these:

- Service as high-quality masks in the manufacture of integrated circuits.

- Storage of huge amounts of densely packed data that are protected against loss of information caused by dust, scratches or cross-talk.

- Speedy, automatic classification and identification of fingerprints and deblurring of photographic images, something that the digital computer with all its brute calculating power cannot do easily.
- Substituting for or complementing large, expensive multi-element lenses.

- Extending the realm of the microscope down to the molecular level, so that medical scientists can "see" inside a virus or an enzyme.

- Three-dimensional movies and television.

Time will tell

Most of the suggested applications are far from realization. Some may never be feasible, while others may be abandoned as impractical when compared with other means. But eventually holography will become an established technology, much like photography or electronics. The prospects are so attractive that more than a hundred academic, scientific and industrial laboratories are investigating holography. Ann Arbor, Mich., for example, is the site not only of the University of Michigan's Radar and Optics Laboratory, one of the wellsprings of holography, but also of at least three companies that sell holographic systems: the Conduction Corp., KMS Industries and GC Optronics.

Holography has progressed to the point where an international conference devoted exclusively to

its industrial applications was held last September at the University of Strathclyde, Scotland. Nevertheless the field has become competitive and practitioners tight-lipped. No one feels he can let the competition make break-throughs that lead to basic patents.

The scrambled picture

An unreconstructed hologram is like a genie in a bottle: You can't tell what's inside just by looking at it.

If you examined a hologram of a statuette under a microscope, all you would see would be a jumble of swirls and stripes (as in the photograph on p. 51). Even an expert could not say, "This swirl is a nose and this an ear," because there is no one-to-one correspondence to any given part of the statuette. But illuminate the hologram with an intense beam of light, and every feature is suddenly unscrambled.

There is another striking difference from a conventional photograph: Cut out a piece of the photograph, and you would lose information (say, a nose or an ear), but cut up a hologram, illuminate one of the sections, and you would still see the complete object, although with reduced resolution. It is like looking through a window; you can always see the entire scene outside so long as the glass hasn't been covered completely. But if you leave only a peephole, you lose your parallax; you can no longer look around corners to see hidden details.

To regard holography as merely a novel photographic technique would be to miss the point altogether. Even from the little you have just read you should be able

to draw the following inferences:

■ The information is real time if the hologram is illuminated properly, but it is incomprehensible otherwise. This suggests that highly complex pictorial information can be transmitted in parallel form at the speed of light.

■ The information is maximally (that is, redundantly) distributed throughout the hologram, so that much of the entire message can be recovered from a small sample. Therefore defects may degrade the total reconstructed image slightly, but it does not ordinarily result in loss of information. This built-in protection of data has tremendous implications for the design of future communications and information-storage systems. At least one scientist³ speculates that the human brain may store memory redundantly in holographic fashion.

■ The hologram contains information that is not ordinarily recorded by the camera, since it gives true three-dimensionality without recourse to multiple exposures.

When a diffusely reflecting object (a suit jacket, say, rather than a mirror) is illuminated, each discrete point on its surface radiates expanding spherical waves (think of the ripples in a pond, but

in three dimensions, like concentric shells). The total radiation from the object is a complex irregular waveform that contains information about the object. However, if this wavefront struck a photographic emulsion, every part of the plate would be uniformly blackened. The lens in a camera avoids this blackening by focusing the light so that two rays from different parts of the object cannot strike the same point on the film. Holography can focus the light without lenses—hence the name lensless photography that is sometimes tacked onto it.

The clash of wavefronts

The dots, the whorls and the lines recorded in the holographic medium (usually a fine-grained photographic emulsion) represent the interference of the rays of light from the object with a reference beam. The reference comes from the same source as the light that illuminates the object, so that it is of the same frequency and, at least at the outset, has the same internal phase relationship. However, since the reference beam strikes the hologram without having been modified, it still contains simple, uniform waves. At the holo-

gram plane, the two beams interact. As in the case of two sinusoids, the crests and troughs of two light waves will add or subtract, depending on the phase relationship.

Photographic film is a square-law detector. Because of the squaring process, it stores neither phase nor amplitude but instead a time-averaged intensity distribution of the light striking the film. Holographic film is no different in this respect. However, by means of the interference, the hologram is able to preserve information that is a function of phase.

Reconstruction of an image is a two-step process: first the film is developed and then it is illuminated with a beam of light. The interference pattern recorded on the hologram diffracts (bends or scatters) the light beam in such a manner that the diffracted light is forced to recreate an image of the original object in space.

It is as though the light rays from the object were frozen into the hologram and then thawed out later. Thus with a hologram, you can see light reflected from an object that no longer exists, exactly as if you were looking at the object. With an ordinary photograph, you see only a two-dimensional representation.

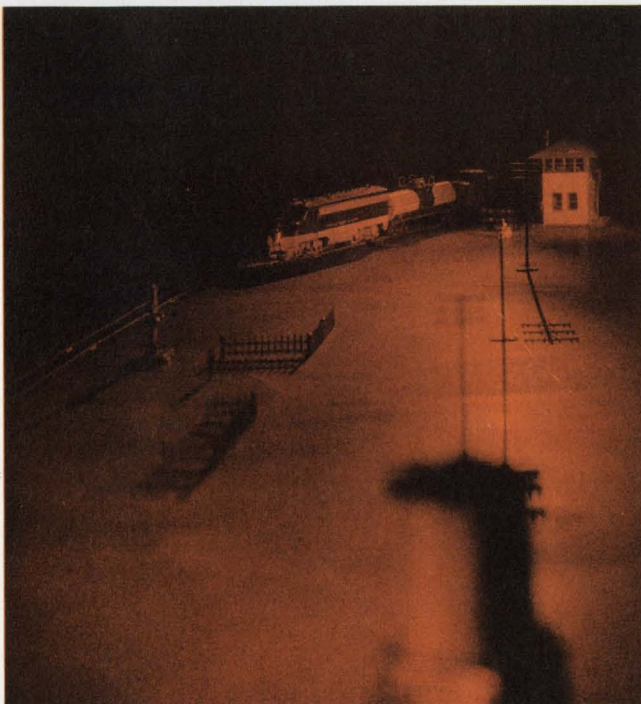

Splitting the reference beam with mirrors and overlapping the segments gives a hologram with a large field of view. The technique was developed by Emmett Leith



and Juris Upatnieks of the University of Michigan. It should be noted that objects in the foreground and background are in focus.

The theory behind the formation of holograms

Brushing aside the mathematical niceties, we can derive a simple expression for the formation of a hologram and the reconstruction of the image.

The intensity of a light source is the square of the absolute value of the amplitude of the light wave. It is equal to the product of the amplitude of the light wave times its complex conjugate. That is:

$$I = a \cdot a^* \quad (1)$$

The light intensity that exposes the film is the square of the sum of terms representing the reference and the object. By analogy with (1):

$$I_f = (R+O)(R^*+O^*) \quad (2)$$

$$= R \cdot R^* + O \cdot O^* + R \cdot O^* + O \cdot R^* \quad (3)$$

Note that

$$R \cdot R^* = I_R \text{ the intensity of light from the reference}$$

and $O \cdot O^* = I_O$ the intensity of light from the object, so

$$I_f = I_R + I_O + R \cdot O^* + O \cdot R^* \quad (4)$$

When the hologram is read out with the reference R , the light transmitted through the film is

$$T_f = I_f \cdot R = RI_R + RI_O + R \cdot R \cdot O^* + R \cdot R^* \cdot O \quad (5)$$

The first two terms may be ignored because they represent unmodulated intensities, but the last term in (5) may be written as $I_R \cdot O$, or the reference intensity modulated by the object amplitude; it is the real image (or virtual image, which is the conjugate of the real image) coming into focus in front of (or behind) the film. Similarly the object intensity modulated by reference amplitude is given by the preceding term. All of the phase information is contained in these two cross terms between O and R .

Most holographic systems use an off-axis reference, but the object may be illuminated by a single light source (see Fig. 1). If the object has clear areas, or if it is small relative to the beamwidth of the light, the reference will be formed by that

portion of the light beam that is not modified by the object. It is often difficult to transmit enough light through or around the object to serve as the reference.

There are two types of on-axis holograms, and they are classified by whether there is characteristic Fresnel or Fraunhofer diffraction—that is, whether you are in the near field or the far field of the object. Prof. Dennis Gabor, the father of holography used the Fresnel.

(An excellent treatment of holographic theory may be found in Ref. 1.)

Briefly the Fresnel hologram is formed by a nearby object and a parallel reference beam, and the Fraunhofer hologram is formed by a reference source and an object placed in the focal plane of a lens.

With a Fresnel hologram, there is a loss in resolution and the image does not appear to be well defined, because in the reconstruction two conjugate images appear on-axis. One or the other is always out of focus and provides a background illumination that decreases the contrast of the focused image.

With a Fraunhofer hologram (Fig. 2), however, reconstruction of the properly focused image suffers very little from the effects of the out-of-focus image. There are two reasons for this: The interference fringing between the two images is essentially constant over the region of observation, and the energy density of the out-of-focus image is very small over the region of existence of the focused image, so that the former appears weak, and focused at infinity.

The holographic technique introduced by Prof. Emmett N. Leith of the University of Michigan and his associate, Juris Upatnieks, records the interference between the light diffracted from an object and an off-axis, non-zero-order reference beam (Fig. 3), much like a

modulated carrier system.

As in the on-axis systems, there are twin images at reconstruction, but they are physically separated. There is still energy on-axis in the form of a zero-order image, but two first-order images are produced off-axis and either one can be detected (photographed) without deterioration. Thus one of the chief shortcomings of on-axis holograms (particularly of the Fresnel type) is avoided. Another big advantage of the offset reference is that diffusely reflecting three-dimensional objects can be recorded. On the other hand, according to what one might expect from communication theory, the sideband Fresnel has poorer resolution with respect to storage of information than off-axis holograms, because the information must be put onto a carrier frequency.

All three systems share one common problem: The phase of the interference pattern is a quadratic function of the distance from the center of the hologram. The fringe frequency increases as you go out toward the edges. Photographic films are bandwidth-limited detectors; beyond their cutoff they will not store information about the object. The effect of lost fringes is not loss of the reconstructed image but poorer resolution.

There is a fourth type, the Fourier transform hologram, which is characterized by a linear rather than a quadratic phase term in the hologram plane. Therefore its fringes maintain relatively constant frequency and are less subject to film cutoff than the other types. Thus the Fourier transform hologram of a two-dimensional object should not only provide higher resolution but also permits the use of larger photographic plates.

Unfortunately not all of this advantage carries over to the three-dimensional case. A quadratic phase factor will show up because the point reference is

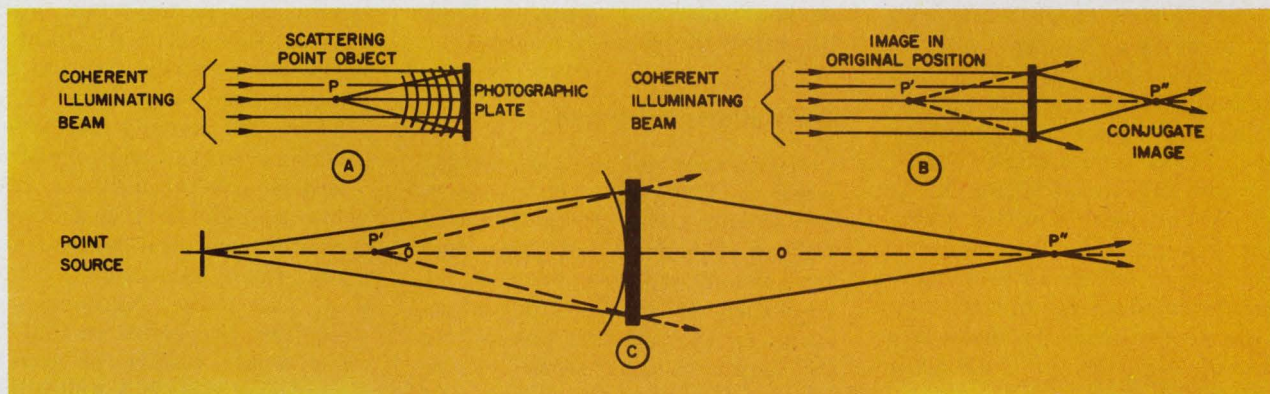

1. **On-axis coherent light beam** (A) used by Gabor to illuminate both point object and hologram. It is called a Fresnel hologram because it diffracts light in the near-optical field of the object. When recon-

structed (B), it reproduces not only the original object but an annoying mirror image. One can also reconstruct the image with another wavelength (C) and obtain either magnification or demagnification.

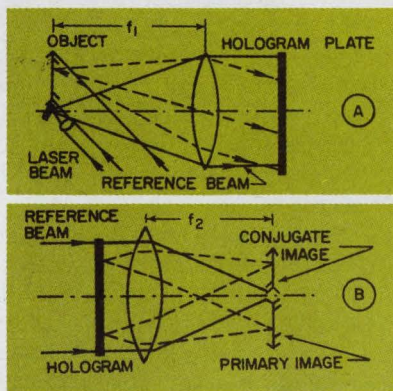

2. **Fraunhofer hologram** forms when the reference source and the object are placed in the focal plane of a lens (A) and thus effectively are at infinite distance from the hologram plate. In reconstruction (B) both the primary and conjugate images are formed in the focal plane of a second lens, magnified or reduced by a factor equal to the ratio of the focal lengths of the two lenses.²

capable of canceling it in only one plane of the object.

As shown in Fig. 4, a Fourier transform hologram may be formed either with or without a lens—and in the far field or the near field of the object. The lensless method is capable of higher resolution, but only if the hologram is taken in the far field.

Unlike other types, Fourier transform holograms reconstruct two real images, which are mirror images of each other, rather than a real and a virtual image.

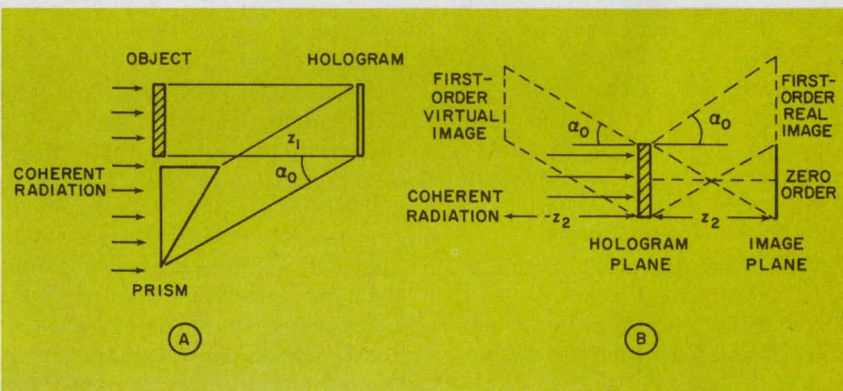

3. **Off-axis reference beam** shown schematically in (A), was used by Leith and Upatnieks to interfere with light from an object. An energy distribution still exists on-axis, but in addition two first-order images are produced off-axis (B). In most holographic systems the first-order virtual image is chosen for the reconstructed image, since the eye itself produces the optical changes needed for viewing. If we were interested in recording a reconstructed image on film, we would choose the first-order real image, since it would automatically be in focus even without a lens.

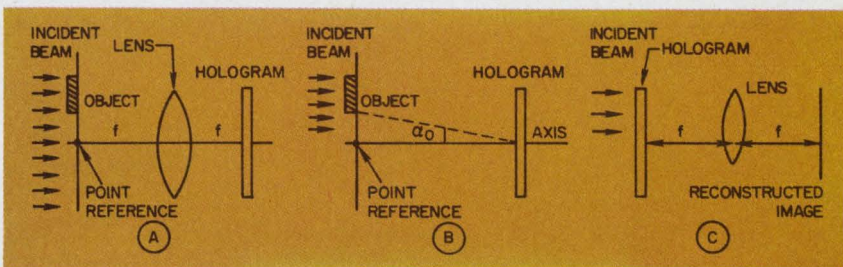

4. **Fourier-transform holograms** may be formed with a lens (A), to effect a Fourier transform of the amplitude distribution of light from the object, or without a lens (B), in which case the amplitude distribution in the hologram plane consists of the object amplitude distribution multiplied by a quadratic phase factor plus an identical quadratic phase factor from the point reference source. The two holograms are equivalent because a lens is used in reconstruction (C) to effect a Fourier transform of the hologram formed in (B).

While this smacks of the occult, when you get right down to it, reconstructing an image is like making a shot in billiards: The balls are forced to go where you want them to go by the workings of physical laws. In fact, if you simulated the interference pattern on film, you could reconstruct the image of a nonexistent object. Scientists have been trying to do precisely this with Fourier transforms generated by a computer.

Holography offers an even more amazing opportunity for tricking the eye: It can make an image leap right out at you so you can view it in the round.

Assume that in reconstruction the hologram is illuminated from behind (the light is directed through the hologram toward the observer). The image that would appear on the same side of the hologram as the observer (but on the side opposite the source) is called the real image, and the one that appears on the opposite side of the hologram from the observer (on the same side as the source) is called the virtual image.

Despite the favorable connotation of "real" and the unfavorable one of "virtual," the real image has the great disadvantage for display purposes of being pseudoscopic—that is, the Z-axis is reversed, causing image points corresponding to the nearest object points to appear farthest from the observer and image points corresponding to the farthest object points to appear nearest.

For example, assume you are viewing the image of a wagon

from the side. If the image is pseudoscopic, the inside of the wheels on the farther side would appear to be closer than the wheels on your side. You would, in effect, be seeing the wagon inside-out.

Early efforts frustrated

Holography got its start in 1947 when a Hungarian microscopist, Dr. Dennis Gabor of the Imperial College of Science and Technology in London, tried to improve the resolution of the electron microscope. In a paper⁴ that was written two decades ago but seemed destined to collect dust in the attic of scientific curiosities, Gabor set forth the principles of wavefront reconstruction and coined the name holography (in Greek it means the total information). He succeeded in making crude two-dimensional holograms of particles and of transparencies, but what hampered Gabor more than anything else was not having a suitable light source. Gabor used a mercury arc lamp, which has a fairly wide spectrum, and he filtered its output to get relatively monochromatic light. Then he passed the filtered radiation through pinholes to get a collimated beam. However, the energy losses in the filter and the pinholes were almost prohibitive.

Then came the needed breakthrough—the development of the laser in 1960. Now scientists had what they lacked before: an intense source of quasi-monochromatic, highly coherent light.

Coherence is crucial to holography. Unless light waves are at

least partially coherent, they cannot interfere, and without an interference pattern, there is no hologram. But the intensity of the laser is just as important, since it puts out monochromatic light with vastly more energy than any other coherent light source.

There are actually two types of coherence: spatial and temporal.

Spatial coherence means that if you beam light from a point-source oscillator (one that has infinitesimally small dimensions) onto a wall, the phase relationship between any two points in that X, Y plane would always be constant. However, a laser has finite dimensions, so that all one can speak of is a high degree of spatial coherence, not of total coherence.

Temporal coherence means that as the rays of light propagate from the source, the phase difference between any two points in the train does not vary, even though, of course, both points are continually changing in phase. What limits this coherence is the spectral bandwidth of the light; no laser radiates at only one precise wavelength, and gradually the two points will lose their fixed phase relationship.

The two types of coherence are related, in that you cannot have perfect spatial coherence without having perfect temporal coherence. But perfection isn't attainable, so the question is what you *can* get.

The distance to which you can get a reasonable degree of constancy in phase between two imaginary points propagating along a light ray is called the coherence length

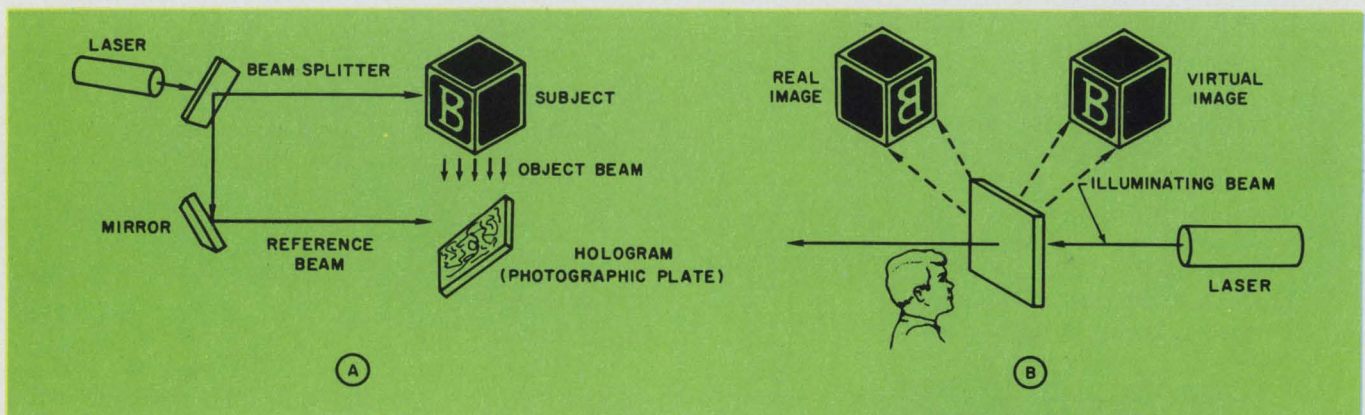

5. 3D holograms are commonly formed (A) by splitting the laser beam so that one portion strikes the object and another the hologram plane at a skew angle. The object and reference beams interface (interact coherently) to

form fine fringes in the film. When the developed plate is illuminated (B), the viewer sees a 3D image (usually the virtual image) of the object seemingly hanging in space.

of the light source. What is reasonable? Try to produce interference fringes on a photographic plate. When you can't get them any longer, you know you've exceeded the coherence length. The coherence length sets a limit on the size of the object that can be recorded. When it is exceeded, you don't get a fuzzy image, you get a fogged plate.

Contrary to what is commonly believed, you can have sufficient coherence to form a hologram even though the wavefronts are not in step like soldiers on parade. For example, a sheet of frosted glass can destroy this uniformity by scattering the light, so that the

phase fronts emerge from the glass in a random pattern. However, they are still invariant with respect to time—that is, they are temporally coherent.

The pioneering work in laser holography was done by Prof. Emmett N. Leith of the University of Michigan and his associate, Juris Upatnieks.⁵ Leith and Upatnieks did much more than merely use the laser as a better light bulb. Borrowing from techniques of side-looking radar, they offset the reference beam (Fig. 5) instead of using it on-axis, as Gabor had done (Fig. 1). This improved the definition of the reconstructed image by neutralizing a troublesome "ghost"

image. Leith and Upatnieks made further innovations, including holographing opaque, three-dimensional objects for the first time. Finally, they hit upon the use of diffuse illumination, which spreads information all over the hologram and provides a great deal of information redundancy.

The work of Leith and Upatnieks ushered in the "modern" era of holography. The equipment and materials in use today are similar to what the two University of Michigan scientists used five years ago: a laser, a light-sensitive storage medium and optics to shape the paths for the object and reference beams. ■■

Overcoming nature's stumbling blocks

Despite the advances that have been made in holography, not all scientists have been won over to its cause. Nature seems to have imposed one obstacle after the other in the way of using some really beautiful effects. Little by little, the engineer and the scientist are removing some of these obstacles. Perhaps they aren't bulldozing through, but the progress is there.

For example, Keeve M. Siegel, the president of KMS Industries in Ann Arbor, Mich., delights in asking a visitor to pick up a champagne goblet. When the visitor does so, he is startled to see another goblet in its place. This one is merely the real image reconstructed from a hologram of the original goblet.

The scoffer would instantly point out that unless round, transparent, symmetrical objects are used (like a goblet), the real images would appear inside-out and would therefore be worthless—and besides, a goblet doesn't exactly make for exciting viewing once the novelty has worn off. But the holographic

tricksters haven't given up. Their suggestion: Make a hologram of a pseudoscopic real image, and in the long run you wind up with an orthoscopic real image. The real image has the useful property that it can be recorded directly on film without the use of focusing lenses.

The possibility of using real images, however spectacular, is a minor point that only serves to illustrate the contest between scientist and physical laws. The skeptics have raised much more serious objections:

- Laser-illuminated subjects display a speckle pattern that is faithfully recorded by the hologram.

- Holograms made with cw lasers require the subject to pose completely still. And even if pulsed lasers could be used, they would be dangerous to eyesight.

- All scenes that are recorded holographically must be illuminated solely with laser light. This rules out daylighted outdoor scenes or the usual artificially illuminated indoor scenes.

- The restricted power and co-

herence length of lasers limits the size of the scene that can be holographed.

- Multicolor images can be recorded only with great difficulty.

Let's take a closer look at some of these objections.

Lasers suitable for holography are of two types: cw and pulsed.⁶ The cleanest, most monochromatic light comes from lasers using one or more of the noble (inert) gases as the active medium. Typical characteristics of various noble gas lasers follow:

Emission (microns)

He-Ne	0.6328 (red)
Ar	0.5145 (green) 0.4880 (blue)
Kr	0.6741 (red) 0.5681 (yellow) 0.5208 (green) 0.4762 (blue)

Power and efficiency (cw)

He-Ne	50 mW; 0.1%
Ar	1 W; 0.1%
Kr	power and efficiency somewhat below argon

Lasers are now much better than they used to be. According to Prof. Emmett N. Leith of the University of Michigan, a pioneer in holography: "In the six years we've been working with holography, the advances have been remarkable. We started out with less than 1 mW of power. Now we have 50 mW, 100 mW and even 1 watt. And the lasers are a lot more stable and coherent, too. The coherence length of the helium-neon laser can be increased to hundreds, if not thousands, of feet with no great loss of power." (This does not imply that a hologram can be made of a Lockheed C-5A superjet; this would require tens, if not hundreds, of watts of cw power, and at present this is asking too much.)

Similar improvements have been effected in the argon ion laser. Recently both RCA and Sperry Gyroscope introduced units with suffi-

cient coherence length to record large scenes.

Actually for several years scientists have been able to make holograms with a field of view that exceeds the coherence length of their lasers. They simply have split the beam a number of times and therefore have been able to illuminate a number of segments coherently. The beams have been overlapped so expertly by such practitioners as Juris Upatnieks of the University of Michigan that one couldn't tell where one beam started and the other left off.

Power, however, remains a vital problem, because holographic subjects are illuminated only with laser light, and only a small percentage of that light reaches the holographic plate. This wouldn't be so bad if the recording media were sensitive—that is, if films with a high ASA rating (the index of film

sensitivity) could be used. Unfortunately a fast film like Eastman Kodak Plus-X is limited in resolution by granularity. On the other hand, films that are fine-grained enough for holography are extremely slow. For example, Kodak 649F has a resolution of 3000 lines/mm as against 50 for Plus-X, but its ASA rating is less than 0.05. (The Scientia series recently introduced by Agfa-Gevaert is from 5 to 60 times faster than 649F, depending on the resolution, but this scarcely changes the situation.)

The insensitivity imposes a severe handicap on the laser. Leith points out: "To expose a photographic emulsion of a given size and a given sensitivity, you need so much energy. If you don't get that energy, you have to expose the plate longer and time-average the signals with a low-power helium-neon laser. You may need an exposure time of 30 seconds, and a lot can happen in 30 seconds."

Indeed it can. A subject might move half an optical wavelength (a few millionths of an inch) while being holographed, and the hologram would be ruined or at least smeared. Or a draft from an air conditioner or even loud talking might cause the optical elements or the holographic plateholder to vibrate. Therefore every holographic laboratory is equipped with massive slabs isolated from ground rumble by some sort of suspension system.

Thus the reciprocal factors of power and sensitivity tend to limit holography to stationary objects (what Dr. Robert J. Collier of Bell Telephone Laboratories has called the "small, small world of dinky toys and book ends") because with a cw laser in the power range now available, nothing short of rigor mortis would prevent human subjects from moving half a wavelength and spoiling the hologram.

The other type of laser that has been tried for holography uses a crystalline solid (usually ruby) as the active lasing medium. Such lasers generally radiate in a relatively broad band because of inhomogeneities in the crystals. Therefore they are inherently less coherent than the cw gas lasers.

Leith points out that in the last few years the "dirty" output of

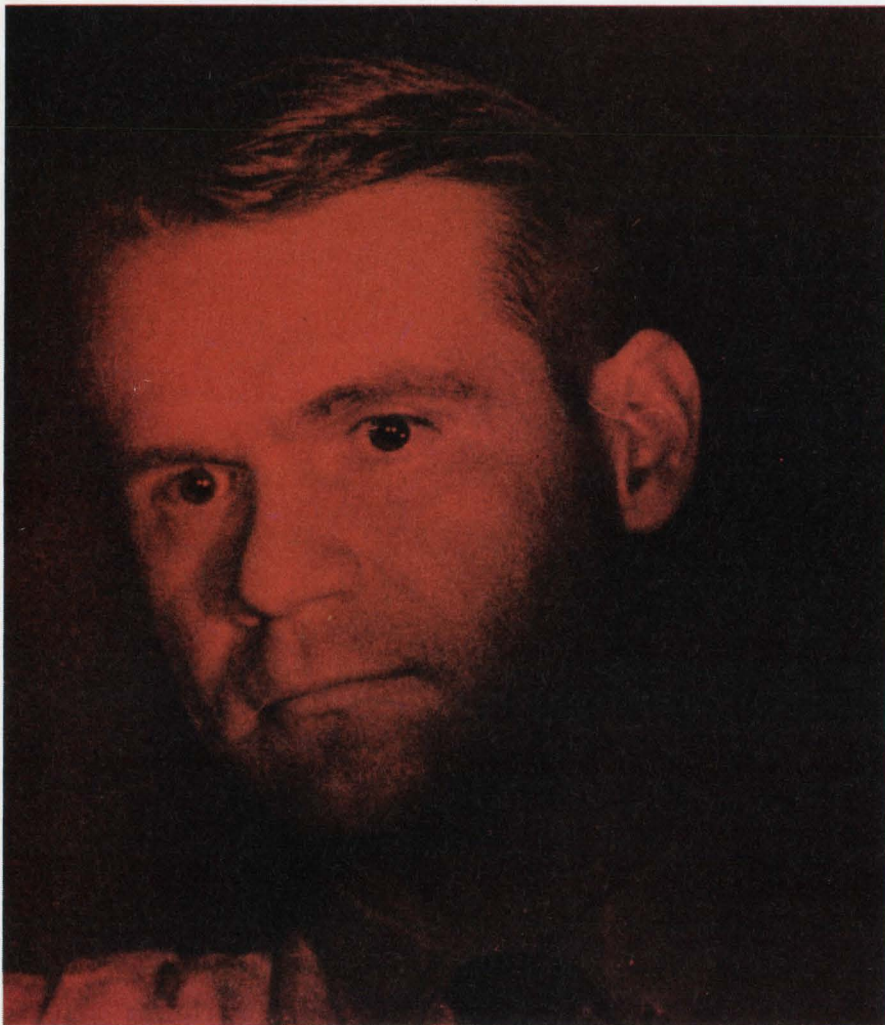

Pulsed laser takes holographic portrait of a human subject. The scientist, Larry Siebert of Conductron Corp., protects his eyes by interposing a diffusing screen between himself and the laser source so that the beam cannot focus to a spot on his retina.

pulsed ruby lasers has been cleaned up by various schemes for filtering out unwanted modes of oscillation in the laser cavity. This has increased the coherence length from millimeters to something more like meters. Now pulsed lasers are definitely in for holography. They offer a way out of the rut of limited power, long exposure times and mechanical constraints.

The mode-suppression techniques reduce the output power, since they discard some of the energy of the oscillator. However, a pulsed-laser holographic system can still deliver 1 joule/cm, enough to expose a 649F emulsion in a 20-to-50-nanosecond burst.

Leith says that in pulsed laser holography there is a problem in choosing the proper pulse width: If it is too long, all of the motion during the pulse interval will be time-averaged. Therefore it is restricted to about 50 nanoseconds for an object moving at the speed of normal hand movements.

On the other hand, Leith says, it must be sufficiently long so that any path length difference between the object and reference beams doesn't prevent interference, or the two pulses might not reach the photographic plate simultaneously.

Smile for the laser

In the last two years a breakthrough has been made in pictorial holography. Many writers were proclaiming that it was "impossible" to make a hologram of a human. Before the ink was dry on some of these pronouncements, the impossible had been achieved. Using a pulsed laser system of its own design, the Conductron Corp. of Ann Arbor, Mich., made holograms of a man's hand. One Conductron scientist, Larry Siebert, even had the audacity to make a pulsed laser hologram of his face.⁷ The setup for Siebert's feat is shown in Fig. 6. Conductron was successful for two reasons: It made the laser oscillate in only one axial and transverse mode—and thereby increased the coherence length—and it benefited from the introduction of a new Agfa-Gevaert film that is said to be 50 times as sensitive to the ruby wavelength as previous films.

Pulsed ruby lasers put out so

much energy that the eye could easily be damaged if the radiation is focused to a spot on the retina. Siebert minimized the hazard by interposing a diffusing screen between himself and the laser. To this day, he says, his vision hasn't been impaired. Incidentally, the danger is not so acute in a playback, since a cw gas laser may be substituted for the ruby laser.

Growth in laser power may help to compensate for the poor sensitivity of holographic recording media, but there is one problem with these media for which laser power is only a partial solution at best: the percentage of applied laser power that is converted by the stored interference pattern into a reconstructed image.

The interference pattern shows up on the photographic emulsion as alternating light and dark areas; where there are silver grains, light

is largely absorbed, and where there is clear gelatin, the light is largely transmitted. Unfortunately too much light is either absorbed by the silver or else transmitted on through the emulsion without being diffracted. Only light diffracted (bent or scattered) by the interference fringes restores the rays of light from the object. Excessive losses produce an image that is lacking in brightness and contrast. The so-called diffraction efficiency of photographic film is a maximum of 6 per cent, and even that is attained only when simple line gratings are stored, not complex interference patterns.

In an effort to increase diffraction efficiency, scientists bleach the absorption hologram into a phase hologram. Bleaching consists of bathing the emulsion in a chemical solution, so that the active ions can combine with the remaining

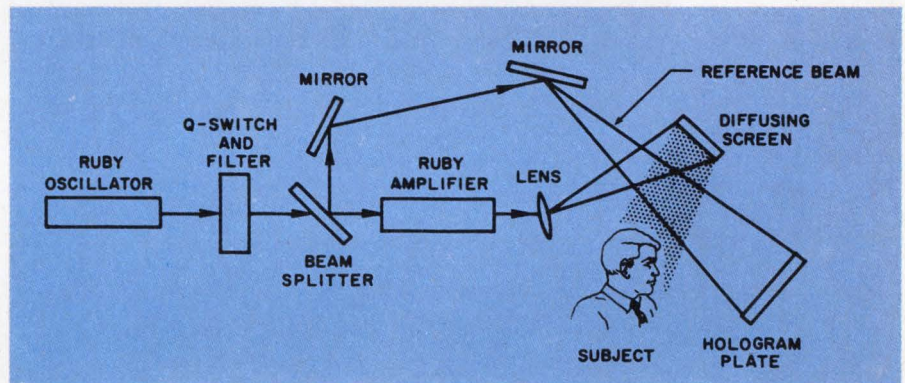

6. Pulsed laser camera forms hologram of a human by passing coherent red light through a glass diffusing screen prior to illuminating the person. This reduces the power density on the retina to a safe level. Q-switched ruby oscillator output is filtered to remove unwanted transverse modes. Another ruby rod is used as an amplifier to compensate for power lost in filtering.

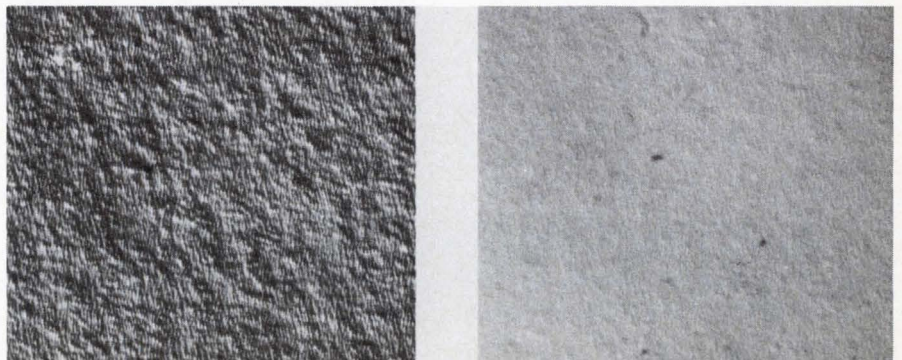

Chemically etching the emulsion gives a smoother surface (right) than conventionally processed hologram, as seen under 250X magnification. This technique is claimed by IBM to give phase-type holograms that diffract 40% of the laser beam into usable reconstructed images. Previous claims of 40% were accompanied by poor S/N.

silver and form a transparent compound whose refractive index is different from that of the surrounding gelatin. Since the silver can no longer absorb light, more light can be diffracted usefully by the interference pattern. The net result is a hologram that gives a better reconstructed image.

In addition to varying the refractive index by bleaching, there is another way of producing a phase hologram: exploiting the thickness of the material. The photographic emulsion is typically no more than 30 optical wavelengths thick (about 15 microns), but the interference patterns are so fine that the fringes can be stored as a volume hologram rather than as a planar hologram.

The physical basis for volume storage is related to the manner in which a crystal diffracts X-rays—by so-called Bragg diffraction. When light is directed at the planes of silver in the emulsion at the Bragg angle, θ , the diffraction is highly directional. The angle θ is related to plane spacing d and wavelength λ by Bragg's law: $\lambda = 2d \sin \theta$ to the first diffraction order. What is special about this type of diffraction is that it is to only one order, not to many. The zero-order diffracted image lies on the axis and the first-order image does not. (Incidentally, the refractive index change induced by bleaching gives a hologram in the first diffracted order, too, so that bleaching and volume techniques are related.)

With volume techniques, it is possible to stack a number of different holograms in the same medium.⁸ Since the volume hologram produces diffraction only for discrete angles and wavelengths of the reconstructing beam, each image is stored uniformly throughout the volume, but separately from all others. In the spectacular General Motors holograms the plate is illuminated at two different angles and a Napoleonic coach and a Cadillac alternately pop into view. Leith and his associates have even made a crude animated movie by recording a number of holograms on a plate at different angles, then rotating the plate during reconstruction.

Multicolor holograms can be formed in black-and-white film

because each light wavelength forms its own characteristic interference pattern. In reconstruction, each pattern diffracts the light beam directionally, thereby scattering its own characteristic wavelength. The object is exposed to one laser wavelength at a time, and in reconstruction separate reference beams are used. In short, a separate hologram is made for each primary color, and the individual images combine to form the multicolor image.

One problem is if the Leith-Upatniek's technique is used with two-dimensional (planar holograms), it is necessary to apply the reference beam for each primary color at a different angle to avoid smearing in reconstruction. Albert Friesem,⁹ a researcher at the University of Michigan, says that with three colors, nine virtual images can be obtained but that six of them are annoying ghosts.

Once again ingenuity has triumphed. Lawrence H. Lin and Keith S. Pennington¹⁰ of Bell Laboratories formed a volume hologram of a photographic transparency and, by means of two lasers, succeeded in reproducing two colors. Since in a volume of hologram the three-dimensional diffraction grating is sensitive to both wavelength and angle (Bragg type of diffraction), color filters aren't needed during reconstruction.

Color techniques advance

Further advances have been scored in multicolor holography. Friesem went beyond Lin and Pennington and successfully made volume holograms of diffusely reflecting three-dimensional objects, not just of transparencies, using the red from a helium-neon laser and the blue and green from an argon laser. He was able to suppress the ghost images and get perfect superposition of the three primary colors.

More recently Friesem has been attracted by the krypton laser, which puts out not only the primaries but yellow as well. It is not merely more convenient, Friesem points out. "The krypton laser gives you better lines than the combination of the argon and helium-neon lasers," he says. "The blue and green are farther apart,

there is less interaction. The only weakness is that the violet line is higher than I'd like."

Meanwhile Lin, Pennington, George W. Stroke and A. E. Labeyrie¹¹ found that when they applied the object and reference beams at a 180-degree angle during recording, they could reconstruct a multicolor hologram with "any white light source ranging from flashlight to sunlight."

White light is a mixture of all the colors in the rainbow. Ordinarily a hologram would scatter each color differently, causing a rainbow-like smear. In recording, however, two lenses may be used to expand the object and reference beams before they strike the subject and the hologram, respectively. The resulting interference fringes are in layers almost parallel to the plane of the emulsion rather than perpendicular to it.

In reconstruction the white light is beamed onto the hologram from the same side of the hologram as the viewer. The fringes reflect some of the light back into the viewer's eyes in a manner that makes it appear that the light comes from a three-dimensional object. Hence this type of hologram is called a reflection hologram, to distinguish it from the conventional transmission hologram. The fringe layers are spaced so they reconstruct the colors without smearing. Thus once again the selectivity of the interference pattern in a volume medium comes to the rescue.

Another problem with multicolor holograms has also been cleared up. Scientists at Bell Laboratories and elsewhere have learned to cope with the problem of emulsion shrinkage, which tends to shift colors to the shorter wavelength portion of the spectrum (for example, in the early attempts by Lin and Pennington, the stripes in the American flag turned out orange rather than red.)

According to Robert Collier at Bell Laboratories, this is not the same thing as changes in conventional color film, which is impregnated with dyes.

"It has to do with the spacing of the Bragg planes in the emulsion," he says. "If they contract, they're responsive to a shorter wavelength, and if they expand,

Comparison of holographic materials

Material	Outstanding Parameters	Comments
Photographic film (Kodak 649F or Agfa Scientia series)	Requires 0.0001 joule/cm ² or less laser power density for optimum exposure. Has maximum diffraction efficiency of 6% or less as absorption type, more as phase type. Resolution is 1500 to 3000 lines/mm.	Must be wet-processed. Has limited storage capacity because of shallow depth. Cannot be reused.
Dichromated gelatin film	96% maximum diffraction efficiency. Resolves 2000 lines/mm or better. Requires 0.01 joule/cm ² .	Phase-only type. No grain, so resolution can be much better than silver emulsions. Insensitive in recordings but its high diffraction efficiency is highly advantageous for reading out stored holograms.
Photochromic crystals (doped calcium fluoride, strontium titanate etc.)	1% maximum diffraction efficiency. Resolution comparable to 649F. Requires 0.05 to 1 joule/cm ² .	Theoretically a crystal can store 1000 pages of data. Has tendency to decay spontaneously. Does not fatigue and can be rewritten, but holograms are gradually bleached by the read-out beam. Must be refrigerated at dry-ice temperature.
Thermoplastic films	Fairly high diffraction efficiencies because phase-only type. Somewhat more sensitive than 649F.	Images formed in real time by surface deformation. Erasable by heat. Material fatigues after a finite number of cycles because of polymer cross-linking. Hysteresis effects appear with erasure and lower the S/N.
Ferroelectric crystals (lithium niobate)	42% diffraction efficiency. 1600 or more lines/mm. Requires 1 to 100 joules/cm ² .	Phase-only (responds to intense light by undergoing refractive index change). Limited storage life, but can be rewritten indefinitely. Erased by heating to 170°C. Can store 10 ⁷ bits in 1 cm ³ .

they're responsive to a longer one.

"If the planes in the emulsion are swelled to the spacing of the original interference pattern, they give you the proper colors, and this can be done by chemical treatment of the hologram."

Up to now the only medium that has been discussed is the silver halide emulsion. But transparent bulk crystals, dichromated gelatin emulsions, thermoplastic films and even liquids have been tried for hologram storage. The bulk crystals are thicker than film. Therefore they have a large d relative to film and offer the possibility of

really high-density storage. A summary of the most promising materials is given in the table.

With all of these advances, it is time to think seriously of applications for holography, and many have been found. Several years before Siebert dared make a holographic portrait of himself, a number of scientists—notably Robert E. Brooks, Lee O. Heflinger and Ralph F. Wuerker of the TRW Systems Group, Redondo Beach, Calif.—had already made high-speed photographs of moving objects using pulsed-laser holography. And by now holography is begin-

ning to be used in various industrial and laboratory applications, such as interferometry, vibration analysis, contouring and testing for fatigue of materials. (See "Finally: A Practical Application for Holography," ED 4, Feb. 15, 1969, p. 25).

While these industrial applications are now considered to be part of an evolutionary technology, what about the early predictions based on the ability of holograms to store images—namely, pictorial applications and data storage? Is holography practical or even feasible in these areas? ■■

Holographic movies and TV?

Many knowledgeable persons in the advertising and entertainment industries have seen holograms. Inevitably they ask whether they couldn't combine the three-dimensional properties of holography with the other techniques of visual realism (color, motion, large screens, etc.). Imagine viewing Raquel Welch holographically. Or hanging a holographic portrait or landscape on your living room wall.

Heady stuff, this, but you may have to wait a long time for it to materialize. Dr. Dennis Gabor, the father of holography, said last year: "3D cinematography without lenses, by means of holograms, appears possible, although I may have to wait 20 years for it."

There are formidable barriers to 3D "holies" at your favorite drive-in theatre or on your TV screen. While progress has been made on a number of fronts, not all of the fundamental problems have been solved.

The obstacles in holographic portraiture are child's play compared with making and playing back 3D holographic moving pictures or transmitting 3D television holo-

graphically.

In holographic motion pictures there are problems on top of problems. The three biggest woes are developing a camera, finding a way to take in outdoor scenes and, above all, projecting the images so an audience can see them in natural colors and in three dimensions.

Impressive results in pulsed-laser holography have been demonstrated by the Conductron Corp. of Ann Arbor, Mich., but the pulsed ruby laser is not an immediate solution to making large-screen motion pictures. Its coherence length is still too limited, its repetition rate too low, and it radiates only in the red region of the spectrum.

Conductron sells a commercial version of its "camera," for which it specifies a coherence length of two meters. Keeve M. Siegel, president of the KMS Industries, Ann Arbor, claims his company has outdone Conductron by achieving a coherence length of 20 feet. This, of course, is enough to encompass a room, but unlike the conventional movie camera, which can be used in sunlight, its use is largely restricted to laser light.

The Conductron system has a

repetition rate of one pulse every 45 seconds. This, of course, doesn't even come close to the standard projection rate of 24 frames a second in a motion-picture theater.

Robert D. Buzzard, a KMS Industries engineer, comments:

"For stop-action photography, 15 frames per second, is tolerable. At 10, flicker becomes noticeable—an arm would appear to jerk. The highest repetition rate you can get right now from a ruby laser is 10 pulses per second—and not for more than a second or two, lest the ruby fly apart. It's a matter of not being able to transfer the heat out of the rod fast enough. You might try a Gatling-gun arrangement using 10 ruby rods, each firing two or three times a second, but it's a brute force approach that's staggeringly expensive."

(Even standard ruby laser systems often cost \$40,000 each.)

As for multicolor, Prof. Emmett N. Leith of the University of Michigan speculates that three pulsed-laser heads, fired in sequence, could give the three primaries. However, he is unable to name any suitable blue or green sources, despite his pioneering in

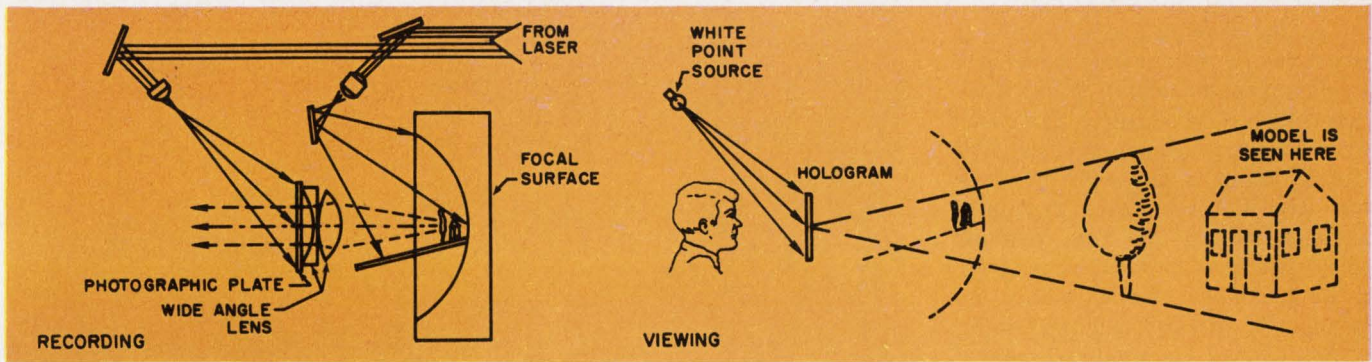

7. Panoramic viewing can be simulated by scaling a model so that it is flattened—compressed in depth relative to its other dimensions. This compensates for an

optical law that states that depth magnification is equal to the product of the other two magnifications. The technique was developed at CBS Laboratories.



Scale models holographed with special concave lenses give a simulated panoramic background. This CBS Laboratories technique may provide the background for holographic portraits and even movies.

holography. Still, considering laser progress, the sources may yet be found.

Dr. Dennis Gabor, discoverer of holography, says that with present technology there is no way to photograph a large garden with coherent light, let alone a landscape. He points out, however, that there are tricks that can be used to give the illusion of a landscape. One must not start with a real landscape but with a model of one, and then make a hologram of that.

The technique of panoramic holography, which was developed at CBS Laboratories, Stamford, Conn., under Gabor's guidance, is illustrated in Fig. 7. A photographic plate is covered in its entirety with a wide-angle lens. The model is placed inside a focal surface that is concave in the direction of the lens. When viewed through the lens, all points on the focal surface appear to have infinite depth of field.

The model is intentionally constructed so that it is compressed in depth relative to its height and

width. The reason for this compression is to avoid depth distortion, since by the laws of optics the depth is magnified by the square of the transverse magnification. For example, to make a model of a house that measures 10 meters in height, width and depth, one would select a ratio, say, of 10 by 10 by 0.1 cm. In reconstruction, this square pancake would actually suggest a real house.

Brief animation achieved

As demonstrated by Leith, Conduccion and others, volume holograms can be used to produce animated motion pictures that last a few seconds, but this is only a beginning. Dominick J. DeBitetto,¹² a physicist at Philips Laboratories, Briarcliff Manor, N.Y., has developed a system for recording thin horizontal holograms onto five-inch-wide rolls of film (see Fig. 8). The strips then pass in sequence through a laser-illuminated viewing aperture at a constant velocity.

The use of thin horizontal strips

cuts down on the field of view by eliminating much of the vertical parallax—one can't even see the tops of the heads of the three-inch figures used in the film. However, DeBitetto says this is the least important information about the subject in most cases.

The continuous-strip method is far less cumbersome than individual holographic plates. For example, if a hologram is used for each frame and images are projected in sequence at 24 frames a second, close to 200,000 plates would be required for a full-length movie. Even the volume hologram technique—in which one stores a hologram on a thick emulsion, rotates the plate 6 or 7 degrees and stores another, and so forth—would require 3600 plates for two hours of viewing.

Nor would it be practical to store pictures in photochromic or ferroelectric crystals, as has been suggested at times. First of all, the viewer would have to look at the image through the crystal, which would drastically reduce the

viewing angle. Secondly, the techniques for storing and accessing a great many holograms have not been perfected. Finally, available materials are unsuitable for long-term storage. Ferroelectrics like lithium niobate are shelf-life-limited—the pictures would gradually be bleached out by the readout beam. Besides, duplicate copies of crystals can't be made readily, as they can be of film, and one simply wouldn't want to send the master copy out.

Regardless of the storage method used, there would be fantastic problems in reconstructing the image so a large audience could view it undistorted and in three dimensions. One sees the image in three dimensions only by looking through the holographic medium; the sightline must include the eye, the image and the hologram. If the observer is too far off to the side, his field of view will be severely reduced and he will lose the three-dimensional effect. Therefore there would always be a limit on the angle at which the seats could fan out.

The largest holograms made to date are the custom plates supplied by Conductron for General Motors headquarters in New York City. But how many people could look through even 18-by-24-inch plates like these from the balcony of a theater?

Keith Pennington, who worked on multicolor holography at Bell Laboratories and is now at IBM, says:

"To be able to illuminate a holographic movie, you would need a very powerful laser, and you would have to arrange it so that the viewer doesn't get the direct beam in his eye. You might use a back-lighted hologram and put the laser beam through a diffusing screen.

"The hologram is going to have to be as big as a movie screen, unless you can come up with some fancy projection scheme—I assume you don't really want to use a hologram frame as large as the screen.

"Now, two-dimensional holograms are within the realm of reason, and you can get the breaks. You project from 35-mm film or crystals, and you still get the high storage capacity. But you're really asking too much if you want to

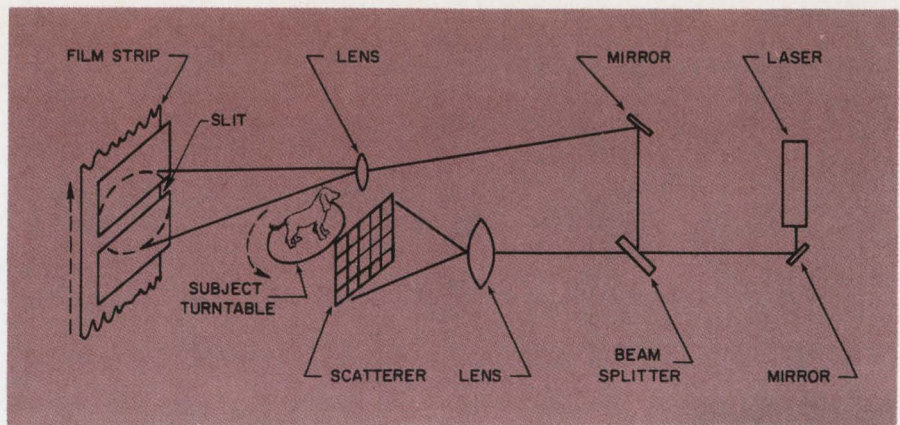

8. Holographic 3D movies can be taken on a moving roll of film by restricting the field of view. Narrow horizontal strips eliminate vertical parallax, but this is expendable. When illuminated, the holographic film reconstructs sequences of real images.

project in 3D. It would need tremendous breakthroughs. But if you give up your 3D, why bother to do it holographically at all?"

The projection problem is this: If a magnifying lens is used, it will reduce the angle of view, compress the object in depth or introduce other distortions. There is no known optical device that will give equal magnification in all three coordinates. However, as panoramic holography by Gabor demonstrates, the eye can be fooled, and perhaps a way can be found.

DeBitetto is not awed by the projection problem. "We have introduced an acceptable magnification factor of two or three in viewing our horizontal strip holograms," he says. "If you're talking about something that's movie-house size and you want it this year, I would say it can't be done. But I wouldn't say it could never be done."

Integral photography promoted

It has been conjectured that the best route to three-dimensional movies, television and displays may lie not in holography as it is known today but in a related field, integral photography, which uses incoherent white light.

In integral photography, light reflected by the subject strikes a special fly's-eye lens in a conventional camera.¹³ Each tiny lens receives rays of light in a unique direction from the object. The result is a plot not only of intensity

but also of spatial frequencies. When the picture is projected through the fly's-eye lens, a three-dimensional image is formed that is similar to a reconstructed hologram.

The coded information is different in each case: The hologram records phase information, and the integral photograph records the spatial frequencies of the rays from the subject—that is, the directions of the light rays.

An integral photograph has several advantages over a hologram. Since it doesn't record fine interference fringes, it doesn't matter so much if the subject moves or the film is a trifle grainy. This greatly simplifies the recording of all sorts of objects.

Taking multicolor pictures is no problem with integral photography. One simply uses color transparency film. In fact, it should be possible to make an ordinary hologram of the integral photograph by shining laser light through it and the fly's-eye lens, so that this light interferes with a laser reference beam on the hologram.¹⁴ With a krypton laser and an intermediate integral photograph, one might even make a multicolor hologram under controlled conditions of something that would be very difficult to holograph otherwise.

Holographic television presents a great challenge to the designer. One of the most formidable problems is the huge information content of a hologram. Leith points out that holograms may have

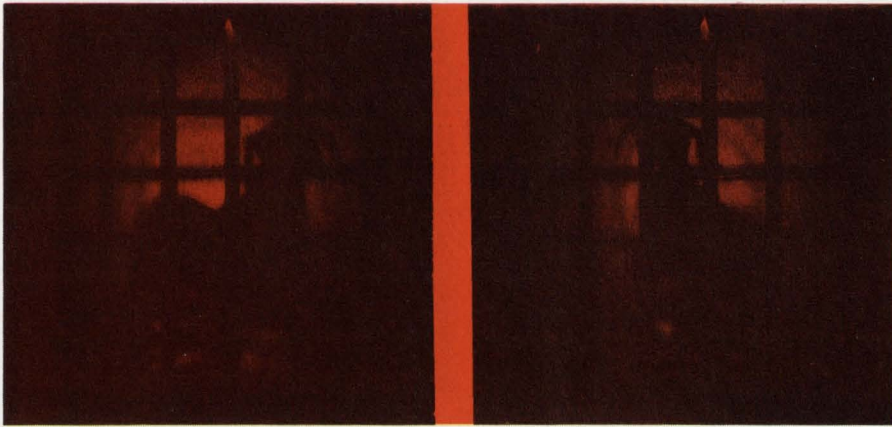

A turntable provides different aspects of a subject in a holographic film strip made by D. J. DeBitetto of Philips Laboratories. The viewer sees a 3D virtual image of a toy dog by looking through the laser-illuminated film strip. Five-inch-wide rolls of film are used.

fringe spatial frequencies of 2000 lines/mm. At the TV scan rates now in use, a bandwidth of 50,000 MHz would be needed to transmit just one 11-by-14-inch hologram. This, of course, exceeds the available communications spectrum.

It is obvious that the information content must be reduced before the electronic processing stage if holographic TV is to have a chance. The alternative would be to transmit the information serially, like some of the video signals sent from space, but no one would be willing to sit for several minutes in front of a monitor waiting for a frame to form. It should also be borne in mind that information reduction is applicable to Picturephone® service as well as TV.

Several information reduction schemes have been conceived. They all involve certain tradeoffs. One would be to reduce the area of the hologram by sampling. The other would be to sacrifice some of the spatial frequencies—that is, some of the stored interference fringes. Gabor estimates the redundancy factor in a hologram to be 10,000.

DeBitetto says his technique of eliminating unnecessary vertical parallax by recording on narrow horizontal strips of film should reduce the bandwidth (to be precise, the space term of the space-spatial frequency bandwidth product) by a factor of 100, so that only 500 MHz would be required for the video channel. The remaining information would still give the

viewer a three-dimensional view if he moved his head from side to side.

Another technique, developed by Christopher B. Burkhardt¹⁵ of Bell Laboratories, entails sampling the hologram by means of a mask and then transmitting only those samples. A new hologram is formed at the receiver by reconstruction of the samples. The image on the screen has a reduced field of view. Also, if the viewer moves his head to observe the parallax changes, he will find that changes occur in abrupt steps, not continuously.

Lawrence H. Lin¹⁶ of Bell Laboratories has gone beyond Burkhardt. His method resembles DeBitetto's in that it sacrifices the vertical parallax in the image. However, Lin's technique is more sophisticated.

Lin considers the holographic subject as a Fourier series of spatial frequencies with particular amplitudes. To get information about the subject, all one really needs is a few of these spatial frequencies. However, the more of these frequencies used, the better the resolution. It's like the difference between a square wave and a sine wave. The resolution is poor if only the first harmonic is used, but as harmonics are added, the result approaches the square wave.

What Lin does is take a Fourier sampling and record various components of the amplitude of each spatial frequency of the subject. Sampling is accomplished by permitting only a limited number of

rays from the object to strike the hologram plane (Fig. 9). These are recorded, and the hologram is transmitted and reconstructed.

At the receiver a mosaic of tiny, identical holograms is formed by iteration of the holographic sample. The mosaic is made large enough to cover the entire field of view. The next frame consists of another mosaic, and so forth.

The resolution of each sample must be as good as possible, or the picture will be terrible. When the information content of the hologram is reduced by a factor of 100—that is, only 1 per cent of the information is retained—the reconstructed image is of acceptable quality. With a thousandfold reduction, however, resolution is reduced, although the image is reasonably good.

No sampling here

A technique that does not involve sampling has been investigated by K. A. Haines of the Hologtron Corp., Wilmington, Del., and Douglas B. Brumm of the University of Michigan.¹⁷ Haines and Brumm interpose a ground-glass diffusing plate between the object and the hologram. The light from the object strikes the diffusing plate and is scattered in all directions, so that information from any point on the object interferes with an offset reference beam at many points on the hologram. While any hologram would contain information about the entire object, this particular type also contains information about the entire object taken from many different directions. Then, no matter how small a portion of the information is transmitted (within reason, of course), the hologram formed at the receiver doesn't suffer from a limited field of view. As Brumm puts it, "You simulate a large hologram with a small one."

There are several disadvantages to this method. First of all, no image can be formed unless the original scattering plate is placed in the path of the illuminating beam. This is not a serious drawback, and could even be an asset, because the built-in coding permits secure communications.

Much more important is the loss of resolution because of the reduc-

tion in spatial frequencies, and possibly also some loss in signal-to-noise ratio and in contrast. The results with various reduction factors are shown in the photograph on page 58.

Brumm suggests as a logical application of this technique a 3D display in an aircraft control tower.

"The air traffic controller doesn't care about the fuzziness. All he wants to know is where the aircraft is in three coordinates," he says.

No one information reduction scheme is sufficient by itself to permit holographic television. It is not just a matter of channel space. The quality of the image has to

be acceptable, too. Considering the tradeoffs, the problem is far from solved. However, the results are interesting enough to encourage further research.

Bandwidth reduction is not the only obstacle to a holographic television system. Almost as forbidding is the conversion of the holographic information into a relatively narrowband electrical signal by means of a camera that has limited spatial resolution.

The only solution seems to lie in the creation of an electronic analog of the optical signals. It would be extraordinarily difficult to form a hologram on the camera tube, because the camera's frequency response is low-pass in nature and

the optical carrier frequency is high. Therefore it has been proposed that instead, a modulated electrical carrier frequency corresponding to the spatial carrier frequency of the hologram be generated by heterodyning the object beam with the reference beam.¹⁸

According to the three Bell Laboratories scientists who conceived of the hologram heterodyne scanner—L. H. Enloe, W. C. Jakes Jr. and C. B. Rubinstein—such a device would allow the hologram information to be low-pass in nature until it has been processed by the transducer. They claim that the required spatial resolution could be relaxed at least a factor of four in comparison with trans-

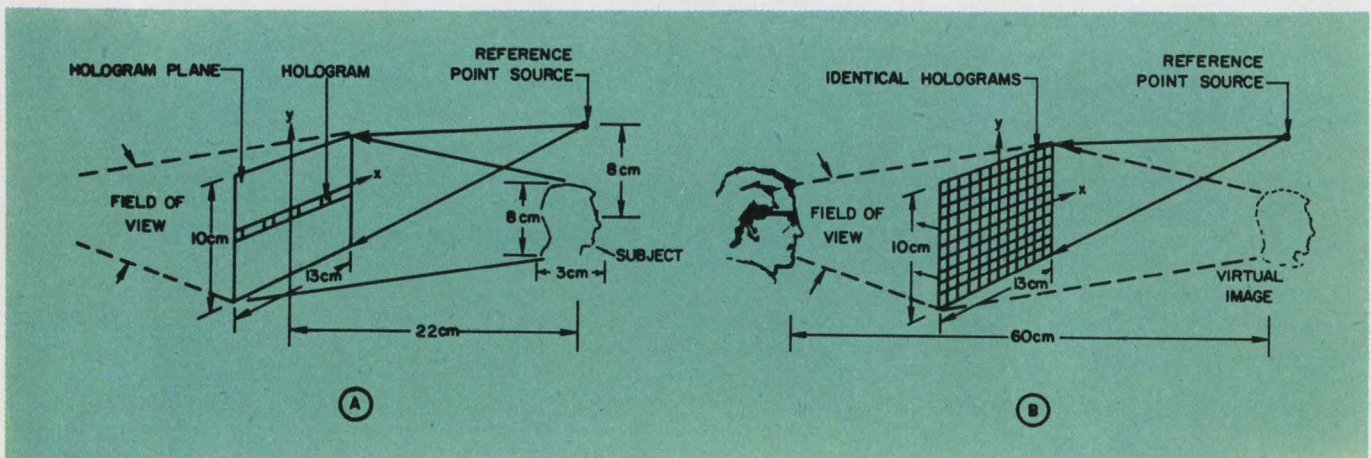

9. Holographic bandwidth can be reduced if small bands of spatial frequencies are sampled from the subject for recording (A). The area of the resultant Fourier-transform hologram covers only a small fraction of the field of view, but in reconstruction (B) it is iterated into a

mosaic of holograms. Four vertical segments are made up by repeating the four small sectors shown in (A). For example, the three columns of tiny holograms at the right in (B) are all the same small hologram indicated by the arrow in (A).



Reducing the redundant information content of a hologram also decreases either the field of view or the resolution (as shown here in successive data reduction

ratios of 140, 500 and 3600 by K. A. Haines and D. B. Brumm). One application utilizing this feature might be holographic TV transmission.

mission of a conventional hologram.

At this point, the Bell scientists say, it is premature to speculate on how the transmitted information should be displayed. One possibility has been suggested by Leith—namely, that photochromic crystals

be used for storage. The output of a laser beam that has been modulated by the holographic electrical signal could be radar-scanned over the photochromic material.

Enloe, Jakes and Rubinstein believe their proposed heterodyne

scanner is compatible with Lin's bandwidth-sampling technique, and in fact could even increase the bandwidth saving. They also claim compatibility with the information-reduction schemes of Haines and Brumm. ■■

The promise of dense data storage

In the brief history of the laser and the even briefer history of laser holography, a number of significant advances have been made. While they are not equal to the demands of 3D movies and television, they may give rise to a potentially more significant technology: holographic data storage.

If present trends in digital computers continue, the machines will grow in complexity and size, despite the maximum use of integrated circuits. This will impose more stringent demands on the data-storage function. If the memory is not to become a bottleneck, storage capacity will have to be increased at no sacrifice in speed. In all likelihood the information will have to be packed more densely. No other storage medium has the high information packing density of photographic materials. But if the conventional optical techniques are used to store data, there are two serious shortcomings:

- Lenses must be used, and no mechanical transport can focus them fast enough.

- Microphotographs are vulnerable to dust and scratches, which can cause loss of data.

Holograms, on the other hand, do not require lenses. They are self-focusing, and the image appears not on the hologram plane but either in front of or behind that plane, where it can be read by a photodetector.

Moreover information is stored

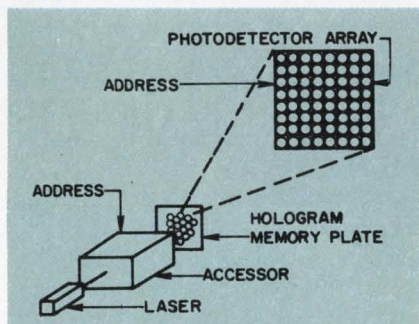

10. Read-only holographic memory accesses 10,000 pages—stored on a substrate, each with 10,000 bits—in about one microsecond. The reconstructed holographic image is read out by a photodetector.

redundantly in a hologram. Therefore, while dust and scratches will lower signal-to-noise ratio, they will not obscure bits of data. A certain amount of noise is tolerable, because only the state (one or zero) matters, not the resolution.

Scientists at a number of companies, including Bell Telephone Laboratories,¹⁹ at Murray Hill, N.J., IBM,²⁰ Poughkeepsie, N.Y., and RCA,²¹ Princeton, N.J., have been investigating read-only memories in which an array of tiny, two-dimensional holograms is deposited on a glass substrate, accessed by a laser beam and read out by a matrix of photodetectors (see Fig. 10).

Writing into this sort of memory is similar to the formation of

data masks for integrated circuits. One forms data masks that might consist of binary-coded pinholes in a 100-by-100 matrix. Each mask, which might contain 10,000 bits, is placed between a lens-focused laser and a holographic medium (presumably a photographic emulsion).

The film is exposed selectively through an aperture, so that a 1-mm-diameter hologram is recorded for each data mask when the modulated laser beam and an offset reference beam interfere.

Perhaps 10,000 data masks, or "pages," are recorded onto the sheet of film, so that, in all, it contains 100 million bits (10^4 pages of 10^4 bits gives 10^8 bits).

Reading is a much more difficult thing to do. To extract any desired page of data in about 1 microsecond, the memory must be of the random-access type. And unlike an X-Y magnetic memory, one cannot reach an address simply by applying current to two lines. A laser beam must be applied to any given 1-mm spot, then whipped around to another spot, all within a microsecond. The upper limit for the number of holograms in each array is set by the maximum access time, and that in turn is determined by the fundamental limits of the deflectors. Without high packing densities, the entire concept wouldn't be worth considering.

Laser deflection techniques have by no means been mastered. If

they were, then laser display systems, scanners and cameras, as well as memories, would be much farther advanced than they are now.

To get microsecond access times Bell Laboratories, IBM and RCA have been forced to consider electro-optic digital light deflectors, which reach more addresses in a given time than any other form of light deflector. However, for large-capacity memories, a binary tree arrangement of a great many precision electro-optic switches would have to be used. This is not a happy prospect because the switches are expensive and they require large drive voltage. Moreover the optical engineering problems are considerable.

"Therefore," says Lawrence K. Anderson, who leads the optical memory project at Bell Laboratories, "for the time being we're working with acousto-optic deflectors. You will eventually be able to access one of 100 or more addresses in a microsecond. Where this kind of performance is adequate, the acoustic-optic deflector will always be simpler, hence cheaper."

An acousto-optic deflector consists of a material whose refractive index can be changed by the application of an acoustic wave. One such medium might be a cell containing water. An applied ultrasonic wave tends alternately to compress and expand the water. The effect is the creation of a three-dimensional diffraction grating. The light beam is deflected through an angle corresponding to the ultrasonic wave length. By changing the frequency in steps, one can obtain a sequence of deflection.

The work of all three companies is still in the research stage. None has configured a huge memory system, so that for the time being the performance of the light deflectors is not crucial.

The hologram that is addressed by the laser readout beam is projected onto the readout plane, where it reconstructs the digital pattern of the data mask. The presence or absence of dots of light is detected by solid-state photodetectors, one detector for each bit on a page. Since every one of the holograms always provides a

focused image, the same photodetectors can be used for all of the holograms—a saving of a factor of 10^4 .

The low diffraction efficiencies of absorption-type holograms will always be lower than that of phase-type holograms, since only a small percentage of the laser light applied to the hologram is converted into usable images. The rest is either absorbed by the silver in the film or transmitted right through the film without being diffracted. Phase-type holograms, which give a higher diffraction efficiency, can be obtained either by bleaching or by using other materials that do not require such chemical treatment.

T. A. Shankoff and L. H. Lin of Bell Laboratories have developed a new emulsion, dichromated gelatin, which has a theoretical maximum diffraction efficiency of 96 per cent. This figure is not attainable in practice, but even allowing for a complex information pattern and some modulation freedom, 20 per cent is reasonable.

Anderson says of dichromated gelatin that potentially it is an extremely high-resolution material because it is continuous—it has no grain structure. On the other hand, the atoms of silver in conventional film emit photons. When light strikes them, there is a gain mechanism. This accounts for the fact that dichromated gelatin is orders of magnitude slower than silver halide film.

In some areas of holography, the insensitivity of dichromated gelatin will disqualify it as a recording medium, but not in data storage. One can compensate for insensitivity by using more laser power in writing on it. This expenditure is more than rewarded by the lower power requirements for readout, since the hologram is written only once but used many times over.

One outstanding application might be in a telephone central exchange, where information does not have to be updated very frequently.

The ideal memory

The perfect material for a read-write holographic memory would have complete reversibility, high

photographic speed, high diffraction efficiency, stability and adjustability over a wide range. The emulsions are unsuitable because they are permanent. This leaves as candidates photochromics, ferroelectrics and thermoplastics, all of which are in the research stage and all of which fail to meet one or more criteria. However, they are still in the running because there are ways of compensating for their defects.

Douglas Bosomworth, an RCA staff scientist, thinks that photochromics have definite prospects.²²

"Some photochromic materials, but not all, have absorption bands that can be classified as read, write and erase," he points out.

"There is no reason a holographic read-write memory could not be built using these materials. There is some question, however, whether it would be a good idea to do so.

"Whenever you're working with holograms, you have to have a laser source and some optics. Designing the system is far from trivial.

"With photochromics you have to apply a certain amount of energy every time you read out, and there is only a limited number of times you can read the stored images before you bleach them away.

"Fortunately we have shown that it is possible with certain materials to read stored images one million times. Even a million times isn't enough for some applications, so we're exploring some ideas about how to make new materials that you can read an infinite number of times. However, there remains a thermal storage lifetime problem, so you couldn't use photochromics for permanent storage.

"Assuming we can work out all the problems, including non-destructive readout with thick holograms, we might be able to store 1000 pages in one crystal. Since maximum packing would be 200 holograms per degree, this is conservative. The holograms would be stored on top of one another and separated by rotation of the crystal."

Bosomworth cautions against undue optimism.

"I'm giving you an assessment based on having all the breaks," he says.

Robert K. Curran, a Bell Laboratories materials scientist, is inclined to oppose photochromics mostly because of their low diffraction efficiencies—they convert very little of the readout beam into useful images. Thus they are wasteful of laser power in readout. (And, as Bosomworth points out, the readout beam bleaches out the images.)

"Photochromics form a wide range of materials, all of the absorption type," Curran says. "The theoretical maximum diffraction efficiency is 1 per cent, and it can range down to 10^{-5} of that.

"Storing a lot of images doesn't do much good if you can't reconstruct them. In principle, a thick absorption material has the ability to store many millions of holograms. However, if, say, a million holograms are formed, then the efficiency goes way down below the 1 per cent level."

Curran says that Bell is more interested in phase holograms, in which the hologram is recorded either by changing the refractive index in the bulk of the material or by, in effect, varying the optical path by local physical changes. Dichromated gelatin is of the first category and thermoplastics of the second.

Thermoplastic recording was invented by William E. Glenn, formerly a General Electric scientist.²³ It consists of applying an electron beam to a heated material in vacuum. The electric charges deform the surface of the film, so that light reflected from the surface is shifted in phase by varying amounts. By this means an image is formed that can be viewed optically. The image is recorded in real time, and it can be erased by heating.

The technique is now being used by CBS Laboratories at Stamford, Conn., where Glenn is manager of research, to record acoustic signals from underwater transducers in real time. One potential application foreseen by Glenn is the real-time recording of acoustic holograms (holograms formed with acoustic, rather than light, waves). The hydrophone signals are put onto the electron beam, and the result is a hologram that reconstructs the image when illuminated with a laser. The holo-

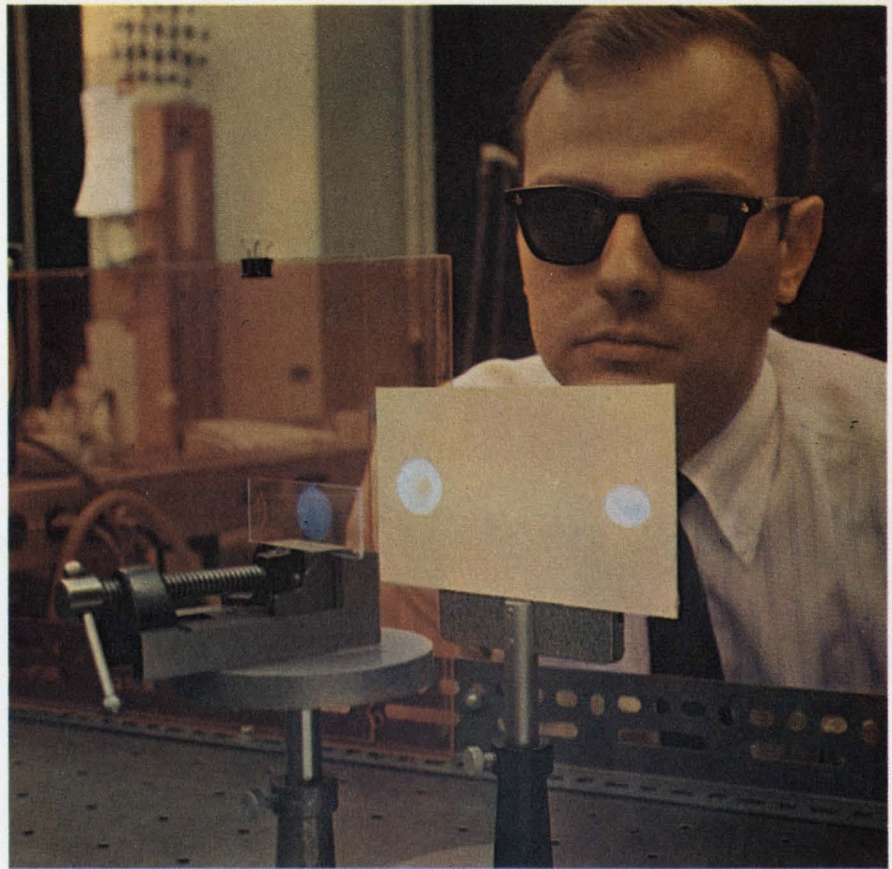

The two bright areas on the card illustrate the high efficiency—over 90%—with which a simple pattern formed in a new holographic material, dichromated gelatin, diffracts a laser beam directed by T. A. Shankoff of Bell Laboratories. The company hopes to store up to 10^8 data bits holographically on a glass slide coated with the emulsion.

gram is phase-only and therefore diffracts efficiently.

In recent years Reinhard Meier and John Urbach of the Xerox Corp., Rochester, N. Y., have been depositing a thermoplastic on a photoconductive medium, surface-charging it, exposing it to a laser and then heating it to form a surface pattern.

Glenn says: "The nice thing about the work Urbach has been doing is that the material is reasonably sensitive—more sensitive by a factor of 10 than 649F—and it's completely stable, unlike photochromics, so that it has the best of both possible worlds."

Urbach is guarded about claiming complete erasability for thermoplastics, and this is crucial for a read-write memory. He cites these problems:

- The material deteriorates with repeated use.
- The signal-to-noise ratio gets progressively worse.
- Previously erased images tend

to reappear (a hysteresis effect).

- The photoconductor's characteristics may change.

Glenn, who has been working with thermoplastics for a decade, comments:

"Under radiation the polymers you're using in the film will eventually cross-link irreversibly, and they'll lose their ability to be melted and reformed. The less radiation-resistant plastics are good for about 50,000 reuses and the better ones for about 500,000.

"As for the memory effect and the increase in noise, they're related. However, with many plastics you can apply a little extra heat without causing evaporation, and this heat erases the image completely. Each plastic has an optimum temperature."

Collier of Bell Laboratories says that CBS and Xerox are probably not working with the same plastics. He thinks Urbach may be a little on the conservative side concerning the possible reuse of the

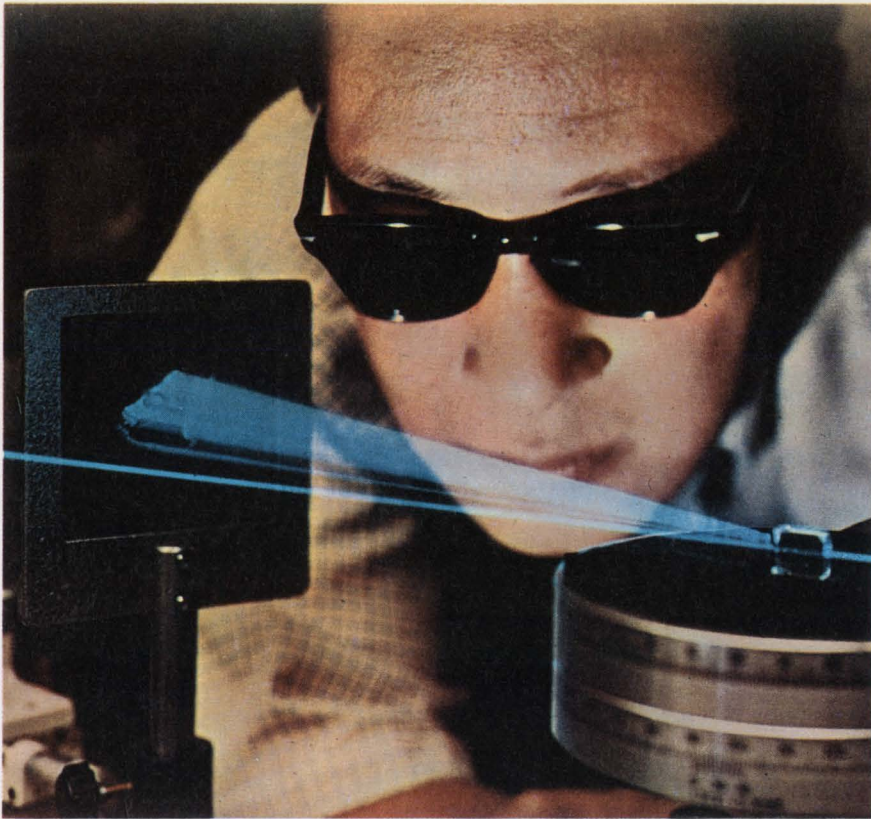

Lithium niobate crystal stores as many as 1000 holograms—but potentially many more—in a lithium niobate crystal. Fong Chen of Bell Laboratories reconstructs one such image. To get a new one, he simply changes the angle at which the laser beam enters the crystal.

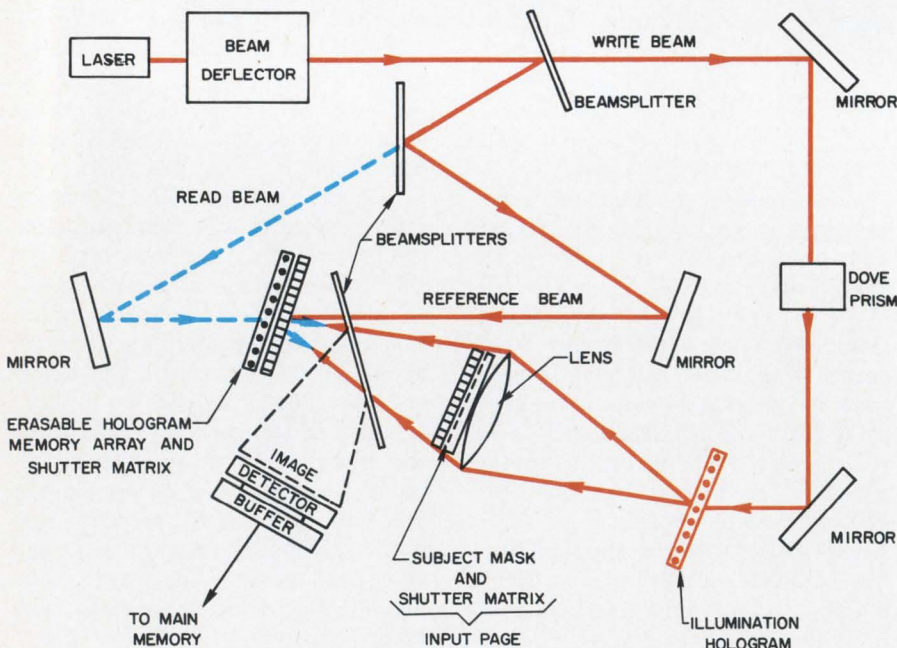

11. Holographic memory reads, writes and erases without having to be removed from the system. The laser output is deflected acousto-optically into any one of 10,000 parallel channels. This permits random writing or interrogation of 10,000 addresses at a hologram memory plane. The beam is split into a read beam and a write beam. The illumination hologram deflects the write beam by diffraction.

plastic. While he is not sure that thermoplastics will be the ultimate answer to the storage problems for a read-write holographic memory, they are the best to date.

At a conference²⁴ last year, Collier described a proposed read-write-erase holographic memory. He predicted that it would have a large capacity, fast random access and would not have to be taken out of the system to be modified. It would be a page-organized memory (with 10,000 bits on a page, 10,000 pages to a frame, like the read-only memory described by Bell Laboratories' Anderson). One would be able to erase any page selectively.

Reading, writing and erasing would be accomplished with a single laser beam (Fig. 11). An acousto-optic deflector would displace the beam to any of 10,000 parallel channels for reading and writing.

The reading beam would illuminate the hologram from the rear, and the writing beam would do this from the front. A thermoplastic would be used as the holographic medium. If another rewritable material were used, such as a photochromic glass, then (as Bosomworth explained in connection with photochromic crystals) there would be separate read, write and erase bands, each of which might require a separate laser wavelength. Besides, a thermoplastic has much higher sensitivity as well as much higher diffraction efficiency.

The readout matrix and its associated electronics would be similar to those in the read-only memories being investigated by Bell Laboratories, IBM and RCA. The writing portion would be unusual, in that it would include a second hologram (the illumination hologram) that would substitute conveniently and inexpensively for such optical components as moving mirrors and lenses. What it would do is bend the write beam in the right direction.

Since the illumination hologram would be acting merely as an aspheric surface and not as an optical record, it would be formed on dichromated gelatin, which would provide both high diffraction efficiency (in this undemanding application it could approach its

maximum of 96 per cent) and high signal-to-noise ratio (it would have no grain).

The shutter matrix, which would be electronically controlled, would govern the passage of light through any hole in the opaque subject mask. This would ensure that the correct hologram is stored in the correct address.

There is still another material with interesting optical properties that might be used in a holographic memory: ferroelectric bulk crystals, such as lithium niobate.²⁵ According to John T. LaMacchia of Bell Laboratories, it might prove useful in a read-write-erase memory where one wanted to store large volumes of information for any time span from minutes to weeks. It could not be used for permanent storage, because the

images cannot be fixed—eventually they vanish like disappearing ink. LaMacchia points out that erasure can be retarded by cooling of the crystal. However, nothing happens to the crystal—it's as good as it ever was, since there's no fatigue or permanent change. Nor is there hysteresis. Therefore it could be reused indefinitely.

"You might not mind rewriting information every week," LaMacchia says. "For certain computer routines, it is adequate. You could break computer programs into a hierarchy of information that almost never changes down to changes in microseconds. Somewhere in between is a large body of information that changes moderately. This latter job may be handled very capably by those crystals."

The mechanism by which holograms are stored in lithium niobate is a change in refractive index caused by exposure to intense light. The result is a phase-only volume hologram with high diffraction efficiency. No processing is required. It has bulk storage capabilities, but unlike photochromics, it does not have any problem in nondestructive readout. Recording in the material is in the green wavelengths and read-out in the red. The red wavelengths do not produce writing.

Prof. Emmett Leith of the University of Michigan, a leading researcher in holography, is impressed with the potential of lithium niobate. Nevertheless, he still hopes that another crystal with higher sensitivity will be found. ■■

References:

1. J. B. DeVelis and G. O. Reynolds, *Theory and Applications of Holography*, Addison-Wesley, Reading, Mass. (1967).
2. E. G. Ramberg, "The Hologram—Properties and Application," *RCA Review*, Vol. XXVII, No. 4 (December 1966).
3. K. H. Pribram, "The Neurophysiology of Remembering," *Scientific American*, Vol. CCXX, No. 1, (January 1969).
4. D. Gabor, "A New Microscopic Principle," *Nature*, Vol. CLXI (1948), p. 777.
5. E. N. Leith and J. Upatnieks, "Wavefront Reconstruction with Diffracted Illumination and Three-Dimensional Objects," *Journal of the Optical Society of America*, Vol. LIV, No. 11 (November, 1964).
6. R. N. Einhorn, "Advances in Lasers," *Electronic Design*, September 12, 1968.
7. L. D. Siebert, "Large-Scene Front-Lighted Hologram of a Human Subject," *Proceedings of the IEEE* (Proceedings Letters), Vol. LVI, No. 7 (July, 1968).
8. E. N. Leith, A. Kozma, J. Upatnieks, J. Marks and N. Massey, "Holographic Data Storage in Three-Dimensional Media," *Applied Optics*, Vol. V, No. 8 (August, 1966).
9. A. A. Friesem and R. J. Fedorowicz, "Multicolor Wavefront Reconstruction," *Applied Optics*, Vol. VI, No. 3 (March, 1967).
10. K. S. Pennington and L. H. Lin, "Multicolor Wavefront Reconstruction," *Applied Physics Letters*,

Vol. VII (1965), p. 56.

11. L. H. Lin, K. S. Pennington, G. S. Stroke and A. E. Labeyrie, "Multicolor Holographic Image Reconstruction with White Light Illumination," *Bell System Technical Journal*, Vol. XLV, No. 4 (April, 1966).
12. D. J. DeBitetto, "A Holographic 3-D Movie with Constant-Velocity Film Transport," *Laser Focus*, Vol. IV, No. 17 (September, 1968).
13. R. J. Collier, "Holography and Integral Photography," *Physics Today*, Vol. XXI, No. 7 (July, 1968).
14. R. V. Pole, "3-D Imagery and Holograms of Objects Illuminated in White Light," IBM Research Paper RC-1767, February 8, 1967.
15. C. B. Burckhardt, "Information Reduction in Holograms for Visual Display," *Journal of the Optical Society of America*, Vol. 58, No. 2 (Feb., 1968).
16. L. H. Lin, "A Method of Hologram Information Reduction by Spatial Frequency Sampling," *Applied Optics*, Vol. VII, No. 3 (March, 1968).
17. K. A. Haines and D. B. Brumm, "Holographic Data Reduction," *Applied Optics*, Vol. VII, No. 6 (June, 1968).
18. L. H. Enloe, W. C. Jakes Jr and C. B. Rubinstein, "Hologram Heterodyne Scanners," *Bell System Technical Journal*, November, 1968.
19. L. H. Anderson, S. Brojdo, J. T. LaMacchia and L. H. Lin, "A High-Capacity, Semipermanent Optical Memory," Digest of Technical Papers 1967 IEEE Conference on Laser En-

gineering and Applications, *IEEE Journal of Quantum Electronics*, Vol. QE-3, No. 6 (June, 1967).

20. J. L. Reynolds, T. Yu Tao and R. S. Schools, "An Experimental Optical Memory System," paper presented by NEREM November 6, 1968.
21. D. H. R. Vilkomerson, R. S. Mezrich and D. I. Bostwick, "Holographic Read-Only Memories Accessed by Light-Emitting Diodes," AFIPS Conference Proceedings, Vol. XXXIII (1968).
22. D. R. Bosomworth and H. J. Gerritsen, "Thick Holograms in Photochromic Materials," *Applied Optics*, Vol. VII, No. 1, (January, 1968).
23. W. E. Glenn, *Journal of Applied Physics*, Vol. XXX, No. 12 (December, 1969), p. 1870.
24. R. J. Collier, "Holograms for Information Storage," Talk delivered at Optical Society of America Meeting at Pittsburgh, October 9, 1968.
25. F. S. Chen, J. T. LaMacchia and D. B. Fraser, "Holographic Storage in Lithium Niobate," *Applied Physics Letters*, Vol. XIII, No. 7, (October 1, 1968).

Selected Articles for Reading:

- G. B. Brandt, "Techniques and Applications of Holography," *Electro-Technology*, April, 1968.
- E. N. Leith and J. Upatnieks, "Photography by Laser," *Scientific American*, June, 1965.
- H. M. A. El-Sum, "Uses for Holograms," *Science and Technology*, November, 1967.

Introducing a new model— the AT-701A



See all the people who came to see our new Model AT-701A. Are you in the photo?

AT-701A, as you've probably guessed, is an improved version of our fabled, pioneering Model AT-701. Based, like the other S. S. White systems—the Model LAT-100 (the \$6,000 system) and the Model AT-704 (the 4,000 per hour system)—on the proven Airbrasive® method for clean, shockless, and noiseless removal of resistance material, without altering the substrate. Precise electronics monitor resistance during the trimming cycle, give 'stop' command when preset value is reached.

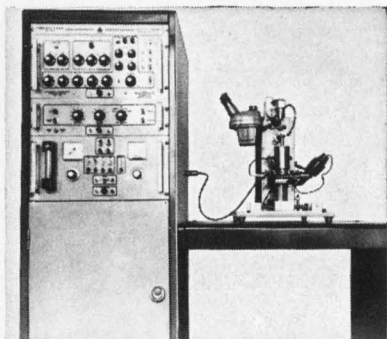

Yes, it sells for less, but be a good chap and read the text of the ad anyway... please?

Accuracy with the AT-701A is guaranteed at $\pm 0.5\%$, with 0.1% frequently attainable. Capacity is up to 600 trims/hour; tolerances may be set from 0 through $\pm 11\%$ with resolution of 0.1% . Final resistance values can be programmed through 5 digits and four multipliers giving four ranges from 0 to 10K and through 0 to 10M.

In fact, in performance, the AT-701A is exactly similar to its non-A predecessor, though it looks a bit different. What's interesting about it, though is this:

It sells for a lot less money. (The number to call (collect) is 212-661-3320. Ask for Hal Skurnick.)

Output of the Model AT-701A can be doubled via a new optional rotary feeding table. Table features automatic gripping of substrates up to 2" x 2", automatic indexing and positioning of sub-

strate for trim. Operator has merely to drop in untrimmed substrates and pick out the trimmed ones. *Doubles production.*

Modesty prevents our saying that the AT-701A, with its carousel feeder stole the IEEE show; it does not prevent our saying that many who came to visit us actually looked at the machine (instead of the pretty girls). If you missed the Show, you'll be

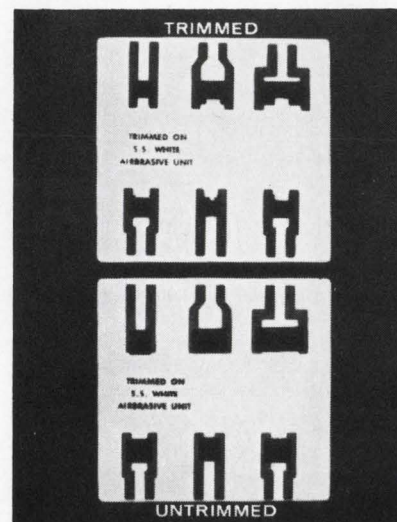

See how clean and neat the trims are — and they're within $\pm 0.1\%$ of programmed value, AND you can repeat the feat as many as 600 times per hour—or more: see text.

happy to know that we will again be demonstrating the AT-701A at the Nep/Con show, June 10, 11, and 12, at the Philadelphia Civic Center. Bring some of your untrimmed substrates and a blank Purchase Order: we can maybe do a little business.

S. S. WHITE INDUSTRIAL
A DIVISION OF PENNSALT CHEMICALS CORPORATION
Dept. 28, 201 E. 42nd St., New York 10017. 212-661-3320.

INFORMATION RETRIEVAL NUMBER 25

Our new reed pushbuttons aren't for everyone. They're a superior breed that perform in a superior manner. But if you demand dependability and long life—even under severe environmental conditions—our reed pushbuttons fill the bill.

Heart of each pushbutton is a reed switch with its glass-enclosed, hermetically sealed contacts. Contaminants just can't get in.

Pressing the button moves a permanent magnet over the reed elements, operating the switch. No mechanical contact is made, eliminating a major cause of switch breakdown.

No wonder reed pushbuttons have been successfully tested at many millions of operations, even under the most severe conditions.

Gold-plated stationary contacts make our reed pushbuttons perfect for dry circuits, too. And our design hardware includes collars and buttons in a wide choice of shapes and colors to give you unmatched design flexibility.

Our line consists of 11 series including two mercury-wetted contact forms and two forms for mounting on keyboards. Ratings range from 0.25 to 3.0 amps, SPST to 4 PDT.

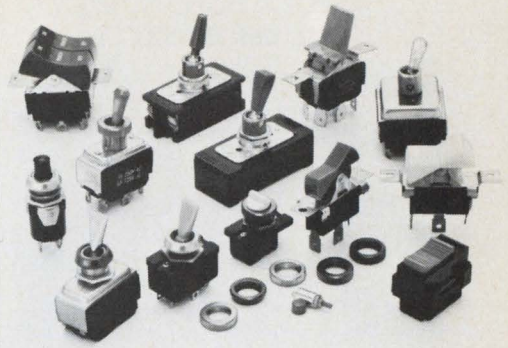

Our selection of Designer Line toggle switches (ac/dc and ac-only); rockette switches; and full-size, compact and ultra-miniature pushbuttons give you unlimited design flexibility.

Introducing the pushbuttons that redefine dependability.



Switch
to No. 1

More than just switches:
prompt availability,
field help, innovation,
quality assurance too.

INFORMATION RETRIEVAL NUMBER 26



CUTLER-HAMMER
SPECIALTY PRODUCTS DIVISION, Milwaukee, Wis. 53201

**NEW DATA
APPLICATION GUIDE
EMI/RFI GASKETS**

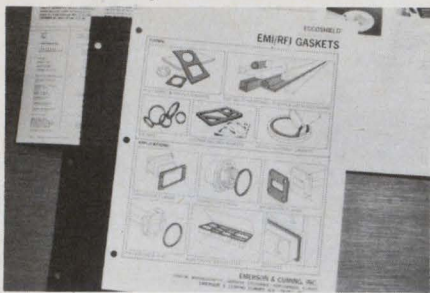

ECCOSHIELD® folder describes the broadest line of conductive plastic gaskets, including forms and applications. All materials feature high insertion loss, hermetic seal, low closing pressures, low compression set, low maintenance. Send for FREE copy.

INFORMATION RETRIEVAL NUMBER 221

**LOW-LOSS THERMOSET
FOR RF AND MICROWAVE
MACHINED PARTS**

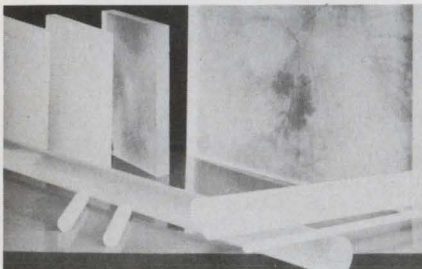

ECCOSTOCK® HI-Q is clear thermosetting rod and sheet. Machineable; won't creep under load; loss tangent below 0.0005 from 1 MHz to 10 GHz. Dielectric constant is 2.4. Highest temp., lowest loss plastic available; use for insulation and support in coax, waveguide, stripline, etc.

INFORMATION RETRIEVAL NUMBER 222

**LOW-DENSITY
FOAM-IN-PLACE
ENCAPSULANT**



ECCOFOAM® FP and FPH are liquid foam-in-place urethane systems to provide shock protection and give mechanical support to airborne and space-borne electronic components. Densities 2 to 26 lb/cu-ft; no outgassing. These encapsulants are spec'd in everywhere and have been used in most U.S. satellites and space vehicles.

INFORMATION RETRIEVAL NUMBER 223

Emerson & Cuming, Inc.



**CANTON, MASS.
GARDENA, CALIF.
NORTHBROOK, ILL.**
Sales Offices
in Principal Cities

EMERSON & CUMING EUROPE N.V., Oevel, Belgium

SIDELIGHTS OF THE ISSUE

Meet the new managing editor



Frank T. Egan: “. . . but above all be accurate.”

This issue of **ELECTRONIC DESIGN** may look almost like any other issue of the magazine, but behind the scenes there's been an important change: We have a new managing editor, Frank T. Egan. Frank has been with us for three years, and in that time he served first as news chief and then as technical editor specializing in test instrumentation and circuit design. Before coming to ED, he held several responsible positions with McGraw-Hill.

Frank majored in physics at New York University and studied electrical engineering at NYU and the Drexel Institute of Technology in Philadelphia. His approach to editing? “Tell the story simply, so everyone will understand it, and colorfully, if possible, so we don't bore anyone, but above all be accurate.”

He replaces Robert C. Haavind, who moves up to editor of Hayden Publishing Company's new magazine, **COMPUTER DECISIONS**.

About that cover photo . . .

If you think this month's cover photo is a knockout, you're right. It has won awards from two professional photographer groups so far. Taken by David Bacon, supervisor of graphic communication for the Conductron Corp., Ann Arbor, Mich., it shows the laser setup that was needed to make a “magical” holographic display for General Motors. (See Special Report, “Holography: The Reality and the Illusion,” p. 43.) The display is now drawing wide attention at GM headquarters in New York City.

Bacon has received blue-ribbon awards from the Professional Photographers of Michigan and the Professional Photographers of the State of Wisconsin. As a result, his photo will be displayed next month at the New York City convention of the Professional Photographers of America.

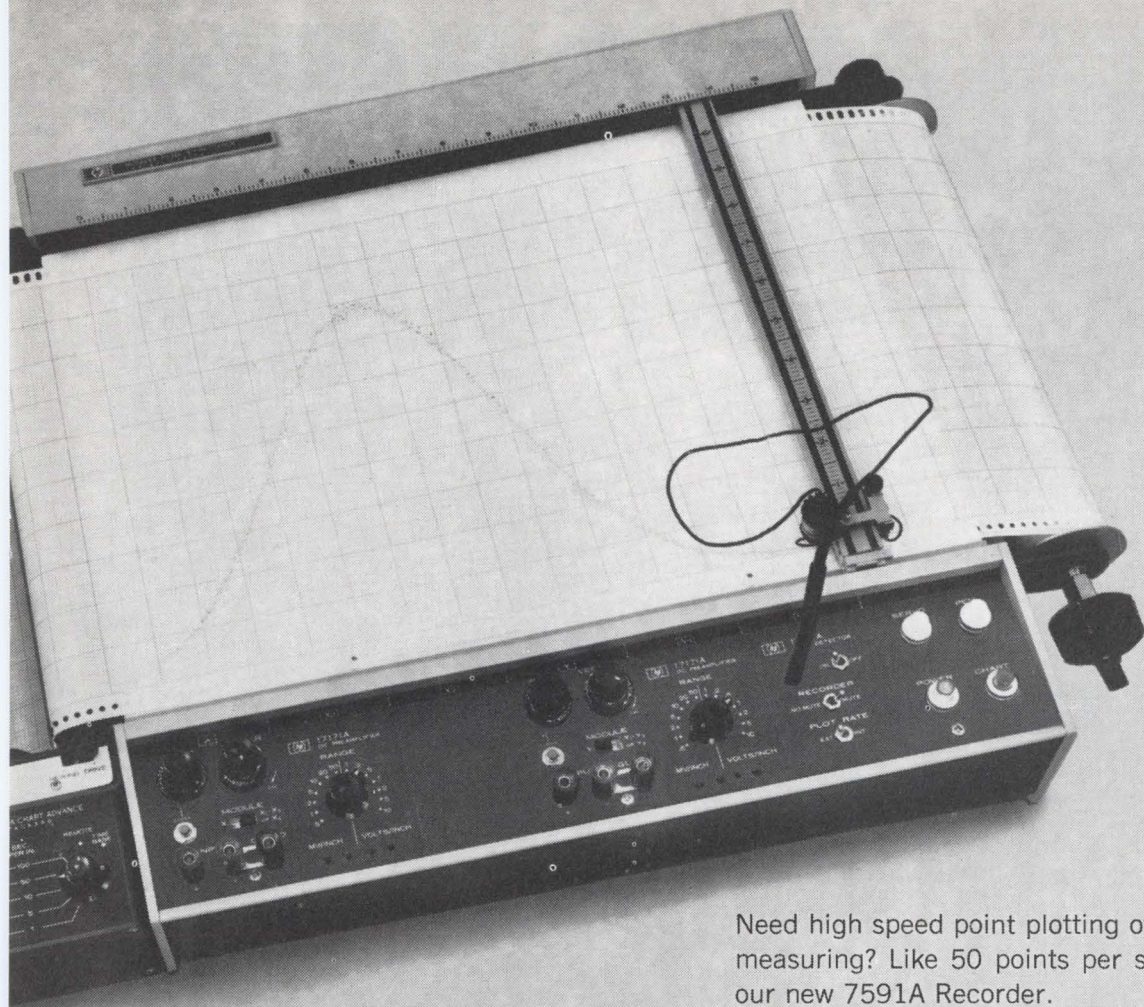

**Get
to the
point
...fast!**

Need high speed point plotting of the data you're measuring? Like 50 points per second? Then try our new 7591A Recorder.

Fifty points/second is a new high in closed-loop data transfer... exactly the type dynamic response needed for such jobs as plotting data from a multi-channel pulse-height analyzer. The null detector accepts analog inputs, positions the X and Y servos, and actuates the plotter... with unequalled speed and accuracy.

Moreover, the 7591A's plug-in design gives you exceptional versatility at a realistic price. The recorder shown here has an incremental chart advance attached to resolve tightly grouped points or permit comparison of groups of recorded data. Z-Fold Adapter available as well.

7591A Point Plotting System with in-put plug-ins and chart advance, ready-to-play, from \$2685.

Your local HP field engineer can point out all the advantages of HP recorders and accessories. Or write Hewlett-Packard, Palo Alto, California 94304; Europe: 1217 Meyrin-Geneva, Switzerland.

HEWLETT  PACKARD
GRAPHIC RECORDERS

**TRW Announces
40 Watts at 50 MHz
40 Watts at 175 MHz
20 Watts at 470 MHz**

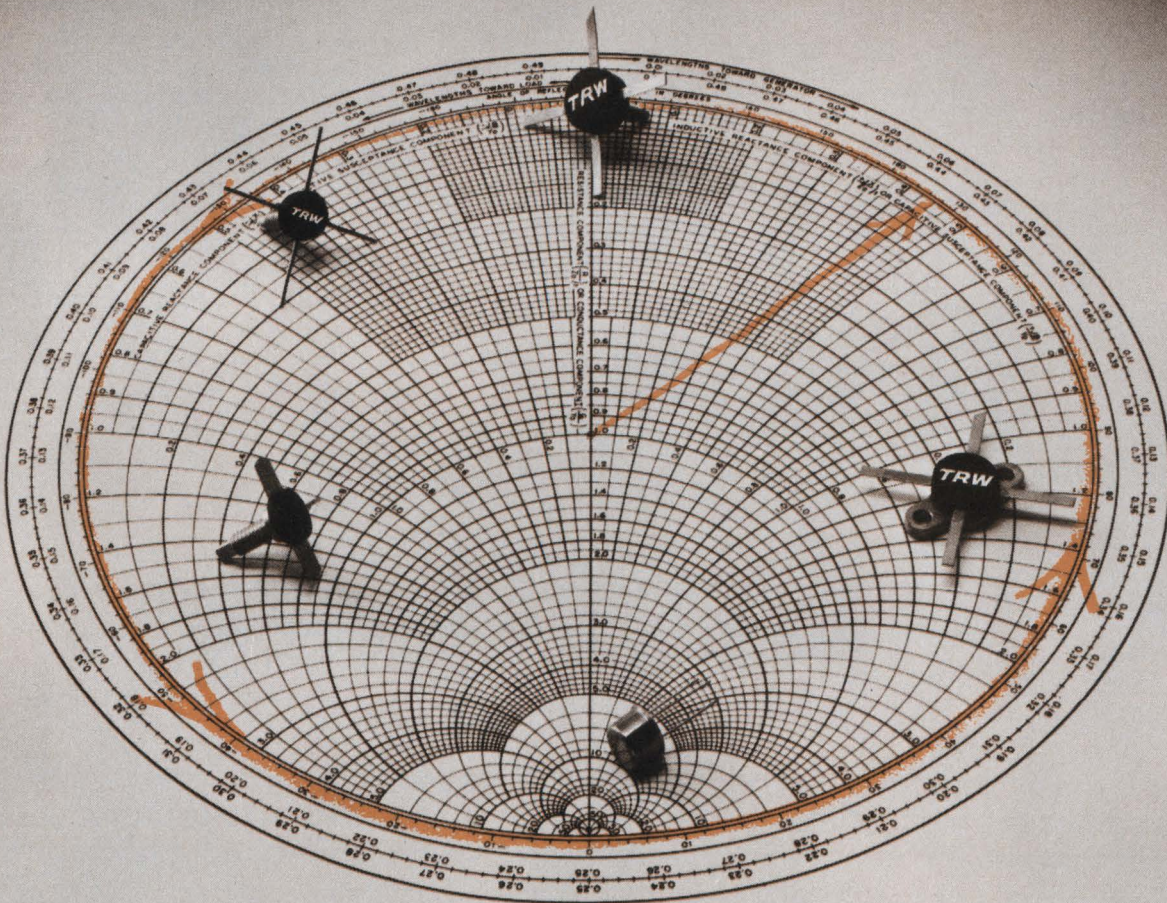

12.5 Volts...withstands infinite VSWR

TRW offers three new families of 12.5 volt RF transistors in a wide range of power levels. These rugged transistors will withstand severe mismatch—any load, any phase. Broken or shorted antennas are no longer a problem.

Complicated push-pull or parallel output stages are a thing of the past.

Using single output devices, you can design transmitters with up to 20 watts output at 470 MHz (2N5701), 40 watts at 175 MHz (2N5706) and 40 watts at 50 MHz (2N5691). Fifteen new devices provide complete RF line-ups.

Contact any TRW Distributor or Dept. MR-1, TRW Semiconductors,

14520 Aviation Blvd., Lawndale, Calif. 90260. TRW Semiconductors Inc., is a subsidiary of TRW INC.

TRW®

Publisher

Hugh R. Roome

Editor

Howard Bierman

Managing Editor

Robert C. Haavind

Technical Editors

Frank Egan
 Michael J. Riezenman
 Raymond D. Speer
 Stella Lawrence

Management and Careers Editor

Richard L. Turmail

Chief News Editor

Ralph Dobriner

Washington News Bureau

Charles D. LaFond, Chief

Military/Aerospace Editor

John F. Mason

East Coast Editor

Jim McDermott

West Coast Editor

Elizabeth deAtley

New Products Editors

Robert Patton
 Lucinda Mattera

Copy Editor

Marion Allen

Editorial Production

Dollie S. Viebig
 Phyllis Gura

Art Director

Clifford M. Gardiner

Art Assistant

William Kelly

Technical Illustrators

William Alvarez
 Rita Jendrzewski
 Lynn E. Thompson

Production Manager

Thomas V. Sedita

Asst. Production Manager

Helen De Polo

Production Assistants

Bernard Wolinsky
 Carl A. Merkin

Circulation Manager

Nancy L. Merritt

Information Retrieval

Genate Piccinetti

EDITORIAL



A fresh breeze of iconoclasm blows into the Pentagon

Deputy Secretary of Defense David Packard entered the Pentagon like a modern gladiator. He had barely arrived in the capital when he was rushed into the public arena to face the slings and arrows of outraged Congressmen, seething over the decision to deploy an ABM system. After a couple of *faux pas*, Packard was sent back to the office to stop arguing and get some work done.

His first major target was the controversial Cheyenne helicopter program, a Lockheed project that the Defense Dept. said was behind schedule and over budget. In addition a test pilot had been killed due to rotor-blade trouble. Lockheed was crisply notified by the Army that it had 15 days to clear up the problems. Otherwise, it would risk losing the contracts.

Clamping down on contractors may be one area in which the Pentagon can use Packard's business skill and engineering expertise. But he can play an even more vital role if he helps bring sound engineering practice back into Government contracting. Paper work, computers, "maintainability," "reliability" and a string of other "abilities," along with political interest, have become the idols of the Defense Establishment. A fresh breeze of iconoclasm is just what's needed.

Why the need to refocus on engineering? For one good example, read John Mason's report on the rapid movement of troops and equipment into Korea (*Electronic Design* 10, May 10, 1969, p. 34). It is full of descriptions of bulky, outmoded equipment that our troops must use, despite the billions poured into defense for several years. In one case the men are eagerly awaiting a "modern" replacement for a communication system. The "new" set is full of tubes and has been under development for 14 years!

Another example is a recent conversation we had with a systems analyst in a large aerospace company. In evident frustration, he described how his employer dutifully turned out tons of paper work and performed myriad tests on a defense system.

"Despite all of this," he freely admitted (as long as he could remain anonymous), "we really don't know if the stuff works when we ship it out the door."

One reason, he explained, is that the testing and reporting procedures are a patchwork drawn from many general military specifications. A much more intelligent approach to insuring soundness of the system, he said, could be worked out by a skilled team of systems analysts if they bypassed many costly and largely extraneous tests and reports that are now required.

Refocusing on practical engineering and solid and rapid accomplishment, rather than on paying homage to Defense Dept. idols, could eliminate much of today's foolishness. The inertia is great, but if anyone is capable of getting things moving, it's hard to think of anyone better qualified to do it than David Packard.

ROBERT C. HAAVIND

Sylvania introduces the MSI supermarket.

FUNCTIONAL ARRAYS, TYPICAL CHARACTERISTICS (+25°C, +5.0 Volts)						
Function	Type Nos.	t_{pd} (nsec)	Avg. Power (mW)	Noise Immunity +(Volts)-		Fanout
Full Adder	SM10 Series	Sum 22 Carry 10	90	1.0	1.0	These arrays are available in fanouts up to 15 and are completely compatible with SUHL I and SUHL II integrated circuits.
Dependent Carry Fast Adder	SM20 Series	Sum 22 Carry 10	125	1.0	1.0	
Independent Carry Fast Adder	SM30 Series	Sum 22 Carry 10	125	1.0	1.0	
Carry Decoder	SM40 Series	2	25	1.0	1.0	
4-Bit Storage Register	SM60 Series	20	30/bit	1.0	1.0	
Bus Transfer Output 4-Bit Storage Register	SM70 Series	20	30/bit	1.0	1.0	
Cascade Pullup Output 16-Bit Scratch Pad Memory	SM80 Series	25	250	1.0	1.0	
Decade Frequency Divider	SM90/92 Series SM91/93 Series	35MHz 30MHz	125 85	1.0	1.0	
4-Bit Shift Register	SM110 Series	25MHz	120	1.0	1.0	
Parity Generator/Checker	SM120 Series	22	125	1.0	1.0	
Comparator	SM130 Series	17	120	1.0	1.0	
Programmable Binary Divider	SM140 Series	25MHz	150	1.0	1.0	
Programmable Decade Divider	SM150 Series	25MHz	150	1.0	1.0	
Binary Counter	SM160 Series	25MHz	135	1.0	1.0	
Decade Counter	SM170 Series	25MHz	135	1.0	1.0	
Binary Up/Down Counter	SM180 Series	25MHz	205	1.0	1.0	
Decade Up/Down Counter	SM190 Series	25MHz	205	1.0	1.0	
BCD to 7-Segment Translator	SM200 Series	85	280	1.0	1.0	
Dual 4-Bit Multiplexer	SM210 Series	10-20	130	1.0	1.0	
Demultiplexer	SM220 Series	9-14	225	1.0	1.0	

Sylvania Electronic Components,
Semiconductor Division,
Woburn, Mass. 01801

SYLVANIA
GENERAL TELEPHONE & ELECTRONICS

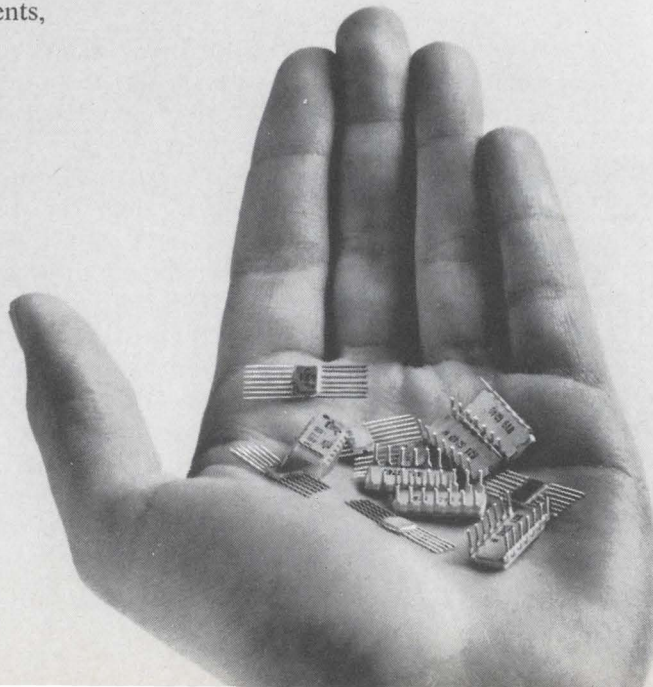

Technology



Who to fire, who to hire and how to keep them—Fairchild's Dr. C. Lester Hogan gives

his candid opinions at a recent Electronic Design interview. See page 96.



Simplify op-amp parameter tests by using a standard oscilloscope and a special test cir-

cuit to check bias current, offsets and transfer function. See page 80.

Also in this section:

Design wideband uhf power amplifiers with these techniques. Page 72.

Select air movers without guesswork. Use impedance measuring. Page 90.

Ideas for Design. Page 102.

Design wideband uhf power amplifiers

with these techniques for broadband matching, gain compensation and parasitic-inductance reduction.

Why is designing a broadband uhf transistor power amplifier such a difficult job? For one thing, the transistor's input impedance is usually very low; it varies from 10 ohms for low-power devices, down to below 2 ohms for the high-power units. It is, therefore, necessary to provide some form of broadband matching between the device and the external circuit (which is usually 50 ohms).

Unfortunately, the device's input impedance is also reactive, which means that there is an inherent device Q limiting the available bandwidth.

Furthermore, because of the low impedance levels involved, parasitic impedances (stray capacitance and, especially, lead inductance) play an unusually large part in any practical circuit. This means that adjustable elements are out of the question unless they are needed as part of a series-tuned circuit. For example, a typical 60-pF mica compression trimmer capacitor, ARCO 404, adjusted to 40 pF, had a series resonance at 260 MHz.

One final problem is that the device gain falls off with increasing frequency, usually at 6 dB per octave. Therefore, some form of gain compensation has to be incorporated into the amplifier circuit.

A bandpass filter provides a match

Let's consider these problems in order. The first one is to provide a broadband match between a 50-ohm line and the low complex impedance presented by the transistor input. One way to do this is to incorporate the transistor reactance into an input filter.

A typical equivalent circuit for the input of a microwave power transistor is shown in Fig. 1a. In Fig. 1b, a two-pole bandpass filter, designed to work at an impedance level R , and derived from the low-pass prototype of Fig. 1c, is shown. The bandpass filter is derived from the low-pass prototype by adding L_1 and C_2 so that the L_1-C_1 and L_2-C_2 combinations are both resonant at the desired center frequency. The bandwidth is the same as the cut-off frequency of the low-pass prototype.

The circuit of Fig. 1b is realized in Fig. 1d with the transistor incorporated into the output section of the filter. Of course, for $L_2 - L$ to be positive, L_2 must be greater than L . This limits the bandwidth and ripple of the filter because L_2 is the low-pass prototype inductive element. As L gets larger, L_2 must increase, thus decreasing the bandwidth.

This basic filter does not match impedances; it simply cancels out the reactive components of the complex input impedance of the transistor. The resistance that remains will not, in general, match the external line. The actual matching is done with a network that performs the function of a matching transformer, as shown in the design sequence of Fig. 2.

Let's say that a transmission line with (real) impedance Z_o must be matched into the transistor. Further, let's say that Z_o is related to the transistor input resistance by a factor ϕ^2 so that $Z_o = \phi^2 R$. How can this job be done?

First, the filter of Fig. 1b can be mentally split at points X , Y and Z , as shown in Fig. 2a. Then, an ideal transformer with a turns ratio of $\phi:1$ is inserted between X and Y (Fig. 2b). This transforms the input impedance and L_1 by a factor of ϕ^2 , as desired. Next, the transformer and capacitor C_1 are lumped together as in Fig. 2c and replaced with an equivalent TEE circuit as in Fig. 2d. (See Fig. 3 for equivalent circuits.) For $\phi > 1$, capacitor C_B will be negative and thus will tend to cancel C_2 . This sets a limit on ϕ : The maximum value occurs when C_B exactly cancels C_2 .

This technique may be used with the shunt L instead of the shunt C . It may also be used with the series elements; in that case an equivalent PI network results when the transformer and element are replaced.

In cases where the matching capability, bandwidth or ripple of the matching filter are not good enough, a filter with an increased number of poles must be used. The absolute limit on bandwidth, however, is imposed by the transistor.

As mentioned earlier, one of the most important bandwidth-limiting factors is the transistor lead inductance. This can be reduced by using a strip-line transistor package with two emitter leads (Fig. 4a). The flat ribbon shape of the leads makes

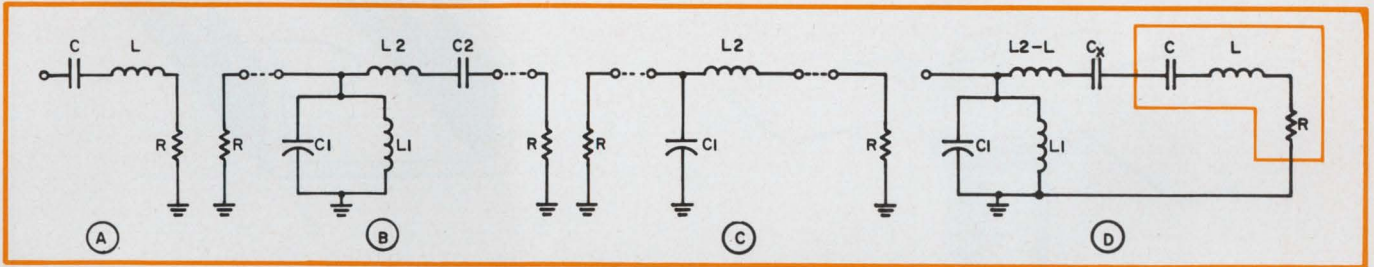

1. **Cancel out the reactance** of a uhf power transistor (A) by incorporating it into a filter (B). The bandpass filter (B) is derived from the low-pass prototype (C). The

bandwidths of the low-pass and bandpass filters are equal. In (D) the complete circuit is shown; C_x is given by $C_x = CC_2 / (C - C_2)$.

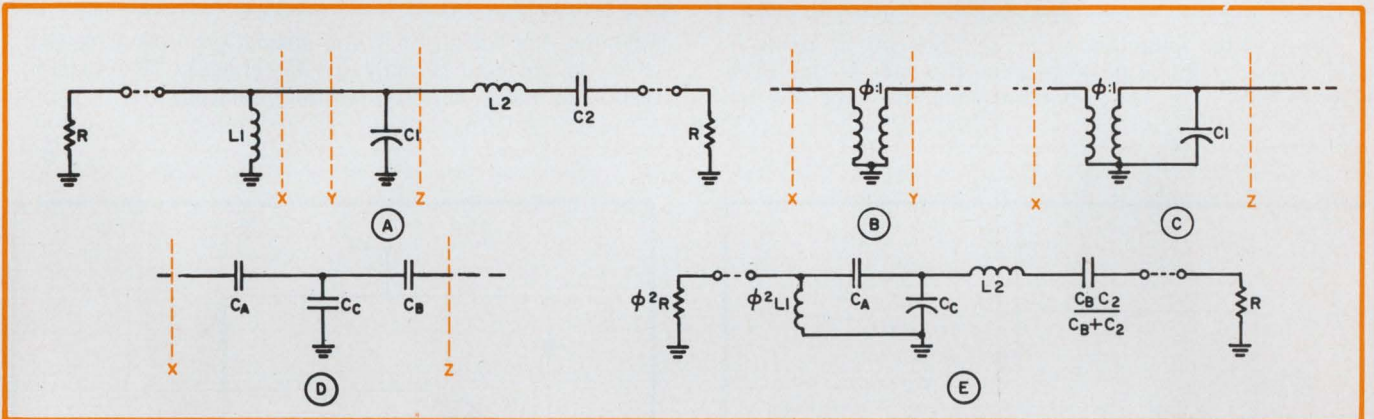

2. **Follow these five steps to better matching:** (1) mentally split the circuit of Fig. 1B at three points (A); (2) insert a matching transformer (B); (3) combine the

transformer with a reactance (C); (4) substitute a TEE (or PI) network for the transformer-reactance combination (D); and (5) achieve the final result (E).

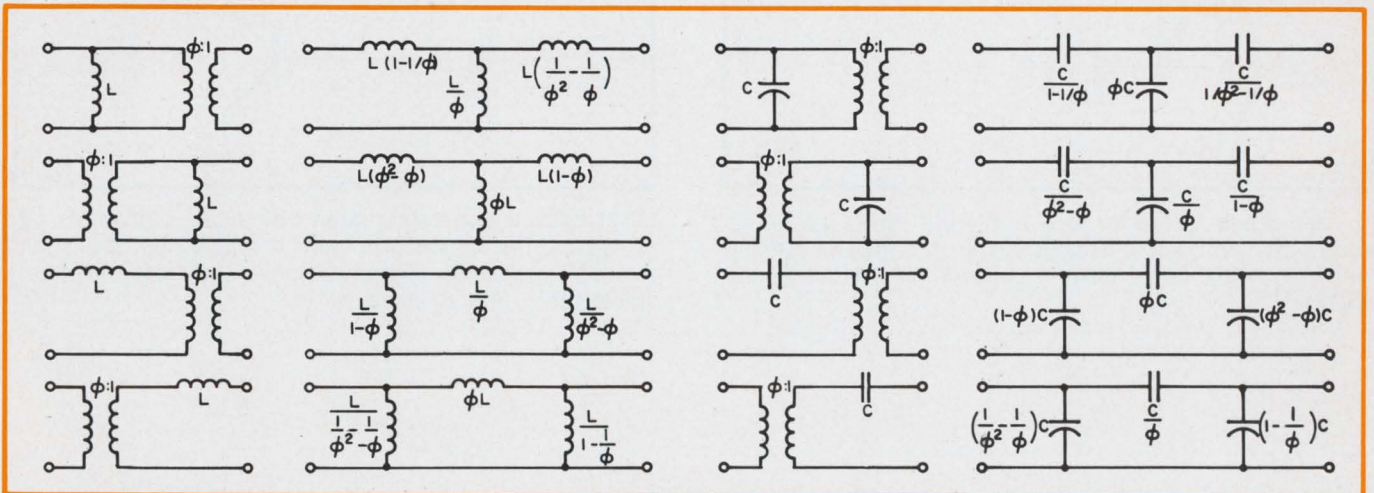

3. **Synthesize a matching transformer/reactance combination** with one of these PI or TEE equivalents.

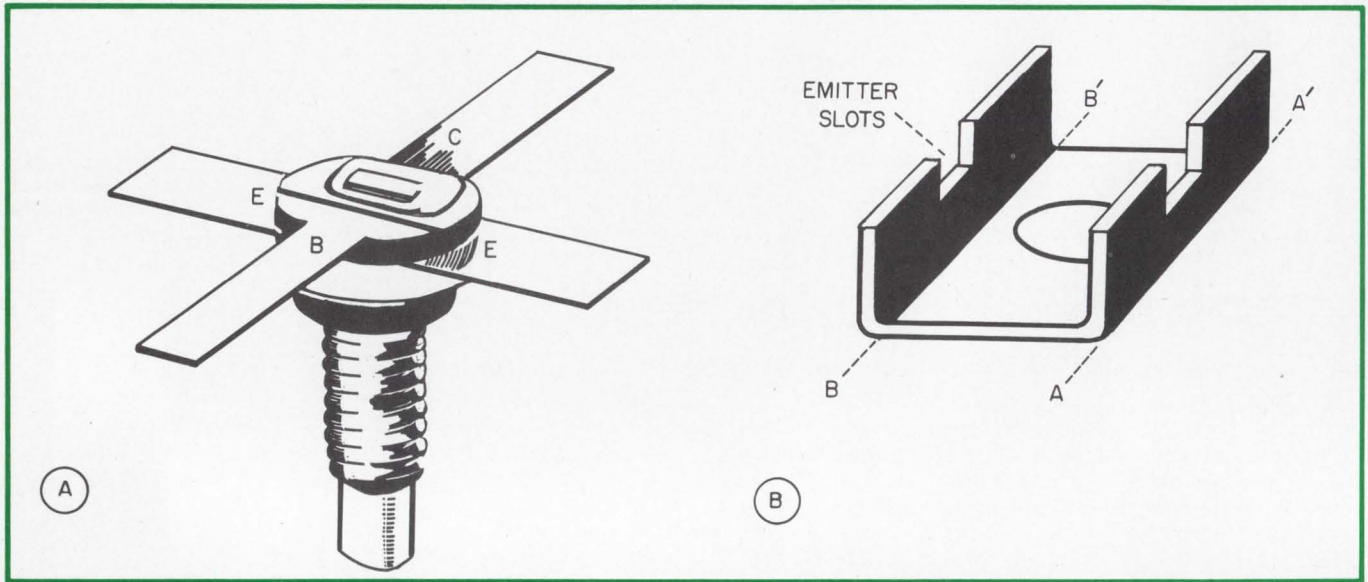

4. **Low emitter inductance** can be obtained by using a dual-emitter stripline package as in the case of this RCA type TA7344 (A). The inductance can be kept low by

mounting the transistor in the special grounding jig (B), which is soldered directly to the chassis. The biasing technique of Fig. 5 may then be employed.

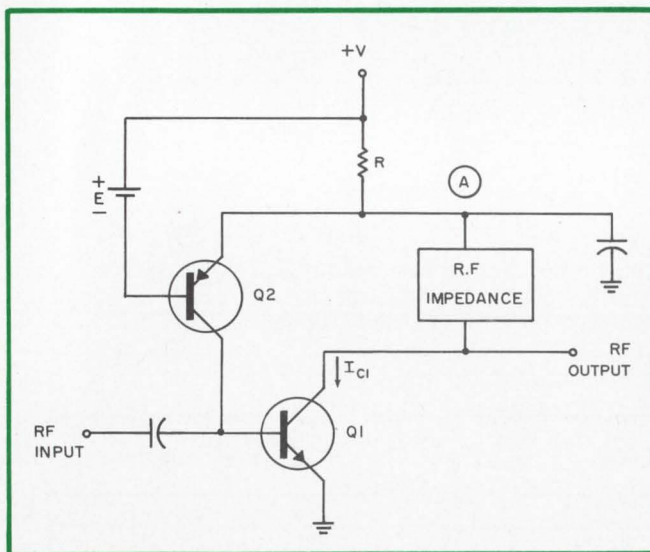

5. **Use a pnp transistor** to bias the uhf power transistor for class A operation. This way, the rf transistor can be operated with its emitter grounded for reduced lead inductance.

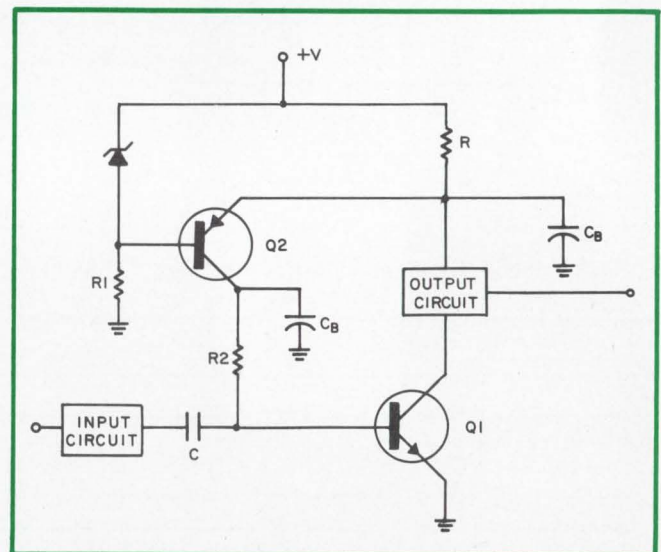

6. **Stabilize the operating point** with a zener diode-biased transistor. This circuit is a more practical approach than that of Fig. 5. The higher the zener voltage, the more stable the operating point will be.

their inductance rather low to start with and by directly grounding both of them, it is possible to reduce the inductance still further.

An emitter-grounding fixture (Fig. 4b) is useful for this purpose. Its dimensions are such that its sides hug the sides of the transistor case, and the emitter leads just bottom in the slots. The fixture is mounted temporarily to the amplifier chassis with a screw; when corners *A-A'* and *B-B'* have been soldered to the chassis, the screw is removed, and the transistor is inserted so that each emitter lead bottoms in its slot. The leads are soldered in place, resulting in a minimum-inductance ground connection.

Unfortunately, grounding the emitter causes biasing difficulties in class A operation. To overcome this, the biasing scheme shown in Fig. 5 is used.

Stabilize biasing with a feedback amplifier

With this configuration, the rf transistor's collector current is independent of its base-emitter voltage and relatively insensitive to the dc β of both transistors. Any change in I_{C1} causes a change in the voltage at point (A). The voltage change, in turn, causes the collector current in *Q2* to change, and this adjusts the base-current drive into *Q1* so that the original change in I_{C1} is almost completely counteracted. The net dc effect of this scheme is therefore the same as having *R* in the emitter circuit of *Q1* with low-impedance bias source *E* in the base circuit.

In actually implementing this idea, the designer will no doubt wish to avoid using a separate *E*-volt battery to bias *Q2*. A zener diode can be used instead, as in Fig. 6. The collector current in *Q1* is given by

$$I_{C1} = \frac{E \left(\frac{R_1}{Z_z + R_1} \right) + V \left(\frac{Z_z}{Z_z + R_1} \right) - V_{BE2}}{R \left(1 + \frac{1}{\beta_1} + \frac{1}{\beta_1 \beta_2} \right) + \left(\frac{Z_z}{\beta_1 \beta_2} \right) \left(\frac{R_1}{Z_z + R_1} \right)} \quad (1)$$

where Z_z is the incremental impedance of the zener diode and V_{BE2} is the base-emitter voltage of *Q2*. Normally $R_1 \gg Z_z$, $\beta_1 \beta_2 \gg 1$ and $Z_z < R$ so that the equation can often be simplified to yield

$$I_{C1} \cong \frac{E + V (Z_z/R_1) - V_{BE2}}{R (1 + 1/\beta_1)} \quad (2)$$

In the circuit of Fig. 6, the "input circuit" and "output circuit" are only incidental to the biasing scheme except that *Q1* collector current must be able to pass through the output circuit from *R* to the *Q1* collector. The input capacitor, *C*, is just a dc blocking capacitor, and the two capacitors labeled C_b are signal bypass capacitors. The zener diode voltage, *E*, must be selected in a trade-off of bias stability and power dissipation. The higher the zener voltage, the more stable the circuit, but

also the greater the power dissipated in *R*. Resistor R_2 is used as a signal impedance and to reduce the dissipation in *Q2*.

Flatten out the gain curve

The final problem to be solved is to compensate for the gain rolloff with frequency that characterizes uhf transistors. The circuit of Fig. 7 can do this job.

When the components are properly chosen, the input impedance of the network is constant with frequency, and the response at the output port is simply that of the single-tuned series circuit (L_2 and C_2). By placing resonance at the high edge of the desired band and choosing the circuit *Q* properly, the response may be made to roll off 6 dB per octave at any given lower frequency. Although the rolloff is not an exact compensation of the 6 dB-per-octave gain, it can be close enough for the purpose.

To choose the component values for the circuit, note that the input impedance, at dc and at infinite frequency, is R_1 . Therefore, the design objective is to have the input impedance equal to R_1 at all frequencies. Since the circuit behavior of each branch is geometrically symmetrical about its resonant frequency, the two resonances must be identical.

Hence $L_1 C_1 = L_2 C_2$ and $R_1 = R$. By writing an expression for the input impedance (or admittance) of the circuit and equating the numerator and denominator term by term, the following two equations relating the component values can be developed:

$$L_2 = R^2 C_1 \text{ and } L_1 = R^2 C_2 \quad (3)$$

Furthermore, if ω_o is defined by

$$\omega_o^2 = 1/L_1 C_1 = 1/L_2 C_2, \quad (4)$$

the *Q* of the series circuit can be seen to be given by $Q_s = \omega_o L_2 / R = \omega_o C_1 R^2 / R = \omega_o C_1 R$.

And the *Q* of the parallel circuit is given by

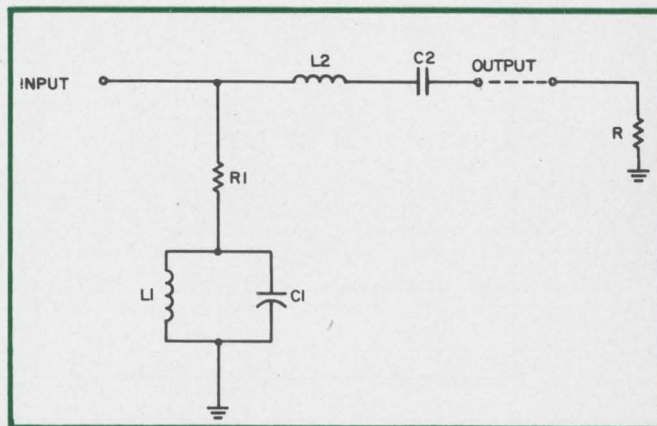

7. Compensate for gain rolloff with this constant-impedance network. For constant impedance, $R_1 = R$.

Table. Gain-compensation circuit error

W	W1								
	0.90	0.80	0.70	0.60	0.50	0.40	0.30	0.20	0.10
1.00	0.00	0.00	0.00	0.00	0.00	0.00	0.00	0.00	0.00
0.95	0.21	0.32	0.36	0.37	0.38	0.39	0.40	0.40	0.40
0.90	0.00	0.41	0.55	0.62	0.66	0.69	0.71	0.72	0.72
0.85	-0.52	0.29	0.59	0.74	0.83	0.89	0.93	0.95	0.97
0.80	-1.21	0.00	0.49	0.74	0.90	1.00	1.07	1.11	1.13
0.75	-1.96	-0.39	0.28	0.65	0.87	1.02	1.12	1.18	1.22
0.70	-2.69	-0.84	0.00	0.47	0.77	0.97	1.10	1.19	1.23
0.65	-3.38	-1.30	-0.32	0.25	0.62	0.86	1.03	1.14	1.20
0.60	-4.01	-1.75	-0.66	0.00	0.43	0.72	0.91	1.04	1.11
0.55	-4.57	-2.19	-0.99	-0.26	0.22	0.55	0.77	0.92	1.00
0.50	-5.07	-2.58	-1.31	-0.53	0.00	0.36	0.61	0.78	0.87
0.45	-5.50	-2.94	-1.61	-0.78	-0.21	0.18	0.45	0.63	0.73
0.40	-5.88	-3.26	-1.89	-1.01	-0.42	0.00	0.29	0.48	0.59
0.35	-6.21	-3.54	-2.13	-1.22	-0.60	-0.17	0.14	0.34	0.46
0.30	-6.48	-3.78	-2.34	-1.41	-0.77	-0.32	0.00	0.21	0.33
0.25	-6.71	-3.99	-2.52	-1.57	-0.91	-0.45	-0.12	0.10	0.22
0.20	-6.89	-4.15	-2.66	-1.70	-1.03	-0.56	-0.22	0.00	0.13
0.15	-7.03	-4.28	-2.78	-1.81	-1.13	-0.64	-0.30	-0.08	0.05
0.10	-7.13	-4.37	-2.86	-1.88	-1.20	-0.71	-0.36	-0.13	0.00
0.05	-7.19	-4.42	-2.91	-1.92	-1.24	-0.74	-0.40	-0.17	-0.03

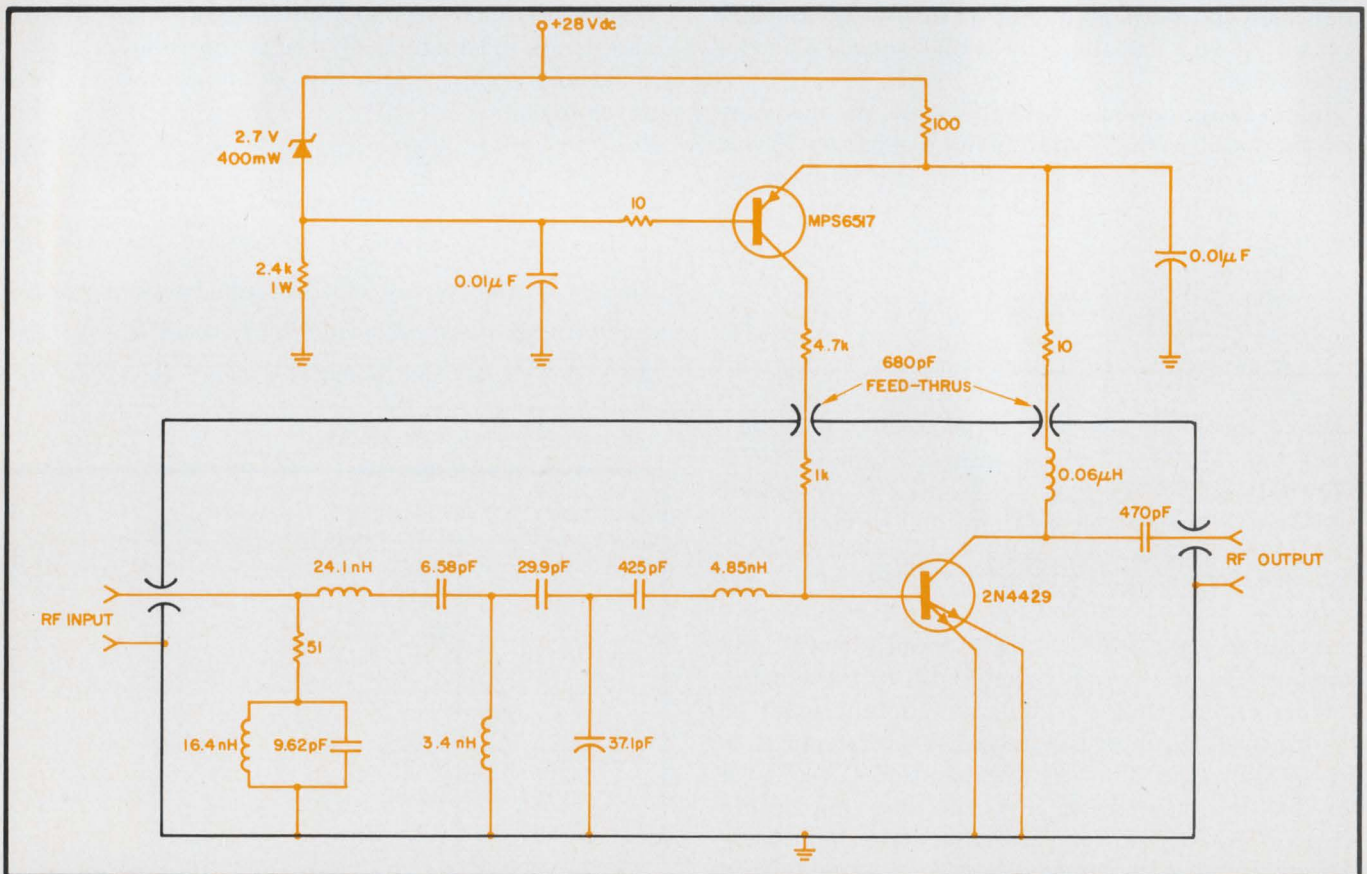

8. The finished product. This amplifier produces about 50 mW over the band from 225 to 400 MHz. The gain

is 12.5 ± 0.6 dB over that range. The VSWR is below 2:1 over the full operating band.

$$Q_p = R/\omega_o L_1 = R/(1/\omega_o C_1) = \omega_o C_1 R. \quad (6)$$

$$\text{Thus } Q_s = Q_p = Q = \omega_o C_1 R. \quad (7)$$

Since the input impedance is constant, the input voltage is also constant. The response is simply that of the series circuit. If the loss is minimized by placing ω_o at the high band edge, then at some lower frequency, ω_1 , the magnitude of the response will be given by

$$A(\omega_1) = \frac{1}{\sqrt{1 + Q^2 \left(\frac{\omega_1}{\omega_o} - \frac{\omega_o}{\omega_1} \right)^2}} \quad (8)$$

If we establish that the transistor is to be exactly compensated at ω_1 , then $A(\omega_1) = \omega_1/\omega_o$. These last two equations can be solved for Q^2 with the result:

$$Q^2 = \frac{\frac{\omega_o^2}{\omega_1^2} - 1}{\left(\frac{\omega_1}{\omega_o} - \frac{\omega_o}{\omega_1} \right)^2} \quad (9)$$

The value of Q is used to design the network using Eq. 7 and previous relations.

Compute the error

The gain compensation is not exact since the 6 dB per octave gain slope has a $1/f$ characteristic, but the compensation network does not have an f characteristic.

If we let ω_o/ω be the uncompensated response; $A(\omega)$ be the compensation function; and $R(\omega)$ be the compensated response, then $R(\omega) = A(\omega) \omega_o/\omega$ where ω_o is a constant that is arbitrarily selected as the upper band edge in order to normalize all frequencies and responses about that point.

To see how much error exists in the over-all response of the compensation network and transistor combination, Eq. 9 can be inserted into Eq. 8, and the result can be plugged into the expression for $R(\omega)$. If the result is then normalized to $\omega_o=1$, the result is:

$$R_{dB} = 10 \log_{10} \left(\frac{1 - W_1^2}{1 - W^2(1 + W_1^2) + W^4} \right) \quad (10)$$

where W_1 is the normalized frequency at which the transistor response is exactly compensated ($W_1 = \omega_1/\omega_o$ and $W = \omega/\omega_o$).

Equation 10 has been solved on a time-shared digital computer using the CAL language program shown in the box. The results, which are shown in the table, show the deviation, in dB, from a flat response as a function of the normalized frequency, W . The analysis has been done for values of W_1 from 0.90 to 0.10 in steps of 0.10.

Output problems are easier

The collector circuit problems are similar to, but not as severe as, those in the base circuit. Shunt capacity is reasonably low (around 4 pF, typi-

CAL program statement

```

1.0 W1=1
1.1 W1=W1-.1
1.2 TO STEP 3.0 IF W1=0
1.3 TYPE IN FORM 2: W1
2.0 W=1
2.1 R=10*LOG10((1-W1^2)/(1-W^2*(1+W1^2)+W^4))
2.2 TYPE IN FORM 1: W, R
2.3 W=W-.05
2.4 TO STEP 1.1 IF W=0
2.5 TO STEP 2.1
3.0 TYPE"END"
FORM 1:
W=%% R=%% DB
FORM 2:
W1=%%

```

cally). With a 50-ohm load, this gives a 780-MHz bandwidth. Most often this capacity is dealt with by resonating it with an rf choke at midband. Matching may be done with a filter technique similar to that used at the input.

A one-stage amplifier built in accordance with the design considerations discussed above is shown in Fig. 8. This amplifier produced about 12.5 dB of power gain (± 0.6 dB) over the full 225 to 400-MHz band. It had an output power of about 50 mW and an input VSWR substantially below 2:1.

The biggest problem in fabricating the amplifier was the reduction of parasitic lead inductances, especially in the capacitors. The use of Mucon miniature capacitors and undipped micas (mica capacitors with the encapsulation removed) with extremely short or no leads was the key to success in this area. ■■

Test your retention

Here are questions based on the main points of this article. Their purpose is to help you make sure you have not overlooked any important ideas. You'll find the answers in the article.

1. What factor is primarily responsible for limiting the bandwidth of transistor power amplifiers?

2. How can a reactive impedance be made to appear purely resistive over a broad bandwidth?

3. What limits the matching ratio of the PI or TEE circuitry used as an impedance transformer?

4. Why is it inadvisable to use an emitter resistor in a wideband power amplifier?

5. What is the biggest problem area in the fabrication of wideband amplifiers?

Let's get specific

1. Some manufacturers advertise "broad line"

TRANSITRON is shipping the following devices: *

SERIES I INTEGRATED CIRCUITS				SERIES II INTEGRATED CIRCUITS											
Type No.	Circuit Function	Fan-out	Temp. Range	Type No.	Circuit Function	Fan-out	Temp. Range	Type No.	Circuit Function	Fan-out	Temp. Range	Type No.	Circuit Function	Fan-out	Temp. Range
TG 40	Dual 4-Input NAND Gate	15	M	TG 142	Quad 2-Input NAND Gate	12	I	TG 200	Expandable	11	M	TG 300	Expandable	11	M
TG 41	7 M			TG 143	6 I			TG 201	Single 8-Input NAND Gate	6	M	TG 301	Triple 3-Input AND-OR Invert	6	M
TG 42	12 I			TG 150	Quad 2-Input OR Expander	—	M	TG 202	9 I			TG 302	9 I		
TG 43	6 I			TG 151	— M			TG 203	5 I			TG 303	Gate	5	I
TG 50	Expandable	15	M	TG 152	— I			TG 210	Expandable	11	M	TG 310	Expandable	11	M
TG 51	Quad 2-Input OR Gate	7	M	TG 153	— I			TG 211	Dual 4-Input OR Gate	6	M	TG 311	Dual 2 + 2 Exclusive OR	6	M
TG 52	12 I			TG 160	Triple 2-Input Bus Driver	30	M	TG 212	9 I			TG 312	5 I		
TG 53	6 I			TG 161	15 M			TG 213	5 I			TG 313	Gate	5	I
TG 60	Single 8-Input NAND Gate	15	M	TG 162	30 I			TG 220	Quad 2-Input NAND Gate	11	M	TG 320	Triple 3-Input NAND Gate	11	M
TG 61	7 M			TG 163	15 I			TG 221	6 M			TG 321	6 M		
TG 62	12 I			TG 170	Dual 4-Input OR Expander	—	M	TG 222	9 I			TG 322	9 I		
TG 63	6 I			TG 171	— M			TG 223	5 I			TG 323	5 I		
TG 70	Expandable	15	M	TG 172	— I			TG 230	Quad 2-Input OR Expander	—	M	TG 350	Quad 2-Input Lamp Driver	22	M
TG 71	Dual 2 x 2 Exclusive OR Gate	7	M	TG 173	— I			TG 232	— M			TG 352	18 I		
TG 72	12 I			TG 180	Dual 4-Input AND Expander	—	M	TG 233	— I			TF 120	Dual 50 MHz JK Flip-Flop (Separate Clock)	11	M
TG 73	6 I			TG 181	— M			TG 240	Dual 4-Input NAND Gate	11	M	TF 121	JK Flip-Flop (Common Inputs)	6	M
TG 80	Dual Pulse Shaper/Delay AND Gate	15	M	TG 182	— I			TG 241	6 M			TF 122	9 I		
TG 81	7 M			TG 183	— I			TG 242	9 I			TF 123	5 I		
TG 82	12 I			TG 190	Triple 3-Input NAND Gate	15	M	TG 243	5 I			TF 130	Dual 50 MHz JK Flip-Flop	11	M
TG 83	6 I			TG 191	7 M			TG 250	Expandable	11	M	TF 131	JK Flip-Flop (Common Inputs)	6	M
TG 90	Exclusive OR with Complement	15	M	TG 192	12 I			TG 251	Quad 2-Input OR Gate	9	I	TF 132	5 I		
TG 91	7 M			TG 193	6 I			TG 252	9 I			TF 200	50 MHz JK Flip-Flop (AND Inputs)	11	M
TG 92	12 I			TF 20	Two-Phase SR Clocked Flip Flop	15	M	TG 253	5 I			TF 201	6 M		
TG 93	6 I			TF 21	7 M			TG 260	Single 8-Input NAND Gate	11	M	TF 202	9 I		
TG 100	Expandable	15	M	TF 22	12 I			TG 261	6 M			TF 203	5 I		
TG 101	Triple 3-Input AND-OR Invert	12	I	TF 23	6 I			TG 262	9 I			TF 210	50 MHz JK Flip-Flop (OR Inputs)	11	M
TG 102	6 I			TF 50	Charge Storage JK Flip Flop (AND Inputs)	15	M	TG 263	5 I			TF 211	6 M		
TG 103	6 I			TF 51	7 M			TG 270	Dual 4-Input OR Expander	—	M	TF 212	9 I		
TG 110	Expandable	15	M	TF 52	12 I			TG 271	— M			TF 213	5 I		
TG 111	Dual 4-Input OR Gate	7	M	TF 53	6 I			TG 272	— I			TF 250	Charge Storage JK Flip-Flop (AND Inputs)	11	M
TG 112	12 I			TF 60	15 M			TG 273	— I			TF 251	6 M		
TG 113	6 I			TF 61	7 M			TG 280	Expandable	10	M	TF 252	9 I		
TG 120	Expandable	15	M	TF 62	12 I			TG 281	Dual 4-Input AND Gate	5	M	TF 253	5 I		
TG 121	Single 8-Input NAND Gate	7	M	TF 63	6 I			TG 282	8 I			TF 260	Charge Storage JK Flip-Flop (OR Inputs)	11	M
TG 122	12 I			TF 100	Dual 35 MHz JK Flip-Flop (Separate Clock)	11	M	TG 283	4 I			TF 261	6 M		
TG 123	6 I			TF 101	6 M			TG 290	Dual 2 + 3 Input OR	—	M	TF 262	9 I		
TG 130	Dual 4-Input Line Driver	30	M	TF 102	9 I			TG 291	— M			TF 263	5 I		
TG 131	15 M			TF 103	5 I			TG 292	— I						
TG 132	24 I			TF 110	Dual 35 MHz JK Flip-Flop (Common Inputs)	11	M	TG 293	— I						
TG 133	12 I			TF 111	6 M										
TG 140	Quad 2-Input NAND Gate	15	M	TF 112	9 I										
TG 141	7 M			TF 113	5 I										

*Electrically and mechanically interchangeable with SUHL I and II

TRANSITRON SALES OFFICES...

BALTIMORE
Baltimore, Maryland 21201
Sutton Place
1111 Park Ave.
(301) 728-5885

BOSTON
Wakefield, Massachusetts 01880
168 Albion Street
(617) 245-5840

CHICAGO
Oak Park, Illinois 60302
6641 West North Ave.
(312) Village 8-5556

DALLAS
Dallas, Texas 75235
Blanton Towers,
Suite B-121
3300 West Mockingbird Lane
(214) Fleetwood 7-9448

DAYTON
Dayton, Ohio 45414
4940 Profit Way
(513) 276-4141

DETROIT
Dearborn, Michigan 48126
13365 Michigan Ave.
Suite 201
(313) 846-9062

KANSAS CITY
Kansas City, Kansas 66103
2707A West 43rd Street
(913) 362-6640

LOS ANGELES
Inglewood, California 90305
3402 West Century Boulevard
Suite 22
(213) 673-0100

MINNEAPOLIS
Minneapolis, Minnesota 55435
Suite 227
4660 West 77th St.
(612) 927-7923

NEW YORK
Larchmont, New York 10538
22 Boston Post Rd.
(914) 834-8000

NEW YORK
Poughkeepsie, New York 12603
2 LaGrange Ave.
Room 212
(914) 452-5250

Syracuse, N.Y. 13211
Pickard Building
5858 East Malloy Road
Room 171
(315) 454-4491

about TTL

2. Some manufacturers talk vaguely about MSI availability

TRANSITRON has the following Series III complex functions available... **NOW:**

3. Some manufacturers talk "fast delivery"

TRANSITRON can ship most requirements within **24 HOURS** of receipt of order

SERIES III DIGITAL FUNCTIONAL ARRAYS

Type No.	Circuit Function	Temp. Range	Type No.	Circuit Function	Temp. Range
TA 10	Full Adder	M	TD 40	Carry Decoder	M
TA 11		M	TD 42		I
TA 12		I	TR 60	4-Bit Storage	M
TA 13		I	TR 61	Register	M
TA 20	Dependent Carry	M	TR 62		I
TA 21	Fast Adder	M	TR 63		I
TA 22		I	TR 70	4-Bit Storage	M
TA 23		I	TR 71	Register Bus	M
TA 30	Independent Carry	M	TR 72	Transfer Output	I
TA 31	Fast Adder	M	TR 73		I
TA 32		I	TM 81	16-Bit Memory	M
TA 33		I	TM 82		I
			TM 83		I

... PLUS THESE EXCLUSIVE TRANSITRON SERIES III DEVICES

Type No.	Circuit Function	Temp. Range	Type No.	Circuit Function	Temp. Range
TC 11	Binary Ripple Counter	M	TR 15	4-Bit Shift Register	M
TC 12		I	TR 16	(Non-resettable)	I
TC 13		M	TR 17		M
TC 14		I	TR 18		I
TC 15	BCD Ripple Counter	M	TR 25	4-Bit Shift Register	M
TC 16		I	126	(Resettable)	I
TC 17		M	TR 27		M
TC 18		I	TR 28		I

Because we maintain depth stocks of all major active types, Transitron can fill 90% of your TTL requirements off the shelf. This means that, when you have an urgent requirement, we can and will ship within 24 hours of the time we receive your order. If you need one of the few specials which we don't stock, it may take us a little longer... but not much.

GET THE SPECIFICS FROM TRANSITRON... Your broadest industry source for TTL.

Write for complete specifications and data on any of the types shown here. And if you want TTL in plastic, ask for information on Transitron's 7400/5400 Series.

TTL PACKAGE OPTIONS

TO-85



TO-86

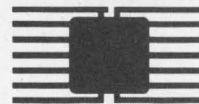

TO-116



ORLANDO
Orlando, Florida 32806
22 W. Lake Beauty Drive
Suite 201
(305) CHerry 1-4526

PHOENIX
Scottsdale, Arizona 85251
77 3rd Avenue West
Suite 210
(602) 945-0771

SAN FRANCISCO
Palo Alto, California 94303
991 Commercial St.
Room 5
(415) 961-1954

CANADA
Toronto 18, Canada
1229 The Queensway
Suite 9
(416) CLifford 9-5461

PHILADELPHIA
King of Prussia, Pa. 19406
580 Shoemaker Road
(215) 242-3995

Transitron
electronic corporation
168 Albion Street Wakefield, Massachusetts 01880

INFORMATION RETRIEVAL NUMBER 30

Simplify op-amp parameter tests.

A standard oscilloscope and a special test circuit check bias current, offsets and transfer function.

Although monolithic op amps are being purchased by the thousands, the equipment used to check their performance is often makeshift. Many designers who use op amps in their circuits haven't had time to design a suitable test set, and the thrown-together setup they're using is a source of frustration. Its reliability is questionable, its measurements often suspect.

A good op-amp test set should be simple, inexpensive, easily calibrated, and suitable for engineering or quality-assurance checking. It should be compatible with test equipment already in use, and perhaps put to work some of that expensive gear that was previously purchased.

All of these objectives are accomplished by a test set, shown in block form in Fig. 1, which measures bias current, offset voltage and current, and transfer function of 709 or 101 series op amps. It can be modified to test any of the generally available series. For the bias and offset tests, the op amp is exercised through its full common-mode range. In all three tests, the power-supply voltage to the op amp can be set at 5, 10, 15, or 20 volts. The tested op amp is operated under ac open-loop conditions so that oscillation difficulties are minimized.

The waveforms and dc operating voltages used in the tests are derived from a waveform generator, positive and negative rectifiers and filters, a test-set voltage regulator, and a test-circuit voltage regulator. Three output functions—a ± 19 -V square wave, a -19 -V to $+19$ -V pulse with a 1% duty cycle, and a ± 5 -V triangular wave—are provided by the waveform generator (Fig. 2). The square wave is the basic waveform from which both pulse and triangular wave outputs are derived.

The square-wave generator is an op amp connected as an astable multivibrator. It provides an output of approximately ± 19 V at 16 Hz, which

is used to drive junction FET switches in the test set and to generate the pulse and triangular waveforms.

The pulse generator is a monostable multivibrator, which is driven by the output of the square-wave generator. This multivibrator is allowed to swing from negative to positive saturation on the positive-going edge of the square-wave input, and has a time constant that will provide a duty cycle of approximately 1%. The output is approximately -19 V to $+19$ V.

A dc stabilized integrator, driven by the output of the square-wave generator, provides the triangular wave, a ± 5 -V output at the square-wave frequency. This output is inverted with respect to the square wave.

Test for bias current over common-mode range

The bias-current test is accomplished by allowing the device under test to draw input current to one of its inputs, through an input resistor, on positive- or negative-going halves of a triangular wave (Fig. 3). The output of the triangular-wave generator and the output of the test circuit, respectively, drive the horizontal and vertical inputs of an oscilloscope.

The op amp under test (cascaded with the integrator, A_7) is connected in a differential amplifier configuration by R_{43} , R_{44} , R_{40} , and R_{52} . The inputs of this differential amplifier are driven in common from the output of the triangular-wave generator through attenuator R_{37} and amplifier A_8 , and the inputs of the op amp are connected to the feedback networks (composed of R_{59} , A_7 , and R_{40}) through resistors R_{41} and R_{47} , shunted by the switch S_{5a} and S_{5b} .

The feedback network provides a closed loop gain of 1000. The integrator time constant serves to reduce noise at the output of the test circuit and provides an ac open so that oscillation is avoided.

Switches S_{5a} or S_{5b} (FET switches Q_6 and Q_7 in Fig. 9) are closed on alternate halves of the triangular wave input. The voltage appearing

William S. Routh, Manager of Engineering, and Mineo Yamatake, Development Engineer, National Semiconductor Corp., Santa Clara, Calif.

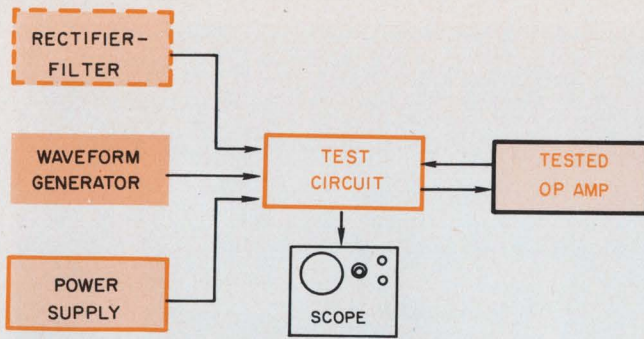

1. The op-amp test set checks the bias current, offset voltage and current, and transfer function of all 709 or 101 series op amps. Test waveforms and voltages are applied to the op amp by the test circuit, and the parameter measurements are made on a standard oscilloscope.

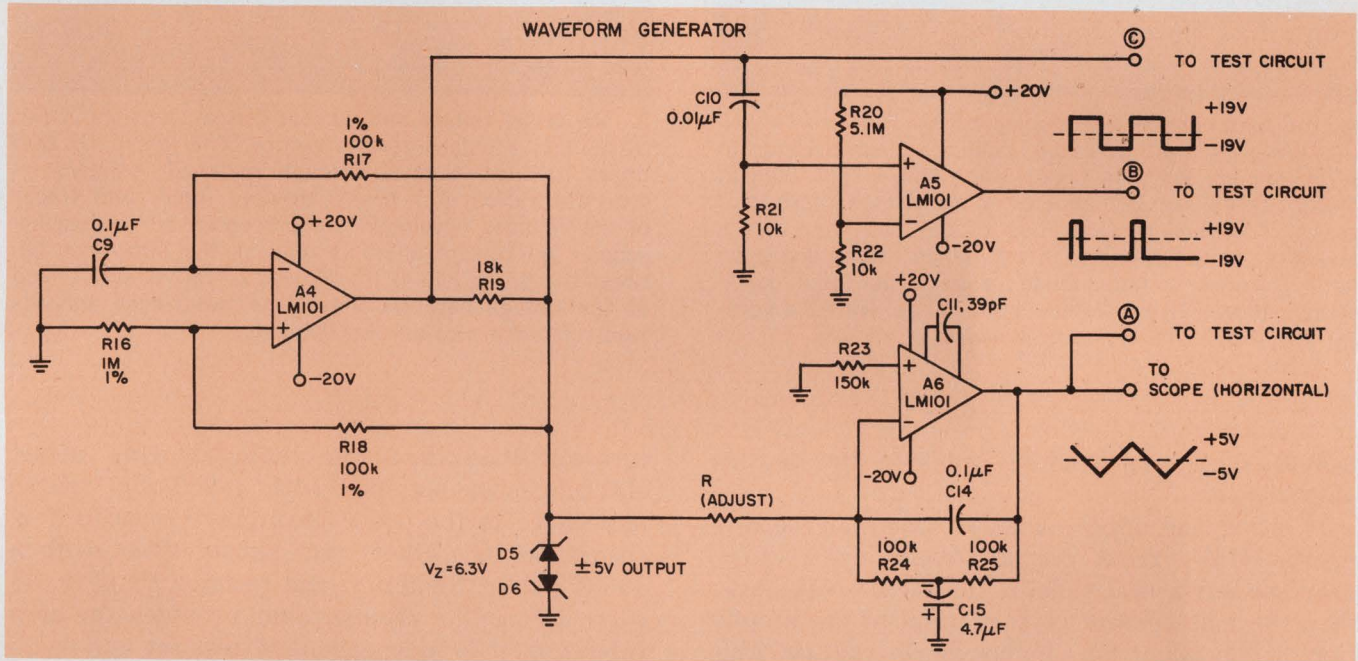

2. The waveform generator provides a square wave, a triangular wave, and a train of pulses for use as test and

control waveforms. Standard components are used throughout; use the LM101 op amp or equivalent.

across each input resistor (R_{11} and R_{17}) is equal to input bias current times the value of the resistor. This voltage is multiplied by 1000 by the feedback loop and appears at both the integrator output and the vertical input of the oscilloscope. The vertical separation of the oscilloscope traces (Fig. 4), representing the two input currents of the amplifier under test, is equivalent to the total bias current.

The bias current may be examined over the entire common-mode range by setting the peak output of A_6 equal to the common-mode range of the amplifier under test. The total input current of the amplifier of Fig. 3 is displayed over a ± 10 -V common-mode range, with a sensitivity of 100 nA per vertical division.

The bias-current display of Fig. 4 has the added advantage that incipient breakdown of the input stage of the device under test, at the extremes of the common-mode range, is easily de-

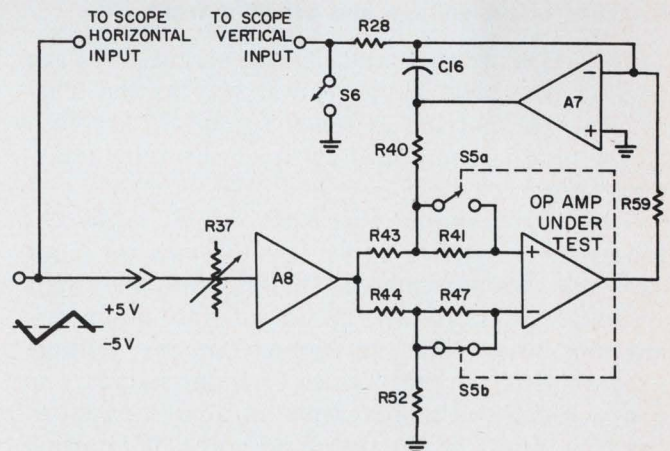

3. The bias-current test circuit allows the tested op amp to draw current to its input, and the current is measured as a voltage drop across a series resistor. FET switches S_{5a} and S_{5b} close on alternate half-cycles to provide a reference (zero current) reading on the oscilloscope. The reading obtained is a comparison of traces observed on the scope.

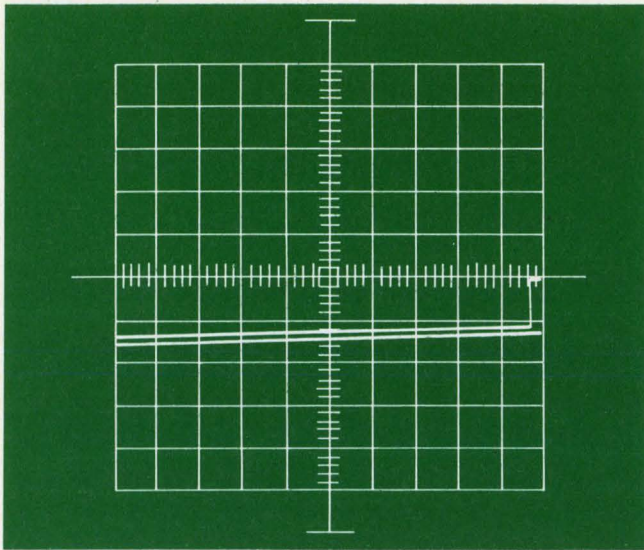

4. The bias current test display consists of two curves: the lower is the reference reading corresponding to zero bias current; the upper trace shows bias current (vertical scale) versus common mode voltage (horizontal scale). The vertical separation of the two curves is a measure of the total bias current, which can be displayed for the entire common-mode range. This trace corresponds to a $\pm 10\text{-V}$ common-mode range, with the vertical scale 100 nA per vertical division.

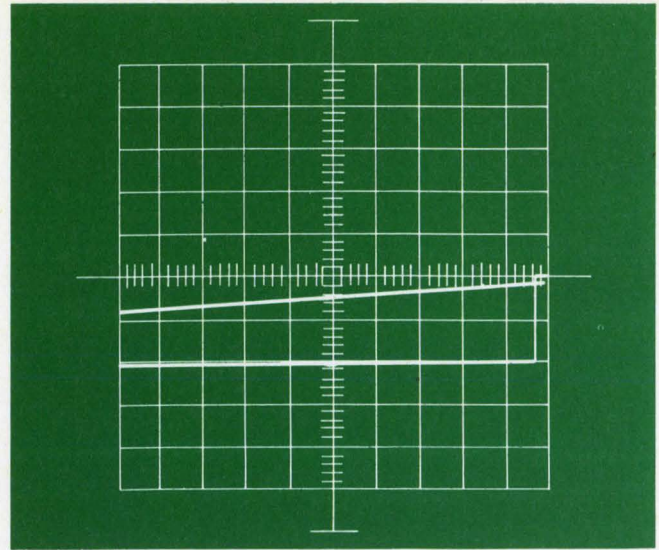

5. The offset voltage and current display consists of two traces and a pulsed zero reference. The tested op amp draws its input current through matched resistors on alternate halves of a triangular-wave input, and traces of the voltages developed are presented on the oscilloscope. The current offset is read as the difference between these two voltage traces, and offset voltage is read as the voltage between one of the two traces and the zero reference provided by the pulse.

tected as a sharp bend or break in the oscilloscope trace.

If either the upper or lower trace—or both—in the bias-current display exhibits curvature near the horizontal ends of the oscilloscope face, then the bias current of that input of the amplifier is dependent on common-mode voltage. The usual causes of this dependency are low breakdown voltage of the differential input stage or current sink.

Measure offset voltage and offset current

The offset-voltage and offset-current tests are performed in the same general way as the bias-current test, but the switches S_{5a} and S_{5b} are both closed on the same half-cycle of the triangular-wave input.

The synchronous operation of S_{5a} and S_{5b} forces the amplifier under test to draw its input currents through matched high- and low-input resistors on alternate halves of the input triangular wave. The difference in the voltage drops across the two values of input resistors is proportional to the difference in input current to the two inputs of the tested op amps. It is measured as the vertical spacing between the two traces appearing on the face of the oscilloscope (Fig. 5).

The offset voltage is measured as the vertical spacing between the trace corresponding to one of the two values of source resistance and the

zero-volt base line. The trace showing offset characteristics obtained with a 200-ohm source impedance is the one containing the zero-reference pulse; the other trace shows offset with a $10\text{-k}\Omega$ source. Switch S_6 and resistor R_9 (Fig. 3) form a base-line chopper that provides the zero reference. It is independent of test set and oscilloscope drift. S_6 is driven from the pulse output of the basic power supply and has a duty cycle of approximately 1% of the triangular wave. The offset voltage and current are displayed at a sensitivity of 1 mV and 100nA per division, respectively.

A functional diagram of the transfer-function test is shown in Fig. 6. The output of the triangular-wave generator and the output of the circuit under test drive the horizontal and vertical amplifiers of an oscilloscope.

Determine transfer function

A $\pm 2.5\text{-mV}$ triangular wave, derived from the $\pm 5\text{V}$ output of the triangular-wave generator (through the attenuators R_{33} , R_{34} and R_{43} , R_{40} and through the voltage follower, A_7) provides drive voltage for the tested op amp. The op amp output is fed to the scope vertical input.

Amplifier A_7 performs a dual function. When S_7 is closed during the bias-current test, a voltage, equal to the amplifier-offset voltage multiplied by the gain of the feedback loop, is developed across C_{16} . When S_7 is open in the

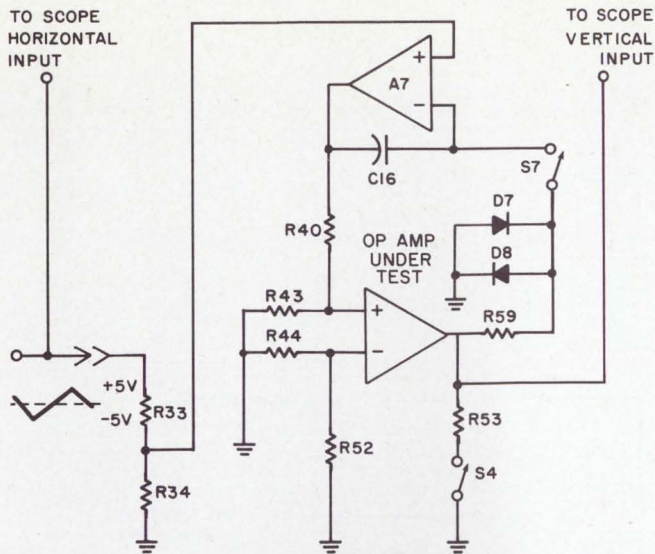

6. The transfer function test circuit simply displays V_{in} versus V_{out} . A ± 2.5 mV triangular wave provides the input stimulus to the op amp; the same triangular wave and the output of the op amp are fed to the horizontal and the vertical inputs of the oscilloscope. Capacitor C16 stores charge during the bias current test, and maintains an offset correction voltage during the transfer function test. The scope trace is thus automatically centered.

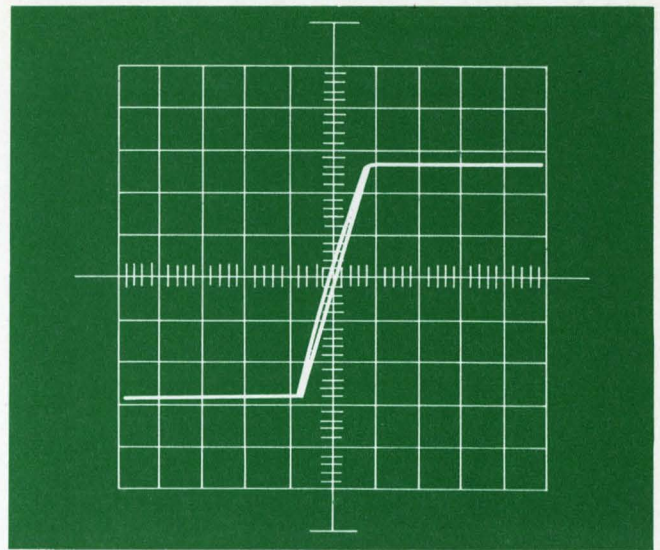

7. The transfer function display contains information on gain, gain linearity with output swing, and output saturation characteristics. Gain is displayed as the slope of the transfer curve. Any gain nonlinearity shows up as variation in this slope, and saturation is clearly visible as an abrupt change in the trace from gain slope to horizontal. Output swing is measured as the total vertical deflection at the horizontal extremes of the transfer function display.

transfer-function test, the charge stored in C_{16} continues to provide this offset correction voltage. In addition, A_7 sums the triangular-wave test signal with the offset correction voltage and applies this sum to the input of the tested op amp through the attenuator R_{43} , R_{40} . This input sweeps the input of the op amp ± 2.5 mV around its offset voltage. The transfer-function display is therefore automatically centered on the scope face.

The transfer-function display is simply a plot of V_{in} versus V_{out} for an amplifier. It provides information about amplifier gain, gain linearity, and output swing. Gain is displayed as the slope, $\Delta V_{out}/\Delta V_{in}$, of the transfer function. Gain linearity is indicated as change in slope of the V_{out}/V_{in} display as a function of output voltage. (The display is particularly useful in detecting crossover distortion in a Class B output stage.) Output swing is measured as the vertical deflection of the transfer function at the horizontal extremes of the display.

Two power supplies are needed in the test set, to supply a fixed ± 20 V to power all other supplies in the test set and to provide ± 5 V to ± 20 V to the circuit under test (Fig. 8).

The test-circuit power supply is referenced to the $+20$ -V output of the positive regulator (through the variable divider R_7 , R_8 , R_9 , R_{10} , and R_{26}). The output of this divider is $+10$ V to $+2.5$ V, according to the position of S_{2a} . It is fed to the non-inverting input of amplifier A_2 ,

which is powered from $+28$ V, and provides $+20$ V to $+5$ V at its output. A_3 is a unity-gain inverter with input direct from the output of A_2 , and is powered from -28 V. The complementary outputs of amplifiers A_2 and A_3 provide dc to the circuit under test.

LM 101 amplifiers are used as A_2 and A_3 to allow operation from one ground-referenced voltage each and to provide protective current limiting for the device under test.

Begin with the proper waveforms

The pulse and triangular waves are derived from the square (Fig. 2), with the pulse referenced to the leading edge of the square wave, and the triangular wave 180° out of phase with the square wave.

An astable multivibrator, A_{11} , generates the square wave, of approximately ± 19 V amplitude with frequency determined by the ratio of R_{18} to R_{16} and by the time constant, $R_{17}C_9$. The operating frequency is stabilized against temperature and power regulation effects by regulating the feedback signal with the divider, R_{19} , D_5 and D_6 .

The half-period of this multivibrator is determined by the time required for the voltage on C_9 to change from the voltage present at the junction of the R_{16} , R_{18} voltage divider, with the multivibrator in one output state, to the voltage at the divider junction with the output in its other state. This half-period for the circuit

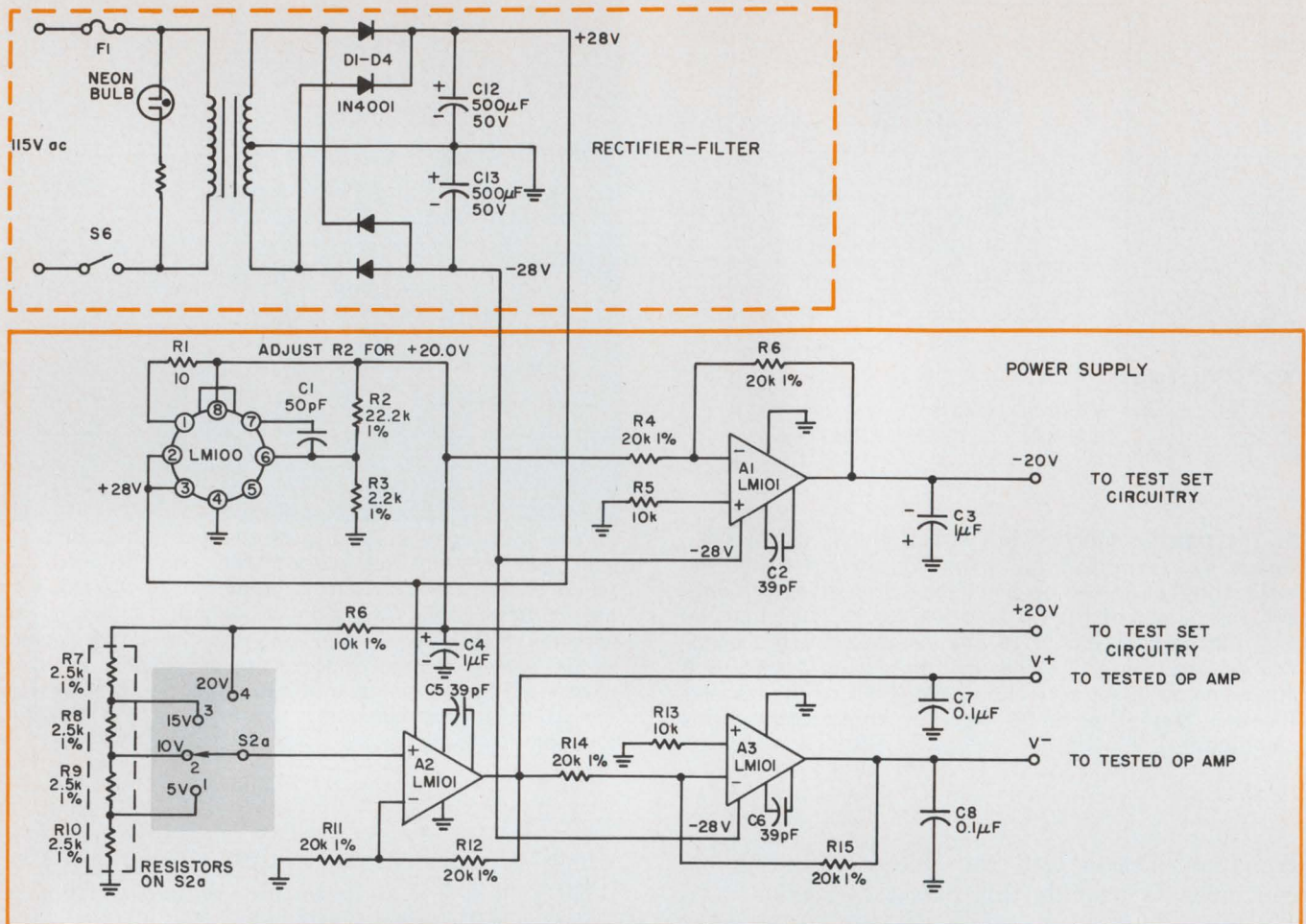

8. The power-supply and voltage-regulator circuits provide regulated supplies at ± 20 V to the test set, and

± 5 V and ± 20 V to the op amp under test. Switch S2a provides for selection of supply voltages.

shown is approximately $3.04 R_{17} C_9$ s.

In the test set shown here, the operating frequency is approximately 16 Hz. The operating frequency should be less than the open-loop 3 dB frequency of the amplifier under test, with the compensation used in the test circuit, because the compensation capacitor provides negative feedback which causes a gain rolloff with increasing frequency above this 3-dB point. (The compensation shown in Fig. 8 is adequate for LM709 and LM101 amplifiers but must be determined for other amplifier types).

Amplifier A_5 is also a monostable multivibrator, triggered by the positive-going output of A_4 . The pulse width of the output of A_5 is determined by the ratio of R_{20} and R_{22} , and by the time constant $R_{21}C_{10}$. The duty cycle is approximately 1%.

Since the offset voltage and bias current traces are clamped to ground during this pulse, it should be wide enough only to determine a ground reference so that minimum information will be lost. The pulse width of this monostable multivibrator is determined by the time required to change the voltage on C_{10} from -19 V to within V_{R22} of $+19$ V. For the circuit shown this

time is approximately $6.85 R_{21} C_{10}$.

Amplifier A_6 is a dc-stabilized integrator, driven from the amplitude-regulated output of A_4 . Its output is a ± 5 V triangular wave, 180° out of phase with the output of A_4 . The amplitude of the output of A_6 is determined by the square-wave voltage developed across D_5 and D_6 , and the time constant $R_{adjust} C_{14}$. Dc stabilization is accomplished by the feedback network R_{24} , R_{25} , and C_{15} . The ac break-point of this feedback network is low enough so that integrator action at the square wave frequency is not degraded.

The operating frequency of the function generator may be varied by adjusting the time constants associated with A_4 , A_5 , and A_6 in the same ratio.

Apply waveforms to the op amp

The test circuit (Fig. 9) accepts the outputs of the power supplies and the function generator and applies them to the tested op amp, and provides horizontal and vertical outputs for an X-Y oscilloscope, which is used as the measurement system.

The primary elements of the test circuit are

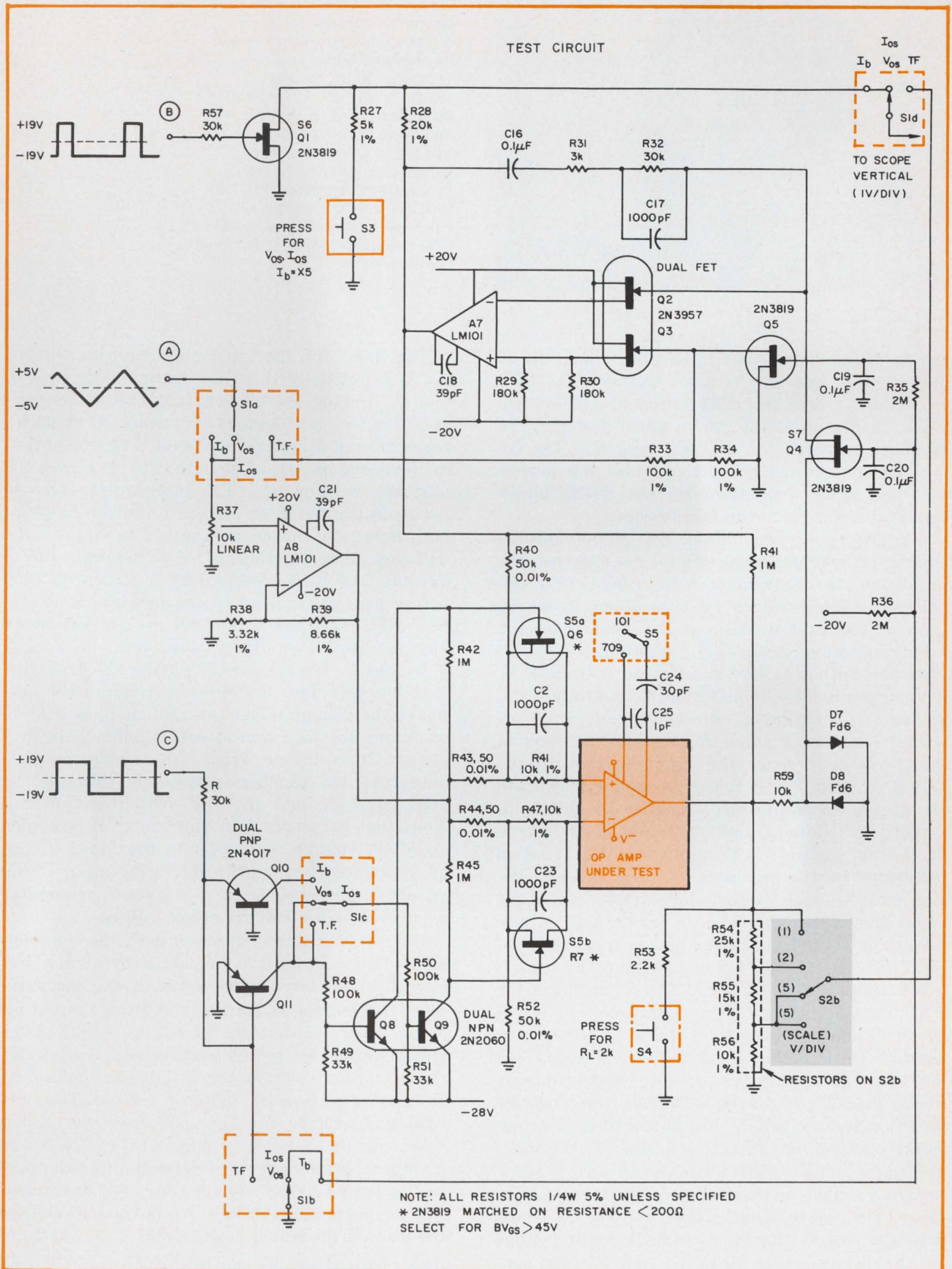

9. The heart of the test set is the switching circuit that applies the proper bias, power conditions, and test wave-

forms to the tested op amp, and provides properly scaled X and Y drive signals for the oscilloscope.

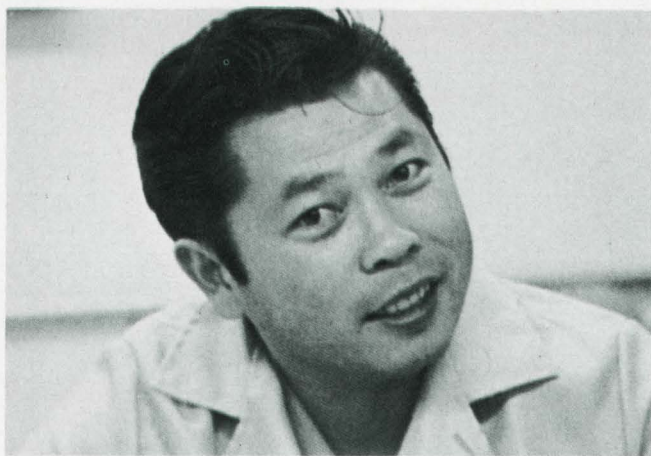

Mineo Yamatake was born in Fresno, Calif. He attended California schools to grade 6, then moved to Japan where he attended Hiroshima Technical High. On his return to the U. S. in 1956 he joined the U. S. Army and served until 1969 in the Signal Corps. He then joined Link Aviation to work in electronic systems, left Link to work with Bob Widlar at Fairchild Semiconductor, and later rejoined Widlar at National Semiconductor.

the feedback buffer and integrator, made up of amplifier A_7 and its feedback network C_{16} , R_{31} , R_{32} , and C_{17} , and the differential amplifier network, made up of the device under test and the feedback network R_{40} , R_{43} , R_{44} , and R_{52} . The remainder of the test circuit provides the proper bias and power conditions for the device under test and scaling for the oscilloscope.

Amplifier A_8 provides a variable-amplitude source of common-mode signal to exercise the amplifier over its common-mode range. This amplifier is connected to provide a non-inverting gain of 3.6, and it receives its input from the triangular-wave generator. Potentiometer R_{37} allows the output to be varied from 0 to ± 18 V. The output drives the differential input resistors, R_{43} and R_{44} , for the op amp under test.

The resistors R_{46} and R_{47} are current-sensing resistors—they sense the input current to the tested op amp. These resistors are switched into the circuit in the proper sequence by the field-effect transistors Q_6 and Q_7 . Q_6 and Q_7 are driven from the square-wave output of the function generator by the pnp pair, Q_{10} and Q_{11} , and the npn pair, Q_8 and Q_9 . Switch sections S_{1b} and S_{1c} select the switching sequence for Q_8 and Q_9 , and hence for Q_6 and Q_7 . In the bias-current test, the FET drivers, Q_8 and Q_9 , are switched by out-of-phase signals from Q_{10} and Q_{11} . This opens the FET switches Q_6 and Q_7 on alternate half cycles of the square-wave output of the function generator. During the offset-voltage/offset-current test, the FET drivers are operated synchronously from the output of Q_{11} . During the transfer function test, Q_6 and Q_7 are switched on continuously by turning off Q_{11} . R_{42} and R_{45} maintain the gates of the FET switches at zero gate-to-source voltage for maximum conductance during their ON cycle. Since the sources of these switches are at the common-mode input voltage of the device under test, R_{42} and R_{45} are connected to the output of the common-mode driver amplifier, A_8 .

The input for the integrator-feedback buffer, A_7 , is selected by the FET switches Q_2 , Q_3 , Q_4 and Q_5 . During the bias-current and offset-voltage/offset-current tests A_7 is connected as an integrator, and it receives its input from the output of the tested op amp. The output of A_7 drives the feedback resistor, R_{40} . The integrator serves to maintain the tested op amp in its linear range at both input and output and serves to amplify the voltages corresponding to bias current, offset current, and offset voltage by a factor of 1000 before presenting them to the measurement system. FET switches Q_3 and Q_4 are turned on by switch section S_{1b} during these tests.

Q_3 and Q_4 are turned off during the transfer-function test. This disconnects A_7 from the output of the op amp under test and changes it from an integrator to a non-inverting unity-gain amplifier. It is driven from the triangular-wave output of the function generator, through the attenuator R_{33} and R_{34} and switch section S_{1a} . Amplifier A_7 serves two functions: it provides an offset voltage correction to the input of the op amp under test, and it drives the input of the op amp under test with a ± 2.5 -mV triangular wave centered about the offset voltage.

During the transfer-function test, the common-mode driver amplifier is disabled by switch section S_{1a} , and the vertical input of the measurement oscilloscope is transferred from the output of the integrator-buffer, A_7 , to the output of the tested device by switch section S_{1d} . Switch S_{2a} allows supply voltages for the device under test to be set at ± 5 , ± 10 , ± 15 , or ± 20 V. The vertical scale factor for the measurement oscilloscope can be changed by means of switch S_{2b} to maintain optimum vertical deflection for the particular power-supply voltage used. A momentary-contact pushbutton switch, S_4 , is used to change the load on the tested device from 10 k Ω to 2 k Ω .

A delay must be provided, when switching from the input tests to the transfer-function tests, to ensure that the integrator function of A_7

Bill Routh was born in Newman, Ga., and holds B.S. degrees in mathematics and physics from Rollins College.

He worked with the Martin Company in inertial guidance and paramagnetic resonance, with Radiation, Inc. in linear ICs, and developed and manufactured special audio equipment with his own firm, Routh & Associates Engineering Services Inc. before joining National Semiconductor in 1968.



is disabled before it is driven by the triangular wave. If this is not done, the offset correction voltage, stored on Q_{16} will be lost. This delay between opening FET switches Q_4 and Q_5 is provided by the RC filter, R_{35} and C_{19} .

Resistor R_{41} and diodes D_7 and D_8 are provided to control the integrator when no test device is present, or when a faulty test device is inserted. R_{41} provides a dc feedback path in the absence of a test device and resets the integrator to zero. The input to the integrator is clamped to approximately ± 0.7 V, by diodes D_7 and D_8 , for protection when a faulty device is inserted.

FET switch Q_1 and resistor R_{28} provide a ground reference at the beginning of the 50- Ω source offset-voltage trace. This trace provides a ground reference that is independent of instrument of oscilloscope calibration. The gate of Q_1 is driven by the output of monostable multivibrator, A_5 , and Q_1 shorts the vertical oscilloscope-drive signal to ground during the time that A_5 is positive.

Switch S_3 , R_{27} , and R_{27} provide a X5 scale increase during input parameter tests to allow measurement of amplifiers with large offset voltage, offset current, or bias current. Amplifier compensation can be changed by means of switch S_5 to suit 101 or 709 model amplifiers.

Particular attention should be paid, of course, to the layout of parts and wiring. The op amps used in the circuit have very high gain, and parasitic coupling between elements can cause difficulties with oscillation or noise pickup.

Calibrate with ease

Calibration of the test system as shown is relatively simple—only one adjustment is required. The triangular-wave generator is adjusted to provide ± 5 V output by changing R_{adjust} . This sets the horizontal sweep for the X-Y oscilloscope used as the measurement system. The

oscilloscope itself is then adjusted for 1 V/division vertical sensitivity and for a full 10-division horizontal sweep. This simple calibration results in scale factors as follows:

For the bias-current display;

I_{bias} total 100 nA/div. vertical
Common-mode voltage variable horizontal

For the offset-voltage/offset-current display;

I_{offset} 100 nA/div. vertical
 V_{offset} 1 mV/div. vertical
Common-mode voltage variable horizontal

For the transfer-function display;

V_{in} 0.5 mV/div.
 V_{out} variable to 5V/div. @ $V_s \pm 20V$
or 5V/div. @ $V_s \pm 15V$
or 2V/div. @ $V_s \pm 10V$
or 1V/div. @ $V_s \pm 5V$

Gain = $\Delta V_{out}/\Delta V_{in}$. ■■

Test your retention

Here are questions based on the main points of this article. Their purpose is to help you make sure you have not overlooked any important ideas. You'll find the answers in the article.

1. The test set is designed to avoid oscillation difficulties with the tested op amp. What precaution is taken?

2. The bias-current test also indicates any dependency of bias current on the common-mode voltage. How does such dependency affect the scope trace?

3. When testing for offset voltage, how can you tell which trace corresponds to the 10-K Ω source test?

4. The transfer function display is automatically centered on the scope face, regardless of the offset voltage. How is this accomplished?

PLAGUED BY RELAY REJECTS?

**The Engineers who specify Comar Relays are not!
They save their company money and here's why:**



We use our Environmental Test Laboratory and our Miss Testers to be certain that all of their requirements are met. This, coupled with our Quality Assurance Program, which covers the entire manufacturing and testing process, assures relay reliability and quality.

This means that they don't have to pre-test a Comar Relay. (We've done all that.) If it's wired in the circuit, they won't have to take it out. They can rely on Comar's maintaining an AQL of 0.15 to 0.65 to keep their Purchasing and Production people out of trouble; and we ship Comar relays on schedule.

Comar engineers can customize our relays to meet your exact requirements, and you can count on them to function reliably from first operate and release throughout their design life. All of this saves your company money!

It's as simple as:
"Comar Quality costs you less."

For complete information on Comar Relays and Solenoids, write:

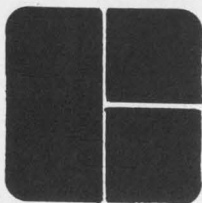

Comar Electric Company
3349 WEST ADDISON ST., CHICAGO, ILLINOIS 60618

Crystal Can, Reed, Clapper and Telephone Type Relays • Military, Aerospace and Commercial Relays • Steppers and Solenoids

INFORMATION RETRIEVAL NUMBER 31

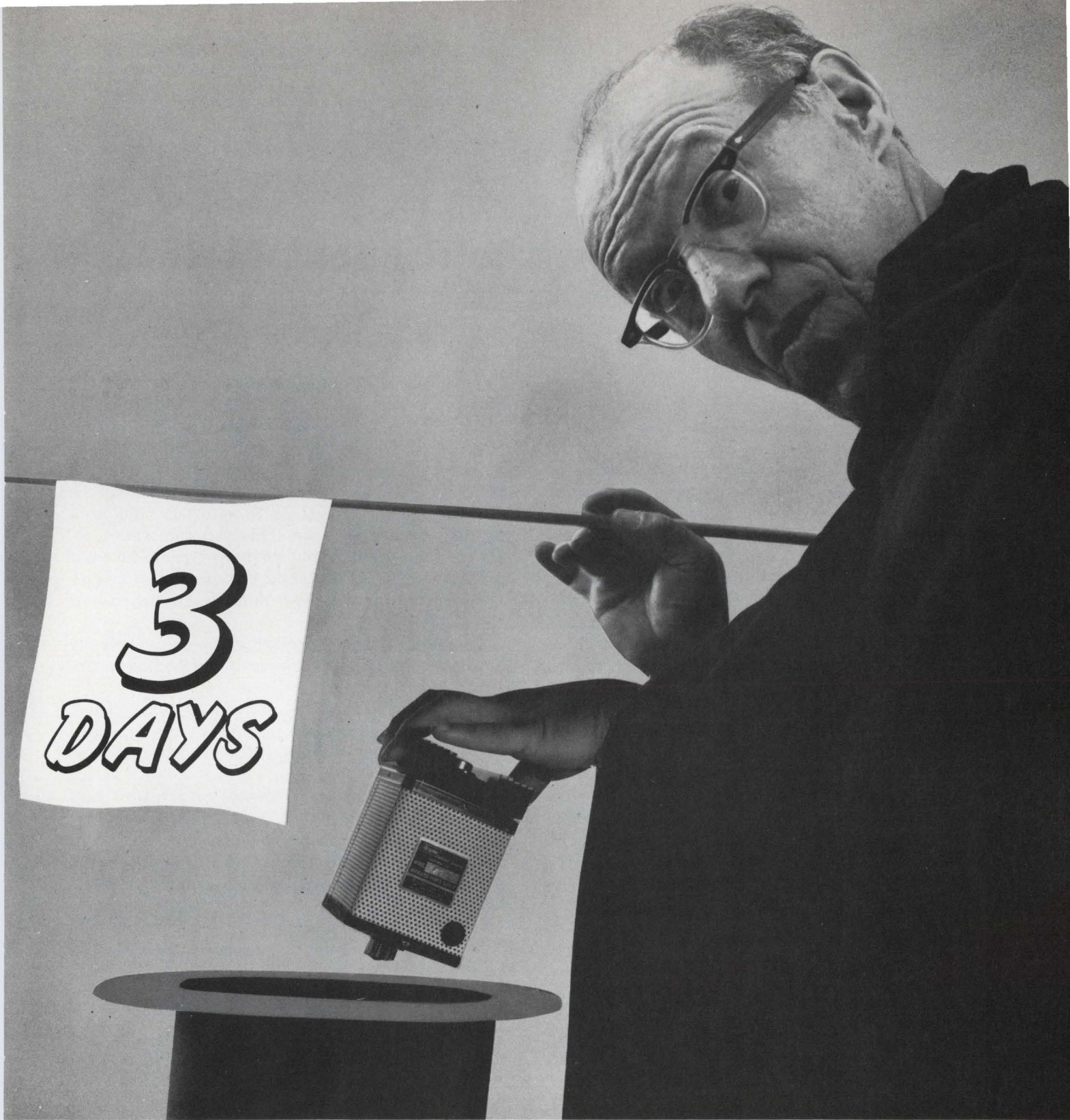

Magic... Acopian style!

We ship any of our 82,000 different AC to DC plug-in power supplies in just 3 days!

Next time you need power supplies in a hurry, contact Acopian. We offer 82,000 different AC to DC plug-in power supplies, any of which will be shipped to you in **just three days!** Choose the exact DC output you need. Singles or duals. Regulated or unregulated. Whether you need one power supply or several, your order will be shipped in just three days! That's our promise. For your copy of our latest catalog, contact your local Acopian rep, call us at (215) 258-5441, or write to Acopian Corp., Easton, Pa. 18042.

Acopian

Select air movers without guesswork.

Use an impedance-measuring technique to determine the type and size of air mover required for any application.

Thanks to integrated circuits and other forms of miniaturization, more and more heat-producing components are being crammed into smaller and smaller electronic packages. This calls for an increased emphasis on good thermal design, and this often requires the use of a cooling fan or blower (more generally called air movers). Haphazard selection of an air mover, however, often results in either insufficient cooling or unreasonably high noise, power and cost. The designer needs an easy way to determine accurately the type and size of air mover required for a given application. Impedance measuring offers such a way.

What is impedance measuring?

For proper selection of an air mover, the air flow it must deliver, as well as the required pressure, should be known. The flow of air needed to cool a piece of electronic equipment, in cubic feet per minute (cfm), can be calculated fairly easily (Box 1). But the pressure required is difficult to estimate, let alone calculate exactly.

Fortunately, for any shape or configuration of enclosure, the basic relationship between air flow and pressure is essentially the same. This relationship (Fig. 1) is in the form of an impedance, or pressure-drop, curve that plots air flow versus pressure. The shape of this impedance curve is almost true quadratic. The curve constants are determined entirely by the geometry of the enclosure together with the components it contains.

Consequently, by using an accurate mock-up of the unit to be cooled, the designer can easily determine the pressure required for a particular cooling application, once the impedance and air flow needed are known. And because of its quadratic nature, the impedance curve can be drawn after only one or two of its points have been determined by means of measurements in the mockup (Box 2).

Arthur H. Mankin, Chief Applications Engineer, IMC Magnetics Corp., Westbury, N. Y.

Thus, with the impedance curve and required quantity of air known, the designer can then determine the needed static pressure, and therefore determine whether a centrifugal, propeller or vaneaxial fan is most suitable. In addition, the internal placement of parts in the unit can be altered, and the effects of these alterations seen on the impedance curve. This can sometimes result in component layout changes that reduce the pressure requirements, and therefore also reduce the required input power, noise level and cost of the air mover.

In essence, then, specifying an air mover by means of the impedance-measuring technique involves the following:

- Construct a mock-up of the unit to be cooled. cardboard, sheet metal—in fact, any material can be used, as long as it has the desired physical configuration.

- Make a few measurements of air flow and pressure on the mock-up, and from these draw the impedance curve of the enclosure.

- Calculate the air flow needed to maintain the enclosure at the desired temperature. Using the calculated value, read off the required pressure from the impedance curve.

- Select an air mover, based on the required pressure and air flow. Where efficiency is the prime consideration, Fig. 2 can be used to select an appropriate type. Where other considerations, such as noise or maintenance requirements, are paramount, the air-mover vendor should be consulted so that the best compromise can be reached. (Various common air-mover types and some typical characteristics of each are given in the table).

Example shows advantages of technique

The steps involved in the impedance-measuring technique, together with the advantages to be gained from it, can be seen clearly from actual case studies.

In the first of these—a camera housing made by Sanders Associates, Nashua, N.H.—the shape of the unit made calculation virtually impossible.

1. Calculating air flow

Since air movers involve the removal of heat, using air as the medium, the basic equation of heat transfer applies:

$$Q = MC\Delta T,$$

where

Q is the heat flow,

M is the mass of air,

C is the specific heat of the air,

ΔT is the change in temperature.

For use in cooling, this simplifies to

$$\text{cfm} = 3160KW/\Delta T_F \quad \text{or}$$

$$\text{cfm} = 1760KW/\Delta T_C,$$

where

cfm = cubic feet per minute,

KW = heat to be dissipated, in kilowatts,

ΔT = permissible heat rise, in either Fahrenheit or Centigrade, as specified.

As an example of the use of the equation, consider the case where a temperature rise of 1°F is permitted. This will require 3160 cfm to remove 1 kilowatt of power. However, if a temperature rise of 100°F is permitted, the flow required drops to 31.6 cfm. It can be readily seen, then, that great economies are possible by not over-designing the air mover. Unfortunately, perhaps up to ninety per cent of the air movers used in electronic applications today are over-designed; some drastically so. Excess air blows up costs, in wasted power and space, and of course increases noise.

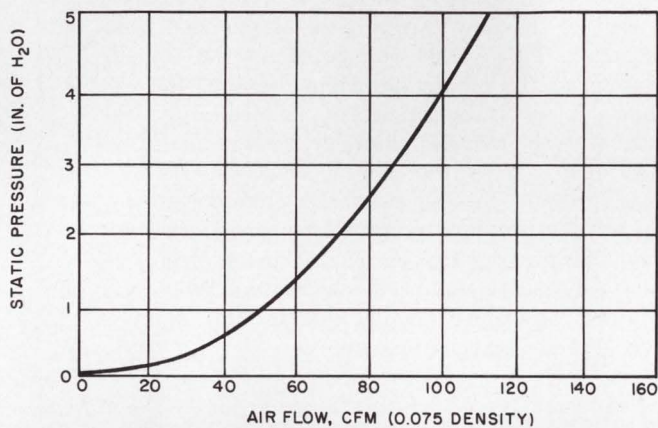

1. The impedance curve shows the pressure required from an air mover to produce a specific air flow in an enclosure. The shape of the curve is essentially the same, regardless of the enclosure configuration.

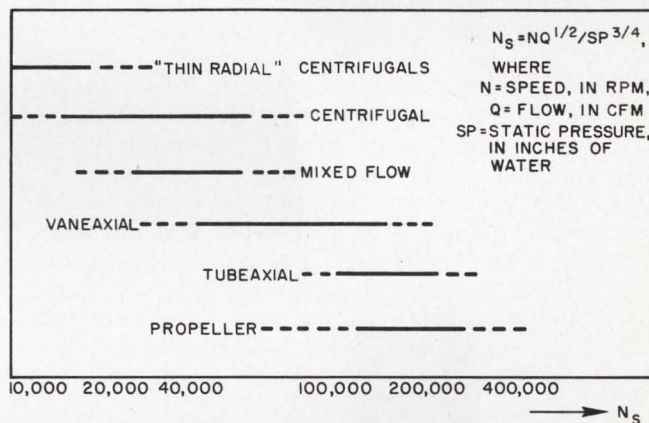

2. The specified speed, N_s , can often be used to select the most suitable type of air mover for a particular application. The dashed lines here represent the borderlines of usability.

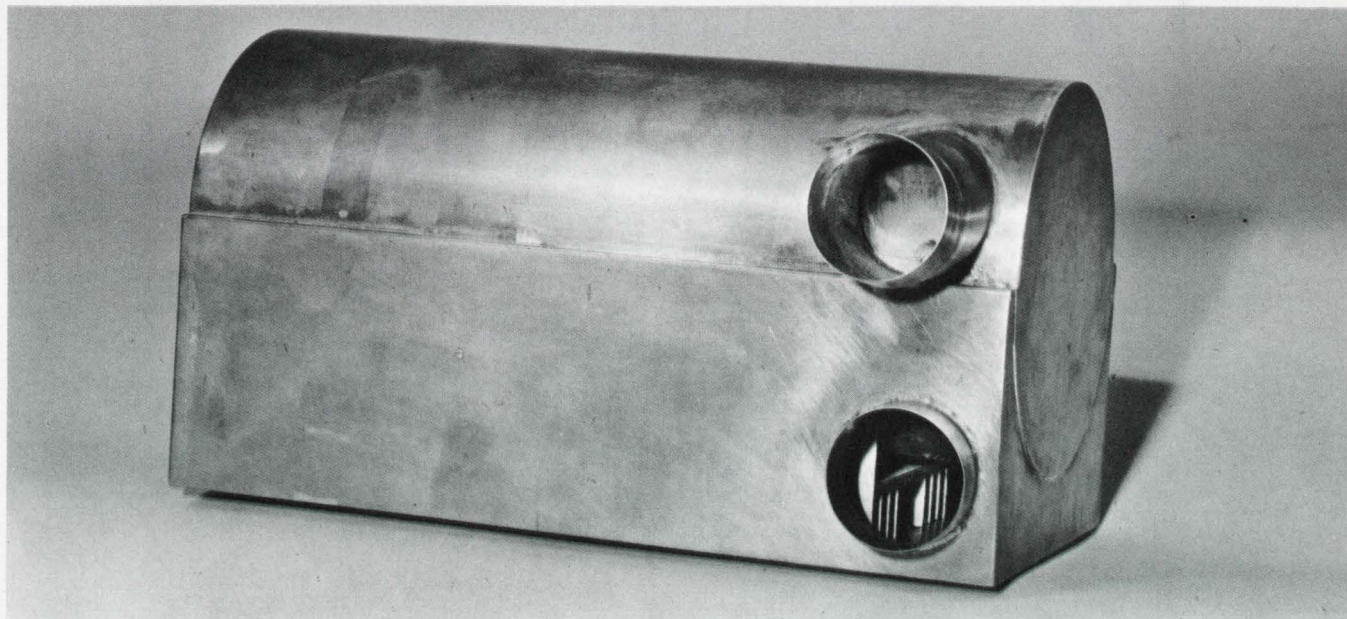

3. Mock-up of camera housing was made of sheet-brass sections soldered together to accurately simulate the

geometry of the actual unit. This technique was used because calculations were virtually impossible.

2. Measuring air flow and pressure

The impedance-measuring technique is based on this principle: if a known amount of air is forced through the unit, the pressure drop—or impedance—across it can be measured. This gives one point on the impedance curve. If the amount of air is changed, the pressure then obtained gives a second point, and so on.

The basic method for measuring air flow is to use an air chamber. The governing specification for air chambers is AMCA* Bulletin 210, which describes various types of chambers. The chamber of most pertinence for the air movers considered here is the plenum chamber.

As shown in (A) an air mover is coupled to a receiving chamber, which in turn is coupled to an exhaust chamber through a calibrated elliptical nozzle—an exhaust blower removes air from the exhaust chamber.

The method of operation is as follows: the air-moving device blows into the receiving chamber. When the exhaust blower is not operating,

*Available from Air Moving & Conditioning Association, 205 W. Touhy Ave., Park Ridge, Ill.

pressure rises in the receiving chamber, and manometer 1 measures static pressure. The same amount of air that blows through the air-moving device also flows through the calibrated nozzle; here manometer 2, which is a differential manometer, measures the pressure drop across the nozzle. Because a nozzle of this type can be calculated, this pressure drop can be related directly to the flow. The relationship between flow and pressure across the nozzle is shown in (B), for typical nozzle sizes.

Thus, static pressure in the receiving chamber as well as the flow through the nozzle has been measured. This yields one point on the impedance curve. To obtain additional points, the exhaust blower is operated to produce a partial vacuum in the exhaust chamber, so that the pressure drop across the nozzle changes. As the static pressure in the receiving chamber drops, a new pressure/flow point is measured. In general, turning on the exhaust blower produces static pressures that are lower than would be obtained otherwise, while closing the damper gives higher static pressures.

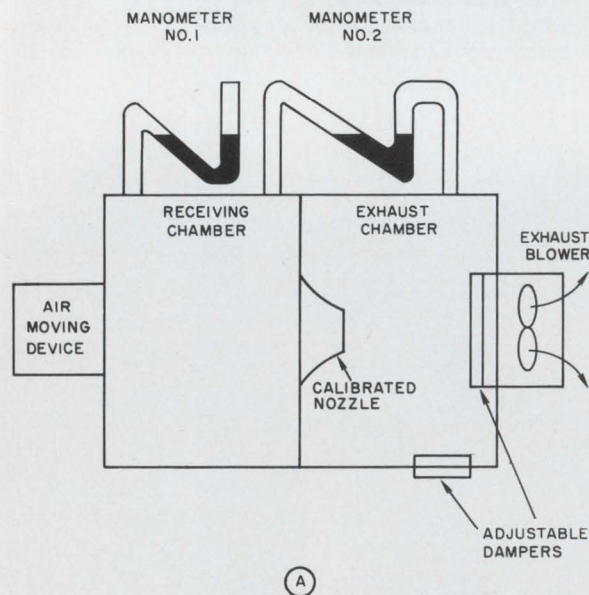

A. Basic air-flow measuring setup uses two chambers connected by a calibrated nozzle. Manometer 1 measures the static pressure produced by the air mover, and manometer 2 measures the air flow.

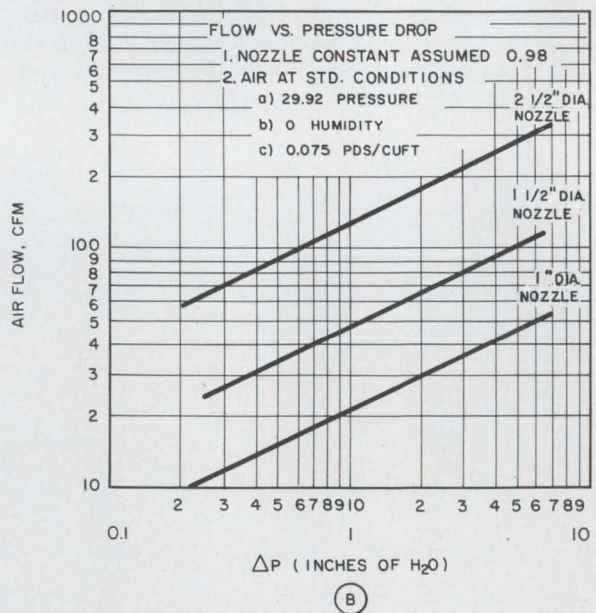

B. If the pressure drop across a nozzle, ΔP , is known, the air flow through the nozzle can be determined from the appropriate curve. Curves are shown here for typical nozzle sizes.

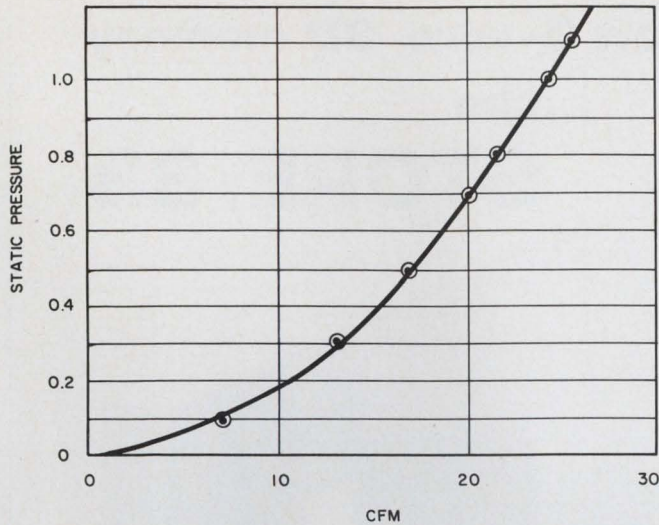

4. Relatively high pressure is required in this application to provide the required air flow.

So a mock-up was made of sheet brass, soldered together (Fig. 3). The impedance curve was then obtained in the following way: an outlet opening was ducted to the air chamber (per AMCA Bulletin 210; see Box 2), and suction was applied with the auxiliary blower in the air chamber. The flow was measured by the pressure drop across a calibrated nozzle; the pressure drop across the system was measured by another manometer, which measured static pressure in the receiving chamber adjacent to the unit under test. From the impedance curve that resulted, the designer was able to specify very accurately a centrifugal blower to cool his unit.

Technique sometimes has unexpected results

The second case study involves an airborne power supply built by Trio Laboratories of Plainview, N.Y. When the unit exhibited a tendency to overheat an attempt was made to cure the problem with a boxer-type fan. The results were extremely unsatisfactory.

When the impedance curve was run (Fig. 4), the reason for the poor results was obvious. The curve showed that a propeller- or tubeaxial-type fan would move almost no air, and that a vaneaxial or possibly a centrifugal unit was better suited. Accordingly, a unit was recommended which would provide the required performance.

In this particular case it was decided, because the pressure requirements were so high, to use the vehicle's own air for cooling, and thus solve the problem in a different way. This is an example of how impedance testing can sometimes do away with the air mover altogether. ■■

Table. Air-mover Types

Type of air mover	Sketch	Efficiency		Remarks
		% Typ.	% Max	
Thin radial centrifugals		65	40	For low flows at high pressure.
Centrifugal		52	33	General-purpose cooling in enclosed volumes. For moderate pressure, low flows.
Mixed flow		60	40	Similar to centrifugal, except higher efficiency and lower noise level at lower pressure.
Vaneaxial		80	60	High efficiency, small volume, usable over wide range. Low noise level. Well suited for airborne applications, ducting.
Tubeaxial		55	35	High flows, relatively low pressure. Exhaust fans.
Propeller		45	28	Very high flow, low pressure.

Test your retention

Here are questions based on the main points of this article. Their purpose is to help you make sure you have not overlooked any important ideas. You'll find the answers in the article.

1. What is an impedance curve?
2. How is the shape of the impedance curve affected by the geometry or configuration of the unit under test.
3. What are the advantages of the impedance-measuring technique?

2½D cycle time at 3D cost!

Data Products' new 3-wire, 3D memory

...the

STORE/33™

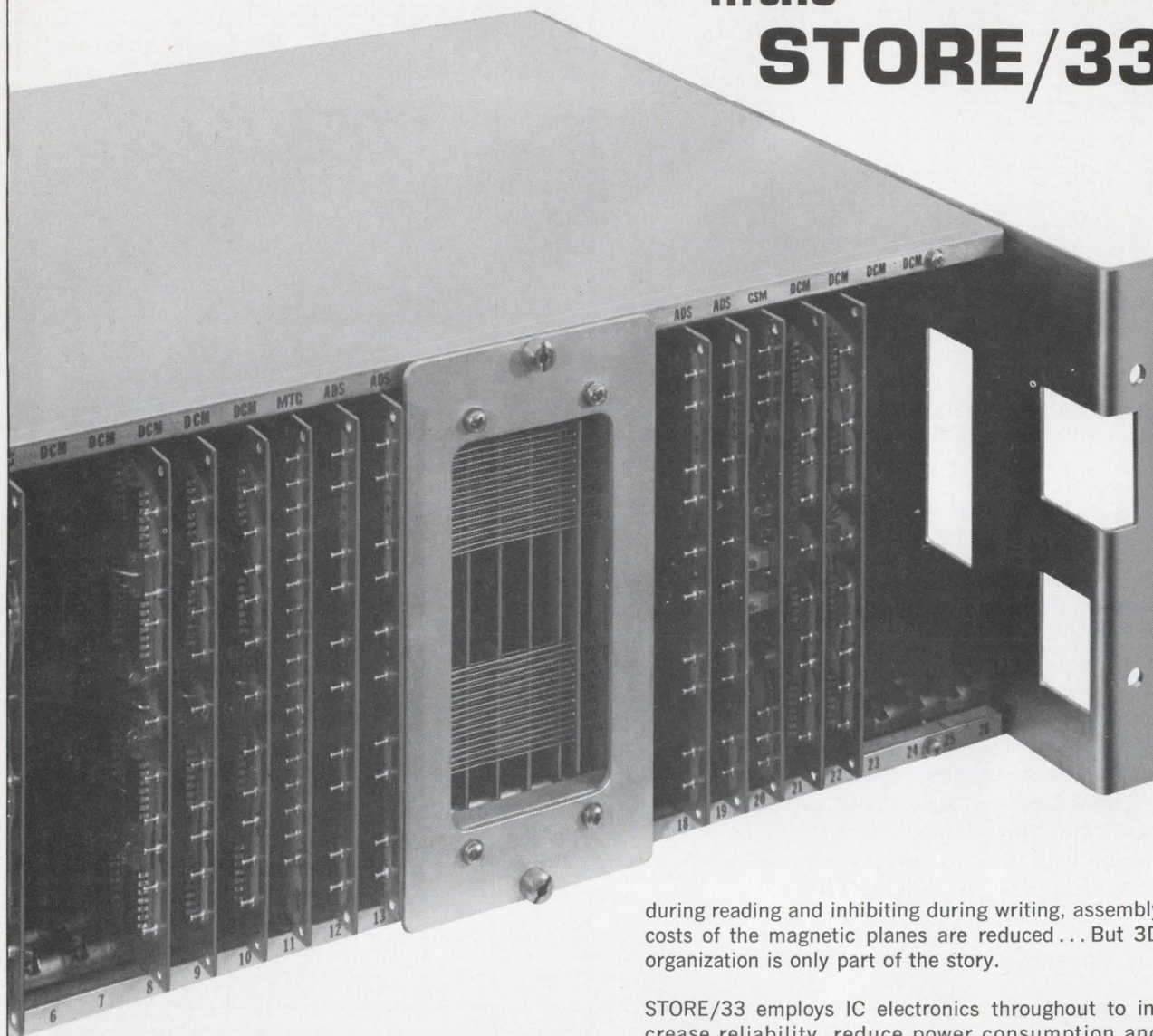

STORE/33 is in full production at Core Memories, Inc.* . . . now you can have 2½D speed at coincident-current prices! For example, the 4K x 16 version of STORE/33 uses 18 mil cores to give a full-cycle time of 650 nsec. The price? Under \$4500** in production quantities.

What makes this price breakthrough possible without a tradeoff in speed? The key, of course, is 3-wire 3D organization in which the fourth winding normally associated with coincident-current organization is eliminated. By utilizing the same winding for both sensing

during reading and inhibiting during writing, assembly costs of the magnetic planes are reduced . . . But 3D organization is only part of the story.

STORE/33 employs IC electronics throughout to increase reliability, reduce power consumption and achieve more compact packaging. The basic memory uses only four types of plug-in cards. The memory stack also plugs in. This standardization of circuit card types and modular construction reduces your inventory costs and simplifies maintenance. Word capacities to 16K, interface flexibility, plus a wide range of options . . . for the full story, write Data Products Corporation, 6219 De Soto Ave., Woodland Hills, Calif. 91364.

*Core Memories, Inc. is a subsidiary of Data Products Corp.
**Price does not include optional power supply.

Data Products manufactures LINE/PRINTERS™, DISCHLES®, Core Memories, Off-Line Printer Systems, Card Readers & Punches.

P data products

"the peripheralists"

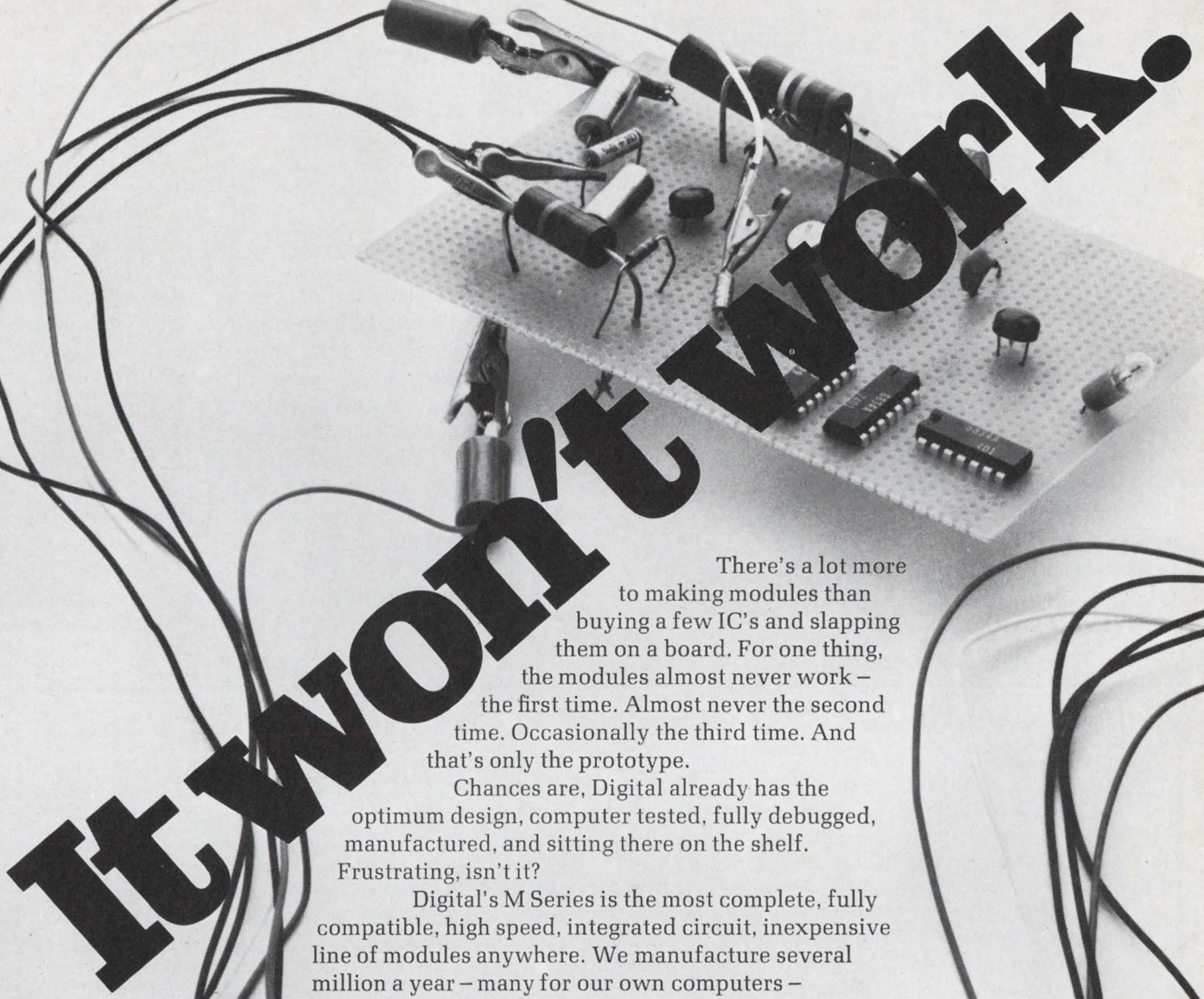

It Won't Work!

There's a lot more to making modules than buying a few IC's and slapping them on a board. For one thing, the modules almost never work – the first time. Almost never the second time. Occasionally the third time. And that's only the prototype.

Chances are, Digital already has the optimum design, computer tested, fully debugged, manufactured, and sitting there on the shelf. Frustrating, isn't it?

Digital's M Series is the most complete, fully compatible, high speed, integrated circuit, inexpensive line of modules anywhere. We manufacture several million a year – many for our own computers – and know how.

Send for our new Logic Handbook. It tells you what, why, and how to build logic systems from modules. But, alas, not how to build the modules themselves.

DIGITAL EQUIPMENT CORPORATION, Maynard, Massachusetts 01754. Telephone: (617) 897-5111 / Cambridge, Mass. / New Haven / Washington, D.C. / Parsippany, Palisades Park, N.J. / Princeton, N.J. / Rochester, N.Y. / Long Island, N.Y. / Philadelphia / Pittsburgh / Cleveland / Dayton / Huntsville / Cocoa, Fla. / Chicago / Denver / Ann Arbor / Salt Lake City / Houston / Albuquerque / Los Angeles / Palo Alto / Seattle. INTERNATIONAL, Carleton Place and Toronto, Ont. / Montreal, Quebec / Edmonton, Alberta, Canada / Reading and Manchester, England / Paris, France / Munich and Cologne, Germany / Oslo, Norway / Stockholm, Sweden / Sydney and West Perth, Australia.

digital
MODULES · COMPUTERS

Hire the bright engineers and let them develop the design on their own, Dr. C. Lester Hogan of Fairchild advises in this exclusive interview.

Richard Turmail, Management & Careers Editor

You're a manager for an imaginative electronics company, and you want to hire the best engineers. What qualities should you look for in applicants?

Men who will be loyal to the company?

Engineers who will check periodically with the boss while doing a job, so they're sure to please him?

Employees who won't hog all the credit for a job well done, but will remember to share it with their superiors?

Not at all, says Dr. C. Lester Hogan, president and chief executive officer and a director to Fairchild Camera and Instrument Corp. Forget the loyalty—what he looks for are bright people. Never mind checking back with the boss—he wants men who can do the job “wholly and completely.” And as for sharing the credit with superiors, forget it: “When the job is done and done well, they know—and you know—they deserve the credit.”

Hogan, who left Motorola Semiconductor last year to head Fairchild's operation from headquarters in Mountain View, Calif., gave his views

Profile on Dr. C. Lester Hogan

When Dr. C. Lester Hogan was selected to head up Fairchild Camera and Instrument Corp. last August, Sherman M. Fairchild's 16% of the company's stock was suddenly worth \$4.7 million more on the market. Wall Street had confirmed what those in-the-know in the field of electronics knew: a positive revolution was about to take place at Fairchild.

The man from Montana lost little time in his efforts to “revolutionize” the company he'd indicated was not capitalizing sufficiently on an outstanding R&D program. He brought nearly a score of his assistants with him from Motorola and he announced that:

- He would capitalize on Fairchild MOS capability by transferring the effort from the laboratory to the production area.
- He would invest heavily in inventory and capital equipment.
- He would remake the corporation around the Semiconductor Division.

“Semiconductor technology will be basic in all electronics,” said Fairchild's new combination president, chief executive officer, and director. “And electronics itself will be basic to all other technology. I want to couple the capabilities of the Semiconductor Division to the other divisions so that they can lead the parade, instead of follow in it.”

Motorola had recruited Dr. Hogan in 1958, from Harvard University where he had received an honorary degree (M.A.) and where he was named Gordon McKay Professor of Applied

Physics in 1957. He had earned his M.S. in physics, and a PhD, at Lehigh University.

Hogan fashioned an enviable reputation for getting things done at Motorola, where he served as vice president and as a director. He has said that he built Motorola's semiconductor business from nothing to best in the field “by copying”—that they second-sourced the entire industry. “The idea,” he said, “was to turn 'em out like jelly beans.” Hogan turned out enough “jelly beans” to account for \$209 million in sales last year.

Much of Hogan's success at Motorola came about by his keeping profit responsibility at a low level on the theory that “you can't force a man to do what you want him to do and then hold him responsible for the results.”

Motorola claimed that Dr. Hogan was offered an interest-free loan to buy 90,000 shares of Fairchild stock at \$60 a share, and another huge block at \$10 a share. He was also given \$250,000 in cash for “moving expenses.” Dr. Hogan's yearly salary is a reported \$120,000.

Recently, the head man at Fairchild stated that “phase one” of his reconstruction plan, that of cleaning up their delinquencies and solving their logistical problems, has concluded. He says that for “phase two” they are ready to take advantage of their technology and put it into large-scale production. The success of “phase two” would bring nearly 300 new products on the market this year.



"If I can't convince my people of my point of view, I do it their way."

"I don't believe in tiptoeing in this kind of business... If you're wrong, it's a helluva big mistake. When I'm wrong, they'll write textbooks about me."

"I want an employe to feel he has a piece of the action."



During the Electronic Design interview, Dr. Hogan suggests whom to hire and how to keep them.

on personnel management in an exclusive interview with *ELECTRONIC DESIGN* in New York. Here are our questions and his candid replies.

What qualities do you look for in prospective employees?

I look for people who are smart, and that's the main thing I ask for. I want bright, alert, aggressive, dynamic, energetic fellows. You want the best you can get. If they leave you and start a business of their own, consider yourself lucky to have had them for a while if they were that damn bright.

How do you maintain staff loyalty?

I don't really look for people I think will be loyal—I couldn't care less. I never will hire Mr. A because I think he's going to be loyal. I'll hire bright Mr. B every time, because he'll get the job done.

If you have people you don't have confidence in, the thing to do is not to direct their effort every day but to fire them and hire people you do have confidence in. That's the way I operate. I think it's a mistake to keep a man around you think is incompetent—someone you're pestering and nit-picking all day long, day in and day out. You don't trust him—not his loyalty, but his competence.

How do you motivate your people?

You get good people and give them the authority to do the job wholly and completely, so they get complete satisfaction out of their performance.

I don't always agree with my people. Half the time they're right, half the time I'm right. But,

I have so much faith in the capability of the people I have that if I can't convince them of my point of view, I do it their way. I have always done that. When the job is done and done well, they know—and you know—they deserve the credit. They don't have to share the credit with me. I just provided an atmosphere in which they were able to perform—that's the big thing.

How do you provide that atmosphere?

You have to provide the facilities in which to perform. I have not been noted to be a niggardly spender, but I have been noted for giving a helluva good return on an investment. I don't believe in tip-toeing into this kind of business. I believe in having so much confidence that you jump in with both feet. You either sink or swim. And if you're wrong, it's a big mistake. When I'm wrong you're going to know about it—they'll write textbooks about me.

How do you keep an employee who's been offered the potential of a better reward than he's getting?

I don't want to lose good people. Now that I have the authority of being the chief executive of a corporation, I am using stock options much more freely and at much lower levels than anyone I've known. I'm trying to harness entrepreneurial ability by making employees feel a part of the business—that they have a piece of the action. If they feel that if they do a fine job they will personally profit, you've done a lot toward keeping them. They'll think twice about going with a smaller operation, where the potential rewards can be greater, but the risk is a lot higher. You have to balance the risk with the financial reward. ■■

**Meet Datapoint.
It's 20 times faster
than other multipoint recorders.
And infinitely more versatile.**

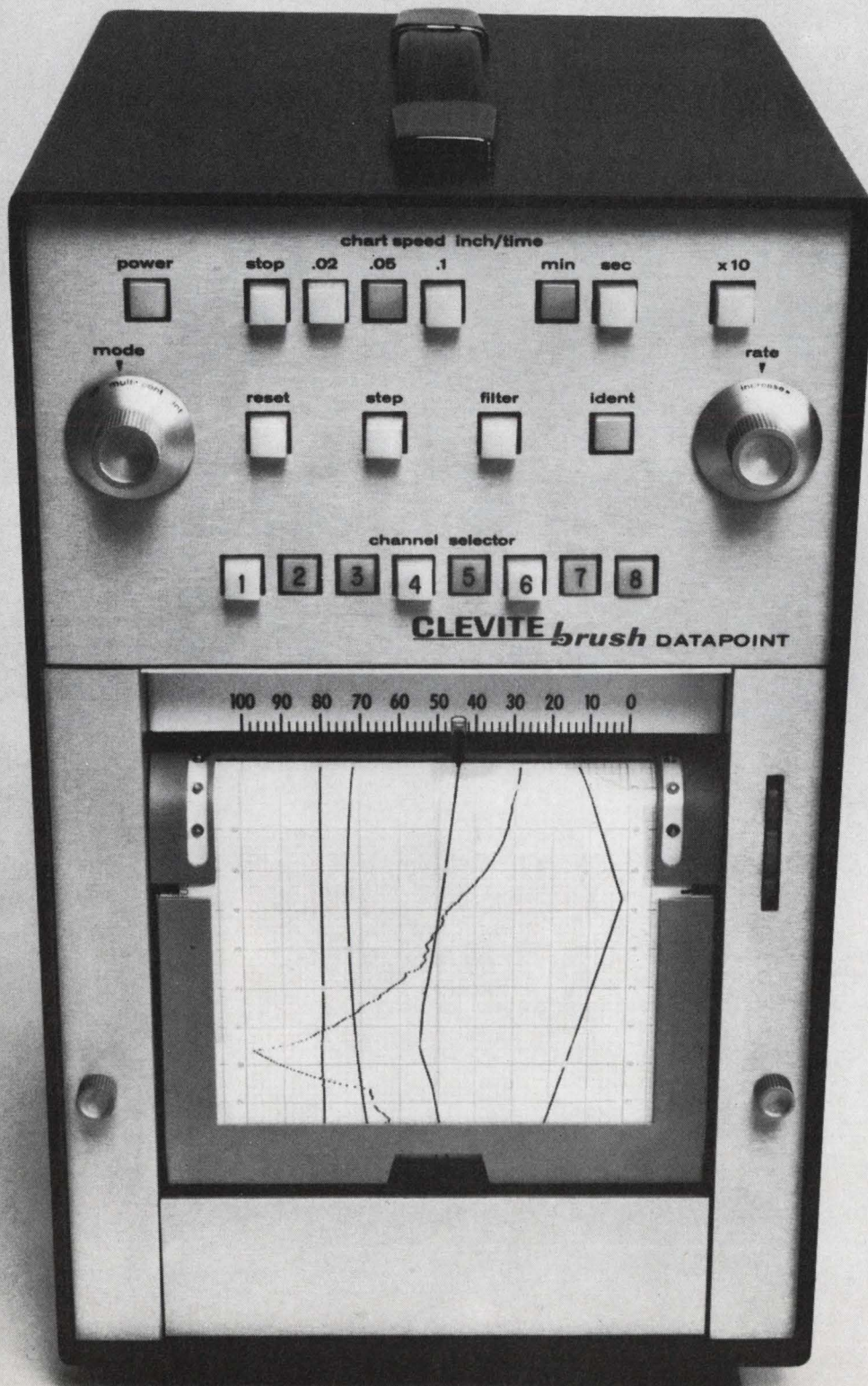

This new high-speed multipoint recorder by Brush runs off as many as 20 samples per second on 2 to 8 channels. So it's great for monitoring fast-changing variables in temperature, flow, pressure, strain, chemical processes, displacement dynamics and the like.



Datapoint handles mixed inputs from high and low level inputs. All on one chart. Recordings come out clear, crisp, uncluttered. And Z-folded. You've got a choice of 12 chart speeds, pushbutton controlled.

About that versatility. Datapoint works in three modes: multipoint sampling, intensified sampling, for channels of high dynamic content, or continuous single channel recording. So you get much more than just a fast multipoint recorder. Without paying more to get it.

And Datapoint is accurate, too. A full 99.5%, enforced by a non-contact position-feedback system. It's a first in this type of recorder. (But a proven success in countless Brush direct writing oscillographs.)

Speed. Versatility. Accuracy. These make Datapoint a new concept in recording. There's never been anything like it. You'll find more proof in the Datapoint brochure. Send for your copy today. Clevite Corporation, Brush Instruments Division, 37th and Perkins, Cleveland, Ohio 44114.

CLEVITE BRUSH

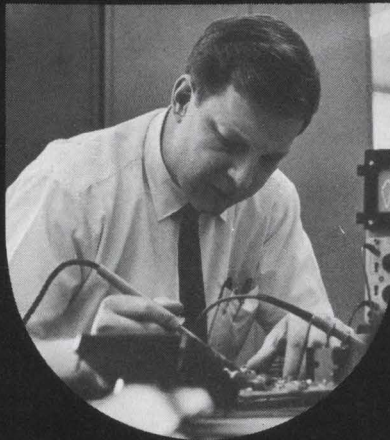

Which discipline will Ed Whitaker use tomorrow

When Delco says multi-disciplinarian, they mean it. Just ask Ed Whitaker. And the solid professionals who have helped him grow into jobs like developing the microcircuits for a fire and overheat detection computer for jet aircraft. Twenty-five hundred components in a package 4" x 2" x 1/2". From concept to hardware in eight months flat. And then a fast hop to Air Force testing. From beginning to final delivery, Ed was a full member of the team. The question is . . . does your job permit you this kind of growth? Take a good look at how your career shapes up, compared with Ed Whitaker's and his colleagues at Delco. You might even call us collect. Or, write: Mr. C. D. Longshore, Supervisor, Salaried Employment, Dept. 602, Delco Radio Division of General Motors, Kokomo, Indiana.

**DELCO
RADIO**



AN EQUAL OPPORTUNITY EMPLOYER
DIVISION OF GENERAL MOTORS
KOKOMO, INDIANA

INFORMATION RETRIEVAL NUMBER 901

Free Career Inquiry Service

Absolutely Confidential

Respond to the career opportunities advertised in this issue. Fill out and send us this handy resume. **Electronic Design** will do the rest – neatly typed copies of this form will be mailed to the companies of your choice, indicated by the circled Career Inquiry Numbers at the bottom of this page.

11

Name		Home Phone	
Home Address (Street)		City	State ZIP Code
Age	U.S. Citizen <input type="checkbox"/> Yes <input type="checkbox"/> No	Security Clearance	
Prime Experience		Secondary Experience	
Desired Salary		Availability Date	

Employment History – present and previous employers

Company			
City, State			
Dates	to	to	to
Title			
Specialty			

Education – indicate major if degree is not self-explanatory

Degree			
College			
City, State			
Dates	to	to	to

Additional Training – non-degree, industry, military, etc.

Professional Societies

Published Articles

- Career Inquiry Numbers:**
- | | | | | | | | | | | |
|-----|-----|-----|-----|-----|-----|-----|-----|-----|-----|-----|
| 900 | 901 | 902 | 903 | 904 | 905 | 906 | 907 | 908 | 909 | |
| 910 | 911 | 912 | 913 | 914 | 915 | 916 | 917 | 918 | 919 | 925 |

ELECTRONIC DESIGN
 850 Third Avenue
 New York, New York 10022

Get emitter-follower action without input/output level shift

Here is a circuit that has the high input impedance and low output impedance of an emitter follower, but does not have that "cursed" 0.6-volt level shift between input and output.

Q1 and Q2 are a dual matched pair of transistors, with Q1 connected as a conventional emitter follower. The emitter of Q1 is approximately 0.6 V less than the input voltage, due to the junction voltage of silicon. Q2 is connected in such a way that it adds 0.6 V to the emitter of Q1, resulting in no level shift between the input and output of the over-all circuit.

For inputs that are small with respect to the supply voltages, the voltage across R1 and the voltage across R2 are both approximately 10 V. R2 is chosen to have twice the resistance of R1 to make the current through R2 half that through R1. This insures that the current through Q1 is equal to that through Q2.

Since the transistors are operating at the same collector current, and since they are matched, $V_{BE1} = V_{BE2}$.

Laboratory measurements on the circuit have shown a level shift between input and output of only 6 mV. This was eliminated completely by adjusting R2 to 7.3 kΩ. No observable change in level shift occurred over the temperature range of -20 to +130°C.

Other circuit characteristics, including fre-

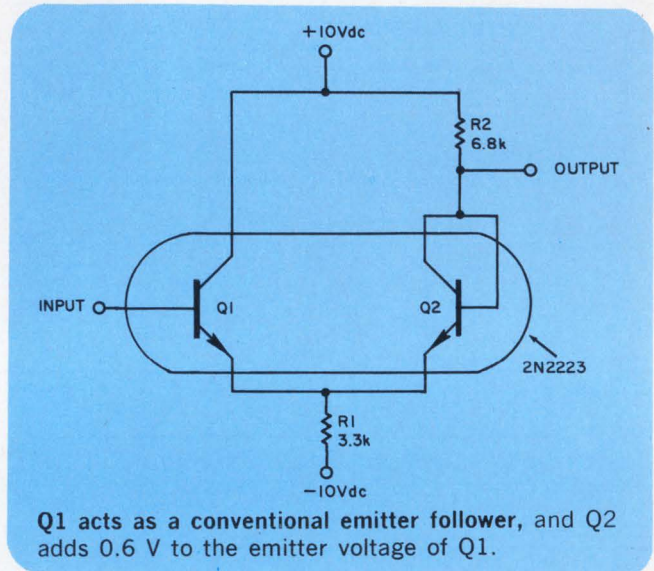

quency response, are about the same as those of an ordinary emitter follower.

Although symmetrical supply voltages are shown for the circuit they are not necessary, provided that R1 and R2 are chosen to divide the current equally between the two transistors.

Ronald C. Chauvin, Associate Electronics System Engineer, LTV Electrosystems, Inc., Greenville, Texas.

VOTE FOR 311

High-gain phase detector circuit uses no transformers

A high-gain, inexpensive phase detector can be built with an integrated circuit, some discrete components and no transformers.

In the circuit, the input signals are applied at f_1 and f_2 , and the phase information is extracted at Φ_{out} . With 200 mV rms at up to 10 MHz applied to each input, the peak-to-peak output swing is 6 to 10 V. With 20 MHz at the inputs, 300 mV is required to maintain the output level, which rolls off smoothly at higher frequencies and is usable to 50 MHz.

In operation, the f_1 input signal appears at the

collectors of Q1 and Q2 in opposite phase. The input signal f_2 appears at the Q1 and Q2 collectors in phase. The resulting collector voltage of Q1 is therefore the sum of the two inputs, and the collector voltage of Q2 is the difference of the two inputs. A pair of voltage-doubling peak detectors, one for each collector, takes the difference between the detected peaks of the two collector signals to extract the necessary phase information.

The circuit has been used for phaselocking a crystal oscillator, and in this application is con-

What this country needs is a good nickel cigar... and a $\frac{3}{8}$ square industrial cermet trimmer.

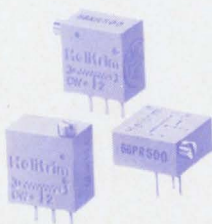

Helipot has the trimmer for \$3.50 list...
now available in local stock.

(But you'll have to find the cigar.)

Beckman®

INSTRUMENTS, INC.

HELIPOT DIVISION

FULLERTON, CALIFORNIA • 92634

INTERNATIONAL SUBSIDIARIES: AMSTERDAM; CAPE TOWN; GENEVA; GLENROTHES,
SCOTLAND; LONDON; MEXICO CITY; MUNICH; PARIS; STOCKHOLM; TOKYO; VIENNA

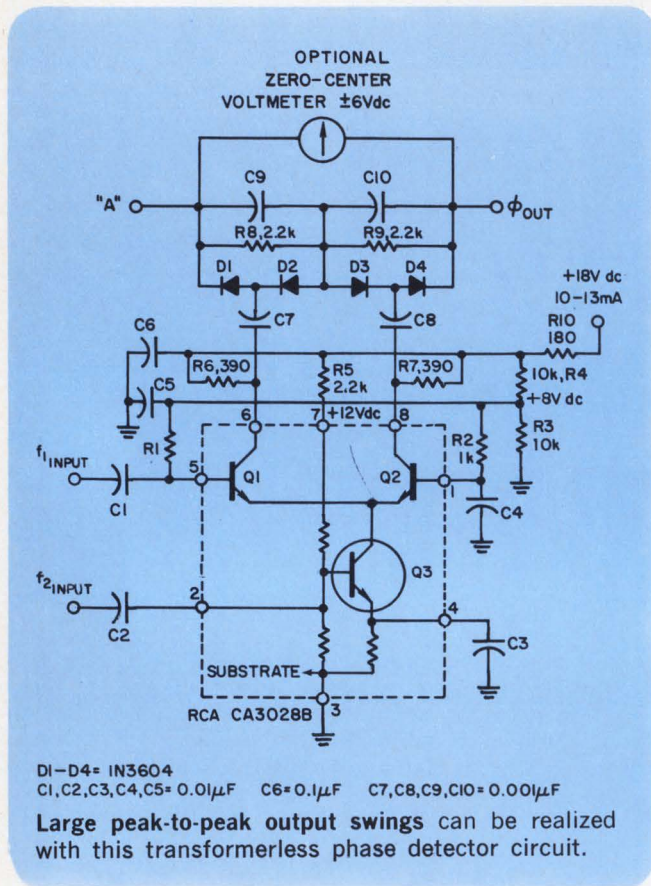

nected to the oscillator tuning varactor through a low-pass filter. Bias for the varactor diode can be added conveniently at point A. A zero-center voltmeter can be connected, as shown, to adjust the entire system to minimum phase error, or to read the phase angle in open-loop applications.

Charles C. Evans, Design Engineer, General Radio Co., West Concord, Mass.

VOTE FOR 312

Constant-frequency multivibrator has variable duty cycle

It is often desirable to generate a pulse train whose duty cycle changes linearly with the position of a shaft but whose frequency remains constant. Such a waveform is ideally suited for proportional control systems, such as radio control of models. It can be provided, as shown, by a potentiometer in the base-bias circuit of a free-running multivibrator.

Circuit operation is based on the fact that the

pulsewidth of a multivibrator is proportional to the base-resistor/coupling-capacitor product, as given by:

$$\tau = kRC$$

If a linear potentiometer is connected between the bases of the transistors, with the center arm connected to the supply voltage, the base resistor values are related by the following equations:

$$R_1 = \alpha R$$

$$R_2 = (1 - \alpha) R$$

where α is proportional to shaft rotation and varies from zero to one. The pulse widths of each partial cycle are given by:

$$\tau_1 = k\alpha RC$$

$$\tau_2 = k(1 - \alpha) RC$$

and the sum of the two widths is the period of oscillation.

It should be noted that this period is constant and independent of α . The duty cycle is:

$$\tau_1/T = \alpha$$

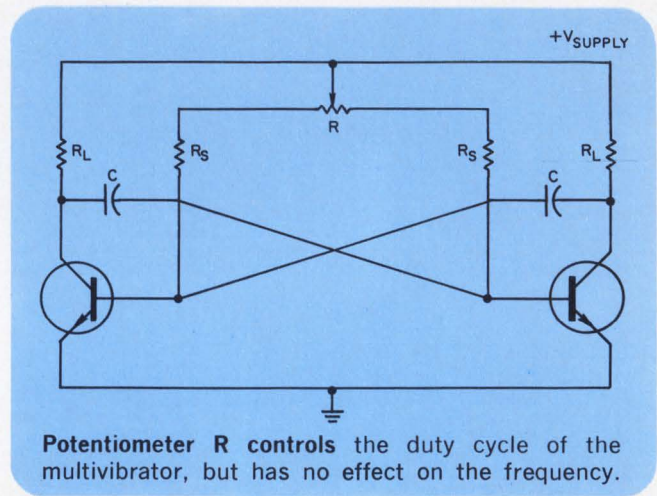

VOTE

VOTE! Go through all Idea-for-Design entries, select the best, and circle the appropriate number on the Reader-Service-Card.

SEND US YOUR IDEAS FOR DESIGN. You may win a grand total of \$1050 (cash)! Here's how. Submit your IFD describing a new or important circuit or design technique, the clever use of a new component or test equipment, packaging tips, cost-saving ideas to our Ideas-for-Design editor. You will receive \$20 for each accepted idea, \$30 more if it is voted best-of-issue by our readers. The best-of-issue winners become eligible for the Idea Of the Year award of \$1000.



Desk-type hp 9100A programmable calculator. Provides dynamic range from 10^{-98} to 10^{99} with resolution to 10 significant figures, and a memory which accommodates 196 program steps. Printed circuit board from calculator shows extensive use of Allen-Bradley hot-molded resistors.

“We specify Allen-Bradley hot-molded resistors for quality, reliability, price and delivery”

Hewlett-Packard

TYPE BB 1/8 WATT

TYPE CB 1/4 WATT

TYPE EB 1/2 WATT

TYPE GB 1 WATT

TYPE HB 2 WATTS

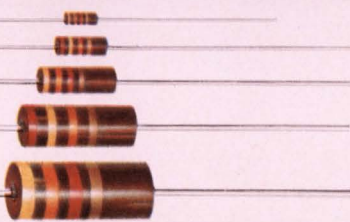

A-B hot-molded fixed resistors are available in all standard resistance values and tolerances, plus values above and below standard limits. A-B hot-molded resistors meet or exceed all applicable military specifications including the new Established Reliability Specification at the S level. Shown actual size.

The computer-like capabilities in this compact hp Model 9100A Calculator have placed severe demands on component performance. Reliability must be of the highest level.

Allen-Bradley hot-molded resistors completely meet the challenge. This is shown by the fact that they satisfy the requirements of the latest MIL-R-390008A Established Reliability Specifications at the *highest* level—the S level. This is true for all three ratings—the 1 watt, ½ watt, and ¼ watt—over the *complete* resistance range from 2.7 ohms to 22 megohms!

The unsurpassed performance of A-B resistors results from an exclusive hot molding manufacturing technique. The equipment is fully automatic—developed and used only by Allen-Bradley. The “built-in” precision control ensures the highest uniformity from resistor to resistor—year after year. Physical properties are constant. Performance is predictable.

For complete specifications on this quality line of hot-molded resistors, please write to Henry G. Rosenkranz and request Technical Bulletin 5000. Allen-Bradley Co., 1201 S. Second St., Milwaukee, Wis. 53204. Export Office: 1293 Broad Street, Bloomfield, N. J., U.S.A. 07003. In Canada: Allen-Bradley Canada Limited.



ALLEN - BRADLEY
QUALITY ELECTRONIC COMPONENTS

To prevent transistor burn-out at the duty cycle extremes, it is necessary to insert a resistor (R_s) in series with each base. Although this tends to somewhat limit the available duty cycle range, the variation is still linear with potentiom-

eter rotation.

Meyer Press and James Teixeira, Design Engineers, Sylvania Electronic Systems, Waltham, Mass.

VOTE FOR 313

Diodes improve 'de-polarization' of polarized capacitors

A nonpolarized capacitor in the microfarad range can be created by connecting two polarized capacitors of twice the desired capacitance back to back. An undesirable feature of this arrangement is that one capacitor has reverse voltage across it even though it is "protected" by the other.

A better method is to place a diode in the reverse direction across each capacitor. Then the capacitors will never see reverse voltage, since the corresponding diode will automatically short out the capacitor that is in backwards. Another equally desirable feature is that each capacitor used can have the desired circuit capacitance

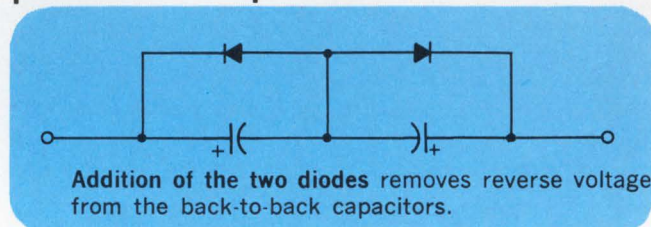

Addition of the two diodes removes reverse voltage from the back-to-back capacitors.

value, instead of twice it. The diodes should have a current rating sufficient to handle the peak capacitor current.

Don Purland, Project Engineer, Research, Inc., Minneapolis, Minn.

VOTE FOR 314

Triangular waveform generator uses complementary transistors

The triangular waveform is frequently used in telemetry and instrumentation applications. These waveforms can be generated, over a wide frequency range and with excellent amplitude stability, by the circuit shown in Fig. 1. The circuit uses a complementary pair of transistors, connected in parallel, to alternately charge and discharge a capacitor linearly. The charging and discharging currents are controlled by a bipolar pulse, so that a symmetrical triangular waveform is produced. With the help of a Schmitt trigger comparator having high hysteresis, and a level transforming circuit, the entire system is made free-running.

As shown in Fig. 1, transistors $Q1$ and $Q2$ are the complementary pair, C is the timing capacitor, and R_E and R_V in series form the common emitter resistor of $Q1$ and $Q2$, across which the bipolar pulse is applied. Also, $Q3$, $Q7$, and $Q9$, are buffer emitter followers, while $Q4$, and $Q5$

form the Schmitt trigger comparator, which is supplied with constant emitter current by $Q6$. Transistor $Q8$ transforms the collector swing of $Q5$ to a pulse, having $+10$ V and -10 V as its upper and lower levels.

In operation, capacitor C is uncharged initially, so that point P is at ground potential. As a result, $Q4$ is OFF and $Q5$ is ON. The collector voltage of $Q5$ is therefore converted by $Q8$ to a level of $+V$ volts, which is fed back to the free end of the R_E and R_V combination.

Since the common-base point (B) of $Q1$ and $Q2$ is at a voltage $+V_B$, more positive than the upper level of the triangular waveform (to prevent saturation of $Q1$), the feedback drives $Q1$ into conduction, cutting off $Q2$. Capacitor C then charges linearly towards $+V_B$ volts; when it reaches the emitter point of the comparator, $Q4$ turns ON and $Q5$ turns OFF. The new level at the collector of $Q5$ is immediately converted to $-V$

Allen-Bradley cuts space requirements with new sealed type Z cermet trimmers

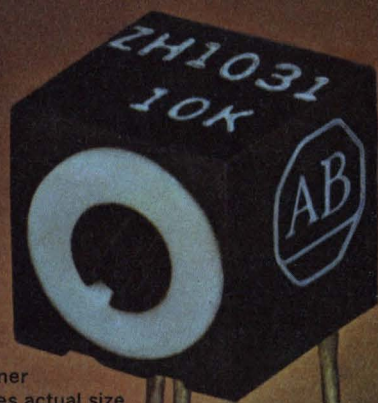

Type Z
½-watt trimmer
shown 5 times actual size

this latest addition to the Allen-Bradley line of cermet trimmers...the type Z...affords high performance in an especially compact package

The cermet material—an exclusive formulation developed by Allen-Bradley—provides superior load life, operating life, and electrical performance. For example, the full load operation (½ watt) for 1000 hours at 70°C produces less than 3% total resistance change. And the temperature coefficient is less than ± 250 PPM/°C for all resistance values and throughout the complete temperature range (–55°C to +125°C).

The Type Z is ruggedly constructed to withstand shock and vibration. The unique rotor design ensures smooth adjustment and complete stability under severe environments. The leads are permanently anchored and bonded. The connection exceeds the lead strength—opens cannot occur. Leads are weldable.

The enclosure is *SEALED*. It is both dust-tight as well as watertight, and can be potted. Mounting pads prevent moisture migration and also post-solder washout. For full specifications on this new spacesaving cermet trimmer, please write Henry G. Rosenkranz, Allen-Bradley Co., 1201 S. Second St., Milwaukee, Wis. 53204. Export Office: 1293 Broad Street, Bloomfield, N.J., U.S.A. 07003. In Canada: Allen-Bradley Canada Ltd.

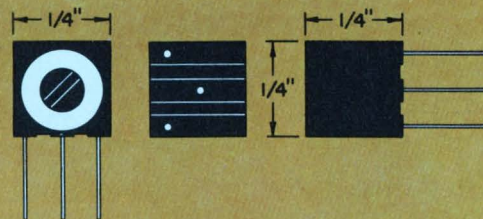

SPECIFICATIONS SUMMARY

- Adjustment:** Horizontal or vertical.
- Temperature Range:** –55°C to +125°C.
- Resistances:** 50 ohms through 1 megohm.
Lower resistances available.
- Tolerances:** $\pm 20\%$ standard, $\pm 10\%$ available.
- Resolution:** Essentially infinite.
- Rotational Life:** Less than 2% total resistance change after 200 cycles.
- Rotation:** 300° single turn.
- End Resistance:** Less than 3 ohms.



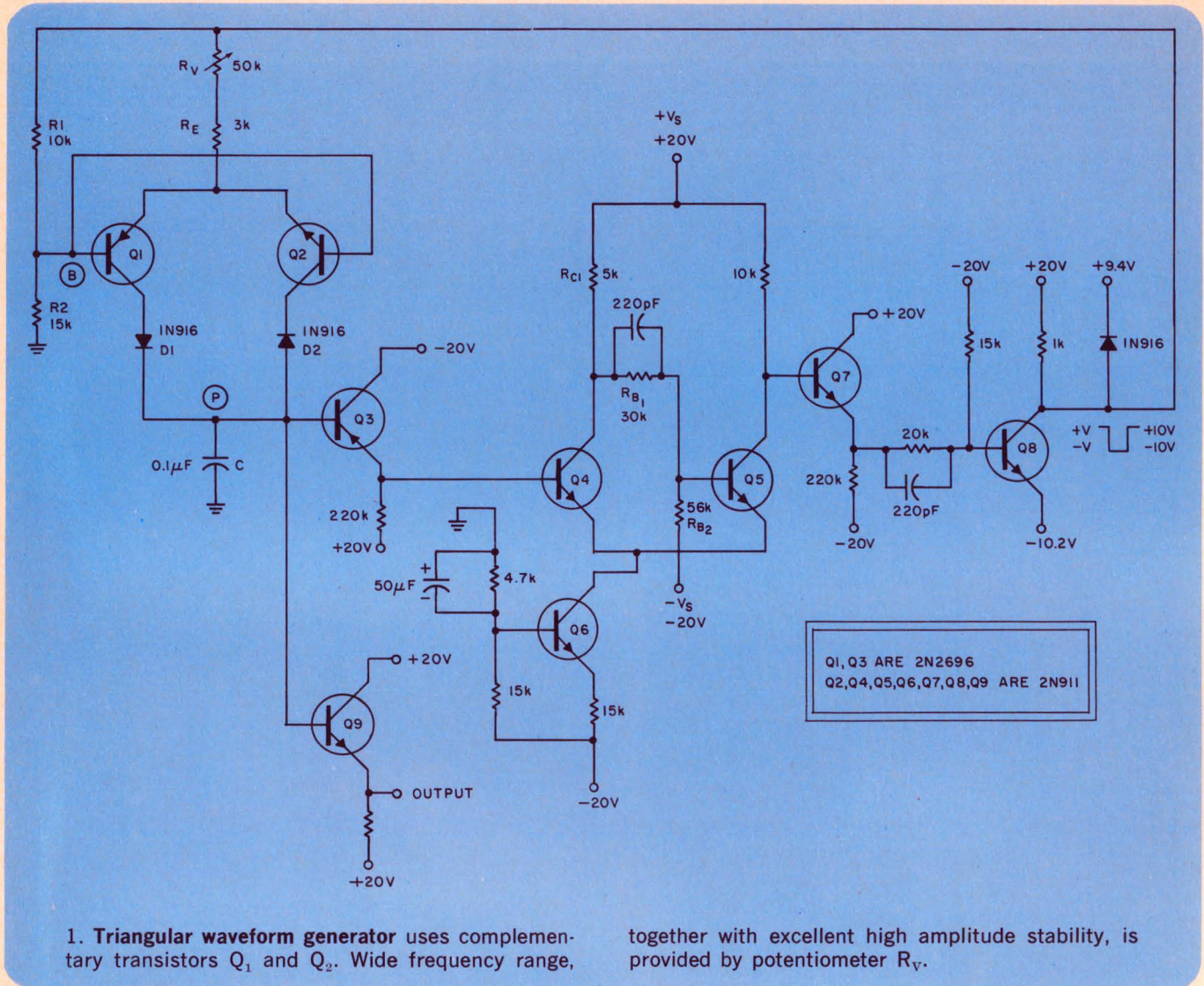

1. Triangular waveform generator uses complementary transistors Q_1 and Q_2 . Wide frequency range,

together with excellent high amplitude stability, is provided by potentiometer R_v .

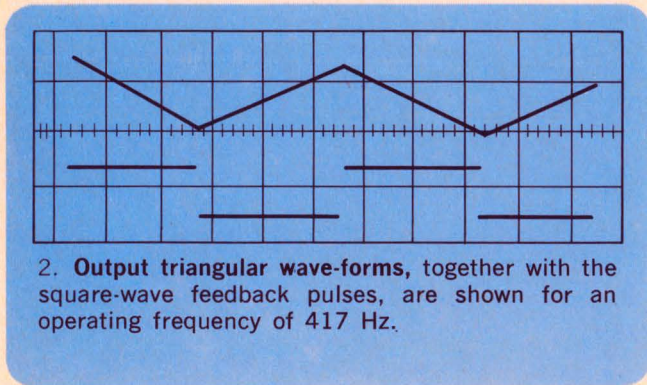

2. Output triangular wave-forms, together with the square-wave feedback pulses, are shown for an operating frequency of 417 Hz.

switches on Q_2 .

Now, C discharges linearly through Q_2 towards ground, until it reaches the trip-point of the Schmitt trigger comparator. At that point, Q_5 switches ON and Q_4 turns OFF. Capacitor C again begins charging, and the cycle repeats itself.

Since the Q_4 collector is not loaded, the upper and lower trip points of the Schmitt trigger, which are dependent on R_{C1} , R_{B1} and R_{B2} , are stable. This results in good amplitude stability of the triangular waveform.

Diodes D_1 and D_2 insure that capacitor C charges only through Q_1 , and discharges through Q_2 .

Santanu Das, Dipak Basu, Lecturers, Computer Center, Jadavpur University, Calcutta, India

VOTE FOR 315

volts by Q_8 . As a result, point B acquires a level of $-V_b$, which is more negative than the lower level of the triangular waveform—to prevent saturation of Q_2 . This cuts off transistor Q_1 and



The den mother.

She always knows where all your little printed circuits are.

So in case you want to know anything about your order, just call (213) 722-6810, ext. 513. The Lockheed computerized control system — better known as our Den Mother — will have the answer for you immediately.

She knows how to keep track of thousands of orders, involving many thousands of lots and goodness knows how many parts. We update her daily, and she likes it. This way she can be aware of what and how many have been

shipped, where parts and lots are and when others will be shipped.

So it only stands to reason. If we care enough to have a Den Mother just to look after our printed circuits — imagine our printed circuits.

LOCKHEED ELECTRONICS COMPANY

LEC A Division of Lockheed Aircraft Corporation, Los Angeles, California

Over-voltage protection circuit can prevent instrument damage

This over-voltage protection circuit can be incorporated into any instrument to prevent damage caused by line surges or improper power application. The circuit is suitable for any voltage, ac or dc, and any power, so long as an appropriate triac is used.

When the protection circuit is incorporated into an instrument, one side of the ac line (generally ground) is applied to the instrument's power supply transformer through the triac. A Schmitt trigger circuit (Q1 and Q2) is used to sense over-voltage conditions, so that should any occur, the ac line is opened instantly. The circuit does not depend on the operation of the instrument, but instead it generates its own 6-V power using a filament transformer and rectifier.

In operation, transistors Q2, Q3 and Q4 are

normally conducting. Should the input voltage exceed the preset level, Q1 turns on, thereby turning Q2, Q3 and Q4 off. With Q4 off, the triac receives no trigger current, so it also turns off, opening the ac line.

The voltage at which the ac line is opened is set by means of the 1-k Ω potentiometer. With the component values shown, the circuit can be set for any voltage between 1% and 25% in excess of the normal ac line voltage. Thus, if the potentiometer is set for 10%, at a line voltage of 117 V, the instrument will be disconnected from the line for any voltage that is greater than 128.7 V.

S. P. Asija, Research and Development Engineer, National Cash Register Co., Dayton, Ohio.

VOTE FOR 316

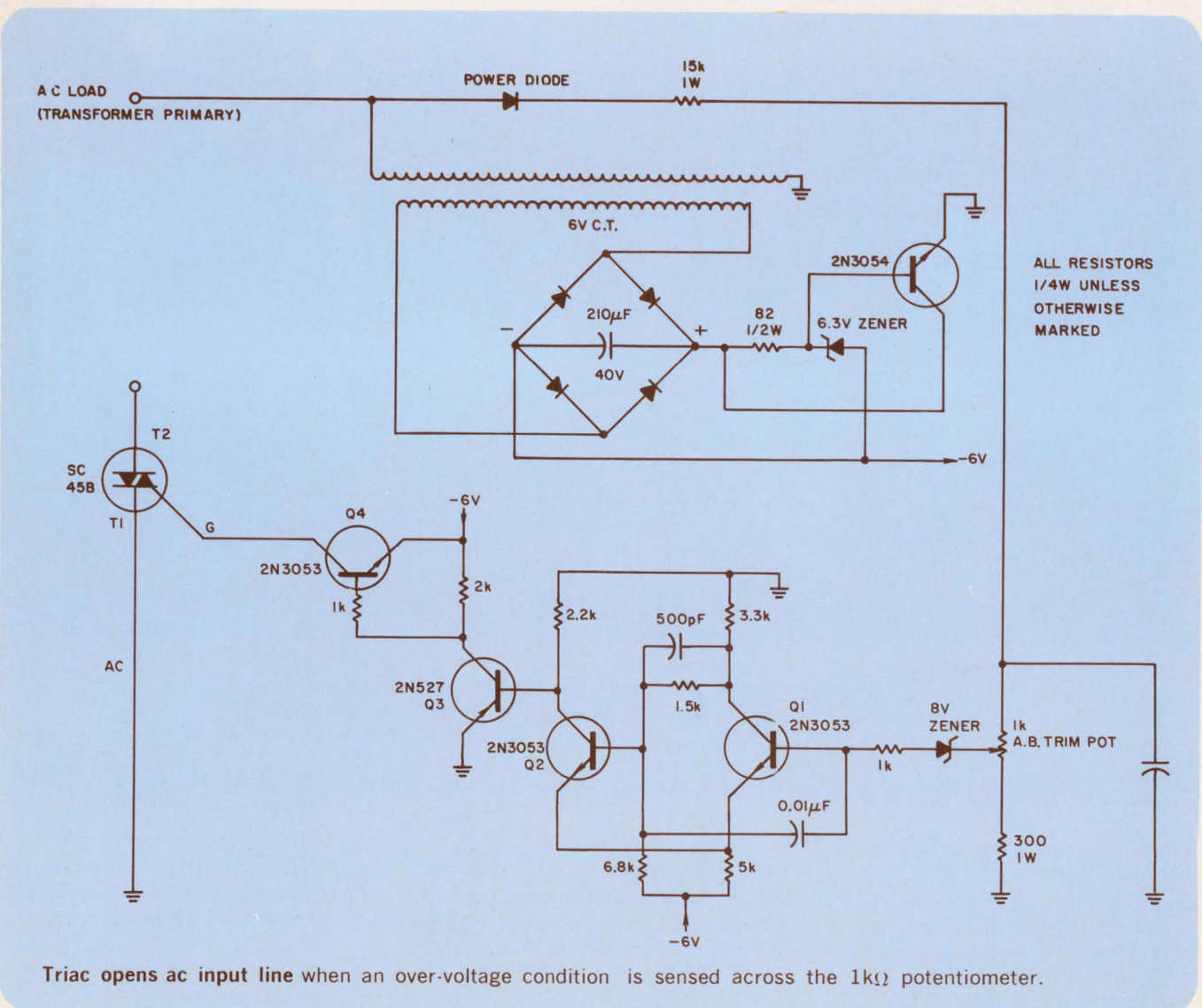

...does away with redundant packaging in your D-A converters.

**A new quad D-A ladder switch
made possible by the Amperex
THIN FILM/LID HYBRID PROCESS**

- 4 ± 1 ohm on-resistance
- 1 mV. max. offset voltage
- \$9.00 per switch

...use ATF-451's...

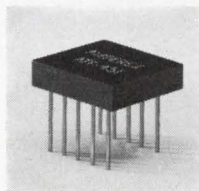

Let's face it — packaging is the name of the hybrid game. And the ATF-451 high-accuracy, matched ladder switch is the latest example of the unique hybrid packaging techniques employed by Amperex. Based on the use of microminiature LID semiconductors and sputtered, thin film ceramic substrates, the ATF-451, measuring only .550 by .550 by .16 inches represents the smallest set of four matched switches ever offered in a single Hybrid IC. It offers the economies of low initial cost, elimination of redundant packaging and the opportunity for combining multiple switches of high accuracy levels in a single circuit.

The ATF-451 at \$9.00 per switch has an on-resistance of only 4 ± 1 ohm from -25° to $+85^{\circ}\text{C}$ and offset of 1mV. max. An identical lower-accuracy version, the ATF-452 with an on-resistance tolerance of ± 3 ohms and maximum offset of 1.25mV. is available at \$8.00 per switch.

These new switches were designed for use in binary and BCD coded voltage summing ladders up to 14 bits with $\frac{1}{4}$ LSB accuracy. Input circuitry is fully compatible with standard DTL and TTL monolithic circuits.

Write for information on the Amperex Thin Film/LID Hybrid Process and for data on the new ATF-451 and '452.

Amperex Electronic Corporation, Microcircuits Division, Cranston, Rhode Island 02910.

**...and leave the packaging
to us!**

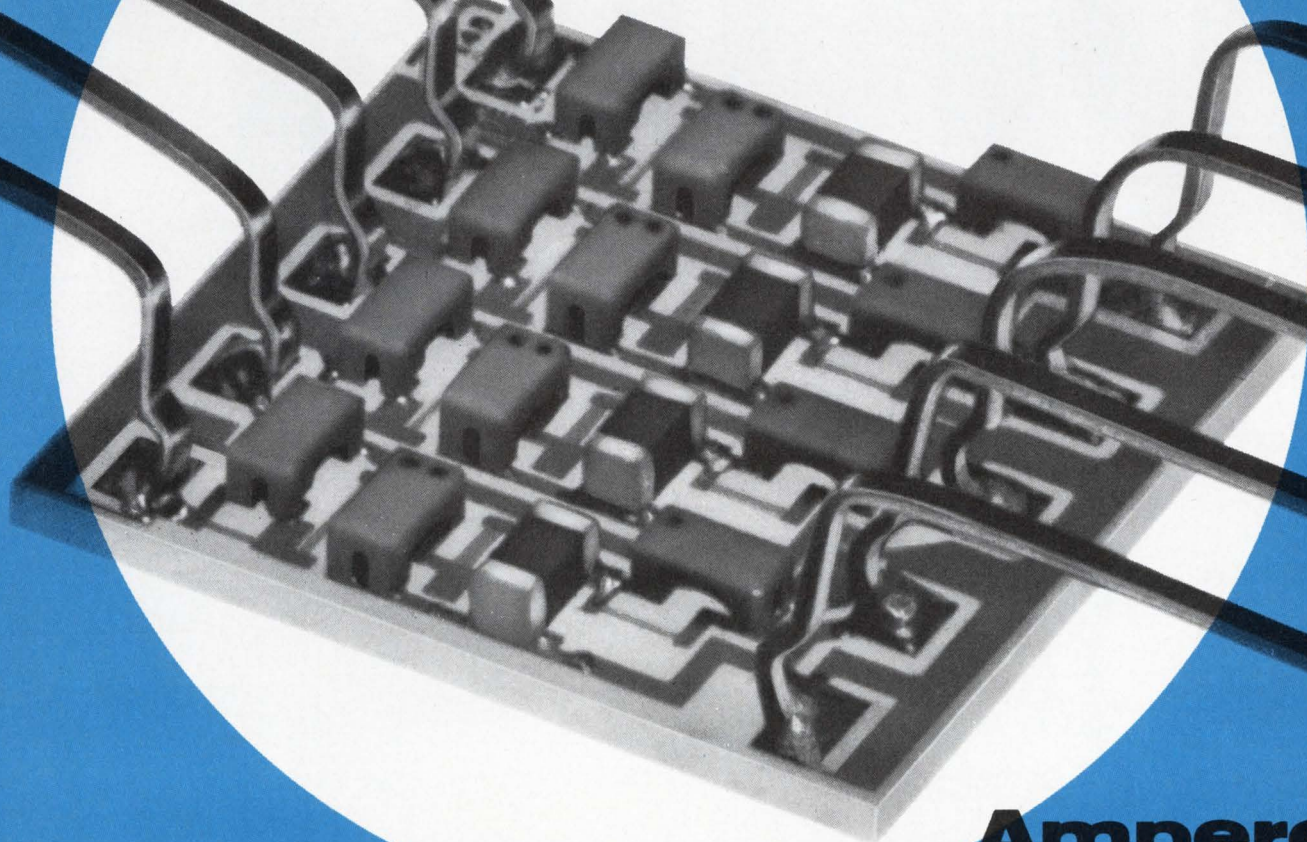

Amperex[®]

TOMORROW'S THINKING IN TODAY'S PRODUCTS
A NORTH AMERICAN PHILIPS COMPANY

"Have another helping of Beluga caviar," smiled Ben Effits, Microdot's director of personnel. The young recruit mumbled his thanks and piled some more of the shiny black stuff on a small graham cracker.

"So this is your R&D supper club, eh Mr. Effits?"

"Call me Ben, my boy. Yes, this is the Ivory Tower Room. We believe that one must have the correct environment for creative performance. And this one is it. So exclusive, no sales engineer has ever seen it, let alone been in it."

The young engineer nodded his approval. "And these pictures on the walls?"

"Oils. Originals. Of those stellar people, much like yourself, with the genius, the essence, who have contributed to Microdot technology. Take that lad there," Ben Effits waved toward a striking oil of a mid-thirtyish Ph.D. in shiny blue serge with eyes to match. "That's Marc. One of our most inventive creators. The father of," Ben lowered his head and eyes, "the MARC 53 line of high density, circular multi-pin connectors."

"And they named the creation after him," the recruit breathed.

"That was just a paltry token of what we did for him," Ben Effits raised a finger and a comely damsel undulated in with another bottle of Piper-Heidsick '59.

"One of our R&D secretaries by day," Ben winked and went on. "The MARC 53 is quite a successful line of subminiature connectors. They're the most advanced high density connectors in the business, from seven to sixty-one contact arrangements in under one inch i.d. They feature Posilock®, the only advanced push-pull, lock coupling mechanism that guar-

The Connector Thing

in which Microdot reveals some of its highly creative thoughts on the care and feeding of engineers.

antees proper engagement under 'blind mating' conditions. And Posiseal®. That's a sandwich insert that uses silicon interwafer seals. With Posiseal®, there's never been an air void problem or moisture problem between contact."

"Remarkable," increduloused the recruit.

"You bet. High density, circular subminiature connectors were really born and raised at Microdot. We also have a MARC 53 RMD version. Rear-insertable and rear-removable pins and sockets. No tools needed for assembly and disassembly. What does that mean to you?"

"Why, no damage to delicate rubber seals or inserts," replied the recruit. "And it also means that it must be one hundred percent field serviceable."

"Of course. And there are many other features. Scuff-proof contacts, for example. Interchangeable parts so that a cracked insulator or worn plating only means a new part, not a new connector."

"My boy, it is that type of connector technology that is rapidly gaining us our rightful place in the industry as the highest quality full-line producer of ultraminiature and subminiature connectors. Naturally, when you value technological contributions as highly as we do, you run the risk of a somewhat diletante reputation. For several years, there were

those who envisioned us as a sort of connector gourmet organization. Tasting little tidbits of the huge smorgasbord of connector technology, so to speak."

"Understandable," gurgled the young engineer, as he swallowed another spoonful of the caviar.

"But no longer so. From Lepra/Con to Twist/Con to Golden Crimp to MARC 53, our repertoire now extends the full range of subminiature or ultraminiature connector requirements.

"Can I write for the specs for MARC 53?"

"Of course. Anybody can. But if you're coming with us, you'll have your own monogrammed and autographed set."

"Well, that's very nice of you Mister, uh Ben. I'd like to..."

"Fine. It's settled."

"Now," added Ben, "after you've signed, we can discuss your bonus and then confer with the decorator about your quarters. Oh, waiter, some more Piper-Heidsick '59 and the check please."



MICRODOT INC.

220 Pasadena Ave., South Pasadena, Calif. 91030





Photographed in Vietnam by Howard Sochurek

When you need a new way to see in the dark...

bring ERIE in early.

The jungle night falls fast for a pilot downed behind "Charlie's" lines. But, rescue choppers no longer wait for morning light to find him. The answer? New portable night vision devices that actually intensify available light...even starlight...thousands of times. From the start, those working on this project have relied on the Research Engineers and component capability of ERIE TECHNOLOGICAL. Our new sub-miniature high voltage supply is at the heart of the system. Proof, once again, that whatever your area of electronics, it pays to bring ERIE in early.

ERIE TECHNOLOGICAL PRODUCTS, INC.

644 West 12th Street, Erie, Pennsylvania 16512
Area Code 814-456-8592

Another useful design tool
from Electronic Design:

"A Practical Design Guide For A/D and D/A Conversion"

By Hermann Schmid, senior engineer, General Electric Company

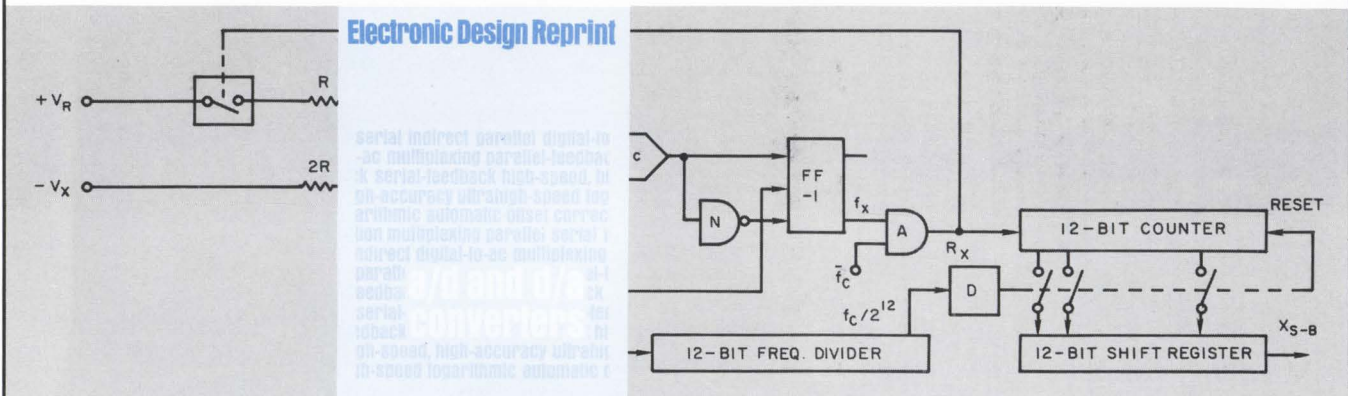

100 pages, 8½ x 11

This Electronic Design reprint contains complete, up-to-date design information covering all aspects of A/D and D/A converters. Here are just some of the subjects covered: A/D Converter Types-Successive Approximation; Charge Equalization; Indirect; Serial Feedback; Ultra-High Speed; D/A Converter types-Parallel; Serial; Indirect; Digital-to-A/C. Also covers automatic offset correction and time sharing.

As digital computation techniques are used in increasingly broad areas such as industrial control systems, instrumentation systems, computers and telemetry systems, this information-packed "how-to-do-it reprint" is one you can't afford to be without. To get your copy, order now at \$2.75 each. To keep the price of this valuable reprint as low as possible, we must ask your check or money order be included with the request.

Reader Service Department, Electronic Design, 850 Third Avenue, New York, N.Y. 10022

Gentlemen:

Please send me copy (ies) of "A Practical Design Guide For A/D and D/A Conversion." (\$2.75 each. This includes all mailing and handling charges.)

Enclosed is Check money order.

Checks payable to Electronic Design.

Name _____

Company _____

Address _____

City _____

State _____

Zip _____

Products



Hard-copy computer terminal handles data at rates to 10 characters per second, p. 114.



Logic pulse indicator, which goes out to 10 MHz, identifies 50-ns pulse widths, p. 148.



Infrared laser diode doubles output power while halving threshold current, p. 126.

Also in this section:

Light emitting diode indicators incorporate solid-state logic, p. 119.

Battery-powered op amp reduces supply drain to 70- μ A quiescent, p. 140.

Monolithic dual differential amplifier reaches out to 500 MHz, p. 134.

Design Aids, p. 156 . . . **Application Notes**, p. 158 . . . **New Literature**, p. 162.

Low-cost computer terminal tapes up to 10 characters/s

TransCom Inc., sub. of Hi-G Inc., Spring St. & Route 75, Windsor Locks, Conn. Phone: (203) 623-2481. P&A: \$1000; 1 day.

Selling for less than \$1000 or renting for under \$25 a month, a new low-cost remote computer terminal with hard-copy readout converts any standard telephone into a data transmission computer terminal.

Making it possible for any user to converse directly with remote computers or information centers over standard telephone lines, the RCT-203 prints information at the rate of 10 characters per second. Hard-copy readout on 3/4-in. tape provides instant verification of messages sent or received and a permanent printed record of every transmission in or out of the unit.

Besides its use as a computer terminal, the RCT-203 can be used to replace more expensive Teletype equipment in any business communications system. By using standard telephone lines, the new ter-



Fully portable computer terminal with hard-copy readout moves data at 10 characters per second.

terminal provides savings through the elimination of mileage rates for rented telephone lines. The low cost of the unit also makes it possible for a company to add more points to its communications network.

The RCT-203 is compatible with any information system and only requires a telephone and a standard 110-V line. It is a fully portable unit that weighs less than 15 pounds and measures 12-3/4 by 12 by 7 in.

Eliminating any unnecessary steps in transmitting and receiving information, the new terminal ends the need to transcribe information that often results in errors. The RCT-203 provides inexpensive verified input and output.

There are three basic modes of operation: a data input mode for sending coded numeric information from remote locations into a central data bank or another terminal; a verification mode to add hard-copy verification of all information transmitted to existing touch-tone systems; and an inquiry response mode for direct conversation with an on-line computer system.

The input telephone handset can be either acoustic or magnetic; and decode capacity consists of twelve characters, two symbolic for coding and 10 numeric for information.

CIRCLE NO. 250



Simple pushbutton telephone-type keyboard eases interface for input and output information.

Small a/d converter encodes 13 bits

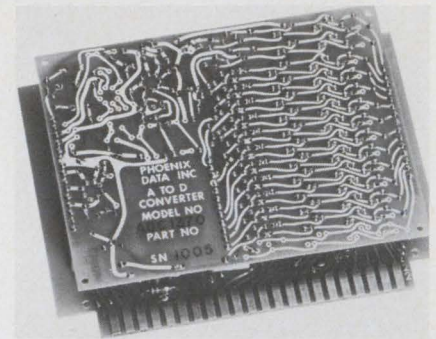

Phoenix Data, Inc., 3065 W. Fairmount Ave., Phoenix, Ariz. Phone: (602) 277-4767. P&A: \$748; 30 days.

Completely contained on a plug-in PC-card module, a new a/d converter is capable of encoding ± 10 -V full-range inputs into 13 binary bits of data with a minimum through-put time of 14 μ s. Model ADC 1370 uses successive approximation to achieve a resolution of one part in 8191 with a full-range accuracy of $\pm 0.015\%$.

CIRCLE NO. 324

Ruggedized computer scoffs at environment

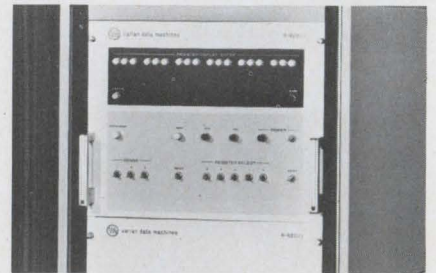

Varian Data Machines, 2722 Michelson Drive, Irvine, Calif. Phone: (714) 833-2400.

A ruggedized version of Varian's 620/i general-purpose computer is now available. Designed for mobile applications, such as shipboard or truck-mounted ground-support equipment, model R-620/i withstands vibration, shock, humidity and other environmental extremes. The new unit is functionally identical to its predecessor, except for some component substitutions to obtain the required environmental characteristics.

CIRCLE NO. 251

A new lead to a 300 W, 100 A silicon power transistor in a TO-3 case

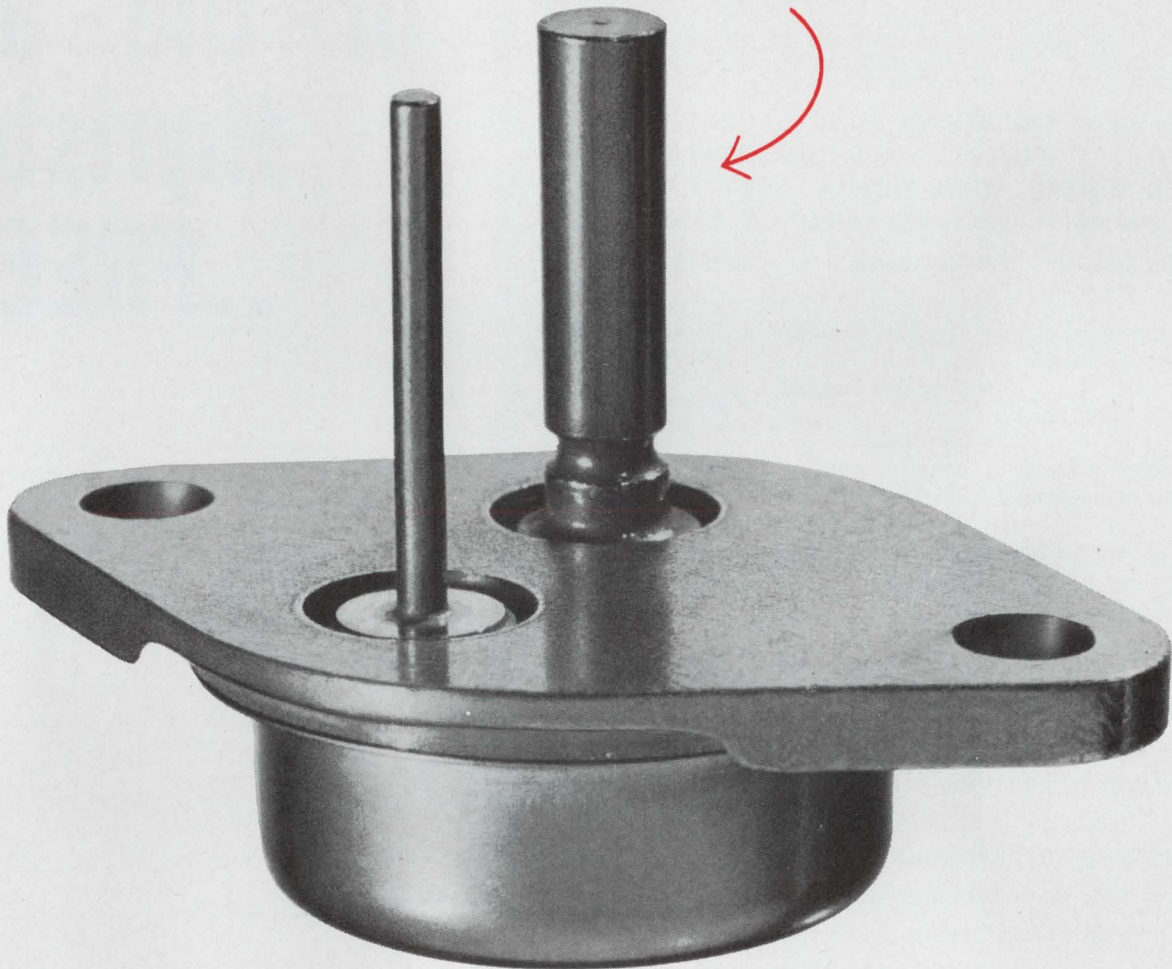

2N5578 showing new, heavy pin terminal design.

What are you looking for in your linear and switching applications? 100 ampere pulsed current capability? 300 watts power dissipation? The highest second breakdown capability of any device on the market in a modified TO-3 package?

Look no further. Here's another first from the silicon power leader—RCA's new 2N5578 family...six high-power, high-current Hometaxial-base silicon n-p-n transistors designed for applications in military, industrial, and commercial equipment.

2N5575, for example, has a pulsed collector current of 100 A. Dissipation

is 300 watts at 25°C with V_{CEX} (sus) of 70 V. The useful beta range is 10-40 at 60 A.

For complete design flexibility, there are three terminal variations: 2N5575 and 2N5578 have heavy pins; 2N5576 and 2N5579 have soldering lugs; and 2N5577 and 2N5580 have flexible leads with solderless connectors.

This family of types all adds up to circuit cost savings in inverters, regulators, motor controls, and other linear and switching applications. Check the chart. For more information, see your RCA Representative or

your RCA Distributor. For technical data, write: RCA Electronic Components, Commercial Engineering, Section No. IG5-11, Harrison, N. J. 07029.

Characteristic	Test Conditions			2N5575 2N5576 2N5577		2N5578 2N5579 2N5580		Units
	V_{CE} V	V_{BE} V	I_C A	Min.	Max.	Min.	Max.	
h_{FE}	4	—	40	—	—	10	40	V
V_{CEO} (sus)	4	—	60	10	40	—	—	
$I_{S/\beta}^\dagger$	—	—	0.2	50	—	70	—	A
$E_{S/\beta}^*$	25	—	—	12	—	12	—	
$\theta_{J/C}$	—	-1.5	7	0.8	—	0.8	—	°C/W
	—	—	—	—	0.5	—	0.5	

[†]With base forward biased

^{*}With base reverse biased and $R_{BE}=10\Omega$, $L=33mH$

RCA

INFORMATION RETRIEVAL NUMBER 53

This month, you can get this state - of - the - art thyristor ..FREE..

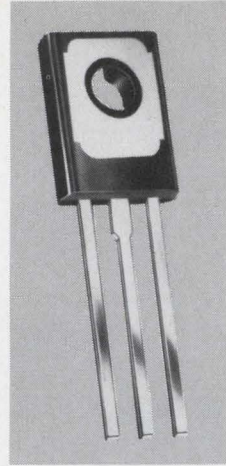
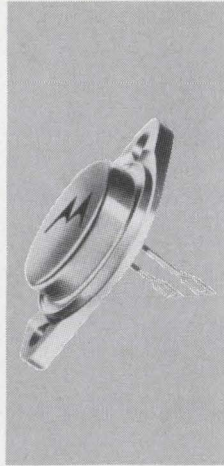
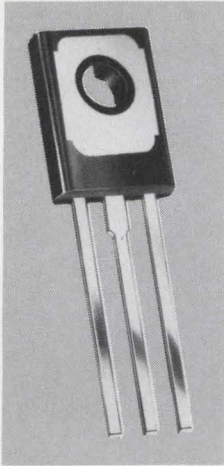

**TURN ON 4 A-@
-95°C CASE SCR
POWER CONTROL
WITH 200 μ A!**

MCR406 Series

- Sensitive gate, high current performance
- 30, 60, 100 & 200 V
- Thermopad* packaging, Annular construction
- Low as 51¢, 1,000-up (30 V)

**DESIGN IN 25 A,
FULL WAVE CON-
TROL WITH A
RUGGED TRIAC!**

MAC21 Series

- 25 to 400 V Application
- 75 mA Gate Triggering
- Low-Silhouette, Low θ_{js} Hermetic, TO-41 Packaging
- Ideal for Industrial Designs

**CONTROL
POWER/COSTS
WITH 8 A
PLASTIC SCR's!**

2N4441 Series

- Low Thermal resistance and minimum de-rating
- Maximum, 80 A fault protection
- 50 to 400 V ratings
- Wins "power vs. price" struggle in numerous designs

Scores of high-performance, new-design application possibilities can now be turned on for your consumer/industrial equipment with these state-of-the-art, thyristor power control products . . . the MCR406/407 high-power-at-high-temperature SCR for your low-level consumer, commercial and light industrial designs . . . the MAC21, Triac-"big power" answer to high current speed, light and heat control application problems . . . the 2N4441-43 series for most rugged, high-volume applications.

Evaluate these state-of-the-art devices now — contact your franchised Motorola distributor today — he'll see that your free device choice is returned to you without delay!

*Trademark of Motorola Inc.

- where the priceless ingredient is care!



...and 10% off
your order
for any
of these
thyristors
from your
Motorola
distributor! †

(SEE FOLLOWING PAGE)

MOTOROLA Thyristors

Motorola Semiconductor Products Inc. / P. O. Box 20912 / Phoenix, Arizona 85036

INFORMATION RETRIEVAL NUMBER 54

This month, you can purchase from your franchised Motorola distributor up to 99 of any of the below Motorola thyristor products at 10% off their regular, published 1-99 prices! Example: ten 200-volt, 2N4442, Thermopad SCRs would normally cost \$15 . . . this month, you can get them for \$13.50 — a \$1.50 saving! If you order the maximum 2N4442 quantity of 99 in this special offer, you can save \$14.85!

Mix 'em or match 'em — SCR's, Triacs, triggers, unijunction transistors — whatever device type you need to design better performance into, and take the cost out of, your power control applications you'll find with Motorola . . . especially during this month!

Contact your Motorola distributor today about this money-saving way to evaluate the best, most complete thyristor products in the industry. Fill in the coupon on the following page† and send it to him immediately. He'll see that you receive your units off-the-shelf!

SILICON CONTROLLED RECTIFIERS

Series	Forward Current—Amps	Blocking Voltage Range—Volts	Package	Price Range	Maximum 10% Off Price Saving
2N5060-62	800 (mA)	30-100	Unibloc Plastic	\$.77- .96	9.50
2N1595-99	1.6	50-400	T0-5	2.15-12.35	122.26
2N2322-26	1.6	25-200		2.30- 5.40	53.46
2N4212-16	1.6	25-200		2.15- 4.95	49.00
MCR 406-1 to -4	4	30-200	Thermopad	.90- 1.27	12.57
2N4441-43	8	50-400		1.20- 2.00	19.80
2N4151-98	8	25-600	Case 85 Var.	1.45- 6.89	68.21
2N1842-50	16	25-500	Case 64	3.00-18.10	179.19
MCR 649-1 to -7	20	25-500	T0-41	3.10-13.70	135.63
MCR2818-1 to -7	20	25-500	Pressfit	3.00- 8.85	87.62
MCR2918-1 to -7	20	25-500	Stud	3.40- 9.20	91.08
2N5164-71	20	50-600	Pressfit/Stud	3.30-10.10	99.99
2N2573-79	25	25-500	T0-41	3.40-15.40	152.46
2N681-89	25	25-500	Stud	3.30-20.60	203.94
MCR1907-1 to -6	25	25-400		9.00-29.25	289.58
MCR2835-1 to -8	35	25-600	Pressfit	3.75-12.35	122.27
MCR2935-1 to -8	35	25-600	Stud	4.10-12.75	126.23

TRIACS

Series	RMS Conduction Current—Amps	Blocking Voltage Range—Volts	Package	1-99 Price Range	Maximum 10% Off Price Saving
MAC1-2 to -6	8	50-400	Case 85	2.40- 5.25	51.98
MAC2-2 to -6	8	50-400	Case 86	2.55- 5.40	53.46
MAC3-2 to -6	8	50-400	Case 87L	2.50- 5.35	56.96
MAC4-2 to -6	8	50-400	Case 85	2.05- 3.70	36.63
MAC5-2 to -6	8	50-400	Case 86	2.20- 3.85	38.11
MAC6-6 to -6	8	50-400	Case 87L	2.15- 3.80	37.62
MAC21-1 to -6	25	25-400	T0-41	4.35-13.50	133.65

BILATERAL TRIGGERS

Series	Peak Pulse Current—Amps(max)	Breakover Voltage—Volts(nom)	Package	1-99 Price Range	Maximum 10% Price Saving
MPT20-32	2.0	20-32	Unibloc Plastic 2-Lead	\$.67	\$6.63

UNIUNCTION TRANSISTORS

Series	Intrinsic Standoff Ratio		Package	1-99 Price Range	Maximum 10% Price Saving
	Min	Max			
2N4870-71	0.70	0.85	Unibloc Plastic	\$.75	\$ 7.43
MU4891-94	0.74	0.86	T0-18	.90-1.23	12.18
2N2647	0.68	0.82		3.00	29.70
2N3980	0.68	0.82		3.40	33.66
2N4851-53	0.70	0.85		1.10-2.25	22.28
2N4948	0.55	0.82		1.35	13.37
2N4949	0.74	0.86		2.40	23.76
2N5431	0.72	0.80		5.70	56.43

†Coupon on following page must be filled in and returned to your distributor for free device (200-volt maximum) and/or 10% reduction on 1-99 thyristor order. Reduction will apply this month only to any Motorola thyristor product listed as long as quantity of each product on order does not exceed 99. In case quantity does exceed 99 regular, published, 100-999 list prices will apply to quantities desired.

Teletype buffer memory works at 120 words/min



Data Vox Division, Data Technology Corp., 1050 East Meadow Circle, Palo Alto, Calif. Phone: (415) 321-0551.

Designed for communication and data systems where it is necessary to handle Teletype signals in a reliable, continuous and unattended manner, series 41 buffer memories accept and store any standard serial Teletype code with inputs up to 120 words per minute. Readout is activated by an externally originated Teletype command or a manual pushbutton on the front panel. Readout rates can be from 1 to 600,000 characters per second.

CIRCLE NO. 259

Acoustic data coupler stops spurious noise



Ford Industries, Inc., 5001 S. E. Johnson Creek Blvd., Portland, Ore. Phone: (503) 774-1104. P&A: \$245; stock.

Connecting a remote terminal to telephone lines and a central processor, a new acoustic/inductive coupler guarantees complete immunity from spurious noise. This eliminates the need to place the receiver into an acoustically isolated container. Called the Fordata 1200, the unit mounts directly on a standard model 500 telephone and therefore requires no desk space.

CIRCLE NO. 253

High-speed modems incorporate MSI

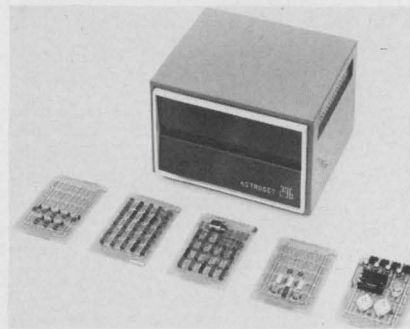

Astrocom Corp., 293 Commercial St., St. Paul, Minn. Phone: (612) 227-8991. Price: from \$1560.

Through the use of medium-scale integration and a unique digital modulation system, series 200 Astroset modems achieve high-speed data rates of 2000 to 9600 bits per second. The new units are designed for synchronous operation between data processors and sophisticated man-machine interface equipment. Operating configurations include simplex, half or full duplex, and party-line situations.

CIRCLE NO. 254

Message generators see Teletype codes

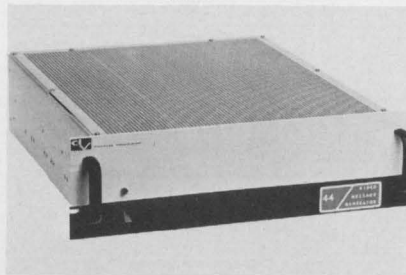

Data Vox Div., Data Technology Corp., 1050 East Meadow Circle, Palo Alto, Calif. Phone: (415) 321-0551.

Intended for communication and data systems, series 44 video message generators convert Teletype alphanumeric data or messages to a visual display on a standard TV monitor or commercial TV set. Inputs can be any of the Teletype transmission codes in serial and parallel form originating from wire, radio, keyboard, tape readers or computers.

CIRCLE NO. 255

Tape data synchronizer has coherent clocks

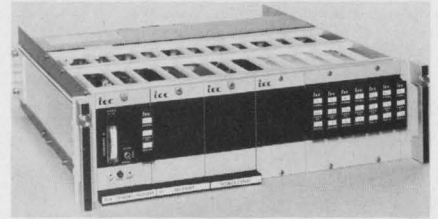

Interstate Electronics Corp., sub. of Automatic Sprinkler Corp. of America, 707 E. Vermont Ave., Anaheim, Calif. Phone: (714) 722-2811.

Model 2755 tape data synchronizer provides coherent clocks for data-processing systems where precise signal analysis or output display is required from unstable data containing record/reproduce errors. During tape playback, the data synchronizer automatically acquires and tracks a recorded reference signal and produces three coherent clock outputs that are synchronous with the data being read from tape.

CIRCLE NO. 256

Multiplexing modem accepts 8 channels

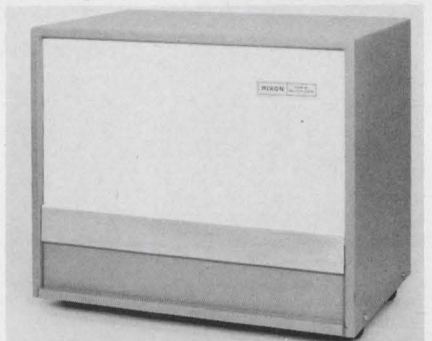

Rixon Electronics, Inc., 2120 Industrial Parkway, Silver Spring, Md. Phone: (301) 622-2121.

Handling up to eight channels of full-duplex communication at speeds to 150 bits per second, the new FDM-8 data modem allows the user to have more than eight remote terminals in the same frequency division multiplexing system through polling. It is available in a free-standing cabinet that houses up to eight channels or a shelf-mounting case with a single channel.

CIRCLE NO. 257

COMPONENTS

PC-board transformers occupy only 1/4 in.³

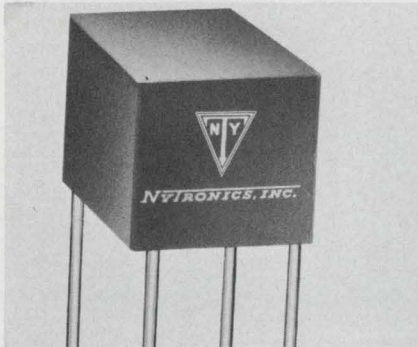

Nytronics, Inc., Third Ave., Alpha, N. J. Phone: (201) 454-1143.

Forming a 1/4-in. cube, a new line of PC-board transformers provides nominal power ratings of 5 mW at 400 Hz and 50 mW at 1 kHz. Designed for use at frequencies up to 250 kHz, Wee-Trans units plug directly into PC boards since their leads are on a 0.2-in. grid. Primary impedances range from 100 Ω to 25 kΩ and secondary impedances go from 3 Ω to 10 kΩ.

CIRCLE NO. 258

LED indicators integrate logic

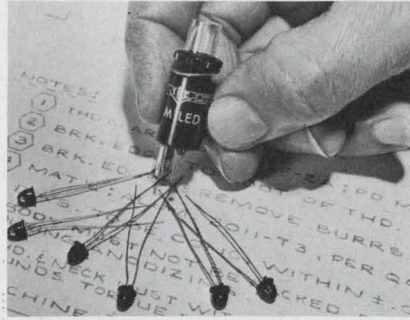

Transistor Electronics Corp., P.O. Box 6191, Minneapolis. Phone: (612) 941-1100.

Consisting of a light-emitting diode (LED) controlled by integral solid-state logic, series MTLED indicators interface directly with RTL, DTL and TTL microcircuits and operate from a +5-V supply. The diode light source offers almost infinite life and reliability, even under extremely adverse environmental conditions. The new indicators are 1/2 in. in diameter.

CIRCLE NO. 252

Military cermet trim to 2.5 MΩ

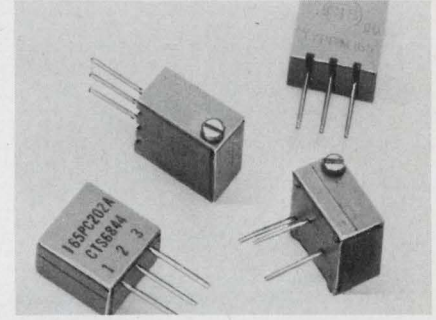

CTS Corp., Berne, Ind. Phone: (219) 589-3111. P&A: \$3.25 in quantity; stock.

Meeting or exceeding the requirements of MIL-R-22097C, new 3/8-in. square cermet trimmers assure infinite resolution over the resistance range of 20 Ω to 2.5 MΩ. Series 165 units are available in three basic configurations: standard mounting, side adjust and top adjust. Power rating is 0.5 W at 85°C with temperature coefficients from ±150 to ±250 ppm/°C.

CIRCLE NO. 260

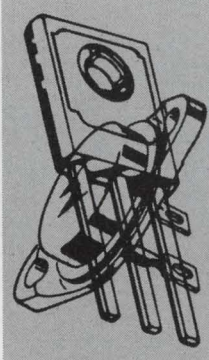

This coupon is the one to use

ALABAMA, Huntsville	ArworkKuff Electronics Corp.	(205) 837-6101	NEW YORK, Binghamton	Federal Electronics, Inc.	(607) 748-8211
ARIZONA, Phoenix	Hamilton Electro of Arizona	(602) 272-2601	NEW YORK, Buffalo	Summit Distributors, Inc.	(212) TR 4-3450
CALIFORNIA, Inglewood	Liberty Electronics Corp.	(213) OR 8-8111	NEW YORK, Flushing	Cramer Electronics, Inc.	(212) GR 8-4000
CALIFORNIA, Los Angeles	Hamilton Electro Sales	(213) 870-1771	NEW YORK, Syracuse	Cramer Eastern	(315) 454-5247
CALIFORNIA, Los Angeles	K-Tronics	(213) OV 5-5888	NEW YORK, Westbury, L.I.	Schweber Electronics	(516) ED 4-7474
CALIFORNIA, Mountain View	Elmar Electronics	(415) 961-3611	NEW YORK, Woodbury, L.I.	Harvey Radio Co., Inc.	(516) 921-8700
CALIFORNIA, Mountain View	Hamilton Electro Sales-North	(415) 961-7000	NORTH CAROLINA, Winston-Salem	Electronic Wholesalers, Inc.	(919) PA 5-8711
CALIFORNIA, San Diego	Hamilton Electro Sales of San Diego	(714) 278-2421	OHIO, Cincinnati	Sheridan Sales Co.	(513) 761-5432
CALIFORNIA, San Diego	Kieruff Electronics, Inc.	(714) BR 8-2112	OHIO, Cleveland	Pioneer-Standard Electronics, Inc.	(216) 432-0010
COLORADO, Denver	Hamilton Electro Sales	(303) 934-5508	OHIO, Cleveland	Sheridan Sales Co.	(216) 237-9145
COLORADO, Denver	Kieruff Electronics Co., Inc.	(303) 343-7050	OKLAHOMA, Tulsa	Hall-Mark Electronics Corp.	(918) TE 5-8458
CONNECTICUT, North Haven	Cramer Electronics, Inc.	(203) 239-5641	PENNSYLVANIA, Philadelphia	Radio Electric Service Co. of Pa.	(215) WA 5-8900
D.C., Washington	Electronic Wholesalers, Inc.	(202) HU 3-5200	PENNSYLVANIA, Philadelphia	Semiconductor Specialists, Inc.	(412) 351-3611
FLORIDA, Miami	ArworkKuff Electronics Inc.	(305) 881-6541	TEXAS, Dallas	Hall-Mark Electronics Corp.	(214) AD 1-6111
FLORIDA, Orlando	Hall-Mark Electronics Corp.	(305) 855-4020	TEXAS, Dallas	Sterling Electronics	(214) FL 7-9131
GEORGIA, Atlanta	Jackson Electronics Co.	(404) 355-2223	TEXAS, El Paso	Midland Specialty Co.	(915) 533-9555
ILLINOIS, Chicago	Allied Electronics Corp.	(312) TA 9-8121	TEXAS, Houston	Hall-Mark Electronics Corp.	(713) SU 1-0011
ILLINOIS, Chicago	Newark Electronics Corp.	(312) 638-4411	TEXAS, Houston	Sterling Electronics, Inc.	(713) MO 6-3811
ILLINOIS, Chicago	Semiconductor Specialists, Inc.	(312) 279-1000	UTAH, Salt Lake City	W. H. Rintz Company	(801) 363-5821
IOWA, Cedar Rapids	Desco, Inc.	(319) 365-7551	WASHINGTON, Seattle	Hamilton Electro of the Pacific Northwest	(206) MA 4-5930
KANSAS, Kansas City	Hall-Mark Electronics Corp.	(913) AD 6-4343	WISCONSIN, Milwaukee	Hall-Mark Electronics/Midwest	(414) 476-1270
LOUISIANA, New Orleans	Sterling Electronics, Inc.	(504) 522-8726			
MARYLAND, Baltimore	Plytronic Industries, Inc.	(301) 539-6255			
MARYLAND, Rockville	Schweber Electronics	(301) 427-4977			
MASSACHUSETTS, Cambridge	R & D Electronics, Inc.	(617) 864-0400			
MASSACHUSETTS, Newton	Cramer Electronics, Inc.	(617) WO 9-7100			
MICHIGAN, Detroit	Semiconductor Specialists, Inc.	(313) 255-0300			
MICHIGAN, Detroit	Radio Specialists Co., Inc.	(313) BR 2-4212			
MINNESOTA, Edina	Low Bonn Co.	(612) 941-4860			
MINNESOTA, Minneapolis	Semiconductor Specialists, Inc.	(612) 866-3434			
MISSOURI, St. Louis	Semiconductor Specialists, Inc.	(314) 423-6500			
NEW JERSEY, Moorestown	Angus, Inc.	(609) 235-1900			
NEW MEXICO, Albuquerque	Kieruff Electronics Co., Inc.	(505) 247-1055			

CANADA

MONTREAL, P.Q.	Cesco Electronics Ltd.	(514) 735-5511
MONTREAL, P.Q.	Zentronics (Quebec) Ltd.	(514) 735-2471
OTTAWA, Ont.	Cesco Electronics Ltd.	(613) 729-5118
QUEBEC CITY, P.Q.	Cesco Electronics Ltd.	(418) 524-3518
DOWNSVIEW, Ont.	Cesco Electronics Ltd.	(416) 638-2550
TORONTO 19, Ont.	Zentronics Ltd.	(416) 787-1271
VANCOUVER, B.C.	Bowtek Electric Co. Ltd.	(604) 685-4628
VANCOUVER, B.C.	L. A. Varah Ltd.	(604) 736-4411
WINNIPEG, Man.	Cam Sare Supply Ltd.	(204) 942-0901



... for a free MCR406/MAC21/2N4441, -42 thyristor unit and/or 10% off your 1-99, Motorola thyristor power control product requirements.

Fill in and send the coupon to your franchised Motorola distributor now!

He's waiting to serve your Motorola thyristor product evaluation needs.



To: _____ (franchised Motorola distributor)

Furnish Me a Free MCR406 SCR 30V . . . 60V . . . 100V . . . 200V . . . MAC21 Triac 25V (circle one) . . . 50V . . . 100V . . . 200V . . . 2N4441 50V or 2N4442 200V SCR

I need the following thyristor products at 10% off regular, 1-99 list prices for evaluation/prototyping:

SCR's/ Triacs	Type	Voltage	TRIGGERS	Type	Voltage	UJT's	Type
_____	_____	_____	_____	_____	_____	_____	_____
_____	_____	_____	_____	_____	_____	_____	_____

Name _____ Title _____

Company _____ Div. _____

Address _____

City _____ State _____ Zip _____

Signature _____ P. O. No. _____

(This coupon must be returned to distributor for free unit - 200V maximum - and/or 10%, 1-99 price reduction. Offer void after June 30, 1969.)

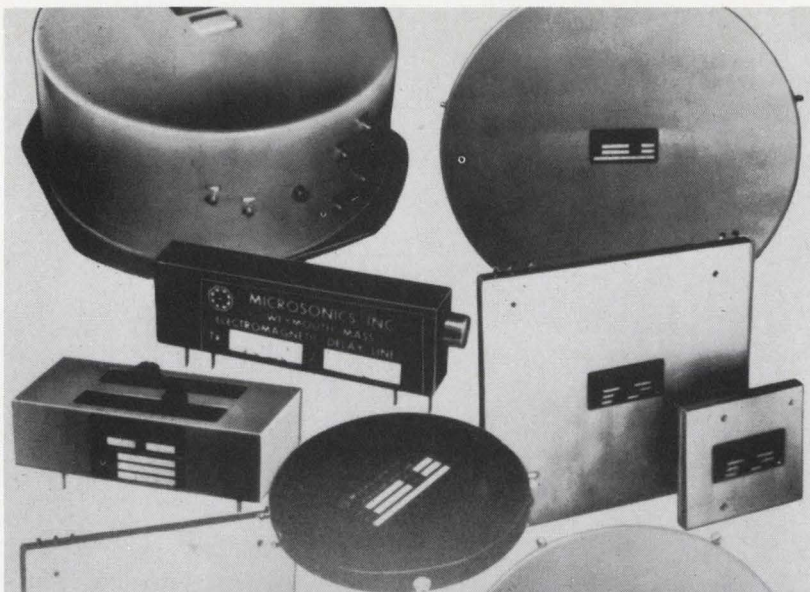

**LC & DC • DISPERSIVE • DIGITAL
MAGNETOSTRICTIVE • QUARTZ
GLASS • VARIABLE • TAPPED
LC & DC • DISPERSIVE • DIGITAL
MAGNETOSTRICTIVE • QUARTZ
GLASS • VARIABLE • TAPPED
LC & DC • DISPERSIVE • DIGITAL
MAGNETOSTRICTIVE • QUARTZ
GLASS • VARIABLE • TAPPED
LC & DC • DISPERSIVE • DIGITAL
MAGNETOSTRICTIVE • QUARTZ
GLASS • VARIABLE • TAPPED
LC & DC • DISPERSIVE • DIGITAL
MAGNETOSTRICTIVE • QUARTZ
GLASS • VARIABLE • TAPPED
LC & DC • DISPERSIVE • DIGITAL**

MICROSONICS

*for proven design, reliability &
performance in*

DELAY LINES

Serial Memories



Write for Bulletins today

MICROSONICS

60 Winter Street, Weymouth, Mass. 02188

Tel: 617 337-4200

A division of the Sangamo Electric Company

COMPONENTS

Small ceramic filters are 11-disc ladders

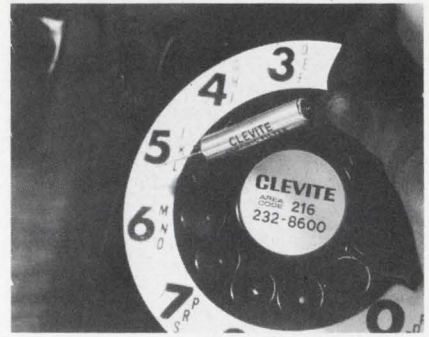

*Clevite Corp., Piezoelectric Div.,
232 Forbes Rd., Bedford, Ohio.
Phone: (216). 232-8600. Avail-
ability: stock.*

Ideal for transistorized i-f amplifier circuitry, as well as other applications requiring a fix-tuned filter element, a new line of 11-disc ceramic ladder filters are enclosed in a package 0.33 in. in diameter by 1.12 in. long. Shape factors are typically 2 to 1 or better, stopband rejection is -60 dB, and input and output impedances range from 1 to 2 k Ω .

CIRCLE NO. 394

Ac/dc reversing motor synchronizes and steps

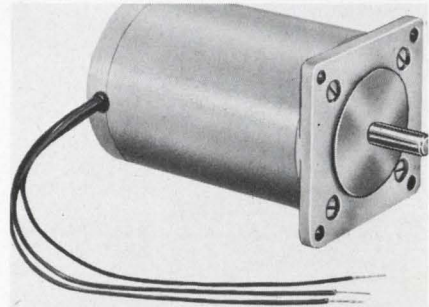

*Superior Electric Co., 383 Middle
St., Bristol, Conn. Phone: (203)
582-9561. P&A: \$75; stock.*

Developing 25 oz-in. of torque, a new bidirectional motor can be used as an ac synchronous unit or as a dc stepping device. As an ac motor, type TS25 has a shaft speed of 200 rpm at a line frequency of 60 Hz. Used for phase-switched dc stepping, the motor takes 72 incremental steps of 5° ($\pm 0.25^\circ$ non-cumulative) to make one revolution. Rated for 120 V at 0.2 A, the unit will start, stop or reverse within 50 ms.

CIRCLE NO. 395

**Zeners from
the Power House.**

We're known as the Power House, mainly for our power rectifiers, SCRs and triacs. But we have another line working hand in glove with our power components: International Rectifier zener diodes, featuring the industry's only lifetime guarantee!

Our silicon zener regulators range from 150 mW to 50 W, from 2.0 V to 200 V. Our temperature compensated voltage references provide standard voltages from 5.9 V to 49.6 V, at standard temperature coefficients from $\pm 0.01\%/^{\circ}\text{C}$ to $\pm 0.0005\%/^{\circ}\text{C}$.

Check our zeners and voltage references. They're stocked in depth at our distributors and covered in detail in our Short Form Catalog. Write for it now from the Power House, 233 Kansas St., El Segundo, California 90245.

INTERNATIONAL RECTIFIER

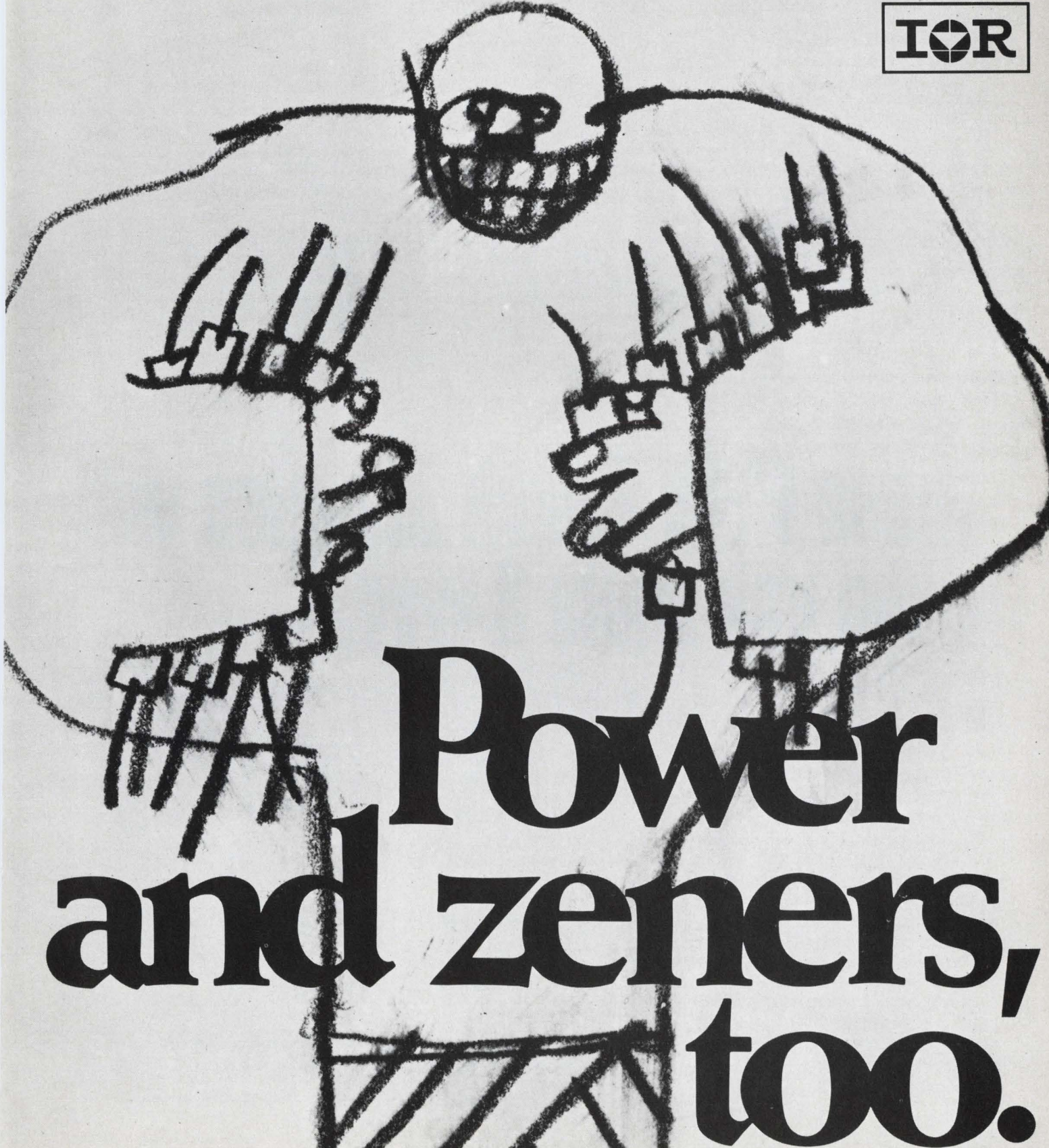

**Power
and zeners,
too.**

Photovoltaic cells minimize leakage

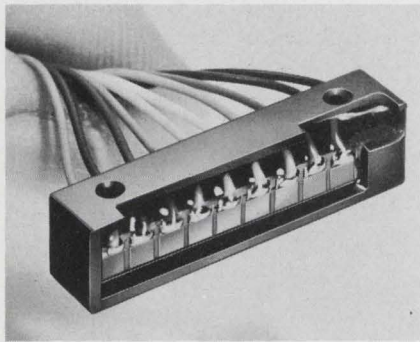

Sensor Technology, Inc., 7118 Gerald Ave., Van Nuys, Calif. Phone: (213) 873-1533.

Developed for improved compatibility with integrated circuits, a new series of silicon photovoltaic cells holds reverse leakage current to 2 μ A at -5 V dc and 25°C. Called Ultra-Cells, the units are said to have a speed of response two to three times better than previous conventional sensors.

CIRCLE NO. 396

Small servo motor is 80% efficient

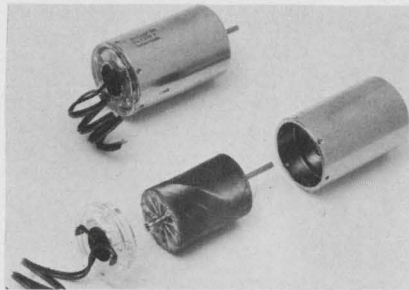

Portescap U. S., 730 Fifth Ave., New York, N. Y. Phone: (212) 245-7716.

A new Swiss-made miniature dc servo motor, Escap 26PL, has an unusually high ratio/power volume and an efficiency that exceeds 80%. Its bell-shaped ironless rotor with self-supporting skew winding rotates around the permanent magnet in a narrow air gap. The speed/torque gradient is less than 2000 rpm/oz-in., and no-load speed is 5000 rpm at 12 V.

CIRCLE NO. 261

PC latching relay switches 3 A at 115 V

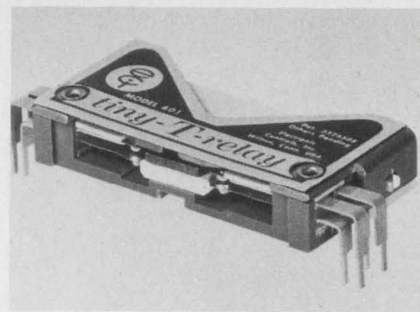

Electronic Controls, Inc., T-Bar Switch/Relay Division, P. O. Box 254, Wilton, Conn. Phone: (203) 762-8351. Price: \$7.95.

Only 0.36-in. high, the magnetic latching low-profile PC relay can switch up to 3 A at 115 V ac. Available with 4 pst or 4 pdt configurations, this tiny T-401L relay has a mechanical life of 100 million cycles. It is ideal for cross-point switching arrays or as a micro-logic buffer relay.

CIRCLE NO. 262

These NEW Bench Supplies will make you smile 3 ways!

- 1 Excellent regulation .01% and -ripple only 250 mv!
- 2 Same Day Shipment. No annoying wait
- 3 Low Price. You can buy several

The BP-89 and BP-118 both give you a regulation of supply within 0.01% and ripple is 250 microvolts. Silicon differential amplifiers and stable voltage references result in excellent stability. They are short circuit and overload protected, and feature MIL spec performance. At such low prices, you can afford to have several of these fine power supplies available. Stop waiting in line to use the more expensive one, and smile!

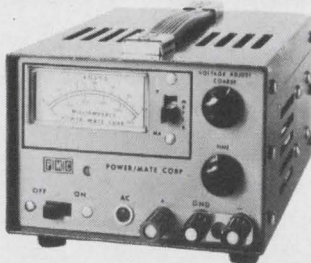

BP-89
0-34 volts at 0.5 amps for



BP-118
0-34 volts at 1.5 amps for

\$89 \$118

SPECIFICATIONS

OUTPUT: 0-34Vdc, BP-89 - 0-500mA BP-118 1.5Amp
INPUT: 105-125Vac, single phase, 50-400Hz
LOAD REGULATION: Less than $\pm 0.01\%$ plus 1mV output voltage change for a load current change equal to the current rating of the supply.
LINE REGULATION: Less than $\pm 0.01\%$ output voltage change for a change in line voltage from 105 to 125 (or 125 to 105) volts at any output voltage and current within rating.

RIPPLE AND NOISE: Less than 200 μ V RMS/1mV p-p
 TEMPERATURE COEFFICIENT: Output voltage change per degree centigrade is less than 0.02% plus 1mV after 30-minutes warmup.

STABILITY: The total drift for 8 hours (after 30 minutes warmup) at a constant ambient is less than 0.1% plus 5mV.

CONSTRUCTION: All metal case with baked enamel finish.



POWER/MATE CORP.

163 Clay St., Hackensack, N. J. 07601
 (201) 343-6294, TWX: (710) 990-5023

SAME DAY SHIPMENT

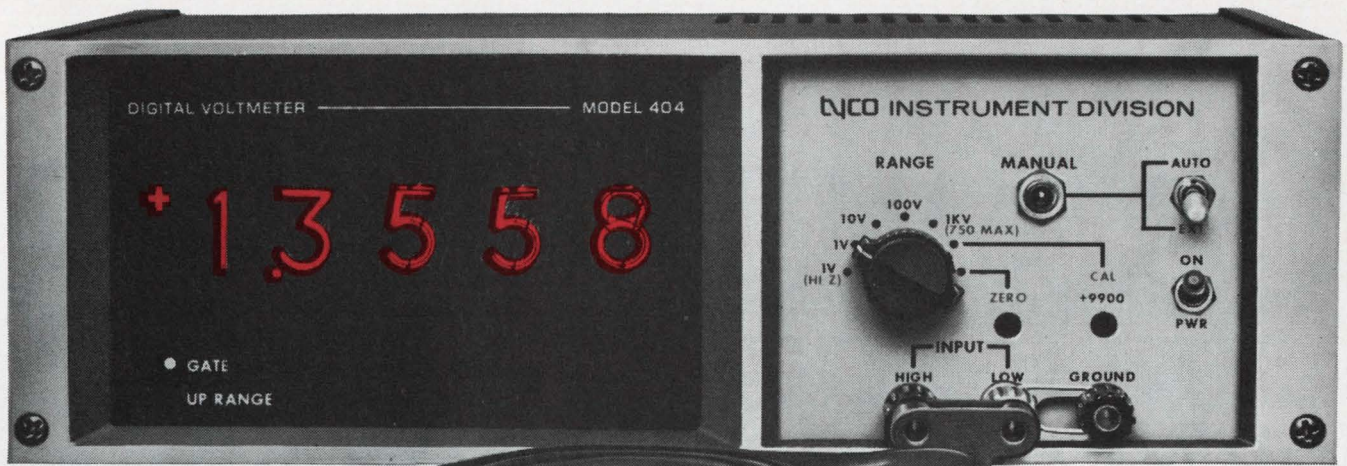

Best DVM on the market. For all practical purposes.

It's the simplest way to measure DC levels . . . visually and with BCD outputs. The 404 is an extremely accurate DVM at a very reasonable price. It's portable. Easy to operate. Has four full digits with a fifth overrange. Accuracy of $0.02\% \pm$ one digit. The 404 offers input flexibility

of five voltage ranges with an ultra-high input of 1,000 megohms on 1-volt range. And high noise rejection with differential input and integration techniques providing common mode rejection greater than 100 db at 60 Hz. It has BCD outputs and remote programming for system compatibility. And it costs only \$595. That's a lot of DVM for a relatively small investment. Call or write us for a

demonstration today. We'll have a 404 operating in your lab tomorrow. Practically. Tyco Instruments Division, Tyco Laboratories, Inc., Hickory Drive, Waltham, Mass. 02154, (617) 891-4700.

**For \$595,
this can lead to
almost anything.**

tyco

3/8" trimmers *with* established reliability for MIL-R-39015/RTR24

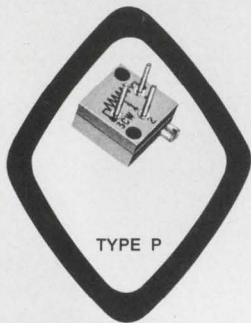

TYPE P

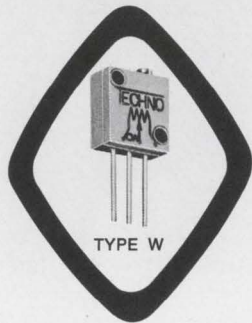

TYPE W

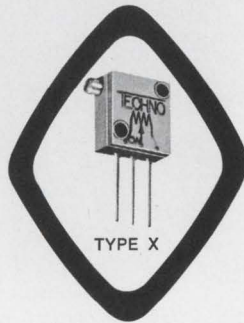

TYPE X

- ✓ Statistically Documented Reliability
- ✓ Complete Traceability
- ✓ 10,000-Hour Life Test
- ✓ One Hundred Percent Screening
 1. 100% burn-in for 96 hours at full rated power.
 2. 100% immersion test.
 3. 100% mechanical inspection before and after assembly.
 4. 100% peak noise and total resistance test.

CONFIDENCE LEVEL	FAILURE RATE PER 1000 HOURS
M	1%

SPECIFICATIONS

Resistance Values: 10 to 10k ohms
 Power Rating: 3/4 watt at 85°C
 Standard Resistance Tolerance: ±5%
 Operating Temperature: -65° to 175°C

Call or write for complete technical data:

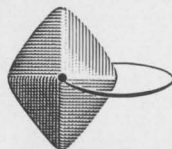

TECHNO-COMPONENTS CORP.

A SUBSIDIARY OF OAK ELECTRO/NETICS CORP.

7803 Lemona Avenue, Van Nuys, California 91405
 (213) 781-1642 TWX 910-495-2015

COMPONENTS

Tilting transducer gives 10 mV at null

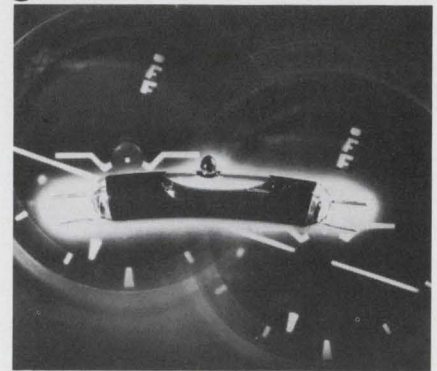

FR Electronics, div. of Flight Refuelling Ltd., Wimborne, Dorset, England.

Offering a unique system for guidance and control applications, a new gravity-sensing electrolytic transducer provides an output of 10 mV at null deflection and 10 V rms at saturation. Model EP106 has a frequency range of 25 Hz to several kHz (dependent on application) and withstands a maximum voltage of 50 V rms at 400 Hz for isolated periods up to 1 minute long.

CIRCLE NO. 263

Fluidic interface keeps out air

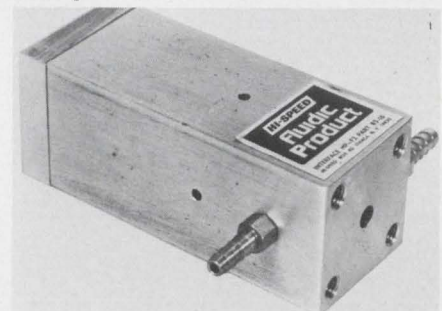

Hi-Speed Checkweigher Co., Inc., 605 W. State St., Ithaca, N. Y.

Complete separation of power air and fluidic output is provided by a new line-pressure-to-fluidic interface that prevents lubricated high-pressure air from entering a fluidic circuit. Previous methods of interfacing power to fluidic circuits usually employed a choke to reduce power line pressure to a sufficiently low level for fluidic output. The interface consists of a spring-loaded cylinder with two back-pressure outputs.

CIRCLE NO. 264

When You Choose An AC Meter Best Isn't Always Most Expensive

So you're going to buy an AC meter. You want the best meter for your job—at the best price. Right? You have a problem! Let's talk about it.

We have AC meters, lots of AC meters. We have AC meters that sell for more than \$4500—and for their job, they can't be beat.

But how about the engineer who doesn't have a big production problem or need 5-digit resolution? How about the engineer who is making only two or three measurements a day... or week? We have a series of meters for him, too.

A series that has built a solid reputation for accurate performance and reliability—most of you have used them in the past. About three years ago, Hewlett-Packard updated with three redesigned, solid-state instruments—the 400 E/EL for broad frequency, 10 Hz and 10 MHz; the 400 F/FL for high sensitivity, 100 μ V to 1000 V; and the 400 GL for broad dB range, -100 to +60 dB, 100 μ V to 1000 V sensitivity.

These instruments are packed with convenience features. Two of these meters have a built-in 100 kHz low-pass filter to take out unwanted high frequencies for low-level audio mea-

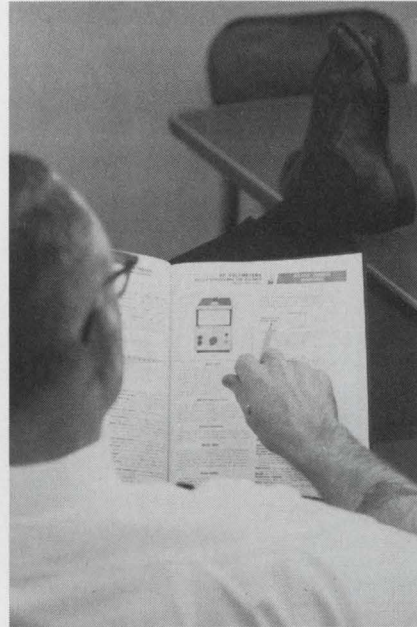

surements. You get fast response—a reading in less than 2 seconds after turn-on, and <2 seconds overload recovery. These instruments have an internal wideband ac amplifier, with an 80 dB gain—so we put an output on the back. With all these you can have the log scale uppermost for greater resolution in dB measurements.

Each HP-made taut-band suspen-

sion friction-free meter movement is individually calibrated to its scale for accurate readings over the entire range. Elimination of friction gives these meters excellent repeatability.

These, and more, are the features that assure reliable, day-in, day-out performance that gets the job done on time. If your problem is in sonar, acoustics, audio response, communications, calibration, ac to dc conversion and amplification—or any other application where precision ac voltage measurements are a must—then consider the HP 400 series carefully. They will fit your measurement requirements, leave your wallet fatter, and make your job easier and faster.

Check your HP catalog, starting on page 201, and choose the meter that best meets your measurement needs. Order today by calling the nearest HP order desk. For data sheets, write to Hewlett-Packard, Palo Alto, California 94304. Europe: 1217 Meyrin-Geneva, Switzerland. Price: \$275 to \$390.

099/18

HEWLETT *hp* PACKARD

ANALOG VOLTMETERS

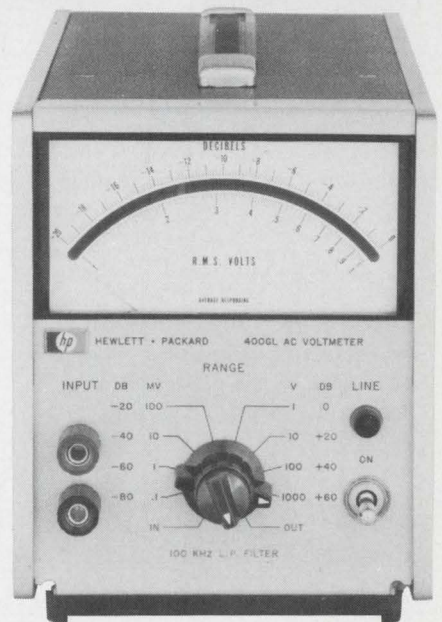
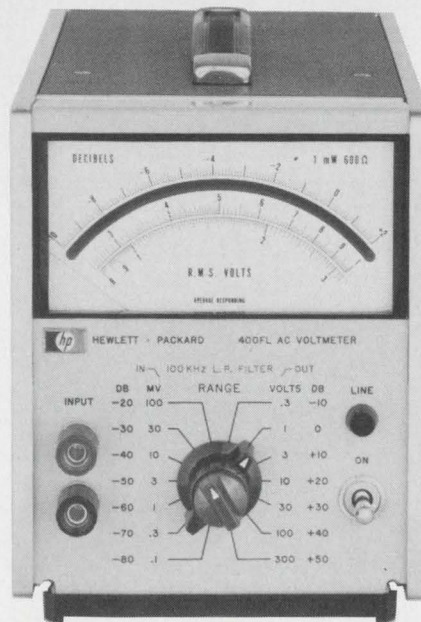
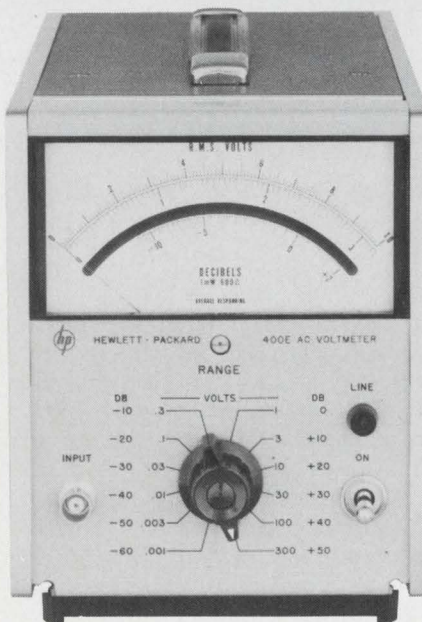

INFORMATION RETRIEVAL NUMBER 61

Microwave noise sources cover 2 to 18 GHz

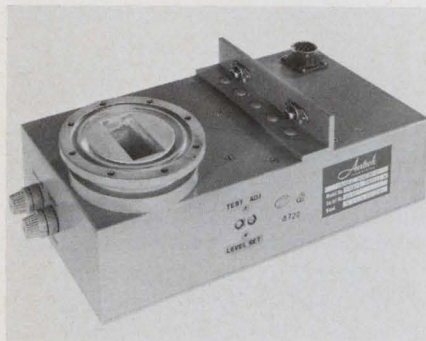

Aerotech Industries, 815 Stewart Dr., Sunnyvale, Calif. Phone: (408) 732-0880.

Solid-state noise sources with 10 to 50 dB excess noise are available over the frequency range of 2 to 18 GHz. The units operate from a low-voltage dc supply or can be supplied for 115-V ac operation. These solid-state units offer a convenient and reliable method of providing built-in noise figure testing.

CIRCLE NO. 265

GaAs infrared laser doubles power output

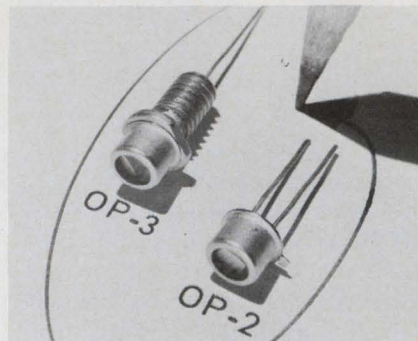

RCA/Electronic Components, 415 S. 5th St., Harrison, N.J. Phone: (201) 485-3900. Price: \$36 to \$50.

A new gallium arsenide infrared injection laser incorporates a close-confinement (CC) feature. Through substantially reduced internal absorption, these lasers feature double the power output and half the threshold current of previously available devices, good performance at room temperature, and an improved uniformity of laser emission. All of these advantages are the result of the new close-confinement structure, which confines the radiation to the junction area.

CIRCLE NO. 266

Can you

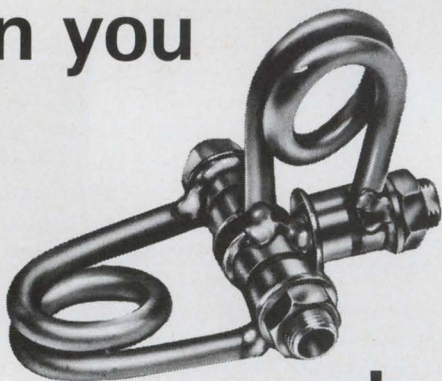

do this?

These new Johanson glass capacitors are designed to bridge the gap between conventional trimmers and high frequency air capacitors. They have high Q—low inductance; they have high RF current characteristics, they can be soldered together with components to simplify circuitry and they are *strong*.

Models include:



Series II: High RF voltage low cost units with $Q > 1200$ and TC; 0 ± 50 ppm.



Johanson 7168: High voltage quartz capacitors which feature 7000 VDC; 2500 V peak RF at 30 mc and current capacity > 2 amps.

Also available are:

- Tuners and ganged tuners; linear within $\pm 3\%$
- Differential capacitors
- Mil spec capacitors
- Microminiature capacitors .075" diameter and .1-1 pf

Write today for full catalog.

Johanson MANUFACTURING CORPORATION

400 Rockaway Valley Road, Boonton, N. J. 07005 (201) 334-2676

Electronic Accuracy Through Mechanical Precision

INFORMATION RETRIEVAL NUMBER 62

GaAs Gunn diodes are noise-free

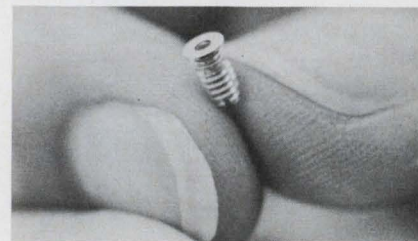

Varian Solid State Microwave Operation, 611 Hansen Way, Palo Alto, Calif. Phone: (415) 326-4000.

Two noise-free series of low-voltage, gallium-arsenide, solid-state diodes use the Gunn-effect principle. When inserted properly into a tunable microwave cavity, each diode in the VSX-9201 series will deliver a typical output of 45 mW, and the VSX-9205 series will typically deliver 8 mW. Tuning range at this power is ± 500 MHz from any specified center frequency between 8.5 and 11.9 GHz.

CIRCLE NO. 267

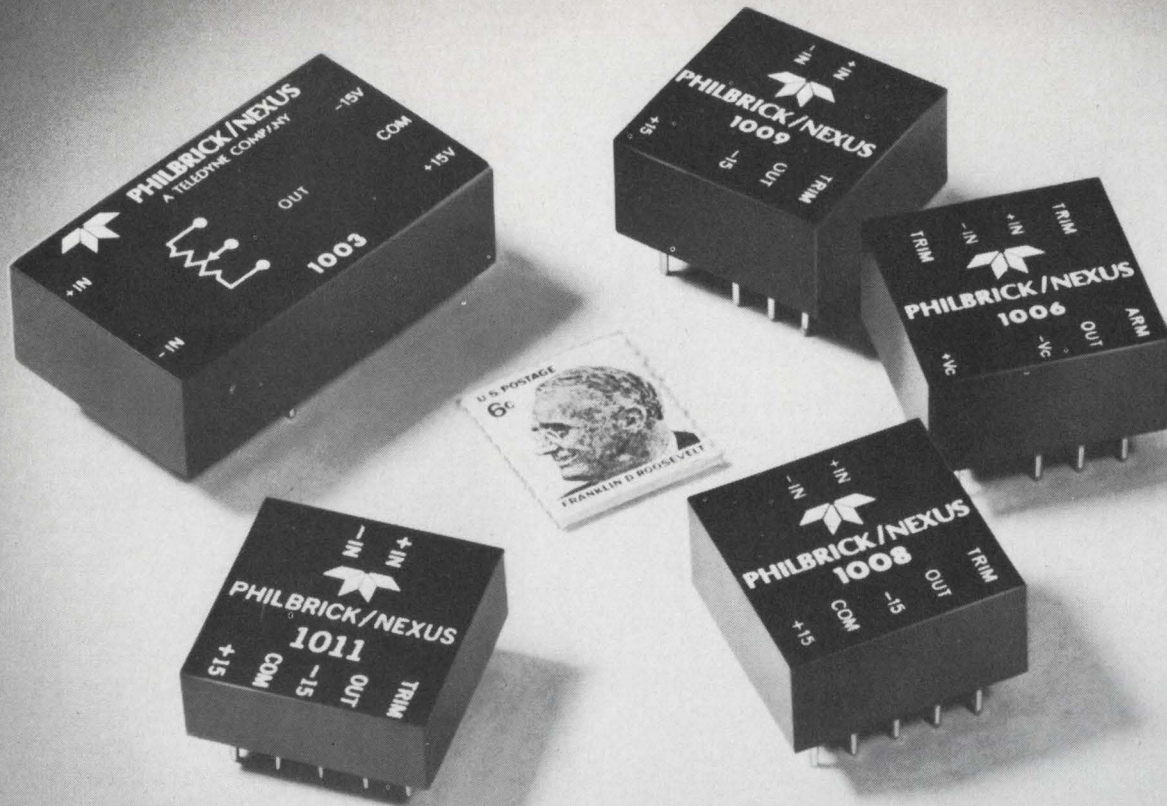

Best FETs yet!

FET operational amplifiers that is.

from the innovators of things Analog.

FOR FAST SETTLING TIME. **Model 1011** with a FET input and an output that settles to 0.01% in 1.5 μ sec. Slew rate is 70V/ μ sec and it can drive 25 mA. Ideal for high speed digital computers.

FOR BATTERY OPERATION. **Model 1006**, a micropower FET with low quiescent power, operates on supply current under 150 μ A. Supply range ± 2 V to ± 16 V with 2.5 mA output. Useful in many portable applications.

FOR HIGH OUTPUT. **Model 1008** delivers high power output to 35 mA. Slew rate is typically 15V/ μ sec. Capable of driving relay coils and low impedance recorders.

FOR HIGH OPEN LOOP GAIN. **Model 1003** provides high open loop gain of 500,000, voltage temperature coefficient of 3 μ V/ $^{\circ}$ C, CMRR of 10^6 and warmup time of 2 sec to $\pm 25\mu$ V of final output. Excellent for differential applications.

FOR LOW COST. **Model 1009** costs only \$20.40 each in hundred quantity. High input impedance (10^{12} ohms) and low bias current (5 pA). Good general purpose FET for integrators, high impedance buffers, etc.

For further information, contact your local Philbrick/Nexus Sales Representative, or write:



PHILBRICK/NEXUS RESEARCH

A TELEDYNE COMPANY

Allied Drive at Route 128 Dedham, Massachusetts 02026 (617) 329-1600

BULOVA MC's* have a Moon Mission!

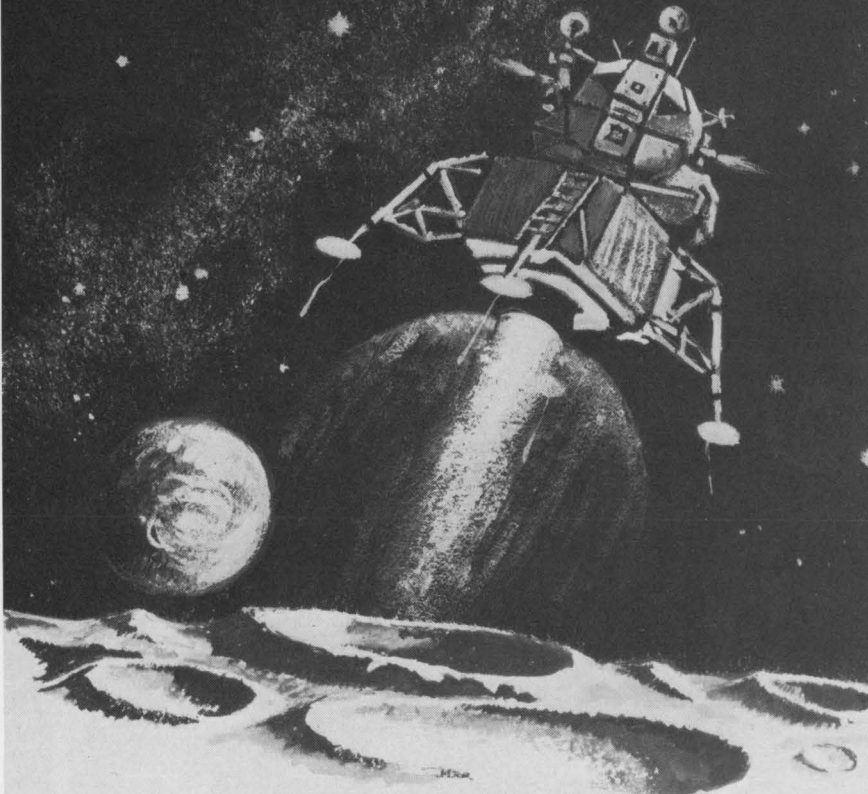

31 different Magnetic Components (MC's) — LC Filters, Transformers and Inductors — were selected for flight control and communications assemblies in the Apollo command module and lunar module — a dramatic demonstration of reliability! Hundreds of other Bulova MC's are in Apollo ground support equipment. The long months of preparation proved time and again the operational capability of Bulova's MC's (Magnetic Components) as well as their ability to produce and deliver on time!

Forward-thinking Bulova design efforts have produced a complete line of thousands of transformers, filters, coils, networks, discriminators, and delay lines. If we haven't made the product that will do your job, we'll design and produce one to your specs. Bulova has more in-depth experience in Magnetic Components than anyone else! Whatever your specification, delivery, or reliability requirements, we can meet them. Just call (212) 335-6000, see EEM Section 2300, or write —

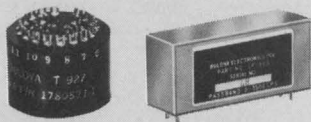

*Magnetic Components



BULOVA FREQUENCY CONTROL PRODUCTS

Electronics Division of the Bulova Watch Company, Inc.
61-20 Woodside Ave., Woodside, N. Y. 11377 (212) 335-6000

Go Bulova, and leave the designing to us!

MICROWAVES & LASERS

Schottky diode series has triple barrier

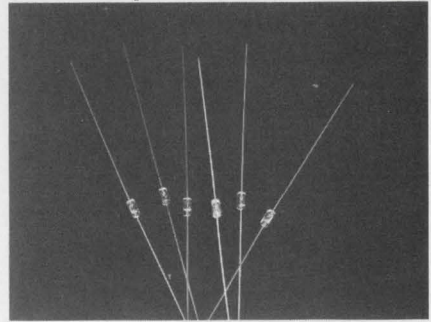

Microwave Associates (West) 999 E. Arques Ave., Sunnyvale, Calif. Phone: (408) 736-9330. Price: \$3 to \$6.

The MA4-A100 triple-barrier Schottky diodes feature high breakdown voltage. These are planar-passivated silicon diodes that combine two Schottky barriers with a pn junction. The MA4-A100 series is recommended for many rf applications up to 4 GHz. Typical applications are in high-level detectors and mixers, modulators and sampling gates.

CIRCLE NO. 268

Coaxial rf switch is motor-driven

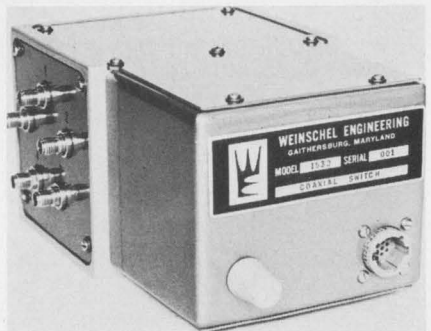

Weinschel Engineering, Gaithersburg, Md. Phone: (301) 948-3434. P&A: \$500 to \$660; July.

Model 1532 precision motorized coaxial rf switch is an accessory to a new microwave parameter measuring system. The unit is a five-port-to-one coaxial switch with input to output capability in either direction. It is most suitable for applications where five independent sources are sequentially scanned to produce a single composite output, or where a single source is to be distributed sequentially to five separate functions.

CIRCLE NO. 269

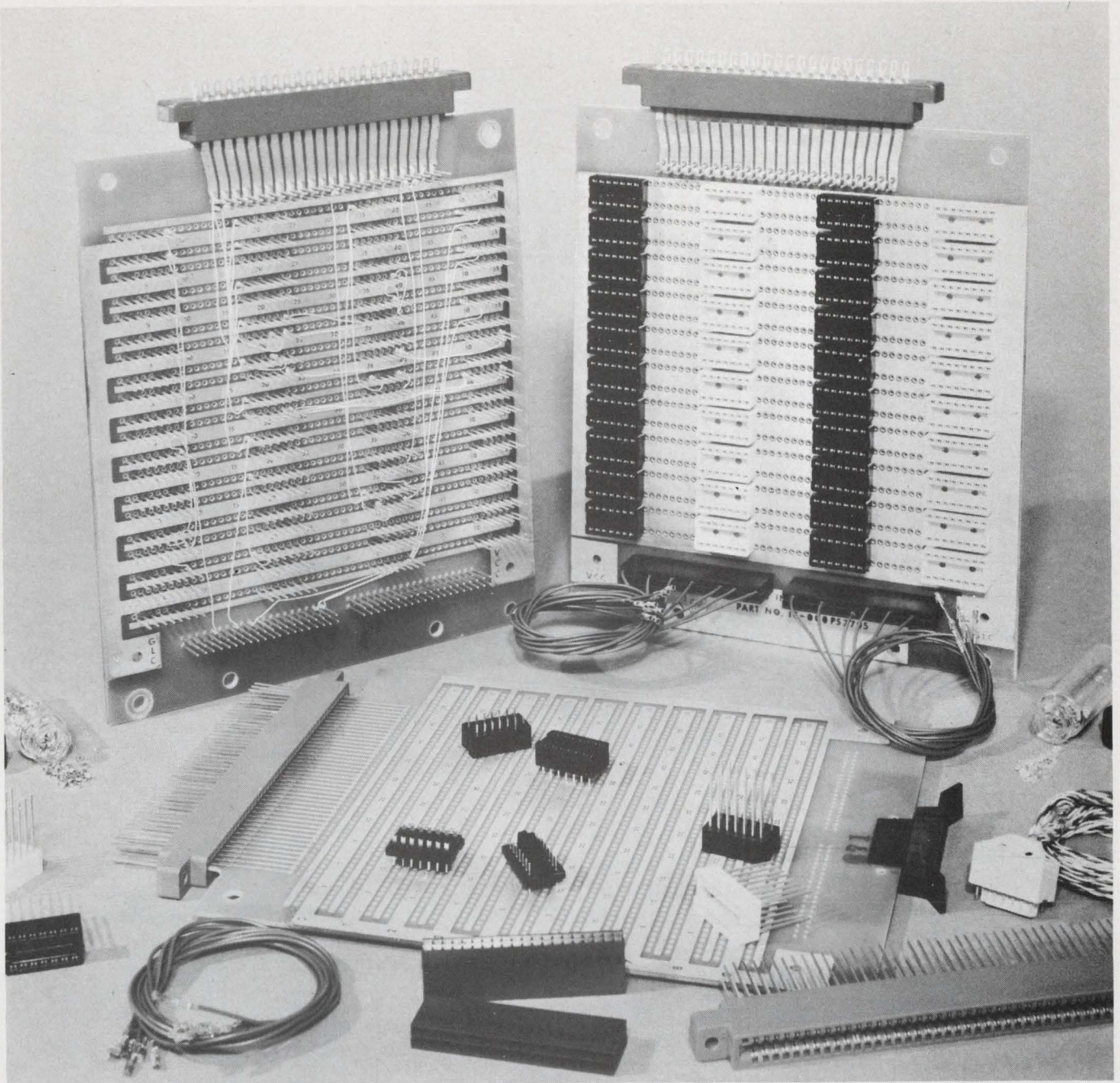

JUST ADD LOGIC

That's all you do with our Select-A-Wrap* panel. It's Texas Instruments exclusive do-it-yourself panel for prototyping and production packaging of integrated circuits. Once your new circuit design is set, just complete our Select-A-Wrap ordering form and TI will take it from there.

You get all the features of custom-designed wire-wrap panels — minus tooling costs and with two weeks or

less turn-around-time. That's because Select-A-Wrap panels and their associated hardware are standard off-the-shelf items; ready for assembly to your specifications.

Flexibility is the key with Select-A-Wrap. You can choose any combination of 14- and 16-pin sockets. Opposed ground and power planes surround all pins so that any pin may be soldered to power or ground. Pins are

individually replaceable without removing sockets from the panel.

If you prefer to do your own breadboarding, TI offers its unique Select-A-Wrap panel prototyping kit. Write or call TI Connector Products Marketing, Attleboro, Mass. 02703, Phone 617-222-2800,

or your local TI Distributor.



TEXAS INSTRUMENTS
INCORPORATED

*Trademark of Texas Instruments Incorporated

INFORMATION RETRIEVAL NUMBER 125

Small wonder!

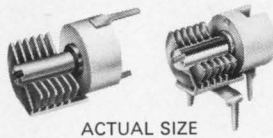

New air variable capacitors only 0.310" in diameter for vertical or horizontal tuning.

Johnson introduces these new Type "T" subminiature air dielectric capacitors for trimming applications that call for small size (0.310" diameter), high Q (greater than 1500 at 1 MHz), low TC, and low cost. Mounting dimensions of vertical mount "T" are identical to common 3/8" diameter PC mount ceramic disc trimmers.

Nominal capacities available range from 1.3 pF minimum to 15.7 pF maximum. Minimum voltage breakdown is 250 VDC. End frame is 95% alumina, grade L624 or

better, DC200 treated. Metal parts are silver plated and Iridited to inhibit discoloration.

Plates are precision machined from brass extrusions and offer exceptional uniformity, stability, and absolute freedom from moisture entrapment. Temperature coefficient is 30 ± 15 ppm/°C. Retrace characteristics are excellent. Outstanding stability during vibration from 10 to 2000 Hz. These new capacitors meet or exceed EIA-RS 204 and MIL Standard 202C Methods 204A and 201A.

- Please rush a sample of your new Type "T" capacitors, detailed specs and prices.
 Include Catalog 701 covering the entire E. F. Johnson component line.

NAME _____ TITLE _____

FIRM _____ ADDRESS _____

CITY _____ STATE _____ ZIP _____



E. F. JOHNSON COMPANY

3305 Tenth Avenue S. W., Waseca, Minnesota 56093

Providing nearly a half-century of communications leadership

INFORMATION RETRIEVAL NUMBER 66

MICROWAVES & LASERS

Milliwatt HeNe laser operates at 632.8 nm

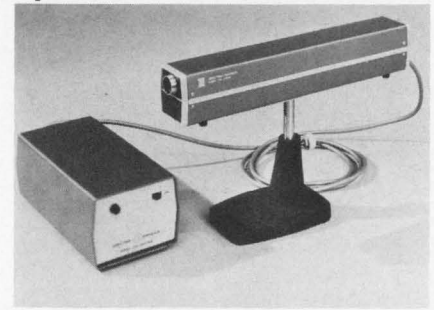

Spectra-Physics, Inc., 1250 W. Middlefield Rd., Mountain View, Calif. Phone: (415) 961-2550. Price: \$300.

Designed for optical bench and systems applications, a small HeNe laser delivers more than a milliwatt of power (TEM₀₀) at 632.8 nm. Laser head and power supply of the model 133 are packaged separately. In optical bench setups, the head can be mounted on a standard optical bench rod, or it can stand alone on its own adjustable base.

CIRCLE NO. 270

Swept-frequency module spans 0.1 to 8.1 GHz



SpaceKom, Inc., P.O. Box 235, Goleta, Calif. Phone: (805) 967-7114. P&A: \$1670 to \$1950; stock to 60 days.

A solid-state swept-frequency module generates signals from 0.1 to 8.1 GHz by down conversion from an external swept-frequency X-band source. This output signal is adjustable from -20 dBm to +5 dBm. Two models are available: model CX-12 generates 0.1 to 5 GHz continuous sweep or any portion of it in one band, and model CX-13 generates 4-GHz continuous sweep or any portion of it in two bands.

CIRCLE NO. 271

Short photomultiplier has 2-in. cathode

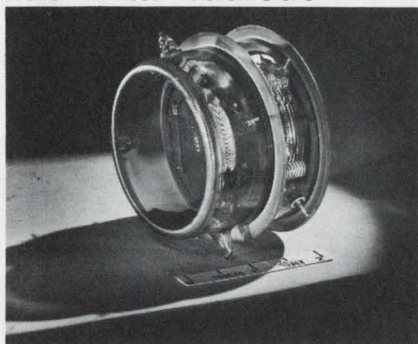

Johnston Labs., Inc., 3 Industry Lane, Cockeysville, Md. Phone: (301) 666-9500.

A very short photomultiplier, type P10, has been developed for use in restricted spaces. Although the photocathode is a full 2 in. in diameter, the tube is only 2 in. long and 3 in. in outside diameter including the dynode resistors. A low-noise, high-quantum efficiency visible light bialkali cathode is standard; UV cathodes and windows are available. The tube has good time-resolution characteristics and a fast pulse risetime.

CIRCLE NO. 272

Miniature connectors mount on bulkhead



Phelps Dodge Electronic Products Corp., 60 Dodge Ave., North Haven, Conn. Phone: (203) 239-3311.

Five new bulkhead receptacle-type miniature microwave connectors have been introduced. All are variations of the basic two- or four-hole square-flange mount receptacle, and are offered in loose and captivated contact versions. The elimination of openings or ports in the sides of the conductor body through which rf energy may leak is a result of a proprietary contact retention system. The five new types meet specification MIL C 39012-A, Type SMA.

CIRCLE NO. 273

New VICTOREEN Mini-Mox Resistors for higher resistance/size ratios

MOX 1125

MOX 750

MOX 400

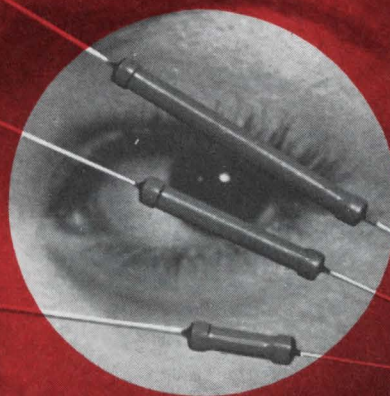

We promised you a wider range of quality Victoreen MOX (metal oxide glaze) resistors for sophisticated electronic applications. And we're delivering on our promises, too, for we're now in volume production on the subminiature Mini-Mox resistor line. Just eyeball these specifications:

Model	Resistance	Rating @70°C	*Max. Oper. Volts	Length Inches	Diameter Inches
MOX-400	1-2500 megs	.25W	1000V	.420 ± .050	.130 ± .010
MOX-750	1-5000 megs	.50W	2000V	.790 ± .050	.130 ± .010
MOX-1125	1-10,000 megs	1.00W	5000V	1.175 ± .060	.130 ± .010

*Max operating temp 220°. Encapsulation — Si Conformal.

*Applicable above critical resistance.

Stability is better than ±2% for 2000 hours at full load, shelf-life drift less than 0.1% per year. Standard tolerances are 1 to 10% depending on resistance value. ½% resistors in limited values, on request.

So let your circuit design imagination run rife. Victoreen MOX and new Mini-Mox Resistors can satisfy all your requirements for ultra-critical applications involving high voltage... high impedance... high stability... high wattage. Check our Applications Engineering Department today. Call (216) 795-8200.

A-3876

VICTOREEN INSTRUMENT DIVISION
10101 WOODLAND AVENUE • CLEVELAND, OHIO 44104
EUROPE: ARNDAL HOUSE, THE PRECINCT, EGHAM, SURREY, ENGLAND • TEL: EGHAM 4887



INFORMATION RETRIEVAL NUMBER 67

S-band oscillators tune via voltage

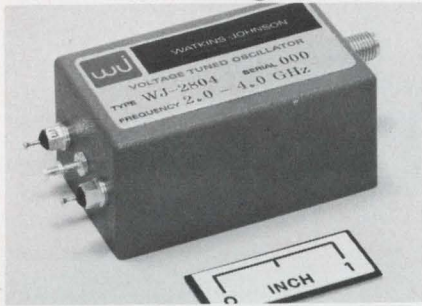

Watkins-Johnson Co., 3333 Hillview Ave., Stanford Industrial Park, Palo Alto, Calif. Phone: (415) 326-8830.

Two new voltage-tuned solid-state oscillators for S-band operation, the WJ-2804 and the WJ-2805, deliver up to 40 mW of fundamental microwave power. Since they are fundamental oscillators, the units exhibit no in-band harmonically related spurious signals. Varactor tuning ensures a high tuning input impedance characteristic.

CIRCLE NO. 274

Flexible absorbers span 1 to 16 GHz

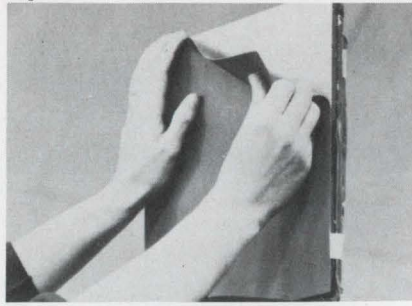

Emerson & Cuming, Inc., Canton, Mass. Phone: (617) 828-3300. P&A: \$15 to \$39/ft²; stock.

Resonant flexible absorbers, Eccosorbs SF, SF-T, and SF-RB, have a frequency range that extends from 1 to 16 GHz. The materials feature ruggedness, minimum weight, and a choice of resonant design frequency and design incidence angle. For the frequency range from 1 to 5 GHz, a 50 per cent weight reduction has been realized in the Eccosorb SF-T design.

CIRCLE NO. 275

Broadband switches isolate 60 dB

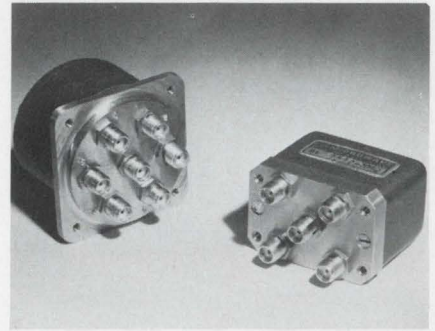

Microwave Associates, Burlington, Mass. Phone: (617) 272-3000.

With only a small movement of stripline contact, subminiature electromechanical switches convert from a conduction mode into waveguide-beyond-cutoff, thus achieving high interchannel isolation. These new broadband switches provide 60-dB isolation up to frequencies well above 18 GHz. Models from spdt through sp6t are available, as well as units with a four-port transfer configuration.

CIRCLE NO. 276

1750 ways to keep in touch

At H. A. Wilson we have over 1750 precious and sintered metals and alloys available for electrical contact applications. Yes! Even more than any other company. This wide variety enables us to produce every conceivable form of contact in sizes ranging from the microminiature forms used on Apollo spacecraft to up to 1 1/4 in. square (NEMA #6 and #7) motor starters. Combine this wide selection of materials with our engineering and production capabilities, and it's obvious there are few, if any, contact problems we can't solve. Even yours.

Contact the H.A. Wilson Technical Service Department today.



ENGELHARD

ENGELHARD INDUSTRIES DIVISION
ENGELHARD MINERALS & CHEMICALS CORPORATION
2655 U. S. ROUTE 22, UNION, NEW JERSEY 07083

34

A word in the hand

or: 20 ways Components, Inc. helps Motorola keep its Handie-Talkie radios handy—and talking

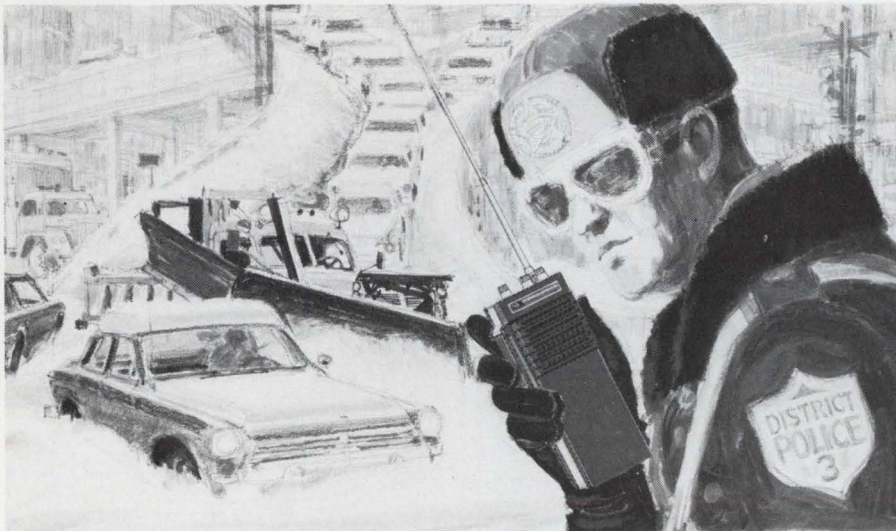

Motorola's new HT-220 Handie-Talkie radio in emergency use. C.I. capacitors helped make it 40% smaller than the previous model.

wire or ribbon leads. A complete line of non-polar Minitans® is offered in standard EIA values as well.

Whenever you want to pack a lot of performance into the smallest possible space, call C.I. for your capacitors. We offer more microminiature case styles and ratings than anyone in the business. (Also check us for our complete lines of CS13's, CSR13's, and dipped epoxy products.) We welcome requests for samples, for application assistance, and of course for performance and reliability data. Standard prototypes are normally shipped within 24 hours. Write or call, and tell us what you need.

In emergencies . . . on construction sites . . . in law enforcement . . . on the job in scores of situations calling for dependable 2-way communications, you'll find Motorola's well-known Handie-Talkie personal radios.

How were Motorola engineers able to squeeze so much talking power into a package 40% smaller than their previous model?

Sophisticated design . . . plus 20 microminiature Minitan® capacitors from Components, Inc.

These tiny solid tantalums, literally the world's smallest electrolytic capacitors, were selected because they offer excellent performance, minimum leakage, and the highest possible reliability up to 125°C. They are available in modular and cordwood styles, with

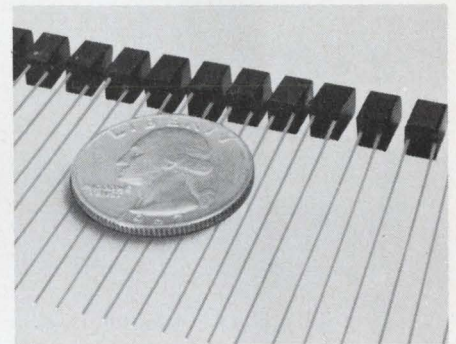

MINITAN MODULAR

(Also available with axial leads)

	U
	F
	M
	L
	S
	J

.47 MFD @ 35 VDC to 220 MFD @ 3 VDC
(Cordwood Series available from .01 MFD @ 50 VDC)

(ACTUAL SIZE)

MINITAN CORDWOOD

Y	
P	
B	
A	
G	

.01 MFD @ 50 VDC to 47 MFD @ 3 VDC
(Modular Series available to 220 MFD)

(ACTUAL SIZE)

 **COMPONENTS, INC.**
CAPACITOR PRODUCTS
BIDDEFORD, MAINE 04005 - TEL: (207) 284-5956 - TWX: 710-229-1559

We did it!

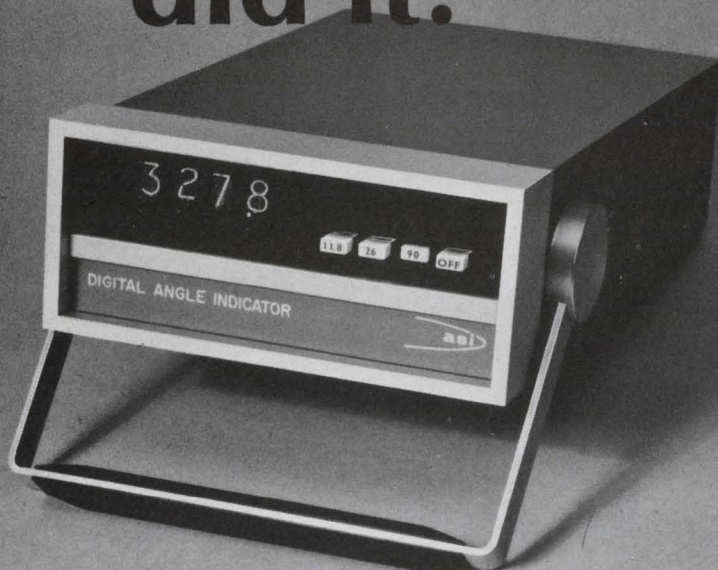

for under \$1500

- All Solid State - No Moving Parts
- Digital Output
- 0.1° Resolution and Accuracy
- High Readability

Astrosystems Digital Angle Indicator is a solid state all electronic device for measuring and displaying angle inputs from remote synchro or resolver inputs. For the first time, a low cost, high reliability, solid state angle indicator is available that does not use gears, motors, synchro receivers or any other rotating components. This rugged, versatile, reliable instrument is ideal for system, ground support and laboratory applications. Some of the outstanding features of this new unit are: **Ultra Reliability**—Accuracy guaranteed for one year without calibration or periodic adjustments. **High Readability**—Large inch-high characters on Nixie® tube readout. **High Input Impedance**—200K. **Versatile**—Accepts synchro or resolver inputs at 11.8, 26 or 90 volts line-to-line. **Low Audible Noise**—No motors or gears. **High Slew Speeds**—100°/second. **Digital Output**—A four decade BCD digital output available.

astrosystems, inc. 6 Nevada Drive, New Hyde Park, New York 11040 516/328-1600 TWX 510/233-0411. West Coast Office 4341 Commonwealth Avenue, Fullerton, California 92633 714/523-0820.

asi

astrosystems, inc.

ICs & SEMICONDUCTORS

Dual amplifier chip goes to 500 MHz

RCA/Electronic Components, 415 S. Fifth St., Harrison, N. J. Phone: (201) 485-3900. Price: \$1.95.

Designed for low-power applications at frequencies up to 500 MHz, a new dual differential amplifier IC has a useful typical gain of 23 dB and a low noise figure of 4.6 dB at 200 MHz. Model CA3049 consists of two independent differential amplifiers with their associated IC constant-current transistor stages. Each of its six npn transistors exhibits a unity-gain cutoff frequency in excess of 1000 MHz. There are no bias and load resistors to allow maximum application flexibility. The device is housed in a 12-lead TO-5 package with independently accessible inputs and outputs.

CIRCLE NO. 277

MOS dynamic register is quad 32-bit IC

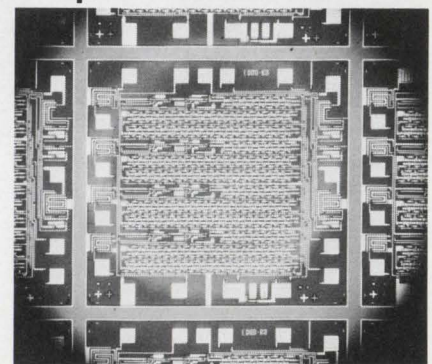

Electronic Arrays, Inc., 501 Ellis St., Mountain View, Calif. Phone: (415) 964-4321. P&A: \$20; stock.

Said to be the first dynamic MOS shift register in a quad configuration, a new monolithic silicon chip contains four separate 32-bit dynamic serial registers with a common clock and common power lines. Each register may be used separately or externally interconnected for different combinations of 32-bit lengths up to a total of 128 bits. Model 1200 operates to 3 MHz with a two-phase 24-V clock, to 1 MHz with a low-power single-phase 9-V clock.

CIRCLE NO. 278

Core memory driver decodes on chip

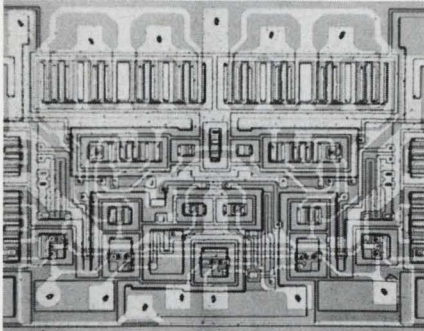

Texas Instruments Inc., Components Group, P.O. Box 5012, Dallas, Tex. Phone: (214) 238-2011. Price: \$12.25 or \$13.70.

Eliminating transformer coupling by putting logic and decoding functions on the same chip, a monolithic 400-mA core memory driver is completely compatible with TTL circuits. Model SN75324 has a typical output saturation voltage of 0.65 V and a typical average propagation delay of 60 ns. It is available in flatpack and plastic dual-in-line packages.

CIRCLE NO. 279

Fast FET switches operate in 40 ns

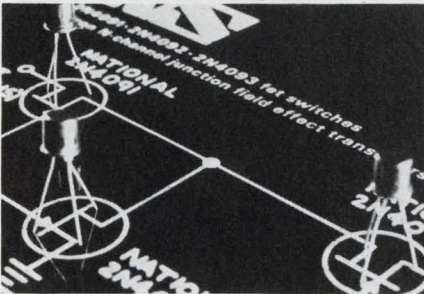

National Semiconductor Corp., 2950 San Ysidro Way, Santa Clara, Calif. Phone: (408) 245-4320. P&A: \$2.30 to \$3.50; stock.

Three new FET switches feature a low on-resistance of 30 Ω , 40-ns switching and 200-pA leakage. Types 2N4091, 2N4092 and 2N4093 can be used as low-level choppers, video and rf amplifiers or a high-gain low-noise amplifiers. They also find application in micro-volt amplifiers and meters, multiplexers and various audio equipment.

CIRCLE NO. 280

Solitrode,

The glass passivated one, is now bigger than ever.

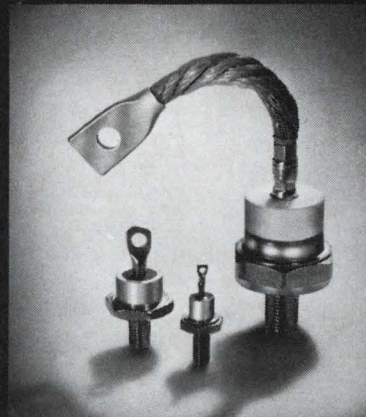

Manufacturers of high current equipment can now get ultra-high reliability in a DO-8 package. Only from Solitron.

We have incorporated our Solitrode chip into this new, larger package, with forward current capabilities up to 150 amps. If you've been using stud rectifiers with junctions coated with conventional materials (plastic, epoxy or varnish) you've probably experienced contamination.

But the Solitrode is glass passivated. Its junction withstands temperatures of up to 1000^o C., giving higher-than-ever reliability. High temperature reverse bias is no longer a problem, due to the elimination of the effects of ionic migration. Our DO-8 exceeds the applicable environmental requirements of MIL-S-19500E.

The DO-8 is available in normal versions and fast-switch versions that have recovery speeds of 250 and 400 nanoseconds, depending upon voltage. Peak inverse voltages of up to 400 volts per junction are available.

For spec sheet and pricing, write or phone.

Solitron

DEVICES, INC.

256 OAK TREE ROAD
TAPPAN, N. Y. 10983
PHONE (914) 359-5050
TWX: 710-576-2654
TELEX: 13-7346

Switching MOSFETs protect themselves

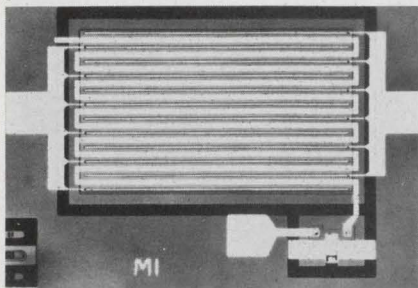

Siliconix Inc., 1140 W. Evelyn Ave., Sunnyvale, Calif. Phone: (408) 245-1000. P&A: \$15.60 or \$23.50; stock.

Two new p-channel enhancement-type switching MOSFETs eliminate the problem of possible oxide breakdown due to a static-charge accumulation on the gate with a built-in zener diode between gate and body. Model 3N167 has minimum breakdown voltages of 30 V, a maximum on-resistance of 20 Ω , and leakage currents of less than 0.5 nA; model 3N168 has values of 25 V, 40 Ω , and 1 nA, respectively.

CIRCLE NO. 281

Hf power transistors handle 20 to 150 W

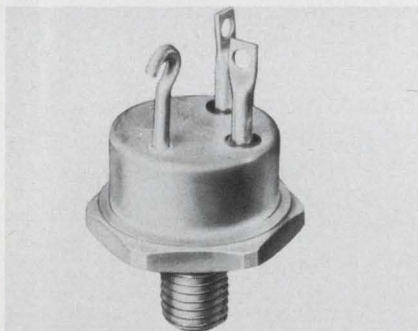

Westinghouse Electric Corp., Semiconductor Div., Youngwood, Pa. Phone: (412) 925-7272. P&A: \$4.40 to \$115; stock.

Spanning the power range from 20 to 150 W with peak collector currents of 10 to 75 A, a new family of npn power transistors, types 1714 to 1776, offers operating frequencies as high as 5 MHz and voltage ratings up to 200 V. Minimum unity-gain cutoff is as large as 40 MHz, while typical storage times range from 400 ns at 2 A to 330 ns at 60 A.

CIRCLE NO. 282

Uhf tuning diodes boast Q of 600

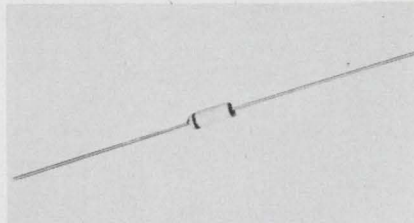

MSI Electronics, 34-32 57th St., Woodside, N. Y. Phone: (212) 672-6500. P&A: \$6.75; 2 to 3 wks.

Giving a sharp response in tuning circuits at 500 MHz and above, a new line of voltage-variable capacitance diodes exhibits a Q of 600 while holding capacitance to between 6.8 and 100 pF with tolerances of 10%. Types 1N5461A through 1N5476A have breakdown voltage ratings of 30 V and a capacitance temperature coefficient of 300 ppm/ $^{\circ}$ C. They are supplied in DO-7 glass packages.

CIRCLE NO. 283

Hybrid driver sinks 500 mA

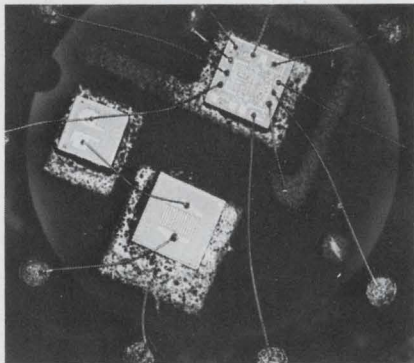

Fairchild Semiconductor, 313 Fairchild Drive, Mountain View, Calif. Phone: (415) 962-3563. Price: \$5.65 to \$17.93.

Able to reduce design and assembly costs by as much as 50% from discrete-component approaches, a new hybrid lamp-and-relay driver delivers a 50-V output and a sinking current of 500 mA at 6 V. Model SH2200 is a multi-chip device that provides a combination of four input NAND gates and an inhibit (NOR) input. It comes in a TO-100 package, a 10-lead flatpack or a plastic 10-lead dual-in-line package.

CIRCLE NO. 284



Ready to "Show and Tell"

- | | |
|---|--|
| ALABAMA
Huntsville
Mekco Associates, Inc.
Tel. (205) 881-3721 | NEW JERSEY
Wayne
B. B. Taylor Corp.
Tel. (516) 223-8000 |
| ARIZONA
Phoenix
Gramer & Company
Tel. (602) 279-1231 | NEW MEXICO
Albuquerque
Hyer Associates, Inc.
Tel. (505) 265-5961 |
| CALIFORNIA
Los Angeles
IEE Factory Sales Office
Tel. (213) 787-0311 | NEW YORK
Baldwin
B. B. Taylor Corp.
Tel. (516) 223-8000 |
| Belmont
IEE District Sales Office
Tel. (415) 591-2551 | Rochester
Ossmann Component
Sales Corp.
Tel. (716) 442-3290 |
| San Diego
L. L. Stoakes, Inc.
Tel. (714) 274-6281 | Syracuse
Ossmann Component
Sales Corp.
Tel. (315) 454-4477 |
| COLORADO
Englewood
Hyer Associates, Inc.
Tel. (303) 771-5424 | Red Hook
Ossmann Component
Sales Corp.
Tel. (914) 297-7773 |
| CONNECTICUT
North Haven
Kitchen & Kutchin, Inc.
Tel. (203) 239-0212 | Vestal
Ossmann Component
Sales Corp.
Tel. (607) 785-9949 |
| FLORIDA
Orlando
Mekco Associates, Inc.
Tel. (305) 841-2215 | NORTH CAROLINA
Burlington
Mekco Associates, Inc.
Tel. (919) 226-7177 |
| ILLINOIS
Chicago
Magnuson Associates
Tel. (312) 622-6322 | OHIO
Cleveland
S. Sterling Company
Tel. (216) 442-8080 |
| KANSAS
Leawood
Poly-Onics, Inc.
Tel. (913) 648-4173 | Dayton
S. Sterling Company
Tel. (513) 298-7573 |
| MARYLAND
Towson
Biechler Associates, Inc.
Tel. (301) 825-8222 | PENNSYLVANIA
Narberth
Biechler Associates, Inc.
Tel. (215) 667-1827 |
| Rockville
Biechler Associates, Inc.
Tel. (301) 762-6210 | Pittsburgh
Russell F. Clark Co.
Tel. (412) 242-9500 |
| MASSACHUSETTS
Lexington
Kitchen & Kutchin, Inc.
Tel. (617) 862-8230 | TEXAS
Dallas
Norvell Associates, Inc.
Tel. (214) 357-6451 |
| MICHIGAN
Southfield
S. Sterling Company
Tel. (313) 357-3700 | Houston
Norvell Associates, Inc.
Tel. (713) 774-2568 |
| MINNESOTA
St. Paul
Magnuson Associates
Tel. (612) 227-8495 | UTAH
Salt Lake City
Hyer Associates, Inc.
Tel. (801) 487-7747 |
| MISSOURI
Hazelwood
Poly-Onics, Inc.
Tel. (314) 837-0597 | WASHINGTON
Seattle
Electronic Sales
Corporation
Tel. (206) 932-0330 |





"Show and Tell"

nimo™ wins the "Show and Tell" of the readout art. A single plane presentation of four bright, legible decades delivered at the low, low price of \$3.50 per decade. No contest.

nimo™, an electronic display tube only 1.135" in diameter, boasts 3/8" high characters, variable brightness, temporary data storage . . . but primarily a price tag *no one can touch*.

The Tell portion

	nimo™ 4-decade tube	gas discharge 4-decade display
Cost per decade	\$ 3.50	\$ 3.95
Mounting Hardware	3.50	2.00
Driver/Decoder	3.75	4.50
Power Supply	3.15	5.00
Total cost per decade	\$13.90	\$15.45

All figures relate to 1,000 quantity.

We can tell you many additional features inherent only in the **nimo™**, four decade display tube, but the real proof of the story is the *show* portion.

IEE Sales Representatives (listed opposite), will be happy to schedule a demonstration so they can "Show and Tell" you why **nimo™** is the only way to display. Call now!

The uncommon readout.



Industrial Electronic Engineers, Inc.
7720 Lemona Ave., Van Nuys, California 91405
Telephone: (213) 787-0311 • TWX 910-495-1707

INFORMATION RETRIEVAL NUMBER 72

FOR RENT:



Few companies can boast 168 Ph.D.s on the payroll—68, for that matter. Yet every organization whose success depends upon advanced technology frequently wishes it did have, to solve a critical problem or to evaluate a broad, expansive program.

The need may be for just one expert or for a top-level interdisciplinary team of specialists. Regardless, finding the best qualified people isn't easy, especially on short notice.

This is where Advanced Technology Consultants (ADTEC) comes in. From its rapidly growing roster of more than 300 outstanding professional Associates—including 168 Ph.D.s—ADTEC can supply anything from a single consultant to a highly qualified team—from one day to a whole year.

To find the consulting assistance you need, call or write to R. F. Horan, vice president.



ADVANCED TECHNOLOGY CONSULTANTS CORPORATION

Dept. ED
 144 South Main Street
 Wallingford, Conn. 06492
 (203) 265-1638

Consultants In:
 Pollution Control
 Aerospace Technology
 Nuclear Energy
 Applied Chemical Technology
 Transportation
 Oceanography
 Medical Electronics
 Instrumentation
 Computer Sciences
 Systems Analysis

INFORMATION RETRIEVAL NUMBER 74



**Now
 She Can
 Save Them
 from
 Rheumatic
 Fever**

Rheumatic fever and rheumatic heart disease, once childhood's greatest health enemies, now can be prevented by controlling "strep" infection.

This is another life-saving victory that your Heart Fund dollars helped to achieve.

For more information write your local Heart Association. For more medical advances against the heart and blood vessel diseases . . .

GIVE . . . SO MORE WILL LIVE HEART FUND



SPACE CONTRIBUTED BY HAYDEN PUBLISHING COMPANY, INC.

ICs & SEMICONDUCTORS

Compensated diodes vary only 0.0005%/°C

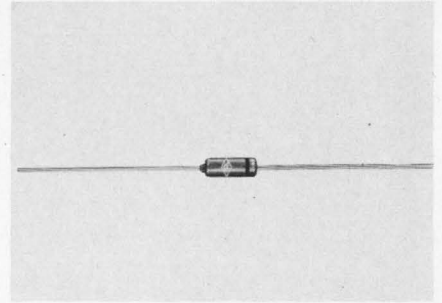

Centralab Semiconductor Div., 4501 N. Arden Drive, El Monte, Calif. Phone: (213) 686-0567. P&A: \$1.15; stock.

Providing high-temperature stability and long-term reliability, a new series of temperature-compensated reference diodes has temperature coefficients as low as $\pm 0.0005\%/^{\circ}\text{C}$. Types 1N4565 to 1N4584A meet the requirements of MIL-S-19500 and can be operated over a temperature range of -55 to $+100^{\circ}\text{C}$. They are hermetically sealed in DO-7 glass cases and can withstand severe environmental conditions.

CIRCLE NO. 285

Low-cost photodiodes offer performance plus

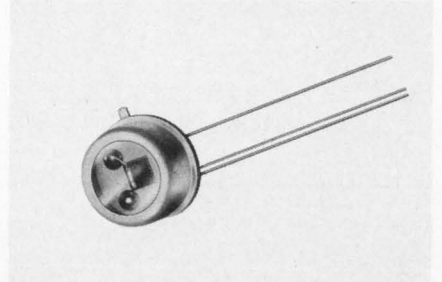

National Semiconductors Ltd., 331 Cornelia St., Plattsburgh, N.Y. Phone: (518) 561-3160. P&A: 69¢ to \$2; stock.

Enclosed in glass-and-metal TO-5 cases, two new low-cost silicon photodiodes have a peak spectral response at 8500 \AA and a sensitive area of 0.06 by 0.08 in. Model 720 is an n or p device with a minimum light current of $90 \mu\text{A}$ at 500 foot-candles and maximum reverse dark current of $1 \mu\text{A}$ at -1 V . Model NSL-820 is similar but offers lower noise and faster speed.

CIRCLE NO. 286

**Monolithic multiplier
senses 10-mV inputs**

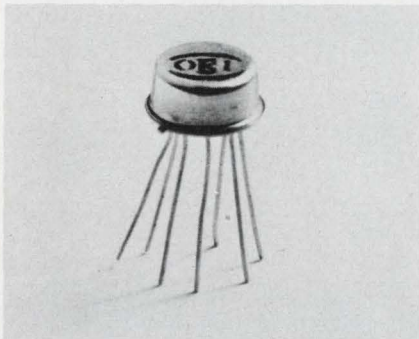

Optical Electronics Inc., P. O. Box 11140, Tucson, Ariz. Phone: (602) Price: \$25.

Reducing the number of external devices needed, a new monolithic four-quadrant analog multiplier boasts a 10-mV maximum input sensitivity with 0.8% linearity over a 5-MHz bandwidth. Working from supply voltages of ± 3 to ± 20 V, model 5507 operates over the temperature range of -55 to $+125^\circ\text{C}$. It is packaged in a seven-lead TO-78 metal can.

CIRCLE NO. 287

**Standard zeners
come as chips**

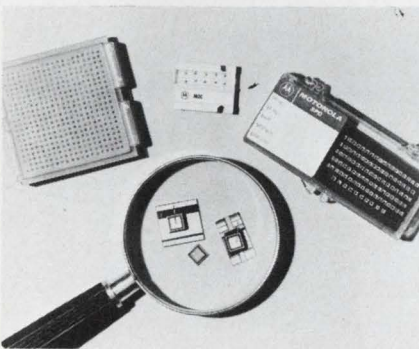

Motorola Semiconductor Products Inc., P. O. Box 20912, Phoenix, Ariz. Phone: (602) 273-6900.

Two new series of standard silicon zener diode chips are now available. The chips are also supplied mounted on ceramic substrates, either U-channel or leadless inverted configurations. Series A zeners have voltage ratings from 2.4 to 200 V and handle current levels of 0.25 to 21 mA; series B units cover the voltage range of 1.8 to 200 V at currents of 250 μA .

CIRCLE NO. 288

FET OP AMP

10 $\mu\text{V}/^\circ\text{C}$

\$16.00

SINGLE LOTS

10 Picoamperes

GAIN - 10^6

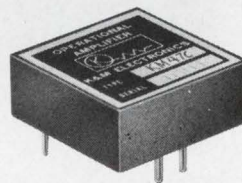

Model KM 45

INPUT IMPEDANCE: $10^{12} \Omega$

OUTPUT: ± 11 VOLTS @ 5 MILLIAMPERES

COMMON MODE REJECTION (CMR): 10,000

COMMON MODE VOLTAGE (CMV): ± 10 VOLTS MAX.

DIMENSIONS: 1.12" x 1.12" x 0.4"

AVAILABLE FROM STOCK

from  and their NATIONWIDE DISTRIBUTORS

K and M ELECTRONICS Corp.

408 PAULDING AVENUE
NORTHVALE, NEW JERSEY 07647

(201) 768-8070

My Requirements: Immediate Within 90 days Need technical help
 Rush Job - have salesman call

INFORMATION RETRIEVAL NUMBER 75

Battery-powered op amp minimizes supply drain

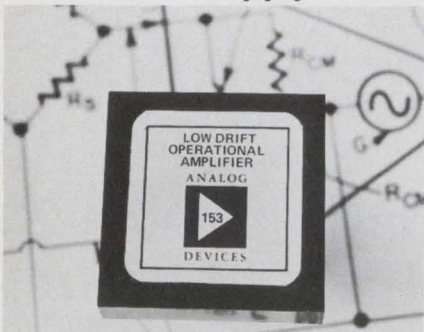

Analog Devices, Inc., 221 Fifth St., Cambridge, Mass. Phone: (617) 492-6000. P&A: \$45; stock.

Holding voltage drift to $2 \mu\text{V}/^\circ\text{C}$ maximum, a new battery-powered op amp runs portable instruments for months without a battery change. For example, while drawing only $70\text{-}\mu\text{A}$ quiescent current from a $\pm 2.7\text{-V}$ supply (less than 0.4 mW), model 153K can operate a portable instrument for up to a year on two 2.7-V batteries. Battery voltages can range from ± 2.7 to $\pm 15 \text{ V}$.

CIRCLE NO. 289

Photocell amplifier handles 2 A at 220 V

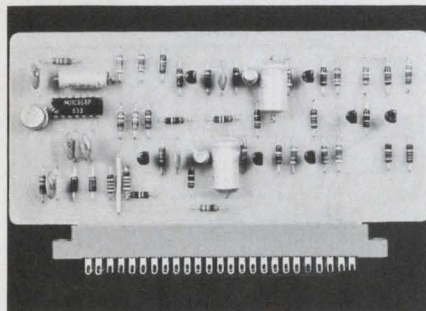

Digital Dynamics, Inc., Donaldson Center, 525 Milledge Loop, Greenville, S. C. Phone: (803) 277-5226. P&A: \$49; stock.

Providing light-initiated functions for a variety of control and logic applications, the Koptic-8 PC-card photocell amplifier can switch ac currents as large as 2 A at 220 V. This main-lead output has a variable delay from 0 to 10 seconds for both light-to-dark and dark-to-light conditions. In addition, there are four logic-level outputs for either light or dark conditions, both delayed and instantaneous.

CIRCLE NO. 290

Logarithmic modules find antilogs too

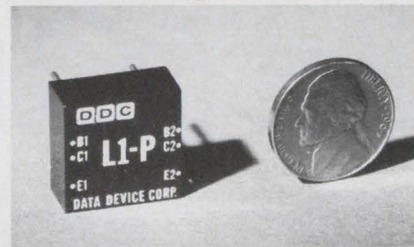

Data Device Corp., 100 Tec St., Hicksville, N.Y. Phone: (516) 433-5330. P&A: \$37.50; stock to 3 wks.

When used with operational amplifiers, two new logarithmic elements perform log and antilog functions, as well as multiplication and division. Designated as L1-P for positive and L1-N for negative input signals, the units have an input range of 10 pA to 1 mA and an output of 60 mV per decade. Each module consists of two independent sections with base-emitter voltage matched to 0.2 mV at 10 μA .

CIRCLE NO. 291

Digital multiplier performs in 250 ns



Unigon Industries, Inc., 200 Park Ave., New York City. Phone: (212) 682-7580. P/A: \$985; 4 to 6 wks.

Accepting a 9-bit two's complement number and a 8-bit magnitude number, the MPY-10 high-speed digital multiplier supplies a 10-bit truncated two's complement product with a maximum delay of 250 ns. No output control signals are required; interface is TTL and DTL compatible; and power requirements are 5 V at 1.5 A. Different bit configurations are available on request.

CIRCLE NO. 292

Small feedback module controls motor speed

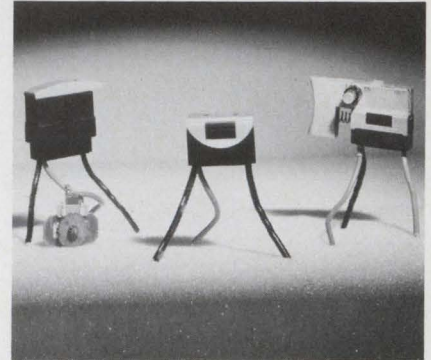

Cutler-Hammer, Inc., Specialty Products Div., 4201 N. 27th St., Milwaukee, Wis. Phone: (414) 442-7800. Price: \$3.

Using an SCR sensing and power circuit, a compact new feedback control module provides nearly constant motor speed characteristics under varying load conditions. The module provides stepless motor speed control when combined with a remote potentiometer and an on/off switch. It is rated at 4 A rms, 125 V ac, 60 Hz.

CIRCLE NO. 293

Analog adder modules compensate internally

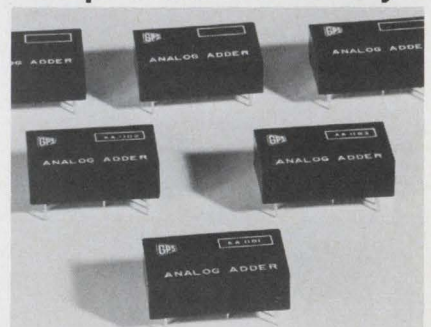

GPS Instrument Co., Inc., 14 Burr St., Framingham, Mass. Phone: (617) 875-0607.

Containing all compensating and stabilizing circuits, six new analog adders can be used for the linear addition of signals and the interconnection of operational elements like multipliers and dividers. Series AA1100 units offer static accuracies that range from 1% with 100-kHz bandwidths to 0.05% with 2-MHz bandwidths. From one to five inputs can be summed at unity gain.

CIRCLE NO. 294

Our package deal is a complete fabrication.

We make every part of our hermetic integrated circuit packages in our own plants.

We have to.

It's the best way we can be sure that every one will measure up to specs. Both ours and yours.

Take, for example, our off-the-shelf dual inline package. It uses our own special blend of hard glass and alumina to get the best properties. High electrical insulation, thermal shock resistance, hermeticity, and a thermal expansion that matches the metal alloy parts.

It meets Mil-specs and can be plated to your requirements.

If this package doesn't suit your needs, we'll design one to your specs.

Each hermetic package gets to you in first-class condition. No bent or shorted leads. No excess glass-ceramic flow.

In short, the perfect package deal.

*Sylvania Metals & Chemicals, Parts Division,
Warren, Pa. 16365.*

SYLVANIA
A SUBSIDIARY OF
GENERAL TELEPHONE & ELECTRONICS



bi-polar DPM

— another benefit other than price is that you get an under-range capability for zeroing-in your instrument. Something Uni-Polar units can't give you.

Our new circuit gives you high accuracy and long-life stability over a wide operating temperature range for positive inputs and reduced accuracy for negative inputs. You get non-blinking, 3-digit in-line readouts, 100 μ V resolution, excellent full scale reading (1999), external hold capability, computer compatibility and BCD outputs as standard. Meter ranges from 100 mV to 100 V and 1 μ a to 100 ma. And, you can get them *from stock* — Model 525 is priced at \$149 in 100 quantities. Or choose from 10 models in 3 other versions, Model 510 Uni-Polar, Model 530 High Input Impedance Isolated and for greater bi-polar accuracy, the Model 520. Contact our custom design group for those special Digital requirements . . . we can provide you with any form factor.

at uni-polar prices!



Write for complete technical bulletin.

Datascan

DATASCAN, INC.

1111 Paulison Avenue, Clifton, N. J. 07013 • Telephone 201-478-2800

904

MODULES & SUBASSEMBLIES

Wideband op amp has 12-V output

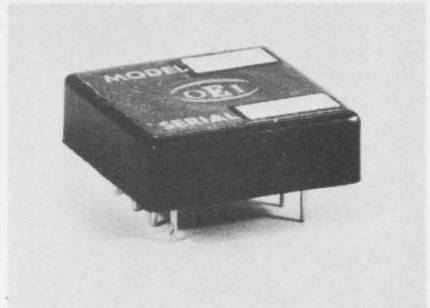

Optical Electronics Inc., P. O. Box 11140, Tucson, Ariz. Phone: (602) 624-8358. P&A: \$52; stock.

Containing an integral current booster, a new hybrid wideband operational amplifier provides an output drive of ± 12 V across a 50- Ω load. Packaged in a 0.32-in.³ module with a maximum height of 0.32 in., model 9412 features a typical open-loop gain of 51 dB and a typical slewing rate of ± 235 V/ μ s. Applications include line drivers, and wideband, video, audio and deflection amplifiers.

CIRCLE NO. 295

Analog multipliers are 0.1% accurate



Hybrid Systems Corp., 95 Terrace Hall Ave., Burlington, Mass. Phone: (617) 272-1522. P&A: \$325; stock to 2 wks.

Two new four-quadrant analog multipliers offer full-scale accuracies of better than 0.1%, including offset, gain and linearity. Without requiring external amplifiers or trimming resistors, both units can be used to multiply, divide, square and find square roots. Type 103 has a transfer function of $+XY/10$; type 104 provides $-XY/10$.

CIRCLE NO. 296

DIP-like amplifier holds down drift

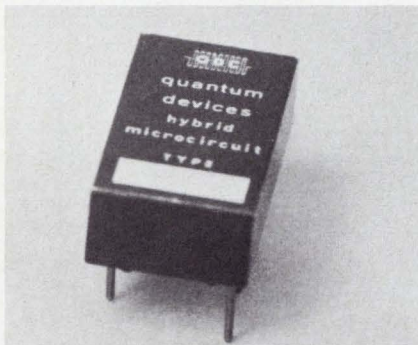

Quantum Devices Corp., 15 West Main St., Bergenfield, N.J. P&A: \$50; stock.

Contained in a miniature dual-in-line type of package, a new hybrid FET-input operational amplifier features an offset voltage drift of $5 \mu\text{V}/^\circ\text{C}$. Using active devices and passive thin-film resistor networks to produce an extremely stable and well balanced circuit, model 0A104 has its initial offset voltage internally trimmed to better than 1 mV.

CIRCLE NO. 297

Hybrid comparator switches 100 mA

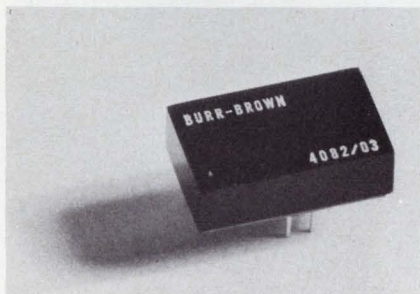

Burr-Brown Research Corp., International Airport Industrial Park, Tucson, Ariz. Phone: (602) 294-1431. P&A: \$19; stock to 4 wks.

Interconnecting an integrated circuit and a transistor switch, a new low-cost hybrid voltage comparator can switch output currents up to 100 mA (load voltages of up to +30 V) in $7 \mu\text{s}$ using a $\pm 15\text{-V}$ supply. Model 4082/03 has a dc gain of 100 dB to ensure an input signal resolution of ± 0.1 mV. Maximum input bias current is 700 nA, and maximum voltage drift is $\pm 30 \mu\text{V}/^\circ\text{C}$.

CIRCLE NO. 298

THE Gulton BROAD BAND FILTER

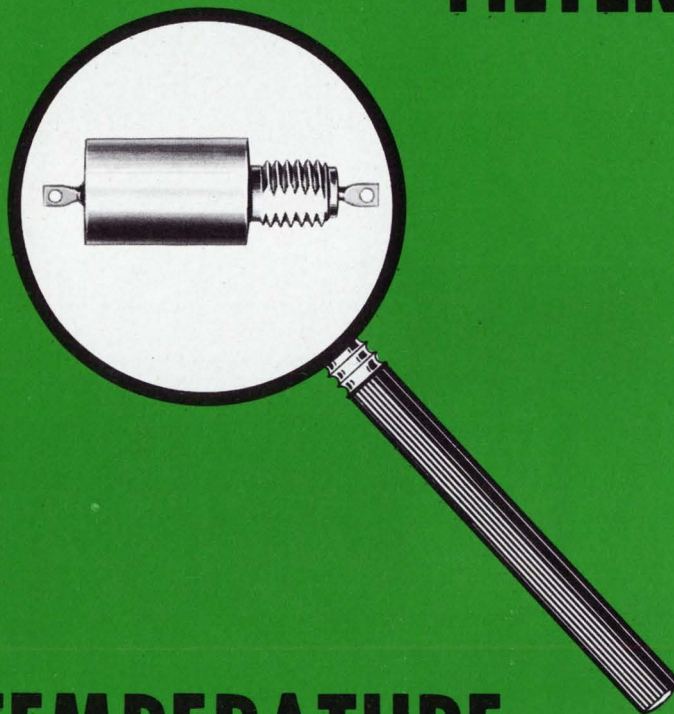

TEMPERATURE STABLE SERIES

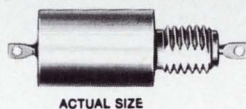

GUARANTEED MINIMUM ATTENUATION
-55°C TO +125°C

Another Gulton **TOTAL CAPABILITY** development for EMI protection is the Temperature Stable broad band filter series.

These filters offer guaranteed minimum attenuation from **-55°C to +125°C** with full load applied.

The Temperature Stable filters are available in L, Pi, and T networks with voltage ratings of 50VDC, 100VDC, 115VAC, 150VDC, and 185VDC.

You can find the answers to your EMI problems at Gulton. Write for literature to:

Gulton Industries, Inc.

Metuchen, New Jersey 08840 / Tel. (201) 548-2800 / TWX 710-998-0592

STABILITY & QUALITY

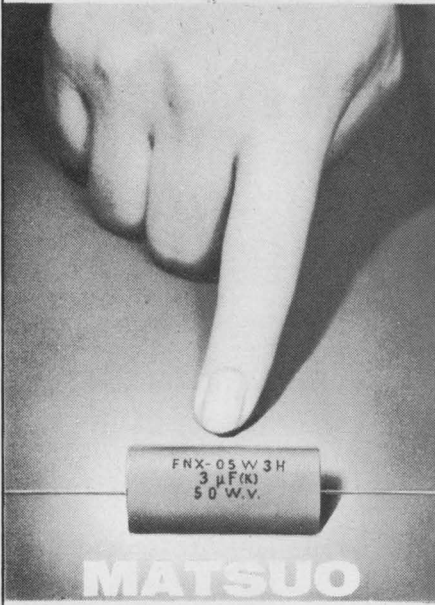

METALLIZED POLYESTER FILM CAPACITOR - "TYPE FNX-H"

Sub-miniature size and oval section ideal for space economy. Lightweight, self-healing and with high insulation resistance. Capacitance values up to 10 MFD. Outer wrap of tough polyester protects against moisture. Perfect in both transistorized and low voltage tube circuits and others where size and cost are paramount.

Specifications:

- Operating Temperature Range: -40°C to +85°C
- Standard Voltage Rating: 100, 200, 400, 600VDC
- Standard Capacitance Value: .1 MFD to 10 MFD.
- Standard Capacitance Tolerance: ±20% (available ±10%)

MATSUO'S other capacitors include:

Solid Tantalum Capacitors: MICROCAP

for hybrid ICs, Type TAX hermetically sealed in metallic case, Type TSX encased in metallic case and sealed with epoxy resin, Type TSL encased in metallic case and sealed with epoxy resin

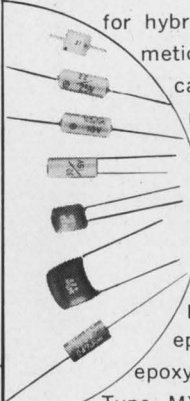

Polyester Film Capacitors: Type MFL epoxy dipped, Type MFK epoxy dipped, non inductive, Type MXT encased in plastic tube, non inductive.

For further information, please write to:

MATSUO ELECTRIC CO., LTD.

Head Office: 3-3, 3-chome, Sennari-cho, Toyonaka-shi, Osaka, Japan
 Cable: "NCCMATSUO" OSAKA Telex: 523-4164 OSA
 Tokyo Office: 7, 3-chome, Nishi-Gotanda, Shinagawa-ku, Tokyo

PACKAGING & MATERIALS

Brush-on primer degreases metals



3M Co., Adhesives, Coatings and Sealers Div., 3M Center, St. Paul, Minn.

In one operation, a new degreasing primer removes oil and grease from the surface of metal parts to prime them for bonding. Scotch-Weld 3911 is applied by brush, with the coating thickness varying according to the amount of oil on the metal surface. Approximately five minutes later, the dry powder remaining on the surface is easily brushed off, and the surface is fully cleaned and primed.

CIRCLE NO. 299

Metal-core PC board dissipates heat

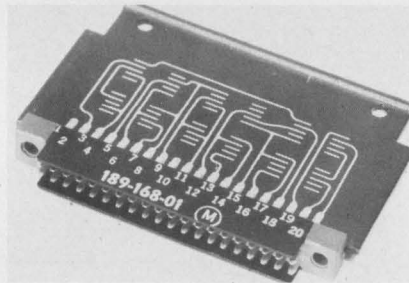

International Electronics Research Corp., Div. of Dynamics Corporation of America, 135 Magnolia, Burbank, Calif. Phone: (213) 849-2481.

A metal-core printed circuit board effectively dissipates heat generated in electronic equipment. The metal-core circuit board serves as a thermal dissipator and a good thermal path to remove heat from equipment through slides, connectors and cold walls. The new circuit board is constructed with an aluminum substrate, insulated and environmentally protected by an insulating coating system with the trade name Insultek 445.

CIRCLE NO. 321

Low-cost plastic solder presents 0.01 Ω-cm

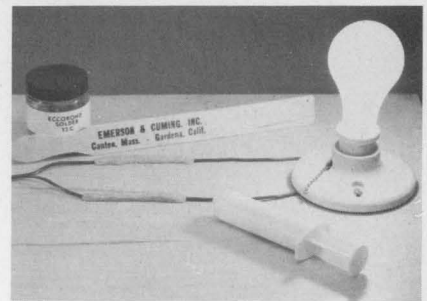

Emerson & Cuming, Inc., Canton, Mass. Phone: (617) 828-3300. P&A: \$14.50/lb; stock.

Effectively replacing hot solder while selling for one-fourth the cost of most silver-filled adhesive systems, a new electrically conductive plastic solder offers a volume resistivity of 0.01 ohm-cm. Ecco-bond 72-C, a two-part epoxy with a pot life of one hour, bonds to aluminum wire or plate. It cures in eight hours at room temperature or in 30 minutes at 200°F.

CIRCLE NO. 322

Silver-filled epoxy conducts like copper

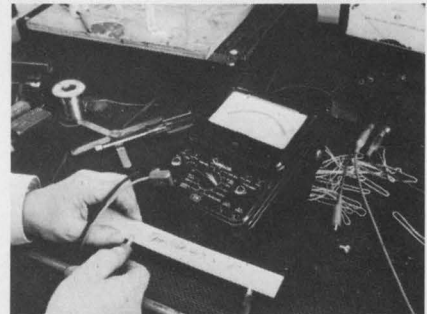

Epoxy Technology, Inc., 65 Grove St., Watertown, Mass. Price: \$17/kit.

With an electrical conductivity approaching that of pure copper wire, a new silver epoxy compound achieves a volume resistivity between 0.00005 and 0.00007 ohm-cm. Useful as an adhesive, ink, sealant, coating or for potting applications, Epo-Tek 417 is a 100% solid, soft thixotropic paste containing pure silver. Its curing schedule ranges from one-half hour at 150°C to four hours at 60°C, or up to three days at room temperature.

CIRCLE NO. 323



ACTUAL SIZE

**if you need
a custom
designed
CRT DISPLAY-
one of
our 3,110
variations
might do...**

spedcor
Lavoie
Analab
Benrus
INSTRUMENT
DIVISION

(And that's not including variations due to options!)

With the Benrus solid state CRT Display, you select the necessary panel height—choice of 3½", 5¼" and 7", as designed to exact modular dimensions Select your own amplifier characteristics in a range of bandwidths and sensitivities for either or both channels And a choice of 40 speed ranges in either "A" or "B" channel sweep Result? A custom-assembled, off-the-line, quality-manufactured unit to your own exacting requirements.

Request catalog 802 for complete details.

ALSO AVAILABLE WITH "BUILDING BLOCK" OPTIONS... the Benrus line of ultra-compact, solid state monitor oscilloscopes for panel installation. A wide range of amplifier, sweep and trigger plug-ins make economy without compromise possible.

Ideally suited for multiple installations because of their modest heat dissipation requirements, the small size, weight and cost of these scopes also makes them adaptable for use in lab, test and inspection... anywhere that these qualities are more important than great versatility.

spedcor electronics, inc.
Lavoie Analab Benrus Instrument Division
70-31 84TH ST., GLENDALE, NEW YORK 11227
212-894-8100

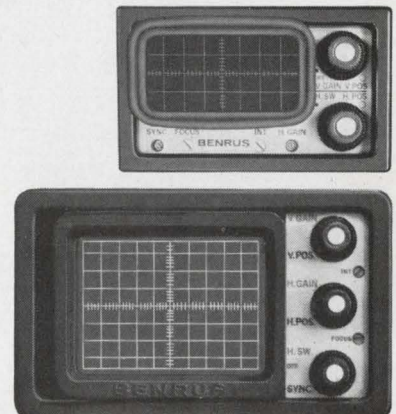

INFORMATION RETRIEVAL NUMBER 81

It takes a lot of savvy
to put this
together... **RIGHT!**

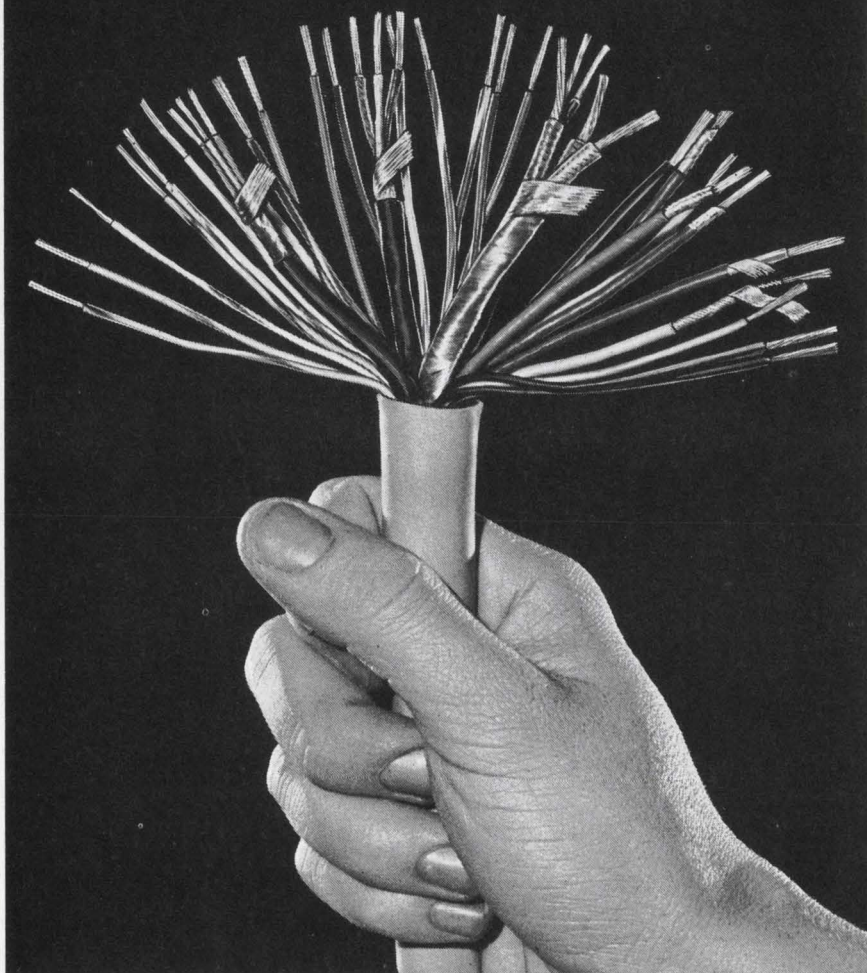

This exceptional multi-conductor cable was designed by Lenz technical staff to meet exacting requirements.

In the 60 years that Lenz has been making wires and cables, we have earned a reputation for high technical standards in the industry.

You are invited to take advantage of this experience by having your engineers contact Lenz with their cable problems.

Write for Catalog!



LENZ ELECTRIC MFG. CO.

1755 No. Western Ave., Chicago, Ill. 60647

In Business Since 1904

In Ind., Ky., Ohio, contact McFadden Sales, Inc., 150 E. Broad St.
Columbus, Ohio 43215, Phone: 614/221-3363

INFORMATION RETRIEVAL NUMBER 82

PACKAGING & MATERIALS

**Four cable ties
lock themselves**

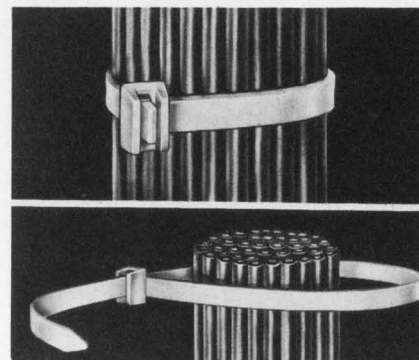

*Electrovert Inc., 86 Hartford Ave.,
Mount Vernon, N. Y. Phone: (914)
664-6090.*

Available in four sizes to fit all bundle diameters from 1/16 to 4-1/16 in., a new line of self-locking cable ties, when threaded, provide an irreversible non-slipping grip that holds even under conditions of severe vibration. Molded of tough virgin nylon, the new ties can be applied manually or with standard tools. Performance and design are in accordance with MIL-S-23190 and MS-17221.

CIRCLE NO. 325

**Pliable Teflon
packs and seals**

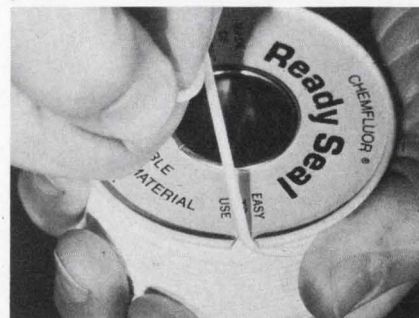

*Chemplast Inc., 150 Dey Rd.,
Wayne, N. J. Phone: (201) 696-
4700. Availability: stock.*

Packaged in a rugged metal container with a handy cut-off notch, a soft pliable gasket and packing material provides a fast, sure way to form a gasket or install a packing, regardless of the type of system or service conditions. Called Ready Seal, the material is a soft cordlike strand of Teflon TFE specially processed to make it highly compressive and self-forming.

CIRCLE NO. 334

Emi/rfi gaskets spiral to shield

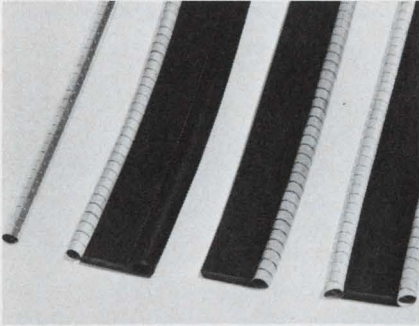

Scanbe Mfg. Corp., 1161 Monterey Pass Rd., Monterey Park, Calif. Phone: (213) 264-2300.

Made of thin stainless-steel stock wound in helical spring form, Spira emi/rfi gaskets minimize the length-to-width ratio of each conductive path. This provides a low-impedance path at all frequencies into the microwave region and, therefore, high shielding effectiveness. At 1 MHz, effectiveness against electrical fields is 115 dB and 68 dB against magnetic fields.

CIRCLE NO. 335

Plastic shielding shrinks to size

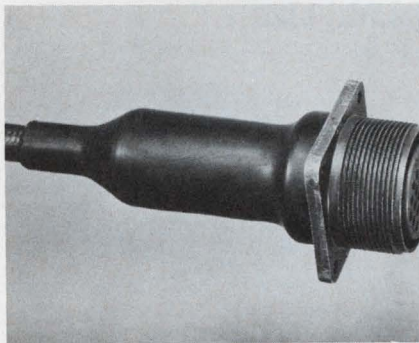

Chomerics, Inc., 85 Mystic St., Arlington, Mass. Phone: (617) 648-8650. Price: \$50/kit.

Available in tubing or boot form, a new conductive heat-shrinkable plastic simultaneously insulates and shields cables and connector terminations. Designated Cho-Shrink, the new material is polyvinylchloride, Teflon, polyolefin or Kynar plastic with a conductive coating on the inside surface that remains intact even after shrinking. Diameters up to 4 in. are available.

CIRCLE NO. 336



Simpson's NEW solid-state VOM with FET-Input

- **HIGH INPUT IMPEDANCE...**
11 Meg Ω DC 10 Meg Ω AC
- **PORTABLE..... battery operated**
- **7-INCH METER..... overload protected**

Simpson's new 313 gives you high input impedance for accurate testing of latest circuit designs . . . free of line cord connections. Over 300 hours operation on inexpensive batteries. And the new 313 is *stable*, which means positive, simplified zero and ohms adjustments. Protected FET-input handles large overloads. DC current ranges to 1000 mA. Sensitive Taut Band movement and 7-inch meter scale provide superior resolution down to 5 millivolts. Write today for complete specifications.

Complete with batteries, 3-way AC-DC-Ohms probe, and operator's manual **\$100.00**

GET "OFF-THE-SHELF" DELIVERY FROM YOUR LOCAL ELECTRONIC DISTRIBUTOR

Simpson

ELECTRIC COMPANY



DIVISION

5200 W. Kinzie Street, Chicago, Illinois 60644 • Phone (312) 379-1121

EXPORT DEPT.: 400 W. Madison Street, Chicago, Illinois 60606. Cable Simelco
IN CANADA: Bach-Simpson Ltd., London, Ontario • IN INDIA: Ruttonsha-Simpson Private Ltd., International House, Bombay-Agra Road, Vikhroli, Bombay

INFORMATION RETRIEVAL NUMBER 83

OPTIMIZE

your avionic cooling system
with AiResearch.

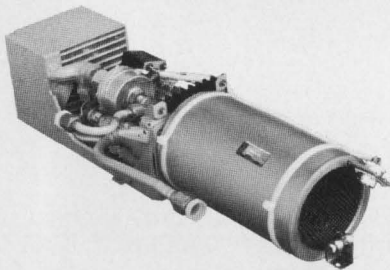

There are a lot of benefits when you start working with AiResearch on avionic cooling in the early design stages.

We can help you work out your thermal optimization studies, and then design a system that offers the maximum savings in power consumption, size, weight and time. Obviously, the total result will be another major step toward complete system economy and efficiency.

The system above cools the traveling wave tube of a radar transmitter. It provides 2800 watts of cooling with only 570 watts of power.

AiResearch capability includes over 30 years of experience and complete in-house component and system control.

For detailed specifications contact: AiResearch Manufacturing Company, 9851 Sepulveda Blvd., Los Angeles, Calif. 90009. Ph. (213) 776-1010 or (213) 670-0131.



AiResearch
Heat Transfer Systems
one of The Signal Companies

INFORMATION RETRIEVAL NUMBER 84

INSTRUMENTATION

Logic pulse indicator detects 50-ns widths



Automated Control Technology Inc., 3452 Kenneth Dr., Palo Alto, Calif. Phone: (415) 328-6080. P&A: \$45 to \$70; stock to 30 days.

Able to detect and indicate the presence of pulses as narrow as 50 ns, a new panel indicator can replace an oscilloscope in many trouble-shooting and spot-checking applications. When linked to the logic circuit under test, Logic Lite indicates repetition rates as fast as 10 MHz.

The unit triggers on for positive pulses and goes off for negative pulses. When identifying 50-ns pulses, it flashes on and off in 40-ms intervals. At low repetition rates, it flashes in synchronism with the input pulse train.

As the repetition rate increases, to 10 MHz, the indicator continues to flash rapidly but visibly at 25 pulses per second. It can display symmetrical or nonsymmetrical waveforms and is not sensitive to variations in pulse risetimes or falltimes.

Logic Lite contains flatpack ICs and is compatible with most DTL, TTL and RTL circuits. Its T-1-3/4 lamp is replaceable from the front. Current requirements are 50 mA with the lamp off and 300 mA with the lamp on.

Three panel-mounted models are available—the 0.8-3P, 1.8-5P and 5-12P with logic-level thresholds of 0.8, 1.8 and 5 V and supply requirements of 3, 5 and 12 V dc, respectively. Additional models with the same voltage combinations are available for PC-board mounting.

In June, the company expects to market a Logic Lite with a variable logic-level control.

CIRCLE NO. 337

Benchtop supplies use MSI chips

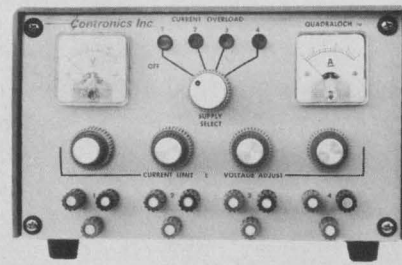

International Contronics Inc., 1038 W. Evelyn Ave., Sunnyvale, Calif. Phone: (408) 736-7620. Price: \$395.

Increasing power density via an MSI chip, series CPS 400-1 benchtop power supplies package four supplies in one-half rack width or eight supplies in one rack width. Key features include current overload indications, floating outputs, remote sensing and short-circuit protection. Outputs are adjustable in each section from 100 mV to 36 V; ripple and noise are less than 4 mV pk-pk under worst-case conditions.

CIRCLE NO. 338

Resistor box trims size

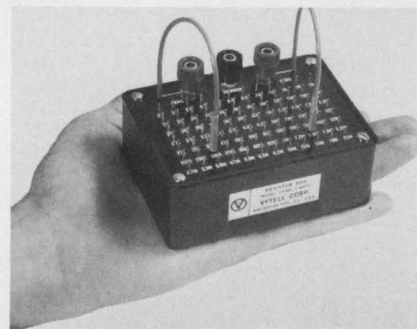

Vytell Corp., P.O. Box 92, Arlington Heights, Ill. Price: \$16.95.

Measuring 3 by 4 by 2-1/4 in., a new miniaturized resistor substitution box provides 84 standard resistance values in a package that is one-third the size of ordinary boxes. Called Mini-Box, the unit uses a push-on connector and a keyboard of resistor leads in place of a control knob switch for resistor selection. The resistors are 1-W, 10% units with values from 2.7 Ω to 22 M Ω .

CIRCLE NO. 339

SMALL WONDER

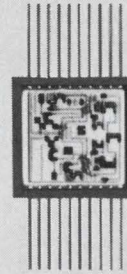

**That's what you call Columbia
custom hi-rel, thick-film hybrids
compared to other circuits.**

That's because they save, not only space and weight, but headaches, too. One reason is that they're more reliable than discrete circuitry. Another is that they consume less power.

Custom design means high performance and MIL-SPEC reliability. So, your concept works exactly the way it should. For as long as it should.

Through every step, from prototype to production to delivery, we take nothing for granted. The fact is, we meet or exceed MIL-Q-9858.

Our people, materials and equipment meet the highest standards. We test, check and counter-check. In short, we do everything to keep you from calling back, except for more.

And our unique production facilities make it easy to produce large quantities fast. What's more, if you need it, we'll help you solve development problems.

So, write for more information or call Hal Salzman at (516) 483-8200. Tell him your toughest circuit problem. Or your simplest. Small wonder if he can't solve it.



COLUMBIA COMPONENTS CORP.

A SUBSIDIARY OF COMPUTER INSTRUMENTS CORP.

60 MADISON AVENUE, HEMPSTEAD, NEW YORK 11550

(516) 483-8200 / TWX 510-222-4189

Ferrite Shielded Air Core Yoke C5380. Designed for high speed precision character displays (nanosecond writing speeds). Undesirable magnetic coupling and stray fields eliminated by unique shield design.



DESIGN DEVELOPMENT FROM *syntronic* THE YOKE SPECIALISTS

Syntronic engineers and manufactures the most extensive line of deflection yokes available . . . and continually develops new designs to satisfy the ever increasing requirements of the display industry. For large production or custom applications get the engineering control and production experience that only SYNTRONIC, the yoke specialists, can provide.

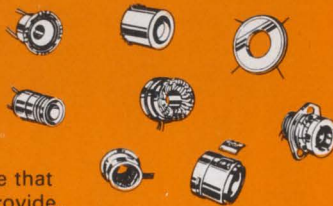

syntronic INSTRUMENTS, INC.
100 Industrial Rd., Addison, Ill. 60101
phone 312-543-6444

INFORMATION RETRIEVAL NUMBER 86

BUILD MDS "DATA-RECORDER QUALITY" INTO YOUR SYSTEMS

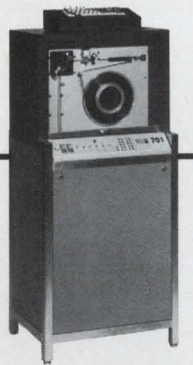

MDS BUFFERED
TAPE UNIT

Transcription . . . verification . . . all the advantages of magnetic tape . . . in the MDS 701 and 901 Buffered Tape Units. These units are buffered magnetic tape transports; each providing three modes of operation . . . Write, Read and Search.

MDS 701 . . . Handles data on 7-channel tape at 200 bpi.
MDS 901 . . . Handles data on 9-channel tape at 800 bpi.
Input and output communication between a parent machine and the magnetic tape is via a program controlled buffer. The controller is your own, designed to fit your application.

Easy integration with a system is made possible through the asynchronous bit parallel, character serial interface provided with the 701 and 901. And you get the high speed, solid state electronics, quiet operation and versatility that are engineered into all MDS Data-Recorders.

Ask for: Folder file on MDS 701/901
Buffered Tape Units
**FOR MORE — MEET YOUR MAN
FROM MDS**

MOHAWK **MS**
DATA SCIENCES CORPORATION
OEM MARKETING
122 E. Ridgewood Ave. • Paramus, N.J. 07652
Telephone 201/265-7333

Every MDS Office is an OEM Marketing Office
Digital Strip Printers • Buffered Tape Units
High-Speed and Low-Speed Line Printers
Card Punches and Readers

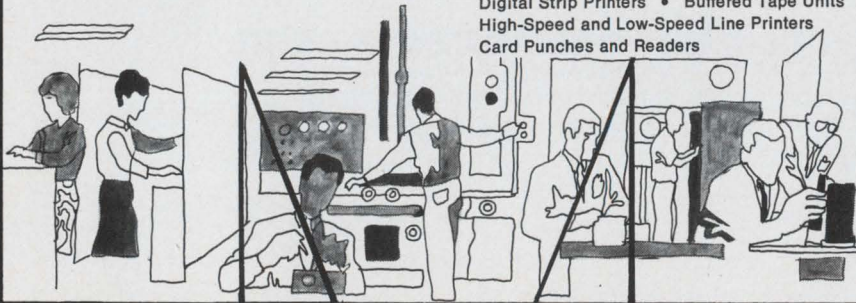

INFORMATION RETRIEVAL NUMBER 87

INSTRUMENTATION

Universal counter times at 500 MHz

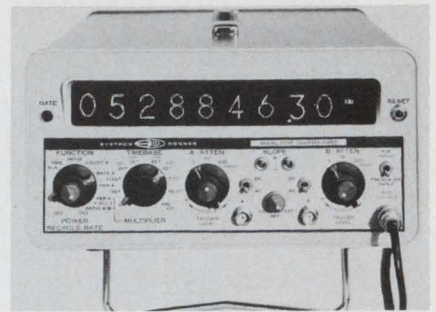

Systron-Donner Corp., 888 Galindo St., Concord, Calif. Phone: (415) 682-6161. P&A: \$2775; 30 days.

The first portable high-frequency counter (no plug-ins) to operate without gaps from dc to 500 MHz also includes a full set of universal counting, timing and time interval functions. The 500-MHz counting range of the model 7035 is achieved by combining a 125-MHz direct counting technique with a new 500-MHz automatic prescaler. Answers appear directly with automatic decimal point and units annunciator.

CIRCLE NO. 340

IC array tester challenges scopes

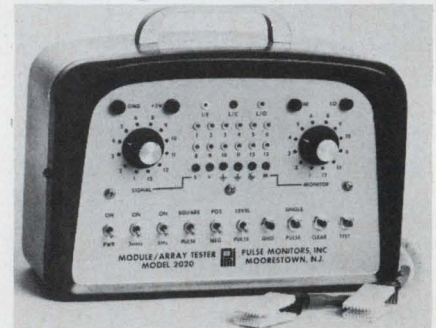

Pulse Monitors, Inc., sub. of Tele-Sciences, Inc., 351 New Albany Rd., Moorestown, N. J. Phone: (609) 234-0556. P&A: \$375; 45 days.

Able to replace expensive oscilloscopes in many instances, a new instrument can performance-test modules and arrays that use dual in-line circuits. Model 2020 module-and-array tester includes high- and low-frequency square-wave generators, a 100-ns pulse generator and pulse detection circuits. It operates directly from the 5-V power leads of the IC under test.

CIRCLE NO. 341

Decade prescaler extends counter range

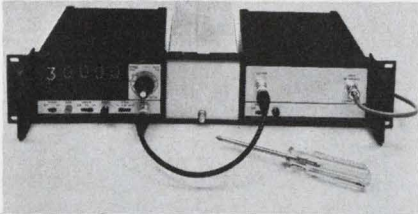

Fairchild Instrumentation, 974 E. Arques Ave., Sunnyvale, Calif. Phone: (408) 735-5211. P&A: \$650; stock.

The model 8051 decade prescaler increases the measurement range of the Fairchild model 8050 to 300 MHz and is compatible with other counters as well. The 8050/8051 system represents an increased user value in performance, cost, and size. The prescaler has an input frequency range of 30 to 300 MHz; input is through a 50- Ω , ac-coupled, front-panel BNC connector. The unit offers 100-mV sensitivity and accepts a 1 V maximum input with overload protection up to 5 V.

CIRCLE NO. 342

Function generator spans 5 MHz



Hewlett-Packard Co., 1501 Page Mill Rd., Palo Alto, Calif. Phone: (415) 326-7000. P&A: \$575; June.

A new function generator, model 3310A, generates waveforms at repetition rates from 0.0005 Hz to 5 MHz, covering the sub-audio, audio, ultrasonic, and video ranges. It also generates sinewaves, squarewaves, triangles, ramps, and pulses. Voltage programmable over a 50-to-1 range when the dial is set at either extreme, the instrument allows control of output amplitudes over a >60-dB range, from 15 V pk-pk maximum into 50 Ω down to 15 mV.

CIRCLE NO. 343

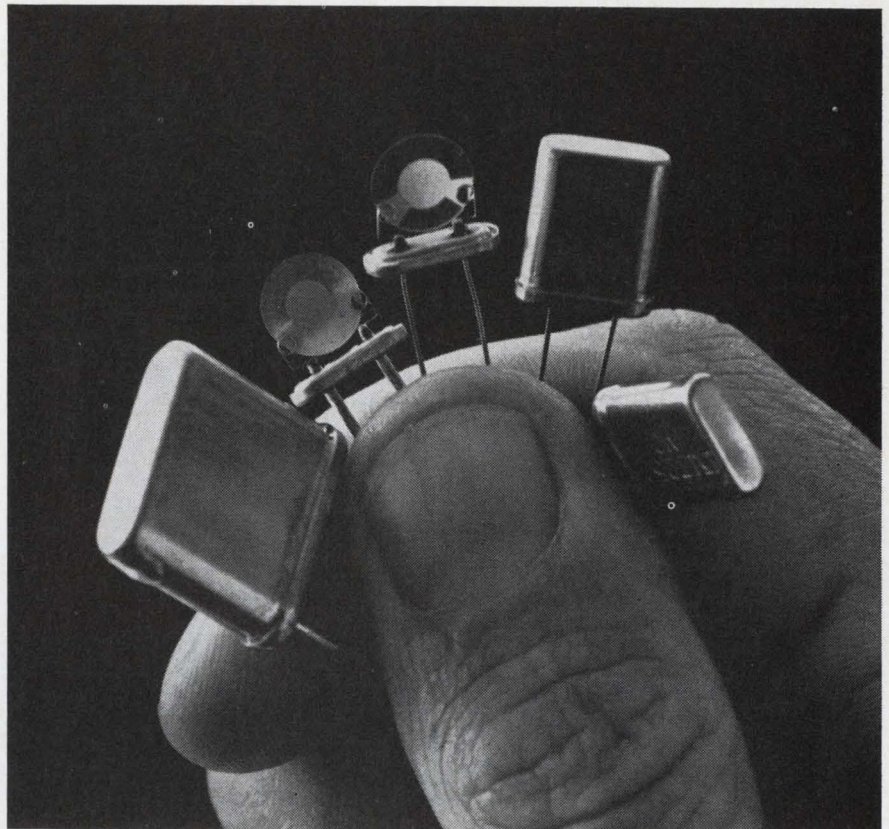

How are Sherold crystals a cut above the competition?

With frequency.

The right frequency. Consistently and with the low-cost quantity production that comes from top-quality crystal technology. Whether you order a few hundred or a few hundred thousand crystals from Sherold, you know you'll get exactly what you ordered — fast and accurate right down to the last MIL spec on the last crystal. We manufacture a variety of crystals from 4 kHz to 175 megaHz in numerous packages, as well as crystal filters and discriminators. In prototypes, short orders and long runs. In addition, Sherold has several plants geographically located to give you specialized local crystal technology assistance. Each has in-house facilities to meet and beat high shock and vibration MIL specs. Whether you're looking for a high-volume, off-the-shelf crystal or a prototype design, tell us about it. We'll give you a quote. With speed. Write Sherold Crystal Products Group, Tyco Laboratories, Inc., 1510 McGee Trafficway, Kansas City, Mo. 64108. Or phone (816) 842-9792. TWX 910-771-2181.

TYCO

INFORMATION RETRIEVAL NUMBER 88



PUTTING CURRENT-LIMITER DIODES TO WORK

PROBLEM: How to decrease common-mode gain without increasing supply voltage V_{BB} ?

SOLUTION: Replace R_s with current limiter diode CL4710.

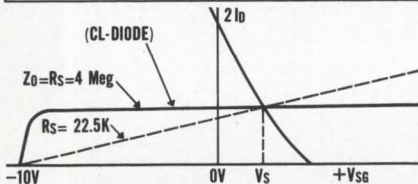
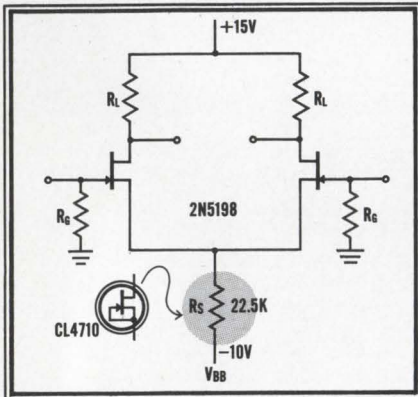

In a balanced circuit the common-mode gain is decreased in approximate proportion to the ratio of source resistances. By substituting the Siliconix CL4710 for the 22.5K source resistance, R_s is raised to 4 megohms. Common-mode gain is decreased by a factor of over 100. **For further information and immediate applications assistance, call the number below. Ask for extension 19.**

Siliconix
incorporated

1140 W. Evelyn Ave. • Sunnyvale, CA 94086
Phone (408) 245-1000 • TWX: 910-339-9216

*Applications Power: An ever-increasing product line, an in-depth applications team waiting to serve you!

PRODUCTION

Marking pen labels ceramics

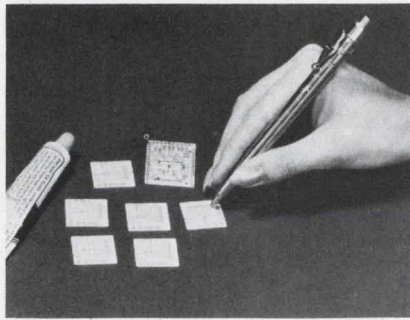

Starnetics Co., 10639 Riverside Dr., N. Hollywood, Calif. Phone: (213) 769-8437. P&A: \$11.75/kit; stock.

Writing with an ink that withstands 2600°F, a new marking pen can be used to label ceramic or glass substrates in the hybrid electronics industry. Prior to firing, the ink can be removed only with solvents; after exposure to print and fire temperatures, the ink is permanently fused into the substrate. Plastics, metals and paper are also compatible with this new writing instrument.

CIRCLE NO. 344

Vibratory feeder speeds production

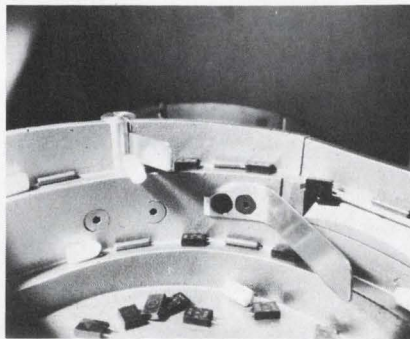

Vimac, Inc., 8853 East Ave., Mentor, Ohio.

An automatic vibratory feeding system for handling, sorting and orienting small parts and components at predetermined feed rates reduces parts-handling costs to a minimum by completely automating production cycles to maximum speeds. Capable of handling a wide range of parts, the unit has multiple tracks that can sort parts into bins, or deliver them automatically to further production operations.

CIRCLE NO. 345

Fluidic detector monitors parts



Corning Glass Works, Fluidic Products Dept., Corning, N. Y. Phone: (607) 962-4444. P&A: \$205; 6 wks.

A universal fluidic detector can be used to determine the parts present or parts absent in a variety of manufacturing processes. Measuring only 6 by 8 by 3.5 in., the system consists of manifold-mounted fluidic industrial control modules and pressure-to-electric interfacing devices with electrical output equivalent to one horsepower at 240 V ac.

CIRCLE NO. 346

Hand desoldering unit pumps unwanted solder



Scientific Industries, Inc., 55 Madison Ave., Hempstead, N. Y. P&A: \$89.50; stock.

Allowing rapid correction of printed circuit and microcircuit work, a new production desolderer draws unwanted solder into an asbestos trap with its continuous-duty diaphragm pump. De-Soldermaster 67-1 is a self-contained unit that can be operated with one hand, plugs into any wall outlet and has interchangeable tips. It permits multicontact desoldering without damage to adjacent components or circuit board.

CIRCLE NO. 347

100% MIL CUSTOM POWER SUPPLIES DIRECT FROM NUCOR

NUCOR offers a first class custom MIL POWER SUPPLY CAPABILITY. We will meet to the LETTER all MIL specifications required by your contract. Contact NUCOR and you will find:

- An outstanding MIL quality control system.
- A complete software capability including reliability and maintainability.
- A hardware capability including single, dual and multi output supplies.
- Proven circuit designs and a full packaging capability.
- A stockroom full of Q.P.L. MIL parts and sub assemblies.
- Competitive price and delivery due to off the shelf sub assemblies.
- A management and staff who really understand the implications of a MIL job.
- An open invitation to your vendor survey team.

Do not be confused by the phrases like, "MIL TYPE" or "DESIGN TO MEET MIL".

Order from NUCOR and we will deliver a 100% MIL POWER SUPPLY.



For additional information write or call
NUCLEAR CORPORATION OF AMERICA
2 Richwood Place, Denville, N. J. 07834 (201) 627-4200

INFORMATION RETRIEVAL NUMBER 89

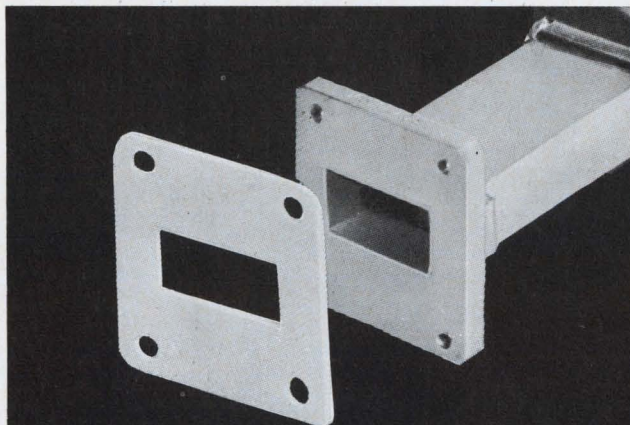

EMI/RFI SHIELDING GASKET CONDUCTIVE SILVER/SILICONE

CONSIL ■ Highly conductive, low volume resistivity; .001 ohm-cm³ ■ All pure silver-silicone rubber compound; 30 to 80 durometer ■ Operating temp. -65°F. to +450°F ■ Available in sheets, molded components, cut gaskets and connector gaskets ■ Write for data #850, and FREE sample.

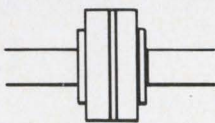

CONSIL — Waveguide flange gaskets or "O" rings.



TECHNICAL WIRE PRODUCTS, INC.

East Division • 129 Dermody St., Cranford, N. J. 07016 (201) 272-5500
West Division • 427 Olive St., Santa Barbara, Calif. 93101 (805) 963-1867

INFORMATION RETRIEVAL NUMBER 90

ELECTRONIC DESIGN 11, May 24, 1969

Oak Versatility

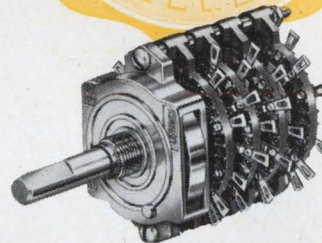

Now! One new exclusive switch replaces seven

You can easily eliminate tedious design engineering problems—just use versatile Multidex[®] switches. They're available in thousands of variations...are smaller than the switches they replace...yet provide more contacts (up to 36) at no additional cost. Crisp Detenting... the patented Unidex™ detent offers uniform "feel" for long life in choices from 10° to 36° throw. Meets MIL-S-3786, SR32 requirements.

Superb Insulation... molded diallyl phthalate meets MIL-M-14 requirements and guarantees electrical continuity between mounting and housing. Glass-alkyd insulation available on request. Special contacts and clips... Oak-pioneered, double-wiping, self-cleaning contacts assure trouble-free operation. Special AF clips with large windows speed wiring.

What's more, Multidex switches meet commercial and military environmental requirements. Special options available on request. For full details, write today for Bulletin SP-324.

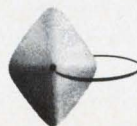

OAK MANUFACTURING CO.

A Division of OAK ELECTRO/NETICS CORP.
Crystal Lake, Illinois 60014
PHONE: 815-459-5000 TWX: 910-634-3353

INFORMATION RETRIEVAL NUMBER 91

LOW COST INTERCHANGEABLE THERMISTORS

from
FENWAL ELECTRONICS, INC.

- **LOW COST** — lowest priced interchangeable thermistors on the market
- **HIGH PRECISION AND ACCURACY** — meets standard R-T Curve from unit to unit to $\pm 0.2^\circ\text{C}$ over a standard range of temperatures from 0°C to 70°C at 25°C
- **STANDARD UNITS** — 3K, 5K, 10K, 30K, 50K, and 100K ohm resistance at 25°C
- **CUSTOMIZED SERVICE** — 1K through 100K ohm resistance to a temperature tolerance of $\pm 0.1^\circ\text{C}$
- **HIGH STABILITY**
- **SMALL SIZE**
- **HIGH RELIABILITY** — meets requirements of MIL-T-23648

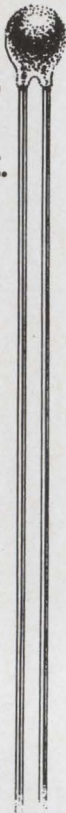

Evaluation Samples

Epoxy tape sample

Impregnated with a B-stage epoxy resin adhesive, a glass fabric tape changes in color from yellow to red when cured. Available in two-inch widths, the material is tacky and will stick to most surfaces. Leal-Lok CC tape has a bond strength of 3000 to 4000 lb/in.² in lap shear. At a temperature of 500°F , cure is effected in under one minute. The flame-retardant material will also withstand exposure to many solvents including methylene chloride, and many acids and bases. The Leal Co.

CIRCLE NO. 348

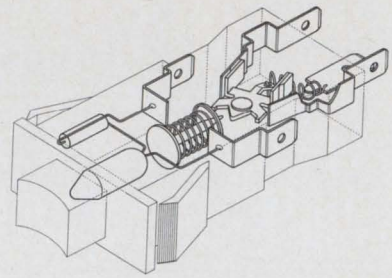

Lighted pushbuttons

The 1820 series lighted pushbutton switch is rated for 2- to 9-A service at 125 or 250 V ac. It is available with spst or spdt action and has square, rectangular or round buttons with hot-stamped legends. A built-in diffusing screen in the button produces a glow light without an objectionable hot spot from the optional neon or incandescent bulb. The 3/16-in. quick-connect space terminals can be used as solder lugs. Units are replaceable and cost about one-quarter that of comparable duty switches. A sample switch is available on request. Molex Products Co.

CIRCLE NO. 350

Uni-Curve



... thermistors are high quality, low cost R-T matched interchangeable thermistors. They offer additional cost savings by eliminating the need for individual R-T calibration, as well as standardization of circuit components, and simplify design and replacement problems.

They are particularly well suited for use in applications such as temperature measurement, indication and control, also for compensation of ambient temperature effects on copper coils, transistors, integrated circuits and other semiconductor devices.

Fenwal Electronics, Inc. high volume UNI-CURVE manufacturing capability provides availability of interchangeable thermistors at low cost with the quality and ruggedness to meet the rigid design requirements of MIL-T-23648.

For more
Informative Data
ask for
Uni-Curve Catalog L-6

Write or Call us at

FENWAL ELECTRONICS, INC.
Division of Walter Kidde & Company, Inc.
63 Fountain Street
Framingham, Mass. 01701
Tele: (617) 872-8841



INFORMATION RETRIEVAL NUMBER 92

Self-adhesive labels

Meeting industrial label users' needs for an economical, volume-produced protective coated label, a new process for imparting high brilliance to self-adhesive label face materials has been developed. High-gloss LusterGuard is a thin, durable plastic-film laminate that provides practical protection to the printed label surface. It is ideal for inexpensive applications that require some abrasion or solvent resistance. These self-adhesive labels are recommended when greater durability and abrasion resistance are required than can be obtained with ordinary varnish. The plastic laminate adds two mils to over-all label thickness. Test and working samples of LusterGuard available. Avery Label Co.

CIRCLE NO. 349



High-temp molybdenum

Remaining ductile after exposure to temperatures from 1500 to 2000°C , high-temperature molybdenum provides the same ease of fabrication as regular molybdenum. The new material is available in cold-rolled bright-finished sheet, ribbon and foil in thicknesses from 0.008 to 0.04 in. and in wire and rod from 0.01 to 0.28 in. in diameter. Samples of both high-temperature and regular molybdenum are available for testing and evaluation. Norton Co., Metals Div.

CIRCLE NO. 351

We don't know who'll design it. But we know where he can get the batteries.

At the nearest Burgess Distributor. They're probably somewhere in his stock of batteries.

One's bound to be right for the electric spaghetti windlass. And one's exactly what you need for whatever you're designing. Another thing. Whether it's a standard or special, your Burgess Battery will be power-fresh. All distributor inventories are checked, rotated, and filled-in according to a systematic schedule.

So the battery you get comes on strong . . . and stays that way.

When you need batteries, check with your Burgess Distributor. He's a great source of power.

And when you need technical information, give us a call. Burgess has a library filled with the latest, most complete engineering data and technical battery material in the business.

Meanwhile, send for our new engineering manual and do a little window shopping. It's got comprehensive listings of all batteries available through Burgess. Clevite Corporation, Burgess Battery Division, Freeport, Illinois 61032.

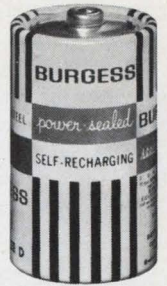

CLEVITE BURGESS

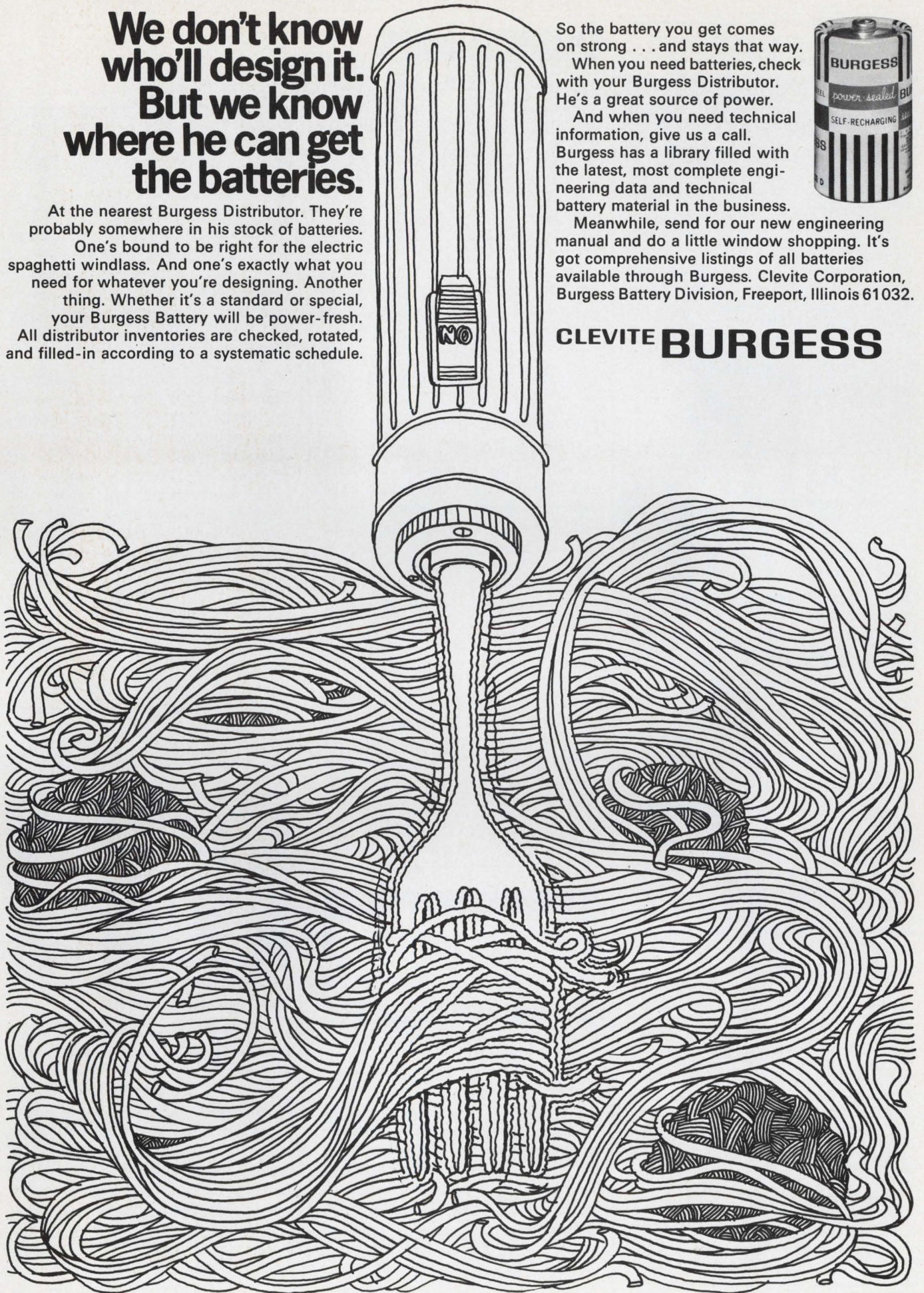

WORKHORSE!

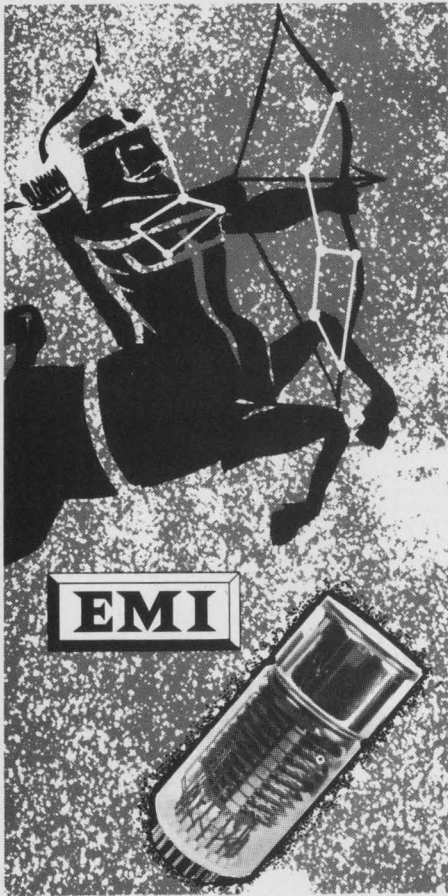

EMI

TYPE 9750

Nothing fancy, and not expensive. Just a good old 10 stage photo-multiplier but: It has a superb alkali cathode with excellent collection efficiency (which is fundamental for good S/N ratio), highly stable CsSb dynodes which provide a gain of 10^6 at just over 1,000 volts, and a dark current of 10^{-10} A. at that voltage (50 A/L).

As usual EMI has provided a number of variations: 9750QB with a spectroil window for UV and low level counting applications, (liquid scintillation) 9750B with Pyrex window for visible applications, and finally 9750KB for those who prefer the B-14A overcapped base. In the "K" configuration, it is directly interchangeable with our 9656KB or a number of competitive types.

The 9750 with its high quantum efficiency and low dark current gives excellent resolution for low energy gamma rays. When used with a thin two inch sodium iodide crystal with a beryllium window, the resolution for Fe^{55} is of the order of 40%.

Flying spot scanners, photometers, thermoluminescent dosimeters, low level scintillation counting are all applications for which the 9750 is highly suitable. Detailed specifications on request from:

Whittaker
CORPORATION
GENCOM DIVISION

80 Express Street • Plainview, N. Y. 11803
516 - 433-5900

Design Aids

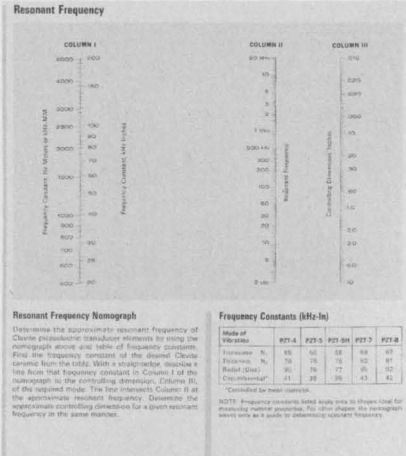

Piezoelectric nomogram

Useful for finding resonant frequencies when frequency constants and controlling dimensions are known, a three-scale nomogram is included with a design manual on the applications of piezoelectric devices. The handbook describes what materials are best suited for specific applications, and a special table lists ceramic properties, definitions and MKS units. Also included are two charts: one on the basic actions of ceramics and another on the typical electromechanical properties of a broad line of ceramics. Complete nomenclature for a standard line of tubes and discs is provided. Clevite Corp., Piezoelectric Division.

CIRCLE NO. 352

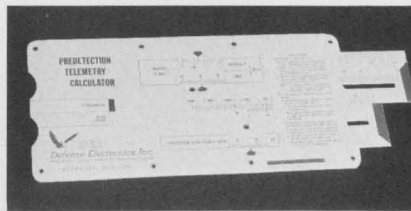

SNR calculator

Providing fast answers for finding signal-to-noise ratios (SNR) for a given rf input, a predetection telemetry calculator can also be used to determine equivalent noise input for a given system. In addition, when input level and predetection signal-to-noise ratio are known, the calculator can find the system noise figure. Defense Electronics, Inc.

CIRCLE NO. 353

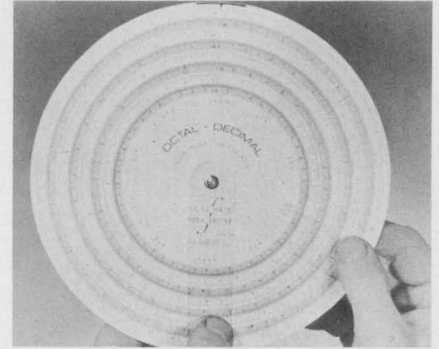

Octal calculator

A new circular slide rule has been designed for octal-decimal calculations. Those engaged in computer-program debugging, programmer training, and other activities are offered a handy computer programming aid with real time-saving advantages. With this low-cost hand calculator, core dump analysis becomes greatly simplified. The 8-in. calculator can be used to perform both conversions and arithmetic operations such as addition, subtraction, multiplication, division, squares and square roots, logarithms, exponentiation, etc. Operation is performed directly in octal or decimal. Science Spectrum, Inc.

CIRCLE NO. 354

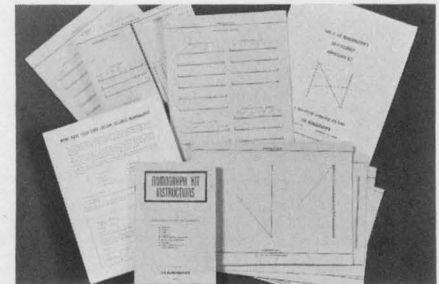

Nomography kit

Tedious technical problems of a time-consuming nature can often be solved rapidly with a nomogram. This method is particularly advantageous when the same calculation must be performed routinely. A kit is now available that makes the preparation of custom nomograms a simple task even for one inexperienced in nomography. The kit includes basic forms, scales, and concise step-by-step instructions. The Nomographer.

CIRCLE NO. 355

TDM SERIES POWER SUPPLY MODULES

BUILT-IN FEATURES...NOT EXTRA-COST OPTIONS

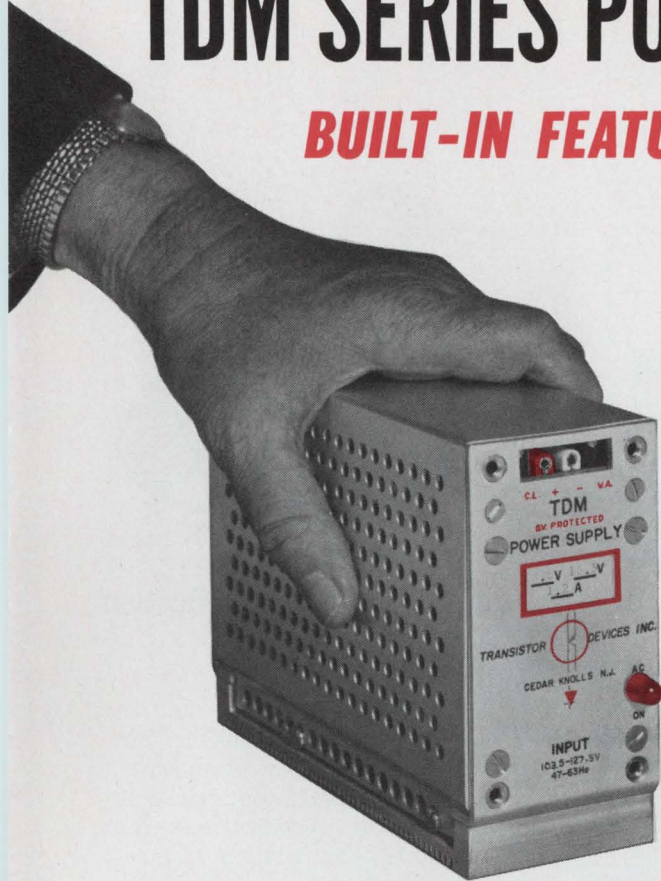

- Overvoltage Crowbar Protection
- Front Panel Test Points
- Front Panel Indicator Lamp
- Front Panel Mounting Provisions
- Multiple Units may be mounted on common 5 1/4" Front Panel
- Chassis Mounting Provisions
- Front Panel Voltage Adjust
- Front Panel Current Limit Adjust
- Military or Computer Grade Components and Workmanship
- Remote Sensing
- Polarity Floating

SPECIFICATIONS

- Input: 103.5 - 127.5 V, 47-63 Hz
- Output Current as selected
- Output Adjustment Range as selected
- Wide Range Adjustment optional (zero to rated voltage)
- Regulation, Line: .01% + 5 MV
- Regulation, Load: .01% + 5 MV
- Ripple: .001% + 200 μ V RMS
- Transient Response 50 usec max. for 1/2 load or 3A whichever is less.
- Temperature Coefficient .01% ° C
- Ambient Temperature Range: -20 to +55° C at full rated current. Derate by .5 for 71° C operation.

ALL TDM SERIES UNITS ARE 4 7/8" IN HEIGHT AND 7 1/2" IN DEPTH

DC OUTPUT VOLTAGE	OVERVOLTAGE MAXIMUM	CASE "A" MAX. AMPS.	CASE "B" MAX. AMPS.	CASE "C" MAX. AMPS.	CASE "D" MAX. AMPS.	CASE "E" MAX. AMPS.	CASE "F" MAX. AMPS.
TDM-3.5-4.5	6	2.8	5	9	12	17	30
TDM-4.5-5.5	7	2.8	5	9	12	17	30
TDM-5.5-8.5	10	1.7	5		10		17
TDM-8.5-11.5	13	1.7	5		10		17
TDM-11.5-13.5	15	1.2	3.5		7		12
TDM-13.5-15.5	18	1.2	3.5		7		12
TDM-15.5-18.5	21	.9	3		6		10
TDM-18.5-22.5	25	.9	3		6		10
TDM-22.5-26.5	30	.7	2		4		7
TDM-26.5-30.5	35	.7	2		4		7
WIDTH		2 1/2"	3 1/2"	5 1/4"	7"	8 1/2"	13"
PRICE		\$109.00	\$135.00	\$150.00	\$185.00	\$235.00	\$315.00
WEIGHT IN POUNDS		4 1/2	7	9	11	13	25

WHEN DOES 1 + 1 + 1 = 1?

When 3 Standard Power Supplies are combined as 1 Special.

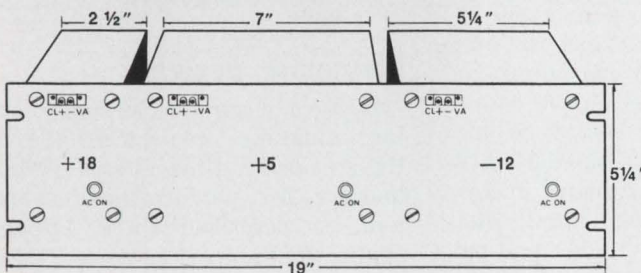

HOW TO PLAN YOUR SPECIAL MULTIPLE OUTPUT POWER SUPPLIES:

The TDM Series of Modules may be directly mounted onto a 5 1/4" front panel by means of four #10 screws. Clearance holes should be cut in the front panel for test points, voltage adjust, current limit adjust, and indicator lamp. Related Power Supply Modules may be mounted side by side (a minimum of 1/2" spacing should be left between modules for ventilation). The utilization equipment may also be mounted on a common front panel with the power supply. This permits the rapid and professional fabrication of special test and measuring equipment, displays, etc., to custom specifications at minimum cost with minimum design and engineering time.

Transistor Devices Inc.

85 HORSEHILL ROAD, CEDAR KNOLLS, N. J. 07927 • (201) 267-1900

INFORMATION RETRIEVAL NUMBER 95

Application Notes

Synchronizer technique

A new eight-page applications guide entitled "Maintaining a Fixed Frequency Separation Between Two Microwave Sources" describes the latest techniques using advanced sweep-lock synchronizers, as well as techniques using conventional discrete frequency synchronizers for sweep locking. With these methods, two signals can be swept from 0.07 to 15 GHz while maintaining a 10^{-6} difference frequency stability. Such techniques should be of particular interest to engineers working with and developing ECM surveillance receivers and swept attenuation measurements. Sage Laboratories, Inc.

CIRCLE NO. 356

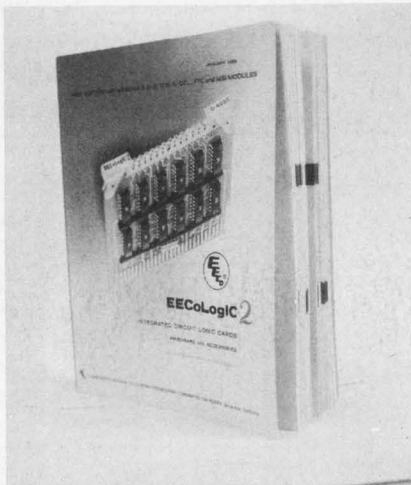

Logic-card manual

A new 266-page catalog and applications manual on integrated circuit logic cards includes 41 DTL types, 18 TTL types, 11 ADC-DAC analog-type modules—all with the advantages of test points, locking/extracting handles, laminated power buses on cards and in hardware, and automatic machine wiring capability. Also included is a fully illustrated 84-page digital and analog applications section. Electronic Engineering Co. of California, Components Div.

CIRCLE NO. 357



Control handbook

Aimed at anyone who specifies, designs, manufactures, or uses electronic or mechanical logic for instrumentation and control, a comprehensive handbook contains useful information on the latest techniques and products available for implementing solid-state electronic control systems. The handbook also includes designs for four kinds of sequencers, digital comparators, thumbwheel switch multiplexers, annunciators, shaft angle pickup logic, and memories for preset codes or limits. Digital Equipment Corp.

CIRCLE NO. 358

Noise susceptibility

A six-page application note covers the subject of noise-susceptibility testing. Military and commercial specifications frequently recognize the problem of high-voltage pulses reflected into the power line by interconnected equipment. Operation of many types of electronic equipment may be impaired by fast risetime pulses, or spikes, superimposed on the power line. The ability to test electronic equipment for noise susceptibility is becoming increasingly important, due to greater circuit and system complexity and greater susceptibility to malfunction or damage of solid-state circuitry as compared to vacuum-type circuitry. Velonex.

CIRCLE NO. 359

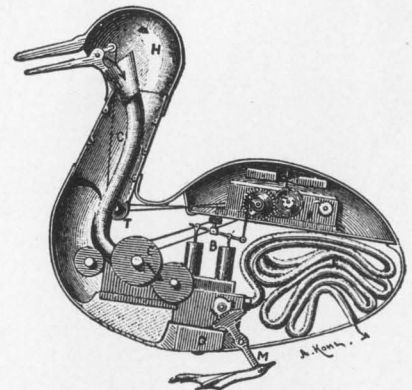

"write the entire specification around one sample..."

Relay hints

Written tongue-in-cheek, but loaded with relay application hints, a new booklet offers an insight to improved relay specifications and usage. Relay application factors such as sensitivity, contact configurations and ratings, environmental conditions, mounting methods, etc., are all considered. Ohmite Mfg. Co.

CIRCLE NO. 360

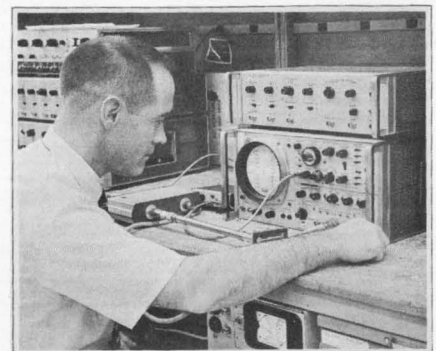

HEWLETT hp PACKARD

Connector design

How to design cable connectors for minimum impedance discontinuity, using time-domain reflectometry for performance evaluation, is described in a 17-page application note. The note traces development of a connector, intended for extremely fast digital pulse transmission, from initial conception to final product design. Hew-

CIRCLE NO. 361

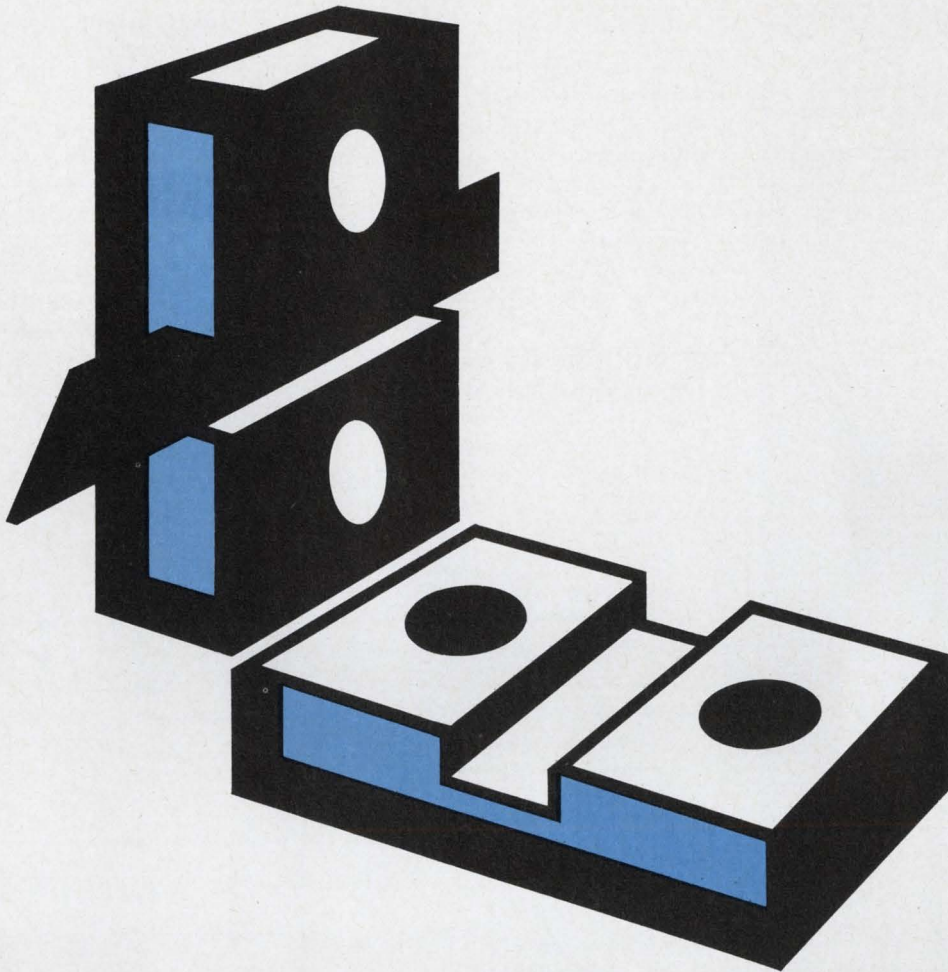

Kingpin

When it comes to controlling and conditioning signals in microwave and UHF systems, the HP Stripline PIN diode is far superior to glass and double-stud ceramic packages. Stripline techniques have the familiar advantages of small size, low weight and low cost, besides fewer parasitics and wider frequency range.

Hybrid integrated, this skinny diode has 20 dB isolation with only 0.5 dB insertion loss from 0.5 to 12.4 GHz—without additional matching structures or other compensating components. As usual, the exact amount of attenuation is controlled by the bias current. Without bias, or with reverse bias, it appears as just another part of the 50-ohm transmission line.

You can use this new PIN diode to limit, attenuate or modulate microwave power up to 18 GHz, at a price of \$25 each in small quantities. Ask your HP field engineer for detailed specs and quantity price quotations on the HP 5082-3040. Or write Hewlett-Packard, Palo Alto, Calif. 94304; Europe: 1217 Meyrin-Geneva, Switzerland.

HEWLETT  PACKARD

SOLID STATE DEVICES

INFORMATION RETRIEVAL NUMBER 96

01817A

Give Us a Requirement to Build to

Broad Frequency Response?



AMF VIDEO PREAMPLIFIER
 • f_1 .1 Hz thru f_2 25 MHz

Ultra Low Noise?

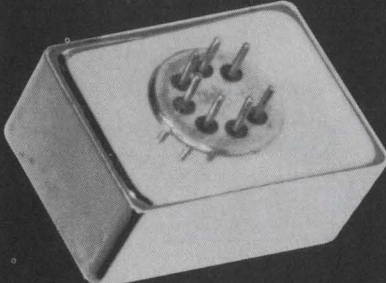

AMF SOLID STATE MODULAR PREAMPLIFIER
 • -165 dbV per cycle

... tailor an AMF Cybertran Preamplifier to fill your needs.

Cybertrans fulfill your needs whether they be ultra-low noise, subsonic requirements or extreme broadband video specifications. The flexibility of our "off-the-shelf" preamplifiers enables AMF to satisfy a wide range of special or standard needs... we call it Cybertran Technology. This new expertise makes it possible for you to specify your preamplifier requirements and have AMF ship it to you. Write or call Jim Campman, Applied Cybernetics Products, AMF Alexandria Division, 1025 North Royal Street, Alexandria, Virginia 22314 Phone (703) 548-7221. TWX 703-931-4209. Representatives in major cities of U.S.A.



INFORMATION RETRIEVAL NUMBER 97

APPLICATION NOTES

Tungsten wire

A 12-page brochure describes various types of tungsten wire and their applications. This high-temperature wire, made originally as a filament for lamps, now finds hundreds of other uses in industry. The brochure provides data on seven major types. Areas of application, information on tolerances, quality control and rating methods of this wire are covered. A guide for ordering the wire is also provided. General Electric Lamp Metals and Components Dept.

CIRCLE NO. 362

Delay-line handbook

A complete engineering handbook features lumped-constant, distributed-constant, and variable delay lines. Included in this comprehensive volume are definitions of the various characteristics of electromagnetic delay lines and engineering information on how delay lines should be specified. Designs and standard industry test circuitry, as well as complete specifications for six standard types of delay lines, are included. RCL Electronics, Inc.

CIRCLE NO. 363

BREAKPOINTS	SLOPES
$V_1 = +15 \frac{R_4}{R_5}$	$S_1 = + \frac{R_0}{R_1}$
$V_2 = +15 \frac{R_4}{R_6}$	$S_2 = + \frac{R_0}{R_1} + \frac{R_0}{R_2}$
$V_3 = +15 \frac{R_4}{R_7}$	$S_3 = + \left(\frac{R_0}{R_1} + \frac{R_0}{R_2} + \frac{R_0}{R_3} \right)$

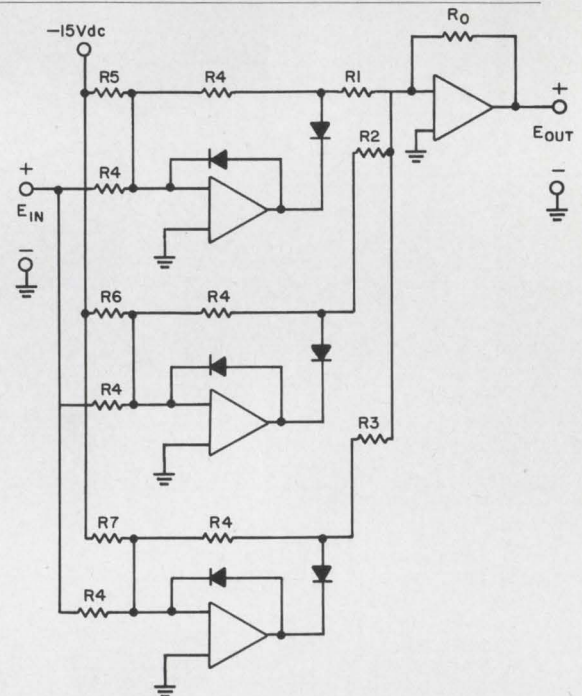
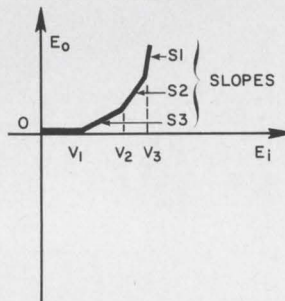

Op-amp applications handbook

Just off the press, the latest edition of the Burr-Brown operational-amplifier handbook is offered to ELECTRONIC DESIGN readers without charge. This is an expanded, updated version of the original manual published in 1963. A must for designers who use operational amplifiers, the handbook gives the reader a solid grounding in the subject. It first discusses fundamental circuit theory and defines electrical specifications, such as unity gain bandwidth, slew rate, full power response and settling time. Several pages are then given over to descriptions of recom-

mended test circuits, and a final section is devoted to operational amplifier applications.

The example depicted above is a function generator that can be used to generate straight line segments that approximate nonlinear functions. The approach shown has the advantage that the location of a given breakpoint is not determined by the setting of any of the other breakpoints. The effect of temperature changes is minimal because diode effects are reduced by the open loop gain of the amplifiers. Burr-Brown Research Corp.

CIRCLE NO. 364

EECO's new Model 1202 Multiplexer/ADC...



**handles 128 separate analog
inputs and still converts
200,000 words/second with
15-bit binary resolution.**

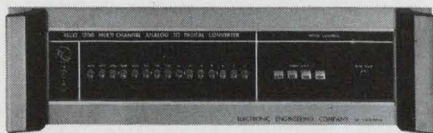

Prices start at \$8000. Send for the Model 1202 brochure for all the features and specifications.

ALSO AVAILABLE: Model 1201 High Performance ADC with computer interface circuitry to your specification. 250,000 conversions/second. 15-bit binary resolution. Prices start at \$7350.



INSTRUMENTS DIVISION

ELECTRONIC ENGINEERING COMPANY OF CALIFORNIA
1601 EAST CHESTNUT AVENUE · SANTA ANA, CALIFORNIA 92701
(714) 547-5501

New Literature

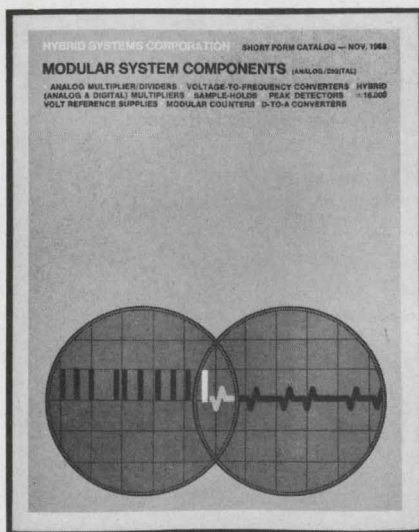

Analog/digital modules

D/a converters, analog multipliers, voltage-to-frequency converters, peak detectors and other encapsulated modules for analog and digital processing systems are described in a new catalog. Applications for these products include simulation, displays, process control, data handling, and hybrid computers. The catalog includes complete electrical specifications as well as waveform information. New products described are: a 0.1% low-bandwidth analog multiplier, a 10-MHz analog multiplier, a 12-bit multiplying d/a converter and a line of low-cost dual op-amp power supplies. Ordering information is included. Hybrid Systems Corp.

CIRCLE NO. 365

Pots, clutches & brakes

High-precision potentiometers, clutches, and brakes are described in a new catalog that covers an entire product line. Included are specifications and illustrations of infinite-resolution and wirewound potentiometers, shaft-position encoders, miniature clutches and brakes (both regular and pancake versions) and hysteresis clutches and brakes. Vogue Instrument Corp.

CIRCLE NO. 366

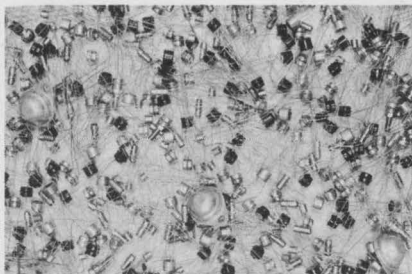

Transistor bargains

Reduced prices on more than 400 current and discontinued pnp and npn silicon and germanium transistors are reflected in a new catalog. This firm maintains a comprehensive stock of over eight million devices in more than 400 standard JEDEC and special classes, including many hard-to-get discontinued numbers. All devices are tested prior to shipment and are guaranteed to meet specifications. Lansdale Transistor & Electronics, Inc.

CIRCLE NO. 367

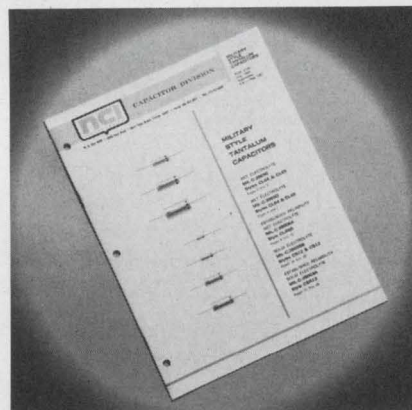

MIL capacitor manual

Designers working on military equipment will have good use for a 28-page tantalum capacitor MIL-reference manual. The booklet condenses 218 pages of MIL-spec data from five military generic specs and five military detail specs on tantalum capacitors into a single compact reference package. The bulletin includes part numbers, electrical limits, and environmental requirements. NCI, Inc. Capacitor Div.

CIRCLE NO. 368

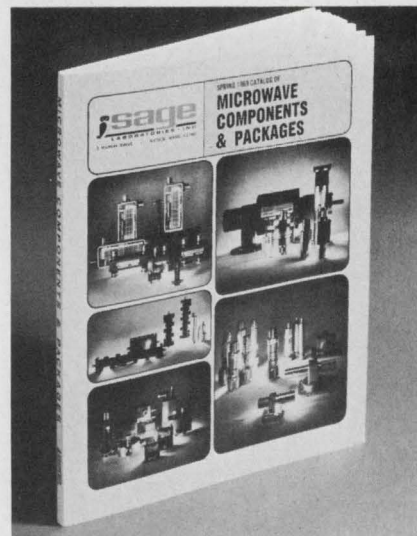

Microwave catalog

A 132-page catalog of microwave components and packages includes 200 new product listings in addition to the 400 products formerly described in a previous catalog. New performance curves have been added for most of the products, and each major product section is preceded by a two-page technical guide on uses and available engineering options. Typical performance and specification limits are shown for all products. Sage Laboratories, Inc.

CIRCLE NO. 369

Infrared spectroscopy

Supplies and sampling accessories for infrared spectrophotometers are the subject of a 32-page bulletin that describes a wide variety of liquid-sampling supplies, variable-temperature accessories, gas-sampling supplies, solid-sampling supplies, ATR accessories, and beam condensers with related equipment. In addition, the bulletin covers such items as reference beam attenuators, linearity discs, the GC-IR fraction collection system, chart paper, pens, ink, and other miscellaneous supplies for infrared spectroscopy. Beckman Instruments, Inc., Scientific Instruments Div.

CIRCLE NO. 370



Some people still don't know Motorola crystals are on the open market.

We've been making precision, high-tolerance crystals for thirty years. Crystals good enough to use in our own equipment. And for thirty years, people have been trying to get their hands on a few. But we found out something. You can't keep a great thing to yourself forever.

Now, our wide range of precision crystals, including temperature com-

pensated varieties, are available to designers and manufacturers in the electronics industry. Characteristics like tight tolerances and low-aging are our specialties. Choose from glass, solder seal and cold weld holders.

Crystals, oscillators, filters, and tone modules: the list of Motorola components currently in production is a mile long, but the way things are

going that may not be long enough. If you need something special, just call. Our designers are ready to go to work on projects for you alone.

For additional information on existing products and on design potentials, write to Motorola Communications & Electronics Inc., 1301 Algonquin Rd., Schaumburg, Ill. 60172

Ask for Bulletin TIC-3401.



NEW

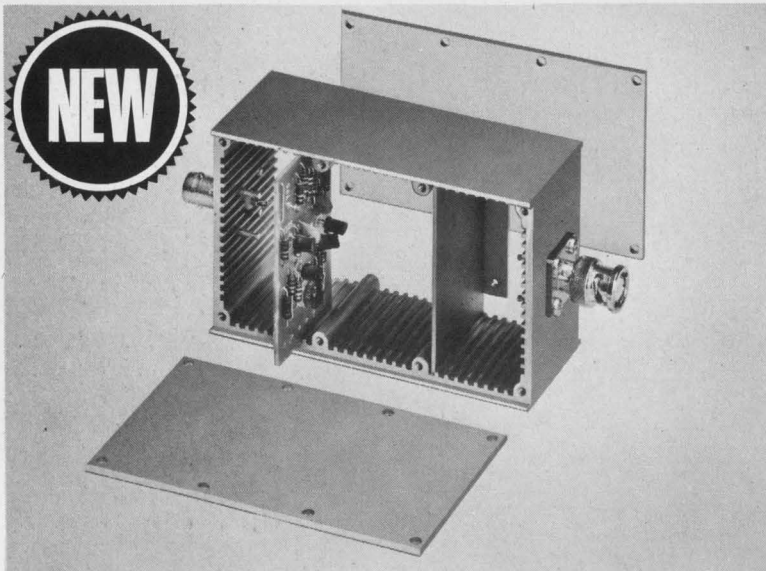

SHIELDED BOXES with CARD GUIDES

Rugged die-cast aluminum boxes, slotted to accept $\frac{1}{16}$ " circuit boards and shielding dividers. Excellent for packaging electronic circuitry. Boxes have removable top and bottom covers. Useable inside space: 4"x2"x1 $\frac{1}{2}$ ". Several models with various connectors.

Write for 1969 Catalog



POMONA ELECTRONICS CO., INC.
1500 E. Ninth Street, Pomona, California 91766

INFORMATION RETRIEVAL NUMBER 102

THE NEW GENERATION



Self-Contained Pulse Generator That Gets The Job Done

Don't let the low price frighten you. Computer Products has the concept required by today's customers: buy output, not frills.

\$98.60*

The PG-610 Pulse Generator is a self-contained, versatile, compact instrument. **Wide frequency range** — 10 Hz to 2 MHz in 6 overlapping ranges. Compatible with TTL, DTL and RTL. High output duty cycle capability. Short circuit protected. Integral regulated power supply. Rise/fall time typically 15 ns. 2.0" x 3.75" x 6.25". Repairable. Beat *that* at *\$98.60, 4 to 9 quantity — or \$119.90, 1-3, or \$93.40, 10 or more.

WITH SHIPMENT 10 DAYS ARO!

Call or write for complete information and specs.
Computer Products, Inc • P. O. Box 23849
Fort Lauderdale, Fla. 33307 • PHONE: 305/565-9565



COMPUTER PRODUCTS™
FORT LAUDERDALE

INFORMATION RETRIEVAL NUMBER 103

NEW LITERATURE

PRODUCT BULLETIN / 693

DIP SOCKETS

for HIGH DENSITY production packaging test and burn-in breadboarding prototype.

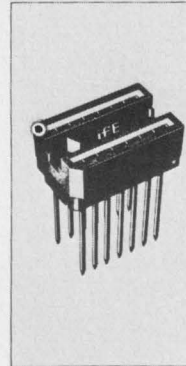

- 14, 16 and 24 contact arrangements.
- High density packaging.
- Sockets accept flat or round lead packages.
- Wire Wrap® and printed circuit terminals.
- Large tapered entry channels provide quick, easy IC insertion and prevent lead damage.
- Dual lead wiring contacts assure low contact resistance and high reliability.
- Operating temperature: — 65° to 150°C.
- All Wire Wrap sockets are furnished complete with mounting hardware.

* Features: Copper-Silver Contacts.
Sockets are also available in multi-pattern arrays on printed circuit boards to customer specifications — contact IFE with your requirements.



IFE DIVISION OF PLASTIC MOLD & ENGINEERING COMPANY
29 Trigg Lane, Providence, R.I. 02914 Tel: (401) 438-2353

DIP sockets

Sockets for 14-, 16-, and 24-lead dual-in-line ICs are described in a new product bulletin. Both wire-wrap and printed circuit sockets are included. Photos, dimensional drawings, and complete specifications provide the user with much helpful design information. IFE Div. of Plastic Mold & Engineering Co.

CIRCLE NO. 371

Logic modules

A 40-page brochure describes various types of logic modules. Each data sheet describes the function of one module and gives technical specifications relevant to its operation. Adtech, Inc.

CIRCLE NO. 372

Labeled compounds

Supplied as two volumes, a new catalog is said to contain one of the most extensive listings of labeled compounds ever compiled. The first volume, which has 15 pages, tabulates radioactive labeled compounds in a-to-z order and includes over 100 radionuclides. The second volume, with 19 pages, lists stable labeled compounds, also in a-to-z order, with NMR spectro-grade deuterium solvents at the end. Laboratory Products Div., Isotopes, a Teledyne Co.

CIRCLE NO. 373

Prototype chassis

An 8-page catalog completely describes a laboratory and prototype chassis system and a line of terminal boards and terminals. The chassis system is based upon a patented locking device that allows the engineer to do all chassis drilling and punching on a flat plate rather than a hard-to-handle pre-assembled welded chassis. Once the circuit is completed, the chassis side rails are snapped together and the top plate is mounted on the frame. More than 500 different chassis sizes are available. Aracon Electronics, Inc.

CIRCLE NO. 374

Teflon terminals

A six-page brochure describes a new series of Teflon-insulated terminals. The literature discusses the design of these new terminals that are intended for use in chamfered and non-chamfered holes. It describes each member of the series with outline drawings and dimensions. Information is also presented on installation and tooling. Hardware Div. of Sealectro Corp.

CIRCLE NO. 375

Wire-marker catalog

A new 24-page wire-marker catalog features an expanded line of stock wire-marker products and a convertible wire-marker dispenser card. New products listed include self-laminating wire markers with a transparent protective shield; clip-sleeves applied with an applicator wand for easier handling; circuit identification number for identifying entire circuits; terminal markers for marking hookup points identically with leads; suffix numbers for a greater variety of marking codes; consecutive numbers in pairs for identical marking of both wire ends; write-on cable markers that accept variable coding; an expanded line of marking sleeves and pocket-kit wire markers. W. H. Brady Co.

CIRCLE NO. 376

What can you do with a blower motor offering up to 7 stages and 3 psi?

With speeds up to 7500 rpm for the WINDJAMMER 9.5 Belt-Driven Blower, and an "airpower" range as wide as the one shown below?

You can obviously solve a wide range of air-moving problems, and fit these solutions exactly to your requirements. Which is just what Lamb Electric's new WINDJAMMER Blower line is designed to do. A stock of standard modular components allows Lamb Electric to build just the power system you need by adding stages (up to seven), with a choice of motor windings, face or foot mountings plus important optional features. These modular components are already engineered and tooled to eliminate excessive costs and to allow for rapid delivery. And expensive air valves and bleed devices are eliminated by the WINDJAMMER Blower "add on" design.

So while there are no "customizing" costs, Lamb can still exactly satisfy your air-moving requirements in a wide variety of applications. And at the same time reduce the "cost per hour of operation" in computers, business machines, magnetic tape transports, card readers and sorters, fluidic devices....

In fact, there are very few problems you can't solve with the WINDJAMMER Blower line working for you. Size problems? We've got a tough 5.7-inch model for you. Noise? The WINDJAMMER is one of the quietest blowers made. Weight? The typical five-stage unit is 18 pounds. Life? It'll go for over 20,000 hours.

For complete specifications and performance data on the entire WINDJAMMER Blower line, write us today: Ametek, Inc., Lamb Electric Division, Kent, Ohio 44240.

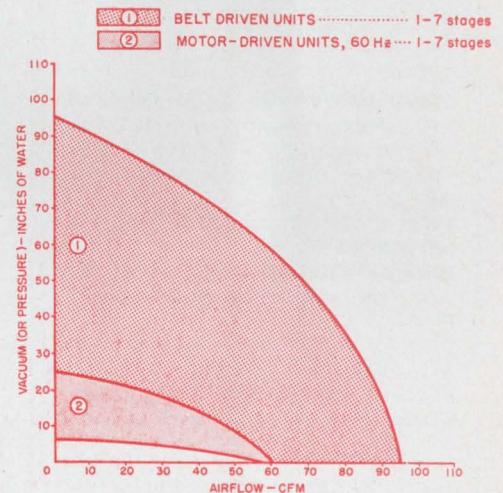
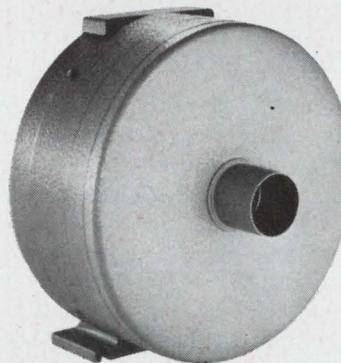
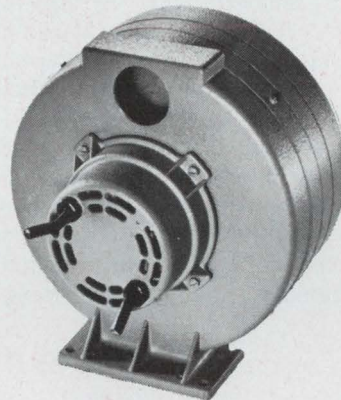

AMETEK / Lamb Electric



INFORMATION RETRIEVAL NUMBER 104

Superimposed Noise Problems Solved!



-TR-5589L 250MHz Universal Counter

This counter employs a unique **ANS Circuit** (Automatic Noise Suppressor...patent pending) in its input circuit. If a large signal to be measured and superimposed noises are fed to a counter, the counter may count both the signal and noise since the trigger threshold level is extremely narrow.

The **ANS** solved the noise problems by keeping the input signal level constant at all times regardless of the magnitude of the input, thereby maintaining the trigger threshold level at the optimum value.

When considered from the input side, the trigger threshold level will increase when a large signal is received, or, decrease when a small signal is received. These operation reduces the error due to noise mixed in the input signal. Since the counter has an input sensitivity of 10mV rms, frequency measurement of an extremely low voltage signal is possible, and measurement of 100V rms signal is also possible with the single range without the use of an attenuator because of the 80 dB dynamic range.

FREQUENCY RANGE—Counts directly up to 250 MHz in decimal, up to 500 MHz with prescaler plug-in unit, covers 10 Hz to 12.5 GHz with frequency converter plug-in unit.

HIGH STABILITY—Long term stability 5 parts in 10^{10} per day.

HIGH SENSITIVITY—10mV to 100V rms in a single range...wide dynamic range...80 dB.

DISPLAY—9-digit storage display.

BCD OUTPUT—8-4-2-1 code output.

PLUG-IN VERSATILITY—8 plugin units increase the counter's versatility as required.

Universal Counter, Digital Voltmeter, Digital Integrator, Electrometer, Frequency Counter, Frequency Synthesizer, Frequency Standard, Data Acquisition System, Operational Amplifier.



Takeda Riken Industry Co., Ltd.

1-32-1, Asahi-cho, Nerima-ku, Tokyo, 176, Japan. Tel: Tokyo 930-4111 Telegramme: TRITRONICS TOKYO

Agents:
Liton Precision Products International Inc.—(West Germany, France, Belgium, Switzerland, England)
Ing. S & Dr. Guido Belotti Ltd.—(Italy) Nores & Co.—(Finland)
Ingenjorsfirma Carl-Eric Larsson AB—(Sweden)
Semco Semlar & Co.—(Denmark)

NEW LITERATURE

Thermal switches

A complete line of precision, snap-acting thermal switches is described and illustrated in an eight-page brochure. The booklet includes an ordering guide and describes the switching concept, the functional characteristics, environmental capabilities, and 30 standard physical configurations. Also displayed are some of the many possible mounting and installation configurations that are possible with the basic thermal switch module. A digest is included that defines many applications for control, indication and limiting. United Control Corp.

CIRCLE NO. 377

Silver copper

Silver copper is essentially identical to ordinary copper except that it recrystallizes at significantly higher temperatures. A 20-page booklet, "The Softening Behavior of Cold Worked Silver Copper," graphically discusses the effects of softening related to prior cold work, exposure time, temperature and amount of silver content. The combined effects are also presented in an equation that gives the time necessary to soften copper to half its original hardness. Copper Range Co.

CIRCLE NO. 378

Machining techniques

A revised 32-page booklet describes machining procedures for nickel and high-nickel alloys. The bulletin discusses major conventional machining operations—turning, drilling, broaching, threading, reaming, planing and shaping, tapping, cutting and sawing, milling and grinding as they apply to these alloys. Procedures are accompanied by graphs and detailed illustrations. Special sections on automatic screw machining and chemical and electrical machining techniques are included. The International Nickel Co., Inc., Huntington Alloy Products Div.

CIRCLE NO. 379

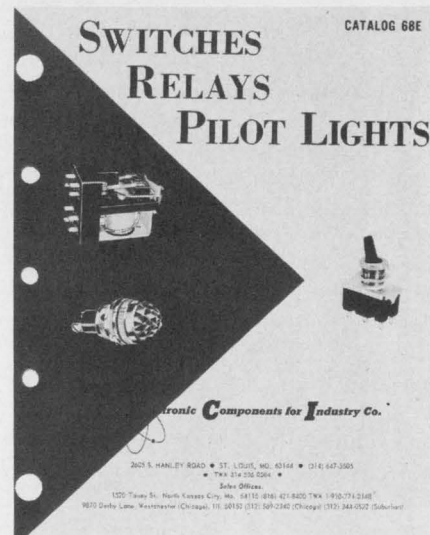

Switch catalog

A comprehensive 120-page switch manual, Catalog 68E, details thirty general types of switches, including lighted pushbutton, limit, military, momentary push, precision, rotary subminiature, and toggle varieties. Complete circuitry, electrical ratings, terminal configuration and dimensions are furnished, as well as general descriptive information. Electronic Components for Industry Co.

CIRCLE NO. 380

Digital panel meters

Literature on a line of three-digit digital panel meters describes 10 models in four versions. DPMs are illustrated in full color with detailed specifications and outline drawings. Datascan, Inc.

CIRCLE NO. 381

Computer-interface ICs

Two new application reports deal with integrated circuits for interfacing in computers—that is, for line driving and receiving, memory driving, and sense amplification. One, a 10-page report that discusses the three types of computer interfacing, describes new integrated circuits for these purposes. A second bulletin provides five pages of more details about one of the ICs mentioned in the first. Texas Instruments, Components Group.

CIRCLE NO. 382

EXPERIMENT
WITH A
TCXO
FOR ONLY
\$50.!



Frequency: 2 to 10 MHz
Stability: ± 10 PPM from -55° to $+85^{\circ}\text{C}$
Supply Voltage: 10 VDC $\pm 5\%$
Input Power: 250 MW Max.
Output: 1.4 Volts P-P Min. into 400 Ω

Arvin has developed a new low-priced series of Temperature Compensated Crystal Oscillators specially engineered for the circuit designer. Experiment with them and learn the advantages of TCXOs without spending a bundle. It's not a gimmick. Use them in prototype or production systems for precise frequency control. \$50 each. (Less in quantity.) Immediate delivery. Write for full specifications, or phone (317) 463-2589.



ARVIN FREQUENCY DEVICES

ELECTRONIC SYSTEMS DIV., ARVIN INDUSTRIES, INC.
2505 N. Salisbury, West Lafayette, Indiana 47906

INFORMATION RETRIEVAL NUMBER 106

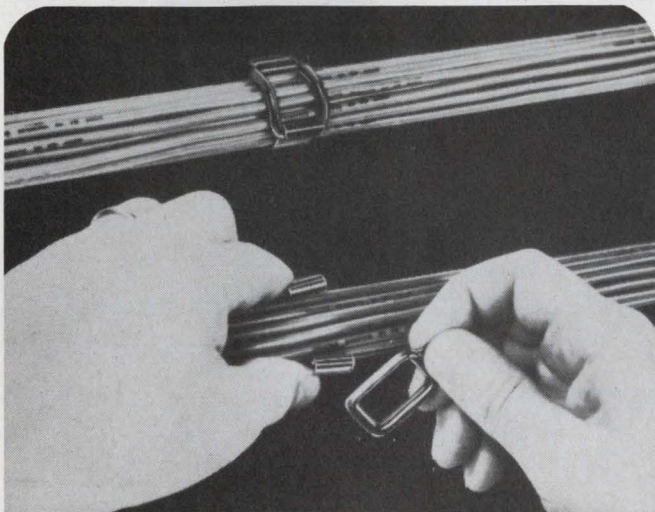

CRADLECLIPS

Versatile high quality harnesses for both supported and unsupported wiring systems. Fast and simple to use. Permit on-the-spot wiring changes without replacement or use of tools. Insuloid Cradleclips can be attached to panels by conventional means either from front or rear. Provide better air circulation and heat dissipation because harnesses are raised.

Send for Free Samples

ELECTROVERT INC.
Components Division
86 Hartford Ave., Mt. Vernon, N. Y. 10553
Milwaukee, Wis. • Burbank, Calif.



SOLD COAST-TO-COAST THROUGH AUTHORIZED DISTRIBUTORS

Visit ELECTROVERT at NEPCON '69 EAST, Booths: 751-755.

INFORMATION RETRIEVAL NUMBER 107

ELECTRONIC DESIGN 11, May 24, 1969

Still using LC's? This might change your mind:

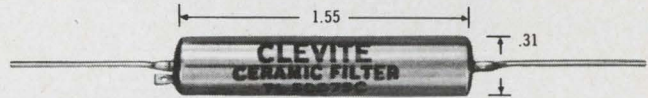

Clevite's ceramic ladder filters deliver 80 db rejection in 0.1 cu.in.!

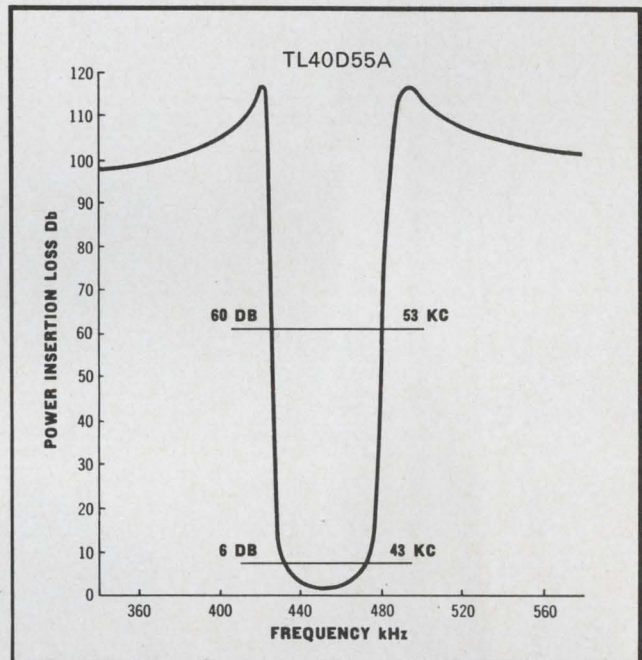

Here's a fixed-tuned filter that offers more selectivity for its size than any conventional i-f filter on the market!

Clevite's non-magnetic, non-microphonic, 17-disc ceramic ladder filter is ideal for i-f stages of high quality superheterodyne radio receivers used in airborne or ground AM and FM communications equipment. Stop band rejection: 60 or 80 db. Center frequency tolerance: ± 1 kHz for 20 kHz B/W and below; ± 2 kHz for 30 kHz B/W and above. Stability: within $+0.2\%$ for 5 years; within 0.2% from -40°C to $+85^{\circ}\text{C}$. Impedance (in and out) 2500 ohms for 12 kHz bandwidth and below; 1500 ohms for 13 kHz to 29 kHz B/W; 1200 ohms for 30 kHz bandwidth and above.

Following models standard at 455 kHz (A) or 500 kHz (C) (custom models on special order):

Model Number	Min. @ 6db	B/W Max. @ 60db	Model Number	Min. @ 6db	B/W Max. @ 60db
TL-2D5 (A)	2 kHz	5 kHz	TL-20D32 (A)	20 kHz	32 kHz
TL-4D8 (A)	4 kHz	8 kHz	TL-30D45 (A)	30 kHz	45 kHz
TL-6D11 (A)	6 kHz	11 kHz	TL-40D55 (A)	40 kHz	55 kHz
TL-8D14 (A)	8 kHz	14 kHz	TL-45D65 (A)	45 kHz	65 kHz
TL-10D16 (A)	10 kHz	16 kHz	TL-50D75 (C)	50 kHz	75 kHz
TL-16D25 (A)	16 kHz	25 kHz			

PRICES: 1 — \$52.50; 25 — \$42.00 ea; 100 — \$36.75 ea; 500 — \$31.50 ea; 2000 — \$26.00 ea.

(Prices subject to change without notice.)

Send order or request for Bulletin 94017 to: Clevite Corporation, Piezoelectric Div., 232 Forbes Rd., Bedford, Ohio 44014, U.S.A. Or: Brush Clevite Company, Limited, Southampton, England.

CLEVITE

INFORMATION RETRIEVAL NUMBER 108

New... FROM SPECTRUM CONTROL —
THE PEOPLE WHO THINK *Electromagnetic Compatibility*

Finally... *Quality Filters*
at **REALISTIC PRICES!**

**SUBMINIATURE
EMI 100 VOLT dc
LINE FILTERS**

Why pay high filter costs when Spectrum Control offers sensibly priced EMI Filters that perform the same function as more expensive filters? For example, these sub-miniature EMI 100 Volt dc Line Filters are high current, broad band, low pass types. An automated production line, plus automated testing facilities permits Spectrum to market these filters at a cost substantially less than comparable units. Our quality is excellent and so is our delivery. Try us!

Write for literature about Spectrum's 100 Volt dc Line Filters TODAY or call John R. Lane 814/474-5593.



SPECTRUM CONTROL INC.
152 EAST MAIN ST. • FAIRVIEW, PENNSYLVANIA 16415

INFORMATION RETRIEVAL NUMBER 109

EXCELLENT FREQUENCY RESPONSE FERRITE
AT 1 MEG PLUS — DENSE ENOUGH TO
AFFORD GEM-LIKE MICROFINISHES

Contact Us

ceramic magnetics, inc.



87 FAIRFIELD ROAD • FAIRFIELD, N. J. 07006 • (201) 227-4222

INFORMATION RETRIEVAL NUMBER 110

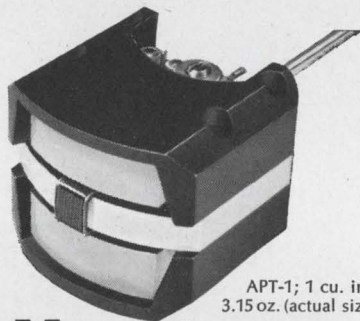

APT-1; 1 cu. in.,
3.15 oz. (actual size)

**More torque,
Less weight
in moving coil mechanism**

Highly stable, linear and accurate mechanism for indicating, control or recording systems. 18-0-18° linearity is 1%. Coil design with over 75% of winding "working" in high energy, uniform field air gap assures greater accuracy. Coil system weighs 0.85 gm, develops 26.4 mmg of torque; 31:1 T/W. Mechanism offers negligible vibration pivots and jewels — custom damping — wide range of sensitivities.

AMMON

AMMON INSTRUMENTS, INC.
345 Kelley St., Manchester, N.H. 03105

INFORMATION RETRIEVAL NUMBER 111

NEW LITERATURE

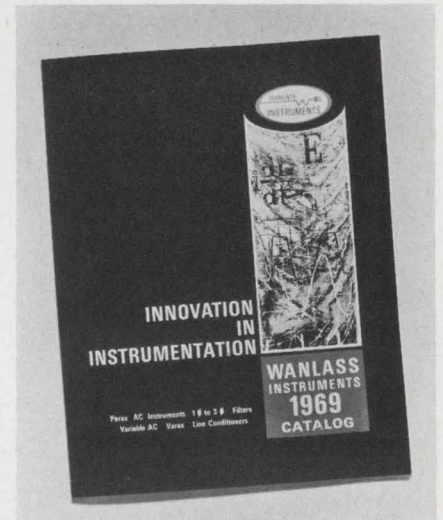

Ac line conditioners

Describing a complete line of ac instruments and power conditioners, a 24-page catalog includes such detailed information as line regulation, load regulation, response time, distortion, frequency, capacity and size. Each type of instrument is explained by a technical description and some basic applications data; waveform comparisons are shown for most instruments. A definition of electrical terms is also included for clarification purposes, as well as engineering of basic concepts. Wanlass Instruments.

CIRCLE NO. 383

Electronic hardware

A revised 1969 catalog features 22,000 electronic components. Fully illustrated and detailed with engineering specifications, performance and ordering data, the 292-page catalog covers an expanding line of miniature connectors, including the latest in sockets, patch cords, plugs and jacks. Cambridge Thermionic Corp.

CIRCLE NO. 384

Crystal filters

A series of six new data sheets provides information on monolithic crystal filters, bandpass/reject crystal filters, gaussian crystal filters, and monolithic discriminators. Electronics Division of Damon Engineering, Inc.

CIRCLE NO. 385

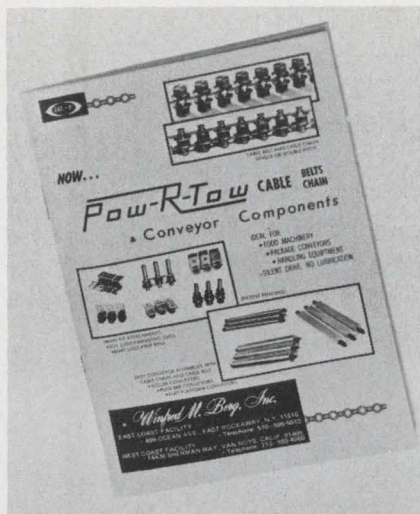

Cable belts & chains

A new catalog on cable belts, cable chain and conveyor components is now available. This 48-page catalog, complete with all dimensions, tolerances and specifications, lists many new items that are ideal for automatic machinery. The line is a new, patent-pending cable drive system made of stainless components that do not require lubrication. All items are offered from stock. Winfred M. Berg, Inc.

CIRCLE NO. 386

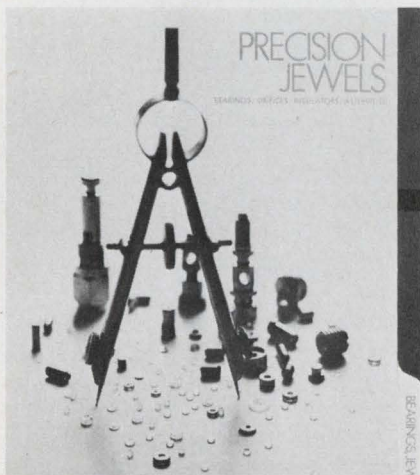

Precision jewels

Precision industrial jewels and jewel assemblies are the subject of a new literature package. This information kit contains a series of data sheets that describe the various configurations of jewel bearings and assemblies. Also described are selection criteria and R&D services. Richard H. Bird & Co., Inc.

CIRCLE NO. 387

INSURE against EMI with DANEX raceways

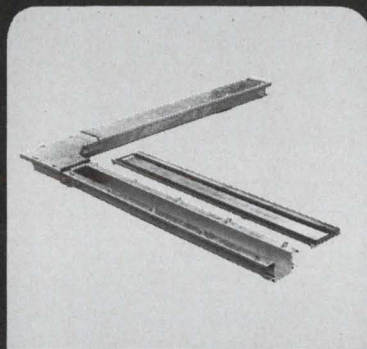

Eliminate electromagnetic interference with Danex shielded ducts and fittings. Danex Shielded Raceways Systems are modular in design and can be used to protect lines of any length against radio frequency interference.

Raceways are 14 gauge high-strength, low carbon galvanized steel with high magnetic permeability and excellent attenuation. Wide variety of adapters available for transition to enclosures.

DANEX CORPORATION

60 Tomlinson Road
Huntingdon Valley, Penna. 19006
(215) 947-4225



A METEX COMPANY

125A

INSURE against EMI with ACE shielded enclosures

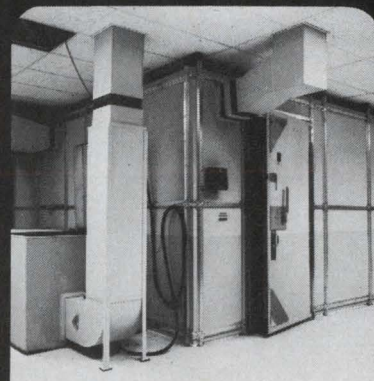

Eliminate electromagnetic interference with Ace shielded enclosures. From a workbench top-shielded test enclosure to an entire computer complex, Ace meets your military and commercial requirements.

Ace offers all standard types of shielded enclosures, plus the exclusive Lindsay construction which is guaranteed maintenance-free. With computers and sophisticated electronic equipment Ace eliminates your problems caused by RFI/EMI ambients.

ACE SHIELDED PRODUCTS CORP.

60 Tomlinson Road
Huntingdon Valley, Penna. 19006
(215) 947-1900



A METEX COMPANY

126A

TUBE/TRANSISTOR/COMPONENT
RETENTION AND COOLING DEVICES

2,000 WAYS to get maximum semiconductor reliability and performance

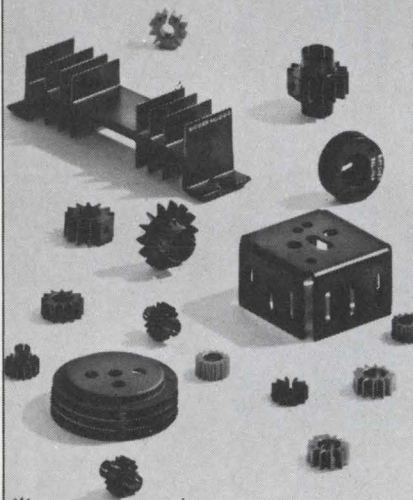

Semiconductor device retention and cooling requirements are dictated by packaging density, power requirements, air flow, etc., which vary from circuit to circuit and from package to package. To insure you of the optimum in semiconductor packaging, performance and reliability in every job, Birtcher offers you more than 2,000 sizes and styles of heat dissipating devices.



Write for catalog and test reports on the world's largest line of semiconductor cooling and retention devices

Available from authorized distributors coast-to-coast

the BIRTCHER CORPORATION
INDUSTRIAL DIVISION

745 Monterey Pass Road
Monterey Park, California 91754

Mailing Address:
P.O. Box D, Monterey Park, California 91754
Tel: (213) 268-8584 • TWX 910-321-3076

NEW LITERATURE

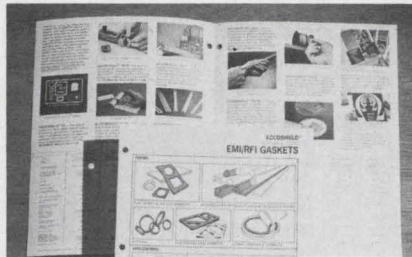

Emi/rfi gaskets

A new folder on Eccoshield gasket materials charts the properties of these compressible conductive plastics for controlling electromagnetic interference and radio-frequency interference. Nine different materials are described, illustrated and presented in comparative-property chart form. They are available as flat sheet from which die-cut gaskets can be made, such as tubes, rods, rectangular sponge, custom-molded shapes, O-rings and special extrusions. Applications for each gasket type are shown in sketches. Emerson & Cuming, Inc., Microwave Products Div.

CIRCLE NO. 390

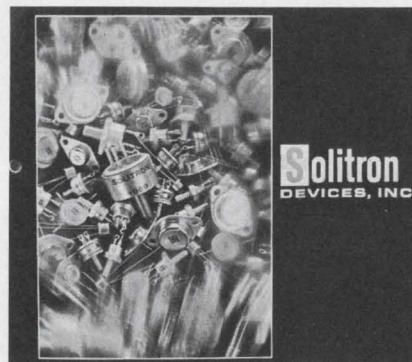

Transistors

Primarily concerning silicon and germanium small-signal and power transistors for military, industrial and commercial applications, a three-color 52-page condensed catalog also shows rf and pnp power transistors and special products like hybrids, die and wafers, and multiples. Each family of transistors is presented in a separate section that includes typical characteristic curves, along with specification charts, outline dimension drawings and actual-size photos of the standard cases. Brief suggested applications are also discussed. Solitron Devices, Inc.

CIRCLE NO. 391

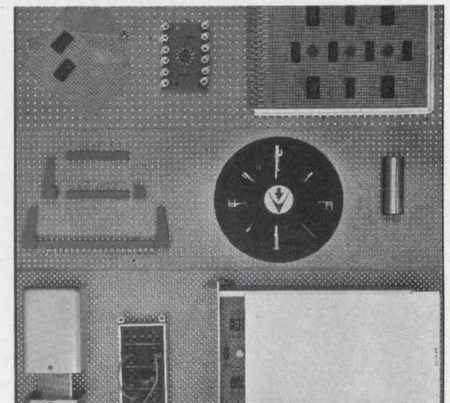

Breadboarding ideas

Nearly 150 pages of breadboarding ideas are contained in a 1969 catalog of wiring devices and packaging items. The catalog is divided into 11 sections that cover everything from perforated boards, connectors, and terminals to experimenter's kits, patchboards, and adapters. Vector Electronic Co., Inc.

CIRCLE NO. 392



Bombs away!

To commemorate the role played by their switches in the B-17s of World War II, Micro-Switch is offering a free Flying Fortress Collector's Kit while the limited supply lasts. The kit includes a full-color 16- x 20-inch print of B-17s on a bomb run as well as a reprint from the June 13, 1968, issue of *Stars and Stripes* that describes the recovery of a Fort from an English peat bog last year. Also included is a 22-page color booklet describing a typical mission. This is Micro Switch's way of attesting to the reliability of its switches, many of which were fully operable after a crash, a fire, and decades of exposure in the peat bog. Micro Switch Div. of Honeywell, Inc.

CIRCLE NO. 393



**THIS IS
C-RITE**



THE "READABLE" DISPLAY

IN ANY LIGHT
Electromagnetic-latching
or Momentary

- No Bulbs to Burn Out!
- Instruments • Stores
- Airports • Traffic Control
- Price Quotations
- Time Signals

Send for complete details



C-Rite parking-lot installation
Sizes to 5"

**JAMES
ELECTRONICS, INC.**

4050 N. Rockwell St., Chicago, Ill. 60618 • Telephone 312 463-6500

INFORMATION RETRIEVAL NUMBER 115

TRUE SOLID-STATE RELAY



Opening New Relay Applications in Multiplexing, Isolated Sensing, High Speed Isolated Control, etc. Offered in A - B - C Contact Configurations for Direct Replacement of Mechanical Types.

- Switching Time less than 65 μ sec
- Contact Open Resistance . . . 10⁹ ohms
- Contacts Capable of switching DC to 4 M HZ
- Non-Polarized Effective Coil
- Effective Coil Accuate/Release Voltage Hysteresis . . . less than 10 mV . . .
- Non-Polarized Contacts
- No Reference Required Between Effective Coil and Effective Contacts
- Life Expectancy—tested to 10¹⁰ operations with no failure.

SHAFFSTALL-BALL CORPORATION

5149 E. 65th Street, Indianapolis, Indiana 46220
Phone: 317-257-6296

INFORMATION RETRIEVAL NUMBER 116

**Transient
Insurance**

\$2

New Dale LVP-6 installs quickly, inexpensively to suppress DC overvoltages

For less than \$2 (in quantity), Dale's new LVP-6 prevents DC overvoltages from wiping out IC's and other costly board-mounted components. Its economy is enhanced by the fact that it saves on assembly time—replacing diodes and capacitors now individually installed to handle voltage suppression.

SENSITIVE The LVP-6 handles surges rising as fast as 10,000 volts/ μ sec.—clamps at preset levels from 6.2 to 13 volts.

COMPACT Epoxy molded units (.50" x .50" x .25") with leads for horizontal or vertical mounting across board's DC input.

- Clamping Voltages:** 6.2, 6.8, 7.5, 8.2, 9.1, 10, 11, 12, 13
- Shunt Capacitance:** 15 μ fd \pm 10%
- Operating Temperature:** -55° C to 85° C
- Storage Temperature:** -55° C to 125° C

For complete information call 605-665-9301 or write...



DALE ELECTRONICS, INC.

SIoux DIVISION Dept. ED
Yankton, South Dakota 57078
A subsidiary of The Lionel Corporation

INFORMATION RETRIEVAL NUMBER 117

ELECTRONIC DESIGN's function is:

- To aid progress in the electronics manufacturing industry by promoting good design.
- To give the electronic design engineer concepts and ideas that make his job easier and more productive.
- To provide a central source of timely electronics information.
- To promote two-way communication between manufacturer and engineer.

Want a subscription? ELECTRONIC DESIGN is sent free to qualified engineers and engineering managers doing design work, supervising design or setting standards in the United States and Western Europe. For a free subscription, use the postfree application form inside the back cover. If none is included, write to us direct for an application form.

If you do not qualify, you may take out a paid subscription for \$25 a year in the U.S.A., \$35 a year elsewhere. Single copies are \$1.50 each.

If you change your address, send us an old mailing label and your new address; there is generally a prepaid postcard for this inside the back cover. You will have to requalify to continue receiving ELECTRONIC DESIGN free.

The accuracy policy of ELECTRONIC DESIGN is:

- To make reasonable efforts to ensure the accuracy of editorial matter.
- To publish prompt corrections whenever inaccuracies are brought to our attention. Corrections appear at the end of the Letters column.
- To refuse any advertisement deemed to be misleading or fraudulent.

Microfilm copies are available of complete volumes of ELECTRONIC DESIGN at \$19.00 per volume, beginning with Volume 9, 1961. Work is now in process to complete the microfilm edition of Volumes 1-8. Reprints of individual articles may be obtained for \$2.00 each, prepaid (\$.50 for each additional copy of the same article) no matter how long the article. For further details and to place orders, contact the Customer Services Department, University Microfilms, 300 North Zeeb Road, Ann Arbor, Michigan 48106; telephone (313) 761-4700.

Want to contact us? If you have any comments or wish to submit a manuscript or article outline, address your correspondence to:

Howard Bierman, Editor,
ELECTRONIC DESIGN,
850 Third Avenue,
New York, N.Y. 10022.

10-DAY FREE EXAM

Circuit Design For Integrated Electronics

BY HANS R. CAMENZIND, Signetics Corporation

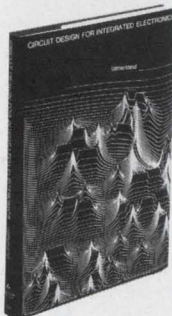

For the practicing engineer with circuit design experience, this new book serves as a bridge to the field of integrated circuits. It provides overview of integrated circuit processes, detailed analysis of integrated components, and thorough discussion of design techniques for both digital and linear circuits.

266 pp, 277 illus. (1968) \$12.95

"... excellent illustrations, has an outstanding organization of material."

Bob Koeper, DESIGN DATALINE

If not satisfied, return book in ten days and pay nothing.

ADDISON-WESLEY PUBLISHING CO., INC.
READING, MASS. 01867

174

A FREE Cross Reference Guide



to better Printed Circuit drafting

No engineer or draftsman should be without the NEW By-Buk Printed Circuit Drafting Aids P-45 Catalog with color-coded MIL-SPEC sizes. Also contains over 2000 pads, shapes, tapes, transistor tri-pads, spaced integrated circuit terminal pad sets and many other drafting aids for faster, more accurate, distortion-free printed circuit master drawings. Send for your FREE catalog.

By-Buk Company

4326 West Pico Blvd., Los Angeles, Calif. 90019
Telephone: (213) 937-3511

175

FUNDAMENTALS OF INTEGRATED CIRCUITS

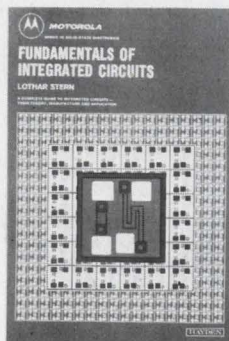

A practical guide to integrated circuits, their theory, manufacture, and applications. This new guide by Lothar Stern offers complete, highly readable coverage of the various techniques of circuit fabrication, and their effect on circuit design and performance. As to marketing considerations, it compares the characteristics of the numerous IC structures devised to date in terms of economics and logistics. A volume in the Motorola Series in Solid-State Electronics. 198 pages, 7 x 10, illustrated. \$8.95, clothbound. Send for 15-day examination copies.

Hayden Book Company, Inc.
116 West 14th Street
New York, N.Y. 10011

176

Manufacturers

Advertisements of booklets, brochures, catalogs and data sheets. To order use Reader-ServiceCard (Advertisement)

Bus Bars For Noise Reduction

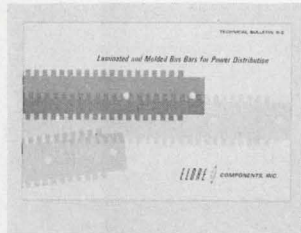

A 16 page Technical Bulletin is now available, describing a new concept in power or signal distribution. Basic mechanical and electrical design principles, along with descriptive pictures and diagrams, are included in this bulletin. These compact buses can replace bulky cable harnesses and repetitive wiring for computer or modular application. This method of construction satisfies the demanding requirements of low inductance and resistance of high-speed, solid state systems, while controlling electrical noises.

Send For Free Sample

Eldre Components, Inc.
1239 University Avenue
Rochester, New York 14607

177

TRANSISTOR AND I. C. PRICE CATALOG

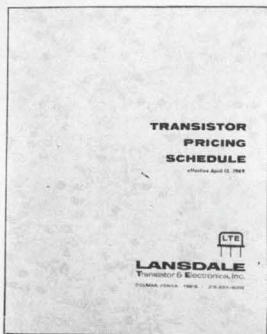

The Industries lowest prices for NPN and PNP germanium and silicon transistors are outlined in LTE's new 1969 price catalog. LTE maintains the largest inventory of devices . . . over 8 million . . . in more than 400 standard JEDEC and special classes, including those hard-to-get discontinued numbers.

Standards include 2N128 thru 2N3346. Specials include T1750 thru T2340. Also included are 702, 709, 710 and 711 integrated circuits in TO 5 packages, in both military and commercial temperature ranges.

All devices are 100% tested.

Write for free catalog and compare.

Lansdale Transistor & Electronics, Inc.
Colmar, Pennsylvania 18915
(215) 855-9002 TWX 510-661-4932

178

CAMLOC'S '69 Catalog Available

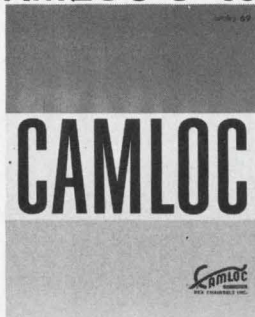

Camloc Div. Rex Chainbelt Inc. new 128 page catalog contains complete specifications and illustrations for a wide variety of industrial fasteners and latching devices including: 1/4-turn panel fasteners; structural fasteners; tension and chassis latches.

CAMLOC Div. Rex Chainbelt, Inc.
Spring Valley Road
Paramus, New Jersey

179

Electronic Design

Advertising Sales Staff

New York 10022

Edward F. Clancy
Sales Service Manager
Robert W. Gascoigne
Thomas P. Barth
Samuel M. Deitch
Byron Adams
850 Third Avenue
(212) Plaza 1-5530
TWX: 867-7866

Philadelphia 19066

William C. Repetto
P. O. Box 206
Merion Station, Pa.
(215) MA-3-5888

Boston 01945

Richard Parker
P.O. Box 645
Clifton Station
Marblehead, Mass.
(617) 742-0252

Chicago 60611

Thomas P. Kavooras
Berry Conner, Jr.
200 East Ontario
(312) 337-0588

Cleveland

Thomas P. Kavooras
(Chicago)
(312) 337-0588
(call collect)

Los Angeles 90303

Stanley I. Ehrenclou
John V. Quillman
W. James Bischof
2930 Imperial Highway
Inglewood, Calif.
(213) 757-0183

San Francisco 94022

Arthur R. Shields, Jr.
175 San Antonio Rd., S 243
Los Altos, Calif.
(415) 941-3084

London W. 1

For United Kingdom & Holland
Brayton C. Nichols
44 Conduit Street
Tel: REGent 4714

Verviers, Belgium

For Continental Europe
Andre Jamar
1, Rue Mallar, 1
(087) 253.83 Telex 41563

Tokyo

Yoshiro Takemura
IPS Group Ltd.
Box 36, Ohsaki Post Office
Phone (504) 1485
Cable Joshplans, Tokyo



FREE SAMPLE

The World's Smallest Temperature Recorder

Temp-Plate, the world's smallest temperature recorder, records surface temperatures within $\pm 1\%$ accuracy. Heat-sensitive indicator turns permanently black upon exposure to critical temperatures for economical and irreversible record. 83 standard sizes from $\frac{3}{16}$ " diameter to $\frac{3}{4}$ " x $1\frac{1}{4}$ " with 1 to 8 different calibrated temperature indicators per recorder. Self-adhesive installation. Max. thickness .006". Ranges from 100°F to 1100°F. As low as \$1.10 each. Qualified on Gemini, Apollo, F-111, DC-8. Specified by more than 1200 companies.

ACTUAL SIZE

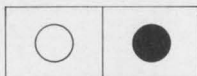

Before After



Write for Free Brochure with 101 Actual Uses and Free Temp-Plate® Sample!

Temp-Plate® Division • William Wahl Corp.
1001 Colorado Ave., Santa Monica, Cal. 90404

INFORMATION RETRIEVAL NUMBER 118

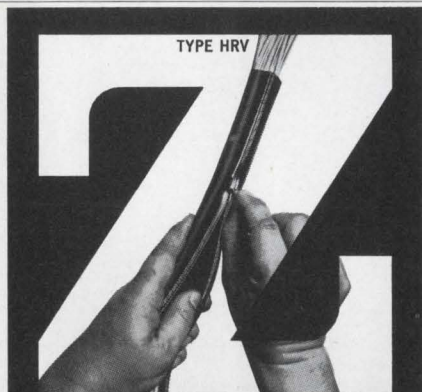

HEAT REACTIVE VINYL ZIPPERTUBING®

best for skin-tight jacketing of cables and wire bundles in minutes!

HRV is made from material that shrinks when heat is applied. (Also available to meet military specifications.)

For full information on specialized, high-performance jacketing, contact

THE ZIPPERTUBING® CO.

CORPORATE HEADQUARTERS
13000 S. BROADWAY
LOS ANGELES, CALIF. 90061
Los Angeles Phone: (213) 321-3901
New Jersey Phone: (201) 256-4980



BALTIMORE • BOSTON • CHICAGO • DALLAS • NEW YORK
ORLANDO • PHOENIX • SAN FRANCISCO • WEST GERMANY

INFORMATION RETRIEVAL NUMBER 119

Advertisers' Index

Advertiser Page

AMF, Alexandria Division	160
Abbott Transistor Laboratories Incorporated	14
Ace Shielded Products Corp.	169
Acopian Corporation	89
Addison-Wesley	172
Advertising Technology Consultants Corporation	138
AiResearch Manufacturing Company	148
Allen-Bradley Co.	105, 107
Ametek/Lamb Division	165
Ammon Instruments, Inc.	168
Amperex Electronic Corporation	111
Arvin Frequency Devices	167
Astrosystems, Inc.	134

Beckman Instruments, Inc., Helipot Division	103
Birtcher Corporation, The	170
Bourns, Inc.	23
Bulova Frequency Control Products	128
Burr-Brown Research Corporation	33
By-Buk Company	172

Camloc Div. Rex Chainbelt, Inc.	179
Ceramics Magnetics, Inc.	168
Cherry Electrical Products Corp.	4, 5
Chicago Switch, Inc.	175
Cinch Manufacturing Company	13
Cinch Nu-line, A Division of United-Carr	15
Clevite Corporation, Burgess Battery Division	155
Clevite Corporation, Brush Instruments Division	99
Clevite Corporation, Piezoelectric Division	167
Columbia Components, Corp.	149
Comar Electric Company	88
Components, Inc.	133
Computer Products, Inc.	164
Corning Glass Works, Electronic Products Division	36, 37
Cutler-Hammer	65

Dale Electronics, Inc.	171
Damon Engineering, Inc.	24
Danex Corporation	169
Data Products Corporation	94
Datascan, Inc.	142
Digital Equipment Corporation	95
Du Pont Company	12

Eldre Components, Inc.	173
Electronic Design	112B
Electronic Engineering Co. of California	161
Electrovert, Inc.	167
Emerson & Cuming, Inc.	66
Erie Technological Products, Inc.	112A

Fenwal Electronics, Inc.	154
-------------------------------	-----

Grayhill, Inc.	175
Gulton Industries, Inc.	143

H P Associates	159
Hayden Book Company, Inc.	172
Hewlett-Packard	1, 67, 125
Hewlett-Packard, New Jersey Division	38
Honeywell, Computer Control Division	7, 41
Honeywell Test Instrument Division	16

Industrial Electronic Engineers, Inc	136, 137
International Rectifier Corp.	121

James Electronics, Inc.	171
Johanson Manufacturing Corp.	126
Johnson Company, E. F.	130

K and M Electronics Corp.	139
--------------------------------	-----

Advertiser Page

Lansdale Transistor & Electronics	173
Leach Corporation	144 A-B
Lenz Electric Manufacturing Co.	146
Lockheed Electronics Company	109

Matsuo Electric Co., Ltd.	144
Mepco, Inc.	6
Microdot, Inc.	112
Microsonics, Inc.	120
Mohawk Data Sciences Corporation	150
Monsanto Company	Cover III
Motorola Communications & Electronics, Inc.	163
Motorola Semiconductor Products, Inc.	116, 117, 119

National Semiconductor Corporation	8, 9
Nuclear Corporation of America	153

Oak Manufacturing Co.	155
----------------------------	-----

Philbrick/Nexus Research, A Teledyne Company	127
Pomona Electronics Co., Inc.	164
Power/Mate Corp.	122, 175

RCA Electronic Components and Devices	115, Cover IV
Radiation, Incorporated	11

S. O. G. I. E.	112B
Schweber Electronics	17
Scientific Atlanta, Inc.	31
Shaffstall Ball Corporation	171
Signetics Corporation, A Subsidiary of Corning Glass Works	27
Siliconix Incorporated	152
Simpson Electric Company	147
Solotron Devices, Inc.	135
Spectrum Control, Inc.	168
Spedcor, Inc.	145
Sprague Electric Company	18, 20
Sylvania Electric Products, Inc., Semiconductor Division	32 A-H
Sylvania Electronic Components, Semiconductor Division	70
Sylvania Metals & Chemicals, Parts Division	141
Syntron Instruments, Inc.	150
Systron-Donner Corporation	2

TRW Semiconductors, A Subsidiary of TRW, Inc.	68
TRW, Globe Industries Division	Cover II
Takeda-Riken Industry Co. Ltd.	166
Techno-Components Corp.	124
Technical Wire Products, Inc.	153
Tektronix, Inc., Oscilloscopes	16 A-B
Texas Instruments Incorporated, Components Group	35
Texas Instruments Incorporated, Metallurgical Materials Division	129
Transistor Devices, Inc.	157
Transitron Electronic Corporation	78, 79
Tyco Laboratories, Inc.	123, 151

United Aircraft Corporation, Electronics Components Division	10
Unitrode Corporation	29

Victoreen Instrument Division	131
-------------------------------------	-----

Wahl Corp., William	174
White Industrial, S. S., A Division of Pennsalt Chemicals Corporation	64
Whittaker Corporation, Gencom Division	156
Wilson Technical Service, H. A.	132

Zippertubing Corp., The	174
-------------------------------	-----

Career Advertising

Delco Radio Division, General Motors	100
IBM Corporation	42



high performance, solid-state plug-in POWER SUPPLIES

If you're looking for a reliable but low cost power supply that gives good regulation and that can be chassis or rack mounted with an octal plug—you can stop. POWER/MATE CORP. has just what you're looking for. The RC/RD series of power supplies feature all silicon solid state circuitry, a MIL-T-27 Transformer, 85°C Capacitors, overload and short circuit protection and 100,000 hours MTBF. In addition to that, only POWER/MATE CORP. can offer you

SAME DAY SHIPMENT!*

All RC Series Models only **\$65.00** All RD Series Models only **\$55.00**

MODEL NO.	OUTPUT VOLTS	OUTPUT AMPS	REGULATION ±%	
			LINE	LOAD
RC-5	3-7	1.0	0.3	0.7
RC-9	7-11	1.0	0.1	0.3
RC-12	11-13	1.0	0.075	0.1
RC-15	13-16	0.5	0.075	0.1
RC-19	16-21	0.5	0.075	0.1
RC-24	21-26	0.5	0.075	0.1
RC-28	26-31	0.5	0.06	0.1
RC-34	31-37	0.5	0.05	0.1
RC-40	37-43	0.5	0.05	0.1
RC-48	43-50	0.5	0.05	0.1

MODEL NO.	OUTPUT VOLTS	OUTPUT AMPS	REGULATION ±%	
			LINE	LOAD
RD-5	3-7	1.0	0.6	1.4
RD-9	7-11	1.0	0.2	0.6
RD-12	11-13	1.0	0.15	0.2
RD-15	13-16	0.5	0.15	0.2
RD-19	16-21	0.5	0.15	0.2
RD-24	21-26	0.5	0.15	0.2
RD-28	26-31	0.5	0.12	0.2
RD-34	31-37	0.5	0.1	0.2
RD-40	37-43	0.5	0.1	0.2
RD-48	43-50	0.5	0.1	0.2

* on RC Models

Write today for complete information on thousands of POWER/MATE CORP. power supplies in voltages to 400 and currents to 50 amps.



POWER/MATE CORP.

163 Clay St., Hackensack, N. J. 07601 / (201) 343-6294, / TWX: (710) 990-5023

INFORMATION RETRIEVAL NUMBER 120

A SMALL ROTARY SWITCH



with **TREMENDOUS** features

- 30° Angle of Throw (12 Positions)
- 0.7" Behind Panel, 0.562 Diameter
- One, Two or Four Poles
- Shorting or Non-Shorting
- PC or Solder Lug Terminals
- Sealed or Unsealed
- Adjustable or Preset Stops
- Commercial or Military Styles

To Make and Break 50 MA for 25,000 cycles,
200 MA for 10,000 cycles (rated at 115 VAC resistive)

REQUEST YOUR ENGINEERING DATA SHEET 157



565 Hillgrove Avenue
LaGrange, Illinois 60525
Area Code 312, Phone 354-1040

... the Difference Between Excellent and Adequate

INFORMATION RETRIEVAL NUMBER 121

ELECTRONIC DESIGN 11, May 24, 1969

FOR ALL T-1-3/4
MIDGET
FLANGE
BASE LAMPS,
1-48 VOLTS

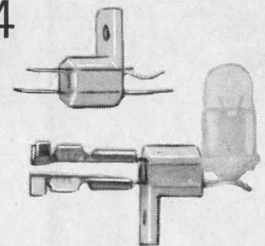

KLIPSOCKET™

- High temperature thermoplastic universal brackets (4 variations pictured)
- Nickel-silver terminals accept either solder without preheating or standard slip-on connectors
- Easy engagement, disengagement, snug fit; suitable for many consumer and industrial uses

Write for Advance Data Sheet No. 690207

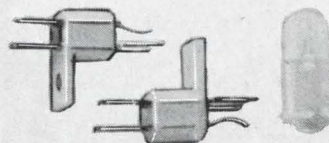

**SIMPLE
COMPACT
STURDY**



CHICAGO SWITCH, INC.

2035 Wabansia Avenue • Chicago, Illinois 60647 • (312) 489-5500

INFORMATION RETRIEVAL NUMBER 122

175

from dc to 3 GHz
with only
one plug-in

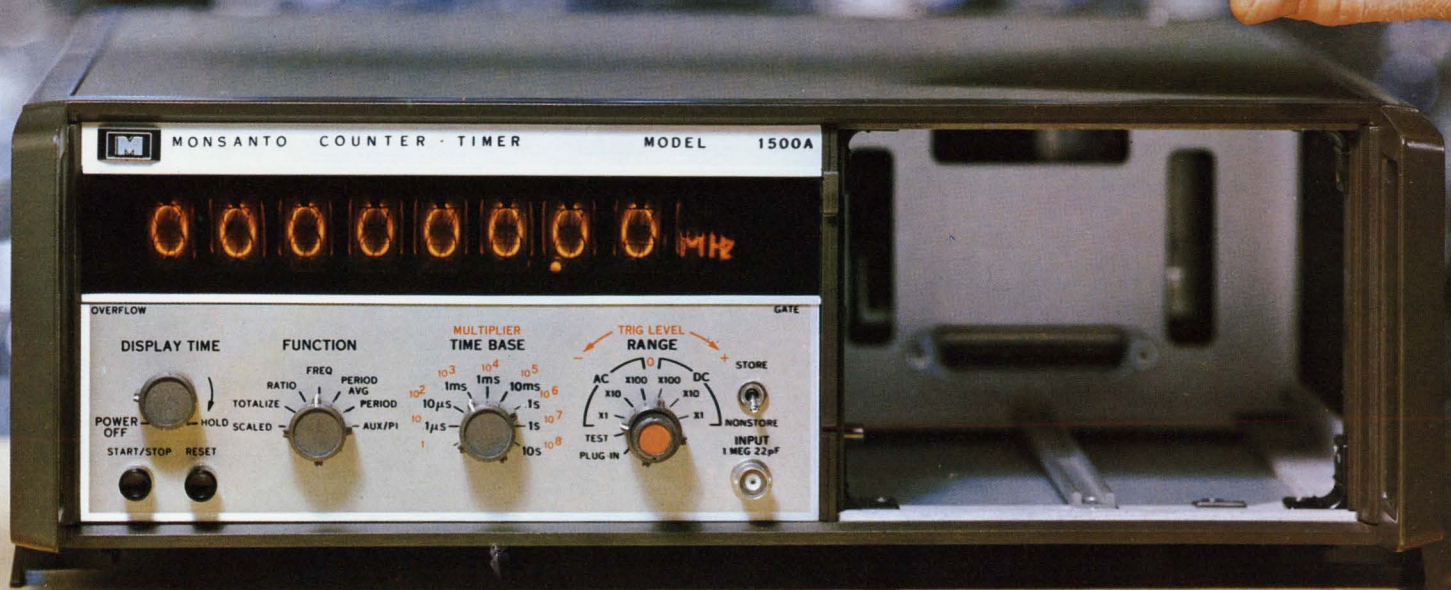

**This new "4th generation"
I-C plug-in counter/timer
Outperforms all others...**

And will for years to come!

Why compromise for less? The Model 1500A has a main frame counting range from dc to 125 MHz (to 3 GHz with a single plug-in). This instrument is fully programmable, has provision for external time base up to 10 MHz, and many other significant features, including the well recognized advantages of Monsanto's "4th generation" 90% integrated circuit design.

Shown above is the Model 1104B 3 GHz frequency converter plug-in. Also available: Model 1100A uncommitted

plug-in; Model 1101A 500 MHz prescale plug-in; Model 1102A 6-digit preset plug-in; Model 1103A 500 MHz frequency converter plug-in; Model 1107A time interval plug-in; Model 1201A DVM plug-in.

Unparalleled performance plus award-winning design make the Model 1500A the ultimate counter for the no-compromise engineer. The price for the main frame is \$2850.00, FOB West Caldwell, N. J. Other models of the 1500 Series offering a wide selection of fea-

tures and capabilities begin at \$1800.00.

Most engineers take Monsanto's reliability for granted because of our 2-year warranty. But, just in case, we maintain 37 Service Centers located strategically throughout the United States and overseas.

For a demonstration, or for full technical details, call your local Monsanto Field Engineer now or contact us directly at: Monsanto Company, Electronic Instruments, West Caldwell, New Jersey 07006, (201) 228-3800.

Here's 15 A to 50 A Performance for your High-Speed Switching Circuits.

Now, RCA brings you high-speed, high-current switching in four of the industry's newest high power units—2N5671 and 2N5672 in regular TO-3 case available in production quantities, and developmental types TA7337 and TA7337A in modified TO-3 case (two 60-mil pins) available on a sampling basis.

These high-current transistors now make available for industrial and commercial users a state-of-the-art combination of high performance and reliability originally dictated by the rigid requirements of aerospace.

All four devices are characterized by double-diffused, double-epitaxial design techniques. As a result, you get reduced saturated switching times, increased current handling capability, and low saturation voltage. These silicon transistors have enhanced second breakdown capability under forward and reverse-bias conditions...backed by safe area operating curves.

Among the applications for these units: switching control amplifiers, power gates, switching regulators, DC-DC converters, DC-AC inverters, DC through RF linear power amplifiers and oscillators.

Check the chart for some of the key parameters of these four new types. Then ask your local RCA Representative or your RCA Distributor for prices and delivery details.

Unit	V _{CEO} (SUS) (V)	I _C (A)	V _{CE} (sat)	f _T MHz	t _{on}
2N5672	120	30	0.75 V @ 15 A	50	0.5 μs @ 15 A
2N5671	90	30	0.75 V @ 15 A	50	0.5 μs @ 15 A

Above types available *now* in production quantities.

TA7337A	120	40	1.2 V @ 40 A	50	1.0 μs @ 40 A
TA7337	90	50	1.5 V @ 50 A	50	1.0 μs @ 40 A

Above types available *now* in sample quantities.



**We know
transistors like the
back of our hand**

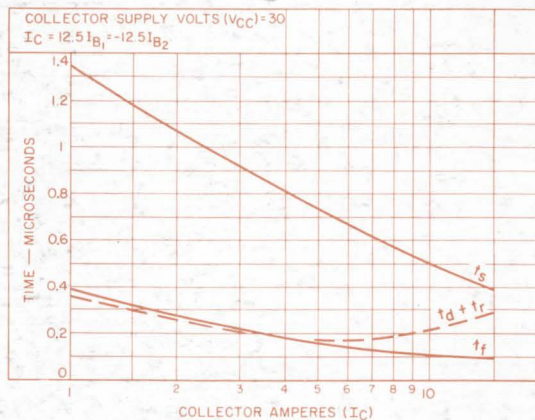

Typical saturated switching characteristics for types 2N5671 & 2N5672

For technical data, write: RCA Electronic Components, Commercial Engineering, Section IG5-4, Harrison, N. J. 07029.